

HEWLETT  PACKARD

MEASUREMENT/COMPUTATION

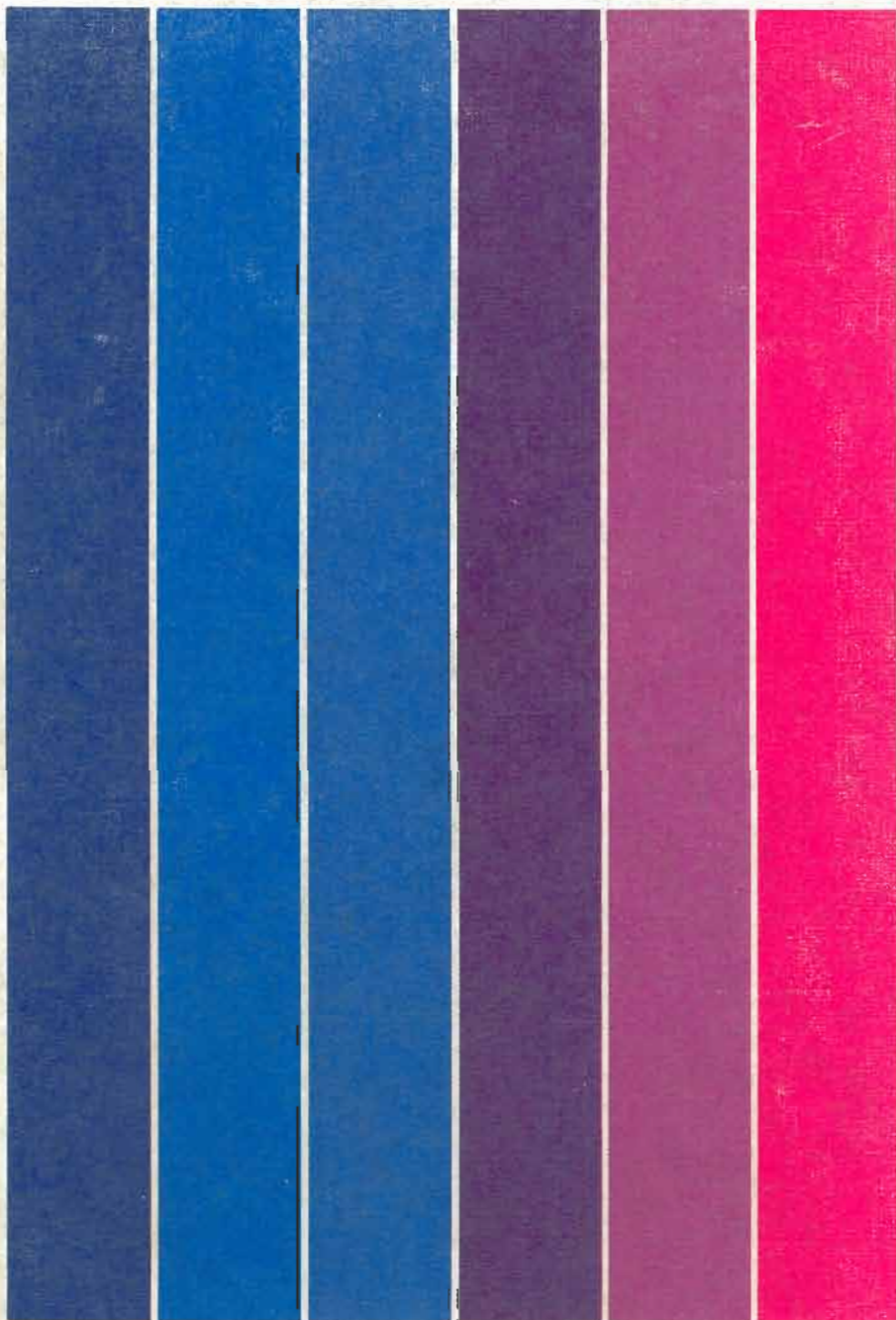

1975

ELECTRONIC
INSTRUMENTS
AND SYSTEMS



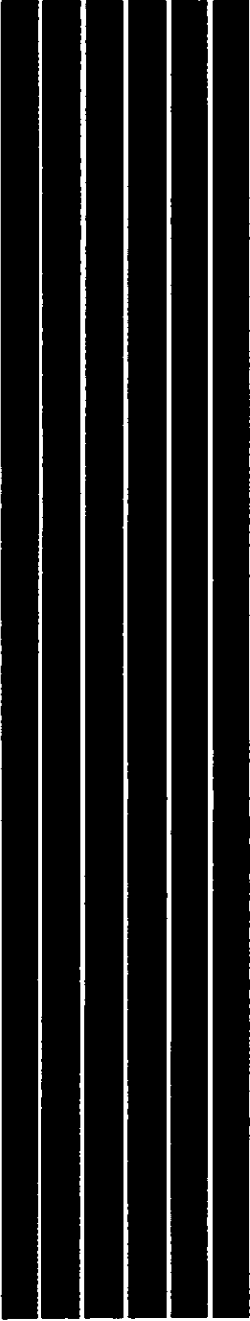

PRODUCT EXCELLENCE WITH LASTING VALUE

Your assurance of lasting value accompanies every Hewlett-Packard product. We intend to continue our long-standing practice of offering you excellent products, supported by a wide variety of useful services both before and after the sale.

HP design technology

Our responsibility to you begins with product designs which apply advanced technologies, often pioneered at HP through our extensive ongoing research activities. Many of today's commonly-accepted measurement standards and practices began with the design of innovative HP products.

Important as advanced technology is, it is not the only design consideration, however. Among other design contributions to an HP product's lasting value are its "manufacturability" and (especially important after you purchase that product) its "serviceability".

HP manufacturing

HP product designers are closely attuned to the practical aspects of product manufacture. This emphasis on modern manufacturing technology, coupled with superior workmanship and high productivity, ultimately delivers high-value HP products to you at competitive prices. In addition, HP manufacturing facilities contribute to the ultimate serviceability of the products you purchase by furnishing you with clear and well-written operating and service instructions.

Today, Hewlett-Packard has 27 product-responsible manufacturing facilities located in California, Colorado, Idaho, New Jersey, Oregon, Pennsylvania and Massachusetts in the U.S. — as well as in Scotland, the German Federal Re-

public, France, Japan, Singapore and Malaysia.

HP product serviceability

Serviceability can mean many things. In the broadest sense, it means getting full utilization and value from your purchase, and this is one of HP's principle objectives in serving you.

In other ways, it can mean having a product that is easy to understand and operate — as well as one that works under a variety of adverse conditions and can be depended upon to perform as expected for years to come. As a practical matter, it also means having a product fully backed by a reputable firm so that subsequent maintenance, repairs and parts are readily available. Hewlett-Packard's worldwide service organization helps you receive full and continuing value from your HP purchase, wherever you are located.

HP SALES AND SERVICE: NEARBY . . AND WORLDWIDE

The previously mentioned product excellence and value are only part of the total HP story. Equally important to you is the ready availability of local sales and service support.

To be responsive to your needs and those of other customers, Hewlett-Packard has over 3,000 sales and service engineers and other technical personnel located in more than 172 offices in 65 countries. This means that a significantly high percentage (more than 10%) of our world-wide total number of employees are *specifically and directly available to you and other HP customers for pre-and-post sale technical support.*

To locate the HP Sales and Service Office nearest you, please see the complete listing inside the back cover of this catalog.

HP Computer Museum
www.hpmuseum.net

For research and education purposes only.





CATALOG CONTENT

This catalog is designed primarily to serve the needs of engineers, scientists and technicians who are concerned or work with electrical/electronic phenomena. It deals with the broad area of *measurement* (plus generation and recording), as well as related *computation*.

HP has many additional capabilities not detailed in this catalog, which are instead summarized on the last few pages. In the event your work is related to any of these other HP capabilities, we will be pleased to send you specific product information on request.

Alphabetical index	1
Model number index	9
Electronic test, measurement & control	18
Telecommunications test & measurement	488
Automatic test, measurement & control	514
Computation	529
Physical and optical measurements	546
X-Ray systems	555
Solid state components and circuits	558
Additional HP capabilities	560
Medical electronic products	
Instrumentation for chemical analysis	
Civil engineering/surveying equipment	
Hewlett-Packard: at your service	565
Ordering & price information	
Warranty, certification & repair service	
Hewlett-Packard interface bus	
Training & video tapes	
Information request cards	
Sales and service office listings	

Capacitance Bridge	66
Capacitive Voltage Divider	476
Card Reader	536
Carriage, Slotted Section	404
Carrier Preamplifiers	239
Cartridge Disc Subsystem	535
Cases	
Combining	482, 483
Operating	484
Transit	485
Cavity Frequency Meters	408
Chromatographic Data Systems	562
Clip, DC Milliammeter	24
Clock, Atomic	282
Coaxial Instrumentation	
Accessories	392
Crystal Detectors	402
Directional Bridge	429, 467
Directional Couplers	400
Directional Detectors	400
Dual Directional Coupler	399
Fixed Attenuators	395
Frequency Meters	408
Harmonic Mixer	410
Low-Pass Filters	407
Sliding Load	406
Slotted Line	403
Slotted Section	404
Step Attenuators	396, 397
Swept Slotted Line Systems	403
Switch	410
Termination	406
Thermistor Mount	386
Thermocouple Mount	382
Waveguide Adapters	411
Comb Generator	467
Combing Cases	482, 483
Communication Test Equipment	496
Computers	
HP 3000	539
Management Data System	542
Scientific and Management Data Systems	543
21MX, Semiconductor Memory	540
Constant Current Sources	202
Controller, Vibration	472
Converter, A-to-D	528
Converters, D-to-A	236, 256, 277
Counters, Electronic	
ASCII Prog.	252, 262
Auto. Freq. Conv.	265

Auto. Ranging	270
Computing	261
Counter/Timer	252, 264, 270
Digital Multimeter/Counter	270
DVM	258, 264
Heterodyne Converter Plug-In	258
Low Cost	269
Microwave	262, 265
Plug-In Adapters	261, 265
Portable, Battery Operated	270
Prescaler Plug-In	258
Preset	258, 279
Programmable	252, 260, 261, 264, 279
Reciprocal	252, 261, 271, 279
Time Interval	252, 258, 261, 264, 270
Transfer Oscillator Plug-In	258
Universal	264, 270
Video Amplifier Plug-In	258
Couplers, Directional (Coax and Waveguide)	399-401
Crystal Detector	402
Current	
Divider	476
Sources	202

D

D/A Converter	211
Data	
Acquisition Systems	57-59, 516, 562
Base Management Software Image/2000	542
Communications	537
Error Analyzer	497
Generator	318
Logger	56
Punch	55
Source Interface	536
Storage Digital Multimeter	44-46
Voice Channel Test Set	493
Data-Set Interface, Asynchronous	540
Data-Set Interface, Synchronous	540
DC	
Amplifier Plug-In Module	218
Attenuator Plug-In Module	219
Bank Amplifier	240
Coupler Plug-In Module	218
Differential Voltmeter	338, 339
Digital Voltmeter	44-46, 52
Milliammeter	24
Nullmeter	23
Offset Plug-In Module	218
Preamplifier Plug-In Module	219

Standard	338, 339	Digitizer	536
Voltage Divider	476	Dimensional Measurement	546, 547
Voltmeter	25, 26, 35	Diodes	558
DC Power Supplies		Directional Couplers	
Amplifier/Power Supply	200	Coaxial	399, 400
Condensed Listing	174	Waveguide	401
Constant Current Sources	202	Directional Detectors	400
Digitally Controlled	211	Disc	
Dual Tracking	196	File Sub-system	541
General Information	173	Operating System (DOS III)	543
General Purpose: 25-200 W Output	182	Sub-system, Cartridge	541
General Purpose: 120-200 W Output	186	Displays	
General Purpose: 300-11,000 W Output	190	Cathode-ray Tube	160
General Purpose: 0-320 V	208	Graphic Storage	170, 171
High Voltage	194	High Resolution	162, 163
Low Cost Lab	176, 178, 179	Large Screen Analog System	172
Modular, Single Output, Series Regulated	203	Large Screen 35.6 cm. (14 in.)	168, 169
Modular, Dual Output, Series Regulated	204	Large Screen 43.2 cm. (17 in.)	164, 165
Modular, 300 W, Switching Regulated	205	Large Screen 48.2 cm. (19 in.)	168, 169
Modular, 500 W Switching Regulated	206	Large Screen 53.3 cm. (21 in.)	166, 167
Precision Voltage Sources	197	Numeric and Alphanumeric	559
Specifications Definitions	209	Terminal Interface	541
Desk, Rack System	481, 482	Distortion Amplifiers	450
Detectors		Distribution Amplifiers	290
Crystal, Coaxial and Waveguide	402	Divider Probe	476
Directional	400	Double Balanced Mixers	362, 558
Slotted Line	404	Dual Tracking, Power Supply	196
Digital		Duplex Register, 8-Bit	541
AC Voltmeters	38, 39, 47-49	Duplex Register, 16-Bit	541
Circuit Test	76, 78, 82, 152, 153	E	
DC Voltmeters	47-49, 52	EIA Registered Visible Light Emitting Diodes	559
Graphic Plotter	215, 227	Electronic Counters	249
High Capacitance Meter	70, 71	Electronic Distance Meters	564
I/O Sub-system	524	Enclosures, Rack System	482
LCR Meter	68, 69	Error Rate Measurement	510, 511
Magnetic Tape Sub-system	541	ESCA Spectrometers	562
Multimeter	35, 44-49	F	
Ohmmeter	44-49	Faxitron™ X-Ray Systems	556
Oscillator	328	Filters	
Plotter	545	Bandpass	463, 407, 467
Power Meters (RF/Microwave)	385	Coaxial and Waveguide	407
Printer	246-248	High Pass	134, 415
Programmable Power Supplies	211	Low Pass	407, 415
Ratio Meter	47-49	Low Pass Plug-In Module	219
Signal Analyzers	76, 470	Fortran: Fast Fortran Processor	542
Spectrum Analyzers	470, 496	Fourier Analyzer	470, 496
Thermometer	43		
Vibration Controller	472		
Voltmeter	35, 42, 44-46		
Digital-to-Analog Converters	236, 256, 277		

Frequency	
Counters	249
Doubblers	352, 359, 363
Meter	279
Meters, Coaxial and Waveguide	408
Response Test Sets	413
Frequency Standards	
Cesium	282
Distribution Amplifier	290
General Information	280
Quartz	287
Rubidium	282
Standby Power Supplies	291
VLF Comparator	289
Frequency and Time Standards	280
Frequency Synthesizers	320-323, 348
Function Generators	329-333
G	
Gas Chromatographs	562
General Information, Digital Voltmeters	32-34
Generators	
Noise	389, 473
Pulse	294-303
Signal	341
Spectrum	471
Sweep	366
Tracking	456, 460, 462, 464
Word	315
Group Delay Network Analyzer	420-422
Guarded Digital Multimeter	47, 48, 49
H	
Hardwired Serial Interface	568
Harmonic Analyzer	447
Hewlett-Packard Interface Bus (HPIB)	568, 569
Hexadecimal Display with Electronics	559
High Capacitance Meter	72
High Frequency Probe	25
High Frequency Voltmeter	31
High Gain Preamplifier	237, 239
High Reliability Testing	558
High Resistance Meter	63
High Resolution DC Digital Voltmeter	52
High Sensitivity Plug-In Module	229
Hi-Rel Numeric Displays	559
I	
IF Switch	506
Image/2000 Software	542
Impatt Diodes	558
Impedance Meter, RF Vector	427
Impedance Probe	430
Incremental Chart Advance	220
Industrial Measurement & Control System	516-519
Inspection Systems, X-Ray	556
Integrated Products	558
Insulation Resistance Meter	63
Insulation Test	63
Interface Bus, Hewlett-Packard	568, 569
Interface Kit, Counter	256
Interfacing, Calculator	536, 568
Integrating DVM	52, 53
Intermodulation Analyzer	447
I/O Expander	524
L	
Laboratory, Strip Chart	215, 228, 233, 235
Laboratory, X-Y Recorder	214, 217, 221, 222, 224, 226
Laser Measurement	546, 547
Laser Transducer	548
LCR Meter	61
Light Emitting Diodes (Red, Yellow, Green)	559
Line Printer, 200 RPM	537
Liquid Chromatographs	562
Loads/Termination, Coaxial and Waveguide	406
Logarithmic Amplifier	30
Logarithmic Converter	30
Logarithmic Preamplifier	240
Logic	
Analyzer	80, 81
Clip	84
Comparator	85
Lab	88, 89
Probe	83, 152, 153
Pulser	84
State Analyzer	78, 79
Troubleshooting Mini-Kit	87
Troubleshooting Kit	86
Low Cost, Counters	269
Low Cost, Lab Power Supplies	176, 178, 179
Low Distortion Generator	329
Low Frequency Spectrum Analyzer	452, 453, 470
Low Gain Preamplifier	237, 239
Low Resistance Meter	62

M

Magnetic Tape Recorder, Digital 244, 541
 Magnetic Tape Subsystem, Digital 541
 Marker Generator 366
 Mass Memory Subsystem 535
 Mass Spectrometers 562
 Mechanical Impedance Analyzer 470, 472
 Medium Gain Preamplifier 239
Meters
 AC 27
 AC/DC 25
 Capacitance 68, 69
 Differential 338, 339
 Digital Multimeter 36, 37
 Frequency 279
 Impedance 65, 73, 424, 427
 Logarithmic Voltmeters 30, 38, 39
 Milliammeter, DC 24
 Multifunction 25, 26, 36, 37, 50, 51
 Multimeter/Counter, Digital 270
 Noise Figure 388
 Ohmmeter 25, 62
 Power (RF/Microwave) 380
 Radiant Flux 554
 Selective VM 448, 449, 507
 True RMS 29
 Microcircuit Interface 541
 Microprogramming Firmware 542
 Microwave Counters 258, 262, 265
 Microwave Link Analyzer of BB, IF (70 MHz)
 and RF 504, 505
 Microwave Power Measuring Equipment 380
 Microwave Test Equipment 390
 Mixers 362, 447
 Mixers, Coaxial and Waveguide 410
 Mixer/Detector 558
 Modal Analysis 472
 Modular Power Supplies 203-206
 Modulators 361, 558
 Modulators, PIN Diode 558
 Multi-Pin Stimulus Kit 87
 Multiple Span Plug-In Module 229
 Multiplexer, Asynchronous 540
 Multiprogrammer 524

N

Network Analysis, General Information 416-419
 Network Analyzers 448, 449
 Network Analyzers, Microwave 431-438

Network Analyzers, RF 420-430, 439
Noise
 Analyzer, Acoustic 471
 Figure Meter 388
 Generator 473
 Source (IF) (UHF) (VHF) and Waveguide 389
 Null Detector Plug-In Module 218
 Numeric LED Displays 559

O

OEM Displays 160
 OEM Modular Power Supplies 203, 204, 205, 206
 OEM Strip Chart Recorders 215, 228, 232
 OEM X-Y Recorders 222, 223
 Ohmmeter 25, 26, 35
 Optical Mark Reader 544
 Optical Radiant Flux Meter/Detectors 554
 Optically Coupled Isolators 559
 Optoelectronics 559
Oscillators
 Audio 326
 Function Generator 332
 General Information 324
 Low Frequency 320, 321
 Quartz 287
 Quartz Component 288
 RF 352
 Sinewave 326
 Sweep 364-379
 Test 335
 Oscillographic Recorder 215, 237, 239
Oscilloscopes
 Accessories 150-155
 Cameras 156, 157
 Contrast Filters 155
 275 MHz Delayed Sweep 98-100
 275 MHz with Microprocessor 101
 Field Portable 90-93
 General Information 110
 High Frequency Plug-In 117, 136, 137
 High Writing Speed Mainframes 135
 Large Screen 116
 Large Screen Mainframe 155
 Light Shields 142-147
 Low Frequency 118-133
 Plug-In, 180 series 138-141
 Plug-In, 183 series 155
 Protective Covers 102-107
 Portable 155
 Rack Mount Slides and Adapters 155

Ruggedized Portables, 35 & 50 MHz		
Sampling	128-130	
Spectrum Analyzer Plug-In	135	
Variable Persistence/Storage	113-115	
Viewing Hoods	155	
Output Voltage Divider	476	
P		
Pad, Attenuator, Coaxial	395	
Paper Tape Reader	536	
Pattern Analyzer	82	
Peak Power Meter, Analog	387	
Phase Meters	426	
Phase Sensitive Demodulator Preamplifiers	240	
Phase Shifters, Waveguide	409	
PIN Diodes	558	
PIN Modulators, Microwave	361	
PIN Photodiodes	559	
Plotter	537	
Plotter, Digital	545	
Plug-In Counters	252, 260	
Plug-In Extender	154	
Plug-In Oscilloscopes	110, 148	
Plug-In Pulse Generator System	186, 310	
Point Plotter Plug-In Modules	220	
Point Plotting System	220	
Portable		
Calculators	531-533	
Counters	270	
Data Acquisition Systems	56	
Instrumentation Tape Recorder	244	
Oscilloscopes	101-107	
Storage Oscilloscopes	106-107	
Strip Chart Recorder	215, 234	
Voltmeter	25	
X-Ray Systems	557	
Power Meters, RF & Microwave	380	
Power Sensors	382, 383	
Power Meter Calibrators	383, 387	
Power Splitter	415	
Power Supplies		
Amplifier/Power Supplies	200	
Condensed Listing	174	
Constant Current Sources	202	
Digitally Controlled	211	
Dual Tracking	196	
General Information	173	
General Purpose: 25-200 W Output	182	
General Purpose: 120-200 W Output	186	
General Purpose: 300-11,000 W Output	190	
General Purpose: 0-320 V	208	
High Voltage	194	
Low Cost Lab	176, 178, 179	
Modular, Single Output, Series Regulated	203	
Modular, Dual Output Series Regulated	204	
Modular, 300 W, Switching Regulated	205	
Modular, 500 W, Switching Regulated	206	
Precision Voltage Sources	197	
Specifications Definitions	209	
Power Supplies: Atomic Clock	291	
Power Supplies: Frequency Standards	291	
Power Meter, Radiant Flux	554	
Power Supplies: Oscilloscope Probe	152, 153	
Power Supply/Amplifier	200	
Preamplifiers	18	
Precision DC Amplifier	338, 339	
Precision Frequency Source	280, 320, 321	
Precision Oscillator	322, 323	
Precision Voltage Sources	197	
Pressure Gauge	552, 553	
Printers	246, 247, 248	
Printer, Line	537	
Printer, Thermal	246, 537	
Probes		
Accessories	152-153	
Active	151, 430, 467	
Current	152, 153	
Impedance	430	
Logic	83, 152, 153	
Slotted Line	404	
Trigger (TTL, MOS, ECL)	152-153	
Voltage Divider	150	
Process Control Interface	524	
Programmable Counters	256, 261, 262	
Programmable Digital Multimeter	44, 45, 46	
Programmable Digital Voltmeter	47, 48, 49	
Programmable Modules (HP Interface Bus)	256	
Programmable Oscillator	320, 321	
Programmable Step Attenuators	396	
Programmable Synthesizer	320, 321	
Programming, 1900 System	313	
Pseudorandom Noise Generator	473	
Pulse Amplifiers	18	
Pulse Generator	292-316	
Pulse Modulators, Microwave	361	
Q		
Q-Meter	74	
Quartz Component Oscillator	288	
Quartz Frequency Standard	287	

R

Rack Cabinets	486, 487
Rack System Desk	481
Radiant Flux Meter/Detector	554
Random Noise Generator	473
Range Calibrator (for 435A)	383
Ratio Meter	47, 48, 49
Real Time Executive Software	542
Receiver, VLF	289
Reciprocal Counters	252, 261, 270, 279
Recorders	
Chart Recorder Supplies	243
Oscillographic	215, 239
Portable Instrumentation Tape	244
Strip Chart	215, 235
X-Y	214-226
Reflection/Transmission Test Sets	429, 435-437
Resistance Meter	63
RF Bridge	67
RF Voltmeter	26, 31
Rotary Air Line, Coaxial	363
Rotary Joint, Coaxial	363
Rotary Machinery Analysis	472
Rotary Vane Attenuators, Waveguide	398
RX Meter	67

S

S-Parameter Test Sets	435, 436
Sample and Hold Digital Multimeter	44-49
Sampling Oscilloscopes	128-130
Sampling & TDR Accessories	132-134
Sampling Voltmeter	31
Scanner Plug-In Module	219
Schottky Diodes	558
Scientific & Industrial X-Ray Systems	555
Selective Level Meter/Gen	508, 509
Selective Level Voltmeters	496, 497
Selective Voltmeter Wave Analyzer	507
Selective Voltmeter	447, 498
Self-Test Digital Multimeter	47, 48, 49
Serial Interface, Hardwired	568
Shorts, Coaxial and Waveguide	406
Signal Analyzers, Digital	469
Signal Analyzers, General Information	440
Signal Analyzers, Spectrum	135, 452-468
Signal Coupler Preamplifier	240
Signal General	322, 323
Signal Generators and Accessories	341-363
Signal Source	322, 323, 332

Signature Analysis	472
Sinewave Generators	322-329
Sinewave Oscillator	326
Single Span Plug-In Module	229
Slotted Lines, Coaxial and Waveguide	403, 404, 405
Slotted Line Detector	404
Slotted Line RF Probe	405
Slotted Line Sweep Adapters	405
Software, Basic Control System	542
Solid State Displays	559
Solid State Lamps	559
Spectrometers	562
Spectrum Analyzer	135, 452-468, 470
Square Wave Gen	327, 329, 332
Standards: Frequency and Time	280
Standing Wave Ratio (SWR) Meter	412
Step Attenuators	396
Step Recovery Diodes	558
Strip Chart Recorder	215, 233
Structural Dynamics	472
Sweep/Offset Plug-In	330, 331
Sweep Oscillators, General Information	364, 365
Sweep Oscillators	366-379
Sweep Plug-In	330, 331
Sweeping Slotted Line	405
Switches	558
Switches, Coaxial	410
Swivel Adapter	411
Synchronizer, Phase Lock	379
Synthesizer, Frequency	348 to 351
Synthesizers — General Information	319
Synthesizers, Spectrum	471
System Desk	481
System Enclosures	486, 487
System, Fourier Analyzer	470
System, Modal Analysis	472
System, Random Vibration Control	472
System, Rotating Machinery Analysis	472
System, Signature Analysis	472

T

Tape Cassette	536
Tape Punch	537
Tape Recorder, Digital Magnetic	244, 541
Telecommunications Test Equipment	488-513
Telephone Oscillators	500
Temperature Plug-In Module	229
Terminal Control System Software	542
Terminal Interface, Display	540

Terminal Multiplexer, Asynchronous	537
Terminations, Coaxial and Waveguide	406
Test Leads	474
Testmobiles	478
Test Oscillators	335
Test Sets, Transmission	496
Thermal Printer	246
Thermistor Mounts, Coaxial and Waveguide	386, 387
Thermometer	550, 551
Time Base External Module	221
Time Base Plug-In Module	218
Time Domain Reflectometers	131, 132
Time Internal Counters	252, 258, 261, 264, 270
Time Mark Generator	154
Time Standard	282
TIMS	493
Tip Kit	87
Tracking Generator	448, 449, 456, 460, 462, 464
Training/Video Tapes	569
Transceiver Test System	523
Transfer Function Analyzer	470
Transmission Impairment Measuring Set	493
Transmission Line Test Equipment, Coaxial	390
Transmission & Noise Meter Psophometer	501
Transmission Test Set	502, 503
Transistors	5-8
Triangle Wave Generator	332
Trigger/Phase Lock Plug-In	330, 331
Trigger Countdown	132, 133
True RMS Voltmeter	29, 38, 39, 44, 45, 46
Transistor Bias Supply	436
Transistor Test Fixtures	435, 436
Tuners, Microwave	409
Twenty Additional Blank Reference BD	87
Twenty Preprogrammed Ref. Bds.	87
Two Channel Amplitude Measurements	420, 421, 422
TWT Amplifiers	20
Type N Short	406
Typewriter	537

U

Universal Bridge	64, 65
Universal Carriage (Slotted Section)	404
Universal Counters	264, 270
Universal Interface	568

V

Variable Phase Function Generator	329
Vector Impedance Meter	73, 427

Vector Voltmeter	439
Vibration Analyzer	470
Vibration Controller	472
Video Tapes	570, 571
VLFC Comparator	289
Voltmeter, Vector	439

W

Wave Analyzer	448, 449
Wave Analyzer	446
Wave and Distortion Analyzers	450, 451
Waveform Analyzer, Fourier	470
Waveguide	
Crystal Detectors	402
Detector Mount	402
Directional Couplers	401
Frequency Meters	408
Harmonic Mixer	410
Holder	411
Instrumentation and Accessories	394
Low-Pass Filters	407
Movable Shorts	406
Phase Shifters	409
Precision Attenuators	398
Shorting Switch	406
Slide Screw Tuners	409
Sliding Loads	406
Sliding Short	406
Slotted Section	404
Stand	411
Terminations	406
Thermistor Mounts	386, 387
Variable Attenuators	398
Waveguide-Waveguide Adapters	411
4-Wire Digital Ohmmeter	47, 48, 49
Word Generator	315
Writable Control Store	540

X

X-Ray Systems, Cabinet	556
X-Ray Systems, Portable	557
X-Ray Systems, Scientific & Industrial	555
X-Y Displays	170, 171
X-Y Plotters	227
X-Y Recorders	214-226

HP-35 Scientific Pocket Calculator	531
HP-45 Advanced Scientific Pocket Calculator	531
HP-46 Scientific Desktop Calculator	538
HP-65 Programmable Pocket Calculator	532
HP-70 Business Pocket Calculator	533
HP-80 Financial Pocket Calculator	533
HP-81 Financial Desktop Calculator	538

100

105A/B Quartz Frequency Standards	287
117A VLF Comparator	289
123A Oscilloscope Camera	156, 157
140B Oscilloscope Mainframe	149
140T Spectrum Analyzer Mainframe	456
141B Variable Persistence Storage Mainframe	148
141T Spectrum Analyzer Mainframe	456
180 series Plug-in Oscilloscopes	110, 130, 135
180C/D High Writing Speed Oscilloscope Mainframes	117, 454
181A/AR/T/TR Variable Persistence/Storage Mainframes	113, 454
182C/T Large Screen Oscilloscope Mainframe	116, 135
183A/B/D Wideband Oscilloscope Mainframe	136, 137
184A/B High Speed Oscilloscope Mainframes	114, 115
195A Oscilloscope Camera	156, 157
197A Oscilloscope Camera	156, 157

200

200AB Audio Oscillator	326
200CD Audio Oscillator	326
201C Audio Oscillator	326
202H FM/AM Signal Generator	360
203A Variable Phase Generator	329
204C Sine, Square Wave Oscillators	327
204D Sine, Square Wave Oscillators	327
207H Univerter	360
209A Sine, Square Wave Oscillators	327
214A Pulse Generator	294
226A Time Mark Generator	154
230B Tuned RF Amplifier	20
236A Telephone Test Oscillator	500
250B RX Meter	67
281 series Coaxial-Waveguide Adapters	411
292 series Waveguide-Waveguide Adapters	411

300

310A Wave Analyzer	447
312/313A Wave Analyzer	448, 449
312C Selective Levelmeter & Generator	508, 509
331A Distortion Analyzer	450
332A Distortion Analyzer	450
333A Distortion Analyzer	450
334A Distortion Analyzer	450, 451
340B Noise Figure Meter	388, 389
342A Noise Figure Meter	388, 389
343A VHF Noise Source	388, 389
345B IF Noise Source	388, 389
347A series Noise Sources	388, 389

349A Noise Source	388, 389
350D Attenuators & Decade Capacitor	75
354A Coaxial Step Attenuators	396
355 series Coaxial Step Attenuators	396
360 series Coaxial Low-pass, Filters	407
362A series Waveguide Low-pass, Bandpass Filters	407
375 series Waveguide Variable Attenuators	398
382 series Waveguide Precision Variable Attenuators	398
393A Coaxial Variable Attenuator	396
394A Coaxial Variable Attenuator	396

400

400E/EL AC Voltmeter	28
400F/FL AC Voltmeter	28
400GL AC Voltmeter	28
403B AC Voltmeter	27
410C General Purpose Multi-Function Meter	26
415E SWR Meter	412
419A DC Null volt-ammeter	23
420A/B Coaxial Crystal Detector	402
422A series Waveguide Crystal Detectors	402
423A Coaxial Crystal Detector	402
424A series Crystal Waveguide Detectors	402
427A Multi-Function Meter	25
428B DC Clip-on Milliammeter	24
432 series Power Meters	385, 386
435A Power Meter	382, 383
440A Detector Mount	405
442B Slotted Line RF Probe	405
444A Slotted Line Detector	404
446B Slotted Line Detector	405
447B Slotted Line Detector	404
448A/B Slotted Line Sweep Adapter	405
456A Current Probe for Voltmeters	476
461A General Purpose Amplifiers	18
462A General Purpose Amplifiers	18
465A General Purpose Amplifiers	18
467A Power Amplifier/Power Supply	18
477B Coaxial Thermistor Mount	387
478A Coaxial Thermistor Mount	386
X485B Waveguide Detector	402
486A series Waveguide Thermistor Mounts	386
487B series Waveguide Thermistor Mounts	387
489A TWT Amplifier	20
491C TWT Amplifier	20
493A TWT Amplifier	20
495A TWT Amplifier	20

500

532 series Waveguide Frequency Meters	408
536A Coaxial Frequency Meter	408
537A Coaxial Frequency Meter	408
580A Digital-to-Analog Converter	236
581A Digital-to-Analog Converter	236

600

606B Signal Generator	354
608E Signal Generator	355



MODEL NUMBER INDEX

612A Signal Generator	356	938A Frequency Doubler Set	359
618C Signal Generator	358	940A Frequency Doubler Set	359
620B Signal Generator	358	970A Probe Digital Multimeter	36, 37
626A Signal Generator	359		
628A Signal Generator	359	1000	
651B Test Oscillator	335	1000A Testmobile	445, 446
652A Test Oscillator	335	1001A Testmobile	445, 446
653A Test Oscillator	335	1001B Testmobile	445, 446
654 Test Oscillator	335	1002A Testmobile	445, 446
680 Strip Chart Recorder	235	1002B Testmobile	445, 446
		1003A Testmobile	445, 446
		1003B Testmobile	445, 446
		1004A Testmobile	445, 446
		1004B Testmobile	445, 446
		1006A Testmobile	445, 446
700		1008A System Work Table	445, 446
740B DC Standard Voltmeter	338, 339	1009A System Work Table	445, 446
745A AC Calibrator	336, 337	1010B High Speed Liquid Chromatograph	562
746A AC Calibrator	336, 337	1051A/1052A Combining Cases	481
752 series Waveguide Directional Couplers	401	1104A/1106B Opt 001 18 GHz Trigger Countdown	132, 133
774D Coaxial Dual Directional Coupler	399	1104A/1108A 10 GHz Trigger Countdown ...	132, 133
775D Coaxial Dual Directional Coupler	399	1105A/1106B 20 ps Pulse Generator	134
776D Coaxial Dual Directional Coupler	399	1105A/1108A 60 ps Pulse Generator	134
777D Coaxial Dual Directional Coupler	399	1109B High Pass Filter (type N)	134
778D Coaxial Dual Directional Coupler	399	1110A Current Probe	152, 153
779D Coaxial Directional Coupler	400	1111A AC Current Amplifier	152, 153
786D Coaxial Directional Detector	400	1116A Testmobile, Oscilloscope	478
787D Coaxial Directional Detector	400	1117B Testmobile, Oscilloscope	478
788C Coaxial Directional Detector	400	1118A Testmobile, Oscilloscope	478
789C Coaxial Directional Detector	400	1120A 500 MHz Active Probe	151
796D Coaxial Directional Coupler	400	1121A AC Probe	430, 467
797D Coaxial Directional Coupler	400	1122A Probe Power Supply	152, 153
798C Coaxial Directional Coupler	400	1124A 100 MHz Active Probe	151
		1125A 250 MHz Impedance Converter Probe	151
		1200A/B Dual Channel Oscilloscope, 100 μ V/div	144-147
800		1201A/B Dual Channel Storage Oscilloscope, 100 μ V/div	144-147
805C Coaxial Slotted Line	403	1205A/B Dual Channel Oscilloscope, 5 mV/div	144-147
809C Universal Carriage	404	1220A Dual Channel Oscilloscope, 15 MHz ..	142, 143
810B series Waveguide	404	1221A Single Channel Oscilloscope, 15 MHz ..	142, 143
814B Slotted Lines	405	1300A Large-Screen Analog System Display	172
815B series Waveguide Slotted Sections	405	1310A 48.3 cm (19 in.) Display	168, 169
816A Slotted Coaxial Sections	404	1311A 35.6 cm (14 in.) Display	168, 169
817A/B Coaxial Swept Slotted Line System	403	1317A 43.2 cm (17 in.) Display	164, 165
870A Waveguide Slide Screw series Tuners	409	1321A 53.3 cm (21 in.) Display	166, 167
885A series Waveguide Phase Shifters	409	1330A X-Y Display	170, 171
895A DC Power Supply	208	1331A/C X-Y Display, Storage	170, 171
		1332A High Resolution Display	162, 163
		1601L Logic State Analyzer	78, 79
900		1620A Pattern Analyzer	82
905A Coaxial Sliding Load	406	1645A Data Error Analyzer	497
907A Coaxial Sliding Load	406	1700 series Portable Oscilloscopes	101
908A Coaxial 50 Ohm Termination	134, 406	1700B Portable Oscilloscope, 35 MHz	104, 105
909A Opt 012 50 Ohm Termination	134	1700B Option 300, 35 MHz	108, 109
909A Coaxial Termination	406		
910 series Waveguide Terminations	406		
911A Coaxial Sliding Load	406		
914 series Waveguide Sliding Loads	406		
920 series Waveguide Moving Shorts	406		
X923A Waveguide Sliding Short	406		
X930A Waveguide Shorting Switch	406		
P932A Waveguide Harmonic Mixer	406		
934A Coaxial Harmonic Mixer	406		

1702A Portable Storage Oscilloscope 106, 107
1703 Portable Storage Oscilloscope, Delayed Sweep 106, 107
1707B Option 300, 50 MHz 108, 109
1707B Portable Delayed Sweep Oscilloscope, 75 MHz 104, 105
1710B Portable Oscilloscope, 200 MHz 102, 103
1720B Oscilloscope, 275 MHz 98-100
1722A 275 MHz, Direct Readout of volts and-time 94-96
1801A Dual Channel Vertical Amplifier, 50 MHz 120, 121
1803A Differential DC Offset Amplifier 124
1804 Four Channel Vertical Amplifier, 50 MHz 122, 123
1805A Dual Channel Vertical Amplifier, 100 MHz 118
1806A 100 V Dual Channel Differential Amplifier 120, 121
1807A Dual Channel Vertical Amplifier, 35 MHz 120, 121
1808A Dual Channel Vertical Amplifier, 75 MHz 119
1809A Four Channel Vertical Amplifier, 100 MHz 122, 123
1810A 1 GHz Dual Channel Sampler 130
1811A 4 or 18 GHz Sampler 128, 129
1815A/B TDR/Sampler 132, 133
1816A Sampling Head, 4 GHz 132, 133
1817A Sampler, 12.4 GHz 132, 133
1818A Time Domain Reflectometer, 170 ps tr 131
1820C Time Base 125
1821A Time Base/Delay Generator 125
1824A Time Base and Sweep Expander 126
1825A Time Base and Delay Generator 126
1830A Dual Channel Vertical Amplifier, 250 MHz 140
1831A Direct Access Vertical, 600 MHz 140
1831B Direct Access Vertical, 500 MHz 140
1834A 200 MHz 4-Channel Amplifier 138
1835A 200 MHz Dual Channel Amplifier 139
1840A Time Base 141
1841A Time Base/Delay Generator 141
1900A Pulse Generator Mainframe 312
1901A Pulse Generator Mainframe 312
1905A Rate Generator 311
1906A Rate Generator 311
1908A Delay Generator 310
1910A Delay Generator 310
1915A Variable Transition Time Output 305
1916A Variable Transition Time Output 305
1917A Variable Transition Time Output 305
1920A Pulse Output 305
1921A Positive Output Plug-in 305
1925A Word Generator 308
1927A Fan-in Amplifier 311
1928A Fan-out Amplifier 311
1930A PR Binary Sequence Generator 308

2000

2070A Data Logger 56
2402A Integrating Digital Voltmeter 52, 53
2607A Line Printer 537
2748B High Speed Tape Reader 536
2801A Quartz Thermometer 550
2802A Digital Thermometer 40, 43, 551
2811B Quartz Pressure Gauge 552, 553
2895B-A Tape 537

3000

3040A Network Analyzer 420-423
3041A Network Analyzer 420-423
3042A Network Analyzer 420-423
3043A Network Analyzer 426
3050B Auto Data Acquisition System 57-59
3200B VHF Oscillator 352
3300A Mainframe Plug-in Function Generator 330
3301A Plug-in Function Generator 330
3302A Plug-in 331
3304A Plug-in 331
3305A Plug-in 331
3310A Function Generator 334
3310B Function Generator 334
3311A Function Generator 332
3312A Function Generator 333
3320A Frequency Synthesizer Hi Accuracy ... 320, 321
3320B Frequency Synthesizer Hi Accuracy ... 320, 321
3320C Level Generator 508, 509
3330B Automatic Synthesizer 322, 323
3352A Laboratory Data System 562
3373B Electronic Digital Integrator 562
3380A Reporting Integrator 562
3400A True RMS Voltmeter 29
3403C True RMS Voltmeter 38, 39
3406A RF Voltmeter 31
3450B Multi-Function Meter 50, 51
3462A Digital Voltmeter 52
3469B Multimeter 35
3470A Digital Multimeter 40-43
3480C Digital Voltmeter 44, 45, 46
3480D Digital Multimeter 44
3482A DC Range Unit for 3480A/B 45
3484A Multi-Function Unit for 3480A/B 45
3489A Data Punch/Coupler 55
3490A Digital Multimeter 47, 48, 49
3550B Portable Test Set 502, 503
3551A Transmission Test Set 492
3552A Portable Transmission Test Set 492
3555B Transmission & Noise Measuring Set 501
3556A Psophometer (same as 3555B) 501
3575A Gain/Phase Meter 424, 425
3580A Spectrum Analyzer 452, 453
3581A Signal Wave Analyzer 446
3581C Selective Voltmeter 498
3590A Selective Voltmeter 507
3591A Selective Voltmeter 507
3594A Sweeping Local Oscillator Plug-in 507

MODEL NUMBER INDEX

3702B IF/BB Receiver	504, 505	5210A Frequency Meter	279
3710A IF/BB Transmitter	504, 505	5245L/M Electronic Counters	260
3722A Noise Generator	473	5246L Electronic Counter	260
3730A Down Converter: RF to IF	504, 505	5248L/M Electronic Counters	260
3740A IF Switch	506	5252A Prescaler Plug-in	259
3750A Attenuator	506	5253B Frequency Converter Plug-in	258
3760A Data Generator	318, 510, 511	5254C Frequency Converter Plug-in	258
3761A Error Detector	510, 511	5255A Frequency Converter Plug-in	258
3770A Amplitude/Delay Distortion Analyzer ..	494, 495	5256A Frequency Converter Plug-in	258
3800A Distance Meter	564	5257A Transfer Oscillator Plug-in	258
3800B Distance Meter	564	5258A Prescaler Plug-in	259
3805A Distance Meter	564	5261A Video Amplifier Plug-in	259
3960A Portable Instrumentation Tape Recorder ..	244	5262A Time Interval Plug-in	259
4000		5264A Preset Plug-in	259
4050A Analog Comparator	72	5265A Digital Voltmeter Plug-in	258
4204A Digital Oscillator	328	5267A Time Interval Plug-in	258
4260A Universal Bridge	64	5300A Counter Mainframe	272
4265B Universal Bridge	65	5300B Counter Mainframe	272
4270A Capacitance Bridge	66	5301A 10 MHz Counter Module	273
4271A Digital LCR Meter	68, 69	5302A 50 MHz Universal Counter Module	273
4282A Digital High Capacitance Meter	70, 71	5303B 500 MHz Counter Module	274
4328A Milliohmmeter	62	5304A Timer/Counter Module	274
4329A Resistance Meter	63	5305A 1100 MHz Counter Module	275
4332A LCR Meter	61	5306A Digital Multimeter/Counter	275
4342A Q Meter	74	5307A Frequency Counter Module	276
4350A/B High Capacitance Meter	72	5308A Timer Counter Module	276
4436A Attenuator	75	5310A Battery Pack Module	278
4437A Attenuator	75	5311B Digital-to-Analog Converter	277
4440B Decade Capacitor	75	5312A ASCII Converter	277
4800A Vector Impedance Meter	73	5323A Automatic Counter	279
4815A Vector Impedance Meter	427	5326A Universal Counter	264
4900A Cable Fault Locator	513	5326B Universal Counter/Digital Voltmeter	264
4901A Cable Fault Locator	513	5326C Multi-Function Counter	264
4904A Cable Fault Locator	513	5327A Universal Counter	264
4905A Ultrasonic Translator Detector	513	5327B Universal Counter/Digital Voltmeter	264
4910F Open Fault Locator	512	5327C Multi-Function Counter	264
4912F Conductor Fault Locator	512	5330A Preset Counter	279
4913A Test Desk Fault Locator	512	5330B Preset Counter	279
4940A Transmission Impairment Measuring Set ..	493	5340A Microwave Frequency Counter	262
5000		5341A Microwave Frequency Counter	262
5000A Logic Analyzer	80, 81	5345A Electronic Counter	252-254
5011T Logic Troubleshooting Kit	86	5353A Channel C: Plug-in for 5345A	255
5015T Logic Troubleshooting Kit	87	5354A 4 GHz Frequency Converter	255
5035A Basic Logic Lab	88	5360A Computing Counter	261
5035T Logic Lab	89	5375A Computing Counter Keyboard	261
5050B Digital Recorder	248	5379A Time Interval Plug-in	261
5055A Digital Recorder	247	5381A Frequency Counter	269
K02-5060A Standby Power Supply	291	5382A Frequency Counter	269
5061A Cesium Beam Frequency Standard	282	5451B Fourier Analyzer	470
E21-5061A Flying Clock (Cesium)	282	5453A Transmission Parameter Analyzer	496
5062C Cesium Beam Frequency Reference	282	5468A Transponder	496
5065A Rubidium Frequency Standard	282	5501A Laser Transducer	548
E21-5065A Portable Rubidium Time Standard ..	282	5526A Laser Interferometer	546, 547
5085A Standby Power Supply	291	5700A Laboratory Gas Chromatographs	562
5087A Distribution Amplifier	290	5750B Research Gas Chromatograph	562
5150A Thermal Printer	246	5830A Reporting Gas Chromatograph	562
		5950A ESCA Spectrometer	562
		5980A Mass Spectrometer	562

6000

6101A DC Power Supply	197
6102A DC Power Supply	197
6104A DC Power Supply	197
6105A DC Power Supply	197
6106A DC Power Supply	197
6110A-6116A DC Power Supply	197
6128C-6131B Digitally Controlled Voltage Sources	211
6140A Digital Current Source	211
6145A Digital Current Source	211
6177C DC Power Supply	202
6181B DC Power Supply	202
6186C DC Power Supply	202
6200B-6209B Power Supply	179
6211A-6218A DC Power Supply	176
6220B DC Power Supply	182
6224B DC Power Supply	182
6226B DC Power Supply	182
6227B DC Power Supply	196
6228B DC Power Supply	196
6236A DC Power Supply	178
6253A DC Power Supply	182
6255A DC Power Supply	182
6256B DC Power Supply	186
6259B DC Power Supply	186
6260B DC Power Supply	186
6261B DC Power Supply	186
6263B DC Power Supply	186
6264B DC Power Supply	186
6265B DC Power Supply	186
6266B DC Power Supply	186
6267B DC Power Supply	186
6268B DC Power Supply	186
6269B DC Power Supply	186
6271B DC Power Supply	186
6274B DC Power Supply	186
6281A DC Power Supply	182
6282A DC Power Supply	182
6284A DC Power Supply	182
6285A DC Power Supply	182
6286A DC Power Supply	182
6289A DC Power Supply	182
6290A DC Power Supply	182
6291A DC Power Supply	182
6294A DC Power Supply	182
6296A DC Power Supply	182
6299A DC Power Supply	182
6384A DC Power Supply	178
6427B DC Power Supply	190
6428B DC Power Supply	190
6433B DC Power Supply	190
6434B DC Power Supply	190
6438B DC Power Supply	190
6439B DC Power Supply	190
6443B DC Power Supply	190
6448B DC Power Supply	190
6453A DC Power Supply	190
6456B DC Power Supply	190

6459A DC Power Supply	190
6464C DC Power Supply	190
6466C DC Power Supply	190
6469C DC Power Supply	190
6472C DC Power Supply	190
6475C DC Power Supply	190
6477C DC Power Supply	190
6479C DC Power Supply	190
6483C DC Power Supply	190
6515A DC Power Supply	194
6516A DC Power Supply	194
6521A DC Power Supply	194
6522A DC Power Supply	194
6525A DC Power Supply	194
6823A DC Power Supply/Amplifier	200
6824A DC Power Supply/Amplifier	200
6825A DC Power Supply/Amplifier	200
6826A DC Power Supply/Amplifier	200
6827A DC Power Supply/Amplifier	200
6830A DC Power Supply/Amplifier	200
6831A DC Power Supply/Amplifier	200
6832A DC Power Supply/Amplifier	200
6920B AC/DC Meter Calibration	340
6940B Multi-Programmer	524
6941B Multi-Programmer Extender	524

7000

7004B X-Y Recorder	217
7010A X-Y Recorder	222
7015A X-Y Recorder	222
7034A X-Y Recorder	217
7035B X-Y Recorder	221
7040A X-Y Recorder	223
7041A X-Y Recorder	223
7044A X-Y Recorder	224
7045A X-Y Recorder	224
7046A X-Y Recorder	226
7047A X-Y Recorder	224
7100B Strip Chart Recorder, 2 Pen	228
7101B Strip Chart Recorder, 1 Pen	228
7123A Strip Chart Recorder	230
7127A Strip Chart Recorder, 1 Pen	228
7128A Strip Chart Recorder, 2 Pen	228
7130A Strip Chart Recorder, 2 Pen	232
7131A Strip Chart Recorder, 1 Pen	232
7132A Strip Chart Recorder, 2 Pen	233
7133A Strip Chart Recorder, 1 Pen	233
7143A Strip Chart Recorder	230
7155A Portable Strip Chart Recorder	234
7202A Graphic Plotter	227
7203A Graphic Plotter	227
7210A Digital Plotter	545
7260A Optical Mark Reader	544
7261A Optical Mark Reader	544
7402A 2-Channel Oscillographic Recorder	237
7404A 4-Channel Oscillographic Recorder	237
7414A 4-Channel Oscillographic Recorder	239
7418A 6 to 8 Channel Oscillographic Recorder	239

MODEL NUMBER INDEX

7562A Log Voltmeter/Converter	30	8552A Spectrum Analyzer—IF Section	456
7563A Log Voltmeter/Amplifier	30	8552B Spectrum Analyzers	456
7591A Point Plotting System	220	8553B Spectrum Analyzer, Tuning Section ...	456, 460
7610A High Efficiency Gas Chromatograph	562	8554B Spectrum Analyzer, Tuning Section ...	456, 462
7670A Automatic Sampler	562	8555A Spectrum Analyzer, Tuning Section ...	456, 464
		8556A Spectrum Analyzer, Tuning Section ...	456, 458
8000		8558B Spectrum Analyzer	135, 454
8002A Pulse Generator	296	8580B Automatic Spectrum Analyzer	468
8004A Pulse Generator	296	8600A Digital Marker	367
8005B Pulse Generator	297	8601A Generator/Sweeper	367
8006A Pulse Generator	315	8614A Signal Generator	357
8007B Pulse Generator	301	8616A Signal Generator	357
8008A Pulse Generator	302	8620A Sweeper Mainframe	368, 369
8010A Pulse Generator	298	8620B Sweeper Mainframe	368, 369
8011A Pulse Generator	295	8621B Multiband Sweeper Drawer	372
8012B Pulse Generator	299	8640A AM/FM Signal Generator	343, 346
8013B Pulse Generator	299	8640B AM/FM Signal Generator	343, 346
8015A Pulse Generator	300	8640A/B Option 002, AM/FM Signal Generator ..	346
8016A Pulse Generator	316	8640B Option 004, Avionics Signal Generator ...	347
8082A Pulse Generator	303	8654A Signal Generator	353
8403A Modulator	361	8660A Synthesized Signal Generator	348
8404A Leveling Amplifier	379	8660B Synthesized Signal Generator	348
8405A Vector Voltmeter	439	8690B Sweep Oscillator	376
8406A Comb Generator	467	8691B-8695B RF Units (PIN leveled BWO)	
8407A Network Analyzer Mainframe	428	for 8690B	377, 378
8410A Network Analyzer Mainframe	434	8691A-8697A RF Units (Grid Leveled BWO)	
8410S series Network Analyzers	431-433	for 8690B	377, 378
8411A Harmonic Frequency Converter	434	8698B-8699B Solid State RF Units for 8690B..	377, 378
8412A Phase-Magnitude Display	429, 434	8700A RF Drawer for 8690B	377
8413A Phase Gain Indicator	434	8705A Signal Multiplexer for 8690B	379
8414A Polar Display	429, 434	8706A Control Unit for 8690B	379
8418A Auxiliary Power Supply	434	8707A RF Unit Holder for 8690B	379
8430A Bandpass Filters	407	8709A Phase-lock Synchronizer	379
8431A Bandpass Filters	407	8717B Transistor Bias Supply	436
8432A Bandpass Filters	407	8721A Coaxial Directional Bridge	429, 467
8433A Bandpass Filters	407	8731-8735 series PIN Modulators	361
8434A Bandpass Filters	407	8740A Transmission Test Unit	436
8435A Bandpass Filters	407	8741A Reflection Test Unit	436
8436A Bandpass Filters	407	8742A Reflection Test Unit	436
8443A Tracking Generator	456, 460	8743A Reflection/Transmission Test Unit	435
8444A Tracking Generator	456, 462, 464	8745A S-Parameter Test Set	435
8445B Automatic Preselector	456, 464	8746B S-Parameter Test Set	436
8447 series Amplifiers	19	K,R 8747A Waveguide	
8470A Coaxial Crystal Detector	402	Reflection/Transmission Test Units	437
8471A Coaxial Crystal Detector	402	X,P 8747A Waveguide	
8472A Coaxial Crystal Detector	402	Reflection/Transmission Test Units	437
8477A Power Meter Calibrator	387	8755L/M Frequency Response Test Set	413
8478B Coaxial Thermistor Mount	385	8761A/B Coaxial Switch	410
8481A Power Sensor	382	8801A Low Gain Preamplifier	239
8482A Power Sensor	382	8802A Medium Gain Preamplifier	239
8483A Power Sensor	382	8803A High Gain Preamplifier	239
8491 series Coaxial Fixed Attenuators	395	8805A Carrier Preamplifier	239
8492A Coaxial Fixed Attenuator	395	8805B Carrier Preamplifier	239
8493 series Coaxial Fixed Attenuators	395	8806B Phase Sensitive Demodulator	240
8495 series Coaxial Step Attenuators	397	8807A AC/DC Converter	240
8496 series Coaxial Step Attenuators	397	8808A Logarithmic Preamplifier	240
8542B 18 GHz Network Analyzer	438	8809A Signal Coupler	240
8543A 18 GHz Network Analyzer	438	8820A DC Bank Amplifier	240

8821A DC Bank Amplifier	240	10113A Triple Banana Plug to Dual BNC Female...	475
8900B Peak Power Calibrator	387	10115A Blue Contrast Filter (1700 series)	155
8925A DME/ATC Test set	360	10116A Light Shield (1220A/1221A)	155
9000		10166A Panel Cover (180C, 181A, 183A, 184A) ..	155
9500D Automatic Test System	520-522	10167A Flexible Cover (180C, 181A, 183A, 184A) ..	155
9510D Automatic Test System	520-522	10169A Panel Cover (1200 series cabinet)	155
9540D Transceiver Test System	523	10170A Flexible Cover (183 cabinet)	155
9551D Instrument Calibration System	523	10172A Flexible Cover (182)	155
9602A Automatic Measurement		10176A Viewing Hood	155
& Control System	516-519	10178A Mesh Contrast/RFI Filter	155
9603A Automatic Measurement		10190A Light Shield (182)	155
& Control System	516-519	10250A TTL Trigger Probe	152, 153
9604A Automatic Measurement		10251A MOS Trigger Probe	152, 153
& Control System	516-519	10252A ECL Trigger Probe	152, 153
9611A Industrial Measurement		10352B Grafflok Back	158, 159
& Control System	516-519	10353A Pack Film Back	158, 159
9810A Programmable Calculator	534	10355A Camera Bezel Adapter	158, 159
9820A Programmable Calculator	534	10356A Camera Bezel Adapter	158, 159
9821A Programmable Calculator	534	10358B Camera Carrying Case	158, 159
9830A Programmable Calculator	535	10360A Camera Bezel Adapter	158, 159
9861A Typewriter	537	10361A Camera Bezel Adapter	158, 159
9862A X-Y Plotter	537	10362A Camera Bezel Adapter	158, 159
9863A Tape Reader	536	10363A Camera Bezel Adapter	158, 159
9864A Digitizer	536	10365A Roll Film Back	158, 159
9865A Tape Cassette	536	10366B Camera Bezel Adapter	158, 159
9866A Thermal Printer	537	10367A Camera Bezel Adapter	158, 159
9868A I/O Expander	536	10369A Camera Bezel Adapter	158, 159
9869A Hopper Card Reader	536	10370A Camera Bezel Adapter	158, 159
9870A Card Reader	536	10371A Camera Bezel Adapter	158, 159
9880B Mass Memory	535	10372A Camera Bezel Adapter	158, 159
		10373A Camera Bezel Adapter	158, 159
		10374A Camera Carrying Case	158, 159
10000		10407B Plug-in Extender (180 system)	154
10001A 10:1 Divider Probe	150	10475A 3 in. Drawer for 1117B	478
10001B 10:1 Divider Probe	150	10476A 8 in. Drawer for 1117B	478
10002A 50:1 Divider Probe	150	10501A Cable	474
10002B 50:1 Divider Probe	150	10502 Cable	474
10003A 10:1 Divider Probe	150	10503 Cable	474
10004D 10:1 Divider Probe	150	10511A Spectrum Generator	362
10005D 10:1 Divider Probe	150	10514A Double Balanced Mixer	362
10006D 10:1 Divider Probe	150	10519A Accessory	440
10007B 1:1 Probe	150, 476	10525-60012 Tip Kit	87
10008B 1:1 Probe	150	10525T, 10525H, 10525E Logic Probe	83
10010C BNC Adapter Tip	154	10526T Logic Pulser	84
10011B BNC Adapter Tip	154	10528A Logic Clip	84
10013A 10:1 Divider Probe	150	10529A Logic Comparator	85
10014A 10:1 Divider Probe	150	10531A Accessory Filter Kit	279
10016A 10:1 Divider Probe	150	10533A Printer Interface	272
10020A Resistance Divider	150	10534A Double Balanced Mixer	362
10035A Probe Tip Kit	154	10536A Adapter for 5201A	261
10036A Probe Tip Kit	154	10541A Troubleshooting Kit	87
10037A Probe Tip Kit	154	K01-10541A Preprogrammed Reference Boards	87
10100B 100 ohm Feedthrough Termination	154	10542A Remote Programming Interface	265
10100C 50 ohm Feedthrough Termination	154	10544A Component Oscillator	288
10104A Viewing Hood (1700) series	155	10548A Service Kit	272
10106A Camera Bezel Adapter	158, 159	10590A Plug-in Adapter	255
10110A BNC to Banana Post	475	10598A/B Microwave Counter	263
10111A Shielded Banana Plug to BNC Female	475	10638A Degausser (Cesium Std.)	282

MODEL NUMBER INDEX

11000

11000A Cable	474
11001A Cable	474
11002A Test Lead	474
11003A Test Lead	474
11021A Probe Accessories	476
11035A Cable	474
11036A AC Probe for 410C	476
11039A Capacitive Voltage Divider	476
11040A Probe Accessory	476
11041A Probe Accessory	476
11042A Probe Accessory	476
11044A Probe Accessory	476
11045A DC Voltage Divider for 410C	476
11047A Probe Accessory	476
11086A Cable	474
11096A High Frequency Probe	476
11143A BNC to Clip Leads	474
11163A System Desk	481
11285A Calculator Peripherals	537
11297B Calculator Peripheral	537
11298B Calculator Peripheral	537
11456A Test Cord	43
11457A Rack Kit	43
11458A Strap	43
11473A-11476A Current Probe Balancing Transformer	477
11500A Cable	474
11501A Cable	474
11507A Output Termination	362
11508A Terminated Output Cable	362
11509A Fuseholder	362
11511A Type-N Short	406
11512A Type N Short	406
11517A Mixer	467
11525A APC7-N Adapter	411, 475
11531A Test Plug-in for 8690B	379
11533A APC7-SMA Adapter	411, 475
11534A APC7-SMA Adapter	411, 475
11536A Probe Tee for 8405A	439
11540A Waveguide Stand	411
11542A-11548A Waveguide Clamps	411
11549A Power Splitter for 8405A	439
11565A APC-7 Short	406
11570A Accessory Kit for 8405A	439
11581A Attenuator Set	395
11582A Attenuator Set	395
11583A Attenuator Set	395
11587A Accessory Kit for 8410 series	437
11588A Rotary Joint	411
11589A/11590A Bias Networks	437
11599A Quick-Connect Adapter for 8745A	437
11600B Transistor Fixture	435
11602B Transistor Fixture	435
11604A Universal Extension for 8745A	435
11605A Flexible Arm for 8743A	435
11606A Rotary Air Line	411
11607A Small Signal Adapter for 8745A	437
11608A Transistor Fixture	436
11609A Cable Kit for 8410S	437
11650A Accessory Kit for 8410S	437
11652A Reflection/Transmission Kit for 8407A series	429
11654A Passive Probe Kit for 8407A	429
11655A Impedance Probe for 8407A	430
11658A Matching Resistor for 8407A	430
11661A Extension Module for 8660A/B	350
11664A Detector for 8755	414
11665B Modulator for 8755	414
11667A DC-18 GHz Power Splitter	415
11668A 50 MHz High Pass Filter	415
11678A Low Pass Filter Kit	415
11683A Range Calibrator	383
11687A Adapter, 50 to 75 Ω	363
11690A Frequency Doubler	363
11691D Coaxial Directional Coupler	363
11692D Coaxial Dual Directional Coupler	399
11693A Limiter	467
11694A Matching Transformer, 75 Ω	467
11697A/B/C Band-pass Filters	363
11698A Accessory Kit	363
13000	
13515A Frequency Doubler Probe	352
14000	
14533B Multiprogrammer Accessories	526
14534A Multiprogrammer Accessories	526
14540A Multiprogrammer Accessories	526
14541A Multiprogrammer Accessories	526
14546A Multiprogrammer Accessories	526
14550A Multiprogrammer Accessories	526
16000	
16008A Resistivity Cell	63
17000	
17005A Incremental Chart Advance	220
17012B Point Plotter	220
17012C Point Plotter	220
17108A Time Base	221
17170A DC Coupler	218
17171A DC Amplifier	218
17172A Time Base	218
17173A Null Detector	218
17174B DC Offset	218
17175A Filter	219
17176A Scanner	219
17177A AC/DC Converter DC Preamplifier	219
17178A DC Attenuator	219
17400A High Gain Preamplifier	237
17401A Medium Gain Preamplifier	237
17402A Low Gain Preamplifier	237
17403A AC Carrier Preamplifier	237
17500A Multiple Span	229
17501A Multiple Span	229
17502A Temperature Module	229
17503A Single Span	229
17504A Single Span	229

17505A High Sensitivity	229
17506A Single Span	229

18000

18019A Carrying Case	43, 272
18641A Digital Voltmeter	43
18642A Digital Voltmeter	43
18643A Digital Voltmeter	43
18644A Digital Voltmeter	43

20000

29400 series Rack Cabinets	452
29411B Rack Cabinets	452
29412B Rack Cabinets	452

30000

33300 series Step Attenuators	396
33321A/B Coaxial Step Attenuators	397
33322A/B Coaxial Step Attenuators	397
34701A DC Voltmeter	40, 41
34702A Multimeter	40, 41
34703A DC/DCI/Ohm Meter	40, 42
34720A Battery Module	40
34721B BCD Module	40
34740A Display	40
34750A Display	40

40000

43501A X-Ray System	557
43802 X-Ray System	557
43804 X-Ray System	556
43805 X-Ray System	556
43807 X-Ray System	556
43808 X-Ray System	556
43846 X-Ray System	557

50000

59301A ASCII—Parallel Converter	257
59303A Digital-to-Analog Converter	257
59304A Numeric Display	257
59306A Relay Actuator	257
59307A VHF Switch	257
59308A Timing Generator	257
59309A ASCII Digital Clock	257

60000

60063B-60246B DC Power Supply	207
62005A-62048G Power Supply	203
62212A-62215G Modular; Dual Output series Regulated	204
62605M-62628J DC Power Supply	206, 207
69321B Multiprogrammer Card	526
69325A-69328A Multiprogrammer Card	526
69330A Multiprogrammer Card	526
69331A Multiprogrammer Card	526
69332A Multiprogrammer Card	526
69335A Multiprogrammer Card	526
69351A Multiprogrammer Card	526
69370A Multiprogrammer Card	526
69380A Multiprogrammer Card	526
69421A Multiprogrammer Card	526

69430A Multiprogrammer Card	526
69431A Multiprogrammer Card	526
69433A Multiprogrammer Card	526
69434A Multiprogrammer Card	526
69435A Multiprogrammer Card	526
69480A Multiprogrammer Card	526
69500A Multiprogrammer Card	526
69501A-69513A Multiprogrammer Cards	526
69600A-Multiprogrammer Card	526
69601A Multiprogrammer Card	526

80000

85426A Bias Insertion Network	430
85428B Minimum Loss Pad	430
86200 series Sweeper Plug-ins for 8620A	370
86290A Broadband Sweeper Plug-in for 8620A	375
86300 series Sweeper Modules for 8620A	372
86601A RF Section for 8660A,B	349
86602A RF Section for 8660A,B	350
86631B Auxiliary Section for 8660A,B	351
86632A Auxiliary Section for 8660A,B	351
86633A Modulation Section for 8660A,B	351

90000

91000A Analog-to-Digital Interface Card for HP 2100 Computer	528
97001A Hand Held Probe	36, 37
97002A Hand Held Probe	36, 37
97003 Hand Held Probe	36, 37

56A-16C Cable for 5055A	43
0950-0090 GR-874 to 50Ω Termination	475
1250-0076 90° BNC Male-Female	475
1250-0077 Type N Female to BNC Male	475
1250-0080 BNC Female to Female	475
1250-0082 Type N Male to BNC Female	475
1250-0176 Type N Male to Type N Female 90°	475
1250-0216 BNC Male to Male	475
1250-0240 GR-874 to Type N Female	475
1250-0739 GR-874 90° Elbow	475
1250-0778 Type N Male to Male	475
1250-0781 BNC 'T' 2 Male, 1 Female	475
1250-0846 Type N tee, Female	475
1250-0847 GR-874 to Type N Male	475
1250-0849 GR-874 to BNC Male	475
1250-0850 GR-874 to BNC Female	475
1250-1158 SMA Male to Male	475
1250-1159 SMA Female to Female	475
1250-1206 GR-874 to Type C Male	475
1250-1207 GR-874 to Type HN Female	475
1250-1208 GR-874 to Type C Female	475
1250-1209 GR-874 to TNC Female	475
1250-1210 GR-874 to TNC Male	475
1250-1211 GR-874 to Type HN Male	475
1250-1263 Single Banana plug to BNC Male	475
1250-1264 Dual Banana plug to BNC	475
1251-2277 Dual Banana plug to BNC Female	475
1251-2816 Dual-Banana-plug	475



AMPLIFIERS

General purpose amplifiers

Model 461A, 462A, 465A, 467A

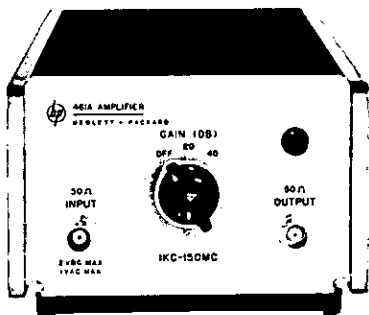

461A

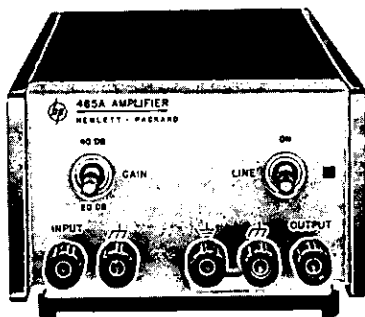

462A

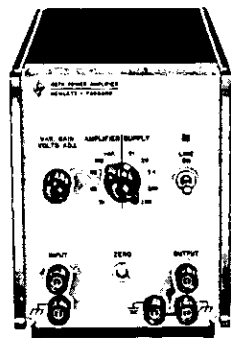

467A

461A, 462A Description

These general purpose amplifiers can be used as preamplifiers to raise the level of a signal or as a buffer.

Solid-state HP amplifiers, Models 461A and 462A, provide stable 20 and 40 dB gain over a wide frequency range with fast rise time.

461A Specifications

Frequency response: ± 1 dB, 1 kHz to 150 MHz when operating into a 50 Ω resistive load (500 kHz reference).

Gain at 500 kHz: 40 dB ± 0.5 dB or 20 dB ± 1.0 dB, selected by front-panel switch (inverting).

Input impedance: nominal 50 Ω .

Maximum input: 1 V rms or 2 V p-p pulse.

Maximum dc input: ± 2 V.

Maximum output: 0.5 V rms into 50 Ω resistive load.

Equivalent wide-band input noise level: < 40 μ V in 40 dB position when loaded with 50 Ω .

Distortion: $< 5\%$ at maximum output and rated load.

Overload recovery: < 1 μ s for 10 times overload.

Dimensions: 130 mm wide \times 76 mm high \times 279 mm deep ($5\frac{1}{8}$ " \times 3" \times 11").

Weight: Net 1.8 kg (4 lb); shipping 2.7 kg (6 lb).

462A Specifications

Pulse response: leading edge and trailing edge: rise time, < 4 ns; overshoot, $< 5\%$.

Pulse overload recovery: < 1 μ s for 10 times overload.

Pulse duration for 10% droop: 30 μ s.

Pulse delay: nominally 12 to 14 ns.

Equivalent input noise level: < 40 μ V in 40 dB position (50 Ω load).

Input impedance: nominal 50 Ω .

Maximum input: 1 V rms or 2 V p-p pulse.

Maximum dc input: ± 2 V.

Gain: 20 or 40 dB selected by front panel switch (inverting).

Output: 1 V p-p into 50 Ω resistive load.

Dimensions: 130 mm wide \times 76 mm high \times 279 mm deep ($5\frac{1}{8}$ " \times 3" \times 11").

Weight: Net 1.8 kg (4 lb); shipping 2.7 kg (6 lb).

465A Description

HP's 465A amplifier provides 20 dB or 40 dB gain (X10 or X100) with flat frequency response from 5 Hz to 1 MHz with floating inputs.

465A Specifications

Voltage gain: 20 dB (X10) or 40 dB (X100), open circuit.

Gain accuracy: ± 0.1 dB ($\pm 1\%$) at 1 kHz.

Frequency response: ± 0.1 dB, 100 Hz to 50 kHz; < 2 dB down at 5 Hz and 1 MHz.

Output: > 10 V rms open circuit; > 5 V rms into 50 Ω (0.5 W).

Distortion: $< 1\%$, 10 Hz to 100 kHz; $< 2\%$, 5 Hz to 10 Hz and 100 kHz to 1 MHz.

Input impedance: 10 M Ω shunted by < 20 pF.

Output impedance: 50 Ω .

Noise: < 25 μ V rms referred to input (with 1 M Ω source resistance).

Dimensions: 130 mm wide \times 76 mm high \times 279 mm deep ($5\frac{1}{8}$ " \times 3" \times 11").

Weight: Net 1.8 kg (4 lb); shipping 3.2 kg (7 lb).

467A Description

HP's 467A Power Amplifier/Supply is a 10 watt peak power amplifier and -20 V (to $+20$ V) dc power supply. The wide band width offers low dc drift from dc to 1 MHz and 0.3% gain. With continuously variable gain and floating inputs, HP's 467A can also be used as a power supply.

467A Specifications

Power amplifier

Voltage gain (non-inverting): fixed steps: X1, X2, X5, X10. Variable: 0-10, resolution is better than 0.1% of full output.

Accuracy: $\pm 0.3\%$ from dc to 10 kHz; $\pm 1.0\%$ from 10 kHz to 100 kHz; $\pm 10\%$ from 100 kHz to 1 MHz with load of $> 40\Omega$.

Output: ± 20 V p at 0.5 A p.

Distortion: $< 0.01\%$ at 1 kHz; $< 1\%$ at 100 kHz; $< 3\%$ at 1 MHz.

Input impedance: 50 k Ω shunted by 100 pF.

DC power supply

Voltage range: $> \pm 20$ V, ± 10 V, ± 4 V, ± 2 V, ± 1 V with adjustable vernier. Resolution: better than 0.1% of full output.

Current: ± 0.5 A p.

Load regulation: (front panel) < 10 mV, no load to full load.

Line regulation: < 10 mV for a $\pm 10\%$ change in line voltage.

General

Output impedance: (front panel): 5 m Ω in series with 1 μ H.

Current limit: < 800 mA.

Dimensions: 130 mm wide \times 159 mm high \times 279 mm deep ($5\frac{1}{8}$ " \times 6 $\frac{1}{4}$ " \times 11").

Weight: Net, 4.5 kg (10 lb); shipping 6.8 kg (15 lb).

Model name and number

HP 461A Amplifier

HP 462A Amplifier

HP 465A Amplifier

HP 467A Power Amplifier/Supply

Price

\$420

\$420

\$305

\$720

AMPLIFIERS



Wide band amplifiers

Models 8447A/B/C/D/E/F

- Wide Band
- Flat Response
- Low Noise

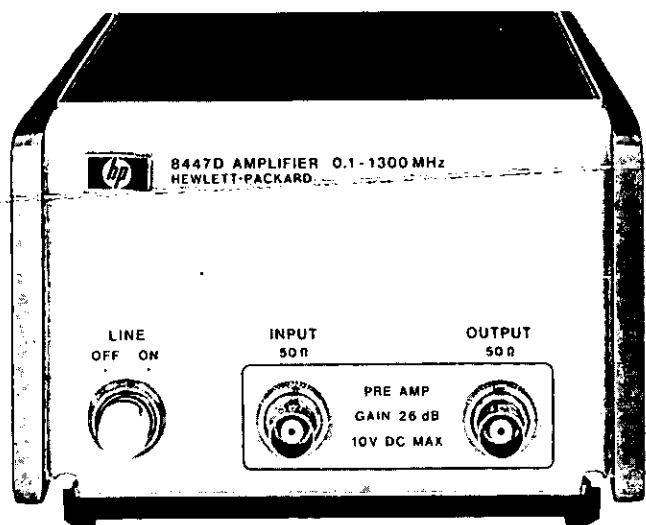

The HP 8447 series of general purpose amplifiers combines high reliability and convenience.

High performance

The performance of these amplifiers qualifies them for a number of

Specifications

	8447A Preamp	8447B Preamp	8447C Power Amp	8447D Preamp	8447E Power Amp	8447F Preamp- Power Amp
Frequency Range	0.1 – 400 MHz	0.4 – 1.3 GHz	30 – 300 MHz	100 kHz – 1.3 GHz	100 kHz – 1.3 GHz	100 kHz – 1.3 GHz
Typical 3 dB Bandwidth	50 kHz – 700 MHz	0.35 – 1.35 GHz	10 – 400 MHz	50 kHz – 1.4 GHz	50 kHz – 1.4 GHz	50 kHz – 1.4 GHz
Gain (Mean)	20 dB ±0.5 dB at 10 MHz	>20 dB 22 dB typical	30 dB ±1 dB	26 dB ±1.5 dB (20° – 30°C)	22 dB ±1.5 dB (20° – 30°C)	
Gain Flatness Across Full Frequency Range	±0.5 dB	±1.5 dB	±1 dB	±1.5 dB	±1.5 dB	
Noise Figure	<5 dB	<5 dB 0.4 – 1.0 GHz <6 dB 1.0 – 1.3 GHz	<11 dB	<8.5 dB	<11 dB typical	
Output Power for 1 dB Gain Compression	>+7 dBm	>–3 dBm	>+17 dBm	>+7 dBm typical	>+15 dBm	
Harmonic Distortion	–35 dB for 0 dBm output	–30 dB for –15 dBm output	–35 dB for +10 dBm output	–30 dB for 0 dBm output (typical)	–30 dB for +10 dBm output	
Typical Output for <–60 dB Harmonic Distortion	–25dBm	–45 dBm	–15 dBm	–30 dBm	–20 dBm	
VSWR	<1.7	<2.0 input <2.2 output	<2.0	<2.0 input <2.2 output 1 – 1300 MHz	<2.2 1 – 1300 MHz	
Impedance	50Ω	50Ω	50Ω	50Ω	50Ω	
Reverse Isolation	>30 dB	>40 dB	>35 dB	>40 dB	>40 dB	
Maximum DC Voltage Input	±10 V	±10 V	±10 V	±10 V	±10 V	
Options Available	001	001, 010, 011	002	001, 010, 011	010	010

↑ 8447D AND 8447E COMBINED IN A SINGLE PACKAGE ↓

uses: to improve the sensitivity of counters, spectrum analyzers, RF voltmeters, EMI meters, power meters and other devices without distortion or degradation of amplitude accuracy; to increase the maximum power available from a signal generator or sweeper.

Broadband frequency coverage

The 8447 series offers an amplifier for nearly every application in the 100 kHz to 1.3 GHz frequency range. The wide bandwidths are compatible with other wideband instruments and accommodate wide-band spectra.

Options

A variety of options are available: a 75Ω impedance model (Option 002) for applications such as television/FM broadcasting and CATV; two dual channel versions (Option 001-BNC connectors and Option 011 – Type N connectors) which operate with dual channel systems such as oscilloscopes or network analyzers (or the channels may be cascaded for increased gain); Type N connectors rather than the standard BNC connectors (Option 010).

General

Weight: Net, 3 pounds, 7 ounces (1.56 kg). Shipping, 5 pounds, 1 ounce (2.30 kg).

Dimensions: 130 mm wide, 85.8 mm high, 216 mm deep, (5 1/8" × 3 3/8" × 8 1/2").

Power requirements: 110 or 230 V ac ± 10%, 48-440 Hz, 15 watts.

Model number and name

	Price
8447A Preamp	\$595
8447B Preamp	\$645
8447C Power Amp	\$495
8447D Preamp	\$695
8447E Power Amp	\$750
8447F Preamp-Power Amp	\$1,235

AMPLIFIERS

Microwave and RF power amplifiers

Models 230B, 489A, 491C, 493A & 495A

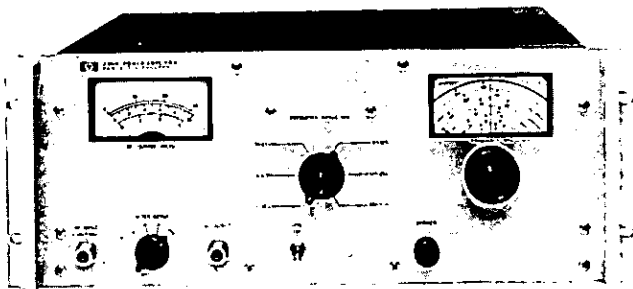

230B

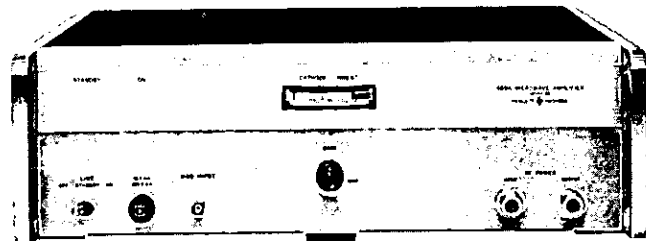

489A

Tuned RF power amplifier

The HP 230B is a tuned RF power amplifier covering 10 to 500 MHz in six continuous ranges. It provides up to 30 dB of gain and has a maximum rated power output of 4.5 watts. With a typical noise figure of 6 to 9 dB, it is also suitable for low-level applications as described in Application Note 76.

230B Specifications

Frequency range: 10 to 500 MHz in six bands: 10 to 18.5 MHz, 18.5 to 35 MHz, 35 to 65 MHz, 65 to 125 MHz, 125 to 250 MHz, 250 to 500 MHz.

RF gain: 30 dB (10 to 125 MHz), 27 dB (125 to 250 MHz), 24 dB (250 to 500 MHz), with 10 volts output into 50 ohms.

RF bandwidth: >700 kHz (10 to 150 MHz), >1.4 MHz (150 to 500 MHz), with 10 volts output into 50 ohms.

RF output:

Level: up to 15 volts across external 50-ohm load (4.5 watts).

Level monitor: full scale ranges of 3, 10, and 30 volts, accurate to 10% from 10 to 500 MHz.

AM range: reproduces 0 to 100% modulation of driving source.

Connectors: type N female.

Dimensions: 425 mm wide, 183 mm high, 459 mm deep (16 $\frac{1}{4}$ " \times 7 $\frac{1}{16}$ " \times 18 $\frac{1}{16}$ ").

Weight: Net 15.8 kg (35 lb); Shipping 23.4 kg (52 lb).

Microwave TWT amplifiers

Amplification of frequencies from 1 to 12.4 GHz is accomplished in four ranges by the Hewlett-Packard medium-power, microwave amplifiers. Each delivers over 1 watt for an input of 1 mW or less — a gain of at least 30 dB. These TWT amplifiers feature amplitude modulation capabilities, front panel meter readout of cathode current, and fail-safe protective circuits. Combined with the 8620 or 8690 sweep oscillator they make an excellent high power swept source.

Advantages

DC coupled modulation circuitry allows power leveling and remote programming.

Periodic-permanent-magnet focusing means fewer alignment problems.

Applications

Antenna efficiency and pattern measurements.

Extends attenuation measuring systems capability by at least 30 dB.

RFI susceptibility tests.

489A-495A Specifications

Output power: 1 watt for an input of ≤ 1 mW.

Gain: 30 dB at rated output.

Input/output: impedance, 50 Ω ; connectors, type N female.

Noise figure: ≤ 30 dB.

Amplitude modulation:

Sensitivity: modulation input of > -20 V peak reduces RF output by ≥ 20 dB from dc to 50 kHz.

Frequency response: dc to 500 kHz (3 dB).

Pulse response: < 1 μ s rise and fall times.

Dimensions: 426 mm wide, 140 mm high, 467 mm deep (16 $\frac{1}{4}$ " \times 5 $\frac{1}{2}$ " \times 18 $\frac{1}{16}$ ").

Weight: net 14.9 kg (33 lb); shipping 18.0 kg (40 lb).

	489A	491C	493A	495A
Frequency range (GHz)	1-2	2-4	4-8	7-12.4
Gain variation with freq. at rated output small signal across any 10% of band	≤ 6 dB	≤ 6 dB	≤ 6 dB	≤ 6 dB
across full band	≤ 5 dB	≤ 5 dB	≤ 5 dB	≤ 5 dB for 300 MHz
	≤ 12 dB	≤ 12 dB	≤ 12 dB	≤ 10 dB

Model number and name

230B, RF tuned power amplifier

489A, 1 to 2 GHz TWT amplifier

491C, 2 to 4 GHz TWT amplifier

493A, 4 to 8 GHz TWT amplifier

495A, 7 to 12.4 GHz TWT amplifier

Information on 12.4 to 18 GHz TWT on request

Price

\$1290

\$2705

\$2705

\$3090

\$3090

Meter movements

Voltage, current and resistance measurements can be easy, fast, and accurate with electronic instruments using meter movements.

The meter movement readout continues to be popular since it is economical and suitable for many jobs. It also lends itself well to special, nonlinear scales such as dB scales.

dB scale and, therefore, a nonlinear voltage scale. Several different types of meter faces are illustrated in Figure 1.

Analog meters (Figure 2) usually have nonlinearities and/or offsets present in the attenuators and amplifiers. The meter movement itself can have nonlinearities — even with individually calibrated meter scales. Nonlinearities cause percent of reading

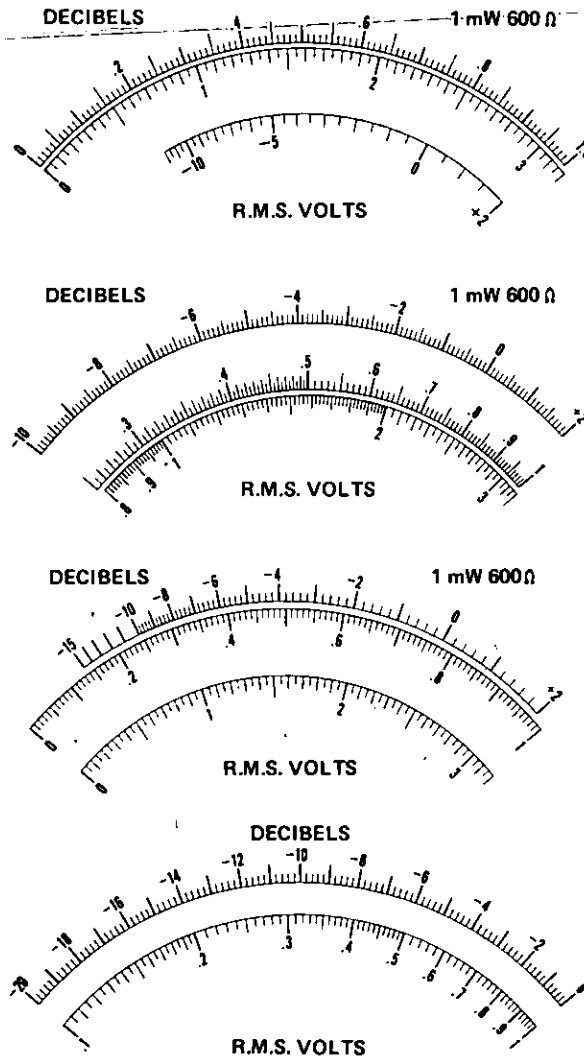

Figure 1. Four different types of meter scales available. (a) Linear 0–3 V and 0–10 V scales plus a dB scale. (b) Linear dB scale plus non-linear (logarithmic) voltage scales. (c) dB scale placed on larger arc for greater resolution. (d) Linear –20 to 0 dB scale useful for acoustical and communications applications.

Voltmeter considerations

Accuracy — Before we can discuss meter accuracy, we must have a familiarity with the various meter scales available. Many instruments have meter scales marked in both volts and decibel (dB) units. It should be noted that dB and voltage are complements of each other. That is, if a voltage scale is made linear, the dB scale on the same meter face will be logarithmic or nonlinear. Likewise, if the dB scale is made linear, the voltage scale becomes nonlinear. The term "linear-log scale" is applied to an instrument that has a linear

errors, and offsets cause percent of full scale errors. Percent of reading errors are constant no matter where the meter pointer is. Percent of full-scale error increases as the pointer goes further down scale.

Looking at instrument specification sheets, accuracy specifications are usually expressed in one of three ways: 1. percent of the full-scale value, 2. percent of the reading, 3. (percent of reading + percent of full-scale). The first is probably the most commonly used accuracy specification. The second (percent of reading) is more commonly applied to meters

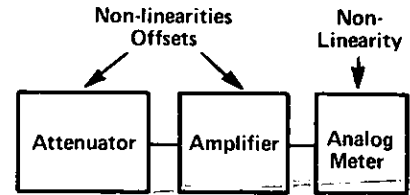

Figure 2. Non-linearities cause % of reading errors. Offset cause % of full scale errors.

having a logarithmic scale. The last method has been used more recently to obtain a tighter accuracy specification on a linear-scale instrument.

Hewlett-Packard uses the two-part accuracy specification to take advantage of the upper-scale accuracy and yet maintain a reasonable specification for the lower portion of the scale.

For a thorough evaluation of accuracy, the following should be considered: Does it apply at all input-voltage levels up to maximum overrange point? (Linearity specifications may be added to qualify this point.) Does it apply to all frequencies throughout its specified bandwidth? Does it apply on all ranges? Does it apply over a useful temperature range for the application? If not, is temperature coefficient specified?

Selecting an analog voltmeter

Basic specs for Hewlett-Packard analog meters are in Table 1. Guidelines are restated below.

1. For measurements involving dc applications, select the instrument with the broadest capability meeting your requirements. Refer to HP Application Note 69.
2. For ac measurements involving sine waves with only modest amounts of distortion (<10%), the average-responding voltmeter can perform over a bandwidth extending to several megahertz. Refer to HP Application Note 60.
3. For high-frequency measurements (>10 MHz), the peak-responding voltmeter with the diode-probe input is the most economical choice. Peak-responding circuits are acceptable if inaccuracies caused by distortion in the input waveform can be tolerated.
4. For measurements where it is important to determine the effective power of waveforms that depart from a true sinusoidal form, the true rms-responding voltmeter is the appropriate choice. In general, true-rms meters reveal only the rms value of an ac signal. Because they are ac coupled, most voltmeters have a frequency cut-off around 20 Hz. This restriction keeps the true-rms voltmeter from accounting for any low frequencies or dc components in a signal.

The 3403C RMS Digital Voltmeter measures dc plus ac from 2 Hz to 100 MHz. See pages 38-39.

For very wide bandwidths (up to 1 GHz) and high-sensitivity measurements of sinusoidal or nonsinusoidal waveforms, the HP 3406A is the proper choice. Although the 3406A is average-responding, it has a sample hold output which makes analysis of waveforms possible.

Table 1. HP analog instruments

DC VOLTMETERS	Voltage Range	Frequency Range Accuracy at FS*	Input Impedance	Model	See Page
DC NULL VOLTMETER	$\pm 3 \mu\text{V}$ — $\pm 1 \text{ kV}$ end scale 0.1 μV resolution (18 ranges)	dc $\pm 2\%$ +1 μV	100 k — 100 M Ω depending on range (infinite when nulled)	419A	23
DC VOLT-AMMETER	DC: $\pm 1 \text{ mV}$, $\pm 300 \text{ V}$ (12 ranges) $\pm 1 \text{ nA}$, $\pm 300 \mu\text{A}$ (12 ranges)	$\pm 3\%$ dc	10 M Ω all ranges	4304B	See Data Sheet
DC DIFFERENTIAL VOLTMETER	1 V to 1 kV (4 ranges)	dc $\pm(0.002\%$ reading +0.0002% range)	$>10^{11}$ at null	3420B	See Data Sheet
DC DIFFERENTIAL VOLTMETER	1 mV — 1 kV (7 ranges)	dc $\pm(0.005\%$ reading +0.0004% range)	$>10^{10}$	740B	338
AC VOLTMETERS	Voltage Range	Frequency Range Typical Accuracy	Response Input Impedance	Model	See Page
RECHARGEABLE BATTERY AC VOLTMETER	1 mV — 300 V (12 ranges)	5 Hz — 2 MHz $\pm 2\%$ — $\pm 5\%$	Average 2 M Ω / <30 — <60 pF	403B	27
FAST-RESPONSE AC VOLTMETER 100 kHz low-pass filter ac amplifier	100 μV — 300 V — 90 dB — +52 dB	20 Hz — 4 MHz — $\pm 1\%$ — $\pm 4\%$	Average 10 M Ω /10 — 25 pF	400F 400 FL	28
HIGH ACCURACY dB VOLTMETER 20 dB log scale (0 dB = 1 V)	-100 dB — +60 dB (8 ranges)	20 Hz — 4 MHz — ± 0.2 dB — 0.4 dB	Average 10 M Ω / <15 — <30 pF	400GL	28
HIGH ACCURACY AC VOLTMETER has dc output ($\pm 0.5\%$) for driving recorder	1 mV — 300 V — 70 dB — +52 dB	10 Hz — 10 MHz $\pm 1\%$ $\pm 5\%$	Average 10 M Ω / <12 — <25 pF	400E 400EL	28
RMS VOLTMETER provides rms readings of complex signals. Has dc output for driving DVM's or recorders	1 mV — 300 V (12 ranges)	10 Hz — 10 MHz $\pm 1\%$ — $\pm 5\%$	10 M Ω /15 — 40 pF	3400A	29
SAMPLING RF VOLTMETER provides true rms measurements when used with 3400A. Many accessories	1 mV — 3 V (8 ranges)	10 kHz to >1.2 GHz $\pm 3\%$ — $\pm 13\%$	Statistical Average: Input Z depends on probe tip used	3406A	31
RF MILLIVOLTMETER	10 mV — 10 V (7 ranges)	500 kHz — 1 GHz $\pm 3\%$ — 1 dB	Average Input Z depends on probe tip used	411A	See Data Sheet
VECTOR VOLTMETER phase and amplitude measurements	100 μV — 10 V (9 ranges)	1 MHz — 1 GHz ± 0.5 dB — ± 1 dB	Average 0.1 M Ω /2.5 pF	8405A	439
MILLIOHMETER; two probes used when making 4 terminal measurements	0.001 to 100 Ω FS (11 ranges)	1 kHz (fixed) $\pm 2\%$ FS	Max. output Voltage: 20 mV	4328A	62
HIGH RESISTANCE METER and picoammeter	0.5 M Ω to $2 \times 10^{16}\Omega$ FS (7 ranges) 0.05 pA — 20 μA	Voltage: $\pm 10\%$ Current: $\pm 5\%$	Max. output Voltage: 1 kV	4329A	63
MULTIFUNCTION METERS	Voltage Range (Accuracy)	Current Range (Accuracy)	Resistance Range (Accuracy)	Model	See Page
BATTERY-OPERATED MULTIFUNCTION METER has 10 M Ω dc input impedance and 10 M Ω /20 pF ac input impedance	DC: $\pm 100 \text{ mV}$ to 1000 V ($\pm 2\%$) 9 ranges AC: 10 mV — 300 V 10 Hz — 1 MHz ($\pm 2\%$) 10 ranges		10 Ω — 10 M Ω mid-scale $\pm 5\%$; from 0.3 to 3 on the meter scale (7 ranges)	427A	25
VERSATILE VOLTMETER has 100 M Ω dc input impedance and 10 M Ω /1.5 pF ac impedance	DC: $\pm 15 \text{ mV}$ to $\pm 1500 \text{ V}$ ($\pm 2\%$) 11 ranges AC: 0.5 V — 300 V 20 Hz — >700 MHz ($\pm 3\%$ at 400 Hz) 7 ranges	DC: $\pm 1.5 \mu\text{A}$ to $\pm 150 \text{ mA}$ ($\pm 3\%$) 11 ranges	10 Ω — 10 M Ω (center scale) 0 to midscale: $\pm 5\%$ or $\pm 2\%$ of midscale (whichever is greater) 7 ranges	410C	26
CURRENT METERS	Current Range	Accuracy	Frequency Range	Model	See Page
DC MILLIAMMETER with clip-on probe eliminates direct connection	1 mA — 10 A FS (9 ranges)	$\pm 3\%$	dc — 400 Hz	428B	24
AC CLIP-ON CURRENT PROBE makes measurements without breaking circuit	1 mA — 1 A rms (to 25 A with divider)	$\pm 2\%$ to 3 dB	25 Hz — 20 MHz	456A	476

*For exact accuracy refer to page designated.

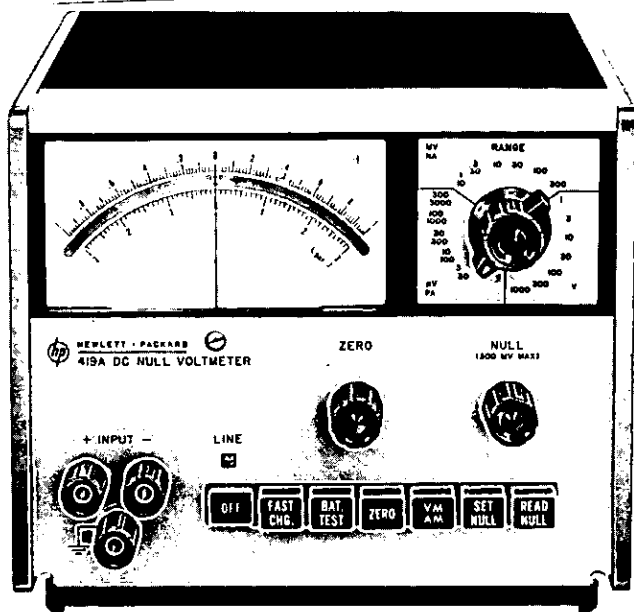

Description

Eighteen voltage ranges with $0.1 \mu\text{V}$ resolution on the lowest range set this HP solid-state dc null voltmeter apart from previous dc null meters. Accuracy of this rechargeable battery-operated instrument is $\pm 2\%$ of end scale $\pm 0.1 \mu\text{V}$ on all ranges. Noise is less than $0.3 \mu\text{V}$ p-p, and drift is less than $0.5 \mu\text{V}/\text{day}$.

An internal nulling voltage allows input voltages up to 300 mV to be nulled giving an infinite input impedance. Input impedance above 300 mV range is 100 megohms .

Seven pushbuttons allow rapid function selection. This dc null voltmeter operates from ac line or from internal rechargeable batteries. During operation from ac line, batteries are trickle-charged. A fast-charge pushbutton is provided to increase the charging rate, recharging batteries in approximately 16 hours. Battery voltage may be easily checked with the battery-test pushbutton. The zero pushbutton allows compensation for any internal offsets before measurement. When this pushbutton is depressed, the positive leg of the voltmeter is disconnected from the positive input terminal.

When the voltmeter pushbutton is depressed, HP 419A functions as a zero-center scale $3 \mu\text{V}$ to 1000 V dc voltmeter.

When the AM pushbutton is depressed, HP 419A functions as a zero-center scale 30 pA to 30 nA ammeter.

Specifications

DC null voltmeter

Ranges: $\pm 3 \mu\text{V}$ to $\pm 1000 \text{ V}$ dc in 18 zero-center ranges.

Accuracy: $\pm(2\%$ of range $\pm 0.1 \mu\text{V})$.

Zero control range: $> \pm 15 \mu\text{V}$.

Zero drift: $< 0.5 \mu\text{V}/\text{day}$ after 30 min warm-up.

Zero temperature coefficient: $< 0.05 \mu\text{V}/^\circ\text{C}$.

Response time: 3 s to within 95% of final reading on $3 \mu\text{V}$ range; 1 s to within 95% of final reading on $10 \mu\text{V}$ to 1000 V ranges.

Noise: $< 0.3 \mu\text{V}$ p-p, input shorted. Noise amplitude approximates Gaussian distribution. RMS value (standard deviation) is $< 0.075 \mu\text{V}$, p-p noise value is $< 0.3 \mu\text{V}$ 95% of the time.

Input characteristics

At null: infinite resistance on $3 \mu\text{V}$ through 300 mV ranges in set null mode. Negative input terminal can be floated to $\pm 500 \text{ V}$ dc from power line ground.

Off null:

Voltage range	Input resistance
$3 \mu\text{V} - 3 \text{ mV}$	$100 \text{ k}\Omega$
$10 \text{ mV} - 30 \text{ mV}$	$1 \text{ M}\Omega$
$100 \text{ mV} - 300 \text{ mV}$	$10 \text{ M}\Omega$
$1 \text{ V} - 1000 \text{ V}$	$100 \text{ M}\Omega$

Negative input terminal can be floated up to $\pm 500 \text{ V}$ dc from power-line ground.

AC normal mode rejection: ac voltages 50 Hz and above and 80 dB greater than end scale affect reading $< 2\%$. Peak ac voltage not to exceed maximum overload voltage.

DC ammeter

Ranges: $\pm 30 \text{ pA}$ to $\pm 30 \text{ nA}$ in 7 zero-center ranges.

Accuracy: $\pm(3\%$ of range $+ 1 \text{ pA})$.

Zero control range: $> \pm 150 \text{ pA}$.

Zero drift: $< 5 \text{ pA}/\text{day}$ after 30 min warm-up.

Zero temperature coefficient: $< 0.5 \text{ pA}/^\circ\text{C}$.

Noise: $< 3 \text{ pA}$ p-p, input shorted.

Input resistance: $100 \text{ k}\Omega$ on all ranges.

Amplifier

Gain: 110 dB on $3 \mu\text{V}$ range, decreases 10 dB per range.

Output: 0 to $\pm 1 \text{ V}$ at 1 mA maximum for end-scale reading. Output level adjustable for convenience when used with recorders.

Output resistance: depends on setting of output level control. $< 35\Omega$ when output control is set to maximum.

Noise: 0.01 Hz to 5 Hz : same as voltmeter (referred to input). $> 5 \text{ Hz}$: $< 10 \text{ mV}$ rms (referred to output).

General

Overload protection: the following voltages can be applied without damage to instrument.

1 V to 1000 V range: 1200 V dc.

10 mV to 300 mV range: 500 V dc.

3 μV to 300 mV range: 50 V dc.

Operating temperature: instrument will operate within specifications from 0°C to 50°C .

Operating humidity: $< 70\%$ R.H.

Storage temperature: -20°C to $+50^\circ\text{C}$.

Power: 115 V or $230 \text{ V} \pm 10\%$, 48 Hz to 440 Hz , 2 VA max. or 4 internal rechargeable batteries (furnished). 30-hr operation per recharge. Operation from ac line permissible during recharge.

Dimensions: 197 mm wide, 156 mm high (without removable feet), 203 mm deep ($7\frac{1}{2}'' \times 6\frac{1}{4}'' \times 8''$).

Weight: net, 3.7 kg (8.3 lb); shipping, 5.4 kg (12 lb).

ANALOG VOLTMETERS

1 mA to 10 A clip-on dc milliammeter

Model 428B

- No circuit interruption
- No circuit loading

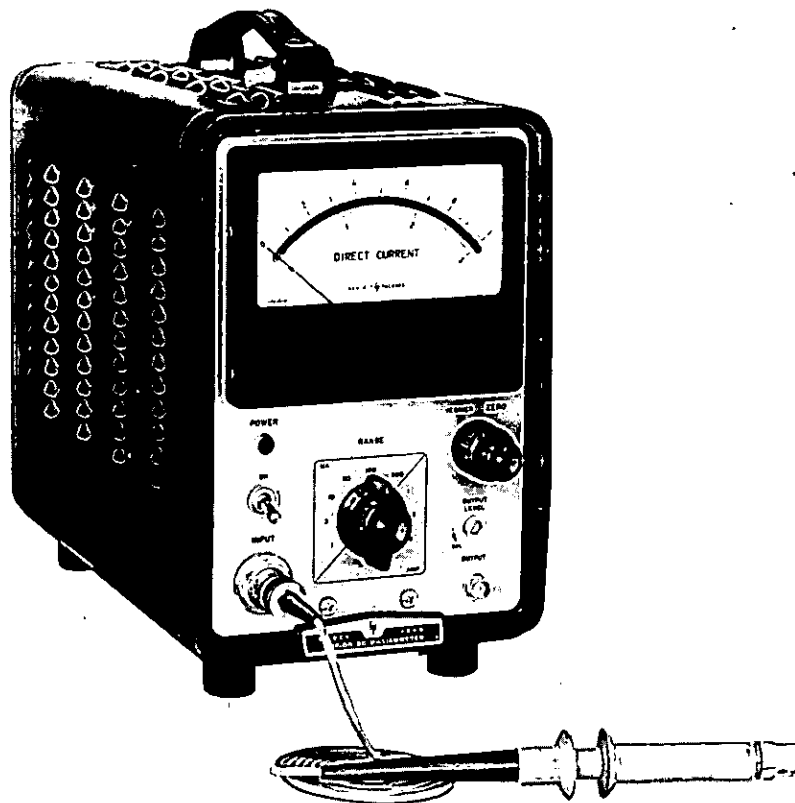

Description

Direct current from 1 milliamperes to 10 amperes full scale can be measured without interrupting your measured circuit or producing loading errors. With the HP Model 428B Clip-on Milliammeter, cutting wires for insertion of current meters and calculating current from voltage and resistance readings are eliminated. All that is required for fast, accurate readings is to clip around the wire and select the proper current range.

The 428B measures current by utilizing a clip-on transducer that converts the magnetic field around the conductor to an ac voltage proportional to dc current. This voltage is detected and displayed as direct current on the 428B's meter. Since there is no direct contact with the circuit being measured, complete dc isolation is assured.

The meter responds to dc current only and is therefore not susceptible to common mode currents. However, low frequency currents up to 400 Hz can be measured by connecting an oscilloscope or voltmeter to the convenient front panel output; or this output can be used to drive a strip chart recorder for permanent long term records.

For even greater sensitivity, several loops of the measured conductor can be put through the probe, increasing sensitivity by the same factor as the number of turns used. Sum or difference measurements of currents in separate wires can also be made. By placing the wires through the probe with currents flowing in the same direction, their sum is indicated; currents flowing in opposite directions will give a difference indication. In this way, balancing currents is easily accomplished by making any difference equal to zero.

To decrease sensitivity on circuits carrying more than 10 amps, it is only necessary to shunt a section of the circuit with two or more wires of the same resistance. A current divider is thereby constructed and the probe can be used to measure the current in one leg. Total current in the circuit is measured by multiplying the 428B reading by the number of legs in the divider.

Specifications

DC current range: 1 mA to 10 A full scale, nine ranges.

Accuracy: $\pm 3\%$ of full scale ± 0.15 mA, from 0°C to 55°C (when instrument is calibrated to probe).

Probe inductance: $< 0.5 \mu\text{H}$.

Probe inducted voltage: < 15 mV p (worst case at 20 kHz and harmonics).

Output: variable linear output level with switch position for calibrated 1 V into open circuit (corresponds to full scale deflection). 1.5 V max. into open circuit in uncalibrated position. 0.73 ± 0.01 V into 1 k Ω in calibrated position.

Noise: 1 mA range, < 15 mV rms across 1 k Ω ; 3 mA range, < 5 mV rms across 1 k Ω ; 10 mA through 10 A ranges, < 2 mV rms across 1 k Ω .

Frequency range: dc to 400 Hz (3 dB point).

AC rejection: signals above 5 Hz with p value $<$ full scale affect meter accuracy $< 2\%$ (except at 40 kHz carrier frequency and its harmonics). On the 10 A range, ac p value is limited to 4 A.

Power: 115 or 230 V $\pm 10\%$, 50 to 60 Hz, approx. 75 VA max.

Operating temperature range: -20°C to $+55^\circ\text{C}$.

Storage temperature: -40°C to $+65^\circ\text{C}$.

Probe insulation: 300 V maximum.

Probe tip size: approximately $\frac{1}{2}$ " by $\frac{2}{32}$ " aperture diameter $\frac{3}{32}$ ".

Dimensions: 191 mm wide, 292 mm high, 368 mm deep ($7\frac{1}{2}$ " \times $11\frac{1}{2}$ " \times $14\frac{1}{2}$ "); rack mount: 483 mm wide, 177 mm high, 330 mm deep (19 " \times $6\frac{3}{32}$ " \times 13 ").

Weight: net 8.6 kg (19 lb); shipping, 10.9 kg (24 lb) (cabinet); net 10.8 kg (24 lb); shipping, 14.4 kg (32 lb) (rack mount).

Model number and name

428B Analog Milliammeter (cabinet)

428BR Analog Milliammeter (rack mount)

Price

\$825

\$755

ANALOG VOLTMETERS



Low-cost multi-function meter

Model 427A

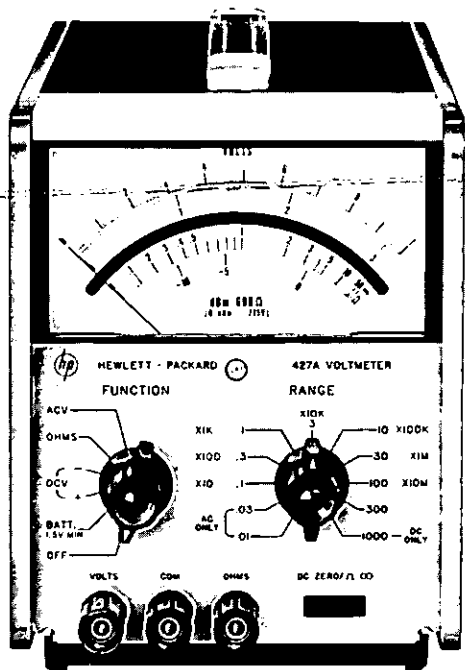

427A

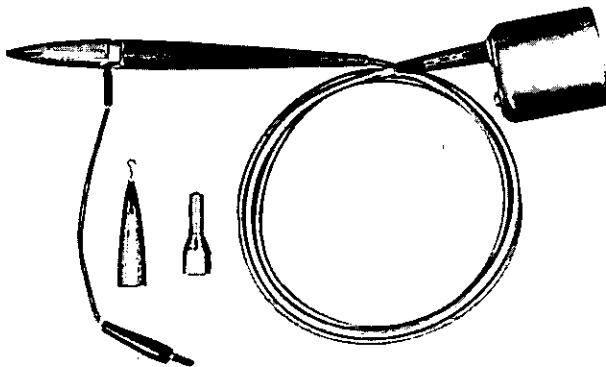

11096A

Description

Hewlett-Packard's Model 427A is a portable, versatile, low cost multi-function meter which is valuable in any laboratory, production line, service department, or in the field. It is capable of measuring dc voltages from 100 mV to 1 kV full scale; ac voltage from 10 mV to 300 V full scale at frequencies up to 1 MHz (>500 MHz with the 11096A High Frequency Probe); and resistance from 10Ω to 10 MΩ center scale.

The 427A will operate continuously for more than 300 hours on its internal 22.5 V dry cell battery. AC line and battery operation is available with option 001.

Specifications

DC voltmeter

Ranges: ±100 mV to ±1000 V in 9 ranges in 10 dB steps.

Accuracy: ±2% of range.

Input resistance: 10 MΩ.

AC normal mode rejection (ACNMR): ACNMR is the ratio of the

normal mode signal to the resultant error in readout. 50 Hz and above: >80 dB.

Overload protection: 1200 V dc.

AC voltmeter

Ranges: 10 mV to 300 V in 10 ranges in 10 dB steps.

Frequency range: 10 Hz to 1 MHz.

Response: responds to average value, calibrated in rms.

Accuracy:

Frequency	Range	
		0.01 V to 30 V
10 Hz to 100 kHz	2% of range	
100 kHz to 1 MHz	2% of range	

Input impedance: 10 mV to 1 V range, 10 MΩ shunted by <40 pF; 3 V to 300 V range, 10 MΩ shunted by <20 pF.

Overload protection: 300 V rms momentarily, 1 V range and below; 425 V rms max above 1 V range.

Ohmmeter

Ranges: 10Ω to 10 MΩ center scale in 7 decade ranges. Accuracy (from 0.3 to 3 on scale): ±5% of reading.

Source current (ohms terminal positive):

Range	Open circuit Voltage	Short circuit Current
X 10	0.1 V	10 mA
X 100	0.1 V	1 mA
X 1 k	1 V	1 mA
X 10 k	1 V	100 μA
X 100 k	1 V	10 μA
X 1 M	1 V	1 μA
X 10 M	1 V	0.1 μA

General

Input: may be floated up to ±500 V dc above chassis ground. Ohms input open in any function except ohms. Volts input open when instrument is off.

Operating temperature: 0°C to 50°C.

Power: >300 hr operation per battery.

HP 427A: 22.5 V dry cell battery, Eveready No. 763 or RCA VS102. HP 427A Option 001: battery operation or ac line operation, selectable on rear panel. 115 V or 230 V ±20%, 48 Hz to 440 Hz, 2 VA max.

Dimensions: (standard 1/2 module): 130 mm wide, 159 mm high (without removable feet), 203 mm deep (5 1/8" × 6 1/4" × 8").

Weight: net, 2.4 kg (5.3 lb); shipping 3.6 kg (8 lb).

Accessories available

HP 11096A High Frequency AC Probe extends range to >500 MHz. With the 11096A, you can measure 0.25 to 30 V rms signals out to 500 MHz with better than ±1 dB accuracy. Usable relative measurements can be made up to 1 GHz (3 dB point at 700 MHz). The 11096A is a peak-responding detector calibrated to produce a dc output proportional to the rms value of a sine wave input. Input impedance is 4 MΩ shunted by 2 pF.

Model number and name

427A Multi-function Meter. (includes batteries)	Price \$375
427A Option 001 AC power supply & battery	Add \$26
11075A High Impact Case. A rugged case for carrying, storing and operating the 427A	\$80
11096A High Frequency AC probe	\$82
11001A 45" test lead, dual banana plug to male BNC	\$15
11002A 60" test lead, dual banana plug to alligator clips	\$10
11003A 60" test lead, dual banana plug to pencil probe and alligator clip	\$10
11039A 1000: 1 capacitive voltage divider; 25-kV max	\$270
10111A BNC female to dual banana adapter	\$15



ANALOG VOLTMETERS

General purpose multi-function voltmeter
Model 410C

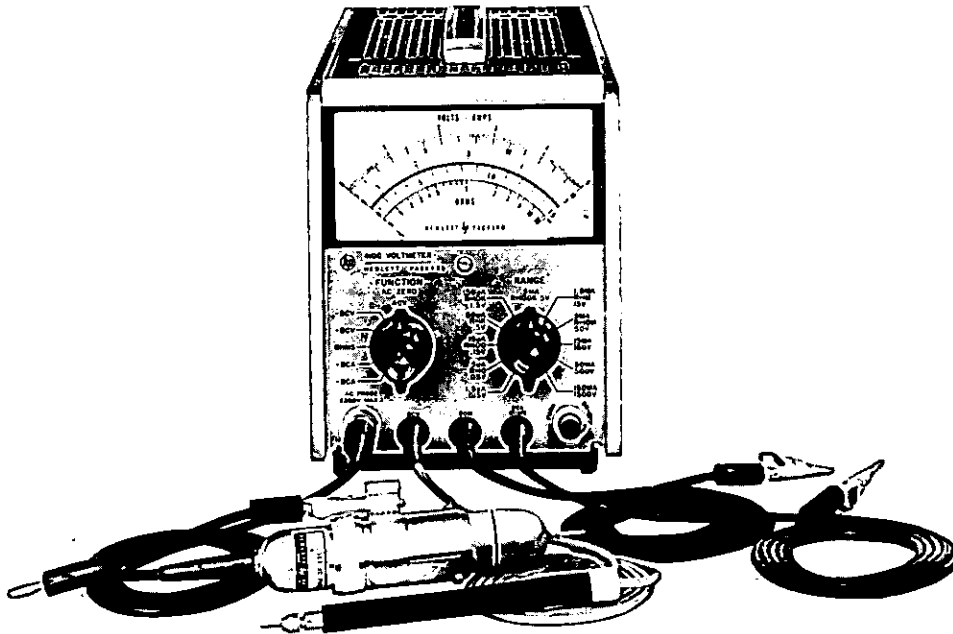

Description

HP's Model 410C is a versatile general purpose instrument for use anywhere electrical measurements are made. This instrument measures dc voltages from 15 mV to 1500 V, direct current from 1.5 μ A to 150 mA full scale, and resistance from 0.2 Ω to 500 M Ω . With a standard plug-in probe, ac voltages at 20 Hz to 700 MHz from 50 mV to 300 V and comparative indications to 3 GHz are attainable.

Specifications

DC voltmeter

Voltage ranges: ± 15 mV to ± 1500 V full scale in 15, 50 sequence (11 ranges).

Accuracy: $\pm 2\%$ of full scale on any range.

Input resistance: 100 M Ω $\pm 1\%$ on 500 mV range and above, 10 M Ω $\pm 3\%$ on 150 mV range and below.

AC voltmeter

Voltage ranges: 0.5 V to 300 V full scale in 0.5, 1.5, 5 sequence (7 ranges).

Frequency range: 20 Hz to 700 MHz.

Accuracy: $\pm 3\%$ of full scale at 400 Hz for sinusoidal voltages from 0.5 V to 300 V rms. The ac probe responds to the positive peak-above-average value of the applied signal. The meter is calibrated in rms.

Frequency response: $\pm 2\%$ from 100 Hz to 50 MHz (400 Hz ref.); 0 to -4% from 50 MHz to 100 MHz; $\pm 10\%$ from 20 Hz to 100 Hz and ± 1.5 dB from 100 MHz to 700 MHz.

Input impedance: input capacitance 1.5 pF, input resistance > 10 M Ω at low frequencies. At high frequencies, impedance drops off due to dielectric loss.

Safety: the probe body is grounded to chassis at all times for safety. All ac measurements are referenced to chassis ground.

DC ammeter

Current ranges: ± 1.5 μ A to ± 150 mA full scale in 1.5, 5 sequence (11 ranges).

Accuracy: $\pm 3\%$ of full scale on any range.

Input resistance: decreasing from 9 k Ω on 1.5 μ A range to approximately 0.3 Ω on the 150 mA range.

Special current ranges: ± 1.5 , ± 5 and ± 15 nA may be measured on the 15, 50 and 150 mV ranges using the dc voltmeter probe, with $\pm 5\%$

accuracy and 10 M Ω input resistance.

Ohmmeter

Resistance range: resistance from 10 Ω to 10 M Ω center scale (7 ranges).

Accuracy: Zero to midscale: $\pm 5\%$ of reading or $\pm 2\%$ of midscale, whichever is greater; $\pm 7\%$ from midscale to scale value of 2; $\pm 8\%$ from scale value of 2 to 3; $\pm 9\%$ from scale value of 3 to 5; $\pm 10\%$ from scale value of 5 to 10.

Amplifier

Voltage gain: 100 maximum.

AC rejection: 3 dB at 0.5 Hz; approximately 66 dB at 50 Hz and higher frequencies for signals < 1600 V p or 30 times full scale, whichever is smaller.

Isolation: impedance between common and chassis is > 10 M Ω in parallel with 0.1 μ F. Common may be floated up to 400 V dc above chassis for dc and resistance measurements.

Output: proportional to meter indication; 1.5 V dc at full scale, maximum current, 1 mA.

Output impedance: $< 3\Omega$ at dc.

Noise: $< 0.5\%$ of full scale on any range (p-p).

DC drift: $< 0.5\%$ of full scale/yr at constant temperature. $< 0.02\%$ of full scale/ $^{\circ}$ C.

Overload recovery: recovers from 100:1 overload in < 3 s.

General

Maximum input: (see overload recovery). DC: 100 V on 15, 50 and 150 mV ranges, 500 V on 0.5 to 15 V ranges, 1600 V on higher ranges. AC: 100 times full scale or 450 V p whichever is less.

Power: 115 V or 230 V $\pm 10\%$, 48 Hz to 440 Hz, 13 VA (20 VA with 11036A AC Probe).

Dimensions: 130.2 mm wide, 165 mm high (without removable feet), 320.7 mm deep (5 $\frac{1}{4}$ " \times 6 $\frac{1}{2}$ " \times 11") behind panel.

Weight: net 4 kg (8 lb); shipping 5.44 kg (12 lb).

Accessories furnished: detachable power cord, NEMA plug, 11036A AC Probe.

Accessories available: see Pages 474-477.

Model number and name

410C Option 002 (less AC probe)

HP 410C with HP 11036A Detachable AC Probe

Price

\$675

\$725

ANALOG VOLTMETERS

5 Hz to 2 MHz AC solid-state voltmeters

Model 403B

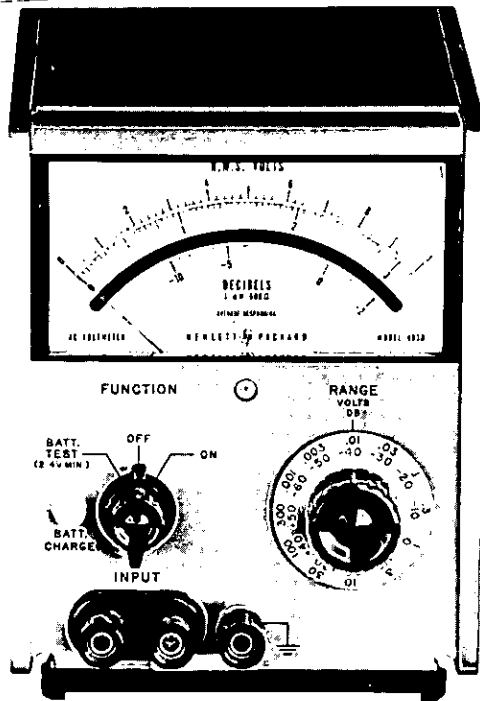

Description

The Hewlett-Packard 403B AC Voltmeter is a versatile, general purpose instrument for laboratory and production work yet is ideal for use in the field since it is solid-state, battery-operated, and portable.

It measures from 100 microvolts to 300 volts, covering 5 Hz to 2 MHz. It operates from internal batteries and thus may be completely isolated from the power line and external grounds, permitting accurate measurements at power line frequency and its harmonics without concern for beat effects. Isolation from external ground also permits use where ground loops are troublesome. Turnover effect and waveform errors are minimized because the meter responds to the average value of the input signal.

The 403B operates from an ac line as well as from the internal battery pack, and batteries recharge during ac operation. Battery charge may be easily checked with a front-panel switch to assure reliable measurements. Normally, about 60 hours of ac operation recharges the batteries; but an internal adjustment is provided which nearly doubles the charging rate. The Model 403B can be used while its batteries charge. A sturdy taut-band meter eliminates friction and provides greater precision and repeatability.

For improved resolution in dB measurements, the 403B Option 001 is available. This version spreads out the dB scale by making it the top scale of the meter.

Specifications

HP Model	403B	403B Option 001
Range	0.001 to 300 V rms full scale, 12 ranges, in a 1, 3, 10 sequence. -60 dB to +50 dB in 12 ranges with 10 dB steps.	
Meter	Responds to average value of input waveform, calibrated in the rms value of a sine wave.	
Frequency Range	5 Hz to 2 MHz	5 Hz to 2 MHz
Accuracy	within $\pm 2\%$ of full scale from 10 Hz to 1 MHz; within $\pm 5\%$ of full scale from 5 to 10 Hz and 1 to 2 MHz, except $\pm 10\%$ 1 to 2 MHz on the 300 V range (0 to 50° C).*	within ± 0.2 dB of full scale from 10 Hz to 1 MHz; within ± 0.4 dB of full scale from 5 to 10 Hz and 1 to 2 MHz, except ± 0.8 dB 1 to 2 MHz on the 300 V range (0 to 50° C).*
Input Impedance	2 M Ω ; shunted by <60 pF; 0.001 to 0.03 V ranges; <30 pF, 0.1 to 300 V ranges.	same as 403B
Maximum Input	Fuse protected (signal ground can be ± 500 V dc from chassis).	same as 403B
Power	4 rechargeable batteries, 40 hr. operation per recharge, up to 500 recharging cycles; self-contained recharging circuit functions during operation from ac line.	same as 403B
Dimensions	130 mm wide, 159 mm high (without removable feet), 203 mm deep (5 $\frac{1}{4}$ " x 6 $\frac{1}{4}$ " x 8").	same as 403B
Weight	net 2.9 kg (6 $\frac{1}{2}$ lb); shipping 3.6 kg (8 lb).	same as 403B
Price	\$425	\$451

*Use 10001A 10:1 Divider and 10111A Adapter to retain $\pm 5\%$ (± 0.4 dB) accuracy while measuring up to 425 V rms at 1 to 2 MHz.

ANALOG VOLTMETERS

AC voltmeter, 10 Hz to 10 MHz

Models 400E, EL, F, FL, & GL

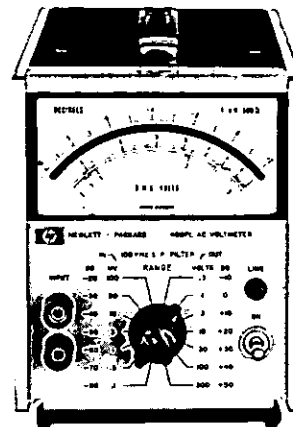
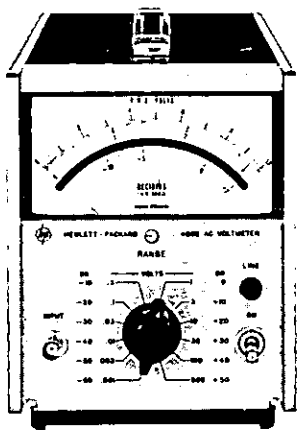

Specifications

	400E/EL*	400F/FL*	400GL
Voltage range:	1 mV to 300 V F.S. 12 ranges	100 μ V to 300 V F.S. 14 ranges	-80 dB to +60 dB F.S. 8 ranges
Frequency range:	10 Hz to 10 MHz	20 Hz-4 MHz	20 Hz-4 MHz
Input impedance:	10 M Ω on all ranges <25 pF to <12 pF depending on ranges	10 M Ω on all ranges <25 pF to <10 pF depending on ranges	10 M Ω on all ranges <30 pF to <15 pF depending on ranges
Accuracy:*	\pm (% reading + % range) 3 mV-300 V ranges 10 Hz-40 Hz: \pm (2.5+2.5) 40 Hz-2 MHz: \pm (1+0) 2 MHz-4 MHz: \pm (1.5+1.5) 4 MHz-10 MHz: \pm (2.5+2.5) 1 mV range 10 Hz-40 Hz: \pm (2.5+2.5) 40 Hz-500 kHz: \pm (1+0) 500 kHz-4 MHz: \pm (2.5+2.5)	\pm (% reading + % range) 300 μ V-300 V ranges 20 Hz-40 Hz: \pm (2+2) 40 Hz-100 Hz: \pm (1+1) 100 Hz-1 MHz: \pm ($\frac{1}{2}$ + $\frac{1}{2}$) 1 MHz-2 MHz: \pm (1+1) 2 MHz-4 MHz: \pm (2+2) 100 μ V range 30 Hz-60 Hz: \pm (2+2) 60 Hz-100 kHz: \pm (1+1) 100 kHz-500 kHz: \pm (0-7)	+60 dB range 20 Hz-40 kHz: \pm 0.4 dB 40 Hz-100 kHz: \pm 0.2 dB -60 dB thru +40 dB ranges 20 Hz-40 Hz: \pm 0.4 dB 40 Hz-500 kHz: \pm 0.2 dB 500 kHz-2 MHz: \pm 0.4 dB 2 MHz-4 MHz: +0.2 -0.8 dB -80 dB range 30 Hz-60 Hz: \pm 0.4 dB 60 Hz-100 kHz: \pm 0.2 dB 100 kHz-500 kHz: +0.2 -0.8 dB
Recovery:	<2 s for 80 dB overload		
Overload:	*500 V rms ac, 300 V dc		*1200 V rms max. input; 1000 V dc max. input
Calibration:	Scale -10 to +2 dB, 10 dB between ranges, 100 divisions on 0 to 1 scale. The dB scale reads -10 to +2 dB; 10 dB between ranges.		Linear dB scale, 100 divisions from -20 to 0 dB. Log voltage scale 0 dB = 1 V.
Weight:	Net, 2.7 kg (6 lb). Shipping, 4.1 kg (9 lb)		
Dimensions:	130 mm wide, 159 mm high (without removable feet), 279 mm deep (5 $\frac{1}{2}$ " \times 6 $\frac{1}{4}$ " \times 11")		
Power:	AC: 115 or 230 V \pm 10%, 48 to 440 Hz, 6 VA max. DC: External batteries: + and - voltages between 35 V and 55 V		
Price:	400E, \$395; 400EL, \$410	400F, \$355; 400FL, \$370	400GL, \$390

*NOTE: 400EL same as 400E, and 400FL same as 400F, except for calibration. Linear dB scale -10 dB to +2 dB, 10 dB between ranges. Log voltage scales 0.3 to 1 and 0.8 to 3, 120 divisions from -10 to +2 dB. 400FL accuracy is % of reading in dB only.

*Ac overload voltage increases with increasing frequency.

ANALOG VOLTMETERS

10 Hz to 10 MHz true RMS voltmeter

Model 3400A

- 10 MHz bandwidth
- High crest factor for accurate pulse measurements
- Stable, linear dc output
- 1 mV full-scale sensitivity
- 10 M Ω input impedance
- Taut-band individually calibrated meter

Permanent plots of measured data and higher resolution measurements can be obtained by connecting an X-Y plotter, strip chart recorder or digital voltmeter to the convenient rear-panel dc output. The dc output provides a linear 0 to 1 volt drive proportional to meter deflection.

RMS current

True rms current measurements can be made conveniently by using the HP Model 456A Current Probe with the Model 3400A. See page 476.

Specifications

Voltage range: 1 mV to 300 V full scale, 12 ranges.

DB range: -72 to +52 dBm (0 dBm = 1 mW into 600 Ω).

Frequency range: 10 Hz to 10 MHz.

Response: responds to rms value (heating value) of the input signal for all waveforms.

Meter accuracy: % of full scale (20°C to 30°C)*

10Hz	50Hz	1MHz	2MHz	3MHz	10MHz
±5%	±1%	±2%	±3%	±3%	±5%

Ac-to-dc converter accuracy: % of full scale (20°C to 30°C)*

10Hz	50Hz	1MHz	2MHz	3MHz	10MHz
±5%	±0.75%	±2%	±3%	±3%	±5%

Crest factor: (ratio of peak to rms amplitude of input signal): 10 to 1 at full scale (except where limited by maximum input) inversely proportional to meter deflection, (e.g., 20 to 1 at half-scale, 100 to 1 at tenth scale).

Maximum continuous input voltage: 500 V ac peak at 1 kHz on all ranges; 600 V dc on all ranges.

Input impedance: from 0.001 V to 0.3 V range: 10 M Ω shunted by <50 pF. From 1.0 V to 300 V range: 10 M Ω shunted by <20 pF ac-coupled input.

Response time: for a step function, <5 s to final value.

AC overload: 30 dB above full scale or 800 V p, whichever is less, on each range.

Output: negative 1 V dc into open circuit at full-scale deflection, proportional to meter deflection from 10-100% of full scale. 1 mA maximum; nominal source impedance is 1000 Ω . Output noise <1 mV rms.

Power: 115 or 230 V \pm 10%, 48 to 440 Hz, 12 VA max.

Dimensions: 130 mm wide, 159 mm high (without removable feet), 279 mm deep (5 $\frac{1}{8}$ " \times 6 $\frac{1}{4}$ " \times 11"); $\frac{1}{2}$ module.

Weight: net: 3.3 kg (7 $\frac{1}{4}$ lb); shipping: 4.5 kg (10 lb).

Accessories furnished: 10110A Adapter, BNC to dual banana jack.

Accessories available:

Accessories available:	Price
11001A Cable, 45 in. long, male BNC to dual banana plug	\$15
10503A Cable, 4 ft. long, male BNC connectors	\$15
11002A Test Lead, dual banana plug to alligator clips	\$10
11003A Test Leads, dual banana plug to probe and alligator clip	\$10
11076A Carrying Case	\$75
456A AC Current Probe, 1 mV/1 mA	\$375

Model number and name

3400A option 001 spreads out the dB scale by making it the top scale of the meter

add \$26

Rear terminals in parallel with front panel terminals and linear log scale uppermost on the meter face are available on special order.

3400A RMS voltmeter

\$705

*TC: \pm 0.1% from 0°C to 20°C and 30°C to 55°C.

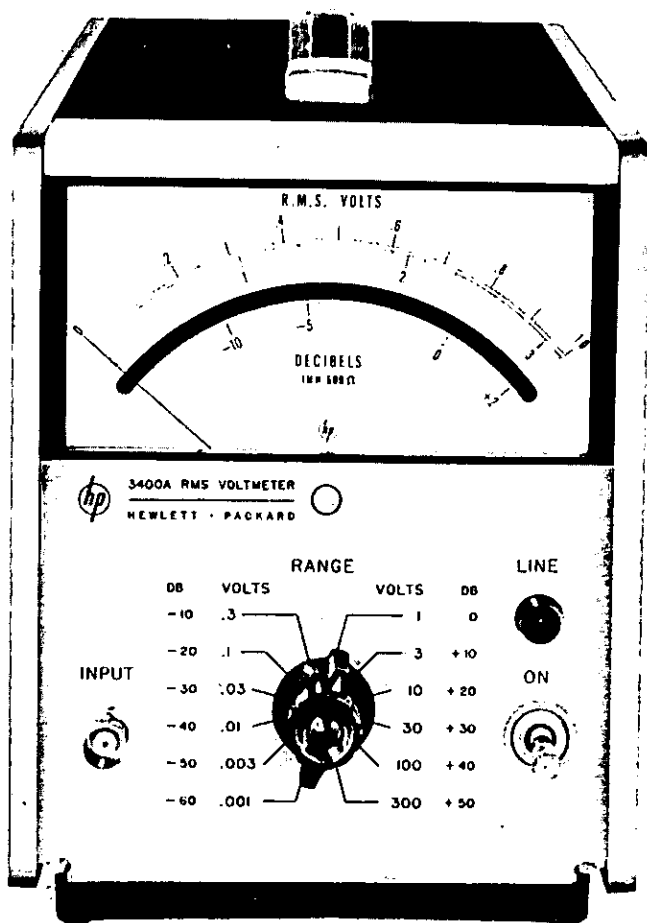

Description

The Hewlett-Packard Model 3400A is a true root-mean-square (rms) voltmeter, providing a meter indication proportional to the dc heating power of the input waveform.

Six-decade frequency coverage makes the 3400A extremely flexible for all audio and most rf measurements and permits the measurement of broadband noise and fast-rise pulse.

Pulses or other non-sinusoids with crest factors (ratio of peak to rms) up to 10:1 can be measured full scale. Crest factor is inversely proportional to meter deflection, permitting up to 100:1 crest factor at 10% of full scale.

ANALOG VOLTMETERS

Logarithmic voltmeters, ac or dc log scaling

Models 7562A and 7563A

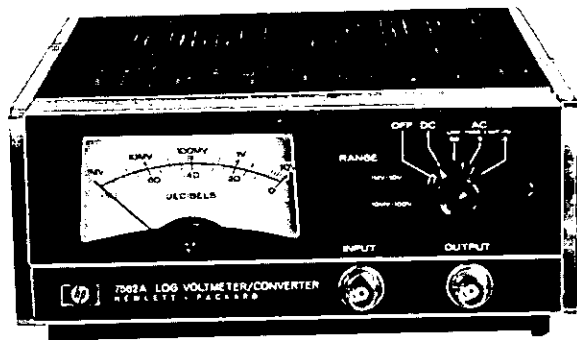

7562A

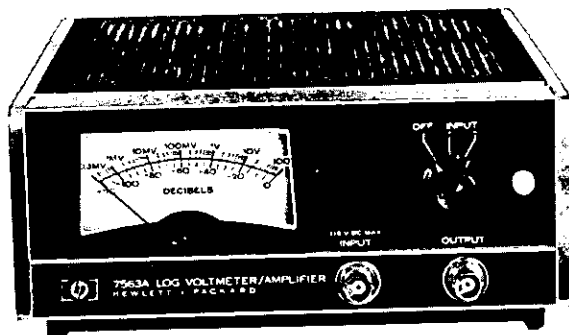

7563A

Description

Hewlett-Packard Model 7562A is a wide range (80 db), single channel logarithmic voltmeter/converter designed to produce dc output voltages in a logarithmic relationship to dc input voltages or the true RMS value of an ac input voltage. It contains a true RMS detector which is not dependent on pure sinusoidal signals to achieve measurement accuracy. A self-contained meter calibrated in volts and dB results in an accurate voltmeter. A constant amplitude oscilloscope output makes the converter compatible with a variety of oscilloscope readout and phase meter applications.

The Model 7563A Logarithmic Voltmeter/Amplifier is a lowcost, single channel, dc logarithmic amplifier with a very high dynamic range (110 dB) designed to produce a logarithmic-related dc output voltage for a very wide range of dc input voltages. A single input range of 316 μ V to 100 V is coupled with an input polarity switch for ease and versatility of operation. A high input impedance (100 k Ω) and a low output impedance (less than 5 Ω) allows the 7563A to be used in systems or on the bench. A front panel meter calibrated in dB and mV provides instantaneous visual indication of operating levels. Applications include log scaling of recorder axes, pulse height analyzers, scope displays, and almost any circumstances where log compression of dc voltage ranges is required. Dual or single rack mounting capability is afforded by a field installable rack mounting adapter, utilizing a minimum of rack space.

7562 Specifications

Performance specifications

AC and dc modes

Input:

Dynamic range: 80 dB.

Voltage range: 1 mV to 10 V or 10 mV to 100 V selectable by front panel switch. Accepts either ac or positive signals.

Output:

Voltage: 0 to 800 mV dc corresponding to 10 mV/dB.

Output impedance: 100 ohms.

DC mode

Accuracy: ± 0.25 dB at 25°C.

Input impedance: 100 k Ω , shunted by less than 100 pF; single ended.

Temperature coefficient: ± 0.02 dB/°C maximum.

Zero stability: ± 0.25 dB.

AC mode

Input impedance: 1 M Ω , shunted by less than 100 pF; single ended.

Accuracy and frequency response: (at 25°C).

Range Setting	0.5 Hz	2	5	20	50	200 Hz	50 kHz	100 kHz
0.5 Hz	± 1 dB	± 0.5 dB					± 1 dB	
5 Hz	± 1 dB		± 0.5 dB				± 1 dB	
50 Hz	± 1 dB				± 0.5 dB		± 1 dB	

Temperature coefficient: ± 0.04 dB/°C maximum.

Slewing speed:

Range setting	Minimum slewing speed
0.5 Hz	1 dB/s
5 Hz	10 dB/s
50 Hz	60 dB/s

Oscilloscope output: approx. 0.5 V rms regardless of input.

Crest factor: 5:1 unless limited by max. input voltage.

General specifications

Maximum peak input voltage: ± 25 V on 1 mV to 10 V range; ± 250 V on 10 mV to 100 V range.

Operating temperature: 10°C to 40°C.

Warm-up time: 20 minutes nominal.

Connectors: front and rear input and output BNC connectors.

Power requirements: 115/230 V ac, 50 to 400 Hz, 40 VA.

Dimensions: 88 mm high, 197 mm wide, 292 mm deep (3 $\frac{1}{8}$ " \times 7 $\frac{3}{4}$ " \times 11 $\frac{1}{2}$ ").

Weight: Net, 3.6 kg (8 lb); Shipping, 5.4 kg (12 lb).

7563 Specifications

Performance specifications

Input

Dynamic range: 110 dB.

Voltage range: 316 μ V to 100 V. Accepts either positive or negative signals, selectable by front panel switch.

Output

Voltage: 0 to 1.1 V dc corresponding to 10 mV/dB. Rear terminals; adjustable 1 to 10 mV/dB.

Output impedance: less than 5 Ω front panel, 300 Ω rear.

Meter accuracy: reading accurate to ± 1.5 dB, referred to output.

Input impedance: 100 k Ω , shunted by less than 100 pF; single ended.

Accuracy: (at 25°C).

316 μ V	1 mV	10 V	31.6 V	100 V
± 0.5 dB	± 0.25 dB	± 1.0 dB	± 1.5 dB	

Temperature coefficient: ± 0.02 dB/°C maximum and ± 3 μ V/°C referred to input.

Zero stability: ± 0.25 dB at constant temperature.

Rise Time:

Maximum Rise Time	
Signal Level	1 mV-10 V Range
316 μ V - 1 mV	2000 μ s
1 mV - 10 mV	400 μ s
10 mV - 100 mV	40 μ s
100 mV - 1 V	4 μ s
1 V - 100 V	2 μ s

General specifications

Operating temperature: 10°C to 40°C.

Warm-up time: 20 minutes nominal.

Connectors: front and rear input and output BNC connectors.

Power requirements: 115/230 V ac, 50 to 400 Hz, 40 VA.

Dimensions: 88 mm high, 197 mm wide, 292 mm deep (3 $\frac{1}{8}$ " \times 7 $\frac{3}{4}$ " \times 11 $\frac{1}{2}$ ").

Weight: Net, 3.6 kg (8 lb); Shipping, 5.4 kg (12 lb).

Model number and name

7562A Logarithmic Voltmeter/Converter

7563A Logarithmic Voltmeter/Amplifier

Price

\$1275

\$955

ANALOG VOLTMETERS

10 kHz to 1.2 GHz RF voltmeter

Model 3406A

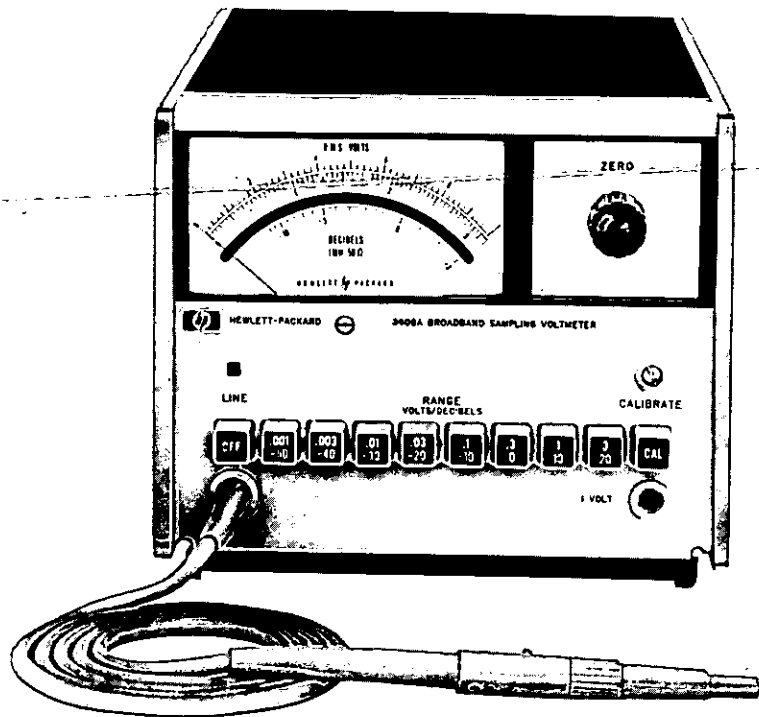

Description

High frequency voltages can be measured easily with HP's 3406A Sampling Voltmeter. Employing incoherent sampling techniques, the HP 3406A has extremely wide bandwidth (10 kHz to 1.2 GHz) with high input impedance. Signals as small as 50 μ V can be resolved on the sampling voltmeter's linear scale. Full scale sensitivity from 1 mV to 3 V is selected in eight 10 dB steps and may be read directly from -62 dBm to +23 dBm for power measurements. Accessory probe tips make the HP 3406A suitable for voltage measurements in many applications such as receivers, amplifiers and coaxial transmission lines.

Measurement indications can be retained on the 3406A meter by depressing a pushbutton located on the pen-type probe. This feature is useful when measurements are made in awkward positions where the operator cannot observe the meter indication and probe placements at the same time. Other features include a dc recorder output and sample hold output for connection to oscilloscopes, and peak or true rms voltmeters if other than absolute average measurements are required.

Specifications

Voltage range: 1 mV to 3 V full scale in 8 ranges; decibels from -50 to +20 dBm (0 dBm = 1 mW into 50 Ω); average-responding instrument calibrated to rms value of sine wave.

Frequency range: 10 kHz to 1.2 GHz; useful sensitivity from 1 kHz to beyond 2 GHz.

Full-scale accuracy (%) with appropriate accessory (after probe is properly calibrated)

10 kHz	20 kHz	25 kHz	100 kHz	100 MHz	700 MHz	1 GHz	1.2 GHz
±13	±8	±5	±3	±5	±8	±13	

Input impedance: input capacity and resistance will depend upon accessory tip used. 100,000 Ω shunted by <2.1 pF at 100 kHz with bare probe; <10 pF with 11072A isolator tip supplied.

Sample hold output

Provides ac signal whose unclamped portion has statistics that are

narrowly distributed about the statistics of the input, inverted in sign (operating into >200 k Ω load with <1000 pF). Output is 0.316 V at f.s. on any range.

Noise: <175 μ V rms referred to input.

Accuracy (after probe is properly calibrated): 0.01 V range and above: same as full scale accuracy of instrument. 0.001 V to 0.003 V range: value of input signal can be computed by taking into account the residual noise of the instrument. Jitter: meter indicates within \pm 2% p of reading 95% of time (as measured with HP 3400A True RMS Voltmeter).

RMS crest factor: 0.001 V to 0.3 V, 20 dB; 1 V, 13 dB; 3 V, 3 dB.

Meter

Meter scales: linear voltage, 0 to 1 and 0 to 3; decibel, -12 to +3. Individually calibrated taut-band meter.

Response time: indicates within specified accuracy in <3 s. Jitter: \pm 1% peak (of reading).

General

DC recorder output: adjustable from 0 to 1.2 mA into 1000 ohms at full scale, proportional to meter deflection.

Overload recovery time: meter indicates within specified accuracy in <5 s (30 V p-p max.).

Maximum input: \pm 100 V dc, 30 V p-p.

RFI: conducted and radiated leakage limits are below those specified in MIL-6181D and MIL-I-16910C except for pulses emitted from probe. Spectral intensity of these pulses are nominally 50 nV/ \sqrt Hz; spectrum extends beyond 2 GHz.

Temperature range: instrument, 0 $^{\circ}$ C to +55 $^{\circ}$ C; probe, +10 $^{\circ}$ C to +40 $^{\circ}$ C.

Power: 115 or 230 V \pm 10%, 48 Hz to 440 Hz, 25 VA max.

Dimensions: 197 mm wide, 159 mm high (without removable feet), 279 mm deep (7 $\frac{3}{4}$ " \times 6 $\frac{1}{4}$ " \times 11"); $\frac{1}{2}$ module.

Weight: net 5.4 kg (12 lb); shipping 6.8 kg (15 lb).

Accessories: refer to data sheet.

Model number and name
3406A RF voltmeter

Price
\$1,010

DIGITAL VOLTMETERS

General information



Digital voltmeters

Digital voltmeters (DVM's) offer many advantages over other types of voltmeters. Among the advantages of DVM's are greater speed, increased accuracy and resolution, reduction of operator errors and the ability to provide automatic measurements in systems applications.

Digital voltmeters display measurement results as discrete numerals rather than as a pointer deflection on a continuous scale, which is commonly used in analog devices. Human error and tedium are reduced by direct numerical readout, and operator training is minimized by automatic polarity and range-changing features of some DVM's.

Digital voltmeters are available to measure ac and dc voltages, current, resistance and ratio. Appropriate transducers can be used to measure other parameters such as strain or temperature. An increasingly popular use of DVM's is in automatic measurement systems. Such a system can be as simple as connecting the DVM digital output to a digital printer or as powerful as a calculator or computer controlled DVM system that provides automatic data reduction and unattended operation.

Building blocks

Digital voltmeters convert an analog signal to an equivalent digital value. To do this, the input signal (ac/dc voltage or current, or resistor value) must pass through the basic building blocks shown in Figure 1.

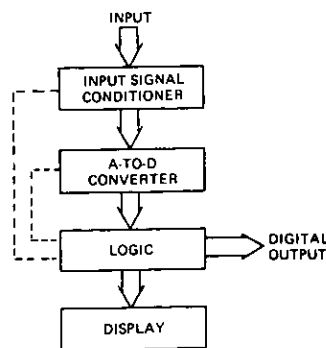

Figure 1 — Basic building blocks of a DVM

Digital voltmeters that have current measuring capability use internal shunt resistors to convert unknown current to an ac or dc voltage. This voltage is then digitized and

scaled (by shunt value) to provide a reading of the current.

The signal to be measured first passes through an input signal conditioner. This converts ac signals, dc signals, or resistances to a proportional dc voltage that is within the range of operation of the analog-to-digital (A-to-D) converter.

The A-to-D converter generates numerical values that correspond to the dc voltage out of the signal conditioner. The logic block controls the order of internal information flow and manages the communication of digital information with external devices. A visual result of measurement is provided by the display block.

Signal conditioners

Of all the parts of a DVM, the signal conditioning and conversion part has the greatest influence on the instrument's characteristics.

A dc input often must be amplified or attenuated to be within the range of the A-to-D converter. For example, if full scale input of the A-to-D unit is 10 V, the dc input amplifier/attenuator would amplify the signal or the 10 mV and 1 V ranges and attenuate the signal on 100 V and 1000 V ranges.

There are two types of ac converters in common use today: average responding and true rms responding. The average responding converter is relatively inexpensive and is intended primarily for measurement of sine waves having little or no distortion. This type of converter measures average value of the rectified sine wave which is then multiplied by a scale factor (rms = 1.11 ave.) to provide the rms value. Errors result from this technique when the input signal is not a distortionless sine wave.

The true rms responding converter is the most accurate ac signal conversion technique. It has wider bandwidth, ability to measure nonsinusoids and is insensitive to distortion. True rms converters measure equivalent heating power of the waveform using a thermocouple or thermopile. The resulting dc voltage is equivalent to heating power, or true rms, of the ac signal. Some Hewlett-Packard true rms converters measure not only ac signal, but also dc components which, in turn, improves low frequency performance. The composite equals $\sqrt{(dc)^2 + (ac\ rms)^2}$.

Ohms converters measure value of resistors by supplying a known constant dc current to the unknown resistor and then measuring the resulting voltage drop across it. There are three popular techniques for supplying dc current to the unknown resistor: two-wire, three-wire, and four-wire.

The two-wire technique is most common and most economical for applications where test leads are short. Since the same input terminals are used to supply dc current and measure voltage drops, this technique is affected by lead resistance.

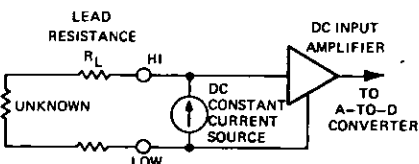

Figure 2 — Simple two-wire ohms converter

A dc current source that is totally isolated from the measuring circuits (Figure 3) is used by the four-wire technique to overcome sensitivities to lead resistance. This scheme offers the ultimate in performance for ohms measurements, particularly for remote measurements, while the two-wire method is more suited to bench use where leads are short.

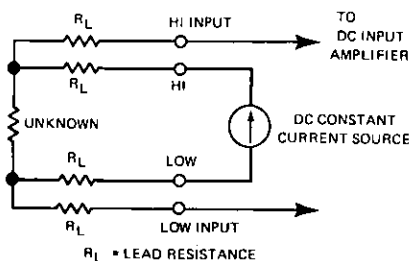

Figure 3 — Simplified 4-wire ohms converter

Like the two-wire converter, the three-wire converter is sensitive to lead resistance, especially on the low side of the input, but it may be possible to null out error caused by lead resistance with an internal adjustment.

A-to-D converters

Analog-to-digital converters change dc signal from signal conditioners and converters to discrete numerical values. The conversion technique used determines speed, resolution and noise rejection characteristics of the DVM. For a detailed discussion refer to Hewlett-Packard Application Note 158.

Noise rejection

Source and type of noise are important in determining the type of noise rejection needed. There are two types of noise which may affect accuracy and sensitivity of a DVM: normal mode and common mode.

Normal mode noise enters the DVM with the signal and is superimposed on it. Filtering is the simplest way to cut down on noise but it slows measurement speed. Integration "calculates" noise out of the measurement by looking at the input signal over a period of

time equal to the period of expected noise. Filtering is advantageous for rejecting broadband noise, while integration is better for rejecting line related noise. Figure 4 shows typical noise rejection for filtering and integrating methods.

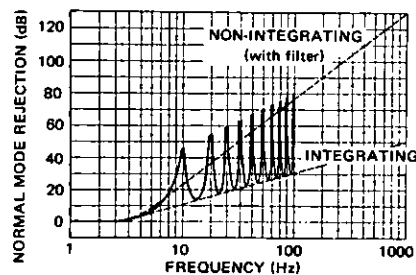

Figure 4 — Normal mode noise rejection for two DVM's, one using filtering and the other using integration

Common mode noise appears between the DVM's input terminals and ground. It is usually caused by grounding differences between the DVM and the device being measured.

Errors caused by common mode noise may be reduced by a passive technique called "guarding." Guarding shunts the noise to ground and away from input terminals. By proper connection of the guard (Figure 5), a remarkable improvement can be seen in a DVM's ability to reject common mode noise.

"Effective" common mode rejection is the specification that usually appears in data sheets. Effective refers to the final reading. Effective CMR is the combined result of "pure" CMR due to guarding plus normal mode rejection of the instrument.

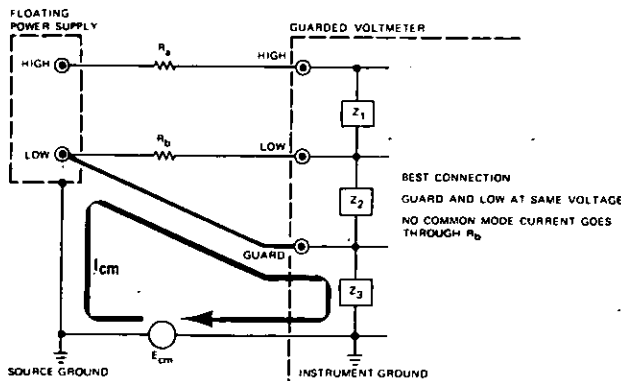

Figure 5 — Best connection—guard connected to low at source

Specifications

Resolution and sensitivity

DVM's are classified according to the number of full digits. An overrange digit is an extra digit added to allow the user to read beyond full scale. This overrange digit is often called a "one-half" or a "partial" digit since it cannot display all numbers through 9. Overranging greatly extends a DVM's usefulness by maintaining resolution up to, and beyond, full scale. For example, if a signal changes from 9.999 V to 10.012 V, a four-digit DVM without overranging could measure the first voltage as "9.999 V," but would require a range change to make the second measurement with a resulting reading of "10.01 V." The 0.002 V change would not be seen. With overranging, the second measurement could be made as "10.012 V" with no loss of resolution.

Overranging is given as a percentage. A four-digit DVM with 100% overranging would have a maximum display of "19999." A spec of 20% overranging would provide a maximum reading of "1199."

Resolution is the ratio of the maximum number of counts that can be displayed to the least number of counts. Full-scale resolution of a five-digit DVM is 100,000 to 1, or 0.001%. Overranging is generally ignored in resolution.

Sensitivity refers to the smallest incremental voltage change that the DVM is able to detect. Mathematically, it is the lowest full-scale range multiplied by the resolution of the DVM. Sensitivity of a five-digit DVM with resolution of 0.001% and a 100 mV lowest full-scale range is $0.001\% \times 100 \text{ mV} = 1 \mu\text{V}$.

Accuracy

Accuracy is the exactness to which a voltage can be determined, relative to the Legal Volt maintained by the U.S. National Bureau of Standards. Accuracy specification equals errors involved in traceability to N.B.S. as well as errors made by the instrument.

To be meaningful, accuracy must be stated along with the conditions under which it will hold. These conditions should include time, temperature, line variations and humidity. Conditions specified should be realistic relative to intended use. For example, a DVM specified with a temperature range of $25^\circ\text{C} \pm 1^\circ\text{C}$ would require a highly controlled environment, whereas $\pm 5^\circ\text{C}$ would cover the majority of environments.

The period of time over which accuracy holds is especially important since it indicates the DVM's stability and how often it will have to be calibrated.

Accuracy is usually expressed as a percent of the reading plus a percent of the range (or full scale). Figure 6 shows that accuracy is always better at or above full scale.

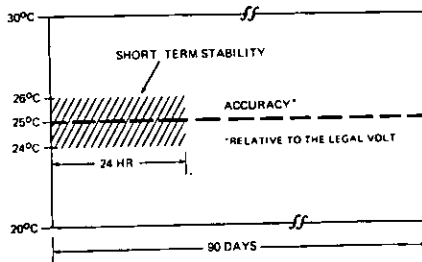

Figure 6 — Typical four-digit DVM accuracy

Reading rate

Most DVM's have their own internal trigger source which may be adjustable or fixed. Quite often, trigger rate is independent of response time of the analog circuits. For example, a DVM may have a fixed sample rate of five readings per second, which is fine for dc measurements, but the ac converter may take two seconds to respond. This means that the user must wait for several samples before obtaining a steady reading. Thus, as Figure 7 shows, the DVM's speed is determined by settling time of its input circuitry, plus time required to digitize the signal.

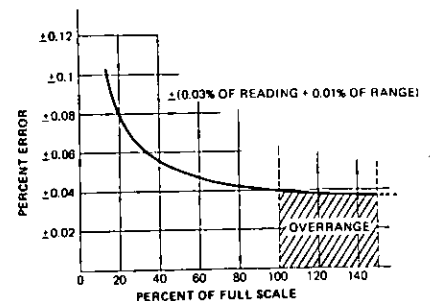

Figure 7 — DVM speed depends upon response time and reading period

When a DVM is used in an automatic system, its internal trigger is seldom used. External triggers are issued by the system incorporating the appropriate delay to allow for settling.

Additional information

For more information on DVM operation and selection, refer to Hewlett-Packard Application Note 158.

DVM SELECTION GUIDE

DIGITS	dc	ac	Ohms	Current	Special Features	HP Model No.	Page
3	•	•	•	Opt.	Probe	970A	36
3	•	•			True rms ac, dB display	3403C	38
3	•	•	•	•	AC sensitivity	3469B	35
4	•	Opt.	Opt.	Opt.	Plug-in modules	3440A Series	see data sheet
4	•	Opt.	Opt.		High speed, plug-ins, scanning	3480C/D	44
4/5	•	Opt.	•	Opt.	Snap-on flexibility	3470A Series	40
5	•	•	•		Self test	3490A	47
5	•	Opt.	Opt.		Systems options	3450B	50
5	•	•	Opt.		Noise rejection frequency	2402A	52
5	•				Exceptional accuracy	3460B	see data sheet
6	•				One-part 10^6 resolution	3462A	54

DIGITAL VOLTMETERS

3 1/2 Digit, high sensitivity, multimeter

Model 3469B

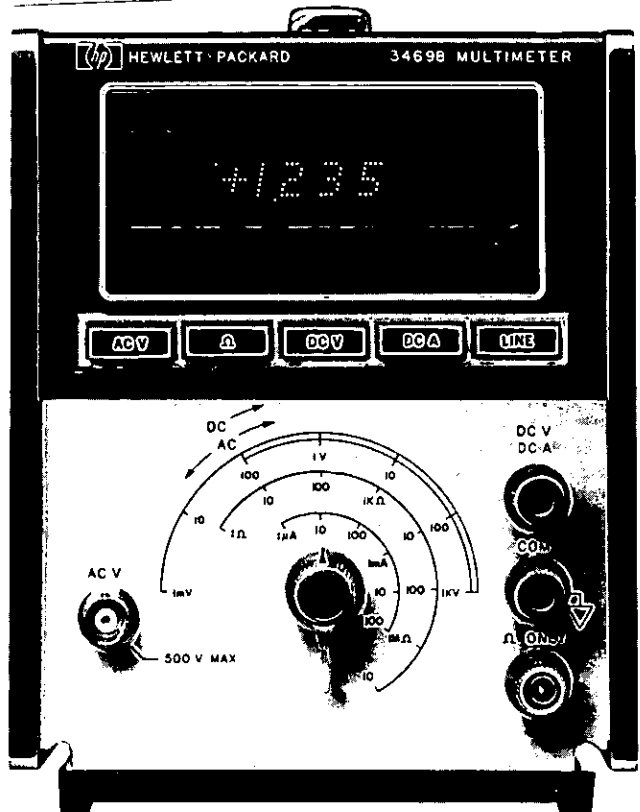

3469B

Description

Twenty-six different range and function combinations of ac volts, dc volts, ohms and dc current.

Specifications

AC voltmeter

Ranges: 1 mV, 10 mV, 100 mV, 1 V, 10 V, 100 V, 1000 V (500 V max input).
Accuracy above 1% of range ±(% reading + % range), 20°C to 30°C.

1 mV range (0.3 mV and above):

20 Hz	100 kHz	4 MHz
1 + 0.75	2.5 + 2.5	

10 mV to 1 V ranges:

20 Hz	100 Hz	100 kHz	1 MHz	6 MHz
0.5 + 0.5	0.3 + 0.3	1 + 1	2.5 + 2.5	

10 V, 100 V, 1000 V ranges:

20 Hz	100 Hz	100 kHz	1 MHz	4 MHz
1 + 0.5	0.4 + 0.3	1 + 1	2.5 + 2.5	

Input impedance: 10 MΩ shunted by <25 pF. Input common connected to chassis.

Overload protection: 500 V at frequencies ≤60 Hz.

DC voltmeter

Ranges: 100 mV, 1 V, 10 V, 100 V, 1000 V.

Accuracy (20°C to 30°C)

100 mV range: ±(0.2% reading + 0.1% range).

1 V to 1000 V ranges: ±(0.1% reading + 0.1% range).

Input impedance: 10 MΩ.

Overload protection: 1000 V.

Normal mode rejection

60 Hz: 40 dB.

Common mode rejection

DC: 60 dB.

Floating voltage: ±500 V max.

Ohmmeter

Ranges: 1Ω*, 10Ω, 100Ω, 1 kΩ, 10 kΩ, 100 kΩ, 1 MΩ, 10 MΩ.

Accuracy (20°C to 30°C)

1Ω range: ±(0.25% reading + 0.5% range).

10Ω range: ±(0.3% reading + 0.2% range).

100Ω to 10 MΩ range: ±(0.2% reading + 0.2% range).

Source characteristics

Short circuit current: 0.1 μA to 10 mA depending upon range.

Open circuit voltage: 10 V negative with respect to common (common connected to chassis).

DC input protection: ±100 V max.

AC input protection: 130 V rms max.

DC ammeter

Ranges: 1 μA, 10 μA, 100 μA, 1 mA, 10 mA, 100 mA.

Accuracy (20°C to 30°C): ±(0.2% reading + 0.2% range).

Full scale voltage drop: 100 mV.

Overload protection: 5 times full scale.

Floating voltage: ±500 V max.

General

Sample rate: 8/s.

Overrange: 100%.

Out of range and illegal range indication: 3 least significant digits blank.

Polarity: automatic.

Operating temperature range: 0°C to 55°C.

Warmup: 10 min.

Power: 115 V or 230 V ±10%, 48 Hz to 440 Hz, 10 VA.

Dimensions: 130 mm wide, 159 mm high (without removable feet), 279 mm deep (5 1/8" × 16 1/4" × 11").

Weight: net 3.15 kg (7 lb); shipping, 4 kg (9 lb).

3469B-Multimeter

\$830

*Allowable reactance <100 μH series, <2 μF parallel.

DIGITAL VOLTMETERS

Digital multimeter

Model 970A

NEW

- Puts a complete DMM in the palm of your hand
- Autoranging, autozero, autopolarity

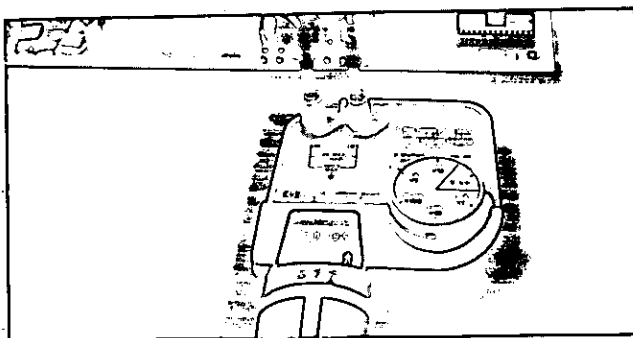
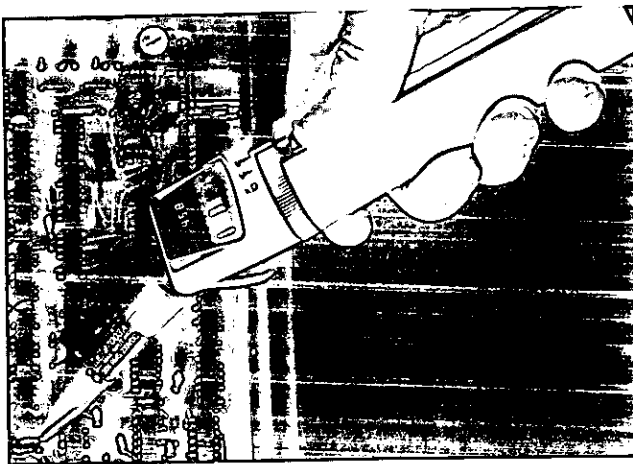
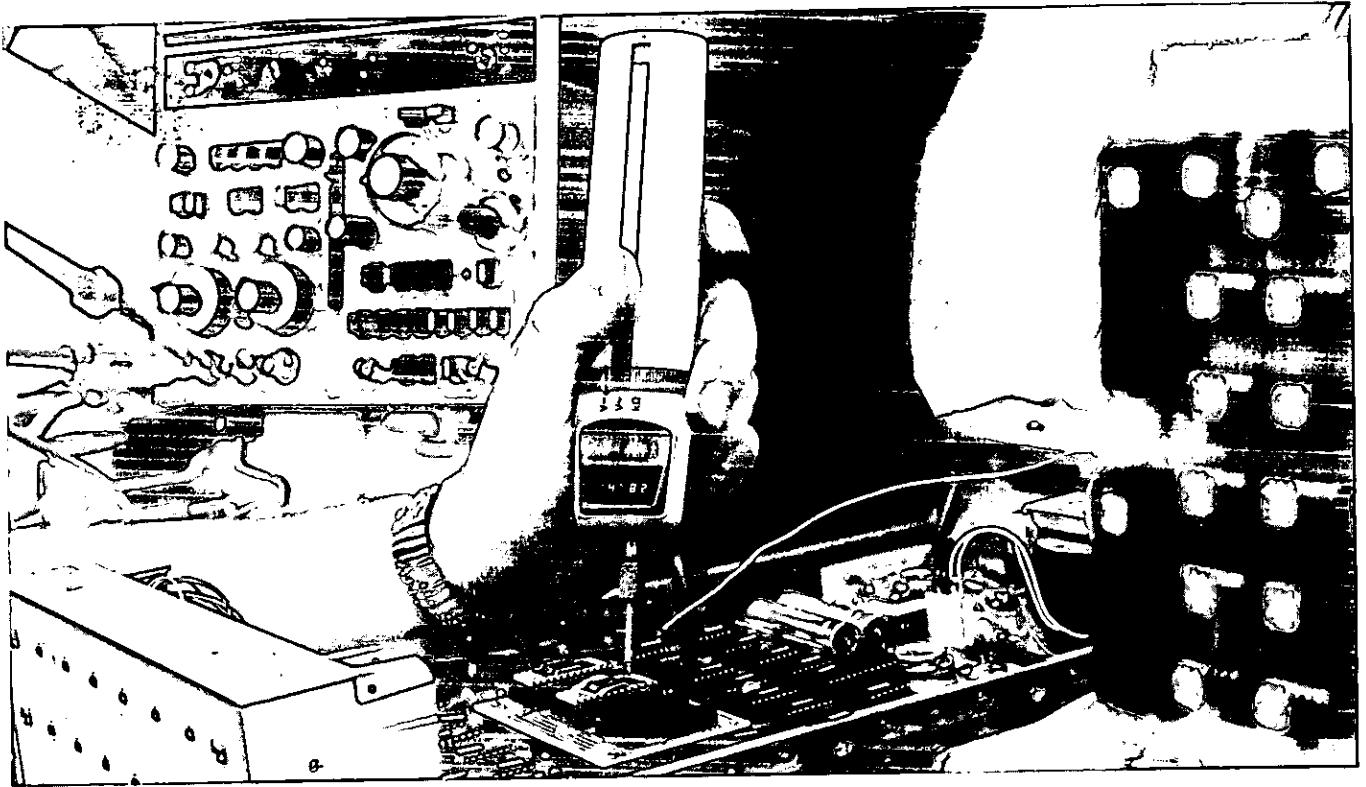

Description

Hewlett-Packard's 970A Probe Digital Multimeter is completely self-contained and autoranges through five ranges of ac and dc volts and ohms.

The pocket-sized multimeter is ideal for field, lab, or bench application. All electronics, including display and batteries, are in one small seven-ounce hand-held package with only one function control to set.

HP's Model 970A automatically selects the right range, making it easy to use by technicians, repairmen, telephone craftsmen and engineers. This battery-operated probe is the first known hand-held DMM incorporating solid-state autoranging technology. All solid-state switching is in its one MOS integrated circuit.

A five-digit light emitting diode cluster is used in this 3½ digit DMM. All probe voltage readings are in volts, and resistance readings in kilohms so there are no scales to misinterpret. Decimal placement is automatic.

Automatic decimal placement and automatic polarity indication save time. After setting the function selector (acV, dcV or kΩ), simply connect the ground clip, touch the probe tip to a test point, press the Push-to-Read bar, and the solid-state LED readout automatically displays the correct reading and polarity. When measuring ohms or dc volts, it takes typically less than two seconds to range and settle to a proper reading.

Since display is close to point of measurement, in closely packed circuits, the probe can be held in one hand and circuit and readout can be seen at a glance. The display can be electronically inverted to avoid errors.



HP's 970A Probe Digital Multimeter can be converted into a five-function bench instrument with optional 97002A Current Shunt/Bench Cradle. A six-position manual switch selects five ranges of ac and dc current plus a straight through position to measure ac and dc volts and ohms.

Two general purpose binding posts accept wrap-around, screw-down, clip-on or banana plug terminations.

AC voltage measurements can be made over a frequency range of 100 kHz to 500 MHz from 0.25 V to 30 V with optional RF adapter, HP 97003A. A broad line of tips, adapters and tees are also available.

970A Specifications

DC voltmeter

Ranges: 0.1 V, 1 V, 10 V, 100 V, 1000 V (500 V max input).
Accuracy (20°C to 30°C): ±(0.7% of reading +0.2% of range).
Input resistance: 10 MΩ, ±5%.
Input protection: ≤750 V peak.
Temperature coefficient: ±(0.05% of reading +0.2% of range)/°C.

AC voltmeter

Ranges: 0.1 V, 1 V, 10 V, 100 V, 1000 V (500 V rms sine wave max input).

Accuracy (20°C to 30°C):

Range	45 Hz to 1 kHz	1 kHz to 3.5 kHz
1 V to 1000 V	±(2% of reading +0.5% of range)	±(3% of reading +0.5% of range)
0.1 V (>3 mV)	±(2% of reading +0.5% of range)	±(5% of reading +0.5% of range)

Input resistance: 10 MΩ, ±5%.

Input capacitance: <30 pF.

Input protection: ≤750 V peak.

Temperature coefficient: ±(0.05% of reading +0.05% of range)/°C.

Ohmmeter

Ranges: 1 kΩ, 10 kΩ, 100 kΩ, 1000 kΩ, 10,000 kΩ.

Accuracy (20°C to 30°C): ±(1.5% of reading +0.2% of range).

Input voltage protection (resistor fused—clip mounted): ≤115 V rms for up to 1 minute. ≤250 V rms for up to 10 seconds.

Temperature coefficient: ±(0.05% of reading +0.02% of range)/°C.

General

Ranging: automatic.

Sample rate: 3/second.

Overrange: 10%.

Calibration cycle: 1 year.

Calibration adjustments: one.

Operating environmental conditions:

Temperature range: 0°C to 40°C.

Humidity: ≤95% RH.

Power: rechargeable batteries.

Typical operating time using fully charged battery: 2.5 hours continuous at 25°C.

Typical battery charging time: 14 hours at 25°C. (Indefinite charging will not damage battery).

Weight (with battery pack): net, 200 g (7 oz); shipping, 1.8 kg (4 lb).

Dimensions: 165 mm long × 45 mm wide × 30 mm deep (6½" × 1¾" × 1¼").

97002A Specifications

DC ammeter

Ranges: 0.1 mA, 1 mA, 10 mA, 0.1 A, 1 A F.S.

Accuracy (20°C to 30°C): ±(2.5% of reading +0.2% of range).

AC ammeter

Ranges: 0.1 mA, 1 mA, 10 mA, 0.1 A, 1 A F.S.

Accuracy (20°C to 30°C, >3% of range): 45 Hz to 1 kHz: ±(4% of reading +0.5% of range). 1 kHz to 3.5 kHz: ±(7% of reading +0.5% of range).

DCV, acV, ohms: same as 970A specifications.

General

Full range insertion voltage: <0.25 V.

Input protection: 2 amp fast acting fuse.

Weight: net, 170 g (6 oz); shipping, 1.8 kg (4 lb).

Dimensions: 95 mm long, 95 mm wide, 51 mm deep (3¾" × 3¾" × 2").

97003A Specifications

Response: The 97003A is a peak responding detector and is calibrated to read rms value of a sine wave.

Voltage range: 0.25 V to 30 V rms.

Max input: 30 V rms ac; 200 V dc.

AC to dc transfer accuracy when operating into HP 970A:

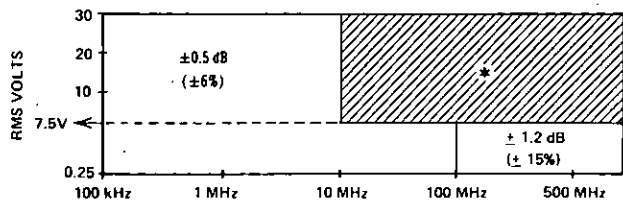

*HP's 97003A is usable from 10 MHz to 500 MHz and 7.5 V rms to 30 V rms. It is not traceable to the United States National Bureau of Standards, however.

Input impedance: input resistance: >25 kΩ.

Shunt capacitance: <3 pF for plastic tips. <4 pF for metal high frequency adapter tip.

General

Accessories supplied: ground lead, straight tip, hook tip, high frequency adapter tip.

Accessories available: 11063A, 50-ohm tee; 11536A, 50-ohm tee; 10218A, BNC Adapter; 10219A, Type 874 Adapter; 10220A, Micro-dot Adapter.

Model number and name

97001A extra rechargeable battery pack

97002A ac/dc current shunt/bench cradle

97003A RF adapter

970A Digital Multimeter (includes soft carrying case, battery and charger)

Price

\$26

\$47

\$85

\$310



DIGITAL VOLTMETERS

True RMS voltmeter
Model 3403C

- DC and 2 Hz To 100 MHz
- 3½ digit

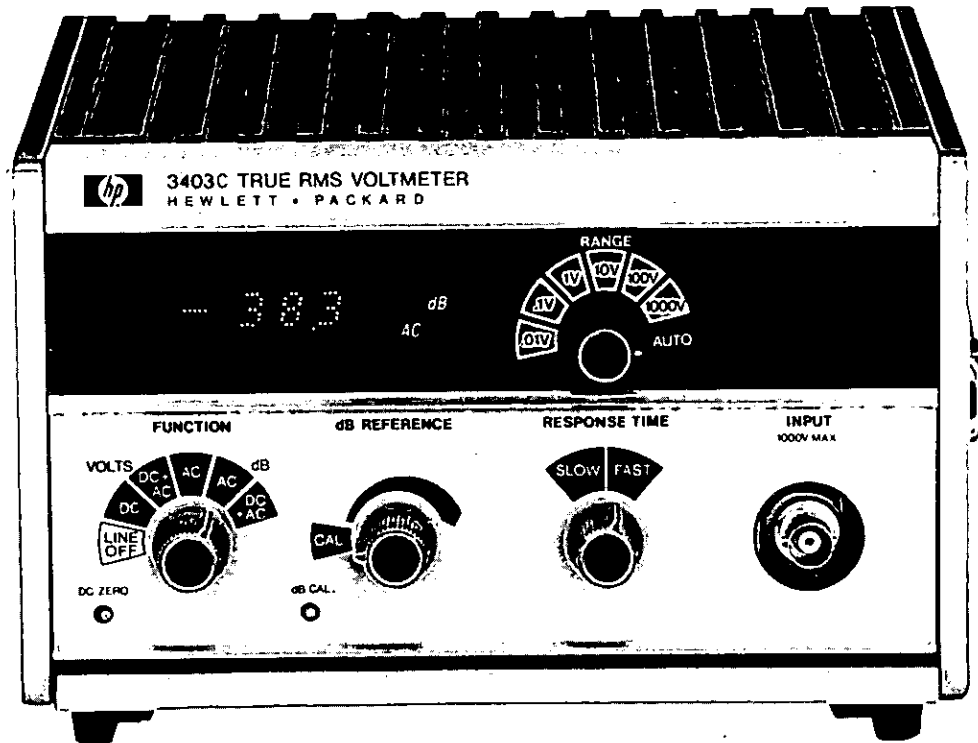

Description

The Model 3403C is usable for dc, low frequency, audio, RF and IF measurements. True rms is especially valuable for measurements of noise, multiplexed signals, modulated waves and other complex signals with high harmonic content.

Optional dB display

The dB display option provides readings directly in dB, a major convenience to ac users. The dB reference to which the measurement is made is conveniently adjustable from the front panel to provide referenced dB measurements, or to provide a convenient means to offset the reading by as much as 13 dB for unreferenced measurements.

Systems Options

A full complement of systems options is available, both isolated and nonisolated, to insure systems compatibility.

The 3403C may be used with Hewlett-Packard printers and may easily be integrated into more complex systems remote control.

Specifications

Ranges

Full range display: 10.00 mV (ac only); 100.0 mV; 1.000 V; 10.00 V; 100.0 V; 1000 V.

Overrange: >90% on all ranges except as limited by max input voltage.

Ranging information: front panel annunciators indicate overrange (approximately 190% of full range), or underrange (approximately 17% of full range) conditions.

Performance

AC frequency range

Slow response: 2 Hz to 100 MHz.

Fast response: 25 Hz to 100 MHz.

Response time

Fast response: 1 s.

Slow response: 10 s.

Instrument reads final reading $\pm 0.1\%$ of input change in stated response time.

Display rate

Fast response: 4 readings per s.

Slow response: 2 readings per s.

$$\text{READING} = \pm \% \text{ OF RANGE} + \pm \% \text{ OF READING} **$$

RANGE	VOLTS			FREQUENCY (Hz)						
	DC	DC-AC	AC	DC	2	25	100K	1M	10M	100M
1000V	.3	.3	.3	.2	.4*	.2				
100V	.2	.2	.2	.2	.4*	.2	1			
10V	.2	.2	.2	.2	.4*	.2	.5	1		
1V	.2	.2	.2	.2	.4*	.2	.5	1	2.5	10
100mV	.6	.6	$\frac{2}{4}$.2	.4*	.2	.5	2	2.5	10
10mV			$\frac{2}{4}$.3	1.2	3	

CAUTION: frequencies and ranges in this area may result in invalid readings without ranging indication.

* DC + AC function and slow response time only

** % of reading specification is representative of typical flatness.

Functions

- DC:** responds to dc component of input signal.
- AC:** responds to true rms value of ac coupled input signal.
- AC + DC:** responds to true rms value of dc and ac input signal; reading is $\sqrt{(dc)^2 + (ac\ rms)^2}$.

Temperature coefficient: $\pm 0.1 \times$ reading accuracy*/°C outside the 25°C \pm 5°C temperature range.

Accuracy: 90 days (25°C + 5°C, <95% RH, 17% of range to 190% of range).

Input characteristics

- Input impedance:** <10 MHz.
- 1 V to 1000 V range:** 10 M Ω \pm 10% shunted by 19 pF \pm 10%.
- 10 mV and 100 mV range:** 20 M Ω \pm 10% shunted by 16 pF \pm 10%.
- 10 MHz to 100 MHz:** the following table gives maximum loading due to input shunt impedance across a terminated source.

System impedance (source and load)	Frequency	
	10 MHz	100 MHz
50 Ω	1%	10%
75 Ω	2%	20%

Crest factor:

2 Hz to 25 Hz	2:1 at full range input.
>25 Hz	10:1 at full range input.

Maximum input voltage

High to low: 1000 V rms, 1500 peak or 10⁸ V-Hz on any range. Maximum dc voltage in ac mode: 500 V dc.

Low to chassis: \pm 500 V dc, when floated with special banana to BNC adapter.

Options

Autoranging 3403C option 001

- Automatic ranging:** uprange at approximately 190% of full range; downranges at approximately 17% of full range.
- Autorange time:** fast response: 1 s per range change. Slow response: 10 s per range change.

Digital output 3403C option 002

The digital output option provides data outputs in digital form for printer and system applications. In addition, input lines are included for external triggering of the instrument.

Remote control + digital output + autoranging (3403C Option 003).

dB display 3403C option 006

- Measurement range:** 108 dB (-48 dBV to +60 dBV).
- Calibrated dB reference:** 0 dB = 1.000 V; reference level may be set for 0 dBm (600 Ω) by adjusting front panel dB calibration adjustment.
- Variable dB reference:** reference level may be shifted downward from calibrated position >13 dB.

*data from accuracy charts.

dB recorder output: output voltage: 200 mV for 20 dB. Output resistance: 1 k Ω \pm 500 Ω .

Accuracy: 90 days (25°C + 5°C, <95% RF).

READING ACCURACY = (\pm dB) + (\pm dB)**

RANGE	dB		FREQUENCY (Hz)										
	AC	DC + AC	DC	2	25	100K	1M	10M	100M				
1000V	.15	.15	.02	.04*	.02								
100V	.15	.15	.02	.04*	.02					.1			
10V	.15	.15	.02	.04*	.02					.05	.1		
1V	.15	.15	.02	.04*	.02					.05	.1	2.5	1
100mV	.15	.15	.02	.04*	.02					.05	.2	2.5	1
10mV	.15				.03					.12	.3		

CAUTION: frequencies and ranges in this area may result in invalid readings without ranging indication.

* DC + AC function and slow response time only

** specification is representative of typical flatness.

General

Operating conditions

- Temperature range:** 0°C to 50°C.
- Humidity:** <95% RH.

Recorder output

- Output voltage:** 1 V dc open circuit for full range input.
- Output resistance:** 1 k Ω \pm 10%.

Power: 115 V or 230 V \pm 10%, 48 Hz to 440 Hz, 35 VA max. (including all options).

Input terminals: BNC front panel connector standard for low to high terminals; rear panel connector available by internally reversing position of ac converter module.

Weight: including all options: Net, 5 kg (11 lb); Shipping, including all options: Net, 7.2 kg (16 lb).

Dimensions: 234.9mm wide \times 127mm high \times 196.8mm deep (9" \times 5" \times 7 3/4").

Accessories furnished: floating adapter-banana to BNC.

Model number and name

Option 001 autoranging	Price
Option 002 digital output	add \$137
*Option 003 remote control + digital output + autoranging	add \$163
*Option 006 dB display	add \$315
3403C True RMS voltmeter	add \$275
	\$2095

*Options 003 and 006 are available only as factory installed options.

DIGITAL VOLTMETERS

DVM Interchangeable modules and displays
Model 3470 system

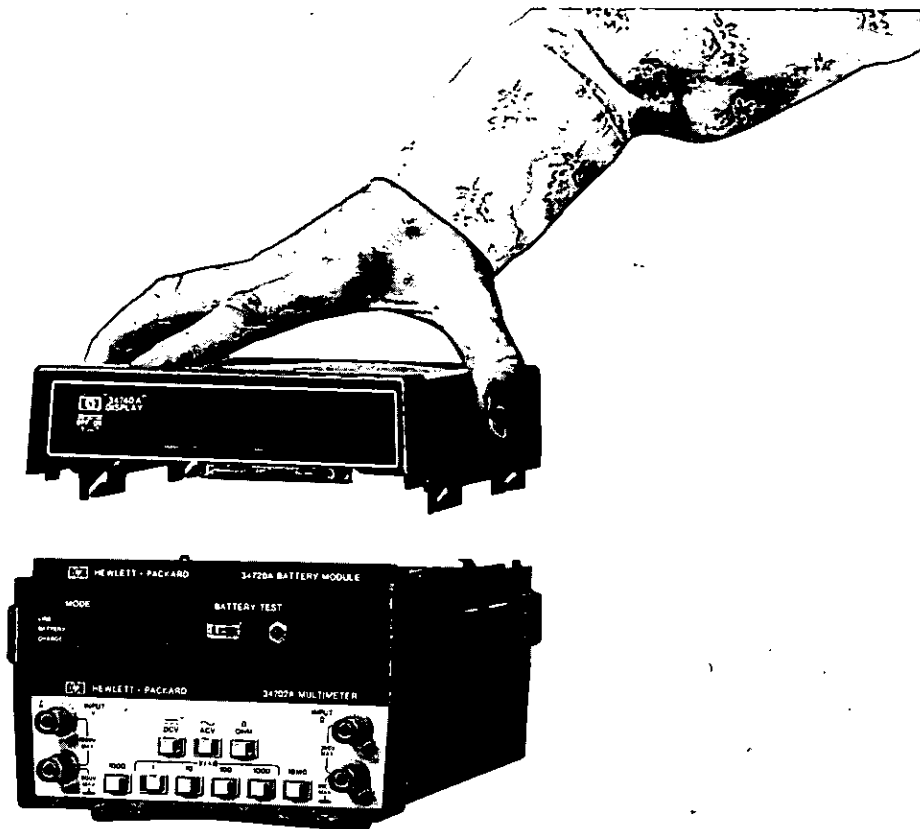

Description

Hewlett-Packard's 3470 is a low cost line of DVM's using a flexible snap-together package. Two display sections provide a choice of 4 or 5 digits, both with 100% overranging and LED display. These displays lock on to a choice of a DC Voltmeter, an AC/DC/ Ω Multimeter or a high sensitivity DCV/DCA/ Ω meter. In addition, a temperature module is available for use with the four-digit display section. Battery pack and BCD module are optional. Functions and ranges are clearly labeled. All maximum voltages are indicated at the input terminals. Voltage protection is 1200 V on ac V and dc V; protection on ohms extends to 350 V peak. This excellent protection prevents accidental damage. Hewlett-Packard's 3470 uses rugged metal castings held together by shock resistant slides. Modular construction makes the 3470 versatile and capability may be expanded as needed. Modules may be shared between displays. This system deters obsolescence.

Snap-out PC boards make servicing easy. Once the display PC board and voltmeter board have been removed from the case, they may be recombined. Components and test points may be reached without extender boards or special connectors. A self-test jumper in the display forces a full scale reading to act as a quick check.

34740A Display

This 4½-digit display locks on to any center section or voltmeter module to form a complete DVM using a clear, LED display with 4 full digits plus 100% overranging.

34750A Display

This 5½-digit display offers five-digit resolution with any voltmeter modules shown on the opposite page. As with the 34740A, it uses a LED display with 100% overranging.

34701A DC voltmeter

This plug-on provides 4 ranges of dc from 1 V to 1000 V at an economical price.

34702A Multimeter

This plug-on provides four ranges of both ac and dc plus six ranges of ohms. AC function covers 45 Hz to 100 kHz. Ohms ranges are 100 Ω

to 10 M Ω full scale.

34703A DCV/DCA/OHM meter

This plug-on provides six ranges of dc volts from 10 mV full scale to 1000 V full scale, six ranges of dc current from 1 μ A full scale to 100 mA full scale, and eight ranges of ohms from 1 Ω full scale to 10 M Ω full scale. Autoranging and self-test further expand the 34703's capabilities.

34720A Battery module

This center section makes HP's 3470 into a portable DVM with up to six hours of continuous operation. Batteries are rechargeable. Module has side handles and front panel battery charge indicator.

34721B BCD module

This center section provides nonisolated BCD output for operation with printers.

2802A Thermometer

This unit includes a thermomodule (lower unit) which contains temperature measuring circuits, probe connections and operating controls: HP's 34740A 4½ digit display is included. Option 001 deletes the display for those that want to use their own 4½ or 5½ digit display.

34701A Specifications

DC voltage

Range: ± 1 V to ± 1000 V full scale in four decade ranges.

Display: 4-digit (34740A) or 5-digit (34750A).

Full range display:

Range	4-digit display	5-digit display
± 1 V	± 1.0000 V	± 1.00000 V
± 10 V	± 10.000 V	± 10.0000 V
± 100 V	± 100.00 V	± 100.000 V
± 1000 V	± 1000.0 V	± 1000.00 V

Overrange: 100% except 20% on 1000 V range.

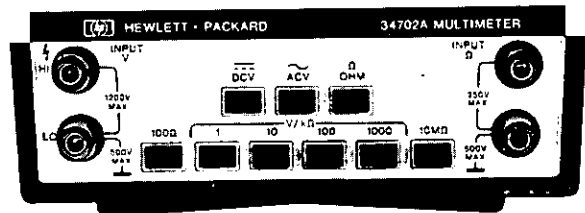
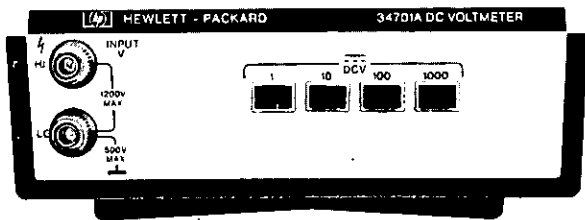
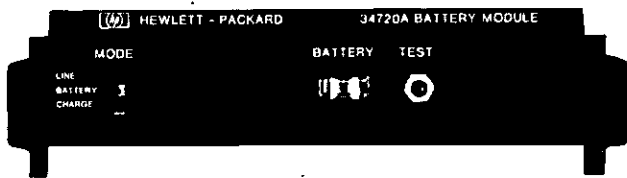

Range selection: manual pushbuttons.
Accuracy (30 days, +23°C ±5°C, ≤95% R.H.):
 4-digit display: ±(0.03% rdg + 0.01% rng).
 5-digit display: ±(0.025% rdg + 0.005% rng).
Temperature coefficient (0°C to +50°C):
 4-digit display: ±(0.0035% rdg + 0.001% rng)/°C.
 5-digit display: ±(0.0025% rdg + 0.0002% rng)/°C.
Stability (24 hours, +23°C ±1°C):
 4-digit display: ±(0.01% rdg + 0.005% rng).
 5-digit display: ±(0.008% rdg + 0.004% rng).
Reading rate:

Display option	4-digit display	5-digit display
Opt 060 (60 Hz rejection)	5/s	5/s
Opt 050 (50 Hz rejection)	8/s	4/s

Input terminals: floating pair.
Input resistance: 10 MΩ ±0.1%.
Effective CMR: 1 kΩ unbalance: >80 dB at dc.
Normal mode rejection: >60 dB at 50 Hz ±0.1% (Opt 050) or at 60 Hz ±0.1% (Opt 060).
Maximum input voltage: ±1200 V, high to low; ±500 V low to chassis.

34702A Specifications (same as 34701A except):

DC Voltage

Input resistance: 11.1 MΩ ±0.1% on 1 V and 10 V ranges; 10.1 MΩ

±0.1% on 100 V and 1000 V ranges.

AC Voltage

Voltage range: 1 V ac to 1000 V ac full scale in four decade ranges.

Full range display:

Range	4-digit display	5-digit display
1 V	1.0000 V	1.00000 V
10 V	10.000 V	10.0000 V
100 V	100.00 V	100.0000 V
1000 V	1000.0 V	1000.00 V

1. Because the internal temperature differs on line and battery operation, references must be adjusted to retain this specification when type of power source is changed.

Detector: average-responding.

Scale: rms for a sine wave.

Frequency range: 45 Hz to 100 kHz.

Accuracy (30 days, 23°C ±5°C, ≤95% RH):

Display	45 Hz to 20 kHz	20 kHz to 100 kHz
4-digit	±(0.25% rdg + 0.05% rng)	±(0.75% rdg + 0.05% rng)
5-digit	±(0.25% rdg + 0.05% rng)	±(0.75% rdg + 0.05% rng)

Temperature coefficient (0°C to +50°C): ±(0.03% rdg + 0.001% rng)/°C.

Stability (24 hours, +23°C ±1°C):

45 Hz to 20 kHz: ±(0.15% rdg + 0.05% rng).

20 kHz to 100 kHz: ±(0.4% rdg + 0.05% rng).

Response time: < 2 s to within +0.3% of final value or 20 counts, whichever is greater.

Input impedance: 11.11 MΩ ±0.1%, 80 pF shunt on 1 V and 10 V ranges; 10.1 MΩ ±0.2%, 80 pF shunt on 100 V range; 10 MΩ ±0.2%, 80 pF shunt on 1000 V range.

Input terminals: floating pair.

Maximum input voltage: 1200 V rms high to low, except 2.5 × 10⁵ V Hz limit on 1 V range with minimum protection of 300 V rms and maximum of 1200 V p; ±500 V, low to chassis.

Resistance

Range: 100Ω to 10 MΩ full scale in 6 decade ranges.

Full range display:

Range	4-digit display	5-digit display
100Ω	100.00Ω	100.000Ω
1 kΩ	1.0000 kΩ	1.00000 kΩ
10 kΩ	10.000 kΩ	10.0000 kΩ
100 kΩ	100.00 kΩ	100.000 kΩ
1 MΩ	1.0000 MΩ	1.00000 MΩ
10 MΩ	10.000 MΩ	10.0000 MΩ

Overrange: 100% on all ranges.

Accuracy (30 days, +23°C ±5°C, ≤95% RH):

Range	4-digit display	5-digit display
10 MΩ	±(0.25% rdg + 0.02% rng)	±(0.25% rdg + 0.015% rng)
Others	±(0.05% rdg + 0.02% rng)	±(0.045% rdg + 0.015% rng)

Temperature coefficient (0° to +50°C):

10 MΩ range: ±(0.035% rdg + 0.001% rng)/°C.

Other ranges: ±(0.006% rdg + 0.001% rng)/°C.

Stability (24 hours, +23°C):

10 MΩ range: ±(0.1% rdg + 0.01% rng).

Other ranges: ±(0.02% rdg + 0.02% rng).

Input terminals: floating pair (different from voltage input terminals).

Current through unknown: 10 mA on 100Ω range decreasing one decade per successively higher range.

Effective CMR: same as dcV specifications.

DIGITAL VOLTMETERS

Model 3470 system (cont.)

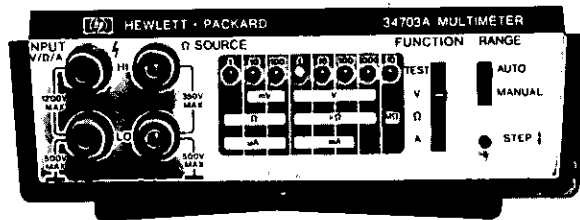
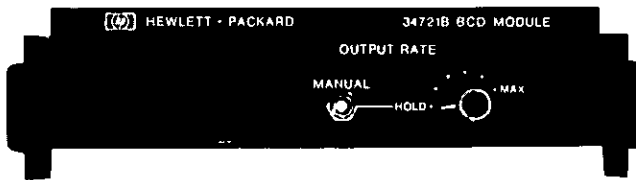
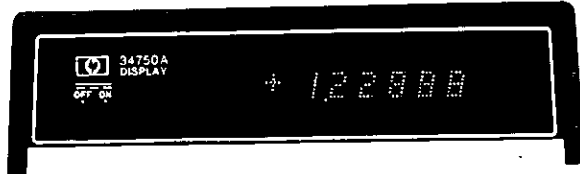

34703A Specifications (same as 34701A except)

Range selection: Auto or manual.

DC voltage

Range: ± 10 mV to ± 1000 V full scale in six decade ranges.

Full range display:

Range	4-digit display	5-digit display
10 mV	± 10.000 mV	± 10.000 mV
100 mV	± 100.00 mV	± 100.000 mV
1 V	± 1.0000 V	± 1.00000 V
10 V	± 10.000 V	± 10.0000 V
100 V	± 100.00 V	± 100.000 V
1000 V	± 1000.0 V	± 1000.00 V

Overrange: 100% except 20% on 1000 V range.

Accuracy (30 days, 23°C $\pm 5^\circ$ C):

Range	4-digit display	5-digit display
10 mV	$\pm(0.05\% \text{ rdg} + 0.03\% \text{ rng})$	$\pm(0.04\% \text{ rdg} + 0.025\% \text{ rng})$
100 mV & 1 V	$\pm(0.04\% \text{ rdg} + 0.01\% \text{ rng})$	$\pm(0.04\% \text{ rdg} \pm 0.01\% \text{ rng})$
Others	$\pm(0.05\% \text{ rdg} + 0.02\% \text{ rng})$	$\pm(0.05\% \text{ rdg} + 0.02\% \text{ rdg})$

Temperature coefficient (0° to 50°C):

Range	4-digit display (% rdg + % rng) per °C	5-digit display (% rdg + % rng) per °C
10 mV	$\pm(0.01\% + 0.03\%)$	$\pm(0.003\% + 0.0035\%)$
100 mV & 1 V	$\pm(0.003\% + 0.004\%)$	$\pm(0.003\% + 0.001\%)$
Others	$\pm(0.004\% + 0.001\%)$	$\pm(0.004\% + 0.0005\%)$

Stability (24 hours, 23°C $\pm 1^\circ$ C):

Range	4-digit display	5-digit display
10 mV	$\pm(0.01\% \text{ rdg} + 0.03\% \text{ rng})$	$\pm(0.008\% \text{ rdg} + 0.025\% \text{ rng})$
All others	$\pm(0.01\% \text{ rdg} + 0.03\% \text{ rng})$	$\pm(0.008\% \text{ rdg} + 0.009\% \text{ rng})$

Input terminals: floating pair.

Maximum input voltage: ± 1200 V, high to low; ± 500 V, low to chassis.

Input resistance: $\geq 10^{10}\Omega$ on 10 mV - 1 V ranges; $10 \text{ M}\Omega \pm 1\%$, 10 V - 1000 V ranges.

Effective CMR (1 k Ω unbalance): > 80 db at dc.

Normal mode rejection: > 60 dB at 50 Hz $\pm 0.01\%$ (Opt 050) or 60 Hz $\pm 0.1\%$ (Opt 060).

Ohms: four-terminal measurement.

Range: 1Ω to $10 \text{ M}\Omega$ full scale in six decade ranges.

Full range display:

Range	4-digit display	5-digit display
1 Ω	1.0000 Ω	1.0000 Ω
10 Ω	10.0000 Ω	10.0000 Ω
100 Ω	100.000 Ω	100.000 Ω
1 k Ω	1.00000 k Ω	1.00000 k Ω
10 k Ω	10.0000 k Ω	10.0000 k Ω
100 k Ω	100.000 k Ω	100.000 k Ω
1 M Ω	1.00000 M Ω	1.00000 M Ω
10 M Ω	10.0000 M Ω	10.0000 M Ω

Overrange: 100%.

Accuracy: 30 days, 23°C $\pm 5^\circ$ C.

Range	4-digit display	5-digit display
1 Ω - 100 Ω	$\pm(0.07\% \text{ rdg} + 0.03\% \text{ rng})$	$\pm(0.06\% \text{ rdg} + 0.03\% \text{ rng})$
1 k Ω - 1 M Ω	$\pm(0.06\% \text{ rdg} + 0.01\% \text{ rng})$	$\pm(0.06\% \text{ rdg} + 0.01\% \text{ rng})$
10 M Ω	$\pm(0.12\% \text{ rdg} + 0.01\% \text{ rng})$	$\pm(0.12\% \text{ rdg} + 0.01\% \text{ rng})$

Stability (24 hours, 23°C $\pm 1^\circ$ C):

Range	4-digit display	5-digit display
1 Ω	$\pm(0.01\% \text{ rdg} + 0.03\% \text{ rng})$	$\pm(0.008\% \text{ rdg} + 0.03\% \text{ rng})$
10 Ω thru 1 M Ω	$\pm(0.01\% \text{ rdg} + 0.01\% \text{ rng})$	$\pm(0.008\% \text{ rdg} + 0.009\% \text{ rng})$
10 M Ω	$\pm(0.05\% \text{ rdg} + 0.01\% \text{ rng})$	$\pm(0.05\% \text{ rdg} + 0.009\% \text{ rng})$

Temperature coefficient (0°C to 50°C):

Range	4-digit display (% rdg + % rng) per °C	5-digit display (% rdg + % rng) per °C
1 Ω	$\pm(0.0095\% + 0.004\%)$	$\pm(0.0095\% + 0.0032\%)$
10 Ω - 1 M Ω	$\pm(0.0095\% + 0.004\%)$	$\pm(0.0095\% + 0.0002\%)$
10 M Ω	$\pm(0.0685\% + 0.001\%)$	$\pm(0.0685\% + 0.0002\%)$

Input terminal: floating pairs (4 terminals).

Maximum voltage across unknown: 8 V.

Maximum current thru unknown: 10 mA on 1 Ω range decreasing to 0.1 μ A on 10 M Ω range.

Overload protection: ± 350 V peak.

Effective CMR (1 k Ω unbalance): > 80 dB at dc.

Normal mode rejection: > 60 dB at 50 Hz $\pm 0.1\%$ (Opt 050) or 60 Hz $\pm 0.01\%$ (Opt 060).

DC current

Range: 1 μ A to 100 mA full scale in six decade ranges.

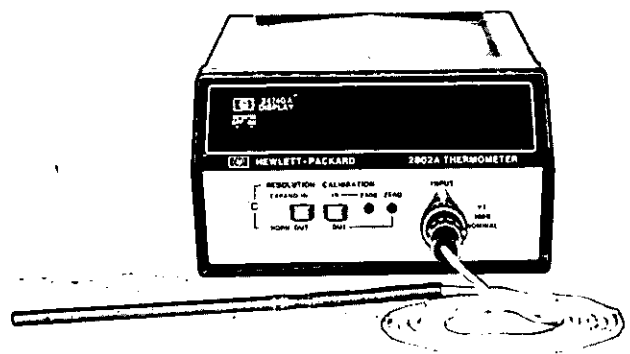

For the following probes, time constant is determined using water flowing at 1 m per second. Sensor ranges specified below are nominal. Consideration must be given to heat deterioration of lead insulation at elevated temperatures.

18641A* Probe contains the sensor in the tip of a 13 cm (5 in.) stainless steel sheath. 6.4 mm (1/4 in.) diameter, with armored cable 1.8 m (6 ft.) long. It operates from -200° to +500°C, to +600°C short term. Cable movement must be prevented above 250°C. Time constant is five seconds.

18642A* Probe is the same as the 18641A except that it has a Teflon-insulated cable 1.8 m long. This cable must be kept below 250°C.

18643A* Probe contains the sensor in the tip of a 13 cm stainless steel sheath. For fast response, the last 5.1 cm (2 in.) of the sheath tip is reduced to 0.32 cm (0.13 in.) diameter. This probe operates from -200° to +500°C, to +600°C short term. It has a 1.8 m Teflon-insulated cable. This cable must be kept below 250°C. Time constant is 1.8 seconds.

*The HP 2802A

Full scale display:

Range	4-digit display	5-digit display
1 μ A	$\pm 1.0000 \mu$ A	$\pm 1.0000 \mu$ A
10 μ A	$\pm 10.000 \mu$ A	$\pm 10.000 \mu$ A
100 μ A	$\pm 100.00 \mu$ A	$\pm 100.00 \mu$ A
1 mA	± 1.0000 mA	± 1.0000 mA
10 mA	± 10.000 mA	± 10.000 mA
100 mA	± 100.00 mA	± 100.00 mA

Overrange: 100%.

Accuracy (30 days, 23°C \pm 5°C):

Range	4-digit display	5-digit display
1 μ A - 1 mA	$\pm(0.10\% \text{ rdg} + 0.03\% \text{ rng})$	$\pm(0.09\% \text{ rdg} \pm 0.03\% \text{ rng})$
10 mA - 100 mA	$\pm(0.30\% \text{ rdg} + 0.03\% \text{ rng})$	$\pm(0.30\% \text{ rdg} + 0.03\% \text{ rng})$

Stability (24 hours, 23°C \pm 1°C):

Range	4-digit display	5-digit display
All ranges	$\pm(0.02\% \text{ rdg} + 0.03\% \text{ rng})$	$\pm(0.018\% \text{ rdg} + 0.025\% \text{ rng})$

Temperature coefficient: $\pm(0.004\% \text{ rdg} \pm 0.004\% \text{ rng})/^\circ\text{C}$.

Maximum input current: 300 mA pk.

Input resistance: 10 k Ω on 1 μ A range decreasing to 1 Ω on 100 mA range.

Effective CMR (1 k Ω unbalance): >80 dB at dc.

Normal mode rejection: >60 dB at 50 Hz \pm 0.1% (Opt 050) or 60 Hz \pm 0.1% (Opt 060).

2802A Digital Thermometer is complete with 4 1/2 digit HP 34740A display, less probe. Option 050 for 50 Hz or Option 060 for 60 Hz operation must be specified.

Specifications

These specifications are "total system specifications" meaning they apply to both the instrument and the probe working together (not just the best electronic specifications for the instrument by itself). HP 2802A Thermometer specifications relate directly to system performance under actual working conditions.

Ranges: -200° to +600°C and -100° to +200°C.

Resolution: 0.1°C on -200° to +600°C range. 0.01°C on -100° to +200°C range.

Accuracy: $\pm(0.5^\circ\text{C} \pm 0.25\%$ of reading) on both ranges.

Display: 4 1/2 digits LED on HP 34740A Module.

Stability: $\pm 0.2^\circ\text{C}$ for seven days (23°C \pm 5°C ambient).

Linear analog output: 1 mV/ $^\circ\text{C}$ on -200° to +600°C range (-0.2 V to +0.6 V FS). 10 mV/ $^\circ\text{C}$ on -100° to +200°C range (-1.0 V to +2.0 V FS). Voltage accuracy equal to that of digital display. Output impedance 1 k Ω on both ranges.

Environmental standard: HP 2802A Thermometer operates within these specifications in environments of 0° to 50°C and up to 95% relative humidity over most of this temperature range. After calibration in some arbitrary ambient temperature, instrument calibration remains valid with ambient temperature changes up to 10°C.

For all models

Operating temperature: 0°C to 50°C.

Storage temperature: -40°C to 74°C.

Power: ≤ 8.7 VA at 100 V, 120 V, 220 V, 240 V + 5%, -10% switchable: 48 Hz to 440 Hz.

Weight:	Net	Shipping
34701A DC VM, 34702A or 34703A Multimeter	0.9 kg (2 lb)	1.47 kg (3 lb 4 oz)
34740A 4-digit display or 34750A 5-digit display	1.36 kg (3 lb)	1.92 kg (4 lb 4 oz)
34750A Battery module	2.27 kg (5 lb)	2.95 kg (6 lb 4 oz)
34721A BCD module	0.68 kg (1 lb 8 oz)	1.25 kg (2 lb 2 oz)
2802A Thermomodule + display	2.27 kg (5 lb)	3.39 kg (7 lb 8 oz)

Dimensions:

Display + meter: 247.7 mm deep \times 158.8 mm wide \times 98.4 mm high (9 3/4" \times 6 1/4" \times 3 7/8").

With battery module: 247.7 mm deep \times 171.5 mm wide \times 136.5 mm high (9 3/4" \times 6 3/4" \times 5 3/8").

With BCD module: 247 mm deep \times 171.5 mm wide \times 127 mm high (9 3/4" \times 6 3/4" \times 5").

Accessories available: 11096A High Frequency Probe, measures to 500 MHz. Accepts 0.25 V to 30 V signals with input impedance of 4 M Ω shunted by 2 pF; 11456A Read Out Test Card for testing and troubleshooting either display; 11457A Rack Mount Kit for either display; 34721A BCD Module and one bottom section; 11458 Carrying Strap; 18019A Carrying Case accommodates either display, a center section and a bottom section plus power cord and input cables; 56A-16C Cable for operating 5055A Digital Recorder; 18641A Probe; 18642A Probe; 18643A Probe; 18644A Probe Kit.

Accessories	Price
11096A High Frequency Probe	\$82
11456A Read Out Test Card	\$57
11457A Rack Mount Kit (for either display)	\$41
11458 Carrying Strap	\$5
56A-16C Cable for operating 5055A Digital Recorder	\$60
18019A Carrying Case	\$35
18641A Probe	\$165
18642A Probe	\$150
18643A Probe	\$180
18644A Probe Kit	\$105

Model number and name

34701A DC Voltmeter	\$165
34702A Multimeter	\$285
34703A DCV/DCA/ Ω Meter	\$600
34720A Battery Module	\$221
34721B BCD Module	\$189
34740A 4-digit display	\$365
34750A 5-digit display	\$600
Option 050, 50 Hz rejection	N/C
Option 060, 60 Hz rejection	N/C
2802A Digital Thermometer (includes 4 1/2-digit display Option 001 - bottom module only).	\$750

DIGITAL VOLTMETER

Multi-function DVM for bench and system use

Models 3480C & 3480D

NEW

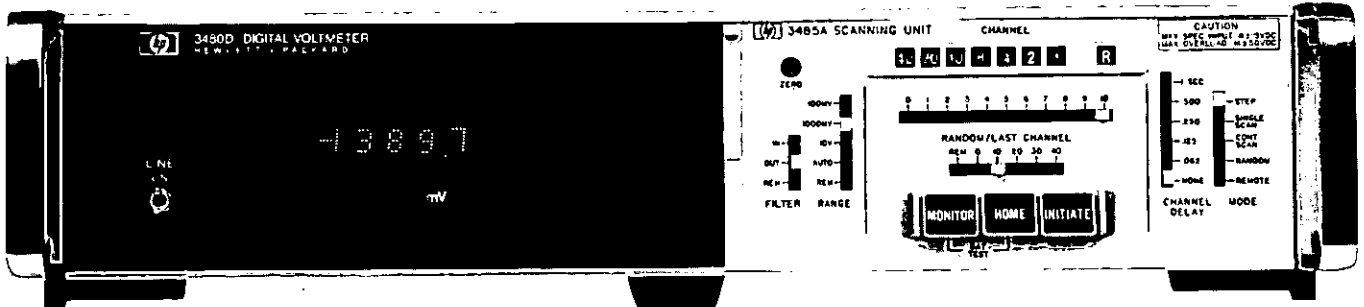

3480D

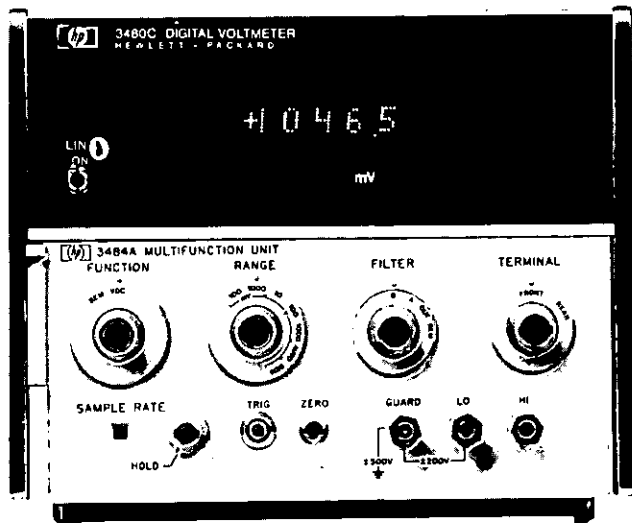

3480C

3480 C/D Description

HP's 3480C/D Digital Voltmeter covers a variety of systems and bench applications. The four-digit mainframe has 50% overranging which is available in two sizes, one-half module 3480C, or full rack width, 3480D. These mainframes may accommodate any of three signal conditioning plug-ins. The 3482A plug-in has five dc ranges; the 3484A has five dc ranges, five true rms ac ranges and six ohms ranges; and the 3485A has up to 50 two-wire dc input channels.

Mainframe options further enhance the flexibility of HP's 3480. To digitize changing voltages at rates up to 1000 readings/s, Option 001 Sample-and-Hold is available. Option 004 Isolated BCD is available to provide digital output information.

HP's 3480 may be purchased as part of a portable data acquisition system, the 2070A Data Logger. The 2070A combines a 3480C DVM with a 5055A Digital Recorder.

Options

The isolated BCD (Option 004) digital output option is designed to transmit digital information from the DVM to external devices such as printers, tape punches, couplers, computers, etc. Information transmitted consists of the reading, polarity, range, function, and overload. When the 3485A Scanning Unit is used, two digits of channel I.D. are also transmitted.

The Sample-and-Hold (Option 001) allows HP's 3480 to be used to economically digitize low frequency wave forms. Precision four-digit measurements are possible on a changing input voltage at reading rates up to 1000/s.

Sample-and-Hold is physically located in the 3480's mainframe. Input voltage is tracked until a trigger is given, then Sample-and-Hold freezes the input voltage and holds it for the 1 ms digitizing period of the 3480. After digitization, tracking resumes automatically.

Sample-and-hold specifications

Plug-in response time, to a step input to settle to within 0.01% of final value.

	PLUG-IN UNIT		
	3482A	3484A	3485A
± 100.00 mV	100 μ s	100 μ s	100 μ s
± 1000.0 mV	70 μ s	70 μ s	70 μ s
RANGE ± 10.000 V	70 μ s	70 μ s	50 μ s
± 100.00 V	70 μ s	70 μ s	
± 1000.0 V	70 μ s	70 μ s	

Maximum plug-in slew rate: any plug-in, 8% of range/ μ .

Aperture time: time between the command to hold and the point in time when the signal is actually held.

1. If Sample/Hold is triggered normally, aperture time is 110 ns.
2. If Sample/Hold is triggered through the built-in delay, add 105 μ s to the normal aperture time. (Used when input amplifier must be allowed to settle).

General

Operating temperature: 0°C to 55°C.

Power: 115 V or 230 V $\pm 10\%$, 40 Hz to 440 Hz, 60 VA max, including any plug-ins or options.

Dimensions:

3480C: 203.2 mm wide \times 154.8 mm high \times 406.4 mm deep (8" \times 6 $\frac{1}{8}$ " \times 16"). (Half-rack width module).

3480D: 422.8 mm wide \times 85.7 mm high \times 466.7 mm deep (16 $\frac{1}{2}$ " \times 3 $\frac{3}{8}$ " \times 18 $\frac{1}{2}$ "). (Rack width module).

Weights:

3480C: net, 5.7 kg (12 lb 8 oz); shipping, 7.65 kg (17 lb).

3480D: net, 6.15 kg (13 lb 8 oz); shipping 8.1 kg (18 lb).

3482A Description

HP's 3482A has five dc voltage ranges selectable either manually or automatically. The 3482A has guarded floating inputs with switchable front and rear terminals. Triggering may be done manually, externally, or internally using a front panel control. A three-position input filter provides selectable degrees of normal-mode noise rejection. Isolated Remote Control, Option 021, adds remote control over filter and range.

3482A DC range unit specifications

DC voltages

Ranges:

Full range display: ± 100.00 mV, ± 1000.0 mV, ± 10.000 V, ± 100.00 V and ± 1000.0 V.

Overrange: 50% on all but 1000 V range. ± 1200 V max input.

Range selection: manual, automatic or remote.

Automatic ranging: upranges at 140% of range; downranges at 10% of range.

Performance

Accuracy: (90 days, 25°C $\pm 5^\circ$ C, <95% RH).

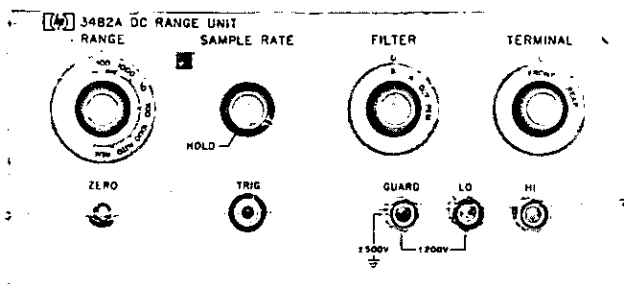

3482A

100 mV range: $\pm(0.01\%$ of reading $+0.02\%$ of range).

All other ranges: $\pm(0.01\%$ of reading $+0.01\%$ of range).

Measuring speed: (the following apply only if no programming changes of any kind occur either during or between readings).

Response time to a step input:

Filter out: 1 ms to within 1 count of final reading.

Filter A: 200 ms to within 1 count of final reading.

Filter B: 1 s to within 1 count of final reading.

Reading rate (without range change):

Manual: initiated with front panel pushbutton.

Internal: 1 to 25 per s with front panel control.

External: 0 to 1000 per s with external trigger.

Input characteristics

Input resistance:

100 mV, 1000 mV, 10 V ranges: $>10^{10}\Omega$.

100 V, 1000 V ranges: $10\text{ M}\Omega \pm 0.1\%$.

Common mode rejection: $>80\text{ dB}$, dc to 60 Hz (1 k Ω unbalanced).

Normal mode rejection:

Filter out: 0 dB.

Filter A: $>27\text{ dB}$ at 50 Hz and above.

Filter B: $>77\text{ dB}$ at 50 Hz and above.

Filter selection: manual or remote.

Noise (100 mV range): 4 counts or less of rack will be observed 95% of the time due to gaussian distribution of the noise.

Maximum input voltage:

Guard to chassis: $\pm 500\text{ V}$ peak.

Guard to low: $\pm 200\text{ V}$ peak.

High to low: $\pm 1200\text{ V}$ peak.

General

Weight: net 1.9 kg (4 lb 4 oz); shipping, 3.15 kg (7 lb).

3484A Description

HP's 3484A offers the same dc capability as the 3482A dc range unit plus five true rms ac ranges and six ohms ranges. The true rms ac converter eliminates error caused by small amounts of distortion on the input signal, and also extends measurement capability to measurement of non-sinusoids. Frequency range extends from 1 Hz to 10 MHz. The ohms converter covers from 100.00 ohms to 10.000 megohm full scale. Remote selection of range, function and filter position is possible with Isolated Remote Control, Option 041.

3484A Multifunction unit specifications

DC voltage

Same specifications as 3482A DC Range Unit.

Ohms, option 042

Ranges:

Full range display: 100.00 Ω , 1000.0 Ω , 10.000 k Ω , 100.00 k Ω , 1000.0 k Ω , and 10.000 M Ω .

Overrange: 50% on all ranges.

Range selection: manual, automatic, or remote.

Automatic ranging: upranges at 140% of range; downranges at -10% of range.

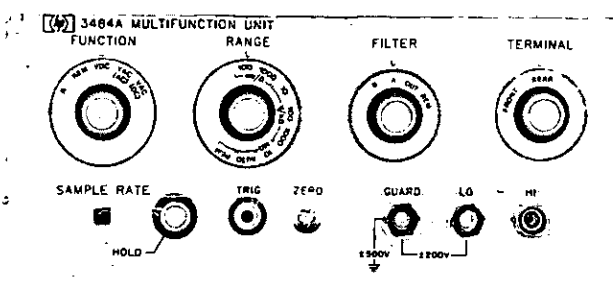

3484A

Performance

Accuracy: (90 days, 25°C $\pm 5^\circ\text{C}$, $<95\%$ RH). 1000 Ω thru 1000 k Ω ranges: $\pm(0.01\%$ of reading $+0.01\%$ of range).

100 Ω range: $\pm(0.02\%$ of reading $+0.05\%$ of range).

10 M Ω range: $\pm(0.1\%$ of reading $+0.01\%$ of range).

Measuring speed: (the following apply only if no programming changes of any kind occur either during or between readings).

Response time to a step input:

Filter out: 100 Ω thru 100 k Ω ranges 1 ms to within 1 count of final reading.

Filter A: 1000 k Ω range, 200 ms to within one count of final reading, 10 M Ω range, 2 s to within 1 count of final reading.

Filter B: not recommended because of long response time.

Reading rate (without range change):

Manual: reading may be manually initiated with front panel pushbutton.

Internal: 1 to 25 s with front panel control.

External: 0 to 1000/s with external trigger.

Input characteristics

Voltage across unknown: 1 V at full scale, all ranges.

Current thru unknown: 10 mA on 100 Ω range, decreasing one decade on each successively higher range.

Overload protection: $\pm 75\text{ V}$ peak on all ranges.

True RMS AC voltage, option 043

Ranges:

Full range display: 100.00 mV, 1000.0 mV, 10.000 V, 100.00 V, and 1000.0 V.

Overrange: 50% on all ranges. 1500 V peak max input.

Range selection: manual, automatic or remote.

Automatic ranging: upranges at 140% of range; downranges at 10% of range.

Performance

Accuracy: (90 days, 25°C $\pm 5^\circ\text{C}$, 95% RH).

DC: $\pm 1.0\%$ of reading, 60% to 150% of range.

AC: as specified by graphs.

Response

VAC (AC) function: responds to true rms value of ac coupled input signal.

VAC (DC) function: responds to true rms value of dc and ac input signal. Reading is $\sqrt{(\text{dc})^2 + (\text{ac rms})^2}$.

Function selection: manual or remote.

Input impedance: 2 M Ω parallel 45 pF.

Crest factor: 7:1 at full scale, derated linearly from 35 Hz to 2.2:1 at 5 Hz.

Maximum input voltage

VAC (DC): 1500 V peak ac, 100 V dc, (10 V dc max on 100 mV range); dc + ac = 1500 V max.

VAC (DC): 1000 V rms; dc + ac = 1500 V max.

Measuring speed

Response time (without range change):

VAC (AC): 1 s to within 10 counts of final reading (input change)

from 10% to 100% of range) or 20 counts of final reading (input change from 100% to 10% of range).

VAC (DC): 15 s to within 10 counts of final reading.

Reading rate:

Manual: reading may be manually initiated with front panel push-button.

Internal: 1 to 25 per s with front panel control.

External: 0 to 1000/s with external trigger.

Accuracy

VAC (AC) AC coupled (these specifications are for 60% of full-scale and above):

Range	FREQUENCY			
	10 Hz to 20 Hz	20 Hz to 200 kHz	200 kHz to 1 MHz	1 MHz to 10 MHz
100 mV and 1000 mV	±0.2% of reading	±0.1% of reading	±0.25% of reading	±2% of reading
10 V, 100 V and 1000 V			±0.4% of reading	

VAC (DC) DC Coupled, AC component (these specifications are for 60% of fullscale and above):

RANGE	FREQUENCY				
	1 Hz to 20 Hz	20 Hz to 100 kHz	100 kHz to 200 kHz	200 kHz to 1 MHz	1 MHz to 10 MHz
100 mV and 1000 mV	±1% of reading	±0.1% of reading		±0.25% of reading	±2% of reading
10 V, 100 V and 1000 V				±0.4% of reading	

DC component ±1% of reading

Weight: Net, 2.75 kg (6 lb 2 oz). Shipping, 3.6 kg (8 lb).

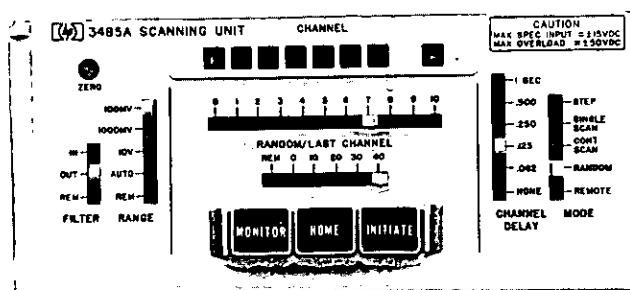

3485A

3485A Description

HP's 3485A is a dc Scanning Unit with up to 50 two-wire floating inputs and three dc voltage ranges from 100.00 mV to 10.000 V full scale. By using FET switches, scan rates up to 1000 channels/s are possible. Scan modes include step, single scan, continuous scan and random. Dwell time on each channel may be varied in six steps from one second to "none." Input resistance is $> 10^7 \Omega$. Autoranging is standard and the 3485A has a switchable 30 dB filter. Isolated Remote Control, Option 057 allows remote control over ranges, filter, scanning modes and random or last channel.

3485A Scanning unit specifications

Channels

Number: up to 50 channels which may be purchased in increments of 10 channels.

Input configuration: floating FET switches with separate Guard for

every block of 10 channels.

Ranges

±100.00 mV, ±1000.0 mV, and ±10.000 V.

Overrange: 50% on all ranges, ±50 V max input.

Range selection: manual, automatic, or remote.

Automatic ranging: upranges 140% of range; downranges of 10% of range.

Time required: 1.5 ms per range change.

Performance

Accuracy (90 days, 25°C, <95% RH):

100 mV range: ±(0.01% of reading + 0.04% of range).

1000 mV and 10 V ranges: ±(0.01% of reading + 0.01% of range).

Maximum operational voltage (for rated accuracy):

High to low: ±15 V dc.

Guard to chassis: ±50 V peak.

Guard to low: ±10 V peak.

The algebraic sum of all voltages in a path between any low to any high must not exceed ±15 V peak.

The maximum algebraic voltage difference between any low to any other low must not exceed ±15 V peak.

Maximum input voltage:

High to low: ±50 V peak.

Guard to chassis: ±50 V peak.

Guard to low: ±50 V peak.

Measuring speed: (the following apply only if no programming changes of any kind occur either during or between readings).

Response time to a step input:

Filter out: 1 ms to within 1 count of final reading.

Filter in: 250 ms to within 1 count of final reading.

Scanning rate:

Manual: up to 2 channels per second.

Automatic: up to 1000 channels per second.

Remote: up to 1000 channels per second.

Autorange time:

Filter out: 1.5 ms per range change.

Filter in: 250 ms per range change.

Channel delay time: (selectable) 1 s, 500 ms, 250 ms, 125 ms, 62 ms, none (1 ms digitization time).

Input characteristics

Input resistance (25°C, ±5° <95% RH): $> 10^7 \Omega$.

Effective common mode rejection (1 k Ω unbalanced):

DC: > 80 dB.

AC (50 - 60 Hz): Filter out: > 70 dB. Filter in: > 105 dB.

Normal mode rejection: Filter: 0 dB. Filter in: > 27 dB at 50 Hz and above.

General

Weight: Net, 3.2 kg (7 lb, 3 oz). Shipping, 4 kg (8 lb, 14 oz).

Options available:

Option	Price
3480C, Option 001, Sample-and-Hold	\$525
3480C, Option 004, Isolated BCD Digital Output	\$395
3480D, Option 001, Sample-and-Hold	\$525
3480D, Option 004, Isolated BCD Digital Output	\$395
3482A, Option 021, Isolated Remote Control	\$221
3484A, Option 041, Isolated Remote Control	\$221
3484A, Option 042, Ohms Converter	\$250
3484A, Option 043, True RMS AC Converter	\$1150
3485A, Option 051, 10 Channels	\$150
3485A, Option 052, 20 Channels	\$300
3485A, Option 053, 30 Channels	\$450
3485A, Option 054, 40 Channels	\$600
3485A, Option 055, 50 Channels	\$750
3485A, Option 057, Isolated Remote Control	\$325

Model number and name

Model Number	Name	Price
3480C	Digital Voltmeter	\$1040
3480D	Digital Voltmeter	\$1075
3482A	DC Range Unit	\$1025
3484A	Multi-function Unit	\$1195
3485A	Scanning Unit	\$1695

DIGITAL VOLTMETERS

Five-digit digital multimeter with self-test

Model 3490A



Description

Hewlett-Packard's Model 3490A Multimeter is a five-digit integrating digital voltmeter. The basic instrument measures dc voltages, ac voltages, and resistances. Additional measurement capability is achieved by the addition of low cost options.

HP's 3490A uses a dual slope integrating technique and is fully guarded, providing excellent noise immunity at five readings per second on all dc ranges. Ranging is automatic over all ranges on all functions. DC measurements can be made with $1 \mu\text{V}$ resolution on the 100 mV range. AC voltage measurements can be made from 20 Hz to 250 kHz in four ranges. The 1 V range provides $10 \mu\text{V}$ of ac voltage resolution. Ohms measurements can be made, utilizing the four-wire conversion technique which eliminates errors due to test lead resistances. Six ranges of ohms, including a 1000 Ω range, are provided. All functions and ranges include 20% overranging except the 1000 V range.

Display

The 3490A uses Hewlett-Packard's light emitting diodes (LED's). These display digits are of the dot matrix type to reduce ambiguity caused by failure of a single diode. The extremely high reliability of this LED display assures maximum life.

Self-test

At the flip of a switch, Hewlett-Packard's 3490A Digital Multimeter sequences itself through 10 tests that check timing signals and autoranging circuits, validate the performance of most logic-circuit IC's and check the six-digit LED display. These tests, and six others provided by six additional front-panel switches, cut calibration costs and ensure the DMM is ready to make accurate measurements.

DC functions

The standard 3490A includes five ranges of dc measurement capability from 100 mV to 1000 V. Measurements are made from the front panel at a precise five readings/s, and at slower rates, using digitally controlled sample rate selector. High input resistance, $> 10^{10}\Omega$ on 100 mV, 1 V, and 10 V range, assures accurate measurement of high impedance sources.



AC functions

Four ranges of ac measurements are provided. The average ac value is accurately detected, and the rms value is displayed with five digits of resolution. Full autoranging, wide frequency response, and 20% overranging are designed-in features to permit easy operation.

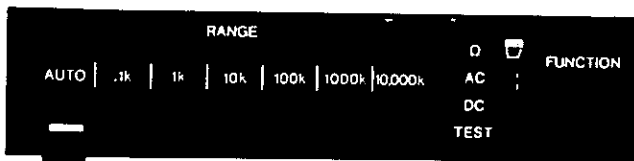

Ohms

Six ohms ranges are standard, and all ranges provide true four-wire ohms measurement capability. Maximum current through the unknown is approximately 1 mA. Over-voltage protection for ohms sensing terminals insures maximum protection against inadvertent application of a high voltage to ohms terminals. Over-voltage protection is provided to 250 V and fuse protection to 1000 V.

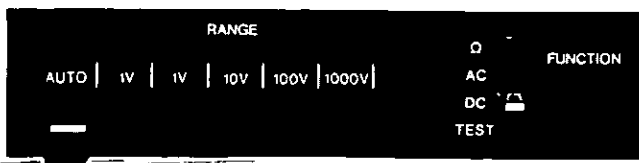



DIGITAL VOLTMETERS

Model 3490A (cont.)

Serviceability

HP's 3490A has been "designed for serviceability." Inside, the 3490's low parts density provides easy access for servicing. Test points and jumpers are keyed to detailed diagnostics.

Several diagnostic aids are available to further minimize 3490A repair time. A service video tape, Accessory No. 11128A, will demonstrate use of self-test and front panel symptoms to isolate failures. The 11126A accessory provides a set of IC reference boards with most of the 3490A logic IC's for use with HP 10529A Logic Comparator. Using these boards with the Logic Comparator, a faulty IC can be isolated in seconds without removing it from the circuit. Also, a spare parts set, Accessory No. 11127A, containing most critical components of the 3490A, will be available.

Options

Systems applications

Model 3490A offers built-in flexibility for systems applications. HP's 3490A offers both HPIB interface and a bit parallel (BCD coded) interface. This combination provides the necessary versatility to configure the lowest cost instrument system.

Ratio, opt 080

DC/DC and AC/DC three-wire ratio measurements can be conveniently added to the 3490A. This capability offers both auto-polarity and a selection of two reference ranges. The 1 V and 10 V ranges are specified from 10% to 120% of selected range. Ratio function is not programmable.

50 Hz operation, opt 050

60 Hz operation, opt 060

Maximum noise immunity is achieved when power line frequency is harmonically related to the sample period of the integrating DMM. Option 050 will maximize normal and common mode rejection for 50 Hz power line frequency, and Option 060 will provide this rejection for 60 Hz.

Sample/hold, option 040 and 045

Sample/Hold provides HP's 3490A with extra and unique measurement capability.

The Sample/Hold option has two modes of operation to solve difficult measurement problems.

Track and hold: in this mode, input voltage is held instantly upon receiving an external command. This mode is useful in digitization of repetitive or transient waveforms.

Acquire and hold: in this mode, a known delay is inserted to permit the input amplifier to settle to a specified accuracy. This is useful in measuring pulse height or any similar step input.

Digital output, opt 021 and remote control, opt 022

These options provide digital control and data output in the parallel BCD code of 8-4-2-1, either negative or positive true logic. Selection is accomplished by positioning an internal switch. The remote control option provides complete control of all functions, ranges, and external trigger commands. The digital output option provides nine columns of information which includes function, polarity, data, and range. These options may be purchased separately to meet specific application requirements. Either of these options require Option 020 Systems Expand.

BCD/remote

Both Option 021 and 022 require Option 020, BCD/Remote Expand. This option provides the required internal and external connectors to permit user installation of Digital Output, Opt 021 and/or Remote Control, Opt 022 and should be ordered as an initial option on HP's 3490A. This option includes rear terminals in parallel (switchable front/rear terminals are available as a special - H19).

HPIB (character serial bit parallel) data input/output, opt 030

The data control and data output option permits HP Model 3490A to operate on a single data/control bus with up to 14 other instruments. This serial code is an eight-bit byte typically using an ASCII-type coding. A unique "talker/listener" address structure makes the system's hardware more economical and associated software much simpler. The HPIB is compatible with Hewlett-Packard Model 9800 Series calculators as well as Hewlett-Packard computers.

Specifications

DC voltage ranges

Full range display: ± 1.00000 V, ± 1.00000 V, ± 10.0000 V, ± 100.000 V, ± 1000.00 V.

Overrange: 20% on all ranges except 1000 V range.

Range selection: manual, automatic, or remote (optional).

DC voltage performance

Accuracy: \pm (% of reading + % of range).

		0.1 V Range		1 V to 1000 V Range	
		% rdg.	% rng.	% rdg.	% rng.
24 hrs	(23°C \pm 1°C)	\pm (0.005 + 0.001)		\pm (0.004 + 0.001)	
30 days	(23°C \pm 5°C)	\pm (0.01 + 0.005)		\pm (0.008 + 0.002)	
90 days	(23°C \pm 5°C)	\pm (0.01 + 0.005)		\pm (0.01 + 0.002)	
6 months	(23°C \pm 5°C)	\pm (0.013 + 0.005)		\pm (0.013 + 0.002)	
1 year	(23°C \pm 5°C)	\pm (0.015 + 0.005)		\pm (0.015 + 0.002)	

DC voltage input characteristics: Fully guarded with 140 dB ECMR at dc and 60 Hz \pm 0.1% with 1 k Ω imbalance between guard and low.

Maximum input voltage:

0.1 V to 1000 V ranges: \pm 1500 V peak.

Guard to chassis: \pm 500 V peak.

Guard to low: \pm 200 V peak.

Input resistance:

0.1 V to 10 V ranges: $> 2 \times 10^{10} \Omega$. (<70% R.H.).

100 V and 1000 V ranges: 10 M Ω \pm 0.15%.

Maximum reading rate: 5 readings/s.

Normal mode rejection ratio: 50 Hz \pm 0.1%; 60 Hz \pm 0.1%; $>$ 50 dB.

Notes:

1. On the 1000 V range, add 0.04 ppm/volt to the % of reading specification.
2. Thermal EMF's generated external to the DVM may be compensated to achieve the % of range accuracy specified by utilizing the rear panel zero adjust provided in the 3490A.

AC voltage ranges

Full range display: 1.00000 V, 10.0000 V, 100.000 V, 1000.00 V.

Overrange: 20% on all ranges except 1000 V range.

Range selection: manual, automatic, or remote (optional).

AC voltage performanceAccuracy: \pm (% of reading + % of range):

		20 Hz - 50 Hz	50 Hz - 100 kHz	100 kHz - 250 kHz
24 hrs	(23°C \pm 1°C)	\pm (0.32 + 0.05)	\pm (0.09 + 0.025)	\pm (0.7 + 0.06)
30 days	(23°C \pm 5°C)	\pm (0.35 + 0.05)	\pm (0.1 + 0.025)	\pm (0.75 + 0.06)
90 days	(23°C \pm 5°C)	\pm (0.35 + 0.05)	\pm (0.1 + 0.025)	\pm (0.75 + 0.06)
6 months	(23°C \pm 5°C)	\pm (0.40 + 0.06)	\pm (0.1 + 0.03)	\pm (0.75 + 0.07)
1 year	(23°C \pm 5°C)	\pm (0.45 + 0.07)	\pm (0.12 + 0.035)	\pm (0.75 + 0.08)

Ohms performanceAccuracy: \pm (% of reading + % of range).

Note: Thermal EMF's generated external to the DVM may be compensated to achieve the % of range accuracy specified by utilizing the rear panel zero adjust provided in HP's 3490A.

		0.1 k Ω		1 k Ω - 100 k Ω		1000 k Ω		10,000 k Ω	
		% rdg.	% rng.	% rdg.	% rng.	% rdg.	% rng.	% rdg.	% rng.
24 hrs	(23°C \pm 1°C)	\pm (0.006 + 0.001)		\pm (0.005 + 0.001)		\pm (0.007 + 0.001)		\pm (0.025 + 0.001)	
30 days	(23°C \pm 5°C)	\pm (0.012 + 0.005)		\pm (0.010 + 0.002)		\pm (0.012 + 0.002)		\pm (0.035 + 0.002)	
90 days	(23°C \pm 5°C)	\pm (0.012 + 0.005)		\pm (0.012 + 0.002)		\pm (0.015 + 0.002)		\pm (0.035 + 0.002)	
6 months	(23°C \pm 5°C)	\pm (0.015 + 0.005)		\pm (0.015 + 0.002)		\pm (0.020 + 0.002)		\pm (0.040 + 0.002)	
1 year	(23°C \pm 5°C)	\pm (0.018 + 0.005)		\pm (0.018 + 0.002)		\pm (0.025 + 0.002)		\pm (0.050 + 0.002)	

AC voltage input impedanceWithout rear terminals: 2 M Ω \pm 1% shunted by <65 pF.With rear terminals: 2 M Ω \pm 1% shunted by <90 pF.

AC voltage maximum reading rate: 1 reading/s.

AC voltage response time: <1 s to within rated accuracy for a step input applied coincident with encode trigger.

AC maximum input voltage: 1000 V rms; \pm 1500 V peak.**Notes:**

- Guard must be connected to low.
- On the 1000 V range, add 0.01 ppm/(volt-kHz).
- Frequencies >100 kHz specified on 1 V and 10 V ranges only.
- Specifications are for input levels above 1/100th of full scale.

Ohms rangesFull range display: .100000 k Ω , 1.00000 k Ω , 10.0000 k Ω , 100.000 k Ω , 1000.00 k Ω , 10000.0 k Ω .

Overrange: 20% on all ranges.

Range selection: manual, automatic, or remote (optional).

Ohms terminal characteristics

Maximum voltage generated across unknown: 20 V for overload; 13 V for valid reading.

Ohms current thru unknown:

0.1 k Ω to 10 k Ω range: 1 mA.100 k Ω to 1000 k Ω range: 10 μ A.10,000 k Ω range: 1 μ A.

Ohms overload protection:

Nondestructive: 250 V rms.

Fuse destructive: \pm 1000 V peak.

Ohms maximum reading rate:

0.1 k Ω to 100 k Ω range: 5 readings/s.1000 k Ω range: 4 readings/s.10,000 k Ω range: 2 readings/s.**General****Data output (BCD), option 021**

Data output is 1-2-4-8 TTL output which is compatible with HP 562A, 5050B, and 5055A Digital Recorders. Either high true or low true logic code can be selected with an internal switch.

Remote control, option 022

The remote control option uses a low true logic (BCD type) code. Required voltage levels for input signal and output signal levels are listed below.

BCD and remote terminals:

	High Level	Low Level
DVM Inputs	+3.9 V \pm 1.5 V, 100 μ A max	+0.3 V \pm 0.3 V, 2 mA max
DVM Outputs	+3.9 V \pm 1.5 V, 400 μ A max	+0.3 V \pm 0.3 V, 15 mA max

Operating temperature: 0°C to 50°C.

Warm-up time: one hour warm-up required to meet all specifications on the 0.1 V range and the 0.1 k Ω range. Thirty minutes warm-up required to meet all other specifications.

Humidity range: <95% R.H., 0°C to 40°C.

Storage temperature: -40°C to +75°C.

Power: 100 V, 120 V, 220 V, 240 V \pm 5%, -10%, 48 Hz to 400 Hz line operation \leq 60 VA with all options.Dimensions: 425.4 mm wide, 85.7 mm high, 466.7 mm deep (16 $\frac{1}{4}$ " \times 3 $\frac{3}{8}$ " \times 18 $\frac{1}{2}$ ").

Weight: net, 9.38 kg (20 lb 11 oz); shipping, 11.79 kg (26 lb).

Options

Options	Price
020: BCD/remote expand, includes rear terminals in parallel	\$221
021: BCD* — full parallel, 1-2-4-8 code	\$275
022: Remote* — full parallel, 1-2-4-8 code	\$189
030: HPIB remote control and data output	\$975
040: Sample-and-hold*	\$490
045: Sample-and-hold (without Opt. 020 or 030)	\$515
050 or 060: 50 Hz or 60 Hz operation	N/C
080: Three-wire ratio	\$221

Rack mounting kit furnished.

Model number and name

3490A Digital Multimeter (includes ac, dc, & ohms)	\$1785
Opt 050 Noise Rejection for 50 Hz	N/C
Opt 060 Noise Rejection for 60 Hz	N/C

*These options require BCD/Remote Expand Option 020.
Note: Rack mounting requires support in rear of instrument.



DIGITAL VOLTMETERS

Multi-function meter

Model 3450B

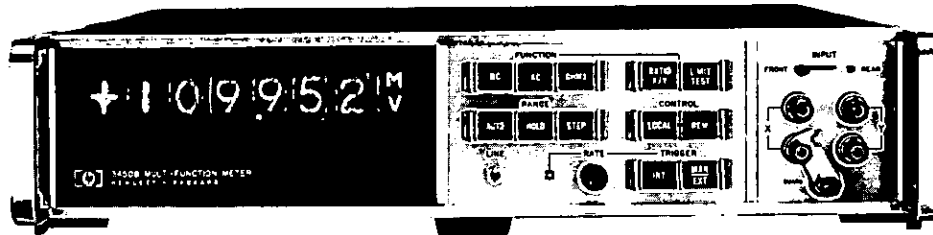

Description

Hewlett-Packard's Model 3450B Multi-Function Meter is a five-digit integrating digital voltmeter. The basic instrument measures dc voltage and dc voltage ratios. Added measurement capability is achieved by addition of plug-in options, all of which can be easily installed in the field.

HP's 3450B uses a dual-slope integration technique and is fully guarded, providing excellent noise immunity at 15 readings per second on all dc ranges. Ranging is automatic over all ranges on all functions. Adding the ac option allows ac measurements from 45 Hz to 1 MHz with true rms response. Six ohms ranges including a 100 Ω range are provided with the ohms option.

Ratio capability is integral in the basic instrument. When ac and ohms options are installed, ac and ohms ratios can be measured. Ratio measurements are made in a truly isolated fashion, allowing measurements never before possible.

A limit test option allows digital comparisons against two preselected limits. This capability is applicable to all functions with no degradation in function performance. Digital output, remote control and rear input options are also available, allowing you to tailor order a 3450B to meet your precise measurement needs.

Specifications

DC voltage ranges

Full range display: ± 100.000 mV, ± 1.00000 V, ± 10.0000 V, ± 100.000 V, and ± 1000.00 V.

Overranging: 20% on all ranges.

Range selection: manual or automatic. Remote optional.

DC voltage performance

Accuracy: 30 day ($25^{\circ}\text{C} \pm 5^{\circ}\text{C}$).

100 mV range:	$\pm(0.008\%$ of reading, $+0.01\%$ of range)
1 V thru 1000 V ranges:	$\pm(0.008\%$ of reading, $+0.002\%$ of range)
90 day:	($25^{\circ}\text{C} \pm 5^{\circ}\text{C}$) add 0.002% of range to 30 day specifications.

DC voltage measuring speed

1/10 s integration period:	380 ms reading period.*
1/60 s integration period:	65 ms reading period.*
Autorange time:	same as reading period per range change.

*Without range change.

DC voltage input characteristics

Input resistance:

100 mV, 1 V and 10 V ranges:	$>10^{10}\Omega$.
100 V and 1000 V ranges:	10 M Ω $\pm 0.1\%$.

Maximum input voltage (peak value):

X-input	Y-input
High to low: ± 1500 V	High to low: ± 200 V
Low to guard: ± 200 V	Low to guard: ± 200 V
Guard to chassis: ± 500 V	Guard to chassis: ± 500 V
X low to Y low: ± 200 V	

Normal mode rejection (NMR):

60 Hz $\pm 0.1\%$: >80 dB (Opt H01); >60 dB (1/10 s integration period); >30 dB (1/60 s integration period).

Effective common mode rejection (ECMR):

DC: 160 dB.

1/10 s integration period: min of 145 dB.

1/60 s integration period: min of 130 dB.

AC voltage – option 001: True rms-responding (45 Hz to 1 MHz).

Ranges

Full range display: 1.00000 V, 10.0000 V, 100.000 V, and 1000.00 V.

Overranging: 20% on all ranges. (1500 V peak on 1 kV.)

Range selection: manual or automatic. Remote optional.

Performance

Accuracy: 90 day ($25^{\circ}\text{C} \pm 5^{\circ}\text{C}$).

*Note 1500 V peak = 1060 V for a sine wave.

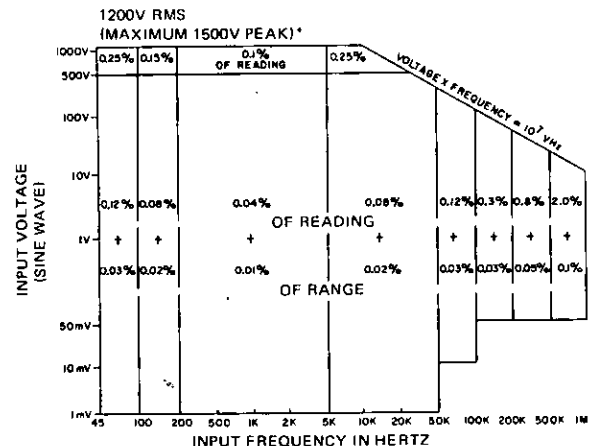

Input characteristics

Input impedance:

Front terminals: 2 M Ω shunted by 90 ± 10 pF.

Rear terminals: 2 M Ω shunted by 135 ± 15 pF.

Crest factor: 7:1 ($f > 1$ kHz, bandwidth = 1 MHz).

Maximum input voltage: same as dc voltage except $< \pm 1000$ V dc offset on X terminals (± 1500 V peak maximum including dc offset).

Measuring speed:

Integration period	Reading period (without range change)	Autorange time (per range change)
1/10 s	2.7 s	2.7 s

Instrument reads within 0.1% of final value in one reading from 10% of range to 100% of range.

DC ratio

Valid ratio measurements can be made for Y inputs between 0.1 V and 120 V and X inputs between 0 and 1200 V.

Overranging: 20% on all ranges.

Range selection: manual or automatic for X input. Remote optional for X input. Automatic for Y input.

Performance

Accuracy:

90 day (25°C ±5°C).
±(0.01% of reading* +0.002% of ratio range
+ $\frac{Y \text{ range}}{Y \text{ voltage}} \times 0.003\%$).

*Add 0.005% of reading for X input >100 V.

Input characteristics

Input resistance, effective common mode rejection, normal mode rejection and max. Input voltage: same as dc voltage specifications.

Input voltage: same as dc voltage specifications.

AC ratio — option 001: True rms-responding

Valid ratio measurements can be made for Y inputs between 0.1 V and 120 V and X inputs between 0.1 V and 500 V.

Overranging: 20% on all ranges.

Range selection: manual or automatic for X input. Remote optional for X input. Automatic for Y input.

Performance

Accuracy: 90 day (25°C ±5°C).

±(0.2% of reading +0.01% of ratio range + sum of accuracies of X and Y inputs determined from ac accuracy graph).

Input characteristics

Input configuration: isolated four-terminal, guarded.

Input impedance: same as ac voltage for X and Y.

Crest factor: 7:1 (f >1 kHz, bandwidth = 1 MHz).

Maximum input voltage: same as dc voltage, except <±1000 V dc offset voltage on X terminals.

Ohms, option 002

Ranges:

Full range display: 100.000Ω, 1.00000 kΩ, 10.0000 kΩ, 100.000 kΩ, 1000.00 kΩ, and 10000.0 kΩ.

Overranging: 20% on all ranges.

Range selections: manual or automatic. Remote optional.

Performance

Accuracy: 30 day (25°C ±5°C).

100Ω range: ±(0.01% of reading +0.01% of range).
1 kΩ thru 100 kΩ ranges: ±(0.01% of reading +0.002% of range).
1000 kΩ range: ±(0.02% of reading +0.002% of range).
10000 kΩ range: ±(0.1% of reading +0.002% of range).
90 day (25°C ±5°C): add 0.002% of range to 30 day specifications.

Measuring speed

Same as dc voltage except 165 ms reading period and autorange time on 10 MΩ range with 1/60 s integration period.

Input characteristics

Input configuration: four-wire, guarded.

Current through resistance:

100Ω thru 10 kΩ ranges: 1 mA.

100 kΩ and 1000 kΩ ranges: 10 μA.

10000 kΩ range: 1 μA.

Effective common mode rejection (ECMR): same as dc voltage.

Normal mode rejection: same as dc voltage.

Overload protection: ±200 V peak for X or Y input.

Ohms ratio, option 002

Valid ratio measurements can be made from Y inputs between 100Ω to 12 MΩ and X inputs between 0 and 12 MΩ.

Overranging: 20% on all ranges.

Range selection: manual or automatic for X input. Remote optional for X input. Automatic for Y input.

Performance

Accuracy: 30 day (25°C ±5°C at terminals) ±(% of ratio range + % of ratio reading error).

Where:

$$\% \text{ of ratio range error} = +(0.004\% + \frac{Y \text{ Range}}{Y \text{ Resistance}} \times 0.002\%).$$

% of ratio reading error is the greater percentage given below for either X or Y resistance.

5%	0.55%	0.1%	0.05%	0.02%*	0.05%	0.2%
0Ω	100Ω	1 kΩ	2 kΩ	9 kΩ	500 kΩ	5 MΩ 12 MΩ

*0.01% for ratios between 0.95 and 1.05 if X and Y are between 10 k and 500 k.

Y ranges: 1 kΩ, 10 kΩ, 100kΩ, 1 MΩ, and 10-MΩ. 90 day (25°C ±5° at terminals).

Same as 30 day specification except % of ratio range error = $+(0.004\% + \frac{Y \text{ Range}}{Y \text{ Resistance}} \times 0.003\%)$.

Input characteristics

Input configuration: isolated four-terminal, guarded. Two wires per resistor.

Current through X and Y resistance: same as ohms function.

Effective common mode rejection (ECMR): same as dc voltage for X input.

Normal mode rejection: same as dc voltage for X input.

Overload protection: ±200 V peak for X or Y input.

Limit test, option 003

Capability:

Applicable to: dc, dc ratio, ac, ac ratio, ohms and ohms ratio. No degradation in performance of above six functions.

Limit selection: Two four-digit limits (with 20% overranging), including polarity, are selectable in 1-2-4-8 BCD form with external closure to ground through <3 kΩ (2.8 mA max) or application of -0.5 V to +2.5 V.

Output signals

Limit indications: High, Go, Low from panel lights defined as follows: High limit ≤High; Lower limit ≤Go <High limit; Low <Lower limit.

Digital output, option 004

Output lines: print command; trigger or print command hold off; BCD output of function; polarity; range or ratio range; and digital data. Levels are 0 V and 12 V or 5 V selectable.

Remote control, option 005

Program lines: 1/60 s integration period; * 100 ms delay; * 10 MΩ input resistance; * ext. trigger; * integration delay; remote program; function; nonratio range; ratio range decimal point.

*These remote capabilities are included in the basic 3450B and do not require the addition of Option 005.

General

Operating temperature: 0°C to 50°C, unless otherwise specified.

Storage temperature: -40°C to +75°C.

Power: 115 V or 230 V ±10%, 50 Hz to 400 Hz, <75 W (including all options, normal environmental conditions).

Dimensions: 425 mm wide, 88 mm high, 542 mm deep (16 3/8" × 3 3/8" × 21 3/8").

Weight:

Basic instrument: net, 14.1 kg (31 lb).

Including all options: net, 16.3 kg (36 lb).

Shipping: 22.7 kg (50 lb).

Model number and name

	Price
Option 001 AC Converter (adds ac, ac ratio)	add \$1355
Option 002 Ohms Converter (adds ohms and ohms ratio)	add \$460
Option 003 Limit Test	add \$410
Option 004 Digital Output	add \$247
Option 005 Remote Control	add \$285
Option 006 Rear Input Terminals (add front/rear selector switch and rear terminals)	add \$79
H50-3450B, Optimum Noise Rejection for 50 Hz line	add \$68
H01-3450B, Optimum Noise Rejection for 60 Hz line with programmable filter	add \$325
H13-3450B, Optimum Noise Rejection for 50 Hz line with programmable filter	add \$390
3450B (includes dc and dc ratio)	\$3995

For more complete technical information, contact your local HP office for a data sheet.



DIGITAL VOLTMETERS

Integrating DVM

Model 2402A

- Precise measurements despite severe noise

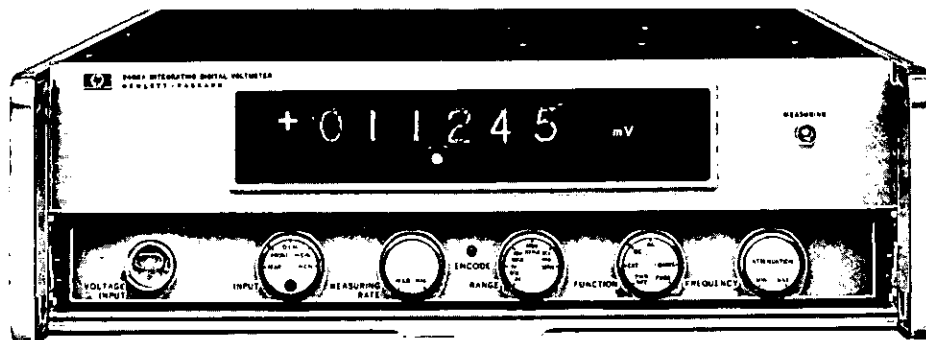

Description

HP's 2402A combines 43 measurements per second sampling rate with the precision and measurement flexibility expected from a laboratory instrument for computerized and noncomputerized data acquisition systems use. High speed and high accuracy are achieved at low levels without preamplifiers in this integrating digital voltmeter.

Instrument design virtually eliminates errors caused by extraneous noise without imposing restrictions on the grounding of the signal source, recording device, or programmer, or upon the measuring speed of the instrument. HP's easy-to-use 2402A permits maximum versatility of application through its control and input/output features.

High accuracy in a DVM must be maintained under everyday conditions and in the presence of noise. HP's 2402A is average-reading, which greatly reduces the effects of superimposed noise. A floated and guarded input circuit eliminates common mode noise error. Combined, these techniques yield effective common mode noise rejection greater than 126 dB (2 million to 1) at any frequency, including dc.

HP's 2402A reads average value of applied voltage over a $\frac{1}{50}$ second sample period, and provides maximum rejection of superimposed noise at 60 Hz ($\frac{1}{50}$ second optional). Since no input filters are employed, it provides both noise rejection capability and rapid accurate response to step input required for data acquisition system applications. Superimposed noise rejection holds for combined signal plus noise amplitudes to 130% of full scale.

Model 2402A features a guard that completely isolates the floating measuring circuit from the chassis, breaking the common mode loop. The combined effect of guarding and averaging a 60 Hz, 100 V peak-to-peak common mode potential will not cause any discernible error in reading on any range.

AC voltages to 750 V peak can be measured on four ranges from 1 V to 1000 V when the 2402A is equipped for optional ac voltage measurement. It is adapted for ac voltage measurement by installation of plug-in ac-to-dc converter and control boards. The converter is average-reading and is calibrated in rms with respect to sinusoidal input. Dc voltage input connectors are also used for ac input. The same guard provides common mode rejection for ac and dc voltage

measurements. Overload detection circuit of the basic 2402A protects the ac converter.

Resistance measurement to 13 megohms can be made on five ranges from 1 k Ω to 10 M Ω when the 2402A is equipped with this option. It is adapted for resistance measurement by installation of a plug-in ohms-to-dc converter and control boards and a four-wire guarded rear panel connector. The converter is installed inside the guard, assuring freedom from common mode errors.

HP's 2402A may be equipped for frequency measurements to 199.999 kHz. Frequency measurement is a plug-in option.

Specifications

(For $\pm 10\%$ line voltage variation and six months operation, assuming daily calibration against internal standard after 30-minute warm-up.)

DC voltage measurement

Noise rejection: overall effective common mode rejection: (ratio of common mode signal to its effect upon readings): 160 dB at dc, decreasing to 126 dB above 30 Hz (infinite rejection cusp gives 168 dB effective CMR at 60 Hz $\pm 15\%$). Overall rejection combines common mode rejection and superimposed noise rejection.

Input circuit: type: floated and guarded signal pair. Signal low and guard may be floated up to 500 V above chassis ground with up to 1000 V input signal (maximum low-to-guard voltage is 50 V).

Ranges: 100 mV and 1, 10, 100 and 1000 V full scale selected by front panel switch, external programming or autoranging.

Overranging: to 130% of full scale, except on 1000 V range. Self protected on any range against input voltage to 1000 V. Protective circuits reset automatically for each new reading.

Input impedance: greater than 1000 M Ω on 100 mV, 1 V and 10 V ranges; 10 M Ω on 100 and 1000 V ranges.

Internal calibration standard: (independent of measuring circuit). Derived from stabilized reference diode operating in constant temperature oven; maintain specified accuracy for six months.

Measurement speed: to 43 measurements per second when triggered externally, self-triggers at speeds continuously adjustable from one measurement every 10 seconds to 10 per second.

Accuracy: (source impedance 10 k Ω , 43 measurements per sec, $\pm 10\%$ line voltage variation after 60-minute warmup.)

Range	1 V, 10 V, 100 V, 1000 V	100 mV
Short term (24 hour) accuracy (at 25° $\pm 1^\circ$ C)	0.003% rdg $\pm 0.003\%$ F.S. (0.006% rdg in overrange)	0.003% rdg $\pm 0.005\%$ F.S. (0.008% rdg in overrange) Below 30 mV accuracy improves to 3 μ V $\pm 0.008\%$ rdg.
Long term (6 months) accuracy (at 25° $\pm 1^\circ$ C)	0.01% rdg $\pm 0.003\%$ F.S. (0.013% rdg in overrange)	0.01% rdg $\pm 0.005\%$ F.S. (0.015% rdg in overrange) Below 30 mV accuracy improves to 3 μ V $\pm 0.015\%$ rdg.

Temp Effect	Per °C change from calibrate temperature	
	0.0015% rdg ± 0.00015% F.S. 0.002% rdg ± 0.00015% F.S.	0.0015% rdg ± 0.0006% F.S. 0.002% rdg ± 0.0006% F.S.
15 to 40°C 10 to 15°C or 40 to 50°C		

Resolution: 1 part in 130,000 on 6-digit display; 100 mV range displays readings to 1 μ V.

AC voltage measurement option 002

Common mode rejection: 160 dB at dc, decreasing to 120 dB at 60 Hz and 6 dB per octave for noise frequencies above 60 Hz, with 10 Ω between guard connected to low side of source and low side of input.

Input circuit: floated and guarded signal pair. Signal low and guard may be floated up to 500 V above chassis ground with maximum input voltage applied.

Input voltage limitations: 240 V peak on 1 V range, 750 V peak on all other ranges without damage.

Input impedance: 1 M Ω \pm 1% shunted by 200 pF (maximum).

AC only operation: frequency range: 50 Hz to 100 kHz.

Ranges: 1, 10, 100, and 1000 V full scale, selected by front panel switch, external programming or autoranging.

Overranging: to 130% of full scale, except 530 V rms on 1000 V range.

Accuracy (with respect to standard used for calibration):

Signal frequency*	50 Hz		100 Hz		10 kHz		30 kHz		100 kHz	
	%rdg \pm %fs	%rdg \pm %fs	%rdg \pm %fs	%rdg \pm %fs	%rdg \pm %fs	%rdg \pm %fs	%rdg \pm %fs	%rdg \pm %fs	%rdg \pm %fs	%rdg \pm %fs
Accuracy (at 25° \pm 1°C)	0.09	0.05	0.06	0.03	0.06	0.03	0.09	0.05	0.3	0.09
Response error**	0.1	—	0.05	—	0.02	—	0.02	—	0.02	—
Ripple error***	0.03	—	0.02	—	—	—	—	—	—	—
Temperature effect**** (Per °C change in ambient from 25°C, over 10 to 50°C range)	0.004	0.003	0.004	0.003	0.004	0.003	0.007	0.003	0.013	0.003

*Straight line interpolation holds for frequencies between points.
 **Applicable only to step input (received from data system signal scanner) or autorange operation.
 ***Ripple error decreases 18 dB per octave above 85 Hz, is zero at 60 Hz because of superimposed noise rejection of basic instrument.
 ****Assumes calibration of 2402A against internal standard at 25°C ambient. Calibration of 2402A at operating temperature decreases % rdg temperature effect 0.0009% per °C.

AC on dc operation: maximum dc component: \pm 200 V on any range.

Ranging: must start from 1000 V range, proceed to lower range as required.

Peak input: ac plus dc to 100% of full scale, except 750 V peak maximum on 1000 V range.

Measurement speed: to 1.9 externally-triggered measurements per second. Self-triggered measurement rate adjustable from 1 measurement every 10 seconds to 1.6 per second.

Resolution: 1 part in 130,000 on 6-digit display; 10 μ V on 1 V range.

Resistance measurement option 003

Noise rejection: measurement circuit enclosed in same guard as dc circuit, reducing effect of ac common mode noise when guard is connected to low side of test resistance. Double-shielded cable extends guard to test resistance.

Input circuit: guarded, modified four-terminal circuit; unknown resistor can be either grounded or floating.

Ranges: 1 k Ω , 10 k Ω , 100 k Ω , 1 M Ω , and 10 M Ω full scale, selected by front panel switch, external programming or optional autoranging.

Overranging: to 130% of full scale. Self-protected on all ranges against up to 50 V across resistance input.

Absolute accuracy:

Resistance range	1 k Ω	10 k Ω	100 k Ω	1 M Ω	10 M Ω
Measurement current	1 mA	1 mA	100 μ A	10 μ A	1 μ A
Accuracy at 25°C	%rdg \pm %fs 0.016 0.003		0.013% rdg \pm 0.003% fs		%rdg \pm %fs 0.025 0.005
Temperature effect*	0.004% rdg 0.0003% fs per °C difference of ambient with respect to 25°C over 10 to 50°C range				

*Calibration of 2402A against internal standard at operating temperature decreases % rdg temperature effect 0.0015% per °C, to 0.0025% rdg per °C.

Measurement speed: to eight externally triggered readings per second. Self-triggered measurement rate is adjustable from one measurement every 10 seconds to 4.5 seconds.

Resolution: 1 part in 130,000; 0.01 Ω on 1 k Ω range.

Frequency measurement option 005

Frequency range: 5 Hz to 199,999 kHz.

Gate time: 1 second; provides 1 Hz resolution.

Accuracy: (\pm 1 count \pm time base stability); time base aging rate: 2 ppm per week over 20 to 30°C; time base temperature effect: 100 ppm over range 10 to 50°C.

Input

Amplitude range: 0.1 to 100 V rms.

Pulse or square wave input: negative 1 to 100 V amplitude, 2 μ s minimum duration, 50% maximum duty cycle.

Impedance: 1 M Ω shunted by 150 pF.

Maximum voltage: 150 V peak dc plus ac or pulse.

Autorange option 001

Range selection: dc voltage ranges; each time autoranger is programmed, it starts on 1 V range to take advantage of fast up-ranging. While autoranging is continuously programmed, autoranger starts at range selected for previous reading, sequences to higher or lower range as required. AC voltage ranges; autoranger starts at 1000 V range, sequences to lower range as required. Up-ranges at 136% of full scale, downranges at 10.2%.

General

Display and system interface: 6-digit display, BCD output and program inputs. Polarity, decimal, measurement units, calibration and overload conditions indicated automatically and included in output as function and decimal digits.

Operating conditions: specifications apply for ambient temperatures 10 to 50°C, relative humidity to 90% at 40°C, altitude to 15,000 feet, maximum storage temperature 40°C.

Power: 115 or 230 V \pm 10%, 50 to 60 Hz, 150 VA.

Dimensions: 425 mm wide, 133 mm high, 495 mm deep behind panel (16 1/4" x 5 1/4" x 19 1/2"); hardware furnished for 19" wide rack mount.

Weight: Net, 22.2 kg (49 lbs); Shipping, 25.4 kg (56 lbs).

Options

001: Autorange	Price add \$325
002: AC Measurement	add \$750
003: Resistance Measurement	add \$850
004: 50 Hz Noise Rejection	add \$120
005: Frequency Measurement	add \$400
006: 8-4-2-1 BCD Output	add \$300
008: 4-2-2-1-BCD-Output	add \$210

Model number and name

2402A Integrating Digital Voltmeter

\$8800

DIGITAL VOLTMETERS

Six-digit dc digital voltmeter (1 part 10^6 resolution)

Model 3462A

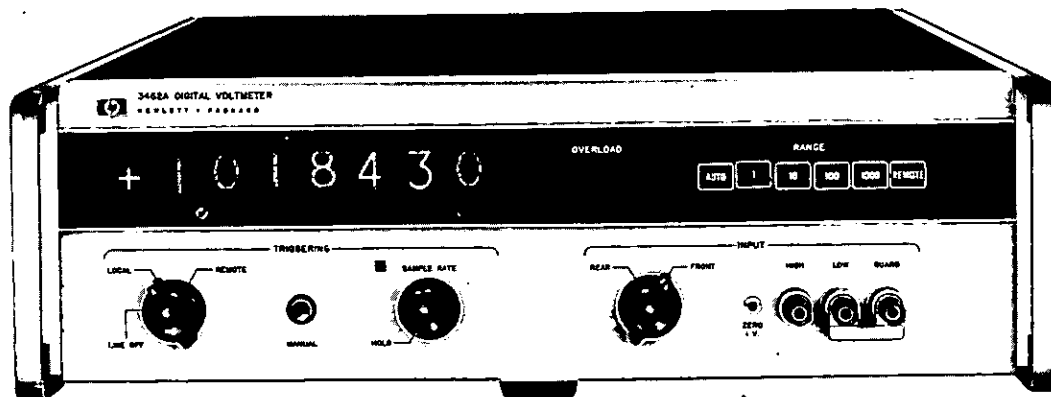

Description

HP's Model 3462A, 6½ digit DVM, offers a resolution of 1 part in 1,200,000 at 20% overrange with sensitivity of $1 \mu\text{V}$ on the 1 V range. The potentiometric-integrating technique is used in the 3462A. True average of input voltage is measured over a fixed sample period. Accuracy results largely from the potentiometric principle using precision resistance ratios and a stable reference voltage. This, in combination with the integration and guarding system, results in superimposed noise immunity of an integrating DVM while retaining potentiometric accuracy.

Four voltage ranges from 1 V to 1000 V full scale are selectable manually, automatically, or remotely. In addition to remote control, HP's 3462A has a BCD digital output for digital recording of data.

Specifications

Ranges

Full range display: $\pm 1.000000 \text{ V}$; $\pm 10.00000 \text{ V}$; $\pm 100.0000 \text{ V}$; $\pm 1000.000 \text{ V}$.

Overranging: 20% on all ranges.

Range selection: manual, automatic, or remote.

Performance

Accuracy (90 days, $25^\circ\text{C} \pm 5^\circ\text{C}$, <50% RH): $\pm(0.004\%$ of reading + 0.0002% of range).

Accuracy (90 days, $25^\circ\text{C} \pm 5^\circ\text{C}$, <95% RH): $\pm(0.004\%$ of reading + 0.0004% of range).

Stability (constant temperature $\pm 1^\circ\text{C}$, <50% RH):

24 hr: $\pm(0.0015\%$ of reading + 0.0002% of range).

180 day: $\pm(0.006\%$ of reading + 0.0004% of range).

Temperature coefficient (0°C to 50°C): $\pm(0.0002\%$ of reading + 0.00002% of range) per $^\circ\text{C}$.

Measuring speed

Reading period (without range changes): 1.1 sec. on all ranges.

Autorange time: 60 ms.

Input characteristics

Maximum input voltage (peak value):

High to low: $\pm 1500 \text{ V}$.

Guard to chassis: $\pm 500 \text{ V}$.

Guard to low: $\pm 50 \text{ V}$.

Input resistance:

1 V and 10 V ranges	$10^{10}\Omega$ within $\pm 5\%$ of null, otherwise $10^7\Omega \pm 0.03\%$
100 V and 1000 V ranges	$10^7\Omega \pm 0.03\%$

Input impedance: 40 pF in parallel with $10^7\Omega$ at front panel.

Effective common mode rejection (ECMR): $>160 \text{ dB}$.

Normal mode rejection (NMR): $>40 \text{ dB}$ at 50 Hz and above.

Remote Control

Remote operation, trigger rate, range selection and input resistance are selected by contact closures to ground through $<100\Omega$.

EFFECTIVE COMMON MODE REJECTION

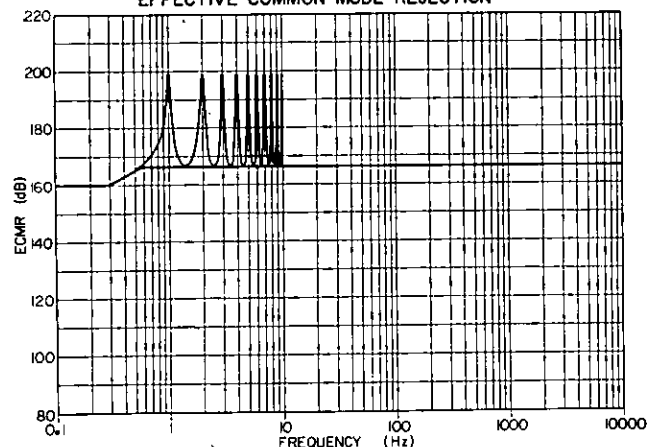

Digital output

BCD outputs: 7 digits of data plus polarity, decimal location and overload.

General

Operating temperature: 0°C to 50°C unless specified otherwise.

Storage temperature: -40°C to $+75^\circ\text{C}$.

RFI: meets MIL-I-6181D.

Power: 115 V or 230 V $\pm 10\%$, 50 Hz to 60 Hz, 90 VA.

Dimensions: 425 mm wide \times 127 mm high \times 543 mm deep ($16\frac{1}{4}'' \times 5'' \times 21\frac{1}{4}''$).

Weight: net 17.2 kg (38 lb); shipping 25.4 kg (56 lb).

Accessories furnished

HP 11065A 6-ft rear input cable, guarding preserved, terminated end mates with 3462A

Additional cable

HP 11085A remote control cable

Additional cable

HP rack mount kit

Accessories and options available

HP 5050B Digital Recorder, basic instrument with 18-column capacity and 3 code discs.

Column boards and cables required for operation are not included

Option 001, 1-2-2-4 BCD output

Option H50 (optimum noise rejection for 50 Hz line frequency)

Option 001, option H50 (1-2-2-4 BCD output and optimum noise rejection for 50 Hz line frequency)

3462A Digital voltmeter

Price

N/C

\$30

N/C

\$32

N/C

\$2150

N/C

add \$68

add \$68

\$5835

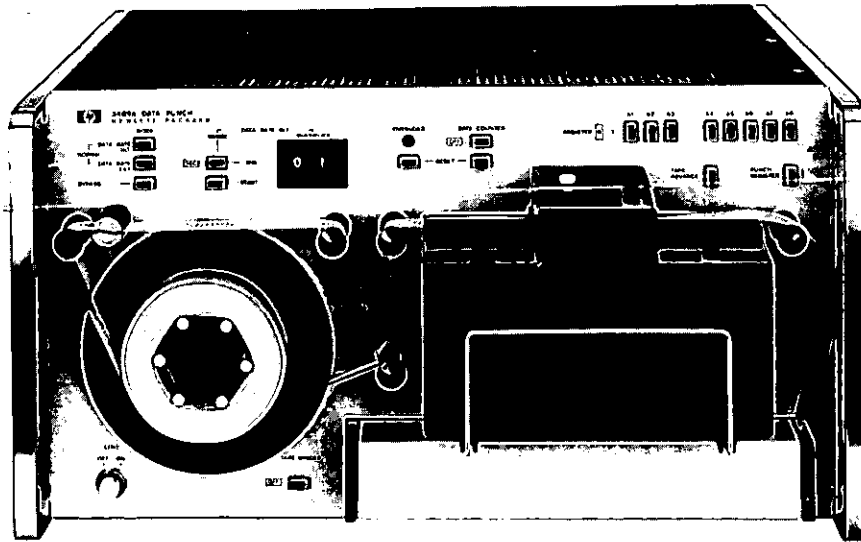

Description

Hewlett-Packard's 3489A Data Punch is a combination coupler and paper tape punch. Features include an internal timer for unattended data logging and a data counter to add line numbers. Output format from the 3489A is controlled by a pin-board so that any paper tape code may be punched, such as ASCII, EBCDIC, BCD or CCITT. Special characters may be added to construct special formats. Length of data words may be varied to 30 characters. Number of readings per line is variable to 7 words.

The 3489A accepts up to eight BCD digits of measurement data plus one for range and one for function.

Character code for the punched tape can be programmed to be compatible with virtually all computer, telex and calculator systems. Up to 10 special characters can be programmed for data formatting on punched tape.

The data punch can be set to sample a measurement at intervals from one to 99 seconds or minutes.

Internal data counter automatically adds a four-digit I.D. to each reading. This number may be used as line numbers or simply to identify readings.

Front panel pushbuttons can be used to punch identification characters on the tape.

Specifications

Punching speed: 70 characters/s nominal.

Punched tape format: any code up to 8 bits can be programmed.

Tape information: accepts all standard widths of paper, oiled paper, mylar or metallized mylar. Holds 300 meters (1000 ft) standard reel. Winder capacity is 80 meters (260 ft) equivalent to 32,000 characters.

Interface lines

Data: TTL compatible, 8 BCD coded digits plus 8421 only.

Punch (print) command: voltage step from high level to low level or low level to high level. TTL compatible.

Hold-off-signal: high or low level selectable. TTL compatible.

General

Operating temperature: +10°C to +40°C.

Humidity: 0 to 95% RH over full temperature range.

Weight: shipping=23-kg;(52-lb)

Dimensions: 425 mm wide × 230 mm high × 533 mm deep (16 1/2" × 9 1/2" × 21").

Power: Option 050: 230 V ±10%, 50 Hz. Option 060: 115 V ±10%, 60 Hz. 145 VA max.

Options and accessories available:

Option 001 Bypass Card: allows up to 8-bit parallel characters from an external device (e.g. computer) to be punched directly.

Option 002 Time Input Card: accepts up to six BCD digits and can be enabled by rear panel switch or by remote signal.

Accessories and options

11462A Cable Assembly: connects between BCD input of data punch and HP 3480C (or D) with 3485A plug-in. Price add \$80

11463A Cable Assembly: connects between BCD input of data punch and 3480C (or D) with plug-in 3482A or 3484A. add \$80

11465A Cable Assembly: connects between BCD input of data punch and 5326A (or B or C) with 5327A (or B or C) plug-in. add \$80

11466A Cable Assembly Open-ended: connects between BCD, bypass or time connectors on the data punch and an unspecified data source. add \$75

11468A Adapter Box: allows data punch to initiate scan cycle of 3485A. 3485A requires opt. 057. add \$115

11469A Test Card: allows punch sequence to be "stepped" on manual command. Logic levels can be analyzed as an aid to troubleshooting. add \$185

11471A Junction Box: allows parallel operation of 3489A with 5050B or 5055A and 3480C/D. A 11462A or 11463A and two 562A-16C interface cables are required with the 11471A. add \$165

Option 001, Bypass Input Card add \$185

Option 002, Time Input Card add \$245

Option 050, 230 V/50 Hz N/C

Option 060, 115 V/60 Hz N/C

02116-6178 (one supplied with instrument) Connector Kit add \$75

5060-1742 Extender Board add \$23

5060-8742 Rack Mount Kit add \$13

562A-16C Printing Cable add \$100

3489A Data Punch

\$3670



DIGITAL VOLTMETERS

Data logger
Model 2070A

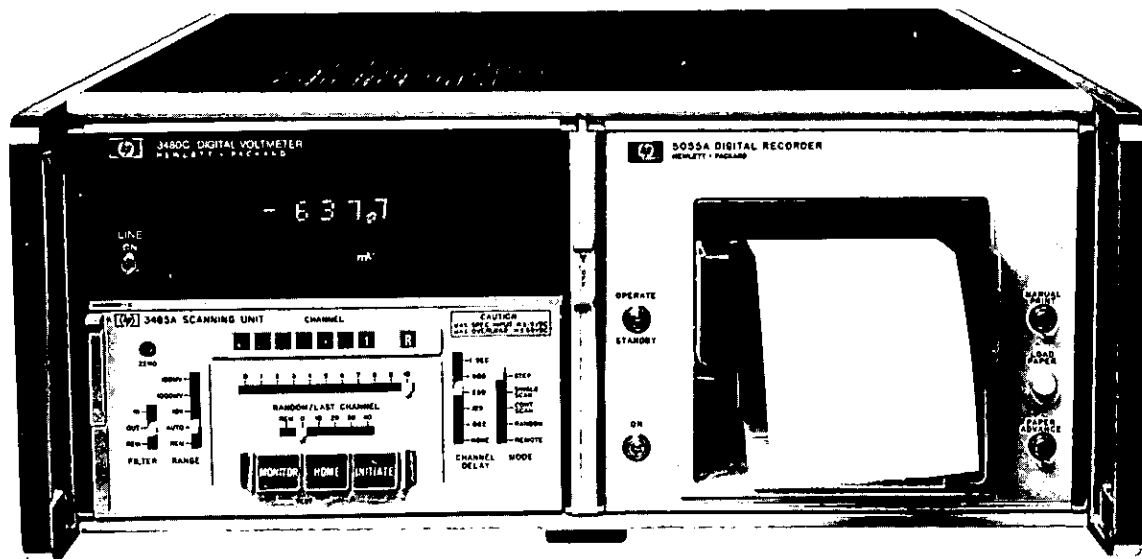

Description

HP's 2070A Data Logger combines a 3480C one-half module DVM with a 5055A one-half module line printer. Both units are combined in a portable fan-cooled case.

HP's 2070A Data Logger is a complete data acquisition system that can use any one of three plug-in units.

The 3482A DC Range Unit is used with the 3480C mainframe to provide five guarded dc voltage ranges. Range selection may be manual or automatic. An internal sample rate control is adjustable from one reading per second to 25 readings per second. HP's 3484A Multifunction Unit provides the same dc capability as the 3482A DC Range Unit plus five true rms ac ranges and six ohms ranges as additional options. With true rms ac option, measurements can be made over the frequency range of 1 Hz to 10 MHz. The ohms option covers the range of 100 ohms full scale to 10 megohms full scale. The 3485A Scanning Unit is used with the 3480C/D mainframe in data acquisition systems where dc readings on up to 50 channels are to be taken at rates up to 1000 per second. Dual floating FET switches are utilized to permit guarded floating measurements at high scan rates.

HP's 3480 mainframe requires 1 ms to make an analog to digital conversion and the input signal level must not change during this time. The sample/hold option effectively "freezes" a time varying input signal for 1 ms, insuring that the analog to digital conversion will be accurate. Sample/hold may be activated by an external command or by the internal sample rate control. Tracking of the input signal resumes automatically after each reading is completed. Sample/hold is useful when measuring ramp linearity, pulse height, settling time, threshold levels and in digitizing low frequency waveforms.

3480C Digital voltmeter

One-half module 3480C DVM is equipped with Option 004, Isolated BCD. Sample-and-hold (Option 001) can be included. Any one of three 3480 plug-ins may be ordered optionally with HP's 2070A. See pages 44-46.

5055A Digital recorder

One-half module, 5055A Digital Recorder, is a 10-column line printer. Printing up to 10 lines/s, it accepts ink roller or pressure sen-

sitive paper. Paper used is "Z" fold. Front panel light controls include a power switch, a stand-by/operate switch, a paper advance button and a manual print button. See page 247.

Specifications

2070A Rear panel controls

Standard:

Line switch: for both 3480C and 5055A.

External trigger: BNC connector brings out Measure line from 3480C.

Trigger mode switch: local mode allows front panel sample rate control to be used. External mode disables front panel sample rate control.

Option 001, sample-and-hold

Mode: local or remote trigger may be selected.

Delay: "On" selects a 105 μ s delay in measurement trigger. "Off" selects immediate measurement trigger. Sample-and-Hold connector provides external trigger lines, program lines and analog output lines.

2070A Data logger

Includes 3480C Option 004 and 5055A Digital Recorder in fan-cooled combining case.

Model number and name

Model number and name	Price
Option 001, Sample-and-Hold	\$540
Option 082, 3482A DC Range Unit	\$1025
Option 842, 3484A Multifunction Unit with dc and ohms	\$1415
Option 843, 3484A Multifunction Unit with ac and dc ohms	\$2345
Option 844, 3484A Multifunction Unit with ac/dc/ohms	\$2505
Option 851, 3485A Scanning Unit with 10 channels	\$1845
Option 852, 3485A Scanning Unit with 20 channels	\$1995
Option 853, 3485A Scanning Unit with 30 channels	\$2145
Option 854, 3485A Scanning Unit with 40 channels	\$2295
Option 855, 3485A Scanning Unit with 50 channels	\$2445
Option 857, Isolated Remote Control for the 3485A	\$325
2070A Data Logger	\$3080

DIGITAL VOLTMETERS

Automatic data acquisition system

Model 3050B



NEW

- Powerful on-line data analysis
- DC, AC, and ohms measurements
- Easy to learn programming



Description

Adding a scanner to a multimeter and controlling them with a calculator yields a low-cost solution to data acquisition and analysis problems.

Scanning random channels under calculator control, measuring dc, ac and ohms at up to 4 readings per second, and calculating results on-line or off-line are accomplished by HP's 3050B Data Acquisition System. With a 3495A Scanner coupled to the front end of an HP Model 3490A Digital Multimeter, the system measures dc in 5 ranges from 100 mV to 200 V with 1 μ V resolution. AC is measured in 4 ranges from 1 V to 200 V with 10 μ V resolution over the frequency range 20 Hz to 100 kHz, and resistance is measured from 100 ohms to 10 meg-ohms with 1 milliohm resolution.

Two switching assemblies are available with the 3050B: a low thermal assembly and a relay actuator assembly. The low thermal assembly has 10 fully guarded channels for switching low level, guarded inputs to the DVM. Two low thermal assemblies can be used to provide fourwire ohms measurement capability with just one scanner.

The relay actuator provides 10 two pole relay closures for control of external switches, low current power supply distribution, or activating low power devices. Multiple channel closure can be programmed on this assembly for IC or circuit board testing.

Data logging is under control of an HP Model 9820A, 9821A or 9830A Programmable Calculator. At the same time, the calculator can be programmed to do any mathematical calculations required, from transducer linearization to statistical analysis. Parameters such as pressure, temperature, torque, velocity, acceleration and weight can be measured with appropriate transducers.

In low level data acquisition measurements, certain system specifications are particularly important because many parameters are ordinarily converted into low-level electrical signals by transducers. Full

scale output on some of these transducers can be as small as 20 mV and a change in output voltage due to parameter change is also quite small. For example, a typical thermocouple generates a potential of 22 μ V/ $^{\circ}$ F. For signals of this level, the 3050B sensitivity of 1 μ V is mandatory. In addition, the 3050B has an uncertainty of less than 3 μ V differential thermal emf noise from the scanner input to minimize the effects of temperature gradients across the switching reeds.

Measurement capability is sometimes limited by common-mode noise signals that may be converted to normal-mode noise and thus added to the signal being measured. HP's Model 3050B System achieves a 120 dB effective common-mode ratio by making fully floating measurements with a switched guard connection for each channel.

Since Model 3050B uses an integrating DVM, the most common source of measurement error, power line related noise is rejected and does not affect the measurement. The system has greater than 50 dB normal-mode noise rejection ratio.

Hewlett-Packard's 3050B Calculator Controlled Data Acquisition System is useful in varied applications.

It can be used for transducer sensing in environmental monitoring; gathering pipeline and well data; furnace and flue temperature monitoring; monitoring temperature of standards labs and environmental enclosures; annealing and heat treating monitoring (including temperature profiling); and physiological parameter monitoring. HP's 3050B can be used in manufacturing testing including multipoint circuit board testing, high volume component and transducer testing and calibration; manufacturing process monitoring and control; or design analysis of initial computations to prototype testing, mechanical or electrical. Data logging of multiple channels; low level dc volts, ac volts and resistance measurement capability; time pacing; hard copy output; magnetic data storage; as well as data analysis for: output in

Model 3050B (cont.)

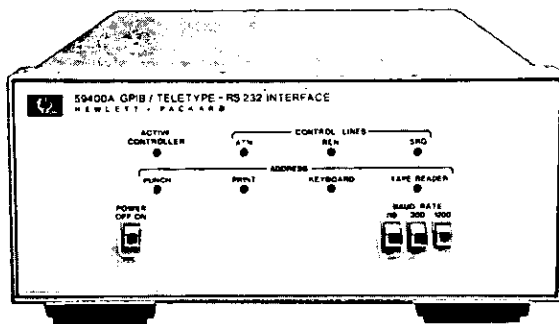
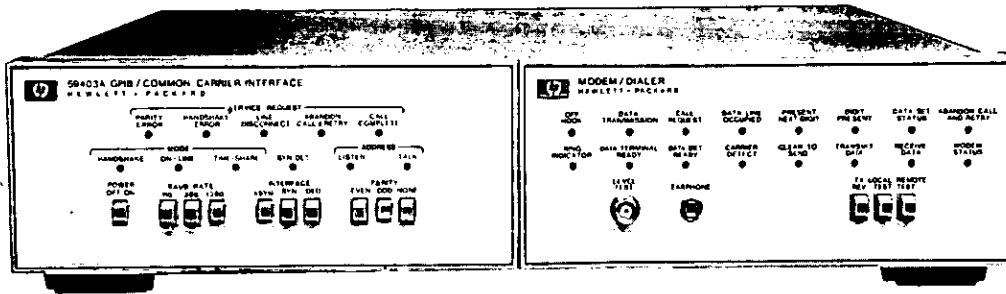

engineering units; transducer linearization and compensation; average values and standard deviations; trend analysis; design computations; real time process profile; efficiency and fast time information; go/no-go limit testing; and comparison with historical test data can be accomplished with this Hewlett-Packard system.

In the field of data acquisition, two general measurement solutions have been available. The simplest alternative is basic data logger (voltmeter/scanner combination with printer or punched tape output) which has no on-site computational capability for analyzing data. When simultaneous data analysis or closed loop control based on measurement results are required, an on-line computerized voltmeter/scanner system is used.

Now, HP's 3050B enables you to move up to on-line data analysis for reliable real-time results without committing the money and support required for a highly capable and complex computer data acquisition system. In application, HP's 3050B will: (1) control system instruments, (2) acquire and convert analog data from physical sensors to digital form, (3) distribute low current power supply voltages or activate low power devices, (4) correct data for nonlinearity and offset and convert it to meaningful scientific units, (5) store data on magnetic cards or tape, (6) determine test results, (7) perform high level statistical and historical analysis, and (8) print, plot, or display results.

The most significant effect is an increase in accuracy and dependability, while at the same time releasing skilled people from the costly routine of meter reading and performing tedious test procedures.

Hewlett Packard Interface bus/TTY-RS232C

HPIB Systems capabilities can now be expanded to include the use of teletypes, or equivalent RS232C equipment, as Bus I/O devices. This capability is provided through the use of a new 59400A interface module that is available as an option to HPIB systems.

The TTY interface module converts all HPIB data and control lines to a serial bit stream of digital information. This information is output (or input) in two commonly used electrical formats (i.e., current loop and RS232C voltage level) for interface to teletypes and related RS232C equipment.

TTY or Terminal may be used as a "dumb" controller of bus systems (instead of, or in addition to, calculator or computer). This per-

mits these common I/O devices to be used as a simple system controller at a remote site for testing purposes, remote readout for HPIB systems, or storing test data on punched paper tape.

Hewlett-Packard Interface bus/common carrier interface Systems option 59403A.

The 59403A is a new HPIB instrument designed to overcome the present HPIB length restrictions of 50 feet. Up to 3,000 feet of additional length can be obtained with just two CCI modules; while with optional modems, length is limited only to the distance covered by available telephone networks.

The CCI module converts all HPIB data and control lines to a serial bit stream of digital information. This information can be sent in this form to another CCI up to 3,000 feet away, or it can be fed into a modem for conversion to a data format that can be used over telephone lines. The same CCI/Modem combination must be used at each end of the phone line.

The optional 300 baud modem (30 HPIB characters/sec max.) allows most HPIB systems measurements to run at normal speed. As faster modems become available, greater data acquisition speeds can be obtained.

A DAA (Data Access Arrangement) must be rented from the phone company to connect a modem to the dial-up network. Automatic Dial option provides "hands-off" connect to desired telephone circuit.

The HP 59403A enables an inexpensive remote system without a minicomputer to do data code conversions and program the individual system components. The CCI/Modem combination eliminates the hardware and software expense associated with the minicomputer at the remote site while providing the same level of system flexibility. Additional HPIB instruments can be added by simply connecting another HPIB cable to the CCI.

3050B Specifications

DC voltage: 5 ranges, 100 mV to 200 V maximum. 5 digits provide 1 μ V resolution on 100 mV range.

Accuracy: \pm (% of reading + % of range) (23°C \pm 5°C).

	0.1 V Range	1 V to 1000 V range
30 days	\pm (0.01 + 0.005)	\pm (0.008 + 0.002)
90 days	\pm (0.01 + 0.005)	\pm (0.01 + 0.002)

Temperature coefficient:

0.1 V range: \pm (0.001% of reading + 0.0007%) of range/°C.

1 V to 1000 V range: \pm (0.001% of reading + 0.0003% of range)/°C.

System uncertainty: <3 μ V differential EMF.

Common mode rejection ratio: 120 dB ECMR at dc and 60 Hz \pm 0.1% with 1 k Ω imbalance between guard and low.

Normal mode rejection ratio: 50 Hz \pm 0.1% and 60 Hz \pm 0.1% both 50 dB.

AC voltage: 20 Hz to 100 kHz. 4 ranges, 1 V to 200 V.

Accuracy: \pm (% of reading + % of range) 90 days (23°C \pm 5°C).

20 Hz - 50 Hz	50 Hz - 100 kHz
\pm (0.35 + 0.05)	\pm (0.1 + 0.025)

Temperature coefficient: $\pm(0.002\%$ of reading $+0.001\%$ of range)/ $^{\circ}\text{C}$.

Ohms: two-wire ohms standard, four-wire ohms is easily accomplished with two low thermal assemblies for each 10 four-wire channels maximum of 20 four-wire channels per scanner.

6 ranges, 100 Ω to 10.M Ω .

1 m Ω resolution on 100 Ω range.

Accuracy: $\pm(\%$ of reading $+$ $\%$ of range)
90 days (23 $^{\circ}\text{C} \pm 5^{\circ}\text{C}$)

0.1 k Ω	1 k Ω - 100 k Ω	1000 k Ω	10,000 k Ω
$\pm(0.012 + 0.005)$	$\pm(0.012 + 0.002)$	$\pm(0.015 + 0.002)$	$\pm(0.035 + 0.002)$

Temperature coefficient: 0.1 k Ω : $\pm(0.001\%$ of reading $+0.0007\%$ of range)/ $^{\circ}\text{C}$; 1 k Ω to 10,000 k Ω : $\pm(0.001\%$ of reading $+0.0003\%$ of range)/ $^{\circ}\text{C}$.

Current thru unknown: 0.1 k Ω to 10 k Ω range: 1 mA; 100 k Ω to 1000 k Ω range: 10 μA ; 10,000 k Ω range: 1 μA .

Channels

Number: 10 - 40 fully guarded channels. More than 40 channels available, expandable to 520 channels.

Type: three pole, low thermal dry reed relays. Third pole is used to switch guard and is not low thermal.

Voltage: 200 volts peak.

Current: 200 mA (noninductive).

Power: 2 VA.

Isolation: $>10^{10}\Omega$.

Maximum input voltage: 250 V between any two input terminals.

Guard to low: 200 V.

Relay actuator assembly:

Caution: for use only in circuits fused at 2 A or less.

Channels:

Number: 10 to 40 channels (more than 40 channels available).

Type: Two-pole armature relay. Single unswitched guard for 10 channels. Any combination of 10 channels may be closed simultaneously.

Maximum contact ratings:

Voltage: 100 V rms.

Current: 2 A rms.

Power: 200 VA.

System uncertainty: $<30 \mu\text{V}$ differential emf.

General

Three calculators available: HP 9820A or 9821A memory size 1.7 k - 16 bit words for writing programs and storing data (expandable to 5.8 k). HP 9830A memory size 1.7 k - 16 bit words (expandable to 8 k).

9820A Calculator memory size: 435 registers for storing data and program steps. 360 of these are available when the supplied User Definable Functions system control routines are loaded into memory. Data can be manipulated to get two readings stored in one register.

Interface input/output slots: four total. One is used for system, leaving three for other peripherals.

ROM slots: All positions are used. 11221A Math, 11224A PCII, and 11222A UDF ROM's are supplied in the 3050A system.

Typical system speeds

a. 3495A Scanner switching time: low thermal assembly: 10 ms; actuator assembly: 40 ms.

b. Optional calculator delay: 9820A: program delay can be added if additional delay is required for settling, etc.

c. Voltmeter sample period with fixed range (in milliseconds):

3490A			*0.1 k Ω -100 k Ω	1000 k Ω	10,000 k Ω
	DC	AC			
60 Hz	200	1000	200	250	550
50 Hz	240	1200	240	300	660

*AC response time: less than 2 s to within rated accuracy for a step input applied coincident with encode trigger.

d. Calculator data manipulation: 9820A: data can be manipulated and stored or output during the 3490A sample period to shorten test time. Since output requires a significant amount of time, the results of a test could be stored to be output later; thus decreasing actual test time. Add all of the following typical calculation times that will be used during each measurement loop to obtain the total calculation time.

Operation	+	-	\times	\div	$\sqrt{\quad}$	Log	exp	X \uparrow Y	SIN	TAN
Time (ms)	4		6	15	20	60	55	120	100	70

Cassette readings

Output		Plot	1 only	1 sequential
Time (ms)	200	50-75	2000	5000

e. Calculator instrument control: System: includes setting scanner channel and accepting reading from 3490A. 50 ms minimum (this is slowed down when using the supplied UDF control routines for programming convenience).

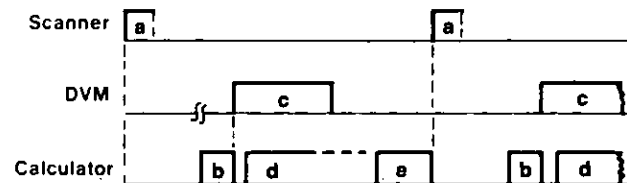

Interface and documentation

All interface and assembly is done at the factory. The system is delivered in an equipment rack ready to turn on and connect the scanner inputs.

Operating and programming manuals with programming instructions and example programs to aid in writing your specific test routines and instrument control routines are also supplied.

Operating temperature: 10 $^{\circ}\text{C}$ to 40 $^{\circ}\text{C}$.

Power: 108 V to 125 V; 210 V to 250 V. 50 - 60 Hz. 240 VA maximum typical.

Weight: Depends on options. Net, 67.5 kg approx. (194 lb) (standard); shipping: 124 kg approx. (273 lb).

Options

001: ten channel low thermal relay assembly (order one or more Option 001 to obtain desired number of channels)	Price
	\$600
002: ten channel relay actuator assembly (order one or more Option 002 to obtain desired number of actuator channels. Option 001 and Option 002 may be used in any combination)	\$400
004: 230 V line	N/C
005: Large equipment rack (56" panel height)	add \$210
006: Delete standard 35" rack (instruments come in 14" combining case)	less \$600
007: additional scanner (one required for each additional 40 channels up to 520 channels or maximum of 15 HP-IB devices including DVM and calculator I/O)	\$700
008: 3490A Sample and hold	\$485
The standard 3050B is supplied with a 1.7 k (16 bit word) memory 9820A. Other controllers and memories are available with the following options.	
020: 9820A, 5.8 k memory	\$1885
021: 9821A, 1.7 k memory and cassette	\$1000
022: 9821A, 5.8 k memory and cassette	\$3500
023: 9830A/9866A, 1.7 k memory & cassette	\$4020
024: 9830A/9866A, 7.9 k memory & cassette	\$7600
050: 50 Hz line	N/C
060: 60-Hz line	N/C
(Option 050 or 060 must be ordered)	
3050B (must have at least one Option 001 or 002)	\$13,650

COMPONENT TEST

General information

C, R, L, D, Q, Z, θ

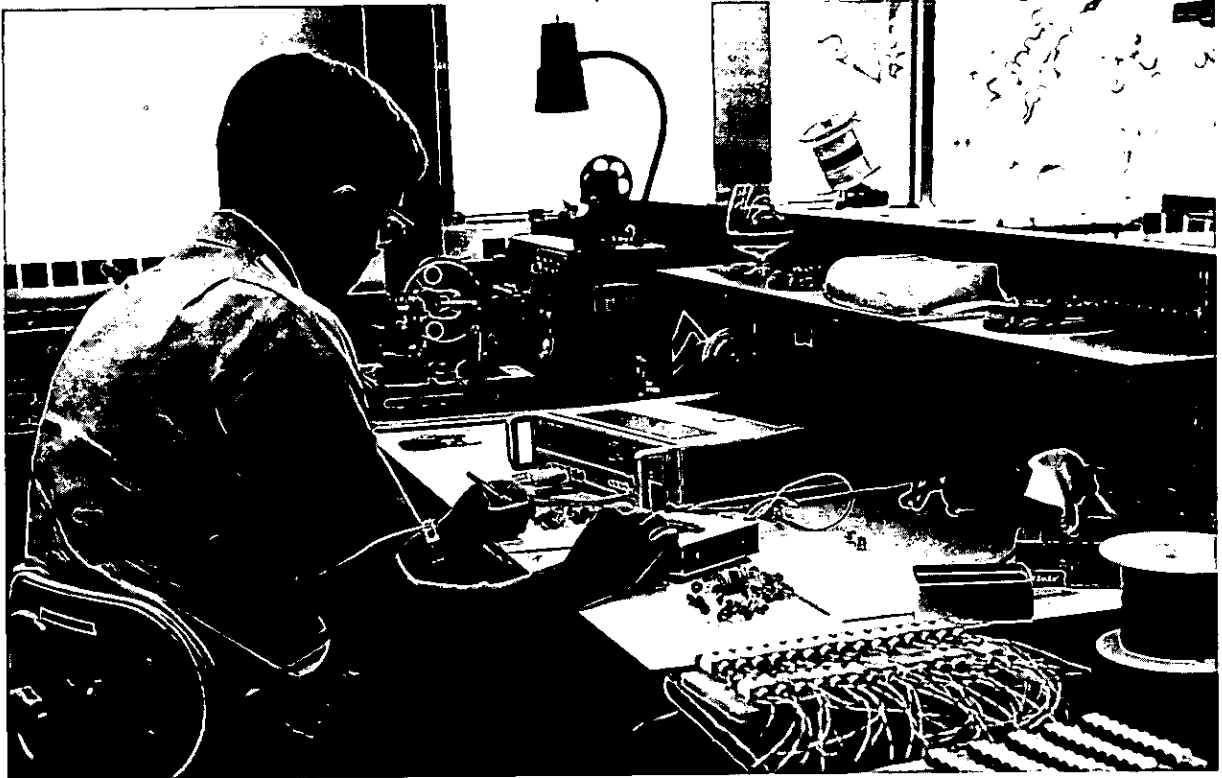

COMPONENT TEST SELECTION GUIDE

Instrument	Frequency				Q or $\frac{1}{D}$		C in farads, L in henries or R in ohms				Basic Accuracy			See Page
	1 Hz	1 kHz	1 MHz	1 GHz	10 ⁰	10 ⁺³	10 ⁻¹²	10 ⁻⁶	10 ⁰	10 ⁺³	.1%	1%	10%	
RX Meter 250B							C							67
Universal Bridge 4260A							C			R 10 ⁶				64
Universal Bridge 4265B							C			R 10 ⁶				65
Auto C-Bridge 4270A							C							66
1 MHz LCR Meter 4271A							C		L	R 10 ⁵				68-69
Digital High Capacitance Meter 4282A								C						70-71
Milliohm Meter 4328A										R				62
High Resistance Meter 4329A								10 ⁶		R 10 ¹⁶				63
LCR Meter 4332A							C		L	R 10 ⁶				61
Q Meter 4342A							C		L					74
High C Meter 4350A/B								C						72
Vector Z/θ Meter 4800A							C		L					73

- Wide range, direct reading
- AC resistance measurement
- Low test voltage

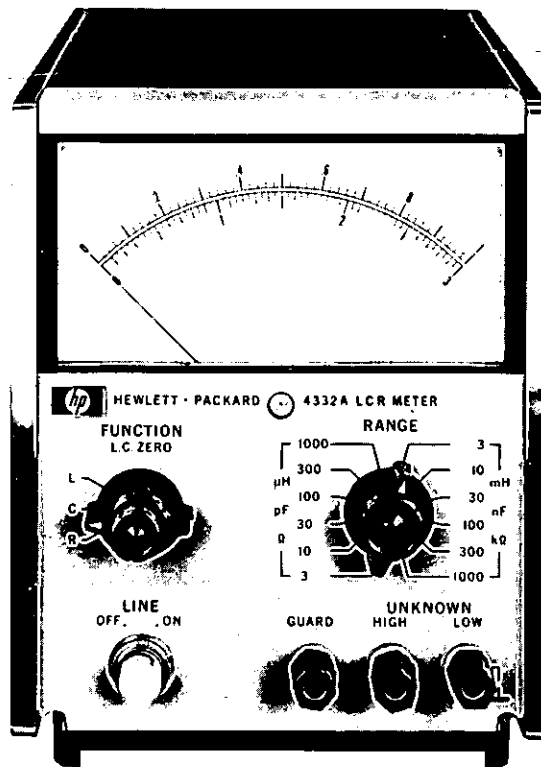

Description

Hewlett-Packard's Model 4332A LCR Meter measures inductance, capacitance, and resistance with speed and accuracy. The instrument provides direct-readings of L, C, and R with linear meter scales. The 4332A is extremely useful for measurements of both linear and non-linear components such as semiconductor capacitor values, inductance of coils with ferrite core. Combining the 4332A analog output with the 4050A Analog Comparator provides a rapid Go/No-Go test system.

Specifications

Inductance measurement

Measurement equivalent circuit: series.

Range: 3 μ H to 1 H full scale, 12 ranges.

Measuring frequency:

3 μ H to 1000 μ H ranges: 100 kHz \pm 5%.

3 mH to 1000 mH ranges: 1 kHz \pm 5%.

Voltage across sample: <1.5 mV rms.

Accuracy (at 25°C): \pm [1% reading + (1.5 + 3/Q) % of full scale + 0.03 μ H].

Capacitance measurement

Measurement equivalent circuit: parallel.

Range: 3 pF to 1 μ F full scale, 12 ranges.

Measuring frequency:

3 pF to 1000 pF ranges: 100 kHz \pm 5%.

3 nF to 1000 nF ranges: 1 kHz \pm 5%.

Voltage across sample: approximately 70 mV rms.

Accuracy (at 25°C): \pm [1% reading + (1.5% + 3/Q) of full scale + 0.03 pF].

Resistance measurement

Range: 3 Ω to 1 M Ω full scale, 12 ranges.

Measuring frequency: 1 kHz \pm 5%.

Voltage across sample: <1 mV rms.

Accuracy (at 25°C):

3 Ω to 30 k Ω ranges: \pm (0.5% reading + 2% full scale + 0.03 Ω).

100 k Ω to 1000 k Ω ranges: \pm (1% reading + 2% full scale).

Analog outputs: 1.0 V dc full scale, independent of range in use and 1.0 V or 0.3 V dc full scale, corresponding to the range in use.

Output impedance: approximately 500 Ω .

Accuracy: 0.5% full scale, better than meter reading.

Overrange: 110% of full scale.

General

Response time: typically 0.25 s for analog outputs. Typically 1.0 s for meter.

Operating temperature: 0°C to 50°C.

Temperature coefficient: \pm 0.05% of full scale/°C or \pm 0.05%/°C, 1°C for 0°C to 50°C.

DC bias: 100 V dc maximum can be applied from external source.

Power: 115 V/230 V \pm 10%, 48 Hz to 66 Hz, 8 VA.

Dimensions: 130 mm \times 152 mm \times 279 mm (5 1/8" \times 6 1/4" \times 11").

Weight: net, 3.5 kg (7 lb 11 oz).

Accessories furnished: 16138A Test Leads, Power Cord 8120-1348.

COMPONENT TEST

Milliohmmeter

Model 4328A

- 1 milliohm to 100 ohm resistance meter

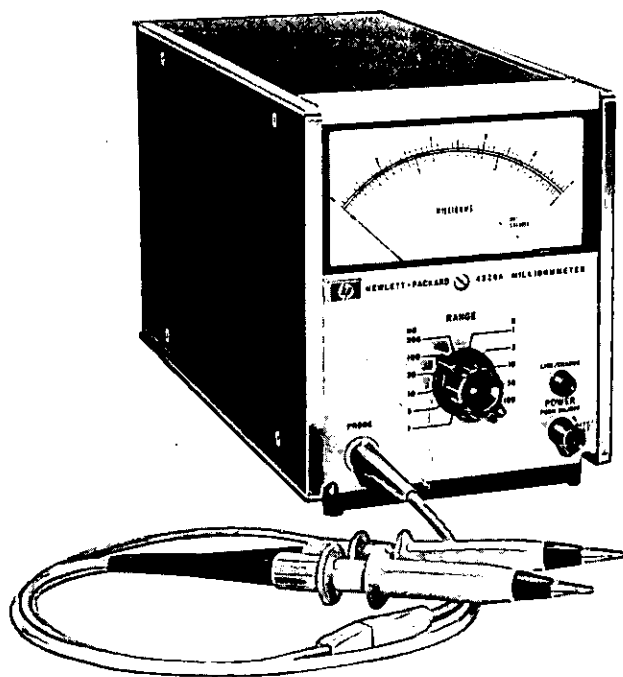

Description

HP's 4328A Milliohmmeter is a portable instrument for measurement of low resistances. It uses a Kelvin Bridge method to obtain its high sensitivity but has incorporated both the current and voltage drives into one probe, so that only two probes are needed in actual measurement.

The range of the 4328A extends from 100 ohms to one milliohm full scale. Maximum sensitivity is 20 microhms, making it ideal for measuring contact resistance of switches, relays, and connectors.

A unique phase discriminator in the meter circuit permits accurate resistive measurements on samples with a series reactance up to twice full scale resistance.

The milliohmmeter is internally driven by a one kilohertz signal. With an ac drive signal, dc bias up to 150 volts can be superimposed without affecting accuracy of measurement. Hence, HP's 4328A can make dynamic resistance measurements in back-biased diodes.

Maximum voltage across any sample with proper range selection is less than 200 microvolts peak. In case of incorrect range setting, a maximum voltage of 20 millivolts peak will never be exceeded, so that explosive devices such as fuses and squibs can be safely checked.

The basic 4328A is line operated. With Option 001, it can be operated from four rechargeable batteries for 15 continuous hours. A recorder output provides an output proportional to meter deflection.

Specifications

Range: 0.001 to 100 ohms full scale in a 1, 3, 10 sequence.

Accuracy: $\pm 2\%$ of full scale. No additional error is caused by series reactance of samples up to two times full scale.

Measuring frequency: 1000 Hz ± 100 Hz.

Voltage across sample: 200 μ V peak at full scale.

Maximum voltage across sample: 20 mV peak in any case.

Superimposed dc: 150 V dc maximum may be superimposed on samples from an external source.

Recorder output: 0.1 V dc output at full scale meter deflection.

Range (ohms)	Applied Current (mA)	Maximum Dissipation in Samples (μ W)
0.001	150	23
0.003	50	8
0.01	15	2.3
0.03	5	0.8
0.1	1.5	0.23
0.3	0.5	0.08
1	0.15	0.023
3	0.05	0.008
10	0.015	0.0023
30	0.005	0.0008
100	0.0015	0.00023

General

Power requirements: 115/230 V switch $\pm 10\%$, 50 to 60 Hz, 1.5 VA.

Weight: 3.2 kg (7 lb).

Dimensions: 130 mm high \times 155.1 mm wide \times 279 mm wide (5 $\frac{1}{8}$ " \times 6 $\frac{1}{32}$ " \times 11").

Accessories furnished: Model 16005A Probe, 16006A Probe and 16007A/B Test Leads. Detachable Power Cord.

Model number and name

Option 001, Rechargeable battery operation
4328 Milliohmmeter

Price

\$44

\$890

COMPONENT TEST

Insulation resistance meter

Model 4329A

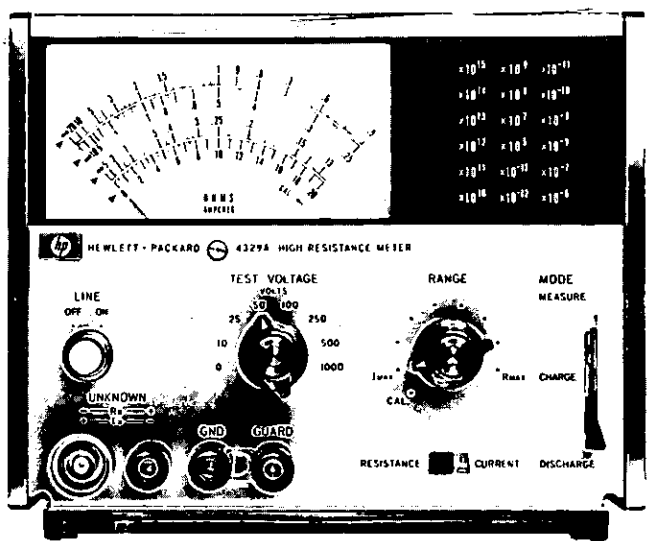

Accuracy: total accuracy is determined by test voltage and range used. At low resistance end of each scale, accuracy is $\pm 3\%$, near center scale $\pm 5\%$, and near the specified upper limit on the meter scale (see table below), accuracy is $\pm 10\%$. Accuracy is not specified above these limits. On all voltage ranges, if multiplier is set to Rmax., an additional $\pm 3\%$ is included.

Current measurement

Range: 5×10^{-14} to 2×10^{-5} A in 8 ranges.

Meter scale: 0 to 20 in 40 linear divisions.

Input resistance: 10^4 to $10^{11} \Omega \pm 1\%$, depending on range.

Accuracy: $\pm 5\%$ of full scale deflection (there can be an additional $\pm 3\%$ error at the top decade). Using current source of infinite z. For finite sources, input resistance must be taken into consideration.

General

Recorder output: 0 to 100 mV dc, proportional to meter deflection; 1 k Ω output resistance.

Power: 115/230 V $\pm 10\%$, 48-66 Hz, approximately 3 VA.

Dimensions: 166 mm high, 198 mm wide, 223 mm deep (6 1/2" \times 7 7/32" \times 8 2/32").

Weight: 3.5 kg (7.7 lb).

Accessory furnished: HP 16117A Low Noise Test Leads.

Accessory available: Model 16008A Resistivity Cell.

Description

The HP 4329A is a solid-state insulation resistance meter designed for easy, accurate and direct readings of the very high resistance values typically found in synthetic resins, porcelain, insulating oils and similar materials. It is also useful for measurements in electrical components like capacitors, transformers, switches and cables. Seven fully regulated dc test voltages (between 10 and 1000 V) are provided as test sources.

Selected scales are identified by illuminated indicators on the meter face. Selected resistance or current multiplying factors are also illuminated for rapid, error-free measurement. Three resistance scales and one current scale are provided. The HP 4329A is instantly convertible from ungrounded-to-grounded-sample operation via a simple relocation of the front panel ground strap from "guard" to "+" position. The instrument cabinet itself is always at ground potential. Test voltage shorts or sample breakdown currents will not damage instrument circuitry.

The HP 4329A also has a current measurement capability. Minute currents as low as 0.05 pA can be readily measured. The standard instrument package includes HP 16117A Low Noise Test Leads; these are used in most types of measurement. An HP 16008A resistivity cell is also available for use with the high resistance meter, for those customers engaged in measurement of volume and surface resistivity of sheet samples.

16008A Description

The HP 16008A can safely, rapidly and conveniently measure the volume and surface resistivity of sheet insulation materials. Conversion from volume to surface resistivity measurement requires operation of one switch only; no lead interchange or disconnection is necessary. Designed for use with the HP 4329A Resistance Meter (other voltage supplies and picoammeters may be used), the complete system allows direct measurement of volume resistivity up to approximately $4 \times 10^{18} \Omega$ (on samples 0.1 cm thick)—and surface resistivity up to approximately $4 \times 10^{17} \Omega$. Test voltages up to 1000 V may be used. Excellent sample-to-electrode contact is maintained through use of a conducting plastic layer bonded to the inner electrode's outer surface. An interlock switch automatically disconnects the test voltage when the cover is raised. Convenient low noise test leads are supplied for direct connection to the HP 4329A.

16008A Specifications

- Inner electrode:** 50 mm diam.
 - Guard electrode:** 70 mm diam.
 - Auxiliary electrode:** 100 mm \times 120 mm.
 - Maximum sample size:** 125 mm \times 125 mm \times 7 mm.
 - Maximum test voltage:** 1000 V dc.
 - Dimensions:** 49 mm high, 198 mm wide, 156 mm deep (2" \times 7 1/16" \times 6 1/8").
 - Weight:** 1.4 kg (3 lb).
 - Model number and name**
- | | |
|-----------------------------|--------|
| 16008A Resistivity cell | Price |
| 4329A High resistance meter | \$380 |
| | \$1170 |

4329A Specifications

Resistance measurement
Range: 500 k Ω to $2 \times 10^{16} \Omega$.

Test voltage	10 V	25 V	50 V	100 V	250 V	500 V	1000 V
Available resistance readings	$5 \times 10^5 \Omega$ to $2 \times 10^{14} \Omega$	$1.25 \times 10^6 \Omega$ to $5 \times 10^{14} \Omega$	$2.5 \times 10^6 \Omega$ to $1 \times 10^{15} \Omega$	$5 \times 10^6 \Omega$ to $2 \times 10^{15} \Omega$	$1.25 \times 10^7 \Omega$ to $5 \times 10^{15} \Omega$	$2.5 \times 10^7 \Omega$ to $1 \times 10^{16} \Omega$	$5 \times 10^7 \Omega$ to $2 \times 10^{16} \Omega$
Meter scale	.5 to 20	.13 to 5	.25 to 10	.5 to 20	.13 to 5	.25 to 10	.5 to 20
Upper limit	5	1.25	2.5	5	1.25	2.5	5



COMPONENT TEST

Universal bridge

Model 4260A

- Electronic autobalance — single control null
- Digital readout for C, R, L
- Direction indicators for fast range selection and balance

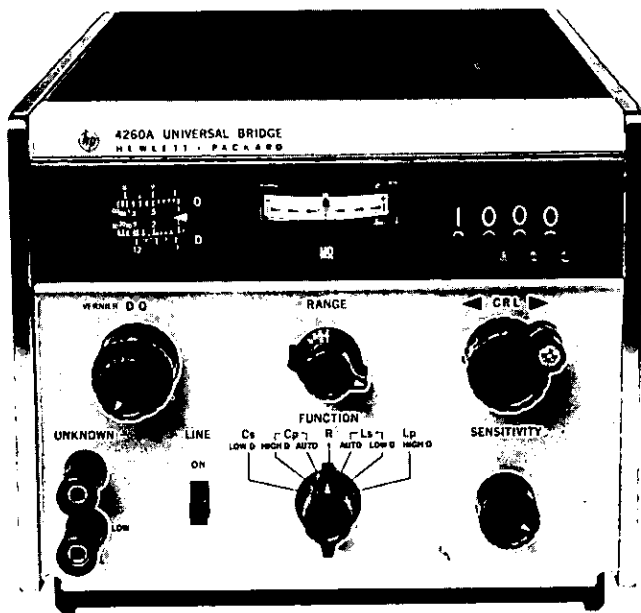

Description

Measurements of C, R, L, D (dissipation factor of capacitors), and Q are easily made with Hewlett-Packard's Model 4260A Universal Impedance Bridge.

Readout for C, R, and L is digital with the decimal point automatically positioned. Units of measurement and equivalent circuit automatically appear with a twist of the function switch. There are no multipliers or confusing nonlinear dials which need interpolation.

Operation is simple. Set the function knob for the parameter to be measured, adjust range switch for an on-scale indication, and obtain a null with CRL control. There are no interacting controls to adjust and readjust, nor any false nulls. A unique electronic autobalance circuit solves all these problems. Components with low Q or high Q are as easy to measure as those without loss.

For D or Q measurements, switch out of auto and turn DQ control until another null is obtained. Only one adjustment is needed for each measurement.

Five bridge circuits are incorporated in HP's 4260A; each is composed of stable, high-quality components for good accuracy and linearity. An internal 1 kHz drives the bridge.

Nulling is easy. Illuminated pointers (<CRL>) automatically tell whether a null is up- or down-scale. Both range and CRL controls can be set watching these pointers.

Components may be biased by connecting a battery to rear terminals. An external oscillator and detector can be used for measurements in the 20 Hz - 20 kHz range.

The compact modular cabinet is ideal for bench use; and it may be rack mounted using accessory hardware. A tilt stand is provided to raise the viewing angle; it also serves as a convenient carrying handle.

Specifications

Capacitance measurement

Range: 1000 pF to 1000 μ F, in 7 full scale ranges.

Accuracy: $\pm(1\% + 1 \text{ digit})$, from 1 nF to 100 μ F. $\pm(2\% + 1 \text{ digit})$, from 1 pF to 1 nF and 100 μ F to 1000 μ F.

Dissipation factor

Range:

Low D — (of series C): 0.001 to 0.12.

High D — (of parallel C): 0.05 to 50.

Accuracy: for C > 100 pF.

Low D $\pm \frac{2}{\sqrt{D \text{ of reading}}}$ %.

High D $\pm (10 D \text{ of reading} + 4)$ %.

Add ± 1 dial division for frequencies other than 1 kHz.

Inductance measurement

Range: 1000 μ H to 1000 H, in 7 full scale ranges.

Accuracy: $\pm(1\% + 1 \text{ digit})$, from 1 mH to 100 H. $\pm(2\% + 1 \text{ digit})$, from 1 μ H to 1 mH and 100 H to 1000 H.

Quality factor

Range:

Low Q — (of series L): 0.02 to 20.

High Q — (of parallel L): 8 to 1000.

Accuracy: for L > 100 μ H.

Low Q $\pm \left(\frac{10}{\sqrt{Q \text{ of reading}}} + 4 \right)$ %.

..... $\pm \left(\frac{10}{\sqrt{Q \text{ of reading}}} + 2 \right)$ %.

High Q $\pm 2 \sqrt{Q \text{ of reading}}$ %.

Add ± 1 dial division for frequencies other than 1 kHz.

Auto-balance

Eliminates need for DQ adjustments in parallel C and series L measurements at 1 kHz.

Accuracy: for D < 1 and Q > 1 add $\pm 0.5\%$ to C and L accuracy specifications.

Resistance measurement

Range: 10 Ω to 10 M Ω , in 7 full scale ranges.

Accuracy: 10 m Ω to 10 Ω $\pm(2\% + 1 \text{ digit})$. 10 Ω to 1 M Ω $\pm(1\% + 1 \text{ digit})$. 1 M Ω to 10 M Ω $\pm(2\% + 1 \text{ digit})$.

To obtain better sensitivity use HP 4304B below 100 Ω and above 100 k Ω .

Oscillator and detector

Internal oscillator: 1 kHz $\pm 2\%$, 100 mV rms $\pm 20\%$.

Internal detector: tuned amplifier at 1 kHz; functions as a broadband amplifier for measurements with external oscillator.

General

Power: 115 or 230 volts $\pm 10\%$, 50-60 Hz, approx. 7 VA.

Dimensions: 190 mm wide \times 166 mm high \times 279 mm deep (7 $\frac{1}{2}$ " \times 6 $\frac{1}{2}$ " \times 11").

Weight: Net, 5 kg (11 lb). Shipping, 6.8 kg (15 lb).

Optional accessories:

4304B for R measurement < 100 Ω and > 100 k Ω .

204C Opt. 001 for measurements 20 Hz-20 kHz.

4260A Universal Bridge

\$940

- 0.1 μH - 1111 H
- 0.1 pF - 1111 μF
- 0.1 m Ω - 1 M Ω

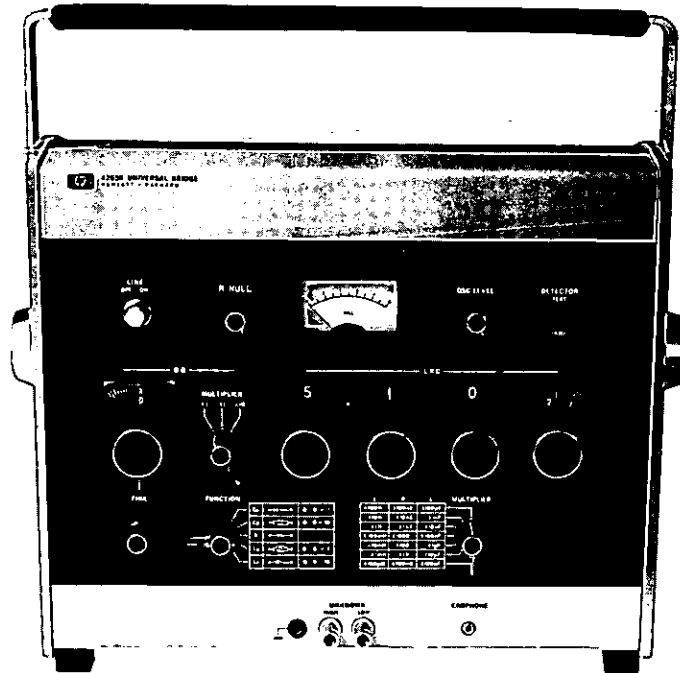

Description

Hewlett-Packard's Model 4265B Universal Bridge provides an economical way to make high precision measurements of L, C, or R and D or Q. Components can be measured in ranges of 0.1 μH to 1111 H in inductance, 0.1 pF to 1111 μF in capacitance and 0.1 m Ω to 1.111 M Ω in resistance. L and C measurements are performed over a wide range of loss with either series or parallel equivalent circuits selected by the function switch. Basic measurement accuracy is 0.2% of reading for L, C, and R.

Measurement frequency range is 50 Hz to 10 kHz with an external oscillator, and 1 kHz with internal oscillator. A dc measurement for resistance is also available with external dc power supply and null detector.

The front panel design provides appropriate space and convenient positioning of knobs for easy balancing. The rugged handle is used as the tilt-stand at angles of 0, 40, or 60 degrees.

Specifications

Resistance measurement

Full scale range: 1000.0 m Ω to 1.0000 M Ω , 7 ranges.

Overrange: 11.1%.

Minimum resolution: 0.1 m Ω .

****Accuracy (at 1 kHz):** $\pm(0.2\%$ of reading $+0.01\%$ of F.S.), $\pm(0.4\%$ of reading $+0.01\%$ F.S.) for 1000.0 m Ω range.

Residual resistance: 1 m Ω .

Inductance measurement

Full scale range: 1000.0 μH to 1000.0 H, 7 ranges.

Overrange: 11.1%.

Minimum resolution: 0.1 μH .

****Accuracy (at 1 kHz):** $\pm(0.2\%$ of reading $+0.01\%$ of F.S.), $\pm(0.4\%$ of reading $+0.01\%$ F.S.) for 1000.0 μH range.

Residual inductance: 0.04 μH (in series with 1 m Ω).

Loss factor range: (at 1 kHz).

Q of series L: 0.001 to 10, accuracy $\pm(5\%$ of reading $+2$ minor divisions)

Q of parallel L: 1 to 1000, accuracy $\pm(5\%$ of reading $+2$ minor divisions).

Capacitance measurement

Full scale range: 1000.0 pF to 1000.0 μF , 7 ranges.

Overrange: 11.1%.

Minimum resolution: 0.1 pF.

****Accuracy (at 1 kHz):** $\pm(0.2\%$ of reading $+0.01\%$ of F.S.), $\pm(0.4\%$ of reading $+0.01\%$ F.S.) for 1000.0 μF range.

Residual capacitance: 0.4 pF.

Loss factor range: (at 1 kHz).

D of series C: 0.001 to 1, accuracy $\pm(5\%$ of reading $+2$ minor divisions).

D of parallel C: 0.1 to 1000, accuracy $\pm(5\%$ of reading $+2$ minor divisions).

****For temperature of 25°C \pm 10°C.**

General

Internal oscillator:

Frequency: 1 kHz \pm 15 Hz.

Output: continuously variable with front panel control. Maximum voltage is 0.4 V rms.

External oscillator:

Frequency range: 50 Hz to 10 kHz or dc for resistance measurement.

Internal detector: Tuned amplifier at 1 kHz. In 1 kHz position, maximum sensitivity of 10 μV , selectivity better than 26 dB. In "flat," operates as a broad band detector from 50 Hz to 10 kHz.

External dc bias: Capacitance measurements in Cs mode, maximum bias voltage of 250 V dc. Inductance measurements in Lp mode.

Operating temperature: 0° to 55°C.

Power: 100/120/200/240 V \pm 10%; 48 to 440 Hz, 5 VA.

Dimensions: 376 mm high, 115 mm deep, 393 mm wide (14 $\frac{1}{16}$ " \times 4 $\frac{1}{32}$ " \times 15 $\frac{3}{64}$ ".)

Weight: net, 5.5 kg (12.1 lb); shipping, 7.1 kg (15.7 lb).

Accessories furnished: Power cord, 230 cm (7 $\frac{1}{2}$ ft). Crystal ear-phone.

Accessories available: Model 16029A Test Fixture.

Model name and number

16029A Test Fixture

4265B Universal Bridge

Price

\$45

\$860



COMPONENT TEST

Capacitance bridge

Model 4270A

- Fully automatic
- 1 kHz to 1 MHz

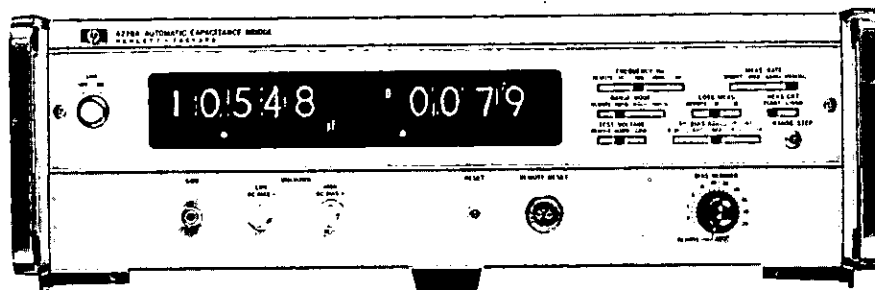

Description

A unique instrument from Hewlett-Packard, the 4270A Automatic Capacitance Bridge provides a wide variety of high speed measurements of both active and passive capacity values. Five-digit readout of capacitance from full-scale ranges of 18,000 pF to 1,2000 μ F is complemented by .001 pF resolution and measurement speed of 0.5 seconds. In addition, a second in-line 4-digit Nixie® display of capacitor loss is given simultaneously in terms of parallel conductance (G) or dissipation factor (D). In the laboratory, HP's 4270A will be extremely useful for examination of semiconductor junction capacities, input capacitances of amplifiers and other active devices, as well as analysis of stray capacity values, cables and simple capacitors. DC biasing, four frequencies from 1 kHz to 1 MHz and a fully guarded measurement will add to laboratory flexibility.

Specifications

Measuring circuit

Float: guarded terminals of unknown are floated from ground. L-ground: one side of known terminals is grounded, guard is retained.

Parameters measured: capacitance, equivalent parallel conductance and dissipation factor.

Measuring frequency: 1 kHz, 10 kHz, 100 kHz and 1 MHz \pm 1%.

Range modes

Auto: range selection and balance performed automatically.

Hold: range is held on fixed position, balance begins with most significant digit. Range determined by previous auto or track range selected or by manually stepping range step.

Track: range held on fixed position, balance begins with last digit.

Balancing time: typically 0.5 s.

Measuring rate: measurement cycle equals balance time plus display time. Balance time typically 0.5 s; display times selected by meas rate are 70 ms, 2 secs, 5 secs, and manual.

Test voltage across unknown

Normal: 1 V rms constant in pF or nF at 1 kHz, 0.1 V rms constant, in μ F at 1 kHz, 0.5 V rms constant at 10 kHz, 100 kHz and 1 MHz.

Low: 1/5 of normal.

Repeatability: \pm 2 digits at normal test voltage, \pm 10 digits at low test voltage.

DC bias: Internal or external to \pm 200 V, in hold and track mode.

Internal bias at float measurement

Voltage: 0 to 20 V dc; 0 to 200 V dc; continuously variable on front panel, monitored on rear panel.

Dial accuracy: \pm 5% of full scale.

Source resistance: 100 k Ω .

Polarity: Low unknown terminal (-), high unknown terminal (+) in float position of meas ckt control.

Remote: programmable by resistor with 250 Ω /V rate at 20 V range,

25 Ω /V rate at 200 V range.

Remote accuracy: \pm 2% of full scale.

Internal bias at L-ground: an additional connection using a blocking capacitor and a coaxial cable is necessary for internal source.

Basic accuracy

	Frequency	1 kHz & 10 kHz	100 kHz	1 MHz
C	D < 0.1	\pm 0.1% \pm 1 digit \pm 0.01 pF	\pm 0.3% \pm 1 digit \pm 0.01 pF	\pm 1% \pm 1 digit \pm 0.01 pF
	Basic accuracy	\pm 0.2% \pm 1 digit \pm 0.01 pF	\pm 0.5% \pm 1 digit \pm 0.01 pF	\pm 2% \pm 1 digit \pm 0.01 pF
	0.1 < D < 0.899	\pm 0.01 pF	\pm 0.01 pF	\pm 0.01 pF
G	Basic accuracy	\pm 1% \pm 10 digits	\pm 3% \pm 10 digits	
D	Basic accuracy	\pm 1% \pm (10 + Cs/Cx) digits		\pm 3% \pm (10 + Cs/Cx) digits

Outputs: 4 line BCD.

Inputs

Trigger hold off level: level must be between 10 V and 15 V.

Remote programming: eight front-panel functions can be remotely controlled by external contact closure to ground with impedance less than 400 Ω . Programmable functions are reset, frequency, range mode, test voltage, loss meas, range step, dc bias, bias vernier.

Operating temperature: 0°C to 50°C.

Power requirements: 115 or 230 V ac \pm 10%, 50 to 60 Hz (approximately 110 W).

Weight: 15.5 kg (net, 34 lb); shipping, 21.6 kg (48 lb).

Interface kits 16150A Control Card and 16151A Data Card are available for interface with Hewlett-Packard computers. Each kit includes mating cable, BCS HP 4270A driver and diagnostic tape.

Accessories available:

Accessories for HP's 4270A Automatic Capacitance Bridge

The following adapters convert BNC Connectors on HP's 4270A to allow direct insertion of components. 16011A converts from BNC to binding posts. 16012A converts from BNC to test axial lead devices. It has a centrally located guard plane to reduce errors due to stray capacitance. 16013A converts from BNC to test vertical lead devices. It has a guard plane similar to 16012A. 11143A converts from BNC to clip leads. 44" overall length with third lead to preserve guard terminal.

Options and accessories

16150A Control Card	Price
16151A Data Card	\$1100
16011A BNC Connector	\$1455
16012A BNC Connector	\$54
16013A BNC Connector	\$64
11143A BNC Cable	\$64
	\$35

4270A Automatic Capacitance Bridge

\$6,420

- Self-contained RF bridge
- Adjustable RF level
- 500 kHz to 250 MHz

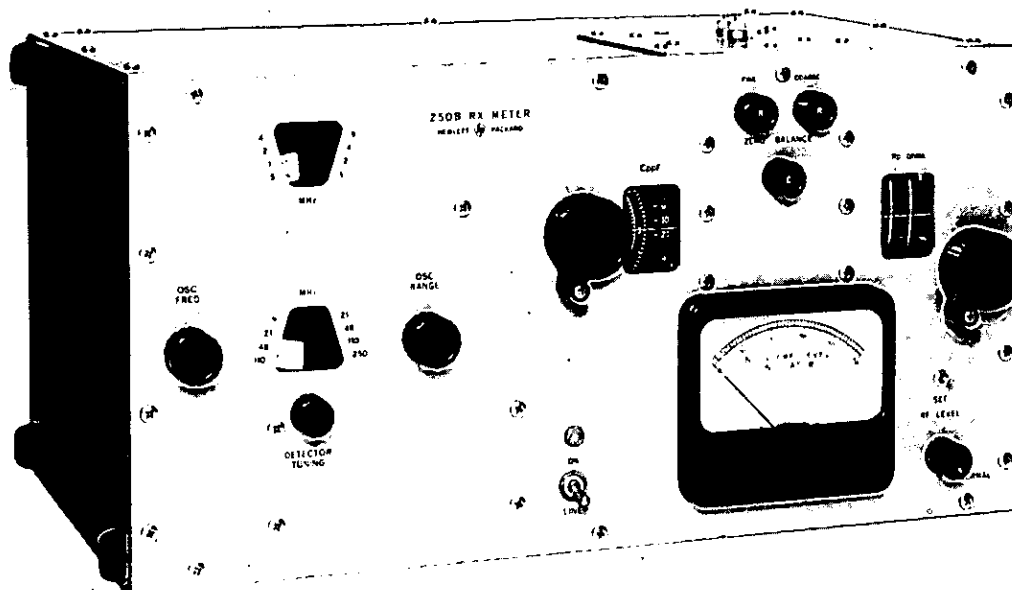

Description

The 250B RX Meter measures two-terminal RF impedance in terms of equivalent parallel resistance and capacitance. The self-contained instrument includes a continuously tuned oscillator, high-frequency bridge, amplifier-detector, and null indicating meter. Connections may be conveniently made to the bridge terminals which are arranged for almost zero lead length. Easily adjusted bridge balance controls are provided, and measurements may be made continuously from .5 to 250 MHz. A front panel control permits adjustment of the RF excitation signal to as low as 20 mV for low level applications. Depression of a momentary switch on the front panel allows the operator to read relative signal level on the null meter. A connector on the rear panel provides an IF output which may be connected to a sensitive voltmeter (3406A) for improved resolution when nulling during reduced signal level operation.

Specifications

RF characteristics

RF range: 500 kHz to 250 MHz in eight bands: 0.5 to 1 MHz, 1 to 2 MHz, 2 to 4 MHz, 4 to 9 MHz, 9 to 21 MHz, 21 to 48 MHz, 48 to 110 MHz, 110 to 250 MHz.

RF accuracy: $\pm 2\%$.

RF calibration: increments of approx. 1%.

Resistance measurement characteristics

Resistance range: 15 to 100,000 ohms.

Resistance accuracy:

$$\pm \left[2 + \frac{F}{200} + \frac{R}{5000} + \frac{Q}{20} \right] \% \pm 0.2 \text{ ohm}$$

F = frequency in MHz, R = RX Meter R_p reading in ohms, Q = $\omega CR \times 10^{-12}$, where C = RX Meter C_p reading in pF.

Resistance calibration: increments of approx. 3% throughout most of range.

Capacitance measurement characteristics

Capacitance range: 0 to 20 pF (may be extended through use of auxiliary coils).

Capacitance accuracy: $\pm(0.5 + 0.5 F^2 C \times 10^{-5})\% \pm 0.15 \text{ pF}$, F = frequency in MHz, C = RX Meter C reading in pF.

Capacitor calibration: 0.1 pF increments.

Inductance measurement characteristics

Inductance range: 0.001 μH to 100 mH (actual range depends on frequency; auxiliary resistors employed).

Inductance accuracy: basic accuracy is capacitance accuracy given above.

Measurement voltage level

RF: 0.05 to 0.75V, approx., depending on frequency, with set rf level control in normal position; adjustable to below 20 mV when set rf level switch is depressed.

DC: 0V (External dc up to 50 mA may be passed through RX Meter terminals).

Dimensions: 509 mm wide, 263 mm high, 343 mm deep (20 $\frac{1}{16}$ " \times 10 $\frac{1}{2}$ " \times 13 $\frac{1}{2}$ ").

Weight: net 18 kg (40 lb); shipping 22.5 kg (50 lb).

Power: 105 to 125 volts or 210 to 250 volts, 50 to 400 Hz, 66 VA.

Accessories available: 00515A Coax Adapter Kit.

The 00515A Coax Adapter Kit permits connection of any coax transmission line or fixture, fitted with a type "N" male connector, to the RX Meter bridge circuit. The kit also includes the 00516A, 50-ohm termination.

Adapter

Connector: type "N" female.

Characteristic impedance: 50 ohms.

Termination: (00516A)

Connector: type "N" male.

Characteristic impedance: 50 ohms.

DC resistance: 50 ohms, $\pm 1\%$.

Maximum parallel capacitance: $\pm 0.2 \text{ pF}$. (mounted on adapter).

VSWR: less than 1:10 up to 800 MHz.

Power: $\frac{1}{2}$ watt maximum.

Model number and name

250B-RX-Meter

00515A Coax Adapter Kit

Price

\$2760

\$82



COMPONENT TEST

1 MHz digital LCR meter

Model 4271A

- Reduce errors with offset adjustment
- 1 MHz test signal for low value components
- 4 pair measurement technique
- General purpose test fixture with cables

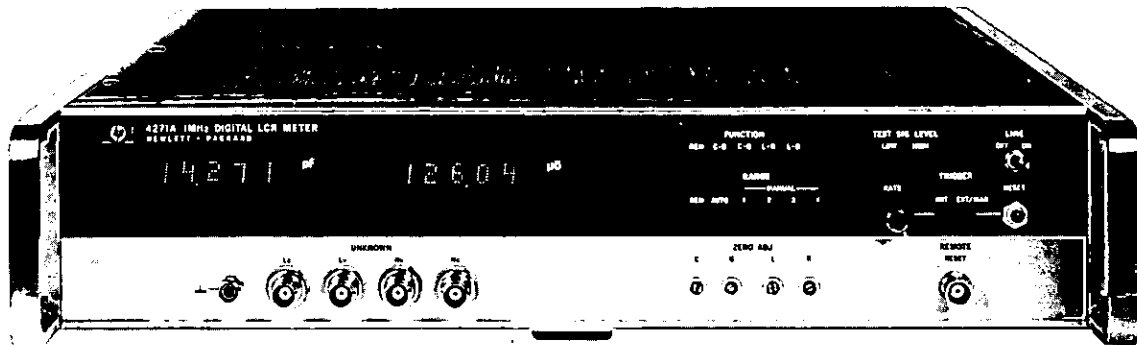

Description

Hewlett-Packard's 4271A features automatic high-speed measurements of low value components. The four-pair measurement technique has the advantage of reducing errors due to residual inductance and stray capacitance. User benefits are derived from high accuracy measurements with as many as ten readings per second.

Specifications

Full scale ranges:

	Range	Capacitance	Conductance	Inductance	Resistance	Dissipation Factor*
Full scale display	1	10.000 pF	100.00 μS	1000.0 nH	10.000 Ω	1.0000
	2	100.00 pF	10000.0 μS	10.000 μH	100.00 Ω	
	3	1000.0 pF	10.000 mS	100.00 μH	1000.0 Ω	
	4	10.000 nF	100.00 mS	1000.0 μH	10.000 k Ω	
Over-ranging	1-4	90%	90%	90%	90%	60%

*When reading of L or C is more than 1500 counts.

Test signal:

Test Level	mV rms; tolerance (%) capacitance		μA rms; tolerance (%) inductance	
	Level-High	Level-Low	Level-High	Level-Low
Range 1	500 ± 10	20 ± 10	2000 ± 20	2000 ± 20
Range 2	500 ± 10	20 ± 10	500 ± 10	200 ± 10
Range 3	500 ± 10	20 ± 10	500 ± 10	20 ± 10
Range 4	20 ± 20	20 ± 10	50 ± 10	2 ± 10

Frequency: 1 MHz $\pm 0.01\%$.

Offset adjustment: offset adj. compensates for (a) stray capacitance or residual conductance of test fixture; variable ranges are 1 pF and 1 μS , or (b) residual inductance or residual resistance of test fixture. Variable ranges are 100 nH and 100 m Ω .

Accuracy

(When conductance reading is less than 100 counts and resistance reading is less than 1000 counts.) Accuracy listed in the following table applies over a temperature range of 23°C $\pm 5^\circ\text{C}$. (At 0°C to 50°C, accuracy is doubled.)

Warm-up Time: one hour required to meet all specifications.

Capacitance measurement:

Range	Test sig level-high $\pm(\% \text{ of reading} + \text{counts})$	Test sig level-low $\pm(\% \text{ of reading} + \text{counts})$
1	0.1 + 7	0.2 + 8
2	0.1 + 3	0.2 + 4
3	0.1 + 3	0.2 + 3
4**	0.4 + 3	0.4 + 3

Conductance:

Range	Test sig level-high $\pm(\% \text{ of reading} + \text{counts})$	Test sig level-low $\pm(\% \text{ of reading} + \text{counts})$
1	$0.2 + \left(7 + \frac{N_c}{1000}\right)$	$0.3 + \left(7 + \frac{2N_c}{1000}\right)$
2	$0.2 + \left(3 + \frac{N_c}{1000}\right)$	$0.3 + \left(3 + \frac{2N_c}{1000}\right)$
3, 4**	$1.2 + \left(2 + \frac{2}{1000}N_c\right)$	$1.2 + \left(2 + \frac{2N_c}{1000}\right)$

Where N_c is capacitance readout in counts.

Dissipation factor:

Range	Test sig level-high $\pm(\% \text{ of reading} + \text{counts})$	Test sig level-low $\pm(\% \text{ of reading} + \text{counts})$
1	$1.0 + \left(10 + \frac{20,000}{N_c}\right)$	$1.0 + \left(15 + \frac{30,000}{N_c}\right)$
2, 3	$1.0 + \left(10 + \frac{10,000}{N_c}\right)$	$1.0 + \left(15 + \frac{20,000}{N_c}\right)$
4**	$1.0 + \left(15 + \frac{30,000}{N_c}\right)$	$1.0 + \left(15 + \frac{30,000}{N_c}\right)$

**On Range 4, Test sig level is low only. N_c is capacitance readout in counts.

Inductance measurement

Inductance:

Range	Test sig level-high ±(% of reading + counts)	Test sig level-low ±(% of reading + counts)
1**	1.0 + 15	1.0 + 15
2	0.6 + 4	0.6 + 6
3, 4	0.2 + 4	0.3 + 6

Resistance:

Range	Test sig level-high ±(% of reading + counts)	Test sig level-low ±(% of reading + counts)
1**	$1.2 + \left(8 + \frac{2NL}{1000}\right)$	$1.2 + \left(8 + \frac{2NL}{1000}\right)$
2	$1.2 + \left(2 + \frac{2NL}{1000}\right)$	$1.2 + \left(2 + \frac{2NL}{1000}\right)$
3, 4	$0.2 + \left(2 + \frac{2NL}{1000}\right)$	$0.3 + \left(2 + \frac{2NL}{1000}\right)$

Where NL is inductance readout in counts.

Dissipation factor:

Range	Test sig level-high ±(% of reading + counts)	Test sig level-low ±(% of reading + counts)
1**	$1.0 + \left(20 + \frac{30,000}{NL}\right)$	$1.0 + \left(20 + \frac{30,000}{NL}\right)$
2, 3	$1.0 + \left(15 + \frac{10,000}{NL}\right)$	$1.0 + \left(20 + \frac{20,000}{NL}\right)$
4	$1.0 + \left(15 + \frac{20,000}{NL}\right)$	$1.0 + \left(15 + \frac{30,000}{NL}\right)$

**At Range 1, test sig level is low only where NL is inductance readout in counts.

Conductance, resistance measurement

Accuracy: when capacitance or inductance is less than 1,000 counts.

Conductance:

Range	Test sig level-high ±(% of reading + counts)	Test sig level-low ±(% of reading + counts)
1	0.2 + 8	0.3 + 9
2	0.2 + 4	0.3 + 5
3, 4***	1.2 + 4	1.2 + 4

***On Range 4, test sig level is low only.

Resistance:

Range	Test sig level-high ±(% of reading + counts)	Test sig level-low ±(% of reading + counts)
1	1.2 + 10	1.2 + 10
2	1.2 + 4	1.2 + 4
3, 4	0.2 + 4	0.3 + 4

Accuracy check: use HP Model 16021A Test Fixture.

DC bias (optional)

Internal source: DC bias is available as a plug-in board, Option 001, which has following specifications:

Range: 00.0 V to 39.9 V, variable in steps of 0.1 V.

Accuracy: ±0.2% of setting ±5 mV at 23°C ±5°C. Warm-up time is >60 min.

Output resistance: 1.5 kΩ ±10%.

Short circuit current: less than 6 mA.

Control: HP Model 16023A DC Bias Controller (available extra) or HP Model 9810/9820A Calculator when Option 005 is installed.

Control input connector: HP P/N 1251-0143, 14-pin receptacle, (Amphenol 57-40140).

Mating connector: HP Part No. 1251-0142. (Amphenol 57-30140).

External source: ±200 V maximum to BNC connector (ext input) on rear panel. Max bias current 20 mA. Input resistance 10.5 kΩ ±10%.

Monitor output: bias voltage monitoring BNC connector monitor on rear panel. Output resistance 480Ω ±10% to HCUR terminal.

General

Measuring speed:

Fixed range: 100 ms to 250 ms in C-G and L-R measurements. 160 ms to 400 ms in C-D and L-D measurements.

Autorange: 100 ms/range step added to above values.

Power: 100 V, 120 V, 220 V, 240 V ±10%, 48-66 Hz, 80 VA.

Dimensions: 88.1 mm high × 425.5 mm wide × 496.9 mm deep (3 1/2" × 16 1/4" × 19 1/8").

Weight: 10 kg (22 lb).

Accessories available:

16021A Calibration Connector.

16023A DC Bias Voltage Controller, used with Option 001.

16032A Test Leads with BNC connectors.

16033A Test Leads with miniature coaxial connectors.

Options available:

Option 001 DC Bias supply. 0.0 V to 39.9 V.

Option 002 C/L BCD output. May be used with Option 003 for simultaneous outputs +8241 Code.

Option 003 G/R/D BCD Output. +8421 Code. (See Option 002).

Option 004 Parameter Serial BCD Output. Allows selection of 1. (C or L) Data only; 2. (D or G or L) Data only; or 3. (C or L) and (D or G or L) Data — 8421 Code.

Option 005 Calculator Interface, HP 9810A/9820A or 9830A. Utilizes HP 11202A I/O Card and Cable.

Available extra.

Option 010 1 MHz Digital LCR Meter. Less 16022A

Test Fixture. Specify 16021A, 16032A, 16033A.

Model number and name:

16021A Calibration Connector	Price \$445
16023A DC Bias Controller	\$375
16032A Test Leads (BNC)	\$145
16033A Test Leads (Micro dot)	\$165
Option 001 DC Bias Supply	add \$235
Option 002 C/L BCD output	add \$125
Option 003 G/R/D BCD output	add \$125
Option 004 Parameter Serial BCD output	add \$215
Option 005 Calculator Interface	add \$370
Option 010 4721A. Less Test-Fixture-	less \$350
4721A 1 MHz Digital LCR Meter	\$4760

COMPONENT TEST

Digital high capacitance meter

Model 4282A

NEW

- Wide range—10 nF to 1 F full scale
- Dissipation factor or ohm-farad measurements
- Internal bias supply
- Digital and analog outputs for recording



Description

Hewlett-Packard's Model 4282A Digital High Capacitance Meter will make precision measurements on high value tantalum or aluminum electrolytic capacitors. Effective applications are found both in capacitor design and production testing — either in incoming or outgoing inspection.

Two types of leads are supplied with the HP 4282A. One is the standard four-wire alligator clip style, and the other, two specially designed clips that maintain the Kelvin four-wire measurement.

Two unique features of the HP 4282A are: alternating mode (displays either capacitance and dissipation factor, C-D, or capacitance and the product of ohms and farads, C-ΩF alternately and the capability to double as a three-digit DVM).

Both digital and analog outputs are available for making permanent recordings.

Four measuring frequencies, 50, 60, 100, 120 Hz come with the standard model. They represent power line frequencies and their second harmonics. Most large value capacitors are used as filters in power supplies and are operated at these frequencies. If your application requires tests at other frequencies, please refer to Models 4260A, 4265B, 4332A, 4270A, 4271A on the adjoining pages.

Specifications

Measuring functions: capacitance, dissipation factor, *ohm-farad

and dc voltage. Selectable by function switch.

***Ohm-farad:** the product of capacitance and equivalent series resistance of a capacitor.

Function switch setting	Function and display
C	Capacitance measurement.
D	Dissipation factor measurement.
ΩF	Ohm-farad measurement.
C-D	Capacitance and dissipation factor measurements alternately.
C-ΩF	Capacitance and ohm-farad measurements alternately.
V	DC bias voltage or external voltage measurements.
	Note All measurements are continuously repeated as long as unknown is connected.

Measuring ranges:

Function	Full-scale display	Over-ranging
C (capacitance)	10.000 nF to 1.0000 F, four full digits, 9 ranges in decade steps, manual selection.	18%
D (dissipation factor)	1.000 to 10.000, three full digits, 2 ranges, auto selection.	18%
Ω F (ohm-farad)	1.000 Ω mF to 10.00 mF three full digits, 2 ranges, auto selection.	18%
V (dc voltage)	10.00 V to 1.000 kV, three full digits, 3 ranges, in decade steps, manual selection (maximum voltage is 600 V).	18%

Measuring circuit: series equivalent circuit using four-terminal method.

Measuring frequencies: 50 Hz, 60 Hz, 100 Hz and 120 Hz (50 Hz and 60 Hz synchronized by line frequency). Accuracy: $\pm 1.5\%$.

Measuring voltages:

10 nF to 10 mF ranges: <1 V rms.

100 mF range: <0.1 V rms.

1 F range: <10 mV rms.

Accuracy: (+23°C $\pm 5^\circ$ C after half hour warm up): $\pm(\%$ of reading + $\%$ of full-scale).

Capacitance:

C Range	% of reading	% of full-scale
10 nF	1.0 + 0.9 · Drdg	0.2
100 nF	0.5 + 0.5 · Drdg	0.1
1 μ F to 1 mF	0.4 + 0.5 · Drdg	0.05
10 mF	1.0 + 0.5 · Drdg	0.05
100 mF	1.5 + 0.5 · Drdg	0.5
1 F	2.5 + 0.5 · Drdg	1.0

Dissipation factor:

C Range	% of reading	% of full-scale
10 nF	1.5 + 0.5 · Drdg	0.2 · Cfs/Crdg + 0.3
100 nF to 1 mF	1.5 + 0.2 · Drdg	0.2 · Cfs/Crdg + 0.3
10 mF	1.5 + 0.2 · Drdg	0.2 · Cfs/Crdg + 0.5
100 mF, 1 F	1.5 + 0.2 · Drdg	0.2 · Cfs/Crdg + 3

Ohm-farad:

C Range	% of reading	% of full-scale
10 nF	1.0 + 0.5 · Ω Frdg	0.2 · Cfs/Crdg + 0.3
100 nF to 1 mF	1.0 + 0.2 · Ω Frdg	0.2 · Cfs/Crdg + 0.3
10 mF	1.0 + 0.2 · Ω Frdg	0.2 · Cfs/Crdg + 0.5
100 mF, 1 F	1.0 + 0.2 · Ω Frdg	0.2 · Cfs/Crdg + 3

Drdg: Reading of dissipation factor.

Ω Frdg: Reading of ohm-farad.

Crdg: Reading of capacitance.

Cfs: Full-scale of C range setting.

DC voltage measurement accuracy:

10 V range: $\pm(0.05\%$ of reading + 0.1% of full-scale).

100 V and 1 kV ranges: $\pm(0.2\%$ of reading + 0.1% of full-scale).

Temperature coefficient: (referred to +23°C, and temperature range of 0°C to 50°C):

Function	Temperature coefficient
C	$\pm 0.02\%$ of reading/ $^\circ$ C
D, Ω F	$\pm 0.03\%$ of reading/ $^\circ$ C
V	$\pm 0.01\%$ of reading/ $^\circ$ C

Option 001 leakage current measurement adds following capabilities to standard model:

Leakage current measurement: (I_L)

Range: 1.000 μ A to 10.000 mA, 5 ranges, three full digits.

Overranging: 18%.

Accuracy: 1 μ A range: $\pm(2\%$ of reading + 2.0% of full-scale). 10 μ A to 10 mA ranges: $\pm(2\%$ of reading + 0.3% of full-scale).

Bias voltages: internal source: 0 to 10 V, 0 to 100 V, 2 ranges, continuously variable over each range. Maximum current is 100 mA for 10 V range and 60 mA (for 1 minute) for 100 V range.

External source: usable up to 600 V dc across ext bias terminals on rear panel.

Protective resistor: 1 k Ω for 100 V range and for external bias, 1 Ω for 10 V range.

General

DC bias voltage: 0 to 10 V, continuously adjustable with DC bias control. Maximum charging current is 100 mA.

Balancing time: normally one second (when measuring on C ranges of 10 nF through 10 mF, capacitance value near full-scale, dissipation factor less than one and without dc bias).

Reading rate: continuously variable from 0.3 seconds to 2 seconds with rate control.

Reset: initiates one reading by depressing reset int pushbutton or contact closure to ground or TTL low level at reset ext line. Mating plug for reset text jack: HP part No. 1251-0918.

Digital output: output signals: BCD + 1-2-4-8, data parallel, decimal point, function and unit, overload and unbalance, and polarity.

Level:

State	Level	Characteristics
Low	0.3 V ± 0.3 V	Max sink current 15 mA
High	3.9 V ± 1.5 V	Max load current 300 μ A

Print command output: negative going TTL pulse of approx. 1 ms.

Printer hold input: TTL low level or contact closure to ground.

Connector: mating, HP P/N 1251-0084; Amphenol 57-30360-375 (36-pin blue ribbon).

Remote programming: programmable functions, C-range, I_L range (option 001) and reset by TTL low level or contact closure to ground.

Connector: mating, HP P/N 1251-0084; Amphenol 57-30360-375 (36-pin blue ribbon).

Analogue output: DC output of 1 V full-scale in proportion to displayed value.

Accuracy: add $\pm 0.5\%$ of reading to accuracy specification.

Operating environment: 0°C to +50°C, <90% RH.

Power requirements: 100 V, 120 V, 220 V or 240 V $\pm 10\%$, 50 Hz or 60 Hz, approx. 70 VA.

Dimensions: 425 mm wide \times 88 mm high \times 467 mm deep. (16 $\frac{1}{2}$ " \times 3 $\frac{1}{2}$ " \times 18 $\frac{1}{2}$ ").

Weight: net 8.8 kg (4 lb); shipping 12.9 kg (5.86 lb).

Accessories furnished

16035A test leads: four alligator clips.

16036A test leads: two alligator-jaw clips. Power cord: 230 cm (7 $\frac{1}{2}$ ft), HP Part No. 8120-1378.

Rack mount kit: HP Part No. 5060-8739.

Model number and name:

4282A-with-option:001=(leakage current)

4282A Digital High Capacitance Meter

Price

\$3500

\$3750



COMPONENT TEST

High capacitance meters

Models 4350A/B

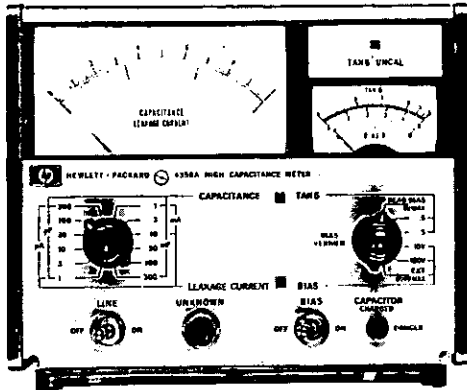

4350A



4050A

Description

Hewlett-Packard Models 4350A/B High Capacitance Meters measure high capacitances from 0.02 μF to 300 mF and simultaneously measure dissipation factor. Leakage current can be measured with the 4350A. HP's 4350A/B provides analog outputs proportional to meter deflection. Combining the 4350A/B with the 4050A Analog Comparator increases speed in sorting applications.

4350A/B Specifications*

Capacitance measurement

Capacitance:

Range: 1 μF to 300 mF full scale in 12 ranges.

Accuracy (% of full scale):

	Capacitance Range Full Scale	
Tan δ range	1 μF to 100 mF	300 mF
0 to 1	$\pm 3\%$	$\pm 4\%$
1 to 5	$\pm 4\%$	$\pm 5\%$

Tan δ :

Range: 0.5 or 5 full scale in 2 ranges.

Absolute accuracy:

0.5 full scale: ± 0.025

$$5 \text{ full scale: } \begin{array}{l} +0.06 + \frac{(\text{reading})^2}{20} \\ -0.06 + \frac{(\text{reading})^2}{25} \end{array}$$

Internal test signal:

Frequency: 120 Hz \pm 5 Hz.

Internal dc bias:

Voltage range: 0 to 6 V dc, continuously adjustable.

Response time (C and tan δ): typically 1 s.

*Refer to data sheet for complete specifications.

Tan δ uncal: Indicates the reading of tan δ is uncalibrated when the deflection of capacitance meter is below 10% or above 130% of full scale.

Leakage current measurement (4350A only)

Current:

Range: 1 μA to 10 mA full scale in 9 ranges.

Accuracy: $\pm 3\%$ of full scale.

DC bias voltage:

Internal: up to 100 V dc in 2 ranges.

External: 600 V dc max.

Warning lamp: indicates "danger" when dc voltage across an unknown is higher than 1.5 V dc.

Analog outputs

Capacitance:

1 V dc all ranges: for use with analog comparator.

1 V dc or 0.3 V dc full scale: for use with DVM.

Overrange: 25% of full scale.

Accuracy:

	Capacitance Range Full Scale	
Tan δ	1 μF to 100 mF	300 mF
0 to 1	$\pm(1.5\%$ of reading $+0.5\%$ of full scale)	$\pm 3\%$ of full scale
1 to 5	$\pm(1.5\%$ of reading $+1.5\%$ of full scale)	$\pm 4\%$ of full scale

Loss angle (δ):

Tan δ vs. analog output voltage: 0.1 V/degree

Tan δ	δ	Output Voltage
0 to 0.5	0° to 26.6°	(0 to 2.66 V dc) ± 0.13 V dc
0.5 to 5	26.6° to 78.7°	(2.66 to 7.87 V dc) ± 0.3 V dc

Residual noise: 40 mV p-p max.

General

Temperature range: 0°C to 50°C.

Power: 115 V or 230 V $\pm 10\%$, 48 Hz to 440 Hz, 38.5 VA max.

Dimensions: 198 mm wide \times 166 mm high \times 305 mm deep (7 $\frac{1}{2}$ " \times 6 $\frac{1}{2}$ " \times 12").

Weight: net, 4.8 kg (11 lb); shipping 6.8 kg (15 lb).

Accessories furnished: 16035A Test Cable with four alligator clips; 16036A Test Cable with two alligator clips.

Description

Hewlett-Packard Model 4050A Analog Comparator compares unknown voltage to preset high and low limits. Contact closures with corresponding high-go-low lights will operate external devices. HP's 4050A increases speed at which the 4350A/B Hi-C Meter or 4332A LCR Meter will operate in sorting applications.

4050A Specifications*

Input

Analog voltage: 0.1 V, 1 V, 10 V full scale.

Resistance: 0.1 V, 1 V range, 1 M Ω ; 10 V range, 100 k Ω .

Output

Limit indications: high, go, and low lights.

Relay contact: 3 SPST contacts, 50 V dc, 0.5 A max.

Connector: binding post.

Limit controls: 000 to 125 are set on digital dials.

Accuracy: $\pm 0.6\%$ of full scale (at 25°C).

Response time: typically 0.1 s.

Operating temperature: 0°C to 50°C.

Power: 115/230 V $\pm 10\%$, 48 Hz to 440 Hz, 3.85 VA max.

Dimensions: 155 mm wide \times 130.1 mm high \times 203.2 mm deep (6 $\frac{1}{2}$ " \times 5 $\frac{1}{8}$ " \times 8") standard $\frac{1}{3}$ module.

Weight: net, 2.8 kg (6 lbs 4 oz); shipping 3.6 kg (8 lbs).

Model number and name

4350A High Capacitance Meter

4350B High Capacitance Meter

4050A Analog Comparator

Price

1340

\$1255

\$790

Vector impedance meter

Model 4800A

- Measures impedance, magnitude and phase
- 5 Hz to 500 kHz
- Analog outputs for impedance magnitude, phase, and frequency

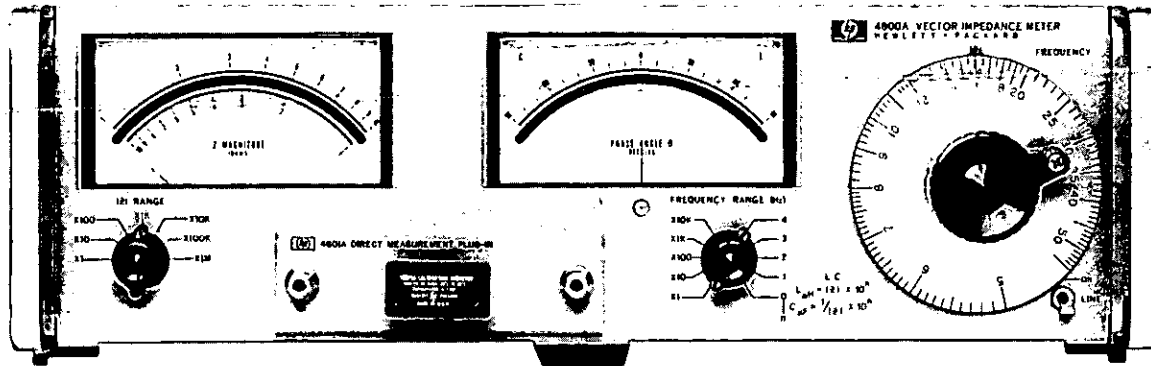

Description

Vector impedance is a quantity involving both magnitude and phase and can be graphically illustrated by a vector in the Z, θ plane. Vector impedance describes the ratio of voltage to current and phase difference between the two.

Impedance of components, complex networks, and other two-terminal devices is measured by simply connecting the "unknown" to HP's 4800A Vector Impedance Meter, selecting the desired test frequency, and adjusting the impedance range switch. Both impedance magnitude in ohms and phase in degrees are read directly. HP's Vector Impedance Meter eliminates all the tedium of traditional techniques for measuring complex impedance. It is a complete system calibrated to read the complex impedance as measured between the terminals.

HP's Vector Impedance Meter measures impedance from 1 ohm to 10 megohms over a phase range of -90° to $+90^\circ$. Frequency adjusts from 5 Hz to 500 kHz in 10 decade ranges. Three controls: impedance range switch, frequency range switch, and frequency dial, are arranged on the front panel to assure simple operation.

Besides measuring vector impedance, HP's 4800A conveniently measures components. At frequencies that are decade multiples of $1/2\pi$, as marked on the frequency dial, L and 1/C are read directly if the phase is approximately $\pm 90^\circ$ respectively. R is equal to the impedance magnitude at frequencies where the phase is approximately 0° . The vector impedance meter also yields Q of circuits and inductors by using either $f_0/\Delta f$, $R_p/\omega L$ or the $\omega L/R_s$ technique. A vector impedance calculator is furnished with each instrument for quick determination of equivalent series resistance, reactance, inductance, capacitance, and Q.

HP's 4800A is equipped with analog outputs for three parameters: impedance magnitude, impedance phase, and frequency. These outputs may be used in conjunction with a two-pen X-Y recorder to provide permanent traces. The rear panel provision for an external oscillator input makes possible swept frequency characterization of "unknowns". The impedance meter can be swept over any decade range of frequency and impedance within the range of the instrument. Analog outputs can also be connected to a digital voltmeter for a high resolution, digital readout with excellent repeatability.

Specifications

Frequency characteristics

Range: 5 Hz to 500 kHz in five bands: 5 to 50 Hz, 50 to 500 Hz, 0.5 to 5 kHz, 5 to 50 kHz, 50 to 500 kHz.

Accuracy: $\pm 2\%$ from 50 Hz to 500 kHz, $\pm 4\%$ from 5 to 50 Hz, $\pm 1\%$ at 15.92 on frequency dial from 159.2 Hz to 159.2 kHz, $\pm 2\%$ at 15.92 Hz.

Monitor output: level: 0.2 V rms minimum; source impedance: nominally 600 ohms in series with 50 μ F.

Impedance measurement characteristics

Range: 1 ohm to 10 megohms.

Meter scale range: 1 ohm to 10 ohms times impedance range.

Impedance ranges: X1, X10, X100, X1k, X10k, X100k, X1M.

Accuracy: $\pm 5\%$ of reading.

Phase angle measurement characteristics

Range: 0° to $\pm 90^\circ$.

Accuracy: $\pm 6^\circ$.

Calibration: increments of 5° .

Direct inductance measurement capabilities

Range: 1 μ H to 100,000 H, direct reading at decade multiples of 15.92 Hz.

Accuracy: $\pm 7\%$ of reading for Q greater than 10 from 159.2 Hz to 159.2 kHz; $\pm 8\%$ of reading for Q greater than 10 at 15.92 Hz.

Direct capacitance measurement capabilities

Range: 0.1 pF to 10,000 μ F, direct reading at decade multiples of 15.92 Hz.

Accuracy: $\pm 7\%$ of reading for D less than 0.1 at 159.2 Hz to 159.2 kHz, $\pm 8\%$ of reading for D less than 0.1 at 15.92 Hz.

Measuring terminal characteristics

Configuration: electrical: both terminals above ground, ground terminals provided for shielding convenience; mechanical: binding posts spaced $1/4$ " at centers.

Waveshape: sinusoidal.

External oscillator requirements: 0.9 V $\pm 20\%$ into 20 k Ω .

Recorder outputs

Frequency: level: 0 to 1 V nominal; source impedance: 0 to 1000 ohms nominal; proportional to frequency dial rotation.

Impedance: level: 0 to 1 V nominal; source impedance: 1000 ohms nominal.

Phase angle: level: 0 ± 0.9 V nominal; source impedance: 1000 ohms nominal.

Accessories furnished: 13525A Calibration Resistor, 00610A Terminal Shield.

Dimensions: 426 mm wide \times 133 mm high \times 467 mm deep (16 $3/4$ " \times 5 $1/4$ " \times 18 $3/4$ ").

Weight: net, 10.8 kg (24 lb); shipping, 13.5 kg (30 lb).

Power: 115 or 230 V $\pm 10\%$, 48 to 440 Hz, 29.7 VA.

4800A Vector Impedance Meter

S1910

COMPONENT TEST

Q Meter

Model 4342A

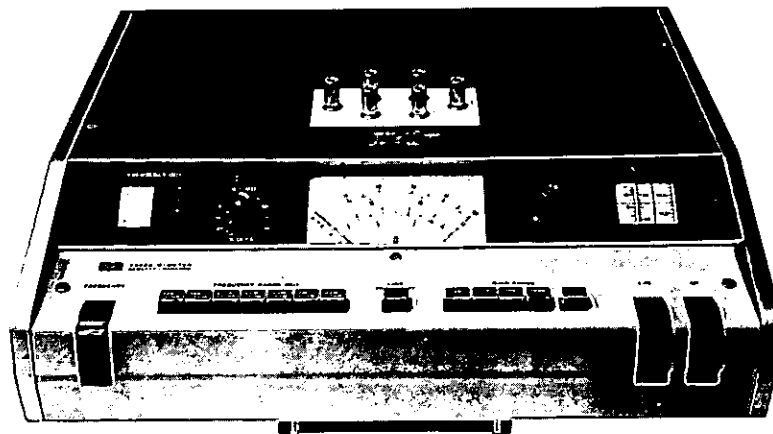

Description

The direct-reading expanded scale of the 4342A permits measurement of Q from 5 to 1000 and readings of very small changes in Q resulting from variation in test parameters. The 4342A is solid state with the elimination of specially matched, fragile thermocouple components.

The 4342A will measure dissipation factor and dielectric constant of insulating materials. The Q meter can measure coefficient of coupling, mutual inductance, and frequency response of transformers. RF resistance, reactance, and Q of resistors and capacitors can also be determined.

Push button operation of frequency range and Q/ Δ Q range selection provides straightforward measurement. Automatic indication of meter scales, frequency dials and frequency multipliers are featured, adding to simplicity and reading speed.

Specifications

RF characteristics

RF range: 22 kHz to 70 MHz in 7 bands: 22 to 70 kHz, 70 to 220 kHz, 220 to 700 kHz, 700 to 2200 kHz, 2.2 to 7 MHz, 7 to 22 MHz, 22 to 70 MHz.

4342A Option 001: 10 kHz to 32 MHz in 7 bands: 10 to 32 kHz, 32 to 100 kHz, 100 to 320 kHz, 320 to 1000 kHz, 1 to 3.2 MHz, 3.2 to 10 MHz, 10 to 32 MHz.

RF accuracy: $\pm 1.5\%$ from 22 kHz to 22 MHz; $\pm 2\%$ from 22 MHz to 70 MHz; $\pm 1\%$ at "L" point on frequency dial.

4342A Option 001: $\pm 1.5\%$ from 10 kHz to 10 MHz; $\pm 2\%$ from 10 MHz to 32 MHz; $\pm 1\%$ at "L" point on frequency dial.

RF increments: approximately 1% resolution.

Q measurement characteristics

Q range: 5 to 1000 in 4 ranges: 5 to 30, 20 to 100, 50 to 300, 200 to 1000.

Q accuracy: % of indicated value: (at 25°C).

Q	4342A & 4342A Opt. 001		4342A
	22 kHz - 30 MHz		30 MHz - 70 MHz
5 - 300	± 7		± 10
300 - 600	± 10		± 15
600 - 1000	± 15		± 20

Q increments: upper scale: 1 from 20 to 100; lower scale: 0.5 from 5 to 30.

Δ Q range: 0 to 100 in 4 ranges: 0 to 3, 0 to 10, 0 to 30, 0 to 100.

Δ Q accuracy: $\pm 10\%$ of full scale.

Δ Q increments: upper scale: 0.1 from 0 to 10; lower scale: 0.05 from 0 to 3.

Inductance measurement characteristics

L range: 0.09 μ H to 1.2 H, direct reading at 7 specific frequencies.

L accuracy: $\pm 3\%$ after substitution of residuals (approx. 10 nH).

Resonating capacitor characteristics

Capacitor range: main dial: 25 to 470 pF; vernier dial -5 to +5 pF.

Capacitor accuracy: main dial: $\pm 1\%$ or 1 pF, whichever is greater; vernier dial ± 0.1 pF.

Capacitor increments: main dial: 1 pF from 25 to 30 pF; 2 pF from 30 to 200 pF; 5 pF from 200 to 470 pF; vernier dial: 0.1 pF.

General

Rear panel outputs

Frequency monitor: 170 mV rms min. into 50 Ω .

Q analog output: 0 to 1 V ± 50 mV dc after 15 minutes warmup, proportional to meter deflection. Output impedance approximately 1 k Ω .

Over limit signal output: contact closure at the rear panel. Relay contact capacity 0.5 A/15 VA.

Over limit display time: selectable, 1 s or continuously on, after limit exceeded.

Temperature range: 0°C to 50°C.

Power: 115 or 230 V $\pm 10\%$, 48-440 Hz, 27.5 VA max.

Dimensions: 425 mm wide \times 138 mm high \times 414 mm deep, (16 $\frac{3}{4}$ " \times 5 $\frac{1}{16}$ " \times 16 $\frac{3}{16}$ ").

Weight: net, 14 kg (31 lb); shipping, 18.45 kg (41 lb).

Accessories available:

HP 16014A: Series Loss Test Adaptor is designed for measuring low impedance components, low-value inductors and resistors, and also high-value capacitors. Using the adaptor adds convenience in connecting components in series with the test circuit of the 4342A Q Meter. This adaptor consists of a teflon printed-circuit base on which are mounted binding posts, to accept the Reference Inductors, and a pair of low-inductance series terminals for the unknown.

HP 16462A: Auxiliary Capacitor is designed to extend the Q and L measurement capability of the 4342A Q Meter. It is especially useful for measuring small inductors at low frequencies.

HP 16470A reference inductors: A range of 20 inductors, any of which can be supplied separately, is available for use with the 4342A Q Meter for measuring the RF characteristics of capacitors, resistors, and insulating materials. These inductors have three terminals. One terminal is connected to the case to stabilize measurements.

Model number and name

Option 001 Frequency Range

16014A, Series Loss Test Adaptor

16462A, Auxiliary Capacitor

16470A, Reference Inductors, for a set of 20 or 37 each.

4342A, Q Meter

Price

add \$163

\$51

\$240

\$740

\$1850

COMPONENT TEST

Decade capacitors and attenuators

Models 4440B, 4436A, 4437A, 350D

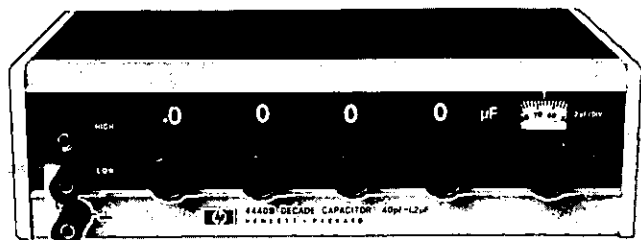

4440B

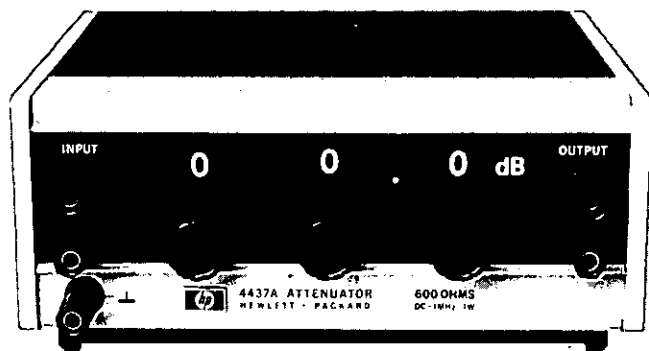

4437A

4440B Description

The Hewlett-Packard 4440B Decade Capacitor is a high accuracy instrument providing usable capacitances from 40 pF to 1.2 μ F. Its 0.25% accuracy makes it an ideal aid for circuit design or as a working standard.

Use of silvered-mica capacitors in four decades of 100 pF provides higher accuracy, low dissipation factors and good temperature coefficient. An air capacitor vernier provides 100 pF (from 40 pF to 140 pF) with resolution of 1 pF. Capacitors are housed in a double shield in such a way that increased capacitance from two terminals to three terminals is held to 1 pF.

4440B Specifications

Capacitance: 40 pF to 1.2 μ F in steps of 100 pF with a 40 pF to 140 pF variable air capacitor providing continuous adjustment to better than 2 pF between steps.

Direct reading accuracy: $\pm(0.25\% + 3 \text{ pF})$ at 1 kHz for three-terminal connection.

Resonant frequency: typical values of the resonant frequency are 450 kHz at 1 μ F, 4 MHz at 0.01 μ F and 40 MHz at 100 pF.

Dissipation factor: 0.001 maximum at 1 kHz.

Temperature coefficient: +70 ppm/ $^{\circ}$ C.

Insulation resistance: 5 G Ω minimum, after 5 minutes at 500 V dc.

Maximum voltage: 500 V peak.

Weight: net, 2.5 kg (5 1/2 lb); shipping 3.6 kg (8 lb).

Dimensions: 264 mm wide \times 152 mm deep \times 76 mm high (11" \times 6" \times 3").

4436A/4437A Description

The Hewlett-Packard Models 4436A/4437A Attenuators provide accurate steps of attenuation with 0.1 dB resolution for power-level measurements, communication system tests, and gain or loss measurements on filters and amplifiers, and similar equipment.

4436A Specifications

Maximum attenuation: 119.9 dB.

Attenuation increments: 0.1 dB.

Input/output impedance: 600 Ω , balanced.

Frequency range: dc to 1.5 MHz (0 to 110 dB) dc to 1 MHz (0 to 119.9 dB).

Accuracy

Attenuation	100 kHz	1 MHz	1.5 MHz*
0 ~ 60 dB	± 0.1 dB	± 0.2 dB	± 0.2 dB
60 ~ 90 dB	± 0.1 dB	± 0.3 dB	± 0.3 dB
90 ~ 110 dB	± 0.2 dB	± 0.5 dB	± 0.5 dB
110 ~ 119.9 dB	± 0.3 dB	± 0.1 dB	

*Typical value

Maximum input power: +30 dBm.

DC isolation: signal ground may be ± 300 V dc from external chassis.

Dimensions: 198 mm wide \times 77 mm high \times 167 mm deep (7 3/4" \times 3" \times 6 5/8").

Weight: net, 1.5 kg (3.3 lb); shipping, 2.7 kg (6 lb).

4437A Specifications

The Model 4437A is a 600 ohms unbalanced type, and its specifications are identical to the 4436A.

350D Description

Two attenuator sections make up the Hewlett-Packard 350D Attenuator. One section is a 100 dB attenuator, adjustable in 10 dB steps. The other is a 10 dB attenuator, adjustable in 1 dB steps.

350D Specifications

Attenuation: 0 to 110 dB, 1 dB and 10 dB steps.

Power capacity: 600 Ω unbalanced; 5 W (55 V dc or rms) max, continuous duty.

DC isolation: signal ground may be ± 500 V dc from chassis.

Accuracy

10 dB section:

	0 dB	10 dB
dc to 100 kHz	$< \pm 0.125$ dB/step	
100 kHz to 1 MHz	$< \pm 0.25$ dB/step	

100 dB section:

	0 dB	70 dB	100 dB
dc to 100 kHz	$< \pm 0.25$ dB	$< \pm 0.5$ dB/step	
100 kHz to 1 MHz	$< \pm 0.5$ dB	$< \pm 0.75$ dB/step	

Dimensions: standard Hewlett-Packard 1/3 module 130 mm wide \times 159 mm high \times 203 mm deep (5 1/8" \times 6 1/4" \times 8").

Weight: net, 1.8 kg (4 lb); shipping 2.7 kg (6 lb).

Model number and name

4440B Decade Capacitor	\$530
4436A Attenuator	\$790
4437A Attenuator	\$530
350D Attenuator	\$191



DIGITAL CIRCUIT TEST AND ANALYSIS

The IC troubleshooters

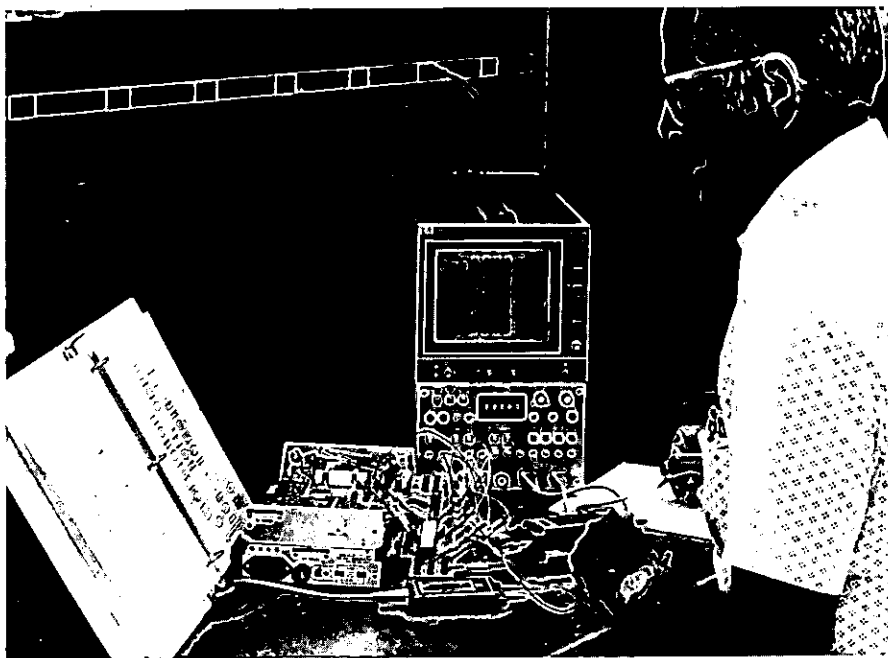

Introduction

Growth in digital IC use continues—and so does the problem of troubleshooting IC circuits. But, it is now possible to localize circuit faults in a fraction of the time it takes using analog techniques by approaching digital problems with digital troubleshooting instruments. Analysis of circuit operation is direct because viewing logic activity with logic analysis tools means that you "see" logic states and pulse activity at a glance, without interpretation.

The need for education has also grown stride for stride with the huge growth of IC usage. Both needs (troubleshooting and training) are commonly based, because well trained logic personnel are by their nature good IC troubleshooters. The 5035T Logic Lab combines these concepts by providing an HP-quality learning experience—even for those users who already know part of the digital story.

HP also provides additional learning tools such as Application Notes 163-1, Techniques of Digital Troubleshooting, and 167, The Logic Analyzers. These are available through local HP Sales Offices.

Electrical vs. functional analysis

Analysis of a digital circuit can be done in basically two ways:

- a. Electrical measurement
- b. Functional analysis

While the goal of both methods may be similar, i.e., to examine IC's, subassemblies, or systems for proper operation, the techniques are not the same. In fact they are dissimilar in such a way that needs careful definition.

Electrical analysis

The traditional analog picture of absolute voltage versus sweep time allows careful an-

alysis of electrical parameters. This is true because the important information—amplitude versus time—is the information that the waveform carries. This method can help decipher noise, ringing, spikes, constant DC levels, voltage swings, and so forth. Further, it is the analysis domain in which typical users are most experienced and have the most confidence. The increase in complexity of digital systems puts a very severe test on electrical analysis, however. Many times the traditional voltage vs. time window is extremely difficult to position accurately within a digital data stream. In addition, electrical viewing of digital signals imposes an extra burden: the signal must be interpreted to extract only pertinent information required, while disregarding parameters which have little effect on circuit operation. The net effect is to slow down digital analysis when using electrical methods.

Functional analysis

Digital information is often nonrepetitive. Extremely long (and fast), data sequences are common. Also, parameters which are significant for analog analysis are less important in a digital measurement. As an example, amplitude is important only in that voltage must be above or below threshold values (logic HIGH, or logic LOW). Also time is often not important in an absolute sense, but becomes critical when related to "system time," or rather the clock rate of a system in operation. Thus, a functional measurement consists of an observation of digital information (logic HIGH or LOW) versus system time (CLOCK).

Using this definition of functional measurement, we can now construct a hierarchy of logic state troubleshooting levels. Each level supplies only the information necessary for that level of digital troubleshooting.

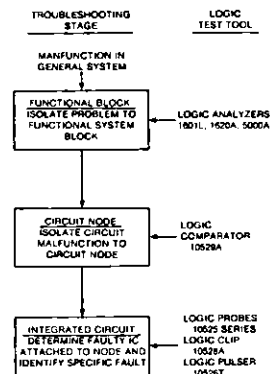

Figure 1. Digital troubleshooting is fast and efficient using the HP family of troubleshooting tools. Each instrument provides a functional indication of logic state activity, whether the problem is at the system level or isolated down to an individual IC.

Logic Analyzers Display requirements

To effectively troubleshoot digital circuits, several basic things are required:

1. **A display:** a window or picture used by the operator to look at logic activity.
2. **A reference:** some trigger point that is sensibly related to the data to be displayed, or a method of defining a unique trigger point within a data sequence.
3. **An indexing method:** the ability to move the display window back and forth in time from the reference.
4. **Storage:** the ability to store and call back single-shot events for detailed analysis.

Large numbers of "channels" (sets of data lines), are cumbersome to interpret when the user is only interested in logic state vs. system time. But, Logic Analyzers such as the HP 1601L solve this problem by displaying a functional picture of groups of data bits (words), versus clock which is very easy to use when examining functional relationships.

The displays are in terms of logic HIGH's (ones) and LOW's (zeros) versus clock cycle. Referencing is accomplished using trigger switches—these allow selection of a unique trigger point. Further, the display may be moved in time from the trigger point using digital delay in either a positive or negative direction.

Negative digital delay is provided due to the inherent storage features of logic analyzers—this allows the instrument to display a number of events leading up to a selected trigger event. The Model 5000A Logic Analyzer, for example, can display up to 64 bits (in Serial A mode), of data that occur before the trigger point.

Positive delay allows movement of the display downstream from the trigger. For instance, in a disc memory the start of a sector

may be the only available unique trigger point, yet the data to be analyzed may be thousands of bits downstream from the trigger. An analyzer with digital delay can position the display window precisely, and without jitter, at the exact location of the character or signal to be examined.

In digital systems very low repetition rate or single-shot events are encountered that require storage to permit analysis. For example, "once per keystroke" calculator sequences fall into this category. Logic Analyzers contain sufficient memory to capture and store such events, thus they are highly useful in single-shot applications.

Digital triggering and delay are necessary for functional analysis, but these features are also of great value when "aiming" or positioning electrical analysis windows on oscilloscopes. These capabilities are needed for both serial and parallel data stream analyses, because they allow a user to "window" in on microsecond events that occur as part of very long data sequences. Thus, a Logic Analyzer can provide trigger signals for electrical analysis of pulses, if required.

Triggering Serial data

In serial data analysis, the problem of data pattern recognition can be solved if the data or instruction portions of a serial word are known. It then becomes possible to generate a unique trigger from a known serial event. If a pattern set on the Model 1620A Pattern Analyzer, for example, matches the bits contained in the instruction portion of a serial word, a trigger is generated. Thus, a unique trigger is defined to allow analysis of serial data streams. Added to this is the capability of digital delay which allows further indexing from the user-selected trigger point.

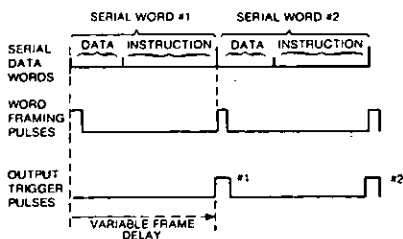

Figure 2. Since frame delay and bit pattern can be user-defined, pattern recognition triggering on serial data can be set to occur when the instruction portion of a serial word matches a user-selected bit pattern.

Parallel data

For parallel data analysis, it is often necessary to trigger on the simultaneous occur-

rence of several events. For example, if one or more channels of data go high at the same point in time that the CLOCK signal goes high, a trigger could be generated at this point. Additionally, the selected trigger events could be either high or low polarity signals.

Triggering need not be clock-related, but instead can be asynchronous. This allows the user to initiate the display sequence on a signal that might not be present when the clock samples the inputs to the analyzer. Signals such as spikes, or other random events can therefore be captured and displayed.

Trigger probes

The HP model 10250 series Trigger Probes feature TTL, MOS, and ECL compatibility, a 4-bit AND gate trigger, and selectable bit levels (HI, LO, OFF). The circuit-powered probes provide 4-bit pattern recognition triggering for digital signal analysis and may be used for both functional and electrical analysis.

Nodal isolation

Once a digital circuit malfunction is detected by an operator using a logic analyzer, other test instruments may be used for fast analysis of a system or circuit.

When a fault has been isolated to a particular circuit area or circuit board, a hand-held group of low-cost instruments are used to observe specific IC's. These products are designed to test digital IC's in-circuit, and they are extremely valuable in their ability to isolate logic faults to a node.

Logic comparison

The time-proven technique of logic comparison can be used to locate specific faulty nodes by testing an IC dynamically within a circuit. This allows the IC to be tested without removing it from the board, or from its normal signal sources. Products such as the Model 10529A Logic Comparator test the responses of a circuit-installed IC against a known-good IC plugged into the Comparator. This method is not affected by faulty signals in the system or by incorrectly operating feedback loops because the Comparator looks for expected outputs based on given inputs to two like devices. The LED display then indicates errors in IC operation.

Nodal analysis

Once a bad circuit node (see Figure 3.) has been isolated, there is the further problem of determining just which IC connected to the node is faulty. To help with this, HP manufactures several logic state stimulus-response, in-circuit logic testers.

Logic probes

The 10525T Logic Probe detects levels or pulses anywhere in a circuit, and displays

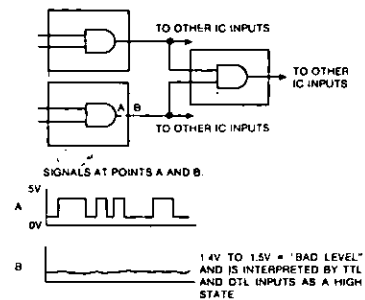

Figure 3. A typical IC failure, an open output bond, allows all inputs normally driven by that output to float to a "bad" level. This is usually interpreted as a logic high by the inputs, thus inputs driven by an open bond respond as though a static high signal is applied.

them by a band of light around the probe tip. Circuits that are normally low and are then pulsed high are indicated by the light turning on periodically. Logic highs that are pulsed low are displayed by having a solidly lit band that turns off momentarily. The probe also detects either very fast, or high frequency pulse activity, and "stretches" them to provide a display at a 10 Hz rate.

While the 10525T probe is used for TTL/DTL applications, probes for ECL, CMOS, HiN1L, and HTL logic families are described on Page 83.

Logic clip

A multi-pin logic state indicator, the Model 10528A Logic Clip indicates the states of either 14- or 16-pin DIP packages. Each pin is displayed by an individual LED, which allows a user to easily follow input versus output relationships. When a circuit's clock rate is slowed down or stopped, the Clip provides a very useful in-circuit test of a device's truth table.

Logic pulser

The model 10526T Logic Pulser provides a unique capability: the ability to inject digital pulses between gates. The Pulser automatically injects the correct polarity, and the 0.65 ampere, 0.3 microsecond pulse has sufficient capability to drive a low node high or a high node low.

Stimulus-response testing

The Pulser/Probe or Pulser/Clip combination helps the user to identify the faulty circuits causing a system malfunction. The logic test instruments mentioned here permit arbitrary signal injection and readouts between gates. Thus, an added capability is provided—the digital troubleshooter: the ability to stimulate a circuit and monitor it for an output response.

DIGITAL CIRCUIT TESTERS & ANALYZERS

10 MHz, 12 Bit parallel state analyzer

Model 1601L

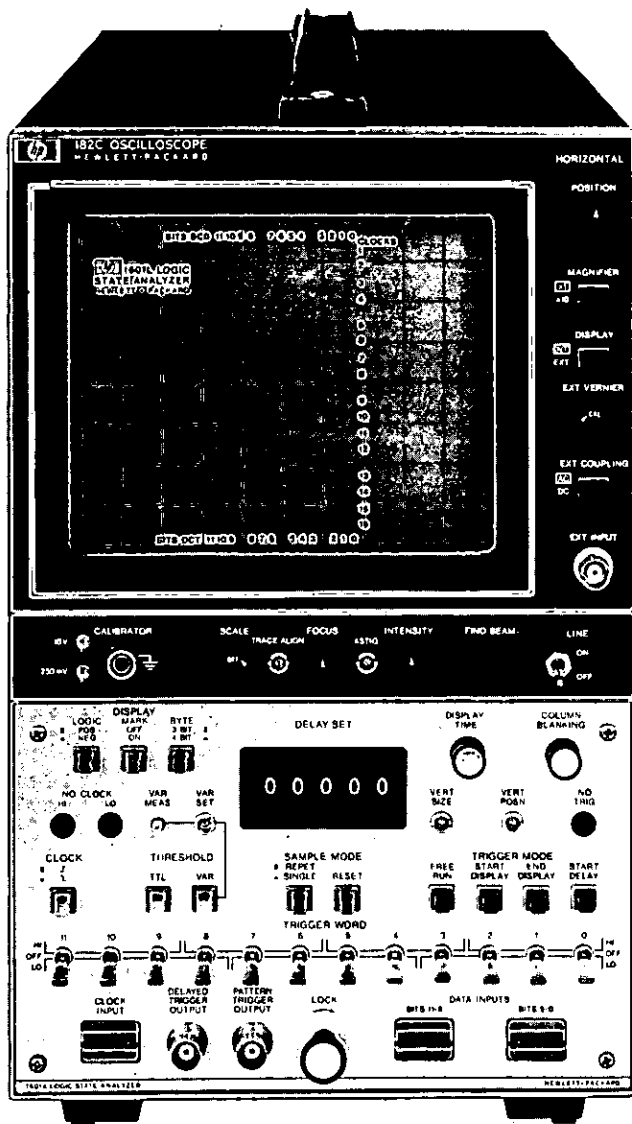
NEW

1601L Logic State Analyzer

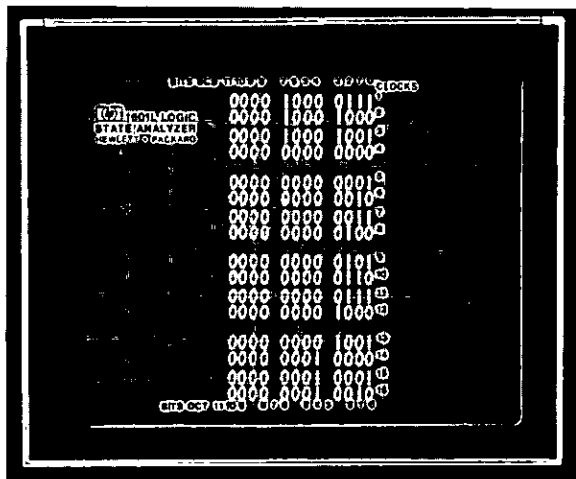

Model 1601L Logic State Analyzer shows a BCD counter resetting prematurely. The display shows that the counter counts to 89 and then returns to zero instead of counting to 90 and continuing.

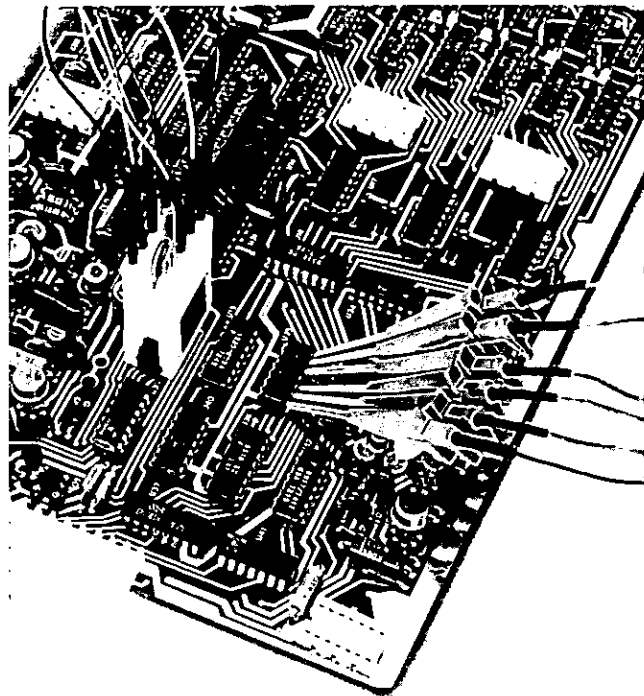

Small, dual purpose probes simplify probing in compact digital circuits. The probes are small enough to connect to adjacent pins on dual in-line packages and the tips can be slipped off the probe wire for direct connection to 0.6 mm (0.025 in.) square pins, IC test clips, and wire wrap pins.

The Model 1601L Logic State Analyzer provides a new measurement capability with quick comprehension of complex digital processes displayed in an easy-to-read format. Twelve parallel data stream measurements at clock speeds to 10 MHz furnish fast functional isolation of digital problems to basic circuit elements. You save time in digital design and troubleshooting with the unique display that uses the same format as truth tables and textbooks.

Data bits in one and zero character form are written horizontally and correspond to the data points where the data probes are connected. The 12 channels (8 bit words with four qualifiers) are displayed vertically in synchronization with 16 consecutive clocks or strobes, maintaining system timing and data relationships. For easy interpretation, the display can be formatted in octal groups of three or groups of four to match the system under test. A logic sense switch is available to match the displayed pattern to either positive or negative true logic systems.

Digital triggering

Triggering occurs in clock synchronism when data matches the preset word with the 12 parallel trigger switches. Triggering capabilities are so varied that the analyzer can easily access virtually any desired 16 word sequence in the data stream. The trigger word can start the counter to delay the display by any preset number of clock cycles (up to 99 999) after the trigger word.

Start display triggering: In Start Display mode, you trigger the analyzer on a unique trigger word and display the trigger word with the 15 following words as they are clocked through a system. The Start Display mode is valuable for paging through a system while following an algorithm to verify operation or to quickly determine where a machine takes a wrong path. A convenient MARK pushbutton increases trigger word intensity for quick recognition of where the Analyzer triggered.

End display triggering: The analyzer's 16 word digital memory captures events leading up to and including the trigger word permitting you to retain and display "negative time." This negative time capability coupled with single sample operation is extremely valuable for troubleshooting, because you can trigger on an illegal or unallowed state and see what led up to the machine malfunction. Fault isolation is much easier, since you can see why an error occurred rather than just the results of the error.

Start delay triggering: When the data you want to see does not immediately follow the desired trigger word, digital delay positions the 16 word "window" an exact number of clock pulses (0 - 99 999) from the trigger word. Digital delay is useful for moving the display window past wait loops, monitoring the contents of tape or disc memories, and measuring lengths of subroutines.

Free run: Free run is equivalent to setting all trigger switches to OFF (don't care) which clocks the display in synchronism with the clock input. This mode aids in troubleshooting a machine by clearly displaying active (superimposed ones and zeros) and inactive (unchanging) data lines.

Clock and trigger indicators

When a display is not present, the No Clock and No Trigger indicators quickly pinpoint the problem and tell you what is preventing a display. The No Clock indicators inform you when the clock input does not cross the logic threshold and will indicate if the clock is above (Hi) or below (Lo) threshold. A TTL Threshold selection gives you convenient compatibility with systems using TTL logic; and a Variable Threshold selection permits adjustment over a +10 V to -10 V range. Absence of trigger signal is shown by the No Trigger indicator which means that the input data does not match the Trigger Word switch setting.

Pattern trigger and delayed trigger outputs

Pattern Trigger and Delayed Trigger Outputs are very useful signals that extend troubleshooting capabilities in digital circuit analysis. A Pattern Trigger Output signal is generated each time the pattern set on the trigger word switches occurs and can be used to synchronize an oscilloscope for electrical analysis at the digital point in time a problem occurs. A Delayed Trigger Output signal is generated coincident with the first displayed word. In the Start Delay mode this delayed output can be used to synchronize an oscilloscope with data that does not occur immediately after the trigger word.

Versatile probes

To simplify probing in compact digital circuits, small, dual purpose probes were developed for direct connection to dual-in-line packages. These probes are small enough to connect to adjacent pins on DIP's and the tips can be slipped off the probe wire for direct connection to 0.6 mm (0.025 in.) square pins, IC test clips, and wire wrap pins.

1601L Specifications

Clock and data inputs

Repetition rate: 0 to 10 MHz

Input RC: 40 ± 3 kΩ shunted by ≤ 14 pF.

Input bias current: ≤ 30 μA.

Input threshold: TTL, fixed at approx. +1.5 V dc; variable, ± 10 V dc.

Maximum input

Level: +15 V dc; -15 V dc.

Swing: 15 V peak from threshold.

Minimum input swing: 0.5 V + 5% of absolute threshold voltage p-p.

Minimum clock pulse width: 25 ns.

Minimum setup time: time data must be present prior to clock transition, 35 ns.

Minimum hold time: time data must be present after clock transition, zero.

Display rate

Variable: from < 40 ns to > 5 s.

Pattern trigger and delayed trigger outputs

High: ≥ 2 V into 50 ohms (line driver interface).

Low: < 0.4 V into 50 ohms (line driver interface).

Pulse duration: approx. 40 ns (RZ format).

General

Weight: net, 14.4 kg (31.75 lb); shipping 19.9 kg (43.75 lb).

Power: 115 V or 230 V ± 10%, 48 to 440 Hz, 200 VA max.

Probe power: supplies power to operate one HP Model 10230B Clock Probe and two HP Model 10231B Six Bit Data Probes.

Dimensions: 201.6 mm wide, 338.1 mm high, 498.5 mm deep overall (7 1/8, 13 1/8, 19 3/8 inches).

Operating environment: temperature, 0 to 55°C (+32°F to +130°F); humidity, to 95% relative humidity at 40°C (104°F); altitude, to 4.6 km (15 000 ft); vibration, vibrated in three planes for 15 min. each with 0.254 mm (0.010 in.) excursion, 10 to 55 Hz.

Accessories supplied: blue CRT mask, 2.3 m (7.5 ft) power cord, Operating and Service Manuals, one Model 10232B probe package containing one Model 10230B Clock Probe and two Model 10231B Six Bit Data Probes, and a blue light filter (P/N 01601-02701) for the 182 display unit.

Model 1601A logic state analyzer

A Logic State Analyzer is also available as the Model 1601A and may use any 180 series mainframe (184 not recommended) as a display unit. The 1601A includes a Model 10232B probe package containing one Model 10230B Clock Probe, two Model 10231B Six Bit Data Probes, and two blue light filters, one for 182 (P/N 01601-02701) and one for 180 (P/N 01601-02702) series display units.

Accessories

Probes: Although clock and data probe assemblies are supplied with the 1601L and 1601A, they may be ordered separately by model number.

Clock probe: Model 10230B Clock Probe includes interconnecting cable with pod and two miniature clock and ground leads with tips.

Six bit data probe: Model 10231B Data Probe includes interconnecting cable with pod, six miniature data leads and one ground lead (P/N 10231-68702) with tips (P/N 10230-62101), and pod decals (for bits 0-5 and bits 6-11).

Model number and name

1601L Logic State Analyzer (complete)	\$3050
1601A Logic State Analyzer Plug-in (includes probes)	\$1850
10230B Clock Probe	\$130
10231B Data Probe	\$190

DIGITAL CIRCUIT TEST AND ANALYSIS

Logic analyzer

Model 5000A

- Logic state vs system time display
- Single shot storage
- 15 ns spike detection
- Negative time display
- Precision digital delay
- Compatible with all logic families

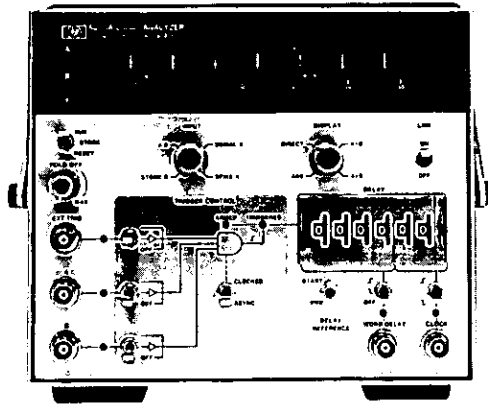

The 5000A Logic Analyzer provides a unique analysis capability by allowing the operator to "see" data at a circuit node exactly like the digital circuitry being examined, with the same timing relationships and format. The analyzer's display is totally digital in nature with amplitude being expressed in a digital format (logic highs and lows) and time as digital time relative to defined clock transitions (clock cycles).

The totally digital nature of the Logic Analyzer allows the user to approach a digital problem in its own domain. The key to this domain is the utilization of the time base of the system under examination as the time base for the Analyzer.

This ability to see the data in the same timing diagram format as the system under examination, allows fast functional isolation of a circuit malfunction to the basic gate or other circuit element which is causing a problem.

Display

The 1 M Ω data inputs to the Logic Analyzer will accept data exactly the way a device such as D flip-flop or shift register does. The Analyzer samples the input data on a defined clock transition (edge) and displays it in terms of bits referenced to the clock of the system under test. These 1's (on LED's) and 0's (off LED's) can be directly compared to the timing diagram of the circuit node.

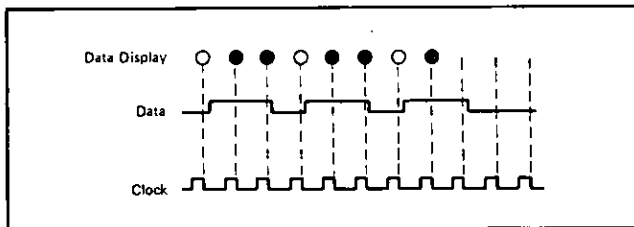

The data display of the Logic Analyzer consists of two rows of 32 LED indicators with each indicator representing the logic state of the signal during a particular clock transition. The Analyzer offers display flexibility to the operator by providing two separate display channels (windows), each with a 32 bit capability. If a larger display window is needed, a second Analyzer mode may be selected which extends the A channel display to a full 64 bits.

Digital triggering

In any display of information with respect to time or events, there must exist some unique sync or starting point for the display. Definition of this point in a digital waveform requires a deviation from the traditional negative or positive slope triggering technique. The 5000A Logic Analyzer utilizes a new digital triggering format which allows indexing to any position within a data sequence by selecting a signal at

either the A or B input, the External Trigger input, or logical AND combinations of two or three of these inputs or their complements. If more than three data inputs are required to define a unique starting point within a sequence, the parallel triggering capability of the Logic Analyzer may be greatly expanded by use of the 10250 series of trigger probes. Use of the 10250 provides up to six parallel bits of triggering and two 32 bit display channels; two 10250's will allow nine parallel bits of triggering and one 64 bit display channel.

Another unique mode of display position reference offered exclusively by the Logic Analyzer is "asynchronous triggering." This triggering technique allows a display sequence to be initiated on a signal that is not present when the inputs are sampled on the selected clock transition (not accessible to synchronous triggering).

This event could be a *spike* or a signal that occurs prior to the present burst of clock pulses.

Digital delay

If the desired data display is not present immediately following the trigger, the variable digital delay of the Analyzer allows repositioning of the display to any point within the data sequence. The 32-bit "display window" can be moved with digital preciseness an exact number of clock pulses relative to the fixed trigger point. Data occurring far downstream in a bit sequence becomes conveniently visible just by dialing the appropriate delay number into the front-panel thumb-wheel delay register.

The Logic Analyzer also offers a look-ahead or "negative delay" feature. The Analyzer always has access to the last 64-bits of data prior to the occurrence of the trigger and has the ability to display this data if desired. Thus, not only can a failure mode be observed, but the sequence of events which lead to the failure can now be displayed for analysis.

Single shot storage

The digital nature of the Analyzer makes single shot storage an inherent capability. By simply placing the Analyzer in the "STORE" position, both input channels will capture the next data sequence and hold this data until reset. It is no longer necessary to adjust a myriad of controls if storage is required.

If selective storage is desired, the "STORE B" mode may be selected. In this mode one channel of data may be held while the other continuously accepts new data. This mode may be used for storing a reference of known good data to which succeeding data can be compared.

Spike detection

One of the Logic Analyzer's special troubleshooting capabilities consists of being able to detect spikes as narrow as 15 ns between clock pulses in a data stream. When placed in the "SPIKE A" mode, the

Analyzer ignores synchronous data and only indicates the location of spikes. These spikes may be caused by race conditions, ringing, noise, or design and are defined as more than one transition of the data on the A channel between clock cycles.

The "SPIKE A" mode, used in conjunction with the digital DELAY, can be used to look for spikes anywhere in a long serial data stream even on a single shot basis.

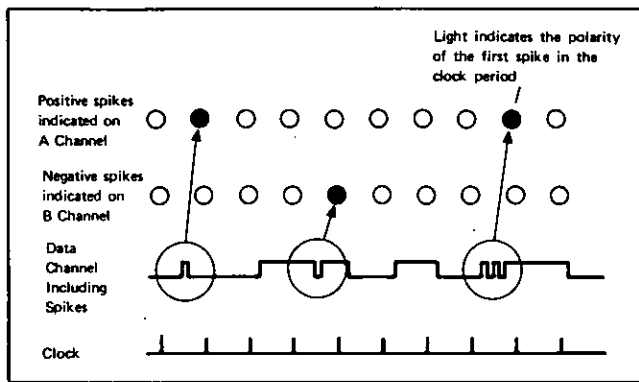

Logic family compatibility

The Logic Analyzer assures complete compatibility with all logic families (both present and future) by providing variable threshold input amplifiers. Two rear panel controls allow easy adjustment of the input threshold level over a continuous range of ± 1.4 V.

The nearly negligible circuit loading of the 1 M Ω , 35 pf inputs is further reduced with the addition of standard 10:1 divider probes. With addition of these probes, input impedance is increased to 10 M Ω , 10 pf and the variable threshold range of the input amplifiers is extended to ± 14 V. The combination of high RC and wide trigger level range means you can test circuits built from such diverse families as TTL, ECL, MOS, RTL, HTL, and even CMOS, completely free of any loading or compatibility problems.

Annunciators

Analyzer operation is always made apparent by its front panel LED annunciators. An LED for each of the five signal inputs functions as a logic probe to dynamically indicate logic states and pulse trains. If a probe isn't making contact or an input isn't receiving pulses, you know it immediately. Two other LED's light to indicate the occurrence of the arming and triggering processes. You never waste time trying to see signals that aren't there.

Combining electrical and functional measurement capabilities

In measurements where analog considerations such as ringing, voltage level or asynchronous timing are of interest, an oscilloscope is an invaluable instrument. The combinatorial triggering and precision digital delay available in the Logic Analyzer can be utilized to trigger an oscilloscope and therefore extend the triggering flexibility of the Analyzer to an oscilloscope.

The TRIG OUT signal, available on the back panel of the Logic Analyzer is used as the external trigger input to the oscilloscope. The TRIG OUT signal goes from TTL low to high at a point that corresponds to the loading of the Analyzer-display. Thus, the Logic Analyzer may be used to position the oscilloscope display to an exact position within a digital data sequence.

Specifications

Inputs

Input impedance: 1 M Ω shunted by 35 pf.

Input threshold voltage: Continuously variable over ± 1.4 V.

Maximum input voltage: ± 200 V continuous, ± 400 V transient.

Data and trigger inputs (channel A.B. external trigger).

Minimum setup time: 15 ns.

Minimum hold time: 0 ns.

Clock input

Maximum pulse repetition rate: 10 MHz.

Minimum pulse width: 15 ns.

Word delay input

Maximum pulse repetition rate: $\frac{1}{2}$ of Clock input repetition rate.

Input modes

A,B: Two-channel operation.

Serial A: A and B display registers cascaded into a single 64-bit display loaded from Channel A input.

Spike A: Detects multiple transitions at A input during a clock period.

Minimum spike width: 15 ns.

Trigger controls

Minimum sweep rearming time: 60 ms after last clock pulse of sweep.

Hold off control: Increases rearming time to 4 sec.

Triggering modes

Clocked mode: Analyzer triggers on first clock pulse after all input conditions defined by slope control switches are met. Trigger condition must remain until clock pulse occurs.

Asynchronous mode: Analyzer triggers when trigger conditions are met. Conditions need not remain until clock pulse occurs.

Minimum pulse width: 40 ns.

Minimum setup time: 60 ns.

Digital delay

Post-trigger delay range: Display begins 0 to 999,999 clock periods after trigger event.

Pre-trigger (negative) delay range: Display begins 0 to 32 clock periods (64 in Serial A mode) before trigger event.

Delay reference

Start: Trigger begins delay countdown. Data input and display begin N clock periods after trigger event (N is number indicated by thumbwheels).

End: Delay countdown begins 32 clock periods (64 in Serial A mode) prior to trigger. Thus, when N = 0, the data displayed is the 32-bits (64 in Serial A mode) occurring before the trigger.

Word delay:

When enabled, permits 2 levels of digital delay.

Delay range: 0 to 9,999 pulses at Word Delay input plus 0 to 99 pulses at Clock input.

Display

Display modes

Direct: Data at A and B inputs displayed by A and B registers.

A · B: Logical AND of A and B inputs displayed in A register, B register blanked.

A + B: Logical OR of A and B inputs displayed in A register, B register blanked.

A ⊕ B: Logical EXCLUSIVE-OR of A and B inputs displayed in A register, B register blanked.

Display relationship to clock: Display advances horizontally one LED per clock pulse.

General

Power: 115 or 230 V $\pm 10\%$. 48 to 440 Hz, approx. 35 watts.

Dimensions: 213 mm wide \times 178 mm high \times 366 mm deep (8.4" \times 7" \times 14.4").

Temperature: 0 to 55°C.

Accessories available

10013A: 10:1 Voltage Divider Probe

10250A: TTL Trigger Probe

Price

\$30

\$150

5000A Logic Analyzer

\$2175

DIGITAL CIRCUIT TEST AND ANALYSIS

16 Bit serial/parallel digital triggering

Model 1620A

NEW

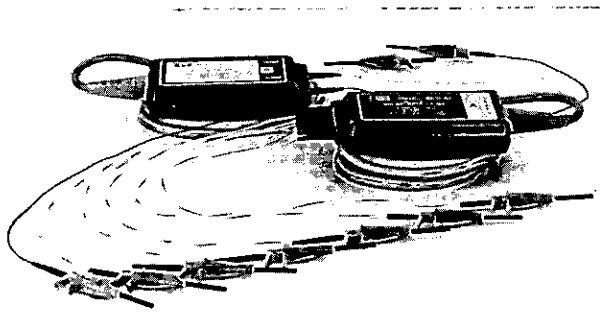
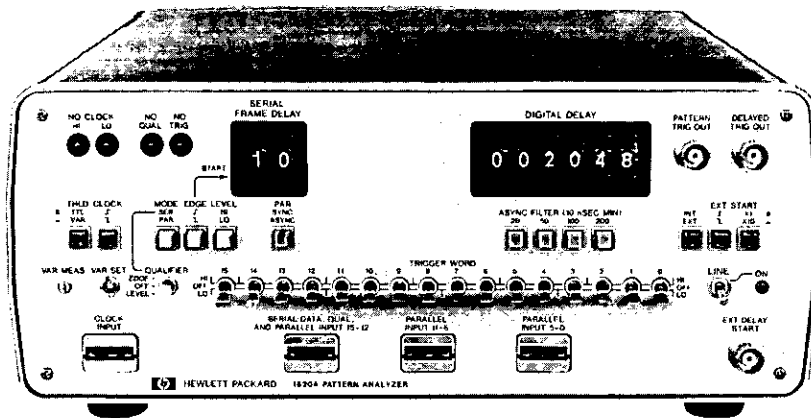

1620A Description

Model 1620A Pattern Analyzer generates a trigger from serial or parallel digital pattern recognition and/or digital delay for oscilloscopes or other externally triggered instruments. Pattern recognition is selectable up to 16 bits in either serial or parallel mode, with digital delay selection up to 999,999 bits.

A separate qualifier line is provided for use in the serial mode, enabling you to look for bit patterns at a discrete time or during time intervals. A serial frame delay gives you window selection in the bit stream, relative to the qualifier starting edge.

In the parallel recognition mode the Analyzer is capable of either synchronous or asynchronous operation. In the parallel asynchronous mode a selectable pulse width filter reduces the possibility of false triggering caused by glitches resulting from skew in the data stream entering the Analyzer.

Digital delay can be started by pattern recognition or by an external trigger input (Ext Delay Start). This allows you to move the measurement window a selectable number of clock cycles downstream from a uniquely selected trigger point defined by the Analyzer or the trigger input.

To simplify probing in compact digital circuits, small dual purpose 20 MHz probes allow direct connection to dual in-line packages and various pins. These probes are small enough to connect to adjacent pins on DIP's or the probes may be slipped off the probe wires for direct connection to 0.6 mm (0.025 in.) square pins, IC test clips, or wire wrap pins.

1620A Specifications

Clock and data probe inputs

Repetition rate: 20 MHz max.

Input RC: 40 k Ω \pm 3 k Ω shunted by <14 pF.

Input bias current (input grounded): <20 μ A.

Input threshold: TTL, fixed at 1.45 \pm 0.05 V dc. Variable, to \pm 10 V.

Maximum input: level, \pm 15 V dc; swing, 15 V peak from threshold.

Minimum input swing: 0.5 V +5% of threshold voltage p-p.

Clock pulse width: 20 ns min.

Setup time: 20 ns min (normally 10 ns).

Hold time: zero ns (normally -5 ns).

BNC inputs: external delay start. Rear panel; serial data, qualifier, and clock. (Ideal for use with Model 5000A Logic Analyzer.)

External delay start input RC: 1 M Ω \pm 5% shunted by <14 pF.

Pattern and delayed trigger outputs

Level: high, \geq 2 V; low, \leq 0.5 V (both into 50 ohms).

Width: approx. 30 ns in sync modes.

Operating modes

16-bit serial pattern recognition:

Qualifier OFF: trigger out approx. 80 ns after clock edge when pattern is matched.

Qualifier at LEVEL: trigger out approx. 80 ns after clock edge, pattern match, and qualifier match.

Qualifier at EDGE: trigger out approx. 100 ns after clock edge, pattern match, and frame delay count complete.

16-bit parallel pattern recognition:

Synchronous: trigger out approx. 65 ns after clock edge and pattern match.

Asynchronous: trigger out approx. 75 ns after pattern match.

Digital delay:

Delay start: internal from pattern trigger; external from front panel input with positive and negative going edge.

Delay length: 0 to 999,999 clock edges.

General

Weight: Net, 4.5 kg (10 lb). Shipping, 6.4 kg (14 lb).

Power: 100, 120, 220, or 240 V ac \pm 5%, -10%; 48 Hz to 440 Hz, max power 58 VA (nominal 43 VA).

Dimensions: 28.4 cm (11 $\frac{1}{16}$ in.) wide; 11.9 cm (4 $\frac{1}{16}$ in.) high; 40.6 cm (16 in.) deep.

Operating environment: same as Model 1601L (page 78).

Accessories furnished: one Model 10230B clock probe, three Model 10231B data probes, one 2.3 m (7.5 ft) power cord, one Operating and Service Manual.

Option 003: 1620A without probes

less \$650

Individual probes:

10230B clock probe

\$130

10231B data probe

\$190

1620A Pattern Analyzer (including probes)

\$1750

Logic probes

Models 10525T, 10525H & 10525E

- Dynamic indicator of logic activity
- Pulse stretching for narrow pulses
- Bad level/open circuit detection

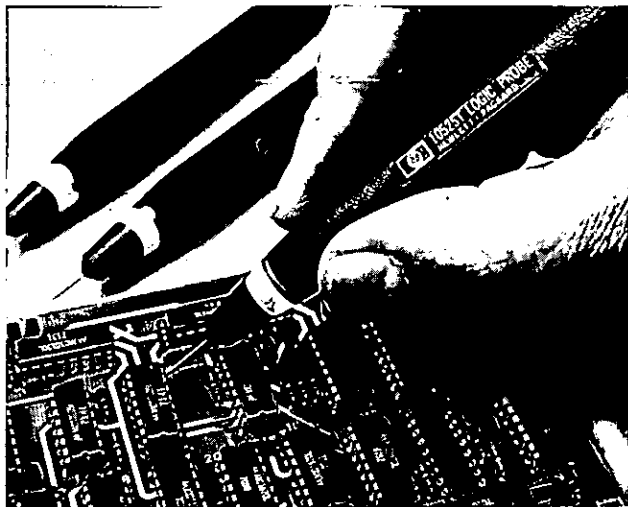

Specifications

Input impedance: >25 kΩ in both the high and low state (<1 low power TTL load).

Logic one threshold: 2.0 V ±0.2 V.

Logic zero threshold: 0.8 V ±0.2 V, -0.4 V.

Input minimum pulse width: 10 ns.

Input maximum pulse repetition frequency: >50 MHz.

Input overload protection: ±70 volts continuous, ±200 volts intermittent, 120 V ac for 30 seconds, 240 V ac for 10 seconds.

Power requirements: 5 V ±10% at 60 mA, internal overload protection for voltages from +7 to -15 volts. Includes power lead reversal protection.

Temperature: 0° to 55° C.

Accessories included: BNC to alligator clips, ground clip.

High level logic probe

The Model 10525H brings fingertip convenience to the testing of high level digital circuits such as HTL, HiNIL, MOS, discrete circuits, and relay logic. Operation is entirely analogous to that of the 10525T Probe except that the "H" model responds to higher input voltage levels and accepts a power supply anywhere in the 12 to 25 V range. Electrical Characteristics have been optimized to match the attributes of the tested devices.

Specifications

Input impedance: >20 kΩ.

Logic one threshold: 9.5 V ±1 V.

Logic zero threshold: 2.5 V ±1 V.

Input minimum pulse width: 100 ns.

Input maximum pulse repetition frequency: >5 MHz.

Input overload protection: ±70 V continuous, ±200 V intermittent, 120 Vac for 30 seconds, 240 Vac for 10 seconds.

Power requirements: +12 to +25 V at 100 mA. Includes power lead reversal protection.

Temperature: 0° to 55° C.

Accessories included: BNC to alligator clips, ground clip.

ECL logic probe

The HP Model 10525E Logic Probe extends the time-proven, cost-saving logic probe troubleshooting technique to high-speed ECL logic.

Operation of the ECL probe is analogous to that of the 10525T except the 10525E's high speed circuitry stretches single shot phenomena so that single pulses as narrow as 5 nanoseconds may be observed.

The 10525E may be powered directly from any -5.2 volt source and its high input impedance minimizes circuit loading.

Specifications

Input impedance: 12 kΩ in both the high and low state.

Logic one threshold: -1.1 V ±0.1 V.

Logic zero threshold: -1.5 V ±0.1 V.

Input minimum pulse width: 5 nsec.

Input maximum pulse repetition frequency: 50 MHz (typically 100 MHz at 50% duty cycle.)

Input overload protection: ±70 volts continuous, 200 volts intermittent, 120 Vac for 30 seconds.

Power requirements: -5.2 V ±10% at 80 mA; supply overload protection for voltages from -7 to +400 volts.

Accessories included: BNC to alligator clips, ground clip.

Accessories available:

10525-60012: Tip Kit Price \$20

Model number and name

10525T Logic Probe \$99

10525H Logic Probe \$99

10525E Logic Probe \$99

TTL/DTL logic probe

Using the HP 10525T Logic Probe greatly simplifies tracing logic levels and pulses through IC circuitry to find nodes stuck HIGH/LOW, intermittent pulses, and normal pulse activity. It instantly tells whether the node probed is high, low, a bad level, open circuited, or pulsing.

The Logic Probe requires but a simple connection to your circuit's 5-volt supply to be ready to go into action; the rigidly strain-relieved power cord and the line voltage protected probe tip insure durability and long life. High input impedance protects against loading your circuit—not just in the HIGH state but for logic LOW's as well.

The 10525T Probe has preset logic thresholds of 2.0 and 0.8 volts which correspond to the high and low states of conventional TTL and DTL circuits. When touched to a high level, a bright band of light appears around the entire probe tip; when touched to a low level, the light goes out. Open circuits or voltages in the bad level region between the preset thresholds cause lamp illumination at half brilliance. Single pulses of 10 ns or greater are easily viewed by stretching to one-twentieth of a second. The lamp flashes on or blinks off depending upon the pulse's polarity. Pulse streams to 50 MHz cause the lamp to blink off and on at a 10 Hz rate. A single lamp at your fingertips provides all this information. Thus, there is never any need for rotating the Probe to see what's happening, no matter where you are probing.

Since most IC failures show up as a node stuck either HIGH or LOW, the Logic Probe provides an inexpensive yet remarkably easy way of detecting the fault. And, with a Logic Probe, those single-shot, short pulses that are nearly impossible to see with even the fastest of scopes are readily displayed at your fingertips.

Also, combining the Probe with the 10526T Logic Pulser greatly enhances the ease of troubleshooting. The Pulser provides a convenient means of injecting single pulses whose effects are monitored with the Probe.

With its high input impedance, Model 10525T also functions quite well with logic families other than TTL and DTL, such as 5-volt CMOS, as long as the logic levels are TTL-compatible.

DIGITAL CIRCUIT TEST AND ANALYSIS

Logic pulser and logic clip

Models 10526T & 10528A

NEW

- In-circuit stimulation without unsoldering
- Automatic injection of proper polarity pulse
- Greatly simplifies digital troubleshooting

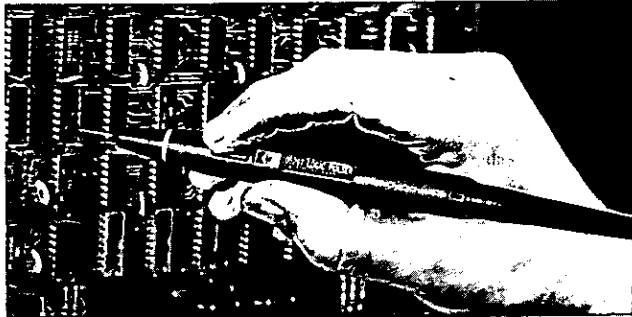

Logic pulser

The Model 10526T Logic Pulser solves the old problem of pulsing IC's on digital logic boards for designers and troubleshooters using TTL/DTL circuits. Merely touch the Pulser to the circuit under test, press the pulse button and all circuits connected to the node (outputs as well as inputs) are briefly driven to their opposite state. No unsoldering of IC outputs is required. Pulse injection is automatic so the user need not concern himself whether the test node is in the high or low state: high nodes are pulsed low and low nodes, high, each time the button is pressed.

The Pulser is essentially a single-shot pulse generator with high output current capability packed in a convenient, easy-to-use probe. Ability to source or sink up to .65 Amperes insures sufficient current to override IC outputs in either the high or low state. Output pulse width of 0.3 μ s limits the amount of energy delivered to the device under test thereby eliminating the possibility of destruction. Additionally the Pulser output is tri-state so that circuit operation is unaffected by probing until the pulse button is pressed.

Combining in-circuit pulse injection with the unique detection capabilities of the HP 10525T Logic Probe and 10528A Logic Clip focuses new power on solving the problems of fault isolation. Pulser/Probe and Pulser/Clip combinations enable the digital designer or troubleshooter to hold complete stimulus-response capability at his finger tips.

Gate operation is tested with the Pulser driving the input and the probe monitoring transmitted pulses at the output. When pulses are not received, the Pulser and Probe on the same pin can detect if the failure is due to a short to ground or V_{cc} .

Testing sequential circuits is the domain of the Logic Clip and Logic Pulser. The Clip simultaneously monitors all output states while the Pulser applies clock and reset pulses to the device. Improper operation, if present, is immediately obvious since the IC will not go through its prescribed sequence of states.

Though the Pulser can source large currents, the charge necessary to supply this current is stored in the Pulser, and power supply requirements are less than 25 mA from any 5 volt supply.

Specifications

Output high pulse voltage: >2 V at 0.65 A (1 A typical at $V_{ps} = 5$ V, 25°C)

Output low pulse voltage: <0.8 V at 0.65 A (1 A typical at $V_{ps} = 5$ V, 25°C)

Output impedance, active state: <2 ohms

Output impedance, off state: >1 Megohm

Pulse width: 0.3 μ s nominal

Input overload protection: ± 50 volts continuous

Power supply input protection: ± 7 volts (includes power lead reversal protection)

Power requirement: 5 V $\pm 10\%$ at 25 mA

Temperature: 0°C to 55°C

Accessories included: BNC to alligator clips, ground clip

- Displays IC logic states at a glance
- Self-powered, self-contained
- No adjustments required

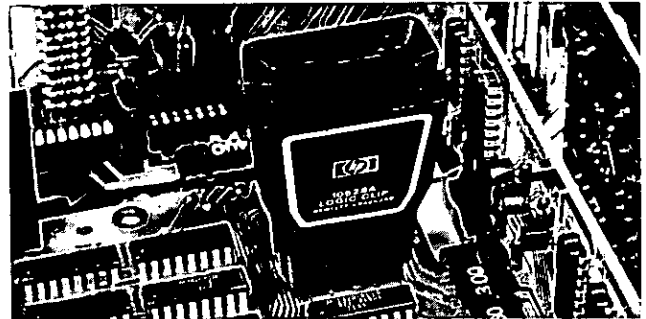

Logic clip

The Model 10528A Logic Clip is an extremely handy service and design tool. This unit clips onto TTL or DTL DIP IC's and instantly displays the logic states of all 14 or 16 pins. Each of the Clip's 16 light-emitting diodes independently follows level changes at its associated pin; a lighted diode corresponds to a high logic state.

The Logic Clip's real value is in its ease of use. It has no controls to be set, needs no power connections, and requires practically no explanation as to how it is used. The clip has its own gating logic for locating the ground and +5 volts V_{cc} pins and the buffered inputs reduce circuit loading. Simply clipping the 10528A onto a TTL or DTL dual in-line package IC makes all logic states visible at a glance.

The Logic Clip is much easier to use than either an oscilloscope or a voltmeter when a logic designer or service engineer is interested in whether a lead is in the high or low state (1 or 0 state), rather than its actual voltage. The Clip, in effect, is 16 binary voltmeters, and the user does not have to shift his eyes away from his circuit to make the readings.

The intuitive relationship of the input to the output—lighted diodes corresponding to high logic states—greatly simplifies the troubleshooting procedure. The user is free to concentrate his attention on his circuits, rather than on measurement techniques. Timing relationships become especially apparent when clock rates can be slowed to about 1 pulse per second.

When used in conjunction with the 10526T Logic Pulser, the Logic Clip offers unparalleled analysis capability for troubleshooting sequential circuits. The Clip first attaches to the IC to be tested; the Pulser is then brought into action. The Pulser's capability to inject pulses between gates allows it to supply signals to the IC under test absolutely independent of gates connected to the IC. All outputs may then be observed simultaneously on the Logic Clip. Deviations from expected results are immediately apparent as the Pulser steps the IC through its output states.

Specifications

Input threshold: 1.4 ± 0.6 V; TTL or DTL compatible (except gates with expander inputs).

Input impedance: One TTL load (-1.2 mA typical per input).

Input protection: Voltages <-1 V or >7 V must be current limited to 10 mA.

Supply voltage: 5 V $\pm 10\%$ across any two or more inputs.

Maximum current consumption: 120 mA.

Temperature: 0 to 55°C.

Dimensions: 55 x 40 x 25 cm (2.15 in. high, 1.5 in. wide, 1 in. deep) maximum.

Weight: Net, 45 gm (1.5 oz). Shipping, 120 gm (4 oz).

Accessories Available:

10526-60002: Multi-pin Stimulus Kit

10525-60012: Tip Kit

Model number and name

10526T Logic Pulser

10528A Logic Clip

Price

\$20

\$20

\$99

\$99

DIGITAL CIRCUIT TEST AND ANALYSIS

Logic comparator

Model 10529A

- New capabilities added
- Dramatically cuts troubleshooting time
- In-circuit IC testing with no unsoldering

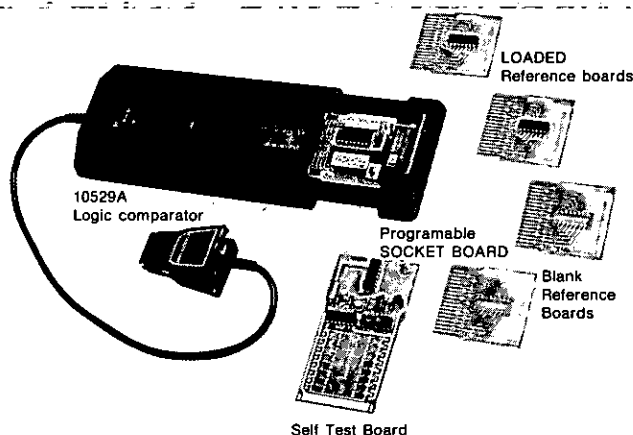

The Model 10529A Logic Comparator is an extremely useful field service and production in-circuit troubleshooting tool. Dozens of IC's may be checked—an entire IC at a time—to detect functional failures in less than a minute per IC. The Comparator clips onto powered TTL or DTL IC's and detects functional failures by comparing the in-circuit test IC with a known good reference IC inserted in the Comparator. Any logic state difference between the test IC and the reference IC is identified to the specific pin(s) on 14- or 16-pin dual in-line packages with the Comparator's display to 16 light emitting diodes (LED's). A lighted LED corresponds to logic difference. The Logic Comparator can save considerable time in locating a faulty IC. There are no controls to be set and no power connections.

The procedure is very simple. First the IC to be tested is identified. An IC of the same type is placed in the Comparator's IC socket, or a reference board with an IC of the same type is inserted in the Comparator. The Comparator is clipped onto the test IC, and an immediate indication is given if the test IC operates differently from the reference IC. Even very brief dynamic errors are detected, stretched, and displayed.

The Comparator will also provide a Logic Clip function when used with the socket board set to the clip mode. In addition to the display of the instantaneous states of the 14 or 16 pins of the IC under examination via the Comparator's 16 LED's (one per pin), the Comparator-Clip also provides stretching on each pin. Thus intermittent highs and lows of 300 nanoseconds or longer will be detected.

As a Comparator, the 10529A connects the test and reference IC inputs in parallel; thus the reference IC is exercised by input signals identical to those of the test IC. The outputs of the two IC's are compared; any differences in outputs are detected, and LED's corresponding to the particular pins are lit on the Comparator's display. Intermittent errors as short as 200 nanoseconds (using a reference board) or 300 nanoseconds (using the socket board) are detected, and the error indication on the Comparator's display is stretched for a visual indication. A failure on an input pin, such as an internal short, will appear as a failure on the IC driving the failed IC; thus a failure indication actually pinpoints the malfunctioning node.

All operating power is obtained from the test circuit. Programming for the specific IC is easily accomplished. Two different methods are available. First, the socket board included with the Comparator is inserted in the Comparator drawer. Outputs of the particular IC to be tested are selected via 16 miniature switches which tell the Compara-

tor which pins of the reference IC are to be allowed to respond freely. The reference IC is then inserted into the socket and locked into place. The socket board automatically seeks V_{cc} and ground. Any new IC may be set up in seconds. Alternatively, if specific IC types are to be tested repeatedly, the reference IC may be soldered into one of the reference boards provided with the Comparator. The reference board is programmed by opening the connections between the test and reference IC's output and solder bridging V_{cc} and ground. The socket board and ten blank reference boards are included with each Comparator.

When troubleshooting, it is reassuring to know that the tester is operating properly. A test board is supplied with the Logic Comparator for this purpose. When inserted in place of a reference board or the socket board, the test board exercises all of the Comparator's circuitry, test leads, and display elements, to verify proper operation.

The Logic Comparator is an unparalleled aid for helping to locate in-circuit failed IC's. Often only a Comparator is necessary for finding failures. Since the functional test is made for the circuit's stimulus pattern, it is unimportant whether or not the input pattern to the IC is correct or not; thus, testing in digital feedback loops is simplified immeasurably. Because the Comparator converts readily to a Logic Clip, the nature of the failure is readily apparent. Further analysis before taking the trouble to remove the IC often saves valuable time.

The Logic Comparator's ease of use and small size make it an invaluable addition to the troubleshooter's test gear either in the field or in the factory. With TTL and DTL failures that are functionally related, the Comparator can find the bad IC up to ten times faster than conventional signal tracing techniques. At its low price, the Logic Comparator can pay for itself in only days.

Specifications

Input threshold: 1.4 V nominal (1.8 V nominal with socket board), TTL or DTL compatible.

Test IC loading: Outputs driving Test IC inputs are loaded by 5 low-power TTL loads plus input of Reference IC. Test IC outputs are loaded by 2 low-power TTL loads.

Input protection: Voltages < -1 V or > 7 V must be current limited to 10 mA.

Supply voltage: 5 V $\pm 10\%$.

Supply protection: Supply voltage must be limited to 7 V.

Maximum current consumption: 300 mA.

Sensitivity:

Error sensitivity: 200 ns with reference board or 300 ns with socket board. Errors greater than this are detected and stretched to at least 0.1 seconds.

Delay variation immunity: 50 ns. Errors shorter than this value are considered spurious and ignored.

Frequency range: Maximum operational frequency varies with duty cycle. An error existing for a full clock cycle will be detected if the cycle rate is less than 3 MHz.

Temperature: 0° to 55°C.

Dimensions: 3.56 × 8.55 × 18.2 cm (1.4 in. deep, 3.375 in. wide, 7.15 in. long).

Weight: Net 1.14 kg (2 lb 6 oz). Shipping 1.62 kg (3 lb 6 oz).

Accessories included: 1 test board; 10 blank reference boards; 1 programmable socket board; 1 carrying case.

Accessories Available:

	Price
10541A: Twenty Blank Reference Boards for the Logic Comparator	\$60
K01-10541A: Twenty Pre-programmed Boards for the Logic Comparator	\$175
10529A Logic Comparator	\$425

DIGITAL CIRCUIT TEST AND ANALYSIS

Logic troubleshooting kit

Model 5011T

- Complete TTL/DTL troubleshooting kit
- Stimulus-response capability
- In-circuit fault finding
- In-circuit analysis
- Dynamic and static testing
- Multi-pin testing

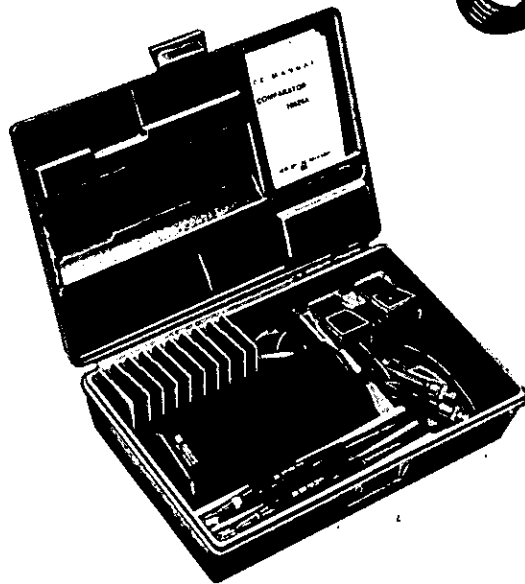

5011T

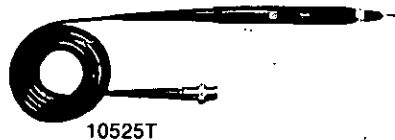

10525T

includes

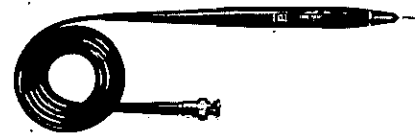

10526T

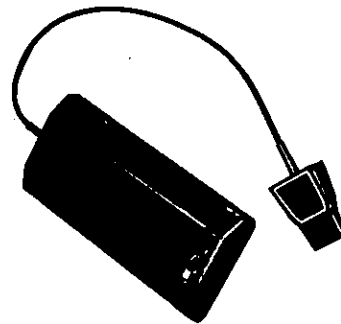

10529A



10528A

The HP 5011T Logic Troubleshooting Kit combines all the troubleshooting capability of four instruments, the 10529A Logic Comparator, the 10526T Logic Pulser, the 10525T Logic Probe, and the 10528A Logic Clip. These instruments have been designed to work together to detect in-circuit logic failures and to analyze failures for their specific causes. The Logic Comparator attaches to 14- and 16-pin dual in-line TTL and DTL circuits—both sequential and combinatorial logic are testable. The IC under test is allowed to operate normally while its outputs are compared against a reference IC of the same type inserted in the Comparator. Should the circuit under test operate improperly, the failure is detected and displayed on the hand held Comparator's panel. Sixteen LED's exactly pinpoint the failed node. Special stretching networks within the Comparator capture intermittent failures as short as 200 nanoseconds and stretch the visual indication to a tenth of a second.

Once a failure has been isolated, the other test instruments can provide exacting analysis. For example, the Logic Probe will indicate if any pulse activity is present at the suspect node; the Probes ability to detect single pulses, high or low, as narrow as 10 nanoseconds can insure the total absence of signals at the node. Placing the Logic Pulser on the suspect node with the Probe will allow detection of shorts to ground or the power supply—even the powerful burst of energy from the Pulser will not cause a pulse on a supply buss or ground. Or should the node be open-circuited, the Logic Probe instantly indicates it. The very high input impedances of the Pulser and the Probe guarantee that they will not affect circuit operation by loading.

Another analysis method employs the Logic Clip and Logic Pulser. The Pulser can be used to inject reset and clear signals directly into

flip-flops, counters, decoders, etc. with the Clip attached to monitor the effects. With the system clock removed or shorted, the Logic Pulser can inject clock pulses one-at-a-time, and deviations from prescribed sequences can be observed on the Logic Clip 16-pins-at-a-time.

Application of the IC Troubleshooters are endless and limited only by the imagination of the troubleshooter. Easy to use, they will rapidly create substantial savings of test time and dollars. The various kit components listed below are described in detail on the pages devoted to the individual instruments.

Specifications

Includes:

10525T Logic Probe
10526T Logic Pulser
10528A Logic Clip
10529A Logic Comparator

Dimensions: 13.2 cm × 20.3 cm × 8.25 cm (12.25 in. × 8.0 in. × 3.25 in.)

Weight: Net 1.36 kg (3 lb). Shipping 2.27 kg (5 lb).

Accessories Available:

10541A: Twenty blank reference boards for Logic Comparator \$60
K01-10541A: Twenty loaded reference boards for Logic Comparator (common TTL IC's) \$175
10526-60002: Multi-pin Stimulus Kit for Logic Pulser \$20
10525-60012: Tip Kit for Logic Probe or Logic Pulser \$20

5011T Logic Troubleshooting Kit

Price

\$650

DIGITAL CIRCUIT TEST AND ANALYSIS

Logic troubleshooting mini kit; accessories

5015T; accessories

NEW

- TTL/DTL troubleshooting kit
- Stimulus-response capability
- In-circuit analysis



10525-60012

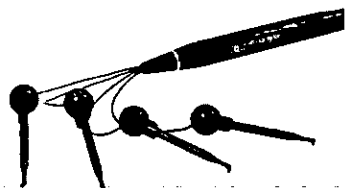

10526-60002

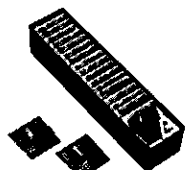

10541A

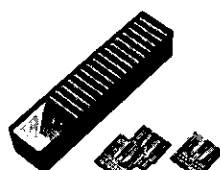

K01-10541A



5015T

5015T Logic troubleshooting mini kit

The HP 5015T Logic Troubleshooting Mini Kit combines the unique logic analysis capability of the 10525T Logic Probe, the 10526T Logic Pulser, and the 10528A Logic Clip into a single, handy kit. These three instruments provide stimulus/response capability for dynamic and static testing of in-circuit integrated circuits. The 10525T Logic Probe provides an indication of logic state at your fingertips. Not only are TTL and DTL highs and lows displayed but also open circuits and bad levels are clearly shown. Dynamically, pulse trains to 50 MHz may be monitored and single pulses as narrow as 10 nanoseconds are detected. Thus the Logic Probe may be used to quickly check for the presence of key signals such as clock, reset, start, shift, transfer, etc.

The 10526T Logic Pulser brings you a new concept in digital troubleshooting; injecting a pulse between logic gates. With high current sinking and sourcing capability, the Pulser, once its pulse button is pressed, can drive low nodes high and high nodes low for 300 nanoseconds before returning to its high-impedance off state. The selection of a high pulse or low pulse is automatic—just press the button!

The Logic Pulser may be used with the Logic Probe in several ways. For example, if a node is found with the Probe to stay high or low, attempting to inject a pulse while monitoring the pin with the Probe will clearly indicate a short to ground or the power supply—even the powerful burst of energy from the Pulser will not override the supply voltages. Or, the Pulser may be used to inject signals into gates while the output is checked by the Logic Probe. The very high input impedances of both Pulser and Probe insure no circuit loading effects.

The 10528A Logic Clip's ability to monitor all the pins of TTL and DTL DIP's make it extremely useful for testing flip-flops, counters, shift registers, decoders, etc. The Logic Pulser can inject clock and reset signals while the Clip allows you to see exactly how the device responds. Improper operation is immediately apparent.

This powerful combination of instruments is useful in the lab, production, field service, and in training applications or wherever lots of capability at a low price is desired. The kit components listed below are described in detail on the pages devoted to the individual instruments.

Specifications

5015T Includes:

Model 10525T Logic Probe
Model 10526T Logic Pulser
Model 10528A Logic Clip

Dimensions: 28.6 cm × 13.3 cm × 6.4 cm (11.25 in. × 5.25 in. × 2.5 in.)

Weight: Net, 0.63 kg (1 lb 6 oz.); Shipping, 0.74 kg (1 lb 10 oz.)

Accessories available

	Price
10526-60002: Multi-pin Stimulus Kit for Logic Pulser	\$20
10525-60012: Tip Kit for Logic Probe or Logic Pulser	\$20

5015T: Logic troubleshooting mini kit \$249

Logic test instrument accessories

10525-60012 Tip Kit: The 10525-60012 Tip Kit gives added flexibility to users of the Logic Probes, Logic Pulser and both Logic Troubleshooting Kits. The Tip Kit facilitates connection of the parent instrument to signal lines in digital circuits. Included are: hook tip, spare straight tip, banana tip, and two adapters for connecting to backplanes and IC pin-extender clips. In addition a BNC to banana adapter is included which will interface the BNC power input connector on the Probes and Pulser to standard binding posts.

\$20

10526-60002 Multi-pin stimulus kit: The 10526-60002 Multi-pin Stimulus Kit consists of a cable assembly that attaches the Pulser output to up to four pins of the test IC. Thus four pins in the same state may be simultaneously pulsed, a useful feature for testing multi-input gates and other circuits. The 10526-60002 Multi-pin Stimulus Kit may be ordered with the Logic Pulser or either Logic Troubleshooting Kit.

\$20

10541A Twenty additional blank reference boards: These boards are identical to the 10 boards provided with the Logic Comparator; they allow additional IC's to be programmed for Comparator testing. The handy package provides easy access for inserting into the Comparator. The 10541A blank reference board set may be ordered with the Logic Comparator or the 5011T Logic Troubleshooting Kit.

\$60

K01-10541A Twenty preprogrammed reference boards: This package provides 20 of the most common TTL IC's already programmed and ready for use with the Logic Comparator or 5011T Logic Troubleshooting Kit. When ordered with K01-10541A, the Comparator is ready for immediate action upon receipt. The loaded reference boards are packaged in a convenient storage container which allows access to the individual boards needed. The K01-10541A includes the following IC's: 7400 Quad 2-input NAND; 7402 Quad 2-input NOR; 7404 Hex inverter; 7408 Quad 2-input AND; 7410 Triple 3-input NAND; 7420 Dual 4-input NAND; 7430 8-input NAND; 7440 Dual 4-input NAND buffer; 7451 Dual 2-wide, 2-input AND-OR-INVERT; 7454 4-wide, 2-input AND-OR-INVERT; 7473 Dual J-K master-slave flip-flop; 7474 Dual D flip-flop; 7475 Quad bistable D latch; 7476 Dual J-K flip-flop with preset and clear; 7483 4-bit binary full adder; 7486 Quad 2-input exclusive-OR; 7490 Decade counter; 7493 4-bit binary counter; 74121 Monostable multivibrator; 9601 Monostable multivibrator, retriggerable.

\$160

DIGITAL CIRCUIT TEST AND ANALYSIS

Logic lab
Model 5035A

NEW

- Flexible circuit breadboard aid
- Use standard IC's, components, and interconnecting wires
- Removable breadboard for circuit expansion
- Completely self-contained



The 5035A Logic Lab brings convenience, simplicity, and flexibility to the task of breadboarding new designs or trying out alternative circuit configurations in R & D, production engineering, and product support. Fully self-contained, this rugged design partner helps you check out ideas quickly without chasing after equipment or soldering components or connections. One of the Logic Lab's key features is the uniquely removable breadboard assembly which acts like a giant socket allowing you to plug in components of all varieties and types and interconnect them with standard 24-gauge hookup wire without soldering. Each component pin for, say, dual-inline IC packages has four common tie points for fan in and fan out. Additional buses allow for signal routing or junctions. Since the breadboard holds up to 16 DIPs, a large circuit under design can be partitioned into subsections and each one checked out individually. Since the breadboard is removable, the circuits do not need to be disassembled after check out. The 1-amp capability of the Logic Lab mainframe could allow several breadboards to be powered simultaneously and interconnected by solderless hookup wire.

In addition to the 5 volt-1 amp laboratory power supply built in the Logic Lab mainframe, 6 data switches can be used to provide HIGH/LOW signals to the circuit under test. These switches are completely "debounced" so that each transition is a single edge. Thus various parts of your circuit may effectively have different "clocks" by using the data switches. Also they may be used as pulse sources since an up-down or down-up operation provides only a single pulse. Four LED indicators allow monitoring of various circuit points with HIGH/LOW indications. Two generators in the mainframe provide squarewave 1 Hz and 100 kHz signals that can be routed to your circuit.

The Logic Lab mainframe also has two 5 volt output connectors on its rear panel for powering the 10525T Logic Probe and the 10526T Logic Pulser. Available separately, these powerful troubleshooting tools provide a valuable complement to the 5035A Logic Lab. For years the Probe and Pulser have provided circuit designers and digital

troubleshooters the in-circuit stimulus/response capability optimized for IC work. The 10528A Logic Clip also is very handy to monitor all pins of 14- and 16-pin DIP's simultaneously. The 10528A clips directly to IC's mounted on the Logic Lab breadboard. Each of the three instruments is available individually or they may be obtained together as the 5015T Logic Kit.

Specifications

5035A Logic lab

Power supply: 5 volts $\pm 5\%$, over 0-1 Amp range; 10 mV rms ripple maximum. Continuous short circuit protection.

Data switches: 6 bounceless slide switches for TTL high/low outputs.

LED indicators: 4 high/low indicators

Clocks: 2 independent; 1 Hz and 100 kHz (nominal, squarewave).

Breadboard assembly (HP part number 1258-0121): removable.

Interconnections: All power supply, data switch, LED indicator, and component contact points may be interconnected by standard 24-gauge hook-up wire.

Power requirements: 100/120/220/240 V ac $\pm 5\%$, -10% 48-400 Hz line frequency; 30 watts max; $0^\circ - 55^\circ\text{C}$.

Dimensions: Mainframe: 89 x 311 x 267 mm (12¼ in. wide, 3½ in. high [max], 10½ in. deep).

Breadboard assembly: 165 x 114 x 13 mm (6½ in. x 4½ in. x ½ in. thick).

Weight: Net 5.9 kg (13 lb); Shipping 6.9 kg (15.13 lb).

Accessories Available:

1258-0121: Additional breadboard assembly	\$45
1540-0258: Heavy duty, padded vinyl carrying case	\$25
05035-60006: Wire interconnect kit (285 prestripped, assorted length and color, 24-gauge hook-up wires)	\$15

5035 Logic Lab

\$295

DIGITAL CIRCUIT TEST AND ANALYSIS

hp

89

Logic lab
Model 5035T

NEW

- Complete digital training program
- Digital text and laboratory workbook

- Digital test instrumentation
- All required components and interconnections

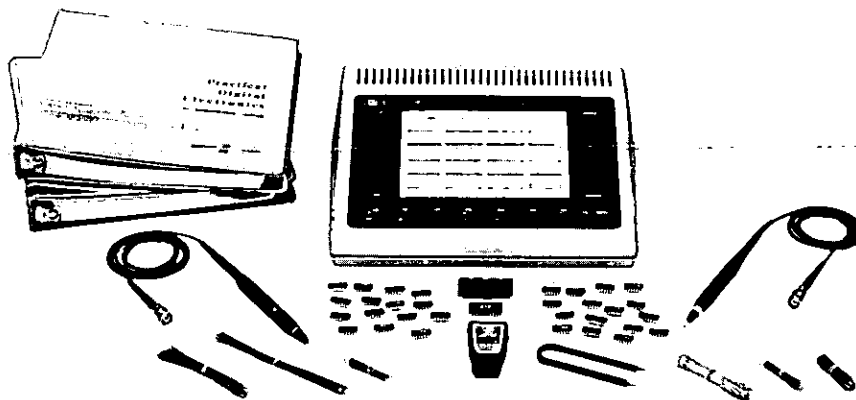

The 5035T Logic Lab is a combination of all the essential elements needed for a successful introductory course in practical digital electronics. This unique program is structured to aid the digital trainee in the *rapid* understanding of theory and the practical aspects of digital circuits.

Each 5035T Logic Lab includes: A completely self-contained mainframe with a removable breadboard assembly, a tutorial text on digital electronics complete with laboratory workbook, and all the components and interconnecting wires needed for the laboratory experiments. Also included with the Logic Lab are three industrially proven digital test instruments: the 10525T Logic Probe, the 10526T Logic Pulser, and the 10528A Logic Clip.

Mainframe

The 5035T Logic Lab mainframe features rugged industrial quality construction with a 5 volt one ampere short-circuit protected power supply. This feature allows the Logic Lab to withstand many years of rough student usage. Also 6 TTL compatible bounceless data switches, 2 independent signal sources of 1 Hz and 100 kHz, and 4 LED logic state indicators make the Logic Lab an extremely versatile training and circuit breadboarding tool.

Removable breadboard assembly

One of the Logic Labs key features is the uniquely removable breadboard assembly which acts like a giant socket allowing insertion of all varieties and types of components. After insertion the busing structure of the breadboard permits circuit interconnections to be easily made without soldering using *standard* 24 gauge wire. The unique structure of the breadboard makes circuit build-up and modification both fast and easy saving hours of valuable assembly time.

The removability of the breadboard allows several individuals to construct circuits simultaneously on separate breadboards, then test their circuits in a common mainframe. This reduces the incremental cost-per-student and allows individual training to proceed at a pace consistent with ability.

When system expansion becomes necessary several breadboard assemblies may be built and checked independently for correct circuit operation then combined and operated simultaneously from a single mainframe.

Text and laboratory workbook

The text and laboratory workbook combine to form the heart of the Logic Lab digital training program. The practical concise text provides the necessary background, while circuit skill and practical hands-on experience are developed by the 26 experiments in the functional laboratory workbook. The program is arranged in modules of complexity so that learning can be tailored to the student's background and end objectives. In addition, its modular nature allows the use of self-paced and individualized study techniques. The text and workbook sections are written to increase the student's knowledge of digital electronics, to provide practical experience with actual circuit

elements and to provide some exposure to the basics of digital circuit design.

Components supplied

Each 5035T Logic Lab includes thirty-two state-of-the-art TTL, SSI, and MSI integrated circuits, including gates, flip-flops, counters, decoders, and an arithmetic logic unit (A.L.U.). Also included are four LED matrix digital displays with built-in BCD to decimal decoders and 285 prestripped, 24 gauge hookup wires of various lengths and colors.

Digital test instrumentation

The increased use of digital integrated circuits has brought new demands for a digital type of test instrumentation. Hewlett-Packard's in-circuit digital troubleshooters, the Logic Probe, Logic Pulser, and Logic Clip have been used in industry for years by technicians and engineers alike. These industrial instruments also make ideal training tools because of their straightforward indication and operation.

Logic probe

The 10525T Logic Probe is a dynamic logic state indicator. It identifies logic highs, lows, open circuits with fingertip display (lit and extinguished band of light), detects single pulses as narrow as 10 nanoseconds and pulse trains to 50 M bits/second. The Logic Probe will provide the student with a unique digital analysis capability unavailable using any other measurement technique.

Logic pulser

The 10526T Logic Pulser provides the student with the equivalent of a hand held digital pulse generator. It injects a pulse *anywhere in-circuit*; no disconnections are necessary. The Pulser overrides momentarily, the existing state of the node, and it selects the proper polarity pulse automatically! High nodes are pulsed low and lows pulsed high with a single depression of the pulse button.

Logic Clip

The 10528A Logic Clip is particularly useful in understanding the functional nature of IC gates. The Clip attaches directly to dual-inline packages, and with no wires or connection displays the logic states at the IC pins simultaneously via 16 LED's—one per pin. An LED lit indicates a logic high and extinguished, a logic low.

Specifications

5035T Logic lab includes

Model 5035A Logic Lab; "Practical Digital Electronics—An Introductory Course" Text and Workbook; Logic Probe, Logic Pulser; Logic Clip; Component and Wire Kit.

Accessories available:

1258-0121: Additional Breadboard Assembly	Price \$45
10656A: Set of 10 "Practical Digital Electronics—An Introductory Course" Text and Lab Workbook	\$125
10657A: Additional Component and Wire Kits	\$125

5035A Logic Lab

\$650

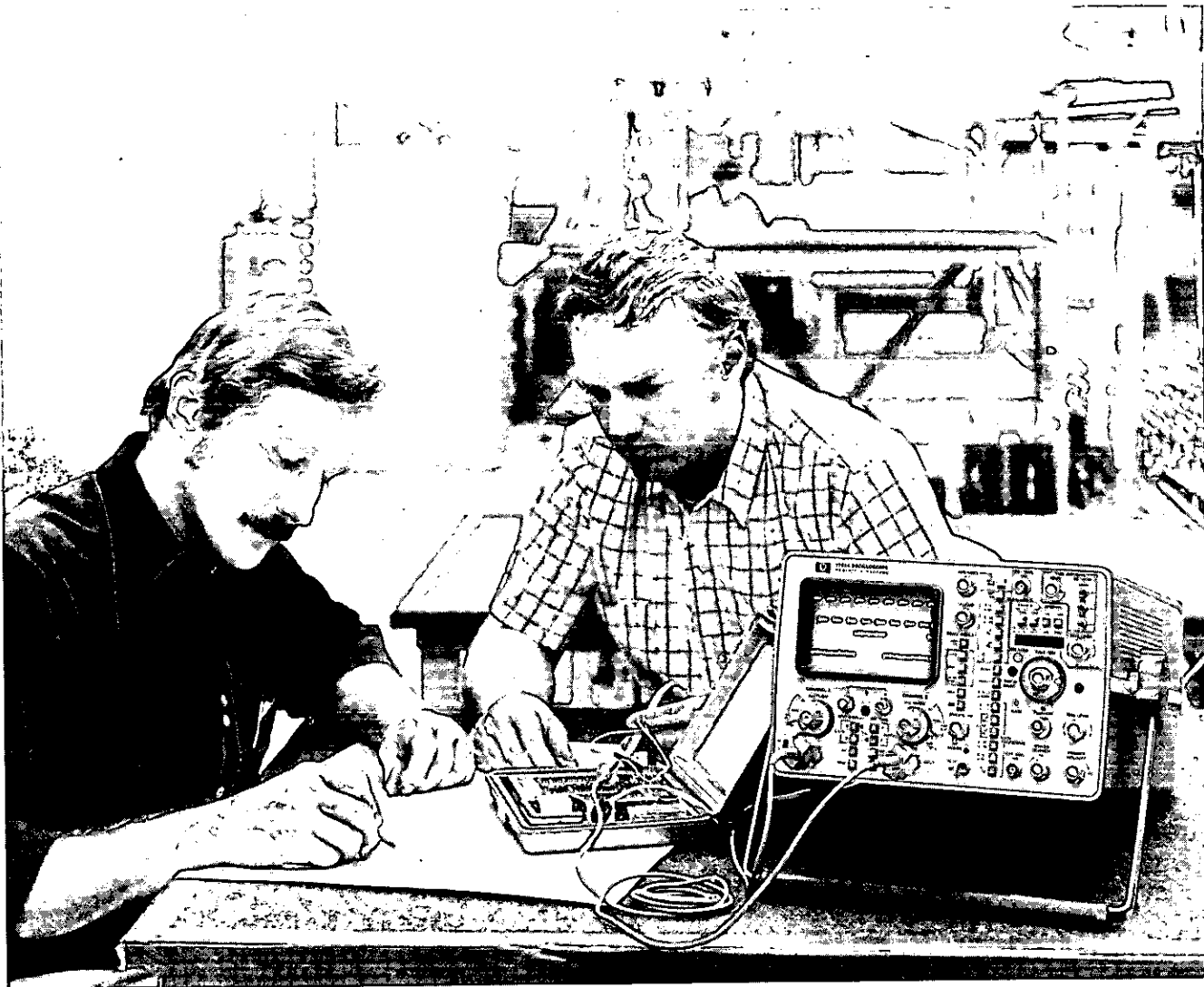

The oscilloscope—the most general purpose and basic tool of the electrical designer—has evolved into a very accurate and versatile measurement tool. With the rapid growth, in the past few years, of technology in integrated circuits, the measuring capabilities have increased tremendously. Bandwidth has increased, sweep speeds are faster and more linear, displays are larger and brighter, and controls are easier to operate. In general, the most versatile test instrument has become even more accurate and more flexible.

Hewlett-Packard pioneered many of the measurement capabilities that are now taken for granted in oscilloscopes. A few of these are internal graticule CRT, beam finder, expansion mesh CRT, trigger holdoff, mixed sweep, general purpose sampling to 18 GHz, time domain reflectometry, and rugged variable persistence/storage.

Selecting an oscilloscope

Today's selection of an oscilloscope is not as easy as it was in previous years. The recent technological changes have considerably improved the price performance ratios that are available. In addition, measurement requirements have also changed and expanded.

To make the best selection, use your immediate measurement application as a starting point. Then look at your past and future requirements. After examining all of the possible measurement requirements, you will have an idea of the type of oscilloscope needed in your application. In a somewhat broad sense oscilloscopes can be classified in two categories, mainframes with plug-ins and nonplug-ins.

Plug-in oscilloscopes

The plug-in oscilloscope (figure 1) offers

maximum flexibility by permitting general purpose measurements as well as retaining the capability to make specialty measurements. By carefully selecting a mainframe, you will be able to change the measurement capability by using different plug-ins rather than having another infrequently used special purpose oscilloscope on hand. Plug-in oscilloscopes are usually called General Purpose Laboratory instruments because of the broad measurement capabilities.

General purpose lab scopes are used in basic circuit design for almost every electronic product and are most often configured as a 2 channel, wide band, delayed sweep instrument. As the general purpose measurement needs expand, the plug-in flexibility allows you to reconfigure your instrument to fit the newer applications.

In addition to general purpose dual channel plug-ins with bandwidths from 35 to 250

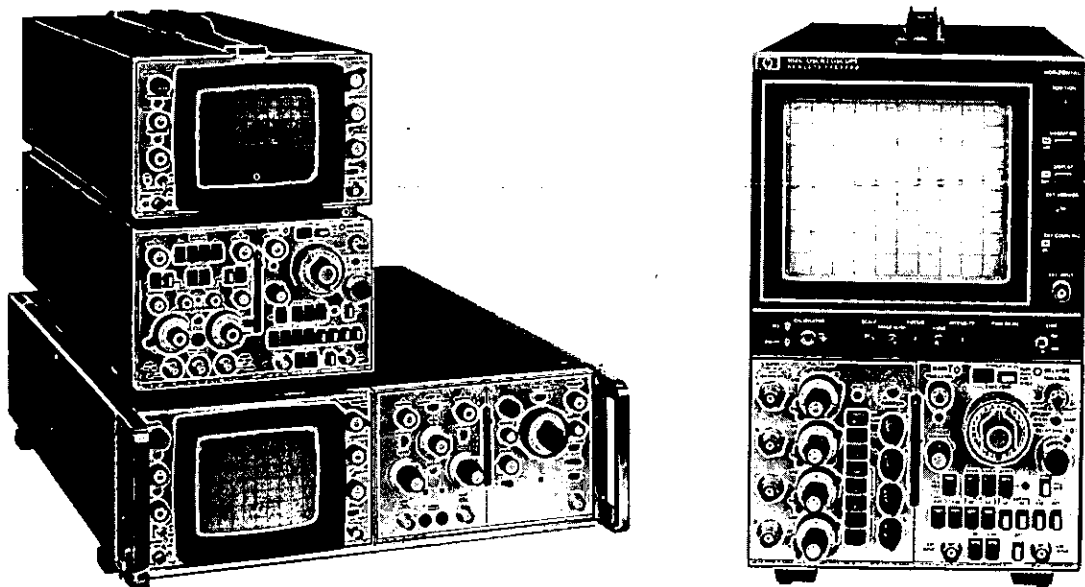

Figure 1. Representative plug-in oscilloscopes from Hewlett-Packard's 180 series.



MHz, many specialty plug-ins are also available — high sensitivity, differential/dc offset; four channels; standard, delayed, expanded, or mixed sweep operation; sampling bandwidths to 18 GHz; time domain reflectometry; spectrum analysis to 1500 MHz, swept frequency testing from 100 MHz to 18 GHz, and digital state analysis. The flexibility of the plug-in system is considerable — it makes one instrument do many jobs.

Nonplug-in oscilloscopes

Nonplug-in oscilloscopes (figure 2) are sometimes referred to as "dedicated" instruments because of their nonplug-in form. Although they are dedicated in form they are truly general purpose in measurement capability with full laboratory accuracy and quality. These oscilloscopes are usually dual channel, delayed sweep instruments with a wide variety of measurement capabilities. If the applications do not require plug-in flexibility for changing requirements, then the lower cost nonplug-in oscilloscope is a useful choice for a general purpose laboratory instrument.

High speed

Hewlett-Packard has two new 275 MHz oscilloscopes that are ideal for use in the design, manufacturing, and testing of high speed computers, peripherals with fast interface logic, high speed digital communications and instrumentation, as well as high frequency rf applications. Model 1720A has conventional volts-versus-time measurements and is particularly suited for digital timing measurements with its 1 ns/div sweep speeds. Model 1722A adds a microprocessor with an LED display to give you direct read-out of time interval, frequency, dc voltage, in-

stantaneous voltage, and relative amplitude expressed in percent. As well as providing a digital readout of a measurement, the microprocessor gives considerably more repeatable measurements than previously possible in real time oscilloscopes. This substantial increase in repeatability makes the 1722A extremely useful in applications requiring comparison to a reference and also reduces the chance of human error. For example, the outstanding repeatability along with 20 ps resolution makes the 1722A ideally suited for clock phasing measurements in computer timing application.

For lower frequency requirements a 200 MHz oscilloscope, Model 1710B, is available with 1 ns/div sweep speed for use in digital and analog applications. The laboratory performance and compact package makes the scope equally well suited for bench or field applications.

35 MHz and 75 MHz

For applications in the 35 MHz and 75 MHz area, there are four scopes with battery, dc, or ac line power capability for field and lab applications. Two of the 35 MHz oscilloscopes offer storage and variable persistence operation with rugged burn resistant CRT's which makes them ideal for general use. A metal front panel cover is also included for front panel protection and storage of accessories required in field work.

The low power requirements of Hewlett-Packard portable oscilloscopes has allowed very rugged instruments to be developed. These scopes, designated as 1700B Opt 300 and 1707B Opt 300 meet the requirements of the AN/USM 339 and AN/USM 338. In fact, a few modifications allowed the oscilloscope to surpass the drip-proof test and operate under water. Meeting these rugged re-

quirements did not reduce the laboratory accuracy of these instruments and they incorporate the same basic proven circuits as the standard 1700 series oscilloscopes.

15 MHz

In the dc to 15 MHz range there are two models available, 1220A dual channel and 1221A single channel, that are designed for industrial and educational applications, and production line testing. Logical front panel layout, large 8 x 10 cm internal graticule, and automatic triggering reduce familiarization time and assure maximum efficiency in production and student environments.

500 kHz

Low frequency scopes which have about 500 kHz bandwidth are used in educational, medical, system monitors, engineering, production, and in some cases field service. These scopes could be classified as the "workhorses" of the electronics industry since they are most commonly found in system applications. The 1200 series scopes easily fill these requirements with their 100 μ V and 5 mV sensitivity, solid-state and lightweight construction, and reliable and stable operation. Also available are storage and variable persistence models which eliminate annoying flicker and retain single-shot traces that are common in bio-medical or electro-mechanical applications.

Oscilloscope basics

Because the oscilloscope can display electrical signals which vary with time, it has become today's most widely used electronic measuring instrument. It produces a visual display of any physical quantity which can be represented as a voltage. This permits precise measurement and analysis of the phe-

OSCILLOSCOPES

General information (cont.)

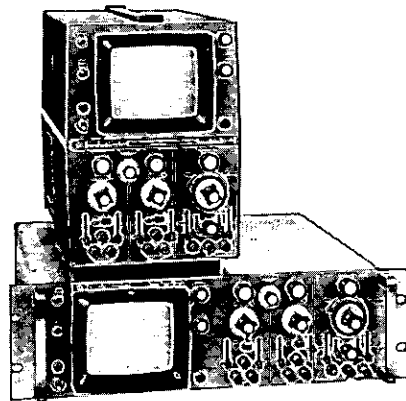
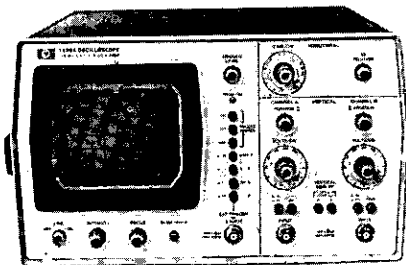
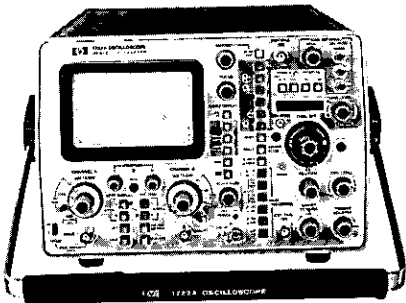
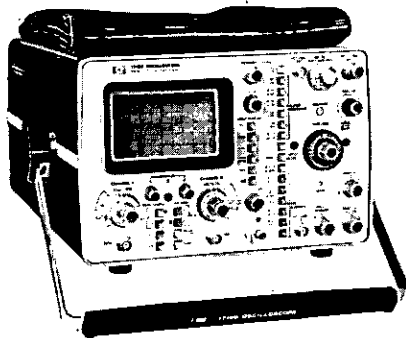

Figure 2. Representative Hewlett-Packard nonplug-in oscilloscopes.

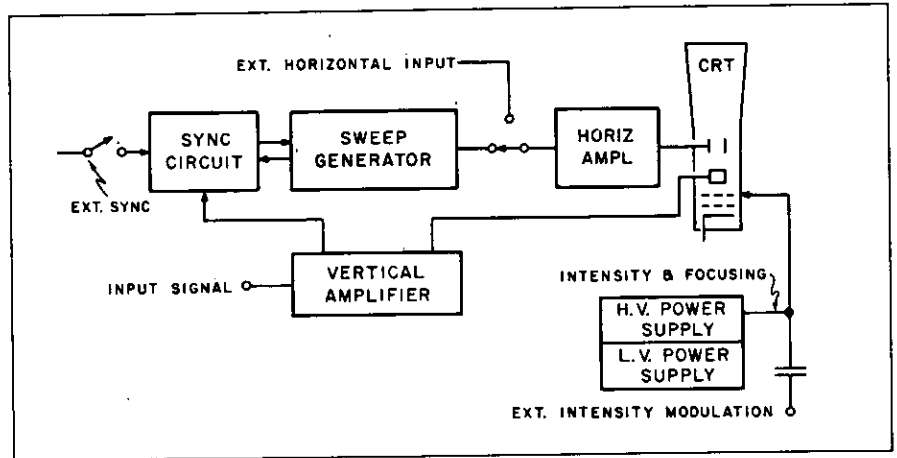

Figure 3. Typical oscilloscope block diagram.

nomenon represented by the voltage.

The block diagram in figure 3 shows the essential parts of an oscilloscope.

The cathode-ray tube

A CRT produces an electron beam whose movement is controlled by the vertical and horizontal amplifiers and by the power supplies which form, shape, and accelerate it. This electron beam strikes a phosphor screen and a visible glow results as the beam is moved.

Since the beam deflection can be calibrated against a grid (graticule) on the CRT face, amplitude and time measurements can be made. All Hewlett-Packard graticules are internal and in the same plane as the phosphor, eliminating parallax.

Hewlett-Packard manufactures all its own CRT's—technological leadership has accompanied this.

An expansion mesh, used first by Hewlett-Packard in 1962, with a voltage on it produces an electrostatic field which bends the beam after its initial deflection at the electron gun structure. By controlling mesh radius, Hewlett-Packard CRT designers have produced increasingly larger display areas while simultaneously reducing the overall length of the tube.

Storage scopes are available with rugged variable persistence (the time it takes for the trace to fade to 10% of its original brightness). This is made possible by use of a storage mesh immediately behind the phosphor. Control circuits then determine the rate at which a display fades away after being stored as a charged pattern on the mesh.

Vertical deflection system

Since the CRT is limited as to the range of deflection voltages which can be applied, a vertical amplifier and attenuator are used. These are accurately calibrated to provide a deflection factor related to the graticule (e.g., 5 mV/division).

Hewlett-Packard vertical deflection systems have been made more useful with sim-

plified, yet functional, controls. As better circuits have been designed, adjustments previously adding to front panel confusion have been eliminated or located inside for use only in periodic calibration. An example of functional and innovative amplifier design is a selectable input impedance, either 50Ω or high Z.

Horizontal deflection system

To deflect the electron beam horizontally, an amplifier and sweep generator are used. A sawtooth waveform generator sweeps the beam at a selectable uniform rate. With such a linear rate of sweep, calibration to the graticule is possible (e.g., 1 ms/division).

For meaningful displays, the horizontal deflection system must provide synchronizing circuits to start the sweep at a specific instant with respect to the measured waveform. Automatic triggering on Hewlett-Packard scopes makes starting of the sweep a quick, easy step. And preset adjustments produce synchronized sweeps with little or no adjustment. This allows stable, one-knob triggering on signals to beyond 500 MHz.

In addition to a direct-reading expander control, which minimizes errors, a time base in the HP 180 System features a X100 sweep expansion. This allows detailed examination of selected portions of a display, a feature normally found only on more expensive delaying time bases.

Power supplies

Scopes contain low and high voltage power supplies and determine, with the CRT, the maximum capability of a scope, especially of a mainframe.

Low voltage power supplies give operating power to scope circuits such as the vertical and horizontal amplifiers. The high voltage power supply forms and controls the CRT electron beam.

Hewlett-Packard has made contributions in power supplies, too, and two examples will show their significance:

1. The 1700 Series portable scopes have an

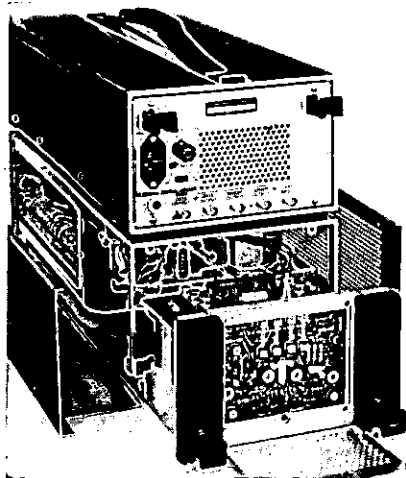

Figure 4. Power supply module can be operated outside the mainframe to facilitate maintenance.

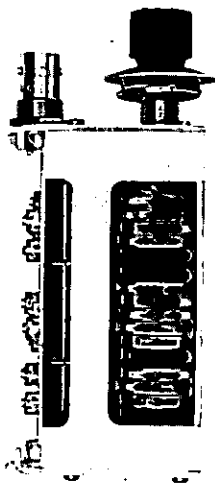

Figure 5. Hewlett-Packard innovation uses thick-film substrate in cam-operated attenuators, allowing selection of 50 Ω or high input impedance with low capacitance.

advanced design LVPS. It is highly efficient and has a newly designed dc-to-dc converter. The result is a scope which consumes approximately 25 watts and operates from ac line, dc line, or optional battery.

2. Mainframes in the 180 System have a reliable LVPS which, when repair may be required, can be removed from the instrument in a fully operating status; refer to figure 4. Repair or calibration time is greatly reduced.

Input probes

Proper selection of well-designed probes will minimize circuit loading effects and provide the most accurate and useful waveform

information. Improper matching of probe to circuit measurement point or of probe to scope will cause rise time errors in pulse measurements and cause both amplitude and phase errors in CW measurements.

The effects of resistive loading have been recognized for some time. High input impedances have been used to reduce the voltage division between circuit and measuring device. This technique will cause minimal error if measurements are at low frequencies and the circuit test point has a low impedance.

When these probing requirements are not met, inaccuracies result for one big reason: CAPACITANCE. And the effects of capacitance in the probe or scope input change drastically because of frequency.

Hewlett-Packard has pioneered in helping solve the capacitance problem in high frequency measurements by providing selectable input impedance — 50 ohms or a high Z with low capacitance. This measurement convenience is available because of Hewlett-Packard's innovative design, illustrated in figure 5, that uses thick-film attenuators, a first for the scope industry.

Sampling oscilloscopes

Sampling oscilloscopes use a technique which is similar in principle to use of a stroboscope for study of periodic or varying motion.

Samples are taken on successive recurrences of a waveform. As each amplitude sample is taken later in time on the waveform, the CRT beam is deflected to the corresponding point where a visible dot is then displayed. The rate at which sampling occurs is very fast; thus the dots are displayed as a coherent appearing waveform on the CRT. Figure 6 illustrates the sampling technique.

Samples are obtained when a pulse "turns on" the sampling circuit for an extremely short time. During this interval the input waveform amplitude is measured, the samples are then effectively "stretched" in time, and amplified at relatively low bandwidths.

Thanks to fast-switching diodes developed by Hewlett-Packard—some even for use in other types of instrumentation—sampling scope bandwidths have progressed to the 18 GHz point. Hewlett-Packard introduced the first commercially available sampling scope over ten years ago. Once again, cumulative technology has kept Hewlett-Packard sampling scopes a leader, both in performance and price, typified by the Model 1810A, a 1

GHz sampling plug-in that is both low in price and as easy to operate as a real time oscilloscope.

Oscilloscope selection

1720 Series 275-MHz oscilloscopes

Wide band measurements for laboratory, production, and field use in digital applications and high frequency rf applications. See Page 94.

1700 Series oscilloscopes

Rugged, light-weight instruments adequate for almost any field service or laboratory application. Bandwidths of 35 MHz, 75 MHz, and 200 MHz. Storage with variable persistence at 35 MHz bandwidth. See Page 101.

180 System high frequency plug-in scope

The one plug-in instrument to solve nearly any general-purpose laboratory or production line measurement problem. Bandwidths of 500 kHz, 35 MHz, 50 MHz, 75 MHz, 100 MHz, 250 MHz, or >600 MHz. Standard, storage/variable persistence, >400 cm/ μ s storage writing speed or big-screen. Sampling to 18 GHz, TDR, spectrum analysis, and swept frequency analysis. See Page 110.

1220 Series 15 MHz bandwidth

Single and dual channel oscilloscopes for production line testing, educational, and industrial applications. See Page 142.

1200 Series low frequency scopes

Low frequency, nonplug-in scopes of proven, all-solid-state circuit design. Many operating features normally found only on much wider bandwidth, more expensive scopes. 500 kHz bandwidths in standard or storage/variable persistence. Deflection factors as low as 100 μ V/div. See Page 144.

140 General-purpose plug-in scope

A valued performer for Hewlett-Packard customers around the world. Standard and storage/variable persistence mainframes. 20 MHz bandwidth with standard or delayed time base and spectrum analyzer plug-ins. See Page 148.

Oscilloscope accessories

Supporting accessories to get the most out of your scope investment. Cameras and adapters, testmobiles, active and passive probes, and adapters to meet most any need. (Note: for testmobiles see page 478.) See Page 150.

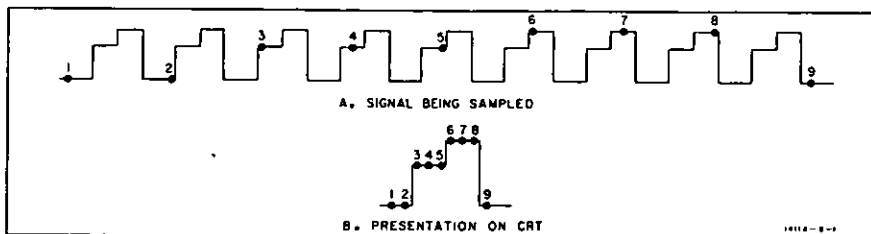
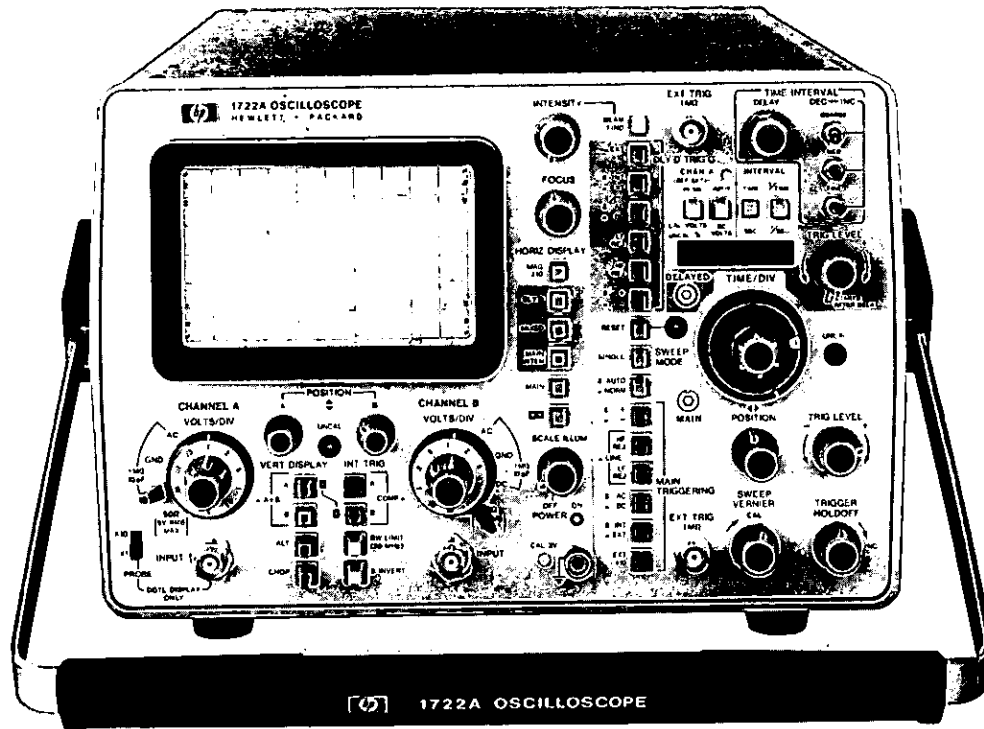

Figure 6. Sampling scope technique reconstructs waveform from consecutive samples.

OSCILLOSCOPES

275 MHz, direct readout of volts and time

Model 1722A

NEW

1722A Description

The Model 1722A is a 275 MHz bandwidth, 1 ns/div sweep speed dual channel oscilloscope with a built-in microprocessor for the most precise real time measurement capabilities available at this time. In addition to the conventional volts versus time CRT display, the microprocessor gives you direct readout of time interval, frequency, dc voltage, instantaneous voltage, and percent.

As well as increased accuracy offered by the microprocessor, you get a digital readout of the answer to your problem in considerably less time than it takes in a conventional scope. You also get a substantial improvement in measurement repeatability which makes the 1722A extremely useful in applications requiring comparison to a reference. For example, the 1722A's outstanding repeatability along with the 20 ps resolution makes it ideally suited for making clock phasing measurements in large computer timing applications.

Time Interval measurements

The Time Interval Mode is ideal for making accurate measurements of rise time, pulse width, and propagation delay.

Time interval measurements can be made between two events on Channel A, two events on Channel B, or when in alternate mode, between an event beginning on Channel A and ending on Channel B. A DUAL DELAYED SWEEP technique displays the start and stop points of your time interval as intensified markers. The technique is to select MAIN INTENSIFIED MODE and adjust marker width with the delay time/division control. Then set the first marker at t_1 with the DELAY dial, and set the 2nd marker at t_2 with the DECREASE-INCREASE controls (coarse, medium, or fine). The $3\frac{1}{2}$ digit LED display automatically and continuously reads the time interval between the two markers (t_2-t_1). Time interval measurements are always displayed in units of sec (exponent 0); ms (exponent -3); μ s (exponent -6); or ns (exponent -9). For increased resolution, select DELAYED sweep mode. The two intensified portions will be displayed alternately. Achieving the maximum accuracy of the 1722A is a simple matter of overlapping the start and stop points using the DEC-INC switches! This new technique eliminates any measurement errors

due to vertical or horizontal drift. It also enables you to compare two waveforms while comparing the time relationship between them.

The microprocessor not only keeps track of the distance between the two markers but automatically expands the measurement resolution by a factor of 10 whenever the two markers are within 1 cm of each other. For example, when making measurements on the 2 ms/div range a measurement of just over a division has a readout of 2.01 ms while a measurement of just under a division has a readout of 1.998 ms.

Accuracy in the time interval mode is basically 1%. The 1722A Data Sheet has more detailed information regarding measurement accuracy.

The microprocessor is not only used to calculate time interval but is also used to interrogate the function switches to help prevent inaccurate measurements. For example, the time interval mode is only valid in either the main intensified mode, where the two markers can be seen, or in the delayed sweep mode, where resolution and accuracy can be improved by overlapping the two delayed sweeps. In other modes where errors might be made (such as in main, mixed, and X-Y), the microprocessor automatically sets the display to zero. The display is also set to zero whenever the sweep vernier is out of the Cal detent or when the delayed trigger level is out of the Starts After Delay position.

1/Time (frequency) measurements

The 1722A gives an automatic 3 or 4 digit display of the reciprocal of time. If a time interval measurement is the period of a waveform, then the 1/Time mode provides a direct readout of repetition rate or frequency. The microprocessor computes the reciprocal of whatever time interval has been set when in the Time mode. 1/Time display units are in Hz (exponent 0), kHz (exponent 3), or MHz (exponent 6). This very convenient measurement eliminates the need for calculations when setting up clock frequencies and measuring the frequency or repetition rate of a waveform. An application of both time and 1/time modes is to preset a desired time interval or frequency, then through the technique of overlapping traces make an external adjustment to bring the system under test into specification.

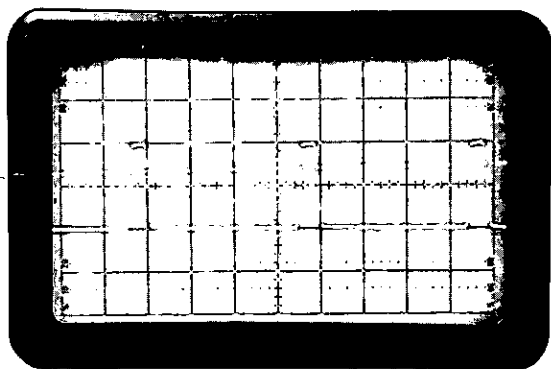

An unknown time interval, $T_2 - T_1$, can be measured directly with the 1722A

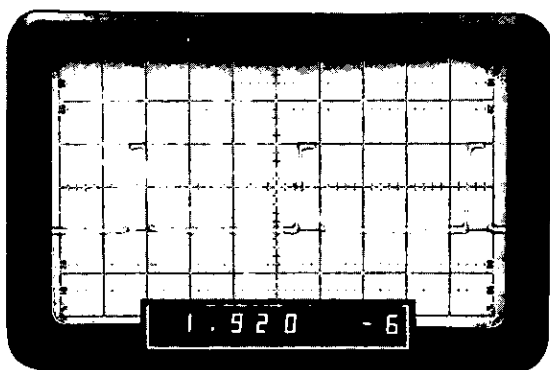

Two intensified markers are positioned to cover the start and stop points of the desired interval. The LED readout automatically and continuously displays the time between the two markers (1.92 μ s).

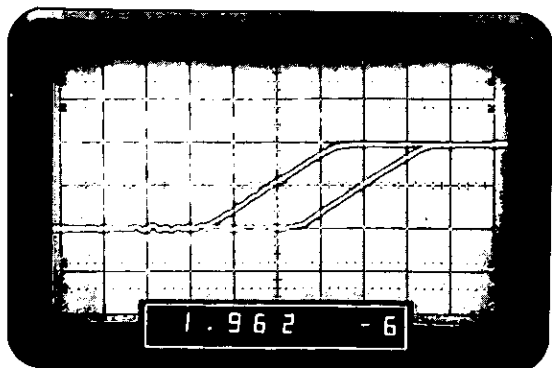

For increased accuracy, the scope is placed in the Delayed Sweep mode to display the two intensified traces alternately. When the two traces are made to coincide using the DEC \leftrightarrow INC controls, maximum accuracy is achieved: (1.962 μ s, $\pm 0.63\%$).

DC voltage measurements

When the 1722A is operated in the Input (dc volts) mode you have a direct digital display of the average value of the waveform at the input to channel A. The display is $3\frac{1}{2}$ digits with a sample rate of approximately 2/s and a response time of less than one second. The DVM is autoranging from 100 mV full scale to 50 V full scale in the X1 range. In the X10 range, which automatically compensates for a 10:1 divider probe, full scale ranges are from 1 volt to 500 V.

The technique for making dc voltage measurements is to ground the scope input and establish a reference level by pressing the reference set pushbutton. Then with the input impedance set to 1 megohm the digital readout displays the average value of the input waveform. The DVM measurement is made using a successive approximation algorithm controlled by the microprocessor which allows you to establish a reference level with respect to any voltage and enables differential dc measurements. For example, you can probe the base of a transistor, push the reference set button, then probe the emitter. The display gives you V_{be} directly.

Instantaneous voltage measurements

In the position mode you can measure the value of any point on a waveform which eliminates the need to count divisions from a base-line and multiply by the attenuator setting. A switch in the channel A input allows you to compensate for a 10:1 divider probe for a direct readout of voltage at the probe tip without any calculations. This measurement mode is useful for measuring peak voltage, power supply ripple, crossover and threshold points in logic circuits, or any other time when you need to know a precise voltage at a particular point on a waveform.

As with the dc voltage measurement, you select the reference point (usually ground) and measure the value of any point on a waveform with respect to the reference point. This measurement mode, like DC Volts, is autoranging; the microprocessor automatically keeps track of the attenuator setting to provide the correct voltage. If the dynamic range is exceeded the display flashes to indicate the overrange condition.

Percentage measurement

The Position Mode gives an automatic readout of percent when the vernier is out of CAL position. This measurement is made by establishing a 5 cm display between the 0 and 100% points with the 0% point positioned on a convenient graticule and zeroed with the Reference Set pushbutton. The desired point on the waveform is positioned on the reference graticule line using the position control and the percentage of that point with respect to the 0 and 100% points is automatically and continuously displayed. Applications for the percentage mode include measuring the 50% points on a pulse and percent of amplitude modulation on an rf carrier.

Storage registers

Storage registers in the microprocessor remember the value of the last setting of different modes. For example, when switching from the Time mode to a Voltage mode and back to Time the display automatically resets to the last display including the spacing between the markers. This memory capability makes it easier to re-establish a display after making measurements in other parts of a circuit.

The digital readout achieves considerable measurement time savings and improves repeatability over conventional scopes. This measurement repeatability makes the 1722A useful for applications where comparison measurements to a reference are required.

Model 1722A (cont.)

NEW

1722A Specifications

Vertical display modes

Channel A; channel B; channels A and B displayed alternately on successive sweeps (ALT); channels A and B displayed by switching between channels at approx. 1 MHz rate with blanking during switching (CHOP); channel A plus channel B (algebraic addition).

Vertical amplifiers (2)

Bandwidth: ≤ 3 dB down from a 6 div reference signal.)

DC-coupled: dc to 275 MHz in both 50 ohm and high impedance input modes.

AC-coupled: approx. 10 Hz to 275 MHz.

Bandwidth limit: limits upper bandwidth to approx. 20 MHz.

Rise time: ≤ 1.3 ns (measured from 10% to 90% points of a 6 div input step).

Deflection factor:

Ranges: 10 mV/div to 5 V/div (9 calibrated positions) in 1, 2, 5 sequence. $\pm 2\%$ attenuator accuracy.

Vernier: continuously variable between all ranges; extends maximum deflection factor to at least 12.5 V/div. Front panel light indicates when vernier is not in CAL position.

Polarity: channel B may be inverted, front panel pushbutton.

Signal delay: input signals are delayed sufficiently to view leading edge of input pulse without external trigger.

Input coupling: selectable, AC or DC, 50 ohm (dc), or ground. Ground position disconnects input connector and grounds amplifier input.

Input RC (selectable):

AC and DC: 1 megohm $\pm 2\%$ shunted by approx. 11 pF.

50 ohm: 50 ohms $\pm 2\%$; VSWR, $\leq 1.3:1$ on 10, 20, and 50 mV ranges and $\leq 1.15:1$ on all other ranges.

Maximum input

AC and DC: ± 250 V (dc + peak ac) at 1 kHz or less.

50 ohm: 5 V rms or ± 250 V peak whichever is less.

A + B operation:

Amplifier: bandwidth and deflection factors are unchanged; channel B may be inverted for A-B operation.

Differential (A - B) common mode: CMRR is at least 40 dB from dc to 5 MHz decreasing to 26 dB at 50 MHz. Common mode signal amplitude equivalent to 12 cm with one vernier adjusted for optimum rejection.

Trigger source:

Selectable from channel A, channel B, or composite.

Channel A: all display modes triggered by channel A signal.

Channel B: all display modes triggered by channel B signal.

Composite: all display modes triggered by displayed signal.

Channel A input — dc volts

Display: light emitting diodes (LED).

Number of digits: $3\frac{1}{2}$.

Display units: -0 exponent indicates volts; -3 exponent indicates millivolts.

X1 range: 100 mV to 50 V full scale vertical deflection (10 mV/div to 5 V/div).

X10 range: 1 V to 500 V full scale vertical deflection (100 mV/div to 50 V/div with X10 probe).

Accuracy: $\pm 0.5\%$ reading $\pm 0.5\%$ full scale (full scale = 10 cm), 20°C to 30°C.

Stability: temperature coefficient, $< \pm 0.02\%/^{\circ}\text{C}$.

Input impedance: X1 range, 1 megohm shunted by approx. 11 pF; X10 range (with X10 probe) 10 megohms shunted by approx. 10 pF.

Sample rate: approx. 2/s.

Response time: ≤ 1 s.

Reference set: meter may be zeroed permitting dc voltage measurements with respect to any voltage within selected range. Drift may be eliminated by the REF SET control.

Overrange: flashing display indicates overrange condition.

Channel A position — volts (channel A vernier in CAL detent)

With the following exceptions, specifications are the same as Channel A Input — DC volts.

Measurement: dc substitution method using channel A position control to determine voltage of any point on displayed waveform using any graticule line as reference.

Bandwidth: dc to 275 MHz (≤ 3 dB down from a 6 div reference signal).

Dynamic range: ± 6 cm from ground referenced to center screen.

Reference set: meter may be zeroed, permits instantaneous voltage measurements with respect to any voltage within selected range.

Accuracy: $\pm 1\%$ reading $\pm 0.5\%$ of full scale (10X the volts/div range) measured at dc.

Channel A position — % (channel A vernier out of CAL detent)

Measurement: dc substitution method using channel A position control to determine percent of any waveform point with respect to user defined 0 and 100% points.

Range: -0 to $\pm 140\%$ (calibrated with vernier so that 100% equals 5 div).

Accuracy: $\pm 1\%$.

Zero reference: meter may be zeroed to permit percent measurements with respect to any waveform point.

Vertical output

Amplitude: one division of vertical deflection produces approx. 100 mV output (dc to 50 MHz).

Cascaded deflection factor: 1 mV/div with both vertical channels set to 10 mV/div.

Cascaded bandwidth: dc to 5 MHz with bandwidth limit engaged.

Vertical output resistance: approx. 100 ohms.

Vertical output selection: trigger source set to channel A selects channel A output; trigger source set to channel B selects channel B output.

Horizontal display modes

Sweep modes: main, main intensified, mixed, delayed, and X10.

Sweep:

Ranges: 10 ns/div to 0.5 s/div (24 ranges) 1, 2, 5 sequence.

Accuracy:

Main sweep time/div	Accuracy (0°C to 55°C)	
	X1	X10
10 ns to 50 ns	$\pm 3\%$	$\pm 5\%$
100 ns to 20 ms	$\pm 2\%$	$\pm 3\%$
50 ms to 0.5 s	$\pm 3\%$	$\pm 3\%$

Vernier: continuously variable between all ranges; extends slowest sweep speed to at least 1.25 s/div. Vernier uncalibrated light indicates when vernier is not in CAL position.

Magnifier: expands all sweeps by a factor of 10; extends fastest sweep to 1 ns/div.

Sweep mode:

Normal: sweep is triggered by internal or external signal.

Automatic: bright baseline displayed in absence of input signal. Triggering is normal above 40 Hz.

Single: in Normal mode, sweep occurs once with same triggering as normal, reset pushbutton arms sweep and lights indicator; in Auto mode, sweep occurs once each time Reset pushbutton is pressed.

Triggering:

Internal: dc to 100 MHz on signals causing 0.5 division or more vertical deflection, increasing to 1 division of vertical deflection at 300 MHz in all display modes. Triggering on line frequency is also selectable.

External: dc to 100 MHz on signals of 50 mV p-p or more increasing to 100 mV p-p at 300 MHz.

External input RC: approx. 1 megohm shunted by approx. 15 pF.

Trigger level and slope:

Internal: at any point on the vertical waveform displayed.
External: continuously variable from +1.0 V to -1.0 V on either slope of the trigger signal; +10 V to -10 V in divide by 10 mode (+10).

Coupling: AC, DC, LF REJ, or HF REJ.

AC: attenuates signals below approx. 10 Hz.
LF REJ: attenuates signals below approx. 15 kHz.
HF REJ: attenuates signals above approx. 15 kHz.

Trigger holdoff: time between sweeps continuously variable exceeding one full sweep from 10 ns/div to 50 ms/div.

Main intensified

Intensifies that part of main time base to be expanded to full screen in delayed time base mode. Time interval controls adjust position of intensified portion of sweep. Rear panel intensity ratio control sets relative intensity of brightened segment.

Delayed time base

Sweep:

Ranges: 10 ns/div to 20 ms/div (20 ranges) in 1, 2, 5 sequence.
Accuracy (0 to 55°C): same as main time base.
Magnifier (0 to 55°C): same as main time base.

Triggering:

Internal: same as main time base except there is no Line Frequency triggering.
Starts after delay: delayed sweep automatically starts at end of delay setting.
Trigger: with delayed trigger level control out of detent (starts after delay) delayed sweep is triggerable at end of delay period.
External: dc to 100 MHz on signals of 50 mV p-p or more, increasing to 100 mV p-p at 300 MHz.
External input RC: approx. 1 megohm shunted by approx. 15 pF.

Trigger level and slope:

Internal: at any point on the vertical waveform displayed when in triggered mode.
External: continuously variable from +1.0 V to -1.0 V on either slope of the trigger signal; +10 V to -10 V in divide by 10 mode (+10).

Coupling: AC, DC, LF REJ, or HF REJ.

AC: attenuates signals below approx. 10 Hz.
LF REJ: attenuates signals below approx. 15 kHz.
HF REJ: attenuates signals above approx. 15 kHz.

Time interval:

Delay time: continuously variable from 10 ns to 5 s.
Delay jitter: refer to Time Interval Measurements, Stability.

Time interval measurements (time):

Function: measures time interval between two events on channel A (channel A display); between two events on channel B (channel B display); or between two events starting from an event on channel A and ending with an event on channel B (Alternate display).
Display units: -0 (s); -3 (ms); -6 (μs); or -9 (ns).
Accuracy:

Main time base setting	Accuracy (+20°C to +30°C)
100 ns/div to 20 ms/div	±0.5% of measurement ±0.02% of full scale (for measurements less than 1 cm). For measurements >1 cm, ±0.5% of measurement ±0.05% of full scale.
50 ns/div	±0.5% of measurement ±0.06% of full scale.
20 ns/div* and 50 ms/div to 0.5 s/div.	±0.5% of measurement ±0.15% of full scale.

*Starting after 3 cm of sweep.

Resolution: intervals <1 cm, >0.01% of full scale; intervals >1 cm, >0.1% of full scale; maximum display resolution, 20 ps.

Stability (0 to +55°C): short term, <0.01%. Temperature, <±0.03%/°C deviation from calibration temperature range.

Reciprocal of time interval measurements (1/time):

Function: calculates and displays the reciprocal of the measured time interval.
Display units: -0 (Hz); 3 (kHz); 6 (MHz).
Accuracy: same as Time Interval.
Resolution: same as Time Interval.
Stability: same as Time Interval.

Mixed time base

Dual time base in which the main time base drives the first portion of sweep and the delayed time base completes the sweep at the faster delayed sweep. Also operates in single sweep mode.

X-Y operation

Bandwidth:

Y-axis (channel A): same as channel A.
X-axis (channel B): dc to >3 MHz.

Deflection factor: 10 mV/div to 5 V/div (9 calibrated positions) in 1, 2, 5 sequence.

Phase difference between channels: <3°, dc to 3 MHz.

Cathode-ray tube and controls

Type: post accelerator, approx. 20.5 kV accelerating potential, aluminumized P31 phosphor.
Graticule: 6 × 10 div internal graticule. 0.2 subdivision markings on major axes. 1 div = 1 cm. Rear panel adjustment aligns trace with graticule. Internal flood gun graticule illumination.
Beam finder: returns trace to CRT screen regardless of setting of horizontal, vertical, or intensity controls.
Intensity modulation: +8 V, ≥50 ns width pulse blanks trace of any intensity, useable to 20 MHz for normal intensities. Input R, 1 kΩ ±10%. Maximum input, +10 V (dc + peak ac).
Auto-focus: automatically maintains beam focus with variations of intensity.
Intensity limit: automatically limits CRT beam current to decrease possible CRT damage. Circuit response time ensures full writing speed for viewing low duty cycle, fast rise time pulses.
Rear panel controls: astigmatism, pattern, main/delayed intensity ratio, and trace align.

General

Rear panel outputs: main and delayed gates, -0.7 V to +1.3 V capable of supplying approx. 3 mA.
Calibrator: 1 kHz ±10% square wave; 3 V p-p ±1%; <0.1 μs rise time.
Power: 100, 120, 220, 240 V, -10%, +5%; 48 to 440 Hz; 110 VA max.
Weight: Net, 13.2 kg (29 lb). Shipping, 17.9 kg (39.5 lb).
Operating environment: temperature, 0 to +55°C (+32°F to +130°F); humidity, to 95% relative humidity at 40°C (104°F); altitude, to 4.6 km (15 000 ft); vibration, vibrated in three planes for 15 min. each with 0.254 mm (0.010 in.) excursion, 10 to 55 Hz.
Dimensions: 335 mm wide (13 3/16 in.); 197 mm high (7 3/4 in.); 570 mm length with handle (22 1/8 in.), 518 mm length without handle (20 1/2 in.).
Accessories furnished: one Model 10115A blue light filter; one front panel cover; one vinyl storage pouch; one 2.3 m (7.5 ft) power cord; one Operating and Service Manual.

Recommended probes:

Divider probes for 1 megohm inputs: models 10014A and 10016A.
Divider probe for 50 ohm inputs: model 10020A, resistive divider.
Active probes for 50 ohm inputs: models 1120A, and 1125A.

Options

001: fixed line cord Price add \$15
003: probe power supply with two rear panel jacks for use with HP active probes. Provides power to operate one 1120A, two 1124A, or two 1125A active probes add \$50
011: P11 phosphor in lieu of P31 N/C

1722A Oscilloscope

\$4500

OSCILLOSCOPES

275 MHz precision performance

Model 1720A

NEW

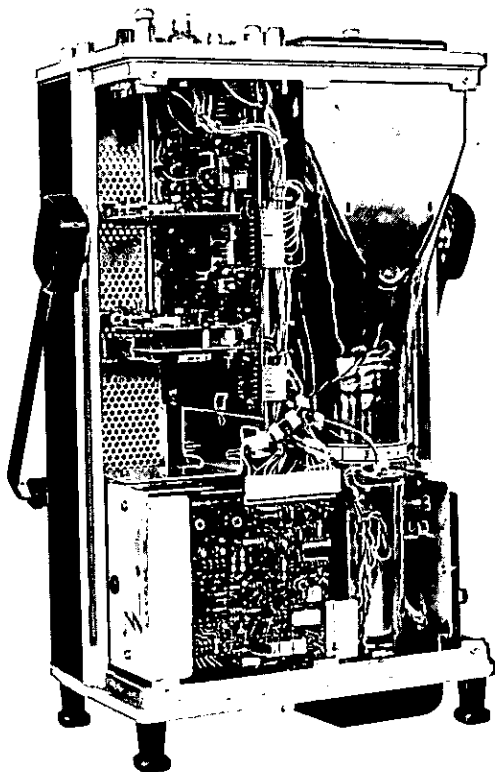
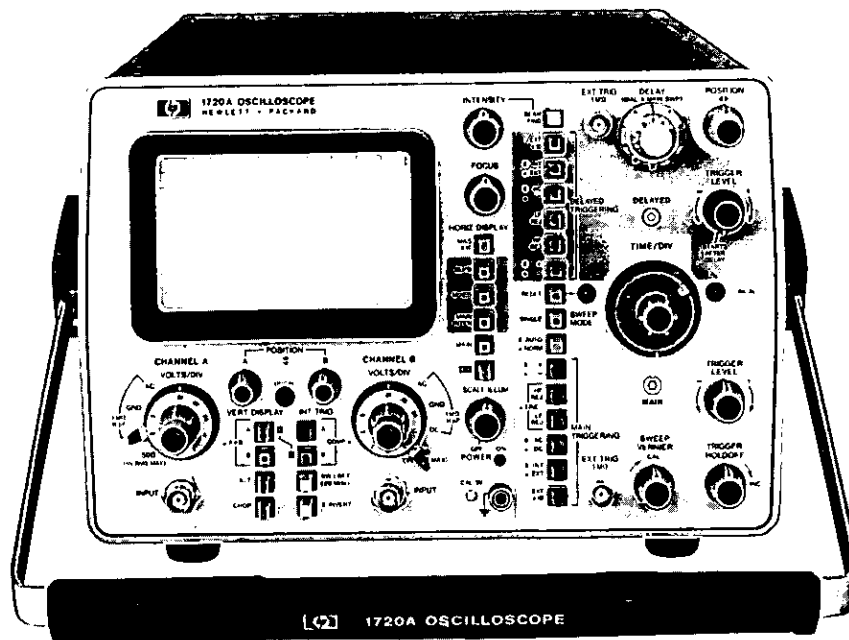

Access to the uncluttered interior for calibration and servicing is easy with the convenient lift-off covers.

1720A Description

Model 1720A high frequency oscilloscope provides precision measurements with dual channel 10 mV/div deflection factors, sweep speeds to 1 ns/div, and frequency response to 275 MHz. The 1720A's performance makes it ideal for use in the design, manufacture, and test of high speed computers, peripherals with fast interface logic, high speed digital communications and instrumentation, as well as high frequency rf applications.

Vertical deflection factors are 10 mV/div to 5 V/div over the full 275 MHz bandwidth with 2% attenuator accuracy. Full 275 MHz bandwidth is specified in both 50 ohm and 1 megohm input modes, over the full 6×10 cm display area, and when the verniers are in use to give you accurate, consistent measurements. Equally as important, the 275 MHz bandwidth can be depended upon over the full 0°C to 55°C environmental temperature range.

Internal triggering is stable to 300 MHz and requires only 1 cm of vertical deflection (only 0.5 cm to 100 MHz). The internal trigger sync take-off is immediately after the attenuator which maintains a stable display regardless of changes in position, vernier, or polarity controls. A full complement of pushbutton trigger selections in both main and delayed sweep modes assures you of the proper trigger signal for your application. Stable triggering on complex digital words while maintaining a full screen calibrated sweep is accomplished with a convenient trigger holdoff control.

Quick selection of Main, Main Intensified, Mixed, Delayed, X vs Y, or X10 Magnifier horizontal display modes is achieved with convenient single-function pushbuttons. The X10 magnifier offers increased measurement flexibility in all sweep speeds by allowing you to expand a pulse for detailed analysis.

The fully specified time base has a tolerance of $\pm 3\%$ in both main and delayed sweep modes over the full 10 cm horizontal display and temperature range of 0° to +55°C. Separate adjustments on the three fastest sweep speeds permit maximum timing accuracy on these critical ranges. Differential timing measurements are accurate to within

1% for most applications.

For maximum measurement flexibility, the 1720A has switch-selectable 50 ohm or 1 megohm inputs. For general purpose probing with 10:1 divider probes, the 1 megohm input which is shunted by only 11 pF offers minimum circuit loading. The 50 ohm input with internal compensation and low reflections provides faithful pulse reproduction for accurate transition time measurements in circuits where low capacitive loading is necessary. Where higher probing impedance is required with the 50 ohm input, active and resistive divider probes are available.

The CRT has a crisp, bright trace which is compatible with the 1 ns/div sweep speeds for easy viewing of low rep-rate, fast transition time signals. For convenient viewing and longer CRT life, beam intensity is automatically regulated. However, the automatic intensity limit circuit is designed so that maximum intensity is maintained for viewing low rep-rate, fast transition time pulses. An automatic focus circuit reduces the need for focus readjustment with intensity level changes while retaining a front panel control for fine adjustments when desired. An internal flood gun uniformly illuminates the CRT phosphor to achieve high quality trace photos as well as an eye-pleasing 6 x 10 cm internal graticule.

Access to the well planned interior for calibration and servicing is easy with convenient lift-off covers. Innovations in circuit design, along with the use of custom integrated circuits, reduce calibration time because of the low number of easy-to-reach adjustments (approximately 55), yet maintain the ability to optimize critical operating functions. Service time is reduced with the use of sockets for devices with more than three leads.

1720A Specifications

Vertical display modes

Channel A; channel B; channels A and B displayed alternately on successive sweeps (ALT); channels A and B displayed by switching between channels at approx. 1 MHz rate with blanking during switching (CHOP); channel A plus channel B (algebraic addition).

Vertical amplifiers (2)

Bandwidth: (3 dB down from a 6 div reference signal.)

DC-coupled: dc to 275 MHz in both 50 ohm and high impedance input modes.

AC-coupled: approx. 10 Hz to 275 MHz.

Bandwidth limit: limits upper bandwidth to approx. 20 MHz.

Rise time: <1.3 ns (measured from 10% to 90% points of 6 div input step).

Deflection factor

Ranges: 10 mV/div to 5 V/div (9 calibrated positions) in 1, 2, 5 sequence. $\pm 2\%$ attenuator accuracy.

Vernier: continuously variable between all ranges; extends maximum deflection factor to at least 12.5 V/div. Front panel light indicates when vernier is not in CAL position.

Polarity: channel B may be inverted, front panel pushbutton.

Signal delay: input signals are delayed sufficiently to view leading edge of input pulse without advanced trigger.

Input coupling: selectable, AC or DC, 50 ohms (dc), or ground. Ground position disconnects input connector and grounds amplifier input.

Input RC (selectable)

AC and DC: 1 megohm $\pm 2\%$ shunted by approx. 11 pF.

50 ohm: 50 ohms $\pm 2\%$; VSWR, $\leq 1.3:1$ on 10, 20, and 50 mV ranges and $\leq 1.15:1$ on all other ranges.

Maximum input

AC and DC: ± 250 V (dc + peak ac) at 1 kHz or less.

50 ohm: 5 V rms or ± 250 V peak whichever is less.

A + B operation

Amplifier: bandwidth and deflection factors are unchanged; channel B may be inverted for A - B operation.

Differential (A - B) common mode: CMRR is at least 40 dB from dc to 5 MHz decreasing to 26 dB at 50 MHz. Common mode signal amplitude equivalent to 12 cm with one vernier adjusted for optimum rejection.

Trigger source

Selectable from channel A, channel B, or Composite.

Channel A: all display modes triggered by channel A signal.

Channel B: all display modes triggered by channel B signal.

Composite: all display modes triggered by displayed signal except Chop.

Vertical output

Amplitude: one division of vertical deflection produces approx. 100 mV output (dc to 50 MHz).

Cascaded deflection factor: 1 mV/div with both vertical channels set to 10 mV/div.

Cascaded bandwidth: dc to 5 MHz with bandwidth limit engaged.

Vertical output resistance: approx. 100 ohms.

Vertical output selection: trigger source set to channel A selects channel A output; trigger source set to channel B selects channel B output.

Horizontal display modes

Sweep modes: main, main intensified, mixed, and delayed.

Sweep

Ranges: 10 ns/div to 0.5 s/div (24 ranges) 1, 2, 5 sequence.

Accuracy:

Main Sweep Time/Div	Accuracy (0°C to 55°C)	
	X1	X10
10 ns to 50 ns	$\pm 3\%$	$\pm 5\%$
100 ns to 20 ms	$\pm 2\%$	$\pm 3\%$
50 ms to 0.5 s	$\pm 3\%$	$\pm 3\%$

Vernier: continuously variable between all ranges; extends slowest sweep to at least 1.25 s/div. Vernier uncalibrated light indicates when vernier is not in CAL position.

Magnifier: expands all sweeps by a factor of 10; extends fastest sweep to 1 ns/div.

Sweep mode

Normal: sweep is triggered by internal or external signal.

Automatic: bright baseline displayed in absence of input signal. Triggering is same as normal above 40 Hz.

Single: in Normal mode, sweep occurs once with same triggering as normal, reset pushbutton arms sweep and lights indicator; in Auto mode, sweep occurs once each time Reset pushbutton is pressed.

Triggering

Internal: dc to 100 MHz on signals causing 0.5 division or more vertical deflection, increasing to 1 division of vertical deflection at 300 MHz in all display modes. Triggering on line frequency is also selectable.

External: dc to 100 MHz on signals of 50 mV p-p or more increas-

ing to 100 mV p-p at 300 MHz.

External input RC: approx. 1 megohm shunted by approx. 15 pF.

Trigger level and slope

Internal: at any point on the vertical waveform displayed.

External: continuously variable from +1.0 V to -1.0 V on either slope of the trigger signal, +10 V to -10 V in divide by 10 mode ($\div 10$).

Coupling: AC, DC, LF REJ, or HF REJ.

AC: attenuates signals below approx. 10 Hz.

LF REJ: attenuates signals below approx. 15 kHz.

HF REJ: attenuates signals above approx. 15 kHz.

Trigger holdoff: time between sweeps continuously variable, exceeding one full sweep from 10 ns/div to 50 ms/div.

Main intensified

Intensifies that part of main time base to be expanded to full screen in delayed time base mode. Delay control adjusts position of intensified portion of sweep. Rear panel intensity ratio control sets relative intensity of brightened segment.

Delayed time base

Sweep

Ranges: 10 ns/div to 20 ms/div (20 ranges) in 1, 2, 5 sequence.

Accuracy (0 to 55°C): same as main time base.

Magnifier (0 to 55°C): same as main time base.

Triggering

Internal: same as main time base except there is no Line Frequency triggering.

Starts after delay: delayed sweep automatically starts at end of delay period.

Trigger: with delayed trigger level control out of detent (starts after delay) delayed sweep is triggerable at end of delay period.

External: dc to 100 MHz on signals of 50 mV p-p or more, increasing to 100 mV p-p at 300 MHz.

External input RC: approx. 1 megohm shunted by approx. 15 pF.

Trigger level and slope

Internal: at any point on the vertical waveform displayed when in triggered mode.

External: continuously variable from +1.0 V to -1.0 V on either slope of the trigger signal, +10 V to -10 V in divide by 10 mode ($\div 10$).

Coupling: AC, DC, LF REJ, or HF REJ.

AC: attenuates signals below approx. 10 Hz.

LF REJ: attenuates signals below approx. 15 kHz.

HF REJ: attenuates signals above approx. 15 kHz.

Delay time: continuously variable from 10 ns to 5 sec.

Differential time measurement accuracy (+15°C to +35°C)

Main time base setting	Accuracy
50 ns/div to 20 ms/div	$\pm(0.5\% + 0.1\%$ of full scale)
20 ns/div and 50 ms/div to 0.5 s/div	$\pm(1\% + 0.2\%$ of full scale)

Delay jitter: <0.005% (1 part in 20 000) of maximum delay in each step.

Mixed time base

Dual time base in which the main time base drives the first portion of sweep and the delayed time base completes the sweep at the faster

delayed sweep. Also operates in single sweep mode.

X-Y operation

Bandwidth

Y-axis (channel A): same as channel A.

X-axis (channel B): dc to >3 MHz.

Deflection factor: 10 mV/div to 5 V/div (9 calibrated positions) in 1, 2, 5 sequence.

Phase difference between channels: <3°, dc to 3 MHz.

Cathode-ray tube and controls

Type: post accelerator, approx. 20.5 kV accelerating potential, aluminum P31 phosphor.

Graticule: 6 × 10 div internal graticule. 0.2 subdivision markings on major horizontal and vertical axes. 1 div = 1 cm. Rear panel adjustment aligns trace with graticule. Internal flood gun graticule illumination.

Beam finder: returns trace to CRT screen regardless of setting of horizontal, vertical, or intensity controls.

Intensity modulation: +8 V, ≥ 50 ns width pulse blanks trace of any intensity, useable to 20 MHz for normal intensities. Input R, 1 k Ω $\pm 10\%$. Maximum input, ± 10 V (dc + peak ac).

Auto-focus: automatically maintains beam focus with variations of intensity.

Intensity limit: automatically limits CRT beam current to decrease possible CRT damage. Circuit response time ensures full writing speed for viewing low duty cycle, fast rise time pulses.

Rear panel controls: astigmatism, pattern, main/delayed intensity ratio, and trace align.

General

Rear panel outputs: main and delayed gates, -0.7 V to +1.3 V capable of supplying approx. 3 mA.

Calibrator: 1 kHz $\pm 10\%$ square wave; 3 V p-p $\pm 1\%$; <0.1 μ s rise time.

Power: 100, 120, 220, 240 V, -10% +5%, 48 to 440 Hz; 110 VA max.

Weight: net, 12.9 kg (28.5 lb); shipping, 17.9 kg (39.5 lb).

Operating environment: temperature, 0 to +55°C (+32°F to +130°F); humidity, to 95% relative humidity at 40°C (104°F); altitude, to 4.6 km (15 000 ft); vibration, vibrated in three planes for 15 min. each with 0.254 mm (0.010 in.) excursion, 10 to 55 Hz.

Dimensions: 335 mm wide (13 $\frac{1}{16}$ "), 197 mm high (7 $\frac{7}{8}$ "), 570 mm length with handle (22 $\frac{1}{16}$ "), 518 mm length without handle (20 $\frac{3}{8}$ ").

Accessories furnished: one Model 10115A blue light filter; one front panel cover; one vinyl storage pouch; one 2.3 m (7.5 ft) power cord; one Operating and Service manual.

Recommended probes (not supplied with the 1720A)

Divider probes for 1 M Ω inputs: models 10014A and 10016A.

Divider probe for 50 Ω inputs: model 10020A.

Active probes for 50 Ω inputs: models 1120A and 1125A.

Options

001: fixed line power cord

Price
add \$15

003: probe power supply with two rear panel jacks for use with HP active probes. Provides power to operate one 1120A, two 1124A, or two 1125A Active Probes

add \$50
N/C

011: P11 phosphor in lieu of P31

A rack mount adapter is available for mounting a 1720A in a standard 48.3 cm (19-inch) rack. Contact your HP Field Engineer for information.

1720A Oscilloscope

\$3400

OSCILLOSCOPES

Portable 35, 75, and 200MHz
Models 1700B thru 1710B

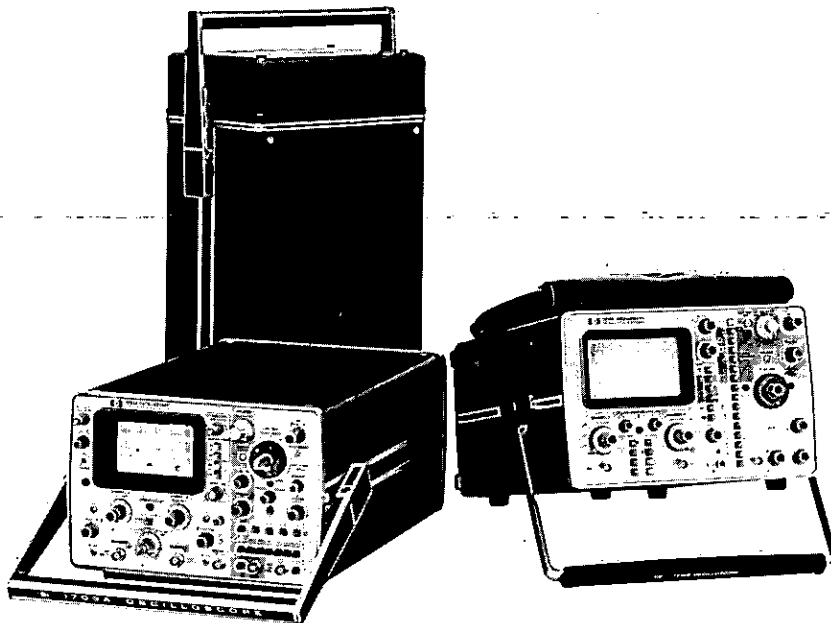

1700 Series

Introduction

Hewlett-Packard 1700 Series oscilloscopes are compact, lightweight, portable, laboratory quality instruments designed for field service applications. All models are dual channel with a selection of 35, 75, or 200 MHz bandwidths which allows you to match a scope to a particular application at lowest cost. Two models with variable persistence and storage are available to capture and retain fast rise time, low rep rate signals long enough for visual waveform analysis.

Operator convenience

All 1700 Series oscilloscopes have large CRT's with sharp traces for easy viewing and high resolution for accurate measurements. The conventional instruments have fully calibrated 6×10 cm graticules; variable persistence/storage displays are slightly smaller.

Front panel controls are grouped according to function and color coded for fast familiarization and pushbuttons are used to further simplify operation. Delayed sweep models have the delayed sweep controls in a gray front panel area for quick identification.

Main and delayed sweep speeds are selected with separate controls which allows you to change sweep speed on one time base without resetting the other. An interlock prevents the delayed time base from sweeping slower than the main time base.

Another convenience feature, on conventional CRT models, is scale illumination which aids in photographic work. A convenient beam finder, introduced by Hewlett-Packard, locates the trace and shows the direction it must be positioned for on-screen viewing. The beam finder also lets you determine if the scope is triggering by displaying horizontal deflection. Indicator lights are provided to show when the vertical deflection and sweep controls are not in the calibrated (detent) position.

Performance

The 1700 Series — though lightweight, rugged, and portable — gives you the performance ordinarily expected of laboratory oscilloscopes. Vertical deflection is specified over the full six divisions of vertical display, as indicated by the 10% and 90% CRT graticule markings. In addition, display mode and trigger source selection assure you of the right trigger signal for your application.

Sweep accuracies to 2% mean that critical timing measurements can

be made with lab-scope precision. In delayed sweep models, you can make differential timing measurements to approximately 1% accuracy by using a common reference graticule.

Calibrated mixed sweep is standard on delayed sweep models. Mixed sweep is useful for detailed examination of individual pulses in a pulse train by allowing you to "peel" them off one at a time. It is also useful when you want to monitor events prior to the occurrence of the pulse under close examination.

Trigger circuits have emitter-coupled logic for greater reliability and stable operation over a wide temperature range. A trigger holdoff control, also introduced by Hewlett-Packard, eliminates double triggering on complex digital waveforms and maintains a full-screen, calibrated sweep.

Reliability

1700 Series oscilloscopes have been designed for low power consumption which increases reliability since most active components operate at only 10 to 20% of their power rating. An example of the low power is that the vertical output transistors do not require heat sinks. The low power requirement also means that the 1700 Series oscilloscopes do not require fans for cooling which reduces the amount of dust and dirt that can accumulate inside the scope. This minimal ventilation requirement also reduces dc drift since the scope is less susceptible to short term temperature changes caused by drafts.

Battery operation

Four portable oscilloscopes (Models 1700B, 1702A, 1703A, and 1707B) are capable of battery operation. The optional, internal battery is easily installed with just two screws and does not require any power supply changes. Battery operation allows use in remote locations without regard for line power connections and is also well suited for many maintenance and checkout applications, especially where line isolation is required.

Ruggedized portables

Models 1700B Option 300 and 1707B Option 300 have been designed to meet the environmental requirements of AN/USM-339 and 338 described in MIL-T-21200. These ruggedized oscilloscopes maintain the fully calibrated features of the 1700B and 1707B and go far beyond the environmental capabilities of any other portable instrument.

OSCILLOSCOPES

Portable, 200 MHz dual channel

Model 1710B

NEW

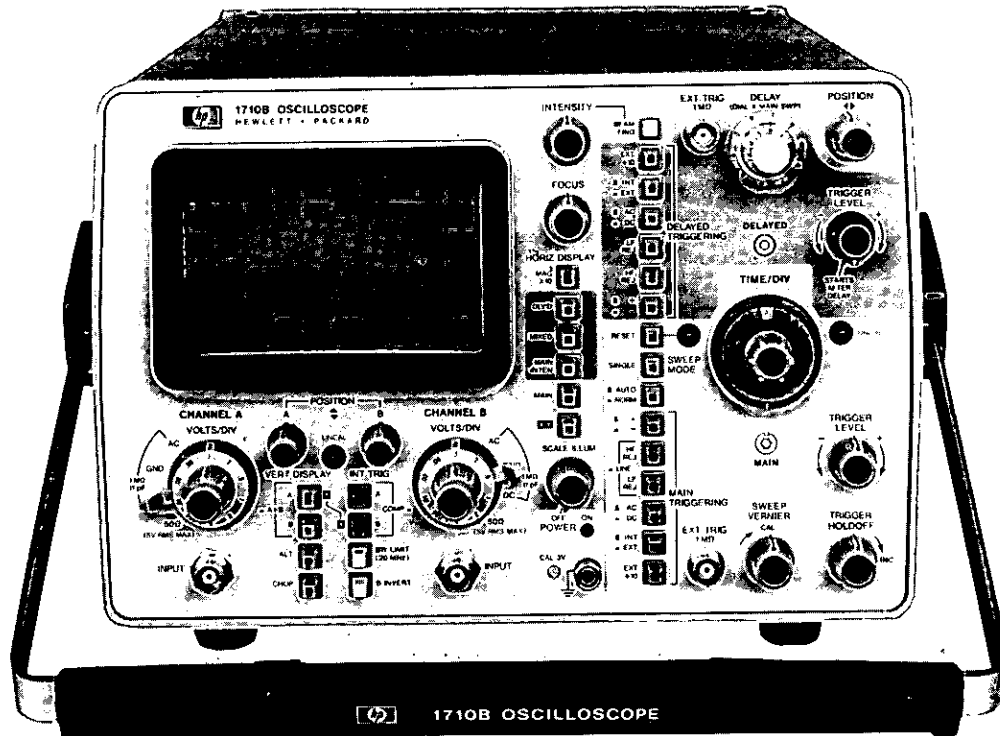

1710B Specifications

Vertical display modes

Channel A, channel B, channels A and B displayed alternately on successive sweeps (ALT); channels A and B displayed by switching between channels at approx. 1 MHz rate with blanking during switching (CHOP); channel A plus channel B (algebraic addition).

Vertical amplifiers (2)

Bandwidth: (3 dB down from a 6 div reference signal.)

DC-coupled: dc to 200 MHz in both 50 ohm and high impedance input modes 10 mV/div to 5 V/div, to 150 MHz at 5 mV/div.

AC-coupled: lower limit is approx. 10 Hz.

Bandwidth limit: limits upper bandwidth to approx. 20 MHz.

Rise time: <1.75 ns 10 mV/div to 5 V/div, <2.3 ns at 5 mV/div (measured from 10% to 90% points of 6 div input step).

Deflection factor

Ranges: 5 mV/div to 5 V/div (10 calibrated positions) in 1, 2, 5 sequence. $\pm 2\%$ attenuator accuracy.

Vernier: continuously variable between all ranges; extends maximum deflection factor to at least 12.5 V/div. Front panel light indicates when vernier is not in CAL position.

Polarity: channel B may be inverted, front panel pushbutton.

Signal delay: input signals are delayed sufficiently to view leading edge of input pulse without advanced trigger.

Input coupling: selectable, AC or DC, 50 ohms (dc) or ground. Ground position disconnects input connector and grounds amplifier input.

Input RC (selectable)

AC and DC: 1 megohm $\pm 2\%$ shunted by approx. 11 pF.

50 ohm: 50 ohms $\pm 2\%$; VSWR <1.3:1 on 5, 10, 20, and 50 mV ranges and <1.15:1 on all other ranges.

Maximum input

AC and DC: ± 250 V (dc + peak ac) at 1 kHz or less.

50 ohm: 5 V rms or ± 250 V peak whichever is less.

A + B operation

Amplifier: bandwidth and deflection factors are unchanged; chan-

nel B may be inverted for A-B operation.

Differential (A - B) common mode: CMRR is at least 40 dB from dc to 5 MHz decreasing to 26 dB at 50 MHz. Common mode signal amplitude equivalent to 12 cm with one vernier adjusted for optimum rejection.

Trigger source

Selectable from channel A, channel B, or Composite.

Channel A: all display modes triggered by channel A signal.

Channel B: all display modes triggered by channel B signal.

Composite: all display modes triggered by displayed signal.

Vertical output

Amplitude: one division of vertical deflection produces approx. 100 mV output (dc to 50 MHz).

Cascaded deflection factor: 1 mV/div with both vertical channels set to 10 mV/div.

Cascaded bandwidth: dc to 5 MHz with bandwidth limit engaged.

Vertical output resistance: approx. 100 ohms.

Vertical output selection: trigger source set to channel A selects channel A output; trigger source set to channel B selects channel B output.

Horizontal display modes

Sweep modes: main, main intensified, mixed, and delayed.

Sweep

Ranges: 10 ns/div to 0.5 s/div (24 ranges) 1, 2, 5 sequence.

Accuracy

Main Sweep Time/Div	Accuracy	
	X1	0°C to 55°C X10
10 ns to 50 ns	$\pm 3\%$	$\pm 5\%$
100 ns to 20 ms	$\pm 2\%$	$\pm 3\%$
50 ms to 0.5 s	$\pm 3\%$	$\pm 3\%$

Vernier: continuously variable between all ranges; extends slowest sweep to at least 1.25 s/div. Vernier uncalibrated light indicates when vernier is not in CAL position.

Magnifier: expands all sweeps by a factor of 10; extends fastest sweep to 1 ns/div.

Sweep mode

Normal: sweep is triggered by internal or external signal.

Automatic: bright baseline displayed in absence of input signal. Triggering is same as normal above 40 Hz.

Single: in Normal mode, sweep occurs once with same triggering as normal, reset pushbutton arms sweep and lights indicator; in Auto mode, sweep occurs once each time Reset pushbutton is pressed.

Triggering

Internal: dc to 100 MHz on signals causing 0.5 division or more vertical deflection, increasing to 1 division of vertical deflection at 200 MHz in all display modes. Triggering on line frequency is also selectable.

External: dc to 100 MHz on signals of 50 mV p-p or more increasing to 100 mV p-p at 200 MHz.

External input RC: approx. 1 megohm shunted by approx. 15 pF.

Trigger level and slope

Internal: at any point on the vertical waveform displayed.

External: continuously variable from 1.0 V to -1.0 V on either slope of the trigger signal, +10 V to -10 V in divide by 10 mode ($\div 10$).

Coupling: AC, DC, LF REJ, or HF REJ.

AC: attenuates signals below approx. 10 Hz.

LF REJ: attenuates signals below approx. 15 kHz.

HF REJ: attenuates signals above approx. 15 kHz.

Trigger holdoff: time between sweeps continuously variable, exceeding one full sweep from 10 ns/div to 50 ms/div.

Main intensified

Intensifies that part of main time base to be expanded to full screen in delayed time base mode. Delay control adjusts position of intensified portion of sweep. Rear panel intensity ratio control sets relative intensity of brightened segment.

Delayed time base

Sweep

Ranges: 10 ns/div to 20 ms/div (20 ranges) in 1, 2, 5 sequence.

Accuracy (0 to 55°C): same as main time base.

Magnifier (0 to 55°C): same as main time base.

Triggering

Internal: same as main time base except there is no Line Frequency triggering.

Starts after delay: delayed sweep automatically starts at end of delay period.

Trigger: with delayed trigger level control out of detent (starts after delay) delayed sweep is triggerable at end of delay period.

External: dc to 100 MHz on signals of 50 mV p-p or more, increasing to 100 mV p-p at 200 MHz.

External input RC: approx. 1 megohm shunted by approx. 15 pF.

Trigger level and slope

Internal: at any point on the vertical waveform displayed when in triggered mode.

External: continuously variable from +1.0 V to -1.0 V on either slope of the trigger signal, +10 V to -10 V in divide by 10 mode ($\div 10$).

Coupling: AC, DC, LF REJ, or HF REJ.

AC: attenuates signals below approx. 10 Hz.

LF REJ: attenuates signals below approx. 15 kHz.

HF REJ: attenuates signals above approx. 15 kHz.

Delay time: continuously variable from 10 ns to 5 s.

Differential time measurement accuracy (+15°C to +35°C):

Main time base setting	Accuracy
50 ns/div to 20 ms/div	$\pm(0.5\% \pm 0.1\%$ of full scale)
20 ns/div and 50 ms/div to .05 s/div	$\pm(1\% \pm 0.2\%$ of full scale)

Delay jitter: <0.005% (1 part in 20,000) of maximum delay in each step.

Mixed time base

Dual time base in which the main time base drives the first portion of sweep and the delayed time base completes the sweep at the faster delayed sweep. Also operates in single sweep mode.

X-Y operation

Bandwidth

Y-axis (channel A): same as channel A.

X-axis (channel B): dc to >3 MHz.

Deflection factor: 5 mV/div to 5 V/div (10 calibrated positions) in 1, 2, 5 sequence.

Phase difference between channels: <3°, dc to 3 MHz.

Cathode-ray tube and controls

Type: post accelerator, approx. 20.5 kV accelerating potential, aluminumized P31 phosphor.

Graticule: 6 x 10 div internal graticule. 0.2 subdivision markings on major horizontal and vertical axes. 1 div = 1 cm. Rear panel adjustment aligns trace with graticule. Internal flood gun graticule illumination.

Beam finder: returns trace to CRT screen regardless of setting of horizontal, vertical, or intensity controls.

Intensity modulation: +8 V, ≥ 50 ns width pulse blanks trace of any intensity, usable to 20 mHz for normal intensities. Input R, 1 k Ω $\pm 10\%$. Maximum input, ± 10 V (dc + peak ac).

Auto-focus: automatically maintains beam focus with variations of intensity.

Intensity limit: automatically limits beam current to decrease possible CRT damage. Circuit response time ensures full writing speed for viewing low duty cycle, fast rise time pulses.

Rear panel controls: astigmatism, pattern, main/delayed intensity ratio, and trace align.

General

Rear panel outputs: main and delayed gates, -0.7 V to +1.3 V capable of supplying approx. 3 mA.

Calibrator: type, 1 kHz $\pm 10\%$ square wave; 3 V p-p $\pm 1\%$, <0.1 μ s rise time.

Power: 100, 120, 220, 240, -10% +5%, 48 to 440 Hz; 110 VA max.

Weight: net, 12.9 kg (28.5 lb); shipping, 17.9 kg (39.5 lb).

Operating environment: temperature, 0 to +55°C (+32°F to +130°F); humidity, to 95% relative humidity at 40°C (104°F); altitude, to 4.6 km (15 000 ft); vibration, vibrated in three planes for 15 min, each with 0.254 mm (0.010 in.) excursion, 10 to 55 Hz.

Dimensions: 335 mm wide (13 $\frac{1}{16}$ in.), 197 mm high (7 $\frac{7}{8}$ in.), 570 mm length with handle (22 $\frac{1}{16}$ in.), 518 mm length without handle (20 $\frac{1}{2}$ in.).

Accessories furnished: one Model 10115A blue light filter; one rear panel cover; two 10014A10:1 divider probes; one 2.3 m (7.5 ft) power cord; one vinyl storage pouch; one Operating and Service Manual.

Options

001: fixed line power cord

Price
add \$15

003: probe power supply with two rear panel jacks for use with HP active probes. Provides power to operate one 1120A, two 1124A, or two 1125A Active Probes

add \$50
N/C

011: P11 phosphor in lieu of P31

A rack mount adapter is available for mounting a 1710B in a standard 48.3 cm (19-inch) rack. Contact your HP Field Engineer for information.

OSCILLOSCOPES

Portable, 35 MHz and 75 MHz dual channel

Models 1700B & 1707B

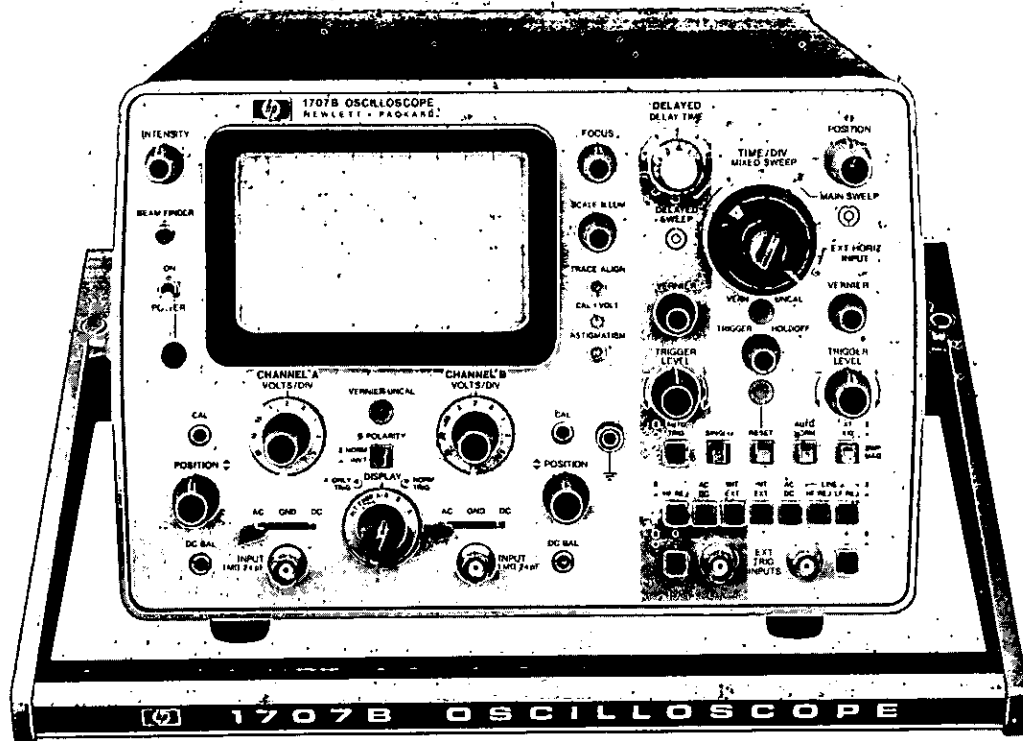

1700B and 1707B Specifications

Modes of operation

Channel A: channel B; channels A and B displayed alternately on successive sweeps (ALT); channels A and B displayed by switching between channels at approx. 400 kHz rate with blanking during switching (CHOP); channel A plus channel B (algebraic addition).

Each channel (2)

Bandwidth: (Direct or with Model 10006D probe, 3 dB down from 50 kHz, 6 div reference signal from a terminated 50 ohm source.)

DC-coupled: dc to 35 MHz in 1700B, dc to 75 MHz in 1707B.

AC-coupled: lower limit is approx. 10 Hz.

Rise time: <10 ns in 1700B, <4.7 ns in 1707B. Direct or with Model 10006D-probe, 10% to 90% points with 6 div input step from a terminated 50 ohm source.

Deflection factor

Ranges: 10 mV/div to 5 V/div (9 ranges) in 1, 2, 5 sequence. $\pm 3\%$ attenuator accuracy with vernier in cal position.

Vernier: continuously variable between all ranges, extends max deflection factor to at least 12.5 V/div. Vernier uncal light indicates when vernier is not in cal position.

Polarity: NORM or INV, selectable on channel B.

Signal delay: input signals are delayed sufficiently to view leading edge of input signals without advanced external trigger.

Input RC: 1 megohm $\pm 1\%$; shunted by approx. 27 pF in 1700B, approx. 24 pF in 1707B.

Input coupling: AC, DC, or Ground. Ground position disconnects signal input and grounds amplifier input.

Maximum input

AC-coupled: $\pm 600V$ (dc + peak ac); rms ac <350 V, 5 V/div to 20 mV/div, <150V at 10 mV/div (10 kHz or less).

DC-coupled: <350 V (rms) 5 V/div to 20 mV/div, <150 V at 10 mV/div (10 kHz or less).

A + B operation

Amplifier: bandwidth and deflection factors are unchanged; channel B may be inverted for A - B operation.

Common mode (A - B): frequency, dc to 1 MHz; rejection ratio, at least 40 dB on 10 mV/div, at least 20 dB on all other ranges with verniers set for optimum rejection. Common mode signal amplitude equivalent to 30 div.

Trigger source

Applies for all five modes of operation.

Norm: on displayed signal.

A only: on signal from channel A.

Main time base

Sweep

Ranges: from 0.1 μ s/div to 2 s/div (23 ranges) in 1, 2, 5 sequence. $\pm 3\%$ accuracy with vernier in cal position.

Vernier: continuously variable between all ranges, extends slowest sweep to at least 5 s/div. Vernier uncal light indicates when vernier is not in cal position.

Magnifier: expands all sweeps by a factor of 10 and extends fastest sweep to 10 ns/div. Accuracy $\pm 5\%$ (including 3% accuracy of time base).

Sweep mode

Normal: sweep triggered by an int or ext signal.

Automatic: bright baseline displayed in absence of input signal. Triggering is same as normal above 40 Hz.

Single: in Normal mode, sweep occurs once with same triggering as normal; reset pushbutton arms sweep and lights indicator; in Auto mode, sweep occurs once each time reset pushbutton is pressed.

Triggering

Internal: dc to 35 MHz on signals causing 0.5 div or more vertical deflection increasing to 1 div at 75 MHz for 1707B in all display modes except chop; dc to 400 kHz in chop mode. Triggering on line frequency is also selectable.

External: dc to 35 MHz on signals 50 mV/p-p or more, increasing to 100 mV/p-p at 75 MHz in the 1707B.

External input RC: approx. 1 megohm shunted by approx. 27 pF.

Level and slope: internal, at any point on the vertical waveform displayed; external, continuously variable from +1.2 V to -1.2 V on either slope of the trigger signal. Max input, $\pm 100V$. In Model 1700B, $\div 10$ extends external trigger input range to +12V to -12V.

Coupling: AC, DC, LF REJ, or HF REJ; AC, attenuates signals below approx. 20 Hz; LF REJ, attenuates signals below approx. 15 kHz; HF REJ, attenuates signals above approx. 30 kHz.

Trigger holdoff: time between sweeps continuously variable.

Delayed time base (1707B)

Trace intensification: intensifies that part of main time base to be expanded to full screen in delayed time base mode. Rotating time base switch from OFF position activates intensified mode.

Sweep

Ranges: 0.1 μs /div to 0.2 s/div (20 ranges) in 1, 2, 5 sequence. $\pm 3\%$ with vernier in calibrated position.

Vernier: continuously variable between all ranges, extends slowest sweep to 0.5 s/div.

Magnifier: expands all sweeps by a factor of 10 and extends fastest sweep to 10 ns/div. Accuracy is $\pm 5\%$ (including 3% accuracy of time base).

Sweep mode

Trigger: delayed sweep is armed at end of delay period.

Auto: delayed sweep is automatically triggered at end of delay period.

Triggering

Internal: same as main time base.

External: same as main time base. Input RC is approx. 1 megohm shunted by approx. 27 pF.

Level and slope: same as main time base.

Coupling: selectable, AC or DC. AC attenuates signals below approx. 20 Hz.

Delay (before start of delayed sweep.)

Time: continuously variable from 0.1 μs to 2 s.

Time jitter: <0.005% (1 part in 20 000) of max delay in each sweep speed.

Calibrated delay accuracy: $\pm 1\%$; linearity, $\pm 0.2\%$.

Mixed sweep (1707B)

Combines main and delayed sweeps into one display. Sweep is started by the main time base and is completed by the faster delayed time base. Also operates in single sweep mode.

External horizontal input

Bandwidth: dc to 1 MHz when driven directly from a terminated 50 ohm source. DC coupled.

Deflection factor (with beam positioned at left edge of CRT): X1, 1 V/div; X10, 0.1 V/div.

Vernier: 10:1 vernier extends deflection factor to at least 10 V/div (X1) or 1 V/div (X10).

Dynamic range: beam may be positioned at left edge of CRT with 0 V to -5 V input.

Maximum input: $\pm 100 V$.

Input RC: approx. 1 megohm shunted by approx. 10 pF.

Cathode-ray tube and controls

Type: post-accelerator, approx. 22 kV accelerating potential, aluminumized P31 phosphor.

Graticule: 6 \times 10 div internal graticule; 0.2 subdivisions on major horizontal and vertical axes. 1 div = 1 cm. Front panel adjustments for trace alignment and astigmatism.

Beam finder: returns trace to CRT screen regardless of setting of horizontal, vertical, or intensity controls.

Intensity modulation: $> +4 V$, dc to 1 MHz blanks trace of any intensity. Input R, 1000 ohms $\pm 10\%$. Max input, $\pm 10 V$ (dc + peak ac).

General

Calibrator: 1 kHz, $\pm 10\%$ square wave; 1 V p-p, $\pm 1\%$.

Operating environment: temperature, 0 to 55°C (+32°C to 130°F); humidity, to 95% relative humidity at 40°C (104°F); altitude, to 4.6 km (15 000 ft); vibration, vibrated in three planes for 15 min. each with 0.254 mm (0.010 in.) excursion, 10 to 55 Hz.

Dimensions: 325 mm wide (12 $\frac{1}{16}$ in.), 198 mm high (7 $\frac{3}{4}$ in.), 530 mm long with handle (20 $\frac{1}{8}$ in.), 400 mm long without handle (15 $\frac{1}{2}$ in.).

Weight

Without panel cover: net, 11 kg (24 lb).

With panel cover and accessories: net, 12.3 kg (27 lb); shipping, 17.2 kg (38 lb).

With panel cover, accessories, and battery pack: net, 16 kg (35 lb); shipping, 20.9 kg (46 lb).

Power

AC line: 115 or 230 V $\pm 20\%$, 48 to 440 Hz; 30 VA max (1700B), 50 VA max (1707B).

DC line: 11.5 to 36 V; 18 watts max (1700B); 25 watts max (1707B).

Battery (optional): operating time, up to 6 hours in 1700B; up to 4.5 hours in 1707B; recharge time, 14 hour maximum; with power switch off, if not operated after power indicator flashes; low battery indicator, power light flashes to indicate that batteries are discharged and further operation may damage battery; recharging, batteries are recharging whenever power mode switch is set to AC with power applied. With power switch off, full charge is applied. With power switch on, trickle charge is applied.

Accessories supplied: one Model 10115A blue light filter; one Model 10101B front panel storage cover; two Model 10006D, 10:1 divider probes, 1.8 m (6 ft) long; one 2.3 m (7.5 ft) power cord with right angle plug (HP P/N 8120-1521); four fuses, one 2A (HP P/N 2100-0002), one 3A (HP P/N 2110-0003), one 0.5A slow blow (HP P/N 2110-0008), one 0.25A slow blow (HP P/N 2110-0018); and one Operating and Service Manual.

1707B option 015 specifications

Channel A output

Amplitude: open circuit output voltage approx. 100 mV per div of display.

Cascaded deflection factor: 1 mV/div with both vertical channels set to 10 mV/div.

Cascaded bandwidth: dc to 3 MHz (use HP Model 10121A 20 cm, 8-inch, BNC cable supplied to connect channel A output to channel B).

Coupling: dc.

DC level: approx. 0 V.

Source resistance: approx. 200 ohms

Model number and name

Model number and name	Price
Model 1700B 35 MHz Oscilloscope	\$1675
Option 012: Model 10103B Battery Pack installed	add \$250
Model 1707B 75 MHz Delayed Sweep Oscilloscope	\$1775
Option 012: Model 10103B Battery Pack installed	add \$250
Option 015 (1707B): adds channel A output	add \$50

OSCILLOSCOPES

Portable, 35 MHz dual channel, storage

Models 1702A & 1703A



1702A and 1703A Specifications

Modes of operation

Channel A; channel B; channels A and B displayed alternately on successive sweeps (ALT); channels A and B displayed by switching between channels at approx. 400 kHz rate with blanking during switching (CHOP); channel A plus channel B (algebraic addition).

Each channel (2)

Bandwidth: (Direct or with Model 10006B probe, 3 dB down from 50 kHz, 6 div reference signal from a terminated 50 ohm source.)

DC-coupled: dc to 35 MHz.

AC-coupled: lower limit is approx. 10 Hz.

Rise time: <10 ns. Direct or with Model 10006D probe, 10% to 90% points with 6 div input step from a terminated 50 ohm source.

Deflection factor

Ranges: 10 mV/div to 5 V/div (9 ranges) in 1, 2, 5 sequence. $\pm 3\%$ attenuator accuracy with vernier in calibrated position.

Vernier: continuously variable between all ranges, extends max deflection factor to at least 12.5 V/div. Vernier uncal light indicates when vernier is not in cal position.

Polarity: NORM or INV, selectable on channel B.

Signal delay: input signals are delayed sufficiently to view leading edge of input signals without advanced external trigger.

Input RC: 1 megohm $\pm 1\%$, shunted by approx. 27 pF.

Input coupling: AC, DC, or Ground. Ground position disconnects signal input and grounds amplifier input.

Maximum input

AC-coupled: ± 600 V (dc + peak ac); rms ac <350 V, 5 V/div to 20 mV/div, <150 V at 10 mV/div (10 kHz or less).

DC-coupled: <350 V (rms) 5 V/div to 20 mV/div, <150 V at 10 mV/div (10 kHz or less).

A + B operation

Amplifier: bandwidth and deflection factors are unchanged; channel B may be inverted for A - B operation.

Common mode (A - B): frequency, dc to 1 MHz; rejection ratio, at least 40 dB on 10 mV/div, at least 20 dB on all other ranges with

verniers set for optimum rejection. Common mode signal amplitude equivalent to 30 div.

Trigger source

Applies for all five modes of operation.

Norm: on displayed signal.

A only: on signal from channel A.

Channel A output

Amplitude: open circuit output voltage approx. 100 mV per div of display.

Cascaded deflection factor: 1 mV/div with both vertical channels set to 10 mV/div.

Cascaded bandwidth: dc to 3 MHz (use HP Model 10121A 20 cm, 8-inch, BNC cable supplied to connect channel A output to channel B).

Coupling: dc.

DC level: approx. 0 V.

Source resistance: approx. 200 ohms.

Main time base

Sweep

Ranges: from 0.1 μ s/div to 2 s/div (23 ranges) in 1, 2, 5 sequence. $\pm 3\%$ accuracy with vernier in cal position.

Vernier: continuously variable between all ranges, extends slowest sweep to at least 5 s/div. Vernier uncal light indicates when vernier is not in cal position.

Magnifier: expands all sweeps by a factor of 10 and extends fastest sweep to 10 ns/div. Accuracy $\pm 5\%$ (including 3% accuracy of time base).

Sweep mode

Normal: sweep triggered by an int or ext signal.

Automatic: bright baseline displayed in absence of input signal. Triggering is same as normal above 40 Hz.

Single: in Normal mode, sweep occurs once with same triggering as normal; reset pushbutton arms sweep and lights indicator; in Auto mode, sweep occurs once each time reset pushbutton is pressed.



Triggering

Internal: dc to 35 MHz on signals causing 0.5 div or more vertical deflection in all display modes except chop; dc to 400 kHz in chop mode. Triggering on line frequency is also selectable.

External: dc to 35 MHz on signals 50 mV/p-p, or more.

External Input RC: approx. 1 megohm shunted by approx. 27 pF.

Level and slope: internal, at any point on the vertical waveform displayed; external, continuously variable from +1.2 V to -1.2 V on either slope of the trigger signal. Max input, ± 100 V. In Model 1702A, $\div 10$ extends external trigger input range to +12 V to -12 V.

Coupling: AC, DC, LF REJ, or HF REJ; AC, attenuates signals below approx. 20 Hz; LF REJ, attenuates signals below approx. 15 kHz; HF REJ, attenuates signals above approx. 30 kHz.

Trigger holdoff: time between sweeps continuously variable.

Delayed time base (1703A)

Trace intensification: intensifies that part of main time base to be expanded to full screen in delayed time base mode. Rotating time base switch from OFF position activates intensified mode.

Sweep

Ranges: 0.1 μ s/div to 0.2 s/div (20 ranges) in 1, 2, 5 sequence. $\pm 3\%$ accuracy with vernier in calibrated position.

Vernier: continuously variable between all ranges, extends slowest sweep to 0.5 s/div.

Magnifier: expands all sweeps by a factor of 10 and extends fastest sweep to 10 ns/div. Accuracy is $\pm 5\%$ (including 3% accuracy of time base).

Sweep mode

Trigger: delayed sweep is armed at end of delay period.

Auto: delayed sweep is automatically triggered at end of delay period.

Triggering

Internal: same as main time base.

External: same as main time base. Input RC is approx. 1 megohm shunted by approx. 27 pF.

Level and slope: same as main time base.

Coupling: selectable, AC or DC. AC attenuates signals below approx. 20 Hz.

Delay (Before start of delayed sweep.)

Time: continuously variable from 0.1 μ s to 2 s.

Time jitter: $< 0.005\%$ (1 part in 20 000) of max delay in each sweep speed.

Calibrated delay accuracy: $\pm 1\%$; linearity, $\pm 0.2\%$.

Mixed sweep (1703A)

Combines main and delayed sweeps into one display. Sweep is started by the main time base and is completed by the faster delayed time base. Also operates in single sweep mode.

External horizontal input

Bandwidth: dc to 1 MHz when driven directly from a terminated 50 ohm source. DC coupled.

Deflection factor (with beam positioned at left edge of CRT): X1, 1 V/div; X10, 0.1 V/div.

Vernier: 10:1 vernier extends deflection factor to at least 10 V/div (X1) or 1 V/div (X10).

Dynamic range: beam may be positioned at left edge of CRT with 0 V to -5 V input.

Maximum input: ± 100 V.

Input RC: approx. 1 megohm shunted by approx. 10 pF.

Cathode-ray tube and controls

Type: post-accelerator, approx. 8.3 kV accelerating potential; aluminized P31 phosphor.

Graticule: 6×10 div internal graticule; 0.2 subdivisions on major horizontal and vertical axes. 1 div = 0.85 cm. Rear panel adjustments for trace alignment and astigmatism.

Beam finder: returns trace to CRT screen regardless of setting of horizontal or vertical controls.

Intensity modulation: $> +4$ V, dc to 1 MHz blanks trace of any intensity. Input R, 1000 ohms $\pm 10\%$. Max input, ± 10 V (dc + peak ac).

Persistence

Normal: natural persistence of P31 phosphor (approx. 40 μ s).

Variable: from < 0.2 s to > 1 min (standard mode).

Storage writing speed

Standard mode: > 20 div/ms over central 5×9 divisions.

Fast write mode: > 1000 div/ms over central 5×9 divisions.

Brightness: approx. 100 foot lamberts.

Storage time: from standard to Store, traces may be stored with STORE TIME full cw for > 1 hr. With STORE TIME full ccw, traces may be viewed at normal intensity for > 1 min. From Fast mode to Store, traces may be stored with STORE TIME full cw for > 5 min. With STORE TIME full ccw, traces may be viewed at normal intensity for > 15 s.

Erase: manual, pushbutton erasure takes approx. 500 ms.

General

Calibrator: 1 kHz, $\pm 10\%$ square wave; 1 V p-p, $\pm 1\%$.

Operating environment: temperature, 0 to 55°C (+32°F to 130°F); humidity, to 95% relative humidity at 40°C (104°F); altitude, to 4.6 km (15 000 ft); vibration, vibrated in three planes for 15 min. each with 0.254 mm (0.010 in.) excursion, 10 to 55 Hz.

Dimensions: 325 mm wide (12 $\frac{1}{16}$ in.), 198 mm high (7 $\frac{3}{4}$ in.), 578 mm length with handle (22 $\frac{3}{4}$ in.), 448 mm length without handle (17 $\frac{1}{2}$ in.).

Weight

Without panel cover: net, 11 kg (24 lb).

With panel cover and accessories: net, 12.3 kg (27 lb); shipping, 17.2 kg (38 lb).

With panel cover, accessories, and battery pack: net, 16 kg (35 lb); shipping, 20.9 kg (46 lb).

Power

AC line: 115 or 230 V $\pm 20\%$, 48 to 440 Hz, 50 VA max.

DC line: 11.5 to 36 V, 25 watts max.

Battery (optional): operating time, up to 4 hours; recharge time, 14 hours max, with power switch off, if not operated after power indicator flashes; low battery indicator, power light flashes to indicate that batteries are discharged and further operation may damage battery; recharging, batteries are recharging whenever power mode switch is set to AC with power applied. With power switch off, full charge is applied. With power switch on, trickle charge is applied.

Accessories supplied: one Model 10115A blue light filter; one Model 10101B front panel storage cover; two Model 10006D, 10:1 divider probes, 1.8 m (6 ft) long; one Model 10121A 20 cm (8-inch) BNC cable; one 2.3 m (7.5 ft) power cord with right angle plug (HP P/N 8120-1521); two fuses, one 1A (HP P/N 2110-0007), one 0.5A slow blow (HP P/N 2110-0008); and one Operating and Service manual.

Option 012: Model 10103B Battery Pack installed add \$250

Model number and name Price

1702A 35 MHz Storage Oscilloscope \$2500

1703A 35 MHz Delayed Sweep Storage Oscilloscope \$2900

OSCILLOSCOPES

Ruggedized portable, 35 MHz and 50 MHz dual channel

Models 1700B Opt 300 & 1707B Opt 300

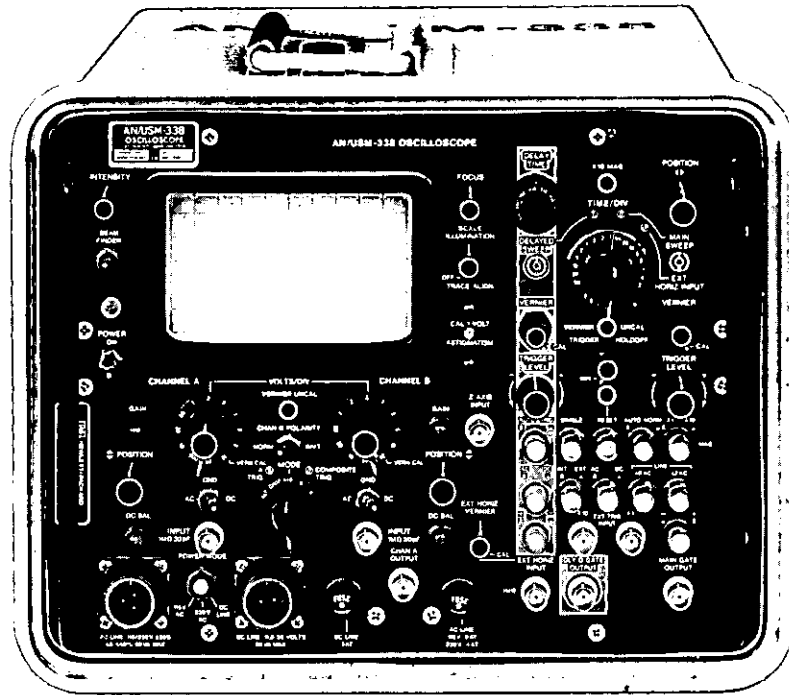

1700B/1707B Opt 300 specifications

Modes of operation

Channel A; channel B; channels A and B displayed alternately on successive sweeps (ALT); channels A and B displayed by switching between channels at approx. 100 kHz rate with blanking during switching (CHOP); channel A + channel B (algebraic addition).

Vertical amplifiers (2)

Bandwidth: (Measured with or without a Model 10006D probe, 3 dB down from a 50 kHz, 6 div reference signal from a terminated 50 ohm source.)

DC-coupled: 1700B, dc to 35 MHz; 1707B, dc to 50 MHz.

AC-coupled: lower limit 1700B approx. 10 Hz, 1707B approx. 2 Hz.

Rise time: 1700B <10 ns, 1707B <7 ns. Direct or with 10006D probe, 10% to 90% of 6 div input step from a terminated 50 ohm source.

Deflection factor

Ranges: 1700B, 10 mV/div to 20V/div (11 ranges); 1707B, 5 mV/div to 20V/div (12 ranges); in 1, 2, 5 sequence.

Attenuator accuracy: $\pm 3\%$ with vernier in CAL position.

Vernier: continuously variable between all ranges, extends maximum deflection factor to at least 50 V/div. Front panel light indicates when vernier is out of VERN CAL position.

Polarity: NORM or INVT, selectable on channel B.

Signal delay: input signals are delayed sufficiently to view leading edge of input signals without advanced external trigger.

Input RC: 1 megohm $\pm 2\%$ shunted by approx. 30 pF.

Input coupling: AC, DC, or GND selectable. Ground position disconnects signal input and grounds amplifier input.

Maximum input

AC-coupled: ± 600 V (dc + peak ac); rms ac <350 V, 20 V/div to 20 mV/div; <150 V at 10 mV/div and 5 mV/div in 1707B (10 kHz or less).

DC-coupled: rms ac <350 V, 20 V/div to 20 mV/div; <150 V at 10 mV/div and 5 mV/div in 1707B (10 kHz or less).

A + B operation

Amplifier: bandwidth and deflection factors are unchanged, channel B may be inverted for A - B operation.

Common mode (A - B): frequency, 1700B dc to 1 MHz; 1707B dc to 3 MHz. Rejection ratio, 1700B at least 40 dB on 10 mV/div and at least 20 dB on all other ranges, 1707B at least 26 dB on all ranges with verniers set for optimum rejection.

Trigger source (applies for all five modes of operation)

Composite trigger: on displayed signal.

A trigger: on signal from channel A.

Channel A output (1707B)

Amplitude: one division of displayed signal in channel A provides approx. 50 mV output.

Cascaded deflection factor: 0.5 mV/div with both vertical channels set to 5 mV/div.

Cascaded bandwidth: dc to 5 MHz (use 20 cm, 8 inch, BNC cable). DC coupled.

Output DC level: approx. 0 V.

Output resistance: approx. 1 megohm.

Time base**Sweep**

Ranges: 0.1 μ s/div to 2 s/div (23 ranges) in 1, 2, 5 sequence. $\pm 3\%$ accuracy with vernier in CAL position.

Vernier: continuously variable between all ranges, extends slowest sweep to at least 5 s/div. Vernier uncalibrated light indicates when vernier is not in CAL position.

Magnifier: expands all sweeps by a factor of 10 and extends fastest sweep speed to 10 ns/div. Accuracy $\pm 5\%$ (including 3% accuracy of time base). Magnifier light indicates the X10 mode.

Sweep mode

Normal: sweep is triggered by an internal, external, or power line signal.

Automatic: bright baseline displayed in absence of input signal. Triggering is same as normal above 25 Hz.

Single: in NORM mode, sweep occurs once with same triggering as normal; reset pushbutton arms sweep and lights indicator; in AUTO mode, sweep occurs once each time reset pushbutton is pressed.

Triggering

Internal: dc to 35 MHz (1700B) 50 MHz (1707B) on signals causing 0.5 div or more vertical deflection in all display modes except Chop; dc to 100 kHz in Chop mode. Triggering on line frequency is also selectable.

External: 1700B, dc to 35 MHz on signals of 50 mV p-p or more. 1707B, dc to 35 MHz on signals of 100 mV p-p or more increasing to 200 mV p-p at 50 MHz.

Line: power line frequency signal (Main only).

External trigger input RC: approx. 1 megohm shunted by approx. 27 pF.

Level and slope: internal, at any point on the vertical waveform displayed; external, continuously variable from +3 V to -3 V (+30 V to -30 V in $\div 10$) on either slope of the trigger signal. Maximum input ± 100 V.

Coupling: AC, DC, LFAC, or HFAC; AC, attenuates signals below approx. 50 Hz; LFAC, attenuates signals above approx. 30 kHz; HFAC, attenuates signals below approx. 5 kHz.

Trigger holdoff: time between sweeps continuously variable.

Delayed time base (1707B)

Trace intensification: intensifies that part of main time base to be expanded to full screen in delayed time base mode. Rotating time base switch from OFF position activates intensified mode.

Sweep

Ranges: 0.1 μ s/div to 0.2 s/div (20 ranges) in 1, 2, 5 sequence. $\pm 3\%$ with vernier in calibrated position.

Vernier: continuously variable between all ranges, extends slowest sweep to 0.5 s/div.

Magnifier: expands all sweeps by a factor of 10 and extends fastest sweep to 10 ns/div. Accuracy, $\pm 5\%$ (including 3% accuracy of time base).

Sweep mode

Trigger: delayed sweep is armed at end of delay period.

Auto: delayed sweep is automatically triggered at the end of delay period.

Triggering: same as internal main time base.

Delay (before start of delayed sweep)

Time: continuously variable from 0.1 μ s to 20 s.

Time jitter: 0.005% (1 part in 20,000) of max delay in each sweep.

Calibrated delay accuracy: $\pm 1\%$; linearity, $\pm 0.2\%$.

External horizontal input

Bandwidth: 1700B dc to 1 MHz, 1707B dc to 2 MHz.

Coupling: dc.

Deflection factor (with beam positioned at left edge of CRT): X1, 1 V/div; X10, 0.1 V/div.

Vernier: 10:1 vernier extends deflection factor to at least 10 V/div (X1) or 1 V/div (X10).

Maximum input: ± 100 V.

Input RC: 1 megohm $\pm 2\%$ shunted by approx. 30 pF in 1700B, 10 pF in 1707B.

Cathode-ray tube and controls

Type: post-accelerator, approx. 15 kV accelerating potential; aluminized P31 phosphor.

Graticule: 6 \times 10 div (1 div = 1 cm) internal graticule. 0.2 subdivision markings on major horizontal and vertical axes.

Trace align: front panel adjustment aligns trace with graticule.

Focus: front panel adjustment of spot for minimum size.

Astigmatism: front panel control allows circular adjustment of spot.

Beam finder: returns trace to CRT screen regardless of setting of horizontal, vertical, or intensity controls.

Z-axis input (1707B): allows intensity modulation $> +5$ V, dc to 15 MHz blanks trace of any intensity. Input R, > 5000 ohms. Maximum input, ± 200 Vdc (dc + peak ac).

General

Outputs (1707B): two front panel outputs for MAIN and DELAYED GATES. Each output provides a pulse of at least 5 volts with a duration equal to or greater than the sweep length.

Calibrator: type, 1 kHz, $\pm 10\%$ square wave; voltage, 1 V p-p, $\pm 1\%$.

Power requirements: ac line, 115 or 230 V $\pm 20\%$, 48 to 440 Hz, 30 VA max (1700B), 50 VA max (1707B); dc line, 11.5 to 36 V, 30 VA max (1700B) 50 VA max (1707B).

Weight

Without panel cover: net, 12.3 kg (27 lb).

With panel cover and accessories: net, 16 kg (35 lb); shipping, 20 kg (44 lb).

Dimensions: 330.2 mm wide (13 in.), 260.4 mm high (10 1/4 in.), 501.7 mm length (19 3/4 in.)

Accessories furnished: Model 10163A Opt 030 Panel Cover with accessories (probes, connectors, adapters, fuses).

Environmental specifications

Model 1700B Opt 300 meets all environmental requirements of AN/USM-339 described in MIL-O-83226 (USAF). Model 1707B Opt 300 meets all environmental requirements of the AN/USM-338 described in MIL-O-83225 (USAF).

Temperature and altitude: non-operating, -62°C to $+85^\circ\text{C}$ to 15.24 km (50 000 ft); operating, -40°C to $+55^\circ\text{C}$, 20 min. at 71°C , to 3.1 km (10 000 ft).

Humidity: non-operating, $+28^\circ\text{C}$ to $+71^\circ\text{C}$ at 95% relative humidity, ten 24 hour cycles for total of 240 hours.

Vibration: non-operating, 5 to 15 Hz, 1.5 mm (0.06 in.); 15 to 25 Hz, 1.0 mm (0.04 in.); 25 to 55 Hz, 0.5 mm (0.02 in.).

Shock: total of 18 shocks, in 3 planes, of 15 g's from an 11 ± 1 ms sawtooth.

Salt fog: non-operating, per method 509, procedure 1 of MIL-STD-810.

Explosive atmosphere: per method 511, procedure 1 of MIL-STD-810.

Dust: non-operating, per method 510, procedure 1 of MIL-STD-810.

Drip proof: per MIL-STD-108, except the front panel cover shall be removed.

Drop test and water tightness: per MIL-T-21200.

Electromagnetic interference: per MIL-STD-462 performed by MIL-STD-461 as follows:

Requirement	Limit Modification
CE03	relax 10 dB
CS01, CS02	none
CS06	none
RE02	relax 10 dB, upper frequency 1 GHz
RS02, RS04	none

Reliability: 1700B, 4550 hour MTBF; 1707B, 2850 hour MTBF. As verified by MIL-STD-781B, Test Plan II, Test Level B.

Model number and name

Model 1700B Opt 300, 35 MHz Price
\$2625
Model 1707B Opt 300, 50 MHz \$3140

OSCILLOSCOPES

General purpose plug-in scopes, to 18 GHz

Model 180 series

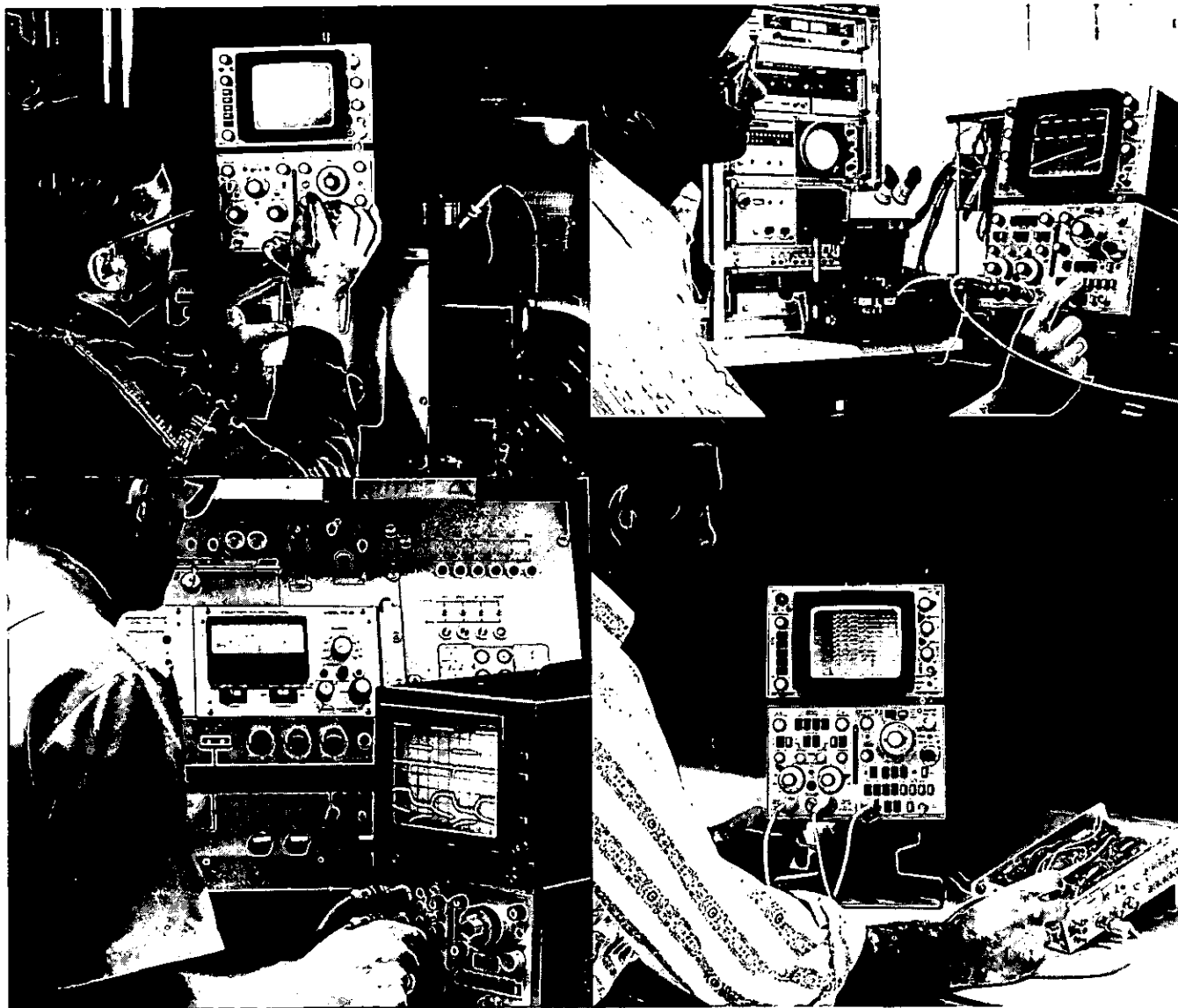

Introduction

The 180 plug-in oscilloscope system has established high performance in 100 MHz and 250 MHz real time and 18 GHz sampling applications for general purpose laboratory measurements. These compact, reliable, solid-state oscilloscopes are ideal for all types of low, medium, and high frequency measurements. Performance in the 180 system means overall capability, not just maximum bandwidth. The focal point for this performance is in the mainframes with their high quality CRT's that provide optimum measurement accuracy. Mainframes are available in cabinet or rack configuration and there is a large screen mainframe in a cabinet configuration.

A selection of storage/variable persistence mainframes offers writing speeds for general purpose or high speed storage applications. A rugged storage surface assures general purpose use with a burn resistant storage surface that does not require special operating procedures.

Storage writing speeds of 100 cm/ μ s or 400 cm/ μ s are available in the 184 and 184 Option 005, for capture and display of elusive transients. With these fast writing speeds you can easily make pulse tim-

ing adjustments, locate noise pulses and missing bits from low duty cycle digital signals. Low duty cycle pulse trains from disc, tape, or drum peripheral units can also be viewed through repetitive sweeps by using variable persistence to build up the intensity of dim traces.

For frequency response to 250 MHz, the 183 mainframes are available with photographic writing speeds to 4 and 8 cm/ μ s. The 183 mainframes with their related plug-ins, offer real time response into the ECL region. The high frequency response is accomplished without sacrificing viewing ease, operating simplicity, or plug-in versatility since they operate with the entire line of 1800 series plug-ins.

Vertical plug-ins

A wide selection of high performance, vertical real time plug-ins assures the right plug-in for almost any measurement application. Real time, dual channel plug-ins are available in 500 kHz, 35 MHz, 50 MHz, 75 MHz, and 100 MHz bandwidths with deflection factors of 100 μ V, 10 mV, and 5 mV/div. Additional measurement capability is provided by four channel plug-ins with 50 MHz and 100 MHz bandwidths and a differential/dc offset amplifier with 40 MHz bandwidth. For measurements greater than 100 MHz, the 183 mainframe plug-ins

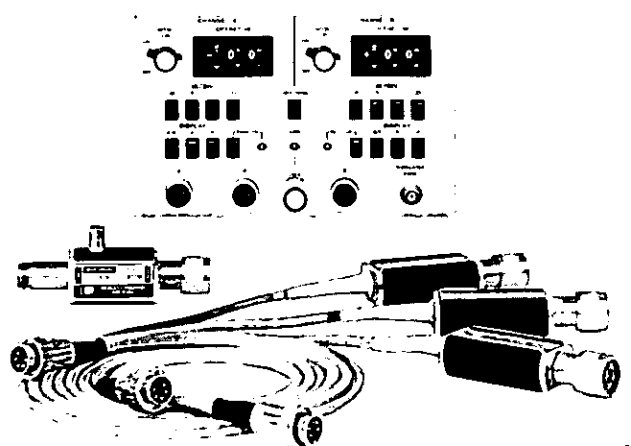
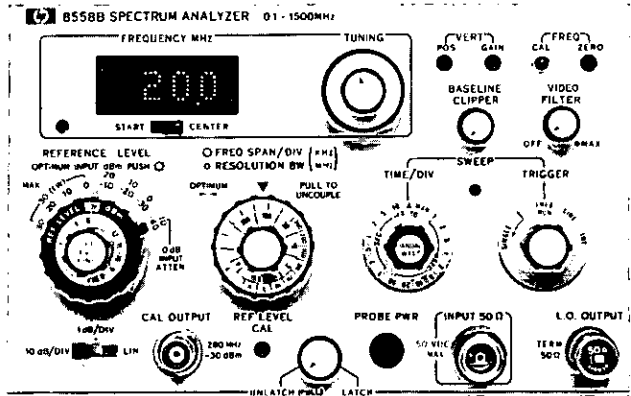
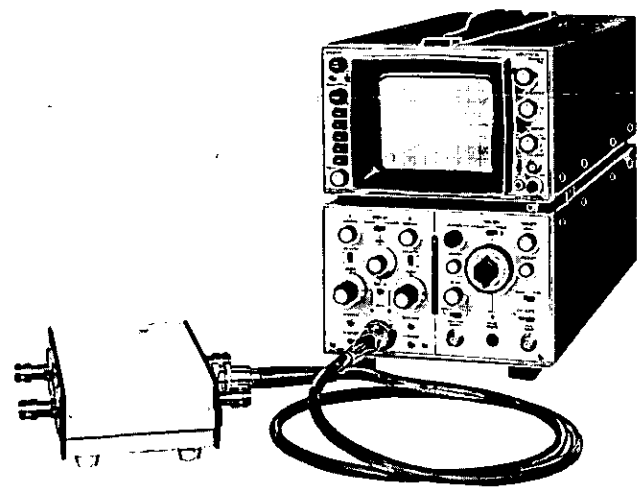

offer two and four channel operation to 200 MHz with selectable input impedance and two channel, 250 MHz response in a plug-in with 50 ohm inputs for optimum high frequency response.

Time base plug-ins

A selection of time base plug-ins offers a choice of single, expanded, and delayed sweeps with magnified sweep speeds to 5 ns/div in 180 mainframes and single and delayed magnified sweeps to 1 ns/div in 183 mainframes. Models 1820C, 1824A, and 1825A have triggering capabilities to 150 MHz and the 1821A triggers in excess of 50 MHz. Models 1821A and 1825A have calibrated delayed and mixed sweeps for accurate timing measurements and detailed examination of selected portions of waveforms. For applications that only require sweep expansion, the 1824A provides expansions to 100 times with $\pm 3\%$ accuracy in the expanded ranges.

Both the 1840A time base and 1841A time base and delay generator offer sweeps to 10 ns/div which can be magnified by the 183 mainframe to 1 ns/div for accurate timing measurements. The sweep circuits will trigger internally to 250 MHz with 1 division or more vertical deflection or from 20 mV p-p external signals. Triggering can be extended to 500 MHz with only 50 mV p-p external signals and variable hold-off allows stable triggering on pulse groups.

Sampling

Models 1810A and 1811A sampling plug-ins provide the easiest and fastest low level, high frequency measurements presently available. The 1810A looks and operates like a real time plug-in which reduces familiarization time for accurate, low-level measurements to 1 GHz. Measurements to 4 GHz and 18 GHz are available with the 1811A and either of two remote feedthrough sampling heads. The remote sampling heads, 1432A for 4 GHz and 1430C for 18 GHz, reduce measurement errors at these high frequencies by eliminating long high frequency interconnecting cables. The feedthrough method of measurement in these sampling heads increases accuracy by allowing measurements to be made while the system is operating with its own loads.

Time domain reflectometry

Time Domain Reflectometry is a fast, convenient technique for measuring the electrical characteristics of transmission systems. This measurement technique provides a display of the impedance profile of a system showing magnitude, nature, and distance of discontinuities. Model 1818A is an easy-to-use 170 ps rise time TDR plug-in for design and installation evaluation of transmission or interconnecting systems. For critical design work or system installations, the 1815A/B with its remote sampling heads will display discontinuities as close as 6.4 mm (0.25 inch) with a system rise time of 35 ps.

Spectrum analysis

The 8558B Spectrum Analyzer displays the absolute amplitude of the frequency components of an input signal. Applications include: distortion and modulation measurements, mixer characterization, filter measurements, and absolute power measurements.

Operation is extremely simple; only three controls are needed for most measurements. Two controls set the frequency scale, and one is used for the amplitude scale. Measurements can be made from +30 dBm (7 volts) to -115 dBm (400 nV), and a 70 dB, distortion-free display is featured. Frequency spans as wide as 1000 MHz are provided, and, for high resolution analysis, you can scan a range as narrow as 50 kHz.

Swept frequency testing

Hewlett-Packard's Model 8755 series Frequency Response Test Sets are precision detection and display systems for making the basic microwave measurements of insertion gain/loss and return loss (VSWR) from 100 MHz to 18 GHz. The 8755L is cabinet mounted with a large screen display for bench applications; the 8755M occupies a minimum of space when rack mounted.

The 8755 system has been specifically designed to achieve a full 60 dB dynamic range when used with solid state sweepers (HP 8620 series) which typically have an output level in excess of +10 dBm. The 60 dB dynamic range from +10 all the way to -50 dB means it is possible to view a full 40 dB of return loss with couplers having a 20 dB auxiliary arm coupling factor.

180 SYSTEM SELECTION CHARTS

MAINFRAMES

Model No.	Description	Page
180C/D	High speed, 8 × 10 cm internal graticule (180D rack style)	117
181A/AR	5 cm/μs storage writing speed/variable persistence (181AR rack style)	113
182C	Large screen, 8 × 10 div internal graticule (10.3 × 12.9 cm)	116
183A/B	4 cm/ns writing speed (183B rack style)	136
183D	Selectable scan, 4 or 8 cm/ns writing speed, rack style.	136
184A/B	100 cm/μs storage writing speed/variable persistence (184B rack style)	114
184A/B Opt 005	400 cm/μs storage writing speed/variable persistence (184B Opt 005 rack style)	114

VERTICAL PLUG-INS

SAMPLING (Vertical Section)

Model No.	1801A	1803A	1804A	1805A	1806A	1807A	1808A	1809A	1830A	1,2 1831A/B	1834A	1835A	1810A	1,4 1815A/B	3,4 1811A
Bandwidth MHz	50	40 (30)	50	100	0.5	35	75	100	250	600 (A) 500 (B)	200	200	1 GHz	4 or 12.4 GHz	4 or 18 GHz
Min. deflection factor/div	5 mV (500 μV Opt 001 cascaded)	10 mV (1 mV cascaded)	20 mV	5 mV	100 μV	10 mV	5 mV	10 mV	10 mV	≈ 6 V	10 mV	10 mV	2 mV	5 mV	2 mV
Channels	2 (opt 001,1 cascaded)	1 diff	4	2 (1 cascaded)	2 (both diff)	2	2	4	2	1 diff (A) 1 single-ended (B)	4	2	2	1	2
Input RC	1 MΩ/25 pF	1 MΩ/27 pF	1 MΩ/25 pF	1 MΩ/13 pF or 50Ω	1 MΩ/45 pF	1 MΩ/27 pF	1 MΩ/12 pF or 50Ω	1 MΩ/12 pF or 50Ω	50Ω	50Ω	1 MΩ/12 pF or 50Ω	1 MΩ/12 pF or 50Ω	50Ω	50Ω	50Ω
Differential input	yes	yes (with dc offset)	no	yes	yes	yes	yes	yes	yes	1831A only	yes	yes	yes	no	yes
Page	120	124	122	118	120	120	119	122	140	140	138	139	130	132	128

TIME BASE PLUG-INS

SAMPLING (Time Base Section)

TDR

FREQUENCY-DOMAIN PLUG-INS

Model No.	1820C	1821A ⁷	1824A	1825A	1840A	1841A	1810A	3,4 1815A/B	3,4 1811A	1818A	3,5 1815A/B	8558B	8755A ⁸
Ext Trig Freq (MHz)	150	100	150	150	>500	>500	>1 GHz	18 GHz with trigger countdown	18 GHz with trigger countdown	<170 ps rise time TDR system	<35 ps rise time TDR	Spectrum Analyzer plug-in, 0.1 – 1500 MHz. Measurements from – 115 dBm to +30 dBm.	Swept Amplitude Analyzer plug-in measures insertion gain/loss and return loss from 15 MHz to 18 GHz.
Int Trig Freq	Determined by Vertical Amplifier Plug-in.						1 GHz						
Sweep Speeds/div ⁶	5 ns 1 s	10 ns 1 s	5 ns 1 s	5 ns 1 s	1 ns 0.1 s	1 ns 0.1 s	100 ps (expanded) – 50 μs	10 ps – 1 μs	10 ps (expanded) – 1 μs	Calibrated in feet and meters	1815A calibrated in feet 1815B calibrated in meters		
Delayed and mixed sweep	No	Yes	Expanded X100	Yes	No	Delayed	No	No	No				
Page	125	125	126	126	141	141	130	132	128	131	132	135	413

MAINFRAME / VERTICAL / TIME BASE COMPATIBILITY CHART

Mainframe	VERTICAL PLUG-INS										TIME BASE PLUG-INS					TDR/SAMPLING FREQ. DOMAIN									
	1801A/Opt 001	1803A	1804A	1805A	1806A	1807A	1808A	1809A	1830A	1831A/B	1834A	1835A	1820C	1821A ⁷	1824A	1825A	1840A	1840A/Opt 035	1841A	1810A	1811A	1815A/B	1818A	8558B	1755A
180C/D	X	X	X	X	X	X	X	X					X	X	X	X				X	X	X	X	X	X
181A/AR	X	X	X	X	X	X	X	X					X	X	X	X				X	X	X	X	X	X
182C	X	X	X	X	X	X	X	X					X	X	X	X				X	X	X	X	X	X
183 A/B/C	≤100 MHz	X	X	X	X	X	X	X					X	X	X	X				X	X	X	X	X	X
	≤250 MHz	X	X	X	X	X	X	X					X	X	X	X				X	X	X	X	X	X
	opt 035	X	X	X	X	X	X	X	X	X	X	X					X			X	X	X	X	X	X
183B Opt 005	X	X	X	X	X	X	X	X					X	X	X	X				X	X	X	X	X	X
183B Opt 005 & 035	X	X	X	X	X	X	X	X	X	X	X						X			X	X	X	X	X	X
184A/B	X	X	X	X	X	X	X	X					X	X	X	X				X	X	X	X	X	X

NOTES

- Operate in 183 System mainframes only.
- Requires Option 035 to 183 mainframe and 1840A Time Base.
- Double width plug-ins.
- Requires remote sampling heads.
- Requires Remote Pulse Generator.
- Includes X10 mainframe magnification.
- For vertical plug-ins up to 50 MHz.
- Requires remote modulator and detectors.

OSCILLOSCOPES



180 Mainframes: storage, 5 cm/ μ s writing speed

Models 181A/AR

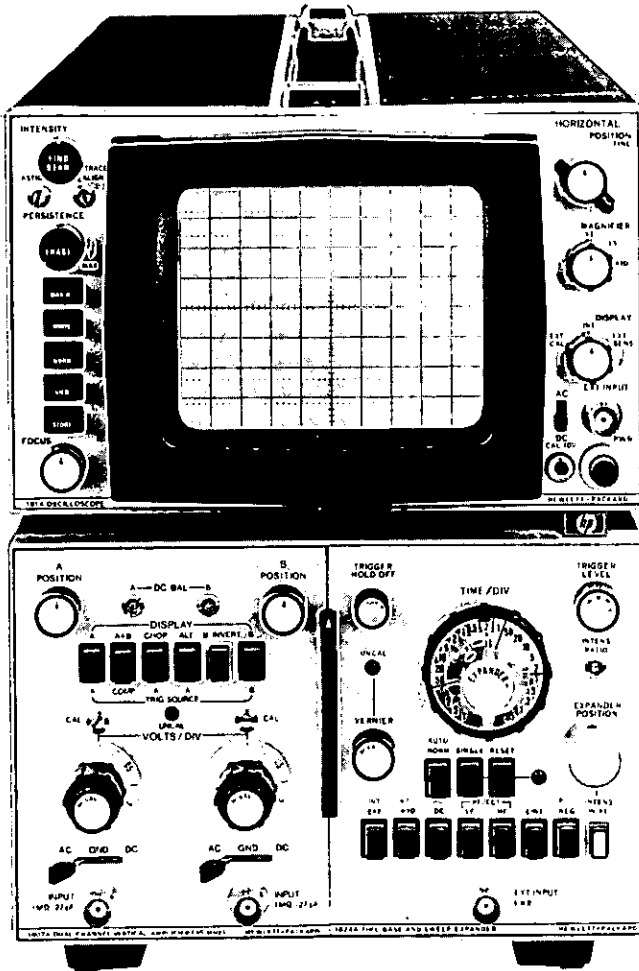

181A/AR Specifications

Cathode-ray tube and controls

Type: post-accelerator storage; approx. 8.5 kV accelerating potential; aluminized P31 phosphor.

Graticule: 8 X 10 div internal graticule, 0.2 subdivision markings on major horizontal and vertical axes. 1 div = 0.95 cm. Front panel adjustment aligns trace with graticule.

Beam finder: returns trace to CRT screen regardless of horizontal or vertical control setting.

Intensity modulation (external input)

Input: approx. +2 V, ≥ 50 ns pulse width (≤ 10 MHz sine wave) will blank trace of normal intensity.

Input R: approx. 5 k Ω .

Maximum input: ± 20 V (dc + peak ac).

Persistence

Normal: natural persistence of P31 phosphor (approx. 40 μ s).

Variable: from <0.2 s to >1 min.

Storage Writing Speed

Write mode: >20 cm/ms.

Max write mode: >5 cm/ μ s.

Brightness: >100 foot lamberts.

Storage time: from Write mode to Store, trace may be stored at reduced intensity for >1 hour; to View mode, traces may be viewed at normal intensity for >1 minute. From Max Write mode to Store, traces may be stored at reduced intensity for >5 minutes; to View mode, traces may be viewed at normal intensity for >15 seconds.

Erase: manual, pushbutton erasure takes approx. 300 ms.

Horizontal amplifier

External input

Bandwidth: dc-coupled, dc to 5 MHz; ac-coupled, 5 Hz to 5 MHz.

Deflection Factor: 1 V/div in X1; 0.2 V/div in X5; 0.1 V/div in X10.

Vernier: provides continuous adjustment between ranges.

Dynamic range: ± 20 V.

Maximum input: 600 V dc (ac-coupled input).

Input RC: approx. 1 megohm shunted by approx. 30 pF.

Sweep magnifier: X5, X10; accuracy, $\pm 5\%$ with 3% accuracy time base.

Outputs

Four rear panel emitter follower outputs for main and delayed gates, main and delayed sweeps or vertical and horizontal outputs when used with TDR/sampling plug-ins. Will drive impedances ≥ 1000 ohms without distortion.

General

Calibrator: approx 1 kHz square wave, 3 μ s rise time; 10 V p-p into ≥ 1 megohm; accuracy, $\pm 1\%$.

Operating environment: temperature, 0 to $+55^\circ\text{C}$ ($+32^\circ\text{F}$ to $+130^\circ\text{F}$); humidity, to 95% relative humidity at 40°C (104°F); altitude, to 4.6 km (15 000 ft); vibration, vibrated in three planes for 15 min. each with 0.254 mm (0.010 in.) excursion, 10 to 55 Hz.

Dimensions

Cabinet Model, 181A: 200 mm wide, 289 mm high, 540 mm deep behind panel (7 $\frac{7}{8}$, 11 $\frac{1}{8}$, 21 $\frac{1}{4}$ inches).

Rack Model, 181AR: 425 mm wide, 132.6 mm high, 543 mm deep overall (16 $\frac{1}{4}$, 5 $\frac{7}{32}$, 21 $\frac{1}{8}$ inches); 493 mm (19 $\frac{1}{4}$ in.) deep behind rack mount tabs.

Weight (without plug-ins)

Model 181A (cabinet): net, 10.9 kg (24 lb); shipping 18.1 kg (40 lb).

Model 181AR (rack): net, 11.8 kg (26 lb); shipping, 18.1 kg (40 lb).

Power: 115 or 230V $\pm 10\%$, 48 to 440 Hz; 115 watts at normal line with plug-ins; max mainframe power, 225 VA.

Accessories supplied: 2.3 m (7 $\frac{1}{2}$ ft) power cord, Model 10178A mesh contrast filter, blue plastic light filter (HP P/N 5060-0548), 230 V fuse package (HP P/N 5080-9672), one Operating and Service Manual. A rack mount kit (HP P/N 5060-0552) and 2 clip-on probe holders (HP P/N 5040-0464) are supplied with the 181AR rack model.

Options

H49: Model 181A or 181AR with remote programming capability for Write, Max Write, Normal, Store, View, and Erase functions. Programming is accomplished with contact closure, DTL, or TTL logic sources.

Option H49 Programming

add \$515

807: non-buffered rear panel auxiliary outputs related to 8558B and 8755A plug-ins

N/C

Model number and name

Price

Model-181A-Storage-Oscilloscope-Cabinet Style

\$2215

Model 181AR Storage Oscilloscope, Rack Style

\$2315

OSCILLOSCOPES

180 Mainframes: storage, 100 or 400 cm/ μ s writing speed

Models 184A/B

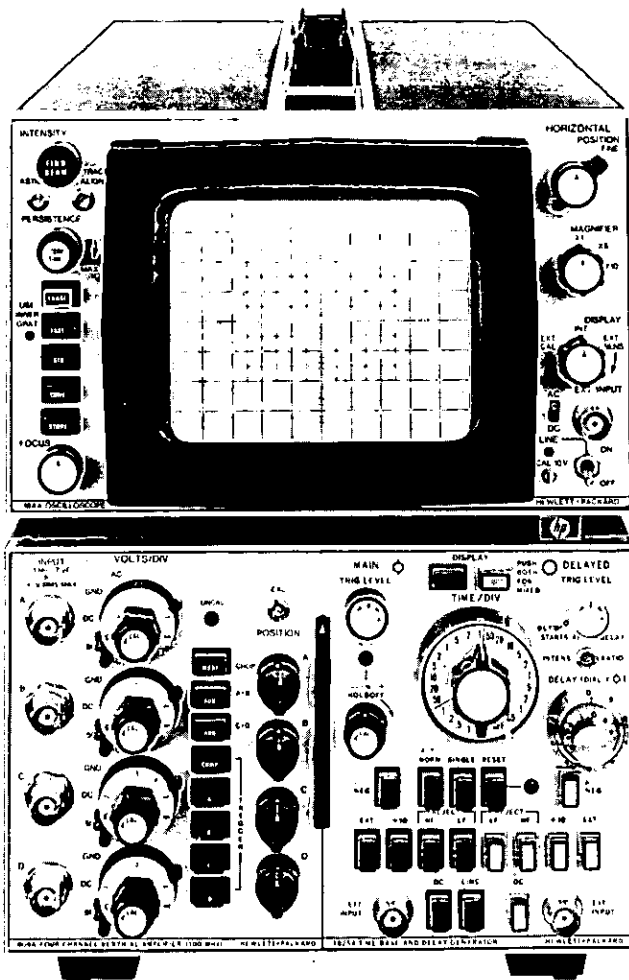

184A/B Mainframes Description

The Model 184A cabinet style and 184B 5/4 inch high rack style variable persistence and storage mainframes provide writing speeds of 100 or 400 cm/ μ s. These writing speeds are fast enough that traces you previously had to photograph to see can now be viewed directly in normal ambient light. A FAST mode optimizes writing speed by switching the CRT display to reduced scan while maintaining calibration and resolution. A second graticule, for the FAST mode, is superimposed in the center of the screen and a front panel light indicates when the scope is in the FAST mode.

The 184 Option 005 offers an excellent FAST writing speed of 400 cm/ μ s and the standard 184 provides 100 cm/ μ s both measured in the reduced scan area. The fast stored writing speed of 400 cm/ μ s is fully compatible with a single-shot, 5 ns rise time transient with an amplitude of greater than 5 divisions. Combining this superior single-shot writing speed with variable persistence also provides bright clear displays of low repetition rate digital waveforms.

Advances in target material and processing provide extremely high writing speed as well as a very rugged storage surface. This highly burn resistant, high-speed storage surface does not require special operating procedures.

The fast storage writing speed of the 184 storage CRT is extremely useful for single sweep displays of low repetition rate signals with fast rise times. This capability allows you to study a waveform or to pho-

tograph the trace with a general purpose scope camera as in figure 1. The digital word from TTL logic in figure 1 is occurring at a 1 Hz rate and is integrated, using variable persistence, to a bright clear display which is easily viewed in normal ambient light. The high writing speed allows storage and display of random noise pulses (figure 1) or single-shot transients (figure 2). For general purpose use where maximum writing speed is not of prime concern, a STD mode provides maximum brightness, high contrast ratio, and largest display area (see figure 3).

A storage time control allows a trade-off of viewing brightness for storage time which makes it possible to retain a display for greater than 10 minutes in STD mode and greater than 30 seconds in FAST mode. Another useful mode is the combination of FAST or STD and store mode coupled with the time base set for single-sweep operation. In this mode the 184 will remain prepared to store a signal for over 10 minutes in STD mode and more than 30 seconds in FAST mode.

This high speed storage tube also provides the same high contrast as a conventional CRT and with a bright display of 100 foot lamberts in the STD mode and 50 foot lamberts in the FAST mode. Also, by modulating the Z-axis, you can easily distinguish between several trace intensities.

Fast, easy setup is provided by the HP developed beamfinder. Pressing the Find Beam pushbutton returns the beam to the CRT regardless of the setting of vertical or horizontal position, sweep, or trigger controls.

All solid-state circuits reduce service and maintenance requirements with the proven reliability of these solid-state components. Solid-state circuits also provide compact, lightweight instruments with minimum warm-up time for stable reliable measurements without frequent recalibration.

The horizontal amplifier increases mainframe measurement flexibility. The external horizontal input may be used to inject external sweep signals or for phase measurements. When used for phase measurements, accurate measurements may be made up to 100 kHz. A convenient phase switch on the horizontal amplifier provides horizontal signal delay in the phase position, so that vertical and horizontal amplifiers are phase-matched.

184A/B Specifications

Cathode-ray tube and controls

Type: post-accelerator storage tube; aluminized P31 phosphor.

Graticule: 8 \times 10 div internal graticule, 0.2 div subdivisions on major axes. 1 div = 0.95 cm. 8 \times 10 div internal graticule superimposed in center of normal scope graticule (for fast writing speed mode). 1 div = 0.475 cm. Front panel adjustment aligns trace with graticule.

Beam finder: returns trace to CRT screen regardless of setting of horizontal or vertical control setting.

Intensity modulation (external input)

Input: approx. +2 V, \geq 50 ns pulse width (\leq 10 MHz sine wave) will blank trace of normal intensity.

Input R: approx. 5 k Ω .

Maximum input: \pm 20 V (dc + peak ac).

Writing modes: conventional (non-storage), standard, and fast (variable persistence and storage). Pressing STORE and either STD or FAST provides maximum persistence with floodguns off for a ready-to-write state. The CRT will remain primed and ready-to-write for the storage time of > 10 min. in STD/STORE and > 30s in FAST/STORE.

Persistence

Conventional: natural persistence of P31 phosphor (approx. 40 μ s).

Variable: from < 50 ms to > 1 min.

Storage writing speed

Model No.	Standard*	Fast**
184A/B	> 0.2 cm/ μ s	> 100 cm/ μ s
184A/B Opt 005	> 0.2 cm/ μ s	> 400 cm/ μ s

*Adjustable writing speeds to approx. 10 cm/ μ s are available with rear panel controls.

**Calibrated 3.8 \times 4.75 cm reduced scan area.

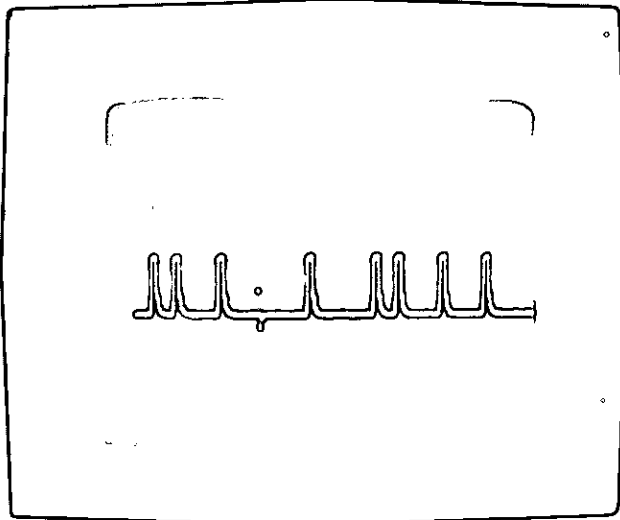

Figure 1. 16 bit word from TTL logic repeated 16 times at a 1 Hz rate. The 10 ns duration noise pulse occurs only once in 16 words.

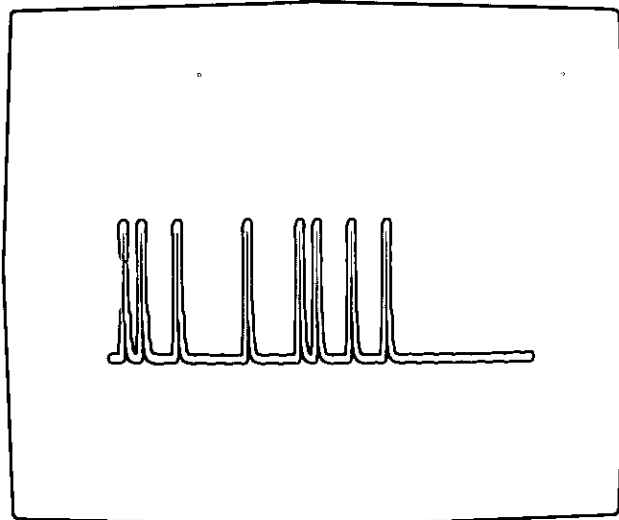

Figure 3. Digital word at 250 Hz rep rate integrated to a bright clear display in STD mode using variable persistence.

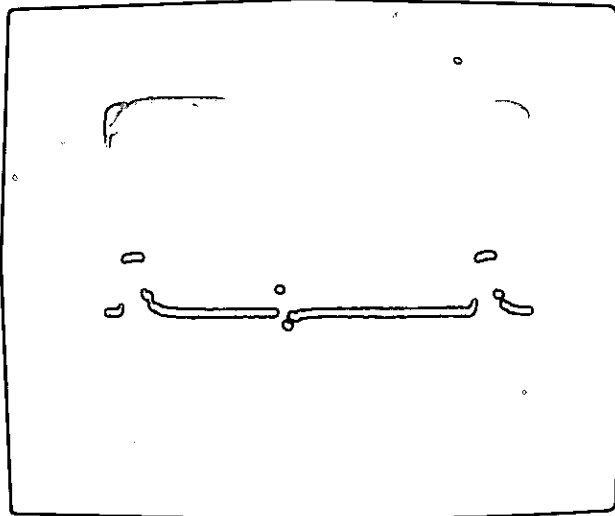

Figure 2. Single-sweep display at 100 ns/div.

Brightness

Standard: >100 foot lamberts.
Fast: >50 foot lamberts.

Storage time

Standard writing speed: variable from >1 min. at normal intensity to >10 min. at reduced brightness.
Fast writing speed: variable from >10 s (8 s for Opt 005) at normal intensity to >30 s at reduced brightness. Storage time may vary with wide temperature changes, specifications are for normal room temperature (+22°C).

Erase: manual, pushbutton erasure takes approx. 300 ms.

Horizontal amplifier

External input

Bandwidth: dc-coupled, dc to 5 MHz, ac-coupled, 5 Hz to 5 MHz.
Deflection factor: 1 V/div in X1; 0.2 V/div in X5; 0.1 V/div in X10; accuracy: ±5%—Vernier provides continuous adjustment be-

tween ranges.

Dynamic range: ±20 V.

Maximum input: 600 V dc (ac-coupled input).

Input RC: approx. 1 megohm shunted by approx. 30 pF.

Sweep magnifier: X5, X10; accuracy, ±5% (with 3% accuracy time base).

Calibrator

Type: approx. 1 kHz square wave, 3 μs rise time.

Voltage: 10 V p-p into ≥1 megohm; accuracy, ±1%.

Outputs

Four rear panel emitter follower outputs for main and delayed gates, main and delayed sweeps, or vertical and horizontal outputs when used with TDR/Sampling plug-ins. Maximum current available, ±3 mA. Will drive impedances ≥1000 ohms without distortion.

General

Operating environment: temperature, 0 to +55°C (+32°F to +130°F); humidity, to 95% relative humidity at 40°C (104°F); altitude, to 4.6 km (15 000 ft); vibration, vibrated in three planes for 15 min. each with 0.254 mm (0.010 in.) excursion, 10 to 55 Hz.

Dimensions:

Cabinet Model, 184A: 200 mm wide, 289 mm high, 540 mm deep behind panel (7⁷/₈, 11¹/₈, 21¹/₄ inches).

Rack Model, 184B: 425 mm wide, 132.6 mm high, 543 mm deep overall (16³/₄, 5¹/₃₂, 21¹/₈ inches); 493 mm (19¹/₈ in. deep behind rack mount tabs).

Weight (without plug-ins)

Model 184A (Cabinet): net, 10.9 kg (24 lb); shipping, 18.1 kg (40 lb).

Model 184B (Rack): net, 11.8 kg (26 lb); shipping, 18.1 kg (40 lb).

Power: 115 or 230 V ±10%, 48 to 440 Hz, 115 watts at normal line with plug-ins. Max mainframe power, 225 VA.

Accessories supplied: 2.3 m (7¹/₂ ft) power cord. Model 10178A mesh contrast filter, blue plastic light filter (HP P/N 5060-0548), 250 V fuse package (HP P/N 5080-9681), one Operating and Service Manual. A rack mount kit (HP P/N 5060-0552) and 2 clip-on probe holders (HP P/N 5040-0464) are supplied with the 184B rack model.

Model number and name

Model number and name	Price
184A Cabinet Storage Mainframe	\$2450
184A Option 005 Fast Storage CRT	add \$500
184B Rack-Style Storage Mainframe	\$2500
184B Option 005 Fast Storage CRT	add \$500



OSCILLOSCOPES

180 Mainframe: large screen

Model 182C

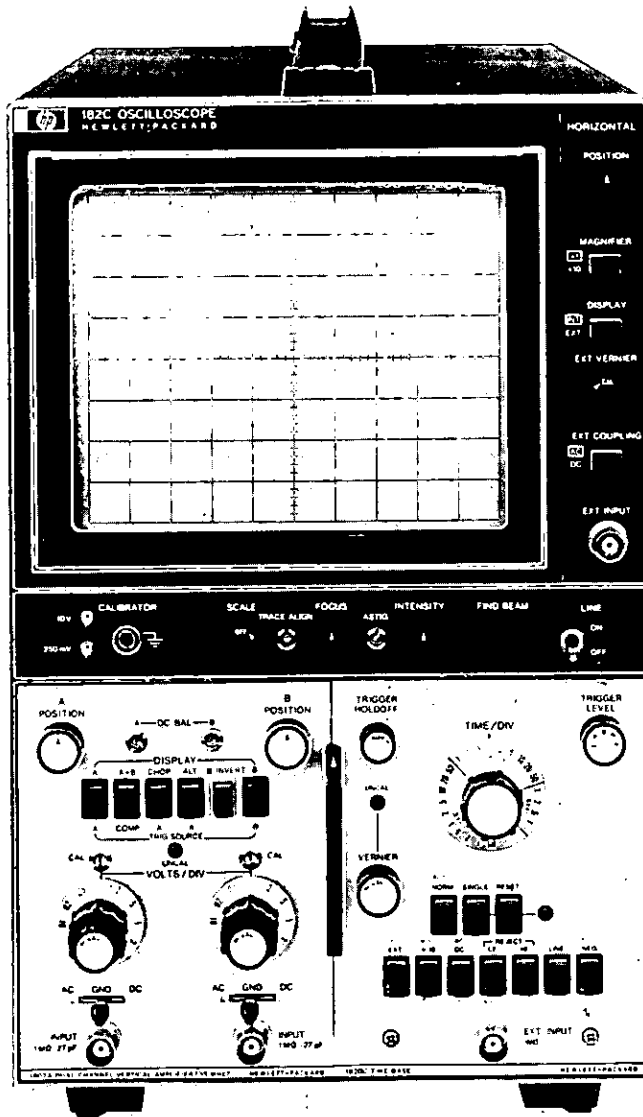

182C Description

Model 182C mainframe provides large, easy-to-read displays on a 7-inch CRT with 100 MHz capability. A parallax free, internal graticule allows accurate readings from any angle or from a distance which is extremely useful in systems testing. The large display also improves measurement accuracy of displays such as four channel, differential/dc offset, sampling, and time domain reflectometer measurements.

The cathode-ray tube has 21 kV accelerating potential for bright displays of low repetition rate signals. Particular attention to electron optics in the CRT assures that the large display size does not cause degradation of the trace. Internal flood guns provide graticule illumination which allows adjustment of background illumination for optimum contrast of graticule and trace for easy-to-read three-shade pho-

tographs. A find beam control reduces set-up time by returning the beam to the display area regardless of vertical, time base, or intensity control settings.

182C Specifications

Cathode-ray tube and controls

Type: post accelerator, 21 kV accelerating potential; aluminized P31 phosphor (other phosphors available, see Options).

Graticule: 8 × 10 div internal graticule. 0.2 div sub-divisions on major axis. 1 div = 1.29 cm. Front panel adjustment aligns trace with graticule. Scale control illuminates CRT phosphor for viewing with hood or taking photographs.

Beam finder: returns trace to CRT screen regardless of setting of horizontal, vertical, or intensity controls.

Intensity modulation (external input)

Input: approx. +2 V, ≥50 ns pulse width (≤10 MHz sine wave) will blank trace of normal intensity. Input R approx. 5 kΩ.

Maximum input: ±20 V (dc + peak ac).

Horizontal amplifier

External input

Bandwidth: dc-coupled, dc to 5 MHz; ac-coupled, 5 Hz to 5 MHz.

Deflection factor: 1 V/div, X1; 0.1 V/div, X10; accuracy, ±5%. Vernier provides continuous adjustment between ranges.

Dynamic range: ±20 V.

Maximum input: ±300 V (dc + peak ac).

Input RC: 1 megohm shunted by approx. 30 pF.

Sweep magnifier: X10; accuracy, ±5% (with 3% accuracy time base).

Calibrator: approx. 1 kHz square wave, <3 μs rise time; 250 mV p-p and 10 V p-p into ≥1 megohm, ±1%.

Outputs

Four rear panel emitter follower outputs for main and delayed gates, main and delayed sweeps or vertical and horizontal outputs when used with TDR/Sampling plug-ins. Maximum current available, ±3 mA. Will drive impedance ≥1000 ohms without distortion.

General

Operating environment: temperature, 0 to 55°C (+32°F to +130°F); humidity, to 95% relative humidity at 40°C (104°F); altitude, to 4.6 km (15 000 ft); vibration, vibrated in three planes for 15 min. each with 0.254 mm (0.010 in.) excursion, 10 to 55 Hz.

Dimensions: 201.6 mm wide, 338.1 mm high, 498.5 mm deep overall (7¹/₁₆, 13³/₁₆, 19⁵/₁₆ inches).

Weight: (without plug-ins) net, 12.02 kg (26¹/₂ lb); shipping, 17.46 kg (38¹/₂ lb).

Power: 115 or 230 V ±10%, 48 to 440 Hz, <110 watts with plug-ins at normal line. Max. mainframe power, 200 VA.

Accessories supplied: 2.3 m (7¹/₂ ft) power cord, blue plastic light filter (HP P/N 5060-0547), 230 V fuse package (HP P/N 5080-9672), one Operating and Service Manual.

Options

002: aluminized P2 phosphor in lieu of P31

Price

N/C

007: aluminized P7 phosphor in lieu of P31

N/C

010: mainframe without rear panel main and delayed sweep and gate outputs

less \$100

011: aluminized P11 phosphor in lieu of P31

N/C

Beamfinder does not intensify display on Option 011 oscilloscopes.

807: non buffered rear panel auxiliary outputs related to 8558B and 8755A plug-ins; aluminized P7 medium persistence phosphor in lieu of P31

N/C

Model number and name

Model 182C Oscilloscope Mainframe

\$1200

Model 182C Option 010 Oscilloscope Mainframe

\$1100

OSCILLOSCOPES

180 Mainframes: high writing speed

Models 180C/D

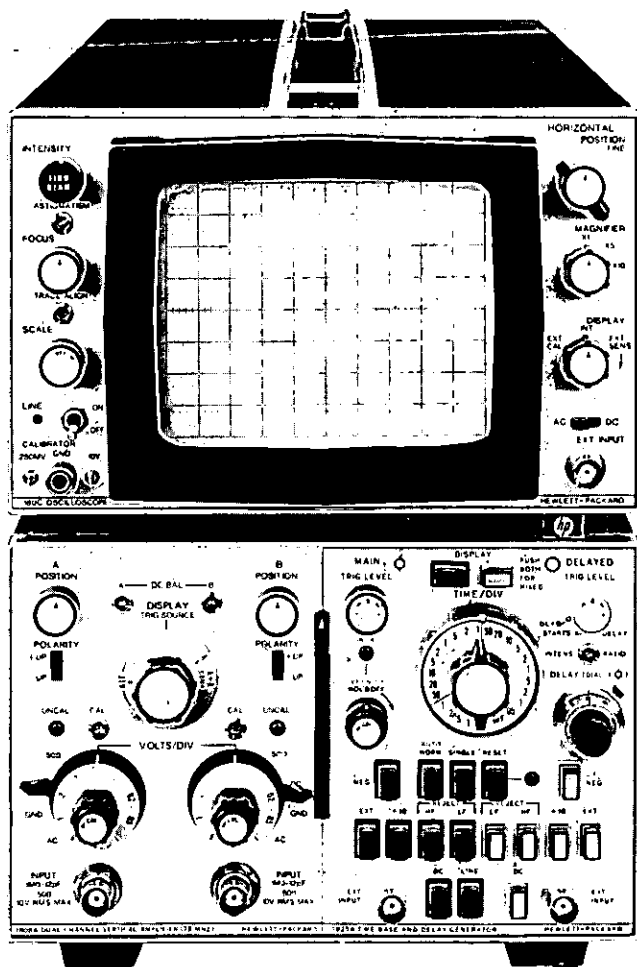

Photographic writing speed: 1500 cm/ μ s. Measured using P31 phosphor, 10 000 ASA film without film fogging and HP Model 195A camera (1.3 lens, 1:0.5 object-to-image ratio). Writing speed may be increased substantially by using film fogging techniques, P11 phosphor, and faster camera lenses.

Horizontal amplifier

External input

Bandwidth: dc to 5 MHz dc-coupled; 5 Hz to 5 MHz ac-coupled.

Deflection Factor: 1 V/div, X1; 0.2 V/div, X5; 0.1 V/div, X10; accuracy $\pm 5\%$. Vernier provides continuous adjustment between ranges.

Dynamic range: ± 20 V.

Maximum input: 600 V dc (ac-coupled input).

Input RC: approx. 1 megohm shunted by approx. 30 pF.

Sweep magnifier: X5, X10, accuracy $\pm 5\%$ (with 3% accuracy time base).

Outputs

Four rear panel, emitter follower outputs provide main and delayed sweeps, or vertical and horizontal outputs when used with TDR/Sampling plug-ins. Maximum current available, ± 3 mA. Outputs will drive impedances of ≥ 1000 ohms without distortion.

General

Calibrator: approx. 1 kHz square wave, 3 μ s rise time; 10 V p-p into ≥ 1 megohm; accuracy, $\pm 1\%$.

Operating environment: temperature, 0 to $+55^\circ\text{C}$ ($+32^\circ\text{F}$ to $+130^\circ\text{F}$); humidity, to 95% relative humidity at 40°C (104°F); altitude, to 4.6 km (15 000 ft); vibration, vibrated in three planes for 15 min. each with 0.254 mm (0.010 in.) excursion, 10 to 55 Hz.

Dimensions

Cabinet model, 180C: 200 mm wide, 289 mm high, 540 mm deep behind panel (7 $\frac{7}{8}$, 11 $\frac{1}{8}$, 21 $\frac{1}{4}$ inches).

Rack model, 180D: 425 mm wide, 132.6 mm high, 543 mm deep overall (16 $\frac{3}{4}$, 5 $\frac{1}{32}$, 21 $\frac{1}{8}$ inches); 493 mm (19 $\frac{3}{8}$ in.) deep behind rack mount tabs.

Weight (without plug-ins)

Model 180C (cabinet): net, 10.9 kg (24 lb); shipping, 16.3 kg (36 lb).

Model 180D (rack): net 11.8 kg (26 lb); shipping, 18.1 kg (40 lb).

Power: 115 or 230 V, $\pm 10\%$; 48 to 440 Hz; normally < 110 watts with plug-ins at normal line. Max mainframe power, 200 VA.

Accessories supplied: 2.3 m (7 $\frac{1}{2}$ ft) power cord, blue plastic light filter (HP P/N 5060-0548), 230 V fuse package (HP P/N 5080-9672), one Operating and Service Manual. A rack mount kit (HP P/N 5060-0552) and 2 clip-on probe holders (HP P/N 5040-0464) are supplied with the 180D rack model.

180 C/D Specifications

Cathode-ray tube and controls

Type: post accelerator, approx. 15 kV accelerating potential; aluminumized P31 phosphor (see Options for other available phosphors).

Graticule: 8 \times 10 div internal graticule, 1 div = 1 cm, 0.2 div subdivisions on major axes. Front panel recessed screwdriver adjustment aligns trace with graticule. Scale control illuminates CRT phosphor when viewing with hood or taking photographs.

Beam finder: returns trace to CRT screen regardless of setting of horizontal, vertical, or intensity controls.

Intensity modulation (external input)

Input: approx. +2 V, ≥ 50 ns pulse width (≤ 10 MHz sine wave) will blank trace of normal intensity.

Input R: approx. 5 k Ω .

Maximum input: ± 20 V (dc + peak ac).

Options

002: aluminumized P2 phosphor in lieu of P31

007: aluminumized P7 phosphor in lieu of P31

010: deletes rear panel outputs for main and delayed gates and main and delayed sweeps

less \$100

011: aluminumized P11 phosphor in lieu of P31

Beam finder does not intensify display on Option 011 oscilloscopes.

N/C

807 (180D only): non-buffered rear panel auxiliary outputs related to 8558B and 8755A plug-ins; aluminumized P7 persistence phosphor in lieu of P31

N/C

Model number and name

180C Cabinet Style Mainframe

\$1150

180C Option 010 (see Options)

\$1050

180D=Rack-Style Mainframe

\$1300

180D Option 010 (see Options)

\$1200



OSCILLOSCOPES

180 Vertical: 2 channel, 100 MHz

Model 1805A

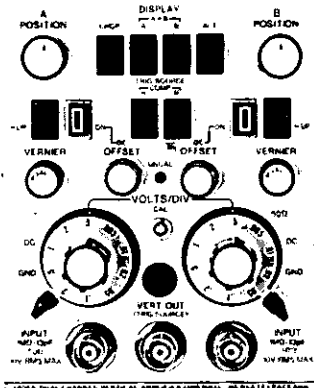

1805A Description

Model 1805A, 100 MHz vertical amplifier provides accurate measurements for both digital and analog design and troubleshooting. A selectable high impedance input with low input capacitance or 50 ohm input provides accurate pulse and CW measurements. Other features that give you accurate, convenient measurements are flexible triggering, 5 mV/div to 5 V/div deflection factors from dc to 100 MHz on all ranges, selectable display polarity on each channel, and up to ± 200 divisions of offset.

The dc offset capability of ± 200 divisions allows low-level, biased (non-symmetrical) logic pulses to be positioned on screen for accurate measurements. This allows you to view biased logic, such as ECL, which is biased several volts from ground and frequently operated with 0.5 volt swings, with a viewable amplitude and maintain dc-coupled information.

1805A Specifications

Modes of operation

Channel A; channel B; channels A and B displayed alternately on successive sweeps (ALT); channel A and B displayed by switching between channels at approx. 500 kHz rate (CHOP) with blanking during switching; channel A plus channel B (algebraic addition).

Each channel (2)

Bandwidth: (Measured with or without 10014A probe, 3 dB down from 8 div reference signal from a terminated 50 ohm source.)

DC-coupled: dc to 100 MHz.

AC-coupled: approx. 10 Hz to 100 MHz (lower limit is approx. 1 Hz with 10014A probe).

Rise time: <3.5 ns (measured with or without 10014A probes, 10% to 90% points of 6 div input step from a terminated 50 ohm source).

Deflection factor

Ranges: 5 mV/div to 5 V/div (10 calibrated positions) in 1, 2, 5 sequence. $\pm 2\%$ attenuator accuracy.

Vernier: provides continuous adjustment between deflection factor settings and extends maximum deflection factor to at least 12.5 V/div. Front panel light indicates when vernier is not in CAL position.

Polarity: + or - up, selectable.

Signal delay: input signals are delayed sufficiently to view leading edge of input pulse without advanced trigger.

Input coupling: AC, DC, 50 ohms (dc), or ground. Ground position

disconnects input connector and grounds amplifier input.

Input RC

AC and DC: 1 megohm $\pm 1\%$ shunted by approx. 13 pF. Constant on all ranges.

50 ohm: 50 ohms $\pm 2\%$. VSWR <1.2:1 at 100 MHz on all ranges.

Maximum input

AC and DC: ± 300 V (dc + peak ac) at 1 kHz or less. ± 150 V (dc + peak ac) on 5 mV/div range at 1 kHz or less.

50 ohm: 10 V rms.

Dynamic range: 6 div at 100 MHz increasing to 16 div at ≤ 15 MHz.

Positioning range: 16 div.

A + B operation

Amplifier: bandwidth and deflection factors are unchanged; either channel may be inverted for $\pm A \pm B$ operation.

Differential input (A - B) common mode: CMRR is at least 40 dB from dc to 1 MHz for common mode signals of 16 div or less. CMRR is at least 20 dB at 50 MHz for common mode signals of 6 div or less.

Triggering

Source: selectable from channel A, channel B, or a composite (Comp) signal from A and B in any display mode. Composite is channels A and B signals switched for Alt and Chop modes and added for A and B mode. Vernier and position controls do not affect A, B, or composite trigger signals. A and B signals are independent of polarity selection.

Frequency

Time Base Plug-in	Trigger Frequency*	Required Vertical Deflection
1820C, 1824A	dc - 50 MHz	1/2 div
1825A, 1840A, 1841A	dc - 100 MHz	1 div
1820B, 1822A	dc - 50 MHz	1/2 div
	dc - 100 MHz	2 div
1820A, 1821A	dc - 50 MHz	1 div

*all display modes except Chop, dc to 100 kHz in Chop.

Offset

± 200 div of offset. Allows offset of dc or ac signals up to the dynamic range and maximum input.

Vertical signal output (selected by trigger source switch)

Bandwidth: >50 MHz into 50 ohms.

Amplitude: >50 mV for each division of display into 50 ohms with usable amplitudes up to 500 mV p-p.

Source impedance: approx. 50 ohms.

General

Operating environment: same as 180 C/D mainframes.

Weight: net, 2.3 kg (5 lb); shipping, 3.6 kg (8 lb).

Accessories supplied: two 10014A 10:1 voltage divider probes approx. 1.1 m (3 1/2 ft) long, one Operating and Service Manual.

Recommended probes

10014A, 10016A passive probes, 10020A resistive divider probe kit, and the 1120A and 1125A active probes will maintain full performance of the 1805A.

75 ohm input

A selectable 75 ohm/1 megohm input is available in place of the 50 ohm/1 megohm input. For further information, contact your Hewlett-Packard Field Engineer.

Option 003: Model 1805A without probes

Model number and name

1805A Dual Channel Vertical Amplifier

1805A Option 003 (without probes)

less \$100

Price

\$1500

\$1400

OSCILLOSCOPES

180 Vertical: 2 channel, 75 MHz

Model 1808A

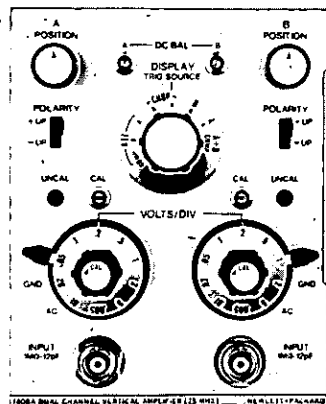

1808A Description

Model 1808A is an ideal vertical amplifier for designing or troubleshooting logic circuits using ECL components. This plug-in provides low drift and flexible triggering for accurate CW and timing measurements. Other convenience features are: 5 mV/div to 10 V/div; dc to 75 MHz bandwidth on all ranges; selectable display polarity on each channel; and selectable high Z or 50 ohm inputs.

General purpose probing is provided by the one megohm input with a very low 12 pF shunt capacitance to reduce phase shift and signal loss in CW measurements.

A switchable, high quality, 50 ohm input is also provided, which allows matching to a 50 ohm source with minimum reflections due to the low 1.2:1 VSWR. This 50 ohm input provides accurate rise time measurements with virtually no reflections to degrade the input signal or introduce phase shift. Signal degradation so common with external 50 ohm feedthrough terminations on high impedance (high capacity) inputs is eliminated. The 50 ohm input also allows active and passive probes with very low input capacitance to be used which further reduces signal degradation.

The two channels may be operated singly, algebraically added, or in dual trace modes with alternate or chopped switching with a selectable trigger source. In chop and alternate modes, the trigger may be derived from channel A or B for timing measurements in relation to either channel. Composite triggering is also selectable in alternate and A + B modes for viewing asynchronous signals.

1808A Specifications

Modes of operation

Channel A; channel B; channels A and B displayed alternately on successive sweeps (ALT); channels A and B displayed by switching between channels at approx. 400 kHz rate (CHOP), with blanking during switching; and channel A plus channel B (algebraic addition).

Each channel (2)

Bandwidth: (Measured with or without 10014A probe, 3 dB down from 8 div reference signal from a terminated 50 ohm source.)

DC-coupled: dc to 75 MHz.

AC-coupled: approx. 8 Hz to 75 MHz (lower limit is approx. 0.8 Hz with 10014A probe).

Rise time: <4.7 ns (measured from 10% to 90% points of 6 div input step from a terminated 50 ohm source).

Deflection factor

Ranges: 5 mV/div to 5 V/div (10 calibrated positions) in 1, 2, 5 sequence.

Attenuator accuracy: $\pm 2\%$.

Vernier: provides continuous adjustment between deflection factor settings and extends maximum deflection factor to at least 12.5 V/div. Front panel light indicates when vernier is not in CAL position.

Polarity: + up or - up, selectable.

Signal delay: input signals are delayed sufficiently to view leading edge of input pulse without advanced trigger.

Input coupling: AC, DC, 50 ohms (dc), or Ground. Ground position disconnects input connector and grounds amplifier input.

Input RC

AC and DC: 1 megohm $\pm 1\%$ shunted by approx. 12 pF. Constant on all ranges.

50 ohm: 50 ohms $\pm 2\%$. VSWR, <1.2:1 at 75 MHz on all ranges.

Maximum input

AC and DC: ± 300 V (dc + peak ac) at 1 kHz or less; ± 150 V (dc + peak ac) on 5 mV range at 1 kHz or less.

50 ohm: 10 V rms (dc-coupled input).

Drift: <100 μ V/ $^{\circ}$ C.

A + B operation

Amplifier: bandwidth and deflection factors are unchanged; either channel may be inverted for $\pm A \pm B$ operation.

Differential input (A - B) common mode: CMRR is at least 40 dB on 5 mV/div and at least 20 dB on other ranges for frequencies between dc and 2 MHz and common mode signal of 24 div or less.

Triggering

Source: A, B, or A+B on the individual or composite signal displayed; chop mode selectable from A or B; alternate mode A, B, or composite (A+B switched).

Frequency: dc to 75 MHz on signals causing 0.5 div p-p or more vertical deflection in all display modes (1820A and 1821A require 1 div p-p); except dc to 100 kHz in chop mode.

General

Operating environment: temperature, 0 to +55 $^{\circ}$ C (+32 $^{\circ}$ F to +130 $^{\circ}$ F); humidity, to 95% relative humidity at 40 $^{\circ}$ C (104 $^{\circ}$ F); altitude, to 4.6 km (15 000 ft); vibration, vibrated in three planes for 15 min. each with 0.254 mm (0.010 in.) excursion, 10 to 55 Hz.

Weight: net, 2.3 kg (5 lb); shipping, 4.1 kg (9 lb).

Accessories supplied: two Model 10014A 10:1 voltage divider probes and one Operating and Service Manual.

Recommended probes

The 10014A, 10016A passive divider probes, 10020A resistive divider probe kit, 1120A, 1124A, and 1125A active probes maintain full performance of the 1808A.

75 ohm input

A selectable 75 ohm/1 megohm input is available in place of the 50 ohm/1 megohm input. For further information, contact your Hewlett-Packard Field Engineer.

Options

003: Model 1808A without probes

Price
less \$100

090: Two 10016A, 10:1 voltage divider probes substituted for two 10014A probes

N/C

Model number and name

1808A-Dual-Channel-Vertical-Amplifier \$950

1808A Option 003 (without probes) \$850



OSCILLOSCOPES

180 Verticals: 2 channel

Models 1801A, 1807A, & 1806A

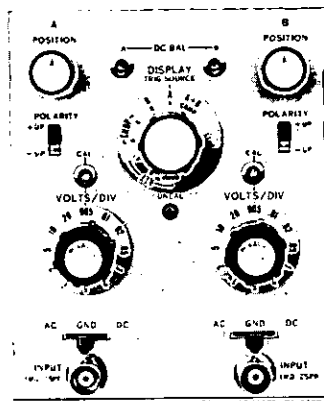

1801A

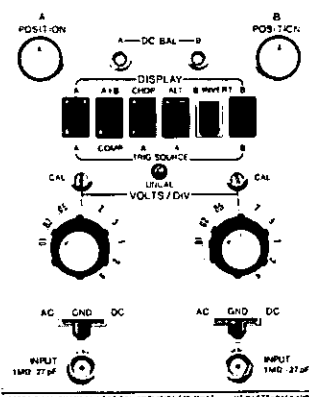

1807A

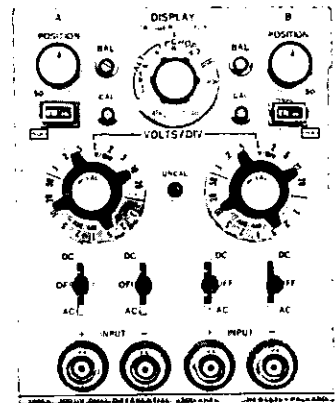

1806A

Description

Model 1801A dual channel amplifier has deflection factors from 5 mV/div to 20 V/div with constant bandwidth of 50 MHz on all ranges. Selectable display polarity and input coupling assure that you obtain the display required for a particular measurement. FET inputs are provided for low drift with a virtual absence of microphonics.

For additional low level measurement capability, a Model 1801A with Option 001 is available. Option 001 adds a X5 multiplier and a channel B vertical output. The X5 mode allows dual channel, 1 mV/div deflection factors to 20 MHz. Channel B output can be cascaded with channel A for a single channel display with 500 μ V/div to 30 MHz.

Model 1807A is an economical dual channel plug-in for applications involving logic timing measurements in circuits using MOS and TTL elements. The 10 mV/div deflection factor and 35 MHz bandwidth give you a low cost answer to the design and testing problems of many of today's digital circuits. A selection of standard, delayed, or expanded sweep time bases allows accurate timing measurements with sweep speed to 5 ns/div.

Model 1806A is a dual differential input amplifier for high sensitivity, low frequency measurements. This plug-in features high stability, low noise and high common mode rejection with 100 μ V/div deflection factors and a 500 kHz bandwidth. It provides accurate waveform measurements and analysis in the subsonic, audio, ultrasonic and low radio frequency range.

Noise is a low 20 μ V, measured tangentially at full bandwidth. A bandwidth limit switch (reduces bandwidth to approximately 50 kHz) eliminates noise in the unused portion of the bandwidth for improved resolution of low level signals.

Input and output signals from a circuit under test can be measured simultaneously in either chop or alternate mode. Trigger source selection is also provided in chop or alternate modes to allow sweep-timing to be derived from either channel.

Applications for the 1806A include: audio system testing and design, biological research, power supply design, timing measurements, strain gauge and transducer monitoring, ultrasonic system testing and educational instruction.

1801A Specifications

Modes of operation

Channel A; channel B; channels A and B displayed alternately on successive sweeps (ALT); channels A and B displayed by switching between channels at approx. 400 kHz rate (CHOP), with blanking during switching; channel A plus channel B (algebraic addition).

Each Channel (2)

Bandwidth: (Measured with or without a Model 10004D probe, 3 dB down from 8 div reference signal from a terminated 50 ohm source.)

DC-coupled: dc to 50 MHz.

AC-coupled: approx. 8 Hz to 50 MHz. Lower limit is approx. 0.8 Hz with 10004D probe.

Rise time: <7 ns (measured with or without 10004D probe 10% to

90% of 8 div input step from a terminated 50 ohm source).

Deflection factor

Ranges: 5 mV/div to 20 V/div (12 positions) in 1, 2, 5 sequence. $\pm 3\%$ attenuator accuracy.

Vernier: provides continuous adjustment between deflection factor settings and extends maximum deflection factor to at least 50 V/div. Front panel light indicates when vernier is not in CAL position.

Polarity: + up or - up, selectable.

Signal delay: input signals are delayed sufficiently to view leading edge of input pulse without advanced external trigger.

Input coupling: selectable, AC, DC, or Ground. Ground position disconnects signal input and grounds amplifier input.

Input RC: 1 megohm shunted by approx. 25 pF, constant on all ranges.

Maximum input

DC-coupled: ± 350 V (dc + peak ac) at 10 kHz or less. ± 150 V (dc - peak ac) on 5 mV/div range at 10 kHz or less.

AC-coupled: ± 600 V dc.

A + B operation

Amplifier: bandwidth and deflection factors are unchanged; either channel may be inverted for $\pm A \pm B$ operation.

Differential input (A - B) common mode: CMRR is at least 40 dB at 5 mV/div and at least 20 dB on other ranges for frequencies between dc and 1 MHz and for common mode signals of 24 div or less.

Triggering

Source: A, B, or A + B modes on the signal displayed.

Chop mode: on channel A or channel B signal.

Alternate mode: on channel A signal, channel B signal or successively (Comp) from the displayed signal on each channel.

Frequency: dc to 50 MHz on signals causing 0.5 div or more vertical deflection in all display modes except Chop; dc to 100 kHz in Chop mode.

General

Operating environment: same as 180C/D mainframe.

Weight: 1.8 kg (4 lb); shipping, 3.2 kg (7 lb).

Accessories supplied: two 10004D, 10:1 divider probes, approx 1.1 m (3 1/2 ft), one Operating and Service manual.

Recommended probes

Models 10004D, 10005D, and 10006D 10:1 divider probes maintain full performance of the 1801A.

Options

001: Model 1801A with channel B vertical signal output and X5 magnifier 1 mV/div deflection factor.

003: Model 1801A without probes.

090: 1.8 m (6 ft) 10006D probes substituted for 10004D probes.

091: 3.0 m (10 ft) 10005D probes substituted for 10004D probes.

1807A Specifications

Modes of operation

Channel A; channel B; channels A and B displayed alternately on successive sweeps (ALT); channels A and B displayed by switching between channels at approx. 100 kHz rate (CHOP), with blanking during switching; and channel A plus channel B (algebraic addition).

Each channel (2)

Bandwidth: (Measured with or without 10004D probe, 3 dB down from 8 div reference signal from a terminated 50 ohm source.)

DC-coupled: dc to 35 MHz.

AC-coupled: approx. 8 Hz to 35 MHz. Lower limit is approx. 0.8 Hz with 10004D probe.

Rise time: <10 ns (measured with or without 10004D probe, 10% to 90% of 8 div input from terminated 50 ohm source).

Deflection factor

Ranges: 10 mV/div to 5 V/div (9 positions) in 1, 2, 5 sequence. $\pm 3\%$ attenuator accuracy.

Vernier: provides continuous adjustment between deflection factor settings and extends maximum deflection factor to 12.5 V/div. Front panel light indicates when vernier is not in CAL position.

Polarity: + up or - up, selectable on channel B.

Signal delay: input signals are delayed sufficiently to view leading edge of input pulse without advanced trigger.

Input RC: 1 megohm $\pm 2\%$ shunted by approx 27 pF. Constant on all ranges.

Input coupling: selectable, AC, DC, or Ground. Ground position disconnects input connector and grounds amplifier input.

Maximum input

DC-coupled: ± 350 V (dc + peak ac) at 10 kHz or less; ± 150 V (dc + peak ac) on 10 mV/div at 10 kHz or less.

AC-coupled: ± 600 V dc.

A + B operation

Amplifier: bandwidth and deflection factors are unchanged; channel B may be inverted for +A \pm B operation.

Differential input (A - B) common mode: for frequencies from dc to 1 MHz CMRR is at least 40 dB on 10 mV/div and at least 20 dB on other ranges for common mode signals of 24 div or less.

Triggering

Source: on channel A for channel A, Chop and Alt modes; on channel B for channel B mode; on composite signal displayed for A + B mode.

Frequency: dc to 35 MHz on signals causing 0.5 div p-p or more vertical deflection in all display modes except dc to 100 kHz in Chop mode.

General

Operating environment: same as 180C/D mainframe.

Weight: net, 1.8 kg (4 lb); shipping, 3.6 kg (8 lb).

Accessories supplied: one Operating and Service Manual.

Recommended probes

The 10004D, 10005D and 10006D passive divider probes maintain full performance of the 1807A.

1806A Specifications

Modes of operation

Channel A alone; channel B alone; channels A and B displayed alter-

nately on successive sweeps (ALT); channels A and B displayed by switching between channels at approx. 100 kHz rate (CHOP) with blanking during switching.

Each channel (2)

Bandwidth: (Measured with or without 10001A/B probe, 3 dB down from an 8 div reference signal from a terminated 50 ohm source.)

DC-coupled: dc to 500 kHz.

AC-coupled: approx. 2 Hz to 500 kHz. Lower limit is approx. 0.2 Hz with 10001A/B probe.

Bandwidth limit switch: limits bandwidth to approx. 50 kHz.

Deflection factor

Ranges: from 100 μ V/div to 20 V/div (17 positions) in 1, 2, 5 sequence. $\pm 3\%$ attenuator accuracy.

Vernier: provides continuous adjustment between deflection factor settings and extends maximum deflection factor to at least 50 V/div. Front panel light indicates when vernier is out of CAL position.

Input: differential or single-ended on all ranges, selectable.

Input coupling: selectable AC, DC, or OFF for both + and - inputs. Off position disconnects signal input and grounds amplifier input for reference.

Input RC: 1 megohm shunted by approx. 45 pF, constant on all ranges.

Maximum input: ± 400 V (dc + peak ac).

Input isolation: ≥ 80 dB between channels at 500 kHz with shielded connectors.

Noise: < 20 μ V, measured tangentially at full bandwidth.

Common mode

Frequency: dc to 10 kHz on all ranges.

Rejection ratio: ≥ 100 dB (100,000 to 1) with dc-coupled input on 100 μ V/div range, decreasing 20 dB per decade of deflection factor to ≥ 40 dB on the 200 mV/div range; CMRR is ≥ 30 dB on the 500 mV/div to 20 V/div ranges.

Maximum signal: ± 10 V (dc + peak ac) on 100 μ V/div to 200 mV/div ranges; ± 400 V (dc + peak ac) on all other ranges.

Triggering

Source: for channel A and B on the signal displayed, Chop is selectable from channel A or B, Alt is selectable from channel A, B, or Comp (channels A and B switched).

Frequency: dc to > 500 kHz on signals causing 0.5 div or more vertical deflection in all display modes except Chop. DC to 100 kHz in Chop.

General

Operating environment: same as 180C/D mainframe.

Weight: net, 1.6 kg (3 1/2 lb); shipping, 3 kg (6 1/2 lb).

Accessories supplied: two BNC to dual banana plug binding post adapters (HP P/N 1250-1264), one Operating and Service Manual.

Recommended probes

Models 10001A/B, 10002A/B, 10003A passive divider probes maintain full performance of the 1806A.

Model number and name

Model number and name	Price
1801A Dual Channel Vertical Amplifier	\$800
Option 001: channel B output and X5 magnifier	add \$155
Option 003: less probes	less \$80
Option 090: 10006D probes in lieu of 10004D	N/C
Option 091: 10005D probes in lieu of 10004D	N/C
1807A Dual Channel Vertical Amplifier	\$650
1806A Dual Channel Vertical Amplifier	\$810



OSCILLOSCOPES

180 Verticals: 4 channel, 100 MHz and 50 MHz
Models 1809A & 1804A

NEW

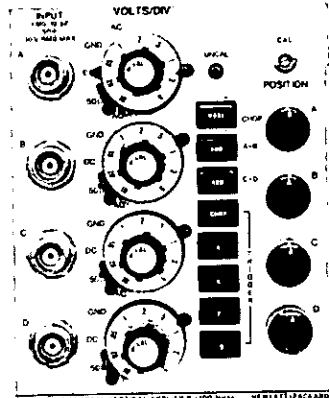

1809A

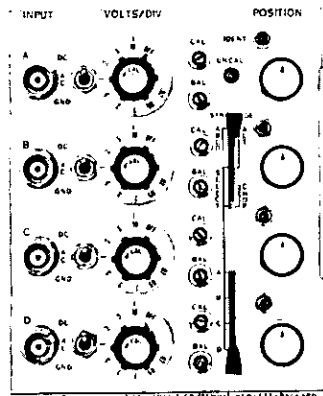

1804A

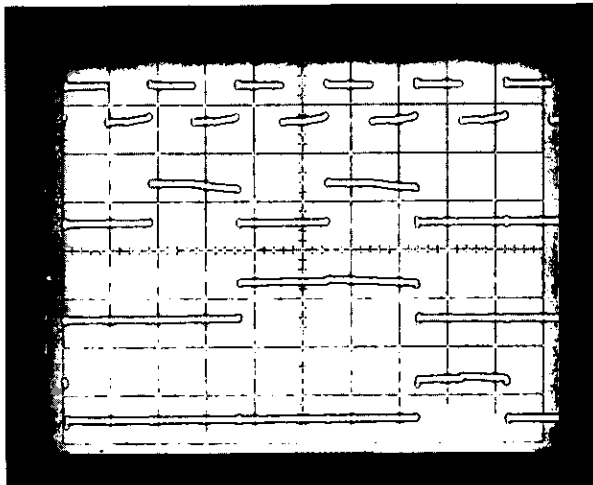

Four channel display shows ease of making timing measurements of the Q outputs on a TTL decade divider.

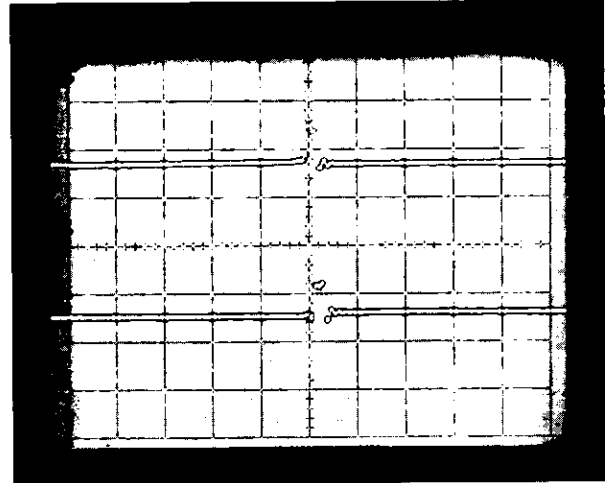

1809A in dual differential mode (A + B) and (C + D) shows transient state (race condition) occurring at count 8 of a TTL decade divider between both Q1 and Q2 (upper trace) and Q2 and Q3 (lower trace).

Description

Model 1809A, 100 MHz four channel vertical amplifier plug-in provides accurate multi-trace, 10 mV/div measurements in both digital and analog applications. Its wide bandwidth coupled with 5 ns/div sweep speeds allows high resolution timing measurements in digital circuits. Multi-channel timing measurements are also aided with the ability to select the alternate sweep mode or a fast chop mode with a 1 MHz chop rate for 2 channels or 500 kHz rate for all four channels.

A thick film, planar attenuator with selectable 1 megohm or 50 ohms input impedance precedes an MSI integrated circuit amplifier to attain 100 MHz bandwidth at 10 mV/div deflection factors. The 1 megohm (ac or dc) input has only 12 pF shunt capacitance for minimal loading in probing applications. For accurate 50 ohm measurements, a precision, dc-coupled, internal 50 ohm input termination may be selected with a front panel switch. The 50 ohm termination maintains low VSWR and pulse fidelity by compensating for normal input capacitance which is not possible with external terminations.

The flexible trigger source selection allows timing measurements referenced from channel A, B, C, or D or each channel triggered independently in composite mode. Any channel may be used as the trigger source whether it is displayed or not.

Any of the four channels may be inverted with a convenient front panel switch. In addition, the ADD mode gives you the capability of looking at two pairs differentially ($\pm A \pm B$), ($\pm C \pm D$) or ($\pm A \pm B$), $\pm C$, $\pm D$ which makes measurements in balanced or differential lines easy.

Model 1804A provides four channel measurement capability to 50 MHz with 20 mV/div deflection factors and is particularly useful in low speed logic applications. Deflection factors from 20 mV/div to 10 V/div assure measurement compatibility with most logic levels. Trace identification is conveniently obtained with a pushbutton on each channel which moves the respective trace approximately $\frac{1}{2}$ division.

A wide selection of trigger sources increases measurement versatility by allowing you to select the trigger mode to fit your particular application. In Chop or Alternate mode, you can trigger on any channel to see the time relationship with the other three channels. In the com-



posite mode, each channel triggers separately for direct comparison of signals in spite of time delays or for display of asynchronous signals.

1809A Specifications

Modes of operation

Channels A, B, C, or D or any combination displayed alternately on successive sweeps (ALT) or chopped (CHOP) with blanking during switching; either channels A and B or C and D may be algebraically added ($\pm A \pm B$) or ($\pm C \pm D$). Approximate chop rate for two channels displayed is 1 MHz, 3 channels is 667 kHz, 4 channels is 500 kHz.

Vertical amplifiers (4)

Bandwidth: (Measured with or without 10014A probe, 3 dB down from a terminated 50 ohm source.)

DC-coupled: dc to 100 MHz.

AC-coupled: approx. 10 Hz to 100 MHz. Lower limit is approx. 1 Hz with 10014A probe.

Rise time: <3.5 ns. Measured with or without 10014A probe, 10% to 90% of 6 div input step from a terminated 50 ohm source.

Deflection factor:

Ranges: from 0.01 V/div to 5 V/div (9 calibrated positions) in 1, 2, 5 sequence.

Attenuator accuracy: $\pm 2\%$.

Vernier: provides continuous adjustment between all deflection factor ranges. Extends maximum deflection factor to at least 12.5 V/div.

Signal delay: input signals are delayed sufficiently to view leading edge of input without advanced external trigger.

Input coupling: ac, dc, 50 ohms (dc), or ground. Ground position disconnects input connector and grounds amplifier input.

Input RC (selectable):

AC or DC: 1 megohm $\pm 1\%$ shunted by approx. 12 pF.

50 ohm: 50 ohms $\pm 2\%$. VSWR, 1.3:1 at 100 MHz on all ranges.

Maximum input:

AC and DC: ± 300 V (dc + peak ac) at 1 kHz or less; ± 150 V (dc + peak ac) on 10 mV/div range at 1 kHz or less.

50 ohm: 10 V rms (dc-coupled input).

Polarity: any channel may be inverted for $\pm A$, $\pm B$, $\pm C$, or $\pm D$ operation.

Algebraic addition (A + B), (C + D)

Amplifier: bandwidth and deflection factors are unchanged, any channel may be inverted for ($\pm A \pm B$) or ($\pm C \pm D$) operation.

Differential input (A - B) or (C - D) common mode: CMRR is at least 20 dB from dc to 80 MHz on all ranges.

Triggering

Source: selectable from channel A, B, C, D, or composite (on displayed signals) in all display modes.

Frequency

Time Base Plug-in	Trigger Frequency*	Required Vertical Deflection
1820C, 1824A, 1825A, 1840A, 1841A	dc - 50 MHz	1/2 div
	dc - 100 MHz	1 div
1820B, 1822A	dc - 50 MHz	1/2 div
	dc - 100 MHz	2 div
1820A, 1821A	dc - 50 MHz	1 div

*All display modes except Chop, dc to 100 kHz in Chop.

General

Weight: net, 3.2 kg (7 lb); shipping, 4.5 kg (10 lb).

Operating environment: same as 180C/D mainframes.

Accessories supplied: one Operating and Service Manual.

Recommended probes

Model 10014A and 10016A will maintain 1809A bandwidth and rise time in the high impedance (ac or dc) mode. Models 10020A and 1125A will maintain bandwidth and rise time in the 50 ohm input mode.

1804A Specifications

Modes of operation

Channels A, B, C, or D or any combination displayed alternately on successive sweeps (ALT) or chopped (CHOP) with blanking during switching. Approximate chop rate for two channels displayed is 500 kHz, 3 channels is 333 kHz, and 4 channels is 250 kHz.

Vertical amplifiers (4)

Bandwidth: (measured with or without 10004D probe, 3 dB down from 8 div reference signal from a terminated 50 ohm source.)

DC-coupled: dc to 50 MHz.

AC-coupled: approx. 10 Hz to 50 MHz (lower limit is approx. 1 Hz with 10004D probe).

Rise time: <7 ns (measured with or without 10004D probe, 10% to 90% of 8 div input step from a terminated 50 ohm source).

Deflection factor:

Ranges: from 0.02 V/div to 10 V/div (9 calibrated positions) in 1, 2, 5 sequence.

Attenuator accuracy: $\pm 3\%$.

Vernier: provides continuous adjustment between deflection factor settings and extends maximum deflection factor to at least 25 V/div. Front panel light indicates when vernier is out of CAL position.

Signal delay: input signals are delayed sufficiently to view leading edge of input pulse without advanced external trigger.

Input coupling: AC, DC, and Ground. Ground disconnects input signal and grounds amplifier input.

Input RC: 1 megohm shunted by approx. 25 pF, constant on all ranges.

Maximum input:

DC-coupled: ± 350 V (dc + peak ac); ± 150 V (dc + peak ac) on 20 mV/div at 10 kHz or less.

AC-coupled: ± 400 Vdc.

Trace identification: pushbutton control displaces respective trace approx. 0.5 div.

Triggering

Source: selectable on signal from any channel in either Chop or Alt mode, or successively from displayed signal on each channel in Alt mode.

Frequency: dc to 50 MHz on signals causing 0.5 div or more vertical deflection in all display modes except Chop. DC to 200 kHz in Chop mode.

General

Operating environment: temperature, 0 to 55°C (+32°F to +130°F); humidity, to 95% relative humidity at 40°C (104°F); altitude, to 4.6 km (15 000 ft); vibration, vibrated in three planes for 15 min. each with 0.254 mm (0.010 in.) excursion, 10 to 55 Hz.

Weight: net, 2.3 kg (5 lb); shipping, 3.6 kg (8 lb).

Accessories supplied: one Operating and Service Manual.

Recommended probes

10004D, 10005D, and 10006D passive probes maintain full performance of the 1804A.

Model number and name

1809A 100 MHz 4 Channel Amplifier

1804A 50 MHz 4 Channel Amplifier

Price

\$2100

\$1200

OSCILLOSCOPES

180 Vertical: differential, dc offset

Model 1803A

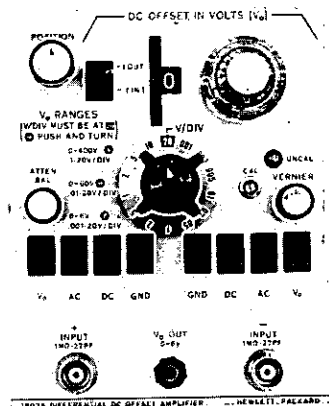

1803A Description

Model 1803A Differential/DC Offset Amplifier provides many measurement capabilities in one versatile plug-in. The 1803A offers a bandwidth of 40 MHz, FET inputs for low noise and drift, deflection factors from 1 mV/div to 20 V/div, and calibrated offset for measurements with 0.5% accuracy. Controls on this plug-in are easy to operate for quick familiarization. Interlocked deflection factor and offset controls prevent offset changes as deflection factor is changed. Push-button controls for input coupling, ground reference offset, and offset polarity speed measurements and reduce possible set-up errors.

As a differential amplifier, the common mode rejection ratio can be as high as 86 dB which assures a clear presentation of your signal. Accurate measurements are also aided with positive and negative inputs that provide similar load impedances to both sides of a balanced system. When used as a dc offset amplifier, the 1803A lets you expand a signal many times to see small perturbations riding on top of the signal or at any point on a large complex waveform. In the differential comparator mode of operation, dc and pulse amplitude measurements can be made with accuracies of 0.5% by using the stable, calibrated offset voltage generated in the 1803A.

1803A Specifications

Vertical deflection

Bandwidth: (Measured with or without 10004D probe. 3 dB down from 8 div reference signal from a terminated 50 ohm source.)

DC-coupled: dc to 40 MHz from 0.005 V/div to 20 V/div; dc to 30 MHz on 0.001 V/div and 0.002 V/div or when using V_0 range of 0 to 6 V or two most sensitive volts/div settings for other V_0 ranges.

AC-coupled: lower bandwidth is approx. 2 Hz, upper bandwidth is the same as dc-coupling. Lower bandwidth is approx. 0.2 Hz with 10004D probe.

Rise time: <10 ns for deflection factors of 0.005 V/div to 20 V/div; <12 ns on 0.001 V/div and 0.002 V/div, on V_0 range of 0 to 6 V and on the most sensitive volts/div settings for other V_0 ranges. Measured with or without 10004D probe; 10% to 90% of 8 div input step from terminated 50 ohm source.

Deflection factor

Ranges: from 0.001 V/div to 20 V/div (14 calibrated positions) in 1, 2, 5 sequence.

Attenuator accuracy: $\pm 3\%$.

Vernier: provides continuous adjustment between deflection factor settings and extends maximum deflection factor to at least 50 V/div. Front panel light indicates when vernier is not in CAL position.

Input coupling: AC, DC, Ground, or V_0 for both + and - inputs. Ground disconnects signal input and grounds amplifier input.

Input RC: 1 megohm shunted by approx. 27 pF, constant on all ranges.

Maximum input

V_0 Range	Deflection Factor	Maximum Input (dc + peak ac)
0 to 6 V	0.001 V/div to 0.02 V/div	± 15 V
0 to 6 V	0.05 V/div to 0.2 V/div	± 150 V
0 to 6 V	0.5 V/div to 20 V/div	± 600 V
0 to 60 V	0.01 V/div to 0.2 V/div	± 150 V
0 to 60 V	0.5 V/div to 20 V/div	± 600 V
0 to 600 V	0.1 V/div to 0 V/div	± 600 V

Overload recovery

6 V overload: within ± 10 mV of final signal value in 0.3 μ s or less, within ± 5 mV in 1 μ s or less, and within 1 mV in 1 ms or less.

60 V overload: within ± 100 mV of final signal value in 0.3 μ s or less, within ± 50 mV in 1 μ s or less, and within ± 10 mV in 1 ms or less.

600 V overload: within ± 1 V of final signal value in 0.3 μ s or less, within ± 0.5 V in 1 μ s or less, and within ± 100 mV in 1 ms or less.

Common mode rejection ratio: measured at a deflection factor of 0.001 V/div. (CMRR decreases with increasing deflection settings.)

Frequency Range	CMRR	Common Mode Input Sinewave (max p-p)
dc to <100 kHz	$\geq 20\,000:1$ (≥ 86 dB)	10 V
100 kHz to <1 MHz	$\geq 10\,000:1$ (≥ 80 dB)	10 V
1 MHz to <10 MHz	$\geq \frac{5\,000:1}{\text{Freq in MHz}}$	$\frac{10\text{ V}}{\text{Freq in MHz}}$
20 MHz	$\geq 50:1$ (≥ 34 dB)	1 V
60 Hz	$\geq 2\,000:1$ (≥ 66 dB)*	10 V

*AC-coupled (all others dc-coupled).

DC offset

V_0 Range	Deflection Factor	Comparison Accuracy
0 to ± 6 V	0.001 V/div to 0.02 V/div	$\pm(0.15\% + 8\text{ mV})$
	0.05 V/div to 0.2 V/div	$\pm(0.75\% + 8\text{ mV})$
	0.5 V/div to 2 V/div	$\pm 1\%$
	5 V/div to 20 V/div	$\pm 3\%$
0 to ± 60 V	0.01 V/div to 0.2 V/div	$\pm(0.4\% + 8\text{ mV})$
	0.5 V/div to 2 V/div	$\pm(0.75\% + 8\text{ mV})$
	5 V/div to 20 V/div	$\pm 3\%$
0 to ± 600 V	0.1 V/div to 2 V/div	$\pm(0.65\% + 0.8\text{ V})$
	5 V/div to 20 V/div	$\pm 3\%$

V_0 output: calibrated dc offset voltage available at front panel connector, continuously variable from 0 to ± 0.006 V, 0 to ± 0.06 V, 0 to ± 0.6 V or 0 to ± 6 V. Accuracy of the 6 V range is $\pm 0.15\%$ of reading ± 8 mV, when driving a resistance of 10 megohms or higher.

Triggering

DC to 40 MHz on signals causing 0.5 div or more vertical deflection.

General

Operating environment: same as 180C/D mainframe.

Weight: net, 2.3 kg (5 lb); shipping, 3.6 kg (8 lb).

Accessories supplied: one Operating and Service Manual.

Recommended probes

Models 10004D, 10005D, and 10006D passive probes maintain full performance of the 1803A.

1803A Differential DC Offset Amplifier

\$1200

OSCILLOSCOPES

180 Time bases: single and delayed

Models 1820C & 1821A

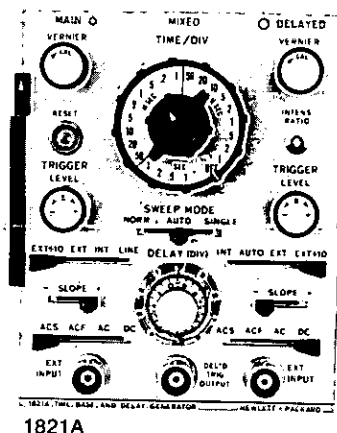
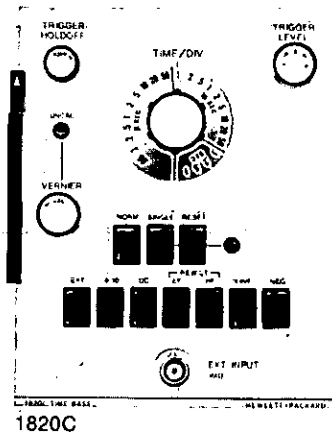

1820C Specifications

Time base

Sweep

Ranges: 0.05 μ s/div to 1 s/div (23 positions) in 1, 2, 5 sequence. $\pm 3\%$ accuracy with vernier in CAL position.

Vernier: continuously variable between ranges, extends slowest sweep to at least 2.5 s/div. Front panel light indicates when vernier is not in CAL position.

Magnifier: (mainframe) expands fastest sweep to 5 ns/div.

Sweep mode

Normal: triggered by an int, ext, or power line signal.

Automatic: bright baseline displayed in absence of trigger signal. Triggering is same as Normal except low frequency limit is 40 Hz.

Single: in Normal, sweep occurs once with same triggering as Normal (reset pushbutton arms and lights indicator); in Auto, sweep occurs once each time reset pushbutton is pressed.

Triggering

Internal: refer to vertical plug-in specifications.

External: dc to 50 MHz on signals 50 mV p-p or more increasing to 100 mV at 100 MHz and 150 mV at 150 MHz.

Line: power line frequency signal.

Level

Internal: at any point on the vertical waveform displayed.

External: continuously variable from +2 V to -2 V on either slope of trigger signal, from +20 V to -20 V in $\div 10$ setting.

Slope: pushbutton selection of + or - slope of trigger signal.

Coupling: front panel selection of AC, DC, HF Reject or LF Reject. AC attenuates signals below approx. 20 Hz. LF reject attenuates signals below approx. 15 kHz. HF reject attenuates signals above approx. 15 kHz.

Trigger holdoff: time between sweeps continuously variable, exceeding one full sweep on all ranges.

General

Operating environment: same as 180C/D mainframe.

Weight: net, 1.4 kg (3 lb); shipping, 3.2 kg (7 lb).

1821A Specifications

Main time base

Sweep

Ranges: from 0.1 μ s/div to 1 s/div (22 positions) in 1, 2, 5 sequence. $\pm 3\%$ accuracy with vernier in cal position.

Vernier: continuously variable between all ranges; extends slowest sweep to at least 2.5 s/div.

Magnifier: (mainframe) expands fastest sweep to 10 ns/div.

Sweep mode

Normal: triggered by an int, ext, or power line signal.

Automatic: bright baseline displayed in absence of input signal. Triggering same as normal except low frequency limit is 40 Hz for internal or external modes.

Single: sweep occurs once with same triggering as normal; reset pushbutton with indicator light.

Delayed time base

Delayed time base sweeps after a time delay set by Main time base and Delay controls.

Sweep

Ranges: from 0.1 μ s/div to 50 ms/div (18 positions) in 1, 2, 5 sequence. $\pm 3\%$ accuracy with Vernier in cal position.

Vernier: continuously variable between all ranges; extends slowest sweep to at least 125 ms/div.

Magnifier: (mainframe) expands fastest sweep to 10 ns/div.

Triggering

Main and delayed time base.

Internal: refer to vertical plug-in specifications.

External: from dc to 50 MHz on signals 0.5 V p-p or more, increasing to 100 MHz on signals 1 V p-p or more.

Line: power line frequency signal.

Level and slope: internal, at any point on the vertical waveform displayed; external, continuously variable from +3 V to -3 V on either slope of the sync signal, from +30 V to -30 V in $\div 10$.

Automatic (delayed only): triggered at end of set time delay.

Coupling: front panel selection of AC, DC, ACF, or ACS. AC attenuates signals below approx. 20 Hz. ACF (ac-fast) attenuates signals below approx. 15 kHz. ACS (ac-slow) attenuates signals above approx. 30 kHz.

Trace intensification: intensifies that part of Main time base to be expanded to full screen on Delayed time base. Rotating Delayed time base sweep switch from Off position activates intensified mode. Front panel screwdriver adjust sets relative intensity of brightened segment.

Delay (before start of Delayed sweep)

Time: continuously variable from 0.1 μ s to 10 s.

Accuracy: $\pm 1\%$. Linearity, $\pm 0.2\%$. Time jitter is $< 0.005\%$ (1 part in 20 000) of maximum delay of each step.

Trigger output: (at end of Delay time) approx. 1.5 V with < 50 ns rise time from 1000 ohm source resistance.

Mixed time base: dual time base in which Main time base drives first portion of sweep and delayed time base completes sweep at up to 1000 times faster. Also operates in single sweep mode.

General

Operating environment: same as 180 C/D mainframes.

Weight: net, 1.8 kg (4 lb); shipping, 3.1 kg (7 lb).

Model number and name

1821A Time Base and Delay Generator

1820C Time Base

Price

\$750

\$485

OSCILLOSCOPES

180 Time bases: expanded and delayed
MODELS 1824A & 1825A

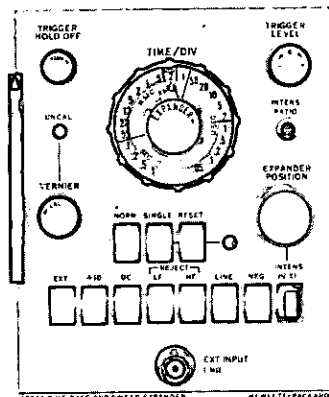

1824A

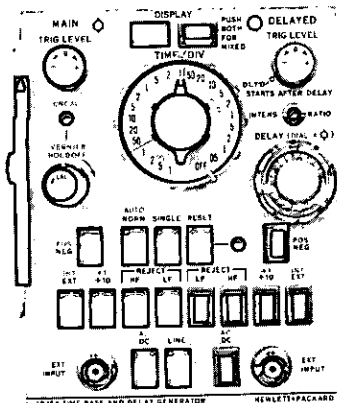

1825A

1824A Description

The Model 1824A time base and sweep expander is designed for use in 180 system mainframes and provides sweep expansion up to 100 times, 5 ns sweep speeds, and triggering to 150 MHz.

The expanded sweep feature allows detailed examination of selected portions of a display. Expansions as great as 100 times are available with direct read-out on the time/div switch. Convenient setup is provided by a trace intensification feature which selects a segment of the sweep that will be expanded to full screen. The position of the expanded sweep is continuously variable over 9 divisions of the basic displayed sweep.

Operation is easy with the pushbutton controls and the automatic sweep mode which displays a baseline in absence of a trigger input signal. A trigger hold off control allows stable triggering on complex waveforms or allows triggering on a particular pulse in a digital word. The external trigger input impedance of 1 megohm allows standard probes to be used which reduces circuit loading at trigger pick-off points. The high external trigger input sensitivity of 50 mV allows 10:1 probes to be used even with 0.5 V logic circuits.

1825A Description

Model 1825A time base and delay generator provides sweep speeds ranging from 0.05 μ s/div to 1 s/div in 23 positions. Delay times are continuously variable from 50 ns to 10 s and are accurate to 0.75% with extremely low jitter of 1 part in 50,000. Also, a calibrated mixed sweep mode is provided. A mainframe X10 magnifier increases sweep-

speed capability to 5 ns/div with 5% accuracy.

One knob control makes triggering easy in main, delayed, and mixed modes. Stable, accurate time displays are provided in main, delayed, and mixed modes with the highly sensitive 50 mV external trigger capability at 50 MHz which increases to only 150 mV at 150 MHz. Trigger synchronization is maintained when switching between main, delayed, and mixed modes, further simplifying use.

Front panel controls are logically arranged for quick familiarization and easy use. Pushbuttons eliminate front panel clutter and reduce the possibility of errors. Easy-to-operate pushbuttons establish main, delayed, and mixed modes of operation.

Trigger level controls on main and delayed sweeps allow selection of the triggering point on the desired portion of the signal for almost every measurement application. Also, the $\div 10$ function provides a wide dynamic range of triggering in both external and internal modes of operation.

External trigger sensitivity of 50 mV on both main and delayed sweeps allows a 10:1 divider probe to be used to reduce circuit loading at trigger pick-off points and reduces the possibility of circuit malfunction caused by the measuring instrument.

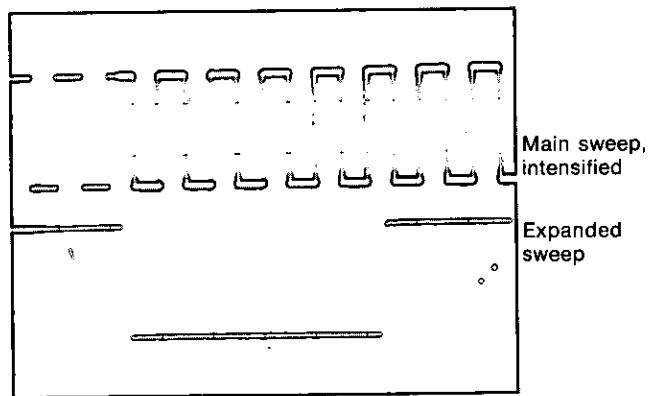

Double exposure shows intensified main sweep with location of intensified portion (top trace). Bottom trace shows expanded sweep.

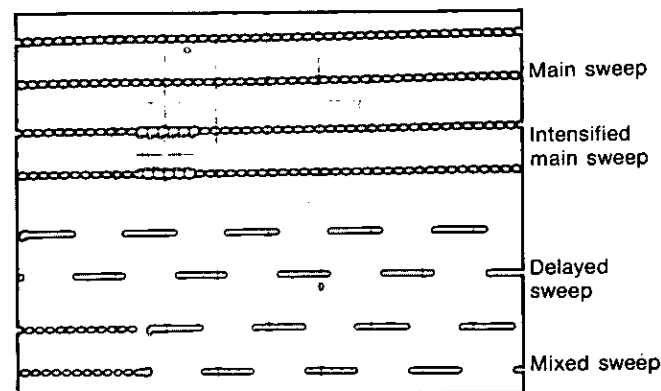

Multiple exposure shows four modes of operation with time relationship maintained in all modes.

1824A Specifications

Time base

Sweep

Ranges: 0.05 μ s/div to 1 s/div (23 calibrated positions) in 1, 2, 5 sequence. \pm 3% accuracy with vernier in calibrated position.

Vernier: continuously variable between ranges, extends slowest sweep to at least 2.5 s/div. Front panel light indicates when vernier is not in CAL position.

Magnifier: (on mainframe) expands fastest sweep to 5 ns/div with 5% accuracy (includes \pm 3% accuracy of time base).

Expanded sweep

Expander: direct reading expander control provides up to 100 times sweep expansion, accuracy \pm 3%. Expand position control selects part of basic time scale to be expanded, continuously variable from <0.5 div of sweep start to >8.5 div of basic time scale.

Trace intensification: front panel switch selects intensified mode for use in establishing start of expanded display. A front panel adjustment sets relative intensity of brightened segment.

Sweep mode

Normal: sweep is triggered by an internal, external, or power line signal.

Automatic: bright baseline displayed in absence of input signal. Triggering is same as Normal except low frequency limit is 40 Hz.

Single: in Normal, sweep occurs with same triggering as Normal; reset pushbutton arms sweep and lights indicator; in Auto, sweep occurs once each time reset pushbutton is pressed.

Triggering

Internal: refer to vertical amplifier plug-in specifications.

External: dc to 50 MHz on signals of 50 mV p-p or more, increasing to 100 mV p-p at 150 MHz.

Line: power line frequency signal.

Level

Internal: at any point on the vertical waveform displayed.

External: continuously variable from +2 V to -2 V on either slope of trigger signal, from +20 V to -20 V in \div 10 setting.

Slope: pushbutton selection of either positive or negative slope of trigger signal.

Coupling: front panel selection of AC, DC, HF Reject, or LF Reject.

AC: attenuates signals below approx. 20 Hz.

LF reject: attenuates signals below approx. 15 kHz.

HF reject: attenuates signals above approx. 15 kHz.

Trigger holdoff: time between sweeps continuously variable. Exceeds one full sweep on all ranges.

General

Operating environment: same as 180C/D mainframes.

Weight: net, 1.4 kg (3 lb); shipping, 3.2 kg (7 lb).

Accessories supplied: one Operating and Service Manual.

1825A Specifications

Main time base

Sweep

Ranges: 0.05 μ s/div to 1 s/div (23 positions) in 1, 2, 5 sequence. \pm 3% accuracy with vernier in calibrated position.

Vernier: continuously variable between ranges, extends slowest sweep to at least 2.5 s/div. Front panel light indicates when vernier is not in CAL position.

Magnifier: (on mainframe) expands fastest sweep to 5 ns/div, accuracy \pm 5%.

Sweep mode

Normal: sweep is triggered by an internal, external, or power line signal.

Automatic: bright baseline displayed in absence of trigger signal. Triggering is same as Normal except low frequency limit is 40 Hz.

Single: in Normal, sweep occurs once with same triggering as Normal; reset pushbutton arms sweep and lights indicator; in Auto, sweep occurs once each time reset pushbutton is pressed.

Delayed time base

Delayed time base sweeps after a time delay set by Main time base and Delay controls. Delayed time base is triggered on first trigger pulse after set delay or automatically triggers after set delay when delayed level control is in detent position.

Sweep

Ranges: 0.05 μ s/div to 20 ms/div (18 positions) in 1, 2, 5 sequence. \pm 3% accuracy.

Magnifier: (on mainframe) expands fastest sweep to 5 ns/div, accuracy \pm 5%.

Triggering

Internal: refer to vertical amplifier plug-in specifications.

External: dc to 50 MHz on signals 50 mV p-p or more increasing to 100 mV p-p at 100 MHz and 150 mV p-p at 150 MHz.

Line: power line frequency signal. (Main only.)

Level

Internal: at any point on the vertical waveform displayed.

External: continuously variable from +2 V to -2 V on either slope of trigger signal, from +20 V to -20 V in \div 10 setting.

Slope: pushbutton selects either positive or negative slope of trigger signal.

Coupling: front panel selection of AC, DC, HF Reject, or LF Reject.

AC: attenuates signals below approx. 20 Hz.

LF reject: attenuates signals below approx. 15 kHz.

HF reject: attenuates signals above approx. 15 kHz.

Trigger holdoff: time between sweeps continuously variable, exceeding one full sweep on all ranges. (Main only.)

Delay (before start of delayed sweep)

Time: continuously variable from 50 ns to 10 s.

Accuracy: \pm 0.75% of differential delay \pm 2 minor divisions of delay dial.

Time jitter: 0.002% (1 part in 50,000) of maximum delay on each range.

Trace intensification

In Main sweep mode, intensifies that part of main time base to be expanded to full screen in delayed time base mode. Rotating time base switch from OFF position activates intensified mode.

Calibrated mixed sweep

Combines Main and Delayed sweeps into one display. Sweep is started by the Main time base and is completed by the faster Delayed time base. Delayed sweep start is aligned with start of intensified marker.

General

Operating environment: same as 180C/D mainframes.

Weight: net, 1.8 kg (4 lb); shipping, 3.1 kg (7 lb).

Accessories supplied: one Operating and Service Manual.

Model number and name

1824A Time Base and Sweep Expander

1825A Time Base and Delay Generator

Price

\$630

\$850

OSCILLOSCOPES

180 Samplers: 4 GHz & 18 GHz
Models 1811A, 1430C & 1432A

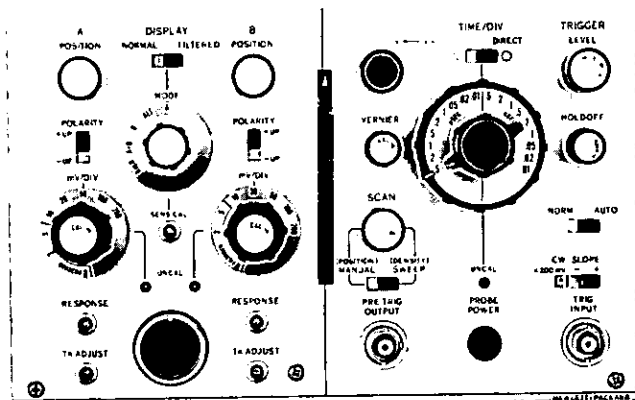

1811A

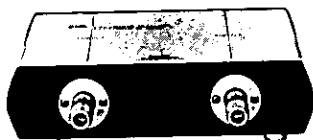

1430C

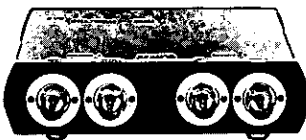

1432A

1811A Description

Model 1811A Sampling plug-in offers 4 or 18 GHz, dual-channel, feedthrough sampling measurements. The logical arrangement of front panel controls reduces familiarization time and measurement errors; and measurements in operating systems are possible with the feedthrough remote sampling heads. This double-size plug-in operates in all 180 series mainframes with a selection of standard CRT's (5-inch), large screen, and variable persistence and storage. With the two remote sampling heads, you match a sampling system to your measurement problem at minimum cost.

The bridged method of extracting a signal is used which extracts only a small amount of the waveform rather than terminating the signal in the measuring system. By using remote sampling heads connected in series with the system under test, the signal displayed is the signal that is passed through the sampler to the next stage of a system. Any problems are then displayed as they exist in the system. Terminated measurements can also be made with the supplied 50 ohm loads.

The two sampling heads available are the Model 1432A with 90 ps rise time (4 GHz) and the 1430C with a 20 ps rise time (18 GHz). These remote samplers are connected to the scope by a five-foot cable which allows the head to be placed at the measurement point, eliminating high frequency losses due to interconnecting cables.

18 GHz triggering with a displayed jitter of 10 ps or less is provided by a 1104A trigger countdown, 1106B tunnel diode, and 1109B high-pass filter. For viewing a signal without using a delay line, a pre-trigger output is available as a signal source which starts the sweep prior to display of the vertical signal.

1811A Specifications

Modes of operation

Channel A; channel B; channels A and B displayed on alternate samples (ALT); channel A plus channel B (algebraic addition); and channel A versus channel B.

Vertical channels

Deflection factor

Ranges: 2 mV/div to 200 mV/div (6 calibrated positions) in 1, 2, 5 sequence.

Accuracy: $\pm 3\%$.

Vernier: provides continuous adjustment between all deflection factor ranges; extends minimum deflection factor to < 1 mV/div. Front panel light indicates when vernier is not in CAL position.

Polarity: + up or - up.

Positioning range: $> \pm 1$ V on all deflection factors.

A + B operation: bandwidth and deflection factors are unchanged; either channel may be inverted for $\pm A \pm B$ operation.

Time base

Ranges

Normal: 1 ns/div to 5 μ s/div (12 calibrated positions) in a 1, 2, 5 sequence. $\pm 3\%$ accuracy with vernier in calibrated position.

Expanded: direct reading expansion up to X100 in seven calibrated steps on all normal time scales, extends the range to 10 ps/div. Accuracy is $\pm 4\%$ (1 ps/div, $\pm 10\%$ using the mainframe magnifier).

Vernier: continuously variable between ranges; increases fastest sweep to < 4 ps/div.

Triggering

Auto: triggers automatically on most signals with a minimum of level control adjustment. A baseline is displayed in the absence of an input signal.

Normal: trigger level control may be adjusted to trigger on a wide variety of signals.

CW: 80 mV p-p for sine wave signals from 1 kHz to 1 GHz for jitter of < 10 ps plus 1% of 1 period of trigger signal. Useful displays can be obtained with trigger signals as low as 5 mV. Triggering may be extended to 18 GHz with HP Model 1104A/1106B trigger countdown.

\pm Slope: triggers on 50 mV/peak, 3 ns wide pulses, for < 30 ps jitter.

Level and slope: continuously variable from +800 mV to -800 mV on either slope of sync signal.

Coupling: ac coupling attenuates signals below approx 1 kHz.

Variable holdoff: variable over at least a 3:1 range in all sweep modes.

Marker position: intensified marker segment indicates point about which the sweep is to be expanded (automatically dimmed with increasing persistence in 181 and 184 variable persistence/storage mainframes).

Scan

Internal: dot density, continuously variable from < 100 to > 1000 dots full screen or from approx 500 to > 2000 dots in filtered mode.

Manual: scan is positioned manually by front panel control.

Trigger output: 1 ns, 1.5 V into 50 ohms.

General

Probe power: supplies power to operate Hewlett-Packard active probe.

Recorder outputs

Vertical: an uncalibrated 1 V vertical output signal from each channel is provided at the rear panel of 180 series mainframes.

Horizontal: an uncalibrated 0.75 V amplitude signal is provided at the rear panel of 180, 181, 182, or 184 mainframes.

Operating environment: temperature, 0 to $+55^\circ\text{C}$ ($+32^\circ\text{F}$ to $+120^\circ\text{F}$); humidity, to 95% relative humidity at 40°C (104°F); altitude, to 4.6 km (15 000 ft); vibration, vibrated in three planes for 15 min. each with 0.254 mm (0.010 in.) excursion, 10 to 55 Hz.

Weight: net, 2.3 kg (5 lb); shipping, 4.5 kg (10 lb).

Accessories supplied: one Operating and Service Manual.

1430C Specifications

Sampling head

Rise time: approx 20 ps (< 28 ps observed with 1105A/1106B pulse

generator and 909A Option 012, 50 ohm load).
Bandwidth: dc to >18 GHz.
Overshoot: <7.5%.
Noise: approx. 10 mV observed noise on CRT excluding 10% of random dots. Noise decreases to approx. 2.5 mV on the automatically filtered 2 mV/div and 5 mV/div ranges and all other ranges when display switch (on 1811A) is set to filtered position.
Dynamic range: 1 V p-p.
Low frequency distortion: <±5%.
Maximum safe input: ±3 volts.
Input characteristics
Mechanical: type N female connectors on input and output ports.
Electrical: 50 ohm feedthrough, dc-coupled. Reflection from sampler is approx. 10%, measured with a 40 ps TDR system. Pulses emitted from sampler input are approx. 10 mV amplitude and 5 ns duration.
Time difference between channels: <5 ps.
Isolation between channels: ≥40 dB over sampler bandwidth.
Connecting cable length: 1.5 m (5 ft).

General
Weight: 1.8 kg (4 lb); shipping 4.1 kg (9 lb).
Accessories supplied: two 50 ohm loads with type N male connectors (HP Model 909A Option 012), one 1.5 m (5 ft) sampling head to 1811A interconnecting cable (HP P/N 5060-0540), and one Operating and Service Manual.

1432A Specifications

Sampling head
Rise time: <90 ps.
Bandwidth: dc to 4 GHz.
Overshoot: <±5%.
Noise: approx. 8 mV observed noise on CRT excluding 10% of random dots. Noise decreases to approx. 2 mV on the automatically filtered 2 mV/div and 5 mV/div ranges and all other ranges when display switch (on 1811A) is set to filtered position.
Dynamic range: 1 V p-p.
Low frequency distortion: <3%.
Maximum safe input: ±5 V.
Input characteristics
Mechanical: GR Type 874 connectors on input and output ports.
Electrical: 50 ohm feedthrough, dc-coupled. Reflection from sampler is approx. 15% measured with a 90 ps TDR system. Pulses emitted from sampler input are approx. 50 mV in amplitude and 10 ns wide.
Time difference between channels: <25 ps.
Isolation between channels: ≥40 dB over sampler bandwidth.
Connecting cable length: 1.5 m (5 ft).

General
Weight: net, 1.8 kg (4 lb); shipping, 4.1 kg (9 lb).
Accessories supplied: two 50 ohm loads with GR Type 874 connectors, one 1.5 m (5 ft) sampling head to 1811A interconnecting cable (HP P/N 5060-0440), and one Operating and Service Manual.

1104A/1106B/1108A Specifications

1104A/1106B 18 GHz trigger countdown
1104A/1108A 10 GHz trigger countdown
Input
Frequency range: (1106B) 1 GHz to 18 GHz. (1108A) 1 GHz to 10 GHz.
Sensitivity: (1106B) signals 100 mV or larger up to 12.4 GHz, produce <20 ps of jitter (200 mV required to 18 GHz). (1108A) signals up to 50 mV or larger up to 10 GHz produce <20 ps jitter.
Maximum safe input: ±1 V.
Input impedance: dc resistance approx 50 ohms. Reflection from

input connector is <10% using a 40 ps TDR system.
Signal appearing at input connector: approx 250 mV.
Output
Center frequency: approx. 100 MHz.
Amplitude: typically 150 mV.

Connectors
1104A: input, type N male; trigger output, BNC female.
1106B: input, type N male; output, type N female.
1106B Opt 001: input, APC-7; output, type N female.
1108A: input, GR Type 874; output type N female.
Weight
1104A: net, 0.9 kg (2 lb); shipping, 1.8 kg (4 lb).
1106B or 1108A: net, 0.5 kg (1 lb); shipping, 0.9 kg (2 lb).

***Components required for sampling systems**

1811A Sampling Plug-in	
18 GHz Sampling 1430C Sampling Head (Type N Female input/output connectors)	4 GHz Sampling 1432A Sampling Head (GR Type 874 input/output connectors)
Trigger Accessories <1 GHz: Cable 11500A Type N Male to Type N Male 1.8 m (6 ft), Adapter 1250-0077 Type N Female to BNC Male. 1 GHz to 10 GHz 1104A Trigger Countdown. 1108A Tunnel Diode. Adapter 1250-0847 GR Type 874 to Type N Male. 1109B High Pass Filter. 10503A Male BNC to Male BNC Trigger Cable 1.2 m (4 ft).	Trigger Accessories <1 GHz: Adapter 1250-1211 GR Type 874 to Type N Female, Cable 11500A Type N Male to Type N Male 1.8 m (6 ft), Adapter 1250-0077 Type N Female to BNC Male. 1 GHz to 10 GHz 1104A Trigger Countdown. 1108A Tunnel Diode. Adapter 1250-0847 GR Type 874 to Type N Male. 1109B High Pass Filter. Adapter 1250-0240 GR Type 874 to Type N Female. 10503A Male BNC to Male BNC Trigger Cable.
TDR with 1430C Sampling Head 1105A Pulse Generator. 1106B Tunnel Diode 20 ps t _r . 10503A Male BNC to Male BNC Trigger Cable 1.2 m (4 ft).	TDR with 1432A Sampling Head 1105A Pulse Generator. 1108A Tunnel Diode 60 ps t _r . 10503A 1.2 m (4 ft) Male BNC to male BNC Trigger Cable.
1105A Pulse Generator. 1108A Tunnel Diode 60 ps t _r . Adapter 1250-0847 GR type 874 to Type N Male. 10503A 1.2 m (4 ft) Male BNC to male BNC Trigger C	

* Use any 180 series mainframe.

Model number and name	Price
1811A Sampler	\$1980
1430C Sampling Head, 18 GHz	\$3250
1432A Sampling Head, 4 GHz	\$1400
1104A Trigger Countdown	\$250
1106B (Type N Connector)	\$610
1108A (GR-874 Connector)	\$250
Recommended Accessory: HP Model 1109B High Pass Filter	\$230

OSCILLOSCOPES

180 Sampler: 1 GHz

Model 1810A

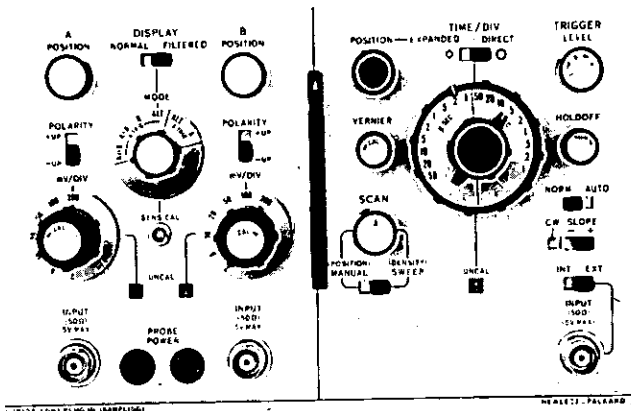

1810A Description

The Model 1810A 1 GHz Sampling plug-in is a dual-channel, double-size plug-in that gives you the easiest sampling measurements available today. Simplified controls look and behave like those on a real time oscilloscope and also give you 2 mV/div to 200 mV/div deflection factors, frequency response to 1 GHz, internal triggering to 1 GHz, and sweep times from 50 μ s/div to 0.1 ns/div (with sweep expansion). This sampling plug-in now allows you to make nanosecond rise time measurements of repetitive signals with minimum familiarization time.

1810A Specifications

Modes of operation

Channel A; channel B; channels A and B displayed on alternate samples (ALT); channel A plus channel B (algebraic addition); and channel A versus channel B.

Vertical channels

Bandwidth: dc to 1 GHz.

Rise time: <350 ps.

Pulse response: $\pm 3\%$ or 3 mV p-p (overshoot and perturbations) in normal display mode.

Deflection factor

Ranges: 2 mV/div to 200 mV/div (7 calibrated positions) in 1, 2, 5 sequence. $\pm 3\%$ accuracy.

Vernier: provides continuous adjustment between all deflection factor ranges; extends minimum deflection factor to <1 mV/div. Front panel light indicates when vernier is not in CAL position.

Polarity: + up or - up.

Dynamic range: > 1.6 V.

Positioning range: $> \pm 1$ V on all deflection factors.

Input R: 50 ohms, $\pm 2\%$.

Maximum input: ± 5 V (dc + peak ac).

VSWR: <1.1:1 to 300 MHz, increasing to <1.5:1 at 1 GHz.

Reflection coefficient: <6%, measured with HP Model 1415A TDR.

Random noise

Normal: <2 mV, observed from center 80% of dots.

Filtered: reduces noise at least 2 to 1.

Isolation between channels: ≥ 40 dB with 350 ps rise time input.

Time difference between channels: <100 ps.

A + B operation: bandwidth and deflection factors are unchanged; either channel may be inverted for $\pm A \pm B$ operation.

Time base

Ranges

Normal: 10 ns/div to 50 μ s/div (12 calibrated positions) in a 1, 2, 5 sequence. $\pm 3\%$ accuracy with vernier in calibrated position.

Expanded: direct reading expansion up to X100 in seven calibrated steps on all normal time scales, extends the range to 100 ps/div. Accuracy is $\pm 4\%$ (10 ps/div, $\pm 10\%$ using the mainframe magnifier).

Vernier: continuously variable between ranges; increases fastest sweep to <40 ps/div. Front panel light indicates when vernier is not in CAL position.

Triggering

Mode

Normal: trigger level control can be adjusted to trigger on a wide variety of signals.

Automatic: triggers automatically on most signals with a minimum of adjustment of the level control. A baseline is displayed in the absence of an input signal.

Internal

Source: selectable; channel A triggers channel A or alternate; channel B triggers channel B, alternate, A + B, or A vs B.

Sine wave: 30 mV p-p for signals from 1 kHz to 200 MHz, 100 mV p-p for signals from 200 MHz to 1 GHz for jitter of <30 ps plus 1% of 1 period. Useful triggering can be obtained with 5 mV signals.

Pulse: 30 mV peak, 3 ns wide pulses for <30 ps jitter. Useful triggering can be obtained with 5 mV signals.

External

Sine wave: 30 mV p-p for signals from 1 kHz to 1 GHz for jitter of <30 ps plus 1% of 1 period. Useful triggering can be obtained with 5 mV signals.

Pulse: 30 mV peak, 3 ns wide pulses for <30 ps jitter. Useful triggering can be obtained with 5 mV signals.

Either internal or external

Auto: 50 mV p-p for CW signals from 10 kHz to 200 MHz for <30 ps jitter plus 2% of 1 period (may be used to 1 GHz with increased jitter). Pulse triggering requires 50 mV peak, 3 ns wide pulses for <30 ps jitter.

Level and slope: level control minimizes jitter and is variable over ± 800 mV range on either slope of sync signal.

Coupling: ac coupling attenuates signals below approx. 1 kHz.

Variable holdoff: variable over at least a 3:1 range in all sweep modes.

Marker position: intensified marker segment indicates point about which the sweep is to be expanded (automatically dimmed with increasing persistence in 181 and 184 mainframes).

Scan

Internal: dot density, continuously variable from <100 to >1000 dots full screen or from approx. 500 to 2000 dots in filtered mode.

Manual: scan is positioned manually by front panel control.

General

Probe power: supplies power to operate two HP active probes.

Recorder outputs

Vertical: an uncalibrated 1 V vertical output from each channel is provided at the rear panel of 180 system mainframes.

Horizontal: an uncalibrated 0.75 V amplitude signal is provided at the rear panel of 180, 181, 182, and 184 mainframes.

Operating environment: same as 180 C/D mainframes.

Weight: net, 3 kg (7 lb); shipping 5.4 kg (12 lb).

Accessories supplied: one Operating and Service Manual.

Model 1810A 1 GHz Sampling

\$1925

OSCILLOSCOPES



180 TDR: 170 ps rise time

Model 1818A

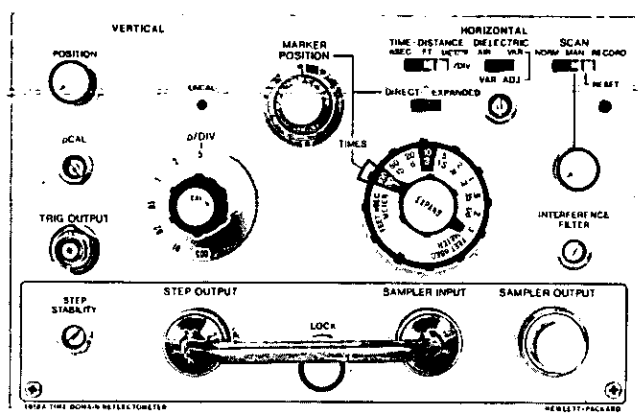

lection coefficient ρ versus nanoseconds operation which gives a reading of the time a step takes to reach a discontinuity and return to the sampler. In the meters or feet per division mode, a display of ρ versus distance is provided with round trip time automatically taken into account for direct reading of distance. The accuracy in the distance mode can be set by selecting Air or Var and adjusting the variable dielectric for proper display calibration.

Model 1818A may also be used in a transmission mode to determine the transmission quality of a passive element. In this mode of operation, the 50 ps step generator signal source is applied to the device under test and the output is detected by the plug-in sampling section. This allows a waveform to be examined for rise time, delay, and pulse top aberrations introduced by the circuit under test.

1818A Specifications

System (in reflectometer configuration)

- Rise time:** <170 ps.
- Overshoot:** $\leq 5\%$ overshoot and ringing (down to $1/2\%$ in 3 ns).
- Internal reflections:** <10% (does not limit resolution).
- Reflectometer sensitivity:** reflection coefficients as small as 0.001 can be observed.

Signal channel

- Rise time:** approx. 150 ps.
- Reflection coefficient:** 0.5/div to 0.005/div in a 1, 2, 5 sequence.
- Input:** 50 ohms, feedthrough type.
- Noise and internal pickup, peak:** 0.1% of step (terminated in 50 ohms).
- Dynamic range:** ± 0.5 volt.
- External signal level:** up to 1 V peak may be safely applied to the Sampler output connector.
- Attenuator accuracy:** $\pm 3\%$.

Step generator

- Amplitude:** approx. 0.25 V into 50 ohms (0.5 V into open circuit).
- Rise time:** approx. 50 ps.
- Output impedance:** 50 ohms ± 1 ohm (dc-coupled).
- Drop:** <1% in 1 μ s.

Distance/time

- Distance scale:** 3 meters/div and 30 meters/div; 10 ft/div and 100 ft/div. Accuracy, $\pm 3\%$.
- Variable dielectric:** $\epsilon = 1$ to $\epsilon = 4$.
- Time scale:** 10 ns/div and 100 ns/div. Accuracy, $\pm 3\%$.
- Magnification:** X1 to X100 in a 1, 2, 5 sequence provides time scales down to 0.1 ns/div and distance scales to 0.03 meters/div or 0.1 ft/div. Accuracy of the basic sweep is maintained at all magnifier settings.
- Delay control:** 0 to 10 div of unmagnified sweep. Accuracy, $\pm 3\%$.
- Jitter:** <20 ps.

General

Recorder outputs

- Vertical:** approx. 1 V vertical output signal is provided at the rear panel of 180 series mainframes.
- Horizontal:** approx. 1 V horizontal output signal is provided at the rear panel of a 180, 181, 182, or 184 mainframe.

- Operating environment:** temperature, 0 to +35°C (35°C to 55°C with small increase in system rise time); humidity, to 95% relative humidity at 40°C (104°F); altitude, to 4.6 km (15 000 ft); vibration, vibrated in three planes for 15 min. each with 0.254 mm (0.010 in.) excursion, 10 to 55 Hz.
- Weight:** net, 1.4 kg (3 lb); shipping, 3.2 kg (7 lb).

- Accessories supplied:** Type N connector assembly. One 50 ohm load with Type N male connector. One Operating and Service Manual.

1818A Description

The 1818A Time Domain Reflectometer plug-in with a 180 series mainframe gives you a completely integrated wide band system for testing of transmission lines, strip lines, cables, connectors, and many other devices in high frequency systems. The easy-to-use controls provide accurate direct distance calibrated displays of up to 300 meters or 1000 feet with dielectric materials from $\epsilon = 1.0$ (air) to $\epsilon = 4.0$. This allows you to quickly determine the magnitude and nature of each resistive or reactive discontinuity in coaxial components such as attenuators, cables, connectors, and delay lines in microwave or pulse circuits. You can also locate and identify faults such as shorts, opens, loose connectors, defective tap offs, splices, and mismatches with measurement resolution as close as 2.54 cm.

A convenient Time/Distance switch allows you to select direct reading of nsec/div, ft/div, or meter/div. The Time mode provides a re-

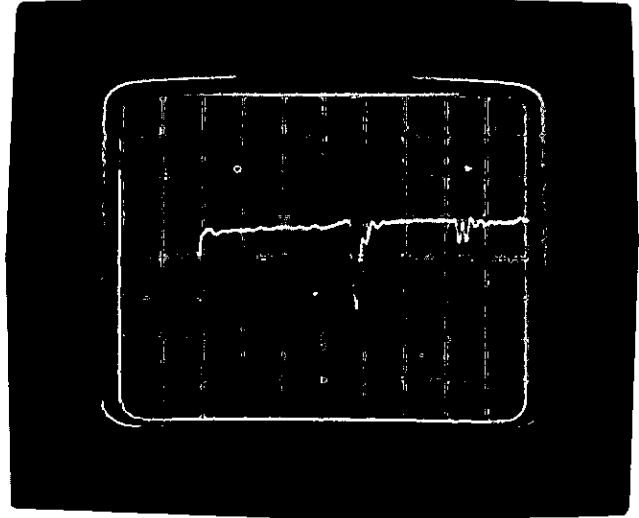

The 1818A provides a system profile which includes quantitative and qualitative information about a transmission cable's impedance loss, rise time, electrical length, and location of discontinuities in a single measurement.

OSCILLOSCOPES

High resolution TDR

Models 1815A/B, 1816A & 1817A

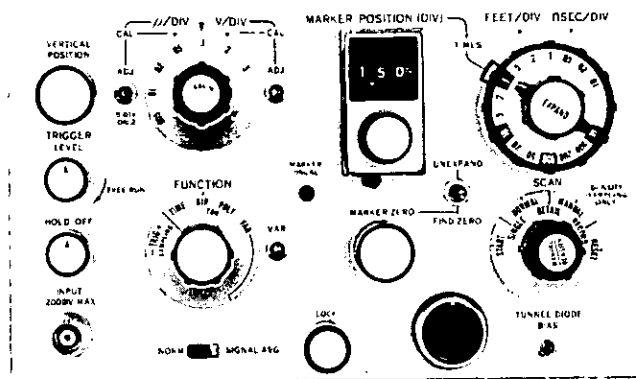

1815A

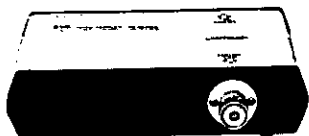

1817A



1816A

1815A/B Description

Models 1815A and 1815B provide calibrated 35 ps system rise time, time domain reflectometry and 12.4 GHz (28 ps rise time) sampling capability with remote feedthrough sampling heads for extremely accurate measurements. This TDR system can locate impedance discontinuities in transmission systems up to 10 000 meters or feet long and also allows measurement of discontinuities spaced only a few millimeters apart. As a single channel, general purpose sampling oscilloscope, you have deflection factors to 2 mV/div and sweep times to 10 ps/div.

To keep signal losses in the interconnecting cables as low as possible, the sampling head is separate from the plug-in so that it can be placed adjacent to the device or in the system being tested. Two sampling heads are available and both use feedthrough sampling for best resolution and accuracy. Model 1817A sampler has a rise time of 28 ps, equivalent to a CW bandwidth of 12.4 GHz, and 1816A has a rise time of 90 ps with a CW bandwidth of 4 GHz.

Two tunnel diode pulse generator mounts are available to match the remote sampling heads. The Model 1106B Opt 001 generator has a step rise time of 20 ps which when used with the 1817A sampler gives a TDR system rise time of 35 ps. The Model 1108A generator's rise time is 60 ps for a total 110 ps system rise time with an 1816A. The separate tunnel diode mounts also allow a device to be inserted between the pulse source and sampler when you require transmission measurements.

The 1815A or B plug-in is designed for operator convenience with easy-to-use front panel controls that do not reduce measurement versatility. A FUNCTION switch allows selection of a vertical display calibrated in units of ρ (reflection coefficient) for direct reading of reflection when used as a TDR, or in volts when used as a sampler. Indicator lights clearly show whether vertical calibration in ρ /div or volts/div is selected by the FUNCTION switch.

Applications

Analysis of connectors

Departures from 50 ohms in a connector or termination can cause a large reflection in a pulse system or high VSWR in a CW system. TDR can rapidly show where mismatches are located, how bad a reflection

is, and if the mismatches are capacitive, or inductive.

Cable impedance

TDR can also be used to determine impedance variations in long sections of coaxial cables. This allows a quick check of irregularities which result from vibration in the braiding process or tightness of the insulating jacket. These impedance measurements are capable of detecting a variation of $\frac{1}{2}$ ohm which corresponds to a one-percent impedance check in 50 ohm cable.

Cable testing

Faults in a high frequency transmission system can cause substantial loss of power, severely distort a transmitted signal, or in digital systems cause a complete loss of some information. The time domain reflectometer will detect and display significant changes in the characteristic impedance of a transmission system. Since time can be easily converted into distance, the exact location of the discontinuity will be displayed. This allows you to locate deteriorated dielectric breakdowns, sections of cable or connectors saturated with water, corroded contacts, conductors with opens or shorts, cut or damaged cables, or even a moisture seal clamp that is too tight.

1815A/B Specifications

Unless indicated otherwise, TDR and sampling performance specifications are the same. Where applicable, TDR specification is given first, followed by Sampler specification in parentheses. Model 1815A is calibrated in feet and Model 1815B is calibrated in meters.

Vertical

Scale: reflection coefficient ρ (volts) from 0.005/div to 0.5/div in 7 calibrated ranges; 1, 2, 5 sequence.

Accuracy: $\pm 3\%$; TDR only, $\pm 5\%$ on 0.01/div and 0.005/div in signal average mode.

Vernier: provides continuous adjustment between ranges; extends scale to >0.002 /div.

Signal average: reduces noise and jitter approx. 2:1.

Horizontal

Scale: provides up to a 10,000 meter or foot display window with round-trip time or distance (time) in four calibrated decade ranges of 1/div, 10/div, 100/div, and 1000/div. Concentric expand control provides direct read-out in 28 calibrated steps in 1, 2, 5 sequence from 0.01 ns/div to 1000 ns/div or from 0.01 meter or foot/div to 1000 meters or feet/div.

Accuracy: time, $\pm 3\%$; distance (TDR only) $\pm 3\%$, \pm variations in propagation velocity.

Marker position: indicator, calibrated in divisions, provides direct read-out of round-trip time or distance (time), number of divisions \times decade range in units/div. Front panel light indicates when vernier is not in CAL position.

Marker zero: ten-turn control provides variable reference for marker position dial, allows direct read-out of round-trip or distance (time) between two or more displayed events.

Zero finder: permits instant location of marker reference.

Dielectric, TDR only: calibrated for air, $\epsilon = 1$ and for polyethylene, $\epsilon = 2.25$. Also provides settings for dielectric constants $\epsilon = 1$ to $\epsilon =$ approx. 4.

Triggering, sampling only:

Pulses: <50 mV for pulses 5 ns or wider for jitter <20 ps.

CW: signals from 500 kHz to 500 MHz require at least 80 mV for jitter $<2\%$ of signal period plus 10 ps; usable to 1 GHz. CW triggering may be extended to 18 GHz with HP models 1104A/1106B trigger countdown.

Recorder outputs

Approx. 100 mV/div; vertical and horizontal outputs at BNC connectors on rear panel of mainframe.

Display modes

Repetitive scan, normal or detail; single scan; manual scan; record.

General

Operating environment: temperature, 0 to +55°C (+32°F to +130°F); humidity, to 95% relative humidity at 40°C (104°F); altitude, to 4.6 km (15 000 ft); vibration, vibrated in three planes for 15 min. each with 0.254 mm (0.010 in.) excursion, 10 to 55 Hz.

Weight: net, 2.3 kg (5 lb); shipping, 4.5 kg (10 lb).

1817A (28 ps Tr)/1816A (90 ps Tr) samplers specifications

Unless indicated otherwise, Model 1817A and Model 1816A specifications are the same. Where applicable, Model 1817A specification used with Model 1106B Opt 001 tunnel diode mount is given first, followed by Model 1816A specification (in parentheses) used with Model 1108A tunnel diode mount.

TDR system (requires 1106B Opt 001 or 1108A)

System rise time: <35 ps (110 ps) incident as measured with Model 1106B Opt 001 (Model 1108A).

Overshoot: <±5%.

Internal reflections: <10% with 45 ps (145 ps) TDR; use reflected pulse from shorted output.

Jitter: <15 ps; with signal averaging, typically 5 ps. Internal pickup: $\rho \leq 0.01$.

Noise: measured tangentially as a percentage of the incident pulse when terminated in 50 ohms and operated in signal averaging mode. <1% (0.5%) on 0.005/div to 0.02/div; <3% (1%) on 0.05/div to 0.5/div.

Low frequency distortion: $\leq \pm 3\%$.

Maximum safe input: 1 volt.

Tunnel diode mount: direct connection of 1106B Opt 001 to 1817A or 1108A to 1816A.

Sampler system

Rise time: <28 ps (90 ps).

Input: 50 ohm feedthrough.

Dynamic range: 1 V p-p.

Maximum safe input: 3 volts (5 volts).

Low frequency distortion: $\leq \pm 3\%$.

Noise:

Normal: <8 mV (3 mV) tangential noise on 0.01 V/div to 0.5 V/div. Noise decreases automatically on 0.005 V/div range.

Signal average: Reduces noise and jitter approx. 2:1.

General

Accessories supplied:

Cable, Plug-in to sampler: connects sampler (1816A or 1817A) to plug-ins (1815A or B), HP P/N 5060-0441.

Cable, tunnel diode to sampler: connects tunnel diode (1106B Opt 001 or 1108A) to sampler, type N male connectors on each end, HP P/N 01817-61603.

Recommended accessories

Trigger source: external trigger source is required for triggering above 500 MHz. 10 GHz source is provided by the 1104A Trigger Countdown with the 1108A Tunnel Diode Mount. 18 GHz source is provided by the 1104A Trigger Countdown with the 1106B Opt 001 Tunnel Diode Mount.

1106B Opt 001 (20 ps Tr)/1108A (60 ps Tr) tunnel diode mounts specifications

Tunnel diode is required for a TDR system. Refer to sampling head specifications for mounting requirements.

Amplitude (both): >200 mV into 50 ohms.

Rise time: 1106B Opt 001 approx. 20 ps; 1108A, <60 ps.

Output impedance: 50 ohms, ±2%.

Source reflections: 1106B Option 001, <10% with 45 ps TDR; 1108A, <10% with 145 ps TDR.

Weight (both): net, 0.5 kg (1 lb); shipping, 1.4 kg (3 lb).

***Components required for TDR/sampling systems**

1815A/B TDR/Sampling Plug-in	
1817A Sampling Head (APC-7 Input/Output Connectors)	1816A Sampling Head (GR Type 874 Input/Output Connectors)
TDR 35 ps tr 1106B Opt 001 Tunnel Diode	TDR 110 ps tr 1108A Tunnel Diode
<p>Sampling up to 12.4 GHz Termination, 50 ohm Model 909A, APC-7 connector.</p> <p>Trigger Accessories <500 MHz Adapter, 1250-0750 APC-7 to Type N female, 11500A Cable Type N Male to Type N Male, 1.8 m (6 ft), Adapter 1250-0077 Type N Female to BNC Male.</p> <p>500 MHz to 10 GHz 1104A Trigger Countdown. 1108A Tunnel Diode. Adapter 1250-0847 GR Type 874 to Type N Male. 1109B High Pass Filter. Adapter 1250-0750 APC-7 to Type N Female. 10503A Male BNC to Male BNC Trigger Cable 1.2 m (4 ft).</p> <p>500 MHz to 18 GHz 1104A Trigger Countdown. 1106B Opt 001 Tunnel Diode. Adapter 1250-0749 APC-7 to Type N Male. 1109B High Pass Filter. Adapter 1250-0750 APC-7 to Type N Female. 10503A Male BNC to Male BNC Trigger Cable 1.2 m (4 ft).</p>	<p>Sampling 4 GHz Termination, 50 ohm with GR Type 874 connector, HP P/N 0950-0090.</p> <p>Trigger Accessories <500 MHz Adapter 1250-1211 GR Type 874 to Type N Female, 11500A Cable Type N Male to Type N Male 1.8 m (6 ft), Adapter 1250- 0077 Type N Female to BNC Male.</p> <p>500 MHz to 10 GHz 1104A Trigger Countdown. 1108A Tunnel Diode. Adapter 1250-0847 GR Type 874 to Type N Male. 1109B High Pass Filter. Adapter 1250-0240 GR Type 874 to Type N Male. 10503A Male BNC to Male BNC Trigger Cable 1.2 m (4 ft).</p>

*Use any 180 series mainframe.

Model number and name	Price
1815A TDR/Sampler (calibrated in feet)	\$1500
1815B TDR/Sampler (calibrated in meters)	\$1500
1817A 28 ps Rise Time Sampling Head	\$1750
1816A 90 ps Rise Time Sampling Head	\$950
1104A Trigger Countdown	\$250
1106B Opt 001 20 ps Tunnel Diode Mount	\$610
1108A-60-ps-Tunnel-Diode-Mount	\$250



OSCILLOSCOPES

180 Sampling and TDR accessories

Models 1105A, 1106B, 1108A & 1109B

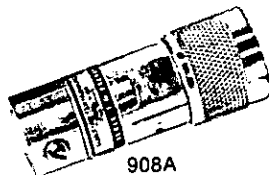
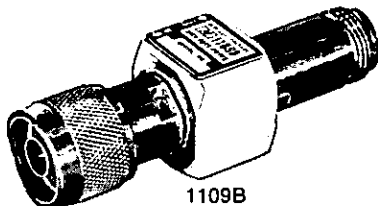
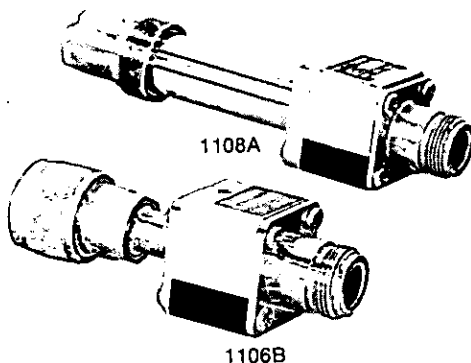
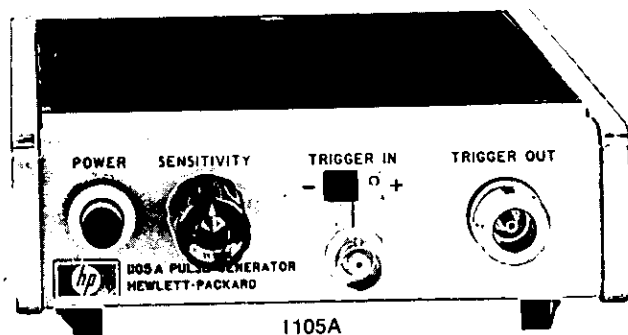

1105A/1106B/1108A Specifications

1105A/1106B/20 ps pulse generator

1105A/1108A/60 ps pulse generator

Output:

Rise time: approx. 20 ps with 1106B, (<60 ps with 1108A), <28 ps observed with HP Model 1411A/1430C 28 ps Sampler and 50 ohm termination HP Model 909A Option 012.

Overshoot: $\pm 7.5\%$ as observed on 1411A/1430C with 909A Option 012.

Droop: <3% in first 100 ns.

Width: approx. 3 μ s.

Amplitude: >+200 mV into 50 ohms.

Output characteristics: (1106B/1108A)

Mechanical: (1106B) Male Type N input connector, Female Type N output connector; (1108A) GR-874 input connector, Female Type N output connector.

Electrical: dc resistance, 50 ohms $\pm 2\%$. Source reflection, <10%, using a 40 ps TDR system. DC offset V, approx. 0.1 V.

Triggering:

Amplitude: at least ± 0.5 V peak required.

Rise time: <20 ns required. Jitter <15 ps when triggered by 1 ns rise time sync pulse.

Width: >2 ns.

Maximum safe input: 10 volts.

Input impedance: 200 ohms, ac-coupled through 20 pF.

Repetition rate: 0 to 100 kHz; free runs at 100 kHz.

Accessories supplied (with Model 1105A): one 1.8 m (6 ft) 50 ohm cable with Type N Male connectors on each end, HP Model 10132A.

Weight:

1106B or 1108A: net, 0.5 kg (1 lb); shipping, 0.9 kg (2 lb).

1105A: net, 0.9 kg (2 lb); shipping, 1.8 kg (4 lb).

1109B High-pass filter

The 1109B High-Pass Filter transmits only frequencies above 1 GHz. It is useful for blocking the 100 MHz "kickout" encountered when using a tunnel diode countdown to view high frequency signals on a sampling oscilloscope. The 1109B is designed for use with the Model 1104A/1106B Trigger Countdown.

1109B Specifications

Lower bandwidth limit: 3 dB down at 3 GHz, nominal.

Input characteristics:

Mechanical: Male type N input connector; Female Type N output connector.

Electrical (with output terminated in 50 ohms)

Reflection: <10% using 40 ps TDR system.

VSWR: typically 1.1:1 up to 10 GHz increasing to 2:1 at 15 GHz.

DC Resistance: 50 ohms $\pm 2\%$ shunted across line.

Weight: net, 0.14 kg (5 oz); shipping, 0.45 kg (2 lb).

Other sampling accessories

50 ohm loads: Models 908A with Type N male connector (4 GHz) and 909A Option 012 with Type N male connector (18 GHz).

50 ohm adapter: Model 11524A has Type N Female and APC-7 connectors.

Air line extensions: Model 11566A, 10 cm, APC-7 connector. Model 11567A, 20 cm, APC-7 connector.

Model number and name

1105A Pulse Generator	\$250
1106B 20 ps Tunnel Diode Mount	\$610
1108A 60 ps Tunnel Diode Mount	\$250
1109B High Pass Filter	\$230
908A 50 ohm Termination	\$50
909A Opt 012 50 ohm Termination	\$75
11524A 50 ohm Adapter	\$120
11566A Air Line Extension	\$120
11567A Air Line Extension	\$120

180 Spectrum analyzer

Model 8558B

NEW

- Economic spectrum analysis 0.1 to 1500 MHz
- Simple, 3 knob operation
- Direct signal power display in dBm

- Resolution bandwidths from 1 kHz to 3 MHz
- Optional 75 Ω input impedance
- Companion tracking generator

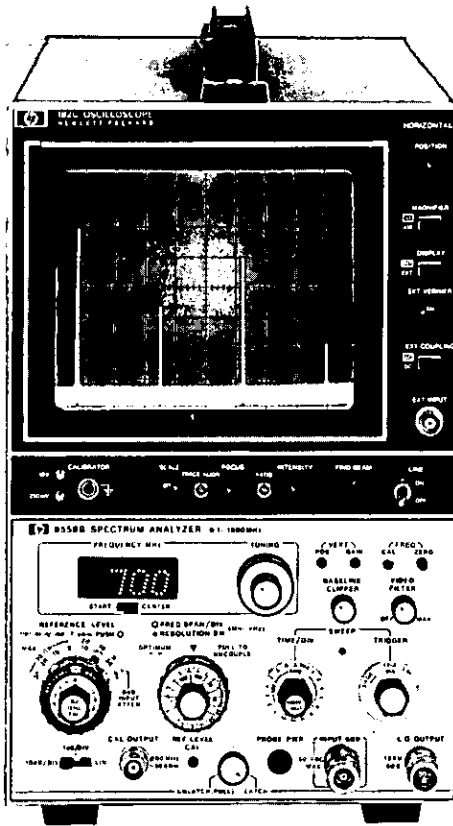

8558B/182T Spectrum analyzer

The 8558B spectrum analyzer plugs into any 180 series oscilloscope mainframe to provide low cost 0.1 to 1500 MHz performance with high amplitude and frequency accuracy, and it's easy to use.

Simple three knob operation

For most measurements only three controls are required; one for amplitude calibration and two for frequency calibration. The center or start frequency of the display is shown on an LED readout, and the analyzer automatically selects the resolution bandwidth and proper scan time to provide calibrated measurements with any desired frequency scan.

Absolute amplitude calibration

Signal levels can be read directly from the CRT display in dBm (or dBmV for option 002) without the use of external standards or calculations. The signal level represented by the top CRT graticule line is always indicated by the reference level control, and scale factors of 10 dB/div, 1 dB/div, and linear can be selected.

Optional 75 ohm input impedance

Two options are available which allow measurements in 75 ohm systems: Option 001 has 75 ohm impedance and retains the dBm power calibration; Option 002 has 75 ohm impedance with the amplitude calibrated in dBmV for measurements in systems such as CATV.

Companion tracking generator

The 8444A Option 058 tracking generator provides a calibrated RF signal matching exactly the 8558B analyzer tuned frequency. This makes swept frequency tests, such as insertion loss and return loss measurement, possible over 0.5 to 1300 MHz frequency range. The 8444A Option 058 is specified on page 454.

Suggested displays

The 8558B spectrum analyzer will function with any 180-series display. However, the following are suggested: for low cost, large screen display, the Model 182T is ideal; the Model 181T offers variable persistence and storage; and the Model 180TR offers a rack mount configuration. Each of these displays provides a long persistence P39 phosphor (except variable persistence displays) and four non-buffered rear panel outputs compatible with most X-Y recorders.

8558B Specifications

Frequency specifications

Frequency range: 100 kHz to 1500 MHz.

Frequency display span (on a 10-division CRT horizontal axis): 14 calibrated spans from 100 MHz/div to 5 kHz/div in a 1, 2, 5 sequence. In "0" the analyzer is a fixed-tuned receiver.

Digital frequency readout:

Indicates center frequency or start frequency of the frequency display scan.

Stability:

Residual FM: Less than 1 kHz peak-to-peak for time ≤ 0.1 sec.

Noise sidebands: More than 65 dB below CW signal, 50 kHz or more away from signal with a 1 kHz resolution bandwidth and full video filter.

Resolution:

Bandwidth ranges: 3 dB resolution bandwidths of 1 kHz to 3 MHz in a 1, 3, 10 sequence.

Resolution bandwidth selectivity: 60 dB/3 dB resolution bandwidth ratio $< 15:1$.

Video filter: Post-detection filter used to average displayed noise.

Amplitude specifications

Absolute amplitude calibration range:

Log calibration range: From -117 dBm to +30 dBm in 10 dB steps. Reference level vernier, 0 to -12 dB continuously.

Log display ranges: 10 dB/div on a 70 dB display, and 1 dB/div on an 8 dB display.

Linear display: From 2.2 microvolts (-100 dBm) full scale to 7.1 volts (+30 dBm) full-scale in 10 dB steps.

Dynamic range:

Average noise level: < -107 dBm with 10 kHz resolution bandwidth (0 dB input attenuation).

Spurious responses: For input signal level \leq Optimum Input Level setting, all image and out-of-band mixing responses, harmonic and intermodulation distortion products are more than 70 dB below input signal level, 5 MHz to 1500 MHz; 60 dB below, 100 kHz to 5 MHz.

Residual responses (no signal present at input): < -100 dBm with 0 dB input attenuation.

Calibrator:

Amplitude: -30 dBm ± 1.0 dB.

Frequency: 280 MHz ± 30 kHz, crystal controlled.

Input specifications

Input impedance: 50 Ω nominal.

Reflection coefficient < 0.20 (1.5 SWR) for all Optimum Input Level settings except -40 dBm (0 dB Input Attenuation).

Input connector: Type N female.

Input attenuator: 70 dB range.

Price and further information: see page 455.



OSCILLOSCOPES

180: Very high frequency measurements

Models 183A/B/D & 1830A - 1841A

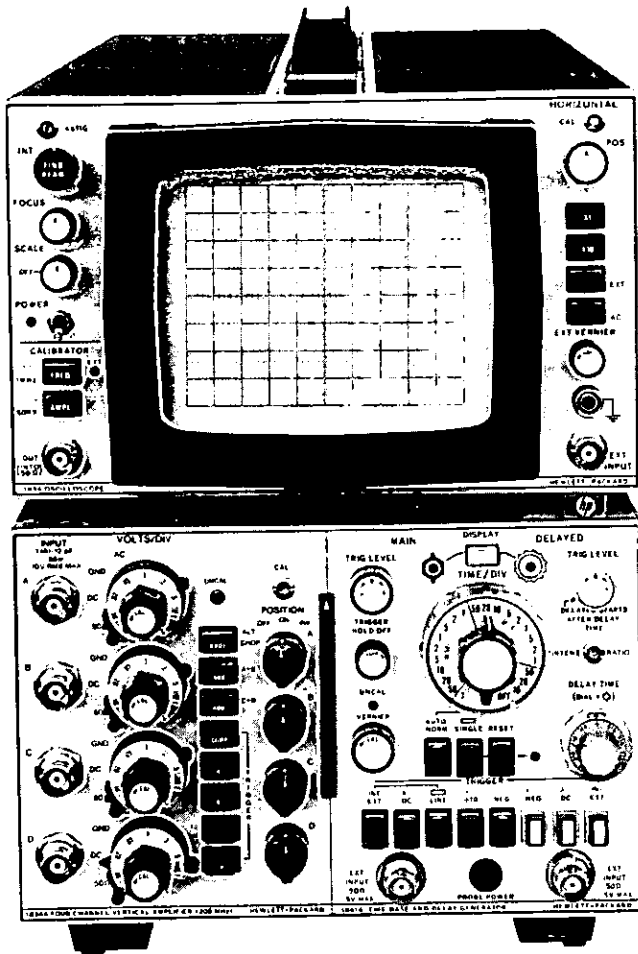

mately one-half normal spot size which increases beam current density at the phosphor surface and increases writing speed. The 6 × 10 cm display is restored by plugging the high voltage post accelerator cable into a different high voltage jack. This offers increased flexibility with a full size 6 × 10 cm display for general purpose use while retaining high writing speed measurements on the 3 × 5 cm display for high speed transients.

Model 183B Opt 005 provides state-of-the-art photographic writing speed capability. Writing speeds up to 28 cm/ns* are possible with P11 phosphor, a high speed camera with an f/1.2 lens, and fogging techniques on a crisp, linear, 6 × 10 div (0.4 cm/div) display. This gives you a mainframe that is expressly designed for the most stringent high speed transient oscillographic applications.

Option 020, available on Models 183B and 183D, adds multiturn controls for intensity, focus, astigmatism, and scale illumination for high-resolution, minutely repeatable settings, and consistent trace photos. Internal, external, and manual floodgun controls add operating convenience in system applications.

General features

A convenient beam finder, introduced by Hewlett-Packard, returns a display to the CRT screen and shows the direction it must be repositioned for on-screen viewing. The beam finder also lets you determine if the scope is triggering by displaying horizontal deflection. An autofocus circuit gives you a trace that is not as susceptible to defocusing with variations in intensity, reducing the need for frequent focus re-adjustment.

A completely specified, close tolerance calibrator allows you to quickly validate both vertical and time base plug-in operation. The calibrator pulse circuit can also be used as a pulse shaping network for external signals with a negative level exceeding -0.5 V and rep rates to 10 MHz. The rear panel switch and a front panel light indicates when the external input is selected.

*Refer to writing speed specifications for additional information.

183A/B/D Specifications

Cathode-ray tube and controls

Type: post accelerator, approx. 20 kV accelerating potentials; aluminumized P31 phosphor (P11 phosphor available).

Writing speed (183A/B): 4 cm/ns. With 10 000 ASA film, P31 phosphor, f/1.3 lens, 1:0.5 object-to-image ratio, and pulsed flood gun fogging.

Writing speed* (183B opt 005 and 183D)

	P31 Phosphor			P11 Phosphor ⁴		
	10 000 ASA ²	3 000 ASA		10 000 ASA ²	3 000 ASA	
Main-frame	With Post ³ Fogging	Without Fogging	Without Fogging	With Post ³ Fogging	Without Fogging	Without Fogging
183B Opt 005	12 cm/ns	6cm/ns	3 cm/ns ¹	24 cm/ns	12 cm/ns	6 cm/ns
183D red. scan	8 cm/ns	4 cm/ns	2 cm/ns	16 cm/ns	8 cm/ns	4 cm/ns

Notes: 1. Production specification; 2. 10 000 ASA writing speeds estimated at approx. twice 3 000 ASA writing speeds; 3. Writing speeds with controlled, repeatable, pulsed flood-gun fogging techniques estimated at approx. twice writing speeds without post fogging; 4. P11 writing speeds estimated at approx. twice P31 writing speeds; 5. All writing speeds given for f/1.3 lens, 1:05 reduction ratio, 2s exposure. Using f/1.2 lens would increase writing speed by approx. 17%.

Graticule

183A/B: 6 × 10 division internal graticule (1 div = 1 cm). 0.2 division subdivisions on major axes.

183B Opt 005: 6 × 10 division internal graticule (1 div = 0.4 cm).

183D: normal scan, 6 × 10 division internal graticule (1 div = 1 cm). 0.2 subdivision markings on major horizontal and vertical axis. Reduced scan, 6 × 10 division internal graticule (1 div = 0.5 cm) superimposed in center of normal scan graticule.

Flood gun: illuminates CRT phosphor. Normal or pulsed mode operation selected with rear panel switch. Scale control adjusts graticule illumination in normal mode and pulse duration in pulsed mode for increased photographic writing speed.

183A/B/D Mainframes description

183A/B Mainframes

Models 183A cabinet style and 183B rack style mainframes have high frequency response with operating ease and plug in versatility for wide-band general purpose applications. These mainframes with their bright displays are ideal for viewing two or four channel displays of low rep-rate digital words or other groups of short duration, fast rise pulses in computers and high speed digital systems.

Bright visual displays and fast photographic writing speeds are assured with the 20 kV cathode-ray tube accelerating potential. Typical writing speeds of 4 cm/ns can be achieved with Models 183A and B using a 195A Camera, P31 phosphor, 10 000 ASA film, 1:0.5 reduction ratio, and pulsed flood gun fogging. Substantially faster writing speeds may be obtained by using P11 Phosphor. For added convenience in timing of single shot events, a rear panel input allows remote time base single sweep reset when timing is critical for recording test results.

An 8 × 10 division graticule (1 div = 0.875 cm) is available in place of the 183A/B 6 × 10 division graticule (1 div = 1 cm) for easier viewing of 4-channel displays. For further information about the 8 × 10 division graticule, contact your Hewlett-Packard Field Engineer.

183B Opt 005/183D mainframes

Models 183B Opt 005 and 183D mainframes provide real time, large-signal, single-shot, transient response to greater than 600 MHz as well as 10 mV/div capability to 250 MHz. Both mainframes are compact 13.3 cm (5/8 inch) high rack design which saves valuable space in system applications.

Model 183D has a selectable scan CRT with a choice of 6 × 10 cm or 3 × 5 cm displays and 4 cm/ns or 8 cm/ns photographic writing speeds* respectively. The reduced scan display (3 × 5 cm) achieves 8 cm/ns writing speeds by compressing the CRT beam to approxi-

Beam finder: returns trace to display area regardless of horizontal or vertical control settings.

Intensity modulation (external input)

Input: approx. +2 V, ≥ 50 ns pulse width (≤ 15 MHz CW) blanks trace of normal intensity, +15 V blanks trace of any intensity.

Input R: approx. 4700 ohms.

Maximum input: ± 20 V (dc + peak ac).

Auto-focus: automatically reduces defocusing with variations in intensity.

Intensity limit: automatically limits beam current at slow sweep speeds to decrease possibility of damage to CRT. Circuit response time ensures full writing speed for viewing low duty cycle, fast rise time pulses.

Calibrator

Pulse timing: selectable, 2 kHz rep rate (0.5 ms period), 50 μ s pulse width; 1 MHz rep rate (1 μ s period), 100 ns pulse width. Accuracy, $\pm 0.5\%$, from +10°C to +40°C; $\pm 1\%$, from 0°C to +55°C.

Amplitude: selectable, 50 mV or 500 mV, $\pm 1\%$ into a 50 ohm $\pm 0.5\%$ load.

Source R: 50 ohms, nominal.

Pulse shape (measured with 1 GHz bandwidth sampler.)

Transition time (negative slope): < 1 ns.

Overshoot and ringing: $\pm 3\%$ max.

Flatness: $\pm 0.5\%$ after 5 ns with pulse top and base line perturbations averaged.

External calibrator input: calibrator shaping network shapes an external negative input that exceeds -0.5 V peak. Rep-rate extends to > 10 MHz. Input R, approx. 10 k Ω . Rear panel input selected with rear panel switch and front panel light indicates when switched to external position.

Horizontal amplifier

External input

Bandwidth: dc-coupled, dc to 8 MHz; ac-coupled, 2 Hz to 8 MHz.

Deflection factor: 1 V/div, X1; 100 mV/div, X10; accuracy, $\pm 5\%$. Vernier provides continuous adjustment between ranges and extends deflection factor to at least 10 V/div.

Dynamic range: ± 20 V.

Maximum input: ± 350 V (dc + peak ac).

Input RC: approx. 1 megohm shunted by approx. 20 pF.

Internal sweep

Magnifier: X10, accuracy, $\pm 5\%$.

Outputs

Two rear panel emitter follower outputs for main or delayed gates (vertical or horizontal outputs when used with sampling plug-ins). Output amplitude is approx. ± 0.75 V with 1840A time base plug-in. Will drive impedances 1000 ohms without distortion.

General

Operating environment: temperature, 0 to +55°C (+32°F to +130°F); humidity, to 95% relative humidity at 40°C (104°F); altitude, to 4.6 km (15,000 ft); vibration: vibrated in three planes for 15 min. each with 0.254 mm (0.010 in.) excursion, 10 to 55 Hz.

Dimensions

Model 183A (cabinet): 100 mm wide, 289 mm high, 578 mm deep, behind front panel ($7\frac{7}{8} \times 11\frac{1}{8} \times 22\frac{3}{4}$ in.).

Model 183B, 183D (rack): 425.4 mm wide, 132.6 mm high, 609.6 mm deep overall ($16\frac{3}{4} \times 5\frac{1}{32} \times 24$ in.), 588.5 mm (22 in.) behind rack mount tabs.

Weight (without plug-ins)

Model 183A (cabinet): net, 15.0 kg (33 lb); shipping, 20.9 kg (46 lb).

Model 183B, 183D (rack): net, 15.9 kg (35 lb); shipping, 21.8 kg (48 lb).

Power: 115 or 230 V $\pm 10\%$, 48 to 440 Hz, approx. 115 watts with 1830A and 1840A plug-ins at 115 V and 60 Hz. Maximum mainframe power 325 VA.

Accessories supplied: 2.3 m ($7\frac{1}{2}$ ft) power cord, Model 10178A mesh contrast filter, blue plastic light filter (HP P/N 5060-0548), 230 V fuse package (HP P/N 5080-9671) and one Operating and Service Manual. A rack mount kit (HP P/N 5060-0552) and 2 clip-on probe holders (HP P/N 5040-0464) are also supplied with rack Models 183B, 183B Opt 005 and 183D. A reduced scan mask (HP P/N 00183-04111) is supplied with Models 183B Opt 005 and 183D.

General

8 x 10 division graticule (183A/B)

An 8 x 10 division graticule (1 div = 0.875 cm) is available in place of the 183A/B 6 x 10 division graticule (1 div = 1 cm). For further information contact your Hewlett-Packard Field Engineer.

Options

011: P11 aluminized phosphor in lieu of P31.

020 (183B Opt 005 and 183D): removes calibrator circuits, incorporates multiturn controls for Intensity, Flood Gun, Focus, and Astigmatism controls. Also provides front panel switches for internal/external, or manual control of the flood gun.

Specifications are the same as those for the 183B Opt 005/183D except as follows:

Flood gun: illuminates CRT phosphor. Normal or pulsed mode of operation selected with rear panel switch. 10 turn scale control, with locking dial, adjusts graticule illumination (dc level) in normal mode or pulse width in pulsed mode. Pulsed mode increases photographic writing speed using repeatable film fogging techniques.

Intensity control: 10 turn, with locking dial.

Focus control: 3.5 turn (5:1 reduction ratio).

Astig control: 3.5 turn (5:1 reduction ratio).

035: eliminates sweep irregularities caused by high amplitude input signals necessary for the 1831A and 1831B direct access plug-ins and also requires an 1840A Option 035 Time Base Plug-in.

Model number and name

Model number and name	Price
183A Mainframe	\$2265
183B Mainframe	\$2375
183B Opt 005 Mainframe	add \$955
183D Mainframe	\$3000
Option 011 (all 183 models)	N/C
Option 020 (183B Opt 005 and 183D)	add \$210
Option 035 (all 183 models)	N/C

OSCILLOSCOPES

180: Very high frequency measurements

Models 183A/B/D & 1830A-1841A

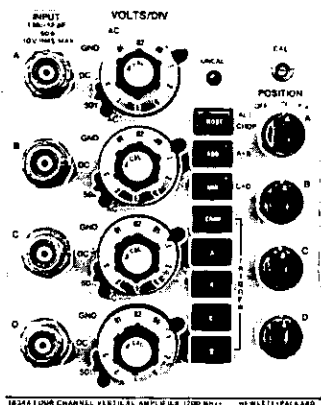

1834A Description

Model 1834A, 200 MHz four channel vertical amplifier plug-in for 183 series oscilloscope mainframes provides accurate measurements for both digital and analog design and troubleshooting. Its wide bandwidth coupled with the 1 ns/div sweep speeds and low jitter available with the 1841A delaying time base allows accurate timing measurements in ECL and TTL logic circuits.

The 10 mV/div deflection factor at 200 MHz is provided by a thick film, planar attenuator which provides selectable 1 megohm or 50 ohms impedance positions. The 1 megohm (ac/dc) input has only 12 pF shunt capacitance for minimal loading in probing applications. This extremely low capacitance can be further reduced by using 10:1 divider probes or active probes. For accurate 50 ohm measurements, a precision internal 50 ohm input termination may be selected with a front panel switch. The 50 ohm termination maintains low VSWR and pulse fidelity by compensating for the normal input capacitance which is not possible with external terminations. Active probes are also available to reduce circuit loading while retaining the 50 ohm input capability.

The flexible trigger source selection allows timing measurements referenced from channel A, B, C, or D or composite. Single channel triggering allows you to trigger on any channel while retaining the time relationship with the other three channels. Composite triggering allows each channel to trigger in an alternate or added display.

Any of the 1834A's four channels may be inverted for convenience. In addition, the ADD mode gives you the capability of looking at two pairs differentially ($\pm A, \pm B$), ($\pm C, \pm D$) or one pair differentially and two single channels $\pm A, \pm B$, ($\pm C, \pm D$) or ($\pm A, \pm B$), $\pm C, \pm D$.

Any of the four channels, in addition to normal or inverted operation, may be turned off. This not only aids in channel identification, but allows the 1834A to be used as a single, dual, three, or four channel plug-in to best fit your application.

Enhanced 4-channel viewing is possible if the 1834A is used in conjunction with the optional 8×10 div (1 div = 0.875 cm) graticule available in the 183A/B mainframe. This combination requires the 1834A to be calibrated for proper operation with the optional CRT. Contact your Hewlett-Packard Field Engineer for further information.

1834A Specifications

Modes of operation

Channel A, B, C, or D or any combination displayed alternately on successive sweeps (ALT); channel A, B, C, or D or any combination displayed by switching between 4 channels at approx 500 kHz rate (CHOP) with blanking during switching; channels ($\pm A, \pm B$) displayed in ALT or CHOP with ($\pm C, \pm D$), chop frequency is approx 1 MHz; channels $\pm A, \pm B$, displayed in ALT or CHOP with ($\pm C, \pm D$) or ($\pm A, \pm B$) displayed in ALT or CHOP with $\pm C, \pm D$, chop frequency is approx. 667 kHz.

Each channel (4)

Bandwidth: (Measured with or without 10014A probe, 3 dB down from a terminated 50 ohm source.)

DC-coupled: dc to 200 MHz.

AC-coupled: approx 10 Hz to 200 MHz. Lower limit is approx 1 Hz with 10014A probe.

Rise time: <1.8 ns. Measured with or without 10014A probe, 10% to 90% of 6 div input step from a terminated 50 ohm source.

Deflection factor

Ranges: from 0.01 V/div to 5 V/div (9 calibrated positions) in 1, 2, 5 sequence.

Attenuator accuracy: $\pm 2\%$.

Vernier: provides continuous adjustment between all deflection factor ranges. Extends maximum deflection factor to at least 12.5 V/div.

Signal delay: input signals are delayed sufficiently to view leading edge of input without advanced external trigger.

Input coupling: ac, dc, 50 ohms (dc), or ground. Ground position disconnects input connector and grounds amplifier input.

Input RC (selectable)

AC or DC: 1 megohm $\pm 1\%$ shunted by approx. 12 pF.

50 ohm: 50 ohms $\pm 2\%$. VSWR, 1.3:1 at 200 MHz on all ranges.

Maximum input

AC and DC: ± 300 V (dc + peak ac) at 1 kHz or less; ± 150 V (dc + peak ac) on 10 mV/div range at 1 kHz or less.

50 ohm: 10 V rms (dc-coupled input).

Polarity: any channel may be inverted for $\pm A, \pm B, \pm C$, or $\pm D$ operation.

Algebraic addition (A + B), (C + D)

Amplifier: bandwidth and deflection factors are unchanged, any channel may be inverted for ($\pm A, \pm B$) or ($\pm C, \pm D$) operation.

Differential input (A - B) or (C - D) common mode: CMRR is at least 20 dB from dc to 80 MHz on 10 mV/div to 5 V/div ranges.

Triggering

Source: selectable from channel A, B, C, D, or composite (on displayed signals) in all display modes.

Frequency: dc to 50 MHz on signals causing 1 div or more vertical deflection increasing to 1.5 div at 200 MHz in all displays modes.

General

Operating environment: same as 183 mainframe.

Weight: net, 3.2 kg (7 lb); shipping, 4.5 kg (10 lb).

Accessories supplied: one Operating and Service Manual.

Recommended probes

Model 10014A (1.07 m, 3.5 ft) will maintain 1834A bandwidth and rise time in the high impedance (ac or dc) mode. If a longer probe is required, the Model 10016A (1.83 m, 6 ft) probe is available which adds approx. 0.1 ns to the 1834A rise time. Models 10020A (1.22 m, 4 ft) and 1125A (1.47 m, 58 in.) will maintain bandwidth and rise time in the 50 ohm input mode.

Model 1834A, 200 MHz 4 Channel Amplifier

\$2400

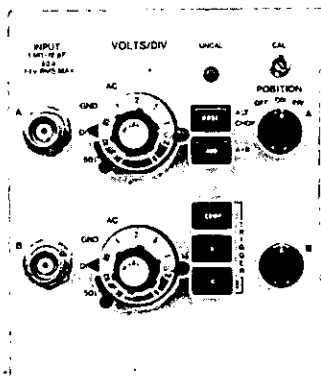

1835A

1835A Description

Model 1835A, 200 MHz two channel vertical amplifier plug-in for 183 series oscilloscope mainframes provides accurate measurements for both digital and analog design and trouble-shooting. Its wide bandwidth coupled with the 1 ns/div sweep speeds available with the 1840A time base or 1841A delaying time base allows accurate timing measurements in ECL and T²L logic circuits.

The 10 mV/div deflection factor at 200 MHz is provided by a thick film, planar attenuator which provides selectable 1 megohm or 50 ohm impedance positions. The 1 megohm (ac/dc) input has only 12 pF shunt capacitance for minimal loading in probing applications. This extremely low capacitance can be further reduced by using 10:1 divider probes or active probes. For accurate 50 ohm measurements, a precision internal 50 ohm input termination may be selected with a front panel switch. The 50 ohm termination maintains low VSWR and pulse fidelity by compensating for the normal input capacitance which is not possible with an external termination. Active probes are also available to reduce circuit loading while retaining the 50 ohm input capability.

The flexible trigger source selection allows timing measurements referenced from channel A, channel B, or composite. Single-channel triggering allows you to trigger on either channel while retaining the time relationship with the other channel. Composite triggering allows each channel to trigger in an alternate or added display.

Either of the two channels may be inverted for convenience. In addition, the ADD mode gives you the capability of looking at the pair differentially ($\pm A \pm B$).

Either of the two channels, in addition to normal or inverted operation, may be turned off. This not only aids in channel identification, but allows the 1835A to be used as a single or dual channel plug-in to best fit your application.

1835A Specifications

Modes of operation

Channel A; channel B; channels A and B displayed alternately on successive sweeps (ALT); channels A and B displayed by switching between channels at approx. 1 MHz (CHOP); channels $\pm A \pm B$ (algebraic addition).

Each channel (2)

Bandwidth: (Measured with or without 10014A probe, 3 dB down from 6 div reference signal from a terminated 50 ohm source.)

DC-coupled: dc to 200 MHz.

AC-coupled: approx. 10 Hz to 200 MHz; lower limit approx. 1 Hz with HP Model 10014A probe when ac-coupled.

Rise time: <1.8 ns (measured with or without 10014A probe, 10% to 90% of 6 div input step from a terminated 50 ohm source).

Deflection factor

Ranges: from 0.01 V/div to 5 V/div (9 calibrated positions) in 1, 2, 5 sequence.

Attenuator accuracy: $\pm 2\%$.

Vernier: provides continuous adjustment between all deflection factor ranges. Extends maximum deflection factor to at least 12.5 V/div. UNCAL indicator lights when vernier not in CAL detent position.

Signal delay: signals are delayed sufficiently to view leading edge of pulse without advanced external trigger.

Input coupling: selectable ac, dc, 50 ohms (dc), or ground. Ground position disconnects input connector and grounds amplifier input.

Input RC (selectable)

AC or DC: 1 megohm $\pm 1\%$ shunted by approx. 12 pF.

50 ohm: 50 ohms $\pm 2\%$, VSWR 1.3:1 at 200 MHz on all ranges.

Maximum input

AC or DC: ± 300 V (dc + peak ac) at 1 kHz or less; ± 150 V (dc + peak ac) on 10 mV/div range at 1 kHz or less.

50 ohm: 10 V rms (dc-coupled input).

Polarity: both channels may be inverted for $\pm A$ and $\pm B$ operation.

Algebraic addition (A + B)

Amplifier: bandwidth and deflection factors unchanged; either channel may be inverted for $\pm A \pm B$ operation.

Differential input (A - B) common mode: CMRR is at least 20 dB from dc to 80 MHz on 10 mV/div to 5 V/div ranges.

Triggering

Source: selectable from channel A, B, or composite (on displayed signal) in all display modes.

Frequency: dc to 50 MHz on signals causing 1 div or more vertical deflection increasing to 1.5 div at 200 MHz in all display modes.

General

Operating environment: temperature, 0 to 55°C (+32°F to +130°F); humidity, to 95% relative humidity at 40°C (104°F); altitude, to 4.6 km (15000 ft); vibration, vibrated in three planes for 15 min. each with 0.254 mm (0.010 in.) excursion, 10 to 55 Hz.

Weight: net, 2.3 kg (5 lb); shipping, 3.6 kg (8 lb).

Accessories supplied: two Model 10014A, 10:1 voltage divider probes 1.07 m (3.5 ft) long; one Operating and Service Manual.



OSCILLOSCOPES

180: Very high frequency measurements

Models 183A/B/D & 1830A-1841A

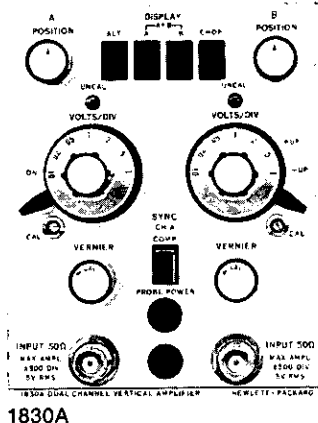

1830A

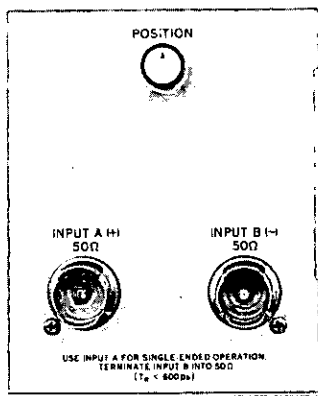

1831A

1830A Specifications

Modes of operation

Channel A, channel B, Channels A and B displayed alternately on successive sweeps (ALT), channels A and B displayed by switching (time shared) between channels, Chop frequency of approx. 250 kHz, channel A plus channel B, and by inverting channel B, channel A minus channel B.

Each channel (2)

Bandwidth: dc to 250 MHz, 3 dB down from 6 div reference signal at 10 MHz from a 50 ohm source.

Rise time: ≤ 1.5 ns, 10% to 90% with 6 div input step with a rise time of ≤ 200 ps from a 50 ohm source.

Pulse response

Overshoot, Ringing, Flatness (Combined): $\leq \pm 4\%$.

Preshoot: $\leq 0.5\%$.

Deflection factor

Ranges: from 0.01 V/div to 1 V/div (7 positions) in 1, 2, 5 sequence.

Attenuator accuracy: $\pm 3\%$. Front panel CAL adjustment.

Vernier: continuously variable between all ranges, extends maximum deflection factor to approx. 2.5 V/div. Vernier UNCAL (uncalibrated) light indicates when vernier is not in the calibrated position.

Polarity: +up or -up selectable on channel B.

Signal delay: > 55 ns, which allows viewing the leading edge of a pulse without external delay or advanced trigger.

Drift: short term drift/min. and long term drift/hr., ≤ 0.05 div after $\frac{1}{2}$ hour from turn-on and at constant ambient temperature.

Input R: 50 ohms.

Maximum input: 5 V rms or ± 500 div peak, whichever is less.

VSWR: ≤ 1.30 on 10 mV/div and ≤ 1.20 from 20 mV/div to 1.0 V/div at 250 MHz.

Reflection coefficient: $\leq 10\%$ on 10 mV/div and $\leq 5\%$ from 20 mV/div to 1.0 V/div. Measured with 1 ns rise time TDR.

A + B operation (A - B with channel B inverted)

Bandwidth: dc to 150 MHz, 3 dB down from 6 div reference signal from a terminated 50 ohm source.

Rise time: ≤ 2.4 ns, 10% to 90% with 6 div input step from a terminated 50 ohm source.

Triggering

Source: channel A or composite (on displayed signal) in all display modes.

Frequency: dc to > 250 MHz on signals causing 1 div or more vertical deflection in all modes (with Models 1840A and 1841A Time Bases).

General

Probe power: provides power for two HP active probes.

Operating environment: same as 183 mainframe.

Weight: net, 2.3 kg (5 lb); shipping 3.6 kg (8 lb).

1831A and 1831B Specifications

Note: These plug-ins require a 183A, B, or D mainframe with Opt 035 and an 1840A time base with Opt 035.

Vertical

Bandwidth: < 20 kHz to > 600 MHz (1831A), > 500 MHz (1831B).

Rise time: < 600 ps (1831A), < 700 ps (1831B).

Pulse response: $< 5\%$ overshoot; $< \pm 5\%$ perturbations with 350 ps rise time step input from a 50 ohm source; $< 6\%$ tilt for a 1 μ s wide pulse at 25°C and $< 10\%$ tilt from 0°C to 55°C.

Deflection factor: 5.75 V/div, $\pm 10\%$.

Input characteristics

Input R: 50 ohms, single-ended or differential (1831A); single-ended (1831B).

Maximum DC input: ± 100 V dc.

Maximum AC input: 2.0 watts, 4 div p-p CW.

VSWR: $< 1.3:1$ to 750 MHz.

Input reflections: $< \pm 10\%$, measured with 150 ps TDR.

Signal delay (1831B): approx. 60 ns which allows viewing the leading edge of a pulse without external delay.

Internal triggering (1831B): stable to 500 MHz with signals producing $\frac{1}{2}$ div or more vertical deflection.

General

Operating environment: same as 183 mainframe.

Weight:

Model 1831A: net, 0.91 kg (2 lb); shipping, 2.27 kg (5 lb).

Model 1831B: net, 1.8 kg (4 lb); shipping, 3.18 kg (7 lb).

Accessories furnished: one 50 ohm load (1831A only). Two mainframe termination resistors.

Model number and name

1830A, 250 MHz Vertical Price \$1095

1831A Direct Access Plug-in \$390

1831B Direct Access Plug-in \$440

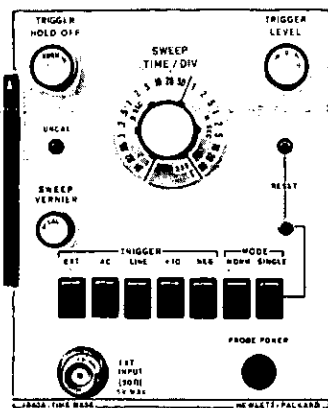

1840A

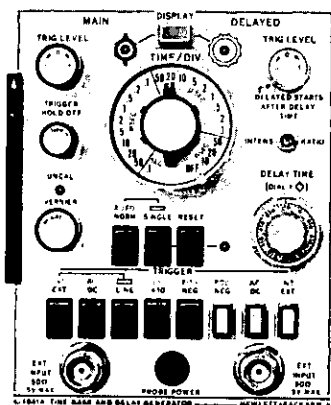

1841A

ohms. $\div 10$ trigger attenuator allows wider dynamic range of EXT trigger input.

*(Automatic triggering is same as normal except low frequency limit is 5 Hz for internal and external triggering.)

Line: power line frequency trigger signal.

Level: internal, at any point on the displayed vertical waveform; external, continuously variable from -100 mV to $+100$ mV in $\div 1$ and 1.0 V to -1.0 V in $\div 10$. Input R, 50 ohms nominal.

Slope: pushbutton selection of either positive or negative slope of trigger signal.

Coupling: front panel selection of ac or dc. AC attenuates signal below approx. 5 kHz.

Delayed time base (1841A)

Internal: refer to vertical amplifier plug-in specifications.

Automatic: delayed sweep is automatically triggered at end of set delay time.

External: dc to >250 MHz with signals of 20 mV p-p or more, increasing to 500 MHz on signals of 50 mV p-p or more. Input R, 50 ohms.

Level: internal, at any point on the displayed vertical waveform; external, continuously variable from $+100$ mV to -100 mV on either slope of trigger signal.

Slope: pushbutton selection of positive or negative slope of trigger signal.

Coupling: front panel selection of ac or dc. AC attenuates signals below approx. 5 kHz.

Delay (before start of delayed sweep)

Time: continuously variable from 50 ns to 1 s.

Accuracy: $\pm 1\%$ from 50 ms to $0.1 \mu\text{s}$, main sweep linearity $\pm 0.2\%$, time jitter is $<0.005\%$ (1 part in 20 000) of maximum delay of each step.

Trace intensification (1841A)

In Main sweep mode, intensifies that part of main time base to be expanded to full screen in delayed time base. Rotating delayed sweep switch from off position activates intensified mode. Front panel adjustment sets relative intensity of brightened segment.

General

Probe power: supplies power to operate one HP active probe.

Operating environment: temperature, 0 to $+55^\circ\text{C}$ ($+32^\circ\text{C}$ to $+130^\circ\text{F}$); humidity, to 95% relative humidity at 40°C (104°F); altitude, to 4.6 km (15 000 ft); vibration, vibrated in three planes for 15 min. each with 0.254 mm (0.010 in.) excursion, 10 to 55 Hz.

Weight

Model 1840A: net, 1.4 kg (3 lb); shipping, 2.7 kg (6 lb).

Model 1841A: net, 1.6 kg (3.6 lb); shipping, 3.2 kg (7 lb).

Options (1840A)

001: contains attenuation and limiting circuits in the external trigger input which allows wider dynamic range of EXT trigger input levels. Specifications for the Model 1840A Option 001 are the same as Model 1840A except as follows:

External Trigger Input

+1 mode: 1 V p-p to 250 MHz, trigger level adjustable over ± 5 volt range.

+5 mode: 5 V p-p to 250 MHz, trigger level adjustable over ± 25 volt range.

Maximum input: 100 V peak with $10 \mu\text{s}$ duration. Maximum continuous input, 5 V rms.

035: required for operation with 1831A or 1831B direct access plug-ins. Also required is Opt 035 to 183 mainframes. This option eliminates sweep irregularities caused by high amplitude input signals required by 1831A and 1831B plug-ins.

Model number and name

1840A, Time Base

Option 001

Option 035

Model=1841A=Time=Base/Delay=Generator

Price

\$775

add \$55

N/C

\$1240

1840A/1841A Specifications

Main time base

Sweep

Ranges: from 10 ns/div to 0.1 s/div (22 positions) in 1, 2, 5 sequence. $\pm 3\%$ accuracy with vernier in calibrated position.

Vernier: continuously variable between all ranges, extends slowest sweep to at least 0.25 s/div.

Magnifier (on mainframe): extends fastest sweep to 1 ns/div, $\pm 5\%$.

Sweep mode

Normal: sweep is triggered by an internal, external, or power-line frequency signal.

Automatic: bright baseline displayed in absence of a trigger signal.

Single: sweep occurs once with same triggering as normal; reset pushbutton with armed indicator light. Rear panel input (on mainframe) provides remote arming capability.

Delayed time base (1841A)

Delayed time base sweeps after the time delay set by main time base and delay controls.

Sweep ranges: 10 ns/div to 1 ms/div in 1, 2, 5 sequence (16 positions), $\pm 3\%$ accuracy.

Triggering

Main time base

Internal: refer to vertical amplifier plug-in specifications.

External: dc* to >250 MHz with signals of 20 mV p-p or more, increasing to 500 MHz with signals of 50 mV p-p or more. Input R, 50

OSCILLOSCOPES

15 MHz dual channel, general purpose

Models 1220A & 1221A

NEW

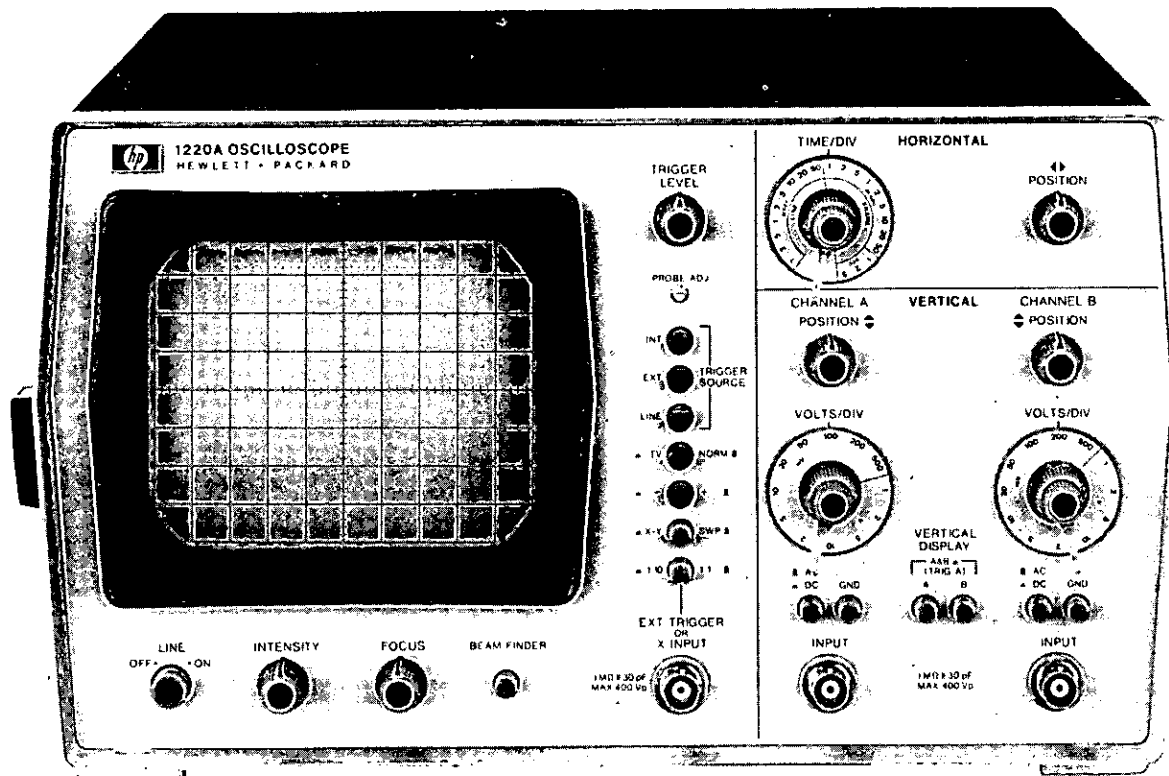

1220A/1221A Description

Hewlett-Packard Models 1220A (dual channel) and 1221A (single channel) 15 MHz oscilloscopes are high quality instruments with features ordinarily found only in laboratory models. Both oscilloscopes have the performance necessary for a wide variety of applications. Features include a large 8×10 internal graticule for no-parallax measurements, 3% vertical attenuator accuracy, 4% horizontal accuracy, calibrated sweep times from 0.5 s/div to 0.1 μ s/div, dc coupling, automatic triggering, a sweep magnifier to expand the display up to ten times for detailed analysis, a pushbutton beam finder, X-Y display capability, and a TV sync separator.

Easy operation

The human engineered front panel with functionally grouped controls and color-coded pushbuttons makes measurements easier and faster. Inputs are protected to 400 V, reducing chances of accidental electrical damage. Automatic triggering assures that a base-line is present even in the absence of a signal or if the trigger level control is set beyond the range of the trigger signal. And, although the dual channel Model 1220A operates in either a chopped or alternate mode, the operator need not concern himself with making a choice since the Time/Div switch automatically selects the best display mode.

The basic stability of the solid-state circuits and components used throughout is such that internal adjustments have been reduced to a minimum. This decreases calibration requirements and provides real savings over the oscilloscope's lifetime. Recalibration, when neces-

sary, is simple and straightforward compared to most other oscilloscopes.

Triggering

Even though the instruments are easy to operate, these oscilloscopes have the flexibility for multi-purpose use. The operator can select the source of sweep trigger (internal, external, ac line, TV) and he can select the trigger slope, adding to the oscilloscope's versatility by allowing triggering on either the positive or negative going transitions of the signal. Further flexibility is added by the ability to preset the signal amplitude required to trigger the sweep, assuring that perturbations below the desired amplitude will not trigger the oscilloscope.

With automatically triggered sweep, displays are stable because the observed signal itself determines when a sweep should start. Automatic triggering produces a free running trace in the absence of a signal for fast set-up. It locks onto any input signal of the proper polarity and amplitude. In addition, accurate time difference measurements can be made with the 1220A since triggering is always derived from the channel A input.

CRT

The internal 8×10 cm CRT graticule eliminates parallax errors that occur when the graticule is external to the CRT. The 3% vertical accuracy combined with the no-parallax graticule enables the oscilloscope to be used as a voltmeter as well as for waveform display. CRT beam intensity can be modulated through a rear panel Z-axis input.

X-Y Inputs

External signals can be applied to the horizontal deflection ampli-

fiers for making X-Y plots, or Lissajous figures for accurate phase shift measurements with phase shift less than 3 degrees at 100 kHz. The horizontal input also allows swept frequency measurements for checking tuners or IF strips.

TV Sync

The built-in TV sync separator assures stable, automatic triggering on frame or line for convenient TV troubleshooting. With the instruments times-ten magnifier, signals can be pulled out easily. The calibrated time base makes it easy to identify timing problems in vertical or horizontal TV circuits. The external horizontal input allows vector presentations of color CRT drive signals. Dual channels make it easy to set color demodulator circuits.

Rugged lightweight design

Models 1220A and 1221A are, except for the CRT, entirely of solid-state design, resulting in low power consumption. The consequent low heat has made possible a rugged, lightweight, closed cabinet with a vinyl-clad aluminum cover that is resistant to shock, dust, and moisture. A convenient side-panel handle and stabilizing feet on the opposite side make handling easy. This allows these oscilloscopes to be used in areas where ruggedness is a necessity. These areas include production lines, numerically controlled machinery, process control equipment, automotive, aircraft and marine electronics, and communications.

Optional accessories

An optional front panel cover is available to protect the instrument during transportation and gives storage space for probes and other accessories. General purpose probing is provided with the Model 10013A 10 to 1 divider probe with 10 megohms input shunted by only 10 pF. It extends input range to 100 V/cm and multiplies input impedance without degrading frequency response. With a rack mount kit the oscilloscopes can be mounted to occupy only 22.2 cm (8 7/8 inches) of vertical space. Also available is the Model 10373A Camera Adapter for the Model 123A camera. Contact your Hewlett-Packard Field Engineer for information concerning these accessories.

1220A/1221A Specifications

Modes of operation (1220A)

Channel A; channels A and B displayed alternately on successive sweeps (Alt); triggering by A channel; channels A and B displayed by switching between channels at approx. 200 kHz rate with blanking during switching (Chop); automatic selection of alternate or chop mode. Chop. at sweep speeds from 0.5 s/cm to 1 ms/cm; Alt. 0.5 ms/cm to 0.1 μ s/cm.

Vertical amplifiers (2 in 1220A, 1 in 1221A)

Bandwidth: (3 dB down from 50 kHz, 6 div reference signal from a terminated 50 ohm source.)

DC-coupled: dc to 15 MHz.

AC-coupled: lower limit is approx. 2 Hz.

Rise time: approx. 23 ns.

Deflection factor

Ranges: from 2 mV/cm to 10 V/cm (12 ranges) in 1, 2, 5 sequence. \pm 3% accuracy with vernier in calibrated position on 10 mV/cm to 10 V/cm ranges, \pm 5% accuracy on 2 mV/cm and 5 mV/cm ranges.

Vernier: continuously variable between all ranges, extends maximum deflection factor to at least 25 V/cm.

Input RC: approx. 1 megohm shunted by approx. 30 pF.

Input coupling: AC, DC, or GND selectable. GND position disconnects signal input and grounds amplifier input.

Maximum input: \pm 400 V (dc + peak ac).

Time base

Sweep

Ranges: from 0.1 μ s/cm to 0.5 s/cm (21 ranges) in 1, 2, 5 sequence. \pm 4% accuracy with Expander in calibrated position.

Expander: continuously expands sweeps at least 10 times. Maximum usable sweep speed is approx. 20 ns/cm.

Sweep mode: sweep is triggered by internal or external signal. Bright baseline displayed in absence of input signal.

Triggering

Internal: approx. 10 Hz to 15 MHz on signals causing 1 cm or more vertical deflection.

External: approx. 10 Hz to 15 MHz on signals 0.1 V p-p or more.

External input RC: approx. 1 megohm shunted by approx. 20 pF.

Line: triggers on line frequency.

TV sync: separator for + or - video, requires 1 cm of video signal to trigger, automatic frame (0.5 s/cm to 100 μ s/cm) and line select (50 μ s/cm to 0.1 μ s/cm). Usable also as a low-pass filter to reject components above 20 kHz.

Level and slope

Internal: at any point on the positive or negative slope of the displayed waveform.

External: continuously variable from +0.5 V to -0.5 V on either slope of the trigger waveform. \div 10 extends trigger range to +5 V to -5 V.

Cathode-ray tube and controls

Type: mono-accelerator, approx. 2 kV accelerating potential, P31 phosphor. P7 phosphor is available as an Option.

Graticule: 8 \times 10 cm internal graticule; 0.2 cm subdivisions on major horizontal and vertical axes.

Beam finder: returns trace to CRT screen regardless of setting of horizontal and vertical controls.

Probe adjust: approx. 0.5 V p-p, 2 kHz square wave for compensating probe.

Intensity modulation: +5 V (TTL compatible) dc to 1 MHz blanks trace of any intensity. Input R approx. 1 k Ω . Maximum input, 7 V rms.

External horizontal input

Bandwidth: dc to 1 MHz.

Coupling: dc.

Expander	X Mode Attenuator	Deflection Factor
Cal.	1:1	1 V/cm
Cal.	1:10	10 V/cm
cw	1:1	100 mV/cm

Continuous adjustment between ranges by Expander.

Input RC: approx. 1 megohm shunted by approx. 30 pF.

X-Y Phase shift: $<$ 3 $^\circ$ at 100 kHz.

General

Power: 100, 120, 220, 240 V, +5, -10%. 48 to 66 Hz, approx. 35 W.

Weight

1220A: net, 7.3 kg (16 1/4 lb); shipping 9.5 kg (21 lb).

1221A: net, 7.0 kg (15 1/2 lb); shipping, 9.3 kg (20 1/2 lb).

Dimensions: 311.2 mm (12 1/4 in.) wide, 181 mm (7 1/8 in.) high, 412.8 mm (16 1/4 in.) deep overall.

Accessories furnished: one blue light filter, one power cord, fuses for 100, 120 V operation and 220, 240 V operation and one Operating and Service Manual.

Operating environment: temperature, 0 to 55 $^\circ$ C (+32 $^\circ$ F to +130 $^\circ$ F); humidity, to 95% relative humidity at 40 $^\circ$ C (104 $^\circ$ F); altitude, to 4.6 km (15 000 ft); vibration, vibrated in three planes for 15 min. each with 0.254 mm (0.010 in.) excursion, 10 to 55 Hz.

Option 007: P7 phosphor in lieu of P31; amber filter add \$20
Note: probes are not supplied with the 1220A or 1221A, Model 10013A probes are recommended for use with these oscilloscopes.

Model number and name	Price
1220A Dual Channel Oscilloscope	\$750
1221A Single Channel Oscilloscope	\$650



OSCILLOSCOPES

500 kHz general purpose

1200 Series

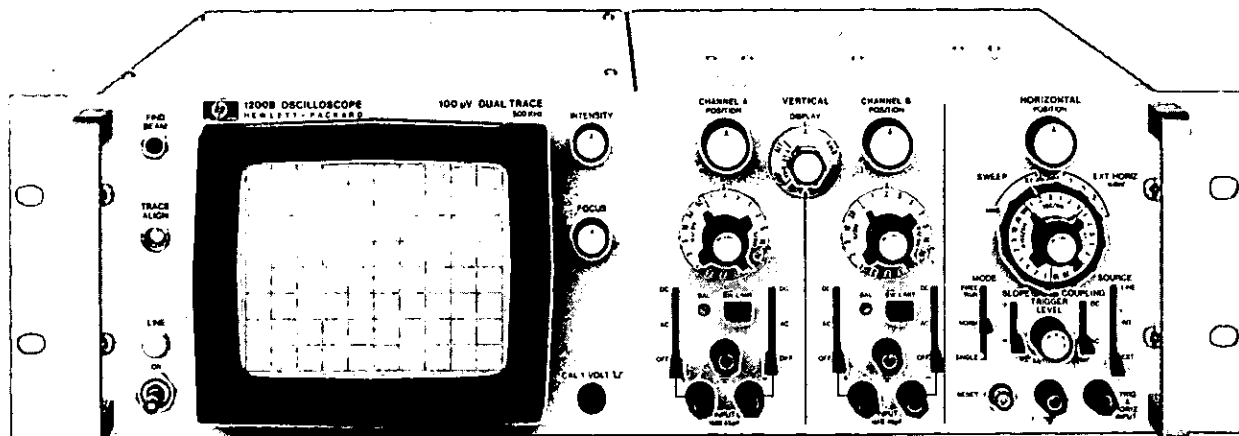

1200B

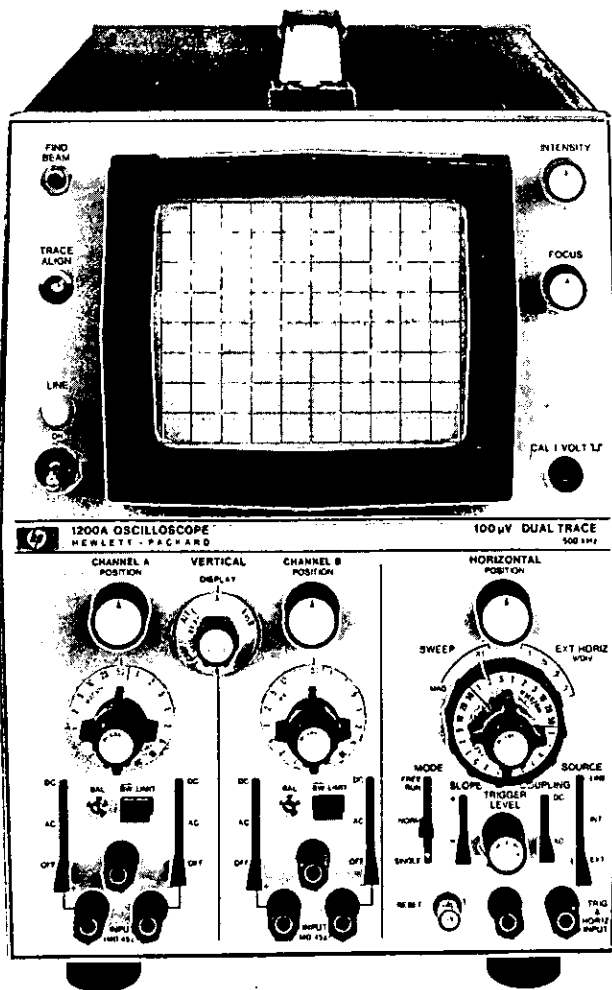

1200A

Feature	1200A/B*	1201A/B*	1205A/B*
Deflection Factor/div	0.1 mV - 20 V	0.1 mV - 20V	5 mV - 20 V
Bandwidth	500 kHz	500 kHz	500 kHz
Number of traces	2	2	2
Differential Input	all ranges	all ranges	all ranges
CMRR	100 dB	100 dB	50 dB
Common-mode Signal Max	±10 V	±10 V	±3 V
Phase Shift (A vs B)	1° to 100 kHz	1° to 100 kHz	1° to 100 kHz
Sweep Speeds/div	1 μs - 5 s	1 μs - 5 s	1 μs - 5 s
Ext. Horiz. Input	yes	yes	yes
DC-coupled Z-axis	yes	yes	yes
Var. Persistence/Storage	no	yes	no

*"A" denotes standard bench model, e.g. 1200A. "B" denotes standard rack model, e.g. 1200B.

1200 Series description

The 1200 series 500 kHz oscilloscopes are versatile general purpose instruments for low frequency applications. These are all solid-state oscilloscopes, light-weight, reliable and stable, which makes them ideal for a variety of applications. The many features of these scopes provide displays that are accurate, versatile, easy-to-obtain and easy-to-read. Logical arrangement of controls, a beam finder to locate off-screen displays, and automatic triggering make operation easy, which is important to persons in production line testing, system applications, and classroom or laboratory instruction.

These dual channel oscilloscopes are available with 5 mV/div or 100 μV/div deflection factors, standard or storage CRTs, and in cabinet or rack configurations. The instruments are light-weight, allowing use in remote or difficult access areas such as: aircraft flight lines, communications field sites, or weapons test sites.

Balanced inputs are provided on all ranges and on each channel which is useful in low level audio applications. Phase shift measurements can be made in the A vs B mode, which displays channel A signal versus channel B signal through identical amplifiers with less than 1° phase shift up to 100 kHz.

Field effect transistors at the vertical amplifier input provide stable, low-drift operation virtually free of annoying trace shifts caused by temperature changes, shock, and vibration. Long term stability also means less frequent calibration and lower periodic maintenance costs.

The common mode rejection ratio is up to 100,000 to 1 (100 dB) in the 1200A/B and 1201A/B models. This high CMRR provides an ac-

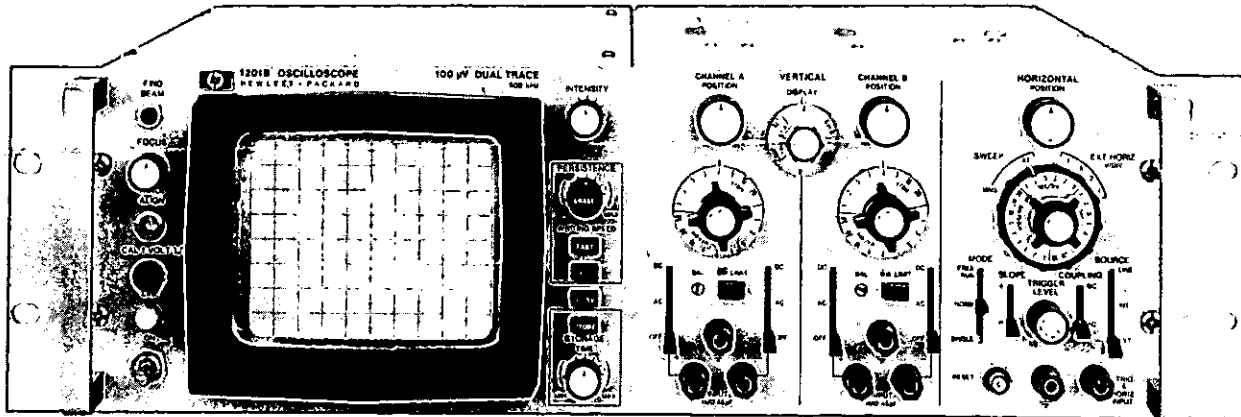

1201B

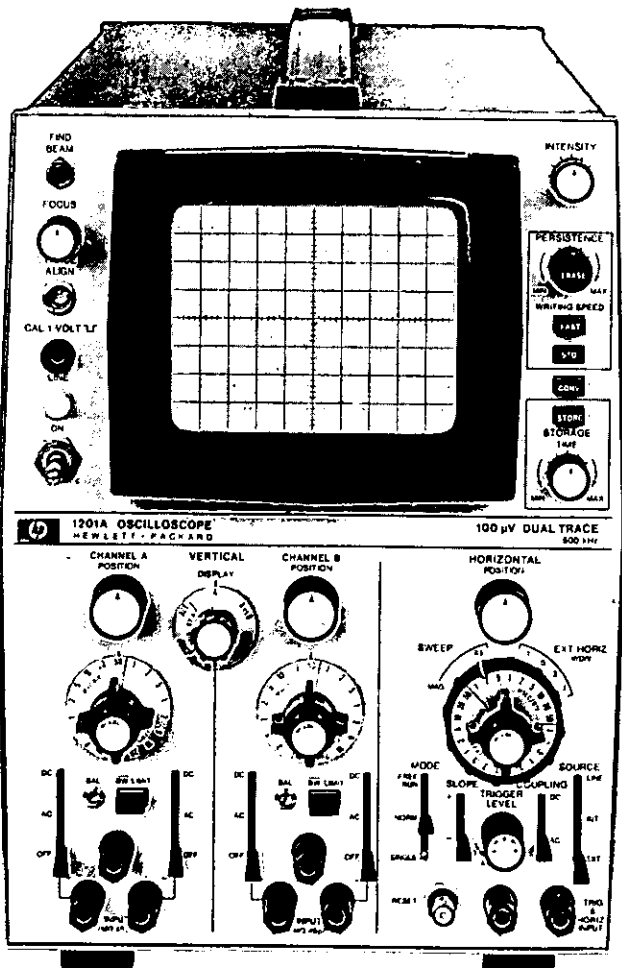

1201A

curate means of measuring the difference between two signals while rejecting those signal components, such as power line hum, common to both inputs.

The rectangular cathode-ray tube has a parallax-free internal graticule to assure accurate measurements. Standard 1200 series oscilloscopes are supplied with P31 phosphor with a selection of optional phosphors available at no extra cost; refer to Options in the specifications.

In applications with displays that occur at slow rates, a storage/variable persistence CRT is available that eliminates annoying flicker and retains single occurrence traces. This longer persistence is useful when displaying slowly moving bio-medical phenomena and in applications where the trace or display information must persist after the excitation is removed. Improvements in target material and processing provide a very rugged storage surface. This highly burn resistant storage surface does not require special operating procedures which increases ease-of-use in low frequency applications.

All 1200 series oscilloscopes have a dc-coupled Z-axis amplifier that allows external modulation of the CRT beam intensity. This allows a display of more information by using changes in intensity to highlight portions of the display or to maintain a constant intensity where the input signal duty cycle changes.

Applications requiring an ac-coupled input are easily filled by adding an external capacitor. And, you can select the capacitor to fit the application rather than adapting to the scope capacitor.

Single, normal, and free run modes of sweep operation are flexible enough for complex measurements, yet operation is simple and straightforward. The sweep time and magnifier controls provide a direct reading of a magnified sweep which reduces the chance of error and time for measurements. An external input to the horizontal deflection system allows the operator to provide external deflection signals for X-Y displays or special sweeps.

The wide dynamic range of the trigger level control allows triggering on any point on an on-screen display or in external on any point up to ± 100 V. Rotating the trigger level control counterclockwise into its detent position selects the auto mode which displays a baseline in absence of a trigger signal. The sweep will automatically synchronize and trigger on most waveforms from 50 Hz to 500 kHz. Auto trigger mode allows the operator to change a trigger signal in amplitude, frequency, or dc-level and remain synchronized without adjusting the trigger level control. The 1200 series oscilloscopes will trigger in Auto or Level mode with a signal of less than 100 mV p-p in external or less than one-half division of vertical display in internal.

Trigger flexibility is expanded by providing a dc or ac-coupled trigger signal of either + or - slopes, from the displayed signal (Int) or from the power line (Line), or from an external input.

Rack versions (designated by a B, "1200B," following the model



OSCILLOSCOPES

1200 Series (cont.)

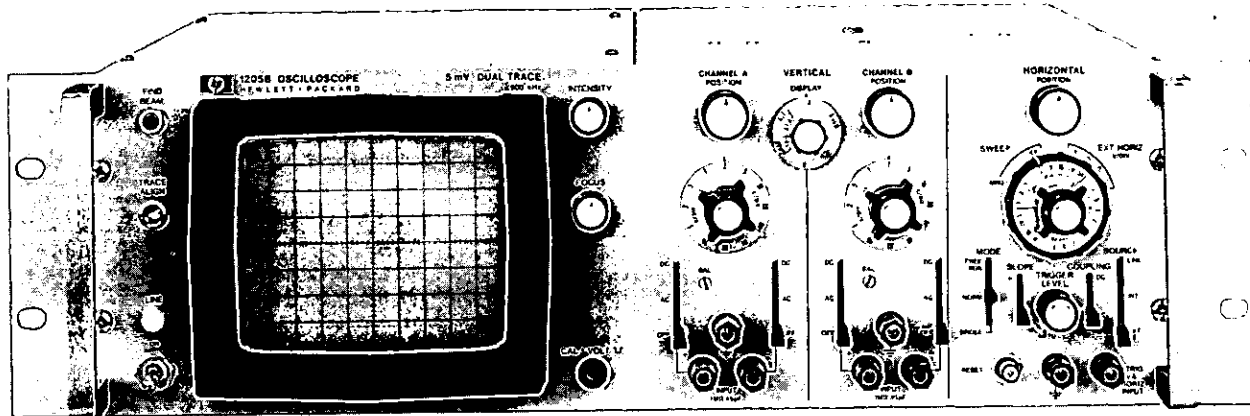

1205B

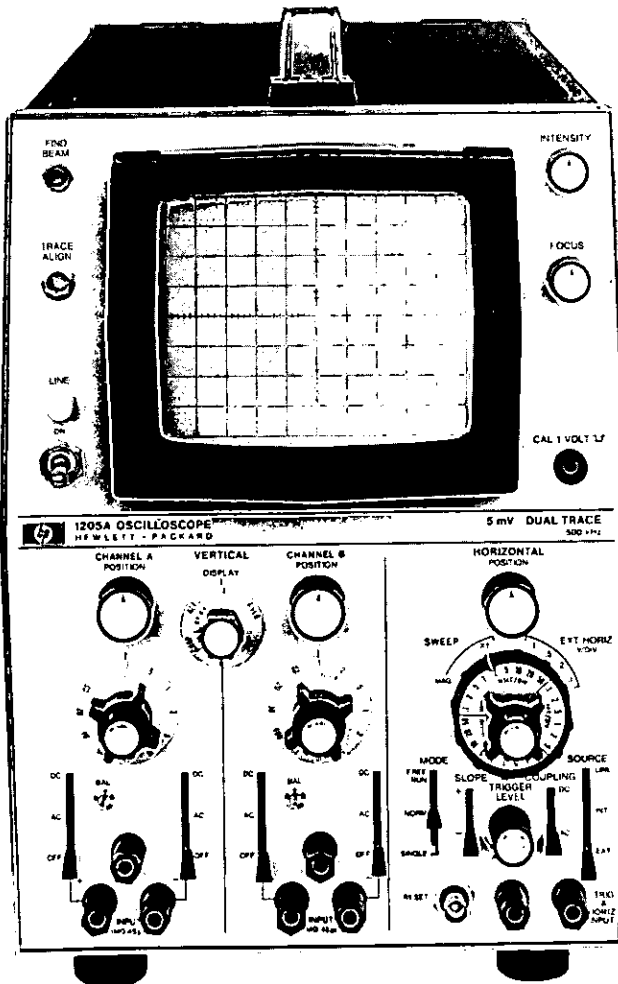

1205A

number) are only 13.34 cm (5 1/4") high which saves valuable rack space and allows more instruments to be included in a rack for a more versatile system. Since these instruments are complete oscilloscopes, they offer the system user a read-out device and a convenient calibration and service tool.

Vertical amplifiers specifications

Modes of operation: Channel A alone; channel B alone; channels A and B (either Chop or Alternate); channels A and B vs horizontal input (Chop only); channel A vs B (A-vertical, B-horizontal). Chop frequency is approx. 100 kHz.

Bandwidth: dc-coupled, dc to 500 kHz; ac-coupled, 2 Hz to 500 kHz. A bandwidth limit switch (1200A/B, 1201A/B) allows selection of upper bandwidth limit to approx. 50 kHz or 500 kHz.

Rise time: 0.7 μ s max.

Deflection factor:

Ranges: 1200A/B, 1201A/B, from 0.1 mV/div to 20 V/div (17 positions) in 1, 2, 5 sequence. 1205A/B, from 5 mV/div to 20 V/div (12 positions) in 1, 2, 5 sequence.

Attenuator accuracy: $\pm 3\%$ with vernier in calibrated position.

Vernier: continuously variable between all ranges; extends maximum deflection factor to at least 50 V/div.

Noise: 1200A/B, 1201A/B, <20 μ V measured tangentially at full bandwidth.

Input: differential or single-ended on all ranges, selectable.

Common mode:

Frequency: dc to 10 kHz on all ranges.

Rejection ratio: 1200A/B, 1201A/B, 100 dB (100,000 to 1) with dc-coupled input on 0.1 mV/div range, decreasing by <20 dB per decade of deflection factor to at least 40 dB on the 0.2 V/div range; 1205A/B, 50 dB with dc-coupled input on 5 mV/div to 0.2 V/div ranges; CMRR is at least 30 dB on the 0.5 V/div to 20 V/div ranges.

Maximum signal: 1200A/B, 1201A/B, ± 10 V (dc + peak ac) on 0.1 mV/div to 0.2 V/div ranges; ± 400 V (dc + peak ac) on all other ranges. 1205A/B, ± 3 V (dc + peak ac) on 5 mV/div to 0.2 V/div ranges; ± 300 V (dc + peak ac) on all other ranges.

Input coupling: selectable AC, DC, or OFF for both + and - inputs.

Input RC: 1 megohm shunted by approx. 45 pF; constant on all ranges.

Maximum input: ± 400 V (dc + peak ac).

Internal trigger source: on channel A signal for A, Chop, and Alternate displays. On channel B signal for B display.

Isolation: >80 dB between channels at 500 kHz, with shielded input connectors.

Phase shift: (channels A vs B) <1° to 100 kHz with verniers in calibrated position.

Time base specifications

Sweep:

Ranges: from 1 μs/div to 5 s/div (21 positions) in 1, 2, 5 sequence. ±3% accuracy with vernier in calibrated position.

Vernier: continuously variable between ranges; extends slowest sweep to at least 12.5 s/div.

Magnifier: direct reading X10 magnifier expands fastest sweep to 100 ns/div with ±5% accuracy.

Automatic triggering:

Baseline is displayed in absence of an input signal.

Internal: 50 Hz to above 500 kHz on most signals causing 0.5 division or more vertical deflection. Triggering on line frequency also selectable.

External: 50 Hz to above 1 MHz on most signals at least 0.2 V p-p.

Trigger slope: positive or negative slope on internal, external, or line trigger signals.

Amplitude selection triggering:

Internal: dc to above 500 kHz on signals causing 0.5 division or more vertical deflection.

External: dc to 1 MHz on signals at least 0.2 V p-p. Input impedance is 1 megohm shunted by approx. 20 pF.

Trigger level and slope: internal, at any point on vertical waveform displayed; or continuously variable from +100 V to -100 V on either slope of the external trigger signal.

Trigger coupling: dc or ac for external, line, or internal triggering. Lower ac cutoff is 2 Hz for external; 5 Hz for internal.

Single sweep: selectable by front panel switch. Reset switch with armed indicator light.

Free run: selectable by front panel switch.

Maximum input: ±350 V (dc + peak ac).

Horizontal amplifier

Bandwidth: dc-coupled, dc to 300 kHz; ac-coupled, 2 Hz to 300 kHz.

Deflection factor: ranges, 0.1 V/div, 0.2 V/div, 0.5 V/div, and 1 V/div; vernier, continuously variable between ranges, extends maximum deflection factor to at least 2.5 V/div.

Maximum input: ±350 V (dc + peak ac).

Input RC: 1 megohm shunted by approx. 20 pF, single-ended.

Cathode-ray tube and controls specifications

Standard CRT, 1200A/B, 1205A/B

Type: mono-accelerator, 3000 V accelerating potential; P31 phosphor standard (refer to Options for other phosphors).

Graticule: 8 × 10 div internal graticule, 0.2 subdivision markings on horizontal and vertical major axes. 1 div = 1 cm.

Variable persistence/storage CRT, 1201A/B

Type: post-accelerator, variable persistence storage tube; 10.5 kV accelerating potential; aluminized P31 phosphor.

Graticule: 8 × 10 div internal graticule, 0.2 subdivision markings on major axes. 1 div = 0.95 cm. Front panel recessed screwdriver adjustment aligns trace with graticule.

Persistence/storage characteristics:

(Referenced to a centered 7 × 9 div area in STD mode and to a cen-

tered 6 × 8 div area in FAST mode.)

Persistence: conventional, natural persistence of P31 phosphor, approx. 40 μs; variable, continuously variable from 0.2 s to >1 min. in STD mode; and from 0.2 s to 15 s in FAST mode.

Storage writing speed: STD mode, 20 div/ms; FAST mode, 0.5 div/μs.

Brightness: 1076 lx (100 fl) in write mode.

Storage time: STD writing speed, variable from approx. 1 min. to >2 hours. Fast writing speed, variable from approx. 15 s to >15 min.

Erase: pushbutton erasure takes approx. 1.2 s. Write gun is blanked and sweep is reset until erasure is completed.

General specifications

Intensity modulation: +2 V signal blanks trace of normal intensity. +8 V signal blanks trace on any intensity. DC-coupled input on rear panel; amplifier rise time approx. 200 ns; input R is approx. 5 kΩ.

Beam finder: returns trace to CRT screen regardless of horizontal or vertical control settings.

Calibrator: 1 V ±1.5% line frequency square wave.

Dimensions:

Cabinet models (designated by A suffix): 211.2 mm wide × 298.5 mm high × 474.7 mm deep (8 1/8" × 11 3/4" × 18 1/8").

Rack models (designated by B suffix): 482.6 mm wide, 132.6 mm high, 433.4 mm deep overall (19" × 5 1/2" × 17 1/8"); 390.5 mm (15 3/8") behind front panel.

Power requirements: 115 V ac ±10%, 48 to 440 Hz; Watts (approx.) 1200A/B, 50 W; 1201A/B, 60 W; 1205A/B, 45 W.

Weight:

1200A, 1205A: net, 11.4 kg (25 lb); shipping, 15.7 kg (34 1/2 lb).

1200B, 1205B: net, 10.2 kg (22 1/2 lb); shipping, 15.9 kg (35 lb).

1201A: net, 13.6 kg (30 lb); shipping, 17.9 kg (39 1/2 lb).

1201B: net, 12.5 kg (27 1/2); shipping, 18.2 kg (40 lb).

Options

Vertical output signals specifications (Opt 015):

Output: 0.3 V/div ±10%, 0 V offset unaffected by position control setting.

Bandwidth: dc to 500 kHz.

Dynamic range: ±3.5 V.

Maximum slewing rate: 12 V/μs with 300 pF load.

Minimum load RC: 10 kΩ shunted by approx. 300 pF.

Source impedance: approx. 300 ohms.

006: rack models only, rear input terminals wired in parallel with front panel vertical and horizontal input terminals add \$60

007: standard CRT only, P7 phosphor in lieu of P31 N/C

009: variable persistence/storage models only, remote erase through rear panel banana jack, shorting to ground provides erasure add \$25

015: vertical channel signal outputs through rear panel connectors add \$100

Model number and name	Price
1200A or 1200B Dual Channel, 100 μV Oscilloscope	\$1250
1201A or 1201B Dual Channel, 100 μV Storage Oscilloscope	\$2250
1205A or 1205B Dual Channel, 5 mV Oscilloscope	\$1150

OSCILLOSCOPES

20 MHz, plug-in oscilloscope

140 Series

- Rugged variable persistence/storage CRT
- Convenient beam finder
- 5 mV/div to 20 MHz
- Dual channel
- Automatic triggering
- Delayed and mixed sweep

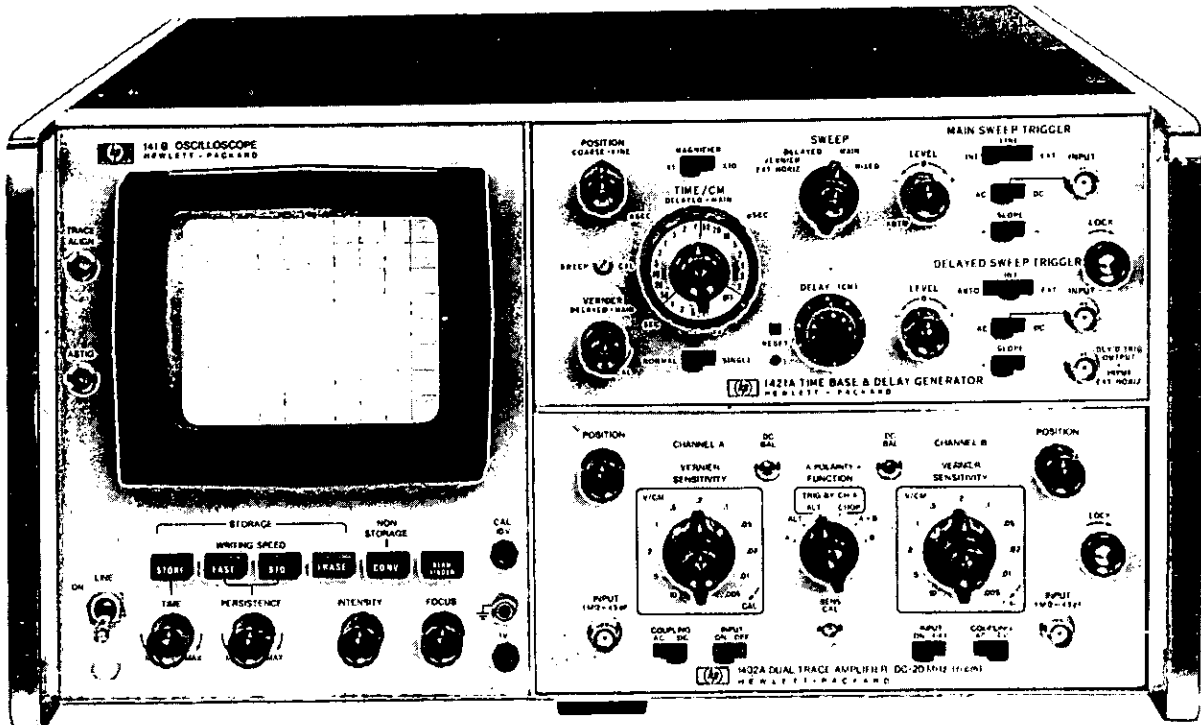

141B Oscilloscope with 1402A Dual Trace Amplifier and 1421A Time Base and Delay Generator.

Hewlett-Packard's 140 Series plug-in oscilloscopes give you proven performance for general purpose measurements in a variety of applications. Logical arrangement of controls, a beam finder to locate off-screen displays, and automatic triggering make these oscilloscopes easy to set up and operate. They are ideally suited for production line testing, systems applications, and classroom or laboratory instruction.

The dual channel vertical amplifier has deflection factors from 5 mV/div to 10 V/div and a bandwidth of 20 MHz. A choice of two time bases allows you to select standard or delayed sweeps. Spectrum analyzer plug-ins are also available; see page 440 for spectrum analyzer information.

140 Mainframes

The 140 Series mainframes contain high quality post-accelerator CRTs which provide a bright clear display. Model 140B has a standard CRT with an 8 x 10 cm internal graticule and Model 141B has a variable persistence and storage CRT. You also get an accurate CRT display reading from any angle with the no-parallax, internal graticule. A convenient beam finder returns a trace to the display area for fast trouble-free set-up.

Variable persistence/storage

The 141B gives you CRT versatility that allows you to match per-

sistence to most any signal. This gives you the capability to use the instrument as a conventional scope, a variable persistence scope or as a storage scope. In addition, the 141B has a highly burn resistant CRT which requires little, if any, more care than a conventional CRT.

The Hewlett-Packard mesh storage tube used in Model 141B offers many advantages. The stored trace has the same high contrast as a conventional CRT. Intermediate trace values stand out clearly so that you can easily distinguish between four or five intensities. Intensity of the 141B CRT can be varied by a front panel control, or modulated externally for X-Y-Z presentation. Maximum viewing intensity in write view mode is 1076 lx (100 f) — many times brighter than bistable phosphor storage tubes. With Hewlett-Packard's mesh storage CRT, trace brightness and writing speed are maintained over the entire life of the tube — specified performance is warranted for one year, just like conventional CRT's.

Variable persistence allows you to build up the brightness of dim traces from low repetition rates signals to an easily viewable display. You can also use variable persistence to eliminate flicker caused by slow sweeps required on slowly changing waveforms. At sweep speeds below 1 ms/div flicker is not only annoying, but also causes eye strain, which makes measurements very difficult. By increasing the persistence you can retain a waveform for as long as you like. You can adjust the persistence, for example, so that one sweep is disappearing from the CRT as the next sweep comes along.

When used as a storage scope, you can capture single shot events,

- Convenient beam finder
- 8x10 cm internal graticule
- 5 mV/div to 20 MHz
- Dual channel
- Sweeps to 20 ns/div
- Trigger hold-off

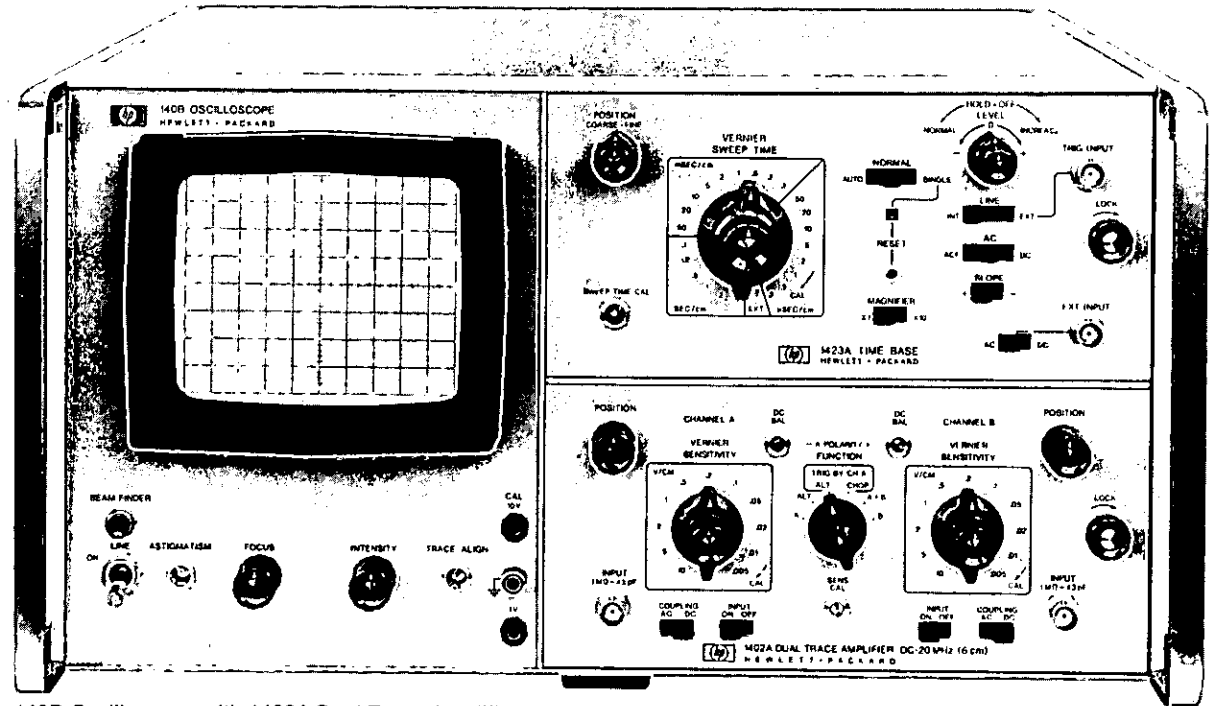

140B Oscilloscope with 1402A Dual Trace Amplifier and 1423A Time Base.

such as noise related transients, or infrequently occurring events, such as random-bit drop-out. Just press STORE and the waveform may be retained for up to one hour. In many applications, this allows you to replace a conventional oscilloscope and camera combination, with its associated inconvenience.

The flexibility and convenience of having storage, variable persistence, and conventional operating capabilities in one instrument are numerous. Typical areas for application include electrical, mechanical, civil, medical, acoustics, biology, chemistry, oceanography, pneumatic, fluid, and many other areas with electronic transducers or electromechanical controls.

140 plug-ins

For wideband real time performance the dual trace 1402A vertical amplifier gives coverage from dc to 20 MHz at 5 mV/div. The 1402A features include algebraic addition, built-in delay line for viewing the leading edge of fast-rise pulses, full 6 div deflection and a wide dynamic range.

Accurate time difference measurements are possible because the sync amplifier in the 1402A can be switched to Channel A alone. This feature is useful when dual traces are displayed on alternate sweeps; switching the sync to Channel A preserves the time relationship between the two signals, because the sweep always triggers on the same point on Channel A. Also, syncing to Channel A when in the chopped dual trace mode assures triggering on the displayed waveform rather

than the chopper. Two unrelated signals can be displayed by triggering on the composite waveform. This feature avoids resorting to external triggering for either of these dual trace presentations.

For easy readability of complex waveforms and accurate time interval measurements, Model 1421A Time Base and Delay Generator provides calibrated time delays from 10 seconds to 0.5 μ s, calibrated sweep speeds from 0.2 μ s/div to 20 ns/div. The 1421A also offers mixed sweep which displays the first portion of a trace at normal sweep speeds, and expands the trailing portion of the trace at a faster delayed sweep speed to allow step-by-step magnified examination.

Model 1423A gives 20 MHz triggering with sweep speeds from 0.2 s/div to 5 s/div. A trigger hold-off control eliminates double triggering on digital waveforms or signals that have the desired trigger level and slope appearing more than once per sweep and maintains a full-screen, calibrated sweep.

A selection of spectrum analyzers with coverage from 20 Hz to 40 GHz further extends versatility of the 140 system. A 140 system display section (mainframe) is combined with a tuning section and IF section to form a complete spectrum analyzer, tailored to your needs. The tuning section determines the frequency range and most of the major specifications; a choice in IF and display section allows you to select the system for your application. See page 440 for information about spectrum analyzers.

For complete 140 real-time system specifications, refer to the 140 System data sheet or contact your Hewlett-Packard Field Engineer.



OSCILLOSCOPES

Probes and other oscilloscope accessories

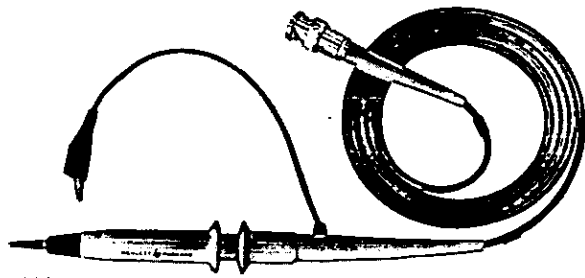

10001A - 10003A

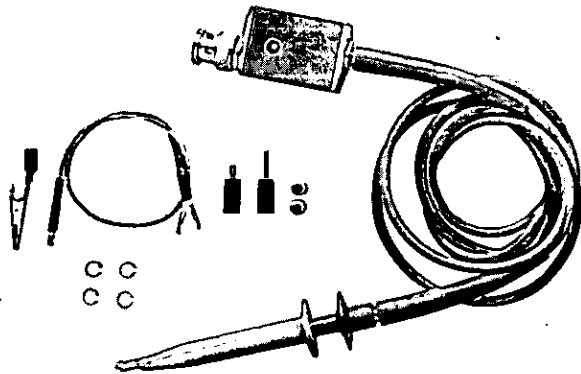

10004D - 10006D, 10014A, 10016A

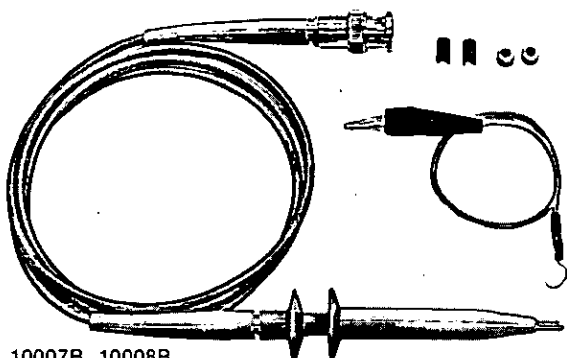

10007B, 10008B

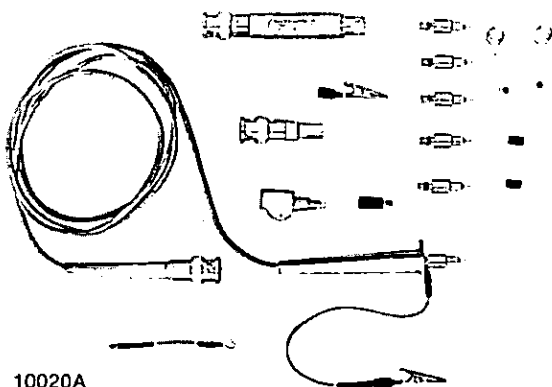

10020A

Probe/instrument compatibility

Scope/ Plug-in	1200 Series	1220A/1221A	1700 thru 1703A	1707B	1710B	1720A	1722A	1402A	1801 thru 1804A	1805A	1806A	1807A	1808A	1809A	1810A	1811A	1815A/B	1830A	1834A	1835A	
Probe																					
10001A	X		L					X	L		X	L									
10001B	X		L					X	L		X	L									
10002A	X		L					X	L		X	L									
10002B	X		L					X	L		X	L									
10003A	X		L					X	L		X	L									
10004D			X	X					X			X									
10005D			X	X					X			X									
10006D			X	X					X			X									
10007B	X		L	L				L	L		X	L									
10008B	X		L	L				L	L		X	L									
10013A	X	X	X	L				X			X										
10014A					X	X	X		X			X	X							X	X
10016A					X	X	X		X			X	X							L	L
10020A					X	X	X		X		X	X	L	L	L	L	L	X	X	X	X
1120A					X	X	X		X		X	X	L	L	L	L	L	X	X	X	X
1124A									L			X	L	L	L	L	L	L	L	L	L
1125A					X	X	X		X		X	X	L	L	L	L	L	L	X	X	X

Notes:

X Indicates that probe will maintain the bandwidth of the instrument.
L Indicates that probe may limit the bandwidth of the instrument.

Voltage divider probe specifications

Model No.	Division Ratio	Resistance MΩ	Shunt Capacitance	Compensates Scope Input Capacities	Peak Volts	Division Accuracy	Overall Length m (ft)	Price
10001A	10:1	10	10 pF	15-55	600	2%	1.5 (5)	\$55
10001B	10:1	10	20 pF	15-45	600	2%	3.0 (10)	\$55
10002A	50:1	9	2.5 pF	15-55	1000	3%	1.5 (5)	\$55
10002B	50:1	9	5 pF	15-55	1000	3%	3.0 (10)	\$55
10003A	10:1	10	10 pF	15-55	600	2%	1.3 (4)	\$55
10004D	10:1	10	10 pF	17-30	500	3%	1.1 (3.5)	\$60
10005D	10:1	10	17 pF	17-30	500	3%	3.0 (10)	\$60
10006D	10:1	10	14 pF	17-30	500	3%	1.8 (6)	\$60
10007B	1:1	-	30 pF	-	600	-	1.1 (3.5)	\$25
10008B	1:1	-	60 pF	-	600	-	1.8 (6)	\$25
10013A	10:1	10	13 pF	30	500	3%	1.8 (6)	\$30
10014A	10:1	10	10 pF	9-13	500	1%	1.1 (3.5)	\$60
10016A	10:1	10	14 pF	9-13	500	1%	1.8 (6)	\$60

10020A Resistive dividers

Division Ratio	Input R* (ohms)	Division Accuracy	Max V** (rms)	Input C (pF)
1:1	50	-	6	-
5:1	250	±3%	9	<0.7
10:1	500	±3%	12	<0.7
20:1	1000	±3%	15	<0.7
50:1	2500	±3%	25	<0.7
100:1	5000	±3%	35	<0.7

*When terminated in 50 ohms.

**Limited by power dissipation of resistive element.

Length (overall): approx. 121.9 cm (4 ft).

Weight: net, 0.45 kg (1 lb); shipping, 1.36 kg (3 lb).

Accessories supplied: blocking capacitor, BNC adapter tip, 6-32 adapter tip, alligator tip, boot extension, cable assy's 5.1 cm (2 in.) and 15.2 cm (6 in.) ground, spanner tip, insulating cap, colored sleeve.

10020A Resistive divider probe kit

\$125

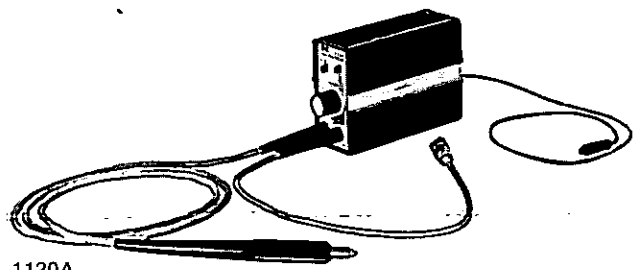

1120A

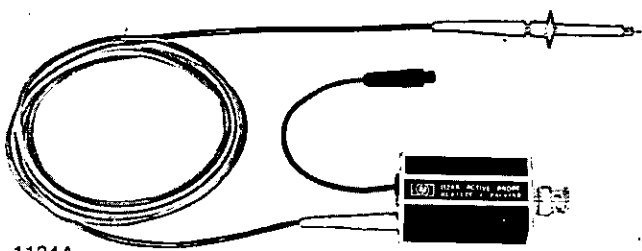

1124A

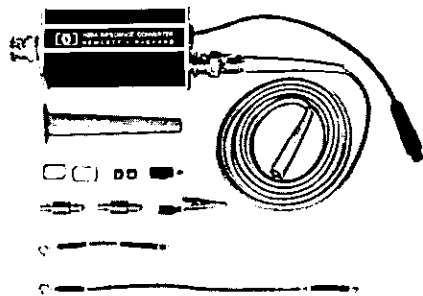

1125A

1120A 500 MHz active probe

(Measured with output connected to a 50 ohm load.)
Bandwidth: (measured from a terminated 50 ohm source) dc-coupled, dc to >500 MHz; ac-coupled, <1.5 kHz to >500 MHz.
Pulse response: (measured from a terminated 50 ohm source) rise time, <0.75 ns; perturbations, <±6% measured with 1 GHz sampler.
Dynamic range: ±0.5 V with ±5 V dc offset.
Noise: approx. 1.5 mV (measured tangentially).
Input RC: 100 kΩ, shunt capacitance approx. 3 pF at 100 MHz; with 10:1 or 100:1 dividers, shunt capacitance is <1 pF at 100 MHz.
Maximum input: ±80 V.
Weight: net, 1.8 kg (4 lb); shipping, 3.2 kg (7 lb).
Power: supplied by oscilloscope plug-ins with probe power jacks or a Model 1122A probe power supply.
Length: 1.3 m (4 ft) overall; with Option 001, 1.8 m (6 ft).

Accessories furnished

Model 10241A 10:1 divider: increases input R to approx. 1 megohm shunted by <1 pF at 100 MHz.
Model 10243A 100:1 divider: increases input R to approx. 1 megohm shunted by <1 pF at 100 MHz.
Model 10242A bandwidth limiter: reduces bandwidth to approx. 27 MHz shunted by approx. 6 pF and reduces gain <2%.
Also included: slip-on hook tip, 6.4 cm (2.5 in.) ground lead, spare probe tips, a slip-on BNC probe adapter, two red ID sleeves, and a probe divider adjustment tool (PN 5020-0570).

1124A 100 MHz active probe

(Measured when connected to a 50 ohm load.)
Bandwidth: (measured from a terminated 50 ohm source) dc-coupled, dc to 100 MHz; ac-coupled, 2 Hz to 100 MHz.

Pulse response: (measured from a terminated 50 ohm source) rise time, <3.5 ns; perturbations, 5% p-p. Measured with pulse rise time of >2.5 ns.

Attenuation ratio: 10:1 ±5%; 100:1 ±5%.
Dynamic range: X10, ±10 V; X100, ±100 V.
Input RC: 10 megohms shunted by approx. 10 pF.
Maximum safe input:

DC-coupled: X10, ±300 V (dc + peak ac) ≤100 MHz; X100 ±500 V (dc + peak ac) ≤100 MHz.
AC-coupled: X10, ±300 V (dc + peak ac) ≤100 MHz. DC component must not exceed ±200 V; X100, ±500 V (dc + peak ac) ≤100 MHz. DC component must not exceed ±200 V.

Accessories supplied: one 20.3 cm (8 in.) ground lead, one retractable hook tip, and two probe tip insulating caps.
Power: supplied by 1800 series plug-ins with probe power jacks or Model 1122A probe power supply.
Weight: net, 0.20 kg (7 oz.); shipping, 0.91 kg (2 lb).
Length: approx. 1.5 m (5 ft) overall.

1125A Impedance converter probe

Attenuation ratio: (oscilloscope gain may be adjusted for 10:1 and 100:1 division ratio) 10.5:1 and 105:1, ±5%.
Dynamic range at probe tip: X10, ±4 V; X100, ±40 V.

Input impedance at probe tip:
High frequency: approx. 500 ohms (X10) or 5 kΩ (X100) shunted by 0.7 pF (in X10 or X100 modes). (See impedance response graph.)
Low frequency: approx. 100 kΩ (dc-coupled). (See impedance response graph.)

Maximum input:
All modes: ±300 V (dc + peak ac) with ±200 V max dc component.
X10: dc to 500 Hz, 200 V rms; decreasing 6 dB per octave to 12 V rms at 10 kHz. ≥10 kHz, 12 V rms is max allowable continuous input.
X100: dc to 1.5 kHz, 200 V rms; decreasing 6 dB per octave to 35 V rms at 10 kHz. ≥10 kHz, 35 V rms is max allowable continuous input.

Bandwidth: (with X10 or X100 tip and supplied 1.3 m (4 ft) cable).

DC-coupled: dc to 250 MHz.
AC-coupled: 20 Hz to 250 MHz.

Pulse response in X10 or X100: ≤±5% perturbations measured from a terminated 50 ohm source.

Accessories supplied: one 1.3 m (4 ft) 50 ohm cable, one X10 divider tip, one X100 divider tip, one rigid boot extension, two red color coding sleeves, two clear plastic insulating caps, two jade gray insulating caps, one 5.1 cm (2 in) 6-32 ground lead, one 15.2 cm (6 in.) 6-32 ground lead, one 6-32 alligator tip and one 6-32 alligator tip.
Power: supplied by instruments with probe power jacks or a Model 1122A probe power supply.
Length: approx. overall length, 147.3 cm (58 in.).
Weight: net, 0.2 kg (7 oz); shipping, 0.9 kg (2 lb).

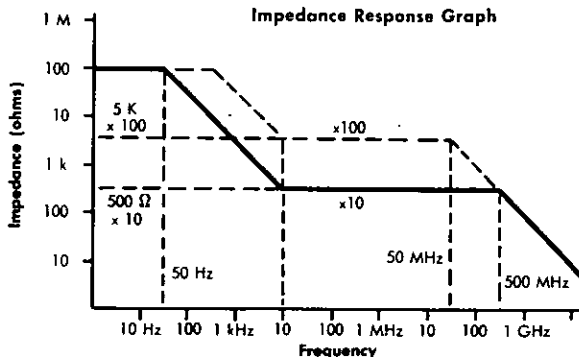

Model number and name	Price
1120A 500 MHz Active Probe	\$475
1120A Opt 001, 1.8 m (6 ft) length	add \$25
1124A 100-MHz Active Probe	\$160
1125A Impedance Converter Probe	\$175

Probes, other accessories (cont.)

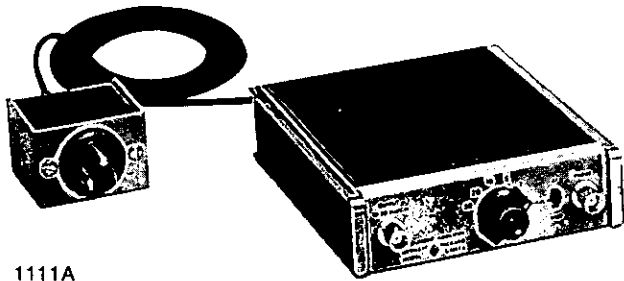

1111A

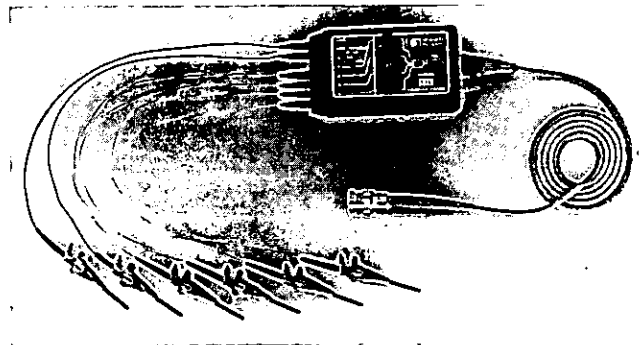

10250A

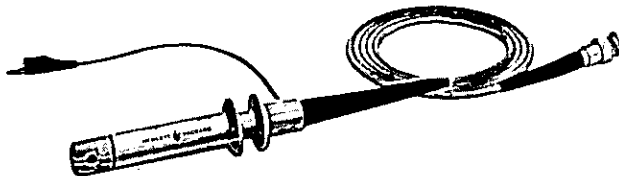

1110A

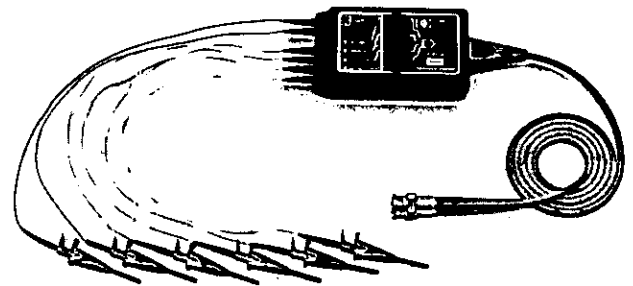

10251A

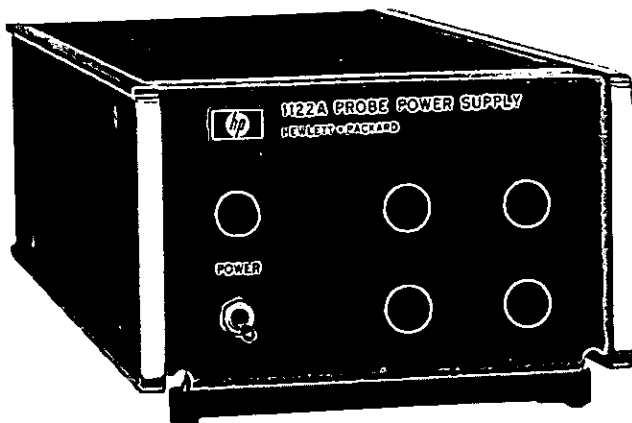

1122A

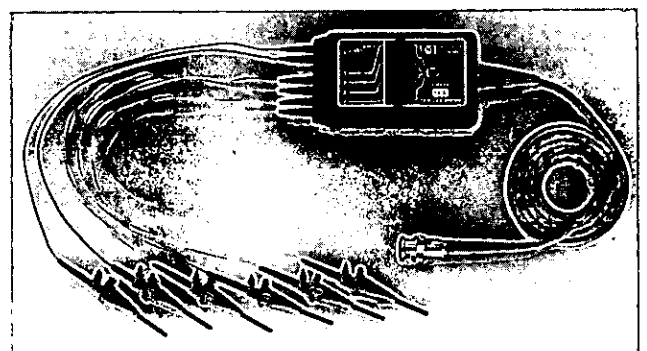

10252A

1111A AC current amplifier

Deflection factor: (with a 50 mV/div oscilloscope deflection factor) in X1, 1 mA/div to 50 mA/div; in X100, 100 mA/div to 5 A/div; 1, 2, 5 sequence in X1 or X100.

Accuracy: in X1, $\pm 3\%$; in X100, $\pm 4\%$.

Rise time: 18 ns.

Noise: $< 100 \mu\text{A}$ p-p, referenced to input signal.

Maximum ac current: above 700 Hz, 50 A p-p; below 700 Hz, decreases at 1.4 A/20 Hz.

Output impedance: 50 ohms.

Dimensions: 38.1 mm high, 130.2 mm wide, 152.4 mm deep ($1\frac{1}{2} \times 5\frac{1}{4} \times 6$ in.).

Weight: net, approx. 0.91 kg (2 lb); shipping, 1.36 kg (3 lb).

Power: 115 or 230 V $\pm 10\%$, 50 to 400 Hz, 1.5 watts.

1110A Current probe

Sensitivity: without 100 ohm termination, 1 mV/mA, with 100 ohm termination, 0.5 mV/mA.

Accuracy: ±3%.

Bandwidth

Lower -3 dB point: without 100 ohm termination, 1700 Hz; with 100 ohm termination, 850 Hz.

Upper -3 dB point: with 4 pF capacitive load, >45 MHz; with 30 pF capacitive load, 35 MHz.

Rise time: with 4 pF capacitive load, 7 ns; with 30 pF capacitive load, 9 ns.

Insertion impedance: approx. 0.01 ohm shunted by 1 μH; capacitance to ground <3 pF.

Maximum dc current: 0.5 A.

Maximum ac current: 15 A p-p above 4 kHz; decreasing below 4 kHz at 3.8 A/kHz rate.

Weight: net, 0.14 kg (5 oz); shipping, 0.91 kg (2 lb).

Dimensions: probe aperture, 3.9 mm (3/32 in.) diameter; overall length, 1.5 m (5 ft).

1122A Probe power supply

Probe driving capability: up to four Hewlett-Packard active probes.

Power output: -12.6 and +15 V, ±3%.

Power input: 115 V or 230 V ±10%, 48 to 440 Hz, 40 W (with four probes).

Weight: net, 2.4 kg (5 1/4 lb); shipping, 3.63 kg (8 lb).

Accessories supplied: four 10131B 91.4 cm (36 in.) extender cables.

Digital trigger probes

Models 10250A (TTL), 10251A (MOS), and 10252A (ECL) Trigger Probes are useful service, production, and design trouble-shooting tools that offer digital pattern triggering to enhance the use of oscilloscopes, logic analyzers, and other test equipment. With the 4-bit trigger probe, you trigger on four parallel events. The four inputs may be switched to HI, LO, or OFF (don't care) for convenient selection of the trigger point. No separate power supply is needed because probe power is obtained from the circuit under test.

The trigger output signal goes high when the preset trigger word occurs and remains high as long as the trigger conditions are present. The amplitude is sufficient to trigger many types of external test equipment. A glitch filter is designed into the 10250A probe which can eliminate the effect of short duration glitches on external test equipment with variable trigger input level. This feature is made possible by the exponential increase in probe output between 3 and 5 volts which allows you to adjust the trigger level above short duration glitches so that external test equipment is not triggered. Electrical measurements that were almost impossible to make in complex digital sequences are now easy.

Small, dual purpose probes simplify connection in compact circuits and directly connect to dual-in-line packages and back-plane pins. The probes are small enough to connect to adjacent pins on DIPs and the tips can be slipped off the probe wire for direct connections to 0.6 mm (0.025 in.) square pins, IC test clips, and wire wrap pins.

10250A Specifications

Input:

Low level: 0.8 V (-0.6 V min); -0.8 mA max at 0.4 V (0.5 standard TTL load).

High level: 2 V (5.0 V max); 100 μA max at 2 V.

Output:

Swing: 0.5 V to 4.5 V min into 1 megohm.

Transition time: 7 ns max from 0.6 V to 1 V; 50 ns min to 4 V with 1 megohm, 20 pF load.

Delay:

Propagation: 30 ns max from any input to trigger output.

Difference: 10 ns max between any two inputs.

Power (supplied by circuit under test):

Voltage: +5 V ±5%; -0.4 V to +7 V max.

Current: 30 mA max; normal operation, 17 mA.

Operating environment: temperature, 0 to 55°C (+32°F to +130°F); humidity, to 95% relative humidity at 40°C (104°F); altitude, to 4.6 km (15000 ft); vibration, vibrated in three planes for 15 min. each with 0.254 mm (0.010 in.) excursion, 10 to 55 Hz.

Overall length: Approx. 168 cm (66 in.).

Accessories included: Six miniature probe tips, one Operating Note, and one vinyl carrying case.

10251A Specifications

Input:

Threshold: (V+ plus V-) ÷ 2, ±20% of (V+ minus V-).

Output:

Swing: V- plus 20% of (V+ minus V-) to V+ minus 20% of (V+ minus V-) min into 1 megohm.

Delay (with specified threshold voltages):

Propagation: 350 ns max at 5 V, 210 ns max at 10 V; from any input to trigger output.

Difference: 70 ns max at 5 V, 35 ns max at 10 V; between any two inputs.

Power (supplied by circuit under test):

Voltage: between +3 V and +15 V (V+ minus V-).

Current: 5 mA max.

Operating environment: temperature, 0 to 55°C (+32°F to +130°F); humidity, to 95% relative humidity at 40°C (104°F); altitude, to 4.6 km (15000 ft); vibration, vibrated in three planes for 15 min. each with 0.254 mm (0.010 in.) excursion, 10 to 55 Hz.

Overall length: approx. 168 cm (66 in.).

Accessories included: Six miniature probe tips, one Operating Note, and one vinyl carrying case.

10252A Specifications

Input:

Low level: approx. (V+ minus 1.6 V).

High level: approx. (V+ minus 0.9 V).

Output:

Swing: 0.5 V p-p.

Transition time: 12 ns max with 1 megohm, 20 pF load.

Delay:

Propagation: 20 ns max from any input to trigger output.

Difference: 5 ns max between any two inputs.

Power (supplied by circuit under test):

Voltage: 5.2 V ±10%; ±7 V max.

Current: 70 mA max.

Operating environment: temperature, 0 to 55°C (+32°F to +130°F); humidity, to 95% relative humidity at 40°C (104°F); altitude, to 4.6 km (15000 ft); vibration, vibrated in three planes for 15 min. each with 0.254 mm (0.010 in.) excursion, 10 to 55 Hz.

Overall length: approx. 168 cm (66 in.).

Accessories included: six miniature probe tips, one Operating Note, and one vinyl carrying case.

Model number and name	Price
Model 1111A Current Amplifier	\$295
Model 1110A Current Probe	\$150
Model 1122A Probe Power Supply	\$325
Model 10250A TTL Trigger Probe	\$150
Model 10251A MOS Trigger Probe	\$150
Model 10252A ECL Trigger Probe	\$150



OSCILLOSCOPES

Probes, other accessories (cont.)

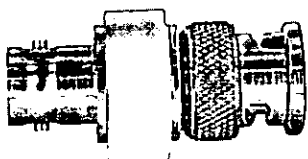

10100C

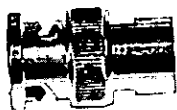

10011B

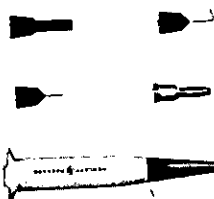

10035A

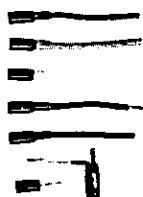

10036A

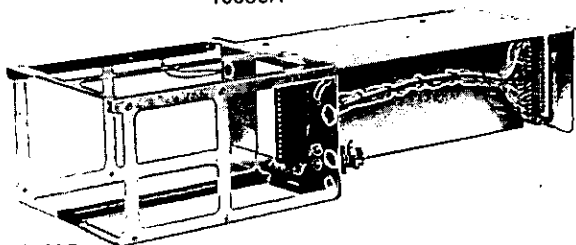

10407B



226A

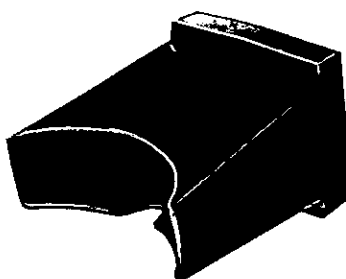

10176A

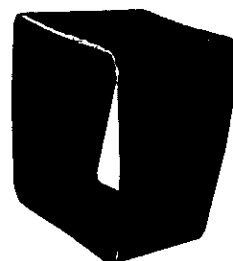

10116A



10166A

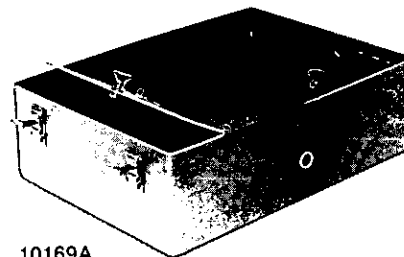

10169A

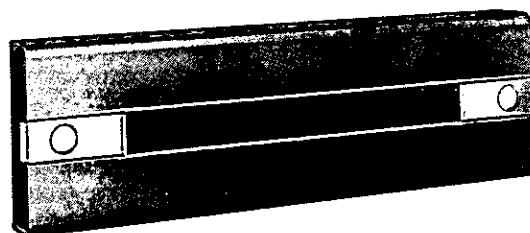

5060-0437

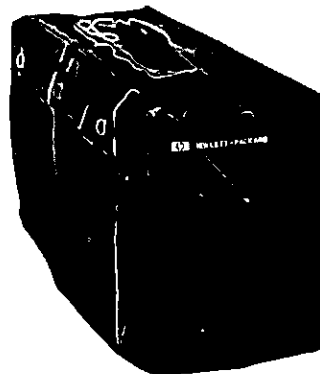

10167A

Probe accessories

Terminations

Model 10100C: 50 ohm feedthrough.

Model 10100B: 100 ohm (± 2 ohm) feedthrough for 1110A current probe.

Probe tips

Model 10010C BNC adapter tip: for probes 10001A-10003A.

Model 10011B BNC adapter tip: for probes 10004D-10006D, 10007B, 10008B, 10014A, 10016A, and 1124A.

Probe tip kits

Probe tip kits, Models 10036A and 10037A, extend usefulness of 10004D, 10005D and 10006D probes. Model 10036A consists of an assortment including tips for the following: 2.0 mm (0.08 in.) jack; 0.6 mm (0.025 in.) and 11.4 mm (0.045 in.) square pin; 1.0 mm-1.6 mm (0.040-0.062 in.) dia pin; and a long pin tip. Model 10037A contains six 0.6 mm (0.025 in.) square pin tips. Probe tip kit, Model 10035A for 10001A-10003A probes contain pincer jaw, banana tip, pin tip, and spring tip.

Calibration and service accessories

Plug-in extender

Model 10407B: 180 system extender (metal frame extends both plug-ins). Allows calibration and maintenance while a unit is operating.

226A Time mark generator

Model 226A is a high quality, time mark generator that provides 30 precision time intervals for calibrating oscilloscope time bases. Marker intervals are in a convenient 1, 2, 5 sequence that matches the sweep time settings on oscilloscopes. A single, easy-to-read front panel rotary switch provides easy use without confusing nomenclature.

Ranges: from 2 ns to 10 s (30 ranges) in 1, 2, 5 sequence.

Output: +1 V peak into 50 ohms. 28 intervals from 10 ns to 10 s. Sine wave output on 2 and 5 ns ranges provides 1 V into 50 ohms.

Accuracy: $\pm 0.005\%$, 0°C to $+55^\circ\text{C}$; $\pm 0.002\%$ at 25°C after 1/2 hour warmup.

Trigger frequency: same as time mark to 100 ns, 10 MHz for all ranges faster than 100 ns.

Programming (optional): all ranges are programmable, requires 6 parallel lines (6 bit word) and 2 timing lines, TTL compatible.

Dimensions: 114.3 mm high, 196.9 mm wide, 203.2 mm deep (4.5; 7.75; 8 in.).

Weight: net, 3.2 kg (7 lb); shipping, 4.1 kg (9 lb).

Power: 115 or 230 V $\pm 10\%$, 48 to 440 Hz; approx. 25 watts.

Model number and name	Price
10100C 50 ohm Feedthrough Termination	\$20
10100B 100 ohm Feedthrough Termination	\$22
10010C BNC Adapter Tip	\$15
10011B BNC Adapter Tip	\$10
10035A Probe Tip Kit	\$8
10036A Probe Tip Kit	\$30
10037A Probe Tip Kit	\$20
10407B Plug-in Extender	\$125
226A Time Mark Generator	\$735
226A Option 003, TTL compatible programming	add \$155

Viewing accessories

Viewing hoods

10176A: viewing hood for 12.7 cm (5 in.) rectangular CRT bezels.

10104A: collapsible viewing hood for 1700 series oscilloscopes.

10116A: collapsible light shield for 1220A/1221A oscilloscopes.

10190A: light shield for large screen 182 oscilloscopes.

Light filters

10178A: metal mesh for 181, 183, 184 oscilloscopes.

10115A: blue light filter for 1700 series oscilloscopes.

Amber plastic filter: HP P/N 5020-0530, for 12.7 cm (5 in.) rectangular CRT.

Blue plastic filter: HP P/N 5060-0548, for 12.7 cm (5 in.) rectangular CRT.

Smoke gray plastic filter: HP P/N 5020-0567, for 12.7 cm (5 in.) rectangular CRT.

Model number and name

Model number and name	Price
10176A Viewing Hood for 12.7 cm (5 in.) rect. CRT	\$15
10104A Viewing Hood for 1700 oscilloscopes	\$15
10116A Light Shield for 1220A/1221A oscilloscopes	\$10
10190A Light Shield for 182 oscilloscopes	\$10
10178A Filter, mesh contrast/RFI for 181,183,184 mainframes	\$20
10115A Filter, blue contrast for 1700 oscilloscopes	\$3
Amber plastic filter (HP P/N 5020-0530) for 12.7 cm (5 in.) rect. CRT	\$2.75
Blue plastic filter (HP P/N 5060-0548) for 12.7 cm (5 in.) rect. CRT	\$3.40
Smoke gray plastic filter (HP P/N 5020-0567) for 12.7 cm (5 in.) rect. CRT	\$5.40

Rack mount slides and adapters

Slides are available for mounting modular and rack style oscilloscopes. A slide adapter is required to secure an oscilloscope to the slides.

140 series modular oscilloscopes

Slide adapter kit: HP P/N 1490-0721 \$40

Fixed slides: HP P/N 1490-0714 \$55

Pivot slides: HP P/N 1490-0718 \$60

180, 181, and 184 rack style oscilloscopes

Fixed slides, 22-in.: HP P/N 1490-0714 \$55

Pivot slides, 22-in.: HP P/N 1490-0719 \$60

183 rack style oscilloscopes

Pivot slides, 24-in.: HP P/N 1490-0924 \$58

Slide adapter for 180 series: HP P/N 1490-0768 \$33

Protective covers

Models 10166A and 10169A provide front panel protection and space for probe and accessory storage for 180, 181, 183, 184 and 1200 series cabinet style oscilloscopes.

10166A: for 180, 181, 183, 184 cabinet oscilloscopes \$45

10169A: for 1200 series cabinet oscilloscopes \$40

A rack style metal front panel cover is available to fit 180, 181, 183 or 184 rack model oscilloscopes. Order HP P/N 5060-0437.

Flexible covers for 180 series cabinet oscilloscopes provide protection during transportation or storage. A slotted cover top allows access to the scope handle and a pocket on one side is included for accessories.

10167A: for 180, 181, or 184 cabinet models \$35

10170A: for 183 cabinet models \$35

10172A: for 182 models \$35

OSCILLOSCOPES

Cameras for display recording

Models 123A, 195A & 197A

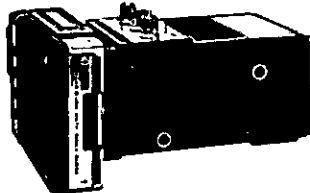

123A

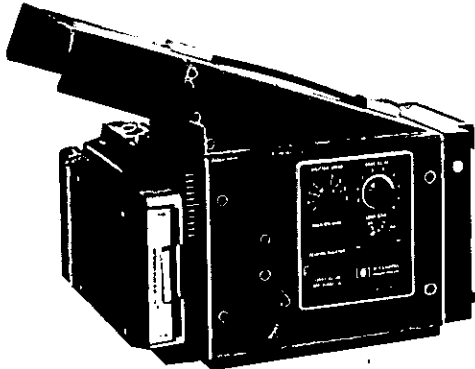

197A

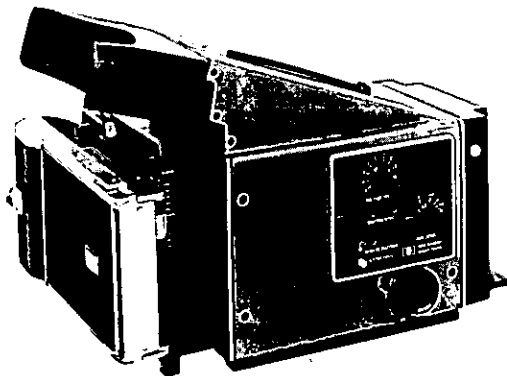

195A

123A Description

Model 123A is a lightweight compact camera which adapts with ease to most Hewlett-Packard oscilloscopes and displays. The camera does not require external power and only weighs 1.6 kg (3½ lb) making it ideal for use in field applications. The 123A has a range finder for easy focusing using a split image technique. This range finder also serves as a viewing port so that you can make minor CRT intensity and graticule illumination adjustments with the camera in place. For convenience in setting up the display the camera has a swing-away feature allowing full visibility of the CRT screen. Controls are color coded for optimum settings and are located outside of the camera for easy reading and fast adjustment to reduce initial setup time.

The reduction ratio (i.e. object-to-image ratio) may be easily set from 1:1 to 1:0.65 by an external adjustment. Synchronization contacts are also provided for use with other equipment.

The 123A mounts directly or with adapters to the oscilloscopes as listed in the oscilloscope/camera adapter table.

123A Specifications

Reduction ratio: continuously adjustable from 1:1 to 1:0.65.

Lens: 56 mm, f/3.5 lens; aperture ranges f/3.5, f/4, f/5.6, f/8, f/16, and f/22.

Shutter speeds: 1/60, 1/30, 1/15, 1/8, 1/4, 1/2, and 1 seconds, Time and Bulb. Cable has thumbscrew lock for time exposures. X-type contacts provided to trigger or synchronize other equipment with shutter release.

Graticule illumination: supplied by the oscilloscope or oscilloscope adapter.

Camera back: 82.6 mm × 108.0 mm (3¼ in. × 4¼ in.) Polaroid® pack back.

Mounting: lift on/off mounting with positive lock. Mounts directly on most HP 1700 series oscilloscopes. Adapters are available to fit other scopes, see Camera accessories.

Range finder: viewing port provides split image of the CRT to allow setting of the focus.

Viewing: range finder viewing port allows viewing the CRT with camera in position. Camera swings away for wide angle viewing.

Focus: adjustable with camera back closed or open; split image focusing plate provided for use when object-to-image ratio is changed.

Dimensions: 220 mm long, 122 mm high, 192 mm wide (8½, 4½, 7½ in.).

Weight: net 1.6 kg (3½ lb); shipping, 2.3 kg (5 lb).

Accessories furnished: combination split image focusing plate and reduction ratio scale, and instruction manual.

“Polaroid”® by Polaroid Corp.

197A Description

Model 197A is a versatile, general purpose oscilloscope camera that can be used for many trace recording applications. All controls are located outside of the camera for easy reading and fast adjustment during set-up. The controls are also color coded for optimum settings for most photos which reduces initial set-up time.

An electronically-controlled shutter, with all solid-state circuits for reliable operation, provides accurate exposure times from 1/30 to 4 seconds. The shutter may be operated remotely by providing a closure to ground and a contact closure is provided when the shutter is open to allow synchronization of other equipment.

The 197A can be directly mounted on most Hewlett-Packard oscilloscopes with 12.7 cm (5 in.) CRTs and will also swing away from the CRT for easy trace viewing. Adapters are available for many other oscilloscopes.

The reduction ratio (i.e., object-to-image ratio) may be varied from 1:1 to 1:0.7 with a screwdriver adjustment. This allows the optimum amount of a graticule to be photographed, which is useful when making multiple exposures or when used on different size graticules. The camera can be quickly focused to match the reduction ratio with the split-image focus plate supplied with the camera.

A technique that enhances the quality of trace photos is built into the 197A camera. A low power ultra violet (UV) light is used to expose the black graticule lines on internal graticule CRT's. The UV light causes the CRT phosphor to glow over its entire surface for optimum trace, background, and graticule contrast. Another feature incorporated using the UV light is a “flash” position which automatically turns the light on for one second. This is useful with long exposure times since the trace and graticule are recorded in a single exposure with optimum trace and graticule illumination.

The 197A camera is supplied with an 82.6 mm × 108.0 mm (3¼ in. × 4¼ in.) Polaroid pack back. The back may be rotated 90° from the



normal horizontal position to a vertical position and can be moved through 11 detented positions for multiple exposures. The back may also be replaced with a Graflok® back which allows use of cut or roll film. A Polaroid roll back is also available which allows roll film with an ASA 10 000 equivalent rating to be used for fast transient trace recording.

“Graflok”® by Graflex, Inc.

197A Specifications

Reduction ratio: continuously adjustable from 1:1 to 1:0.7. Reference scale provided on focus plate.

Lens: 75 mm, f/1.9 high transmission lens; aperture ranges f/1.9 to f/16.

Shutter speeds: 1/30, 1/15, 1/8, 1/4, 1/2, 1, 2, 4 seconds, Time and Bulb; shutter has a sync contact closure output for triggering external equipment and an input jack for remote operation.

Graticule illumination: provided internally with ultra violet light with variable intensity control and OFF, FLASH, ON switch.

Camera back: 82.6 mm × 108.0 mm (3¼ in. × 4¼ in.) Polaroid pack back (other backs are available, see Options); backs may be interchanged without focusing and may be rotated in 90-degree increments.

Mounting: lift on/off mounting with positive lock, swing-away hinging to left. Mounts directly on most HP oscilloscopes with 12.7 cm (5 in.) round or rectangular CRTs. Adapters are available to fit many other scopes.

Viewing: low-angle, direct viewing through a flexible facemask.

Multiple exposure: back can be moved through 11 detented positions (½ cm per detent at 1:0.9 object-to-image ratio).

Focus: adjustable focusing with lock; split image focusing plate provided.

Dimensions: 356 mm long, 267 mm high, 194 mm wide (14, 10½, 7¾ in.).

Weight: net, 4.5 kg (10 lb); shipping, 7.3 kg (16 lb).

Power: 115 V ± 10%, 48 to 440 Hz, 6 watts.

Accessories furnished: combination split image focusing plate and reduction ratio scale, 2.3 m (7.5 ft) power cord and instruction manual.

Options

001: without ultra violet light.

003: Graflok back in place of pack back (on initial order).

004: Polaroid roll film back in place of pack back (on initial order).

012: factory wired for 230 V operation.

195A Description

Model 195A is a high speed trace recording camera for photographing fast rise time low repetition rate waveforms. A high quality 80 mm, f/1.3 lens with a 2:1 reduction ratio provides the high light transmission required for fast transient photography.

An electronically-controlled shutter, with all solid-state circuits for reliable operation, provides accurate exposure times from 1/30 to 4 seconds. The shutter may be controlled remotely with a closure to ground and a contact closure is provided when the shutter is open to allow synchronization of other equipment.

The 195A can be directly mounted on all Hewlett-Packard oscilloscopes with 12.7 cm (5 in.) CRTs and will also swing away from the CRT for easy trace viewing. Adapters are available for many other oscilloscopes.

The 195A 80 mm, f/1.3 lens allows capturing high sweep speed, single-shot displays with the high light gathering capability of its 1:0.5

object-to-image ratio. Also, by rotating the back, you have the capability of placing two separate images on one sheet of film.

Normally the 195A is used with Hewlett-Packard oscilloscopes that have an internal flood gun for graticule illumination and to increase the effective film writing speed.

A Polaroid roll film back is supplied with the 195A camera which allows either 3000 ASA or 10 000 ASA film to be used. The roll film back may also be replaced with a Polaroid Pack film back or a 10.2 cm × 12.7 cm (4 in. × 5 in.) Graflok back for using cut or roll film.

195A Specifications

Reduction ratio: 1:0.5 fixed.

Lens: 80 mm, f/1.3 high transmission lens; aperture ranges from f/1.3 to f/11.

Shutter speeds: 1/30, 1/15, 1/8, 1/4, 1/2, 1, 2, 4 seconds, Time and Bulb; shutter has a sync contact closure output for triggering external equipment and an input jack for remote operation.

Shutter open indicator: provides visual indication when shutter is open and shutter speed control is set to T, B, and all other shutter speeds except 1/15 and 1/30 seconds.

Graticule illumination: normally supplied by HP oscilloscopes with internal flood gun. Optional ultra violet internal light is available, see Options.

Camera back: Polaroid roll film holder supplied (other backs are available, see Options); backs may be interchanged without focusing and may be rotated in 90-degree increments.

Mounting: lift on/off mounting with positive lock; swing-away hinging to left. Mounts directly on most HP oscilloscopes with 12.7 cm (5 in.) round or rectangular CRTs. Adapters are available to fit many other scopes, see oscilloscope/camera adapter table.

Viewing: low-angle, direct viewing through a flexible face mask.

Multiple exposure: back can be moved through 11 detented positions at 0.45 cm per detent.

Focus: adjustable focusing with lock; split image focusing plate provided.

Power: 115 V ± 10%, 48 to 440 Hz, approx. 6 watts.

Dimensions: 368 mm long, 267 mm high, 248 mm wide (14½, 10½, 9¾ in.).

Weight: net, 5.4 kg (12 lb); shipping, 8.2 kg (18 lb).

Accessories furnished: combination split image focusing plate and reduction ratio scale, 2.3 m (7½ ft) power cord, and instruction manual.

Options:

001: with ultra violet light.

002: Graflok back in place of roll back (on initial order).

003: Polaroid pack back in place of roll back (on initial order).

004: factory wired for 230 V operation.

Model number and name

Model number and name	Price
123A Oscilloscope Camera	\$475
197A Oscilloscope Camera	\$725
Option 001: without ultra violet light	less \$50
Option 003: Graflok back (on initial order)	N/C
Option 004: Polaroid roll film back (on initial order)	N/C
Option 012: factory wired for 230 V operation	N/C
195A High Speed Oscilloscope Camera	\$1110
Option 001: with ultra violet light	\$60
Option 002: Graflok back (on initial order)	N/C
Option 003: Polaroid pack back (on initial order)	N/C
Option 004: factory wired for 230 V operation	N/C

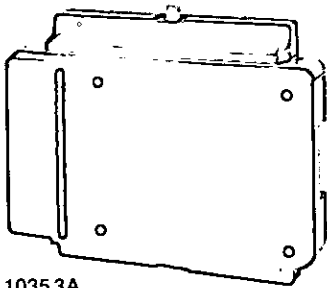

10353A

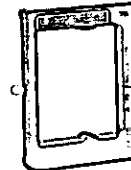

10106A

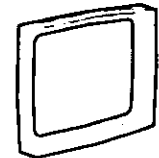

10366B

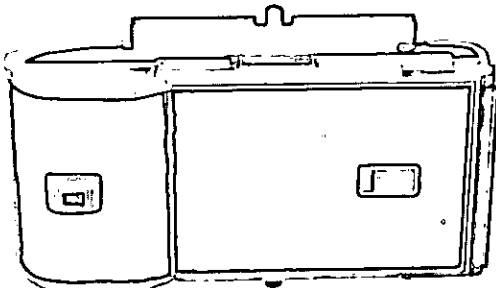

10365A

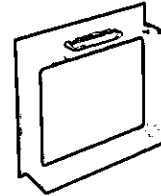

10367A

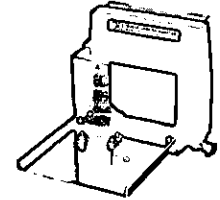

10369A

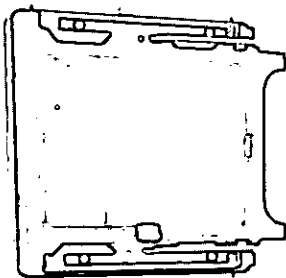

10352B

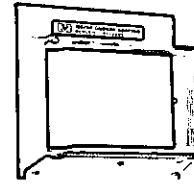

10370A

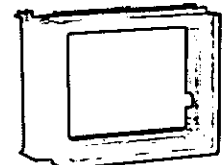

10371A

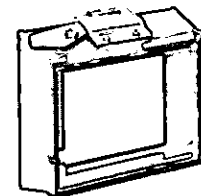

10372A

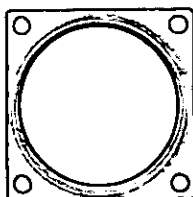

10355A

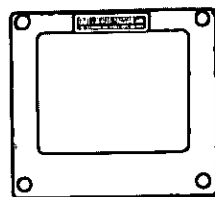

10356A

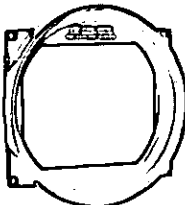

10360A

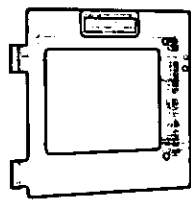

10361A

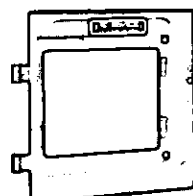

10362A

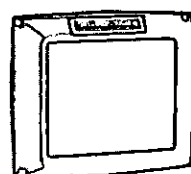

10363A

Film backs for 195A and 197A cameras

These film backs provide added flexibility of performance and selection of film for optimum trace photos to fit many applications. Model 195A has the Polaroid Roll Film back and the 197A has the Polaroid Pack Film back as standard equipment. Any of these backs may be ordered initially as options at no extra charge or may be ordered separately to fit a variety of applications.

10353A Pack film back: uses Polaroid Land Film, 82.6 mm × 108.0 mm (3¼ in. × 4¼ in.), with eight exposures.

10365A Roll film back: uses Polaroid Land Film, 82.6 mm × 108.0 mm (3¼ in. × 4¼ in.), with eight exposures. This back allows a selection of 3000 and 10 000 ASA film for general purpose or high-speed trace photography.

10352B Grafflok back: requires a film holder available from local camera stores. The back accepts Polaroid Land 101.6 mm × 127.0 mm (4 in. × 5 in.) film holder, standard cut-film holders, film-pack adapters, and roll film holders.

Camera bezel adapters

Hewlett-Packard Models 195A and 197A cameras directly fit HP 127.0 mm (5 in.) rectangular and round CRT oscilloscopes and can be mounted on many other oscilloscopes by using bezel adapters (see oscilloscope/camera adapter table). HP Model 123A camera attaches directly to most 1700 series oscilloscopes and can also be adapted to other oscilloscopes (see oscilloscope/camera adapter table).

10355A: adapts 195A and 197A cameras to Tektronix and Fairchild/Dumont 127.0 mm (5 in.) round bezels.

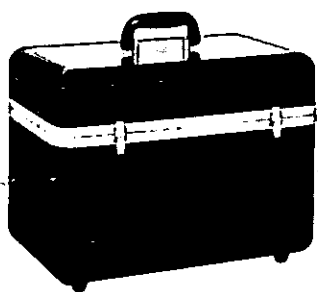

10358B

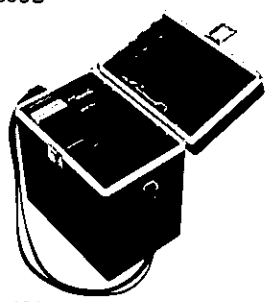

10374A

- 10358A:** adapts 195A and 197A cameras to Tektronix 560 Series rectangular bezels.
- 10360A:** adapts 196A/B camera to Hewlett-Packard 127.0 mm (5 in.) rectangular CRT.
- 10361A:** adapts Tektronix C12 camera to Hewlett-Packard 127.0 mm (5 in.) rectangular CRT.
- 10362A:** adapts Tektronix C27 camera to Hewlett-Packard 127.0 mm (5 in.) rectangular CRT.
- 10363A:** adapts Tektronix C30A, C31, C32, or C40 cameras to Hewlett-Packard 127.0 mm (5 in.) rectangular CRT.
- 10106A:** adapts Tektronix C30A, C31, C32, or C40 cameras to most Hewlett-Packard 1700 series oscilloscopes.

- 10366B:** adapts 195A and 197A cameras to HP display models 1330A/1331A (serial prefix 1110A and above) and 1331A (serial prefix 1116A and above). For lower serial prefix numbers contact your Hewlett-Packard Field Engineer.
- 10367A:** adapts Models 195A and 197A cameras to Model 182 oscilloscope.
- 10369A:** adapts 123A camera to Hewlett-Packard 127.0 mm (5 in.) rectangular CRT (180 series).
- 10370A:** adapts 123A camera to Hewlett-Packard 182 large screen CRT.
- 10371A:** adapts 123A camera to Tektronix 422/453/454/485 oscilloscopes.
- 10372A:** adapts 123A camera to Tektronix 465/475.
- 10373A:** adapts 123A camera to Hewlett-Packard 1220A/1221A.

Carrying cases

- 10358B:** constructed of fiberglass and aluminum with padding for protection during transit. The carrying case will accommodate the 195A or 197A cameras.
- 10374A:** carrying case for 123A camera with storage space for 1 pack of film.

Model number and name	Price
10353A Pack Film Back	\$120
10365A Roll Film Back	\$130
10352B Graflok Back	\$120
10355A Camera Adapter	\$25
10356A Camera Adapter	\$25
10360A Camera Adapter	\$25
10361A Camera Adapter	\$25
10362A Camera Adapter	\$25
10363A Camera Adapter	\$30
10106A Camera Adapter	\$25
10366B Camera Adapter	\$15
10367A Camera Adapter	\$30
10369A Camera Adapter	\$45
10370A Camera Adapter	\$25
10371A Camera Adapter	\$25
10372A Camera Adapter	\$30
10358B Carrying Case	\$95
10374A Carrying Case	\$30

Oscilloscope/Camera Adapter Table ¹																					
OSCILLOSCOPE	CAMERA																				
	HEWLETT-PACKARD	HEWLETT-PACKARD					TEKTRONIX INC.				DUMONT										
	123A	195A	*196A/B	197A	*198A	C12	C27	C30A/31/32/40	C50 Series	450A-1	453A-1	450A-7B	321A								
5-in. Round CRT	—	Direct	Direct	Direct	Direct	—	—	—	—	Direct	Direct	Direct	Direct								
175A Only	—	Direct	Direct	Direct	Direct	—	—	—	—	10360A	10360A	10360A	10360A								
5-in. Rectangular CRT	10369A	Direct	10360A	Direct	Direct	³ 10361A	³ 10362A	10363A	10363A	10360A	10360A	10360A	10360A								
182	10370A	10367A	—	10367A	—	—	—	—	—	—	—	—	—								
1220A/1221A	10373A	—	—	—	—	—	—	—	—	—	—	—	—								
1330/1331 ²	—	² 10366B	—	² 10366B	² 10366B	—	—	10363A	—	—	—	—	—								
1332A	—	—	—	—	—	7	7	7	Direct	—	—	—	—								
1700 Series ⁶	Direct	—	—	—	—	—	—	10106A	—	—	—	—	—								
TEKTRONIX INC.⁵																					
5-in. Round 549	—	10355A	10355A	10355A	10355A	Notes 1. This chart only includes HP adapter and camera compatibility, for other combinations contact your Field Engineer. 2. 1330A/1331A serial prefixes 1110A and above and 1331C serial prefix 1116A and above require 10366B adapter. For lower serial prefixes contact your HP Field Engineer. 3. The 10361A and 10362A adapter hinge mounts interfere with the Find Beam pushbutton on 180 mainframes. 4. Model 196A/B and 198A cameras are no longer in production. 5. No adapters are available for mounting HP cameras on Tektronix Inc. 5100 and 7000 series oscilloscopes. 6. 1700 Series with 6 × 10 div CRT's. 7. Tektronix Inc. cameras with adapters for 7000 series scopes can be used with HP 1332A Display.															
5-in. Rect. & 560 Series	—	10356A	—	10356A	10356A																
529 Series	—	10356A	—	10356A	10356A																
465/475	10372A	—	—	—	—																
422/453/454/485/323/324	10371A	—	—	—	—																
DUMONT																					
5-in. Round CRT	—	10355A	Direct	10355A	10355A																

CATHODE-RAY TUBE DISPLAYS

Displays for OEM applications



Hewlett-Packard's cathode-ray tube displays are high-performance instruments with bright, high quality readouts which are ideal for both end user and OEM applications. These displays are complete units which include the cathode-ray tube, vertical and horizontal deflection amplifiers, a video (Z-axis) amplifier, and high and low voltage power supplies.

Yokeless, electrostatic deflection in HP displays provides increased writing speeds and reduced power requirements when compared to magnetic deflection displays. The most important advantage of electrostatic deflection is that characters and vectors can be written about ten times faster than with customary magnetic displays.

Half-rack displays

Model 1332A is a high resolution, high brightness display with a 158.8 mm (6 1/4 inch) diagonal CRT which is only 133.4 mm (5 1/4 in.) high. The 1332A is designed to meet the stringent requirements of medical diagnostic and instrumentation system applications.

The major features in the 1332A include a small crisp spot size that varies by no more than 10% over the quality area; multiple gray levels with focus independent of intensity setting; high stability of position, gain, and brightness; regulated CRT filament voltage to eliminate light output variations with changes in line voltage; large 115 cm² display area; bright 22.5 kV CRT; and Underwriters Laboratories Listing.

One application of the 1332A is in conjunction with the Scintillation Camera (Gamma Camera). This medical diagnostic system uses the 1332A to display the output of a special nuclear detector that is sensitive to radiation emitted from a patient's body. In this case, radioactive isotopes introduced into the blood stream are selectively absorbed by different cells. The difference in radiation levels are displayed as concentrations of dots that show up on film as intensity modulation. The 1332A's high resolution, light output uniformity, and stable light output give clear time exposure photographs necessary for diagnosis by the medical specialist.

Another application requiring stable CRT light output for long scan periods is in Medical Thermography. In this diagnostic technique, a very sensitive infrared detector scans the body to detect skin temperature. Similar to other applications, the stable light output and focus permits time exposure photographs to accurately map a profile of skin temperature.

5 MHz bandwidth, large display area, and excellent picture quality make the 1332A ideal for use in instrumentation systems. System applications include display monitors, nuclear spectrometers, swept frequency measurements, frequency ratios, spectrum analysis, Fourier analysis, spectrophotometry, chemical analysis, and nuclear magnetic resonance.

Storage displays

Models 1331A and 1331C are ideal for displaying alphanumeric and graphic data in either stored or refreshed modes of operation. The mesh type storage tube used in these displays eliminates the need for external circuitry to constantly refresh the displays.

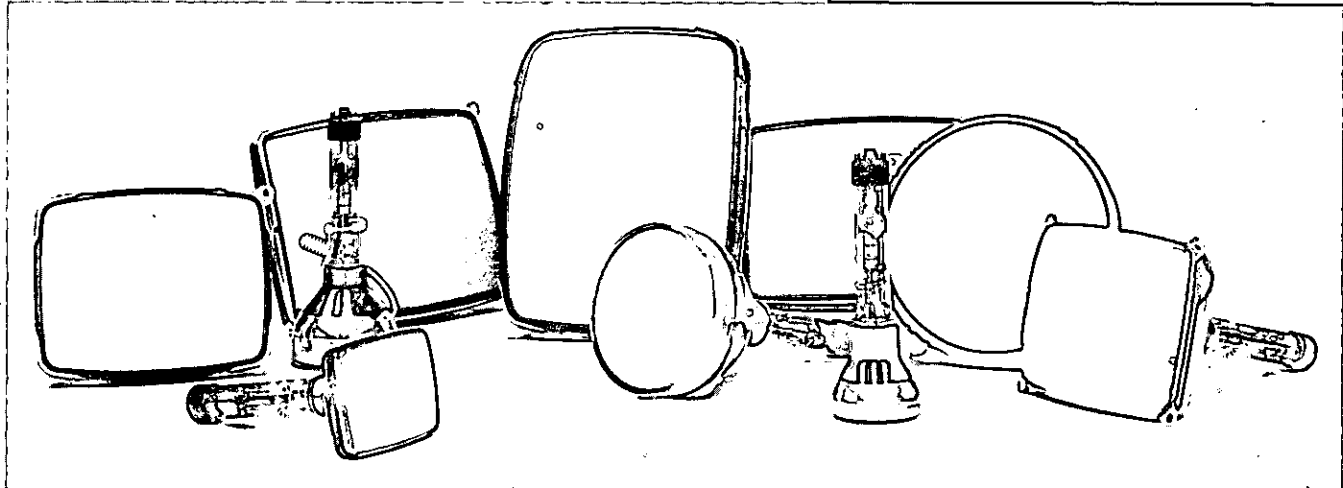
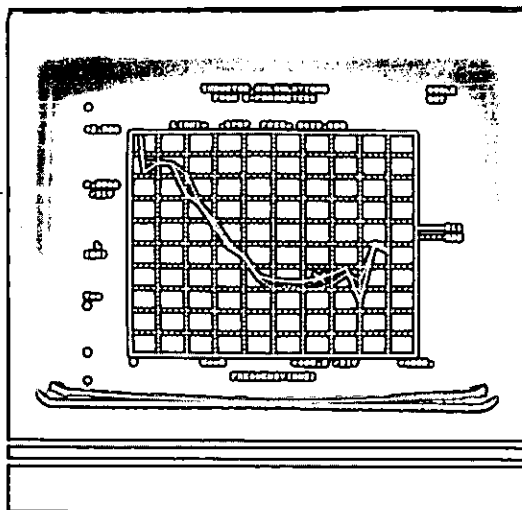
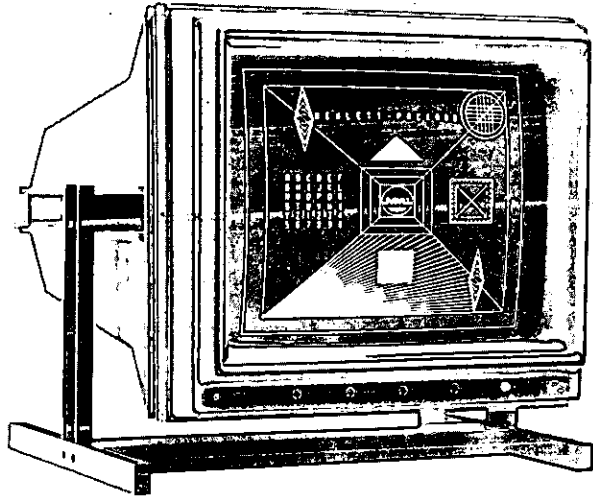

Model 1331A has convenient front panel controls for manual operation of X-Y position and storage parameters when not controlled by the system. Model 1331C has rear panel controls and a programming connector for remote programming in computer or graphic display systems.

Large screen displays

Five large screen graphic displays are available for OEM computer graphic and instrumentation applications. Linear writing speed, in these displays, is an unmatched 25.5 cm/μs (10 in./μs) for visible writing and is capable of slew rates in excess of 255 cm/μs (100 in./μs) when the spot does not have to be seen. These speeds are attained with a yokeless, electrostatic deflection system which consumes much less power than the multiwinding coils of magnetic deflection systems. Overall power consumption of these displays is a low 100 watts compared to 500 or more for others. Additionally, the much faster response of electrostatic deflection permits as much as 10 times the amount of information

to be displayed as that of magnetic displays.

Fast amplifier response (5 MHz bandwidth) and electrostatic CRT deflection also simplifies system programming since vectors and characters can be written randomly from anywhere in the display area in less time than the sequential programming necessary for raster scan magnetic displays. Since coils are not used for deflection, no delay line is needed to properly synchronize Z-axis blanking with spot movement thus eliminating the possibility of display smearing and also making the display easier to interface with a system.

Model 1321A has a 533 mm (21 inch) diagonal display with excellent geometry and linearity and a small 0.51 mm (0.020 inch) spot size. The large 305 x 305 mm (12 x 12 inch) quality area is ideal for presenting complex graphic information while using the additional viewing area for character writing.

Model 1317A is a 432 mm (17 inch) diagonal display which is the largest X-Y display presently made that mounts directly in a 482.6 mm (19 inch) rack with its long CRT

axis horizontal. This large, high resolution display is ideal for the readout in computer graphic and instrumentation systems, since it mounts directly in standard 482.6 mm (19 inch) EIA racks.

Models 1310A (482.6 mm, 19 inch, diagonal) and 1311A (355.6 mm, 14 inch, diagonal) displays are housed in attractive plastic covers which when ordered with a tilt stand, make them ideal for table top applications.

20 MHz display

Model 1300A has an extremely wide dc to 20 MHz bandwidth in the X, Y, and Z amplifiers which is ideal for high speed graphic and analog system displays. The 203.2 x 254 mm (8 x 10 inch) viewing area with a bright display provides the resolution needed in many system applications.

Fast, 20 ns rise time, 200 ns settling time, and 80 ns point plotting time allow rapid switching of input data without flicker. This, coupled with less than 0.15% repeatability error and 1% linearity, provides accurate graphic displays even with several unsynchronized multiplexed inputs.

CATHODE-RAY TUBE DISPLAYS

High resolution OEM system display

Model 1332A

NEW

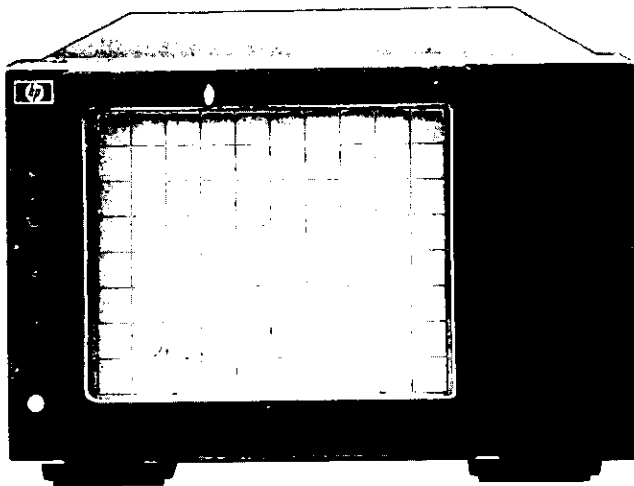

1332A Description

Model 1332A is an exceptional cathode-ray tube display which is capable of meeting a wide variety of OEM medical and electronic instrument display needs. The cathode-ray tube has the resolution and picture quality required for medical diagnostic systems plus an extremely bright display needed for differentiating between many gray shades. Electrical performance has been extended to 5 MHz to meet the display needs of today's OEM systems and digital processors. The 1332A (Opt. 330) is listed with Underwriters Laboratories in accordance with the UL 544 Medical Safety Standard which defines detailed patient protection requirements.

The 133.4 mm high (5 1/4 in.) half-rack width frame houses a large cathode-ray tube (114 cm²), X and Y deflection circuits, a wide-band blanking (Z-axis) amplifier, and high and low voltage power supplies. A number of Options are available to allow the OEM user to tailor the 1332A to fit a particular application.

Picture clarity

Spot resolution is an unmatched 0.305 mm (0.012 in.) diameter at high intensity levels and remains extremely well focused over the entire range of intensity levels. This resolution makes the 1332A well suited for applications requiring sharp focusing on multiple gray shades with frequent video drive level changes. Spot resolution, within the quality area, varies by less than 10% making the display especially useful in applications where sharp focus is required throughout the quality area. An example of this is where alphanumeric characters are mixed with traces, curves or graphs.

In some applications it is important for the light emitted from the various areas of the phosphors to be matched within some specified uniformity. The 1332A has this important parameter specified. In addition, the specified light output stability (drift) includes the Z-axis amplifier. Applications requiring a high degree of uniformity are usually associated with the integration of random dots or scans on photographic film such as in medical diagnosis.

Cathode-ray tube

The Model 1332A has a post deflection accelerator CRT with an accelerating potential of approximately 22.5 kV to assure a bright crisp display under many operating conditions. An aluminized layer is deposited behind the phosphor to distribute the PDA voltage and serves to increase the overall trace brightness by reflecting the light that would ordinarily be lost inside the tube. In addition, the opaque aluminum layer prevents light from the CRT filament from reaching photographic film when integrating video information during time exposures.

Low power filaments operate from a regulated high voltage power supply to assure a constant light output under varying line voltages and frequencies. This low power CRT filament operation also reduces stray grid emissions associated with high temperature cathodes.

Electronics

The X and Y amplifiers have 70 ns rise time (bandwidth is 5 MHz) and the Z-axis blanking amplifier has a 25 ns rise time. If faster X and Y amplifier response is required, an Option is available to obtain 25 ns rise times. All amplifiers employ fully differential designs that operate at exceptionally low power levels for stable, drift free performance over wide ranges of operating temperatures.

The time required to make any size movement on the CRT, including the response time for the amplifiers to settle within one spot diameter of final position, is less than 300 ns. This means that many thousands of vectors and characters can be written on the display without flicker.

Circuit options

Options are available for selection of input deflection factors, polarity, impedance, blanking range, and light output characteristics of the Z-axis and CRT. An optional TTL Z-axis input permits direct operation from a TTL digital source. Since the TTL input unconditionally overrides the analog Z-axis input, this option can be used for CRT protection.

Many graphic applications require intensity compensation for different vector lengths. A gamma correction option is available to equalize the video amplifier gain so that the CRT light output is linearly related to the input video signal.

OEM features

The 133.4 mm high (5 1/4 inch) mechanical frame has a very low profile while housing a CRT with a display area approximately 50% larger than a 127 mm (5-inch) diagonal CRT display. The mechanical frame, designed by Hewlett-Packard, offers the OEM user maximum utility and flexibility. Empty half width modules equal in size to the 1332A are available to form an attractive full width package with an integrated appearance. The empty module is ideal for your custom designed circuits and also contains a built-in locking mechanism housing for your custom designed plug-in. Rack mounting hardware, front handles, and slides are available to complete the OEM package.

All frequently used controls are adjustable from the front panel for maximum accessibility when the 1332A is mounted in a rack, cabinet, or system. The most frequently used controls such as intensity, focus, and position have knobs while infrequently used controls such as astigmatism, trace align, and X and Y gain are screwdriver adjustments. A front panel door covers the controls to reduce the possibility of untrained operators misadjusting them. The ac line switch is mounted on the rear panel which prevents inadvertent turn off and assures that the display has power when the system is turned on.

1332A Specifications

Vertical and horizontal amplifiers

Response:

Rise time: ≤ 70 ns (10% to 90% points) for full screen deflection or less.

Bandwidth: dc to approx. 5 MHz for 7.6 cm (3 in.) deflection.

Phase shift: $< 1^\circ$ dc to 1 MHz (measured with X and Y gain set to maximum).

Deflection factor:

Horizontal: 100 mV/div (1 V p-p for 10 div deflection). Front panel adjustable from approx. 80 mV/div to 200 mV/div. 1 div = 1.2 cm (0.47 in.).

Vertical: 100 mV/div (0.8 V p-p for 8 div deflection). Front panel adjustable from approx. 80 mV/div to 200 mV/div. 1 div = 1.2 cm (0.47 in.).

Settling time: signal settles to within one spot diameter of final value in < 300 ns for any large or small screen movement. Off screen deflection not to exceed specified dynamic range.

Inputs: rear panel BNC connectors with shield grounded. Full differential inputs available.

Input RC: approx. 1 megohm shunted by <60 pF.
Maximum input: ±50 V (dc + peak ac).
Polarity: positive vertical input moves beam up; positive horizontal input moves beam right.

Position: front panel controls adjust zero input to an offscreen position in any direction from anywhere within the viewing area. Beam position with both inputs shorted (0 V into X and Y amplifiers) and position control electrically centered is in the geometric center of display area.

Dynamic range: at least ±1.5 screen diameters from center screen.
Crosstalk: <0.254 mm (0.010 in.) with one input terminated in 50 ohms and the other driven by a 1 V, 500 kHz signal. <0.38 mm (0.015 in.) at 5 MHz, driven from a 50 ohm source.

Drift:
Position: ≤0.5 mm/hr (0.020 in./hr) and ≤1.02 mm (0.040 in.) in 24 hr with covers installed after 15 min. warmup.
Gain: <1.0% under all combinations of specified line voltage with covers installed after 15 min. warmup. Temperature between +20°C and +55°C.

Common mode rejection ratio: at least 40 dB (100:1) up to 10 kHz for 1 V (full screen) inputs; at least 25 dB (18:1) at 1 MHz for 1 V (full screen) inputs.

Z-axis amplifier
Rise time: <25 ns; CW bandwidth approx. 5 MHz.
Blanking range: 0 to 1-V.
Blanking polarity: +1 V into positive input fully unblanks CRT.
Input: rear panel BNC connector with shield grounded. Full differential input available.

Input RC: approx. 1 megohm shunted by <60 pF.
Maximum input: ±50 V (dc + peak ac).
Gain: internally adjustable over 2.5:1 attenuation ratio.
Light output stability (drift): spot photometer measurements of light output made at one hour intervals will not vary more than 10% from previous measurement for any location within the usable display area, under all specified conditions of line voltage and temperature with intensity set to >5% of peak brightness.

Cathode-ray tube
Type: post deflection accelerator, approx. 22.5 kV accelerating potential, aluminized P31 phosphor, electrostatic focus and deflection.
Viewing area: 114 cm² (17.67 in.²) approx. 9.6 cm (3.8 in.) vertically by 11.9 cm (4.7 in.) horizontally.
Quality area: center 9 div horizontally and center 7 div vertically.
Graticule: 8 × 10 div internal graticule. 1 div = 1.2 cm (0.47 in.).
Resolution:
Spot size: ≤0.3 mm (0.012 in.) at center screen. Does not vary by more than 10% over entire quality area with intensity held constant. Measured using shrinking raster method. Line resolution is approx. 31.5 lines/cm (80 lines/in.).

Light output
Line brightness: at least 50 fl at a writing speed of 0.254 cm/μs (0.1 in./μs), 60 Hz refresh rate, P31 phosphor, 0.3 mm (0.012 in.) spot size.
Uniformity: light output of spots located anywhere in the quality area does not vary by more than 40%.

Geometry: <3% pincushion and barrel distortion over usable display area.
Linearity: <3% of full scale along major axes.
Contrast ratio: 4:1 or greater. Measured by photometrically summing the trace brightness and background, then dividing by the background brightness.

Safety protection
Implosion: transparent safety panel between CRT and bezel protects viewer.

High voltage shock: Anode lead is permanently bonded to CRT.
X-ray emission: <0.05 mr/hr. Not measurable with Victoreen Model 440 RF/C in background noise.

UL listing: meets Underwriter's Laboratories listing for Electronic Measuring Instruments and for Dental and Medical Electronic equipment.

NOTICE TO USER: This instrument is designed and manufactured primarily for OEM systems applications. Therefore, without Option 315 or Option 330, the top and bottom protective covers are not provided and internal wiring connections of HAZARDOUS VOLTAGES ARE EXPOSED. Operator protection from these hazardous voltages must be provided by the purchaser and/or user of the instrument. If in doubt, ORDER OPTION 315 or OPTION 330. OPTION 330 meets UL listing for Dental and Medical Electronic Equipment.

General
Input connectors: rear panel BNC for X, Y and Z inputs with shields grounded.

Front panel controls with knobs: position X, position Y, focus, and intensity located behind front panel door.

Front panel screwdriver adjusts: trace align, astigmatism, gain X, gain Y.
Line indicator: front panel lamp.

Operating environment: temperature, 0 to +55°C (non-operating, -40°C to +70°C); humidity, to 95% relative humidity at 40°C; altitude, to 4.6 km, 15 000 ft (non-operating, to 6.3 km, 25 000 ft); shock, 30 g level with 11 ms duration and ½ sine wave shape, vibration, vibrated in three planes for 15 min. each with 0.254 mm (0.010 in.) excursion, 10 to 55 Hz.

Power: selectable 100, 120, 220, or 240 V ac; +5%, -10%; 48 Hz to 440 Hz*; max power 50 VA (approx. 40 W). Average power dissipation at 60 Hz and 120 V without any options is approx. 24 watts.
*Systems requiring UL Dental and Medical listing must operate from 48 Hz to 66 Hz only.

Dimensions: 212.7 mm (8 3/8 in.) wide, 133.4 mm (5 1/4 in.) high, 523.9 mm (20 5/8 in.) deep.

Weight: net, 8.6 kg (19 lb) with covers, feet; shipping, 10.5 kg (23 lb).

Accessories supplied: one blue contrast filter; one Operating and Service Manual; one 0.375 A fuse for 220, 240 V ac operation; and one 2.3 m (7.5 ft) line cord (90° IEC to NEMA 5-15P, 3 conductor) for use in Canada, Mexico, Japan, and U.S.

Options: a wide range of options are available to meet almost any OEM requirement. Horizontal and vertical amplifier options allow choices in deflection factor, polarity, input impedance, and rise time. Options in the Z-axis amplifier include several blanking ranges, polarities, input impedances, gain characteristics, and a digital (TTL) input. CRT options include various phosphor types and filters with or without an 8 × 10 division internal graticule, an RFI coated surface, and light output uniformity of less than 10% in specified area. Front panel control options provide scale illumination, a 25 pin connector for X, Y, and Z inputs, and allow changes in type and location of controls and adjustments. Other options available are a wide selection of ac line cords, increased ac line voltage tolerance, and covers with feet and tilt stand. For information concerning options, contact your Hewlett-Packard Field Engineer.

1332A High Resolution Display \$1200
OEM discounts are available; contact your Hewlett-Packard Field Engineer for information.

CATHODE-RAY TUBE DISPLAYS

Instrumentation systems, 43.2 cm (17-inch)

Model 1317A

NEW

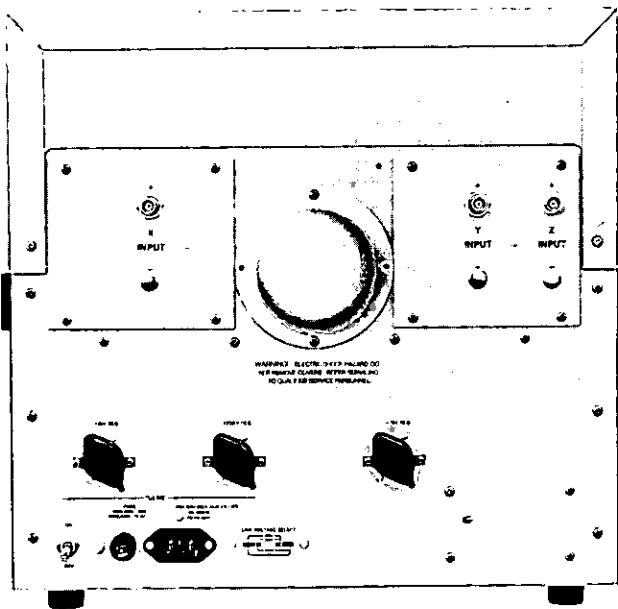
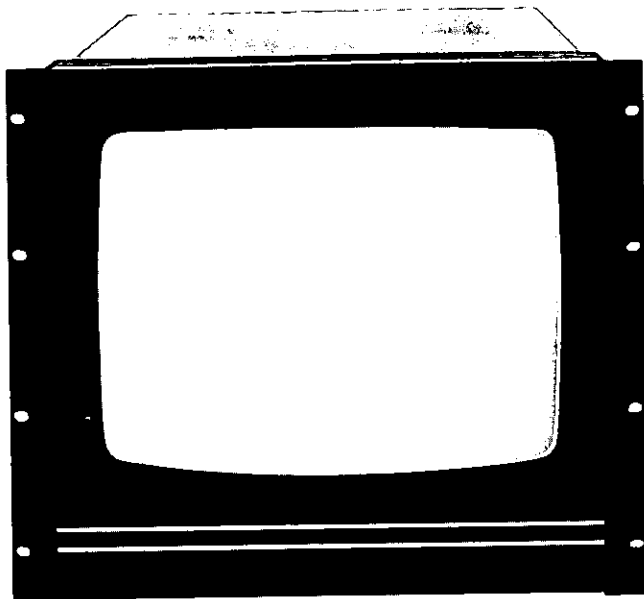

Rear panel X, Y, and Z input BNC connectors are mounted on removable panels for easy adaption to any input configuration.

1317A Description

Advanced display performance

The Model 1317A large screen, 43.2 cm diagonal (17-inch) graphic display is the answer to many OEM display requirements because of its unique performance. This high resolution display is ideal for the readout in computer graphic and instrumentation systems because it combines high slewing speed with low power operation.

High writing speed

Linear writing speed is an unmatched 25.5 cm/ μ s (10 inches/ μ s) for visible writing, however, the all solid-state deflection amplifiers are capable of slew rates greater than 255 cm/ μ s (100 inches/ μ s) when the spot does not have to be seen. Character stroke writing capability of

less than 100 ns per stroke means that this display can refresh 4096 alphanumeric characters in less than 5 ms. Point plotting time for small steps is less than 200 ns per point minimizing the writing time for dot matrix type character generation. The fast amplifier response simplifies system programming since vectors can be written in random fashion from anywhere in the display area.

Yokeless deflection

The yokeless, electrostatic deflection system consumes much less power than the multi-winding coils of magnetic systems. Additionally, the much faster response of electrostatic deflection permits more information to be displayed at a refresh rate that eliminates flicker. A sharp, clear display even with the wide-angle deflection and low curvature faceplate is maintained with dynamic focusing. Dynamic correction of focus occurs with changes in beam position and intensity (drive level) at video speeds.

Designed for OEM systems

This high-quality, large-screen display is designed for easy interfacing to systems needing a high resolution, visual readout. The very large CRT is mounted in a rugged frame that fits in a standard 48.3 cm (19-inch) rack with the attractive front panel flush with the rack. Display controls are conveniently located behind a front panel door under the CRT for easy access.

Rear panel X, Y, and Z input connectors are standard BNC or floating BNC configuration and are mounted on removable panels for easy adaptation to any input configuration. Line power is switch selectable for 100, 120, 220, 240 V ac to match local power requirements. Options for different phosphors, conformal contrast filters with anti-glare surface, Z-axis input changes, and fixed slides are available to permit you to tailor the 1317A display to your specific requirement. For additional convenience, an accessory interconnecting cable containing three color coded coaxial cables is also available.

1317A Specifications

Vertical and horizontal amplifiers

Response:

Rise time: ≤ 75 ns (10% to 90% points) for full screen deflection or less.

Bandwidth: dc to 5 MHz (3 dB down at 5 MHz) with 10.2 cm (4 in.) deflection.

Phase shift: $< 0.1^\circ$ to 50 kHz and $< 1^\circ$ to 250 kHz for full screen signal inputs.

Deflection factor: approx. 39.3 mV/cm (100 mV/in.); 1 V p-p for 25.4 cm (10 in.) deflection.

Gain adjust: provides continuous deflection factor adjustment from approx. 31.4 mV/cm (80 mV/in.) to 51.2 mV/cm (130 mV/in.).

Linear writing time: < 39.4 ns/cm (100 ns/in.).

Linear writing speed: > 25.4 cm/ μ s (10 in./ μ s).

Diagonal settling time: signal settles to within one spot diameter of final value in < 500 ns for any on or off screen movement. Off screen deflection not to exceed one screen diameter.

Repeatability: $< 0.15\%$ error (of full screen) for readdressing a point from any direction on or off screen. Off screen deflection not to exceed one screen diameter.

Sequential point plotting time: signal settles to within 0.254 mm (0.010 in.) of final value in < 200 ns for any 2.54 mm (0.10 in.) step.

Dynamic range: at least ± 1.5 screen diameters from center screen.

Crosstalk: < 0.381 mm (0.015 in.) with one input terminated in 50 ohms and the other input excited by a 1 V 500 kHz signal.

Drift: 1.27 mm/hr (0.05 in./hr) and 2.54 mm (0.10 in.) in 24 hr with covers installed after $\frac{1}{2}$ hr warmup.

Spot jitter and motion: < 0.254 mm (0.010 in.).

Inputs: BNC connectors with floating shield. Separate differential inputs (shield grounded) available, see Options.

Input RC: driven side 10 k Ω shunted by approx. 40 pF. Shield input is approx. 47 ohms to ground which can be replaced with 10 k Ω for differential input. A switchable 50 ohm termination between shield and center conductor is also provided.

Maximum input: ± 50 V (dc + peak ac) with 10 k Ω internal termination; ± 5 V (dc + peak ac) with 50 ohm internal termination.

Polarity: positive vertical input moves beam up; positive horizontal input moves beam to the right.

Position: front panel controls allow zero input to be set off screen in any direction from anywhere within the viewing area.

Z-axis amplifier (see options)**Rise time:** <20 ns (CW bandwidth approx. 15 MHz).**Blanking range:** 0 to 1 V.**Blanking polarity:** positive input unblanks CRT, internally reversible for negative unblanking.**Input:** BNC connector (shield grounded).**Input RC:** approx. 10 kΩ shunted by approx. 60 pF. 50 ohm termination may be selected with internal switch.**Maximum input:** ±50 V (dc + peak ac) with 10 kΩ internal termination. ±5 V (dc + peak ac) with 50 ohm internal termination.**Offset:** internal adjustment provides ±1 V offset (continuous) to blanking range.**Gain adjust:** extends blanking range by over 2.5:1 (continuous).**Cathode-ray tube****Type:** post deflection accelerator, approx. 28.5 kV accelerating potential. P31 aluminized phosphor standard (refer to Options for additional phosphors). Electrostatic focus and deflection.**Viewing area:** 43.2 cm (17 in.) diagonal; approx. 34.3 cm (13.5 in.) × 26 cm (10.25 in.).**Resolution:****Spot size**

Inside quality area	Outside quality area	Quality area
0.51 mm (0.020 in.)	0.76 mm (0.030 in.)	25.4 cm × 25.4 cm (10 in. × 10 in.)

Lines: approx. 19.7 lines/cm (50 lines/in.) measured with shrinking raster method.**Light output:****Line brightness:** approx. 538.2 lx (50 f) at a writing speed of 0.25 cm/μs (0.10 in./μs), 60 Hz refresh rate, P31 phosphor, 0.51 mm (0.020 in.) spot size.**Geometry:** <3% pincushion and barrel distortion within quality area.**Linearity:** <3% of full scale along major axis within quality area.**Phosphor protection:** automatically detects absence of beam deflection and limits beam current to a safe but viewable level.**Dynamic focus:** automatically corrects spot geometry for position location and beam intensity (video drive level).**Contrast ratio:** 4:1 or greater with 1076 lx (100 f) ambient light and CRT face in a vertical plane. Measured by photometrically summing the trace and background brightness and then dividing by the background brightness.**Trace align:** rotates X-axis into geometric alignment with CRT viewing area.**Orthogonality:** separately aligns Y-axis perpendicular to X-axis.**Consumer safety protection****Implosion:** exceeds safety requirements of IEC 348 (IEC 65) and ANSI C39.5 for Electronic Measuring Apparatus.**High voltage:** anode lead is permanently bonded to CRT.**X-ray emission:** <0.1 mr/hr. Measured with Victoreen Model 440 RF/C.

The display is being submitted to Underwriters Laboratories for Electronic Data Products listing, thereby meeting OSHA (Subpart S) approval.

General**X, Y and Z input connectors:** rear panel BNC female connectors.**Front panel controls:** Intensity, Position X, Gain X, Position Y, Gain Y, Trace Align, Orthogonality, Focus, and Astigmatism located below the CRT behind a hinged door.**Line indicator:** lamps mounted behind front panel door and on rear panel.**Power:** selectable 100, 120, 220, or 240 V ac, +5% - 10%, 48 to 440 Hz, maximum power 115 VA (approx. 100 watts).**Dimensions:** 425.5 mm (16 3/4 in.) wide, 409.6 mm (16 1/8 in.) high including feet, 566.7 mm (22 3/16 in.) deep.**Weight:** net, 26.3 kg (58 lb); shipping, 33.4 kg (73 1/2 lb).**Operating environment:** temperature, 0 to +55°C, non-operating -40° to +70°; humidity, up to 95% relative humidity to 40°C; altitude, up to 4.6 km (15 000 ft), non-operating up to 6.2 km (25 000 ft); shock, 30 g level with 11 ms duration and 1/2 sine wave shape; vibration, vibrated in three planes for 15 min. each with 0.254 mm (0.010 in.) excursion, 10 to 55 Hz.**Accessories supplied:** 0.75 A slow blow fuse for 220 and 240 V operation, one 2.3 m (7.5 ft) power cord, and one Operating and Service Manual.**Options****005:** form fitting green contrast filter with anti-glare surface improves trace to background contrast for easier viewing in bright ambient lighting.**006:** form fitting blue contrast filter with anti-glare surface.**604:** aluminized P4 phosphor in lieu of P31, open viewing area.**607:** aluminized P7 phosphor in lieu of P31, open viewing area. Includes amber form fitting contrast filter with anti-glare surface.**639:** aluminized P39 phosphor in lieu of P31, open viewing area.**050:** TTL blanking input. High state, +2.5 V to +5 V, blanks any analog Z input. Low level, 0.0 V to 0.8 V, returns blanking to analog Z-axis input.**051:** differential inputs to X, Y, and Z amplifier. Inputs for each axis through separate BNC connectors (shield grounded).**052:** four bit binary Z-axis input provides 16 levels of gray (TTL compatible). Settling time ≤300 ns.**053:** linear light output changes (±20%) with linear Z-axis drive changes (gamma correction).**054:** TTL blanking input. Low state, 0.0 V to 0.8 V, blanks any analog Z-axis input. High state, +2.5 V to +5 V, returns blanking to analog Z-axis input.**055:** fixed slides for EIA Standard 48.3 cm (19 in.) rack.**Accessories****Display cable, Model 10488A:** single cable for convenient interconnection between the display and signal source. The display cable contains three color-coded coaxial cables with three male BNC connectors on each end for X, Y, and Z input. Total cable length is approx. 3.6 m (12 ft).

Model number and name	Price
1317A Large Screen Display	\$3050
Option 005: green contrast filter	add \$50
Option 006: blue contrast filter	add \$50
Option 604: aluminized P4 phosphor	add \$25
Option 607: aluminized P7 phosphor/amber filter	add \$100
Option 639: aluminized P39 phosphor	add \$25
Option 050: TTL high state blanks analog Z-input	add \$25
Option 051: diff. inputs to X, Y, and Z amplifiers	add \$25
Option 052: four bit binary Z-axis input	add \$100
Option 053: gamma correction (±20%)	add \$50
Option 054: TTL low state blanks analog Z-input	add \$25
Option 055: fixed slides for 48.3 cm (19 in.) rack	add \$100
10488A Display Cable (see Accessories)	\$50

CATHODE-RAY TUBE DISPLAYS

Computer graphic, 53.3 cm (21-inch)

Model 1321A

NEW

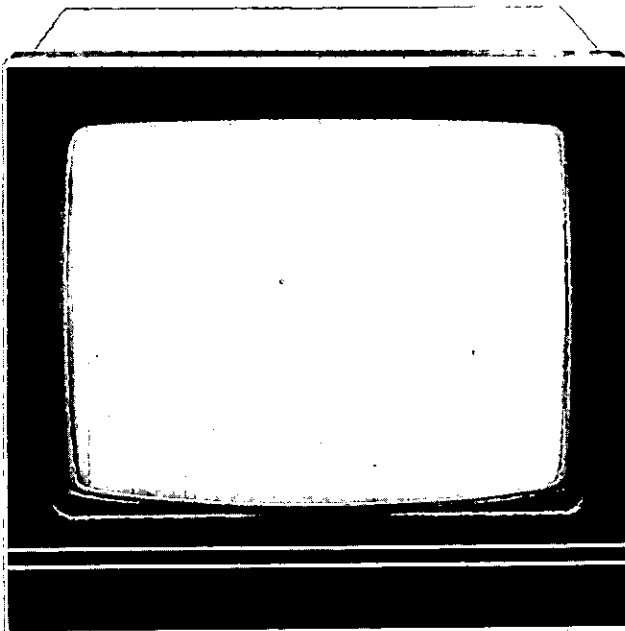

1321A Description

High speed performance of the Model 1321A large screen, 53.3 cm (21-inch) diagonal display makes it the answer to many OEM graphic display requirements. This CRT display is an ideal readout in graphic and instrumentation systems because it combines high slewing speeds with low power operation and a large 30.5 cm by 30.5 cm (12 × 12 in.) quality area. The large quality area has excellent geometry and linearity specifications with a small 0.51 mm (0.020 in.) spot size necessary for presenting complex graphic information. The additional viewing area, outside of the quality area, is ideal for character writing.

High writing speed

Linear writing speed is an unmatched 25.5 cm/μs (10 in./μs) for visible writing, however, the all solid-state deflection amplifiers are capable of slew rates in excess of 255 cm/μs (100 in./μs) when the spot does not have to be seen. Character stroke writing capability of less than 100 ns per stroke means that 4096 alphanumeric characters can be refreshed in less than 5 ms. Point plotting time for small steps is less than 200 ns per point, minimizing the writing time for dot matrix type character generation. The fast amplifier response simplifies system programming since vectors and characters can be written randomly from anywhere in the display area.

Yokeless deflection

The yokeless, electrostatic deflection system consumes much less

power than the multi-winding coils of magnetic deflection systems. Overall power consumption of the 1321A is a low 110 watts. Additionally, the much faster response of electrostatic deflection permits more information to be displayed without flicker. A sharp clear display, even with the wide-angle deflection and curved faceplate, is maintained with dynamic focus and astigmatism correction. Focus is corrected for changes in beam position and intensity (drive level) at video speeds (20 ns).

Designed for OEM systems

This high-quality, large-screen display is designed for easy interfacing to graphic systems needing a high resolution, visual readout. The very large CRT is mounted in a rugged frame with an attractive front panel that fits flush with the system panel. Display controls are conveniently located behind a front panel door under the CRT for easy access.

Rear panel X, Y, and Z input connectors are standard BNC or floating BNC configuration, mounted on removable panels for easy adaption to any input configuration. Line power is switch selectable for 100, 120, 220, 240 V ac to match local power requirements.

Options

Options for different phosphors, conformal contrast filters with an anti-glare surface, Z-axis input changes, and fixed slides are available to permit you to tailor the 1321A Display to your specific requirement. For convenient system interconnection, a 3.6 m (12 ft.) display cable containing three color coded cables is available as an accessory.

1321A Specifications

Vertical and horizontal amplifiers

Response

Rise time: ≤75 ns (10% to 90% points) for full screen deflection or less.

Bandwidth: dc to 5 MHz (3 dB down) for 12.7 cm (5 in.) deflection or less.

Phase shift: <0.1° to 50 kHz and <1° to 250 kHz for full screen signal inputs.

Deflection factor: approx. 39.3 mV/cm (100 mV/in.); 1 V p-p for 30.5 cm (12 in.) deflection.

Gain adjust: provides continuous deflection factor adjustment from approx. 19.7 mV/cm (50 mV/in.) to 58.7 mV/cm (150 mV/in.).

Linear writing time: <39.4 ns/cm (100 ns/in.).

Diagonal settling time: signal settles to within one spot diameter of final value in <500 ns for any on or off screen movement. Off screen deflection not to exceed one screen diameter.

Repeatability: <0.15% error (of full screen) for readdressing a point from any direction on or off screen. Off screen deflection not to exceed one screen diameter.

Sequential point plotting time: signal settles to within 0.254 mm (0.010 in.) of final value in <200 ns for any 2.54 mm (0.010 in.) step.

Inputs: rear panel BNC connectors with floating shield. Fully differential inputs are available, see Options.

Input RC: driven side 10 kΩ shunted by approx. 40 pF. Shield input is approx. 47 ohms to ground which can be replaced with 10 kΩ for differential input. A switchable 50 ohm termination between shield and ground is also provided.

Maximum input: ±50 V (dc + peak ac) with 10 kΩ internal termination. ±5 V (dc + peak ac) with 50 ohm internal termination.

Polarity: positive vertical input moves beam up; positive horizontal input moves beam to the right.

Position: front panel controls allow zero input to be set offscreen in any direction from anywhere within the viewing area.

Position: front panel controls allow zero input to be set offscreen in any direction from anywhere within the viewing area.

Dynamic range: at least ± 1.5 screen diameters from center screen.

Crosstalk: < 0.381 mm (0.015 in.) with one input terminated in 50 ohms and the other input excited by a 1 V 500 kHz signal.

Drift: ≤ 1.27 mm/hr (0.05 in./hr) and ≤ 2.54 mm (0.10 in.) in 24 hr with covers installed after $\frac{1}{2}$ hr warmup.

Spot jitter and motion: < 0.19 mm (0.005 in.).

Z-axis amplifier

Rise time: < 20 ns (CW bandwidth approx. 15 MHz).

Blanking range: 0 to 1 V.

Blanking polarity: positive input unblanks CRT, internally reversible for negative unblanking.

Input: BNC connector (shield grounded).

Input RC: approx. 10 k Ω shunted by approx. 60 pF. 50 ohm termination may be selected with internal switch.

Maximum input: ± 50 V (dc + peak ac) with 10 k Ω internal termination. ± 5 V (dc + peak ac) with 50 ohm internal termination.

Offset: internal adjustment provides ± 1 V offset (continuous) to blanking range.

Gain adjust: extends blanking range by over 2.5:1 (continuous).

Cathode-ray tube

Type: post deflection accelerator, approx. 28.5 kV accelerating potential. P31 aluminized phosphor standard (refer to Options for additional phosphors). Electrostatic focus and deflection.

Viewing area: 53.3 cm (21 in.) diagonal; approx. 35.6 cm (14 in.) \times 30.5 cm (12 in.).

Resolution

Spot size

Inside quality area	Outside quality area	Quality area
.051 mm (0.020 in.)	< 1.02 mm (0.040 in.)	30.5 cm \times 30.5 cm (12 in. \times 12 in.)

Lines: approx. 19.7 lines/cm (50 lines/in.) measured with shrinking raster method.

Light output

Line brightness: approx. 538.2 lx (50 fl) at a writing speed of 0.25 cm/ μ s (0.10 in./ μ s), 60 Hz refresh rate, P31 phosphor, 0.51 mm (0.020 in.) spot size.

Geometry: $< 2\%$ pincushion and barrel distortion within quality area.

Linearity: $< 1\%$ of full scale along major axis within quality area.

Phosphor protection: automatically detects absence of beam deflection and limits beam current to a safe but viewable level.

Dynamic focus: automatically corrects spot geometry for position location and beam intensity (video drive level).

Contrast ratio: 4:1 or greater with 1076 lx (100 fl) ambient light and CRT face in a vertical plane. Measured by photometrically summing the trace and background brightness and then dividing by the background brightness.

Trace align: rotates X-axis into geometric alignment with CRT viewing area.

Orthogonality: separately aligns Y-axis perpendicular to X-axis.

Focus uniformity: spot size will not vary more than 20% anywhere within the quality area at a fixed video drive level.

Consumer safety protection

Implosion: exceeds safety requirements of UL 478 for EDP units and systems.

High voltage: anode lead is permanently bonded to CRT.

X-ray emission: < 0.1 mr/hr. Measured with Victoreen Model 440 RF/C.

The display is being submitted to Underwriters Laboratories for Electronic Data Products listing, thereby meeting OSHA (Subpart S) approval.

General

X, Y, and Z input connectors: rear panel BNC female connectors. X and Y inputs have the shield floating and Z input has the shield grounded.

Front panel controls: intensity, Position X, Gain X, Position Y, Gain Y, Trace Align, Orthogonality, Focus, and Astigmatism located below the CRT behind a hinged door.

Line indicator: lamps mounted behind front panel door and on rear panel.

Power: selectable 100, 120, 220, or 240 V ac, $+5\%$ or -10% ; 48 to 440 Hz; maximum power 135 VA (approx. 110 watts).

Dimensions: 527.1 mm (20 $\frac{1}{4}$ in.) wide, 482.6 mm (19 in.) high with feet, 631.8 mm (24 $\frac{3}{8}$ in.) deep.

Weight: net, 176 kg (80 lb); shipping, 209 kg (95 lb).

Operating environment: temperature, 0° to $+55^\circ\text{C}$, non-operating -40° to 70°C ; humidity, up to 95% relative humidity to 40°C ; altitude, up to 4.6 km (15 000 ft), non-operating up to 6.2 km (25 000 ft); vibration, vibrated in three planes for 15 min. each with 0.254 mm (0.010 in.) excursion, 10 to 55 Hz.

Accessories supplied: 0.75 A slow blow fuse for 220 and 240 V ac operation, one 2.3 m (7.5 ft) power cord, and one Operating and Service Manual.

Options and accessories

005: form fitting green contrast filter with anti-glare surface. Price add \$60

006: form fitting blue contrast filter with anti-glare surface. Price add \$60

604: aluminized P4 phosphor in lieu of P31. Price add \$25

607: aluminized P7 phosphor in lieu of P31. Includes form fitting amber filter with anti-glare surface. Price add \$100

639: aluminized P39 phosphor in lieu of P31. Price add \$25

050: TTL blanking input. High state, $+2.5$ V to $+5$ V, blanks any analog Z-input. Low state, 0.0 V to 0.8 V, returns blanking to analog Z-axis input. Price add \$25

051: differential inputs to X, Y, and Z amplifiers. Inputs for each axis through separate BNC connectors (shield grounded). Price add \$25

052: four bit binary Z-axis input with 16 levels of gray (TTL compatible). Settling time ≤ 300 ns. Price add \$100

053: linear light output changes ($\pm 20\%$) with linear Z-axis drive changes (gamma correction). Price add \$50

054: TTL blanking input. Low state, 0.0 V to 0.8 V, blanks any analog Z-axis input. High state, $+2.5$ V to $+5$ V, returns blanking to analog Z-axis input. Price add \$25

10488A Display Cable: single cable to connect the display to a system. The display cable contains three color-coded coaxial cables with three male BNC connectors on each end for X, Y, and Z inputs. Total cable length is approx. 3.6 m (12 ft). Price \$50

1321A Large Screen Display Price \$3500

CATHODE-RAY TUBE DISPLAYS

Large-screen computer graphic

Models 1310A and 1311A

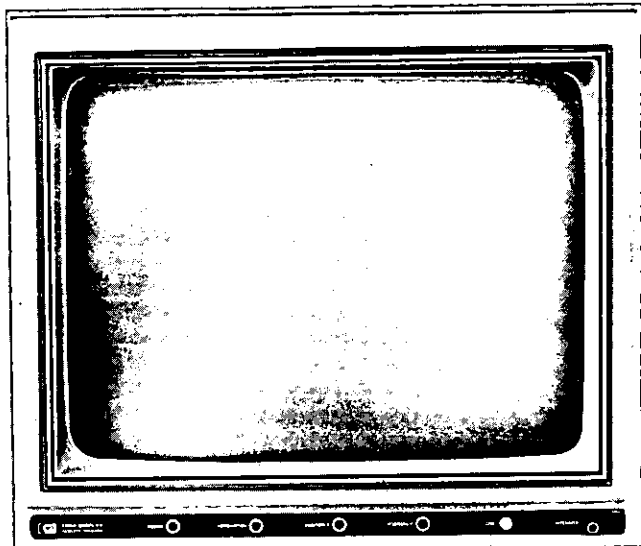

1310A

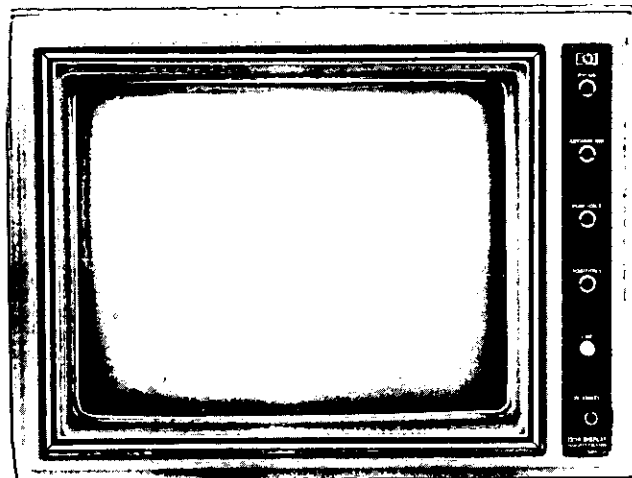

1311A

1310A and 1311A Description

Advanced display performance

Models 1310A and 1311A are directed beam, high speed 48.3 cm (19 in.) and 35.6 cm (14 in.) graphic displays with excellent dynamic performance that matches speeds with computer generated graphic information. The electrostatic CRT provides a crisp, small spot anywhere in the large quality area of the CRT. Also, the CRT has a rectangular shape and information can be written anywhere in this large viewing area. Bright, easy-to-see displays result from the 28.5 kV accelerating potential while X-ray emissions are unmeasurable, ensuring a safe operating environment.

High writing speeds

Linear writing speed is 25.4 cm (10 in.) per microsecond which allows character strokes to be written in less than 100 nanoseconds. Maximum slew rate of the electronics is >254 cm (100 in.) per microsecond. The large-step jump and settle time is 1 μ s. This offers programming simplicity since characters and vectors can be plotted in random fashion from anywhere in the display area. A typical application of this high speed would be to plot a video signal on the display and write characters or vectors during the vertical retrace or blanking interval. Point plotting time for small steps is less than 200 ns per point; thus matrix type displays are written in minimal time.

Electrostatic deflection

Electrostatic deflection replaces deflection coils needed by magnetic CRTs and the high powered circuits to drive the coils. The power consumption of these displays is a low 100 watts which eliminates noisy fans and over-sized mechanical cooling assemblies. Electrostatic deflection ends the need for major and minor deflection systems with multiple input connections. The single differential input for each axis significantly reduces the effects of common mode signals. Input RC is 10 k Ω shunted by <40 pF with switchable 50 ohm terminations available when required.

Modular construction

Internal construction is modular, and very serviceable. Plug-in circuit cards reduce calibration or troubleshooting time.

These displays are supplied with open frame construction for

mounting in a standard 48.3 cm (19 in.) rack or in your custom designed enclosures. Covers and a tilt stand are available for free standing applications. Refer to Options and Accessories in the specifications for listings of the standard items that are available.

1310A and 1311A Specifications

Vertical and horizontal amplifiers

Rise time: <75 ns, 10% to 90% points for full screen deflection or less.

Bandwidth: dc to 5 MHz (3 dB down at 5 MHz) with 8.9 cm (3.5 in.) deflection in 1311A and 12.7 cm (5 in.) deflection in 1310A.

Phase shift: <0.1° to 50 kHz and <1° to 250 kHz for full screen signals.

Linear writing time: <39.4 ns/cm (<100 ns/inch).

Linear writing speed: >25.4 cm/ μ s (>10 inches/ μ s).

Diagonal settling time: signal settles to within 1 spot diameter of final value in <500 ns for any on screen movements.

Sequential point plotting time: signal settles to within 0.254 mm (0.01 in.) of final value in <200 ns for any 2.54 mm (0.1 in.) step.

Repeatability: <0.15% of full screen error for re-addressing a point from any direction on screen.

Crosstalk: <0.381 mm (<0.015 in.) with one input shorted and the other input excited by 500 kHz.

Deflection factor*

	Vertical	Horizontal
1310A	1 volt for 27.9 cm (11 in.) deflection	1 volt for 38.1 cm (15 in.) deflection
1311A	1 volt for 21.6 cm (8½ in.) deflection	1 volt for 27.9 cm (11 in.) deflection

*Horizontal and vertical deflection factors adjustable from front panel control with attenuation of 1.75:1.

Spot jitter and motion: <0.38 mm (<0.015 inch).

Position: zero input can be set to any on screen position.

Polarity: positive vertical input moves beam up; positive horizontal input moves beam right. Polarity can be reversed by changing internal lead connections.

Input RC: driven side 10 kΩ shunted by <40 pF. Shield input is 47 ohms to ground. This can be replaced with 10 kΩ for differential input. A switchable 50 ohm termination between shield and center conductor is also provided.

Maximum input: ±50 V (dc + peak ac) with 10 kΩ internal termination; ±5 V (dc + peak ac) with 50 ohm internal termination.

Linearity: 1% of full scale display along major axes.

Drift: 1.27 mm/hour (0.05 inch/hour) and 2.54 mm (0.10 inch) in 24 hours with covers installed.

Z-axis amplifier

Rise time: <20 ns.

Sensitivity: 1 V provides full blanking or intensity.

Input polarity: internal switch selects polarity (switch is normally set so negative voltage unblanks signal).

Gain adjust: internally adjustable over 2.5:1 attenuation ratio.

Balance: internal adjustment provides ±1 V offset.

Input RC: approx. 10 kΩ shunted by approx. 60 pF. 50 ohm termination may be selected with internal switch.

Maximum input: ±50 V (dc + peak ac) with 10 kΩ internal termination; ±5 V (dc + peak ac) with 50 ohm internal termination.

Cathode-ray tube

Viewing area:

Model 1310A (48.26 cm) (19 in.): 27.94 cm high × 38.1 cm wide (11 × 15 in.).

Model 1311A (35.56 cm) (14 in.): 21.59 cm high, 27.94 cm wide (8½ × 11 in.).

Type: post-accelerator, 28.5 kV accelerating potential, P31 aluminized phosphor is standard (refer to options for other phosphors). Electrostatic focus and deflection.

Resolution:

Model 1310A: 20 lines/cm (50 lines/inch), shrinking raster method.

Model 1311A: 27 lines/cm (67 lines/inch), shrinking raster method.

Spot size

	Spot size in Quality Area	Size of Quality Area
1310A	0.5 mm (0.020 in.)	27.94 × 27.94 cm (11 × 11 in.)
1311A	0.38 mm (0.015 in.)	21.59 × 21.59 cm (8½ × 8½ in.)

Brightness: at least 50 foot-lamberts measured at 2.54 mm/μs (0.1 in./μs). 60 Hz rate, with spot size of 0.5 mm (0.020 in.) on 1310A and 0.38 mm (0.015 in.) on 1311A.

Contrast ratio: 4:1 or greater.

X-ray emission: CRT emission <0.05 mr/hr (not measurable in background noise with Victoreen Model 440RF/C).

Impllosion protection: rim and tension banding prevents implosive devacuation.

Phosphor protection: circuit detects absence of deflection and limits beam current.

General

X, Y, and Z input connectors: BNC type mounted to rear panel.

Weight

Model 1310A: net, 24 kg (53 lb), with covers 26.8 kg (59 lb); shipping, 32.2 kg (71 lb).

Model 1311A: net, 18.1 kg (40 lb), with covers 20.4 kg (45 lb); shipping, 28.1 kg (62 lb).

Dimensions: dimensional drawings are too numerous for presentation in this catalog. Contact your local HP Field Engineer for a data sheet with these drawings.

Power: 115 V ac ±10% or 230 V ac ±10%, 48 Hz to 440 Hz, maximum power 115 VA.

Operating environment: temperature, 0 to +55°C (+32°F to +130°F); humidity, to 95% relative humidity at 40°C (104°F); altitude, to 4.6 km (15 000 ft); vibration, vibrated in three planes for 15 min. each with 0.254 mm (0.010 in.) excursion, 10 to 55 Hz.

Accessories supplied: rack mount adapter, front panel cover, one 0.75 A slow blow fuse for 230 V ac operation, one power cord, and one Operating and Service Manual.

NOTICE TO USERS: This instrument is designed and manufactured primarily for OEM systems applications. Therefore, without OPTION 003, the Top and Bottom Protective Covers are not provided and internal wiring connections of HAZARDOUS VOLTAGES ARE EXPOSED. Operator protection from these hazardous voltages must be provided by the purchaser and/or user of the instrument. If in doubt, ORDER OPTION 003.

Options*

003: top and bottom covers with tilt stand (rack mount adapter not supplied with Option 003 instruments).

005: form fitting neutral density contrast filter with anti-glare surface improves trace contrast for easier viewing.

006: form fitting blue contrast filter with anti-glare surface.

604: P4 aluminized phosphor in lieu of P31.

607: P7 aluminized phosphor in lieu of P31 with form fitting amber anti-glare contrast filter.

639: P39 aluminized phosphor in lieu of P31.

*Special displays, such as round CRT's and different size CRT's, are available. Contact your local HP Field Engineer for information.

Accessories

Cover kits: top and bottom cover for field installation. For desk top operation, a tilt stand is required since the covers are not designed to support an instrument. Cover kit for 1310A is HP P/N 01310-68703, for 1311A HP P/N 01311-68703.

Tilt stand kits: provide field installation of tilt stand for stand alone operation. Kit for 1310A is HP P/N 01310-68702, for 1311A HP P/N 01311-68702.

Rack mounting kits: rack mounting adapters are supplied with standard instruments on initial order or may be ordered later as a kit. Rack mounting kit for the 1310A is HP P/N 01310-68701, for the 1311A HP P/N 01311-68701.

Slide kits: fixed slide kits are available for mounting the 1310A and 1311A Displays in a standard 19-inch (48.3 cm) rack. A pivoting slide kit is also available for the 1311A. Fixed slide kit for 1310A is HP P/N 01310-68704, for 1311A HP P/N 01311-68704. The pivoting slide kit for the 1311A is HP P/N 01311-68705.

Model number and name	Price
(OEM discounts are available.)	
1310A 48.26 cm (19-inch) Display	\$3400
1311A 35.56 cm (14-inch) Display	\$3100
Options for 1310A and 1311A:	
Option 003: top and bottom covers/tilt stand	\$105
Option 005: neutral density contrast filter for 1310A	\$45
neutral density contrast filter for 1311A	\$30
Option 006: blue contrast filter for 1310A	\$45
blue contrast filter for 1311A	\$30
Option 604: aluminized P4 phosphor	N/C
Option 607: aluminized P7 phosphor	add \$50
Option 639: aluminized P39 phosphor	N/C
1310A Cover Kit HP P/N 01310-68703	\$100
1311A Cover Kit HP P/N 01311-68703	\$100
1310A Tilt-Stand Kit HP P/N 01310-68702	\$120
1311A Tilt-Stand Kit HP P/N 01311-68702	\$120
1310A Rack Mount Kit HP P/N 01310-68701	\$20
1311A Rack Mount Kit HP P/N 01311-68701	\$20
1310A Fixed Slide Kit HP P/N 01310-68704	\$200
1311A Fixed Slide Kit HP P/N 01311-68704	\$100
1311A Pivoting Slide Kit HP P/N 01311-68705	\$130

CATHODE-RAY TUBE DISPLAYS

OEM Storage/standard displays

Models 1330A & 1331A/1331C

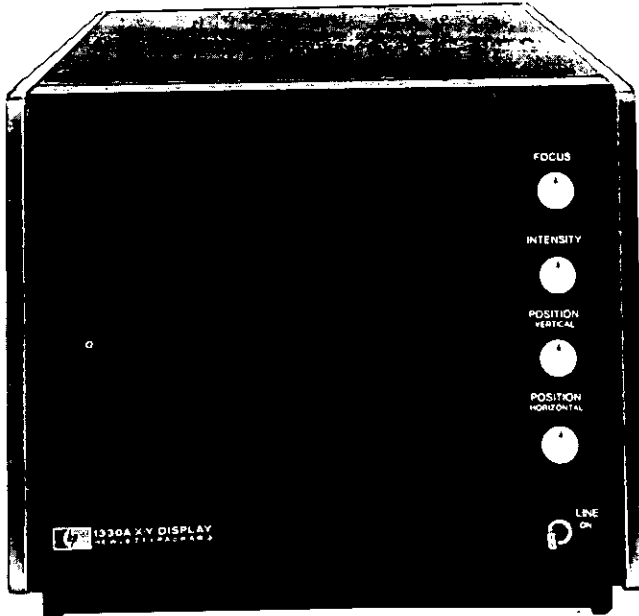

1330A

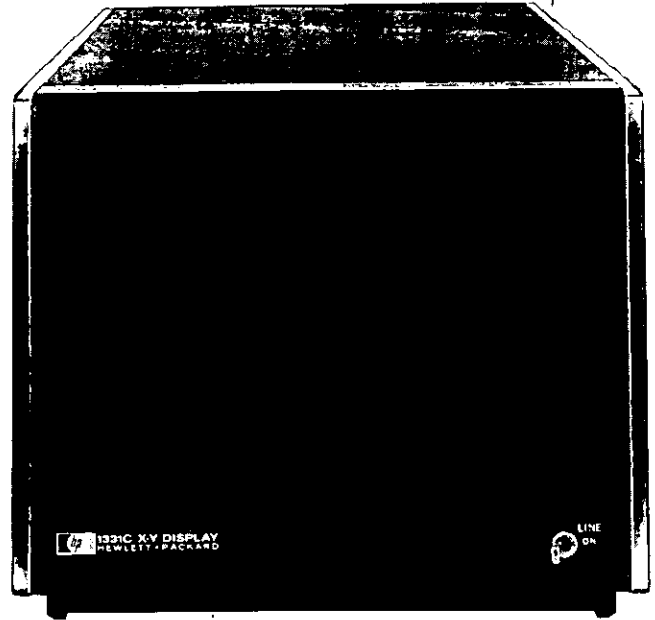

1331C

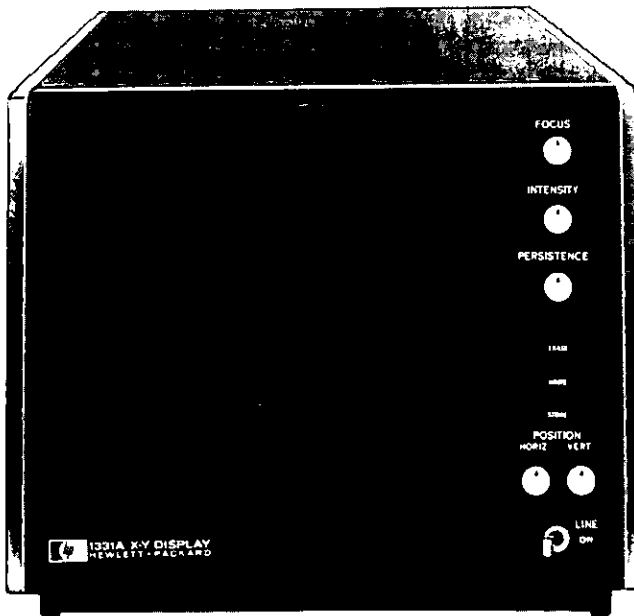

1331A

1330A, 1331A/1331C Description

Models 1330A, 1331A, and 1331C Displays are compact half-rack size instruments for displaying digital or analog computer-processed data and real time information. The frequency response of these instruments makes them extremely useful readout devices in applications such as system display monitors, graphic, and alphanumeric displays, nuclear spectrometers, semi-conductor curve tracers, swept-frequency measurements, frequency ratios, phase shift measurements, raster displays, and amplitude versus time displays.

The 5 MHz Z-axis bandwidth provides sharp, high resolution displays in raster and directed beam applications. Differential input amplifiers on vertical and horizontal inputs reduce noise common to the inner and outer conductors of the input cables. Careful design of the solid-state X and Y amplifiers provides stable operation, long-term reliability, minimum maintenance, and low power consumption.

Model 1330A has convenient front panel controls for X-Y positioning and focusing. Model 1331A also has front panel positioning and focus controls plus storage and variable persistence controls for use where spot deflection and dot writing speed vary. Model 1331C has rear panel operating adjustments and a programming connector for remote programming in computer or graphic display systems.

The 1331A and 1331C write and store shades of gray, adding a third dimension to displayed data. Full spot blanking is obtained with -1 volt applied to the Z-axis and $+1$ volt turns the beam full on with in-between voltages providing shades of gray.

Model 1331C remote programming functions are DTL and TTL compatible allowing direct interface with most systems. If desired, transfer from Write to View modes and erase may be accomplished by contact closure to ground at the remote program plug. Transition from Store to Write and back to Store can be made in approximately 7 μ s. This effectively increases the storage time available by allowing the display to take advantage of the inherent longer storage time offered by the view mode between writing commands.

The HP developed mesh type storage tube in the 1331A and 1331C eliminates the need for memory devices to constantly refresh the display. Other advantages of this type tube which make it ideal for system applications are: bright stored displays which allow viewing in high ambient light conditions; long life, comparable to standard CRT tube life, with no reduction in storage characteristics or brightness; and use in the storage mode does not reduce tube life.

A rack adapter is available for mounting two displays side-by-side in a standard 48 cm (19 in.) rack. And, a filler panel is available for use when only one display is in the frame adapter.

1330A, 1331A/1331C Specifications

Vertical and horizontal amplifiers

Bandwidth: dc to 1 MHz (3 dB down at 1 MHz).

Phase shift: <1° to 0.5 MHz.

Settling time: signal settles to within 1 spot diameter of final value in <1 μs for any on screen movement.

Deflection factor

Vertical: 1 V for 8 div deflection. Internally adjustable from 0.09 V/div to 0.14 V/div.

Horizontal: 1 V for 10 div deflection. Internally adjustable from 0.09 V/div to 0.14 V/div.

Common mode rejection ratio: 40 dB to 10 kHz for differential input of 3 V max between inner and outer coaxial input leads.

Maximum input: ±50 V (dc + peak ac).

Input: differential between center conductor and shield, shield may be grounded with internal connection. Polarity is internally reversible.

Input RC: driven side, 100 kΩ shunted by approx. 80 pF to ground; shield input is 47 ohms to ground which may be replaced with 100 kΩ for differential input.

Z-axis amplifier

Bandwidth: dc to 5 MHz.

Rise time: approx. 70 ns.

Input RC:

Single ended: approx. 10 kΩ shunted by approx. 60 pF to ground.

Differential: approx. 20 kΩ shunted by approx. 60 pF.

Input: -1 V blanks spot of any intensity; +1 V provides maximum intensity.

Maximum input: ±10 V (dc + peak ac).

1330A Cathode-ray tube and controls

Type: mono-accelerator, approx. 3 kV accelerating potential; P31 phosphor standard (refer to Options for other phosphors).

Graticule: 8 × 10 div internal graticule. 1 div = 1 cm. Subdivision markings of 0.2 div on major horizontal and vertical axes.

Linearity

Horizontal: <5% difference between any 2 div.

Vertical: <5% difference between any 2 div.

Resolution: 18 lines/div, shrinking raster method.

1331A/1331C Cathode-ray tube and controls

Type: post-accelerator storage tube, approx. 10.5 kV accelerating potential, aluminized P31 phosphor.

Graticule: 8 × 10 div internal graticule. 1 div = 0.95 cm. Subdivision markings of 0.2 div on major horizontal and vertical axes.

Storage parameters (center 7 × 9 div)

Writing speed: >20 div/ms.

Dot writing time: <4 μs.

Information storage rate: >200 kdots/sec.

Storage time: writing mode, >1 min.; storage mode, >15 min.; minimum persistence, approx. 0.25 s.

Brightness: >1076 lx (100 fl).

Erase time: <0.5 s.

1331C Programmable functions (write, store, erase)

All program inputs are TTL/DTL compatible.

Input levels: high state is +2.0 V or greater, low state is +0.8 V or less for all program plug inputs. For high state = 2.4 V, I_{sink} = 0.4 mA max. For low state = 0.4 V, I_{source} is <1 mA.

Remote erase: low state for 10 μs minimum initiates erase cycle.

Remote mode transfer: high state is View Mode, low state is Write Mode.

Dot writing using mode transfer: dot may be written by transferring to Write Mode for 7 μs per dot. No degradation of View/Storage time occurs.

Erase verify: indicates end of erase cycle. The output voltage is high approx. 125 ms after start of erase cycle. Voltage then drops to low state and remains low to the end of the erase cycle. High state is 2.4 V minimum with I_{source} = 80 μA max. Low state is 0.4 V maximum with I_{sink} = 3.2 mA max.

General

Input connectors

X, Y, and Z inputs: rear panel BNC with shield floating.

Programming connector (1331C): Cannon Model DBM-25S mates with Cannon or Cinch plug number DBM-25P.

Power: (1330A) 115 or 230 V, ±10%, 48 to 440 Hz, 150 VA max; (1331A/C) 100, 120, 220, 240 V, +7.5% -10%, 48-66 Hz, 150 VA max.

Weight: net, 8.9 kg (19½ lb); shipping, 11.3 kg (25 lb).

Dimensions: 19.8 cm (7¾ in.) wide; 15.6 cm (6¼ in.) high without feet, 16.5 cm (6½ in.) with feet; 42 cm (17¼ in.) deep.

Options

004: (1330A) P4 phosphor in lieu of P31.

007: (1330A) P7 phosphor in lieu of P31.

016: (1331C) provides direct connection of the 1331C to an HP computer through a 12555B interface kit.

604: (1330A) non-internal graticule with P4 phosphor.

607: (1330A) non-internal graticule with P7 phosphor.

631: non-internal graticule with P31 phosphor.

Accessories

Display cable, model 10488A: interconnection cable between the display and signal input source. The cable contains three color-coded coaxial cables with three male BNC connectors on each end for the X, Y, and Z inputs. Length is approx. 3.6 m (12 ft).

Frame adapter: an 18 cm (7 in.) high panel (HP P/N 5060-8762) for mounting two displays side-by-side in a standard 48 cm (19 in.) rack.

Filler panel: covers half of the Frame Adapter when only one display is in a frame adapter (HP P/N 5060-8760).

Camera adapter: Model 10366B adapter provides mounting of an HP Model 195A or 197A camera.

Options

004: (1330A)

007: (1330A)

016: (1331C)

604: (1330A)

607: (1330A)

631: (1330A)

631: (1331A/C)

Model number and name

1330A Display

1331A Storage Display

1331C Programmable Storage Display

10488A Display Cable

10366B Camera Adapter

Frame Adapter (HP P/N 5060-8762)

Filler-Panel-(HP P/N 5060-8760)

Price

N/C

add \$30

add \$155

add \$20

add \$50

add \$20

add \$30

\$975

\$1780

\$1800

\$50

\$15

\$33

\$8.10

CATHODE-RAY TUBE DISPLAYS

Large-screen analog system

Model 1300A

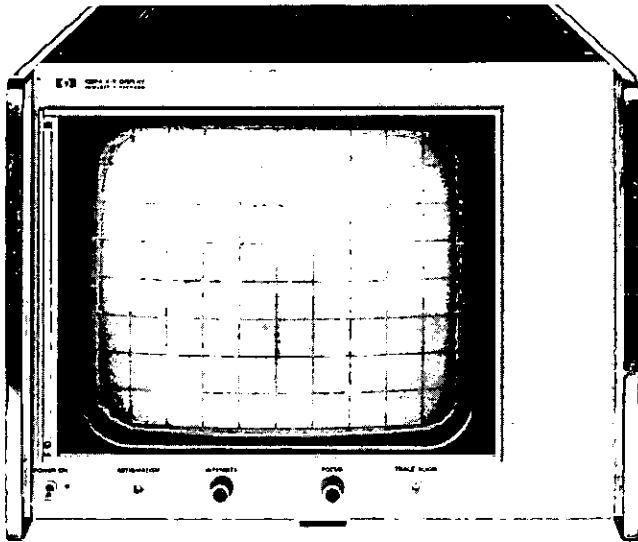

1300A Specifications

X-Y amplifiers

Bandwidth: (20.3 cm, 8-inch reference at 50 kHz); dc-coupled, dc to 20 MHz; ac-coupled, 2 Hz to 20 MHz.

Rise time: <20 ns (10% to 90% points).

Deflection factor: at least 39.3 mV/cm (0.1 V/in.) gain control allows deflection factor to be adjusted between approx. 39.3 mV/cm (0.1 V/in.) and 98 mV/cm (0.25 V/in.).

Drift: <0.5% of full screen/hr after 1/2 hr warmup; <1%/8 hr.

Jitter and movement: <0.254 mm (<0.010 in.).

Linear writing speed: >50.8 cm (>20 in./μs).

Settling time: (jump scan time) <200 ns to within a trace width of final value for any on screen movement.

Sequential point plotting time: signal settles to within one spot diameter of final position in <80 ns for any step ≤2.54 mm (0.1 in.).

Repeatability: <0.15% error for readdressing a point from any direction from a source impedance of <4 kΩ.

Input RC: 1 megohm shunted by approx. 20 pF.

Input: single-ended; maximum input ±500 V (dc + peak ac).

Linearity: over 20.3 × 25.4 cm (8 × 10 in.) screen, ±1% of full screen; any 2.54 cm (1 in.) with respect to any other 2.54 cm (1 in.) within 10%. Includes geometric distortion caused by pincushion and symmetry.

Phase shift: 0.1° to 50 kHz, up to 254 cm (100 in.) signal; 1° to 1 MHz, up to 25.4 cm (10 in.) signal.

Cross talk: 40 dB at 20 MHz with full scale input signals, inputs driven from 50Ω source impedance; imperceptible below 5 MHz.

Z-axis amplifier

Analog input: dc to 20 MHz bandwidth over the 0 to 1 V range; +1 V for full blanking, -1 V for full intensity; vernier provides 2.5:1 reduction, balance adjustment allows intensity reference level adjustment of ±1 V, maximum input ±500 V (dc ± peak ac); differential delay with respect to either X or Y amplifier, ±2 ns.

Rise time: <20 ns (10% to 90% points).

Sweep blank input: digital dc blanking with <1 kΩ source and -0.7 V to +5 V; unblanking with >20 kΩ source and 0 V to -5 V. Repetition rates to 1 MHz.

Chop blank input: ac-coupled blanking, +50 V pulse blanks CRT. Input grounded when not in use. (Duty cycle should be <5% for proper operation.)

Cathode-ray tube

Viewing area: 20.3 × 25.4 cm (8 × 10 in.).

Accelerating potential: 20 kV.

Photographic writing speed: >50.8 cm/μs (>20 in./μs), using Polaroid® CU-5 camera and 3000 speed film.

Brightness:

Vector: ≥322.9 lx (30 f) line brightness for beam velocity of 0.254 cm/μs (0.1 in./μs), refreshed at a 60 Hz rate.

Dot: ≥32.3 lx (≥3 f) brightness for a 40 ns dot refreshed at a 60 Hz rate.

Spot size: <0.8 mm (<30 mils) throughout 20.3 × 25.4 cm (8 × 10 in.) screen at 30 ft lamberts light output; nominally 0.51 mm (20 mils) at center screen (shrinking raster).

Phosphor and graticule: aluminized P31 phosphor with 2.54 cm (1 in.) grid and 0.51 cm (0.2 in.) subdivisions on major axes of internal graticule. Other phosphors are available, refer to options. Other graticules are available on special order. A light green light filter is supplied for implosion protection.

Controls and inputs location

Front panel: intensity, astigmatism, trace align, focus, and on-off switch.

Rear panel: X-Y-Z inputs, calibrator, X-Y gain, position and ac/dc input switches, Z-axis gain and balance.

Dimensions: 42.6 cm (16 3/4 in.) wide; 31 cm (12 1/4 in.) high; 50.8 cm (20 in.) deep overall, 45.7 cm (18 in.) deep from rack mount adapters.

General

Calibrator: line frequency square wave, 0.5 V ±2%.

Weight: net, 20.41 kg (45 lb); shipping, 29.94 kg (66 lb).

Power: 115 V or 230 V ±10%; 48 to 440 Hz; approx. 175 W.

Accessories supplied: rack mounting kit, green light filter, power cord, and one Operating and Service Manual.

Options

Options	Price
001: neutral density anti-glare light filter	add \$15
004: P4 aluminized phosphor in lieu of P31	N/C
007: P7 aluminized phosphor in lieu of P31	add \$30
604: non-internal graticule, aluminized P4 phosphor	add \$20
607: non-internal graticule, aluminized P7 phosphor	add \$50
631: non-internal graticule, aluminized P31 phosphor	add \$20

Accessories

Light filters

10181A: amber for P7 phosphor (supplied with Option 007 and 607 displays) \$50

10182A: green for standard phosphor (supplied with standard 1300A Display) \$50

Display cable, Model 10488A: provides interconnection between the display and signal input source. The cable contains three color-coded coaxial cables with three male BNC connectors on each end for X, Y, and Z inputs. Approx. 3.6 cm (12 ft) long. \$50

Chassis slides

Fixed slides: HP P/N 1490-0714 \$42

Pivot slides: HP P/N 1490-0718 \$50

Slide adapter kit: one adapter kit (HP P/N 1490-0721) is required for mounting one pair of slides to a display. \$40

1300A X-Y Monitor

OEM discounts are available.

©Registered Trademark Polaroid Corporation.

\$2675

POWER SUPPLIES

General information

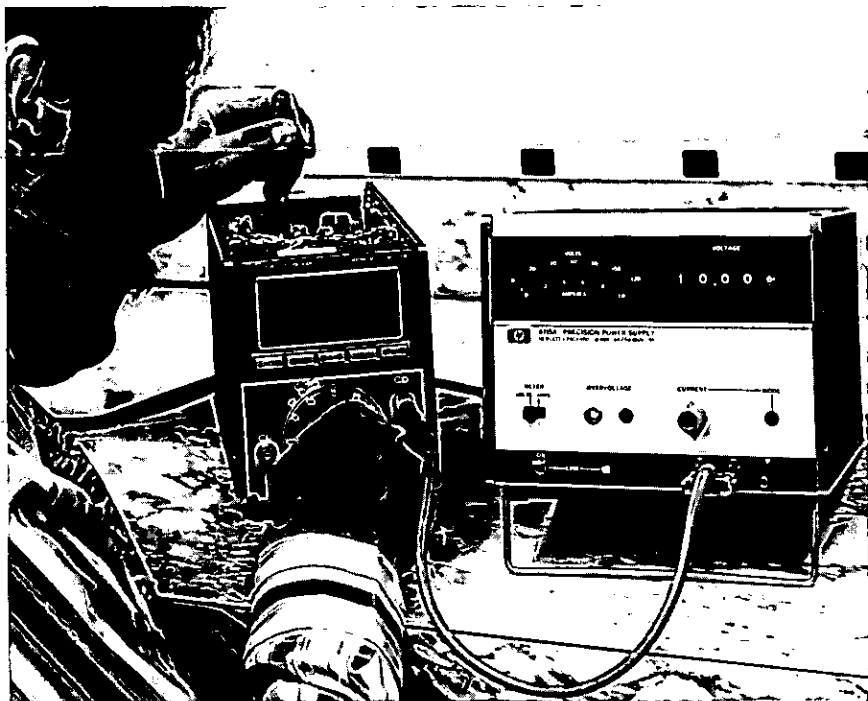

A power supply for every need

Hewlett-Packard power supplies are available in many types, sizes, and ratings. There are laboratory supplies used in circuit development, modular supplies to power systems, high power supplies for industrial processes, and many special purpose supplies ranging from constant-current sources to bipolar power supply amplifiers.

The true value of a power supply

The best power supply for the job must first satisfy all the physical criteria: voltage and current ratings, performance specifications, size, and features. But equally important are the less tangible aspects that affect the real cost of ownership. Such factors as the experience and expertise of the manufacturer's engineering staff should be considered. Are his designs conservative—does he use quality components—does he have established QA procedures?

If you have a problem or need application assistance, are the manufacturers' reps accessible, responsive, and knowledgeable? Are spare parts and service available on a worldwide scale?

These factors do not show up on a spec sheet, but are closely related to a company's capability and responsibility towards its customers. When you purchase a power supply from Hewlett-Packard, you receive guaranteed product performance plus all the intangibles that add up to long-term value—and it usually costs no more.

Regulation techniques

HP power supplies are designed using one of four proven stabilization techniques: series, switching, SCR, and SCR pre-regulator/series regulator.

Series regulation: This technique uses a feedback loop to control the voltage drop across a series-pass transistor located between the rectified dc input and the output terminals of the power supply. The feedback network senses changes in the output voltage and develops an error signal which adjusts the drop across the series transistor such that it maintains the output terminal voltage at the desired level. Good regulation (0.001% to 0.05%), low ripple and noise (50 μ V to 1 mV), and fast transient response (<50 μ s) characterize this type of regulator.

With all its attributes of excellent performance and circuit simplicity, the series regulator has one drawback: it is relatively inefficient (typically 30 to 40%). Heat sinks are employed to dissipate the heat generated by the series transistors and this necessarily increases the size and weight of the supply.

All linear OEM modular and low power lab supplies use this technique.

Switching regulation: This technique regulates the output voltage by essentially switching a series transistor on and off at a rapid rate (about 20 kHz) and delivering this "chopped" current to an output filter. A feedback network senses changes in the output and feeds back a correction signal which adjusts the transistors on-off duty cycle to

maintain a constant output voltage. Since a transistor dissipates very little power when it's fully on or off, the regulator has excellent efficiency (typically 65-80%).

Besides low power dissipation, another advantage of this technique is that the high pulse repetition rates make possible the use of transformers, inductors, and filter capacitors that are much smaller than those required for operation at power line frequencies.

Modular supplies that use switching regulators are thus smaller, lighter, and cooler running than their series-regulated counterparts.

Stabilization performance of the switching regulator is somewhat lower than the series regulator (typically 0.2% regulation; 20 mV rms, 40 mV p-p ripple and noise) but well suited for the majority of OEM system applications.

SCR regulation: In many high power applications, the tight regulation and low ripple and noise characteristics of the series regulator can be beneficially traded for economy, efficiency, and compact size. This is where the SCR regulator is most valuable. Typical performance specifications for SCR supplies are 0.05 to 1% regulation, 50 mV rms, 500 mV p-p ripple and noise, 50-200 ms transient response, and 70% efficiency. Regulation is accomplished by sensing both the AC input and DC output of the supply and generating a firing pulse for SCR's located in two legs of a bridge rectifier. If the output voltage tries to decrease, the control circuit generates the firing pulse earlier in the input half cycle. More voltage is then passed through the SCR to the output filter to raise the output voltage to the correct level.

SCR pre-regulator/series regulator: This technique incorporates the best of both worlds, and is used in most medium to high power, high performance power supplies. In these supplies, the SCR pre-regulator changes the rectifier output in coordination with the output voltage of the supply so that only a small voltage drop is maintained across the series pass transistor. This reduces the power dissipation in the series elements and greatly improves the efficiency (up to 70%). Typical performance specifications are similar to series regulated supplies except for transient response, which is somewhat slower (\approx 50 μ s).

Selecting power supplies

By model number: If you know the model number, you can find the power supply description page from the numerical index in the front of this catalog.

Free technical literature

Hewlett-Packard publishes two application notes related to power supply theory and applications:

- (1) DC Power Supply Handbook, AN-90A.
- (2) Applications of A DC Constant Current Source, AN-128.

Both can be obtained at no charge from your local HP Field Engineer.

DC Volts	DC Amps (Max.)	Type	Model	Page
4-5.5	8	Low Cost Lab	6384A †	178
0 ± 5 & ± 20 Dual Range	1	BPSA*	6825A/6830A †	200
0 ± 5 & ± 50 Dual Range	1	BPSA*	6826A/6831A †	200
5 ± 0.50	2	Modular	62005A	203
5 ± 0.50	4	Modular	62005C	203
5 ± 0.50	8	Modular	62005E	203
5 ± 0.50	16	Modular	62005G	203
5 ± 0.50	40	Modular	62605J	205
5 ± 0.25	100	Modular	62605M	206
6 ± 0.60	1.5	Modular	60063B	207
6 ± 0.60	3	Modular	60065A	207
6 ± 0.60	8	Modular	60066A	207
0-6, 0 ± 20, Dual Tracking	2.5 & 0.5	Low Cost Lab	6236A	178
0-7.5	3	Low Cost Lab	6203B †	179
0-7.5	5	Gen. Purpose	6281A †	182
0-8	1000	High Pwr.	6464C †	190
0-10	1	Low Cost Lab	6213A †	176
0-10	1	Low Cost Lab	6214A †	176
0-10	2	Prec. Volt	6113A †	197
0-10	10	Gen. Purpose	6282A †	182
0-10	20	Gen. Purpose	6256B †	186
0-10	50	Gen. Purpose	6259B †	186
0-10	100	Gen. Purpose	6260B †	186
0 ± 10 & 0 ± 100 Dual Range	0.5	BPSA*	6827A/6832A †	200
12 ± 1.30	0.5	Modular	60122B	207
12 ± 1.30	1	Modular	60123B	207
12 ± 0.60	1.5	Modular	62012A	203
12 ± 1.30	2.2	Modular	60125B	207
12 ± 0.60	3	Modular	62012C	203
12 ± 0.60	6	Modular	62012E	203
12 ± 1.30	6	Modular	60126B	207
12 ± 0.60	12	Modular	62012G	203
12 ± 0.60	23	Modular	62612J	205
± 12 ± 0.60 Dual	1.4	Modular	62212A	204
± 12 ± 0.60 Dual	3.3	Modular	62212E	204
± 12 ± 0.60 Dual	6	Modular	62212G	204
0-15	200	High Pwr.	6453A †	190
15 ± 0.75	1.25	Modular	62015A	203
15 ± 0.75	2.5	Modular	62015C	203
15 ± 0.75	5	Modular	62015E	203
15 ± 0.75	10	Modular	62015G	203
15 ± 0.75	20	Modular	62615J	205
± 15 ± 1.50 Dual	0.2	Modular	60153D	207
± 15 ± 1.50 Dual	0.75	Modular	60155C	207
± 15 ± 0.75 Dual	1.25	Modular	62215A	204

DC Volts	DC Amps (Max.)	Type	Model	Page
± 15 ± 0.75 Dual	3	Modular	62215E	204
± 15 ± 0.75 Dual	5.2	Modular	62215G	204
0-16 or 0-18	600 or 500	High Pwr.	6466C †	190
0 ± 16	12.5	Dig. Prog. Volt.	6128C †	211
18 ± 0.90	1	Modular	62018A	203
18 ± 0.90	2.25	Modular	62018C	203
18 ± 0.90	4.5	Modular	62018C	203
18 ± 0.90	9	Modular	62018G	203
18 ± 0.90	16.7	Modular	62618J	205
0 ± 20, 0-6 Dual Tracking	0.5 & 2.5	Low Cost Lab	6236A	178
0-20 & 0-40 Dual Range	0.6 & 0.3	Low Cost Lab	6204B †	179
0-20 & 0-40 Two Dual Range	0.6 & 0.3	Low Cost Lab	6205B †	179
0-20	1	Prec. Volt.	6101A †	197
0-20	1	Prec. Volt.	6111A †	197
0-20	1.5	Low Cost Lab	6201B †	179
0-20 & 0-40 Dual Range	1.5 & 0.75	Low Cost Lab	6200B †	179
0-20 & 20-40 Dual Range	2 & 1	Prec. Volt.	6104A †	197
0-20 & 20-40 Dual Range	2 & 1	Prec. Volt.	6114A †	197
0-20	3	Gen. Purpose	6284A †	182
0-20 & 0-20 Two Outputs	3 & 3	Gen. Purpose	6253A †	182
0-20	5	Gen. Purpose	6285A †	182
0-20	10	Gen. Purpose	6263B †	186
0-20	10	Gen. Purpose	6286A †	182
0-20	15	High Pwr.	6427B †	190
0-20	20	Gen. Purpose	6264B †	186
0-20	45	High Pwr.	6428B †	190
0-20	50	Gen. Purpose	6261B †	186
0 ± 20	0.5	BPSA	6823A †	200
20-40 & 0-20 Dual Range	1 & 2	Prec. Volt.	6104A †	197
20-40 & 0-20 Dual Range	1 & 2	Prec. Volt.	6114A †	197
0-24	3	Gen. Purpose	6224B †	182
24 ± 2.40	0.25	Modular	60242B	207
24 ± 2.40	0.5	Modular	60243B	207
24 ± 1.20	0.75	Modular	62024A	203
24 ± 2.40	1	Modular	60244B	207
24 ± 2.40	1.5	Modular	60245B	207
24 ± 1.20	1.75	Modular	62024C	203
24 ± 2.40	3.5	Modular	60246B	207
24 ± 1.20	3.75	Modular	62024E	203
24 ± 1.20	7.5	Modular	62024G	203
24 ± 1.20	12.5	Modular	62624J	205

*BPSA=Bipolar Power Supply/Amplifier

†Available on GSA contract

DC Volts	DC Amps (Max.)	Type	Model	Page
0-25	0.4	Low Cost Lab	6215A †	176
0-25	0.4	Low Cost Lab	6216A †	176
0-25 & 0-50				
Dual Range	1 & 0.5	Gen. Purpose	6220B †	182
0-25 & 0-25				
Two-Tracking	2	Gen. Purpose	6227B †	196
28 ±1.40	0.7	Modular	62028A	203
28 ±1.40	1.5	Modular	62028C	203
28 ±1.40	3.25	Modular	60282E	203
28 ±1.40	6.5	Modular	62028G	203
28 ±1.40	10.7	Modular	62628J	205
0-30 & 0-60	1 & 0.5	Low Cost Lab	6206B †	179
Dual Range				
0-36	10	High Pwr.	6433B †	190
0-36	100	High Pwr.	6456B †	190
0-36	300	High Pwr.	6469C †	190
0-40 & 0-20	0.3 & 0.6	Low Cost Lab	6204B †	179
Dual Range				
0-40 & 0-20	0.3 & 0.6	Low Cost Lab	6205B †	179
Dual Range				
0-40	0.5	Prec. Volt.	6102A †	197
0-40	0.5	Prec. Volt.	6112A †	197
0-40	0.75	Low Cost Lab	6202B †	179
0-40 & 0-20	0.75 & 1.5	Low Cost Lab	6200B †	179
Dual Range				
0-40 & 0-40				
Two Outputs	1.5 & 1.5	Gen. Purpose	6255A †	182
0-40	1.5	Gen. Purpose	6289A †	182
0-40	3	Gen. Purpose	6265B †	186
0-40	3	Gen. Purpose	6290A †	182
0-40	5	Gen. Purpose	6266B †	186
0-40	5	Gen. Purpose	6291A †	182
0-40	10	Gen. Purpose	6267B †	186
0-40	25	High Pwr.	6434B †	190
0-40	30	Gen. Purpose	6268B †	186
0-40	50	Gen. Purpose	6269B †	186
48 ±2.40	0.45	Modular	62048A	203
48 ±2.40	1	Modular	62048C	203
48 ±2.40	2	Modular	62048E	203
48 ±2.40	4	Modular	62048G	203
0-50	0.2	Low Cost Lab	6217A †	176
0-50	0.2	Low Cost Lab	6218A †	176
0-50 (Compliance)	0-0.5	Prec. Cur.	6177C †	202
0-50 & 0-25	0.5 & 1	Gen. Purpose	6220B †	182
0-50 & 50-100				
Dual Range	0.8 & 0.4	Prec. Volt.	6105A †	197
0-50 & 50-100				
Dual Range	0.8 & 0.4	Prec. Volt.	6115A †	197
0-50 & 0-50				
Two-Tracking	1	Gen. Purpose	6228B †	196

DC Volts	DC Amps (Max.)	Type	Model	Page
0-50	1.5	Gen. Purpose	6226B †	182
50-100 & 0-50				
Dual Range	0.4 & 0.8	Prec. Volt.	6115A †	197
50-100 & 0-50				
Dual Range	0.4 & 0.8	Prec. Volt.	6105A †	197
0 ±50	5	Dig. Prog. Volt.	6129C †	211
0 ±50	1	Dig. Prog. Volt.	6130C †	211
0 ±50	1	BPSA*	6824A †	200
0-60 & 0-30	0.5 & 1	Low Cost Lab	6206B †	179
Dual Range				
0-60	1	Gen. Purpose	6294A †	182
0-60	3	Gen. Purpose	6296A †	182
0-60	3	Gen. Purpose	6271B †	186
0-60	5	High Pwr.	6438B †	190
0-60	15	Gen. Purpose	6274B †	186
0-60	15	High Pwr.	6439B †	190
0-64	50	High Pwr.	6459A †	190
0-64	150	High Pwr.	6472C †	190
0-100 (Compliance)	±0.016	Dig. Prog. Cur.	6140A †	211
0-100 (Compliance)	±0.016	Dig. Prog. Cur.	6145A †	211
0-100	0.1	Low Cost Lab	6211A †	176
0-100	0.1	Low Cost Lab	6212A †	176
0-100	0.2	Prec. Volt.	6106A †	197
0-100	0.2	Prec. Volt.	6116A †	197
0-100 (Compliance)	0.25	Prec. Cur.	6181C †	202
0-100	0.75	Gen. Purpose	6299A †	182
0 ±100	0.5	Dig. Prog. Volt.	6131C †	211
0-110	100	High Pwr.	6475C †	190
0-120	2.5	High Pwr.	6443B †	190
0-160	0.2	Low Cost Lab	6207B †	179
0-220	50	High Pwr.	6477C †	190
0-300 (Compliance)	0.1	Prec. Cur.	6186C †	202
0-300	35	High Pwr.	6479C †	190
0-320	0.1	Low Cost Lab	6209B †	179
0-320	1.5	Gen. Purpose	895A	208
0-440 or 0-500 or 0-600	25 or 20 or 15	High Pwr.	6483C †	190
1-600	1.5	High Pwr.	6448B †	190
0-1000	0.2	High Volt.	6521A †	194
0-1600	0.005	High Volt.	6515A †	194
0-2000	0.1	High Volt.	6522A †	194
0-3000	0.006	Prec. Volt.	6110A †	197
0-3000	0.006	High Volt.	6516A †	194
0-4000	0.05	High Volt.	6525A †	194

POWER SUPPLIES

Low cost lab: versatile, inexpensive sources

Models 6211A-6218A

- Low ripple and noise
- Impact-resistant stackable case
- Compact package – 133 x 83 x 368 mm, (3¼"H x 5¼"W x 8"D)

- 10 V, 25 V, 50 V & 100 V @ 10 W output
- Fully adjustable output voltage
- Short-circuit proof

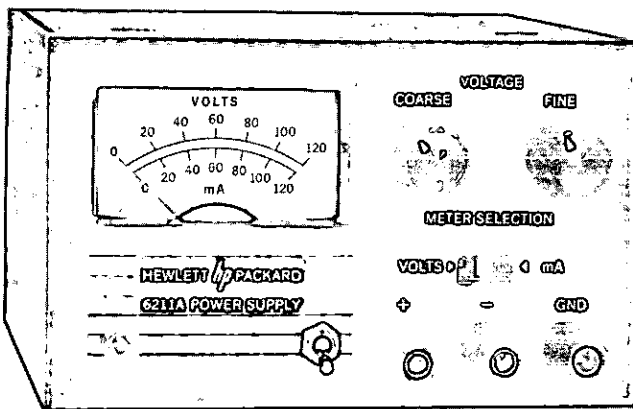

6211A-6217A

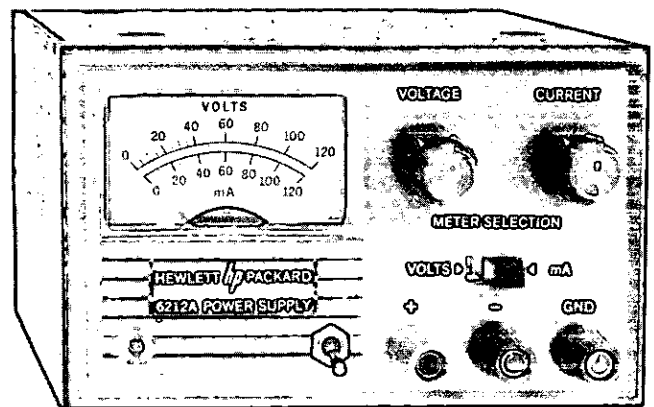

6212A-6218A

Description

These popular low-cost bench supplies are designed for general laboratory use. All models are equipped with front-panel mounted voltage controls, a combination volt/ammeter, and output binding posts. Output voltage is continuously variable, via coarse and fine voltage controls, from 0 V to 15% above the maximum rated output of the supply. A meter function switch selects either output voltage or current for display on the panel meter.

Load connections are made via three binding posts. Either the + or the - post may be grounded through an adjacent GND terminal provided for that purpose, or the supply may be operated floating at up to 300 volts above ground.

The Constant Voltage/Constant Current Models have concentric coarse and fine current controls which allow the current-limit point to be set to any value within the current rating. Using these controls, the CV/CC supplies can also be operated as constant current sources with 500 μ A load regulation. All CV/CC models can be connected in series or parallel.

The Constant Voltage/Current Limiting (CV/CL) Model supplies are short-circuit protected by a fixed current limiting circuit which is activated at approximately 120% of rated load current. The CV/CL models can be connected in series only.

The molded, impact-resistant case includes an interlocking feature for stacking several units vertically, thus minimizing bench space required for multiple supplies. Alternatively, up to three units can be mounted side by side in a 19" rack using Rack Mounting Kit 14521A.

Accessories & options

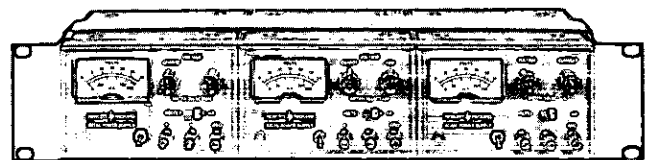

14521A

- 14521A Rack kit for one, two, or three supplies.
Includes two filler panels \$35
Option 028 230 V ac single phase input \$10

Model number & name

Model number & name	Price
6213A, 6215A, 6217A CV/CL Low Cost Lab Supplies	\$105
6211A CV/CL Low Cost Lab Supply	\$115
6214A, 6216A, 6218A CV/CC Low Cost Lab Supplies	\$135
6212A CV/CC Low Cost Lab Supply	\$145

Specifications †

R
A
T
I
N
G

DC Output	Volts	0-10 V	0-10 V	0-25 V	0-25 V	0-50 V	0-50 V	0-100 V	0-100 V
	Amps	1 A	0-1 A	0.4 A	0-0.4 A	0.2 A	0-0.2 A	0.1 A	0-0.1 A
Model		6213A	6214A	6215A	6216A	6217A	6218A	6211A	6212A

P
E
R
F
O
R
M
A
N
C
E

Load Effect* (Load Regulation):	V	4 mV	4 mV	4 mV	4 mV	4 mV	4 mV	8 mV	8 mV
	C	NA	500 μ A	NA	500 μ A	NA	500 μ A	NA	500 μ A
Source Effect (Line Regulation):	V	4 mV	4 mV	4 mV	4 mV	4 mV	4 mV	4 mV	4 mV
	C	NA	750 μ A	NA	500 μ A	NA	500 μ A	NA	500 μ A
PARD rms/p-p: (Ripple and Noise):	V	200 μ V/1 mV	200 μ V/1 mV	200 μ V/1 mV	200 μ V/1 mV	200 μ V/1 mV	200 μ V/1 mV	200 μ V/1 mV	200 μ V/1 mV
	C	NA	150 μ A/500 μ A	NA	150 μ A/500 μ A	NA	150 μ A/500 μ A	NA	150 μ A/500 μ A
Temperature Coefficient:	V	0.02% + 1 mV	0.02% + 1 mV	0.02% + 1 mV	0.02% + 1 mV	0.02% + 1 mV	0.02% + 1 mV	0.02% + 1 mV	0.02% + 1 mV
	C	NA	6 mA	NA	2 mA	NA	1 mA	NA	0.5 mA
Drift (Stability):	V	0.1% + 5 mV	0.1% + 5 mV	0.1% + 5 mV	0.1% + 5 mV	0.1% + 5 mV	0.1% + 5 mV	0.1% + 5 mV	0.1% + 5 mV
	C	NA	15 mA	NA	5 mA	NA	2.5 mA	NA	1.3 mA
Resolution:	V	5 mV	5 mV	5 mV	5 mV	10 mV	10 mV	20 mV	20 mV
	C	NA	75 μ A	NA	20 μ A	NA	10 μ A	NA	10 μ A
Output Impedance (Typical):		5 m Ω , 1 μ H	5 m Ω , 1 μ H	20 m Ω , 1 μ H	20 m Ω , 1 μ H	40 m Ω , 1 μ H	40 m Ω , 1 μ H	80 m Ω , 6 μ H	80 m Ω , 6 μ H
Load Effect Transient Recovery:	Time	50 μ s	50 μ s	50 μ s	50 μ s	50 μ s	50 μ s	50 μ s	50 μ s
	Level	15 mV	15 mV	15 mV	15 mV	15 mV	15 mV	15 mV	15 mV

F
E
A
T
U
R
E
S

Output Mode:	CV/CL	CV/CC	CV/CL	CV/CC	CV/CL	CV/CC	CV/CL	CV/CC
DC Output Isolation:	300 V	300 V	300 V	300 V	300 V	300 V	300 V	300 V
Meter Ranges:	12 V, 1.2 A \pm 4%	12 V, 1.2 A \pm 4%	30 V, 500 mA \pm 4%	30 V, 500 mA \pm 4%	60 V, 250 mA \pm 4%	60 V, 250 mA \pm 4%	120 V, 120 mA \pm 4%	120 V, 120 mA \pm 4%

G
E
N
E
R
A
L

Power:	115 V ac \pm 10% 48-440 Hz 0.29 A, 28 W	115 V ac \pm 10% 48-440 Hz 0.3 A, 28 W	115 V ac \pm 10% 48-440 Hz 0.25 A, 25 W	115 V ac \pm 10% 48-440 Hz 0.25 A, 26 W	115 V ac \pm 10% 48-440 Hz 0.25 A, 25 W	115 V ac \pm 10% 48-440 Hz 0.25 A, 26 W	115 V ac \pm 10% 48-440 Hz 0.29 A, 27 W	115 V ac \pm 10% 48-440 Hz 0.29 A, 28 W
Weight:	Net	2 kg (4.5 lb)	2 kg (4.5 lb)	2.2 kg (4.8 lb)	2 kg (4.5 lb)	2.2 kg (4.8 lb)	2 kg (4.5 lb)	2.2 kg (4.8 lb)
	Ship	2.9 kg (6.5 lb)	3.1 kg (6.8 lb)	2.9 kg (6.5 lb)	3.1 kg (6.8 lb)	2.9 kg (6.5 lb)	3.1 kg (6.8 lb)	3.1 kg (6.8 lb)
Options Available:	028	028	028	028	028	028	028	028

* CV load regulation given for rear terminals only. At front terminals, CV load regulation is 0.5 mV per amp greater due to front terminal resistance.

† Refer to page 209 for complete specification definitions.

POWER SUPPLIES

Low cost lab: for integrated circuit applications

Models 6236A & 6384A

- 0 to 6 V up to 2.5 A and 0 to ± 20 V @ 0.5 A tracking
- Short circuit proof
- Compact, light weight package

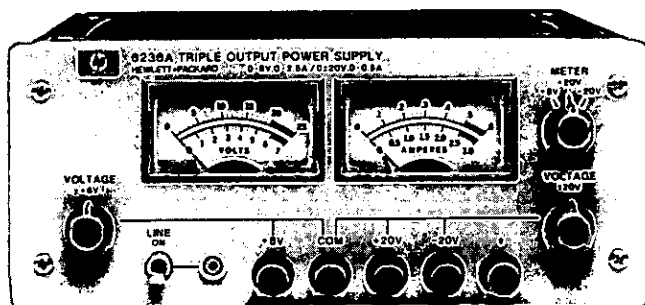

6236A (New)

Model 6236A

Small size, ease of operation, and outstanding performance make HP's new triple output supply a valued addition to any R & D lab engaged in digital or linear IC circuit development. Measuring only 3/4 in. H x 8 1/2 in. W x 12 1/2 in. D, the 6236A takes up a minimum of bench space; and weighing only 9.5 lb, it can easily be moved with one hand.

In addition to being compact and portable, the supply is extremely easy to operate. All controls, meters, and binding posts are located on a neatly laid-out front panel. Control of the 6 V and ± 20 V outputs is provided by separate single-turn potentiometers. A three-position meter switch (+6 V, +20 V, -20 V) selects the desired output voltage and current for display on the dual panel meters. The 0 to +20 V and 0 to -20 V outputs track one another within 1%; they can also be connected in series to obtain a single 0 to 40 V @ 0.5 A output.

Both the 6 V and ± 20 V outputs are protected from overloads by fixed current limiting circuits. The 6 V supply uses a foldback current limiter that reduces the output current from 2.5 A maximum at the 6 V setting, to 1 A maximum at the 0 V setting. Under short circuit conditions the maximum current is limited to 1 A. The +20 V and -20 V output are limited to 0.5 A output for all overload conditions.

Units may be bench operated or rack mounted individually or in pairs using accessory rack mounting hardware.

6236A Specifications

DC output: 0 to 6 V dc (6 V @ 2.5 A adjustable to 0 V @ 1 A); 0 to +20 V dc and 0 to -20 V dc @ 0.5 A, dual tracking.

AC input: 104 to 127 V ac, 47-63 Hz, 112 W. An attached 3-wire, 5-foot cord, is provided. (See option listings for nominal 100 V ac, 220 V ac, and 240 V ac operation).

Load effect (load regulation): 0.01% +2 mV (all outputs) for no load to full load change.

Source effect (line regulation): 0.01% +2 mV (all outputs) for any line voltage change within rating.

PARD (ripple & noise): 0.35 mV rms, 1.5 mV p-p (20 Hz to 20 MHz).

Resolution: 15 mV for 6 V output, 50 mV for +20 and -20 V outputs.

Temperature coefficient: 0.02% +1 mV output change per degree centigrade change in ambient following 30-minutes warm-up (all outputs).

Temperature ratings:

Operating: 0 to 40°C (output current is derated linearly to 50% at 71°C).

Storage: -50 to +75°C.

Cooling: Natural convection.

Dimensions: 89 mm H x 216 mm W x 317 mm D; (3/4" H x 8 1/2" W x 12 1/2" D).

Weight: 4.3 kg. (9.5 lb).

- 4 to 5.5 V @ 8 A output with low ripple and noise
- Built-in overvoltage crowbar & cutback current limiting

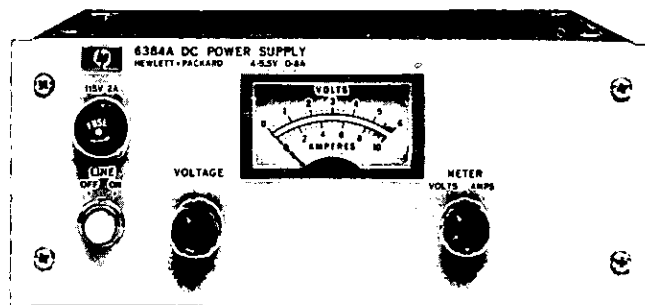

6384A

Model 6384A

This low-cost bench supply is designed specifically for use with digital-logic integrated circuits. Its output ratings and superior performance, combined with the protection of built-in overvoltage crowbar and current limiting circuits, make it an excellent IC supply for both laboratory and systems use.

Voltage-sensitive loads are protected by the overvoltage crowbar circuit. Following detection of an overvoltage condition, the crowbar is activated and shorts the output. The crowbar threshold is factory-set to 6.25 V, but is field-adjustable down to 5 V.

The power supply will not be damaged by an overload condition. If the load current exceeds 8.5 \pm 0.2 A, the cutback current limit circuit is activated and reduces the output current to a safe level.

6384A Specifications

DC output: 4 to 5.5 V dc @ 8 A.

AC input: 115 V ac \pm 10%, 48-63 Hz, 1.4 A, 120 W. (See Option 028 for 230 V ac operation).

Load effect (load regulation): 2 mV for a load current change from no load to full load.

Source effect (line regulation): 2 mV for a change in line voltage between 104 and 127 V ac or 208 and 254 V ac at any output voltage and current within rating.

PARD (ripple and noise): 5 mV p-p (20 Hz to 20 MHz), 1 mV rms at any line voltage and any load condition within rating.

Voltage resolution: 15 mV using output voltage control.

Temperature coefficient: Output change per degree centigrade change in ambient following 30 minutes warm-up is 3 mV.

Drift (stability): Under constant line, load, and ambient conditions, total drift (dc to 20 Hz) following 30-minutes warm-up is 0.3% plus 10 mV.

Temperature ratings:

Operating: 0 to 55°C

Storage: -40 to +75°C

Cooling: Natural convection.

Weight: (Net/Shipping): 5.44 kg. (12 lb)/6.8 kg (15 lb).

Dimensions: 216 mm W x 89 mm H x 317 mm D; (8 1/2" W x 3 1/2" H x 12 1/2" D).

Accessories and options — Models 6236A and 6384A

14523A Rack kit for two supplies	\$10
14513A Rack kit for one supply	\$20
Option 028: 230 V ac single-phase input (6384A only)	\$10
Option 100: 87-106 V, 47-63 Hz input (6236A only)	N/C
Option 220: 191-233 V, 47-63 Hz input (6236A only)	N/C
Option 240: 208-250 V, 47-63 Hz input (6236A only)	N/C

Model number and name

6236A Triple Output Power Supply	\$325
6384A Digital Logic Bench Supply	\$280



POWER SUPPLIES

Low cost lab: general bench applications

Models 6200B-6209B

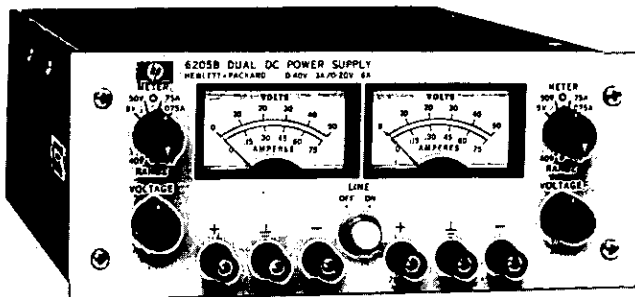

6205B

- Auto-series, -parallel, & -tracking operation
- Floating output (up to 300V above ground) – can be used as a positive or negative source.
- Front and rear output terminals
- High-speed remote programming & sensing.
- Bench or rack mounting
- Multi-range meter.

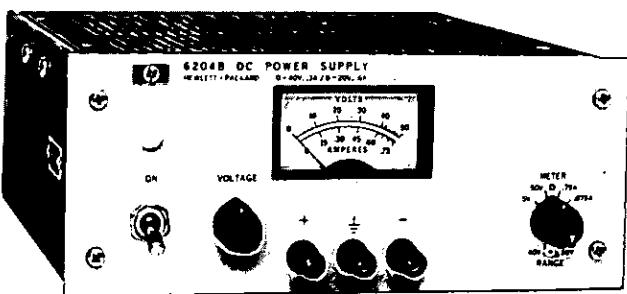

6204B, 6206B

Description

This series of low-cost bench supplies includes nine models covering an output voltage range from 0-7.5V to 0-320V. All models are equipped with coarse and fine output voltage controls (except Models 6207B and 6209B, which have 10-turn voltage controls), volt/ampere meter, meter function/range switch, and front and rear output terminals. In addition, on the dual-range models (6204B-6205B), an output range switch permits the selection of either a high or a low output voltage range.

Model 6205B combines the versatility of a dual power supply with the flexibility of auto-parallel and auto-series operation to extend the output ratings of this supply to 20V/1.2A, 40V/0.6A, and 80V/0.3A. In addition, using the supply's auto-tracking capability, opposite polarity voltages ($\pm 20V$, $\pm 40V$) can conveniently be obtained from this one supply.

The Constant Voltage/Current Limiting supplies (6204B-6205B), are short-circuit protected by a fixed current limiting circuit which is activated at approximately 110% of rated load current. The current-limit point can be reduced by changing the value of a single internal resistor. For the Constant Voltage/Constant Current supplies, concentric coarse and fine current controls allow the current-limit point to be set to any value within the current rating. Using these controls, the CV/CC supplies can also be operated as constant current sources.

Units may be bench operated or rack mounted individually or in pairs using accessory rack-mounting hardware.

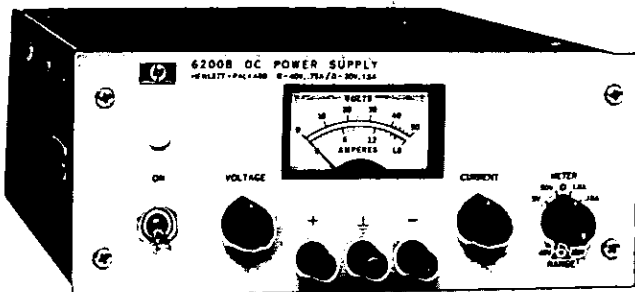

6200B-6203B, 6207B, 6209B



POWER SUPPLIES

Models 6200B-6209B (cont.)

Specifications†

RATING

DC Output	Volts	0-7.5 V		0-20 V		Dual Range 0-20 V 0-40 V		2 Dual Range 0-20 V 0-40 V		Dual Range 0-20 V 0-40 V	
		Amps		Amps		Amps		Amps		Amps	
		0-3 A		0-1.5 A		0.6 A 0.3 A		0.6 A 0.3 A		0-1.5 A 0-0.75 A	
Model		6203B		6201B		6204B		6205B		6200B	

PERFORMANCE

Load Effect* (Load Regulation):	V	5 mV	0.01% + 4 mV	0.01% + 4 mV	0.01% + 4 mV	0.01% + 4 mV	0.01% + 4 mV
	C	0.03% + 250 μ A	0.03% + 250 μ A	NA	NA	NA	0.03% + 250 μ A
Source Effect (Line Regulation):	V	3 mV	0.01% + 4 mV	0.01% + 4 mV	0.01% + 4 mV	0.01% + 4 mV	0.01% + 4 mV
	C	0.01% + 250 μ A	0.01% + 250 μ A	NA	NA	NA	0.01% + 250 μ A
PARV rms/p-p: (Ripple and Noise):	V	200 μ V/1 mV	200 μ V/1 mV	200 μ V/1 mV	200 μ V/1 mV	200 μ V/1 mV	200 μ V/1 mV
	C	500 μ A	500 μ A	NA	NA	NA	500 μ A rms
Temperature Coefficient:	V	0.02% + 1 mV	0.02% + 1 mV	0.02% + 1 mV	0.02% + 1 mV	0.02% + 1 mV	0.02% + 1 mV
	C	0.02% + 2 mA	0.02% + 1 mA	NA	NA	NA	0.02% + 1 mA
Drift (Stability):	V	0.1% + 5 mV	0.1% + 5 mV	0.1% + 5 mV	0.1% + 5 mV	0.1% + 5 mV	0.1% + 5 mV
	C	0.01% + 10 mA	0.01% + 5 mA	NA	NA	NA	0.1% + 5 mA
Resolution:	V	5 mV	5 mV	10 mV	10 mV	10 mV	10 mV
	C	2 mA	1 mA	NA	NA	NA	2 mA
Output Impedance (Typical):		2 m Ω , 1 μ H	20 m Ω , 1 μ H	25 m Ω , 1 μ H	25 m Ω , 1 μ H	25 m Ω , 1 μ H	20 m Ω , 1 μ H
Load Effect Transient Recovery:	Time	50 μ s	50 μ s	50 μ s	50 μ s	50 μ s	50 μ s
	Level	10 mV	10 mV	10 mV	10 mV	10 mV	10 mV

FEATURES

Output Mode:		CV/CC	CV/CC	CV/CL	CV/CL	CV/CC	CV/CC			
R E M O T E	Res	V	200 Ω /V \pm 1%	200 Ω /V \pm 1%	200 Ω /V \pm 1%	200 Ω /V \pm 1%	200 Ω /V \pm 1%			
	Coef	C	500 Ω /A \pm 10%	1 k Ω /A \pm 10%	NA	NA	0.5 k Ω /A \pm 10% 1 k Ω /A \pm 10%			
	Volt	V	1 V/V \pm 1%	1 V/V \pm 1%	1 V/V \pm 1%	1 V/V \pm 1%	1 V/V \pm 1%			
C O N T R O L	Coef	C	0.5 V/A \pm 10%	1 V/A \pm 1%	NA	NA	1 V/A \pm 10% 2 V/A \pm 10%			
	Up	NL	2 ms	1 ms	2 ms	8 ms	2 ms	8 ms	1 ms	4 ms
		FL	4 ms	3 ms	7.5 ms	30 ms	7.5 ms	30 ms	3 ms	12 ms
	Down	NL	10 ms	15 ms	60 ms	90 ms	60 ms	90 ms	15 ms	30 ms
		FL	5 ms	4 ms	20 ms	80 ms	20 ms	80 ms	4 ms	10 ms
	Overvoltage Protection	Range		2.5-10 V	2.5-23 V	2.5-44 V	2.5-44 V	2.5-44 V		
Margin			4% of output +2 V	4% of output +2 V	4% of output +2 V	4% of output +2 V	4% of output +2 V			
Meter Ranges:		0.9 V, 9 V \pm 3% 0.4 A, 4 A \pm 3%	2.4 V, 24 V \pm 3% 0.18 A, 1.8 A \pm 3%	5 V, 50 V \pm 3% 0.075 A, 0.75 A \pm 3%	5 V, 50 V \pm 3% 0.075 A, 0.75 A \pm 3%	5 V, 50 V \pm 3% 0.18 A, 1.8 A \pm 3%	5 V, 50 V \pm 3% 0.18 A, 1.8 A \pm 3%			

GENERAL

Power:		115 V ac \pm 10% 48-440 Hz 0.9 A, 70 W	115 V ac \pm 10% 48-440 Hz 0.8 A, 66 W	115 V ac \pm 10% 48-440 Hz 0.4 A, 24 W	115 V ac \pm 10% 48-440 Hz 0.5 A, 50 W	115 V ac \pm 10% 48-440 Hz 0.9 A, 70 W
Temperature Ratings:	Cool.	Convection	Convection	Convection	Convection	Convection
Dimensions:		216 mm \times 89 mm \times 317 mm (8 1/2" W \times 3 1/2" H \times 12 1/4" D)	216 mm \times 89 mm \times 317 mm (8 1/2" W \times 3 1/2" H \times 12 1/4" D)	216 mm \times 89 mm \times 317 mm (8 1/2" W \times 3 1/2" H \times 12 1/4" D)	216 mm \times 89 mm \times 317 mm (8 1/2" W \times 3 1/2" H \times 12 1/4" D)	216 mm \times 89 mm \times 317 mm (8 1/2" W \times 3 1/2" H \times 12 1/4" D)
Weight:	Net	4.5 kg (10 lb)	4.5 kg (10 lb)	3.6 kg (8 lb)	4.5 kg (10 lb)	4.5 kg (10 lb)
	Ship	5.4 kg (12 lb)	5.4 kg (12 lb)	4.5 kg (10 lb)	5.4 kg (12 lb)	5.4 kg (12 lb)
Options Available:		7, 8, 9, 11, 13, 14, 28	7, 8, 9, 11, 13, 14, 28	7, 11, 13, 28	7, 11, 13, 28, 40	7, 8, 9, 11, 13, 14, 28

*CV load regulation given for rear terminals only. At front terminals, CV load regulation is 0.5 mV per amp greater due to front terminal resistance.

†Refer to page 209 for complete specification definitions.



Dual Range 0-30 V 0-60 V		0-40 V	0-160 V	0-320 V
1 A	0.5 A	0-0.75 A	0-0.2 A	0-0.1 A
6206B		6202B	6207B	6209B

0.01% + 4 mV	0.01% + 4 mV	0.02% + 2 mV	0.02% + 2 mV
NA	0.03% + 250 μA	200 μA	200 μA
0.01% + 4 mV	0.01% + 4 mV	0.02% + 2 mV	0.02% + 2 mV
NA	0.01% + 250 μA	200 μA	200 μA
200 μV/1 mV	200 μV/1 mV	500 μV/40 mV	1 mV/40 mV
NA	500 μA rms	200 μA rms	200 μA
0.02% + 1 mV	0.02% + 1 mV	0.02% + 1 mV	0.02% + 1 mV
NA	0.02% + 0.5 mA	0.02% + 150 μA	0.02% + 75 μA
0.1% + 5 mV	0.1% + 5 mV	0.1% + 5 mV	0.1% + 5 mV
NA	0.1% + 2.5 mA	0.1% + 750 μA	0.1% + 350 μA
10 mV	10 mV	25 mV	40 mV
NA	1 mA	500 μA	200 μA
40 mΩ, 2 μH	20 mΩ, 1 μH	20 mΩ, 1 μH	20 mΩ, 1 μH
50 μs	50 μs	50 μs	50 μs
10 mV	10 mV	10 mV	10 mV

CV/CL	CV/CC	CV/CC	CV/CC
300Ω/V ±1%	200Ω/V ±1%	300Ω/V ±1%	300Ω/V ±1%
NA	1 kΩ/A ±10%	7.5 kΩ/0.1 A ±10%	15 kΩ/0.1 A ±10%
1 V/V ±1%	1 V/V ±1%	1 V/V ±1%	1 V/V ±1%
NA	2 V/A ±10%	0.75 V/0.1 A ±10%	1.5 V/0.1 A ±10%
12 ms 50 ms	4 ms	200 ms	200 ms
30 ms 120 ms	12 ms	1.5 sec	1.5 sec
360 ms 600 ms	30 ms	2.0 sec	1.5 sec
140 ms 50 ms	30 ms	0.5 sec	0.5 sec
2.5-65 V	2.5-44 V	NA	NA
4% of output +2 V	4% of output +2 V	NA	NA
7 V, 70 V ±3% 0.12 A, 1.2 A ±3%	5 V, 50 V ±3% 0.09 A, 0.9 A ±3%	20 V, 200 V ±3% 24 mA, 240 mA ±3%	40 V, 400 V ±3% 12 mA, 120 mA ±3%

115 V ac ±10% 48-440 Hz 1 A, 66 W	115 V ac ±10% 48-440 Hz 0.8 A, 66 W	115 V ac ±10% 48-63 Hz 1 A, 60 W	115 V ac ±10% 48-63 Hz 1 A, 60 W
Convection	Convection	Convection	Convection
216 mm × 89 mm × 317 mm (8 3/4" W × 3 3/4" H × 12 1/2" D)	216 mm × 89 mm × 317 mm (8 3/4" W × 3 3/4" H × 12 1/2" D)	216 mm × 89 mm × 317 mm (8 3/4" W × 3 3/4" H × 12 1/2" D)	216 mm × 89 mm × 317 mm (8 3/4" W × 3 3/4" H × 12 1/2" D)
4.5 kg (10 lb)	4.5 kg (10 lb)	4.5 kg (10 lb)	4.5 kg (10 lb)
5.4 kg (12 lb)	5.4 kg (12 lb)	5.4 kg (12 lb)	5.4 kg (12 lb)
7, 11, 13, 28	7, 8, 9, 11, 13, 14, 28	8, 13, 14, 28	8, 13, 14, 28



Accessories available

14523A Rack Kit for two supplies	Price \$10
14513A Rack Kit for one supply	\$20

Options

- 007:** Ten-turn output voltage control. Replaces concentric coarse and fine voltage controls for improved mechanical stability and convenience (except 6205B). Model 6205B \$25
 - 008:** Ten-turn output current control. Replaces concentric coarse and fine current controls for improved mechanical stability and convenience. \$25
 - 009:** Ten-turn output voltage and current controls. Consists of Options 007 and 008 on same instrument. \$45
 - 011:** Internal overvoltage protection crowbar. Protects delicate loads against power supply failure or operator error. Monitors the output voltage and places a virtual short circuit (conducting SCR) across load after preset trip voltage is exceeded. On all models except 6205B, the crowbar adjustment potentiometer is accessible from the front panel. On Model 6205B, dual crowbar controls are accessible from the top of the unit. \$50
 - 013:** Three-digit graduated decadal voltage control. Includes single 10-turn control replacing coarse and fine voltage controls. Provides improved resettability of output voltage. Models 6200B, 6204B, 6206B \$60
Models 6207B, 6209B \$35
Model 6205B \$120
 - 014:** Three-digit graduated decadal current control. Includes single 10-turn control replacing coarse and fine current controls. Provides improved resettability of output current. \$60
 - 028:** 230 V ac ±10%, single phase input. Factory modification consists of reconnecting the multi-tap input power transformer for 230 V operation. \$10
 - 040:** Interfacing for Multiprogrammer Operation. Prepares standard HP power supplies for resistance programming by the 6940A Multiprogrammer or 6941A Multiprogrammer Extender. Operation with either of these instruments requires that the power supply be subjected to (1) Special Calibration, and (2) Protection Checkout. The former procedure insures that the power supply will not be damaged by the rapid, repetitive programming possible with the Multiprogrammer. \$60
 - C05:** Eight-inch black handle attached to side of power supply. \$15
- Model number and name**
- | | |
|--|-------|
| 6200B Dual Range CV/CC Bench Supply | \$235 |
| 6201B Single Range CV/CC Bench Supply | \$210 |
| 6202B Single Range CV/CC Bench Supply | \$210 |
| 6203B Single Range CV/CC Bench Supply | \$210 |
| 6204B Dual Range CV/CL Bench Supply | \$190 |
| 6205B Independent Dual Range, Dual Output CV/CL Bench Supply | \$285 |
| 6206B Dual Range CV/CL Bench Supply | \$210 |
| 6207B Single Range CV/CC Bench Supply | \$285 |
| 6209B Single Range CV/CC Bench Supply | \$285 |

POWER SUPPLIES

General purpose: 25-200W output

Models 6220B-6299A

- Constant voltage / constant current operation
- Remote sensing and programming
- Auto-series, -parallel & -tracking operation

- Front and rear output terminals
- Floating output — can be used as positive or negative source
- Bench or rack mounting

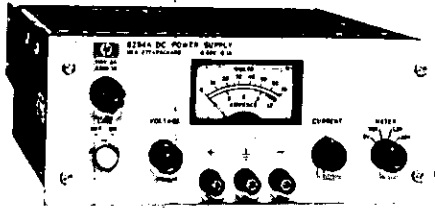

6281A, 6284A, 6289A,
6294A, 6299A

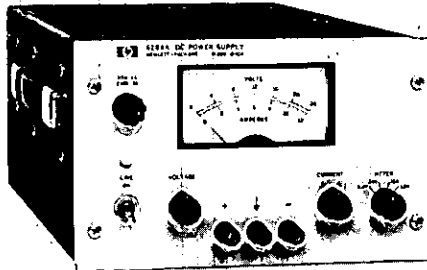

6282A, 6285A, 6286A,
6290A, 6291A, 6296A

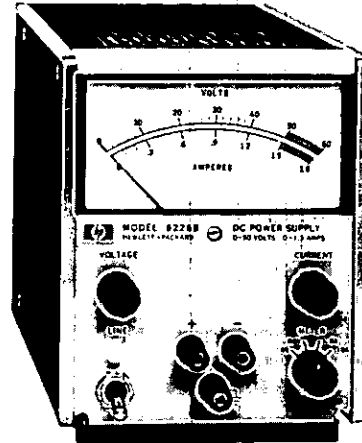

6220B, 6224B,
6226B

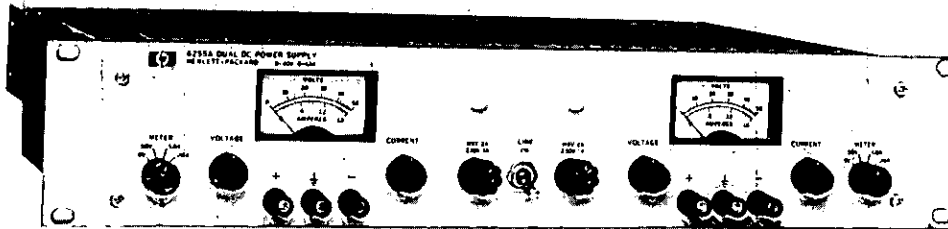

6253A, 6255A

Description

6281A-6299A

This series of medium-power Constant Voltage/Constant Current power supplies is available in two power ranges: 37-75 watts (packaged in 3½-inch high half-rack cases), and 100-200 watts (packaged in 5¼-inch high half-rack cases). All models except 6294A and 6299A have separate coarse and fine voltage and current controls that allow the voltage and current outputs to be varied from zero to the maximum rated values. The latter two models have ten-turn voltage controls. Crossover from constant voltage to constant current operation occurs automatically when the load current exceeds the value established by the current control settings. A four-position meter function switch selects either of two output voltage or output current ranges (X1, X0.1) for display on the panel meter.

The 37-75 watt models are of the series-regulated type. They have excellent regulation and ripple characteristics and include a special output-capacitor discharge circuit for improved programming speed. The 100-200 watt models employ a series-regulator/SCR-preregulator configuration to achieve the high efficiency necessary for a convection-cooled package of this size. They also have excellent regulation, low ripple and noise, and moderate programming speeds.

6253A and 6255A

These versatile dual-output models each contain two identical, in-

dependently-adjustable 60-watt power supplies in a full-rack width case. The regulator, voltage and current control, and metering circuits of each section of the supply are electrically identical to those of the individual 37-75 watt models described above.

By combining the versatility of a dual power supply with the flexibility of auto-series and auto-parallel operation, twice the maximum rated output voltage or current of each section can be obtained from the one supply. In addition, using the supply's auto-tracking capability, opposite-polarity voltages (± 20 V for Model 6253A or ± 40 V for Model 6255A) are possible.

6220B, 6224B, and 6226B

These Constant Voltage/Constant Current supplies are designed for general laboratory use. All have excellent regulation, low ripple and noise, and high speed programming characteristics. Large easy-to-read meter scales, 10-turn voltage and current controls, and front and rear output terminals; enhance ease of operation. Model 6220B is a dual-range instrument with output ratings of 0-25 V at 0-1 A or 0-50 V at 0-0.5 A. It is the only model of the three employing convection cooling. Model 6224B and 6226B have single outputs of 0-24 V at 0-3 A and 0-50 V at 0-1.5 A, respectively.

Accessories and options

The accessories and options available for use with Models 6220B-6299A are listed on page 10.13.

Specifications†

RATING

PERFORMANCE

FEATURES

GENERAL

DC Output		0-7.5 V	0-10 V	Two Outputs 0-20 V	0-20 V	0-20 V	0-20 V		
Amps		0-5 A	0-10 A	0-3 A	0-3 A	0-5 A	0-10 A		
Model		6281A	6282A	6253A	6284A	6285A	6286A		
Load Effect* (Load Regulation):	V	5 mV	0.01% + 1 mV	0.01% + 4 mV	0.01% + 4 mV	0.01% + 1 mV	0.01% + 1 mV		
	C	0.01% + 250 μA	0.05% + 1 mA	0.01% + 250 μA	0.01% + 250 μA	0.05% + 1 mA	0.05% + 1 mA		
Source Effect (Line Regulation):	V	0.01% + 2 mV	0.01% + 1 mV	0.02% + 2 mV	0.01% + 2 mV	0.01% + 1 mV	0.01% + 1 mV		
	C	0.01% + 250 μA	0.05% + 1 mA	0.01% + 250 μA	0.01% + 250 μA	0.05% + 1 mA	0.05% + 1 mA		
PARD rms/p-p: (Ripple and Noise):	V	200 μV/1 mV	500 μV/25 mV	200 μV/1 mV	200 μV/1 mV	500 μV/25 mV	500 μV/25 mV		
	C	4 mA rms	5 mA rms	2 mA rms	2 mA rms	3 mA rms	5 mA rms		
Temperature Coefficient:	V	0.02% + 500 μV	0.02% + 500 μV	0.02% + 500 μV	0.02% + 500 μV	0.02% + 500 μV	0.02% + 500 μV		
	C	0.02% + 2.5 mA	0.02% + 5 mA	0.02% + 1.5 mA	0.02% + 1.5 mA	0.02% + 2.5 mA	0.02% + 5 mA		
Drift (Stability):	V	0.1% + 2.5 mV	0.1% + 2.5 mV	0.1% + 2.5 mV	0.1% + 2.5 mV	0.1% + 2.5 mV	0.1% + 2.5 mV		
	C	0.1% + 12.5 mA	0.1% + 25 mA	0.1% + 7.5 mA	0.1% + 7.5 mA	0.1% + 12.5 mA	0.1% + 25 mA		
Resolution:	V	5 mV	2 mV	5 mV	5 mV	3 mV	3 mV		
	C	2 mA	3 mA	1 mA	1 mA	2 mA	3 mA		
Output Impedance (Typical):		1 mΩ, 1 μH	0.001Ω, 1 μH	4 mΩ, 1 μH	4 mΩ, 1 μH	0.001Ω, 1 μH	0.001Ω, 1 μH		
Load Effect Transient Recovery:	Time	50 μs	50 μs	50 μs	50 μs	50 μs	50 μs		
	Level	15 mV	15 mV	15 mV	15 mV	15 mV	15 mV		
REMOVAL CONTROL	Res	V	200Ω/V ±1%	200Ω/V ±1%	200Ω/V ±1%	200Ω/V ±1%	200Ω/V ±1%		
		C	200Ω/A ±10%	100Ω/A ±10%	500Ω/A ±10%	500Ω/A ±10%	200Ω/A ±10%	100Ω/A ±10%	
	Volt	V	1 V/V ±1%	1 V/V ±1%	1 V/V ±1%	1 V/V ±1%	1 V/V ±1%	1 V/V ±1%	
		C	0.2 V/A ±10%	100 mV/A ±10%	0.33 V/A ±10%	0.33 V/A ±10%	200 mV/A ±10%	100 mV/A ±10%	
	Up	NL	1 ms	70 ms	30 ms	30 ms	150 ms	150 ms	
		FL	2 ms	200 ms	80 ms	80 ms	150 ms	150 ms	
		Down	NL	10 ms	9 sec	400 ms	400 ms	9 sec	9 sec
			FL	6 ms	40 ms	100 ms	400 ms	90 ms	70 ms
Overvoltage Protection Crowbar:	Range	2.5-10 V	1-13 V	2.5-23 V	2.5-23 V	2-22 V	2-22 V		
	Margin	4% of output +2 V	7% of output +1 V	4% of output +2 V	4% of output +2 V	7% of output +1 V	7% of output +1 V		
Meter Ranges:		0.9 V, 9 V ±3% 0.6 A, 6 A ±3%	1.2 V, 12 V ±3% 1.2 A, 12 A ±3%	2.4 V, 24 V ±3% 0.4 A, 4 A ±3%	2.4 V, 24 V ±3% 0.4 A, 4 A ±3%	2.4 V, 24 V ±3% 0.6 A, 6 A ±3%	2.4 V, 24 V ±3% 1.2 A, 12 A ±3%		
	Power:	115 Vac ±10% 48-440 Hz 1.3 A, 118 W	115 Vac ±10% 57-63 Hz 3.5 A, 200 W	115 Vac ±10% 48-440 Hz 2.6 A, 235 W	115 Vac ±10% 48-440 Hz 1.5 A, 128 W	115 Vac ±10% 57-63 Hz 3.5 A, 160 W	115 Vac ±10% 57-63 Hz 5.5 A, 320 W		
Dimensions:		216 mm × 89 mm × 368 mm (8 3/8" W × 3 1/2" H × 14 1/4" D)	216 mm × 133 mm × 406 mm (8 3/8" W × 5 3/4" H × 16" D)	483 mm × 89 mm × 368 mm (19" W × 3 1/2" H × 14 1/4" D)	216 mm × 89 mm × 368 mm (8 3/8" W × 3 1/2" H × 14 1/4" D)	216 mm × 133 mm × 406 mm (8 3/8" W × 5 3/4" H × 16" D)	216 mm × 133 mm × 406 mm (8 3/8" W × 5 3/4" H × 16" D)		
Temperature Ratings:	Cool.	Convection	Convection	Convection	Convection	Convection	Convection		
Weight:	Net	6.4 kg (14 lb)	11.3 kg (25 lb)	12.7 kg (28 lb)	6.4 kg (14 lb)	10 kg (22 lb)	10.8 kg (26 lb)		
	Ship	7.2 kg (16 lb)	13.6 kg (30 lb)	17.7 kg (39 lb)	7.2 kg (16 lb)	10.9 kg (24 lb)	13.1 kg (29 lb)		
Options Available:		7, 8, 9, 11, 13, 14, 28	5, 7, 8, 9, 11, 13, 14, 18	7, 8, 9, 10, 11, 13, 14, 28, 40	7, 8, 9, 11, 13, 14, 28, 40	5, 7, 8, 9, 11, 13, 14, 18	5, 7, 8, 9, 11, 13, 14, 18		

* CV load regulation given for rear terminals only. At front terminals, CV load regulation is 0.5 mV per amp greater, due to front terminal resistance.

† Refer to page 209 for complete specification definitions.



POWER SUPPLIES

Models 6220B-6299A

Specifications †

RATING

DC Output	Volts	0-24 V	Dual Range 0-25 V 0-50 V		Two Outputs 0-40 V	0-40 V	0-40 V	0-40 V
	Amps	0-3 A	0-1 A	0-0.5 A	0-1.5 A	0-1.5 A	0-3 A	0-5 A
Model		6224B	6220B		6255A	6289A	6290A	6291A

PERFORMANCE

Load Effect* (Load Regulation):	V	0.01% + 4 mV	0.01% + 2 mV		0.01% + 2 mV	0.01% + 2 mV	0.01% + 1 mV	0.01% + 1 mV
	C	0.01% + 250 μA	0.01% + 250 μA		0.01% + 250 μA	0.01% + 250 μA	0.05% + 1 mA	0.05% + 1 mA
Source Effect* (Line Regulation):	V	0.01% + 2 mV	0.01% + 2 mV		0.01% + 2 mV	0.01% + 2 mV	0.01% + 1 mV	0.01% + 1 mV
	C	0.01% + 250 μA	0.01% + 250 μA		0.01% + 250 μA	0.01% + 250 μA	0.05% + 1 mA	0.05% + 1 mA
PARD rms/p-p: (Ripple and Noise):	V	200 μV/1 mV	200 μV/1 mV		200 μV/1 mV	200 μV/1 mV	500 μV/25 mV	500 μV/25 mV
	C	200 μA/1 mA	200 μA/1 mA		500 μA rms	500 μA rms	3 mA rms	3 mA rms
Temperature Coefficient:	V	0.02% + 500 μV	0.02% + 1 mV		0.02% + 500 μV	0.02% + 500 μV	0.02% + 500 μV	0.02% + 500 μV
	C	0.02% + 1.5 mA	0.02% + 1 mA		0.02% + 0.8 mA	0.02% + 0.8 mA	0.02% + 1.5 mA	0.02% + 2.5 mA
Drift (Stability):	V	0.1% + 2.5 mV	0.1% + 5 mV		0.1% + 2.5 mV	0.1% + 2.5 mV	0.1% + 2.5 mV	0.1% + 2.5 mV
	C	0.1% + 7.5 mA	0.1% + 5 mA		0.1% + 4 mA	0.1% + 4 mA	0.1% + 7.5 mA	0.1% + 12.5 mA
Resolution:	V	20 mV	40 mV		10 mV	10 mV	6 mV	6 mV
	C	3 mA	1 mA		2 mA	2 mA	1 mA	2 mA
Output Impedance (Typical):		5 mΩ, 1 μH	20 mΩ, 1 μH		10 mΩ, 1 μH	10 mΩ, 1 μH	3 mΩ, 1 μH	2 mΩ, 1 μH
Load Effect Transient Recovery:	Time	50 μs	50 μs		50 μs	50 μs	50 μs	50 μs
	Level	10 mV	10 mV		15 mV	15 mV	15 mV	15 mV

FEATURES

R E M O T E C O N T R O L	Res	V	200 Ω/V ±1%	200 Ω/V ±1%		200 Ω/V ±1%	200 Ω/V ±1%	200 Ω/V ±1%	200 Ω/V ±1%
	Coef	C	500 Ω/A ±10%	1 kΩ/A ±10%	2 kΩ/A ±10%	500 Ω/A ±10%	500 Ω/A ±10%	500 Ω/A ±10%	200 Ω/A ±10%
	Volt	V	1 V/V ±1%	1 V/V ±1%	1 V/V ±1%	1 V/V ±1%	1 V/V ±1%	1 V/V ±1%	1 V/V ±1%
	Coef	C	0.33 V/A ±10%	1 V/A ±10%	2 V/A ±10%	0.66 V/A ±10%	0.66 V/A ±10%	333 mV/A ±10%	200 mV/A ±10%
U P D O W N	Up	NL	4 ms	12 ms	50 ms	15 ms	15 ms	275 ms	275 ms
		FL	10 ms	30 ms	120 ms	45 ms	45 ms	275 ms	275 ms
	Down	NL	50 ms	200 ms	400 ms	200 ms	200 ms	6 sec	13 sec
		FL	15 ms	30 ms	120 ms	40 ms	40 ms	150 ms	275 ms
Overvoltage Protection Crowbar:	Range	NA	NA		2.5-44 V	2.5-44 V	6-43 V	6-43 V	
	Margin	NA	NA		4% of output +2 V	4% of output +2 V	7% of output +1 V	7% of output +1 V	
Meter Ranges:		3 V, 30 V ±3% 0.4 A, 4 A ±3%	6 V, 60 V ±3% 0.12 A, 1.2 A ±3%		5 V, 50 V ±3% 0.18 A, 1.8 A ±3%	5 V, 50 V ±3% 0.18 A, 1.8 A ±3%	5 V, 50 V ±3% 0.4 A, 4 A ±3%	5 V, 50 V ±3% 0.6 A, 6 A ±3%	

GENERAL

Power:		115 Vac ±10% 48-63 Hz 1.8 A, 164 W	115 Vac ±10% 48-440 Hz 0.5 A, 44 W	115 Vac ±10% 48-440 Hz 2.6 A, 235 W	115 Vac ±10% 48-440 Hz 1.3 A, 110 W	115 Vac ±10% 57-63 Hz 3.5 A, 170 W	115 Vac ±10% 57-63 Hz 5.5 A, 280 W
Dimensions:		130 mm × 159 mm × 279 mm (5¼" W × 6¼" H × × 11" D)	130 mm × 159 mm × 279 mm (5¼" W × 6¼" H × 11" D)	483 mm × 89 mm × × 368 mm (19" W × 3½" H × 14½" D)	216 mm × 89 mm × 368 mm (8½" W × 3½" H × × 14½" D)	216 mm × 133 mm × 406 mm (8½" W × 5¼" H × 16" D)	216 mm × 133 mm × 406 mm (8½" W × 5¼" H × 16" D)
Temperature Ratings:	Cool.	Fan	Convection	Convection	Convection	Convection	Convection
Weight:	Net	7.3 kg (16 lb)	5.9 kg (13 lb)	12.7 kg (28 lb)	6.4 kg (14 lb)	11.8 kg (26 lb)	11.3 kg (25 lb)
	Ship	9.5 kg (21 lb)	6.8 kg (15 lb)	17.7 kg (39 lb)	7.2 kg (16 lb)	12.7 kg (28 lb)	12.7 kg (28 lb)
Options Available:		13, 14, 28, 40	13, 14, 28, 40	7, 8, 9, 10, 11, 13, 14, 28, 40	7, 8, 9, 11, 13, 14, 28, 40	5, 7, 8, 9, 11, 13, 14, 18	5, 7, 8, 9, 11, 13, 14, 18

*CV load regulation given for rear terminals only. At front terminals, CV load regulation is 0.5 mV per amp greater due to front terminal resistance.
†Refer to page 209 for complete specification definitions.

0-50 V	0-60 V	0-60 V	0-100 V
0-1.5 A	0-1 A	0-3 A	0-750 mA
6226B	6294A	6296A	6299A

0.01% + 2 mV	0.01% + 2 mV	0.01% + 1 mV	0.01% + 2 mV
0.01% + 250 μA	0.01% + 250 μA	0.05% + 1 mA	0.01% + 250 μA
0.01% + 2 mV	0.01% + 2 mV	0.01% + 1 mV	0.01% + 2 mV
0.01% + 250 μA	0.01% + 250 μA	0.05% + 1 mA	0.01% + 250 μA
200 μV/1 mV	200 μV/1 mV	500 μV/25 mV	200 μV/1 mV
200 μA/1 mA	500 μA rms	3 mA rms	500 μA rms
0.02% + 500 μV	0.02% + 500 μV	0.02% + 500 μV	0.02% + 500 μV
0.02% + 0.8 mA	0.02% + 0.5 mA	0.02% + 1.5 mA	0.02% + 0.4 mA
0.1% + 2.5 mV	0.1% + 2.5 mV	0.1% + 2.5 mV	0.1% + 2.5 mV
0.1% + 4 mA	0.1% + 2.5 mA	0.1% + 7.5 mA	0.1% + 2 mA
20 mV	10 mV	7 mV	20 mV
2 mA	0.5 mA	1 mA	1 mA
10 mΩ, 1 μH	15 mΩ, 1 μH	5 mΩ, 1 μH	30 mΩ, 1 μH
50 μs	50 μs	50 μs	50 μs
10 mV	15 mV	15 mV	15 mV

200 Ω/V ±1%	300 Ω/V ±1%	300 Ω/V ±1%	300 Ω/V ±1%
500 Ω/A ±10%	1 kΩ/A ±10%	500 Ω/A ±10%	1 kΩ/A ±10%
1 V/V	1 V/V ±1%	1 V/V ±1%	1 V/V ±1%
1 V/A	1 V/A ±10%	333 mV/A ±10%	1.3 V/A ±10%
20 ms	25 ms	600 ms	25 ms
65 ms	80 ms	600 ms	200 ms
200 ms	2 sec	5 sec	1.5 sec
250 ms	175 ms	200 ms	200 ms
NA	5-65 V	9-66 V	20-106 V
NA	4% of output +2 V	7% of output +1 V	4% of output +2 V
6 V, 60 V ±3% 0.18 A, 1.8 A ±3%	7 V, 70 V ±3% 0.12 A, 1.2 A ±3%	7 V, 70 V ±3% 0.4 A, 4 A ±3%	12 V, 120 V ±3% 0.1 A, 1 A ±3%

115 V ac ±10% 48-63 Hz 1.8 A, 164 W	115 V ac ±10% 48-440 Hz 1.3 A, 114 W	115 V ac ±10% 57-63 Hz 4.5 A, 250 W	115 V ac ±10% 48-440 Hz 1.5 A, 135 W
130 mm × 159 mm × 279 mm (5¼" W × 6¼" H × 11" D)	216 mm × 89 mm × 368 mm (8½" W × 3½" H × 14½" D)	216 mm × 133 mm × 406 mm (8½" W × 5¼" H × 16" D)	216 mm × 89 mm × 368 mm (8½" W × 3½" H × 14½" D)
Fan	Convection	Convection	Convection
7.3 kg (16 lb)	5.9 kg (13 lb)	11.3 kg (25 lb)	5.9 kg (13 lb)
8.2 kg (18 lb)	6.8 kg (15 lb)	12.7 kg (28 lb)	6.8 kg (15 lb)
13, 14, 28, 40	8, 11, 13, 14, 28, 40	5, 7, 8, 9, 11, 13, 14, 18	8, 11, 13, 14, 28, 40

Accessories available

5060-8762 Adapter Frame, for rack mounting one, two or three ½ rack width units.	Price
-1052A-Combining-Case-for-rack-mounting-one;two-or-three ½ rack width units for quick removal. A cooling kit must be installed at the rear of the combining case.	\$33
5060-0789 Cooling Kit for 115 V ac, 50-60 Hz input.	\$170
5060-0796 Cooling Kit for 230 V ac, 50-60 Hz input.	\$37
5060-8760 Blank Filler Panel.	\$45
14513A 3½" High Rack Kit for one supply.	\$8
14523A 3½" High Rack Kit for two supplies.	\$20
14515A 5¼" High Rack Kit for one supply.	\$10
14525A 5¼" High Rack Kit for two supplies.	\$25
	\$15

Options

005: 50 Hz ac input (No charge with Option 018).	
007: Ten-turn output voltage control. Replaces concentric coarse and fine voltage controls. Models 6253A and 6255A have dual controls.	\$60
All other models in this series have single controls.	\$30
008: Ten-turn output current control. Models 6253A and 6255A have dual controls.	\$60
All other models in this series have single controls.	\$30
009: Ten-turn output voltage and current controls. Consists of Options 007 and 008 on same instrument. Models 6253A and 6255A have sets of dual controls.	\$110
All other models in this series have single controls.	\$60
010: Chassis slides. Slides are attached to supply at factory.	\$145
011: Internal overvoltage protection crowbar. Models 6253A and 6255A have dual crowbars.	\$130
Models 6281A, 6284A, 6289A, 6294A, 6299A have single crowbars.	\$65
Models 6282A, 6285A, 6286A, 6290A, 6291A, 6296A have single crowbars.	\$70
013: Three-digit graduated decadal voltage control. Includes single 10-turn control. Models 6253A, and 6255A have dual controls.	\$150
Models 6220B, 6224B, 6226B, 6294A, 6299A have single controls.	\$45
All other models in this series have single controls.	\$75
014: Three-digit graduated decadal current control. Includes single 10-turn control.	
018: 230 V ac ±10%, single phase input. Modification includes installation of a 230 V input transformer.	\$55
028: 230 V ac ±10%, single phase input.	\$10
040: Interfacing for Multiprogrammer Operation. Prepares standard HP power supplies for resistance programming by the 6940A/6941A Multiprogrammer. Models 6253A and 6255A require special calibration of dual programming circuits.	\$135
All other models in this series require special calibration of a single programming circuit.	\$75

Model numbers and name

6220B General Purpose, Dual-Range Output	\$330
6224B, 6226B, 6285A, 6290A General Purpose, Single Output	\$395
6253A, 6255A General Purpose, Two Outputs	\$520
6281A, 6294A General Purpose, Single Output	\$310
6282A General Purpose, Single Output	\$385
6284A General Purpose, Single Output	\$280
6286A, 6291A, 6296A General Purpose, Single Output	\$440
6289A General Purpose, Single Output	\$280
6299A- General-Purpose,-Single-Output	\$310



POWER SUPPLIES

General purpose: 120-2000 W output

Models 6256B - 6274B

- Built-in overvoltage crowbar
- Constant voltage/constant current operation
- Remote programming of voltage and current

- Remote sensing
- Auto-series, -parallel, and -tracking operation
- $< 50 \mu$ sec load transient recovery

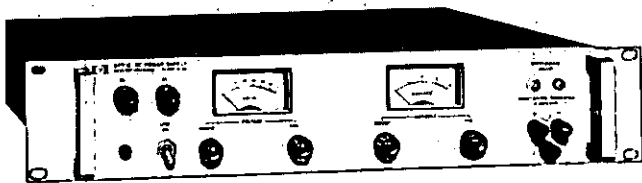

6263B, 6265B, 6266B, 6271B

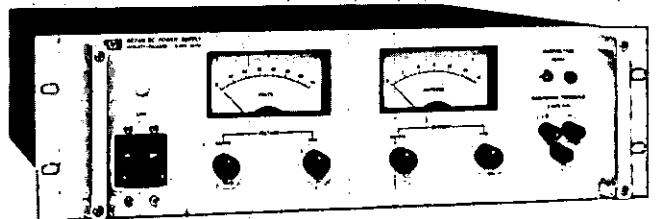

6274B

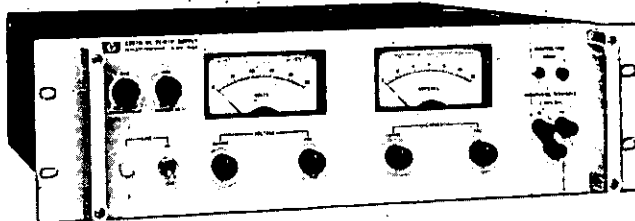

6256B, 6264B, 6267B

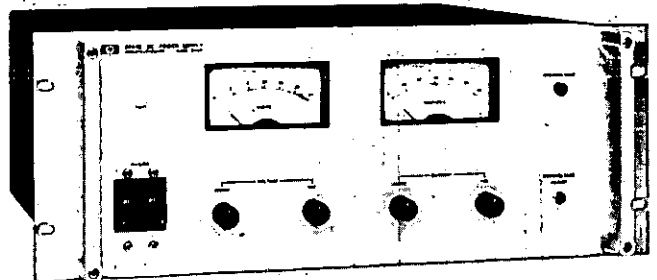

6259B, 6260B, 6261B, 6268B, 6269B

Description

This series of high-performance Constant Voltage/Constant Current supplies includes thirteen models with output ratings from 10 to 60 V. All models employ a transistor series-regulator/triac-preregulator circuit to achieve high efficiency, excellent regulation, low ripple and noise, and moderate programming speeds in a compact full-rack width package.

Separate coarse and fine voltage and current controls allow the voltage and current outputs to be varied from zero to the maximum rated value. Crossover from constant voltage to constant current operation occurs automatically when the load current exceeds the value established by the current control settings.

Additional features include built-in overvoltage crowbar protection; remote error sensing; and auto-series, auto-parallel, and auto-tracking operation. The crowbar trip point adjustment and associated

overvoltage indicator are conveniently located on the front panel.

For systems applications, the overvoltage protection circuit can be tripped by an external trigger pulse, or can initiate a pulse when the circuit is triggered from within.

Auto-series, auto-parallel, and auto-tracking connections should ordinarily include no more than three supplies. If a specific application requires the use of more than three supplies in any of the three connections, consult your local HP Field Engineer for additional information.

All dc output, ac input, sensing, control, and programming connections are made to rear-panel terminals. Either the positive or negative output terminal may be grounded or the supplies may be operated floating at up to 300 volts above ground. Models 6256B, 6263B, 6264B, 6265B, 6266B, 6267B, and 6271B are convection cooled. All other models in this series employ cooling fans.

Specifications†

RATING

DC Output	Volts	0-10 V	0-10 V	0-10 V	0-20 V	0-20 V	0-20 V
	Amps	0-20 A	0-50 A	0-100 A	0-10 A	0-20 A	0-50 A
Model		6256B	6259B	6260B	6263B	6264B	6261B

PERFORMANCE

Load Effect (Load Regulation):	V	0.01% + 200 μV	0.01% + 200 μV	0.01% + 200 μV	0.01% + 200 μV	0.01% + 200 μV	0.01% + 200 μV
	C	0.02% + 500 μA	0.02% + 1 mA	0.02% + 2 mA	0.02% + 500 μA	0.02% + 500 μA	0.02% + 1 mA
Source Effect (Line Regulation):	V	0.01% + 200 μV	0.01% + 200 μV	0.01% + 200 μV	0.01% + 200 μV	0.01% + 200 μV	0.01% + 200 μV
	C	0.02% + 500 μA	0.02% + 1 mA	0.02% + 2 mA	0.02% + 500 μA	0.02% + 500 μA	0.02% + 1 mA
PARO rms/p-p: (Ripple and Noise):	V	200 μV/10 mV	500 μV/5 mV	500 μV/5 mV	200 μV/10 mV	200 μV/10 mV	500 μV/5 mV
	C	5 mA rms	25 mA rms	50 mA rms	3 mA rms	5 mA rms	25 mA rms
Temperature Coefficient:	V	0.01% + 200 μV	0.01% + 200 μV	0.01% + 200 μV	0.01% + 200 μV	0.01% + 200 μV	0.01% + 200 μV
	C	0.01% + 2 mA	0.01% + 4 mA	0.01% + 8 mA	0.01% + 2 mA	0.01% + 2 mA	0.01% + 4 mA
Drift (Stability):	V	0.03% + 500 μV	0.03% + 2 mV	0.03% + 2 mV	0.03% + 500 μV	0.03% + 500 μV	0.03% + 2 mV
	C	0.03% + 6 mA	0.03% + 10 mA	0.03% + 20 mA	0.03% + 6 mA	0.03% + 6 mA	0.03% + 10 mA
Resolution:	V	1 mV	1 mV	1 mV	2 mV	2 mV	2 mV
	C	20 mA	50 mA	100 mA	10 mA	20 mA	50 mA
Output Impedance (Typical):		100 mΩ, 1 μH	0.05 mΩ, 1 μH	0.02 mΩ, 1 μH	0.5 mΩ, 1 μH	0.2 mΩ, 1 μH	0.1 mΩ, 1 μH
Load Effect Transient Recovery:	Time	50 μs	50 μs	50 μs	50 μs	50 μs	50 μs
	Level	10 mV	10 mV	10 mV	10 mV	10 mV	10 mV

FEATURES

Res	V	200Ω/V ±1%	200Ω/V ±1%	200Ω/V ±1%	200Ω/V ±1%	200Ω/V ±1%	200Ω/V ±1%
	C	10Ω/A ±10%	4Ω/A ±10%	2Ω/A ±10%	100Ω/A ±10%	10Ω/A ±10%	4Ω/A ±10%
Voll	V	1 V/V ±1%	1 V/V ±1%	1 V/V ±1%	1 V/V ±1%	1 V/V ±1%	1 V/V ±1%
	C	25 mV/A ±10%	10 mV/A ±10%	5 mV/A ±10%	50 mV/A ±10%	25 mV/A ±10%	10 mV/A ±10%
Up	NL	60 ms	70 ms	70 ms	150 ms	140 ms	150 ms
	FL	60 ms	70 ms	70 ms	150 ms	140 ms	150 ms
Down	NL	5 sec	200 ms	200 ms	7 sec	10 sec	250 ms
	FL	40 ms	10 ms	5 ms	60 ms	80 ms	25 ms
Overvoltage Protection Crowbar:	Range	2-12 V	2-12 V	2-12 V	2-23 V	2.5-23 V	2-23 V
	Margin	5% of output +1 V	5% of output +2 V	5% of output +2 V	5% of output +1 V	5% of output +1 V	5% of output +2 V
Meter Ranges:		12 V, 24 A ±2%	12 V, 60 A ±2%	12 V, 120 A ±2%	24 V, 12 A ±2%	24 V, 24 A ±2%	24 V, 60 A ±2%

GENERAL

Power:		115 Vac ±10% 57-63 Hz 5 A, 375 W	230 Vac ±10% 57-63 Hz 6 A, 850 W	230 Vac ±10% 57-63 Hz 12 A, 1600 W	115 Vac ±10% 57-63 Hz 4 A, 350 W	115 Vac ±10% 57-63 Hz 8 A, 600 W	230 Vac ±10% 57-63 Hz 12 A, 1500 W
Connections		3 Terminal Strip	3 Terminal Strip	3 Terminal Strip	3-wire, 5-ft cord	3 Terminal Strip	3 Terminal Strip
Temperature Ratings:	Cool.	Convection	Fan (2)	Fan (2)	Convection	Convection	Fan (2)
Dimensions:		483 mm × 133 mm × 445 mm (19" W × 5¼" H × 17½" D)	483 mm × 178 mm × 445 mm (19" W × 7" H × 17½" D)	483 mm × 178 mm × 445 mm (19" W × 7" H × 17½" D)	483 mm × 89 mm × 445 mm (19" W × 3½" H × 17½" D)	483 mm × 133 mm × 445 mm (19" W × 5¼" H × × 17½" D)	483 mm × 178 mm × 445 mm (19" W × 7" H × 17½" D)
Weight:	Net	15.8 kg (35 lb)	31.3 kg (69 lb)	43.9 kg (97 lb)	15.4 kg (34 lb)	21.3 kg (47 lb)	35.3 kg (78 lb)
	Ship	18.1 kg (40 lb)	35.3 kg (78 lb)	48 kg (106 lb)	18.6 kg (41 lb)	24.5 kg (54 lb)	39.4 kg (87 lb)
Options Available:		5, 7, 8, 9, 10, 13, 14, 20, 21, 22, 27, 28, 40	5, 7, 8, 9, 10, 13, 14, 20, 21, 22, 26, 27, 40	5, 7, 8, 9, 10, 13, 14, 16, 20, 21, 22, 27, 40	5, 7, 8, 9, 10, 13, 14, 20, 21, 22, 27, 28, 40	5, 7, 8, 9, 10, 13, 14, 20, 21, 22, 27, 28, 40	5, 7, 8, 9, 10, 13, 14, 20, 21, 22, 26, 27, 40

†Refer to page 209 for complete specification definitions.



POWER SUPPLIES

Models 6256B - 6274B (cont.)

Specifications†

RATING

DC Output	Volts	0-40 V	0-40 V	0-40 V	0-40 V	0-40 V
	Amps	0-3 A	0-5 A	0-10 A	0-30 A	0-50 A
Model		6256B	6266B	6267B	6268B	6269B

PERFORMANCE

Load Effect (Load Regulation):	V	0.01% + 200 μ V	0.01% + 200 μ V	0.01% + 200 μ V	0.01% + 200 μ V	0.01% + 200 μ V
	C	0.02% + 500 μ A	0.02% + 500 μ A	0.02% + 500 μ A	0.02% + 2 mA	0.02% + 2 mA
Source Effect (Line Regulation):	V	0.01% + 200 μ V	0.01% + 200 μ V	0.01% + 200 μ V	0.01% + 200 μ V	0.01% + 200 μ V
	C	0.02% + 500 μ A	0.02% + 500 μ A	0.02% + 500 μ A	0.02% + 2 mA	0.02% + 2 mA
PARD rms/p-p: (Ripple and Noise):	V	200 μ V/10 mV	200 μ V/10 mV	200 μ V/10 mV	1 mV/5 mV	1 mV/5 mV
	C	3 mA rms	3 mA rms	3 mA rms	20 mA rms	25 mA rms
Temperature Coefficient:	V	0.01% + 200 μ V	0.01% + 200 μ V	0.01% + 200 μ V	0.01% + 200 μ V	0.01% + 200 μ V
	C	0.01% + 1 mA	0.01% + 1 mA	0.01% + 1 mA	0.01% + 2 mA	0.01% + 4 mA
Drift (Stability):	V	0.03% + 500 μ V	0.03% + 500 μ V	0.03% + 2 mV	0.03% + 2 mV	0.03% + 2 mV
	C	0.03% + 3 mA	0.03% + 3 mA	0.03% + 3 mA	0.03% + 5 mA	0.03% + 10 mA
Resolution:	V	5 mV	5 mV	5 mV	5 mV	5 mV
	C	3 mA	5 mA	10 mA	30 mA	50 mA
Output Impedance (Typical):		2 m Ω , 1 μ H	1 m Ω , 1 μ H	0.5 m Ω , 1 μ H	0.2 m Ω , 1 μ H	0.1 m Ω , 1 μ H
Load Effect Transient Recovery:	Time	50 μ s	50 μ s	50 μ s	50 μ s	50 μ s
	Level	10 mV	10 mV	10 mV	10 mV	10 mV

FEATURES

Res	V	200 Ω /V \pm 1%	200 Ω /V \pm 1%	200 Ω /V \pm 1%	200 Ω /V \pm 1%	200 Ω /V \pm 1%
	C	300 Ω /A \pm 10%	200 Ω /A \pm 10%	100 Ω /A \pm 10%	6 Ω /A \pm 10%	4 Ω /A \pm 10%
Volt	V	1 V/V \pm 1%	1 V/V \pm 1%	1 V/V \pm 1%	1 V/V \pm 1%	1 V/V \pm 1%
	C	167 mV/A \pm 10%	100 mV/A \pm 10%	50 mV/A \pm 10%	16.7 mV/A \pm 10%	10 mV/A \pm 10%
Up	NL	275 ms	275 ms	275 ms	300 ms	350 ms
	FL	275 ms	275 ms	275 ms	300 ms	350 ms
Down	NL	12 sec	13 sec	13 sec	1 sec	1 sec
	FL	400 ms	275 ms	140 ms	30 ms	20 ms
Overvoltage Protection Crowbar:	Range	2.5-45 V	2.5-45 V	2.5-45 V	4-45 V	4-45 V
	Margin	5% of output +1 V	5% of output +1 V	5% of output +1 V	5% of output +1 V	5% of output +1 V
Meter Ranges:		50 V, 4 A \pm 2%	50 V, 6 A \pm 2%	50 V, 12 A \pm 2%	50 V, 35 A \pm 2%	50 V, 60 A \pm 2%

GENERAL

Power:		115 V ac \pm 10% 57-63 Hz 3 A, 180 W	115 V ac \pm 10% 57-63 Hz 4 A, 325 W	115 V ac \pm 10% 57-63 Hz 8 A, 550 W	230 V ac \pm 10% 57-63 Hz 11 A, 1600 W	230 V ac \pm 10% 57-63 Hz 18 A, 2500 W
Connections:		3-wire, 5-ft cord	3-wire, 5-ft cord	3 Terminal Strip	3 Terminal Strip	3 Terminal Strip
Temperature Ratings:	Cool.	Convection	Convection	Convection	Fan (2)	Fan (2)
Dimensions:		483 mm \times 89 mm \times 445 mm (19" W \times 3 1/2" H \times \times 17 1/2" D)	483 mm \times 89 mm \times 445 mm (19" W \times 3 1/2" H \times \times 17 1/2" D)	483 mm \times 133 mm \times 445 mm (19" W \times 5 1/4" H \times 17 1/2" D)	483 mm \times 178 mm \times 445 mm (19" W \times 7" H \times 17 1/2" D)	483 mm \times 178 mm \times 445 mm (19" W \times 7" H 17 1/2" D)
Weight:	Net	15.4 kg (34 lb)	15.4 kg (34 lb)	17.7 kg (39 lb)	34.4 kg (76 lb)	40.3 kg (89 lb)
	Ship	18.6 kg (41 lb)	18.6 kg (41 lb)	20.8 kg (46 lb)	38.1 kg (84 lb)	44 kg (98 lb)
Options Available:		5, 7, 8, 9, 10, 13, 14, 20, 21, 22, 27, 28, 40	5, 7, 8, 9, 10, 13, 14, 20, 21, 22, 27, 28, 40	5, 7, 8, 9, 10, 13, 14, 20, 21, 22, 27, 28, 40	5, 7, 8, 9, 10, 13, 14, 20, 21, 22, 26, 27, 40	5, 7, 8, 9, 10, 13, 14, 20, 21, 22, 27, 40

† Refer to page 209 for complete specification definitions.

Specifications †
RATING

DC Output	Volts	0-60 V	0-60 V
	Amps	0-3 A	0-15 A
Model		6271B	6274B

PERFORMANCE

Load Effect (Load Regulation):	V	0.01% + 200 μ V	0.01% + 200 μ V
	C	0.02% + 500 μ A	0.02% + 500 μ A
Source Effect (Line Regulation):	V	0.01% + 200 μ V	0.01% + 200 μ V
	C	0.02% + 500 μ A	0.02% + 500 μ A
PARD rms/p-p: (Ripple and Noise):	V	200 μ V/10 mV	200 μ V/20 mV
	C	3 mA rms	5 mA rms
Temperature Coefficient:	V	0.01% + 200 μ V	0.01% + 200 μ V
	C	0.01% + 1 mA	0.01% + 2 mA
Drift (Stability):	V	0.03% + 500 μ V	0.03% + 2 mV
	C	0.03% + 3 mA	0.03% + 5 mA
Resolution:	V	10 mV	10 mV
	C	3 mA	15 mA
Output Impedance (Typical):		5 m Ω , 1 μ H	1 m Ω , 1 μ H
Load Effect Transient Recovery:	Time	50 μ s	50 μ s
	Level	10 mV	10 mV

FEATURES

REMOVAL	Res	V	300 Ω /V \pm 1%	300 Ω /V \pm 1%
	Coef	C	300 Ω /A \pm 10%	67 Ω /A \pm 10%
CONTROL	Volt	V	1 V/V \pm 1%	1 V/V \pm 1%
	Coef	C	167 mV/A \pm 10%	33.3 mV/A \pm 10%
CONTROL	Up	NL	600 ms	600 ms
		FL	600 ms	600 ms
	Down	NL	7 sec	40 sec
		FL	0.2 sec	40 ms
Overvoltage Protection Crowbar:	Range		6-66 V	6-66 V
	Margin		5% of output +1 V	5% of output +1 V
Meter Ranges:			70 V, 4 A \pm 2%	70 V, 18 A \pm 2%

GENERAL

Power:		115 V ac \pm 10% 57-63 Hz 4 A, 300 W	115 V ac \pm 10% 57-63 Hz 15 A, 1200 W
Connections:		3-wire, 5-ft cord	3 Terminal Strip
Temperature Ratings:	Cool.	Convection	Fan (3)
Dimensions:		483 mm \times 89 mm \times 445 mm (19" W \times 3 1/2" H \times 17 1/4" D)	483 mm \times 133 mm \times 445 mm (19" W \times 5 1/4" H \times 17 1/4" D)
Weight:	Net	15.4 kg (34 lb)	21.7 kg (48 lb)
	Ship	18.6 kg (41 lb)	24.5 kg (54 lb)
Options Available:		5, 7, 8, 9, 10, 13, 14, 20, 21, 22, 27, 28, 40	5, 7, 8, 9, 10, 13, 14, 20, 21, 22, 27, 28, 40

† Refer to page 209 for complete specification definitions.

Options

005: 50 Hz ac input.	Price \$10
007: Ten-turn output voltage control. Replaces coarse voltage control for improved resolution in setting the output voltage.	\$25
008: Ten-turn output current control. Replaces coarse current control for improved resolution in setting the output current.	\$25
009: Ten-turn output voltage and current controls. Consists of Options 007 and 008 on same instrument.	\$50
010: Chassis slides. Enables convenient access to rack-mounted power supply interior for maintenance. Chassis slides are attached to supply at factory.	\$55
013: Three-digit graduated decadal voltage control. Includes a ten-turn control, replacing coarse voltage control. Option 013 provides improved mechanical stability and accurate resetting of the output voltage.	\$65
014: Three-digit graduated decadal current control. Includes a ten-turn control, replacing coarse current control. Option 014 provides improved mechanical stability and accurate resetting of the output current.	\$65
016: 115 V ac \pm 10% single-phase input. Factory modification consists of replacing the input power transformer and circuit breaker, and reconnecting the bias transformer, RFI choke, and fans for 115 V ac operation.	\$80
020: Voltage programming adjust. Allows the voltage programming coefficient and zero output voltage to be conveniently adjusted to an accuracy of 0.1% via access holes in the rear panel. Option 020 consists of two potentiometers, two fixed resistors, and appropriate connections located inside the rear panel.	\$25
021: Current programming adjust. Allows the current programming coefficient and zero output current to be conveniently adjusted to an accuracy of 0.1% via access holes in the rear panel. Option 021 consists of two potentiometers, two fixed resistors, and appropriate connections located inside the rear panel.	\$25
022: Voltage and current programming adjusts. Consists of Options 020 and 021 on same instrument.	\$50
026: 115 V ac \pm 10%, single-phase input. Factory modification consists of replacing the circuit breaker, and reconnecting the input power transformer, bias transformer, RFI choke, and fans for 115 V ac operation.	\$10
027: 208 V ac \pm 10%, single-phase input. Factory modification consists of reconnecting the multi-tap input power transformer (and other components where necessary) for 208 V operation.	\$15
028: 230 V ac \pm 10%, single-phase input. Factory modification consists of reconnecting the multi-tap input power transformer (and other components where necessary) for 230 V operation.	\$10
040: Interfacing for Multiprogrammer Operation. Prepares standard HP power supplies for resistance programming by the 6940A Multiprogrammer or 6941A Multiprogrammer Extender.	\$65
Model number and name	
6256B, 6263B High Performance DC Power Supply	\$545
6259B High Performance DC Power Supply	\$810
6260B High Performance DC Power Supply	\$990
6261B High Performance DC Power Supply	\$955
6264B, 6267B High Performance DC Power Supply	\$620
6265B High Performance DC Power Supply	\$450
6266B, 6271B High Performance DC Power Supply	\$520
6268B High Performance DC Power Supply	\$840
6269B High Performance DC Power Supply	\$985
6274B High Performance DC Power Supply	\$780

POWER SUPPLIES

General purpose: 300-11,000 W output
Models 6427B - 6483C

- Outstanding Value-Low Cost/Watt
- Up to 75% Efficiency at Full Output
- Constant Voltage/Current Operation

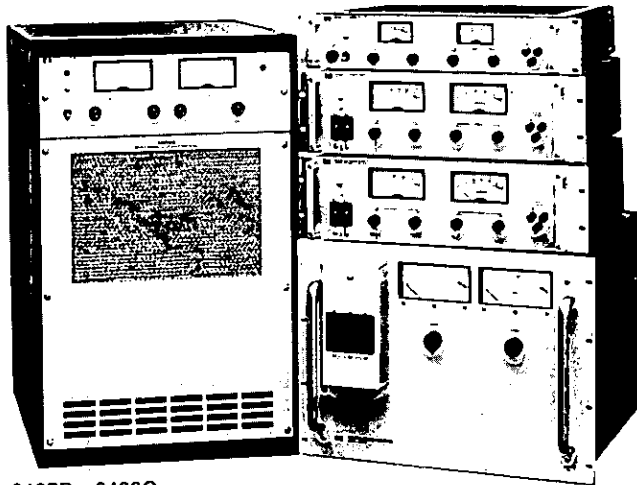

6427B-6483C

Description

This series of SCR-regulated power supplies is designed for high-power applications requiring a fixed or variable DC source with moderate regulation and ripple.

Operating features

All supplies in this series are of the Constant Voltage/Constant Current Type. Large easy-to-read panel meters continuously monitor output voltage and current.

Input and output power, remote sensing, remote programming, and auto-series, -parallel, and -tracking connections are made to bus bars and terminal blocks on the rear panel.

Voltage and current controls

The lower power models (6427B - 6439B) and the high power models with output voltages below 100 volts (6464C - 6472C) employ separate coarse and fine controls. Above 100 volts, the high power supplies (and Model 6448B) use 10-turn voltage and 1-turn current controls. All medium power models (6453A, 6456B, 6459A) use single-turn voltage and current controls.

Protective features

In addition to the overload protection inherent in Constant Voltage/Constant Current operation, there are many other built-in protective features included in these supplies. The features vary within the three model classifications as follows:

6427B-6448B: (1) Reverse voltage protection. (2) Fused AC input line.

6453A, 6456B, 6459A: (1) AC line loss protection circuit monitors 3-phase input and cuts off SCR's and opens output bus if a phase drops out; operation resumes when AC input returns to normal. (2) 3-phase input circuit breaker. (3) Optional internal crowbar (Option 006) protects load from overvoltage condition.

6464C-6483C: (1) High-temperature protection thermostat opens input to power transformer and lights front panel indicator if supply overheats. (2) Prolonged overload protection circuit is activated and lights front panel indicator if output current exceeds approximately 115% of maximum rating. (3) Optional internal crowbar (Option 006) protects load from overvoltage condition. (4) Turn-on circuit limits peak line current during start-up into low impedance loads. (5) Phase-

balance circuit permits operation with line-to-line input voltage imbalance up to 8%. (6) Overcurrent and overvoltage circuits of master and slave supplies used in auto-series, -parallel, or -tracking operation can be interlocked.

Auto-series, -parallel, -tracking operation

Supplies may be connected in auto-series, or auto-tracking. (Exceptions are Models 6448B and 6483C which cannot be connected in auto-series.)

For the lower power models (6427B-6448B), up to three supplies may be connected in any of the above configurations. Connection of the higher-power models (6453A-6483C) in auto-series, -parallel, or -tracking should ordinarily include no more than two supplies.

Remote sensing

Remote sensing permits regulation with respect to the point of load connection, rather than at the output terminals of the power supply. In all cases, there are limits to the permissible load-lead voltage drops, and the amount varies within the model groups, as follows:



Models 6427B-6448B: 2 volts in negative output lead.

Models 6453A, 6456B, 6459A: 1 volt in negative output lead.

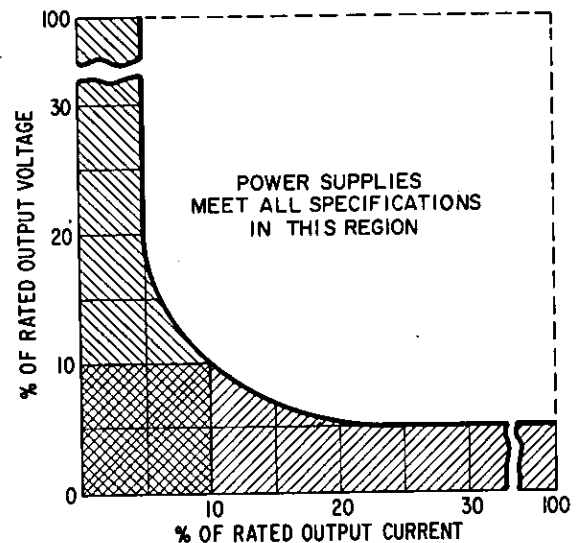
Models 6464C-6483C: 3 volts in negative output lead.



POWER SUPPLY OUTPUT RESTRICTIONS AS A FUNCTION OF LOADING
(REFER TO NOTE 6 ON SPECIFICATION PAGES)

-  UNSPECIFIED REGION FOR CC OPERATION. MEETS SPECIFICATIONS IN CV OPERATION.
-  UNSPECIFIED REGION FOR CV OPERATION. MEETS SPECIFICATIONS IN CC OPERATION.
-  UNSPECIFIED REGION FOR BOTH CC AND CV MODES OF OPERATION.

Remote programming

The voltage and current outputs of the supplies can be programmed by a remote resistance, or, for most models, a voltage source. Programming speeds and coefficients are detailed in the specifications table.

AC power requirements

The AC power requirements vary with the three model classifications (see option listings). When powered from a 50 Hz source (possible with Option 005), the rms ripple and transient response specifications increase by 50%. The p-p ripple specification is unchanged by line frequency.

Accessories and options: See page 193.

Specifications Δ

RATING

DC Output	Volts	0-8 V §	0-15 V §	0-16 V	0-18 V §	0-20 V	0-20 V	0-36 V	0-36 V
	Amps	0-1000 A §	0-200 A §	0-600 A	0-500 A §	0-15 A	0-45 A	0-10 A	0-100 A
Model		6454C	6453A	6456C	6427B	6426B	6433B	6456B	

PERFORMANCE

Load Effect (Load Regulation):	V	0.05% + 5 mV	0.2% + 10 mV comb. line & load	0.05% + 5 mV	20 mV	40 mV	36 mV	0.2% + 10 mV comb. line & load
	C	0.1% + 1 A	1% or 2 A comb. line & load	0.1% + 0.6 A	150 mA	450 mA	100 mA	1% or 1 A comb. line & load
Source Effect (Line Regulation):	V	0.05% + 5 mV	0.2% + 10 mV comb. line & load	0.05% + 5 mV	10 mV	20 mV	18 mV	0.2% + 10 mV comb. line & load
	C	0.1% + 1 A	1% or 2 A comb. line & load	0.1% + 0.6 A	150 mA	450 mA	100 mA	1% or 1 A comb. line & load
PAR rms/p-p: (Ripple and Noise):	V	80 mV/1 V †	150 mV rms †	180 mV/1 V †	40 mV/400 mV †	40 mV/500 mV †	36 mV/400 mV †	180 mV rms †
	C	**	**	**	**	**	**	**
Temperature Coefficient:	V	0.03% + 100 μV	0.05% + 2 mV	0.03% + 200 μV	0.03% + 3 mV	0.03% + 3 mV	0.03% + 5 mV	0.05% + 2 mV
	C	0.06% + 0.25 A	1.2 A	0.06% + 0.15 A	45 mA	135 mA	30 mA	0.6 A
Drift (Stability):	V	0.3% + 1 mV	0.25% + 10 mV	0.2% + 1 mV	0.1% + 10 mV	0.1% + 10 mV	0.1% + 15 mV	0.25% + 10 mV
	C	0.6% + 1 A	6 A	0.5% + 0.6 A	150 mA	450 mA	100 mA	3 A
Resolution:	V	8 mV	65 mV	18 mV	10 mV	10 mV	9 mV	90 mV
	C	1 A	1 A	0.5 A	7.5 mA	22.5 mA	5 mA	0.5 A
Output Impedance (Typical):		—	—	—	10 mΩ, 1 μH	2 mΩ, 1 μH	10 mΩ, 1 μH	—
Load Effect Transient Recovery:	Time	50 ms, 100 ms †	50 ms †	50 ms, 100 ms †	200 ms †	200 ms †	200 ms †	50 ms †
	Level	1.5 V, 500 mV †	150 mV †	1.5 V, 500 mV †	200 mV †	200 mV †	200 mV †	300 mV †

FEATURES

R E M O T E	Res	V	200Ω/V ±2%	200Ω/V ±2%	200Ω/V ±2%	200Ω/V ±2%	200Ω/V ±2%	200Ω/V ±2%	200Ω/V
	Coef	C	1Ω/A ±2%	1Ω/A	1.66Ω/A ±2%	20Ω/A ±20%	6Ω/A ±20%	30Ω/A ±20%	2Ω/A
	Volt	V	1 V/V ±1%	0.4 V/V	1 V/V ±1%	1 V/V	1 V/V	1 V/V	166 mV/V
	Coef	C	6.2 mV/A ±7%	30 mV/A	10.3 mV/A ±7%	NA	NA	NA	60 mV/A
C O N T R O L	Up	NL	1.6 sec	1 sec	1.6 sec	0.29 sec	0.16 sec	0.29 sec	1 sec
		FL	0.6 sec	0.5 sec	0.6 sec	1.4 sec	0.72 sec	1.4 sec	0.5 sec
	Down	NL	6 sec	20 sec	15 sec	100 sec	65 sec	110 sec	60 sec
		FL	0.1 sec	0.2 sec	0.2 sec	1.4 sec	0.72 sec	1.4 sec	0.5 sec
Overvoltage Protection Crowbar:	Range	NA	9-17 V	8-20 V	NA	NA	NA	22-41 V	
	Margin	NA	5% of output +1 V	10% of output V	NA	NA	NA	5% of output +1 V	
Options	NA	Option 06	Option 06	NA	NA	NA	Option 06		
DC Output Isolation:	100 V	300 V	100 V	300 V	300 V	300 V	300 V		
Meter Ranges:	10 V, 1200 A ±2%	20 V, 200 A ±2%	20 V, 700 A ±2%	24 V, 18 A ±2%	24 V, 50 A ±2%	40 V, 12 A ±2%	40 V, 100 A ±2%		

GENERAL

Power:	Option 1, 2, 3, 5, 31, 32	Option 1, 2, 3, 5, 31, 32	Option 1, 2, 3, 5, 31, 32	115 V ac ±10% 57-63 Hz 6.5 A, 450 W	115 V ac ±10% 57-63 Hz 17 A, 1200 W	115 V ac ±10% 57-63 Hz 7 A, 450 W	Option 1, 2, 3, 5, 31, 32	
Connections:	4-Terminal Strip	4-Pin Plug & Jack	4-Terminal Strip	3-Wire, 5-Ft. Cord	3-Terminal Strip	3-Wire, 5-Ft. Cord	4-Pin Plug & Jack	
Temperature Ratings:	Cool. Fan	Fan	Fan	Convection ‡	Fan ‡	Convection ‡	Fan	
Weight:	Net	235 kg (518 lb)	108 kg (238 lb)	226 kg (500 lb)	16.3 kg (36 lb)	30.4 kg (67 lb)	14.9 kg (33 lb)	108 kg (238 lb)
	Ship	255 kg (562 lb)	135 kg (299 lb)	251 kg (555 lb)	22.7 kg (50 lb)	38.5 kg (85 lb)	21.7 kg (48 lb)	135 kg (299 lb)
Dimensions:	426 mm × 667 mm × 664 mm (16 3/4" W × 26 1/4" H × 26 1/4" D)	483 mm × 356 mm × 464 mm (19" W × 14" H × 18 1/4" D)	426 mm × 667 mm × 664 mm (16 3/4" W × 26 1/4" H × 26 1/4" D)	483 mm × 89 mm × 445 mm (19" W × 3 1/2" H × 17 1/2" D)	483 mm × 133 mm × 426 mm (19" W × 5 1/4" H × 17 1/4" D)	483 mm × 89 mm × 445 mm (19" W × 3 1/2" H × 17 1/4" D)	483 mm × 356 mm × 464 mm (19" W × 14" H × 18 1/4" D)	
Options Available:	1, 2, 3, 5, 23, 31, 32	1, 2, 3, 5, 6, 10, 31, 32	1, 2, 3, 5, 6, 23, 31, 32	5, 10, 27, 28	5, 10, 27, 28	5, 10, 27, 28	1, 2, 3, 5, 6, 10, 31, 32	

§(1) Under light loading conditions, power supply may not meet all published specifications. The graph on page 190 defines the permissible operating regions for CV and CC modes of operation. †Operating temperature range for this supply is 0 to 55°C. — indicates that information was not available at time of printing.
 (2) For operation with a 50 Hz input (possible only with Option 05), output current is linearly derated from 100% †, †, †. ** See page 192 for definitions.
 at 40°C to 80% at 50°C.



POWER SUPPLIES

Models 6427B - 6483C (cont.)

Specifications Δ

RATING

DC Output	Volts	0-36 V \S	0-40 V \S	0-60 V \S	0-60 V \S	0-64 V \S	0-64 V \S	0-110 V \S	0-120 V \S
	Amps	0-300 A \S	0-25 A \S	0-5 A \S	0-15 A \S	0-50 A \S	0-150 A \S	0-100 A \S	0-2.5 A \S
Model		6459C	6434B	6438B	6439B	6459A	6472C	6475C	6443B

PERFORMANCE

Load Effect (Load Regulation):	V	0.05% + 5 mV	40 mV	60 mV	120 mV	0.2% + 10 mV comb. line & load	0.05% + 100 mV	0.05% + 100 mV	120 mV
	C	0.1% + 0.3 A	200 mA	50 mA	150 mA	1% or 0.5 A comb. line & load	0.1% + 0.15 A	0.1% + 0.1 A	25 mA
Source Effect (Line Regulation):	V	0.05% + 5 mV	18 mV	30 mV	60 mV	0.2% + 10 mV comb. line & load	0.05% + 100 mV	0.05% + 100 mV	60 mV
	C	0.1% + 0.3 A	200 mA	50 mA	150 mA	1% or 0.5 A comb. line & load	0.1% + 0.15 A	0.1% + 0.1 A	25 mA
PARD rms/p-p: (Ripple and Noise):	V	180 mV/1 V \dagger	40 mV/500 mV \dagger	120 mV/400 mV \dagger	60 mV/500 mV \dagger	160 mV rms \dagger	160 mV/2 V	220 mV/2 V \dagger	240 mV/400 mV \dagger
	C	**	**	**	**	**	**	**	**
Temperature Coefficient:	V	0.03% + 400 μ V	0.03% + 5 mV	0.03% + 10 mV	0.03% + 10 mV	0.05% + 2 mV	0.03% + 4 mV	0.03% + 5 mV	0.03% + 20 mV
	C	0.06% + 0.1 A	75 mA	15 mA	45 mA	0.3 A	0.06% + 85 mA	0.06% + 75 mA	8 mA
Drift (Stability):	V	0.15% + 1 mV	0.1% + 20 mV	0.1% + 30 mV	0.1% + 30 mV	0.25% + 10 mV	0.15% + 16 mV	0.15% + 20 mV	0.1% + 60 mV
	C	0.4% + 0.4 A	250 mA	50 mA	150 mA	1.5 A	0.3% + 0.35 A	0.3% + 300 mA	25 mA
Resolution:	V	36 mV	10 mV	9 mV	9 mV	110 mV	64 mV	22 mV	30 mV
	C	0.3 A	12.5 mA	2.5 mA	7.5 mA	0.25 A	0.15 A	0.1 A	1.3 mA
Output Impedance (Typical):		—	10 m Ω , 1 μ H	20 m Ω , 1 mH	10 m Ω , 1 μ H	—	—	—	0.1 Ω , 2 μ H
Load Effect Transient Recovery:	Time	50 ms, 100 ms \dagger	200 ms \dagger	200 ms \dagger	200 ms \dagger	50 ms \dagger	50 ms, 100 ms \dagger	50 ms, 100 ms \dagger	200 ms \dagger
	Level	1.5 V, 500 mV \dagger	200 mV \dagger	300 mV \dagger	600 mV \dagger	600 mV \dagger	2 V, 750 mV \dagger	2.5 V, 1 V \dagger	600 mV \dagger

FEATURES

R E M O T E C O N T R O L	Res	V	200 Ω /V \pm 2%	200 Ω /V \pm 2%	300 Ω /V \pm 2%	300 Ω /V \pm 2%	300 Ω /V \pm 2%	300 Ω /V \pm 2%	300 Ω /V \pm 2%	
	Coef	C	3.33 Ω /A \pm 2%	12 Ω /A	60 Ω /A	20 Ω /A	4 Ω /A	6.7 Ω /A \pm 2%	10 Ω /A \pm 2%	120 Ω /A
	Volt	V	1 V/V \pm 1%	1 V/V	1 V/V	1 V/V	94 mV/V	1 V/V \pm (1% \pm 1 V)	1 V/V \pm (1% \pm 1 V)	1 V/V
	Coef	C	20.6 mV/A \pm 7%	NA	NA	NA	120 mV/A	41.2 mV/A \pm 7%	62 mV/A \pm 7%	NA
O P E R A T I O N	Up	NL	1.6 sec	0.256 sec	0.52 sec	0.26 sec	1 sec	1.4 sec	1.5 sec	0.5 sec
		FL	2 sec	1.2 sec	2.5 sec	1.3 sec	0.5 sec	2 sec	1.2 sec	2 sec
	Down	NL	20 sec	75 sec	205 sec	76 sec	45 sec	55 sec	80 sec	210 sec
		FL	0.5 sec	1.2 sec	2.5 sec	1.3 sec	0.7 sec	0.7 sec	0.7 sec	2 sec
Overvoltage Protection	Range		18-40 V	NA	NA	NA	38-73 V	32-70 V	55-120 V	NA
	Margin		10% of output V	NA	NA	NA	5% of output +1 V	10% of output V	10% of output V	NA
Options			Option D6	NA	NA	Option D6	Option D6	Option D6	Option D6	NA
DC Output Isolation:			100 V	300 V	300 V	300 V	100 V	300 V	300 V	300 V
Meter Ranges			40 V, 350 A \pm 2%	50 V, 30 A \pm 2%	70 V, 6 A \pm 2%	70 V, 18 A \pm 2%	80 V, 50 A \pm 2%	80 V, 180 A \pm 2%	125 V, 120 A \pm 2%	150 V, 3 A \pm 2%

GENERAL

Power:		Option 1, 2, 3, 5, 31, 32	115 V ac \pm 10% 57-63 Hz 19 A, 1300 W	115 V ac \pm 10% 57-63 Hz 6.5 A, 490 W	115 V ac \pm 10% 57-63 Hz 17 A, 1200 W	Option 1, 2, 3, 5, 31, 32	Option 1, 2, 3, 5, 31, 32	Option 1, 2, 3, 5, 31, 32	115 V ac \pm 10% 57-63 Hz 6.5 A, 400 W
Connections		4-Terminal Strip	3-Terminal Strip	3-Wire, 5-Ft. Cord	3-Terminal Strip	4-Pin Plug & Jack	4-Terminal Strip	4-Terminal Strip	3-Wire, 5-Ft. Cord
Temperature Ratings:	Cool.	Fan	Fan $\dagger\dagger$	Convection $\dagger\dagger$	Fan $\dagger\dagger$	Fan	Fan	Fan	Convection $\dagger\dagger$
Weight:	Net	226 kg (500 lb)	30.4 kg (67 lb)	14 kg (31 lb)	27.6 kg (61 lb)	108 kg (238 lb)	226 kg (500 lb)	226 kg (500 lb)	14 kg (31 lb)
	Ship	251 kg (555 lb)	37.1 kg (82 lb)	22.7 kg (50 lb)	36.2 kg (80 lb)	135 kg (299 lb)	251 kg (555 lb)	251 kg (555 lb)	20.4 kg (45 lb)
Dimensions:		426 mm \times 667 mm \times 664 mm (16 3/4" W \times 26 1/4" H \times 26 1/4" D)	483 mm \times 133 mm \times 426 mm (19" W \times 5 1/4" H \times 16 3/4" D)	483 mm \times 89 mm \times 445 mm (19" W \times 3 3/8" H \times 17 3/8" D)	483 mm \times 133 mm \times 426 mm (19" W \times 5 1/4" H \times 16 3/4" D)	483 mm \times 356 mm \times 464 mm (19" W \times 14" H \times 18 3/4" D)	426 mm \times 667 mm \times 664 mm (16 3/4" W \times 26 1/4" H \times 26 1/4" D)	426 mm \times 667 mm \times 664 mm (16 3/4" W \times 26 1/4" H \times 26 1/4" D)	483 mm \times 89 mm \times 445 mm (19" W \times 3 3/8" H \times 17 3/8" D)
	Options Available:		1, 2, 3, 5, 6, 23, 31, 32	5, 10, 27, 28	5, 10, 27, 28	5, 10, 27, 28	1, 2, 3, 5, 6, 10, 31, 32	1, 2, 3, 5, 6, 23, 31, 32	1, 2, 3, 5, 6, 23, 31, 32

\dagger For operation with a 50 Hz input (possible only with Option 05), the rms ripple and transient response specifications are increased by 50%.

* The output capacity is up to 25 A at 440 V, up to 20 A at 500 V, and 15 A at 600 V.

** Constant Current ripple and noise depends on the value and characteristics of the load. For a resistive load, the rms current ripple can be calculated by dividing the rms ripple voltage by the load resistance.

Δ Refer to page 209 for complete specification definitions.



Options

AC Input power:

6427B-6448B Price
Std: 115 V ac, ±10%, single phase, 57-63 Hz.
027: 208 V ac, ±10%, single phase, 57-63 Hz. \$15
028: 230 V ac, ±10%, single phase, 57-63 Hz. \$15
005: Realignment for 50 Hz operation at any of the above line voltages. \$10
6453A, 6456B, 6459A: AC input may be delta or wye with isolation neutral. AC input connections are by means of Hubbell No. 7413G connector at rear of unit. A matching connector is furnished.
001: 208 V ac, ±10%, 3-phase, 15.5 A per phase, 57-63 Hz. N/C
002: 230 V ac, ±10%, 3-phase, 14 A per phase, 57-63 Hz. N/C
031: 380 V ac, ±10%, 3-phase, 8.5 A per phase, 57-63 Hz. \$55
032: 400 V ac, ±10%, 3-phase, 8.0 A per phase, 57-63 Hz. \$55
003: 460 V ac, ±10%, 3-phase, 7 A per phase, 57-63 Hz. N/C
005: Realignment for 50 Hz operation at any of the above line voltages. \$25
6464C-6483C: AC input may be delta or wye with isolated neutral. AC input connections are by means of enclosed 4-wire terminal block.
001: 208 V ac, ±10%, 3-phase, 55 A per phase, 57-63 Hz. N/C
002: 230 V ac, ±10%, 3-phase, 50 A per phase, 57-63 Hz. N/C
031: 380 V ac, ±10%, 3-phase, 30 A per phase, 57-63 Hz. \$200
032: 400 V ac, ±10%, 3-phase, 28.5 A per phase, 57-63 Hz. \$200
003: 460 V ac, ±10%, 3-phase, 25 A per phase, 57-63 Hz. \$210
005: Realignment for 50 Hz operation at any of the above line voltages. N/C
006: Internal overvoltage protection crowbar. For complete specifications, refer to specifications table.
 6456A, 6459A, 6477C, 6479C, 6483C \$310
 6453A \$360
 6472C, 6475C \$415
 6466C \$515
 6469C \$465
010: Chassis slides. Enables convenient access to rack mounted power supply for maintenance. Chassis slides (one pair, 1 1/4" high on models 6427B-6448B) \$130
 (Two pair, 3" high on models 6453A-6459A) are attached to supply at factory. \$200
023: Rack kit (attached at factory) for mounting one 6464C-6483C supply in standard 19" rack. \$25
Accessories:
 14545A Set of 4 snap-on casters for one 6464C-6483C supply. \$40
Model number and name:
 6427B High Power D.C. Supply \$475
 6428B High Power D.C. Supply \$655
 6433B, 6438B High Power D.C. Supply. \$440
 6434B High Power D.C. Supply \$640
 6439B High Power D.C. Supply \$620
 6443B High Power D.C. Supply \$430
 6448B High Power D.C. Supply \$665
 6453A High Power D.C. Supply \$1600
 6456B, 6459A High Power D.C. Supply \$1495
 6464C High Power D.C. Supply \$3920
 6466C High Power D.C. Supply \$3145
 6469C High Power D.C. Supply \$2900
 6472C, 6475C, 6477C, 6479C and 6483C High Power D.C. Supplies \$3145

0-220 V _g	0-300 V _g	0-440, 500, 600 V _g *	1-600 V _g
0-50 A _g	0-35 A _g	0-25, 20, 15 A _g	5 mA-1.5 A _g
6477C	6479C	6483C	6448B

0.05% + 100 mV	0.05% + 100 mV	0.05% + 100 mV	1% + 400 mV
0.1% + 50 mA	0.1% + 35 mA	0.1% + 35 mA	2% + 10 mA
0.05% + 100 mV	0.05% + 100 mV	0.05% + 100 mV	600 mV
0.1% + 50 mA	0.1% + 35 mA	0.1% + 35 mA	15 mA
330 mV/2 V†	330 mV/3 V†	600 mV/5 V†	600 mV/2 V†
**	**	**	**
0.03% + 8 mV	0.03% + 11 mV	0.03% + 20 mV	0.03% + 100 mV
0.06% + 65 mA	0.06% + 60 mA	0.06% + 60 mA	5 mA
0.15% + 35 mV	0.15% + 45 mV	0.15% + 80 mV	0.1% + 300 mV
0.03% + 250 mA	0.3% + 250 mA	0.3% + 250 mA	15 mA
44 mV	60 mV	60 mV	60 mV
50 mA	35 mA	25 mA	0.75 mA
-	-	-	0.5Ω, 10 μH
50 ms, 100 ms†	50 ms, 100 ms†	50 ms, 100 ms†	200 ms†
5 V, 2 V†	7 V, 3 V†	12 V, 5 V†	3 V†

300 Ω/V ±2%	300 Ω/V ±2%	300 Ω/V ±2%	300 Ω/V ±2%
20 Ω/A ±2%	28.6 Ω/A ±2%	40 Ω/A ±2%	600 Ω/A
1 V/V ±(1% ±1 V)	1 V/V ±(1% ±1 V)	1 V/V ±(1% ±1 V)	1 V/V
124 mV/A ±7%	177 mV/A ±7%	0.25 V/A ±7%	NA
1.5 sec	1.5 sec	1.5 sec	0.2 sec
2 sec	2 sec	2 sec	1 sec
95 sec	75 sec	120 sec	45 sec
1 sec	1.6 sec	2 sec	1 sec
110-240 V	150-330 V	300-660 V	NA
10% of output V	10% of output V	10% of output V	NA
Option 06	Option 06	Option 06	NA
300 V	300 V	100 V	300 V
250 V, 60 A ±2%	350 V, 40 A ±2%	700 V, 30 A ±2%	700 V, 1.8 A ±2%

Option 1,2,3,5,31,32	Option 1,2,3,5,31,32	Option 1,2,3,5,31,32	115 V ac ±10% 57-63 Hz 16 A, 1200 W
4-Terminal Strip	4-Terminal Strip	4-Terminal Strip	3-Terminal Strip
Fan	Fan	Fan	Fan
226 kg (500 lb)	226 kg (500 lb)	226 kg (500 lb)	27.6 kg (61 lb)
251 kg (555 lb)	251 kg (555 lb)	251 kg (555 lb)	32.6 kg (72 lb)
426 mm × 667 mm × 664 mm (16 1/4" W × 26 1/4" H × 26 1/4" D)	426 mm × 667 mm × 664 mm (16 1/4" W × 26 1/4" H × 26 1/4" D)	426 × 667 mm × 664 mm (16 1/4" W × 26 1/4" H × 26 1/4" D)	426 × 667 mm × 664 mm (19" W × 5 1/4" H × 16 1/4" D)
1, 2, 3, 5, 6, 23, 31, 32	1, 2, 3, 5, 6, 23, 31, 32	1, 2, 3, 5, 6, 23, 31, 32	5, 10, 27, 28

POWER SUPPLIES

General purpose: high voltage output

Models 6515A — 6525A

- Short circuit proof
- Precise voltage control—four-decade thumbwheel or switch-and-vernier
- Convection cooling
- Floating output—can be used as a positive or negative source
- Front-panel meters
- Bench or rack mounting

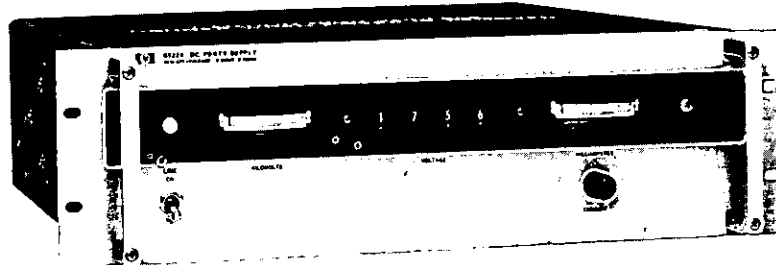

6521A, 6522A, 6525A

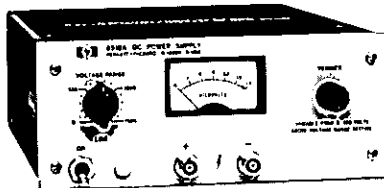

6515A

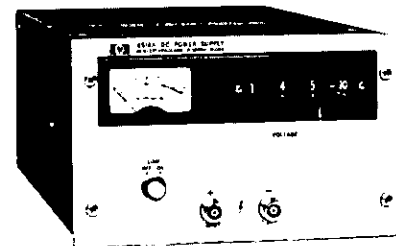

6516A

Description

6521A, 6522A, 6525A

This series of high performance power supplies has broad application both in the laboratory and in the system. They have sufficient output current to power devices such as TWT's, klystrons, magnetrons, backward-wave oscillators, high-power gas lasers, electron-beam welding devices, etc. Output voltage is set easily and precisely by a three-decade thumbwheel switch plus a thumbwheel vernier providing 0.002% resolution. In constant voltage operation, a single-turn current control allows the current-limit point to be set to any value within the current rating. In constant-current operation, the current control varies the output current while the voltage controls (thumbwheels) provide an adjustable voltage limit. The supplies are protected against reverse voltages that could be generated by an active load. Protection from reverse current requires pre-loading the supply with a dummy load to ensure that the supply outputs current through the entire operating cycle of the load.

Plus and minus output connectors (Type UG-931/U) are provided on the rear panel. Mating connectors (Type UG-932/U) are supplied with each unit. Either the positive or negative terminal may be grounded or the supply may be operated floating at up to 2000 V above ground. Units are packaged in a 19-inch wide case, suitable for rack or bench mounting.

6515A and 6516A

These high-voltage power supplies are lower in cost and output

power than the 6521A-6525A supplies. Their small size, low price, and short-circuit-proof operation make them excellent high-voltage laboratory supplies, or high-voltage system supplies where current requirements are no more than 6 mA.

Model 6515A employs a sixteen-position rotary switch and a ten-turn vernier control to adjust the output voltage. The rotary switch selects output voltage increments from 0 to 1500 V in 100-volt steps; the vernier control permits fine adjustment (100 mV resolution) over any 100-volt span. Model 6516A uses a three-decade thumbwheel switch plus a thumbwheel vernier for convenient and precise (0.1 V resolution) output voltage control.

Non-adjustable current-limit protection is provided on both models. On Model 6516A, the current-limit point is fixed at approximately 8 mA. On Model 6515A, the current limit value varies with the selected output voltage range as follows (voltage range/current limit): 0-300 V/7.5 mA, 400-700 V/65 mA, 800-1100 V/32 mA, 1200-1500 V/25 mA. Both supplies are protected against reverse voltages that could be generated by an active load. Pre-loading is necessary to protect the supplies from reverse currents.

Plus and minus output connectors (Type UG-931/U) are provided on the front panel of both supplies. Mating connectors (Type UG-932/U) are supplied with each unit. Either the positive or negative terminal may be grounded or the supply may be operated floating at up to 1000 V above ground. Units are packaged in half-rack width cases. They may be bench operated or mounted individually or in pairs using accessory rack-mounting kits.

Specifications †

RATING

DC Output	Volts	0-1000 V	0-1600 V	0-2000 V	0-3000 V	0-4000 V
	Amps	0-200 mA	5 mA	0-100 mA	6 mA	0-50 mA
Model		6521A	6515A	6522A	6516A	6525A

PERFORMANCE

Load Effect (Load Regulation):	V	0.005% or 20 mV*	0.01% or 16 mV*	0.005% or 20 mV*	0.01% or 16 mV*	0.005% or 20 mV*
	C	2% or 1 mA*	NA	2% or 1 mA*	NA	2% or 1 mA*
Source Effect (Line Regulation):	V	0.005% or 20 mV*	0.01% or 16 mV*	0.005% or 20 mV*	0.01% or 16 mV*	0.005% or 20 mV*
	C	1 mA	NA	1 mA	NA	1 mA
PARV rms/p-p: (Ripple and Noise):	V	1 mV/500 mV	2 mV/5 mV	1 mV/500 mV	1 mV/50 mV	1 mV/500 mV
	C	2 mA rms	NA	1 mA rms	NA	500 µA rms
Temperature Coefficient:	V	0.012% + 1 mV	0.02% + 2 mV	0.012% + 1 mV	0.02% + 2 mV	0.012% + 1 mV
	C	0.2% + 0.2 mA	NA	0.2% + 0.1 mA	NA	0.2% + 0.05 mA
Drift (Stability):	V	0.036% + 3 mV	0.05% + 5 mV	0.036% + 3 mV	0.05% + 5 mV	0.036% + 3 mV
	C	0.25% + 0.5 mA	NA	0.25% + 0.25 mA	NA	0.25% + 0.12 mA
Resolution:	V	20 mV	100 mV	40 mV	1 V	80 mV
	C	0.6 mA	NA	0.3 mA	NA	0.15 mA
Accuracy:		1% of setting	NA	1% of setting	1% of setting	1% of setting
Output Impedance (Typical):		0.1Ω, 1 µH	—	0.1Ω, 1 µH	—	0.1Ω, 1 µH
Load Effect Transient Recovery	Time	50 µs	100 µs	50 µs	100 µs	50 µs
	Level	0.005% or 20 mV*	0.01% or 16 mV*	0.005% or 20 mV*	0.01% or 16 mV*	0.005% or 20 mV*

FEATURES

Output Mode:	CV/CC	CV/CL	CV/CC	CV/CL	CV/CC
DC Output Isolation:	2 kV	1 kV	2 kV	1 kV	2 kV
Meter Ranges:	1 kV, 200 mA ±2%	1.8 kV ±2%	2 kV, 100 mA ±2%	3.5 kV ±2%	4 kV, 50 mA ±2%

GENERAL

Power:	115 Vac ±10% 48-440 Hz 4 A, 270 W	115 Vac ±10% 60 ±0.3 Hz 162 mA, 19 W	115 Vac ±10% 48-440 Hz 4 A, 270 W	115 Vac ±10% 57-63 Hz 1 A, 40 W	115 Vac ±10% 48-440 Hz 4 A, 270 W	
Connections	3-wire, 5-ft cord	3-wire, 5-ft cord	3-wire, 5-ft cord	3-wire, 5-ft cord	3-wire, 5-ft cord	
Cooling	Convection	Convection	Convection	Convection	Convection	
Weight:	Net	19 kg (42 lb) ⁰	4.1 kg (9 lb)	19 kg (42 lb)	7.7 kg (17 lb)	19 kg (42 lb)
	Ship	28.5 kg (63 lb)	5.0 kg (11 lb)	28.5 kg (63 lb)	9.5 kg (21 lb) ^o	28.5 kg (63 lb)
Dimensions:	483 mm × 133 mm × 457 mm (19" W × 5¼" H × 18" D)	216 mm × 89 mm × 299 mm (8½" W × 3¼" H × 11¾" D)	483 mm × 133 mm × 457 mm (19" W × 5¼" H × 18" D)	216 mm × 133 mm × × 406 mm (8½" W × 5¼" H × 16" D)	483 mm × 133 mm × 457 mm (19" W × 5¼" H × 18" D)	
Options Available:	NA	13	NA	5, 18	NA	

* Whichever Quantity is Greater
† Refer to page 209 for complete specification definitions.

Accessories available

14513A—89 mm (3½") High Rack Kit for one 6515A	Price \$20
14523A—89 mm (3½") High Rack Kit for two 6515A's	\$10
14515A—133 mm (5¼") High Rack Kit for one 6516A	\$25
14525A—133 mm (5¼") High Rack Kit for two 6516A's	\$15

Options

005: 50 Hz ac input. Standard instrument is designed for 60 Hz input. Option 005 includes substitution of 50 Hz magnetic components and readjustment of internal protection circuits.	\$55
013: Three-digit-graduated-decimal-voltage-control	

Includes a calibrated 10-turn control replacing the 10-turn vernier to provide resettability within 0.1%.
018: 230 V ac ±10%, single-phase input. Factory modification includes the replacement of input inductor and power and bias transformers for operation at 230 V ac. \$55

Model number and name

6515A, 1.6 kV High Voltage Power Supply	\$285
6516A, 3 kV High Voltage Power Supply	\$385
6521A, 1 kV High Voltage Power Supply	\$960
6522A, 2 kV High Voltage Power Supply	\$960
6525A, 4 kV High Voltage Power Supply	\$960

POWER SUPPLIES

General Purpose: dual-tracking outputs

Models 6227B & 6228B

- Two 50-watt power supplies for independent or tracking operation
- Built-in overvoltage protection crowbars

- Auto-parallel and auto-series capability
- Constant current in addition to constant voltage outputs

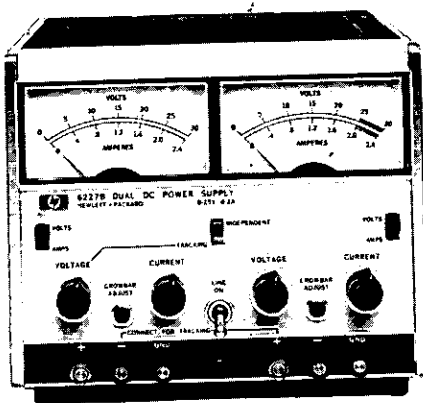

6227B

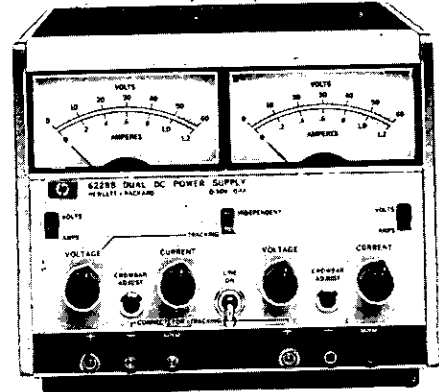

6228B

Description

These versatile lab supplies each house two identical 50 W regulated power supplies. A convenient front panel switch selects either independent or tracking operation. In the tracking mode, the right supply tracks the left within $0.2\% \pm 2$ mV. The tracking mode is especially useful for powering operational amplifiers, push-pull stages, deflection systems, or any application where plus and minus voltages must track with insignificant error. The independent mode permits operation of the two supplies individually, in auto-parallel or in auto-series.

Each side of the dual supply can be operated as a constant voltage or constant current source, and each has its own crowbar for overvoltage protection. In the tracking mode, an overvoltage condition in either supply trips both crowbars. The power supply outputs are isolated up to 300 V from output to chassis or output to output.

Specifications

DC output: 6227B, 0-25 V @ 0-2 A; 6228B, 0-50 V @ 0-1 A.

AC input: 115 or 230 V ac $\pm 10\%$, 48-63 Hz, 260 W. Selected by rear panel switch.

CV load effect (load regulation): For a load current change equal to the current rating of the supply; $0.01\% + 1$ mV.

CC load effect: For a load voltage change equal to the voltage rating of the supply; $0.01\% + 250$ μ V.

Source effect (line regulation): For a change in line voltage between 103.5 and 126.5 V ac or 207 and 253 V ac at any output voltage and current within rating; CV, 1 mV; CC, 100 μ A.

PARD (ripple and noise): At any line voltage and under any load condition within rating (20 Hz to 20 MHz); CV, 250 μ V rms/4 mV p-p; CC, 250 μ A rms/2 mA p-p.

Temperature coefficient: Output change per degree Centigrade change in ambient following 30 minutes warm-up; CV, $0.02\% + 200$ μ V; CC, $0.02\% + 300$ μ A.

Drift (stability): Total drift in output (dc to 20 Hz) over 8-hour interval under constant line, load, and ambient following 30 minutes warm up; CV, $0.2\% + 2$ mV; CC, $0.2\% + 3$ mA.

Remote resistance programming: CV, $200\Omega/V \pm 1\%$; CC, $500\Omega/A \pm 10\%$ (6227B); $1\text{ k}\Omega/A \pm 10\%$ (6228B).

Remote voltage programming: CV, $1\text{ V/V} \pm 1\%$; CC, $0.5\text{ V/A} \pm 10\%$ (6227B); $1\text{ V/A} \pm 10\%$ (6228B).

Output impedance (typical): Approximated by a resistance in series with an inductance; 6227B, $2\text{ m}\Omega/2\ \mu\text{H}$; 6228B, $1\text{ m}\Omega/6\ \mu\text{H}$.

Resolution (fine control): voltage, 5 mV (6227B), 10 mV (6228B); current, 1 mA (6227B), 0.5 mA (6228B).

Internal overvoltage crowbars: During independent operation,

each supply is protected by its own crowbar. In the tracking mode, an overvoltage in either supply results in firing both crowbars.

Trip voltage margin: The minimum trip voltage above the operating output voltage of the supply to prevent false crowbar tripping: 7% of the output voltage + 1.5 V.

Trip voltage range: 6227B, 5-28 V dc; 6228B, 5-55 V dc.

Tracking error: In tracking mode, the slave supply is matched to $0.2\% \pm 2$ mV of the master.

Transient recovery time: In constant voltage, the output will recover in 50 μ sec to within 10 mV of its nominal value for a resistive load change demanding an output current change equal to the current rating of the supply. The nominal output voltage is defined as the mean between the no load and full load voltages.

Temperature ratings: Operating: 0 to 55°C; Storage: -40 to +75°C.

Cooling: Natural convection cooling.

Weight (net/shipping): 11/12.9 kg (24/28 lb).

Dimensions: 197 mm W \times 155 mm H \times 310 mm D ($7\frac{1}{4}$ in. W \times $6\frac{1}{4}$ in. H \times 12 $\frac{1}{4}$ in. D).

Finish: Mint gray panel with olive gray case.

Accessories Available:

5060-8762 — Rack kit for mounting one or two dual supplies

5060-8760 — Filler panel to block unused half of rack when mounting only one dual supply

Options

007: Two ten-turn output voltage controls replace both sets of concentric coarse and fine voltage controls

008: Two ten-turn output current controls replace both sets of concentric coarse and fine current controls

009: Four ten-turn output voltage and current controls replace all four concentric coarse and fine voltage and current controls

013: Three digit graduated decadal voltage control includes graduated ten-turn control replacing standard coarse and fine voltage controls

014: Three digit graduated decadal current control includes graduated ten-turn control replacing standard coarse and fine current controls

040: Interfacing for Multiprogrammer operation. Prepares standard HP power supplies for resistance programming by the 6940A Multiprogrammer or 6941A Multiprogrammer Extender

Model number and name

6227B Dual Tracking Power Supply

6228B Dual Tracking Power Supply

Price

\$33

\$8

\$10

\$60

\$60

\$110

\$150

\$150

\$150

\$135

\$625

\$625

POWER SUPPLIES

Special purpose: precision sources

Models 6101A - 6116A

- 0.025% output voltage accuracy
- 5-minute warm-up
- Built-in overvoltage crowbar

- Constant voltage/current operation
- Thumbwheel or ten-turn voltage controls
- 0.1% output voltage accuracy

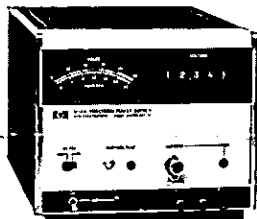

6114A, 6115A

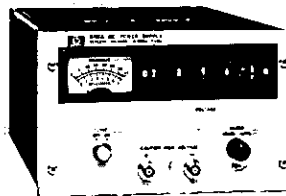

6110A



6111A, 6112A, 6113A, 6116A



6104A, 6105A

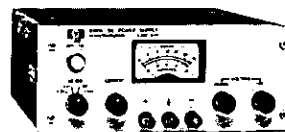

6101A, 6102A, 6106A

Description

6104A, 6105A, 6114A, and 6115A

These four 40-watt precision power supplies are ideal for applications where an accurate, highly stable, and easy-to-use source of dc voltage is required. All four models feature automatic dual range operation. For example, Models 6104A and 6114A can supply 0-20 V at 0-2A, and 20-40 V at 0-1 A, without manual range switching. Automatic output current range crossover occurs when the supply is providing greater than one-half of the maximum rated output voltage.

Output voltage controls

Pushbutton voltage controls on Models 6114A and 6115A allow the output voltage to be set rapidly and accurately. The setting is displayed in large, easy-to-read numerals. A fifth digit, set via a thumbwheel on the switch assembly, provides output voltage resolution of 200 μ V.

Models 6104A and 6105A are intended for applications where the supply is to be primarily remote programmed. The output voltage control on these units is a ten-turn potentiometer; an optional three-digit Decadial is available for improved resettability (Option 013).

Output current controls

A front-panel current control allows the output current to be set to any desired value within the maximum rating. Using this control, the supplies can be operated as constant current sources with 0.01% current regulation. A current mode indicator (a light-emitting diode) immediately lights when either the supply is operated in the gross current limit region, or the output current level established by the setting of the front panel control is reached.

Remote programming

All four of these supplies can be remote programmed by means of an external voltage or resistance; when remote resistance programmed, output voltage accuracy is 0.01% plus the accuracy of the remote programming resistor, and output current accuracy is 0.25% plus the accuracy of the remote programming resistor.

For computer controlled applications, these supplies are designed to be digitally programmed with the HP Model 6940A Multiprogrammer or 6941A Multiprogrammer Extender.

Overvoltage protection

A new circuit technique used in these supplies permits the output voltage to drop completely to zero once the overvoltage protection circuit has been triggered, rather than to only 1-3 V as is typical with

other SCR crowbars. This same circuit technique also permits the trip threshold to be set as low as 0.5 V, thus providing load protection at very low output voltage levels.

6101A, 6102A and 6106A

Although these 20-watt precision power supplies do not provide quite the level of performance and flexibility of Models 6104A, 6105A, 6114A, and 6115A, they are lower in cost and are suitable for many precision power applications. Output voltage is adjusted by separate coarse (10-turn) and fine (single-turn) controls; resolution is 0.002% + 100 μ V of the output voltage. A single-turn current control allows full-range adjustment of the current-limit point. Additional features include a volt/ampere meter and associated meter function switch. The four-position function switch selects either of two output voltage or output current ranges (X1, X0.1) for display on the panel meter.

The d-c output of these supplies is floating, allowing the supplies to be used as either positive or negative sources. Terminals for +OUT, -OUT, and GND are provided on both the front and rear of the supply. The rear terminal strip also includes terminals for remote resistance programming, remote sensing, and auto-series, auto-tracking operation.

Units are packaged in 3/2-inch high, half-rack cases which may be bench operated or rack mounted using accessory rack mounting hardware.

6111A, 6112A, 6113A and 6116A

This series of precision power supplies has essentially the same features and characteristics as models 6101A-6106A described above, but also includes a five-decade thumbwheel voltage programmer for convenient and precise (100 μ V resolution) adjustment of output voltage. Units are packaged in 5/4-inch high, half-rack cases which are suitable for bench or rack installation.

6110A

Model 6110A is designed for applications requiring a precise and stable source of high-voltage dc power. Output voltage is set easily and precisely by a five-digit thumbwheel programmer providing 2 mV resolution. A non-adjustable current-limit circuit protects the supply from all overload conditions regardless of degree or duration. Plus and minus output connectors (Type UG-931/U) are provided on the front panel. Mating connectors (Type UG-932/U) are supplied with each unit. Either the positive or the negative terminal may be grounded, or the supply may be operated floating at up to 1,000 volts above ground. Units are packaged in 5/4-inch high, half-rack cases which are suitable for bench or rack installation.



POWER SUPPLIES

Models 6101A - 6116A (cont.)

Specifications*

RATING

DC Output	Volts	0-10	0-20	0-20	0-20	20-40	0-20	20-40	0-40	0-40	0-50	50-100
	Amps	0-2 A	0-1 A	0-1 A	0-2.0 A	0-1.0 A	0-2.0 A	0-1.0 A	0-0.5 A	0-0.5 A	0-0.8 A	0-0.4 A
Model		6113A	6101A	6111A	6104A	6114A	6102A	6112A	6105A			

PERFORMANCE

Load Effect (Load Regulation):	V	0.001% + 100 μ V*	0.001% + 100 μ V*	0.001% + 100 μ V*	0.0005% + 100 μ V	0.0005% + 100 μ V	0.001% + 100 μ V*	0.001% + 100 μ V*	0.0005% + 50 μ V
	C	NA	NA	NA	0.01% + 500 μ A	0.01% + 500 μ A	NA	NA	0.01% + 500 μ A
Source Effect (Line Regulation):	V	0.001%	0.001%	0.001%	0.0005% + 40 μ V	0.0005% + 40 μ V	0.001%	0.001%	0.0005% + 100 μ V
	C	NA	NA	NA	0.005% + 40 μ A	0.005% + 40 μ A	NA	NA	0.005% + 20 μ A
PARD (Ripple and Noise):	V	40 μ V/100 μ V	40 μ V/100 μ V	40 μ V/100 μ V	40 μ V/100 μ V*	40 μ V/100 μ V*	40 μ V/100 μ V	40 μ V/100 μ V	40 μ V/100 μ V*
	C	NA	NA	NA	200 μ A/1 mA	200 μ A/1 mA	NA	NA	200 μ A/1 mA
Temperature Coefficient:	V	0.001% + 10 μ V	0.005% + 30 μ V	0.001% + 10 μ V	0.005% + 25 μ V	0.001% + 15 μ V	0.005% + 50 μ V	0.001% + 10 μ V	0.005% + 50 μ V
	C	NA	NA	NA	0.02% + 50 μ A	0.02% + 50 μ A	NA	NA	0.02% + 25 μ A
Drift (Stability):	8-hour V	0.01% + 100 μ V	0.01% + 300 μ V	0.01% + 100 μ V	0.005% + 50 μ V †	0.0015% + 15 μ V**	0.01% + 500 μ V	0.01% + 100 μ V	0.005% + 50 μ V †
	90 day V	—	—	—	0.01% + 100 μ V †	0.0075% + 30 μ V**	—	—	0.01% + 100 μ V †
	8-hour C	NA	NA	NA	0.25% + 7 mA ‡	0.25% + 7 mA ‡	NA	NA	0.25% + 4 mA ‡
Output Voltage Accuracy:	V	0.1% + 1 mV	NA	0.1% + 1 mV	NA	0.025% + 1.0 mV	NA	0.1% + 1 mV	NA
Resolution:	V	20 μ V	0.002% + 100 μ V	200 μ V	8 mV	200 μ V	0.002% + 100 μ V	200 μ V	16 mV
	C	NA	NA	NA	15 mA	15 mA	NA	NA	8 mA
Output Impedance (Typical):	V	0.2 m Ω , 1 μ H	0.5 m Ω , 1 μ H	0.5 m Ω , 1 μ H	0.05 m Ω + 3 μ H	0.05 m Ω + 3 μ H	2 m Ω , 1 μ H	2 m Ω , 1 μ H	0.05 m Ω + 3 μ H
	C	NA	NA	NA	<50 μ s	<50 μ s	NA	NA	<50 μ s
Load Effect Transient Recovery:	Time	NA	NA	NA	50 mV	50 mV	NA	NA	50 mV
	Level	NA	NA	NA	NA	NA	NA	NA	NA

FEATURES

Output Mode:	CV/CL	CV/CL	CV/CL	CV/CC	CV/CC	CV/CL	CV/CL	CV/CC	
Auto-Ser., -Par., -Track:	Series & Tracking	Series & Tracking	Series & Tracking	Yes	Yes	Series & Tracking	Series & Tracking	Yes	
Remote Sensing:	Yes	Yes	Yes	Yes	Yes	Yes	Yes	Yes	
R E M O T E	Res	1 k Ω /V \pm 0.1%	1 k Ω /V \pm 0.1%	1 k Ω /V \pm 0.1%	2000 Ω /V \pm 0.01%	2000 Ω /V \pm 0.01%	1 k Ω /V \pm 0.1%	1 k Ω /V \pm 0.1%	2000 Ω /V \pm 0.01%
	Coef	NA	NA	NA	500 Ω /A \pm 0.25%	500 Ω /A \pm 0.25%	NA	NA	1000 Ω /A \pm 0.25%
	Volt	1 V/V \pm 0.1%	1 V/V \pm 0.1%	1 V/V \pm 0.1%	1 V/V §	1 V/V §	1 V/V \pm 0.1%	1 V/V \pm 0.1%	1 V/V §
	Coef	NA	NA	NA	0.5 V/A \pm 1.0%	0.5 V/A \pm 1.0%	NA	NA	1 V/A \pm 1.0%
C O N T R O L	Up	NA	150 ms	NA	1.75 sec	1.75 sec	300 ms	NA	4.46 sec
	FL	NA	150 ms	NA	1.75 sec	1.75 sec	300 ms	NA	4.46 sec
	Down	NA	9 sec	NA	350 ms	350 ms	3 sec	NA	500 ms
	FL	NA	200 ms	NA	100 ms	100 ms	300 ms	NA	175 ms
Overvoltage Protection Crowbar:	Range:	3-13 V	2.5-23 V	2.5-23 V	0.5 V-45 V	0.5 V-45 V	2.5-44 V	2.5-44 V	0.5 V-110 V
	Margin:	4% of output + 2 V	4% of output + 2 V	4% of output + 2 V	2% + 0.5 V	2% + 0.5 V	4% of output + 2 V	4% of output + 2 V	2% + 0.5 V
	Options	Option 011	Option 011	Option 011	Standard	Standard	Option 011	Option 011	Standard
DC Output Isolation:	300 V	300 V	300 V	300 V	300 V	300 V	300 V	300 V	
Meter Ranges:	1.2 V, 12 V \pm 3% 250 mA, 2.5 A \pm 3%	2.4 V, 24 V \pm 3% 120 mA, 1.2 A \pm 3%	2.4 V, 24 V \pm 3% 120 mA, 1.2 A \pm 3%	0-50 V \pm 2% Two 0-2.4 A \pm 2% Meters	0-50 V \pm 2% One 0-2.4 A \pm 2% Meter	5 V, 50 V \pm 3% 68 mA, 600 mA \pm 3%	5 V, 50 V \pm 3% 60 mA, 600 mA \pm 3%	0-120 V \pm 2% Two 0-1.0 A \pm 2% Meters	

GENERAL

Power:	115 V ac \pm 10% 48-63 Hz 0.5 A, 52 W	115 V ac \pm 10% 48-63 Hz 0.5 A, 52 W	115 V ac \pm 10% 48-63 Hz 0.5 A, 52 W	104-127 or 208-254 V ac (switchable), 48-440 Hz, 150 VA max.	104-127 or 208-254 V ac (switchable), 48-440 Hz, 150 VA max.	115 V ac \pm 10% 48-63 Hz 0.5 A, 52 W	115 V ac \pm 10% 48-63 Hz 0.5 A, 52 W	104-127 or 208-254 V ac (switchable), 48-440 Hz, 150 VA max.
Power cord:	Attached	Attached	Attached	Removable	Removable	Attached	Attached	Removable
Temperature Ratings:	Convection	Convection	Convection	Convection	Convection	Convection	Convection	Convection
Overall Dimensions:	216 mm \times 133 mm \times 318 mm	216 mm \times 89 mm \times 318 mm	216 mm \times 133 mm \times 318 mm	197 mm \times 166 mm \times 336 mm	197 mm \times 166 mm \times 336 mm	216 mm \times 89 mm \times 318 mm	216 mm \times 133 mm \times 318 mm	197 mm \times 166 mm \times 336 mm
	(8 $\frac{1}{2}$ " W \times 5 $\frac{1}{4}$ " H \times 12 $\frac{3}{4}$ " D)	(8 $\frac{3}{4}$ " W \times 3 $\frac{1}{2}$ " H \times 12 $\frac{3}{4}$ " D)	(8 $\frac{1}{2}$ " W \times 5 $\frac{1}{4}$ " H \times 12 $\frac{3}{4}$ " D)	(7 $\frac{1}{2}$ " W \times 6 $\frac{1}{2}$ " H \times 13 $\frac{1}{4}$ " D)	(7 $\frac{1}{2}$ " W \times 6 $\frac{1}{2}$ " H \times 13 $\frac{1}{4}$ " D)	(8 $\frac{1}{2}$ " W \times 3 $\frac{1}{2}$ " H \times 12 $\frac{3}{4}$ " D)	(8 $\frac{3}{4}$ " W \times 5 $\frac{1}{4}$ " H \times 12 $\frac{3}{4}$ " D)	(7 $\frac{1}{2}$ " W \times 6 $\frac{1}{2}$ " H \times 13 $\frac{1}{4}$ " D)
Weight:	Net 5 kg (11 lb)	4.5 kg (10 lb)	5 kg (11 lb)	7.7 kg (17 lb)	7.7 kg (17 lb)	4.5 kg (10 lb)	5 kg (11 lb)	7.7 kg (17 lb)
	Ship 6.8 kg (14 lb)	5.4 kg (12 lb)	6.8 kg (14 lb)	9.5 kg (21 lb)	9.5 kg (21 lb)	5.4 kg (12 lb)	6.3 kg (14 lb)	9.5 kg (21 lb)
Options Available:	11, 28, 40	11, 28, 40	11, 28, 40	008, 013, 014	8, 14	11, 28, 40	11, 28, 40	8, 13, 14

*Refer to page 209 for specification definitions.

** Specified with final decade pot set to zero. If pot is set to value other than zero, pot wiper jump effect may cause drift of 0.0015% + 200 μ V (90-day).

† Pot wiper jump effect may add 5 mV (6104A) or 10 mV (6105A). When remote programmed, drift is 0.001% + 15 μ V (8-hour) or 0.0075% + 30 μ V (90-day) plus stability of remote programming device.

‡ When remote programmed, drift is 0.25% + 500 μ A plus stability of remote programming device.

§ Accuracy is equal to accuracy of remote programming device \pm 200 μ V.

* 100 μ V p-p noise is typical with a maximum 400 μ V p-p spike of less than 1 μ sec duration occurring at a repetition rate of twice power line frequency under worst case conditions of high line, full output voltage. When operated at 400 Hz input, peak-to-peak ripple is less than 10 mV.

0-50	50-100	0-100	0-100	0-3000
0-0.8 A	0-0.4 A	0-200 mA	0-200 mA	6 mA
6115A		6106A	6116A	6110A

0.0005% +50 μV	0.001% +100 μV	0.001% +100 μV	0.001% +100 μV
0.01% +500 μA	NA	NA	NA
0.0005% +100 μV	0.001%	0.001%	0.001%
0.005% +20 μA	NA	NA	NA
40 μV/100 μV*	40 μV/100 μV	40 μV/100 μV	2 mV/5 mV
200 μA/1 mA	NA	NA	NA
0.001% +15 μV	0.005% +100 μV	0.001% +10 μV	0.001% +50 μV
0.02% +25 μA	NA	NA	NA
0.0015% +15 μV**	0.01% +1 mV	0.01% +100 μV	0.01% +500 μV
0.0075% +30 μV**	—	—	—
0.25% +4 mA ‡	NA	NA	NA
0.025% +1.0 mV	NA	0.01% +1 mV	0.1% +100 mV
200 μV	0.002% +100 μV	200 μV	20 mV
8 mA	NA	NA	NA
0.05 mΩ +3 μH	10 mΩ, 1 μH	10 mΩ, 1 μH	—
<50 μs	NA	NA	NA
50 mV	NA	NA	NA

CV/CC	CV/CL	CV/CL	CV/CL
Yes	Series & Tracking	Series & Tracking	Standard
Yes	Yes	Yes	No
2000Ω/V ±0.01%	1 kΩ/V ±0.1%	1 kΩ/V ±0.1%	NA
1000Ω/A ±0.25%	NA	NA	NA
1 V/V §	1 V/V ±0.1%	1 V/V ±0.1%	NA
1 V/A ±1.0%	NA	NA	NA
4.46 sec	700 ms	NA	NA
4.46 sec	700 ms	NA	NA
500 ms	1 sec	NA	NA
175 ms	700 ms	NA	NA
0.5 V-110 V	20-106 V	20-106 V	NA
2% +0.5 V	4% of output +2 V	4% of output +2 V	NA
Standard	Option 011	Option 011	NA
300 V	300 V	300 V	1000 V
0-120 V ±2% One 0-1.0 A ±2% Meter	12 V, 120 V ±3% 0.5 A, 250 mA ±3%	12 V, 120 V ±3% 0.5 A, 250 mA ±3%	3500 V, 7 mA ±3%

104-127 or 208-254 V ac (switchable), 48- 440 Hz, 150 VA max.	115 V ac ±10% 48-63 Hz 0.5 A, 52 W	115 V ac ±10% 48-63 Hz 0.5 A, 52 W	115 V ac ±10% 57-63 Hz 1 A, 50 W
Removable	Attached	Attached	Attached
Convection	Convection	Convection	Convection
197 mm × 166 mm × 336 mm	216 mm × 89 mm × 318 mm	216 mm × 133 mm × 318 mm	216 mm × 133 mm × 406 mm
(7 7/8" W × 6 1/2" H × 13 3/4" D)	(8 5/8" W × 3 5/8" H × 12 1/2" D)	(8 5/8" W × 5 1/4" H × 12 1/2" D)	(8 5/8" W × 5 1/4" H × 16" D)
7.7 kg (17 lb)	4.5 kg (10 lb)	5 kg (11 lb)	8.6 kg (19 lb)
9.5 kg (21 lb)	5.4 kg (12 lb)	6.8 kg (14 lb)	10.4 kg (23 lb)
8, 14	11, 28	11, 28	5, 18

Accessories available

- 5060-8762 Rack Adapter — for rack mounting one or two Precision Power Supplies in a standard 19-inch rack. \$33
- 5060-8760 Blank Panel — filler panel for blocking unused half of rack frame. \$8
- 11057A Carrying Handle — For added portability and handling convenience. \$5
- 1052A Combining Case — For mounting one or two Precision Power Supplies in a standard 19-inch rack where quick and easy removal and reinstallation of instruments is desirable. A cooling kit (listed below) must be installed at the rear of the combining case when one or two Precision Power Supplies are operated in the case. \$170
- 5060-0789 Combining Case Cooling Kit — For 115 V ac, 50-60 Hz input. \$37
- 5060-0796 Combining Case Cooling Kit — For 230 V ac, 50-60 Hz input. \$45
- 14513A, 89 mm (3 1/2") High Rack Kit for one supply. \$20
- 14523A, 89 mm (3 1/2") High Rack Kit for two supplies. \$10
- 14515A, 133 mm (5 1/4") High Rack Kit for one supply. \$25
- 14525A, 133 mm (5 1/4") High Rack Kit for two supplies. \$15

Options

- 005: 50 Hz ac input. For 50 Hz operation of 6110A. \$55
- 008: Ten-turn output current control. Replaces the standard single-turn current control. \$25
- 011: Internal overvoltage protection crowbar. Protects delicate loads against power supply failure or operator error. \$55
- 013: Three-digit graduated decadal voltage control. Attaches to the standard ten-turn voltage control. \$35
- 014: Three-digit graduated decadal current control. Includes a ten-turn control replacing the standard single-turn current control. \$60
- 018: 230 V ac ±10%, single-phase input. Factory modification includes installation of a 230 V input power transformer to replace the standard 115 V transformer. \$55
- 028: 230 V ac ±10%, single-phase input. Factory modification consists of reconnecting the multi-tap input power transformer for 230 V operation. \$10
- 040: Interfacing for Multiprogrammer Operation. Prepares standard HP power supplies for resistance programming by the 6940A Multiprogrammer or 6941A Multiprogrammer Extender. \$30
- C05: Handle — Eight-inch black handle attached to side of 3 1/2" high instrument. Standard on 5 1/4" high instruments. \$15

Model number and name

- 6101A Precision Power Supply \$300
- 6102A Precision Power Supply \$300
- 6104A Precision Power Supply \$440
- 6105A Precision Power Supply \$455
- 6106A Precision Power Supply \$305
- 6110A Precision Power Supply \$590
- 6111A Precision Power Supply \$420
- 6112A Precision Power Supply \$420
- 6113A Precision Power Supply \$420
- 6114A Precision Power Supply \$560
- 6115A Precision Power Supply \$575
- 6116A Precision Power Supply \$420



POWER SUPPLIES

Special purpose: dc power supply amplifiers

Models 6823A - 6832A

- High-speed remote programming
- Overload protection
- Wide-band response

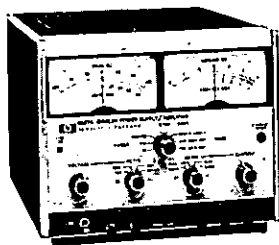

6825A-6827A

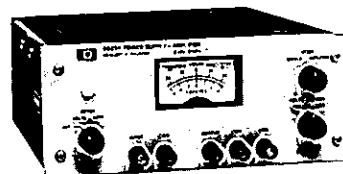

6823A



6830A-6832A

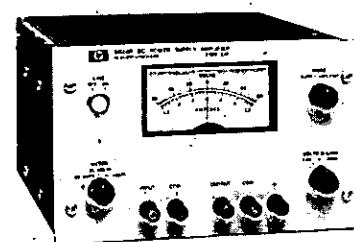

6824A

Description

The Power Supply/Amplifier is a general-purpose instrument useful in any laboratory engaged in research and development of electronic systems, circuitry, or components. The unit can be operated in one of two basic operating modes: power supply or amplifier. Terminals at the rear permit access to various internal control points to further expand the operational capabilities of the instrument. The resulting flexibility lends the Power Supply/Amplifier to an almost unlimited number of applications.

Models 6825A through 6832A

These models feature dual-range output, Constant Voltage/Constant Current operation, and metering of the ac and dc output voltage and current. Output voltage and current as a dc supply, or gain as a power amplifier, are remotely controllable and are compatible with Hewlett-Packard Multiprogrammer Systems.

Each of the standard units (Models 6825A, 6826A, and 6827A) is available in a blank panel version (Models 6830A, 6831A, and 6832A). The blank panel models are intended for dedicated system use where metering and front panel access to controls is not required.

As a dc power supply, the unit can furnish a bipolar, Constant Voltage or Constant Current output. It can be remotely programmed with a resistance, voltage, or current and its high speed programming characteristics adapt it to a wide variety of laboratory and production testing applications. The supply can sink, as well as source, current permitting it to serve as a variable load device.

As a direct-coupled power amplifier, each unit offers a signal-to-noise ratio of approximately 80 dB at full output with low distortion, and a frequency response up to 40 KHz in the fixed gain mode.

Models 6823A and 6824A

Although these models do not provide quite the level of performance and flexibility of Models 6825A through 6832A, they are lower in cost and are suitable for many applications.

As power supplies, these units offer Constant Voltage/Current Limiting operation, remote programming, and Auto-Series, Auto-Parallel operation.

As power amplifiers, the units exhibit a high signal-to-noise ratio with a 20 dB gain from dc to 10 KHz. They are useful in servo systems, as pulse or oscillator amplifiers, for motor control, and a variety of other applications.

ety of other applications.

Accessories available

Models 6825A - 6832A

Accessory	Price
5060-8762 Rack Adapter Frame. For mounting one or two half-rack units in a standard 19-inch rack	\$33
5060-8760 Blank Panel. Filler panel for blocking unused half of rack frame	\$8
11057A Carrying Handle. Handle for added portability and handling convenience	\$5
1052A Combining Case. For mounting one or two half-rack units in a standard 19-inch rack	\$170
5060-0789 Combining Case Cooling Kit. For 115 V ac, 50-60 Hz input	\$37
5060-0796 Combining Case Cooling Kit. For 230 V ac, 50-60 Hz input	\$45

Models 6823A & 6824A

14513A Rack Kit for one 3 1/2" high supply	\$20
14515A Rack Kit for one 5 1/2" high supply	\$25
14523A Rack Kit for two 3 1/2" high supplies	\$10
14525A Rack Kit for two 5 1/2" high supplies	\$15

Options

007: Ten-turn output voltage control. For models 6825A, 6826A, 6827A; replaces single-turn voltage control for improved resolution	\$25
For model 6824A; replaces concentric coarse and fine voltage control for improved mechanical stability and convenience	\$40
028: 230 V ac $\pm 10\%$, single phase input. Factory modification consists of reconnecting the input power transformer for the 230 V operation. (Models 6823A and 6824A)	\$10

Model number and name

6823A Bipolar Power Supply/Amplifier	\$280
6824A Bipolar Power Supply/Amplifier	\$445
6825A Bipolar Power Supply/Amplifier	\$800
6826A Bipolar Power Supply/Amplifier	\$800
6827A Bipolar Power Supply/Amplifier	\$800
6830A Bipolar Power Supply/Amplifier	\$900
6831A Bipolar Power Supply/Amplifier	\$900
6832A Bipolar Power Supply/Amplifier	\$900



Specifications†

MODELS	Standard (Blank Panel)	6825A (6830A)	6826A (6831A)	6827A (6832A)	6823A	6824A
OPERATION AS A POWER SUPPLY						
Output	DC Voltage High Range	-20 to +20 V	-50 to +50 V	-100 to +100 V	-20 to +20 V dc	-50 to +50 V dc
	Low Range	-5 to +5 V	-5 to +5 V	-10 to +10 V		
	DC Current	0-2.0 A	0-1.0 A	0-0.5 A	0-0.5 A	0-1.0 A
Load Effect	Voltage High Range	0.01% +0.5 mV	0.01% +1 mV	0.01% +1 mV	0.02% +5 mV	
	Low Range	0.01% +1 mV	0.01% +1 mV	0.01% +0.3 mV		
	Current	0.01% +400 μ A	0.01% +250 μ A	0.01% +250 μ A		
Source Effect	Voltage High Range	0.01% +2 mV	0.01% +5 mV	0.01% +10 mV	0.02% +5 mV	
	Low Range	0.01% +0.2 mV	0.01% +0.5 mV	0.01% +1 mV		
	Current	0.01% +0.25 mV	0.01% +0.25 mV	0.01% +0.25 mV		
PARD (20 Hz-20 mHz) (rms/p-p)	Voltage High Range	5/15 mV	6/35 mV	10/50 mV	2 mV rms	10 mV rms
	Low Range	1.5/4 mV	2/10 mV	2.5/15 mV		
	Current	3/10 mA	0.8/5 mA	0.4/5 mA		
Load Effect Transient Recovery	Voltage	20 mV	50 mV	100 mV	Less than 100 μ sec to within 0.02% +5 mV of the nominal output.	
	Time	100 μ sec.	100 μ sec.	100 μ sec.		
Resistance Programming Coefficient	Voltage High Range	500 Ω /V	200 Ω /V	100 Ω /V	500 Ω per volt	
	Low Range	2000 Ω /V	2000 Ω /V	1000 Ω /V		
	Current	5 Ω /mA	10 Ω /mA	10 Ω /mA		
OPERATION AS A POWER AMPLIFIER						
Output	DC Voltage High Range	40 V p-p	100 V p-p	200 V p-p	40 V p-p	100 V p-p
	Low Range	10 V p-p	10 V p-p	20 V p-p		
	DC Current	2 A pk.	1 A pk.	0.5 A pk.	0-0.5 A pk.	0-1.0 A pk.
Voltage Gain	Fixed (Inverting)	4 \times 1 \times	10 \times 1 \times	20 \times 2 \times	Variable 0-10 (20 dB) output inverted	
	Variable (Non-invert.)	0-8 0-2	0-20 0-2	0-40 0-4		
Frequency Response (+1, -3 dB)	Fixed Gain	dc-40 kHz	dc-40 kHz	dc-30 kHz	At full output, dc to 10 kHz	
	Variable Gain	dc-15 kHz	dc-15 kHz	dc-15 kHz		
Distortion	100 Hz & full output	0.1% THD	0.1% THD	0.1% THD	0.1% maximum	
Fixed Gain Accuracy (100 Hz.)	High	4 \times : $\pm 0.1\%$ +2 mV	10 \times : $\pm 0.1\%$ +5 mV	20 \times : $\pm 0.1\%$ +10 mV		
	Low	1 \times : $\pm 0.1\%$ +0.5 mV	1 \times : $\pm 0.1\%$ +0.5 mV	2 \times : $\pm 0.1\%$ +1 mV		
Gain, Variable* $A_v = \frac{k R_f}{10.24 k\Omega}$	High Range	4 $R_f/10.24 k\Omega$	10 $R_f/10.24 k\Omega$	20 $R_f/10.24 k\Omega$		
	Low Range	$R_f/10.24 k\Omega$	$R_f/10.24 k\Omega$	2 $R_f/10.24 k\Omega$		
Voltage Programming Coefficient	High	4 V/V	10 V/V	20 V/V	1 V/V	
	Voltage Low	1 V/V	1 V/V	2 V/V		
	Current	1 A/V	1 A/V	1 A/V		
COMMON SPECIFICATIONS						
Power:		104-127/208-254 1.2 A, 150 W 48-63 Hz	104-127/208-254 1.2 A, 150 W 48-63 Hz	104-127/208-254 1.2 A, 150 W 48-63 Hz	104-127 V ac 0.3 A, 24 W 48-440 Hz	104-127 V ac 1.3 A, 96 W 48-63 Hz
Dimensions:		197 mm \times 154 mm \times 316 mm (7 $\frac{3}{4}$ " W \times 6" H \times 12 $\frac{1}{2}$ " D)	197 mm \times 154 mm \times 316 mm (7 $\frac{3}{4}$ " W \times 6" H \times 12 $\frac{1}{2}$ " D)	197 mm \times 154 mm \times 316 mm (7 $\frac{3}{4}$ " W \times 6" H \times 12 $\frac{1}{2}$ " D)	208 mm \times 88 mm \times 319 mm (8 $\frac{1}{4}$ " W \times 3 $\frac{1}{2}$ " H \times 12 $\frac{1}{2}$ " D)	208 mm \times 131 mm \times 303 mm (8 $\frac{1}{4}$ " W \times 5 $\frac{1}{4}$ " H \times 11 $\frac{3}{4}$ " D)
Options Available:		7	7	7	28	7, 28

*Where k is the constant indicated, and R_f is the programming resistance.

†See page 209 for specification definitions.



POWER SUPPLIES

Special purpose: constant current sources

Models 6177C, 6181B & 6186C

- Continuously variable voltage limit
- Output useful to micro-ampere region

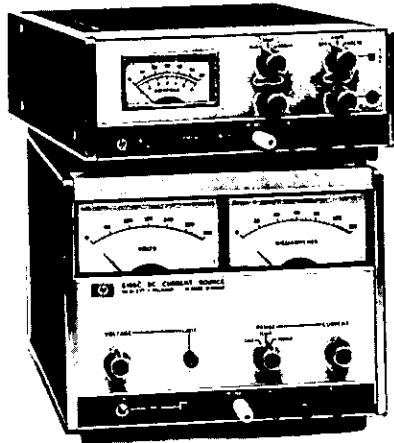

6177C, 6181B

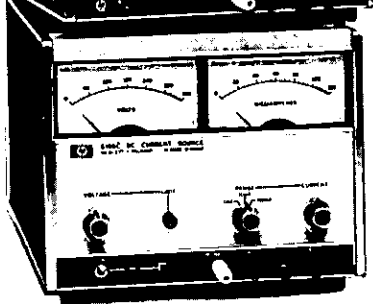

6186C

Description

These solid-state constant-current sources are ideal for semiconductor circuit development, component testing, and precision electroplating applications.

Their high-speed remote programming characteristics make these supplies useful in testing and sorting semiconductors, resistors, relays, meters, etc. The ability to superimpose ac modulation on the dc output permits the supplies to be used for measurement of dynamic or incremental impedance of circuit components.

Specifications

Load effect (load regulation): Less than 25 ppm of output ± 5 ppm of range switch setting for a load change which causes the output voltage to vary from zero to maximum.

- High output impedance—no output capacitor

Source effect (line regulation): Less than 25 ppm of output ± 5 ppm of range switch setting for a change in the line voltage from 104 to 127 V ac (or 127 to 104 V ac) at any output current and voltage within rating.

Load effect transient recovery: Less than 800 μ s for recovery to within 1% of nominal output current following a full load change in output voltage. (On 6186C, recovery time for 100 mA/10 mA/1 mA ranges is 800 μ s/1.6 ms/4 ms, respectively.)

Temperature coefficient: Output change per degree C is less than 75 ppm of output current $+5$ ppm of range switch setting.

Drift (stability): Less than 100 ppm of output current $+25$ ppm of range switch setting. Stability is measured for eight hours after one hour warm-up under conditions of constant line, load, temperature, and output setting.

Resolution: 0.02% of range switch setting.

Temperature rating: Operating 0 to 55°C, Storage -40 to +75°C.

Accessories available

5060-0808: Rack adapter for rack mounting one or two 6177B or 6181B supplies.

5060-0797: Rack adapter for rack mounting one or two 6186C supplies.

5060-0097: Filler panel for Models 6177B, 6181B

5060-0794: Filler panel for Model 6186C

Options

014: Three digit graduated decadal current control. Includes calibrated 10-turn control replacing front panel current knob. The dial is calibrated from 0 to 99.9 with minor divisions equal to 0.1.

028: 230 V ac $\pm 10\%$, single phase input. Models 6177C and 6181B only.

Model number and name

6177C, 6181B Constant Current Source

6186C Constant Current Source

Price

\$25

\$25

\$5

\$5

\$40

\$10

\$555

\$725

Model		6177C	6181B	6186C
Output Current		0-500 mA	0-250 mA	0-100 mA
Voltage Compliance		0-50 V dc†	0-100 V dc†	0-300 V dc†
Output Ranges		A	0-5 mA	0-1 mA
		B	0-50 mA	0-10 mA
		C	0-500 mA	0-100 mA
AC Input		115 V ac $\pm 10\%$, 48-63 Hz; 0.6 A, 55 W at 115 V ac For 230 V ac see Option 028	115 V ac $\pm 10\%$, 48-63 Hz; 0.6 A, 55 W at 115 V ac For 230 V ac see Option 028	115/230 V ac, 48-63 Hz; 0.9 A, 90 W at 115 V ac 115/230 V ac switch
Constant Current Remote Programming	Voltage Control (Accuracy: 0.5% of output current $+0.4\%$ of range)	Range A	200 mV/mA	1 V/mA
		Range B	20 mV/mA	100 mV/mA
		Range C	2 mV/mA	10 mV/mA
	Resistance Control (Accuracy: 1% of output control $+0.04\%$ of range)	Range A	400 ohms/mA	2 k Ω /mA
		Range B	40 ohms/mA	200 ohms/mA
		Range C	4 ohms/mA	20 ohms/mA
Voltage Limit Remote Programming	Voltage Control (Accuracy: 20%)	1 V/V	1 V/V	1 V/V
	Resistance Control	870 ohms/V	440 ohms/V	820 ohms/V
	Accuracy	20%	20%	15%
Typical Output Impedance (R in parallel with C)*		Range A	R = 330 Meg, C = 500 pF	R = 1330 Meg, C = 10 pF
		Range B	R = 33 Meg, C = 0.005 μ F	R = 133 Meg, C = 100 pF
		Range C	R = 3.3 Meg, C = 0.05 μ F	R = 13.3 Meg, C = 1000 pF
PARD (Ripple and Noise): rms/p-p (dc to 20 MHz). Either output terminal can be grounded.		Range A	1.6 μ A rms/40 μ A p-p	0.8 μ A rms/20 μ A p-p
		Range B	16 μ A rms/200 μ A p-p	8 μ A rms/100 μ A p-p
		Range C	160 μ A rms/1 mA p-p	80 μ A rms/500 μ A p-p
Programming Speed: from 0 to 99% of range switch setting with a resistive load. ** (Output Current Modulation)		6 msec	6 msec	8 msec
Dimensions:		7" (W) \times 3 $\frac{1}{2}$ " (H) \times 12" (D) 197 mm (W) \times 88 mm (H) \times 315 mm (D)	7" (W) \times 3 $\frac{1}{2}$ " (H) \times 12" (D) 197 mm (W) \times 88 mm (H) \times 315 mm (D)	7" (W) \times 6 $\frac{1}{2}$ " (H) \times 12" (D) 197 mm (W) \times 158 mm (H) \times 315 mm (D)
Weight: (Net/Shipping)		4.53 kg (10 lb)/5.9 kg (13 lb)	4.53 kg (10 lb)/5.9 kg (13 lb)	5.9 kg (13 lb)/7.7 kg (17 lb)

* This network is a simplified representation of a complex network. The formula $Z = R \times C / \sqrt{R^2 + X_C^2}$ is used for frequencies up to 1 MHz by substituting the values given for R and C. Above 1 MHz, the output impedance is greater than the formula would indicate—load transient overshoots are less than 20% of range setting for a full load change with a 1 μ sec rise time.

** Output current can be modulated 100% up to 100 Hz; percent modulation decreases linearly to 10% at 1000 Hz.

† In constant voltage operation, minimum voltage is less than 0.5 V.

POWER SUPPLIES



Modular: single output, series regulated

Models 62005A - 62048G

- UL recognized
- Cut-back current limiting
- Built-in overtemperature and reverse voltage protection

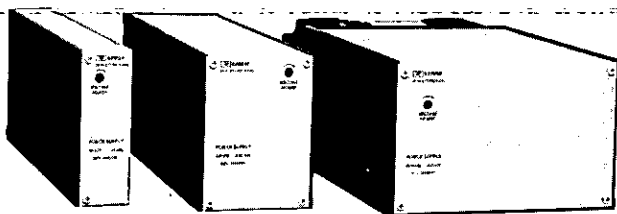

"A" Module

"C & E" Module

"G" Module

62000 Series

Description

This series of modular power supplies covers seven of the most widely used voltage ratings, with four current ratings available at each voltage. Each nominal output voltage is adjustable over a ± 0.5 V or $\pm 5\%$ range (whichever is greater), by means of a front-panel accessible screwdriver control. All supplies deliver full output to 50°C, with linear derating by only 50% at 71°C.

Packaging: The units are packaged in three uniform height and depth cases which are fractions of standard 19-inch rack width: $\frac{1}{8}$ -width, $\frac{1}{4}$ -width, and $\frac{1}{2}$ -width. Combinations of the three packages can be mounted in an accessory rack mounting tray (page 10.35) or the supplies can be mounted individually on various sides.

Protective Features: Overcurrent, overtemperature, and reverse voltage protection are standard on all models; built-in overvoltage protection is optional (Option 011).

The current limit circuit is the self-restoring cutback type, in which an overload causes the output current to cut back linearly from approximately 105% to approximately 10% of rated output as the load varies from slightly over the maximum rated value to a complete short circuit.

Overtemperature protection is provided through a heat-sink mounted thermostat which opens the fused ac line if the supply is subjected to overheating caused by high ambient temperatures. The supply is also protected against reverse voltages and currents which might be generated by an active load or by parallel-or series-connected power supplies. Remote voltage sensing is standard, and the load is protected against receiving a sudden large increase in output voltage due to inadvertently opening one of the sensing leads.

DC output ratings:

62000 Series modular power supplies					
Model	dc voltage	Current (amperes) at 50°C			
		$\frac{1}{8}$ rack (A module)	$\frac{1}{4}$ rack (C module)	$\frac{1}{2}$ rack (E module)	$\frac{1}{2}$ rack (G module)
62005	5	2.0	4.0	8.0	16.0
62012	12	1.5	3.0	6.0	12.0
62015	15	1.25	2.5	5.0	10.0
62018	18	1.0	2.25	4.5	9.0
62024	24	0.75	1.75	3.75	7.5
62028	28	0.70	1.5	3.25	6.5
62048	48	0.45	1.0	2.0	4.0

Specifications

Load effect (load regulation): less than 0.01% or 1 mV, whichever is greater, for a no load to full load (or vice versa) change in output current.

Source effect (line regulation): less than 0.01% or 1 mV, whichever is greater, for change in ac input voltage over the specified range, at any output voltage and current within rating.

PARD (ripple and noise): less than 1 mV rms, 2 mV p-p (20 Hz to 20 MHz) at any line voltage and under any load condition within rating.

Temperature coefficient: less than 0.01%/°C over the temperature range from 0 to 50°C, under conditions of constant load and line following 30-minute warmup.

Drift (stability): 0.1% total drift in dc output voltage over 8-hour interval, under conditions of constant line, load, and ambient temperature following 30-minute warmup.

Load effect transient recovery: output voltage recovers to within 15 mV of nominal output voltage in 50 μ s following a load change from full to half load (or vice versa).

AC input power: 104-127 V ac, 48-63 Hz, single phase. See Options 101, 102, and 103 for other line voltage ratings available.

Storage temperature: -55°C to +85°C.

Operating temperature: 0 to 50°C ambient. Output current is linearly derated to 50% of maximum at 71°C ambient.

Cooling: convection cooled.

DC output isolation: output is isolated; either output terminal may be grounded.

Dimensions:

A-suffix models: 48 mm (W) \times 128 mm (H) \times 311 mm (D) [1.91" (W) \times 5.03" (H) \times 12.25" (D)]

C- & E-suffix models: 100 mm (W) \times 128 mm (H) \times 311 mm (D) [3.94" (W) \times 5.03" (H) \times 12.25" (D)]

G-suffix models: 206 mm (W) \times 128 mm (H) \times 292 mm (D) [8.11" (W) \times 5.03" (H) \times 11.50" (D)]

Weight (net/shipping):

A-suffix models: 2.7 kg. (6 lb)/3.6 kg. (8 lb)

C-suffix models: 4.5 kg. (10 lb)/5.4 kg. (12 lb)

E-suffix models: 5.9 kg. (13 lb)/7.3 kg. (16 lb)

G-suffix models: 9.5 kg. (21 lb)/11.3 kg. (25 lb)

Accessories available

See page 207.

Options

011: Internal overvoltage protection crowbar. Adjustment range is from +0.5 V dc above the minimum rated output voltage to +2 V above the maximum rated output voltage.

101: 220 V ac Nominal (190-233 V ac), 48-63 Hz, single phase ac input.

102: 240 V ac Nominal (208-254 V ac), 48-63 Hz, single phase ac input.

103: 120/240 V ac Nominal (104-127/208-254 V ac), 48-63 Hz, single phase, field-changeable ac input.

Model number and name

62000 series modular power supplies

A-suffix Models

C-suffix Models

E-suffix Models

G-suffix Models

(Quantity & OEM discounts are available.)

Price

\$30

N/C

N/C

\$25

\$110

\$150

\$190

\$250



POWER SUPPLIES

Dual output, series regulated

Models 62212A - 62215G

- UL recognized
- Cut-back current limiting
- Built-in overtemperature and reverse voltage protection

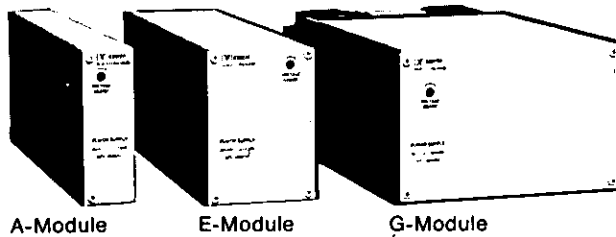

A-Module

E-Module

G-Module

Description

This series of dual-output modular power supplies includes six models covering two output voltage ratings (± 12 V and ± 15 V), with three current ratings available at each voltage. The supplies are designed primarily for applications such as powering operational amplifier, core drivers, D/A and A/D converters, MOS devices, and voltage comparators where equal but opposite polarity voltages must track with insignificant error.

A single front-panel voltage control provides $\pm 5\%$ adjustment of both outputs. All supplies deliver full rated output from 0 to 40°C, with derated operation up to 71°C.

Packaging: The units are packaged in three uniform height and depth cases which are fractions of a standard 19-inch rack-width: $\frac{1}{8}$ -width, $\frac{1}{4}$ -width, and $\frac{1}{2}$ -width.

The supplies may be used alone, in buried applications, or combined with other 62000 series supplies using an accessory rack mounting tray (page 10.35).

Protective features: Overcurrent, overtemperature, and reverse voltage protection are standard on all models; built-in overvoltage protection is optional (Option 011). The master and slave supplies each have self-restoring cutback-type current limit circuits which are factory adjusted to limit at approximately 105% of maximum rated load current. The same protection is maintained for single output load connections across the (+) and (-) terminals.

Overtemperature protection is provided through a heat-sink mounted thermostat which opens the fused ac line if the supply is subjected to overheating caused by high ambient temperatures. The supply is also protected against reverse voltages and currents which might be generated by an active load or by parallel- or series-connected power supplies. Remote voltage sensing is standard, and the load is protected against receiving a sudden increase in output voltage due to inadvertently opening one of the sensing leads.

DC Output ratings:

Model	Nominal Voltage	DC Current (each side) at 40°C.,	
		50 Hz Input	60 Hz Input
62212A	± 12 V	1.25 A	1.40 A
62212E	± 12 V	3.00 A	3.30 A
62212G	± 12 V	5.00 A	6.00 A
62215A	± 15 V	1.10 A	1.25 A
62215E	± 15 V	2.75 A	3.00 A
62215G	± 15 V	4.50 A	5.20 A

Specifications

(either output with respect to COM).

Load effect (load regulation): less than 0.01% for a no load to full load (or vice versa) change in output current.

Source effect (line regulation): less than 0.01%, for a change in ac input voltage over the specified range, at any output voltage and current within rating.

PARD (ripple and noise): less than 1 mV rms, 5 mV p-p (20 Hz to 20 MHz) at any line voltage and under any load condition within rating.

Temperature coefficient: less than 0.01%/°C over the temperature range from 0 to 40°C under conditions of constant load and line following 30-minutes warmup.

Drift (stability): 0.1% total drift in dc output voltage (dc to 20 Hz) over 8-hour interval under conditions of constant line, load, and ambient temperature following 30-minutes warmup.

Load effect transient recovery: output voltage recovers to within 15 mV of nominal output voltage in 50 μ s following a load change from 100% to 50% or 50% to 100%.

AC input power: 104-127 V ac, 57-63 Hz, single phase. See Options 101, and 102 for other line voltage ratings available.

Storage temperature: -55°C to +85°C.

Operating temperature: 0 to 40°C ambient. Output current is derated from 41°C to 71°C ambient.

Cooling: Convection cooled.

DC output isolation: output is isolated; any output terminal may be grounded.

Tracking accuracy: The slave supply is matched to within $\pm 1\%$ maximum of the master supply.

Dimensions:

A-suffix models: 48 mm W \times 128 mm H \times 311 mm D (1.91" W \times 5.03" H \times 12.25" D)

E-suffix models: 100 mm W \times 128 mm H \times 311 mm D (3.94" W \times 5.03" H \times 12.25" D)

G-suffix models: 206 mm W \times 128 mm H \times 292 mm D (8.11" W \times 5.03" H \times 11.50" D)

Weight (net/shipping):

A-suffix models: 2.7 kg (6 lb)/3.6 kg (8 lb)

E-suffix models: 5.9 kg (13 lb)/7.3 kg (16 lb)

G-suffix models: 9.5 kg (21 lb)/11.3 kg (25 lb)

Accessories available

See page 207.

Options

011: Internal overvoltage protection crowbar. The adjustable trip level is factory set to 2 volts above the nominal output voltage for either output (4 V for both outputs)

Price

\$50

Note

For options 101 and 102, the dc output current for 50 or 60 Hz operation is shown in the 50 Hz input column of the dc output ratings table.

101: 220 V ac nominal (190-233 V ac), 47-63 Hz, single phase ac input

N/C

102: 240 V ac nominal (208-254 V ac), 47-63 Hz, single phase ac input

N/C

Model number and name

62200 Series

A-suffix models

\$165

E-suffix models

\$225

G-suffix models

\$345

(Quantity & OEM discounts are available)

POWER SUPPLIES



Modular — 200-300 W, switching regulated

Models 62605J — 62628J

- Up to 80% efficiency
- Overvoltage, overcurrent, overtemperature and reverse voltage protection are standard
- Compact half-rack package

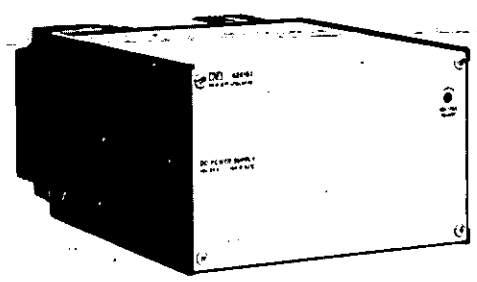

Description

This family of switching-regulated supplies covers output voltage ratings from 5 V to 28 V with output currents to 40 A. Each nominal output voltage is adjustable over a ± 0.5 V or $\pm 5\%$ range (whichever is greater), by means of a front-panel accessible screwdriver control. All supplies deliver full output from 0 to 50°C, with linear derating by only 50% at 71°C.

An advanced 20 kHz transistor switching design is employed in these units. The design takes advantage of the foremost virtue of the switching regulator, namely efficiency, while holding down ripple and noise to levels that are compatible with most low-voltage applications including computer mainframes, digital systems, and systems for industrial process automation. Radiated and conducted interference are minimized through use of filters and shielding of critical circuits as is indicated by the relatively low output peak-to-peak ripple content.

Packaging: All models are packaged in a standard 5" H x 8" W x 1 1/2" D case. The supplies may be used alone, in buried applications, or combined with other 62000 series supplies using accessory rack mounting hardware (see page 207).

Protective Features: Overvoltage, overcurrent, overtemperature and reverse voltage protection are standard on all models.

The self-restoring current limit circuit protects the supply and load against externally caused overload or short circuit conditions. An internal adjustment allows the overcurrent trip point to be set anywhere from 50% to 113% of full load. It is adjusted at the factory to limit at approximately 110% of full load.

An overvoltage protection circuit monitors the output voltage and reduces it to less than 50 mV after the preset trip voltage is exceeded. The trip range is adjustable from 1.5 V dc above the nominal rated output voltage to 3.0 V dc above the nominal rated output voltage. Minimum trip margin to prevent false triggering is 1.5 V dc above the output voltage setting.

DC Output rating:

Model	DC Output	
	Nominal Voltage (Minimum Adj. Span)	Current at 50°C
62605J	5 V (± 0.5 V)	40.0 A
62612J	12 V (± 0.6 V)	23.0 A
62615J	15 V (± 0.75 V)	20.0 A
62618J	18 V (± 0.90 V)	16.7 A
62624J	24 V (± 1.20 V)	12.5 A
62628J	28 V (± 1.40 V)	10.7 A

Specifications

Load effect (load regulation): less than 0.15% for a load change from 0 to 15% of rated output, and less than 0.10% for a change from 15% to 100% of rated output.

Source effect (line regulation): less than 0.1% for a change in ac input voltage over the specified range, at any output voltage and current within rating.

PARD (ripple and noise): less than 20 mV rms, 40 mV p-p (20 Hz to 20 MHz) at any line voltage and under any load condition within rating.

Temperature coefficient: less than 0.02%/°C over the temperature range from 0 to 50°C under conditions of constant load and line following 30-minute warmup.

Drift (stability): 0.1% total drift in dc output voltage (dc to 20 Hz) over 8-hour interval under conditions of constant line, load, and ambient temperature following 30-minute warmup.

Load effect transient recovery: output voltage recovers to within 0.1% of nominal output voltage in less than 3 ms following a load change from 100% to 50% or 50% to 100%.

Overshoot: turn-on transient is within regulation and ripple band. Turn-off is smooth exponential decay.

Carry-over time: output voltage remains within 2% of specified nominal for a minimum of 30 ms under full load following removal of ac input power.

AC input power: 104-127 V ac, 48-440 Hz, single phase. See Options 101 and 102 for other line voltage ratings available.

Storage temperature: -55°C to +85°C.

Operating temperature: 0 to 50°C ambient. Output current for continuous operation is derated linearly from full output at 50°C to 50% of output at 71°C.

Cooling: convection cooled.

DC output isolation: output is isolated. Either output terminal may be grounded or the supply may be floated at up to 100 volts above ground.

Dimensions: 207 mm W x 127 mm H x 292 mm D (8.14" W x 5.03" H x 11.50" D).

Weight (net/shipping): 6.6 kg. (14.5 lb)/8.2 kg. (18 lb).

Accessories available

See page 207

Options

101: 220 V ac nominal (190-233 V ac), 48-440 Hz single phase

Price

N/C

102: 240 V ac nominal (208-254 V ac), 48-440 Hz single phase

N/C

Model number and name

62600J Series Switching Regulated Supplies

\$460

(Quantity & OEM discounts are available).



POWER SUPPLIES

Modular: 500 W, switching regulated

Model 62605M

- 5 volts, 100 amps
- Up to 70% efficiency

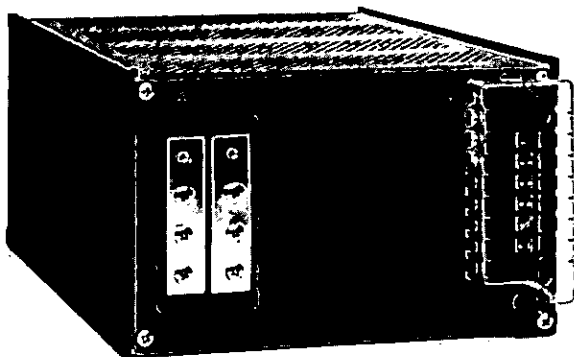

Description

This single output 5-volt, 100-amp modular power supply is designed for permanent installation in a wide range of electronic equipment. The supply uses an advanced 20 kHz switching regulator which has 70% energy conversion efficiency, resulting in less energy loss and equipment heating. Further contributing to reduced size and improved reliability is a unique heat transfer system. A continuous stream of air from a quiet, low-speed fan is directed over critical components and through thermal convectors in a controlled manner. Elimination of conventional heat sinks permits more freedom in orienting the power supply within operating equipment, since cooling is not dependent on convective air flow.

Radiated and conducted interference are minimized through the use of filters and shielding of critical circuits as is indicated by the relatively low output peak-to-peak ripple content.

Packaging: The 62605M is packaged in a 5" H × 8" W × 11½" D case. The area in front of the air inlet and over the top surface must be clear of solid obstruction for approximately 1" (25.4 mm) to permit free air flow. Clearance is not necessary along the side or bottom surfaces.

Protective features: Overcurrent, overvoltage, overtemperature, reverse voltage protection and ac inrush current limiting are standard on the 62605M.

The self-restoring output current limit circuit protects the supply against an externally caused overload or short circuit. An accessible screwdriver control allows the overcurrent trip point to be set anywhere from 75% to 105% of rated load current. It is factory set at approximately 105% of full load. The supply also features cutback current limiting, which reduces the output current by approximately 35 A below the current limit setting if the output is short circuited.

The overvoltage protection circuit monitors the output voltage and reduces it to less than 50 mV after the preset trip level of 6.0 V, ±0.3 V is exceeded.

A controlled turn-on circuit is provided which limits transient inrush current to less than 70 A at 120 V ac line (35 A at 240 V ac).

Specifications

Output voltage: 5 V ±0.25 V.

Output current: 100 A at 40°C.

- Overvoltage, overcurrent, overtemperature and reverse voltage protection are standard

Load effect (load regulation): 0.05% from 0 to 100% of rated output current.

Source effect (line regulation): 0.05% for change over entire input voltage range.

PARD (ripple and noise): less than 20 mV rms, 40 mV p-p (20 Hz to 20 MHz).

Temperature coefficient: less than 0.02%/°C.

Drift (stability): less than 0.1% over 8-hour interval following 30-minutes warmup.

Load effect transient recovery: output voltage returns within 1% of nominal in less than 1.5 ms following a load change from 100% to 50%, or 50% to 100%.

Turn-on and turn-off transient: no overshoot outside of regulation and ripple band. Output voltage decreases smoothly after carryover time.

Carryover time: output voltage remains within 2% of specified nominal for more than 15 ms while delivering full load current following removal of ac input power.

Temperature ratings:

Storage: -55°C to +85°C.

Operating: 0 to 40°C ambient. Output current for continuous operation is derated linearly from 100 amps at 40°C to 60 amps at 70°C.

Cooling: Built-in fan.

DC output isolation: output is isolated from chassis ground. Either output terminal may be grounded.

Thermal protection: internal thermostat shuts off output for an overtemperature condition. Reset requires removal of the overtemperature condition and a momentary interruption of the ac power.

Reverse voltage protection: supply is protected against application of reverse polarity voltage across the output terminals. The maximum steady state reverse current can be up to 25% of the rated output current.

AC input protection: 15 A line fuse in extractor post on rear of the supply for 120 V ac operation.

Input power:

Line: 104-127 V ac, 48-63 Hz, single phase. See Option 106 for other line voltage ratings.

Line current: 11.5 amps rms maximum at 127 V ac line.

Input power: approximately 750 watts input at 5.25 V, 100 A output.

Efficiency: approximately 70%.

Input trip signal: contact closure between terminals A1 and +S on the rear barrier strip remotely trips the overvoltage circuit.

Overvoltage trip signal: terminal A1 has a voltage of 15 V ±2 V with respect to +S under normal operating conditions. This voltage falls to approximately 0.5 volts when an overvoltage occurs. Terminal A1 can supply 0.1 mA in the high state and can sink 10 mA in the low state.

Remote sensing: terminals are provided which will correct for load lead voltage drop of up to 0.25 V while maintaining 5 V at the load. Load is protected if sensing leads are inadvertently opened.

Mounting: supply can be mounted in any position provided the air intake and outlet holes are not blocked.

Dimensions: 20.7 cm W × 12.8 cm H × 29.2 cm D (8.14" W × 5.03" H × 11.50" D).

Weight (net/shipping): 6.4 kg. (14 lb)/8.2 kg. (18 lb).

Accessories available

See page 207.

Options

106: 187-250 V ac, 48-63 Hz, single phase

62605M Switching Regulated Supply

Price
N/C

\$650

POWER SUPPLIES

62000-Series mod. accessories; 60000-series supplies

Models 60063B & 60246B; also 62410A & 62415A

62000 Series modular power supply accessories



62411A



62412A

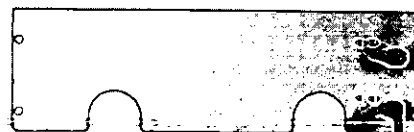

62415A

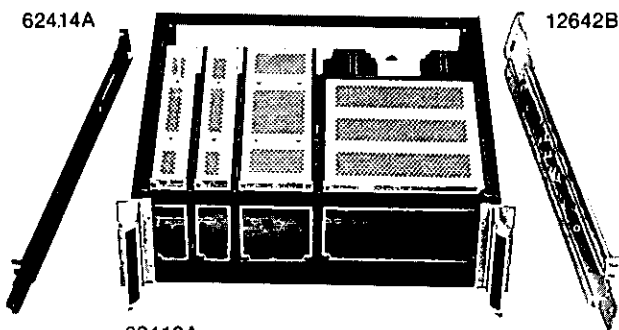

62410A

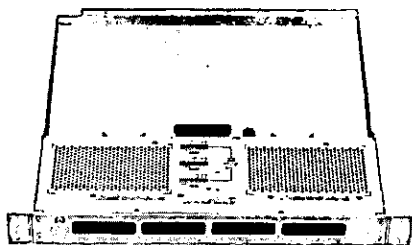

62413A

Specifications

- Load effect:** better than 0.05%.
- Source effect:** better than 0.05%.
- PARD:** less than 1.5 mV rms, 6 mV p-p (except 60245B & 60246B which are 9 and 12 mV p-p, respectively).
- Temperature coefficient:** 0.025% following 30-minutes warmup.
- Drift:** 0.1%, measured within dc to 20 Hz bandwidth, under constant line, load, and ambient, following 30-minutes warmup.
- Slave tracking error (dual supplies):** less than 30 mV for each 1 V change in output voltage of master supply.
- Temperature ratings:** 0 to 55°C. Output current is linearly derated from 100% at 55°C to 70% at 71°C.
- Output ratings:**

Model	DC Output		Dimensions W × H × D	Price*
	Volts	Amps		
60063B	5-6.5	1.5	105 mm × 86 mm × 152 mm	\$ 95
60065A	5-6.5	3.0	130 mm × 86 mm × 186 mm	\$120
60066A	5-6.5	8.0	130 mm × 108 mm × 279 mm	\$210
60122B	11.75-14.25	0.5	105 mm × 86 mm × 105 mm	\$ 80
60123B	11.75-14.25	1.0	105 mm × 86 mm × 152 mm	\$ 85
60125B	11.75-14.25	2.2	130 mm × 86 mm × 186 mm	\$110
60126B	11.75-14.25	6.0	130 mm × 108 mm × 279 mm	\$190
60242B	23.5-28.5	0.25	105 mm × 86 mm × 105 mm	\$ 80
60243B	23.5-28.5	0.5	105 mm × 86 mm × 152 mm	\$ 85
60244B	23.5-28.5	1.0	130 mm × 86 mm × 152 mm	\$ 95
60245B	23.5-28.5	1.5	130 mm × 86 mm × 186 mm	\$110
60246B	23.5-28.5	3.5	130 mm × 108 mm × 279 mm	\$190
60153D	±15 (±1.5)	0.2	105 mm × 86 mm × 152 mm	\$105
60155C	±15 (±1.5)	0.75	130 mm × 86 mm × 186 mm	\$145

*Quantity and OEM discounts are available. Contact your local Hewlett-Packard sales office.

60000 Series Supplies

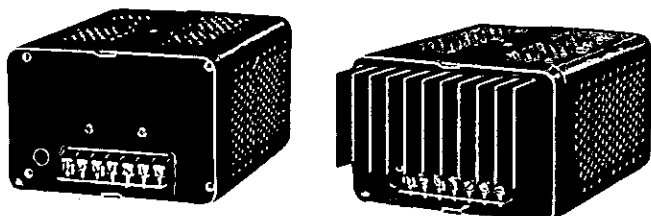

60063B-60246B

Description

These single and dual output modular supplies are intended for applications requiring a fixed constant voltage source of dc. The nominal output voltage is regulated to 0.05% and may be offset from the design center by up to ±10%. All supplies are short circuit proof and will not be damaged by overload.

Accessories:

- 62415A:** Mounts on rear of rack tray for convenient ac power connections to supplies Price \$25
- 62414A:** A 20" slide kit for use with standard 19" wide equipment racks of 20" depth \$55
- 62411A:** Covers front of rack mounting tray. A clearance of 2¼" behind the panel controls, meters, switches, etc. \$15
- 62410A:** Accommodates any combination of 62000 Series modular supplies totaling a full rack width or less. Attaches to a 19" equipment rack, via front mounting ears \$70
- 62413A:** Occupies only 1¼" of rack space, yet provides over 45CFM of cooling air to modular supplies installed in rack tray \$150
- 62412A:** Mounts on rear of rack mounting tray. A 2¼" clearance behind the panel permits addition of connectors, terminal blocks, etc. \$15
- 12692B:** Used with 2940A/B Series HP cabinet enclosures \$65

POWER SUPPLIES

General purpose: 0 – 320 V dc output

Model 895A

- Remote programming and sensing
- Current limiting
- Excellent regulation, low ripple and noise

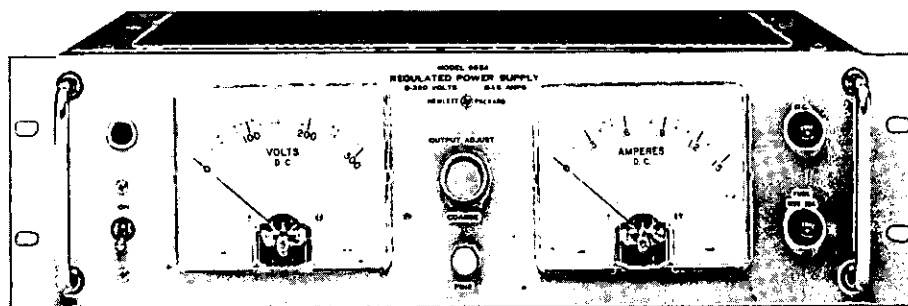

Description

Model 895A is a general purpose Constant Voltage/Current Limit supply. Output voltage is adjustable from 0 – 320 V via a front panel 10-turn potentiometer with concentric knoblock and a single-turn fine control. Separate voltage and current meters provide continuous indication of power supply outputs. High performance specifications include 0.007% line and load regulation and 1 mV rms ripple and noise. Remote sensing and programming are standard features. Units are packaged in convection-cooled, 5¼ inch high, full-rack width modules.

Specifications

DC Output: 0 – 320 V dc @ 0 – 1.5 A

AC Input: 115 V ac $\pm 10\%$, 57-63 Hz, 8.7 A, 585 W

Load effect (load regulation): Less than 0.007% or 10 mV change (whichever is greater) for a load current change from no load to full load.

Source effect (line regulation): Less than 0.007% or 10 mV change (whichever is greater) for a change in line voltage between 104 and 127 V ac at any output voltage and current within rating.

PARD (ripple and noise): Less than 1 mV rms at any load condition within rating.

Load effect transient recovery (load transient recovery): Less than 100 μ sec is required for output voltage recovery to within 20 mV of the nominal output voltage following a full load change in output current.

Temperature coefficient: Output change per degree Centigrade

change in ambient following 30 minutes warm-up is 0.03% plus 1.5 mV.

Drift (stability): Change in output over 8-hour interval under constant line, load, and ambient following 30 minutes warm-up is 0.1% plus 5 mV.

Output impedance (typical): Approximated by a 40 m Ω resistance in series with 0.16 μ H inductance.

Temperature ratings:

Operating: 0 to 55°C. Storage: –40 to +75°C.

Cooling: Natural convection.

Input connections: Includes an attached three-wire, 5-foot (1.52 m) power cord.

Output terminals: Rear barrier strip includes +OUT, –OUT, GND, +SENSING, –SENSING, and AI (remote programming).

Remote programming: The remote programming coefficient is 300 ohms/volt.

Isolation: Either output terminal can be grounded or the output may be operated floating up to 300 V off ground.

Remote sensing: Separate remote sensing leads are provided. This feature will correct for load lead voltage drops up to 0.3 V per lead.

Meter ranges: 0 – 320 V, 0 – 1.5 A.

Dimensions: 483 mm W \times 133 mm H \times 426 mm D (19" W \times 5¼" H \times 16¼" D).

Weight (net/shipping): 22.6 kg (50 lb)/29.4 kg (65 lb).

Finish: Mint gray front panel with olive gray case.

895A Power Supply

\$760

Specifications definitions

The following definitions expand on the terms used in the individual power supply specification tables.

Load effect (load regulation): Voltage Load Effect is given for a load current change equal to the current rating of the supply. Current Load Effect is given for a load voltage change equal to the voltage rating of the supply. In general, where a supply has both front and rear output terminals, load effect is specified for the rear terminals only.

Source effect (line regulation): Given for any change in line voltage within the specified range at any output voltage and current within rating.

PARD (ripple and noise): Measured within 20 Hz to 20 MHz bandwidth at any line voltage and under any load condition within rating. For the high voltage supplies, models 6515A-6525A, the measurement bandwidth is 1 Hz to 20 MHz.

Temperature coefficient: Output change per degree Centigrade change in ambient following 30-minutes warm-up.

Drift (stability): Change in output (dc to 20 Hz) over 8-hour interval under constant line, load, and ambient following 30-minutes warm-up.

Resolution: Minimum output voltage or current change that can be obtained using front panel controls.

Output impedance: Typical values, approximated by a resistance in series with an inductance.

Load effect transient recovery (load transient recovery): Time required for output voltage recovery to within the specified level of the nominal output voltage following a change in output current equal to the current rating of the supply or 5 amps, whichever is smaller.

Remote programming speed: Typical time required to non-repetitively change from zero to within 99.9% of the maximum rated output voltage, or from the maximum rated output voltage to within 0.1% of that voltage above zero (99% and 1% for high power models 6427B-6483C and precision models 6101A-6116A).

General power supply terms

Control: The determination of the power supply output by means of a variable element or signal, the relevant value of which may be changed continuously or in steps to change the value of the stabilized output quantity accordingly.

(1) Local Control (Programming): The determination of the power supply output by means of a control element integral with the power supply.

(2) Remote Control (Programming): The setting of the power supply output by means of an external control quantity. In general, particular modes of remote control are designated according to the applied signal or signal quantity, for example:

- a. Resistance control
- b. Voltage control
- c. Current control
- d. Digital control

Efficiency: The total output power divided by the active input power.

Remote sensing: A means by which the power supply monitors a stabilized output quantity directly at the load using extra "sensing"

leads. Usually, the remote sensing leads monitor voltage directly at the load, and the resulting circuit action compensates for voltage drops in the load leads up to a specified limit.

Source: A point of origin of electrical energy. It is used as an adjective to describe the AC input to the equipment.

Stabilized power supply: An apparatus which takes electrical energy from a source and supplies it in a stabilized form to one or more pairs of output terminals.

(1) Constant Voltage Power Supply: A power supply that stabilizes output voltage with respect to changes of influence quantities.

(2) Constant Current Power Supply: A power supply that stabilizes output current with respect to changes of influence quantities.

(3) Constant-Voltage/Constant-Current Power Supply: A power supply that operates as a constant-voltage power supply or constant-current power supply, depending on load conditions.

Terms related to static operation

Constant-voltage/constant-current cross-over: The behavior of a power supply that automatically converts the mode of operation from voltage stabilization to current stabilization when the output current reaches a preset value and vice versa.

Discontinuous control resolution (resolution): In the case of discontinuous control (e.g., by means of switches, wire-wound adjustable resistors), the maximum increment in the value of a stabilized output quantity arising from the smallest reproducible control element step.

Drift: The maximum change of an output quantity during a specified period of time following the warm-up time, with all influence and control quantities maintained constant during the warm-up time and the period of drift measurement. Drift includes both periodic and random deviations over the bandwidth from zero frequency (dc) to a specified upper frequency limit. This specified upper frequency limit for drift must coincide with the lower frequency limit for PARD so that all deviations under constant operating conditions are covered by specifying one or the other.

(1) Warm-Up Time: The time interval after switching on the power supply until it complies with all performance specifications.

Nominal value: The value which exists "in name only" not the actual value. For example, in the case of a power supply with a calibrated output control, the nominal output is the value indicated by the control setting. For a supply with a fixed output, the nominal output is the output indicated on the nameplate. For alternating-current line input voltages, the nominal value is usually the "design center" value. For example, the nominal value of a 115 volt ± 10 percent line voltage is 115 volts. In the case of remote control, the nominal value is the output value predicted by the remote control coefficient.

Output effect (regulation): The change in the steady-state value of a stabilized output quantity (voltage, current or power) due to a specified change in the steady-state value of one or more influence quantities with all other influence quantities maintained constant.

(1) Individual Effect: The change of value of a stabilized output quantity resulting from a specified change in one influence quantity, with all other influence quantities maintained constant. In general, abbreviated terms are used for individual effects, e.g. "source effect" to designate the effect of the stabilized output quantity due to changes of the source voltage.

Output effect coefficient: The maximum change in value of an output quantity per unit change of one influence quantity, with all other influence quantities maintained constant. Temperature coefficient is the most commonly used output effect coefficient.

PARD periodic and random deviation (ripple and noise): The periodic and random deviation of a direct-current output quantity from its average value, over a specified bandwidth, with all influence and control quantities maintained constant. It is stated in rms and/or peak-to-peak values for a specified bandwidth.

Steady-state value: The value of a quantity which persists after all nonrecurring transients have decayed to an insignificant magnitude.

Warm-up time: The time interval after switching on the power supply until it complies with all performance specifications.

Terms related to dynamic operation:

Output impedance: The complex ratio of a sinusoidal voltage and a sinusoidal current at the output terminals, the one being caused by the other and being of external origin.

Transient recovery time: The time interval between a step change in one of the influence quantities or control quantities and the instant when the stabilized output quantity returns to and stays within the transient recovery band.

Turn-on (turn-off) overshoot: The overshoot resulting from the application (removal) of the source power or from the power supply source switch being turned on (turned off).

Terms related to physical and environmental aspects

Ambient temperature: The temperature of the medium in which the power supply is immersed, usually the temperature of the air surrounding the power supply.

Isolation voltage: In the case of a floating output, input, or control input, the maximum voltage that may be permanently maintained between specified terminals.

Terms related to combined operation of two or more power supplies

Combined operation of power supplies: In order to extend the output capabilities of a single power supply, two or more power supplies may be connected for a combined mode of operation. Frequently, terminals other than the output terminals may be interconnected, e.g., to provide a mode of operation where one power supply (the master) may serve to control the others (the slaves).

Parallel operation: The operation of two or more power supplies with all positive output terminals connected together, and all negative output terminals connected together, so that the total load current equals the sum of output current of all power supplies.

(1) Parallel Operation With Specified Load Sharing: A parallel connection of two or more power supplies, with the total load being shared between them in a prescribed ratio.

(2) Slave Parallel Operation: A parallel connection of one master supply, with one or more slaves with output current(s) always equal or proportional to the output current of the master unit.

Series operation: The operation of two or more power supplies with the positive output terminal of one connected to the negative output terminal of another, so that the output voltages of the supplies are ad-

ditive.

(1) Series Operation With Specified Load Sharing: A series connection of two or more power supplies, with the total voltage being shared between them in a prescribed ratio.

(2) Slave Series Operation: A series connection of one master supply, with one or more slaves, with their output voltage(s) always equal or proportional to the output voltage of the master unit.

Slave operation: A method of interconnecting two or more stabilized power supplies and achieving coordinated control of the assembly by means of controlling the master supply alone, such combinations being characterized by essentially proportional outputs from all units.

(1) Slave Tracking Operation: An interconnection of two or more slaves with output(s) always held equal or proportional to the output of the master unit. The slave may be of the same or opposite polarity as the master with respect to the common output terminals in the latter case, the configuration is sometimes referred to as complementary tracking.

Protection terms

Crowbar protection circuit: A protection circuit which rapidly places a low resistance shunt across the output terminals of the power supply, thereby initiating action to reduce output voltage to a low value.

Current limiting: The action of limiting the output current of a constant-voltage supply to some predetermined maximum value (fixed or adjustable) and automatically restoring the output voltage to its normal value when the overload or short circuit is removed. There are three types of current limiting.

(1) By constant-voltage/constant-current crossover.

(2) By decreasing output voltage as current increases (otherwise known as automatic current limiting.)

Overcurrent protection: Protection of the power supply and/or connected equipment against excessive output current, including the short-circuit current.

Overtemperature protection: Protection of the power supply or parts of it against temperatures exceeding specified values.

Reverse voltage protection: Protection of the power supply against reverse voltage applied at the output terminals.

Short-circuit current: The steady-state current delivered by a constant voltage power supply when its output terminals are short-circuited.

Thermal disconnect: A device which prevents the maintenance of excessively high temperature in certain parts of the apparatus by disconnecting those parts from their supply.

Voltage limiting: The action of limiting the output voltage of a constant-current supply to some predetermined maximum value (fixed or adjustable) and automatically restoring the output current to its normal value when the load conditions are restored to normal. There are two types of voltage limiting:

(1) By constant-voltage/constant-current crossover.

(2) By decreasing output current as voltage increases (otherwise known as automatic voltage limiting.)

Open-circuit voltage: The voltage at the terminals of a constant-current power supply when there is no load connected.

POWER SUPPLIES

Digitally controlled: binary or BCD

Models 6128C - 6131C, 6140A & 6145A

- Digitally programmable in binary or BCD
- Complete digital-to-analog subsystem in one package
- Fast, accurate, bipolar output

- Digital inputs isolated from analog output
- Internal storage of digital data
- Digitally programmable current latch (on DVS models) or voltage limit (on DCS models)

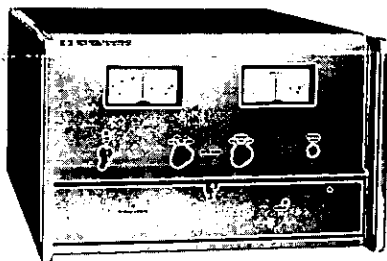

6128C, 6129C

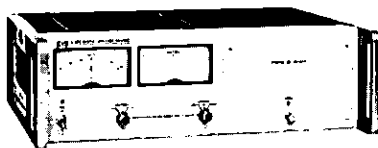

6130C, 6131C

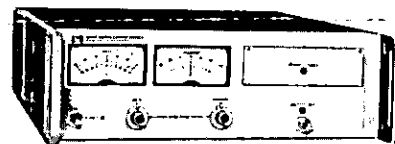

6140A

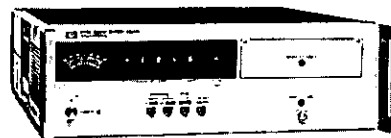

6145A

Digital voltage sources

HP's family of digital voltage sources (DVS's) include models 6128C, 6129C, 6130C, and 6131C. All models are programmable in binary or 8421 BCD and have many system-oriented features that enhance their use in automatic testing and control environments. Among these features are: isolation between the digital input and analog output lines, digital storage of programmed inputs, programmable current latch, analog input, and current monitoring terminals.

Isolation

All digital lines of the DVS's are isolated from the analog output. This feature is essential in automatic test systems to avoid forming ground loops that could impair system operation and damage the computer and instruments.

Nearly all computer manufacturers ground the power supplies for the digital I/O logic to the mainframe of the computer, which is connected to the ac power line ground. If a DVS did not have isolation, one of its analog output terminals would be connected to the digital input common line.

Internal storage

The DVS's internally store the computer's output magnitude (voltage setting), polarity, range, and output latch/limit digital inputs when the computer's gate command is received. When the DVS has finished processing the digital input, it notifies the computer by transmitting its flag. Since the DVS stores the digital data, the computer does not have to continually refresh the DVS; it is free to carry out other important tasks. The DVS maintains its programmed output indefinitely, changing the output only when the computer changes the digital input data and sends another gate command.

In addition to eliminating the need for redundant programming by the computer, internal storage also facilitates the control of multiple DVS's from a single computer I/O channel. The number of DVS's that can be controlled from a single I/O channel depends on the capabilities of the computer's I/O data bus drivers. Most computers can easily drive up to eight DVS's.

Programmable current latch

Overcurrent protection is provided by a current latch circuit which can be externally programmed to one of eight values between 2% and

100% (six values for the 6131C) of the unit's rated output current. When activated, the current latch circuit turns off the output power amplifier reducing the output current to less than 20 mA. The reaction time of the current latch circuit (time between the start of a current overload and turn off of the power amplifier) can be adjusted by adding an external capacitor at the rear terminals. The upper current limit is safeguarded by a separate fixed current limit circuit that prevents the output current from exceeding 110% of the current rating. The computer is continuously informed of possible current overload or current latch conditions by status outputs which are fed back to the programming source.

Analog input

In automatic test systems, it is often desirable to inject an ac "wobble" on top of a programmable dc level to measure impedance at various voltage levels, to simulate worst case power supply conditions for a module under test, or measure component parameters such as dynamic gain or transconductance. Many automatic control systems require this feature to provide "dither" for the system. All DVS's provide an analog input to fulfill this need.

Current monitoring terminals

The output current of all DVS's can be measured without upsetting voltage accuracy by connecting a voltmeter across the current monitoring terminals on the rear barrier strip.

Specifications

See pages 212 and 213.

Digital current sources

The Digital Current Sources, Models 6140A and 6145A, are ideally suited for system applications requiring a rapidly programmable, high-precision source of current. The 6104A DCS is available for operation with either binary or 8421 BCD control devices while the 6145A is available only for BCD operation. The 6145A, however, also features manual, high resolution thumbwheel switches that allow it to be utilized as a bench instrument or in system applications.

The isolation, internal storage, and analog input features described for the DVS's also apply to the DCS's. In addition, the DCS's have programmable voltage limiting and voltage monitoring terminals.



POWER SUPPLIES

Models 6128C-6131C, 6140A & 6145A (cont.)

Programmable voltage limit

DCS's incorporate programmable gross voltage limiting to protect the load from overvoltage conditions. The nominal positive or negative voltage limit is programmed and, if the output voltage exceeds the programmed value by approximately 0.2 V dc, a shunt regulator within the DCS automatically activates and begins to draw current away from the load. At the onset of voltage limiting, the DCS starts to reduce output current to compensate for the voltage overload. If the overload increases and output voltage reaches approximately $\pm 10\% + 1.4$ V dc of the programmed limit, the DCS attains full voltage limit operation during which output current is reduced towards zero if necessary to hold output voltage at the maximum limit value $\pm 10\% + 1.4$ V dc of programmed limit. When in full voltage limit operation, but not before, the DCS returns status and flag signals to the computer to notify it of the current overload condition.

If the overload was temporary (whether or not full voltage limit was reached), the DCS automatically re-establishes the programmed current output. At this time, if full voltage limit was reached, another Flag is generated and another overload status signal returned to notify the computer that an overload occurred. This status signal (overload stored) is not removed until the DCS is reprogrammed.

The DCS also includes a Voltage Limit Override input that allows the programmed voltage limit setting to be overridden and the DCS placed at the minimum voltage limit (2 V dc). This input is especially useful in systems applications in which one computer override signal is distributed to all DCS's in a chain and all of them set to the minimum voltage limit simultaneously.

Voltage monitoring

The DCS is a precise constant current source that employs an active guard supply to eliminate leakage current flow between the output terminals. The guard is maintained within 10 mV of the HI output terminal at the DCS and completely surrounds it so that any leakage current is "captured" by the guard and does not flow in the load. The guard output is also provided at a rear terminal and provides a convenient point at which to monitor the output voltage. If a voltmeter were connected directly to the HI output terminal, it would lower the output impedance and the meter would draw current from the load. By connecting the meter to the guard, however, the voltage output can be monitored without impairing current regulation of the DCS.

Common specifications

(Refer to table on page 213 for additional specifications.)

AC power input:

6128C, 6129C: 115/230 V ac, 48-63 Hz; 6.4 A, 780 W @ 115 V ac; 115/230 V ac switch-selected.

6130C, 6131C: 115 V ac $\pm 10\%$, 48-440 Hz; 1.2 A, 100 W.

6140A, 6145A: 115/230 V ac, 48-440 Hz; 1.2 A, 100 W @ 115 V ac; 115/230 V ac switch-selected.

Dimensions:

6128C, 6129C: 42.55 W \times 26.67 H \times 54.3 cm D; (16 $\frac{1}{4}$ " W \times 10 $\frac{1}{2}$ " H \times 21 $\frac{1}{2}$ " D).

6130C, 6131C: 42.55 W \times 13.34 H \times 39.69 cm D; (16 $\frac{1}{4}$ " W \times 5 $\frac{1}{4}$ " H \times 15 $\frac{3}{4}$ " D).

6140A, 6145A: 42.55 W \times 13.34 H \times 49.40 cm D; (16 $\frac{1}{4}$ " W \times 5 $\frac{1}{4}$ " H \times 19 $\frac{1}{2}$ " D).

Weight:

6128C, 6129C: net, 33 kg (72 lb); shipping, 35 kg (78 lb).

6130C, 6131C: net, 15 kg (32 lb); shipping, 22 kg (48 lb).

6140A, 6145A: net, 20 kg (45 lb); shipping, 24 kg (52 lb).

Cooling:

6130C, 6131C: are convection cooled.

6128C, 6129C, 6140A, 6145A: are forced air cooled.

Accessories furnished:

1251-0086 50-contact rear plug.

5060-8743 Rack mounting kit for Models 6128C and 6129C.

5060-8740 Rack mounting kit for Models 6130C, 6131C, 6140A, and 6145A.

5060-7948 Plug-in extender board for DVS models.

5060-7948/5060-7982 Two plug-in extender boards for DCS models.

Accessories available

	Price
14533B Pocket programmer permits manual programming of all input functions by switch closure	\$120
14534A Pocket programmer extension cable (18')	\$60
14535A HP computer interface kit includes 12661A computer I/O card, 14539A cable, verification software and BCS driver. Up to eight DCPS's may be controlled from one 14535A	\$1700
14539A cable connects the first DCPS in a chain of up to eight instruments to the 12661A DVS programming card for Hewlett-Packard computers	\$170
14536A chaining cable connects an additional DCPS to the existing chain of DCPS's	\$170
14544A Cable connects a DCPS with option J95 (no charge) to a DEC PDP-8/1 computer. Includes instructions for constructing the interface from DEC logic modules	\$155

Software for HP computers

Drivers in the form of punched paper tape with accompanying operating manuals are available for Hewlett-Packard BCS, DOS, RTE, and BASIC software operating systems. Contact your HP Field Engineer for prices and ordering information.

AC power option

028 Transformer tap change for 230 V ac $\pm 10\%$, single phase input on 6130C and 6131C.

\$10

Standard interface options

These options apply to all DVS's and the 6140A DCS. Standard options are not available on Model 6145A, which uses BCD microcircuit logic levels.

J20: binary interface for 12661A I/O programmer card for Hewlett-Packard computers.

061: BCD interface for NPN open collector circuits.

062: binary interface for NPN open collector circuits.

063: BCD interface for microcircuit logic levels.

064: binary interface for microcircuit logic levels.

Special options

If none of the standard interface options meet your requirements, quotations for special options may be obtained from your Hewlett-Packard field engineer.

Model number and name

	Price
6128C, 6129C Digital Voltage Source	\$2900
6130C, 6131C Digital Voltage Source	\$1900
6140A Digital Current Source	\$2575
6145A Digital Current Source	\$2990

Specifications

	6128C	6129C	6130C	6131C	6140A 6145A (BCD Only)
DC OUTPUT: Binary Instruments (Option J20, 062, or 064) X1 Range	-16.384 to +16.3835 V, 12.5 A	-16.384 to +16.3835 V, 5 A	-16.384 to +16.3835 V, 1 A	-16.384 to +16.3835 V, 0.5 A	-16.384 to +16.3835 mA, 100 V
X10 Range		-50 to +50 V, 5 A	-50 to +50 V, 1 A	-100 to +100 V, 0.5 A	-163.84 to +163.835 mA, 100 V
8421 BCD Instruments (Option 061 or 063) X1 Range	-9.999 V to +9.999 V, 12.5 A	-9.999 V to +9.999 V, 5 A	-9.999 V to +9.999 V, 1 A	-9.999 V to +9.999 V, 0.5 A	-9.999 mA to +9.999 mA, 100 V
X10 Range		-50 to +50 V, 5 A	-50 to +50 V, 1 A	-99.99 V to +99.99 V, 0.5 A	-99.99 mA to +99.99 mA, 100 V
RESOLUTION: Binary Instruments	X1 Range: 0.5 mV	X1 Range: 0.5 mV X10 Range: 5 mV			X1 Range: 500 nA X10 Range: 5 μ A
8421 BCD Instruments	X1 Range: 1 mV	X1 Range: 1 mV X10 Range: 10 mV			X1 Range: 1 μ A X10 Range: 10 μ A
BASIC ACCURACY (90 DAYS): Accuracy at 23°C \pm 3°C, 115 V ac input, no load, following 30 minutes warm-up	X1 Range: 1.5 mV	X1 Range: 1.5 mV X10 Range: 15 mV	X1 Range: 1 mV X10 Range: 10 mV		X1 Range: 1 μ A \pm 0.01% X10 Range: 10 μ A \pm 0.01%
PROGRAMMING TIME: For output to settle within 0.1% of programmed change	350 μ sec	300 μ sec			
STABILITY: DC output drift under constant line, load, and ambient temperature for 8 hours after 30 minutes warm-up. Binary Instruments	X1 Range: 500 μ V	X1 Range: 500 μ V X10 Range: 2.5 mV	X1 Range: 500 μ V X10 Range: 5 mV	X1 Range: 500 μ V X10 Range: 5 mV	X1 Range: 500 nA X10 Range: 5 μ A
8421 BCD Instruments	X1 Range: 300 μ V	X1 Range: 300 μ V X10 Range: 1.5 mV	X1 Range: 300 μ V X10 Range: 3 mV	X1 Range: 300 μ V X10 Range: 3 mV	X1 Range: 500 nA X10 Range: 5 μ A
RIPPLE AND NOISE: At any line & load condition within rating	6 mV p-p 2 mV rms	12 mV p-p 3 mV rms	X1 Range: 2 mV p-p, 0.5 mV rms X10 Range: 7 mV p-p, 1.5 mV rms		X1 Range: $\frac{p-p}{rms}$ 2 μ A / 0.5 μ A X10 Range: 8 μ A / 2 μ A
LOAD EFFECT Change in output voltage (or current for DCS's) for any load change within rating	150 μ V	X1 Range: 150 μ V X10 Range: 500 μ V		X1 Range: 150 μ V X10 Range: 1.5 mV	X1 Range: <50 nA X10 Range: <500 nA
SOURCE EFFECT Change in output voltage (or current for DCS's) for any line voltage change within specified range					
Binary Instrument	300 μ V	X1 Range: 250 μ V X10 Range: 2.5 mV	X1 Range: 500 μ V X10 Range: 5 mV		X1 Range: 200 nA X10 Range: 500 nA
8421 BCD Instruments	250 μ V	X1 Range: 200 μ V X10 Range: 2 mV	X1 Range: 400 μ V X10 Range: 4 mV		X1 Range: 200 nA X10 Range: 500 nA
TEMPERATURE COEFFICIENT Change in output per $^{\circ}$ C in ambient temperature Binary Instruments	160 μ V/ $^{\circ}$ C	X1 Range: 160 μ V/ $^{\circ}$ C X10 Range: 800 μ V/ $^{\circ}$ C		X1: 160 μ V/ $^{\circ}$ C X10: 1.6 mV/ $^{\circ}$ C	X1 Range: 150 nA + 0.0006% of output/ $^{\circ}$ C X10 Range: 1.50 μ A + 0.0006% of output/ $^{\circ}$ C
8421 BCD Instruments	100 μ V/ $^{\circ}$ C	X1 Range: 100 μ V/ $^{\circ}$ C X10 Range: 500 μ V/ $^{\circ}$ C		X1: 100 μ V/ $^{\circ}$ C X10: 1 mV/ $^{\circ}$ C	X1 Range: 150 nA + 0.0006% of output/ $^{\circ}$ C X10 Range: 1.50 μ A + 0.0006% of output/ $^{\circ}$ C
ANALOG INPUT DC Gain	-1 V/V \pm 0.2%	X1 Range: -1 V/V \pm 0.2% X10 Range: -10 V/V \pm 0.2%			X1 Range: -1 mA/V X10 Range: -10 mA/V
Bandwidth (\pm 3 dB)	\approx 9.0 kHz	\approx 25 kHz			
Stability -8 hrs. (+ Stab. of input signal)	500 μ V + input	X1 Range: 500 μ V + input X10 Range: +5 mV + input			X1: 0.5 μ A + input X10: 5 μ A + input
Impedance		10 k Ω			600 Ω
Max. Input	\pm 16.38 V	X1 Range: \pm 20 V X10 Range: \pm 5.0 V		X1: \pm 20 V X10: \pm 10 V	16 V (either range)

RECORDERS & PRINTERS

General information

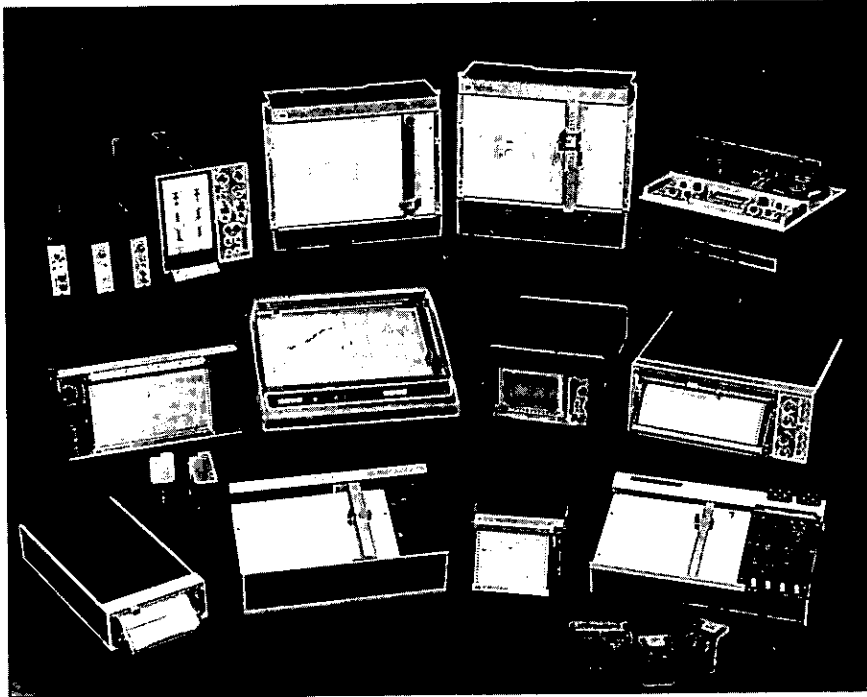

Introduction

Hewlett-Packard offers a wide selection of recorders that record and display data accurately, quickly, and reliably. Some areas of application include manufacturing, education, laboratories, and hospitals. The recorders can also be utilized by the original equipment manufacturer (OEM) to fulfill the need for recording and displaying data from the OEM's equipment. The wide selection includes X-Y, strip chart, oscillographic, and instrumentation tape recorders, along with graphic plotters for computer, timeshare, and calculator users. For more detail, refer to the specific type of recorder or graphic plotter which fits your application.

X-Y recorders

The Hewlett-Packard X-Y Recorders are designed for the laboratory or the industrial user to plot Cartesian Coordinate graphs from dc electrical information. This results in providing the most effective methods for presenting related data clearly.

A self-balancing potentiometer circuit compares an unknown external voltage with a stable internal reference voltage. The difference between these voltages is amplified and applied to a servo motor to drive a potentiometer in a direction that will null any difference or error voltage.

A stepped attenuator or range selector is included for each axis, so voltages as high as 500 volts may be handled directly. Input resistance is typically 1 megohm. Sensitivity may be as high as 20 $\mu\text{V}/\text{cm}$ for dc.

Zeroing potentiometers permit the user to locate the plotting origin as desired.

To fit the range of the recorder's response exactly to the coordinates of the paper in use,

or to the units of measurement desired, a continuously adjustable vernier control may be switched in as a substitute for the calibrated control. Thus, the response range of the recorder can be adjusted smoothly to match, for example, some calibrated maximum from a transducer, so the paper's coordinates directly correspond to the desired units of measurement (psi, $^{\circ}\text{C}$, etc.).

Applications

The X-Y Recorders may be selected among models in the two basic chart sizes and from three basic levels of performance depending upon measurement needs. Certain models have high sensitivity and high common mode rejection. Models are available with and without time sweep capability. Metric and English models are available. Additionally, two pen models may also be selected which are capable of simultaneously plotting two curves. Whether the application be in the Bio-Medical, Chemical, Material Testing, etc., a wide variety of X-Y Recorders is available to fit the requirement.

Plug-in modules

To expand the versatility and application of one group of X-Y recorders, plug-in modules are provided. If the application changes, the needed measurement capability is available by simply adding an inexpensive plug-in. In addition to these advantages, their high dynamic performance allows the recorders to be used in practically any application.

Recorders that utilize plug-ins include the 7004B and 7034A. The modules available include Amplifiers, Time Bases, DC offset, Filters and Null Detector. The flexibility inherent in the plug-ins will meet the constantly changing requirements of laboratory measurements.

Hewlett-Packard X-Y recorders

Description	Model	Chart Size	Maximum Sensitivity (mV/cm)	Other
General Performance	7035B	8½ × 11	0.4	External Time Base Available Two Pen, Time Base Standard Time Base Optional Time Base Optional
	136A	8½ × 11	0.2	
	7015A	8½ × 11, A4	1.0	
	7044A	11 × 17 and A3	0.25	
High Performance	7004B	11 × 17	0.25	Uses Plug-ins Uses Plug-ins High Speed Two Pen High Perf. Input, DC Offset
	7034A	8½ × 11	0.25	
	7045A	11 × 17 and A3	0.25	
	7046A	11 × 17 and A3	0.25	
	7047A	11 × 17 and A3	0.02	
OEM	7040A	11 × 17 and A3	0.2	Single Sensitivity High Speed Single Range
	7041A	11 × 17 and A3	0.2	
	7010A	8½ × 11 and A4	1.0	

Digital graphic plotters

The Hewlett-Packard Graphic Plotters offer the user an opportunity to produce graphs of computer-generated data. They operate with terminals which communicate with a computer directly or in a time-sharing environment. Simple mnemonic commands, which can be generated by any computer in any language, are used to feed data and control the plotter.

Data is supplied in pairs of four-digit X and Y coordinates so each new data point is totally defined and not dependent upon the accuracy of previous points. As true vector plotters, the 7200 series interpolate straight lines between data points, eliminating the need for the computer to generate immediate points.

Applications

Graphic plotters are particularly useful for the graphing of functions, curve fitting, regression analysis, transfer functions, probability distribution, shear and moment diagrams, checking of numerical control machine programs, or anything else that can be graphed. BASIC routines for curve and alphanumeric generation are available to be used on major time-sharing systems.

Strip chart recorders

Hewlett-Packard Strip Chart Recorders are servo driven devices designed to provide permanent records of slowly varying analog signals versus time. Pen movement on these instruments is accomplished by comparing the input signal with the voltage present along the internal linear feedback element (slidewire), amplifying this error signal and applying it to a servo motor. The motor then

repositions the slidewire contact until electrical balance is achieved. Systems using this technique can be expected to have accuracies around 0.2 percent of full scale and have full scale response times of from 1/3 to 1/2 second.

Movement of the time axis in most strip charts is accomplished by a synchronous motor. The accuracy is, therefore, dependent on the frequency stability of the power input. It is necessary to specify either 50 or 60 Hz operation when the instrument is ordered. One recorder, the 7155A Portable, uses a stepper motor drive in conjunction with an internal oscillator and, therefore, operates independently of line frequency.

Writing systems

Hewlett-Packard Strip Chart Recorders provide two types of writing systems: capillary ink and disposable pens (ink).

Capillary ink systems use replaceable ink cartridges and have been traditional on SCR's for many years. More recently, disposable pens have been introduced which permit the user to rapidly change ink colors and perform less ink system maintenance.

Oscillographic recorders

The advantages of using direct writing recorders are highlighted by the Hewlett-Packard Oscillographic Recorder family.

Time correlation of multiple channels of data, instantaneous read out, and the capability to use calibrated units of the customer's choice are just some of those advantages. Permanent and easily reproduced records of signals from dc to 150 Hz can also be made on HP Oscillographs. From two to eight channels of recording can be made, depending upon the recorder model selected.

The wide range of plug-in signal conditioning available for these recorders allows the customer to record dissimilar signals on the same chart paper.

The 7402A 2-channel ink recorder is unique in that it can also be used as a single channel recorder with a wide 100 mm trace. The 7404A 4-channel ink recorder can also be converted to a 2, or 3-channel recorder.

Applications

With appropriate signal conditioners, oscillographic recorders can record electrical signals from microvolts to volts. Add transducers and they can make records of all types of physical measurements such as force, position, strain, stress, acceleration, and temperature.

Oscillographs can also be used for troubleshooting since the chart paper can show real time correlation of a number of variables. The chart paper provides a historical record that can be used conveniently in reports.

Writing systems

Both ink and thermal writing systems are available. The 7402A 2-Channel and 7404 4-Channel recorders use ink. The 7414A 4-Channel and 7418A 6 and 8-Channel recorders use hot tip thermal writing techniques.

The ink writing system utilizes an ink that dries instantly to the touch, a low pressure ink system, and rugged stainless steel stylus with hard tungsten carbide tips.

Thermal writing systems utilize a hot tip stylus which is a major redesign of the heated stylus used on past HP thermal recorders. As a result, the reliability of the writing systems used in these recorders is vastly improved.

Oscillographic recorder system specifications

System	Number of Channels, Chart Width	Writing Method	Preamplifier Configuration	With Amplifier Model No.	Maximum Sensitivity (mV/div)	Response (-3 dB @ 10 div)	10% to 90% (ms, 10 div)
7402A	2 x 50 mm*	Ink	Plug-in		.001 1 20	125 Hz 140 Hz 140 Hz	7.5 (50 mm) 7 (50 mm) 7 (50 mm)
7404A	4 x 40 mm**	Ink	Plug-in			100 Hz 100 Hz 80 Hz	5 5 7
7414A	4 x 50 mm	Thermal	Plug-in	5 1	.001		
7418A	6 x 8 x 40 mm	Thermal	Plug-in/Bank				

* Single channel 100 ma operation standard.
** Dual channel 80 ma operation standard.

Signal conditioners — Plug-in preamps

A wide line of Plug-in Signal Conditioners is available for both ink and thermal recorders which provide unmatched flexibility for the recorder user.

Bank amplification

Two bank amplifiers are available for gen-

eral purpose applications where economy is desired. They are used exclusively in the 7418 6- and 8-Channel recorder. Each Model 8820A low gain or 8821A medium gain is provided in 6- or 8-Channel versions.

3960A Instrumentation tape recorder

The H-P Model 3960A is a small-size,

light-weight portable instrumentation tape recorder designed to perform in a large assortment of applications — data acquisition and data reproduction — formerly performed by large, expensive recorders. Portability is further enhanced by the capability of operating from either AC or DC power sources, a built-in DC calibrator, and peak AC/DC meter to facilitate any required pre-recording adjustments.

The 17400 Series of Plug-in Signal Conditioners is used in the 7420A 2-Channel and 7404A 4-Channel ink recorders.

Model No.	Description	Max Sensitivity
17400A	High Gain D.C.	1 μ V/div differential, floated and guarded. Cal zero suppression.
17401A	Medium Gain D.C.	1 mV/div balanced to ground. Option 001 adds Cal zero suppression.
17402A	Low Gain D.C.	20 mV/div single ended.
17403A	A.C. Carrier	Internal Excitation (2.4 kHz) for passive transducers such as strain gage and differential transformers. Cal zero suppression. Differential floating inputs.

The 8800 Series of Plug-in Signal Conditioners are used in the 7414A 4-Channel and 7418A 6- and 8-Channel ink recorders.

Model No.	Description	Max Sensitivity
8801A	Low Gain D.C.	5 mV/div Differential Inputs. Cal Zero Suppression.
8802A	Medium Gain D.C.	1 mV/div Differential Inputs. Cal Zero Suppression.
8803A	High Gain D.C.	1 V/div Guarded floating input. Cal Zero Suppression.
8805A	A.C. Carrier	Internal Excitation (2.4 kHz) for passive transducers such as strain gages and differential transformers. Cal Zero Suppression.
8805B	A.C. Carrier	Same as 8805A, adds quadrature signal balance, signal averaging capability and internal calibration.
8806B	Phase Sensitive Demodulator	0.5 mV rms/div High impedance, transforms isolated inputs.
8807A	AC to DC Converter	50 Hz to 100 kHz 1 mV/div Average responding.
8808A	Log Level	100 dB Span 5 Hz to 100 kHz 1 dB accuracy 100 μ V sensitivity.
8809A	Signal Coupler	1.5 V (1 mA into 1.5 k Ω) for Full Scale Deflection.

Transport description

Designed to be rugged, as well as portable, the 3960A encompasses engineering design techniques to ensure it will perform like the large sophisticated and expensive instrumentation tape recorder. All tape drive assemblies are mounted on a solid aluminum casting. The tape guides and the Record/Reproduce heads are mounted on the capstan motor subassembly. This subassembly is then mounted on the solid aluminum casting assuring a permanent tape path alignment.

Data electronics

Data electronics are selected by opting for Direct recording when a wide passband is required or FM recording where higher SNR or DC response is needed. Four channels of data electronics, with up to a 16:1 time base expansion or contraction are available.

Both Direct and FM electronics can be used simultaneously in any desired combination for the four data channels. Located on the front panel of the transport assembly are the input sensitivity and output level controls plus the input and output BNC connectors. A systems connector for data input and output is also located on the back of the transport assembly to facilitate wiring when the instrument is rack mounted.

Other features

An optional Voice Amplifier permits voice annotating of data for locating specific test data during playback. Other options such as the Tape Speed Servo and Tape Loop Adapter may be chosen to enhance the 3960 capability for many diversified applications.



RECORDERS & PRINTERS

Fast response X-Y recorder, plug-in-modules

Models 7004B & 7034A

- High performance

- Plug-in versatility

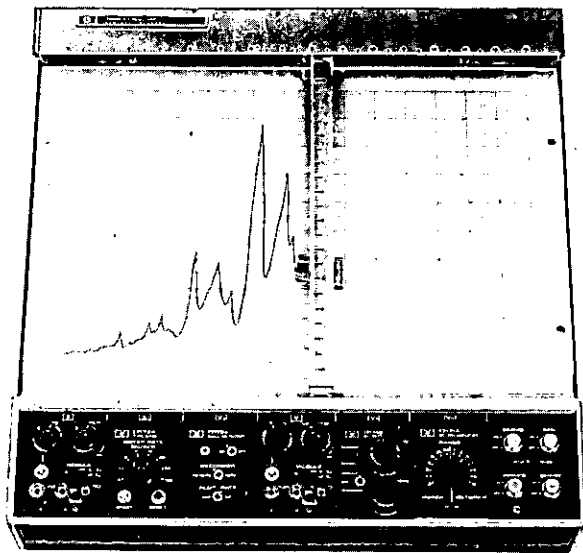

7004B

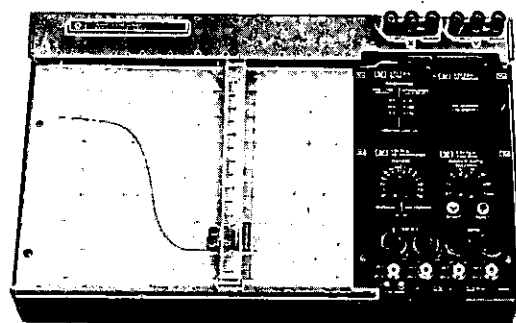

7034A

The 7004B and the 7034A meet the constantly changing requirements of laboratory measurements. Plug-in modules and a variety of accessories form a versatile high performance X-Y Recorder. Circuitry, common to all plug-in modules (power supplies, interfaces, etc.), is located in the main frame. This allows the user to purchase additional low cost modules to expand the measurement capabilities of the system.

With an acceleration of more than 3800 cm/s^2 (1500 in./s^2) and slewing speed of 76 cm/s (30 in./s) the 7004B and 7034A record more phenomena than earlier X-Y Recorders. The high acceleration allows the pen to follow small, quick input changes.

Front and rear guard terminals are available for signal inputs. Guarding helps eliminate the common mode voltage effects that are troublesome when recording from low-level sources such as thermocouples, strain gauges, and similar sources.

Additional features include the proven Autogrip electrostatic paper holddown, the disposable ink pen that produces a clean, crisp, continuous trace, a RECORD/SETUP switch, knob locks, five-way binding posts, tilt stand, to name a few.

Selection of the plug-ins is dependent upon the type of X-Y recorder as well as purpose. Two plug-ins per axis are placed in the mainframe. Each may be used individually or in series by setting the front panel switch. A description of each follows:

7004B & 7034A Specifications

Performance specifications

Number of plug-ins: frame will accept the equivalent of four single-width plug-ins, two per axis.

Type of input: floating and guarded signal pair. Available at the front panel or at the rear connector.

Zero set: zero may be set ± 1 full scale from zero index.

Zero check switches: pushbutton zero check switch in each axis allows verification of recorder's zero position without removal or shorting of the input signal.

Mainframe accuracy: $\pm 0.2\%$ of full scale.

Range vernier: lockable, covers 2.5 times range setting.

Slewing speed: more than 75 cm/s (30 in./s) independent of line voltage and frequency.

Acceleration: more than 3800 cm/s^2 (1500 in./s^2).

Reference stability: better than $0.003\%/^{\circ}\text{C}$.

Terminal based linearity: $\pm 0.1\%$ of full scale.

Resettability: $\pm 0.05\%$ of full scale.

General specifications

Paper holddown: Autogrip paper holddown grips charts of any size up to size of platen.

Pen lift: local and remote control (contact closure or TTL).

Dimensions: 7004B: 445 mm wide, 445 mm high, 121 mm deep, ($17\frac{1}{2}'' \times 17\frac{1}{2}'' \times 4\frac{3}{4}''$). 7034A: 445 mm wide, 267 mm high 121 mm deep ($17\frac{1}{2}'' \times 10\frac{1}{2}'' \times 4\frac{3}{4}''$).

Weight: 7004B: Net, 12.7 kg (28 lb). Shipping, 14.1 kg (42 lb). 7034A: Net, 7.3 kg (16 lb). Shipping, 14.1 kg (31 lb).

Power: 115 or 230 volts ac $\pm 10\%$, 50 to 400 Hz, approximately 85 VA (depending on the plug-ins used).

17170A DC coupler

The DC Coupler couples the input signal to the recorder mainframe. The input signal range of 50 mV/cm (100 mV/in.) may be adjusted to 125 mV/cm (250 mV/in.) with the recorder vernier control.

17170A Specifications

Input range: a single fixed calibrated range of 50 mV/cm (100 mV/in.).

Input resistance: constant, $1 \text{ M}\Omega$.

Common-mode rejection: 120 dB at dc and 70 dB at 50 Hz and above with 100 ohms between low side and guard connection point with source impedance $10 \text{ k}\Omega$ or less.

Models 7004B & 7034A (cont.)

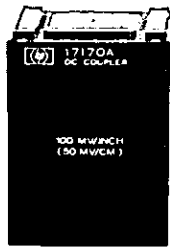

17170A



17171A



17172A



17173A



17174B

17171A DC amplifier

This plug-in is a stable, low noise dc amplifier. The 14 calibrated input ranges are supplemented by the recorder vernier control and provides a continuously variable range from 0.25 mV/cm (0.5 mV/in.) to 12.5 V/cm (25 V/in.).

17171A Specifications

Input ranges: Metric: 0.25, 0.5, 1, 2.5, 5, 10, 25 mV/cm, 0.05, 0.1, 0.25, 0.5, 1, 2.5, 5 V/cm. English: 0.5, 1, 2, 5, 10, 20, 50 mV/in., 0.1, 0.2, 0.5, 1, 2, 5, 10 V/in.

Input resistance: 1 M Ω .

Maximum allowable source resistance:

Range	Max. Source Resistance
0.25 mV/cm (0.5 mV/in.)	10 k Ω
0.5 mV/cm (1 mV/in.)	20 k Ω
1.0 mV/cm (2 mV/in.)	40 k Ω
2.5 mV/cm (5 mV/in.)	100 k Ω
5.0 mV/cm (10 mV/in.)	200 k Ω
10.0 mV/cm (20 mV/in.)	400 k Ω
25 mV/cm (50 mV/in.)	1 M

Common-mode rejection: 120 dB at dc and 100 dB at 50 Hz and above with 100 ohms between low side and guard connection point at 0.25 mV/cm (0.5 mV/in.). On other ranges CMR decreases 20 dB per decade step in attenuation.

System accuracy: $\pm 0.2\%$ full scale.

Zero drift: 1 μ V/C with a maximum of 25 μ V from 0 to 50°C.

17172A Time base

Provisions for X-T or Y-T recordings are accomplished by this module. Standard features include eight speeds, automatic reset and pen lift at completion of sweep and remote start control. The vernier extends the sweep speed through 125 s/cm (250 s/in.).

17172A Specifications

Sweep speeds: Metric: 0.25, 0.5, 1, 2.5, 5, 10, 25, 50 s/cm; English: 0.5, 1, 2, 5, 10, 20, 50, 100 s/in.

System accuracy: $\pm 1\%$ of full scale on the six fastest ranges, $\pm 2.5\%$ on the remaining two ranges.

Terminal based linearity: $\pm 0.5\%$ of full scale.

17173A Null detector

Closed-loop plotting of data in point form, at up to 50 pps, is provided by the Null Detector. Plotting is accomplished with the 17012B/C Point Plotter which has a cable that plugs into the 17173A. Upon receipt of a seek signal and after the recorder reaches balance the 17173A commands the 17012B/C to plot and initiates a plot-complete pulse.

17173A Specifications

Plot rate: up to 50 plots/s.

Enable-disable: required disable voltage +3 volts minimum to +20 volts maximum. Required enable voltage: 0 V dc or no connection. Other voltage combinations available on request.

Muting: local or remote.

Plotting accuracy: $\pm 0.25\%$ of full scale.

Input: all inputs, except analog inputs, are available through rear input connectors in the module. Analog inputs are applied to the input terminals of the main frame. Mating connector supplied.

17174B DC offset

The recorder is provided with the capability of recording small signals superimposed on a steady-state dc voltage by the DC offset plug-in. The plug-in suppresses the steady-state dc voltage allowing recorder sensitivity to be increased.

17174B Specifications

Offset: less than 1 mV to approximately 1 volt.

Controls: two lockable, ten-turn high resolution controls (less than 1 mV to approximately 10 mV and less than 1 mV to approximately 1 V). An offset polarity switch allows upscale or downscale zero offset.

Offset voltage stability: greater than 0.005%/°C.

Insertion loss: less than 0.05%.

17175A Filter

Rejecting ac input signal components is provided by the Filter. Insertion of the 17175A in front of any other signal conditioning input module will improve normal mode rejection.

17175A Specifications

Input voltage range: -5 to +50 V dc, 10 V ac maximum peak-to-peak.

Maximum source impedance: 1 k, higher impedance decreases filter response.

Rejection: more than 55 dB at 50 Hz and higher ($\frac{1}{4}$ s rise time) or more than 70 dB at 50 Hz and higher (1 s rise time). Front panel selectable.

Insertion loss: 1%; filter may be switched out with no change in insertion loss.

17176A Scanner

This plug-in electrically scans between two inputs, and provides the capability of plotting two dependent variables versus one independent variable. The Scanner, utilizing the 17012 B/C, can scan two selectable inputs (module or main frame) in two scan modes. The scan rate is adjustable from 0.1 s/scan to 4 s/scan.

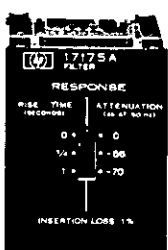

17175A

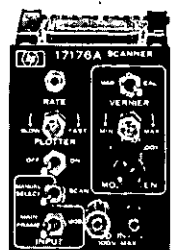

17176A

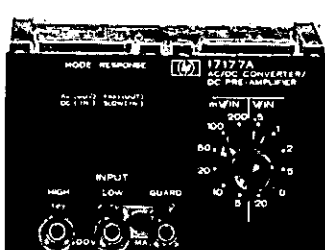

17177A

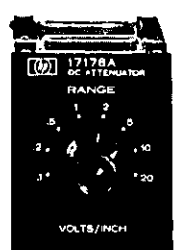

17178A

17176A Specifications

Input: module input; front panel miniature binding posts isolated from ground (high and low only). Main frame input; utilizes existing input connectors on main frame.

Attenuator: fixed attenuator in decade steps from X1 to X0.001. Variable attenuator provides continuous coverage.

Input impedance: 100 kΩ.

Accuracy: 0.2% of full scale.

Scan rate: adjustable from 0.1 to 4 s/scan.

17177A AC/DC converter DC preamplifier

The ability to record both ac and dc signals is combined in the 17177A plug-in. The average-responding ac mode features an extremely flat frequency response from 5 Hz to 100 k Hz. This double-width module may be used in either axis.

17177A Specifications

Input ranges: 2.5 mV/cm to 10 V/cm (5 mV/in. to 20 V/in.) in 1, 2, 5, steps.

Minimum usable input (ac only): ±0.2% of full scale.

Maximum allowable input: 300 V peak.

Type of input: floating and guarded signal pair. Rear inputs not available.

Input impedance: 1 MΩ shunted by less than 40 pF.

Maximum allowable source resistance: 10Ω.

Common mode rejection: 80 dB at dc and 50 Hz and above with 100Ω between low side and guard connection point and at 2.5 mV/cm (5 mV/in.). On other ranges CMR decreases 20 dB per decade step in attenuation.

Rise/fall time (ac only, 10-90%):

Slow response (5 Hz to 100 kHz): 2.5 s maximum.

Fast response (50 Hz to 100 kHz): 0.5 s maximum.

Calibration (ac only): responds to average value of input waveform; calibrated in rms value of sine wave.

Accuracy (% of full scale):

dc: ±0.5%;

ac (fast response): ±0.25% from 150 Hz to 50 kHz, ±0.5% from 50 Hz to 150 Hz and 50 kHz to 100 kHz;

ac (slow response): ±0.25% from 30 Hz to 50 kHz from 5 Hz to 30 Hz and 50 kHz to 100 kHz.

Linearity (AC): expressed as % of full scale, measured from 0.5% of full scale.

Warm-up time: 3 minutes nominal.

Zero drift (referred to input): ±30 μV/°C.

Offset: up to one full scale of offset by use of recorder's zero.

Size: double width, occupies both plug-in spaces in axis.

17178A DC attenuator

A stable, passive attenuator with eight ranges is provided by the 17178A. The recorder vernier control allows continuously variable settings between fixed ranges of this module.

17178A Specifications

Input ranges: Metric: 0.05, 0.1, 0.25, 0.5, 1, 2.5, 5, 10 V/cm; English: 0.1, 0.2, 0.5, 1, 2, 5, 10, 20 V/in.

Input resistance: 1 MΩ.

Common-mode rejection: 120 dB at dc and 70 dB at 50 Hz and above with 100 ohms between low side and point where the guard is connected (at 50 mV/cm or 100 mV/in.). On other ranges CMR decreases 20 dB per decade step in attenuation.

System accuracy: ±0.2% of full scale.

Model number and name

7004B — 28.26 cm × 43.18 cm (11" × 17")	Price
7034A — 21.59 cm × 28.26 cm (8½" × 11")	\$1660
Option 001 — Metrically scaled and calibrated	\$1500
Option 002 — X-axis retransmitting potentiometer, 5 kΩ ±0.1% linearity (7004B only)	N/C
Option 003 — Tank type pens (7004B only)	\$85
Option 004 — Power supply for 17005-04 incremental chart advance (7004B only)	N/C
17170A	\$55
17171A	\$40
Option 001 — Metrically scaled	\$315
17172A	N/C
Option 001 — Metrically scaled	\$245
17173A	N/C
Option 001 — +3 to +20 V enable, 0 V disable	\$270
Option 002 — -3 to -20 V disable, 0 V enable	add \$25
Option 003 — -3 to -20 V enable, 0 V disable	add \$25
17174B	add \$25
17175A	\$135
17176A	\$110
17177A	\$405
Option 001 — Metrically scaled	\$645
17178A	N/C
Option 001 — Metrically scaled	\$135
	N/C

Incremental chart advance, point plotter
Models 7591A, 17005A & 17012B/C

- Fast, economical
- Roll or fanfold paper

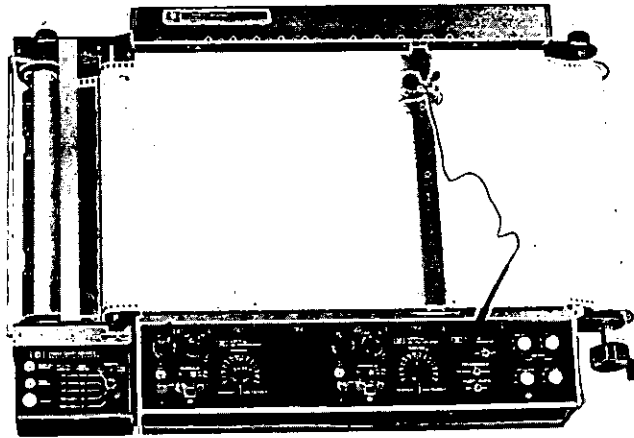

7591A

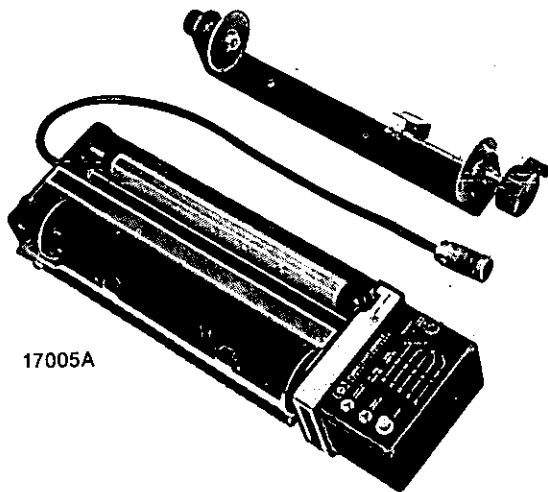

17005A

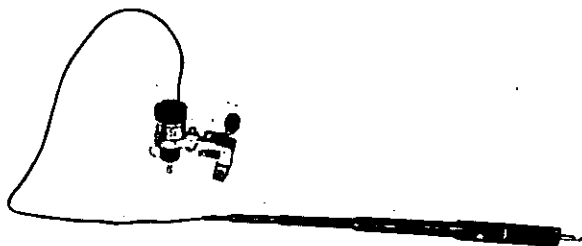

17012B/C

The 7591A Point Plotter System, which includes the 17005A Incremental Chart Advance, a 7004B X-Y Recorder, 17012B Point Plotter, the 17173 Null Detector, and other plug-ins like the dc offset, filter, or scanner which may be added to extend capabilities, is a fast and economical way to point plot analog data from computers, pulse height analyzers, signal averagers, and multi-channel analyzers. The system is capable of operating in a closed-loop mode up to 3000 plots/minute and control signals are provided to operate external logic or equipment. It will plot on any size of sheet paper up to 27.9 cm X 43.2 cm (11 X 17 in.), on a roll, or fanfold paper.

The 17005A chart advance, which may be selected individually for other applications, is available in several types of chart advance modes. The frame advance mode, which permits successive X-Y plots to be made during unattended operation, indexes to within 0.13 mm (0.005 in.) of the original chart location. The time base mode converts the recorder from X-Y to strip chart operation, while the incremental mode advances the chart in small increments in response to an external signal.

The 17012B is a high speed point plotter with maximum plot rates of 50 plots/second. The assembly mounts on the recorder pen carriage block in place of the pen and pen holder. This model is used on the 7591A System or an individual 7004B recorder. The 17012C is designed for use on the 7034A recorder. Actuating sources for both are obtained from the 17173A Null Detector which allows rapid plotting for applications such as high speed readout for a multi-channel pulse height analyzer, or the 17176A Scanner that permits plotting of two inputs on a single axis to form X-Y₁, Y₂ or X₂, X₂-Y recorder.

7591A Specifications

Plot rate: Up to 50 plot/s. Limited by amplitude excursion of recorder.

17005 Specifications

Frame advance mode:

Advance distance: 60 cm (24 in.); time: less than 20 s.

Accuracy: 0.0125 cm (±0.005 in.) non-cumulative.

Time base mode:

Speeds: 0.4, 2, 4, 20, 40 s/cm (1, 5, 10, 50, 100 s/in.).

Accuracy: ±2%.

Incremental advance mode:

Plot density: 80, 40, 20, 8, 4 plots/cm (200, 100, 50, 20, 10 plots/in.).

Max advance rate: 100, 90, 50, 20, 10 plots/s.

Accuracy: 0.005 cm (±0.002 in.) non-cumulative.

Power: supplied by recorder.

Weight: net, 5 kg (11 lb); shipping, 7.3 kg (16 lb).

Model number and name

7591A (includes 7004B-004, 17173A, 17012B, and 17005A-004) — one additional plug-in is required for each axis

Option 001 — Metrically scaled and calibrated

Option 002 — X-axis retransmitting potentiometer, 5 kΩ, ±0.1% linearity

Option 003 — Fan fold adapter (used with 17005A)

Option 008 — 7591A without 17005A (Option 004) Incremental Chart Advance

17005A

Option 001 — Fan fold adapter

Option 002 — Metric scale

Option 004 — Compatibility with 7004B — Option 004

17012B (fits Model 7004B)

17012C (fits Model 7034A)

Price

\$3145

N/C

\$85

\$135

less \$1130

\$1065

\$135

N/C

N/C

\$105

\$105



RECORDERS & PRINTERS

General performance X-Y recorder, time base

Models 7035B & 17108A

• Low cost

• High quality

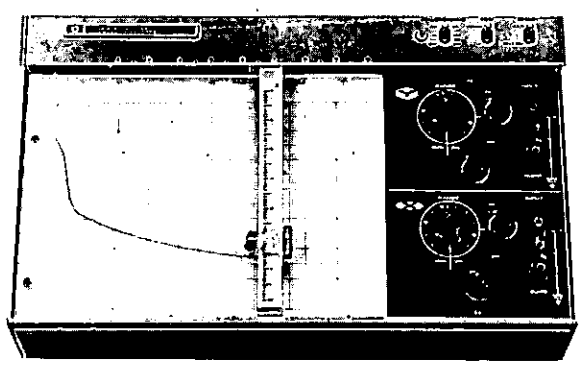

7035B

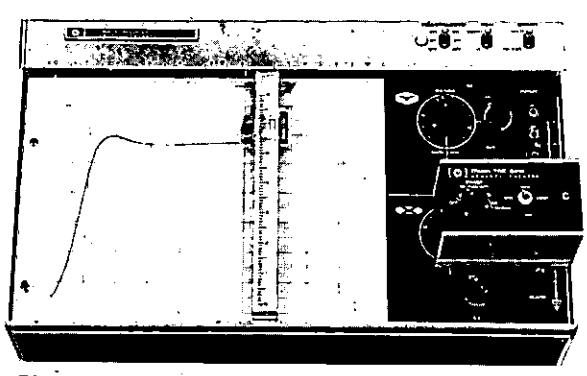

7035B with 17108A

The 7035B is a high-quality, low cost instrument designed for use in general purpose applications. Each axis has an independent servo system with no interaction between channels. The 7035B plots two graphs from two dc signals representing the function being measured.

Input terminals accept either open wires or plug-type connectors. Five calibrated ranges from 0.4 mV/cm (1 mV/in.) to 4 V/cm (10 V/in.) are provided in each axis. A variable range control permits scaling of signal for full scale deflection. High input impedance (1 megohm on all but the first two ranges), floated and guarded input, and 0.2% accuracy is provided.

Each closed-loop servo system uses a high-gain, solid-state servo amplifier, servo motor, long-life balance potentiometers, photochopper, low pass filter, guarded inputs, and attenuator and balance circuit.

A plug-in time base, Model 17108A, operates on either axis to provide five sweep speeds from 0.2 to 20 s/cm. The unit is self-contained, external, and designed to directly plug into the 7035B input terminals. A supplied adapter allows the use of the module with a variety of other Hewlett-Packard recorders, as well as the 7035B. Any number of recorders may be driven simultaneously, provided the combined parallel input resistance is 20 kΩ or more.

7035B Specifications

Performance specifications

Input ranges:

Metric: 0.4, 4, 40, 400 mV/cm and 4 V/cm;

English: 1, 10, 100 mV/in.; 1 and 10 V/in. Continuous vernier between ranges.

Types of inputs: floated and guarded signal pair; rear input connector.

Input resistance:

Range	Input resistance
0.4 mV/cm (1 mV/in.)	Potentiometric (essentially infinite at null)
Variable	11 kΩ
4 mV/cm (10 mV/in.)	100 kΩ
Variable	100 kΩ
40 mV/cm (100 mV/in.)	1 kΩ
Variable	1 kΩ
400 mV/cm (1 V/in.)	1 kΩ
Variable	1 kΩ
4 V/cm (10 V/in.)	1 kΩ
Variable	1 kΩ

Input filter: >30 dB at 60 Hz; 18 dB/octave above 60 Hz.

Maximum allowable source impedance: no restrictions except on fixed 0.4 mV/cm (1 mV/in.) range. Up to 20 kΩ source impedance will not alter recorder's performance.

Accuracy: ±0.2% of full scale.

Linearity: ±0.1% of full scale.

Resetability: ±0.1% of full scale.

Zero set: zero may be set up to one full scale in any direction from zero index. Lockable zero controls.

Slewing speed: 50 cm/s, (20 in./s) nominal at 115 V.

Interference rejection: conditions for the following data are line frequency with up to 1 kΩ between the negative input and guard connection point.

Range		DC (CMR)	AC (CMR)
Metric	English		
0.4 mV/cm	1 mV/in.	130 dB	100 dB
4 mV/cm	10 mV/in.	110 dB	80 dB
40 mV/cm	100 mV/in.	90 dB	60 dB
400 mV/cm	1 V/in.	70 dB	40 dB
4 V/cm	10 V/in.	50 dB	20 dB

General specifications

Paper holddown: Autogrip electrostatic paper holddown grips any chart up to size of platen.

Pen lift: electric pen lift capable of being remotely controlled.

Dimensions: 226 mm high, 445 mm wide, 121 mm deep (10¹/₂" × 17¹/₂" × 4 4¹/₄" deep).

Weight: Net, 8 kg (18 lb). Shipping, 10.9 kg (24 lb).

Power: 115 or 230 V ±10%, 50 to 60 Hz, approximately 45 VA.

17108A Specifications

Sweep speeds: 0.2, 0.4, 2, 4, 20 s/cm (0.5, 1, 5, 10, 50 s/in.).

Accuracy: 5% of recorder full scale.

Linearity: 0.5% of full scale (20°C to 30°C).

Output voltage: 0 to 1.5 V.

Power: replaceable mercury battery (100 hr).

Model number and name

7035B

Option 001 — Metric calibration

Option 003 — Retrasmittting potentiometer on X-axis

5 kΩ ±3%

17108A

17108AM (metric)

Price	
\$1055	
N/C	
\$85	
\$185	
\$185	

RECORDERS & PRINTERS

OEM, lab X-Y recorders

Models 7010A & 7015A

NEW

- Versatility

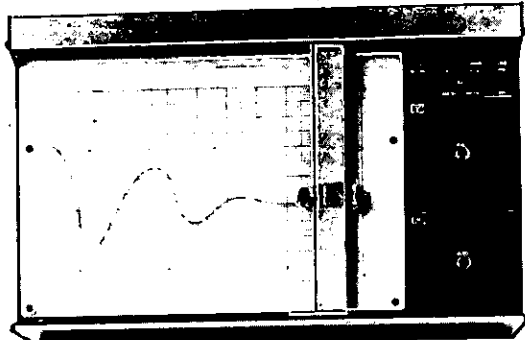

7010A-002

- Performance

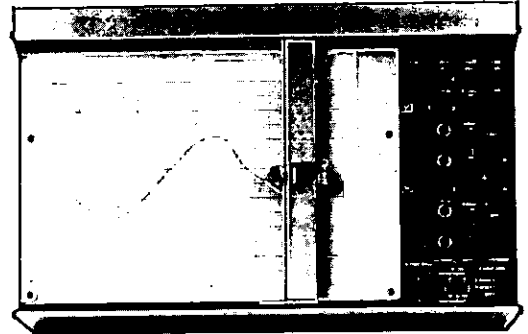

7015A

The Hewlett-Packard Models 7010A and 7015A X-Y Recorders are low cost, one-pen, DIN A4 (8½ × 11 in.) instruments that feature maximum electrical and mechanical flexibility to fit many and varied applications. The 7010A is specifically designed for the OEM user who is concerned with cost and space. Optional voltage spans from 0.01 V/div to 1 V/div, as well as time base sweep options, control panel, metric calibration, electrical pen lift, and carrying case are available. The 7015A is for the laboratory user such as schools and other institutions where cost is the primary consideration without sacrificing reliability or dependability. A control panel supplied with power on/off, standby, and range switches (three spans from 10 mV/in. to 1 V/in.), as well as vernier and zero controls is provided with the standard recorder. Options available include metric calibration, time base, electric pen lift, and carrying case. Standard equipment supplied on both units includes the electrostatic paper hold-down, rear connector, rack mounting brackets, and a universal pen holder (located in the standard Accessory Kit) that will hold most fiber tip pens.

7010A and 7015A Specifications

Performance specifications

Input ranges: 7010A — single range, 0.1 V/div., 7015A — three ranges 0.01 V/in., 0.1 V/in., 1 V/in. (0.01 V/cm, 0.1 V/cm, 1 V/cm). Vernier adjustment overlapping all ranges.

Type of inputs: differential, constant 1 ohm impedance.

Impedance to ground: 10 MΩ from either terminal to ground.

Common mode rejection: 110 dB, 90 dB ac under room ambient conditions. Degrades 20 dB/decade step in attenuator (both ac and dc).

Connection: 7010A — via circuit board pins or standard rear connector. 7015A — front panel binding posts or standard rear connector.

Accuracy: ±0.3% of full scale at 25°C on 0.1 V/div. (includes linearity and deadband). Temperature coefficient ±0.02%/°C.

Range accuracy: ±0.3% of full scale ±0.2% of deflection (includes linearity and deadband) at 25°C. Temperature coefficient 0.02%/°C.

Deadband: 0.2% of full scale.

Overshoot: 2% full scale maximum.

Slewing speed: 50 cm/s, (20 in./sec) minimum.

Peak acceleration: X-axis — 1270 cm/sec² (500 in./sec²) min. Y-axis — 2540 cm/sec² (1000 in./sec²) minimum.

Zero conditions:

Control ranges: pen positioned at any location on chart using 10 T pot +1 full scale zero suppression.

Resolution: pen positioned within +0.005 in. of any point on chart.

Zero drift: pen will not move more than 2.5 mm/day (0.1 in./day) independent of temperature.

General specifications

Front panel controls:

7010A: optional

7015A: power on/off, servo standby, range switches, vernier, zero controls and chart hold. Pen lift switches optional.

Writing system: Disposable pens, and universal pen holder to hold most fiber tip pens.

Platen size: holds DIN A4 or 8½ × 11 in. size chart paper.

Dimensions: 266.7 mm high, 431.8 mm wide, 127 mm deep (10½ × 17 × 5 inches). Provisions provided for rack mounting in DIN or 19" size rack.

Power: Switch selectable for 100, 115, 200, 230 V ac, 47.5-440 Hz power consumption. 70 VA maximum.

Weight: Net, 7.2 kg (16 lb); Shipping, 10 kg (22 lb).

Time base: (optional)

Sweep rates: 7010A: single rate — 1 sec/div, 10 sec/div. 7015A: six from 0.1 sec/div to 50 sec/div (0.5 sec/div. to 100 sec/div.).

Accuracy: 1.5%, temperature coefficient ±0.1% per °C over temperature range of 10°C to 40°C.

Controls: start, reset, actuated by remote contact closure or TTL. 7015A also from control panel.

Options

7010A:

001: Metric calibration

002: Control panel — provides power on/off servo standby, chart hold switch, zero controls, and, if ordered, electric pen lift

003: Electric pen lift

004: Deletes recorder case

005: Single span — 10 mV/div — X-axis

006: Single span — 1 V/div — X-axis

007: Single span — 10 mV/div — Y-axis

008: Single span — 1 V/div — Y-axis

009: Sweep rate — 1 sec/div — X-axis

010: Sweep rate — 10 sec/div — X-axis

011: Case, carrying (not to be used for shipping)

7015A:

001: Metric calibration — 10 mV/cm, 100 mV/cm, 1 V/cm

Time base:

002: Sweep rates — 0.1, 0.5, 1, 5, 10, 50 sec/cm (0.5, 1, 5, 10, 50, 100 sec/in. in 1-5-10 sequence)

003: Electric pen lift

004: Case, carrying (not to be used for shipping)

Model number and name

7010A OEM X-Y recorder

7015A Lab X-Y recorder

Price

N/C

\$50

\$50

less \$50

N/C

N/C

N/C

N/C

\$150

\$150

\$75

N/C

\$200

\$50

\$75

\$900

\$945



RECORDERS & PRINTERS

OEM, Dedicated applications X-Y recorders

Models 7040A & 7041A

- Rugged one-piece casting
- 42 standard options

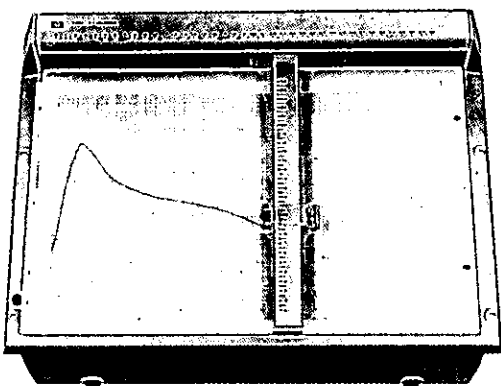

7040A

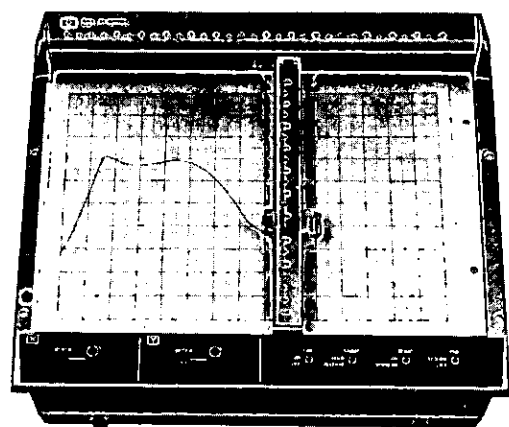

7041A



The 7040A and 7041A X-Y recorders are specifically designed for dedicated, single-purpose recording applications. The 7040A is a medium-speed unit while the 7041A is a high-speed unit featuring fast acceleration for applications where recording time is critical or incoming data is at a high rate.

Both models use a one-piece aluminum casting mainframe which eliminates the need for critical mechanical adjustments. They are also equipped with the Autogrip paper holddown system and the quick-change disposable pen.

Additionally, over 40 options give these recorders the ability to be customized for the needed application. Most of the options can be easily and quickly installed or changed in the field. This includes a control panel (Option 038) which would provide the basic recorder functions such as zero set, servo, pen, and chart operation. Other options include a time base, a plug-in X-axis event marker, TTL logic remote control, plus a variety of input ranges.

A functional and quantity discount is available for both units when qualified for the OEM purchase agreement.

7040A & 7041A Specifications

Input ranges: single range from 0.2 to 500 mV/cm (0.5 mV/in. to 1 V/in.), specified by option choice.

Type of Input: floating, 200 V dc or peak ac max; internal polarity switch; inputs through rear barrier strip or optional connector.

Input resistance: 1 mΩ constant.

Common mode rejection: 100 dB dc; 80 dB at line frequency.

Slewing speed:

7040A: 50 cm/s (20 in./s) min.

7041A: 75 cm/s (30 in./s) min.

Acceleration (peak):

7040A: Y axis 2540 cm/s² (1000 in./s²); X axis 1270 cm/s² (500 in./s²).

7041A: Y axis 7620 cm/s² (3000 in./s²); X axis 5080 cm/s² (2000 in./s²).

Accuracy: ±0.2% of full scale.

Sweep: optional, single range.

Zero set: external control provided by user; front panel controls available as Option 038.

Paper holddown: Autogrip electric paper holddown grips charts 279.4 × 431.8 mm (11" × 17") and international DIN A3 size or smaller.

Pen lift: electric pen lift controlled remotely by contact closure; TTL logic level provided by Option 039.

Dimensions: 356 mm high, 438 mm wide, 165 mm deep (14 × 19 × 6½"); rack mounting structure integral with unit.

Weight: Net, 13.2 kg (29 lb). Shipping, 16.8 kg (37 lb).

Power: 115 or 230 V ± 10%, 50 to 400 Hz, approx. 130 VA.

Note: OEM discounts available on both models.

Options

Input range: specify one range option for each axis; must be both English or both metric

X	Y	Range	Price	X	Y	Range	Price
001	007	0.5 mV/in.	\$30	013	019	0.2 mV/cm	\$30
002	008	1 mV/in.	\$30	014	020	0.5 mV/cm	\$30
003	009	10 mV/in.	\$30	015	021	5 mV/cm	\$30
004	010	100 mV/in.	N/C	016	022	50 mV/cm	N/C
005	011	500 mV/in.	N/C	017	023	100 mV/cm	N/C
006	012	1 V/in.	N/C	018	024	500 mV/cm	N/C

Note: other ranges available on special order.

Sweep range: specified by option choice, X axis only; accuracy ±1% of full scale ±0.1%/°C max; TTL logic start and reset

	Sweep	Price		Sweep	Price
025	1 s/in.	\$135	030	0.5 s/cm	\$135
026	5 s/in.	\$135	031	1 s/cm	\$135
027	10 s/in.	\$135	032	5 s/cm	\$135
028	50 s/in.	\$135	033	10 s/cm	\$135
029	100 s/in.	\$135	034	50 s/cm	\$135

Note: other sweep ranges available on special order.

- 035:** Event marker, upper margin of X axis Price \$85
- 036:** X axis retransmitting potentiometer (19.2 kΩ) \$55
- 037:** Y axis retransmitting potentiometer (13.1 kΩ) \$55
- 038:** Control panel; for line, pen lift, chart, servo standby, zero, and zero check; add 44 mm (1¾") to height \$135
- 039:** TTL logic remote control; for pen lift and servo standby; also event marker if installed \$55
- 040:** Rear connector; X, Y input signals and retransmitting potentiometers, time base controls, Autogrip servo standby, pen lift, event marker and Option 039 control lines brought to a single locking connector \$85
- 041:** Side trim panels and dust cover (355.6 mm, [14"]) for standard unit \$15
- 042:** Side trim panels and dust cover (400.1 mm, [15¾"]) for unit with Option 038 installed \$15

Model number and name

7040A Medium Speed X-Y Recorder	\$955
7041A High Speed X-Y Recorder	\$1150

RECORDERS & PRINTERS

High performance X-Y recorders

Models 7044A, 7045A, & 7047A

NEW

- High dynamic response

- Tough environmental specifications

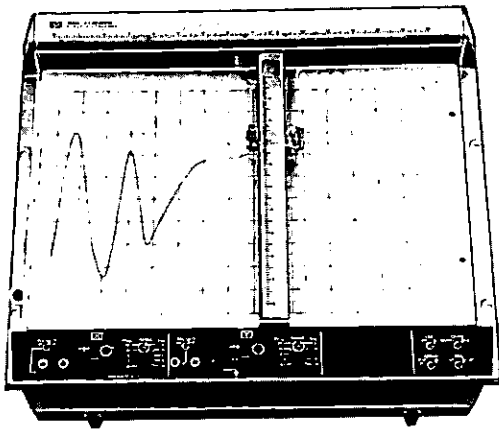

7044A

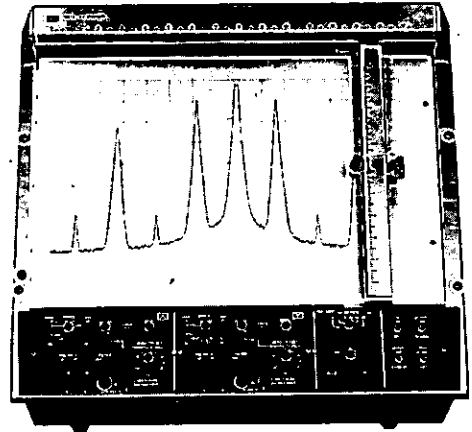

7047A

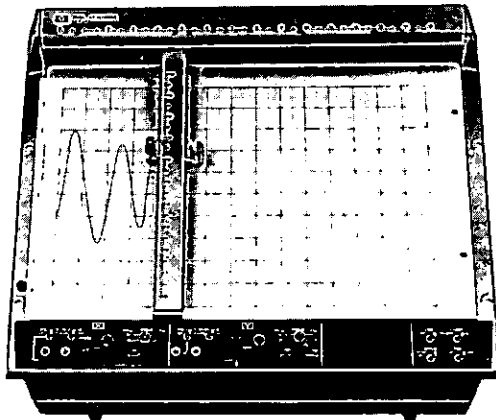

7045A

The Models 7044A, 7045A, and the 7047A are general purpose X-Y recorders specifically designed to offer the needed requirements to perform laboratory measurements. This allows for a wide range of quick-changing signals to be reproduced accurately and dependably. The 7044A is a medium-speed recorder designed for most general-purpose applications. The 7045A and 7047A offer higher speed and Y-axis acceleration exceeding 7620 cm/sec^2 (3000 in./sec^2).

Other outstanding features found on the recorders include 10 calibrated dc input ranges on each axis of the 7044A and 7045A from 0.25 mV/cm to 5 V/cm (0.5 mV/in. to 20 V/in.) and 12 calibrated dc input ranges on each axis of the 7047A from 0.02 mV/cm to 5 V/cm (0.05 mV/in. to 10 V/in.). In between, a 1-5-10 sequence is used (except for the 0.02 mV/cm, most sensitive range setting on the metric option) on the 7047A. On all three, arbitrary full scale voltage ranges may be established with the vernier control in conjunction with the calibrated dc ranges.

Additionally, these recorders are equipped with front panel polarity switches which reverse pen direction, eliminating the need for reversing the input leads. The 7045A and 7047A are provided with a RESPONSE switch which allows the user to slow the response of the recorder for easier setup. The 7047A preamplifiers for the X and Y axes are contained in two specially designed aluminum enclosures. These contain chopper dc amplifiers and have the unique serviceability feature of being removable and operational outside of the main-frame, using the cable extender included in the Accessory Kit.

Also available on all models is the continuous duty, aluminum framed dc servo motor; the X-axis of the 7045A and 7047A contain the larger, faster motor. This ends overheating or wear if the pen is driven offscale for an indefinite time. The trouble-free Autogrip electrostatic holddown platen capable of holding chart paper of the European size A3 and 11 in. \times 17 in. size is included, as well as a disposable pen with four color choices, and plastic coated wirewound balance potentiometer. Latest circuitry design and assembly techniques have also been incorporated, thereby reducing failure and maintenance time.

Options include the Time Base (standard on the 7047A) Event Marker and Metric Scaling. TTL Remote Control and Rear Connector are standard on all models.

7044A, 7045A Specifications

Performance specifications

Input ranges: 0.25, 0.5, 2.5, 5, 25 mV/cm; 0.05, 0.25, 0.5, 2.5, 5 V/cm (English calibration available in 0.5, 1, 5, 10, 50 mV/in.; 0.1, 0.5, 1, 5, 10 V/in.). Continuous vernier between ranges.

Type of input: floating, 500 V dc or peak ac maximum. Polarity reversal switch located on front panel, guard internally connected. Inputs through front panel 5-way binding posts or rear connector.

Input resistance: 1 megohm constant on all ranges.

Common mode: 110 dB dc and 90 dB at 50 Hz and above (exceeds 130 dB dc and 110 dB ac under normal lab environmental conditions) with 1 k Ω between HI and LO terminals, CMR voltage applied between ground and LO, and attenuator on most sensitive range. CMR decreases 20 dB per decade step in attenuation.

Slewing speed:

7044A: 50 cm/sec (20 in./sec) minimum.

7045A: Fast Response, 76 cm/sec (30 in./sec) minimum. Slow Response, 36 cm/sec (15 in./sec) typical.

Acceleration (peak):

7044A: Y-axis 2540 cm/sec² (1000 in./sec²), X-axis 1270 cm/sec² (500 in./sec²).

7045A: (Fast Response only) Y-axis 7620 cm/sec² (3000 in./sec²), X-axis 5080 cm/sec² (2000 in./sec²).

Accuracy: $\pm 0.2\%$ of full scale (includes linearity and deadband) at 25°C. Temp Coefficient $\pm 0.01\%$ per °C.

Range Accuracy: $\pm 0.2\%$ of full scale $\pm 0.2\%$ of deflection (includes linearity and deadband) at 25°C. Temp Coefficient $\pm 0.01\%$ per °C.

Deadband: 0.1% of full scale.

Overshoot: 7044A — 2% of full scale (maximum). 7045A — 1% of full scale (maximum).

Zero set: zero may be placed anywhere on the writing area or electrically off scale up to one full scale from zero index.

Environmental (operating): 0° to 55°C and <95% relative humidity (40°C).

General specifications

Writing mechanism: servo actuated ink pen.

Writing area: 25 cm \times 38 cm (10" \times 15").

Paper holddown: Autogrip electric paper holddown grips chart 29.7 cm \times 42 cm (European size A3) and 11" \times 16.5" or smaller. Special paper not required.

Pen lift: electric.

Dimensions: 400 mm high, 483 mm wide, 165 mm deep (15 1/4" \times 19" \times 6 1/2"); rack mounting structure integral with unit.

Power: 115 or 230 V ac $\pm 10\%$, 50 to 400 Hz; 7044A, 135 VA; 7045A, 175 VA.

Weight: Net, 13.7 kg (30 lb). Shipping, 19.1 kg (42 lb).

Options

006: Metric Calibration

001: Time Base

Sweep rates: 0.25, 0.5, 2.5, 5, 25, 50 sec/cm (0.5, 1, 5, 10, 50, 100 sec/in.).

Time Base Accuracy: 1.0% at 25°C.

Temp Coefficient $\pm 0.1\%$ per °C.

General: Switchable to either X or Y axis. Start and reset by front panel control, remote by momentary contact closure to ground or TTL levels. Automatic reset at full scale, recycle accomplished by continuous start signal.

002: Event Marker: Writes in upper margin, aligned with X-axis position, approximately 0.13 cm (0.05 in.) excursion completed 50 msec after application of signal. Controlled remotely by contact closure to ground or by TTL levels.

Price

N/C

add \$220

7047A Specifications

Performance specifications

Input ranges: 0.02, 0.05, 0.1, 0.5, 1, 5 mV/cm; 0.01, 0.05, 0.1, 0.5, 1, 5 V/cm (0.05, 0.1, 0.5, 1, 5, 10 mV/in.; 0.05, 0.1, 0.5, 1, 5, 10 V/in.) Continuous vernier between ranges.

Type of input: Differential, floating, and guarded (front input only). Employs a unique common mode driver circuit that eliminates the need for connecting CMV to the recorder if CMV is less than or equal to 10 V.

Input resistance: 1 megohm constant on all ranges.

Accuracy: $\pm 0.2\%$ of full scale (includes linearity and deadband) at 25°C. Temp Coefficient $\pm 0.01\%$ per °C.

Range accuracy: $\pm 0.2\%$ of full scale $\pm 0.2\%$ of deflection (includes linearity and deadband) at 25°C. Temp Coefficient $\pm 0.01\%$ per °C.

Deadband: 0.1% of full scale.

Common mode rejection: 140 dB and 130 dB ac with 1 K Ω imbalance in either the high or low terminal — exceeds 150 dB and 140 dB ac under normal laboratory conditions. CMR decreases 20 dB per decade step in attenuation.

Normal mode rejection: 30 dB minimum at line frequency with FILTER IN. (50 dB typical at 60 Hz and 40 dB typical at 50 Hz).

Slewing speed: 76 cm/second (30 in./sec) minimum. 97 cm/sec (38 in./sec) typical under normal lab conditions.

Acceleration (peak): Y-axis 7620 cm/sec² (3000 in./sec²)

X-axis 5080 cm/sec² (2000 in./sec²)

Overshoot: 1% of full scale maximum.

Calibrated zero offset: Provides eleven scales of calibrated zero offset in both axes. Switchable in steps of one full scale from +1 to -10 scales.

Offset accuracy: At 25°C, $\pm 0.1\%$ of full scale times N where N = number of scales of offset.

Temperature coefficient: $\pm 0.004\%$ of full scale times N per °C.

Time base: Speeds of 0.1, 0.5, 1, 5, 10, 50 sec/cm (0.5, 1, 5, 10, 50, 100 seconds/in.). Switchable into X or Y axis.

Time base accuracy: 1.0% at 25°C. Temp Coefficient $\pm 0.1\%$ per °C.

General specifications

Writing mechanism: servo actuated ink pen.

Writing area: 25 cm \times 38 cm (10 in. \times 15 in.).

Paper holddown: Autogrip electric paper holddown grips charts 25 \times 38 cm (11 \times 16.5 in.) and standard European size DIN A3, or smaller. Special paper not required.

Pen lift: Electric (remote via TTL level).

Power: 115 or 230 V ac $\pm 10\%$, 48 to 66 Hz, 180 VA maximum.

Weight: Net, 18.6 kg (41 lb). Shipping, 24 kg (53 lb).

Metric calibration — option 001

Ranges are 0.02, 0.05, 0.10, 0.50, 1, 5 mV/cm; 0.01, 0.05, 0.1, 0.5, 1, 5 V/cm.

Price

N/C

Event marker — option 002

\$85

Marking area: In margin at same X coordinate as recorder pen.

Excursion: Approximately 0.050 inch.

Actuation time: Stroke complete 50 ms after application of signal.

Ink capacity: 0.45 cc cartridge, cartridge reloading type. Writing distance 500 ft minimum.

Model number and name

7044A

\$1665

7045A

\$2015

7047A

\$2850

add \$85



RECORDERS & PRINTERS

Two-pen, three parameter X-Y/Y recorder

Model 7046A

- Small pen separation

- Virtually no overshoot

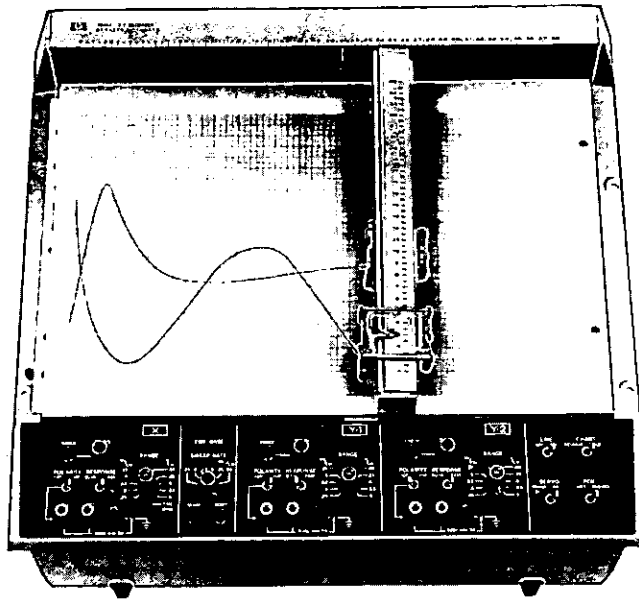

The Model 7046A is a general-purpose 2-pen laboratory X-Y recorder designed to assure high quality recordings without sacrificing ruggedness, reliability and high performance so necessary for a laboratory recorder. The unit has dynamic performance that surpasses most 2-pen recorders by offering Y-axis acceleration exceeding 6350 cm/s² (2500 in./sec²). This high acceleration plus very little overshoot results in the 7046A reproducing a wide range of fast changing input signals.

New thin line disposable pens that feature a visible ink supply and have a trace separation of 1.2 mm (0.05 in.) are provided. These pens, available in three colors, produce good clean traces. A front panel polarity switch that switches pen direction, and the response switch which reduces the speed of the unit, are also available. The Autogrip paper holddown system which holds up to 27.9 cm × 43.2 cm (11 × 17 in.) and standard European DIN A3 size paper is also standard.

7046A Specifications

Performance specifications

Input ranges: metric calibration available in 0.25, 0.5, 2.5, 5, 25 mV/cm; 0.05, 0.25, 0.5, 2.5, 5 V/cm (0.5, 1, 5, 10, 50 mV/in.; 0.1, 0.5, 1, 5, 10 V/in.). Continuous vernier between ranges.

Type of input: floating, 500 V dc or peak ac maximum. Polarity reversal switch located on front panel, guard internally connected. Inputs through front panel binding posts or rear connector.

Input resistance: 1 megohm constant on all ranges.

Common mode: 110 dB dc and 90 dB at 50 Hz and above exceeds 130 dB dc and 110 dB ac under normal lab environmental conditions) with 1 k ohm between HI and LO terminals, CMR voltage applied between ground and LO, and attenuator on most sensitive range. On other ranges, CMR decreases 20 dB per decade step in attenuation.

Slewing speed: Fast Response, 76 cm/s (30 in./s) minimum; Slow Response, 36 cm/s (15 in./s) typical.

Acceleration (peak, fast response only): Y-axis 6350 cm/s² (2500 in./s²), X-axis 3800 cm/s² (1500 in./s²).

Accuracy: ±0.2% of full scale (includes linearity and deadband) at 25°C. Temp Coefficient ±0.01% per °C.

Range accuracy: ±0.2% of full scale ±0.2% of deflection (includes linearity and deadband) at 25°C. Temp Coefficient ±0.01% per °C.

Deadband: 0.1% of full scale.

Overshoot: 1% of full scale (maximum).

Zero set: zero may be placed anywhere on the writing area or electrically off scale up to one full scale from zero index.

Environmental (operating): 0 to 55°C and <95% relative humidity (40°C).

General specifications

Writing mechanism: servo actuated ink pens, offset by 0.12 cm (0.05 in.) in X direction.

Writing area: 25 cm × 38 cm (10" × 15").

Paper holddown: Autogrip electric holddown grips charts on standard European DIN A3 or smaller and 11" × 16.5". Special paper not required.

Pen lift: electric (remote, via contact closure or TTL level).

Dimensions: 441 mm high, 483 mm wide, 173 mm deep (17 3/8" × 19" × 6 7/8"); rack mounting structure integral with unit.

Power: 115 or 230 volts ac ±10%, 50 to 400 Hz, 175 VA.

Weight: net, 16 kg (35 lb); shipping, 21.4 kg (47 lb).

Options

007: Metric Calibration

001: Time Base

Sweep rates: Metric calibration is 0.25, 0.5, 2.5, 5, 25, 50 s/cm (0.5, 1, 5, 10, 50, 100 s/in.).

Accuracy: ±1% at 25°C (±0.1%/°C maximum).

General: switchable to X-axis. Start and reset by front panel control, remote by momentary contact closure to ground or TTL levels. Automatic reset at full scale, recycle accomplished by continuous start signal.

002: Event Marker

Writes in upper margin, aligned with X-axis position of Y pen, approximately 0.12 cm (0.05 in.) excursion completed 50 ms after application of signal. Controlled remotely by contact closure to ground or by TTL levels. Contact resistance: 4 kΩ (maximum).

7046A

Price
N/C
\$220

\$85

\$3065

RECORDERS & PRINTERS



Digital input graphic plotters

Models 7202A & 7203A

- Easy to own

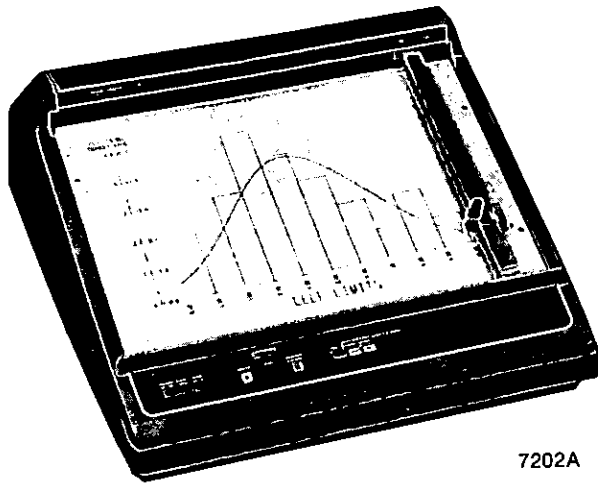

7202A

- Easy to interface

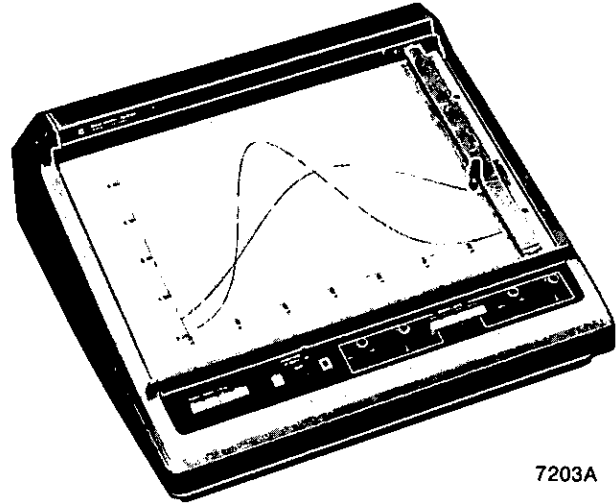

7203A

A 7200 Series Graphic Plotter will add a new dimension to your communications terminal. Instead of a column of numbers, your data appears as easy-to-understand charts and graphs. Operation is simple and smooth. Use any size graph paper up to 27.9 × 43.2 cm (11 × 17 inches) with or without grids. Front panel controls adjust the plot size to fit preprinted grids. Paper is secured in place by an electrostatic holddown system. Clean disposable pens are available in four colors.

The 7202A accepts serial, ASCII characters utilizing a brief and concise input format. All that is required is to add a few statements to your existing program. The plotter recognizes the following command mnemonics: PLTL — Plotter active, plots lines between coordinates; PLTP — Plotter active, plots points at coordinates; PLTT — Plotter inactive, does not accept data. Data is supplied as follows: X and Y coordinates are expressed as positive, four-digit numbers, less than or equal to 9999; X and Y coordinates are transmitted on one line separated by a space; the Y coordinate is followed by a carriage return, line feed, and six fill characters (fill characters can be any of 64 non-typing characters and are required at 300 baud only). Up Arrow (↑) immediately following the Y coordinate causes the 7202A to proceed to the next point with pen up in PLTL mode.

The 7203A accepts serial, binary data. It interprets the characters transmitted by the time-share system as binary position data. Four characters are used for the 7203A control: Plotter On — lower case w (Octal 167) — Plotter is enabled and remains on until Plotter Off Command received; Plotter Off — lower case s (Octal 163) — Plotter circuits disabled, remain off until Plotter On received; Pen Up — rub-out (DEL) (Octal 177) — raises pen; Pen Down — left bracket ([) (Octal 173) — lower pen. Four characters are required for each move.

1. The numbers in bits 1 thru 6 indicate bit weight.
2. Bit 7 is used for synchronization.
3. The Plotter accepts data ranging from 0000 to 9999; any other data will cause an error indication.

To ensure maximum plotter efficiency, the time-share system must add null characters to some moves. This allows adequate time for completion of a move before starting another. Refer to Specifications for complete move length information.

7202A Specifications

Plotting area: Front panel scaleable from 12.7 × 12.7 cm to 25.4 × 38.1 cm (5 × 5 to 10 × 15 inches).

Paper size: Any size up to 27.9 × 43.2 cm (11 × 17 inches).

Plotting maneuvers: Plots lines or points.

Speed: Up to 105 Vectors per minute.

Numerical code: ASCII.

Plotting mode: Absolute coordinates.

Numerical resolution: 1/10,000 (0.001%).

Plot accuracy: Better than 0.076 cm (0.03 inch).

Resettability: 0.018 cm (0.007 inch) maximum.

Writing method: Ink, disposable pens.

Controls: Power, Chart Hold, Terminal Mute, Line/Local, Pen Down, Graph Limits.

Indicators: Power, Plot, Improper Format.

Interface — EIA RS232C: For other interfaces refer to 7202A — Interface guide P/N 5952-2768.

Move length: 3 inches maximum with pen down; 10 inches maximum with pen up.

Power requirements: 115/230 V ac, 48-400 Hz, 100 VA maximum.

Physical: Height: 216 mm (8½ inches)

Width: 508 mm (20 inches)

Depth: 511 mm (20¼ inches)

Weight: 18.1 kg (40 lb)

Shipping weight: 23.6 kg (52 lb).

7203A Specifications

Plotting area: Front panel scaleable from 0 × 0 cm to 25.4 × 38.1 cm (0 × 0 to 10 × 15 inches).

Paper size: Any size up to 27.9 × 43.2 cm (11 × 17 inches).

Plotting maneuvers: Pen or Position. Pen and Position maneuvers are independent commands.

Speed: Up to 405 Vectors per minute.

Numerical code: Position data is received in Binary Format.

Plotting mode: Absolute coordinates.

Numerical resolution: 1/2500 (0.04%).

Plot accuracy: Better than 0.10 cm (0.04 inch) in 38.1 cm (15 inches).

Resettability: 0.18 mm (0.007 inch) maximum.

Writing method: Ink, disposable pens.

Controls: Line, Chart Hold, Mute, Line/Local, Pen Up, Pen Down.

Indicators: Power, Error, Plot.

Interface: — EIA RS232C:

Move length:

	10 CPS	30 CPS
Plotter units without additional null characters	2182	532
Additional units per null character	627	209

Power requirements: 100, 115, 200, or 230 V ± 10%, 48 to 66 Hz; 100 VA maximum.

Physical: Height: 216 mm (8½ inches)

Width: 508 mm (20 inches)

Depth: 511 mm (20¼ inches)

Weight: 18.1 kg (40 lb)

Shipping weight: 23.6 kg (52 lb).

Model number and name

7202A

7203A

Price

\$3830

\$3830



RECORDERS & PRINTERS

Lab strip chart recorders, plug-in modules

Models 7100B, 7101B, 7127A, 7128A, 17500A thru 17506A

- One and two pen mainframes

- Seven plug-in modules

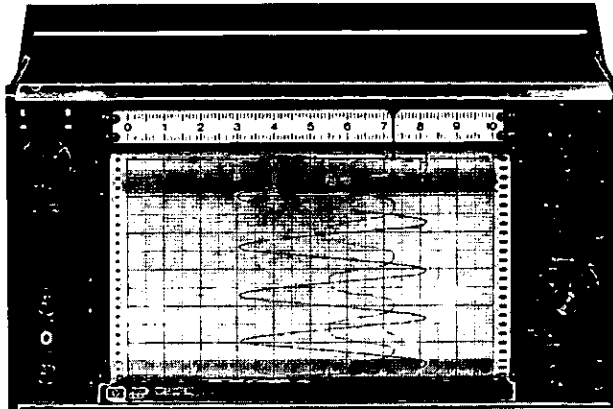

7100B

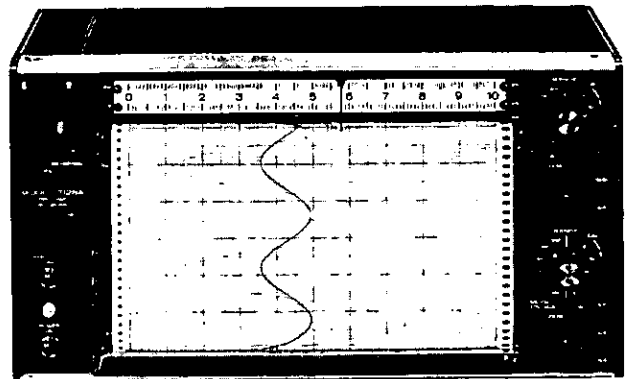

7128A

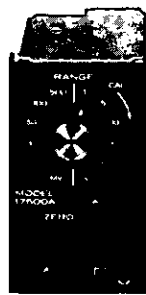

17500A



17501A



17502A



17505A

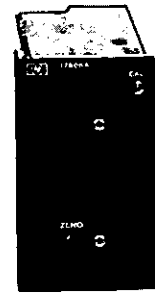

17506A

The Hewlett-Packard Models 7100B/7101B and 7127A/7128A Strip Chart Recorders are basic recorder frames containing all the mechanical and electrical elements for strip chart recording. A wide line of interchangeable plug-ins complete their recording ability. Models 7100B and Models 7128A have two independent pens and require two input modules; Model 7101B and Model 7127A are single pen recorders and require one input module.

7100 Series specifications

Performance specifications

Response Time: <0.5 s (50 Hz, <0.6 s).

Linearity (terminal based): $\pm 0.1\%$ full scale.

Resetability: $\pm 0.1\%$ full scale.

Chart Speeds:

7100BM/7101BM: 2.5, 5, 15, 30 cm/h; 1.25, 2.5, 5, 15, 30 cm/min; 1.25, 2.5, 5 cm/s.

7100B/7101B: 1, 2, in./h; 0.1, 0.2, 0.5, 1, 2 in./min; 0.1, 0.2, 0.5, 1, 2 in./s.

7127A/7128A: $\frac{1}{4}$, $\frac{1}{2}$, 1, 2 in./min.

Option H01: 6, 12, 24, 48 in./hr.

Option H02: $\frac{1}{2}$, 3, 6, 12 in./hr.

Chart speed accuracy: synchronous with line frequency.

General specifications

Writing system: servo actuated ink pen.

Grid width: 25 cm or 10 in.

Chart length: 36 m or 120 ft.

Pen lift: manual (remote optional).

Power: 115/230 V $\pm 10\%$, 60 Hz (50 Hz optional).

7100B/7128A: 65 VA

7101B/7127A: 42 VA

Weight:

7100B/7128A: Net, 11.8 kg (26 lb). Shipping, 18.2 kg (40 lb).

7101B/7127A: Net, 10.9 kg (24 lb). Shipping, 17.3 kg (38 lb).

Dimensions:

7100B/7101B series (cabinet): 304 mm high, 445 mm wide, 210 mm deep ($11\frac{3}{32}$ " \times $17\frac{1}{2}$ " \times $8\frac{1}{4}$ ").

7100BR/7101BR (rack): 222 mm high, 483 mm wide, 210 mm deep ($8\frac{23}{32}$ " \times 19" \times $8\frac{1}{4}$ ").

7127A/7128A series (cabinet): 231 mm high, 425 mm wide, 210 mm deep ($9\frac{3}{32}$ " \times $16\frac{1}{4}$ " \times $8\frac{1}{4}$ "). (Rack; brackets supplied) 222 mm high, 483 mm wide, 210 mm deep ($8\frac{23}{32}$ " \times 19" \times $8\frac{1}{4}$ ").

17500A/17501A Specifications

Voltage spans:

17500A: 5, 10, 50, 100, 500 mV; 1, 5, 10, 50, 100 V full scale.

17501A: 1, 2, 5, 10, 20, 50, 100, 200 mV; 0.5, 1, 2, 5, 10, 20, 50, 100 V full scale.

Accuracy: $\pm 0.2\%$ of full scale.

Input resistance: 1 megohm at null on all fixed calibrated and variable spans except 100 kΩ in the variable mode on the four most sensitive spans on the 17500A only.

Interference rejection: dc common mode; 120 dB on the four most sensitive spans of the 17500A and the three most sensitive of the 17501A. Line frequency, 100 dB on the four most sensitive spans of 17500A and the three most sensitive of 17501A.

Zero-set: adj. full scale, plus one full scale of suppression. 5 scales of zero suppression available on the 17501A.

Maximum source impedance: up to 10 kΩ source impedance will not alter the recorder's performance on the four most sensitive spans of the 17500A and the six most sensitive of the 17501A. No source impedance restrictions on spans above 100 mV fs.

Reference stability: 0.005%/°C.

Weight: Net, 0.9 kg (2 lb). Shipping, 2.2 kg (5 lb).

17502A Specifications

Voltage spans: single span to match cold-junction thermocouples of types J, K, R, S, and T.

Accuracy: ±0.5% or ±1°C, (whichever is greater); refer to NBS CIR 561, dated 1955.

Input resistance: potentiometric.

Interference rejection: dc common mode, 120 dB; line frequency, 100 dB.

Weight: Net, 1.8 kg (4 lb). Shipping, 3.2 kg (7 lb).

17503A Specifications

Voltage span: 1 mV.

Type of input: floating (500 V dc max) rear input only.

Input resistance: potentiometric.

Maximum allowable source resistance: 5 kΩ

Normal mode rejection: >60 dB at 60 Hz.

Common mode rejection: 120 dB (dc) and 100 dB (60 Hz).

Accuracy: ±0.2% full scale.

Reference stability: 0.005%/°C.

Zero set: ±1 scale.

Weight: Net, 0.9 kg (2 lb). Shipping, 2.2 kg (5 lb).

17504A Specifications

Voltage spans: 5 mV thru 100 V, determined by range card, no vernier.

Type of input: floating (500 V dc max) rear input only.

Input resistance: 1 MΩ at null on all spans

Maximum allowable source resistance: 10 kΩ.

Normal mode rejection: >60 dB at 60 Hz.

Common mode rejection: 120 dB (dc) and 90 dB (60 Hz) four most sensitive range cards.

Accuracy: ±0.2% full scale.

Reference stability: 0.005%/°C.

Zero set: ±1 scale, screwdriver adjust.

Weight: Net, 0.9 kg (2 lb). Shipping, 2.2 kg (5 lb).

17505A/17506A Specifications

Voltage spans:

17505A: .1, .2, .5, 1, 2, 5, 10, 20, 50, 100, 200, 500 mV; 1, 2, 5, 10, 20, 50, 100 V full scale.

17506A: any one of the above spans (specify).

Accuracy: ±0.25% of full scale.

Input resistance: 1 MΩ at null.

Interference rejection: dc CMR: 120 dB on most sensitive span.

Line frequency CMR: 100 dB on most sensitive span. Line frequency

normal mode: 17505A: switchable, 60 dB or 100 dB. 17506A: 100 dB.

Zero set: +2, -1.5 scales. Optional calibrated offset of +1 to -10 scales in one scale steps on 17505A.

Zero stability: ±1 μV after one hour.

Maximum source impedance: 10 kΩ on nine most sensitive spans; no source impedance restrictions on spans above 100 mV fs.

Reference stability: 0.005%/°C.

Weight: Net, 0.9 kg (2 lb). Shipping, 2.2 kg (5 lb).

7100 Series options

		7100B 7101B	7127A 7128A	Price \$
Retransmitting 5 kΩ Potentiometer	Channel 1	004	014	55
	Channel 2	016	015	55
High-Low Limit Switches (Each limit SPDT with 0.5 A, 30 V dc contacts)	Channel 1	005	001	55
	Channel 2	017	009	55
	Both Channels	018	010	110
Event Marker	Left side: ink	012	004	40
	Both sides: ink	014	006	80
Remote Control	Pen Lift	006	008	55
	Chart ON-OFF	007	002	25
Right Hand Zero	Hard (scale, 10 to 0)	020	020	N/C
	Soft (scale, 10 to -0.5) ²	025	025	N/C
50 Hz Operation		010	003	N/C
Locking Glass Door		011	013	55
Integrator (Integrates Channel 2 if 2 pen unit) ¹⁻²		015	007	855
Disposable Pen Tips		024	024	N/C
Carrying Handle		Std	011	25
Mint Gray Control Panel		029	029	N/C

1. Not compatible with event marker (right hand), retransmitting potentiometer (Channel 2), or metric calibration.

2. Requires special Hewlett-Packard chart paper.

Plug-in options

17500A/17501A/17502A:

001: 5 scale zero suppression (17501A)

Price
\$55

002: Calibrated for use with Integrator (8 in. span)
17500A/17501A)

N/C
N/C

029: Mint gray control panel

17503A:

001: Detector Selector Switch

N/C

002: 50 Hz

N/C

003: Calibrated for use with Integrator (8 in. span)

N/C

029: Mint gray control panel

N/C

17504A:

001: 50 Hz

N/C

002: Calibrated for use with Integrator (8 in. span)

N/C

010-019: Range cards (specify opt)

N/C

Additional range cards (order by part number)

\$25

17505A:

001: +1 to -10 scales of calibrated offset in one scale steps. Accuracy ±0.25% per step

\$110

002: Calibrated for use with Integrator (8 in. span)

N/C

003: 50 Hz

N/C

029: Mint gray control panel

N/C

17506A:

002: Calibrated for use with Integrator (8 in. span)

N/C

003: 50 Hz

N/C

005-023: Spans (specify one)

N/C

029: Mint gray control panel

N/C

Model number and name

Single Channel:

7101B/BR, 7101BM/BMR

\$1070

7127A (English only)

\$910

Dual Channel:

7100B/BR, 7100BM/BMR

\$1605

7128A (English only)

\$1445

17500A

\$350

17501A

\$405

17502A

\$430

17503A

\$320

17504A

\$295

17505A

\$450

17506A (specify voltage span)

\$300



RECORDERS & PRINTERS

Linear motor strip chart recorders

Models 7123A & 7143A

NEW

• Low Silhouette

• Only One Moving Part

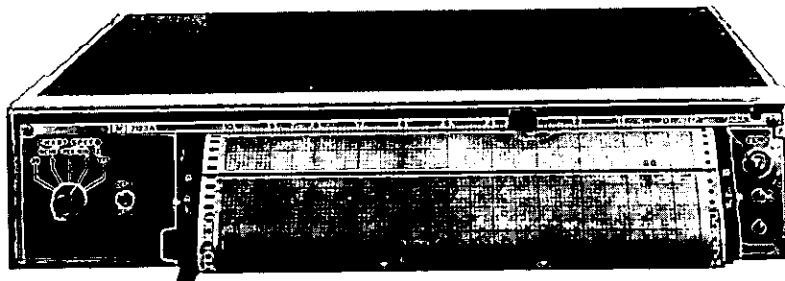

7123A,045,015

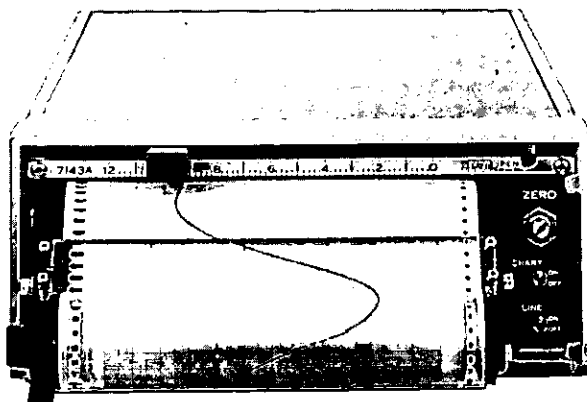

7143A

The Hewlett-Packard Models 7123A and 7143A Strip Chart Recorders are designed specifically for dedicated recording applications. High reliability, exceptional performance, plus a large assortment of options allow custom tailoring to each application. These 3½-inch high recorders conserve rack space without sacrificing chart drive or chart view capabilities, or overall operation.

Reliability

Reliability is the keynote. Maximum reliability was achieved through the development of a unique linear servo motor. The motor enabled the design of a servo drive system with only one moving part — the motor slider/pen assembly. This single moving part replaces the many cables, pulleys, and gears found in a conventional servo system.

The entire radial field of the motor is produced by a permanent magnet, resulting in low power consumption and virtually no internal temperature rise. In addition, the motor can be driven continuously off scale with no audible noise and no possibility of damage to the recorder.

Precise response

The linear motor also provides extremely quick response, producing full scale response in less than ½ second. In addition, non-mechanical tachometer feed-back is incorporated. The tachometer and the high gain solid state servo amplifier allow the units to faithfully reproduce the input signal and respond to step inputs with less than 1% overshoot.

Versatile chart drive

A unique chart drive and viewing system is incorporated. The system allows the paper to be rolled up, or to be fed out and conveniently torn off for inspection or filing. In addition, a slanted viewing/writing area is incorporated. Chart paper may be manually advanced at any time without gear changing or performance interruption.

Minimum panel height

The unique linear motor and chart drive/viewing system combine to make a recorder that requires only 3½ inches of rack height. This low silhouette provides the user with additional rack space without sacrificing recorder capability.

Low cost

The basic price is low. Additional savings are available when qualified for the OEM Purchase Agreement.

Flexibility of options

With almost 50 options available, the 7123A and 7143A can be "designed" to fit your exact requirements. Most options are modular and options such as span and chart speed can be changed in the field if the need arises.

7123A, 7143A Specifications

Performance specifications

Input ranges: single span, 1 mV thru 100 V (specified by option).

Type of input: single-ended, floating.

Input resistance: 1 megohm constant on all spans.

Normal mode rejection (at line frequency): >66 dB with optional filter).

Common mode rejection: >100 dB at dc and >80 dB at line frequency.

Response time with R_s <10 kilohm: <1/2 sec (<1/2 sec for spans below 1 V).

Overshoot: <1% of full scale.

Accuracy (including linearity and deadband):

7123A: $\pm 0.25\%$ of full scale.

7143A: $\pm 0.4\%$ of full scale.

Zero drift: < $\pm 0.2 \mu V/^\circ C$ $\pm 0.03\%$ full scale/ $^\circ C$ for 7143, $\pm 0.015\%$ full scale/ $^\circ C$ for 7123.

Linearity (terminal based):

7123A: $\pm 0.1\%$ of full scale.

7143A: $\pm 0.2\%$ of full scale.

Reference stability: $\pm 0.002\%/^\circ C$.

Chart speeds: speed determined by option choice.

Chart speed accuracy: synchronous with line frequency.

Zero set: left hand, adjustable ± 1 full scale (right hand optional).

Environmental (operating):

7123A and 7143A: 0° to $55^\circ C$, and 95% relative humidity ($40^\circ C$).

General specifications

Writing mechanism: servo actuated disposable ink pen.

Grid width:

7123A: 25 cm or 10 inch.

7143A: 12 cm or 5 inch.

Chart length: 28.5 meters or 95 ft.

Pen lift: manual (remote optional on 7123A only).

Power: 115/230 V $\pm 10\%$.

Option 060: 60 Hz, 60 VA.

Option 050: 50 Hz, 60 VA.

Weight:

7123A: Net, 19 kg (42 lb). Shipping, 23 kg (51 lb).

7143A: Net, 11.3 kg (25 lb). Shipping 15 kg (33 lb).

Options

Span: MUST SPECIFY ONE. The front scale is determined by choice of English or metric chart speed.

Span	7123,7143	Price	Span	7123,7143	Price
1 mV	001	\$160	1 V	008	N/C
5 mV	002	\$160	5 V	009	N/C
10 mV	003	\$110	10 V	010	N/C
50 mV	004	\$110	50 V	011	N/C
100 mV	005	\$110	100 V	012	N/C
500 mV	006	\$110			

Chart speeds: MUST SPECIFY ONE basic speed or one basic chart speed and one reducer or one multiple speed.

Speed	Option	Price	Speed	Option	Price
6 in./min	016	N/C	15 cm/min	022	N/C
4 in./min	017	N/C	10 cm/min	023	N/C
1 in./min	018	N/C	5 cm/min	024	N/C

1/2 in./min	019	N/C	3 cm/min	025	N/C
1/4 in./min	020	N/C	15 cm/hr	026	N/C
1 in./hr	021	N/C	3 cm/hr	027	N/C

Variable speed options:

Dual speed via speed reducer:

	Option	Price
60:1 Speed Reducer*	028	\$40
10:1 Speed Reducer*	029	\$40
4:1 Speed Reducer*	030	\$40
2:1 Speed Reducer*	044	\$40

*The slowest speed resulting from the addition of a speed reducer must not be less than 2.54 cm/hr (1 in./hr).

Options requiring power supply:

	Option	Price
Option Power Supply	041	\$45
Remote Speed Change	031	\$25
Remote Chart On-Off (Not Compatible with Options 045 & 048).	032	\$25
Remote Pen Lift (7123 Only)	033	\$40
Limit Switches	040	\$130
Event Marker (Right Hand) Ink	034	\$45
Event Marker (Right Hand) Electric	037	\$40

Multiple speeds (7123 ONLY):

	Option	Price
4 Speed: 1/4, 1/2, 1, 2 in./min plus external input	045	\$165
4 Speed: .5, 1, 2.5, 5 cm/min, plus external input	048	\$165

Other options:

	Option	Price
Retransmitting Potentiometer (5 K Ω , $\pm 0.5\%$ linearity, 10 VDC max)	039	\$55
Input Filter		
1 thru 5 mV spans	007	\$50
10 mV thru 100 V spans	013	\$30
Right Hand Zero Hard Right (Scale, 10 to 0)	014	N/C
Right Hand Zero Soft (Scale, 10 to -0.5; 7123 Only)	015	N/C
Rack Slides (7123 Only)	043	\$75
Chart Integrator (7123 Only)	035	\$805

Analytical option combinations:

7123A ONLY

The following three options are for analytical applications such as chromatography and include 1 mV span, input filter for added line frequency rejection (60 dB), right hand zero, mint-gray control panels, and chart speeds as indicated.

Speeds	Option	Price
1/2 and 1/4 in./min	090	\$255
1 and 1/4 in./min	091	\$255
1/4, 1/2, 1 and 2 in./min plus external input	092	\$440

Model number and name

7123A (One Pen 25 cm or 10 in.)	\$900
7143A (One Pen, 12 cm or 5 in.)	\$845

NOTE: Must specify power line frequency.

RECORDERS & PRINTERS

OEM 10-inch strip chart recorders

Models 7130A & 7131A

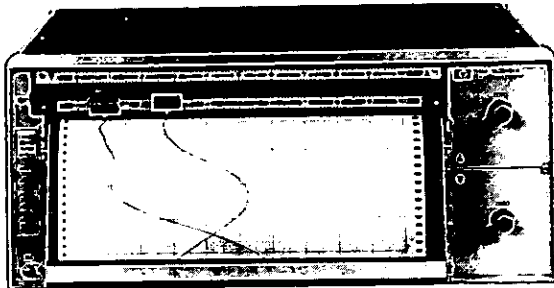
NEW

7130A

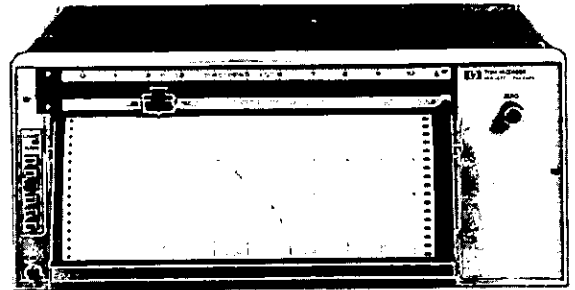

7131A

The Model 7130A is a 10-inch, two-pen recorder; the 7131A is a 10-inch, one-pen recorder. Spans and chart speeds are selected by options.

7130A and 7131A Specifications

Performance specifications

Input ranges: single span, 1 mV thru 100 V (specified by option).

Type of input: single ended, floating.

Maximum allowable source resistance (R_s): no restriction.

Normal mode rejection (at line frequency): >40 dB.

Common mode rejection: 120 dB at dc and >90 dB at line frequency.

Response time: <1/2 sec.

Overshoot: <2% of full scale.

Accuracy (including linearity and deadband): ±0.2% of full scale.

Deadband: ±0.1% of full scale.

Chart speeds: speed determined by option choice.

Chart speed accuracy: synchronous with line frequency.

Zero set: left hand, adjustable ±1 full scale (right hand optional).

Environmental (operation): 0°C to 55°C, 95% relative humidity (40°C).

General specifications

Writing mechanism: servo actuated ink pens.

Grid width: 25 cm or 10 in.

Chart length: 30 meters or 100 ft.

Pen lift: manual (electric or independent optional).

Power:

7130A, 7131A: 115/230 V ±10%, 60 Hz, 120 VA.

7130B, 7131B: 115/230 V ±10%, 50 Hz, 120 VA.

Weight: Net, 12.3 kg (27 lb). Shipping 17.4 kg (38 lb).

Span: Must specify one for each channel; spans may be different. The front scale is determined by choice of English or metric chart speed. The 500 series options are for the lower channel of the 7130A only.

	Option			Option			Price
	Upper Channel	Lower Channel	Price	Upper Channel	Lower Channel	Price	
Span							
1 mV	001	501	\$160	1 V	008	508	N/C
5 mV	002	502	\$160	5 V	009	509	N/C
10 mV	003	503	\$110	10 V	010	510	N/C
50 mV	004	504	\$110	50 V	011	511	N/C
100 mV	005	505	\$110	100 V	012	512	N/C
500 mV	006	506	\$110				

Chart speeds: must specify one basic speed.

Speed	Option	Price	Speed	Option	Price
6 in./min	016	N/C	15 cm/min	022	N/C
4 in./min	017	N/C	10 cm/min	023	N/C
1 in./min	018	N/C	5 cm/min	024	N/C
1/2 in./min	019	N/C	3 cm/min	025	N/C
1/4 in./min	020	N/C	15 cm/hr	026	N/C
1 in./hr	021	N/C	3 cm/hr	027	N/C

Speed reducers:

	Option Price		Option Price
60:1 Speed Reducer*	028 \$45	4:1 Speed Reducer*	030 \$45
10:1 Speed Reducer*	029 \$45	2:1 Speed Reducer*	031 \$45

*The slowest speed resulting from the addition of a speed reducer must not be less than 2.54 cm/hr (1 in./hr).

Multiple speeds:

	Option	Price
4 speed: 1/4, 1/2, 1, 2 in./min plus external input	046	\$160
4 speed: 0.625, 1.25, 2.5, 5 cm/min plus external input	049	\$160

Options requiring option power supply:

	Option	Price
Option Power Supply	041	\$ 45
8 chart speeds: 1, 2, 4, 6 in./min and hr plus external input	045	\$190
8 chart speeds: 2.5, 5, 10, 15 cm/min and hr plus external input	048	\$190
Remote Speed Change*	032	\$ 20
Remote Chart On-Off*	033	\$ 20
Remote Pen Lift*	036	\$ 45
Right Hand Event Marker*	037	\$ 45
Left Hand Event Marker*	537	\$ 45

*Actuated by contact closure to ground or TTL levels. Closed circuit current 1.5 mA (maximum), open circuit voltage +1.5 V (minimum).

Other Options:

	Upper Channel	Lower Channel	Price
Retransmitting Potentiometers	040	540	\$ 55
Limit Switches*	044	544	\$110
Input Filter (1-500 mV)	007	507	\$ 30
Right Hand Zero Hard (Scale, 10 to 0)		014	N/C
Right Hand Zero Soft (Scale, 10 to -0.5)		015	N/C
Independent Mechanical Pen Lift (7130 only)		034	N/C
Rack Slides		042	\$ 75
Rack Mounting Brackets		052	\$ 10
Rear Control Connector		056	\$ 10

*Contact rating 1 amp at 1.5 V, 0.5 amp at 250 V non-inductive.

Analytical option combinations: The following two options are for analytical applications such as chromatography and include 1 mV span each channel, right hand soft zero, front panel detector switch on the 7131A, and two chart speeds as indicated.

	Option	7130	7131
2 speeds: (1/2 and 1/4 in./min)	090	\$365	\$230
2 speeds: (1 and 1/4 in./min)	091	\$365	\$230

Model number and name

7130A 10 inch two-pen recorder	\$1340
7131A 10 inch one-pen recorder	\$925

RECORDERS & PRINTERS

Laboratory 10-inch strip chart recorder

Models 7132A & 7133A

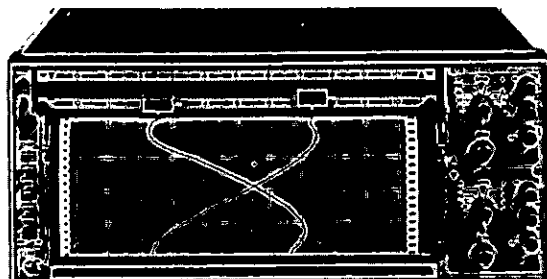

NEW

- Multi-range attenuators

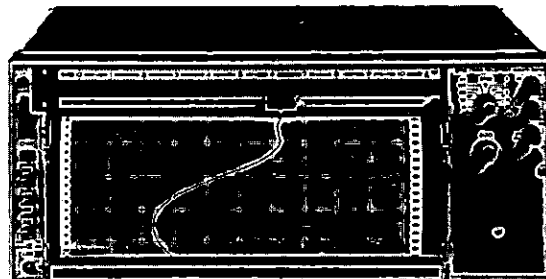

7132A

- Disposable pens



7133A

The Hewlett-Packard Models 7132A two-pen and 7133A one-pen Strip Chart Recorders are laboratory instruments equipped with standard features that qualify them to accommodate your laboratory or scientific application needs.

The 7132A and 7133A are equipped with multi-range attenuators providing eleven input ranges from 1 mV to 100 V full scale in a 1-5-10 sequence. Both models have eight chart speeds of 2.5, 5, 10, 15 cm/minute and 2.5, 5, 10, 15 cm/hour (1, 2, 4, 6 inches per minute and 1, 2, 4, 6 inches per hour). Disposable ink pens are standard. These pens provide a clear, continuous trace, and are easily replaced.

Modular construction facilitates easy removal of the servo module for inspection or maintenance of the drive system, slidewire, or pen lift. The elimination of slip clutches in the servo module contributes to quiet, reliable operation. In addition, should the pen go off scale, the amplifier gain is automatically reduced, preventing noise or damage to the equipment. A stepper motor chart drive eliminates mechanical shifting of gears.

The chart magazine may be adjusted to any of three angles to provide a comfortable writing surface. Chart paper may be automatically rolled up or fed out of the recorder. A convenient front panel indicator lets you know when the paper supply is low.

In addition to multi-range capability, the Models 7132A and 7133A offer as standard features: Eight Chart Speeds, Disposable Pens, Rack Mounting Brackets, Remote Pen Lift, and Remote Chart On/Off.

Options include: Metric Calibration, Right Hand Zero (Hard), Right Hand Event Marker, and 50 or 60 Hz Operation.

7132A and 7133A Specifications

Performance specifications

Input ranges: Eleven ranges from 1 mV to 100 V full scale in 1-5-10 sequence with overlapping vernier.

Type of input: Single ended, floating.

Input resistance: 1 megohm on all ranges.

Maximum source resistance: 10 k Ω (without spec. degradation).

Normal mode rejection (at line frequency): Greater than 40 dB.

Common mode rejection: Greater than 120 dB dc and 100 dB ac.

Accuracy: $\pm 0.2\%$ of full scale (includes linearity and deadband) at 25°C. Temp Coefficient $\pm 0.01\%$ per °C.

Range accuracy: $\pm 0.2\%$ of full scale $\pm 0.2\%$ of deflection (includes linearity and dead/band) at 25°C. Temp Coefficient $\pm 0.01\%$ per °C.

Deadband: 0.1% of full scale.

Response time: Less than 0.5 second.

Overshoot: Less than 2% of full scale.

Chart speeds: 2.5, 5, 10, 15 cm/min., and 2.5, 5, 10, 15 cm/hour (1,

2, 4, 6 inches/minute, and 1, 2, 4, 6 inches/hour).

Chart speed accuracy: $\pm 0.08\%$ plus line frequency/accuracy.

Zero set: Provides three full scales of offset.

Environmental (operating): 0 to 55°C, less than 95% relative humidity (40°C).

General specifications

Writing mechanism: servo actuated ink pens.

Grid width: 25 cm (10 inches).

Chart length: 30 meters (100 ft).

Pen lift: manual (electric or independent optional).

Power: 115/230 V $\pm 10\%$, 50 Hz or 60 Hz, 120 VA.

Dimensions: 178 mm high, 432 mm wide, 340 mm deep (7" \times 17" \times 13 $\frac{3}{8}$ ").

Weight: Net 12.3 kg (27 lb); shipping, 17.4 kg (38 lb).

Supplies furnished with each instrument:

1. Accessory Kit	07130-60055
Plastic Kit Box	1540-0149
Slidewire Lubricant	5080-3635
Slidewire Cleaner	5080-3605
Disposable Pens — Blue (pkg of 3)	07130-62500
Disposable Pens — Red (pkg of 3)	07130-62510
Fuse, $\frac{1}{4}$ Amp, 250 V SB	2110-0379
2. Operating and Service Manual	07132-90000
3. One roll chart paper	
Chart paper, Metric	9280-0265
Chart paper, English	9280-0264
4. Power Cord (2.1 meters or 7 ft)	8120-1378
5. Ink Cartridge Blank (For Event Marker Option)	07130-60002

Options

001: Metric Calibration. Provides chart speeds of 2.5, 5, 10, and 15 cm per minute, and 2.5, 5, 10, and 15 cm per hour.

014: Right Hand Zero (Hard). Positive voltage input causes pen to deflect from right to left.

037: Right Hand Event Marker

537: Left Hand Event Marker

050: 50 Hz Line Power

060: 60 Hz Line Power

(Span and chart speed options must also be ordered):

Model number and name

7132A (two pen)

7133A (one pen)

Price

N/C

N/C

\$50

\$50

N/C

N/C

\$1950

\$1395



RECORDERS & PRINTERS

Portable, battery power strip chart recorder
Model 7155A

NEW

- Under 30 pounds with internal battery
- 12 centimeter chart width
- Operates at -28°C to $+65^{\circ}\text{C}$

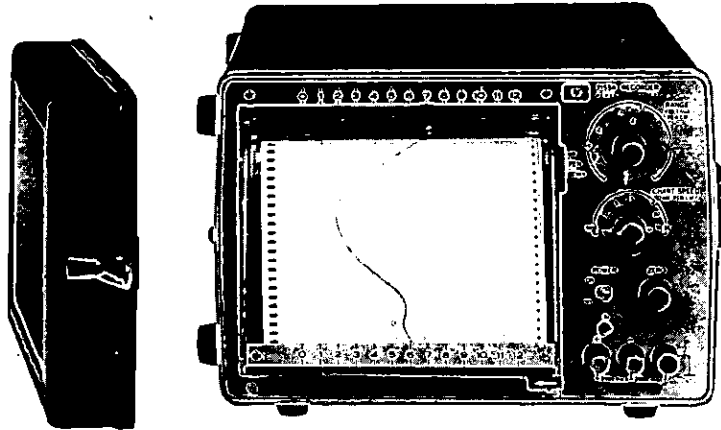

The Hewlett-Packard 7155A is the portable strip chart recorder designed especially for field applications while maintaining laboratory specifications. It is a rugged, light-weight instrument weighing under 30 pounds with the rechargeable battery installed. The standard unit operates on external dc or ac from 48 to 440 Hz. The optional internal battery, which operates for nine hours on a single charge, may be selected. The instrument operates within HP Class A temperature range (-28°C to $+65^{\circ}\text{C}$); a first in the strip chart recording field.

This unit is provided with 16 calibrated spans, seven chart speeds, the totally-electronic transmission that eliminates the need for mechanically shifting the gears, and a sealed jelled-electrolyte battery that allows operation in any orientation. Additional standard items include the disposable pen, front plexiglass cover, three chart magazine tilt angles, and easy access to PC boards for serviceability.

7155A Specifications

Performance specifications

Input ranges: 0.1 mV/cm thru 10 V/cm in a 1, 2, 5 sequence with overlapping vernier (12 cm full scale).

Type of input: single ended, floating.

Input resistance: 1 megohm.

Maximum allowable source resistance: 5 k Ω for rated response and accuracy.

Common mode rejection: 120 dB dc and 100 dB ac.

Full scale response time: 0.6 sec to within rated accuracy.

Overshoot: 1% of full scale maximum.

Accuracy: $\pm 0.4\%$ of full scale (includes linearity and deadband) at 25°C . Temp Coefficient $\pm 0.01\%$ per $^{\circ}\text{C}$.

Range accuracy: $\pm 0.4\%$ of full scale $\pm 0.2\%$ of deflection (includes linearity and deadband) at 25°C . Temp Coefficient $\pm 0.01\%$ per $^{\circ}\text{C}$.

Deadband: 0.2% of full scale.

Chart speeds: 30, 10, 5, 2.5, 1 minute/cm; 30 and 10 sec/cm.

Chart speed accuracy: 1%.

Environmental (operating): -28°C to $+65^{\circ}\text{C}$ <95% relative humidity (40°C).

General specifications

Writing mechanism: servo actuated disposable ink pens.

Grid width: 12 cm.

Chart length: 21.3 meters (70 ft).

Pen lift: mechanical.

Weight: Net 13.64 kg (30 lb) with battery option installed.

Power: External ac (48 to 440 Hz, 85 to 130 V or 172 V to 260 V).
External dc (10.5 to 36 V, 0.5 amp typical 0.9 amp maximum independent of voltage).

Supplies furnished

1. Operating and Service Manual
2. Chart Paper (one 21.3 m (70 ft))
3. Power Cord (2.3 m (7.5 ft))
4. Accessory Kit:
 - DC Connector
 - 0.5 Amp SLBL Fuse
 - Slidewire Lubricant
 - Disposable Pens (three, red)
 - Disposable Event Marker Pens (if ordered) (three, red)

Part Number
07155-90000
9780-0778
8120-1378
07155-60045
1251-2614
2110-0012
07143-69134
07155-60014
.07155-60015

Supplies Available

See Chart Recorder Supplies.

Options

005: Right Hand Zero

(Positive voltage input causes pen to deflect from right to left).

006: Event Marker

Contact closure on rear panel causes approximately 0.025 inch deflection of event pen. Marking occurs along left hand edge of paper.

008: Internal Battery

The jelled electrolyte battery operates nine hours on a single charge (at 25°C). Recharging is from external AC only and requires approximately 14 hours to full charge. Instrument may be operated while charging.

7155A

Price
N/C

\$85

\$150

\$1095

RECORDERS & PRINTERS



Compact strip chart recorder

Model 680

- Multi-range—Compact

- High accuracy, fast response

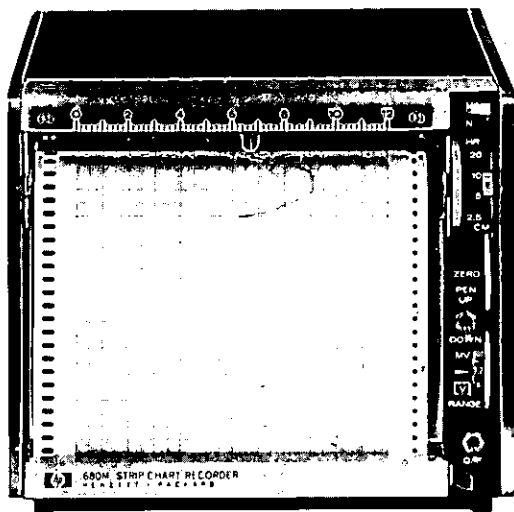

680M

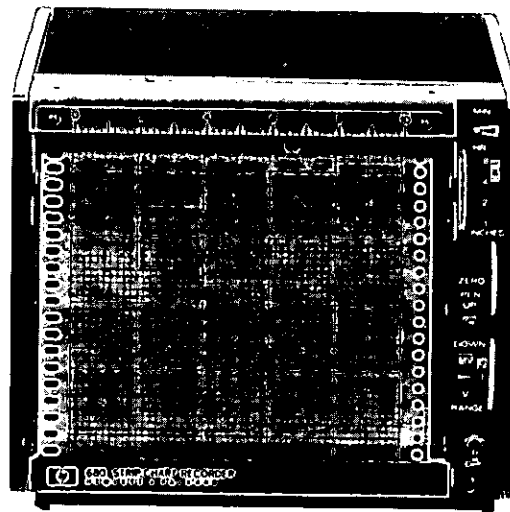

680

The Hewlett-Packard Model 680 12 cm (5 in.) strip chart recorders provide high accuracy and fast response for a wide range of performance for general or specialized use. The 680 is equipped with multi-range spans, multispeed chart transport, full range zero set, and electric pen lift. The instrument is useful as a monitor for instrumentation with dc outputs and for digital devices utilizing digital to analog converters.

Features include modular construction with all-transistor circuitry, synchronous motor chart drive, and full-view tilting chart magazine.

680 Specifications

Performance specifications

Spans: ten calibrated spans; Metric — 6, 12, 60, 120, 600 mV; 1.2, 6, 12, 60, 120 V (English — 5, 10, 50, 100, 500 mV; 1, 5, 10, 50, 100 V).

Type of input: input floating with respect to ground.

Maximum dc common mode voltage: 500 V.

Input resistance: 200 kΩ/V (166 kΩ/V, metric models) full scale, through 10 V span; 2 MΩ on all others. Constant 100 kΩ input resistance on all spans, Option H02.

Common mode rejection: dc 100 dB on most sensitive range. Decreases 20 dB per decade step in attenuation.

Accuracy: ±0.2% of full scale.

Response time: maximum, 0.5 s full scale.

Resettability: 0.1% of full scale.

Chart speed: synchronous motor driver; Metric — 2.5, 5, 10, 20 cm/min; 2.5, 5, 10, 20 cm/hr (English — 1, 2, 4, 8 in./min; 1, 2, 4, 8 in./hr). Option 008, gear ratio 16/1 instead of 60/1 speeds — 1/16, 1/8, 1/4, 1/2, 1, 2, 4, 8 in./min.

Zero set: adjustable over full span.

General specifications

Writing mechanism: Ink.

Pen lift: electric, controlled by local switch or remote contact closure.

Power: 115/230 V, 60 Hz, 22 VA.

Weight: Net, 5 kg (11 lb); shipping 7.6 kg (17 lb).

Accessory kit supplied with each instrument—

Ink Writing:

1. Slidewire cleaner, slidewire lubricant, remote pen lift connector, spare pen, pen cleaning wire, four cartridges each of red ink and blue ink.
2. One roll of graph paper.
3. Power Cord 2.1 m (7 ft).
4. Fuse, 1/4 Amp 125 V SB
5. Instruction Manual.

Options

001: With installed 5 kΩ, 0.1% linearity retransmitting potentiometer

002: With ink event marker installed

003: With installed high-low limit switches

008: With 16/1 instead of 60/1 speed reducer

009: With remote chart drive switch

010: For 50 Hz operation

014: Glass door with lock

018: Disposable pen tips

H01 1 mV span added (H01-680)

1.2 mV span added (H01-680M)

H02 100 kΩ input resistance, all spans

Note: Options H01 and H02 not compatible.

OEM discounts available.

680 M (Metric)

680 (English)

Price

- add \$55
- add \$40
- add \$100
- add \$25
- add \$25
- N/C
- add \$50
- N/C
- add \$55
- add \$55
- add \$85

\$995

\$995



RECORDERS & PRINTERS

Digital-to-analog converters

Models 580A & 581A

- Resolution to 1 part in 10^6
- Automatic Zero-Shift
- Error free Digital Zero-Suppression
- 1 ms Transfer Time
- Solid State reliability

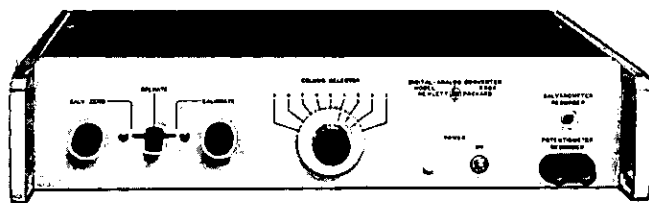

580A

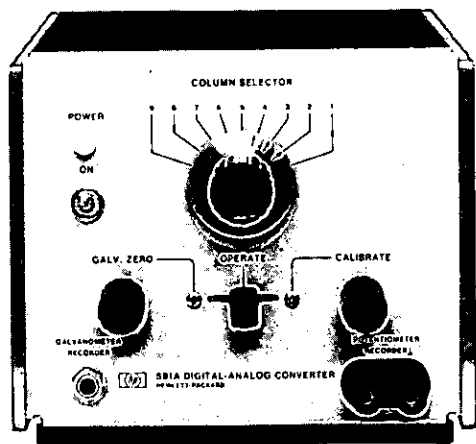

581A

Description

General

Digital-to-Analog Converters make possible automatic, high-precision analog records from electronic counters, digital voltmeters and other devices providing the proper 4-line BCD output code. These converters operate directly with H-P Quartz Thermometer, HP Nuclear Scalers and most H-P solid-state counters. Since the digital-to-analog converters tolerate a wide range of input voltages, they are suitable for use with other tube and solid-state devices. The 580A and 581A are identical except for dimensions and weight.

Versatile

Output signals for strip-chart or x-y recorders of both the potentiometer and galvanometer types are available, and controls for recorder calibration and zero adjustment are provided. A 50-pin connector accepts 4-line data from a maximum of nine decade counting units. This information is transferred to storage binary units upon receipt of a command pulse from the counting source. The stored data are then translated and weighted to provide the proper analog output voltage or current.

High Resolution

Any three successive digits (or the right-hand two) of the input may be chosen for analog output. By selecting the two or three least significant digits, analog records of high resolution and accuracy may be obtained with conventional strip chart and x-y recorders. For example, recording the three right-hand digits of eight- or nine-column data can provide an analog record with resolution of 1 part in 10^3 .

Auto Shifting

Since the data in three successive columns can range only from 000 to 999, automatic zero-shifting is inherent in the output, keeping the record "on scale" at all times. As an example, consider successive readings of: 000, 120, 257, 496, 732, 998, 1024. Except for the last reading, the analog record would proceed up-scale to 998 (99.8% of full scale). Recording of the 1024 value would be made at 024 (2.4% of full scale). The quick transition of the pen from 998 to 024 would serve to indicate that the range has been shifted up by 1000. Down-scale shifts of zero are similarly indicated.

Specifications

Accuracy: 0.5% of full scale or better.

Potentiometer output: 100 mV full scale; minimum load resistance 20K; calibrate control; dual banana plugs front and rear; typical 5 mV residual output at "000."

Galvanometer output: 1 mA full scale into 1500 ohms; zero and calibrate controls; phone jack front and rear.

Driving source: parallel entry 4-line BCD 4-2-2-1 (9 digits maximum); "1" state +4 to 75 volts with reference to "0" state.

Reference voltages: reference voltages required for both the "0" and "1" state, reference voltages not to exceed ± 150 V to chassis.

Command pulse: positive or negative pulse, 20 μ s or greater in width, 6 to 20 volts amplitude.

Power: 115 or 230 volts $\pm 10\%$, 50 to 1000 Hz, 11 W.

Dimensions:

580A (rack mount): 425 mm \times 88 mm \times 286 mm (16 $\frac{3}{4}$ " wide, 3 $\frac{1}{2}$ " high, 11 $\frac{1}{4}$ " deep).

581A: 198 mm \times 155 mm \times 203 mm (7 $\frac{3}{32}$ " wide, 6 $\frac{1}{2}$ " high, 8" deep).

Weight:

580A: net: 6 kg (13 lbs) shipping: 7.2 kg (16 lb)

581A: net: 3.5 kg (8 lb) shipping: 6 kg (13 lb)

Options

001: 4221 BCD code "1" state positive; "1" state +4 to +75 V with reference to "0" state.

002: 8421 BCD code "1" state positive (voltages same as above).

003: 8421 BCD code "1" state negative; "0" state +4 to +75 V with reference to "1" state.

580A or 581A D to A Converter

Supplied with 562A-16C cable, 6' (1830 mm) long with an amphenol 57-30500 connector at each end.

Price

N/C

N/C

N/C

\$725

RECORDERS & PRINTERS

Two and four-channel oscillographic recorders

Models 7402A, 7404A, 17400A, 17401A, 17402A, & 17403A Series Preamps

NEW

- Instant drying ink

- Interchangeable plug-ins

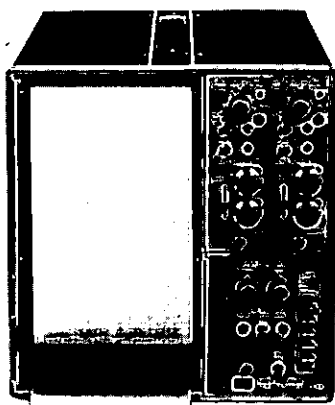

7402A

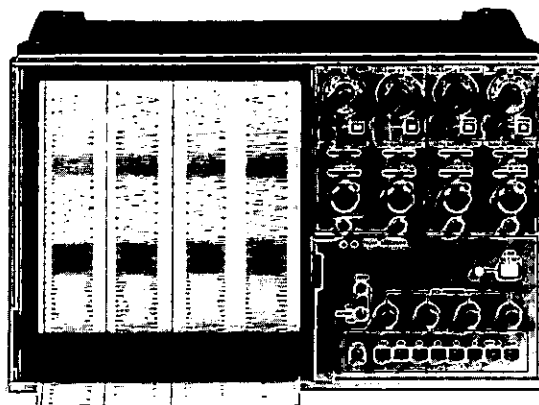

7404A

The Hewlett-Packard Models 7402A and 7404A are rectilinear, low pressure ink writing oscillographic recorders, which, when used with interchangeable 17400A Series preamplifiers, measure and record one to four input signals against time. The 7402A Recorder is portable and records on either two 50 mm channels or a single 100 mm channel. The 7404A is a four-channel recorder, but will also record on two 80 mm channels.

Clear traces that dry immediately on contact with the paper are produced by the pressurized ink system of these units. The pen is constructed with stainless steel with a rough carbide tip. Pens will last the life of the instrument. Four chart speeds are provided on the 7402A, while 12 are available on the 7404A. Remote control of the chart speed is either by contact closure or TTL.

Oscillographic recorders with plug-ins can be used to measure parameters such as voltage, pressure, flow, force, displacement, and temperature with respect to time. These recorders can be used in applications such as line production, troubleshooting, or physiological measurements.

17400A High gain

This plug-in is equipped to handle all normally encountered dc signal sources. A unique error indicator is included to signal over-driven inputs. It provides 1 μ V/div sensitivity, 1 megohm input resistance, guarded and floated inputs, and calibrated zero suppression.

17401A Medium gain

Stable and solid, this dc-coupled preamplifier provides the basic signal conditioning required to cover the majority of applications. The optional calibrated zero suppression supports 1 mV/div maximum sensitivity balance-to-ground inputs.

17402A Low gain

As an economical unit, no compromises are made in basic performance. The single-ended input is available through a conventional rear connector as well as convenient front panel binding posts. Eight calibrated ranges are provided from 20 mV/div to 5 V/division.

17403A AC carrier

LVDT, RVDT, and strain gauge based devices are just some of the ac and dc (passive) transducers compatible with the unit. The 7402A with the 17403A supplies 2.4 kHz, 5 V ac excitation to transducers and has standard calibrated zero suppression. Option 011, a plug-in electronics board, must be installed in the 7402A. On existing 7402A, use Part No. 07402-60252.

7402A Specifications

Input specifications

Type of input: Compatible with 17400 Series Preamplifiers.

Accuracy: $\pm 0.75\%$ of full scale at 25°C. Temperature coefficient $\pm 0.06\%/^{\circ}\text{C}$.

Dynamic specifications

Frequency response: 100 div $\pm 2\%$ of full scale from DC to 25 Hz.
50 div $\pm 2\%$ of full scale from DC to 40 Hz.

Overshoot: $< 2\%$ of full scale.

Step response (rise time): 7.0 msec (10% to 90% of 50 mm or 100 mm deflection).

Time specifications

Chart speeds: 1, 5, 25, 125 mm/sec or mm/min (Opt 009). Front panel or remote selection, including STOP, via contact closure or TTL level.

Chart speed accuracy: $\pm 0.5\%$ plus nominal power line frequency variation.

General specifications

Writing area: Two channels, each 50 mm (50 div) wide or one channel 100 mm (100 div) wide. Chart length, 84 m (275 ft) roll.

Writing system: Pressurized ink.

Environmental: 0°C to 55°C, $< 95\%$ relative humidity (25°C to 40°C).

Power: 115/230 V ac $\pm 10\%$, 140 VA.

Weight: 18.4 kg (40 lb) (with two 17401A and paper).

7404A Specifications

Input specifications

Type of input: Compatible with 17400 Series Preamplifier.

Accuracy: $\pm 0.25\%$ of full scale at 25°C. Temperature coefficient $\pm 0.05\%/^{\circ}\text{C}$.

Dynamic specifications

Frequency response: 100 div $\pm 2\%$ of full scale for DC to 48 Hz.
50 div $\pm 2\%$ of full scale for DC to 48 Hz.

Overshoot: $< 2\%$ of full scale.

Step Response (rise time): 6.2 msec (10% to 90% of 40 mm or 80 mm deflection).

Time specifications

Chart speeds: 5, 10, 25, 50, 100, 200 mm/sec and mm/min controllable from front panel or with rear panel TTL level or contact closure with front panel set to "RMT".



17400A



17401A



17402A



17403A

Chart speed accuracy: $\pm 0.5\%$ plus nominal power line frequency variation.

General specifications

Writing area: Four channels each 40 mm wide with 50 div or two channels 80 mm wide with 100 div. Also, one 80 mm wide channel and two 40 mm wide channels operation is possible. Chart length 84 m (275 feet) roll.

Writing system: Pressurized ink.

Environmental: 0° to 55°C , $<95\%$ relative humidity (25°C to 40°C).

Power: 115/230 V ac, $\pm 10\%$, 300 VA.

Weight: 36.8 kg (80 lb), with four each 17400A Preamplifiers and paper.

17400A with 7402A and 7404A

Gain accuracy (at $25^\circ\text{C} \pm 1^\circ\text{C}$): within 0.75% of full scale value, $\pm 0.06\%/^\circ\text{C}$.

Linearity: $\pm 0.6\%$ of full scale value.

Frequency response (at 50 div): $+0\%$ -6% of full scale from dc to 40 Hz at $5 \mu\text{V}/\text{div}$ and above; 28 Hz at $2 \mu\text{V}/\text{div}$, 15 Hz at $1 \mu\text{V}/\text{div}$. (at 10 div). -3 dB at 125 Hz at $5 \mu\text{V}/\text{div}$ and above; dc to greater than 80 Hz at $2 \mu\text{V}/\text{div}$; dc to greater than 45 Hz at $1 \mu\text{V}/\text{div}$.

Rise time (from 10% to 90% of 50 mm deflection): 7.5 milliseconds.

17401A with 7402A and 7404A

Gain accuracy (at $25^\circ\text{C} \pm 1^\circ\text{C}$): within 0.75% of full scale value, $\pm 0.06\%/^\circ\text{C}$.

Linearity: $\pm 0.6\%$ of full scale value.

Frequency response (at 50 div): $\pm 2\%$ of full scale from dc to 40 Hz (at 10 div); -3 dB at 140 Hz.

Rise time (from 10% to 90% of 50 mm deflection on 1 mV/div range): 7 milliseconds.

17402A with 7402A and 7404A

Gain accuracy (at $25^\circ\text{C} \pm 1^\circ\text{C}$): within 0.75% of full scale value, $\pm 0.06\%/^\circ\text{C}$.

Linearity: $\pm 0.6\%$ of full scale value.

Frequency response (at 50 div): $\pm 2\%$ of full scale from dc to 40 Hz (at 10 div); -3 dB at 140 Hz.

Rise time (from 10% to 90% of 50 mm deflection on 20 mV/div range): 7 milliseconds (nominal).

17403A with 7402A and 7404A

Gain accuracy (at $25^\circ\text{C} \pm 1^\circ\text{C}$): within 0.75% of full scale.

Gain temperature coefficient: $\pm 0.08\%/^\circ\text{C}$.

Linearity: $\pm 0.6\%$ of full scale (terminal based).

Zero temperature coefficient (referred to output): $\pm 0.5 \text{ mV}/^\circ\text{C}$ with preamplifier sensitivity control in OFF position.

Frequency response (with preamplifier filter switch to 200): Flat for DC to 40 Hz (less than 3 dB down at 55 Hz).

Rise time (from 10% to 90% deflection on 10 mV/V range): Pre-amplifier filter switch to 50 or 200: 7.5 msec. Preamplifier filter switch to AVG: 1 sec.

7402A Options

001: Event marker (left hand)	Price
002: Event marker/timer (right hand)	\$75
003: Both event marker and event marker/timer	\$110
004: 50 Hz power line operation	\$170
005: Paper take-up (external)	N/C
006: Rack mount adapter	\$120
008: Event marker, right hand minute/second timer	\$55
009: 60:1 speed reducer	\$130
010: Hard storage cover	\$155
011: 2.4 kHz oscillator board	\$30
	\$40

7404A Options

004: 50 Hz line power	Price
005: Paper take-up	N/C
006: Rack mount kit	\$150
007: Hard cover	\$150
	\$75

Supplies/accessories available

	HP Part Number	Price
1000A Mobile Cart: (7402A)		\$195
1000B Mobile Cart: (7404A)		\$195
Field Installation Kits —		
Paper Take-Up	07402-60022	\$137
Rack Mount Adapter	07402-60023	\$98
60:1 Chart Speed Reduction (60 Hz)	07402-60068	\$275
(50 Hz)	07402-60069	\$275
7402A Hard Storage Cover	07402-60062	\$40
Oscillator Board Kit (2.4 kHz) for 7402A used with 17403A	07402-60252	\$45
Model number and name		
7402A Mainframe (less plug-ins)		\$1755
7404A Mainframe (less plug-ins)		\$4400
17400A High-Gain Preamplifier		\$725
17401A Medium-Gain Preamplifier		\$235
Option 001 (Zero Suppression)		add \$135
17402A Low-Gain Preamplifier		\$155
17403A AC Carrier Preamplifier		\$675

RECORDERS & PRINTERS

Four and eight-channel oscillographic recorders
Models 7414A, 7418A, & 8800 series signal conditioners

- Versatile configuration
- Hot tip thermal writing

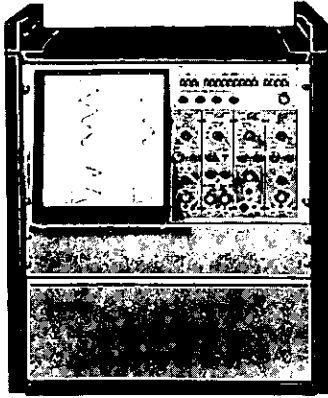

7414A

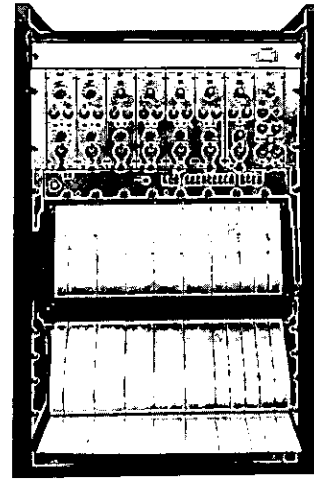

7418A

The Hewlett-Packard Models 7414A, 4 channel and 7418A, 6 and 8 channel oscillographic recorders provide permanent reproducible records of multichannel real-time low frequency data. They can be contained in a single benchtop package, in a mobile cart, or in an upright cabinet. The unit selected, depending upon channel needs, represents a unique combination of reliability, high performance, and flexibility. Accepting a complement of the 8800 Series Plug-in Signal Conditioners results in a system capable of meeting many measurement requirements.

Thermal writing tips featuring long stylus life and rectilinear presentation are provided on these recorders. A closed-loop feedback system results in 0.5% linearity. The system provides flat response (± 0.5 dB) to 50 Hz at full scale 50 divisions amplitude. On the 7418A, at 10 divisions, amplitude is 3 dB down at 100 Hz.

A 500-sheet Z-fold chart paper pack loads easily. Z-fold allows for convenient data review and storage. Additionally, nine pushbutton chart speeds are provided ranging from 0.25 to 100 mm/sec on the 7414A and 0.5 to 200 mm/sec on the 7418A. Options 025 (50 Hz) and 026 (60 Hz) on the 7414A and 7418A provide all nine speeds in millimeter per minute.

Standard recorders are supplied with two event marker pens. One marker pen is activated by either a one-second or one-minute timer selectable on the front panel. The second pen is activated by the event-button. Both markers can be activated remotely.

Plug-in signal conditioners

The entire 8800 Series is compatible with the 7414A and 7418A providing a versatile 4, 6, or 8-channel oscillographic recording system. The general characteristics of each preamplifier are given.

8801A, 8802A, 8803A DC preamplifiers

These three units are primary general-purpose devices used to measure 1 μ V/div to 5 V/div signals.

8805A/B Carrier preamplifiers

Carrier preamplifiers measure physical variables with almost any passive transducers. Strain gages and Linear Variable Differential Transformers (LVDTs) are some of these ac or dc type transducers. The 8805B adds automatic quadrature signal balance, signal averaging capability, and selectable internal calibration for 2% to 100% of full scale.

8806B Phase sensitive demodulator

The 8806B provides a dc output proportional to the rms value of the input signal that is in phase or 180° out of phase with respect to a reference voltage.

8807A AC-DC converter

This plug-in provides a dc voltage output proportional to the average value of a full wave rectified ac input signal.

8808A Logarithmic preamplifier

The 8808A is an average detecting logarithmic converter. The unit can operate over a 50 dB or 100 dB span allowing signals from 100 μ V to 1 V rms to be recorded without changing ranges.

8809A Signal coupler

A low-cost, solid-state unit, the 8809A inexpensively connects an external signal for recording.

8820A, and 8821A DC bank amplifiers

The 8820A and 8821A combine six or eight independent channels of amplification into one front panel unit for maximum operating convenience and economy. Each amplifier contains its own power supply.

7414A Specifications

Frequency response: flat within ± 0.5 dB ($\pm 6\%$), dc to 50 Hz, reference 50 div. at 10 Hz; down less than 3 dB at 100 Hz, reference 10 div. at 10 Hz.

Chart speeds: 0.25, 0.5, 1.0, 2.5, 10, 25, 50, and 100 mm/sec. Speed regulation: $\pm 1\%$. Paper weave: less than 0.5 mm. (Speeds selected via front panel pushbuttons.)

Rise time: 5 milliseconds over any 20 divisions (10% to 90%), with overshoot adjusted for 4% or less.

Limiting: Electrical limiting keeps stylus within a range of 1.5 mm beyond edge of channel.

Markers: event: local or remote control (monopolar), located on right side, between channels 3 and 4. Timed: 1 minute or 1 second interval (monopolar), located on left side, between channels 1 and 2.

Chart paper: four 40 mm wide channels, each with 50 divisions; time lines every 1 mm, heat sensitive Z-fold Permapaper® with green grid lines is available in packs of 500 sheets, each sheet 30 cm (12 inches) long, and numbered for footage and indexing.

Green grid lines and black stylus trace make recording suitable for reproduction.

Paper loading: no threading required.

Remote operation: rear panel connector J8: Remote operation of chart drive, event marker, optional extra marker. Connector also supplies ± 12 , ± 20 , and -24 V dc.

Power required: 115/230 volts ac ($\pm 10\%$), 60 Hz (50 Hz optional), 300 watts. Warmup time, approximately 15 seconds.

Dimensions: Height: 29 cm (10.5 inches). Width: 48.3 cm (19.0 inches), for standard rack. Depth: 57.3 cm (22.75 inches). Projection: 6.3 cm (2.5 inches) from rack front.

Weight: Recorder: 34.4 kg (76 lb). Bench Top Enclosure: 42.5 kg (95 lb); with paper take-up shelf 43.3 kg (95.5 lb); with Mobile Cart 81 kg (191 lb).

7418A Specifications

Frequency response: flat with $\pm 6\%$ (± 0.5 dB) from Dc to 50 Hz. Reference 50 div at 10 Hz. Down less than 3 dB at 100 Hz. Reference 10 div at 10 Hz.

Rise time: 5 Msec over any 20 div range with overshoot adjusted to no more than 4%.

Chart speeds: speeds are 0.5, 1, 2.5, 5, 10, 25, 50, 100 and 200 mm/sec. Speed Regulation: $\pm 1\%$. Paper weave: less than 0.5 mm. Speeds are electrically selected via front panel pushbuttons.

RECORDERS & PRINTERS

Models 7414A, 7418A, & 8800 series (cont.)



8801A



8802A



8803A



8805B

Remote operation: rear panel connector J14 provides for full remote operation of chart drive, event marker, and optional extra markers. Circuits operate remotely only when front panel REMOTE button is depressed. Remote connector also supplies -20 V.

Power requirements: 115/230 V ac, $\pm 10\%$ at 60 Hz. Recorder only — 425 watts. System plug-in — 545 watts. System bank — 430 watts, 455 watts.

Dimensions: recorder alone: Height — 29 cm (10.5 inches). Width — 48.3 cm (19.0 inches), for standard RETMA equipment rack. Depth — 57.3 cm (22.75 inches) Projects 6.3 cm (2.5 in.) from front of rack.

Weight: recorder alone: 49.9 kg (110 lb) including driver amplifiers. With bench top enclosure, 58 kg (128 lb). In mobile cart with power supply, but less preamplifier, 160 kg (354 lb).

8801A Specifications

Input ranges: 5, 10, 20, 50, 100, 200 mV/div; 0.5, 1, 2, 5 V/div. Accuracy $\pm 1\%$.

Type of input: balanced to ground; 500 k Ω —1% in parallel with approx. 100 pF each side.

Common mode rejection: 48 dB min, dc to 140 Hz; ± 50 V max on 5, 10, 20 mV/div ranges; ± 500 V max all other ranges.

Output frequency response and rise time: 50 Hz at -0.5 dB at 50 div. 5 ms at 10 div 10-90%, 4% overshoot.

Zero suppression: 0 to ± 10 and ± 100 V for single-ended or differential signals (± 50 V max on 5, 10, 20 mV/div ranges); calibrated 10-turn potentiometer with $\pm 0.1\%$ resolution; accuracy $\pm 0.5\%$ of suppression range, $\pm 1\%$ of reading.

Calibration: internal, $+100$ mV $\pm 1\%$.

8802A Specifications

Input ranges: 1, 2, 5, 10, 20, 50, 100, 200, 500, 1000 mV/div; accuracy $\pm 1\%$.

Type of input: balanced to ground; 180 k Ω $\pm 1\%$ in parallel with approx. 100 pF each side.

Common mode rejection: 48 dB min, dc to 60 Hz on 1000 mV/div range, dc to 150 Hz all other ranges; ± 12.5 V max on 1, 2, 5 mV/div ranges; $+125$ V max on 10, 20, 50 mV/div ranges; ± 500 V max all other ranges.

Output frequency response and rise time: 50 Hz at -0.5 dB at 50 div. 5 ms at 10 div 10-90%, 4% overshoot.

Zero suppression: 0 to ± 2 and ± 20 V for single-ended or differential signals (± 12.5 V max on 1, 2, 5 mV/div ranges); calibrated 10-turn potentiometer with $\pm 0.1\%$ resolution; accuracy $\pm 0.5\%$ of suppression range, $\pm 1\%$ of reading.

Calibration: internal, $+20$ mV $\pm 1\%$.

8803A Specifications

Input ranges: 1 to 5000 μ V/div and 10 to 5000 mV/div, 21 ranges in a 1, 2, 5 sequence. Accuracy $\pm 2\%$.

Type of input: floating and guarded signal pair; 1 M Ω on mV ranges.

Common mode rejection (dc): 160 dB min on μ V ranges, 100 dB min on mV ranges; 1 k Ω max source unbalance; ± 300 V max.

Common mode rejection (ac): 120 dB min on μ V ranges, 60 dB on mV ranges at 60 Hz; 500 k Ω max source unbalance; ± 10 V max, 1

μ V/div; ± 20 V max, 2 μ V/div; ± 50 V max, 5 μ V/div; 100 V max, 10 μ V/div and 10 mV/div; ± 220 V max all other ranges.

Zero suppression: μ V ranges: 0 to ± 1 , 10, 100 mV; mV ranges: 0 to ± 1 , 10, 100 V; calibrated 10-turn potentiometer with $\pm 1\%$ resolution, accuracy $\pm 1\%$ of suppression range.

Calibration: internal, $+200$ μ V $\pm 1\%$ on μ V range, $+200$ mV $\pm 1\%$ on mV range.

Output frequency response and rise time: 50 Hz at -0.5 dB at 50 div. 5 ms at 10 div 10-90%, 6% overshoot.

8805A, 8805B Specifications

Sensitivity: 10 μ V/div.

Input attenuator: X1, 2, 5, 10, 20, 50, 100, 200; accuracy $\pm 2\%$.

Input impedance:

8805A: approx. 10 k Ω .

8805B: 1 M Ω $\pm 10\%$, single ended.

Transducer impedance: transducer load impedance connected to excitation terminals 100 ohms min; transducer impedance connected to signal input terminals 5 k Ω max.

Excitation: floating source 5 V nominal, 2400 Hz $\pm 2\%$; internal full bridge/half bridge switch grounds C.T. of excitation for use with half-bridge transducers.

Quadrature rejection: greater than 40 dB; quadrature signal less than 50 div; C bal control permits bucking of transducer quad unbalance up to ± 5 mV/V.

Zero suppression: 0 to 100% of transducer full load rating, for transducer cal factor up to 10 mV/V at full load; calibrated 10-turn potentiometer with 0.1% resolution; accuracy $\pm 0.5\%$ of suppression range; R bal control permits bucking of inphase unbalance to ± 3 mV/V regardless of cal factor.

Output frequency response: 50 Hz (-0.5 dB at 50 div).

Rise time: 5.6 msec (at 10 div, 10-90%, 4% overshoot).

Calibration:

8805A: 2% $\pm 0.02\%$ of transducer full scale output.

8805B: switchable, 2%, 10%, 50%, 100% $\pm 1\%$ of full scale.

8806B Specifications

Input ranges: 0.5, 1, 2, 5, 10, 20, 50, 100, 200, 500 mV rms/div; reference voltage 3-133 V rms in two overlapping ranges, internal range switch.

Type of input: signal input: transformer isolated, floating and guarded, approx. 1 M Ω ; reference input: differential, transformer coupled, approx. 500 k Ω each side to ground.

Common mode rejection: 40 dB min to 10 Hz, 500 V rms max; quadrature tolerance 50 div max.

Reference frequency range: 50 Hz to 40 kHz in six bands with variable frequency plug-in; fixed frequency calibrated plug-ins 60 Hz, 400 Hz, 50 kHz.

Output frequency response (3 dB @ 10 div) and rise time (at 10 div, 10-90%, 4% overshoot): Ref frequency: @ 60 Hz: 12 Hz; @ 400 Hz: 65 Hz; @ 5 kHz: 100 Hz, 5 msec.

Phase shifter (plug in):

Fixed frequency: 0°–90° dial; 2° graduations in four quadrants; accuracy $\pm 3\%$.

Variable frequency: continuous 0–360°.

Calibration: internal, 1 V rms at carrier ref frequency.



8806B



8807A

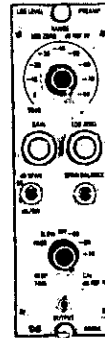

8808A



8809A

8807A Specifications

Input ranges: 0.02, 0.05, 0.1, 0.2, 0.5, 1, 2, 5, 10, V rms/div; accuracy $\pm 2\%$; scale expansion: X1, 2, 5, 10, 20 $\pm 2\%$.

Type of input: floating and guarded signal pair; approx. 1 M Ω shunted by 10 pF and stray cable capacitance.

Input frequency range: standard model, 330 Hz to 100 kHz; Option 001, 50 Hz to 100 kHz.

Common mode rejection: 60 dB min at 60 Hz, 40 dB min at 400 Hz, with up to 10 k Ω source unbalance; ± 500 V max.

Zero suppression: 0 to 100% of full scale, any range; calibrated 10-turn potentiometer.

Frequency response and rise time:

Standard model: 54 Hz (3 dB @ 10 div) 11 ms (10 div 10-90%, 4% overshoot).

Option 001: 9 Hz (3 dB @ 10 div) 70 ms (10 div 10-90% 4%, overshoot).

Calibration: internal, 1 V $\pm 1\%$; approx. 500 Hz.

8808A Specifications

Sensitivity ranges:

50 dB span: bottom scale -80 to 0 dB below 1 V in 10 dB steps.

100 dB span: -80 to -50 dB below 1 V in 10 dB steps.

Type of input: single ended, 1 M Ω min.

Input frequency range: 5 Hz to 100 kHz slow response range; 500 Hz to 100 kHz fast range.

Rise time 10% to 90% (10 div): fast response, 20.5 ms (875 dB/s); slow response 2 s (9 dB/s).

Calibration: internal at approx. 500 Hz: -80 , -30 , $+20$ dB referred to 1 V; accuracy of -30 dB position ± 0.25 dB.

8809A Specifications

Input range: adjustable from 20 to 50 mV/div.

Type of input: switch selected, 1.5 k Ω $\pm 2\%$ or 100 k Ω min, single ended.

Output frequency response and rise time: 50 Hz (-0.5 dB at 50 div), 5 ms (10 div, 10-90%, 4% overshoot).

Calibration: internal, 600 mV $\pm 2\%$.

8820A/8821A Bank amplifier system

Specifications	8820A	8821A
Sensitivity	0.05 V/div (Amplifier Gain 2)	0.001 V/div (Amplifier Gain 100)
Maximum Full Scale Input	250 volts (edge to edge)	250 volts (edge to edge)
Sensitivity Ranges (attenuation)	0.05, 0.1, 0.2, 0.5, 1, 2, 5 V/div Att. Accuracy $\pm 2\%$	0.001, 0.002, 0.005, 0.010, 0.020, 0.050, 0.1, 0.2, 0.5, 1, 2, 5 V/div Att. accuracy (dc) $\frac{1}{2}\%$ on 0.001 to 0.050 V/div ranges, 1% on 0.1 to 5 V/div ranges
Common Mode Rejection	Not Applicable	100 dB at 60 Hz, 0.001 V/div sensitivity, 1 k source unbalance, decreases to 66 dB at 0.05 V/div, 66 dB at 60 Hz, 0.1 to 5 V/div sensitivities, 1 k source unbalance
Common Mode Tolerance	Not Applicable	± 20 V on 0.001 to 0.05 V/div ranges (six most sensitive) ± 250 V on 0.1 to 5 V/div ranges (six least sensitive)
Frequency Response 7418A System (with amplifiers)	DC to less than 0.5 dB down at 50 Hz (50 div p-p) DC to less than 3 dB down at 100 Hz (10 div p-p)	DC to less than 0.5 dB down at 50 Hz (50 div p-p) DC to less than 3 dB down at 100 Hz (10 div p-p)
Amplifier Only	On four most sensitive ranges, response is DC to 7 kHz ($+0.5$, -1.0 dB), or DC to 15 kHz ($+0.5$, -3.0 dB). On three least sensitive ranges, response is DC to 7 kHz ($+0.5$, -2.0 dB), or DC to 15 kHz ($+0.5$, -4.0 dB).	DC to 15 kHz ($+1.0$, -3.0 dB)
Rise Time 7418A	Less than 6 milliseconds, 10-90% of final deflection, 4% overshoot, 20 div p-p	Less than 6 milliseconds, 10-90% of final deflection, 4% overshoot, 20 div p-p

RECORDERS & PRINTERS

Models 7414A, 7418A & 8800 series (cont.)

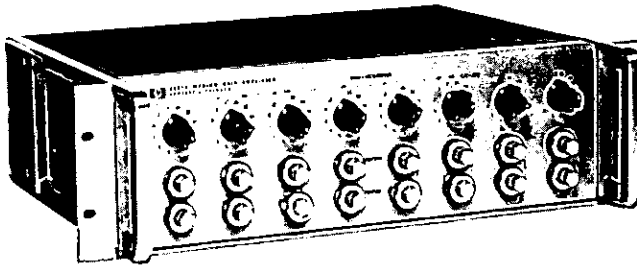

8821A

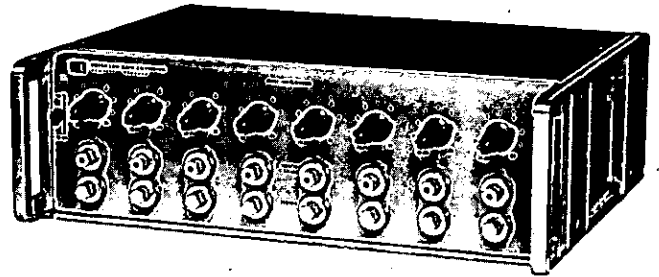

8820A

7414A Options

001: Rack mount; includes slides and all mounting hardware. Deletes case.	Price
008: 50 Hz operation	N/C
012: 1 channel decrease; extreme right hand channel deleted, blank panel installed for plug-in. Not compatible with option 015.	N/C
015: Extra event marker, installed between channels 2 & 3. Not compatible with option 012.	\$210
025: 50 Hz speed reduction (60:1).	\$40
026: 60 Hz speed reduction (60:1).	310
054: Installed in mobile cart. Includes paper takeup drawer.	\$310
	\$485

7418 Options

7418 8-channel Hot-Tip Thermal Oscillographic Recorder only*. (Includes paper take-up tray.)

001: 6-channel Hot-Tip Thermal Oscillographic Recorder only.* (Includes paper take-up tray.)	\$600
002: Rack Mount Kit	\$200
003: Bench Top Configuration	\$250
004: 63" Cabinet (includes 7 inch drawer)	\$1300
005: 42" Cabinet (includes 7 inch drawer)	\$1300
006: 21" Portable Cart	\$875
008: 50 Hz Operation	N/C
009: 230 V ac Operation	N/C
014: Extra Event Marker between Channels 4 and 5	\$85
015: Extra Event Marker between Channels 5 and 6	\$85
025: 50 Hz Speed Reduction 60:1	\$300
026: 60 Hz Speed Reduction 60:1	\$300
030: 8848A Plug-in Pre-amplifier Power Supply (required for operation of 8800 plug-in preamplifiers — can be ordered separately as 8848A).	\$1135
031: 8820A 8-channel Low-Gain Bank Amplifiers (can be ordered separately as 8820A).	\$1600
032: 8821A 8-channel Medium-Gain Bank Amplifier (can be ordered separately as 8821A).	\$2700
033: 8820A 6-channel Low-Gain Bank Amplifier (can be ordered separately as 8820A).	\$1600
034: 8821A 6-channel Medium-Gain Bank Amplifier (can be ordered separately as 8821A).	\$2500

* For plug-in preamplification, Option 030 Power Supply is required to operate the 8800 Series Plug-in Preamps. For Bank Amplification, select one of options 031 through 034 as desired.

8801A, 8802A, 8808A, and 8809A Options

001: bench-top unit with power supply and portable case	Price
	\$445

8803A Options

001: bench-top unit with power supply and portable case	\$540
--	-------

8805A, 8805B Options

001: (either model) bench-top unit with power supply and portable case	\$520
002: harmonic filter kit	\$30

8806B Options

001: bench-top unit with power supply and portable case	\$475
002: variable frequency phase shifter plug-in, 50 Hz to 40 kHz	\$220
003: calibrated phase shifter plug-in, 60 Hz	\$200
004: calibrated phase shifter plug-in, 400 Hz	\$160
005: calibrated phase shifter plug-in, 5 kHz	\$160

8807 Options

001: 50 Hz to 100 kHz signal filter	N/C
002: dc plug-in	N/C
003: bench-top unit with power supply and portable case	\$445

Model number and name

7414A	\$5000
7418A	\$6600
8801A	\$375
8802A	\$375
8803A	\$780
8805A	\$500
8805B	\$730
8806B	\$600
8807B	\$830
8808A	\$670
8809A	\$135
8820A	\$1600
8821A	\$2700

RECORDERS & PRINTERS



Chart recorder supplies

Graphic recorders

Chart recorder supplies

The following supplies are those most frequently used in recording applications. A complete list of available supplies may be obtained by contacting your local Hewlett-Packard sales and service office.

X-Y recorder supplies

Graph paper, 21.6 cm × 28 cm (8½ in. × 11 in.):

Type	Plot Area	Weight	Part Number 100-sheet box	Price
Metric	18 cm × 25 cm	light	9270-1027	\$4.45
		heavy	9270-1023	\$4.70
English	7 in. × 10 in.	light	9270-1007	\$4.40
		heavy	9270-1006	\$3.80

Graph paper, 28 cm × 41.9 cm (11 in. × 16½ in.):

Type	Plot Area	Weight	Part Number 100-sheet box	Price
Metric	25 cm × 38 cm	light	9270-1042	\$6.35
		heavy	9270-1024	\$6.60
English	10 in. × 15 in.	light	9270-1005	\$6.00
		heavy	9270-1004	\$6.60

Disposable pens (one pen recorders):

Color	Part Number (package of 3)	Price
Red	5081-1190	\$4.85
Blue	5081-1191	\$4.85
Green	5081-1192	\$4.85
Black	5081-1193	\$4.85

Disposable pens (two pen recorder — 7046A):

Color	Part Number (package of 3)	Price
Red	5060-6662	\$4.50
Blue	5060-6664	\$4.50

Strip chart recorder supplies

Chart paper, 5-inch (680, 7143A):

Type	Description	Part Number	Price
Ink Writing			
Metric	12 cm × 28.5 m	9270-1025	\$3.25
English	5 in. × 95 ft	9270-1012	\$2.65

Chart paper, 10-inch (7100B, 7101B, 7127A, 7128A):

Type	Description	Part Number	Price
Ink Writing			
Metric	25 cm × 36 m	9270-1037	\$4.65
English	10 in. × 120 ft	9270-1010	\$4.65

Chart paper, 10-inch (7123A):

Type	Description	Part Number	Price
Ink Writing			
Metric	25 cm × 28.5 m	9280-0176	\$4.35
English	10 in. × 95 ft	9280-0175	\$4.75

Chart paper, 10-inch (7130A, 7131A, 7132A, 7133A):

Type	Description	Part Number	Price
Ink Writing			
Metric	25 cm × 30 m	9280-0265	\$4.10
English	10 in. × 100 ft	9280-0264	\$4.10

Thermal writing:

Type	Description	Part Number	Price
Metric	25 cm × 24 m	9280-0289	\$6.00
English	10 in. × 80 ft	9280-0288	\$6.00
English, R.H.	10 in. × 80 ft	9280-0290	\$6.00
Soft Zero			

Chart paper, 12 cm (7155A):

Type	Description	Part Number	Price
Ink Writing			
Metric	12 cm × 21.3 m	9280-0278	\$4.70
English	5 in. × 70 ft	9280-0277	\$4.70

Disposable pens (7123A, 7143A):

Color	Part Number (package of 3)	Price
Blue	07143-60002	\$4.85
Red	07143-60003	\$4.85
Black	07143-60024	\$4.50

Disposable pens (7130A, 7131A, 7132A, 7133A):

Color	Part Number (package of 3)	Price
Red	07130-62510	\$4.50
Blue	07130-62500	\$4.50

Disposable pens (7155A):

Color	Type	Part Number (package of 3)	Price
Red	Main pen	07155-60014	\$5.00
Red	Event pen	07155-60015	\$5.00
Blue	Main pen	07155-60016	\$5.00
Blue	Event pen	07155-60017	\$5.00

Recording ink, 3 cc cartridge (680, 7100B, 7101B, 7127A, 7128A):

Color	Part Number	Price
Red	1530-1024	\$.55
Green	1530-1025	\$.55
Black	1530-0705	\$.55
Blue	1530-1034	\$.55
Purple	1530-0984	\$.55

Recording ink, 5 cc cartridge (7123A, 7143A):

Color	Part Number	Price
Blue	07143-61701	\$2.00
Red	07143-61700	\$1.60
Black	07143-61702	\$1.60

Recording ink, 5 cc cartridge (7130A, 7131A, 7132A, 7133A Event Markers)

Color	Part Number	Price
Red	5060-6506	\$1.50
Blue	5060-6505	\$1.50
Black	07130-60002	\$1.50

Instrumentation tape supplies

3M 951 tape ¼ inch, 1 mil, 2300 ft. HP P/N 9162-0006 \$26.00

Oscillographic recorder supplies

Chart paper

Recorder System	Description	Part Number	Price
7402A	2 × 50 mm, 84 m (275 ft) roll	9280-0258	\$ 7.00
	1 × 100 mm, 84 m (275 ft) roll	9280-0276	\$ 7.00
7404A	4 × 40 mm, 84 m (275 ft) roll	9270-0878	\$28.35
	4 × 50 DIV. 84 m (275 ft)	9280-0293	\$15.00
7404A	2 × 100 DIV. 84 m (275 ft)	9280-0294	\$15.00
7414A	500 sheet Z-fold pack	651-52	\$12.35
7702B	2 × 50 mm		
	96 m (200 ft) roll	9270-0946	\$53.50
7418A	8 × 40 mm		
	500 sheet Z-fold pack		

Recording Ink, cartridge:

Recorder System	Description	Part Number	Price
7402A/7404A	Blue-black, 55 cc	07402-60008	\$15.00

RECORDERS & PRINTERS

Portable instrumentation tape recorder

Model 3960A

- 48 dB FM signal to noise ratio
- 38 dB unfiltered DIRECT signal to noise ratio
- 16:1 time base expansion and contraction
- DC/peak AC monitor meter
- DC calibration voltages provided
- Operated from 110/220 V ac and 12/28 V dc

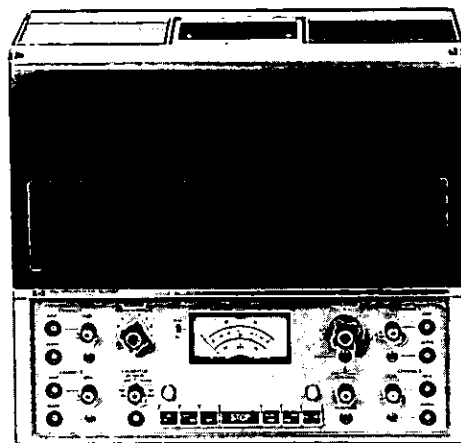

The 3960A Portable Instrumentation Tape Recorder is a combination of a superior electromechanical tape drive assembly plus high performance electronics. Standard features such as the DC/Peak AC Monitor Meter and the DC Calibration Voltage Source make this instrument non-dependent on other test equipment when used in the field. Optional features such as 'Voice Annotation,' 'Tape Speed Servo,' 'Remote Controllability' and the 'Tape Loop Adapter' make it adaptable to most data acquisition and reduction applications.

3960A Specifications

Transport specifications

Tape width: 1/4 inch.

Reel size: standard 7-inch plastic reels.

Heads: 4-track Record and 4-track Reproduce.

Tape speeds: 1/16, 3/4, 15 ips. For other speed combinations, see Speed Option Table.

Capstan drive: DC motor with phaselock servo.

Tape speed accuracy: ±0.2%.

Time base error (TBE): Measured in accordance with IRIG 118-73. These specifications applicable only with Option 040.

Tape Speed (ips)	TBE (microseconds)	Tape Speed (ips)	TBE (microseconds)
15	±4	1 1/2	±15
7 1/2	±5	15/16	±25
3 3/4	±7 1/2		

Flutter: Measured in accordance with IRIG 118-73.

Tape Speed (ips)	Passband (Hz)	Flutter (% p-p)	Tape Speed (ips)	Passband (Hz)	Flutter (% p-p)
15	0.2 - 2500	0.35	1 1/2	0.2 - 312	0.50
7 1/2	0.2 - 1250	0.35	1.5	0.2 - 250	0.55
3 3/4	0.2 - 625	0.40	15/16	0.2 - 156	0.70
3	0.2 - 500	0.45			

Operating modes: Forward and Reverse Record, Forward and Reverse Play, Fast Forward, Fast Rewind, Stop.

Start and stop times (typical):

Tape Speed: (ips)	15	3 3/4	15/16
Start: (seconds)	2.00	0.90	0.25
Stop: (seconds)	0.25	0.25	0.25

Rewind time (typical): 2300-ft reel in 130 seconds.

Braking: Fail-Safe mechanical differential brakes.

End-of-tape-sensing: Reels stop at end of tape.

Reel revolution counter: 4-digit revolution counter.

Remote control: see Option 050.

FM electronics specifications

(Options A01 through A04)

Passband, signal-to-noise ratio and distortion:

Tape Speed (ips)	Carrier Center Frequency ⁽¹⁾ (kHz)	Passband (Hz)	S/N Ratio (dB)	Distortion (%)
15	27.00	0 - 5000	48	1.5
7 1/2	13.50	0 - 2500	48	1.5
3 3/4	6.75	0 - 1250	48	1.5
3	5.40	0 - 1000	48	1.5
1 1/2	3.38	0 - 625	48	1.5
1 1/4	2.70	0 - 500	47	2.0
15/16	1.69	0 - 312	44	2.0

(1) Signal measured at 10% of upper passband.

Flutter compensation: standard on all models. Switched on and off with slideswitch behind front access door.

Linearity: ±1% of p-p output for best straight line through zero.

DC drift: ±0.1% of peak-to-peak output per °C.

Input level: 1 V peak-to-peak to 30 V peak-to-peak.

Input impedance: 50 kΩ, shunted by 200 pF maximum.

Output level: 0 to 5 V peak-to-peak (adjustable).

Output impedance: 140 ohms maximum, single-ended.

Direct electronics specifications

Passband, signal-to-noise ratio and distortion:

Tape Type	Tape Speed (ips)	Passband (±3 dB)	Signal/Noise Ratio* (dB)
3M 951	15	70 Hz - 60.00 kHz	38
	7 1/2	50 Hz - 30.00 kHz	38
	3 3/4	50 Hz - 15.00 kHz	38
	3	50 Hz - 12.00 kHz	38
	1 1/2	50 Hz - 7.50 kHz	38
	1 1/4	50 Hz - 6.00 kHz	38
	15/16	50 Hz - 3.75 kHz	38

*Referenced to a 500 Hz sine wave with a maximum of 1% THD.

Input level: 0.1 V rms to 10 V rms.

Input impedance: 50 kΩ, shunted by 200 pF maximum.

Output level: 0 to 5 V peak-to-peak (adjustable).

Output impedance: 140 ohms maximum, single-ended.

Signal monitoring

Peak reading meter: In Record, meter reads in percentage of full deviation (40%) or drive level on tape. In Reproduce, meter reads output voltage. On meter, 100% (0 dB) output corresponds to 5 V peak-to-peak. Red calibration marks provided for 1 V rms.

Meter modes: Meter has two modes: In PEAK mode it reads peak of absolute value, including any dc components. In DC mode it reads dc component of signal.

Meter accuracy: better than ±½ dB for signals with 50 to 100% duty cycle; better than ±1 dB for 1 to 50% duty cycle.

DC calibration source

Voltages: ±10, ±5, ±2.5, or ±1.4 V dc

Record control

Combination Record Disable Switch/Level Control for each channel. In OFF position, no signal is fed to record head. Any combination of tracks can be recorded, including one track at a time.

General specifications

Size: 425 mm × 381 mm × 187 mm (16¼" × 15" × 7½").

Weight: 22.7 kg (50 pounds).

Power requirements: 115-230 V AC ±10%, 48-440 Hz.

Environment:

Temperature: Operating — 0°C to +55°C.

Altitude: Operating — 15,000 ft; Nonoperating — 25,000 ft.

Humidity: 10% to 95% (+25°C to 40°C), noncondensing.

Shock: 30 g maximum (11 ms) nonoperating.

Speed options

Option No.	Description	Price
001	1½, 1, and 3¾ ips	\$140
002	1½, 1, and 7½ ips	\$140
003	1½, 1, and 15 ips	\$140
004	1½, 3¾, and 7½ ips	\$140
005	1½, 7½, and 15 ips	\$140
006	1, 3¾, and 7½ ips	\$140
007	1, 3¾, and 15 ips	\$140
008	1, 7½, and 15 ips	\$140
009	3¾, 7½, and 15 ips	\$140
010	1, 3, and 15 ips	N/C

Data electronic options

Option No.	Description	Price
A01	One Channel F.M. Record/Reproduce	\$ 450
A02	Two Channel F.M. Record/Reproduce	\$ 900
A03	Three Channel F.M. Record/Reproduce	\$1350
A04	Four Channel F.M. Record/Reproduce	\$1800

Direct record/reproduce electronics (equalized for 3M951):

G01	One Channel Direct Record/Reproduce	\$ 425
G02	Two Channel Direct Record/Reproduce	\$ 750
G03	Three Channel Direct Record/Reproduce	\$1075
G04	Four Channel Direct Record/Reproduce	\$1400

Direct record/reproduce electronics (equalized for 3M150):

Option No.	Description	Price
H01	One Channel Direct Record/Reproduce	\$ 440
H02	Two Channel Direct Record/Reproduce	\$ 780
H03	Three Channel Direct Record/Reproduce	\$1120
H04	Four Channel Direct Record/Reproduce	\$1460

Direct record/reproduce electronics (equalized for 3M203 or ampex 641):

J01	One Channel Direct Record/Reproduce	\$ 450
J02	Two Channel Direct Record/Reproduce	\$ 800
J03	Three Channel Direct Record/Reproduce	\$1150
J04	Four Channel Direct Record/Reproduce	\$1500

NOTE: A bias oscillator is included with each of the above data electronic options except A01 through A04.

Miscellaneous options

- 021:** Inverter DC/AC, 23 V dc input; cannot be installed in 3960A with Option 040. When ordering separately, order P/N 13061A Price \$215
- 022:** Inverter DC/AC, 28 V dc input; cannot be installed in 3960A with Option 040. When ordering separately, order Part No. 13061B \$215
- 023:** Voice Channel Amplifier, including microphone. When ordering separately, order Part No. 13063A \$215
- 024:** Tape Loop Adapter. When ordering separately, order Part No. 13062A \$425
- 025:** Rack Mount Kit. When ordering separately, order Part No. 13065A \$25
- 026:** Rack Slide Kit. When ordering separately, order Part No. 13068A. This option deletes the standard outer case, adds protective cover \$190
- 027:** Rack Slide Kit. When ordering separately, order Part No. 13068B. This option deletes the standard outer case, adds protective cover \$190
- 028:** Remote ON/OFF foot switch. When ordering separately, order Part No. 13060A \$45
- 029:** Transit Case. When ordering separately, order Part No. 13066A \$425
- 030:** HP Med White Paint N/C
- 040:** Tape Speed Servo; for controlling time base from recorded reference on tape. This option requires at least one channel of Direct Record/Reproduce Electronics for recording and reproducing the reference. Cannot be installed in 3960A with Option 010 or Options 021 and 022 \$405
- 050:** Remote Control; provides capability of remotely switching 3960A functional controls Forward Play, Reverse Play, Record, Rewind, Fast Forward, and Stop \$440
- 060:** Limited Remote Control; provides capability of remotely switching 3960A controls Play, Record, and Stop only \$95
- 3960A Transport Assembly** (for 1½, 3¾, 15 ips standard speeds) \$3700

RECORDERS & PRINTERS

Alpha-Numeric, 20 column thermal printer
Model 5150A

NEW

- Alpha-Numeric
- Silent
- 20 Columns
- 3.5 lines/second

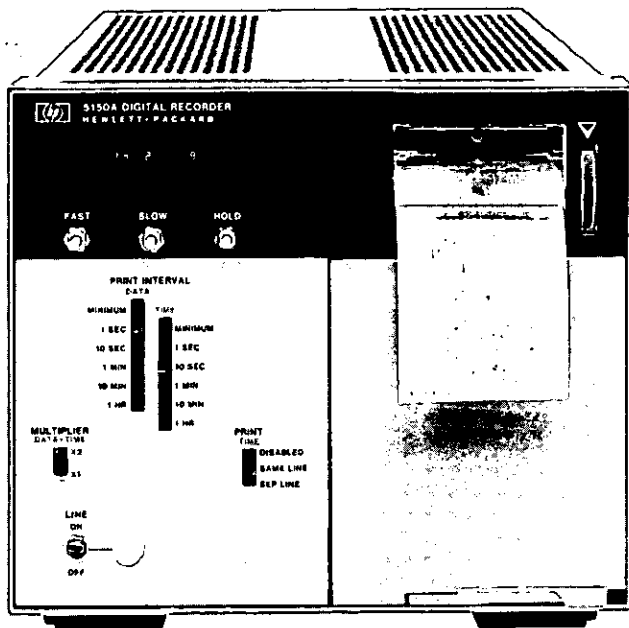

5150A, option 004

Description

General

The 5150A printer uses the thermal printing technique and plug-in design to provide silent printing with either BCD or ASCII coded input. The print head has 20 column capacity. With the BCD plug-in only 10 columns are used; however, two BCD plug-ins can be installed for 20 column capability. The ASCII plug-in uses all 20 columns. A clock option is available with either BCD or ASCII input that controls the rate at which data and the real time are printed. A Scanner option is also available with the ASCII plug-in for use on the HP Interface Bus. This option allows the printer to scan up to 13 different talkers. The information from the talkers is presented in blocks of data with a letter designation for each individual instrument. The maximum printer speed in any configuration is 3 lines/sec.

Option 001 ASCII interface

The ASCII Interface option is a plug-in board to the 5150A mainframe. It can be bought installed in the mainframe or, for a slightly higher price, can be bought after purchase of the mainframe as an accessory kit and installed by the customer. This option is designed for use on the HP Interface Bus and allows printing of the entire uppercase, 64 character ASCII set of alpha characters, numbers and special characters. To use this option the Interface Bus Cable must be employed between the printer and talker.

Option 002 BCD interface

The BCD Interface option is a plug-in board to the 5150A mainframe and provides 10 columns of printed data. Two option 002's can be installed in one 5150A mainframe to provide 20 column capability. In the standard mode each column can print any of sixteen of the following characters: 0 through 9, +, -, $\sqrt{\quad}$, A, R and [blank]. For a nominal charge up to four special ROM's (Read-only-Memories) can be programmed and installed in the printer to give any sixteen characters each (from the 64 character set) in up to 4 different character sets in any column for each 10 column board purchased (for more details see the data sheet). Option 002 can be bought installed in the printer or for a nominal extra charge can be purchased as an accessory kit and installed by the customer.

Option 003 scanner

The Scanner option is a plug-in board to the 5150A mainframe and must be used with Option 001 on the HP Interface Bus. This option may be bought installed in the 5150A mainframe or for a slightly higher price can be bought as an accessory kit and installed by the customer in his 5150A printer. The scanner option allows the user to scan up to 13 different talkers on the interface bus and print their data with an alpha-character designation. The user merely tells the scanner (through back panel switches) how many instruments he wants the option to scan and whether their addresses are odd or even (see manual for more detailed instructions).

Option 004 clock

The Clock option is a plug-in board to the 5150A, but, because of a front panel change and certain soldering operations, it may be purchased installed in the 5150A printer only. It will not be available in accessory kit form. The clock can be used with either ASCII or BCD input and controls the elapsed time between the acceptance of a print command by the 5150A mainframe. In addition the clock will cause the time in hours, minutes and seconds to be printed as often as the setting put on the time switch. An added feature allows the time to be printed on the same line as the data or on the line directly above the data (after the data).

Specifications

Principle: Thermal print

Columns: 10 or 20 BCD
20 ASCII

Paper advance mechanism: Direct drive, stepping motor

Paper: Thermal sensitive in rolls or fan-folded

Printing rate: 3 lines/second

Character set: BCD: 0 through 9, +, -, $\sqrt{\quad}$, A, R and [blank], and special character sets at a nominal charge. ASCII: 64 character upper case set.

Character print: 5 x 7 dot Matrix

Input Requirements: BCD parallel (± 8421) with no storage; ASCII byte-serial with storage.

Line spacing: Set to approximately 6 lines/inch

Operating temperature: 0°C to 50°C

Power: 115 V/230 V, 48 to 440 Hz

Logic levels: TTL (low < 4 V, High > 2.5 V)

Print Command: + or - same levels as above; 2 K Ω input impedance.

Dimensions: Half rack module. 216 mm W x 178 mm H x 356 mm D (8 1/2" W x 7 1/2" H x 14 1/4" D)

Weight: 7 kg approximately (16 lb) (5150A + 1 option)

Model number and name

5150A Thermal Printer Price \$800

Supplied with one roll of thermal sensitive paper

Option 001: ASCII Interface \$175

Option 002: BCD Interface \$110

Option 003: Scanner \$175

Option 004: Clock \$250

Operating supplies/accessories

59004A Interface Kit \$200

59005A BCD Interface Kit \$130

59006A Scanner Kit \$200

10533A BCD Interface Cable for 5300A \$155

10859A BCD Input Cable for 3450B, 3480C/D, \$65

5326A/B/C, 5505A \$55

10631A Interface Bus Cable, 3 ft. \$55

10631B Interface Bus Cable, 6 ft. \$60

10631C Interface Bus Cable, 12 ft. \$70

RECORDERS & PRINTERS



10-column BCD digital printer

Model 5055A

- 10 lines/sec.
- 10 columns of data
- 4-line \pm 8421 BCD

- TTL Logic Levels
- Ink or pressure sensitive printing

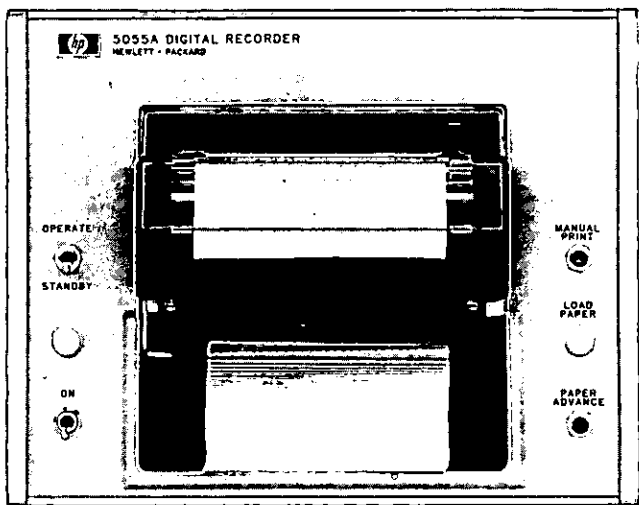

Specifications

Printing

Accuracy: Identical to input device used

Print cycle time: 100 ms.

Printing rate: 10 lines/sec maximum, asynchronous

Line spacing: fixed, 4, to 5 lines per inch.

Printing: ink roller or pressure sensitive paper. Pressure sensitive paper is recommended for operation under extreme temperature.

Print wheels: 16 positions, numerals 0 to 9, +, -, V, A, Ω , *; special wheels available.

Column capacity: Supplied complete for 10-column operation.

Electrical

Data input: parallel entry, BCD \pm 8421 (selected by rear panel switch)

Blanking: Hewlett-Packard counters with blanking will give insignificant zero suppression when blanked digits output is (1111). May be defeated with rear panel switch.

Logic levels: high state \geq +2.4 V, +5 V maximum (open input line results in high state); low state \leq +0.4 V (1.6 mA max., low), 0 V minimum.

Print command: line 1-low to high transition causes print (nominal 1k Ω input impedance); line 2-high to low transition causes print (nominal 400 Ω input impedance). Voltage levels are same as logic levels above, and a minimum pulse width of 0.5 μ s is required.

Inhibit voltage: (+) inhibit = transition from (\geq 0, \leq 0.4V) to (\geq 2.4V, \leq 5.0V) upon receipt of print command. Remains at high state until paper advance occurs, approximately 85 ms ($<$ mA in low state). (-) inhibit = inverse of (+) inhibit.

General

Operating temperature: 0 $^{\circ}$ C to +50 $^{\circ}$ C with pressure sensitive paper, +10 $^{\circ}$ C to +40 $^{\circ}$ C with ink roller.

Input connector: amphenol 57-40500-375, HP Part No. 1251-0087, 50-pin female. Mating input cable connector: amphenol type 57-30500-375, HP Part No. 1251-0086, 50-pin male.

Front panel controls: power switch, power on indicator light, manual print pushbutton, manual paper advance pushbutton, out-of-paper light, standby/operate switch. (Paper loaded from front.)

Power: 115 or 230 V \pm 10%, 60 or 50 Hz (two-speed motor pulley incorporated), approximately 25 W idle, 55 W at 10 lines/sec.

Dimensions: cabinet: 203 mm \times 154 mm \times 406 mm (8" wide, 6 $\frac{1}{2}$ " high, 16" deep)

Weight: Net, 10 kg (18.5 lb) (approximately); shipping, 8.9 kg (22 lb) (approximately).

Operating supplies/accessories:

Price

9260-0071 Ink roller (black)	\$15.60
9281-0386 Standard paper (250' pad)	\$2.15
9281-0387 Pressure sensitive paper (305' pad)	\$3.75
5060-0797 Rack adapter frame	\$27.00
10533A Interface Cable for 5300 series counters	\$155.00

Options

001: 50 Hz line operation no charge

002: 562A-16C input cable interconnects with 3450B, 3480C/D, 5326A/B/C, and 8443A \$65

5055A Digital Printer

\$1400

Supplied with Ink roller (9260-0071), one pad standard paper (9281-0386) and one pad pressure sensitive paper (9281-0387). Each pad provides two loadings of recorder.

Description

General

The Hewlett-Packard Model 5055A Digital Recorder provides a high-performance economical method of making permanent records of digital data. It prints up to 10 columns of data from 4-line BCD data sources at rates up to 10 lines/sec. Printing is asynchronous; i.e. the print cycle starts the instant the external print command is received and requires only 100 ms under any condition. The eight inch cabinet width allows for either bench use or side-by-side rack mounting, using the HP Adapter Frame, 5060-0797. The codes offered are \pm 8421, selectable by a rear panel switch. Each column has an individual print wheel with 16 characters—10 numeric and 6 non-numeric. Special wheels can be ordered at minimal cost. The 5055A is supplied complete for 10 columns of printed data and accepts TTL compatible integrated circuit logic levels. Leading zeros are suppressed when the printer is used with HP instruments which have blanking.

Reliability

Reliability is enhanced by design simplicity; i.e. there are an unusually small number of moving parts in the printer. The printer mechanism, manufactured by Hewlett-Packard, is a modified version of a mechanism whose reliability and serviceability has been demonstrated in other H-P printers for many years.

Ink or pressure sensitive printing

The 5055A prints in ink on regular paper or on pressure sensitive paper. For ink printing, the mechanism includes a continuously rotating ink roller—inherently more reliable than a start-stop ribbon mechanism. Paper loading is easy from the front, and when the paper runs out an alarm lamp lights and recording stops automatically. An output signal is provided for inhibiting the data source.

Versatile

Each column has an individual print wheel which can be changed independently of the other 9 wheels if a different character set is desired. This can apply to as many columns as desired. Special print wheels can be factory installed or may be field installed at a later date. Both can be done at a nominal cost.



RECORDERS & PRINTERS

Versatile 18-column BCD digital printer Model 5050B

- 20 lines/sec.
- Up to 18 columns of data
- 4-line \pm 8421, + 4221 BCD
- Storage option
- Ink or pressure sensitive printing

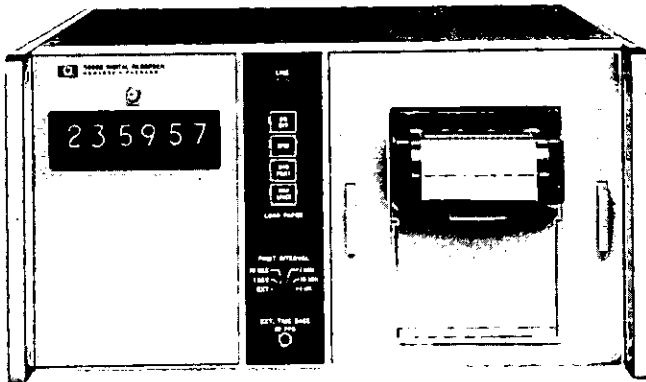

5050B, option 055

Description

Compatible

This recorder is compatible with a wide range of Hewlett-Packard solid state and integrated circuit instruments and a wide variety of other equipment. It prints up to 18 columns of 4 line BCD data from one or two sources up to 20 lines/sec.

Versatile

The user can easily change code to +8421, -8421, or +4221 by an inexpensive substitutable code disc, and can change print wheels to have a different code and/or character set in each column. Character suppression allows suppressing a character in each column.

Storage

An optional data storage feature is available at extra cost to reduce the time required to transfer data to the recorder. This means that the data source is inhibited for only about 0.1 ms out of a print cycle of 50 ms duration, compared to being inhibited during the complete print cycle without storage.

Specifications

Printing

Accuracy: identical to input device used.

Print cycle time: 50 ms.

Printing rate: 20 lines/second, max. (asynchronous)

Line spacing: adjustable, 3.5 to 4.5 lines/inch

Printing: ink roller or pressure sensitive paper.

Pressure sensitive paper is recommended for operation under extreme temperatures.

Print wheels: 16 positions, numerals 0 through 9, -, +, Z, V, Ω , *; special wheels available at minimal cost.

Electrical

Input requirements without data storage: parallel entry, BCD (\pm 8421, +4221), "1" state must differ from "0" state by >4.5 V but <75 V.

Input requirements with data storage: parallel entry, BCD, "1" state must differ from "0" state by >1.3 V but <35 V. Input drive ≥ 100 μ A. Data must be on lines when print command occurs and remain until release of holdoff (85 μ s after print command).

Transfer time: 50 ms without storage, 0.1 mx with storage.

General

Operating temperature: -20°C to $+55^{\circ}\text{C}$ with pressure sensitive paper, $+10^{\circ}\text{C}$ to $+40^{\circ}\text{C}$ with ink roller.

Power: 115 or 230 V $\pm 10\%$, 50 to 60 Hz, about 100 W idle, 190 W at 20 lines/sec. 50 Hz model with 20 prints/second also available.

Dimensions: cabinet: 426 mm \times 226 mm \times 467 mm (16 $\frac{1}{4}$ " wide, 8 $\frac{1}{2}$ " high, 18 $\frac{3}{8}$ " deep). Rack mount hardware supplied.

Weight: Net, 18 kg (40 lb), shipping, 24 kg (53 lb)

Option 055 clock for 5050B printer

General: The Option 005 Clock provides a compact, convenient and versatile method for recording time—with 0.1 second resolution—along with other data measurements being recorded by the 5050B Printer. In addition Option 055 serves as an automatic measuring-recording system programmer by allowing printing at preselected time intervals.

High resolution: Easy to read display tubes indicate time to 23 hours, 59 minutes, 59 seconds. In the printout there is a seventh digit available for indicating tenths of a second.

Specifications

Time base: Selectable to be 50 Hz, 60 Hz or external. External requires 10 pps negative pulse.

Print interval:

Internal: selectable to be 1s, 10s, 1 min., 10 min., or 1 hour between prints.

External: rates up to 20 prints per second.

Time of measurement accuracy: time recorded may be 0.1s less than correct time \pm line accuracy.

Visual indication: 6 in-line digital display tubes indicate to 23 hours, 59 minutes, 59 seconds.

Printed output: seven digits indicate to 23 hours, 59 min., 59.9s.

BCD output code: +8421 or -8421 selectable. Output adaptable to other recorder codes.

Print format: time printable in any recorder column.

Clock set: 4 switches electronically set clock to desired initial time.

Power: 115 V or 230 V $\pm 10\%$. 50 Hz or 60 Hz.

Weight: net, 1.4 kg (3 lb)

Operating supplies:

9281-0386 Standard paper (1 pad)

9281-0387 Pressure sensitive paper (1 pad)

Price

\$2.15

\$3.75

Options

001: 8421 "1" state positive code disc

no charge

002: 8421 "1" state negative code disc

no charge

003: 4221 "1" state positive code disc

no charge

All three code discs are supplied with each 5050B at no charge. However, one of the above options must be specified so the 5050B can be delivered with the desired disc installed.

010: 50 Hz operation

add \$15

015: Motor Control

add \$80

020: Column Boards (one required, in addition to basic instrument, for each two columns to be operated)

add \$130 ea.

032: Input cable, one per data source

add \$65 ea.

035: Input cable, one per IC counter

add \$80 ea.

037: Input cable, to 5360A

add \$80 ea.

050: Storage for 20 columns

\$415

051: Storage for 10 columns

add \$210

055: Clock (factory installed)

add \$980

(Price of kit for field installation available on request.)

081: Package for 5360A

add \$1535

5050B Digital Printer

\$2,150

ELECTRONIC COUNTERS



General information



Introduction

The digital electronic frequency counter has come a long way since the first versions appeared over two decades ago. Once the luxury of large metrology labs and some crystal manufacturers, the frequency counter is now common-place in laboratories, on production lines, as a service tool and in automatic instrumentation systems. Moreover, counters have become increasingly more versatile and more powerful in the measurements they perform, thereby finding much wider applications. When Hewlett-Packard introduced the 524A in 1952 it was considered a milestone; the counter could measure frequencies up to 10 MHz, or the time between two electrical events to a resolution of one ten millionth of a second, 100 ns. Twenty years later, HP's product line features counters that can measure the frequency of a 10 mV signal at 18 GHz completely automatically, or can resolve time to one ten billionth of a second (100 psec), the same time it takes light to travel one inch!

Basic counter measurements

The basic measurements which counters are capable of performing are described in this section.

Frequency

This fundamental measurement is per-

formed by totalizing the number of input cycles or events for a precisely known period of time. The total count that results is proportional to the unknown frequency, and logic circuits internal to the counter position the decimal point such that the display directly indicates the input frequency. The time reference is usually derived from a precision quartz oscillator internal to the counter.

Using this basic technique allows measurements to 500 MHz to be made. Several methods are available, however, to extend this frequency range to 18 GHz and more. These are described in more detail below.

Period

The inverse of frequency, this capability is sometimes offered to provide the user with high resolution, low frequency measurements. In digital systems a period measurement represents the average bit to bit time of the input signal.

Totalize

This measurement is similar to frequency except that the user now controls the time over which the measurement takes place. With digital systems becoming more prevalent, this fundamental measurement assumes considerable importance. The HP 5345A, with its ability to totalize at a 500 megabit

rate, represents the state of the art at this time.

Ratio

The ratio between two input frequencies is a measurement that is also offered by some counters. The major application for ratio is measurement of harmonically related signals.

Scaling

Some counters offer the capability of providing a digital output signal whose frequency is a scaled or divided version of the input frequency.

Time Interval

The measurement of the time between two events or the time between two points on a common event, commonly referred to as time interval, is of major importance and is used in a wide variety of applications.

The 2 nanosecond single shot measurement resolution of the HP 5345A represents today's state of the art. Utilizing an analog interpolation scheme, however, allows the HP 5360A Computing Counter to obtain a 100 picosecond resolution. HP also pioneered the concept of time interval averaging, whereby for repetitive inputs substantial improvement in resolution over the single shot measurement can be obtained. Time interval averaging is offered in four HP counters (5345; 5326A/B; 5327A/B and 5308A).

Application Note 172: The Fundamentals of Electronic Frequency Counters

This forty-four page application note describes in detail the measurements mentioned above. In addition, the key considerations in making frequency and time measurements, plus the major characteristics required of a counter for certain applications are also described. For those readers who require more than the brief resumé above, this application note is available on request at any Hewlett-Packard sales office.

The contents of application note 172 are as follows:

Introduction

Fundamentals of Electronic Counters

More About the Basic Frequency Counter

Input Considerations

Oscillator Characteristics

Sources of Measurement Error

Prescaling — Increasing the Frequency Response

Normalizing and Preset Counters

Period Measuring Frequency Counters

Time Interval

Input Considerations

Trigger Level

Measurement Accuracy

Increasing Accuracy and Resolution

Microwave Frequency Measurements

Heterodyne Conversion

Transfer Oscillator

Some Examples of Component Technology

The major types of electronic counters

While counters can potentially offer all the measurement capabilities described above, they essentially fall into three classes: microwave, universal and frequency counters. These are described below.

Frequency counters

These counters offer the basic capability of

Table 1. Frequency counters summary

Model No.	Frequency Range	Number of Digits	Time Base	Other Functions*
5300A/5301A	10 MHz	6	3×10^{-7}	T
5326C	50 MHz	7	3×10^{-7}	MPA, T, R
5381A	80 MHz	7	3×10^{-7}	
5382A	225 MHz	8	3×10^{-7}	
5300A/5303B	500 MHz	6	3×10^{-7}	
5327C	550 MHz	7	3×10^{-7}	MPA, T, R
5300A/5305A	1100 MHz	6	3×10^{-7}	
5341A, Op. 003	1500 MHz	10	1×10^{-7}	
5341A	4500 MHz	10	1×10^{-7}	
5340A	18000 MHz	8	3×10^{-7}	

*See legend on page 251.

Table 2. Universal counter summary

Model No.	Frequency Range	Time Interval Resolution		Time Base	Other Functions*
		Single Shot	Averaging		
5300A/5304A	10 MHz	100 nsec	—	3×10^{-7} per Month	P, MPA, T, R
5300A/5302A	50 MHz	100 nsec	—	3×10^{-7} per Month	MPA, T, R
5326A/5326B	50 MHz	100 nsec	50 psec	3×10^{-7} per Month	P, MPA, T, R, V
5300A/5308A	75 MHz	100 nsec	100 psec	3×10^{-7} per Month	P, MPA, T, R
5345A	500 MHz	2 nsec	2 psec	5×10^{-10} per Day	P, MPA, T, R
5327A/5327B	550 MHz	100 nsec	50 psec	3×10^{-7} per Month	P, MPA, T, R, V

*See legend on page 251

frequency measurement and in addition sometimes provide some or all of the other measurements described above except time interval. HP has a wide range of counters that fall into this class including: a) the 5380 low cost bench series, a family of two counters featuring 80 MHz-7 digit and 225 MHz-8 digit instruments; b) the 5300 portable, battery operated snap-on series with the 5303B snap-on covering 525 MHz and the 5305A 1100 MHz counter; and c) the 5326C 50 MHz and 5327C 550 MHz rack-mounted high stability programmable instruments.

Universal counters

These instruments provide time interval capability in addition to the other measurements provided by the frequency counter. The 5302A snap-on is a perfect example of such an instrument featuring 50 MHz frequency, 100 nsec time interval plus period, ratio and totalize. Another member of the same family, the 5308A is ideally suited as a general purpose bench instrument, for in addition to the 5302A capabilities the 5308A offers time interval averaging, totalizing (with electronic start, and stop) and frequency to 75 MHz. The 5304A snap-on is especially oriented towards time interval featuring adjustable hold off. The 5326A/B (50 MHz) and 5327A/B (550 MHz) are precision rack-

mounted programmable instruments with useable time interval resolutions to 50 psec via averaging. Finally, the 5345A offers a 500 MHz bandwidth, with totalizing, ratio and period capability to this speed (50 psec), plus 2 nsec single shot time interval and 2 psec time interval averaging! This extremely powerful instrument features plug-in flexibility (see page 252), and a reciprocal frequency measurement mode (see below).

Microwave counters

As Application Note 172 describes, the two techniques of microwave measurement, heterodyne and transfer, each offer their own advantages; with the former having higher resolution per unit measurement time and better FM tolerance, and the latter having a wider frequency range and better sensitivity. The 5354A 4 GHz heterodyne converter is a plug-in to the 5345A and features extremely high resolution, wideband FM tolerance and the ability to measure pulsed RF for pulse widths down to 50 nsecs. The 5341A is also a heterodyne type microwave counter with 4.5 GHz frequency range. Conversely the 5340A is a transfer type counter that can measure frequency from 10 Hz to 18 GHz via a single input at -35 dBm sensitivity! In fact the H10-5340A is guaranteed to 23 GHz at -15 dBm sensitivity.

Table 3. Microwave counter summary

Model No.	Frequency Range	Technique	Time Base	Sensitivity	Number of Digits
5354A*	4 GHz	Auto Heterodyne	5×10^{-10} per Day	-10 dBm	11
5341A	4.5 GHz	Auto Heterodyne	1×10^{-7} per Month	-20 dBm	10
5254C/5255A/5256A**	to 18 GHz	Manual Heterodyne	3×10^{-9} per Day	-13 dBm	8
5257A**	18 GHz	Manual Transfer Osc	3×10^{-9} per Day	-7 dBm	8
5340A	18 GHz	Auto Transfer Osc	3×10^{-7} per Month	-35 dBm	8

*Plug-In to 5345A Counter **Plug-In to 5245 Series Counters

A special class of frequency counters, referred to as reciprocal counters, are also available from Hewlett-Packard. The distinction between these and conventional counters is that the latter provides 1 Hz resolution in one second, whereas the resolution of the reciprocal counter is proportional to the frequency of the internal counted clock. The four instruments available are summarized in Table 4 below. Note that both the 5360A and 5345A are plug-in instruments and hence the high mainframe resolving power offered by both apply to any of the compatible plug-ins. These two instruments also have pulsed RF measurement capability via an externally "triggered" mode. In addition the 5345A includes a unique frequency averaging mode that allows high resolution measurements on repetitive pulses even if pulse width is 50 nsecs.

HP Interface bus

The more recently introduced counters (and other HP digital instruments) have a digital input/output structure which is compatible with the interface bus developed by HP. This commonality of digital I/O greatly facilitates instrument interconnect. For example, the 59310A I/O Card interfaces any compatible instrument to the HP 2100 series computers and, in fact, fifteen such instru-

ments can be connected through the one I/O card. Some HP calculators are also compatible with the bus and this greatly facilitates real time data reduction and control as well as expanding the capabilities of the individual instruments. Kits are available which allow the user to interface the individual instruments to the HP 9820/21 series of calculators. At this time compatible instruments are the 5345A, 5340A, 5341A and 5312A (for 5300B system).

Table 4. Reciprocal frequency counters

Model No.	Frequency Range	Measurement Resolution	Number of Digits	Time Base	Sensitivity
5300A/5307A	2 MHz	3×10^{-5}	6	3×10^{-7} per Month	10 mV rms
5323A	20 MHz	1×10^{-7}	7	3×10^{-7} per Month	100 mV rms
5360A/5365A	320 MHz	5×10^{-10}	12	5×10^{-10} per Day	20 mV rms
5345A	500 MHz	2×10^{-9}	11	5×10^{-10} per Day	10 mV rms

Table 5. Counter selection guide

Classification	Description	Frequency	Functions*	Time Base	Price	Page
5381A & 5382A Low Cost	Traditional HP quality and reliability at new low prices.	To 220 MHz	F	3×10^{-6} /Mo. Optional 1×10^{-7} /Mo.	From \$249	269
5300 Series Economic Portable	Select from 8 plug-ons to meet present needs. Move up in functions or frequency range when needed. Battery pack and D to A converter extend versatility.	To 1100 MHz	F, P, MPA, TI, TI AVG, T, R, V	3×10^{-7} /Mo. Optional 1×10^{-7} /Mo.	From \$560	270
5326/27 Series Universal Counters	A family of six universal counters that can include sub nanosecond time interval averaging, a built in DVM, burst frequency measurements and systems options.	To 550 MHz	F, P, MPA, TI, TI AVG, T, R, V	3×10^{-7} /Mo. Optional to 1.5×10^{-8} /Mo.	From \$1250	264
5245 Series General Purpose Plug-in Counters	A family of 5 mainframes and 12 plug-ins provide unmatched versatility. Plug-ins provide up to 18 GHz frequency, 10 nsec time interval, voltage and preset capabilities.	To 18 GHz	F, P, MPA, TI T,R,V	Optional to 1.5×10^{-8} /Mo.	From \$2350	258
5345 Series High Performance Plug-in Counters	A new series of high performance mainframe and plug-ins, providing 500 MHz direct count, 2 nsec time interval, and 4 GHz automatic pulsed RF measurements.	To 18 GHz	F, P, MPA, TI, TI AVG, T, R	1.5×10^{-8} /Mo.	From \$3450	252
5340 & 5341 Automatic Counters	Broad band, high sensitivity, microwave frequency measurements 1 Hz — 4.5 GHz and 1 Hz — 23 GHz.	To 23 GHz	F	Optional to 1.5×10^{-8} /Mo.	From \$3500	262
5360 Computing Systems	Most accurate frequency measurements available plus time interval measurements to 100 psecs.	To 18 GHz	F, P, MPA, TI	1.5×10^{-8} /Mo.	From \$6695	261
Miscellaneous	5210A 20 MHz Analog Frequency Meter & FM discrimination. 5323A 20 MHz High Resolution Frequency Counter. 5330A/B Programmable Preset Timebase & Preset Limit Counter.				\$ 905 \$1850 \$1800	279

***Legend for Functions**

- F = Frequency
- P = Period
- MPA = Multiple Period Average
- TI = Time Interval
- TI AVG = Time Interval Average
- T = Totalize
- R = Ratio
- V = Voltage

ELECTRONIC COUNTERS

500 MHz plug-in counter

Model 5345A

NEW

- 500 MHz Direct Counting
- 10 mv Sensitivity DC to 500 MHz
- 2 nsec Single Shot T.I. Resolution

- Averaging to 2 psec resolution
- Pulsed RF and Microwave Measurements
- Programmable for systems applications via HPIB

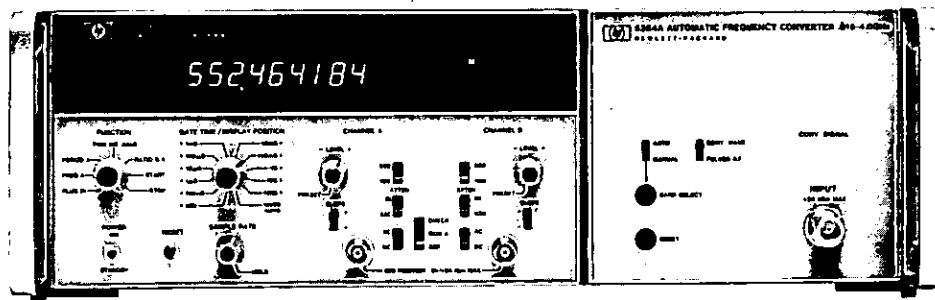

The 5345A Electronic Counter represents the most advanced general purpose instrument in the Hewlett-Packard Counter Product line. Utilizing state of the art monolithic bipolar integrated circuit technology especially designed and manufactured at Hewlett-Packard, this instrument provides unsurpassed power, versatility and flexibility in frequency and time measurements.

Major mainframe features

Frequency: direct from DC to 500 MHz - Reciprocal technique provides high measurement resolution

Time interval: resolution of 2 nsec single shot.

Averaging: New modulated clock technique gives true averages under all conditions. T.I. resolution extended to 2 psec. Frequency averaging improves RF pulse measurements similarly.

Totalize: to 500 megabit rate on both A and B inputs A \pm B functions also available

Ratio: from DC to 500 MHz on both inputs

Fully programmable: Provides great flexibility when used with calculators and computers

Plug-in versatility: Two plug-ins presently available (see page 254) with an on-going R&D program to extend this number. In addition the 10590A plug-in adapter allows all the existing 5245 plug-ins to be used.

Signal input circuits

Signal conditioning: Fully optimized front end includes switchable

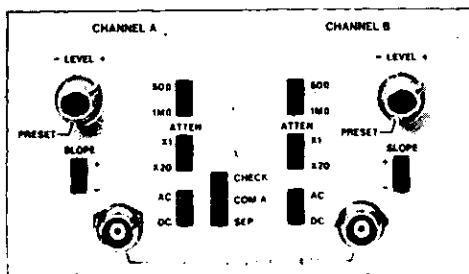

Figure (1) Input Switches

50 Ω /1M Ω input impedances, DC/AC coupling, and slope selection that assures triggering on any waveform.

Sensitivity, dynamic range: Highly sensitive wideband amplifiers

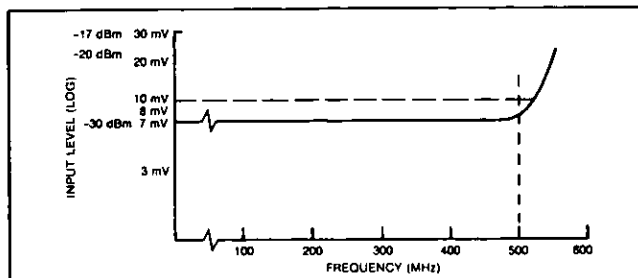

Figure (2) Typical Amplifier Sensitivity

assure measurements on even the lowest level sinusoidal and digital signals. The inputs also feature an extremely wide linear dynamic range of ± 0.5 V that greatly increases measurement versatility, especially on digital input signals.

Frequency measurements

Reciprocal capability: One of the advantages of measuring period

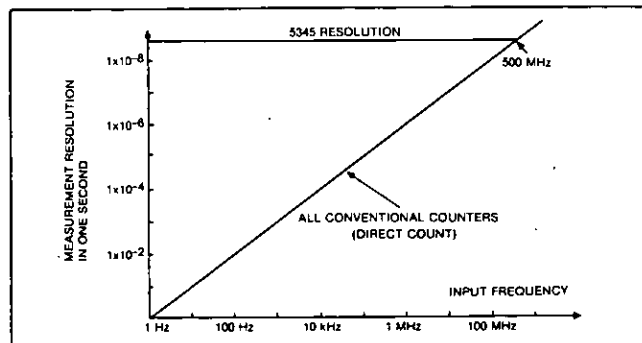

Figure (3) Measurement Resolution

and computing the frequency is that measurement resolution is independent of input frequency and at the maximum to which the instrument is capable of resolving. Thus for example, a 1 MHz input can be resolved to 2×10^{-9} (= .002 Hz) in one second, whereas the conventional counter provides 1 Hz resolution, some 500 times less.

Measurement speed

Mode of Operation	Readings per Second
Normal Operation (Max sample rate)	10
Externally armed	500
Externally gated	500
Computer dump	5,000

The extremely high resolution obtained in one second can be traded for measurement speed. For example a 100 μ sec gate time provides a resolution of 2×10^{-3} yet the measurements can now be made 5000 times a second, thus making the 5345A an invaluable tool in high speed data acquisition systems.

Ext. gate capability: Via the rear panel gate control input; this capability allows the operator to determine at what point in real time and for how long the measurement is to be made. This capability essentially replaces the front panel "sample rate" and "gate time" controls.

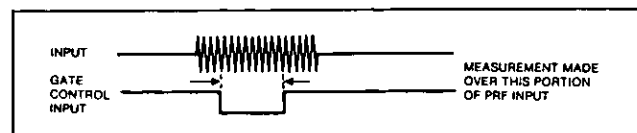

Figure (4) External Gate Control

The major application is in the measurement of pulsed RF signals. **Frequency averaging:** The minimum pulse width for which the input frequency can be measured is 50 nsecs. The single shot measurement resolution is 2×10^{-9} divided by the GATE TIME. This resolution can be improved up to 1000 times by a unique mode of operation known as frequency averaging that is built into the mainframe. The only requirement being that the signal is repetitive.

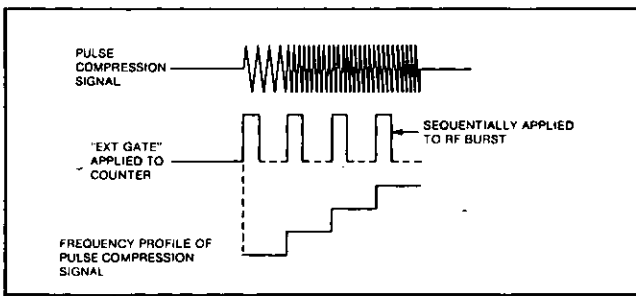

Figure (5) Frequency Averaging to Increase Resolution

In addition to greatly enhancing narrow pulse measurement capability, the frequency averaging mode also allows higher resolution on pulse profile measurements.

Time interval

Precision measurement: The single shot time interval measurement resolution of the 5345A is 2 nsecs, which is the time it takes light to travel approximately 2 feet—the 5345A is an extremely high resolving time measuring device.

Trigger level: Quantitative high speed time interval measurements are provided by the 5345A since the user can simply determine where triggering occurs even on complex waveforms. The method of determination involves measuring the DC levels at which triggering occurs. These DC levels are available at rear panel BNC's.

The ability to determine trigger level, together with the high sensitivity and wide dynamic range of the inputs greatly enhances the versatility and power of the 5345A in time interval measurements.

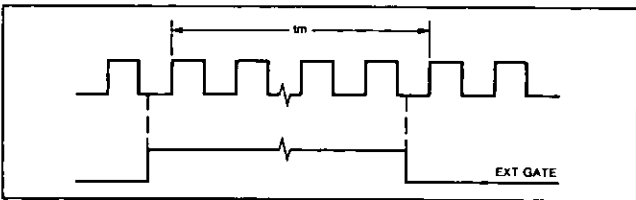

Figure (6) Using EXT GATE to Measure TM

Ext. gate capability: External gating adds even more versatility to the time interval measurements of the 5345A, as measurements such as that shown in figure (6) indicate.

Time interval averaging: For repetitive inputs a successive number of measurements may be automatically averaged by the 5345A, obtaining up to 1000 times improvement in resolution (2 psecs). This averaging mode may be used irrespective of whether the instrument is in the conventional or ext. gate mode of operation.

Totalize

High speed: The 5345A has the ability to totalize to a 500 megabit

rate through either or both A and B inputs. Coupled with the high sensitivity and full signal conditioning of both channels, this capability enables measurements to be made on most modern digital systems.

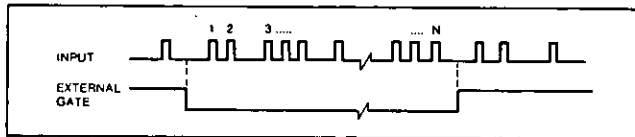

Figure (7) Selecting a Portion of a Pulse Train

Ext. gate capability: Using the external gated mode allows the user to select only the desired portion of the input pulse train for measurement.

A ± B modes

The A - B mode is used for comparison tests between high speed reference and test signals applied to the two mainframe inputs.

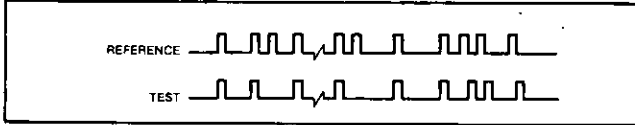

Figure (8) Comparison Measurements

Any difference between the total number of events accumulated in each channel is indicated by the 5345A display after the measurement is completed.

The primary application for the A + B mode is in the measurement of NRZ signals. By setting the "A" trigger slope to "+" and the B slope to "-" allows all transitions and hence bits of the NRZ signal to be counted. Thus 1 gigabit NRZ waveforms can be measured.

This mode of operation does not introduce any limitations—maximum input rate is 500 megabits on either channel and external gating may be used.

Ratio

This measurement represents the ratio of the number of events occurring through channel B divided by the number occurring through channel A. The major features are: a) that the measurement or comparison between the two signals occurs during the same real time duration (similar to the A ± B totalize modes); and, b) the frequency or bit rate of either channel can vary from DC to 500 MHz. These features allow this measurement to be extremely useful in digital systems and synthesizer check out.

Digital I/O

Option 011 provides complete digital input-output capability (except slope and level control) to the 5345A. Digital output is a bit parallel, byte serial ASCII coded format and the I/O structure conforms to the Hewlett-Packard Interface Bus (HP-IB) standard. This option is particularly recommended for a bench top calculator controlled environment.

Option 012 is similar to Option 011, but includes programmable control of slope and level. Option 012 is recommended for a computer controlled environment.

The model 59310A Interface Kit provides a complete operational package for use with the HP 2100 Series Computers. Similarly, other interface kits allow the user to interface the 5345A Option 011 or 012 and other HP-IB compatible devices to the 9820, 9821 and 9830 Series HP Calculators. This powerful calculator counter combination is described in more detail on page 256.

Model 5345 (cont.)

NEW

5345A Condensed specifications

Frequency/period measurements

Range: 0.0005 Hz to 500 MHz

Accuracy: $\frac{\pm 2 \times 10^{-9}}{\text{gate time}} \pm \text{trigger error}^* \pm \text{time base error}$

Gate time: 1000 seconds to 100 nanoseconds in decade steps; plus MIN setting, which equals one period of the input signal or 10 nsecs, whichever is greater.

Time interval/time interval average

Range: 10 nsec to 20,000 sec

Minimum time between trigger points: 10 nsec

Trigger pulse width: 1 nsec minimum width input at minimum voltage input

Accuracy:

Time interval: $\pm \text{trigger error}^{**} \pm 2 \text{ ns} \pm \text{time base error}$

Time interval averaging:

 $\pm \frac{\text{trigger error}^{**} \cdot 2 \text{ nsec}}{\sqrt{\text{intervals averaged}}} \pm 0.7 \text{ nsec} \pm \text{time base accuracy}$
not affected by harmonics of clock frequency.

Resolution:

Time interval: 2 nsec

Time interval average:

 $\pm \frac{2 \text{ nsec}}{\sqrt{\text{intervals averaged}}} \pm 2 \text{ picoseconds}$ *Trigger error is $< (\pm 0.3\% \text{ of one period} \div \text{number of periods averaged})$ for signals with 40 dB or better signal-to-noise ratio.

**For any wave shape, trigger error is less than

 $\pm \frac{0.0025 \mu\text{s}}{\text{Signal Slope (V/\mu s)}}$

Ratio B/A

Range: Both channels accept dc to 500 MHz

Accuracy: $\pm \text{L.S.D.} \pm \text{trigger error}^*$

Start/stop

Range: Both inputs dc to 500 MHz

Modes: A, A \pm B determined by rear panel switch

Scaling

Range: dc to 500 MHz

Scaling factor: Selectable by GATE TIME setting. Scaling factor equals GATE TIME setting/ 10^{-9} seconds.

Input: Input signal through channel A

Output: Output frequency equals input frequency divided by scaling factor. Rear panel BNC supplies 80% duty cycle TTL compatible pulses.

Input channels A and B

Range: 0 to 500 MHz dc coupled 50 Ω and 1 M Ω ; 4 MHz to 500 MHz ac coupled, 50 Ω ; 200 Hz to 500 MHz ac coupled, 1 M Ω Impedance: Selectable, 1 M Ω shunted by less than 30 pF or 50 Ω (nominal).

Sensitivity: X1, 10 mV rms sine wave and 30 mV peak-to-peak pulse. X20, 200 mV rms sine wave and 600 mV peak-to-peak pulse

Dynamic range: $\pm 0.5 \text{ V}$ times attenuator setting

Trigger level: Continuously adjustable to more than cover the DYNAMIC RANGE

Output: Rear panel BNC connectors bring out CHAN A TRIG LEVEL and CHAN B TRIG LEVEL for convenient DVM monitoring. Accurate to $\pm 15 \text{ mV}$

Common input

In this mode the signal is applied to channel A

Range: ac coupled 50 Ω , 4 MHz to 500 MHz; ac coupled 1 M Ω , 300 Hz to 500 MHzImpedance: 50 Ω remains 50 Ω ; 1 M Ω becomes 500 k Ω shunted by 60 pFSensitivity: 50 Ω : 20 mV rms; 1 M Ω : No changeDynamic range: 50 Ω $\pm 1.0 \text{ V}$ times attenuator setting. 1 M Ω : No change.

General

Display: 11 digit LED display and sign. Annunciator displays ksec to nsec, k to n, μHz to GHz. Decimal point is positioned with DISPLAY POSITION control or positioned after the first, second or third most significant digit if DISPLAY POSITION is in AUTO. Leading zeros are suppressed.

Overflow: Asterisk is illuminated when display is overflowed

Sample rate: Continuously variable from $< 0.1 \text{ sec}$ to $> 5 \text{ sec}$ with front panel control. In HOLD position the last reading is maintained until the counter is reset.External arm input: Counter can be armed by a -1.0 V signal applied to the rear panel 50 Ω input.

External gate input: Same conditions as for EXT ARM

Gate Output: $> 1 \text{ volt}$ into 50 Ω

Time base

Standard high stability time base: Crystal Frequency, 10 MHz (10544A)

Stability:

Aging rate: $< 5 \times 10^{-10}$ per dayShort term: $< 1 \times 10^{-11}$ for 1 sec averageTemperature: $< 3 \times 10^{-9}$, 0°C to 55°C

Option 001: Crystal Frequency, 10 MHz

Stability:

Aging rate: $< 3 \times 10^{-7}$ per monthShort term: $< 2 \times 10^{-9}$ rms for 1 secTemperature: $< 7 \times 10^{-9}$, 0°C to 55°C $< 5 \times 10^{-9}$, 0°C to 55°C Line voltage: $< 1 \times 10^{-8}$, $\pm 10\%$ from nominal

Self test: A 100 MHz signal is internally applied

External frequency standard input: Input voltage $> 1.0 \text{ V}$ rms into 1 k Ω required from source of 1, 2, 2.5, 5, or 10 MHz $\pm 5.0 \times 10^{-8}$. Input can be sine or square wave.Frequency Standard Output: $> 1 \text{ V}$ rms into 50 Ω at 10.0 MHz sine wave. All non-harmonics and spurs down 80 dBOperating temperature: 0°C to 55°C Power requirements: 115 or 230 V rms $\pm 10\%$ 48 to 66 Hz, maximum power 200 watts

Weight: 17 kg (37 lb)

Model number and name

5345A Plug-In Counter

Option 001: Room Temperature Time Base

Option 002: Same as 5345A but with no input amplifiers. Signal must be applied through plug-in

Option 010: Digital output only. HP Interface Bus format, talk only. Useful with 59301A ASCII-to-Parallel Converter and 5050B or 5055A Digital Printers.

Option 011: Digital Input/Output same as Option 010. Compatible with HP Interface Bus and allows 5345A to be remotely programmed.

Option 012: Computer Digital I/O similar to Option 011. Includes slope and level control.

Accessories Available

K13-59992A: Includes state machine tester as an aid for trouble-shooting the arithmetic processor.

10595A Board extender kit: Useful for trouble-shooting plug-in boards while in operation.

10597A Replacement board kit

10590A Plug-in adapter: Adapts 5245 series plug-ins to 5345. See page 255.

Reference Literature Available:

HP Journal, Vol. 25-10, June 1-74

AN 173 Recent Advances in Pulsed Microwave Measurements

AN 174A Series of Application Notes on Counter/Calculator Applications

Price

\$3450

less \$400

less \$350

\$125

\$800

\$1450

\$2100

\$230

\$2900

\$375

- Fully automatic to 4 GHz
- Pulse measurements
- Frequency averaging

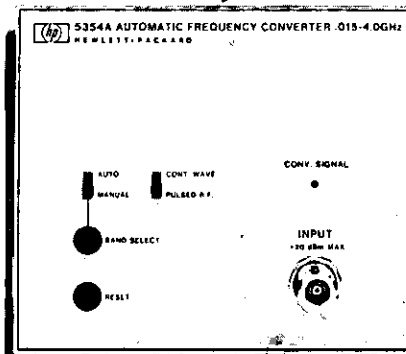

5354A

5354A Automatic frequency converter

The 5354A translates not only the microwave signal but all its modulation directly to the 500 MHz window of the counter (via the heterodyne technique) it allows signals with a large amount of FM to be easily characterized.

Perhaps even more powerful is its ability to take direct measurements on the carriers of very narrow microwave pulses. Pulse measurements can be easily automated for the first time.

Range: 15 MHz to 4 GHz

Sensitivity: -10 dBm (70 mV rms) to +20 dBm (2.2 V rms)

Input signal capability: CW signals. Pulsed microwave signals. Signals with very high FM content.

RF Pulse width: Determined by counter GATE TIME setting

FM Sensitivity: Overlap at band edges ± 10 MHz

Maximum deviation at band center

± 250 MHz, above 1 GHz and below 500 MHz

± 125 MHz, between 500 MHz and 1 GHz

Operating modes: Automatic and Manual

Automatic: Measures lowest frequency signal of sufficient amplitude to trigger counter.

Manual: Measures signal within selected band. Signals of sufficient amplitude between 15 MHz and 525 MHz will also be counted.

Acquisition time:

Automatic mode: CONT, WAVE, $< 160 \mu\text{sec}$; PULSED R.F., < 1 sec.

Manual mode: When proper band has been selected CONT. WAVE $< 5 \mu\text{sec}$; PULSED R.F. < 20 nsec.

Price: \$1950

Option 011: Remote control via HP Interface Bus and L.O. ± 1 F.

Price: \$200

- Count a group of events between A and B
- Frequency sum and difference measurements

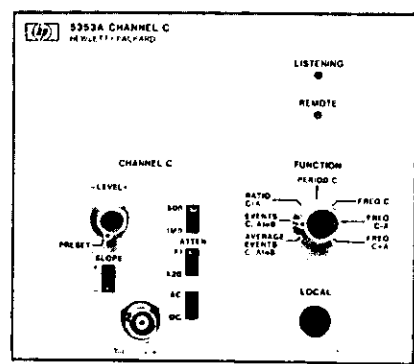

5353A

5353A Channel C plug-in

The 5353A Channel C Plug-In consists of a third input to the 5345A Counter. When the plug-in counting capability is combined with the mainframe gating capability suddenly it becomes quite easy to make frequency sum and frequency difference measurements.

For high speed digital applications, the greatest benefit the plug-in offers is the ability to count a specific group of events while ignoring others. This measurement is required in many applications such as computer peripheral testing and digital communications systems. It is accomplished in the events C between A and B mode by applying a start signal to CHAN A and a stop signal to CHAN B while applying the data to be counted to CHAN C.

Range: dc coupled: 0 to 500 MHz; ac coupled: 10 MHz to 500 MHz

Impedance: 50 Ω (nominal), or 1 M Ω shunted by less than 30 pF

Sensitivity: Variable to 10 mV rms sine wave and 30 mV peak-to-peak pulse. Attenuator settings are X1 and X20.

Modes of operation: Frequency C & A; Frequency C - A; Period C; Frequency C; Ratio C/A; Average Events C, A to B; Events C, A to B.

Events accuracy: Plus or minus one count worst case

Price: \$850

Option 011: Digital Input. Full compatibility with HP Interface Bus. Provides for digital control over all functions excluding amplifier.

Price: \$250

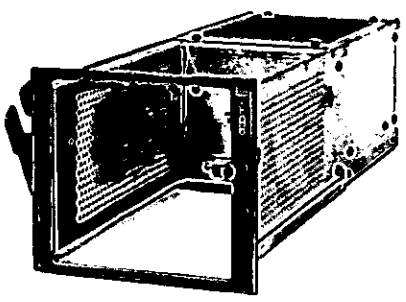

10590A

10590A Plug-in adapter

The 10590A allows the user to interface any of the 5245 series of plug-ins (except the 5264A) to the 5345A (see page 254 for details on these plug-ins). The major application is to extend the frequency range to 18 GHz via the 5255A, 5256A and 5257A plug-ins. In addition the adapter is "intelligent" in that it detects the plug-in being used and automatically adjusts the 5345 accordingly.

Price: \$375

ELECTRONIC COUNTERS

Accessory modules

59300A Series

- 9820A or 9821A Calculator
- Interface Cards and Cables
- Verification Software
- 9820A/21A/30A Calculator
- HP Interface Bus
- Instrument Capability Expansion

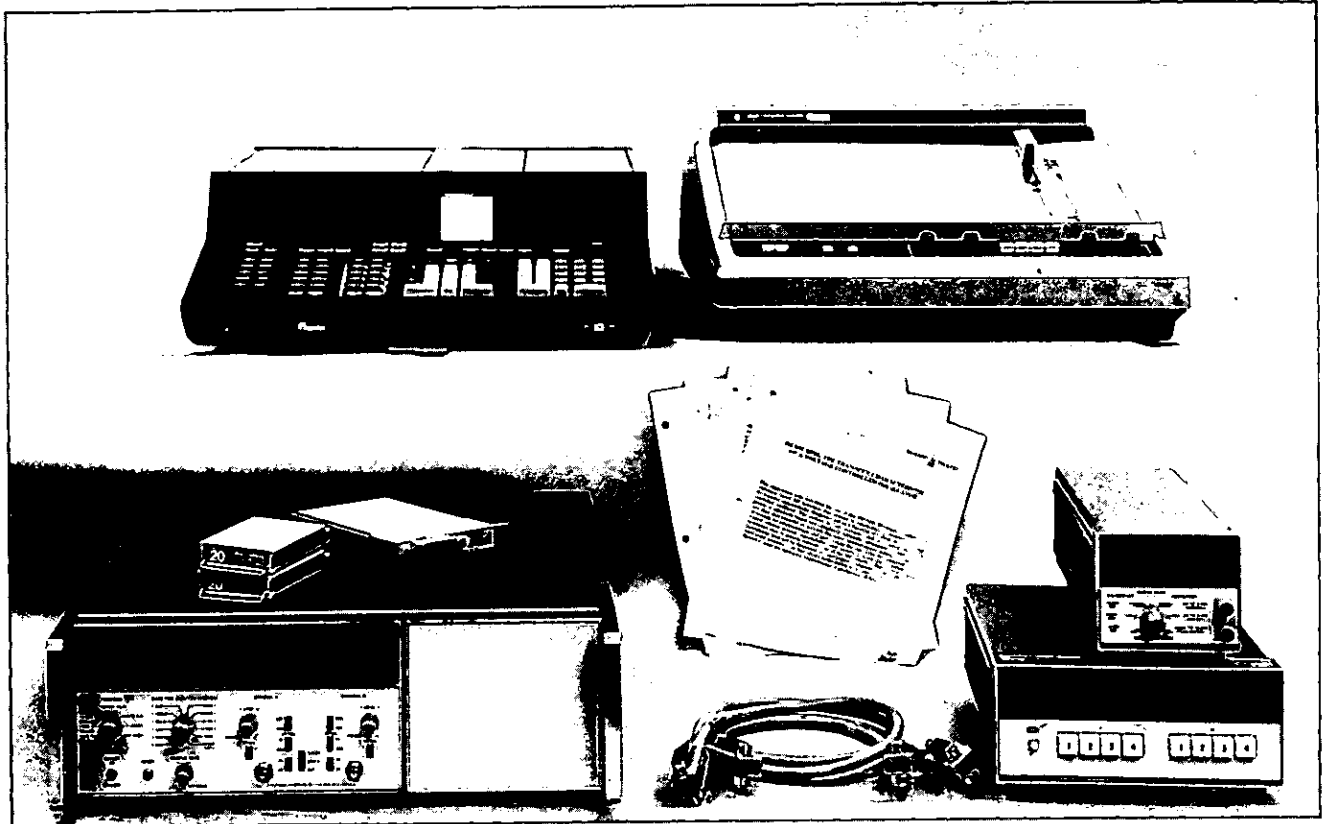

Benchtop System: 5345A Counter, 9821A Calculator, 9862A Calculator Plotter, and Modules

ASCII Programmable Modules

Modules in the HP 59300A Series are ideal building blocks for use with instruments such as the HP 5345A Counter Opt 011 to extend measurement capabilities. All modules can be interconnected via the Hewlett-Packard Interface Bus with compatible measuring instruments. The list of instruments which offer options providing HP Interface Bus compatibility is growing rapidly and includes multimeters and frequency synthesizers in addition to frequency counters (5345A, 5340A, 5300B).

The HP Interface Bus (HPIB) serves as a digital communications pathway for instruments and modules. Joined by the bus cables, they can talk and listen to each other to exchange data and commands. An addressing scheme organizes the flow. One device addressed to talk can direct messages to others addressed to listen.

The range of capability can be extended by including a powerful system controller such as the HP 9820A/21A/30A Calculator. For example, a counter can be joined with a calculator, a remote display, and input switches to make up a semi-automatic system that measures, reduces, and logs data.

Instrument requirements differ. Some only output or accept data on the HPIB. Others can be remotely programmed by ASCII characters sent along the HPIB. The Series 59300A Modules can work with instruments on any of these levels with or without a controller. Each module can be operated stand-alone from its front panel or can be placed in automatic operation under program control.

Module provision for stand-alone, local operation also has important system benefits. The operator can set up and check out the system under manual control, avoiding otherwise complex and time

consuming error tracing. Each module has status indicator lights that make it easy to monitor operation.

Hewlett-Packard has an ongoing program of application notes that help you gain maximum benefit from a benchtop system utilizing HPIB by providing complete solutions to a variety of measurement problems. For example, the photo shows equipment for making measurements on voltage controlled oscillators as described in Application Notes 174-1 through 174-4, measurements such as transfer characteristic, linearity, and tracking. Final data presentation is a plot complete with legends and measurement limits.

The Series 174 Application Notes come with a listing of the program for the 9820A/21A Calculator to operate the instrument group automatically under remote control. These measurements take full advantage of the 5345A Counter's state-of-the-art performance and extend its capabilities to automated set-ups that make otherwise difficult analysis tasks a simple matter to run and to interpret. Subjects covered include the determination of probability density functions; measuring fractional frequency deviation (short-term stability); FM peak-to-peak deviation; and precision crystal oscillator warm-up characteristics.

Modules in the 59300A Series are 4 inches high and a quarter or a half of full rack width. The instrument case is a new HP design. The front frame clamps rigidly to like units side by side or stacked for benchtop or rack use. The case is high strength, lightweight Marbon®. Brief descriptions of the modules are presented on the next page. Look them over. See how they can help you extend the capability of your measuring instruments.

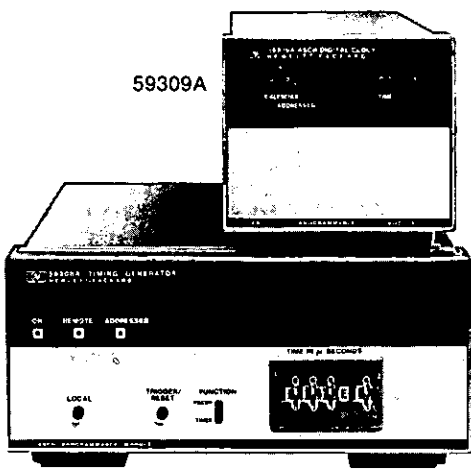

59309A

59308A

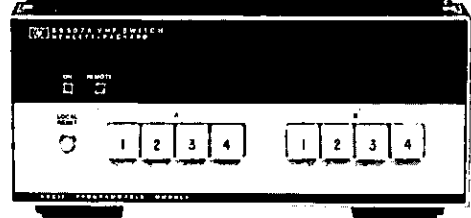
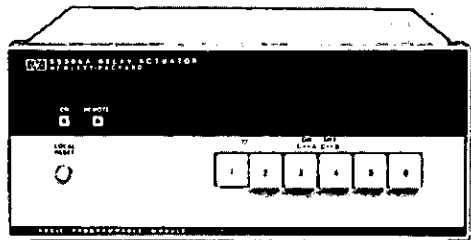

59306A(Top), 59307A

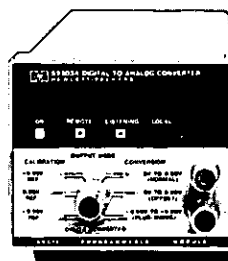

59303A

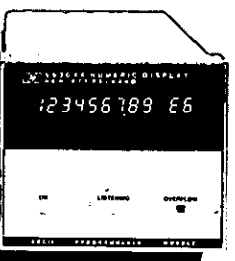

59304A

59309A ASCII digital clock, 59308A timing generator

This ASCII programmable timing family offers time-of-day and precision timed intervals over a wide range from sub-seconds to days. The clock and generator are independent of each other and can operate under program control or stand-alone. The 59309A ASCII Digital Clock displays month, day, hour, minute, and second; and upon command outputs time via the Interface Bus to logging devices. Time can be updated by remote command. The clock accepts a small internal battery to provide glitch-free power and more than a day's standby; alternatively, the clock operates up to a year on standby supplied by ordinary D-size batteries. The 59308A Timing Generator

provides pacing and timing signals output for remote use via the Interface Bus or on rear panel BNC's. Timed intervals can be selected by thumbwheels or can be programmed to have precise lengths from microseconds to minutes to more than a day. Accepts trigger inputs from front panel pushbutton, from rear panel connectors, or remotely via the Bus.

Rear panel BNC's output TTL and ECL levels with switch selection of square wave or pulse and of positive-going or negative-going edge. Output pulses are 500 ns ±100 ns wide, rise time 50 ns.

59307A VHF switch, 59306A relay actuator

These ASCII programmable relay boxes provide for switching signals into frequency counters for measurement (59307A) and for switching external devices (59306A). They operate from front panel pushbuttons or remotely via the Interface Bus. 59307A offers a pair of single throw 4-pole switches (dc to 500 MHz, 50 ohm) optimized for fast risetime (1 ns) pulse waveforms. 59306A is six Form-C relays spec'd to handle 0.5 amp and useful to control, say, microwave step attenuators. Switches light to indicate relay state; all relay contacts are accessible.

59304A Numeric display

Presents a highly visible readout of up to 12 characters and decimal point. Operates as an Interface Bus monitor displaying Bus traffic, or can be addressed to display, say, frequency readout or intermediate calculator results.

59303A Digital-to-analog converter

Accepts an ASCII string and converts any three consecutive digits to analog voltage accurate to 0.1% in 30 μs. Fully programmable via the Interface Bus or operates stand-alone from the front panel. Offers three output modes for conversion: normal, offset, or plus-minus (9.99 volts to -9.99 volts) to make it convenient for operating strip chart recorders.

The primary application for the HP 59303A is to present on a logging device the data points being taken with a frequency counter such as the HP 5345A Counter. No controller is required for operation. Compatible logging devices include strip chart recorders, X-Y plotters, and displays.

59301A ASCII-Parallel converter

The 59301A ASCII-Parallel Converter (not shown) accepts byte-serial ASCII characters on the HP Interface Bus and converts them to parallel output. A string of up to 16 characters terminated by linefeed is converted and placed upon the output lines; the linefeed character signals execution of a print command (strobe). With the 59301A, instruments with the HPIB interface can be operated with the 5050B/5055A Printers and their accessories. A switch selects output to be formatted as print format or hexadecimal format. Requires two output cables, HP Part No. 562-16C (not furnished).

Dimensions:

- Quarter width:** (59303, 04, 09) 105.9 mm (4.17 inches)
- Half width:** (59301, 06, 07, 08) 212.9 mm (8.38 inches)
- Depth (max):** 294.6 mm (11.6 inches)

Power requirements: 115 V or 230 V ±10%; 50 to 400 Hz; 15 VA Max.

Environmental: Operating Temperature, 0 to 50°C. Relative Humidity, to 95% at 40°C.

Ordering information: Included with each module, cable 10631A (3 ft) and power cord (229 cm, 7½ ft) with NEMA plug.

Model No.	Net Wt.	Shpg Wt.	Price
59301A	1.70 kg (3 lb 12 oz)	2.32 kg (5 lb 2 oz)	\$550
59303A	2.61 kg (5 lb 12 oz)	3.17 kg (7 lb)	\$850
59304A	1.23 kg (2 lb 11 oz)	1.58 kg (3 lb 8 oz)	\$650
59306A	2.64 kg (5 lb 13 oz)	3.23 kg (7 lb 2 oz)	\$650
59307A	2.64 kg (5 lb 13 oz)	3.23 kg (7 lb 2 oz)	\$750
59308A	2.10 kg (4 lb 10 oz)	3.83 kg (8 lb 7 oz)	\$875
59309A	1.70 kg (3 lb 12 oz)	2.84 kg (6 lb 4 oz)	\$975

ELECTRONIC COUNTERS

Plug-Ins for 5245L/M, 5246L, 5248L/M & 5345A

Models 5252A-5267A

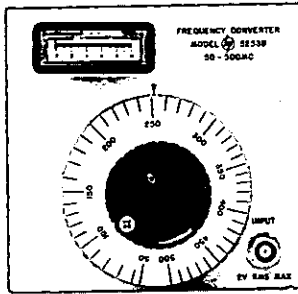

5253B

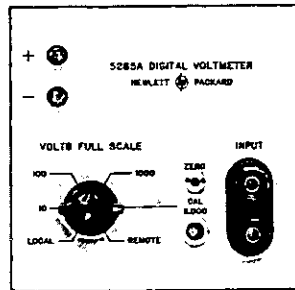

5265A

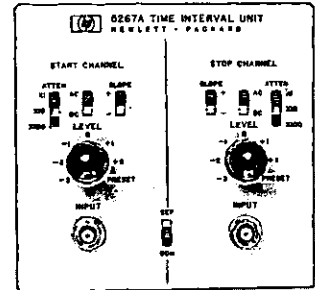

5267A

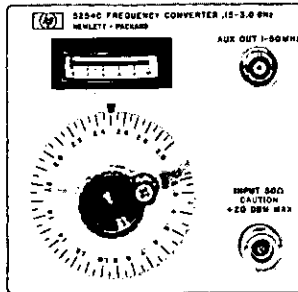

5254C

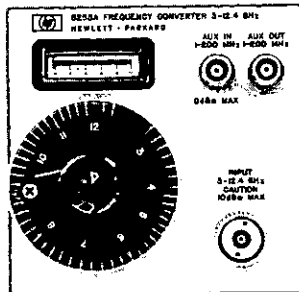

5255A

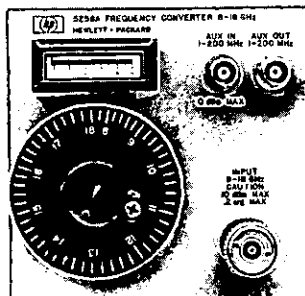

5256A

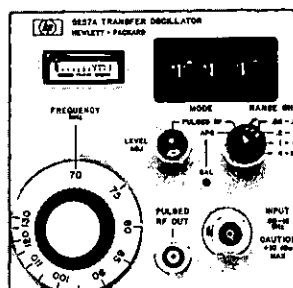

5257A

The 5245 series of plug-ins adds greatly to the versatility of the 5245 series of plug-in counters. In addition, these plug-ins enhance the measurement capability of the 5345A Electronic Counter and the 5360A Computing Counter by the use of plug-in adapters which provide an interface between the plug-in and the 5345A and 5360A mainframes. A compatibility summary for presently available plug-ins is shown below, followed by brief descriptions of the individual plug-ins. Refer to the 5245 series data sheet for complete details and specifications for all the plug-ins.

Plug-in compatibility summary

5345A compatibility (using 10590A plug-in adapter): all except the 5264A

5360A compatibility (using 10536A plug-in adapter): all except the 5265A, 5267A, 5262A, 5264A

5245L/M compatibility: all

5248L/M compatibility: all

5246L compatibility: all except the 5264A

Specifications

5253B Heterodyne converter

Price

\$850

Frequency range: 50 MHz to 512 MHz

Sensitivity: -13 dBm to +13 dBm

Mixing frequencies: 50 to 500 MHz in 10 MHz steps

Input coupling: ac

Accuracy: Maintains counter accuracy

Input impedance: 50Ω

5254C Heterodyne converter

\$1150

Frequency range: 150 MHz to 3 GHz

Sensitivity: -13 dBm to +13 dBm

Mixing frequencies: 0.15 to 3 GHz in 50 MHz steps

Input coupling: ac

Accuracy: Maintains counter accuracy

Input impedance: 50Ω

Auxiliary output: 1 MHz - 50 MHz

5255A Heterodyne converter

\$2270

Frequency range: 3 GHz to 12.4 GHz

Sensitivity: -7 dBm to +10 dBm

Mixing frequencies: 2.8 to 12.4 GHz in 200 MHz steps

Input coupling: dc

Accuracy: Maintains counter accuracy

Input impedance: 50Ω

Auxiliary input: 1 MHz - 200 MHz at 5 mV sensitivity

Auxiliary output: 1 MHz - 200 MHz

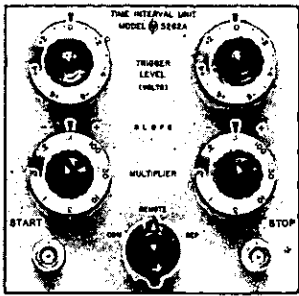

5262A

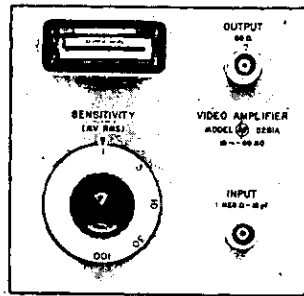

5261A

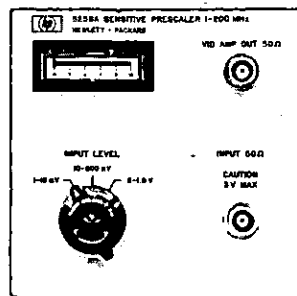

5258A

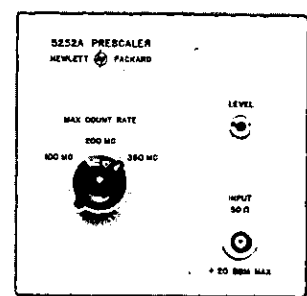

5252A

5256A Heterodyne converter

\$2370

Frequency range: 8 GHz to 18 GHz
Sensitivity: -7 dBm to +10 dBm
Mixing frequencies: 8 to 18 GHz in 200 MHz steps
Input coupling: dc
Accuracy: Maintains counter accuracy
Input impedance: 50Ω
Auxiliary input: 1 MHz - 200 MHz at 5 mV sensitivity.
Auxiliary output: 1 MHz - 200 MHz

5257A Transfer oscillator

\$2650

Frequency range: 50 MHz to 18 GHz
Input signal: CW, pulsed RF or FM modulated
Sensitivity: -7 dBm, 50 MHz to 15 GHz; -4 dBm, 15 GHz to 18 GHz
APC lock range: Approximately ±0.2% of input frequency
Pulse carrier frequency measurements: Minimum pulse width: 0.5 μsec. Minimum repetition rate: 10 pulses per second
Input impedance: 50Ω
VFO stability: typically 1×10^{-7} per minute after 2 hours

5265A Digital voltmeter

\$905

Voltage ranges: 10 V, 100 V and 1000 V full scale
Resolution: 100 μV
Accuracy: ±0.1% of reading, ±0.01% of full scale for readings < 1/10 of full scale
Sample rate: 5 per second
Input resistance: 10.2 MΩ on all ranges
Range selection: Manual
Noise rejection: 30 dB at 60 Hz, increasing at 12 dB per octave

5267A Time interval unit

\$580

Range: 100 nsec to 10⁸ sec with 5248L/M; 1 μsec to 10⁸ sec with 5245L/M; 1 μsec to 10⁶ sec with 5246L
Resolution: 10 nsec with 5248L/M only; 0.1 μsec otherwise
Input sensitivity: 100 mV rms
Start-Stop: Independent or common channels
Trigger slope: Positive or negative on Start and Stop channels, independently selected
Trigger amplitude: Both channels adjustable from -300 to +300 V peak
Input repetition rate: 5 MHz, max
Input impedance: 1 MΩ/35 pF

5262A Time interval unit

\$435

Range: 1 μsec to 10⁸ sec (to 10⁶ sec with 5246L)
Resolution: 0.1 μsec
Input sensitivity: 100 mV rms
Start-Stop: Independent or common channels
Trigger slope: Positive or negative on Start and Stop channels, independently selected
Trigger amplitude: Both channels adjustable from -250 to +250 V peak
Input repetition rate: better than 2 MHz
Input impedance: from 10k/10 pF at ×0.1 multiplier setting to 10 MΩ/20 pF at ×100 setting

5261A Video amplifier

\$595

Bandwidth: 10 Hz to 50 MHz
Input sensitivity: 1 mV
Input impedance: 1 MΩ/15 pF
Auxiliary output: 40 dB gain max into 50Ω; 300 mV rms max output undistorted into 50Ω; source impedance 50Ω

5258A Sensitive prescaler

\$1110

Bandwidth: 1 MHz to 200 MHz
Input sensitivity: 1 mV, 10 mV, 200 mV rms
Input impedance: 50Ω
Scaling factor: 4

5252A Prescaler

\$915

Bandwidth: dc to 350 MHz
Input sensitivity: 100 mV rms
Input impedance: 50Ω
Scaling factor: 2, 4 and 8

5264A Preset unit

\$875

Performs following basic functions:

- (i) N × frequency
 N × period measurements are made by mainframe.
 N × ratio
 - (ii) Counts N events where input is applied to AUX INPUT of 5264A.
 - (iii) Divides a frequency input applied to AUX INPUT by N. Divided output available at f/N OUTPUT.
- Frequency range aux input:** 20 Hz to 100 kHz
N range: 1 to 99,999 in integral steps



ELECTRONIC COUNTERS

General purpose plug-in counters

Models 5245L/M, 5246L & 5248L/M

- Highest performance in general purpose counters
- Wide selection of plug-ins provide unmatched versatility
- Extremely high reliability proven from over forty million hours of field operation

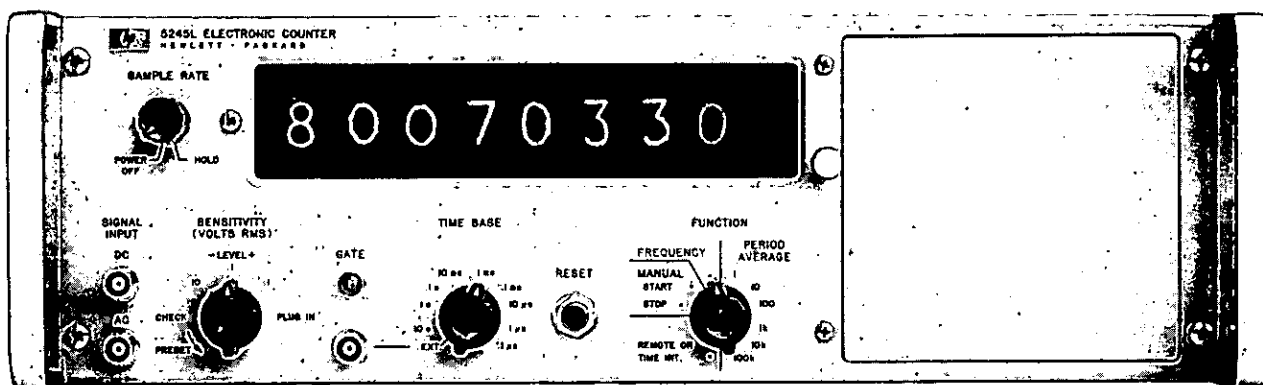

5245L

The Hewlett-Packard 5245L is representative of the highest performance attainable in a general purpose counter. This instrument, which is the heart of the 5245 series, has become the industry standard... for instruments of its type, there are more 5245L counters in operation today than all the rest put together.

The 5245 series consists of a family of mainframes and a series of plug-ins. The plug-ins provide frequency measurement to 18 GHz, high sensitivity, time interval and preset capability. The wide choice of mainframes and plug-ins means that virtually any measurement task performable by counters can be accomplished by appropriate selection within this family.

The 5245 series of counters are not only leaders in terms of performance and versatility, they are unsurpassed in the industry for ruggedness, wide operating temperature range, and field-proven reliability.

The following is a description of the 5245L mainframe. The other mainframes are similar to the 5245L. The main differences are delineated in these condensed specifications. Refer to the 5245 series data sheet for complete details and specifications on all mainframes and plug-ins.

Specifications

5245L/M

Frequency measurements

Range: dc to 50 MHz

Gate time: 1 μ s to 10 seconds in decade steps

Accuracy: ± 1 count \pm time base accuracy

Period average measurements

Range: dc to 1 MHz for single period; dc to 300 KHz for multiple period

Periods averaged: 1 period to 10^3 periods in decade steps

Accuracy: ± 1 count \pm time base accuracy \pm trigger error*

Mainframe measurement functions: frequency, period, period average, ratio, scaling

Signal input

Sensitivity: 100 mV rms

Coupling: AC and DC

Impedance: 1 M Ω in parallel with approx. 25 pf all ranges

Attenuation: Step attenuator provides nominal sensitivities of .1, 1, and 10 V rms (SENSITIVITY switch)

Trigger Level: Continuously adjustable over ± 3 V multiplied by the setting of the SENSITIVITY switch

Compatible 5245 series plug-ins: all

L version: 1 MHz oscillator, aging rate $< 2 \times 10^{-7}$ /mo.

M version: .5 MHz oscillator, aging rate $< 5 \times 10^{-10}$ /day

Display: 8 digits

Operating temperature range: -20°C to $+65^\circ\text{C}$

Weight: Net, 14.4 kg (32-lb) with blank plug-in panel

Dimensions: 133 mm high, 425 mm wide, 416 mm deep (5 $\frac{1}{4}$ ", 16 $\frac{1}{2}$ ", 16 $\frac{3}{8}$ ")

5246L

Frequency range: dc to 50 MHz

Mainframe measurement functions: Frequency only

Compatible 5245 series plug-ins: all except 5264A

Display: 6 digits, optionally expandable to 8

5248L/M

Frequency range: dc to 150 MHz

Mainframe measurement functions: Frequency, period, period average, ratio, scaling

Compatible 5245 series plug-ins: all

L version: 1 MHz oscillator, aging rate $< 2 \times 10^{-7}$ /mo.

M version: 5 MHz oscillator, aging rate $< 5 \times 10^{-10}$ /day

Model number and name

5245L 50 MHz Electronic Counter	Price \$3150
5245M 50 MHz Electronic Counter	\$3975
5246L 50 MHz Electronic Counter	\$2350
5248L 150 MHz Electronic Counter	\$3500
5248M 150 MHz Electronic Counter	\$4325

* Trigger error is $< (\pm 3\% \text{ of one period} + \text{number periods averaged})$ for signals with 40 dB signal-to-noise ratio and 100 mV rms amplitude; error decreases as signal to noise ratio increases.

ELECTRONIC COUNTERS



Computing counter system

Models 5360A & 5375A - 5379A

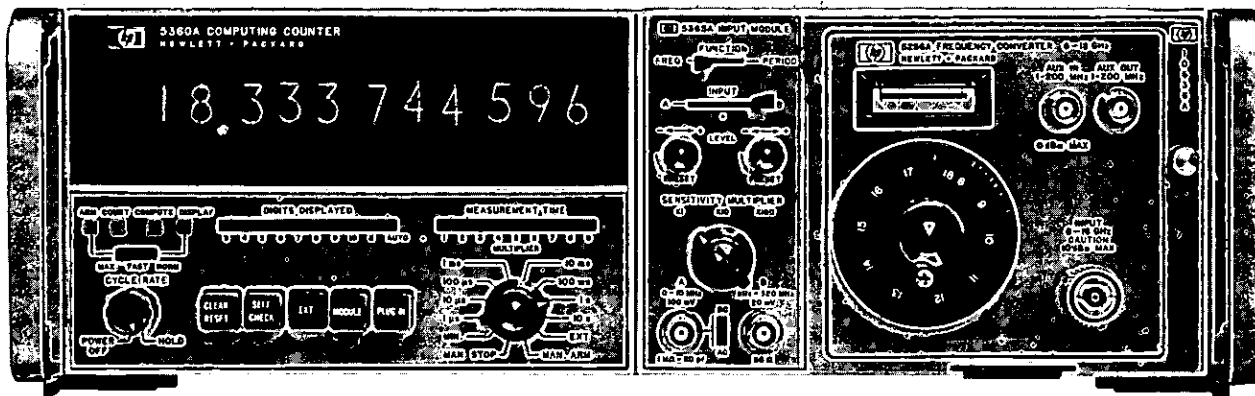

5360A

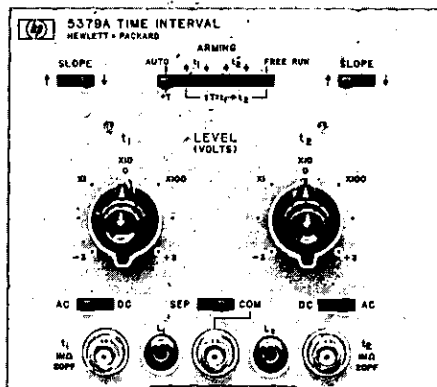

5379A

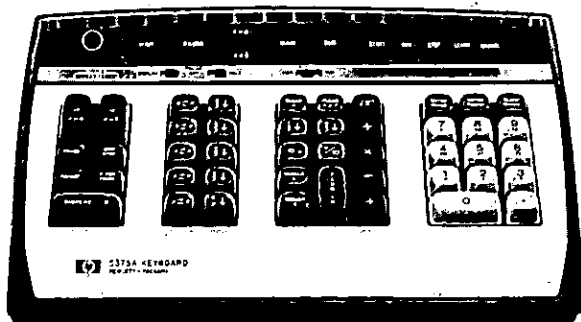

5375A

The Computing Counter is a general purpose precision digital instrument with built-in arithmetic capability. As a measuring device the Computing Counter provides unequalled precision. For example, it can measure the time between two events to a resolution of 100 picoseconds, about the time it takes light to travel one inch.

The Computing Counter's unique measurement technique employs extensive use of digital computation. Thus the mainframe contains an arithmetic unit which is an inherent, indispensable part of the measurement cycle. The arithmetic capability of the machine has been made available to the user via several programming devices. This allows the system to be programmed to solve equations where measurements are the variables, in real time. This capability enormously increases the power of the Computing Counter System.

Key specifications include a dc to 320 MHz direct count frequency range, measurement resolution of 1 part in 10^{10} per second of gate time, and ± 100 psec single shot time interval resolution using the 5379A Time Interval plug-in. A detailed description of the Computing Counter System and complete specifications are contained in the Computing Counter data sheet, available upon request.

5379A Time Interval plug-in

With the 5379A Time Interval Plug-In, the Computing Counter becomes a high precision and versatile time interval meter. Measurements can be made down to zero and even "negative" times by virtue of a unique arming scheme. Single shot events can be measured with ± 100 psec resolution and an accuracy of ± 1 nsec. By programming the Computing Counter from any of a number of programming devices (such as the 5375A Keyboard), the average of a number of measurements can be displayed to resolutions better than 5 psec.

5375A Keyboard

The 5375A provides the Computing Counter with the capability to add, subtract, multiply, divide and perform square root, logarithm and exponential functions. Decision capability and branching are possible also. Electrical outputs are made available for limit testing and peak to peak measurements.

10536A Plug-In Adapter

The 10536A Adapter is a versatile accessory which allows nine of the 5245 series plug-ins to be used in the Computing Counter. Frequency range can be extended to 18 GHz with these plug-ins.

Model number and name	Price
5360A Computing Counter	\$6695
5379A Time Interval Plug-In	\$1000
5375A Keyboard	\$1570
10536A Plug-In Adapter	\$350



ELECTRONIC COUNTERS

Automatic microwave counters

Models 5340A & 5341A

- Single input 10 Hz to 18 GHz
- Automatic amplitude discrimination
- High sensitivity, -35 dBm
- Optional extension to 23 GHz
- Superior AM and FM tolerance
- Exceptional reliability

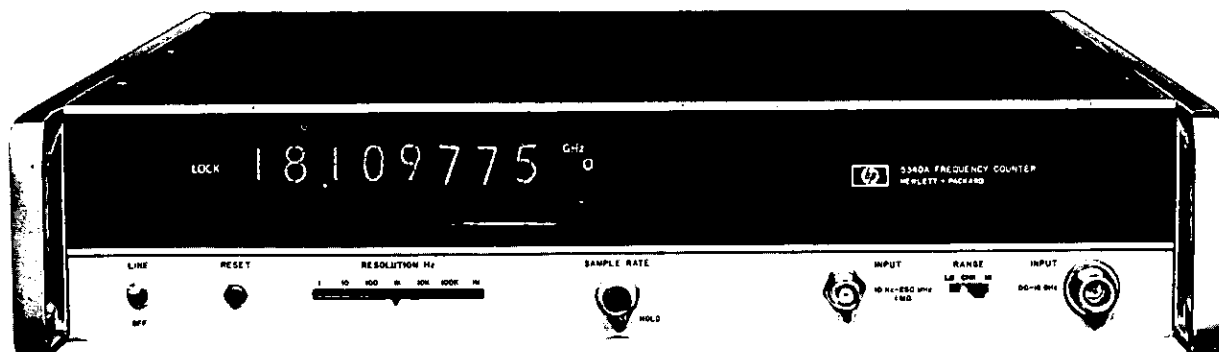

5340A

The 5340A Frequency Counter provides a modern, easily used, more versatile instrument for the direct measurement of frequencies from 10 Hz through 18 GHz via a single input connector. Utilizing new microwave samplers incorporated in advanced phase-lock loops, this counter excels in virtually every specification parameter. It is therefore suited to a wider range of applications than ever before possible for a fully automatic microwave counter.

The exceptional sensitivity of this instrument enhances measurement in the microwave field, where signals are commonly low level and many times are connected via directional couplers or lossy devices. Wide tolerance of AM, FM, and residual noise insure accurate measurement of microwave carrier frequencies despite the presence of these deviations. Automatic amplitude discrimination allows the 5340A to choose the largest signal in a spectrum (250 MHz to 18 GHz) and measure only that signal's frequency, ignoring all others.

Access to the HP Interface Bus via Option 011 provides a particularly flexible systems interface. The ability to program octave range via this input allows reduction of acquisition time to typically less than 25 msec. Application Note 181-1 describes the use of a calculator-controlled measurement system built around the HP Interface Bus for microwave component testing.

5340A Specifications

Signal input

Input 1

Range: 10 Hz to 18 GHz

Symmetry: Sinewave or squarewave input (40% duty factor, worst case)

Sensitivity: -30 dBm, 10 Hz-250 MHz (direct count); -35 dBm, 250 MHz-12.4 GHz; -25 dBm, 12.4-18 GHz

Dynamic range: 37 dB, 10 Hz-250 MHz; 42 dB, 250 MHz to 12 GHz; 32 dB, 12 GHz to 18 GHz

Impedance: 50Ω

VSWR: <2:1, 10 Hz-12.4 GHz; <3:1, 12.4-18 GHz

Connector: Precision Type N

Coupling: dc to load, ac to instrument

Damage level: +30 dBm ± 7 V dc (total power not to exceed 1 watt)

Acquisition time: <150 ms mean typical

Input 2

Range: 10 Hz-250 MHz direct count

Sensitivity: 50 mV rms, 150 mV p-p pulses to 0.1% duty factor; minimum pulse width 2 nsec

Impedance: 1 MΩ shunted by <25 pF

Connector: Type BNC female

Coupling: ac

Maximum input: 200 V rms, 10 Hz to 100 Hz; 20 V rms, 100 Hz to 100 kHz; 2 V rms, 100 kHz to 250 MHz

Automatic amplitude discrimination: The counter will automatically select the largest of all signals present (250 MHz to 18 GHz phase-lock range), providing that signal is 20 dB (10 dB typical) larger than any other.

Maximum AM modulation: Any modulation index as long as the minimum voltage of the signal is not less than the sensitivity specification.

Time Base

Crystal frequency: 10 MHz

Stability:

Aging rate: $< \pm 3 \times 10^{-7}$ per month

Short term: $< 5 \times 10^{-10}$ rms for 1 second averaging time

Temperature: $< \pm 2 \times 10^{-6}$ over the range of 0° to 50°C

Line variation: $< \pm 1 \times 10^{-7}$ for 10% line variation from nominal

Output frequency: 10 MHz, ≥ 2.4 V square wave (TTL compatible) available from rear panel BNC.

External time base: Requires 10 MHz approximately 1.5 V p-p sine wave or square wave into 1 KΩ via rear panel BNC. Switch selects either internal or external time base.

Optional time base (Option 001) aging rate: $< \pm 5 \times 10^{-10}$ per day after 24 hour warm-up for less than 24 hour off-time.

General

Accuracy: ± 1 count \pm time base error

Resolution: Front panel switch selects 1 MHz, 100 kHz, 10 kHz, 1 kHz, 100 Hz, 10 Hz, or 1 Hz.

Display: Eight in-line long life display tubes with positioned decimal point and appropriate measurement units of kHz, MHz, or GHz.

Self check: Counts and displays 10 MHz for resolution chosen.

Sample rate: Controls time between measurements. Continuously adjustable from 50 msec typical to 5 seconds. HOLD position holds display indefinitely. RESET button resets display to zero and activates a new measurement.

Operating temperature: 0° to 50°C

Power: 115 V or 230 V $\pm 10\%$, 50-60 Hz, 100 VA

Weight:

Net: 11.3 kg (25 lb)

Shipping: 14.1 kg (31 lb)

Dimensions: 425 mm W \times 467 mm D \times 88.2 mm H (16 $\frac{1}{4}$ " \times 13 $\frac{1}{4}$ " \times 3 $\frac{1}{2}$ ")

Model number and name

Model number and name	Price
5340A Frequency Counter	\$5900
Option 001: High Stability Time Base	\$500
Option 002: Rear Panel Connectors	\$105
Option 011: Remote Programming-Digital Output	\$390
Option H10: Frequency Extension to 23 GHz	\$500

- Automatic or manual band-selection
- Wide FM tolerance
- Optional 1.5 GHz range

- Fast acquisition time
- High sensitivity
- Fully automatic diagnostics

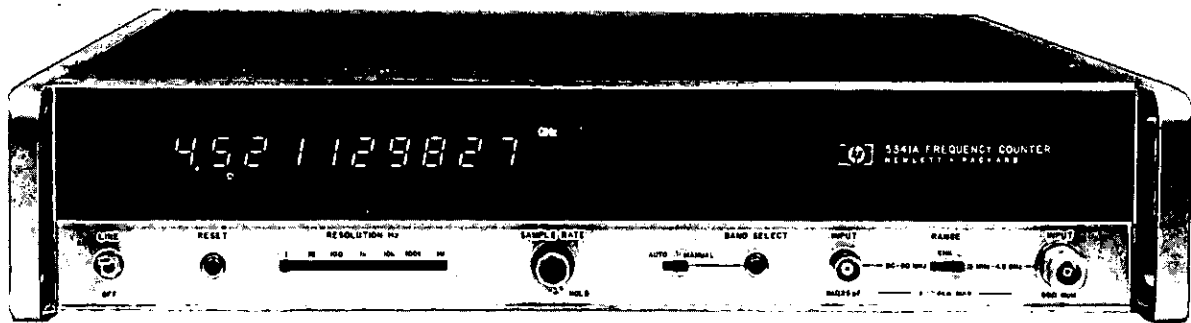

The new 5341A Frequency Counter performs exceptionally fast measurements of frequency up to 4.5 GHz. Using a unique HP-designed microwave switchable filter, its automatic heterodyne measurement technique insures high tolerance of FM on the measured signal. In the normal mode of operation, the 5341A will automatically measure and display the lowest CW signal within its sensitivity; in the manual mode, the operator can choose to search within any of ten frequency bands which cover the counter's full range. Also at the operator's command, a convenient routine provides "qualifiers" in the display for complete diagnostic information concerning both the measured signal and the counter's internal operation.

The high sensitivity (-15 dBm in automatic mode, -20 dBm in manual) of the 5341A makes it ideal for measurement of low-level signals in the testing of UHF and microwave components and equipment. An extremely fast acquisition time (100 μ sec in manual mode) makes this counter the optimum choice for systems applications.

Option 003 limits the frequency range of the 5341A to 1.5 GHz, at a considerably reduced cost. Option 011 connects the 5341A to the high-speed HP Interface Bus for data output and complete programmability, including the ability to remotely select the manual search bands.

5341A Specifications

Signal input

Input 1

Range: 50 MHz to 4.5 GHz

Impedance: 50 Ω nominal

Connector: Precision Type N

Sensitivity: -15 dBm (AUTO operating mode); -20 dBm (MANUAL operating mode)

Maximum input: +20 dBm

Damage level: +30 dBm

Operating modes: AUTO: Counter automatically selects and displays lowest frequency within its sensitivity range; MANUAL: Measurement band is selected manually, and counter measures within a 525 MHz range above displayed band number (in the 500 MHz and 750 MHz bands, counter measures within a 250 MHz range).

Measurement time: Acquisition time + gate time

Acquisition time: 600 μ sec (AUTO operating mode); 100 μ sec (MANUAL operating mode)

FM Characteristics: Tolerates \pm 250 MHz maximum deviation (0-500 MHz and 1.0-4.5 GHz) and \pm 125 MHz maximum deviation (500 MHz - 1.0 GHz) in center of bands; bands overlap 30 MHz at band edges.

Input 2

Range: 10 Hz to 80 MHz

Impedance: 1 M Ω , shunted by 50 pF

Connector: Type BNC female

Coupling: ac

Sensitivity: 10 millivolts

Maximum input: 5 volts peak-to-peak

Damage level: 400 volts dc; 250 volts rms ac, 10 Hz to 100 kHz, decreasing 6 dB per octave to 80 MHz.

Time base

Crystal frequency: 10 MHz

Stability:

Aging rate: $< 1 \times 10^{-7}$ per month

Temperature: $< \pm 1 \times 10^{-6}$ over the range 0°C to 50°C

Line variation: $< \pm 1 \times 10^{-7}$, $\pm 10\%$ from nominal

Output frequency: 10 MHz, ≥ 2.4 V square wave (TTL compatible) available from rear panel BNC.

External time base: Requires 10 MHz approximately 1.5 V p-p sine wave or square wave into 1 k Ω via rear panel BNC. Switch selects either internal or external time base.

Optional time base (Option 001) aging rate: $< \pm 5 \times 10^{-10}$ per day after 24 hour warm-up for less than 24 hour off-time.

General

Accuracy: ± 1 count \pm time base error

Resolution: Front panel switch selects 1 MHz, 100 kHz, 10 kHz, 1 kHz, 100 Hz, 10 Hz, or 1 Hz.

Display: Ten-digit sectionalized LED display and appropriate measurement units of kHz, MHz, or GHz.

Self check: Counts and displays 1 GHz for resolution chosen.

Sample rate: Continuously adjustable from 40 msec to 10 seconds and HOLD.

Operating temperature: 0°C to 50°C

Power: 115 or 230 volts, $\pm 10\%$, 50-60 Hz, 104 VA

Remote programming and digital output: Optional (Option 011) via 24-pin, series 57 Microribbon connector. Program and output information are 7-bit ASCII code.

Weight:

Net: 10.5 kg (23 lb)

Shipping: 13.2 kg (29 lb)

Dimensions: 425 mm W \times 467 mm D \times 88.2 mm H (16 $\frac{1}{2}$ " \times 13 $\frac{1}{4}$ " \times 3 $\frac{1}{2}$ ")

Model number and name

5341A Frequency Counter	Price
Option 001: High Stability Time Base	\$3475
Option 002: Rear Panel Connectors	\$500
Option 003: 1.5 GHz Frequency Range	\$105
Option 011: Remote Programming-Digital Output	less \$1000
	\$390

ELECTRONIC COUNTERS

50 MHz and 550 MHz universal counters

5326/5327 Family

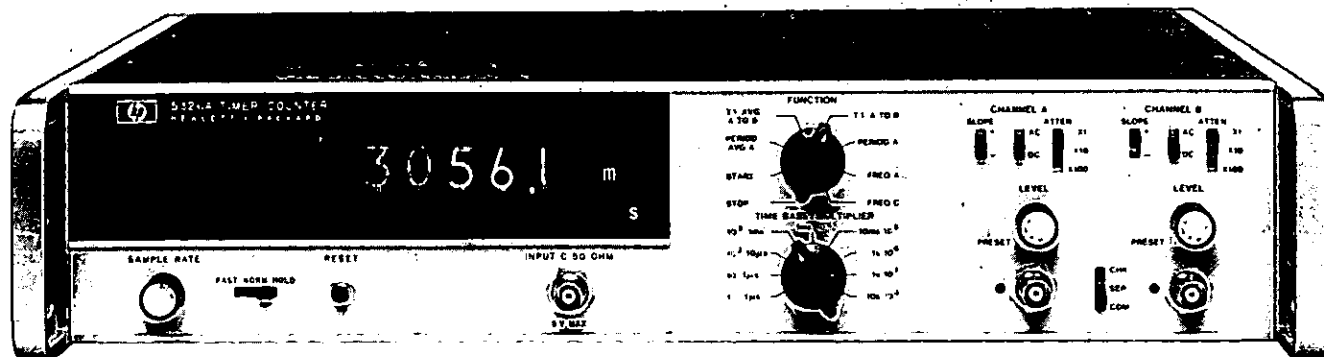

5326A

Description

The Hewlett-Packard 5326/5327 family offers versatile, high precision counters to measure frequency, time intervals, or voltage. With six models to choose from, you can select just the capability to solve your own measurement problems without paying for extras. The 5326 series covers the frequency range to 50 MHz; the 5327 series measures to 550 MHz. In addition, the 5326/5327 family offers the following features to make your measurements simpler, easier to set up, and more accurate:

Burst and CW measurement: special gating circuits start a count only when your input signal is present. You can measure a frequency burst as easily as a CW signal.

One shot time interval measurements: from 0.1 μ sec to 10⁶ sec.

Time interval averaging: resolution better than 100 ps for intervals as short as 150 ps with repetitive signals.

Built-in DVM: set trigger levels with ease; plus measure external DC voltages.

Period, ratio, totalize and scale measurements: extra problem solving capability for your special requirements.

High sensitivity input channels: for measuring the frequency of low level signals down to 5 mV to 50 MHz and 25 mV to 550 MHz.

Fused input protection: for 550 MHz channels to prevent expensive damage from accidental overloads.

Systems options: select remote programming and digital output to suit your application.

Time base options: even greater precision and accuracy for demanding applications.

Front panel trigger lights: to show when the counter is triggering properly on the input signal.

These features and capabilities make counters of the 5326/5327

family excellent tools for general lab use, for electronic service, and for production test.

Numerous technical advances provide the extended capability in these counters. For example, unique high speed synchronizers provide the key to effective time interval averaging. Averaging can dramatically improve the resolution of time interval measurements. The synchronizers set up a very accurate statistical average for up to 10⁹ time intervals; resolution improves in proportion to the square root of the number of intervals averaged.

Time interval averaging may be used whenever the repetition rate of the input signal is asynchronous with the counter's 10 MHz clock. This condition is easily met for many potential applications including measurement of logic timing and propagation delays where time intervals are well below the range of conventional one-shot counter techniques.

The built-in DVM

Both the 5326B and the 5327B include a built-in DVM. The single DVM gives the user two major benefits. The first benefit is more accurate and far more convenient setting of trigger levels for time interval measurements. The second benefit is substantially increased single instrument capability.

With the built-in DVM, you can actually set trigger levels with digital accuracy. The unique functions READ A and READ B monitor the internal trigger level settings for the A and B channels. The values are shown directly on the display. This method has been found far superior to conventional marker techniques using Z-axis modulation on a scope.

Of course, the integrating DVM can also make accurate external voltage measurements. Thus a single instrument can do the job of two. For systems applications, this means there is only one instrument to program and a single set of outputs for all measurements.

5326/5327 Family selection guide

Model	Description	Frequency Range	Period Average Totalize/Ratio Scaling	Time Interval Time Interval Averaging	DVM (DC Voltage)
5326C	Multi-Function Counter	50 MHz	—————	—————	—————
5326A	Universal Timer/Counter	50 MHz	—————	—————	—————
5326B	Universal Timer/Counter/DVM	50 MHz	—————	—————	—————
5327C	Multi-Function Counter	550 MHz	—————	—————	—————
5327A	Universal Timer/Counter	550 MHz	—————	—————	—————
5327B	Universal Timer/Counter/DVM	550 MHz	—————	—————	—————

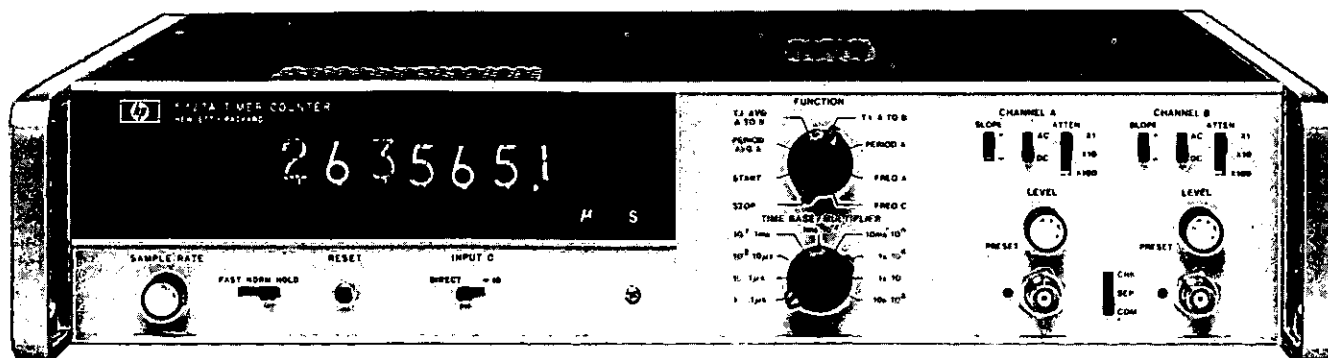

5327A



High stability time bases

The standard time base for the 5326/5327 family uses a stable 10 MHz crystal oscillator. This room temperature crystal provides fast warm-up with a long term aging rate of less than 3 parts in 10^7 per month. Two higher stability time bases are available as options. Both meet FCC specifications for checking base station transmitters. Option 010 uses a TCXO to provide additional temperature stability. Option 011 uses a proportional oven controlled crystal oscillator with excellent long term aging rate to provide ultra high stability. A summary of time base option specifications appears on the bottom of this page.

Systems compatibility

Each member of the 5326/5327 family can be effectively used as a fast efficient systems instrument.

Option 003 provides BCD output suitable for use with systems or with devices such as the HP Model 5050B or 5055A Digital Recorders or the 3489A Data Punch.

Option 002 provides remote programming of most front panel controls, including function and time base controls. Option 004 provides all the capabilities of Option 002 plus additional control including input attenuators and ac-dc input coupling.

The HP 10542A Remote Programming Interface enables the 5326/27 series with Option 004 to be completely programmed from a standard 40-bit digital output register for the HP 2100 series computers. The 10542A contains two digital-to-analog converters for digital control of the analog trigger levels.

General Specifications

Display: 7 digits (8 optional).

Blanking: suppresses display of unwanted zeros left of the most significant digit.

Display storage: holds reading between samples. Rear panel switch overrides storage.

Sample rate: FAST and NORM ranges, and HOLD position.

Overflow: neon indicates when display range is exceeded.

Operating temperature: 0° to 50°C (see DVM Temp. Range).

Gate output: TTL level pulses, low while gate open, rear panel.

Power requirements: 115/230 V $\pm 10\%$, 50/60 Hz, 70 watts (max).

Weight: max: net, 7.4 kg (16 lb); shipping, 8.7 kg (19 lb).

Dimensions: 88.2 \times 425 \times 286 mm (3 $\frac{1}{2}$ " high \times 15 $\frac{3}{4}$ " wide \times 11 $\frac{1}{4}$ " deep).

Accessories furnished: 7 $\frac{1}{2}$ ft power cord; rack mount kit.

Accessories available: HP 10542A: remote programming interface enables interfacing between the 5326/5327 series counters with Option 004 and a 40-bit output register. Includes two (2) 7 bit digital-to-analog converters for level controls and decoding for time base and function selector.

Option 001: 8-digit display.

Option 002: remote programming. All front panel controls are single line programmable except: Input attenuators; AC/DC input signal coupling; FAST/NORM mode; SEP-COM switch (CHECK is programmable 5326A/B, 5327A/B only).

Option 003: digital output (for numerals and polarity only)

Option 004: remote programming including all signal input conditions (includes attenuators and ac/dc switches). All front panel controls are programmable except FAST/NORM mode.

Model name and number

Model name and number	Price
5326A Universal Timer/Counter	\$1450
5326B Universal Timer/Counter/DVM	\$1795
5326C Multifunction Counter	\$1250
5327A Universal Timer/Counter	\$1950
5327B Universal Timer/Counter/DVM	\$2295
5327C Multifunction Counter	\$1675

Options:

001: 8 digit display	\$80
002: Remote Programming	\$80
003: Digital Output	\$55
004: Full Remote Programming (5326A/B, 5327A/B only)	\$275
010: Temperature Compensated Oscillator	\$175
011: High Stability Oven Oscillator	\$450

Accessories:

10542A Remote Programming Interface	\$515
-------------------------------------	-------

Oscillator	Aging Rate	Short Term Stability	Temperature Stability
Standard	$<3 \times 10^{-7}/\text{mo}$	$<5 \times 10^{-9}/1 \text{ sec rms (typ)}$	$<\pm 2.5 \times 10^{-6}, 0^\circ \text{ to } 50^\circ\text{C}$
Option 010	$<1 \times 10^{-7}/\text{mo}$	$<1 \times 10^{-9}/1 \text{ sec rms (typ)}$	$<\pm 5 \times 10^{-7}, 0^\circ \text{ to } 50^\circ\text{C}$
Option 011	$<5 \times 10^{-10}/\text{day}$	$<1 \times 10^{-11}/1 \text{ sec rms}$	$<7 \times 10^{-9}, 0^\circ \text{ to } 50^\circ\text{C}$

5326/5327 (cont.)

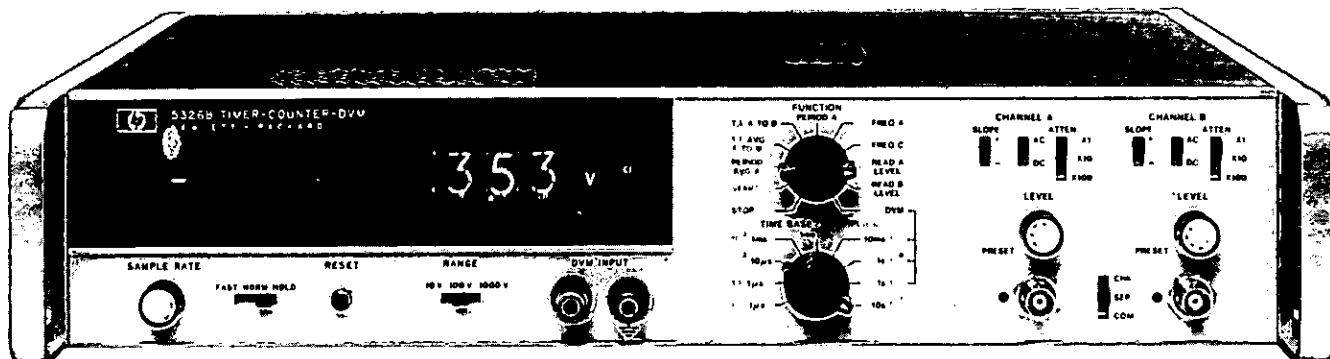

5326B

5326A/B and 5327A/B Specifications

Input Channels A and B

Range: dc-coupled: 0-50 MHz; ac-coupled: 20 Hz-50 MHz.

Sensitivity (min): 0.1 V rms sine wave; 0.3 V p-p pulse; 8 ns minimum pulse width. Sensitivity can be decreased by 10 or 100 times, using the ATTENUATOR switch.

Impedance: 1 MΩ shunted by less than 25 pF.

Dynamic input voltage range: 0.1 to 3 V rms ac times attenuator setting. ±5 V dc times attenuator setting.

Trigger level: PRESET to center triggering about 0 V or variable over the range of -3 V to +3 V times attenuator setting. Trigger threshold band <1.0 mV, referred to input at maximum frequency.

Overload protection: 250 V rms on all attenuator settings, except 25 V rms on X1 about 50 kHz.

Slope: Independent selection of positive or negative slope.

Channel inputs: Common or separate lines.

Marker outputs: Rear panel BNC's. DTL pulse, low for approx. 2 μs after trigger point for A and B channels.

Input Channel C

Range: 5326A/B and 5327A/B: direct counting: dc-coupled, 0-50 MHz. 5327A/B: prescaled (÷10): dc-coupled, 0-550 MHz.

Sensitivity: 5326A/B: 5 mV rms. 5327A/B: direct counting: 15 mV rms; prescaled: 25 mV rms.

Impedance: 50Ω nominal.

Maximum input: 3.5 volts rms; 5.0 volts peak.

Trigger level: 0 volts.

Location: Rear panel, except front panel on 5326A.

Frequency

Range: 5326A/B: direct counting: 0-50 MHz. 5327A/B: direct counting: 0-50 MHz; prescaled: 0-550 MHz.

Input: 5326A/B: Channel A or Channel C. Channel A provides triggered frequency measurement. 5327A/B: direct counting: Channel A or Channel C; prescaled: Channel C. Channel A provides triggered frequency measurement.

Gate times: 0.1 μs to 10 s in decade steps.

Accuracy: direct: ±1 count ± time base accuracy. Prescaled: ±10 counts* ± time base accuracy.

Display: kHz, MHz, or GHz with positioned decimal point.

Time interval

Range: 0.1 μs to 10⁸ seconds.

Input: Channels A and B; can be common or separate.

Frequency counted: 10 MHz to 0.1 Hz in decade steps.

Accuracy: ±1 count ± time base accuracy ± trigger error.**

Display: μs, ms, seconds or 10's of seconds with positioned decimal point.

Time interval average

Range: 0.15 ns to 10 s.

Intervals averaged: 1-10⁸ selectable in decade steps.

Input: Channels A and B; can be common or separate.

Frequency counted: 10 MHz.

Accuracy: ± time base accuracy ± 2 ns

$$\pm \frac{(\text{Trigger Error}^{**} \pm 100 \text{ ns})}{\sqrt{\text{Intervals Averaged}}}$$

Display: ns, μs with positioned decimal point.

Period

Range: 0-10 MHz.

Input: Channel A.

Frequency counted: 10 MHz to 0.1 Hz in decade steps.

Accuracy: ±1 count ± time base accuracy ± trigger error.***

Display: μs, ms, seconds or 10's of seconds with positioned decimal point.

Period average

Range: 0-10 MHz.

Periods averaged: 1-10⁸ selectable in decade steps.

Input: Channel A.

Frequency counted: 10 MHz.

Accuracy: ± count ± time base accuracy ± trigger error.***

Display: ns, μs with positioned decimal point.

F_{ext}.

* ±10 counts of input frequency. (±1 count displayed.)

** For any wave shape, trigger error is less than

$$\pm \frac{0.0025 \mu\text{s}}{\text{Signal Slope (V}/\mu\text{s})}$$

*** Trigger error is less than ±0.3% of one period + periods averaged for signals with 40 dBm or better signal-to-noise ratio and 100 mV rms amplitude.

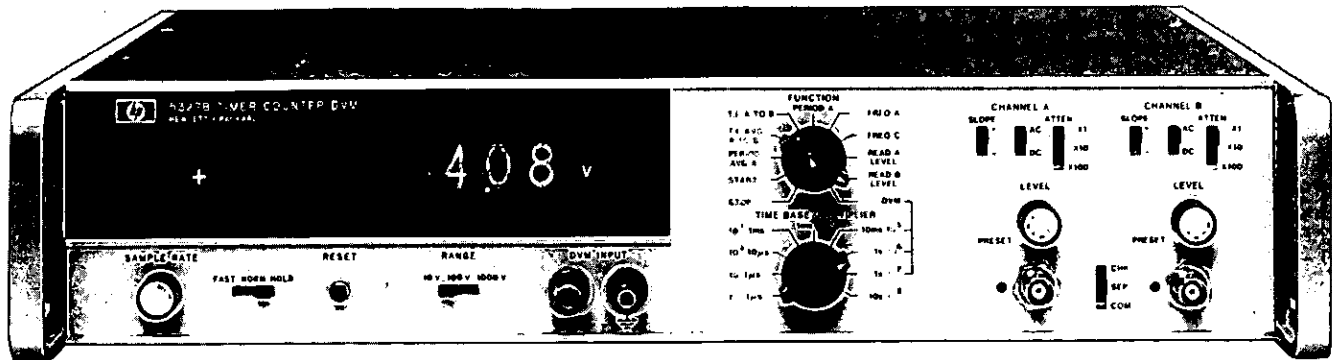

5327B

Start (totalizing and scaling)**Range:** 0-10 MHz.**Factor:** 1-10⁸ selectable in decade steps.**Output:** Rear panel TIME BASE BNC.**Display:** Channel A input divided by scaling factor.**Ratio****Display:** Any input function/ F_{EXT} times Multiplier (M). M = 1 to 10⁸ (10-10⁸ when prescaling) selectable in decade steps.**Range:** Any input function. See appropriate function section. F_{EXT} : (External Oscillator Input) 100 Hz-10 MHz.**Mode:** Any input function.**Accuracy:** Accuracy of selected input function \pm trigger error of**Integrating digital voltmeter (5326B and 5327B only)**

The unique combination of an integrating digital voltmeter and an electronic timer/counter produces an instrument which can do much more than a separate counter and DVM. The mainframe DVM in the 5326B and 5327B easily measures \pm dc levels in three programmable ranges from ± 10 V to ± 1000 V. Plus, the DVM can internally measure and set the start and stop time interval trigger levels. This feature, together with hysteresis compensation, gives the 5326B and 5327B the easiest and most accurate trigger level setting system available with none of the drawbacks of oscilloscope marker techniques. The DVM measurement (integration) time is selectable from 1 ms to 10 sec to permit a trade-off of resolution vs. measurement time.

Specifications**Technique:** voltage-to-frequency conversion.**Voltage ranges:** manual selection.

Range (V dc)	Resolution (1 sec, integration time)	Input Impedance
10	100 μ V	10 M Ω
100	1 mV	10 M Ω
1000	10 mV	10 M Ω

Input: single ended.**Polarity:** automatic polarity detection.**Overrange:** 25% overrange on 10 V and 100 V ranges with full accuracy.**Overload protection:** 1100 V dc all ranges.**Accuracy:** After 10 minutes warm-up (within 90-day calibration period).

Range	Stability (% of Reading)	Linearity (% of Range)	Zero Drift (% of Range)	Counter
10 V	$\pm 0.04\%$	$\pm 0.01\%$	$\pm 0.01\%$	± 1 count
100 V	$\pm 0.04\%$	$\pm 0.01\%$	$\pm 0.01\%$	± 1 count
1000 V	$\pm 0.08\%$	$\pm 0.01\%$	$\pm 0.01\%$	± 1 count

Operating temperature: 10°C to 40°C, <80% RH.**Measurement time:**

1 msec 2 digits

10 msec 3 digits

100 msec 4 digits

1 sec 5 digits

10 sec 6 digits

} Decimal points automatically displayed

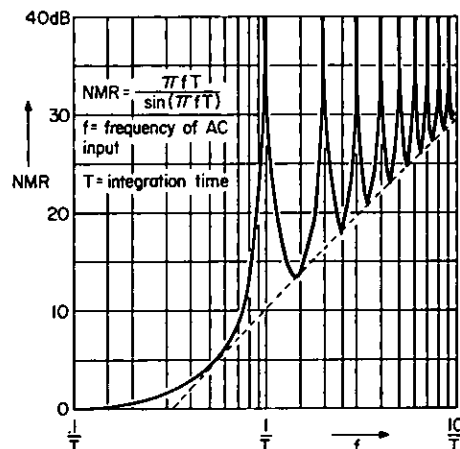
Response time: <100 μ s for full accuracy with a step function input.**AC noise rejection:** infinite for multiples of (measurement time)⁻¹. See graph for Normal Mode Rejection.

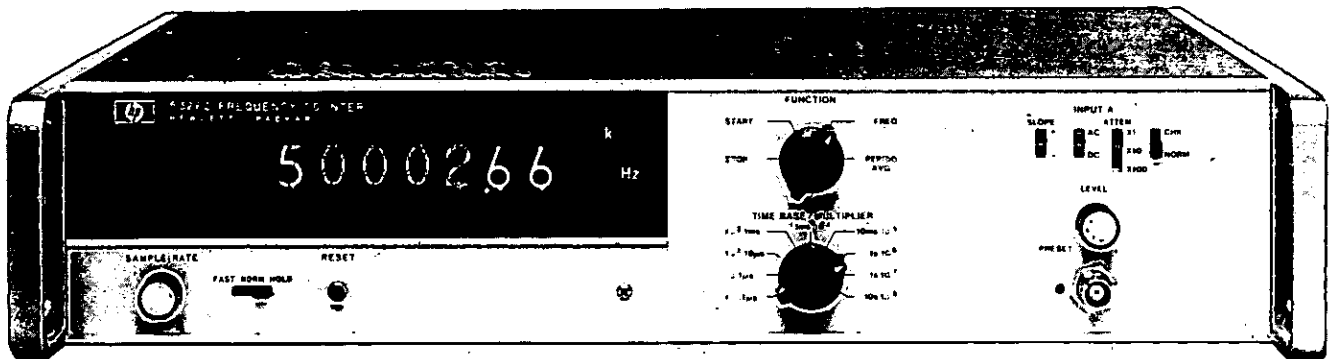

5326C

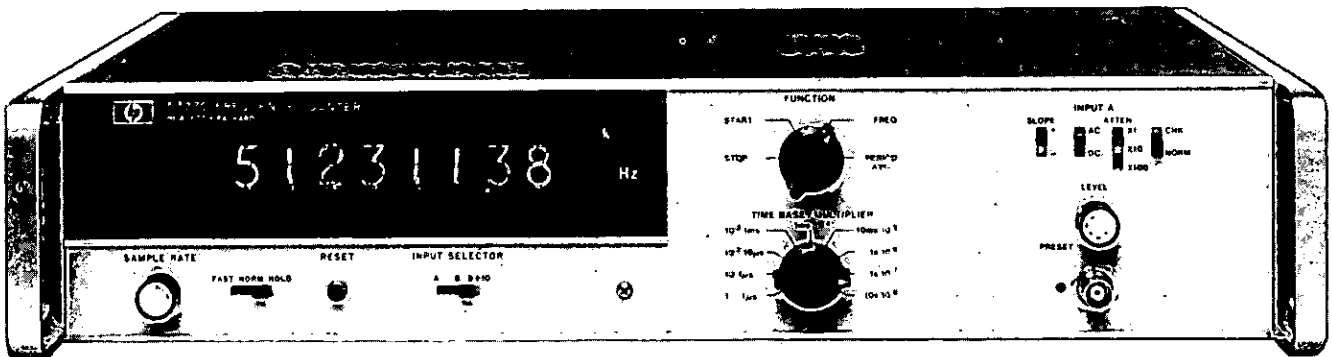

5327C

5326C and 5327C Specifications

Input channel A

Range: dc-coupled: 0-50 MHz; ac-coupled: 20 Hz-50 MHz

Sensitivity: 0.1 V rms sine wave; 0.3 V p-p pulse; 8 ns minimum pulse width. Sensitivity can be decreased by 10 or 100 times, using the ATTENUATOR switch.

Impedance: 1 M Ω shunted by less than 25 pF.

Dynamic input voltage range: 0.1 to 3 V rms ac times attenuator setting. ± 5 V dc times attenuator setting.

Trigger level: PRESET to center triggering about 0 V or variable over the range of -3 V to +3 V times attenuator setting. Trigger threshold band <1.0 mV, referred to input at maximum frequency.

Overload protection: 250 V rms on all attenuator settings, except 25 V rms on X1 above 50 kHz.

Slope: independent selection of positive or negative slope.

Input channel B and B \div 10 (5327C only)

Range: Channel B: dc-coupled, 50 MHz; B \div 10: dc-coupled, 0-550 MHz.

Sensitivity: Channel B: 15 mV rms; B \div 10 (prescaled): 25 mV rms

Impedance: 50 Ω nominal.

Maximum input: 3.5 volts rms, 5.0 volts peak.

Trigger level: 0 volts.

Start (totalizing and scaling)

Range: 5326C: 0-10 MHz. 5327C: 0-10 MHz (direct); 0-100 MHz (prescaled).

Factor: 5326C: 1-10⁸ in decade steps. 5327C: Channel A or Channel B: 1-10⁸ in decade steps; B \div 10: 10-10⁹ (1-10⁸ on selector) in decade steps.

Output: Rear panel TIME BASE BNC

Display: Channel A, B, or B \div 10 input divided by scaling factor.

Frequency

Range: 5326C: 0-50 MHz. 5327C: 0-50 MHz (direct); 0-550 MHz (prescaled)

Input: 5326C: Channel A. Channel A provides triggered frequency measurement. 5327C: Channel A; Channel B for direct and B \div 10 for prescaled (switchable). Any channel provides triggered frequency measurement.

Gate times: 0.1 μ s to 10 s in decade steps.

Accuracy: direct: ± 1 count \pm time base accuracy. Prescaled: ± 10 counts* \pm time base accuracy.

Display: kHz, MHz or GHz with positioned decimal point

Period average

Range: 5326C: 1-10 MHz. 5327C: 0-50 MHz (direct); 0-550 MHz (prescaled)

Periods averaged: 5326C: 1-10⁸ in decade steps. 5327C: Channel A or Channel B: 1-10⁸ in decade steps; B \div 10: 10-10⁹ (1-10⁸ on selector) in decade steps.

Frequency counted: 10 MHz

Accuracy: direct: ± 1 count \pm time base accuracy \pm trigger error.***

Prescaled: ± 10 counts* \pm time base accuracy \pm trigger error.***

Display: ns, μ s with positioned decimal point

Ratio

Display: any input function/ F_{ext} times Multiplier (M). M = 1 to 10⁸ (10-10⁹ when prescaling) selectable in decade steps.

Range: any input function. See appropriate function section. F_{ext} : (External Oscillator Input) 100 Hz-10 MHz.

Mode: any input function

Accuracy: accuracy of selected input function \pm trigger error of F_{ext} .

* ± 10 counts of input frequency (± 1 count displayed).

** For any wave shape, trigger error is less than

$$\pm \frac{0.0025}{\text{Signal Slope (V/\mu s)}} \mu s$$

*** Trigger error is less than $\pm 0.3\%$ of one period \div periods averaged for signals with 40 dBm or better signal-to-noise ratio and 100 mV rms amplitude.

ELECTRONIC COUNTERS

Low cost counters for frequency measurements

Models 5381A & 5382A

NEW

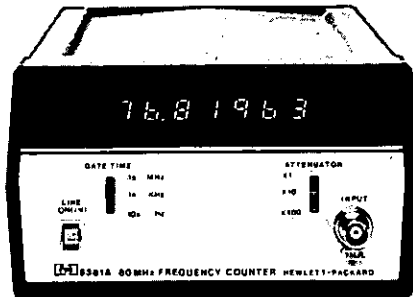

5381A

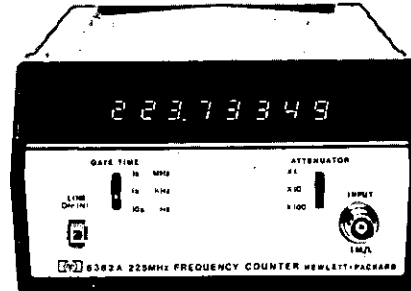

5382A

Description

General

The 5381A and 5382A are a logical result of H-P's long-standing leadership in frequency counter development. Leadership in quality, technology and efficient production procedures allows H-P to offer a price/performance combination in these two precision instruments unequalled in their product category. These counters are designed to deliver reliable, high quality operation in such diverse areas as: Production Line Testing, Service and Calibration (2-Way Radio and test equipment), Frequency Monitoring, Education and Training.

Resolution

Both the 5381A and 5382A employ the direct counting technique and with 7 and 8 digits respectively offer resolution of 10 Hz in .1 sec, 1 Hz in 1 sec and .1 Hz in 10 seconds.

Specifications

5381A

Frequency Range: 10 Hz to 80 MHz

Display: 7 Digit (LEDs)

Input impedance: 1 MΩ, <50 pf

Sensitivity: 25 mV (rms sinewave) 30 Hz to 20 MHz 50 mV (rms sinewave) 10 Hz to 80 MHz

Input attenuator: Three Position (X1, X10, X100)

Maximum input levels:

Attenuator "X1"	DC to 40 Hz	200 V (dc + Peak ac)
	40 Hz to 100 kHz	250 V rms
	100 kHz to 5 MHz	2.5×10^7 V·Hz
	>5 MHz	5 V rms

Attenuator "X10"	DC to 40 Hz	200 V (dc + Peak ac)
	40 Hz to 1 MHz	250 V rms
	1 MHz to 50 MHz	2.5×10^8 V·Hz
"X100"	50 MHz to 80 MHz	5 V rms

Accuracy: ± 1 Count \pm Time Base Accuracy

Gate times: Manually Selected .1 second, 1 second, 10 seconds

Resolution: 10 Hz at 0.1 second gate time; 1 Hz at 1 second gate time; 0.1 Hz at 10 second gate time

Time base: Internal

Frequency: 1 MHz Crystal

Aging: <0.3 ppm/Month

Temperature: ± 10 ppm 0°C to 40°C

Line voltage: ± 1 ppm for 10% line variation

External input

Frequency range: 10 kHz to 2 MHz

Sensitivity: TTL Level or 2.5 V rms Sinewave

Maximum input: 25 V rms dc to 2 MHz

5382A

Frequency range: 10 Hz to 225 MHz

Display: 8 Digit (LEDs)

Input impedance: 1 MΩ, 40 pf

Sensitivity: 25 mV (rms sinewave) 30 Hz to 10 MHz; 50 mV (rms sinewave) 10 Hz to 225 MHz

Input attenuator: Three Position (X1, X10, X100)

Maximum input levels:

Attenuator "X1"	DC to 40 Hz	200 V (dc + Peak ac)
	40 Hz to 100 kHz	250 V rms
	100 kHz to 5 MHz	2.5×10^7 V·Hz
	>5 MHz	5 V rms

Attenuator "X10"	DC to 40 Hz	200 V (dc + Peak ac)
	40 Hz to 1 MHz	250 V rms
	1 MHz to 50 MHz	2.5×10^8 V·Hz
"X100"	50 MHz to 225 MHz	5 V rms

Accuracy: ± 1 Count \pm Time Base Accuracy

Gate times: Manually Selected .1 second, 1 second, 10 seconds

Resolution: 10 Hz at 0.1 second gate time; 1 Hz at 1 second gate time; 0.1 Hz at 10 second gate time

Time base: Internal

Frequency: 10 MHz Crystal

Aging: <0.3 ppm/Month

Temperature: ± 2.5 ppm 0°C to 40°C

Line Voltage: ± 0.5 ppm for 10% line variation

External Input

Frequency Range: 100 kHz to 10 MHz

Sensitivity: 250 mV rms; 1 kΩ input impedance

Maximum Input: 25 V rms dc to 10 MHz

Option for 5382A only -

Option 001: Temperature Compensated Crystal Oscillator

Frequency: 10 MHz

Aging: <1 part in 10^7 /month

Temperature: ± 1 ppm 0°C to 40°C

(No external oscillator input with Option 001.) Exceeds F.C.C. requirements

5381A and 5382A General data

Operating temperature: 0°C to 40°C

Power requirements: 100, 120, 220 and 240 V rms (48 Hz to 440 Hz) (+5% - 15%) 20 VA max.

Weight: Net: 2.2 kg (4.75 lb). Shipping: 2.8 kg (6 lb)

Dimensions: 89 mm \times 160 mm \times 248 mm (3.5 in. H \times 6.25 in. W \times 9.75 in. D)

Model number and name

5381A Frequency counter

5382A Frequency counter

Option 001 TCXO (5382A only)

Price

\$249

\$450

add \$100

ELECTRONIC COUNTERS

Plug-on modular/portable counter system

Model 5300 A/B system & 5301A-5312A

NEW

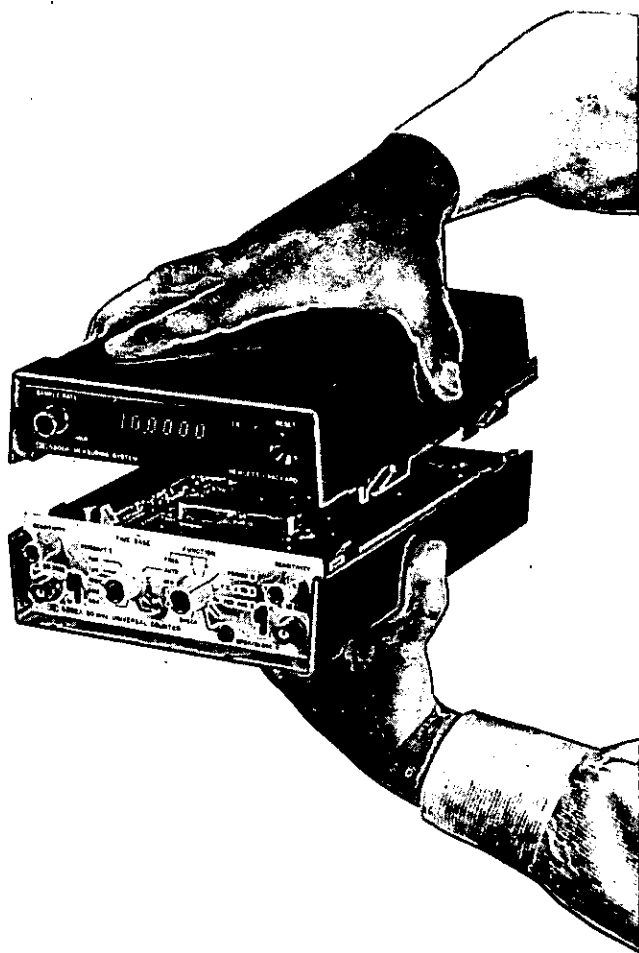

5300 Measuring system

The 5300 measuring system marks a new era of high performance and versatility for low cost counters.

Features include

- 10 MHz, 50 MHz, 525 MHz and 1.1 GHz
- 100 ns Time interval resolution and time interval averaging
- Up to 8 digits
- Auto ranging
- Unique time interval hold off
- Expandable with interchangeable modules
- Optional FCC type approved TCXO time base
- Portable-battery operation with all modules
- Compact and rugged
- High reliability MOS/LSI circuitry and LED display
- Designed for quick & easy owner-servicing
- Output via BCD, ASCII, or D to A converter

Description

Large scale integration and solid state display technology have helped to produce a uniquely versatile and capable counter at a surprisingly low cost. Easy to use and reliable, this counter does what is important—solves your measurement problems while saving your money. Versatility and antiobsolescence come from modular construction. Take your choice from two mainframes and select the snap on module that you need now. Expand the capability later with more modules, if and when you need them. You can expand the capability of your 5300 Measuring system to match your expanding needs and budget. Hewlett-Packard is engaged in an on-going program to develop expanded capabilities for the 5300 as shown by the "new modules" just added in this catalog. An optional battery pack provides portable cord-free operation of any of the modules, eliminating power problems and ground loops. The new plug-between digital to analog converter gives you an analog output that can drive a strip chart recorder, providing hard copy of any of the 5300 System's measurements. You can now easily obtain hard copy recordings of frequency drifts, time interval shifts, ratio changes, ohms variations, and even totalized levels from the 5300 system and its plug-between D to A converter. The BCD output and ASCII module lets you interface digitally with other instruments and systems. This is versatility that truly avoids obsolescence and optimizes your instrument dollars.

Unique benefits

Snap-together modularity allows you to match the display/mainframe capabilities with the functional module of your choice to match your present needs. Additional modules can be added as your measurement needs and budget expand, including the selection of three center modules which allows you to add a battery, a D to A Converter, or an ASCII output to your system when and if you need them. Frequencies up to 1.1 GHz can be measured with this portable precision frequency counter. Single time intervals can be measured with 100 ns resolution. Time interval averaging over up to 10^8 intervals allows you much greater resolution than ever available before in a counter of this price range.

Auto ranging

Auto ranging is included in many of the functions, enhancing the ease of operation by automatically selecting a correct gate time to fill the display. Any frequency within the range of the 5301A, 5302A, 5304A, 5307A and 5308A may be counted with the counter's logic circuits automatically selecting the correct gate time up to 1 second for maximum resolution without exceeding the display range. In the 5302A and 5304A auto ranging is also provided for the Period Average function to select the number of periods to be averaged. The high performance 5308A Universal Counter provides autoranging in the Frequency, Period Average, Ratio, and Time Interval average modes, a first for counters in any price range.

Time interval holdoff

Time interval holdoff is a unique feature of the 5304A Time/Counter module. This feature allows you to add a fixed delay between the start of a time interval measurement and the enabling of the stop channel. Thus any electrical pulses or irregularities in a waveshape that occur between the desired trigger points can be ignored. Even the delay itself can be measured with the 5304A.

5300A 6 DIGIT MAINFRAME										\$410 pg 272
5300B 8 DIGIT MAINFRAME										\$460 pg 272
5310A BATTERY PACK										\$245 pg 278
5311B DIGITAL TO ANALOG CONVERTER										\$325 pg 277
5312A ASCII INTERFACE										\$350 pg 277
Model	Frequency MHz	Period	Period Average	Time Interval	Time Interval Average	Totalize	Ratio	Multimeter ACV, DCV, Ω	High Resolution Reciprocal	
5301A	10									\$ 150pg 273
5302A	50									\$ 305pg 273
5303B	.525									\$ 825pg 274
5304A	10									\$ 360pg 274
5305A	1100									\$1100pg 275
5306A	10									\$ 465pg 275
5307A	2									\$ 360pg 276
5308A	75									pg 276

Typical Configurations

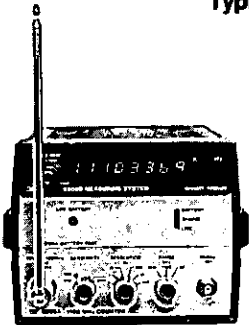

5300B, 5310A, 5305A

Frequency Measurement System For Mobile Communications
Go Anywhere Portability

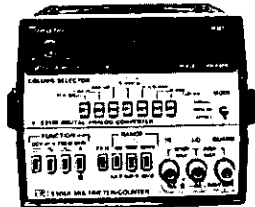

5300A, 5311B, 5306A

Trend Recording System For Voltage, Resistance, and Frequency
Graphic Copy For Visual Analysis

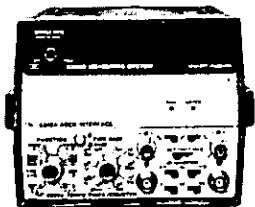

5300B, 5312A, 5308A

Data Acquisition System For Measurement And Recording Of Data
Reduction Of All Measurements

High resolution

High resolution at low frequencies is provided by the 5307A counter module. This easy to use counter makes a period average measurement, inverts it and displays the result as a frequency, thereby providing the high resolution of a period measurement and the ease of use of a frequency measurement automatically.

Digital and analog output

Digital output is available in BCD format (standard in 5300A mainframe) or ASCII format via the HP Interface Bus (to be used with 5300B mainframe) to provide interfacing with digital printers or with desktop calculators and other data processing equipment. Analog output for long term monitoring with strip chart recorders is provided by a digital to analog converter. This provides the capability to generate hard copy results of any of the measurements made by any of the 5300 modules.

Battery pack

A snap between battery pack provides a truly portable, light weight, go-anywhere measuring system for any of the 5300 Systems.

Serviceability

Reliability and easy servicing have been major design criteria for all of the 5300 modules. The small number of components and the use of modular design techniques allows problems to be easily traced to functional blocks. A check function is built into most of the functional modules to allow immediate checking of the basic counter circuits from the front panel. A user oriented service support package is available that provides plug-in cards with automatic diagnostic routines that allow the 5300 mainframes to troubleshoot themselves. Features like these make the net cost of owning either a 5300A or 5300B Measuring System less than that of conventional counters.



ELECTRONIC COUNTERS

5300 A/B systems (cont.)

NEW

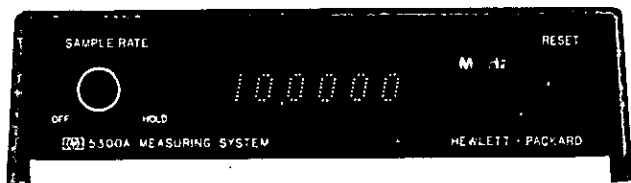

5300A and 5300B measurement system mainframe

The mainframe units provide the system with power, reference frequency, display, counting logic and timing control.

The 5300A has a six digit, dot matrix display, standard time base, external time base input and BCD output as a standard rear panel output. The 5300B has an 8-digit 7-segment display, standard time base or optional TCXO time base, external time base input and no digital output from the mainframe. See mainframe/plug-on display chart below for number of display digits with a particular mainframe and plug-on combination.

Time-base

Standard crystal frequency: 10 MHz

Stability:

Aging rate: <3 Parts in 10^7 /mo

Temperature: < ± 5 Parts in 10^6 , 0° to 50°C

Typically: < ± 2 Parts in 10^6 , 15° to 40°C

Line voltage: < ± 1 Part in 10^7 for 10% Line Variation

Oscillator output: 10 MHz, Approximately 1 V rms at rear panel BNC, 100 Ω source impedance

External input: 1 MHz to 10 MHz, 1 V rms into 200 Ω

Option 001: High stability time base (5300B Only)

Frequency: 10 MHz

Stability:

Aging rate: <1.2 part in 10^6 /year

Temperature: < ± 5 parts in 10^7 , 0° to 50°C

Line voltage: < ± 5 parts in 10^8 for 10% line variation

Oscillator output: 10 MHz, approximately 1 V rms at rear panel BNC, 200 Ω source impedance

External input: 1 to 10 MHz, 1 V rms into 500 Ω

General

Display: 6 Digit, Dot Matrix (5300A) or 8 Digit, 7 Segment Matrix (5300B)

Solid state LED display (Gallium Arsenide Phosphide Light Emitting Diodes) including decimal point and annunciator units.

Overflow: LED Light indicates when display range is exceeded.

Display storage: Holds reading between samples

Sample rate: Sample rate control adjusts the delay from the end of one measurement to the start of a new measurement. Continuously variable from less than 50 msec to greater than 5 seconds. HOLD position: display can be held indefinitely. Reset: Front panel pushbutton switch resets all registers and initiates new measurement. Reset input by contact closure to ground or TTL type low level also available on rear panel connector (5300A only).

Operating temperature: 0° to 50°C

Power requirements: 115 or 230 volts $\pm 10\%$, 50 to 400 Hz, 25 VA maximum (depends on plug-on module). Mainframe power without

plug-on nominally 5 watts. Battery operation: with 5310A rechargeable battery pack (see 5310A specifications).

Digital output (5300A only)

Digital serial, 4-bit BCD parallel available at rear panel connector.

Code: 4-line 1-2-4-8 BCD, "1" state low, TTL type logic levels.

Decimal point: Decimal point code (Binary "1111") automatically inserted at correct digit position.

Print command: Positive step, TTL output

Holdoff: Contact closure to ground or TTL low level, inhibits start of new measurement cycle.

Connector: 20-pin PC connector. Mating connector Viking 2VH10/1JN or equivalent.

Parallel data output: Available from Printer Interface. See 10533A specification.

Note: Digital output for 5300B Mainframe is provided by 5312A ASCII Module.

Weight: Net 1.5 kg (3 $\frac{1}{2}$ lb), shipping 2.5 kg (5 $\frac{1}{2}$ lb)

Dimensions (with snap-on module): Height, 89 mm (3 $\frac{1}{2}$ "), Width, 160 mm (6 $\frac{1}{4}$ "), Depth, 248 mm (9 $\frac{3}{4}$ ")

Mainframe/plug-on compatibility

Plug-on	Display Digits	
	with 5300A	with 5300B
5301A	6	7
5302A	6	7
5303B	6	8
5304A	6	7
5305A	6	8
5306A (Frequency)	6	7
(ACV, DCV, OHMS)	5	5
5307A	6	6
5308A	N/A	8

Accessories

Digital Recorder Interface: (for use with 5300A, BCD output) See 10533A Specifications, Page 273

Service support package: Contains an interface card and 4 diagnostic cards for easy trouble shooting of 5300A or 5300B, 10548A, Page 278

Leather carrying case: Holds 5300A or 5300B, snap-on module and 5310A battery pack plus accessories 18019A.

Rack mount kits:

10851A Single

10852A Double

10853A Single/with plug-between

10854A Double/with plug-between

Model number and name

5300A 6 digit mainframe

5300B 8 digit mainframe (new)

OPT 001 TCXO (5300B only)

Price

\$95

\$35

\$40

\$40

\$40

\$40

Price

\$410

\$460

\$180

- 10 MHz
- Auto ranging
- External gate

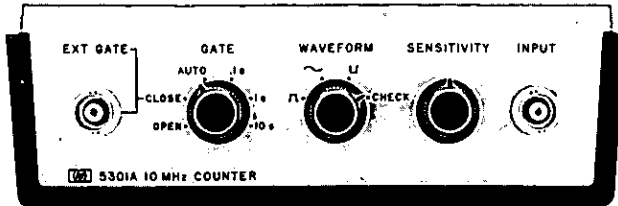

5301A 10 MHz frequency counter module

Input

Range: 10 Hz to 10 MHz

Sensitivity (min): 25 mV rms sine wave 50 Hz to 1 MHz. 50 mV rms sine wave 10 Hz to 10 MHz; 150 mV p-p pulse at minimum pulse width, 50 ns. Sensitivity variable to 2.5 V rms.

Impedance: 1 M Ω shunted by less than 30 pF.

Overload Protection: 500 V (dc + peak ac), 250 V rms, dc to 400 Hz, 10 V rms at 10 MHz.

Trigger Level: Selectable positive, negative, or zero volts

Frequency measurement

Range: 10 Hz to 10 MHz

Gate times: Manually selected 0.1, 1, or 10 seconds AUTO position selects gate time to 1 second for maximum resolution.

Accuracy: ± 1 count \pm time base accuracy

Open/close (totalizing)

Range: 10 MHz max count rate.

External gate: Gate signal by contact closure to ground or TTL low.

General

Check: Counts internal 10 MHz reference frequency.

Operating temperature: 0° to 50°C.

Power requirements: Including mainframe, nominally 8 watts.

Weight: Net, 0.9 kg (2 lb); shipping, 1.5 kg (3¼ lb)

Dimensions: See Mainframe

Price: \$150

10533A Recorder interface specifications

The 10533A accessory provides an interface between the 5300A measurement system mainframe and a standard parallel-input recorder such as the HP 5055A. The interface module provides conversion from the 5300A serial data output to a standard parallel format.

Output format: 10 parallel digits; 6 data, 1 decimal point, 1 overflow, 1 exponent and 1 exponent sign.

Code: 4-line 1-2-4-8 BCD; "1" state low, TTL levels.

Decimal point: Floating decimal point automatically inserted at correct digit position. Coded "1111" ("*" on standard HP 5055A print wheels). Internal jumper wire removes decimal point from data format if desired.

Overflow: Coded "1111" ("*") printed in first printer column when 5300A overflow light is on.

Exponent: ± 0 , ± 3 , ± 6 corresponding with 5300A measurement units.

Print command: Negative step. TTL levels.

Inhibit input: +2.0 V or higher prevents the 5300A from recycling.

Power requirements: 100 mA at 5 volts, provided by 5300A mainframe.

Price: \$155

- 50 MHz universal counter.
- Automatic or manual gate selection.
- 100 nsec time interval resolution.

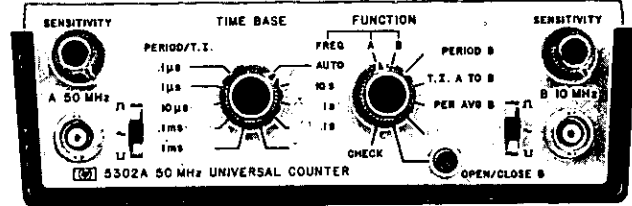

5302A 50 MHz universal counter module

Input channels A and B

Range: Channel A: 10 Hz to 50 MHz, Channel B: 10 Hz to 10 MHz

Sensitivity (min): 25 mV rms sine wave 50 Hz to 1 MHz. 50 mV rms sine wave 10 Hz to 10 MHz. 100 mV rms sine wave at 50 MHz. 150 mV p-p pulse at minimum pulse width, 50 ns. Sensitivity variable to 2.5 V rms.

Impedance: 1 M Ω shunted by less than 30 pF.

Overload protection: 500 V (dc + peak ac), 250 V rms, dc to 400 Hz, 10 V rms above 10 MHz.

Trigger level: Selectable positive, negative, or zero volts.

Slope: Automatically switched to trigger on positive slope for positive pulse and negative slope for negative pulse. Positive slope for sinusoidal inputs.

Marker outputs: Rear panel BNC, TTL low level while gate is open.

Frequency

Range: Channel A: 10 Hz to 50 MHz, prescaled by 10; channel B: 10 Hz to 10 MHz

Gate times: Manually selected 0.1, 1, or 10 seconds AUTO position selects gate time to 1 second for maximum resolution.

Accuracy: ± 1 count \pm time base accuracy

Time interval

Range: 500 nsec to 1000 seconds

Input: Channels A and B

Resolution: 100 ns to 1 ms in decade steps

Accuracy: ± 1 count \pm time base accuracy \pm trigger error*

Period

Range: 10 Hz to 1 MHz

Input: Channel B

Resolution: 100 ns to 1 ms in decade steps

Accuracy: ± 1 count \pm time base accuracy \pm trigger error*

Period average

Range: 10 Hz to 1 MHz

Input: Channel B

Periods averaged: 1 to 10³ automatically selected.

Frequency counted: 10 MHz

Accuracy: ± 1 count \pm time base accuracy \pm trigger error*

Ratio

Display: F_A/F_B times multiplier (N), N = 10 to 10⁷, selectable in decade steps

Range: Channel A: 10 Hz to 1 MHz, Channel B: 10 Hz to 10 MHz

Accuracy: \pm count of $F_B \pm$ trigger error of F_A *

Open/close (totalizing)

Range: 10 MHz max

Input: Channel B opening and closing of gate initiated by front panel pushbutton switch.

General

Check: Counts internal 10 MHz reference frequency.

Operating temperature: 0° to 50°C

Power requirements: Including mainframe, nominally 10 watts

Weight: Net, 0.9 kg (2 lb); shipping, 1.5 kg (3¼ lb)

Dimensions: See Mainframe

Price:

\$305

*For any wave shape, trigger error (μ s) is less than

$$\pm \frac{0.005 \mu\text{s}}{\text{Signal Slope (V/\mu s)}}$$

For period average this is less than $\pm 0.3\%$ of one period + period average for signals with 40 dB or better signal-to-noise ratio.

ELECTRONIC COUNTERS

5300A/B System (cont.)

- CW or burst to 525 MHz
- Automatic gain control and fused input
- FCC type approved

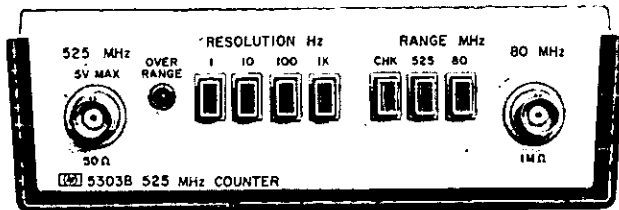

5303B Frequency counter module

This counter module was especially designed for servicing and calibrating mobile communications equipment and AM & FM broadcast equipment. An automatic gain control (AGC) amplifier has been provided on the 80 MHz channel. This provides ease of use by compensating for input level variations and rejecting noise up to 50% of the peak-to-peak level of the input signal. The front end circuitry of the 525 MHz channel is fuse protected against high input signal levels that would normally cause expensive frontend damage. The addition of the battery pack makes this an ideal portable instrument for the lab or the field.

Input channel A (CW or burst)

Range: DC to 525 MHz, prescaled by 8

Sensitivity (fixed):

100 mV rms sine wave, dc to 500 MHz

125 mV rms sine wave, 500 MHz to 525 MHz

Signal must pass through zero.

Impedance: 50 Ω

Overload protection: 5 V rms (input circuitry fuse protected)

Input channel B (CW or burst)

Range: 50 Hz to 80 MHz, direct

Sensitivity (automatic):

25 mV rms sine wave, 100 Hz to 50 MHz

50 mV rms sine wave, 50 Hz to 100 Hz and 50 MHz to 80 MHz

Sensitivity is adjusted automatically by AGC (automatic gain control).

Effective up to input clipping level of 10 V p-p.

Impedance: 1 MΩ shunted by less than 40 pF

Overload protection: 250 V rms, 50 Hz to 10 KHz declining to 10 V rms above 10 MHz

Frequency measurement

Resolution: (selectable): 1, 10, 100, 1000 Hz

Accuracy: ± 1 digit \pm time base accuracy

General

Check: counts internal 10 MHz reference frequency.

Overflow: light indicates display exceeded.

Operating temperature: 0° to 50°C

Power requirements: including mainframe, nominally 10 watts

Weight: Net 0.9 kg (2 lb) Shipping, 1.5 kg (3¼ lb)

Dimensions: see mainframe.

Price:

\$825

Option 001: High stability time base (for use with 5300A)

Frequency: 10 MHz

Stability:

Aging rate: <1.2 part in 10⁶/year

Temperature: < ± 5 parts in 10⁷, 0° to 50°C

Line voltage: < ± 5 parts in 10⁶ for 10% line variation

Oscillator output: 10 MHz, approximately 1 V rms at rear panel BNC, 200 Ω source impedance

External input: 1 to 10 MHz, 1 V rms into 500 Ω

Price:

\$180

*For any waveshape, trigger error is less than $\pm \frac{0.005 \mu s}{\text{Signal Slope (V/}\mu\text{s)}}$

**Trigger error is less than $\pm 0.3\%$ of one period + periods averaged for 40 dB or better signal-to-noise ratio.

- Matched input amplifiers
- Time interval hold-off
- 100 nsec time interval resolution

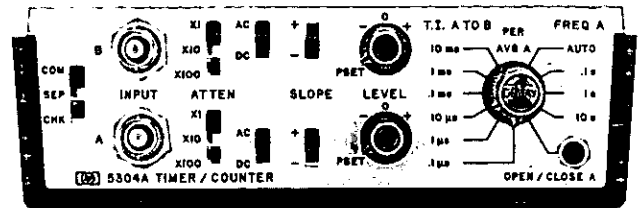

5304A Timer/counter module

Input channels A and B

Range: DC coupled: 0 to 10 MHz, AC coupled: 100 Hz to 10 MHz

Sensitivity (min): 25 mV rms sine wave to 1 MHz, 50-mV rms sine wave to 10 MHz, 150 mV p-p pulse at minimum pulse width, 40 nsec. Sensitivity can be decreased by 10 or 100 times using ATTENUATOR switch.

Impedance: 1 MΩ shunted by less than 30 pF.

Overload protection: 250 V rms on X10 and X100 attenuator settings. On X1 attenuator setting 120 V rms up to 1 kHz, decreasing to 10 V rms at 10 MHz.

Trigger level: PRESET position centers triggering about 0 volts, or continuously variable over the range of -1 V to +1 V times attenuator setting.

Slope: Independent selection of triggering on positive or negative slope.

Channel inputs: Common or separate lines.

Gate output: Rear panel BNC. TTL low level while gate is open.

Time interval

Range: 500 ns to 10⁴ sec

Input: Channels A and B; can be common or separate.

Resolution: 100 ns to 10 ms in decade steps.

Accuracy: ± 1 count \pm time base accuracy \pm trigger error*

Time interval holdoff: Front panel concentric knob which inserts variable delay of approximately 100 μs to 100 ms between START (channel A) and enabling of STOP (channel B); may be disabled. Electrical inputs during delay time are ignored. Delay may be digitally measured in CHECK and TIME INTERVAL positions. Delay output: rear panel BNC. TTL low level during delay time.

Period average

Range: 10 Hz to 1 MHz

Input: Channel A

Period averaged: 1 to 10³ automatically selected.

Frequency counted: 10 MHz

Accuracy: ± 1 count \pm time base accuracy \pm trigger error**

Frequency

Range: 0 to 10 MHz

Input: Channel A

Gate times: Manually selected 0.1, 1, or 10 seconds. AUTO position selects gate time to 1 second for maximum resolution.

Accuracy: ± 1 count \pm time base accuracy

Open/close (totalizing)

Range: 10 MHz max

Input: Channel A Opening and closing of gate initiated by front panel pushbutton switch.

General

Check: Inserts internal 10 MHz reference frequency into channels A and B.

Operating temperature: 0° to 50°C

Power requirements: Including mainframe, nominally 10 watts.

Weight: Net, 0.9 kg (2 lb); shipping, 1.5 kg (3¼ lb).

Dimensions: See mainframe

Price:

\$360

- 1100 MHz
- 25 mV rms sensitivity
- Fused input

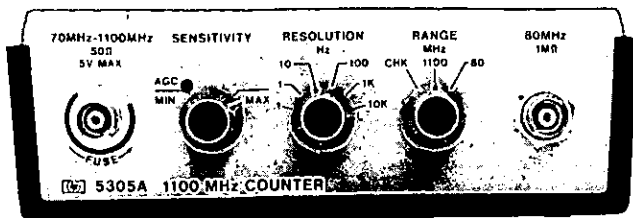

5305A 1100 MHz frequency counter module

Input channel A (CW or burst)

Range: 70 MHz to 1100 MHz, prescaled by 16

Sensitivity:

- 10 mV to 500 MHz
- 25 mV to 1100 MHz

Signal must pass through zero.

Sensitivity can be varied continuously up to 5 V rms by adjusting sensitivity control.

Sensitivity can be set automatically by use of AGC (Automatic Gain Control) mode. Counter automatically transfers to AGC mode whenever amplifier is over driven, for added amplifier protection. Transfer of control, lights front panel indicator.

Overload protection: 5 V rms (Input circuitry fuse protected) Fuse is located in BNC connector, accessible from front panel.

Input channel B (CW or burst)

Range: 50 Hz to 80 MHz Direct

Sensitivity AGC (automatic gain control):

- 25 mV rms sine wave, 100 Hz to 50 MHz
- 50 mV rms sine wave, 50 Hz to 100 Hz and 50 MHz to 80 MHz

Sensitivity is adjusted automatically by AGC.

Effective up to input clipping level of 10 V p-p.

Impedance: 1 mΩ shunted by less than 40 pF

Overload protection: 250 V rms 50 Hz to 10 kHz, declining to 10 V rms above 10 MHz

Frequency measurement

Resolution (selectable):

.1, 1, 10, 100, 1000, 10000 Hz corresponding to 10, 1, 0.1, 0.01, 0.001, 0.0001 Sec Gate Times on the 80 MHz Channel and 160, 16, 1.6, 0.16, 0.016, 0.0016 Sec Gate Times on the 1100 MHz Channel

Accuracy: ±1 digit ± time base accuracy

Display: Hz, kHz, MHz with positioned decimal point

General

CHECK: Counts internal 10 MHz Reference Frequency.

Operation temperature: 0° to 50°C

Power requirements: AC operation: 115 or 230 V ± 10%, 50 to 400 Hz through 5300A or 5300B mainframe (nominally 10 watts including mainframe).

Weight: Net, 1.3 kg (2¾ lb). Shipping, 1.8 kg (4 lb)

Dimensions: See mainframe.

Price:

\$1100

Option 001: High Stability Time Base (for use with 5300A)

Frequency: 10 MHz

Stability:

Aging rate: <1.2 part in 10⁶/year

Temperature: <±5 parts in 10⁷, 0° to 50°C

Line voltage: <±5 parts in 10⁸ for 10% line variation

Oscillator output: 10 MHz, approximately 1 V rms at rear panel BNC, 200Ω source impedance

External input: 1 to 10 MHz, 1 V rms into 500Ω High stability time base is also available in the 5300B mainframe and can be used with other modules.

Price:

\$180

- DC volts, AC volts, ohms and frequency

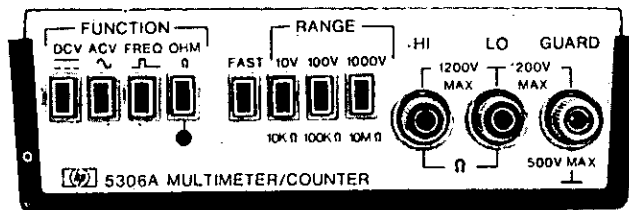

5306A Digital multimeter/counter module

DC voltage

Range	Accuracy (60 days, 23°C ±5°C, <80% RH)	Sensitivity
10 V	±(0.03% of reading + 0.003% of range)	100 μV
100 V	±(0.03% of reading + 0.003% of range)	1 mV
1000 V	±(0.097% of reading + 0.03% of range)	10 mV

Temperature coefficient: ±(0.002% of reading/°C + 0.0002% of range/°C)

Sample times: Normal: 0.5 sec, Fast: 0.05 sec

Input: Floating pair, 10 MΩ resistance, all ranges

Effective common mode rejection (1 kΩ imbalance): DC: >80 dB; 50 Hz or 60 Hz ±0.1%: >80 dB

Normal mode rejection: 50 Hz or 60 Hz ±0.1%: >50 dB

Maximum input: High to Low: 1100 V dc all ranges

Low to Guard: ±200 V dc or peak ac

Guard to Ground: ±500 V dc or 240 V rms at 50 or 60 Hz

AC voltage

Range	Frequency	Accuracy (60 days, 23°C ±5°C, <80% RH)
10 V	40 Hz to 10 kHz	±(0.98% of reading + 0.02% of range)
	10 kHz to 100 kHz	±(0.98% of reading + 0.10% of range)
100 V	40 Hz to 500 Hz	±(1.5% of reading + 0.05% of range)
	40 Hz to 500 Hz	±(1.5% of reading + 0.05% of range)

Temperature coefficient:

10V and 100V range: ±(0.05% of reading + 0.003% of range/°C)

1000V range: ±(0.5% of reading + 0.003% of range/°C)

Input impedance: 10 MΩ shunted by <75 pF maximum

Maximum input voltage: (See DC voltage specification)

Effective common mode rejection (1 kΩ imbalance): DC: >80 dB; 50 Hz or 60 Hz ± 0.1%: >50 dB (10 V range)

Ohms

Range	Accuracy (60 days, 23°C, ±5°C, <80% RH)	Sensitivity
10 kΩ	±(0.5% of reading + 0.003% of range)	0.1Ω
100 kΩ	±(0.5% of reading + 0.003% of range)	1Ω
10 MΩ	±(0.75% of reading + 0.003% of range)	100Ω

Temperature coefficient: ±(0.0002% of range/°C)

Current through unknown: 1 mA on 10 kΩ range; 100 μA on 100 kΩ range; 1 μA on 10 MΩ range

Overload protection: 10 kΩ range; 240 V rms for 1 min. 140 V rms continuous (warning lamp indicates overvoltage) 100 kΩ, 10 MΩ ranges; 240 V rms continuous

Frequency

Range: 40 Hz to 10 MHz

Sensitivity (min): 50 mV rms to 1 MHz; 125 mV rms to 10 MHz

Trigger level: Automatically adjusts to 40% of peak level of input

Overload protection: 1000 V rms. On 10 V range: 240 V rms from 40 Hz to 400 kHz, 10⁶ V Hz from 400 kHz to 10 MHz

Gate times: Normal: 1 sec, Fast: 0.1 sec

Accuracy: ±1 count ± time base accuracy

Power requirements: Including mainframe, nominally 12 watts

Weight: Net, 1.1 kg (2.3 lb). Shipping, 1.7 kg (3.6 lb)

Price:

\$465

ELECTRONIC COUNTERS

5300A/B System (cont.)

- High resolution at low frequencies
- 10 mV rms sensitivity
- 100 Hz and 10 kHz low pass filters

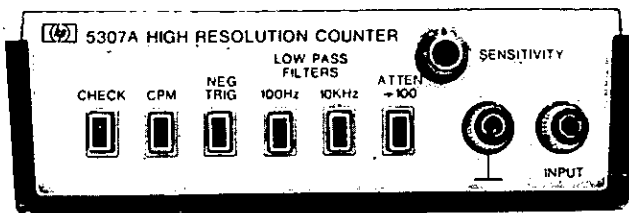

5307A High resolution counter module

5307A is a period average measuring, frequency indicating (reciprocal) counter, that provides very high resolution measurements in a minimum of time: (i.e. 60,000 Hz in $<1/2$ second). The CPM mode converts Hz to counts/minute.

Input

Range: Hz mode: 5 Hz to 2 MHz. CPM mode: 50 to 10M counts/minute (0.8333 Hz to 166 kHz).

Sensitivity (Min.):

10 mV rms	5 Hz - 1.2 MHz	120 CPM - 10 MCPM
25 mV rms	1.2 MHz - 2.0 MHz	50 CPM - 120 CPM

Pulses:

For low-duty cycle pulses (<15%).
15 mV peak for 250 nsec pulses.
100 mV peak for 100 nsec pulses.

Basic sensitivity can be varied continuously up to 2.5 V rms by adjusting sensitivity control.

Attenuator: $\div 1$ or $\div 100$ effectively raises basic input sensitivity by a factor of 100 (10 mV \rightarrow 2.5 V to 1 V \rightarrow 250 V).

Low pass filters: (3 dB Point)

	100 Hz	10 kHz
Max. Attenuation	60 dB	40 dB
Roll-off	20 dB per Decade	

Impedance:

No filters	1 M Ω shunted by <50 pF
100 Hz filters	1 M Ω shunted by series of 100 k Ω and 0.015 μ F
10 kHz filter	1 M Ω shunted by series of 100 k Ω and 150 pF

Coupling: AC coupled amplifier.

Overload protection: 200 V rms below 10 kHz; 2×10^6 V Hz rms to 0.4 MHz; 5 V rms above 0.4 MHz; 300 V rms with $\div 100$ attenuator

Trigger level: Selected positive or negative for optimum triggering from sinusoidal inputs or \pm pulses.

Frequency measurement

Periods averaged: Automatically selected for maximum resolution. Two periods are averaged for signals up to 100 Hz. Periods averaged increase decade for decade up to 200,000 periods averaged above 1 MHz.

Measurement time: Varies from 312 msec for a display of 170000 to 815 msec for a display of 999000. Hold-off adjustable from .35 μ sec to 3.5 μ sec and 1 msec to 10 msec.

Accuracy: $\pm 3 \times 10^{-5} \pm$ trigger error** \pm time base error.

Display: Hz mode: Hz and MHz with automatic decimal point. CPM mode: M with automatic decimal point.

General

Check: Measures internal reference frequency. Displays 1.00000 MHz in Hz mode, 100000 M in CPM mode.

Operating temperature: 0° to 50°C

Power requirements: including Mainframe, nominally 10 watts.

Weight: Net, 0.9 kg (2 lb). Shipping, 1.5 kg (3 1/4 lb).

Price: \$360

* $\pm 3 \times 10^{-5}$ is due to reciprocity scheme and is worst case.

** For any wave shape, trigger error (μ s) is less than

$$\pm \frac{0.005 \mu\text{s}}{\text{Signal Slope (V}/\mu\text{s})}$$

For period average this is less than $\pm 0.3\%$ of one period + periods averaged for signals with 40 dB or better signal-to-noise ratio.

- 75 MHz
- Time Interval Averaging
- Auto Ranging or Manual Operation

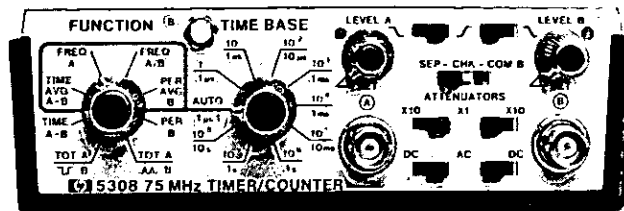

5308A Universal counter/timer module

Input (channels A and B)

Range: DC coupled; 0 to 75 MHz, AC coupled; 20 Hz to 75 MHz.
Sensitivity: (Min) 25 mV rms to 10 MHz, 50 mV rms to 75 MHz 150 mV p-p pulse at pulse width of 10 nsec.

Impedance: 1 M Ω shunted by less than 40 pF

Overload protection: X1: 125 V rms to 400 kHz declining to 10 V rms at 75 MHz X10: 250 V rms to 4 MHz declining to 13 V rms at 75 MHz.

Trigger Level: Variable over the range of ± 2.0 V and ± 20 V.

Slope: Independent selection of triggering on + or - slope.

Rear outputs: Gate, trigger levels and time base/scaling.

Frequency

Range: 0 to 75 MHz, Channel A or Channel B

Gate Times: 8 selectable times from 1 μ s to 10 S

Accuracy: ± 1 count \pm time base accuracy

Frequency ratio

Display: Fa/Fb, 1 to 10^8 periods selectable manual or auto.

Range: Channel A; 0 to 75 MHz, Channel B; 0 to 10 MHz

Accuracy: ± 1 count of Fa \pm trigger error of Fb.**

Period

Range: 0 Hz to 5 MHz, Channel B

Resolution: 100 nsec to 10 sec

Accuracy: ± 1 count \pm time base accuracy \pm trigger error**

Display: μ s, or s with positioned decimal point.

Period average

Range: 0 - 10 MHz; (100 nsec to 10 sec), Channel B

Periods averaged: 1 - 10^8 selectable manual or automatic

Accuracy: ± 1 count \pm time base accuracy \pm trigger error**

Time interval

Range: 200 nsec to 10^9 sec, 25 ns minimum pulse width

Inputs: Separate A and B or Common B

Resolution: 100 nsec to 10 sec

Accuracy: ± 1 count \pm time base accuracy \pm trigger error**

Display: μ s, ks or s with positioned decimal point

Time interval average

Range: 1 ns to 10 s, dead time between intervals 200 ns

Inputs: Channels A and B separate or common B

Intervals averaged: 1 to 10^9 , selectable manual or automatic

Accuracy: \pm time base accuracy ± 5 ns

$$\pm \frac{[\text{Trigger Error}^{**} \pm 100 \text{ ns}]}{\sqrt{\text{Intervals Averaged}}}$$

Totalize

totalizes Channel A while Channel B is low.

totalizes Channel A between pulses on Channel B.

Range: 75 MHz in X1 Position, 10 MHz in X10^N positions.

Accuracy: ± 1 count \pm trigger error** on Channel B

General

Auto position: Automatically sets time base to give maximum resolution within 1.1 second measurement time for Frequency, Frequency Ratio, Period Average, and Time Interval Average.

Check: Counts internal 10 MHz reference frequency.

Operating temperature: 0° to 50°C

Power requirements: Including 5300B, nominally 15 watts.

Weight: Net, 0.9 kg (2 lb). Shipping, 1.5 kg (3 1/4 lb)

Note: Compatible with 5300B only.

- Three modes of operation
- Battery compatible
- Column selective

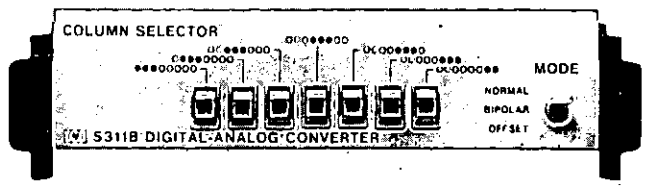

5311B Digital to analog converter module

The 5311B Digital to Analog Converter conveniently snaps in-between the mainframe and plug-on module of any 5300 system. It provides high resolution, expanded scale analog output of any of the 5300 system measurements. With the 5311B you can select any three consecutive digits, or the right-hand two of the mainframe display for conversion to analog output. This makes it possible to focus on just that part of the display that contains the important information. Now your stripchart recorder can give you a permanent record of any functional measurement made by any 5300 measurement system. Easy to use, just snap it in place. The 5311B can also be used with the 5310A battery pack to provide a rugged, portable, go-anywhere monitoring system. Three modes of output makes it possible to tailor the output to the application.

Operating modes

Three modes selectable by switch on front panel.
Normal mode: Analog output is directly proportional to digital input. Digital 000 produces zero output; 999 produces full scale output.
Plus/minus mode: Digital 000 produces center scale output; -999 produces zero output; 999 produces full scale output.
Offset mode: 500 produces zero output; 000 produces midscale output; 499 produces full scale output. This mode effectively adds 500 to digital input to acquire half scale offset. Compatible with all mainframes and plug-on modules.

Mode	Output		
	0 to 50% of Scale	50% of Scale	50% to 100% of Scale
Normal	0 to 499	500	501 to 999
Plus/Minus	-999 to -001	000	001 to 999
Offset	500 to 999	000	001 to 499

Output selection

Manual pushbuttons to select any three consecutive digits or the last two digits of the Mainframe display.

Output ranges

Potentiometric Recorder Output: 0.1 V, 1.0 V, or 10 V full scale into >20 kΩ. Dual banana plugs.
 Galvanometer Recorder Output: 1 mA full scale into <1.5 kΩ phone jack.

General

Accuracy: ±0.25% of range ±50 μV/°C on potentiometric output, ±20 nA/°C on galvanometer output after calibration for appropriate range.
Calibration: Zero and full scale calibration switch and adjustments on rear panel.
Transfer time: <5 ms
Operating temperature: 0° to 50°C
Power requirements: Nominally 1 watt
Weight: Net: 0.8 kg (1.7 lb), Shipping: 1.4 kg (3.0 lb)
Dimensions: Digital-to-Analog Converter plugs between Mainframe and plug-on module. Increases height of instrument by 38.4 mm (1.5 in.).
Price:

\$325

- Expanded digital output
- ASCII format

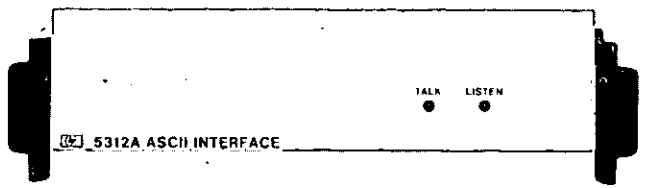

5312A ASCII interface module

The ASCII Interface Module snaps in between the 5300B and any plug-on module. It provides digital Output capability via the HP Interface Bus. This is an easy to implement method of interfacing any 5300 system that utilizes the 8-digit 5300B mainframe with any HPIB compatible printer.

The 5312A outputs fifteen bits of information in the following format.

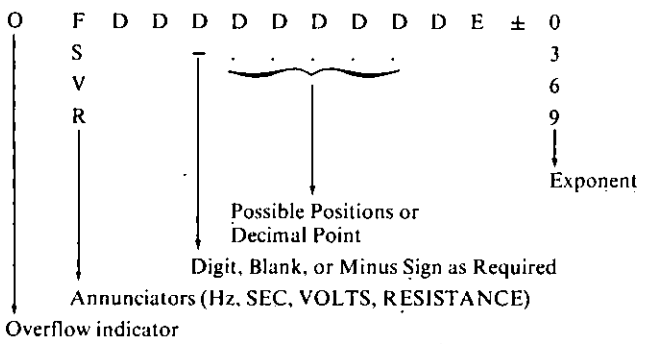

General

Sample rate: Controlled by mainframe front panel control or by setting rate of reset command (when in listening mode, counter can be reset by sending "initialize" command).
Transfer time: 20 Milliseconds
Transfer rate: Maximum of 40 reading/Sec depending on capabilities of plug-on.
Indicator lights: Indicates if instrument is in Talk or Listen Modes.
Self test mode: Checks functioning of basic interface.

```

OF  0171135E+0
F   10171.92E+3
F   10173.10E+3
F   10173.38E+3

R   2.3175E+3
R   2.3409E+3
R   2.3759E+3

OV  0.0000E+0
V   -2.1655E+0
V   -2.1654E+0

F   1076268E+0
    
```

Samples of digital output from 5300 measuring system utilizing the 5312A ASCII interface and the 5150A thermal printer. Note the indication of function, decimal position, exponent and overflow when required.

Programmability: Front panel controls are not programmable
Note: The 5312A is not compatible with the 5300A mainframe which contains its own BCD Digital Output.

Price:

\$350

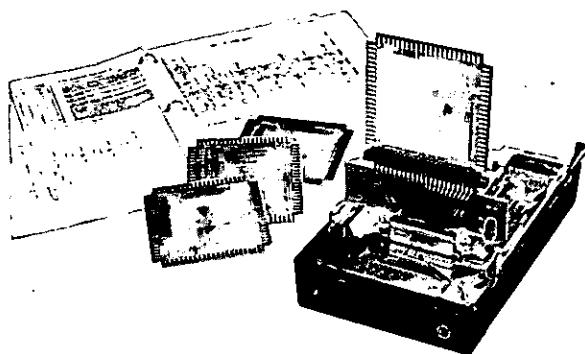

10548A Service support package

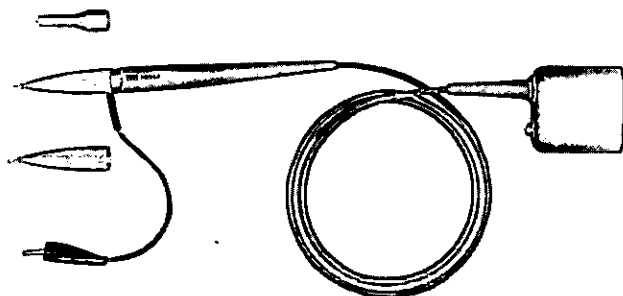

11096A High frequency probe

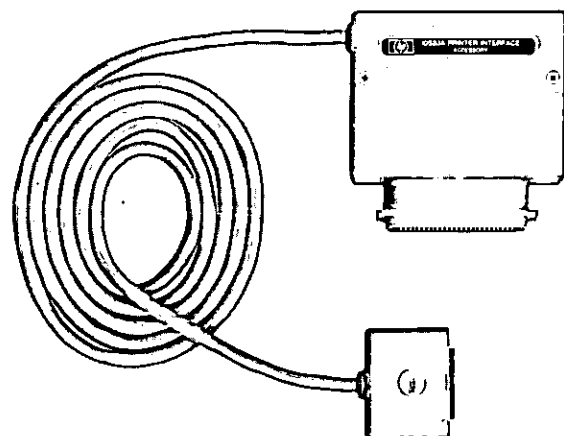

10533A BCD Serial to parallel interface

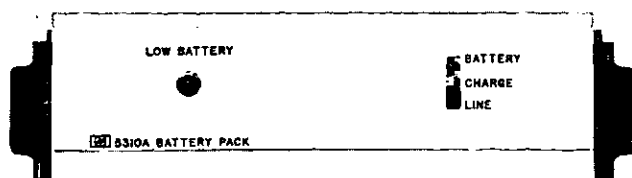

5310A Battery pack

5310A Battery pack module

Provides battery power to 5300A mainframe and snap on modules from rechargeable nickel-cadmium cells.

The 5310A Battery Pack is easily inserted between the 5300A or 5300B mainframe and any functional module, providing a truly portable measurement system. Low voltage strobed solid state displays and the MOS/LSI IC design of the mainframes make efficient battery operation possible. The front panel warning light indicates a low battery condition. Any 5300 system with the battery inserted will automatically switch over to battery operation in the event of power failure, providing extra reliability for unattended operation. Floating operation is also possible with the 5310A Battery Pack, thus avoiding ground loops.

Battery capacity: 48 watt-hours, nominal. Minimum 3, typically 5 hours of continuous operation at charging and operating temperature (20° to 30°C).

Recharging time: 18 hours from minimum level (indicated by Low Voltage Indicator) to full charge.

Battery voltage: 12 Vdc

Low voltage indicator: Solid state warning light begins to glow at approximately 90% discharge.

Line failure protection: Allows instrument to be operated in LINE position with automatic switch-over to battery power if line voltage fails. Batteries receive trickle charge in LINE position to maintain charge.

Operating temperature: Operating: 0° to 50°C. Charging: 0° to 40°C, mainframe not operating.

Power requirements: Charging power via mainframe, nominal 7.5 watts

Weight: Net: 2.3 kg (5 lb). Shipping: 2.9 kg (6¼ lb).

Accessories furnished: Shoulder carrying strap

Dimensions: Battery pack plugs between 5300A or 5300B mainframes and any plug-on module. Increase height of instrument by 38.4 mm (1.5 in.)

Price: \$245

10548A Service support package

The unique HP 10548A Service Kit provides an easy and efficient means of trouble shooting the 5300A or 5300B mainframes. The four diagnostic cards, shown in use above, contain 16 self running tests that locate problems to the component level. Complete diagnostic flow charts in the manuals provide further step by step procedures. When failures are diagnosed, repair is simple. All components are easily accessible by merely removing a single screw and snapping out the main PC board.

Price: \$95

11096A High frequency probe

Allows the 5306A to make high frequency ac voltage measurements. This probe is used for ac voltage measurements of 0.25 volt to 30 volts over a frequency range of 100 kHz to 500 MHz with an accuracy of $\pm 5\%$ from 100 kHz to 100 MHz and $\pm 7\%$ to 500 MHz over 10° to 30°C. Three probe tip accessories are supplied to extend the probe's versatility.

Price: \$82

ELECTRONIC COUNTERS

Special purpose counters
Models 5210A, 5323A, 5330A, 5330B

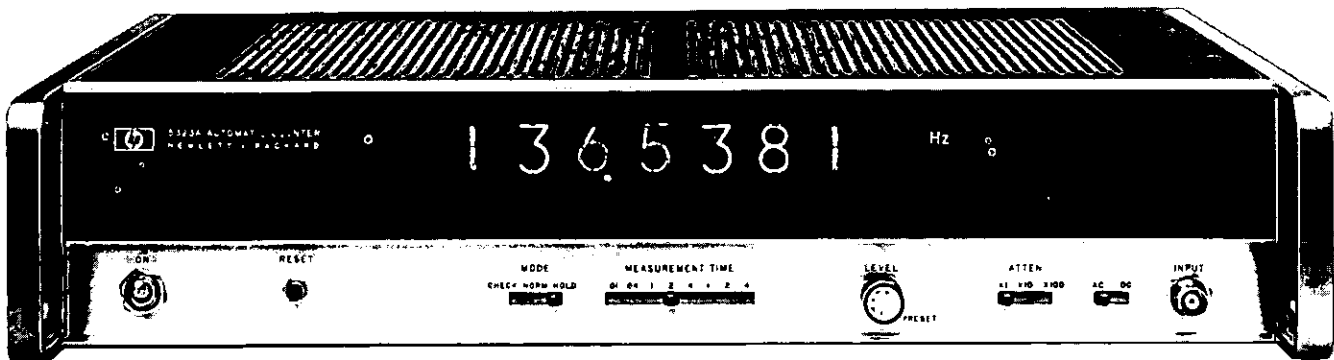

5323A

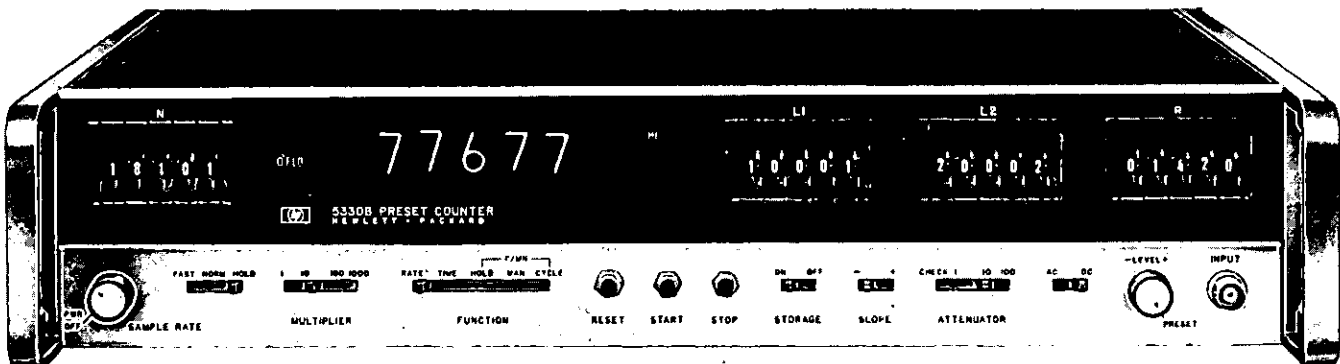

5330B, option 001

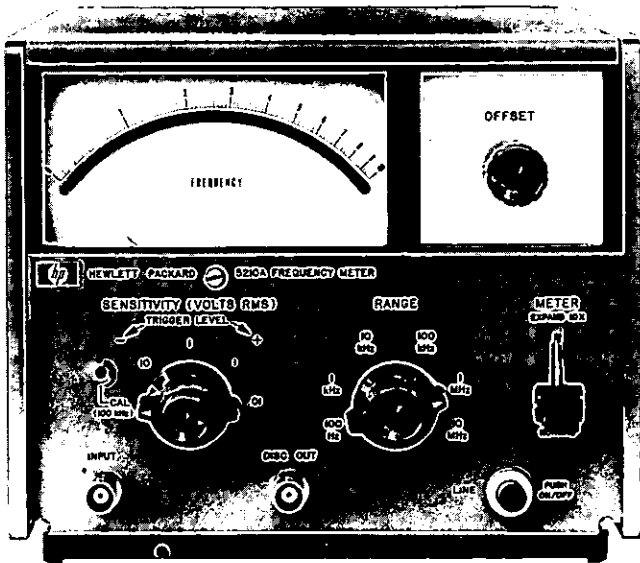

5210A

5210A Frequency meter

The Model 5210A Frequency Meter/FM Discriminator directly measures frequency or repetition rate of signals from 3 Hz to 10 MHz, independent of input voltage waveform. The special log linear scale offers an accuracy of 1% of reading from 10% of full scale up. With calibrated offset (Option 001) the accuracy is up to 0.2% of full scale.

The 5210A is also a wideband highly linear FM discriminator with a 3dB output bandwidth of better than 1 MHz for precise measurements on FM and PM signals. With the HP 10531A Accessory Filter Kit, frequency deviation, modulation index, frequency response, distortion, incidental FM, and FM noise can be determined as well as "flutter" and "wow" to better than 100 dB below carrier frequency.

For more details see Hewlett-Packard Application Note 87 and the 5210A data sheet.

5323A Automatic counter

The 5323A Automatic Counter offers much greater resolution and measurement speeds than conventional counters when measuring low frequencies. For example, the counter provides 10^3 times greater resolution than a conventional counter when measuring 100 Hz (in the same measurement time). The counter achieves such high speed and high resolution by measuring the period of an input signal then automatically converting the result to frequency using built-in computing circuits. The 5323A gives fully automatic operation from 0.125 Hz to 20 MHz. A rear panel X60 multiplier switch converts the display to RPM for tachometry applications.

5330A and 5330B Preset counters

The 5330A Preset Counter offers normalized measurements using a preset (variable) time base. Thumbwheel switches allow the user to convert traditional counter measurements to read directly in engineering units such as RPM, GPM or PSI. The four operating modes provide the following measurements: rate (frequency), time (period), ratio, and F/MN (frequency division). Maximum input rate is 10 MHz.

Option 001 provides offset counting. The counter starts all counts at the value set in the "R" switch and resets to this value.

The 5330B adds upper and lower limit testing capability to the features of the 5330A. Rear panel outputs indicate whether each counter measurement is below, above, or within the limits, L1 and L2.

Both the 5330A and the 5330B include remote programming and digital output as standard features.

Model Number & Name	Price
10531A Accessory Filter Kit for 5210A	\$260
5210A Frequency Meter	\$905
Opt 001 Calibrated Offset	\$130
5323A Automatic Counter	\$1850
5330A Preset Counter	\$1800
Opt 001 Offset Counting ("R" switches)	\$105
5330B Preset Counter	\$2150
Opt 001 Offset Counting ("R" switches)	\$105

FREQUENCY AND TIME STANDARDS

General information

Hewlett-Packard offers Frequency Standards and clocks which provide accurate frequency, time interval and timekeeping capabilities. Further, Hewlett-Packard standards provide means for comparing these quantities against national standards such as the National Bureau of Standards (NBS) and the U.S. Naval Observatory. Units of frequency or time cannot be kept in a vault for ready reference. They must be generated for each use, hence be regularly compared against recognized primary standards.

Frequency Standard and clock systems manufactured by Hewlett-Packard are used for control and calibration at observatories, national centers for measurement standards, physical research laboratories, missile and satellite tracking stations, communication systems, radio navigation systems, manufacturing plants and radio monitoring and transmitting stations.

Types of frequency standards

At the present time, three types of frequency standards are in common use. These are:

1. The cesium atomic beam controlled oscillator.
2. The rubidium gas cell controlled oscillator, and
3. The quartz crystal oscillator.

Hewlett-Packard is the only manufacturer of all three types of frequency standards. Of these three standards, the first is a primary frequency standard and the last two are secondary frequency standards. The distinction between a primary standard and a secondary standard is that the primary standard does not require any other reference for calibration; whereas the secondary standard requires calibrations both during manufacturing and at intervals during use depending on the accuracy desired.

Cesium beam frequency standard

Cesium beam standards are in use wherever the goal is a very high accuracy primary frequency standard. In fact, the NBS frequency standard itself is of the cesium beam type. The cesium beam standard is an atomic resonance device which provides access to one of nature's invariant frequencies in accord with the principles of quantum mechanics. The cesium standard is a true primary standard and requires no other reference for calibration.

The HP Model 5061A and the new 5062C are portable cesium beam standards proved capable of realizing the cesium transition frequency to the same levels of accuracy and

TABLE 1

Comparison of Frequency Standards

Standard	Principal construction feature	Principal advantage
Cesium Atomic Beam Resonator Controlled Oscillator.	Atomic beam interaction with fields—minimum disturbances of resonating atoms due to collisions and extraneous influences.	High intrinsic reproducibility and long-term stability. Designated as primary standard for definition of time interval.
Rubidium Gas Cell Resonator Controlled Oscillator.	Gas buffered resonance cell with optically pumped state selection.	Compact and light weight. High degree of short-term stability.
Quartz Crystal Oscillator.	Piezoelectrically active quartz crystal with electronic stabilization.	Very compact, light and rugged. Inexpensive.

long term stability usually achieved by large-scale laboratory models. Recent beam tube improvements have made the short-term stability comparable to that of the Rubidium Frequency Standard. With this improved performance cesium standards now have the capability of rapid measurement to high precision along with the excellent long term stability necessary for timekeeping.

Rubidium frequency standard

Rubidium frequency standards feature a high order of both short-term and long-term frequency stability. These are both important in certain fields such as deep-space communications, satellite ranging, and doppler radar.

Rubidium standards are similar to cesium beam standards in that an atomic resonant element prevents drift of a quartz oscillator through a frequency lock loop. Yet the rubidium gas cell is dependent upon gas mixture and gas pressure in the cell, it must be calibrated and then it is subject to a small degree of drift. The drift is typically 100 times less than the best quartz crystal standard.

Quartz crystal oscillators

Quartz oscillators are used in virtually every frequency control application. They are an integral part of atomic standards and are used extensively as independent frequency sources for the less demanding applications. The quartz oscillator designs have improved over the years to provide a relatively low cost, small size source of frequency.

However, an inherent characteristic of crystal oscillators is that their resonant frequency changes with time. After an initial aging period of a few days to a month, the rate of change of frequency or aging rate is

almost constant. Over a long period the accumulated drift could amount to a serious error, and periodic frequency checks are needed to maintain an accurate quartz crystal frequency standard.

Stability

Stability is specified in two ways, long term stability refers to slow changes in the average frequency with time due to secular changes in the resonator and is usually expressed as a ratio, $\Delta f/f$ for a given period of time. For quartz oscillators this is often termed "aging rate" and specified in "parts per day." Rubidium standards being more stable are specified in "parts per month." On the other hand, Cesium Beam Standards are primary units with no systematic drift. Therefore, the frequency of these primary standards is guaranteed to a specified accuracy.

Short term stability refers to changes in frequency over a time sufficiently short so that change in frequency due to long term effects is negligible.

Short-term stability is usually specified as the rms average of a number of measurements each over a specified period of time. The longer the averaging time used, the more any deviation is obscured since the average must approach the mean or nominal output frequency in the long run. Hewlett-Packard specifies the short-term stability of its standards in accordance with the definition developed by the National Bureau of Standards and others.* Measurements conforming to this definition can be easily made with available test equipment including the HP 5360A Computing Counter. Figure 1 is a comparison of the short-term stability of various frequency standards.

*Statistics of Atomic Standards, D. Allen, Proceedings of IEEE, Feb 1966, page 221.

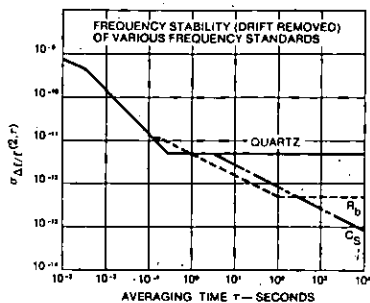

Figure 1. Short term stability of various standards.

Spectral purity

Spectral purity is the degree to which a signal is coherent, or, expressed in another way, a single frequency with a minimum of sideband noise power. It is very desirable to have high spectral purity in a standard signal. This is especially important in applications where the standard frequency is multiplied to very high or microwave frequencies so that the frequency spectrum of the signal will be reasonably narrow.

The signal and its frequency spectrum are analogous to a frequency modulated wave where the total power is constant. If the frequency multiplying device is broadband, the ratio of the total sideband power to the signal power increases as the square of the multiplying factor. With frequency multiplication the signal-to-noise ratio will be degraded 6 dB per octave and 20 dB per decade.

Hewlett-Packard oscillators are designed to give exceptional spectral purity. One method of indicating spectral purity is with a phase noise plot. Figure 2 shows the performance of the HP 5061A, Opt. 004 Cesium Beam Atomic Frequency Standard. (See Hewlett-Packard Application Note 52-3, Stability: Theory and Measurement, for details of noise measurement).

Frequency standards and clocks

Frequency standards and clocks have no fundamental differences — they are based upon dual aspects of the same phenomenon. Time and frequency are intangible quantities which can be measured only with respect to some physical quantity. The basic unit of time, the second, is defined as the duration of 9,192,631,770 periods of transition within the cesium atom. Conversely an unknown frequency is determined by counting the number of cycles over the period of a second. The U.S. Naval Observatory (USNO) deter-

mines and keeps standard time for the United States. The Master Clock at the Observatory, one of the world's most accurate clocks, is made up of an ensemble of more than a dozen Hewlett-Packard cesium beam frequency standards. The USNO directly controls the distribution of precise time and time interval (frequency) from Naval radio stations, LORAN-C (operated by U.S. Coast Guard), Omega and Satellite Navigation Systems. Hewlett-Packard portable cesium standards, "flying clocks," are used to periodically check the synchronization between these stations and the Master Clock.

Hewlett-Packard cesium beam standards are widely used to drive precision clocks because of the extremely good long-term stability and reliability of this primary standard. If a quartz oscillator or other secondary standard is used, it must be evaluated for rate of drift and be corrected periodically.

Frequency comparison by VLF broadcast

One excellent way to keep a local system's frequency—hence, time interval—referenced against master time interval is by use of a LF or VLF standard broadcast such as those of the National Bureau of Standards and the U.S. Navy. A prime means for doing this with ease and convenience is the HP 117A Receiver which is designed to monitor the NBS 60 kHz broadcast from WWVB. This unit is a complete system in itself. The strip chart produced by the 117A records minute by minute the results of a precision phase comparison (resolution, 1 μs) of the local signal against the received signal to show frequency offset or error of the local standard.

Time scale

The time interval of the atomic time scale is the International Second, defined in October 1967 by the Thirteenth General Conference of Weight and Measures. Since January 1972 the frequency offset between UTC and Atomic Time has been zero and the UTC time scale is kept in synchronism with the rotation of the earth to within ±0.7 second by step-time adjustments of exactly 1 second, when needed. The UTC signal is broadcast from the NBS station; WWVB (60 kHz) and several other stations throughout the world. The HP 117A VLF Receiver will provide direct comparison to this international time (frequency) reference.

Standby power supplies

Minimum down-time, important for any system, is vital to a time standard. Its worth depends directly on continuity of operation.

Noninterrupted operation is also important to ultra-precise quartz oscillators.

Hewlett-Packard standby power supplies ensure continued operation despite line interruptions, and operate over a range of ac line voltage to supply regulated dc to operate frequency standards and frequency dividers and clocks. The batteries in the supplies assume the full load immediately when ac power fails.

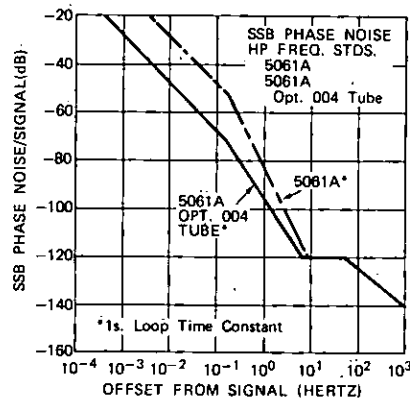

Figure 2. 5061A Phase Noise

Hewlett-Packard time and frequency standard

The Hewlett-Packard House Standard at the Santa Clara Division consists of an ensemble of four Hewlett-Packard Cesium Beam Standards including three HP 5061A's with Option 004 High Performance Tubes. The output is continually compared in phase with the U.S. National Bureau of Standards Frequency Standard (NBS FS) at Boulder, Colorado by reception of NBS standards station WWVB via an HP 117A Receiver. The standard is also compared to the U.S. Naval Observatory Master Clock in Washington D.C. by means of LORAN-D and the USASTRATCOM Communication Satellite time intercomparisons. The frequency uncertainty of the standard is within a few parts in 10¹³ with respect to the standards maintained by the NBS and the USNO.

Time is maintained relative to the Naval Observatory and the National Bureau of Standards master clocks to an accuracy of better than ±2.5 microseconds. This accuracy is verified with Flying Clock trips from the Naval Observatory to both Hewlett-Packard Santa Clara Division and Hewlett-Packard Geneva. Both locations have been designated U.S. Naval Observatory Time Reference Stations.

FREQUENCY & TIME STANDARDS

Atomic frequency standards

Models 5061A, 5062C, 5065A

- Primary standard, 1×10^{-11} accuracy
- Proven reliability
- World-wide usage

- Option 004: Accuracy $\pm 7 \times 10^{-12}$
- Settability $\pm 1 \times 10^{-13}$
- Short term 5×10^{-12} (1 sec avg)

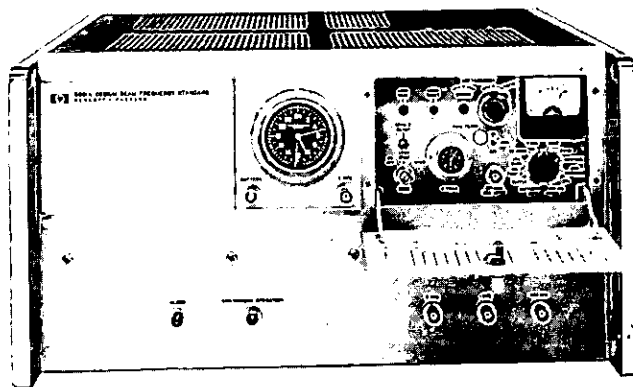

5061A

Introduction

Hewlett-Packard Atomic Frequency Standards have become the world-wide standards for frequency and time keeping since the introduction of the 5060A Cesium Standard in 1964. With the introduction of the 5062C the user now has a choice of four different frequency standards to satisfy a wide variety of applications:

1) 5061A Cesium Beam Frequency Standard. This standard with an accuracy of $\pm 1 \times 10^{-11}$ was introduced in 1967 to replace the 5060A. The high accuracy and excellent reliability of these units have gained world-wide acceptance of HP frequency standards.

2) 5061A with Option 004 High Performance Cesium Beam Tube. With the unique design features in this improved Cesium Beam Tube, the 5061A accuracy is $\pm 7 \times 10^{-12}$ and short term stability is improved by a factor of 10.

3) 5062C Cesium Beam Frequency Reference. This new unit with its small cesium beam tube is designed for system applications where a rugged primary standard is required.

4) 5065A Rubidium Frequency Standard. This instrument features excellent long and short term stability performance at approximately one-half the cost of a cesium standard.

These units are described in detail on the following pages and the specifications are combined in a table to facilitate the comparison and selection of the best unit to suit the user's application.

Principles of operation

The basic block diagram of both cesium and rubidium standards is the same (see Figure 1). The output of the 5 MHz Crystal Oscillator is

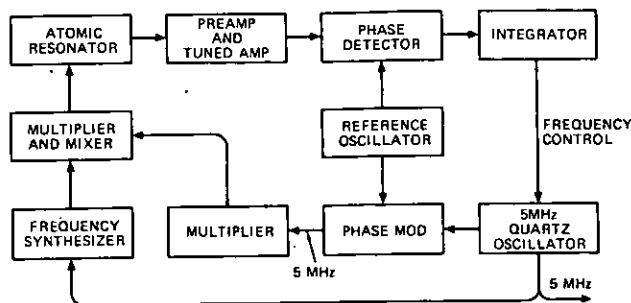

Figure 1. Block diagram of atomic frequency standards.

multiplied and synthesized to the atomic resonance frequency (6834+ MHz for rubidium and 9192+ MHz for Cesium). This signal is phase modulated to sweep through the atomic resonance frequency causing the beam intensity in the cesium tube or transmitted light through the

rubidium cell to vary. The output signal is amplified and through a phase detector controls the frequency of a low noise 5 MHz quartz crystal oscillator. This oscillator provides the 5 MHz output. Dividers produce 1 MHz and 100 kHz outputs.

The invariant resonance frequency of the cesium atoms passing through the microwave cavity maintain the output frequency of the cesium standard constant to extremely high accuracy. The accuracy is in part a function of the microwave cavity length and is highest in the 5061A with the long cavity of the high performance beam tube.

In the rubidium standard a buffer gas is required to reduce collisions between the rubidium atoms in the gas cell and the resonant frequency varies slightly with pressure of the buffer gas. As a result, the rubidium standard has to be calibrated and the frequency drifts slowly with time because of small changes in gas pressure and other effects within the rubidium cell and lamp. Offsetting this disadvantage are: 1) high signal-to-noise ratio of the rubidium cell output which results in excellent short term stability and; 2) a lower cost standard because of the simpler rubidium cell and associated electronics.

Front panel controls and a circuit check meter for monitoring performance are protected by a panel door. Front panel lights indicate any interruption of continuous operation and that the crystal oscillator is locked to the atomic resonance.

Applications: Starting with their initial usage as reference standards in national laboratories the applications of HP atomic standards have expanded to include use in operational systems such as the LORAN C and OMEGA navigation transmitters, satellite tracking and guidance stations, very long base line interferometers, navigation receivers based on direct distance measurement (LORAN Rho-Rho), geophysical survey positioning systems and communications systems. Precise timing for frequency control is required for some secure communication systems and to improve efficiency of PCM and spread spectrum systems.

Cesium standard accuracy: The cesium beam standard is a primary frequency standard. A cesium beam tube carefully constructed along with the required supporting electronics will, when independently aligned, put out the correct frequency within very narrow limits. The frequency spread of the output for over 250 independently aligned 5061A standards with the standard beam tube is shown in Figure 2. It can be seen from this data that the frequency perturbations in the standard beam tube are so small that all the units are within $\pm 5 \times 10^{-12}$ of each other and of the NBS frequency. The one sigma standard deviation is 1×10^{-12} between units. This performance is intrinsic to the 5061A and is achieved without calibration. The absolute accuracy, intrinsic reproducibility and absence of any perceptible long-term drift or aging are important advantages of cesium standards and assure that the output frequency of a cesium standard is always within the specified accuracy.

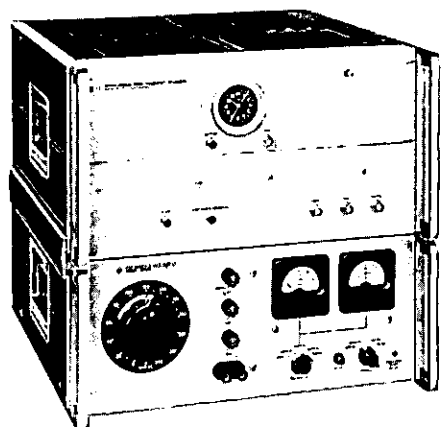

E21-5061A

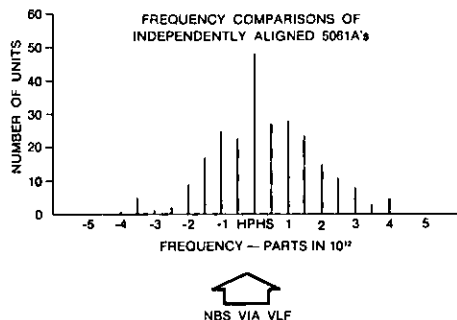

Figure 2. Frequency of independently aligned 5061A Cesium Beam Standards with standard beam tube.

5061A Cesium beam standard

The first Hewlett-Packard Cesium Beam Standard, the 5060A, was introduced in 1964. This was followed in 1967 with the improved 5061A and in 1973 with the high performance beam tube option for the 5061A. Over this 11 year period the accuracy and reliability of Hewlett-Packard cesium standards has been demonstrated and these standards have become the world-wide standard for frequency and time keeping.

Reliability and warranty: Over 15 million operational hours have proven the performance and reliability of Hewlett-Packard cesium beam standards in various world-wide applications. The units have provided dependable microsecond accuracy in aircraft, ship and fixed environments.

A three-year warranty on the 5061A and the standard cesium beam tube is provided as a result of proven field reliability over an extended period. This warranty includes replacement of the cesium beam tube if it should fail within the warranty period. Typically, beam tube life has been in excess of four years.

The 5061A has provision for an optional digital divider and clock (Option 001) and for a battery with ½ hour standby power capacity with automatic charging (Option 002).

5061A with Option 004, high performance cesium beam tube

The Hewlett-Packard Model 5061A primary frequency standard with the new Option 004 cesium beam tube offers increased stability

and accuracy in the instrument which has become the worldwide standard of frequency and time keeping since its introduction in 1967. Improvements in magnetic shielding, ruggedization and environmental performance will permit improved performance and expansion of navigation and communication systems that have been made practical by the 5061A.

The design concept of the high performance beam tube includes unique HP designed dual beam optics with higher beam intensity to accomplish better short term stability and greater immunity to effects of shock and vibration. A 50 percent increase in resonance cavity length without change in the overall beam tube size contributes to better accuracy and settability because of the high Q of the narrower resonant line width. This tube retains the unique cesium standard feature of virtually no long term instability or aging. This new beam tube is offered as Option 004 in new instruments and is also available in a retrofit kit for units already in use. (Information on the 10653A/B/C Retrofit Kit is available from HP Sales Offices.)

The intrinsic accuracy is improved to $\pm 7 \times 10^{-12}$ which provides an excellent reference standard without need of calibration. If desired, as in many timekeeping applications, two or more units may be calibrated to determine the difference in rate or may be adjusted to the same frequency. With the improved settability specification of 1×10^{-13} small changes in frequency are accomplished rapidly and accurately. A provision for degaussing the tube without adversely affecting the instrument operation allows removal of any residual magnetic field in the tube. This is important in achieving the settability performance.

The short term stability specification is improved by a factor of ten with the new tube. The 5×10^{-12} (1 sec avg.) performance compares very favorably with that of rubidium type standards which are noted for their excellent short term stability. An important advantage from the better short term stability is the capability to make measurements to 1 sigma precision of 1×10^{-12} in about one minute compared to the two hours required previously.

Reliability and warranty: The 5061A with the High Performance Tube has the same high reliability as the 5061A with the standard tube. The new high performance tube is warranted for 14 months (10,000 hours) and is designed to have the same long life as the standard tube.

10638A Degausser

The 10638A Degausser is available as an accessory unit to degauss the high performance beam tube in the 5061A Cesium Standard. The degausser removes any residual magnetic field which could cause a small frequency offset by passing a gradually decreasing alternating signal through an auxiliary coil around the beam tube magnetic shields.

E21-5061A Flying clock

The E21-5061A consists of a 5061A Cesium Beam Standard with Option 001 Clock and a K02-5060A Power Supply joined together to make one portable unit. The power supply, which can be operated from 6 or 12 V dc, 24 to 30 V dc, or 115/230 V $\pm 10\%$, 50 to 400 Hz, will provide approximately 7 hours standby power (from sealed nickel-cadmium batteries) for the 5061A Cesium Beam Standard.

This wide range of operating power capabilities enables the E21-5061A to operate on local power in virtually any country in the world. Operation is approved aboard commercial aircraft. The seven hours of standby capability make it possible to travel where there is no power available and, of course, allow the E21-5061A to conveniently be transported between power sources and operated in almost any air or surface vehicle as a "flying clock" (see Hewlett-Packard Journal, August 1966 and December 1967).

The Option 004 tube, because of the improved shielding, offers a significant increase in accuracy under the varying earth's magnetic field conditions experienced by flying clocks and is a desirable addition to the E21-5061A. In addition, the better short term stability permits more accurate and rapid comparison of standards. The Option 002 Battery may also be added to increase standby capability.

FREQUENCY & TIME STANDARDS

Atomic frequency standards

Models 5061A, 5062C, 5065A (cont.)

NEW

- Primary frequency/time reference
- Fast warm-up
- Rugged, reliable

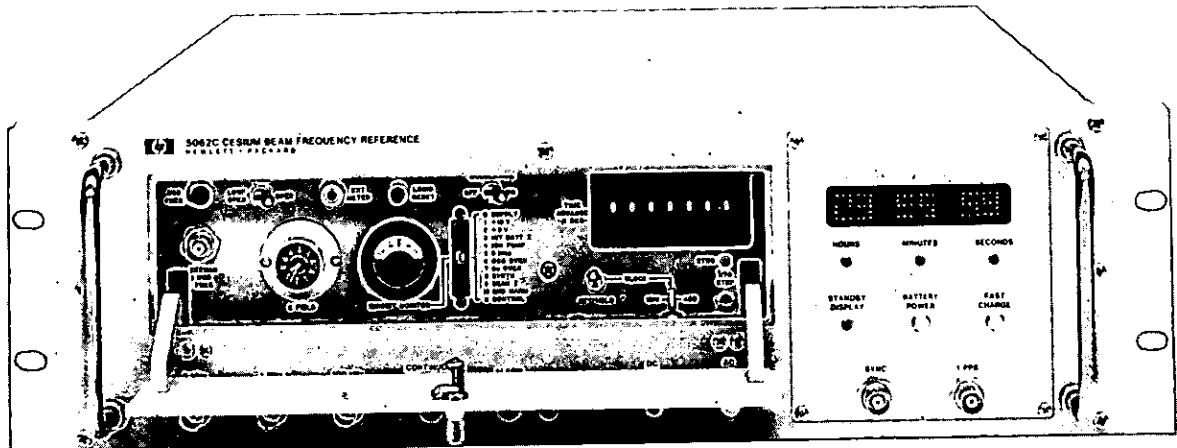

5062C

5062C Cesium beam frequency reference (New)

The Model 5062C Cesium Beam Frequency Reference is a rugged and compact precision oscillator designed for use in surface and airborne systems such as shipboard navigation systems and air transport communications systems. The unit is a self-contained primary standard with the frequency controlled by a cesium beam tube resonator. Features important for system operation are the expanded operating temperature range (-28°C to $+65^{\circ}\text{C}$), 20-minute warm-up, frequency accuracy of within ± 3 parts in 10^{11} (including temperature and DC magnetic field effects) with negligible long-term drift and no need for calibration.

The basic design of the Model 5062C is patterned after that of the Hewlett-Packard Model 5060A and the 5061A Cesium Beam Clocks, but this rugged unit is 25% smaller in size. Yet, space is provided for an optional clock and standby batteries. Other features such as special output frequencies or a time code generator may be added. This reduction in size has been accomplished by using a newly developed, smaller and more rugged cesium beam tube and more compact electronics. Particular attention has been given to the temperature, shock and vibration encountered in system applications, and the resulting rugged design assures stable operation under the various combinations of environmental effects encountered.

Reliability: The unit incorporates conservatively designed circuits to insure reliability. Similar designs in the 5061A Cesium Beam Standard have demonstrated mean time between failures (MTBF) in excess of 20,000 hours in laboratory environments. Ease of maintenance features such as plug-in circuit cards, key test points and accessible controls minimize the unit's mean time to repair (MTTR) in the event of a failure.

Options: The design of the 5062C includes space for several optional features. A solid-state digital readout clock with a 1 pps output is available as Option 001. Its output will automatically sync to within 0.5 microseconds of an external sync pulse. A variable phase control advances the output in digital steps over a range of 1 second with a resolution of 100 nanoseconds. This option will meet the needs of precision timekeeping applications.

Option 002 standby battery consists of sealed gelled-electrolyte battery cells which will allow operation independent of external power for periods up to 1 hour.

5065A Rubidium frequency standard

The HP Model 5065A is an atomic-type secondary frequency standard which uses a rubidium vapor resonance cell as the stabilizing element. As a result, it has long term stability of better than 1×10^{-11} per month which exceeds that of high quality quartz oscillator frequency standards by 50 to 100 times. Furthermore, it has excellent short term stability. These features contribute to its desirability as a coherent signal source, as a master oscillator for radio and radar systems where special requirements for stability and/or narrow bandwidth must be met, as a precision time keeper where the better performance of a cesium beam primary standard is not required, and as a house frequency standard for improved accuracy with fewer NBS calibrations compared to that required with quartz standards.

The magnetic field control provides fine frequency adjustment with which the frequency can be set to a precision of better than 2×10^{-12} without reference to a chart.

The HP Model 5065A is contained in a small sized package and is lightweight in comparison to a cesium beam standard. The rubidium resonance cell is much more frequency stable than quartz oscillators while subjected to shock and vibration. Its environmental specifications include temperature, shock, vibration, EMC, humidity and magnetic field effects.

Reliability and warranty: The most significant module in the HP 5065A in terms of performance is the Rubidium Vapor Frequency Reference (RVFR). This temperature controlled, magnetically shielded unit includes the RB⁸⁷ gas cell and a photo sensitive detector designed for maximum possible reliability. Field experience, including several million hours of operation, have demonstrated this reliability and the module is now warranted for a period of three years. This increased warranty protects the owner in the event of random failure.

E21-5065A Portable time standard

E21-5065A Portable Time Standard is a complete system for precision timekeeping and for transporting time from one location to another. It consists of the 5065A Rubidium Standard with digital clock and divider (Option 001) and the K02-5060A Power Supply with 6 or more hours standby capability. The component units are held together by side bars, and the interconnecting cables are protected by a back cover.

- Compact, low-price atomic standard
- Long term drift rate $< 1 \times 10^{-11}/\text{mo}$

- Short term stability $< 5 \times 10^{-13}$ (100 sec avg)

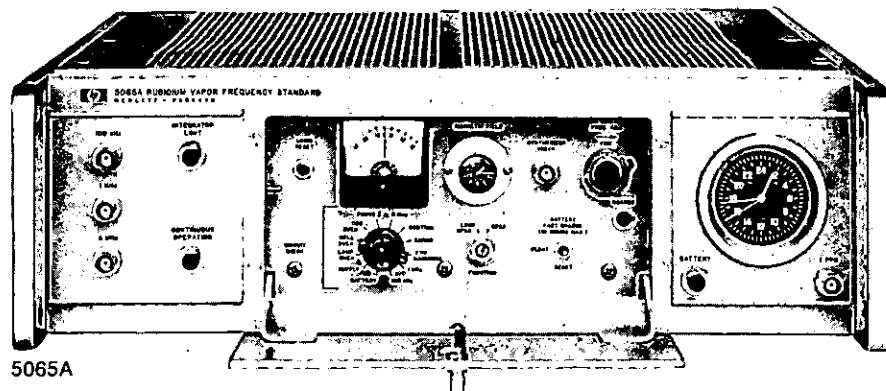

5065A

Specifications

Instrument:	5061A Option 004	5061A	5062C	5065A
Type of Standard:	Cesium	Cesium	Cesium	Rubidium
Accuracy: maintained in magnetic field to 2 gauss and over temperature range of:	$\pm 7 \times 10^{-12}$ 0 to 50°C	$\pm 1 \times 10^{-11}$ 0 to 50°C	$\pm 3 \times 10^{-11}$ -28°C to +65°C	
Stability: Long Term: Short Term (2):	$\pm 3 \times 10^{-12(1)}$ 1.5×10^{-10} 5×10^{-12} 2.7×10^{-12} 8.5×10^{-13}	$\pm 5 \times 10^{-12(1)}$ 1.5×10^{-10} 5.6×10^{-11} 2.5×10^{-11} 8×10^{-12}	$\pm 1 \times 10^{-11(1)}$ 4×10^{-10} 7×10^{-11} 2.2×10^{-11} 7×10^{-12}	$\pm 1 \times 10^{-11}/\text{month}$ 1.5×10^{-10} 5×10^{-12} 1.6×10^{-12} 5×10^{-13}
Averaging time:	0.01 sec 1 sec 10 sec 100 sec			
Reproducibility	$\pm 3 \times 10^{-12}$	$\pm 5 \times 10^{-12}$	$\pm 1 \times 10^{-11}$	
Settability (frequency):	$\pm 1 \times 10^{-13(3)}$	$\pm 7 \times 10^{-13}$	$\pm 2 \times 10^{-12}$	$\pm 2 \times 10^{-12}$
DC Magnetic Field Stability:	$\pm 2 \times 10^{-13}$ 2 Gauss Field	$\pm 2 \times 10^{-12}$ 2 Gauss Field	$< 2 \times 10^{-12}$ 2 Gauss Field	$< 5 \times 10^{-12}$ 1 Gauss Field
Warm-up:	At 25°C 30 Min.	At 25°C 45 Min.	At -28°C 20 Min.	At 25°C 1×10^{-10} 1 hr. 5×10^{-11} 4 hrs.
Sinusoidal Outputs: Output Voltage:	5 MHz, 1 MHz, 100 kHz, Front & Rear BNC 1 V into 50 ohms			
Harmonic Distortion: (below rated output)	>40 dB	>40 dB	>30 dB	>40 dB
Non-Harmonic related output: (below rated output)	>80 dB	>80 dB	>80 dB	>80 dB
Under vibration or AC Mag Field:	>60 dB	>60 dB	>60 dB	>60 dB
Signal-to-Phase Noise Ratio in 30 kHz noise BW (5 MHz):	>87 dB	>87 dB	>87 dB	>87 dB
Environmental				
Temperature, operating with Option 001: 002:	0 to 50°C 0 to 50°C	0 to 50°C 0 to 50°C	-28° to +65°C -28° to +55°C	0 to 50°C 0 to 50°C
Freq. change from 25°C:	$< 5 \times 10^{-12}$	$< 5 \times 10^{-12}$	$< 2 \times 10^{-11}$	$< 4 \times 10^{-11}$
Temperature, non-operating without options: Option 001: Option 002:	-40° to 75°C -40° to 50°C -40° to 50°C	-40° to 75°C -40° to 50°C -40° to 50°C	-62° to 75°C -40° to 75°C -40° to 60°C	-40° to 75°C -40° to 50°C -40° to 50°C
Humidity, operating: 95% up to	40°C	40°C	50°C	40°C
Altitude, operating: Max: frequency change:	40,000 Ft. 2×10^{-12}	40,000 Ft. 2×10^{-12}	50,000 Ft. 5×10^{-12}	40,000 Ft. 5×10^{-11}
NOTES: (1) For life of beam tube. (2) Short-term stability for the 5061A with both standard and high performance tubes is given for the normal loop time constant. For improved short-term stability in controlled environments the long time constant may be used. (3) With 10638A Degausser.				

FREQUENCY & TIME STANDARDS

Atomic frequency standards

Models 5061A, 5062C, 5065A (cont.)

NEW

Instrument:	5061A Option 004	5061A	5062C	5065A
AC Magnetic Field: 50, 60 and 400 Hz $\pm 10\%$	$< 2 \times 10^{-12}$ for 2 Gauss peak	$< 2 \times 10^{-12}$ for 2 Gauss peak	$< 2 \times 10^{-12}$ for 2 Gauss peak	$< 5 \times 10^{-12}$ 1 G peak
Vibration: with isolators:	MIL-STD-167 MIL-T-21200	MIL-STD-167 MIL-T-21200	MIL-STD-167 MIL-E-5400, Curve 1	MIL-STD-167 MIL-E-5400, Curve 1
Shock:	MIL-E-5400, Class 1 (30 G)			
	MIL-T-21200, C.1	MIL-E-16400		MIL-T-21200, C.1
EMC:	MIL-STD-461, Notice 3, Class A			
General				
Power: AC:	50, 60 or 400 Hz $\pm 10\%$, 115/230 V $\pm 10\%$			
DC:	43 W 22 to 30 V 27 W	43 W 22 to 30 V 27 W	48 W 22 to 30 V 33 W	49 W 23 to 30 V 35 W
Option 001: Add (AC/DC) 002: Add (AC/DC)	10/7.5 W 22/4.5 W	10/7.5 W 22/4.5 W	12/7 W 25/3 W	10/7.5 W 6/0 W
Dimensions (H \times W \times D): Inches: mm:	8" \times 16" \times 16" 221 \times 425 \times 416	8" \times 16" \times 16" 221 \times 425 \times 416	5" \times 19" \times 21" 133 \times 482 \times 533	5" \times 16" \times 16" 133 \times 425 \times 416
Weight: (lb/kg) Option 001: Add (lb/kg) 002: Add (lb/kg)	70/31.8 2/0.9 5/2.3	67/30.5 2/0.9 5/2.3	50/22.7 5/2.3 15/6.8	34/15.4 2/0.9 3.5/1.6
Option 001, Clock				
1 PPS Outputs: Master: Clock:	Front & Rear BNC	Front & Rear BNC	Rear BNC Front & Rear BNC	Front & Rear BNC
Amplitude:	10 V peak into 50 Ω load			
Width:	20 μ s min	20 μ s min	20 μ s $\pm 5\%$	20 μ s min
Rise Time:	<50 ns	<50 ns	<20 ns	<50 ns
Fall Time:	<2 μ s	<2 μ s	<1 μ s	<2 μ s
Jitter, pulse-to-pulse:	<5 ns, rms	<5 ns, rms	<0.5 ns, rms	<5 ns, rms
Synchronization:	Automatic, 10 ± 1 μ s delay	Automatic, 10 ± 1 μ s delay	Auto. to within ± 500 ns	Auto., 10 ± 1 μ s delay
Clock pulse adjustment range:	1 μ s to 1 s	1 μ s to 1 s	0.1 μ s to 1 s	1 μ s to 1 s
Clock display:	24-hr. sweep second	24-hr. sweep second	Solid State Digital	24-hr sweep second
Option 002, Standby Power Supply				
Capacity at 25°C with Option 001 Clock:	30 Minutes	30 Minutes	One Hour	10 Minutes
Recharge, Fast/Float:		Automatic, fast charge		Switch

Model number and name

5061A Cesium Beam Frequency Standard

Option 001 Clock

Option 002 Standby Power Supply

Option 003 Clock and Standby Power Supply

Option 004 High Performance Beam Tube

E21-5061A Flying Clock

Consists of: 5061A with Option 001 and K02-5060A Standby Power Supply.

Weight: 64 kg (141 lb).

Dimensions: 425 mm \times 405 mm \times 546 mm (16" \times 15" \times 21") (includes handles).

10638A Degausser

Weight: 1.2 kg (3 lb)

Dimensions: 130 mm \times 77 mm \times 279 mm (5" \times 3" \times 11")

Price

\$18,565

\$1950

\$770

\$2,720

\$2900

\$24,465

\$515

5062C Cesium Beam Frequency Reference

Option 001 Clock

Option 002 Standby Power Supply

Option 003 Clock and Standby Power Supply

5065A Rubidium Frequency Standard

Option 001 Clock

Option 002 Standby Power Supply

Option 003 Clock and Standby Power Supply

E21-5065A Portable Time Standard

Consists of: 5065A with Option 001 and K02-5060A Standby Power Supply.

Weight: 50 kg (110 lb)

Dimensions: 425 mm \times 314 mm \times 546 mm (16" \times 12" \times 21") (includes handles).

\$15,500

\$1800

\$1000

\$2800

\$7950

\$1950

\$425

\$2375

\$13,825

FREQUENCY & TIME STANDARDS

Quartz frequency standards

Models 105A/B

- High spectral purity
- Well-buffered outputs
- Aging $< 5 \times 10^{-10}$ per day

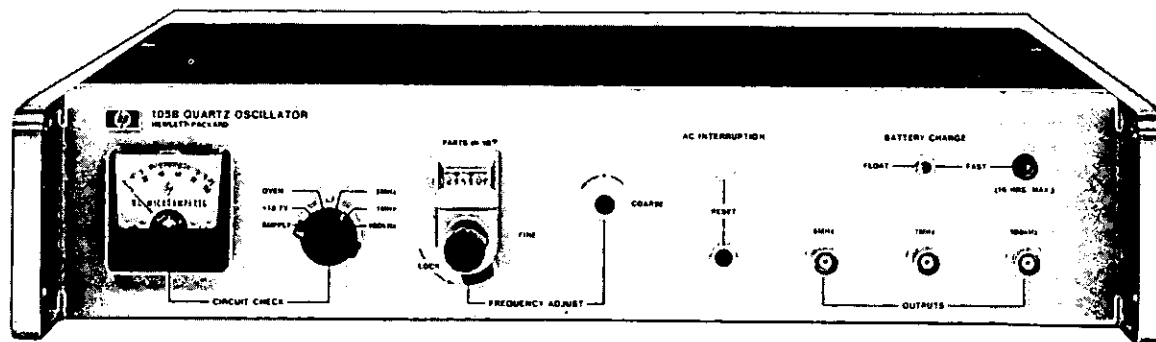

105B



Models 105A and B Quartz Oscillators provide state-of-the-art performance in precision frequency and time systems because of their excellent long and short term stability characteristics, spectrally pure outputs, unexcelled reliability, and ability to operate under a wide range of environmental conditions. They fill a need for a small and economical yet highly stable precision quartz oscillator for frequency and time standards. Both models can be operated from the ac line; the 105B has a built-in 8-hour standby battery for uninterrupted operation should line power fail. Both have 5 MHz, 1 MHz and 100 kHz buffered sinusoidal outputs with excellent short term stability (5 parts in 10^{12} rms for 1 s averaging time) and aging rate (< 5 parts in 10^{10} per day).

The 105A/B features rapid warm-up. Typically, the oscillator will be within 1 part in 10^9 of the previous frequency in 30 minutes after an "off" period of 24 hours. The basis of these oscillators is an extremely stable 5 MHz, 5th overtone quartz crystal developed by Hewlett-Packard. New technologies in the crystal mounting and packaging have resulted in a cleaner crystal which in turn has a lower aging rate. The crystal, oscillator and AGC circuit are all enclosed in a proportional oven which reduces the temperature effects on these components and circuits.

The 68 mm \times 68 mm \times 137 mm (2.7" \times 2.7" \times 5.4") package containing the oven enclosed crystal oscillator with AGC circuit and buffer amplifier are available separately as a component oscillator, the K07-105A, for use in equipment where a high quality 5 MHz source is required. Details are available from Hewlett-Packard sales offices.

Particular care was taken to provide a spectrally pure 5 MHz output which, when multiplied high into the microwave region, provides signals with spectra only a few cycles wide. Spectra less than 1 Hz wide can be obtained in X-band (8.2 to 12.4 GHz). The stability and purity of the 5 MHz output make it suitable for doppler measurements, microwave spectroscopy, and similar applications where the reference frequency must be multiplied by a large factor.

Specifications

Outputs: 5 MHz, 1 MHz, 100 kHz; 1 V rms into 50 Ω front and rear connectors.

Clock output: 1 MHz or 100 kHz; 0.5 V rms into 1 k Ω , rear connector. Normally supplied wired for 1 MHz output.

Frequency stability:

Aging rate: $< 5 \times 10^{-10}$ per 24 hours.

Short-term stability: for 5 MHz output only.

τ (sec)	$\sigma \Delta f / f(2, \tau)$	$\sigma \Delta f(2, \tau)$ sec
10^{-2}	1.5×10^{-10}	1.5×10^{-12}
10^{-1}	1.5×10^{-11}	1.5×10^{-12}
10^0	5×10^{-12}	5×10^{-12}

Temperature: $< 2.5 \times 10^{-9}$ total change 0°C to 50°C.

Load: $\pm 2 \times 10^{-11}$ open to short circuit, 50 Ω R, L or C load change.

Supply voltage: $\pm 5 \times 10^{-11}$ for 22-30 V dc from 26 V dc reference and for 115/230 V $\pm 10\%$.

Warm-up (at 25°C): to within 1×10^{-7} of previous frequency in 15 min., 1×10^{-8} in 20 min., 1×10^{-9} in 30 min.

Distortion (5 MHz, 1 MHz, 100 kHz) below rated output:

Harmonic: > 40 dB.

Non-harmonic: > 80 dB.

Signal-to-noise ratio: for 1 and 5 MHz, > 90 dB in a 30 kHz noise bw (5 MHz output filter bw is approximately 100 Hz).

Frequency adjustments:

Fine: 5×10^{-8} range with digital dial reading parts in 10^{10} .

Coarse: 1×10^{-6} front panel screwdriver control.

Phase locking: external +5 V to -5 V allows $> 2 \times 10^{-8}$ frequency control for locking to external source.

Environmental:

Temperature, operating: 0°C to +50°C.

Temperature, storage: -40°C to +75°C (+50° for 105B).

Altitude: 50,000 ft.

Shock: MIL-T-21200 (30 Gs).

Vibration: MIL-STD-167 and MIL-T-21200.

Electromagnetic compatibility (EMC): MIL-I-6181D.

Standby supply capacity: Model 105B only, 8 hours at 25°C ambient temperatures.

Power requirements: 115/230 V $\pm 10\%$, 50-400 Hz at 17 W (70 W warm-up) for 105A. For 105B add 1 W for float charge and 12 W for fast charge. 22-30 V dc at 6.4 W (10.3 W warm-up).

Dimensions: 88 mm high \times 425 mm wide \times 286 mm deep (3 $\frac{1}{2}$ " \times 16 $\frac{1}{2}$ " \times 11 $\frac{1}{4}$ ").

Weight: 105A — net, 8 kg (16 lb); shipping, 10.5 kg (23 lb). 105B — net, 11 kg (24 lb); shipping, 14 kg (31 lb).

105A \$2100

105B \$2470

FREQUENCY & TIME STANDARDS

Component oscillator

Model 10544A

- Excellent spectral purity
- Low power
- Fast warm-up
- High reliability
- Rugged
- Compact

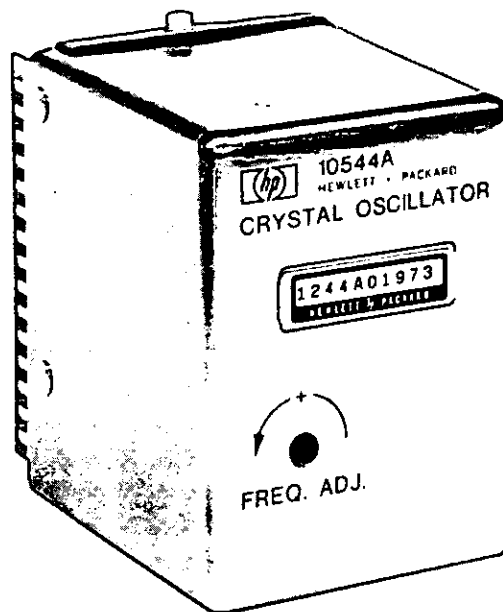

The 10544A Quartz Crystal Oscillator was developed by Hewlett-Packard to meet the needs for compact, high stability oscillators for use in test equipment and systems. Its excellent short term stability and high spectral purity is especially desirable in applications where multiplication and synthesis are used to generate microwave frequencies. Rugged construction and high quality components assure high reliability and optimum performance. With the extremely low aging rate of this oscillator a significant cost savings can be realized by the end user because of the reduced frequency of calibration needed to stay within FCC accuracy requirements.

The crystal for the oscillator is supported in a new rugged mounting in a cold-welded, high bake out enclosure. The housing around the crystal enclosure is massive with high thermal conductivity which contributes both to rapid warmup and excellent temperature stability. The oscillator, AGC amplifier and oven control circuits are all inside a thermally insulated oven. Rigid plastic foam with extremely low thermal conductivity is used to provide thermal insulation and firm mechanical support for the oven enclosure.

Low priced and compact, the 10544A uses an efficient thermistor control of the heater current duty cycle to maintain the oven temperature. The oven heater may be operated over the range of 15 to 30 V while the oscillator and oven controller require a regulated 11.0 to 13.5 V source. A simple external IC regulator may be used if the necessary voltage is not available.

The 10544A is ideally suited for use in communication and navigation systems, synthesizers, time-code generators, counters and spectrum analyzers. The 10 MHz output frequency is a convenient starting point since it is easily divided or multiplied.

A screwdriver adjustment through the top of the oven enclosure permits frequency adjustment over a range of 2×10^{-9} (20 Hz), yet the control is sensitive enough to allow adjustment to better than 1×10^{-9} (0.01 Hz). Frequency can also be controlled electronically over a 1 Hz range with an externally applied voltage.

Specifications

Frequency:⁽¹⁾ 10 MHz

Output:

Voltage, rms: 1 V $\pm 20\%$

Impedance, ohms: 1000

Frequency stability:

aging rate:⁽²⁾ $< 5 \times 10^{-10}$ /day
 $< 1.5 \times 10^{-7}$ /year

Short term:

avg. time: 1 s 1×10^{-11}
 10 s 1×10^{-11}
 100 s 2×10^{-11}

Temperature:

0 to 71°C: $< 7 \times 10^{-9}$
 -55°C to +71°C: $< 1.5 \times 10^{-8}$
 Load: $< 5 \times 10^{-10} \pm 250\Omega$

Warmup:⁽³⁾ (25°C, at 20 V dc) $< 5 \times 10^{-9}$ in 20 min.

Supply Voltage: (20-30 V dc⁽⁴⁾) $< 1 \times 10^{-10}$, $\pm 10\%$ ⁽⁵⁾
 (11.0 - 13.5 V dc regulated) $< 5 \times 10^{-10}$, $\pm 1\%$

SSB phase noise ratio (1 Hz bw):

Offset from carrier: 10 Hz 115 dB
 100 Hz 120 dB
 1 kHz 125 dB
 10 kHz 130 dB

Distortion below rated output: Harmonic > 25 dB; Nonharmonic > 80 dB

Frequency adjustment:

Coarse (18-turn control): $> 2 \times 10^{-6}$

Fine (EFC): $> 1 \times 10^{-7}$

Connector: 15 pin PC Board

Input power, 25°C: 2.75 watts

Case size: 72 x 52 x 62 mm (2.8" x 2" x 2.4")

Weight: 0.31 kg (11 oz.)

(1) Frequencies from 4.5 to 12 MHz available on special order.

(2) For oscillator off-time less than 24 hours.

(3) Final value is defined as frequency 24 hours after turn-on. With 15 V dc oven input, warm-up time is 60 minutes.

(4) 15-30 V dc, 0 to 71°C operating temperature.

(5) A 10% voltage change will cause a frequency change of $< 1 \times 10^{-8}$ for < 2 min.

10544A 10 MHz Component Oscillator

Quantity discounts available.



FREQUENCY & TIME STANDARDS

VLF comparator
Model 117A

- Parts in 10^{11} accuracy possible over 24 hour period
- Provides traceability to national standards
- Complete system for frequency comparison

- Offset and drift determinations for crystal oscillators
- Quick and easy checks of counter time-base accuracy
- Monitors atomic standards against national standard

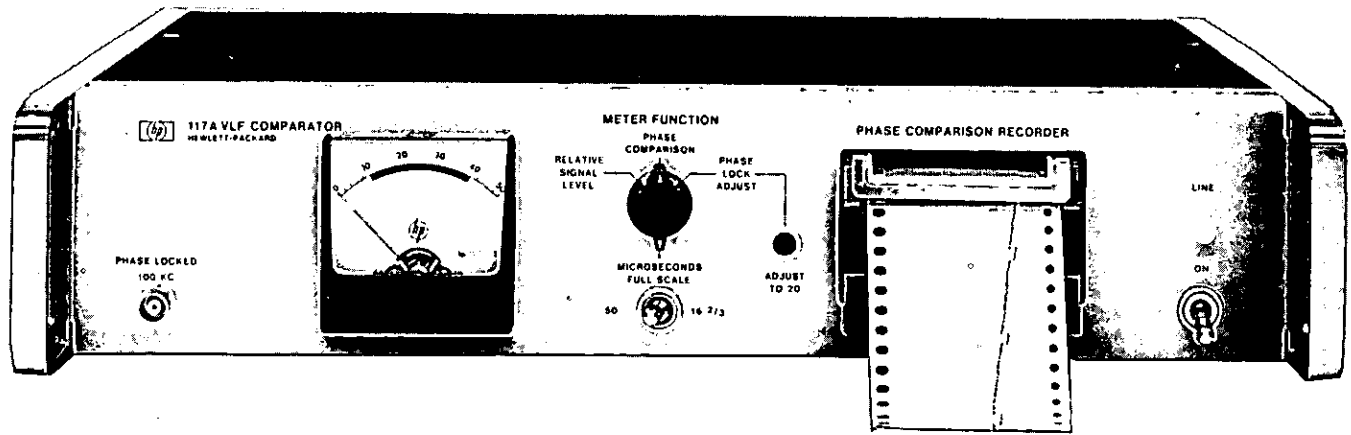

The HP 117A VLF Comparator measures the frequency offset of a local standard frequency source against a standard radio frequency to an accuracy that can reach 2 parts in 10^{11} in a 24-hour period or parts in 10^{12} over longer periods. The 117A receiver thus provides a link between house frequency standards and national standards. The 60 kHz broadcast by WWVB links the Boulder, Colorado laboratories of the National Bureau of Standards (NBS) with the entire continental United States and adjacent areas in Canada and Mexico.

The H88-117A is modified to receive the 60 kHz broadcast from MSF in Rugby, United Kingdom, providing a link to the standards maintained by the National Physical Laboratory. The H44-117A is designed to receive the 75 kHz broadcasts of HBG in Prangins, Switzerland.

The strip chart record of the HP 117A provides a precision phase comparison to show frequency offset of the local standard permitting its calibration to parts in 10^{10} in a few hours or long term monitoring to measure oscillator drift rate. A transparent template overlaid on the recording enables the operator to read at a glance the frequency offset of his local standard. A front panel meter shows relative level of the received signal, proper adjustment of the phase-locked oscillator and phase difference. Full-scale chart width and meter reading can be set for either a 50 μ s or 16 2/3 μ s phase difference. (40 μ s or 13 1/3 μ s for H44-117A).

Rear panel outputs provide for connection to external meters or recorders. An external recorder with a chart speed of several inches a minute can be used to record the amplitude modulated time code giving time of day and UT1 time corrections broadcast by WWVB.

The VLF Comparator is a complete receiver system for comparison of a standard broadcast signal with a local standard. It includes a servo-controlled oscillator which functions as a narrow band tracking filter (and assures a continuous output signal despite noise and interference), a linear phase comparator with chart recorder and a loop antenna with a built-in preamplifier which may be located up to 300 meters from the Comparator. The connecting cable also carries power to the preamplifier.

Specifications

- Received standard frequency:** 60 kHz, NBS Station WWVB.
- Sensitivity:** 1 μ v rms into 50 Ω . Minimum field strength, 60 μ v/meter.
- Local standard input:** 100 kHz, 1 V rms into 1 K Ω (divider to accept 1 MHz available as option).
- 100 kHz Phase-locked output:** 5 V rectangular positive pulses into 5 K Ω . Phase-locked to received signal.
- Recorder outputs:** Phase comparison, 0-1 mA dc into 1400 Ω . Relative signal strength, 0-100 mV dc from 2 K Ω .
- Overall phase stability:** $\pm 1 \mu$ s, 0-50°C.
- Chart speed:** 1 in/hr.
- Temperature:** Operating 0 to 50°C, Storage -50 to 75°C.
- Dimensions:** 425 x 77 x 286 mm (3 1/2" x 16 1/4" x 11 1/4").
- Weight:** 117A: 9.1 kg (20 lb); Antenna: 5.7 kg (12.5 lb).
- Power:** 115 or 230 V $\pm 10\%$, 60 Hz, 40 watts.

Accessories

	Price
10509A Loop Antenna: Electrical height 1.6 cm, 43 in. (109 cm) in dia., mounts on 1-in. pipethread. Operating temperature: -60°C to 80°C. (Available separately for use only with HP 117A, includes 10512A cable)	\$600
10512A Coaxial Lead-In Cable: 50 Ω BNC Connectors, 100 feet (30.5 m) long. Available in lengths to 300 m on special order	\$45
Recorder Chart Paper: Box (six 30 ft rolls) (HP #9281-0081)	\$9.90

Model number and name

117A VLF Comparator: Supplied with one 10509A Loop Antenna, one 10512A Coaxial Lead-In Cable (100 ft), and one roll of Recorder Chart Paper	\$2300
H44-117A: 117A modified to receive HBG, 75 kHz, 115/230 V, 50 Hz	add \$515
H88-117A: 117A modified to receive MSF, 60 kHz, 115/230 V, 50 Hz	add \$440

FREQUENCY & TIME STANDARDS

Distribution amplifier

Model 5087A

- Versatile with 3 input and 12 output channels
- Low noise, high stability, and isolation

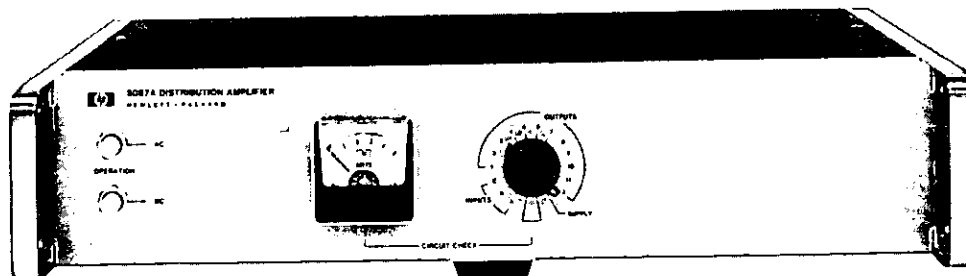

The Hewlett-Packard Model 5087A Distribution Amplifier provides the isolation and flexibility required for distribution of the output of high quality frequency standards. Low distortion and excellent isolation make it ideal for providing multiple outputs from atomic or crystal frequency standards. The 3 input channels will accept 10 MHz, 5 MHz, 1 MHz or 100 kHz in any combination with the number of outputs for each channel selectable up to a total of 12 outputs. The output levels are individually adjustable from 0 to 3 V rms. All input and output levels are monitored on a front panel meter.

The Distribution Amplifier features plug-in modular construction, short circuit isolation, exceptional phase stability, low noise and crosstalk, and uninterrupted switchover to standby dc in event of ac power failure.

The shielding around each input and output plug-in amplifier assures minimum noise and crosstalk. The tuned output amplifiers provide clean signals and high channel-to-channel isolation.

The instrument is designed for maximum versatility and can be supplied to meet a wide variety of special requirements. The standard configuration of input and output amplifiers is shown in Figure 1.

Several other commonly used configurations are also available and special combinations of the various input and output modules can be supplied. Input and output amplifiers can be added or the configuration easily changed at any time.

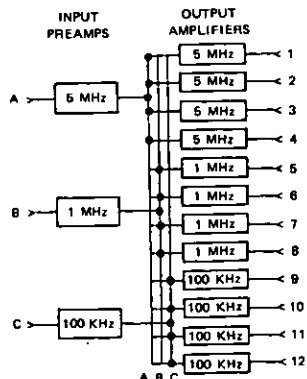

Figure 1. 5087A Distribution Amplifier with Option 031, Standard Configuration input and output amplifiers.

Specifications

Inputs

(up to three, rear panel BNC)

Frequencies: 10 MHz, 5 MHz, 1 MHz or 100 kHz.

Level: 0.3 to 3.0 V rms, 50 ohms.

Outputs

(up to 12 rear panel BNC)

Frequencies: 10 MHz, 5 MHz, 1 MHz or 100 kHz.

Level: 0-3 V into 50 ohms (screwdriver adjustment).

Harmonic distortion: >40 dB below rated output.

Non-harmonic distortion: >80 dB below rated output.

Isolation

Load (open or short on any other channel)

Amplitude change: 0.1 percent

Phase change: <0.1 ns at 5 or 10 MHz

<0.5 ns at 1 MHz

<5.0 ns at 100 kHz

SSB phase noise (5 MHz): >145 dB below signal in 1 Hz BW for frequencies >1 kHz from carrier.

Environmental

Temperature: MIL-E-16400, Class 4.

Operating: 0-50°C; storage: -62° to +75°C.

Stability:

Amplitude: ±0.5 dB, 0° to 50°C.

Phase: <0.1 ns/°C., 5 and 10 MHz.

EMC: MIL-STD-461A.

Humidity: 95% at 40°C.

Vibration: MIL-STD-167.

Altitude: Up to 30,000 ft.

Shock: MIL-T-21200, Class 1 and MIL-E-5400 (30 Gs).

General

Power: 115 or 230 V ±10%, 48 to 440 Hz, 20 VA, max, or 22-30 V dc, 500 milliamperes, max.

Dimensions: 3¹/₂" × 16¹/₄" × 11¹/₄" (88 × 425 × 286 mm).

Weight: Typical, Option 031 - Net 7 kg (15 lb).

Normal configurations (input and output amplifiers)

Option 031: 5, 1 and 0.1 MHz inputs and 4 outputs at each frequency

\$860

Option 032: Single 5 MHz input and 12 outputs

\$800

Option 033: Single 10 MHz input and 12 outputs

\$800

Option 034: Single 5 MHz input, 4 each outputs at 5, 1 and 0.1 MHz

\$935

Special configurations:

Input preamplifiers (up to 3 total):

Option 004: Input Preamplifier (0.1 to 10 MHz)

\$30

Option 005: 5 to 1 MHz Input Divider

\$70

Option 006: 1 to 0.1 MHz Input Divider

\$70

Option 011: 5 to 10 MHz Input Doubler

\$70

Option 013: 10 to 5 MHz Input Divider

\$70

Option 014: 10 to 1 MHz Input Divider

\$70

Output amplifiers (up to 12 total):

Option 001: 5 MHz Output Amplifier

\$70

Option 002: 1 MHz Output Amplifier

\$70

Option 003: 0.1 MHz Output Amplifier

\$70

Option 012: 10 MHz Output Amplifier

\$70

5087A: Distribution Amplifier Mainframe

\$825

Standby power supplies

Models 5085A & K02-5060A

- 12 Amp-hr capacity
- Sealed nickel-cadmium cells
- Used in "flying clocks"

- 18 Amp-hr capacity
- Vented nickel-cadmium cells

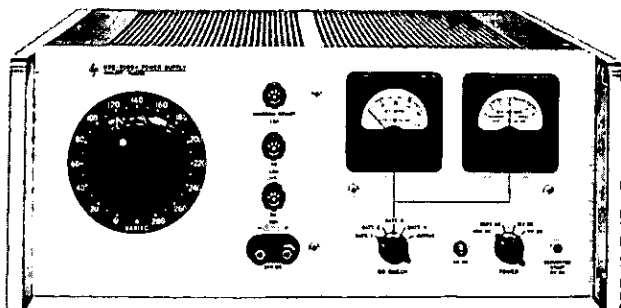

K02-5060A

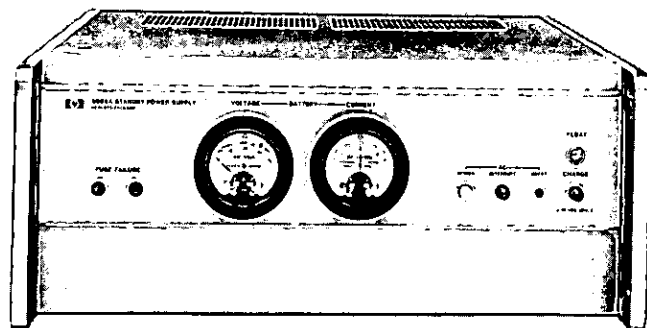

5085A

The HP Models 5085A and K02-5060A Standby Power Supplies furnish dc power to keep frequency or time standard systems operating during extended interruptions of ac line power. For applications where it is essential to maintain continuous operation and avoid loss of precise time, the use of a standby power supply is an absolute necessity. These units are designed for use with the Hewlett-Packard Cesium Beam Standards, Rubidium Vapor Standards, Quartz Oscillators and other equipment which will operate from 26 V dc. No switching is used in transferring power from line to battery operation and back again thus assuring uninterrupted operation.

HP K02-5060A

The K02-5060A is a very versatile unit which was designed specifically as a portable power supply for the 5061A and 5065A "Flying Clocks" where it is necessary to operate from a wide range of power sources along with the standby capability to maintain continuous operation where no external power is available. A special inverter permits operation from a 6 or 12 V dc car battery in addition to the 115/230 V ac and 24-30 V dc capability. The 12 ampere-hour standby batteries are the sealed, nickel-cadmium type and thus spill-proof. Mounting hardware is available to attach the K02-5060A to either the 5061A or 5065A Standards to make a portable standard, the E21-5061A or E21-5065A.

HP 5085A

The HP 5085A is intended for installations where 115 or 230 V ac is available. Vented nickel-cadmium batteries with an 18 ampere-hour guaranteed capacity (derated from 25) are used. They provide about 10 hours of standby power for the 5061A Cesium Standard or 5065A Rubidium Standard (at average ambient temperature of 25°C).

Front panel lights indicate mode of operation, report fuse failure, and ac interrupt. A float-charge switch permits rapid recharge after an ac power failure.

K02-5060A Specifications

Input and output voltages:

Input	Output
6 or 12 V dc	0-230 V, 60 Hz nominal
115 or 230 V ac, 50-400 Hz	0-230 V ac
24-30 V dc	24-30 V dc

Standby battery, 26 ±4 V dc available at all times.
AC and both dc inputs may be connected simultaneously.

Output current: 0.5 A ac, 2 A dc.

Standby capacity: 12 ampere-hours at 25°C, 7 hours standby when used in E21-5061A, 6 hours in E21-5065A.

Recharging: 1.6 hours recharging time required for each ampere hour of discharge.

Alarm indicator: external power failure.

Panel meters: voltmeter, ammeter indicating voltage and current of 4 internal batteries and load.

Battery: four paralleled rechargeable battery packs each containing 20 sealed nickel-cadmium cells. Packs may be removed individually without interfering with power supply operation.

Temperature:

Operating: 0 to 50°C.

Storage: -40 to 60°C.

Dimensions: 425 mm wide × 177 mm high × 416 mm deep (16 1/4" × 6 3/32" × 16 3/8").

Weight: net, 30.5 kg (67 lb)

Accessories furnished: ac and dc input and output cables.

5085A Specifications

Output voltage: 24 ±2 V dc at rated current.

Output current: 2 amperes (2.5 A for 30 min.).

Standby capacity: (at 25°C) 18 amp-hrs. after 48 hours charge.

Alarm indicators: panel lamps indicate: (1) FUSE FAILURE, (2) AC POWER, (3) AC INTERRUPT, (4) CHARGE.

Remote alarm provisions: SPDT relay contacts provided at rear terminals for operating remote alarm from separate power system.

Panel meters: battery voltage and charge/discharge current.

Power requirements: 115 or 230 ±10% V ac; 50 to 400 Hz (2.0 A max. at 115 V line).

Battery (supplied): vented nickel-cadmium 25 ampere-hour capacity derated to 18 ampere-hours. Periodic maintenance required.

Additional (external) battery provision: rear connector.

Temperature:

Operating: 0 to 50°C.

Storage: -40 to 75°C.

Dimensions: 425 mm wide × 177 mm high × 416 mm deep (16 1/4" × 6 3/32" × 16 3/8").

Weight: net, 34.1 kg (75 lb); shipping, 45.9 kg (101 lb) including battery. Option 001 (no batteries) is 22.8 kg (50 lb) less.

Accessories furnished:

AC Power Line Power Cable, 6 ft. long, DC Output Connector, Instrument Extension Slides (for std. 24" deep rack).

Model number and name

5085A (complete with batteries)

Option 001, without batteries

K02-5060A

Price

\$2100

\$1460

\$3500

PULSE GENERATORS

General information

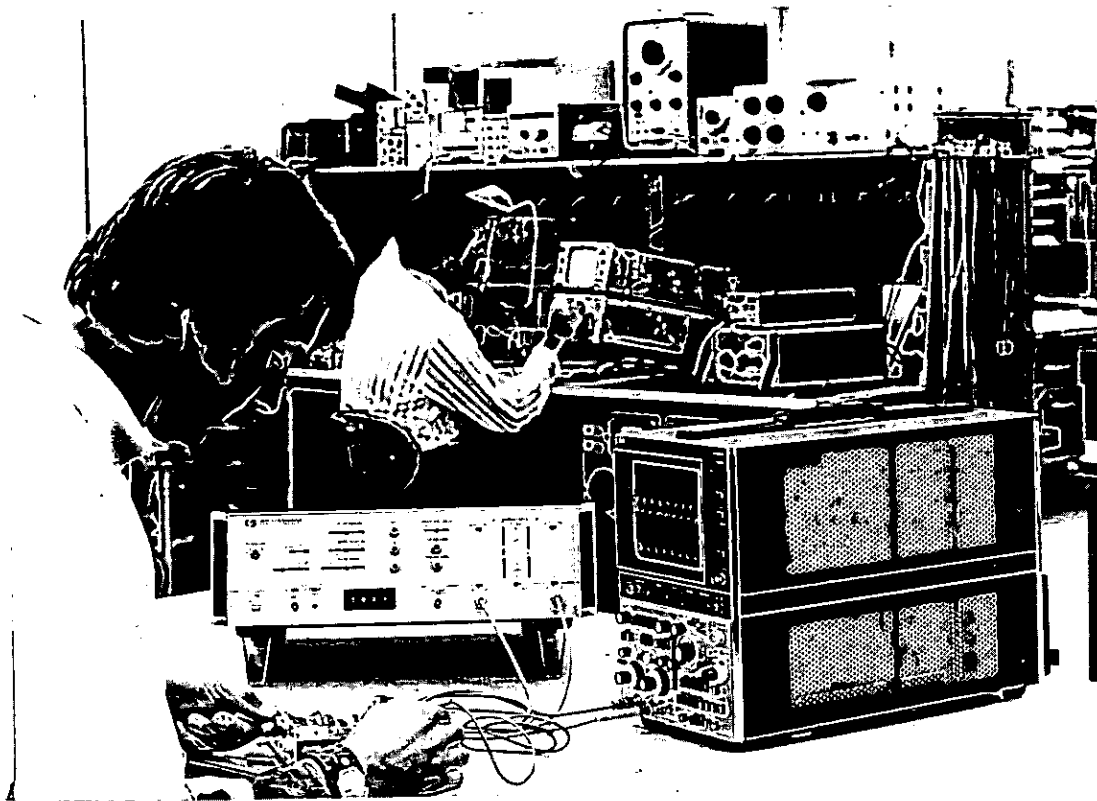

Introduction

The present range of professional pulse generators offered by Hewlett-Packard is the result of years of experience in the design and manufacture of such instruments. The range is divided into two: a series of dedicated pulse generators from simple to sophisticated, and a plug-in pulse generator system, the 1900 series.

The complete product line extends from the simplest, most economical model with a limited number of variable parameters to the most complex model with all variable parameters, very fast transition times and a wide variety of output configurations. This enables a customer to choose a pulse generator exactly suited to his needs and thus avoid having to pay for features he does not want. For very special combinations, the 1900 system with its 13 plug-in modules provides the customer with a tailor-made system.

Logical design

Experience gained in the design of instrument front panels has enabled Hewlett-Packard to produce pulse generators with logical and simple front panel layouts that greatly improve ease of operation and minimize the risk of incompatible control settings. On many of the Hewlett-Packard pulse generators the horizontal parameters are adjusted by horizontal controls and the vertical parameters by vertical controls. In addition,

compatible pulse settings are assured provided that the pulse delay and width controls are either set to the left of the pulse period control or, if set vertically below the period control, that the delay and width verniers are set counter clockwise of the period vernier.

50 ohm source impedance

All Hewlett-Packard pulse generators have a 50 ohm source impedance; a feature which plays a very important part in producing clean output pulses. Signal reflections from the circuit under test are effectively absorbed by the 50 ohm source thus avoiding the reflections that can occur with high impedance sources. The significant advances made by Hewlett-Packard in I.C. technology have made it possible to produce an almost perfect 50 ohm source impedance in the model 8082A. When used without an external termination, 98% of all reflections are absorbed from signals up to 4 V amplitude. This is because the 50 ohm source is deposited as a resistive pad on the substrate of the output amplifier IC, thus producing a 50 ohm source of extremely low reactance.

Independent parameters

All variable pulse parameters on Hewlett-Packard pulse generators can be adjusted completely independently of each other. This means that if, for example, pulse offset is varied, the amplitude is not affected and if

transition times are varied, pulse width is not affected. In addition, all pulse parameters are completely specified including complete specifications of pulse perturbations, thus the customer knows exactly what pulses to expect from his generator and can accurately measure distortion caused by the circuit under test.

Pulse stability

A further feature is the extremely low jitter on all pulse timing parameters. This is very important when working with digital logic because it is essential that clock and data pulses maintain a fixed time relationship to each other to prevent incorrect strobing of gates, decoders, shift registers.

Applications

Hewlett-Packard has a pulse generator to fit every application, whether it requires very fast variable transition times, a high voltage output or a PRBS sequence. The following applications areas are typical.

Digital logic applications

The digital logic applications area is very large, covering logic families from MOS to ECL/III. MOS devices are being used in increasing quantities due to their low power consumption and high packing density. These devices require a phased clock system to drive them with voltages ranging from -27 V (high threshold MOS) to $+16$ V (CMOS).

Circuits using MOS devices can be tested using the 1915A output plug-in in a 1900 system (± 50 V output) or the 8015A (up to 32 V with both channels combined). A further advantage with the 8015A is the pulse burst option which enables a preset number of pulses to be output for shift register testing. This pulse burst option is also available on the 8011A.

At the other end of the digital logic range, ECL III, with propagation delays of 1-2 ns, is the fastest logic family on the market at present. The 8082A, with variable transition times down to <1 ns and a maximum repeti-

tion rate of 250 MHz, is ideally suited to testing ECL III. Alternatively, the 1920A output plug-in used in a 1900 system provides pulses with transition times of <350 ps.

The 8016A word generator is ideally suited to testing LSI integrated circuits. With its variable word lengths from one 256 bit word to eight 32 bit words and the variable delay facility on each channel, the testing of LSI shift registers, encoders, decoders becomes simplicity itself. The 8016A can even be used as a replacement for a ROM enabling different bit patterns to be generated without having to change the ROM.

Communications applications

Another important applications area for Hewlett-Packard pulse generators is in testing both analog and digital communications systems. Communications links can be tested by transmitting bit patterns along the link using one word generator and checking the received pattern using a second word generator; the 1930A formatting plug-in in the 1900 system can be used in this application. Pseudo-random-binary sequences and variable length words are also used for communications testing and can be provided by the 8006A, 8016A, 1925A or 1930A.

Dedicated pulse generators

Model No.	Pulse generators												Word generators	
	214A	8002A	8004A	8005B	8007B	8008A	8010A	8011A	8012B	8013B	8015A	8022A	8006A	8016A
Max. rep. rate (MHz)	1	10	10	20	100	200	10	20	50	50	50	250	10	50
Output V into 50Ω	± 100	$\pm 5/10$	± 5	$\pm 5/\pm 10$	± 5	$\pm 4/ECL$	$\pm 5/\pm 10$	± 16	± 10	± 10	± 16	$\pm 5/ECL$	$+2.5/-5$	ECL/TTL
Simultaneous output				+, -, TTL		+, -, COMPL	\pm, \pm			+, -	\pm, \pm	\pm, \pm	\pm, \pm	8
Transition times	<15 ns	10 ns to 2 s	<1.5 ns	<10 ns to 2 s	<2 ns to 250 μs	<1.2 ns	<10 ns to 1 s	<10 ns	5 ns to 0.5 ms	<3.5 ns	<6 ns to 0.5 s	<1 ns to 0.5 ms	10 ns	2 ns/2.5 ns
Width	50 ns to 10 ms	30 ns to 3 s	0 to 1 ms	25 ns to 3 s	5 ns to 50 ms	2.5 ns to 50 ms	20 ns to 1 s	25 ns to 100 ms	10 ns to 1 s	10 ns to 1 s	10 ns to 1 s	2 ns to 0.5 ms		10 ns to 1 μs
Offset (V into 50Ω)			± 2	± 2	± 4 symm.	± 2	± 2	symm.	± 2.5 symm.		± 8	± 2		
Square wave mode				•			•	•	•	•	•	•		
Delay control	•		•	•	•	•	•		•	•	•	•		•
Double pulse	•		•	•	•	•	•		•	•	•	•		•
Gated output	•	•	•	•	•	•	•		•	•	•	•	•	•
Ext. trigger	•	•	•	•	•	•	•	•	•	•	•	•	•	•
Digital formatting (Word generation)													two 16 bit, one 32 bit	eight 32 bit
RZ/NRZ formats													•	•
Pseudo-random binary sequence													•	
Remote control													•	
Pulse burst								Optional			Optional		Optional	Optional
Selectable source impedance		•		•					•	•	•	•		
Normal/Complement				•	•	•		•	•	•	•	•	•	•

1900 Pulse generator system plug-ins

Model No.	Rate		Delay		Digital				Output pulse shaping				
	1905A	1906A	1908A	1910A	1925A	1927A	1928A	1930A	1915A	1916A	1917A	1920A	1921A
Max. rep. rate (MHz)	25	125	25	125	50	125	125	40	25	100	25	25	125
Output V into 50Ω	>3	>3	>3	>3	>2	>2	>2	>2	± 50	± 5 compl. ± 5 compl.	± 10	± 5	± 5
Transition times	<5 ns	<3 ns	<5 ns	<3 ns	<4 ns	<3 ns	<3 ns	4 ns	7 ns to 1 ms	2.5 ns to 250 μs	7 ns to 500 μs	<350 ps/ <400 ps	<2 ns
Width	<10 ns	<5 ns	<10 ns	5 ns	RZ/NRZ	NRZ	NRZ	RZ/NRZ	15 ns to 40 ms	5 ns to 1 ms	15 ns to 40 ms	0 to 10 μs	4 ns to 1 ms
Offset (V into 50Ω)									± 1.5	± 2.5	± 2.5	± 2	± 5
Output complement					•					•			•
Delay control			Var.	5 ns steps									
Advance/Double pulse			•										
Gated output	•	•											
Ext. trig. input	•	•			•								
Digital formatting (Word generation)					2-16 bits	8-1 fan-in	1-8 fan-out						
RZ/NRZ format					•			•					
NRZ shaping									•		•		•
Pseudo-random binary sequence					•								
Bit error detection								•	•				
Programmable	Optional	Optional	Optional		Std.			Std.	Optional		Optional	Optional	Optional



PULSE GENERATORS

High pulse power: 100 V, 200 W output
Model 214A

- 1 MHz repetition rate
- Double pulse mode

- Wide amplitude range; 0.08V to 100V
- 15 ns transition times

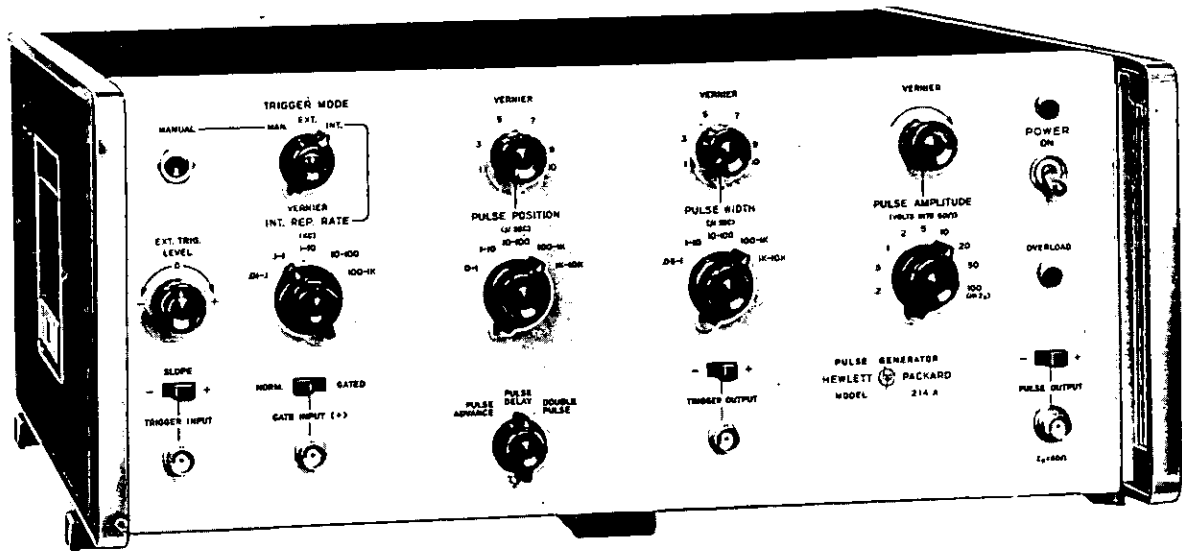

The 214A is a well-proven pulse generator with a very wide range of applications. The high 200 watts of pulse power (2 amp peak, ± 100 volts into 50 ohms) and fast rise time of 15 ns are particularly suited for testing current-driven devices such as magnetic cores, as well as high-power modulators. The fast rise and fall times combined with high power output pulses facilitate checking switching time of high power semiconductors. The positive or negative pulse output, with identical characteristics, provides a simple means of checking either npn or pnp type transistors. By gating the Model 214A output, a burst of pulses may be obtained for making computer logic measurements. The double pulse feature may also be used for pulse resolution tests of amplifiers and memory cores. Because of its ability to provide a 100 V amplitude output pulse, the 214A is ideally suited as a trigger source in high power applications where a poor signal-to-noise ratio is present.

Source impedance is 50 ohms on all but the highest (100-volt) range, to minimize errors caused by re-reflections when operating into unmatched loads. At lower output levels (down to 80 mV), the rise time is less than 13 ns (typically less than 10 ns). Carefully controlled pulse shape, pulse rate and width, and minimum pulse jitter ensure accurate and dependable test results. All characteristics of the pulse waveform, including overshoot, preshoot, pulse droop, and pulse top variations, are completely specified, and pulse irregularities are kept to a minimum.

An external trigger source of dc to 1 MHz can be used instead of the internal rate generator to produce the output pulses. Positive or negative trigger signals of 0.5 volts peak may be used and trigger slope and level may be selected to determine the triggering point on the waveform. A single pulse may be obtained from an internal circuit each time a manual button is pushed. Gating of pulses is easily achieved by applying an external signal and an output occurs only when the gating signal reaches a positive 8 volt level. Three modes of pulse operation allow: (1) setting of the output pulse to occur from 0 to 10 ms before (advance) the trigger output, (2) setting of the output pulse to occur from 0 to 10 ms after (delay) the trigger output, or (3) a double pulse output with variable spacing between the two pulses.

Specifications

Pulse characteristics

Source impedance: 50 ohms on 50 V and lower ranges; approx. 1500 ohms on the 100 V range.

Transition times: <13 ns on 20 V and lower ranges and the -50 V range, <15 ns on the +50 V range; typically <10 ns with the vernier set for maximum attenuation and typically 15 ns on the 100 V range.

Pulse amplitude: 100 V into 50 ohms. Attenuator provides 0.2 to

100 V in 1, 2, 5, 10 sequence (9 ranges); vernier reduces output of 0.2 V setting to 80 mV and provides continuous adjustment within ranges.

Polarity: positive or negative.

Overshoot: <5%, both leading and trailing edges (measured on a 50 MHz oscilloscope).

Pulse top variation: <5%.

Droop: <6%.

Preshoot: <2%.

Pulse widths: 50 ns to 10 ms in 5 decade ranges; continuously adjustable vernier.

Width jitter: <0.05% of pulse width + 1 ns.

Maximum duty cycle: 10% on 100 V and 50 V ranges; 25% on 20 V range; 50% on 10 V and lower ranges.

Repetition rate and trigger

Internal:

Repetition rate: 10 Hz to 1 MHz (5 ranges), continuously adjustable vernier.

Rate jitter: <0.5% of the period.

Manual: pushbutton single pulse, 2 Hz maximum rate.

External:

Repetition rate: dc to 1 MHz.

Sensitivity: <0.5 V peak.

Slope: positive or negative.

Level: adjustable from -40 V to +40 V.

Delay: delay between input trigger and leading edge of pulse is approximately 250 ns in Pulse Advance mode (approx. 420 ns minimum in Pulse Delay mode).

External gating: +8 V signal gates pulse generator on. Maximum input, 40 V peak.

Double pulse:

Minimum Spacing: 1 μ s on the 0.05 to 1 μ s pulse width range and 25% of upper limit of width range for all other ranges.

Trigger output:

Amplitude: >10 volts open circuit.

Source impedance: approximately 50 ohms.

Width: 0.05 μ s nominal.

Polarity: positive or negative.

General

Power: 115 or 230 V $\pm 10\%$, 48 to 66 Hz, approx. 325 VA.

Dimensions: 426 mm wide, 178 mm high, 467 mm deep (16 $\frac{3}{4}$ " \times 7" \times 18 $\frac{3}{8}$ ").

Weight: net 15.8 kg (35 lb); shipping 18.5 kg (41 lb).

214A Pulse generator

51400



PULSE GENERATORS

Economical 16 V output, pulse burst option

Model 8011A

NEW

- Repetition rate 0.1 Hz to 20 MHz
- Designed for easy operation
- Positive/negative/symmetrical output

- Normal/complement switch
- Switchable 50 ohm source
- Square wave mode for rapid pulse set-up

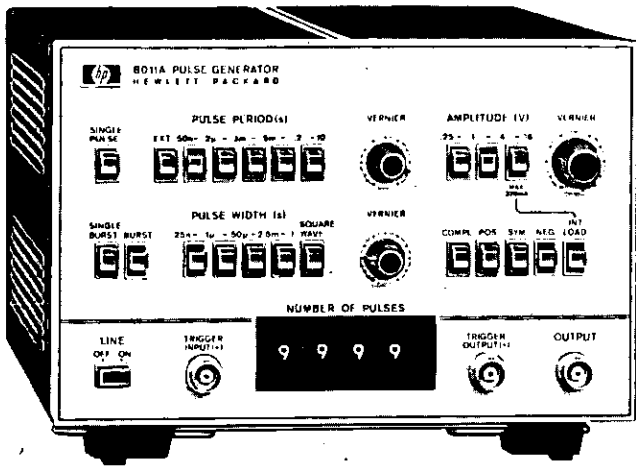

Specifications

Pulse characteristics (50 ohm source and load impedances)

- Transition times:** <10 ns fixed.
- Overshoot, ringing and preshoot:** <±5% of pulse amplitude. May increase to 10% at counter-clockwise positions of amplitude vernier.
- Pulse width:** 25 ns to 100 ms in four ranges. Vernier provides continuous adjustment within each range.
- Width jitter:** <0.1% + 50 ps of any width setting.
- Maximum duty cycle:** >50% (100% using pulse complement).
- Maximum output:** 16 V, with internal 50 ohms and external high impedance or with internal high impedance and external 50 ohms. 8 V with 50 ohms source and load impedances.
- Attenuator:** three step attenuator provides the ranges 0.25 V-1 V-4 V-16 V. Vernier provides continuous adjustment within each range.
- Source impedance:** 0.25 V-1 V-4 V ranges, 50 ohms ±10% shunted by 30 pF. 4 V-16 V range, 50 ohms ±10% or high impedance, switch selectable.
- Polarity:** positive, negative or symmetrical switch selectable.
- Format:** normal or complement switch selectable.

Repetition rate and trigger

- Repetition rate:** 0.1 Hz to 20 MHz in 5 ranges. Vernier provides continuous adjustment within each range.
- Period jitter:** <0.1% +50 ps of any period setting.
- Square wave:** 0.05 Hz to 10 MHz.
- Trigger output:** dc coupled 50 ohm (typ) source delivering ≥+1 V across 50 ohm load (can increase to +5 V).
- Trigger pulse width:** 20 ns ±10 ns.

Externally controlled operation

- External input:**
 - Input impedance:** 50 ohms ±10%.
 - Maximum input:** ±5 V.
 - Trigger polarity:** positive.
 - Sensitivity:** 1 V.
 - Manual:** front panel pushbutton for generating single pulse.
- External triggering:**
 - Repetition rate:** 0 to 20 MHz. In square wave, output frequency is half input frequency.
 - Trigger source:** manual or external signal. Min external signal width 10 ns.
 - Pulse burst mode (option 001):** preselected number of pulses generated on receipt of trigger.
 - Burst trigger source:** external signal or manual. Min external signal width 25 ns.

General

- Operating temperature range:** 0°C to 55°C.
- Power:** 100 V, 120 V, 220 V or 240 V, +5%, -10%, 48 Hz to 440 Hz, 70 VA max.
- Weight:** net 4 kg (9 lb), shipping 6.5 kg (14.6 lb).
- Dimensions:** 200 mm wide X 142 mm high X 300 mm deep (7.9 in. X 5.6 in. X 11.8 in.).

Accessories and options	Price
15179A Adapter frame: Rack mounting for two pulse generators	\$85
Option 001: Pulse burst	\$300
8011A Pulse Generator	\$500

Introduction

The 8011A is a versatile, reliable, low price pulse generator. This compact instrument features an uncomplicated design using high quality components to ensure long, dependable service. Ease of operation is a natural result of the logical and simple front panel layout. These qualities, and the variety of pulse formats available, make the model 8011A a very cost-effective solution to pulse problems encountered in a variety of situations.

Pulse burst option

For anyone working with counters, shift registers, memories or logic in general, 8011A option 001 offers a new approach to driving, troubleshooting or analyzing logic designs. With this original option, model 8011A can generate precisely any number of pulses from 1 to 9999, independent of pulse rate. The number of pulses required in the burst is set on thumbwheel switches. All other pulse parameters are set on the front panel as normal.

The burst can be started in one of two ways - by external electrical trigger or by pressing the single burst pushbutton. Synchronous trigger pulses occur for the duration of each burst. At the end of a burst, extra pulses can be generated individually by pressing the single pulse button. Thus, circuits can be clocked to a desired state at their operational clock rate and then analysed under static conditions. The internal preset counter of 8011A option 001 eliminates the need to use an external Timer/Counter to check the number of pulses.

Applications

The 8011A proves itself with its wide range of amplitudes to cover CMOS and the commonly used logic families as well as linear circuits. Students and engineers alike will find the clear and uncluttered front panel layout makes it very easy to use. With the pulse burst option, model 8011A is a powerful tool in the problems of logic design and troubleshooting. This compact instrument features a simple design with adjustments reduced to a minimum so that routine recalibration is a quick and easy operation. Reliability is assured by the high quality components mounted on a gold plated printed circuit board and a short circuit proof output prevents accidental damage. Also, rigorous testing in hostile conditions (such as 95% relative humidity at 40°C) has proved that model 8011A will meet specifications when operated at temperatures between 0°C and 55°C.

PULSE GENERATORS

Simple operation, flexible output parameters

Model 8002A & 8004A

- 10 MHz repetition rate
- Variable transition times 10ns-2s
- Sawtooth/triangular/trapezoidal waveforms

- 10 MHz repetition rate
- 1.5ns transition times
- Double pulse and 2V offset

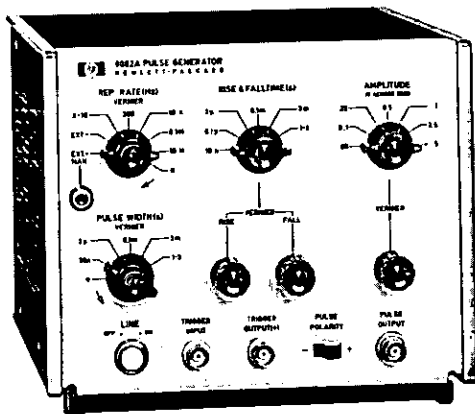

8002A

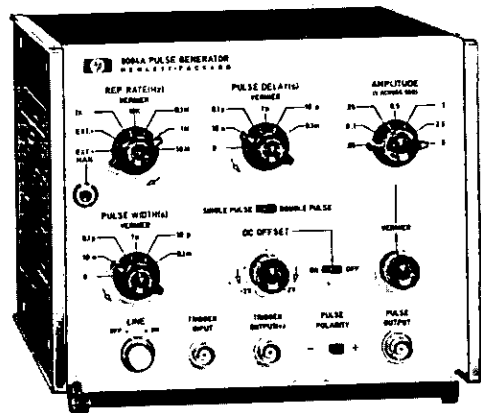

8004A

The 8002A is one of the cheapest variable transition time pulse generators available. The other pulse parameters are also variable which enables the 8002A to produce triangular, sawtooth and trapezoidal shapes as well as pulses and square waves.

Either positive or negative output signals can be selected; the source impedance is a constant 50Ω. Output amplitude is continuously adjustable from 0.02 to 5 volts and can be doubled by switching off the internal 50Ω load. The output is protected against damage from a short circuit.

The generator can be triggered externally with pulses of either polarity. A trigger output signal is also available.

Specifications

Pulse characteristics (50Ω source and load impedance)

Transition times: 10 ns to 2 s, 6 ranges, two verniers allow independent control of leading and trailing edges.

Preshoot, overshoot, ringing: <5% of pulse amplitude.

Non-linearity: for transitions >20 ns, <4% from 10%-90%.

Amplitude: 5 V max. (10 V across 50Ω if internal 50Ω load switched out). Output short circuit protected. Seven step attenuator reduces output voltage to 0.05 V.

Polarity: + or - selectable.

Pulse width: 30 ns to 3 s in 5 ranges.

Maximum duty cycle: >90% from 0.3 Hz - 1 MHz. >50% from 1 MHz - 10 MHz.

Delay: 18 ns or 35 ns fixed delay between trigger and pulse.

Repetition rate and trigger

Free running: 0.3 Hz to 10 MHz, 5 ranges.

Manual: pushbutton for single pulse.

Trigger input: sine waves 2 V p-p or pulses ±1 V peak up to 10 MHz, ≥15 ns wide. Impedance 1 kΩ dc coupled. ±10 V max.

External trigger delay: approximately 35 ns, leading edge of external input pulse to leading edge of trig. output pulse.

Trigger output pulse: >+2 V across 50Ω, width 15 ns ±5 ns.

Synchronous gating: -2 V to -20 V signal turns generator "on"; last pulse completed even if gate ends during pulse.

Input impedance: approximately 1 kΩ, dc coupled.

General

Power: 115 or 230 V +10%, -15%, 50 Hz - 400 Hz, 40 VA.

Dimensions: 166 × 190 × 279 mm (6½" high, 7¼" wide, 11" deep).

Weight: net 4 kg (9 lb); shipping 5 kg (11 lb).

The 8004A generates pulses with extremely fast transition times. Both pulse width and delay are variable down to zero. A double pulse mode provides convenient test signals for logic and memory circuits

and increases the max. rep. rate to 20 MHz, ±2 V dc offset is provided and is independent of pulse amplitude controls. A 50 ohm source ensures clean pulses for ECL propagation delay measurements.

Specifications

Pulse characteristics (50Ω source and load impedance)

Transition times: <1.5 ns.

Preshoot, overshoot, ringing: <5% of pulse amplitude.

Amplitude: 5 V max. seven-step attenuator down to <0.02 V.

Polarity: + or - selectable.

DC offset: ±2 V across 50Ω load; can be switched off.

Pulse width: 0 to 1 ms in six ranges. Adjustable in ranges.

Maximum duty cycle: >50% from 100 Hz to 1 MHz; >25% from 1 to 10 MHz.

Width jitter: <0.1% on any width setting, plus 50 ps.

Pulse delay: 0 - 1 ms (with respect to trig. output) in 5 ranges.

Delay jitter: <0.1% on any delay setting.

Repetition rate and trigger

Free running: 100 Hz to 10 MHz, five ranges.

Period jitter: <0.1%.

Double pulse: increases max. rate to 20 MHz.

External triggering: 0 to 10 MHz.

Sensitivity: sine waves 2 V p-p; pulses 1 V peak, >10 ns; maximum input ±10 V. Delay: approx. 125 ns trig. input to trig. output (down to 35 ns with slide switch on board).

Input impedance: approx. 1 kΩ dc coupled.

Manual: pushbutton for single pulse.

Trigger output: ampl. >+2 V across 50Ω, 15 ns ±10 ns wide.

Gating

Synchronous gating: gating signal turns generator "on". Last pulse is completed even if gate ends during pulse.

Asynchronous gating: gating signal turns output pulse "on". Trigger output always available; last pulse ends with gate.

Gate input: -2 V to -20 V enabling.

Input impedance: approx. 1 kΩ, dc coupled.

General

Power: 115 or 230 V, +10%, -15%, 50 to 400 Hz, 35 VA.

Weight: net 3.5 kg (7 lb); shipping 4.5 kg (9 lb).

Dimensions: 197 mm wide × 165 mm high × 279 mm deep (7¾" × 6½" × 11").

Model number and name

8002A Variable transition time pulse generator

8004A Pulse generator

Price

\$850

\$1200

PULSE GENERATORS

General purpose, triple output

Model 8005B

297
hp
NEW

- Dual outputs, +10 V and -10 V
- TTL output

- 50 ohm/high impedance source, selectable
- Five modes of operation

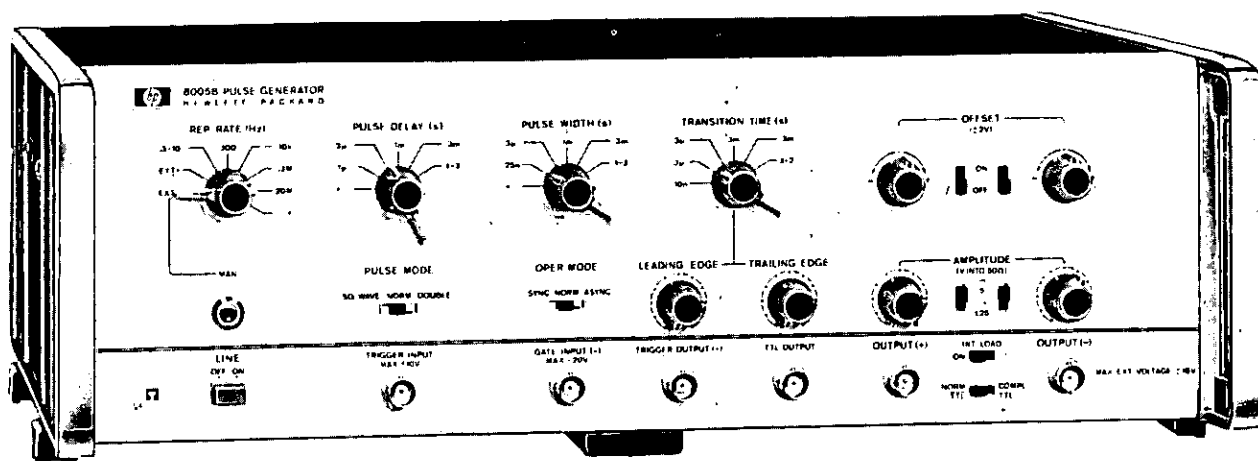

The 8005B is a general purpose, triple output pulse generator. This versatile instrument has all variable parameters and produces simultaneous positive and negative pulses. It also has a TTL output which has all variable parameters except amplitude. This feature, together with the normal/complement facility, greatly improves the ease of operation. Features which contribute to the flexibility of the 8005B are synchronous and asynchronous gating, double pulse and square wave modes and the selectable source impedance.

Specifications

Pulse characteristics

Internal 50Ω	Load	Amplitude Range Selected	Amplitude	Offset	
				Output (+)	Output (-)
ON	50Ω	1.25/2.5 V	300 mV to 1.25 V	±2 V	±2 V
ON	High Z	1.25/2.5 V	600 mV to 2.5 V	±4 V	±4 V
OFF	50Ω	1.25/2.5 V	600 mV to 2.5 V	±2 V to ±4 V ²	±2 V to ±4 V ²
ON	50Ω	5 V/10 V	1.25 V to 5 V	±2 V	±2 V
ON	High Z	5 V/10 V	2.5 V to 10 V	±4 V ¹	±4 V ¹
OFF	50Ω	5 V/10 V	2.5 V to 10 V	±2 V to 0 V, -4 V ²	±2 V to 0 V, +4 V ²

1. The maximum output (amplitude + offset) is 10 V.
2. Offset range with amplitude vernier CCW is ±2 V. Offset range increases as shown when amplitude vernier is CW.

Transition times: ≤10 ns to 2 s in six ranges. Separate verniers provide independent control of leading and trailing edges within each range. Max leading/trailing edge ratio, 1:30 or 30:1.

Linearity: for transition times >30 ns, straight line deviation is <4% of pulse amplitude.

Overshoot, preshoot, ringing: <5% of pulse amplitude.

Pulse width: <25 ns - 3 s, 5 ranges. Adjustment within ranges.

Width jitter: <0.1% of any width setting.

Maximum duty cycle: >80% for repetition rates from 0.3 Hz to 1 MHz >50% from 1 MHz to 20 MHz. Up to 100% when using pulse complement.

Square wave: 0.15 Hz to 10 MHz. Duty cycle: 50% ±5% for repetition rates ≤1 MHz, increasing to 50% ±15% at 10 MHz.

Pulse delay: <100 ns to 3 s (with respect to trigger output) in five ranges. Continuous adjustment within each range.

Delay jitter: <0.1% of any delay setting.

Pulse outputs: simultaneous positive, negative and TTL compatible output.

Maximum pulse amplitude: (from positive and negative outputs) 5 V, with internal 50 ohms and external 50 ohms, 10 V with internal 50

ohms and external high impedance, or with internal high impedance and external 50 ohms.

Output protection: cannot be damaged by short circuit or application of external voltages ≤±10 V (at 25°C ambient) independent of control settings.

Source impedance: 50 ohms ±10% (shunted by typ 20 pF) or output impedance of a current source, switch selectable.

TTL compatible output: fixed amplitude, +4.6 V across open circuit.

Source impedance: 50 ohms typ.

Pulse formats: normal or complement, switch selectable.

Repetition rate and trigger

Repetition rate: 0.3 Hz to 20 MHz in five ranges. Vernier provides continuous adjustment within each range.

Period jitter: <0.1% of any period setting.

Double pulse: 10 MHz max. Simulates 20 MHz.

Trigger output: positive pulses >2 V amplitude across external 50 ohm load. Pulse width >6 ns.

Externally controlled operation

External triggering:

Repetition rate: dc to 20 MHz.

Delay: approx. 35 ns trig. input to trig. output.

Manual: push button for generating single pulse (two in double pulse).

Trigger input:

Maximum input: ±10 V; impedance: approx. 1 kΩ dc-coupled.

Sensitivity: sine waves; 2 V p-p. Pulses 1 V peak.

Polarity: positive or negative, switch selectable.

Minimum pulse width: 10 ns.

Gating:

Synchronous: gate signal turns on repetition rate. Time between start of gate and first pulse defined by delay control. Last pulse is always completed even if gate ends during pulse. Synchronous trigger pulses occur for duration of gate.

Asynchronous: gate signal controls output of rate generator.

Gate input:

Input impedance: approx. 1 kΩ, dc coupled.

Gate amplitude: 2 V to 20 V (max), polarity: negative.

General

Operating temperature range: 0°C to 55°C.

Power: 115 V or 230 V, +10%, -15%, 48-440 Hz, 180 VA max.

Weight: net 7 kg (16 lb), shipping 9 kg (20 lb).

Dimensions: 425 mm wide, 140 mm high, 336 mm deep, (16¼ in. × 5½ in. × 13¼ in.).

8005B Triple Output Pulse Generator

\$1310

PULSE GENERATORS

Calibrated source of complex waveforms

Model 8010A

- 2 independent pulse generators in one
- Simulation of complex analog signals
- Independent timing for driving digital IC's
- No waveshape degradation when channels combined

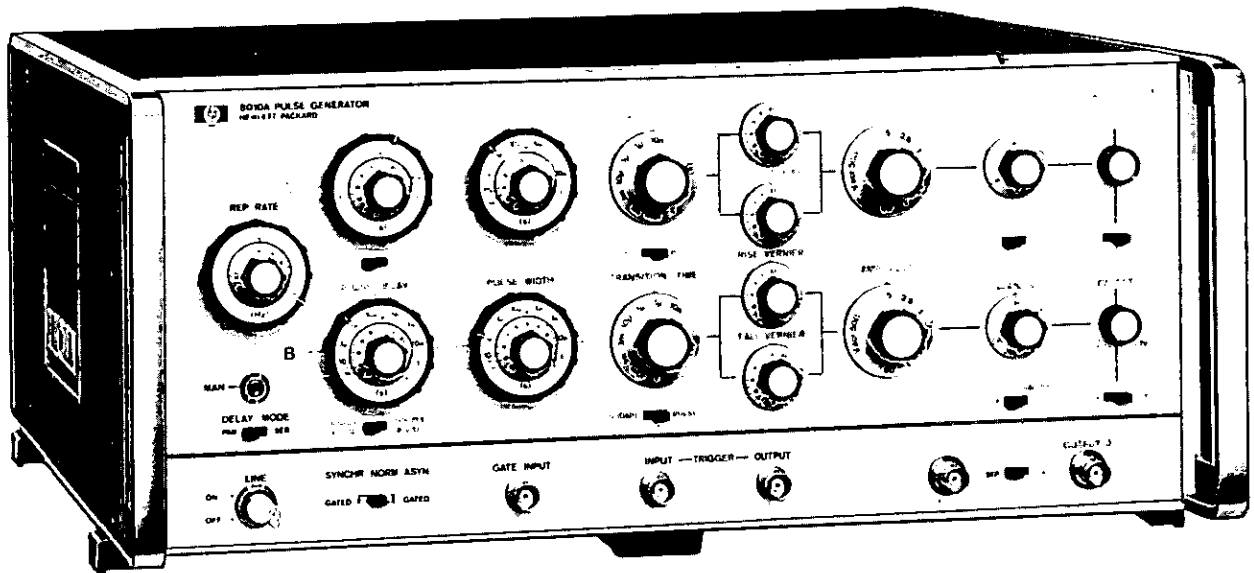

The 8010A is the most versatile pulse generator in the range. This is because the 8010A is really two pulse generators in one, all pulse parameters except repetition rate being generated separately for each channel. The two outputs can be used separately for digital logic applications or can be combined (full 10 V output) at the output amplifiers to provide extremely complex waveforms for analog applications. The repetition rate can be triggered separately for each channel thus enabling one channel to be controlled by the repetition rate generator while the other is triggered externally. Variable parameters, high stability and accuracy, and fully calibrated verniers (except for offset) enable exact pulse settings to be repeated accurately and easily.

Specifications

Pulse characteristics (with 50 Ω load impedance)

Transition times: sep. outputs: <10 ns to 1 s in eight ranges. Independent verniers control leading and trailing edge within each range up to a max. ratio of 1:10. In A + B mode <12 ns to 1 s. With 10 V output <20 ns to 1 s.

Accuracy: $\pm 10\%$ of setting $\pm 2\%$ of full scale ± 4 ns.

Linearity: for transition time >30 ns, straight line deviation is <4% of pulse amplitude.

Overshoot and ringing: <5% of pulse amplitude.

Pulse width (A and B): <20 ns to 1 s eight ranges, continuous adjustment within ranges.

Accuracy: $\pm 10\%$ of setting $\pm 2\%$ of full scale ± 4 ns.

Maximum duty cycle: >80% for repetition rates from 1 Hz to 1 MHz. >50% from 1 to 10 MHz.

Width jitter: <0.1% on any width setting.

Maximum output: 5 V sep., 10 V combined (channel B).

Attenuator: seven-step attenuator reduces output to 0.02 V.

Accuracy: $\pm 10\%$ of setting $\pm 2\%$ of full scale.

Source impedance: 50 Ω $\pm 10\%$ shunted by typ. 20 pF.

DC-offset: ± 2 V across 50 Ω load; can be switched off.

Pulse delay: (A and B) 50 ns to 1 s delay related to trig. output in 8 ranges. Accuracy: $\pm 10\%$ of setting, $\pm 2\%$ of full scale ± 4 ns. Jitter: <0.1% of setting.

Repetition rate and trigger

Free running: 1 Hz - 10 MHz in seven ranges.

Accuracy: $\pm 10\%$ of setting $\pm 2\%$ of full scale.

Period jitter: <0.1%

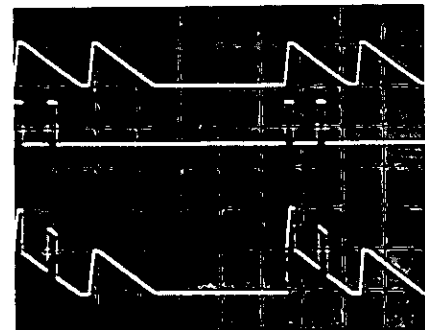

Figure 1. Channels A and B combined

Square wave: 1 Hz - 10 MHz. Symmetrical to ground.

Double pulse: channel A and B independently selectable.

External triggering

Rep. rate: 0 to 10 MHz. + 2 for square wave output.

Trigger input: sine waves 1 V p-p. Pulses 0.5 V, ≥ 20 ns.

Input impedance: 1.0 k

Delay: approximately 30 ns trig. input to trig. output.

Manual: pushbutton for single pulse. Sep. triggering for both channels: spikes +2 V amplitude, >50 ns width. Input impedance 50 Ω (inputs on rear panel).

Trigger output

Amplitude: >+2 V across 50 Ω . 15 ns ± 10 ns. 50 Ω impedance.

Gating

Synchronous: -2 V to -10 V signal turns rate generator "on."

Asynchronous: -2 V to -10 V signal turns the output pulse "on." Trigger output always available.

General

Power: 115 or 230 V $\pm 10\%$, -15% 50 to 400 Hz 200 VA.

Dimensions: 425 mm wide \times 184 mm high \times 466 mm deep (16 $\frac{1}{4}$ " \times 7 $\frac{1}{4}$ " \times 18 $\frac{3}{8}$ ").

8010A Pulse generator

\$2700

PULSE GENERATORS

Extremely flexible 50 MHz sources

Models 8012B & 8013B

NEW

- Variable transition times down to 5 ns
- $\pm 10V$ amplitude; selectable source impedance
- Ideal for testing TTL

- Fixed 3.5 ns transition times
- 10V amplitude; selectable source impedance
- 2 outputs

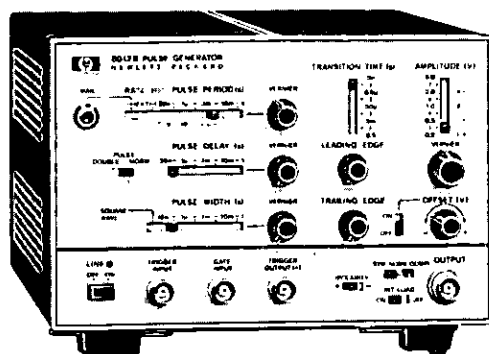

8012B

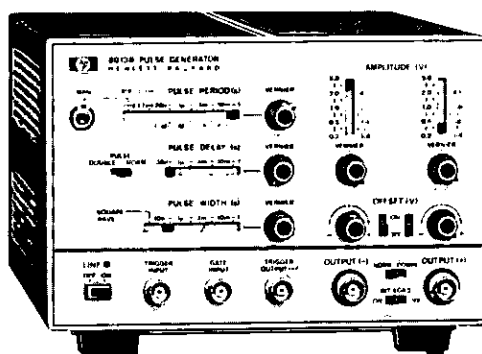

8013B

The 8012B and 8013B are at the top of their class for versatility, ease of operation and wide range of application. They provide the ideal solution to almost all digital logic testing problems with fixed 3.5 ns transition times on the 8013B and variable transition times down to 5 ns on the 8012B. The well-composed layout of the front panel controls (horizontal controls for horizontal parameters, vertical controls for vertical parameters) enables output pulses to be set up quickly and accurately with minimum risk of incompatible settings. Both models feature normal and complement outputs and a switchable internal 50 ohm source.

Specifications

Pulse characteristics

Parameter	8012B		8013B	
	Int. load IN	Int. load OUT	Int. load IN	Int. load OUT
Transition times	5 ns - 0.5 μ s 4 ranges, Verniers provide separate control of both edges within ranges up to max. ratios of 100:1 or 1:100.	6 ns - 0.5 μ s	3.5 ns fixed	5 ns fixed
Source impedance	50 ohms $\pm 10\%$ shunted by typically 20 pF	>50 ohms	50 ohms $\pm 3\%$ shunted by typically 20 pF	>50 ohms shunted by typically 20 pF

Parameter	8012B / 8013B	
	Internal load IN	Internal load OUT
Overshoot, ringing	$< \pm 5\%$ of pulse amplitude	May increase to $\pm 10\%$ when amplitude is between 0.4 V - 4 V
Maximum output	5 V across 50 ohms, 10 V across open circuit. Short cct. protection.	10 V across 50 ohms, Short cct. protection.
Attenuator	4-step, reduces output to 0.2 V	4-step, reduces output to 0.4 V.
DC offset	± 2.5 V across 50 ohms. Independent of amplitude settings.	DC offset switched off.

Linearity (8012B): for transition times > 30 ns, maximum straight line deviation is 5% of pulse amplitude.

Preshoot: $< \pm 5\%$ of pulse amplitude.

Pulse width: < 10 ns to 1 s in four ranges. Vernier provides continuous adjustment within ranges.

Width jitter: $< 0.1\% + 50$ ps on any width setting.

Maximum duty cycle: $> 75\%$ from 1 Hz to 10 MHz, decreasing to $\geq 40\%$ at 50 MHz. Up to 100% in COMPL mode.

Polarity: 8012B; positive or negative selectable, NORM/COMPL/SYM selectable; 8013B, one positive + one negative channel, NORM/COMPL selectable.

Pulse delay: < 35 ns to 1 s (with respect to trigger output) in four ranges; vernier provides continuous adjustment within ranges.

Delay jitter: $< 0.1\% + 50$ ps on any delay setting.

Repetition rate and trigger

1 Hz to 50 MHz in four ranges, continuous adjustment within ranges.

Period jitter: $< 0.1\% + 50$ ps on any rate setting.

Square wave: 0.5 Hz to 25 MHz in four ranges. Duty cycle 50% $\pm 5\%$ up to 1 MHz, tolerance increases to $\pm 15\%$ at 25 MHz.

Trigger output: $> +1$ V across 50 Ω , 16 ns ± 10 ns wide. Suitable for triggering another 8012B/13B.

External triggering

0 to 50 MHz, for square wave output, frequency divided by factor 2.

Trigger input: sine waves 1.5 V p-p (about zero) or pulses > 0.8 V either polarity, > 7 ns wide. Maximum input ± 7 V.

Impedance: 50 $\Omega \pm 10\%$, dc coupled.

Delay: 25 ns ± 8 ns leading edge trig. input to trig. output.

Manual: pushbutton for single pulse.

Gating

Synchronous gating: gating signal turns generator "on". Last pulse is completed even if the gate ends during pulse.

Gate input: dc-coupled; voltage at open connector approx. +1.8 V. Shorting current ≤ 12 mA. Input impedance approx. 160 Ω .

Gate input signal: voltage $> +1.5$ V or resistor > 1 k Ω to ground enables rep. rate generator. Voltage $< +0.8$ V or resistor $< 160\Omega$ disables rep. rate generator. Gate input TTL compatible. Maximum input ± 5 V.

External width and RZ

External width: output pulse width determined by width of drive input signal. Amplitude, transition times selectable. Trigger output independent of external width input signal. RZ mode: external drive input switched to delay generator. Period determined by period of drive input signal. Delay, amplitude and width selectable.

Input signal: $> +1$ V, > 7 ns wide. Maximum ± 5 V. Impedance 50 Ω , dc coupled.

General

Operating temperature range: 0°C to 55°C.

Power: 100/120/220/240 V $+5\%$, -10% , 48 to 400 Hz, 100 VA max.

Weight: Net, 4 kg (8.8 lb). Shipping, 6.5 kg (14.6 lb).

Dimensions: 200 mm wide, 142 mm high, 330 mm deep (7.9" \times 5.6" \times 13").

Accessories: 15179A Adapter Frame; rackmount for two units.

Model number and name

8012B Pulse generator

8013B Pulse generator

15179A Adapter frame

Price

\$950

\$750

\$85

PULSE GENERATORS

Versatile source, unique level controls

Model 8015A

NEW

- 50 MHz repetition rate
- 2 output channels
- 16 V amplitude and offset
- Counted burst option, 0-9999 pulses
- Ideal for MOS, TTL and analog applications
- Each control ergonomically designed

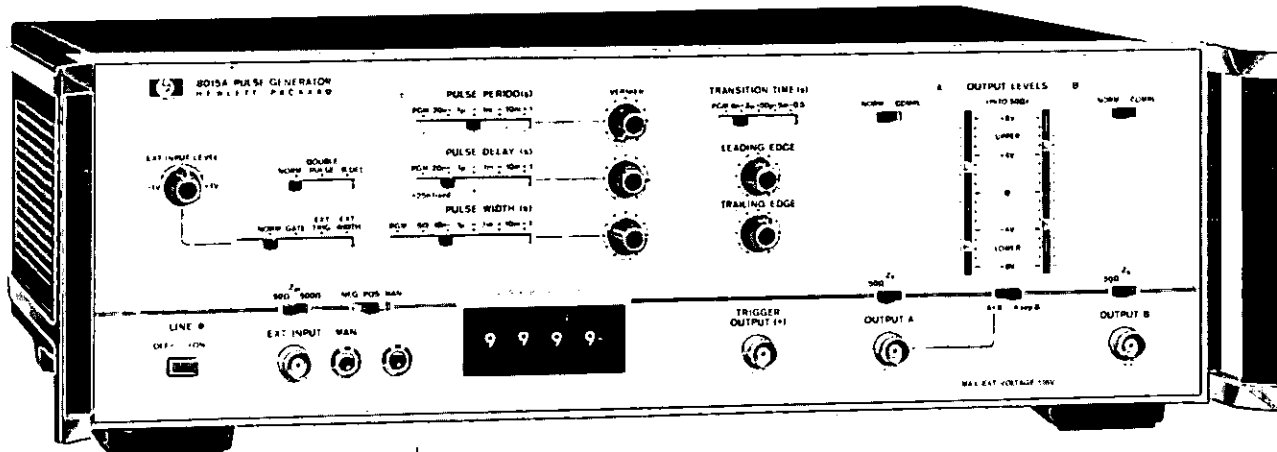

The 8015A with its two outputs capable of 16 V each or 30 V combined, is compatible with all low threshold devices, including CMOS and N channel MOS. The 8015A has unique pulse level controls: each channel has two independent sliders, one for the pulse high level and one for the pulse low level. This feature, together with the logical layout of the front panel controls makes the 8015A extremely easy to operate. Each output also has its own source impedance switch (50 ohms/1 k Ω).

Specifications

Pulse characteristics

Transition times: minimum to 0.5 s in four ranges (see table). Common for leading and trailing edges within each range up to maximum ratios of 100:1 or 1/100.

Non-linearity: transitions >30 ns: <5% of pulse amplitude.

Overshoot and ringing: $\pm 5\%$ of pulse amplitude, possibly increasing < $\pm 10\%$ at minimum amplitude.

Prehoot, droop: <5% of pulse amplitude.

Pulse width: <10 ns to 1 s in four ranges.

Width jitter: <0.1% +50 ps for any width setting.

Maximum output: ± 16 V.

Maximum duty cycle: >75% from 1 Hz to 1 MHz, decreasing to $\geq 50\%$ at 50 MHz. Square wave: 50% $\pm 5\%$ from 1 Hz to 1 MHz, $\pm 15\%$ at 25 MHz.

Pulse delay: 20 ns (+25 ns fixed) to 1 s, in four ranges.

Delay jitter: <0.1% +50 ps for any delay setting.

Repetition rate and trigger

Repetition rate: 1 Hz to 50 MHz in four ranges (see table).

Period jitter: <0.1% +50 ps for any rep. rate setting.

Square wave: 0.5 Hz to 25 MHz.

Double pulse: 25 MHz max. (simulates 50 MHz).

B Delay: 20 MHz max. Channel B pulse delayed on channel A pulse by amount set on delay controls.

Trigger output: dc coupled, 50 Ω (typ.) source impedance, delivering ≥ 1 V across 50 Ω load. 9 ns ± 5 ns width.

Externally controlled operation

External input: 50 Ω $\pm 10\%$ or 500 Ω $\pm 10\%$, dc coupled.

Maximum input: ± 7 V (50 Ω input), ± 25 V (500 Ω input).

Trigger polarity: positive or negative slope selectable.

Threshold level: +1 V to -1 V (50 Ω input impedance) or +10 V to -10 V (500 Ω input impedance).

Sensitivity: 50 Ω input impedance, sinewaves 1 V p-p, pulses ± 0.5 V; 500 Ω input impedance, sinewaves 10 V p-p, pulses ± 5 V.

Minimum pulse width: 5 ns in Ext. Trig., 20 ns in Burst mode.

Manual button: push to activate input.

External triggering: manual or 0 to 50 MHz signals. <50 ns delay between trigger input and trigger output.

External width: output pulse width and rate determined by width and rate of drive signal.

Synchronous gating: gating signal turns on repetition rate. Last pulse completed even if gate ends during pulse. Max. repetition rate: 40 MHz.

Burst mode (optional): Trigger source: external or manual. Number of pulses 1 to 9999. Repetition rate: 0 to 40 MHz. Minimum time between bursts: 200 ns.

General

Operating temperature range: 0°C to 55°C.

Power: 100 V, 120 V, 220 V or 240 V, +5%, -10%, 48 to 440 Hz. 180 VA maximum.

Weight: net 11 kg (24.26 lb), shipping: 12 kg (26.46 lb).

Dimensions: 426 mm wide, 145 mm high, 380 mm deep, (16 $\frac{1}{16}$ in. X 5 $\frac{11}{16}$ in. X 15 in.).

Accessories provided: rack mounting flanges, power cord and Operating and Service manual.

Options:

001: single channel version (deletes channel B) Price less \$400

002: pulse burst (adds preset counter, 0 to 9999) \$500

003: remote control (5 vernier, 4 amplitude, 13 range inputs) \$1000

004: direct output amplifier access (60 MHz, var. gain, offset) \$150

005: extra TTL output, as output A, with fixed levels 0/4.7 V \$150

006: upper level tracking with ext. voltage, lower level 0 V. Tracking of clock/data pulses for CMOS with power supply. \$150

Options 001 and 002 exclude each other, as do 003 and 006.

8015A Pulse generator \$2300

Mode	Source/Load Impedance	Transition Times	Upper Level Voltage (V_{UL})	Lower Level Voltage (V_{LL})	Upper Level Current (I_{UL})	Lower Level Current (I_{LL})	$V_{UL}-V_{LL}$ Max Min	$I_{UL}-I_{LL}$ Max Min	Max. Rep. Rate
AsepB	50 Ω /50 Ω	*6 ns-0.5 s	+8 V to -7 V	+7 V to -8 V	+320 mA to -280 mA	+280 mA to -320 mA	8 V 1 V	320 mA 40 mA	50 MHz
	50 Ω /1 k Ω or 1 k Ω /50 Ω	8 ns-0.5 s	+16 V to -14 V	+14 V to -16 V			16 V 2 V		40 MHz
A+B	50 Ω /50 Ω	15 ns-0.5 s	+16 V to -14 V	+14 V to -16 V	+640 mA to -560 mA	+560 mA to -640 mA	16 V 2 V	640 mA 80 mA	20 MHz
	50 Ω /1 k Ω or 1 k Ω /50 Ω	15 ns-0.5 s	+16 V to -12 V	+12 V to -16 V			30 V 4 V		20 MHz

*6 ns at 8 V, may increase to 6.5 ns at 4 V.

PULSE GENERATORS

Clean waveshape, all parameters variable

Model 8007B

- 100 MHz repetition rate
- Variable transition times down to 2 ns.
- Extremely linear slopes
- Designed to drive TTL-S and commonly used ECL

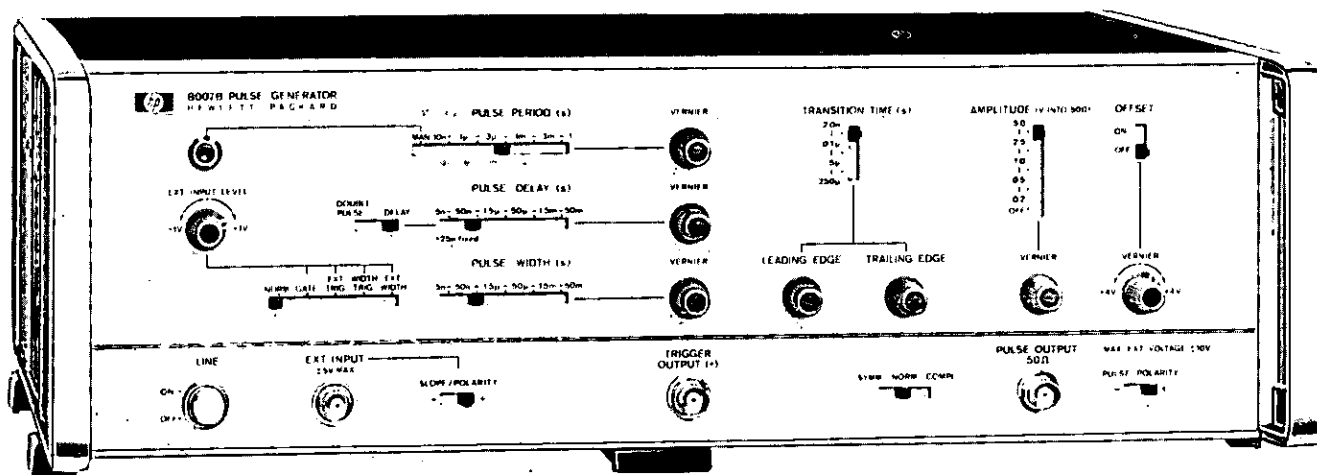

The 8007B is a very versatile pulse generator with variable transition times as fast as 2 ns.

The output can be set to positive or negative polarity, complement or symmetrical to ground, square waves can be simulated by adjusting pulse width. A high dc-offset of up to ± 4 V is also available.

External triggering and synchronous gating are provided. The trigger level is adjustable for all externally controlled modes with the slope polarity selectable. This is very useful for avoiding malfunctions caused by noise and ringing on the external trigger signal.

In "External Width" mode external input and pulse output have equal width. Transition times and amplitude of the output pulse can be set by the front panel controls. This mode is useful for shaping NRZ signals, as the width information is passed on to the output pulse unchanged.

The "Width Trigger" mode is suitable for RZ signal shaping. Delay, width, transition times and amplitude are determined by the front panel controls.

Specifications

Pulse characteristics

(50 Ω source and load impedance):

Transition times: < 2 ns to 250 μ s, three ranges (common for both transition times). Independent verniers for adjusting leading and trailing edge within each range up to maximum ratios of 1:50 or 50:1.

Linearity: maximum deviation from a straight line between 10% and 90% points $\leq 5\%$ of pulse amplitude.

Preshoot, overshoot, ringing: $\leq \pm 5\%$ of pulse amplitude.

Pulse width: < 5 ns to 50 ms in five ranges. Vernier provides continuous adjustment within ranges.

Width jitter: < 0.1% on any width setting.

Maximum duty cycle: normal > 50%; complement approx. 100%.

Amplitude: 5 V max (10 V across an open circuit); four-step attenuator reduces output voltage to 0.5 V. Vernier provides continuous adjustment between steps and reduces output to 0.2 V. Pulse can be switched off for offset adjustment.

Pulse output: + or - polarity selectable; normal, complement, or symmetrical to ground.

Source impedance: 50 $\Omega \pm 4 \Omega$ shunted by typ. 10 pF.

DC-offset: ± 4 V across 50 Ω load. Independent of amplitude setting, can be switched off.

Pulse delay: < 30 ns to 50 ms with respect to trigger output. Five ranges, with continuous adjustment within ranges.

Delay jitter: < 0.1% on any delay setting.

Repetition rate and trigger

10 Hz to 100 MHz in 5 ranges.

Continuous adjustment within ranges.

Period jitter: < 0.1%.

Double pulse: available only up to pulse rate setting of 50 MHz, representing an output pulse rate of 100 MHz.

Trigger output: > +1 V across 50 Ω , 4 ns ± 2 ns wide.

External triggering

0 to 100 MHz.

Delay: approx. 15 ns between trig. input and trig. output.

Manual: front panel pushbutton for single pulse.

External width and width trigger

External width: output pulse width determined by width of drive input.

Width trigger: external drive input switched to the width generator. Pulse width determined by front panel width setting.

Rate generator: provides trigger pulses independent of drive input.

Synchronous gating

Gating signal turns generator "on." Last pulse is completed even if gate ends during pulse.

External input

Impedance: 50 Ω , dc-coupled.

Max. input: ± 5 V.

Level: adjustable from +1 V to -1 V, Polarity: + or -

Sensitivity: sine waves 1 V p-p; pulses 1 V.

General

Operating temperature range: 0°C to +55°C.

Power requirements: 115 or 230 V $\pm 10\%$, -15%, 48 to 440 Hz, 100 VA (maximum).

Weight: net 8 kg (17.6 lb); shipping 9 kg (19.8 lb).

Dimensions: 425 \times 140 \times 344 mm (16 1/4" wide, 5 1/2" high, 13 3/4" deep).

8007B Pulse Generator

\$2000



PULSE GENERATORS

High speed, fixed transition times

Model 8008A

- 200 MHz repetition rate
- 1.2 ns fixed transition times

- Switch selectable ECL levels
- Dual outputs (normal and complement)

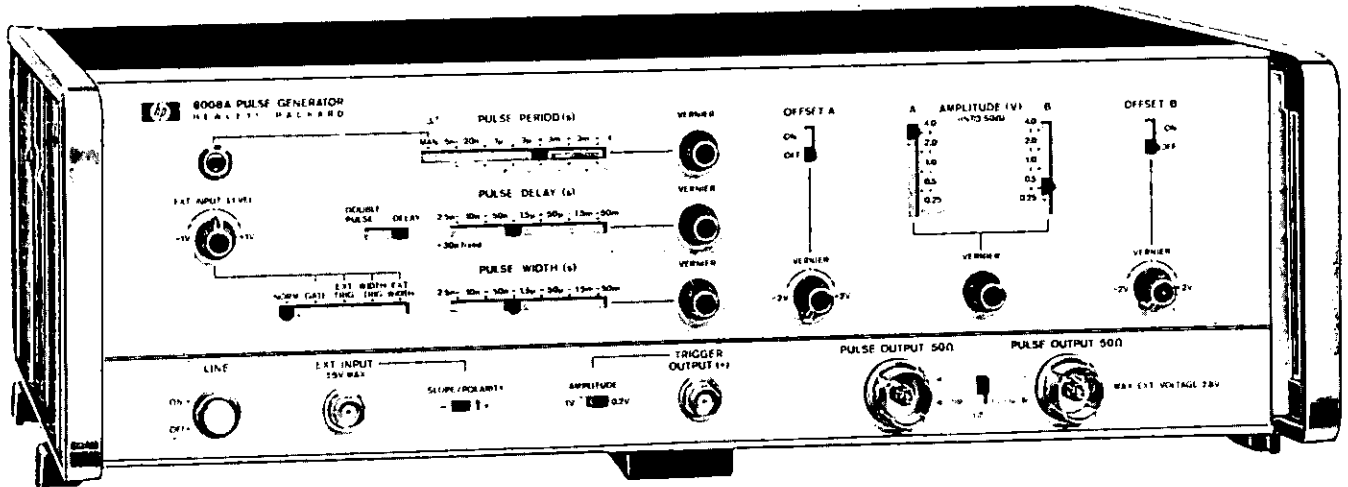

The Model 8008A is a very fast pulse generator with pulse transition times < 1.2 ns and repetition rate variable from 10 Hz – 200 MHz. An optional 7 step risetime converter enables adjustment of transition times up to 2.50 ns.

The two outputs deliver simultaneously complementary signals with selectable polarity. To absorb external reflections, both outputs have constant 50 ohm source impedances. A feature of the 8008A is that ECL compatible outputs (high -0.9 V, low -1.7 V) can be selected without tedious adjustment of amplitude and offset controls. This feature and the maximum output amplitude of 4 V with up to ± 2 V dc offset ensures compatibility with the majority of logic integrated circuits.

The 8008A can be operated as a pulse shaper for RZ and NRZ format input signals. Similarly, external gating and triggering are possible. The trigger level for any external input signal can be adjusted between $+1$ V and -1 V on either a positive or negative slope.

Specifications

Pulse characteristics

(50 Ω source and load impedance)

Fixed transition times: 10%-90%: ≤ 1.2 ns; 20%-80%: ≤ 0.9 ns.

Overshoot and ringing: $\leq \pm 5\%$ of pulse amplitude (may increase to $\leq 10\%$ with amplitude vernier ccw).

Preshoot: $\leq 5\%$ of pulse amplitude.

Pulse width: < 2.5 ns to 50 ms in six ranges. Vernier provides continuous adjustment within ranges.

Width jitter: $< 0.1\% + 50$ ps on any width setting.

Maximum duty cycle: $> 50\%$ (in NORM Mode).

Pulse delay: 2.5 ns ($+30$ ns fixed) to 50 ms (with respect to trigger output) in six ranges. Vernier provides continuous adjustment within ranges.

Delay jitter: $< 0.1\% + 50$ ps on any delay setting.

Maximum variable delay: $\geq 50\%$ of pulse period.

Pulse output: normal and complement available simultaneously. Output polarity selectable.

ECL compatible output: fixed pulse levels from both outputs, -0.9 V to -1.7 V. Both levels internally adjustable.

Maximum amplitude: normal and complementary; 4 V into 50 Ω (8 V across open circuit).

Source impedance: 50 $\Omega \pm 5\%$ shunted typically 10 pF.

Output protection: cannot be damaged by application of external voltage $\leq \pm 8$ V (at 25°C) or short circuit, independent of control settings.

Attenuator: two separate four-step attenuators reduce the outputs to

0.5 V. Vernier provides continuous adjustment between steps to < 250 mV. Vernier is common to both output channels.

DC offset: ± 2 V across 50 Ω . Independent of amplitude attenuator and vernier settings. Can be switched off.

Repetition rate and trigger

Repetition rate: 10 Hz to 200 MHz in six ranges. Vernier provides continuous adjustment within ranges.

Double pulse: 100 MHz max. (simulates 200 MHz).

Period jitter: $< 0.1\% + 50$ ps on any period setting.

Trigger output: amplitude: 1 V or 200 mV (switchable) into 50 Ω load.

Width: typically: 3 ns at 200 MHz up to 1.5 ms at 10 Hz.

Externally controlled operation

External input:

Input impedance: 50 Ω (typically).

Coupling: dc-coupled.

Maximum input: ± 5 V.

Trigger level: continuously adjustable $+1$ V to -1 V.

External triggering

Repetition rate: 0 to 200 MHz.

Delay: approx. 15 ns between trig. input and trig. output.

Manual: front panel pushbutton for single pulse.

Width trigger: external drive input switched to delay generator. Pulse width determined by width setting. Trigger output available from rate generator independent of input signal.

External width: output pulse width determined by width of drive input. Trigger output available from rate generator independent of input signal.

Synchronous gating: gating signal turns generator "on." First pulse is delayed (by fixed and variable delay) with respect to leading edge of gate, last pulse is of normal width even if gate ends during the pulse. Rep. rate, width, amplitude and polarity determined by control settings.

General

Operating temperature range: 0°C to 55°C.

Power: 115 V or 230 V, $+10\%$, -15% , 48 – 440 Hz, 100 VA max.

Weight: net 8 kg (17.6 lb); shipping 9 kg (19.8 lb).

Dimensions: 425 x 140 x 336 mm (16 $\frac{1}{2}$ " wide, 5 $\frac{1}{2}$ " high, 13 $\frac{1}{4}$ " deep).

Ordering information

Options:

001: 15171A Rise time converter

002: Two 15171A Rise time converters

8008A Pulse Generator

Price

\$230

\$455

\$2820

PULSE GENERATORS

Very fast & variable transitions, 1 ns to 0.5 ms

Model 8082A

NEW

- 250 MHz repetition rate
- Ultra-clean 50 ohm source
- Switch-selectable ECL levels

- Dual outputs (normal and complement)
- Designed using hybrid IC's
- 250 MHz square wave

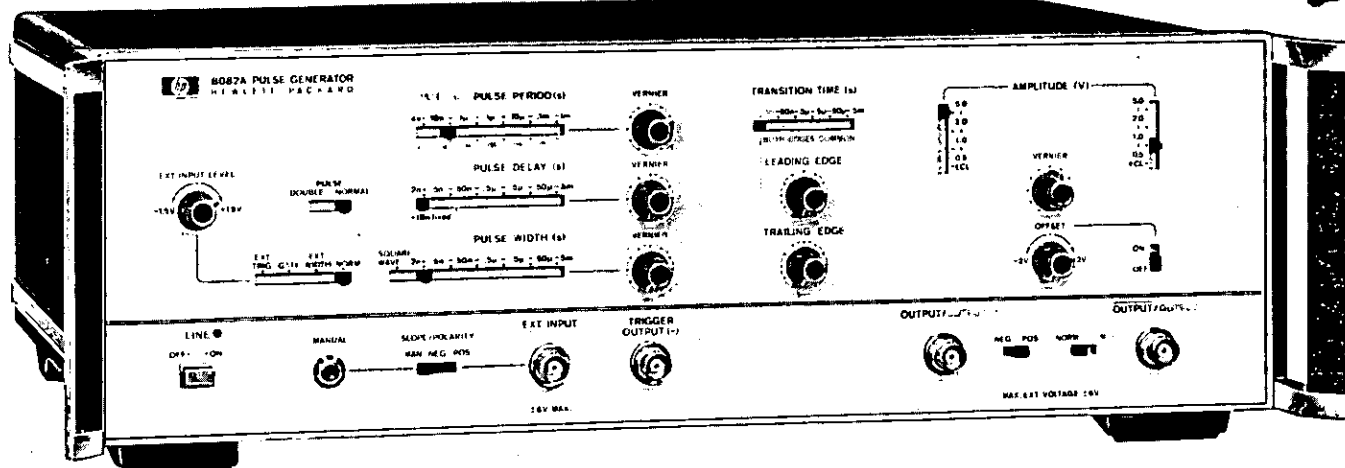

The 8082A is the result of years of experience in designing and manufacturing professional pulse generators. Its 250 MHz repetition rate, variable transition times down to 1 ns and low reactance 50 ohm source enable it to meet the stringent demands of today's fast logic like ECL and TTL-S. Although a highly sophisticated instrument, the 8082A is still extremely easy to operate because of its logical front panel layout and switch selectable ECL outputs.

The low reactance 50 ohm source impedance of the 8082A helps provide a clean pulse where it's needed - at the input of the device to be tested. When operating without an external termination, the low reactance of the 8082A 50 ohm source absorbs 98% of reflections from signals of up to 4 V amplitude leaving only 2% signal distortion.

Custom-made hybrid IC's are used extensively in the design of the 8082A. These IC's, manufactured by HP, eliminate the need for fans, reduce the power consumption and contribute to the 8082A's high reliability.

Specifications

Pulse characteristics

(50Ω source and load impedance)

Transition times: ≤ 1 ns - 0.5 ms in 6 ranges. First range from < 1 ns to 5 ns controls leading and trailing edges simultaneously. For all other ranges transition times variable independently up to 1:10.

Overshoot and ringing: $\leq \pm 5\%$ of pulse amplitude may increase to $\pm 10\%$ with amplitude vernier CCW.

Preshoot: $\leq \pm 5\%$ of pulse amplitude.

Linearity: Linearity aberration for both slopes $\leq 5\%$ for transition times > 5 ns.

Output: maximum amplitude is 5 V from 50Ω into 50Ω. Maximum output voltage is ± 5 V (amplitude + offset).

Offset: ± 2 V, into 50Ω.

DC-source impedance: 50Ω $\pm 5\%$.

Reflection coefficient: reflection is 2% typical for steps with 1 ns rise time applied to output connector on all amplitude ranges except 5 V range. On the 5 V range, the reflection may be 15%.

Output protection: cannot be damaged by open or short circuits or application of ext $\leq \pm 6$ V or ± 200 mA independent of control settings.

Attenuator: two separate three step-attenuators reduce the outputs to 1 V. Vernier is common for both outputs and reduces the output to 0.4 V minimum. A further position provides ECL-compatible outputs (-0.9 V to -1.7 V typ. open circuit).

Timing

Repetition rate: 250 MHz to 1 kHz in 6 ranges.

Period jitter: $< 0.1\%$ of setting +50 ps.

Delay: 2 ns - 0.5 ms in 6 ranges plus typ. 17 ns fxd. with respect to trigger output.

Delay jitter: $< 0.1\%$ of setting +50 ps.

Double pulse: up to 125 MHz max. (simulates 250 MHz).

Delay duty cycle: $> 50\%$.

Pulse width: < 2 ns - 0.5 ms in 6 ranges.

Width jitter: $< 0.1\%$ of setting + 50 ps.

Width duty cycle: $> 50\%$.

Square wave: a further position of the Pulse Width switch provides Square Wave output. (Delay and double pulse are disabled, max. Rep. Rate 250 MHz). Duty cycle is $50\% \pm 10\%$ up to 100 MHz, $50\% \pm 15\%$ for > 100 MHz.

Trigger output: negative going Square Wave (50% duty cycle typ.) > 500 mV from 50Ω into 50Ω. Internal 50Ω load can be switched off by slide-switch on PC-board. Amplitude increases to ≥ 1 V into 50Ω up to 200 MHz.

Trigger output protection: cannot be damaged by short circuit or application of external ± 200 mA.

Externally controlled operation

External input:

Input impedance: 50Ω $\pm 10\%$. DC coupled.

Maximum input: ± 6 V.

Trigger level: adjustable -1.5 V to +1.5 V.

Slope control: positive, negative or manual selectable. In the manual position all ext. functions can be controlled by push button. Button pushed in simulates an "on-signal."

Sensitivity: sine-wave > 200 mVpp pulses > 200 mV.

Repetition rate: 0 to 250 MHz.

Ext.-controlled modes:

Ext. trigger: there is approximately 7 ns delay between the external input and the trigger output. Rep. rate is externally controlled (is triggered by external signal). Trigger output provides the pulse-shaped input signal. Square wave mode is disabled.

Synchronous gating: gating signal turns rep. rate generator on. Last pulse normal width even if gate ends during pulse.

External width: output pulse width determined by width of drive input. Rep. rate and delay are disabled. Trigger output provides shaped input signal.

General

Power requirements: 100 V, 120 V, 220 V, 240 V (+5%, -10%) 48-440 Hz. Power consumption 85 VA max.

Weight: net 7.9 kg (17.44 lb), shipping 8.9 kg (19.63 lb).

Dimensions: 426 mm wide, 145 mm high, 380 mm deep (16 1/4 in. \times 5 1/8 in. \times 15 in.).

8082A Pulse Generator

83355

PULSE GENERATORS

Model 1900 Plug-in pulse generator system

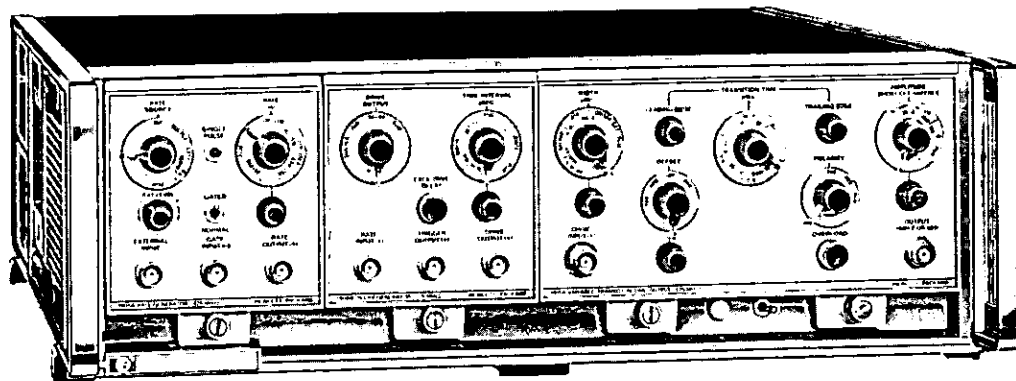

1900 System introduction

Unlike conventional pulse generators the Hewlett-Packard 1900 system with its modular construction offers the maximum possible flexibility and versatility. It makes available an extremely wide range of facilities which could otherwise only be implemented by several conventional instruments. In many cases the plug-in concept offers the only sensible solution to the ever changing requirements of technology.

The 1900 pulse system comprises 16 plug-in units which fall into three functional groups: SYSTEM CLOCK (Rate), INFORMATION (Timing) and INTERFACE (Output). There are two clock units with a repetition rate of 25 Hz to 25 kHz and 10 Hz to 125 MHz. There are six information units devoted to pulse delay, bit error detection, word generation and pseudo-random-binary-sequence generation, and eight interface and output units for the control of width, transition times, polarity, offset and amplitude. A selected combination of medium or high power modules find space within one of the two mainframes. Additional features include the internal wiring of a mainframe, which permits the choice of external or internal interconnection of plug-ins, and built-in shielding to minimize radio frequency interference (RFI).

Applications

Because of its flexibility the 1900 system covers a very wide range of applications. The following applications areas have been chosen as typical.

MOS applications

MOS circuits are used in such applications as computer memories and peripherals and in process control equipment, and a pulse source is required to control the MOS circuits and enable them to perform the digital logic functions. The pulses required range from

-27 V amplitude with high threshold MOS to +16 V amplitude with CMOS in either 2 phase static or dynamic systems. The 1900 system provides all the necessary facilities for solving problems concerned with MOS interfacing, timing, data testing, clock pulse degradation and worst case test patterns.

The 1915A, for example, has a ± 2.5 V to 50 V output from an impedance of 50 Ω . When modified by Option H51, the 1915A can produce single pulses or operate with duty cycles less than 0.2% over the complete range of 0 to 25 MHz. The variable transition times, down to 7 ns, allow simulation of pulse degradation due to capacitive loading. The internal 50 Ω load enables the use of long interconnecting cables with a minimum of reflection.

For low threshold, P-channel, N-channel and C-MOS devices the 1917A provides 0.2 V to 10 V from a 50 Ω source into a 50 Ω load. When the internal or external load is disconnected an output of 0 to 17 volts is available.

Fast logic applications

The two main types of high-speed logic on the market today are Schottky-clamped TTL (TTL-S) and non-saturating emitter-coupled logic (ECL). The 1900 output plug-ins, with transition times as fast as 350 ps, can be used in any high speed logic applications.

The 1916A, for example, has dual normal and complementary outputs ideally suited to driving twisted pairs and differential amplifiers. Also, with a repetition rate of up to 100 MHz and variable transition times down to 2.5 ns it can be used for propagation delay and reflection measurements.

One problem with sub-nanosecond logic is pulse degradation caused by the capacitive loading effect of the device under test. The 1920A plug-in, with its 25 MHz repetition rate and 350 ps transition times produces pulse edges fast enough to tolerate this degradation and still come within the manufacturer's specification.

The 1921A plug-in has a feedthrough output that permits noise spikes to be injected in to a 50 ohm system to test a circuit for noise toleration or to generate bipolar signals.

Communications applications

Information can be transmitted using either digital or analog communications systems. Digital systems are often used in preference to analog systems because even badly distorted digital signals can be reconstructed and because they can easily be used to transmit messages in code (cryptography).

The 1900 system provides facilities for word generation, random signal simulation, bit error detection and cryptography with the 1925A and 1930A pulse pattern generators.

The 1925A can generate words of 2 to 16 bits in length at frequencies up to 50 MHz and also a pseudo-random binary sequence (PRBS) of 32,767 bits in length for testing communications channels. The output can be switched to either non-return-to-zero (NRZ) or return-to-zero (RZ) mode.

The 1930A can generate a PRBS sequence in either NRZ or RZ mode at clock rates up to 40 MHz. The sequence can be varied from 7 to 1,048,575 bits in length before being repeated. It also has a facility for checking the validity of messages over communications links and producing error signals as errors occur.

Programmability

A remote programming facility is available for the 1900 system which permits analog or digital programming of most 1900 system functions. Analog programming can be used for semi-automatic testing of components or equipment that require a limited number of different repeatable pulse waveforms. For digital programming, the 1900 system is connected to a 6940A multiprogrammer which allows control of a large number of pulse parameters with a single 16-bit parallel computer word.



PULSE GENERATORS

1900 System: output plug-ins

Models 1915A, 1916A, 1917A, 1920A & 1921A

- 50 V maximum amplitude
- 350 ps minimum fixed transitions

- 2.5 ns minimum variable transitions
- 125 MHz maximum repetition rate

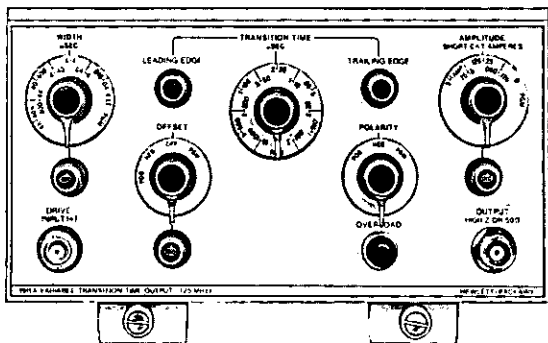

1915A

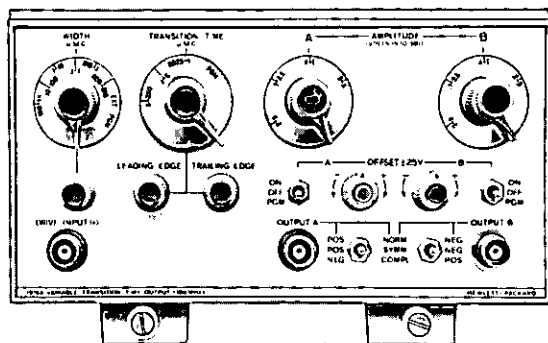

1916A

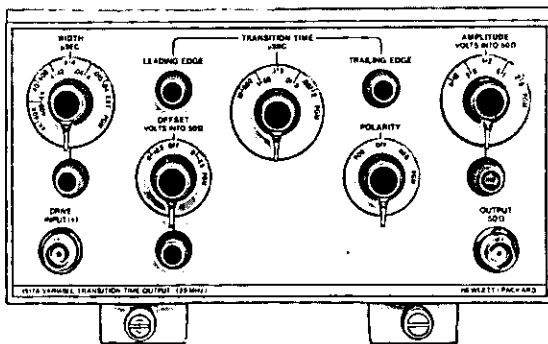

1917A

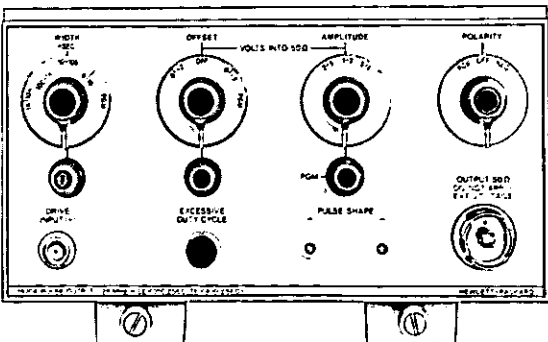

1920A

The 1900 system output plug-ins are listed first because they are the plug-ins that primarily determine the output pulse characteristics.

The 1915A is the high power plug-in of the range. Its 50 V, 1 A max. output and variable transition times from 7 ns to 1 ms make it ideal for testing magnetic memory devices, MOS devices and other high voltage, high current devices. In external width mode the 1915A can also be used in pulse code modulation (PCM) and digital non-return-to-zero (NRZ) applications. An overload circuit and lamp are provided to protect the output amplifier from damage.

The 1917A has variable transition times from 7 ns to 0.5 ms. It covers a wide range of digital applications from MOS memories to TTL testing and is the most economical output plug-in of the 1900 system.

The 1916A also has variable transition times, from 2.5 ns to 250 µs, and can be used to test a range of digital logic from RTL to MECL 10 K at repetition rates up to 100 MHz. In addition, the two output channels, with independent amplitude and offset controls, and the wide range of output configurations enable the 1916A to be used for analog applications.

The 1921A with a maximum repetition rate of 125 MHz provides the high speed pulse shaping capabilities in the 1900 system. With its 5 V amplitude, ±5 V offset and <2 ns transition times, the 1921A can be used for a variety of testing and design applications. An additional feature is a feedthrough output which allows the 1921A to inject pulses into a 50 ohm transmission line for generating bipolar and complex pulses.

The 1920A is the output plug-in that provides the very fast transition times (<350 ps leading edge, <400 ps trailing edge) in the 1900 system. These very fast transitions enable the 1920A to be used for testing rise-time, propagation delay, bandwidth and storage time of high speed logic families such as ECL III. The zero pulse width facility also enables the 1920A to be used for impulse testing.

Magnetic

MOS

HTL

RTL

DTL

TTL

TTL-S

MECL 10K

ECL III

1915A

1917A

1916A

1921A

1920A



PULSE GENERATORS

Models 1915A, 1916A, 1917A, 1920A & 1921A (cont.)

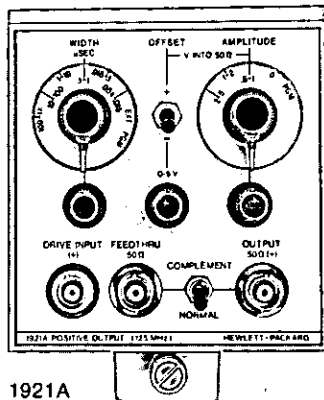

1921A

1915A Specifications

Pulse characteristics

Source impedance: 50 ohms or high impedance; self contained 50 ohm termination can be disconnected.

High impedance output: approx. 4 k Ω shunted by <45 pF.

50 ohm output: approx. 50 ohms shunted by <45 pF.

Amplitude (short-circuit current): 50 mA to 1 A in 4 ranges, 2.5:1 vernier allows continuous control within ranges. Voltage into external 50 ohms is ± 2.5 V to ± 50 V with high impedance source or ± 1.25 V to ± 25 V with 50 ohm source. Maximum amplitude (including offset) is ± 50 V.

Pulse top variations: 50 ohm source and 50 ohm load, $\pm 5\%$ for transition times 7 ns to 20 ns, $\pm 2\%$ for transition times >20 ns; high impedance source and 50 ohm load, $\pm 5\%$ for all transition times.

Transition times: 7 ns (10 ns with high Z source) to 1 ms in 11 ranges (1, 2, 5 sequence), two 100:1 verniers provide independent control of rise and fall times. Transition time variations over entire amplitude range (± 0.2 V to ± 25 V); $\pm 15\%$, ≥ 100 ns; $\pm 40\%$, 7 ns to 100 ns.

Polarity: positive or negative, selectable.

Baseline offset: ± 60 mA, max. offset into external 50 ohms is ± 1.5 V with 50 ohms source, ± 3 V with high Z source.

Pulse width:

Internal: 15 ns to 40 ms in 7 decade ranges (except first range — 15 ns to 40 ns), 10:1 vernier provides continuous adjustment within ranges; width jitter <0.5% of selected width.

External: provides pulse amplifier operation; output pulse width determined by drive input width.

Duty cycle: >65% on all ranges except >50% on 0.015 to 0.04 μ s width range; 0 to 100% in external mode. For <0.2% duty cycle operation, refer to overload specification.

Overload

Overload lamp lights to indicate when power detector protection circuits are turning off the output current to prevent damage to the output transistors. The power detector is energized for single pulse of <0.2% duty cycle operation for pulse widths >1 μ s. If single pulse or low duty cycle operation is required, Option H15 or, in programmable (005) versions, H51 or H52 may be ordered.

Drive input

Repetition rate: 0 to 25 MHz (see overload specification for low rep. rate considerations).

Amplitude: 1 V peak min., 5 V peak max.

Input impedance: 50 ohms, dc-coupled.

Maximum delay: (after drive input) <45 ns.

General

Weight: net 2.5 kg (5½ lb); shipping 4.1 kg (9 lb).

1916A Specifications

Pulse characteristics

(50 Ω source and load impedance).

Transition times: 2.5 ns to 250 μ s in 3 ranges; 50:1 verniers provide separate control of rise and fall times. Nonlinearity; maximum deviation from straight line between 10% and 90% amplitude, less than 5% of pulse amplitude.

Overshoot, ringing and preshoot: <5% of pulse amplitude.

Amplitude: <200 mV to 5 V (across 50 Ω) in four ranges. Vernier provides continuous adjustment within ranges.

Pulse output: channel A; pos-normal, pos-symmetrical (about offset voltage) or neg-complement. Channel B; neg-normal, neg-symmetrical or pos-complement, Switch selectable.

Maximum duty cycle: >50% for internal width; up to 100% with complement; up to 100% for external width.

Source impedance: 50 Ω $\pm 4\Omega$ shunted by 10 pF (typ.).

DC offset: ± 2.5 V across 50 Ω , independent of amplitude. Can be switched off.

Pulse width: 5 ns to 1 ms in 6 ranges. 10:1 vernier provides continuous adjustment within ranges.

Width jitter: <0.1% +25 ps of pulse width.

External width: pulse width within ± 2 ns of external input width when input width measured at 0.6 V.

Drive input

Repetition rate: 0 to 100 MHz.

Input impedance: 50 Ω , dc coupled.

Pulse shape: amplitude, >1.5 V; width >3 ns; slope, >0.25 V/ns in internal width, >0.15 V/ns in external width (smaller slopes may cause performance degradation).

Maximum input: ± 5 V.

Propagation delay: internal width mode, 23 ns approx.; external width mode, 18 ns approx.

General

Weight: net 1.13 kg (2½ lb); shipping 2.8 kg (6¼ lb).

1917A Specifications

Pulse characteristics

Source impedance: 50 ohms or high Z; selected with internal switch. High impedance output, approx. 3 k Ω shunted by 45 pF; 50 ohms output, approx. 50 ohms shunted by 45 pF.

Amplitude: (volts into 50 ohms) 0.2 to 10 V with 50 ohms source; 0 to 14 V (8 to 400 mA) with 3000 ohms source; 2.5:1 vernier provides continuous adjustment over each range.

Pulse top variations: $\pm 5\%$ for transition times >7 ns.

Transition times: 7 ns to 500 μ s in 5 ranges; two 50:1 verniers provide independent control of rise and fall times.

Transition time variations over entire amplitude range (± 0.2 to +10 volts): $\pm 15\%$, ≥ 100 ns; $\pm 40\%$, 7 to 100 ns.

Polarity: plus or minus, selectable.

Baseline offset: ± 2.5 V into external 50 ohms with 50 ohm source; 100 mA with 3000 ohm source.

Pulse width:

Internal: ranges, 15 ns to 40 ms in 7 ranges; 10:1 vernier provides continuous adjustment over each range; width jitter, <0.25% of selected pulse width.

External: provides pulse amplifier operation; output pulse width determined by width of drive input.

Duty cycle: internal width mode, 65% except for 15 to 40 ns width range, 50% on 15 to 40 ns width range; external width mode, up to 100%; limited by output pulse transition times.

Drive input

Repetition rate: 0 to 25 MHz.

Input impedance: 50 ohms, dc-coupled.

Amplitude: 1 V peak min., 5 V peak max.

Maximum delay after drive input: approx. 35 ns.

General

Weight: net 1.13 kg (2½ lb); shipping 2.8 kg (6¼ lb).

1920A Specifications

Pulse characteristics

Source impedance: 50 ohms ±5%.

Amplitude: 0.5 V to 5 V into 50 ohms in three ranges; 1, 2, 5 sequence. 2.5:1 vernier provides continuous adjustment over each range. Output circuit cannot be damaged by shorting.

Pulse shape (measured at 5 V into 50 ohms)

Leading edge: risetime, <350 ps; preshoot, <1%, overshoot and ringing, <10% p-p; time to settle to within 3% of flat top, <5 ns; rounding <5%.

Trailing edge: falltime, <400 ps; preshoot, <1% for pulse width >5 ns; overshoot and ringing, <10% p-p; time to settle to within 3% of baseline, <5 ns except for perturbation 10-20 ns after trailing edge <±4%; rounding, <5%.

Polarity: plus or minus, selectable.

Baseline offset: plus, minus, or off; selectable, 0-2 V into 50 ohms.

Width: 0 to 10 µs in four ranges. 10:1 vernier provides continuous adjustment between ranges.

Width jitter: <20 ps or 0.1% whichever is greater.

Duty cycle: 0 to >25% (0 to 20 MHz rep. rate); 0 to 10% (>20 MHz rep. rate).

Drive input

Repetition rate: 0 to 25 MHz.

Amplitude: 1 V peak min., 5 V peak max.

Maximum delay after rate input: approx. 60 ns.

Input impedance: 50 ohms, dc-coupled.

General

Weight: net 1.8 kg (4 lb); shipping 4.5 kg (10 lb).

1921A Specifications

Pulse characteristics

Source impedance: approx. 50 ohms shunted by 9 pF. Reflection coefficient is typically <0.15 for incident pulses with rise times >1.5 ns.

Pulse amplitude: (volts into 50 ohms) 0.5 to 5 V; 2.5:1 vernier provides continuous adjustment over each range.

Polarity: positive. Opposite pulses can be obtained by adjusting offset, amplitude and complement controls.

Duty cycle: >50% in internal; up to 100% with complement; external width mode, up to 100%.

Feedthru mode: allows output pulses to be added on a 50 ohm transmission line for bipolar applications.

Complement: selects normal pulse or its logic complement.

Transition time shift: normal to complement, typically <±1 ns.

Pulse top variations: <±5% for amplitudes from 1 to 5 V and <±7% for amplitudes of <1 V.

Base line offset: 0 to ±5 V into 50 ohms.

Transition times: <2 ns.

Pulse width:

Internal: ranges, 4 ns to 1 ms in 6 ranges (10:1 vernier provides continuous adjustment over each range); jitter, <25 ps + 0.1% of pulse width; time intersymbol interference, width change with rep rate <1.5 ns + 0.2% of pulse width.

External: provides pulse amplifier operation; output pulse width is determined by width of drive input. Pulse width tracking is within approx. ±1 ns width input pulse width measured at 0.6 V. Time intersymbol interference: transition shift with rep. rate, <1 ns.

Drive input

Repetition rate: 0 to 125 MHz.

Input impedance: 50 ohms, dc-coupled.

Pulse shape: amplitude, >1.5 V; width, >3 ns; slope, >0.25 V/ns at 0.7 V in internal width, >0.15 V/ns at 0.7 V in external width (smaller slopes may cause degradation of performance).

Maximum input: ±5 V.

Propagation delay: internal width mode, approx. 18 ns; external width mode, approx. 15 ns, feedthru mode, approx. 4 ns.

General

Weight: net 1.4 kg (3 lb); shipping 2.7 kg (6 lb).

1915A Options

001: analog programming. Provides connector and circuits to control width, transition time, amplitude, polarity and offset.	Price \$300
002: positive output. Provides positive-only pulse output and positive-only offset.	less \$225
003: negative output. Provides negative-only pulse output and negative-only offset.	less \$225
004: voltage calibration. Calibration of pulse amplitude in voltage.	\$25
005: digital programming. Provides digital control of Width, Transition Time, Amplitude, Polarity and Offset. Refer to 1900/6940A description or contact your Hewlett-Packard Field Engineer for more information.	\$2835
007: Rear Panel outputs.	\$25

1917A Options

001: analog programming. Provides connector and circuits to control Width, Transition Time, Amplitude, Polarity and Offset.	\$300
005: digital programming. Provides digital control of Width Transition Time, Amplitude, Polarity and Offset. Refer to 1900/6940A description or contact your Hewlett-Packard Field Engineer for more information.	\$2250
007: Rear Panel outputs.	\$25

1920A Options

001: analog programming. Provides connector and circuits to control width range and vernier, offset range and vernier, and amplitude vernier.	\$155
--	-------

1921A Options

001: analog programming. Provides connector and circuits to control Width, Amplitude, Complement and Offset.	\$200
---	-------

Model number and name

1915A Output plug-in	\$1950
1916A Output plug-in	\$1460
1917A Output plug-in	\$700
1920A Output plug-in	\$2300
1921A Output plug-in	\$1100

PULSE GENERATORS

1900 System: pulse pattern generator plug-ins

Models 1925 & 1930A

- 50 MHz, 1 x 16 bit
- RZ/NRZ format
- Fixed $2^{15}-1$ PRBS

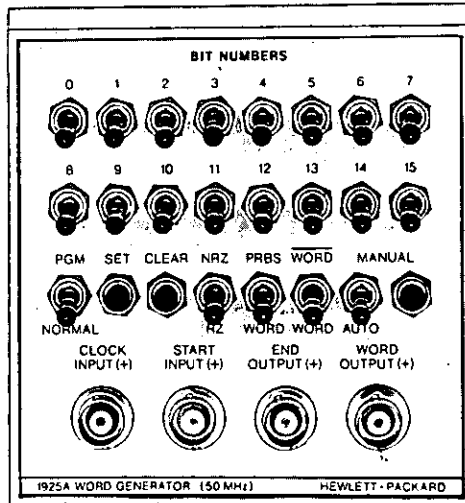

1925A



1925A Description

The 1925A is a digital word-generating plug-in unit. It generates a variable length word at a repetition rate of 0-50 MHz. Thus it can be driven by either the 1905A or 1906A rate generator plug-ins and will drive any of the 1900 output plug-ins.

Word lengths of 2 to 16 bits can be selected using internal switches and the word content can be set either using the front panel switches or by external programming. The word can be initiated by an external command signal or by a manual pushbutton or it can be recycled automatically with one clock period between words.

Alternatively a pseudo-random sequence of fixed $2^{15}-1$ (32,767) bits can be generated by switching the 1925A to PRN. This facility is extremely useful for testing communications channels or LSI computer memories. The internal register can be set or cleared to establish reference levels and sequences when PRN mode is being used.

The 1925A will operate in either return-to-zero (RZ) mode or non-return-to-zero (NRZ) mode and the output can be switched to complement if required. An end-of-word synchronization signal is also available at a separate socket.

1930A Description

Model 1930A is a quarter-size, formatting plug-in for the 1900 pulse system. It can generate a pseudo-random binary sequence (PRBS) in either return-to-zero (RZ) or non-return-to-zero (NRZ) formats at clock rates up to 40 MHz (typically to 50 MHz). The length of a sequence can be varied from 7 to 1,048,575 bits before being repeated. A PRBS is apparently random in that, for samples of n bits or less, it follows closely the statistical characteristics of a binomial distribution but it is deterministic and periodic.

Random signal simulation

Random signal simulation allows a device that processes digital information to be completely exercised while providing the stationary characteristics of a repetitive signal. In pattern sensitive devices, pseudo-random binary sequences provide a fast, easy and complete

- 40 MHz PRBS 2^3 up to $2^{20}-1$
- 40 MHz bit error detection
- 40 MHz cryptography

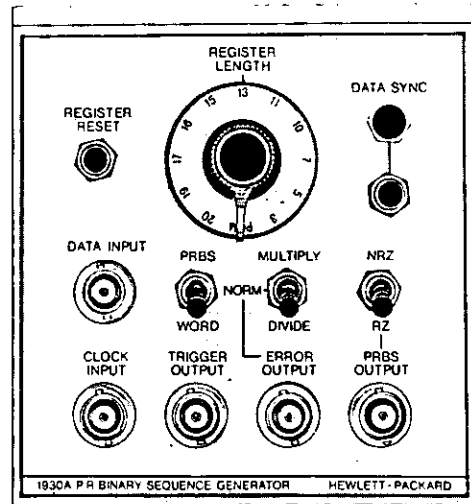

1930A



method of generating all possible combinations of up to 20 bits for detecting worst case patterns. Also, in an n cell device, a random sequence can be generated that is 2^n-1 bits long and contains all possible combinations of n bits except the all zeros combination. In the 1930A, 'n' can be between 3 and 20, thus it is possible to select the sequence length to avoid "beating" with other signals in the device being exercised.

Bit error detection

One of the main reasons for testing digital processing equipment is to determine how accurately the transmitted signal is received and to find the effect of noise in the transmission system. A measure of the quality of a digital system is Bit Error Rate (BER).

Bit error detection in digital transmission systems is simplified by the ability of 1930A to synchronize rapidly to a data stream (either words or pseudo-random sequences) and compare the incoming data bit by bit with a stored replica. For example: one 1930A generates a signal that is transmitted over a digital communication link while a second 1930A synchronizes to the incoming signal from the link. Each time the received signal differs from the stored replica an error pulse is produced at the error output. Error pulses can be counted to provide the bit error rate. This technique is not restricted to transmission systems, it is equally applicable when testing mass-storage memory devices.

Coding

Coding in digital applications is accomplished by dividing the incoming data stream by the characteristic equation of the generator. The pseudo-random binary sequence completely scrambles the original data in both time and frequency domains. Eleven different scrambling patterns can be selected with a front panel register length switch, and feedback tapes inside the plug-in allow over 73,000 different pseudo-random patterns. Scrambling patterns may also be set by remote, electronic program signals through the rear panel of an Option 001 mainframe. To decode the information, another 1930A set to the same sequence multiplies the scrambled signal by the same equation to regain the original data.

1925A Specifications

Clock input

Rep. rate: 0 to 50 MHz (15-35°C), 0 to 45 MHz (0-50°C).

Input impedance: 50 ohms, dc-coupled.

Amplitude: +1 V min, +5 V max.

Width: >4 ns, <18 ns at +0.6 V.

Propagation delay: 35 ns max., leading edge of transition of output data.

Transition time jitter: (between clock or END and WORD-OUT) 100 ps.

Start input

Period: >(word length plus 30 ns).

Input impedance: 50 ohms, dc-coupled.

Amplitude: +1 V min, +5 V max.

Width: >5 ns.

Programming inputs (requires 1900A Option 001 or 1901A Option 001 mainframe).

True: contact closure to ground, saturated DTL, or voltage source (TTL) <+0.2 V.

False: open, off DTL, or voltage source (TTL) >2.5 V, <4.0 V.

Noise immunity: >0.7 V p-p. True <0.2 V, False >3.5 V.

Noise bandwidth: <15 MHz.

Word and End output

True: 45 ±5 mA current source or >1 V into 25 ohms.

False: <1 mA.

Risetime and falltime: <4 ns (10% to 90%).

Perturbations: <15%.

Source impedance: unterminated current source.

Functions

Word length: 2 to 16 bits, set by internal switches; not programmable.

Word content: set by front-panel switches or external programming.

Word format: NRZ/RZ, selectable from front panel or external program. RZ pulse width less than 1/2 clock period or 15 ns (whichever is smaller). WORD/WORD selectable from front-panel switch.

Word cycling: automatic (continuous with one clock period delay between words), external start command, or manual pushbutton.

Manual/Auto: selectable from front-panel switch or external program. In AUTO mode, word continuously recycles with one clock period delay between words. In program mode, content of each word corresponds to the previous parallel word input that existed during END. In manual mode, a word starts after receiving an external start signal or pressing MANUAL pushbutton.

End out: available from front-panel BNC corresponding to end-of-word.

Set: serially loads 1's into shift register. Output word bits are all 1's after 16 clock pulses. Used to start the PRN sequence.

Clear: parallel reset of shift register. Output word bits are all zero. Used to manually load the beginning of the PRN sequence if desired.

Pseudo-random noise: provides a linear shift-register sequence of 32,767 bits. The sequence starts with the last 16-bit word in shift register. Maximum clock rate is 30 MHz.

Programming: all data bits, NRZ/RZ, PRN/WORD, and MANUAL/AUTO.

General

Weight: net 1.02 kg (2¼ lb); shipping 2.04 kg (4½ lb).

1930A Specifications

Clock input

Repetition rate: 0 to 40 MHz (typically to 50 MHz in most sequences).

Input impedance: 50 ohms, dc-coupled.

Amplitude: +1 V min.

Width: >4 ns and <15 ns.

Propagation delay: 40 ns max. (clock input to transition of output data).

Maximum input: ±5 V.

Data input

Repetition rate: 0 to 40 MHz (typically to 50 MHz).

Input impedance: 50 ohms, dc-coupled.

Amplitude

One level: +1 V min.

Zero level: 0 V.

Maximum input: ±5 V.

Trigger output

Amplitude: 1 V (open circuit).

Width: approx. 1 clock period.

Source impedance: 50 ohms.

Error output

Amplitude: 45 ±5 mA current source or >2 V into 50 ohms.

Width: >10 ns, <50% of period in RZ mode.

Source impedance: unterminated current source.

Self generated error rate: <1 × 10⁻¹².

PRBS output

Amplitude: 45 mA ±5 mA or >2 V into 50 ohms.

Rise and fall times: <4 ns.

Width: typically >7 ns and <14 ns.

Source impedance: unterminated current source.

Programming inputs

(Requires option 001 1900A or 1901A mainframes)

False: contact closure to <0.6 V.

True: open or >3.0 V.

Response: <300 ns.

Threshold: approx. 2.2 V or 5.5 kΩ.

General

Weight: net 1.02 kg (2¼ lb); shipping 2.04 kg (4½ lb).

Options

005: digital programming. Enables control by a 6940A Multi-programmer. For more information see 1900/6940A description or contact your Hewlett-Packard field engineer

Model number and name

1925A Pulse pattern generator plug-in

1930A Pulse pattern generator plug-in

Price

\$310

\$900

\$1240

PULSE GENERATORS

1900 System: delay plug-ins

Models 1908A & 1910A

- 25 MHz max. repetition rate
- 15ns—10ms delay
- Delay, advance, double pulse functions

- 125 MHz max repetition rate
- Delay line, 100 ns in 5 ns increments
- Delay may exceed period

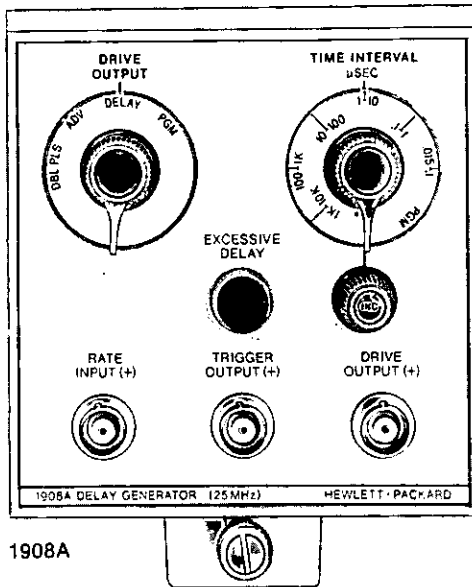

1908A

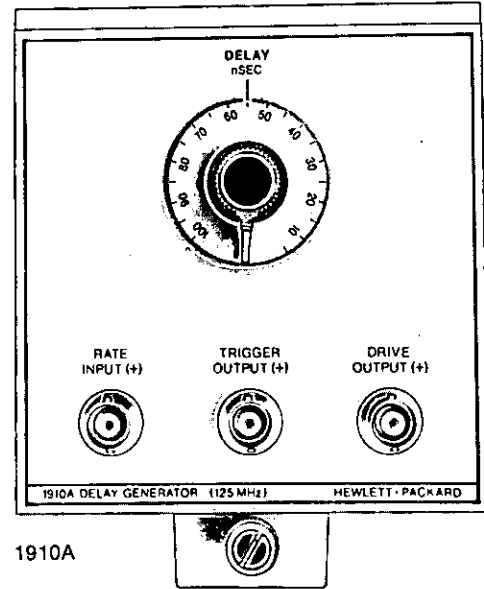

1910A

1908A Specifications

Functions (drive output switch)

Delay: drive output delayed with respect to trigger output.

Advance: trigger output delayed with respect to drive output.

Double pulse: generated from drive output connector. Spacing determined by time interval setting.

Time interval (between trigger and drive outputs)

Range: 15 ns to 10 ms in 6 ranges. 10:1 vernier provides continuous adjustment in any range.

Jitter: <0.1% of selected time interval.

Excessive delay light: indicates that selected delay time exceeds pulse period.

Rate input

Repetition rate: 0 to 25 MHz.

Amplitude: >1.5 V peak min., 5 V peak max.

Maximum delay after rate input (with delay control set to minimum).

Trigger output: approx. 14 ns in delay mode; approx. 29 ns in advance mode.

Drive output: approx. 29 ns in delay mode; approx. 14 ns in advance mode.

Input impedance: approx. 50 ohms, dc-coupled.

Trigger and drive outputs

Output impedance: approx. 50 ohms.

Amplitude: >1.5 V into 25 ohms (drives two 1900 series plug-ins).

Risetime: <5 ns.

Width: <10 ns.

General

Weight: net 0.6 kg (1¼ lb); shipping 2.7 kg (6 lb).

Accessories

Programming kit: HP Part No. 01908-69501. provides for field installation for Option 001.

1910A Specifications

Time interval (between trigger and time outputs)

Range: 5 ns to 100 ns in 5 ns increments.

Jitter: <10 ps.

Rate input

Repetition rate: 0 to 125 MHz.

Amplitude: 0 to 25 MHz; 1 V peak min, 5 V peak max. 25 MHz to 125 MHz; 1.5 V peak min, 5 V peak max.

Maximum delay after rate input (with delay control set to min):

Trigger output: approx. 5 ns.

Drive output: approx. 10 ns.

Input impedance: approx. 50 ohms, dc coupled.

Trigger and drive outputs

Output impedance: approx. 50 ohms.

Amplitude: >1.5 V into 25Ω (drives 2 1900 series plug-ins).

Risetime: <3 ns.

Width: <5 ns.

General

Weight: 1.13 kg (net 2½ lb); shipping 2.2 kg (4¾ lb).

1908A Options:

001: analog programming. Provides connector and circuits for control of Drive Output (Delay, Double Pulse) and Time Interval. Drive Output modes and Time Interval ranges are selected by contact closure to ground. Time Interval vernier is controlled by analog current.

005: digital programming. Provides digital control of Drive Output (Delay, Double Pulse) and Time Interval. Refer to 1900/6940A description or contact your Hewlett-Packard Field Engineer for more information.

Model number and name

1908A Delay plug-in

1910A Delay plug-in

Price

\$105

\$515

\$250

\$270

PULSE GENERATORS



1900 System: rate plug-ins
Models 1905A, 1906A, 1927A & 1928A

- 1905A 25 MHz rate generator
- 1906A 125 MHz rate generator

- 1927A 8 wide OR-gate
- 1928A 8 wide fan-out amplifier

1905A and 1906A Rate generators specifications

(Except as noted, specifications apply to both rate generators.)

Frequency
Internal: 1905A, 25 MHz to 25 MHz in 6 ranges. 1906A, 10 Hz to 125 MHz in 8 ranges. 10:1 range vernier.
External: 1905A, 0 to 25 MHz; 1906A, 0 to 125 MHz.
Period jitter: <0.1% of selected period.

External trigger
Amplitude: 1905A, 0.5 V p-p min., 5 V p-p max.; 1906A, 0 to 50 MHz, 0.5 V p-p min.; 50 to 125 MHz 1.5 V p-p min. Maximum input 5 V p-p.
Slope: positive or negative (selectable).
Trigger level: selectable on input waveform from 0 to ± 3 V.
Delay: 1905A, approx. 27 ns external input to rate output; 1906A, approx. 12 ns external input to rate output.
Input impedance: approx. 50 ohms, dc-coupled.

Synchronous gating
Amplitude: 1905A, -2 V gates generator on, -5 V max.; 1906A, +1 V gates generator on, +5 V max; 50 ohms, dc-coupled.

Output pulse:
Impedance: approx. 50 Ω , dc-coupled.
Amplitude: >1.5 V into 50 Ω (drives 2 1900 series plug-ins).
Risetime: 1905A, <5 ns; 1906A, <3 ns.
Width: 1905A, <10 ns; 1906A, <5 ns.

General
Weight: net 0.6 kg (1 1/4 lb), shipping 2.7 kg (6 lb).

Accessories
Programming kit: HP Part No. 01905-69501, provides for field installation for Option 001.

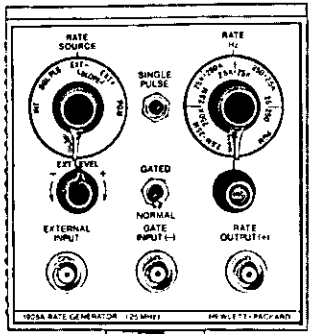

1905A

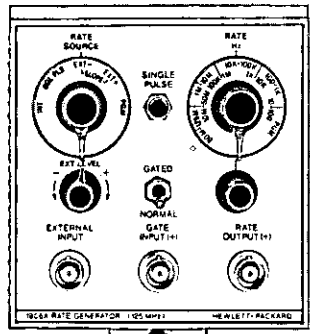

1906A

1927A Fan-in amplifier and 1928A Fan-out specifications

Amplifier
 (Except as noted, specifications apply to both amplifiers)

1927A
 This plug-in is used to OR several signals together which may then be amplified by a single output stage.

1928A
 Normal 1900 plug-in drives 2 other plug-ins. The 1928A can drive 16 others.

Input
Threshold: continuously variable from +0.5 V to +3 V. In 1927A, one adjustment for all eight inputs.
Repetition rate: 0 to 125 MHz.
Amplitude: 1 V min., 4 V max; impedance 50 ohms, dc-coupled.
Width: >4 ns.
Propagation delay: 1927A, <8 ns; 1928A, <10 ns.

Output
Source impedance: unterminated current source.
Logic one: 45 mA \pm 5 mA current source; <3 ns transition times.
Pulse stretching: increase in pulse width is <3 ns.
1928A differential delay between output ports: <3 ns.

General
Weight: net 0.6 kg (1 1/4 lb), shipping 2.7 kg (6 lb).

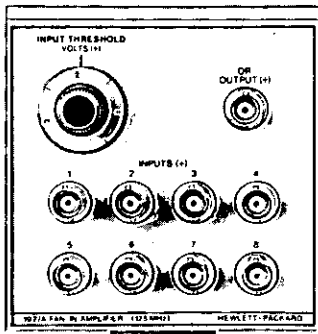

1927A

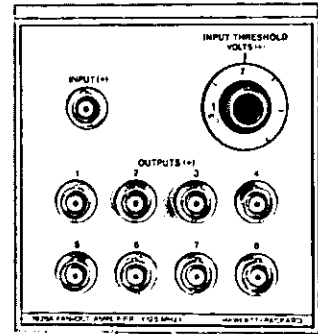

1928A

1905, 1906 Options	Price
001: analog programming. Connector and circuit card for control of Rate Source (INT, EXT, +, -) and pulse rate.	\$105
005: (1905A only) digital programming. Digital control of Rate Source and Pulse Rate. Ref. 1900/6940A description or contact Hewlett-Packard Field Engineer for more information.	\$515
Model number and name	
1905A Rate plug-in	\$250
1906A Rate plug-in	\$325
1927A Rate plug-in	\$200
1928A Rate plug-in	\$300.



PULSE GENERATORS

1900 System: mainframes

Models 1900A, 1901A

- Powers all plug-ins including 1915A
- RFI shielded
- Internal signal routing between plug-ins

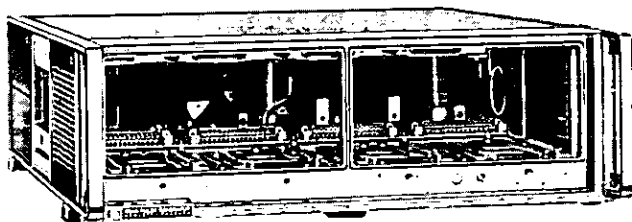

1900A

- Powers all plug-ins except 1915A
- RFI shielded
- Internal signal routing between plug-ins



1901A

The 1900A mainframe supplies the same voltages as the 1901A mainframe plus special positive and negative variable supplies for the 1915A output plug-in. Thus the 1900A mainframe can power all plug-ins in the 1900 system and the 1901A mainframe can power all plug-ins except the 1915A.

A further difference is that the 1901A mainframe has higher power capabilities in the other supplies than the 1900A mainframe for driving the remaining 1900 system plug-ins (this can be seen from the table below).

Both mainframes are fitted with RFI shielding and contain wiring to provide internal connections between plug-ins. These connections can be changed for any combination of plug-in interconnections. The choice of internal or external interconnection of plug-ins is made using switches in the plug-ins.

Plug-in compatibility

For a given combination of plug-ins, add up the applicable percentages of each column. The configuration is compatible when no column exceeds 100%.

Plug-in	Mainframe space	1900A Power			1901A Power		
		+25 V	-25 V	-10 V	+25 V	-25 V	-10 V
1905A	25%	9%	9%		6%	6%	
1906A	25%	11%	12%		8%	8%	
1908A	25%	8%	8%		6%	6%	
1910A	25%	4%	4%		4%	3%	
1915A	50%	27%	25%		—	—	
1916A	50%	41%	43%	7%	27%	30%	5%
1917A	50%	40%	38%		27%	25%	
1920A	50%	55%	55%		36%	36%	
1921A	25%	43%	21%		28%	14%	
1925A	25%	10%	2%	38%	6%	2%	25%
1927A	25%	2%	2%		2%	2%	
1928A	25%	28%	19%		18%	12%	
1930A	25%	13%	5%	42%	8%	4%	30%

1900A and 1901A Mainframes specifications

General

Dimensions: 425 × 133 × 543 mm (16 3/4" wide, 5 1/4" deep over-all), 492 mm (19 3/4") behind rack mount.

Weight: 1900A, net 16 kg (35 lb); shipping 21 kg (46 lb); 1901A, net 12.7 kg (28 lb); shipping 17.6 kg (39 lb).

Power: 115 V or 230 V ±10%, 48 to 66 Hz. 1900A, 300 watts max., will drive 1915A plug-in. 1901A, 250 watts max., will not drive 1915A plug-in.

Accessories furnished: rack mounting tabs and power cord.

Accessories

Analog programming kit (HP P/N 01900-69502): provides field installation of Option 001.

Chassis slide kit (HP P/N 01900-69501): Allows installation on non-pivoting slides with an adjustable length of 20 to 22 inches.

Blank plug-ins: blank plug-ins fill unused plug-in compartments to provide proper plug-in cooling and reduce RFI. Model 10481A, quarter-size plug-in. Model 10482A, half-size blank plug-in.

Plug-in extender: provides access to components when servicing and calibrating an operating plug-in. Extender accommodates both quarter- and half-size plug-ins. Model 10482A plug-in extender.

Options

001: provides internal cabling and connectors from plug-ins to rear panel for digital or analog programming.

002: non-pivoting chassis slides with adjustable length of 20 to 22 inches.

007: Rear Panel inputs and outputs

Model number and name

1900A Main frame

1901A Main frame

Price

\$200

\$95

\$80

\$1000

\$650



PULSE GENERATORS

1900 System: programming information

- Full control of all parameters
- Both analog and digital control available

- Occupies only one controller I/O slot
- System can be easily expanded

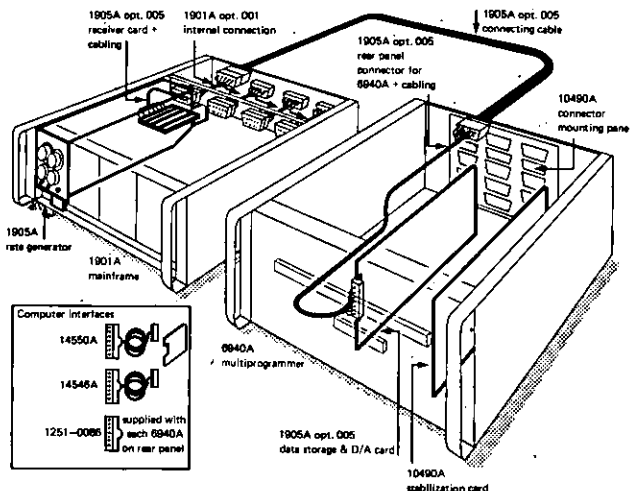
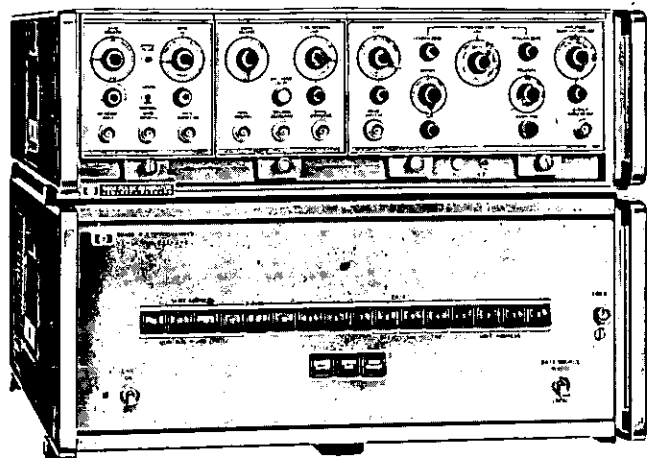

Analog control

Analog control is particularly suitable for simple applications where only partial control is needed or when only a few pulse waveforms are required repeatedly. Available in the 1900 series are six plug-ins which feature analog programming as an option. They are:

1905A	001	1915A	001	Programming of these modules requires an option 001 1900A or 1901A mainframe.
1906A	001	1920A	001	
1908A	001	1921A	001	

Programming is by contact closure for ranges and by resistor or analog current for vernier functions.

Digital programming

For flexible control of a pulse generator, digital programming is the answer and Hewlett-Packard's contribution is the 1900/6940A programmable pulse generator.

The plug-in 1900 system and the 6940A Multiprogrammer allow reliable and efficient control of a large number of functions by a mini-computer, using only a single 16 bit I/O slot. Up to fifteen 6941A Extenders may be added to provide control of up to 240 separate functions still using only one computer I/O slot. A 10490A connector mounting panel and stabilization card are necessary when using the 6940A with a 1900 system.

Available in the 1900 series are six plug-ins which feature digital programming as an option. They are:

1905A	005	1917A	005	Programming of these modules requires an Option 001 1900A or 1901A mainframe.
1908A	005	1925A	005	
1915A	005	1930A	005	

Only the functions with parameters to be varied need be programmed. For the others, standard plug-ins may be used or part of the programming hardware can be omitted. For example; if only the width of an output stage and not offset, amplitude, etc. is to be programmed, then the cards in the 6940/6941A which would be required to control these non-varying parameters can be omitted.

The 1900/6940A works with any digital computer, however, for Hewlett-Packard digital computers, software in FORTRAN and BASIC is available.

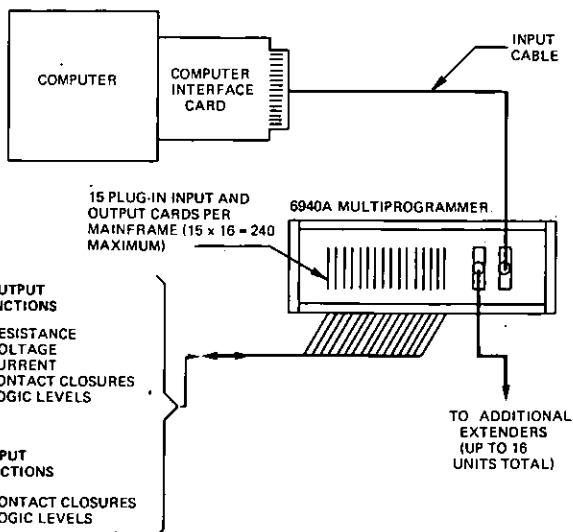

Introduction

If a pulse generator can be programmed, it can be incorporated in automatic or semi-automatic test systems. This added flexibility is invaluable for applications that require several different but repeatable pulse waveforms. Hewlett-Packard offers this capability in a number of their pulse generators, particularly in the 1900 series.

Option 005 (1900/6940A) specifications

Pulse parameter specifications are contained in the individual specifications for each plug-in. The following specifications apply to programming accuracies for the 1905A, 1908A, 1915A, 1917A, 1925A and 1930A.

1905A Rate generator

Programmable functions

Period: 25 Hz to 25 MHz in 6 ranges.

Accuracy: $\pm 5\%$ of digital input or ± 10 ns, whichever is greater.

Resolution: 360 points in each range.

Mode: + Ext, - Ext, Internal.

Response time: $< 30 \mu\text{s}$ plus one period.

General

6940A: 1 slot required.

Equipment supplied: 1 output card and interconnecting cables.

1908A Delay generator

Programmable functions

Mode: delay, advance, double pulse.

Delay interval: 15 ns to 10 ms in 6 ranges.

Accuracy: $\pm 5\%$ of digital input or ± 10 ns, whichever is greater.

Resolution: 900 points in each range.

Response time: $< 30 \mu\text{s}$ plus one period.

Duty cycle: 50% max.

Temperature range: 10°C to 40°C . From 0°C to 55°C , specifications are the same except for Accuracy, which is $\pm 15\%$ of digital input or ± 10 ns, whichever is greater.

General

6940A: 1 slot required.

Equipment supplied: 1 output card and interconnecting cables.

1915A Variable transition time output

Programmable parameters

Width: 15 ns to 40 ns in 7 ranges.

Accuracy: $\pm 10\%$ of digital input or ± 10 ns, whichever is greater.

Resolution: 360 points in each range.

Response time: $< 30 \mu\text{s}$ plus one period.

Duty cycle: 50% max.

Transition time: 7 ns to $100 \mu\text{s}$ in 5 ranges.

Accuracy: $\pm 15\%$ of digital input or 10 ns, whichever is greater.

Resolution: 450 points in each range.

Response time: $< 30 \mu\text{s}$ plus one period.

Amplitude: 0.05 A to 1.0 A (1.25 V to 25 V into 25 ohms) in 4 ranges.

Polarity: positive or negative.

Accuracy: digital input $\pm 5\%$ of max. vernier on each range.

Resolution: 300 points in each range.

Response time: < 50 ms for 50 V pulses from high Z source into 50 ohm load. < 15 ms for 25 V pulses from 50 ohm source into 50 ohm load. Typically $> 500 \mu\text{s}$ for duty cycle $> 0.2\%$.

Offset: 0 to 60 mA in 1 range (0 to 1.5 V into 25 ohms).

Polarity: positive or negative.

Accuracy: ± 2 mA of digital input (± 50 mV into 25 ohms).

Resolution: 150 points.

Response time: $< 250 \mu\text{s}$.

Temperature range: 10°C to 40°C . From 0°C to 55°C , specifications are the same except for the following: Offset Accuracy, $\pm 15\%$ or 60 mV, whichever is greater; Transition Time Accuracy, $\pm 20\%$ or ± 10 ns, whichever is greater; Width Accuracy, $\pm 15\%$ or ± 10 ns, whichever is greater; Amplitude Accuracy, $\pm 15\%$ or ± 50 mV, whichever is greater.

General

6940A: 5 slots required.

Equipment supplied: 5 output cards and interconnecting cables.

1917A Variable transition time output

Programmable parameters

Width: 15 ns to 40 ns in 7 ranges.

Accuracy: $\pm 5\%$ of digital input or ± 10 ns, whichever is greater.

Resolution: 360 points in each range.

Response time: $< 30 \mu\text{s}$ plus one period.

Duty cycle: 50% max.

Transition time: 7 ns to $100 \mu\text{s}$ in 5 ranges.

Accuracy: $\pm 15\%$ of digital input or ± 5 ns, whichever is greater for all amplitudes between 2 and 10 volts.

Resolution: 450 points on each range.

Response time: $< 30 \mu\text{s}$ plus one period.

Amplitude: 0.2 V to 10 V in 5 ranges.

Polarity: positive or negative.

Accuracy: $\pm 5\%$ of digital input or ± 50 mV, whichever is greater.

Resolution: 300 points in each range.

Response time: $< 30 \mu\text{s}$ plus one period.

Offset: 0 to 2.5 V in one range.

Polarity: positive or negative.

Accuracy: $\pm 7\%$ or ± 70 mV of digital input, whichever is greater.

Resolution: 250 points.

Response time: < 80 ms.

Temperature range: 10°C to 40°C . From 0°C to 55°C , specifications are the same except for the following: Offset Accuracy, $\pm 15\%$ or 60 mV, whichever is greater; Width Accuracy, $\pm 15\%$ or ± 10 ns, whichever is greater; Transition Time Accuracy, $\pm 20\%$ or ± 10 ns, whichever is greater; Amplitude Accuracy, $\pm 15\%$ or ± 50 mV, whichever is greater.

General

6940A: 5 slots required.

Equipment supplied: 5 output cards and interconnecting cables.

1925A Word generator

(Specifications identical to standard version).

1930A PR binary sequence generator

(Specifications identical to standard version).

Model 10490A kit is required to adapt the Models 6940A and 6941A to the 1900A or 1901A.

PULSE GENERATORS

2 × 16 Bit word & PRBS generator

Model 8006A



- 10 MHz repetition rate
- Selectable PRBS and word length
- Selectable formats RZ/NRZ, normal/complement

- TTL compatible output
- Bit pattern programmable
- Single and continuous cycling

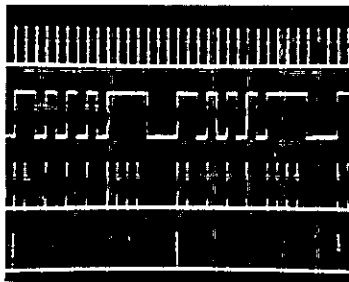
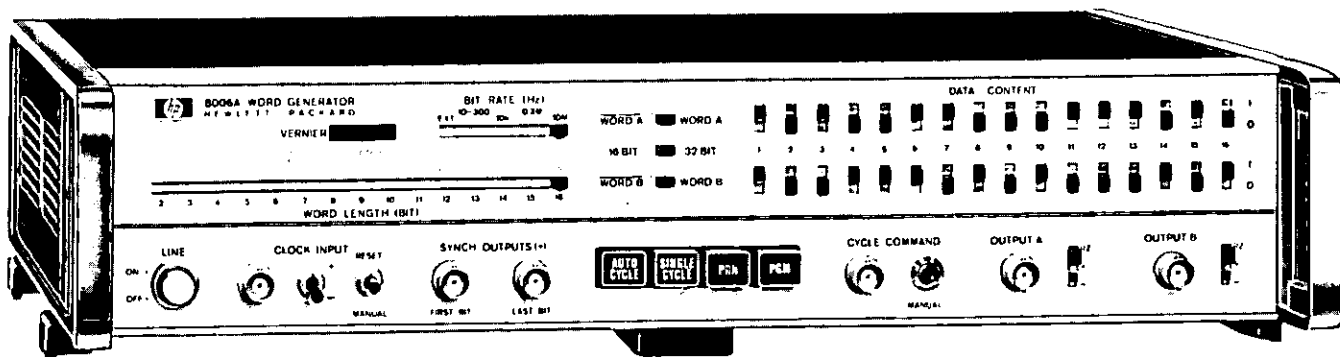

1. External clock
2. NRZ Output (16 bit continuous word recycling)
3. RZ Output signal
4. First bit sync pulse

The 8006A generates serial digital words of variable length at clock rates up to 10 MHz. An easy selection of two 16 bit words is available. A single action puts the two 16 bit words in series to provide a 32 bit word at each output. Selectable operating modes include positive return-to-zero (RZ) format, positive and negative non-return-to-zero (NRZ) format, manual or automatic word cycling, complementary output signals, and remote programming of the data content. The remote programming feature allows conversion of parallel words to serial words. Two outputs provide trigger pulses coincident with the first and the last bit.

Additionally, a pseudo-random binary sequence variable from 7 to 65535 bits can be obtained from channel A output, with the inverted sequence available at channel B.

Specifications

Word generation:

One 4 to 32 bit word (even numbers only) or two 2 to 16 bit words. No clock period between words.

Word content: independently set for both words by front panel switches or remote programming (parallel data input). Complement of each word selectable by front panel switches, WORD A - WORD A, WORD B - WORD B.

Word cycling: continuous or by cycle command (external trigger or manual).

Bit rate: internal, 10 Hz to 10 MHz, four ranges, continuous adjustment within ranges. Manual or external clock 0 to 10 MHz.

Reset: manual reset of word outputs to bit 1 in AUTO CYCLE mode and to word pause in SINGLE CYCLE mode.

Word format: RZ/ NRZ/-NRZ selectable for each word output. Positive outputs have current sink capability to drive integrated circuits (TTL/DTL).

Synch outputs: trigger pulses corresponding to the first bit (leading edge) and last bit (trailing edge).

Pseudo-random sequence generation PRN: provides a linear shift register sequence at channel A output and the inverted sequence at channel B output. Maximum bit rate is 9 MHz.

Sequence length: variable from 7 to 65535 bits.

Trigger pulse: selectable for each bit in sequence.

Interface

Clock input:

Repetition rate: 0 to 10 MHz, Amplitude $\geq \pm 2$ V, $\leq \pm 10$ V.

Width: > 15 ns at ± 1 V. Input impedance: $> 500\Omega$.

Cycle command input:

Minimum period: word length plus 100 ns. Amplitude $> +2$ V, $< +10$ V.

Width: > 15 ns at +1 V. Input impedance: $> 500\Omega$.

External data inputs: no storage capability for programmed data.

Low state: contact closure, saturated DTL or voltage source (TTL) > 0 V, $< +0.8$ V.

High state: open, off DTL or voltage source (TTL) $> +2.4$ V, $< +5$ V.

Synch outputs:

Amplitude: $> +2$ V across 50Ω .

Width: approx. 40 ns. Output impedance: 50Ω .

Word outputs:

Positive NRZ, RZ: high: $+2.5$ V across 50Ω , source impedance 50Ω . Low: ≥ -0.3 V, $\leq +0.3$ V, source impedance approx. 0Ω . Current sink capability 80 mA maximum.

RZ pulse width: approx. 45 ns.

Negative NRZ: high: 0 V. low: -5 V across 50Ω , source impedance 50Ω .

Transition times: < 10 ns.

General

Operating temperature: 0°C to 50°C .

Power: 115 V or 230 V, $\pm 10\%$, 48 Hz to 440 Hz, 59 VA.

Weight: net 6 kg (13 1/4 lb).

Dimensions: 425.5 mm wide \times 88.2 mm high \times 337 mm deep (16 1/2" \times 3 1/2" \times 13 1/4").

Computer interface kit: Model 12556B and cable 08006-61650.

Option

001: rear panel clock output. Amplitude 2 V across 50Ω . Source impedance approx. 50Ω . Pulse width approx. 30 ns.

Price

\$33

8006A 2 × 14 Bit Word and PRBS Generator

\$1520

PULSE GENERATORS

Highly flexible word generator, 9 × 32 bit
Model 8016A

NEW

- 0.5 Hz to 50 MHz repetition rate
- 2 complementary outputs per channel, RZ/NRZ formats
- Variable RZ width, 4 delay channels
- Channel serializer
- TTL/ECL output levels selectable
- Remote programming of bit pattern

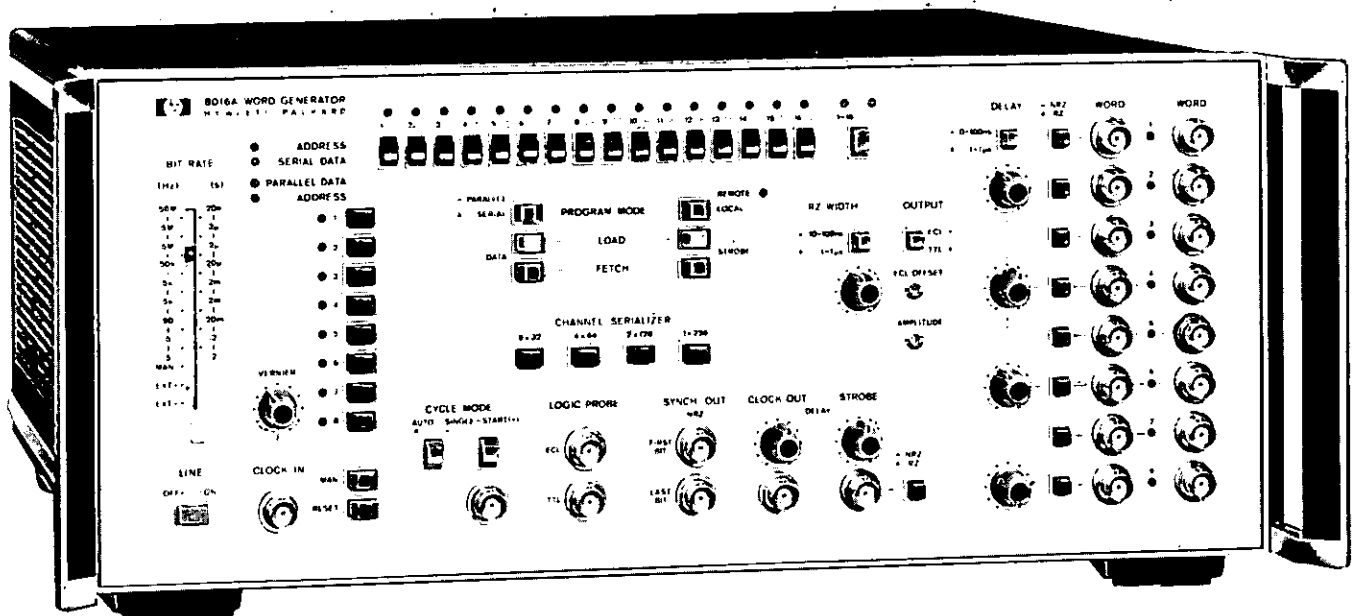

High speed, high capacity, high timing stability and unrestricted bit pattern programmability, all at an economic price, put the 8016A at the top of the word generator class. The 8016A covers a very wide range of applications. It forms an ideal system component for large test systems because it can provide the complex signals necessary for testing IC's and circuit boards. It is also an ideal solution for testing complex communications systems.

The high capacity and free programmability of bit pattern produce a flexibility of output, both in content and in format. The output of data can be in parallel or serial form. In parallel, data is output as 32 bytes each 8 bits wide; in serial, data is output as 8 words each 32 bits long. When in the serial mode, the output channels can be serialized via a channel serializer to produce word length of up to 256 bits. This feature ensures that maximum use of the memory is retained when fewer channels are required. The channel serializer also determines the function of the strobe output. The strobe can function either as a ninth data channel (channel serializer in the 8 × 32 position only), or as a 32-bit trigger word which can be assigned to any or all words in the serialized 8-word data frame. Additional outputs for synchronizing purposes are provided in the form of first and last bit outputs, and the clock output.

Complex word generators usually have complex data loading requirements. Complicated front panels create confusion and hence more work for the user. The 8016A front panel is designed with simplicity the objective. The number of data-setting pushbuttons is optimized to a 'single row of 16'/single column of 8' arrangement. Each pushbutton controls a one-bit shift register whose state is indicated by an LED, i.e. illuminated for data '1'. Data can be loaded in parallel or serial form dependent on the selected position of the PARALLEL/SERIAL switch. When data is loaded into the buffer register, a single switch transfers the data to the 288-bit high speed memory. If data in any memory address needs to be checked or transferred, there is a 'fetch' facility for returning the required data to the buffer register, where it is indicated by LEDs. Besides the front panel method, bit patterns can be loaded into the 8016A via a card reader. This feature is unique to the 8016A and enables 256 data bits to be loaded in 2 seconds.

Too often, a word generator is limited in application by a fixed am-

plitude or a fixed delay. One solution to the fixed delay limitation is to connect several pulse generators in series with the word generator, i.e. one pulse generator/output channel. A better solution is the 8016A — it has 6 independent delay circuits, with two selectable delay ranges, 0 ns — 100 ns or 0.1 μ s — 1 μ s. Similarly, one solution to the fixed amplitude is to design or buy attenuators/amplifiers for different applications. Again the 8016A provides an alternative solution — selectable output levels to meet ECL or TTL test specifications. (The transition times also meet these test specifications: ≤ 3 ns for TTL, ≤ 2.5 ns for ECL.) In addition, a choice of RZ or NRZ formats with variable RZ width is provided.

Although an invaluable work-saver, the 8016A is also designed for flexibility as demonstrated by the free programmability of bit pattern, which, combined with the short cycle time (50 MHz clock), makes the 8016A especially effective for determining worst case conditions in I.C. testing, e.g. high speed testing of critical areas of memory. The free programmability of bit pattern is also useful both for complement evaluation, by enabling small quantities of devices to be tested by unskilled personnel, and for feeding controlled bit patterns into data bus lines, e.g. data communications systems, time-sharing systems, telemetry systems etc.

Finally, the flexibility of the 8016A does not reduce the stability. Consider the following specifications:

Delay jitter: $\leq 0.1\% + 50$ ps.

RZ width jitter: $\leq 0.2\% + 50$ ps.

Overshoot and ringing at full amplitude (ECL and TTL): $\leq 10\%$.

This is very important when working with digital logic because it is essential that clock and data pulses maintain a fixed time relationship to each other to prevent incorrect strobing of gates, decoders, shift registers, etc.

Flexibility, stability, and ease of operation were the design objectives and a competitive price the marketing objective. Now, with superior technology and an economic price, the 8016A has achieved its objectives — and become the last word in word generation.

Model number and name
8016A Word generator
Option 001

Price
\$7000
\$900

Specifications

Data capacity

Number of channels: 8 data channels plus 1 strobe channel.

Number of bits per channel: 32 (fixed).

Total bit capacity: 288.

Data can be loaded in parallel or serial form depending on the position of the PROGRAM MODE switch. The data is loaded via a single row and single column of pushbuttons, each pushbutton controlling a one-bit buffer register.

Serial capacity

One word consists of 32 bits in serial. A front panel switch serializes words to form a frame.

Serial formats:

9 words on 9 channels, including strobe word, each 32 bits long.

4 frames on 4 channels, each consisting of 2 words or 64 bits.

2 frames on 2 channels, each consisting of 4 words or 128 bits.

1 frame on 1 channel consisting of 8 words or 256 bits.

Parallel capacity

Parallel format: 32 words with up to 9 bits in parallel-strobe channel included — will be generated. The number of bits per word depends on the number of output channels serialized.

Data outputs

Two separate outputs per channel, one for normal and one for complement.

Amplitude: TTL or ECL voltage levels, variable by front panel control.

Source impedance: 50 ohms.

Delay: Four channels can be separately delayed between 0 ns and 1 sec with reference to the channels 1, 3, 5 or 7.

Two ranges: 0 ns — 100 ns

0.1 μ s — 1 μ s

Ranges are common to all delayable channels. Channels have individual vernier controls.

Delay jitter: $\leq 0.1\%$ +50 ps

Skewtime: Skewtime of undelayable channels (3, 5, 7) in reference to channel one: ± 1 ns.

Format: RZ or NRZ separately selectable for each data channel and strobe channel.

RZ Width: 10 nsec to 1 μ sec in two ranges. Vernier provides continuous adjustment within ranges. Range switch and vernier common to all channels.

Width jitter: $\pm 0.2\%$ +50 ps.

Aux. outputs

First bit: Corresponds with parallel word one or with the first bit of the serial word. Format is NRZ.

Last bit: Corresponds with the last parallel word or with the last bit of the last word of a frame. Format is NRZ.

Clock: Delivers one trigger pulse per bit. Format is RZ.

Clock pulse width: controlled by RZ-Width control. Clock pulse may be delayed between 0 ns and 1 μ s in reference to channels 1, 3, 5 or 7.

Strobe word: Separate LOAD and FETCH pushbuttons and length 32 bits (can be extended to 256 bits by repetition). The strobe word may be delayed between 0 ns and 1 μ sec in reference to channels 1, 3, 5 or 7.

Amplitude of aux. outputs: TTL or ECL voltage levels variable by front panel control.

Source impedance: 50 ohms.

Probe power

ECL: -5.2 V dc $\pm 10\%$; 80 mA.

TTL: +5 V dc $\pm 10\%$; 100 mA.

Bit rate

Internal: 0.5 Hz to 50 MHz in eight ranges. Vernier provides continuous adjustment within ranges.

External: dc up to 50 MHz or manual triggering.

Clock input

Repetition rate: 0 to 50 MHz.

Trigger pulse width: ≥ 10 nsec.

Trigger amplitude: selectable by internal switches on Bit Rate board A5. Max. Amplitude: ± 7 V at 100% duty cycle.

Ext. + (TTL): amplitude $\geq +2$ V, input impedance ≥ 1 k to GND.

Ext. +: amplitude $\geq +1$ V, input impedance 50 ohms to GND.

Ext. - (ECL): amplitude ≤ -1.6 V, input impedance 50 ohms to -2 V.

Ext. -: Trigger level adjustable at Potentiometer A5R114 from +1 V to -1 V.

Input impedance: 50 ohms to GND.

Recycling

Auto mode: data is recycled continuously.

Single cycle (2 modes):

a) one word generated for each cycle command.

b) words generated as long as the cycle command is active. Last word always completed. If channels are serialized, the serialized word (64 bits, 128 bits, 256 bits) is always completed.

Period between cycle commands: Byte (frame) length plus 200 ns.

Amplitude: $> +2$ V, $\leq +10$ V.

Width: ≥ 12 ns.

Input impedance: 1 k Ω .

Manual reset

Auto cycle: all channel outputs are set to "0". The next clock pulse after RESET generates byte number one.

Single cycle: all channel outputs are reset to word pause. Word pause can either be "ZERO" or "LAST BYTE", controlled by a rear panel switch.

Pulse characteristics

The level of all output signals is controlled by a TTL/ECL switch. Adjusts for amplitude and offset. Source Impedance is 50 ohms.

TTL (across 50 ohms): HIGH LEVEL variable from 2.5 V to 1 V. LOW LEVEL ≤ 0.2 V.

Transition times: ≤ 3.0 ns (First/Last Bit Trigger < 4.0 ns).

ECL (across 50 ohms): HIGH LEVEL OFFSET variable from -0.9 V to +1.1 V. Amplitude variable from 0.3 V to 1.0 V.

Transition times: ≤ 2.5 ns (First/Last Bit Trigger < 4.0 ns).

General

Operating temperature range: 0°C to +50°C.

Power requirements: 100 V/120 V/220 V or 240 V +5%, -10%, 48 Hz to 66 Hz, 200 VA (maximum).

Weight: net 14.5 kg (31.96 lb); shipping 16 kg (35.27 lb).

Dimensions: 460 X 475 X 178 mm (18 X 18.650 X 7 inches).

Options:

001: Remote programming: Bit pattern can be programmed via a marked-card reader

Price

\$900

8016A 9 X 32 Bit Word Generator

\$7000



PULSE GENERATORS

PRBS and WORD generation up to 150 Mb/s

Model 3760A

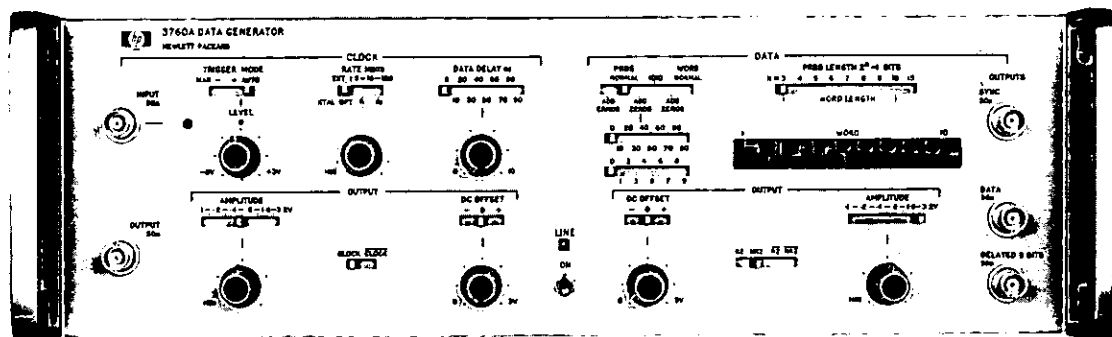

The 3760A Data Generator is a fast, versatile PRBS and WORD generator intended for both factory and field use, with many features which make it especially attractive for applications in high frequency digital communications.

The generator can be manually or automatically triggered from an external clock in the frequency range 1 kHz–150 MHz. Alternatively the clock can be derived from an optional internal clock source which can be variable or crystal controlled in the frequency range 1.5–150 MHz. A clock output is always provided in normal or complemented form, which is variable in amplitude and DC offset.

The pseudo-random binary sequence, PRBS, is variable in length from $2^3 - 1$ to $2^{10} - 1$ bits, with an additional long sequence of $2^{15} - 1$ bits. A sync pulse occurs once per PRBS and may be varied in position relative to the sequence. As the 3760A generator is often used in conjunction with the 3761A Error Detector, a pair of consecutive errors can be inserted once per 4000 sequences to check the accuracy of the 3760A/3761A system.

The length of the binary WORD is variable from 3 to 10 bits and its content is selected on the front panel. A sync pulse is generated once per WORD. Alternatively, a preprogrammed repetitive pattern can be selected.

The sync pulse can be used to initiate a block of 1 to 99 zeros which can be added to the data stream and used to examine regenerator clock extraction and threshold circuits in PCM systems.

The data output which can be PRBS, WORD or the fixed pattern 1010, is available in normal or complemented form. Either RZ or NRZ formats may be selected and the data output can be delayed by up to 100 ns with respect to the clock. As with the clock, the data output can be varied in amplitude and DC offset. A second data output, which is synchronously delayed by 8 bits from the normal data output, is also available as an option. This feature makes the generator ideally suited for driving digital radio systems employing four phase modulation.

Specifications

Modes of operation

PRBS normal: Generates a repetitive $2^n - 1$ bit. Maximal length PRBS where $n = 3$ to 10 and 15.

PRBS add zeros: Addition of a block of 1 to 99 zeros with PRBS normal, occurring after the sync pulse.

PRBS add error: Introduction of two errors per 4000 sequences.

1010: Generates a preset repetitive word, content 1010.

WORD normal: Generates a continuous 3 to 10 bit word with selectable content.

WORD add zeros: Addition of a block of 1 to 99 zeros into WORD normal, occurring between words.

Clock input

Rate: 1 kHz to 150 MHz.

Impedance: 50 ohms $\pm 5\%$ dc coupled (75 ohms optional).

Trigger: manual with level range -3 V to $+3$ V, +ve or $-ve$ slope. Auto with input mark:space ratio range 10:1 to 1:10.

Sensitivity: Better than 500 mV p-p.

Amplitude: 5 V p-p maximum. Limits ± 5 V.

Pulse width: 3 ns minimum at 50% pulse amplitude.

Indicator: Lamp showing clock present and triggering correctly.

Internal clock (optional)

Variable: Range 1.5 to 150 MHz.

Crystal: Two rates in the range 1.5 to 150 MHz, stability ± 20 ppm.

Jitter: $< 0.5\%$ of period $+0.05$ ns p-p.

Clock output

Outputs: CLOCK or $\overline{\text{CLOCK}}$.

Impedance: Source impedance 50 ohms $\pm 5\%$ (75 ohms optional).

Amplitude: Continuously variable in 5 ranges from 0.1 to 3.2 V symmetrical about offset level.

DC offset: Zero, $< 2\%$ of pulse amplitude. Variable, continuous 0 to ± 3 V.

Transition times: < 1.4 ns into 50 ohms. < 1.6 ns into 75 ohms.

Overshoot: $< 10\%$ of pulse amplitude.

Data output

Outputs: DATA or $\overline{\text{DATA}}$.

Format: NRZ or RZ (up to 130 Mb/s).

Delay: Data (and sync) delayed with respect to clock continuously in 10 ranges from 0 to 100 ns.

Other specifications as for clock output.

Delayed data output (optional)

Outputs: DATA or $\overline{\text{DATA}}$ ganged with normal Data output.

Delay: Synchronous 8 bits with respect to normal Data output. Other specifications as for normal Data output with ganged amplitude and DC offset controls.

Sync output

Rate: Once per PRBS or WORD cycle.

Amplitude: $+1$ V into 50 ohms.

General

Power: 100 to 125 V or 200 to 250 V. 40 to 400 Hz consumption 90 W.

Weight: 13.5 kg. (30 lb).

Dimensions: 425 mm wide, 140 mm high, 467 mm deep. (16 $\frac{1}{4}$ " \times 5 $\frac{1}{2}$ " \times 18 $\frac{3}{4}$ ".)

3760A Data Generator

\$5740

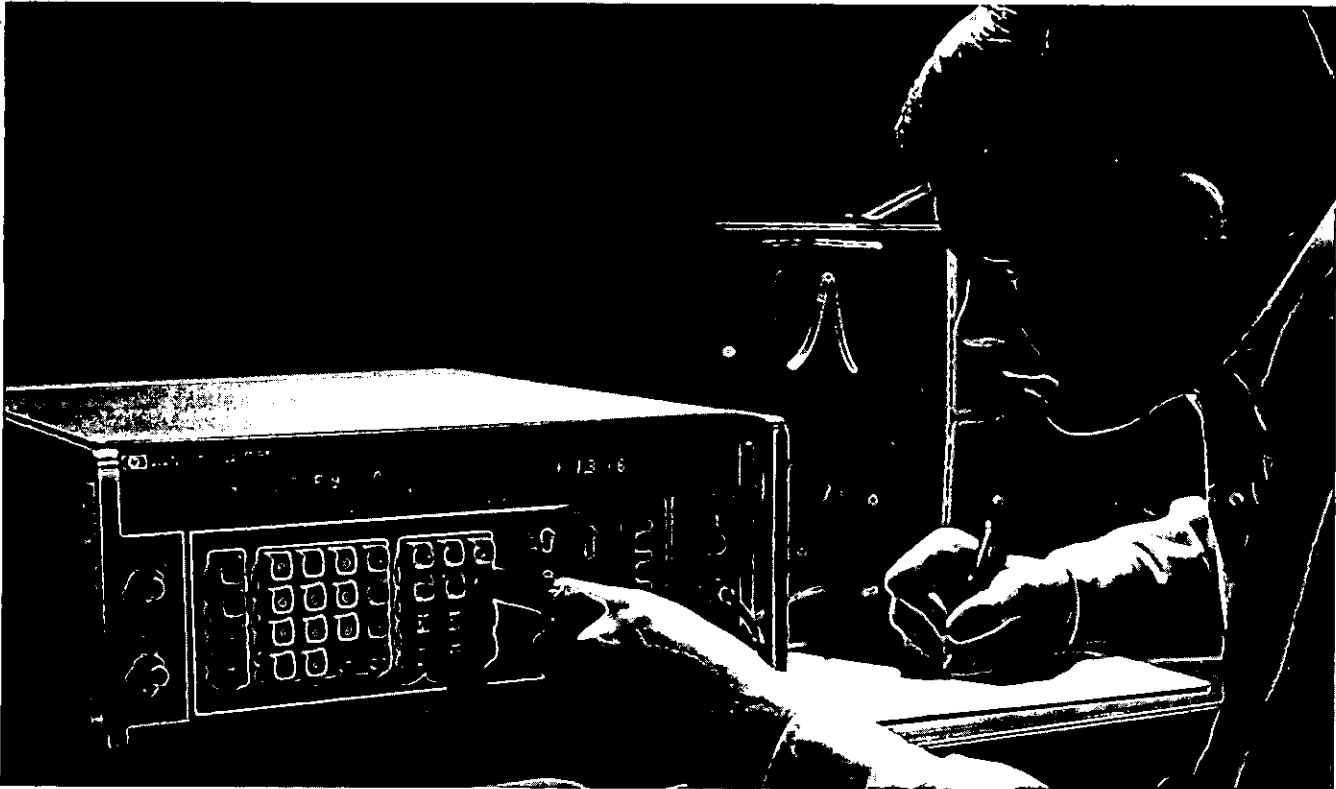

Hewlett-Packard frequency synthesizers translate the stable frequency of a precision frequency standard to one of thousands or even billions of frequencies over a broad spectrum that extends from dc to 1300 MHz. The table below highlights HP's complete line of frequency synthesizers.

HP Model	Frequency Range	Frequency Resolution	Frequency Stability	Level Range dBm — 50Ω	Level Resolution	Remote Control	Other* Features
3320A (Pg. 320)	DC — 13 MHz 5 ranges	0.01 Hz to 10 kHz (4 digits)	10 ⁻⁷ /day	0 to +13	¼ turn Vernier	Freq.	1
3320B (Pg. 320)	DC — 13 MHz 5 ranges	0.01 Hz to 10 kHz (4 digits)	10 ⁻⁷ /day	- 73 to +27	0.01 dB (4 digits)	Freq. and Ampl.	1
3330B (Pg. 322)	DC — 13 MHz	0.1 Hz (9 digits)	10 ⁻⁸ /day	- 87 to +13	0.01 dB (4 digits)	Freq. and Ampl.	2, 3, 4, 6
8660A** (Pg. 348)	10 kHz to 1300 MHz (2 plug-ins)	1 Hz (10 digits)	3 × 10 ⁻⁸ /day	-146 to +13	1 dB steps plus Vernier	Freq. and Ampl. & Modulation	5, 7
8660B** (Pg. 348)	10 kHz to 1300 MHz (2 plug-ins)	1 Hz (10 digits)	3 × 10 ⁻⁸ /day	-146 to +13	1 dB steps plus Vernier	Freq. and Ampl. & Modulation	3, 5, 7

*Other features: (1) 10⁻⁴/day freq. stability optional, (2) 10⁻⁷/day freq. stability optional, (3) digital freq. sweep, (4) digital ampl. sweep, (5) internal AM/FM, (6) external AM, (7) 3 × 10⁻⁹/day stability Opt. 001.

**The 8660 A/B is a synthesizer—signal generator—and is discussed in detail in the section labeled "Signal Generators."

FREQUENCY SYNTHESIZERS

.01 Hz to 13 MHz frequency synthesizer

Models 3320A & 3320B

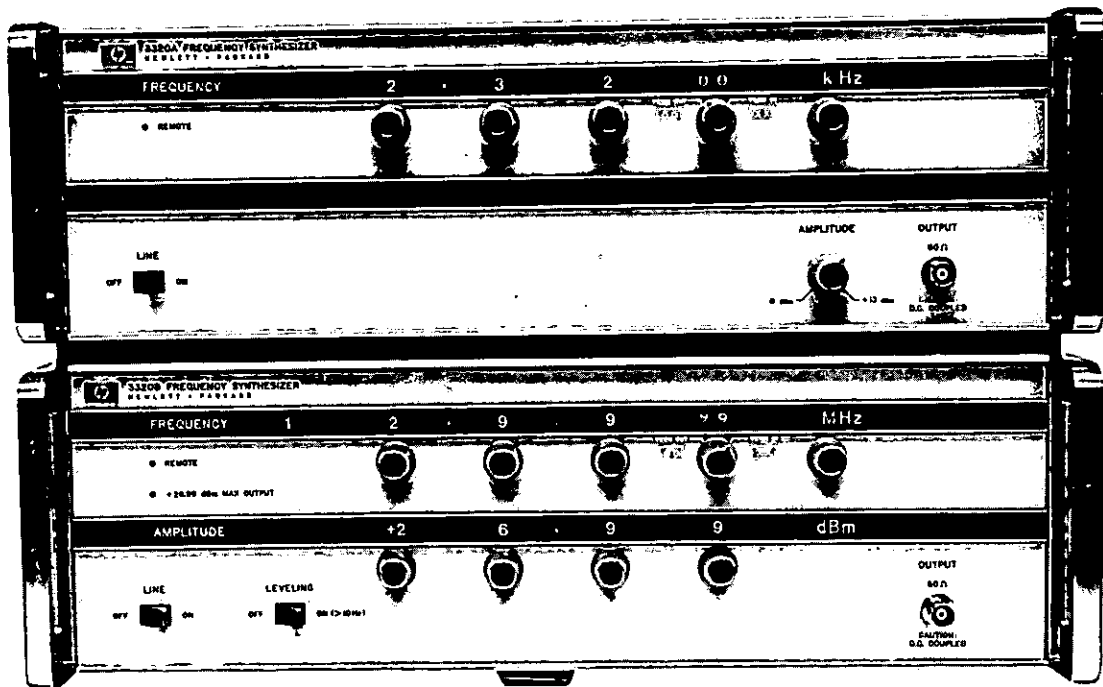

Description

The 3320A/B Frequency Synthesizer has the frequency accuracy, stability, and resolution demanded by many of today's exacting applications. The ease and flexibility of adding greater stability means the 3320A/B can be tailored to your needs as they emerge. Spectral purity and low signal-to-phase noise complement the frequency qualities of the 3320A/B.

The 3320B is more than a synthesizer. It offers precise level control, superior frequency response, low harmonic distortion and high power output.

Two choices of digital remote control afford great flexibility for today's system applications. High precision in both frequency and amplitude means that expensive system monitoring is unnecessary.

Frequency

The 3320A/B Frequency Synthesizer has a broad frequency range of 0.01 Hz to 13 MHz in seven frequency ranges.

Three digits plus a ten-turn two-digit continuous vernier, plus 30% overrange capability, gives the 3320A/B one part in 10^6 frequency resolution across its total frequency range.

Amplitude

The 3320A has a maximum one volt rms into 50 ohms output (+13 dBm) with a continuous +13 dBm to 0 dBm amplitude vernier.

The 3320B features a four-digit leveling loop with a 0.01 dB level resolution of a calibrated output from +26.99 dBm to -69.99 dBm (-73.00 dBm under remote control).

Frequency response of ± 0.05 dB over the range of 10 Hz to 13 MHz, and level accuracy of ± 0.05 dBm absolute at 10 kHz, complement the level capability of the 3320B.

Programmability/remote control

The 3320A/B is a programmable signal source. Digital remote control capability may be purchased installed in the instrument, or may be added later if the need arises.

The 3320A, with its Option 003, allows parallel BCD remote control of frequency only. The first digit of the frequency vernier, the frequency range, and the main frequency digits may be controlled remotely.

The 3320B has two remote control options. Both options allow full control of all functions except the last vernier digit and the line switch. Option 004 is parallel BCD remote control capability. Option 007 is a unique bit-parallel/word serial ASCII programming option. This option is advantageous where several 3320B's need to be controlled, since only one programming device is needed. The ASCII programming option has eight input lines, thus allowing direct interface to the HP 3260A Marked Card Programmer, photo reader, or any other eight-bit controller. This buss line programming means a saving of computer interface slots and a simplification of software.

Specifications

Frequency range: 0.01 Hz to 13 MHz in 7 ranges.

Frequency ranges: 10 MHz, 1000 kHz, 100 kHz, 10 kHz, 1000 Hz, 100 Hz and 10 Hz (optional). 30% overrange on all ranges.

Frequency resolution:

Range	Vernier Out (local or remote)	Vernier In (local)	Vernier in (remote)
10 MHz	10 kHz	10 Hz	1 kHz
1000 kHz	1 kHz	1 Hz	100 Hz
100 kHz	100 Hz	0.1 Hz	10 Hz
10 kHz	10 Hz	0.01 Hz	1 Hz
1000 Hz	1 Hz	1 mHz	0.1 Hz
100 Hz	0.1 Hz	0.1 mHz	0.01 Hz
10 Hz	0.01 Hz	0.01 mHz	0.001 Hz

Frequency accuracy

Vernier out: ±0.001% of setting for 6 mo, 0°C to 55°C.

Vernier in: ±0.01% of range for 6 mo, 0°C to 55°C.

Frequency stability

Long term: ±10 parts in 10⁶ of setting per year (vernier out) with ambient temperature reference. Optional high stability crystal reference oven available (Option 002).

Signal-to-phase noise (integrated): >40 dB down in 30 kHz band, excluding ±1 Hz, centered on carrier. 10 MHz range, vernier out. Improves on lower frequency ranges.

Harmonic distortion: with output frequencies >0.1% of range at full output amplitude, any harmonically related signal will be less than the following levels: -60 dB with output from 5 Hz to 100 kHz; -50 dB with output from 100 kHz to 1 MHz; -40 dB with output from 1 MHz to 13 MHz.

Spurious: >60 dB down.

Internal frequency standard: 20 MHz crystal.

Phase locking: the 3320A/B may be phase locked with a 200 mV to 2 V rms signal that is any subharmonic of 20 MHz.

Rear panel output: front or rear panel output is standard.

Auxiliary outputs

Tracking outputs: 20 MHz to 33 MHz offset signal. >100 mV rms/50Ω.

1 MHz reference output: 220 mV rms/50Ω (>dBm/50Ω).

Low level output: same frequency as main output but remains between 50 mV rms and 158 mV rms (into 50Ω) depending on main output level setting.

3320A Amplitude section

Amplitude: maximum 1 V rms ±10% into 50Ω.

Amplitude range: 0 dBm to +13 dBm range through ¼ turn front panel control (not programmable).

Frequency response: ±2 dB over total range.

Output impedance: 50Ω (75Ω, Option 001).

3320B Amplitude section

Amplitude range: +26.99 dBm (½ watt) to -69.99 dBm (-73.00 dBm under remote control) into 50Ω. (+26.99 dBm = 5 V rms into 50Ω).

Amplitude resolution: 0.01 dB.

Frequency response (10 kHz reference):

dc	10 Hz	13 MHz
±0.5 dB	±0.05 dB	+26.99 dBm
	±0.1 dB	- 3.00 dBm
	±0.2 dB	-23.00 dBm
	±0.4 dB	-53.00 dBm
		-73.00 dBm

Amplitude accuracy (absolute): +26.99 dBm, ±0.05 dB at 10 kHz and (20°C to 30°C).

Output impedance: 50Ω (75Ω Option 001).

Options

001 (3320A/B) 75 ohm: Amplitude range (3320B only) is +24.99 dBm to -69.99 dBm (-75.00 dBm under remote control) into 75Ω.

002 (3320A/B) crystal oven*: 5 MHz crystal in temperature stabilized oven. Long term stability: ±1 part in 10⁸/day; ±1 part in 10⁷/mo. Frequency accuracy: ±1 part in 10⁷ of setting per mo. For field installation order accessory kit HP 11237A.

003 (3320A only) BCD remote control*: Allows digital remote control of frequency only on 3320A. The most significant digit of the vernier may be programmed, thus giving four digits, plus 30% overrange, control of frequency in seven ranges (two are optional). Frequency switching and settling time: ±0.1% of range, 15 ms, ±0.001% of range, 60 ms. For field installation order accessory kit HP 11238A.

004 (3320B only) BCD remote control*: Allows digital remote control of frequency and amplitude. **Four digits of frequency, over-range, frequency range, Vernier In/Out, four digits of amplitude, and leveling loop response times are all controlled digitally. Frequency switching and settling time is ±0.01% of range, 15 ms; ±0.001% of range, 60 ms. Amplitude switching and setting time: <1.5 s to rated accuracy.

007* (3320B only) HPIB remote control: Allows bit-parallel word-serial remote control of all functions. **A 3320B with this option will recognize an address and then accept instructions in a serial fashion. Instructions are a seven-bit parallel HPIB code. Due to the addressing feature, up to ten 3320B's (with this option) may be programmed from one programmer. The HP 3260A Marked Card Programmer may be used as a programmer for this option. This option requires eight digital input lines for full control. **Seven of the eight are programming input lines and one is a data command line. Full digital isolation is standard with this option.

Logic Level Requirements for all Digital Remote Control Options.

State	Requirements
"Low" (logical "1")	0 V to 0.4 V (5 mA max.) or contact closure to ground through <80 ohms.
"High" (logical "0")	+2.4 V to +5 V or removal of contact closure to ground.

006 (3320A/B) 100 Hz, 10 Hz Ranges*: Adds two lower frequency ranges, 100.0 Hz and 10.00 Hz, yielding greater resolution for low frequency outputs (see resolution section of specifications). These two ranges are fully programmable if digital remote options are installed. For field installation, order Accessory Kit HP 11240A.

General

Operating temperature: 0°C to 55°C.

Storage temperature: -40°C to +70°C.

Power requirements: 115 V or 230V ±10%, 48 Hz to 63 Hz, 110 VA max (400 Hz operation on special basis).

Weight

3320A: 14.4 kg (32 lb); shipping, 21.3 kg (47 lb).

3320B: 15.4 kg (34 lb); shipping, 22.2 kg (49 lb).

Dimensions: 425 mm wide, 491.5 mm deep, 132.6 mm high (16¼" × 19½" × 5½").

Accessories furnished: rack mounting kit.

Model number and name	Price
3320A Option 001, 75Ω output	N/C
3320A Option 002, crystal oven	add \$310
3320A Option 003, BCD remote control	add \$320
3320A Option 006, 100 Hz/10 Hz ranges	add \$216
3320B Option 001 75Ω output	N/C
3320B Option 002, crystal oven	add \$310
3320B Option 004, BCD remote control	add \$495
3320B Option 006, 100 Hz/10 Hz ranges	add \$216
3320B Option 007, HPIB remote control	add \$695
11048C, 50Ω feedthrough	\$15
11094B, 75Ω feedthrough	\$15
3260A Marked Card Programmer allows the 3320B with HPIB remote to be easily programmed by a punched or marked card	\$995
11473-76A Balancing Transformers. (see page 477)	\$200 ea
3320A Frequency Synthesizer	\$2,115
3320B Frequency Synthesizer	\$2,960

*Field installable.

**Except last vernier digit and line switch.

FREQUENCY SYNTHESIZERS

0.1 Hz to 13 MHz automatic synthesizer

Model 3330B

- Digital sweeping of frequency and amplitude

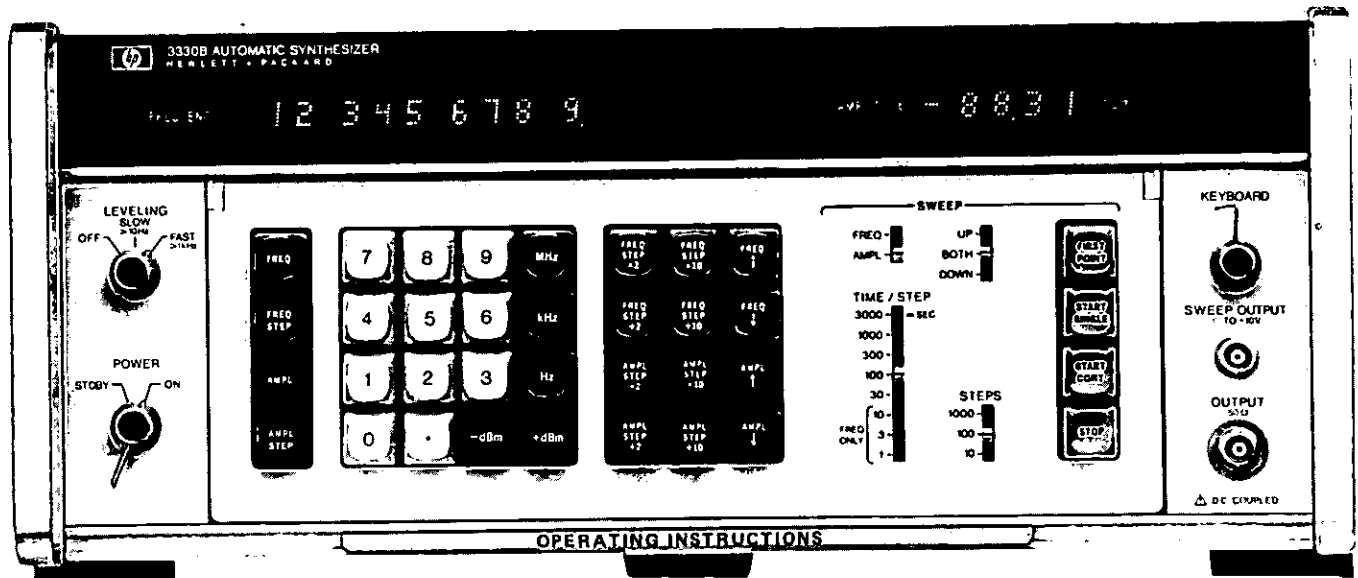

Description

The fully programmable 3330B Frequency Synthesizer has a frequency stability of $\pm 1 \times 10^{-8}$ per day, -50 dB signal-to-phase noise, with a constant resolution of 0.1 Hz up to 13 MHz. Amplitude can be controlled to a resolution of 0.01 dB over a 100 dB range.

Solid-state displays show frequency and amplitude. Nine digits of frequency and four digits of amplitude are displayed on the Model 3330B.

Spectral purity, not normally associated with frequency synthesizers, is a unique feature of the 3330B. Spurious is >70 dB below the carrier and harmonics are >60 dB to 40 dB below the carrier, depending upon the frequency setting. As a sweeper, the 3330B uses digital sweeping for linearity. Either single or continuous sweeps may be set up. Parameters such as center frequency, frequency step, time per step, and the number of steps, go into the memory, then are executed by pressing a single button. The ROM operates the sweep as set up until told to stop. Many of the sweep parameters can be changed while the instrument is sweeping. The instrument sweeps amplitude in steps as small as 0.01 dB. The amplitude can be stepped at the end of each frequency sweep cycle to produce a family of curves.

Specifications

Frequency range: 0.1 Hz to 13,000,999.9 Hz.

Frequency resolution: 0.1 Hz (8 digits + overrange).

Frequency stability

Long term: $\pm 1 \times 10^{-8}$ of frequency per day, $\pm 1 \times 10^{-7}$ of frequency per month.

Temperature: $\pm 1 \times 10^{-8}$ of frequency at $25^\circ\text{C} \pm 10^\circ\text{C}$. $\pm 1 \times 10^{-7}$ of frequency at 0°C to 55°C .

Signal to phase noise (integrated): 50 dB down in a 30 kHz band, excluding ± 1 Hz, centered on carrier.

Harmonic distortion: with full output amplitude, any harmonically related signal will be less than the following specified levels.

5 Hz to 100 kHz: -60 dB.

100 kHz to 1 MHz: -50 dB.

1 MHz to 13 MHz: -40 dB.

Spurious

All nonharmonically related spurious signals will be greater than 70 dB below selected output level or ≤ 110 dBm/50 Ω , whichever is greater.

Frequency switching and settling time: the time required for frequency switching and settling is a function of the largest frequency digit affected by the frequency change in question.

Largest digit changed	0.1 Hz or 1 Hz	10 Hz or 100 Hz	1 kHz or 10 kHz	100 kHz, 1 MHz or 10 MHz
Switching and settling time	<1 ms to within 500 μHz	<1 ms to within 0.05 Hz	<1 ms to within 5 Hz <50 ms to within 0.01 Hz	<1 ms to within 500 Hz; <50 ms to within 1 Hz

Internal frequency reference: 5 MHz crystal oscillator in temperature stabilized oven.

Frequency adjustments

Coarse: internal adjustment adequate for five years of aging.

Fine: one turn pot or ± 5 V dc for 1.2 to 2.5×10^{-7} max control with internal reference or 3×10^{-5} max control with rear panel switch in ext. ref. position without an external reference applied.

External frequency reference: the 3330B may be phase locked with a 200 mV to 2 V rms signal that is any subharmonic of 20 MHz from 1 MHz through 10 MHz.

Rear panel output: front or rear panel output is standard.

Auxiliary outputs

20 - 33 MHz tracking output: >100 mV rms/50 Ω .

1 MHz reference output: >220 mV rms/50 Ω (0 dBm/50 Ω).

Synthesized search or tune: a frequency step (0.1 Hz min) may be entered. This step may be added to or subtracted from the synthesized output signal. Rate of search or tune is selected by the time per step control.

Digital sweeping of frequency: accomplished by entering and setting the center frequency, a frequency step, number of steps, time per step, and sweep direction.

Sweep width: the product of the step size and number of steps. STEPS.

Step size: continuously adjustable in 0.1 Hz increments.

Step accuracy: $\pm 1 \times 10^{-8}$ per day for standard reference crystal.

Number of steps: 10, 100, or 1000.

Time per step: 1 ms, 3 ms, 10 ms, 30 ms, 100 ms, 300 ms, 1000 ms, and 3000 ms.

Direction of sweep: up, both, down.

Single sweep: initiated by momentary pushbutton.
Continuous sweep: initiated by momentary pushbutton.
Manual sweep: accomplished by holding down the freq ↑ or freq ↓ keys. Display will follow output.
Sweep output: stepped dc voltage proportional to sweep position, 0 to +10 V.
Accuracy: ±0.2% of full scale.
Linearity: ±0.1% of full scale.

Digital outputs

Step count: 0 to 1000 count on 12 BCD (1-2-4-8) lines to indicate sweep position.
Sweep status: line to indicate when instrument is sweeping.
Step ready: indicates instrument has spent the selected time per step and is ready to go to the next step.
Sweep modification (continuous): during a continuous sweep, the step size, center frequency, sweep direction, and time per step may be changed without stopping the sweep.
Center frequency modification: accomplished by pressing freq ↑ or freq ↓.
Frequency step: to widen or narrow the sweep width, the frequency step size may be expanded or contracted by factors of 2 or 10. The keys labeled freq step ×2, freq step ÷2, freq step ×10 and freq step ÷10 may be pressed.
Sweep modification (single): during a single sweep, the time per step and direction sweep may be changed without stopping the sweep.

Amplitude section

Amplitude: maximum 2.1 V rms into open circuit; maximum 1.05 V rms into 50Ω.
Amplitude range: +13.44 dBm to -86.55 dBm into 50Ω.
Amplitude resolution: 0.01 dB.
Output impedance: 50Ω (75Ω Option 001).
Display: four digit readout in dBm with reference to 50Ω. Leveled frequency response (10 kHz reference) 10 Hz - 13 MHz.*
 +13.44 dBm to -16.55 dBm: ±0.05 dB.
 -16.55 dBm to -36.55 dBm: ±0.1 dB.
 -36.55 dBm to -66.55 dBm: ±0.2 dB.
 -66.55 dBm to -86.55 dBm: ±0.4 dB.
Amplitude attenuator accuracy: ±0.02 dB/10 dB step (at 10 kHz) of attenuation down from maximum output.
Amplitude accuracy (absolute): ±0.05 dB at 10 kHz and +13.44 dBm (15°C ±5°C). (For absolute accuracy at other frequencies and amplitudes, add 0.05 dB to the leveled frequency response specification, plus the attenuator accuracy specification.)
Amplitude modulation: requires external modulation source. Rear panel BNC. ALC switch must be in slow position.
Modulating signal: 100 Hz to 100 kHz.
Modulation depth: 0.95 V rms modulating signal for 95% modulation depth.

Digital sweeping of amplitude: accomplished by entering and setting the center amplitude, an amplitude step, number of steps, time per step and sweep direction.
Type: linear and symmetrical about the center amplitude.
Sweep width: product of the step size and number of steps.
Step size: 0.01 dB to 99.99 dB in 0.01 dB increments.
Number of steps: 10, 100, or 1000.
Time per step: 30 ms, 100 ms, 300 ms, 1000 ms, 3000 ms.
Direction of sweep: up, both, down.
Single sweep: momentary pushbutton. Display follows output.
Continuous sweep: momentary pushbutton. Display of center amplitude or step.
Manual sweep: accomplished by holding down the ampl ↑ or ampl ↓ keys. Display will follow output. Sweep output, digital outputs, sweep modification (continuous), sweep modification (single), all the same as with frequency sweep.

*Add ±0.5 dB for leveling off.

Digital remote control

The 3330B allows full programming of frequency, amplitude and sweeping. Each key, slideswitch position, and control has a seven-bit parallel ASCII code assigned to it. Programming is accomplished by sending

the 3330B a series of seven-bit codes (instructions). Before the instrument will accept instructions, it must be addressed. This is done by preceding the first instructions with the ASCII code for the instrument being addressed. The address of a 3330B is set at Octal "044" by the manufacturer but may be easily changed by the user.

The addressing capability of the 3330B allows up to 15 units to be connected in parallel on the ASCII buss. Up to 63 different addresses are available.

The HP 3260A Marked Card Programmer may be used as a programmer for one or more 3330B.

Timing: maximum of 310 μs per digit. Maximum of 1 ms to enter and initiate program control codes. Maximum of 2.5 ms to enter and initiate sweep.

Input control lines: 7 Program Data lines, 1 MRE,* 1 Data Strobe line, 1 Remote Enable line, 1 Step Inhibit line (use not required).

Output control lines: 1 Ready for Data, 1 Data Accepted, 14 Sweep Parameter lines (use not required).

Isolation: the input and output control lines on the standard 3330B do not have isolated grounds with respect to output signal ground. For isolation of these digital grounds, order Option 004.

Logic level requirements:

State	Requirements
"Low" (logical "1")	0 V to 0.4 V (5 mA max) or contact closure to ground through <80 ohms.
"High" (logical "0")	+2.4 V to +5 V or removal of contact to ground.

*Multiple Response Enable

Options

Option 001: 75 ohms - 1 V rms (factory installation only). Attenuation and output referenced to 75Ω.

Amplitude range: +11.25 dBm to -88.74 dBm.

Option 002: High Stability Crystal Oven

Long term frequency stability: ±1 × 10⁻⁹ per day. +2 × 10⁻⁸ per month.

Long term temperature: ±1 × 10⁻⁹ total frequency at 25°C, ±10°C. ±1 × 10⁻⁸ total of frequency at 25°C, 0°C to +55°C.

Frequency adjustments: same as standard instrument.

Option 003: Deletion of Crystal Oven. 20 MHz ambient temperature crystal reference oscillator.

Frequency stability: ±10 parts in 10⁶/yr.

Frequency adjustments: rear panel 1 turn pot or rear panel voltage control input for 30 × 10⁻⁶ maximum control.

Option 004: Isolated Digital Input (factory installation only.) With this option, the digital input lines are electrically isolated from the signal ground.

DC isolation: ±250 V.

AC isolation: >30 dB, 0 to 1 MHz.

Option 005: 5 V rms - 50 ohm output. This option gives the 3330B a ½ watt output.

Amplitude range: +26.99 dBm to -73 dBm into 50 ohms.

General

Operating temperature: 0°C to +55°C.

Storage temperature: -40°C to +70°C.

Turn on time:

Application of power to "On": 20 min to within ±1 × 10⁻⁷ of the final frequency.

"Standby" to "On": 15 s to full specifications.

Power requirements: 115 V or 230 V ±10%, 48 Hz to 63 Hz, (400 Hz line frequency operation on special basis), 20 W standby, 200 W on.

Weight: 22.6 kg (53 lb); shipping, 26.8 kg (63 lb).

Dimensions: 426 mm wide × 178 mm high × 547 mm deep (16¼" × 7" × 21½").

Model name and number

Option 001, 75Ω - 1 V output	Price N/C
Option 002, crystal oven	add \$530
Option 003, deletion of oven	less \$200
Option 004, isolated ASCII	add \$400
Option 005, 5 V - 50Ω output	add \$270
3330B Automatic Synthesizer	\$6365

OSCILLATORS & FUNCTION GENERATORS

General information

Oscillators, function generators

Signal sources have been described by various names—oscillators, test oscillators, audio signal generators, function generators, etc. Different names are applied, depending on design and intended use of the source. In recently developed sources, the name "test oscillator" has been used to describe an oscillator having a calibrated attenuator and output monitor. The term "signal generator" is reserved for an oscillator with modulation capability.

A function generator is a signal generator that delivers a choice of different waveforms with frequencies adjustable over a wide range. Function generators produce sine, triangle, square wave, saw-tooth waves, pulses, sweep, and modulation. Hewlett-Packard's function generators extend from a low frequency of 0.00005 Hz (HP 203A Option 002) up to a high frequency of 13 MHz (HP 3312A).

Basic requirements

In selecting an oscillator or function generator, the user will be most interested in its frequency coverage. The question to be answered here is, "Will the instrument supply both the lowest and highest frequencies of interest for anticipated tests?" As shown in Table 1, Hewlett-Packard manufactures a broad range of oscillators and function generators covering the frequency spectrum from 0.00005 Hz to 13 MHz.

The user's next concern will be with available output power or voltage. Some tests require large amounts of power, while others merely require sufficient voltage output. For almost any application, there is a Hewlett-Packard oscillator capable of delivering desired voltage output into a high-impedance load or of supplying desired power into lower impedance loads.

Besides frequency range and power output, the user will be interested in instrument stability, its dial resolution, and the amount of harmonic distortion, hum and noise in the output signal, and functions available. See Table 1 for a comparison of Hewlett-Packard oscillators and function generators.

Frequency stability

Frequency stability of an oscillator determines the ability of the instrument to maintain a selected frequency over a period of time. Component aging, power-supply variations and temperature changes all affect stability. Carefully chosen components, such as

FUNCTIONS ~ □ ~ ~ ~	FREQUENCY RANGE											POWER OUTPUT	INST.	PAGE		
	0.1 mHz	1 mHz	.01 Hz	0.1 Hz	1 Hz	10 Hz	100 Hz	1 kHz	10 kHz	100 kHz	1 MHz				10 MHz	
●														3 W	201C	326
●	●	●	●	●	●	●	●	●	●	●	●	●	●	1.1W	3310A/B	334
●														1 W	200AB	326
●	●	●	●	●	●	●	●	●	●	●	●	●	●	250 mW	3312A**	333
●	●	●	●	●	●	●	●	●	●	●	●	●	●	200 mW	3311A	332
●														200 mW	651B/652A 654A	335
●														160 mW	200CD	326
●														160 mW	202C	SEE DATA SHEET
●														160 mW	4204A	328
●	●	●	●	●	●	●	●	●	●	●	●	●	●	100 mW	3300A	330
●	●	●	●	●	●	●	●	●	●	●	●	●	●	100 mW	3300A 3305A	331
●														40 mW	203A*	329
●	●	●	●	●	●	●	●	●	●	●	●	●	●	40 mW	203A* (Opt. 002)	329
●														40 mW	209A	327
●														20 mW	653A	335
●														20 mW	3320A/B	320
●														10 mW	236A	500
●														10 mW	204C	327

* Four outputs: two variable phase

**Two Generators, AM, FM, Sweep, Tone Burst, Trigger/Gate

Table 1. Functions, frequency range and power output of Hewlett-Packard oscillators and function generators.

precision resistors and variable capacitors in the frequency-determining networks, contribute to long-term stability.

Amplitude stability

Amplitude stability is important in certain oscillator applications. Amplitude stability is inherent in the Hewlett-Packard RC oscillator circuit because of large negative feedback factor and amplitude stabilizing techniques. "Frequency response," or amplitude variation as frequency is changed, is of special interest when the oscillator is used for response measurements throughout a wide range of frequencies.

Distortion

Distortion in the oscillator's output signal is an inverse measure of the purity of the oscillator's waveform. Distortion is undesirable in that a harmonic of the test signal may feed through the circuits under test, generat-

ing a false indication at output. If the oscillator is used for distortion measurements, the amount of distortion that it contributes to measurements should be far less than that contributed by the circuits under test.

Hum and noise

Hum and noise can be introduced at a variety of points in oscillator circuits; but when the circuit operates at a relatively high level, the amount of hum and noise introduced into the device under test is usually negligible. Hum and noise introduced by a power amplifier usually remain constant as output signal amplitude is diminished. Hence, even though hum and noise power may be quite small compared to rated output, these spurious signals sometimes become a significant portion of low-level output signals. To overcome such a limitation, many Hewlett-Packard oscillators have their amplitude control

on the output side of the power amplifier so that hum and noise are reduced proportionally with the signal when low-level signals are desired for test purposes.

Function generators

The function generator has emerged as a versatile multiwaveform signal source capable of very wide frequency coverage. The function generator has become an indispensable general purpose signal source for production testing, instrument repair, and the electronics laboratory. Diverse fields of applications in which the function generator is being used include medical research, education, chemical, communications, geo-physics, industrial control, military, and aerospace.

Most function generators are designed around the block diagram shown in Figure 1.

The basis of this circuit is generation of a triangle waveform through a feedback network. The upper current source delivers 2I to the integrator and the lower current source takes away $-I$. This, with the upper current source "on" the integrator, charges linearly with a current I. Output of the integrator is sensed by a voltage comparator.

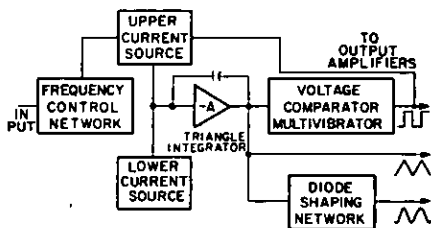

Figure 1. Block diagram typical function generator.

When the proper level is reached, the comparator is triggered which in turn "disconnects" the upper current source. With upper current source disconnected, the integrator discharges linearly at a $-I$ rate due to the lower current source. When the proper discharge voltage is reached, the comparator again triggers turning "on" the upper current source; thus, completing the cycle. The resulting triangular waveform is varied in frequency by changing the charge current I. To obtain a sine wave, the triangular

waveform is processed by a diode shaping network. The square wave is already available at the output of the voltage comparator. By varying current ratio between two current sources, ramp and pulse waveforms may be generated.

3310A/B

Hewlett-Packard's 3310A/B utilizes this basic circuit with many refinements resulting in a versatile seven function instrument covering a frequency range from a high of 5 MHz down to the millihertz range (0.0005 Hz). The 3310B has additional capability of tone burst with variable start/stop phase.

3311A

For the user with general requirements and a tight budget, Hewlett-Packard's 3311A is an ideal choice. This instrument generates sine, square, triangle and pulse waveforms over a 0.1 Hz to 1 MHz frequency range. The small size, cast aluminum case, and output protection make it a rugged performer.

3300A

Hewlett-Packard's 3300A Series offers the user a broad selection of functional capability through the use of plug-ins. The 3300A, in combination with the 3302A, offers triggered and phase lock of the mainframe. Phase between locking signal and mainframe output is continuously variable through a front panel control.

If a log sweeper is called for in audio testing, the 3300A combined with the 3305A Plug-in is the answer. This combination will sweep from 0.1 Hz to 100 kHz (6 decades) in one continuous sweep. Narrower sweeps can also be made through independent start/stop adjustments.

209A

A modification to the Wien bridge oscillator is HP's 209A Sine-Square Wave Oscillator. Stable, accurate signals, which can be synchronized with an external source, are instantly available over a frequency range of 4 Hz to 2 MHz. Amplitude of the sine and square wave outputs are separately adjustable and are available simultaneously. Distortion and flatness can be improved at low frequencies by a low distortion modes switch.

3312A (New)

The 3312A combines two generators in one instrument. The generators may be used separately or combined internally. The combi-

nations available are: AM, FM, Sweep, Trigger/Gate, Tone Burst with variable start/stop phase. Each generator has sine, square, triangle, pulse and ramp functions. The waveforms available are almost unlimited. Frequency range of this instrument is 0.01 Hz to 13 MHz.

Selecting an osc./function gen.

In selecting an oscillator or function generator, the user is faced with a broad spectrum of available instruments. To narrow this spectrum, the following guidelines may be used:

1. Define current requirements and probable future requirements in terms of frequency range, power output, functional capability desired,* sine wave harmonic distortion, frequency stability, and output flatness vs. frequency.

*Functions of interest are: multiple output, output level monitor, calibrated attenuator, sine wave, square wave, triggered output, pulse, phase lock, ramp, dc offset, and modulation capability. Another feature which may be of interest is internal sweep. Most function generators may be swept externally; some have internal sweep as well. Sweep may be linear for narrow-band testing or log for multi-decade sweeps.

2. If application is general purpose in nature with no stringent requirements, such as .01% harmonic distortion, consider the function generator. This class of instruments may be used as a sine wave source, square wave test source, pulse generator, low frequency ramp for x-y recording, etc. If, however, any of the intended applications have specific requirements, the function generator will, in most cases, not have sufficiently tight specs to satisfy these requirements. In this case, the user must look to dedicated instrumentation.

3. In general, test oscillators or oscillators will be your choice when large voltage output or low harmonic distortion are requirements.

4. If frequency stability and accuracy are paramount requirements, then synthesizers should be considered. (See page 323.)

5. Specialized output impedances other than 50 or 600 ohm single-ended, will require specialized instruments such as the 654A.

6. If maximum versatility per dollar is the prime consideration, then function generators are your best choice.

7. In the sub-Hertz frequency range, the function generators are top performers.

8. For digital frequency selection, the 4204A or the frequency synthesizers should be considered.

OSCILLATORS & FUNCTION GENERATORS

5 Hz to 600 kHz audio oscillators

Models 200AB, 200CD, 200CD Opt: H20, & 201C

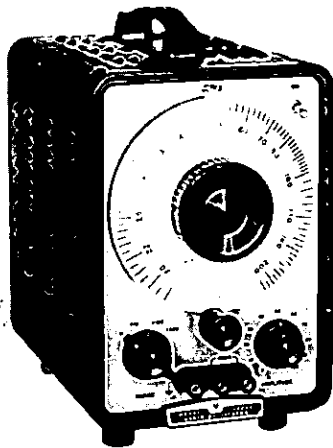

200AB

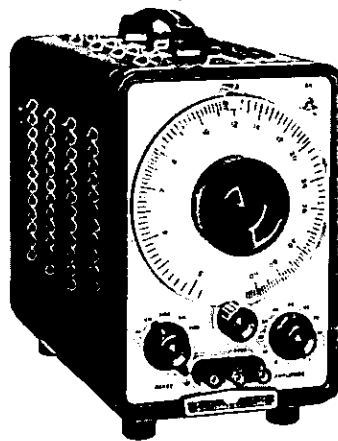

200CD

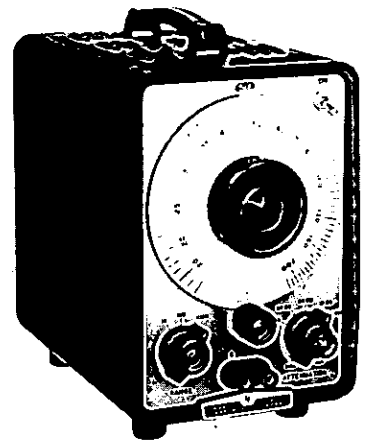

201C

Description

These Hewlett-Packard oscillators have high stability and accurate, easily resettable tuning circuits. Low-impedance operating levels, together with superior insulation, guarantee peak performance throughout years of trouble-free service. The instruments have a wide frequency range and long dial lengths and feature an improved vernier

frequency control.

Accessories available:

11000A Cable Assembly
11001A Cable Assembly
11004A Line Matching Transformer
11005A Line Matching Transformer

Price
\$15
\$15
\$72
\$100

Specifications

	200AB	200CD	201C
Frequency Range	20 Hz to 40 kHz	5 Hz to 600 kHz	20 Hz to 20 kHz
Number of Ranges	4 overlapping	5 overlapping	3 overlapping
Dial Accuracy	±2%	±2%	±1%
Frequency Response	±1 dB (1 kHz ref)	±1 dB (1 kHz ref)	±1 dB (1kHz ref)
Output (into 600Ω load)	1 W (24.5 V)	> 160 mW (10 V) Opt. H20, 93 mW (7.5 V)	3 W (42.5 V)
Output Impedance	<75Ω from 20 Hz - 15 kHz	600Ω	600Ω ±10%, 20, 30 and 40 dB settings <600Ω, 0 dB and 10 dB settings
Output Balance	Balanced to ground and floating over entire frequency range	Balance and floating Better than 0.1% at lower frequencies and approx. 1% at higher frequencies	One terminal at ground potential
Distortion	<1%, 20 Hz to 20 kHz <2%, 20 kHz to 40 kHz (into 600Ω load or higher impedance)	0.2%, 20 Hz to 200 kHz 0.5%, 5 Hz to 20 Hz and 200 kHz to 600 kHz Opt. H20: 0.06%, 60 Hz to 50 kHz 0.1%, 20 Hz to 60 Hz and 50 kHz to 400 kHz 0.5%, 5 Hz to 20 Hz and 400 kHz to 600 kHz	<0.5% 50 Hz to 20 kHz at 1 W <1%, 20 Hz to 20 kHz at 3 W
Hum and Noise	66 dB below maximum rated output	<0.1% of rated output	<0.03% of rated output
Attenuator	Bridged "T"	Bridged "T"	0 to 40 dB in 10 dB steps Coarse and fine controls
Input Power	115 or 230 V (must be specified) 50/400 Hz, 75 VA	115 or 230 V, 50 to 1000 Hz 90 VA	115 or 230 V, 50 to 400 Hz, 75 VA
Weight kg (lb)	Net: 6.7 kg (15 lb) Shipping: 7.2 kg (16 lb)	Net: 9.9 kg (22 lb) Shipping: 10.8 kg (24 lb)	Net: 7.2 kg (16 lb) Shipping: 8.6 (19 lb)
W × H × D Dimensions	191 mm × 292 mm × 305 mm (7½" × 11½" × 12")	187 mm × 292 mm × 365 mm (7¾" × 11½" × 14¾")	191 mm × 292 mm × 318 mm (7½" × 11½" × 12½")
Price	200AB: \$340.	200CD: \$385 Opt. H20: \$452	201C: \$390.

OSCILLATORS & FUNCTION GENERATORS

4 Hz to 2 MHz sine, square wave oscillators

Models 209A, 204C & 204D

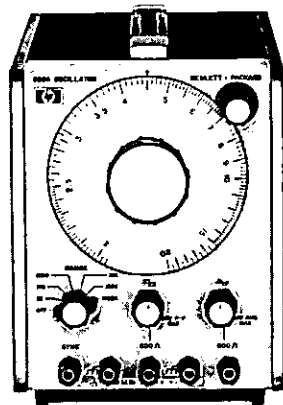

209A

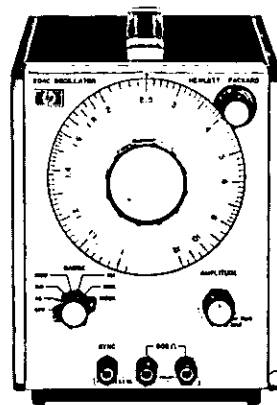

204C

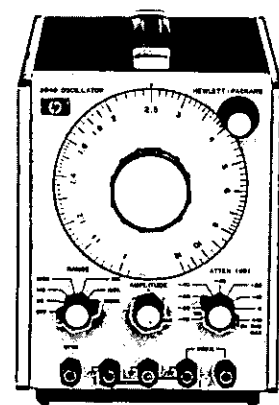

204D



Description

The HP 209A is a small, lightweight, sine/square oscillator. Stable, accurate signals which can be synchronized with an external source are instantly available over a frequency range from 4 Hz to 2 MHz. Separately adjustable sine/square outputs are located on the front panel. Distortion and flatness can be minimized at low frequencies by a real panel low distortion mode switch.

The HP 204C is a small, lightweight capacitive-tuned oscillator. Interchangeable power packs, line, rechargeable batteries or mercury batteries make this instrument ideal for both field and laboratory use.

The HP 204D Oscillator is identical to the 204C with the addition of an 80 dB attenuator and vernier. The attenuator with the vernier provides excellent output amplitude settability.

209A Specifications

Frequency: 4 Hz to 2 MHz in 6 ranges.

Dial accuracy: $\pm 3\%$ of frequency setting.

Flatness: at maximum output into 600 Ω load, 1 kHz reference.

Low distortion mode	$\pm 1\%$	$\pm 0.5\%$	$\pm 1\%$	$\pm 5\%$
Normal mode	+5%, -1%	$\pm 0.5\%$	$\pm 1\%$	$\pm 5\%$
	4	100	300 k	1 M 2 M (Hz)

Distortion: 200 Hz to 200 kHz, 0.1% (-60 dB); 4 Hz to 200 Hz, <0.2% (-54 dB); 200 kHz-2 MHz, <1% (-40 dB).

Hum and noise: <0.01% of input.

Output characteristics sine wave

Output voltage: 5 V rms (40 mW) into 600 Ω ; 10 V open circuit.

Output impedance: 600 Ω .

Output control: >26 dB range continuously adjustable.

Output balance: >40 dB below 20 kHz. Output can be floated up to ± 500 V p between output and chassis ground.

Output characteristics square wave

Output voltage: 20 V p-p open circuit symmetrical about 0 V. Output can be floated up to ± 500 V p.

Rise and fall time: <50 ns into 600 Ω . Symmetry: $\pm 5\%$.

Output impedance: 600 Ω .

Synchronization

Sync output: sine wave in phase with output; 1.7 V rms open circuit (high end affected by capacitive loads); impedance 10 k Ω .

Sync input: same as 204C.

204C Specifications

Frequency: 5 Hz to 1.2 MHz in 6 overlapping ranges.

Dial accuracy: $\pm 3\%$ of frequency setting.

Flatness: at maximum output into 600 Ω load, 1 kHz reference.

Low distortion mode	$\pm 1\%$	$\pm 0.5\%$	$\pm 1\%$
Normal mode	+5%, -1%	$\pm 0.5\%$	$\pm 1\%$
	5	100	300 k 1.2 M (Hz)

Distortion: 30 Hz to 100 kHz, 0.1% (-60 dB); 5 Hz to 30 Hz, <0.6% (-44 dB); 100 kHz-1.2 MHz, linearly derated to <1%.

Hum and noise: <0.01% of output.

Output characteristics

Output voltage: >2.5 V rms (10 mW or +10 dBm) into 600 Ω ; >5 V rms open circuit.

Output impedance: 600 Ω .

Output control: >40 dB range; continuously adjustable.

Output balance: >40 dB below 20 kHz. Can be floated up to ± 500 V p between output and chassis ground.

Synchronization

Sync output: sine wave in phase with output; >100 mV rms into <100 pF over entire range; impedance 10 k Ω .

Sync input: oscillator can be synchronized to external signal. Sync range, the difference between sync frequency and set frequency, is a linear function of sync voltage: $\pm 1\%/V$ rms for sine wave with a maximum input of ± 7 V p (± 5 V rms).

204D Specifications

(Identical to 204C except "output control" is replaced by the following):

Output attenuator

Range: 80 dB in 10 dB steps.

Overall accuracy: ± 0.3 dB, +10 dB through -60 dB ranges; ± 0.5 dB on -70 dB range.

Output vernier: >10 dB range, continuously adjustable.

General

Operating temperature: specifications are met from 0 $^{\circ}$ C to 55 $^{\circ}$ C.

Power: standard: ac-line 115 V or 230 V $\pm 10\%$, 48 Hz to 440 Hz, <7 VA max. Opt. 001: mercury batteries 300 hours operation. Opt. 002: line/rechargeable batteries 115 V or 230V $\pm 10\%$, 48 Hz to 440 Hz, <7 VA max. 35 hours operation per recharge.

Dimensions: 130 mm wide, 155 mm high (without removable feet), 203 mm deep (5 $\frac{1}{8}$ " \times 6 $\frac{3}{32}$ " \times 8").

Weight: net 2.7 kg (6 lb); shipping, 3.6 kg (8 lb).

Accessories available:

11136A Mercury power pack for 204C/D	Price \$82
11137A Rechargeable battery/AC power pack for 204C/D	\$103
11075A Instrument case	\$80

Model number and name:

Option 001, 204C/D (for mercury batteries)	\$75
Option 002, 204C/D (for rechargeable batt/ac line)	\$85
209A Sine, square wave oscillator	\$400
204C Sine wave oscillator	\$295
204D Sine wave oscillator	\$370

OSCILLATORS & FUNCTION GENERATORS

10 Hz to 1 MHz digital oscillator

Model 4204A

- 0.2% frequency accuracy
- Accurate 80 dB output attenuator
- 0.01% frequency repeatability
- Excellent stability
- Flat frequency response

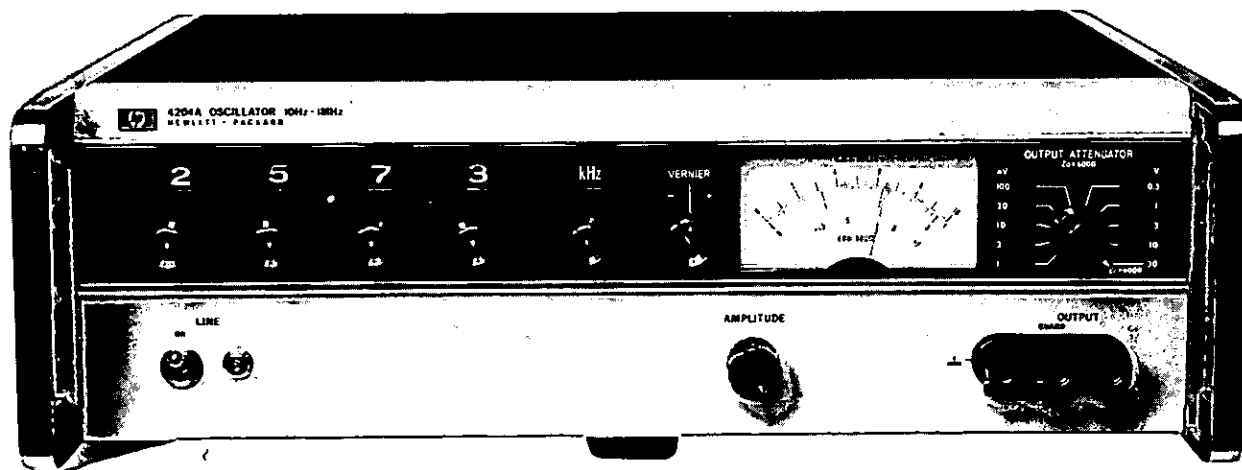

Description

Hewlett-Packard's 4204A Digital Oscillator provides accurate, stable test signals for both laboratory and production work. This one instrument does the job of an audio oscillator, an ac voltmeter, and an electronic counter where an accurate frequency source of known amplitude is required.

Any frequency between 10.0 Hz and 999.9 kHz can be digitally selected with an in-line rotary switch, to four significant figures. As many as 36,900 discrete frequencies are available. Infinite resolution is provided by one vernier control, which also extends the upper frequency limit to 1 MHz. Frequency accuracy is better than $\pm 0.2\%$ and repeatability is typically better than $\pm 0.01\%$.

A built-in high impedance voltmeter measures output. The meter is calibrated to read volts or dBm into a matched 600 ohm load. (0 dBm = 1 mW into 600 ohms.) The output attenuator has an 80 dB range, adjustable in 10 dB steps with a 20 dB vernier. Maximum output power can be increased to 10 volts (22 dBm) into 600 ohms or 20 volts open circuit.

Frequency response is flat with less than $\pm 3\%$ variation over the entire frequency range at any attenuator setting. Frequency stability is better than 10 parts in 10^6 per minute.

Specifications

Frequency range: 10 Hz to 1 MHz, 4 ranges.

Frequency accuracy: $\pm 0.2\%$ or ± 0.1 Hz (at 25°C).

Frequency stability:

$\pm 10\%$ line voltage variation: less than $\pm 0.01\%$.

Change of frequency with temperature: $< \pm 100$ ppm/°C.

Drift: < 10 ppm/minute.

Frequency response: flat within $\pm 3\%$.

Output: 10 V (22 dBm) into 600 ohms (160 mW). 20 V open circuit.

Output attenuator: 80 dB in 10 dB steps; $< \pm 0.5$ dB error.

Output monitor: voltmeter monitors level at input of attenuator in volts or dB.

Accuracy: $\pm 2\%$ of full scale.

Flatness: $\pm 1\%$ at full scale, 10 Hz to 500 kHz; $\pm 2\%$ at full scale, 500 kHz to 1 MHz.

Distortion: less than 0.3%, 30 Hz to 600 kHz. Less than 1.2%, 10 Hz to 1 MHz.

Hum and noise: less than 0.05% of output.

Temperature range: 0°C to +50°C.

Power: 115 V/230 V switch, $\pm 10\%$, 10 VA, 50 to 60 Hz.

Weight: net, 8.5 kg (19 lb); shipping, 11 kg (28 lb).

Dimensions: 134 mm high \times 426 mm wide \times 286 mm deep (5 $\frac{1}{4}$ " \times 16 $\frac{3}{4}$ " \times 11 $\frac{1}{4}$ ").

Accessories available:

11000A Cable: dual banana plugs

Price

\$15

11001A Cable: banana plug to BNC male connector

\$15

11004A Line Matching Transformer has a frequency response of 5 kHz to 600 kHz providing fully balanced outputs for 135 or 600 ohms

\$72

11005A Line Matching Transformer has a frequency response of 20 Hz to 45 kHz providing full balanced output into 600 ohms

\$100

16252A Matching Transformer has a frequency response of 10 kHz to 1 MHz providing unbalanced 75 ohm output, terminated in UG-657/U female BNC connector

Price on request

Model number and name

Option 001, 4204A Output Monitor top scale calibrated in dBm/600 Ω . Bottom scale calibrated in volts
4204A Digital Oscillator

add \$24

\$1305

OSCILLATORS & FUNCTION GENERATORS



0.00005 Hz to 60 kHz Variable-phase function generator

Model 203A

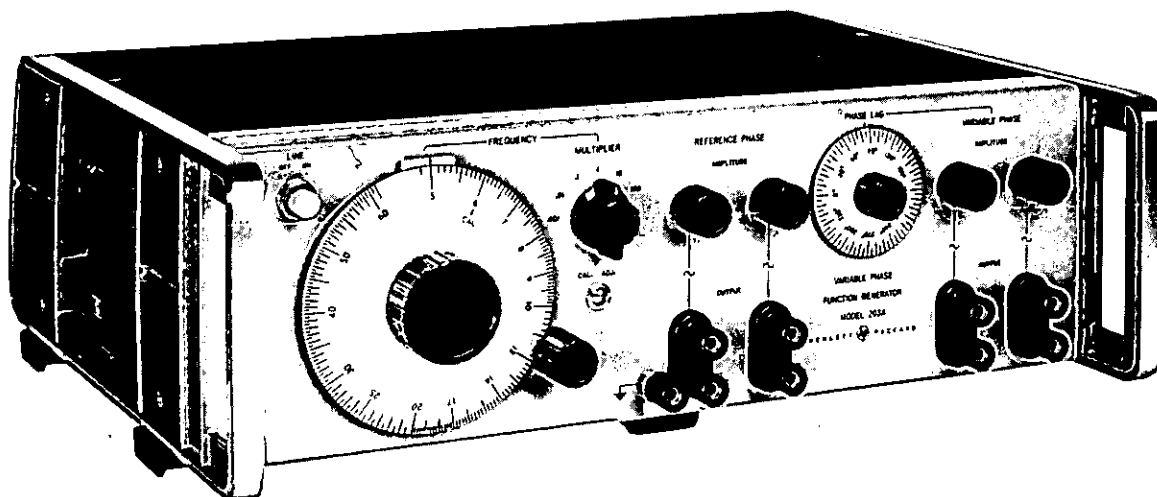

Description

HP's solid-state 203A Variable Phase Function Generator provides two transient-free square and low-distortion sinusoidal test signals particularly useful for a wide variety of low-frequency applications. Field and laboratory testing of servo, geophysical, medical and high-quality audio equipment becomes practical when using the 203A.

HP's 203A frequency range of 0.005 Hz to 60 kHz is covered in seven overlapping bands (two additional ranges available on special order offering frequency range to 0.00005 Hz). Accurate $\pm 1\%$ frequency setting is provided by 180 dial divisions. A vernier drive allows precise adjustment.

HP's 203A provides a maximum output voltage of 30 V peak-to-peak for all waveforms. Sinusoidal signals have less than 0.06% distortion and provide virtually transient-free outputs when frequency and operating conditions are varied rapidly. Four output circuits of the 203A have individual 40 dB continuously variable attenuators.

Outputs consist of a reference sine and square wave, and a variable-phase sine and square wave. Both sine-and-square-wave outputs are electrically identical except that one sine-and-square-wave output contains a 0-to-360 degree phase-shifter. These four signals (two reference phase and two variable phase) are available simultaneously from the 203A. The output system is floating with respect to ground and may be used to supply an output voltage that is terminal grounded, or may be floated up to 500 volts dc above chassis ground. Output impedance is 600 ohms for all outputs.

Specifications

- Frequency range:** 0.005 Hz to 60 kHz in seven decade ranges.*
- Dial accuracy:** $\pm 1\%$ of reading.

Frequency stability: within $\pm 1\%$ including warmup drift and line voltage variations of $\pm 10\%$.

Output waveforms: sine and square waves are available simultaneously; all outputs have common chassis terminal.

Reference phase: sine wave, 0 to 30 V peak-to-peak; square wave, 0 to 30 V peak-to-peak (open circuit).

Variable phase: sine wave, 0 to 30 V peak-to-peak; square wave, 0 to 30 V peak-to-peak; continuously variable, 0 to 360°; phase dial accuracy, $\pm 5^\circ$ sine wave, $\pm 10^\circ$ square wave (open circuit).

Output impedance: 600 ohms.

Output power: 5 volts into 600 ohms (40 mW); 40 dB continuously variable attenuation on all outputs.

Distortion: total harmonic distortion hum and noise > 64 dB below fundamental ($< 0.06\%$) at full output.

Output system: direct-coupled output is isolated from ground and may be operated floating up to 500 V dc.

Frequency response: $\pm 1\%$ referenced to 1 kHz.

Square wave response: rise and fall time, < 200 ns; overshoot, $< 5\%$ at full output.

Power: 115 or 230 V $\pm 10\%$, 50 to 1000 Hz, 27.5 VA max.

Dimensions: cabinet: 425 mm wide \times 133 mm high \times 286 mm deep (16 $\frac{1}{4}$ " \times 5 $\frac{1}{4}$ " \times 11 $\frac{1}{2}$ "); rack mount kit (00203-84401) furnished with instrument.

Weight: net, 9.17 kg (20 lb 4 oz); shipping, 12.6 kg (28 lb).

Model number and name

Option 001, 0.0005 Hz

Option 002, 0.00005 Hz

203A, Variable Phase Function Generator

Price

add \$89

add \$270

\$2145

*Two lower ranges of 0.0005 Hz (Option 001) and 0.00005 Hz (Option 002) are available on special order.

OSCILLATORS & FUNCTION GENERATORS

Function generator

Models 3300A & 3301A plug-in

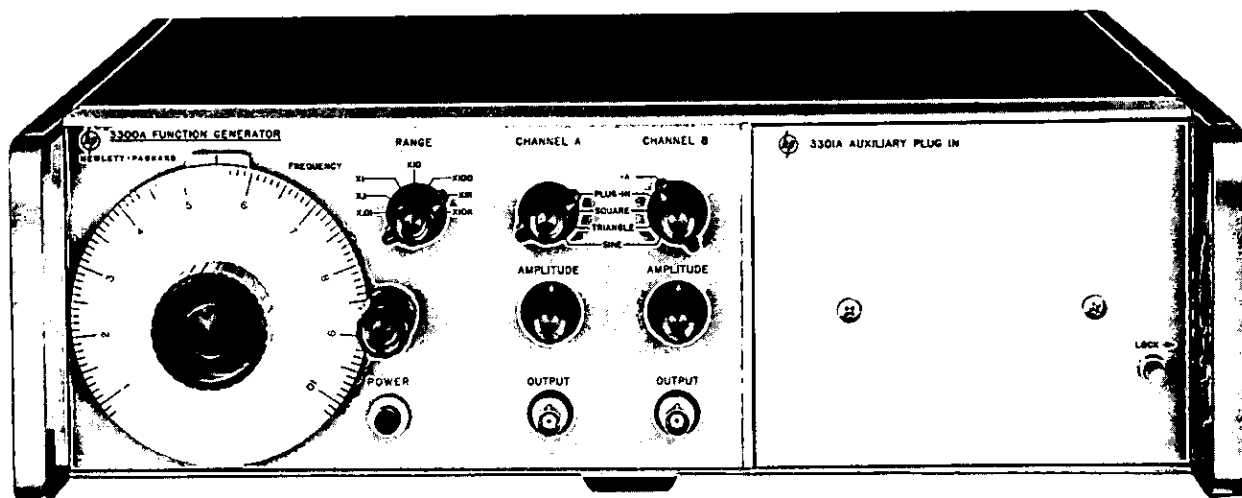

Description

Plug-ins and multiple outputs set Hewlett-Packard's 3300A Function Generator apart from other function generators. Any two of three waveforms—sine, square or triangular—may be selected by a front-panel switch over the frequency range from 0.01 Hz to 100 kHz, continuously adjustable in seven decade ranges. This solid-state, multi-purpose source provides simultaneous signals of any two waveforms over the entire frequency range with independent variable amplitudes.

Plug-ins, which insert directly into the front panel, include HP's 3301A Auxiliary Plug-in to provide internal connections for basic unit operation. The 3302A plug-in provides single and multiple-cycle operation with adjustable start-stop phase. A phase-lock loop in the 3302A permits synchronizing the 3300A with an external signal and permits adjustable phase control. The 3305A Sweeper Plug-in supplies internal log sweep and manual sweep over four decades with calibrated variable start-stop frequency control within four decades. Sweep width is continuously adjustable. It has manual or external triggering. Sweep can be analog-programmed with horizontal sweep available for driving scopes or recorders.

The frequency of the HP 3300A can be controlled by either the front-panel frequency dial or an external voltage applied to a rear-terminal connector. This feature is useful for sweeping filters, amplifiers and other frequency dependent devices and for externally programming frequencies for production testing.

Specifications

Output waveforms: sinusoidal, square and triangular selected by panel switch (any two outputs available simultaneously).

Frequency range: 0.01 Hz to 100 kHz in 7 decade ranges.

Typical frequency stability:

Short term: drift $< \pm 0.05\%$ of setting for 10 min.

Long term: drift $< \pm 0.25\%$ of setting for 24 hrs.

Frequency response: $\pm 1\%$, 0.01 Hz to 10 kHz; $\pm 3\%$, 10 kHz to 100 kHz on the X10 k range.

Dial accuracy: $\pm 1\%$ of maximum dial setting (1 minor division), 0.01 Hz to 10 kHz at $+25^\circ\text{C}$; $\pm 2\%$ of maximum dial setting (2 minor divisions), 10 kHz to 100 kHz on the X10 k range.

Maximum output per channel: $> 35\text{ V p-p}$ open circuit; $> 15\text{ V p-p}$ into 600Ω ; $> 2\text{ V p-p}$ into 50Ω .

Output attenuators (both channels): 40 dB range.

Sine-wave distortion: $< 1\%$, 0.01 Hz to 10 kHz; $< 3\%$, 10 kHz to 100 kHz on the X10 k range.

Square-wave response: $< 250\text{ ns}$ rise and fall time on all ranges; $< 1\%$ sag, $< 5\%$ overshoot at full output; $< 1\%$ symmetry error; $< 500\text{ ms}$ rise and fall time ($-A$).

Triangle-linearity error: $< 1\%$, 0.01 Hz to 10 kHz; $< 2\%$, 10 kHz to 100 kHz at full output; $< 1\%$ symmetry error.

Sync-pulse output: $> 10\text{ V p-p}$ open circuit. $< 5\ \mu\text{s}$ duration. Output impedance (both channels): $600\Omega \pm 20\%$.

DC stability: drift $< \pm 0.25\%$ of p-p amplitude over a period of 24 hours (after 30-min. warmup).

Remote frequency control: 0 to -10 V will linearly change frequency > 1 decade within a single range. Frequency resettability with respect to voltage $\pm 1\%$ of maximum frequency on range selected.

Power: 115 or 230 V $\pm 10\%$, 48 to 440 Hz, 65 VA max.

Dimensions: standard Hewlett-Packard full module 425mm wide \times 133mm high \times 279mm deep ($16\frac{3}{4}'' \times 5\frac{1}{2}'' \times 11''$).

Weight: net, 9 kg (20 lb); shipping, 11.3 kg (25 lb).

Accessories furnished: rack mount kit for 19" rack.

Plug-ins available

3301A Auxiliary Plug-in

3302A Trigger/Phase Lock Plug-in

3305A Sweeper Plug-in

(must have a plug-in to operate).

Price

\$41

\$325

\$1075

3300A Function Generator

\$900

OSCILLATORS & FUNCTION GENERATORS

Lin/log sweep, phase lock, dc offset plug-ins

Models 3302A & 3305A

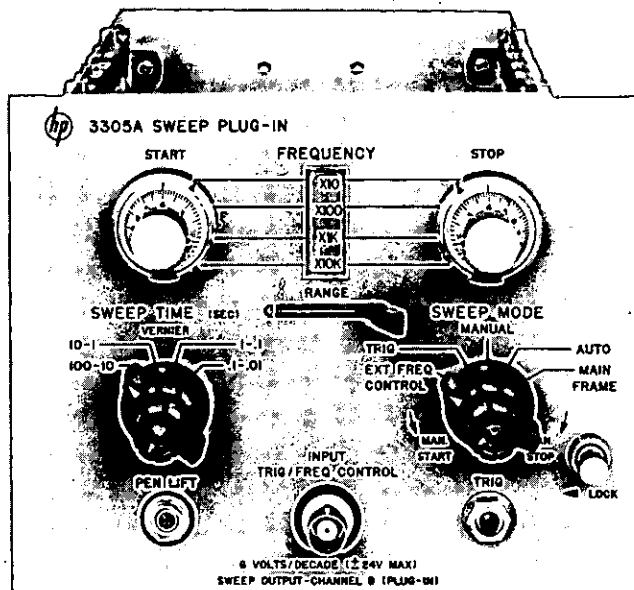
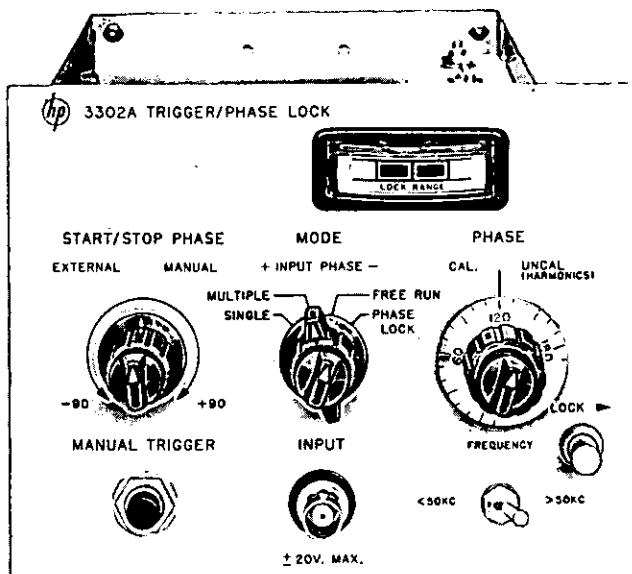

Description

HP's 3302A Trigger/Phase Lock Plug-in provides single-cycle, multiple-cycle, and phase-lock operation. The instrument can be triggered over the entire frequency range, either manually or by applying an external voltage.

Hewlett-Packard's 3305A Sweep Plug-in will sweep logarithmically, repetitively between any two frequencies within one of three (4-decade) ranges: 0.1 Hz to 1 kHz, 1 Hz to 10 kHz, and 10 Hz to 100 kHz. Calibrated independent start-stop controls greatly simplify setting desired sweep end points.

3302A Specifications

Trigger requirements

Single cycle: manual or external, dc coupled. Requires at least 0.5 V to trigger externally. May be triggered with positive or negative input voltage which starts at or goes through 0 V (± 20 V p max.).

Multiple cycle: manual or external start/stop, dc coupled. Requires at least 0.5 V to start, 0 V to stop. May be triggered with either positive or negative (± 20 V p max.).

Phase lock: 10 Hz to 100 kHz (upper 4 ranges only), dc coupled. Requires + and -0.5 V p to lock, 10 V p-p for specified accuracy with sine wave input. The 3302A will lock on a fundamental or harmonic of the input signal.

Phase dial accuracy: $\pm 10^\circ$ from 10 Hz to 10 kHz; $\pm 20^\circ$ from 10 kHz to 100 kHz on X10 k range (fundamental).

Introduced distortion: <1%, 10 Hz to 10 kHz; <3%, 10 kHz to 100 kHz on X10 k range (fundamental).

3305A Specifications

Frequency range: 0.1 Hz to 100 kHz in 3 overlapping ranges.

Sweep width: limits adjustable 0 to 4 decades in any of 3 (4-decade) bands: 0.1 Hz to 1 kHz, 1 Hz to 10 kHz, 10 Hz to 100 kHz. Start-stop

dial accuracy: $\pm 10\%$ of setting.

Sweep modes

Automatic: repetitive logarithmic sweep between start and stop frequency settings.

Manual: vernier adjustment of frequency between start and stop frequency settings.

Trigger: sweep between start and stop frequency settings and retrace with application of external trigger voltage or by depressing front-panel trigger button.

Trigger requirements: ac coupled, positive going at least 1 V p with >2 V per ms rise rate. Max. input, ± 90 V p.

Sweep time: 0.01 s to 100 s in 4 decade steps, continuously adjustable vernier.

Retrace time: <0.003 s for 0.1 to 0.01 s sweep times; <0.03 s for 1 to 0.1 s sweep times; <4 s for 100 to 1 s sweep times.

Blanking: oscillator disabled during retrace.

Pen lift: terminals shorted during sweep; open during retrace in auto and trigger modes for 100 to 1 s sweep times.

Sweep output: linear ramp at channel B output (plug-in); amplitude adjustable independently of sweep width; max. output >15 V p-p into open circuit, >7 V p-p into 600 Ω .

External frequency control

Sensitivity: 6 V/decade (refer: start setting), ± 24 V max. V-to-F conversion accuracy: for each 6 V change in programming voltage, frequency changes 1 decade $\pm 5\%$ of end F.

Input impedance: 400 k Ω $\pm 5\%$. Max. rate: 100 Hz.

General

Dimensions: 154 mm wide \times 121 mm high \times 260 mm deep (6 $\frac{1}{16}$ " \times 4 $\frac{3}{4}$ " \times 10 $\frac{1}{4}$ ").

Weight: net, 2 kg (4 lb 6 oz); shipping, 3.6 kg (8 lb).

Model number and name:

3302A Trigger/Phase Lock Plug-in

3305A Sweep Plug-in

Price

\$325

\$1075

OSCILLATORS & FUNCTION GENERATORS

0.1 Hz to 1 MHz
Model 3311A

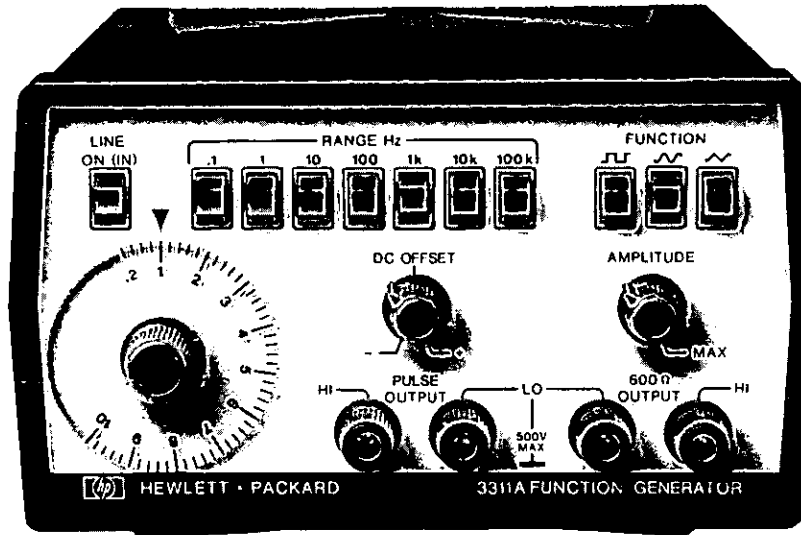

Description

The 3311A Function Generator offers wide functional capability at a modest price. This compact unit has seven decades of range from 0.1 Hz to 1 MHz. Pushbutton range and function selection add convenience to versatility. Added features normally not found on function generators in this price range are 10:1 voltage control and a separate pulse output suitable for synchronization or driving TTL logic circuits.

Output

Ten V p-p into 600 Ω (20 V p-p O.C.). This output may be attenuated by >30 dB by a variable attenuator and offset by ± 5 V. The dc offset allows the sine, square, and triangle functions to be positioned to the most desired level. This feature adds to the usefulness of all three functions.

VCO

The dc coupled voltage control allows the use of an external source to sweep the 3311A >10:1 in frequency. An ac voltage can be used to FM the function generator.

A separate TTL compatible pulse output provides current sinking for up to 20 TTL loads. The pulse has a 15/85 aspect ratio with a <25 ns rise time.

Specifications

Waveforms: sinusoid, square, triangle, and positive pulse.

Frequency range: 0.1 Hz to 1 MHz in seven decade ranges.

Dial accuracy: $\pm 5\%$ of full scale.

Isolation: using an external supply, outputs may be floated up to ± 500 V relative to the instrument case (earth ground).

600 Ohm output

Maximum output amplitude: 20 V p-p open circuit; 10 V p-p into 600 Ω .

Amplitude control: continuously variable, >30 dB range. DC offset: up to ± 10 V open circuit, ± 5 V into 600 Ω , continuously adjust-

able and independent of amplitude control. Maximum V_{ac} peak + V_{dc} offset without clipping is ± 10 V open circuit, ± 5 V into 600 Ω .

Output impedance: 600 Ω $\pm 10\%$.

Sine wave amplitude flatness: within $\pm 3\%$ of 10 kHz reference (maximum output amplitude) to 100 kHz, $\pm 6\%$ to 1 Hz.

Sine wave total harmonic distortion: <3% (maximum output amplitude).

Triangle linearity: deviation <1% from best straight line at 100 Hz (maximum output amplitude).

Square wave transition time: rise time: <100 ns; fall time: <100 ns.

Square wave time axis symmetry error: $\pm 2\%$ maximum to 100 kHz.

Pulse output

Output amplitude: >3 V positive (open circuit) TTL compatible.

Duty cycle: 13.5% to 16.5% of the total period.

Transition times: <25 ns.

External frequency control

VCO range: >10:1 on any frequency range.

Input requirement: with frequency dial set to 1.0, a linear ramp of 0.0 V to -10 V ± 2 V will linearly increase frequency >10:1.

Input impedance: 10 k Ω $\pm 10\%$.

General

Operating temperature: 0-55°C; specifications apply from +15°C to +35°C.

Storage temperature: -40°C to $+75^\circ\text{C}$.

Power: 100/120/220/240 V -10% , $+5\%$ switchable; 48 Hz to 440 Hz; ≤ 12 VA.

Dimensions: 89 mm high \times 160 mm wide \times 248 mm deep (3 $\frac{1}{2}$ " \times 6 $\frac{1}{4}$ " \times 9 $\frac{3}{4}$ ").

Weight: net, 1.5 kg (3 $\frac{1}{3}$ lb); shipping, 2.5 kg (5 $\frac{1}{2}$ lb).

3311A Function Generator

\$270

- AM, FM, sweep, trigger, gate and burst

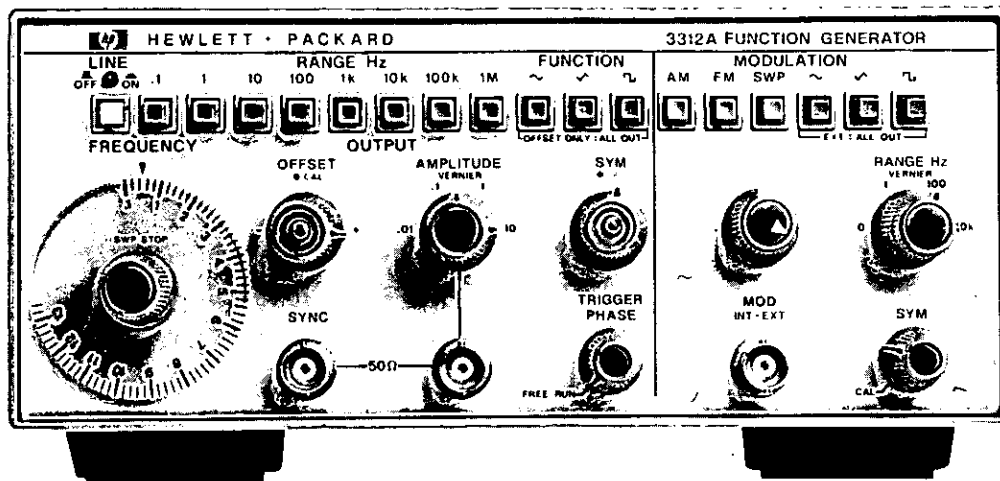

Description

Hewlett-Packard's 3312A Function Generator combines two separate, independent function generators with a modulator section in one compact instrument.

The main generator can—via pushbutton control—be triggered by the modulation generator to provide sweep functions, AM, FM, FSK, or tone burst.

Ten V p-p into 50 Ω provides power for most applications. The output attenuator has a range of more than 10,000:1 so clean low-level signals from 10 V to 1 mV p-p into 50 Ω can be obtained.

The main generator includes dc offset up to 10 volts p-p 50 Ω .

Hewlett-Packard's 3312A is an effective low cost solution for generating a multitude of functions.

3312A Specifications

Output waveforms: Sine, square, triangle, \pm ramp, pulse, AM, FM, sweep, trigger and gate.

Frequency characteristics

Range: 0.1 Hz to 13 MHz in 8 decade ranges.

Dial accuracy: $\pm 5\%$ of full scale.

Square wave rise or fall time (10% to 90%): <18 nsec.

Aberrations: <10%.

Triangle linearity error: <1% at 100 Hz.

Variable symmetry: 80:20:80 to 1 MHz.

Sine wave distortion: <0.5% THD from 10 Hz to 50 kHz. >30 dB below fundamental from 50 kHz to 13 MHz.

Output characteristics

Impedance: 50 Ω \pm 10%.

Level: 20 V p-p into open circuit, 10 V p-p into 50 Ω .

Level flatness (sine wave): < $\pm 3\%$ from 10 Hz to 100 kHz at full rated output (1 kHz reference). < $\pm 10\%$ from 100 kHz to 10 MHz.

Attenuator: 1:1, 10:1, 100:1, 1000:1 and >10:1 continuous control.

Attenuator accuracy: <5%.

Sync output: impedance: 50 Ω \pm 10%, >1 V p-p square wave into open circuit. Duty cycle varies with symmetry control.

DC offset: ± 10 volts, continuously adjustable, independent of variable attenuator setting. Instantaneous ac voltage + Vdc offset must be between ± 10 V (not terminated) or ± 5 V (terminated with 50 Ω) in the 1:1 attenuator position.

Modulation characteristics

Types: internal AM, FM, sweep, trigger, gate or burst; external AM, FM, sweep, trigger, gate or burst.

Waveforms: sine, square, triangle, ramp or pulse variable symmetry.

Frequency range: 0.01 Hz to 10 kHz.

Output level: >1.0 V p-p into 10 k Ω .

Amplitude modulation

Depth: 0 to 100%.

Modulation frequency: 0.01 Hz to 10 kHz (internal). Dc to >1 MHz (external).

Carrier 3 dB bandwidth: <100 Hz to >5 MHz.

Carrier envelope distortion: <2% at 70% sine wave modulation with $f_c = 1$ MHz, $f_m = 1$ kHz.

External sensitivity: <10 V p-p for 100% modulation.

Frequency modulation

Deviation: 0 to $\pm 5\%$ (internal).

Modulation frequency: internal: 0.01 Hz to 10 kHz; external: Dc to >50 kHz.

Distortion: <-35 dB at $f_c = 10$ MHz, $f_m = 1$ kHz, 10% modulation.

Sweep characteristics

Sweep width: >100:1 on any range.

Sweep rate: 0.01 Hz to 100 Hz, 90:10 ramp, and 0 Hz (provides manual setting of "Sweep Start" without modulation generator oscillating).

Sweep mode: repetitive linear sweep between start and stop frequency settings. Retrace time can be increased with symmetry control.

Gate characteristics: start/stop phase range: +90 $^\circ$ to -80 $^\circ$.

Frequency range: 0.1 Hz to 1 MHz (useful to 10 MHz).

Gating signal frequency range (external): Dc to 1 MHz, TTL compatible.

External frequency control

Range: 1000:1 on any range.

Input requirement: with dial set at 10, 0 to -2 V $\pm 20\%$ will linearly decrease frequency >1000:1. An ac voltage will FM the frequency about a dial setting within the limits (0.1 < f < 10) \times range setting.

Linearity: ratio of output frequency to input voltage ($\Delta f/\Delta V$) will be linear within 0.5% over a 100:1 frequency range.

Input impedance: 2.8 k Ω \pm 5%.

General

Operating temperature: 0 $^\circ$ C to +50 $^\circ$ C; specifications apply from 0 $^\circ$ C to 35 $^\circ$ C.

Storage temperature: -40 $^\circ$ C to +75 $^\circ$ C.

Power: 100 V, 120 V, 220 V, 240 V +5%, -10%, switchable; 48 Hz to 440 Hz; ≤ 25 VA.

Dimensions: 102 mm high \times 213 mm wide \times 377 mm deep (4" \times 8 1/2" \times 14 3/4").

Weight: 3.5 kg (7 lb 12 oz).

3312A Function Generator

\$900

hp OSCILLATORS & FUNCTION GENERATORS

0.0005 Hz to 5 MHz function generators

Model 3310A/B

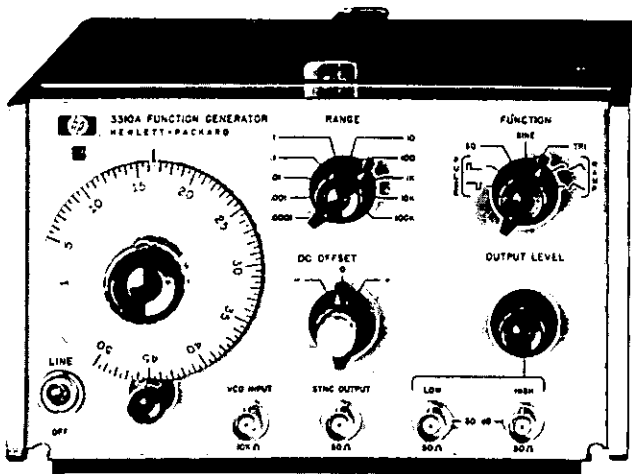

3310A

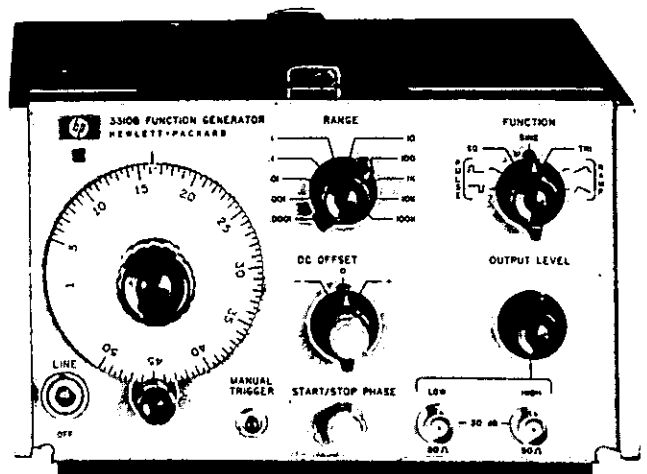

3310B

The 3310A Function Generator is a compact voltage-controlled generator with 10 decades of range. Ramp and pulse functions are available in addition to sine, square and triangle. DC offset and external voltage control provide wide versatility. A fast rise time sync output is provided. Aspect ratio of nonsymmetrical function is 15%/85%.

The 3310B has all the features of the standard 3310A plus single and multiple cycle output capability.

3310A Specifications

Output waveforms: sinusoidal, square, triangle, positive pulse, negative pulse, positive ramp and negative ramp. Pulses and ramps have a 15% or 85% duty cycle.

Frequency range: 0.0005 Hz to 5 MHz in 10 decade ranges.

Sine wave frequency response

0.0005 Hz to 50 kHz: $\pm 1\%$; 50 kHz to 5 MHz: $\pm 4\%$. Reference, 1 kHz at full amplitude into 50 Ω .

Dial accuracy

0.0005 Hz to 500 kHz all functions: $\pm(1\%$ of setting + 1% of full scale).

500 kHz to 5 MHz sine, square and triangle: $\pm(3\%$ of setting + 3% of full scale).

500 kHz to 5 MHz pulse and ramps: $\pm(10\%$ of setting + 1% of full scale).

Maximum output on high: >30 V p-p open circuit; >15 V p-p into 50 Ω (except for pulses at frequency >2 MHz).

Pulse (frequency >2 MHz): >24 V p-p open circuit; >12 V p-p into 50 Ω .

Minimum output on low: <30 mV p-p open circuit; <15 mV p-p into 50 Ω .

Output level control: range >30 dB. High and low outputs overlap for a total range of >60 dB; low output is 30 dB down from high output.

Sine wave distortion

0.0005 Hz to 10 Hz: >40 dB (1%).

10 Hz to 50 kHz (on 1 k range): >46 dB (0.5%).

50 kHz to 500 kHz: >40 dB (1%).

500 kHz to 5 MHz: >30 dB (3%).

Square wave and pulse response: <30 ns rise and fall times at full output.

Triangle and ramp linearity: 0.0005 Hz to 50 kHz, <1%.

Impedance: 50 Ω .

Sync

Amplitude: >4 V p-p open circuit, >2 V p-p into 50 Ω .

DC offset

Amplitude: ± 10 V open circuit, ± 5 V into 50 Ω (adjustable).

Note: max V ac p + V dc offset is ± 15 V open circuit.

External frequency control: 50:1 on any range.

Input requirement: with dial set to low end mark, a positive ramp of 0 to +10 V ± 1 V will linearly increase frequency 50:1. With dial set at 50, a linear negative ramp of 0 to -10 V ± 1 V will linearly decrease frequency 50:1. An ac voltage will FM the frequency about a dial setting within the limits $(1 < f < 50) \times$ range setting.

Linearity: ratio of output frequency to input voltage ($\Delta f/\Delta V$) will be linear within 0.5%.

Sensitivity: approximately 100 mV/minor division.

Input impedance: 10 k Ω .

General

Power: 115 V or 230 V $\pm 10\%$, 48 Hz to 440 Hz, <20 VA max.

Dimensions: 197 mm wide, 114 mm high (without removable feet), 203 mm deep (7 $\frac{3}{4}$ " \times 4 $\frac{1}{2}$ " \times 8").

Weight: net, 2.7 kg (6 lb); shipping, 4.5 kg (10 lb).

Accessories available

HP Part No. 5060-0105 filler strip for use with HP 1051A Combining Case or HP 5060-0797 Rack Adapter Frame.

3310B Specifications

Same as 3310A with the following additions:

Modes of operation: free run, single cycle, multiple cycle.

Frequency range: 0.0005 Hz to 50 kHz (usable to 5 MHz).

Single cycle:** ext trigger (ac coupled) requires a positive-going square wave or pulse from 1 V p-p to 10 V p-p. The triggering signal can be dc offset, but $(V$ ac peak + V dc) $\leq \pm 10$ V ext gate (dc coupled) will trigger a single cycle on any positive waveform ≥ 1 V but ≤ 10 V which has a period greater than the period of the 3310B output, and a duty cycle less than the period of the 3310B output. The gate signal cannot exceed 10 V.

Multiple cycle:** manual trigger will cause the 3310B to free run when depressed. When the trigger button is released, the waveform will stop on the same phase as it started. Ext gate will cause the 3310B to free run when the gate is held at between +1 and +10 V. When the gate signal goes to zero, the 3310B will stop on the same phase as it started.

Start-stop phase: The start-stop phase can be adjusted over a range of approximately $\pm 90^\circ$.

Model number and name

3310A Function Generator

3310B Function Generator

Price

\$635

\$800

**This specification applies on the X.0001 to X1 k range only.

OSCILLATORS & FUNCTION GENERATORS



10 Hz to 10 MHz test oscillators

Models 651B, 652A, 654A

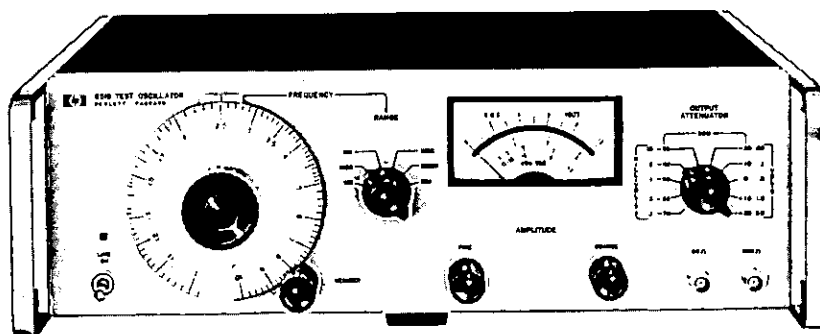

Specifications

MODEL NO.	651B	652A	654A
DESCRIPTION	Amplitude and frequency stability of this solid state capacitance-tuned test oscillator provides high quality signals for general purpose lab or production measurements.	Same as Model 651B, HP's Model 652A offers an expandable output monitor for amplitude control to 0.25% across its entire frequency band for greater output resolution and resetability.	Similar to the 651B Test Oscillator, HP's Model 654A has balanced outputs of 135Ω, 150Ω, and 600Ω. Automatic leveling over entire frequency range and expanded meter.
FREQUENCY RANGE	10 Hz to 10 MHz, 6 bands.		
FREQUENCY ACCURACY	±2%, 100 Hz to 1 MHz; ±3%, 10 Hz to 100 Hz and 1 MHz to 10 MHz.		±2% 100 Hz to 5 MHz; ±3% 10 Hz to 100 Hz; ±4% 5 MHz to 10 MHz.
FREQUENCY RESPONSE (FLATNESS)	±2%, 100 Hz to 1 MHz; ±3%, 10 Hz to 100 Hz; (±4%, 1 MHz to 10 MHz applies only at 50Ω or 75Ω output and amplitude readjusted to a reference on the output monitor.)	±0.25% 3 V and 1 V range; ±0.75% 0.3 V to 0.3 mV range; ±1.75% 0.1 mV range. (Amplitude readjusted using expanded scale on output monitor).	(+10 dBm and 0 dBm) ±0.5% from 10 Hz to 10 MHz for unbalanced outputs and 10 Hz to 5 MHz for 135Ω and 150Ω outputs, and 10 Hz to 1 MHz for 600Ω output.
DISTORTION	<1%, 10 Hz to 2 MHz; <2%, 2 MHz to 5 MHz; <4%, 5 MHz to 10 MHz.		10 Hz to 1 MHz, >40 dB below fundamental; 1 MHz to 10 MHz, >34 dB below fundamental.
OUTPUT	3.16 V into 50 Ω or 600 Ω; 6.32 V open circuit. 0.1 mV to 3.16 V full scale, 10 steps in 1, 3, 10 sequence; -70 dBm to +23 dBm (50Ω output) full scale, 10 dBm per step; 20 dB coarse and fine adjustable amplitude control.		+11 dBm to -90 dBm, 10 dB and 1 dB steps with adjustable ±1 dB meter range, calibrated for each impedance of 50Ω and 75Ω unbalanced and 135Ω, 150Ω and 600Ω balanced.
OUTPUT MONITOR (MONITOR'S LEVEL AT INPUT OF ATTENUATOR)	Top scale calibrated in volts, bottom scale in dB. Accuracy ±2% of full scale.	Same as 651B plus Expand Scale which expands reference voltage of the normal scale from 0.9 to 1.0 or 2.8 to 3.2.	±1 dBm full scale with 0.02 dB resolution. Accuracy ±0.05 dB.
OUTPUT* CONNECTORS	BNC connectors.		
ATTENUATOR	90 dB range in 10 dB steps; ±0.075 dB, -60 dBm to +20 dBm; ±0.2 dB, -70 dBm to -60 dBm.		99 dB range in 10 dB and 1 dB steps; ±1.5% (0.15 dB) except ±10% (1 dB) at output levels below 60 dBm at frequencies >300 kHz.
TEMPERATURE RANGE	0°C to +55°C (32°F to 130°F).		
POWER	115 V or 230 V ±10%, 48 Hz to 440 Hz, 30 VA max.		115 V or 230 V ±10%, 50 Hz to 400 Hz, 35 VA max.
WEIGHT	Net, 7.6 kg (17 lb). Shipping, 9.90 kg (22 lb).		Net, 9.4 kg (21 lb). Shipping, 11.8 kg (26 lb).
DIMENSIONS	425 mm wide × 133 mm high × 286 mm deep (16 1/4" × 5 1/2" × 11 1/4").		
PRICE	\$775	\$900	\$1060

*Maximum dc voltage that can be applied to output: <±3 V p.



OSCILLATORS & FUNCTION GENERATORS

AC calibrator, high voltage amplifier

Models 745A & 746A

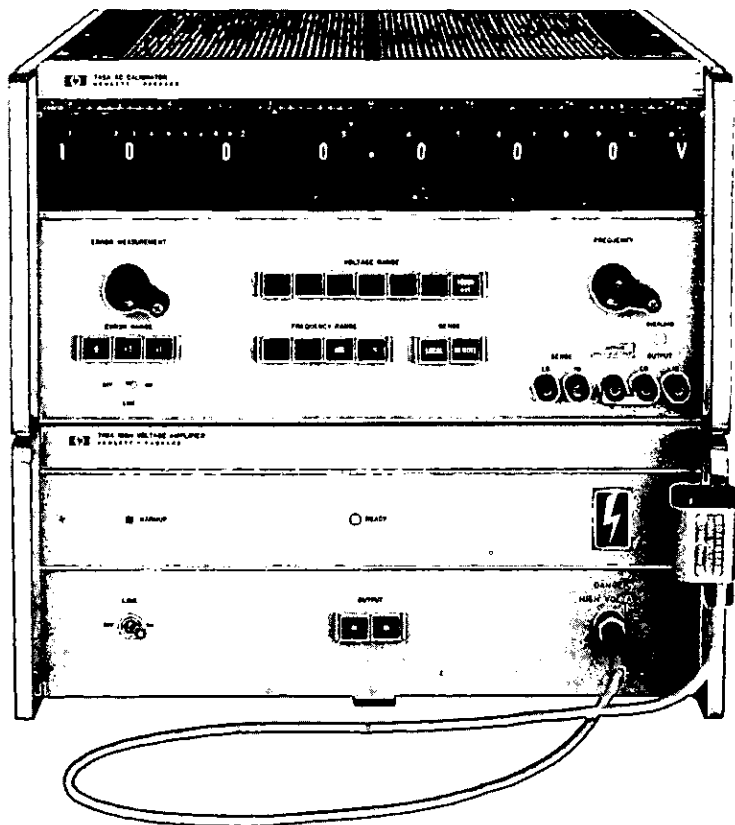

Description

Hewlett-Packard's Model 745A AC Calibrator combined with Model 746A High Voltage Amplifier is a compact, calibrated ac source with continuously adjustable frequency output from 10 Hz to 110 kHz. Output voltage can be varied from 0.1 mV to 1099.999 V in steps as small as 1 ppm of range over the entire frequency range.

HP's 745A provides the first six voltage ranges, 0.1 mV to 109.9999 V, while the combination of the 745A and 746A permits expansion to 1099.999 V as a seventh range. Model 746A can only be used with the 745A.

Specifications

Ranges

Output voltage ranges: seven ranges with 10% overrange as follows:

Range	Settability and resolution
1 mV	0.100000 mV to 1.099999 mV in 1 nV steps
10 mV	1.00000 mV to 10.99999 mV in 10 nV steps
100 mV	10.0000 mV to 109.9999 mV in 100 nV steps
1 V	0.100000 V to 1.099999 V in 1 μ V steps
10 V	1.00000 V to 10.99999 V in 10 μ V steps
100 V	10.0000 V to 109.9999 V in 100 μ V steps
1000 V	100.000 V to 1099.999 V in 1 mV steps

Output voltages from 100 μ V to 110 V are available from 745A output terminals; voltages from 100 V to 1100 V are available from the 746A output cable.

Output frequency ranges: continuously adjustable from 10 Hz to 110 kHz in four decade ranges with 10% overlap.

Error measurement: two ranges with zero center dial; $\pm 0.3\%$, $\pm 3\%$. A zero range is provided to easily switch out the effects of the error measurement system.

Performance rating

Accuracy: accuracy holds for a 90-day period and is met after a one-hour warm-up period at $25^\circ\text{C} \pm 5^\circ\text{C}$ with $<95\%$ RH. This applies only to the 745A. Warm-up time required for HP's 746A is approximately 30 s.

Voltage: specifications are absolute, traceable to National Bureau of Standards.

1 mV to 100 V ranges:

Frequency	Accuracy
50 Hz to 20 kHz	$\pm(0.02\%$ of setting $+0.002\%$ of range $+10 \mu\text{V})$
20 Hz to 50 Hz 20 kHz to 110 kHz	$\pm(0.05\%$ of setting $+0.005\%$ of range $+50 \mu\text{V})$
10 Hz to 20 Hz	$\pm(0.2\%$ of setting $+0.005\%$ of range $+50 \mu\text{V})$

1000 V range:

Frequency	Accuracy
50 Hz to 20 kHz	$\pm 0.04\%$ of setting
20 Hz to 50 Hz 20 kHz to 50 kHz	$\pm 0.08\%$ of setting
50 kHz to 110 kHz	$\pm 0.15\%$ of setting
10 Hz to 20 Hz	$\pm(0.2\%$ of setting $+0.005\%$ of range)

Frequency: $\pm(2\%$ of setting $+0.2\%$ of end scale).

Error measurement: $\pm(0.5\%$ of setting $+0.5\%$ of range).

Temperature coefficient

Voltage: 1 mV to 100 V ranges: $\pm 0.0003\%$ of setting per $^{\circ}\text{C}$, 0°C to 55°C . 1000 V range: $\pm 0.0005\%$ of setting per $^{\circ}\text{C}$, 0°C to 55°C .

Frequency: $\pm 0.05\%$ of end scale per $^{\circ}\text{C}$, 0°C to 55°C . Derate accuracy specification by this temperature coefficient for operation in temperature range of 0°C to 20°C and 30°C to 50°C .

Voltage stability: stability met after one-hour warm-up period at constant temperature with $<95\%$ RH. 1 mV to 100 V ranges:

Long-term: $\pm 0.01\%$ of setting for six months.

Short-term: $\pm 0.005\%$ of setting for 24 hours.

1000 V range:

Long-term: 50 Hz to 20 kHz: $\pm 0.01\%$ of setting for six months; 10 Hz to 50 Hz and 20 kHz to 110 kHz: $\pm 0.02\%$ of setting for six months.

Short-term: $\pm 0.005\%$ of setting for 24 hours.

Output characteristics

Total distortion and noise: 0.05% of setting + $10\ \mu\text{V}$ over 100 kHz bandwidth on all ranges.

Total distortion, cycle-to-cycle instability and noise: will cause $<\pm 0.005\%$ of error when used to calibrate an average-responding or true rms-responding instrument from 1 mV to 1100 V.

Load regulation (no load to full load):

Output impedance: $<1\ \Omega$ on 1 mV, 10 mV, 100 mV ranges. On the 1 V, 10 V, 100 V and 1000 V ranges for output current equal to or less than that shown in the diagram below, error is included in the accuracy specification.

Load capability: 1000 pF or 50 mA on 1 mV to 100 V ranges (50 mA allows 800 pF at 100 V, 100 kHz). 1000 pF or 63 mA on 1000 V range (63 mA allows 100 pF at 1000 V, 100 kHz).

Line regulation: $\pm 0.001\%$ of setting change in output voltage for a 10% change in line voltage (included in accuracy specs).

Output terminals: high and low output terminals can be floated $\pm 500\ \text{V}$ dc above chassis ground.

Counter output: frequency counter output on 745A rear panel, 2.2 V $\pm 20\%$, protected against short circuits.

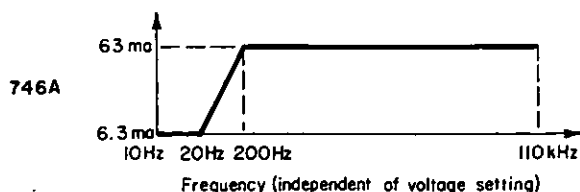
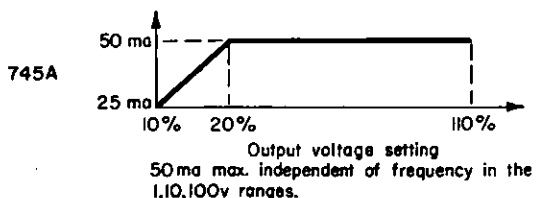
**Remote programming:**

Voltage range, frequency range, error range, and senses	Requirements
Contact closure	Less than $400\ \Omega$ to ground
NPN transistor	Open circuit voltage 5 V Short circuit current 2 mA Maximum voltage on programming line at closure 0.8 V
Reed switch through diode	
NPN transistor through diode	
Frequency vernier	Minimum to maximum of range
Analog voltage	+1 V to +10 V DC
Resistance to ground	$500\ \Omega - 10\ \text{k}\Omega$

General

Operating temperature: 0°C to 55°C .

Storage temperature: -40°C to $+75^{\circ}\text{C}$.

RFI: meets MIL-I-6181D when using shielded output connectors.

Power:

745A: 115 V or 230 V $\pm 10\%$, 50 Hz to 400 Hz, 100 VA max.

746A: 115 V or 230 V $\pm 10\%$, 50 Hz to 60 Hz, 850 VA max.

746A aux power rated at 120 VA max.

Weight:

745A: net 29.3 kg (65 lb); shipping 36.3 kg (80 lb).

746A: net 34 kg (75 lb); shipping, 38.5 kg (85 lb).

Dimensions:

745A: 425 mm wide \times 221 mm high \times 467 mm deep ($16\frac{1}{4}'' \times 8\frac{3}{4}'' \times 18\frac{1}{2}''$).

746A: 425 mm wide \times 177 mm high \times 464 mm deep ($16\frac{1}{4}'' \times 7'' \times 18\frac{1}{4}''$).

745A Accessories furnished:

Rack mount kit.

HP Part No. 5060-0630, 22-pin printed circuit board extender.

HP Part No. 5060-0043, 15-pin printed circuit board extender.

HP Part No. 5060-0031, 10-pin printed circuit board extender.

HP Part No. 1251-0084 remote programming plug.

746A Accessories furnished:

Rack mount kit.

HP Part No. 1251-0485, remote right angle connector.

HP Part No. 1450-0356, incandescent lamp.

HP Part No. 4040-0427, extractor.

HP Part No. 5040-0404, probe holder.

HP Part No. 5060-0216, joining kit bracket.

HP Part No. 5060-0630, 22-pin printed circuit board extender.

HP Part No. 00746-02701, foam filter.

Model number and name

HP 745A AC Calibrator

HP 746A High Voltage Amplifier

Price

\$4240

\$2750

hp OSCILLATORS & FUNCTION GENERATORS

DC Standard / Δ DC voltmeter / DC amplifier

Model 740B

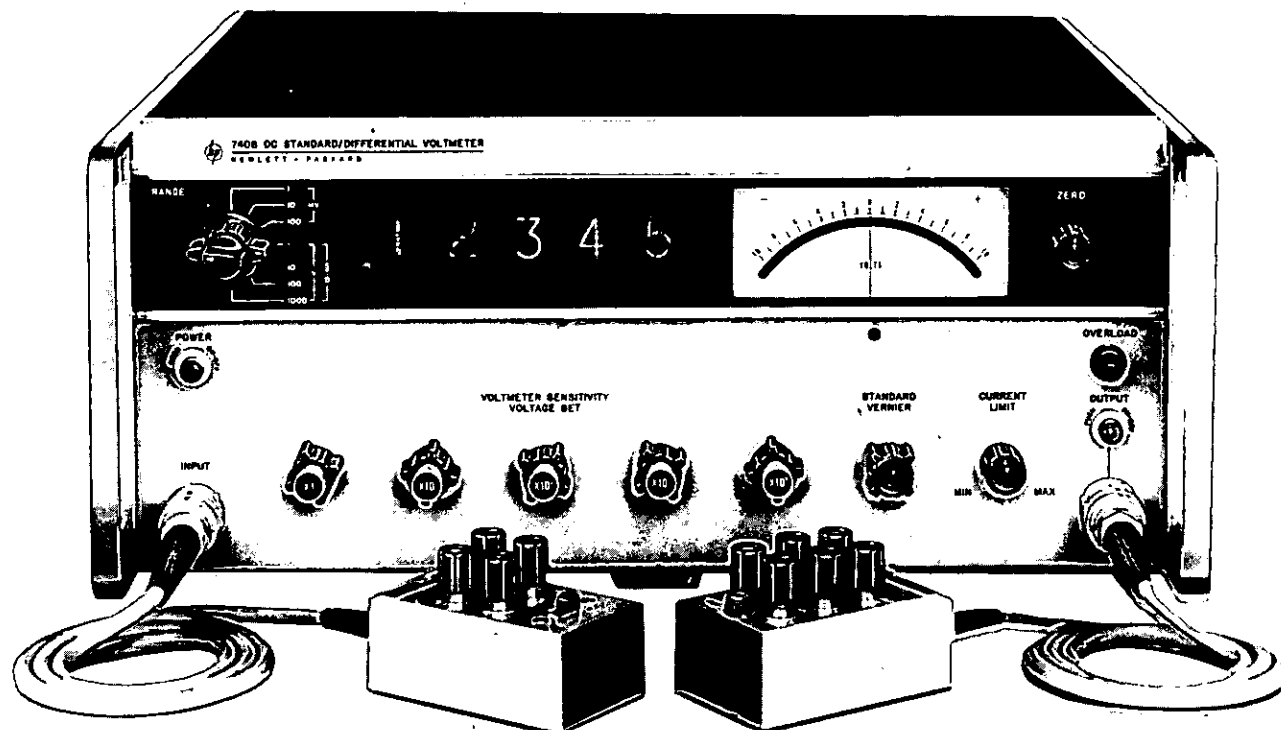

Description

DC standard

The 740B is an ultra stable, high resolution DC calibration source which delivers output voltage from zero to 1000 volts with specified accuracy of $\pm(0.002\%$ of setting + 0.0004% of range). Designed for calibrating digital voltmeters, differential voltmeters, potentiometers, voltage dividers and for general standards lab application, the 740B has six digit resolution with discrete steps of 1 ppm of full scale.

The 740B will deliver current up to 50 mA and may be set at any desired limit between 5 mA and 50 mA by a continuously adjustable front panel control. A front panel indicator displays overload conditions if the load current exceeds the current limit setting. Low output impedance is maintained by remote sensing terminals which control the output voltage at the load. The entire circuit is floating and guarded.

Differential voltmeter

As a differential voltmeter, the 740B measures voltage from zero to 1000 volts dc with an input resistance of $>10^{10}$ ohms independent of null condition. Meter sensitivity pushbuttons allow input voltages to be measured to six digits for a maximum resolution of 1 ppm of range, with a maximum usable sensitivity of $1 \mu\text{V}$ full scale. Specified accuracy is $\pm(0.005\%$ of reading + 0.0004% of range + $1 \mu\text{V}$).

Specifications

DC standard ranges

Output voltage: 0 to 1000 V* in 4 decade ranges as follows: 0 to 1 V in $1 \mu\text{V}$ steps, 0 to 10 V in $10 \mu\text{V}$ steps, 0 to 100 V in $100 \mu\text{V}$ steps, 0 to 1000 V in 1 mV steps. Digital display tubes indicate first 5 digits, meter displays 6th digit.

DC standard performance

Accuracy: ($<70\%$ RH, constant line, load and temperature $\pm 1^\circ\text{C}$.)

Calibrated at factory at 115 V and 23°C .) 30 day: $\pm(0.002\%$ of setting + 0.0004% of range). 90 day: $\pm(0.005\%$ of setting + 0.0004% of range).

Stability: ($<70\%$ RH, constant line, load and temperature $\pm 1^\circ\text{C}$.)

Period	Zero stability ppm of range	Voltage stability (excludes zero stability) ppm of setting + ppm of range
1 hr	± 1 ppm	$\pm(0 \text{ ppm} + 1 \text{ ppm})$
24 hr	± 2 ppm	$\pm(5 \text{ ppm} + 1 \text{ ppm})$

Temperature coefficient: 10°C to 40°C : $<\pm 0.0002\%$ of setting/ $^\circ\text{C}$ or $\pm 0.0001\%$ of range/ $^\circ\text{C}$, whichever is greater.

Line regulation: $<\pm(0.0005\%$ of setting + 0.0001% of range) for 10% line voltage change.

Load regulation (no load to full load): $<(0.0005\%$ of setting + $10 \mu\text{V}$).

DC standard output characteristics

Terminals: plus and minus output, plus and minus sense, circuit guard, and chassis ground. Minus output and circuit guard can be floated up to ± 500 V with respect to chassis ground.

Output current: maximum output current 50 mA at 1 V output, decreasing linearly to 20 mA at 1000 V output. Current limiter continuously adjustable from 10% to 100% of maximum output current.

Output resistance: $<(0.0002 + 0.0001 E_{\text{out}})\Omega$.

Noise: (rms value)

Range	0.01 Hz - 1 Hz	1 Hz - 1 MHz
1 V	$<1 \mu\text{V}$	$<100 \mu\text{V}$
10 V	$<10 \mu\text{V}$	$<100 \mu\text{V}$
100 V	$<100 \mu\text{V}$	$<1 \text{ mV}$
1000 V	$<1 \text{ mV}$	$<10 \text{ mV}$

DC differential voltmeter ranges

Voltage: 1 mV to 1000 V* in 7 decade ranges.

Resolution: 6-digit readout yields resolution of 0.0001% of range (6th digit indicated on meter).

DC differential voltmeter performance

Accuracy: (<70% RH, constant line and temperature $\pm 1^\circ\text{C}$. Calibrated at factory at 115 V and 23°C .)

30 day: $\pm(0.005\%$ of reading $+0.0004\%$ of range $+1 \mu\text{V}$).

90 day: $\pm(0.008\%$ of reading $+0.0004\%$ of range $+1 \mu\text{V}$).

Stability: (<70% RH, constant line and temperature $\pm 1^\circ\text{C}$.)

Period	Zero stability	Reading stability (excludes zero stability) ppm of reading + ppm of range
1 hr	$\pm(1 \text{ ppm of range} + 1 \mu\text{V})$	$\pm(0 \text{ ppm} + 1 \text{ ppm})$
24 hr	$\pm(1 \text{ ppm of range} + 2 \mu\text{V})$	$\pm(5 \text{ ppm} + 1 \text{ ppm})$

Temperature coefficient: 10°C to 40°C : $< \pm(0.0002\%$ of reading $+ 1 \mu\text{V})/^\circ\text{C}$.

Line regulation: $< \pm(0.001\%$ of reading $+ 2 \mu\text{V})$ for 10% line voltage change.

DC differential voltmeter input characteristics

Terminals: plus and minus input, circuit guard and chassis ground. Minus input and circuit guard can be floated up to $\pm 500 \text{ V}$ with respect to chassis ground.

Input resistance (independent of null): 100 mV to 1000 V ranges: $> 10^{10}\Omega$; 10 mV range: $> 10^9\Omega$; 1 mV range: $> 10^8\Omega$.

Effective common-mode rejection (ECMR): ECMR is the ratio of the common-mode signal to the resultant error in readout with 1 k Ω unbalance resistor in either lead. At 60 Hz and above: $> 120 \text{ dB}$.

Normal-mode rejection (NMR): NMR is the ratio of the ac normal-mode signal to the resultant error in readout. At 60 Hz and above: $> 100 \text{ dB}$. Maximum ac normal-mode signal: 25 V rms.

Overload protection: 1000 V* dc may be applied on any range or sensitivity without damaging instrument.

DC voltmeter

Voltage ranges: 1 μV to 1000 V* in 10 decade ranges.

Accuracy: $\pm(2\%$ of range $+0.1 \mu\text{V}$).

Input resistance: 100 mV to 1000 V range: $> 10^{10}\Omega$; 10 mV range: $> 10^9\Omega$; 1 μV to 1 mV range: $> \pm 10^8\Omega$.

Zero control limits: $> \pm 10 \mu\text{V}$.

Zero drift: $< 2 \mu\text{V}$ per day.

Normal mode rejection: same as dc differential voltmeter.

DC amplifier

Voltage gain:

Range	Gain
1 mV	60 dB
10 mV	40 dB
100 mV	20 dB
1 V - 1000 V	0 dB

Bandwidth: dc to 0.2 Hz.

Gain accuracy: $\pm(0.01\%$ of input $+0.0005\%$ of range $+2 \mu\text{V}$) referred to input.

Linearity: $\pm 0.002\%$ on any range.

Stability:

Temperature coefficient:

Line regulation:

Input resistance:

ECMR:

NMR:

Overload protection:

Load regulation:

Output current:

Output resistance:

Noise (rms value, referred to input):

Same as DC Differential Voltmeter

Same as DC Standard

Range	0.01 Hz - 1 Hz	1 Hz - 1 MHz
1 mV	$< 0.2 \mu\text{V}$	$< 100 \mu\text{V}$
10 mV	$< 0.4 \mu\text{V}$	$< 100 \mu\text{V}$
100 mV	$< 1 \mu\text{V}$	$< 100 \mu\text{V}$
1 V	$< 1 \mu\text{V}$	$< 100 \mu\text{V}$
10 V	$< 10 \mu\text{V}$	$< 100 \mu\text{V}$
100 V	$< 100 \mu\text{V}$	$< 1 \text{ mV}$
1000 V	$< 1 \text{ mV}$	$< 10 \text{ mV}$

General

Recorder output: provides voltage proportional to meter deflection in all modes of operation. Adjustable output supplies up to $\pm 1 \text{ V}$ dc across 1 k Ω load; voltage polarity same as meter deflection.

Operating temperature: 10°C to 40°C unless specified otherwise.

Storage temperature: -40°C to $+65^\circ\text{C}$.

RFI: meets MIL-I-6181D†.

Power: 115 V or 230 V $\pm 10\%$, 50 to 400 Hz, $< 125 \text{ W}$.

Dimensions: 425 mm wide, 175 mm high, 464 mm deep ($16\frac{1}{4}'' \times 6\frac{1}{4}'' \times 18\frac{1}{4}''$).

Weight: net 21.3 kg (47.3 lb); shipping, 27 kg (60 lb).

Accessories furnished: 11054A input cable assembly; 4 banana jacks mounted on terminal box with 3-ft cable and mating connector. Terminals include positive and negative input, circuit guard, and chassis ground. Positive and negative terminals are solid copper, gold flashed. A switch allows reduction of input resistance to 2 M Ω . 11055B output cable assembly; 6 banana jacks mounted on terminal box with 3-ft cable and mating connector. Terminals include positive and negative output, positive and negative sense, circuit guard, and chassis ground. Output and sense terminals are solid copper, gold flashed. Rack mount kit.

740B DC Standard / Δ DC voltmeter

\$3280

*Maximum of -500 V dc with respect to line ground can be applied to or obtained from the HP 740B.

†Positive or negative output terminals of the output box (HP 11055B) connected to chassis, and guard and chassis terminals of the input box (HP 11054A) connected together.

OSCILLATORS & FUNCTION GENERATORS

AC/DC meter calibrator
Model 6920B

- Calibrate/test DC ammeters up to 4 amps
- Calibrate/test average reading AC ammeters up to 5 amps
- Calibrate/test DC voltmeters up to 1000 volts
- Calibrate/test average reading AC voltmeters up to 1000 volts

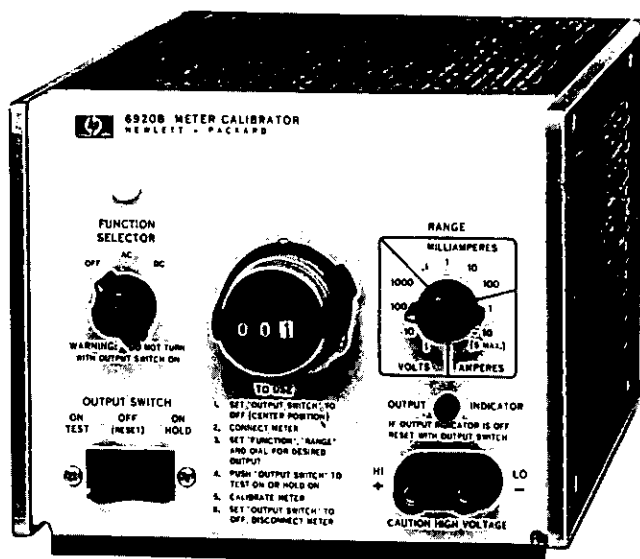

Description

Model 6920B is a versatile ac/dc meter calibrator, capable of both constant voltage and constant current output. Its absolute accuracy makes it suitable for laboratory or production testing of panel meters, multimeters, and other meters having accuracy of the order of 1.0% or higher. This calibrator has been designed for convenience, and combines in one instrument all the outputs needed to test the more commonly used meters.

Output switch

An output switch selects the safest mode of operation for the particular type of meter being tested. A "lock" position leaves the testing parameters in operation to free both hands for attaching and disconnecting successive meters. A spring-loaded "test" position facilitates testing meters with several full-scale values and reduces the danger of burn-out.

AC output waveshape

When the function switch is set on "AC", the output wave-shape is sinusoidal (to a first approximation) and has the same frequency as the input line power applied to the instrument (except when an external ac reference is used). The feedback loop, which controls and regulates this ac, is actually monitoring the average value of the ac output, although the front panel controls are calibrated in terms of rms. Thus, this calibrator is suitable for use with average reading ac voltmeters scaled in rms. In addition, the calibrator can be used with true rms meters, provided allowance is made for the total output distortions. This distortion is approximately equal to the line input waveshape distortion (or distortion of the external ac reference) plus 3%.

Specifications

Output voltage ranges

- 0.01-1 V: current capability 0 - 5 A
- 0.1-10 V: current capability 0 - 1 A
- 1-100 V: current capability 0 - 100 mA
- 10-1000 V: current capability 0 - 10 mA

Above output voltage ranges and maximum current capabilities for each range apply in full for either dc or ac operation.

Output current ranges

- (5 A maximum output)
 - 1-100 μ A: voltage capability 0-500 V (uncalibrated in AC)
 - 0.01-1 mA: voltage capability 0-500 V
 - 0.1-10 mA: voltage capability 0-500 V
 - 1-100 mA: voltage capability 0-50 V
 - 0.01-1 A: voltage capability 0-5 V
 - 0.1-10 A: (5 A max. output) voltage capability 0-0.5 V
- Above output current ranges and maximum voltage capabilities for each range apply in full for either dc, 50 Hz or 60 Hz operation.
- Output accuracy:** DC — 0.2% of set value plus 1 digit. AC — 0.4% of set value plus 1 digit (when used with average reading meters). Above accuracy applicable over a temperature range from 15°C to 35°C, over full input voltage range, and after 1 hour warmup.

Controls

Function switch: This is a 3-position switch: "off", "AC" and "DC". In the "off" position the ac power input is disconnected from the unit. In the "AC" position the meter calibrator produces an ac output; similarly, in the "DC" position the calibrator produces a dc output.

Range switch: 10 positions, one for each voltage and current range.

Calibrated output control: digital potentiometer readout control (3 significant digits) determines exact value of output.

Output switch: Switch described at left.

Output terminals: two front panel terminals are provided; these are the output terminals for both ac and dc operation. In voltage ranges, the negative terminal is grounded.

Ripple: in dc operation the output ripple is typically less than 1.0% rms/5% p-p of the output range switch setting.

Input: 115 V ac \pm 10%, single phase, 58-62 Hz, 0.7 A, 65 W max. (See options 005 and 028 for 50 Hz and 230 Vac operation).

Operating temperature range: 0-50°C.

Size: 172 mm H \times 198 mm W \times 279 mm D. (6 $\frac{1}{2}$ " H \times 7 $\frac{1}{16}$ " W \times 11" D).

Weight: 6.8 kg (15 lb) net. 7.71 kg (17 lb) shipping.

Accessories available

Accessories available	Price
5060-0797 Rack kit for mounting one or two 6920B's in a 19" rack	\$27.00
5060-0794 Filler panel to block unused half of rack adapter	\$7.50
11057A Clip-on carrying handle	\$5.00
1051A Combining case for two 6920B's that is both portable and easily rack mounted	\$150.00

Options

005: 50 Hz output regulation realignment	N/C
028: 230 V ac \pm 10%, single phase input	N/C
6920B Meter calibrator	\$855.00

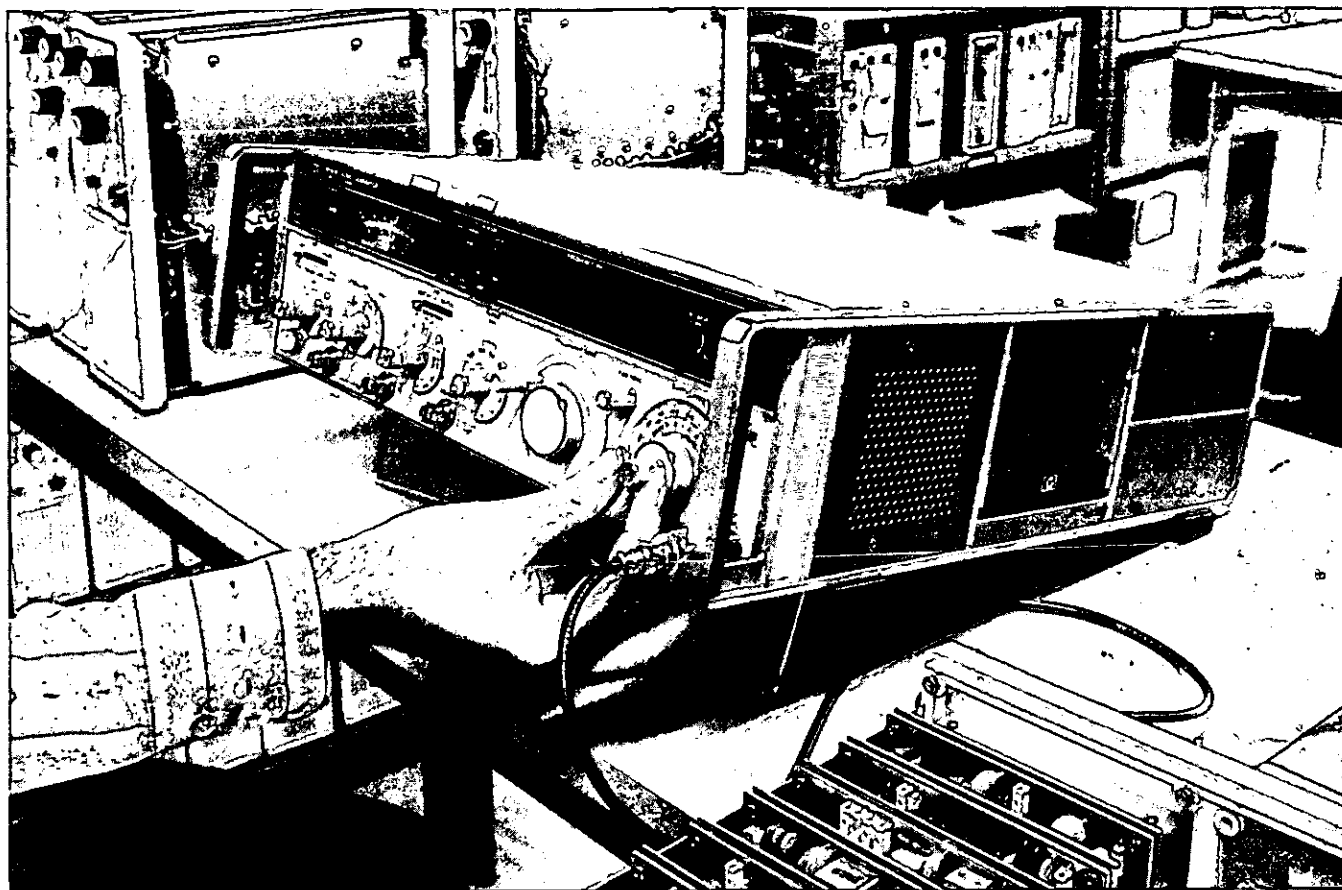

Signal generators

Hewlett-Packard offers a complete line of easy to use HF, VHF, UHF, and SHF signal generators covering frequencies between 10 kHz and 40 GHz. This line includes new solid-state generators and synthesized signal generators as well as a complete line of performance-proven vacuum tube signal generators. Each includes the following features:

- 1) accurate, easy-to-read frequencies, calibrated and variable.
- 2) accurately calibrated variable output level.
- 3) wide modulation capability.

Beside these basic features, HP signal generator characteristics ensure the utmost convenience and accuracy for all kinds of measurements and signal simulations, including receiver sensitivity, selectivity or rejection, signal-to-noise ratio, gain bandwidth characteristics, conversion gain, antenna gain, and transmission line characteristics, as well as power to drive bridges, slotted lines, filter networks, etc.

New solid-state generators

This new group of signal generators offers all the advantages of solid-state design, such as increased portability, ruggedness, and reliability, while still retaining the outstanding signal quality characteristic of Hewlett-Packard's older vacuum tube signal generators. In addition these generators offer many new features not found on the older generators such

as digital frequency readout (8640B, 8660B), ability to count external signals (8640B), field portability (8654A) and complete remote programming (8660A, 8660B).

HF to UHF

The newest member of the solid-state family is the 8640 signal generator covering 450 kHz to 550 MHz. Frequency coverage can be extended to 1100 MHz with an internal doubler, (OPT 002) and an optional built-in audio oscillator extends the CW output range down to 20 Hz (OPT 001). This new generator is available in two models: the 8640B featuring a built-in 550 MHz counter and the 8640A with a mechanical slide rule frequency dial.

The 8640B with built-in counter includes two significant new features not previously found on Hewlett-Packard signal generators: 1) the ability to count external signals at frequencies up to 550 MHz and 2) a front panel pushbutton to phase-lock the generator's RF output to the built-in counter time base for frequency stability of better than 5×10^{-8} /hour.

Internally, the heart of the 8640 is a mechanically tuned high-Q cavity oscillator that operates over the range of 230 to 550 MHz. This oscillator has very good inherent stability and exceptionally low noise characteristics. Nine lower frequency ranges are obtained by dividing down the basic oscillator frequency and filtering out the unwanted har-

monics.

The 8640's broad frequency coverage and calibrated output range, together with full AM/FM modulation capability and exceptionally low noise, make it the ideal choice for complete RF and IF performance tests on virtually any type of HF, VHF, or UHF receiver.

Compact, field portable

Compact, portable signal generators form another part of the solid-state family. The 8654A covering 10 to 520 MHz features calibrated output level with a full range attenuator and both AM and FM modulation capability. Small size and light weight make it well suited for field maintenance and operational readiness checks in addition to general purpose signal generator applications.

The 8601A covering 100 kHz to 110 MHz is a unique instrument with full sweep capability in addition to AM/FM modulation and a wide range output attenuator. Hewlett-Packard microcircuit technology is used extensively in the 8601A to provide this broad range of performance in a very small package.

Synthesized signal generators

The 8660A/B Synthesized Signal Generator is a plug-in family instrument combining synthesizer stability and accuracy with the precise modulation and output level calibration of a high quality signal generator.

Two TTL programmable mainframes are available, the 8660A and the 8660B. The 8660B mainframe is the most versatile of the two offering a keyboard control panel, synthesized digital sweep, and frequency step capability. Two RF sections provide frequency coverage of 10 kHz to 110 MHz and 1 MHz to 1300 MHz. Modulation section plug-ins include calibrated AM and FM as well as external pulse modulation.

The synthesized signal generator is a natural choice for applications requiring maximum signal stability and very fine frequency resolution (1 Hz). With its full digital programming interface, the 8660 is also an ideal RF source for automatic systems.

Performance-proven vacuum tube signal generators

HF to UHF

The HP 606B, 608E, and 612A signal generators collectively cover frequencies from 50 kHz to 1.23 GHz. All feature extremely low drift and incidental frequency modulation, and may be amplitude (sine, square, pulse) modulated.

A feedback loop in the 606B and 608E keeps their output and percent modulation constant as frequency is varied. The 606B and 608E offer an auxiliary fixed-level CW signal which can be applied to a counter for very accurate indication of carrier frequency.

UHF to SHF

A complete line of Hewlett-Packard microwave signal generators provides coverage from 800 MHz to 21 GHz. The 618C, 620B, 626A, and 628A incorporate cavity tuned klystron oscillators with very low drift and residual FM. They may be pulse, square-wave and frequency modulated, making them useful for microwave receiver testing as well as SWR and transmission line measurements.

The HP 8614A and 8616A signal generators covering 0.8 to 2.4 GHz and 1.8 to 4.5 GHz feature built-in PIN diode modulators. These modulators allow internal or external output power leveling as well as a wide range of pulse and amplitude modulation.

HP 938A and 940A Frequency Doubler Sets provide low-cost signal generator capability in the 18 to 40 GHz range by doubling the frequency of signal sources in the 9 to 20 GHz range.

Special signal generators

Hewlett-Packard's FM signal generators offer unusual modulation linearity and stability. The 202H FM-AM Signal Generator operates in the 54 to 216 MHz range and is designed to serve the broadcast FM, VHF-TV, and mobile communications markets. An accessory 207H Univerter provides additional coverage when used with the 202H Signal Generator.

For Avionics navigation and communications applications, the 8640B option 004 combines the digital readout, phase lock fea-

tures with a demodulated output and special AM circuitry. Combined with suitable external modulation sources the 8640B provides for testing and calibration of aircraft VOR/ILS and Marker Beacon receivers.

The 8925A DME/ATC Test Set is designed to provide for the testing and calibration of aircraft DME radios and ATC transponders; suitable external modulators are required, such as the Collins 578D-1 and 578A-1, to simulate ground station operation.

Signal generator accessories

A variety of available accessories enhance the operation of Hewlett-Packard signal generators. The HP 10511A Spectrum Generator and HP 10515A and 11690A Frequency Doublers extend the usable frequency range of signal sources/generators up to 1 GHz. The HP 11507A Output Termination provides three useful positions for matching 50Ω signal generators to other than 50Ω impedances and the HP 11687A allows 50Ω generators to be used for measurement in 75Ω systems. The HP 11509A Fuseholder protects generator output attenuators against accidental burnout during transceiver testing. HP 10514A and 10534A Balanced Mixers offer varied mixing as well as AM, pulse, and squarewave modulation applications.

The HP 8730 series of PIN modulators increases the modulation capability of microwave signal sources and at the same time virtually eliminates incidental FM. The HP 8403A Modulator provides complete control of the 8730 series of PIN modulators.

Signal generator summary

Model	Frequency range	Characteristics	Page
8660A/B Synthesized Generator	0.01 to 110 MHz 1 to 1300 MHz	1 Hz frequency resolution, 3×10^{-8} /day stability. Calibrated output from +13 to -146 dBm. Completely TTL programmable. Plug-ins determine frequency range and AM/FM capability	348
606B Signal Generator	50 kHz to 65 MHz	output 3 V to 0.1 μ V, mod. BW dc to 20 kHz, low drift and noise, low incidental FM, low distortion, auxiliary RF output	354
8640A/B Signal Generator	0.5-1024 MHz	output +19 to -145 dBm into 50Ω; AM, FM, and ext. pulse modulation, direct calibration, leveled output. 8640B has built-in counter and phase-lock capability. All solid state	343
608E Signal Generator	10 to 480 MHz	output 1 V to 0.1 μ V, into 50-ohm load; AM, pulse modulation, direct calibration, leveled power output, aux RF output	355
3200B Oscillator	10-1000 MHz	1 V to 1 μ V output into 50Ω, 120 dB attenuator range 0.002% stability, compact, portable; weight, 15 lb. Doubler extends frequency to 1000 MHz	352
8654A Signal Generator	10-520 MHz	output 0 to -120 dBm into 50Ω, direct calibration, leveled output, amplitude and frequency modulation, solid-state, compact, weight 16 lb	353
202H FM/AM Signal Generator	54 to 216 MHz	0.2 V to 0.1 μ V output into 50Ω, AM, FM used to test and calibrate FM receivers	360
207H Univerter	100 kHz to 55 MHz	extends frequency range and capabilities of 202H	360
8925A DME/ATC Test Set	962 to 1213 MHz	output up to -10 dBm. Provides Pulse Avionics Signals when used with external modulators for DME/ATC/TACAN tests	360
612A Signal Generator	450 to 1230 MHz	output 0.5 V to 0.1 μ V into 50-ohm load; pulse or square-wave modulation, direct calibration	356
8614A, 8616A Signal Generator	0.8 to 2.4 GHz 1.8 to 4.5 GHz	output +10 (8616: +3 dBm above 3 GHz) to -127 dBm into 50 ohms, leveled below 0 dBm; internal square-wave; external pulse, AM and FM; auxiliary RF output	357
618C, 620B Signal Generators	3.8 to 7.6 GHz 7 to 11 GHz	output 1 mW to -127 dBm (0.1 μ V) into 50 ohms, pulse, frequency or square-wave modulation, direct calibration, ext FM and pulse modulation, auxiliary RF output	358
626A, 628A Signal Generators	10 to 15.5 GHz 15 to 21 GHz	output +10 dBm to -90 dBm; pulse, frequency or square-wave modulation, direct calibration	359
938A, 940A Frequency Doublers	18 to 26.5 GHz 26.5 to 40 GHz	driven by 9 to 13.25 GHz source, 13.25 to 20 GHz source, HP 626A, 628A, 8690 series sweepers or klystrons; 100 dB precision attenuator	359

SIGNAL GENERATORS

Precision, high stability, AM-FM, 0.5 to 1024 MHz

Models 8640A, 8640B

- Wide frequency and power range
- Low broadband and close-in noise
- Calibrated, metered AM and FM

- All 8640A features plus
- Internal pushbutton synchronizer
- External counter to 550 MHz

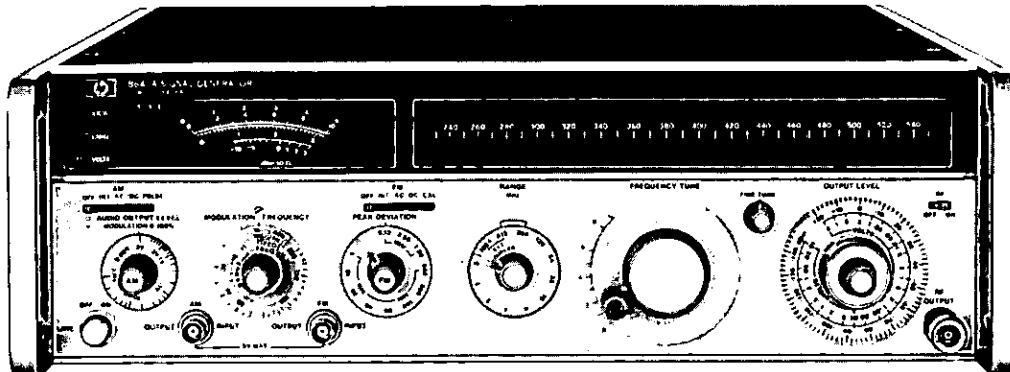

8640A

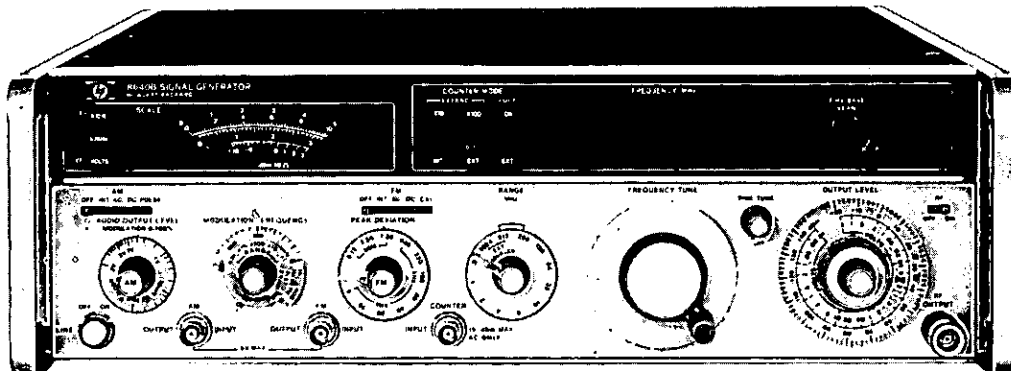

8640B

Description

The 8640 signal generator covers the frequency range 500 kHz to 512 MHz (450 kHz to 550 MHz with band overrange) and can be extended to 1100 MHz with an internal doubler (option 002). An optional audio oscillator is also available to extend the CW output range of the generator down to 20 Hz. This broad coverage, together with calibrated output and modulation, provides for complete RF and IF performance tests on virtually any type of HF, VHF, and UHF receivers.

Both solid state generators 8640A and B have an output level range of +19 to -145 dBm (2 V to 0.013 μ V) which is calibrated, metered, and leveled to within ± 0.5 dB across the full frequency range of the instrument.

The 8640A/B generators provide AM, FM, and pulse modulation for a wide range of receiver test applications. This modulation is calibrated and metered for direct readout under all operating conditions.

Other significant features of the 8640A/B signal generators include: extremely low noise, built-in phase lock and counter (B version only) and front panel controls designed for operating convenience and flexibility.

Spectrally pure output signals

Noise performance of the 8640 is state-of-the-art for a solid-state generator. The high-Q cavity oscillator has been optimized with use of a low-noise microwave transistor for spectrally pure output signals.

At 20 kHz offsets from 230 to 450 MHz, SSB phase noise is > 130 dB/Hz below the carrier level and rises to 122 dB/Hz at 550 MHz. This signal-to-noise ratio increases by approximately 6 dB for each division of the output frequency down to the broadband noise floor of better than 140 dB/Hz. This exceptional noise performance is also preserved during FM modulation and in the phase-locked mode of the 8640B.

Mechanical dial or built-in counter

There are two versions of the 8640 Signal Generators. One, the 8640A, has an easy-to-read slide rule dial with scales for each of the 10 output frequency ranges. There is an additional scale, to provide direct readout of the output frequency even in the INTERNAL DOUBLER band, 512-1024 MHz.

The 8640B has the same performance features as the 8640A, but incorporates a built-in 550 MHz frequency counter and phase lock synchronizer.

The built-in 6-digit counter displays the output frequency and can also be used to count external input signals from 20 Hz to 550 MHz. This eliminates the need for a separate frequency counter in many measurement systems.

Internal pushbutton synchronizer

At the push of a button, the 8640B built-in phase lock synchronizer locks the RF output frequency to the crystal time base used in the counter. In this locked mode, the output stability is better than 5×10^{-8} /hr and the spectral purity and FM capability of the unlocked mode are preserved. For higher stability, it is possible to lock to an externally applied 5 MHz standard. Two 8640B's can also be locked together for various 2-tone measurements.

FM while phase locked

When phase locked, full FM capability is preserved down to modulation rates of 50 Hz. The narrow bandwidth of the phase lock loop (< 5 Hz) provides for FM modulation up to 250 kHz rates and assures no degradation in noise from the unlocked mode. This crystal stability, coupled with the precision modulation and low noise, makes the 8640B ideal for testing narrowband FM or crystal-controlled receivers.

8640A/B Specifications

(See Technical Data Sheet for Complete Specifications) All specifications apply over the nominal Frequency Bands and over the top 10 dB of the output level vernier range unless otherwise specified.

Frequency characteristics

Range: 500 kHz to 512 MHz in 10 octave bands (to 1024 MHz with option 002 internal frequency doubler).

Bands and band overlap: bands extend 10% below and 7% above the nominal frequency bands shown below.

Frequency bands (MHz)		
0.5 - 1	8 - 16	128 - 256
1 - 2	16 - 32	256 - 512
2 - 4	32 - 64	512 - 1024
4 - 8	64 - 128	(opt 002)

Fine tuning:

8640A and 8640B unlocked: >200 ppm total range.

8640B locked mode: >±20 ppm by varying internal time base vernier.

Counter resolution (8640B):

Frequency Bands (MHz)	Normal Mode	Expand X10	Expand X100
0.5 - 1	10 Hz	1 Hz	0.1 Hz
1 - 16	100 Hz	10 Hz	1 Hz
16 - 128	1 kHz	100 Hz	10 Hz
128 - 1024	10 kHz	1 kHz	100 Hz

Accuracy:

8640A, mechanical dial; accuracy better than 0.5%, resettability better than 0.1%.

8640B, 6-digit LED display with X10 and X100 expand; accuracy depends on internal or external reference used.

$$\left[\begin{array}{c} \text{Total} \\ \text{Count} \\ \text{Accuracy} \end{array} \right] = \left[\begin{array}{c} \text{Counter} \\ \text{Resolution} \\ (\pm 1 \text{ count}) \end{array} \right] + \left[\begin{array}{c} \text{Reference} \\ \text{Error} \\ (\text{INT or EXT}) \end{array} \right]$$

Internal reference error (15°C to 35°C): <±2 ppm when calibrated at 25° every 3 months and operated between 15°C and 35°C.

Stability (after 2-hr warm-up):

Normal: <10 ppm/10 min.

Locked: (8640B) <0.05 ppm/hr.

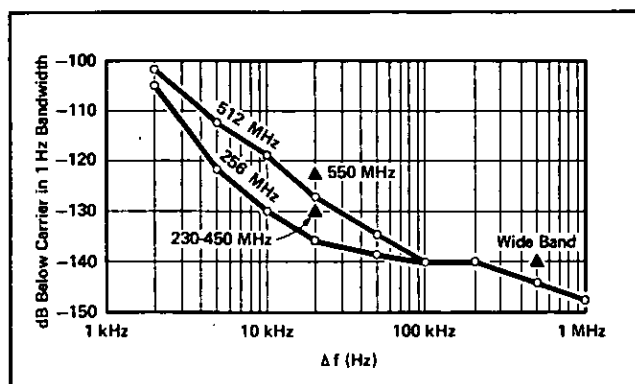

Measured SSB Noise vs. Offset from Carrier. Markers indicate specified limits.

Restabilization time after frequency change:

Normal: <15 min.

Locked (8640B): 1 min after relocking to be within 0.1 ppm of steady state frequency.

Output characteristics

Range: continuously selectable from +19 to -145 dBm (2 V to 0.013 μV) into 50Ω.

Level accuracy: (worst case as indicated on level meter) +19 to -7 dBm, ±1.5 dB; -7 to -47 dBm, ±2.0 dB; -47 to -137 dBm, ±2.5 dB; -137 to -145 dBm, ±3.0 dB.

Level flatness: <±0.5 dB from 0.5 to 512 MHz referred to output at 50 MHz. (Flatness applies to +13 dBm to -7 dBm output range and for top 10 dB of vernier range.)

Impedance: 50Ω, VSWR <2.0 on 2 V and 1 V output ranges. VSWR <1.3 on all other ranges.

Auxiliary output: rear panel BNC output is >-5 dBm into 50Ω, source impedance is approximately 500Ω.

Leakage (with all unused outputs terminated properly): leakage limits are below those specified in MIL-I-6181D. Furthermore, less than 3 μV is induced in a 2-turn, 1-inch diameter loop 1 inch away from any surface and measured into a 50Ω receiver, and less than 1 μV, 2 inches away. This permits receiver sensitivity measurements to at least <0.03 μV in a shielded system.

Spectral purity

Harmonics: (at 1 volt (+13 dBm) output range and below) >35 dB below fundamental of 0.5 to 128 MHz. >30 dB below fundamental of 128 to 512 MHz.

Subharmonics and nonharmonic spurious: (excluding line-related sidebands)

8640A: none detectable.

8640B: >100 dB below carrier.

Noise: averaged RMS noise level below carrier stated in a 1 Hz bandwidth. SSB phase noise at 20 kHz offset from carrier.

256 MHz to 512 MHz: >130 dB down from 230 to 450 MHz increasing linearly to >122 dB down at 550 MHz.

0.5 MHz to 256 MHz: decreases 6 dB for each divided frequency range until it reaches SSB broadband noise floor of >140 dB down.

Residuals	Post-detection Bandwidth	
	300 Hz to 3 kHz	20 Hz to 15 kHz
Residual AM:	>85 dB down	>78 dB down
Residual FM:		
CW and up to ¼ ΔF	<5 Hz	<15 Hz
max. peak dev. (ΔF)	<15 Hz	<30 Hz

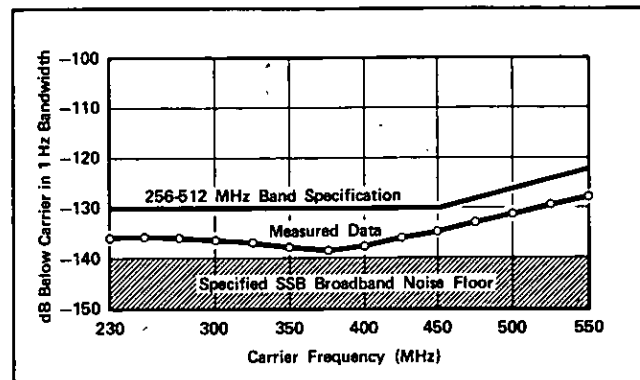

Specified Signal to Phase Noise Ratio at 20 KHz Offset vs. Carrier Frequency.

Modulation characteristics

General

Types: Int AM and FM, Ext AM, FM and PULSE.

Internal modulation sources: (independently adjustable output is available at front panel).

Standard: 8640A or 8640B.

Frequency: fixed 400 Hz and 1 kHz, $\pm 2\%$.

Output level: 10 mV to 1 V. Accuracy $\pm 20\%$.

Optional: (internal variable audio oscillator Option 001, 8640A or 8640B).

Frequency: variable 20 Hz to 600 kHz, $\pm 10\%$ plus fixed 400 Hz and 1 kHz $\pm 3\%$.

Output level: 10 mV to 3 V. Accuracy $\pm 20\%$.

Amplitude modulation

(AM specifications apply to the top 10 dB of output vernier range unless otherwise specified.)

Depth: 0 to 100% for output level range of +13 dBm and below and for top 10 dB of vernier range.

AM rates: INT and EXT ac; 20 Hz to AM 3 dB bandwidth below. EXT dc; dc to AM 3 dB bandwidth below.

AM 3 dB bandwidth:

Freq. Bands	0 to 50% AM	50 to 90% AM
0.5 - 2 MHz	25 kHz	12.5 kHz
2 - 8 MHz	40 kHz	25 kHz
8 - 512 MHz	60 kHz	50 kHz

AM distortion: (at 400 Hz and 1 kHz rates).

Freq. Bands	0 to 50% AM	50 to 90% AM
0.5 - 512 MHz	<1%	<3%

External AM sensitivity: 0.1% $\pm 0.005\%$ AM per mV peak into 600 Ω with AM vernier at full cw position.

Indicated AM accuracy: (400 Hz and 1 kHz rates using internal meter) $\pm 8\%$ of meter reading on 0-10 scale, $\pm 9\%$ of meter reading on 0-3 scale (for greater than 10% of full scale).

Peak incidental PM: (at 30% AM)

Less than 0.15 radians, 0.5 to 128 MHz.

Less than 0.3 radians, 128 to 512 MHz.

Peak incidental FM: equals peak incidental PM \times modulation frequency.

Pulse modulation:

Frequency Bands (MHz)	0.5 - 1	1 - 2	2 - 4	4 - 8	8 - 32	32 - 512
Rise and Fall Times	<9 μ S	<4 μ S	<2 μ S	<1 μ S		
Pulse Repetition Rate	50 Hz to 50 kHz		50 Hz to 100 kHz	50 Hz to 250 kHz	50 Hz to 500 kHz	
Pulse Width Minimum ¹	10 μ S		5 μ S	2 μ S		
ON/OFF ratio at max vernier	>40 dB					
Peak Input Required	Nominally +0.5 V (5 V max) Sinewave or Pulse return to zero into 50 Ω schmitt trigger.					

¹For level accuracy within 1 dB of CW (<0.1% duty cycle).

Frequency modulation

Deviation: maximum allowable deviation equals 1% of lowest frequency in each nominal output frequency band.

Frequency Band (MHz)	Maximum Peak Deviation (kHz)
0.5 - 1	5
1 - 2	10
2 - 4	20
4 - 8	40
8 - 16	80
16 - 32	160
32 - 64	320
64 - 128	640
128 - 256	1280
256 - 512	2560
512 - 1024	5120

FM 3 dB bandwidth:

Internal and external ac; 20 Hz to 250 kHz.

External dc; dc to 250 kHz.

FM distortion: (at 400 Hz and 1 kHz rates)

<1% for deviations up to $\frac{1}{8}$ maximum allowable.

<3% for maximum allowable deviation.

External FM sensitivity: 1 volt peak yields maximum deviation indicated on PEAK DEVIATION switch with FM vernier at full CW position.

Indicated FM accuracy: (using internal meter) $\pm 10\%$ of meter reading, above 10% of full scale.

Incidental AM: (at 400 Hz and 1 kHz rates)

<0.5% AM for FM up to $\frac{1}{8}$ max. allowable deviation.

<1% AM for FM at maximum allowable deviation.

Counter characteristics (8640B)

External RF input:

Frequency range: 20 Hz to 550 MHz.

Sensitivity: ≥ 100 mV rms into 50 Ω .

Resolution: 6-digit LED DISPLAY.

Mode	Normal	Expand X10	Expand X100
0 - 10 MHz	100 Hz	10 Hz	1 Hz
0 - 550 MHz	10 kHz	1 kHz	100 Hz

Internal reference characteristics: (after 2-hr warmup).

Accuracy: (after calibration at 25°C)

Better than ± 1 ppm for 15° to 35°C.

Better than ± 3 ppm for 0° to 55°C.

Drift rate: (constant temperature and line voltage) <0.05 ppm per hour; <2 ppm per year.

Frequency tuning:

> ± 20 ppm using internal time base vernier.

Rear output: >0.5 V p-p into 500 Ω . This will drive another 8640B.

External reference input: 5 MHz, nominally >0.5 V (5 V max) into 1 k Ω .

General characteristics

Operating temperature range: 0 to 55°C.

Power requirements: 100, 120, 220, and 240 volts, +5%, -10%, 48 to 440 Hz; 175 VA maximum.

Weight: 8640A and 8640B: net, 20.4 kg (45 lb); shipping 24.1 kg (53 lb).

Dimensions: 134 mm high \times 425 mm wide \times 476 mm deep (5 $\frac{1}{4}$ " \times 16 $\frac{3}{4}$ " \times 18 $\frac{3}{4}$ ").

Model number and name

8640A Signal Generator

Price

\$4200

8640B Signal Generator

\$5700

Option 001: (internal variable audio oscillator, 20 Hz to

600 kHz) 8640A or 8640B

add \$200

Option 002: (internal doubler 512-1024 MHz)

add \$750

Option 004: (Avionics option)

add \$515

SIGNAL GENERATORS

Internal doubler option, 512 to 1024 MHz

8640A/B option 002

NEW

- 8640A/B Option 002 Internal Doubler

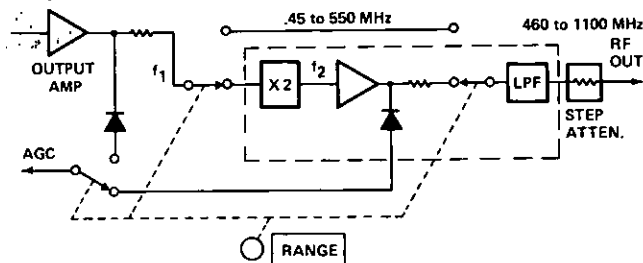

Figure 1. Internal Doubler Block Diagram

Option 002 of the 8640A and 8640B signal generators is an internal passive doubler which extends the generator frequency range another octave, from 512-1024 MHz. Thus, when an 8640A or 8640B is fitted with this doubler, it covers the frequency range from 0.5 to 1024 MHz (0.45-1100 MHz with overrange). Figure 1 shows a simplified doubler block diagram. The doubler is available in an accessory kit so it can be retrofitted into standard 8640A or B. (See HP11698A, Page 363).

The output level range of the Option 002 is +13 dBm to -145 dBm (1 volt to 0.013 μ V) and is leveled within ± 1.5 dB. In the doubled band, AM and FM can be performed independently or simultaneously in either the internal or external mode. Pulse on/off ratio increases to >60 dB. The FM peak deviation is calibrated and metered for direct readout up to 5.12 MHz. The AM percent is metered, its accuracy is not specified, however, a procedure is available to calibrate each generator individually.

The 8640A has a dial scale for the 512-1024 MHz internal doubler band to indicate the correct doubled output frequency. The 8640B also anticipates the use of an internal doubler by displaying the correct doubled output frequency when the 512 to 1024 MHz range is selected.

Option 002 Specifications

Internal doubler

The internal doubler can be ordered factory-installed as 8640A/B Option 002 or as an accessory kit HP Model 11698A. When an internal doubler is installed in the 8640A/B, some output level characteristics change. These changes are noted with a star (*). All other specifications remain unchanged. All specifications apply over the nominal frequency level and over the top 10 dB of the output level vernier range unless otherwise specified.

Frequency characteristics

Range: 512-1024 MHz (460 to 1100 MHz with overlap)

Fine tuning: same as 8640 A/B

Stability: same as 8640A/B, except

	Normal	Locked (8640B)
Mode Change (CW to FM)	<1% of selected peak deviation, or 400 Hz whichever is greater.	None measurable

Restabilization time: same as 8640A/B.

Spectral purity

Harmonics: (at 1 volt, +13 dBm output range and below) >12 dB below fundamental, 512-1024 MHz.

Subharmonics and nonharmonics: (excluding frequencies within 15 kHz of the signal whose effects are specified in residual AM and FM).

Subharmonic related¹: >20 dB below carrier (8640A and 8640B)

Nonharmonic spurious: none detectable (8640A); >100 dB down (8640B).

Noise: Averaged RMS noise level below carrier stated in a 1 Hz bandwidth.

SSB phase noise at 20 kHz offset from carrier: >124 dB down from 460 to 900 MHz increasing linearly to >116 dB at 1100 MHz.

SSB broadband noise floor at maximum vernier greater than 500 kHz offset from carrier: >137 dB down.

Residual AM: same as 8640A/B.

Residual FM: (Averaged RMS) twice the value of the 8640A/B in the 230-550 MHz range.

Output level characteristics

Range: 10 dB steps and 18 dB vernier provide output power settings from +13 dBm to -145 dBm (1 V to 0.013 μ V) into 50 Ω .

Level flatness: referred to output at 50 MHz and applies to 1 V range and below. < ± 0.5 dB, 0.5-64 MHz; * < ± 1 dB, 64-512 MHz; < ± 1.5 dB, 512-1024 MHz

Impedance: 50 Ω , ac coupled, 40 V dc maximum, VSWR (see table)

Frequency Range	Output Level Range	Signal Frequency VSWR ²	Broadband VSWR ³
0.5 - 512	2 V & 1 V 0.3 V & below	2 1.3	*2.5 ⁴ 1.3 ⁴
512 - 1024	1 V 0.3 V & below	2 1.5	2.5 ⁵ 1.5 ⁵

Auxiliary output: same as 8640A/B (not doubled)

Leakage: same as 8640A/B

Level accuracy:

Total accuracy as indicated on level meter: 0.5-64 MHz: +19 to -7 dBm, ± 1.5 dB; -7 to -47 dBm, ± 2 dB; -47 to -137 dBm, ± 2.5 dB. *64-512 MHz: +19 to -7 dBm, ± 2 dB; -7 to -47 dBm, ± 2.5 dB; -47 to -137 dBm, ± 3 dB. 512-1024 MHz: +13 to -7 dBm, ± 2.5 dB; -7 to -47 dBm, ± 3 dB; -47 to -127 dBm, ± 3.5 dB.

Modulation characteristics

General: same as 8640A/B

Amplitude modulation

Depth: 0 to 100% for output levels of +13 dBm⁶ and below and for top 16 dB of vernier range.

AM rates: INT and EXT ac; 20 Hz to AM 3-dB bandwidth, EXT dc; dc to AM 3-dB bandwidth.

AM 3 dB bandwidth: 60 kHz, 0-50%; 30 kHz, 50-90%.

AM distortion: (at 400 Hz and 1 kHz rates) <5%, 0-30%; <10%, 30-90%

External AM sensitivity: (400 Hz and 1 kHz rates)

Nominal 0.1% AM per mV peak into 600 Ω with AM vernier at full cw position.

Indicated AM accuracy: Not specified, each generator can be individually calibrated.

Peak incidental PM (at 30% AM): <0.6 radians

Pulse modulation: same as 8640A/B in the 32-512 MHz band except on/off ratio at max vernier: >60 dB

Frequency modulation: same as 8640A/B

Deviation: 5.12 MHz maximum allowable deviation

Incidental AM: (at 400 Hz and 1 kHz rates)

<1% AM for FM up to $\frac{1}{2}$ maximum allowable deviation.

<7% AM for FM up to maximum allowable deviation.

Model number and name

Option 002 Internal Doubler

11698A Internal Doubler Retrofit Kit

Price

add \$750

\$750

⁶This specification applies below 512 MHz when Internal Doubler is installed.

¹ in the doubler range, subharmonically related signals are 1/2F (i.e. oscillator fundamental), 3/2F, 5/2F, etc.

² also known as in-band VSWR

³ also known as out of band VSWR

⁴ applies only for frequencies within 0.5-512 MHz

⁵ applies only for frequencies within 512-1024 MHz

⁶ the peak envelope power (carrier output plus AM depth) may not exceed the maximum cw output level of any output level range.

- Demodulated output from RF detector, AC and DC.
- Phase shift; less than 0.01° at 30 Hz.
- External Count Capability: 1 Hz to 550 MHz.

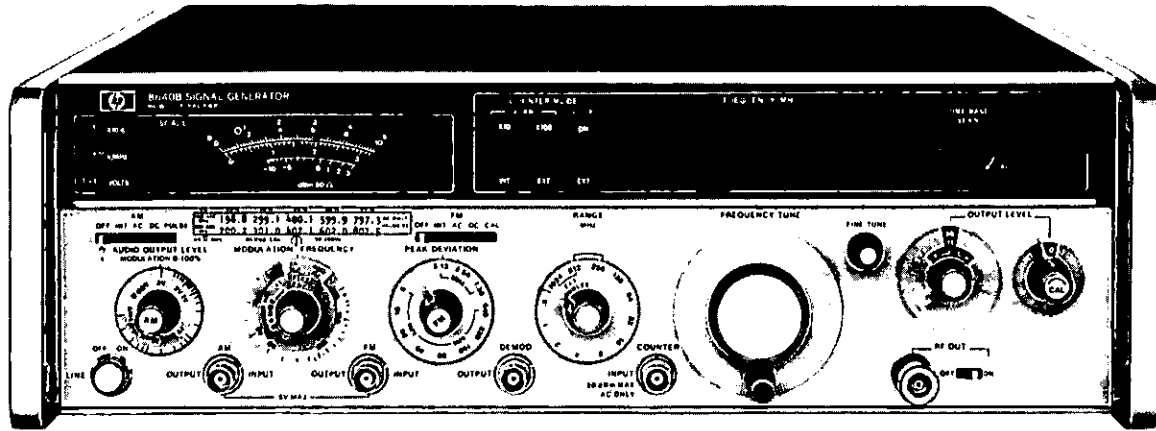

The Hewlett-Packard Model 8640B OPTION 004 NAV/COM SIGNAL GENERATOR is an 8640B AM/FM SIGNAL GENERATOR specially adapted for testing ILS (Marker Beacon, Localizer and Glide Slope), VOR and VHF communications receivers used throughout the Aviation industry. VOR, LOCALIZER and VHF communications frequencies (108 to 136 MHz) are available on one frequency band for rapid channel selection. GLIDE SLOPE (329 to 335 MHz) and MARKER BEACON (75 MHz) frequencies are also easily set using the 6-digit LED display.

The 8640B OPTION 004 provides highly stable, spectrally pure RF signals for testing narrow-channel, crystal controlled receivers. For avionics testing, external audio generators are required to provide the composite modulation. Designed with versatile AM and FM modulation, OPTION 004 features low distortion modulation when used with suitable, external VOR/ILS Audio Generators.

Operation and specifications of the 8640B Option 004 are the same as the Standard 8640B AM/FM Signal Generator with the following additions.

Demodulated output

One front panel BNC connector provides demodulated output from the RF peak detector for precise AM settings. A choice of combined AC/DC at 1 V rms or AC only at 5 V rms is provided.

Output level setting

To ensure the best possible demodulated output linearity, Option 004 combines a 1 dB step attenuator and a vernier with a 10 dB step attenuator. This provides output levels from +15 dBm to -142 dBm (1.3 V to 0.018 μ V). The output level can be read directly from the attenuator dial in dBm or from the front panel meter in dBm or volts.

External AM Input Impedance

External AM input impedance of 2K ohms allows compatible operation with old and new generations of external audio generators.

Low distortion modulation

The 8640B Option 004 provides flat AM response and minimum phase shift at 30 Hz and 9960 Hz as well as constant group delay between 9 kHz and 11 kHz for accurate VOR and ILS testing.

Specifications

(These specifications apply to 8640B Option 004 in addition to standard 8640B specifications. See 8640B AM/FM Signal Generator Data Sheet for complete specifications.)

Spectral purity

Noise: SSB Broadband Noise Floor: greater than 500 kHz off/set from carrier, >130 dB down.

Output characteristics

Range: +15 dBm to -142 dBm (1.3 V to 0.018 μ V)

Attenuators: a 10 dB step attenuator, a 1 dB step attenuator with vernier allow selection of any output level over the full output level range.

Vernier: 2 dB continuously variable from a CAL detent position.

Level flatness: <±0.75 dB from 0.5 to 512 MHz referred to output at 190 MHz. <±0.5 dB from 108 to 336 MHz referred to output at 190 MHz. (Flatness applies to +10 to -10 dBm.)

Level accuracy:

Output Level (dBm)	+15 to -10	-10 to -50	-50 to -142
Total Accuracy as Indicated on Level Meter	±1.5 dB	±2.0 dB	±2.5 dB

Modulation characteristics

Demodulated output (Output vernier in CAL position) (108 to 118 and 329 to 336 MHz): An internal selector switch allows selection of AC only or AC and DC at the demodulated output.

AC only output: Directly proportional to AM depth, (90 to 150 Hz modulation frequency).

%AM equals: (20 ± 0.6)% per V rms, 0 to 55°C; (20 ± 0.4)% per V rms, 20 to 30°C; (20 ± 0.2)% per V rms (using calibration sheet provided by factory.)

AC and DC output: AC output voltage is directly proportional to AM depth (90 to 150 Hz modulation frequency)

%AM equals: (100 ± 3)% per V rms, 0 to 55°C; (100 ± 2)% per V rms, 20 to 30°C; (100 ± 1)% per V rms (using calibration sheet provided by factory.)

DC output equals 1.41 V dc with vernier in CAL position.

Amplitude Modulation Characteristics (+10 dBm output and below):

External input impedance: nominally 2k Ω .

Frequency response: ±0.05 dB from 90 Hz through 150 Hz (108 to 118 and 329 to 335 MHz.); ±0.05 dB from 9 kHz through 11 kHz (108 to 118 MHz); ±3 dB (0 to 70% AM) from dc through 50 kHz (8 to 512 MHz); ±3 dB (0 to 90% AM) from dc through 35 kHz (8 to 512 MHz)

Phase shift from Audio Input to Demodulated Output (108 to 118 MHz) (AM EXT DC mode):

30 Hz <±0.01°

30 Hz to 10 kHz <±3°

9 kHz to 11 kHz <±1° difference.

Model number and name
8640B Avionics Option 004

Price
\$6215



SIGNAL GENERATORS

Synthesized signal generators

Model 8660A & 8660B

- 10 kHz to 1300 MHz
- Synthesizer Stability and Accuracy
- 1 Hz resolution
- Calibrated output over 150 dB range
- AM, FM or Pulse modulation
- Fully TTL programmable

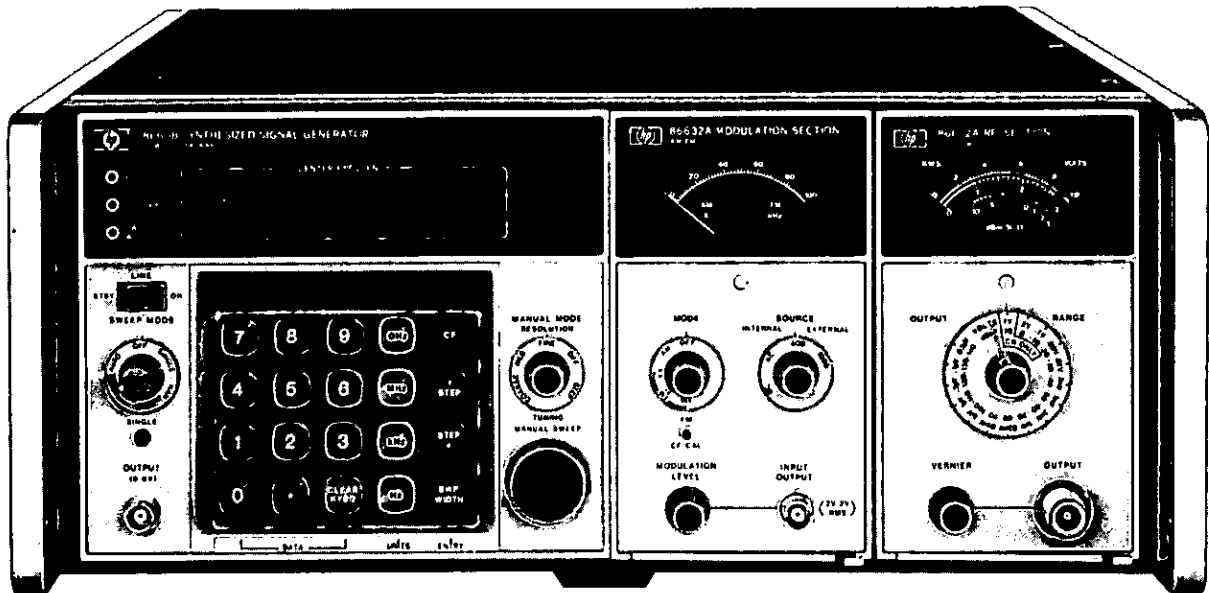

System concept

The 8660A/B family is a modular solid-state plug-in system. Each system includes: 1) a programmable synthesized signal generator mainframe, 2) at least one RF section plug-in, and 3) at least one modulation section or the 86631B Auxiliary Section plug-in.

This modular plug-in construction allows an 8660 system to be configured for any specific application while minimizing the extra money spent on unnecessary features. And as new needs arise, additional RF or modulation plug-ins can easily be added.

As its name implies, the 8660 is a true frequency synthesizer. Yet it is finding even broader appeal as a high performance AM/FM signal generator. And being completely programmable, the 8660 is the perfect choice for most automated receiver or component testing situations.

Mainframes

There are two different synthesized signal generator mainframes to choose from, the 8660A and the 8660B. Both feature complete TTL programming of frequency, output level, and modulation and can be operated from an internal 10 MHz crystal reference oscillator or from any external 5 MHz or 10 MHz frequency standard. The standard programming interface is BCD, but an optional interface (referred to as the HP Interface Bus, and utilizing ASCII code) is offered, allowing direct connection to HP calculator based systems.

The 8660A mainframe uses front panel thumbwheel switches to select CW output frequencies with 1 Hz resolution. An economical version of the mainframe with 100 Hz resolution is also available. An internal 10 MHz crystal oscillator with 3×10^{-8} /day stability is included in the basic mainframe with an optional higher stability crystal oscillator (3×10^{-9} /day) available.

The 8660B keyboard mainframe includes all the capability of the 8660A plus a keyboard control panel. Added capabilities of the 8660B include digital sweep, frequency stepping, synthesized search, and a ten-digit numerical LED display.

Swept testing of very narrowband devices such as crystal filters is made possible by the 8660B's digital sweeping capability. The selected sweep width is divided into either 100 or 1000 discrete steps depending on the sweep speed selected. Since the RF output is synthesized at each step, the result is a very linear sweep with extremely low residual FM. A 0-8 V horizontal sweep output is provided for driving XY plotters, oscilloscopes, etc.

For receiver testing and similar applications which require frequency to be changed in uniform increments, a frequency stepping ca-

pability is provided on the 8660B. For example, if a receiver with 50 kHz channel spacing is being tested, 50 kHz can be entered on the keyboard. Then the step \uparrow or step \downarrow buttons will step the frequency to the next higher channel or lower channel respectively.

A unique synthesized search provides the dial tuning convenience of a signal generator while maintaining synthesizer signal quality. As the dial is rotated the output frequency is tuned up or down in discrete synthesized steps which may be chosen as small as 1 Hz. When the 8660B is used as a local oscillator in a manual communication receiver, the synthesized search dial is very helpful in quickly locating unknown signals while maintaining the full-spectral purity of the synthesizer.

The ten-digit LED readout provides a continuous numerical display of the selected CW or center frequency, with spring-loaded push-buttons to display sweep width, frequency step size, or a partially entered new command.

Plug-in RF sections

Two RF sections are presently available for 8660 mainframes. The 86601A covers the 10 kHz to 110 MHz frequency range with a calibrated output of +13 dBm to -146 dBm. The 86602A, used in conjunction with the 11661A Frequency Extension Module, covers 1 MHz to 1300 MHz with a calibrated output of +10 to -146 dBm. Both RF sections have 1 Hz frequency resolution and in the remote mode output level can be programmed in 1 dB steps over the full operating range.

Plug-in modulation sections

Two AM/FM modulation sections are available, the 86632A and 86633A. Both provide AM to 95% at rates up to 100 kHz and a choice of internal or external modulation. An accurate modulation meter indicates % AM or FM peak deviation in both internal and external modes.

The 86633A differs from the 86632A in that it features a phase locked carrier while FM modulating at rates and deviations up to 100 kHz. The 86632A utilizes a free running VCO during FM, but allows rates and deviations up to 1 MHz. All modulation capabilities of both plug-ins are fully programmable through the 8660 mainframe.

The 86631B Auxiliary Section is an economical, non-programmable modulation plug-in which provides both external AM and pulse modulation capability. Providing necessary inter-connections for mainframe operation, the 86631B Auxiliary Section must be used when another modulation plug-in is not installed.

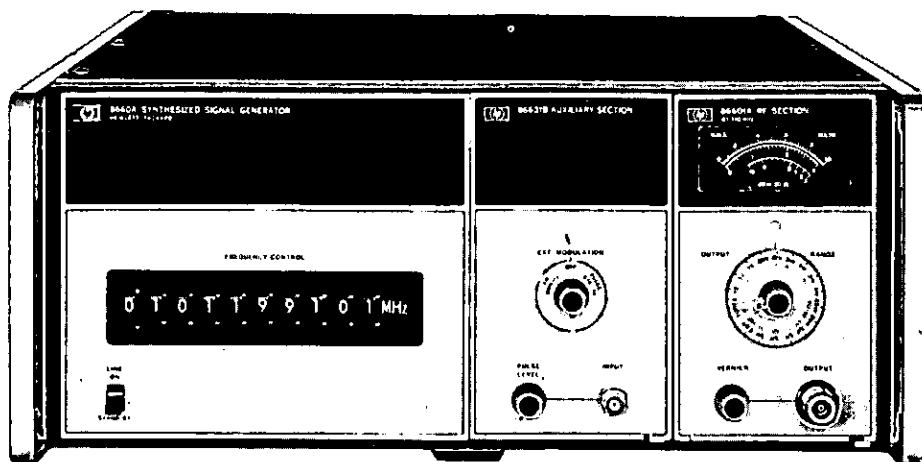

New additions to the 8660 line

- Frequency range extended to 2600 MHz
- Phase modulation capability added

8660C Mainframe: Similar to the 8660B keyboard mainframe but will accept all RF sections up to 2600 MHz.

86603A RF section (1-2600 MHz): Provides frequency coverage from 1 to 2600 MHz with leveled output from +10 dBm to -146 dBm. Compatible with 8660C mainframe. Optional version available for 8660A/B mainframes.

86603A Option 002 (phase modulation): Adds phase modulation capability to 86603A RF Section. For use with 86634A or 86635A modulation sections.

86634A Phase modulation section: For use with 86603A Option 002 RF Section. Provides analog phase modulation at DC to 10 MHz rates. Maximum peak deviation is $\pm 100^\circ$ below 1300 MHz and $\pm 200^\circ$ above 1300 MHz.

86635A Phase/FM modulation section: For use with 86603A Option 002 RF Section. Provides analog phase modulation similar to the 86634A but the FM rates limited to 1 MHz. Also includes FM capability for carrier frequencies up to 2600 MHz.

For full details on these additional capabilities contact your nearest Hewlett-Packard sales office.

8660A/B Mainframe specifications

Frequency accuracy and stability: CW frequency accuracy and long term stability are determined by reference oscillator in 8660A/B mainframe (3×10^{-9} /day) or by external reference if used.

Reference oscillator

Internal: 10 MHz quartz oscillator. Aging rate less than ± 3 parts in 10^9 per 24 hours after 72 hours warm-up. (± 3 parts in 10^9 per 24 hours, Option 001).

External: rear panel switch allows operation from 5 MHz or 10 MHz frequency standard at a level between 0.2 V and 2.0 V rms into 170 ohms.

Reference output: rear panel BNC connector provides output of reference signal selected at level of at least 0.5 V rms into 170 ohms.

Digital sweep (8660B): Auto, single or manual. Selectable speeds 0.1, 1, or 10 seconds.

Remote programming: 8660A — all front panel frequency, output level, and modulation functions are programmable. 8660B — CW frequency, frequency stepping (Step \uparrow , Step \downarrow), output level, and modulation are programmable.

Switching time: less than 5 ms to be within 100 Hz of any new frequency selected. (Less than 100 ms to be within 5 Hz).

Maximum stepping rate: 1 ms per step.

Programming input:

Connector type: 36-pin Cinch type 57. [Optional Hewlett-Packard Interface Bus — 24 pin connector]

Logic: TTL compatible (negative true)

General

Operating temperature range: 0° to 55°C

Power: 100, 120, 200, 240 V rms $\pm 5\%$, -10% , 48 to 66 Hz; approximately 375 W.

Size: 426 mm W \times 184 mm H \times 610 mm D ($16\frac{1}{4}'' \times 7\frac{1}{4}'' \times 24''$)

Weight: Net, 23.6 kg (52 lb). Shipping, 29.5 kg (65 lb).

Options:

001: $\pm 3 \times 10^{-9}$ /day internal reference oscillator.

002: No internal reference oscillator.

003: Operation from 50 to 400 Hz line.

004: 100 Hz frequency resolution.

005: Hewlett-Packard Interface Bus.

009: (8660A only): LED display indicates selected frequency in 1-2-4-8 BCD code.

100: 11661A frequency extension module factory installed.

86601A RF section specifications

Frequency range: 0.01 to 109.999999 MHz. Selectable in 1 Hz steps.

Output level: Continuously adjustable from +13 to -146 dBm into 50 ohms; programmable in 1 dB steps.

Output accuracy: [Local and remote]

± 1 dB from +13 dBm to -66 dBm

± 2 dB from -67 dBm to -146 dBm

Output flatness: Output level variation with frequency is less than ± 0.5 dB across entire frequency range.

Harmonics: < -40 dB

Spurious signals: non-harmonically related < -80 dB; power line related < -70 dB.

Signal-to-phase noise ratio: > 50 dB in a 30 kHz band centered on the carrier excluding a 1 Hz band centered on the carrier.

Signal-to-AM noise ratio: > 70 dB in a 30 kHz band centered on the carrier excluding a 1 Hz band centered on the carrier (at 0 dBm output level).

Amplitude modulation

Modulation depth: 0 to 95%

AM 3 dB bandwidth:

Center Frequency	0 to 30% AM	70% AM	90% AM
$F_c < 0.4$ MHz	200 Hz	125 Hz	100 Hz
$0.4 \leq F_c < 4$ MHz	10 kHz	6 kHz	5 kHz
$F_c > 4$ MHz	100 kHz	60 kHz	50 kHz

AM distortion: [at 400 Hz and 1 kHz rates]

Frequency Range	30%	70%	90%
0.4 - 110 MHz	$< 1\%$	$< 3\%$	$< 5\%$

Incidental FM: $0.2 \times f_{\text{mod}}$ at 30% AM

Frequency modulation

Rate: DC to 1 MHz with 86632A; 20 Hz to 100 kHz with 86633A.

Maximum deviation: 1 MHz with 86632A; 100 kHz with 86633A.



SIGNAL GENERATORS

Model 8660A & 8660B (cont.)

• RF Sections

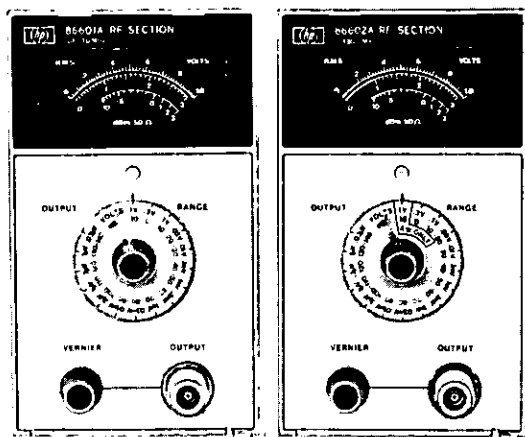

86601A

86602A

• Modulation Sections

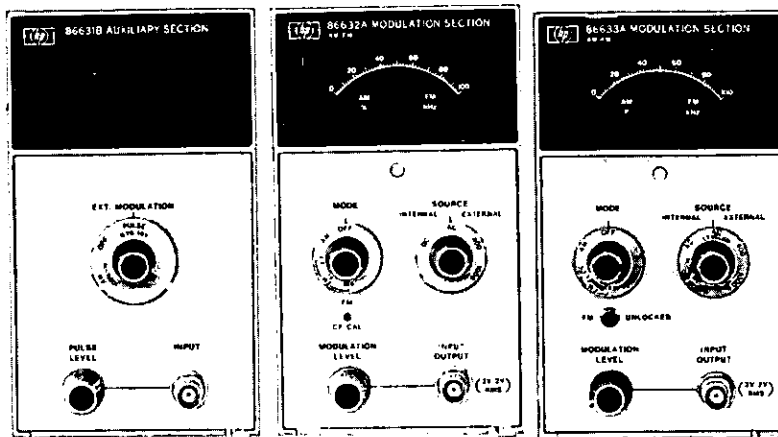

86631B

86632A

86633A

Incidental AM: With 75 kHz peak deviation at a 1 kHz rate, AM modulation sidebands are < -60 dB.

Weight: Net, 5 kg (11 lb); shipping 6.0 kg (13 lb).

Options: Option 001 — no RF output attenuator. Output level adjustable from +13 to 0 dBm.

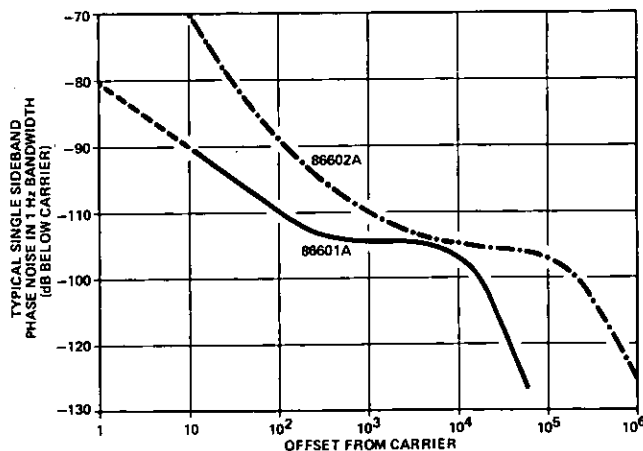

86602A RF Section specifications

(must be used with 11661A Frequency Extension Module)

Frequency range: 1 to 1299.999999 MHz. Selectable in 1 Hz steps.

Output level: continuously adjustable from +10 to -146 dBm into 50 ohms; programmable in 1 dB steps.

Output accuracy: [local and remote]

± 1.5 dB, +10 dBm to -76 dBm

± 2.0 dB, -77 dBm to -146 dBm

Output flatness: output level variation with frequency is less than 1.0 dB (typically ± 0.5 dB, 100 MHz to 1300 MHz) across entire frequency range.

Harmonics: < -30 dB (< -25 dB for output levels above +3 dBm).

Spurious signals:

Below 700 MHz, -80 dB.

Above 700 MHz, -80 dB within 45 MHz of carrier; -70 dB greater than 45 MHz from carrier (-50 dB on 1 V range).

Power line related, -70 dB.

Signal-to-phase noise ratio: > 45 dB in a 30 kHz band centered on the signal excluding a 1 Hz band centered on the carrier.

Signal-to-AM noise ratio: > 65 dB in a 30 kHz band centered on the carrier excluding a 1 Hz band centered on the carrier (at +10 dBm output level).

Amplitude modulation

Modulation depth: 0-90% on 0.3-volt range and below. (Modulation is possible on 1 V range depending on setting of vernier.)

AM 3 dB Bandwidth:

Center Frequency	0 to 30% AM	70% AM	90% AM
$F_c < 10$ MHz	10 kHz	60 kHz	5 kHz
$F_c \geq 10$ MHz	100 kHz	60 kHz	50 kHz

AM distortion: (at 400 Hz and 1 kHz rates)

Frequency Range	30%	70%	90%
1 - 1300 MHz	$< 1\%$	$< 3\%$	$< 5\%$

Incidental FM: $0.2 \times f_{mod}$ at 30% AM.

Frequency modulation

Rate: DC to 200 kHz with 86632A; 20 Hz to 100 kHz with 86633A.

Maximum deviation: 200 kHz with 86632A; 100 kHz with 86633A.

FM distortion: (at rates up to 20 kHz) $< 1\%$ for deviations up to 200 kHz.

Incidental AM: with 75 kHz peak deviation at a 1 kHz rate, AM modulation sidebands are < -60 dB.

Weight: Net, 3.9 kg (9 lb); shipping 4.9 kg (11 lb).

Options: Option 001 — no RF output attenuator. Output level adjustable from +10 to 0 dBm.

11661A Frequency extension module

Use: Must be installed in 8660A/B mainframe to enable operation of 86602A RF Section (does not affect operation of 86601A). 86602A specifications imply 11661A installation in 8660A/B mainframe.

Ordering note: The 11661A may more conveniently be ordered as Option 100 on either the 8660A or 8660B mainframe. This includes factory installation at no additional cost.

Weight: Net, 1.8 kg (4 lb); shipping 2.6 kg (6 lb).

86631B Auxiliary section specifications

External amplitude modulation

Modulation frequency: DC to maximum specified for RF Section installed.

Modulation depth: maximum specified for RF Section installed.

Input level required: 0 V to ±1.4 V peak. Percent AM is linear with input level over this range.

Input impedance: 600 ohms.

External pulse modulation

Rise/fall time:

86601A RF Section, 200 ns. (Limited by RF rise/fall time at low RF frequencies.)

86602A RF Section, 50 ns.

On/off ratio: with pulse level control at Max.

86601A RF Section, at least 50 dB.

86602A RF Section, at least 40 dB.

PULSE LEVEL control allows continuous adjustment of peak pulse power.

Input level required: 0 to -10 V (86602A); 0 to -5 V (86601A). Negative voltage turns RF on.

Input impedance: 50 ohms.

Weight: Net 1.2 kg (3 lb); shipping, 2.1 kg (5 lb).

86632A Modulation section specifications

Functions: Internal and external AM or FM. Both modes are fully programmable.

Meter: AM range 0 to 100%. FM deviation in three ranges: 0 to 10 kHz, 100 kHz, or 1 MHz.

FM-CF CAL: In the FM mode, depressing the front panel CF CAL button initiates a 5-second internal calibration cycle to correct any VCO drift. This feature is also programmable.

Internal modulation

Internal rates: 400 Hz and 1 kHz ±5%.

AM:

Modulation Depth: Continuously adjustable from 0 to 100% or maximum specified for RF section installed.

FM:

Deviation: adjustable from 0 to 1 MHz peak or maximum specified for RF section installed.

Distortion: Maintains minimum AM/FM distortion specified for RF section used.

Modulating signal output: selected internal 400 Hz and 1 kHz signal provided at front panel, 200 mV rms minimum into 10 kΩ.

External modulation

Input level required:

AC coupled mode: external modulating signal must be between 0.2 V and 2 V rms to provide full vernier control range and calibrated remote programming of modulation.

DC coupled mode: external modulation signal must be 2.0 V rms minimum to maintain full vernier range and calibrated remote programming of modulation.

Input impedance: 600 ohms.

AM:

Rate: DC to 1 MHz maximum in dc mode or 20 Hz to 1 MHz maximum in ac mode. Maximum usable modulation rate depends on specifications for RF section installed.

FM:

Rate: DC to 1 MHz in dc mode, or 20 Hz to 1 MHz in ac mode. Maximum usable rate depends on specifications for RF section installed.

Deviation: adjustable from 0 to 1 MHz peak or maximum specified for RF section installed.

Distortion: partially determined by external modulating signal distortion. Modulation signal distortion must be less than 0.3% to meet RF section distortion specification.

Remote programming

Functions: All 86632A front panel controls are programmable through the 8660A or 8660B mainframe programming interface.

Remote modulation setting resolution: modulation level can be remotely set in steps of 1/100 of the range selected.

Weight: Net 2.6 kg (6 lb); shipping, 3.2 kg (7 lb).

86633A Modulation section specifications

(Specifications same as for 86632A except as follows)

FM center frequency accuracy and long term stability: same as CW mode -3 × 10⁻⁸/day with standard internal reference oscillator.

Functions: Two external ac-coupled modes are provided:

AC leveled: external modulating signals 0.2 V and 2 V rms are internally leveled to a standard amplitude. Allows calibrated programming of external modulation level.

AC (unleveled): external modulating signal is ac-coupled but not leveled.

Meter: indicated FM peak deviation in two ranges: 0 to 10 kHz or 0 to 100 kHz.

Internal modulation

FM:

Deviation: adjustable from 0 to 100 kHz peak.

External modulation

Input level required:

AC leveled mode: 0.2 V to 2 V for full vernier control range.

AC (unleveled) mode: 2.0 V rms minimum for full vernier control range.

DC mode: cannot be used for FM modulation. Same as standard 86632A for AM modulation.

FM:

Rate: 20 Hz to 100 kHz (25 Hz minimum rate above 80 kHz deviation).

Deviation: adjustable from 0 to 100 kHz peak.

AM:

Rate: 100 kHz maximum.

Weight: Net, 2.6 kg (6 lb); shipping, 3.2 kg (7 lb).

Model number and name	Price
8660A Synthesized Signal Generator Mainframe	\$5600
8660B Synthesized Signal Generator Mainframe	\$7400
Option 001: ±3 × 10 ⁻⁹ /day internal reference oscillator	\$210
Option 002: no internal reference oscillator	less \$300
Option 003: operation from 50 to 400 Hz line	\$155
Option 004: 100 Hz frequency resolution	less \$350
Option 005: Hewlett-Packard Interface Bus	\$250
Option 009 (8660A only): LED display indicates selected frequency in 1-2-4-8 BCD code.	\$210
Option 100: 11661A factory installed inside mainframe	\$2800
86601A RF Section	\$2900
86602A RF Section	\$4100
Option 001: No RF output attenuator (for either the 86601A or 86602A).	less \$600
86631B Auxiliary Section	\$250
86632A AM/FM Modulation Section	\$1550
86633A AM/FM Modulation Section	\$1700



SIGNAL GENERATORS

VHF oscillator

Model 3200B

- 10 to 500 MHz
- to 1000 MHz with accessory Probe

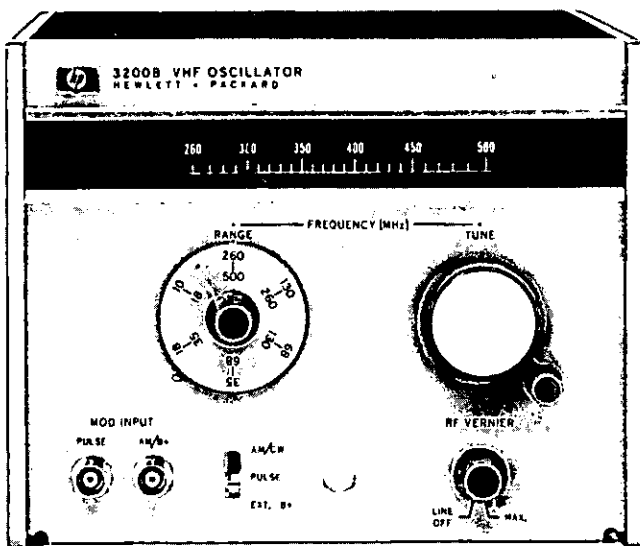

3200B



1351A

The HP 3200 VHF Oscillator provides low cost, stable, 10 to 500 MHz RF for testing receivers and amplifiers, and driving bridges, slotted lines, antennas, and filter networks. Good pulse modulation sensitivity allows standard audio oscillators to be used to provide usable square-wave modulation; a 2.5-volt sine wave will provide adequate drive for this type application. The 3200B can also serve as a local oscillator for heterodyne detector systems and as a marker source for swept systems. An optional accessory Frequency Doubler Probe, HP 1351A, provides additional frequency coverage from 500 to 1000 MHz.

The 3200B will typically recover specified stability in 30 minutes following a frequency band change. Long-term warmup (24 hours) can reduce this time as much as 50%. Following in-band frequency dial changes, the oscillator typically requires 10 minutes to recover specified stability. With the instrument in thermal equilibrium with its surroundings, (i.e., long-term warmup and constant temperature lab), stabilities of 0.0001% are typical at some frequencies, if sufficient settling time is allowed after a frequency change.

Effective RF shielding permits measurements at levels down to 1 μ V.

RF is read on an expanded slide-rule type scale. The oscillator may be precisely tuned by means of a mechanical vernier activated by the main tuning control.

3200B Specifications

Frequency characteristics

Frequency range: 10 to 500 MHz in six bands: 10 to 18.8 MHz; 18.5 to 35 MHz; 35 to 68 MHz; 68 to 130 MHz; 130 to 260 MHz; 260 to 500 MHz.

Frequency accuracy: within $\pm 2\%$ after $\frac{1}{2}$ hour warmup.

Frequency calibration: increments of less than 4%.

Frequency stability (after 4-hour warmup under 0.2 mW load): short term (5 minutes) $\pm 0.002\%$; long term (1 hour) $\pm 0.02\%$; line voltage (5-volt change) $\pm 0.001\%$.

RF output

Maximum power (across 50-ohm external load): >200 mW (10 to 130 MHz); >150 mW (130 to 260 MHz); >25 mW (260 to 500 MHz)

Range: 0 to >120 dB attenuation from maximum output.

Load impedance: 50 ohms nominal.

RF leakage: sufficiently low to permit measurements at 1 μ V.

RFI: meets requirements of MIL-I-6181D.

Amplitude modulation: externally modulated.

Range: 0 to 30%.

Distortion: 1% at 30% AM.

External requirements: approximately 32 volts rms into 600 ohms for 30% AM, 200 Hz to 100 kHz.

Pulse modulation: externally modulated.

External requirements: 2.5-volt negative pulse into 2000 ohms.

Power: 105 to 125 V or 210 to 250 V, 50 to 400 Hz, 30 W.

Dimensions: 7 $\frac{1}{8}$ " wide, 6 $\frac{1}{8}$ " high, 13 $\frac{1}{2}$ " deep (194 × 167 × 333 mm).

Weight: net, 15 lb (6.8 kg); shipping, 17 lb (7.7 kg).

Accessories available: 13515A Frequency Doubler Probe; 00502B Patching Cables.

Model number and name

3200B VHF Oscillator

13515A Frequency Doubler Probe

Price

\$750

\$95

SIGNAL GENERATORS

Rugged solid-state generator 10-520 MHz

Model 8654A

- Calibrated output power
- AM, FM internal, external, independent
- Compact size and shape

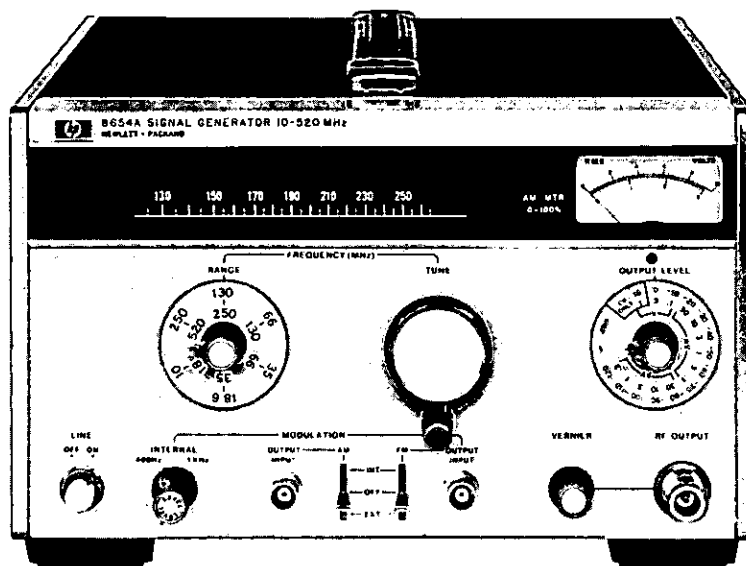

The HP 8654A Signal Generator is a portable, low-cost, solid-state generator providing calibrated output and versatile modulation capabilities over the 10 to 520 MHz frequency range. The 8654A provides stable RF signals for testing receivers, amplifiers, antennas and filter networks.

Its compactness and small size allow the 8654A to fit easily into production, mobile, airborne and shipboard test locations. Its rugged, lightweight construction is also suitable for field maintenance and service applications.

Internal oscillators provide both amplitude modulation and frequency modulation at 400 Hz and 1000 Hz or external modulation can be accomplished using standard audio oscillators. The front panel meter accurately indicates amplitude modulation percentage from 0-90% by using the AM meter mode switch.

Effective RF shielding and output range permit receiver sensitivity measurements to be made down to power levels of 1.0 μ V.

Specifications

Specifications apply from 10-520 MHz for output power $\leq +10$ dBm and over the top 10 dB of output level vernier range unless otherwise specified.

Frequency characteristics

Range: 10 to 520 MHz in 6 bands

10-18.6 MHz, 35-66 MHz, 130-250 MHz, 18.6-35 MHz, 66-130 MHz, 250-520 MHz.

Accuracy: $\pm 2\%$ after 1-hour warmup.

Settability: Setttable to within 5 ppm of the desired frequency with an external indicator after 1 hour warmup.

Stability

Time: < 1 kHz plus 20 ppm/5 min. (after 2 hr warmup and 15 min. after frequency change).

Line Voltage: < 1 ppm for $+5\%$ to -10% change from nominal line voltage.

Spectral purity

Harmonic distortion: > 20 dB below carrier for output level of $\leq +3$ dBm.

Subharmonics and non-harmonics spurious: (excluding line related) none measurable.

Residuals (averaged rms)	Post-detection Bandwidth	
	300 Hz to 3 kHz	50 Hz to 15 kHz
Residual AM:	> 70 dB down	> 60 dB down
Residual FM:	< 0.5 ppm	< 1 ppm

Output characteristics

Range: 10 dB steps and a 13 dB vernier provide continuous power settings from $+10$ dBm to -130 dBm (0.7 V to 0.07 μ V) into 50 Ω .

Level accuracy: (total as indicated on level meter) $+10$ to -7 dBm, ± 1.5 dB; -7 to -57 dBm, ± 2.0 dB; -57 to -97 dBm, ± 2.5 dB; -97 to -127 dBm, ± 3 dB.

Level flatness: ± 1 dB referenced to the output at 50 MHz for output levels > -7 dBm.

Impedance: 50 Ω as coupled, 75 V dc maximum, VSWR $< 1.3:1$ on 0.1 V range or lower.

Auxiliary RF output: nominally -7 dBm (100 mV).

Leakage: (with all RF outputs terminated properly) Leakage limits are below those specified in MIL-I-6181D. Furthermore, with an output level < 0.01 V, less than 0.5 μ V is induced in a 2-turn, 1-inch diameter loop 1 inch away from any surface and measured into a 50 Ω receiver.

Modulation characteristics

Amplitude modulation: Specifications apply for output power $< +3$ dBm.

Depth: 0 to 90%.

Modulation rate: Internal, 400 & 1000 Hz $\pm 10\%$; External 3 dB bandwidth, dc-coupled to > 20 kHz.

External AM sensitivity: $(0.1 \pm 0.01)\%$ AM/mV_{PK} into 600 Ω at 400 and 1000 Hz rates.

Indicated AM accuracy: $\pm(5\%$ of reading $+5\%$ of full scale) for modulation rates of 400 and 1000 Hz.

Peak incidental frequency deviation: (30% AM), less than 100 Hz plus 0.1 times modulation rate.

Envelope distortion: (at 1 kHz rate) $< 2\%$ to 30% AM; $< 3\%$ to 70%; $< 5\%$ to 90% AM.

Frequency modulation

Deviation: $> 0.1\%$ of carrier frequency, maximum.

Modulation rate: Internal, 400 & 1000 Hz $\pm 10\%$ External 3 dB bandwidth, dc-coupled to > 25 kHz driven from 600 ohms or less.

External FM sensitivity: 10 V_{PK} into 600 Ω yields $> 0.1\%$ deviation (± 15 volts max).

Power: 100, 120, 220 or 240 Volts $+5\%$, -10% , 48 to 440 Hz; 15 VA maximum.

Weight: Net, 7.4 kg (16 lb 4 oz); Shipping 10 kg (22 lb).

Dimensions: 266 mm W \times 155 mm H \times 279 mm D (10 $\frac{1}{2}$ " \times 6 $\frac{1}{8}$ " \times 11").

8654A Signal Generator

Price
\$1700



SIGNAL GENERATORS

HF signal generator

Model 606B

- 50 kHz to 65 MHz

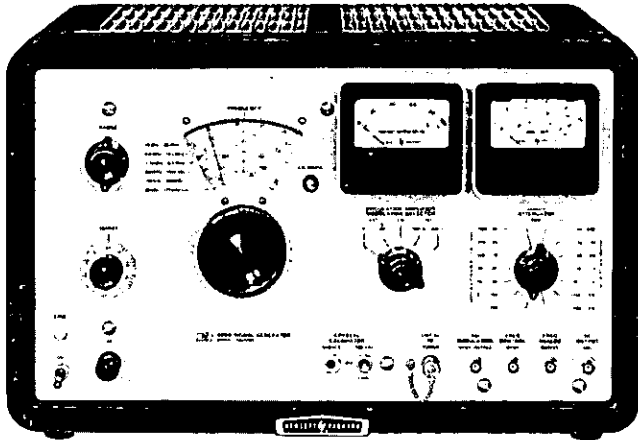

The Hewlett-Packard 606B Signal Generator provides you with high quality, versatile performance with distinctive ease of operation in the important and widely used 50 kHz to 65 MHz frequency range. Output signals are stable and accurately known, output amplitude can be precisely established over a very wide dynamic range, and versatile modulation capabilities are incorporated to satisfy virtually all measurement requirements. Convenient size and shape, together with a simple, straightforward control panel layout, make the 606B well suited for production line use as well as laboratory or field applications.

Design

The 606B is a master oscillator-power amplifier (MOPA) design with a broadband buffer amplifier stage between the oscillator and power amplifier circuits for isolation. The MOPA design permits optimization of the oscillator circuit for highest stability including low drift, minimum residual FM, low harmonics, etc., without restricting the modulation characteristics. Modulation is applied to the power amplifier circuit with negligible effect on the oscillator frequency (because of the buffer stage). Very fine frequency settability is achieved through incorporation of a ΔF control which provides better than 10 ppm resolution.

606B Specifications

Frequency and output characteristics

Range: 50 kHz to 65 MHz in 6 bands; accuracy: $\pm 1\%$.

Drift: (1 V output and below) less than 50 ppm (or 5 Hz, whichever is greater) per 10 min period after 2-hr warmup; less than 10 min to re-stabilize after changing frequency.

ΔF control: better than 10 ppm settability; range of ΔF control approximately 0.1%.

Resettability: better than 0.15% after warmup.

Crystal calibrator: provides frequency checkpoints every 100 kHz and 1 MHz; jack provided for audio frequency output; crystal frequency accuracy better than 0.01% from 0°-50°C.

Residual FM: less than ± 1 ppm or ± 20 Hz peak, whichever is greater.

Frequency control input: front panel input can be used with 8708A Synchronizer and external frequency control; limits: 0 to -50 V, 4 k Ω nominal input impedance.

Output level: continuously adjustable from 0.1 μ V to 3 V into 50-ohm resistive load, calibrated in voltage and dBm.

Frequency response and output accuracy: at output below 1 V, output variation with frequency is less than 2 dB; output accuracy is better than ± 1 dB at any frequency.

Impedance: 50 ohms, SWR less than 1.2 on 0.3 V attenuator range and below.

RFI: meets all conditions specified in MIL-I-6181D; permits receiver sensitivity measurements down to at least 1.0 μ V.

Harmonic output: at least 30 dB below the carrier.

Spurious AM: hum and noise sidebands are 70 dB below carrier down to thermal level of 50-ohm output system.

Auxiliary RF output: on front panel.

Synchronizer or other external equipment: Minimum output: 100 mV rms into 50 ohms from 50 kHz to 19.2 MHz, 200 mV rms from 19 to 65 MHz.

Modulation characteristics

Internal AM:

Frequency: 400 and 1000 Hz, $\pm 5\%$.

Modulation level: 0 to 95% on 1 V attenuator range and below; 0 to at least 30% on 3 V range.

Incidental FM (attenuator on 1 V range and below, 30% modulation): less than $5 \times 10^{-6} + 100$ Hz peak.

Carrier envelope distortion: $< 1\%$ at 30% AM, $< 3\%$ at 70% AM (attenuator on 1 V range and below).

External AM:

Frequency: dc to 20 kHz maximum, dependent on carrier frequency (F_c) and percent modulation as tabulated.

Maximum modulation frequency:

30% Mod:	70% Mod:	Square wave Mod:
0.06 f_c	0.02 f_c	0.003 f_c (3 kHz max.)

Modulation level: 0 to 95% on 1 V attenuator range and below, 0 to at least 20% on 3 V range.

Input required: 4.5 V peak produces 95% modulation (maximum input 50 V peak); input impedance 1000 ohms.

Carrier envelope distortion: same as for internal AM.

Modulation meter accuracy: $\pm 5\%$ of full scale, 0 to 90%, for modulation frequencies to 10 kHz, $\pm 10\%$ of full scale for frequencies from 10 kHz to 20 kHz.

Modulation level constancy (internal or external AM; attenuator on 1 V range and below): modulation level stays constant within $\pm 1/2$ dB regardless of carrier frequency and output level changes.

General

Power: 115 or 230 V 10%, 50 to 400 Hz, 135 W.

Dimensions: cabinet, 527 mm W \times 318 mm H \times 370 mm D, (20 3/4" \times 12 1/2" \times 14 3/4"); rack, 483 mm W \times 266 mm H \times 367 mm D behind panel, (19" \times 10 1/2" \times 14 3/4").

Weight: cabinet, net, 24.8 kg (55 lb); shipping 29.3 kg (65 lb); rack, net, 22.5 kg (50 lb); shipping 28.4 kg (63 lb).

Accessories available:

11507A Output Termination, provides 3 positions: 50 ohms, 5 ohms and IEEE Standard Dummy Antenna

11509A Fuseholder, protection for 606B transceiver tests.

10534A Mixer, for use as a nonosecond pulse modulation.

Model number and name

606B HF Signal Generator (cabinet)

606BR HF Signal Generator (rack)

Price
\$2400
\$2400

- Versatility and value, 10-480 MHz

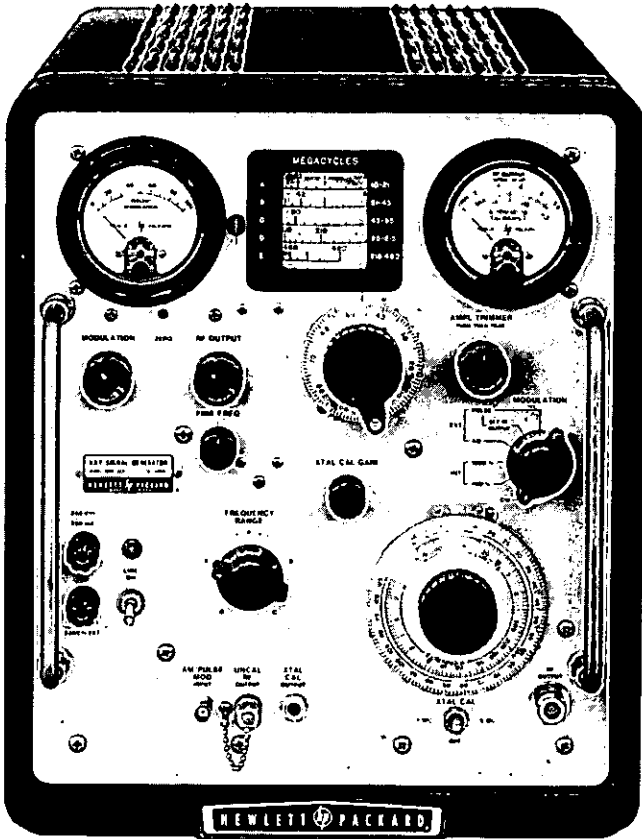

Model 608E provides high-quality, versatile performance with distinctive ease of operation. The 608E provides an output of up to 1 volt over the range from 10 to 480 MHz.

The 608E is an improved version of the popular and time-proven HP 608C/D Signal Generators. The instrument is a master oscillator-power amplifier (MOPA) type with a broadband buffer amplifier stage between the oscillator and power amplifier circuits for isolation. The MOPA design permits optimization of the oscillator stage for high stability of 0.005% per 10 minutes, minimum residual FM, and low harmonics without restricting the modulation characteristics. Modulation is applied to the power amplifier stage with negligible effect on the oscillator frequency.

608E Specifications

Frequency characteristics

Range: 10-480 MHz in five bands

Accuracy: $\pm 0.5\%$

Drift: less than $50 \times 10^{-6}/10$ min after one hr warmup.

Resettability: better than $\pm 0.1\%$ after initial warmup; fine-frequency-adjust provides approximately 25 kHz settability at 480 MHz.

Crystal calibrator: provides frequency check points every 1 MHz up to 270 MHz or every 5 MHz over total range; jack provided for audio frequency output; crystal frequency accuracy better than 0.01% at room temperatures.

Residual FM: less than ± 5 parts in 10^7 peak.

Harmonic output: at least 35 dB below the carrier for harmonic frequencies below 500 MHz.

Output characteristics

Output level: continuously adjustable from 0.1 μ V to 1.0 V into a 50-ohm resistive load; output calibrated in volts and dBm.

Accuracy: within ± 1 dB of attenuator dial reading at any frequency when RF output meter indicates "ATTENUATOR CALIBRATED."

Impedance: 50 Ω with a maximum SWR of 1.2 for attenuator setting below -7 dBm.

RFI: meets all conditions specified in MIL-I-6181D; permits receiver sensitivity measurements down to at least 0.1 μ V.

Auxiliary RF output: at least 180 mV rms into 50 Ω provided at front panel.

Modulation characteristics

Internal AM

Frequency: 400 and 1000 Hz, $\pm 10\%$.

Modulation level: 0 to 95% modulation at carrier levels 0.5 V and below

Carrier envelope distortion: less than 2% at 30% AM, less than 5% at 70% AM.

External AM

Frequency: 20 Hz to 20 kHz.

Modulation level: 0 to 95% modulation at carrier levels of 0.5 V and below; continuously adjustable from front panel MOD LEVEL control; input required, 1-10 V rms (1000 Ω input impedance).

Carrier envelope distortion: less than 2% at 30% AM, less than 5% at 70% AM (modulation source distortion less than 0.5%).

Modulation meter accuracy: $\pm 5\%$ of full scale 0 to 80%, $\pm 10\%$ from 80% to 95% (for INT AM or 20 Hz to 20 kHz EXT AM).

Incidental FM (at 400 and 1000 Hz modulation): less than 1000 Hz peak at 50% AM for frequencies above 100 MHz; below 100 MHz, less than 0.0001% at 30% AM.

External pulse modulation

Rise and decay time: from 40 MHz to 220 MHz, combined rise and decay time less than 4 μ s; above 220 MHz combined rise and decay time less than 2.5 μ s.

On-off ratio: at least 20 dB for pulsed carrier levels of 0.5 V and above.

Input required: positive pulse, 10-50 V peak, input impedance 2 k Ω

General

Power: 115 or 230 V 10%, 50 to 400 Hz; approx. 220 W.

Dimensions: cabinet, 337 mm W \times 416 mm H \times 533 mm D (13 $\frac{1}{4}$ " \times 16 $\frac{1}{2}$ " \times 21"); rack mount: 483 mm W \times 335 mm H \times 467 mm D behind panel (19" \times 13 $\frac{3}{32}$ " \times 18 $\frac{1}{4}$ ").

Weight: cabinet mount: net, 28 kg (63 lb); shipping 33.4 kg (74 lb); rack mount: net, 28 kg (62 lb); shipping, 37.4 kg (83 lb).

Accessories available:

11508A Output Cable for high impedance circuits.

11509A Fuse Holder: protection for transceiver tests.

10514A Mixer for use as nanosecond pulse modulator.

Model number and name

608E VHF Signal Generator (cabinet)

608ER VHF Signal Generator (rack)

Price

\$3600

\$3600

SIGNAL GENERATORS

UHF signal generator

Model 612A

- 450 to 1230 MHz

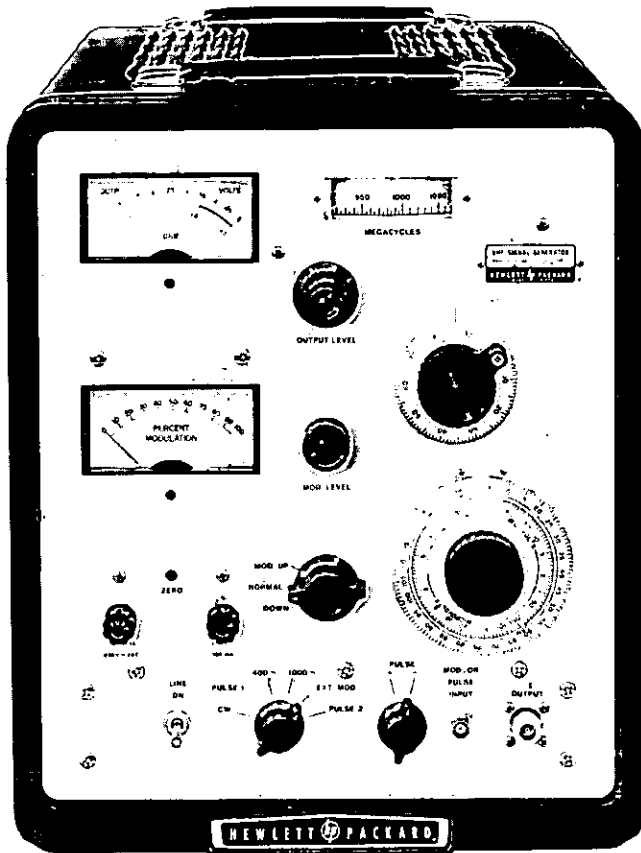

Here is an all-purpose, precision signal generator particularly designed for utmost convenience and applicability throughout the important UHF-TV frequency band. It is ideally suited for measurements in UHF-television broadcasting, studio-transmitter links, citizen's radio and public service communications systems. The HP 612A also covers the important frequencies used in aircraft navigation aids such as DME, TACAN and airborne transponders. Accessory modulators, available from many of the manufacturers of these navigational aids, enable the 612A to provide the complex modulation patterns required for testing and aligning these systems. In the laboratory, the 612A is a convenient power source for driving bridges, slotted lines, antennas and filter networks. In addition, the HP 8731 PIN Modulators can be used with the 612A to obtain RF pulses with 30 ns rise time and 0.1 μ s minimum duration—with on-off ratios approaching 80 dB.

MOPA circuit

The master oscillator-power amplifier circuit in the HP 612A provides 0.5 volt into 50 ohms over the full frequency range of 450 to 1230 MHz. There is very low incidental FM (less than 0.002% at 30% AM) and excellent amplitude modulation capabilities by all frequencies from 20 Hz to 5 MHz. The degree of modulation is easily read from the large percent modulation meter. The instrument can be amplitude-modulated (either internally or externally), and provision is made for external pulse modulation as well. Pulse modulation can be applied to the amplifier or directly to the oscillator when high on-off signal ratios are required (signal may be completely cut off between pulses). Modulation can be up or down from a preset level to simulate TV modulation characteristics accurately.

Cavity oscillator

The oscillator-amplifier circuit in the 612A employs high-frequency pencil triodes in a cavity-tuned circuit for precise tracking over the entire band. Noncontacting cavity plungers are die-cast to precise tolerances, then injection-molded with a plastic filler for optimum Q. The frequency drive is a direct screw-operated mechanism, free from backlash. A waveguide-beyond-cutoff piston attenuator and crystal monitor circuit are used to ensure accurate, reliable output, down to 0.1 μ V. The attenuator is calibrated over a range of 131 dB and has been carefully designed to provide a constant impedance-versus-frequency characteristic. The SWR of the 50-ohm output system is less than 1.2 over the complete frequency range.

Specifications

Frequency range: 450 to 1230 MHz in one band; scale length approximately 381 mm (15").

Calibration accuracy: within $\pm 1\%$, resettability better than 5 MHz at high frequencies.

Output voltage: 0.1 μ V to 0.5 V into 50-ohm load; calibrated in V and dBm (0 dBm = 1 mW).

Output accuracy: ± 1 dB, 0 to -127 dBm over entire frequency range.

Output impedance: 50 ohms; maximum reflection coefficient, 0.091 (1.2 SWR, 20.8 dB return loss) for attenuator settings of 0 dBm and below.

Amplitude modulation: above 470 MHz, 0 to 90% at audio frequencies, indicated by panel meter; accuracy $\pm 10\%$ of full scale, 30 to 90% modulation.

Incidental FM; less than 0.002% for 30% AM.

Internal modulation: 400 and 1000 Hz $\pm 10\%$; envelope distortion less than 3% at 30% modulation.

External modulation: 20 Hz to 5 MHz; above 470 MHz, 2 V rms produces 85% AM at modulating frequencies up to 500 kHz, at least 40% AM at 5 MHz; modulation may be up or down from the carrier level or symmetrical about the carrier level; positive or negative pulses may be applied to increase or decrease RF output from the carrier level.

Pulse Modulation

Pulse 1 (pulse applied to amplifier): positive or negative pulses, 4 to 40 V peak produce an RF on-off ratio of at least 20 dB; minimum RF output pulse length, 1.0 μ s.

Pulse 2 (pulse applied to oscillator): positive or negative pulses, 4 to 40 V peak; no RF output during off time; minimum RF output pulse length, 1.0 μ s.

RF: conducted and radiated leakage limits are below those specified in MIL-I-6181D; permits receiver sensitivity measurements down to 1 μ V.

Power: 115 or 230 volts $\pm 10\%$, 50 to 400 Hz, 215 watts.

Dimensions: cabinet: 333 mm W \times 419 mm H \times 546 mm D (13 $\frac{1}{2}$ " \times 16 $\frac{1}{2}$ " \times 21 $\frac{1}{2}$ "); rack mount: 483 mm W \times 355 mm H \times 514 mm D behind panel (19" \times 13 $\frac{3}{32}$ " \times 20 $\frac{1}{4}$ ").

Weight: net, 25.2 kg (56 lb); shipping, 30.6 kg (68 lb) (cabinet); net, 25.2 kg (56 lb); shipping, 34.6 kg (77 lb) (rack mount).

Accessories available: 11500A RF Cable Assembly; 10503A Video Cable Assembly; 360B Low-Pass Filter (may be used where harmonic output must be reduced to a minimum, as in slotted line measurements).

Model number and name

612A UHF Signal Generator (cabinet)
612AR UHF Signal Generator (rack)

Price
\$2600
\$2650

- Stable, easy to use, 800-4500 MHz

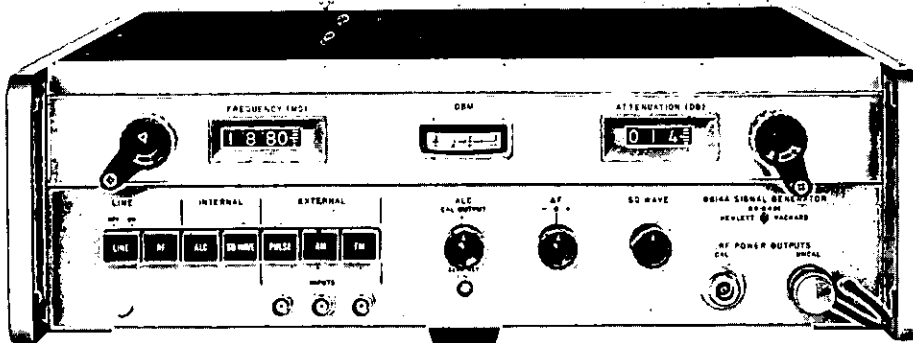

HP 8614A, 8616A Signal generators

The HP 8614A and 8616A Signal Generators provide stable, accurate signals from 800 to 2400 MHz (8614A) and from 1800 to 4500 MHz (8616A). Both frequency and attenuation are set on direct-reading digital dials, while selectable functions include CW, leveled output, square-wave modulation, and external AM, FM and pulse modulation. Modulation can be accomplished simultaneously with or without leveling.

Two RF power outputs are simultaneously available from separate front-panel connectors. One provides at least 10 mW (2 mW above 3000 MHz) or a leveled output from 0 to -127 dBm. The other is at least 0.5 mW across the band and is independent of attenuator setting. This signal can be used for phase-locking the signal generators for extreme stability, or it can be monitored with a frequency counter for extreme frequency resolution without adversely affecting the primary output.

A unique PIN diode modulator permits amplitude modulation from dc to 1 MHz or furnishes RF pulses with a 2 μ s rise time. This broad modulation bandwidth permits remote control of output level or precise leveling using external equipment. The internal leveling is also obtained by using a PIN modulator.

The 8614A and 8616A can also be used with companion modulators, HP 8403A modulators and HP 8730-series PIN modulators to provide 80 dB pulse on/off ratio (see page 361). In addition, TWT amplifiers can be used with these generators to provide high power levels.

Specifications

8614A

Frequency range: direct reading within 2 MHz 800 to 2400 MHz.
Vernier: Δ F control has a minimum range of 1.5 MHz for fine tuning.

Frequency calibration accuracy: ± 5 MHz

Frequency stability: Approximately 0.005%/°C change in ambient temperature, less than 2500 Hz peak residual FM, negligible incidental FM in pulse and AM operation below -10 dBm, 0.003% change for line voltage variation of $\pm 10\%$.

RF output power: +10 dBm (10 mW) into 50 Ω load. Output attenuation dial directly calibrated in dBm from 0 to -127 dBm. A second uncalibrated output (approximately 0.5 mW) is provided on front panel.

RF output power accuracy (with respect to attenuation dial): ± 0.75 dB + attenuator accuracy (0 to -127 dBm) including leveled output variations

Attenuator accuracy: +0, -3 dB from 0 to -15 dBm; ± 0.2 dB ± 0.06 dB/10dB from -15 to -127 dBm; direct reading dial, 0.2 dB increments.

Output impedance: 50 Ω ; SWR <2.0

Modulation: On-off ratio at least 20 dB for square wave, pulse

Internal square wave: 950 to 1050 Hz. Square wave can be synchronized with a +1 to +10 V signal at PULSE input.

External pulse: 50 Hz to 50 kHz; 2 μ sec rise time, +20 to +100 V peak input.

External AM: DC to 1 MHz

External FM: a) Front panel connector capacity-coupled to repeller of klystron; b) Two-terminal rear panel connector (Cinch-Jones type S304AB) is dc-coupled to repeller of klystron

Power source: 115 or 230 V $\pm 10\%$, 50 to 60 Hz, approximately 125 W

Dimensions: 425 mm W \times 467 mm D \times 141 mm H (16 $\frac{1}{4}$ " \times 18 $\frac{3}{4}$ " \times 5 $\frac{1}{2}$ "); Rack Mount 483 mm \times 416 mm \times 133 mm (19" \times 16 $\frac{1}{8}$ " \times 5 $\frac{1}{32}$ ")

Weight: Net, 19.5 kg (43 lb), shipping, 22.3 kg (49 lb)

Option 001: External modulation input connectors on rear panel in parallel with front-panel connectors; RF connectors on rear panel only.

8616A

Frequency range: direct reading within 2 MHz 1800 to 4500 MHz.

Vernier: Δ F control has a range of approximately 1.5 MHz for fine tuning.

Frequency calibration accuracy: ± 10 MHz

Frequency stability: Approximately 0.005%/°C change in ambient temperature, less than 2500 Hz peak residual FM, negligible incidental FM in pulse and AM operation for attenuator settings below -10 dBm, 0.003% change for line voltage variation of $\pm 10\%$.

RF output power: +10 dBm (10 mW) to -127 dBm into 50 Ω load, 1800 to 3000 MHz; +3 dBm to -127 dBm from 3000 to 4500 MHz into a 50 Ω load. Output attenuation dial directly calibrated in dBm from 0 to -127 dBm. A second uncalibrated output (approximately 0.5 mW) is provided on the front panel.

RF output power accuracy (with respect to attenuation dial): ± 1.0 dB + attenuator accuracy (0 to -127 dBm).

Attenuator accuracy: +1, -2 dB from 0 to -10 dBm, ± 0.2 dB ± 0.06 dB/10 dB from -10 to -127 dBm.

Output impedance: 50 Ω ; SWR less than 2.0.

Modulation: On-off ratio at least 20 dB for square wave, pulse.

Internal square wave: 950 to 1050 Hz. Other frequencies available on special order.

External pulse: 50 Hz to 50 kHz; 2 μ sec rise time, +20 to +100 V peak input.

External AM: DC to 1 MHz

External FM: a) Front panel connector capacity-coupled to repeller of klystron; b) Four terminal rear panel connector (Cinch-Jones type S304AB) is DC-coupled to repeller of klystron.

Dimensions: 425 mm W \times 467 mm D \times 141 mm H (16 $\frac{1}{4}$ " \times 18 $\frac{3}{4}$ " \times 5 $\frac{1}{2}$ "); Rack Mount 483 mm \times 416 mm \times 133 mm (19" \times 16 $\frac{1}{8}$ " \times 5 $\frac{1}{32}$ ")

Weight: Net, 19.1 kg (42 lb), Shipping, 21.8 kg (48 lb).

Option 001: External modulation input connectors on rear panel in parallel with front-panel connectors; RF connectors on rear panel only.

Model number and name

8614A Signal Generator (800-2400 MHz)

8616A Signal Generator (1800-4500 MHz)

8614A Option 001

8616A Option 001

Price

\$3100

\$3100

add \$25

add \$25



SIGNAL GENERATORS

SHF Signal generators

Models 618C, 620B

- Multiple-purpose instruments, 3.8 to 11 GHz

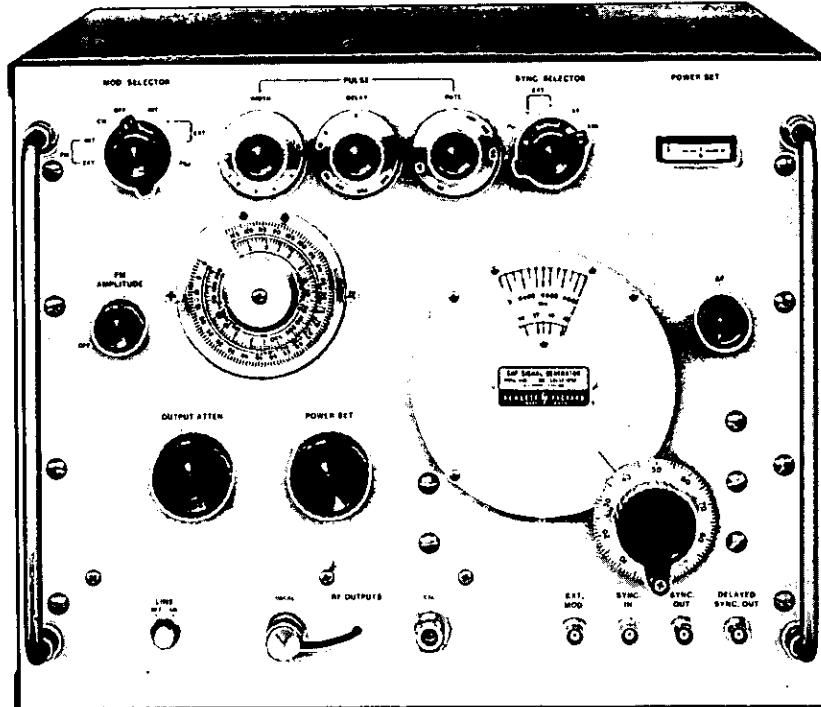

The Models 618C and 620B SHF Signal Generators provide versatility, accuracy, and stability in the range from 3.8 to 11 GHz. Frequency is set on a large, direct-reading dial. A ΔF vernier control provides ultra-fine tuning capability. There is also a provision for remote fine tuning.

A calibrated output from 0 to -127 dBm (0.224 volts to 0.1 microvolt) is also set on a large, direct-reading dial. The dial is calibrated in both dBm and volts. An auxiliary output of at least 0.3 milliwatt is available and is independent of attenuator setting. Thus, it can be used for phase-locking the signal generator when crystal-oscillator stability is required, or it can be monitored with a frequency counter for extreme frequency resolution.

The 618C and 620B Generators both feature oscillators of the reflex klystron type, with external resonant cavity. Oscillator frequency is determined by a movable plunger which varies the length of the cavity. Oscillator output is monitored by a temperature-compensated detector circuit. This circuit operates virtually unaffected by ambient temperature conditions.

Modulation includes internal pulse, square wave, and frequency modulation plus external pulse and frequency modulation.

618C and 620B Specifications

Output

Frequency range:

618C: 3,800 to 7,600 MHz covered in a single band.

620B: 7 to 11 GHz covered in a single band; repeller voltage automatically tracked and proper mode automatically selected.

Calibration: direct reading; frequency calibration accuracy better than $\pm 1\%$.

Frequency stability: with temperature: less than 0.006%/°C change in ambient temperature; with line voltage less than 0.02% change for line voltage variation of $\pm 10\%$; residual FM: <15 kHz peak.

Output range: 1 milliwatt or 0.224 volt to 0.1 microvolt (0 dBm to -127 dBm) into 50 ohms; directly calibrated in microvolts and dB; coaxial type N connector.

Output accuracy: within ± 2 dB from -7 to -127 dBm, within ± 3 dB from 0 to -7 dBm, terminated in 50-ohm load.

Source impedance: 50 ohms nominal; reflection coefficient less than 0.33.

Modulation

Modulation: internal or external pulse, FM, and square wave.

Internal pulse modulation: repetition rate variable from 40 to 4,000 pps, pulse width variable $\frac{1}{2}$ to 10 microseconds.

Sync out signals: simultaneous with RF pulse, positive; in advance of RF pulse, positive, variable 3 to 300 microseconds (better than 1 microsecond rise time and 25 to 100 volts amplitude into 1,000-ohm load).

External synchronization: sine wave: 40 to 4,000 Hz, 5 to 50 V rms; pulse: 40 to 4,000 pps, 5 to 50 V peak, positive or negative, 0.5 to 5 μ s wide, 0.1 to 1 μ s rise time.

Internal square-wave modulation: variable 40 to 4,000 Hz.

Internal FM: sawtooth sweep rate adjustable 40 to 4,000 Hz; frequency deviation to 5 MHz peak-to-peak over most of the frequency range.

External pulse modulation: pulse requirements: amplitude from 20 to 70 volts positive or negative, width 0.5 to 2,500 microseconds.

External FM: frequency deviation approximately 5 MHz peak-to-peak over most of the band; sensitivity approximately 20 V/MHz at front-panel connector, approximately 10 V/MHz at rear-panel connector (mating connector supplied); front-panel connector is capacitively coupled to klystron repeller; rear-panel connector is dc-coupled to klystron repeller and is suitable for phase-lock control input.

General

RFI: conducted and radiated leakage limits are below those specified in MIL-I-6181D.

Power source: 115 or 230 volts $\pm 10\%$, 50 to 60 Hz 230 W.

Dimensions: cabinet, 445 mm W \times 353 mm H \times 518 mm D (17 $\frac{1}{2}$ " \times 13 $\frac{3}{4}$ " \times 20 $\frac{3}{4}$ "); rack mount 483 mm \times 355 mm \times 483 mm (19" \times 13 $\frac{1}{2}$ " \times 19").

Weight: net, 31.1 kg (69 lb); shipping, 40.5 kg (90 lb).

Accessory furnished: 11001A Cable Assembly, 1830 mm (6 ft) of RG-214A/U 50-ohm coax, terminated on each end by type N male connectors.

Model number and name

618C or 620B SHF Signal Generator (cabinet mount)
618CR or 620BR SHF Signal Generator (rack mount)

Price
\$3800
\$3850

SHF generators/doublers

Models 626A, 628A, 938A, 940A

- Generate stable signals, 10 to 40 GHz

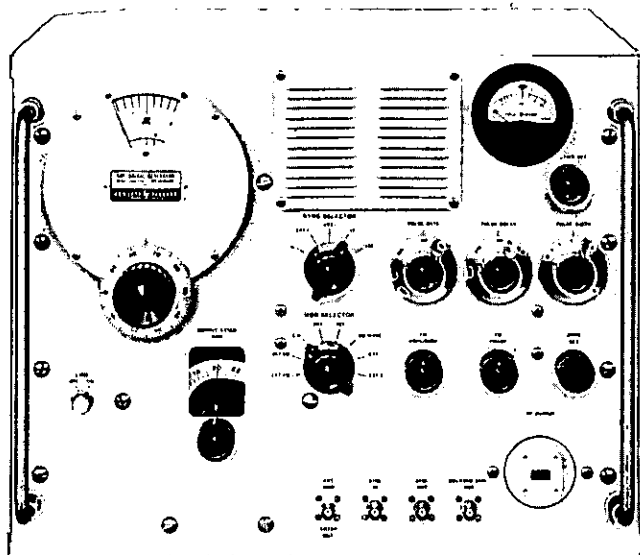

628A

Description

The 626A covers frequencies 10 to 15.5 GHz, and the 628A covers frequencies 15 to 21 GHz. In design and operation, the instruments are similar to Hewlett-Packard generators for lower frequency ranges. Carrier frequency is set and read directly on the large tuning dial. No voltage adjustment is necessary during tuning because repeller voltage is tracked with frequency changes automatically. Oscillator output also is set and read directly, and no frequency correction is necessary throughout operating range. A frequency logging scale permits frequency to be reset within 0.1%.

Both the 626A and 628A offer internal and external pulse, square-wave and frequency modulation. The pulse generators may be synchronized with an external sine wave and positive or negative pulse signals.

The high power output of these signal generators makes them ideally suited for driving HP 938A and 940A Frequency Doubler sets. These doubler sets retain the modulation and stability of the driving source and have accurate power monitors and attenuators.

626A, 628A Specifications

Frequency range: 626A, 10 to 15.5 GHz; 628A, 15 to 21 GHz.

Frequency calibration: dial direct-reading in GHz, accuracy better than $\pm 1\%$.

Output range: 10 mW to 1 pW (+10 dBm to -90 dBm, 0 dBm = 1 mW); attenuator dial calibrated in output dBm.

Source impedance: 50 ohms nominal; **reflection coefficient:**

626A: less than 0.43 at +10 dBm, 0.15 at 0 dBm and below.

628A: less than 0.43 at +10 dBm, 0.091 at 0 dBm and below.

Output monitor accuracy: better than ± 1 dB; temperature-compensated thermistor bridge circuit monitors RF oscillator power level.

Output connector: 626A: 0.850 \times 0.475 inch waveguide, WR75, flat cover flange; 628A: 0.590 \times 0.335 inch waveguide, WR51, flat cover flange.

Output attenuator accuracy: better than $\pm 2\%$ of attenuation in dB introduced by output attenuator.

Modulation: internal or external pulse, FM, or squarewave.

Internal pulse modulation: repetition rate variable from 40 to 4000 pps; pulse width variable 0.5 to 10 μ s.

Internal square-wave modulation: variable 40 to 4000 Hz con-

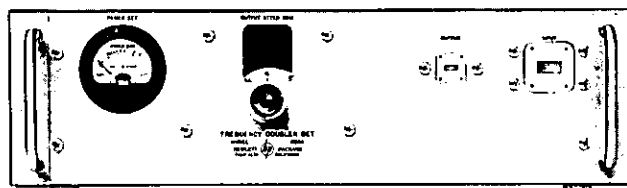

938A

trolled by "pulse rate" control.

Internal frequency modulation: power line frequency, deviation up to ± 5 MHz.

External pulse modulation: pulse requirements: amplitude 15 to 70 volts peak positive or negative; width 1 to 2500 μ s.

External frequency modulation: provided by capacitive coupling to the klystron repeller; maximum deviation approximately ± 5 MHz.

Sync out signals: positive 20 to 50 V peak into 1000-ohm load; better than 1 μ s rise time; 1) simultaneous with RF pulse, positive; 2) in advance of RF pulse, positive, variable 5 to 300 μ s.

External synchronization: 1) sine wave, 40 to 4000 Hz, amplitude 5 to 50 V rms; 2) pulse signals 0 to 4000 pps, 5 to 50 V amplitude, positive or negative; pulse width 0.5 to 5 μ s; rise time 0.1 to 1 μ s.

Power: 115 or 230 volts $\pm 10\%$, 50 to 60 Hz, approx. 200 watts.

Dimensions: cabinet: 432 mm W \times 356 mm H \times 381 mm D (17" \times 14" \times 15"); rack mount: 483 mm W \times 356 mm H \times 313 mm D (19" \times 14" \times 12 $\frac{1}{16}$ ").

Weight: 626A,AR: net, 29.5 kg (65 lb); shipping 33.6 kg (74 lb); 628A,AR: net, 28.6 kg (63 lb), shipping 32.7 kg (72 lb).

Accessories furnished: 626A, MX 292B and MP 292B Waveguide Adapters; 628A, NP 292A and NK 292A Waveguide Adapters.

Accessories available: 10503A Video Cable Assembly for 626A; M362A low-pass filter.

Frequency doubler sets

Model 938A supplies power from 18 to 26.5 GHz and Model 940A from 26.5 to 40 GHz when driven by 9 to 13.25 GHz and 13.25 to 20 GHz sources respectively. For a swept output, use a swept-frequency source such as Model 8690B or Model 8620A/B series with appropriate RF units.

938, 940A Specifications

Frequency range: 938A, 18 to 26.5 GHz; 940A, 26.5 to 40 GHz.

Conversion loss: less than 18 dB at 10 mW input.

Output power: approximately 0.5-1 mW when used with typical 626A, 628A signal generators; input power: 100 mW maximum.

Output attenuator: accuracy, $\pm 2\%$ of reading or ± 0.2 dB, whichever is greater; range, 100 dB.

Output reflection coefficient: approx. 0.33 at full output; less than 0.2 with attenuator set to 10 dB or greater.

Output flange: 938A K-band flat cover flange for WR-42 waveguide; 940A R-band flat flange for WR-28 waveguide.

Dimensions: 137 mm H \times 489 mm W \times 457 mm D (5 $\frac{1}{8}$ " \times 19 $\frac{1}{4}$ " \times 18").

Weight: net, 9 kg (20 lb); shipping, 11.8 kg (26 lb).

Model number and name

626A or 628A (Cabinet)
626AR or 628AR (Rack mount)
938A or 940A

Price
\$6200
\$6250
\$4000



SIGNAL GENERATORS

Special signal generators

Models 202H, 207H, 8925A

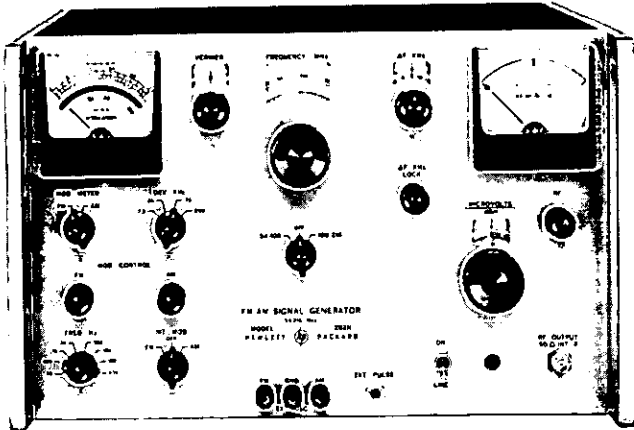

202H

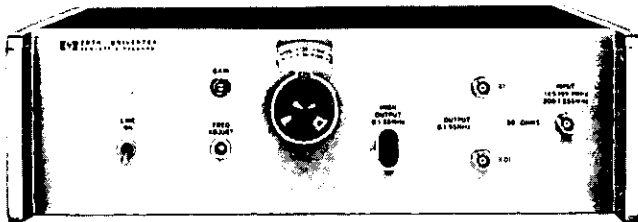

207H

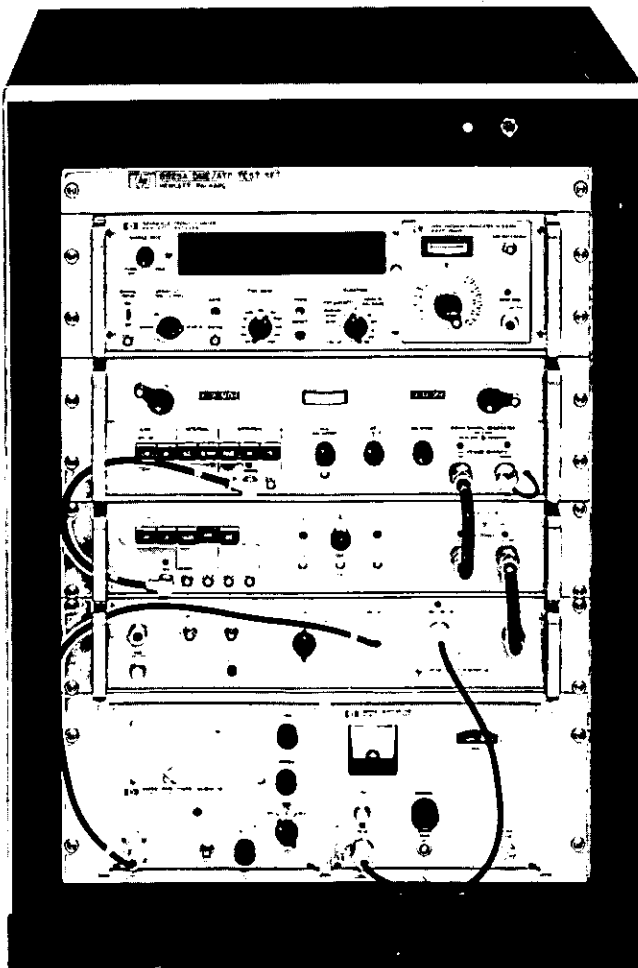

202H

The HP 202H FM-AM Signal Generator covers the frequency range 54 to 216 MHz and is designed for the testing and calibration of FM receiving systems in the areas of broadcast FM, VHF, TV, mobile and general communications.

RF range: 54 to 216 MHz in two bands.

RF accuracy: main dial: $\pm 0.5\%$; electronic vernier $\pm (10\% + 1 \text{ kHz})$; after 1-hour warm-up.

RF stability: $< 0.01\%$ per hour (after 2-hour warm-up).

RF output: range: 0.1 μV to 0.2 V (across external 50 Ω load at panel jack).

VSWR: < 1.2 .

Spurious output: 50 Ω > 30 dB below carrier.

AM range: internal: 0 to 50%; external: 0 to 100%.

AM accuracy: $\pm 10\%$ of reading at 400 Hz INT.

AM distortion: $< 5\%$ at 30%, $< 8\%$ at 50%.

AM fidelity: ± 1 dB, 30 Hz to 200 kHz.

FM deviation: range, int. or ext. 0 to 250 kHz in 4 ranges; accuracy, $\pm 5\%$ of f.s. (for 400 Hz sinewave).

FM distortion: $< 0.5\%$ at 75 kHz (100 MHz), $< 1\%$ at 75 kHz (54 to 216 MHz) at 400 Hz rate.

Oscillator frequency: 50 Hz, 400 Hz, 1000 Hz, 3000 Hz, 7.5 kHz, 10 kHz, 15 kHz, 67 kHz; $\pm 5\%$.

Oscillator distortion: $< 0.5\%$ 50 Hz to 15 kHz.

207H

The HP 207H Univerter is a frequency converter with unity gain designed for use with the HP 202H Signal Generators to provide additional frequency coverage from 100 kHz to 55 MHz. The 207H duplicates AM & FM of the 202H with no appreciable distortion for input levels less than 50 mV.

RF range: 100 kHz to 55 MHz (with 199.9 to 145 MHz input from 202H).

RF output: 1 V to 0.1 V and 0.01 V to 1 mV across external 50-ohm load at panel jack; 1 V open circuit with 0.1 V input.

Power: 105 to 125 V or 210 to 250 V, 50 to 400 Hz, 50 W.

8925A

The HP 8925A DME/ATC Test Set is specifically designed for testing and calibrating DME (Distance Measuring Equipment) and ATC (Air Traffic Control) transponder aircraft equipment. When used with suitable external modulators, the test set will also simulate some TACAN and IFF signals. Completely self-contained (except for video modulators), the system consists of a continuously tuneable signal generator (HP 8614A Option H01), direct-reading frequency counter (HP 5245L), solid-state modulator (HP 8403A Option H01), frequency converter (HP 5254C), wavemeter (HP 8905A), peak power measuring system (HP 8900B), and all necessary circuitry for interconnection to the radio set under test (HP 13505A).

Frequency range: 962 to 1213 MHz.

Model number and name

HP 202H	Price
HP 207H	\$2040
HP 8925A	\$740
Opt 001 (less counter)	\$15,920
Opt 002 (less cabinet)	less \$3575
Opt 003 (dual power range)	less \$800
Opt 004 (5246L counter)	add \$135
	less \$630

SIGNAL GENERATORS

PIN modulators, modulators

8730 Series, 8403A

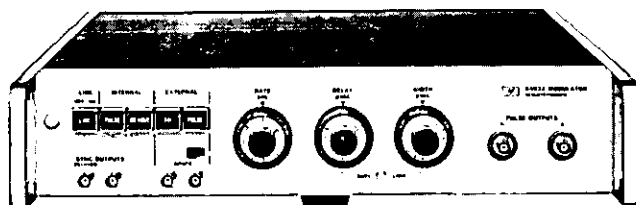
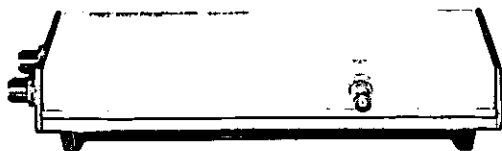

8730 PIN modulators

With HP 8730 series PIN Modulators, signal sources, including klystrons, can be pulse-modulated, leveled or amplitude-modulated with sinusoidal and complex waveforms. Fast rise-times, low incidental FM and a nearly constant impedance match to source and load are typical of these absorption-type modulators.

8403A Modulator

The Model 8403A provides complete control of the PIN modulators, supplying the appropriate modulation wave shapes and bias levels for fast rise times, rated on/off ratios and amplitude modulation. An internal square-wave and pulse modulator with PRF of 50 Hz to 50 kHz and adjustable pulse width and delay also provide square wave and pulses for general pulse applications. For applications requiring an absorption-type modulator plus controls in a single unit, a PIN modulator can be installed in the Model 8403A.

8403A Specifications

Output characteristics

(available separately at front panel)

For driving 8730 pin modulators: AM and pulse output, pulse output specially shaped for optimum RF rise and decay times.

For general pulse applications: positive dc-coupled pulse 25 to 30 volts in amplitude, approximately symmetrical about 0 volt; no AM signal.

Modulation

Internal square wave:

Frequency: variable from 50 Hz to 50 kHz.

Symmetry: better than 45/55%.

Internal pulse:

Repetition rate: variable from 50 Hz to 50 kHz.

Delay: variable from 0.1 μ s to 100 μ s, between sync out pulse and RF output pulse.

Width: variable from 0.1 μ s to 100 μ s.

External sync:

Signal: 5 to 15 volts peak, + or -, pulse or sine wave.

Input impedance: approximately 2000 ohms, dc-coupled.

Trigger out:

Sync out: simultaneous with or 0.1 to 100 μ s in advance of RF pulse, as set by delay control.

Delayed sync out: simultaneous with output pulse.

Amplitude: approximately -2 volts.

Source impedance: approximately 330 ohms.

External pulse rate

Amplitude and polarity: 5 volts to 15 volts peak, + or -.

Repetition rate: maximum average PRF, 500 kHz/sec.

Input impedance: approximately 2000 ohms, dc-coupled.

Width: minimum 0.1 μ s; maximum 1/PRF - 0.4 μ s.

Continuous amplitude modulation

(with 8730 series)

Frequency response: dc to approximately 10 MHz (3 dB).

Sensitivity: approx. 10 dB/volt with HP 8730A series; approx. 20 dB/volt with HP 8730B series.

Input impedance: approximately 100 ohms.

General

Power: 115 or 230 volts \pm 10%, 50 to 400 Hz, approx. 10 watts.

Dimensions: 425 mm W \times 96 mm H \times 467 mm D (16 $\frac{1}{2}$ " \times 3 $\frac{3}{4}$ " \times 18 $\frac{3}{8}$ "), hardware furnished for rack mount 483 mm W \times 89 mm H \times 416 mm D (19" \times 3 $\frac{1}{2}$ " \times 16 $\frac{3}{8}$ ").

Weight: Net, 6.5 kg (14.5 lb). Shipping, 8.3 kg (18 lb).

Model number and name

8403A Modulator

Price

\$1050

PIN Modulators installed in 8403A:

Option 001, 8731A; 003, 8732A; 005, 8733A; 007, 8734A

add \$570

Option 002, 8731B; 004, 8732B; 006, 8733B; 008, 8734B

add \$825

Option 009 Input and Output Connectors on rear panel

add \$25

8730 Series specifications

HP Model	8731A	8731B	8732A	8732B	8733A	8733B	8734A	8734B	8735A	8735B	H10-8731B*
Frequency range (GHz)	0.8-2.4	0.8-2.4	1.8-4.5	1.8-4.5	3.7-8.3	3.7-8.3	7.0-12.4	7.0-12.4	8.2-12.4	8.2-12.4	0.4-0.9
Dynamic range (dB)	35	80	35	80	35	80	35	80	35	80	35
Max. residual atten. (dB) ¹	<1.5	<2.0	<2.0	<3.5 ²	<2.0	<3.0	<4.0	<5.0	<4.0	<5.0	<2.0
Typical rise time (ns) ³	40	30	40	30	30	30	30	30	30	30	35
Typical decay time (ns) ³	30	20	30	20	20	20	20	20	20	20	30
SWR, min. attenuation	1.5	1.6	1.5	1.6 ⁴	1.8	2.0	1.8	2.0	1.7	2.0	2 ⁷
SWR, max. attenuation	1.8	2.0	1.8	2.0	2.0	2.2	2.0	2.2	2.0	2.2	1.5 ⁷
Forward bias input resistance (ohms)	300	100	300	100	300	100	300	100	300	100	300
RF connector type	N	N	N	N	N	N	N	N	W/G ⁵	W/G ⁵	N
Weight, net kg (lb)	1.4 (3)	2.5 (5.5)	1.4 (3)	2.5 (5.5)	1.1 (2.5)	1.6 (3.5)	1.1 (2.5)	1.6 (3.5)	1.1 (2.5)	1.6 (3.5)	2.5 (5.5)
Shipping kg (lb)	1.8 (4)	4.1 (9)	1.8 (4)	4.1 (9)	1.8 (4)	2.3 (5)	1.8 (4)	2.3 (5)	1.8 (4)	2.3 (5)	4.1 (9)
Dimensions											
Length, mm (in)	283 (11 $\frac{1}{4}$)	289 (11 $\frac{3}{8}$)	283 (11 $\frac{1}{4}$)	289 (11 $\frac{3}{8}$)	213 (8 $\frac{3}{8}$)	311 (12 $\frac{1}{4}$)	213 (8 $\frac{3}{8}$)	311 (12 $\frac{1}{4}$)	171 (6 $\frac{3}{4}$)	267 (10 $\frac{5}{8}$)	289 (11 $\frac{3}{8}$)
Width, mm (in)	83 (3 $\frac{1}{4}$)	124 (4 $\frac{1}{2}$)	83 (3 $\frac{1}{4}$)	124 (4 $\frac{1}{2}$)	83 (3 $\frac{1}{4}$)	83 (3 $\frac{1}{4}$)	83 (3 $\frac{1}{4}$)	83 (3 $\frac{1}{4}$)	83 (3 $\frac{1}{4}$)	83 (3 $\frac{1}{4}$)	124 (4 $\frac{1}{2}$)
Height, mm (in)	57 (2 $\frac{1}{4}$)	57 (2 $\frac{1}{4}$)	57 (2 $\frac{1}{4}$)	57 (2 $\frac{1}{4}$)	57 (2 $\frac{1}{4}$)	57 (2 $\frac{1}{4}$)	57 (2 $\frac{1}{4}$)	57 (2 $\frac{1}{4}$)	57 (2 $\frac{1}{4}$)	57 (2 $\frac{1}{4}$)	57 (2 $\frac{1}{4}$)
Price	\$575	\$800	\$575	\$800	\$575	\$800	\$575	\$850	\$575	\$800	\$800

Maximum ratings: maximum input power, peak or CW: 1 W; bias limits: +20 V, -10 V.
 Bias polarity: negative voltage increases attenuation.
 RF1: radiated leakage limits are below those specified in MIL-I-6181D at input levels less than 1 mW; at all input levels radiated interference is sufficiently low to obtain rated attenuation.

1. With +5 V bias.
 2. 4 dB, 4 to 4.5 GHz.
 3. Driven by HP 8403A Modulator.
 4. 2.0 SWR, 4 to 4.5 GHz.

5. Fits 1 \times $\frac{1}{2}$ in. (WR 90) waveguide.
 6. External high-pass filters required.
 7. Excluding high-pass filters.



SIGNAL GENERATORS

Accessories

Models 10511A, 10514A, 10534A, 11507A, 11508A, 11509A

- Additional Capabilities for Signal Generators

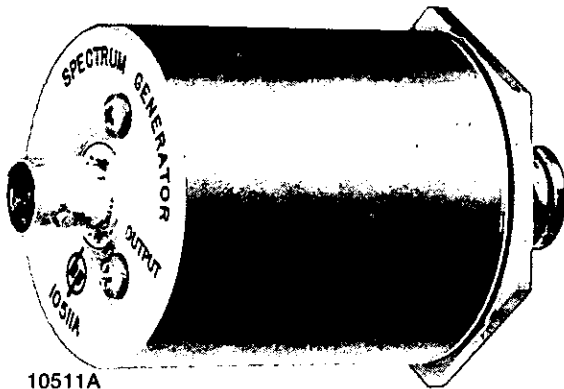

10511A

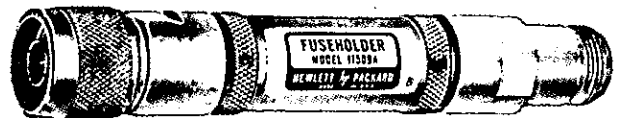

11509A

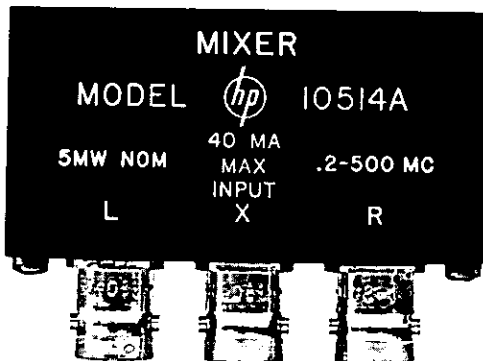

10514A

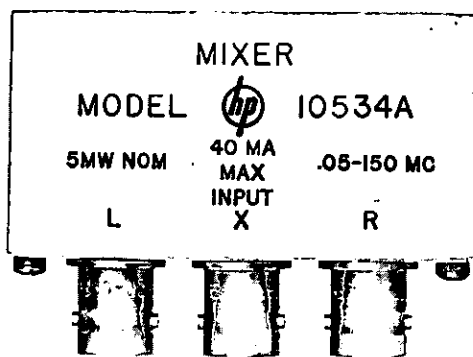

10534A

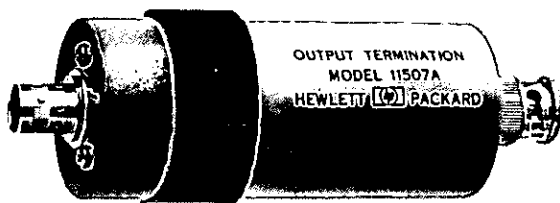

11507A

10511A Spectrum generator

Extends the useful frequency range of signal generators, sources and frequency synthesizers by providing a spectrum of harmonics up to 1 GHz from sine-wave inputs between 10 and 75 MHz. A 50Ω band-pass filter can then be cascaded with the 10511A to extract the desired harmonic. The harmonic power available is at least -19 dBm for harmonics 1 through 10.

Input requirements: 1 to 3 volts rms into 50Ω, 10 to 75 MHz.

10514A, 10534A Double balanced mixers

Used with signal generators in a variety of mixing as well as AM, pulse and square-wave modulation applications. The careful balancing of the hot carrier diodes in the 10514 and 10534 Mixers provides excellent suppression of the local oscillator and input frequencies at the output port. Frequency range of the 10514 is 0.2-500 MHz and the 10534 is 0.5-150 MHz.

11507A Output termination

A multi-purpose termination which enhances the usefulness of the 606A or 606B by providing the following:

1. A matched 50-ohm termination to permit use into high impedance circuits.
2. A 20-dB (10:1) terminated voltage divider which reduces the source impedance to 5 ohms.
3. A dummy antenna having the IEEE standard characteristics for receiver measurements (driven from 10:1 divider).

Frequency range: 50 kHz to 65 MHz on 0 to 20 dB positions. 540 kHz to 23 MHz on dummy antenna.

11508A Output cable

Provides 50Ω termination and standard binding posts at the end of a 610 mm (24-inch) length of cable. Allows direct connection of the signal generator to high impedance circuits.

11509A Fuseholder

Prevents accidental burnout of attenuators in HP 8640, HP 606 and 608 Signal Generators during transceiver testing by introducing a fuse element between the signal generator and the transceiver. Several watts of RF power could otherwise be applied to the signal generator attenuator should the transceiver accidentally be switched to "Transmit." While the fuseholder provides protection, it in no way limits the usable output from the signal generators.

Accessories furnished: 10 extra fuses.

Model number and name

Model number and name	Price
10511A Spectrum Generator	\$250.00
10514A Double Balanced Mixer	\$115.50
10534A Double Balanced Mixer	\$90.30
11507A Output Termination	\$100.00
11508A Output Cable	\$35.00
11509A Fuseholder	\$80.00

SIGNAL GENERATORS



Accessories

Models 11687A, 11690A, 11697A/B/C, 11698A

NEW

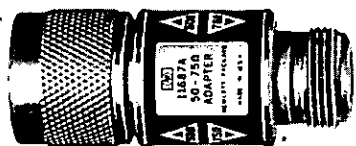
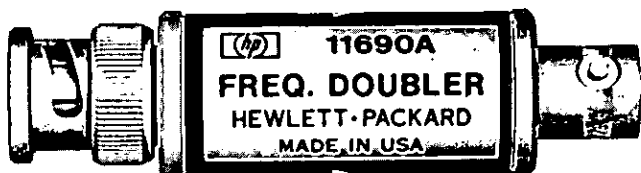

This kit was specifically designed to enable present or future owners of the standard 8640A or 8640B to extend frequency coverage of the generator to 1024 MHz. The installation procedure is simple and straightforward, and it can be done at a Hewlett-Packard Service Center or at the customer's own facility.

Once the kit is installed and calibrated, the generator acquires the same specifications as shown for the 8640A/B Option 002 on the previous pages.

11690A Frequency doubler

The HP 11690A Frequency Doubler is designed to extend the 8640A or 8640B frequency range by doubling the 256-512 MHz Frequency Band up to 1024 MHz (to 1100 MHz with band overrange). Its recommended input level for optimum performance with AM modulation is +10 dBm.

The 8640A has a dial scale for the 512 to 1024 MHz external doubler band to indicate the correct doubled output frequency. The 8640B also displays the correct doubled output frequency when the 512 to 1024 range is selected. For FM in the doubled range, an additional position on the PEAK DEVIATION RANGE switch allows peak deviation up to 5.12 MHz.

The following specifications describe the 11690A when used with the 8640A or 8640B:

Input required: +10 to +19 dBm (0.707 V to 2 V).

Conversion loss: <13 dB.

Level flatness: 4 dB total variation.

Suppression of 1st and 3rd harmonic of input typically >20 dB.

11687A 50-75Ω Adapter

This 50-75Ω Adapter with Type N connectors is recommended for use with the 8640A/B for measurements in 75Ω systems. The voltage calibration on the output level meter is unaffected by use of the adapter, but a correction of 1.76 dB must be made when using the dB scale.

11697A/B/C Bandpass filters

The Option 002 Internal Doubler covers several communication bands including UHF-TV, Mobile Radio and some ATC/DME. External band pass filters can be used to improve the generator spurious and harmonic performance in any of these bands. Three such filters are available, 11697A, 11697B and 11697C.

1. Option 002 cannot be fitted in the 8640B Option 004.

11698A Retrofit kit

The 11698A is an accessory kit which has all the components necessary to install the Option 002 Internal Doubler into either the 8640A or 8640B. This kit contains the doubler board assembly, output amplifier, low pass filter and interconnect cables plus a Manual Supplement and Service Note which gives a step by step installation procedure.

Model number and name

Model number and name	Price
11698A Retrofit Kit	\$750
11697A Bandpass Filter	\$270
11697B Bandpass Filter	\$270
11697C Bandpass Filter	\$270
11690A Frequency Doubler	\$155
11687A 50-75Ω Adapter	\$100

Model	Pass Band (MHz)	Pass Band VSWR	Pass Band Attenuation	Mid-Band Attenuation	Rejection Band Attenuation			
					Below Passband		Above Passband	
					Frequency (MHz)	Attenuation	Frequency (MHz)	Attenuation
11697A	512-674	≤1.4	≤1.1 dB	≤0.6 dB	≤337	≥20 dB	768 - 3000	≥20 dB
11697B	674-890	≤1.4	≤1.1 dB	≤0.6 dB	≤445	≥20 dB	1011 - 3000	≥20 dB
11697C	800-1100	≤1.4	≤1.1 dB	≤0.6 dB	≤550	≥20 dB	1333 - 3000	≥20 dB



Sweep oscillators

Swept frequency oscillators are used in applications where the characteristics of a device must be determined over a wide, continuous range of frequencies. Combined with a broadband detector and display test set, sweep oscillators provide many benefits compared to CW frequency sources. A swept measurement provides a dynamic display of the data. The results of any adjustments to the unknown test device are seen immediately (real time) on the display. By replacing laborious point-by-point techniques swept measurements increase the speed and convenience of broadband testing. The continuous frequency characterization of the unknown device also eliminates the chance of missing important information between frequency points. Swept techniques are applicable in all phases of design, manufacture and maintenance.

Hewlett-Packard sweep oscillators

Hewlett-Packard sweepers cover the entire frequency spectrum from dc to 40 GHz. Self-contained, multi-octave sweepers cover the frequency range to 110 MHz. The 8690 series of backward wave and solid state oscilla-

tors' features plug-ins from 400 kHz to 40 GHz. The 8620 family of solid state oscillators provide a versatile choice of configurations — single band, multiband, or very wide band plug-ins from 3 MHz to 18 GHz. A chart of the individual frequency bands available appears on page 18.3.

Sweep oscillator features Sweep flexibility

Every HP sweeper has several different sweep modes available for setting the frequency limits of the instrument. A full band or independently adjustable start/stop frequency sweep can be selected. Alternatively, a marker sweep or a symmetrical ΔF sweep about the desired center frequency can be chosen. Switching from one sweep mode to another is a simple pushbutton operation. In the auto mode the sweep retriggers automatically. Sweep times of 0.01 to more than 100 seconds can be selected. A manual sweep is also available as a front panel control, a real convenience for calibrating displays such as X-Y recorders. An external trigger is provided as well for applications where the sweeper must be synced to other instrumentation or remotely controlled.

On all sweeps a linear voltage proportional to frequency is available on an external connector which is useful for driving the horizontal of the display. Blanking and pen lift signals are also provided at rear output connectors during flyback time when the RF is off.

The 8620 solid state family also features a self-contained multi-band capability in one compact instrument. Different octave range oscillators (up to three in one drawer) can be selected by simply pressing one band select lever. This results in performance, cost, and size benefits compared to externally multiplexed sweeper systems.

Power output and leveling

Power output is continuously adjustable at the front panel over approximately a 10 dB range. Built-in attenuators are also available for greater power control. Internal or external leveling is employed to obtain (1) a constant power output and (2) a good source match (low VSWR). This ensures high accuracy when making swept measurements.

Modulation

Modulation capabilities further extend the sweeper's usefulness both as a sweeper and a signal generator for signal simulations. Wide

AM and FM bandwidths are useful for a variety of tests on communication receivers. The flexible FM capability allows remote analog frequency programming which is important for many applications.

Programming

Digital programming is available as an option on the 8620 solid state sweeper mainframe. One-thousand frequency points per band, band switching, RF attenuation and remote/manual operation can all be programmed remotely through a rear panel connector. This allows the sweeper to be used in a wide variety of automatic systems and sophisticated signal simulation applications.

Digital sweeping synthesizers

The 8660B and 3330A/B combine the precision frequency accuracy and stability of a synthesizer with the time saving convenience of a sweeper. Parameters such as center frequency, frequency step, time per step, and sweep width are entered and executed through a convenient keyboard or remote programming connector. An additional feature on the 3330B is amplitude sweeping in steps as small as 0.01 dB. The combination of frequency and amplitude sweeping can be used to produce a comprehensive family of curves.

Sweeper applications

Sweepers are used extensively with swept frequency test sets to characterize the ampli-

tude response of broadband devices or with network analyzers when the phase characteristics of the device (or S-parameters) are needed as well. Two RF measurements — transmission and reflection — are basic to both types of analyzer. Hewlett-Packard offers a complete line of directional couplers, power splitters, and other transducers which together with the analyzers and sweep oscillators provide a total swept measurement solution. Figure 1 shows a complete swept sys-

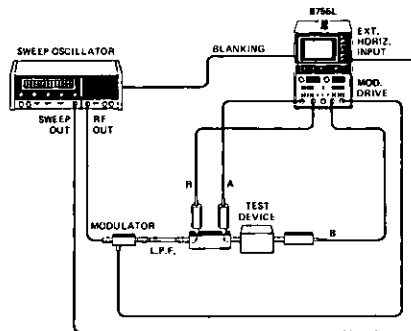

tem that can be used to simultaneously characterize the transmission and reflection properties of devices from 15 MHz to 18 GHz.

For high power applications such as RFI-susceptibility tests and high attenuation measurements, Hewlett-Packard offers TWT am-

plifiers which provide better than 1 watt from 1 to 12.4 GHz.

By phase locking Hewlett-Packard sweep oscillators to a very stable reference, excellent microwave signal purity can be achieved. It is possible to maintain phase lock while sweeping the oscillator by using the 8709A synchronizer. The high stability obtainable is important for many applications including microwave spectroscopy and high-Q swept frequency cavity measurements.

The modulation and built-in attenuator features of Hewlett-Packard sweep oscillators make them useful in many traditional CW signal generator applications.

For wideband applications the 86290A, 2-18 GHz plug-in features performance that rivals octave band oscillators in the area of frequency purity and accuracy, harmonics, and flatness.

For a complete discussion of swept frequency measurements the following application notes and others are available from your local Hewlett-Packard sales office:

AN 65 "Swept Frequency Techniques"

AN 95 "S-Parameters . . . Circuits Analysis and Design"

AN 117-1 "Microwave Network Analysis Applications"

AN 117-2 "Stripline Component Measurements"

AN 121-1 "Network Analysis with the 8407A, 0.1 - 110 MHz"

Sweep oscillator — summary chart

Frequency Range*	Model Number			100	1	10	100	1	2	4	8	12	18	26	40
	8620 Series	8690 Series	Other Sweepers	kHz	MHz	MHz	MHz	GHz	GHz	GHz	GHz	GHz	GHz	GHz	GHz
dc - 100 kHz 0.1 Hz - 13 MHz 10 kHz - 1300 MHz			3304/5A 3330A/B 8660A/B	←	←	←	←	←							
100 kHz - 110 MHz 400 kHz - 110 MHz 3 - 350 MHz 10 - 1300 MHz	86210A 86220A	8698B	8601A	←	←	←	←	←							
100 MHz - 4 GHz 1.0 - 2.0 GHz 1.4 - 2.5 GHz 1.7 - 4.2 GHz	86330B/86320A	8699B 8691A/B 8691A Opt 200 8692B Opt 100						←	←	←	←	←	←		
1.7 - 4.3 GHz 1.8 - 4.2 GHz 2 - 4 GHz 2 - 18 GHz	86331B 86230B or 86330B 86290A	8692A/B						←	←	←	←	←	←		
3.2 - 6.5 GHz 3.5 - 6.75 GHz 3.7 - 8.3 GHz 4 - 8 GHz	86241A or 86341B	8693A Opt 200 8693B Opt 100 8693A/B						←	←	←	←	←	←		
5.9 - 9.0 GHz 7 - 11 GHz 8 - 12.4 GHz 8 - 18 GHz	86242B or 86342A 86350A Opt H20 86250B or 86350A	8694A/B Opt 200 8694A/B 8694A/B Opt 300						←	←	←	←	←	←		
10 - 15 GHz 12.4 - 18 GHz 18 - 26.5 GHz 26.5 - 40 GHz	86260A Opt H03 86260A	8695A Opt 100 8695A/B 8696A 8697A						←	←	←	←	←	←	←	←

*Other Special Frequency Ranges Can Be Provided Upon Request.

SWEEP OSCILLATORS

Digital marker & generator/sweeper

Models 8600A & 8601A

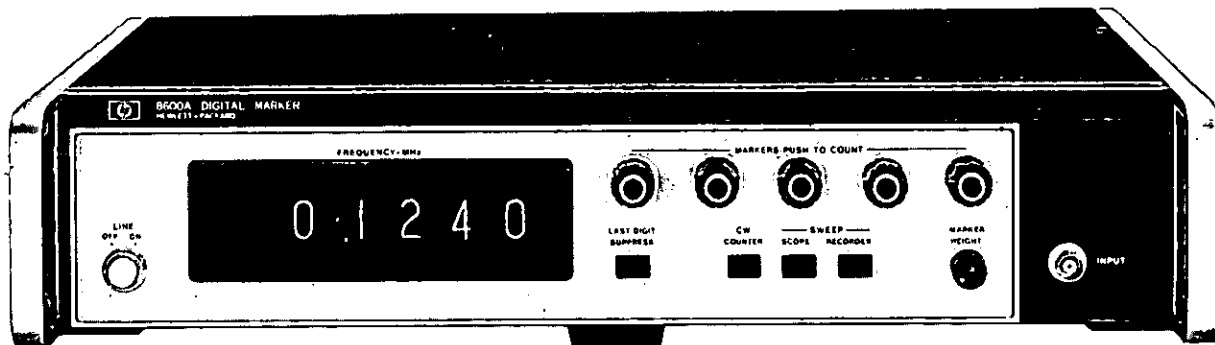

8600A

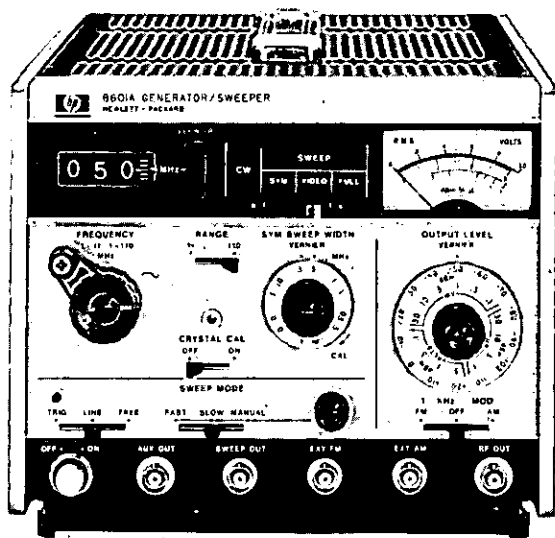

8601A

Covering 100 kHz to 110 MHz, the Model 8601A Generator/Sweeper combines the high linearity and flatness of a precision sweeper with a signal generator's frequency accuracy and wide range of calibrated power levels. Though it's small and lightweight, it does the work of two instruments easily and conveniently.

8601A Specifications

Frequency range: low range, 0.1-11 MHz; high range, 1-110 MHz.
Frequency accuracy: approximately $\pm 1\%$ of frequency.
Power output: +20 to -110 dBm; 10-dB steps and 13-dB vernier provide continuous settings over entire range. Meter monitors output in dBm and rms volts into 50 Ω .
Power accuracy: ± 1 dB accuracy for any output level from +13 dBm to -110 dBm.
Flatness: ± 0.25 dB over full range, ± 0.1 dB over any 10 MHz portion (+10 dBm step or below).

Impedance: 50 Ω , SWR <1.2 on 0 dBm step and below.
Harmonics and spurious signals: (CW above 250 kHz, output levels below +10 dBm) harmonics at least 35 dB below carrier. Spurious at least 40 dB below carrier.
Residual FM: noise in a 20 kHz bandwidth including line related components (dominant component of residual FM is noise).
CW: <50 Hz rms, low range; <500 Hz rms high range.
SYM 0, sweep: <100 Hz rms, low range; <1 kHz rms, high range.

Residual AM: AM noise modulation index (rms, 10 kHz bandwidth) is <-50 dB; (typically -60 dB at 25°C).
Crystal calibrator: internal 5 MHz crystal allows frequency calibration to $\pm 0.01\%$ at any multiple of 5 MHz.
Sweep modes: full, video, and symmetrical.
Internal AM: fixed 30% $\pm 5\%$ at 1 kHz.
External AM: 0 to 50%, dc to 400 Hz; 0 to 30%, up to 1 kHz.
Internal FM: 1 kHz rate, fixed 75 kHz $\pm 5\%$ deviation, high range; 7.5 kHz $\pm 5\%$ deviation, low range; <3% distortion.
External FM: sensitivity, 5 MHz per volt $\pm 5\%$, high range; 0.5 MHz per volt $\pm 5\%$, low range; negative polarity; FM rates to 10 kHz.
Weight: net, 9.5 kg (21 lb); shipping 12.3 kg (27 lb).
Dimensions: 190 mm (7 $\frac{1}{2}$ " wide, 155 mm (6 $\frac{1}{2}$ " high, 416 mm (16 $\frac{1}{2}$ " deep

The Model 8600A Digital Marker provides five independent, continuously variable frequency markers over the range 0.1 - 110 MHz when used with the HP 8601A or 8690B/8698B Generator Sweeper.

The high resolution controls and 6-digit readout permit 0.05% frequency settability. The frequency of any marker may be read while sweeping, simply by pushing a button within the marker control. The marker selected is brighter than the others and points in the opposite direction, ensuring positive marker identification.

8600A Specifications

Marker accuracy: any marker may be placed at a desired frequency \pm (0.05% of sweep width + sweeper stability).
Weight: net, 5.9 kg (13 lb); shipping 8.2 kg (18 lb).
Dimensions: 99 mm (3 $\frac{1}{4}$ " high, 413 mm (16 $\frac{1}{4}$ " wide, 337 mm (13 $\frac{1}{4}$ " long).
Option 001: includes modification kit for 8690B/8698B; no additional charge.
Model number and name

8600A Digital Marker	\$1400
8601A Generator/Sweeper	\$2800

SWEEP OSCILLATORS

Solid state sweeper family, 3 MHz to 18 GHz

8620 System

• Single-band, multi-band, and wide band plug-ins

• > 10 mW to 18 GHz

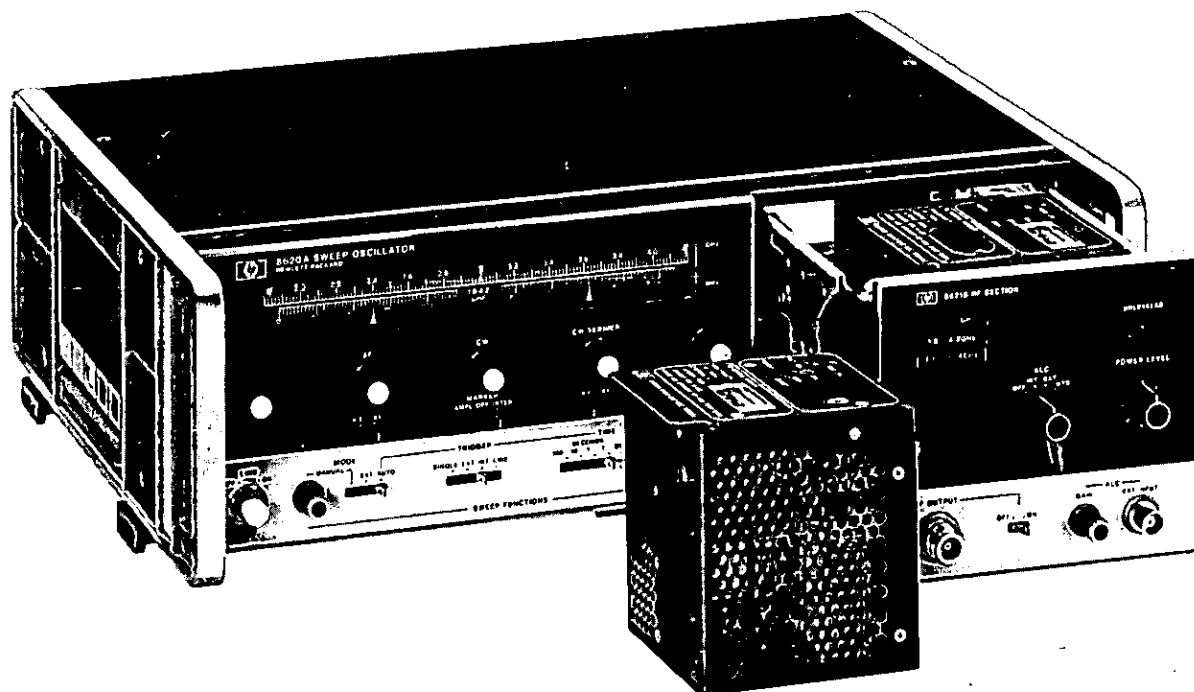

8620 System

The Hewlett-Packard 8620 solid state sweeper system offers the flexibility of the 8620A mainframe in addition to a choice of single-band, multiband, and the NEW 2-18 GHz wide band plug-ins. The 8620 system also offers high power output with solid state reliability - greater than 10 mW leveled to 18 GHz.

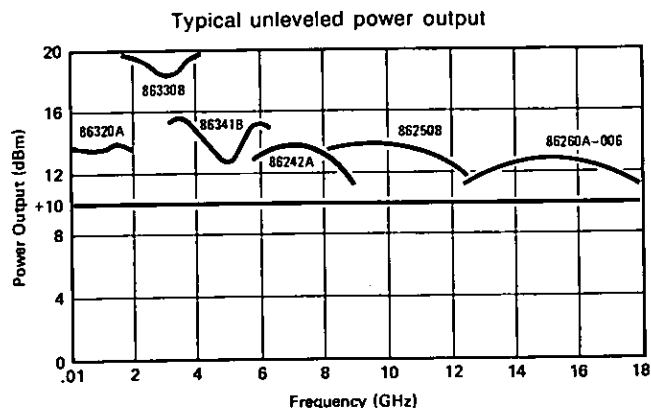

The fundamental oscillators used in the plug-ins and modules are YIG tuned transistor or bulk effect circuits. YIG tuning results in exceptional tuning linearity, low noise, and low spurious content; it also allows frequency modulation at high rates and wide deviations with low distortion.

8620A Sweeper mainframe

The 8620A has many features which are highly useful in stringent applications. With convenient functionally grouped controls and lighted pushbutton indicators the mainframe offers extreme ease of operation and flexibility. In addition, it can be a completely programmable source, an indispensable feature for automatic systems and signal simulation applications.

86200 Series single-band plug-ins

The 86200 series of plug-ins covers both ends of the frequency spectrum from 3 MHz to 18 GHz with a choice of more than seven plug-ins.

8621B and 86300 Series multiband plug-ins

The 8621B drawer provides capability for up to two fundamental oscillator modules (86300 series) plus a heterodyne module (86320A). Selecting the band is as simple as pressing a front panel lever.

New 86290A wide band plug-in

The 86290A covers the full 2 to 18 GHz frequency range in just one plug-in the same size as the 86200 series single band plug-ins. The full flexibility of the 8620A mainframe can be utilized to allow continuous calibrated sweep of any portion of the band.



SWEEP OSCILLATORS

8620 Family: mainframe

Model 8620A

- Full programming capability
- Convenient, flexible operation

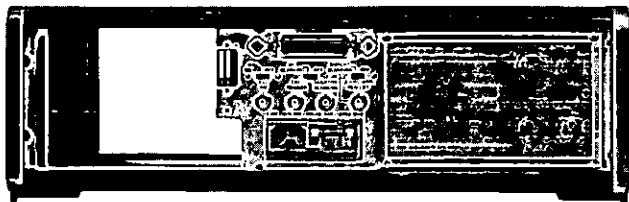
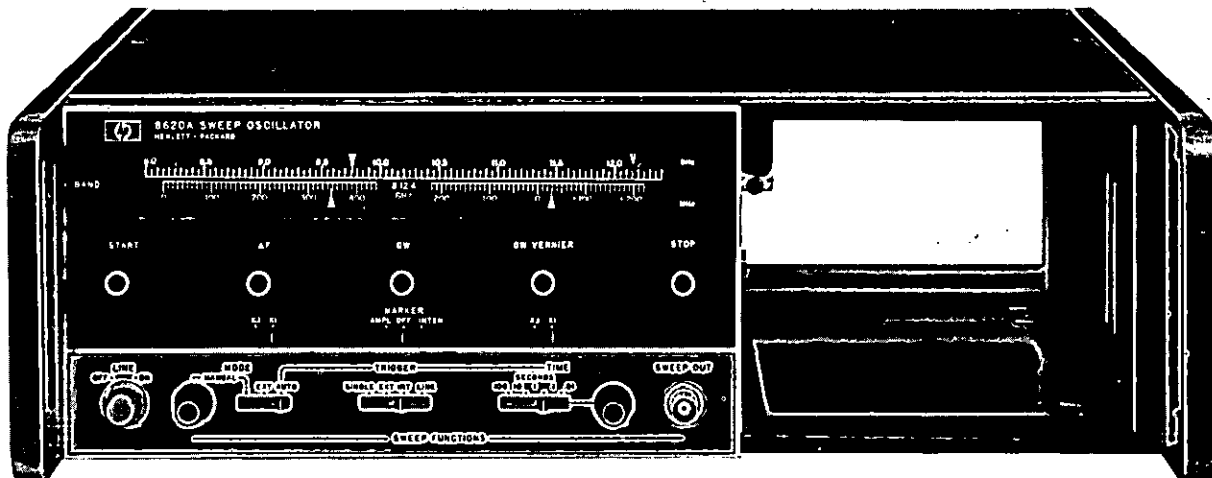

The 8620A offers many features as standard equipment. For example, up to four separate bands and their respective frequency scales can be selected with a touch of the band select lever just to the left of the dial scale. This represents a truly convenient wide-band capacity, one which doesn't necessitate changing plug-ins or the addition of costly, bulky, additional instruments to make wide-band swept measurements. Pushbuttons, concentrically located in the frequency control knobs, light when actuated to indicate the sweep function in use. As such, they also indicate the frequency controls to be utilized in set-

ting frequencies. For example, the wideband START/STOP function is selected by actuating either the START or STOP button in its respective frequency control knob. Both knobs light to indicate both controls are in use.

The 8620 is fully and continuously calibrated for any ΔF sweep width. Having chosen an optimum width, one can read the total sweep width from the calibrated ΔF dial scale. Two continuously variable ΔF ranges are available by using the range switch below the ΔF knob. This allows calibrated sweep widths of up to 1% or 10% of full band at the users choice.

The CW function is selected by depressing the CW knob. It is possible to also engage the CW vernier knob to achieve very accurate setability. With the main dial scale cursor placed on any convenient mark, it is possible to accurately interpolate between dial scale markers by utilizing the CW vernier. This vernier makes the effective length of the dial scale >20 inches and contributes to the increased setability.

Another feature is the capability to fully program the sweeper. The standard 8620A includes programming inputs for band selection, attenuator setting (with 8621B Opt 010 installed), sweep function selection, and analog frequency programming. Option 001 provides, in addition, 1000-point digital frequency programming.

8620A Specifications

Frequency

Frequency range: Determined by band switching lever and RF unit.

Frequency linearity: Refer to RF unit specifications.

Sweep functions

START-STOP sweep: Sweeps from START to STOP frequency setting. Selected by depressing either START or STOP frequency buttons on the front panel.

Range: Both independent settings are fully calibrated and continuously adjustable over the entire frequency range; can be set to sweep either up or down in frequency.

End-point accuracy: Refer to RF unit specifications, same as frequency accuracy.

ΔF Sweep: Sweeps symmetrically upward in frequency, centered on CW setting. CW vernier can be activated for fine control of center frequency.

Width: Continuously adjustable from zero to 10% or zero to 1% of usable frequency band as selected with front panel switch. Dial scale calibrated directly in MHz.

Width accuracy: $\pm 1\%$ of maximum ΔF plus $\pm 2\%$ of ΔF being swept.

Center-frequency Accuracy: Refer to RF unit specifications, same as frequency accuracy.

CW operations: Single-frequency RF output controlled by CW knob selected by depressing pushbutton in CW/MARKER control.

Preset frequencies: START-STOP sweep end points in manual sweep mode and CW frequency can be used as preset CW frequencies.

CW vernier: Calibrated directly in MHz about CW setting. CW vernier activated by pushbutton in CW vernier control. Zero to $\pm 0.5\%$ or zero to $\pm 5\%$ of full bandwidth, selectable with front panel switch.

Accuracy: Refer to RF unit specifications, same as frequency accuracy.

Frequency marker: The constant width frequency marker is fully calibrated and independently adjustable over the entire range and set with the CW/MARKER control. Front panel switch provides for the selection of either amplitude or intensity markers (amplitude modulating the RF output or Z-axis modulating the CRT display).

Resolution: Better than 0.25% of RF unit bandwidth.

Marker output: Rectangular pulse, typically -5 volts peak available from Z-axis BNC connector on rear panel. Source impedance, approximately 1000 ohms.

Accuracy: Refer to RF unit specifications, same as frequency accuracy.

Sweep modes

Auto: Sweep recurs automatically.

Line: Sweep can be synchronized with the ac power line.

External trigger: Sweep is actuated by external trigger signal $> +2$ volts peak, $> 0.5 \mu s$ pulse width and < 1.0 MHz repetition rate.

Sweep time: Continuously adjustable in four decade ranges typically 0.01 to 100 seconds.

Single sweep: Activated by front panel switch.

Manual sweep: Front panel control provides continuous manual adjustment of frequency between end frequencies set in any of the above sweep functions.

External sweep: Sweep is controlled by external signal applied to programming connector. Zero volts for start of sweep increasing lin-

early to approximately +6 volts for end of sweep.

Sweep output: Direct-coupled sawtooth, zero to approximately +10 volts, at front panel BNC connector, concurrent with swept RF output. Zero at start of sweep, approximately +10 volts at end of sweep regardless of sweep width or direction. In CW mode, dc output is proportional to frequency. Source impedance, approximately 10,000 ohms.

Modulation

Internal AM: Square-wave modulation continuously adjustable from 950 to 1050 Hz on all sweep times. On/Off ratio, refer to RF unit specifications.

External AM: Refer to RF unit specifications.

External FM: Refer to RF unit specifications.

Phase-lock: Refer to RF unit specifications.

Remote programming

Remote band select: Frequency range can be controlled remotely by three binary contact closure lines available at programming connector.

Remote attenuation select: 0 to 70 dB attenuation in 10 dB steps can be controlled by 4 binary contact closure lines when used with 8621B Option 010.

Remote frequency programming: See option 001 below.

Remote frequency programming, option 001

Functions:

Enable: Remote/Manual, One-line Binary.

Frequency: 1000 points, 12-line BCD.

Sweep function: Automatically in CW mode during remote programming.

Logic: TTL compatible.

General

Blanking:

RF: With blanking switch enabled, RF automatically turns off during retrace, and remains off until start of next sweep. On automatic sweeps, RF is on long enough before sweep starts to stabilize external circuits and equipment whose response is compatible with the selected sweep rate.

Display (Z-axis/MKR/Pen Lift Output): Direct-coupled rectangular pulse approximately +5.0 volts coincident in time with RF blanking is on rear panel.

Negative (Negative blanking output): Direct-coupled rectangular pulse approximately -5.0 volts coincident in time with RF blanking, fully compatible with 8410A/B network analyzer.

Pen lift: For use with X-Y recorders having positive power supplies. Transistor-switch signal is available on Z-axis/MKR/Pen lift connector. This signal is also available on the programming connector.

Furnished: 229 cm (7½-foot) power cable with NEMA plug; rack-mounting kit; 2 spare 3 amp fuses; extender board for servicing; and calibration scale.

Power: 115 or 230 volts $\pm 10\%$, 50 to 400 Hz. Approximately 140 watts.

Weight (not including RF unit): Net, 11.1 kg (24 lb). Shipping, 13.4 kg (30 lb).

Dimensions: 425 mm wide, 132.6 mm high, 337 mm deep (16¼" \times 5½" \times 13¼").

Model number and name

8620A sweep oscillator mainframe

Option 001, Remote frequency programming

Price

\$1750

\$515

SWEEP OSCILLATORS

8620 family: single band plug-ins

86200 Series

- High Performance
- 3 MHz – 18 GHz

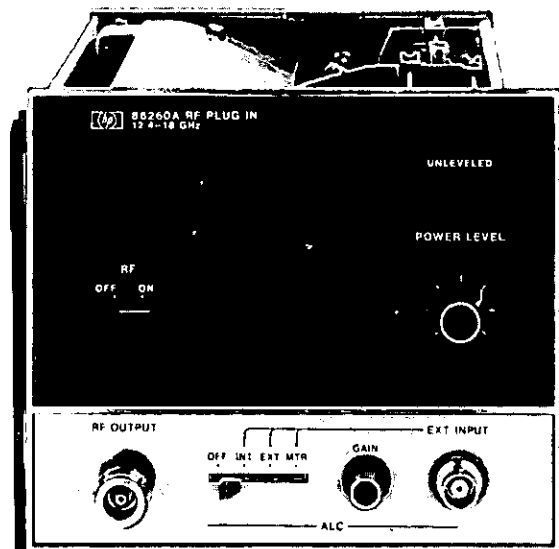
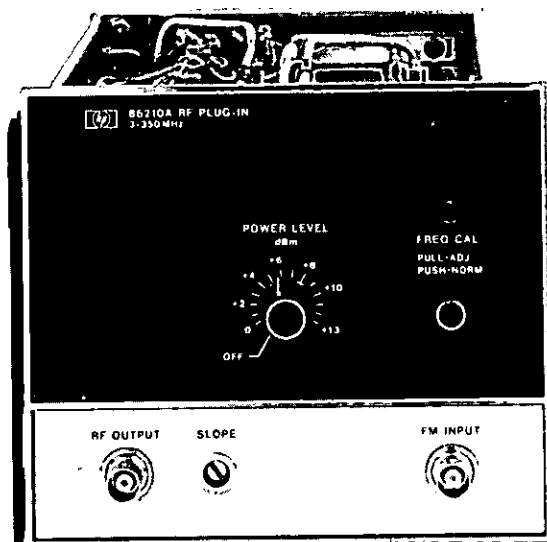

Specifications

86200 Series

Frequency linearity: Typically $\pm 1\%$

Reference output: DC-coupled voltage which is an analog of frequency is available for referencing or phase-locking external equipment to the plug-in.

RF power leveling: Internal dc-coupled leveling amplifier and PIN modulator provided.

Internal, option 001: Selected by front panel switch; refer to RF plug-in specifications. (Standard on 86210A and 86220A.)

External:

Crystal input: Approximately ± 20 to ± 250 mV for specified leveling at rated output; for use with positive or negative polarity detectors such as 780 Series Directional Detectors, 423A and 8470 Series Crystal Detectors; polarity switch provided in RF plug-in.

Power meter input: The 8404A Leveling Amplifier and external AM input on the 8620 Mainframe must be used with all RF plug-ins except the 86260A. It contains an internal leveling amplifier selected by front panel ALC switch.

Indicator: Front panel indicator lights when RF power level is set

too high to permit leveling over entire selected sweep range or when operating in unlevelled mode.

Residual AM in 1 kHz bandwidth: >50 dB below fundamental at maximum power.

External AM:

Frequency response: Typically dc to 100 kHz unlevelled, dc to 50 kHz leveled (at maximum leveled power).

Input impedance: Approximately 5000 ohms.

Mainframe compatibility: May be used interchangeably in 8620A or 8620B Mainframe.

RF output connector: Type N Female.

Dimensions: 152 mm wide, 127 mm high, 295 mm deep (6" \times 5" \times 11 $\frac{1}{2}$ ").

Weight: Net, 2.3 kg (5 lb). Shipping 3.2 kg (7 lb).

Options:

001: Internal leveling. Refer to RF plug-in specifications.

002: 70 dB attenuator in 10 dB steps, available in 86210A and 86220A.

004: Rear panel RF output

005: APC-7 RF output connector available on 86260A

006: $>+10$ dBm leveled output power guaranteed on 86260A

Price

add \$180

add \$80

add \$40

add \$300

Single band plug-ins

Specifications with plug-in installed in 8620A or 8620B	86210A	86220A	86230B	86241A	86242A	86250B	86260A
Frequency range ¹ (GHz):	0.003 – 0.35	0.01 – 1.3	1.8 – 4.2	3.2 – 6.5	5.9 – 9.0	8.0 – 12.4	12.4 – 18.0
Frequency accuracy CW mode (MHz): All sweep modes (sweep time > 100 ms) (MHz):	±7 ±10	±10 ±15	±15 ±20	±30 ±33	±35 ±40	±40 ±50	±50 ±70
Residual FM (10 kHz BW) CW mode (kHz peak):	<5	<5	<7	<7	<15	<15	<25
Maximum leveled power ¹ (dBm):	+13	+10	>+10	>+5	>+10	>+10	>+7 (for >+10 order Opt 006)
Power variation: Internally leveled (dB): Externally leveled (dB) (excluding coupler & detector variation):	<±0.25 Internal leveling, cal'd output std.	<±0.5	<±1.2 <±0.1	<±0.7 <±0.1	<±1 <±0.1	<±1 <±0.1	<±0.6 <±0.1
Spurious signals: (dB below fund. at specified max power) Harmonics: Nonharmonics:	>27 @ 13 dBm >35 @ 0 dBm >60	>25 >60	>20 >60	>16 (3.2 – 3.8 GHz) >20 (3.8 – 6.5 GHz) >60	>30 >60	>30 >60	>25 >50
Source VSWR: (50Ω nom, internally leveled)	<1.2	<1.3	<1.6	<1.6	<1.5	<1.5	<1.6
External FM: Max deviations (MHz) for modulation frequencies: DC – 100 Hz: DC – 1 MHz: Sensitivity (nom, MHz/V):	±15 ±5 +3.5	±15 ±5 +3.5	±25 ±2 -4	±25 ±2 -6	±25 ±2 -6	±25 ±2 -6	±75 ±5 (DC – 200 kHz) -20/-6
AM: Internal square Wave on/off ratio & Ext AM sensitivity To -10 V (dB):	>40	>35	>25	>25	>40	>40	>25
Price: Plug-in: Option 001 (int. lev):	\$1520 Included	\$1985 Included	\$2010 \$ 390	\$1625 \$ 390	\$2210 \$ 390	\$2315 \$ 390	\$2840 \$ 550

¹Special frequency bands and higher power outputs available on request.

SWEEP OSCILLATORS

8620 Family: multiband plug-ins

Model 8621B, 86300 series

- Modular construction

- > 40 mW in S-band

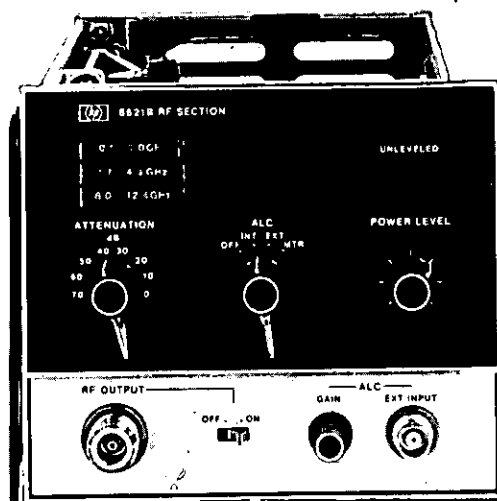

8621B

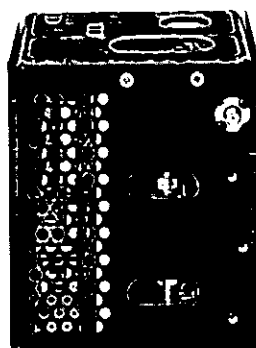

86300 Series

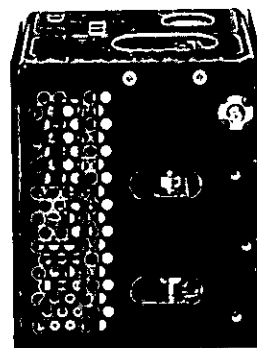

The 8621B RF Drawer houses the 86300 series RF Modules. The standard drawer will accept one fundamental oscillator module. In addition, with the 1.8 to 4.2 GHz fundamental oscillator module, the standard drawer also accepts the 0.1 to 2 GHz heterodyne module to give 0.1 to 4.2 GHz coverage. The 8621B Option 100 will accept two fundamental oscillator modules and the heterodyne module. This will allow, for example, 0.1 to 6.5 GHz coverage in one plug-in.

Specifications

8621B

70 dB step attenuator, option 010:

Range: 70 dB in 10 dB steps set by front panel switch.

Insertion loss: <2.0 dB.

Accuracy (including frequency response):

For 10 dB: <±0.6 dB.

For >10 dB: <±5% of attenuation.

Programming capability: 4-line binary logic, open or contact closure to ground. (8620A Mainframe only, input available at programming connector.)

Weight: Net, 0.9 kg (2 lb).

RF power leveling: Internal dc-coupled leveling amplifier provided. **Internal:** Selected by front panel switch; refer to RF module specifications.

External:

Crystal input: Approximately ±20 to ±250 mV for specified leveling at rated output; for use with positive or negative polarity detectors such as 780 Series Directional Detectors, 423A and 424 Series Crystal Detectors; polarity switch provided in RF drawer.

Power meter input: Switch in RF drawer selects proper compensation for Models 431B/C or 432A/B/C power meters.

Indicator: Front panel indicator lights when RF power level is set too high to permit leveling over entire selected sweep range or when operating in unlevelled mode.

Reference output: DC-coupled voltage which is an analog of frequency is available for referencing or phase locking external equipment to the sweeper.

Mainframe compatibility: May be used interchangeably in 8620A or 8620B Mainframe.

RF output connector: Type N Female.

Dimensions: 152 mm wide, 127 mm high, 295 mm deep (6" × 5" × 11 $\frac{5}{8}$ ").

Weight: Net, 1.4 kg (3 lb). Shipping, 2.3 kg (5 lb).

Common specifications

86300 series

Frequency linearity: Typically ±1%.

Residual AM in 1 kHz bandwidth: >50 dB below fundamental at maximum power.

External AM:

Frequency response: Typically dc to 100 kHz unlevelled, dc to 50 kHz levelled (at maximum levelled power).

Input impedance: Approximately 5000 ohms.

Dimensions: 92 mm wide, 103 mm high, 95 mm deep (3 $\frac{5}{8}$ " × 4" × 3 $\frac{3}{4}$ ").

Weight: Net, 1.4 kg (3 lb). Shipping, 1.8 kg (4 lb).

Options:

001: Internal Leveling (refer to RF module specifications). Standard on 86320A.

030: For use with 8690/8700A. Refer to 8690 Sweeper Family Specifications.

Model number and name

8621B RF Drawer

8621B Options

004: Rear panel RF output

010: 70 dB Attenuator

100: Multiband capability

Price

\$465

add \$80

add \$770

add \$440

Multiband plug-ins

Specifications with unit installed in 8621B and 8620A/B	86320A ¹	NEW 86330B	NEW 86331B	86341B	86342A	86350A
Frequency range ² (GHz):	0.1 – 2.0	1.8 – 4.2	1.7 – 4.3	3.2 – 6.5	5.9 – 9.0	8.0 – 12.4
Frequency Accuracy: CW mode (MHz): All sweep modes (sweeptimes > 100 ms)(MHz):	±15 ±20	±15 ±20	±20 ±25	±30 ±33	±35 ±40	±40 ±50
Residual FM (10 kHz BW) CW mode (kHz Peak):	<15	<7	<7	<7	<15	<15
Maximum leveled power ² (dBm):	>+13	>+16 (40 mW)	>+16 (2 – 4 GHz) >+13 (1.7 – 4.3)	>+10	>+7	>+6
Power variation: Internally leveled (dB): Externally leveled (dB) (Excluding coupler-detector or thermistor variation):	±0.7 <±0.1	<±0.7 <±0.1	<±0.8 <±0.1	<±0.7 <±0.1	<±1 <±0.1	<±1 <±0.1
Spurious signals: (dB below fund. at specified max power) Harmonics: Nonharmonics:	>30 @ 10 dBm >24 @ 13 dBm >30 @ 10 dBm >24 @ 13 dBm	16 (1.8 – 2 GHz) >20 (2 – 4.2 GHz) >60	>16 (1.7 – 4.3 GHz) >20 (2 – 4 GHz) >60	>16 (3.2 – 3.8 GHz) >20 (3.8 – 6.5 GHz) >60	>30 >60	>30 >60
Source VSWR: (50Ω nom, internally leveled)	<1.6	<1.6	<1.6	<1.6	<1.5	<1.5
External FM: Max deviations (MHz) for Modulation frequencies: DC – 100 Hz: DC – 1 MHz: DC – 2 MHz: Sensitivity: nominal FM mode (MHz/V): Phase lock mode (MHz/V):	±75 ±5 ±2 –20 –6	±75 ±5 ±2 –20 –6	±75 ±5 ±2 –20 –6	±75 ±5 ±2 –20 –6	±75 ±5 ±2 –20 –6	±75 ±5 ±2 –20 –6
AM: Internal square wave on/off ratio and Ext. AM sensitivity to –10 V (dB)	>15	>40	>40	>25	>40	>40
Price: Module: Option 001 (int. lev):	\$1855 Included	\$2050 \$ 250	\$2300 \$ 250	\$1980 \$ 260	\$2110 \$ 260	\$2110 \$ 260

¹86320A is a heterodyne unit which must be used with 86330B or 86331B.

²Special frequency bands and higher power outputs are available on request.

SWEEP OSCILLATORS

8620 System: broadband plug-in

Model 86290A

NEW

- 2 to 18 GHz continuous sweep
- Extended capability for network analysis

- Advanced technology provides outstanding performance

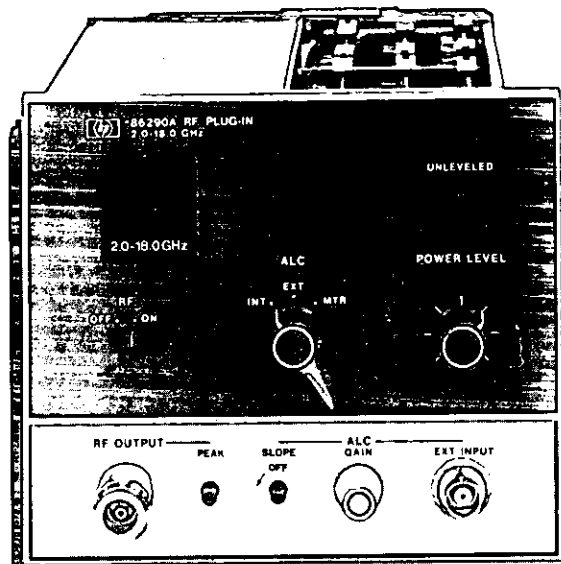

HP 86290A Typical Levelled Power Output

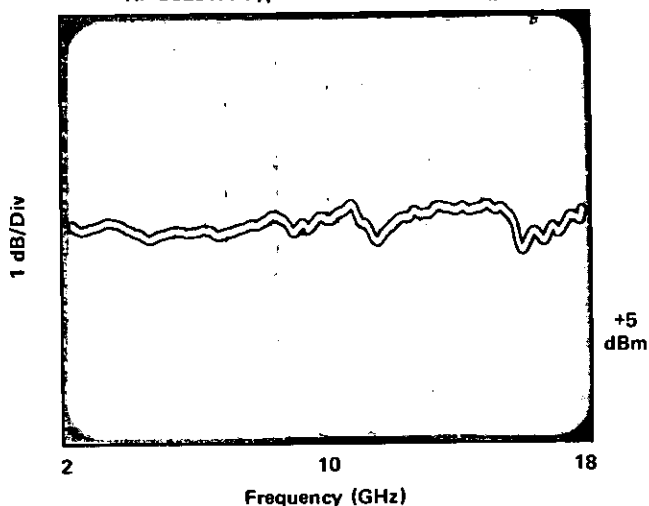

The 86290A broadband plug-in sets new standards in wideband sweeper value with versatile frequency coverage and excellent performance characteristics at an attractive size and price. For broadband testing, a continuous sweep from 2 to 18 GHz (or anywhere in between) is provided. In addition, higher frequency resolution is achieved by covering the 2 to 18 GHz range in three individual bands of 2 to 6.2 GHz, 6 to 12.4 GHz, and 12 to 18 GHz. Individual bands and corresponding dial scales are selected using the band select lever on the 8620A mainframe. Front panel lights indicate the frequency range selected. In each frequency band, all sweeper mainframe controls are operable.

The 86290A plug-in offers outstanding electrical performance along with small size and simplicity of operation. The key microelectronic elements of the 86290A are a 2 to 6.2 GHz fundamental oscillator, 100 mW amplifier, and high-efficiency multiplier integrated with a tracking YIG filter, which combine to produce a 5 dBm swept output over the 2 to 18 GHz range. This output is low in harmonic and spurious content and has excellent frequency linearity. On wideband sweeps,

the 6.2 GHz and 12.4 GHz switch points can be Z-axis blanked as well as RF blanked, resulting in a spurious-free, clean continuous trace on any display.

The 86290A plug-in has unique advantages as a source for network measurements. For 2 to 18 GHz scalar measurements, the 86290A accepts direct 27.8 kHz square wave AM modulation from the HP 8755 Frequency Response Test Set. Thus the need for an external modulator is eliminated providing convenience and cost savings, and more important, making full sweeper power available at the test device. Phase/amplitude network analysis over the continuous 2 to 18 GHz range becomes a reality using the 86290A and the new HP 8410B Network Analyzer. Interfacing between the 8410B and the sweeper permits the 8410B to automatically phase-lock over multi-octave sweeps. Together, the 86290A and the 8410B provide the only means of making phase and amplitude measurements from 2 to 18 GHz in one continuous sweep.

As a stand-alone sweeper, the 8620A and 86290A plug-in provide still more features for ease in swept testing. Even at 18 GHz, frequency can be set with ± 20 MHz accuracy. Sweep linearity is 0.05% which means frequencies in the swept mode can be identified to accuracies comparable with wavemeters. Internal leveling is standard. External crystal and power meter leveling circuitry is also provided. A SLOPE control permits the frequency-dependent losses of a test setup to be compensated. The 2 to 6.2 GHz fundamental oscillator signal is always available through a rear output connector. Phase-locking from 2 to 18 GHz is accomplished using only 6.2 GHz hardware via this output. Accurate frequency readout is possible by connecting a DVM to the calibrated 1 volt/GHz output located on the rear panel.

With the plug-in flexibility and these exceptional features, the 8620/86290A sweeper is the ideal source for broadband sweep testing of components, transmission lines, antenna systems and ECM equipment.

General specifications

Switch points: Broadband switch points are at 6.2 and 12.4 GHz. Frequency overlap is typically 0 to 20 MHz at switch points.

Auxiliary output: Rear panel 2 to 6.2 GHz fundamental oscillator output, nominally -10 dBm.

Slope control: Front panel control allowing compensation for frequency dependent losses of a test setup by attenuating power at lower frequencies.

Peak control: Front panel control for peaking power over desired frequency range.

1 volt/GHz output: 2-18 volt rear panel BNC output, CW frequency accuracy typically ± 35 MHz.

Mainframe modification: Order modification kit for sequential sweep capability on all 8620B mainframes, and on existing 8620A mainframes with serial prefix 1332A and below. (Kit included for 8620A mainframe with 86290A Option 060.)

Weight: Net, 4.4 kg (9.6 lb). Shipping, 5.9 kg (13 lb).

86290A Broadband plug-in

Specifications with plug-in installed in an 8620A mainframe	BAND 1	BAND 2	BAND 3	BAND 4
Frequency range: (GHz)	2-6.2	6-12.4	12-18	2-18
Frequency accuracy (25°C) CW mode (or >100 ms sweep time with FM switch in FM/PL): (MHz) All sweep modes: (MHz) Marker: (MHz) Frequency linearity (correlation between frequency and sweep out voltage) typically: (MHz)	±20 ±30 ±30 ±8	±20 ±30 ±30 ±8	±20 ±30 ±30 ±8	±80 ±80 ±80 ±30
Frequency stability With temperature: (MHz/°C) With 10% line voltage change: (kHz) With 10 dB power level change: (kHz) With 3:1 load VSWR, all phases: (kHz) Frequency drift (in 10 minute period after 30 minute warm-up): typically (kHz) Residual FM (10 kHz bandwidth; FM switch in norm) CW mode: (kHz peak)	±0.5 ±100 ±200 ±100 ±300 <10	±1.0 ±100 ±400 ±200 ±600 <20	±1.5 ±100 ±600 ±300 ±900 <30	±2.0 ±100 ±600 ±300 ±900 <30
Maximum leveled power (25°C): (dBm) Power level control range: (dB)	>5 >10	>5 >10	>5 >10	>5 >10
Power variation Internally leveled: (dB) Externally leveled (excluding coupler and detector variation) Crystal detector: Power meter: With temperature (typically): (dB/°C)	±0.7 ±0.15 ±0.15 ±0.1	±0.7 ±0.15 ±0.15 ±0.1	±0.8 ±0.15 ±0.15 ±0.1	±0.9 ±0.15 ±0.15 ±0.1
Spurious signals (below fundamental at specified maximum power) Harmonic related signals: (dB) Nonharmonics: (dB)	>25 >50	>25 >50	>25 >50	>25 >50
Residual AM in 100 kHz bandwidth (below fundamental at specified maximum power): (dB)	>55	>55	>55	>55
Source VSWR internally leveled, 50Ω nominal impedance	<1.9	<1.9	<1.9	<1.9
External FM Maximum deviations for modulation frequencies. DC to 100 Hz: (MHz) 100 Hz to 2 MHz: (MHz) Sensitivity (typically) FM mode: (MHz/volt) Phase-lock mode: (MHz/volt)	±75 ±5 -20 -6	±75 ±5 -20 -6	±75 ±5 -20 -6	±75 ±5 -20 -6
AM (At specified maximum power) Specific requirements guaranteeing HP 8755 operation with ±6 V, 27.8 kHz square wave mod drive connected to external AM input. On/Off ratio: (dB) Symmetry: Attenuation for +5 volt input: (dB) Internal 1 kHz square wave On/Off ratio: (dB) RF blanking (selected by mainframe switch) On/off ratio: (dB)	>30 45/55 >30 >25 >30	>30 45/55 >30 >25 >30	>30 45/55 >30 >25 >30	>30 45/55 >30 >25 >30
Sweep time typically: (ms)	10	10	10	60
CW remote programming settling time (typical time to settle into CW frequency accuracy specification, 8620A Opt. 001; FM switch in FM/PL): (ms)	5	5	5	10

Model number and name
86290A 2 to 18 GHz plug-in (internal leveling standard):
Option 004, rear panel RF output:
 (See Data Sheet for specifications)
Option 005, APC-7 RF output connector:
Option 060, 08620-60099 kit included for modifying 8620A mainframes with serial prefix 1332A and below:

Price
 \$13,250
 \$80
 \$40
 \$300

Sequential Sweep modification kits (ordered separately):
 08620-60099, for existing 8620A mainframes with serial prefix 1332A and below: \$300
 08620-60100, for all 8620B mainframes (8620B dial scales included): \$300

SWEEP OSCILLATORS

8690 Sweeper Family, 400 kHz to 40 GHz

8690 System

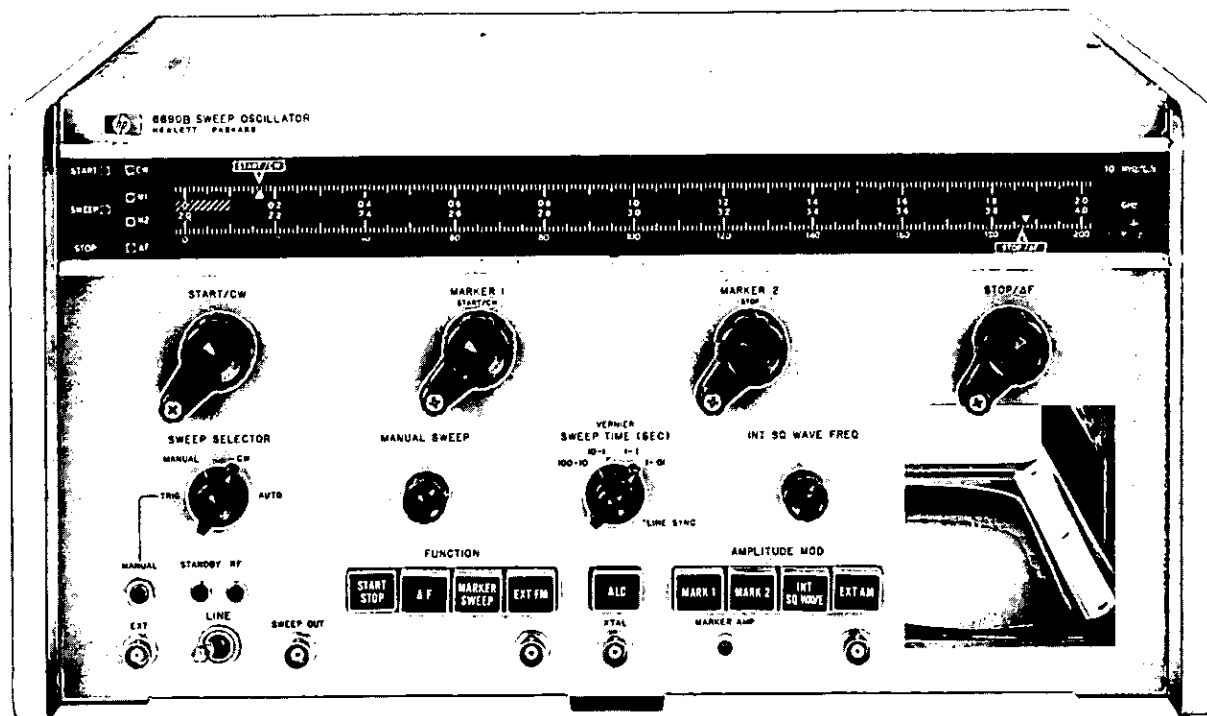

8690 System

The familiar 8690 BWO sweeper family offers exceptional value in performance, operation and versatility. With the ability to accept both BWO and solid state plug-ins, the 8690 mainframe allows BWO coverage where necessary, and more reliable, high performance solid state coverage at lower frequencies.

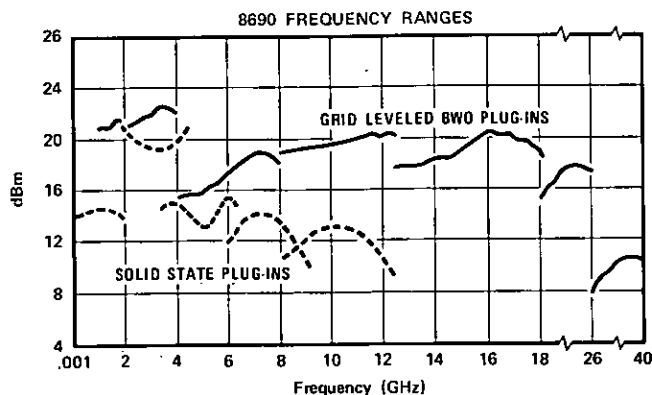

8690B Mainframe specifications

Sweep functions

START-STOP sweep: Sweeps from "start" to "stop" frequency setting. Both settings continuously adjustable over entire frequency range.

MARKER sweep: Sweeps from "Marker 1" to "Marker 2" frequency setting. Both settings continuously adjustable over entire fre-

quency range and accurate to 1% of full scale for all RF units.

ΔF sweep: Sweeps upward in frequency, centered on CW setting. Width is continuously adjustable from zero to 10% of the frequency band and is calibrated in MHz. Accuracy is $\pm 1\%$ of maximum ΔF plus $\pm 10\%$ of ΔF being swept.

CW operation: Single-frequency RF output selected by START/CW or MARKER 1 control, depending on sweep function selected.

Sweep modes

Auto, manual, and triggered sweep modes; sweep indicator lights during each sweep.

Sweep time: Continuously adjustable in four decade ranges, 0.01 to 100 seconds.

Sweep output: Direct-coupled sawtooth, zero to approximately +15 V, concurrent with swept RF output, regardless of sweep width or direction.

General

Frequency markers: Two markers independently adjustable over entire frequency range accurate to 1% of full scale. Amplitude is adjustable from front panel. A -5 V triangular pulse is available as an intensity marker on the rear panel.

Internal AM: Square wave modulation continuously adjustable from 950 to 1050 Hz.

External AM: Frequency response dc to 3 kHz. Deviation from CW setting approximately 6% of frequency band per volt.

Blanking: Both negative (-4 V) and RF blanking available along with pen lift output.

Weight: Net, 23.9 kg (53 lb). Shipping 32 kg (71 lb).

Dimensions: 425 mm wide, 222 mm high, 467 mm deep (16 $\frac{1}{4}$ " \times 8 $\frac{3}{4}$ " \times 18 $\frac{3}{8}$ ").

8690B Sweeper mainframe

\$1905

- Solid state plug-ins

- Both pin and grid leveled BWO plug-ins

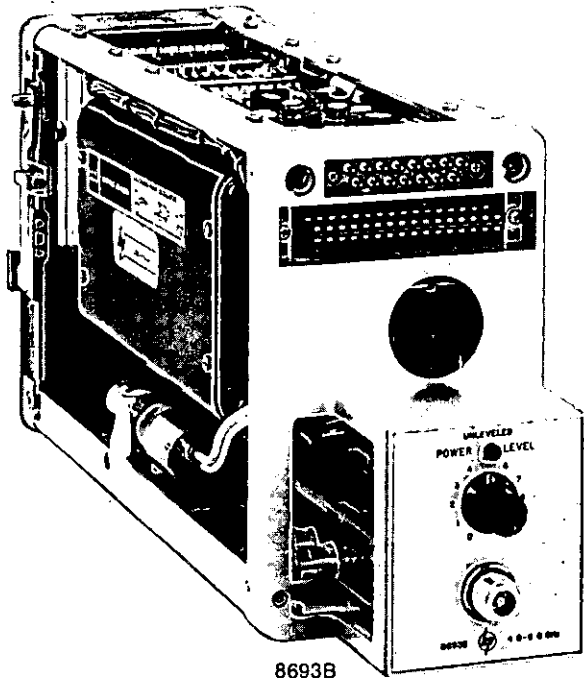
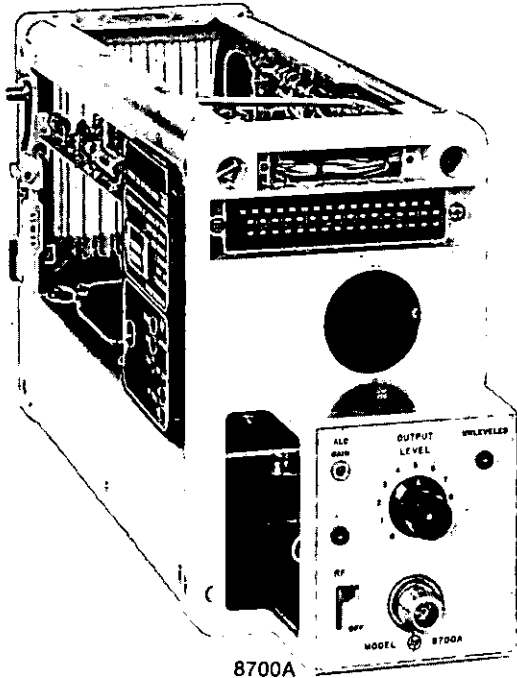

Solid state plug-ins

Solid state plug-ins from 400 kHz to 12.4 GHz are available for the 8690 mainframe. BWO replacement is both expensive and inconvenient. Solid state plug-ins not only offer high reliability, but also provide low residual FM and good spectral purity. This capability allows one mainframe to cover high frequency, high power BWO applications, yet facilitate high performance, longer life solid state coverage of lower frequencies.

Solid state frequency coverage is accomplished two ways. The 8698B covers 400 kHz to 110 MHz while the 8699B plug-in has a 200 MHz to 4 GHz range. Utilizing the 8700A RF drawer, 86300 series solid state modules from the 8620 sweeper line (page 18.10) can be used in the 8690 mainframe. These modules enable solid state coverage from 1.7 to 12.4 GHz. Furthermore, since the same modules are used with the 8620A, later expansion to the 8620 all solid state sweeper can be made conveniently and at minimum extra cost.

8700A specifications

Frequency coverage: Accepts one module from the 86300 series line, 1.7 to 12.4 GHz.

Leveling indicator: Front panel LED indicates unlevelled operation.

ALC gain: Adjusts ALC loop-gain for optimum leveling.

Sweep reference: dc voltage proportional to RF frequency output ≈ 40 V/octave.

FM input: FM and phase lock input. Refer to RF module specifications.

Internal AM: Frequency response typically dc to 100 kHz unlevelled, dc to 15 kHz leveled.

Weight: Net 4.1 kg (9 lb). Shipping 5.5 kg (12 lb).

BWO plug-ins

Both grid leveled and pin leveled BWO plug-ins are available covering 1 to 40 GHz. Grid leveled BWO oscillators achieve power and

leveling control by varying bias on the BWO grid. Although some degradation in frequency performance specifications is seen by this method, grid leveling provides an economical means of power control and delivers higher power output since there are no components (pin modulators) between BWO and front panel output.

PIN leveled BWO plug-ins offer superior frequency stability characteristics. As in all solid state plug-ins, leveling is accomplished through use of a pin diode modulator between oscillator and output. Use of the pin allows the oscillator to work at constant bias and into a constant impedance load, resulting in very low residual FM and very little frequency pulling. Pin leveling also results in a better source impedance match.

Common specifications: BWO plug-ins

Warranty: All BWO's are unconditionally warranted for one year.

Spurious signals: Harmonics, >20 dB below CW output, nonharmonics, >40 dB below CW output.

Residual AM: >40 dB below CW output.

Magnetic shielding: All plug-ins except the 8691A/B have shielded BWO's.

Reference output: dc voltage proportional to frequency output ≈ 40 V/octave.

Leveling indicator: Front panel light indicates unlevelled operation.

Power variation:

Unlevelled: <10 dB over full band

Externally leveled: ± 0.2 dB for A units

± 0.1 dB for B units

Frequency stability with temperature: $\pm 0.01\%/^{\circ}\text{C}$.

Weight:

8691-8692: Net 7.6 kg (20 lb). Shipping 12.6 kg (28 lb).

8693-8697: Net 5.4 kg (12 lb). Shipping 9 kg (20 lb).

Model number and name

8700A RF drawer

Option 004 rear panel RF output

Price

\$465

\$80



SWEEP OSCILLATORS

8690 Sweeper family (cont.)

Pin leveled solid state plug-ins and modules

Frequency Range	Model Number	Maximum Leveled Power	Frequency Accuracy	Frequency Stability With		Residual FM ³	Option 001 Int. Leveling Power Variation	Connector	Price	Option 001 Int. Leveling Price-Add
				Temperature	10 dB Power Level Change					
0.4-11 MHz	8698B	>20 mW	$\pm 1\% \pm 50$ kHz	$\pm 0.05\%/^{\circ}\text{C}$	—	<300 Hz rms	± 0.3 dB	BNC ²	\$1750	Standard
11-110 MHz		>20 mW	$\pm 1\% \pm 500$ kHz	$\pm 0.05\%/^{\circ}\text{C}$	—	<500 Hz rms	± 0.3 dB			
0.1-2 GHz	8699B	>20 mW	± 10 MHz	± 750 kHz/ $^{\circ}\text{C}$	<100 kHz	<3 kHz rms	—	Type N	\$3990	—
2-4 GHz		>6 mW	± 10 MHz	± 750 kHz/ $^{\circ}\text{C}$	<500 kHz	<3 kHz rms	—			
1.8-4.2 GHz	86330B ¹ Opt. 030	>40 mW	± 15 MHz	± 500 kHz/ $^{\circ}\text{C}$	± 1 MHz	<15 kHz Pk	± 0.7 dB	Type N	\$2050	\$250
1.7-4.3 GHz	86331B ¹ Opt. 030	>20 mW	± 20 MHz	± 500 kHz/ $^{\circ}\text{C}$	± 1 MHz	<15 kHz Pk	± 0.8 dB	Type N	\$2300	\$250
3.2-6.5 GHz	86341B ¹ Opt. 030	>10 mW	± 30 MHz	± 650 kHz/ $^{\circ}\text{C}$	± 1 MHz	<20 kHz Pk	± 0.7 dB	Type N	\$1980	\$260
5.9-9.0 GHz	86342A ¹ Opt. 030	>5 mW	± 35 MHz	± 750 kHz/ $^{\circ}\text{C}$	± 4 MHz	<25 kHz Pk	± 1.0 dB	Type N	\$2110	\$260
8.0-12.4 GHz	86350A ¹ Opt. 030	>4 mW	± 40 MHz	± 1.2 MHz/ $^{\circ}\text{C}$	± 2 MHz	<25 kHz Pk	± 1.0 dB	Type N	\$2110	\$260

1. Must be used with the 8700A. Includes 8690 dial scale. Refer to page 372 for further 86300 information.

2. 75 Ω BNC output available. Add \$55.

3. Residual FM measured with 10 kHz bandwidth. Multiply by (3) for 8690A mainframe.

Grid and pin leveled BWO plug-ins

Frequency	Model Number	Power Control	Maximum Leveled Power	Frequency Accuracy	Freq. Stability With Power Level Change ¹	Residual FM Peak ²	Option 001 Int. Leveling Power Variation	Connector	Price	Option 001 Int. Leveling Price-Add
	8691B	PIN	>70 mW	± 10 MHz	± 500 kHz	<10 kHz	—	Type N	\$2900	—
1.4-2.5 GHz	8691A Opt. 200	GRID	>100 mW	$\pm 1\%$	<30 MHz	<30 kHz	—	Type N	\$2775	—
1.7-4.2 GHz	8692B Opt. 100	PIN	>15 mW	± 25 MHz	± 4 MHz	<20 kHz	—	Type N	\$3040	—
2.0-4.0 GHz	8692A	GRID	>70 mW	$\pm 1\%$	<40 MHz	<30 kHz	± 0.4 dB	Type N	\$2320	\$360
	8692B	PIN	>40 mW	± 20 MHz	4 MHz	<15 kHz	—	Type N	\$2680	—
3.5-6.75 GHz	8693A Opt. 200	GRID	>40 mW	$\pm 1\%$	<80 MHz	<50 kHz	—	Type N	\$2705	—
3.7-8.3 GHz	8693B Opt. 100	PIN	>5 mW	± 45 MHz	± 1 MHz	<20 kHz	± 0.4 dB	Type N	\$2810	\$390
4.0-8.0 GHz	8693A	GRID	>30 mW	$\pm 1\%$	<80 MHz	<50 kHz	± 0.5 dB	Type N	\$2060	\$390
	8693B	PIN	>15 mW	± 40 MHz	± 1 MHz	<15 kHz	± 0.4 dB	Type N	\$2475	\$390
7.0-11.0 GHz	8694A Opt. 200	GRID	>25 mW	$\pm 1\%$	<160 MHz	<60 kHz	± 0.75 dB	Type N	\$2110	\$490
	8694B Opt. 200	PIN	>15 mW	± 40 MHz	± 1 MHz	<20 kHz	± 0.75 dB	Type N	\$2580	\$490
7.0-12.4 GHz	8694A Opt. 100	GRID	>25 mW	$\pm 1\%$	<160 MHz	<60 kHz	± 0.75 dB	Type N	\$2365	\$490
	8694B Opt. 100	PIN	>15 mW	± 50 MHz	± 1 MHz	<20 kHz	± 0.75 dB	Type N	\$2835	\$490
8.0-12.4 GHz	8694A	GRID	>50 mW	$\pm 1\%$	<160 MHz	<60 kHz	± 0.75 dB	Type N	\$2055	\$490
	8694B	PIN	>30 mW	± 40 MHz	± 1 MHz	<15 kHz	± 0.75 dB	Type N	\$2525	\$490
8.0-18.0 GHz	8694A Opt. 300	GRID	>10 mW	$\pm 1\%$	± 150 MHz	<150 kHz	—	Type N	\$4555	—
	8694B Opt. 300	PIN	>5 mW	$\pm 1\%$	± 1 MHz	<50 kHz	—	Type N	\$5000	—
10-15.5 GHz	8695A Opt. 100	GRID	>25 mW	$\pm 1\%$	<0.25 GHz	<150 kHz	—	Flat Flange for WR-75WG	\$3320	—
12.4-18.0 GHz	8695A	GRID	>40 mW	$\pm 1\%$	<0.25 GHz	<150 kHz	—	UG-419/U	\$2185	—
	8695B	PIN	>15 mW	± 56 MHz	± 1 MHz	<25 kHz	—	UG-419/U	\$2680	—
18.0-26.5 GHz	8696A	GRID	>10 mW	$\pm 1\%$	<0.36 GHz	<200 kHz	—	UG-595/U	\$2985	—
26.5-40 GHz	8697A	GRID	>5 mW	$\pm 1\%$	<0.53 GHz	<350 kHz	—	UG-599/U	\$4835	—

1. Power level change specification for B units typically 10 dB, A units 6 dB.

2. Residual FM measured with 10 kHz bandwidth.

Options 004 rear output 8691-8694
Options 004 rear output 8695-8697
Option 400 phase lock input

add \$80
add \$155
add \$250

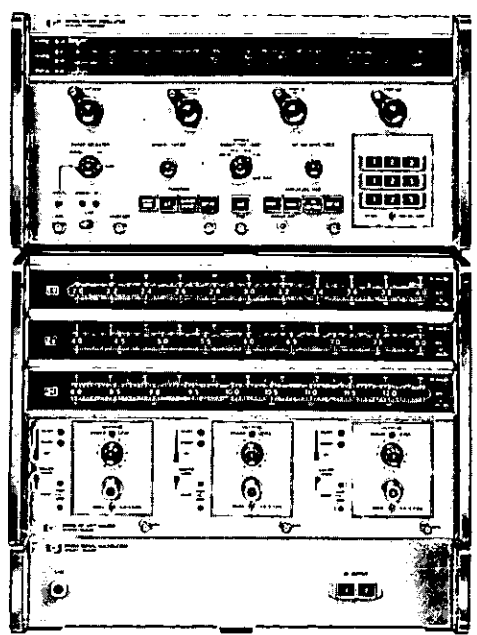

8690B/8706A, 8707A, 8705A

8705A, 8706A, 8707A Multiband system

Multiband systems 400 kHz to 40 GHz are available using the 8706A control unit plug-in and the 8707A RF unit holder. The 8706A allows pushbutton control of RF plug-ins installed in the 8707A. The 8705A multiplexer switches RF signals up to 12.4 GHz from three RF units and provides an ALC signal for the 8690B leveling circuits.

Specifications

8705A Multiplexer
Frequency range: dc to 12.4 GHz. Output port SWR ≤ 1.67 . Input port SWR ≤ 1.35 .
Insertion loss: 3 dB.
Weight: Net, 7.8 kg (17 lb). Shipping, 10 kg (22 lb).

8706A Control plug-in
Compatibility: The 8706A controls up to three 8707A RF unit holders; Option H26 for remote band switching of the 8699B.
Weight: Net, 7.3 kg (16 lb). Shipping, 11.4 kg (25 lb).

8707A RF Unit Holder
Capability: Accepts up to three 8690 plug-ins.
Sweep functions:
Normal: permits all 8690B sweep functions.
Preset: allows screwdriver setting of individual start/stop points.
Weight: Net, 13.6 kg (30 lb). Shipping, 16.8 kg (37 lb).

8709A Phase lock synchronizer

The 8709A synchronizer is a phase comparator designed to stabilize the frequency of both HP BWO and solid state sources by phase locking to a reference oscillator. Under these conditions system stability is determined primarily by the stability of the reference oscillator. Phase lock capability is standard on solid state plug-ins from 1.7 to 18 GHz. Order Option 400 for BWO plug-ins. Information on complete phaselocked systems available on request.

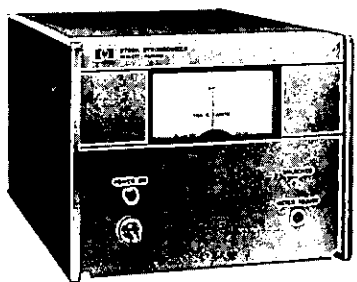

8709A

Specifications

Input frequency: The locking frequency of the 8709A is 20 MHz. This signal is obtained by multiplying and mixing the reference oscillator with the microwave signal.
Sensitivity: -65 dBm.
Minimum output voltage: High level ± 12.0 V dc; low level ± 8.0 V dc.
Modulation sensitivity: 8690 BWO Option 400 plug-ins, 0.5 to 6.0 MHz/V. 8620 solid state plug-ins 6.0 MHz/V.
Weight: Net 4.5 kg (10 lb). Shipping 5.3 kg (11.6 lb).

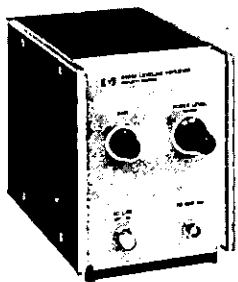

8404A

8404A Power meter leveling amplifier

The 8404A leveling amplifier permits the 431B/C or 432A/B/C power meter to level both the 8620 and 8690 sweeper plug-ins. RF output is leveled to ± 0.5 dB or less when connected to the AM input of the sweeper.

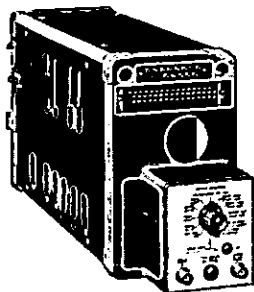

11531A

11531A Mainframe test plug-in

The 11531A test unit plug-in allows complete calibration of the 8690 mainframe, including sweep modes, markers and BWO. All voltages are selected from a front panel switch.

Model number and name	Price
8404A power meter leveling amplifier	\$410
Option 001, 4 line BCD level control	add \$210
8705A signal multiplexer dc — 12.4 GHz	\$2140
8706A control unit plug-in	\$725
8707A RF unit holder	\$1745
8709A phase-lock synchronizer	\$1130
11531A mainframe test unit plug-in	\$415

POWER & NOISE FIGURE METERS

Power measurements

Power measurements

At microwave frequencies, power is the basic measure of signal amplitude. Unlike voltage and current, microwave power remains constant along a lossless transmission line. Thermocouple and thermistor power meters are the most common type of instruments used to measure microwave power.

Thermocouple power meters

The use of thermocouples as a sensing element is the most recent development in microwave power measurement. Wide power range, low drift, low VSWR, and simple operation are the major advantages of thermocouples over other power sensing devices.

A thermocouple measurement system consists of a power sensor which produces a dc output voltage proportional to the power dissipated in it and a power measurement circuit which measures the dc voltage and displays it in units of power.

The power sensor provides an impedance match between the thermocouple element and the microwave transmission line. In the Hewlett-Packard 8480 Power Sensor family, input power is dissipated in silicon-tantalum nitride thermocouple elements. The dissipated power causes the junction temperatures to rise above the ambient temperature of the sensor substrate. This temperature differential and resulting thermocouple voltage are proportional to the applied power. The small physical size of the element and careful design of the structure assure that changes in ambient temperature affect all junctions equally, thus making the system relatively insensitive to zero drift.

The dc output voltage is amplified by an FET, chopper-stabilized amplifier in the power sensor and delivered to the power meter.

With thermocouple type power meters, accuracy is fundamentally dependent on the instrument's gain being matched to the power sensor sensitivity. Since thermocouple sensitivity is subject to change with variations in temperature, overload, and aging, a convenient means of calibration is vital.

The Hewlett-Packard 435A Power Meter provides an accurate, built-in power reference, as shown in Figure 1, for use in calibrating the meter-power sensor combination. In this way, long term accuracy is assured. With the 8480 Power Sensor family, the meter mea-

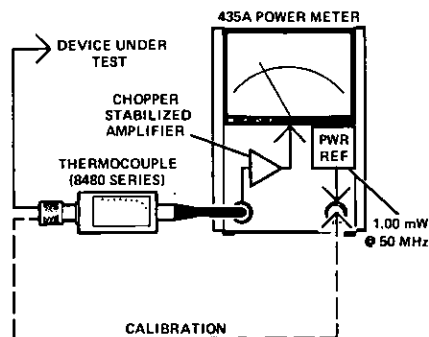

Figure 1. Power measurement system. Built-in power reference provides convenient means of calibrating the meter-power sensor combination.

sures power from 0.3 μ W to 3 W at frequencies from 100 kHz to 18 GHz, depending on the power sensor used.

The largest source of uncertainty in power measurements is mismatch. For example, consider the effect of mismatch when measuring the output of a microwave source at a frequency of 1 GHz and a VSWR of 1.5. If the power sensor also has a VSWR of 1.5, the total mismatch uncertainty, which *cannot* be calibrated out, is $\pm 8\%$; the diagram in Figure 2 shows this. With the 8481A Power Sensor, that has a VSWR of 1.1 at 1 GHz, the mismatch uncertainty is only $\pm 1.9\%$ when measuring the same source. See figure 3.

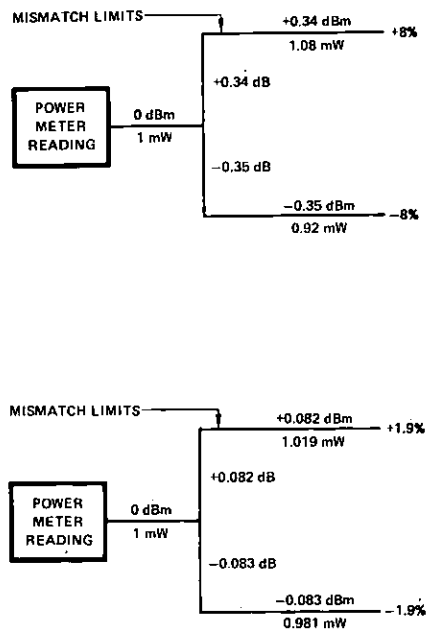

Figure 3. Limits of mismatch uncertainty when VSWR of source is 1.5 and VSWR of power meter is 1.1.

Thermistor power meters

Thermistors offer an alternative means to measure microwave power. A thermistor is a resistive element whose resistance decreases with increasing temperature. In a thermistor type instrument, the sensor elements are contained in a mount and form one leg of a Wheatstone bridge through a bias connection to the power meter. Dc or ac excitation biases the thermistor elements to balance the bridge. When microwave power is applied to the sensor elements, the resulting temperature rise causes the thermistor resistance to fall, unbalancing the bridge. Withdrawing an equal amount of bias power from the thermistors rebalances the bridge. The change in bias power is then measured and displayed on a meter.

Automatic thermistor bridges

There are a number of thermistor bridge designs which provide various degrees of accuracy, speed, and convenience.

The Hewlett-Packard 432 Series of Power Meters use a temperature-compensated, automatically balanced bridge of versatile design. Operating with any of the Hewlett-

Packard temperature-compensated thermistor mounts, the meter automatically maintains bridge balance and reads substituted bias power over ranges of 10 microwatts to 10 milliwatts (full scale).

Since thermistor elements are temperature-sensing devices, they are unable to distinguish between applied power level changes and environmental temperature changes. As thermistor bridge sensitivity is increased, even minute temperature variations can unbalance the bridge. This results, if uncompensated, in "zero drift" of the power meter and erroneous power measurements.

A dual bridge arrangement, as shown in Figure 4, is used in the 432-series to compensate for variations in temperature at the thermistor mount. The thermistor mounts used have two thermistor elements. The two are in close thermal proximity and are affected equally by changes in ambient temperature. Thus R_D responds to both ambient temperature and applied RF power; R_C , isolated from the RF power, responds only to ambient temperature. Each element is connected to its own bridge circuit in the power meter which automatically controls bias power. This arrangement compensates for temperature changes, thus reducing zero drift by a factor of 100 over uncompensated thermistor meters. Another advantage of this design is that when zeroed on the most sensitive range, the meter may be switched to any other power range without rezeroing (zero-carryover is within $\pm 0.5\%$ on all ranges). A dc output proportional to the meter deflection is available for recording purposes or control of external circuits such as power meter leveling of microwave sweep oscillators and signal generators.

Compensated thermistor mounts available for the 432-series of power meters included the 478A (10 MHz to 10 GHz) and the 8478B (10 MHz to 18 GHz) coaxial mounts. The 486A Waveguide Series collectively cover the waveguide bands from 2.6 to 40 GHz. All mounts have low SWR over their frequency ranges without tuning.

Peak power measurement

A frequent requirement in microwave work is the measurement of peak power in a periodic pulse. This may be done by various indirect techniques using thermocouples or thermistors. Hewlett-Packard produces a versatile instrument that conveniently measures peak power directly in the 50 MHz to 2 GHz frequency range. This instrument (the model 8900B) utilizes a video comparator technique to bring a known dc voltage, supplied by the instrument, in a known impedance to a level which is equal to the pulse being measured. This allows simple measurement of peak pulse power with a basic accuracy of 1.5 dB even when the waveform is not rectangular. A custom calibration chart increases accuracy to 0.6 dB for critical applications.

Applications

Information on virtually all aspects of microwave power measurement, including detailed descriptions and illustrations of instruments, measurement techniques, error analysis, and applications, is contained in

Application Note 64. Sources of measurement error and systematic methods for error reduction allow selection of the best procedure for specific applications. Application Note 64, entitled "Microwave Power Measurement," is available on request through your Hewlett-Packard Sales Office.

Steps toward better accuracy

The fundamental standards of microwave power lie in dc or low-frequency ac voltage and resistance standards which may be accurately measured and used for comparison or substitution. Other factors, such as impedance matching and efficiency of the sensing device, also play an important role in overall measurement accuracy.

The basic accuracy of Hewlett-Packard power measuring equipment satisfies the requirements of most applications without complicated setups requiring extensive manual operations and calculation. Should greater accuracy be required, the versatility and stability of Hewlett-Packard equipment allows easy enhancement of its basic accuracy in a step-by-step manner until the degree of accuracy needed is achieved.

Effective efficiency and calibration factor

A power meter can only be responsive to the power which is actually dissipated within its sensor elements. Power which is dissipated elsewhere in the sensor or reflected by it will not be indicated. Furthermore, the spatial distribution of current and resistance within the sensor elements differs for power at microwave frequencies and the dc or audio power used for reference or substitution. The effects of these sources of error are measured at a number of frequencies for all Hewlett-Packard power sensors and temperature-compensated thermistor mounts and presented on the nameplate as Effective Efficiency and Calibration Factor.

For thermistor mounts, Effective Efficiency is the ratio of substituted bias power in the power meter to the microwave power absorbed by the mount. Effective Efficiency accounts for all losses except the reflection due to impedance mismatch. Calibration Factor is the ratio of substituted bias power in the meter to the microwave power incident on

the mount. Calibration Factor, therefore, accounts for all losses. Although direct traceability to the National Bureau of Standards is not yet available in certain bands, the extensive tests and crosschecks conducted by Hewlett-Packard on literally thousands of mounts assure a high level of confidence in the calibration of all mounts. In addition, the mounts are swept-frequency tested to reveal any "holes" in their response.

For the thermocouple power sensor, the same concepts apply. However, to simplify operation, the data is presented as a Calibration Factor which normalizes the data to the value at 50 MHz, the frequency of the internal Power Reference, simplified for the user. Effective Efficiency data is not displayed since the extremely low SWR of the power sensor means it varies only slightly from the Calibration Factor.

Tuners

In most applications it is sufficient to correct for the various losses associated with the sensor by using Calibration Factor data. Source mismatch (SWR) is also a factor in any power measurement, and the combination of source and load SWR can result in serious mismatch errors. Uncertainty can be re-

duced by using an HP 870A Slidescrew Tuner, ahead of the sensor. When a tuner is used, only correction for Effective Efficiency is necessary. Of course, the lower the sensor SWR, the smaller the effect of mismatch will be; maximum accuracy is always obtained from the lowest SWR. In the case of the model 8481A Power Sensor, the reflection coefficient in both magnitude and phase is supplied for 17 frequencies from 2 - 18 GHz. By making the same measurement on the source under test, you can calculate the effect of mismatch and eliminate this source of error.

Instrumentation

Maximum instrumentation uncertainty of the model 435A Power Meter is $\pm 1\%$ of full-scale on all ranges. This uncertainty can be reduced by directly measuring the voltage at the recorder output. A digital voltmeter, such as the Hewlett-Packard 3480A, may be used.

The 432-series of Power Meters provides instrumentation accuracy of $\pm 1\%$ ($\pm 0.5\%$ with the digital readout of the 432B and 432C) in measuring the substituted power to the thermistor. Rear panel connectors allow direct measurement of the bridge voltages and computation of substituted dc power to within $\pm 0.2\% \pm 0.5 \mu W$.

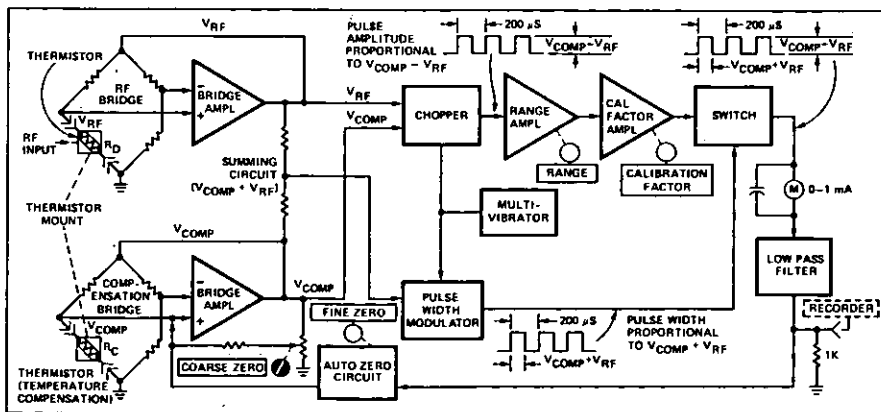

Figure 4. Block diagram of 432A Power Meter. Dual bridge provides proper bias to thermistor mount to correct for temperature variation and reduce zero drift.

POWER & NOISE FIGURE METERS

Thermocouple power meter

Model 435A, 8480 Series, & 11683A

NEW

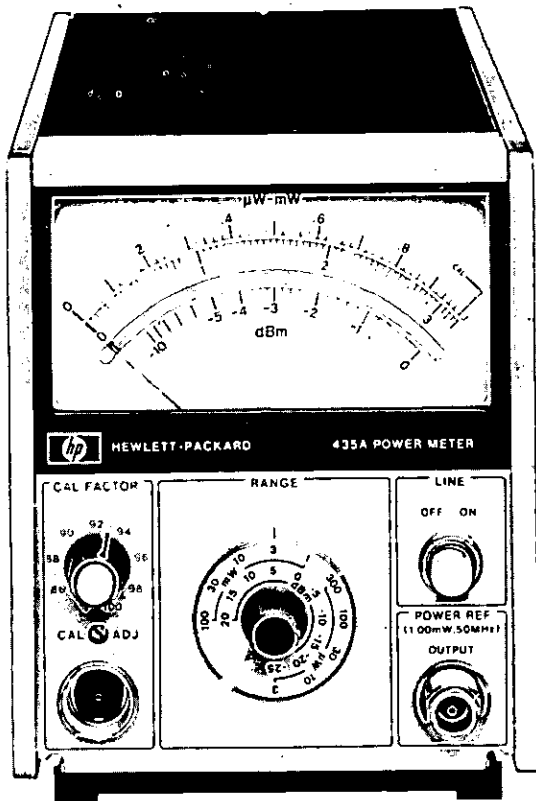

435A

Accurate power measurements

The 435A Power Meter and its family of power sensors (8481A, 8482A, 8483A, 8481-H01 and 8482A-H01) represents a significant advance in microwave power measurement. The power measurement circuit consists of a thermocouple sensing element which develops an output voltage proportional to the input power, a chopper stabilized amplifier, and a calibrated meter circuit.

Overall measurement accuracy is dependent on careful consideration of all sources of error. Instrumentation uncertainty, mismatch uncertainty, and sensor calibration must all be considered to arrive at a final accuracy figure.

Mismatch is usually the largest single source of error in power measurement. The VSWR of the sensor must be reduced to an extremely low level to obtain high measurement accuracy (see example page 380). The 8480 family of power sensors uses a physically small silicon monolithic thermocouple to do this.

The accuracy of any power measurement in a thermocouple power meter depends on the accuracy of the thermocouple sensitivity. Therefore, some method must be provided to allow matching the sensor to a particular meter and accounting for physical changes in the sensing element. The 435A power meter has a built-in power reference to insure a proper match between the power meter and the thermocouple sensitivity.

435A Power meter

Improved overall measurement accuracy

Low instrumentation uncertainty ($\pm 1\%$) and a built-in power reference contribute to the overall measurement accuracy. The power reference assures that the meter is properly matched to the thermocouple sensitivity, a prerequisite to highest accuracy and confidence in the measurement.

Low drift-auto zero

Even on the lowest range, drift and noise are less than 1.5%. In those cases where occasional zeroing of the meter is required, this may be accomplished by merely depressing a front panel switch.

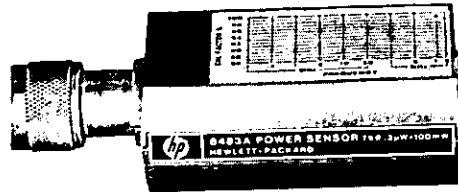

8483A

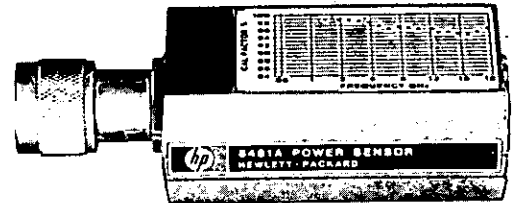

8481A

Battery operation-long cables

An FET chopper amplifier in the power sensor provides a relatively high output level with low power consumption. Thus, long cables (up to 200 feet) can be used in the power sensor circuit to allow remote power monitoring. Also, an optional internal battery allows truly portable operation.

Recorder output

Long-term monitoring and leveling of sweep oscillators may be accomplished by utilizing the recorder output.

8481A Power sensor

Wide frequency and amplitude range

Measure power from $0.3 \mu\text{W}$ to 100 mW over a frequency range from 10 MHz to 18 GHz with a single power sensor.

Low VSWR reduces measurement uncertainty

A silicon monolithic thermocouple is used as the sensing element and its small physical size allows reduction of VSWR to < 1.1 over the range of 50 MHz to 2 GHz; < 1.18 up to 12.4 GHz; and < 1.28 to 18 GHz. This assures low mismatch uncertainty, usually the largest single source of error in power measurement.

Individually calibrated

Each sensor is individually calibrated, traceable to the National Bureau of Standards, and a Cal Factor control on the meter compensates for power sensor efficiency at any frequency. In addition, a precise Automatic Network Analyzer printout at 17 frequencies for Cal Factor and reflection coefficient in magnitude and phase is supplied. This means you can eliminate mismatch uncertainty by calculating the mismatch error.

8482A Power sensor (new)

RF sensor (similar to the 8481A power sensor)

Measure power from $0.3 \mu\text{W}$ to 100 mW over a frequency range from 100 kHz to 4.2 GHz with a VSWR < 1.2 over the range of 300 kHz to 1 MHz; < 1.1 between 1 MHz and 2 GHz; and < 1.3 to 4 GHz.

8483A Power sensor (new)

75 ohm RF sensor (similar to the 8482A power sensor)

Measure 75 Ω source power from $0.3 \mu\text{W}$ to 100 mW over a frequency range from 100 kHz to 2 GHz with a VSWR < 1.18 over the range of 600 kHz to 2 GHz (75/50 Ω adapter furnished).

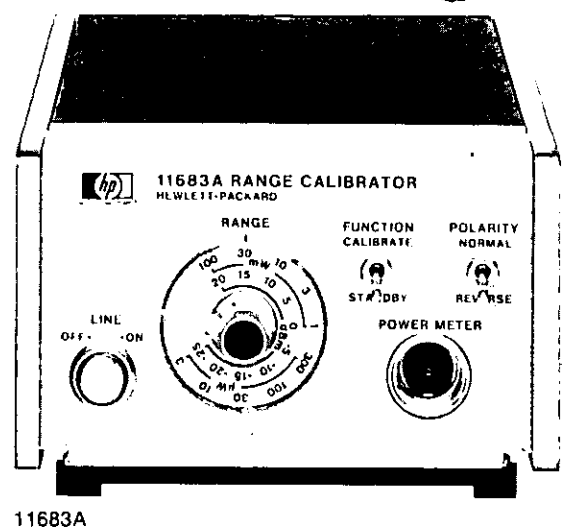
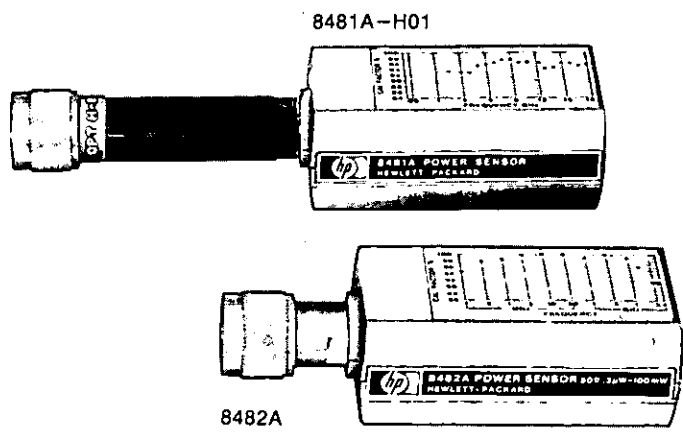

8481A Power sensor opt. H01 (new)

Higher power version of the 8481A power sensor
Measure power from 30 μ W to 3 W over a frequency range from 10 MHz to 18 GHz with a single power sensor (offered as a factory special).

8482A Power sensor opt. H01 (new)

Higher power version of the 8482A power sensor
Measure power from 30 μ W to 3 W over a frequency range from 100 kHz to 4.2 GHz with a single power sensor (offered as a factory special).

11683A Range calibrator (new)

The 11683A calibrator is specifically designed for use with the 435A power meter. It allows verification of full-scale meter readings on all ranges, as well as meter tracking. Simply connect the cable between the power meter and calibrator. The CAL ADJ control, on the power meter, is used to set the meter to full scale on the 1 mW range. The calibrator and meter are then stepped through the other ranges verifying accuracy within $\pm 1\%$ plus noise and drift. The 11683A also has a polarity switch which tests the Auto-Zero circuit.

Specifications

- 435A power meter**
- Frequency range:** 100 kHz to 18 GHz (depending on power sensor used).
- Power range:**
 - 435A and 8481A, 8482A or 8483A:** 55 dB with 10 full-scale ranges of 3, 10, 30, 100 and 300 μ W; 1, 3, 10, 30, and 100 mW; also calibrated in dB from -25 dBm to +20 dBm full scale in 5 dB steps.
 - 435A and 8481A-H01 or 8482A-H01:** 50 dB with 9 full-scale ranges of 0.3, 1, 3, 10, 30, 100 and 300 mW; 1 and 3 W; also calibrated in dB from -5 dBm to +35 dBm full scale in 5 dB steps.
- Instrumentation uncertainty:** $\pm 1\%$ of full scale on all ranges (0° to 55°C).
- Zero carryover:** $\pm 0.5\%$ of full scale when zeroed on the most sensitive range.
- Ref Osc:** internal oscillator with Type N female connector on front panel or rear panel (Option 003 only). Power output 1.00 mW $\pm 0.70\%$ at 50 MHz (traceable to National Bureau of Standards).
- Stability:** $\pm 0.02\%/^{\circ}\text{C}$ (0°-55°C).
- Noise and drift (with 8481A, 8482A, and 8483A):** <1.5% of full-

- scale peak on 3 μ W range, less on higher ranges (typical, at constant temperature).
 - Response time:** (with 8481A, 8482A, and 8483A sensors): 2 seconds on 3 μ W range, 0.75 second on 10 μ W range, 0.25 second on 30 μ W range, and 100 msec on all other ranges. (Typical, time constant measured at recorder output.)
 - Zero:** automatic, operated by front panel switch.
 - Cal factor:** 16-position switch normalizes meter reading to account for Calibration Factor or Effective Efficiency. Range 85% to 100% in 1% steps. 100% position corresponds to Calibration Factor at 50 MHz.
 - Recorder output:** proportional to indicated power with 1 volt corresponding to full scale; 1 k Ω output impedance. BNC connector.
 - RF blanking output:** provides a contact closure to ground when auto-zero mode is engaged.
 - Cal adj:** front panel adjustment provides capability to adjust gain of meter to match power sensor in use.
 - Power:** 100, 120, 220, or 240 V $\pm 5\%$, -10%, 48 to 440 Hz, less than 4 watts (less than 10 watts for option 001 when recharging battery).
 - Weight:** Net, 2.6 kg (5 lb, 12 oz). Shipping, 4.2 kg (9 lb, 3 oz).
 - Dimensions:** 155 mm high, 130 mm wide, and 279 mm deep (6 $\frac{1}{2}$ \times 5 $\frac{1}{8}$ \times 11 in.).
 - Accessories furnished:** 1.52 m (5 ft) cable for the power sensor; 2.29 m (7 $\frac{1}{2}$ ft) power cable. Mains plug shipped to match destination requirements.
 - Accessories available:**
 - 11076A carrying case.
 - 5060-8762 rack adapter frame (holds three instruments the size of the 435A).
 - Combining cases:**
 - 1051A:** 286 mm (11 $\frac{1}{4}$ in.) deep.
 - 1052A:** 416 mm (16 $\frac{3}{8}$ in.) deep.
- The combining cases accept the 1/3-module Hewlett-Packard instruments for bench use or rack mounting. See 1051A data sheet for details.
- 11683A Range calibrator**
- Calibration functions:** outputs corresponding to meter readings of 3, 10, 30, 100 and 300 μ W; 1, 3, 10, 30, and 100 mW.
 - Calibration uncertainty:** $\pm 0.25\%$ in all ranges.
 - Power:** 115 or 230 V $\pm 10\%$; 50-400 Hz, less than 2 W.
 - Weight:** Net, 1.13 kg (2 lb 8 oz). Shipping, 1.9 kg (4 lb 3 oz).
 - Dimensions:** 88.9 mm high, 133.35 mm wide, and 215.9 mm deep (3 $\frac{1}{2}$ \times 5 $\frac{1}{4}$ \times 8 $\frac{1}{2}$ in.).



POWER & NOISE FIGURE METERS

Model 435A, 8480 series & 11683A cont'd.

NEW

Power sensor specifications

Specification	Model	8481A	8482A	8483A	8481A-H01 (Factory Special)*	8482A-H01 (Factory Special)*
Frequency Range:		10 MHz - 18 GHz	100 kHz - 4.2 GHz	100 kHz - 2 GHz	10 MHz - 18 GHz	100 kHz - 4.2 GHz
Nominal Impedance:		50Ω	50Ω	75Ω	50Ω	50Ω
Maximum SWR: (Reflection Coefficient)		1.1 (<0.048) 50 MHz - 2 GHz	1.1 (<0.048) 1 MHz - 2 GHz	1.18 (<0.082) 600 kHz - 2 GHz	1.2 (<0.091) 10 MHz - 8 GHz	1.2 (<0.091) 100 kHz - 4.2 GHz
		1.18 (<0.082) 30 - 50 MHz	1.2 (<0.091) 300 kHz - 1 MHz	1.8 (<0.286) 100 - 600 kHz	1.3 (<0.13) 8 - 12.4 GHz	
		1.18 (<0.082) 2 - 12.4 GHz	1.3 (<0.13) 2 - 4.2 GHz		1.5 (<0.20) 12.4 - 18 GHz	
		1.28 (<0.123) 12.4 - 18 GHz	1.6 (<0.231) 100 - 300 kHz			
		1.4 (<0.17) 10 - 30 MHz				
Maximum Average Power:		300 mW	300 mW	300 mW	3.5 W	3.5 W
Maximum Peak Power:		15 W	15 W	10 W	100 W	100 W
Maximum Energy Per Pulse:		30 W-μsec	30 W-μsec	30 W-μsec	100 W-μsec	100 W-μsec
RF Connector:		Type N male	Type N male	Type N male (75Ω)	Type N male	Type N male
Power Sensor Calibration:		Cal Factor data individually calibrated for each power sensor. 8481A and 8481A-H01 Sensors also supplied with individual automatic network analyzer printout at 17 frequencies for Cal Factor and phase and magnitude of reflection.				
Dimensions: (includes RF Connector)		30 mm wide 38 mm high 105 mm long (1 ³ / ₁₆ × 1 ¹ / ₂ × 4 ¹ / ₄ in.)	30 mm wide 38 mm high 105 mm long (1 ³ / ₁₆ × 1 ¹ / ₂ × 4 ¹ / ₄ in.)	30 mm wide 38 mm high 105 mm long (1 ³ / ₁₆ × 1 ¹ / ₂ × 4 ¹ / ₄ in.)	30 mm wide 38 mm high 149 mm long (1 ³ / ₁₆ × 1 ¹ / ₂ × 5 ⁷ / ₁₆ in.)	30 mm wide 38 mm high 149 mm long (1 ³ / ₁₆ × 1 ¹ / ₂ × 5 ⁷ / ₁₆ in.)
Weight:	Net:	0.2 kg (6 oz)	0.2 kg (6 oz)	0.2 kg (6 oz)	0.2 kg (8 oz)	0.2 kg (8 oz)
	Shipping:	0.5 kg (1 lb)	0.5 kg (1 lb)	0.5 kg (1 lb)	0.5 kg (1 lb, 2 oz)	0.5 kg (1 lb, 2 oz)

*Only specifications listed in this table apply to H01 special options. No other specifications are implied.

Model number and name

11683A range calibrator	Price	\$425
8481A power sensor		\$360
Option 001: precision 7 mm (APC-7) connector	add	\$25
Option H01: 0.3 mW to 3 W power range	add	\$135
8482A RF power sensor		\$400
Option H01: 0.3 mW to 3 W power range	add	\$135
8483A RF power sensor (75Ω)		\$400
435A power meter		\$700

435A Power meter options:

001: rechargeable battery installed, provides up to 16 hours of continuous operation	add	\$100
--	-----	-------

Model number and name

002: input connector placed on rear panel in parallel with front	add	\$25
003: input connector and reference oscillator output on rear panel only	add	\$10
009: 3.05 m (10-foot) cable for power sensor	add	\$30
010: 6.10 m (20-foot) cable for power sensor	add	\$55
011: 15.24 m (50-foot) cable for power sensor	add	\$105
012: 30.48 m (100-foot) cable for power sensor	add	\$155
013: 60.96 m (200-foot) cable for power sensor	add	\$260

POWER & NOISE FIGURE METERS



Thermistor power meters
Models 432A/B/C

- Automatic zero
- High accuracy

- Recorded outputs, analog & digital
- Long cable options

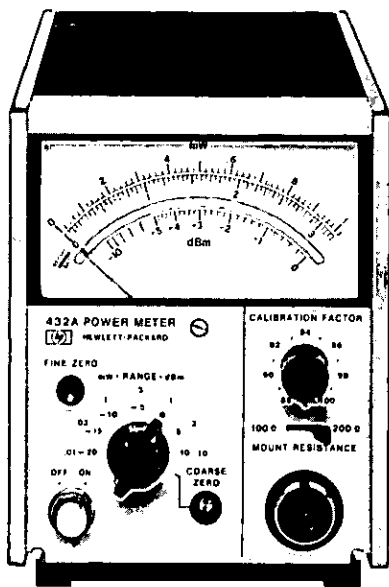

432A

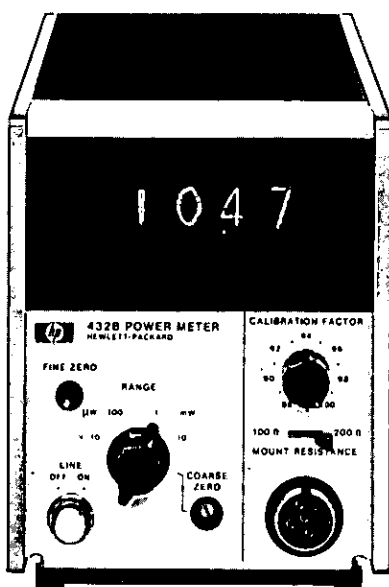

432B

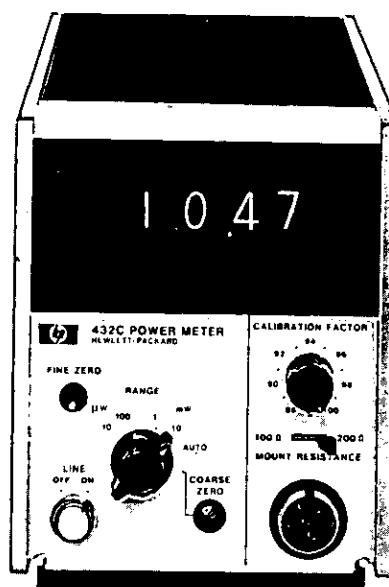

432C

432A/B/C Power meters

DC bridge circuit: Using dc instead of the conventional 10 kHz bias current results in three benefits: 1) No signal emission from the mount to disturb sensitive circuits, 2) meter zeroing is independent of the impedance connected to the RF input of the thermistor mount, 3) the instrument is not affected by capacitance changes caused by movement of the thermistor mount cable.

High accuracy—no thermoelectric error: High accuracy over a wide temperature range is featured on the 432 Power Meters. By measuring the output voltage of the thermistor bridges, and computing the corresponding power, even higher accuracy of $\pm 0.2\% \pm 0.5 \mu\text{W}$ can be obtained.

Accuracy is maintained on even the most sensitive range because the error due to thermoelectric effect is reduced to a negligible level.

Calibrated mounts: Each thermistor mount is furnished with data stating the Calibration Factor* and Effective Efficiency* at various frequencies across the operating range. For easy and accurate power measurements, the front panel of the 432 contains a calibration factor control, calibrated in 1% steps from 88% to 100%, that compensates for losses in the mount and eliminates the need for calculation.

*"Calibration Factor" and "Effective Efficiency" are figures of merit expressing the ratio of the substituted signal measured by the power meter to the microwave power incident on and absorbed by the mount, respectively.

Instrument type: automatic, self-balancing power meter for use with temperature-compensated thermistor mount.

Specifications

Power range

432A: seven ranges with full scale readings of 10, 30, 100, and 300 μW , 1, 3, and 10 mW; also calibrated in dBm from -20 dBm to +10 dBm full scale in 5 dB steps.

432B, 432C: four ranges with full scale readings of 10 and 100 μW , and 1 and 10 mW.

Noise:

Less than 0.25% of full scale peak.

Response time

At recorder output, 35 ms times constant (typical).

Fine zero

Automatic, operated by front panel switch. Remote fine zero may be accomplished with 432C.

Zero carryover

Less than 0.50% of full scale when zeroed on most sensitive range.

RFI

Meets all conditions specified in MIL-I-6181D.

Meter

432A: taut-band suspension, individually calibrated, mirror-backed scales. Milliwatt scale more than 108 mm (4 1/4") long.

432B, 432C: three digits with one digit overrange. 20% overrange capability on all ranges.

Calibration factor control

13-position switch normalizes meter reading to account for thermistor mount calibration factor. Range 100% to 88% in 1% steps.

Thermistor mount

External temperature-compensated thermistor mounts required for operation (HP 478, 8478B, and 486 Series; mount resistance 100 or 200 ohms).

Recorder output

Proportional to indicated power with 1 volt corresponding to full-scale. 1 k Ω output impedance.

BCD output

8, 4, 2, 1 code: "1" positive. TTL compatible logic. Operates with HP 5055A Digital Recorder. "Print" and "Inhibit" lines available. (432B and 432C only.)

Bridge outputs

(V_{RF} and V_{COMP}). Direct connections to the thermistor bridges; used in instrument calibration and precision power measurements.

Model 432C control lines

Instrument is referenced to +5 V, "Logic 0" is equivalent to 0 V.

Outputs:

BCD output as described above.

Overrange: single bit indicates meter overrange.

Underrange: single bit indicates meter underrange.

Range: two-bit code indicates range selected.

Print: single bit indicates data is ready.



POWER & NOISE FIGURE METERS

Thermistor mounts

Models 478A, 8478B, 486 Series, and 432A, B, C Cont'd.

- Broad band frequency coverage

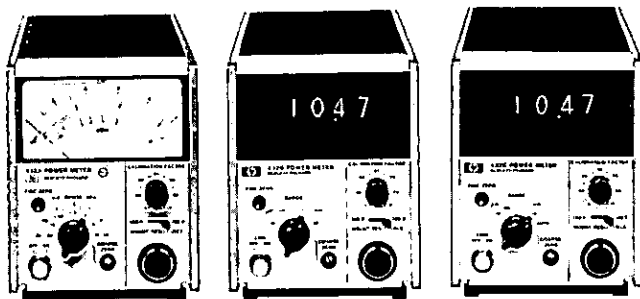

Inputs:

Remote enable: single bit establishes control of instrument ranging and fine zero controls for remote programming. Remote fine zero may be accomplished in remote or local modes of operation.

Remote range: two-bit code selects instrument range.

Auto zero: contact closure to ground or TTL "0" zeroes meter.

Inhibit: single bit holds data and stops A/D converter.

External trigger: when in inhibit mode, single bit starts new data conversion. Data ready in 10 msec.

Inputs and outputs: compatible with 5055A Digital Recorder and 12566A interface card for 2100 Series computers.

Power consumption

432A: 115 or 230 V ac 10%, 50 to 400 Hz, 2½ watts. Optional rechargeable battery provides up to 24 hours continuous operation. Automatic battery recharge.

432B: 115 or 230 V ac 10%, 50 to 400 Hz, 10 watts.

432C: 115 or 230 V ac 10%, 50 to 400 Hz, 16 watts.

Weight

432A: net, 3.1 kg (6 lb 14 oz); shipping, 4.7 kg (10 lb 5 oz).

432B: net, 3.1 kg (6 lb 14 oz); shipping, 4.7 kg (10 lb 5 oz).

432C: net, 3.2 kg (7 lb); shipping, 4.8 kg (10 lb 7 oz).

Dimensions

130 mm wide, 155 mm high, 279 mm deep (5¼" × 6½" × 11").

Accessories furnished

1.52 m (5 ft), cable for Hewlett-Packard temperature-compensated thermistor mounts; 2.29 m (7½ ft) power cable. Mains plug shipped to match destination requirements.

Model number and name

432A, 432B, 432C Power meter options

001: rechargeable battery installed, provides up to 24 hours continuous operation (432A only)

002: input connector placed on rear panel in parallel with front

003: input connector on rear panel only

Note: thermistor mount cable impedance is part of the 432 input bridge circuit. For cables over 10 feet long, the bridge is matched to specific cable options, so the various cables should not be interchanged.)

009: 3.05 m (10 ft) cable for 100-ohm or 200-ohm mount

010: 6.10 m (20 ft) cable for 100-ohm or 200-ohm mount

011: 15.24 m (50 ft) cable for 100-ohm or 200-ohm mount

012: 30.48 m (100 ft) cable for 100-ohm or 200-ohm mount

013: 60.96 m (200 ft) cable for 100-ohm or 200-ohm mount

432A Power meter

432B Power meter

432C Power meter

Price

add \$105

add \$25

add \$10

add \$30

add \$55

add \$105

add \$155

add \$260

\$625

\$1200

\$1550

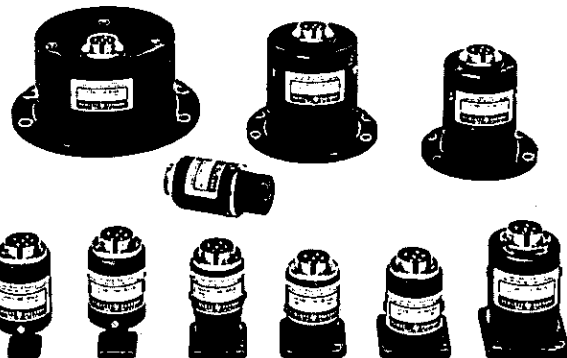

Temperature compensated thermistor mounts

High efficiency and good RF match are characteristic of the HP 478A and 8478B Coaxial and 486A-Series Waveguide Thermistor mounts which, in conjunction with the 432 Power Meter, provide you with high accuracy even in routine power measurements. These thermistor mounts are temperature-compensated for low drift, even in the presence of thermal shocks, permitting measurement of microwave power as low as one microwatt. Each mount contains data showing Calibration Factor and Effective Efficiency at six frequencies, directly traceable to the National Bureau of Standards at those frequencies where NBS provides calibration service.

Specifications

HP Model ¹	Frequency range, GHz	Maximum SWR	Operating resistance (ohms)	Price
478A	10 MHz to 10 GHz	1.75, 10 to 25 MHz 1.3, 25 MHz to 7 GHz 1.5, 7 to 10 GHz	200	\$200
8478B ²	10 MHz to 18 GHz	1.75, 10 to 30 MHz 1.35, 30 to 100 MHz 1.1, 0.1 to 1 GHz 1.35, 1 to 12.4 GHz 1.6, 12.4 to 18 GHz	200	\$335
S486A	2.60 to 3.95	1.35	100	\$450
G486A	3.95 to 5.85	1.5	100	\$325
J486A	5.30 to 8.20	1.5	100	\$325
H486A	7.05 to 10.0	1.5	100	\$325
X486A	8.20 to 12.4	1.5	100	\$225
M486A	10.0 to 15.0	1.5	100	\$375
P486A	12.4 to 18.0	1.5	100	\$275
K486A ³	18.0 to 26.5	2.0	200	\$375
R486A ³	26.5 to 40.0	2.0	200	\$450

¹11528A Adapter adapts mount to 430 Series Power Meter (thermistor circuit unbalanced, no temperature compensation).

²Option 011, furnished with APC-7 RF connector add \$25

³Circular flange adapters:

K-band (UG-425/U) HP 11515A \$100

R-band (UG-381/U) HP 11516A \$100

POWER & NOISE FIGURE METERS

Peak power calibrator & power meter calibrator

Models 8900B & 8477A

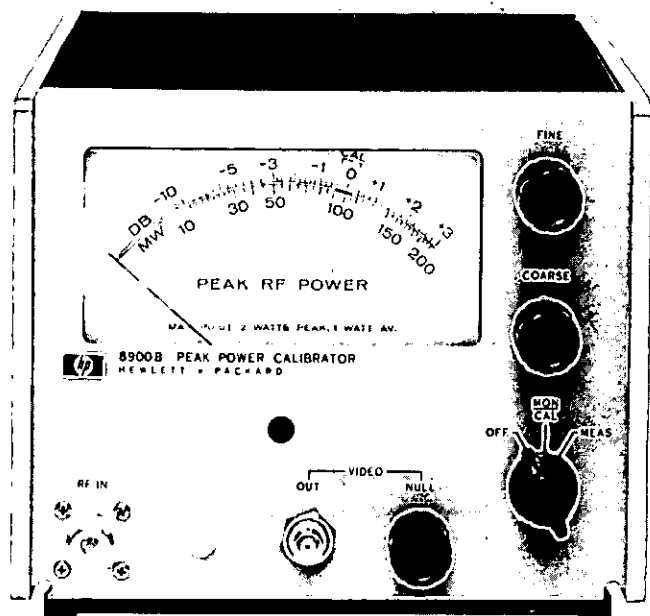

8900B

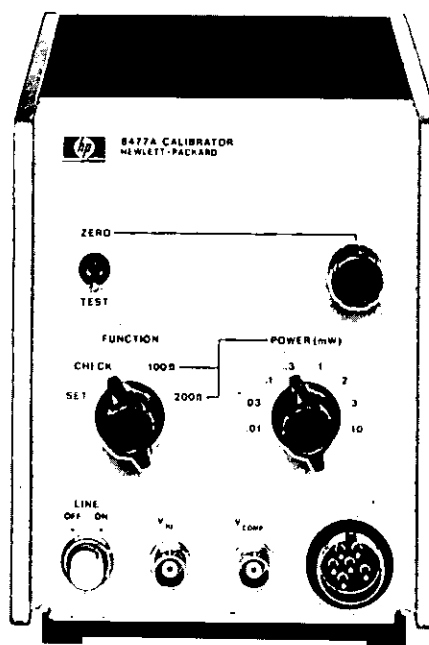

8477A

Description

The HP 8900B peak power calibration provides a convenient means for measuring the peak RF power of pulses in the range from 50 to 2000 MHz. The power level is read out directly on the panel meter and is completely independent of repetition rate and pulse width (>0.25 μ sec).

Specifications

Radio frequency measurement characteristics

Frequency range: 50 to 2000 MHz.

RF power range: 10-200 mW peak full scale (may be readily increased through use of external attenuators or directional couplers).

RF power accuracy: ± 1.5 dB (± 0.6 dB) with custom calibration curve furnished with instrument).

RF power precision: 0.1 dB.

RF pulse width: >0.25 μ s.

RF repetition rate: 1.5 MHz maximum.

RF impedance: 50 ohms.

RF VSWR: <1.25.

Monitor output

Level: >0.2 volt for 20 mW input (nominal).

Impedance: 150 ohms nominal.

Bandwidth: >7 MHz.

Physical characteristics

Dimensions: 197 mm wide, 156 mm high, 279 mm deep (7 $\frac{3}{4}$ " \times 6 $\frac{1}{8}$ " \times 11").

Weight: net, 4.5 kg (10 lb); shipping 5.9 kg (13 lb).

Power

105 to 125 or 210 to 250 volts, 50 to 60 Hz.

8477A Description

The 8477A Calibrator is specifically designed for use with the 432 Power Meter. It allows you to verify full-scale meter readings on all ranges, and meter tracking. Simply connect three cables between the power meter and calibrator; no charts or additional instruments are required.

Specifications

Calibration points: outputs corresponding to meter readings of: 0.01, 0.03, 0.1, 0.3, 1.0, 2.0, 3.0, and 10 mW (for mount resistance switch settings of both 100 and 200 ohms).

Calibration uncertainty: $\pm 0.2\%$ on the top five ranges, and $\pm 0.5\%$ on the 0.01 and 0.03 mW ranges from +20° to +30°C.

RFI: meets all conditions specified in MIL-I-6181D.

Power: 115 or 230 V $\pm 10\%$, 50-400 Hz, approximately 2 W.

Weight: net, 2.0 kg (4 $\frac{1}{2}$ lb); shipping, 2.9 kg (6 $\frac{1}{4}$ lb).

Dimensions: 155 mm high, 130 mm wide, 203 mm deep (6 $\frac{3}{32}$ " \times 5 $\frac{1}{8}$ " \times 8").

Uncompensated mounts for power meters

The Model 477B Thermistor Mount allows measurements from 10 MHz to 10 GHz, and the 487-Series waveguide mounts cover the 8.2-18.0 GHz frequency range. These uncompensated thermistor mounts may be used with a variety of power meters such as the HP 430-series. Approximately 13 mA bias current is required to obtain the nominal resistance of the thermistor.

477B Thermistor mount specifications

Frequency range: 10 MHz to 10 GHz.

Maximum VSWR: 1.5 over full frequency range; 1.3 from 50 MHz to 7 GHz.

Power range: 0.001 to 10 mW (with HP 430C) 10 mW maximum average power; 1 W maximum peak power.

Element: 200-ohm, negative temperature coefficient thermistor included; approximately 13 mA bias required.

RF connector: Type N male.

487 Thermistor mount specifications

HP Model	Maximum SWR	Frequency range* GHz
X487B	1.5	8.2 - 12.4
P487B	1.5	12.4 - 18.0

* HP 486A Waveguide Thermistor Mounts are available in S- through R-band (2.6 to 40 GHz); 1152BA Adapter required.

Model number and name

8900B Peak calibrator
8477A Power meter calibrator
477B Thermistor mount
P487B Thermistor mount
X487B Thermistor mount

Price
\$785
\$510
\$175
\$225
\$225

POWER & NOISE FIGURE METERS

Noise figure meters; sources

Models 340B, 342A, 343A, 345B, 347A, 349A

- Reads noise figure directly in dB
- Completely automatic measurement to 18 GHz
- No periodic recalibration needed
- Measure noise figure of radars, receivers, and amplifiers

- Compare unknown noise sources against known noise levels
- Adjust parametric amplifiers for optimum noise figure

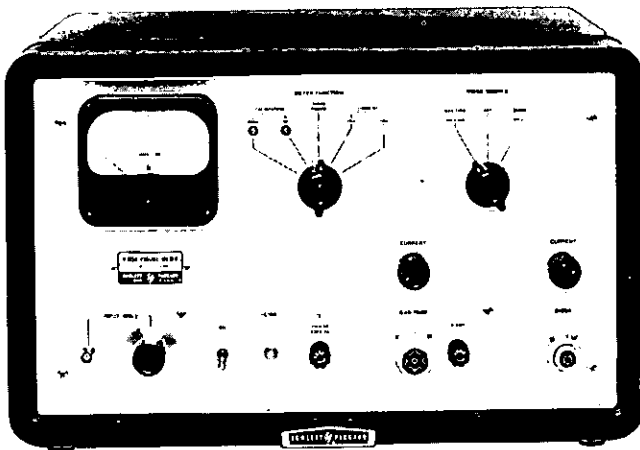

340B



349A



343A



345B



X347A

In microwave communications, radar, etc., the weakest signal that can be detected is usually determined by the amount of noise added by the receiving system. Thus, any decrease in the amount of noise generated in the receiving system will produce an increase in the output signal-to-noise ratio equivalent to a corresponding increase in received signal. From a performance standpoint, an increase in the signal-to-noise ratio by reducing the amount of noise in the receiver is more economical than increasing the power of the transmitter.

The quality of a receiver or amplifier is expressed in a figure of merit, or noise figure. Noise figure is the ratio, expressed in dB, of the actual output noise power of the device to the noise power which would be available if the device were perfect and merely amplified the thermal noise of the input termination rather than contributing any noise of its own.

The Hewlett-Packard system of automatic noise figure measurement depends upon the periodic insertion of a known excess noise power at the input of the device under test. Subsequent detection of noise power results in a pulse train of two power levels. The power ratio of these two levels contains the desired noise figure information. Hewlett-Packard noise figure meters automatically measure and present this ratio directly in dB of noise figure.

Noise figure is discussed in detail in Hewlett-Packard Application Note 57, which is available from your local Hewlett-Packard field office upon request. Application Note 57, "Noise Figure Primer," derives noise figure formulas, describes general noise figure measurements and discusses accuracy considerations. One of the measurement systems discussed in Application Note 57 is shown in Figure 1. The portion of the diagram within the dashed box is a simplified block diagram of the HP 340B and 342A Noise Figure Meters, and the excess noise source could be any of the noise sources described on these pages.

Operation

HP noise figure meters and noise sources offer time-saving and cost-reducing advantages. Their ease of operation and continuous, automatic metering of noise figure reduce the time required for alignment and adjustment and simplify measurements so that they can be done by nontechnical personnel. No periodic recalibration of the meters is needed, and accurate alignment is easy, so high-level, on-line perfor-

mance is assured.

In operation, a noise source is connected to the input of the device under test. The IF output of the device is connected to the 340B or 342A. The noise figure meter gates the noise source on and off. When the noise source is on, the noise level is that of the device plus the noise source. When the noise source is off, the noise level is that of the de-

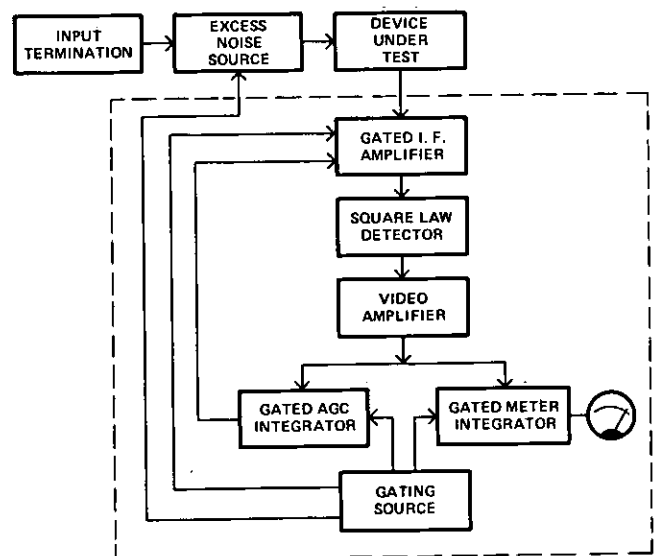

Figure 1. Noise figure measurement.

vice and its termination. The noise figure meter automatically compares the two conditions and displays noise figure directly in dB. Power to operate the noise source is supplied by the noise figure meter. Simply connect the noise source, adjust drive current using the

controls and meter on the 340B or 342A, and the noise source is ready for operation.

Noise figure meters

Model 340B Noise Figure Meter, when used with an HP noise source, automatically measures and continuously displays noise figure for frequencies of 30 and 60 MHz. On special order up to four custom frequencies between 10 and 70 MHz, and some frequencies outside this range, can be supplied.

Model 342A is similar to Model 340B, except that it operates on five frequencies: 60, 70, 105, 200, and the basic tune-amplifier frequency of 30 MHz. Up to six custom frequencies between 10 and 200 MHz, including 21.4 MHz, are available on special order.

Noise sources

343A VHF noise source: Specifically for IF and RF amplifier noise measurement, a temperature-limited diode source with broadband noise output from 10 to 600 MHz with 50-ohm source impedance and low SWR.

345B IF noise source: Operates at either 30 or 60 MHz, as selected by a switch; another selector permits matching 50-, 100-, 200-, and 400-ohm impedances.

347A Waveguide noise source: Argon gas discharge tubes mounted in waveguide sections; for waveguide bands 3.95 through 18 GHz, they provide uniform noise throughout the range; maximum SWR is 1.2.

349A UHF noise source: Argon gas discharge tubes in Type N coaxial configuration for automatic noise figure readings, 400 to 4000 MHz.

340B and 342A Specifications

Noise figure range: with a 5.2 dB noise source, 0 to 15 dB, indication to infinity; with a 15.2 dB noise source, 3 to 30 dB, indication to infinity.

Accuracy (excluding source accuracy): noise diode scale: ±0.5 dB, 0 to 15 dB; gas tube scale: ±0.5 dB, 10 to 25 dB; ±1 dB, 3 to 10 dB and 25 to 30 dB.

Input frequency: 340B; 30 or 60 MHz, selected by switch; 342A: 30, 60, 70, 105, and 200 MHz, selected by switch. Other frequencies available; prices and details on request.

Bandwidth: 1 MHz minimum.

Input requirements: -60 to -10 dBm (noise source on); corresponds to gain between noise source and input of approximately 50 to 100 dB for 5.2 dB noise source and 40 to 90 dB for 15.2 dB noise source.

Input impedance: 50 ohms nominal.

AGC output: nominal 0 to -6 V from rear binding posts.

Recorder output: 1 mA maximum into 2000 ohms maximum.

Power input: 115 or 230 volts ±10%, 50 to 60 Hz, 185 to 435 watts, depending on noise source and line voltage.

Power output: sufficient to operate 343A, 345B, 347A or 349A Noise Sources.

Dimensions: cabinet: 527 mm wide, 324 mm high, 368 mm deep (20 3/4" × 12 3/4" × 14 1/2"); rack mount: 483 mm wide, 266 mm high, 353 mm deep behind panel (19" × 10 1/2" × 13 3/4").

Weights: net 19.4 kg (43 lb), shipping 23.9 kg (53 lb) (cabinet); net 16.2 kg (36 lb), shipping 22.5 kg (50 lb) (rack mount).

Accessory furnished: one 340A-16A Cable Assembly, connects noise figure meter to 347A or 349A Noise Source.

343A Specifications

Frequency range: 10 to 600 MHz.

Excess noise ratio¹: 10 to 30 MHz, 5.20 dB ± 0.20 dB; 100 MHz, 5.50 dB ± 0.25 dB; 200 MHz, 5.80 dB ± 0.30 dB; 300 MHz, 6.05 dB ±

0.30 dB; 400 MHz, 6.30 dB ± 0.50 dB; 500 MHz, 6.50 dB ± 0.50 dB; 600 MHz, 6.60 dB ± 0.50 dB.

Source impedance: 50 ohms nominal.

Reflection coefficient: <0.091 (1.2 SWR), 10 to 400 MHz; <0.13 (1.3 SWR), 400 to 600 MHz.

Noise generator: temperature-limited diode.

Dimensions: 70 mm wide, 63 mm high, 127 mm deep (2 3/4" × 2 1/2" × 5").

Weight: net 0.34 kg (3/4 lb); shipping 0.9 kg (2 lb).

345B Specifications

(Same weight and dimensions as 343A)

Spectrum center: 30 or 60 MHz, selected by switch.

Excess noise ratio¹: 5.2 dB.

Source impedance: 50, 100, 200 or 400 ohms, ±4%, as selected by switch; less than 1 pF shunt capacitance.

Noise generator: temperature-limited diode.

347A Specifications

HP Model	Range (GHz)	Excess noise ratio ^{1,2}	Approx. length	
			(in.)	(mm)
G347A	3.95-5.85	15.2 ± 0.5	19	483
J347A	5.30-8.20	15.2 ± 0.5	19	483
H347A	7.05-10.0	15.6 ± 0.5	16	406
X347A	8.20-12.4	15.7 ± 0.4	14 3/4	375
P347A	12.4-18.0	15.8 ± 0.5	14 3/4	375

Reflection coefficient for all models, fired or unfired, 0.091 (SWR 1.2) max. (source terminated in well-matched load).

349A Specifications

Frequency range: 400 to 4000 MHz, wider with correction.

Excess noise ratio¹: 15.6 dB ± 0.6 dB,² 400 to 1000 MHz; 15.7 dB ± 0.5 dB,² 1000 to 4000 MHz.

Source impedance: 50 ohms nominal.

SWR: <1.35 (fired), <1.55 (unfired) up to 2600 MHz; <1.55 (fired or unfired), 2600 to 3000 MHz; <2.0 (fired), <3.0 (unfired) 3000 to 4000 MHz.

Dimensions: 76 mm wide, 51 mm high, 381 mm long (3" × 2" × 15").

Weight: net 1.4 kg (3 1/4 lb); shipping 2.7 kg (6 lb).

Model number and name	Price
340B Noise Figure Meter (cabinet)	\$1195
340BR Noise Figure Meter (rackmount)	\$1180
342A Noise Figure Meter (cabinet)	\$1320
342AR Noise Figure Meter (rackmount)	\$1305
343A Noise Source	\$165
343A Noise Source Option 001: spare noise diodes calibrated and supplied with instrument	add \$45
345B Noise Source	\$250
349A Noise Source	\$360
G347A Noise Source	\$650
H347A Noise Source	\$750
J347 Noise Source	\$700
P347A Noise Source	\$600
X347 Noise Source	\$550

$$ENR (dB) = 10 \log \frac{k(T - T_0)B}{kT_0B}$$

where kTB = available noise power, and kT_0B = available noise power with noise source at 290°K

²Includes factor for insertion loss.

MICROWAVE TEST EQUIPMENT

Microwave measurements; frequency, impedance, attenuation

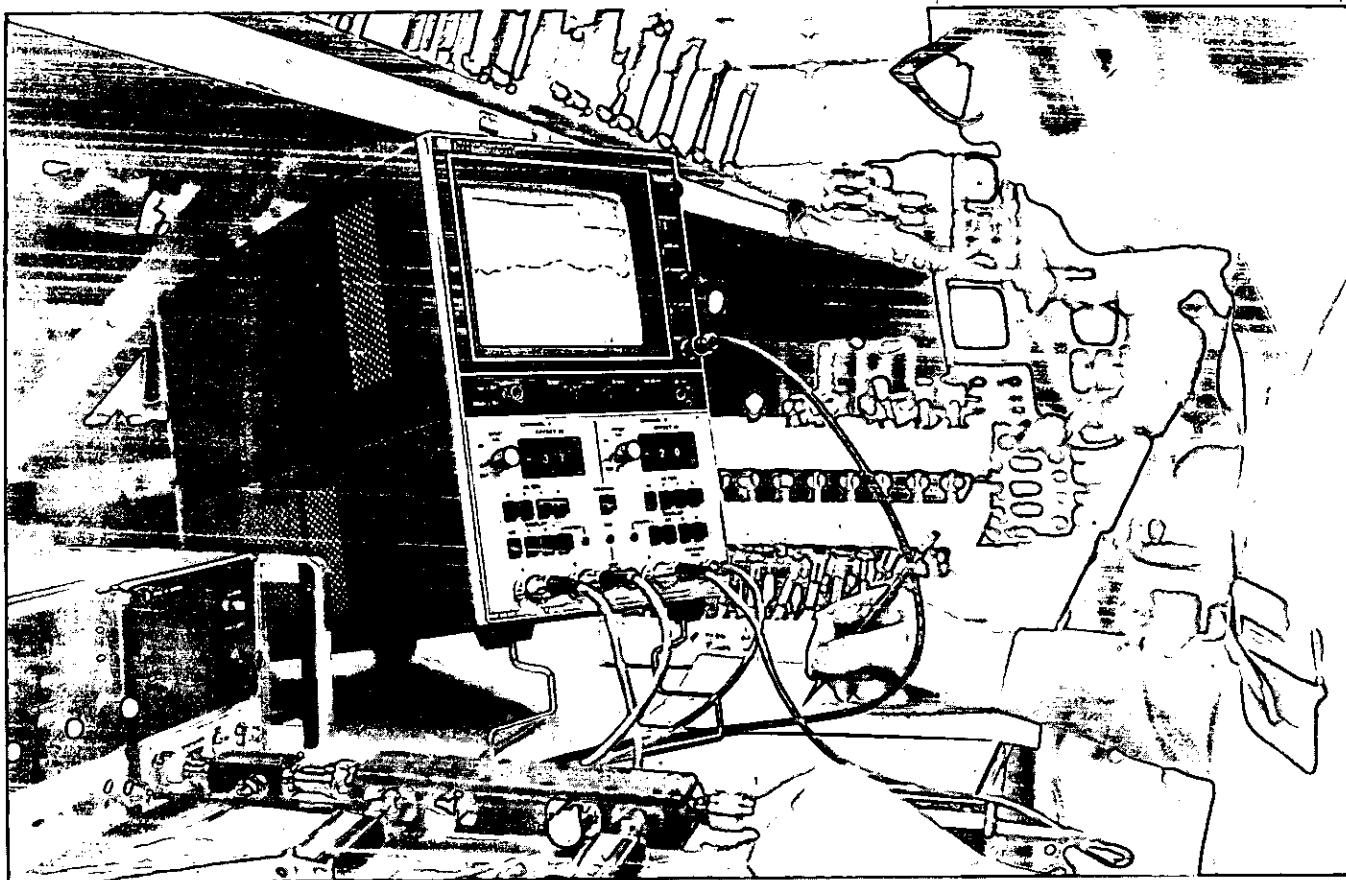

Measuring techniques

Hewlett-Packard offers a complete line of microwave test equipment from which systems can be assembled for making accurate reflections, transmission and frequency measurements. Equipment ranges from inexpensive CW systems which measure a magnitude response to powerful network analyzers which furnish a dynamic CRT display of swept frequency magnitude and phase. Measurement techniques and equipment functions are discussed briefly in the following paragraphs. More detailed information is available in Application Notes 64, 65, and 84, complimentary copies are available from Hewlett-Packard sales offices.

Passive catalog

Hewlett-Packard now offers a comprehensive catalog of coaxial and waveguide measurement accessories. It contains complete information about our extensive selection of precision RF passive instruments and accessories such as directional couplers, fixed and variable attenuators, frequency meters, detectors, mixers, filters, modulators, terminations, etc. A free copy may be obtained through your local Hewlett-Packard sales office.

Frequency measurements

There are two general classes of frequency measuring devices — active and passive

types. Electronic counters, transfer oscillators, and frequency converters are examples of active types. HP manufactures a complete line of these instruments which measure frequency with accuracies of a few parts in 10^6 .

Where the accuracy of active devices is not required, passive devices offer direct readout at a considerable saving in cost. Passive transmission-type frequency meters, such as the HP 532, 536A, and 537A, are two-port devices that absorb part of the input power in a tunable cavity. When the cavity is tuned to resonance, a dip occurs in the transmitted power level. This dip can be observed on a meter or oscilloscope display of the detected RF voltage. Frequency is then read from a calibrated dial driven by the cavity tuning mechanism. The frequency meters achieve accuracies of a few parts in 10^4 .

Impedance measurements

Impedance-matching a load to its source is one of the most important considerations in microwave transmission systems. If the load and source are mismatched, part of the power is reflected back along the transmission line toward the source. This reflection not only limits maximum power transfer, but also can be responsible for erroneous measurements of other parameters or even cause circuit damage in high-power applications.

The signal reflected from the load interferes with the incident (forward) signal, causing standing waves of voltage and current

along the line. SWR, which is the ratio of standing wave maxima to minima, is directly related to the impedance mismatch of the load. The standing wave ratio (SWR), therefore, provides a valuable means of determining impedance magnitude and mismatch. There are two common methods for measuring SWR; slotted line measures the ratio of standing wave maxima to minima while a reflectometer separates the incident and reflected voltage waves and then measures their ratio.

Network analyzers, such as the 8410 system, give a more complete and convenient impedance characterization by providing simultaneous phase and amplitude information. For more details see page 431 of this catalog.

Slotted line techniques — single frequency

Standing-wave ratio can be measured directly with a slotted line. The slotted line has a probe that is loosely coupled to the RF field in the line, thus sensing relative amplitudes of the standing-wave pattern as the probe is moved along the line. The ratio of maxima to minima (SWR) is displayed directly on a SWR meter, such as the HP 415E.

A typical slotted-line set up consists of a CW signal source; a low pass filter to eliminate spurious responses from the source; the slotted-line; the device under test, and an SWR meter.

The swept slotted line

A measuring system which combines the speed and convenience of swept-frequency measurements and the inherent accuracy of the slotted line can be built around the HP 817B Swept Slotted Line System. The setup is similar to the single frequency method except that the source is replaced with a sweep oscillator, the slotted line is an 817B and the 415E is replaced by the HP 8755A/181A. This system will operate throughout the frequency range from 1.8 to 18 GHz. The measurement results are displayed on a storage oscilloscope as an envelope of the SWR in dB. See Figure 1. At any given frequency, the ratio of the maximum and minimum amplitude of the envelope is the SWR. A plot of SWR can be generated in a few seconds and retained on the CRT for evaluation or photography. Accuracy of slotted-line measurements is limited primarily by the residual SWR of the line itself, 1.01 in waveguide and 1.02 to 1.06 in coax depending upon the frequency and type of connector.

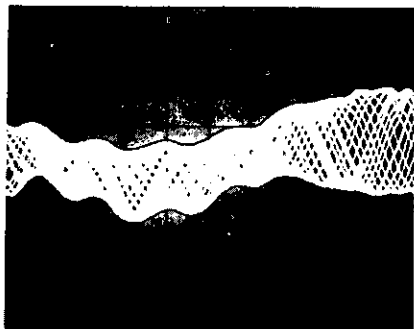

Figure 1. Multi-sweep slotted-line measurement. Vertical scale 0.5 dB/cm.

Reflectometer techniques

The reflection coefficient (ρ) of a device or system is another useful term in establishing the impedance match of microwave devices. The following relationships of ρ and SWR are frequently used in impedance work:

$$\rho = \frac{|E \text{ reflected}|}{|E \text{ incident}|} = \frac{SWR - 1}{SWR + 1}$$

Reflection coefficient (ρ) is a linear quantity varying between zero and one. The logarithmic expression of ρ is known as return loss and defined as: $\text{dB} = -20 \text{ LOG}_{10} |\rho|$. A reflection coefficient of 1.0 (total reflection) therefore, corresponds to zero dB return loss.

Reflection coefficient is measured by separating the incident and reflected waves propagating in the transmission line connecting the source and load. The reflectometer uses either coaxial or waveguide couplers to accomplish this separation. Reflectometers permit dynamic oscilloscope displays or permanent X-Y recordings of reflection coefficient or return loss across complete operating bands.

The reflectometer technique is an economical way for making swept measurements (see

Hewlett-Packard Application Note 65 for more information). However, greater speed and convenience is possible with the HP 8755 Series Frequency Response Test Sets. Measured data can be either plotted on an X-Y recorder or read directly from a fully calibrated CRT display. See Figure 3.

Accuracy of reflectometer measurements is limited by directional coupler directivity. A residual SWR of 1.02 (40 dB directivity) is common in waveguide and 1.02 to 1.1 in coax depending on the frequency range and connectors.

Attenuation measurements

Attenuation is defined as the decrease in power (at the load) caused by inserting a device between a Z_0 source and load. Under this condition, the measured value is a property of the device alone. The term Z_0 is used to describe a unity SWR condition where the load and source impedance equal the transmission line impedance.

There are three common methods for measuring RF attenuation: 1) square-law detection with audio substitution, 2) direct RF substitution, and 3) linear detection with IF substitution.

Square-law detection technique

Figure 2 shows a waveguide system for swept attenuation measurements of 25 to 30 dB.

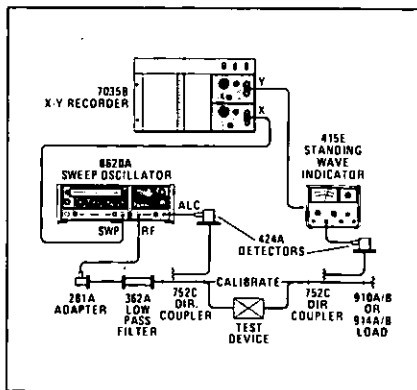

Figure 2. Swept attenuation system for measurements up to 30 dB.

With the 8620A sweeping the frequency range of interest, a zero-dB reference level is established on the X-Y recorder without the test device in the system. The device is then inserted as indicated in Figure 2 and its attenuation versus frequency determined by the amplitude decrease from the reference level previously established.

A much improved square-law detection technique uses the HP 8755L Frequency Response Test Set. The setup diagram in Figure 3 permits simultaneous measurements of attenuation and return loss over a continuous 60 dB dynamic range. Readout is either on a CRT display calibrated directly in dB or an

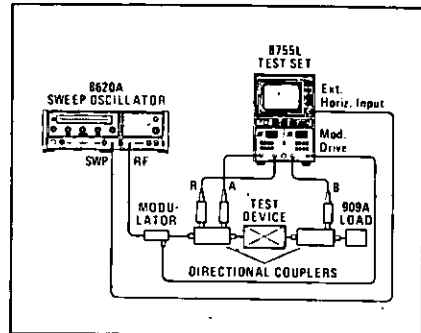

Figure 3. Setup for simultaneous swept measurement of transmission and reflection.

X-Y recorder. The 8755L has a frequency range of 15 MHz to 18 GHz.

RF substitution technique

Swept attenuation measurements up to 45 to 50 dB can be made using the RF pre-insertion X-Y recorder system shown in Figure 4. Coupler tracking and detector errors are eliminated by plotting a calibration grid on the X-Y recorder prior to the actual measurement. The grid is plotted by setting in specific values of attenuation on the 382A near the anticipated test device attenuation. The 382A is then set to 0 dB and the test device inserted as shown in Figure 4. A final sweep plots attenuation of the test device over the calibration grid.

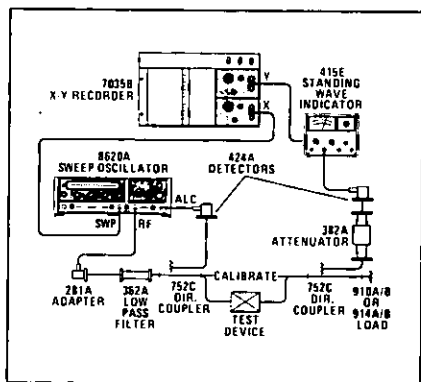

Figure 4. RF pre-insertion technique for swept attenuation measurements.

IF substitution technique

The IF substitution technique of attenuation measurement involves conversion of the microwave frequency to a constant, much lower frequency for which very accurately calibrated attenuators are available. Detection at a constant IF frequency improves the system sensitivity permitting measurements over a wide (>60 dB) dynamic range.

The 8410 Network Analyzer is an instrument where IF substitution is used; thus allowing accurate measurements to be made over a frequency range of 110 MHz to 40 GHz.



MICROWAVE TEST EQUIPMENT

Waveguide instrumentation

- For waveguide systems operating 2.60-40 GHz

Instrument Name	Uses	Family ¹ Model Number	Frequency coverage by band — GHz									
			S 2.6— 3.95	G 3.95— 5.85	J 5.30— 8.20	H 7.05— 10.0	X 8.20— 12.4	M 10.0— 15.0	P 12.4— 18.0	K 18.0— 26.5	R 26.5— 40.0	
Adapters	Interconnect coaxial-waveguide systems	281A	X	X	X	X	X					
	Interconnect two different waveguide systems	281B 292A 292B					X		X	X	X	
Low-pass filters	Output filters for signal sources to eliminate harmonics	362A					X	X	X	X	X	
Variable attenuators	Measurement of reflection coefficient, insertion loss, transfer characteristics by RF substitution; reduction of power levels; reduction of source mismatch	382A 375A	X	X	X	X	X		X	X	X	
Crystal Detectors	RF detection; reflection coefficient, attenuation measurements	424A 422A	X	X	X	X	X	X	X		X	X
Detector mount	Tunable detector mount for accurate matching of waveguide sections to crystal or bolometer	485B					X					
Thermistor mount	Power measurements with 432 series (486A), and 430C (487B).	486A 487B	X	X	X	X	X	X	X	X	X	X
Frequency meters	Frequency measurements	532A 532B			X	X	X		X	X	X	
Directional couplers	Power measurements; power leveling; reflection measurements; isolation	752A			X	X	X		X	X	X	
		752C			X	X	X		X	X	X	
		752D			X	X	X		X	X	X	
Slotted line systems	Measurement of SWR, wavelength, impedance; fixed and swept-frequency slotted line measurements	810B 815B		X	X	X	X		X	X	X	
PIN modulators	Sinusoidal and complex AM and RF pulsing of microwave sources without incidental FM	8735A 8735B					X	X				
Fixed and sliding loads	Fixed loads for terminating waveguide systems. Sliding loads for separating load reflections from other system reflections	910A 910B 914A 914B			X	X	X		X		X	
Fixed and sliding shorts	Establish measurement planes, reflection phase and magnitude references	920A 920B 923A 930A			X	X	X		X	X	X	
Mixers	Harmonic Mixer	932A							X			
Slide screw tuners Phase shifters	Correct discontinuities in waveguide Provide phase control	870A 885A			X		X	X	X			

1. Instrument model number consists of family model number prefixed by letter of waveguide band, e.g., X281B specifies X-band waveguide to coax adapter.



MICROWAVE TEST EQUIPMENT

Coaxial attenuators

Models 8491A, B; 8492A; 8493A, B

NEW

- Flat frequency response
- Low VSWR

- Specifications traceable to NBS
- Fully tested with HP Automatic Network Analyzer

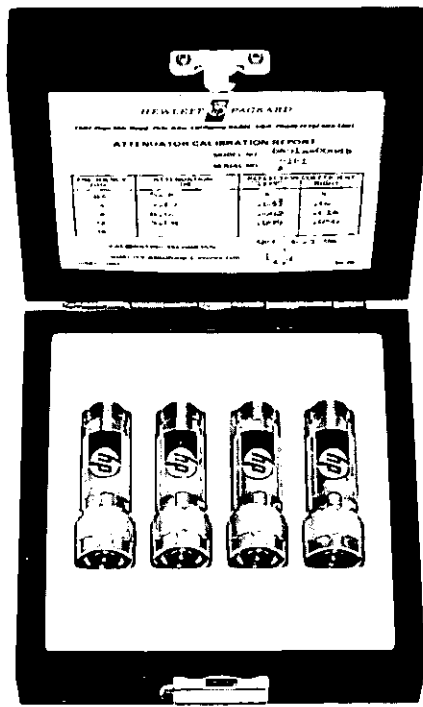

11582A



8491A



8492A



8493A

8491A/B, 8492A, 8493A/B Fixed attenuators

Hewlett-Packard fixed coaxial attenuators provide precision attenuation, flat frequency response, and low VSWR over broad frequency ranges at low prices. Attenuators are available in nominal attenuations of 3 dB, 6 dB and 10 dB increments from 10 dB to 60 dB. These attenuators are swept-frequency tested to insure meeting specifications at all frequencies.

11581A, 11582A, 11583A Attenuator sets

A set of four Hewlett-Packard attenuators, 3, 6, 10 and 20 dB are furnished in a handsome walnut accessory case. In addition to the calibration stamping on the bodies of the attenuators, the set includes a calibration report. The calibration report is certified traceable to the National Bureau of Standards. The calibration report also includes accuracy of both the attenuation and the reflection coefficients at selected frequencies.

Model number and name

Model number and name	Price (Qty 1-4)
8491A 3-30 dB Fixed attenuator	\$65
8491A 40-60 dB Fixed attenuator	\$90
8491B 3-30 dB Fixed attenuator	\$85
8491B 40-60 dB Fixed attenuator	\$120
8492A 3-30 dB Fixed attenuator	\$155
8492A 40-60 dB Fixed attenuator	\$190
8493A 3-20 dB Fixed attenuator	\$70
8493A 30 dB Fixed attenuator	\$75
8493B 3-20 dB Fixed attenuator	\$85
8493B 30 dB Fixed attenuator	\$90
11581A (8491A's) includes 3, 6, 10, 20 dB	\$260
11582A (8491B's) includes 3, 6, 10, 20 dB	\$340
11583A (8492A's) includes 3, 6, 10, 20 dB	\$635

8491A/B, 8492A, 8493A/B Specifications

	8491A	8491B	8492A	8493A	8493B
Attenuation ¹ (dB)	Option: 3, 6, 10, 20, 30, 40, 50, 60	Option: 3, 6, 10, 20, 30, 40, 50, 60	Option: 3, 6, 10, 20, 30, 40, 50, 60	Option: 3, 6, 10, 20, 30	Option: 3, 6, 10, 20, 30
Frequency	DC - 12.4 GHz	DC - 18 GHz	DC - 18 GHz	DC - 12.4 GHz	DC - 18 GHz
SWR ²	DC-8 GHz 1.2 8-12.4 GHz 1.3	DC-8 GHz 1.2 8-12.4 GHz 1.3 12.4-18 GHz 1.5	DC-8 GHz 1.15 8-12.4 GHz 1.25 12.4-18 GHz 1.35	DC-8 GHz 1.2 8-12.4 GHz 1.3	DC-8 GHz 1.2 8-12.4 GHz 1.3 12.4-18 GHz 1.5
Max input Power	2 W avg 100 W peak	2 W avg 100 W peak	2 W avg 100 W peak	2 W avg 100 W peak	2 W avg 100 W peak
Attenuation Accuracy					
3 dB	±0.3 dB	±0.3 dB	±0.3 dB	±0.3 dB	±0.3 dB
6 dB	±0.3 dB	±0.3 dB ³	±0.3 dB ³	±0.3 dB	±0.3 dB ³
10 dB	±0.5 dB	±0.5 dB	±0.5 dB	±0.5 dB	±0.5 dB
20 dB	±0.5 dB	±0.5 dB ⁴	±0.5 dB ⁴	±0.5 dB	±0.5 dB
30 dB	±1 dB	±1 dB	±1 dB	±1 dB	±1 dB
40 dB	±1.5 dB	±1.5 dB	±1.5 dB	—	—
50 dB	±1.5 dB	±1.5 dB	±1.5 dB	—	—
60 dB	±2 dB	±2 dB	±2 dB	—	—
Connector	N	N	APC-7	SMA	SMA
Dimensions mm (in)	61.9 × 20.6 (2 ¹¹ / ₁₆ × 1 ³ / ₁₆)	61.9 × 20.6 (2 ¹¹ / ₁₆ × 1 ³ / ₁₆)	69.9 × 20.6 (2 ⁷ / ₁₆ × 1 ³ / ₁₆)	39.7 × 12.7 (1 ⁹ / ₁₆ × 1/2)	39.7 × 12.7 (1 ⁹ / ₁₆ × 1/2)
Shipping Weight kg (lb)	0.17 (6 oz.)	0.17 (6 oz.)	0.20 (7 oz.)	0.11 (4 oz.)	0.11 (4 oz.)

1. Option numbers same as attenuator values; e.g., Option 003 for 3 dB, Option 006 for 6 dB, Option 010 for 10 dB etc.
2. Check data sheet for SWR slight variation of options 003 and 006 with frequency bands.

3. 6 dB option accuracy is ±0.4 dB, 12.4 - 18 GHz.
4. 20 dB option accuracy is ±1 dB, 12.4 - 18 GHz.

MICROWAVE TEST EQUIPMENT

Coaxial attenuators

Models 354A, 355C-F, 393A, 394A, 33300 Series



354A



33300A

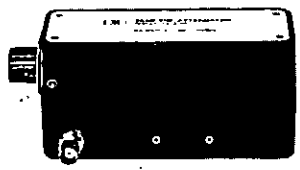

355D

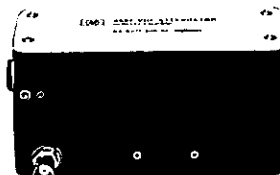

355E

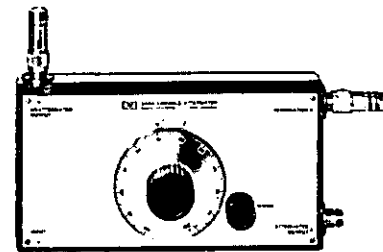

394A

354A Step attenuator, dc to 12.4 GHz

The Model 354A is a turret-type coaxial attenuator which provides 0 to 60 dB of attenuation in 10-dB steps over the frequency range from dc to 12.4 GHz. Attenuation changes are made with a simple knob rotation: no pull-turn-push sequence is required. For bench use the attenuator is supplied with a base; however, the base is removable for easy conversion to panel mount.

355C, D, E, F manual and programmable attenuators, dc to 1 GHz

These are precision attenuators from dc-1 GHz. The 355C and D are manual while the 355E and F are programmable. 0-12 dB in 1-dB steps are provided by the 355C and E; 0-120 dB in 10 dB steps are provided by the 355D and F. Attenuator sections are inserted and removed by cam-driven microswitches. The programmable version uses a 7-pin connector which allows remote control by BCD signals.

393A, 394A Attenuators, 500 MHz to 1 GHz and 1 GHz to 2 GHz

Each of these coaxial variable attenuators uses the principle of a di-

rectional coupler to achieve a wide range of attenuation over a full octave. The HP 393A covers 5 to 120 dB from 500 to 1000 MHz; HP 394A covers 6 to 120 dB from 1 to 2 GHz. With special high-power terminations they handle up to 200 watts average. Since these instruments are variable directional couplers, they are particularly useful for mixing signals while maintaining isolation.

33300/01/04/05 Programmable step attenuators, dc to 18 GHz

These step attenuators provide a fast and precise means for electrically controlling the level of signal attenuation in automatic test systems. They are available in four basic configurations: 0-70 dB in 10-dB steps (33300), 0-42 dB in 6-dB steps (33301), 0-11 dB in 1-dB steps (33304) and 0-110 dB in 10-dB steps (33305). Magnetic latching solenoids (12 and 24 volts) are used to switch individual attenuation elements into and out of contact with a 50 ohm transmission line. A and B are "no contacts" and C and D are "with contacts." Refer to data sheet for further specifications of the 33300/01/04/05.

Specifications

HP Model	Mode Of Operation	Frequency Range GHz	VSWR 50Ω Nominal	Accuracy	Incremental Attenuation	Maximum Residual Attenuation (0 dB Setting)	Power Handling Capability	Dimensions mm (in)	Shipping Weight kg (lb)	KF Connectors	Price
354A	Manual	DC - 12.4	1.5 to 8 GHz 1.75: 8 to 12.4 GHz	±2 dB	0 - 60 dB in 10 dB steps	1.5 dB	2 W avg 100 W peak	102 × 114 × 79 (4 × 4½ × 3¼)	1.8 (4 lb)	Type N Female	\$ 440
355C	Manual	DC - 1	1.2 to 250 MHz	±0.1 dB at 1000 Hz ±0.25 dB to 500 MHz ±0.35 dB to 1 GHz	0 - 12 dB in 1 dB steps	0.25 dB to 100 MHz	0.5 W avg 350 V peak	152 × 70 × 67 (6 × 2¾ × 2¾)	1.4 (3 lb)	BNC ¹ female	\$ 180
355D	Manual	DC - 1	1.3 to 500 MHz	±0.3 dB to 120 dB at 1000 Hz; ±1.5 dB to 90 dB below 1 GHz; ±3 dB to 120 dB below 1 GHz.	0 - 120 dB in 10 dB steps	0.75 dB to 500 MHz					\$ 180
355E	Program	DC - 1	1.5 to 1 GHz			1.5 dB to 1 GHz					\$ 300
355F	Program	DC - 1	1.5 to 1 GHz								\$ 300
393A	Manual	0.5 - 1	2.5; 5 to 15 dB 1.5; 15 to 30 dB 1.4; 30 to 120 dB	±1.25 dB or ±1.75% whichever is greater	5 - 120 dB Continuously Variable	—	200 W avg	305 × 140 × 70 (12 × 5½ × 2¾)	4.1 (9 lb)	Type N female	\$ 950
394A	Manual	1 - 2	2.5; 6 to 10 dB 1.8; 10 to 15 dB 1.6; 15 to 120 dB	±1.25 dB or ±2.5% whichever is greater	6 - 120 dB Continuously Variable	—	200 W avg				\$ 875
A,B 33300 C,D	Program	DC - 18	Refer to Data Sheet	3% to 12.4 GHz 4% to 18 GHz	0 - 70 dB in 10 dB steps	0.5 dB +0.08 dB/GHz	2 W avg ⁴ 500 W peak ³	209.6 × 38.1 × 31.8 ² (8¼ × 1½ × 1¼)	1.4 (3 lb)	Several Options Available	\$ 785
A,B 33301 C,D	Program	DC - 18			0 - 42 dB in 6 dB steps	0.5 dB +0.08 dB/GHz					\$ 815
A,B 33304 C,D	Program	DC - 18			0 - 11 dB in 1 dB steps	0.7 dB +0.1 dB/GHz					\$ 785
A,B 33305 C,D	Program	DC - 18			0 - 110 dB in 10 dB steps	0.7 dB +0.1 dB/GHz					\$ 815
					Refer to Data Sheet for more details						
								266.7 × 38.1 × 31.8 ² (10½ × 1½ × 1¼)	1.4 (3 lb)	Refer to Data Sheet	\$1080

1. Type N female connector available as option 001 — TNC female connector available as option 005
2. With SMA female Connectors

3. Maximum Pulse Width 10 μsec
4. Power Sensitivity 0.001 dB/dB/Watt

MICROWAVE TEST EQUIPMENT



Coaxial step attenuators

Models 8495A, B; 8496A, B; 33321A, B; 33322A, B

NEW

- High Accuracy
- Low VSWR

- High Repeatability
- Convenient Size

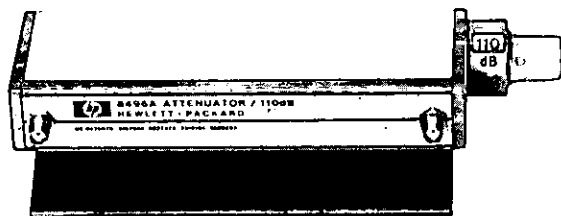

8496A

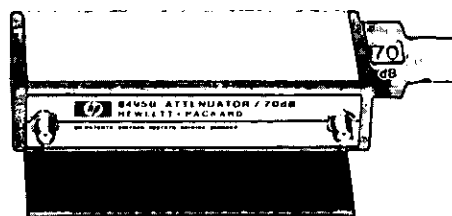

8495B

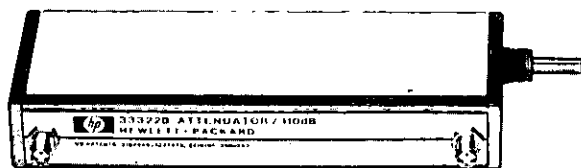

33322B

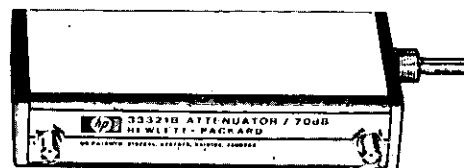

33321B

8495A,B; 8496A,B

These new miniature, precision coaxial step attenuators offer outstanding performance at attractive prices. The attenuators offer the choice of two frequency ranges and two attenuation ranges. The high frequency version covers from dc to 18 GHz in two attenuation ranges, 0 to 70 dB and 0 to 110 dB. The low frequency version, dc to 4 GHz, is available also in two attenuation ranges, 0 to 70 dB and 0 to 110 dB. A choice of three connector types is available: Type N, SMA, and APC-7.

Attenuator sections are inserted and removed by low-torque cam-actuated contacts. These contacts are gold-plated leaf-springs to ensure long life and extremely high repeatability (typically 0.02 dB).

The attenuators employ a resistive thin-film deposited on attenuator cards as the resistive elements. The thin-film deposition process ensures high accuracy and low VSWR (1.35 at 4 GHz, 1.7 at 18 GHz) over the specified frequency range. Performance to specifications is verified by fully testing each attenuator with the HP Automatic Network Analyzer.

33321A,B; 33322A,B

The HP coaxial step attenuators provide you low cost RF/microwave signal attenuation in accurate, highly repeatable steps. The HP 33321A/B (0-70 dB in 10 dB steps) and the 33322A/B (0-110 dB in 10 dB steps) are lightweight and compact for simple integration into your instrument or system. Both models are available in either dc-4 GHz or dc-18 GHz versions. They are similar in construction to the 8495A/B and 8496A/B.

The attenuator elements are miniature thin film T-pads, utilizing tantalum resistive films on sapphire substrates. This thin film technique permits the construction of circuits which are truly distributed and without stray reactances, even at very high microwave frequencies. The result is exceptionally flat attenuation from dc to 18 GHz. The inherent stability of the sapphire-tantalum combination results in an extremely small variation of attenuation with temperature (less than 0.0001 dB/dB/°C) and thus contributes to the attenuator accuracy and repeatability.

Performance to specifications is verified by fully testing each attenuator with the HP Automatic Network Analyzer.

Specifications

HP Model	Frequency Range GHz	VSWR ¹ (50Ω Nominal)	Accuracy ⁴	Increments ² Attenuation	Maximum Residual Attenuation (0 dB Setting)	Power ³ Handling Capability	Dimensions mm (in)	Shipping Weight kg (lb)	RF ⁶ Connectors	Price
8495A	DC - 4	1.35	1.7% ⁴	0 - 70 dB in 10 dB Steps	0.4 dB + 0.07 dB/GHz	1 W avg 100 W peak ⁵	130.2 × 54 × 43 (5 1/8 × 2 1/8 × 1 3/8)	0.9 (2 lb)	Type N (F) ⁶	\$280
8495B	DC - 18	1.35; to 8 GHz 1.5; to 12.4 GHz 1.7; to 18 GHz	3% ⁴ to 12.4 GHz 4% ⁴ to 18 GHz						Type N (F) ⁶	\$280
									SMA (F) ⁶	\$330
									APC - 7 ⁶	\$450
8496A	DC - 4	1.5	1.7% ⁴	0 - 110 dB in 10 dB steps	0.6 dB + 0.09 dB/GHz	1 W avg 100 W peak ⁵	158.8 × 54 × 43 6 1/8 × 2 1/8 × 1 3/8	0.9 (2 lb)	Type N (F) ⁶	\$400
8496B	DC - 18	1.5; to 8 GHz 1.6; to 12.4 GHz 1.9; to 18 GHz	3% ⁴ to 12.4 GHz 4% ⁴ to 18 GHz						Type N (F) ⁶	\$400
									SMA (F) ⁶	\$450
									APC - 7 ⁶	\$540
									SMA (F) ⁶	\$540
									APC - 7 ⁶	\$590
33321A	DC - 4	1.35	1.7% ⁴	0 - 70 dB in 10 dB steps	0.4 dB + 0.07 dB/GHz	1 W avg 100 W Peak ⁵	123.2 × 45.3 × 22.4 (4 7/8 × 1 7/8 × 7/8)	0.9 (2 lb)	SMA (F)	\$275
33321B	DC - 18	1.35 to 8 GHz 1.5 to 12.4 GHz 1.7 to 18 GHz	3% ⁴ to 12.4 GHz 4% ⁴ to 18 GHz							\$395
33322A	DC - 4	1.5	1.7% ⁴	0 - 110 dB in 10 dB steps	0.6 dB + 0.09 dB/GHz	1 W avg 100 W peak ⁵	150.7 × 45.3 × 22.4 (5 7/8 × 1 7/8 × 7/8)	0.9 (2 lb)	SMA (F)	\$395
33322B	DC - 18	1.5; to 8 GHz 1.6; to 12.4 GHz 1.9; to 18 GHz	3% ⁴ to 12.4 GHz 4% ⁴ to 18 GHz							\$535

1. VSWR Specification applies irrespective of connector type.

2. Repeatability is typically 0.02 dB.

3. Power Sensitivity: 0.001 dB/dB/watt for all models.

4. Refer to Data Sheet for more details.

5. Maximum pulse width: 10 μ sec

6. When ordering, Connector Option must be specified:

Option 001, Type N(F)

Option 002, SMA(F)

Option 003, APC-7

MICROWAVE TEST EQUIPMENT

Waveguide attenuators

Model 382A, C & 375A

- Frequency coverage to 40 GHz
- High accuracy

- Low VSWR
- Excellent repeatability

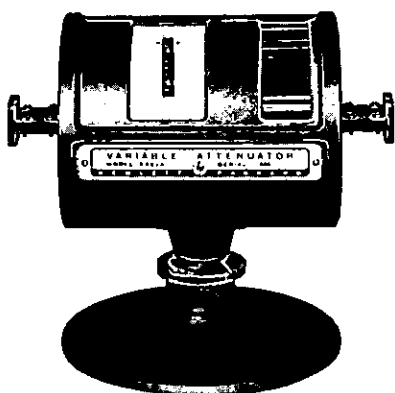

K and R382A



S382C

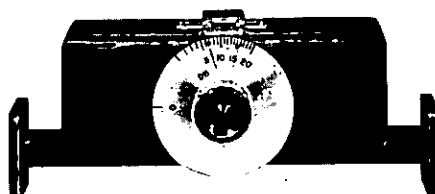

X375A

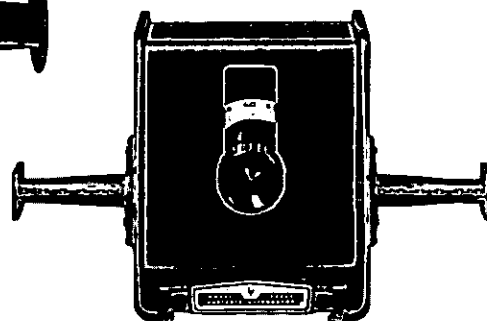

H, X and P382A

382 Precision variable attenuators

Operation of these direct-reading, precision attenuators depends on a mathematical law, rather than on the resistivity of the attenuating material. Accurate attenuation from 0 to 50 dB (0 to 60 dB for S382C) is assured regardless of temperature and humidity. The instruments can handle considerable power and feature large, easily read dials. In addition, the S382C achieves both long electrical length and short physical dimensions through dielectric loading. The result is an S-band attenuator which is only 641 millimeters (25 $\frac{1}{4}$ inches) long and yet is more accurate than previously available units.

375A General-purpose attenuators

Variable flap attenuators provide a simple, convenient means of adjusting waveguide power level or isolating source and load. They consist of a slotted section in which a matched resistive strip is inserted. The degree of strip penetration determines attenuation. A dial shows average reading over the frequency band, and a shielded dust cover reduces external radiation and eliminates hand capacity effects. Attenuation is variable from 0 to 10 dB, ± 2 dB from 10 to 20 dB. Maximum VSWR 1.15.

Specifications

HP Model	Frequency Range (GHz)	VSWR	Accuracy ¹	Attenuation ² Range in dB	Power dissipation watts	Waveguide Size mm (in)	Dimensions mm (in)			Shipping Weight kg (lb)	Price
							L	H	W		
S382C	2.6-3.95	1.2 (2.6-3 GHz) 1.15 (3-3.95 GHz)	$\pm 1\%$ of reading or 0.1 dB whichever is greater	0-60	10*	(3 \times 1 $\frac{1}{4}$) WR284	641 (25 $\frac{1}{4}$)	152 (6)	203 (8)	9.9 (22)	\$1960
I382A	5.3-8.2	1.15	$\pm 2\%$ of reading or 0.1 dB whichever is greater	0-50	10	(1 $\frac{1}{2}$ \times $\frac{1}{4}$) WR137	635 (25)	200 (7 $\frac{7}{8}$)	157 (6 $\frac{1}{8}$)	7.7 (17)	\$1100
H382A	7.05-10.0	1.15	$\pm 2\%$ of reading or 0.1 dB whichever is greater	0-50	10	(1 $\frac{1}{4}$ \times $\frac{1}{4}$) WR112	508 (20)	202 (7 $\frac{7}{8}$)	165 (6 $\frac{5}{8}$)	6.8 (15)	\$1100
X382A	8.2-12.4	1.15	$\pm 2\%$ of reading or 0.1 dB whichever is greater	0-50	10	(1 \times $\frac{1}{4}$) WR90	397 (15 $\frac{5}{8}$)	194 (7 $\frac{7}{8}$)	119 (4 $\frac{11}{16}$)	3.6 (8)	\$ 600
P382A	12.4-18.0	1.15	$\pm 2\%$ of reading or 0.1 dB whichever is greater	0-50	5	(0.702 \times 0.391) WR 62	318 (12 $\frac{3}{4}$)	197 (7 $\frac{7}{8}$)	121 (4 $\frac{3}{4}$)	3.6 (8)	\$ 600
K382A ⁴	18.0-26.5	1.15	$\pm 2\%$ of reading or 0.1 dB whichever is greater	0-50	2	($\frac{1}{2}$ \times $\frac{1}{4}$) WR42	194 (7 $\frac{7}{8}$)	156 (6 $\frac{1}{8}$)	121 (4 $\frac{3}{4}$)	2.7 (6)	\$1100
R382A ⁴	26.5-40.0	1.15	$\pm 2\%$ of reading or 0.1 dB whichever is greater	0-50	1	(0.36 \times 0.22) WR 28	162 (6 $\frac{3}{8}$)	156 (6 $\frac{1}{8}$)	121 (4 $\frac{3}{4}$)	2.7 (6)	\$1100
X375A	8.2-12.4	1.15	± 1 dB (0-10 dB) ± 2 dB (10-20 dB)	0-20	2	(1 \times $\frac{1}{4}$) WR 90	198 (7 $\frac{7}{8}$)	89 (3 $\frac{5}{8}$)	47.6 (1 $\frac{1}{2}$)	1.4 (3)	\$ 275

1. Includes calibration and frequency error

2. Residual attenuation (0 dB reading) less than 1 dB

3. $\pm 2\%$ of reading above 50 dB

4. Circular flange adapters: K-band (UG-425/U) 11515A \$60

R-band (UG-381/U) 11516A \$50

MICROWAVE TEST EQUIPMENT

Broadband coax couplers

Models 774D-778D & 11692D

NEW

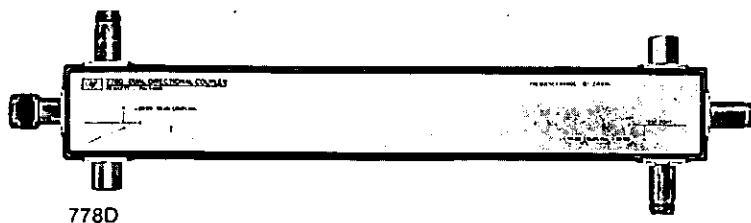

778D

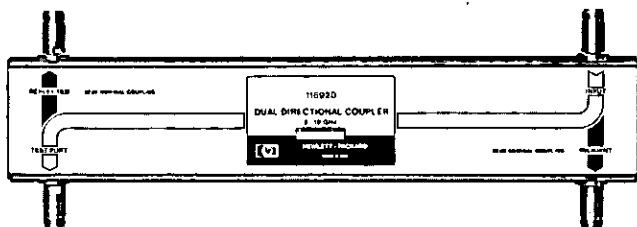

11692D

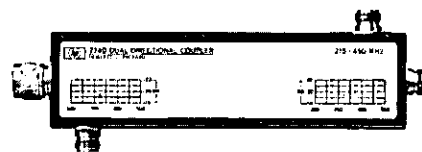

774D

774D-777D Dual directional couplers

The economical 774D-777D couplers cover frequency spreads of more than two-to-one, each centered on one of the important VHF-UHF bands. With their high directivity, these couplers are ideal for reflectometer applications. Furthermore, the close tracking of the auxiliary arms makes these couplers particularly useful for reflectometers driven by externally-leveled sweep oscillators such as HP 8690B and 8620A/B. The forward signal is detected and used to level the output of the sweep oscillator while the reflected signal, after detection is applied to a display device. Changes in the leveled power due to the coupling variation in the forward arm are virtually cancelled by a similar coupling variation in the reverse arm.

778D Dual directional coupler

The HP 778D is a 20-dB dual directional coupler with a frequency range of 100 MHz to 2 GHz. High directivity and close tracking (typically 0.7 dB and 4°) of the auxiliary arms make it ideal for reflectometer measurements of complex reflection coefficient.

11692D Dual directional coupler (new)

The high directivity, dual directional 11692D coupler is a precision instrument designed for broadband swept reflometer applications in the 2 to 18 GHz frequency range. With its wide frequency coverage, the 11692D coupler can replace several couplers without performance degradation, thus adding economy and convenience to swept reflection and transmission coaxial microwave measurements by reducing set up and calibration time.

774D, 775D, 776D, 777D, 778D and 11692D Specifications

HP Model	Frequency Range MHz	Coupling Attenuat.	Coupling Variation	Directivity	SWR	Max Input	Connector	Length mm (in)	Shipping Weight kg (lb)	Price
774D	215-450	20 dB	±1 dB	40 dB	1.15 pri 1.2 aux.	50 W avg. 500 W peak 0.1 sec duty cycle	Pri: type N(m,f) Aux: type N (f)	230 (9 ¹ / ₁₆)	1.8 (4)	\$ 425
775D	450-940	20 dB	±1 dB	40 dB	1.15 pri 1.12 aux			230 (9 ¹ / ₁₆)	1.8 (4)	\$ 425
776D	940-1900	20 dB	±1 dB ¹	40 dB	1.15 pri 1.2 aux			161 (6 ³ / ₁₆)	1.4 (3)	\$ 400
777D	1900-4000	20 dB	±0.4 dB ¹	30 dB	1.2 pri 1.3 aux			225 (8 ⁷ / ₁₆)	1.4 (3)	\$ 425
778D	100-2000	20 dB nominal	±1 dB ²	Reflected Port: 36 dB, 0.1-1 GHz 32 dB, 1-2 GHz Inc. port: 30 dB, 0.1-2 GHz	1.1 all	50 W avg. 10 kW Pk.	Pri line ³ input: N(m) output: N(f) Aux arms: N(f)	425 (16 ³ / ₁₆)	2.3 (5)	\$ 500
11692D	2-18 GHz	22 dB nominal	±1 dB ⁴	30 dB; 2-8 GHz 26 dB, 8-18 GHz ⁵	Pri: 1.3; 2-12.4 GHz 1.4; 12.4-18 GHz aux: 1.3	50 W avg. 250 W Pk.	Pri Line ⁶ input: N(f) output: APC-7 Aux. arms: N(f)	404.8 (15 ⁷ / ₁₆)	2.9 (6.5)	\$1400

1. Aux arm tracking: 0.3 dB for 776D, 0.5 for 777D.

2. Auxiliary arm typically trace within 0.7 dB and 4°.

3. Option 011: APC-7 output, N (f) input.

Option 012: N (m) output, N (f) input.

4. Incident to test port.

5. 24 dB with type N connector on the test port.

6. Other connector options are available. See data sheet for details.

MICROWAVE TEST EQUIPMENT

Directional couplers

Models 779D, 790 Series, 780 Series, & 11691D

- Broadband coverage
- High directivity

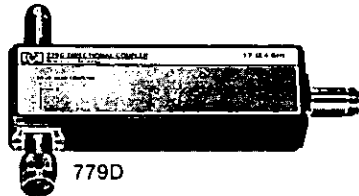

779D

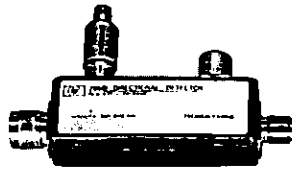

786D



796D



11691D

779D Directional coupler

The HP 779D spans more than two octaves from 1.7 to 12.4 GHz with excellent directivity. With increased coupling factor (typically 24 dB), the 779D is useful down to 500 MHz. Upper frequency usefulness extends to 18 GHz with directivity reduced to about 15 dB.

The 779D is normally supplied with type N connectors on all ports. On special order, a precision APC-7 connector can be supplied on any, or all, ports.

790 Directional couplers

The 790 directional couplers are ultra-flat, high directivity couplers which are ideal for power-monitoring applications in coaxial systems. Output coupling (ratio of output power from main and auxiliary arms) is specified rather than coupling factor. Thus, no correction factor is required to account for insertion losses in the main arm.

779D, 790 Series, 11691D specifications

HP Model	Frequency range (GHz)	Mean output coupling (dB) ¹	Output coupling variation (dB) ²	Directivity (dB) ²	Equiv. source match ^{2,3}	Max. primary line SWR	Max. aux. arm SWR	Max input (W)	Max insertion loss (dB) ⁴	Length		Shipping weight		Price
										(mm)	(in)	(kg)	(lb)	
779D	1.7 to 12.4	20 ±0.5	<±0.75	30, 1.7–4 GHz, 26, 4–12.4 GHz	1.2	1.2	1.2	50	0.5	196	7¾	1.4	3	\$570
796D	0.96 to 2.11	20 ±0.5	±0.2	30	1.13	1.15 ²	1.20 ²	50	0.4	152	6	0.9	2	\$325
797D	1.9 to 4.1	20 ±0.5	±0.2	26	1.16	1.15 ²	1.25 ²	50	0.5	124	4¾	0.9	2	\$330
798C	3.7 to 8.3	10 ±0.3	±0.3	20	1.25	1.20	1.20	10	0.8	124	4¾	0.9	2	\$400
11691D	2 to 18	22 Nominal	±1	30 (2–8 GHz) 26 ⁵ (8–18 GHz)	1.2	1.3 (2–12.4 GHz) 1.5 (12.4–18 GHz)	1.3	50	2	404.8	15½/16	2.25	5	\$825

For all models: RF connectors; primary line, type N (m, f) (except 11691D); auxiliary arm, type N (f).

For 11691D: RF connectors; primary line, APC-7/APC-7; auxiliary arm, type N (f).

1. Difference in dB between power out of primary line and auxiliary arm.
2. Swept-frequency tested.
3. The apparent SWR at the output port of a directional coupler when it is used in a closed-loop leveling system.

4. Includes loss due to coupling.
5. 24 dB with type N connector on the input port.
6. Other connector options available. See data sheet for details.

780 Series specifications

HP ³ Model	Frequency range (GHz)	Freq. resp. (dB) ¹	Low-level sens. (μV/μW)	Directivity (dB)	Equiv. source SWR ²	Max. SWR	Max. input (W, peak or avg.)	Max. insertion loss (dB)	Length		Shipping weight		Price
									(mm)	(in)	(kg)	(lb)	
786D	0.96 to 2.11	±0.2	>4	30	1.13	1.15	10	0.4	152	6	0.9	2	\$350
787D	1.9 to 4.1	±0.2	>4	26	1.16	1.15	10	0.5	124	4¾	0.9	2	\$350
788C	3.7 to 8.3	±0.3	>40	20	1.25	1.20	1	0.8	124	4¾	0.9	2	\$450
789C	8.0 to 12.4	±0.5	>20	17	1.25	1.40	1	1.2	295	11¾	1.4	3	\$725

For all models: Detector output impedance: 15 kΩ maximum shunted by approximately 10 pF.

Detector element: supplied.

Noise: <200 μV peak-to-peak with CW power applied to produce 100 mV output.

1. Includes coupler and detector variation with frequency as read on a meter calibrated for square-law detectors (e.g., HP 415E SWR Meter).
2. The apparent reflection coefficient at the output of an RF generating system, using a directional detector in a closed-loop leveling system.

Detector output polarity: negative (positive polarity available, no extra charge, specify option 003).

Detector output connector: BNC female.

RF connectors: type N, one male (input), one female (789C: Both female)

3. Options available

002, Matched load resistor for optimum square law operation

<±0.5 dB variation from square law, over a range of at least 30 dB, up to 50 mV peak output into >75 kΩ, sensitivity typically one-fourth of unloaded sensitivity.

003, positive polarity detector output

add \$20

no additional charge

MICROWAVE TEST EQUIPMENT



Directional couplers

Model 752A, C, D

- High directivity > 40 dB
- Low SWR

- Measure reflection coefficient (SWR)
- Monitor power



J752A



X752A

The HP 752 Directional Couplers are important tools in waveguide measurements. They can be used to monitor power, measure reflections, mix signals, or isolate signal sources or wavemeters.

Each coupler has an overall directivity of better than 40 dB (including reflection from built-in termination and flange) over its entire range. Performance characteristics are unaffected by humidity, temperature or time, thus making these units especially useful in microwave "standards" measurements. Coupling factors are 3, 10 and 20 dB; mean coupling accuracy is ± 0.4 dB (± 0.7 dB for K- and R-bands); and coupling variation vs frequency is ± 0.5 dB (± 0.6 dB for R752D).

Used together and connected back to back, two couplers are most useful with the HP 8620A Sweep Oscillator (see Signal Source) in broadband reflection and SWR measurements. One directional coupler samples power traveling toward the load, and the detected sample can be used to maintain a constant forward power. The output of the auxiliary arm of the second coupler, which samples power reflected from the load, is then a direct indication of reflection coefficient and SWR. After detection, this signal can be viewed on an oscil-

loscope or permanently recorded on an X-Y recorder. The HP 424A Series Crystal Detectors are ideal for use with the 752 couplers.

In the system described above, the variation in coupling with frequency of the two couplers tends to cancel. This cancellation effectively improves the leveling of the signal source and increases the accuracy of the measurement. For applications in which the actual variations in source output must be minimized, matched pairs of couplers for the leveling loop are available on special order. The pair comprises a 3- and 10- or 20-dB coupler. The 3-dB coupler is connected to the auxiliary arm of the 10- or 20-dB coupler, reducing coupling variation to less than ± 0.2 dB. Swept-frequency techniques are described in detail in Application Note 65, available from any HP field office.

Model number and name

Model number and name	Price
J752A, C, D Directional coupler	\$600
H752A, C, D Directional coupler	\$425
X752A, C, D Directional coupler	\$325
P752A, C, D Directional coupler	\$325
K752A, C, D Directional coupler	\$400
R752A, C, D Directional coupler	\$450

752 Series specifications

Band ^{1,2} (prefix)		J*	H	X	P	K†	R†
Frequency (GHz)		5.85 – 8.2	7.05 – 10	8.2 – 12.4	12.4 – 18	18 – 26.5	26.5 – 40
Fits waveguide size mm (in)		38.10 × 19.05 (1.50 × 0.75)	31.75 × 15.88 (1.25 × 0.625)	25.40 × 12.70 (1.00 × 0.50)	17.83 × 9.93 (0.702 × 0.391)	12.70 × 6.35 (0.50 × 0.25)	9.14 × 5.59 (0.36 × 0.22)
Mean coupling accuracy (dB) ^{3,4}		± 0.4	± 0.4	± 0.4	± 0.4	± 0.7	± 0.7
SWR ^{5,6} main guide	752A	1.1	1.1	1.1	1.1	1.1	1.1
	752C,D	1.05	1.05	1.05	1.05	1.05	1.05
Average power aux. guide load (W)		1	1	1	1	0.5	0.5
Length mm (in)	A	673.1 (26½)	473.1 (18%)	423.9 (16½/16)	349 (13%)	269.9 (10%)	295.3 (11%)
	C	649.3 (25½/16)	444.5 (17½)	398.5 (15½/16)	311.2 (12¼)	254 (9½/16)	219.1 (8%)
	D	649.3 (25½/16)	444.5 (17½)	398.5 (15½/16)	311.2 (12¼)	252.4 (9½/16)	221.5 (8¾/32)
Shipping weight kg (lb)		3.6 (8)	1.8 (4)	1.4 (3)	0.90 (2)	0.90 (2)	0.90 (2)

1. When ordering, specify suffix letter to indicate nominal coupling: A for 3 dB, C for 10 dB, D for 20 dB (example: X-band, 3 dB coupling, Model X752A).
 2. Directivity is at least 40 dB for all bands, swept-frequency tested.
 3. Mean coupling is the average of the maximum and minimum coupling values in the rated frequency range.
 4. Coupling variation over rated frequency range is not more than ± 0.5 dB about mean coupling (± 0.6 dB for R752D).

5. Auxiliary arm SWR is 1.15 (1.2 for P-, K- and R-band units).

6. Swept-frequency tested.

* 1752 Couplers operate to 5.3 GHz with reduced performance.

† Circular flange adapters: K-band (UG-425/U), HP 11515A, R-band (UG-381/U), HP 11516A.

MICROWAVE TEST EQUIPMENT

Crystal detectors

Models 8470A, 8471A, 8472A, 423A, 424A, 420A/B, 422A

- Flat response
- High sensitivity

- Low VSWR
- Excellent square law characteristics

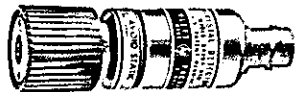

8470A



8472A



8471A



423A



420A



X424A

Description

The HP 8470A and 8472A extend the frequency range of coaxial crystal detectors to 18 GHz. Like the 423A and 424A Crystal Detectors, the 8470A and 8472A combine extremely flat frequency response with high sensitivity and low SWR, making them extremely useful as the detecting element in closed-loop leveling systems. Matched pairs are available for applications requiring the utmost in detector tracking, and all but the 8472A can be supplied with video loads for optimum conformance to square law over a range of at least 30 dB.

The 422A Crystal Detectors are convenient waveguide detectors which cover K- and R-bands. They have a dynamic range of 40 dB or more, making them suitable for reflectometer as well as general-purpose applications.

The 420A is a low-cost crystal detector which covers the coaxial range from 10 MHz to 12.4 GHz, making it ideal for general-purpose video detection. The 420B is essentially the same unit as the 420A with the addition of a selected video load for optimum square-law characteristics in the 1 to 4 GHz range.

Specifications

HP Model	Frequency Range GHz	Frequency Resp. (dB)	Low-Level Sensitivity (mV/μW)	Maximum SWR	RF Input	Matched Pair Available	Square-Law Available	Length		Shipping Weight		Price
								(in.)	(mm)	(lb)	(kg)	
8471A	100 KHz—1.2 GHz	±0.6; typ ±0.1/100 MHz	>0.35	Typically 1.3	BNC Male	No	No	2¾	70	1	0.5	\$ 50
423A	0.01—12.4	±0.2/octave to 8 GHz; ±0.5 overall	>0.4	1.2 to 4.5 GHz; 1.35, 4.5—7 GHz; 1.5, 7—12.4 GHz	Type N Male	Yes ¹	Yes ²	2½ ³²	63	0.5	0.2	\$150
420A	0.01—12.4	±3.5 dB	>0.1	3.0	Type N Male	No	No	3	76	0.5	0.2	\$ 65
420B	1—4 GHz with load	±3	>0.05	3.0	Type N Male	Yes ¹	Yes ²	3	76	0.5	0.2	\$ 95
8470A	0.01—18	±0.2/octave to 8 GHz; ±0.5 to 12.4 GHz ±1 Overall	>0.4	1.2 to 4.5 GHz; 1.35 to 7 GHz; 1.5 to 12.4 GHz; 1.7 to 18 GHz	APC-7 ⁵	Yes ¹	Yes	2½	64	1	0.5	\$190
8472A ⁶	0.01—18	Same as 8470A	>0.4	Same as 8470A	SMA Male	Yes ¹	No	2½	64	0.2	0.1	\$175
S424A	2.60—3.95	±0.2	>0.4	1.35		Yes ³	Yes ²	2¼ ¹⁶	62	2	0.9	\$210
G424A	3.95—5.85	±0.2	>0.4	1.35		Yes ³	Yes ²	2¼ ¹⁶	52	2	0.9	\$200
J424A	5.30—8.20	±0.2	>0.4	1.35	Wave-Guide	Yes ³	Yes ²	1¾	48	1	0.5	\$200
H424A	7.05—10.0	±0.2	>0.4	1.35	Guide	Yes ³	Yes ²	1¾	40	0.6	0.3	\$190
X424A	8.20—12.4	±0.3	>0.4	1.35	Cover	Yes ²	Yes ²	1¾	35	0.5	0.2	\$170
M424A	10.0—15.0	±0.5	>0.3	1.5	Flange	Yes ²	Yes ²	1	25	0.5	0.2	\$290
P424A	12.4—18.0	±0.5	>0.3	1.5		Yes ³	Yes ²	1½ ¹⁶	24	0.4	0.2	\$210
K422A ⁷	18.0—26.6	±2	χ0.3	2.5		Yes ⁴	Yes ²	2	51	0.6	0.3	\$350
R422A ⁷	26.5—40.0	±2	χ0.3	3		Yes ⁴	Yes ²	2	51	0.6	0.3	\$350

For all models—Maximum Input: 100 mW peak or average, 8471A: 3 V rms, (4.2 V pk). Detector element: supplied.

Output polarity: negative (positive output available: for 423A, 8470A, 424A specify Option 003—no additional charge; for 8471A specify Option 004—no additional charge; for 8472A by special order only). Output connector: BNC female.

¹Opt. 001: Matched pair coaxial detectors frequency tracking (excluding basic sensitivity) ±0.2 dB over an octave from 10 MHz to 18 GHz; ±0.3 dB from 8 to 12.4 GHz; and ±0.6 dB from 12.4 to 18 GHz (for 8470A and 8472A).

add \$40

²Opt. 002: Matched load resistor for square law operation <±0.5 dB variation from square law up to 50 MV peak into >75 kΩ; sensitivity typically >0.1 mV/μW.

add \$20

³Opt. 002: Matched pair waveguide detectors frequency tracking (excluding basic sensitivity) ±0.2 dB for S, G, I, and H bands; ±0.3 dB for X-band; and ±0.5 dB for M and P-bands.

add \$20

⁴Opt. 001: Matched pair of waveguide units fitted with square-law loads frequency tracking (excluding basic sensitivity) ±1 dB for power levels less than approximately 0.05 mW (−13 dBm).

add \$80

⁵Opt. 12 type N male input connector for 8470A

add \$15

⁶Opt. 13 type N female input connector for 8470A

add \$15

⁷Opt. 100 OSSM female output connector for 8472A

add \$15

⁸Circular flange adapters:

11515A (U6-425/U) for K-band

each \$100

11516A (U6-381/U) for R-band

each \$100

Slotted lines

Models 805C, 809C, 810B, 816A, 817A/B, 444A, 447B

- Precision tools for measurements to 40 GHz

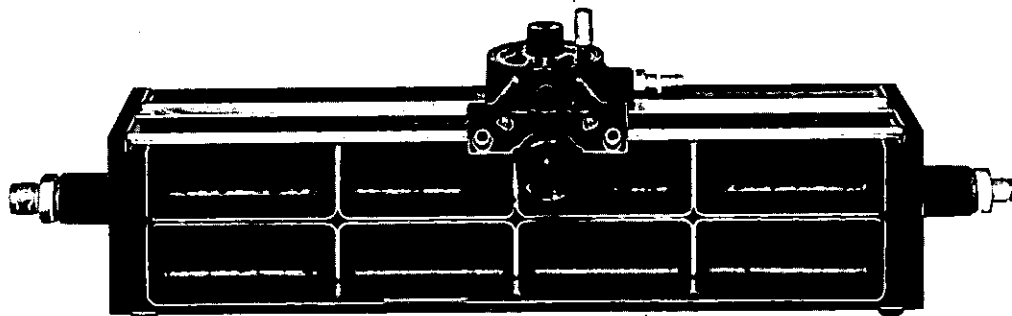

805C

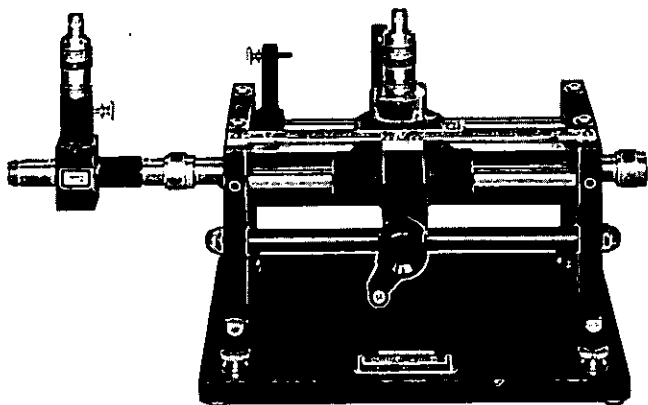

817A

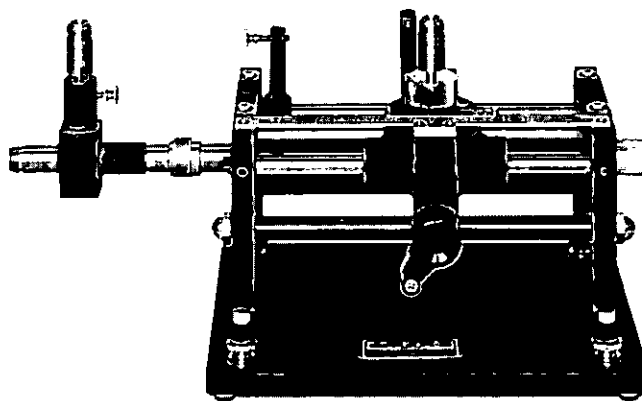

817B

Slotted lines

Hewlett-Packard offers a broad line of slotted lines and associated equipment to measure standing-wave ratio covering the frequency range of 0.5-40 GHz. A summary of this product group is presented on the following three pages.

805C Coaxial slotted line, 0.5-4 GHz

Model 805C is a coaxial slotted line with an integral probe circuit tunable from 500 to 4,000 MHz. The slotted line consists of two parallel planes and a rigid center conductor. This configuration results in negligible slot radiation, minimum sensitivity to variation in probe depth or centering, and greater structural stability.

805C Specifications

Frequency range: 500 to 4,000 MHz.

Impedance: 50Ω.

Residual SWR: less than 1.04:1.

Connectors: type N, one male/female.

Calibration: metric, cm and mm; vernier reads to 0.1 mm.

Dimensions (maximum envelope): 637 × 178 × 178 mm (25 × 7 × 7 in).

Shipping weight: 12.1 kg (27 lb).

Detector probe: tunable; detector may be 1N21B crystal (supplied) or 821 series barretter or selected 1/100-amp instrument fuse.

Accessories furnished: 11511A N female short; 11512A N male short.

817A/B Coaxial swept slotted line systems, 1.8-18 GHz

The HP 817A/B is a fully tested system that permits accurate swept-frequency SWR measurements in coax from 1.8 to 18 GHz. In this range, especially above 4 GHz, coaxial directional couplers suffer from low directivity, thus limiting the accuracy of swept-frequency reflectometers. The 817A/B enables you to realize the accuracy of the

slotted line technique and the complete coverage and time saving of swept-frequency testing. Higher accuracies can be achieved only by using error correcting automatic network analyzer systems.

The Model 817B Swept Slotted Line System consists of an 816A coaxial slotted line, an 809C carriage with baseplate, and the 448B slotted line sweep adapter which accepts the detectors of the HP 8755 Frequency Response Test Set. The 817A system consists of the 816A slotted line, the 809C carriage, and the 448A sweep adapter equipped with its own matched detectors for use with logarithmic amplifiers.

817A/B Specifications

Frequency range: 1.8 to 18 GHz.

Impedance: 50Ω ±0.2Ω.

Output connector: APC-7 or type N female, depending upon which end of the 816A is connected to the load.

Residual SWR:

APC-7 connector: 1.02-1.04 depending on frequency coverage.

Type N connector: 1.04-1.06 depending on frequency coverage.

Accessories furnished: 11512A N male short, 11565A APC-7 short.

Dimensions (maximum envelope): 343 × 178 × 178 mm. (13½", 7", 7").

Shipping weight: 9.0 kg (20 lb).

Option 011: Both connectors APC-7.

Option 022: type N male connector in lieu of APC-7.

Model number and name

805C Coaxial Slotted Line

817A Coaxial Swept Slotted Line system

817B Coaxial Swept Slotted Line system (accepts the detectors of the 8755A Frequency Response Test Set)

Opt. 011 (For both 817A and 817B) Both Connectors APC-7

Opt. 022 (For both 817A and 817B) type N male connector in lieu of APC-7

Price

\$1250

\$1250

\$1200

add \$25

less \$15

MICROWAVE TEST EQUIPMENT

Slotted lines

Models 816A, 809C, 810B's, 444A & 447B

- Precision tools for measurements to 40 GHz



816A

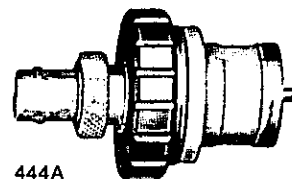

444A

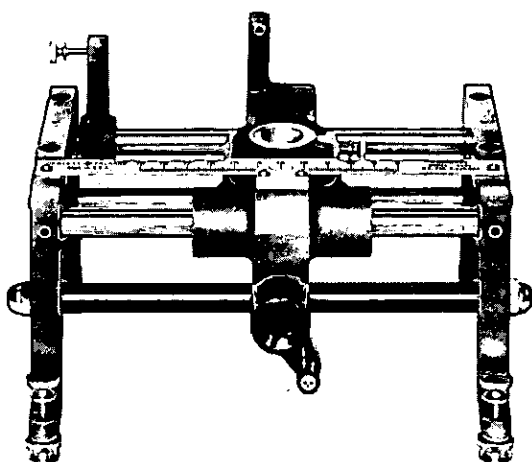

809C



447B



X810B

809C Carriage

The 809C Carriage operates with the 816A Coaxial Slotted Section and four 810B Waveguide Slotted Sections. Four detectors can be used with the 809C: the 442, 444A, 447B, and 448A/B. The carriage has a centimeter scale with a vernier reading to 0.1 mm, and provision is made also for mounting a dial gauge if more accurate probe position reading is required.

816A Coaxial slotted section, 1.8-18 GHz (Used with 809C Carriages and 447B or 448A/B Detector Probes).

The 816A consists of two parallel planes and a rigid center conductor. This configuration virtually eliminates radiation and minimizes the effect of variation in probe penetration and centering. It is fitted with one APC-7 and one type N female connector.

816A Specifications

Frequency: 1.8-18 GHz.

Residual VSWR: APC-7, 1.02-1.04 depending on frequency coverage. Type N, 1.04-1.06 depending on frequency coverage.

Length: 248 mm (9 7/8 inches).

Weight: net, 0.68 kg (1 1/2 lb); shipping 1.4 kg (3 lb).

Accessories furnished: 11512A type N male short; 11565A APC-7 short.

Option 011: both connectors APC-7.

Option 022: type N (m) connector in lieu of APC-7.

447B Detector

Model 447B consists of a crystal diode detector plus a small antenna probe for sampling energy in HP 816A Coaxial Slotted Lines. The untuned probe is extremely sensitive over its frequency range of 1.8 to 18 GHz. The 447B fits HP 809C Carriage or other carriages with a 19 mm (3/4") mounting hole.

444A Untuned probe, 2.6-18 GHz

The 444A Untuned Probe, for use with HP 810B Waveguide Slot-

ted Sections, consists of a crystal, plus a small antenna in convenient housing. The probe is held in position by friction or may be fixed by a locking ring. No tuning is required and sensitivity equals or exceeds many elaborate single and double-tuned probes. The 444A fits the 809C Carriage or other carriages with a 3/4 inch (19 mm) mounting hole. Frequency range is 2.6 to 18 GHz.

Accessory furnished: 11506A Probe Extension Kit.

810B Slotted sections, 5.3-18 GHz (used with 809C carriage and 442B/444A detector)

Waveguide slotted line measurements in the frequency range 5.3-18 GHz are made using the 810B Slotted Section, the 809C Carriage and 444A Probe or 440A plus 442B Probe combination.

810B Specifications

HP Model	Frequency range (GHz)	Fits Waveguide size EIA	Equivalent	Price
J810B	5.30-8.20	WR137	UG441/U	\$375
H810B	7.05-10.0	WR112	UG138/U	\$375
X810B	8.20-12.4	WR90	UG135/U	\$375
P810B	12.4-18.0	WR62	UG419/U	\$375

Model number and name

809C Slotted-Line Carriage	Price \$375
816A Coaxial Slotted-Line Section	\$400
Option 011 both connector APC-7	add \$25
Option 022 type N (m) Connector in lieu of APC-7	less \$15
447B Untuned Probe for use with 816A coaxial slotted-line	\$150
444A Untuned Probe for use with 810B waveguide slotted-line	\$90

MICROWAVE TEST EQUIPMENT



Slotted lines

Models 440A, 442B, 446B, 448A/B, 814B, K815B, R815B

- Precision tools for measurement to 40 GHz

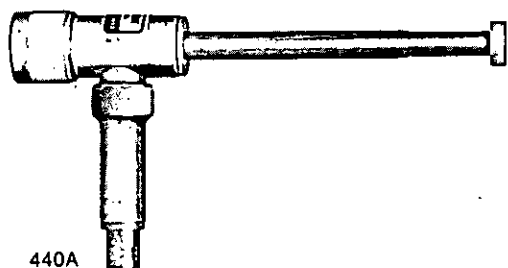

440A



442B

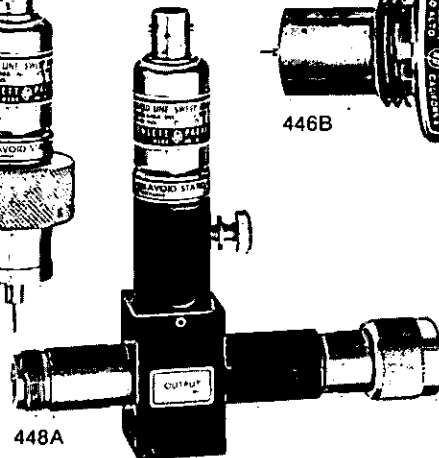

448A

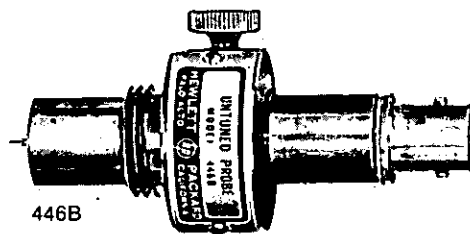

446B

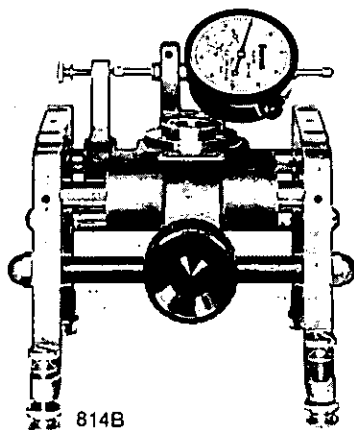

814B



K815B

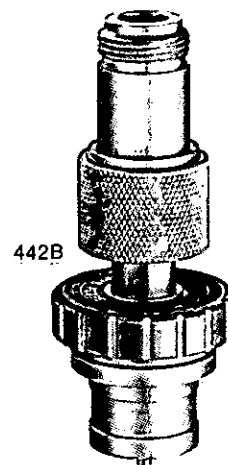

R815B

440A Detector mount

The 440A is a tunable mount used for detecting RF energy in coaxial systems or in conjunction with the HP 442B in waveguide or coaxial slotted sections. Detector (not supplied) can be a 1N21 or 1N23 Crystal or 821 Series Barretter.

442B Broadband probe, 2.6-12.4 GHz

Model 442B is a probe whose depth of penetration into a slotted section is variable. Held in position by friction, it may be fixed in place by a locking ring. Sampled RF appears at a type N jack. It can be connected to a 440A Detector Mount to form a sensitive and convenient tuned RF detector for HP 810B Waveguide Slotted Sections. The 442B fits the 809C Carriage. Frequency range is 2.6 to 12.4 GHz.

448A/B Slotted line sweep adapter, (detector probe) 1.8-18 GHz

The 448B consists of a short section of slotted line and two adjustable probes fitted with Type N connectors for mating with the detectors of the 8755 Frequency Response Test Set.

The 448A consists of a short slotted line and two matched detectors with adjustable probes. One detector levels the signal source, the other monitors the standing waves in the 816A.

448A/B Specifications

Frequency Range: 1.8-18 GHz.

Connectors: type N, one male/female.

Weight: net, 7 oz (0.20 kg); shipping, 14 oz (0.40 kg).

815B Slotted section, 18-40 GHz (used with 814B carriage and 446B detector)

The 815B Waveguide Slotted Sections are designed to fit the 814B Carriage. Like the lower-frequency slotted sections, each 815B is precision-manufactured, broached and checked with precision gauges for careful control of guide wavelength. The slot is tapered to insure a low SWR.

815B Specifications

	K815B*	R815B*
Frequency range (GHz):	18 to 26.5	26.5 to 40
Residual SWR:	1.01	1.01
Overall length:	192 mm (7 5/8")	192 mm (7 5/8")

*Circular flange adapters: K-band (UG425/U) 11515A, R-band (UG381/U) 11516A.

814B Carriage

The HP 814B Carriage is designed for use with the K815B (18 to 26.5 GHz) and R815B (26.5 to 40 GHz) Waveguide Slotted Sections and HP 446B Untuned Probe. The carriage is equipped with a dial indicator for accurate reading. Slotted Sections and HP 446B Untuned Probe. The carriage is equipped with a dial indicator for accurate reading. Slotted sections are easily interchanged.

446B Broadband detector

The HP 446B is a broadband detector and probe which consists of a modified 1N53 silicon diode in a carefully designed shielded housing. No tuning is required, and probe penetration may be varied quickly and easily. Designed for use with the 814B Carriage, the 446B has a frequency range of 18 to 40 GHz.

Model number and name

440A Detector Mount	Price \$175
442B RF Probe	\$100
448A Slotted Line Sweep Adapter	\$450
448B Slotted Line Sweep Adapter	\$325
446B Broadband Untuned Probe	\$350
814B Slotted Line Carriage Assembly	\$850
K815B Waveguide Slotted Line Section	\$695
R815B Waveguide Slotted Line Section	\$725

MICROWAVE TEST EQUIPMENT

Terminations

Models 905; 907-911; 914; 920; 930

- Loads and shorts for measurements to 40 GHz



907A



909A



11512A



X923A

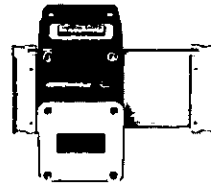

X930A



X914B



H920A



X910B

905A, 907A, 911A Sliding loads

The 905A, 907A and 911A are movable 50Ω, low reflection loads for precision measurements. The 905A and 907A are supplied with three interchangeable connectors, N-male, N-female and APC-7. The 911A is supplied with SMA male and female.

908A, 909A Terminations

The 908A and 909A Terminations are low-reflection loads for terminating 50Ω coaxial systems in their characteristic impedance:

905A, 907A, 911A Specifications

HP Model	Frequency range	Load SWR	Power rating	Length in. (mm)	Shipping weight	Price
905A	1.8–18 GHz	1.05	1 W avg. 5 kW pk	17½ (440)	3 lb (1.4 kg)	\$310
907A	1–18 GHz	1.1, 1–1.5 GHz; 1.05, 1.5–18 GHz	1 W avg. 5 kW pk	30% (778)	9 lb (4.1 kg)	\$525
911A	2–18 GHz	1.1, 2–4 GHz; 1.05, 4–18 GHz	1 W avg. 5 kW pk	14% (380)	3 lb (1.4 kg)	\$260

908A, 909A Specifications

HP Model	Frequency Range	Impedance	SWR	Power Rating	Connector	Price
908A	dc–4 GHz	50 ohms	1.05	½ W avg. 1 kW pk	N male	1 to 4, \$50 ea. 5 to 9, \$39 ea. 10 to 24, \$35 ea.
909A	dc–18 GHz	50 ohms	1.05, 0–4 GHz 1.1, 4–12.4 GHz 1.25, 12.4–18 GHz	2 W avg. 300 W pk	APC-7	1 to 4, \$90 ea. 5 to 9, \$79 ea. 10 to 24, \$75 ea.
909A Option 012 and Option 013	dc–18 GHz	50 ohms	1.05 0–4 GHz 1.11, 4–12.4 GHz 1.3, 12.4–18 GHz	2 W avg. 300 W pk	Opt. 012 N male Opt. 013 N female	deduct \$15

11511A, 11512A, 11565A Shorts

These shorts are used for establishing measurement planes and known reflection phase and magnitude in 50Ω coaxial systems.

Model number and name

11511A N-female short	Price \$10
11512A N-male short	\$10
11565A APC-7	\$30

910A/B, 914A Waveguide terminations

The 910A/B are fixed termination for waveguide systems. The 914A/B are similar to the 910A/B, except that its absorptive element is movable and a lockable plunger controls the position of the element.

920A/B, X923A, X930A Shorts

The 920A/B are movable shorts, adjustable through at least half a wavelength at the low end of the band. The X923A is also a movable short, but is adjustable through about two wavelengths at 8.2 GHz. The X930A is a removable short. SWR is less than 1.02 in "open", greater than 125 in "short."

910A/B, 914A/B Specifications

Model	Frequency Range (GHz)	SWR	Power Rating	Type	Waveguide Size (EIA)	Price
J910A	5.3–8.2	1.02	1 watt	fixed	WR137	\$150
H910A	7.05–10.0	1.02	1 watt	fixed	WR112	\$115
X910B	8.2–12.4	1.015	1 watt	fixed	WR90	\$ 75
P910A	12.4–18	1.02	1 watt	fixed	WR62	\$ 75
J914A	5.3–8.2	1.01	2 watt	sliding	WR137	\$300
H914A	7.05–10.0	1.01	1 watt	sliding	WR112	\$300
X914B	8.2–12.4	1.01	1 watt	sliding	WR90	\$110
P914A	12.4–18	1.01	½ watt	sliding	WR62	\$225
K914B	18–26.5	1.01	½ watt	sliding	WR42	\$450
R914B	26.5–40	1.01	½ watt	sliding	WR28	\$415

920A/B, X923A, X930A Specifications

Model	Frequency Range (GHz)	Waveguide Size EIA	Price
J920A	5.3–8.2	WR137	\$210
H920A	7.05–10.0	WR112	\$210
X923A	8.2–12.4	WR90	\$200
P920B	12.4–18	WR62	\$225
K920B	18.0–26.5	WR42	\$450
R920B	26.5–40.0	WR28	\$385
X930A	8.2–12.4	WR90	\$350

MICROWAVE TEST EQUIPMENT



Low-pass; bandpass filters

Models 360A-D; 362A; 8430A-8436A

- Effective elimination of undesirable signals
- Low insertion loss through passband
- No spurious response



360D



X362A

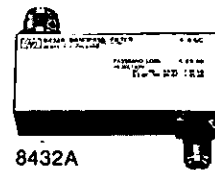

8432A

These Hewlett-Packard low-pass and bandpass filters facilitate microwave measurements by eliminating undesirable signals (such as harmonics) from the measurement system. Suppression of such signals is particularly important in applications such as broadband reflection and transmission measurements or slotted line measure-

ments, where harmonics generated by the signal source could otherwise impair measurement accuracy. These filters also can be used as preselectors for the HP 8555A Spectrum Analyzer. As such, they permit the maximum utilization of the analyzer's broad spectrum-width capability while ensuring virtually spurious-free displays.

Coaxial low pass filters, 360 series specifications

HP Model	Cut-off frequency MHz	Insertion Loss	Rejection	Impedance	VSWR	Connectors	Overall Length mm (in)	Shipping Weight kg (lb)	Price
360A	700	Less than 1 dB below 0.9 times cut-off frequency	Greater than 50 dB at 1.25 times cut-off frequency	50Ω	<1.6 to within 100 MHz of cut-off	Type N (M, f)	276 (10 $\frac{3}{4}$)	0.9 (2)	\$175
360B	1200			50Ω		Type N (M, f)	183 (7 $\frac{1}{32}$)	0.9 (2)	\$175
360C	2200			50Ω	<1.6 to within 200 MHz of cut-off	Type N (M, f)	274 (10 $\frac{29}{32}$)	0.9 (2)	\$125
360D	4100			50Ω	<1.6 to within 300 MHz of cut-off	Type N (M, f)	187 (7 $\frac{3}{8}$)	0.45 (1)	\$125

Waveguide low pass filters, 362 series specifications

HP Model	Passband GHz	Stopband GHz	Passband Insertion Loss	Stopband Rejection	VSWR	Waveguide Size mm (in)	Length mm (in)	Shipping Weight kg (lb)	Price
X362A	8.2 - 12.4	16 - 37.5	Less than 1 dB	At Least 40 dB	1.5	25.4 × 12.7 (1 × $\frac{1}{2}$) WR 90	136 (5 $\frac{11}{32}$)	0.9 (2)	\$575
M362A	10.0 - 15.5	19 - 47			1.5	21.59 × 12.07 (0.85 × 0.475) WR 75	114 (4 $\frac{15}{32}$)	0.9 (2)	\$400
P362A	12.4 - 18.0	23 - 54			1.5	17.83 × 9.93 (0.702 × 0.391) WR 62	94 (3 $\frac{11}{16}$)	0.37 (13 oz)	\$550
K362A ¹	18.0 - 26.5	31 - 80			1.5	12.7 × 6.35 ($\frac{1}{2}$ × $\frac{1}{4}$) WR 42	64 (2 $\frac{1}{2}$)	0.15 (5.3 oz)	\$415
R362A ¹	26.5 - 40.0	47 - 120	Less than 2 dB	At Least 35 dB	1.8	9.14 × 5.59 (0.36 × 0.22) WR 28	42 (1 $\frac{21}{32}$)	0.11 (4 oz)	\$465

¹Circular flange adapters: K-band (UG-425/U), HP11515A \$100

R-band (UT-381/U), HP11516A \$100

8430 Series bandpass filters specifications

HP Model	Passband frequency (GHz)	Maximum passband insertion loss	Rejection band attenuation				Dimensions		Shipping weight		Price
			Below passband		Above passband		(in.)	(mm)	(lb)	(kg)	
			Frequency (GHz)	Attenuation	Frequency (GHz)	Attenuation					
8430A	1 to 2	2 dB	≤0.8	≥50 dB	2.2 to 20	≥45 dB	5 $\frac{1}{2}$ × 4 $\frac{1}{4}$ × 1	140 × 121 × 25	3	1.4	\$360
8431A	2 to 4	2 dB	≤1.6	≥50 dB	4.4 to 20	≥45 dB	5 $\frac{1}{2}$ × 3 × 1	140 × 76 × 25	3	1.4	\$360
8432A	4 to 6	2 dB	≤3.5	≥50 dB	6.5 to 20	≥45 dB	4 $\frac{1}{2}$ × 2 × 1	114 × 51 × 25	2	0.9	\$360
8433A	6 to 8	2 dB	≤5.5	≥50 dB	8.5 to 20	≥45 dB	4 × 1 $\frac{1}{2}$ × 1	102 × 38 × 25	2	0.9	\$360
8434A	8 to 10	2 dB	≤7.5	≥50 dB	10.5 to 17	≥45 dB	4 $\frac{1}{4}$ × 1 × 1	118 × 25 × 25	2	0.9	\$360
8435A	4 to 8	2 dB	≤3.2	≥50 dB	8.8 to 20	≥45 dB	3 $\frac{3}{4}$ × 1 $\frac{3}{4}$ × 1	92 × 45 × 25	2	0.9	\$360
8436A	8 to 12.4	2 dB	≤6.9	≥50 dB	13.5 to 17	≥45 dB	2 $\frac{1}{2}$ × 1 × 1	73 × 25 × 25	1	0.45	\$360

Connectors: Type N, one male, one female.





MICROWAVE TEST EQUIPMENT

Frequency meter

Models 532A/B, 536A & 537A

- High resolution, easy-to-read dial
- Direct reading
- Broadband
- Accuracy specified over 20°C and 0 to 100% relative humidity

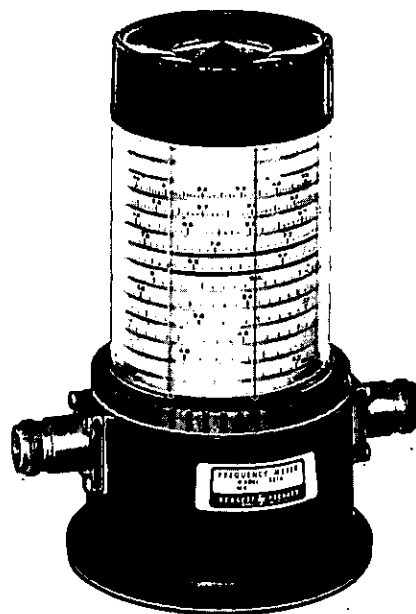
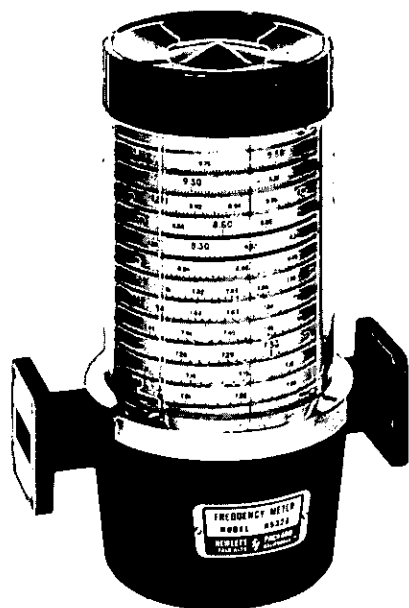

These direct-reading frequency meters allow you to measure frequencies from 5.30 to 40 GHz in waveguide and from 960 MHz to 12.4 GHz in coax quickly and accurately. Their long scale length and numerous calibration marks provide a high resolution which is particularly useful when measuring frequency differences or small frequency changes. Frequency is read directly in GHz so no interpolation or charts are required.

The instruments comprise a special transmission section with a high-Q resonant cavity which is tuned by a choke plunger. A 1-dB or greater dip in output indicates resonance; virtually full power is transmitted off resonance. Tuning is by a precision lead screw, spring-loaded to eliminate backlash. Resolution is enhanced by a long, spiral scale calibrated in small frequency increments. For example, Model

X532B has an effective scale length of 1956 mm (77 inches) and is calibrated in 5-MHz increments. Resettability is extremely good, and all frequency calibrations are visible so you can tell at a glance the specific portion of the band you are measuring. Except for the J532A, there are no spurious modes or resonances. (See note 4 below.)

Model number and name

536A Frequency meter	Price \$775
537A Frequency meter	\$600
H532A Frequency meter	\$950
J532A Frequency meter	\$950
K532A Frequency meter	\$700
P532A Frequency meter	\$500
R532A Frequency meter	\$700
X532B Frequency meter	\$500

532A Series, 536A and 537A Specifications

Model	Frequency Range (GHz)	Dial Accuracy (%)	Overall Accuracy ¹ (%)	Dip at Resonance	Calibration Increment (MHz)	Fits Waveguide		Equivalent Flange	Size In. (mm)			Weight lb (kg)	
						Nom. OD(in)	EIA		Length	Height	Depth	Net	Shipping
536A	0.96—4.20	0.10 ²	0.17 ³	Note 6	2				152 (6)	232 (9¼)	152 (6)	10 (4.5)	13 (5.9)
537A	3.7—12.4	0.10	0.17	1 dB min	10				118 (4¾)	146 (5¾)	89 (3¾)	4 (1.8)	5 (2.3)
J532A	5.30—8.20 ⁴	0.033	0.065	1 dB min	2	1½ × ¾	WR137	UG-441/U	159 (6¼)	232 (9¼)	114 (4¾)	8 (3.6)	11 (5.0)
H532A	7.05—10.0	0.040	0.075	1 dB min	2	1¼ × ¾	WR112	UG-138/U	159 (6¼)	203 (8)	111 (4¾)	6 (2.7)	9 (4.1)
X532B	8.20—12.4	0.050	0.08	1 dB min	5	1 × ½	WR90	UG-39/U	114 (4½)	156 (6¼)	73 (2¾)	3 (1.4)	4 (1.8)
P532A	12.4—18.0	0.068	0.10	1 dB min	5	0.702 × 0.391	WR62	UG-419/U	114 (4½)	159 (6¼)	70 (2¾)	3 (1.4)	4 (1.8)
K532A ⁵	18.0—26.5	0.077	0.11	1 dB min	10	¾ × ¾	WR42	UG-595/U	114 (4½)	137 (5¾)	73 (2¾)	2 (0.9)	3 (1.4)
R532A ⁵	26.5—40.0	0.083	0.12	1 dB min	10	0.360 × 0.220	WR28	UG-599/U	114 (4½)	140 (5½)	70 (2¾)	2 (0.9)	3 (1.4)

¹Includes allowance for 0 to 100% relative humidity, temperature variation from 13 to 33°C, and backlash.

²0.15, 0.96 to 1 GHz.

³0.22, 0.96 to 1 GHz.

⁴Because of the wide frequency range of the J532A, frequencies from 7.6 to 8.2 GHz can excite the TE₁₁₁ mode when the dial is set between 5.3 and 5.6 GHz.

⁵Circular flange adapters: K-band (UG-425/U) 11515A, R-band (UG-381/U) 11516A.

⁶1 dB min., 1-4 GHz; 0.6 dB min., 0.96-1 GHz and 4-4.2 GHz.

MICROWAVE TEST EQUIPMENT



Tuners, phase shifters

Models 870A & 885A

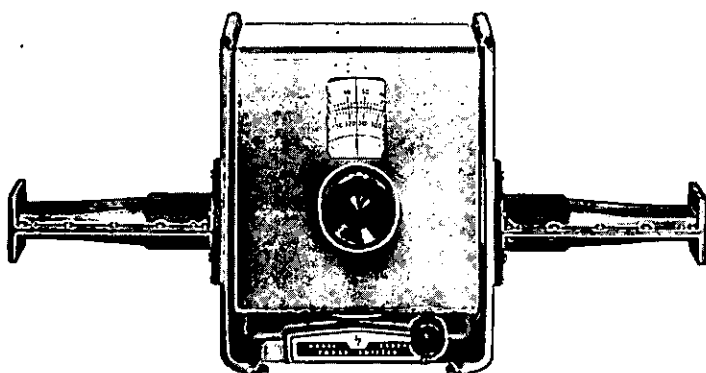

X885A

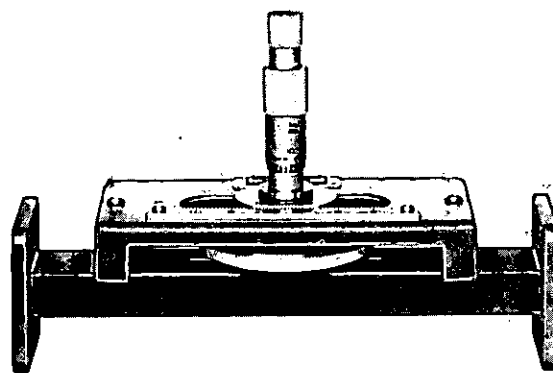

X870A

885A Waveguide phase shifters

HP 885A Phase Shifters provide accurate, controllable phase variation in the J-, X-, and P-band frequency ranges. They are particularly useful in microwave bridge circuits where phase and amplitude must be adjusted independently. They are also used in the study of phased arrays.

The instruments are differential phase devices; that is, they add or subtract a known phase shift from the total phase shift which a wave undergoes in traveling through the device.

The instruments have high accuracy over their entire phase range, -360 to $+360$ electrical degrees, have low power absorption, are simple to operate, and require no charts or interpolation. They are sturdily built, comprising two rectangular-to-circular waveguide transitions with a dial-driven circular waveguide mid-section. These waveguide phase shifters are housed in cast aluminum containers for extreme rigidity and durability.

870A Slide-screw tuners

Waveguide slide-screw tuners are used primarily for correcting discontinuities or for "flattening" waveguide systems. They are also used to match loads, terminations, power sensors, or antennas to the characteristic admittance of the waveguide. They are particularly valuable in determining experimentally the position and magnitude of matching structures required in waveguide system.

HP 870A tuners consist of a waveguide slotted section with a precision-built carriage on which an adjustable probe is mounted. The position and penetration of the probe are adjusted to set up a reflection which is used to cancel out an existing reflection in a system.

Probe penetration into the guide is varied by a micrometer drive. Position of the probe along the guide is adjusted by a thumb-operated wheel, and position can be read to 0.1 mm on a vernier scale. An SWR of 20 can be corrected to 1.02, and small SWR's can be corrected exactly.

885A Specifications

Model	Frequency Range (GHz)	Differential Phase Angle Range ¹	Accuracy ² (The smaller of)	Insertion Loss ³	SWR (max.)	Power Rating (Watts)	Waveguide Size mm (in) EIA	Flange	Length mm (in)	Shipping Weight		Price
										kg	lb	
J885A	5.3-8.2	-360° to $+360^\circ$	$\pm 3^\circ$ or $0.1\Delta\phi$	< 2 dB	1.35	10	38.1×19.05 (1.5 \times .75) WR 137	UG-344/U	638 (25%)	8.2	18	\$1400
X885A	8.2-12.4	-360° to $+360^\circ$	$\pm 2^\circ$ ($\pm 3^\circ$, 10-12.4 GHz) or $0.1\Delta\phi$	< 1 dB, 8.2-10 GHz; < 2 dB, 10-12.4 GHz	1.35	10	25.4×12.7 (1 \times 0.5) WR 90	UG-39/U	397 (15%)	5.0	11	\$1100
P885A	12.4-18	-360° to $+360^\circ$	$\pm 4^\circ$ or $0.1\Delta\phi$	< 3 dB	1.35	5	17.83×9.93 (0.702 \times 0.391) WR 62	UG-419/U	312 (12 $\frac{1}{2}$ %)	3.6	8	\$1200

(1) Can be shifted continuously through any number of cycles.

(2) $\Delta\phi$ = phase difference in degrees.

(3) Variation with frequency (fixed phase setting): approx. 1 dB.

Variation with phase setting (fixed frequency): < 0.4 dB, J885A; 0.3 dB max. 8.2 to 10 GHz and 0.4 dB max. 10 to 12.4 GHz. X885A: < 0.5 dB, P885A.

870A Specifications

Model	Freq. Range (GHz)	Fits Waveguide Size		Equivalent Flange Type	Length		Net Weight		Shipping Weight		Price
		Norm. OD (in.)	(EIA)		(mm)	(in.)	(kg)	(lb)	(kg)	(lb)	
X870A	8.20-12.40	1 \times ½	WR90	UG-39/U	140	5½	0.34	¾	0.9	2	\$375
P870A	12.40-18.00	0.702 \times 0.391	WR62	UG-419/U	127	5	0.23	½	0.9	2	\$375

Correctable SWR on all models: 20.

Insertion loss dB at corrected SWR of 20: 2 dB max.

MICROWAVE TEST EQUIPMENT

Mixers, coaxial switches

Models 934A, P932A & 8761A/B

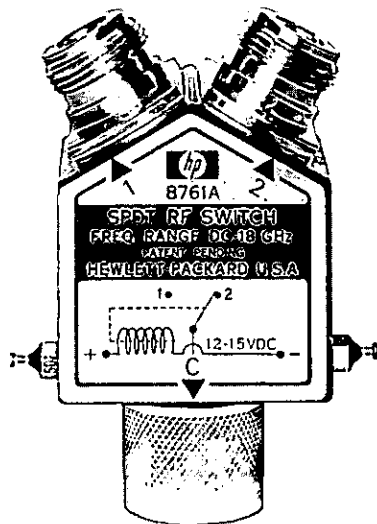

8761A Option 001

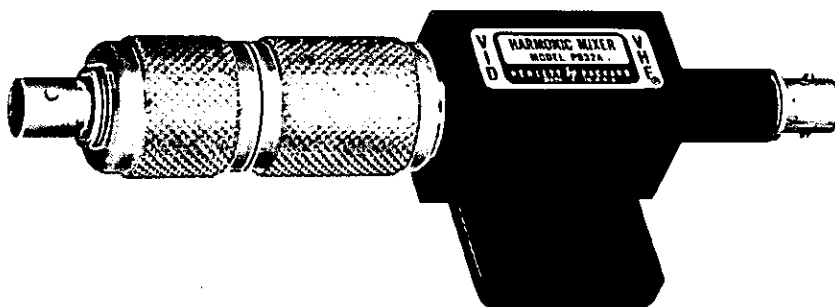

P932A

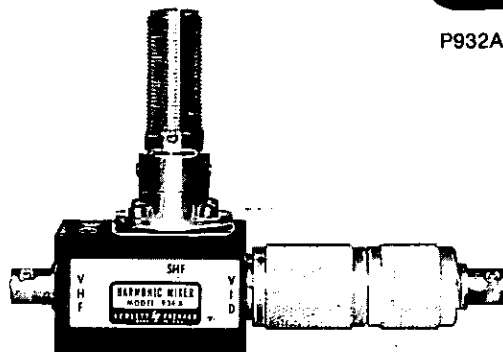

934A

934A, P932A Harmonic mixers

HP 934A, P932A simplify frequency measurements from 2 to 18 GHz. They are also excellent as RF mixers in phase-stabilized signal sources. Both feature high sensitivity, yet require no tuning.

Specifications 934A, P932A				
Model	Frequency Range (GHz)	Maximum Input	Typical Sensitivity	Min. video output*
934A	2 to 12.4	100 mW	-48 dBm at 3.5 GHz -25 dBm at 10 GHz	1.4 mV p-p
P932A	12.4 to 18	100 mW	-10 dBm	0.4 mV p-p

*With 0 dBm input signal.

8761A/B Coaxial switch

The HP 8761 is a single-pole, double-throw coaxial switch with low standing-wave ratio, low insertion loss, and excellent isolation from dc to 18 GHz. Mechanically, the switch is a break-before-make type controlled by a latching solenoid. Solenoids are available in 12- and 26-volt ratings and can be operated by dc or pulsed signals. Any of seven coaxial connectors, or a 50-ohm termination, may be specified for each port.

8761A/B Specifications

Characteristic impedance: 50 ohms.

Frequency range: dc to 18 GHz.

Standing-wave ratio: looking into one of the connected ports with 50 ohms (or built-in termination) on the other, third port open.

Frequency	Connector type		
	7-mm	N	3-mm(SMA)
dc-12.4 GHz	<1.15 (1.20)	<1.20 (1.25)	<1.25 (1.30)
dc-18 GHz	<1.20 (1.25)	<1.25 (1.30)	<1.30 (1.35)

SWR in parenthesis applies to switch with built-in termination.

These specifications apply when connected ports are of the same connector type; for mixed connector types, the larger of the two VSWR's applies. N-connector VSWR specifications apply to Option 4 connectors.

Insertion loss: <0.5 dB, dc-12.4 GHz; <0.8 dB, dc-18 GHz.

Isolation: >50 dB, dc-12.4 GHz; >45 dB, dc-18 GHz.

Power: safely handles 10 W average, 5 kW peak, without built-in termination; built-in termination rates at 2 W average, 100 W peak.

Switching energy: 1.5 W for 20 ms (permanent magnet latching).

Solenoid voltages (dc or pulsed): 12-15 V, 8761A.
24-30 V, 8761B.

Switching speed: 35-50 ms (includes settling time).

Life: >1,000,000 switchings.

Dimensions: 41 × 38 × 38 mm (1.6 × 1.5 × 1.5 in.), excluding connectors and solenoid terminals.

Weight: net, 140-220 g (5-8 oz); shipping, 220-300 g (8-11 oz).

8761A/B Ordering information

Specify solenoid voltage and connectors (including built-in 50Ω termination) by the alphabetic suffix on the switch model number and the appropriate three-digit option number.

Port 1 Port 2 Port C

8761A Option 001

Solenoid Voltage Connector Configuration

A: 12-15 V; B: 24-30 V

Option Code	Connector Type	Option Code	Connector Type
0	N female	4	7-mm for UT-250 Coax
1	N male	5	3-mm female
2	7-mm female	6	3-mm male
3	7-mm male	7	50Ω Termination

Model number and name

934A Harmonic Mixer (2-12.4 GHz)

P932A Harmonic Mixer (12.4-18 GHz)

8761A/B Coaxial Switch (Quantity 1-9)

8761A/B Coaxial Switch (Quantity 10-24)

8761A/B Coaxial Switch with built-in termination

Price

\$200

\$400

\$155

\$145

add \$35

MICROWAVE TEST EQUIPMENT



Miscellaneous equipment

Models 281A-B, 292A-B, 11524A/25A, 11588A, 11606A

- Increase versatility of microwave measurements

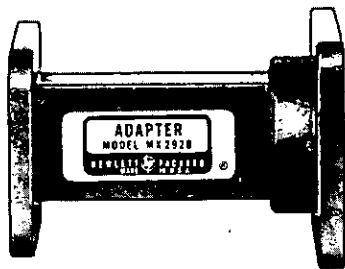

MX292B

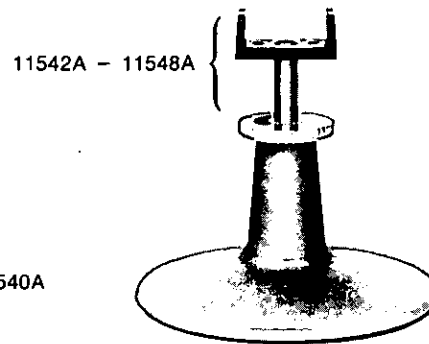

11540A

11542A - 11548A

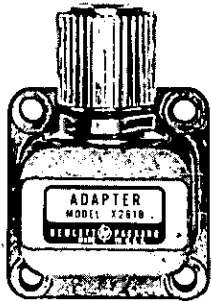

X281B

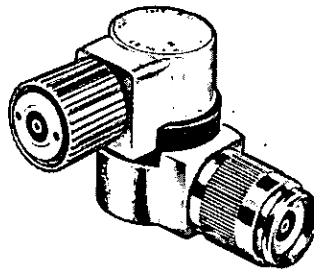

11588A



11606A

292A, B Specifications

HP Model	SWR	Length		Frequency range (GHz)	Price
		mm	(in.)		
HX292B	1.05	38	1½	8.20 to 10.0	\$ 90
MX292B	1.05	60	2½	10.0 to 12.4	\$125
MP292B	1.05	60	2½	12.4 to 15.0	\$ 95
NP292A	1.05	60	2½	15.0 to 18.0	\$ 75
NK292A	1.05	60	2½	18.0 to 22.0	\$ 75

281A,B Specifications

HP Model	SWR	Frequency Range (GHz)	Waveguide Size EIA	Coaxial Connector	Length ³		Qty 1-4 Price
					mm	(in.)	
S281A	1.25	2.60-3.95	WR284	N Female	64	2½	\$100
G281A	1.25	3.95-5.85	WR187	N Female	54	2½	\$ 90
J281A	1.25 ¹	5.30-8.20	WR137	N Female	51	2	\$ 60
H281A	1.25	7.05-10.0	WR112	N Female	41	1½	\$ 55
X281A	1.25	8.20-12.4	WR90	N Female	35	1½	\$ 50
X281B	1.25	8.20-12.4	WR90	APC-7 ²	35	1½	\$125
P281B	1.25	12.4-18	WR62	APC-7 ²	24	1 ⁵ / ₁₆	\$115

- 1.3 from 5.3 to 5.5 GHz.
- Option 013. Furnished with stainless steel N-female connector, less \$15.
- Shipping weight for all models, approximately 0.45 kg (1 lb).

11524A, 11525A, 11533A, 11534A Specifications

HP Model	Description	Shipping Weight	Price
11524A	APC-7 to N female	110 gm (4 oz)	\$ 75
11525A	APC-7 to N male	140 gm (5 oz)	\$ 75
11533A	APC-7 to SMA male	140 gm (5 oz)	\$120
11534A	APC-7 to SMA female	140 gm (5 oz)	\$120

11588A, 11606A Specifications

HP Model	Frequency Range GHz	VSWR	Connectors	Dimensions mm (in)	Shipping Weight kg (lb)	Price
11588A	DC - 12.4	1-1 ¹ / ₂	7 mm, male 7 mm, female	42 × 59 × 30 (1½ × 2¼ × 1¼)	0.28 (10 oz)	\$250
11606A	DC - 12.4	1-1 ¹ / ₂	APC-7 7 mm, female	100 × 19 (4 × ¾)	0.45 (1 lb)	\$200

1. Insertion Loss: <0.5 dB
2. Uncertainty due to rotation: -57 dB

Model number and name

11540A Waveguide stand	Price \$15
11542A Waveguide holder	\$10
11543A to 48A Waveguide holder	\$ 5

Price
\$15
\$10
\$ 5

292A,B Waveguide to waveguide adapters

Models 292A,B waveguide-to-waveguide adapters connect two different waveguide sizes with overlapping frequency ranges. The 292A consists of a short tapered section of waveguide. The 292B is broached waveguide with a step transition between waveguide sizes.

281A,B Coax to waveguide adapters

HP 281A,B adapters transform waveguide impedance into 50-ohm coaxial impedance. Power can be transmitted in either direction, and each adapter covers the full frequency range of its waveguide band with SWR less than 1.25.

11524A; 11525A, 11533A, 11534A Coax to coax adapters

These coaxial adapters, not pictured above permit easy interconnection of 50-ohm precision 7-mm (APC-7) connectors and 50-ohm Type N or SMA (3-mm type) connectors.

11588A Swivel adapter, 11606A rotary air line

The 11606A rotary air line and the 11588A swivel adapter are capable of a full 360° of rotation. A combination of the air line and the adapter permits rigid coax movement in three dimensions. Even the most awkwardly shaped devices can be easily connected or disconnected in a coax system with the aid of these components.

Waveguide stand, waveguide holder

The 11540A waveguide stand locks HP waveguide holders at any height from 70 to 133 mm (2¾" to 5¼"). The stand is 64 mm (2½") high, and the base measures 121 mm (4¾") in diameter. The waveguide holders are offered in seven sizes to hold waveguide covering frequencies from 2.95 to 40 GHz. They consist of a molded plastic cradle with a center rod.

MICROWAVE TEST EQUIPMENT

SWR meter

Model 415E

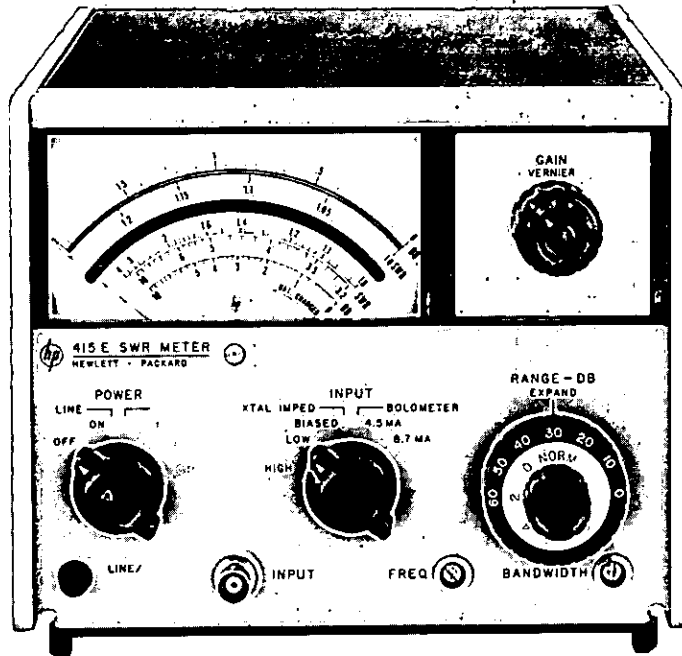

The Hewlett-Packard Model 415E SWR meter is a low noise, tuned amplifier-voltmeter calibrated in dB and SWR for use with square law detectors. It is an extremely useful instrument for measuring SWR, attenuation, and gain directly from metered scales, or as a tuned amplifier for driving an X-Y recorder when making RF substitution measurements. The 415E responds to a standard tuned frequency of 1000 Hz. This frequency is front panel adjustable over a range of 7% for exact matching to the internal 1 kHz modulation of the signal source being used. Amplifier bandwidth is also adjustable from 15 to 130 Hz. The narrow bandwidth allows maximum sensitivity at CW frequencies while the wider bandwidths enable swept tests to be displayed on an oscilloscope or X-Y recorder.

A precision 60 dB attenuator with an accuracy of 0.05 dB/10 dB assures high accuracy in making substitution measurements. An expand-offset feature allows any 2 dB range to be expanded to full scale for maximum resolution. Linearity is ± 0.02 dB on expanded ranges and is limited only by meter resolution on normal scales. This performance, together with the inherently low noise figure, allows maximum measurement range with exceptional resolution and linearity.

The Model 415E operates with either crystal or bolometer detectors (see page 402). Both high and low-impedance inputs are available for crystal detectors. Precise bias currents of 4.5 and 8.7 mA (200 Ω) are available for operation with bolometers as selected at the front panel. This bias is peak limited for positive bolometer protection.

Both ac and dc outputs located on the rear panel allow use of the 415E as a high-gain tuned amplifier or for X-Y recorder operation. In addition, the 415E can be operated with an internally mounted battery pack (option 001) for completely portable use.

Specifications

Sensitivity: 0.15 μ V rms for full-scale deflection at maximum bandwidth (1 μ V rms on high impedance crystal input).

Noise: At least 7.5 dB below full scale at rated sensitivity and 130 Hz bandwidth with input terminated in 100 or 5000 Ω ; noise figure less than 4 dB.

Range: 70 dB in 10 and 2-dB steps.

Accuracy: ± 0.05 dB/10 dB step; maximum cumulative error between any two 10 dB steps, ± 0.10 dB; maximum cumulative error between any two 2 dB steps, ± 0.05 dB; linearity, ± 0.02 dB on expand scales, determined by inherent meter resolution on normal scales.

Input: Unbiased low and high impedance crystal (50-200 and 2500-10,000 Ω optimum source impedance respectively for low noise); biased crystal (1 V into 1 k Ω); low and high current bolometer (4.5 and 8.7 mA $\pm 3\%$ into 200 Ω), positive bolometer protection; input connector, BNC female.

Input frequency: 1000 Hz adjustable 7%; other frequencies between 400 and 2500 Hz available on special order.

Bandwidth: Variable, 15-130 Hz; typically less than 0.5 dB change in gain from minimum to maximum bandwidth.

Recorder output: 0-1 V dc into an open circuit from 1000 Ω source impedance for ungrounded recorders; output connector, BNC female.

Amplifier output: 0 - 0.3 V rms (Norm), 0 - 0.8 V rms (Expand) into at least 10,000 Ω for ungrounded equipment; output connector, dual banana jacks.

Meter scales: Calibrated for square-law detectors; SWR: 1 - 4, 3.2 - 10 (Norm); 1 - 1.25 (Expand). dB: 0 - 10 (Norm); 0 - 2.0 (Expand); battery: charge state.

Meter movement: Taut-band suspension, individually calibrated mirror-backed scales; expanded dB and SWR scales greater than 108 mm (4 $\frac{1}{4}$ ") long.

RFI: Conducted and radiated leakage limits are below those specified in MIL-I-6181D.

Power: 115-230 V $\pm 10\%$, 50-400 Hz, 1 W; optional rechargeable battery provides up to 36 hr continuous operation.

Dimensions: 190 mm wide, 155 mm high, 279 mm deep (7 $\frac{2}{32}$ " \times 6 $\frac{1}{32}$ " \times 11").

Weight: Net 4 kg (9 lb). Shipping 5.8 kg (13 lb).

Accessory available: 11057A handle, fits across top of instrument for carrying convenience.

Combining cases: 1051A, 286 mm deep (11 $\frac{1}{4}$ "). 1052A 416 mm deep (16 $\frac{1}{4}$ ").

Model number and name

415E SWR meter	Price
Option 001: rechargeable battery installed	\$490
Option 002: rear panel input connector in parallel with front panel connector	\$105
1051A Combining case	\$25
1052A Combining case	\$150
11057A Handle kit	\$170
	\$5

MICROWAVE TEST EQUIPMENT

Frequency response test sets, 15 MHz to 18 GHz

Models 8755L & 8755M

- 15 MHz to 18 GHz frequency range
- Absolute and ratio measurement capability

- 60 dB dynamic measuring range
- Excellent stability with time and temperature

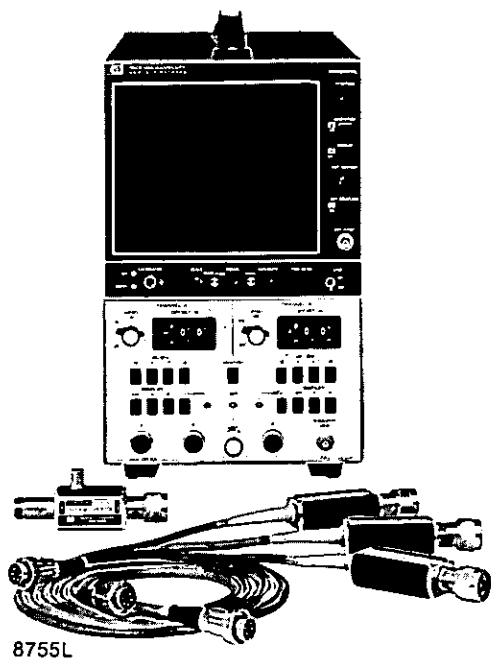

8755L

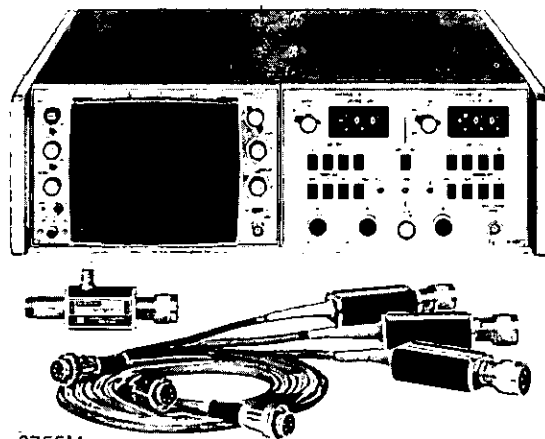

8755M

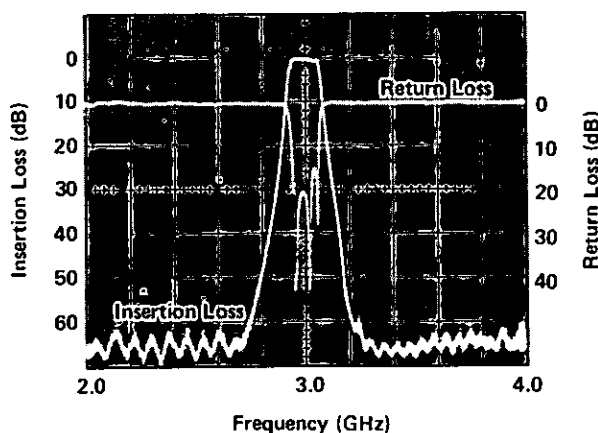

Swept amplitude measurements over a frequency range of 15 MHz to 18 GHz can be made using the 8755 Frequency Response Test Set. This versatile measuring system consists of an 8755A plug-in for 180 series oscilloscope displays, three 11664A hot carrier diode detectors, and an 11665B modulator. The dual channel 8755 allows simultaneous swept-frequency display of two ratio measurements or measures absolute power at the push of a button. The 8755 offers a number of advantages besides covering a wide frequency range; the 11665B modulator allows AC signal processing enabling virtually drift-free operation with time and temperature compared to non-modulated systems. Use of hot carrier diode detectors, which are completely interchangeable, enable a -50 dBm sensitivity as compared to -35 dBm with crystal detectors. This means a 60 dB dynamic measuring range is available with solid state sweepers having a 10 mW output (8620 Family). Front panel controls are both easy to understand and operate. Each channel is separated, but identical, and all functions are push button controls. A direct reading digital dB offset thumbwheel allows the magnitude of any displayed signal to be easily determined. An offset cal vernier is used to average frequency response variations of directional couplers and detectors, and to compensate for coupling factors.

Applications

A common measurement set-up for using the 8755 is shown in the diagram. The reference detector samples incident power. The A detector measures reflected power while the third (B) detector measures insertion loss of a bandpass filter. The ratio A/R then provides return loss (SWR) information directly in dB, while the B/R trace displays transmission data simultaneously. At any time absolute power can be measured without disturbing the calibration performed for a ratio measurement.

Its wide frequency coverage and simplicity of operation make the 8755 well-suited for a number of other microwave applications. Antenna measurements are simplified since the AC system enables use of long extension cables on detectors without performance degradation. Cable measurements, including fault location, are made quickly and accurately using the HP 11667A power splitter. Amplifier measurements including gain, harmonic content, and 1 dB gain compression, can be made while zero dc offset recorder outputs enable hard copy results. Since the 8755 responds only to the 27.8 kHz modulated signal, LO feedthrough can be eliminated from mixer measurements.

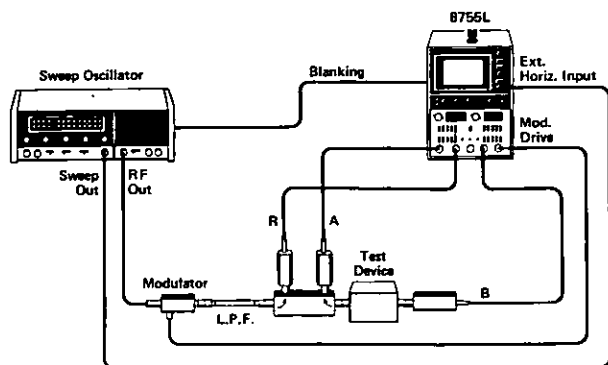



MICROWAVE TEST EQUIPMENT

Models 8755L & 8755M (cont.)

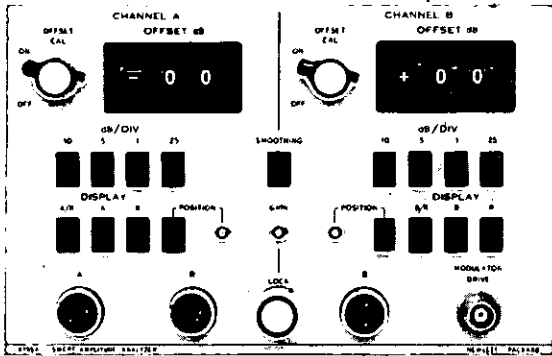

8755A

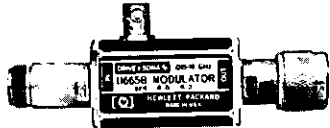

11665B

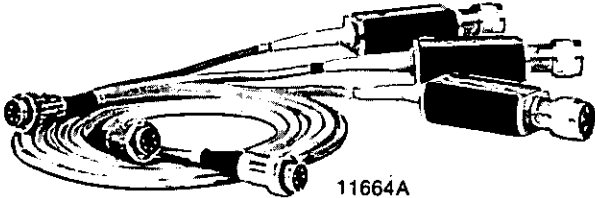

11664A

Accurate SWR measurements from 1.8 to 18 GHz can be made using the HP 817B Swept Slotted Line. Simultaneous reflection and transmission measurements from 2 to 18 GHz can be made using the HP 11692D coupler with the HP 8620A/86290A broadband solid state sweeper.

Specifications

8755L and 8755M Systems

Function: The 8755L and 8755M are configured test sets complete with plug-in and display, three detectors, and modulator.

Frequency range: 15 MHz to 18 GHz.

Measurement range:

Single channel: +10 dBm to -50 dBm (noise level).

Ratio of two channels: 60 dB.

Frequency response (ratio measurement):

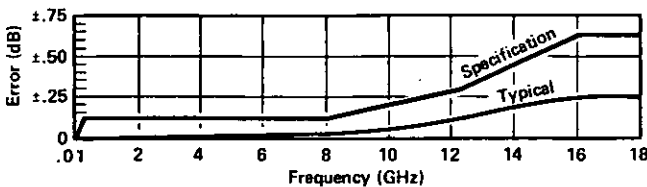

Ratio measurement accuracy:

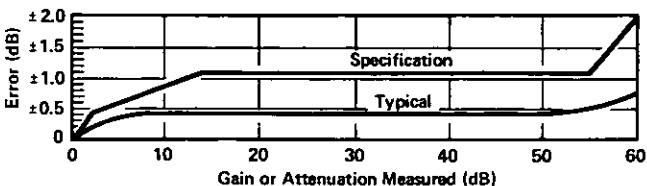

Note: This specification curve applies for attenuation measurements with initial calibration at +10 dBm signal levels at the A and B detectors and a constant signal level at the reference (R) detector.

Detector return loss:

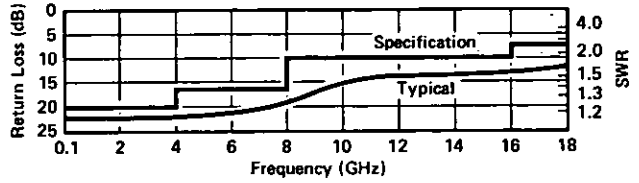

Impedance: 50Ω.

Resolution: Each channel independent, 10, 5, 1 or 0.25 dB per division.

Offset: Each channel independent, ±59 dB in 1 dB steps.

Recorder outputs: 0.5 volt/division; zero dc offset.

Marker and blanking inputs: Accepts both positive and negative marker and blanking inputs.

Temperature range: Operation, 0 to 55°C; storage -40°C to 75°C. Temperature drift typically 0.01 dB/°C from 5° to 55°C.

Standard connectors:

11664A detectors: Type N-male.

11665B modulator: Input N-female, output N-male.

Dimensions:

8755L (182T display): 202 mm wide, 338 mm high, 499 mm deep (7 1/8" × 13 1/8" × 19 3/4").

8755M (180TR display): 425 mm wide, 133 mm high, 543 mm deep (16 1/4" × 5 1/2" × 21 1/4").

Weight:

8755L: Net 15.5 kg (34.3 lb). Shipping 23 kg (52 lb).

8755M: Net 14.5 kg (31.8 lb). Shipping 22 kg (50 lb).

Individual instrument specifications

8755A Plug-in

Function: Swept amplitude analyzer for 180 series displays. Has inputs for three 11664A detectors and supplies 27.8 kHz drive for 11665B modulator.

Weight: Net, 2.8 kg (6.3 lb). Shipping 4.5 kg (10 lb).

11665B Modulator

Function: Absorptive on-off modulator designed for and power by the 8755A plug-in.

Frequency Range	Return Loss On and Off	Insertion Loss	
		On	Off
15 - 40 MHz	≥10 dB	≤7.0 dB	≥35 dB
40 MHz - 4 GHz	≥15 dB	≤3.2 dB	≥35 dB
4 - 8 GHz	≥12 dB	≤3.8 dB	≥40 dB
8 - 12.4 GHz	≥8 dB	≤4.3 dB	≥45 dB
12.4 - 18 GHz	≥8 dB	≤5.0 dB	≥45 dB

Modulator drive feedthrough: ≤8 mV (peak) at 27.8 kHz at either port when powered by the 8755A. Reduced to ≤1 mV (peak) using the 11668A. (See 11668A High Pass Filter).

Drive current: Nominally +50 mA in ON condition, -50 mA Off condition.

Weight: Net, 0.17 kg (6 oz). Shipping, 0.9 kg (2 lb).

11664A Detectors

Function: Hot carrier diode detects envelope of the modulated microwave signal, 15 MHz to 18 GHz.

Frequency response:

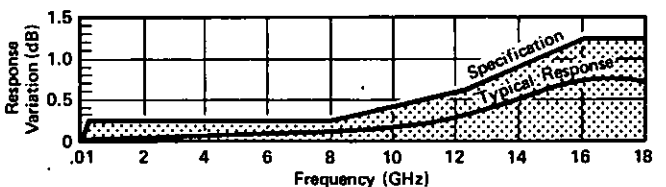

Weight: Net, 0.17 kg (6 oz). Shipping, 0.9 kg (2 lb).

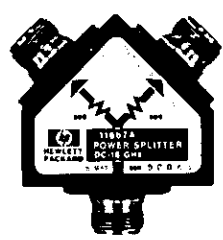

11667A



11668A



11678A

Display units

The 8755A can be used with any 180 series display. However, the 180 "T" series displays are recommended. These mainframes provide long persistence P7 phosphor which reduces flicker on slow sweeps, negative z-axis blanking input, and zero dc offset recorder outputs. Both 8755L and 8755M systems come with "T" displays. Retrofit kits are available.

Accessories

11668A High pass filter

The 11668A High Pass Filter accessory is recommended when making measurements on active devices which have gain below 50 MHz. Use of the 11668A, placed after the 11665B, reduces the modulator drive feedthrough from 8 mV to 1 mV and prevents possible amplifier saturation. Use of the 11668A filter is not necessary for passive measurements since the feedthrough from the 11665B is <-65 dBm and causes no degradation in system performance.

Frequency range: 50 MHz to 18 GHz.

	Insertion Loss	Return Loss
50 - 100 MHz	≤2.5 dB	≥12 dB
100 MHz - 8 GHz	≤1.0 dB	≥16 dB
8 - 12 GHz	≤1.0 dB	≥14 dB
12 - 18 GHz	≤1.5 dB	≥14 dB

Maximum input: +27 dBm.

Connectors: N-female, N-male.

Weight: 0.13 kg (5 oz). Shipping 0.28 kg (10 oz).

New 11667A Power splitter

The 11667A Power Splitter is recommended when making wide-

band transmission measurements using the 8755 Test Set. This two-resistor type splitter provides excellent output SWR at the auxiliary arm when used for source leveling or ratio measurement applications. The 0.25 dB tracking between output arms over a frequency range from dc to 18 GHz allows wideband measurements to be made with a minimum of uncertainty.

Frequency range: dc - 18 GHz.

Impedance: 50Ω.

	dc-4 GHz	dc-8 GHz	dc-18 GHz
Input SWR: (leveling or ratio measurement)	1.15	1.25	1.45
Equivalent output SWR:	1.10	1.20	1.33
Output tracking: (between output arms)	0.15	0.20	0.25

Insertion loss: 6 dB nominal (input to either output).

Maximum input power: +27 dBm.

Connectors: Type N female on all ports.

Dimensions: 50 mm wide, 46 mm high, 19 mm deep (2" x 1 3/8" x 3/4").

Weight: Net, 0.06 kg (2 oz). Shipping 0.22 (8 oz).

New 11678A low pass filter kit

The 11678A Low Pass Filter Kit contains five filters conveniently matched to HP 8620 sweeper bands. These filters have <1.1 dB insertion loss with >40 dB rejection at 1.25 fc. Filter use is recommended to reduce undesirable harmonics causing errors in broadband detector measurements.

Frequency range: low pass filters, cutoff frequency fc: 11688A, 2.8 GHz; 11689A, 4.4 GHz; 11684A, 6.8 GHz; 11685A, 9.5 GHz; 11686A, 13.0 GHz.

Connectors: Type N; one male, one female.

Weight: Net, 0.44 kg (1 lb). Shipping, 1.2 kg (2.9 lb).

Ordering information

Two complete test systems have been configured for ordering convenience. The 8755L is cabinet configured in a 182T large screen display. The 8755M provides the 180TR rack mount display. Both systems include the 8755A plug-in, three 11664A detectors and the 11665B modulator with standard connector options only. To order a different mainframe or non standard connector options each part of the system must be listed individually.

Model number and name	Price
8755L Complete cabinet test set	\$3740
8755M Complete rack test set	\$3825
8755A Test set plug-in only	\$1520
11665B 15 MHz - 18 GHz modulator	\$345
Option 011 Input N-female, Output N female	N/C
Option 013 Input N-female, output APC-7	add \$25
Option 021 Input N-male, output N-male	N/C
Option 022 Input N-male, output N-male	N/C
Option 023 Input N-male, output APC-7	add \$25
11664A 15 MHz - 18 GHz detector	\$225
Option 001 APC-7 connector	add \$25
Option 002 SMA female connector	N/C
Option 003 SMA male connector	N/C
182T Large screen cabinet scope display	\$1200
180TR Standard screen rack display	\$1300
181T Storage, cabinet display	\$2215
181TR Storage, rack display	\$2315

Accessories:

11679A 25 ft detector extension cable	\$55
11679B 200 ft detector extension cable	\$195
11668A 50 MHz high pass filter	\$150
Option 001 APC-7 input and output	add \$55
Option 002 Type N female input and output	N/C
11667A DC - 18 GHz power splitter	\$475
Option 001 Type N male input, type N female outputs	N/C
Option 002 Type N female input, APC-7 outputs	add \$75
11678A Low pass filter kit	\$450
Individual filters, specify model number	\$90

NETWORK ANALYZERS

Complete characterization of linear networks

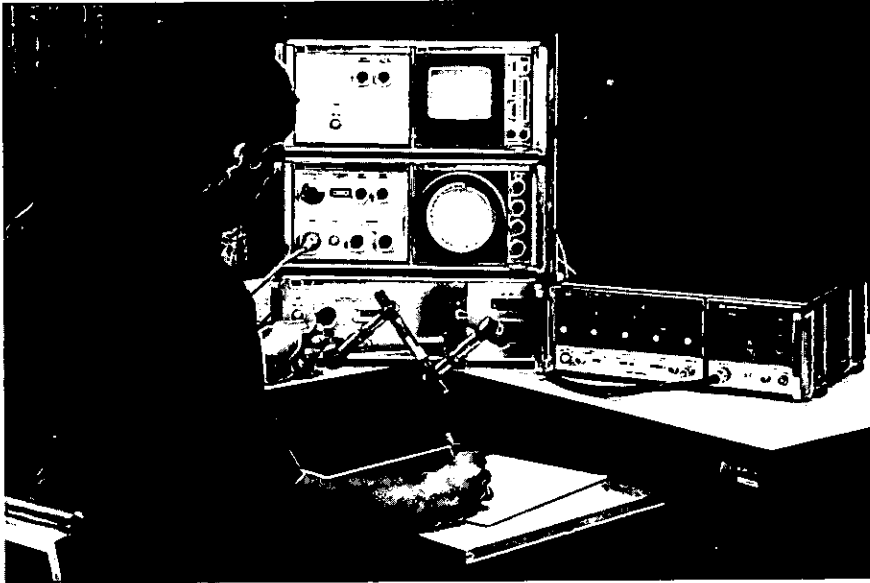

Why network analysis?

Characterizing the behavior of linear networks that will be stimulated by arbitrary signals and interfaced with a variety of other networks is a fundamental problem in both synthesis and test processes. For example, the engineer designing a multicomponent network must predict with some certainty the final network performance from his knowledge of the individual components. Similarly, a production manager must know allowable tolerances on the products he manufactures and whether the final products meet the specified tolerances. Network analysis offers a solution to these problems through complete description of linear network behavior in the frequency domain.

Network analysis accomplishes the description of both active and passive network by creating a data model of such component parameters as impedances and transfer functions. However, these parameters not only vary as a function of frequency but are also complex variables in that they have both magnitude and phase. Until the advent of the modern network analyzer, phase was difficult to measure at CW frequencies and often involved laborious calculations; these measurements were accomplished by conventional oscilloscopes at lower frequencies and slotted lines at microwave frequencies. However, swept network analyzers now measure amplitude and phase (the total complex quantity) as a function of frequency with less difficulty than conventional CW measurements. Impedance and transfer functions can then be conveniently displayed on a swept CRT, X-Y recorder, or on calculator (or computer) controlled peripherals such as a printer and/or a plotter. HP digital calculators (and computers) also combine with net-

work analyzers to give new levels of speed and accuracy in swept measurement that could only be attained previously by long and laborious calculations at CW frequencies.

Thus, network analysis satisfies the engineering need to characterize the behavior of linear networks quickly, accurately, and completely over broad frequency ranges. In design situations, this minimizes the time required to test new designs and components, allowing more time to be spent on the design itself. Likewise, production test times may be minimized while reducing the uncertainties surrounding the test.

What is network analysis?

Network analysis is the process of creating a data model of transfer and/or impedance characteristics of a linear network through sine wave testing over the frequency range of interest. All network analyzers in the HP product line operate according to this definition.

Creating a data model is important in that actual circuit performance often varies considerably from the performance predicted by calculations. This occurs because the perfect circuit component doesn't exist and because some of the electrical characteristics of a circuit may vary with frequency.

At frequencies above 1 MHz lumped elements actually become "circuits" consisting of basic element plus parasitics like stray capacitance, lead inductance, and unknown absorptive losses. Since parasitics depend on the individual device and its construction they are almost impossible to predict. Above 1 GHz component geometries are comparable to a signal wavelength, intensifying the variance in circuit behavior due to device construction. Further, lumped-element circuit

theory is useless at these frequencies, and distributed-element (or transmission-line) parameters are required to completely characterize a circuit.

Data models of both transfer and impedance functions must be obtained to completely describe the linear behavior of a circuit under test. At lower frequencies, h , y , and z -parameters are examples of transfer and/or impedance functions used in network description; at higher frequencies, S -parameters are used to characterize input-output impedances and transfer functions. Therefore, a network analyzer must measure some form of a circuit's transfer and impedance functions to achieve its objective of complete network characterization.

Network analysis is limited to the definition of linear networks. Since linearity constrains networks stimulated by a sine wave to produce a sine wave output, sine wave testing is an ideal method for characterizing linear network's amplitude and phase responses as a function of frequency. In nonlinear measurements phase is often meaningless and amplitude has to be defined with respect to individual frequency components. For nonlinear measurements see sections on spectrum analyzers and wave analyzers.

Network analyzers

Hewlett Packard Network Analyzers are instruments that measure transfer and/or impedance functions of linear networks through sine wave testing. A network analyzer system accomplishes these measurements by configuring its various components around the device under test. The first requirement of the measurement system is a sine wave signal source to stimulate the device under test. Since transfer and impedance functions are ratios of various voltages and currents, a means of separating the appropriate signals from the measurement ports of the device under test is required. Finally, the network analyzer itself must detect the separated signals, form the desired signal ratios, and display the results.

Signal sources and signal separation

In the general case, any sine wave source meeting the network analyzer's specifications can be used to stimulate the device under test. For CW measurements a simple oscillator may suffice; for greater CW frequency accuracy a signal generator or synthesizer may also be desirable. If the analyzer is capable of swept measurements, great economies in time can be achieved by stimulating the device under test with a sweep oscillator or sweeping synthesizer. This allows quick and easy characterization of devices over broad frequency ranges. Some network analyzers will operate only with companion source which both stimulates the device under test and acts as the analyzer's internal oscillator.

At low frequencies it is not particularly dif-

difficult to separate the appropriate voltages and currents required for transfer and impedance function measurements. Signal separation is merely the process of establishing the proper shorts, opens, and connections at the measurement ports of the device under test. As frequencies increase the problem of signal separation usually involves traveling waves on transmission lines and becomes correspondingly more difficult. Hewlett Packard manufactures test sets (often called "transducers") applicable for separating the appropriate traveling waves in a variety of high frequency measurements.

Broadband and narrowband detection

After the desired signals have been obtained from the test set (or transducer) they must be detected by the network analyzer; HP network analyzers can use one of two detection methods. Broadband detection accepts the full frequency spectrum of the input signal while narrowband detection involves tuned receivers which convert CW or swept RF signals to a constant IF signal. There are certain advantages to each detection scheme.

Broadband detection reduces instrument cost by eliminating the IF section required by narrowband analyzers but sacrifices noise and harmonic rejection. However, noise is not a factor in many applications, and careful measurement techniques, using filters, can eliminate harmonic signals that would otherwise produce inaccurate measurements. Broadband systems are generally source independent while some narrowband systems require companion tracking sources. Finally, broadband systems can make measurements where the input and output signals are not of the same frequency, as in the measurement of the insertion loss of mixers and frequency doublers. Narrowband systems cannot make these measurements.

Narrowband detection makes a more sensitive low noise detection of the constant IF possible. This allows increased accuracy and dynamic range for frequency selective measurements (as compared to broadband systems) and high resolution accuracy through IF substitution using precision IF attenuators. Source dependent narrowband systems utilize a companion tracking source not only to stimulate the device under test but also to produce a signal offset from the RF by a fixed frequency for tuning the analyzer's constant IF.

Signal processing and display

Once the RF has been detected, the network analyzer must process the detected signals and display the measured quantities. All HP network analyzers are multichannel receivers utilizing a reference channel and at least one test channel; absolute signal levels in the channels, relative signal levels (ratios) between the channels, or relative phase difference between channels can be measured depending on the analyzer. Using these measured quantities, it is possible to either dis-

play directly or compute the amplitude and phase of transfer or impedance functions.

Amplitude measurements fall into two categories, relative and absolute; absolute measurements involve the exact signal level in each channel while relative measurements involve the ratios of the two signal channels. Absolute measurements are usually expressed in voltage (dBV) or in power (dBm). The units dBV are derived by taking the log ratio of an unknown signal in volts to a one volt reference. Similarly, dBm is the log ratio of unknown signal power to a one milliwatt reference.

Relative ratio measurements are usually made in dB which is the log ratio of an unknown signal (Test Channel) with a chosen reference signal (Reference Channel). This allows the full dynamic range of the instrumentation to be used in measuring variations in both high and low level circuit responses. For example, 0 dB implies the two signal levels have a ratio of unity while ±20 dB implies a 10:1 voltage ratio between two signals.

All network analyzer phase measurements are relative measurements with the reference channel signal considered to have zero phase. The analyzer then measures the phase difference of the test channel with respect to the reference channel.

Measurement results at CW frequencies may be displayed on analog meters, LED's, or calculator (or computer) controlled printers. Swept frequency measurements of amplitude and phase may be displayed versus frequency on CRT's or X-Y plotters. Real-time dynamic displays are both fast and convenient in either design optimization or production testing.

Low frequency network analysis

Networks operating at frequencies below 10 MHz are generally characterized by measuring the gain and phase changes through the network and the associated input and output impedance; h, y, and z-parameters as well as other lumped-component models are typical analytical and computational tools used to represent these measurements. The first derivative of phase with respect to frequency, group delay, is an important measurement of distortion in communications systems. Hewlett-Packard produces a broad line of instrumentation capable of measuring all of these parameters.

Phase information complements amplitude data in the measurement of low frequency parameters because it is more sensitive to network behavior and because it is a required component of complex impedance and transfer functions. For instance, phase is more sensitive than amplitude in determining the frequency of network resonances (poles) and anti-resonances (zeroes). This is because the phase shift of a network transfer function is exactly zero at the frequency of resonance. Phase information is also vital in circuit de-

sign, particularly loop design, where phase margins are critical.

Phase data are also required to measure delay distortion or group delay of networks. Delay distortion occurs when a complex waveform's frequency components experience nonlinear phase shifts as they pass through a network. Group delay is defined as:

$$T_g \times \frac{d\theta}{d\omega}$$

There are several techniques for measuring group delay; the most common techniques are phase slope, amplitude modulation, frequency modulation and frequency deviation. Most HP network analyzers can make measurements with at least one of these techniques.

High frequency network analysis

Total voltage and current along a transmission line begin to vary periodically with distance as frequency increases. Consequently, it becomes difficult to establish the required shorts and opens in the correct measurement plane to determine low frequency parameters. Transmission-line theory explains the variations in total voltage and current at high frequencies through forward and reverse traveling waves. Thus, traveling waves are the logical variables to measure at higher frequencies.

Scattering parameters or S-parameters were developed to characterize linear networks at high frequencies. S-parameters define the ratios of reflected and transmitted

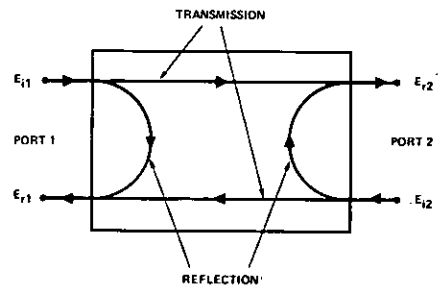

traveling waves measured at the network ports. S₁₁ is the complex reflection coefficient at port 1 and is the ratio of E_{r1}/E_{i1}, if E_{i2} = 0 (port 2 terminated in its characteristic impedance). S₂₁ is the complex transmission coefficient from port 1 to port 2, E_{r2}/E_{i1}, if E_{i2} = 0. E_{i1}, E_{i2}, E_{r1}, and E_{r2} are normalized voltages (voltage divided by the characteristic impedance of the system) and represent the amplitude and phase of the traveling waves. By reversing the ports and terminating port 1 in its characteristic impedance, S₂₂ and S₁₂ can be similarly defined. From these definitions, the following equations can be derived:

$$E_{r1} = S_{11} E_{i1} + S_{12} E_{i2}$$

$$E_{r2} = S_{21} E_{i1} + S_{22} E_{i2}$$

where incident signals act as independent var-

NETWORK ANALYZERS

Complete characterization of linear networks (cont.)

ables determining the signals leaving the network. The definition of a S-parameter can be easily extended to multiport networks; measurement is also easily accomplished by terminating additional ports in their characteristic impedances. Thus, S-parameters completely describe linear network behavior in the same manner as low frequency parameters.

S-parameters offer numerous advantages to the microwave engineer because they are both easy to use and easy to measure. They are easy to measure because the device is terminated in its characteristic impedance which is accurate at high frequencies, allows swept broadband frequency measurement without tuning, enhances the stability of active devices, and permits a test set up to be used for different devices. The design process is simplified because S-parameters are directly applicable to flow graph analysis. HP network analyzers with the appropriate test sets will measure and directly display S_{21} or S_{12} as gain or attenuation and S_{11} or S_{22} as reflection coefficient, return loss or impedance. Also, S-parameters may be directly related to h, y, and z-parameters through algebraic transformations.

With the increased utilization of microwave frequencies in a broad spectrum of applications, S-parameter measurements have become more important and more generally used in designing both active and passive networks. Hewlett-Packard has developed a series of tutorials for measurement and design with S-parameters; Application Notes 95, 117-1, 117-2, 154, video tapes #800586 and #800600 deal with general S-parameter techniques. Further aids include special S-parameter design seminars and a new set of calculator programs "Microwave Circuit Design PAC" for computationally aided design. A continuing program in all medias is underway to disseminate information on both designing and testing with S-parameters.

Additional capabilities

The computational capabilities of digital calculators and computers can complement the network analyzer's versatility through simplifying and speeding measurements, data processing, and accuracy enhancement. Hewlett-Packard has integrated network analyzers into computer systems and now offers some analyzers that may be easily interfaced with HP programmable calculators through the Hewlett-Packard Interface Bus.

Precision design work and important manufacturing tolerances demand highly accurate measurements, but most errors in network measurements are complex quantities that vary as a function of frequency, making manual error correction prohibitive. However, the calculator or computer can make

great contributions to measurement confidence by quickly and easily performing the complex mathematics for sophisticated error correction.

Aside from new levels of accuracy, calculator (or computer) controlled network analyzers can be programmed to set up and make many measurements automatically. The measurement process is further accelerated by the calculator's ability to store, transform, summarize, and output data in a variety of formats on a number of peripherals. These capabilities make the calculator controlled network analyzer ideal for both computationally aided design or automatic production testing.

Network analyzer product line

Hewlett-Packard offers a complete line of network analyzers capable of measurements throughout the 1 Hz to 40 GHz frequency range. Brief descriptions of the individual instruments are given below so that you can determine which instrument most economically satisfies your measurement needs. Further information is available on the following pages.

3575A

The 3575A measures Phase and Amplitude or Gain. With the 3575A, the complete response picture is available at a reasonable cost from a single instrument, over an 80 dB range, from 1 Hz to 13 MHz. The 3575A uses a broadband measurement technique, which is attractive because the measurement is not constrained by an internal tracking source or dedicated external device. The 3575A is not dependent on the wave shape, thus measurements can be made on a variety of waveforms such as triangle and square waves. Noise and harmonic tolerance further enhances the range of measurement, so the instrument is useful under bench conditions.

3040A/3041A/3042A

The 3040A is a network analysis system capable of measuring amplitude and phase to 13 MHz. Group delay is an optional capability. The system consists of a synthesizer signal source and a two-channel tracking detector. The system has a 100 dB dynamic range, and measures amplitude to a resolution of 0.01 dB and phase to a resolution of 0.01°. Measurement applications include filter design and production, amplifier testing, delay measurements on communications devices, and measurements on any linear two-port device.

The 3041A extends the capabilities of the 3040A to semiautomatic use. The 3260A Card Reader provides control over all front panel functions such as frequency, level, and sweep. Repetitive tests can be done quickly and easily without operator error. The 3041A provides not only the amplitude, phase and

group delay, but limit test and offset as standard features.

The 3042A is a fully automatic system which uses the Hewlett-Packard 9820A Calculator (9821A or 9830A are optional) as a controller. The memory, computational power and decision making power of the calculator-controller extend the measurements to complex network solutions in the lab or rapid production line testing system. Accuracy can be improved by subtracting system errors from the measurements by using the memory and algebraic powers of the calculator.

8407A

The 8407A network analyzer tracks the 8601A generator/sweeper (or the 8690B/8698B sweeper) from 100 kHz to 110 MHz. The 8407A achieves great swept measurement versatility through a set of four different transducers. Measurement capabilities include:

- 1) Transmission (gain, loss, phase shift) and reflection (return loss, impedance) measured quickly and easily by sweeping over the frequency range of interest. Measurements can be made in 50Ω and 75Ω.
- 2) Complex impedance [Z], θ , or $R \pm jX$ over the wide impedance range 0.1Ω to > 10 kΩ.
- 3) Voltage and current transfer functions (voltage or current gain, loss, phase shift).
- 4) High impedance in-circuit probing.

A rectangular and a polar display and various CRT overlays permit direct readings of parameters of interest as frequency is swept. Applications are detailed in Application Notes 121-1, 121-2. A videotape "8407 Network Analyzer System," #800475, is also available.

4815A

Accurate CW component impedances are required to design circuits for maximum power transfer and desired frequency characteristics. The 4815A RF Vector Impedance Meter greatly simplifies impedance measurement methods by providing direct readout of complex impedance values [Z] and θ on adjacent meters. Operating range of the 4815A is 1Ω to 100 kΩ and 0° to 360° over a frequency range 500 kHz to 108 MHz. Only CW measurements are possible.

These operating characteristics are similar to the 8407A/11655A impedance measuring system. The 8407A/11655A offers superior accuracy and speed because probe parasitics may be calibrated out and swept measurements are possible. However, if CW measurements suffice, the 4815A is a more economical solution.

8405A

The 8405A vector voltmeter is a dual-channel RF millivoltmeter and phasemeter. It reads the absolute voltages on either of two

channels and simultaneously determines the phase relationship between them. CW measurements can be made over the frequency range 1 MHz to 1 GHz.

Besides its use as a voltmeter, applications of the 8405A include:

- 1) Transmission measurements (gain, loss, phase shift) and reflection measurements (impedance, return loss) in 50Ω systems.
- 2) Group delay and amplitude modulation index.
- 3) In-circuit probing.
- 4) S-parameters in 50Ω systems.

Application Notes 77-1, 77-3, 77-4, and 91 are available for more detail on the above measurements.

8410B

The 8410B network analyzer system measures the transmission and reflection characteristics of linear networks in the form of gain, attenuation, phase shift, reflection coefficient, normalized impedance and S-parameters in the frequency range of 110 MHz to 40 GHz.

Harmonic frequency conversion of the RF to a constant IF is accomplished by the 8411A Harmonic Frequency Converter from 110 MHz to 12.4 GHz; the 8411A Options 018 operates from 110 MHz to 18 GHz. In the frequency ranges 18 – 26.5 GHz (K-band) and 26.5 – 40 GHz (R-band), the K8747A

and R8747A Reflection/Transmission Test units use crystal mixers and a local oscillator to heterodyne the signals down into the range of the 8410B/8411A. In this manner, waveguide components can be measured from 18 to 40 GHz.

The 8410B is a ratiometer using both reference and test signal inputs; consequently, the sweeper output must be divided into channels. This is accomplished by a "Test Set" whose other major function can be to provide the switching required for making transmission and reflection measurements with minimum or no changes in the measurement setup. Hewlett-Packard offers a total of twelve different test sets covering various frequency ranges and switching functions.

Another major instrument required in the 8410 measurement system is a unit for the detection and display of the IF amplitude and phase. Three plug-in displays (for the 8410B mainframe) are available for this purpose: a phase-gain indicator with meter readouts for CW measurements; a phase-gain display for displaying log amplitude and phase versus frequency; and a polar display for displaying amplitude and phase in polar coordinates.

The 8410B is capable of swept measurements in octave bands through 18 GHz. Between 18 GHz and 40 GHz, 2 GHz windows may be viewed. Measurements of more than

60 dB of attenuation and 40 dB of gain are possible. The line stretcher in the reference channel of most test sets is an important feature making possible the equalization of electrical lengths in both channels for accurate differential phase measurements.

The variety of test sets, displays, and accessories for measuring active devices makes the 8410B adaptable to almost any linear network measurement. Further information is available in Application Notes 117-1, 117-2, and 95 and in videotape #800473.

8540 Series

The 8540 series system (100 kHz to 18 GHz) couples the network analyzer's ability to completely characterize a linear network with the computer's ability to completely setup a measurement, store data, and solve complex mathematics. As a result, the automated system offers these advantages: increased speed of measurement; increased accuracy through sophisticated error-correction techniques; ease of operation; and a variable data output format (alphanumeric or graphic with hardcopy, cassette or CRT presentations).

Data can also be made readily accessible to computer aided design programs to assist designer in evaluating overall network performance based on component measurement data.

Model	Frequency Range	Source	Measurement Capabilities
3575A Gain Phase Meter Page 424, 425	1 Hz – 13 MHz	None	Gain Phase and Amplitude Low Frequency Analysis
3040A Manual Network Analyzer Page 420-423	50 Hz – 13 MHz	3320A/B or 3330A/B	Amplitude and Phase Optional Group Delay Gain or Loss Linear Frequency Sweep
3041A Semiautomatic Network Analyzer Page 420-423	50 Hz – 13 MHz	3330B Synthesizer	Amplitude, Phase, Group Delay Limit Test Offset Card Reader Control
3042A Automatic Network Analyzer Page 420-423	50 Hz – 13 MHz	3330B Synthesizer	9820, 9821, or 9830 Calculator Control Complex Network Analysis Decision Making Ability Computational Capability
8407A Network Analyzer Page 428	100 kHz – 110 MHz	8601A Generator/Sweeper 8690B/8698B Sweep Oscillator	Transfer Functions, Impedance in 50Ω, 75Ω systems Complex Impedance 0.1Ω to > 10 kΩ High Impedance In-Circuit Probing S-parameters in 50Ω, 75Ω systems
4815A Vector Impedance Meter Page 427	500 kHz – 108 MHz (CW)	Internal (external possible)	Complex Impedance, 1Ω to > 100 kΩ
8405A Vector Voltmeter Page 439	1 MHz – 1 GHz (CW)	3200B Oscillator, VHF Signal Generators, 608E (VHF), 612A (UHF) 8654 (UHF), and 8640 A/B	Voltmeter Transfer Functions, Impedance in 50Ω systems Group Delay, Amplitude Modulation Index S-parameters in 50Ω systems
8410B Network Analyzer Page 434	110 MHz – 40 GHz	8620 or 8690 Series Sweep Oscillators	Transmission/Reflection Characteristics in 50Ω systems S-parameters in 50Ω systems
8540 Series Automatic Network Analyzer Page 438	100 kHz – 18 GHz	8620 or 8690 Series Sweep Oscillators	Automatic Measurements of Transmission/Reflection Characteristics Full Error Correction Virtually No Programming Required Versatile Output: 28 Parameter Alphanumeric or Graphic; Hardcopy; Cassette or Cathode-Ray-Tube



NETWORK ANALYZERS

Three solutions to network analysis problems

Models 3040A, 3041A & 3042A

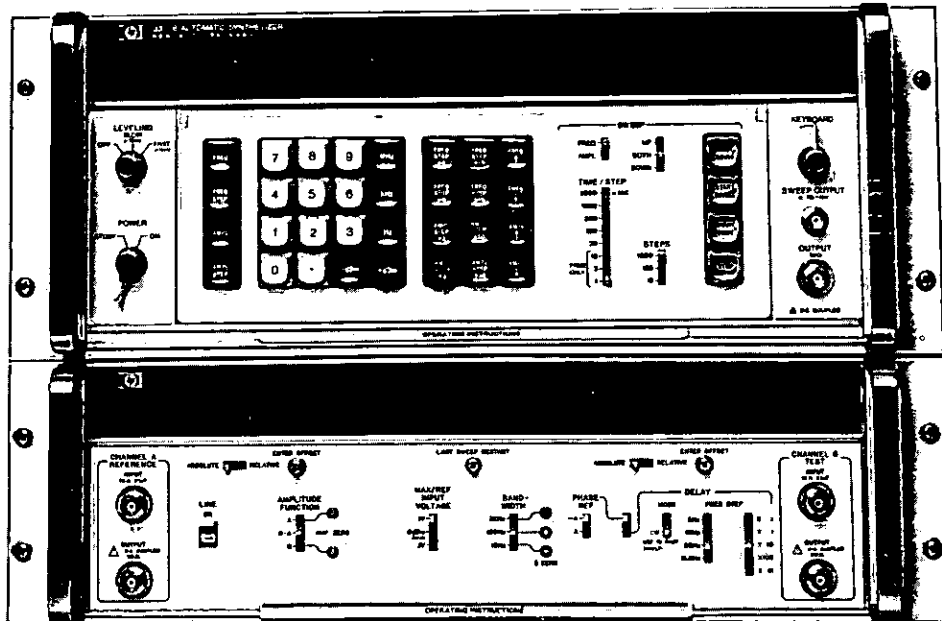

3040A

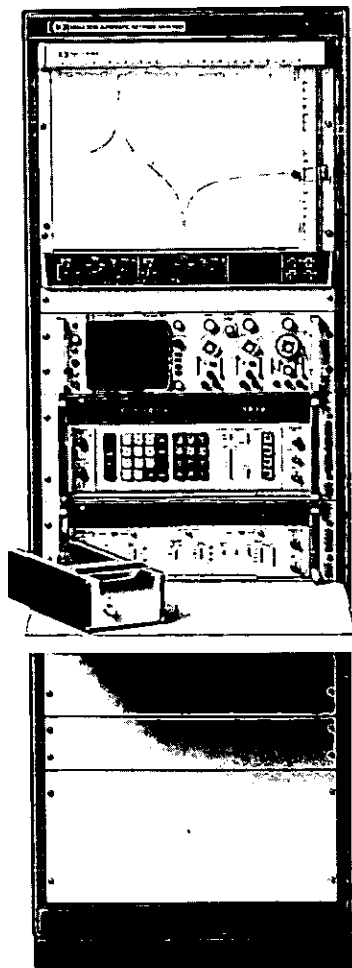

3041A

Description

3040A Network analyzer

HP's 3040A consists of a synthesizer stimulus and a detector to measure amplitude and phase. Available with this manual system are several automatic features including digital frequency and amplitude sweeping, offset capability for relative measurements, and group delay. These features are not found in more conventional network analyzers. The system provides frequencies from 50 Hz to 13 MHz, two channel amplitude measurements with 120 dB measurement range and 0.01 dB resolution and phase measurements with 0.01° resolution.

3041A Semi-automatic network analyzer

A Marked Card Programmer extends the performance of this fully integrated system to provide semi-automatic measurements. In addition to the capability of the manual system, HP's 3041A provides programmable hi-go-lo limit testing, offset, and group delay. Extensive production testing can be performed by simple insertion of a marked card into the card reader. Optional display devices, such as oscilloscopes and X-Y recorders, make visual and hard copy test data available.

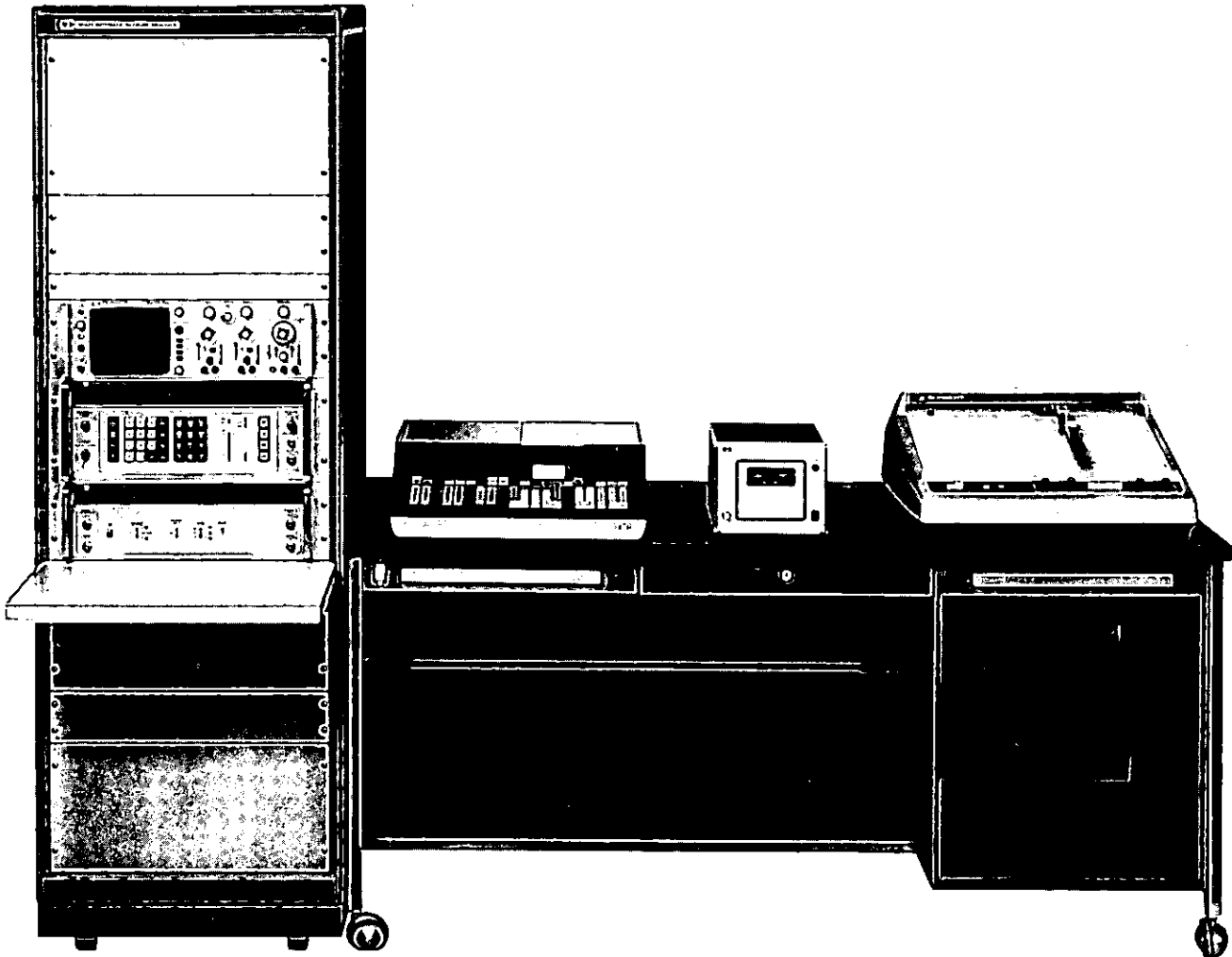

3042A

3042A Automatic system

A programmable calculator, coupled to the manual 3040A, provides a level of control and performance never before available in this price range. The calculator can be programmed to make complex tests, make decisions based on measured data, and perform mathematical manipulation of data.

The calculator display and printer permit step-by-step production adjustments and pass/fail QA testing. The calculator memory permits storage of complex test procedures and production data for such things as yield analysis. Programs of computer system complexity can be easily handled with calculator extended memory options. Computational capability allows system error correction and engineering units data presentation.

The system is provided in a cabinet, fully integrated and tested. It is available with 9820A, 9821A, and 9830A controllers and a variety of accessories including CRT and digital plotter.

3042A System controllers

Considering price/performance and ease of use, Model 9820A Calculator is the optimum controller for Hewlett-Packard's 3042A Automatic Network Analyzer System. Its easy to learn algebraic language makes it simple to write test programs, even without prior programming experience. HP's simple 9820A run procedure, along with conversational alphanumeric display and printer, enable relatively unskilled operators to perform complicated production tests with ease and repeatability.

While achieving programming and operating simplicity, HP's Model 20 programming language has some of the best computer language features, including branching and subroutines capability. It also adds many of its own unique features such as immediate error detection and flexible statement and program line editing. A built-in magnetic card reader facilitates recording programs and data, and permits using prerecorded programs.

NETWORK ANALYZERS

Models 3040A, 3041A & 3042A (cont.)

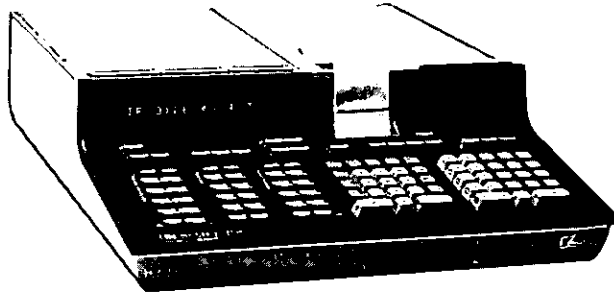

9820A



9821A



9830A

The real power of HP's 9820A as a controller is in performing on-line data analysis to calculate such parameters as Q and bandwidth, to average out noise, and to do statistical analysis on measurement data.

HP's 9821A combines all of the 9820A features with a built-in cassette and cassette ROM for recording programs and data. Both programs and data can be recalled from cassette memory and run in the 9821A under program control with no operator intervention. One cassette can store up to 6000 data registers or 48,000 program keystrokes with numbered file search capability.

HP's 9821A is the best solution for applications which call for several programs in succession or where large data storage capability is required.

Hewlett-Packard's 9830A is the optimum controller with basic language programming. It combines high level basic language with many unique programming and editing features which shorten programming time. The major portion of the keyboard duplicates that of a typewriter or teletype. Twenty special keys can be defined by functions or subprograms to simplify system programming. Program, data, and special function key storage is easily and quickly done on the built-in cassette memory with up to 40,000 word capacity (16-bit words). Operator system interaction is greatly simplified with the 32 character alphanumeric display in HP's 9830A and 80 character 9866A Thermal Printer. Of the three controllers, the 9830A has the largest memory option with 7.9 K (16-bit words) of user read-write memory.

Specifications

3330B

Frequency range: 0.1 Hz to 13,000,999.9 Hz.

Frequency resolution: 0.1 Hz (8 digits + overrange).

Amplitude: maximum 2.1 V rms into open circuit, maximum 1.05 V rms into 50Ω.

Amplitude range: +13.44 dBm to -86.55 dBm into 50Ω.

Amplitude resolution: 0.01 dB.

Output impedance: 50Ω (75Ω Option 001).

Leveled frequency response (10 kHz reference):*

10 Hz

13 MHz

±0.05 dB	+13.44 dBm
±0.1 dB	-16.55 dBm
±0.2 dB	-36.55 dBm
±0.4 dB	-66.55 dBm
	-86.55 dBm

*Add ±0.5 dB for leveling switch in off position.

Amplitude attenuator accuracy: ±0.02 dB/10 dB (at 10 kHz) step of attenuation down from maximum output (25°C ±5°C).

Amplitude accuracy (absolute): ±0.05 dB at 10 kHz and +13.44 dBm (25°C ±5°C). (For absolute accuracy at other frequencies and amplitudes, add 0.05 dB to the leveled frequency response spec. plus the attenuator accuracy spec.)

Amplitude stability (24 hr, 25°C ±1°C): ±0.01 dBm.

3570A Network analyzer

Frequency range: 50 Hz to 13 MHz.

Channel A and B outputs: electrically identical — equal in frequency and amplitude to the signal generator output.

Output impedance: 50Ω or 75Ω ±2%.

Maximum output: 1 V rms into 50Ω or 75Ω.



Channel A and B inputs: electrically identical – both tuned to the signal generator's frequency.

Measurement range:

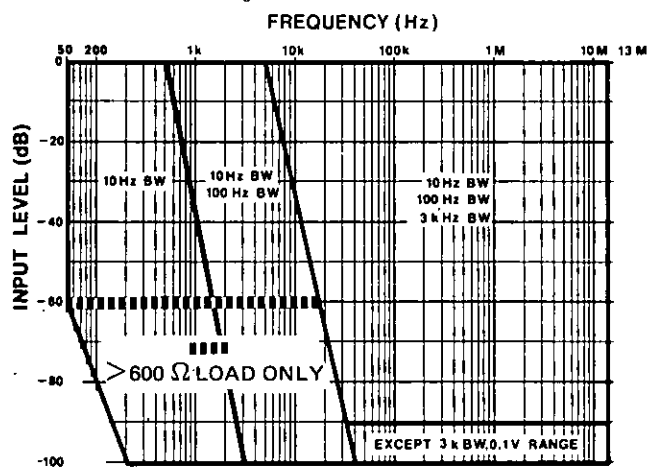

Input impedance: 1 MΩ ±2% shunted by <30 pF.

Input signal range: 1 V rms to 1 μV rms.

Input selectivity: 10 Hz, 100 Hz and 3 kHz bandwidths.

Amplitude measurements: dB measurement reference is determined by the position of the "Max/Ref Input Voltage" switch.

Display resolution: 0.01 dB.

Display range: 0 to -100 dB (using A or B amplitude function).
-100 dB to +100 dB (using B-A amplitude function).

Amplitude accuracy (25°C ±5°C):

Absolute: No spec — may be calibrated to source using front panel adjustments.

Relative (relative to 0 dB input for 1 V, 0 dBm, and 0.1 V range): A or B amplitude function (B-A specification determined by sum of Channel A and B accuracies).

	0 dB	-20 dB	-70 dB	-80 dB	-100 dB
10 Hz BW, 100 Hz BW, 3 kHz BW, 1 V range	±0.2 dB	±0.5 dB			±1.5 dB
3 kHz BW, 0.1 V and 0 dBm ranges	±0.2 dB	±0.5 dB			No spec*

*Due to lower noise rejection of 3 kHz BW.

Stability (8 hr., 25°C ±1°C, after 3 hr. warmup):

	0 dB	-20 dB	-80 dB	-100 dB
100 Hz and 3 kHz BW	±0.05 dB	±0.08 dB	No spec	
10 Hz BW	±0.08 dB	±0.15 dB	No spec	

Temperature coefficient (20°C to 30°C):

100 Hz and 3 kHz BW: ±0.02 dB/°C.
10 Hz BW: ±0.05 dB/°C.

Frequency response:

A or B amplitude function: ≤0.5 dB p-p error.
B-A amplitude function: ≤0.1 dB p-p error.

Phase measurements: Phase reference is Channel A.

Display resolution: 0.01°.

Display range: -179.5° to +179.5° (display recycles).

A/-A reference offset: 180° ±0.1°.

Phase accuracy: 25°C ±5°C.

Phase linearity: ±0.2°.

Frequency response: (channels at 0 dB).

±0.8°	±0.2°	±1°
50 Hz	100 Hz	1 MHz
		13 MHz

Amplitude response: Channel B within 6 dB of Channel A.

0 dB	-20 dB	-70 dB	-80 dB	-100 dB
±0.4°	±0.6°	±1°	No Spec	

For channels at different levels (specification determined by lowest input).

0 dB	-20 dB	-60 dB	-80 dB	-100 dB
±1.3°	±1.5°	±3°	No Spec	

Options

3040A Network analyzer	Price
100: Standard 50Ω 3570A	\$5650
101: Standard 75Ω 3570A	\$5650
102: 50Ω Delay/Limit Test and Offset (Must select Option 100)	\$425
103: 75Ω Delay/Limit Test and Offset (Must select Option 101)	\$425
104: Isolated Hewlett-Packard Interface Bus	\$600
3320B Frequency synthesizer	
300: Standard 50Ω 3320B	\$2960
301: Standard 75Ω 3320B	\$2960
302: XTAL Oven (10 ⁻⁸ /day)	\$310
306: 100 Hz/10 Hz ranges	\$216
307: Isolated Hewlett-Packard Interface Bus	\$695
3330B Automatic synthesizer	
500: Standard 50Ω 3330B	\$6365
501: Standard 75Ω 3330B	\$6365
502: XTAL Oven (10 ⁻⁹ /day)	\$530
503: Delete Standard XTAL Oven	less \$200
504: Isolated Hewlett-Packard Interface Bus	\$400
505: 5 V 50Ω Output	\$270
3041A Semi-automatic network analyzer	
100: Standard 50Ω System	\$14,850
101: Standard 75Ω System	\$14,850
102: Isolated Hewlett-Packard Interface Bus (required when connected to computer or calculator)	\$1000
103: 7044A X-Y Recorder with switch panel for RTIP	\$1800
104: 1201 B Oscilloscope 10 × 10 div. scale, RTIP	\$2425
105: 230 V Powerline version (50 - 60 Hz)	N/C
106: XTAL Oven (10 ⁻⁹ /day)	\$530
3042A Automatic network analyzer	
100: Standard 50Ω System	\$21,950
101: Standard 75Ω System	\$21,950
102: 50Ω Delay/Limit test/Offset (must select Option 100)	\$425
103: 75Ω Delay/Limit test/Offset (must select Option 101)	\$425
104: 1201B Oscilloscope 10 × 10 div. scale, RTIP	\$2425
105: 230 V powerline version (50 - 60 Hz)	N/C
106: XTAL Oven (10 ⁻⁹ /day)	\$530
The standard 3042A is supplied with a 1.7k (16-bit word) memory 9820A. Other controllers and memories are available with the following options.	
120: 9820A 5.8k memory	\$2500
121: 9821A 1.7k memory and cassette	\$1000
122: 9821A 5.8k memory and cassette	\$3500
123: 9830A/9866A 1.7k memory and cassette	\$4520
124: 9830A/9866A 7.9k memory and cassette	\$8100

NETWORK ANALYZERS

Gain/phase meter

Model 3575A

- dBV and dB ratio from 1 Hz to 13 MHz

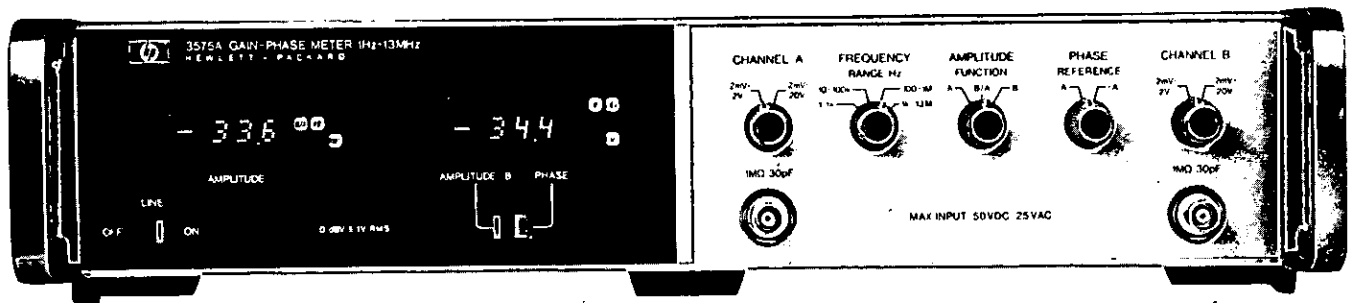

Description

HP's 3575A Gain/Phase Meter is used for making network measurements over a seven decade frequency and 100 dB amplitude range. A number of different instrument configurations are possible, allowing variations in the basic phase and amplitude measurements. The flexibility also implies applications in such measurements as impedance, delay and complex root location.

The outputs are phase in degrees and amplitude in dB or dBV. Phase and amplitude information is available from a LED digital readout, analog outputs on the rear panel, or BCD outputs in Option 002 or 003. Phase and amplitude readings can be plotted by hand on log paper yielding a Bode plot, or analog outputs can drive an X-Y recorder to give the same information. A storage scope can be used to display the frequency response; and BCD information can be used by a computer or HP calculator.

Phase

Two input signals are necessary for phase measurement: a reference signal and a phase shifted signal. Both input channels have identical high impedance input circuits, so low voltage signals can be used on either channel and loading is eliminated. A 10:1 low capacitance scope probe or a low impedance termination reduces phase errors caused by capacitive loading. The 10:1 probe also extends the voltage range to 200 V.

Phase angles are measured by the time difference between successive zero crossings of the two input signals. Because zero crossings are the only significant information used, the shape of the waveform is not significant. Square, triangle and distorted waveforms will give the same answer as a sine wave.

Harmonics

HP's 3575A has been designed so measurement errors cannot occur with even harmonics or with in-phase odd harmonics. This is an important instrument feature as input signals always have some harmonic content. Most oscillators have harmonics 40 dB below the fundamental, and phase errors could result. HP's 3575A has been designed so errors from input signals are commensurate with the basic accuracy of the instrument.

Noise

HP's 3575A has unique logic circuitry (patent applied for) which makes it tolerant of noise. This feature keeps the digits from racking when using low level signals and prevents ambiguous readings at the lower amplitude range of the instrument.

The noise tolerant 3575A is able to reject noise. A front panel switch selects the appropriate three-decade frequency range so plots and sweeps can be made without repeated adjustment and noise rejection is still achieved. HP's 3575A can be used over its wide amplitude and frequency ranges in the presence of noise and harmonics without external signal conditioning.

Amplitude

Amplitude measurements fall into two categories and the amplitude of either channel or the ratio can be measured. The channel measurements are in dB where 0 dB $V = 1$ V rms. Measurements of ratio are in dB where 0 dB means channel levels are the same. If the input signal level is too low for phase or ratio functions to operate, a measurement of channel amplitude will reveal this. If the level is too high, digits will be blanked and the overload annunciator will indicate which channel is in overload.

A wide dynamic range log amplifier achieves a wide dynamic range without internal or external ranging. It uses eight log segments to achieve an 80 dB range. The 20 dB attenuator associated with each channel allows 100 dB of signal difference.

The amplifier in both channels continuously logs the input signal. Logged signals are then rectified to give a dc voltage proportional to the log of the input. With the two dc signals available, it is possible to measure either the level of Channel A or B to obtain log ratio by subtracting dc voltage. Using this technique, amplitude ratio of waveforms (at different frequencies or different waveforms) can be measured.

The technique of subtracting Channel A from B directly yields gain or loss through a network. By measuring input and output to find gain, the input stimulus isn't required to have a flat frequency response. The stimulus can also have a distorted waveshape without affecting results. The Bode plot is then independent from the stimulus and in-circuit measurements are possible.

Specifications

Phase accuracy*

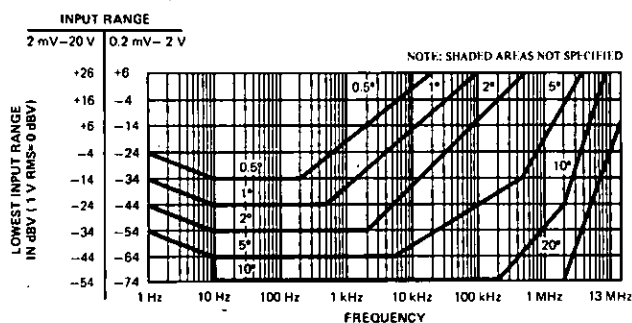

*Conditions: Temperature: 25°C ±10°C; Frequency range switch on lowest applicable range; Analog Output accuracy (rear panel).

Input signal range: 200 μV rms to 20 V rms.

Harmonic rejection

Even harmonics no error.

Odd harmonics in phase no error.

Odd harmonics out of phase 0.57° worst case error when total odd harmonic distortion is 40 dB below the fundamental.

Noise tolerance: 2° error for a 10 kHz, 1 V sine wave on one channel. One volt sine wave added to Gaussian noise (limited to a 1 MHz bandwidth and 30 dB S/N ratio) on the other channel. The 100 Hz to 1 MHz frequency range was used.

Display:

Range: ±180° with 12° of overrange.

Resolution: 0.1°.

Panel meter accuracy: ±3 counts (0.3 degrees, 0.3 dB/dBV). The panel meter error must be added to the phase and amplitude errors to obtain the display error.

Inputs

Impedance: 1 MΩ 30 pF.

Protection: ±50 V dc, 25 V rms.

Response time to achieve 90% of final reading:

Frequency Range	Time
1 Hz to 1 kHz	20 s
10 Hz to 100 kHz	2 s
100 Hz to 1 MHz	0.2 s
1 kHz to 13 MHz	20 ms

Rear terminal inputs are available as a special (3575A-C09). Digital (Opt. 002). 0, +5 ground true. Twelve lines to fully program all functions.

Outputs

Analog:

Phase: 10 mV/degree.

Amplitude: 10 mV/dB or dBV.

Output impedance: 1 kΩ.

Digital (Opt. 002): 0, +5 V ground true. 31 output lines (1-2-4-8 BCD).

Digital readout: 3½ digits with sign and annunciators. Four readings per second, fixed.

Amplitude accuracy*

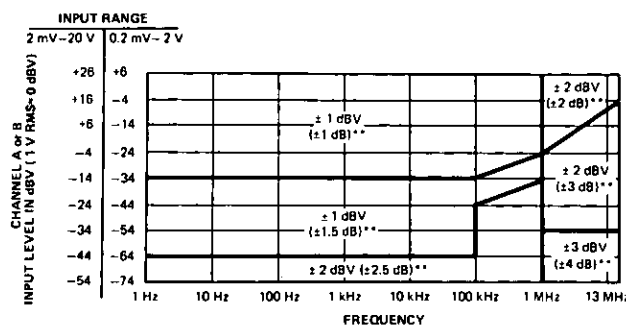

*Conditions: Temperature: 25°C ±10°C; accuracy applies to dB V and ratio measurements with the same frequency on both channels; for ratio measurements, the lowest level channel determines accuracy; analog output accuracy (rear panel).

Amplitude functions: A dBV, B dBV or B/A dB.

Amplitude reference: (A dBV, B dBV) 1 V rms = 0 dBV.

Display:

Range: A dBV, B dBV: -74 dBV to +26 dB (in two ranges). B/A dB: -100 to +100 dB. (Both input signals must be within the range of 0.2 V rms to 20 V rms).

Resolution: 0.1 dBV, 0.1 dB.

Options

001 Dual panel meters

HP's 3575A Opt. 001 is equipped with two digital readouts and two analog outputs for simultaneous amplitude and phase readings. This option has no additional measurement capability over the standard instrument.

Dual analog outputs: rear panel BNC connectors provide dc output voltages that correspond to the respective panel meter readings.

002/003 Programmable

3575A Opt. 002 and Opt. 003 are equipped with dual panel meters and dual analog outputs (same as Opt. 001) plus BCD outputs and complete remote control capability. Option 002 has negative true output levels and Opt. 003 has positive true output levels. BCD information from the 3575A (Opt. 002) can be read by the 9810 or 9820 HP Calculators.

General

Power: 115 V/230 V ±10%, 48 Hz to 440 Hz, 40 VA.

Weight: net 8.3 kg (18.4 lb); shipping 11.3 kg (25.8 lb).

Dimensions: 425 mm wide × 88 mm high × 337 mm deep (16¼" × 3½" × 13¼").

Accessories furnished: Rack mount kit, extender boards, line cable and 50-pin connector (Opt. 002 and 003 only).

Model number and name

Model number and name	Price
3575A, Opt. 001, Dual Readout	add \$465
3575A, Opt. 002, Programmable (negative true output levels)	add \$825
3575A, Opt. 003, Programmable (positive true output levels)	add \$825
3575A, Gain/Phase Meter	\$2710

NETWORK ANALYZERS

1 Hz to 13 MHz

Model 3043A

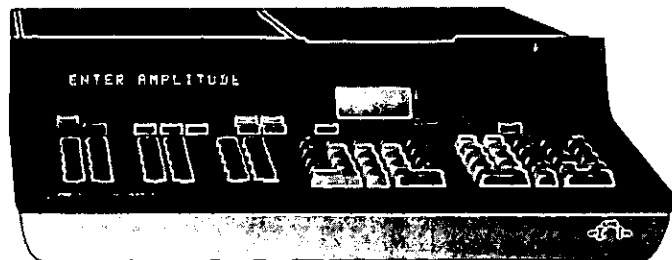
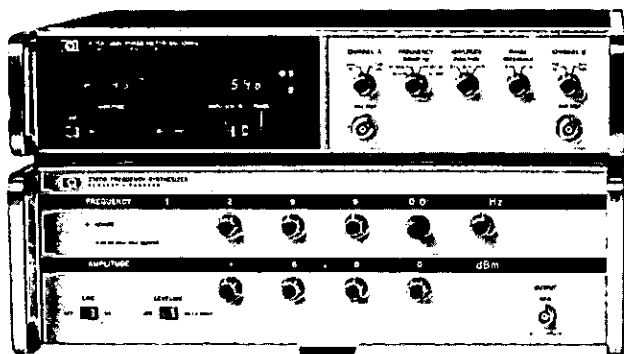

Description

Hewlett-Packard's 3043A Network Analyzer System combines the features of a network analyzer and synthesizer with the control and analysis capability of a calculator.

A circuit can be analyzed using calculator network analysis programs; and the physical circuit can be compared to the theoretical using the network analyzer system.

The calculator controls the instruments, eliminating tedious and error-prone manual settings. Data from the network analyzer can be processed and displayed by the calculator.

This man-machine interface eliminates manual analysis, and provides a high-performance answer to design and analysis needs.

3043A Specifications

Frequency range: 1 Hz to 13 MHz.

Stimulus sine wave output

Output impedance: 50 Ω or 75 Ω .

Maximum output level: 5 V rms into 50 Ω or 75 Ω .

Measurement input

Input impedance: 1 M Ω shunted by 30 pF.

Input signal range: 20 V rms to 0.2 mV rms.

Amplitude measurements

Display resolution: 0.1 dB.

Display range: +6 to -74 dBV in A or B amplitude function. +100 to -100 dB in B/A amplitude function.

Phase measurements

Display resolution: 0.1 $^\circ$.

Display range: $\pm 180^\circ$.

System reading rate

1 Hz - 1 kHz	1.90 sec/reading
1 kHz - 100 kHz	0.80 sec/reading
100 kHz - 1 MHz	0.65 sec/reading
1 MHz - 13 MHz	0.60 sec/reading

3575A System analyzer

Hewlett-Packard's Model 3575A Gain Phase meter performs all amplitude and phase measurements in the system. The broadband measurement scheme and wide dynamic range of the 3575A minimize frequency and amplitude range changing during measurements.

3575A Specifications

Power: 115 V/230 V $\pm 10\%$, 48 Hz to 440 Hz, 40 VA.

Weight: net, 8.3 kg (18.4 lb); shipping, 11.3 kg (25.8 lb).

Response time:

Frequency range	To achieve 90% of final reading
1 Hz to 1 kHz	20 sec
10 Hz to 100 kHz	2 sec
100 Hz to 1 MHz	0.2 sec
1 kHz to 13 MHz	20 ms

3320B System stimulus

Hewlett-Packard's 3320B Synthesizer provides accurate frequency and amplitude inputs to the device under test. This synthesizer offers a low-distortion sine wave output to reduce spurious responses of the circuit under test. Phase-continuous switching minimizes transients during frequency changes so repeatable measurements can be made.

3320B Specifications

Operating temperature: 0 $^\circ$ C to 55 $^\circ$ C.

Storage temperature: -40 $^\circ$ C to +70 $^\circ$ C.

Power requirements: 115 V or 230 V $\pm 10\%$, 48 Hz to 63 Hz, <110 VA, (400 Hz operation on special basis).

Weight: 3320B, 15.4 kg (34 lb); shipping, 22.2 kg (49 lb).

9820A System controller

Hewlett-Packard's model 9820A Calculator, with its simple program language, is the optimum controller for this type of system. The conversational capability of the system is enhanced by alphanumeric LED display and paper tape printer in the 9820A.

Details of controlling instruments for swept frequency response are solved by the software provided. Basic parameters such as signal frequency and amplitude must be specified. Invalid data entry and possible error modes are indicated.

9820A Specifications

Memory size: 435 registers; 264 registers are available for user programming.

Operating temperature: 0 $^\circ$ C to 45 $^\circ$ C.

Power requirements: 100 V, 120 V, 220 V or 240 V nominal operating range +5%, -10% of nominal values; 50 Hz to 60 Hz; 150 VA.

Weight: 14.4 kg (36 lb); 23 kg (51 lb).

Dimensions: 490.9 mm wide (at keyboard) \times 142.2 mm high \times 533.4 mm deep (17 $\frac{1}{4}$ " \times 5 $\frac{5}{8}$ " \times 21").

Model number and name

100: 50 Ω system	Price \$15,250
101: 75 Ω system	\$15,250
102: High Stability Crystal Oven	add \$310
120: Opt. 002 9820A 1453 Register Memory	add \$2500
3043A Network Analyzer — price determined by option purchased.	

NETWORK ANALYZERS

RF vector impedance meter

Model 4815A



• Measures Z and θ quickly and easily

• 0.5 – 108 MHz

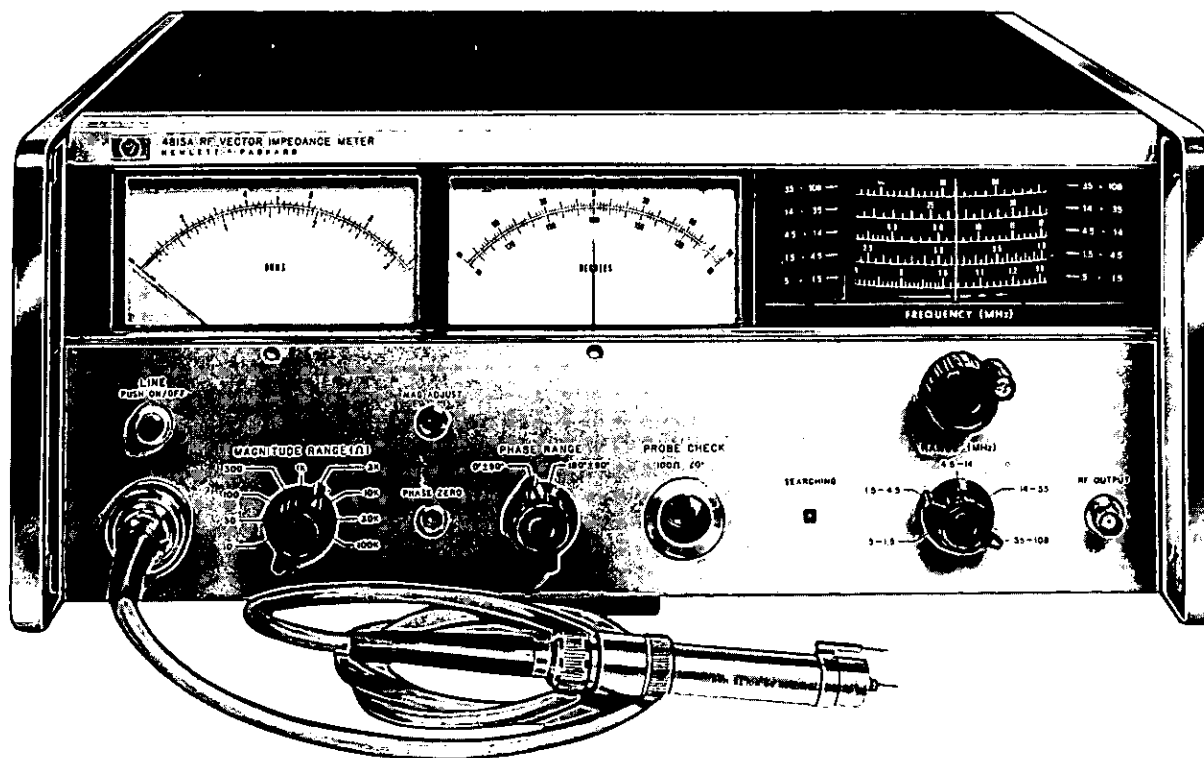

The RF Vector Impedance Meter offers these significant advantages:

- Direct reading of impedance and phase
- Convenient probe for in-circuit measurements
- Self calibration check provides measurement confidence
- Analog outputs for data recording
- Low-level test signal minimizes circuit disturbance

The HP 4815A RF Vector Impedance Meter provides all of the convenience of "probe and read" measurements. In use, the probe is connected directly into the circuit to be evaluated, frequency is selected, and complex impedance is read. This type measurement allows a straightforward adaptation to various jigs and fixtures for special measurements. Where only component values are to be determined, a quick-mount adapter is provided to allow rapid measurements. For critical component applications, the unit to be evaluated may be mounted directly in its working circuit and its value determined in its actual environment, at the frequency of interest.

Specifications

Frequency

Range: 500 kHz to 108 MHz in five bands: 500 kHz to 1.5 MHz, 1.5 to 4.5 MHz, 4.5 to 14 MHz, 14 to 35 MHz, 35 to 108 MHz.

Accuracy: $\pm 2\%$ of reading, $\pm 1\%$ of reading at 1.592 and 15.92 MHz.

RF monitor output: 150 mV minimum into 50 ohms.

Impedance magnitude measurement

Range: 1 ohm to 100 k ohms; full-scale ranges: 10, 30, 100, 300, 1 K, 3 K, 10 K, 30 K, 100 K ohms.

Accuracy: $\pm 4\%$ of full scale $\pm (f/30 \text{ MHz} + Z/25 \text{ k}\Omega)\%$ of reading, where f = frequency in MHz and Z is in ohms; reading includes probe residual impedance.

Calibration: linear meter scale with increments 2% of full scale.

Phase angle measurement

Range: 0 to 360° in two ranges: $0 \pm 90^\circ$, $180^\circ \pm 90^\circ$.

Accuracy: $\pm (3 + f/30 \text{ MHz} + Z/50 \text{ k}\Omega)$ degrees where f = frequency in MHz and Z is in ohms.

Calibration: increments of 2°.

Adjustments: front panel screwdriver adjustments for Magnitude and Phase Zero.

Recorder outputs

Frequency: 0 to 1 volt from 0 to 1 k Ω source, proportional to dial rotation.

Impedance magnitude: 0 to 1 volt from 1 k Ω source.

Phase angle: 0 ± 0.9 volt from 1 k Ω source.

Dimensions: 426 mm wide, 185 mm high, 476 mm deep (16 $\frac{1}{4}$ " \times 7 $\frac{1}{4}$ " \times 18 $\frac{3}{4}$ ").

Weight: 17.6 kg (net 39 lb), shipping 24.8 kg (55 lb).

Power: 105 to 125 V or 210 to 250 V, 50 to 400 Hz, 50 W.

Accessories furnished:

1. 00600A Probe Accessory Kit: contains BNC Type "N" adapter, Probe Socket, 00601A Component Mounting Adapter, 2 probe center pins, probe ground assembly.
2. Rack Mount Kit.

Model number and name

4815A RF vector impedance meter

Price
\$3040

NETWORK ANALYZERS

RF network analyzer system, 100 kHz to 110 MHz

Model 8407 system

- Complete swept characterization of linear networks
- Modular system flexibility
- 50 Ω and 75 Ω measurements

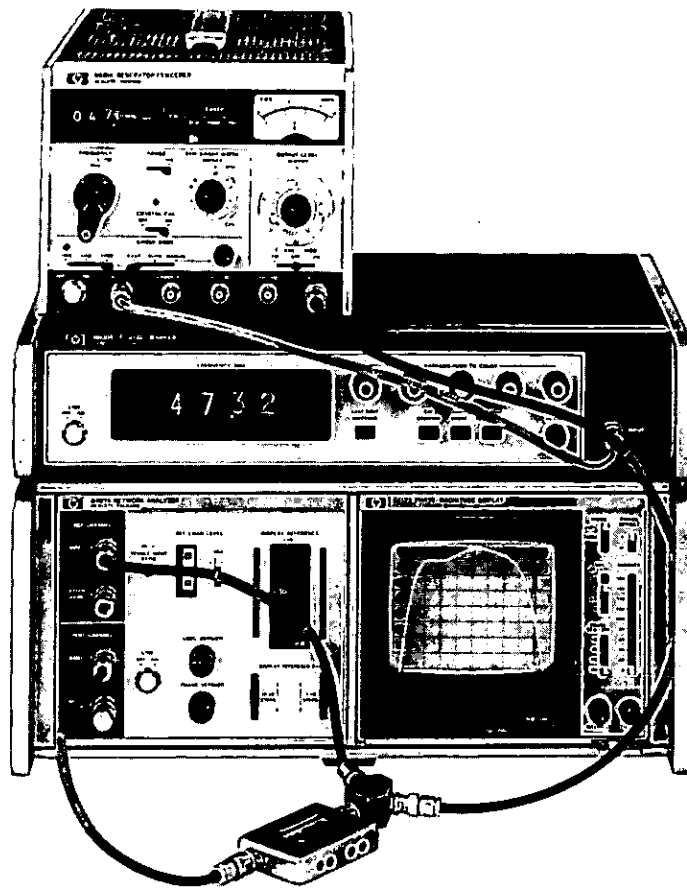

Swept measurements for either designing or testing are made with ease by HP's versatile 8407 Network Analyzer System. Since phase as well as magnitude is measured by a Network Analyzer, the behavior of both active and passive linear networks can be completely characterized from 100 kHz to 110 MHz by swept measurement.

Measurements of gain, loss, phase shift (compute group delay), return loss, and complex reflection coefficient are all possible in either 50 Ω or 75 Ω systems. These measurements allow the linear behavior of the networks under test to be completely characterized by their complex S-Parameters Swept complex impedance $|Z|$ and θ (for $|Z|$ from 0.1 Ω to >10 k Ω) as well as voltage and current transfer functions are also measured quickly and easily by the 8407 system. Typical linear networks designed and tested with the 8407 are filters, amplifiers, attenuators, antennae, detectors, cables, and recording heads.

Much of the 8407's versatility stems from its modular construction which allows the system to perform a variety of measurements or be economically tailored to one application. The basic instruments of the 8407 system are: The HP 8407A Network Analyzer, one of two REQUIRED sources (HP 8601A Sweeper/Generator or HP 8690B/8698B Sweep Oscillator), choice of two plug-in displays (HP 8412A Phase-Magnitude Display or HP 8414A Polar Display), an optional digital marker (HP 8600A), and one of four transducers (HP 11652A, 11654A, 11655A, or 1121A) depending on the measurement. Because

the 8407A is a tracking receiver, the HP 8601A and HP 8690B/8698B are the only sources providing the VTO output required to operate the network analyzer. Thus, an operating system must be configured with one of the required sources, the network analyzer, a display and one or more of the transducers depending on the device under test and the network parameters desired.

Specifications

8407A

General: 8407A is a two input tracking receiver, using both inputs (reference and test channels) to form their magnitude ratio and phase difference before routing to display.

Frequency range: 0.1 - 110 MHz.

Impedance: 50 Ω , Option 008: 75 Ω . VSWR <1.08 .

Dynamic range: 80 dB.

Test input: DIRECT -10 to -90 dBm signal range. ATTENUATED, +20 to -50 dBm signal range. Damage level +26 dBm/50 Vdc.

Reference input: DIRECT level required, -10 to -60 dBm. ATTENUATED level required +20 to -20 dBm. Damage level +26 dBm/50 Vdc.

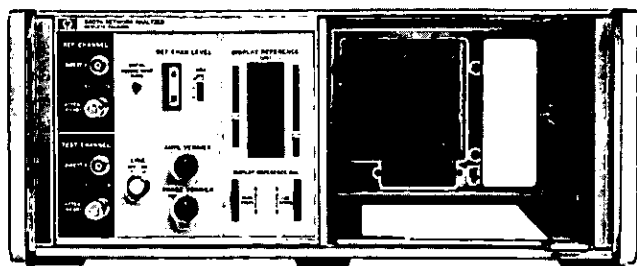

8407A

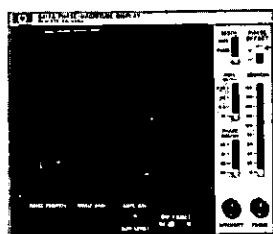

8412A

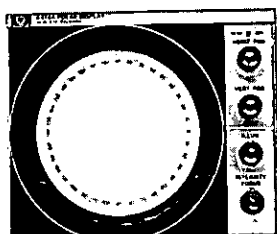

8414A

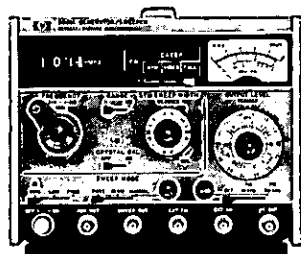

8601A

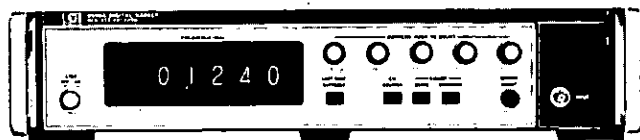

8600A

Amplitude accuracy: FREQUENCY RESPONSE ± 0.2 dB for DIRECT input (test input > -60 dBm), 0.1 – 110 MHz; ± 0.05 dB over any 10 MHz portion; may be calibrated out. Typically ± 0.05 dB for DIRECT inputs. (REFERENCE level of -10 dBm). DISPLAY REFERENCE, < 0.05 dB/1 dB step, total error ≤ 0.1 dB; < 0.1 dB/10 dB step, total error ≤ 0.25 dB. ATTENUATED INPUTS, 40 dB ± 0.5 dB. REFERENCE CHANNEL GAIN CONTROL, 20 dB and 40 dB steps ± 0.5 dB/step. CROSSTALK, > 0.03 dB when test/ref = -40 dB to < 4 dB when test/ref = -80 dB.

Phase accuracy: FREQUENCY RESPONSE, $\pm 5^\circ$ for DIRECT input (test input > -60 dBm), 0.1 to 110 MHz; $\pm 2^\circ$ over any 20 MHz portion; may be calibrated out. Typically $\pm 2^\circ$ from 1 – 110 MHz for DIRECT inputs (REFERENCE level of -10 dBm). DISPLAY REFERENCE, $< 0.5^\circ/10$ dB step; total error $< 3^\circ$. ATTENUATED inputs, $\pm 2^\circ$ from DIRECT inputs. REFERENCE CHANNEL GAIN CONTROL, $\pm 2^\circ$ /step. CROSSTALK, $< 0.3^\circ$ when test/ref = -40° to $< 11^\circ$ when test/ref = -80 dB.

Power: 65 watts, 50-60 Hz, 115/230 $\pm 10\%$ Vac.

Weight: Net, 14.6 kg (32 lb). Shipping, 17.8 kg (39 lb).

8412A

General: Plug-in PHASE-MAGNITUDE CRT Display. Displays magnitude and/or phase vs. frequency.

Amplitude accuracy: Display, 0.08 dB/dB from midscreen. Rear output: 0.03 dB/dB variation from 0 volt output.

Phase accuracy: DISPLAY, $0.065^\circ/\text{degree}$ from midscreen. PHASE OFFSET, $0.3^\circ/20^\circ$ step, $\leq 3^\circ$ for 360° change, positive or negative direction. VS. DISPLAYED AMPLITUDE, $< 1^\circ/10$ dB; total $< 6^\circ$ over 80 dB range.

Rear panel inputs: Sweeping, ≤ 15 Vdc. Blanking, -4 Vdc blanks CRT. Z axis (marker), -5 Vdc intensified and $+5$ Vdc blanks trace.

Rear panel outputs: Amplitude, 50 mV/dB; phase, 10 mV/degree.

Power: 23 watts, supplied by 8407A.

Weight: 7.8 kg (17 lb). Shipping 10 kg (22 lb).

8414A

General: Normalized POLAR coordinate display with magnitude calibration in 0.2 of full scale gradations. Full scale is determined by DISPLAY REFERENCE on 8407A; phase calibration is in 10° increments over 360° range. Smith Chart overlays available.

Accuracy: All errors in amplitude and phase due to display are contained within a circle of 3mm about measurement point.

Rear panel inputs: Blanking, -4 to -10 Vdc blanks CRT. Marker, intensified trace with -4 to -10 Vdc.

Rear panel outputs: Horizontal and vertical both ± 2.5 V for full scale deflection.

Power: 35 watts, supplied by 8407A.

Weight: Net, 5.9 kg (13 lb). Shipping 8.0 kg (18 lb).

8601A

General: GENERATOR/SWEEPER operating in either CW or SWEPT modes. Sweep modes are full, variable stop frequency, and symmetrical (up to 10 MHz). Features very low residual FM, spurious, harmonics, and drift. 8601A provides the VTO signal required to operate the 8407A.

Frequency: .1 – 110 MHz in two sweep ranges, .1 – 11 MHz and 1 – 110 MHz.

Impedance: 50 Ω . Option 008: 75 Ω . VSWR < 1.2 .

Accuracy: 1% of frequency, 0.5% linearity, and 2% of sweep width.

Calibrated output: ± 0.25 dB flatness over full range, output accuracy ± 1 dBm from $+10$ to -110 dBm.

Auxiliary outputs: Sweep out, blanking (for 8412 and 8414), VTO (required by 8407A), and auxiliary output (0.1 – 11 MHz both ranges) for 8600 counter/digital marker.

Detailed specifications on page 366.

8600A

General: DIGITAL MARKER used with 8601A generator/sweeper to provide five continuously variable markers on a display while reading out the frequency of any one marker. Six digit display.

Markers/accuracy: 5 markers accurate at desired frequency \pm (0.05% sweep width + sweep stability).

Counter frequency range: 0.1 – 15 MHz (automatically scales up by ten when 8601A on 0.1 – 110 MHz range).

Detailed specifications on page 366.

11652A

General: REFLECTION-TRANSMISSION KIT containing power splitter, 8721A DIRECTIONAL BRIDGE, precision termination, calibrating short, three BNC adapters, and four matched, low-leakage cables for both transmission and reflection measurements. All 50 Ω BNC connectors, Option 008 75 Ω .

Directional bridge: 8721A: 6dB insertion loss and 6dB coupled to auxiliary arm. Frequency response ± 0.5 dB (0.1 – 110 MHz). Directivity > 40 dB (1 to 110 MHz). Load port return loss > 30 dB ($\rho < 0.03$). Max input power $+20$ dBm. 50 Ω , Option 008: 75 Ω .

Power splitter: 6 dB through each arm. Max input power $+20$ dBm. 50 Ω .

50 Ω termination: Return loss > 43 dB.

Weight: 0.7 kg (1.5 lb). Shipping, 1.2 kg (2.5 lb).

11654

General: Passive probe kit for measuring current and voltage transfer functions and accurate complex impedance below 11 MHz contains a pair each of six resistive divider probes (1:1, 5:1, 10:1, 20:1, 50:1, 100:1), current probes and a variety of adapters.

Weight: Net, 0.9 kg (2 lb). Shipping, 1.4 kg (3 lb).

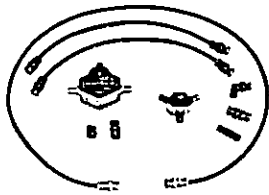

11652A



11654A

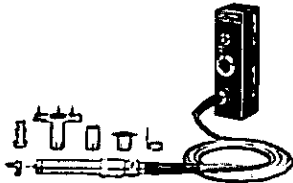

11655A



11658A



1121A

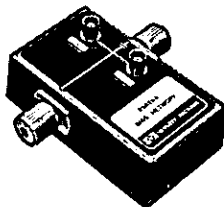

85426A

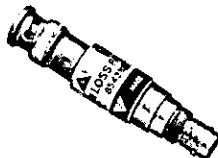

85428B

11655A

General: Swept or CW impedance probe mounting directly to 8407A. Mount contains internal calibrator, $100\Omega \pm 0.5\%$ and $0^\circ \pm 2^\circ$; parasitic capacitances are calibrated out; and simple charts are available for calculating out residual resistances. Contains component adapter, probe to BNC adapter, probe to type N adapter, and various ground assemblies.

Frequency: 0.5 - 110 MHz (usable to 0.1 MHz).

Measurement range: Amplitude, 0.1Ω to $>10\text{ k}\Omega$; phase, $0^\circ \pm 90^\circ$.

CW accuracy: Amplitude $\pm 5\%$; $\pm 5^\circ$ for $|Z| > 3.16\Omega$.

Swept accuracy: Typically $\pm 5\%$ in amplitude (3 - 110 MHz), $\pm 5^\circ$ in phase (5 - 110 MHz); accuracy decreases below 3 MHz. Note all accuracy specs valid only for proper input levels and calibration.

Max external voltage to probe: 50 Vdc, 5 V rms.

Weight: Net, 0.9 kg (2 lb). Shipping, 2.7 kg (6 lb).

11658A

General: 50Ω to 75Ω matching resistor for matching the 50Ω of the 8407A to a 75Ω environment. Two 11658A's are very useful for frequent 50Ω to 75Ω changes. The 11658A's mount directly on the front panel of 8407A. FREQUENCY, 0.1 - 110 MHz. INSERTION LOSS, 3.5 dB. RETURN LOSS, >40 dB. CONNECTORS, 50Ω BNC male and 75Ω BNC female.

Net weight: 28 g (1 oz).

1121A

General: 1:1 active probe for making measurements without disturbing circuitry and measuring voltage transfer functions in systems different from 50Ω . 10:1 and 100:1 dividers and BNC adapter also furnished.

Frequency response: ± 0.5 dB and $\pm 2\%$ from 0.1 - 110 MHz with a bandwidth (3 dB) of 1 kHz to >500 MHz and gain 0 dB ± 1 dB.

Input impedance: 100 k Ω , shunt capacitance of 3 PF at 100 MHz. With 10:1 or 100:1 divider, 1 M Ω , shunt capacitance 1 PF at 100 MHz.

Output impedance: 50Ω nominal.

Maximum input: 300 mV rms, ± 80 V dc; with 10:1 divider, 3 V rms, ± 350 V dc; with 100:1 divider, 30 V rms, ± 350 V dc.

Power: Supplied by 8407A through PROBE PWR jacks.

Weight: Net, 0.7 kg (1.5 lb). Shipping, 1.2 kg (2.5 lb).

85426A

General: Bias insertion network providing DC biasing to devices under test on RF transmission lines. Operating frequency range is 0.1 - 500 MHz with insertion loss <0.4 dB and return loss >28 dB. Max biasing current of 750 mA and max biasing voltage of 70 V. Connectors are BNC for DC biasing and APC-7 for RF.

Weight: Net, 0.5 kg (1 lb). Shipping, 0.8 kg (1.7 lb).

85428A

General: 50Ω to 75Ω minimum loss pad. Pad operates from 0.1 - 110 MHz with an insertion loss of 5.7 dB and VSWR <1.05 . Connectors are 50Ω BNC male and 75Ω BNC female.

Weight: Net, 0.1 kg (2 oz). Shipping, 0.2 kg (6 oz).

Model number and name:

8407A Network Analyzer	Price
Option 008	\$3195
8412A Phase Magnitude Display	add \$115
8414A Polar Display	\$1855
8601A Sweeper/Generator	\$1445
Option 008	\$2470
8600A Digital Marker	add \$50
11652A Reflection/Transmission Kit	\$1135
Option 008	add \$60
11654A Passive Probe Kit	\$500
11655A Impedance Probe Kit	\$1000
11658A Matching Resistor	\$30
1121A AC Probe Kit	\$430
85426A Bias Insertion Network	\$350
85428B Minimum Loss Pad	\$100

NETWORK ANALYZERS

Microwave network analyzer, 110 MHz to 40 GHz

Model 8410S systems

- Complete microwave measurement systems
- Measures all network parameters
- Multioctave swept frequency measurement
- System accuracy fully specified

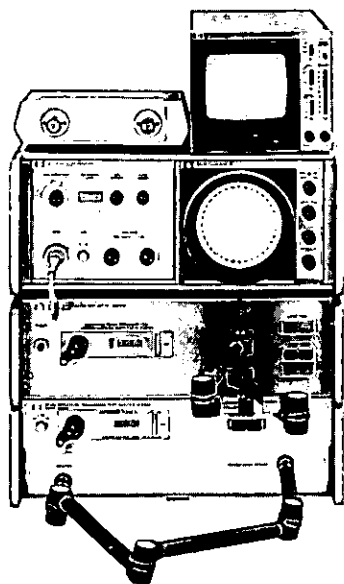

8410S option 310

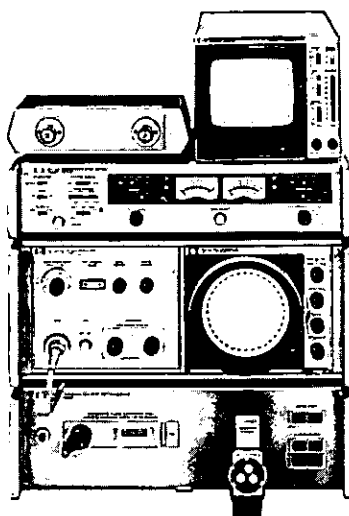

8410S option 400

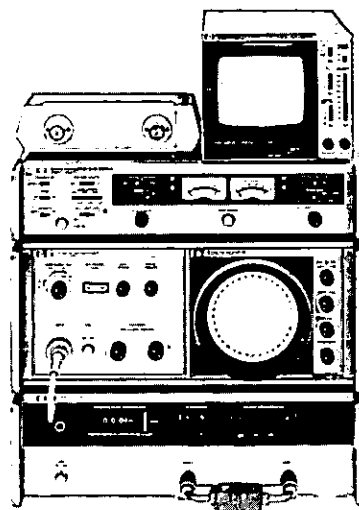

8410S option 500

All 8410S Systems measure transmission and reflection parameters of coaxial or semiconductor components in the form of gain, attenuation, phase, reflection coefficient or impedance. Each option has been configured and fully specified for making general measurements within a frequency range or for pushbutton S-parameter measurements on semiconductor devices in a variety of

package styles. The 8410S Systems enable the operator to view a real time CRT display over octave or multioctave bands with a dynamic range of 60 dB amplitude and 360° phase. Multioctave, continuous network measurements over the frequency range of 2 to 18 GHz are possible when the 8410B is used with the HP 8620/86290A Sweep Oscillator.

8410S Network Analyzer Systems Table

GENERAL PURPOSE MEASUREMENTS			All 8410S Systems Include the Following Instrument Model Numbers: 8410B 8411A, 8412A*, 8414A and 11609A										PRICE
Frequency Range	Option No.	Measurement Port Configuration	8743A	8745A	8746A	8717B	11600B	11602B	11608A	11604A	11605A	11650	
0.11 to 2 GHz	110*	Coaxial (APC-7)		X						X		X	\$15,345
0.11 to 12.4 GHz	310*	Coaxial (APC-7)	X	X						X	X	X	\$19,745
2 to 12.4 GHz	210*	Coaxial (APC-7)	X								X	X	\$14,720
SEMICONDUCTOR CHARACTERIZATION													
0.11 to 2 GHz	400	T018/T072 Packages		X		X	X						\$15,965
0.11 to 2 GHz	401	T05/T012 Packages		X		X		X					\$15,965
0.5 to 12.4 GHz	500	T051 Package			X	X			X				\$18,140
0.5 to 12.4 GHz	501	HPAC-200 Package			X	X			X				\$18,140

*Options 100, 200 and 300 are identical to 110, 210 and 310 respectively except for the 8412A which is replaced by the 8413A.

8410S Systems(cont.)

Specifications

8410S Common performance specifications

Function: All systems measure transmission and reflection parameters on a swept-frequency or CW basis with readout of attenuation, gain, phase shift, reflection coefficient, return loss, impedance, depending on display unit.

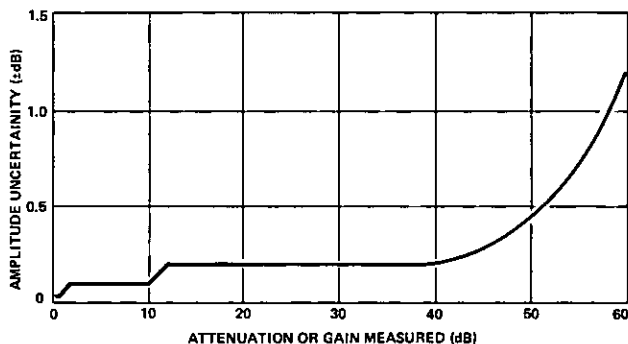

8412A Phase-magnitude display: Rectangular coordinate dual-channel CRT.

Amplitude range: 80 dB.

Phase range: $\pm 180^\circ$.

Resolution:

Selectable amplitude: 10, 2.5, 1, 0.25 dB/division.

Selectable phase: 90, 45, 10, 1 degree/division.

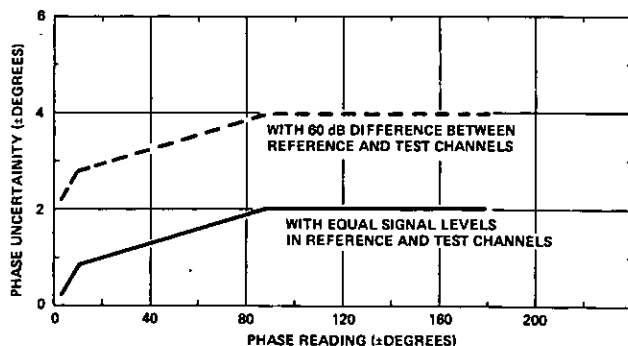

8414A Polar display: Polar Coordinate CRT with magnitude calibration divisions at 20, 40, 60, 80 and 100% of full scale. Outer range settable by IF gain control and amplitude vernier.

Connectors: RF Input, Type N female stainless steel; Measurement Ports, APC-7 precision 7-mm connectors.

Transmission measurement (using 8412A): Accuracy curves show overall system uncertainty when measuring amplitude and phase. Sources of error included are IF gain control, display accuracy, phase offset, system noise and cross-talk. System frequency response is specified separately and is not included in accuracy curves.

Amplitude accuracy (60 dB dynamic range):

IF gain control: 69 dB in 10 dB and 1 dB steps.

± 0.1 dB/10 dB } ± 0.2 dB maximum cumulative
 ± 0.05 dB/1 dB }

Display: 0.08 dB/dB from midscreen.

Phase accuracy:

Phase offset: $0.3^\circ/20^\circ$ step; maximum 3° for 360° change.

Display: $0.065^\circ/\text{degree}$ from midscreen.

8410S Options 100/110 specifications

Function: The 8410S option 100/110 measurement systems give all four s-parameters for a two-port network with pushbutton ease over the frequency range of 110 MHz to 2 GHz. A choice in Log display units is made by selecting the Option 100 (8413A display) or Option 110 (8412 display) system.

Frequency range: 0.11 to 2.0 GHz.

RF input: 20 dB range between -21 dBm and $+7$ dBm.

Source reflection coefficient: ≤ 0.09 , 0.11 - 2.0 GHz.

Termination reflection coefficient: ≤ 0.11 , 100 - 200 MHz; ≤ 0.09 , 200 - 2000 MHz.

Directivity: > 36 dB 0.11 - 1.0 GHz; > 32 dB 1.0 - 2.0 GHz.

Insertion loss, RF input to test port: 4 dB nominal.

Frequency response:

Transmission: Typically $\leq \pm 0.35$ dB amplitude and $\leq \pm 3^\circ$ phase.

Reflection: Typically $\leq \pm 0.06$ magnitude and $\pm 5^\circ$ phase with a short on the test port.

Transmission measurement accuracy: (See common performance specifications).

Reflection measurement accuracy (using 8414A): Sources of error included in the accuracy equations are directivity, source match, and polar display accuracy.

Magnitude accuracy:

$\rho_u = \pm(0.015 + 0.03 \rho_L + 0.06 \rho_L^2)$ 0.11 - 1.0 GHz

$\rho_u = \pm(0.025 + 0.03 \rho_L + 0.06 \rho_L^2)$ 1.0 - 2.0 GHz

ρ_u = magnitude uncertainty

ρ_L = measured reflection coefficient magnitude.

Phase accuracy:

$\Phi_u = \sin^{-1} \rho_u / \rho_L$ for $\Phi_u < 90^\circ$

Φ_u = phase uncertainty

See 8410S network analyzer systems table for price and instrument breakdown.

8410S Options 200/210 specifications

Function: The 8410S Option 200/210 measurement systems cover a frequency range of 2 to 12.4 GHz. With just one simple setup and calibration both transmission and reflection measurements are easily made by pushing a button. A choice in Log display units is made by selecting the Option 200 (8413A display) or Option 210 (8412A display) system.

Frequency range: 2.0 to 12.4 GHz.

RF input: 20 dB range between -14 dBm and $+14$ dBm.

Source reflection coefficient: ≤ 0.09 , 2 - 8 GHz; ≤ 0.13 , 8 - 12.4 GHz.

Termination reflection coefficient: ≤ 0.09 , 2 - 8 GHz; ≤ 0.13 , 8 - 12.4 GHz.

Directivity: ≥ 30 dB, 2 - 12.4 GHz.

Insertion loss, RF input to test port: 20 dB nominal.

Frequency response:

Transmission: Typically $< \pm 0.5$ dB amplitude and $< \pm 5^\circ$ phase.
Reflection: Typically $< \pm 0.06$ magnitude and $< \pm 7^\circ$ phase, with a short on the unknown port.

Transmission measurement accuracy: (See common performance specifications).

Reflection measurement accuracy (using 8414A): Sources of error included in the accuracy equations are directivity, source match, and polar display accuracy.

Magnitude accuracy:

$\rho_u = \pm(0.0316 + 0.03 \rho_L + 0.09 \rho_L^2) 2 - 8$ GHz
 $\rho_u = \pm(0.0316 + 0.03 \rho_L + 0.13 \rho_L^2) 8 - 12.4$ GHz
 ρ_u = magnitude uncertainty
 ρ_L = measured reflection coefficient magnitude

Phase accuracy:

$\Phi_u = \sin^{-1} \rho_u / \rho_L$ for $\Phi_u < \pm 90^\circ$
 Φ_u = phase uncertainty

See 8410S network analyzer systems table for price and instrument breakdown.

8410S Options 300/310 specifications

Function: The 8410S Option 300/310 measurement systems encompass both the 8410S Option 110 and 210 system specifications and flexibility. The two RF transducer units cover the frequency range of 110 MHz to 12.4 GHz and both offer calibrated line stretchers for extending the reference plane. Coaxial rotary joints and airlines mounted on the front of the transducer units allow easy connections to the test device. A choice in log display units is made by selecting either the Option 300 (8413 display) or Option 310 (8412 display) system.

See 8410S network analyzer systems table for price and instrument breakdown.

8410S Options 400/401 specifications

Function: The 8410S Option 400/401 S-parameter measurement system provides two port S-parameters for semiconductors in TO-18/TO-72 (Option 400) or TO-5/TO-12 (Option 401) packages. A short circuit Termination and a 50 ohm through section are included with each type fixture for reference plane calibration.

Frequency range: 0.11 to 2.0 GHz.

Transistor DC bias selection: Front panel slide switches establish proper dc biasing for both Bi-polar and FET transistors. The voltage and current controls operate independently and are continuously adjustable over a current range of 0 to 500 ma and a voltage range of 0 to 30 V.

RF input: 20 dB range between -21 dBm and $+7$ dBm.

Incident power at device under test: $+3$ dBm to -25 dBm.

Source reflection coefficient:

Option 400: Typically < 0.062
Option 401: Typically < 0.067

Termination reflection coefficient:

Option 400: Typically < 0.11 , 100 to 200 MHz
 < 0.09 , 0.2 to 2.0 GHz
Option 401: Typically < 0.14 , 100 to 200 MHz
 < 0.10 , 0.2 to 2.0 GHz

Directivity:

Option 400: Typically < 31 dB, 0.11 to 1.0 GHz
 < 29 dB, 1.0 to 2.0 GHz
Option 401: Typically < 28 dB, 0.11 to 1.0 GHz
 < 27 dB, 1.0 to 2.0 GHz

Frequency response:

Transmission: Typically $< \pm 0.35$ dB, $\pm 3^\circ$

Reflection: Typically $< \pm 5$ dB, $\pm 5^\circ$

Transmission measurement accuracy: (See common performance specification).

Reflection measurement accuracy (using 8414A): Sources of error included in the accuracy equations are directivity and source match.

Magnitude accuracy:

Option 400:

$\rho_u = \pm(0.029 + 0.048 \rho_L + 0.06 \rho_L^2) 1.1$ to 1 GHz
 $\rho_u = \pm(0.035 + 0.051 \rho_L + 0.062 \rho_L^2) 1.0$ to 2.0 GHz

Option 401:

$\rho_u = \pm(0.038 + 0.054 \rho_L + 0.067 \rho_L^2) 1.0$ to 2.0 GHz
 ρ_u = magnitude uncertainty

ρ_L = measured reflection coefficient magnitude

Phase accuracy:

$\Phi_u = \sin^{-1} \Phi_u (\rho_u / \rho_L)$ for $\Phi_u < 90^\circ$
 Φ_u = phase uncertainty

See 8410S network analyzer systems table for price and instrument breakdown.

8410S Options 500/501 specifications

Function: The 8410S Option 500/501 S-parameter measurement systems provide the capability of biasing and measuring all four S-parameters of strip-line transistors in the TO-51 (Option 500), HPAC-200 (Option 501) packages. A short circuit termination and a 50-ohm through section are included with each fixture for reference plane calibration.

Frequency range: 0.5 to 12.4 GHz.

Transistor dc bias selection: Front panel slide switches establish proper dc biasing for both Bi-polar and FET transistors. The voltage and current controls operate independently and are continuously adjustable over a current range of 0 to 500 ma and a range of 0 to 30 V dc.

RF input: 20 dB range between -7 and $+13$ dBm.

Incident power at device under test: -27 dBm to -7 dBm with INCIDENT ATTENUATION set to 0 dB.

Incident attenuation range: 0 to 70 dB in 10 dB steps.

Source reflection coefficient: (Typically) < 0.13 , 0.5 to 8.0 GHz; < 0.14 , 8.0 to 12.4 GHz.

Termination reflection coefficient: (Typically) < 0.13 , 0.5 to 8.0 GHz; ± 0.14 , 8.0 to 12.4 GHz.

Directivity: > 28 dB, 0.5 to 4.0 GHz; > 23 dB, 4 to 12.4 GHz.

Frequency response: (Typically) < 1.0 dB, ± 5 degrees, 0.05 to 4.0 GHz; < 1.5 dB, ± 5 degrees, 4.0 to 8.0 GHz; < 2.5 dB, ± 5 degrees, 8.0 to 12.4 GHz.

Transmission measurement accuracy: (See common performance specifications).

Reflection measurement accuracy: Sources of error included in the accuracy equation are directivity and source match.

Magnitude accuracy:

$\rho_u = \pm(0.04 + 0.08 \rho_L + 0.13 \rho_L^2) 0.5$ to 4.0 GHz
 $\rho_u = \pm(0.07 + 0.09 \rho_L + 0.135 \rho_L^2) 4.0$ to 8.0 GHz
 $\rho_u = \pm(0.074 + 0.098 \rho_L + 0.14 \rho_L^2) 8.0$ to 12.4 GHz
 ρ_u = magnitude uncertainty

ρ_L = measured reflection coefficient magnitude

Phase accuracy:

$\Phi_u = \sin^{-1} \rho_u / \rho_L$ for $\Phi_u < 90^\circ$
 Φ_u = phase uncertainty

See 8410S network analyzer systems table for price and instrument breakdown.

NETWORK ANALYZERS

Individual instruments

8410 family

NEW

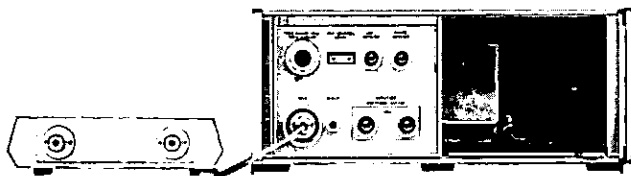

8411A

8410B

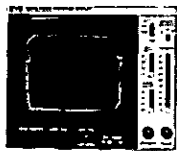

8412A

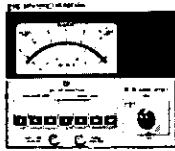

8413A

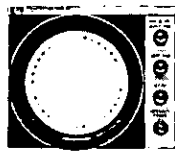

8414A

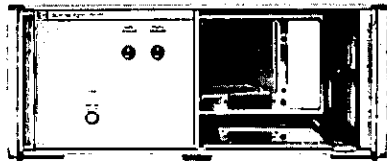

8418A

Specifications

New 8410B/8411A Network Analyzer

Function: 8411A converts RF signals to IF signals for processing in 8410B mainframe. 8410B is the mainframe for display plug-in units. Mainframe includes tuning circuits (octave bands or multioctave bands when used with HP 8620/86290 sweep oscillator), IF amplifiers and precision IF attenuator.

8410B frequency range: 0.11 to 18 GHz.

8411A frequency range: 0.11 to 12.4 GHz.

Option 018: 0.11 to 18 GHz.

8411A input impedance: 50 ohms nominal. SWR <1.5, 0.11 to 8.0 GHz; <2.0, 8.0 to 12.4 GHz; typically increases to a 10:1 SWR, 12.4 to 18 GHz.

Channel isolation: >65 dB, 0.1 to 6 GHz; >60 dB, 6 to 12.4 GHz; >50 dB, 12.4 to 18 GHz.

Amplitude:

Reference channel: Any 20 dB range between -16 and -44 dBm.

Test channel: -10 to -78 dBm from 0.11 to 12.4 GHz; -10 to -68 dBm from 12.4 to 18 GHz.

Maximum RF input to either channel: 50 mW.

IF gain control: 69 dB range in 10 dB and 1 dB steps with a maximum cumulative error of ± 0.2 dB.

Phase:

Phase range: 0 to 360°.

Control: Vernier control >90°.

Connectors (8411A): APC-7.

Power: 115 or 230 V ac $\pm 10\%$, 50-60 Hz, 70 watts (includes 8411A).

Weight:

8410B: Net, 14.9 kg (33 lb). Shipping, 18.5 kg (41 lb).

8411A: Net, 3.2 kg (7 lb). Shipping, 4.5 kg (10 lb).

Dimensions:

8410B: 425 mm wide, 191 mm high, 467 mm deep (16 $\frac{3}{4}$ " \times 7 $\frac{1}{2}$ " \times 18 $\frac{3}{8}$ ").

8411A: 228 mm wide, 67 mm high, 143 mm deep (9" \times 2 $\frac{5}{8}$ " \times 5 $\frac{5}{8}$ "), exclusive of connectors and cable.

8412A Phase-magnitude display

Function: Plug-in CRT display unit for 8410B. Displays relative amplitude in dB and/or relative phase in degrees between reference and test channel inputs versus frequency.

Amplitude:

Range: 80 dB display range with selectable resolutions of 10, 2.5, 1 and 0.25 dB/division.

Accuracy: 0.08 dB/dB from midscreen.

Phase:

Range: $\pm 180^\circ$ display range with selectable resolutions of 90, 45, 10, and 1°/division.

Accuracy: 0.065°/degree from midscreen.

Phase offset: 0.3°/20° step cumulative <3°.

Power: 23 watts supplied by mainframe.

Weight: Net, 7.8 kg (17 lb). Shipping, 10 kg (22 lb).

Dimensions: 186 mm wide, 152 mm high, 395 mm deep (7 $\frac{3}{32}$ " \times 6" \times 15 $\frac{1}{16}$ "), excluding front panel knobs.

8413A Phase-gain indicator

Function: Plug-in meter display unit for 8410B. Displays relative amplitude in dB between reference and test channel inputs or relative phase in degrees. Pushbutton selection of meter function and range.

Amplitude:

Range: ± 30 , ± 10 , and ± 3 dB full scale.

Accuracy: $\pm 3\%$ of end scale.

Log Output: 50 millivolts per dB up to 60 dB total.

Phase:

Range: ± 180 , ± 60 , ± 18 , ± 6 degrees full scale.

Accuracy: $\pm 2\%$ of end scale.

Output: 10 millivolts per degree.

Phase offset: ± 180 degrees in 10-degree steps.

Accuracy: $\pm(0.2^\circ + 0.3^\circ/10^\circ \text{ step})$, cumulative <2°.

Power: Additional 15 watts supplied by 8410B.

Weight: Net, 4.9 kg (11 lb). Shipping, 6.7 kg (15 lb).

Dimensions: 186 mm wide, 152 mm high, 395 mm deep (7 $\frac{3}{32}$ " \times 6" \times 15 $\frac{1}{16}$ "), excluding front panel knobs.

8414A Polar display

Function: Plug-in CRT display unit for 8410B. Displays amplitude and phase data in polar coordinates on 5-in. cathode ray tube.

Range: Normalized polar coordinate display; magnitude calibration 20% of full scale per division. Scale factor is a function of IF setting on 8410B. Phase calibrated in 10-degree increments over 360-degree range.

Accuracy: Error circle on CRT ± 3 mm.

Power: Additional 35 watts supplied by 8410B.

Weight: Net, 5.8 kg (13 lb). Shipping, 8.1 kg (18 lb).

Dimensions: 186 mm wide, 152 mm high, 395 mm deep (7 $\frac{3}{32}$ " \times 6" \times 15 $\frac{1}{16}$ "), excluding front panel knobs.

8418A Auxiliary power supply

Function: The 8418A power supply unit provides power for operation of the 8412A, 8413A or the 8414A display units. Used in conjunction with the 8410B Network Analyzer, it provides the capability of viewing amplitude and phase readout in both rectangular and polar coordinates simultaneously.

Weight: Net, 11.2 kg (25 lb). Shipping, 19.7 kg (44 lb).

Dimensions: 483 mm wide, 177 mm high, 450 mm deep (19" \times 6 $\frac{3}{32}$ " \times 17 $\frac{1}{8}$ ").

Model number and name

Model number and name	Price
8410B mainframe	\$3400
8411A frequency converter	\$2680
Option 018	add \$415
8412A phase-magnitude display	\$1855
8413A phase-gain display	\$1445
8414A polar display	\$1445
8418A auxiliary power supply	\$1050

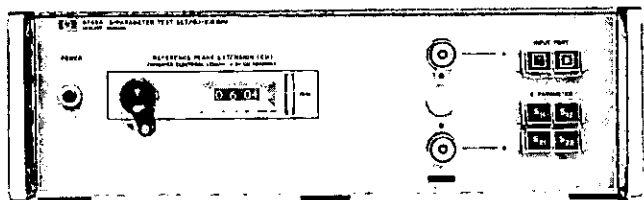

8745A

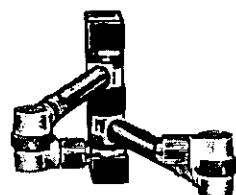

11604A

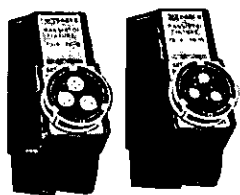

11600B 11602B

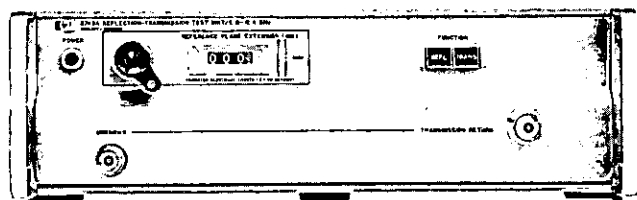

8743A

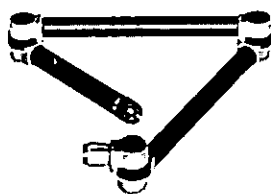

11605A

8745A S-Parameter test unit

Function: Wideband RF power splitter and reflectometer with calibrated line stretcher. Pushbutton operated for either transmission or reflection measurements with network analyzer.

Frequency range: 100 MHz to 2 GHz.

Impedance: 50 ohms nominal.

Source reflection coefficient: ≤ 0.057 , 0.11 to 2.0 GHz.

Termination reflection coefficient: < 0.10 , 100 to 200 MHz; < 0.063 , 200 MHz to 2.0 GHz.

Directivity: ≥ 36 dB, below 1 GHz; ≥ 32 dB, 1 to 2 GHz.

Reference plane extension: 0 to 15 cm for reflection; 0 to 30 cm for transmission.

Maximum RF power: 2 watts.

Connectors: RF input, type N female; all other connectors APC-7.

Rear panel programming and bias inputs.

Option 001: Output connectors type N female.

Power: 115 or 120 V ac $\pm 10\%$, 50 to 400 Hz, 40 watts.

Weight: Net, 15.4 kg (34 1/4 lb). Shipping, 18.0 kg (40 lb).

Dimensions: 425 mm wide, 140 mm high, 654 mm deep (16 3/4" \times 5 1/2" \times 25 3/4").

11604A Universal Extension

Function: Mounts on front of 8745A; connects to device under test. Rotary air-lines and rotary joints connect to any two port geometry.

Frequency range: dc to 2 GHz.

Impedance: 50 ohms nominal.

Reflection coefficient: 0.035.

Acc. included: Semi-rigid coax. cable, HP Part #11604-20021.

Weight: Net, 1.8 kg (4 lb). Shipping, 2.2 kg (5 lb).

Dimensions: 32 mm wide, 127 mm high, 267 mm deep (1 1/4" \times 5" \times 10 1/2").

11600B/11602B Transistor Fixtures

Function: Mounts on front of 8745A S-parameter test set; holds devices for S-parameter measurements in a 50-ohm, coax circuit. Both fixtures provide bias for bipolar transistors and FETs. Other devices also fit the fixtures (tunnel diodes, etc.).

Transistor base patterns:

Model 11600B: Accepts TO-18/TO-72 packages.

Model 11602B: Accepts TO-5/TO-12 packages.

Calibration references: Short circuit termination and a 50-ohm through-section.

Frequency ranges: dc to 2 GHz.

Impedance: 50 ohms nominal.

Reflection coefficient: < 0.05 , 100 MHz to 1.0 GHz; < 0.09 , 1.0 to 2 GHz.

Connectors: Hybrid APC-7; Option 001, type N female.

Weight: Net, 1.1 kg (2 3/8 lb). Shipping, 1.8 kg (4 lb).

Dimensions: 44 mm wide, 152 mm high, 229 mm deep (1 1/4" \times 6" \times 9").

8743A Reflection/transmission test unit

Function: Wideband RF power splitter and reflectometer with calibrated line stretcher. Pushbutton operated for either transmission or reflection measurements with network analyzer.

Frequency range: 2 to 12.4 GHz, (option 018: 2 to 18 GHz).

Impedance: 50 ohms nominal.

Source reflection coefficient: ≤ 0.09 , 2.0 to 8.0 GHz; ≤ 0.13 , 8.0 to 12.4 GHz; < 0.2 , 12.4 to 18 GHz.

Termination reflection coefficient: ≤ 0.13 in reflection mode, 2.0 to 12.4 GHz; ≤ 0.2 in transmission mode, 2.0 to 12.4 GHz; typically < 0.2 , 12.4 to 18 GHz.

Directivity: ≥ 30 dB, 2.0 to 12.4 GHz; ≥ 18 dB, 12.4 to 18 GHz.

Reference plane extension: 0 to 15 cm for reflection; 0 to 30 cm for transmission.

Connectors: RF input, type N female; all other connectors APC-7.

Power: 115 or 230 V ac $\pm 10\%$, 50-400 Hz, 15 W.

Weight: Net, 12.1 kg (29 lb). Shipping, 15.3 kg (34 lb).

Dimensions: 425 mm wide, 140 mm high, 467 mm deep (16 3/4" \times 5 1/2" \times 18 3/8").

11605A Flexible arm

Function: Mounts on front of 8743A; connects to device under test. Rotary air lines and rotary joints connect to any two-port geometry.

Frequency range: dc to 12.4 GHz. (Option 018, 2 to 18 GHz).

Impedance: 50 ohms nominal. Reflection coefficient of ports: ≤ 0.11 , dc to 12.4.

Option 018: ≤ 0.23 , 2.0 to 12.4 GHz; ≤ 0.31 , 12.4 to 18 GHz.

Connectors: APC-7.

Weight: Net, 1.8 kg (4 lb). Shipping, 2.7 kg (6 lb).

Length: 257 mm (10 1/2") closed; 648 mm (25 1/2") extended.

Model name and number

8745A test set	Price
Option 001	\$3750
11604A universal arm	N/C
11600B/11602B transistor fixtures	\$1275
Option 001	\$750
8743A reflection/transmission test set	less \$30
Option 018	\$3400
11605A flexible arm	add \$750
Option 018	\$1000
	add \$525

NETWORK ANALYZERS

8410 family (cont.)

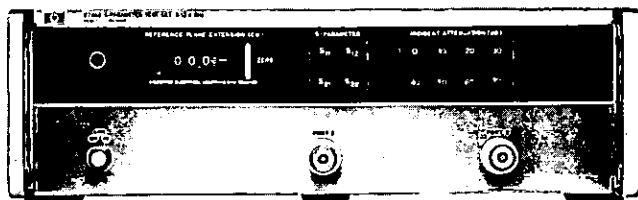

8746B



11608A

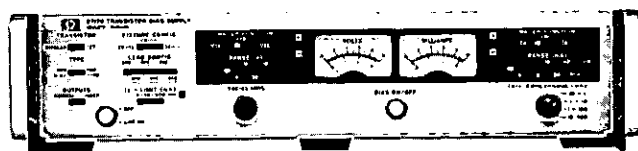

8717B

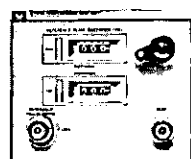

8740A

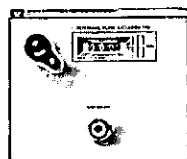

8741A



8742A

8746B S-parameter test unit

Function: Wideband RF power divider and reflectometer with calibrated line stretcher and a selectable 0 - 70 dB incident signal attenuator. Provides internal bias tees for completely characterizing two port active devices.

Frequency range: 0.5 to 12.4 GHz.

Source and termination reflection coefficient: ≤ 0.13 .

Directivity: ≥ 30 dB, 0.5 to 4.0 GHz; ≥ 26 dB, 4.0 to 12.4 GHz.

Incident attenuation: 0 - 70 dB in 10 dB steps $\pm 5\%$.

Reference plane extension: Adds 0 - 15 cm (30 cm in transmission path).

Remote programming: Ground closure to 36 Pin connector.

Transistor biasing: via 36 Pin connector.

Connectors: Input type N female, test ports APC-7

Option 001: Provides 10 dB higher power level at the test port.

Power: 115 or 230 V $\pm 10\%$, 48 to 440 Hz, 110 VA max.

Weight: Net, 16.1 kg (35 lb). Shipping, 19.1 kg (42 lb).

Dimensions: 425 mm wide, 140 mm high, 467 mm deep (16 $\frac{1}{4}$ " \times 5 $\frac{1}{2}$ " \times 18 $\frac{3}{8}$ ").

11608A Transistor fixture

Function: Provides the capability of completely characterizing strip-line transistors in either the TO-51 or HPAC-200 package styles. For special package styles, a through-line microstrip and bolt-in grounding structure machinable by customer is available.

Frequency range: dc to 12.4 GHz.

Reflection coefficient: < 0.05 , dc to 4 GHz; < 0.07 , 4.0 to 8.0 GHz; < 0.11 , 8 to 12.4 GHz.

Package styles:

Option 001: Customer machinable.

Option 002: TO-51 (0.250" dia.).

Option 003: HPAC-200 (0.205" dia.).

Calibration references: Options 002 and 003 only, short circuit termination and a 50-ohm through-section.

Connectors: APC-7 Hybrid (Option 100 type N female).

Weight: Net, 0.9 kg (2 lb). Shipping, 1.4 kg (3 lb).

Dimensions: 143 mm wide, 25 mm high, 89 mm deep (5 $\frac{5}{8}$ " \times 1" \times 3 $\frac{1}{2}$ ").

8717B Transistor bias supply

The 8717B Transistor Bias Supply is an ideal power supply for manual or programmable transistor testing. It is particularly useful with the 11600B, 11602B, and 11608A Transistor Fixtures. The 8717B has two meters for independently monitoring current and voltage on any of the three leads of a transistor under test. Bias connections are conveniently selected for all transistor configurations with a front panel switch. Special circuitry protects sensitive devices from excessive current transients which commonly occur in less sophisticated supplies.

Voltage ranges: 1, 3, 10, 30, 100 V.

Current ranges: 0.1, 0.3, 1, 3, 10, 30, 100, 300, 1000 mA.

Accuracy: 4% of full scale for both current and voltage.

Option 001: Programmable D/A converter.

Weight: Net, 9.0 kg (20 lb). Shipping, 11.0 kg (25 lb).

Dimensions: 425 mm wide, 86 mm high, 336 mm deep (16 $\frac{1}{2}$ " \times 3 $\frac{3}{8}$ " \times 13 $\frac{1}{2}$ ").

8740A Transmission test unit

Function: RF power splitter and calibrated line stretcher for transmission measurement with network analyzer.

Frequency range: dc to 12.4 GHz.

Output reflection coefficient: < 0.07 , dc to 7 GHz; < 0.11 , 7.0 to 12.4 GHz.

Connectors: RF input, type N female; output, APC-7.

Reference plane extension: Electrical, 0 to 10 cm; mechanical 1 - 10 cm.

Weight: Net, 7.1 kg (16 lb). Shipping, 9.4 kg (21 lb).

Dimensions: 186 mm wide, 152 mm high, 410 mm deep (7 $\frac{1}{2}$ " \times 6" \times 16 $\frac{1}{6}$ ").

Recommended accessory: 11587A accessory kit.

8741A and 8742A Reflection test units

Function: Wideband reflectometer, phase-balanced for swept or single frequency impedance tests with 8410B. Calibrated adjustable reference plane.

Frequency range: 0.11 - 2.0 GHz (8741A); 2.0 - 12.4 GHz (8742A).

Directivity: ≥ 36 dB 0.11 - 1 GHz, ≥ 32 dB 1 - 2 GHz (8741A); ≥ 30 dB 2 - 12.4 GHz (8742A).

Connectors: RF input, type N female; all others APC-7.

Reference plane extension: 0 - 15 cm.

Accessories furnished: 11565A, APC-7 short.

Weight: Net, 6.7 kg (15 lb). Shipping, 8.9 kg (20 lb).

Dimensions: 186 mm wide, 152 mm high, 410 mm deep (7 $\frac{1}{2}$ " \times 6" \times 16 $\frac{1}{6}$ ").

Recommended accessory: 11587A Accessory Kit

Model number and name	Price
8746B Test Unit	\$6100
Option 001	N/C
11608A Transistor Fixture	
Option 001	\$450
Option 002	\$550
Option 003	\$550
Option 100	less \$30
8717B Transistor Bias Supply	\$2010
Option 001	add \$670
8740 Transmission Test Set	\$2400
8741 Reflection Test Set	\$1755
8742 Reflection Test Set	\$2500

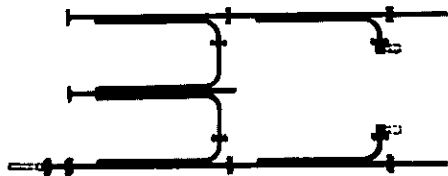

X8747A and P8747A

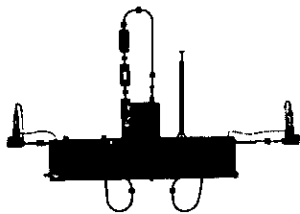

K8747A and R8747A



11587A



11650A



11609A

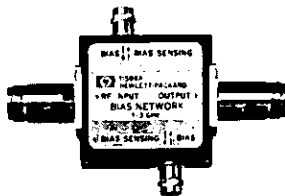

11589A and 11590A

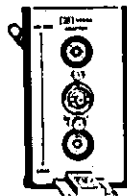

11599A

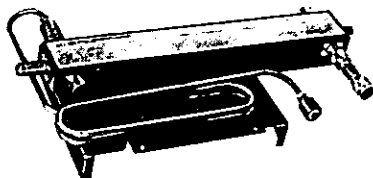

11607A

P, X 8747A Reflection/transmission test units

Function: Waveguide setup for measuring reflection and transmission parameters of waveguide devices with the network analyzer.

Frequency range: X8747A: 8.2 – 12.4 GHz; P8747A: 12.4 – 18 GHz.

K, R 8747A Reflection/transmission test units

Function: Waveguide setup for measuring reflection and transmission parameters of waveguide devices with the network analyzer; down-converts with built-in mixers to the frequency range of the 8411A.

Frequency range: K8747A: 18 – 26.5 GHz; R8747A: 26.5 – 40 GHz.

11587A Accessory kit

Function: Accessories normally used for transmission and reflection tests with the 8740A, 8741A, and 8742A.

Weight: Net, 1.34 kg (3 lb). Shipping, 2.23 kg (5 lb).

11650A Accessory kit

Function: Accessories normally used for transmission and reflection tests with the 8745A and 8743A.

Weight: Net, 1.34 kg (3 lb). Shipping, 2.23 kg (5 lb).

11609A Cable kit

Function: Interconnecting cables normally required for network measurements using the 8410B network analyzer.

Weight: Net, 0.9 kg (2 lb). Shipping, 1.36 kg (3 lb).

11589A and 11590A Bias networks

Function: Auxiliary units for use with the 11600B, 11602B and 11608A transistor fixtures. These bias networks provide dc bias to the center conductor of a coaxial line while blocking the dc bias from the input RF circuit.

Frequency range: 11589A — 0.1 to 3.0 GHz; 11590A — 1.0 to 12.4 GHz.

Connectors: BNC for dc biasing; type N female for RF (Option 001: APC-7).

Weight: Net, 0.3 kg (9 oz). Shipping, 0.5 kg (1 lb).

Dimensions: 76 mm wide, 29 mm high, 114 mm deep (3" x 1 1/8" x 4 1/2").

11599A Quick connect adapter

Function: Quickly connects and disconnects the 8745A and the transistor fixtures or 11604A universal extension.

Weight: Net, 397 gm (14 oz). Shipping, 652 gm (2 lb).

Dimensions: 76 mm wide, 127 mm high, 108 mm deep (3" x 5" x 4 1/2").

11607A Small signal adapter

Function: Used with the 8745A S-parameter test set. The incident signal levels to the test device are reduced to the -20 to -40 dBm range.

Weight: Net, 4.1 kg (4 1/2 lb). Shipping, 4.5 kg (10 lb).

Dimensions: 413 mm wide, 60 mm high, 244 mm deep (16 1/4" x 2 3/8" x 9 5/8").

Model number and name

Model number and name	Price
X8747A Waveguide Test Set	\$2010
P8747A Waveguide Test Set	\$2350
K8747A Waveguide Test Set	\$7000
R8747A Waveguide Test Set	\$8200
11587A Accessory Kit	\$1040
11650A Accessory Kit	\$840
11609A Cable Kit	\$100
11589A Bias Network	\$300
Option 001	add \$30
11590A Bias Network	\$350
Option 001	add \$30
11599A Quick Connect Adapter	\$140
11607A Small Signal Adapter	\$700



NETWORK ANALYZERS

Automatic measurements to 18 GHz

Model 8542B

- The standard for accuracy, speed, and ease of operation

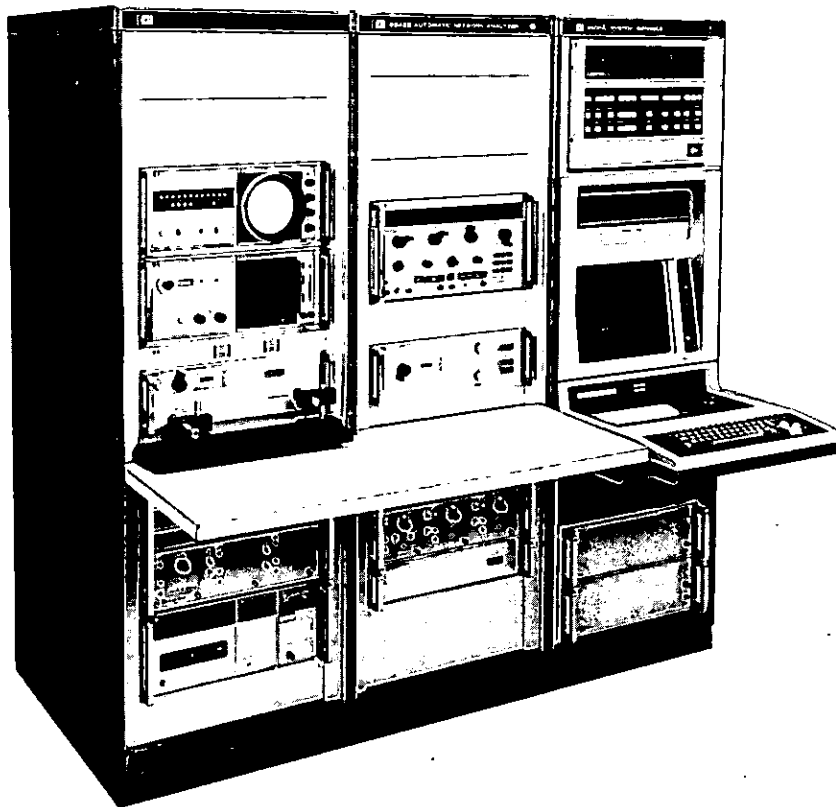

Description

An 8542B Automatic Network Analyzer couples the network analyzer's ability to measure the linear characteristics of a device with a computer's ability to completely set up a measurement, store data, and solve complex mathematics. As a result the system greatly improves the measurement accuracy and speed. It formats the data in the most useful manner by computing a variety of parameters and outputting in alphanumeric and graphic form on hardcopy and cathode-ray tube, or alphanumeric on cassette. Systems are currently in use in numerous facilities covering the full range of production, design, calibration, and metrology applications.

Speed and accuracy

The 8542B Automatic Network Analyzer's high accuracy is the result of applying known standards with calibration techniques to characterize, store, and correct for systematic errors. Mismatch, directivity, crosstalk, and frequency response errors are completely eliminated.

The 8542B consists of three major subsystems:

1. Synthesized Signal Source
2. Measurement
3. Processor/Operator Interface

The Signal Source subsystem provides a programmable signal to excite the device under test.

The Measurement subsystem includes an automatic two-channel magnitude and phase detector (network analyzer), a programmable synthesizer to act as receiver local oscillator, and programmable test units to select signal paths to determine the unknown device parameters.

The Processor/Display includes a stored program computer and its input/output peripherals.

Powerful applications software

The 8542B is supplied with a complete set of ready-to-run Microwave Applications Programs (MAP). The General Purpose Measurement programs GPM-1 and GPM-2 provide for display of any seven of 28 different parameters, including VSWR, insertion loss, phase deviation, and group delay. Program GPM-1 runs forward characterizations of one or two measurement paths. Program GPM-2 gives forward and reverse characterization of one measurement path with full error correction. The multi-measurement program, VAT-1, provides forward characterization of up to eight measurement paths with cross comparison of any two paths. Program XTR-2 is used for measuring transistors, including device biasing. Program CUP-1 provides highly accurate coupler directivity measurements. In addition to the MAP series programs, the 8542B is also supplied with a BASIC language interpreter containing high-level microwave measurement instructions. Interactive graphics (optional) allows rapid display of data in either graphical or tabular format. Graphs can be displayed in the most useful format: rectilinear, polar, or as a Smith chart.

Options

001: to 18 GHz

002: Interactive graphics

Model number and name

8542B Network Analyzer (0.1 to 12.4 GHz)*

Price	
add \$11,000	
add \$19,000	
from \$162,000	

*The Model 8543A provides frequency coverage from 100 kHz to 110 MHz with extremely high accuracy and the same advantages of speed and flexibility as the Model 8542B.

NETWORK ANALYZERS



Vector voltmeter

Model 8405A

• Accurate voltage and phase measurement

• 1 – 1000 MHz

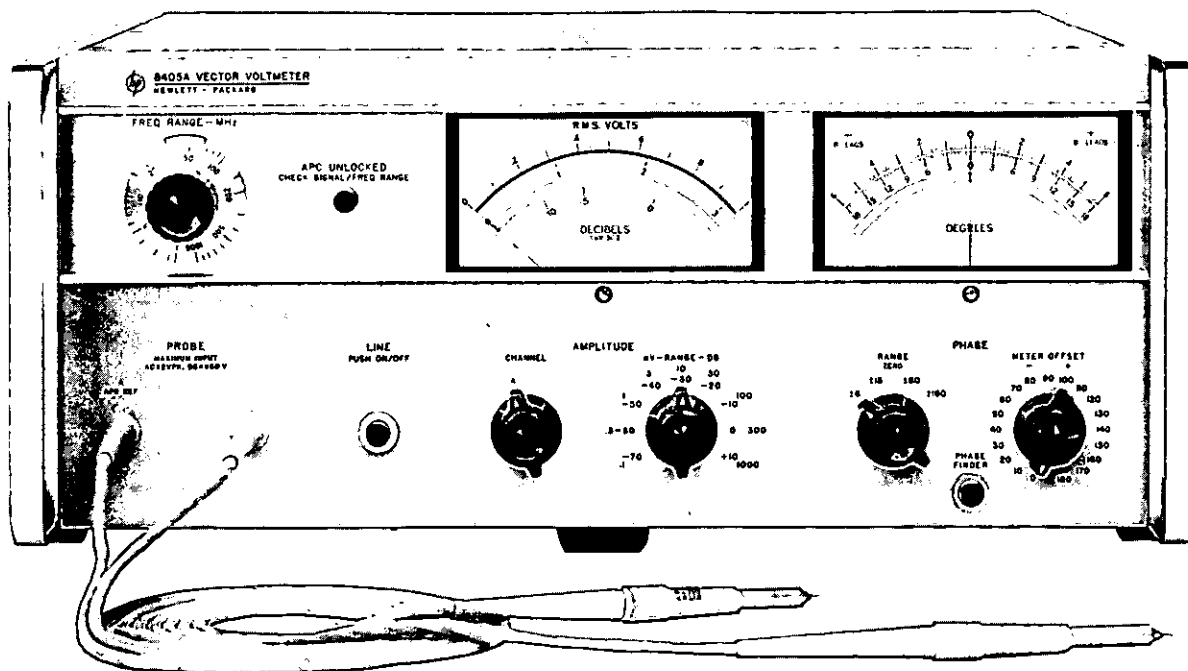

The 8405A Vector Voltmeter measures voltage vectors described by both magnitude and phase. This capability makes the 8405A a unique instrument for about any design and test application in the frequency range 1 to 1000 MHz.

In addition to absolute voltage measurements, capabilities include insertion loss and group delay of passband-filters and other transmission devices, gain and phase margin of amplifiers, complex impedance of mixers, antennas, matching the electrical lengths of cables, s-parameters of transistors, amplitude modulation index, RF distortion measurements and in-circuit probing.

The 8405A achieves this measurement versatility through its two-channel capability enabling voltage magnitude measurements in either channel, thus allowing ratio measurements, and phase difference measurements between the two channels. Gain or loss in excess of 90 dB and phase measurements with 0.1° resolution over a 360° phase range are possible.

Accuracy is achieved through the 1 kHz bandwidth entailing response only to the fundamental frequency of the input signal. Also, phase-locked coherent sampling to translate 1 to 1000 MHz RF signals to 20 kHz IF signals enables accurate detection of voltage magnitude and phase. Automatic phase-locked tuning makes it possible to select the one of 21 overlapping octave ranges which contains the input signal frequency by simply rotating a switch.

Specifications

Frequency range: 1 MHz to 1 GHz in 21 overlapping octave bands; tuning automatic within each band.

Isolation between channels: 1 to 300 MHz, >100 dB; 300 to 1,000 MHz >80 dB.

Maximum input: ac, 2 V peak; dc, ±50V.

Input impedance (nominal): 0.1 MΩ shunted by 2.5 pF; 1 MΩ shunted by 2 pF when 11576A 10:1 Divider is used; 0.1 MΩ shunted by 5 pF when 10216A Isolator is used. AC coupled.

Voltage range (rms):

Channel	1 – 10 MHz	10 – 500 MHz	500 – 1000 MHz
A	1.5 mV – 1.0 V	300 μV – 1.0 V	500 μV – 1.0 V
B	<20 μV – 1.0 V	<20 μV – 1.0 V	<20 μV – 1.0 V

Voltmeter ranges: 100 μV to 1 V rms full scale in 10 dB steps.

Voltage ratio accuracy: 1-200 MHz, 0.2 dB for -60 to 0 dB ranges; 200-1000 MHz, 0.2 dB for -60 to -10 dB ranges.

Phase range: 360° indicated on zero-center meter with end-scale ranges of ±180°, ±60°, ±18°, and ±6°.

Phase resolution: 0.1° at any phase angle.

Phase meter offset: ±180° in 10° steps.

Phase accuracy: ±1.5° (equal voltage Channel A and B).

Accessories furnished: two 11576A 10:1 Dividers, two 10216A Isolators, two 10218A BNC Adapters, six ground clips for 11576A or 10216A; six replacement probe tips.

Bandwidth: 1 kHz

Power: 115 or 230 V ±10%, 50 to 400 Hz, 35W.

Weight: 13.9 kg (net, 31 lb); 16.3 kg (shipping, 36 lb).

Dimensions: 425 mm wide, 177 mm high, 467 mm deep (16 1/4" × 7" × 18 3/4")

11570A Accessory kit

50Ω TEE: 11536A: For monitoring signals on 50Ω transmission lines without terminating line. Kit contains two with type N RF fittings.

Power splitter: 11549A: All connectors Type N female.

50Ω termination: 908A: for terminating 50Ω coaxial systems in their characteristic impedance.

Shorting plug: 11512A: Shorting Plug, Type N male.

Model number and name

8405A Vector Voltmeter

Option 002, linear dB scale

11570A Accessory Kit (measurement in 50Ω system only)

Price

\$3195

add \$25

\$350

SIGNAL ANALYZERS

Wave, distortion, spectrum and Fourier analyzers

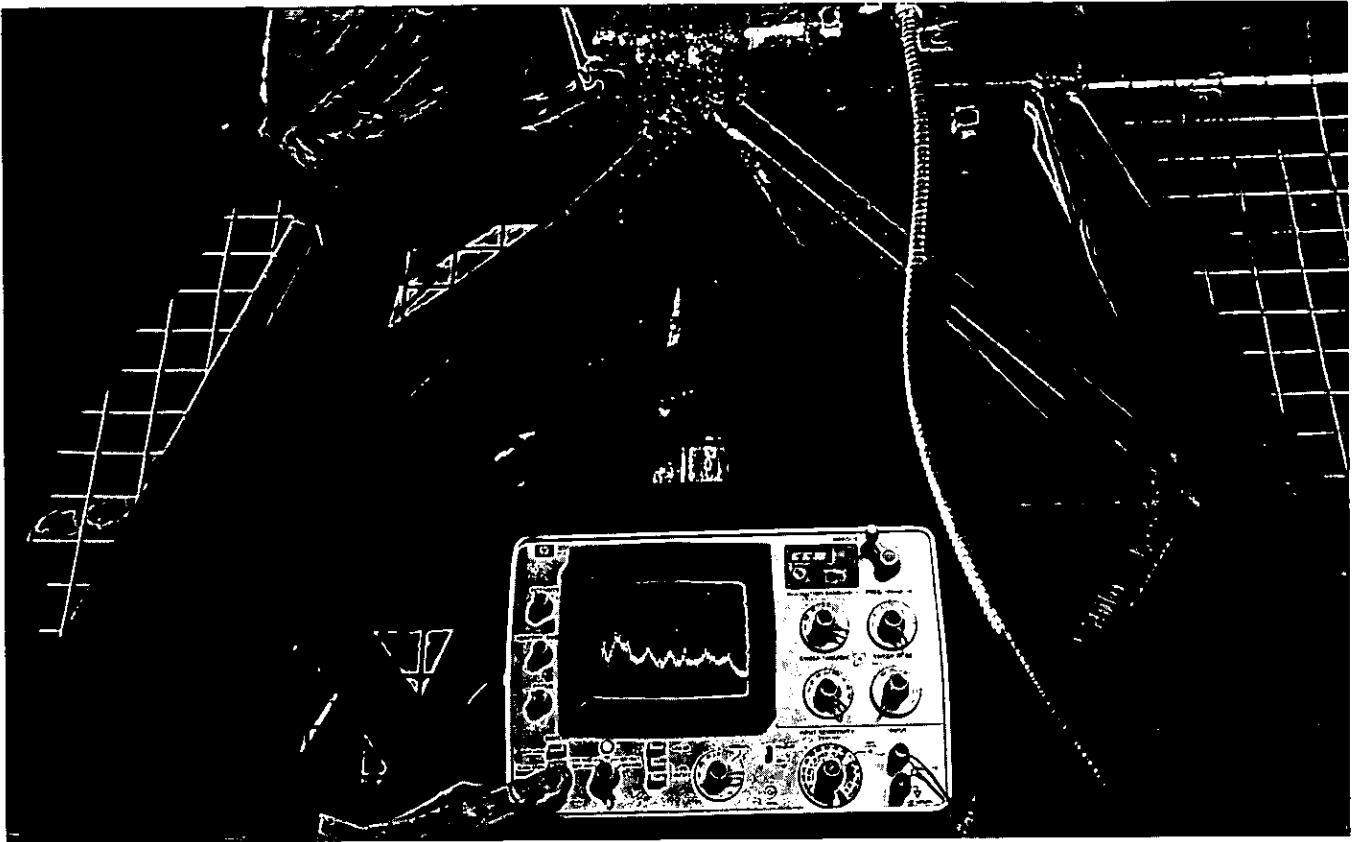

Almost every electronic circuit element has critical specifications in the frequency domain. The frequency response of filters, mixers, modulators, amplifiers, oscillators, and detectors must be quantified for satisfactory overall circuit performance. This section discusses the definition and use of three types of instruments for frequency response signal analysis: spectrum analyzers, wave analyzers, and distortion analyzers.

Each of these instruments quantifies the magnitude of CW signals through a specific bandwidth, just the same as a tuned voltmeter. But each measurement technique is different. The spectrum analyzer is a swept receiver that provides a visual display of amplitude versus frequency. It shows on a single display how energy is distributed as a function of frequency, displaying the absolute value of Fourier components of a given waveform. The Fourier analyzer uses sampling and transformation technique to form a Fourier spectrum display that has phase as well as amplitude information. The wave analyzer is the truly tuned voltmeter, showing on a meter the real time amplitude of the energy in a specific frequency window and tunable over a specific frequency range. The distortion analyzer performs an almost reciprocal function to that of the wave analyzer. It collectively measures the energy outside a specific bandwidth, tuning out the fundamental signal and displaying the energy of the harmonics and other distortion products on a

meter.

Figure 1 shows a graphical representation of the way the three analyzers view a simple CW signal and one harmonic. In 1.a. $A(t)$ is the complex voltage waveform as it would be viewed on an oscilloscope. The

dashed lines represent the vector components of the signal: $A_1(t)$, the fundamental and $A_2(t)$ the second harmonic. In 1.b. the spectrum analyzer displays the frequency spectrum showing both vector components and their amplitude relationship. Spectrum analysis is useful from 5 Hz to over 40 GHz.

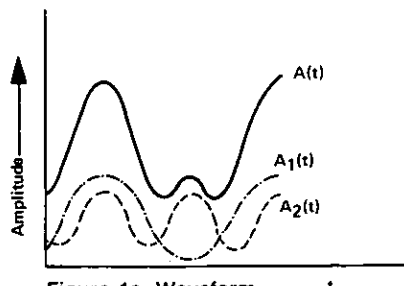

Figure 1a. Waveform

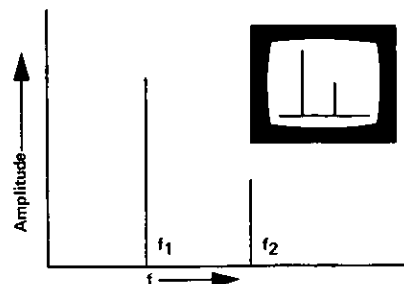

Figure 1b. Spectrum and Fourier analyzers

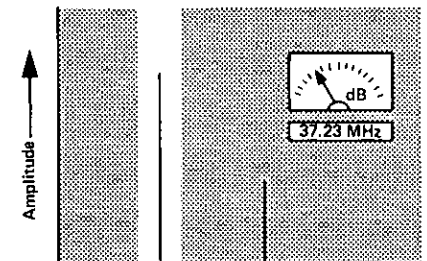

Figure 1c. Wave analyzer

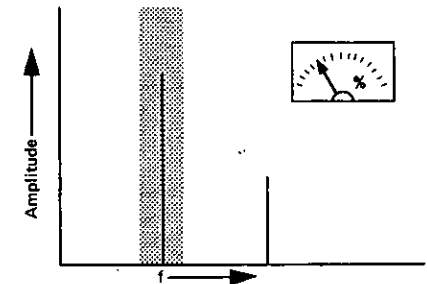

Figure 1d. Distortion analyzer

Fourier analysis is a real time spectrum analysis of the Fourier components of the waveform in a similar manner, using high precision digital techniques. Hewlett-Packard Fourier analysis techniques are used up to 200 kHz where real time measurements need to be made. For more information on Fourier analysis, see page 469. The wave analyzer in Figure 1.c. measures the amplitude and frequency of the signal in the frequency window to which it is tuned. This window can be moved to measure the amplitude of the second harmonic, thereby making a precise comparison with the fundamental. This technique is practical from 10 Hz to above 18 MHz.

The distortion analyzer as pictured in Figure 1.d. rejects the fundamental to which it has been tuned and measures the energy everywhere else within the instrument's frequency spectrum. Distortion, as a percentage or in dB down from the fundamental is displayed directly on a meter. Hewlett-Packard distortion analyzers cover 5 Hz to 600 kHz.

The following section probes each instrument technique, showing the particular strength and flexibility of each.

Spectrum analyzer

To display useful information about a frequency scan, a spectrum analyzer must be sensitive, frequency stable, wideband free of spurious responses, and have calibrated accuracy in the CRT display. The examples which follow best demonstrate the wide variety of information which can be measured on the spectrum analyzer.

Measurements with the spectrum analyzer

CW signal: The most basic spectrum analysis measurement is the single CW signal.

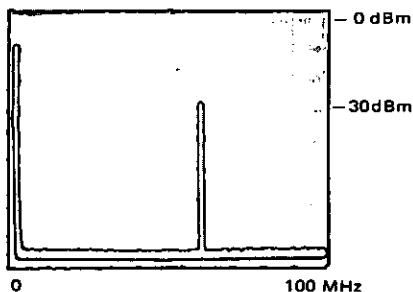

Pictured is a -30 dBm signal at 60 MHz. The zero frequency indicator is at the far left graticule.

Spectral purity of a CW signal: One very important oscillator signal measurement is spectral purity. This 70 MHz carrier has power line related sidebands (± 60 Hz) which are 65 dB down.

Such sidebands may result from power supply ripple. The 50 Hz/division spectrum analyzer scan and the 10 Hz analyzer bandwidth provide the high degree of resolution required to see these sidebands.

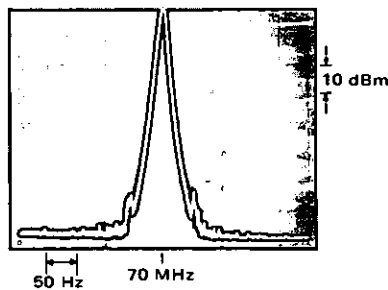

Frequency conversion products: The spectrum analyzer is well suited for frequency conversion measurements such as the

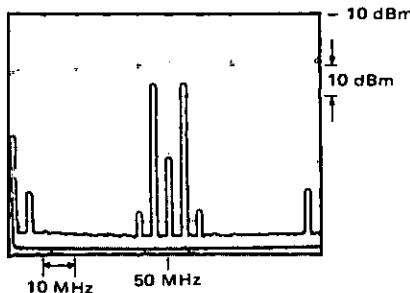

output of a balanced mixer as shown. With the 50 MHz local oscillator input at 0 dBm and a 5 MHz, -30 dBm mixer signal, two sidebands at 45 MHz and 55 MHz result. The sidebands are -36 dBm, giving the mixer a 6 dB conversion loss. Other information easily extracted from this spectrum analyzer display is the 60 dB local oscillator isolation and the 5 MHz signal has 41 dB isolation. Second order distortion products at 40 and 60 MHz are 40 dB below the desired mixer outputs. **Amplitude modulation:** Percent amplitude modulation is often more easily measured

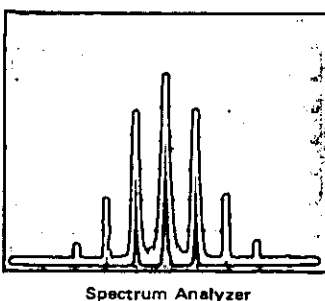
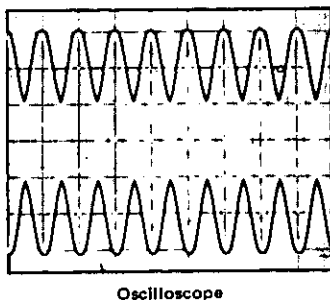

with the spectrum analyzer than it is with the oscilloscope.

With the oscilloscope time display, percent modulation, M, is measured as a ratio of the signal's dimensions: $M = 100 \cdot (6 - 2)/(6 + 2) = 50\%$. In the spectrum analyzer display, whose vertical calibration is 10 dB/division, the carrier and sidebands differ by 12 dB, the voltages in the sidebands are $1/4$ that of the carrier and again, $M = 50\%$. At the same time the second and third harmonic distortion of the sidebands can be measured at 28 and 44 dB respectively.

Frequency modulation: Information transmitted by FM can be thoroughly characterized by the spectrum analyzer.

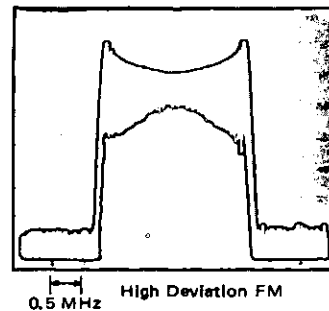
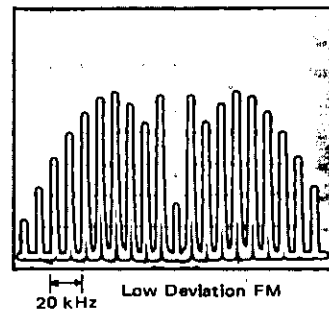

Low deviation FM is applied to a 60 MHz carrier in the first photo. The deviation has been adjusted for the second carrier null ($M_r = 5.52$). The sidebands spacing is 10 kHz, the modulation frequency; therefore, $\Delta f_{peak} = 5.52 \times 10 \text{ kHz} = 552 \text{ kHz}$.

The second photo is an example of high deviation FM. The transmission bandwidth is 2.5 MHz.

Pulsed CW power: By viewing the spectra of a repetitive RF pulse on the spectrum analyzer, pulse width average and peak power, occupied bandwidth, and duty cycle can be determined.

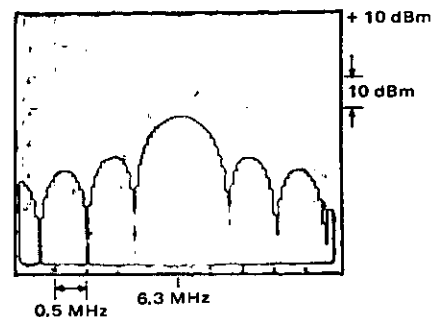

SIGNAL ANALYZERS

Wave, distortion, spectrum and Fourier analyzers (cont.)

From the spectral output shown the pulse's complete characteristics are determined: 6.3 GHz RF at 0 dBm, pulsed at 50 kHz rate. The pulse width is 1.3 μ sec.

Noise: Spectrum analysis is effective in measuring impulse noise, random noise, carrier to noise ratio, and amplifier noise figure.

Frequency response: Using a tracking signal source and a spectrum analyzer the frequency response of filters can be displayed with ease.

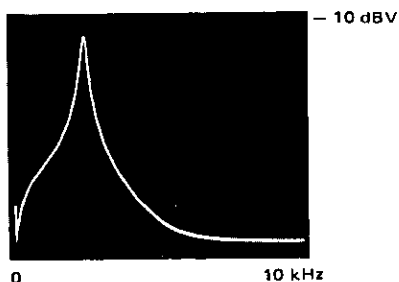

In this case, an audio filter used in a communications system is being measured. Since the input reference level to the filter is -13 dBV, the insertion loss at 2.4 kHz is 4 dB. Extremely high Q devices can be measured with this system.

Spectrum analyzer capabilities

To be useful in making measurements in the frequency domain, the analyzer must be capable of making quantitative measurements. Specifically, an analyzer must:

- 1) make absolute *frequency* measurements
- 2) make absolute *amplitude* measurements
- 3) operate over a *large amplitude dynamic range*
- 4) have *high resolution* of frequency and amplitude
- 5) have *high sensitivity*
- 6) provide means of *observing, preserving, and recording* its output in a convenient and rapid manner by using variable persistence, digital storage and adaptive sweep.

Hewlett-Packard spectrum analyzers excel in these six measures of performance.

Let us consider each of these performance standards in greater detail.

Absolute frequency measurements:

There are two ways to measure absolute frequency with a Hewlett-Packard spectrum analyzer. The absolute frequency can be read off the slide-rule type of frequency dial. Accuracy in this case is approximately 1% of full scale. When the spectrum analyzer is used in conjunction with a tracking generator (a source whose frequency is the same as the analyzer tuning frequency) accuracy much better than 1% can be achieved by counting the generator output.

Absolute amplitude measurements: All Hewlett-Packard spectrum analyzers are absolutely calibrated for amplitude measurements. This means the spectrum analyzer indicates to the user what the log/reference level or linear sensitivity is regardless of control settings. An uncalibrated warning light makes operation of the analyzer easy and foolproof.

Dynamic range: The dynamic range of a spectrum analyzer is defined as the difference between the input signal level and the average noise level or distortion products whichever is greater. Hence, dynamic range can be either distortion limited, noise limited or display limited.

Frequency and amplitude resolution: Frequency resolution is the ability of the analyzer to separate signals closely spaced in frequency. The frequency resolution of an analyzer is a function of three factors: 1) minimum IF bandwidth, 2) IF filter shape factor, 3) spectrum analyzer stability.

The minimum IF bandwidth ranges down to 1 Hz on Hewlett-Packard spectrum analyzers.

One way to define IF filter shape factor is the ratio of 60 dB bandwidth to 3 dB bandwidth. Filter shape factor specifies the selectivity of the IF filter. Hewlett-Packard spectrum analyzers have IF filter shape factors as low as 11:1.

Analyzer frequency stability also limits resolution. The residual FM (short term stability) should be less than the narrowest IF bandwidth. If not, the signal would drift in and out of the IF pass band. Hewlett-Packard analyzers have excellent stability. The residual FM ranges from <1 Hz at low frequency, to <100 Hz at microwave frequencies, enabling the measurement of noise sidebands. The stabilization circuitry is completely automatic and foolproof. No signal recentering, phase-lock loop, manual search, or checking is required.

Amplitude resolution is a function of the vertical scale calibration. Hewlett-Packard analyzers offer both log calibration for observing large amplitude variations (10, 2 and 1 dB/div) and linear calibration for observing small amplitude variations.

Sensitivity: Sensitivity is a measure of an analyzer's ability to detect small signals, and is often defined as the point where the signal level is equal to the noise level or $(S + N)/N = 2$. Since noise level decreases as the bandwidth is decreased, sensitivity is a function of bandwidth. The maximum attainable sensitivity ranges from -140 dBm to -125 dBm with Hewlett-Packard analyzers.

Variable persistence, digital storage, and adaptive sweep: High resolution and sensitivity both require narrow bandwidths and consequently slow sweep rates. Because of

these slow sweeps, variable persistence is virtually indispensable in providing a bright, steady, flicker-free trace. (In effect, variable persistence allows one to vary the length of time a trace remains on the CRT.)

Hewlett-Packard low frequency analyzers have two features which make measurement and CRT photography simple. Digital storage gives the CRT display a dot matrix connected by line generators for an unbroken and uniform intensity scan. Adaptive sweep is the second feature. On the very slow sweep times required when using the 1 Hz bandwidth adaptive sweep allows the scan to sweep rapidly when no signals occur. At signals above a preset level the sweep is slowed for an accurate measurement. The measurement time savings can be greater than 20:1.

Tracking preselector

The only way to simultaneously avoid spurious, multiple, harmonic and image responses, is to filter the RF signal through a tracking preselector. This is an electronically tuned bandpass filter that automatically tracks the analyzer's tuning. A preselector improves the spurious-free range of the analyzer from less than 70 dB to 100 dB.

Tracking generator

A tracking generator expands the measurement capability of the spectrum analyzer by providing a signal source which tracks the tuning frequency of the analyzer. The source/receiver combination can be used to measure insertion loss, frequency response, return loss and precision frequency count.

It helps make these additional measurements with increased distortion-free dynamic range, sensitivity and selectivity. The tracking generator is also an excellent stable sweeping signal generator. The residual FM ranges from ± 1 Hz for low frequency tracking generators to ± 400 Hz for microwave tracking generators.

Automatic spectrum analyzers

The measurement capability of a spectrum analyzer can be greatly enhanced by allowing a small computer to control instrument functions and record frequency and amplitude information. Data can be gathered and processed into a variety of formats at a very rapid rate. Through comprehensive self-calibration, automatic spectrum analysis offers amplitude accuracy of up to ± 0.2 dB with 0.02 dB resolution. User cost savings are realized through faster, more comprehensive measurements, lower operator skill requirements, and unattended operation capability.

Further discussion of applications can be found on page 468, the description of the Hewlett-Packard 8580B Automatic Spectrum Analyzers.

Wave analyzer

Wave analyzers are known by several dif-

ferent names: frequency selective voltmeter, carrier frequency voltmeter, and tuned oscillator and selective level meter. These names describe the instrument's function rather well.

As mentioned in the introduction to this section a wave analyzer can be thought of as a finite bandwidth window filter which can be tuned throughout a particular frequency range.

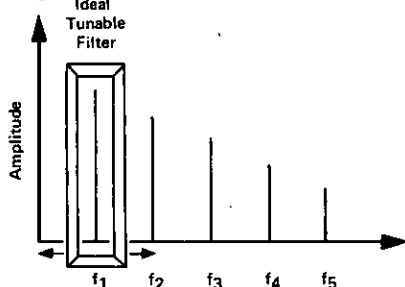

Figure 2. Wave analyzer tunable filter

Signals will be selectively measured as they are framed by the frequency window. Thus, for a particular signal, the wave analyzer can indicate its frequency (window position) and amplitude. Amplitude is read on an analog meter; frequency is read on either a mechanical or electronic readout. It has the advantage of accuracy, resolution, ease of operation and low cost.

The uses of wave analyzers can be categorized into three broad areas: 1) amplitude measurement of a single component of a complex frequency spectrum, 2) amplitude measurement in the presence of noise and interfering signals and, 3) measurement of signal energy appearing in a specified, well defined bandwidth.

Wave analyzer considerations

Frequency characteristics:

Range: should be selected with the future in mind as well as present requirements.

Accuracy and resolution: should be consistent with available bandwidths. Narrow bandwidths require frequency dial accuracy to place the narrow window in the proper position for measurement. Accuracy of instruments with selectable bandwidths is determined by the basic center frequency accuracy of the IF bandwidth filters in addition to the local oscillator frequency accuracy. Accuracy is usually specified as a fixed frequency error at any point on the dial, thus meaning poorer percentage accuracy at the low frequency settings.

Readout: usually a frequency dial but newer instruments use a frequency counter whose accuracy and ease of use outweigh the increased cost.

Stability: frequency stability is important when using narrow bandwidths and for long

term signal monitoring. Stability is best achieved with automatic frequency control (AFC). AFC locks the local oscillator to the incoming signal and eliminates any relative drift between the two. It serves as a tuning aid to pull the signal to within the passband eliminating peaking the frequency control. The AFC always tunes within the passband improving accuracy on repetitive measurements.

Sweep: some instruments are equipped with sweep to allow use as a spectrum analyzer. Readout is a CRT or X-Y recorder.

Amplitude characteristics:

Range: the amplitude range is determined by the input attenuator and the internal noise of the instrument. Sensitivity is defined as the lowest measurable signal equal to the noise level for a unity signal-to-noise ratio (often called tangential sensitivity). Sensitivity will vary with bandwidth and input impedance.

Dynamic range: defined as the dB ratio of the largest and smallest signals that can be simultaneously accommodated without causing an error in the measurement.

Attenuators: the amplitude range switch is an attenuator in the input and IF stages. Intermodulation distortion is lowest when the input amplifier has the minimum signal applied and the IF gain is greatest. Conversely the internal noise, important when making sensitive measurements, is lowest with maximum input signal and lowest IF gain. The two attenuator instruments allow this transfer of gain between input and IF to be accomplished easily.

Accuracy: amplitude accuracy is a function of frequency, input attenuator response, IF attenuator performance, calibration oscillator stability and accuracy, and meter tracking. Often specifications are broken up to separately describe each contributor.

Readout: amplitude readout is usually a meter calibrated in dB and/or volts. Linear voltage meters are used to allow the user to see down into the noise at the bottom of the scale. Digital readouts are not used because of their slow response and lack of directional and positional information. This is important since the readout is used as a tuning indicator to show presence of a signal in the passband and when it has reached a peak. Expanded scale meters allowing expansion of any 1 or 2 dB portion of the scale into a full scale presentation allow resolution of input level changes of a few hundredths of a dB. This is useful when the wave analyzer is used as a sensitive indicator in bridge or comparison measurements. The expanded scale meter is included in some instruments and is an optional accessory on others.

Input characteristics:

Impedance: may be high impedance bridging input or terminating impedance to match

standard transmission lines. High frequency measurements require matched systems to avoid error-producing standing waves on interconnecting cables. The measure of impedance accuracy is usually return loss or reflection coefficient ($RL = 20 \log \rho$). In lower frequency instruments, percent accuracy is used. High input impedance instruments are usually poorer in frequency and noise performance and are usually low frequency instruments. High impedance at high frequencies is accomplished by using a bridging probe to place the impedance at the point of measurement. The probe may be active with unity gain or passive with 20-30 dB insertion loss. **Input arrangement:** input may be balanced to ground or unbalanced. Communications system usage typically requires balanced input. Standard 600 and 135/150Ω balanced inputs are limited in frequency to less than 1 MHz and 124Ω balanced to less than 10 MHz in most instruments. The impedance may be balanced to ground with the center point grounded or may be completely isolated from ground. Unbalanced inputs do not have frequency range limitations.

Typical application

Frequency response testing: With its BFO output, the wave analyzer is particularly useful for measuring filter and amplifier frequency responses. An alternative approach is to drive the device with a flat oscillator and measure its output with an accurate broadband voltmeter. However, this technique can lead to some very misleading results. If a notch filter is being measured, the rejection can only be as great as the largest distortion component of the driving signal. Reasoning shows that when the driving signal's fundamental is tuned to the notch center frequency, it will be filtered out, allowing all of its harmonics to be passed and measured.

A similar problem exists when trying to measure the response of a high-pass filter. The fundamental is again rejected while the harmonic distortion components are being passed and measured.

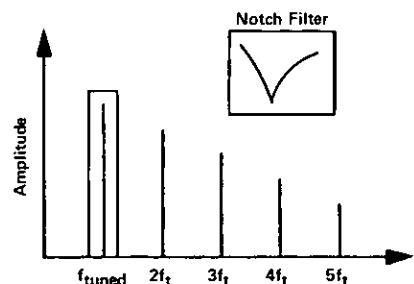

Figure 3. Only signal detected by wave analyzer. For example, the notch of a filter can be accurately measured to its full depth.



NETWORK ANALYZERS

Wave, distortion, spectrum and Fourier analyzers (cont.)

To be sure that the measurement will be accurate, Hewlett-Packard wave analyzers track and detect only the BFO fundamental components. The notch of the filter will then be accurately measured to its full depth...

Distortion analyzers

The goal of audio and communications equipment is to reproduce input signals faithfully at the output. System nonlinearity distorts the waveshape of the signals. Poor reproduction brought about by distortion will appear to the user of audio equipment as a change in the quality or as noise; to the user of communications gear, it appears as channel crosstalk.

Distortion in amplifiers, created by nonlinear circuits, consists of frequency components present in the output that are not contained in the input signal. An ac signal that appears to be a pure sine wave as viewed on an oscilloscope may have some harmonic distortion. The total of these frequency components present in the signal, in addition to the fundamental frequency, can be measured quickly and easily with Hewlett-Packard distortion analyzers.

One type of distortion analyzer contains a narrow band rejection filter which, when properly tuned, removes the fundamental frequency so that the amplitude of the remaining components can be measured simultaneously. Hewlett-Packard distortion analyzers are used for fast quantitative measurements of total harmonic distortion and noise.

Total harmonic distortion analysis

This measurement technique compares the amplitude of the harmonics to that of the fundamental. The defining equation is:

$$(1) \text{ total harmonic distortion} = \frac{(\text{harmonics})^2}{\text{fundamental}}$$

A frequency-selective voltmeter is needed to measure the fundamental, and either a selective voltmeter with a wide dynamic range or a frequency rejection circuit with a true rms detector is needed to measure the harmonics. The frequency rejection circuit nulls the fundamental and passes its harmonics to the detector with no attenuation so that the ratio between the fundamental and harmonics can be determined.

A less expensive way to measure the total harmonic distortion, however, is to use a rejection filter and a broadband detector. Since the fundamental is not directly measured, the equation becomes:

$$(2) \text{ THD} = \frac{\text{harmonics}^2}{(\text{fundamental})^2 + (\text{harmonics})^2}$$

If the distortion is less than 10%, the denominator of equation 2 will be within 1/2% of the denominator in equation 1, which is as accurate as any frequency selective voltmeter.

There are two difficulties in making total harmonic distortion measurements. First, to get a measurement within the desired accuracy, the harmonic content of the test signal

must not be more than a third of the distortion expected to be caused by the system. Second, the chore of nulling the fundamental can be time-consuming. Oscillators that meet the distortion requirements and nulling equipment, which has recently become available, can overcome the difficulties.

Automatic null

Since the nulling of the fundamental is normally the time-consuming portion of total harmonic distortion measurement, great savings can be realized, especially in production line testing with an analyzer which automatically rejects the fundamental. The time saved is as much as 25 seconds of a 30-second measurement. With automatic nulling, the accuracy of the null achieved is no longer a function of operator training, manual dexterity, or signal source frequency drift.

The analyzer will maintain a null even though there is a slow drift in the input frequency. This ability to "pull" the null has opened the door to a number of applications where the total harmonic distortion measurements were not readily applied in the past. Among them are:

1. Single-frequency production line testing of such components as integrated-circuit amplifiers or transformers.
2. Optimizing the performance of an oscillator.
3. Correcting distortion in signal generators which produce sine waves by mixing or by nonlinear shaping.

Signal analyzers selection guide

Spectrum analyzers

Frequency Range	Amplitude Calibration Range	Bandwidths		Model Description	Companion Instruments	Page
		Min	Max			
5 Hz - 50 kHz	-150 to +30 dBm	1 Hz	300 Hz	3580A Spectrum Analyzer		452
20 Hz - 300 kHz	-130 to +10 dBm	10 Hz	10 kHz	8556B Tuning Section Plug-In (See Note 1)		458
1 kHz - 110 MHz	-130 to +10 dBm	10 Hz	300 kHz	8553B Tuning Section Plug-In (See Note 1)		460
100 kHz - 1250 MHz	-122 to +10 dBm	100 Hz	300 kHz	8554B Tuning Section Plug-In (See Note 1)	8443A Tracking generator (100 kHz - 110 MHz)/Counter	460
100 kHz - 1500 MHz	-115 to +30 dBm	1 kHz	3 MHz	8558B Spectrum Analyzer Plug-In (See Note 2)	8444A Tracking Generator (500 kHz - 1250 MHz)	462
10 MHz - 40 GHz	-130 to +10 dBm	100 Hz	300 kHz	8555A Tuning Section Plug-In (See Note 1)	8444A Opt 058 (500 kHz - 1300 MHz)	454
					8444A Tracking Generator (10 MHz - 1300 MHz)	454
					8445B Automatic Preselector (10 MHz - 18 GHz)	464
					8444A Tracking Generator (10 MHz - 1300 MHz)	465
					8445B Automatic Preselector (10 MHz - 18 GHz)	464

NOTE 1: For use in oscilloscope mainframes 140T and 141T (pages 456-457) with IF section plug-ins 8552A or 8552B (pages 456-457).

Note 2: For use in oscilloscope mainframes 180TR, 1817/TR, 182T (see pages 454-455).



Distortion analyzers

Frequency Range	Auto Nulling	Hi-Pass Filter	Lo-Pass Filter	AM Detector	Gear Reduction Tuning	Model No.	Page
5 Hz to 300 kHz					X	331A	450
				X	X	332A	450
			X	X	X	332A Opt. H05	450
	X	X				333A	450
	X	X		X		334A	450
	X		X	X		334A Opt. H05	450

Wave analyzers

Frequency Range	Selective Bandpasses	Dynamic Range Absolute	Relative	Freq. Readouts	Type of Inputs	Type of Outputs	Modes of Operation	Model Number	Page
15 Hz to 50 kHz	3 Hz 10 Hz 30 Hz 100 Hz 300 Hz	0.1 μ V — 300 V full scale	>85 dB	5-place digital	Banana Jacks	rec: 5 V full scale, with pen lift BFO, Local oscillator, tuning loudspeaker, and headphone jack	AFC, normal, BFO	3581A/ 3581C	446, 498
20 Hz to 620 kHz	10 Hz 100 Hz 1000 Hz 3100 Hz	3 μ V — 30 V full scale	>85 dB	5-place digital	BNC unbalanced or input bridged/ terminated bal. or unbal. and modified input circuitry.	rec: X and Y axes log and linear BFO: to 1 V rms L.O.: (1.28 MHz-1.9 MHz) 0.65 V rms	AFC, restored, BFO, USB, LSB, AM sweep	3590A/ 3594A or 3591A/ 3594A	507 507
1 kHz to 1.5 MHz	200 Hz 1000 Hz 3000 Hz	10 μ V — 100 V full scale	>75 dB	Dial	Banana Jacks	rec: 1 mA dc into 1500 Ω full scale BFO: 0.5 V into 135 Ω meter at full scale output impedance 135 Ω	AFC, normal BFO, USB, LSB AM	310A	447
1 kHz to 18 MHz 18 ranges or 1 kHz to 22 MHz 18 ranges	200 Hz 1000 Hz 3100 Hz	3 μ V — 3 V full scale or —97 to +23 dBm —107 to +13 dBm (600 Ω only)	>72 dB	7-place decade counter	BNC & probe 11530A bridged/ terminated balanced or unbalanced or WE-477B input unbalanced or BNC input 50 Ω unbalanced	rec: 1 V dc full scale 1 k Ω source aux: 1 MHz (1 V p-p) 30 MHz (40-70 mV) rms L.O.: (30-48 MHz) 60 to 90 mV rms audio: >0.5 V into 10 k Ω 313A: Track or tuned 75 Ω unbalanced, —99.9 to +10 dBm	AFC, AM, beat LSB, USB	312A/ 313* or 312A/ 313A/ Opt H01 or 312A/ 313A Opt H05	448, 449 448, 449

*313 Option 001, 50 Ω unbalanced output.

SIGNAL ANALYZERS

15 Hz to 50 kHz wave analyzer

Model 3581A

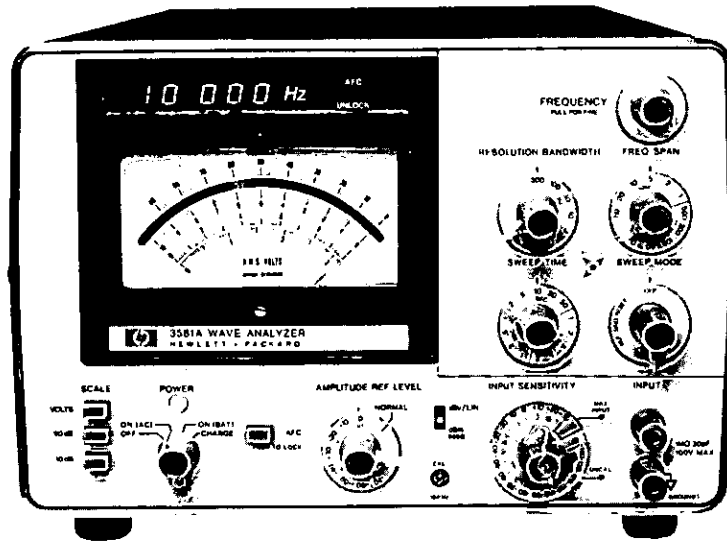
NEW

Description

Hewlett-Packard's 3581A Wave Analyzer separates and measures the amplitude and frequency of spectral components. This inexpensive instrument offers accurate amplitude and frequency resolution in a portable, easy to use measuring tool. Since not all signals originate from a stable frequency source, the 3581A incorporates an AFC circuit which locks to a drifting signal for stable, accurate measurements.

HP's 3581A has other important features that are necessary when making measurements of small voltages from transducers and harmonics signals. Its 30 nV sensitivity becomes important for these measurements. Battery operation or balanced input option can be used to reduce the line related interference common in low level measurements so only the real spectrum is measured.

Digital readout of tuned frequency is located above the analog meter. It has been grouped with the meter for ease of reading. Resolution of the digital readout is 1 Hz for any frequency between 15 Hz and 50 kHz. Readout is updated five times per second so delay between tuning and reading is minimized.

Four meter scales are used to provide a wide range of displays. Two scales are used for linear voltage readings. Two log scales provide either a 90 dB or 10 dB display. In any case, the large meter with its mirror backing can present readings in dB V or dBm or volts. A meter was specifically chosen for amplitude display rather than digital readout because it is easier to peak a meter reading and because it's much easier to get a feel for noise or other amplitude variations by watching the meter. The same voltage used to drive the meter is also available on the rear panel for driving X-Y recorders.

Specifications*

Frequency characteristics

Range: 15 Hz to 50 kHz.

Display: 5 digit LED readout.

Resolution: 1 Hz.

Accuracy: ± 3 Hz.

Typical stability: ± 10 Hz/hr after 1 hour and ± 5 Hz/ $^{\circ}$ C.

Automatic frequency control (AFC) hold-in range: ± 800 Hz.

Amplitude characteristics

Instrument range:

Linear: 30 V to 100 nV full scale.

Log: +30 dBm or dBV to -150 dBm or dBV.

Amplitude accuracy:

Frequency response, 15 Hz - 50 kHz

Log ± 0.4 dB

Linear $\pm 4\%$

Dynamic range: >80 dB.

Noise sidebands: greater than 70 dB below CW signal, 10 bandwidths away from signal.

Spurious responses: >80 dB below input reference level.

Sweep characteristics

Scan width: 50 Hz to 50 kHz. These scans can be adjusted to cover a group of frequencies within the overall instrument range.

Sweep error light: this LED indicates a sweep that is too fast to capture full response. When the light is on, response will be lower than it should be.

External trigger: a short to ground stops the normal sweep. Opening the short then enables a sweep.

Input characteristics

Impedance: 1 M Ω , 30 pF.

Maximum input level: 100 V rms, ± 100 V dc.

Output characteristics

Tracking generator output (also known as BFO or tracking oscillator output).

Restored output:

Range: 0 to 2 V rms.

Frequency response: $\pm 3\%$ 15 Hz to 50 kHz.

X-Y recorder analog outputs:

Vertical: 0 to +5 V $\pm 2.5\%$.

Horizontal: 0 to +5 V $\pm 2.5\%$.

Impedance: 1 k Ω .

Pen lift: contact closure to ground during sweep.

General

Power requirements: 100 V, 120 V, 220 V or 240 V +5% -10%, 48 Hz to 440 Hz, 10 VA typical.

Dimensions: 412.8 mm high \times 203.2 mm wide \times 285.8 mm deep (16 $\frac{1}{4}$ " \times 8" \times 11 $\frac{1}{4}$ ").

Weight: 11.5 kg (23 lb). Option 001: 13.5 kg (30 lb).

Option 001, battery: 12 hours from full charge. Internal battery is protected from deep discharge by an automatic turnoff. Useful life of this battery is over 100 cycles.

Model number and name

Option 001: battery

3581A Wave Analyzer

Price

add \$325

\$2600

*Note: for complete specifications, refer to page 498 (HP 3581C selective voltmeter) which is a dedicated telecommunications version of the HP3581A wave analyzer.

SIGNAL ANALYZERS



Wave analyzer

Model 310A

- Measure harmonics, intermodulation products

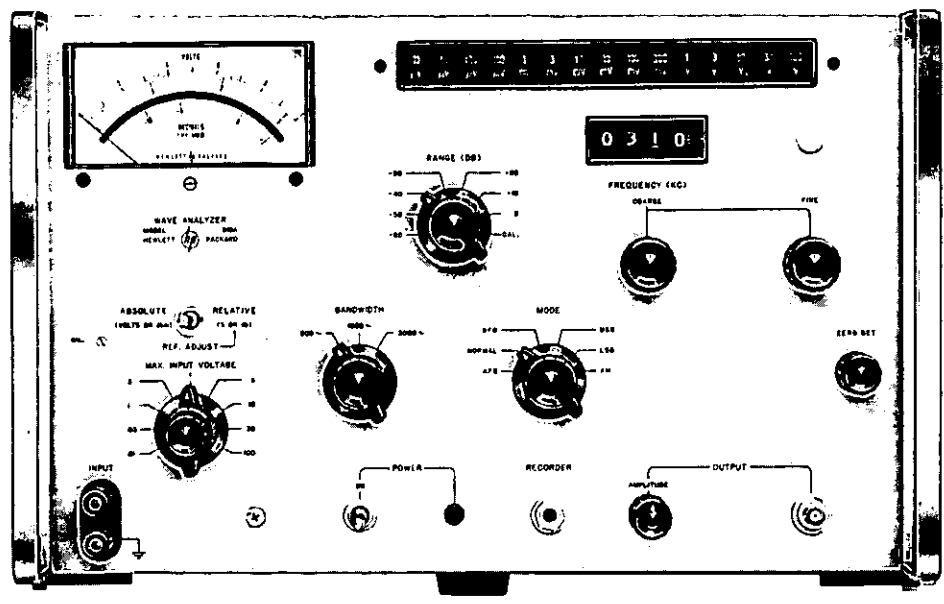

Description

Model 310A High Frequency Wave Analyzer separates the various frequency components of an input signal so that the fundamental, harmonics, or intermodulation products can be determined and analyzed. Any signal component between 1 kHz and 1.5 MHz may be selected for measurement. Model 310A also functions as an efficient tuned voltmeter for accurately measuring relative or absolute signal levels, as a signal source for selective response measurements, and as either an AM receiver or carrier insertion oscillator for demodulating single sideband signals.

Specifications

Frequency range: 1 kHz to 1.5 MHz (200 Hz bandwidth); 5 kHz to 1.5 MHz (1000 Hz bandwidth); 10 kHz to 1.5 MHz (3000 Hz bandwidth).
Frequency accuracy: $\pm(1\% + 300 \text{ Hz})$.
Frequency scale: linear graduation, 1 div per 200 Hz.
Selectivity: 3 1F bandwidths, 200 Hz, 1000 Hz and 3000 Hz; mid-point of the passband (f_0) is readily distinguished by a rejection region 1 Hz wide between the 3 dB points.

	200 Hz bandwidth	1000 Hz bandwidth	3000 Hz bandwidth
Rejection*	frequency (Hz)	frequency (Hz)	frequency (Hz)
$\geq 3 \text{ dB}$	$f_0 \pm 108$	$f_0 \pm 540$	$f_0 \pm 1550$
$\geq 50 \text{ dB}$	$f_0 \pm 500$	$f_0 \pm 2400$	$f_0 \pm 7000$
$\geq 75 \text{ dB}$	$f_0 \pm 1000$	$f_0 \pm 5000$	$f_0 \pm 17000$

*Rejection increases smoothly beyond the -75 dB points.

Voltage range: 10 μV to 100 V full scale, ranges provided by input attenuator and meter range switch in steps of 1:3 or 10 dB.
Voltage accuracy: $\pm 6\%$ of full scale.
Internal calibrator stability: $\pm 1\%$ of full scale.
Dynamic range: $> 75 \text{ dB}$.
Noise and spurious response: at least 75 dB below a full-scale reference set on the 0 dB position of Range switch.
Input resistance: determined by input attenuator; 10 k Ω on most

sensitive range, 30 k Ω on next range, 100 k Ω on other ranges; shunt capacitance $< 100 \text{ pF}$ on three most sensitive ranges, $< 50 \text{ pF}$ on other ranges.

Automatic frequency control: dynamic hold-in range is $\pm 3 \text{ kHz}$ minimum at 100 kHz; tracking speed is approximately 100 Hz/s; locks on signal as low as 70 dB below a full-scale reference set on the 0 dB position of the Range switch.

Restored-frequency output: restored signal frequency maximum output is at least 0.25 V (meter at full scale) across 135 Ω , with approximately 30 dB of level control provided; output impedance approximately 135 Ω .

BFO output: 0.5 V across 135 Ω with approx. 30 dB of level control provided; output impedance approx. 135 Ω .

Recorder output: 1 V dc into an open circuit from 1000 Ω source impedance for single-ended recorders; output of 1 mA dc into 1500 Ω or less available on special order.

Receiver function (aural or recording provision): internal carrier reinsertion oscillator is provided for demodulation of either normal or inverted single sideband signals; AM signal also can be detected, tested.

RFI: conducted and radiated leakage limits are below those specified in MIL-I-6181D.

Power: 115 or 230 V $\pm 10\%$, 50 to 400 Hz; 20.5 VA max.

Dimensions: 426 mm wide \times 274 mm high \times 467 mm deep (16 $\frac{1}{2}$ " \times 10 $\frac{3}{4}$ " \times 18 $\frac{3}{8}$ "); hardware furnished for conversion to rack mount 483 mm wide \times 266 mm high \times 416 mm deep behind panel (19" \times 10 $\frac{1}{2}$ " \times 16 $\frac{3}{8}$ ").

Weight: net 20.3 kg (45 lb); shipping 23.4 kg (52 lb).

Options

001: internal frequency calibrator providing check points every 100 kHz; interpolation accuracy (between check points): $\pm 2 \text{ kHz}$ up to 1.4 MHz, $\pm 3 \text{ kHz}$ between 1.4 and 1.5 MHz.

002: dB scale uppermost on meter face and extended to -25 dB.

Model number and name	Price
310A, Opt. 001 Calibrator	\$118
310A, Opt. 002 DC Scale	\$31
11001A Cable Assembly	\$15
10503A Cable Assembly	\$15
10111A Adapter	\$15
310A Wave Analyzer	\$3185



SIGNAL ANALYZERS

1 kHz to 18 MHz

Models 312A & 313A

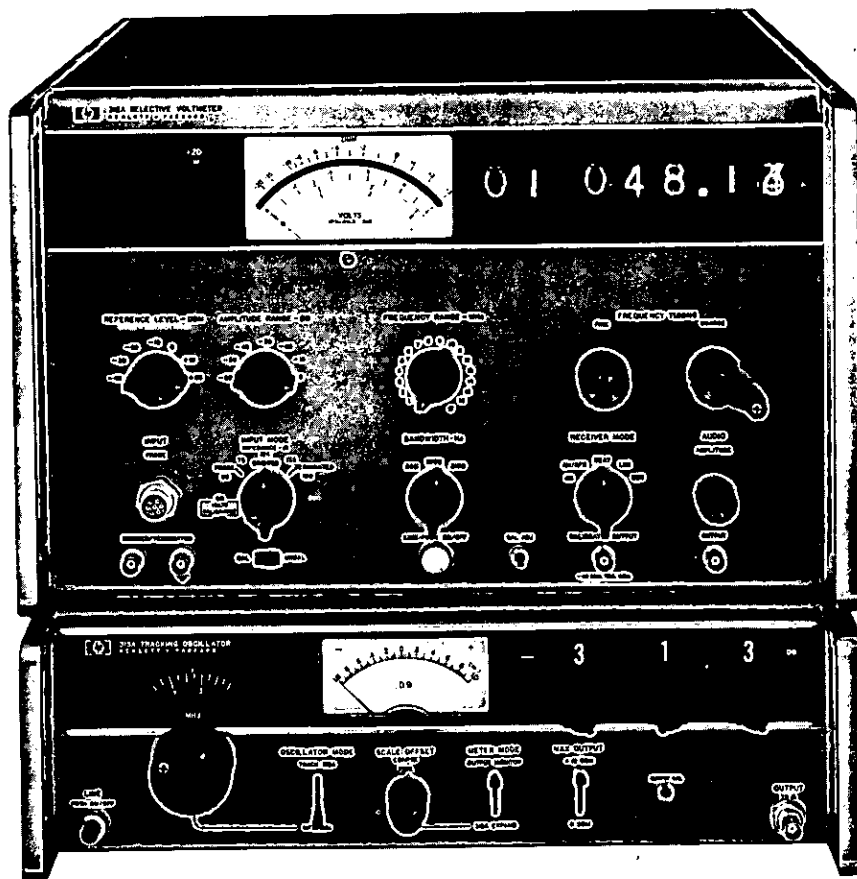

Description

Hewlett-Packard Model 312A/313A is a frequency selective voltmeter/tracking oscillator operating in the frequency range of all commercially available carrier and radio systems. The set is capable of making transmission and noise measurements with unparalleled speed and accuracy. A 312C is available with special features for telecommunications applications. See Page 508-509.

HP's 312A uses a frequency synthesizer for tuning that is automatically phase locked in 1 MHz steps. Tuning between lock points is indicated on a 7-place digital readout with 10 Hz plus time-base accuracy. Coupled with this digital indication of unambiguous frequency is an automatic tuning aid known as automatic frequency control (AFC). The AFC will automatically fine tune frequency to the center of the set's passband, and automatically correct any relative frequency drift between the set and the signal being measured. Long term monitoring of pilots is possible without periodic readjustment. High frequency accuracy coupled with AFC gives clear, instantaneous tuning and eliminates the need to search for signals or bump tones for identification.

Input and IF attenuators allow a maximum of dynamic range with-

out concern for overloading the set. Attenuators can be easily set for minimum distortion or noise performance. Attenuator settings are indicated clearly on a lighted annunciator which, when added to meter indication, gives a fast, error-free indication of input level. An accessory expanded scale meter allows 0.02 dB resolution of input level for accurate measurements.

The set is equipped with both balanced and unbalanced inputs to fit any measuring situation without the need for external accessory transformers. A wide selection of input impedances, either bridging or terminated, is provided along with provisions for an accessory high impedance, balanced bridging probe to eliminate measurement errors. The set always indicates directly in dBm or volts any impedance, eliminating time consuming calculations or conversion charts.

Three selectable bandwidths are provided for all measurement situations. A narrow 200 Hz bandwidth is used for highly selective measurements, a 1000 Hz bandwidth for general measurements, and a 3100 Hz bandwidth for noise measurements.

Demodulation of upper or lower sideband channels with an audio output is provided for monitoring noise, traffic, or tones in any channel. The accurate digital frequency readout requires only a quick ref-

erence to the system frequency charts to determine frequency for perfect demodulation. No tuning around for natural sounding demodulation is required. In this respect, Model 312A can be thought of as a single-channel, tuneable, multiplex, receive terminal.

HP's Model 313A Tracking Oscillator provides an accurate, flat output at the frequency to which the 312A is tuned for frequency response measurements. Output frequency is quickly and easily set by the digital tuning indicator on the selective voltmeter.

Output level is easily set by a 3-digit presentation with 0.1 dB resolution. Output level is also easily read and remains constant with changes in frequency requiring no time consuming resetting of level at each new frequency.

A built-in meter provides an expanded scale display of the 312A's meter indication with 0.02 dB resolution of input level.

312A Specifications

Tuning characteristics

Frequency range: 1 kHz to 18 MHz in 18 overlapping bands, 200 kHz overlap between bands.

Frequency accuracy: ± 10 Hz + time base accuracy. Frequency indicated on in-line digital readout with ± 10 Hz resolution.

Selectivity:

Instrument	Bandwidth Hz	3 dB BW	60 dB BW
312A	200 Hz	200 Hz $\pm 10\%$	< 470 Hz
312A	1000 Hz	1 kHz $\pm 10\%$	< 2350 Hz
312A	3100 Hz	3100 Hz $\pm 10\%$	< 6680 Hz

Amplitude characteristics

Amplitude range (full scale):

50 Ω to 150 Ω : -97 dBm to +23 dBm.

600 Ω : -107 dBm to +13 dBm.

Voltage: 3 μ V full scale to 3 V (50 Ω reference).

Amplitude accuracy

Frequency response (bridging input with external termination of 50 Ω $\pm 1\%$).

1 kHz to 10 kHz: ± 0.5 dB (5% of reading).

10 kHz to 10 MHz: ± 0.2 dB (2% of reading).

10 MHz to 18 MHz: ± 0.5 dB (5% of reading).

Matching impedance: 50 Ω , 60 Ω , 75 Ω , 124 Ω , 135 Ω , 150 Ω or 600 Ω , balanced or unbalanced on 312A.

Distortion

Harmonically related, 1 kHz to 1 MHz: >55 dB below zero reference. 1 MHz to 18 MHz: >65 dB below zero reference. Residual response (with no input and reference level in any position: 72 dB below zero reference).

Receiver characteristics

Receiver mode outputs:

AM: diode-demodulated audio.

Beat: beat frequency audio centered at f_0 .

LSB: product-demodulated audio, carrier reinserted at $f_0 + 1.8$ kHz.

USB: product-demodulated audio, carrier reinserted at $f_0 - 1.8$ kHz.

Audio output level: >0.5 V rms into 10 k Ω with full-scale meter deflection.

Recorder output level: 1 V ± 0.1 V with full-scale meter deflection across open circuit.

Power: 115 V or 230 V $\pm 10\%$, 50 Hz to 400 Hz, 90 VA.

Dimensions: 425 mm wide \times 266 mm high \times 467 mm deep (16 $\frac{1}{4}$ " \times 10 $\frac{1}{2}$ " \times 18 $\frac{3}{4}$ ").

Weight: net 20.7 kg (46 lb).

313A Specifications

Frequency range

As tracking oscillator: same as 312A (18 MHz).

As signal source: 10 kHz to 22 MHz in one band, continuous tuning.

Frequency accuracy

As tracking oscillator: 35 Hz ± 4 Hz above 312A tuning.

As signal source:

10 kHz to 2 MHz: $\pm 1\%$ of max dial setting.

2 MHz to 8 MHz: $\pm 3\%$ of max dial setting.

8 MHz to 22 MHz: $\pm 5\%$ of max dial setting.

Frequency stability

As signal source: short-term (5 min) drift <1 kHz in stable environment after warmup.

Frequency response: ± 0.1 dB, 10 kHz to 22 MHz.

Amplitude stability: ± 0.1 dB for 90 days (0 $^\circ$ to 55 $^\circ$ C).

Maximum output: 0 dBm or +10 dBm ± 0.1 dB, selectable at front panel.

Output attenuator: 3-section attenuator provides 0 dB to 99.9 dB attenuation in 0.1 dB steps.

Attenuator accuracy

0.9 dB section (0.1 dB steps): ± 0.02 dB.

9 dB section (1 dB steps): ± 0.1 dB.

90 dB section (10 dB steps): ± 0.1 dB to 50 dB, ± 0.2 dB to 90 dB.

Output impedance: 75 Ω unbalanced.

Harmonic distortion: more than 34 dB below fundamental.

Recorder output: ± 0.3 V for full-scale deflection. Output impedance 1 k Ω , BNC female connector.

Power: 115 V or 230 V $\pm 10\%$, 50 Hz to 1000 Hz, 30 VA max.

Dimensions: 425 mm wide \times 132.6 mm high \times 467 mm deep (16 $\frac{1}{4}$ " \times 5 $\frac{1}{2}$ " \times 18 $\frac{3}{4}$ ").

Weight: net 11.3 kg (25 lb).

Model number and name

312A Wave Analyzer

313A Tracking Oscillator

Price

\$4670

\$1790

SIGNAL ANALYZERS

Distortion analyzers

Models 331A, 332A, 333A, 334A

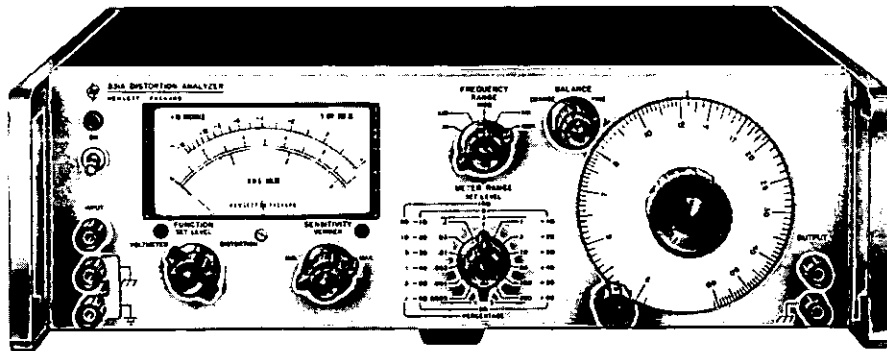

331A

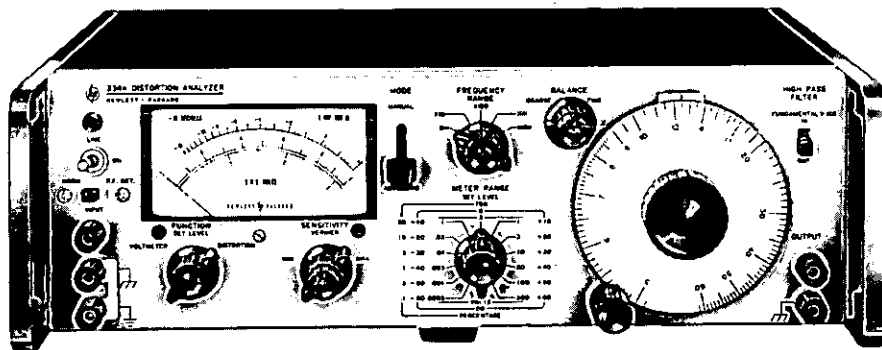

334A

Description

Hewlett-Packard's models 331A, 332A, 333A and 334A Distortion Analyzers measure total distortion down to 0.1% full scale at any frequency between 5 Hz to 600 kHz; harmonics are indicated up to 3 MHz. These instruments measure noise as low as 50 microvolts and measure voltages over a wide range of level and frequency. Refer to table below for available models and features.

Model No.	Auto Nulling	Hi-Pass Filter	Lo-Pass Filter	AM Detector
331A				
332A				X
332A Opt. H05			X	X
333A	X	X		
334A	X	X		X
334A Opt. H05	X		X	X

Option 001, for each model, features VU meter characteristics conforming to FCC requirements.

Automatic fundamental nulling

Automatic fundamental nulling speeds up the normally time-consuming portion of the measurement. This is done by manually nulling with the coarse tuning and balance controls to less than 10% of the Set Level Reference. The automatic mode is used to complete rejection of the fundamental on more sensitive ranges without any further manual tuning.

High-pass filter

In order to reduce the effect of hum components, a high pass filter is provided which attenuates frequencies below 400 Hz. The filter may be activated by a front panel switch when measuring distortion of signals greater than 1 kHz in frequency.

Amplitude modulation detector

HP's models 332A and 334A Analyzers are provided with an amplitude modulation detector having a frequency range from 550 kHz to greater than 65 MHz.

The high impedance dc restoring peak detector which utilizes a semi-conductor diode measures distortion at carrier levels as low as 1 volt. Input to the detector is located on the rear of the instrument. HP's model 334A is similar to Model 332A, but is provided with Automatic Fundamental Nulling and a High-Pass Filter. The switchable RF Detector at the input of the instrument has a frequency range of 550 kHz to 65 MHz. Input connector is located on the rear panel of the instrument.

High impedance voltmeter

The transistorized metering circuit of HP 331A through 334A employs feedback to insure stability and a flat frequency response from 5 Hz to 3 MHz. The voltmeter mode offers 13 ranges in 10 dB steps. Range is from 300 μ V to 300 V rms full scale. The bandwidth is 5 Hz to 3 MHz for 1 mV to 30 V ranges; 5 Hz to 500 kHz for 100 V to 300 V ranges; and 20 Hz to 500 kHz for the 300 μ V range. Average responding meter is calibrated to rms value of a sine wave.

VU Option available

Option: 001 provides an indicating meter having VU ballistic characteristics.

Distortion analyzers: Meet FCC requirements.

Models H05-332A, H05-334A

Two solid-state distortion analyzers offer extended frequency range, greater set level sensitivity, improved selectivity, greater overall accuracy, and unprecedented ease of use. The units meet FCC requirements on broadcast distortion levels. Both models measure total distortion down to 0.1% full scale. Model H05-334A features automatic fundamental nulling (>80 dB rejection). The H05-332A and 334A have a switchable low pass filter to reduce effect of unwanted high frequencies (noise, etc.) when measuring low frequency signals with high accuracy. Also included is a 3 MHz voltmeter, 300 μ V to 300 V full scale. Both models have an AM detector covering 550 kHz to >65 MHz at carrier levels as low as 1 V.

331A Specifications

Distortion measurement range: Any fundamental frequency, 5 Hz to 600 kHz. Distortion levels of 0.1%–100% are measured full scale in 7 ranges.

Distortion measurement accuracy:
Harmonic measurement accuracy (full scale):

Fundamental Input Less Than 30 V

Range	±3%	±6%	±12%
100%–0.3%	10 Hz–1 MHz	10 Hz–3 MHz	
0.1%	30 Hz–300 kHz	20 Hz–500 kHz	10 Hz–1.2 MHz

Fundamental Input Greater Than 30 V

Range	±3%	±6%	±12%
100%–0.3%	10 Hz–300 kHz	10 Hz–500 kHz	10 Hz–3 MHz
0.1%	30 Hz–300 kHz	20 Hz–500 kHz	10 Hz–1.2 MHz

Elimination characteristics: fundamental rejection >80 dB. Second harmonic accuracy for a fundamental of 5 to 20 Hz: better than +1 dB; 20 Hz to 20 kHz: better than ±0.6 dB; 20 kHz to 100 kHz: better than -1 dB; 100 kHz to 300 kHz: better than -2 dB; 300 kHz to 600 kHz: better than -3 dB.

Distortion introduced by instrument: >-70 dB (0.03%) from 5 Hz to 200 kHz. >-64 dB (0.06%) from 200 kHz to 600 kHz. Meter indication is proportional to average value of a sine wave.

Frequency calibration accuracy: better than ±5% from 5 Hz to 300 kHz. Better than ±10% from 300 to 600 kHz.

Input impedance: distortion mode; 1 MΩ ±5% shunted by <70 pF (10 MΩ shunted by <10 pF with HP 10001A 10:1 divider probe).

Voltmeter mode: 1 MΩ ±5% shunted by <35 pF 1 to 300 V rms; 1 MΩ ±5% shunted by <70 pF, 300 μV to 0.3 V rms.

Input level for distortion measurements: 0.3 V rms for 100% set level or 0.245 V for 0 dB set level (up to 300 V may be attenuated to set level reference).

DC isolation: signal ground may be ±400 V dc from external chassis.

Voltmeter range: 300 μV to 300 V rms full scale (13 ranges) 10 dB per range.

Voltmeter accuracy: (Using front panel input terminals)

Range	±2%	±5%
300 μV	30 Hz–300 kHz	20 Hz–500 kHz
1 mV–30 V	10 Hz–1 MHz	5 Hz–3 MHz
100 V–300 V	10 Hz–300 kHz	5 Hz–500 kHz

Noise measurements: voltmeter residual noise on the 300 μV range: <25 μV rms, when terminated in 600 (shielded) ohms, <30 μV rms terminated with a shielded 100 kΩ resistor.

Output: 0.1 ±0.01 V rms open circuit and 0.05 ±0.005 V rms into 2 kΩ for full scale meter deflection.

Output impedance: 2 kΩ.

Power supply: 115 or 230 V ±10%, 50 to 400 Hz, approximately 4 VA.

332A Specifications

Same as Model 331A except as indicated below:

AM detector: high impedance DC restoring peak detector with semiconductor diode operates from 550 kHz to greater than 65 MHz. Broadband input, no tuning is required.

Maximum input: 40 V p-p AC or 40 V peak transient.

Distortion introduced by detector: Carrier frequency: 550 kHz–1.6 MHz: <50 dB (0.3%) for 3–8 V rms carriers modulated 30%. 1.6 MHz–65 MHz: <40 dB (1%) for 3–8 V rms carriers modulated 30%.

Note: Distortion introduced at carrier levels as low as 1 Volt is normally <40 dB (1%) 550 kHz to 65 MHz for carriers modulated 30%.

333A Specifications

Same as Model 331A except as indicated below:

Automatic nulling mode: set level: at least 0.2 V rms.

Frequency ranges: X1, manual null tuned to less than 3% of set level; total frequency hold-in ±0.5% about true manual null. X10 through X10 k, manual null tuned to less than 10% of set level; total frequency hold-in ±1% about true manual null.

Automatic null accuracy: 5 Hz to 100 Hz: meter reading within 0 to +3 dB of manual null. 100 Hz to 600 kHz: meter reading within 0 to +1.5 dB of manual null.

High-pass filter: 3 dB point at 400 Hz with 18 dB per octave roll off. 60 Hz rejection >40 dB. Normally used only with fundamental frequencies greater than 1 kHz.

Power supply: same as Model 331A.

334A Specifications

Same as Model 333A except includes AM Detector described under Model 332A.

H05-332A and H05-334A Specifications

Same as HP 332A and 334A except as indicated below:

A low-pass filter is added in Model H05-332A and is substituted for a high-pass filter in Model H05-334A.

Frequency range: 5 Hz to 30 kHz, switchable to 3 MHz.

Low-pass filter: 4 pole, 3 dB down at 30 kHz.

Meter range switch: calibrated and referenced in dBm (0 dBm = 1 mW into 600Ω).

General

Dimensions: 426 mm wide × 126 mm high × 337 mm deep (16 1/4" × 5" × 13 1/4").

Weight: net, 7.98 kg (17 1/4 lb); shipping, 10.35 kg (23 lb).

Model number and name

Option 001, indicating meter has VU characteristics conforming to FCC requirements for AM/FM and TV broadcasting

H05-332A (meets FCC requirements)

H05-334A (meets FCC requirements)

331A Distortion Analyzer

332A Distortion Analyzer

333A Distortion Analyzer

334A Distortion Analyzer

Price

add \$15

add \$115

add \$93

\$775

\$795

\$1025

\$1050

SIGNAL ANALYZERS

5 Hz to 50 kHz spectrum analyzer

Model 3580A

NEW

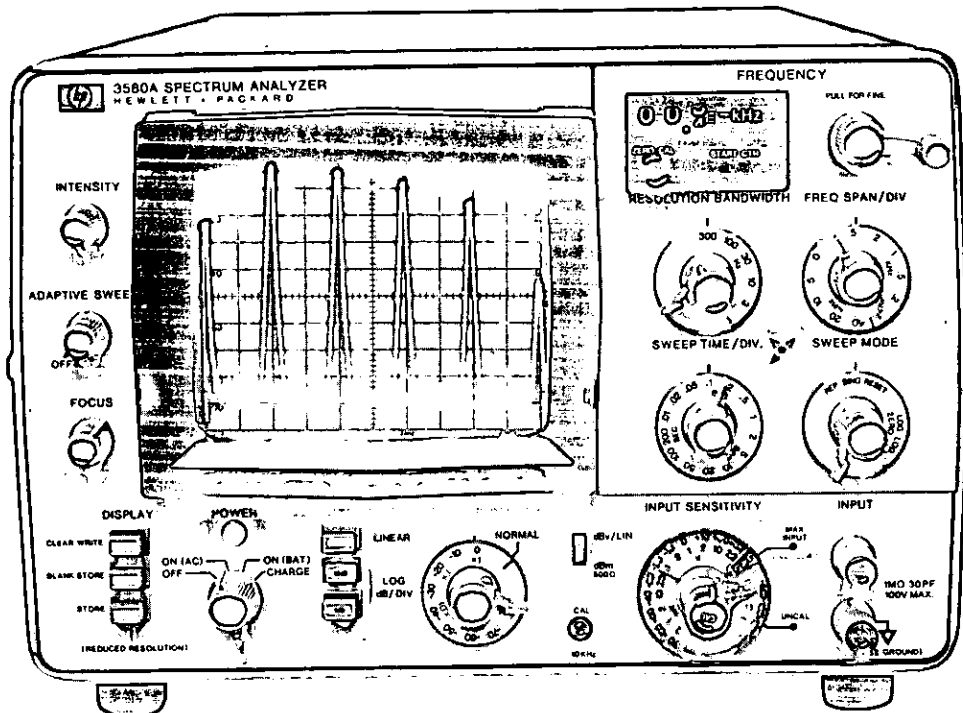

Description

Hewlett-Packard's 3580A Spectrum Analyzer has been optimized for frequencies between 5 Hz and 50 kHz. The largest single problem in this frequency range has been the display. Digital storage CRT exhibits display at high speed on a conventional CRT from a digital memory.

Sweep time required is another problem with low frequency analysis. Spectrum of interest is usually above a noise or threshold; it is possible to speed sweep. When signals are encountered again, sweep slows down to reproduce full response. Speed gain to a factor of ten becomes possible with this adaptive sweep feature. A bandwidth of 1 Hz gives this instrument the best resolution of any spectrum analyzer, and also simplifies noise analysis.

Digital storage

Trace is derived from a digital memory although it looks like traditional analog display. Trace can be stored indefinitely and by dividing the memory into two parts, two traces can be stored and compared. Spectral information can be studied and interpreted.

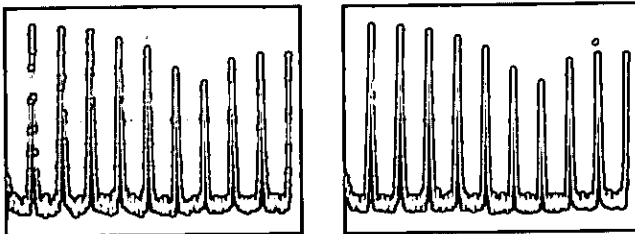

Adaptive sweep

A tremendous savings in sweep time can be achieved by using adap-

tive sweep. In the left trace over 80 dB of dynamic range is used to look at low level signals and noise. Two hundred seconds were required to make the sweep. In the right trace, baseline is raised to give 50 dB of dynamic range. Noise and other responses are not analyzed so sweep now takes only 14 seconds.

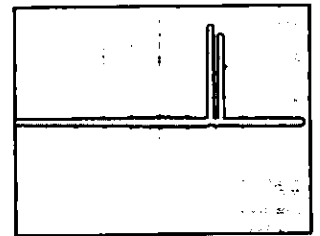
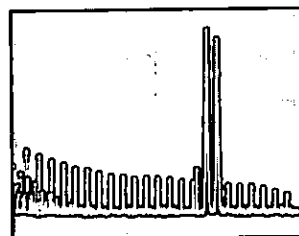

1 Hz bandwidth

Using 1 Hz bandwidth, line related responses are clearly exposed. With 10 Hz bandwidth these responses are hidden. If you are using a spectrum analyzer to expose spurious responses not visible in time domain, it is important to have a narrow filter bandwidth for maximum resolution.

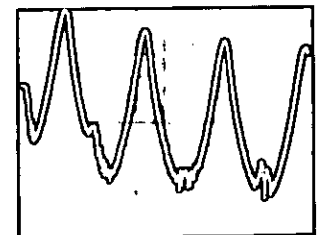
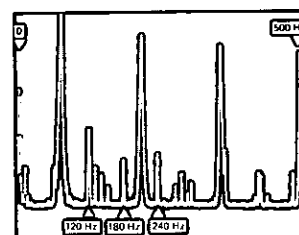

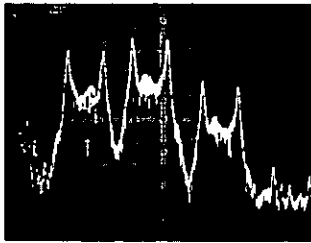

Telecommunications application

Besides analysis of voice spectrum, HP's 3580A gives a clear picture of frequency spectrum for digital transmission. This picture shows a 1200 baud full duplex modem using double sideband suppressed carrier FSK modulation. The "answer" band covers 850 Hz to 1450 Hz while the "transmit" band covers 1950 Hz to 2550 Hz. The higher frequency band at high levels from 3150 Hz to 3750 Hz comes from 3rd order products of the answer band.

Internal cal signal

A 10 kHz pulse derived from a crystal can be used to compensate for internal errors. A 10 kHz cal pot is provided so 10 kHz fundamental can be adjusted to fall on the top line of the display. With this feature, operation and calibration can be verified for most of the instrument.

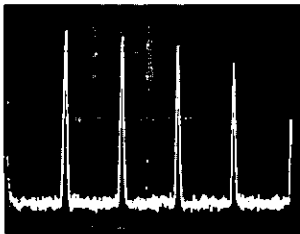

Specifications

Frequency characteristics

- Range:** 5 Hz to 50 kHz.
- Frequency dial accuracy:** ±100 Hz, 20°C to 30°C; ±300 Hz, 0°C to 55°C.
- Display accuracy:** frequency error between any two points is less than ±2% of their indicated separation.
- Typical stability:** ±10 Hz/hr after 1 hour; ±5 Hz/°C.
- Frequency dial resolution:** 20 Hz on frequency dial.

Bandwidths: (accuracy ±15%)	1 Hz	3 Hz	10 Hz	30 Hz	100 Hz	300 Hz
	(25°C ±5°C)					
Shape factor:	10					8

Out of range blank: IF controls are set so portions of displayed signal lie below 0 Hz or above 50 kHz; the baseline is displayed.

Amplitude specifications

Overall instrument range:

Linear	20 V – 100 nV full scale
	+30 dBm or dB V;
Log	–150 dBm or dB V

Amplitude accuracy:	Log	Linear
Frequency response:		
20 Hz – 20 kHz	±.3 dB	±3%
5 Hz – 50 kHz	±.5 dB	±5%
Switching between bandwidths (25°C):		
3 Hz – 300 Hz	±.5 dB	±5%
1 Hz – 300 Hz	±1 dB	±10%
Amplitude display:	±.2 dB	±2%
Input attenuator:	±.3 dB	±3%
Amplitude reference level: (IF attenuator)		
Most sensitive range:	±1 dB	±10%
All other ranges:	±1 dB	±3%

Dynamic range: 80 dB.

IF feedthru: Input level >10 V, –60 dB; <10 V, –70 dB.

Spurious responses: >80 dB below input reference level.

Smoothing: 3 positions, rolloff is a function of bandwidth.

Overload indicator: This LED indicator warns of possible input amplifier overloading. Without this indication it would be possible to introduce spurious responses without knowing it.

Sweep characteristics

Scan width: 50 Hz to 50 kHz.

Log sweep: 20 Hz to 43 kHz ±20%.

Sweep times: 0.1 sec to 2000 sec.

Rep: In the repetitive mode, sweep will continuously sweep specified band.

Reset: HP's 3580 is set to the start frequency of the sweep.

Manual: In combination with the concentric knob, manual sweep fully duplicates the span of the electronic sweep.

Adaptive sweep: When in adaptive sweep below the threshold level, scan speed is 20 to 25 times faster. Threshold is adjustable to cover 0-60% of screen. Signals greater than about 6 dB above threshold are detected and swept slowly.

Sweep error light: This LED indicates a sweep that is too fast to capture full response. When the light is on, response will be >5% lower than it should.

Zero scan: To look at the time varying signal at the center or start frequency within the bandwidth selected, the zero scan is used.

Output characteristics

Tracking generator output: (also known as BFO or tracking oscillator output).

Range: 0 to 2 V rms.

Frequency response: ±3%, 5 Hz to 50 kHz.

Impedance: 600Ω.

Total harmonic and spurious content: 40 dB below 1 volt signal level.

X-Y recorder analog outputs:

Vertical: 0 to +5 V ±2.5%.

Horizontal: 0 to +5 V ±2.5%.

Impedance: 1 kΩ.

Pen lift: contact closure to ground during sweep.

Dimensions: 412.8 mm wide × 203.2 mm high × 285.8 mm deep (16 1/4" × 8" × 11 1/4").

Weight: net, 12.25 kg (27 lb); 3580A Opt. 001: net, 15.88 kg (35 lb).

Temperature range: 0°C to 55°C.

Power: 100 V, 120 V, 220 V, or 240 V +5% – 10%. 48 Hz to 440 Hz, 35 VA max.

Option 001 battery: 5 hours from full charge. 14 hours to fully recharge. The internal battery is protected from deep discharge by an automatic turn off. Useful life of batteries is over 100 cycles.

Model number and name

3580A Option 001: internal rechargeable battery	Price
3580A Option 002: floating input	\$345
3580A Spectrum Analyzer	\$95
	\$4230



SIGNAL ANALYZERS

Spectrum analyzer, 0.1 to 1500 MHz

8558B/182T & 8444A

NEW

- Simple, 3 knob operation
- Digital frequency readout
- Display of signal levels directly in dBm

- Resolution bandwidths from 1 kHz to 3 MHz
- Optional 75 Ω input with dBm or dBmV calibration
- Available 0.5 to 1300 MHz Tracking Generator

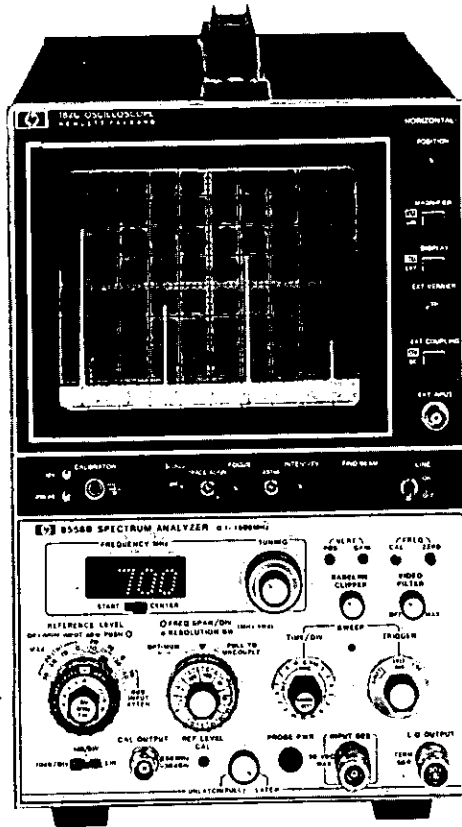

8558B/182T

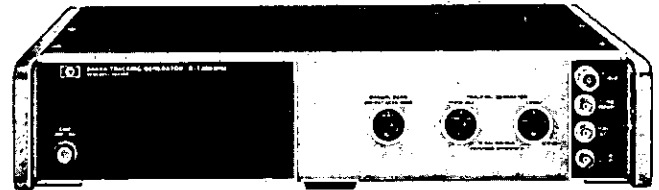

8444A

Suggested displays

The 8558B will function with any 180-series display. However, the following are suggested: For a low cost, large screen display, the Model 182T is ideal; the Model 181T offers variable persistence and storage; and the Model 180TR offers a rack mount configuration. In addition, it is advantageous to order the 180T, 180TR, 181T, 181TR or 182T displays which provide a long persistence P39 phosphor (except the 181T and 181TR variable persistence displays) and four non-buffered, rear panel outputs compatible with most X-Y recorders.

8444A-058 Tracking generator (0.5 - 1300 MHz)

Make swept frequency response measurements to ± 1.5 dB from 0.5 to 1300 MHz with greater than 90 dB of dynamic range. The output is absolutely calibrated at 0 dBm and continuously variable to -10 dBm. The frequency of unknown signals as well as the frequency of any point on the frequency response curve can be measured to counter accuracy using the external counter output on the tracking generator.

8558B Specifications

Frequency specifications

Frequency range: 100 kHz to 1500 MHz.

Frequency display span (on a 10-division CRT horizontal axis): 14 calibrated spans from 100 MHz/div to 5 kHz/div in a 1, 2, 5 sequence. In "0" the analyzer is a fixed-tuned receiver.

Accuracy: Frequency error between any two points on the display is less than $\pm 5\%$ of the indicated frequency separation.

Digital frequency readout: Indicates center frequency or start frequency of the frequency display scan. Two ranges: 0 to greater than 195 MHz with 100 kHz resolution; 195 MHz to 1500 MHz with 1 MHz resolution. ZERO control allows frequency readout to be adjusted for accurate calibration anywhere in the frequency range; CAL control removes frequency hysteresis.

Accuracy (after zeroing on the LO feedthrough and operation of the CAL button, 20°-40°C):

0 - 195 MHz: ± 1 MHz +20% of FREQUENCY SPAN PER DIVISION setting (≤ 1 MHz per division).

195 - 1500 MHz: ± 5 MHz +20% of FREQUENCY SPAN PER DIVISION setting.

Stability:

Residual FM: Less than 1 kHz peak-to-peak for time ≤ 0.1 sec.
Noise sidebands: More than 65 dB below CW signal, 50 kHz or more away from signal with a 1 kHz resolution bandwidth and full video filter.

Resolution:

Bandwidth ranges: 3 dB resolution bandwidths of 1 kHz to 3 MHz in a 1, 3, 10 sequence. Resolution bandwidth may be coupled to frequency display span at a ratio of two display spans per resolution bandwidth.

Resolution bandwidth accuracy: Individual resolution bandwidth 3 dB points calibrated to $\pm 15\%$.

Resolution bandwidth selectivity: 60 dB/3 dB resolution bandwidth ratio $< 15:1$.

New 8558B Spectrum analyzer

Economy plus performance

The Model 8558B is a 0.1 to 1500 MHz spectrum analyzer which plugs into any model 180-series oscilloscope display. This low cost, easy-to-use analyzer provides high accuracy in both amplitude and frequency measurements.

Simple, 3-knob operation

For most measurements, only three knobs are required; two to set up the frequency scale and one for the amplitude scale. The center or start frequency of the display is shown on an LED readout, and the analyzer automatically selects the resolution bandwidth and the proper scan time to provide calibrated measurements with any desired frequency scan.

Absolute amplitude calibration

Signal levels can be read directly from the CRT in dBm (dBmV for Option 002) without the use of external standards or calculations. The signal level represented by the top CRT graticule line is always indicated by the reference level control, and scale factors of 10 dB/div, 1 dB/div, and linear can be selected.

Optional 75 ohm input

Two options are available which allow measurements in 75 ohm systems: Option 001 has 75 ohms impedance and retains the dBm power calibration; Option 002 is also 75 ohms, but the amplitude is calibrated in dBmV for measurements on systems such as CATV.

Video filter: Post-detection filter used to average displayed noise. Bandwidth variable from approximately 3X Resolution Bandwidth to approximately 0.01X Resolution Bandwidth. In the MAX position provides a noise averaging filter with a bandwidth of approximately 1.5 Hz.

Amplitude specifications

Absolute amplitude calibration range:

Log calibration range: From -117 dBm to +30 dBm in 10 dB steps. Reference level vernier, 0 to -12 dB continuously.

Log display ranges: 10 dB/div on a 70 dB display, and 1 dB/div on an 8 dB display.

Linear display: From 2.2 microvolts (-100 dBm) full scale to 7.1 volts (+30 dBm) full-scale in 10 dB steps. Full-scale signals in linear translate to approximately full-scale signals in log.

Dynamic range:

Average noise level: < -107 dBm with a 10 kHz resolution bandwidth (0 dB input attenuation).

Spurious responses: For input signal level \leq Optimum Input Level setting, all image and out-of-band mixing responses, harmonic and intermodulation distortion products are more than 70 dB below input signal level, 5 MHz to 1500 MHz; 60 dB below, 100 kHz to 5 MHz.

Spurious responses due to 3rd order intermodulation distortion: For two input signals 10 dB above Optimum Input Level setting 3rd Order Intermodulation distortion products are >70 dB below the input signals, 5 - 1500 MHz; 60 dB below, 100 kHz to 5 MHz (signal separation \geq 50 kHz).

Residual responses (no signal present at input): < -100 dBm with 0 dB input attenuation.

Amplitude accuracy:

Frequency response (flatness): ± 1.0 dB.

Switching between bandwidths (at 20°-30°C):

3 MHz to 300 kHz: ± 0.5 dB.

3 MHz to 1 kHz: ± 1.0 dB.

Reference level accuracy (at fixed center frequency, fixed resolution bandwidth): ± 1.5 dB (includes input attenuator and IF gain accuracy. May be improved using IF or RF substitution techniques).

Amplitude log display: ± 0.1 dB/dB but not more than ± 1.5 dB over full 70 dB display range.

Calibrator:

Amplitude: -30 dBm ± 1.0 dB.

Frequency: 280 MHz ± 30 kHz, crystal controlled.

Input specifications

Input connector: Type N female.

Input impedance: 50 Ω nominal.

Reflection coefficient <0.20 (1.5 SWR) for all Optimum Input Level settings except -40 dBm (0 dB input attenuation).

Input attenuator: 70 dB range.

Accuracy ± 0.4 dB per 10 dB step but not more than ± 1.0 dB over full 70 dB range.

Maximum input levels:

AC or peak: Peak or average power +10 dBm (1.0 V ac peak) incident on mixer (0 dB input attenuation), +30 dBm (10 V ac peak or 1 W), incident on input attenuator. (MAX input markings on front panel indicate maximum input allowable for <1 dB gain compression or attenuator overload).

DC: ± 50 V dc.

Output characteristics

LO output: +10 dBm nominal, 50 ohms; 2.05-3.55 GHz.

Cal output: -30 dBm, 280 MHz with 2nd through 5th harmonics greater than -60 dBm.

Probe power: +15 V, -12.6 V; 150 mA max.

Powers 1120A, 1121A, 1123A, or 1124A high impedance probes.

Note: The following oscilloscope display rear panel outputs refer to 180T, 180TR, 181T, 181TR displays and older 180-series displays with Option 807 only.

Vertical output: (AUX A on oscilloscope display rear panel.) 0 to 0.8 V for 8-division deflection on CRT display; 50 Ω output impedance.

Pen lift/blanking output: (AUX B on oscilloscope display rear panel.) 0 to 15 V (0 V, pen down). Approximately 10 k Ω impedance when blanked. Compatible with HP 7004B, 7034B, 7005B, and 7035B X-Y RECORDERS.

21.4 MHz IF output: A 21.4 MHz output linearly related to the RF input to the analyzer. Bandwidth controlled by analyzer Resolution Bandwidth setting. Amplitude controlled by input attenuator, IF gain vernier, and first six IF step gain positions (-10 through -60 dBm Ref Level with 0 dB input attenuation). Output is approximately -10 dBm for full-scale signals on the CRT. (AUX C on oscilloscope display rear panel, 50 Ω output impedance.)

Horizontal output: (AUX D on oscilloscope display rear panel.) -5.0 to +5.0 V for 10 div CRT deflection, 5 k Ω output impedance.

Sweep characteristics

Sweep time:

Auto: Sweep time is automatically controlled by Frequency Span, Resolution Bandwidth, and Video Filter.

Manual: Sweep determined by front panel control, continuously variable across CRT in either direction.

Calibrated sweep time: 16 internal sweep times from 0.1 ms/div to 10 sec/div in a 1, 2, 5 sequence. For sweep times of 2 ms/div to 10 sec/div, the analyzer is operable in its normal swept frequency mode. Faster sweeps are useful for analyzing modulation waveforms when the analyzer is being operated as a fixed-tuned receiver with 0 Display Span. Sweep times may be reduced to an effective 10 μ sec/div by using the 180-series X10 horizontal magnifier.

Accuracy: $\pm 10\%$.

Sweep trigger:

Internal: Sweep internally triggered by envelope of RF input signal (signal amplitude of 1.0 division peak-to-peak required on CRT display).

Line: Sweep triggered by power line frequency.

Free run: Sweep triggered repetitively by internally generated ramp.

Single: Sweep triggered by front panel sweep trigger switch (spring return position).

Display characteristics

Oscilloscope display sections:

180 Series compatibility: The 8558B is compatible with all 180A, 180AR, 180C, 180D, 180F, 181A, 181AR, 182A, 184A, and 184B mainframes. It is operable with the 183A, 183B mainframes, but the display is limited to 6 divisions by the 6-division CRT. The following 180-series oscilloscope displays are recommended for use with the 8558B Spectrum Analyzer because they provide 4 non-buffered rear panel auxiliary outputs (for unattenuated vertical, horizontal, and penlift outputs) and P39 medium-persistence CRT phosphor (except with 181T, 181TR which provide variable persistence):

180T	P39 phosphor
180TR	P39 phosphor
181T	P31 phosphor with variable persistence
181TR	P31 phosphor with variable persistence
182T	P39 phosphor

See HP Service Notes 180A/AR/C/D-1, 181A/AR-7, and 182A-1 for information needed to modify standard display to provide auxiliary outputs.

Model number and name

8558B Spectrum Analyzer	Price
182T Display	\$3900
180TR Display	\$1200
181T Display	\$1300
8444A Opt. 058 Tracking Generator	\$2215
Option 001: 75 ohm input (BNC), dBm calibration	\$3450
Option 002: 75 ohm input (BNC), dBmV calibration	add \$100
	add \$100

SIGNAL ANALYZERS

Plug-in spectrum analyzer system, 20 Hz to 40 GHz

Model 141T system

- 20 Hz to 40 GHz with just a tuning section change.
- Advantages of fully calibrated solid state system.
- Add measurement capability to your system as needed.

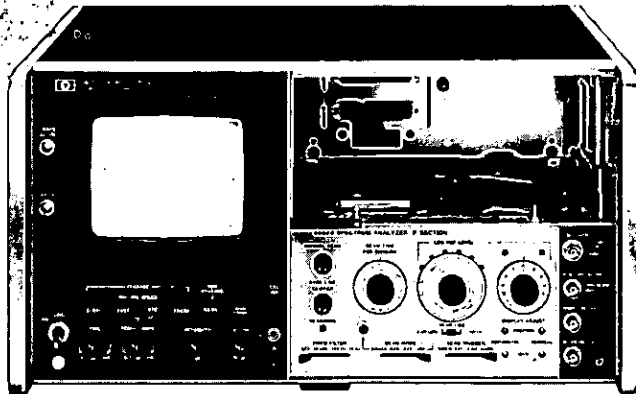

141T, 8552B

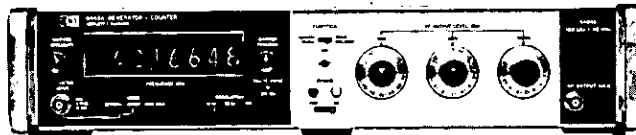

8443A



8444A

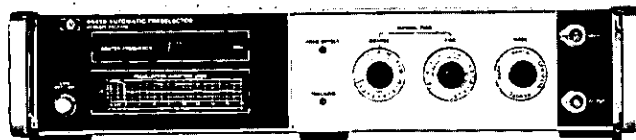

8445B

Hewlett-Packard's high performance plug-in spectrum analyzer family makes frequency domain measurements from 20 Hz to 40 GHz. Because of the system's modularity, the user need purchase only analyzer components necessary to meet immediate production or laboratory measurement requirements. Then, as broader frequency capability is required, additional tuning sections or companion instruments can be added.

The models 8553B, 8554B, 8555A, and 8556A are tuning sections which plug into a 141T display mainframe along with an 8552B IF section to form a member of the Hewlett-Packard high performance spectrum analyzer family. Each tuning section covers a frequency range convenient for equipment design or spectrum surveillance: 8556A, 20 Hz to 300 kHz; 8553B, 1 kHz to 110 MHz; 8554B, 500 kHz to 1250 MHz; and 8555A, 10 MHz to 40 GHz. The IF section plug-in which is used with each tuning section, serves to condition the measurement signal for proper display on the CRT. Two IF sections are available, the 8552B high performance model and the 8552A model for economy. The spectrum analyzer specifications included in this catalog assume the use of the 8552B.

The 8443A, 8443B, and 8444A are tracking generators complementing the basic spectrum analyzer function with an RF source locked to the tuning frequency. The 8445A is an automatic pre-selector which enhances the dynamic range of the 100 MHz to 40 GHz 8555A tuning section analyzer.

- Tracking generator expands measurement capability.
- Increase dynamic range with tracking preselector.

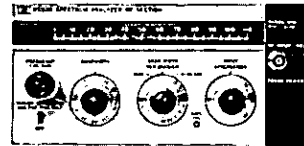

8553B

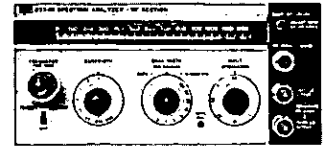

8554B

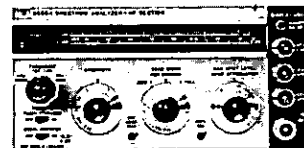

8555A

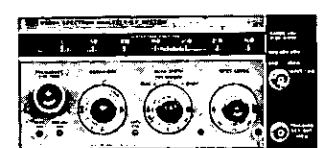

8556A

The 141T based spectrum analyzer features absolute calibration of frequency and amplitude, high resolution and sensitivity, wide dynamic range and simple to interpret display output.

The following pages cover spectrum analyzer performance with each of the tuning sections and comparison tracking generator/pre-selector.

Absolute amplitude calibration

For ease and speed of measurement, full frequency band amplitude calibration allows direct interpretation of signal power or voltage from the CRT display. A choice of logarithmic or linear scaling calibrates the CRT in dBm or μV respectively. The top horizontal graticule on the CRT is established as a specific power or voltage level by front panel settings. Any signal registering on the CRT can be quantified by comparing its amplitude with this reference level.

When a combination of frequency scan, bandwidth or video filter settings are chosen such that the display becomes uncalibrated, a warning light indicates the condition.

High resolution frequency calibration

The frequency measurement capability of the spectrum analyzer is responsive to user need, making spectrum measurements simply and accurately with three frequency scan modes.

First is the FULL scan mode, which displays the entire tuning section frequency band on the 10 cm horizontal CRT graticule. This mode is effective in viewing broadband effects of circuit adjustments and refinements as they are made. In FULL scan and marker on the CRT corresponds in frequency to the position of the pointer on the tuning section frequency scale, so signals can be readily identified.

The second mode, PER DIVISION scan, centers the display about the frequency indicated by the tuning section pointer. In this mode, narrow, calibrated scan per division and automatic frequency STABILIZATION make high resolution measurements for analysis of signal purity, sidebands and low deviation FM.

In the third mode, ZERO scan, the analyzer becomes a receiver tuned to the frequency indicated on the scale. Amplitude modulation in an input signal at the tuned frequency is displayed on the CRT in the time domain. The scan time control provides a calibrated time base.

High resolution

The ability to resolve close-in signal sidebands, such as line related modulation is important in frequency domain analysis. The Hewlett-Packard 141T plug-in spectrum analyzers each have narrow bandwidths for such resolution. Up to 110 MHz, the analyzers offer 10 Hz bandwidths and to 18 GHz, 100 Hz bandwidths. The frequency stabilization feature already mentioned ensures high resolution by maintaining a jitter free display.

Wide dynamic range, sensitive

Confidence in signal identification is given by the analyzer's ability to measure wide amplitude differentials without distortion products and to measure very low level signals. The plug-in spectrum analyzers



have typically 70 dB of distortion free dynamic range; that is, the capability of measuring 0.03% signal distortion from the CRT display. With the 8445A preselector the 8555A has a dynamic range of 100 dB. The CRT displays full dynamic range on a linear, easy to read scale.

Signals at as low a level as -142 dBm (20 nanovolts, 50 ohms) can be detected by the spectrum analyzer with 10 Hz bandwidth. At high frequencies and with 100 Hz bandwidth -125 dBm signals can be measured.

A parallax free, storable display

The 141T spectrum analyzer mainframe and display features a variable persistence CRT which enables response storage for any measurement. With very narrow bandwidth measurements, extremely slow sweeps are necessary to maintain amplitude calibration (allowing band pass filters time to respond). A recording CRT is necessary to save this response for viewing. Of course, any response can be stored for a display ready to be photographed. Another display mainframe, the 140T, is available with the standard persistence.

Interpretation of response levels on the CRT are free from parallax since the graticule is etched on the inside of the display screen adjacent to the phosphor.

IF section adds convenience features

The high resolution 8552B or the economic 8552A IF section features video filtering, recorder outputs, manual scan and an internal calibration standard to make the spectrum analyzer easier to use. Video filtering is a low pass filter which averages out noise amplitude response for easier small signal readings. It also makes wide band noise and EMI measurements easier.

Recorder outputs, including pen lift, allow hard copy duplication of the CRT display. Manual scan allows setting up of accessories, such as X-Y recorders, adjusting signals on screen during slow scans and measuring frequency with a counter.

The internal calibration standard is a very stable -30 dBm, 30 MHz signal for quick front panel calibration.

Tracking generators for each frequency band

Either available internally, or as a companion instrument, are leveled signal sources designed to track the swept tuning frequency of the spectrum analyzer. Amplifiers, filters or any circuit which requires an input signal can be characterized to 1300 MHz, with typically wider dynamic range and more precise frequency accuracy than with the spectrum analyzer alone.

The 8556A low frequency tuning section has an internal tracking generator, standard with the instrument. The 8553B and 8554B/8555A use separate generators namely 8443B and 8444A respectively.

General specifications

141T spectrum analyzer system

Input impedance: 50Ω nominal. Reflection coefficient <0.30 (1.85 SWR), input attenuator ≥10 dB.

Maximum input level: Peak or average power +13 dBm (1.4 V ac peak), ±50 V dc.

Attenuator: 0 to 50 dB in 10 dB steps

Scan time: 16 internal scan rates from 0.1 ms/div to 10 sec/div in a 1, 2, 5 sequence, and manual scan (8552B only).

Scan time accuracy:

0.1 ms/div to 20 ms/div: ±10%

50 ms/div to 10 s/div: ±20%

Scan Mode:

Int: Analyzer repetitively scanned by internally generated ramp; synchronization selected by scan trigger.

Single: Single scan with front panel reset.

Ext: Scan determined by 0 to +8 volt external signal.

Manual: Scan determined by front panel control.

Scan trigger: For Internal scan mode, select between:

Auto: Scan-free runs.

Line: Scan synchronized with power line frequency.

Ext: Scan synchronized with >2 volt (20 volt max.) signal.

Video: Scan internally synchronized to envelope of RF input.

Auxiliary outputs:

Vertical output: 0 to -0.8 V for full deflection.

Scan output: to +5 V for 10 div CRT deflection.

Pen lift output: 0 to 14 V (0 V, pen down).

Display characteristics

141T, 140T

Plug-ins: Accepts Models 8552A/B, 8553B, 8554B, 8555A and 8556A and Model 1400-series Oscilloscope plug-ins.

Cathode-ray tube type:

Model 141T: Post-accelerator storage tube, 9000-volt accelerating potential; aluminized P31 phosphor.

Model 140T: Post-accelerator, 7300 volt potential medium-short persistence (P39) phosphor.

Cathode-ray tube graticule:

Model 141T: 8 × 10 division (approximately 7.1 × 8.9 cm) parallax-free internal graticule.

Persistence, model 141T only:

Normal: Natural persistence of P31 phosphor (0.1 second).

Variable:

Normal writing rate mode: Continuously variable from less than 0.2 second to more than one minute.

Maximum writing rate mode: From 0.2 second to 15 seconds.

Erase: Manual; erasure takes approximately 350 ms.

Storage times model 141T only: Normal writing rate; more than 2 hours at reduced brightness (typically 4 hours).

Fast writing speed, model 141T only: More than 15 minutes.

Functions used with oscilloscope plug-ins only: Intensity modulation, calibrator; beam finder.

EMI: Conducted and radiated interference is within requirements of MIL-I-16910C and MIL-I-6181D and methods CE03, and RE02 of MIL-STD-461 (except 35 to 40 kHz) when 8554B and 8552A or 8552B are combined in a 140T or 141T Display Section.

Temperature range: Operating, 0° to +55°C; storage, -40° to 75°C.

Power requirements: 100, 120, 220, or 240 V +5%, -10%, 50 to 60 Hz, normally less than 225 watts (includes plug-ins used).

Weight:

Model 8552A or 8552B IF section: Net, 9 lb (4.1 kg). Shipping, 14 lb (6.4 kg).

Model 140T display section: Net, 37 lb (16.8 kg). Shipping, 45 lb (20 kg).

Model 141T display section: Net, 40 lb (18 kg). Shipping, 51 lb (23 kg).

Tuning section: See following pages.

Dimensions: Model 140T or 141T with plug-ins: 425 mm deep, 221 mm high, 416 mm deep (16¼" × 8¾" × 16¾").

Special order: Chassis slides and adapter kit.

Model number and name

140T Normal Persistence Display

141T Variable Persistence Display

8552A Economy IF Section

8552B High Resolution IF Section

Price

\$1165

\$2035

\$2575

\$3275

SIGNAL ANALYZERS

141T spectrum analyzer system: 20 Hz to 300 kHz

Model 8556A

- Accurate signal level measurements (± 0.95 dB)
- Accurate frequency measurements (± 3 Hz)

- High sensitivity (-152 dBv)
- Built-in tracking generator

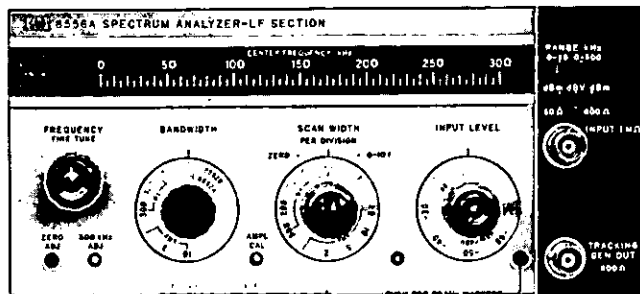

8556A

General purpose measurement flexibility

The 8556A Spectrum Analyzer covers the frequency range from 20 Hz to 300 kHz. It was designed to accommodate the variety of characteristic impedances and amplitude units used in making audio measurements. Balanced or unbalanced inputs are available, and open circuit voltages (dBv or linear) or dBm in several characteristic impedances may be measured. The analyzer is capable of high resolution; frequencies can be measured very accurately. A built-in tracking generator further increases the instrument's utility.

Frequency range

The 8556A has two frequency scales, 0-300 kHz for full coverage and 0-30 kHz for better resolution at low frequencies. The analyzer may be swept symmetrically about a tunable center frequency, swept from 0 Hz to a tunable end point, or operated as a fixed tuned receiver. 20 kHz crystal markers (accurate to 0.01%) can be generated on the CRT to make very accurate relative frequency measurements.

Absolute amplitude calibration

The 8556 is calibrated for dBm in 600 Ω , dBm in 50 Ω , dBv, and volts. The very accurate reference level control (± 0.2 dB) and vernier (± 0.25 dB) allow the IF substitution technique to be used to improve amplitude measurement accuracy.

Low distortion

Careful design has decreased analyzer distortion to the point where a full 70 dB dynamic range is achieved. This allows small signals, such as harmonic or intermodulation distortion, to be measured in the presence of large ones.

Resolution - sensitivity

Resolution bandwidths between 10 kHz and 10 Hz are available on the 8556A. Using the narrow bandwidth, 50 or 60 Hz line related sidebands can be measured. The analyzer's extremely low noise figure together with its narrow bandwidths makes the 8556A very sensitive. Signals as low as -152 dBv (25 nv) can be measured in a 10 Hz bandwidth. The 8556A may be used to measure EMI, such as interference conducted along an AC power line.

Isolated input

The isolated input eliminates the possibility of spurious signal pickup which could be caused by line related ground currents flowing in the ground connections between the analyzer and signal source. The input impedance (1 M Ω) is high enough so that a scope probe may be used with a minimum of loading. An optional balanced input is available which is transformer coupled for isolation and high common mode rejection. The input impedance is 15 k Ω , and the analyzer is calibrated for either dBm-135 Ω or dBm-150 Ω as well as dBm-500 Ω and dBm-900 Ω . Balance (symmetry) is 80 dB at 50 Hz, and 50 dB at 300 kHz.

Tracking generator

A tracking generator is built into the 8556A. If an external counter is connected to the tracking generator, frequencies can be measured to an accuracy of ± 3 Hz. Swept insertion loss or return loss measurements can be made on a device such as an amplifier or filter. A 140 dB measurement range is possible using the narrowest resolution band-

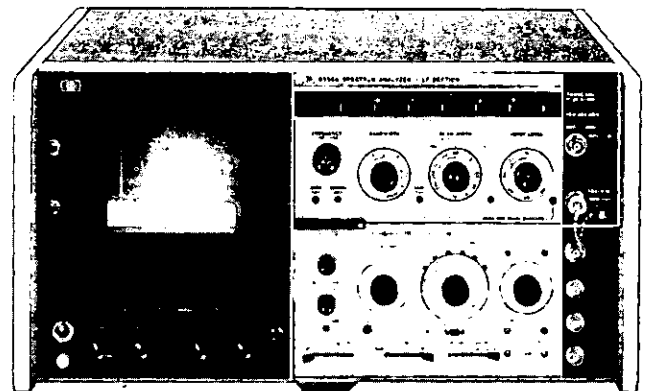

width. The tracking generator also provides a convenient signal for compensating an oscilloscope probe used with the 8556A.

Other applications

The combination of a tracking generator and spectrum analyzer in this frequency range is valuable in applications such as receiver testing and fault location.

Specifications

Frequency specifications

Frequency range: 20 Hz to 300 kHz — 8552B IF Section. Tuning dial ranges of 0 - 30 kHz and 0 - 300 kHz.

Scan width: (On a 10-division CRT horizontal axis).

Per division: 10 calibrated scan widths from 20 Hz/div to 20 kHz/div in a 1, 2, 5 sequence.

0 - 10 f: 10 calibrated preset scans, from 200 Hz to 200 kHz in a 1, 2, 5 sequence. Analyzer scans from zero frequency to ten times the scan width per division setting.

Zero: Analyzer is a fixed tuned receiver.

Frequency accuracy:

Center frequency accuracy: 0 - 30 kHz Range: ± 500 Hz; 0 - 300 kHz Range: ± 3 kHz.

Marker accuracy: RF markers every 20 kHz accurate to within $\pm 0.01\%$. Markers controlled by front panel on/off switch.

Scan width accuracy: with 8552B IF Section: Frequency error between any two points on the display is less than $\pm 3\%$ of the indicated frequency separation.

Stability:

Residual FM 8552B: Sidebands > 60 dB down 50 Hz or more from CW signal, scan time ≥ 1 sec/div, 10 Hz bandwidth.

Noise sidebands: More than 90 dB below CW signal, 3 kHz away from signal, with a 100 Hz IF bandwidth.

Frequency drift: Less than 200 Hz/10 min (8552B).

Resolution:

Bandwidth ranges: IF bandwidths of 10 Hz (8552B) to 10 kHz are provided in a 1, 3, 10 sequence.

Bandwidth accuracy: Individual IF bandwidth 3 dB points calibrated to $\pm 20\%$ (10 kHz bandwidth $\pm 5\%$).

Bandwidth selectivity: 60 dB/3 dB IF bandwidth ratios, with 8552B IF section: $< 11:1$ for IF bandwidths from 10 Hz to 3 kHz; $< 20:1$ for 10 kHz bandwidth. For 10 Hz bandwidth, 60 dB points are separated by less than 100 Hz.

Amplitude specifications

Absolute amplitude calibration

Log calibration modes:

dBv	0 dBV = 1 V rms
dBm - 600 Ω	0 dBm = 1 mW - 600 Ω
dBm - 50 Ω	0 dBm = 1 mW - 50 Ω

Input impedance is 1 M Ω . dBm ranges are referenced with input properly terminated externally.

Log calibration range: From -150 dBm/dBV to +10 dBm/dBV.
Log display range: 10 dB/div on a 70 dB display, or 2 dB/div on a 16 dB display (with 8552B only).
Linear sensitivity: From 0.1 μ V/div to 1 V/div in a 1, 2, 10 sequence. Linear sensitivity vernier X1 to X0.25 continuously.

Dynamic range:

INPUT LEVEL control: -10 to -60 dBm/dBV in 10 dB steps. Accuracy ± 0.2 dB. Marking indicates maximum input levels for 70 dB spurious-free dynamic range.
 Average noise level (specified with a 600 Ω or less source impedance and INPUT LEVEL at -60 dBm/dBV):

Mode	1 kHz IF Bandwidth	10 Hz IF Bandwidth
dBm - 50 Ω	<-122 dBm (180 nV)	<-142 dBm (18 nV)
dBm - 600 Ω	<-130 dBm (250 nV)	<-150 dBm (25 nV)
dBV	<-132 dBV (250 nV)	<-152 dBV (25 nV)
Linear	<400 nV	<40 nV

Video filter: Averages displayed noise, bandwidth of 10 kHz, 100 Hz, and (8552B only) 10 Hz. Bandwidth accuracy $\pm 20\%$.

Spurious responses: Input signal level \leq INPUT LEVEL setting; out of band mixing responses, harmonic and intermodulation distortion products are all more than 70 dB below the input signal level 5 kHz to 300 kHz; 60 dB, 20 Hz to 5 kHz. Third order intermodulation products are more than 70 dB below the input signal level, 5 kHz to 300 kHz with signal separation >300 Hz.

Residual responses: (No signal present at input.) With the INPUT LEVEL at -60 dBm/dBV and the input terminated with 600 Ω or less, all line related residual responses from 0 to 500 Hz are below -120 dBm/dBV. All other residual responses are below -130 dBm/dBV.

Amplitude accuracy:	Log	Linear
Frequency response	± 0.2 dB	$\pm 2.3\%$
Amplitude display	± 0.25 dB/dB but not more than ± 1.5 dB over 70 dB display range	$\pm 2.8\%$ of full 8 div display

Log reference level control: Provides 90 dB IF gain control in 10 dB steps to cover log and linear ranges. Accurate to ± 0.2 dB ($\pm 2.3\%$).

Log reference level vernier: Provides continuous 12 dB range. Accurate to ± 0.1 dB ($\pm 1.2\%$) in 0, -6, -12 dB positions; otherwise ± 0.25 dB ($\pm 2.8\%$).

Amplitude measurement accuracy: ± 0.95 dB with proper technique.

General

Scan time: 16 internal scan rates from 0.1 ms/div to 10 sec/div in a 1, 2, 5 sequence.

Scan mode:

Int: Analyzer repetitively scanned internally.

Ext: Scan determined by 0 to +8 volt external signal.

Single: Single scan actuated by front panel button.

Manual: Scan determined by front panel control.

Input level: Provides 50 dB control of input preamplification and at-

tenuation to prevent input overload. INPUT LEVEL markings of -60 dBm/dBV to -10 dBm/dBV indicate maximum input level for a minimum of 70 dB spurious-free dynamic range. Accuracy ± 0.2 dB (2.3%).

Input impedance: 1 M Ω shunted by ≈ 32 pF.

Maximum input level: 10 V rms, ± 200 V dc. Ground terminals of BNC input connectors are isolated from the analyzer chassis ground to minimize ground loop pickup at low frequencies.

Maximum voltage, isolated ground to chassis ground: ± 100 V dc.

Isolated ground to chassis ground impedance: 100 k Ω shunted by approximately 0.3 μ F.

Gain compression: For input signal level 20 dB above INPUT LEVEL setting, gain compression is less than 1 dB.

Tracking generator specifications

Frequency range: Tracks the analyzer tuning, 20 Hz to 300 kHz.

Amplitude range: Continuously variable from 100 mV rms to greater than 3 V rms into an open circuit.

Amplitude accuracy: With TRACKING GEN LEVEL in CAL position and 20 kHz markers off, output level at 100 kHz is 100 mV ± 0.3 dB into an open circuit.

Frequency response: ± 0.25 dB 50 Hz to 300 kHz.

Output impedance: 600 Ω

Residual FM: <1 Hz peak-to-peak.

Power requirements: 100, 120, 200, or 240 V $\pm 5\%$, -10%, 50 to 60 Hz, normally less than 225 watts.

Weight: Model 8556A LF section: Net, 8 lb (3.7 kg). Shipping, 12 lb (5.3 kg).

Dimensions: 226 mm wide, 102 mm high, 344 mm deep (8 $\frac{7}{8}$ " \times 4" \times 13 $\frac{1}{2}$ ").

Specifications with 8556A options 001, 002-balanced input

Amplitude:

Log calibration modes-balanced (bridged) input:

dBm - 135 Ω (Option 001)	0 dBm = 1 mW - 135 Ω
dBm - 150 Ω (Option 002)	0 dBm = 1 mW - 150 Ω
dBm - 600 Ω	0 dBm = 1 mW - 600 Ω
dBm - 900 Ω	0 dBm = 1 mW - 900 Ω

Input impedance is typically 15 k Ω . dBm ranges are referenced with input properly terminated externally.

Input

Maximum input levels: Normal Mode, ± 20 V rms or ± 150 V dc for normal mode (symmetrical) signals between input signal connectors; Common Mode, 200 V rms at 60 Hz or ± 500 V dc for common mode (asymmetrical) voltages between input signal connectors and GUARD or instrument chassis; Guard, ± 100 V dc from GUARD to instrument chassis. (GUARD to chassis impedance is approximately 100 k Ω shunted by 0.3 μ F.)

Balance (Symmetry): 0 - 30 kHz Range, greater than 80 dB, 50 Hz to 1 kHz; 1 - 300 kHz range, greater than 60 dB, 1 kHz to 20 kHz.

Model number and name

8556A RF section	Price
Option 001 Balanced input	\$1975
Option 002 Balanced input	add \$220
	add \$220

SIGNAL ANALYZERS

141T spectrum analyzer system: 1 kHz to 110 MHz

Models 8553B & 8443A

- Wide frequency range
- 10 Hz resolution bandwidth
- High sensitivity (- 140 dBm)
- Accurate amplitude measurements (± 1.25 dB)
- 10 Hz frequency accuracy with tracking generator
- 130 dB swept measurement range

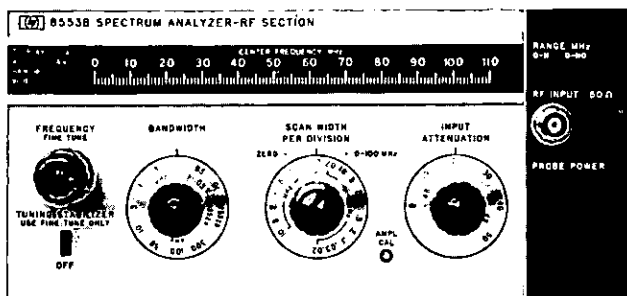

8553B

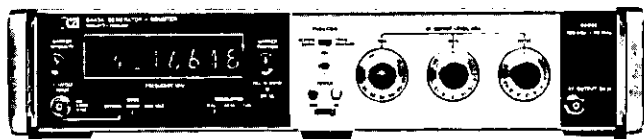

8443A

General purpose

The 8553B Spectrum Analyzer makes absolute amplitude and frequency measurements over the 1 kHz to 110 MHz range. This frequency span includes audio, video, navigation aids, telemetry, multiplex communication systems basebands, commercial AM, FM, TV, and land mobile communication. The analyzer features high resolution and stability, low distortion, high sensitivity, and a wide dynamic range. A tracking generator is available which improves the frequency measurement accuracy of the analyzer and can be used to make swept measurements.

Wide frequency range

The broad frequency range of 1 kHz to 110 MHz extends from audio through the FM broadcast band. Scan widths from 200 Hz to 100 MHz allow a user to view all or selected parts of the frequency spectrum while the zero scan mode turns the analyzer into a fixed tuned receiver and displays amplitude variations in the time domain. The analyzer has two dial scales, 0 - 100 MHz for full coverage and 0 - 11 MHz for better resolution at low frequencies.

Resolution - stability

The 8553B has resolution bandwidths that range from 300 kHz to 10 Hz. Wide bandwidths are necessary for making measurements on a wideband spectrum such as FM. The extremely high resolution 10 Hz bandwidth and 11:1 60 dB to 3 dB bandwidth ratio allow 50 or 60 Hz sidebands to be measured. Such high resolution is made possible by automatic stabilization through phase lock, which reduces residual FM to less than 1 Hz peak to peak. Good stability is required to measure oscillator residual FM and drift.

Absolute amplitude calibration

The 8553B Spectrum Analyzer is absolutely calibrated in both dBm and volts from -142 dBm ($.02 \mu\text{V}$) to +10 dBm (.7 V). This absolute calibration is derived from a built-in calibrator (-30 dBm at 30 MHz) and extremely flat analyzer frequency response (± 0.5 dB). A display uncal. light warns if the display becomes uncalibrated. The probe power output supplies power to a high impedance probe which can be used to make bridging measurements on circuits terminated at both ends.

High sensitivity

A low analyzer noise figure and narrow bandwidths give the 8553B very high sensitivity. Signal levels as low as -140 dBm can be measured in a 10 Hz bandwidth, and a preamplifier is available to further increase sensitivity by 16 dB. Video filtering in 10 kHz, 100 Hz, and 10 Hz bandwidths will average the displayed noise. High analyzer sensitivity is required if distortion in an amplifier or oscillator is to be mea-

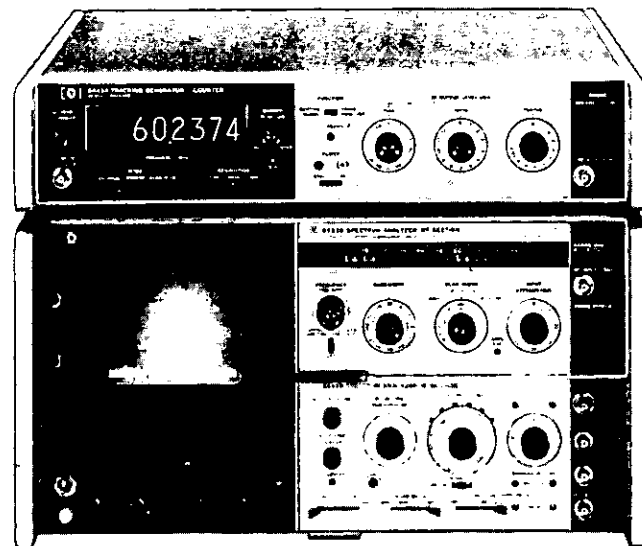

sured as a function of output level. In EMI studies, field strength can be measured with a calibrated antenna.

70 dB dynamic range

The 8553B has a 70 dB dynamic range when the signal level is properly conditioned at the input mixer. A wide dynamic range is necessary to measure small signals in the presence of large ones, such as harmonic or intermodulation distortion or to monitor signals of widely varying amplitudes, such as in EMC, RFI, and surveillance work.

8443 tracking generator

A tracking generator, 8443A, is available which covers the 100 kHz to 110 MHz frequency range of the 8553B. It has a built-in counter, and precision RF attenuators which are useful making substitution measurements.

Frequency accuracy

In conjunction with an 8443 tracking generator, the 8553B Spectrum Analyzer, can measure frequencies to an accuracy of ± 10 Hz. When the 8443A is operated in the "track analyzer" mode, the counter will read the frequency at a tunable marker which is generated on the analyzer CRT. The "restore signal" mode is a more convenient way to measure signal frequencies in wide scans because the counter reads the signal frequency automatically without fine tuning. The 8443A tracking generator may also be used externally as a 120 MHz direct reading counter.

Swept measurements

The 8443 tracking generators can be used with the 8553B to make swept insertion loss and return loss measurements over the 100 kHz to 110 MHz frequency range. Because the signal source tracks the analyzer's tuning, up to 130 dB dynamic measurement range is possible (at 10 Hz bandwidth). Excellent system flatness (± 1.0 dB) insures the accurate determination of swept response characteristics.

Specifications

Frequency specifications

Frequency range: 1 kHz - 110 MHz (0 - 11 MHz and 0 - 110 MHz tuning ranges).

Scan width (on 10-division CRT horizontal axis):

Per division: 18 calibrated scan widths from 20 Hz/div to 10 MHz/div in a 1, 2, 5 sequence.

Preset: 0 - 100 MHz, automatically selects 300 kHz bandwidth IF Filter.

Zero: Analyzer is fixed tuned receiver with selectable bandwidth.

Frequency accuracy:

Center frequency accuracy: The dial indicates the display center frequency within ± 1 MHz on the 0 - 110 MHz tuning range; ± 200 kHz on the 0 - 11 MHz tuning range with FINE TUNE centered, and temperature range of 20° to 30°C.

Scan width accuracy: Scan widths 10 MHz/div to 2 MHz/div and 20 kHz/div to 20 Hz/div: Frequency error between two points on the display is less than $\pm 3\%$ of the indicated frequency separation between the two points (8552B). Scan widths 1 MHz/div to 50 kHz/div: Frequency error between two points on the display is less than $\pm 10\%$ of the indicated frequency separation (8552B only).

Resolution:

Bandwidth 8552B IF section: IF bandwidths of 10 Hz to 300 kHz are provided in a 1, 3 sequence.

Bandwidth accuracy: Individual IF bandwidths' 3 dB points calibrated $\pm 20\%$ (10 kHz bandwidth $\pm 5\%$).

Bandwidth selectivity: 60 dB/3 dB IF bandwidth ratios 8552B IF section: 10 Hz to 3 kHz bandwidths, <11:1; 10 kHz to 300 kHz bandwidths, <20:1.

Stability:

Residual FM stabilized: 8552B IF Section: Sidebands >60 dB down 50 Hz or more from CW signal, scan time ≥ 1 sec/div, 10 Hz bandwidth (typically less than 1 Hz peak-to-peak).

Residual FM unstabilized: <1 kHz peak-to-peak.

Noise sidebands: More than 70 dB below CW signal, 50 kHz or more away from signal, with 1 kHz IF bandwidth.

Long term drift (after 1-hour warm-up), stabilized: 50 Hz/min, 500 Hz/10 min; unstabilized: 5 kHz/min, 20 kHz/10 min.

Amplitude specifications

Absolute amplitude calibration range:

Log: From -130 to +10 dBm, 10 dB/div on a 70 dB display or 2 dB/div on a 16 dB display (8552B only).

Linear: From 0.1 μ V/div to 100 mV/div in a 1, 2 sequence on an 8-division display.

Dynamic range:

Average noise level: <-110 dBm with 10 kHz IF bandwidth.

Video filter: Averages displayed noise: 10 kHz, 100 Hz, and 10 Hz bandwidths. (10 Hz on 8552B IF Section only.)

Spurious responses: Are below a -40 dBm signal at the input mixer as follows: All image and out-of-band mixing responses, harmonic and intermodulation distortion less than 70 dB down, 2 MHz to 110 MHz; less than 60 dB down, 1 kHz to 2 MHz. Third order intermodulation products less than 70 dB down, 1 kHz to 110 MHz (Signal separation >300 Hz for 8552B IF Section).

Residual responses (no signal present at input): With input attenuation at 0 dB: <-110 dBm (200 kHz to 110 MHz); <-95 dBm (20 kHz to 200 kHz).

Amplitude accuracy:

Frequency response (Flatness: attenuator settings > 10 dB):	Log	Linear
1 kHz to 110 MHz	± 0.5 dB	$\pm 5.8\%$
Amplitude Display	± 0.25 dB/dB	$\pm 2.8\%$ of full 8 div deflection
	but not more than ± 1.5 dB over the full 70 dB display range	

Calibrator amplitude: -30 dBm, ± 0.3 dB.

Calibrator frequency: 30 MHz, ± 3 kHz (8552B)

Log reference level control: Provides 70 dB range (60 dB below 200 kHz), in 10 dB steps. Accurate to ± 0.2 dB ($\pm 2.3\%$, Linear Sensitivity).

Log reference level vernier: Provides continuous 12 dB range. Accurate to ± 0.1 dB ($\pm 1.2\%$) in 0, -6, and -12 dB positions; otherwise ± 0.25 dB ($\pm 2.8\%$).

Amplitude measurement accuracy: ± 1.25 dB with proper technique.

General

Input impedance: 50 Ω nominal, BNC connector. Reflection coefficient <0.13 (1.3 SWR), input attenuator ≥ 10 dB. A special 75 Ω 8553B/8552B is available.

Maximum input level: Peak or average power +13 dBm (1.4 V ac peak), ± 50 V dc. 1 dB compression point, -10 dBm.

Scan time: 16 internal scan rates from 0.1 ms/div to 10 sec/div in a 1, 2, 5 sequence, or manual scan (8552B only).

Scan mode:

Int: Analyzer repetitively scanned internally.

Single: Single scan with reset actuated by front panel pushbutton.

Ext: Scan determined by 0 to +8-volt external signal.

Manual: Scan determined by front panel control.

Attenuator: 0 to 50 dB, in 10 dB increments, coupled to Log Reference Level indicator; automatically maintains absolute calibration. Attenuator accuracy ± 0.2 dB.

Power requirements: 100, 120, 220, or 240 V +5%, -10%, 50 to 60 Hz, normally less than 225 watts.

Weight: Model 8553B RF Section: Net, 12 lb (5.5 kg). Shipping, 17 lb (7.8 kg).

Dimensions: 226 mm wide, 102 mm high, 344 mm deep (8 $\frac{7}{8}$ " \times 4" \times 13 $\frac{1}{2}$ ").

Tracking generator (8443A)

Frequency range: 100 kHz to 110 MHz.

Amplitude range: <-120 dBm to +10 dBm in 10 and 1 dB steps with a continuous 1.2 dB vernier.

Amplitude accuracy:

Frequency response (flatness): ± 0.5 dB.

Absolute: 0 dBm at 30 MHz: ± 0.3 dB.

Output impedance: 50 Ω , BNC connector, ac coupled, reflection coefficient ≤ 0.09 (1.2 SWR) with output <0 dBm.

Counter:

Display: 7 digits with 1 digit over-range. Reads to ± 10 Hz increments.

Resolution (gate time): 1 kHz (1 ms), 100 Hz (10 ms), 10 Hz (100 ms).

Accuracy: ± 1 count \pm time base accuracy.

Time base aging rate: $< 3 \times 10^{-9}$ /day (0.3 Hz/day) after warm-up.

External counter inputs: 10 kHz to 120 MHz, 50 Ω , -10 dBm min.

Power: 100, 120, 220, or 240 V +5%, -10%, 48 to 440 Hz. 8443A, 75 watts.

Net weight: 8443A, 24 lb, 5 oz (11.04 kg). Shipping weight 31 lb, 14 oz (14.47 kg).

Dimensions: 425 mm wide, 88.2 mm high, 332 mm deep (16 $\frac{1}{4}$ " \times 3 $\frac{1}{2}$ " \times 13 $\frac{1}{4}$ ").

Model number and name

8553B RF section

8443A Tracking generator

Price

\$2650

\$3925

SIGNAL ANALYZERS

141T Spectrum analyzer system, 100 kHz to 1250 MHz

Models 8554B & 8444A

- High resolution to 100 Hz
- Flat frequency response ± 1 dB
- High sensitivity to -122 dBm (180 nV)

- Variable persistence display
- Companion Tracking Generator
- External counter capability

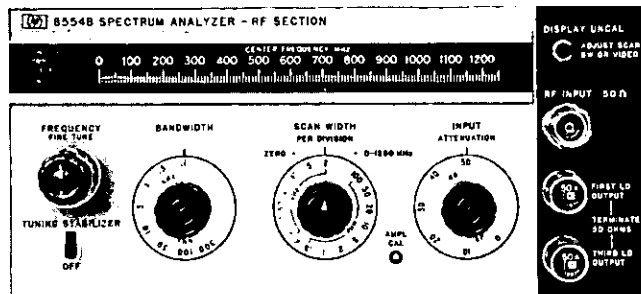

8554B



8444A

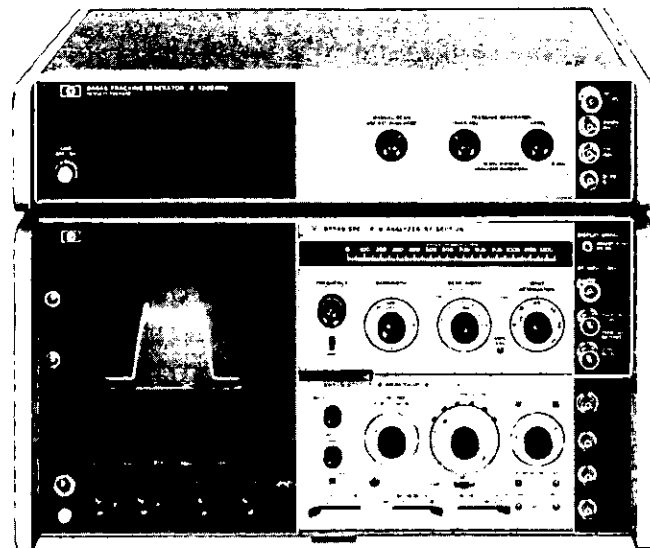

8554B Spectrum analyzer

The 8554B Spectrum Analyzer RF Section covers the frequency range from 100 kHz to 1250 MHz. This broad frequency coverage allows analysis from baseband through UHF navigation bands. Absolute amplitude calibration is maintained over the entire range. Some typical applications include power and frequency measurements on modulation, distortion and spurious outputs, frequency response measurements of filters, amplifiers, modulators and mixers. The analyzer can also be used to make noise measurements and EMI and EMC measurements using a calibrated antenna or current probe.

Absolute amplitude calibration

Absolute amplitude measurements can be made from $+10$ to -122 dBm with ± 2.5 dB accuracy. This accuracy can be increased to ± 1.5 dB using IF substitution. The display is calibrated in log (dBm) to obtain a wide display range and linear (voltage) for measurements requiring maximum resolution. The top graticule line on the CRT is a calibrated reference level which can be changed by the front panel controls from $+10$ to -72 dBm for greater IF substitution measurements. Amplitude calibration is dependent upon the proper relationship between sweep width, sweep time, resolution bandwidth and video filtering. An uncal warning light is present to indicate an uncalibrated situation.

Flat frequency response

In broadband use, the wide bandwidths allow fast sweeping of the entire spectrum. The analyzer is extremely flat (± 1 dB) over its entire range, allowing direct comparisons of signal amplitudes displayed on the CRT. A 0 to 50 dB input attenuator is provided to prevent overdriving the input mixer.

Resolution

The low residual FM (<100 Hz peak-to-peak) of the 8554B makes possible resolution bandwidths as narrow as 100 Hz. This enables resolving closely spaced signals such as 1 kHz and 400 Hz sidebands. Bandwidths range from 100 Hz to 300 kHz in a 1, 3, 10 sequence making it easy to select an optimum bandwidth to scan width ratio. The resolution bandwidths consist of synchronously tuned "gaussian" shaped filters to enable faster sweeping for any given bandwidth. In

addition, these filters have narrow shape factors making it possible to measure closely spaced signals differing greatly in amplitude.

Sensitivity

The high sensitivity (-122 dBm in 100 Hz bandwidth) and wide spurious-free measurement range (>65 dB) of the 8554B means accurate measurements can be made on low level signals and signals varying widely in amplitude. For example, modulation as low as 0.2% can be measured. Low level harmonic and intermodulation distortion, spectrum surveillance and EMI are just a few of the measurements possible. A video filter is provided in the IF section to average displayed noise and simplify the measurement of low level signals.

Automatic tuning stabilization

The 8554B Spectrum Analyzer is automatically stabilized in narrow scans. This gives the stability (<100 Hz peak-to-peak residual FM) needed for high resolution analysis. Stabilization is accomplished by phase locking the LO's (local oscillators) to a crystal reference in scan widths 10 MHz and below. No signal recentering or checking for stabilization is required because the signal remains on screen when phase locked.

8444A Tracking generator

The 8444A Tracking Generator is a signal source, which, when connected to the 8554B Spectrum Analyzer, has an output whose frequency is the same as the swept frequency of the analyzer. The tracking generator is used as a signal source to measure the frequency response of a device. It can also be used for precision frequency measurements. An external counter output is provided on the 8444A and the frequency of unknown signals as well as the frequency of any point on a frequency response curve can be measured. The use of the 5300A/5303A Counter is suggested for frequency measurements to 500 MHz and the 5245L/5254C Counter for measurements to 1240 MHz.

The tracking generator-spectrum analyzer system can be used to supply test signals for other devices as a sweeper. The sweep widths and sweep rates are controlled from the spectrum analyzer and the output level from the tracking generator.



8554B Specifications

Frequency specifications

Frequency range: 100 kHz to 1250 MHz.

Scan width (on 10-division CRT horizontal axis):

Per division: 15 calibrated scan widths from 100 MHz/div to 2 kHz/div in a 1, 2, 5 sequence.

Preset: 0 - 1250 MHz, automatically selects 300 kHz bandwidth IF filter.

Zero: Analyzer is fixed-tuned receiver.

Frequency accuracy:

Center frequency accuracy: The dial indicates the display center frequency with 10 MHz.

Scan width accuracy: Frequency error between two points on the display is less than 10% of the indicated separation.

Resolution:

Bandwidth: IF bandwidths of 0.1 to 300 kHz provided in a 1, 3 sequence.

Bandwidth accuracy: Individual IF bandwidths 3 dB points calibrated to $\pm 20\%$ (10 kHz bandwidth $\pm 5\%$).

Bandwidth selectivity: 60 dB/3 dB IF bandwidth ratio $< 20:1$ for IF bandwidths from 10 kHz to 200 kHz. 60 dB/3 dB bandwidth ratio $< 11:1$ for IF bandwidths 100 Hz to 3 kHz (8552B only).

Stability (residual FM):

Stabilized: < 100 Hz peak-to-peak

Unstabilized: < 10 kHz peak-to-peak

Noise sidebands: More than 70 dB below CW signal, 50 kHz or more away from signal, with 1 kHz IF bandwidth.

Amplitude specifications

Absolute amplitude calibration range:

Log: From -122 to $+10$ dBm. 10 dB/div on a 70 dB display, or 2 dB/div on a 16 dB display (8552B only).

Linear: From $0.1 \mu\text{V/div}$ to 100 mV/div in a 1, 2 sequence on an 8-division display.

Dynamic range:

Average noise level: < -102 dBm with 10 kHz IF bandwidth.

Spurious responses: All image and out-of-band mixing responses, harmonic and intermodulation distortion products are more than 65 dB below a -40 dBm signal at the input mixer.

Residual responses (no signal present at input): With input attenuation at 0 dB: < -100 dBm.

Amplitude accuracy:

	Log	Linear
Frequency response (flatness) 100 kHz to 1250 MHz	± 1 dB	$\pm 12\%$
Switching between bandwidths (at 20°C)	± 0.5 dB	$\pm 5.8\%$
Amplitude display	± 0.25 dB/dB but not more than ± 1.5 dB over the full 70 dB display range.	2.8% of full 8 div deflection

Calibrator output:

Amplitude: -30 dBm, ± 0.3 dB.

Frequency: 30 MHz, ± 3 kHz (8552B only).

RF input specifications

Input impedance: 50 Ω nominal. Reflection coefficient < 0.30 (1.85 SWR), input attenuator ≥ 10 dB.

Maximum input level: Peak or average power $+13$ dBm (1.4 V ac peak), ± 50 V dc.

General

Scan time: 16 internal scan rates from 0.1 ms/div to 10 sec/div in a 1, 2, 5 sequence, and manual scan (8552B only).

Scan time accuracy:

0.1 ms/div to 20 ms/div: $\pm 10\%$

50 ms/div to 10 s/div: $\pm 20\%$

Weight:

Model 8554B RF section: Net, 4.7 kg (10 lb, 4 oz). Shipping 7.8 kg (17 lb).

8444A

Specifications for swept frequency response measurements

Dynamic range: > 90 dB from spectrum analyzer 1 dB gain compression point to average noise level (approximately -10 dBm to -100 dBm). Spurious responses not displayed.

Gain compression: for -10 dBm signal level at the input mixer, gain compression < 1 dB.

Absolute amplitude calibration range:

Tracking generator (drive level to test device): 0 to -10 dBm continuously variable. 0 dBm absolutely calibrated to ± 0.5 dB at 30 MHz.

Frequency range: 500 kHz to 1250 MHz.

Frequency resolution: 1 kHz.

Stability:

Residual FM (peak-to-peak):

Tuning:

Section	Stabilized	Unstabilized
8554B	100 Hz	10 kHz

Amplitude accuracy:

System frequency response: ± 1.50 dB.

Tracking generator calibration: 0 dBm at 30 MHz to ± 0.5 dB.

Specifications for precision frequency measurements

Frequency accuracy: For unknown signals ± 10 kHz. (Tracking drift typically 5 kHz/10 min after 2-hour warm-up). For points on frequency response curve, counter accuracy \pm Residual FM (200 Hz).

Counter mode of operation:

Manual scan: Scan determined either by front panel control of 8552B IF Section or by external scan signal provided by the 8444A.

Zero scan: Analyzer is fixed-tuned receiver. Counter reads center frequency to accuracy of tracking drift.

Counter output level: Typically 0.1 V rms.

Specifications for sweep/CW generator

Frequency: Controlled by spectrum analyzer. Range 500 kHz to 1250 MHz with 8554B. Scan widths are as enumerated on this page.

Frequency accuracy: ± 10 MHz using spectrum analyzer tuning dial. Can be substantially improved using external counter output.

Flatness: ± 0.5 dB.

Spectral purity:

Residual FM (peak-to-peak): 100 Hz.

Harmonic distortion: 25 dB below output level (Typical).

Nonharmonic (spurious) signals: > 35 dB below output level.

Long term stability: Drift typically less than 30 kHz/hour when stabilized after 2-hour warm-up.

Sweep width: 20 kHz to 1000 MHz.

Sweep rates: Selected by Scan Time per Division on spectrum analyzer.

General

Temperature range: Operation, 0 to 55°C, storage -40 °C to 75°C.

EML: Conducted and radiated energy is within the requirements of MIL-I-6181D.

Power: 115 V and 230 V, 48 to 440 Hz, 12 watts max.

Weight: Net, 7.1 kg (15 lb, 10 oz). Shipping, 9.5 kg (21 lb).

Model number and name

8554B RF Section

8444A Tracking Generator

Price

\$3700

\$3150

SIGNAL ANALYZERS

141T Spectrum analyzer system, 10 MHz to 40 GHz

Models 8555A, 8444A & 8445B

- Absolute amplitude calibration
- High sensitivity to -125 dBm (2.5 nV)
- Resolve signals to 100 Hz
- Scan up to 8 GHz full screen
- 100 dB distortion free dynamic range with preselector
- Companion tracking generator to 1.3 GHz

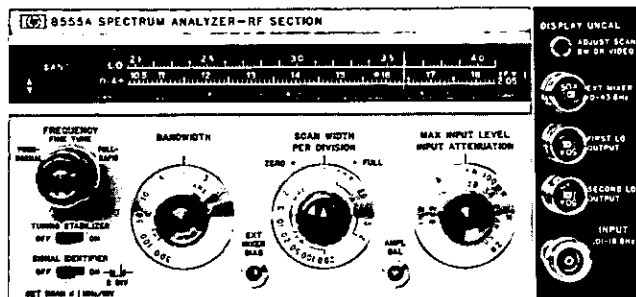

8555A



8444A

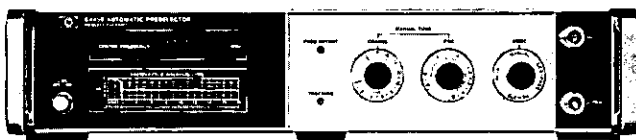

8445B

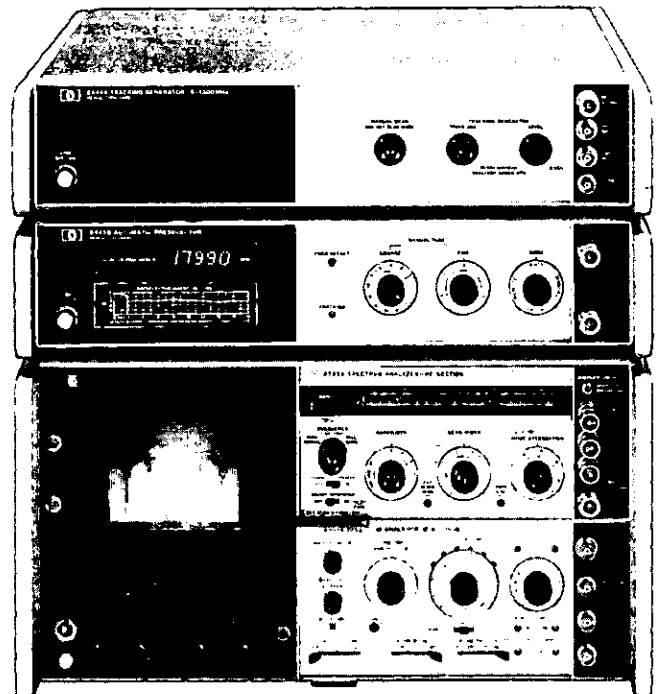

8555A Spectrum analyzer

The 8555A spectrum analyzer covers 10 MHz to 18 GHz with fundamental and harmonic mixing. External waveguide mixers can provide 12.4 GHz to 40 GHz coverage. This broad frequency range coupled with its high sensitivity and resolution bandwidth allow a variety of power measurements, frequency measurements, modulation and noise analysis on almost every type of design module: the frequency response of amplifiers, mixers, and modulators, response and alignment of filters isolators, couplers and limiters. With wide scan widths and calibrated amplitude the 8555A is ideal for spectrum surveillance and RFI/EMC field strength analysis with a calibrated antenna.

Absolute amplitude calibration

The 8555A offers absolute amplitude calibration from $+10$ dBm to -125 dBm over the 10 MHz to 18 GHz frequency range. This capability makes possible not only absolute signal power measurements, but also the measurement of the power differential between two signals separated by as much as 18 GHz. The parallax free CRT graticule can read as a log scale (dBm) or a linear scale (volts) with a frequency response accuracy of ± 1.5 dB to 6 GHz and ± 2.0 dB to 18 GHz. The top line of the display is established as the reference level by front panel controls. A light warns of an uncalibrated condition.

High sensitivity

The high sensitivity from -125 dBm (fundamental mixing) to -100 dBm (4th harmonic) in a 100 Hz bandwidth makes it possible to measure large values of attenuation, out of band filter and amplifier response, weak transmitted signals in surveillance work or microvolt signals in EMC applications. A post detection filter with 10 kHz, 100 Hz and 10 Hz (8552B only) position averages any noise and yields an

extremely clean observed trace.

High resolution

Due to low residual FM (<100 Hz peak-to-peak) the 8555A offers outstanding 100 Hz resolution which allows the users to resolve closely spaced signals and low level sidebands resulting from a 1 kHz modulating signal. The resolution capability makes it possible to analyze spurious low frequency modulation of microwave signals. The high stability of the analyzer results in more accurate measurements of residual FM, long-term drift, phase noise and spectral purity. Furthermore, the Gaussian shape of the IF filters allow fastest sweep for a given resolution bandwidth.

Automatic tuning stabilization

When scanning over a relatively narrow frequency range, the frequency stability of the analyzer's internal local oscillators become important for high resolution and frequency measurements. For this reason the 8555A is equipped with a tuning stabilizer circuit which automatically phase locks the analyzer to a crystal oscillator. Display jitter and signal recentering are virtually eliminated.

8445B Tracking preselector, 10 MHz to 18 GHz

The 8445B tracking preselector is a YIG tuned to filter coupled to the 8555A spectrum analyzer in order to be tuned exactly to the analyzer's reception frequency. The preselector eliminates harmonic mixing image and multiple responses from 1.8 to 18 GHz. The result is a wide measurement range and an end to signal identification. Clean, full band sweeps possible in scans of 2, 4, 6 or 8 GHz depending upon the band selected.

Below 1.8 GHz the image and multiple responses are eliminated by a low pass filter in the preselector.

A five digit LED display with 1 MHz resolution allows accurate measurement of either the display frequency at the display marker in full scan mode or the center frequency in per division scan.

8444A Tracking generator, 10 MHz to 1300 MHz

The 8444A tracking generator provides a level, calibrated RF signal which is exactly the tuned frequency of the spectrum analyzer. This enables swept frequency tests such as frequency response and return loss measurements up to 1300 MHz. With an external counter the frequencies of unknown signals on points along a frequency response curve can be made.

8555A Specifications

Frequency specifications

Frequency range: 0.01 – 40 GHz.

Tuning range:

With internal mixer: 0.01 – 18.0 GHz.

With external mixer: 12.4 – 40 GHz.

Harmonic mixing mode:

Signal identification: Not normally required with preselector. Signal identifier provided for positive identification of all responses. Rejection of images and multiple responses with preselector is >70 dB.

Scan width:

Full scan: The width of the scan depends on mixing mode. Scan width = $n \times 2000$ MHz, where n is the mixing mode; e.g. for $n = 2$, scan width is 4 GHz. Maximum scan width full screen is 8 GHz with coaxial mixer. Preselector necessary to make wide scans usable.

Per division: 16 calibrated scan widths from 2 kHz/div to 200 MHz/div in a 2, 5, 10 sequence.

Zero scan: Analyzer becomes fixed tuned receiver.

Frequency accuracy:

Dial accuracy: $n \times (\pm 15 \text{ MHz})$ where n is the mixing mode.

Scan accuracy: Frequency error between two points on the display is less than $\pm 10\%$ of the indicated separation.

Stability: Residual FM stabilized <100 Hz (peak-to-peak) (fundamental mixing).

Noise sidebands: For fundamental mixing. More than 70 dB below CW signal 50 kHz or more away from signal, with 1 kHz IF bandwidth and 100 Hz video filter.

Frequency drift:

Long term drift: (At fixed center frequency after 2-hour warm-up.) (Typical.)

Stabilized: ± 3.0 kHz/10 min.

Unstabilized: ± 25 kHz/10 min.

Stabilization range: First LO can be automatically stabilized to internal crystal reference for scan widths of 100 kHz/div or less.

Resolution:

Bandwidth range: Selectable 3 dB bandwidths from 100 Hz to 300 kHz in a 1, 3, 10 sequence.

Bandwidth shape: Gaussian.

Bandwidth selectivity: (8552B) 11:1 to 20:1 (60 dB/3 dB).

Bandwidth accuracy: Individual IF bandwidth 3 dB points calibrated to $\pm 20\%$. (10 kHz bandwidth $\pm 5\%$.)

Amplitude specifications

Measurement range:

Log reference level: From -130 dBm to +10 dBm.

Linear sensitivity: From 0.1 $\mu\text{V}/\text{div}$ to 100 mV/div.

Sensitivity and frequency response with internal coaxial mixer:

Average noise level: Specified for 1 kHz bandwidth.

Frequency response: With 10 dB input attenuator setting.

Frequency Range (GHz)	Mixing Mode (n)	Average Noise Level (dBm max.)	Frequency* Response (dB max.)
0.01 – 2.05	1-	-115	± 1.0
1.50 – 3.55	1-	-117	± 1.0
2.07 – 6.15	2-	-108	± 1.3
2.60 – 4.65	1+	-117	± 1.0
4.11 – 6.15	1+	-115	± 1.0
4.13 – 10.25	3-	-103	± 1.5
6.17 – 10.25	2+	-105	± 1.5
6.19 – 14.35	4-	-95	± 2.0
8.23 – 14.35	3+	-100	± 2.0
10.29 – 18.00	4+	-90	± 2.0

*Includes mixer frequency response, RF attenuator frequency response, mixing mode gain variation, RF input VSWR.

Sensitivity and frequency response with 11517A external waveguide mixer and appropriate waveguide tapers:

Average noise level: 10 kHz bandwidth (dBm typical).

10.31 – 22.55	6-	-90
14.41 – 26.65	6+	-85
18.55 – 38.95	10-	-85
22.65 – 43.05	10+	-75

Residual responses: Referred to input on fundamental mixing: <-90 dBm.

Display range:

Log: 70 dB, 10 dB/div and (with 8552B) 2 dB/div log expand on a 16 dB display.

Linear: From 0.1 μV to 100 mV/div in a 1, 2 sequence on an 8-division display.

Spurious responses due to second harmonic distortion with preselector:

Frequency Range	Power Incident on Input Mixer	2nd Harmonic Distortion
0.01 – 1.85 GHz	-40 dBm	-63 dB
1.85 – 18.0 GHz	0 dBm	-100 dB

Spurious responses due to third order intermodulation distortion with preselector:

Frequency Range	Signal Separation	Power Incident on Input Mixer	Third Order Intermodulation Distortion
0.01 – 18.0 GHz	> 1 MHz <20 MHz	-30 dBm	-70 dB
0.01 – 1.85 GHz	>70 MHz	-30 dBm	-70 dB
1.85 – 18.0 GHz	>70 MHz	0 dBm	-100 dB

Video filter: Post detection filter used to average displayed noise. With 8552A nominal bandwidths: 10 kHz and 100 Hz. With 8552B nominal bandwidths: 10 kHz, 100 Hz, and 10 Hz.

Gain compression: For internal mixer gain compression <1 dB for -10 dBm peak or average signal level to input mixer. 11517A external mixer (12.4 – 40 GHz) gain compression <1 dB for -15 dBm peak or average signal level to input mixer.

Amplitude accuracy:

IF gain variation with different bandwidth settings: (At 20°C.)

Log: ± 0.5 dB.

Linear: $\pm 5.8\%$.

Amplitude display:

Log: ± 0.25 dB/dB, but not more than ± 1.5 dB over the full 70 dB display range.

Linear: $\pm 2.8\%$ of full 8-division deflection.

Log reference level: Accurate to ± 0.2 dB ($\pm 2.3\%$ linear sensitivity).

Log reference level vernier: Accurate to ± 0.1 dB (1.2%) in 0, -6, and -12 dB positions; otherwise, ± 0.25 dB ($\pm 2.8\%$).

Input attenuator range: 0 - 50 dB in 10 dB steps.

Frequency response: Typically ± 0.6 dB from 10 MHz to 18 GHz.

Calibrator output: Amplitude -30 dBm, ± 0.3 dB. Frequency 30 MHz ± 3 kHz (8552B).

Absolute calibration accuracy: Overall accuracy is a function of measurement technique. With the appropriate technique, absolute accuracy of ± 1.6 dB (fundamental mixing) and ± 2.6 dB (4th harmonic mixing) is achievable.

Input characteristics

Input impedance: 50 ohms nominal (0.01 - 18 GHz).

Reflection coefficient: < 0.130 (1.30 SWR) for input RF attenuator settings ≥ 10 dB.

Maximum input level: Peak or average power +13 dBm (1.0 V ac rms) incident on mixer (+30 dBm with Option 002), +33 dBm incident on input attenuator.

RF input connector: Type N female.

LO emission: -10 dBm without preselector, -80 dBm with preselector over recommended operating ranges (10 dB input attenuator setting).

Specifications with option 002; internal limiter installed:

All specifications are the same as for the standard unit except the following:

Maximum input level:

Continuous: 1 W (+30 dBm).

Pulse: 75 watts peak, pulse width ≤ 1 μ sec, 0.001 duty cycle.

Reflection coefficient: < 0.33 (2.0 SWR).

Frequency response (flatness): $< \pm 0.5$ dB degradation in response, 0.1 - 12.4 GHz.

General

Scan time: 16 internal scan rates from 0.1 ms/div to 10 sec/div in a 1, 2, 5 sequence.

Power requirements: 100, 120, 220, 240 V + 5% - 10%, 50 - 60 Hz, normally less than 225 watts (varies with plug-in units used).

Dimensions: 226 mm wide, 102 mm high, 344 mm deep (8 $\frac{7}{8}$ " \times 4.0" \times 13.5").

Weight: Net, 16.8 kg (14 lb, 15 oz). Shipping 8.7 kg (19 lb).

8445B Tracking preselector

Frequency specifications

Frequency range: DC - 1.8 GHz low-pass filter. 1.8 - 18 GHz tracking filter.

Tracking filter 3 dB bandwidth: Typically 20 - 45 MHz.

Tracking filter skirt roll-off: Characteristics of a three-pole filter. (Nominal: 18 dB/octave.)

Insertion loss:

	Frequency	Insertion Loss (Except Opt. 004)	Insertion Loss (Opt. 004)
Low-Pass Filter	DC - 1.8 GHz @ 2.05 GHz	< 2.5 dB > 50 dB	*
Tracking Filter	1.8 - 12 GHz 12 - 18 GHz	< 8 dB < 10 dB	< 7 dB < 8 dB

*Low-Pass Filter deleted with Option 004.

Typical preselector minimum insertion loss at 25°C.

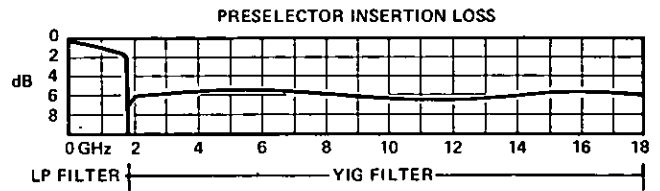

Out-of-band rejection: For YIG filter 1 GHz from center of pass-band > 70 dB.

Digital frequency readout (Option 003):

Function:

Full scan mode: Displays frequency at inverted marker.

Per division scan: Displays center frequency.

Manual or remote operation of preselector: Displays tuned frequency of filter.

Resolution: 1 MHz.

Accuracy: 0.01 - 1.0 GHz: ± 6 MHz.

1.0 - 4.0 GHz: ± 8 MHz.

4.0 - 18 GHz: $\pm 0.2\%$

Input specifications

Input connector: Precision Type N female.

Input VSWR: Typically < 2.0 (1.8 - 18 GHz).

Limiting level: (Maximum input level for < 1 dB signal compression) $> +5$ dBm.

Damage level: $> +20$ dBm.

General

Remote function: YIG filter frequency can be set by externally supplied voltage.

Power requirements: 100, 120, 220 or 240 V + 5% - 10%, 48 to 440 Hz, less than 110 watts.

Dimensions: 425 mm wide, 88.2 mm high, 467 mm deep (16 $\frac{1}{4}$ " \times 3 $\frac{1}{2}$ " \times 18 $\frac{3}{8}$ ").

Weight: Net, 8.8 kg (19 lb 8 oz). Shipping, 11.9 kg (26 lb).

8444A Tracking generator

Frequency range: 10 MHz to 1300 MHz.

Frequency resolution: 1 kHz.

Residual FM (peak-to-peak): 200 Hz (stabilized).

Amplitude range:

Spectrum analyzer display: from -130 dBm to +10 dBm, 10 dB/div on a 70 dB display or 2 dB/div on a 16 dB display (8552B only).

Tracking generator (drive level to test device): 0 to -10 dBm continuously variable.

Amplitude accuracy:

System frequency response: ± 1.50 dB.

Tracking generator calibration: 0 dBm at 30 MHz to ± 0.5 dB.

Dynamic range: > 90 dB.

Counter output: Typically 0.1 V rms.

General

Power: 115 V and 230 V, 48 to 440 Hz, 12 watts max.

Dimensions: 425 mm wide, 85.2 mm high, 467 mm deep (16 $\frac{1}{4}$ " \times 3 $\frac{1}{2}$ " \times 18 $\frac{3}{8}$ ").

Weight: Net, 7.1 kg (15 lb, 10 oz). Shipping, 9.5 kg (21 lb).

Model number and name

8555A tuning section	\$6750
Option 001 APC-7 connectors	\$40
Option 002 Internal limiter	\$210
Option 005 Video tape	\$105
8445B tracking preselector, dc - 18 GHz	\$2370
Option 001 APC-7 connectors	\$155
Option 002 Add manual controls	\$80
Option 003 Add digital frequency readout	\$670
Option 004 Delete low-pass filter	less \$425
Option 005 Delete interconnect rigid coax	less \$50
8444A tracking generator (10 MHz - 1300 MHz)	\$3150

SIGNAL ANALYZERS

Spectrum analyzer accessories

8447 Series, 11694A, 1121A

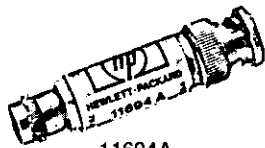

11694A

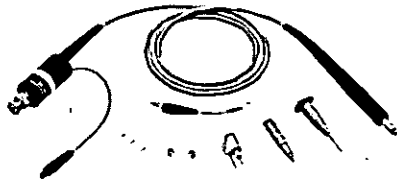

1121A

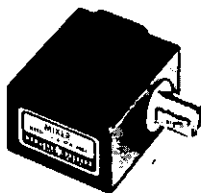

11517A



8430 Series

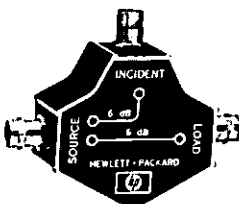

8721A



8406A

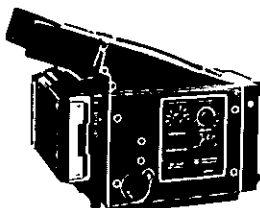

197A

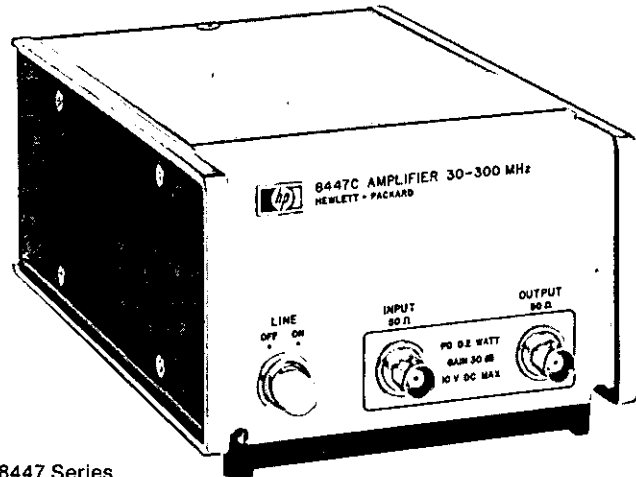

8447 Series

8447 Series amplifiers (0.1 – 1300 MHz)

The 8447 Series amplifiers feature low noise and wide bandwidth. This makes them ideal for improving spectrum analyzer sensitivity and noise figure while providing input isolation. Accurate measurements over a wide frequency range are assured due to the broad frequency coverage, flat frequency response and low distortion of these amplifiers. (See page 19).

11694A 75Ω Matching transformer (3 – 500 MHz)

Allows measurement in 75-ohm systems while retaining amplitude calibration. VSWR is less than 1.2, and insertion loss is less than 0.75 dB. Note: Also see Options 001 and 002 for 75Ω versions of 8558B.

1121A Active probe (0.1 – 500 MHz)

Provides high impedance (>100 kΩ shunted by <3 pF) input to spectrum analyzer for measurements on sensitive circuits. Probe power is provided by the spectrum analyzer and flat response with unity gain assures accurate, convenient measurements. (See page 430).

11517A External mixer

To extend the frequency range of the analyzer to 40 GHz. Taper sections for 12.4–18 GHz (11518A), 18–26.5 GHz (11519A) or 26.5–40 GHz (11520A) bands are required.

11693A Limiter (0.1 to 12.4 GHz)

The Model 11693A Limiter provides input protection for a variety of instruments in general applications (usable from 0.01 to 18 GHz). For example, the input circuits of spectrum analyzers, samplers, or amplifiers may be protected for inputs up to 75 watts peak or 1 watt average power. Also, signal generators can be protected from application of reverse power.

8721A Directional bridge

For making return loss measurements from 100 kHz to 110 MHz. (See page 429 under "11652A: Directional bridge").

8406A Frequency comb generator

Produces frequency markers at 1, 10, and 100 MHz increments accurate to ±0.01%. External oscillator can be used to generate precision interpolation sidebands. Comb is usable to 5 GHz.

197A Oscilloscope camera

Maximum flexibility is assured by the design of the 197A. An internal UV light source allows photos to be readily made from unlighted CRT's. The 10367A Adapter is required to use the camera with 182-series displays. (See page 156).

8430 Series passive filters

To improve the performance of the analyzer by eliminating unwanted responses. (See page 407).

Model number and name

Model number and name	Price
11694A 75Ω Matching Transformer	\$60
11517A External Mixer (Mixer only)	\$220
11518A/11519A/11520A Waveguide Taper Sections	\$135
11693A Limiter	\$200
8406A Frequency Comb Generator	\$695

SIGNAL ANALYZERS

Automatic spectrum monitoring, component testing

Model 8580B

- Economically test RF/microwave components and subsystems

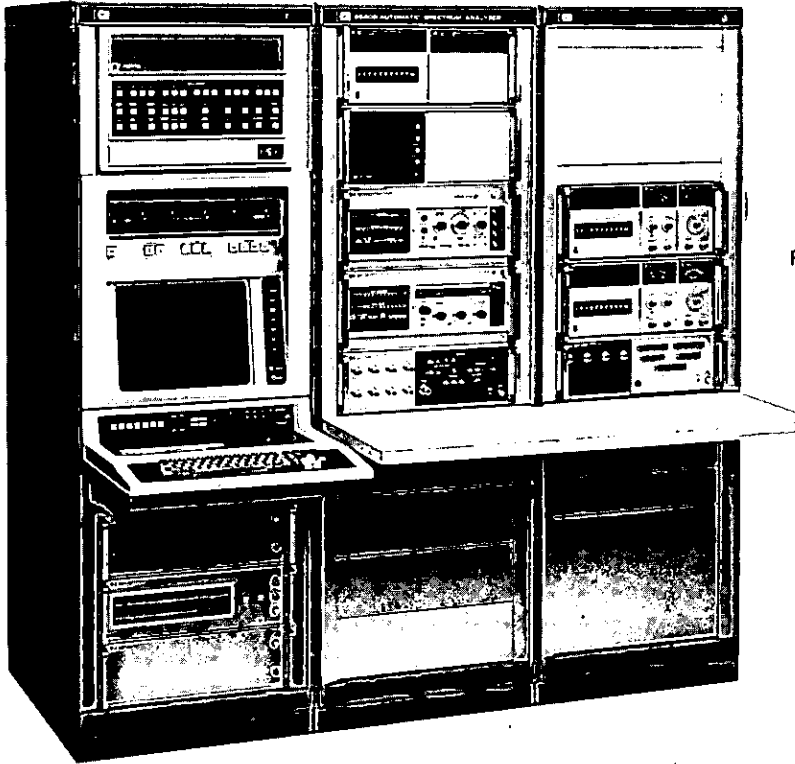

Typical 8580 System — 10 kHz to 18 GHz

Performance Features

- Rapid, accurate, and detailed signal characteristics
- Powerful data handling capability
- Easy to program and operate
- Optional signal generation and display

Description

The 8580B Automatic Spectrum Analyzer is a flexible measurement system for applications in spectrum monitoring and network characterization from 10 kHz to 18 GHz.

The key measuring instrument is a calibrated receiver with programmable tuning and bandwidth. This receiver can be tuned from 10 kHz to 18 GHz by BASIC measurement programs using simple, one-line statements. Receiver bandwidth is selectable from 10 Hz to 300 kHz. Other programmable system functions include input port selection, input attenuation, IF bandwidth, IF gain, and video filtering.

Optional signal sources expand the capability of the 8580 systems. Precision RF sources with programmable frequency and amplitude supply signals required to excite test devices for testing RF systems or for network analysis measurements.

Applications

The 8580B Automatic Spectrum Analyzer is a valuable tool for gathering spectral data on signals present in complex electronic equipment or in a geographic region. RFI testing, for example, is enhanced by the automatic system's ability to correct for antenna gain variations and compare measured data against specification limits. Performance of complex communication networks can be continually monitored to report network performance on a periodic basis. Similarly, radiation in a particular locale can be surveyed to gather statistics on spectrum usage or unauthorized transmissions. These applications emphasize an important feature of the Automatic Spectrum Analyzer: totally unattended operation. The 8580 may be programmed to

measure, analyze, and record data for long periods without human intervention. This makes continuous, comprehensive monitoring a practical tool for spectrum management.

Network characterization is also greatly advanced through use of an Automatic Spectrum Analyzer. An 8580 can measure the magnitude of reflection and transmission coefficients of linear networks, as well as the distortion parameters (harmonic, intermodulation, cross-modulation) of non-linear devices such as amplifiers. Frequency translators such as mixers, modulators, and frequency multipliers are also readily characterized. Additionally, oscillators can be evaluated for frequency accuracy, output level, distortion, and spurious output signals.

For both surveillance and network characterization applications, the 8580B's absolute calibration (frequency and power), broad frequency coverage, high frequency accuracy, wide dynamic range, speed, and ease of programming, combined with the flexible hardware option list, offer a measurement system that can be tailored to your application. Contact your local Hewlett-Packard office for complete technical information.

Options

151: Signal Source, 0.01-110 MHz	add \$12,500
152: Signal Source, 1-1300 MHz	add \$16,000
257: Interactive Graphics	add \$19,000

8580B Automatic Spectrum Analyzer

\$119,000



SIGNAL ANALYZERS

Introduction to digital Fourier analysis

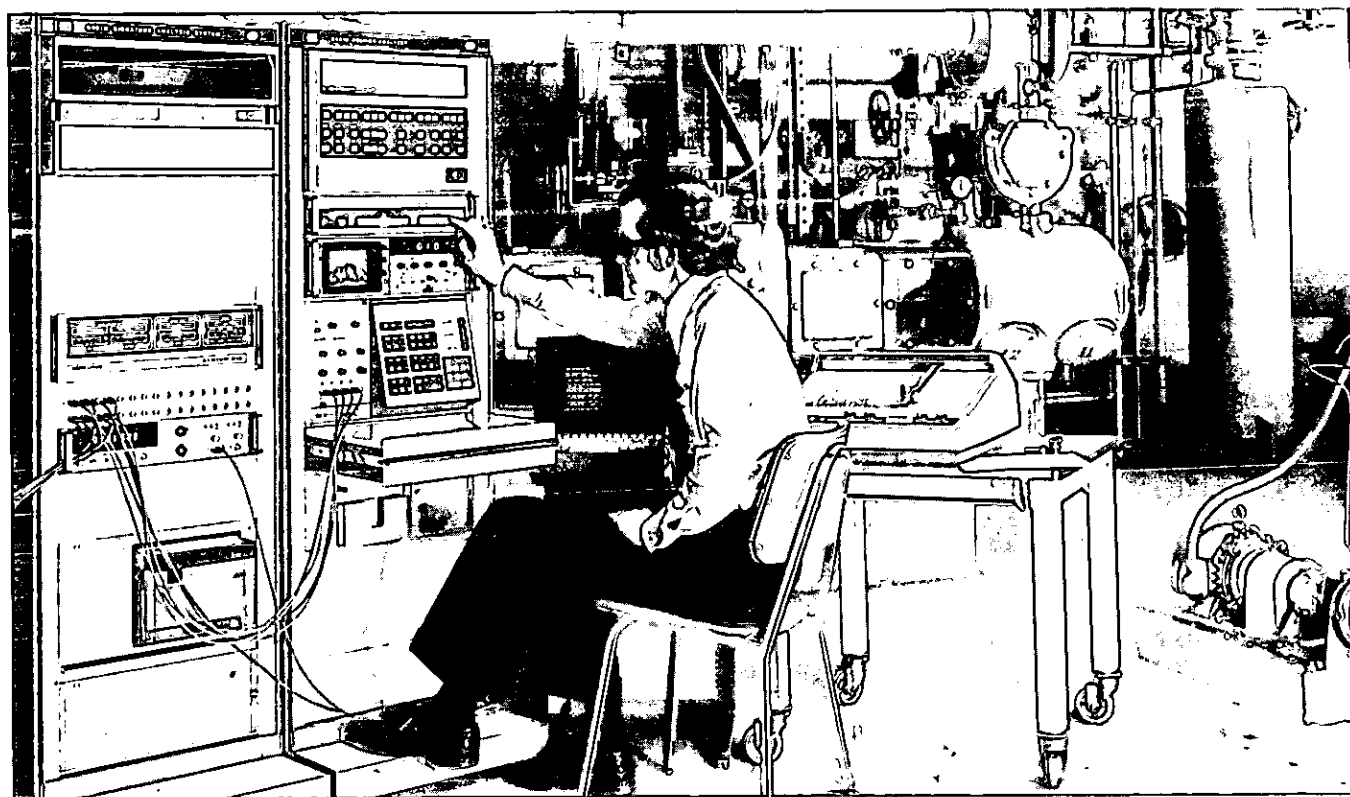

What is Fourier analysis?

Fourier Analysis is one of a variety of digital signal analysis techniques that allow analysis of signals that cannot be adequately measured by "traditional" instrumentation. Among these are: Random signals or signals obscured by noise, joint properties or relationships of two or more signals, statistical properties of signals, or very low frequency signals.

The basis of Fourier Analysis lies in the fact that signals may be represented either as time waveforms (time domain) or as a number of individual frequency components (frequency domain). The Fourier transform allows signals to be represented in either domain, thus providing the inherent advantages of each domain's representation for a given signal or signals.

The fundamental steps involved in this analysis are: Digitizing the time waveform (sampling at interval Δt) and storing the values in memory, computing the desired function and again storing the results in memory. The contents of memory are now available for display, plotting or further calculations. The entire operation is under the control of a central processor.

Advantages

The digital nature of Fourier analysis insures high accuracy, stability and essentially no low frequency limit. Since the transform provides all frequency lines from DC to some

maximum frequency at the same time, a great time savings is obtained over analog swept techniques. New digital techniques allow extremely high resolution about any center frequency. For example, a one kilohertz signal centered in a 100 hertz band could be investigated with 0.05 hertz resolution and 90 dB dynamic range.

The Fourier Analyzer also accepts multiple inputs. With simultaneous sampling, the relationship between two or more signals may be calculated, such as the input and output of a mechanical, electrical, or acoustic system. This flexibility, as well as the ability to compute many different statistical functions and output the data in a variety of formats, makes this analyzer an extremely cost effective general purpose instrument.

Equally important, the Fourier Analyzer is easy to use. It can be operated without special programming and contains a built-in calibrated CRT display for easy interpretation of results.

These advantages have opened up several new applications for Fourier analysis, many of them in fields which are not traditional users of digital instrumentation.

Applications

The versatility and performance of the 5451B Fourier Analyzer make it an ideal tool for a variety of applications. Mechanical engineers, electrical engineers, geophysicists and bio-medical researchers are applying its

advanced digital analysis capability to a broad spectrum of problems. Power spectrum analysis, ensemble averaging, cross spectrum measurements, transfer function measurements, and correlation are fundamental measurement techniques. Although the use or source of the data may differ, these analyses form the basis for understanding and solving complex dynamic problems.

Applications for Fourier analysis cover a broad range of areas. Rotating machinery analysis, structural dynamics, vibration control, electromechanical systems analysis and acoustic studies are just a few of the areas where these advanced techniques are being applied. Here are just a few examples:

Canada: For teaching and research at a major university.

France: Vibration studies of helicopters to help reduce noise.

California: For vibration analysis and testing of spacecraft.

Iowa: Acoustic and vibration analysis of linear servo systems.

Michigan: Vehicle crash studies. Used to help design automatic components such as steering wheels.

New York: Vibration analysis of cutting tools to determine chatter and wear characteristics.

Pennsylvania: Vibration analysis of steam turbine blades and other components.

Washington: Analysis of vibration data from aircraft flutter models.

SIGNAL ANALYZERS

Digital Fourier analysis, DC to 100 kHz

Model 5451B

- Multichannel Operation
- Keyboard Controlled
- Microcoded FFT
- Full Range of Peripherals

- 80 dB Dynamic Range
- Dedicated Applications Packages
- 3 Levels of Programmability
- Fully Calibrated Results

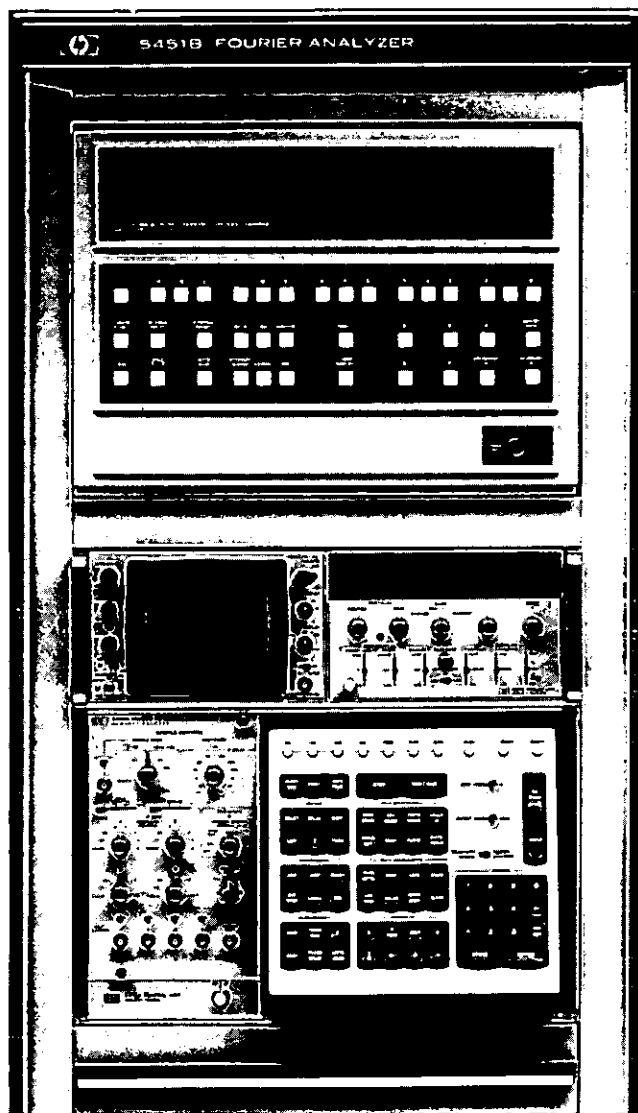

5451B SYSTEM (shown without teleprinter and with optional cabinet)

Description

The 5451B Fourier Analyzer provides digital frequency domain analysis of complex time signals in the low frequency range of DC to 100 kHz. The system is completely integrated and consists of a general purpose mini-computer for digital processing, a keyboard for operator control of the system, a dual channel analog-to-digital converter, a display control unit and CRT, a teleprinter, and an operating software package. It is a fully calibrated multipurpose system for data acquisition, data storage, and data analysis. The primary analysis functions it performs are: Forward or Inverse Fourier Transform, Auto or Cross Power Spectrum, Transfer and Coherence Function, Auto and

Cross Correlation, Convolution, Amplitude Histogram, and Time or Frequency Domain Averaging.

The ability to measure these functions quickly and accurately and with large dynamic range is what makes the Fourier Analyzer a powerful tool for: Stimulus-Response measurements, system identification, Vibration Control, Modal Analysis, Signature Analysis, Underwater Sound, Acoustics, Communications, and more.

Specifications

Analog-to-digital converter

Input ranges: ± 0.125 V to ± 8 V peak in steps of 2.

Input coupling: dc or ac.

Input impedance: 1 M Ω in parallel with <75 pF.

Input channels: 2 channels wired for 4 standard, 4 channels optional with plug-in cards.

Resolution: 10 bits including sign. 12 bits optional.

Sample rate control:

Maximum frequency mode: Maximum frequency selectable from 0.1 Hz to 100 kHz in steps of 1, 2.5, 5.

Frequency resolution mode: Frequency resolution selectable from 0.2 mHz to 1000 Hz in steps of 1, 2, 5.

External clock: An external time base may be used to allow external control of the sampling rate.

Display unit

Data may be displayed in single sweeps or refreshed continuously.

Type of display: Points, bars, or continuous (interpolation).

Vertical scale calibration: Data in memory is automatically scaled to give a maximum on-screen calibrated display. The scale factor is given in volts/division, volts²/division, or in dB offset.

Linear display range: ± 4 divisions with scale factor ranging from 1×10^{-512} to 5×10^{-512} in steps of 1, 2, 5, and 10.

Log display range: 80 dB with a scale factor ranging from 0 to ± 998 dB. Offset selectable in 4 dB steps.

Horizontal scale calibration:

Linear sweep length: 10, 10.24, or 12.8 divisions.

Log horizontal: 0.5 decade/division.

Markers: Intensity markers every 8th or every 32nd point.

Overall system

Accuracy and range: The Fourier Transform is implemented using conditional scaling for maximum accuracy with no data overflows allowed. All calculations use floating point arithmetic on a block basis with full 16 and 32-bit arithmetic.

Data word size: 16-bit real and 16-bit imaginary with 32 bits preserved for double precision functions. Division, addition, or subtraction operations performed in 16 or 32 bits depending on data.

Transform time: Typically 100 ms for a Fourier Transform of 1024 time domain points.

Dynamic range: 80 dB for a minimum detectable spectral component in the presence of one full scale spectral component after eight ensemble averages for a block size of 1024.

Power requirements, size, weight

Power source: 115/230 volts $\pm 10\%$, 50/60 Hz, 1400 watts typical for base system (excluding teleprinter).

Environmental conditions: 0°C to 55°C (131°F).

Relative Humidity: To 95% at 40°C (104°F).

Size: Dimensions are for the base system (excluding teleprinter). Height: 711 mm (28 in.), width: 425 mm (16 $\frac{1}{4}$ in.), depth: 616 mm (24 $\frac{1}{4}$ in.).

Weight: Net weight for the base system (excluding teleprinter), 96 kg (210 lb).

5451B Base system

\$45,500

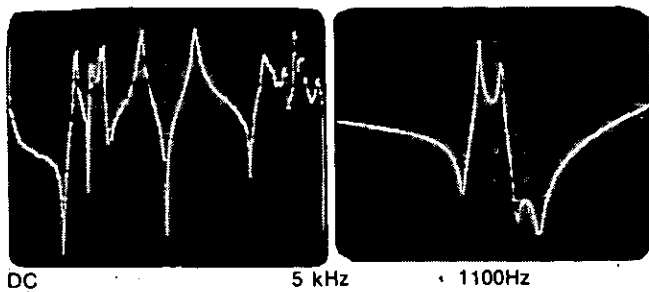

Band Selectable Fourier Analysis

Options

A number of options are available to expand and enhance the capabilities of the 5451B system. These options may be purchased with the system or added on later. Where applicable, special software drivers are provided to enable control of standard computer peripheral options from the 5451B control keyboard for full system integration.

Mass storage

Data and program storage capacity may be enlarged with the addition of digital magnetic storage devices to the 5451B system. These include the 7900A Magnetic Disc unit and the 7970B and 7970E Magnetic Tape units. The mass storage peripherals are integrated into the Fourier system through Fourier Mass Store Software, Option 710. This software configures the available storage in six files. Each file is independently read, written, and positioned even though all may be located on the same physical device. All files are simply and quickly accessed under convenient keyboard control and access to any of the six files is identical whether using magnetic tape, magnetic disc, or both. The only distinction is the speed and storage capability of the device itself.

Fourier/BASIC

5451B Option 720 provides a link between HP Instrument BASIC and the 5451B Fourier Analyzer System. The link is provided through special routines incorporated into the standard Instrument BASIC repertoire which allow the BASIC operator to access files on the 5451B Mass Store Disc peripheral (available separately). The BASIC operator can: Access Fourier Data from the disc and operate on it point-by-point, read and write BASIC core images from the disc for storing and recalling BASIC programs, call another BASIC program or a Fourier keyboard program as a subroutine to the running BASIC program. The disc provides fast data access and system/program interchange while maintaining the independence of both the BASIC and Fourier operating systems. The advantages and conveniences of both systems are at the user's fingertips.

Analog output

5451B Option 250 combines the capabilities of many signal generators into one ideal generator. Virtually any desired waveform can be synthesized digitally in the Fourier Analyzer and then converted to an analog signal to provide total stimulus/response measurement of any device or system. Features are: Keyboard or off-line generation of waveforms, leakage-free measurements, transient or continuous output, spectrum shaping, and calibrated amplitude.

BSFA

5451B Option 270 Band Selectable Fourier Analysis allows the digital analyzer user to perform digital spectrum analysis over a frequency band whose center frequency and bandwidth are independently selectable by the operator. This frees the user from the DC to F_{max} (baseband) restrictions of conventional digital analysis. With BSFA the frequency resolution of a measurement can be increased by a factor of 400:1 without a corresponding increase in the amount of computer data space required because only a portion of the spectrum rather than the complete baseband is analyzed and stored. By using unique digital filtering, rather than analog filters or simple raised cosine digital filters, frequencies outside the band of interest are attenuated by more than 90 dB. Because of this the full dynamic range of the analyzer (80 dB) can be applied to the band of interest without interference from outside frequencies.

Features include: all digital operation, on-line or off-line analysis, keyboard operation, dual channel analysis for cross measurements, and center frequency range of DC to 19 kHz.

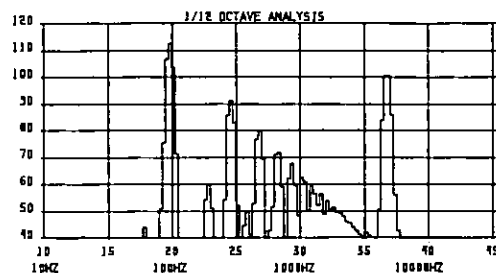

1/12 Octave Analysis of Triangle and Sine Waves

1/3 Octave analysis

With standard Fourier analysis, the frequency resolution of a measurement (Δf) is constant. With 5451B Option 740, the relative frequency resolution ($\Delta f/f$) is constant (the resolution is proportional to the center frequency). Option 740 allows selection of six different ranges within the overall frequency limits of 80 mHz to 20 kHz. It simultaneously calculates five different frequency ratios within the selected range: $1/2$ octave, $1/6$ octave, $1/3$ octave, $1/2$ octave, and full octave. Any ratio may be selected and displayed at any time, even while the measurement is being made. A, B, C, and D weightings, power spectral density weighting, or no weighting along with microphone correction factors can be included in the analysis. Option 740 finds application in the mechanical vibration, acoustics, and environmental noise pollution areas where noise level requirements are specified in octave formats.

Specifications

Option 270

Center frequency range:

On-line: DC to 9 kHz with external clock

Off-line: DC to 19 kHz with external clock and mag disc peripheral

Maximum resolution enhancement:

On-line: 400:1 (dependent on data storage space available)

Off-line: >400:1 (dependent on data storage space available)

Dynamic range: 90 dB from peak out-of-band spectral component to the peak level of the passband noise after four ensemble averages of a power spectrum at blocksize of 1024.

Out-of-band rejection: Greater than 90 dB.

Passband flatness: ± 0.01 dB without anti-aliasing filters.

Option 710

Number of records per file: The amount of records that can be stored depends on how the mass store files are formatted and on the device used. For example, a typical allocation for the 7900A disc would be as follows:

Data block file: 223 records (4096 blocksize max./record).

ADC thrupt file: 201 records (4096 blocksize max./record).

Keyboard program stack file: 90 records (352 steps per record).

ASCII text file: 352 records (70 characters per record).

Index file: 18 records (10 pointers per record).

System coreload file: 8 records (32 k words per record).

ADC thrupt file: The following are maximum ADC Sampling Rates (single channel) for 100% Real Time Data Acquisition:

7900A: 39 kHz at blocksize 4096.

7970E: 30 kHz at blocksize 4096.

7970B: 16 kHz at blocksize 4096.

Option 740:

Center frequency range: 80 mHz to 20 kHz.

Filters available: 10 octave, 21 $1/2$ -octave, 32 $1/3$ -octave, 65 $1/6$ -octave, or 132 $1/12$ -octave filters. Each group may be used to analyze the entire center frequency range in six selectable ranges.

Update rate: Once every second for $1/3$ -octave range of 26 filters. Fewer filters can be used resulting in increased update rate.

Display: System CRT with alphanumeric capability. Full graphics output capability included.

For prices and detailed information on these and other 5451B options, contact your nearest HP Sales Office.

SIGNAL ANALYZERS

Fourier systems for mechanical applications

Model 5451B Options 300, 400, 450

NEW

- One versatile system for mechanical measurement problems
- A simple, dedicated control panel for each application package

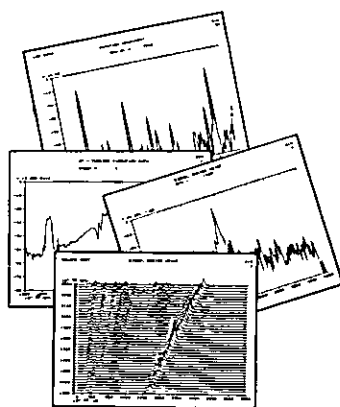
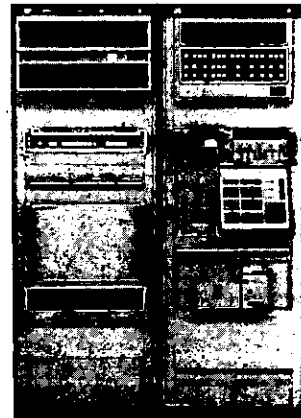
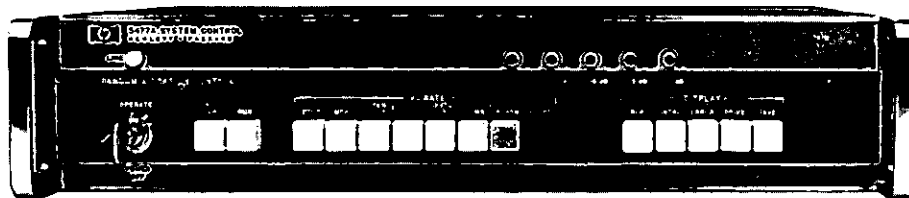

SIGNATURE ANALYSIS

AVERAGE MODAL FREQUENCIES AND DAMPING			
MODE	NAT. FREQ. (HZ)	DAMP. FACT. (ξ)	DAMP. COEFF. (RAD/SEC)
1	511.368	.354	11.373
2	1895.916	.160	11.835
3	1880.864	.150	17.775
4	2191.487	.313	43.859
5	2843.769	.150	26.747
6	2879.987	.853	9.568
7	3487.504	.851	182.297
8	3469.874	.411	89.558

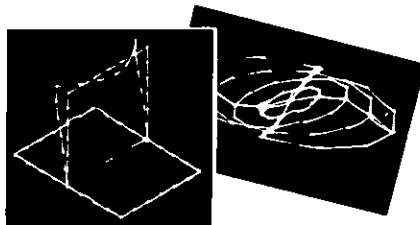

MODAL ANALYSIS

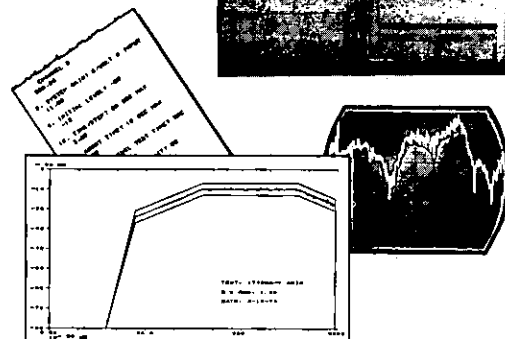

VIBRATION CONTROL

Digital vibration control – option 300

Closed-loop control of broadband random vibration tests to 5000 Hz is provided by this applications package for the Fourier Analyzer. The option consists of special hardware and software to quickly and easily set up, control, and store results for random vibration tests. The system is intended to interface with customer-supplied vibration exciters and transducers. Operator interaction is through question and answer dialog on the system terminal for parameter entry and the entire test sequence is controlled from a dedicated control panel. No computer programming is required. Extensive use of disc data storage is used to provide rapid program changes and quick access to 50 stored random test specifications. On-line storage of test data is also provided.

Important system features include: averaging up to 4 feedback channels, auxiliary PSD measurement channel during the test, extensive safety checks to reduce the possibility of over or under testing. Data Recall mode for data analysis and documentation, built-in capability for expansion to Shock and Sine testing, and complete Fourier analysis available when the control functions are not being used.

Modal analysis – option 400

Modal analysis is a technique for determining the dynamic characteristics of an elastic body by identifying its modes of vibration. The HP Modal Analysis Package is a specially designed system built around the HP 5451B Fourier Analyzer which gives it the capability for acquisition and analysis of modal data. The package operates on experimental transfer function data and determines modal properties such as natural frequency, damping factor and damping coefficient. In addition, a mode shape matrix is generated along with an animated isometric display of the part under test. No other "off-line" computers are needed to reduce the modal data, thus allowing on-line, in-the-laboratory measurements and results. The system can accommodate 500 transfer function measurements, identify up to 35 modes

from a single measurement and display more than 250 points in the animated isometric display. The system is not restricted by input type since it operates on transfer function data; as a result, it can accommodate transient, random, and periodic excitation. The entire modal analysis procedure is controlled from the 5477A System Control, making the system software invisible to the dynamicist or engineer making modal measurements.

Signature analysis – option 450

Noise, vibration, and failure problems in rotating machinery are quickly analyzed using this new applications package. The system is used for design analysis, production quality control, preventive maintenance, and noise and vibration studies. The system combines all of the key rotating machinery measurements into one powerful, dedicated system that is user oriented. All measurements are controlled by simple pushbutton operation. No programming is required. Rather than causing the user to connect a set of instruments and design the measurement logic, the system has this all built in. All the user needs to do is tell the system the measurement variables such as transducer sensitivities, frequency range, speed range, and plot formats, via a simple question and answer format. Six measurements are pushbutton selectable: RPM and TIME Spectral Maps, Power Spectrum Analysis, Composite Power Spectrum, Order Ratio, and Order Tracking. By having Spectral Maps available, a user can gain insight as to the overall dynamic characteristics of the device, in many cases eliminating the trial and error procedure dictated by other methods. After any basic measurements are made, the full computational ability of the Fourier Analyzer stands ready for further use in reducing test data.

Pricing: Mechanical application packages require certain minimum Fourier Analyzer configurations. Approximate starting price for a Fourier system with a dedicated package is indicated. Additional application packages and peripherals are available to enhance the system's capability.

\$82,500

SIGNAL ANALYZERS

Calibrated noise for system stimulation

Model 3722A

NEW

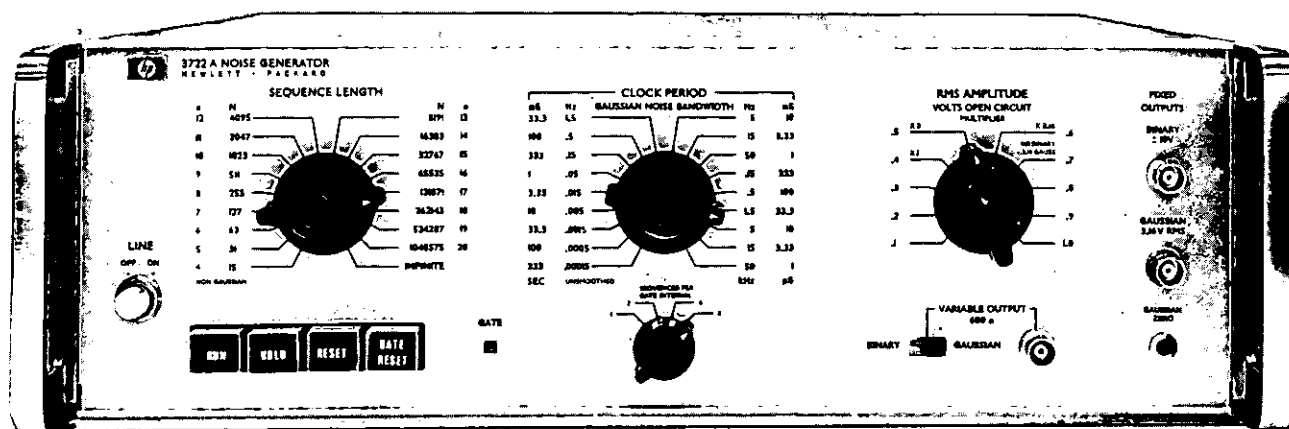

3722A

The Model 3722A Noise Generator uses digital techniques to synthesize binary and Gaussian noise patterns. These 'pseudo-random' patterns, which are of known content and duration, are repeated over and over without interruption. Since one pattern is identical with the next, each pattern has the same effect on the system under test: For this reason, pseudo-random noise signals cause no statistical variance in test results. The Model 3722A also generates truly random binary and Gaussian noise.

The basis of the Model 3722A is a binary waveform generator. The binary output has a $(\sin x/x)^2$ shaped spectrum and the Gaussian output, which is derived from the binary signal by precision low-pass filtering, has an almost-rectangular spectrum. Both binary and Gaussian outputs are controllable in bandwidth, but the output power remains constant regardless of selected bandwidth. The frequency of the first null in the binary spectrum is selectable from 0.003 Hz to 1 MHz, and the bandwidth (at -3 dB point) of the Gaussian noise is selectable from 0.00015 Hz to 50 kHz.

Option H01

Model 3722A Option H01 is a standard Model 3722A Noise Generator modified to provide a second binary output which can be delayed by a selectable number of clock periods with respect to the main binary output. The delayed binary output is available only when the instrument is in the pseudo-random mode. The delay introduced between the two binary outputs is selected by three decade switches on the front panel. These switches are set according to a conversion table supplied with the instrument.

Specifications

Binary output (fixed amplitude)

Amplitude: ± 10 V.
Output impedance: $< 10\Omega$.
Load impedance: $1\text{ k}\Omega$ minimum.
Rise time: < 100 ns.
Power density: approximately equal to $(\text{clock period} \times 200) \text{ V}^2/\text{Hz}$ at low frequency end of spectrum.
Power spectrum: $(\sin x/x)^2$ form: first null occurs at clock frequency, and -3 dB point occurs at $0.45 \times$ clock frequency.

Gaussian output (fixed amplitude)

Amplitude: 3.16 V rms.
Output impedance: $< 1\Omega$.
Load impedance: 600Ω minimum.
Zero drift: < 5 mV change in zero level in any 10°C range from 0° to $+55^\circ\text{C}$.
Power density: approximately equal to $(\text{clock period} \times 200) \text{ V}^2/\text{Hz}$ at low frequency end of spectrum.
Power spectrum: rectangular, low-pass: nominal upper frequency f_0 (-3 dB point) equal to $1/20$ th of clock frequency. Spectrum is flat within ± 0.3 dB up to $1/2 f_0$, and more than 25 dB down at $2 f_0$.
Crest factor: up to 3.75, dependent on sequence length.

Variable output (binary or gaussian)

Amplitude (open circuit):

Binary: 4 ranges: ± 1 V, ± 3 V, ± 3.16 V, and ± 10 V, with ten steps in each range, from X0.1 to X1.0.

Gaussian: 3 ranges: 1 V rms, 3 V rms, and 3.16 V rms, with ten steps in each range, from X0.1 to X1.0.

Output impedance: $600\Omega \pm 1\%$.

Main controls

Sequence length switch: first 17 positions select different pseudo-random sequence lengths: final position selects random mode of operation (INFINITE sequence length). $N = 2^n - 1$, where n is the range 4 through 20.

Clock period switch: selects 18 frequencies from internal clock.

Internal clock

Crystal frequency: 3 MHz nominal.

Frequency stability: $< \pm 25$ ppm over ambient temperature range 0° to $+55^\circ\text{C}$.

Output: $+12.5$ V rectangular wave, period as selected by CLOCK PERIOD switch.

External clock

Input frequency: Usable BINARY output (pseudo-random only) with external clock frequencies up to 1 MHz.

Input level: Negative-going signal from $+5$ V to $+3$ V initiates clock pulse.

Maximum input: ± 20 V.

Remote control

Control inputs: Remote control inputs for RUN, HOLD, RESET, and GATE RESET functions are connected to 36-way receptacle on rear panel.

Sequence length indication: 18 pins plus one common pin on the 36-way receptacle are used for remote signaling of selected sequence length (contact closure between common pin and any one of the 18 pins).

Delayed binary output

Typical performance figures for the delayed output are:

Amplitude: Switches between $+1.5$ V and $+12$ V.

Maximum sink current at 1.5 V level: 10 mA.

Impedance: 50Ω ($+1.5$ V) and 600Ω ($+12$ V).

Rise Time: < 50 ns.

Fall Time: < 20 ns.*

*Measured with \div probe shunted by 10 pF.

General

Dimensions: 425 mm wide \times 132.6 mm high \times 416 mm deep ($16\frac{1}{4}'' \times 5\frac{1}{2}'' \times 16\frac{3}{8}''$)

Weight: net 10.5 kg (23 lb); shipping, 13.5 kg (30 lb).

Model number and name

3722A Noise Generator
 Option H01 Delayed Output

Price

\$3625

\$320

hp CABINETS AND MEASUREMENT ACCESSORIES

Instrument accessories

Cables, adapters, connectors

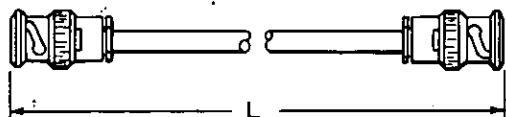
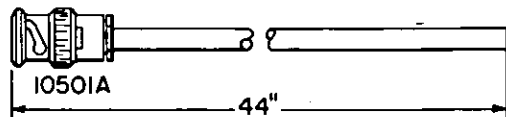

10502A L= 9"
11086A L= 24"
10503A L= 48"
10519A L= 72"

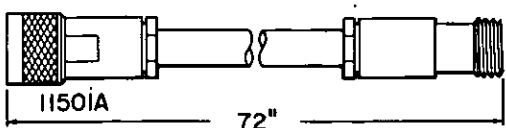
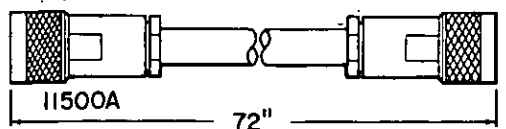
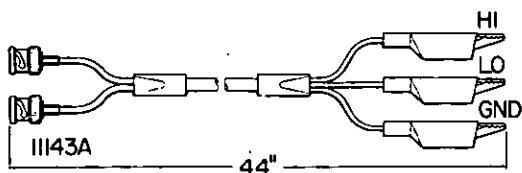
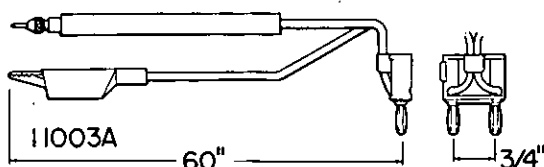
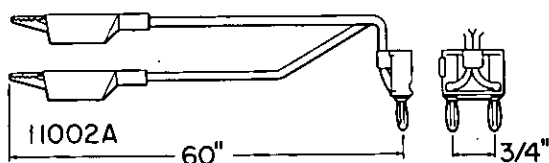
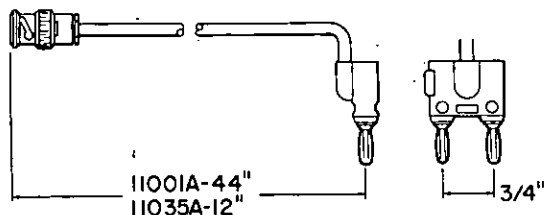
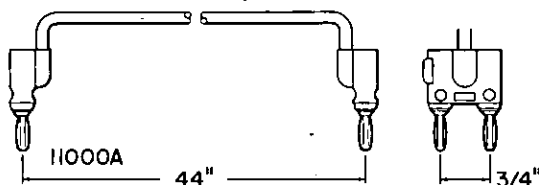

Cable assemblies

10501A Cable assembly

44" of 50Ω coaxial cable terminated on one end only with UG-88C/U BNC male connector.

10502A Cable assembly

9" of 50Ω coaxial cable terminated on both ends with UG-88C/U BNC male connectors.

10503A Cable assembly

48" of 50Ω coaxial cable terminated on both ends with UG-88C/U BNC male connectors.

10519A Cable assembly

72" of 50Ω coaxial cable terminated on both ends with UG-88C/U BNC male connectors.

11000A Cable assembly

Dual banana plugs terminate a section of 50Ω cable, 44" overall; plugs for binding posts spaced 3/4".

11001A Cable assembly

Identical with 11000A except dual banana plug on one end and UG-88C/U BNC male on the other.

11002A Test leads

Dual banana plug to alligator clips, 60" long.

11003A Test leads

Dual banana plug to probe and alligator clip, 60" long.

11035A Cable assembly

12" of 50Ω coaxial cable terminated on one end with a dual banana plug and on the other end with a UG-88C/U BNC male connector.

11086A Cable assembly

24" of 50Ω coaxial cable terminated on both ends with UG-88C/U BNC male connectors.

11143A Cable assembly

44" of balanced shielded cable, BNC to clip lead.

11500A Cable assembly

72" of 50Ω coaxial cable terminated on both ends with UG-21D/U Type N male connectors.

11501A Cable assembly

72" of 50Ω coaxial cable terminated with UG-21D/U Type N male and UG-23D/U Type N female connectors.

Model number and name

Model number and name	Price
10501A Cable Assembly	\$10
10502A Cable Assembly	\$15
10503A Cable Assembly	\$15
10519A Cable Assembly	\$15
11000A Cable Assembly	\$15
11001A Cable Assembly	\$15
11002A Test Leads	\$10
11003A Test Leads	\$10
11035A Cable Assembly	\$15
11086A Cable Assembly	\$15
11143A Cable Assembly	\$35
11500A Cable Assembly	\$20
11501A Cable Assembly	\$25

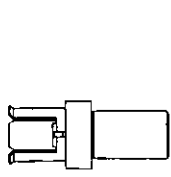

0950-0090

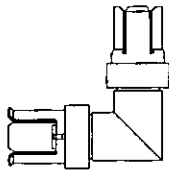

1250-0239

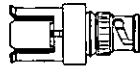

1250-0849

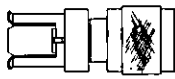

1250-1207

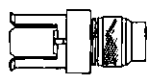

1250-1209

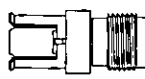

1250-1211

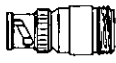

1250-0077

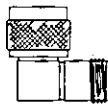

1250-0176

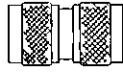

1250-0778

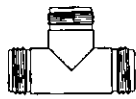

1250-0846



1250-1158



1250-1159



11525A



1250-1012



1250-1263

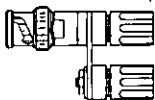

1250-1264

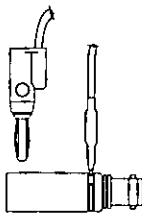

10111A

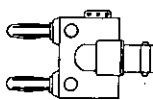

1250-2277

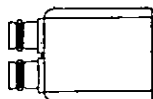

10113A



1250-0076



1250-0080



1250-0216



1250-0781

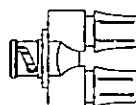

10110A

Adapters GR type 874

Part No.	Description	Price
0950-0090	GR Type 874 to 50 ohm Termination	\$68.00
1250-0239	GR Type 874 to GR Type 874, 90° elbow	\$48.00
1250-0240	GR Type 874 to Type N female	\$21.50
1250-0847	GR Type 874 to Type N male	\$18.50
1250-0849	GR Type 874 to BNC male	\$18.50
1250-0850	GR Type 874 to BNC female	\$17.00
1250-1206	GR Type 874 to Type C male	\$27.00
1250-1207	GR Type 874 to Type HN female	\$29.00
1250-1208	GR Type 874 to Type C female	\$30.00
1250-1209	GR Type 874 to TNC female	\$30.00
1250-1210	GR Type 874 to TNC male	\$38.00
1250-1211	GR Type 874 to Type HN male	\$33.00

Adapters type N

Part No.	Description	Price
1250-0077	Type N female to BNC male	\$7.40
1250-0082	Type N male to BNC female	\$12.50
1250-0176	Type N male to Type N female right angle	\$7.50
1250-0240	Type N female to GR Type 874	\$21.50
11525A	Type N male to APC-7	\$75.00
11524A	Type N female to APC-7	\$75.00
1250-0778	Type N male to Type N male	\$23.00
1250-0846	Type N female tee	\$6.20
1250-0847	Type N male to GR Type 874	\$18.50

Adapters SMA

Part No.	Description	Price
11533A	SMA male to APC-7	\$120.00
11534A	SMA female to APC-7	\$120.00
1250-1158	SMA female to SMA female	\$8.70
1250-1159	SMA male to SMA male	\$9.10

Adapters APC-7

Part No.	Description	Price
11525A	APC-7 to Type N male	\$75.00
11524A	APC-7 to Type N female	\$75.00
11533A	APC-7 to SMA male	\$120.00
11534A	APC-7 to SMA female	\$120.00

Adapter banana plug

Part No.	Description	Price
1250-1263	Single banana plug to BNC male	\$8.70
1250-1264	Dual banana plug to BNC male	\$15.10
1251-2277	Dual banana plug to BNC female	\$6.90
1251-2816	Dual banana plug	\$1.70
Model 10111A	Shielded banana plug to BNC female	\$15.00
Model 10113A	Triple banana plug to dual BNC female	\$15.00

Adapters BNC

Part No.	Description	Price
1250-0076	Right angle BNC (UG-306/D)	\$4.60
1250-0080	BNC female to BNC female (UG-914/U)	\$4.60
1250-0216	BNC male to BNC male	\$4.60
1250-0781	BNC Tee 1 male, 2 female	\$5.80
1250-1263	BNC male to single banana plug	\$8.70
1250-1264	BNC male to dual banana plug	\$15.10
1251-2277	BNC female to dual banana plug	\$6.90
Model 10110A	BNC male to dual banana jack	\$10.00
Model 10111A	BNC female to shielded banana plug	\$15.00
Model 10113A	Dual BNC female to triple banana plug	\$15.00

Instrument accessories

Probes, voltage dividers



10007B

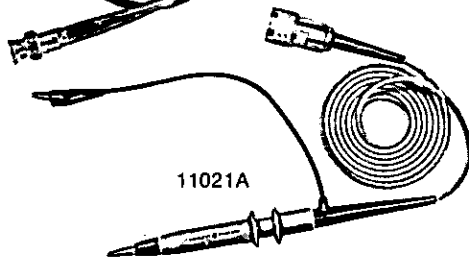
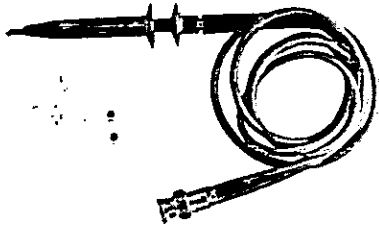

11021A

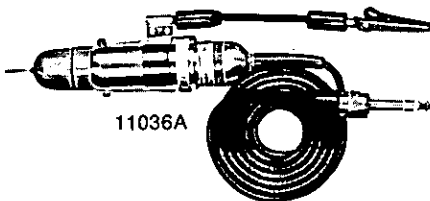

11036A



11040A

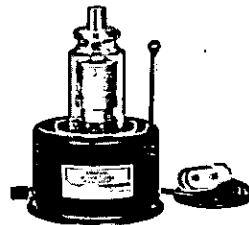

11039A

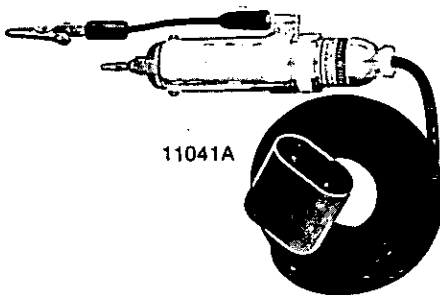

11041A



11045A

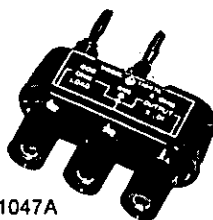

11047A

10007B, 10008B Divider probe

The 10007B and 10008B are straight-thru BNC probes with the following changeable tips: hook tip, pin tip, spanner tip, and 6" ground lead with alligator tip included.

	Peak Voltage	Shunt Capacitance	Length
10007B	600 V	30 pF	3.5 ft.
10008B	600 V	60 pF	6 ft.

11021A Divider probe

1000:1 divider probe increases range of HP 425A DC Microvolt-Ammeter to 1000 volts.

11028A Current divider

100:1 divider for extended range measurements for 456A AC Current Probe.

11036A AC probe

Peak responding for use with 410C.

11039A Capacitive voltage divider

For 400 and 410 series voltmeters. Safely measures power voltages to 25 kV. Accuracy $\pm 3\%$. Division ratio 1000:1. Input capacity 15 pF ± 1 . Maximum voltage ratings (sea level) 60 Hz, 25 kV; 100 kHz, 22 kV; 1 MHz, 20 kV; 10 MHz, 15 kV; 20 MHz, 7 kV. Usable dielectric heating, power and ultrasonic voltages. (Accessory 11018A should be used to connect the 410 series voltmeters.)

11040A Capacitive voltage divider

For 410 series voltmeters. Increases range so transmitter voltages can be measured quickly and easily. Accuracy $\pm 1\%$. Division ratio 100:1. Input capacity approximately 2 pF. Maximum voltage 2000 V at 50 MHz, decreasing to 100 V at 400 MHz. Frequency range 10 kHz to 400 MHz.

11041A Capacitive voltage divider

For 400 series voltmeters. Permits safe measurements of ac voltages up to 1500 V rms. Accuracy $\pm 3\%$. Division ratio 100:1. Input impedance 50 M Ω resistance shunted with 2.75 pF capacity.

11044A DC voltage divider

For 410B voltmeter. Gives maximum safety and conveniences for measuring high voltages as in television receivers, etc. Accuracy $\pm 5\%$. Division ratio 100:1. Input impedance 12 G Ω . Maximum voltage 30 kV. Maximum current drain 2.5 μ A.

11045A DC voltage divider

For 410C voltmeter. Same as 11044A except input impedance, 10 G Ω .

11047A Output voltage divider

Input 600 Ω . Output 600 $\Omega \pm 1\%$. 6 $\Omega \pm 1\%$. Voltage rating $\frac{1}{2}$ watt.

Model number and name	Price
10007B Divider Probe	\$25
10008B Divider Probe	\$25
11021A Divider Probe	\$70
11028A Current Divider	\$75
11036A AC Probe	\$95
11039A Capacitive Voltage Divider	\$270
11040A Capacitive Voltage Divider	\$80
11041A Capacitive Voltage Divider	\$95
11044A DC Voltage Divider	\$65
11045A DC Voltage Divider	\$67
11047A Output Voltage Divider	\$26

CABINETS & MEASUREMENT ACCESSORIES

Instrument accessories
Models 456A & 11473A - 11476A

NEW

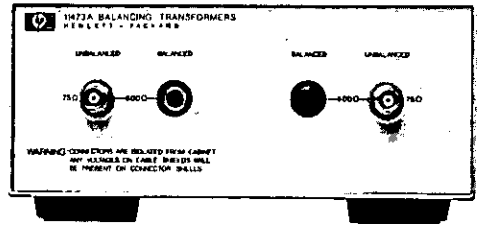
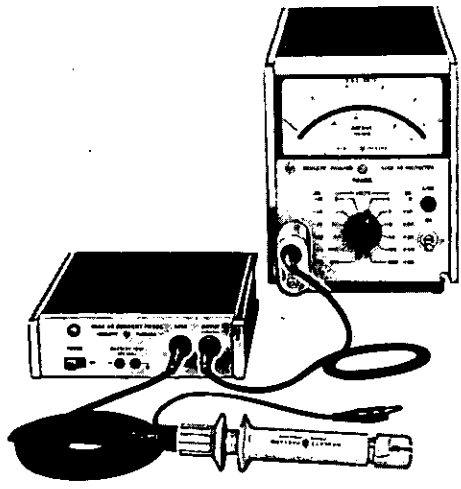

456A Description

Conventional voltmeters or oscilloscopes can measure current quickly and dependably — without direct connection to the circuit under test or any appreciable loading to test circuit. HP's 456A AC Current Probe clamps around the current-carrying wire, and provides a voltage output read on a voltmeter or scope. Model 456A's 1 mA to 1 mV conversion permits direct reading up to 1 A rms.

456A Specifications

- Sensitivity:** 1 mV/mA $\pm 1\%$ at 1 kHz.
- Frequency response:** $\pm 2\%$, 100 Hz to 3 MHz; $\pm 5\%$, 60 Hz to 4 MHz; -3 dB at < 25 Hz and > 20 MHz.
- Pulse response:** rise time is < 20 ns, sag $< 16\%$ /ms.
- Maximum input:** 1 A rms, 1.5 A peak; 100 mA above 5 MHz.
- Effect of dc current:** no appreciable effect on sensitivity and distortion from dc current up to 0.5 A.
- Input impedance:** (impedance added in series with measured wire by probe) < 50 m Ω in series with 0.05 μ H (this is approximately the inductance of 1 1/2 in. of hookup wire).
- Probe aperture:** 4 mm (1/2") diameter.
- Probe shunt capacity:** approx. 4 pF added from wire to ground.
- Distortion at 1 kHz:** for 0.5 A input at least 50 dB down; for 10 mA input at least 70 dB down.
- Equivalent input noise:** < 50 μ A rms (100 μ A when ac powered).
- Output impedance:** 220 Ω at 1 kHz; approximately +1 V dc component; should work into load of not less than 100,000 Ω shunted by approximately 25 pF.
- Power:** Battery life (two), approximately 400 hours; ac power supply; Option 001, 115 or 230 V $\pm 10\%$, 50 to 1000 Hz approx. 1 W.

11473A-11476A Description

New balancing transformers provide a balanced output from a single-ended input, or a single-ended output from a balanced input. Impedances available are 75 ohms unbalanced to 124 Ω , 135 Ω , 150 Ω , and 600 Ω balanced. Frequency response is ± 0.5 dB.

(Each module contains two transformers with the following specifications)

Model No.		11473A	11473B	11474A	11475A	11476A
Impedance*	Unbal	75 Ω	75 Ω	75 Ω	75 Ω	75 Ω
	Bal	600 Ω	600 Ω	135 Ω	150 Ω	124 Ω
Mating connectors	Unbal	BNC	BNC	BNC	BNC	BNC
	Bal	WECO 310	Siemens 9 REL STP-6AC	WECO 241	Siemens 9 REL STP-6AC	WECO 408A
Frequency range:		20 Hz - 50 kHz	20 Hz - 50 kHz	2 kHz - 2 MHz	2 kHz - 2 MHz	5 kHz - 5 MHz
Frequency response:		± 0.5 dB	± 0.5 dB	± 0.5 dB	± 0.5 dB	± 0.5 dB
Insertion loss:		< 0.75 dB at 1 kHz	< 0.75 dB at 1 kHz	< 0.25 dB at 50 kHz	< 0.25 dB at 50 kHz	< 0.25 dB at 50 kHz
Longitudinal balance:		> 40 dB	> 40 dB	> 40 dB	> 40 dB	> 35 dB
Max input power:		+13 dBm	+13 dBm	+27 dBm	+27 dBm	+27 dBm

* 50 Ω unbalanced to balanced transformer available on special basis. Above specifications apply.

Model number and name
Option 001 AC Power Supply
456A AC Current Probe
11473A Balancing Transformer

Price	11473B Balancing Transformer	\$200
add \$21	11474A Balancing Transformer	\$200
\$375	11475A Balancing Transformer	\$200
\$200	11476A Balancing Transformer	\$200

CABINETS AND MEASUREMENT ACCESSORIES

Testmobiles: save bench space, easily moved

Models 1117B, 1118A & 1116A

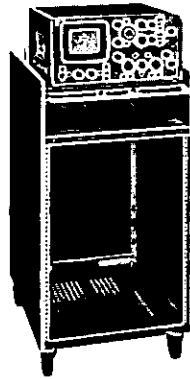

1117B

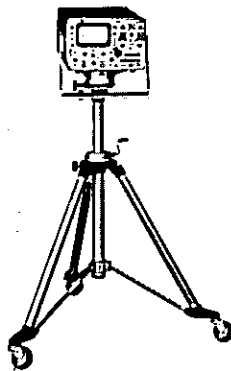

1118A

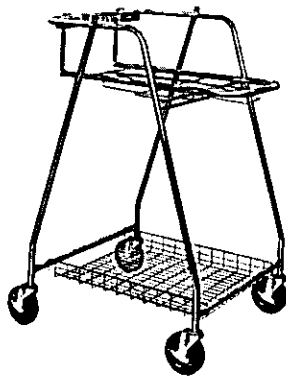

1116A

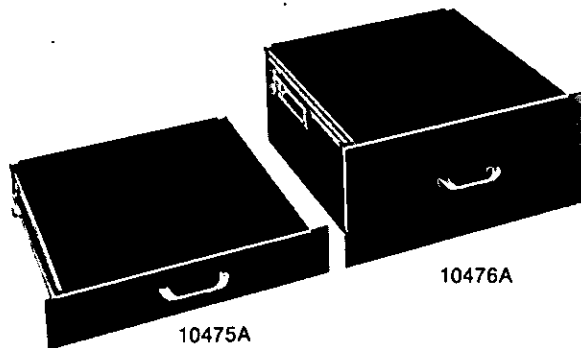

10475A

10476A

1117B Description

Model 1117B for cabinet and rack instruments provides tilt tray angles from -15° to $+30^{\circ}$ in $7\frac{1}{2}^{\circ}$ increments. In addition, other instruments can be mounted in the standard relay racks of the lower compartment. Rack mounting depth is 58.4 cm (23 in.) and power distribution is supplied.

Optional accessory drawers 7.6 cm (3 in.) and 20.3 cm (8 in.) deep are available. The drawers may be installed in many vertical positions of the relay racks.

1117B Specifications

Oscilloscope compatibility: cabinet or 48.3 cm (19 in.) rack models.
Tilt angle: -15° to $+30^{\circ}$ in $7\frac{1}{2}^{\circ}$ steps.
Dimensions: 511.2 mm (20 in.) wide, 1000.3 mm (39½ in.) high, 660.4 mm (26 in.) deep overall.
Wheel size: 101.6 mm (4 in.).
Weight: net, 41.3 kg (91 lb); shipping, 49.4 kg (109 lb).
Instrument mounting hardware supplied: 8 screws (10-24 \times ¼) (HP Part No. 2680-0029), 8 Tinnennan nuts (HP Part No. 0590-0128).

Optional accessories

10475A 7.6 cm (3 in.) drawer:

Weight: net, 4.1 kg (9 lb); shipping, 5.9 kg (13 lb).

10476A 20.3 cm (8 in.) drawer:

Weight: net, 5.4 kg (11 lb); shipping, 8.2 kg (18 lb).

1118A Description

Model 1118A Testmobile is designed for 180 or 1200 series cabinet models, and (with a 10105A adapter) 1700 series oscilloscopes. Instruments can be tilted, rotated and vertically adjusted. This tripod testmobile also folds for easy transportation.

1118A Specifications

Oscilloscope compatibility: 180 and 1200 series cabinet models direct, 1700 series with 10105A Adapter Plate. (Use Model 1001B or 1002B Testmobile for 183A Oscilloscopes.)
Tilt angle: $\pm 45^{\circ}$.
Horizontal rotation: 360° .
Dimensions: 901.7 mm (35½ in.) maximum at base, fully extended; 838.2 mm (33 in.) to 1117.6 mm (43 in.) adjustable height.
Wheel size: 76.2 mm (3 in.) with locks on two wheels.
Weight: net, 5.9 kg (13 lb); shipping, 7.7 kg (17 lb).

Optional accessory

10105A adapter plate: adapts 1700 series oscilloscopes to 1118A Testmobiles.

Weight: net, 0.5 kg (1 lb); shipping, 0.9 kg (2 lb).

1116A Description

Model 1116A is a light weight testmobile constructed of chrome-plated tubular steel and is well suited for holding general purpose instrumentation.

1116A Specifications

Oscilloscope compatibility: 140 series, 180 series rack models, 1200 series rack models, and other rack width instruments.
Tilt angle: horizontal to 30° in $7\frac{1}{2}^{\circ}$ steps.
Dimensions: 647.7 mm (25½ in.) wide, 1035.1 mm (40¾ in.) high, 736.6 mm (29 in.) deep.
Wheel size: 101.6 mm (4 in.).
Weight: net, 15.5 kg (32 lb); shipping, 22.2 kg (49 lb).

Model number and name

Model number and name	Price
1117B Testmobile (less drawers)	\$295
10475A 7.6 cm (3 in.) drawer	\$45
10476A 20.3 cm (8 in.) drawer	\$60
1118A Testmobile	\$150
10105A adapter plate	\$15
1116A Testmobile	\$125

CABINETS AND MEASUREMENT ACCESSORIES

Testmobiles: save bench space, easily moved

Model 1000 series

479
hp

NEW

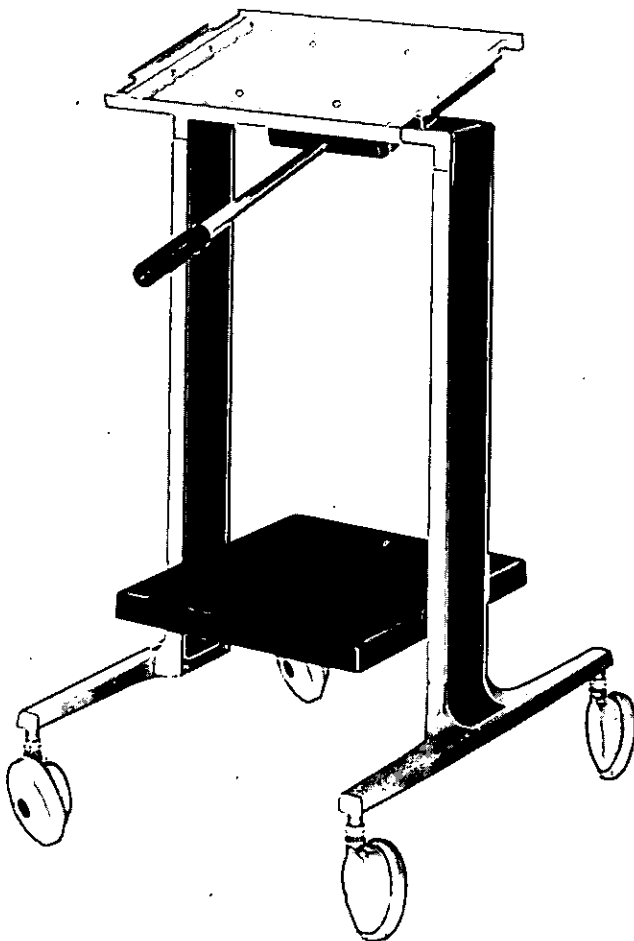

1003A

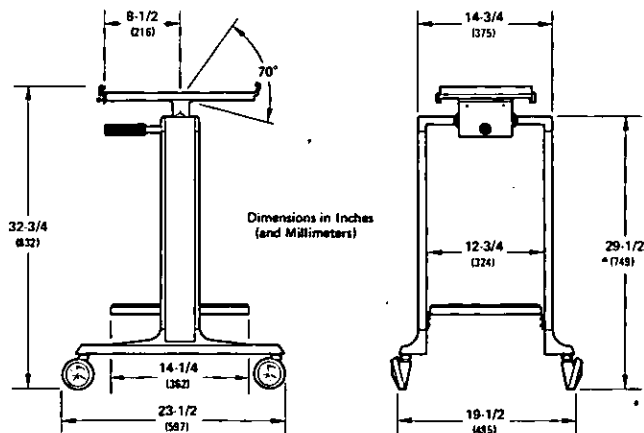

Hewlett-Packard Testmobiles are designed to mobilize your equipment, for greater efficiency, flexibility, and space saving. There is a model suitable for nearly every HP instrument and, with suitable adapters, testmobiles can accommodate a large number of non-HP instruments. Contact the nearest sales office for special applications.

HP Testmobiles are constructed of strong, lightweight aluminum die castings and extrusions, with an accent of rich vinyl trim. They are table top height and have an adjustable instrument mount which can be easily tilted with one hand to the desired viewing angle. The instrument mount is also self-centering, returning to a level position when the handle is released. High quality casters, with mar-resistant rubber tires, permit silent, smooth movement of the testmobile.

Two styles are produced—standard and deluxe. Standard units have a single, sturdy shelf below the instrument mount for holding additional equipment. Deluxe units are fitted with a large central storage cabinet which includes a molded top shelf, sturdy 102 mm (four inch) drawer, and two internal shelves. The shelves are lined with a non-slip resilient surface and have a raised security lip at the front so they are suitable for storing instrument plug-ins. The front casters on deluxe units are fitted with brakes.

1000A

Designed to accommodate the 7402 Oscillographic Recorder. This unit departs from our normal standard-deluxe format slightly. It has no storage shelf below the instrument mount, and front casters are fitted with brakes.

1001A

Standard Testmobile designed for the 1220 and 1700 series oscilloscopes.

1001B

Standard Testmobile designed for the 180 series oscilloscopes.

1003A

Standard Testmobile accommodating any full width HP instrument which utilizes the existing HP modular instrument enclosure.

1003B

Standard Testmobile accommodating any full width HP instrument which utilizes the new (Modular System II) HP modular instrument enclosure.

1000A, 1001A, 1001B, 1003A, 1003B

Specifications

Dimensions: see outline drawing.

Tilt angle: infinite within 70° range (55° above, 15° below horizontal).

Wheel size: 102 mm (4 inch) diameter.

Trim color: Olive gray.

Weight: Net 11.35 kg (25 lb); shipping: 17.25 kg (38 lb).

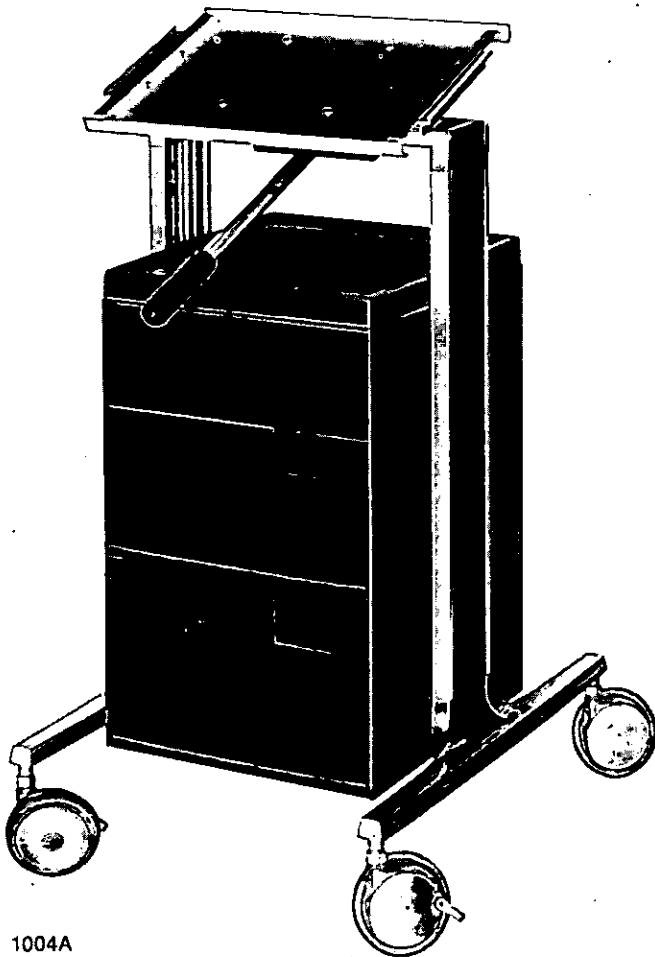

1004A

1002A

Deluxe Testmobile designed to accommodate the 1220 and 1700 series oscilloscopes.

1002B

Deluxe Testmobile designed to accommodate the 180 series oscilloscopes.

1004A

Deluxe Testmobile (with storage cabinet) accommodating any full width HP instrument which utilizes the existing HP modular instrument enclosure.

1004B

Deluxe Testmobile (with storage cabinet) accommodating any full width HP instrument which utilizes the new (Modular System II) HP modular instrument enclosures.

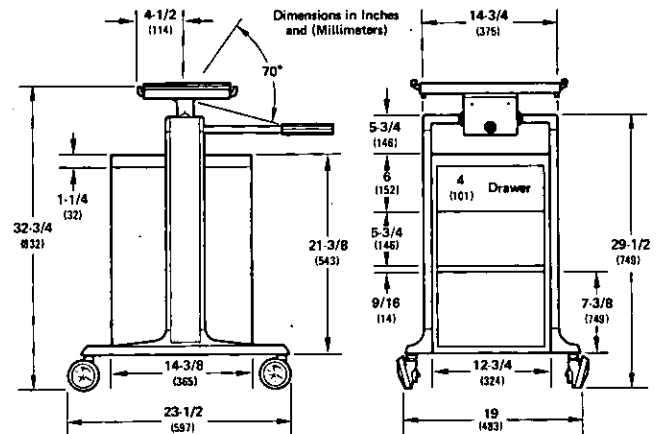
**1002A, 1002B, 1004A, 1004B Specifications**

Dimensions: see outline drawing.

Tilt angle: infinite within 70° range (55° above, 15° below horizontal).

Wheel size: 102 mm (4 inch) diameter.

Trim color: Olive gray.

Weight: Net 17.25 kg (38 lb); shipping, 23.15 kg (51 lb).

Model number and name

Model number and name	Price
1000A Standard Testmobile	\$195
1001A Standard Testmobile	\$180
1001B Standard Testmobile	\$180
1002A Deluxe Testmobile	\$240
1002B Deluxe Testmobile	\$240
1003A Standard Testmobile	\$190
1003B Standard Testmobile	\$190
1004A Deluxe Testmobile	\$250
1004B Deluxe Testmobile	\$250

CABINETS & MEASUREMENT ACCESSORIES

Equipment desks and tables

Models 29411B, 29412B, 11163A, 1000 Series

NEW

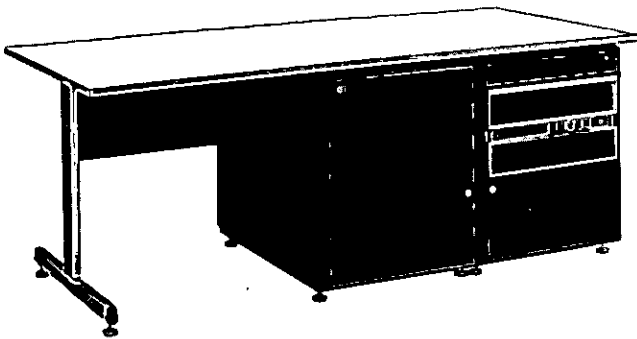

29412B

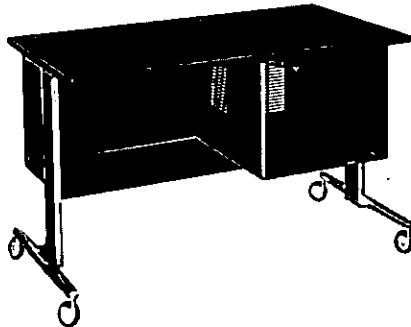

11163A

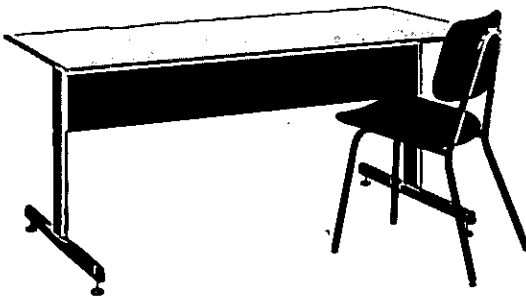

1009A

29411B and 29412B Rack system desk

The 29411B and 29412B rack system desks are to be used as packaged data systems, combining a versatile rack cabinet with a convenient operator worktable. The very low profile will enhance any office area plus offer maximum table space usage.

The 29411B includes one rack (bay) of 533 mm (21") rack space. The model incorporates all the assets of the 29400 series system enclosures, including design, power options, and safety features. The durable work surface is light grey suede formica, high pressure laminated, 762 x 1524 mm (30 x 60"). Features include a snap-in rear panel, adjustable glides, vinyl clad modesty and trim panels, and color coordinated table leg of aluminum extrusions.

The 29412B rack system desk has two bays, either to the right or left side of the 762 x 1829 mm (30 x 72") top, and includes all the features of the 29411B.

29411B, 29412B Specifications

29411B: 762 x 1524 x 711 mm (30 x 60 x 28"), 1 bay.

29412B: 762 x 1829 x 711 mm (30 x 72 x 28"), two bays.

Color: top: suede light grey; side: moss grey.

Option 003: Screw on side panels (available on both models).

Optional power distribution, for both models:

Option 110: 120/208/240 V, 10 amps per bay

Option 111: 230 V, 10 amps per bay

11163A Systems desk

The 11163A systems desk can serve a variety of uses from a compact and portable calculator systems desk, to a general office storage and worktable. A unique hinged rear panel conceals all accessory cords and a 4 outlet power supply. This AC outlet includes a filtered power distribution system to reduce current fluctuations.

The 11163A provides 629 x 1143 mm (24.75 x 45") of top working area with additional space on a convenient rollout reference shelf. Both top surfaces are a high pressure vinyl laminate, stain resistant and washable. An enclosed vented area of 457 x 343 x 470 mm (18 x 13.5 x 18.5") provides space for installation of peripheral equipment. The storage bookcase is 584 x 356 x 305 mm (23 x 14 x 12") deep.

The integrated system of aluminum die castings and extrusions with high quality, mar-resistant casters ensures durability. The 11163A color scheme is rich olive gray with sculptured brushed aluminum accents.

The 11163A is supplied with 5 power cords: one standard cord (90" long, HP part number 8120-1378) to connect the unit to an AC power outlet and 4 power cords to connect elements of HP systems to the power distribution unit (male CEE to female CEE, 30" long, HP part number 8120-1575).

11163A Specifications

Dimensions: width 629 mm (24.75"); height 699 mm (27.5"); length of table surface 1143 mm (45"); overall length 1175 mm (46.25").

Weight: 41.8 kg (92 lb); maximum gross weight 227 kg (500 lb); maximum weight of rollout shelf 11.4 kg (25 lb).

Maximum power rating of power line filter: 960 VA.

Number of power outlets on power panel: 4.

Color: work surface: gunstock walnut; body: olive grey.

1006A-1009A System worktables

The 1000 series worktables are multi-purpose units: to function as accessory tables to other desk and rack systems or for general office use. The series is available in three lengths: 1219 mm (48"), 1524 mm (60") and 1829 mm (72"), and a common width of 762 mm (30"). The table surface is durable suede light grey formica, and side trim and modesty panel is vinyl clad in moss grey. The sturdy supporting structure is strong, lightweight, aluminum extrusions with a brushed, hard anodized surface for a bright accent.

1000 Series specifications

1006A: 762 x 1829 x 711 mm (30 x 72 x 28"), weight: 38.6 kg (85 lb).

1008A: 762 x 1219 x 711 mm (30 x 48 x 28"), weight: 29.5 kg (65 lb).

1009A: 762 x 1500 x 711 mm (30 x 60 x 28"), weight: 34 kg (75 lb).

Color: work surface: suede light grey; panels: moss grey.

Option 001: heavy-duty 76 mm (3") mar-resistant rubber casters, for replacing the adjustable glides.

Model number and name

Model number and name	Price
29411B rack systems desk	\$600
29412B rack systems desk	\$900
Option 003 side panels	\$10
29411B Option 110 power distribution	\$350
29411B Option 111 power distribution	\$350
29412B Option 110 power distribution	\$525
29412B Option 111 power distribution	\$525
11163A Systems Desk	\$435
1006A System worktable	\$300
1008A System worktable	\$250
1009A System worktable	\$275
Option 001 casters (4)	\$15

CABINETS AND MEASUREMENT ACCESSORIES

Combining cases, rack adapters, panel covers, carrying cases

1051A, 1052A, 11046A, 11075A, 5060 Series

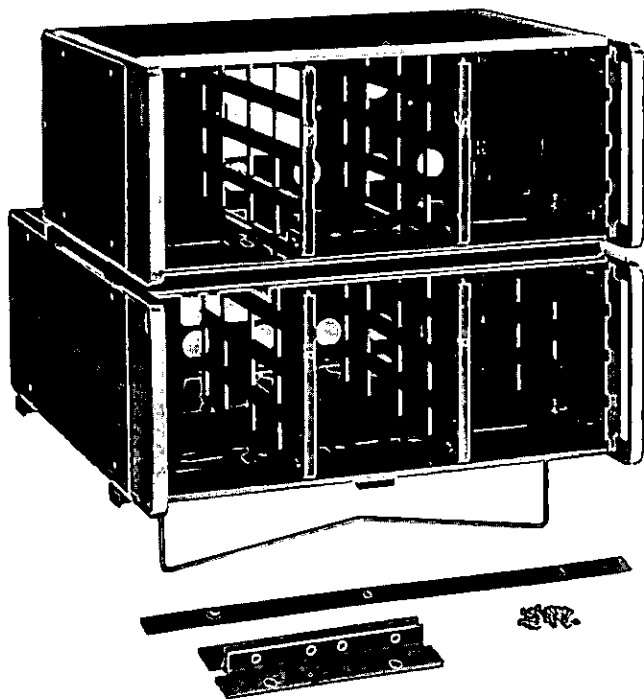

1051A, 1052A

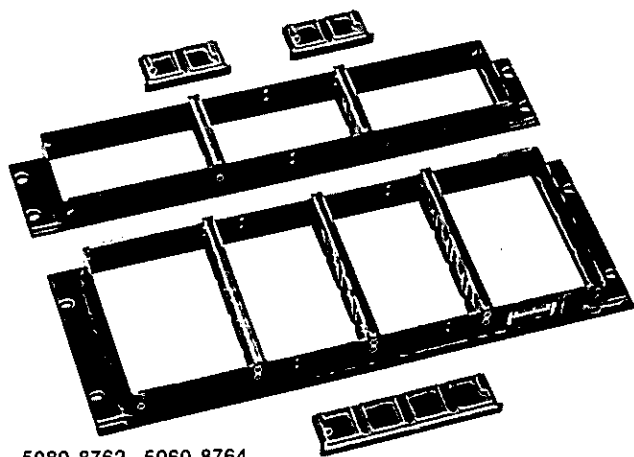

5060-8762, 5060-8764



5060-8756 to 5060-8761

1051A, 1052A Combining cases

Models 1051A and 1052A combining cases conveniently rack or bench mount combinations of small modular Hewlett-Packard instruments. In addition, these cases can be stacked on each other or on any full module instrument. Both cases accept $\frac{1}{3}$ or $\frac{1}{2}$ instrument modules, 130 mm or 198 mm wide ($5\frac{1}{8}$ or $7\frac{7}{32}$ inches). The basic difference is that the 1052A is 130 mm ($5\frac{1}{4}$ ") deeper, and will accept modules up to 416 mm deep ($16\frac{3}{8}$ "). The extra length provides more space in the rear for wiring. The 1051A accepts instruments up to 286 mm deep ($11\frac{1}{4}$ "). Each case is furnished with a rack mounting kit and two dividers.

1051A, 1052A Specifications

Dimensions:

1051A: 178 × 483 × 337 mm (7 × 19 × 13 $\frac{1}{4}$ ").

1052A: 178 × 483 × 467 mm (7 × 19 × 18 $\frac{3}{8}$ ").

Weight:

1051A: Net, 4.5 kg (10 lb). Shipping, 6.7 kg (15 lb).

1052A: Net, 5.4 kg (12 lb). Shipping, 8.1 kg (18 lb).

Rack adapter frames 5060-8762, 5060-8764, 5060-8765

These frames can be used to hold combinations of $\frac{1}{3}$ and $\frac{1}{2}$ width module HP instruments. Each frame is furnished with mounting hardware and divider panels. Three different models are available for different instrument heights. Adapter frames are for permanent or semi-permanent rack mounting. Where quick removal and reinstallation of instruments is desirable, the 1051A and 1052A combining cases should be used.

5060-8762: Accepts instrument heights of 38, 77, or 155 mm ($1\frac{1}{2}$, $3\frac{1}{32}$, or $6\frac{1}{32}$ ").

5060-8764: Accepts only instrument heights of 38 or 77 mm ($1\frac{1}{2}$ or $3\frac{1}{32}$ ").

5060-8765: Accepts only instrument heights of 38 mm ($1\frac{1}{2}$ ").

Filler panels, 5060-8757 to 5060-8761

Filler panels can be used to close off any leftover space after instruments are mounted in combining cases or adapter frames. Panels are made in a variety of widths and heights. Available widths are $\frac{1}{8}$, $\frac{1}{3}$, and $\frac{1}{2}$ modules; heights are $\frac{1}{4}$, $\frac{1}{2}$ and the full 155 mm ($6\frac{1}{32}$ ").

Specifications, filler panels

Part No.	Module Case Width × Height	Dimensions	
		mm	in
5060-8757	$\frac{1}{3} \times \frac{1}{4}$	130 × 38	$5\frac{1}{8} \times 1\frac{1}{2}$
5060-8758	$\frac{1}{3} \times \frac{1}{2}$	130 × 77	$5\frac{1}{8} \times 3\frac{1}{32}$
5060-8759	$\frac{1}{3} \times \text{full}$	130 × 155	$5\frac{1}{8} \times 6\frac{1}{32}$
5060-8760	$\frac{1}{2} \times \text{full}$	198 × 155	$7\frac{25}{32} \times 6\frac{1}{32}$
5060-8761	$\frac{1}{8} \times \text{full}$	63 × 155	$2\frac{31}{64} \times 6\frac{1}{32}$

Accessory drawer 5060-8756

The accessory drawer can be used in place of a filler panel to finish off unused space in the combining cases. The drawer is $\frac{1}{3}$ width and $\frac{1}{2}$ height.

Dimensions: 130 × 77 × 279 mm ($5\frac{1}{3} \times 3\frac{1}{32} \times 11$ ").

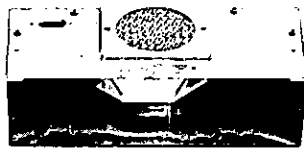

5060-0789

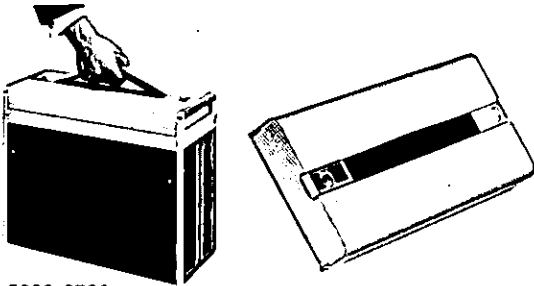

5060-8768

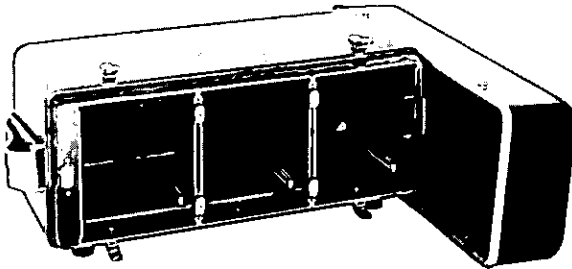

11046A

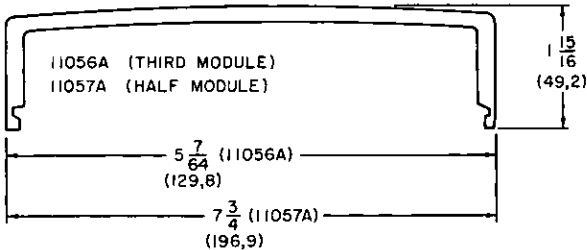

11056A 11057A

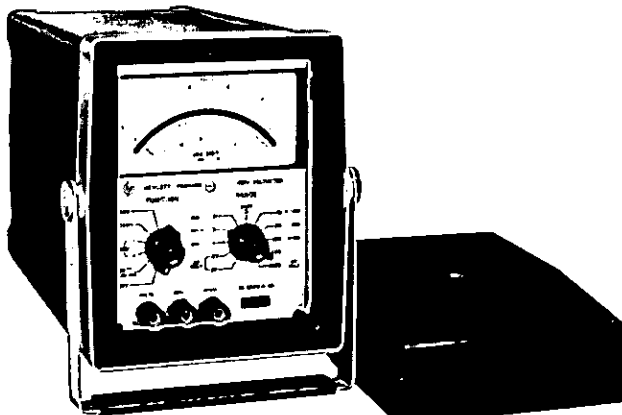

11075A

Cooling kits, 5060-0789 and 5060-0796

These cooling kits are designed to be easily installed in the 1052A combining case. They can be installed in the 1051A, at the factory upon special request, but installation in the shorter case limits the depth of instruments the case can accept, and makes it impossible to use the accessory drawer.

5060-0789: 115 V, 50 to 60 Hz

5060-0796: 230 V, 50 to 60 Hz

Control panel covers, 5060-8766 to 5060-8771

A series of control panel covers equipped with carrying handles are available for full rack width instruments. These covers protect instrument front panels and make rack mounted instruments tamper-proof.

One of these covers, the 5060-8768, fits either the 1051A or 1052A. Other covers are available to fit the six modular enclosures with front panel heights ranging from 89 to 311 mm ($3\frac{1}{2}$ to $12\frac{1}{4}$ ").

5060-8766: 88 mm ($3\frac{1}{2}$ ") EIA panel height.

5060-8767: 133 mm ($5\frac{1}{2}$ ") EIA panel height.

5060-8768: 177 mm ($6\frac{3}{2}$ ") EIA panel height.

5060-8769: 221 mm ($8\frac{2}{3}$ ") EIA panel height.

5060-8770: 266 mm ($10\frac{1}{2}$ ") EIA panel height.

5060-8771: 310 mm ($12\frac{1}{2}$ ") EIA panel height.

11046A Carrying case

This rugged, splashproof carrying case accepts $\frac{1}{2}$ width module instruments (maximum depth 203 mm or 8"). The case includes a shoulder carrying strap. Weight 5.4 kg (12 lb).

11056A Handle kit

A handle for carrying HP instrument modules of $\frac{1}{2}$ width.

11057A Handle kit

A handle for carrying HP instrument modules of $\frac{1}{2}$ width.

11075A, 11076A Module instrument case

A rugged, high impact plastic instrument case for HP $\frac{1}{2}$ module instruments. Instruments can be operated, stored or carried in this splashproof case. Storage compartment for power cord in rear of case is accessible through a removable hatch. Front lid contains adequate storage space for cables, test leads, etc. The dual purpose tilt stand also serves as a carrying handle. 11075A is 203 mm deep (8"); 11076A is 279 mm (11") deep.

Model number and name

Model number and name	Price
1051A combining case	\$150.00
1052A combining case	\$170.00
5060-8762 rack adapter frame	\$33.00
5060-8764 rack adapter frame	\$33.00
5060-8765 rack adapter frame	\$33.00
5060-8757 filler panel	\$5.15
5060-8758 filler panel	\$6.25
5060-8759 filler panel	\$6.25
5060-8760 filler panel	\$8.10
5060-8761 filler panel	\$6.25
5060-8756 accessory drawer	\$37.00
5060-0789 cooling kit	\$37.00
5060-0796 cooling kit	\$45.00
5060-8766 control panel cover	\$28.00
5060-8767 control panel cover	\$31.00
5060-8768 control panel cover	\$34.00
5060-8769 control panel cover	\$29.50
5060-8770 control panel cover	\$31.00
5060-8771 control panel cover	\$33.50
11046A carrying case	\$160.00
11056A handle kit	\$5.00
11057A handle kit	\$5.00
11075A module instrument case	\$80.00
11076A module instrument case	\$75.00

CABINETS & MEASUREMENT ACCESSORIES

Field cases: rugged protection for instruments

9211-series

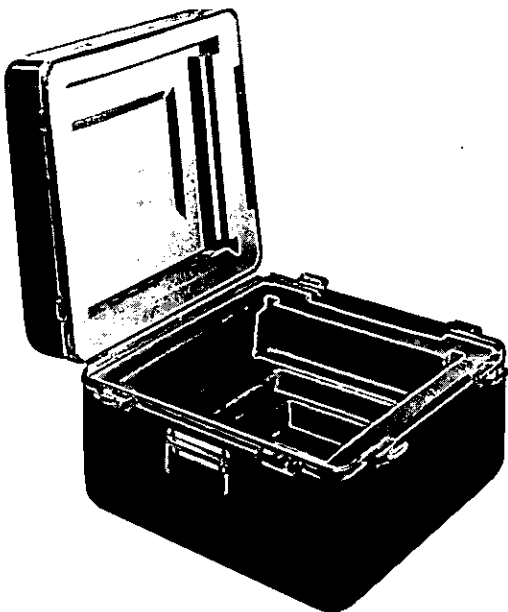

Typical Transit Case



Operating Case showing T-Bars installed

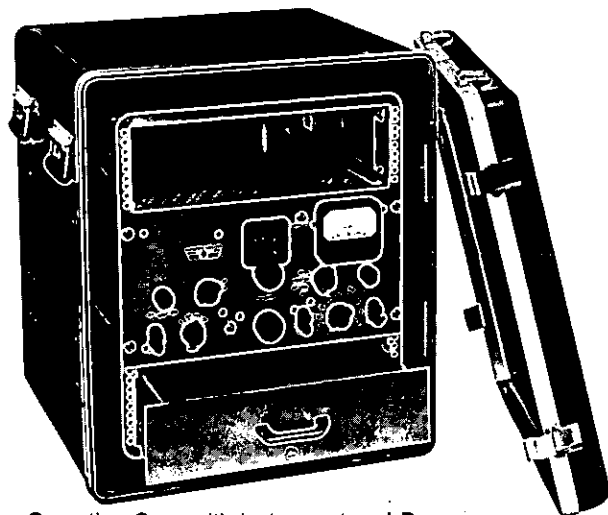

Operating Case with instrument and Drawer

HP field cases are rugged protective outer shells for use when instruments must be frequently transported and used away from laboratory conditions. They are molded of strong fiberglass and have conveniently placed carrying handles that fold flat when not in use. All are sealed tightly with O-ring gaskets and clamping latches and are rainproof under the test conditions of MIL-STD-108. Field cases meeting the requirements of MIL-C-4150 are available on special order. Custom cases and foam pads may be ordered to accommodate nearly any size instrument or combination of instruments. Two basic case styles are available, transit cases and operating cases.

Transit cases

Transit cases are provided with foam cushions that are formed to fit the standard HP modular cabinets. Such an arrangement provides excellent cushioning for protection against damage from handling, dropping, crushing, and other abuse. The selection of case sizes available accommodates nearly any HP modular instrument and combination of accessories.

Operating cases

Operating cases are equipped internally with shock-mounted frames¹ that accept any standard 19-inch rack-mounting instruments or combination of rack-mounting instruments up to the maximum height of the frames. This arrangement offers the convenience of operation without removing the instrument from its carrying case. At the same time, environmental protection is afforded.

When several instruments are combined in a single operating case for convenience in setting up and operating, patch-cable interconnections may be left in place within the case. When the case has been transported to its site, the covers are removed and the instruments inside are ready to put into use with a minimum of delay.

Drawers are available in three different heights so that small accessories, tools, etc., can be kept inside the case with the instruments. The drawers have hinged lids and fitted foam cushions can be made up to accommodate nearly any shape article. The drawers are supplied with slides for convenient installations.

Casters

A caster kit is available to fit both operating and transit cases. With casters, the operating case becomes a mobile rack. Once the kit is installed, the casters themselves may be attached or removed in seconds. With casters removed, the attaching hardware adds nothing to the overall dimensions of the case.

Measurement systems

On special order, complete transportable field instrument groups can be assembled to suit individual requirements. Consult your HP field engineer for a delivery quotation; a list of sales offices is located inside the back cover.

¹Patented

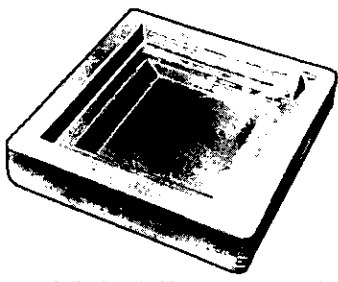

Typical cushion — full size (16 1/4 in wide) module

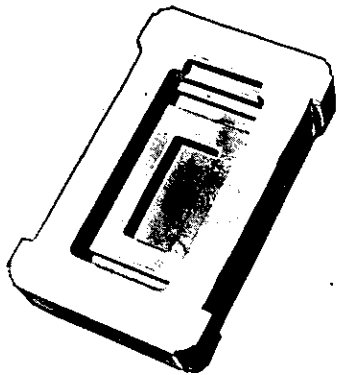

Typical cushion — half size module (7-25/32 in wide)

Transit cases

Instrument size — h x w x d		Case size (O.D.) — h x w x d		Shipping Weight		HP Part No.	Unit price		
Inches	mm	Inches	mm	lb	kg		1-9	10-49	50-999
3 1/2 x 16 1/4 x 13 1/4	88 x 425 x 336	9 1/2 x 18 1/16 x 21 1/16	241 x 465 x 551	15	68	9211-1288	\$130	\$120	\$110
3 1/2 x 16 1/4 x 18 1/4	88 x 425 x 466	9 1/2 x 21 15/16 x 24 1/16	241 x 557 x 611	18	82	9211-1292	\$150	\$140	\$130
5 1/4 x 16 1/4 x 13 1/4	133 x 425 x 336	11 x 18 3/16 x 21 1/16	279 x 465 x 551	16	73	9211-1289	\$130	\$120	\$110
5 1/4 x 16 1/4 x 18 1/4	133 x 425 x 466	11 x 21 15/16 x 24 1/16	279 x 557 x 611	19	86	9211-0839	\$150	\$140	\$130
5 1/4 x 16 1/4 x 21 1/4	133 x 425 x 542	11 x 24 3/16 x 26 1/16	279 x 617 x 678	24	110	9211-1296	\$220	\$210	\$200
6 1/2 x 5 1/2 x 8	165 x 130 x 203	11 x 9 1/4 x 14 1/4	279 x 232 x 365	8	36	9211-1317	\$ 80	\$ 75	\$ 70
6 1/2 x 5 1/2 x 11	165 x 130 x 279	11 x 10 1/4 x 16 1/4	279 x 276 x 429	11	50	9211-1318	\$ 90	\$ 85	\$ 80
6 1/2 x 7 25/32 x 8	165 x 197 x 203	11 x 10 1/4 x 16 1/4	279 x 276 x 429	11	50	9211-1316	\$ 90	\$ 85	\$ 75
6 1/2 x 7 25/32 x 11	165 x 197 x 279	11 x 20 1/4 x 16 1/4	279 x 276 x 429	11	50	9211-1315	\$ 90	\$ 85	\$ 80
6 7/32 x 7 25/32 x 16	165 x 197 x 406	11 1/2 x 13 1/4 x 21 1/4	302 x 337 x 549	15	68	9211-1734	\$165	\$155	\$145
7 x 16 1/4 x 21 1/4	179 x 425 x 542	12 1/2 x 24 x 26 1/16	318 x 607 x 665	17	77	9211-1735	\$220	\$210	\$200
7 1/4 x 16 1/4 x 13 1/4	184 x 425 x 336	12 1/2 x 18 1/16 x 21 1/16	324 x 465 x 551	21	95	9211-1290	\$130	\$120	\$110
7 1/4 x 16 1/4 x 18 1/4	184 x 415 x 466	14 1/4 x 21 1/4 x 23 1/4	362 x 556 x 603	20	91	9211-1293	\$150	\$140	\$130
7 1/4 x 16 1/4 x 18 1/4	184 x 425 x 466	12 1/2 x 21 15/16 x 24 1/16	324 x 557 x 611	19	86	9211-1293	\$150	\$140	\$130
8 1/4 x 16 1/4 x 13 1/4	222 x 425 x 336	14 1/2 x 18 3/16 x 21 1/16	368 x 465 x 551	18	82	9211-1291	\$130	\$120	\$110
8 1/4 x 16 1/4 x 18 1/4	222 x 425 x 466	14 1/2 x 21 15/16 x 24 1/16	368 x 557 x 611	21	95	9211-1294	\$150	\$140	\$130
10 1/2 x 16 1/4 x 18 1/4	266 x 425 x 466	15 1/2 x 21 15/16 x 24 1/16	400 x 557 x 611	22	100	9211-1295	\$150	\$140	\$130
12 1/2 x 16 1/4 x 24 1/4	311 x 425 x 619	30 x 19 1/4 x 25 1/4	262 x 502 x 638	32	150	9211-1297	\$240	\$230	\$220
12 1/2 x 16 1/4 x 18 1/4	317 x 425 x 466	15 1/2 x 21 15/16 x 24 1/16	400 x 557 x 611	22	100	9211-1313	\$150	\$140	\$130

Operating cases

Frame Height (nominal)		Case size (O.D.) h x w x d		Shipping Weight		HP Part No. ¹	Unit price		
in	mm	in	mm	lb	kg		1-9	10-49	50-999
5 1/4	133.4	12 1/16 x 25 1/2 x 28 1/4	322 x 657 x 718	40	18	9211-1302	\$ 460	\$435	\$410
8 1/4	222.3	17 1/4 x 26 1/4 x 28 1/4	435 x 667 x 718	50	23	9211-1303	\$ 490	\$460	\$430
12 1/4	311.2	20 13/16 x 25 1/2 x 28 1/2	528 x 657 x 724	56	25	9211-1163 ²	\$ 515	\$485	\$455
14	355.6	22 1/4 x 25 1/2 x 28 1/2	572 x 657 x 724	62	28	9211-1241	\$ 650	\$615	\$580
15 1/4	400.1	24 1/4 x 25 1/2 x 28 1/2	616 x 657 x 724	66	30	9211-1242	\$ 660	\$625	\$590
17 1/4	444.5	26 x 25 1/2 x 28 1/2	660 x 657 x 724	70	32	9211-1243	\$ 675	\$635	\$595
19 1/4	489	27 1/4 x 25 1/2 x 28 1/2	705 x 657 x 724	74	34	9211-1244	\$ 685	\$645	\$605
21	533	29 15/16 x 25 1/2 x 23 1/4	760 x 657 x 603	62	28	9211-1253 ³	\$ 685	\$645	\$605
21	533	29 15/16 x 25 1/2 x 26 1/4	760 x 657 x 676	66	30	9211-1280 ⁴	\$ 685	\$645	\$605
21	533.4	29 15/16 x 25 1/2 x 28 1/4	760 x 657 x 724	70	32	9211-1245	\$ 685	\$645	\$605
33 1/4	844.6	39 1/2 x 30 1/4 x 23 1/4	1000.3 x 768.4 x 603.3	66	30	9211-1713 ⁴	\$1398	—	—

- Each Operating Case is supplied with one T-bar set for supporting rides of instruments.
- Has interlocking feet for stacking.
- For rack mounts no deeper than 431.8 mm (17 in.); uses 431.8 mm (17 in.) T-Bar Sets
- For rack mounts no deeper than 533.4 mm (21 in.); uses 431.8 mm (17 in.) T-Bar Sets

Accessories

T-Bar sets:

Size	HP Part No.	Price
mm in		
508 20	(standard) 9211-1173	\$ 9.20
431.8 17	9211-1283	\$ 8.90

Power strip: 4 outlets for operating several instruments in one case. HP P/N 0950-0122 \$18.50

Caster kit: Set of 4 detachable wheels and brackets that fit both style cases. HP P/N 1490-0913 \$51.00

Drawers:¹ —All are equipped with hinged lids.

Height				Wide		Deep		HP Part No.	Price
in.		mm		in.	mm	in.	mm		
O.D.	I.D.	O.D.	I.D.						
3 1/4	3 3/4	88.9	79.4	16 1/2	417.5	18 1/4	460.4	9211-1164	\$85.00
5 1/4	4 1/4	133.4	125.4	16 1/2	417.5	18 1/4	460.4	9211-1165	\$91.00
7	6 1/4	177.8	166.7	16 1/2	417.5	18 1/4	460.4	9211-1166	\$85.00

1. Foam cushions are available for drawer interiors to suit various HP accessory combinations. Order by the HP instrument model number(s) to be accommodated. \$15.00

CABINETS AND MEASUREMENT ACCESSORIES

Rugged and durable cabinets
Series 29400

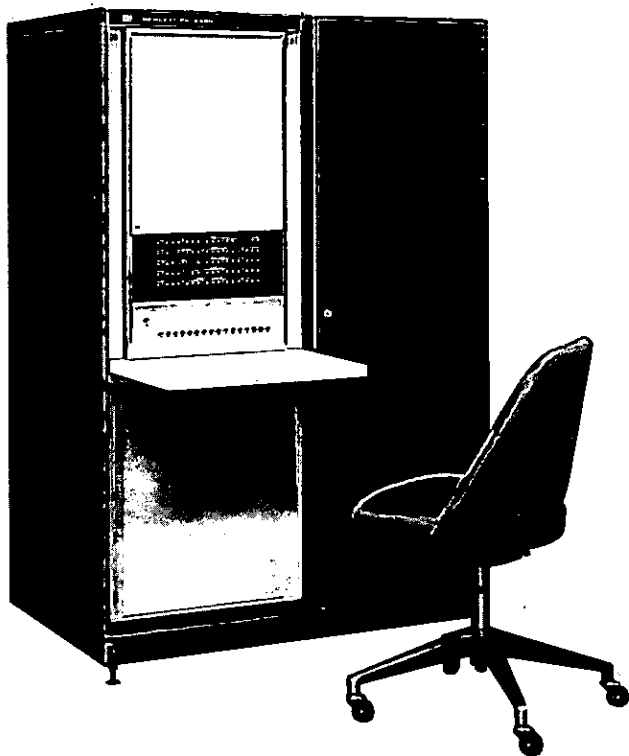

29400 Series rack cabinets

The Hewlett-Packard 29400 series of rack cabinets offer a wide choice of exceptionally rugged yet lightweight enclosures. Choices include one, two, three, and four bay cabinets with 889, 1422, and 1778 millimeter (35, 56, and 70 inch) vertical panel openings (889 mm panel opening available on one and two bay cabinets only). The enclosures accept instruments with a standard front panel width of 483 mm (19 inches) depth of up to 686 mm (27 inches). Except for the 889 mm (35 inch) model, cabinets are equipped with eyebolts and casters for ease of handling. An optional anti-tip base can be included with the cabinet and is recommended for enclosures to be equipped with computers, tape units, or any other heavy instrument that swings or slides outward for servicing. Fixed instrument support rails are supplied standard as follows: 4 pair per 889 mm bay; 5 pair per 1422 mm bay; 6 pair per 1778 mm bay.

Cabinets are also available fully wired in accordance with IEC and CSA specifications and have been awarded recognition by Underwriters Laboratories. Included with all electrical options is one fan per bay to maintain internal temperature rise to less than 15°C over ambient temperature when power consumption per bay does not exceed 2000 watts (500 watts for 889 mm cabinets). One power outlet strip per bay is provided with all electrical options.

A number of accessories are also available and can be included with the cabinet or installed at a later date. These accessories include transparent or solid panel front doors, equipment slides, storage drawers, writing surfaces, instrument support rails, blank front panels, service shelf, and heavy-duty lifting fixtures.

Cabinets and accessories are finished to coordinate with the standard HP color scheme; Moss Grey side panels and top covers, Mint Grey rear doors and blank front panels, and Smoke Grey transparent front door panels.

Customers unable to find a cabinet in standard configuration that meets their needs, either physical or electrical, may have cabinets built to order on a special basis.

Cabinet specifications

Model	No. of Bays	Overall Width ²	Panel Height ²	Overall ¹ Height ³	Net Weight ²
29401B	1	533 (21)	889 (35)	1099 (43.25)	52.2 (115)
29402B	1	533 (21)	1422 (56)	1632 (64.25)	67.1 (148)
29403B	1	533 (21)	1778 (70)	1988 (78.25)	76.2 (168)
29404B	2	1067 (42)	1422 (56)	1632 (64.25)	122.9 (271)
29405B	2	1067 (42)	1778 (70)	1988 (78.25)	140.6 (310)
29406B	3	1600 (63)	1422 (56)	1632 (64.25)	181.9 (401)
29407B	3	1600 (63)	1778 (70)	1988 (78.25)	209.1 (461)
29408B	4	2133 (84)	1422 (56)	1632 (64.25)	250 (551)
29409B	4	2133 (84)	1778 (70)	1988 (78.25)	282 (623)
29410B	2	1067 (42)	889 (35)	1099 (43.25)	97 (213)

¹Dimensions in millimeters and (inches).

²Weights in kilograms and (pounds).

³Overall height does not include eyebolts.

Options

002 Anti-tip base: provides extendable legs which can provide a tip resisting moment of up to 1600 Nm (1200 pounds-force-feet).

003 Bolt-on side panels: provides easy access to inner sides of cabinet for servicing or loading of equipment.

Electrical options

Option Number	Primary Power Input	Internal Power	Remarks
110	115 V ac 10 230 V ac 20 115/208 V ac 30	115 V ac 10 Amps	USA 60 Hz NEMA 5-15R
111	230 V ac 10	230 V ac 10 Amps	Europe 50 Hz CEE-22R
120	115 V ac 10 230 V ac 20 115/208 V ac 30	115 V ac 20 Amps	USA 60 Hz NEMA 5-15R (not available on 889 mm cabinet)
100	115 V ac 10		USA Fan only supplied
101	Europe		Europe Fan only supplied
030	USA		1 each, extra power strip NEMA 5-15R
031	Europe		1 each, extra power strip CEE-22R

Electrical power options 110, 111, and 120 are each provided with one power strip per bay as follows: 889 mm (35 inch) cabinet, 6 outlets; 1422 mm (56 inch) cabinet, 9 outlets; 1778 mm (70 inch), 11 outlets.

Installation of Option 030 or 031 (extra power strip) does not increase total load capacity of cabinet.

Cabinet accessories

Front doors

Standard size front doors provide 62 mm (2⁵/₁₆") of usable space from front of rack mounted instruments to inside of door to allow for knobs and other protrusions. This adds 51 mm (2") to the overall cabinet depth. Standard sized doors are designed for mounting on cabinets with total enclosed panel height equal to specified door height. Thus the 889 and 1422 mm (56 and 70") doors are full length mounting. Partial length front doors can be made to order. (Allow 44 mm [1¹/₂"] loss of rack space for hinge bracket if partial doors are mounted at top or bottom; allow 89 mm [3¹/₂"]—2 brackets—if door does not reach top or bottom of cabinet). Order by Accessory No. and specify right- or left-side hinge.

Transparent (Smoke grey tint)

Door Height	Net Weight	Accessory No.
1422 (56")	8.2 (18½)	12677C
1778 (70")	10 (22½)	12687C

HP moss grey

1422 (56")	7.2 (16)	12678C
1778 (70")	8.8 (19½)	12688C

Wood grain

1422 (56")	8.2 (18½)	12686C
1778 (70")	10 (22½)	12689C

Front door options

(Specify Accessory No. plus Option No.)
003: Extra deep door for 1422 or 1778 mm cabinet. Allows 138 mm (5⁵/₁₆") of usable space inside door. Adds 127 mm (5") to overall cabinet depth.
004: Extra deep door for 1422 or 1778 mm cabinet with provision for entrance of additional ventilating air at the bottom. For use with racked instruments having cooling fans requiring air supply from the front.

Equipment slides

Accessory slides are designed for mounting instruments, and are rated at 68 kg (150 pounds) per pair.
 Accessory No. 12692B instrument slide
002: brackets for mounting 89 mm (3¹/₂") high HP instrument with side frames.
003: brackets for mounting HP instruments greater than 89 mm (3¹/₂") high.
 HP highly recommends the use of the safety Anti-Tip legs on cabinets when mounting instruments on slides.

Storage drawers (slide mounted) 34 kg (75 lb) load capacity

Height mm (in)	Depth mm (in)	Accessory No.
89 (3.5)	406 (16)	12672B
133 (5.25)	406 (16)	12673B

Writing shelf topped with white formica

Shell Type	Usable Area mm (in)	Panel Height mm (in)	Accessory No.
1 bay slide out	406 × 419 (16 × 16.5)	89 (3.5)	12674B
1 bay Fixed	381 × 1041 (15 × 20)	44 (1.75)	12675B
2 bay Fixed	381 × 508 (15 × 41)	44 (1.75)	12676B

Instrument support rails

One pair with hardware: Accessory No. 12679B

Blank panels (front) mint grey

Height mm (in)	Accessory No.	Height mm (in)	Accessory No.
44 (1.75)	12680B	178 (7)	12683B
89 (3.5)	12681B	222 (8.75)	12684B
133 (5.25)	12682B	267 (10.5)	12685B

Rack cabinet prices

Model	29401B	29402B	29403B	29404B	20405B
Basic Price	\$600	\$700	\$750	\$1200	\$1375
Options 002	\$ 75	\$ 75	\$ 75	\$ 90	\$ 90
003	\$ 10	\$ 10	\$ 10	\$ 10	\$ 10
110	\$350	\$395	\$415	\$ 540	\$ 550
111	\$350	\$395	\$415	\$ 540	\$ 550
120	N/A	\$395	\$415	\$ 540	\$ 550
030	\$ 70	\$ 75	\$ 75	\$ 75	\$ 75
031	\$ 70	\$ 75	\$ 75	\$ 75	\$ 75

Model	29406B	29407B	29408B	29409B	29410B
Basic Price	\$1600	\$1800	\$2400	\$2700	\$1150
Options 002	\$ 140	\$ 140	\$ 210	\$ 210	\$ 90
003	\$ 10	\$ 10	\$ 10	\$ 10	\$ 10
110	\$ 780	\$ 780	\$ 810	\$ 810	\$ 460
111	\$ 780	\$ 780	\$ 810	\$ 810	\$ 460
120	\$ 780	\$ 780	\$ 810	\$ 810	N/A
030	\$ 75	\$ 75	\$ 75	\$ 75	\$ 70
031	\$ 75	\$ 75	\$ 75	\$ 75	\$ 70

Service shelf

Accessory No. 40008A dismountable shelf used for servicing instruments not mounted on slides. 90.8 kg (200 lb) capacity.

Lifting fixture

Accessory No. 40010A used for lifting or tilting up loaded systems weighing up to 1814 kg (4000 lb).

Accessory Number	Price
12677C Front door, smoke grey	\$325
12687C Front door, smoke grey	\$325
12678C Front door, HP moss grey	\$325
12688C Front door, HP moss grey	\$325
12686C Front door, wood grain	\$325
12689C Front door, wood grain	\$325
Option 003 Front door	add \$20
Option 004 Front door	add \$20
12692B Instrument slide	\$65
Option 002 Brackets	\$25
Option 003 Brackets	\$30
12672B Storage drawers 89 mm (3.5")	\$110
12673B Storage drawers 133 mm (5.25")	\$110
12674B Writing shelf	\$190
12675B Writing shelf	\$115
12676B Writing shelf	\$175
12679B Instrument support rails	\$10
12683B Blank panels	\$10
12684B Blank panels	\$10
12685B Blank panels	\$10
40008A Service shelf	\$75
10010A Lifting fixture	\$30

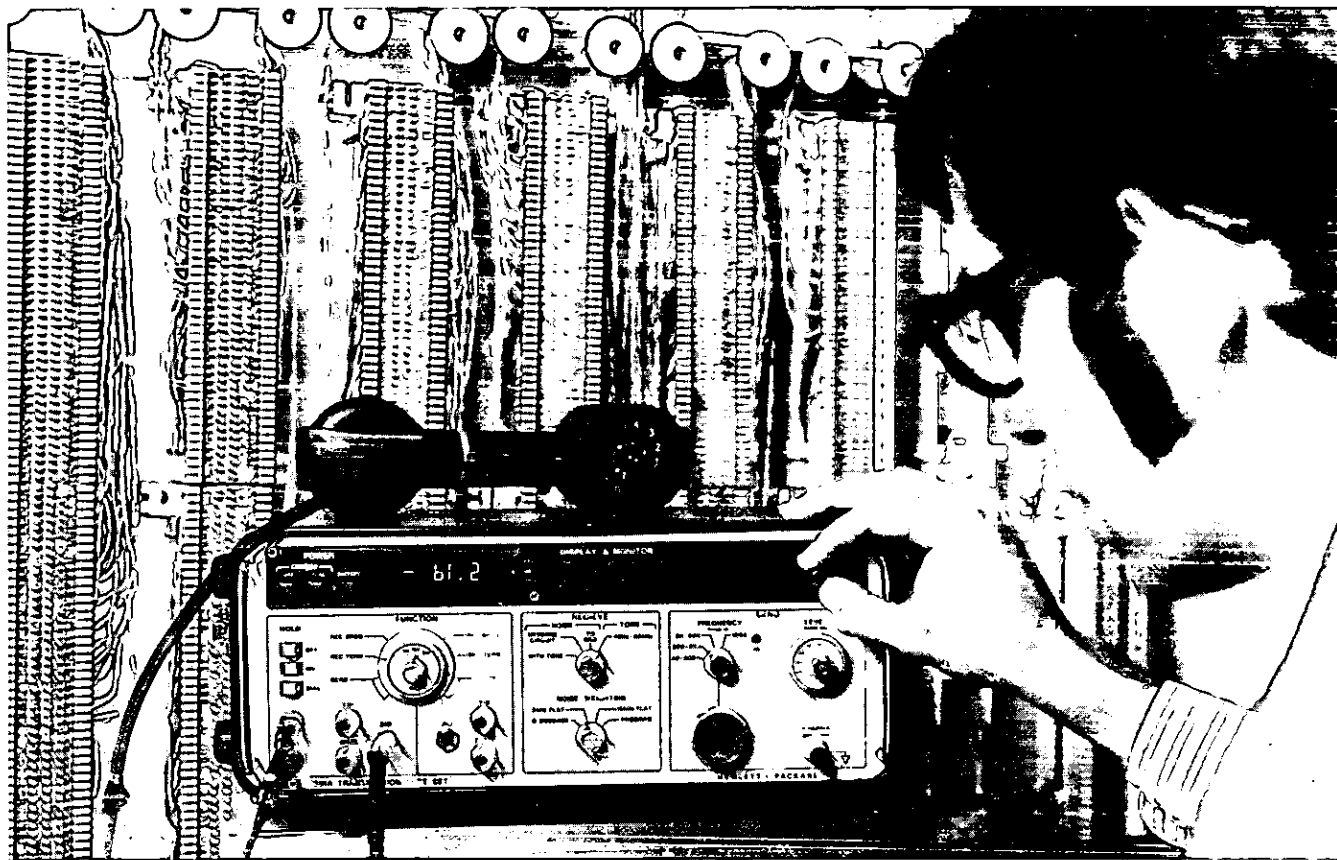

Measurement standards

Hewlett-Packard designs and manufactures many different types of test and measuring equipment specifically for use in telecommunications. Because two distinct measurement standards are in widespread use throughout the world, appropriate HP products on the following pages are identified for compatibility with the CCITT (International Telegraph and Telephone Consultative Com-

mittee of the International Telecommunications Union) or North American (Bell) standards.

Voice/data channel testing

The standard voice channel is a fundamental building block of all telecommunications systems. This channel has an approximate bandwidth from 300 Hz to 3000 Hz. Many kinds of transmission facilities are used

to move the information signal (e.g. speech, data, telemetry, etc.) from point to point—and each kind of facility introduces voice channel impairments as indicated by the adjoining table.

Voice communication is affected primarily by loss, noise and echo. However, when the voice channel is used for transmission of digital data or analog facsimile, a number of additional impairments can affect the information signal, particularly at rates above 1200 bits per second (bps). Fidelity of the information signal is related to the type and magnitude of transmission impairments. Measurement of these impairments is therefore important both when installing and when maintaining high quality telecommunication transmission facilities.

The table at the end of this general information section lists voice channel transmission impairments, measurement techniques for each, and Hewlett-Packard equipment suited for measuring the impairments. Note that three of the instruments make measurements according to the standards of the CCITT, while all others measure to North American standards.

Noise measurement

The technique generally used in the U.S. and Canada for measuring background noise is to quiet-terminate the transmit end and then measure background noise power by using a C-message weighting filter and a quasi-rms-detecting level meter. The corre-

Typical voice channel impairments introduced by transmission facilities

Facility	Impairments introduced
Cable pairs: loaded and non-loaded	Loss, attenuation distortion, phase distortion, noise (cross-talk)
Hybrids	Echo, phase distortion, attenuation distortion
Central office switches	Impulse noise
Frequency division multiplex (FDM) transmission systems	Attenuation distortion, phase distortion, phase jitter, noise, non-linear distortion, frequency offset, single frequency interference, phase hits, gain hits, dropouts
Time division multiplex (TDM) transmission systems	Attenuation distortion, phase distortion, noise, non-linear distortion, gain hits, phase hits, dropouts, crosstalk
Microwave radio and satellite transmission systems	Attenuation distortion, phase distortion, noise, non-linear distortion, phase jitter, phase hits, gain hits, dropouts, echo

sponding CCITT technique requires that a psophometric weighting filter be used.

Noise-With-Tone is a new technique that is used for signal-to-noise measurements. Rather than using a quiet termination, a nominal 1 kHz tone is transmitted. This signal is rejected by a notch filter in the receiving instrument, and the remaining energy is measured as previously described. Since this 1 kHz signal activates devices such as companders and echo suppressors, the resultant noise measurement is more representative of noise that is present when an information signal is being transmitted. The HP 3551A Transmission Test Set, HP 4940A Transmission Impairment Measuring Set and HP 5453A/5468A Transmission Parameter Analyzer all use this new Noise-With-Tone measurement technique.

Envelope delay

The CCITT has standardized on a test technique, which alternately transmits a reference frequency and a measurement frequency. Each frequency is amplitude modulated with 41.66 Hz, and a burst of identifying modulation at the end of each reference period enables the remote instrument to synchronize to the carrier changeover (see adjacent illustration). This technique permits measurements to be made on a straight away basis—and the HP 3770A Amplitude/Delay Analyzer measures envelope delay distortion according to the requirements of CCITT Recommendation 0.81 (formerly COM IV-98).

North America (Bell System) has standardized on an envelope delay measuring technique which requires an 83.33 Hz Modulation signal to be demodulated from the test frequency at the receive end, and remodulated on a fixed frequency for transmission over a separate channel to the transmitting end, where the phase comparison can be made. This is commonly referred to as the return reference technique. The HP 4940A Transmission Impairment Measuring Set uses this technique. The HP 5453A/5468A Transmission Parameter Analyzer obtains measurements that agree with this technique.

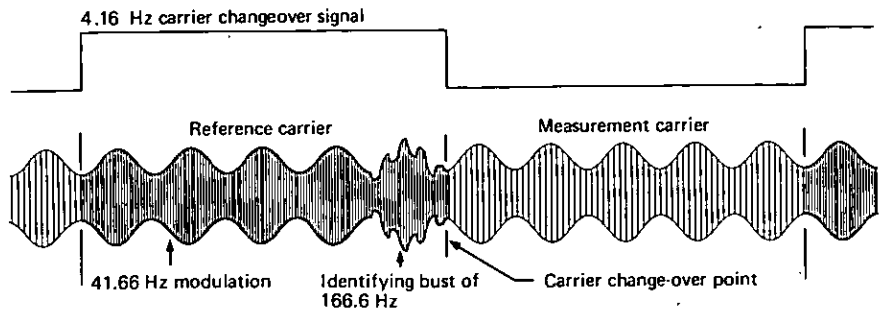

Standard CCITT envelope delay test signal

Phase jitter

Some transmission facilities introduce incidental phase modulation (phase jitter) to the information signal. The peak-to-peak phase deviation is measured on a nominal 1 kHz test frequency, and the Bell System has specified a measurement bandwidth of 20 Hz to 300 Hz. The HP 4940A and the HP 5453A/5468A both make this measurement.

Nonlinear distortion

Nonlinear distortion in a transmission facility is caused by nonlinear loss of gain with respect to input signal level. The measurement has been commonly made by transmitting a single test frequency, and measuring the power of the second and then the third harmonics.

In 1972, the Bell System standardized on a technique using two pairs of frequencies (four total) as shown in the adjacent figure (and as recommended by Bell System Technical Reference — PUB 41008). Second order distortion is determined by measuring the power of B+A and B-A intermodulation products. Third order distortion is determined by measuring the 2B-A intermodulation product. The HP 4940A uses this technique, and the HP 5453A/5468A obtains measurements that agree with this technique.

Phase hits, gain hits, dropouts and impulse noise

The adjacent figure showing impulse noise, phase hits, gain hits, and dropouts illustrates the effect these impairments can have on a single test frequency. These transient phenomena must be kept to a minimum to ensure reliable data transmission. The HP 4940A counts all of these transient phenomena simultaneously and distinguishes each from the rest.

Voice band data communications

To use a voice channel for digital data communications, modulator-demodulators (modems) are used to convert the unipolar digital information signal to a modulated carrier signal suitable for transmission within the voice band. All previously mentioned transmission impairments can affect this signal. To measure end-to-end effects of the data transmission link, digital tests are em-

TRANSMITTER

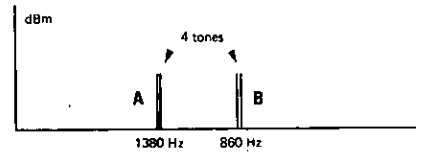

RECEIVER

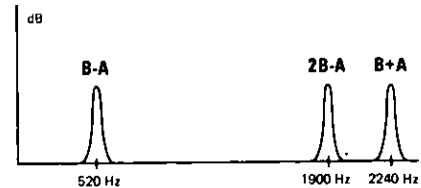

Nonlinear distortion measurement technique

ployed. These are: Bit Error Rate (BER); Block Error Rate (BKER); Data Error Skew. In addition, it is very useful to count the total carrier losses (loss of information signal), count the total number of clock slips, and measure the total peak distortion.

Through transmission of a known data pattern, these measurements can be made simultaneously. The HP 1645A Data Error Analyzer is capable of performing all of these tests over a wide range of data speeds.

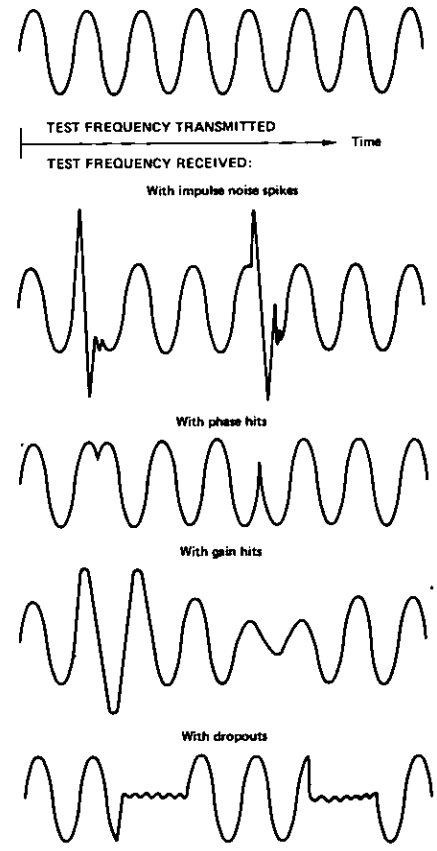

Transient impairments

Transmission testing: Frequency Division Multiplex (FDM)

The most commonly used method for transmitting large numbers of voice channels for long distances is to stack individual voice channels in the frequency spectrum. When an impairment exists in the FDM multiplex, it will cause the fidelity of the information signal to degrade in one or more voice channels. Since these systems can carry up to approximately 10,800 channels on a single transmission facility, it is very important that transmission parameters be precisely maintained.

Traditionally, FDM transmission measurements have been concerned with maintenance of the multiplex. Routines such as carrier leak, out-of-band noise, gain and loss, group-and-cross-modulation checks, alignment of line pilots, etc. are established procedures that have been performed for years.

Traditional selective level meters perform these tasks adequately. However, as more sophisticated traffic is passed through the system and as systems get larger, the emphasis has shifted to the need for faster and more accurate measurements. Under these newer circumstances, a selective level meter should approach the usefulness of an invisible portable bank that can down-convert any voice channel from the hierarchy in order to make noise measurements directly. Phase jitter, impulse noise measurements, amplitude hits and dropouts are made by using the level meter's demodulated output to control external instruments that actually make the measurement. For FDM transmission measurements, see the HP 312C/3320C instrument system.

Transmission testing: Time Division Multiplex (TDM)

All signals, when passed through a dispersive transmission medium, experience distortion which degrades their fidelity. The principal advantage of transmitting information in digital form is that the majority of this distortion can be eliminated by reconstructing the signal at frequent intervals along the transmission link. However, this process of regeneration can give rise to digital errors when the signal-to-noise ratio is such that incorrect decisions occur in the regenerator. Timing jitter can also cause errors in regenerators or other parts of the digital transmis-

sion system. The principal measure of quality of any digital link is therefore Bit Error Rate (BER)—where the number of received bits in error is divided by the total number of transmitted bits. BER is normally measured by stimulating the system under test with a pseudo-random binary sequence (PRBS) and then comparing the system output, bit by bit, with an independent reference sequence. All errors, whether burst, systematic or random, can in this way be detected.

The HP 3760A/3761A Bit Error Rate Measuring System has been designed to evaluate the quality of digital transmission systems operating in the range of 1 kilobit/second to 150 megabits/second.

Microwave radio testing

In most countries, the main communications system consists of a network of FM microwave radio links. These links can typically carry up to 1800 telephony channels, using a 70 MHz IF carrier and an RF band in the range 1.7 to 13.25 GHz.

The common objective for all types of information signals carried by these links, whether it be speech, television or data, is to convey the information with maximum fidelity. Failure to keep distortion of these links within acceptable limits not only results in an unusable signal, but also incurs a severe financial penalty due to lost revenue. Fortunately, the major causes of distortion can be identified and in many cases, with the availability of suitable test equipment, can be minimized to acceptable levels.

The main contributors to distortion in FM links are the baseband and carrier sections, of which modulators, demodulators, IF amplifiers and filters are examples. In addition, technological development has led to more signal processing at RF, necessitating distortion measurements in the RF bands.

Link parameters such as carrier amplitude and group delay variations need to be measured in order to characterize and/or diagnose faults. As the number of channels carried by a link increases, measurements of differential gain and phase become important since they show the intermodulation effects of link parameters. Differential gain and differential phase measurements have the advantage of characterizing the link more completely, and yield diagnostic information about the link. Further, these two measurements can be mathematically related to the classical baseband measurement of noise power ratio. This allows microwave link man-

ufacturers to define link parameters with much more certainty.

The HP 3710A/3702B/3730A Microwave Link Analyzer was developed specifically for the purpose of measuring various forms of distortion on terrestrial and satellite microwave radio links. The measurement capabilities of HP's link analyzer were established in close cooperation with the telecommunications industry.

Outside plant test equipment

The most effective method of transmitting voice band information signals from a distribution point to the communication terminal at the subscriber's location is by means of a cable pair.

Cable fault location

Telephone cables can contain many hundreds of conductor pairs, and most pairs are usually in service. It is therefore extremely important that damage to these cables (faults) be quickly located and repaired. In addition, with so much cable being buried underground, there is an increasing need to subsequently trace its path and determine its depth. The HP 4900A, 4901A and 4904A tone-type Fault Locators have varied capabilities for these applications.

Occasionally, water will enter a cable through a break in the outer jacket and cause conductor-to-conductor faults. These are conveniently sectionalized with the HP 4913A and localized with the HP 4912F Fault Locators. Another type of cable fault is the open conductor caused by cable damage or a poor splice—and these can best be located with the HP 4910F Open Fault Locator.

Pressurized cable leak detection

A cable is often pressurized with dry nitrogen or compressed air to prevent water from entering. Loss of cable pressure indicates a leak which, if not repaired, can eventually allow water to enter the cable sheath and cause conductor faults. The HP 4905A Ultrasonic Translator Detector and its accessories are designed to locate such pressurized cable leaks in aerial and ducted underground cable.

Related HP information and capabilities

Several telecommunications-related articles have appeared in recent issues of the *Hewlett-Packard Journal*. These include: "A New Microwave Link Analyzer with High-Frequency Test Tones," "MLA Measures



RF Performance with Down Converter," and "Communications-Oriented Microwave Solid-State Sweeper" (all in September 1972 issue); "A High-Speed Pattern Generator and an Error Detector for Testing Digital Systems" (November 1973); "Telecommunication Cable Fault Location from the Test Desk" (December 1973); "A Data Error Analyzer for Tracking Down Problems in Data Communications" (February 1974); and "Measuring Analog Parameters of Voice-band Data Channels" (August 1974). These articles typically provide in-depth technical information, and we will be pleased to provide you with a copy of any of the above

listed *Journal* issues as long as our supplies last.

Video tapes are another helpful Hewlett-Packard resource. They provide an efficient and convenient means for in-depth training in specialized concepts and measurements. Typical subjects include "Voice Frequency Measurements," "Carrier Frequency Measurements," "Data Communications," "Introduction to PCM," "Bit Error Measurement with the HP 3760A/3761A," "Microwave Link Analyzer Operation," and "Basics of Cable Fault Locating." For complete information about currently available HP video tapes, please ask for your copy of *HP*

VIDEO TAPES: A Better Way to Learn (publication number 5952-0027).

Finally, it goes almost without saying that HP has a wealth of other test and measuring instruments highly suited for work in telecommunications. These include signal analyzers (spectrum, distortion, waveform and Fourier), signal sources (pulsers, audio oscillators, function generators, signal generators, sweep oscillators, and frequency synthesizers), power meters, oscilloscopes, electronic counters, voltmeters, etc. In addition, Hewlett-Packard CRT displays, computers and peripherals are found in many OEM applications.

HP equipment capabilities for measuring voice/data channel impairments

Impairment	Measurement technique	HP model numbers								
		236A & 3555B	236A-H10 & 3556B	3550B	3551A	3552A	3581C	3770A	4940A	5453A & 5468A
Loss	Level	N	C	N	N	C	N	C	N	N
Attenuation distortion	Level and frequency	N	C	N	N	C	N	C	N	N
Noise (signal-to-noise)	Message circuit/psophometric noise	N	C		N	C			N	N
	Noise-to-ground	N	C		N	C			N	
	Noise-with-tone				N	C			N	N
Phase distortion	Envelope delay							C	N	N
Impulse noise	Impulse noise								N	
Echo	Echo return loss									
Single frequency interference	Listening test				N	C	N*		N	N*
Frequency offset	Frequency				N	C	N		N	N
Phase jitter	Phase jitter								N	N
Nonlinear distortion	Harmonic distortion, or									
	Intermod distortion								N	N
Phase hits	Phase hits								N	
Gain hits	Gain hits								N	
Dropouts	Dropouts								N	

Measurement standards compatibility: N = North American, C = CCITT

* (uses spectral analysis technique)

TELECOMMUNICATIONS TEST EQUIPMENT

Portable test set

Model 3550B

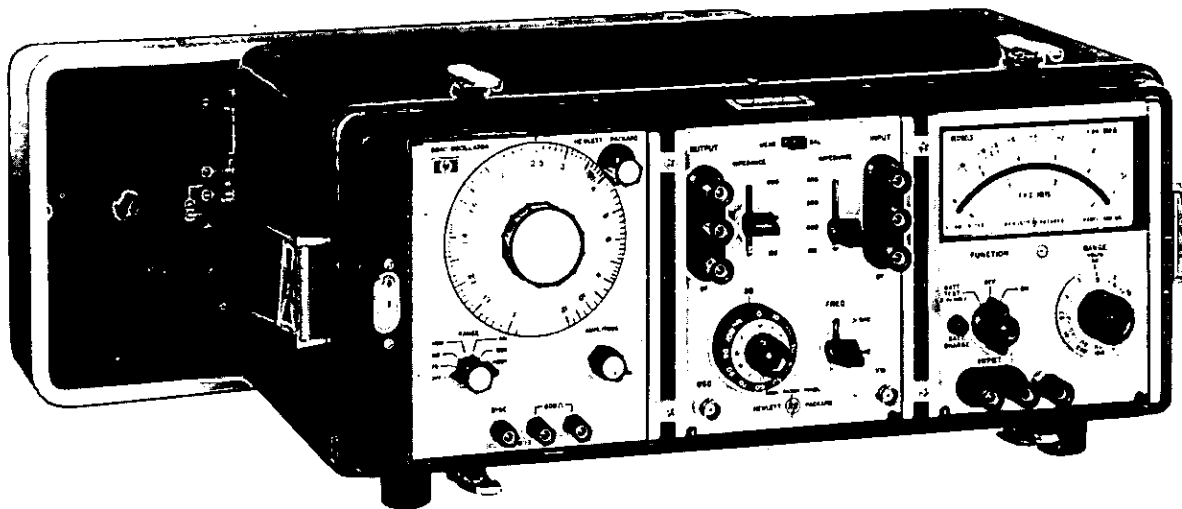

Description

Hewlett-Packard's Model 3550B Portable Test Set is designed specifically to measure transmission line and system characteristics such as continuity and attenuation distortion. It is particularly useful for lineup and maintenance of multi-channel communication systems. Model 3550B contains a wide range oscillator, a voltmeter, and a patch panel to match both oscillator and voltmeter to 135, 600, and 900 ohm lines. These instruments are mounted in a combining case that is equipped with a splash-proof cover. In addition, the oscillator, voltmeter, and patch panel may be used separately whether they are in or removed from the combining case.

Both the oscillator and voltmeter are transistorized and operate from their internal rechargeable batteries or from the ac line. Batteries provide 40 hours of operation between charges and are recharged automatically during operation from the ac line.

Specifications

Oscillator HP 204C opt. H25

(Refer to Page 327)

Voltmeter, HP 403B option 001

(Refer to Page 27)

Patch panel, HP 353A

(Specifications apply with oscillator and voltmeter).
Input: (receiver).

Frequency range: 50 Hz to 560 kHz.

Frequency response: ± 0.5 dB, 50 Hz to 560 kHz.

Impedance: 135 Ω , 600 Ω , and 900 Ω and bridging (10 k Ω center tapped).

Balance: better than 70 dB at 60 Hz for 600 Ω and 900 Ω ; better than 60 dB at 1 kHz for 600 Ω and 900 Ω ; better than 40 dB over entire frequency range for 135 Ω , 600 Ω , and 900 Ω .

Insertion loss: less than 0.75 dB at 1 kHz.

Maximum level: +22 dBm (10 V rms at 600 ohms).

Output: (send).

Frequency range: 50 Hz to 560 kHz.

Frequency response: ± 0.5 dB, 50 Hz to 560 kHz.

Impedance: 135 Ω , 600 Ω , and 900 Ω center tapped.

Balance: better than 70 dB at 60 Hz for 600 Ω and 900 Ω ; better than 60 dB at 1 kHz for 600 Ω and 900 Ω ; better than 40 dB over entire frequency range for 135 Ω , 600 Ω , and 900 Ω .

Insertion loss: less than 0.75 dB at 1 kHz.

Distortion: less than 1%, 50 Hz to 560 kHz.

Maximum level: +22 dBm (10 V rms into 600 ohms).

Attenuation: 110 dB in 10 and 1 dB steps.

Accuracy, 10 dB section: error is less than ± 0.25 dB at any step.

Accuracy, 100 dB section: error is less than ± 0.5 dB at any step.

Connectors: two 3-terminal binding posts for external circuit con-

nection and two BNC female connectors for oscillator and voltmeter connection.

Patch panel, option H02-353A

(Same as Model 353A except as indicated below).

Attenuator: 23 dB ± 0.5 dB (1-step slide switch).

Hold circuit (send terminals):

***Frequency response:** 300 Hz to 3 kHz ± 0.5 dB, 1 kHz reference.

DC resistance: 240 ohms nominal.

Maximum DC current: 100 mA.

Maximum DC voltage: 150 volts.

Connectors: Special telephone jacks to accept Western Electric No. 309 and 310 plugs. Sleeve jack is connected to sleeve of jacks 309 and 310. Two 3-terminal binding posts for external circuit connection.

Two terminal (Tel Set) connector for Hand Set, two BNC female connectors for oscillator and voltmeter connection.

Patch panel, option H03-353A

(Same as Model 353A except as indicated below).

Hold circuit (rec terminals):

***Frequency response:** 300 Hz to 3 kHz ± 0.5 dB, 1 kHz reference.

DC resistance: 240 ohms nominal.

Maximum DC current: 100 mA.

Maximum DC voltage: 150 volts.

Attenuation: 23 dB ± 0.5 dB (1-step slide switch).

Hold circuit (send terminals):

***Frequency response:** 300 Hz to 3 kHz ± 0.5 dB, 1 kHz reference.

DC resistance: 240 ohms nominal.

Maximum DC current: 100 mA.

Maximum DC voltage: 150 volts.

Connectors: Special telephone jacks to accept Western Electric No. 309, 310 and 241 at send and rec terminals. Sleeve jack is connected to sleeve of jacks 309 and 310.

Two terminal (Tel Set) connector available for Hand Set. Two BNC female connectors for oscillator and voltmeter connection.

General

Dimensions: 213 mm wide \times 489 mm high \times 336 mm deep (8 $\frac{3}{8}$ " \times 19 $\frac{1}{4}$ " \times 13 $\frac{3}{4}$ ") with cover installed.

Weight: Net, 13.5 kg (30 $\frac{1}{2}$ lb); shipping, 18 kg (40 lb).

Model number and name

3550B Portable Test Set (with 353A Patch Panel)

Price

\$1335

H02-3550B (with H02-353A substituted for standard 353A)

add \$150

H03-3550B (with H03-353A substituted for standard 353)

add \$150

*This is the frequency response with the holding coil across the line. Refer to Model 353A Specifications for response in "non-holding" condition.

TELECOMMUNICATIONS TEST EQUIPMENT

Transmission Impairment Measuring Set (TIMS)

Model 4940A

NEW

- Compatible with North American Standard
- Complete analog testing of the voice/data channel in communication systems

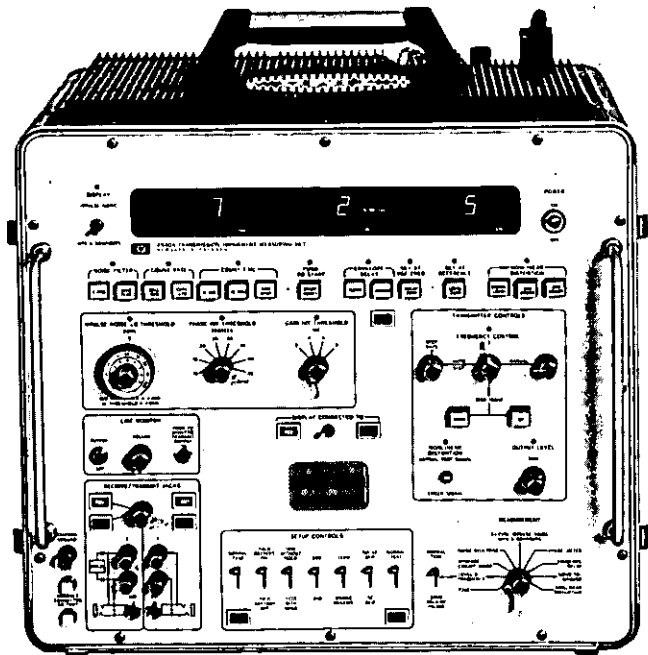

Description

The Hewlett-Packard 4940A Transmission Impairment Measuring Set (TIMS) is a special purpose test set for data communications problems caused by transmission line impairments. Up to now, there have been two alternatives in qualifying voice channels for data transmission: a bit error rate tester which tested digital variables, but did not isolate problems in the data line from malfunctions in the modem, or a collection of analog test sets for testing the voice channel quality. Unfortunately, there are so many variables of the voice channel to be tested (the Bell System's Technical References list nearly 20) that five or more test sets were required. The difficulty in transporting, setting up and testing with all of these test sets was enormous.

The Hewlett-Packard TIMS offers a new solution to the analog testing problems. It is portable (under 40 lb), easy to operate, and costs substantially less than the assorted test sets necessary to perform the same measurements.

Applications

There are a variety of applications where the Hewlett-Packard 4940A Transmission Impairment Measuring Set (TIMS) can be used. Operating telephone companies and other common carriers can utilize TIMS for installing and maintaining voice grade lines for data service. Firms that are heavily dependent on large intracompany data systems can utilize TIMS for quickly isolating and restoring failures in their networks. In applications where a high reliability data network is essential, TIMS can be used to routine the line quality of these systems in order to identify problems before the system actually fails. Modem and communications terminal manufacturers can utilize TIMS in their field service organization to help isolate the causes of reportedly defective modems. These same manufacturers can further utilize TIMS in their R&D labs to help correlate performance of their new designs to transmission parameters of a voice channel. These applications represent varied examples of the type of situations for which TIMS is well suited.

Measurements

The Hewlett-Packard 4940A Transmission Impairment Measuring Set (TIMS) tests all telephone voice channel parameters required by tariff and transmission objectives. Most measurement modes are compatible with test sets already in the field.

Attenuation distortion

With TIMS, attenuation distortion runs can be set up and logged in a fraction of the time previously needed because the frequency can be stepped up or down from 204 Hz to 3904 Hz in 100 Hz increments and attenuation distortion is automatically calculated and displayed directly in dB.

Envelope delay

The same automatic frequency step controls can be used to make envelope delay runs. Level, frequency, and delay are shown simultaneously. The delay is shown clearly in microseconds. No calculation is required.

Noise

Background message circuit noise can be tested in two ways: the traditional message circuit noise measurement with a quiet termination at the end of the circuit, or a noise-with-tone measurement with typical signal power on the circuit. In addition, noise-to-ground measurement can show common mode noise problems.

Impulse noise and transient phenomena

By counting phase hits, gain hits, drop outs, and 3 levels of impulse noise at the same time, more accurate analysis can be made of error causes and channel quality.

Phase jitter

TIMS measures the instantaneous peak to peak phase deviations of a special holding tone to calculate phase jitter.

Nonlinear distortion (optional feature)

TIMS utilizes a special intermodulation distortion technique which was developed to give consistent readings on typical telephone networks. Consequently, TIMS is only compatible with sets utilizing this improved technique.

P/AR — peak/average ratio (optional feature)

P/AR is a single number rating — indicative of the degradation a data signal might undergo over the channel. P/AR is designed to improve specifications and as such is generally not compatible with other P/AR sets.

Input circuitry and set-up controls

TIMS connects to most circuits without requiring additional test sets or interface hardware. TIMS is able to test on 2 or 4 wire, wet or dry circuits. TIMS also allows dialing, holding, and talking on the line under test.

Specifications

For detailed specifications ask your local HP sales office for a 4940A TIMS data brochure.

General

Power: 105 volts to 129 volts AC, 60 Hz.

Dimensions: 18.50" wide, 18.25" high, 12.75" deep (47.0 × 46.4 × 32.4 cm).

Weight: Net, 39 lb (18 kg); shipping 54 lb (25 kg).

Options

001: Adds P/AR Measurement Price \$350

002: Adds Nonlinear Distortion Measurement \$750

003: Adds P/AR and Nonlinear Distortion Measurements \$1100

019: 19" Rack Mounting Model N/C

023: 23" Rack Mounting Model N/C

4940A Transmission Impairment Measuring Set **\$8400**

Measures level and frequency; message circuit noise; noise-with-tone; 3 level impulse noise; hits and drop-outs; phase jitter; envelope delay; noise-to-ground.

TELECOMMUNICATIONS TEST EQUIPMENT

Amplitude/delay distortion analyzer

Model 3770A

NEW

- Measures Delay and Attenuation Distortion
- Frequency Range 200 Hz to 20 kHz
- Compatible with CCITT Recommendation O-81
- Sender and Receiver combined in a single portable unit

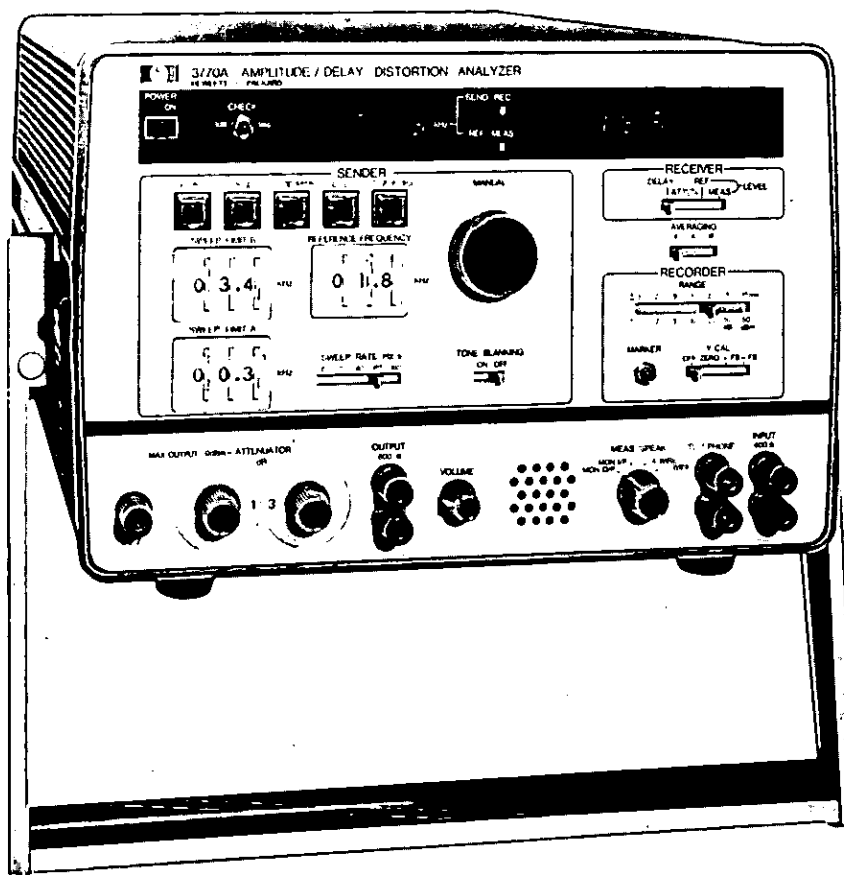

Description

The HP 3770A makes point-by-point and swept measurements of Delay Distortion, Attenuation Distortion and Received Level over the frequency range 200 Hz to 20 kHz. It is designed to meet the need for Delay and Attenuation Distortion measurements on Audio Channels used for data and other non-voice traffic. Other applications include the measurement and calibration of filters, line equalisers and similar transmission equipment.

The instrument is easy to use with no synchronisation, zeroing or ranging required. End-to-end channel measurements can be made using two instruments and no reference channel is required in either direction.

The measuring frequency can be adjusted manually with a tuning control, incremented in 100 Hz steps, or swept over any part of the band using the continuous or single sweep modes.

Using outputs provided on the rear panel, swept responses can be plotted directly using an X-Y recorder. A suitable recorder can be supplied as an option.

A built-in telephone facility allows voice communication in a two or four wire mode over the line or lines under test. The test is interrupted while this facility is in use. An integral loudspeaker allows the operator to monitor either the input or output lines.

Measurement principle

The operation of the 3770A is compatible with CCITT Recommendation O-81. With this method, the Sender generates a carrier signal which switches between the Reference and Measuring Frequencies at a rate of 4.16 Hz. The composite signal is amplitude modulated by a 41.6 Hz sinewave and transmitted through the channel to be ana-

lyzed. The relative group delay of the channel at the two frequencies is measured by comparing the delay of the envelope recovered during the measuring period with that recovered during the reference period. The relative attenuation measurement is made by comparing the amplitude of the two envelopes.

Level measurement

The 3770A Receiver can measure the absolute level of either the Measuring or Reference Carrier within the range -50 to $+10$ dBm. As the Sender Output is calibrated in dBm, this measurement allows the absolute loss of the transmission path to be calculated.

In addition to normal operation, absolute level measurements can be made using a pure tone.

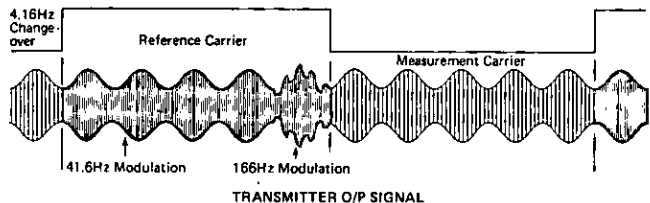

Specifications

Sender

Reference carrier: 0.4 to 19.9 kHz in 100 Hz steps.

Measuring carrier: 0.20 to 20.00 kHz in 10 Hz steps.

Modulation envelope frequency: 41.66 Hz (Mod. Index 0.4 ± 0.05).

Identification-burst frequency: 166 Hz* (Mod. Index 0.2 ± 0.05).

Carrier changeover frequency: 4.166 Hz.*

Changeover maintains envelope and carrier phase continuity.

Deviation between changeover point and envelope minimum: <0.2 ms.

Accuracy of above frequencies: $\pm 0.1\%$.

* Locked to envelope frequency.

Measuring frequency sweep rates: 10, 20, 40, 80, 160 Hz/s. The Measuring Frequency is maintained constant during the measurement frequency transmission.

Measuring frequency sweep limits: Settable in range 0.2 to 19.9 kHz (100 Hz steps). Accuracy as for measurement frequency.

Carrier level: 0 to -49 dBm in 1 dB steps.

Carrier harmonic distortion: <1% (40 dB) total.

Carrier spurious distortion: <0.03% (70 dB) per 100 Hz bandwidth.

Spurious sideband power w.r.t. wanted sideband power: <1%.

Receiver

Operating level range: <-50 dBm to >+10 dBm.

Frequency measurement range: 0.2 to 20 kHz in 10 Hz steps.

Accuracy: 0.1% (with sender other than 3770A: 0.1% ± 5 Hz).

Recorder

X-axis output: 0 to +5 V for 0 to 20 kHz or 0 to 5 kHz.

Y-axis: ± 5 V for \pm FS of the recorder range selected. One range in LEVEL, +1 to -5 V for +10 to -50 dBm.

Recorder output accuracy: As display $\pm 1\%$ of range selected.

Output/input circuits

Impedance: 600 Ω balanced.

Return loss: >40 dB.

Degree of balance: >50 dB. (Receiver 200 Hz to 6 kHz: >60 dB).

Maximum operating longitudinal voltage (having regard to balance): 10 V ac rms, 100 V dc.

Maximum safe longitudinal voltage: 150 V ac rms, 50 Hz to 20 kHz, or 100 V dc.

Combined sender and receiver**Group delay distortion:**

Delay range: 0 to ± 10 ms.

Accuracy: (rms) (5 to 40°C). 0.2 to 0.4 kHz <15 μ s $\pm 1\%$ of reading. (Sender only <5 μ s). 0.4 to 0.6 kHz <8 μ s $\pm 1\%$ of reading. (Sender only <2 μ s). 0.6 to 20 kHz <5 μ s $\pm 1\%$ of reading. (Sender only <1 μ s). For 0 to 50°C, $\pm 1\%$ becomes $\pm 2\%$ of reading.

Additional delay errors

Increase in allowable error, due to amplitude difference between Measurement and Reference carriers:

0 to 20 dB: 1 μ s

20 to 30 dB: 3 μ s

30 to 40 dB: 10 μ s (above 0.5 kHz)

Error due to gaussian white noise at 26 dB per 4 kHz bandwidth below the level of measurement or reference carrier: <16 μ s rms (with the average control set to 16).

Error due to discrete tone 150 Hz from measurement or reference frequency and 26 dB below the carrier level: <5 μ s rms (with the average control set to 16).

And at 200 Hz spacing: <2 μ s rms (with the average control set to 16).

Increase in allowable error, due to low receiver level:

	Additional error when either carrier is between -40 and -45 dBm.
5 to 40°C	3 μ s $\pm 1\%$ of reading
0 to 50°C	3 μ s $\pm 2\%$ of reading
	Additional error when either carrier is between -45 and -50 dBm.
5 to 40°C	6 μ s $\pm 1\%$ of reading
0 to 50°C	6 μ s $\pm 2\%$ of reading

with average control set to 4.

Attenuation distortion

Receive Level Range within which both Measurement and Reference carrier levels are contained	Receiver Maximum Error of Attenuation in the range 0 to +40 dB		Sender Max. Error
	5 to 40°C	0 to 50°C	
+ 5 to -5 dBm	0.15 dB $\pm 1\%$	0.15 dB $\pm 1\%$	0.1 dB
+ 5 to -20 dBm	0.15 dB $\pm 1\%$	0.15 dB $\pm 1.5\%$	0.1 dB
+10 to -30 dBm	0.2 dB $\pm 1\%$	0.2 dB $\pm 2\%$	0.1 dB
+10 to -40 dBm	0.2 dB $\pm 1.5\%$	0.3 dB $\pm 2.5\%$	0.1 dB
+10 to -50 dBm	0.6 dB $\pm 2.5\%$	0.7 dB $\pm 3\%$	0.1 dB

Level measurement (without changeover and unmodulated)

Receive range: +10 dBm to -50 dBm.

Accuracy:

	5 to 40°C		0 to 50°C	
	Sender	Receiver	Sender	Receiver
+10 to -20 dBm	± 0.2 dB	± 0.2 dB	± 0.3 dB	± 0.3 dB
-20 to -30 dBm	± 0.2 dB	± 0.4 dB	± 0.3 dB	± 0.5 dB
-30 to -40 dBm	± 0.3 dB	± 0.7 dB	± 0.4 dB	± 0.8 dB
-40 to -50 dBm	± 0.5 dB	± 1.2 dB	± 0.5 dB	± 1.6 dB

Absolute level measurements can also be made with modulation and changeover.

Options**Output level (option 001):**

Send level range extended to -49 to +10 dBm.

Loop holding (option 002):

Loop holding provided for sender output and receiver input.

Maximum DC loop holding current: 100 mA.

Voltage drop at maximum current: Approximately 12 V.

Dynamic output impedance: Approximately 50 k Ω .

Tone blanking:

Range: Up to two bands in the range 0.2 to 9.9 kHz.

Range limits: Any multiple of 100 Hz.

Option Number	Frequency Range Blanked (Hz)
004/101	500 to 700
004/102	600 to 900
004/103	1900 to 2200
004/104	2000 to 2400
004/105	2100 to 2500
004/106	2200 to 2600
004/107	2300 to 2700
004/108	2400 to 2800
004/109	2600 to 3000

Other tone blanking regions are available on request. The option number 004/100 should be used instead of one of the above numbers and the required frequency range specified. Option 005/10X/10X specifies two option ranges.

Operating instructions - other languages

Operating instructions in English are supplied. In Lid operating instructions are also available in:

German - Option 031; French - Option 032

Italian - Option 033; Spanish - Option 034

Option 040: Suitable X-Y Recorder in carrying case.

General

Dimensions: 270 mm wide, 200 mm high, 560 mm deep (11.3" \times 7.8" \times 22").

Weight: 12 kg. (26.5 lb).

Operating temperature range: 0 to 50°C unless otherwise specified.

Storage temperature range: -40 to +75°C.

Supply voltages: 90 to 126 V ac; 195 to 253 V ac; (48 to 66 Hz).

Power consumption: 50 W.

This instrument conforms to the CCITT recommendation, is compatible with all other instruments designed to this standard and is licensed under Wandel u Gollermann patents. The instrument uses a novel, improved principle of measuring Group Delay.

TELECOMMUNICATIONS TEST EQUIPMENT

Transmission parameter analyzer

Models 5453A & 5468A

- Characterize a data channel in 2 minutes
- Hard copy or magnetic storage of results

- Hardware independent measurements
- Economical, lightweight remote unit



Introduction

The HP 5453A Transmission Parameter Analyzer, together with the HP 5468A Transponder, provides operators and users of private 4-wire communication networks with the capability to rapidly evaluate critical network parameters and, hence, establish the operational status of a communication channel. Complex tests are performed easily and repeatably by nontechnical personnel. Results may be instantly compared to either a past history of the channel or to any desired specification which the channel must meet.

The rapid availability of all the pertinent data, all the time, speeds the alignment of newly installed channels, and the fault location and troubleshooting of inoperative channels. In addition, routine measurements on critical services are technically and economically feasible allowing preventive maintenance procedures to reduce the frequency of outages.

Test results can be preserved as hard-copy or stored in the 5453A disc memory for later recall and analysis. Data to be saved is automatically labeled with a serial number and date as well as with additional arbitrary identifying fields. Examples of additional fields are circuit identification number, customer name, or geographic location. The data file may then be searched by any desired category. For example, the identification and locations of all circuits belonging to a specific customer can be obtained in seconds.

Operation

Figure 1 illustrates a simple setup with the 5453A located in a central test center and a 5468A Transponder at a user location. In practice, the 5468A is placed at any desired test board or data set location along the channel. Once connected, and with the appropriate transmit and receive levels set into the front panel thumb-wheel switches, operation is fully automatic and no further action is required.



Figure 1. Typical point-to-point measurement. The 5468A is controlled by the 5453A over the channel to be tested.

Command tones, generated by the 5453A, are used to control the transponder. For measurements on the receive line, the 5468A can be commanded to generate appropriate test signals or to provide a quiet termination. Characteristics of the transmit line are obtained by causing the transponder to apply appropriate conditioning to signals received from the 5453A before looping them back. In this manner, true measurements of transmit line noise and distortion are obtained. Measurements performed are indicated in the Voice/Data Channel Measurement Capability Table on page 491. The results, for both directions of transmission, are available in approximately two minutes.

Tests conducted over different channel segments may be combined by the 5453A to obtain the point-to-point characteristics. With sufficient 5468A Transponders available, troubled sections are quickly isolated and corrective action initiated with a minimum of coordination. During installation of a new service, end-to-end measurements are made as often as necessary and alignment procedures followed until the channel meets specifications.

The low cost, light weight, and ease of use of the 5468A Transponder mean that the purchaser of data communication service can afford to install the units in his data centers and that his non-technical personnel can use them. Problems are quickly determined to lie with either the channel or the terminal equipment.

Remote access

Remote access to a centrally located 5453A is available on an optional basis for offices where the workload does not justify installation of a dedicated system. The measurement ports of the 5453A are extended to distant locations using high quality dedicated test lines. Up to 16 such locations can be accommodated by a single 5453A. During the calibration procedure, the loss and phase characteristics of each dedicated test line are measured and stored by the 5453A. These characteristics are then removed from any subsequent measurement automatically.

Remote offices are equipped with CRT Terminals, modems, and other interface equipment to enable them to communicate with and control the 5453A over a DDD connection. By employing a rotary connection of the central location, contending users can be placed in a queue and served in turn without the necessity of re-dialing. Operation is automatic and it is not necessary to man the central location. Once a distant user has identified himself, the dedicated test line to his location is automatically connected to the 5453A and the requested measurement made.

Measurement results appear on the remote CRT terminal automatically. Hard copy output is also available if the distant locations are equipped with teletypes. All the capabilities described above for storing and manipulating data are available to the remote operator.

Additional applications

The 5453A Transmission Parameter Analyzer is an essentially hardware independent measurement system. Based on the principles of digital signal analysis, it does not require hardware oscillators, voltmeters, power meters, counters, spectrum analyzers, or other such specialized equipment to accomplish a given measurement task. In addition, the 5453A has a number of capabilities not normally found in traditional instrumentation. Some examples are the ability to convert between the time and frequency domain as appropriate, the ability to work with random signals and signals buried in noise, the ability to compute statistical properties of a signal and to measure the joint properties of two signals and, finally, the ability to work with transient signals.

These characteristics suit the 5453A to a wide range of research, manufacturing and even educational applications in the telecommunication industry. Many types of communication equipment such as modems, facsimile transceivers, equalizers and telephone sets can be rapidly and completely characterized. The 5453A can even add various transmission impairments to actual communication signals, allowing performance to be studied under controlled conditions.

For complete technical, price, and leasing information or for application assistance with either the 5453A Transmission Parameter Analyzer or the 5468A Transponder, contact your local Hewlett-Packard office.

TELECOMMUNICATIONS TEST EQUIPMENT

Six simultaneous, automatic data measurements

Model 1645A

NEW

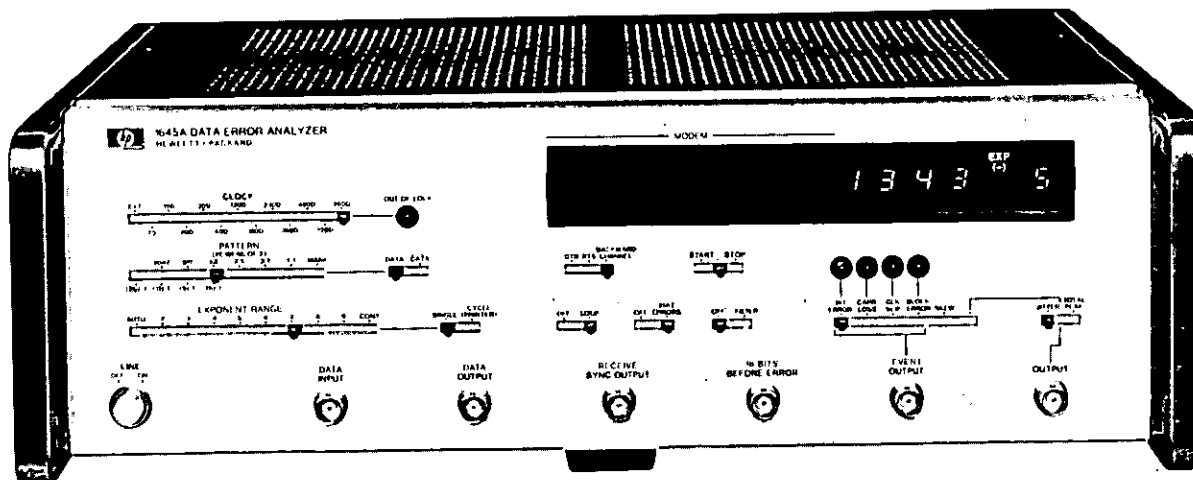

Direct reading, autoranged indications are displayed on an LED readout. Handshake signals conforming to CCITT convention are included for operation through any modem system.

1645A Description

Hewlett-Packard's Model 1645A Data Error Analyzer quickly isolates data communications link problems through six simultaneous measurements. During tests, the 1645A can be left totally unattended because it automatically maintains synchronization even in the presence of dropouts. And for added convenience, the 1645A can be equipped with a printer for hard-copy, permanent recordings of long tests.

Bit-error and block-error rate tests are autoranged and displayed directly on an LED readout, there is no need to perform any calculation. Additionally, the 1645A measures jitter or total peak distortion (the sum effect of jitter and bias), counts the number of times carrier loss or dropouts occur, measures data-error skew and counts the number of clock slips resulting from phase hits on the link or modem sync problems.

With all these measurements made during the same test interval, you'll know precisely what is causing your problems in modems, data channels, complete communications systems.

Indicators and controls

Indicators

Out of lock; bit error; carrier loss; clock slip; block error; data set ready (DSR); clear to send (CTS); loss of data; test on.

Selector switches

Clock; pattern; data/data; exponent range; single/cycle (printer); DTR/RTS/backward channel; start/stop; off/loop; off/xmit errors; off/filter; event, bit error, carrier loss, clock slip, block error, skew, jitter/total peak.

1645A Specifications

Bit rate

Internal: selectable 75, 150, 200, 300, 600, 1200, 1800, 2400, 3600, 7200, 9600.

External: 5 MHz max.

Data outputs/inputs

Front panel

Input: data input requires TTL levels; max input 5.5 V.

Outputs: receiver sync, 16 bits before error, and event at TTL levels; data output is >2 V into 50 ohms; jitter/total peak is 1 V p-p for each 10% of p-p distortion from waveform causing distortion.

Rear panel

Inputs: backward channel data, external transmitter and receiver clocks require TTL levels; max input 5.5 V.

Outputs: bits lost and transmitter sync are TTL levels; internal transmitter clock is >2 V into 50 ohms.

Multipin connectors: 25 pin RS 232C (CCITT V24) female connector, interfaces with standard communications systems. 36 pin (female) printer output at TTL levels in BCD 8421 code.

General

Power: 115 or 230 V ac, 48 to 440 Hz, 150 VA max.

Operating environment: temperature, 0 to +55°C (+32°F to +130°F); humidity, to 95% relative humidity at 40°C (104°F); altitude, to 4.6 km (15 000 ft); vibration, vibrated in three planes for 15 min. each with 0.254 mm (0.010 in.) excursion, 10 to 55 Hz.

Dimensions: 133 mm high (5¼ in.), 416 mm wide (16¼ in.), 286 mm deep (11¼ in.).

Weight: net, 10 kg (22 lb); shipping, 12.7 kg (28 lb).

Accessories supplied: one 2.3 m (7.5 ft) 3-wire power cord, one 3.1 m (10 ft) interconnecting cable in RS 232C configuration, 25 pin male connectors on each end, one Operating and Service Manual.

Special interfaces

Contact your local HP Field Engineer for details.

Accessories

Front panel cover: provides front panel protection and has a convenient carrying handle. HP P/N 5060-8767

Printer interconnecting cable: Model 10233A cable connects the 1645A to printer, 36 pin male connector on one end and a 50 pin male connector on the other

1645A Data Error Analyzer

Price

\$31

\$50

\$2300

TELECOMMUNICATIONS TEST EQUIPMENT

15 Hz to 50 kHz selective voltmeter

Model 3581C

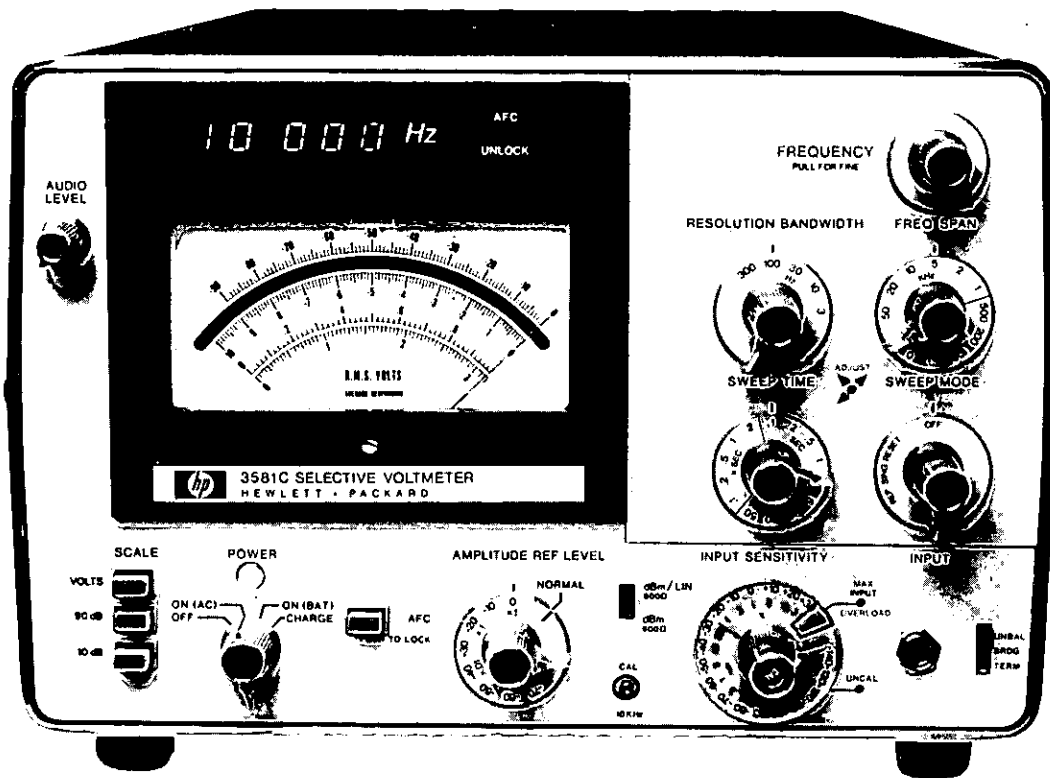
NEW

Description

Hewlett-Packard's 3581C Selective Voltmeter is a dedicated telecommunication version of HP's 3581A Wave Analyzer. Balanced inputs and a speaker monitor have been incorporated for telecommunication measurements.

Specifications

Frequency range: 15 Hz to 50 kHz.

Display: 5 digit LED readout. Resolution: 1 Hz. Accuracy: ± 3 Hz.

Typical stability: ± 10 Hz/hr. after 1 hour. ± 5 Hz/ $^{\circ}$ C.

Automatic frequency control (AFC), hold-in range: ± 800 Hz.

Pull-in range: $> 5 \times$ bandwidth for 3 Hz to 100 Hz bandwidth; > 800 Hz for 300 Hz bandwidth for full-scale signal.

Lock frequency: center of passband ± 1 Hz.

Amplitude

Instrument range:

Linear: 30 V to 100 nV full scale.

Log: +30 dBm or dBV to -150 dBm or dBV.

Amplitude accuracy*

15 Hz - 50 kHz, frequency response

Log	Linear
± 0.4 dB	$\pm 4\%$
± 0.5 dB	$\pm 5\%$
± 2 dB	$\pm 2\%$
± 0.3 dB	$\pm 3\%$

Switching between bandwidths

Amplitude display

Input attenuator

Amplitude reference level

(IF Attenuator)

Most sensitive range

All other ranges

± 1 dB $\pm 10\%$

± 1 dB $\pm 3\%$

*Note: these specifications cover the full temperature frequency and amplitude range, and represent worst case. Accuracy is significantly better for measurements not at the extremes.

Dynamic range: > 80 dB.

Noise level:

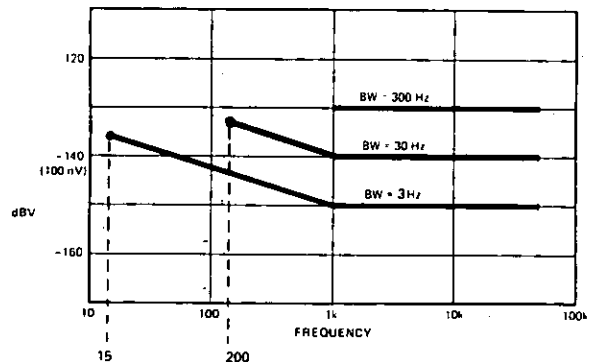

Noise sidebands: greater than 70 dB below CW signal. 10 bandwidths away from signal.

IF feedthrough: input level > 10 V: -60 dB; input level < 10 V: -70 dB.

Spurious responses: > 80 dB below input reference level.

Line related spurious: > 80 dB below input reference level or -140 dBV (0.1 μ V) or -90 dBm on 3581C in balanced terminated mode.

Zero beat response: > 30 dB below full scale at 25° C $\pm 5^{\circ}$ C. > 15 dB for 0° C to 55° C.

Smoothing: 3 position, rolloff is a function of BW.

Overload indicator: this LED warns of possible input amplifier overloading.

Uncal indicator: the variable input attenuator may be set to positions between steps. This is useful for scaling signals. When this feature is being used, the Uncal indicator clearly shows the instrument is not on a standard setting.

Meter scales: taut band with mirror backing

0 dB to -90 dB Log
0 dB to -10 dB
0 to 1 Linear
0 to 3.2

Calibrator: the 10 kHz fundamental of the calibrator may be used along with the 10 kHz cal adjustment to set the meter to full scale. This calibrates the circuitry that follows the input attenuator to an accuracy of $\pm 1.5\%$ at full scale, 10 kHz and same bandwidth.

Sweep

Scan width: 50 Hz to 50 kHz. These scans can be adjusted to cover a group of frequencies within the overall instrument range.

Sweep times: 0.1 sec to 2000 sec.

REP: in the repetitive mode, sweep will continuously sweep the specified band.

Single scan: after triggering a single sweep, HP's 3581C will remain at upper end of sweep. A sweep may also be triggered externally through a BNC connector on the rear panel labeled "external trigger." Grounding inhibits internal trigger.

Reset: HP's 3581C is set to the start frequency of sweep.

Manual: in combination with concentric knob, manual sweep fully duplicates span of electronic sweep.

Off: sweep circuits and associated controls are turned off.

Sweep error light: this LED indicates a sweep that is too fast to capture full response. When the light is on, response will be lower than it should.

Zero scan: to look at the time varying signal at center or start frequency within bandwidth selected.

External trigger: a short to ground stops normal sweep. Opening the short then enables a sweep.

Input

Meter Scale Buttons	Terminated	Bridging	Unbalanced
Volts 900 Ω dBm/LIN	Input impedance 900 Ω . Reads volts on volt scales of meter. 1 V rms input gives 1 V rms on meter.	Input impedance 10 k Ω . Reads volts on volt scales of meter. 1 V rms input gives 1 V rms on meter.	Input impedance 1 M Ω . Reads volts on volt scales of meter. 1 V rms input gives 1 V rms on meter.
dB 900 Ω dBm/LIN	Input impedance 900 Ω . Reads dBm 900 Ω on dB scales of meter. 0.949 V rms input gives 0 dB reading on meter.	Input impedance 10 k Ω . 900 Ω termination necessary to be calibrated with a source that has 900 Ω output impedance. 0.949 V rms input gives 0 dB reading on meter.	Input impedance 1 M Ω . 900 Ω termination necessary to be calibrated with a source that has 900 Ω output impedance. 0.949 V rms input gives 0 dB reading on meter.
Volts 600 Ω /dBm	Not a valid combination.		
dB 600 Ω /dBm	Input impedance 600 Ω . Reads dBm 600 Ω on dB scales of meter. 0.775 V rms input gives 0 dB reading on meter.	Input impedance 10 k Ω . Termination necessary to be calibrated with a source that has 600 Ω output impedance. 0.775 V rms input gives 0 dB reading on meter.	Input impedance 1 M Ω . Termination necessary to be calibrated with a source that has 600 Ω output impedance. 0.775 V rms input gives 0 dB reading on meter.

Impedance: 1 M Ω , 30 pF.

Maximum input level: 100 V rms, ± 100 V dc.

External L.O.: an external oscillator may be used to set frequency of filter.

Frequency range: 1 MHz to 1.5 MHz to tune internal filter from 0 Hz to 50 kHz.

Level: 100 mV to 1 V.

To make floating measurements or break ground loops use the battery option.

Input connector: WECO 310 with balancing transformer.

Input unbalanced: impedance 1 M Ω /40 pF. Maximum input level 100 V rms or ± 100 V dc.

Balance/bridged: Impedance: 10 k Ω .

Maximum input level: +30 dBm or ± 100 V dc.

Frequency response: 40 Hz - 20 kHz ± 0.5 dBm for signals <20 dBm.

Dynamic range: 80 dB for signals <0 dBm and >100 Hz. **CMR:** >70 dB at 60 Hz.

Balanced terminated: Same as balance/bridged except **CMR:** >64 dB at 60 Hz.

Output

Tracking generator output (also known as BFO or tracking oscillator output).

Restored output

Range: 0 to 2 V rms.

Frequency response: $\pm 3\%$ 15 Hz to 50 kHz.

Frequency accuracy: ± 1 Hz relative to center of filter.

Impedance: 600 Ω .

Total harmonic and spurious content: (for tracking generator output) >40 dB below 1 V rms signal level.

LO Output: 100 mV signal from 1 MHz to 1.5 MHz as input is tuned from 0 to 50 kHz.

Output connector: WECO 310, for connection to tracking generator output or restored output. In addition to monitoring restored output with headphones, an internal speaker also provides an audio indication of signal content.

Restored and tracking generator:

Output impedance: 600 Ω balanced.

Frequency response: ± 0.5 dB 100 Hz to 20 kHz.

X-Y recorder analog outputs:

Vertical: 0 to +5 V $\pm 2.5\%$.

Horizontal: 0 to +5 V $\pm 2.5\%$.

Impedance: 1 k Ω .

Pen lift: contact closure to ground during sweep.

General

Operating temperature range: 0 to 55°C.

Humidity: 95% relative, maximum at 40°C.

Power requirements: 100 V, 120 V, 220 V or 240 V +5% -10%, 10 VA typical, 48 Hz to 440 Hz.

Dimensions: 412.8 mm high \times 203.2 mm wide \times 285.8 mm deep (16 $\frac{1}{4}$ " \times 8" \times 11 $\frac{1}{4}$ ").

Weight: 11.5 kg (23 lb); Option 001, 13.5 kg (30 lb).

Accessory available: 7035B Option 20, X-Y recorder.

Option 001 battery: used to make floating measurements or to break ground loops; 12 hours from full charge; 12 hours to fully charge. The internal battery is protected from deep discharge by an automatic turn-off.

Model number and name

7035B Option 20 X-Y Recorder

Option 001 Battery

3581C Selective Voltmeter

Price

add \$285

add \$265

\$2700

TELECOMMUNICATIONS TEST EQUIPMENT

Telephone test oscillators

Model 236A

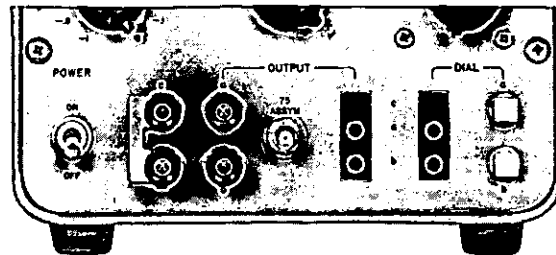
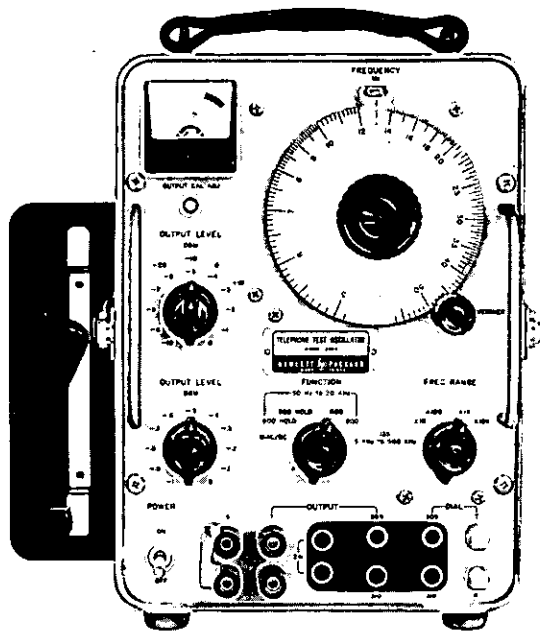

General

Hewlett-Packard's Models 236A and 236A Option H10/H20 Telephone Test Oscillators are particularly useful for lineup and maintenance of telephone voice and carrier systems when used with their companion instruments 3555B and 3556A Transmission Noise Meters. CCITT requirements are met with the HP 236A Option H10 and HP 3556A when used together.

Model number and name

HP 236A Option H10, CCITT (ac line and dry battery)	add \$113
HP 236A Option H20, CCITT (ac line and rechargeable batteries)	add \$250
HP 236A Telephone Oscillator (Bell)	\$695

Specifications

	236A (Bell)	236A Option H10 (CCITT)
Frequency range	50 Hz to 560 kHz	
Frequency dial accuracy	±3% of setting	
Frequency response		
600Ω output	±0.3 dB from 50 Hz to 20 kHz	
900Ω output	±0.3 dB from 50 Hz to 20 kHz	
135Ω output	±0.3 dB from 5 kHz to 560 kHz	
150 and 75Ω outputs	±0.3 dB from 5 kHz to 560 kHz	
Output level/accuracy	-31 to +10 dBm in 0.1 dBm step/±0.2 dBm from -31 to +10 dBm (1 kHz ref., Opt. H10, 800 Hz ref.)	
Noise	At least 65 dB below total output or -90 dBm - whichever noise is greater. 3kHz bandwidth	
Distortion	At least 40 dB below fundamental output.	
Output circuit	Balanced (symmetrical) and floating. Can be operated up to ±500 V dc above (earth) ground.	
Output impedance	600 and 900Ω ±5% 135Ω ±10%	600 and 150Ω symmetrical 75Ω asymmetrical
Output balance (output symmetry)	600 and 900Ω outputs: 70 dB at 100 Hz, 55 dB at 3 kHz 135 and 150Ω outputs: 50 dB at 5 kHz, 30 dB at 560 kHz	
Output jacks	Accepts Western Electric 241, 309, and 310 plugs.	Accepts 3-prong Siemens 9 REL, STP 6 AC or 4 mm diameter banana plugs.
	Binding posts accept banana plugs, spade lugs, phone tips or bare wires.	
Dial jacks	Accepts Western Electric 309 and 310 plugs. Clip posts accept Western Electric 1011B lineman's hand-set clips.	Accepts 3-prong Siemens 9 REL, STP 6 AC or 4 mm diameter plugs. Clip posts accept lineman's hand-set clips as alligator clips.
DC holding coil	600 and 900Ω outputs only. 700Ω ±10% dc resistance; 60 mA maximum loop current at 100 Hz.	
Power requirements	Line: 115 or 230 V (switch) ±10% ac, 48 Hz to 440 Hz, <2 VA. Internal battery: single NEDA 202 45 V "B" battery. 236A Option H20: (same as 236A Option H10 except) five 6.25 V rechargeable batteries; 90 V - 250 V ac, 48 Hz - 440 Hz, <10 VA during battery charge.	
Weight	Net, 6.1 kg (13.5 lb). Shipping, 7.7 kg (17 lb)	
Complementary equipment	HP 3555B Transmission and Noise Measuring Set	HP 3556A Psophometer

TELECOMMUNICATIONS TEST EQUIPMENT

Transmission & noise meter

Models 3555B & 3556A

NEW

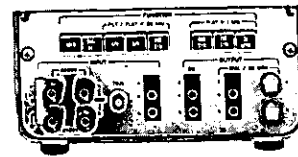
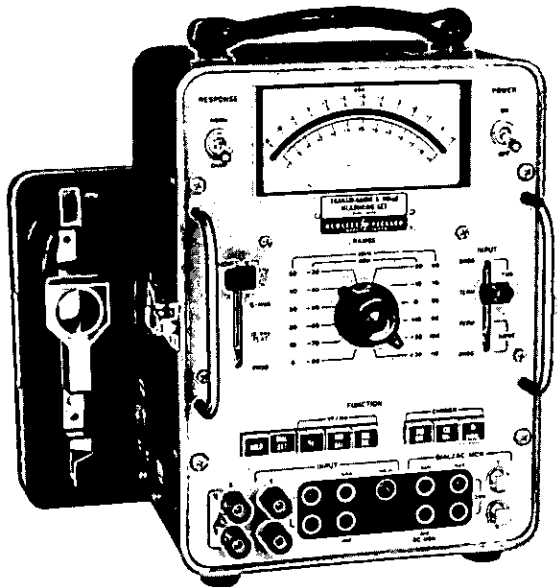

Description

HP's 3555B Transmission and Noise Measuring Set is designed especially for telephone plant maintenance. It measures attenuation, distortion, cross-talk coupling, and noise. Weighting networks comply with Bell System Technical Reference Publication number 41009, and include C-message, 3 kHz and 15 kHz flat and program.

HP's 3556A performs the same tasks as the 3555B. It also has built-in weighting networks that comply with 1960 CCITT requirements, which include telephone (psophometric) 3 kHz flat, and 15 kHz flat, programme weighting filters.

Operating instructions printed in the protective cover are available in different languages at no extra charge.

Complementary equipment for the 3555B is HP 236A Telephone Test Oscillator (236A Opt. H10 for the 3556A). When used together, they make a complete transmission test set for accurate, convenient voice and carrier measurements.

Specifications

	3555B (Bell Standards)	3556A (CCITT Standards)
VOICE FREQUENCY LEVEL MEASUREMENTS: 20 Hz to 20 kHz		
dB/volt Range	-91 dBm to +31 dBm	-78 dBm to +32 dBm/0.1 mV to 30 V F.S.
Level accuracy**	±0.5 dB; ±0.2 dB, 40 Hz to 15 kHz, level >60 dBm	100 Hz to 5 kHz: ±0.2 dB; 20 Hz to 20 kHz: ±0.5 dB
Input	Terminated or bridged 600Ω or 900Ω balanced. Bridging loss: <0.3 dB at 1 kHz. Balance: >80 dB at 60 Hz, >70 dB at 6 kHz, >60 dB to 20 kHz. Return loss: 30 dB min (50 Hz to 20 kHz)	Terminated: 600Ω symmetrical. Non-terminated: 10 kΩ symmetrical. Non-terminated error: <0.4 dB at 800 Hz. Symmetry: >80 dB at 50 Hz, >70 dB at 6 kHz, >50 dB to 20 kHz. Return loss: 30 dB min (50 Hz to 20 kHz)
Holding circuit	700Ω dc resistance, 60 mA max. loop line current at 300 Hz. With holding circuit in, above specs apply from 300 Hz to 4 kHz	
NOISE MEASUREMENTS:		
dB/volt range	-1 dBm to +121 dBm	-78 dBm to +32 dBm/0.1 mV to 30 V F.S.
Weighting filters	3 & 15 kHz flat, C-message, and program (Bell system technical reference pub. #41009)	3 & 15 kHz flat, telephone and programme (P53, CCITT)
Input	Same as for voice frequency measurements	
CARRIER FREQUENCY LEVEL MEASUREMENTS:		
dB/volt range	-61 dBm to +11 dBm	-48 dBm to +12 dBm/3 mV to 3 V F.S.
Level accuracy	600Ω balanced (symmetrical): 1 kHz to 150 kHz, ±0.5 dB; 10 kHz to 100 kHz, ±0.2 dB. 135Ω balanced (or 150Ω balanced)†: 1 kHz to 600 kHz, ±0.5 dB; 10 kHz to 300 kHz, ±0.2 dB, 75Ω unbalanced (asymmetrical): 100 Hz to 600 kHz, ±0.2 dB; 30 Hz to 1 MHz, ±0.5 dB; 1 MHz to 3 MHz, ±0.5 dB ±10% of meter reading	
Input	Terminated or bridged 135Ω† or 600Ω balanced (symmetrical) and 75Ω unbalanced (asymmetrical)	
Return loss	600Ω: 26 dB min., 3 kHz to 150 kHz; 135Ω†: 26 dB min. 1 kHz to 600 kHz; 75Ω: 30 dB min. to 3 MHz	
Bal/symmetry	>70 dB to 10 kHz, >60 dB to 100 kHz, >40 dB to 600 kHz	
GENERAL:		
Meter	Linear dB scale	Linear dBm scale
External battery	24 V or 48 V office battery, <15 mA	
Internal battery	Single NEDA 202, 45 V "B" battery Option H03 uses rechargeable batteries and similar to 3556A	4 rechargeable batteries (25 V total) or power line from 90 V to 250 V ac, 48 Hz to 440 Hz, <10 VA. Option 001 uses same battery as 3555B
AC	115 or 230 V (specify for 3555B) (switch for 3556A) 48 Hz to 440 Hz, <10 VA	
Dimensions	197 mm wide × 299 mm high × 207 mm deep (7¾" × 11¾" × 8¼")	
Weight	Net, 6.8 kg (15 lb). Shipping, 7.5 kg (17 lb).	
Jacks	Will accept Western Electric 241, 309, 310, 358, 289 and 347 plugs; 1011B hand-set or 52 type headset	Will accept Siemens 9 REL KL1-6A, 4 mm diameter banana plugs or 3-prong Siemens 9 REL STP-6AC connector
**For levels >1 dBm accuracy spec applies only for freq. above 100 Hz. †150Ω for 3556A.		

Model number and name

HP 236A Telephone Test Oscillator (complementary equipment for 3555B)

Price

see opposite page

HP 236A, Opt. H10 Telephone Test Oscillator (complementary equipment for 3556A)
3555B Transmission and Noise Measuring Set
3556A Psophometer

see opposite page
\$860
\$1060

TELECOMMUNICATIONS TEST EQUIPMENT

Transmission test sets

Models 3551A & 3552A

NEW

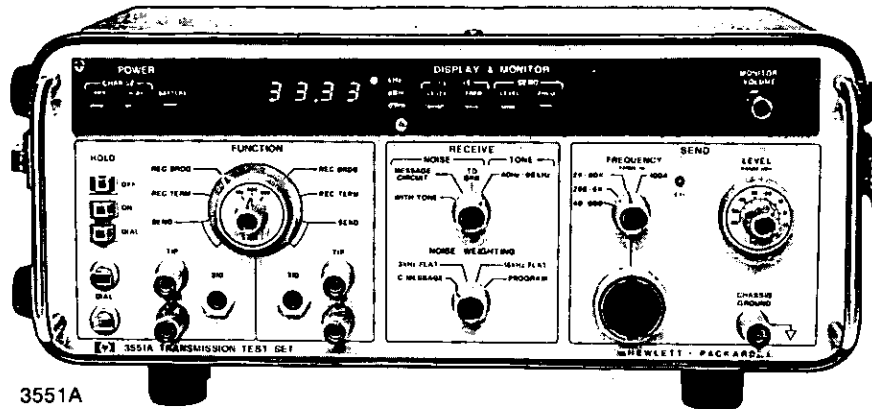

3551A

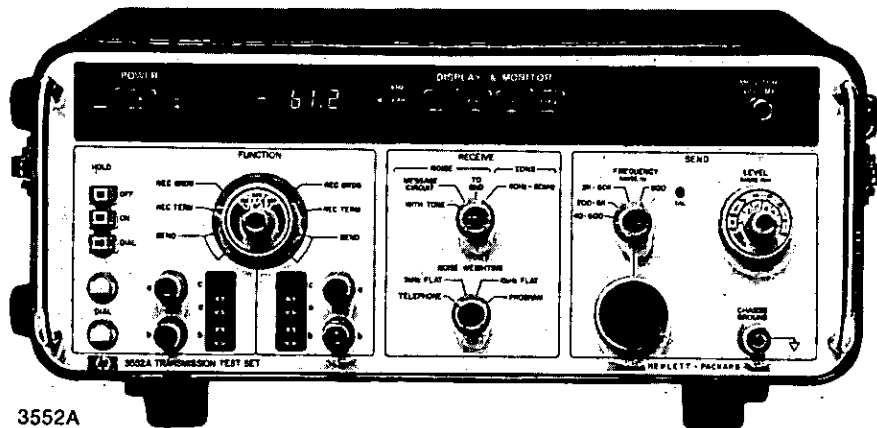

3552A

Description

Hewlett-Packard's 3551A (North American Measurement Standard) and 3552A (CCITT) Transmission Test Sets are rugged, portable and ideally suited for measurements on voice, program and data circuits up to 50 Kb/s.

These four-function test sets are capable of measuring tone level, noise level, and frequency, while simultaneously sending tone. Both level and frequency are fully autoranging.

A sampling rate of 10 per second in tone level and frequency allows a "direct feel" between an adjustment and the ensuing reading. Digital LED readout displays either level or frequency of input or output regardless of terminal function selected.

Appropriate resolution, time constant and sample rate are automatically provided to simplify operation for the user.

These test sets can measure both two-wire and four-wire balanced circuits. Impedances of 135, 600, and 900 ohms can be selected on the 3551A; impedances of 150, 600, and 900 ohms are available on the 3552A. In addition, the receiver may be either terminated or bridged.

The test sets may be powered by either ac line or internal rechargeable batteries and are suited for both inside and outside plant maintenance.

A full wave average detector is used for tone level measurements. Automatic ranging eliminates the need to set attenuators and thus reduces the possibility of errors due to faulty calculations. Direct digital

readout gives a 0.1 dB resolution over the entire 85 dB dynamic range.

For frequency measurements, a four-digit autoranging frequency counter is provided. The readout is calibrated in kHz and features 1 Hz resolution from 40 Hz to 10 kHz and 10 Hz resolution from 10 kHz to 60 kHz. The decimal point is automatically positioned to avoid the possibility of errors due to overflow of the four digits.

Noise measurements are made with an RMS detector and displayed in dBm on the 3551A and dBm on the 3552A, with 1.0 dB resolution. Display rate is slowed to 2 per second to provide analog feel of slowly changing noise levels. Both test sets have the capability of measuring noise-with-tone, message circuit noise, and noise-to-ground. Four switch selectable weighting networks are provided; C-message, Program, 3 kHz, and 15 kHz Flat in the 3551A; and Telephone (CCITT Psophometric), Programme, 3 kHz and 15 kHz Flat in the 3552A. In the noise-with-tone position, a notch is inserted before the selected weighting network.

Send oscillator covers a frequency range of 40 Hz to 60 kHz in three bands; 40 Hz to 600 Hz, 200 Hz to 6 kHz, and 2 kHz to 60 kHz. The output level is continuously variable from +10 dBm to -60 dBm.

In addition, a fixed position is provided to be used as the holding tone when making a noise-with-tone measurement.

A convenient set of clip posts for connecting a lineman's handset is provided. This allows a line connection to be dialed up and then held in an off-hook (busy) condition while making either receive or send measurements on a two-wire wet line.

3551A and 3552A Specifications

Receiver

Level measurements

Frequency range: 40 Hz to 60 kHz.
Dynamic range: +15 dBm to -70 dBm.
Resolution: 0.1 dB.
Sample rate: 10/second.
Detector type: average responding.
Accuracy: at 25°C ±10°C, temperature coefficient: ±0.005 dB/°C beyond this range.

Frequency measurements

Frequency range: 40 Hz to 60 kHz.
Dynamic range: +15 dBm to -70 dBm.
Resolution: 1 Hz (40 Hz to 10 kHz), 10 Hz (10 kHz to 60 kHz).
Sample rate: 10/second.
Accuracy: ±1 count.

Transmitter 3551A & 3552A

Frequency range: 40 Hz to 60 kHz.
Ranges: 40 Hz to 600 Hz, 200 Hz to 6 kHz, 2 kHz to 60 kHz, 800 Hz fixed. (Other frequencies available 3552A), 1004 Hz fixed, 3551A.
Resolution: 1 Hz (40 Hz to 10 kHz), 10 Hz (10 kHz to 60 kHz).
Sample rate: 10/second.
Harmonic distortion: >-50 dB (THD 100 Hz to 4 kHz), >-55 dB (all harmonics 100 Hz to 4 kHz), >-60 dB (THD 800 Hz or 1004 Hz fixed).
Accuracy: ±1 count.
Level range: +10 dBm to -60 dBm (40 Hz to 60 kHz), +6 dBm to -60 dBm (+100 Hz fixed).
Resolution: 0.1 dB.
Sample rate: 10/second.
Accuracy: at 25°C ±10°C, temperature coefficient: ±0.005 dB/°C beyond this range.

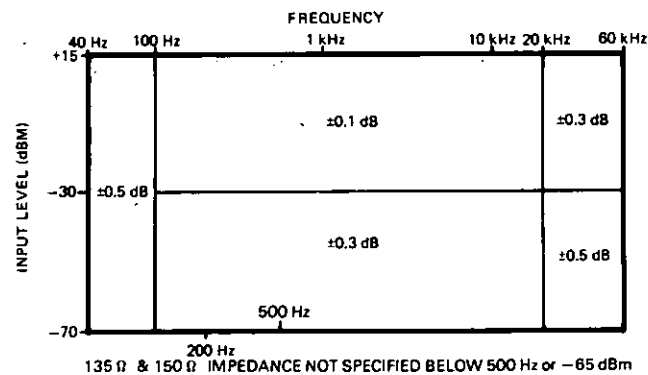

3551A Noise measurements

Dynamic range

Message circuit noise: 0 dBm to +85 dBm.
Noise-with-tone: +10 dBm to +85 dBm. (600Ω, 900Ω).
Noise-to-ground: +40 dBm to +125 dBm.
Resolution: 1 dB.
Sample rate: 2/second.
Detector type: Quasi RMS.

Accuracy

Message circuit noise: ±1 dB (+20 dBm to +85 dBm), ±2 dB (0 dBm to +20 dBm).
Noise-with-tone: ±1 dB (+20 dBm to +85 dBm), ±2 dB (+10 dBm to +20 dBm).

Noise-to-ground: ±1 dB (+60 dBm to +125 dBm), ±2 dB (+40 dBm to +60 dBm).
Weighting filters: C-message, 3 kHz flat, 15 kHz flat, program.

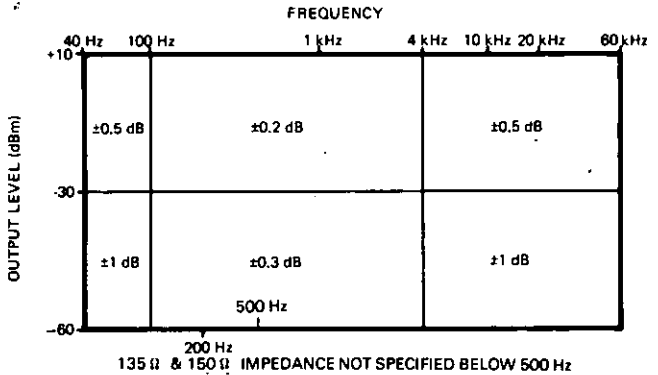

3552A Noise measurements

Dynamic range

Message circuit noise: -90 dBm to -5 dBm.
Noise-with-tone: -80 dBm to -5 dBm (600Ω, 900Ω).
Noise-to-ground: -50 dBm to +35 dBm.
Resolution: 1 dB.
Sample rate: 2/second.
Detector type: RMS responding.
Accuracy
Message circuit noise: ±1 dB (-70 dBm to -5 dBm), ±2 dB (-90 dBm to -70 dBm).
Noise-with-tone: ±1 dB (-70 dBm to -5 dBm), ±2 dB (-80 dBm to -70 dBm).
Noise-to-ground: ±1 dB (-30 dBm to +35 dBm), ±2 dB (-50 dBm to -30 dBm).
Weighting filters: Telephone (CCITT Psophometric), 3 kHz flat, 15 kHz flat, programme (CCITT).

General

Monitor: built-in speaker, monitors received or transmitted signal.
Balanced impedances: 135Ω, 600Ω, 900Ω (3551A).
Balanced impedances: 150Ω, 600Ω, 900Ω (3552A).
Bridging loss: <0.2 dB.
Return loss: >30 dB.
Longitudinal balance: >60 dB at 6 kHz, >126 dB at 50 Hz.
Hold circuit: 24 milliamps constant current, <0.2 dB holding loss, resistive fuse protection.
Input/output protection: blocks 300 V dc.
Maximum longitudinal voltage: 200 V rms.
Battery supply: 4-6 hours continuous operation on internal rechargeable batteries at 25°C. Battery drain is automatically turned off when discharged below proper operating level. Complete recharge in 12 hours.
Power requirements: 100 V, 120 V, 220 V, 240 V ±10%; 48 Hz to 440 Hz; 14 VA.
Temperature range: 0°C to 55°C, operating; -20°C to +65°C, storage.
Relative humidity: 0 to 95% (<40°C).
Dimensions: 343 mm wide × 133 mm high × 254 mm deep (14½" × 6½" × 10") with cover.
Weight:
Net: 6.6 kg (13 lb).
Shipping: 7.3 kg (16 lb).
Model number and name
 3551A Transmission test set
 3552A Transmission test set (CCITT)

Price
\$1750
To be announced.

TELECOMMUNICATIONS TEST EQUIPMENT

Microwave link analyzer at BB, IF (70 MHz) and RF

Models 3710A/3702B/3730A

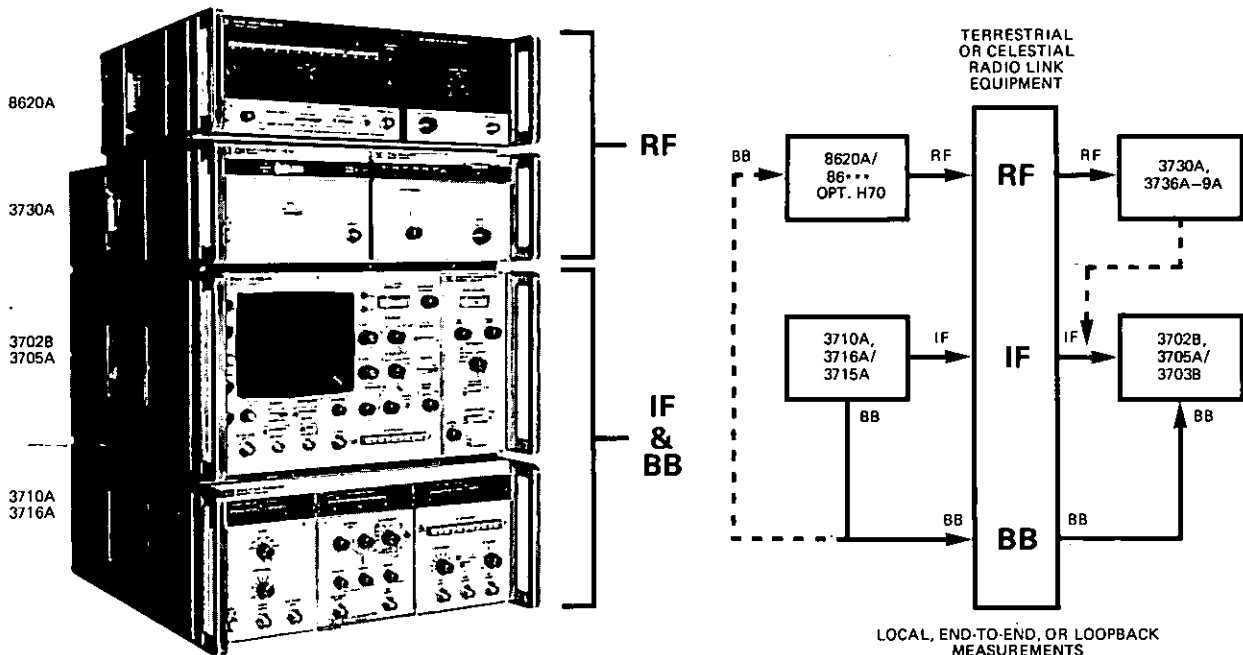

LOCAL, END-TO-END, OR LOOPBACK MEASUREMENTS

Description

The Microwave Link Analyzer, Down Converter and RF Sweeper, as a package, enables the full BB, IF & RF capability of terrestrial and celestial radio links to be realized. The Microwave Link Analyzer (3710A IF/BB Transmitter + 3716A or 3715A plug-in and 3702B IF/BB Receiver + 3705A or 3703B plug-in) is a combined Baseband (BB) and Intermediate Frequency (IF) analyzer, allowing the various forms of distortion occurring in a link to be identified, measured and localized to BB and IF devices. The Down Converter (3730A + 3736A, 3737A, 3738A, 3739A or 37301A plug-in) and RF Sweeper (8620A/86*** Opt H70) which is used as an Up Converter, ensure that this capability is extended into the RF range. The Down Converter may be used independently of the Hewlett-Packard Microwave Link Analyzer.

Benefits

- An easy to operate, four instrument package.
- Comprehensive BB frequency coverage, 83.333 kHz to 8.2 MHz.
- Comprehensive IF coverage, 45 to 95 MHz.
- Comprehensive RF coverage.
- Minimum cabling interconnections and alterations for changes in measurement.

MLA: seven selected baseband test tones up to 8.2 MHz.
 Internal demodulation up to 5.6 MHz.
 Inbuilt CRT with dual trace display.
 Receiver can be remote from transmitter for between-station measurements. Slave facility for local display of remote measurements.
 IF frequency stability of ± 100 kHz/5 hr period.
 IF frequency markers of 70 MHz, 2 MHz "comb" and sliding symmetrical pair.

RF capability: permits separate characterization of transmitter and receiver by BB, IF, or RF to RF tests. No plotting and differentiating — easy equalization. Permits active and passive component tests — avoids the problems of other systems.

Specifications

MLA

- IF frequency range:** 45 to 95 MHz centered on 70 MHz.
- IF flatness (residual):** ± 0.05 dB from 45 to 95 MHz.
- BB linearity and differential gain (residual):** 0.1% (BB-BB), 0.4% (IF-IF) from 45 to 95 MHz.
- Group delay (residual):** 0.1 ns (BB-BB), 1 ns (IF-IF) from 45 to 95 MHz.
- Differential phase (residual):** 0.1° (BB-BB), 0.8° (IF-IF) from 45 to 95 MHz.
- IF power range:** +21 dBm to -10 dBm.
- BB power range:** -10 dBm to -49 dBm.
- Modulator sensitivity:** -49 dBm to 0 dBm.
- Demodulator sensitivity:** -10 dBm to -49 dBm.
- Impedances:** 75 Ω .
- Power:** 100/120/220/240 V (+5 -10%), 48 to 66 Hz, approx. 150 VA for transmitter, approx. 190 VA for receiver.
- Dimensions:**
 - 3710A:** 425 mm wide, 172 mm high, 457 mm deep (16 $\frac{1}{4}$ " \times 6 $\frac{3}{4}$ " \times 18").
 - 3702B:** 425 mm wide, 216 mm high, 457 mm deep (16 $\frac{1}{4}$ " \times 8 $\frac{1}{2}$ " \times 18").

Down converter

- RF input:**
 - RF frequency range:** 1.7 to 11.7 GHz.
 - Minimum input level:** -20 dBm (-44 dBm with Opt. 010). 4 dB higher level for correct operation of MLA.
 - Impedance:** 50 Ω .
- IF output:**
 - Meter accuracy:** ± 0.5 MHz at 70 MHz, (± 2 MHz f.s.).
 - Return loss:** 28 dB min.
 - Impedance:** 75 Ω .
 - Power:** 115 or 230 V ($\pm 10\%$), 48 to 66 Hz.
 - Dimensions:** 425 mm wide, 141 mm high, 467 mm deep (16 $\frac{1}{4}$ " \times 5 $\frac{1}{2}$ " \times 18 $\frac{3}{4}$ ").

Option selection chart

Instruments to suit customer requirements may be compiled from the following groups. Specify only ONE option from each group.	INSTRUMENTS							
	3710A	3716A	3715A	3702B	3705A	3703B	8620A	3730A
CONNECTORS	OPTIONS							
BNC	STD	STD	STD	STD	-	-	STD	STD
Siemens large	002	002	002	002	-	-	*	002
Siemens small	003	003	003	003	-	-	*	003
Commercial equivalent of WECO 477B with 75/124 ohm bal.	004	004	004	004	-	-	*	004
Type N (for RF)	-	-	-	-	-	-	STD	STD
BB FREQUENCIES	OPTIONS							* Not assigned
83.333, 250, 500kHz	-	-	STD	-	-	STD	-	-
83.333, 250, 500kHz and 2.4, 4.43, 5.6, 8.2MHz	-	STD	-	-	STD	-	-	-
92.593, 277.778, 555.556kHz with phase lock control	-	-	009	-	-	009	-	-
92.593, 277.778, 555.556kHz, 2.4, 3.58, 5.6, 8.2MHz	-	010	-	-	010	-	-	-
92.593, 277.778, 555.556kHz, 2.4, 3.58, 4.43, 8.2MHz	-	011	-	-	011	-	-	-
92.593, 277.778, 555.556kHz, 2.4, 4.43, 5.6, 8.2MHz	-	012	-	-	012	-	-	-
83.333, 250, 500kHz and 2.4, 3.58, 5.6, 8.2MHz	-	013	-	-	013	-	-	-
83.333, 250, 500kHz and 2.4, 3.5, 5.6, 8.2MHz	-	014	-	-	014	-	-	-
83.333, 250, 500kHz and 2.4, 4.5, 5.6, 8.2MHz	-	016	-	-	016	-	-	-
83.333, 250, 500kHz and 2.4, 3.58, 4.43, 8.2MHz	-	018	-	-	018	-	-	-
83.333, 250, 500kHz and 2.4, 3.58, 4.43, 5.6MHz	-	019	-	-	019	-	-	-
SWEEP FREQUENCIES	OPTIONS							
70Hz internal	STD	-	-	STD	-	-	-	-
50Hz internal	006	-	-	STD	-	-	-	-
100Hz internal	007	-	-	STD	-	-	-	-
18Hz internal with bandwidths of 90 and 180Hz	015	-	-	STD	015	015	-	-
VARIABLE PHASE SWEEP	OPTIONS							
0° ± 100° and 180° ± 100° from 45 to 100Hz	008	-	-	-	-	-	-	-
RF FREQUENCIES	DOWN CONVERTER PLUG-INS							
	3736A	3737A	3738A	3739A	37301A			
1.7 to 4.2GHz	STD	-	-	-	External local oscillator - frequency depends on sweep oscillator used.			
3.3 to 6.5GHz	-	STD	-	-				
6.3 to 8.5GHz	-	-	STD	-				
10.7 to 11.7GHz	-	-	-	STD				

System selection chart

Measurement	MLA				UP CONVERTER	DOWN CONVERTER	
	3710A	3716A/3715A	3702B	3705A/3703B	8620A/86*** Opt. H70	3730A	3736A - 9A, 37301A
BB to BB	•	•	•	•			
BB to IF	•	•	•	•			
BB to RF	•	•	•	•		•	•
IF to BB	•	•	•	•			
IF to IF	•	•	•	•			
IF to RF	•	•	•	•		•	•
RF to BB	•	•	•	•	•		
RF to IF	•	•	•	•	•		
RF to RF	•	•	•	•	•	•	•

TELECOMMUNICATIONS TEST EQUIPMENT

IF switch; general purpose 75 ohm attenuator
Model 3740A & 3750A

NEW

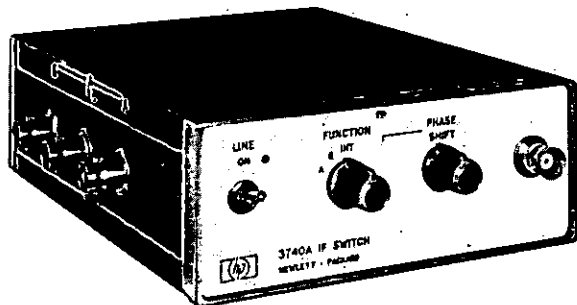

3740A

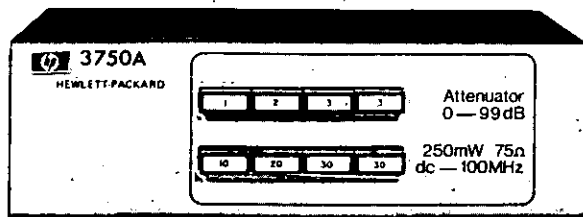

3750A

3740A Description

The 3740A IF Switch is a general purpose single-pole, double-throw IF switch. Optionally, a DPDT switch and various types of connector may be specified. It has excellent delay characteristics, making it ideal for DADE (differential absolute delay equalization) measurements when used with the Microwave Link Analyzer. The internal switching rate is 150 Hz. An external dc to 10 kHz signal may also be used to control the switch. The standard 3740A has a single IF switch unit and 75Ω BNC connectors fitted.

Specifications

Bandwidth: 45 to 95 MHz.

Isolation: >65 dB (between any two ports).

Flatness: ±0.05 dB.

Amplitude difference: 0.03 dB (between channels).

Input level: +10 dBm (max).

Through loss: <1 dB.

Group delay distortion: 0.5 ns (500 kHz test tone, 200 kHz rms deviation).

Differential absolute delay: <0.25 ns (between channels).

Impedance: 75Ω.

Return loss: >28 dB (all switching ports).

Power requirements: 100/120/220/240 V ac, 48 to 66 Hz, <10 VA.

Dimensions: 127 mm wide, 50 mm high, 178 mm deep (5" × 2" × 7").

Options

001: DPDT switch.

002: Siemens 2.5 mm connectors.

003: Siemens 1.6 mm connectors.

004: WECO 477B (equivalent) connectors.

3750A Description

The 3750A Attenuator is a general purpose 75Ω impedance attenuator operating in the frequency range dc to 100 MHz. Attenuation of 0 to 99 dB is provided in 1 dB steps by the operation of pushbutton switches. The 3750A is symmetrical so that either port can be used as the input or output. The Attenuator is fitted with 75Ω BNC connectors.

Specifications

Attenuation: 0 to 99 dB in 1 dB steps.

Frequency range: 0 to 100 MHz.

Impedance: 75Ω.

Accuracy: unit steps ±0.1 dB

decade steps ±0.2 dB

cumulative ±0.5 dB to 79 dB

±1.0 dB to 89 dB

±2.0 dB to 99 dB

Maximum input power: +24 dBm (250 mW).

Return loss: 28 dB at either port when properly terminated.

VSWR: 1.08:1.

Insertion loss: 0.1 dB at 10 MHz.

0.4 dB at 50 MHz.

0.6 dB at 100 MHz.

Dimensions: 203 mm wide, 70 mm high, 102 mm deep (8" × 2¾" × 4").

Model number and name

3740A IF Switch

3750A Attenuator

Price

\$410

\$185

TELECOMMUNICATIONS TEST EQUIPMENT



Selective voltmeter, 20 Hz to 620 kHz

Models 3590A & 3591A

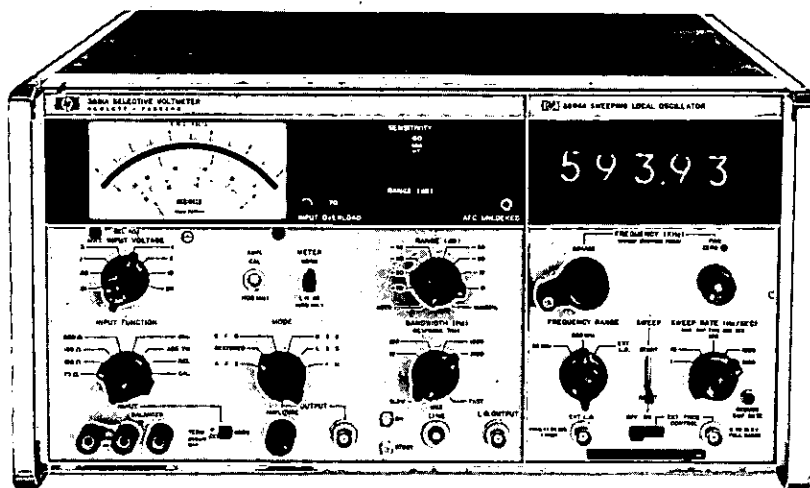

Description

Hewlett-Packard's 3591A is a general purpose 20 Hz to 620 kHz frequency selective voltmeter having balanced input with selectable impedances. With balanced input circuitry, HP's 3591A is particularly useful for communications applications in the lab, field, or production line. Other than input differences, the 3591A is essentially identical to the 3590A, having all the virtues of automatic ranging, wide dynamic range, and log and linear X and Y recorder outputs.

Specifications

Frequency range: 20 Hz to 620 kHz.

Amplitude ranges: 3 μ V to 30 V full scale in 15 ranges.

Amplitude accuracy with input terminated

Meter switch in normal position: overall accuracy: ± 0.43 dB to ± 0.67 dB of reading depending on frequency, including:

Frequency response flatness, total deviation: 600 Ω : 20 Hz to 100 Hz ± 0.53 dB ($\pm 5\%$); 100 Hz to 620 kHz ± 0.26 dB ($\pm 3\%$).

All other terminations: 5 kHz to 620 kHz ± 0.26 dB ($\pm 3\%$).

Meter tracking: ± 0.1 dB or $\pm 1\%$ of reading, 0 dB to -10 dB.

Meter switch in linear dB position: overall accuracy: ± 1 dB.

Internal calibrator: frequency, 100 kHz ± 10 Hz; amplitude, full scale on 0 dB range in CAL mode: accuracy, ± 0.1 dB.

Dynamic range: (1M and harmonic distortion products), > 85 dB below zero dB reference level when absolute measurements are being made (> 70 dB 20 Hz to 50 Hz). > 80 dB below zero dB reference level when relative adjustment is used (> 70 dB for 20 Hz to 50 Hz).

Residual responses

> 80 dB below zero reference (> 70 dB for 20 Hz to 50 Hz).

Return loss: 100 Hz to 620 kHz, 600 Ω > 30 dB; 5 kHz to 620 kHz, 150 Ω , 135 Ω , 75 Ω , > 35 dB.

Noise level:

Bandwidths	Input noise level (600 Ω input impedance)
10 Hz and 100 Hz 1 kHz and 3.1 kHz	< -125 dBm or 0.44 μ V < -115 dBm or 1.38 μ V

Selectivity:

Rejection	Bandwidths			
	10 Hz	100 Hz	1 kHz	3.1 kHz
3 dB	10 Hz	100 Hz	1 kHz	3.1 kHz
60 dB	35 Hz	320 Hz	3.1 kHz	9.6 kHz

(Frequency accuracy $\pm 10\%$)

Automatic frequency control

Capture threshold: 75 dB below 0 dB reference.

Dynamic hold-in range: > 3 bandwidths. Tracking rate proportional to bandwidth.

Inputs: balanced or single-ended, not floating, terminating, or bridging.

Input functions

dBm: levels calibrated in dBm for impedances selected.

Abs Vm: level calibrated in volts.

Rel: input level can be set arbitrarily to 0 dB Ref. (10 dB set level range).

Cal: internal level calibrator.

Input impedances*

Resistances: 75 Ω , 135 Ω , 150 Ω , 600 Ω terminated; 50 k Ω (single ended bridging) and 100 k Ω (balanced bridging).

Capacitance (each terminal to ground): 10 mV, 30 mV ranges < 55 pF; 100 mV to 30 V ranges < 40 pF.

Common mode rejection: 20 Hz to 620 kHz, > 40 dB.

Automatic ranging: 8 ranges, 0 dB to -70 dB. Ranging rate proportional to bandwidth.

Output: amplitude: adjustable 0 to 1 V rms open circuit.

BFO frequency response flatness: ± 0.2 dB or $\pm 2\%$.

Resistance: 600 Ω .

L.O. output: frequency, 1.28 MHz to 1.90 MHz (1.28 MHz + tuned frequency); amplitude, 0.65 V rms $\pm 20\%$ open circuit; resistance, 250 Ω .

Recorder outputs:

X-axis (3593A/3594A only)	Plug-in frequency ranges	
	62 kHz	620 kHz
X-axis linear output:	0 to -12.4 V	0 to -12.4 V
(1 k Ω source resistance)	(200 mV/kHz $\pm 5\%$)	(20 mV/kHz $\pm 5\%$)
X-axis log output:	5 V/decade $\pm 5\%$	5 V/decade $\pm 5\%$
(1 k Ω source resistance)	(50 Hz - 62 kHz)	(500 Hz - 620 kHz)

Y-Axis:

Linear Y axis output: $+10$ V dc $\pm 2\%$ for full scale meter indication, 1 k Ω source resistance.

Log Y axis output: $+1$ V to $+10$ V dc, proportional to linear dB meter indication (-90 to 0 dB, 0.1 V/dB) 1k Ω source resistance.

Power: 115 V or 230 V $\pm 10\%$, 50 Hz to 400 Hz, < 70 VA.

Dimensions: 425 mm wide \times 221 mm high \times 467 mm deep (16 $\frac{1}{4}$ " \times 8 $\frac{3}{4}$ " \times 18 $\frac{3}{4}$ ").

Weight: net, 17.2 kg (38 lb); shipping 24.9 kg (55 lb).

Accessories furnished: rack mounting kit for 19" rack.

Model number and name

3590A Wave Analyzer and 3594A sweeping local oscillator plug-in

Price

3591A Selective Voltmeter and 3594A sweeping local oscillator plug-in

\$5520

\$5665

*Other terminations available on special order.

TELECOMMUNICATIONS TEST EQUIPMENT

Selective level meter/generator

Models 312C & 3320C

NEW

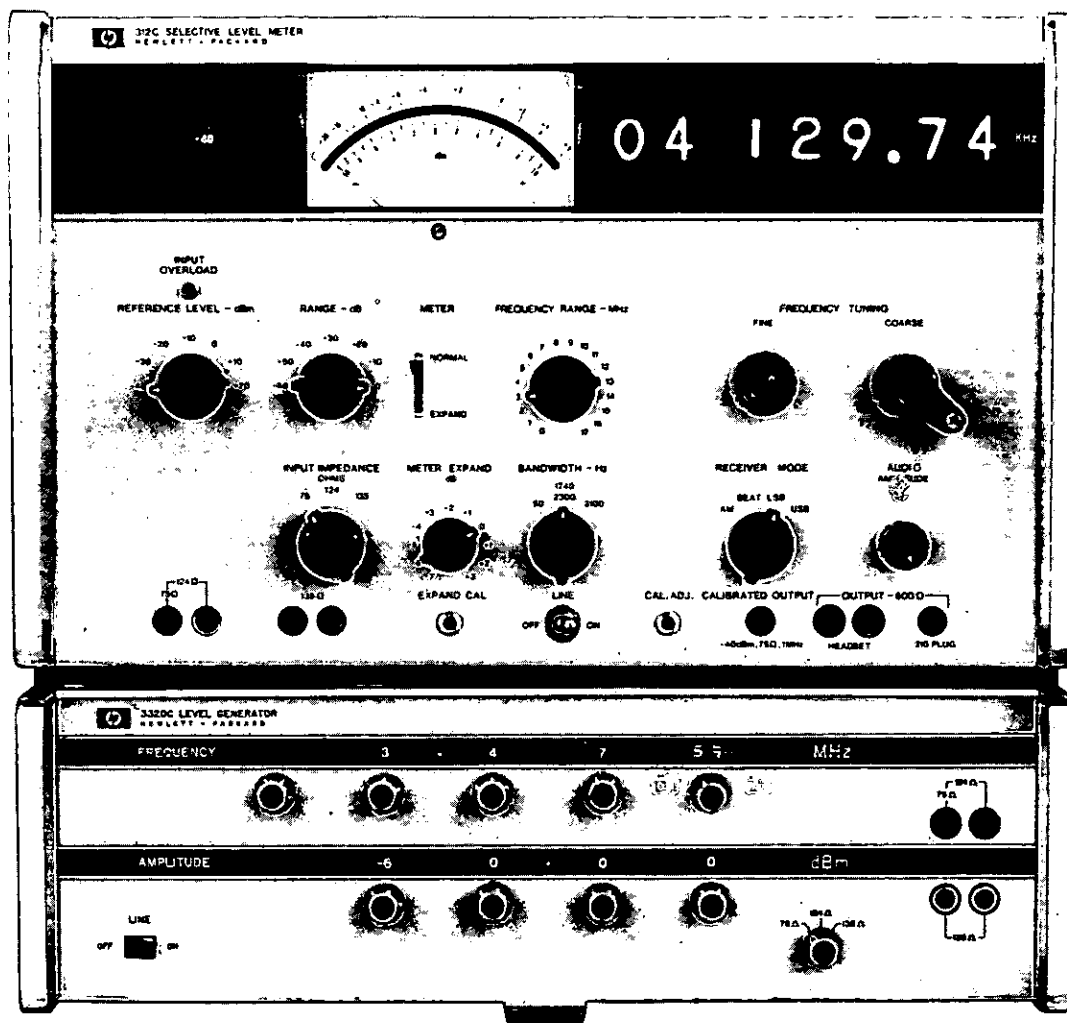

Description

Hewlett-Packard Model 312C Selective Level Meter and companion Model 3320C Level Generator provide an accurate, easy-to-use transmission measuring set in the 1 kHz to 18 MHz frequency range ideally suited for maintenance and operations requirements. It provides proper input and output connectors and impedances to interface directly into most FDM carrier multiplex equipment.

HP's 312C has a noise equivalent bandwidth that provides a direct reading of C-message noise. The instrument has sufficient fidelity to act as an invisible channel bank to down-convert any 4 kHz voice channel and make typical measurements such as phase jitter and impulse noise. It also features 10 Hz frequency resolution, 0.02 dB level resolution on the meter expand scale, and an input overload lamp to guarantee valid measurements.

HP's 3320C companion generator is a frequency synthesizer that provides signals with an amplitude resolution of 0.01 dB over a fre-

quency range of 10 kHz to 17 MHz with a resolution of 20 Hz.

312C Specifications

Frequency

Range: 1 kHz to 18 MHz; 18 bands; 200 kHz overlap; coarse and fine tuning.

Accuracy: ± 10 Hz + time base stability (with reference to ext. std.).

Stability: ± 20 ppm/ $^{\circ}$ C; 25° C + 5° ; line variations of 10%; ± 0.1 ppm.

Resolution: 10 Hz.

Level:

Range: -120 dBm to +23 dBm full scale.

Attenuator accuracy: ± 0.1 dB.

Stability: ± 0.1 dB 90 days.

Resolution: 0.02 dB on expand meter.

Flatness: ± 0.2 dB, 10 kHz to 10 MHz; ± 0.5 dB, 10 MHz to 18 MHz; 75 ohms matched load; max. level ≤ 0 dBm.



Overload: Light indicates incorrect range selection.
Meter:
Range: -20 dBm to +3 dBm (back lighted scales).
Tracking: ±0.05 dB.
Expand scale:
Range: -1 dB to +1 dB.
Tracking: ±0.05 dB.
Resolution: ±0.02 dB; will expand any 2 dB range of receiver meter indication from -7 dB to +3 dB.
Recorder output: (Normal meter) 1.00 V F.S., 1 kΩ.
Range: 120 dB.
Distortion: >65 below zero reference; reference set with range dB set to 0 dBm.
Accuracy: 0.5 dB to 0.05 dB depending on method.
Noise level: -117 dBm at 2300 Hz selectivity.
Return loss:
 75 ohms; unbalanced; 10 kHz to 18 MHz; 26 dB.
 124 ohms; balanced; 10 kHz to 10 MHz; 26 dB.
 135 ohms; balanced; 10 kHz to 5 MHz; 26 dB.
Residual response: >72 dB below zero ref. Ref set with range dB set at 0 dB.
CMR: >40 dB 10 kHz to 5 MHz.
 >30 dB 5 MHz to 17 MHz.
Internal calibrator output: 1 MHz, -40 dBm into 75 ohms, ±0.1 dB amplitude stability for 90 days.
Measurement:

	Bandwidth Hz	3 dB BW	60 dB BW	Effective Noise BW
Selectivity	*50 Hz	50 Hz ±10%	110 Hz ±10%	1740 Hz ±10%
	**2300/1740 Hz	2300 Hz ±10%	4800 Hz ±10%	
	**3100 Hz	3100 Hz ±10%	6200 Hz ±10%	

*Order Option 001 for 150 Hz bandwidth.
 **Notch filters are provided to eliminate adjacent Channel Carrier.

Input impedance: 75 ohms unbalanced; 124 and 135 ohms balanced selectable.
Audio Output: AM demodulated audio.
 LSB: demodulated audio, carrier reinserted at $f_0 + 1.8$ kHz.
 USB: demodulated audio, carrier reinserted at $f_0 - 1.8$ kHz.
 Output level +14 dBm/600 ohms with full scale meter deflection. Sufficient to drive a 52 type operator's head set. Speaker normally in circuit. Disconnected when plug inserted into front panel output jack.
Jacks: 75 ohm jacks accept 358A plugs; 124 ohm jacks accept 408A plugs; 135 ohm jacks accept 305A plugs.
Dimensions: 483 mm wide × 266 mm high × 467 mm deep (19" × 10½" × 18¾").
Weight: Net, 20.7 kg (46 lb). Shipping, 26.6 kg (59 lb).
Power: 115 or 230 V ±10%, 50 to 400 Hz, 90 VA.
 Accessory AC power connector provided on rear for companion 3320C Level Generator.

3320C Specifications

Frequency range:
75 ohm output impedance: 10 kHz to 17 MHz.
124 ohm output impedance: 50 kHz to 5 MHz.
135 ohm output impedance: 10 kHz to 1 MHz.
Frequency resolution:
Vernier out: 10 kHz. **Vernier in:** 20 Hz.
Internal frequency standard: 20 MHz ambient temperature crystal.
Phase locking (external frequency reference input): May be phase locked with an external signal which is within 200 mV rms and 2 V rms and which is any subharmonic of 20 MHz from 1 MHz through 10 MHz (e.g., 1 MHz, 2 MHz, 2.5 MHz, 5 MHz, 10 MHz). BNC female connector.
Amplitude range: +11.99 dBm to -79.99 dBm in steps of 0.01 dB, 0.1 dB, 1 dB or 10 dB.
Amplitude resolution: 0.01 dB.
Output impedance: 75 ohms unbalanced; 124 ohms and 135 ohms balanced.
Auxiliary outputs:
Tracking output: 20 MHz to 37 MHz offset signal. Tracks main output with 20 MHz offset. Rear panel female BNC >100 mV rms into 50 ohms.
Low level output: Same frequency as main output but remains between 50 mV rms and 158 mV rms into 50 ohms. Rear panel female BNC.
1 MHz output: Reference output. Rear panel female BNC, >220 mV rms into 50 ohms.
Power requirements: 115 V ±10% or 230 V ±10%, 48 Hz to 66 Hz, <110 W (400 Hz operation on special basis).
Operating temperature: 20°C to 30°C (68°F to 86°F).
Frequency accuracy:
Vernier out: ±0.001% of setting.
Vernier in: ±600 Hz, 10 kHz to 12.5 MHz. ±750 Hz, 12.5 MHz to 17 MHz.
Frequency stability:
Long term: ±10 ppm of setting per year.
 Optional high stability crystal reference oven available (Option 001).
Signal to phase noise (integrated): >40 dB in 30 kHz band, excluding ±1 Hz, centered on carrier.
Option 001: 5 MHz reference crystal oscillator in temperature stabilized oven.
Long term stability: ±1 part in 10⁸/day. ±1 part in 10⁷/month.
Frequency accuracy: ±1 part in 10⁷ of setting/month.
 For field installation order accessory kit 11237A.
Model number and name

312C option 001 150 Hz bandwidth	Price
3320C option 001 crystal oven 5 MHz	N/C
312C Selection Level Meter	add \$310
3320C Level Generator	\$5810
	\$3500

TELECOMMUNICATIONS TEST EQUIPMENT

Error detection up to 150 Mb/s
Models 3760A & 3761A

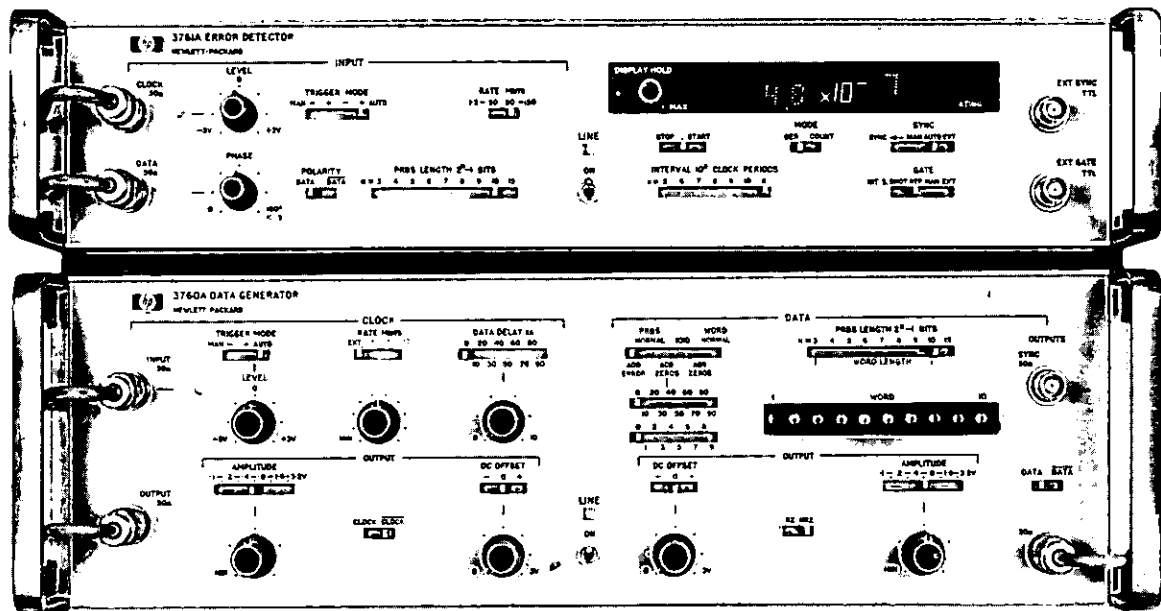

The 3760A/3761A Error Rate measurement system has been designed for general use in the evaluation of digital systems operating in the frequency range 1 Kb/s - 150 Mb/s. It has particular applications in the design and development of PCM systems.

The measurement system comprises the 3760A Data Generator, which provides a variable length PRBS to the item or system under test, and the 3761A Error Detector which has been specifically designed for operation with the pseudo random sequences produced by the Data Generator. Error Detection is accomplished by comparing the output from the item under test, bit-by-bit, with an independent, closed loop, reference sequence in the 3761A Error Detector. This technique ensures detection of every error, random or systematic, and avoids the problems associated with open loop reference sequence generation. Errors may be counted and directly displayed in the 3761A either as Bit Error Rate (BER) or Total Error Count (COUNT).

The 3760A Data Generator is a versatile PRBS and WORD generator and can supply many of the test sequences required for the development and evaluation of digital transmission equipment. Its features are described fully in the Data Generator Model 3760A Data Sheet and only those which complement the 3761A Error Detector are described here.

The Data Generator can be manually or automatically triggered from an external clock in the frequency range 1 kHz - 150 MHz. The clock input will accept continuous or burst information. Alternatively, the generator may be driven from an internal clock source which can be variable or crystal controlled in the frequency range 1.5 - 150 MHz. A clock output is always provided in normal or comple-

mented form, which is variable in amplitude and DC offset.

The PRBS is variable in length from $2^3 - 1$ to $2^{10} - 1$ bits, with an additional long sequence of $2^{15} - 1$ bits. A sync pulse occurs once per PRBS and may be varied in position relative to the sequence. For back-to-back testing of the Data Generator and Error Detector, an error can be inserted once per 2000 sequences. The data output is available in normal or complemented form and may be varied in amplitude and DC offset. Either RZ or NRZ formats may be selected and the data output can be delayed by up to 100 ns with respect to the clock.

The 3761A Error Detector requires both clock and data inputs. The inputs accept continuous or burst signals in the frequency range 1 kHz to 150 MHz. For the CLOCK INPUT manual and automatic triggering on both +ve and -ve slopes of the input waveform are provided. Indication of clock presence with correct triggering is given by a front panel lamp. The data input conditions for frequency range, waveshape, impedance and sensitivity are similar to those for the clock. Triggering on data is automatic for continuous inputs with compensation for DC offsets. For burst inputs a switch inside the 3761A can be used to set a ground threshold trigger level. The input can be inverted with a DATA/DATA switch to allow for an inversion in the item or system under test. A front panel variable phase control is used to ensure that coincidence between clock and data edges is avoided. A lamp indicates when a correct phase relationship between the clock and data has been attained.

Synchronization of the 3761A Error Detector to the incoming data can be accomplished automatically, manually or externally. In the automatic mode, correct synchronism is ensured by continually moni-

toring the average error rate over a period long enough to remove the effect of error bursts. In the manual synchronization mode, the Error Detector searches for synchronism on command from a front panel switch, and in the external mode, by command from an external TTL signal. A "gating" flag indicates the instrument is in synchronism and making a measurement. Whenever the instrument is out of synchronism a "sync loss" flag is displayed.

The BER measurement is computed from more than 100 errors and the results displayed directly in the form $A.B \times 10^{-n}$ giving a range 0.1×10^{-9} to 9.9×10^{-1} . The COUNT measurement totalises errors over a gating period, which may be controlled internally or externally, and the result is displayed as a four digit number with leading zeros blanked. The internal gating period can be selected within the range 10^3 to 10^{11} clock periods and can be single shot or repetitive in operation. When a count of 9999 is exceeded an "overflow" flag is lit. When using manual, external or internal single shot gating the display continues to register the least significant digits of the count. A TTL compatible external gate input is provided, and manual gating is controlled with a front panel start/stop switch.

In both BER and COUNT modes, the display is continually updated at a rate which may be set by the operator.

A BCD printer output of the current display is available from a rear panel socket. This output is in 8421 format and includes the sync loss and overflow flag indications. An output of one transition per error is also available at the rear panel for further analysis.

Specifications

Measurements

Bit error rate, BER:

Range: 0.1×10^{-9} to 9.9×10^{-1} , automatically scaled.

Gating: Automatic.

Accuracy: Computation based on at least 100 errors.

Total error count, COUNT:

Range: 0 to 9999.

Gating: Internal, single shot or repetitive, manual or external.

Internal: 10^3 to 10^{11} clock periods.

Manual: Front panel switch.

External: TTL logic levels.

Patterns:

PRBS: Maximal length $2^n - 1$ where $n = 3$ to 10 and 15.

Data generator

Clock input:

Rate: 1 kHz to 150 MHz.

Impedance: $50\Omega \pm 5\%$ dc coupled (75 Ω optional).

Trigger: Manual with level range -3 V to $+3$ V, +ve or -ve slope. Auto with input mark: space ratio range 10:1 to 1:10.

Sensitivity: Better than 500 mV pk-pk.

Amplitude: 5 V p-p maximum. Limits ± 5 V.

Pulse width: 3 ns minimum at 50% pulse amplitude.

Indicator: Lamp showing clock present and triggering correctly.

Clock output:

Outputs: CLOCK or $\overline{\text{CLOCK}}$ selectable.

Impedance: Source impedance $50\Omega \pm 5\%$ (75 Ω optional).

Amplitude: Continuously variable in 5 ranges from 0.1 to 3.2 V symmetrical about offset level.

DC offset: Zero, <2% of pulse amplitude. Variable, continuous 0 to ± 3 V.

Transition times: <1.4 ns into 50Ω . <1.6 ns into 75 Ω .

Overshoot: <10% of pulse amplitude.

Data output:

Outputs: DATA or $\overline{\text{DATA}}$ selectable.

Format: NRZ or RZ (up to 130 Mb/s).

Delay: Data (and Sync) delayed with respect to Clock continuously in 10 ranges from 0 to 100 ns.

Other specifications as for clock output

Sync output:

Rate: Once per PRBS.

Position: Front panel selectable.

Amplitude: +1 V into 50Ω .

Error detector

Clock input: Specifications as for Data Generator Clock Input except that both +ve and -ve slope triggering is available in automatic mode.

Data input:

Inputs: DATA or $\overline{\text{DATA}}$ selectable.

Rate: 1 Kb/s to 150 Mb/s.

Impedance: $50\Omega \pm 5\%$ dc coupled (75 Ω optional).

Trigger level: Automatic.

Sensitivity: Better than 500 mV pk-pk.

Amplitude: 5 V p-p maximum. Limits ± 5 V.

DC offset: ± 3 V maximum.

Pulse width: 5 ns minimum at 50% pulse amplitude.

Phasing

Control: Clock phase variable relative to data.

Indication: Lamp off when clock and data edges coincide.

Range: 0 to 180° for 1.5 to 50 Mb/s.

0 to 12 ns for 50 to 150 Mb/s.

This range must also be selected for 1 Kb/s to 1.5 Mb/s operation.

Synchronization:

Modes: Auto, Manual, External.

Auto: Automatically searches for synchronism if more than 20,000 errors in 100,000 bits.

Manual: Resynchronization commanded from front panel.

External: Resynchronization commanded by TTL input.

Display:

BER: Two digits plus exponent $A.B \times 10^{-n}$

COUNT: Four digits.

Flags: Sync loss, overflow and gating.

Printer output:

Format: 8421 BCD.

BER & COUNT: Updated display for the duration of the print command pulse.

Flags: Sync loss, 0 printed in column 1. Overflow in repetitive count, output inhibited.

Command: TTL pulse at display change.

Error output:

Format: One transition per error.

Amplitude: +1 V into 50Ω .

Options

3760A Data generator: Options available include continuously variable and crystal controlled clocks, and delayed data output. Full details are given in the 3760A Data Generator Data Sheet.

3761A Error detector:

Option 001: 75 Ω CLOCK and DATA input impedances.

Option 002: Printer interface cable.

General

3760A Data generator:

Power: 100 to 125 V or 200 to 250 V, 40 to 400 Hz, 90 W.

Dimensions: 425 mm wide, 140 mm high, 467 mm deep (16 $\frac{1}{4}$ " \times 5 $\frac{1}{2}$ " \times 18 $\frac{3}{4}$ ").

Weight: 13.6 kg (30 lb).

3761A Error detector:

Power: 100 to 125 V or 200 to 250 V, 40 to 400 Hz, 70 W.

Dimensions: 425 mm wide, 95 mm high, 467 mm deep (16 $\frac{1}{4}$ " \times 3 $\frac{3}{4}$ " \times 18 $\frac{3}{4}$ ").

Weight: 10.4 kg (23 lb).

Model number and name

3760A Data Generator

3761A Error Detector

Price
\$5740
\$4770

TELECOMMUNICATIONS TEST EQUIPMENT

Telephone cable fault locators

4900 Series

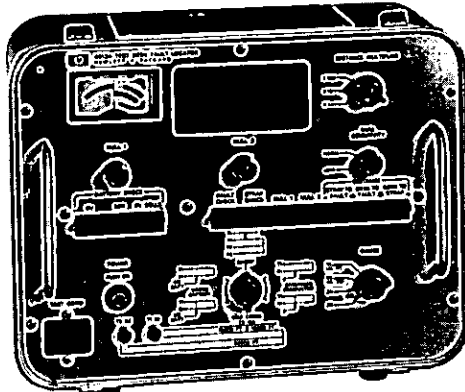

4913A

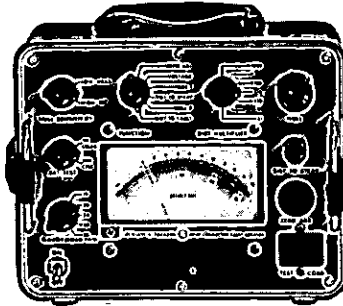

4912F

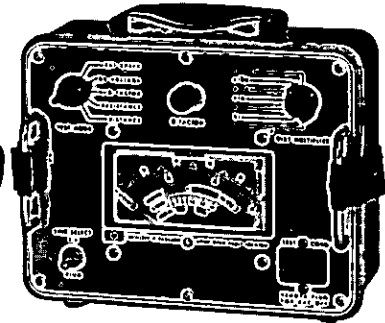

4910F

Cable fault locating

Of prime interest in telephone cable maintenance is the location of physical damage to the cables. Telephone cable fault location has become an especially acute problem in recent years as more cable is placed underground. Although better protected from the environment, the cable is subject to new dangers and the telephone craftsman is faced with locating damage hidden by several feet of earth. In addition, higher traffic density on cables and demands for higher quality transmission have placed more emphasis on cable reliability and quality.

A logical plan of attack is essential to successful fault locating. After a trouble report is received at a test center the fault must be thoroughly analyzed and classified by type. Next, a sectionalization measurement is made at the test desk to get the craftsman to the closest access point in the field. Finally, the craftsman in the field localizes the fault from the closest access point and subsequently pinpoints its exact location with an appropriate field instrument.

The HP cable fault locators fall into four basic categories: Test Desk Fault Locators, Direct Reading Fault Locators for field use, Tone Type Fault Locators, and Ultrasonic Leak Detectors.

Test desk fault locators

Fault sectionalization is performed from the test center with the 4913A Test Desk Fault Locator and the C01 and C02 4910F Open Fault Locators. They locate the closest cable access point to the fault so that the craftsman can be dispatched to pinpoint the fault and repair the damage.

New 4913A test desk fault locator

The 4913A is a semi-automatic wheatstone bridge used to locate shorts, crosses and grounds of up to 10 million Ohms in paired conductor telephone cables. The operator simply requests a strap placed in the field, performs a series of checks and nulls and then reads the fault distance on a digital display. A self-check artificial line is built in to facilitate checking its operation. The set has a distance range of 37 miles and will operate on cables with load coils, gauge changes and bridge taps. The 4913A is designed to interface with a test desk by means of 310-type plugs which are compatible with Western Electric and Automatic Electric test desks. Three test cord options are available:

18080A Test Cord for use with Western Electric 12-type and 14-type (cord type) test desks.

18081A Test Cord for use with Automatic Electric Type 1 (cord type) test desks.

18082A Test Cord for use with Western Electric 16-type and modified 14-type console (cordless type) test desks.

Option C01 and C02 4910F open fault locator

Locates open faults from the test desk. All calculations are performed by the test set. Option C01 is for cord type test desks and Option C02 is for console type test desks.

Direct reading fault locators for field use

Field instruments that provide a direct distance-to-fault reading in feet (or meters) have the benefit of relieving the craftsman of the drudgery of performing manual calculations. Locating faults becomes faster, requires less training and is less error prone than with manual bridge techniques.

4912F Conductor fault locator

The 4912F is a direct reading, semi-automatic calculating bridge operating on the Varley principle. This instrument is designed to locate extremely high resistance shorts, crosses and grounds, such as might occur from minute amounts of moisture in plastic insulated cable (PIC). The 4912F is connected to an access point on the cable and the far end of the cable is strapped to form a bridge configuration. The distance-to-fault result is obtained by a simple sequence of adjustments of the instrument controls. The 4912F is battery powered, light and compact. It is housed in a rugged fiberglass case and is designed to withstand the demands of field use.

4910F Open fault locator

Similar in construction and operation to the 4912F, the Model 4910F is designed to provide direct distance readings to open faults in paired telephone cable. The 4910F operates on a capacitance charge sampling principle which relates the charge placed on a length of wire to its capacitance and hence to its length. This entire sequence is performed automatically by the 4910F, providing an answer in just a few thousandths of a second. The 4910F is calibrated to the capacitance of the cable under test by the D FACTOR control.

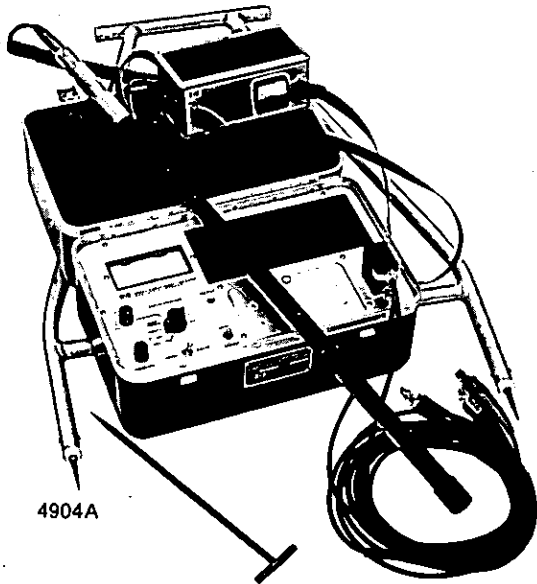

4904A

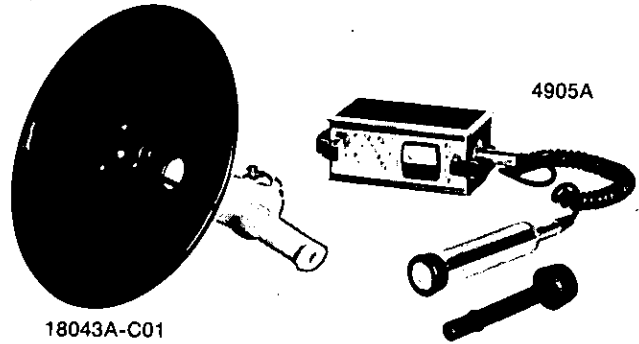

18043A-C01

4905A

Tone type fault locators

The tone type locator, such as the Model 4904A, places a pulsed tone on the faulted circuit which is traced by an inductive pickup coil and a sensitive tuned receiver. At the point of the fault, the signal drops in level, thereby pinpointing the exact physical location of the fault. The tone locator also has the advantage of being able to precisely trace the path of the cable and, by triangulation, determine its depth at any point. This information is necessary for use in accurately locating the fault. It is also necessary for accurately marking the cable location to protect it from construction and excavation work being performed in the vicinity of the cable. The tone locator system is designed such that only the transmitted signal is detected, so that interfering signals (such as power line harmonics) do not interfere with the measurement. Output power of the transmitter is kept low to prevent interference with other working circuits in the cable and to prevent "carry-by" of the signal beyond the fault.

4904A Cable fault locator

The 4904A is a pulsed tone system for locating shorts, crosses and grounds in direct buried, underground (ducted) and aerial utilities cable. It also accurately locates path and depth of buried cables and pipes. The sensitive narrow bandwidth receiver rejects ac hum and permits locating high resistance faults. It produces a pulsed 990 Hz tone for buried cable fault locating and a pulsed 150 Hz tone for aerial cable. The tone transmitter unit also has a built-in ohmmeter for analyzing faults. The accessory earth contact frame is especially useful for locating high resistance pinhole faults in the cable sheathing. It comes complete with transmitter, receiver, search wand, earth contact frame, cables and ground rod.

4901A Cable fault locator

The 4901A is an economically priced cable fault locator functionally similar to the 4904A. It produces only the pulsed 990 Hz and is limited to locating path, depth and low resistance faults. It has a built-in ohmmeter.

4900A Cable fault locator

The 4900A is identical to the Model 4901A except without the ohmmeter feature.

Ultrasonic leak detection

As pressurized gas escapes through an aperture it creates consider-

able noise in the ultrasonic region of 36 to 44 kHz. The HP Ultrasonic Translator Detectors (such as Model 4905A) detect this characteristic sound with a sensitive, directional Barium Titanate microphone and translates the signal to audio by mixing it with a 40 kHz local oscillator signal. The audio signal is then amplified and monitored on a speaker and level meter.

The most common causes of pressure leaks in cable plant are corrosion (particularly in coastal areas), electrolysis, squirrels, boring beetles, abrasion from wind and weather, hunters, and outside workmen. Abrasion (during installation) and corrosion are the most frequent causes of cable sheath trouble in cable installed underground in ducted passages.

To detect leaks in aerial cables, the craftsman merely scans the cable from the ground with the flashlight-size microphone, listening for the characteristic hissing sounds of a leak. By simultaneously observing the level meter, he can "peak in" on the leak and determine its exact location. Pole mounted accessories are available for closer scanning of the cable and the 18043A-C01 Ultrasonic Reflector accessory is a parabolic type dish allowing exact aerial leak locating from ground level.

Leaks in ducted underground systems are located with a unique "Duct Probe" accessory.

4905A Ultrasonic translator detector

The 4905A is a lightweight, portable ultrasonic detector which includes a directional probe, a 6-ft. coil cord and a leather utility case. It has a self-contained speaker, a logging meter, and provision for headphones.

More information on 4900 series fault locators

U.S.A. Customers. HP Delcon products are sold directly to the customer from the manufacturing division. Please direct all orders and inquiries to:

HEWLETT-PACKARD COMPANY
 DELCON DIVISION
 690 E. Middlefield Road
 Mountain View, California 94043
 Telephone (415) 969-0880

Customers outside the U.S.A.: Orders should be directed to your local Hewlett-Packard distributor or representative.

General information

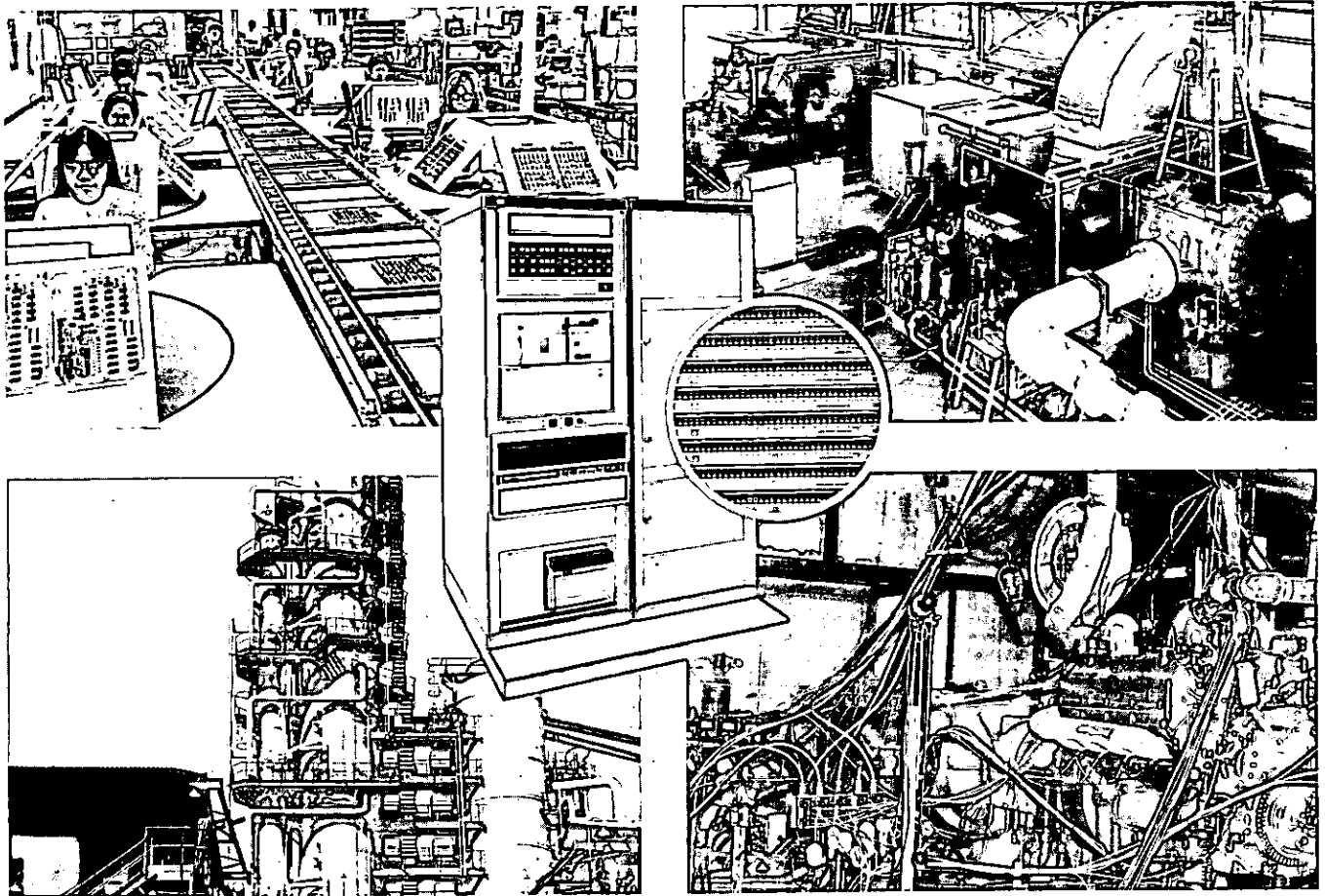

Some typical applications showing the versatility of Hewlett-Packard automatic measurement and control systems. (Enlarged view inset shows the new and simplified sensor wire connect panel.)

General information

Hewlett-Packard has for many years been an industry leader in the development, manufacture, and supply of computer automated systems, both for **stimulus-response automatic testing** and for **sensor-based industrial measurement and control**. These systems offer significant advantages over manual data measurement methods. They are faster, more accurate, have excellent test-to-test repeatability, and are far more dependable.

Their reliability has been proven in over a thousand installations with conditions ranging from controlled-environment laboratories to harsh industrial environments. Combining the power of the minicomputer with many years of systems experience has resulted in a broad selection of automatic test, measurement, and control systems — all featuring Hewlett-Packard's reputation for quality and excellence.

Automatic test systems

The Hewlett-Packard 9500 Series Automatic Test Systems cover stimulus-response testing over the frequency range of DC to LF (to 10 MHz), RF (to 1.3 GHz), and microwave (to 18 GHz). These systems perform analog testing, and optionally hybrid analog/digital testing.

The 9510D covers stimulus-response testing over the frequency ranges of DC to LF (to 10 MHz) and RF (to 500 MHz). Other Hewlett-Packard automatic test systems include the 8542B Network Analyzer and the 8580B Spectrum Analyzer. The network analyzer automatically measures transmission/reflection characteristics of a device to 18 GHz. The spectrum analyzer automatically measures absolute frequency and characterizes mixers, doublers, and other frequency conversion devices to 18 GHz.*

Hewlett-Packard also offers several special-purpose test systems, all related to the

successful modular building-block approach of the 9500 Series. These dedicated systems include the: (a) HP9540D Transceiver Test System. The system is particularly useful for production and final assembly testing, and for maintenance labs and service shops. It provides a fast, accurate, and highly repeatable means of testing communications receivers, transmitters, power supplies, as well as complete two-way radio sets. (b) HP9551D Instrument Calibration System. The system meets exacting requirements in a calibration laboratory for testing high-population, highworkload instruments. It calibrates a wide variety of passive meters, multimeters, electronic meters (voltage, current, VSWR, power), differential voltmeters, digital voltmeters, frequency counters, and oscilloscopes. Modular expansion capabilities include calibration of signal sources and generators, oscillators, pulse generators, and function generators.



Automatic measurement and control systems

Hewlett-Packard systems for automatic measurement and control (HP9602A, 9603A, 9604A, and 9611A) are sensor-based systems that acquire, process, and control physical measurements. Typical parameters measured include temperature, pressure, and strain. In addition, these systems can: (a) automatically correct for sensor non-linearity, (b) calculate results (efficiencies, flow rates, heating trends, statistical distributions, etc.), (c) check results against limits, and, (d) log or display results. The systems are widely used in closed-loop process control applications. Capabilities offered include: (a) high-speed (9603A, 9604A, and 9611A) or medium-speed high-resolution (9602A) analog inputs, (b) millivolt-level (9602A) and high level (9603A, 9604A, and 9611A) analog inputs, (c) analog output (9602A, 9603A, 9604A, and 9611A), (d) digital input and output (9602A, 9603A, 9604A, and 9611A), and (e) event sense (9602A, 9603A, 9604A, and 9611A).

The 9611A System is specifically dedicated to measurement and control in an industrial environment. Besides the capabilities mentioned above, this system features screw-type input/output terminals with each pair clearly numbered. Sections are set aside and labeled "relay register", "event sense", "isolated input", etc., providing an accurate and easy method for connecting sensors and control elements.

Solving measurement problems

Hewlett-Packard automated systems are solving measurement problems in virtually every area of industrial research, development, manufacturing, and production. Applications range from relatively small needs, such as a single measurement task requiring high accuracy and repeatability, to highly complex multiple-task systems measuring thousands of variables with speed and accuracy.

Nearly 300 Hewlett-Packard automatic test systems have been installed. Typical of the test problems being solved by these systems is aircraft maintenance testing. Complete maintenance support for an advanced supersonic aircraft (family) is provided by a complex of several Hewlett-Packard automatic test systems. The systems handle all testing at three levels of support: flightline, intermediate repair, and depot repair. In practice, 70-90% reduction in test times (over manual testing) is consistently realized. This is particularly significant in flightline support where maximum aircraft availability is important.

Hewlett-Packard's expertise in automatic testing equipment is clearly exemplified in the fact that users have had their systems actually testing production line radios two weeks after installation.

Similarly, a typical measurement and control problem being solved by Hewlett-Packard systems involves industrial measurement and control. A Hewlett-Packard system simultaneously performs a series of tests on complex electromechanical subassemblies used for high-speed serial printers and split-platen forms handlers. During the production cycle, the automated system controls run-in, adjustment, quality audit checking, life test, and debugging. Overall, the system has cut in half the total labor time for manufacturing a serial printer. Additionally, the system is providing a data base of quality audit information that is being used to improve product design and development.

Distributed systems

Particularly useful and advantageous in multiple test station applications (remote test sites) is Hewlett Packard's Distributed Systems capability. A distributed system consists of a central computer (disc-based) system and a number of satellite measurement and control systems (usually one at each remote site). Satellites commonly concentrate the measured data prior to transmission to central. Data phone interface allows virtually unlimited distances (over the telephone network) between satellites and central. About three kilometers separation is possible over simple hardwire lines. Satellites can call on central to process data for them, and data can be transferred directly between programs in the satellites and in central, increasing productivity. Satellites and central share the use of peripherals (disc, line printer, card reader, plotter, etc.), thus minimizing total system cost. The concept and applications of distributed systems is covered in greater detail in the next few pages.

Operating system for automatic testing

Hewlett-Packard's automatic test systems utilize a disc-based operating system. The disc-based system provides virtually unlimited program/data storage and, combined with the automatic system's operator control panel, offers test program and data retrieval by pushbutton selection.

ATS BASIC is the programming language for the Hewlett-Packard family of automatic test systems. Because there are only a few rules to remember, test technicians can learn the fundamentals of HP ATS BASIC and be using it effectively to write and debug test programs within a few days after completing a one-week training course.

Operating systems for measurement and control

Hewlett-Packard automatic measurement and control systems are available with a choice of operating systems to match your needs. These include: Basic Control System (BCS) and three real-time executives (RTE): RTE, RTE-B and RTE-C.

The BCS is a single task, event-scheduled system that is programmable in HP Assembly language, FORTRAN, and HP ALGOL. As a cpu-memory-based, interrupt-driven system, BCS allows measurements, processing, and logging of results to take place concurrently.

The RTE is a clock-and-interrupt-driven system providing multiprogramming, foreground-background operation with priority scheduling, interrupt handling, and program load-and-go capabilities. Under RTE control, several real-time foreground programs, e.g., multiple test stations, can run concurrently with general-purpose background programs. While data are being taken on demand, processed, and output in the foreground, the time not used for real-time processing is available for background processing, such as the development of test programs or performing analysis of measured data.

The RTE-C is also a cpu-memory-based (no disc storage) system for real-time measurement, control, and reporting. The system is programmable in HP FORTRAN, or HP Assembly language. The system provides time and interrupt-driven, scheduled concurrent operation of multiple programs with on-line control by the operator.

The RTE-B is a cpu-memory-based (no disc storage) system for real-time measurement, control, and reporting. The system features programming in Hewlett-Packard's Real-Time BASIC, an augmented version of the BASIC language.

Distributed system applications utilize Hewlett-Packard's distributed systems capabilities. A typical distributed system consists of a Hewlett-Packard multiprogramming system (9603A) as the central control over a number of measurement and control systems (9603R or 9611R) or automatic test systems (9500 Series and 9510D). An RTE system can also function as a remote job entry terminal for IBM 360/370 systems for extension of distributed system communication to the highest level.

The following few pages more fully describe Hewlett-Packard's automatic test, measurement, and control systems.

*Network Analyzers and Spectrum Analyzers, pages 438 and 468 respectively.

AUTOMATIC TEST, MEASUREMENT, AND CONTROL

Measurement and control systems

9600 Series and distributed systems

NEW

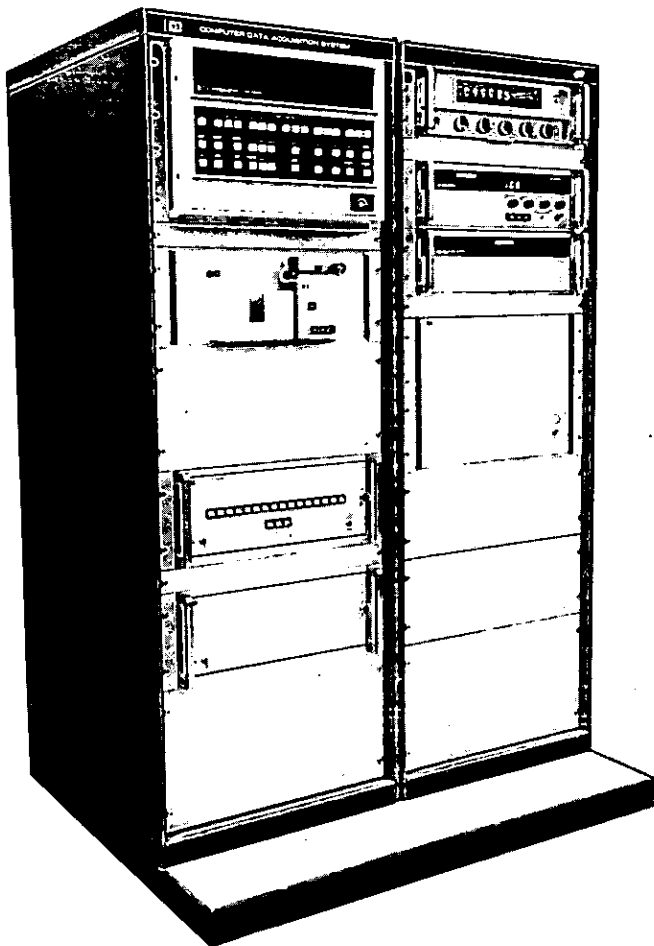

High-accuracy automatic measurement and control system

Hewlett-Packard 9600 Systems for automatic measurement and control acquire, process, and control physical measurements in research, development, manufacturing, and production applications. By using these systems to speed up the acquisition, processing, and output of data you can increase the productivity and profitability of your operation. More and more research lab managers, manufacturing managers, and production managers are realizing these facts. They have seen that the cost effectiveness of their operations are increasingly dependent upon the speed and accuracy with which essential data are acquired, processed, and provided in readily interpretable form. Hewlett-Packard 9600 Systems are uniquely qualified by our more than 18 years experience in building automatic measuring systems and more than 30 years of contribution to the fields of measurement and instrumentation.

Wide selection of capabilities

The major functions of Hewlett-Packard measurement and control systems are shown in the block diagram. Hewlett-Packard 9600 Systems are available in a range of configurations with capabilities to meet virtually every sensor-based measurement and control need.

You can choose the system that best suits your application needs from the following:

- (a) For measurement applications requiring high accuracy and high-resolution, multifunction (dc, ac, resistance, frequency) capabilities, choose the 9602A system.
- (b) For scientific measurement and control applications requiring fast sampling (to 45 kHz) of analog inputs, choose the 9603A or 9604A system.
- (c) For industrial measurement and control applications where conditioned analog and digital I/O are required, choose the 9611A system.
- (d) Further, you can choose from four software operating systems:
 - (1) The RTE-B (Option A01 for 9602A/9603A/9611A) is a low-priced, cpu-memory-based measurement and control system combining the ease and speed of conversational BASIC language programming with real-time multi-tasking operation of up to 16 different time and event-scheduled tasks.
 - (2) The RTE-C (Option A02 for 9602A/9603A/9611A) is a low-priced, cpu-memory-based multiprogramming system for real-time applications not requiring the extensive storage capacity of disc memory. It offers program-compatible upgrading to disc-based RTE.
 - (3) The RTE (Option A03 for 9602A, 9603A, 9611A) system adds 2.47 million words of mass storage on a moving-head, interchangeable cartridge disc memory to the capabilities of the RTE-C system. It offers the advantage of program development concurrently with real-time measurement and control operations.
 - (4) The BCS (Basic Control System for 9604A) system is a cpu-memory-based single-task, event-scheduled system that is programmable in Hewlett-Packard Assembly language, FORTRAN, and Hewlett-Packard ALGOL. As an interrupt-driven system, BCS allows measurement, processing and logging of results to take place concurrently.

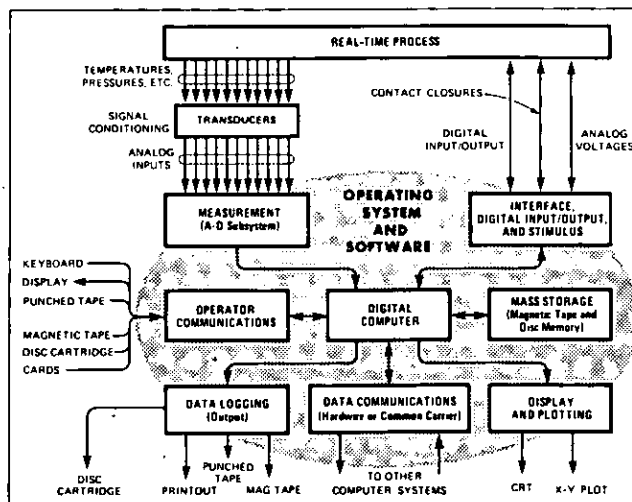

Automatic measurement and control system major functions

Computation and system control

Central element in the measurement and control systems is a Hewlett-Packard microprogrammable processor (minicomputer), designed specifically for convenient and flexible system control. These processors are Hewlett-Packard's latest achievements in a highly successful line of minicomputers. They are built to work, and keep on working—on the factory floor, aboard ship, and in aircraft, as well as in air conditioned computer rooms.

High-accuracy measurement (9602A)

In many applications of data acquisition, the low-level analog output signals from thermocouples, strain gages, and other types of physical sensors change slowly. Where this is true, it is desirable to digitize the analog signals with a high-accuracy analog-to-digital subsystem for two important reasons. First the high-accuracy subsystem provides maximum resolution for low-level measurements (1 microvolt on the 0.1 volt range) and optimum accuracy. Second, the high-accuracy subsystem provides superimposed noise rejection by integration during the measurement, avoiding the necessity for input signal filtering or for digital integration in the computer. In addition, guarded input in the high-accuracy subsystems rejects common mode noise. The combination of these noise rejection techniques preserves the excellent overall system accuracy even in the presence of electrical noise from heavy machinery. Principal performance specifications of the high-accuracy measurement subsystems are shown in the following table. The 40 dc readings per second subsystem is also supplied with the scanning capability for single-channel monitoring with maximum noise rejection.

Sample rate (dc chan/sec)	Input Range	Accuracy	Channels	Measurement Options
14	0.1 to 1000 V (500 V max.)	0.01% rdg \pm 0.005% fs	200 3-wire expandable to 1000	AC, resistance, frequency
40	0.1 to 100 V	0.012% rdg \pm 0.005% fs	10 3-wire expandable to 1000	AC frequency

For measurement of the relative timing and frequency of physical events a timer-counter subsystem is available. It provides sensitivity of 25 mV in a frequency range to 550 MHz and offers time interval measurements from 0.1 μ s to 10⁸ seconds.

High-speed measurements (9603A/9604A/9611A)

Recovery of dynamic information from accelerometers and similar transducers, or sampling many channels of data with reasonable frequency, requires the use of a high-speed analog-to-digital subsystem to digitize the analog data. For this purpose, Hewlett-Packard offers wide capabilities through plug-in analog-to-digital converters, digital-to-analog converters, and multiplexers, as shown in the table below.

Function	Throughput Rate	Range (fs)	Number of Channels*	Accuracy (fs)
High-Level Multiplexer	45,000 chan/sec	\pm 10.24 V	Up to 1056 single-ended or 528 diff.	\pm 0.09% \pm 1/2 LSB
Low-Level Multiplexer	8,000 chan/sec	\pm 10 mV to \pm 800 mV	Up to 528 differential (16 per multiplexer)	\pm 0.33% to \pm 0.14%
Relay Multiplexer	150 chan/sec	\pm 10 mV to \pm 400 mV		\pm 0.29% to \pm 0.14%
D-A Converter	15,000 points/sec	\pm 10.24 V	Up to 44 (two chan/converter)	\pm 0.025%

*Number of channels of each input/output function depends upon others in use; maximum numbers shown assume only that function is used.

An optional sample-and-hold amplifier (included with the A-D converter subsystem) assures minimum sample-to-sample timing variation with respect to measurement commands. Subsystem timing variation (aperture) is held within 30 to 100 nanoseconds. Further assurance of minimum timing variation is obtained by using an optional Hewlett-Packard pacer to provide measurement commands with very low jitter. For example, the A-D converter achieves an absolute system aperture time of 50 nanoseconds when the pacer is used in conjunction with the sample-and-hold amplifier.

Digital input/output

Oftentimes, the measurement and control systems must respond to external contact closures and other digital inputs. In addition, the systems may have to provide contact closures or other digital outputs for control of external devices. Digital input/output is provided by general-purpose plug-in interface cards. (Other digital input/output capabilities are provided by the Multiprogrammer Subsystem, described below.) Digital input/output capabilities include: (a) 32-bit digital input for connecting multiple contact closures, control, or status inputs to the system from switches on controlled devices or similar sources. (b) Duplex Registers which provide digital input/output for bi-directional transfer of control and status information via a single cable. These are available in 16-bit and 8-bit versions at transistor logic levels with NPN or PNP logic. (c) Microcircuit Interface which provides 16-bit input/output at DTL- or TTL-compatible IC logic levels with a choice of ground-true or positive-true logic. (d) Relay Contact Closure Output for applications in which external equipment must be isolated from the system. Sixteen individual floating contact closures permit flexible use of output bit states in addition to assuring isolation from system ground. Applications include energizing of control actuators, control of power supply output, amplifier gain, or amplifier response by switching control-loop resistances, inductances, or capacitances, and energizing of remote indicators. (e) 40-bit digital output for control situations where high precision is required. It is useful for connecting multiple bit states from the system to indicators and other external circuits. Both positive-true and positive-false logic are available.

Multiprogrammer system expansion

The measurement and control system (9603A/9604A/9611A) capabilities can be greatly expanded by means of a Hewlett-Packard Multiprogrammer Subsystem. The Multiprogrammer provides 15 channels which may be used for 12-bit digital input/output. The basic input/output capacity of the Multiprogrammer can be further extended to as many as 240 channels through the use of up to 15 Multiprogrammer Extenders. The versatile Multiprogrammer Subsystem accepts the following plug-in digital input/output cards: (a) Digital Input Card which accepts 12 bits of data from digital measuring instruments, pushbuttons, switches, relays, and other digital devices in the form of logic levels or contact closures. Isolated Digital Input is also available for monitoring circuits driven from power supplies that cannot be connected to system (earth) ground. (b) Digital Output Card that provides 12 bits with TTL/DTL-compatible logic level as its output for digitally controlled instruments, indicators, and solid-state relays. Instruments requiring more than 12 bits of data can be controlled from several digital output cards. (c) Relay Output Card that provides 12 independent SPST normally-open contact pairs. (d) Event Sense Card that monitors up to 12 external contact closures and interrupts the system when one or more contacts change state with respect to 12 reference bits stored on the card. The card can be set to interrupt when the 12 bits being monitored are equal to, not equal to, greater than, or less than a 12-bit reference pattern stored on the card.

9600 Series and distributed systems (cont.)

NEW

This flexibility allows the Multiprogrammer to act as an alarm sensor, freeing the system to perform other tasks during non-alarm conditions. (e) Stepping Motor Control Card produces from one to 2047 square wave pulses at either of two output terminals. When applied to a stepping motor translator, these pulses are converted to drive pulses for an associated stepping motor. (f) Timer and Frequency Reference Card that provides a one-shot on/off output signal that is programmable from one microsecond to 40 days in duration. When connected to a safety switch or audible alarm, the unit can serve as a watchdog timer. The square wave outputs can be used to control the timing of external measurement and data acquisition devices. (g) Pulse Counter Card that totalizes digital logic level pulses or contact closures. The counter may be preset to any count from 0 to 4095; count up/count down inputs are available. Remote I/O capability is available up to three kilometers (10,000 feet).

Hewlett-Packard offers an array of peripheral equipment for operator communication with the system and also for data recording, storage, and display.

A Keyboard-Printer Terminal provides quiet communications between the operator and the system at a data rate of 30 characters per second. A terminal with keyboard and display is also available for quiet communication with the system. It is particularly desirable in systems where hard copy is provided by a Line Printer. This terminal operates at a data rate of 200 characters per second, and displays 25 lines with up to 80 characters per line.

A modified ASR-33 Teleprinter is available for operator-system communication. It provides tape read/punch capabilities and a hard-copy printed record, in addition to the operator keyboard. However, the Teleprinter's 10-character-per-second data rate may be too slow for certain operations. For this reason, the 9600 Series systems are equipped with a 500-character-per-second Tape Reader to speed compilation and input of programs.

An Optical Mark Reader can give a measurement and control system added versatility for program and data entry by using either mark-sense or punched cards. A combination mark-sense/punched-card reader can read 300 cards per minute. Also available is a punched card only reader that reads up to 600 cards per minute.

Storage of system software on Magnetic Tape enables programs to be compiled, edited, and input to the system far more quickly and conveniently than with punched tape. Magnetic Tape Units are available in 7- and 9-channel versions, with tape speeds ranging from 10 to 45 inches per second at densities up to 1600 characters per inch, yielding data read/write rates up to 72,000 characters per second.

A Moving Head Disc Drive Unit is used in RTE (Option A03) Systems. In this unit, an interchangeable disc cartridge and a fixed disc together store 2.5 million words with average access time of less than 35 milliseconds and 122,800 words per second transfer rate. Up to three additional disc drives, operated from the same controller, can be used to increase storage capacity to ten million words.

Data recording, storage, and display

Peripherals for direct printout include the Keyboard-Terminal and

the Teleprinter mentioned previously, plus two Line Printers. For maximum printout rate, a high-speed Line Printer is recommended. Line Printers are available to print up to 132 columns per line at a rate of 600 lines per minute.

For applications where the Keyboard-Terminal and Teleprinter are too slow for data logging, a Tape Punch is available. The punch logs data at 75 characters per second.

Data logging and mass storage on magnetic tape is provided by a wide selection of Magnetic Tape Units, previously described.

Fastest read/write communication with mass storage is obtained with a Disc Memory Unit, previously described.

Interpretation of data gathered and processed is often simplified by graphic presentation. One means of providing such presentation is an X-Y Display Unit. Hewlett-Packard offers an 8 × 10 centimeter (3.2 × 4 inch) X-Y Display with high intensity storage that minimizes display refresh time. The display features 1 part in 256 resolution along the X and Y axes. Annotations can be added easily with the character and graph generator software supplied with the system. Permanent X-Y recordings on a 25 × 38 centimeter (10 × 15 inch) writing area can be obtained with a Graphic Plotter that offers resolution of 1 part in 10,000 on X and Y axes with 0.18 millimeter (0.007 inch) resettability.

Operating systems for measurement and control

The key to successful implementation of any measurement and control system often is found within the capabilities of the operating system supplied with the hardware. The four operating systems, briefly described earlier, represent the most comprehensive software available for automatic measurement and control systems. Included are FORTRAN and ALGOL compilers, BASIC interpreter, Hewlett-Packard Assemblers, and source program editing and debugging routines. A comprehensive program library is included with each system. A FORTRAN IV compiler is available with RTE (Option A03) Real-Time Executive Systems. FORTRAN, ALGOL, BASIC, and Assembly language callable driver routines, compatible with the selected system, are furnished with most of the system measurement and peripheral modules and interfaces.

Hewlett-Packard real-time executive systems offer the capability of automatic assembly, compilation, loading, and execution of programs in the "background." These activities take place concurrently with the real-time ("foreground") operations of the system. With these systems, programs can be added or deleted on-line without interrupting current operations.

Industrial measurement and control

Specifically dedicated to industrial measurement and control needs is the 9611A system. This system derives basic measurement and control capabilities from the 9603 system, i.e., all of the analog and digital input/output capabilities, mentioned earlier, are directly applicable to the 9611A.

Industrial applications often require a wide mix of analog and digi-

tal input/output capabilities. For this reason, the versatile Multiprogrammer subsystem is included as standard with the 9611A. Also included is a screw-type termination panel that provides an easy-to-connect interface for analog sensors and transducers, contacts, limit switches, and other system elements. All plug-in card expansions to the Multiprogrammer are supplied complete with a terminal panel strip, clearly labeled by function, ready for mounting on the terminal rack.

Industry-oriented utility software

The implementation of automated measurement and control systems often involves special data and signal processing functions. To minimize user's time, effort, and cost investment in providing these additional functions, a library of seven different routines for sensor-based measurement and control applications is available, as listed below. Routines in the library are callable from FORTRAN, ALGOL, and Hewlett-Packard Assembly language. All of the routines except Code Conversion and integer routines of the Statistical Analysis Package are also programmable in Hewlett-Packard Real-Time BASIC. The measurement and control utility library consists of the following: (a) Thermocouple Linearization Package that converts thermocouple voltage to °C or °F. Corrections are made for thermocouple non-linearity for Type J, K, and T thermocouples from -150°C to 900°C (-238° to 1650°F). Accuracy is ±0.28°C (±0.5°F). (b) Humidity from dew point temperature or wet and dry bulb temperatures. Also, vapor pressure is calculated from dew point temperature, relative humidity, or wet and dry bulb temperatures. Accuracy is within 1%. (c) Statistics Package that calculates mean, standard deviation, and histogram from fixed or running data. (d) Code Conversion Package that converts ASCII to EBCDIC or BCD, and vice versa. (e) Curve Fitting Package that performs least squares error curve fit of user's data to choice of six different standard functions. (f) Interpolation Package that performs linear and second-order interpolation of uniformly-spaced or randomly-spaced data. (g) Integration Package that performs numerical integration of first- and second-order fixed data or running data.

Remote measurement stations

The 9603R Remote Scientific Measurement Station and the 9611R Remote Industrial Measurement Station are designed for remote measurement applications. These stations provide analog/digital input/output under control of 9603A Scientific or 9611A Industrial Computer-based Measurement and Control Systems. The remote stations can be separated from the computer-based system by as much as three kilometers (10 000 feet).

Distributed systems

For applications where data must be acquired from widely-separated sites and coordinated at a central location, Hewlett-Packard offers complete distributed systems capability. The distributed system consists of a disc-based real-time multiprogramming central system,

satellite measurement and control systems, plus the hardware-operating system interface that establishes, controls, and monitors distributed system communications. A simplified block diagram of a Hewlett-Packard distributed system is shown in the illustration.

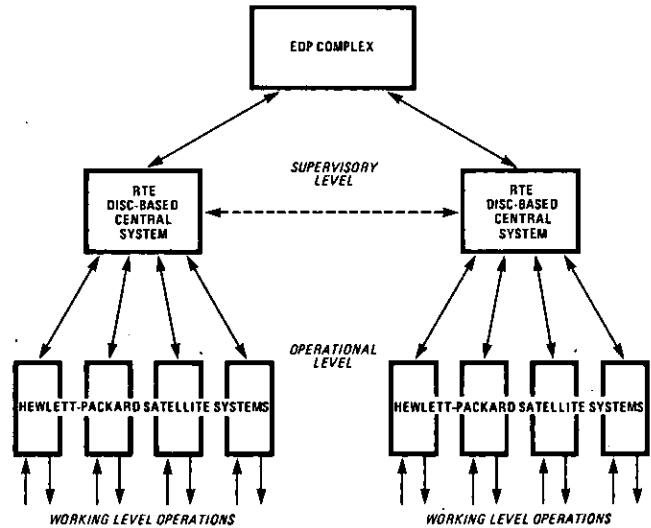

Typical Hewlett-Packard distributed system

An IBM 360/370 computer in the EDP complex receives processed information from multiple supervisory-level central systems. User's programs in the EDP computer can merge the real-time distributed systems information to provide comprehensive, up-to-the-minute reports on operations to top managers. At the same time, the EDP computing capabilities can serve the lower-echelon computers on a remote job entry basis.

Supervisory-level disc-based, Hewlett-Packard RTE central systems support communications with satellite systems and the top management level EDP complex. They also provide centralized program development, program and data storage, and additional data processing for the satellite systems. The satellite systems can communicate with central via direct wire up to three kilometers (10,000 feet). Over longer distances, or for greater routing flexibility, communications can be via synchronous or asynchronous modem and the telephone network.

Hewlett-Packard satellite systems are typically used for computer-aided manufacturing, lab experiment control, and similar operational-level applications. Satellite systems can exchange programs and data and share processing workloads and use of peripherals with central, considerably enhancing their effectiveness.

AUTOMATIC TEST, MEASUREMENT, AND CONTROL

Automatic test systems

Models 9510D & 9500D

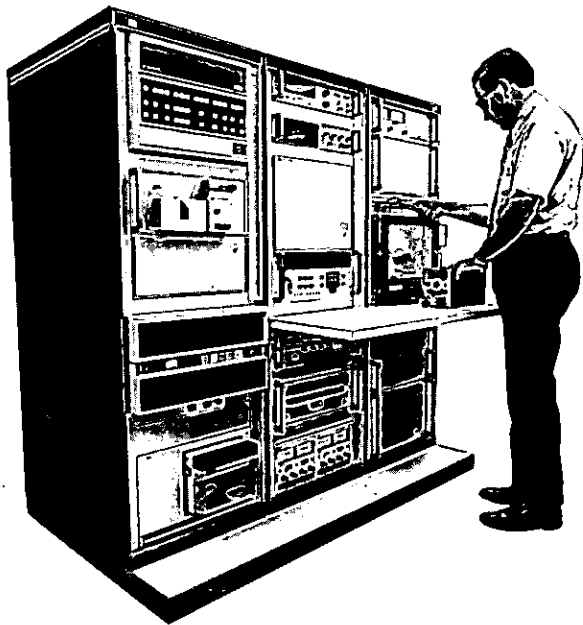

HP9510D Automatic Test System with typical device being readied for testing

Hewlett-Packard 9510D and 9500D Automatic Test Systems offer a highly cost-effective solution to the testing requirements of modern electronic equipment. The automated systems utilize stimulus-response techniques and encompass a wide range of testing capability, from individual circuit modules and sub-assemblies to highly complex avionic systems. These systems can significantly increase the volume of products tested per unit time as compared to manual methods, thus eliminating production bottlenecks at test stations. The speed of the automated system makes it possible to conduct many more measurements on your unit under test (UUT), allowing you to more thoroughly characterize your products and specify them with greater assurance of reliable operation. Each test represents very accurate performance specifications for the UUT. System printed data sent along with the UUT gives the end-user a high confidence that the product will perform as specified. Moreover, the automated systems perform with consistent repeatability and accuracy from test to test, without human errors from interpreting analog meter readings or transposition of digits when logging results. The automated system can catch virtually all faults at module or subassembly level before they become costly troubleshooting puzzles during final checkout.

Comprehensive testing capabilities

The 9510D Automatic Test System is a fully-specified, stimulus-response system that covers the frequency range from dc to 10 MHz, and optionally, up to 500 MHz.

The automated system stimulates and measures dc and ac voltages, resistance, and frequency functions. In addition, distortion, FM deviation, and phase are measured by means of innovative techniques using software algorithms. This eliminates the need for corresponding measuring instruments while providing equivalent performance at far less cost. Optional RF (to 500 MHz) test capability provides for automatic stimulus and measurement of carrier frequency, RF power,

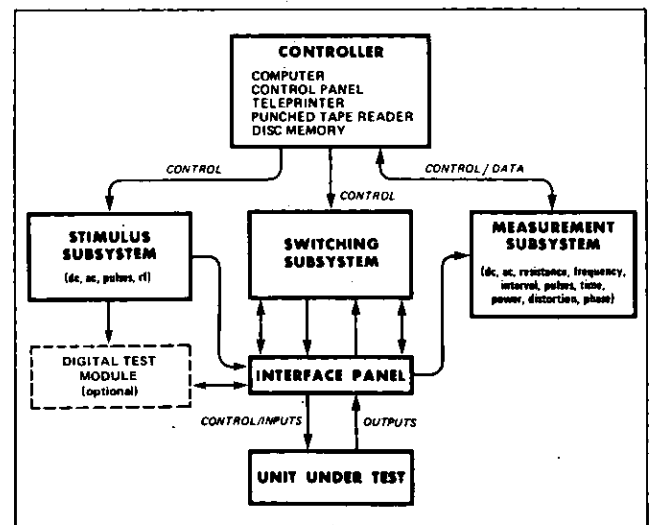

Hewlett-Packard Automatic Test System overall concept

AM modulation depth, FM deviation, plus AM and FM modulation distortion. Other optional capabilities include pulse stimulus and waveform analysis. While the majority of applications involve testing of analog devices, the 9510D can also perform digital testing with an optional Digital Test Module. The digital module performs static functional testing. The block diagram shows a general layout typical of Hewlett-Packard automatic test systems.

Fully-specified performance

The 9510D offers a significant contribution to the field of automatic testing because it is a total system, thoroughly engineered with system-level performance specified at the point where the UUT interfaces with the system. Furthermore, system calibration is initially traceable to the National Bureau of Standards (NBS) at time of shipment. The fully-specified performance means you can match your requirements and pre-plan your testing facility with complete assurance that all essential parameters are known beforehand.

Verifying system performance

The 9510D Automatic Test System has built-in capabilities to verify system performance on a day-to-day basis throughout the system's lifetime. On a daily basis, the System Functional Test (SFT) provides a check of overall system operation. Periodically, the Calibration Verification Test (CVT) can be performed by the user to verify that the system performs in accordance with the electrical specifications. Both the SFT and CVT are performed by Hewlett-Packard, at the factory, prior to shipment. Test records are shipped with each system.

The SFT consists of a series of software programs used in conjunction with a self-test adapter (supplied) that inserts into the front of the system. The SFT checks functional operation of system modules. The entire test is completely automated, making it easy to perform as a weekly, or even daily, system confidence check.

The CVT is a series of software programs linked together and used in conjunction with the self-test adapter. The 9510D measuring instruments (digital voltmeter, counter and optional power meter), periodically calibrated by the user in his standards laboratory, are designated as transfer standards and connected to the self-test adapter through their front panel terminals. In operation, the CVT performs detailed tests on the stimulus functions against these transfer standards in accordance with published electrical specifications. Accuracy performance is verified at the UUT interface panel on the front of the system. The CVT provides instructions to the operator for interconnecting and setting up the computer-assisted portion of the system verification tests.

Flexible test interface

The 9510D Automatic Test System is supplied (optional in 9500D Systems) with a UUT adapter module that provides a general-purpose cabling interface between the system stimulus, measurement, and switching modules and the UUT. The interface connectors are grouped into two major sections. The first section is mounted in the system rack and consists of: (A) a 1768-pin interface panel for dc and low-frequency signals, (B) a 52-pin coaxial connector for high-frequency signals, and (C) a high-current connector. These connectors are cabled to all stimulus, measurement, and switching functions in the system. The second section consists of a removable 1768-pin ma-

9510D Specifications

Stimulus

- DC power:** 25 V, 2 A; 40 V, 10 A*, up to a total of 9 DC sources*
- Precision DC:** 100 V, 500 mA
- Precision AC:** to 13 MHz
- Multifunction AC:** to 1 MHz* (sine, square, triangular)
- Pulse:** to ± 10 V; from 25 Hz to 25 MHz*
- CW:** to 500 MHz* from -70 dBm to +9.5 dBm
- AM:** Rate to 100 kHz at up to 90% depth*
- FM:** Rate to 100 kHz; to 99 kHz deviation

Switching

- Crossbar Scanner for 100 measurement channels
- Low-Frequency Relay Switching for stimulus functions
- Coaxial Switching for high-frequency stimulus and measurement functions

Measurement

- DC volts:** ± 300 volts
- Resistance:** to 15 M Ω
- AC rms volts:** ± 300 V, to 1 MHz

trix connector (adapter frame) which plugs directly into the interface panel from the front of the system. User test connectors and cables are then wired to the adapter frame.

Pushbutton operating convenience

The system Controller allows the operator to load and execute programs using pushbuttons on an Operator Panel. Other system-directed operator responses may also be entered in the same manner. The system is also safeguarded from tampering by means of a key-switch that locks out unauthorized writing or modifying of programs. Therefore, testing can be performed by unskilled operators without danger to the system or your units to be tested.

Test-oriented software

The 9510D Automatic Test System incorporates HP ATS BASIC* test language and a software control executive - Hewlett-Packard's Test Oriented Disc System (TODS)*. This powerful software combination offers the time and money-saving benefits inherent in BASIC programming plus data management, multi-language processing, and applications programming aids that simplify the overall test preparation procedures.

An important contribution to the return on investment in the automatic test system is provided by the ability to tie test programs directly to fault analysis programs. The results can be printed out to aid in repairing faulty units, and can also be stored in the system for further analysis to determine failure trends. Analysis of failure data and subsequent corrective action invariably leads to improvements in product yields which, in turn, means improved profits.

HP ATS BASIC test language is an augmented version of the BASIC familiar to time-share terminal users. The simplicity of BASIC itself and the generally accepted ease of learning how to use it, fully apply to the test language version as well. Test language statements use abbreviations for instruments, as commonly used by engineers and technicians, to complement the English statements of BASIC, making it possible to communicate with the stimulus, measurement, and switching instrumentation of the system. These statements provide range, function, frequency, voltage, or other control information, and receive measurement results or status information for use by

*ATS BASIC Brochure, 5952-1330, and TODS Brochure, 5952-1381, are available from Hewlett-Packard Field Sales Offices.

- Freq/time:** to 50 MHz (500 MHz optional)
- Distortion:** 15% max., 3 kHz
- Phase:** 1° to 360° at 10 Hz to 5 kHz
- Waveform analysis:** from 20 mV; from 1 ns r.t.**
- CW:** to 500 MHz**
- RF power:** -30 dBm to ± 10 dBm**
- AM:** to 3 kHz at up to 95% modulation depth**
- FM:** to 15 kHz deviation, at rates up to 3 kHz**

Digital Testing**

- Driver:** ± 12 V
- Comparator:** ± 12 V
- I/O:** 24 pins; up to 120 pins

Controller and peripherals

- Computer/controller:** 24 K memory; to 32 K memory**
- Disc memory:** 2.5 M words
- Tape punch:** 75 char/sec**
- Input/output peripherals:** Keyboard 30 char/sec Keyboard/Display**

**Optional

9510D and 9500D (cont.)

the test program. Mathematical statements, following a comparably simple format, can be used to access a library of mathematical functions, contained in the system, for computation of data received from the instruments.

The TODS executive, utilizing the system's large capacity disc storage, offers a number of other useful functions designed to increase the efficiency and productivity of the automatic test system. For example:

- A program can request loading and execution of another program without operator intervention.
- Comprehensive data management functions can handle test cataloging, program storing and retrieving, program/disc cartridge duplication, and general data file maintenance.

Peripherals for controller expansion

Hewlett-Packard offers several very useful peripherals for automatic test systems. Some of the most commonly used peripherals are: (A) Keyboard-Printer Terminal for quiet communication at 30 characters per second. (B) Digital Clock module that provides time by day, hour, minutes, and seconds; for 9500D only. (C) Keyboard-Display Terminal often used in systems where hard copy is provided by a line printer. (D) Heavy-Duty Teleprinter rather than a standard teleprinter in systems that require usage in excess of five hours per day or thirty hours per week; for 9500D only. (E) A choice of two Line Printers with maximum output of 600 lines per minute; for 9500D only. (F) Tape Punch that provides data logging on punched tape at a rate of 75 characters per second. (G) Magnetic Tape Mass Storage; for 9500D only.

General-purpose automatic test system

Complementing the automatic testing capabilities of the 9510D, is the 9500D Automatic Test System. Based on modular building-block techniques, the 9500D systems provide a wide latitude in testing capabilities, with easy expansion to handle future testing needs.

Hewlett-Packard's 9500 Systems are, at the same time, fully standardized and fully flexible in configuration and operation. Since both systems perform stimulus-response testing, the hardware shown in the block diagram also applies to the 9500D System. The broad testing capabilities of the 9500D System lie in the fact that it is supplied with a standard disc-based controller while all stimulus, measurement, switching, and interface hardware are available as options. Each controller consists of a computer and certain peripherals. Other blocks represent essential elements, but within each element is a number of options. For example, Stimulus Subsystems consist of a variety of optional instruments. Thus, only those instruments providing the needed stimuli would be ordered with your system.

Stimulus subsystems

Stimulus Subsystems provide the signals applied to the UUT. The subsystems are supplied complete with all hardware and software drivers. Optional stimulus subsystems available include: (A) Signal Sources providing outputs from 0.001 Hz to 1.3 GHz. (B) Waveform Synthesizer providing sine, square, and triangular waveforms up to 1 MHz. (C) Pulse Generator with plug-ins for rate, delay, variable pulse width, rise and fall time, amplitude, and offset. (D) Digital Voltage Sources providing voltage stimuli at ± 50 volts and 5 amps, and ± 100

volts and 0.5 amp. Higher power available includes 10 volts at 20 amps, 40 volts at 10 amps, and 60 volts at 15 amps.

Measurement subsystems

Measurement Subsystems measure signals from the UUT and also check applied stimulus signals. The subsystems are supplied complete with all hardware and software drivers. Optional measurement subsystems available include: (A) High-Speed Digital Voltmeter that measures dc voltage, true rms ac voltage, and resistance. (B) Distortion Analyzer measuring from 50 Hz to 100 kHz. (C) Timer/Counter that measures frequency up to 550 MHz and time interval down to 100 nsec. (D) Vector Voltmeter for measuring from 1 MHz to 1 GHz. (E) RF Power Meter that measures from 1 MHz to 3 GHz or 10 MHz to 18 GHz.

Switching subsystems

Electrical switches provide the paths to connect stimulus and measurement instruments to the UUT, and to each other for self-checking. The type of switch needed depends on the type of signal to be carried (dc, rf, pulse, current level, etc.), the number of connections to be made, and operating speed. The subsystems include all hardware and a software driver. Optional Switching Subsystems available include: (A) Guarded Crossbar Scanner for switching analog inputs to the digital voltmeter. Up to 200 three-wire channels can be switched. (B) Modular Switching Subsystem that can handle an extremely large number of switches. Plug-in switch cards offer a choice of relay trees for distribution switching, general purpose relays, reed relays, and transistor switches with storage for each. The maximum switch capacity is 16,384, and the actual number of switches depends upon the selection of switching card options. (C) Coaxial switching to switch high-frequency signals.

Expanding system capabilities

The modular construction of the 9500D Automatic Test System makes it possible to choose and individualize your system from the wide selection of stimulus, measurement, and switching modules previously described. Hewlett-Packard also has available a wide selection of system-oriented instrumentation that can provide added testing capabilities. These include:

- Waveform Analysis • Spectrum Analysis • Phase/Gain Measurement • RF Digital Voltage Measurements • High-Resolution Digital Voltage Measurements • Preset Counter Functions • Computing Counter High-Accuracy Counting Functions • Digital-to-Synchro Resolver Capabilities • Synchro-to-Digital Resolver Capabilities • 400 Hz High-Power Supplies (single and multiphase) • Switching for High-Frequency Inputs (to 18 GHz) • Serial Word Generation • High-Power RF Generation • High-Current Switching • Interface for High-Frequency UUTs • Interface for High-Current UUTs

Special-engineered systems

Hewlett-Packard can custom-engineer added capabilities into the 9500D Systems using a selection of the system-oriented instruments above. These expansion capabilities can be used to meet a broad range of specialized customer test problems. Hewlett-Packard's expertise in system design is available to help you plan your automatic test system by contacting the nearest Hewlett-Packard Field Sales Office.

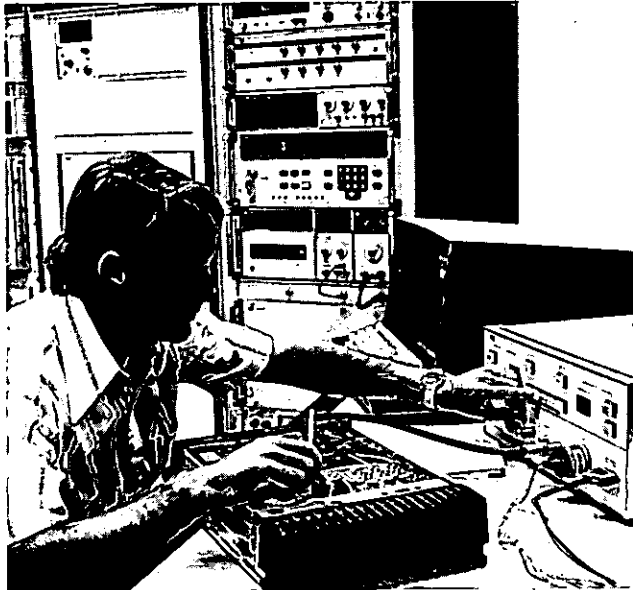

Two-way radio transmitter alignment utilizing a 9540D Transceiver Test System.

Based on the highly-successful 9500 Series systems, Hewlett-Packard has developed specialized systems with capabilities dedicated to specific automatic testing needs. They are: 9540D Transceiver Test System and 9551D Instrument Calibration System.

These computer-controlled systems incorporate the same programming language, HP ATS BASIC, and the same operating system, Hewlett-Packard's Test Oriented Disc System (TODS), as the 9500 Systems. The ease-of-learning aspect of HP ATS BASIC makes it the ideal programming language for these systems because programming can be done by test engineers or test technicians. Each system also incorporates its own unique operator panel that eliminates the need for a test operator to handle any computer switches. Particularly significant, from the cost-effectiveness standpoint, is that these systems do not require a full-time programmer in attendance; rather, they are truly designed for operation by test technicians, or production workers.

Testing transceivers

The 9540D Transceiver Test System provides a fast, accurate, and consistently repeatable means of testing communications receivers, transmitters, power supplies, as well as complete two-way radio sets. These systems perform all the testing requirements for AM and FM two-way radios operating from 10 MHz to 1300 MHz at one watt to 100 watts power output (special attenuators allow testing below one watt and above 100 watts).

The systems are particularly effective for production and final assembly testing applications, and for the testing needs of maintenance labs and service shops.

In operation, the 9540D displays all operator instructions, such as "enter serial no.," "adjust squelch to max," etc. Also, tests can be repeated at new frequencies and amplitudes, desired results can be calculated from measured values, the system can check itself for malfunctions, show whether the unit under test (UUT) has passed or failed, and repeat these functions accurately every time. Hewlett-Packard supplies several sample test programs (measuring receiver sensitivity, audio distortion, etc.) with each system, as a guide to as-

Transmitter tests	
Carrier Power Output	FM Deviation
Carrier Frequency and Stability	Audio Distortion
AM Hum and Noise	Audio Frequency Response
FM Hum and Noise	Audio Sensitivity
AM Modulation	
Receiver tests	
SINAD Sensitivity	Audio Frequency Response
Quieting Sensitivity	FM Modulation Acceptance
Audio Sensitivity	Bandwidth
Squelch Operation	Hum and Noise Levels
Audio Power Output	Image Channel Rejection
Audio Distortion	IF Rejection
Modules & subassemblies	
Modulators and Subassemblies	Audio Amplifiers
Local Oscillators	Filters
Frequency Synthesizers	Selective Signaling Circuits
IF Amplifiers	Power Supplies

sist in writing programs for your specific needs. Testing capabilities of the 9540D System are shown in the table above.

Calibrating instruments

The 9551D Instrument Calibration System brings to the calibration laboratory a cost-effective solution to calibrating the myriad complex instruments in use today. At the same time, these automated systems effectively reduce the costs of training skilled technicians, while increasing efficiency by helping to solve present and future workloads and other lab management problems.

The system incorporates a wide variety of calibration-quality instruments, easily recognized by those involved in cal lab work as required for calibration purposes. The system calibrates a wide variety of passive meters, multimeters, electronic meters (voltage, current, VSWR, power, etc.) differential voltmeters, digital voltmeters, frequency counters, and oscilloscopes along with their plug-ins and amplifiers. In addition, the system can optionally calibrate signal sources and generators, oscillators, pulse generators, and function generators.

The 9551D System has built-in capabilities to maintain peak performance and accuracy on a day-to-day basis throughout the system's lifetime. On a daily basis, the System Functional Test (SFT) provides a quick check of system operation. Periodically, the Calibration Verification Test (CVT) can be performed by the user to verify that the system performs in accordance with the electrical specifications. The SFT and CVT are equivalent to the SFT and CVT associated with the 9510D System, as described on the pages immediately preceding this page.

The 9551D System is suited for installation in new cal labs or in existing labs to upgrade the procedures to automatic calibration. To give you a head start, in putting your system to work, or to facilitate a changeover, Hewlett-Packard has available 24 different ready-to-use sample instrument calibration programs. These programs are supplied, along with other instructional material, to each student who attends the Hewlett-Packard Instrument Calibration System Training course. Students are instructed in the use of the programs which include performance tests, alignment procedures, and printout of test data for the sample instrument calibration programs. The calibration procedures are available for some of the most-commonly-used instruments with selections of oscilloscopes, electronic meters, counters, and signal sources.

Expert assistance available

Hewlett-Packard welcomes the opportunity to offer expert engineering assistance to solve your communications testing, calibration, or digital testing needs. Brochures covering the systems briefly described here are available from Hewlett-Packard field sales offices.

AUTOMATIC TEST, MEASUREMENT, AND CONTROL

Multiprogrammer: bidirectional system interface

Models 6940B & 6941B

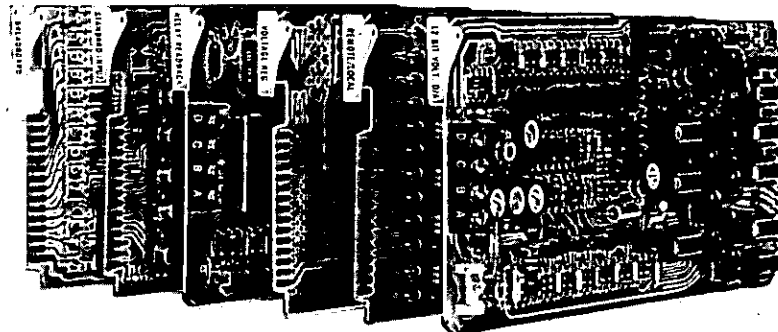
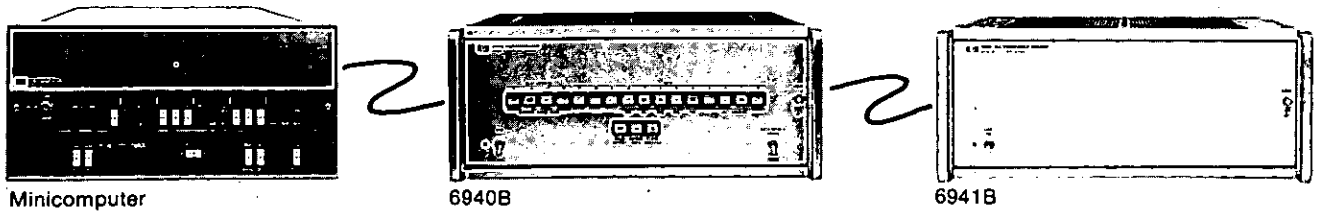

Programmable I/O Cards

Description

The HP 6940B/6941B Multiprogrammer is a versatile building-block system for automatic test and control. As shown above, the Multiprogrammer building-block components include two types of mainframes and a family of programmable plug-in cards.

For small systems, only one 6940B Mainframe and from 1 to 15 plug-in cards are needed. The cards are randomly addressable by the computer allowing them to be mixed in any order within the mainframe; cards can be added or removed from the system without upsetting the operating software. The computer program "writes" data on output cards or "reads" data from input cards. An output or "write" operation is carried out by simply addressing the desired card and depositing 12 bits of data in the card's storage registers. Conversion circuits then develop the output function (contact closures, D/A conversion, stepping motor drive, etc.) unique to that type of output card.

To "read" data, the computer sends out the desired input card's address and reads in digital data from the external device.

System expansion up to 240 I/O functions is easily accomplished by adding 6941B Extender mainframes and plug-in cards.

The Multiprogrammer mainframes and plug-ins function together as an integrated unit possessing many built-in systems features. Among these features are:

- Digital data storage on plug-in output cards to reduce computer overhead.
- The ability to program all plug-in cards to a safe state (in case of computer failure or system alarm).
- The ability to program specific output cards individually or in selected groups.
- The generation of a computer interrupt when digital lines being sensed change state.
- The program selection of data transfer rates between the computer and the Multiprogrammer to proceed either at the maximum possible rate or at a rate governed by a particular device being controlled by a plug-in card.
- A front-panel switch register on the 6940B mainframe which permits manual control of the system and thus enhances serviceability.

For detailed information on the 6940B/6941B, ask your local Hewlett-Packard field sales engineer for a copy of the new 40-page Multiprogrammer brochure.

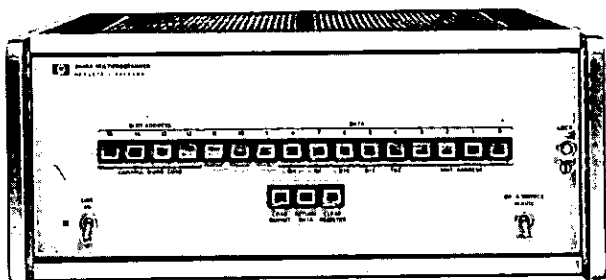

6940B front panel

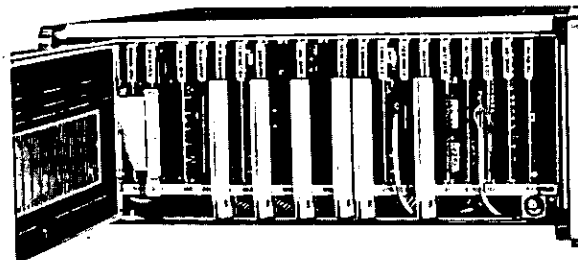

6940B/6941B door open

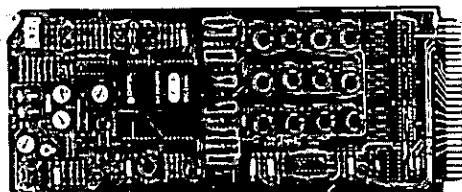

Typical output card

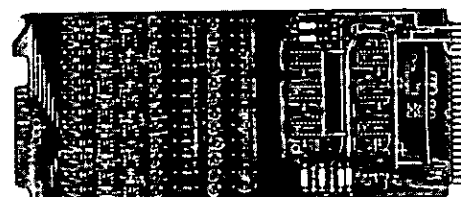

Typical input card

Multiprogrammer features

6940B Multiprogrammer

The 6940B serves as the I/O interface between the controlling computer and all other system elements including extender mainframes, plug-in cards, and devices controlled or sensed by the plug-in cards. It has a basic fifteen channel I/O capacity. Any combination of plug-in input or output cards can be programmed through these slots.

The 6940B has many hardware features of significant importance in the design and implementation of real-time systems. These features are described below.

Local switch register: An important aid in system checkout and troubleshooting, these touch-type switches permit manual programming of all Multiprogrammer output, input and control functions. Fault isolation to a functional area of the system (computer, multiprogrammer, or external devices), as well as mainframe and plug-in card troubleshooting can all be accomplished from the 6940B front panel.

System cabling: All cabling between the multiprogrammer plug-in cards and external devices are routed through a cable channel in the lower section of the mainframe. Molded edge connectors supplied with most programmable I/O cards afford added convenience in wiring to external devices.

DC power supplies: Power for all plug-in cards, including four isolated ± 15 volt supplies for up to 15 analog I/O cards, are built in to the mainframes. The main 5 V power supply has crowbar and current limiting circuits to protect the plug-in cards from overvoltage and overcurrent conditions.

AC power module: AC power is connected to the mainframes through a power module on the rear panel of each unit. The module permits selection of either 115 V or 230 V, 48-440 Hz as the power source. A safety interlock makes it impossible to change the AC voltage selection without first removing the power cable.

6941B Extender

Each Extender mainframe accommodates up to fifteen programmable plug-in cards. Up to fifteen extenders can be chain-cabled together to obtain up to 240 I/O channels. Except for the switch register, the 6941B has the same features described for the 6940B.

Typical applications

Over 30 models of programmable input and output cards are currently available. Brief descriptions of a few applications utilizing the I/O cards are given below. Specifications for all programmable I/O cards are given on page 526.

Programmable DC voltage and current: Resistance output cards (models 69501A-69513A) control the voltage and current outputs of HP power supplies with ratings up to 100 volts or 100 amps. A two-wire connection to the power supply establishes a fully isolated, programmable dc source for bias of electronic subassemblies under test or control of dc motors, solenoids, or other electromechanical process equipment.

Digital-to-analog conversion: Both voltage and current DAC's are available. The voltage DAC (69321B) provides -10 to $+10$ V @ $0-5$ mA; the current DAC (69370A) can be programmed from $0-20$ mA @ $0-10.5$ V. The DAC outputs are completely isolated from the computer's ground for strip chart, X-Y, and analog tape recordings as well as control of instruments and process control devices with $0-5$ volt or $4-20$ mA inputs.

Digital output and switching: Digital output cards provide 12-bit logic outputs for digitally controlled instruments, indicators, and solid-state AC relays. Model 69331A provides TTL levels; model 69332A has open collector outputs.

Mercury-wetted relays on the 69330A and 69433A Relay Output Cards route stimulus and control signals up to 100 volts, 1 amp.

Stepping motor control: One computer word to a 69335A Stepping Motor Control Card produces from 1 to 2047 square-wave pulses at either of two outputs to control motor translators. Pulses from the 69335A are also used for pulse train update of supervisory control stations.

Programmable amplifiers: Bipolar, dc coupled, 50-watt amplifiers boost the outputs of many types of signal sources. Amplifier gain may be programmed to one of 4095 discrete values with a 69328A Amplifier Control Card. The amplifiers and control cards are also used as bipolar power supplies whenever energy must be alternately delivered to and absorbed from loads such as current-sinking logic, relays, batteries, capacitors, and inductors. Models 69325A and 69326A control cards are used to program the voltage and current outputs in the bipolar power supply mode.

Voltage, current and resistance measurements: Voltage Monitor Card (Model 69421A) is a 12-bit A/D converter that measures dc voltages even in the presence of 100 volts of common mode noise. Placing an external 500 ohm resistor across the inputs to the voltage monitor card converts it to a current measuring card for $4-20$ mA current loops used in process control.

The combination of a 69421A Voltage Monitor Card and a 69370A D/A Current Converter Card measures resistances from 50 ohms to 50 kilohms.



AUTOMATIC TEST, MEASUREMENT, AND CONTROL

Models 6940B & 6941B (cont.)

Digital input: Digital input cards accept 12 bits of data from digital measuring instruments, pushbuttons, switches, relays, and other digital devices in the form of logic levels or contact closures.

The 69431A Digital Input Card is suitable for most applications not requiring isolation between the external data source and the computer. The 69430A Isolated Digital Input Card is used to monitor circuits driven from power supplies that cannot be connected to computer (earth) ground.

Scanning and input multiplexing: Simple single-ended switches or multi-wire scanner matrices are formed by interconnecting mercury-wetted relays on a 69330A Relay Output or a 69433A Relay Output/Readback Card. The relay output card scanners act as input multiplexers for 69421A Voltage Monitor, 69435A Pulse Counter, and 69431A Digital Input Cards.

Event sensing: Test and control systems often must respond quickly to external digital signals that indicate an alarm condition, operator intervention, or some other request for immediate attention. The 69434A Event Sense Card interrupts the computer only when any of the 12 external alarm signals change from their previous condition.

Timer and frequency reference: The Timer Card (Model 69600A) provides a one-shot on/off output signal that is programmable from 1 microsecond to 40 days in duration. When connected to a safety switch or audible alarm, the 69600A can serve as a watchdog timer. The square-wave outputs of the 69601A Frequency Reference Card can control the timing of external measurement and data acquisition devices.

Pulse counting-preset and up/down: Digital logic level pulses or contact closures may be totalized with a 69435A Pulse Counter Card. The counter may be preset to any count from 0 to 4095; count up/count down inputs are available. Cascading two pulse counter cards extends the total count capability to 16×10^6 , and any number of counters may be cascaded to extend the count further. The counter may be examined without disturbing the counting process (read-on-the-fly capability).

Frequency measurement: Pulse Counter Card (Model 69435A) can accumulate counts over a precise time interval when a 69600A Programmable Timer Card is connected to the enable line of the counter. The computer divides the count by the time interval to measure frequencies from 200 kHz to 0.001 Hz.

Time interval measurement: The time that elapses between external logic level changes or contact openings and closings can be measured in the range of 10 microseconds to 1 hour by connecting a 69601A Frequency Reference Card to the count input of a 69435A Pulse Counter Card. The contact closure or logic level to be measured is connected to the enable line of the counter. The computer divides the accumulated count in the 69435A by the frequency of the 69601A Frequency Reference Card to determine the time interval.

Specifications

6940B/6941B Common specifications

Input/output card positions: Maximum of 15 plug-in input or output cards per mainframe. Side-hinged front panel provides access to card slots.

Mainframe data connectors: Two 50-contact, rear-mounted, female ribbon connectors.

Data transfer rate: 25 k word/sec.

Maximum data resolution: 12 bits per plug-in card.

Accessories furnished: Data Input Plug, Rack Mounting Kit, PC Board Extender Card.

Cooling: Natural convection.

Temperature: 0 to +55°C operating, -40 to +75°C storage.

Dimensions: 42.54 cm W × 17.22 cm H × 53.98 cm D (16.75" ×

6.78" × 21.25").

Power: 115 or 230 V ac ±10%, 48 to 440 Hz, 230 watts.

6940B Specifications

Front panel controls: Power ON/OFF switch and indicator lamp, REMOTE/LOCAL switch for selecting computer or manual control, 19 proximity switches for manual data entry and control.

Interfacing: A 6940B mainframe equipped with the standard interface card is designed to interface with binary sources employing TTL or DTL microcircuit logic. An interface kit (14550A) containing the necessary hardware and software to interface the 6940B with any Hewlett-Packard computer is available.

Weight: 15.9 kg (35.0 lb) net; 19.5 kg (43.0 lb) shipping.

6941B Specifications

Front panel controls: Power ON/OFF switch and indicator lamp.

Weight: 15.2 kg (33.5 lb) net; 18.3 kg (40.3 lb) shipping.

Programmable plug-in cards

Output cards

69500A-69504A Resistance output cards: Provide a single 12-bit resistance programming channel; the programming coefficients of these models are compatible with Hewlett-Packard programmable power supplies equipped with option 040. Model 69500A is supplied with resistors allowing the user to install his own series adding elements.

69510A-69513A Resistance output cards: Provide two 6-bit resistance programming channels; these models are designed for programming the current limit of Hewlett-Packard programmable power supplies equipped with option 040.

69321B Voltage D/A converter card: Provides a high speed, bipolar output voltage that is the analog of the digital input data to the card. Output range is from -10.240 to +10.235 V, at 0-5 mA. Conversion speed is 30 μsec maximum to within 5 mV of final value. (69351A voltage regulator also required).

69370A Current D/A converter card: Provides a high speed constant current output that is the analog of the digital input data to the card. Output range is 0 to +20.475 mA, at 0-10.5 V dc. Conversion speed is 30 μsec maximum to 5 μA of final value. (69351A voltage regulator also required).

69330A Relay output card: Provides 12 separate form A (SPST, normally open) mercury-wetted contact outputs that reflect the status of 12 programmed data bits. Includes gate/flag circuits for exchange of control signals with user's device.

69433A Relay output/readback card: Provides 12 separate form A (SPST, normally open) mercury-wetted contact outputs. Also supplies 12 input data lines that can be read by the computer and which indicate the relay coil voltage status.

69331A Digital output card: Provides programmed microcircuit logic level outputs on 12 separate output lines. Card includes gate/flag circuits for exchange of control signals with user's device.

69332A Open collector output card: Provides 12 open-collector driver outputs. IC buffers on the card act as switches for voltages up to 30 volts dc and currents up to 40 mA.

69335A Stepping motor control card: Used to drive stepper motor and pulse-update type controls. Can be programmed to generate from 1 to 2047 pulse outputs to either of two terminals.

69600A Programmable timer card: Can be programmed to generate crystal controlled, one-shot timing pulses. Time increment is variable from 1 μsec to 40 days.

69380A Breadboard output card: This card allows user to design and build a custom analog or digital output card. Card includes basic address, storage, and control signal buffer circuits.

Input cards

69421A Voltage monitor card: This card monitors bipolar dc voltages in the range of +10.235 V to -10.240 V, and returns a 12-bit 2's complement digital word to the computer to indicate the magnitude and sign of the measured voltage. Up to 150 conversions per second can be performed as commanded by the program or an external gate input.

69431A Digital input card: This card monitors 12 bits of TTL, DTL, or contact closure data from user's device. Card includes gate/flag circuits for exchange of control signals with user's device. Return bits to computer reflect the status of 12 input bits.

69430A Isolated digital input card: This card monitors 12 bits of input data from user's device. All input lines are isolated from one another and from the multiprogrammer power supply. Eight options of the card are available to accommodate either ground-true or positive-true logic sense inputs and a wide range of input levels.

69434A Event sense card: This card compares the magnitude of an external 12-bit input word with a stored reference word and generates a computer interrupt for any of four conditions, depending on the placement of a jumper on the card. The four possible conditions are: In = Ref, In ≠ Ref, In > Ref, In < Ref. The reference word is loaded from the computer. Both the input and reference words can be read back to the computer.

69435A Pulse counter card: This card counts pulses, up or down, in the range of 0 to 4095. A carry or borrow pulse is generated as the count goes above 4095 or below 0. These pulses allow multiple counter cards to be cascaded for greater counting capability or they can serve as alarm signals. The card can also be used as a pre-set counter.

69601A Frequency reference card: This card provides six square-wave outputs at fixed frequencies from 1 Hz to 100 kHz, derived from a 1 MHz crystal. The outputs may be turned off with an external TTL logic gate or a contact closure.

69480A Breadboard input card: This card allows user to design and build a customer input card. Card includes basic address and readback circuits.

Instruction manuals

A separate Operating and Service Manual is supplied with each Multiprogrammer mainframe and each type of programmable plug-in card. The manuals contain operating instructions, circuit theory, troubleshooting instructions, complete circuit diagrams, and replaceable parts lists.

In addition to the mainframe and plug-in card manuals, software driver manuals are also available at nominal cost.

Accessories available Price

14550A Interface kit for HP computers \$1800

This kit provides all the equipment necessary to install, verify, and operate a Multiprogrammer with HP 2100 series computers. This kit includes:

1. A specially modified 12566B Ground True Microcircuit Interface Card, tested with logic sense jumpers in proper positions for the Multiprogrammer. This is a 16-bit duplex register card that plugs into the HP computer. Hardware manuals, a test connector and a software verification routine for the Microcircuit card are provided in the kit.
2. The 14540A Multiprogrammer-to-12566B 12-foot cable with service manual.
3. A 69431A Digital Input Card with option 095, 69331A Digital Output Card, 14550-60001 Slot Verification Cable, and 14910A Complete Diagnostic tape. This equipment is used to completely test the

digital paths between the computer and the Microcircuit card, 14540A cable, Multiprogrammer Mainframe, 14541A Chaining Cables, 6941B Multiprogrammer Extenders and each Multiprogrammer plug-in I/O slot. The diagnostic also tests the front panel lamps and proximity switches by interfacing with the operator.

4. Binary object tapes and software operating manuals for BCS, DOS/DOS-M, and RTE Multiprogrammer Drivers. Also included is a tape and manual for the BCS Multiprogrammer Library that allows the Multiprogrammer BCS Driver to be used with FORTRAN or ALGOL languages.

5. Instructions that allow you to completely test the Interface Kit and Mainframes. On-site installation by HP is not included with the kit. The kit is designed to help you become familiar with the Multiprogrammer as you install it and verify its operation.

14546A Interface cable for DEC PDP 8/I \$155

This cable connects the Multiprogrammer with interface hardware that functions as a 16-bit duplex register under control of the 12-bit DEC PDP-8/I computer. Instructions for assembling this interface from DEC logic modules (not included with the cable) are provided in HP Interface Manual 5952-3935.

14540A Main input cable \$170

This 12-foot cable connects the Multiprogrammer to the specially Modified Ground True 12566B Microcircuit Card. This cable is included in the 14550A Interface Kit.

14541A Chaining cable \$170

This cable connects 6940B to 6941B Mainframes and 6941B to other 6941B Mainframes. Length of cable is 18-inches.

14533B Pocket programmer \$120

The Pocket Programmer is used to check digital input/output connector J1 of the 6940B Multiprogrammer Mainframe. Changes in the manual switch positions on the Pocket Programmer are visible on the front panel of the 6940B, and the outputs of the 6940B proximity switches are available at test points on the Pocket Programmer.

14534A Pocket programmer cable \$60

The Pocket Programmer plugs directly into the rear of the Multiprogrammer. The 3-foot 14534A extender cable is a convenience that allows you to operate the Pocket Programmer in front of the 6940B.

Model number and name.	Price
6940B Multiprogrammer	\$1600
6941B Extender	\$1000
69321B Voltage D/A Converter Card	\$450
69325A-69328A Amplifier Control Cards	\$400
69330A Relay Contact Closure Output Card	\$400
69331A TTL Output Card	\$210
69332A Open Collector Driver Card	\$130
69335A Stepping Motor Control Card	\$400
69351A Voltage Regulator Card	\$130
69370A Current D/A Converter Card	\$450
69380A Breadboard Output Card	\$100
69421A Voltage Monitor Card	\$600
69430A Isolated Digital Input Card	\$250
69431A Digital Input Card	\$210
69433A Relay Output/Readback Card	\$450
69434A Event Sense Card	\$400
69435A Pulse Counter Card	\$400
69480A Breadboard Input Card	\$100
69500A Resistance Plug-in Card	\$350
69501A-69513A Resistance Programming Cards	\$400
69600A Timer Card	\$500
69601A Frequency Reference Card	\$450

AUTOMATIC TEST, MEASUREMENT, AND CONTROL

Analog-to-digital subsystem

Model 91000A

NEW

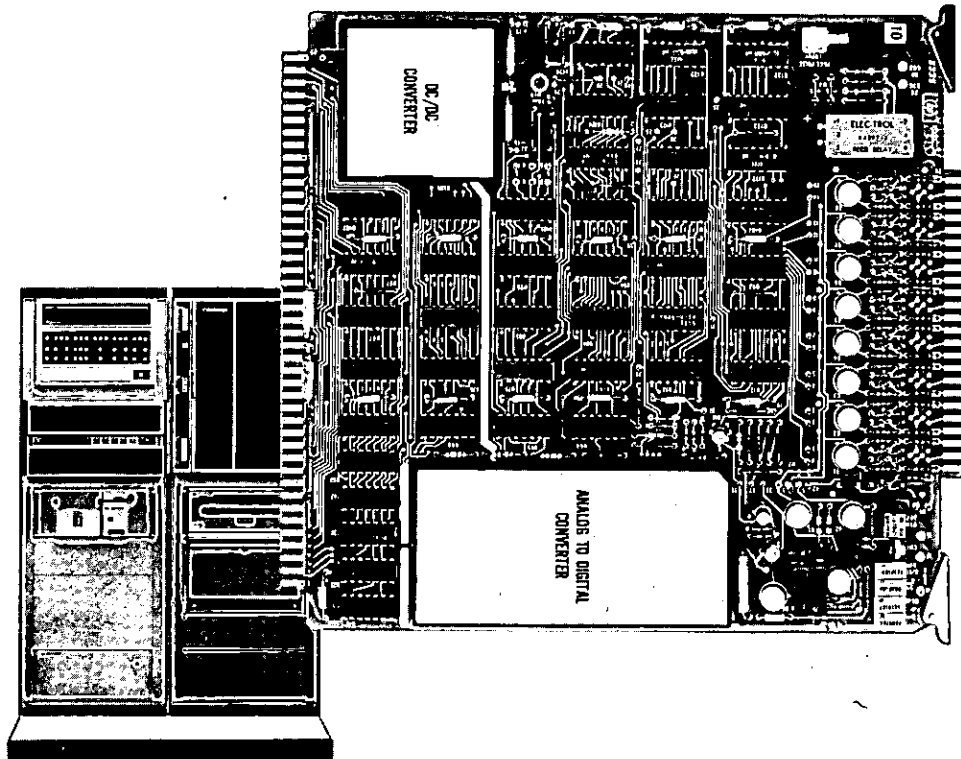

HP 91000A plugs directly into Hewlett-Packard measurement and control systems.

The HP 91000A is a complete high-level measurement subsystem on a single card that plugs into Hewlett-Packard measurement and control systems. It includes all necessary interface and control logic, a sample and hold amplifier, an ADC, and an input multiplexer with capacity for 16 single-ended or 8 differential inputs. The card accepts external TTL-level pacing signals.

Software drivers and interface routines allow user programs written in FORTRAN, ALGOL, BASIC, or Hewlett-Packard Assembly languages to interface with this analog-to-digital subsystem. Operation is under control of one of the following Hewlett-Packard real-time executive systems: BCS, RTE-B, RTE, or RTE-C. Also included is a unique verification program in which the operator commands any mode of operation via the system keyboard input unit or paper tape reader. An easy-to-follow printout or display of the results is provided. This program can substitute for applications programming during the early stages of system set-up. It will thus save time and effort, at the same time confirming correct operation of the A-D card.

Multiple A-D interface cards can be used together in a Hewlett-Packard measurement and control system. The A-D card is software-compatible with the HP 2313B Analog-Digital Interface Subsystem, which can thus be substituted with little or no change of programs as measurement needs grow beyond requirements that the A-D card can satisfy economically.

Specifications

- Number of inputs:** 16 single-ended or 8 differential.
- Resolution:** 12 bits, including sign; LSB = 5 mV.
- Full scale input:** +10.235 V to -10.24 V.
- Throughput rate to buffer:** to 20 kHz, maximum, via DMA.
- Sample and hold:** Delay: 150 ns, Aperture: <250 ns.
- External pace pulse input:** +4.5 V \pm 0.5 V, 1.5 \pm 0.5 μ s pulse (0° \pm 0.5 V baseline, 100 Ω source).
- Overall accuracy:** At 25° \pm 5°C: \pm 0.1% fs \pm 1/2 LSB.
- Temp. coeff.:** \pm 0.004% fs/°C over 0 to 55°C range.
- Input impedance:** Power On: >5 M Ω ; Power Off: 1 k Ω \pm 10%.
- Source resistance:** To 1 k Ω , balanced or unbalanced.
- Crosstalk rejection:** \geq 80 dB, dc to 100 Hz, using differential input.
- Common mode rejection:** \geq 80 dB, dc to 100 Hz, using differential input.

HP91000A A-D Interface subsystem includes A-D interface card, mating connector for analog input, operation and service manual, verification routine, and optional software driver and interface routine.

Options

- 005:** Single-ended input cable, 4.8 meters (16 feet) long
- 006:** Differential input cable, 4.8 meters (16 feet) long

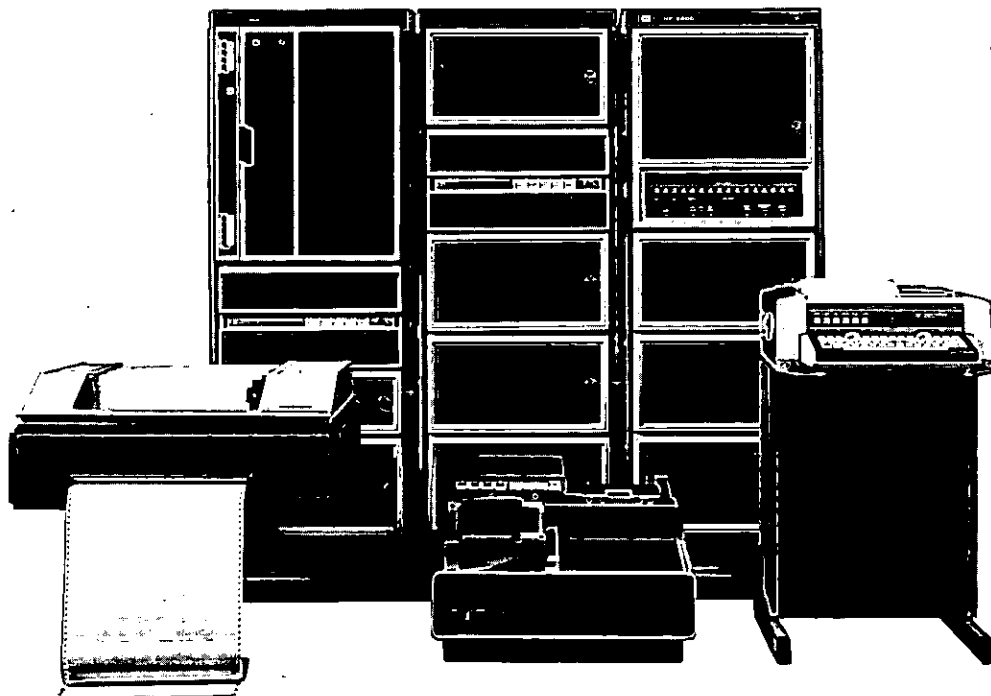

A wide variety of HP data processing equipment has evolved since the company introduced its first scientific minicomputer in 1967. Today HP designs and manufactures a broad range of computational products that include a medium-sized computer system with multiprogramming and multilingual capabilities, minicomputers, minicomputer systems, programmable electronic desktop calculators, and pocket-sized electronic scientific and business-oriented calculators. Besides an extensive selection of software, the company also offers a wide variety of HP-supported peripheral devices to perform data input and output functions.

HP Computers

The company's entrance into the computational field began with a minicomputer designed specifically to interface with HP's test and measurement instruments so customers could easily combine data gathering with data processing. HP minicomputers have since entered other areas of application including science, industry, education and business.

As key elements in the company's timeshared and data management systems, for example, the minicomputers handle such tasks as order processing, inventory control, sales analysis, production scheduling and financial reporting. In schools and colleges HP computing systems are used at all levels of education for problem solving, computer-assisted instruction, complex model simulations, computer science education and curriculum development. Systems also are avail-

able to perform administrative and student record keeping tasks.

HP's powerful 3000 computer system brings the full range of computer capabilities to a number of users concurrently. The disc-based system offers true multiprogramming and multilingual capabilities and can handle time-sharing, real-time and batch operation concurrently. The HP 3000 makes four high-level languages available to the user—FORTRAN, BASIC, COBOL, and HP's Systems Programming language (SPL).

Not only is the HP 3000 unusual among timeshare systems in its ability to handle multilanguage batch programs in the background, but the system also uses identical file systems both for timeshare and batch so that all files can be made available to any user in any operating mode.

With a front-end microprogrammable controller, the HP 3000 has entered into new application areas such as real-time data acquisition from instruments and on-line process control devices. The controller also enables the computer to communicate with and transfer entire files to other larger computing systems. This adds new importance to the already versatile HP 3000 computer in the area of distributed computing systems.

Newest member in the growing family of Hewlett-Packard computers is the HP 21MX minicomputer, among the first to use 4k RAM semiconductor memory instead of traditional core memory. The new minicomputer series is smaller, faster, more reliable, uses less power and is potentially far less ex-

pensive than minicomputers using core memory.

The 4k RAM is an integrated circuit which contains 4,096 bits of random access memory on a single chip of silicon.

To take maximum advantage of user benefits associated with semiconductor memory HP has developed a new series of microprogrammable processors. These contain built-in instructions which determine the operating characteristics of the minicomputer. The semiconductor memory modules and processors can be assembled in any combination to meet the computational needs of the user.

Power source of the minicomputer remains unaffected by line voltage fluctuations of $\pm 20\%$ or power interruptions of up to $2\frac{1}{2}$ line cycles. The HP 21MX has passed rugged environmental tests including vibration tests up to 2Gs at 55 Hz.

To the scientific user, Hewlett-Packard now offers a new family of seven scientific computing systems. Each is tailored to specific end-user requirements in such areas as computation and problem solving, data management and data acquisition from instrumentation. Based on the HP 2100 user-microprogrammable minicomputer, the systems are compatible with existing HP-supported peripherals, interface cards and library programs.

One of the systems, the S/250, incorporates IMAGE/2000 data base management software that allows the user to manage constantly growing and dynamically changing data bases.

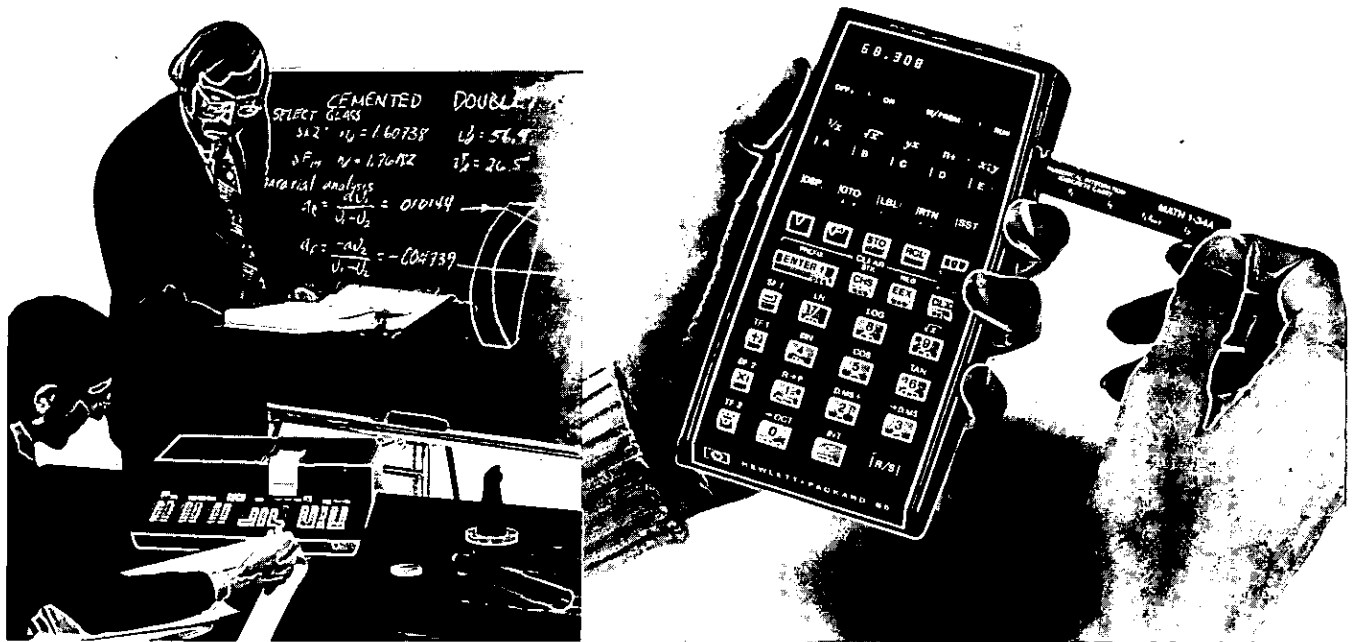

Programmable calculators

Combining the power of a computer with convenience and ease of operation, today's programmable calculator is fast becoming the most popular computing device by encroaching areas traditionally reserved for computers alone.

In essence, the programmable calculator is a desk-top computer with keyboard input, memory, processor and display all in a neat, self-contained package. It has the ability to 'memorize' complex mathematical problems involving hundreds, even thousands, of operations and then execute them without human intervention.

What's more, the programmable calculator has extensive data handling capability through a wide range of peripheral equipment. Nearly every type of input/output device found on large computers is also available for the desk-top programmable calculator including tape drives, plotters, card readers and line printers, to name a few.

The problem-solving calculators have been designed with emphasis on interaction between the operator and the machine. So the operator concentrates on solutions instead of programming.

Many of these calculators have their own step-oriented language, whereby numbers are first positioned and then operated upon. 'Algebraic' and 'conversational' language calculators came onto the market recently enabling problems to be entered just as they are written on paper. Calculators with alphanumeric capability permit the user to enter variables in the form of letters as well as numbers. Nested parentheses can also be used in writing equations.

The most sophisticated of the Hewlett-Packard desk-top calculators, however, the HP 9830A, uses a formal computer language—BASIC. Since its language is compatible, this calculator can 'talk' to a computer. Many of the programs written specifically for computers in BASIC can therefore be run on the calculator.

Non-programmable desk-top calculators

To provide users a wider choice of computing instruments, Hewlett-Packard added two non-programmable, printing calculators to its line. The HP-46 is designed for use in science, engineering, surveying, navigation, statistics and mathematics. The HP-81 is a business calculator preprogrammed with financial equations used in calculations relating to time and money. Both these machines offer solid-state memories similar to those used in computers.

Pocket-sized computing power

Since introduction of the HP-35, the world's first electronic scientific pocket-sized calculator, Hewlett-Packard has developed a whole family of these pocket calculators to aid users in scientific and business calculations.

The more powerful HP-45, the first mini-calculator to offer nine addressable memory registers, has more than 40 sophisticated functions that enable the user to solve complex, multi-step problems with greater ease and in less time that was previously possible with pocket machines.

Programmable like a large-scale computer, the HP-65 is designed for use in science, many types of engineering, medicine, surveying, statistics, mathematics and busi-

ness. The 11-ounce calculator enables users to write, edit, record and reenter program steps used to solve frequently encountered mathematical problems.

Users can record programs on tiny magnetic cards for use as often as needed. When inserted into the HP-65, the magnetic card instructs the machine to perform the calculations when the user presses the appropriate key. Up to 100 program steps can be recorded on a single card.

In addition to writing their own programs, users can expand the capability of the machine with a series of prerecorded programs from HP.

With the HP-80 and HP-70 pocket-sized financial calculators, Hewlett-Packard has brought portable, computational power to the world of business. Virtually all financial calculations involving the relationship between time and money can be done quickly and easily.

As with the scientific models, the two financial calculators have 'operational stacks' that hold intermediate answers until needed. The machines also eliminate the need to consult cumbersome financial tables, since the necessary equations are already stored in the calculators' memory.

Hewlett-Packard has the computational tool for many levels of sophistication, whether for scientists, engineers, educators or bankers. We build what is clearly the most extensive line of computing alternatives for science, engineering and business. So it's easy for HP experts to help you find the right equipment to solve your problems. Call the Hewlett-Packard sales office nearest you for an honest appraisal.

COMPUTATION

Scientific pocket calculators

HP-35 & HP-45

NEW

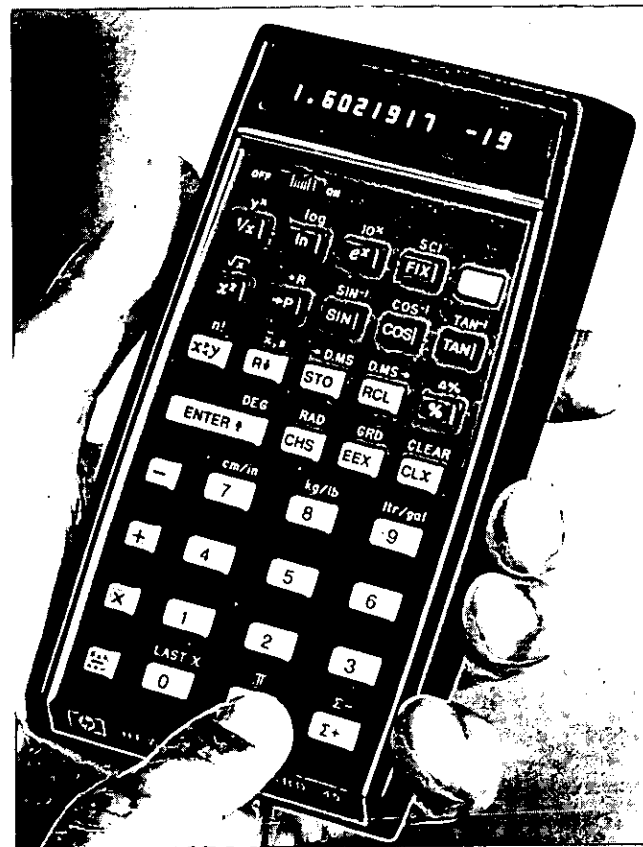
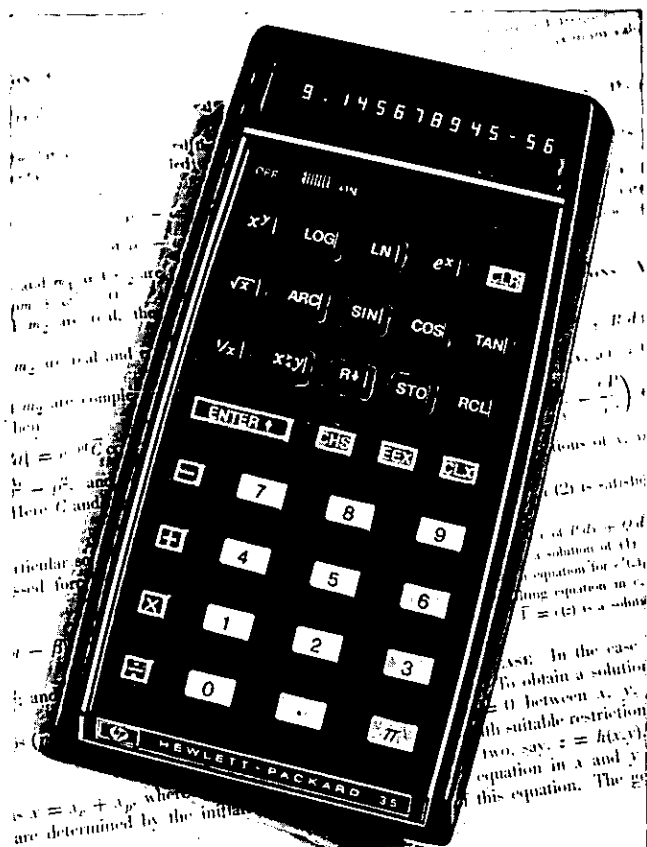

Description

Often called the "original electronic slide-rule," the HP-35 scientific pocket calculator offers features and functions not available on apparently similar models. Most important of these is the unique Hewlett-Packard four-register operational memory stack which automatically stores and retrieves intermediate answers during lengthy calculations and which virtually eliminates the need for scratch notes or the reentry of data. Stack control key permits roll-down of any entry to the display for review or further processing. The HP-35 also provides a separate, addressable storage register for selective storage or retrieval of constants or other data. Like all Hewlett-Packard pocket calculators, the HP-35 has a 200-decade range (10^{-99} to 10^{99}) and can display all numbers within this range with an accuracy of up to 10 significant digits while automatically positioning the decimal point.

General specifications (HP-35)

Pre-programmed functions

Arithmetic: add, subtract, multiply, divide, square root.

Trigonometric (decimal degrees): sine, arc sine, cosine, arc cosine, tangent, arc tangent.

Logarithmic: common logarithm (base 10), natural logarithm (base e), natural antilogarithm (base e).

Other: x^y , $1/x$, π , data storage and positioning functions.

Power (HP-35 and HP-45): AC: 115 or 230 V, $\pm 10\%$, 50 to 60 Hz, 5 watts. Battery: 500 mW derived from nickel-cadmium rechargeable battery pack.

Dimensions (HP-35 and HP-45):

Length: 14.7 cm (5.8")

Width: 8.1 cm (3.2")

Height: 1.8 to 3.3 cm (0.7 to 1.4")

The HP-45 scientific calculator is an advanced version of the popular HP-35 that offers many additional capabilities. In addition to the powerful operational stack, the HP-45 has nine addressable storage registers which can be used for register arithmetic as well as selective storage and retrieval of data. A 10th, "Last X" register automatically stores the last input argument permitting easy error correction or multiple operations on the same number.

The HP-45 performs all trig functions in any of three operating modes: decimal degrees, radians or grads. Answers in any of these modes can be converted to degrees/minutes/seconds and back again. A special key sets the display for either fixed-decimal or scientific notation, rounded to a specified number of decimal places.

General specifications (HP-45)

Pre-programmed functions

Arithmetic: add, subtract, multiply, divide, square root, square.

Trigonometric (decimal degrees, radians or grads): sine, arc sine, cosine, arc cosine, tangent, arc tangent, rectangular/polar coordinate conversions, vector arithmetic, conversions between operating mode and degrees/minutes/seconds.

Logarithmic: natural logarithm, natural antilogarithm, common logarithm, common antilogarithm.

Statistical: mean, standard deviation, sum-of-the-squares, factorial.

Other: y^x , $1/x$, π , $\%$, $\Delta\%$, metric/U.S. unit conversion constants, register arithmetic, data storage and positioning functions.

COMPUTATION

Programmable pocket calculator

HP-65

NEW



Programmable pocket calculator

Hewlett-Packard's newest and most advanced pocket calculator is the HP-65, a fully programmable instrument which features a built-in magnetic card reader/writer, a 100-step program memory, 51 pre-programmed functions and operations and nine addressable memory registers. These capabilities allow the HP-65 to be used three ways:

1. As a *user-programmed calculator*, the HP-65 lets you program up to five functions callable from the keyboard or by other programmed functions; conditional skips based on logic comparisons; and branches. You can also edit any program and save it on a magnetic card for future use.

2. With *pre-recorded program cards* from Hewlett-Packard, the HP-65 can be used by anyone to solve complex problems in such fields as electrical engineering, statistics, mathematics, medicine, finance, marine navigation, surveying and aviation. Simply select the right pre-recorded program card, and start the program. A current catalog of HP-65 Application Pacs, each of which contains up to 40 pre-recorded program cards, can be obtained via the attached reply card.

3. Even as a *keyboard operated calculator*, the HP-65 can perform all trig functions in three angle modes, handle logarithms, and permit register arithmetic. Other pre-programmed functions include: factorial, polar/rectangular coordinate conversions, square-root, square, reciprocal, decimal/octal integer conversions, and the ability to add or subtract degrees/minutes/seconds.

General specifications

Pre-programmed functions:

Trigonometric: Sin x , Arc sin x , Cos x , Arc Cos x , Tan x , Arc Tan x .

Logarithmic: Log x , Ln x , e^x , 10^x :

Also: y^x , \sqrt{x} , $1/x$, π , x^2 , $n!$, Conversion between Decimal Angle, Degrees/minutes/seconds, Radians or Grads, Rectangular/Polar Coordinate Conversion, Decimal/Octal Conversion, Degrees (Hours)/minutes/seconds arithmetic, Integer/Fraction Truncation.

Other functions:

Register Arithmetic, Addition, Subtraction, Multiplication or Division in Serial, Mixed Serial, Chain or Mixed Chain Calculations.

Features and specifications

Display: Up to 10 significant digits plus 2-digit exponent and appropriate signs.

Dynamic range: 10^{-99} to 10^{99} .

Primary functions activated by single keystroke; alternate functions utilize prefix keys.

Five User Definable Keys.

Four-register operational stack.

Program memory for storage of up to 100 steps.

Single step running and/or inspection of a program.

Unique insert/delete editing features.

Nine addressable memory registers.

"Last X" register for error correction and number reuse.

Two flags for skip or no-skip programming or branching to another part of program.

$x = y$, $x \leq y$, $x = y$, $x \geq y$, relational tests.

Magnetic card reader/writer.

Built-in counter.

Automatic decimal point positioning.

Selective round-off; range: 0-9 decimal places.

Two display modes: fixed point and scientific.

Indicators for improper operations and low battery condition.

Operates on rechargeable batteries or AC.

Solid state electronics.

Light-emitting diode (LED) display.

Tactile feedback keyboard.

Compact, contoured case.

Power: AC: 115 or 230 V, $\pm 10\%$, 50 to 60 Hz, 5 watts. Battery: 500 mW derived from nickel-cadmium rechargeable battery pack.

Dimensions: Length: 14.7 cm (5.8"). Width: 8.1 cm (3.2"). Height: 1.8 to 3.4 cm (0.7 to 1.4").

COMPUTATION

Business pocket calculators

HP-70 & HP-80

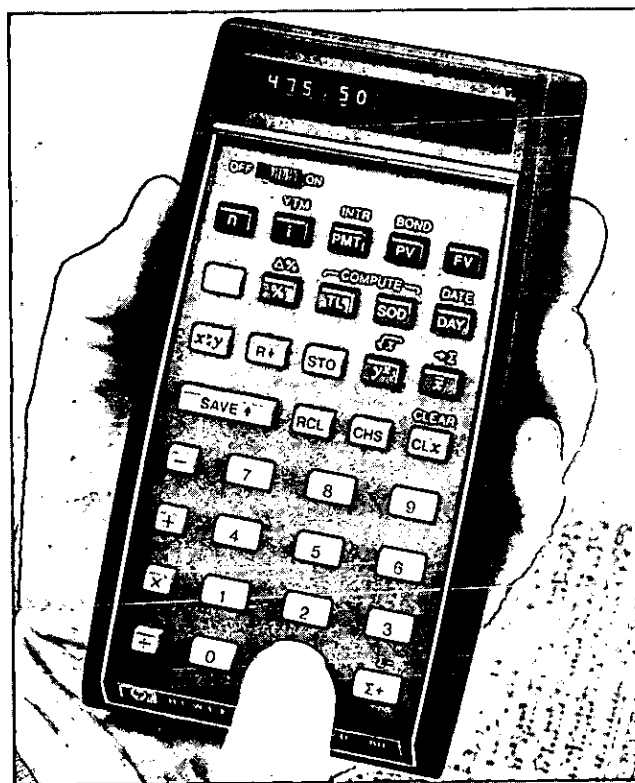
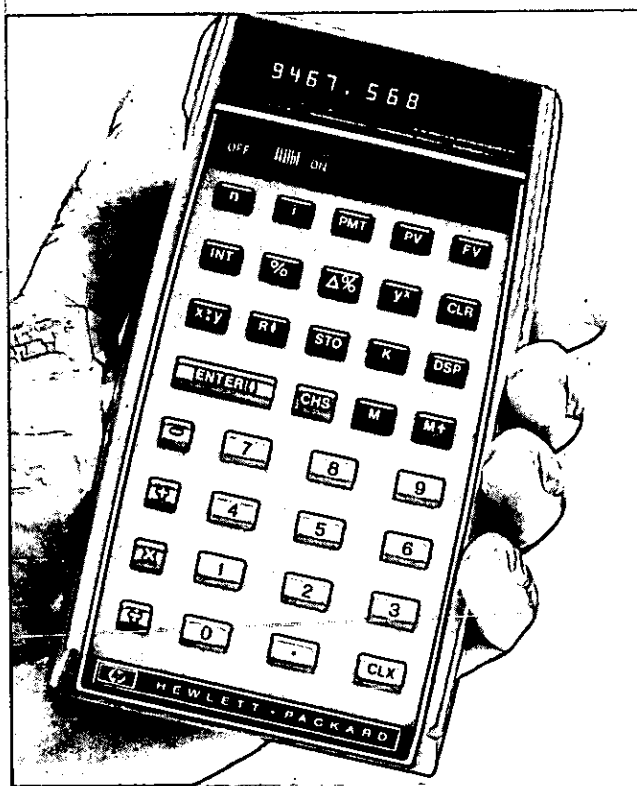
NEW

The Hewlett-Packard HP-70 is the calculator to choose for personal and general-business time-and-money problems.

Its patented RPN logic system and 5-memory registers take the drudgery out of routine accounting problems like extensions, accumulations, markups, discounts and percents. It automatically displays subtotals as they are calculated and even lets you keep two running totals at the same time.

But, the HP-70 gives you more—the power and versatility to compute interest rates, loan payments, rates-of-return and the future values of your investments. Even though you may not need these calculations every day, they could save you enough on a single transaction—like negotiating a business loan or evaluating an investment opportunity—to pay for the calculator.

That's why the HP-70 provides so much more capability than calculators that are limited to the four basic arithmetic functions. The HP-70 is as easy to use as an ordinary machine yet gives you enough calculating power to last your financial lifetime.

And, like all HP pocket calculators, the HP-70 is built to the same quality and reliability standards that have made Hewlett-Packard a leading manufacturer of precision electronic products throughout the world.

The HP-80 financial pocket calculator is a more sophisticated version of the HP-70. It provides 36 separate financial capabilities, in-

cluding bond yield and price, compound interest, mortgage payment and analysis, trend lines, rate of return analysis, accrued interest, discounted notes, true equivalent annual yield, annual percentage rate conversions, mean and standard deviation. And, the HP-80 has a built-in 200-year calendar.

In short, the HP-80 can solve almost any financial problem you're liable to run into—without resort to cumbersome tables or expensive computer time. Moreover, you can use the HP-80 anywhere—in a meeting, in a plane, in your customer's office.

The HP-80 features a 200-decade operating range, and provides answers with an accuracy of up to 10 significant digits. Or, you can round the display any number of decimal places from 0 to 6. Numbers too large or small for conventional, fixed-decimal notation are automatically displayed in scientific notation. The HP-80 also provides a four memory stack, and a separate addressable memory register for storage of constants or other data.

General specifications (HP-70 and HP-80)

Power: AC: 115 or 230 V, $\pm 10\%$, 50 to 60 Hz, 5 watts battery: 500 mW derived from nickel-cadmium rechargeable battery pack.

Dimensions: Length: 14.7 cm (5.8"), Width: 8.1 cm (3.2"), Height: 1.8 to 3.3 cm (0.7 to 1.3").

COMPUTATION

Calculators, programmable

9800 Series, 2607A & 2895B

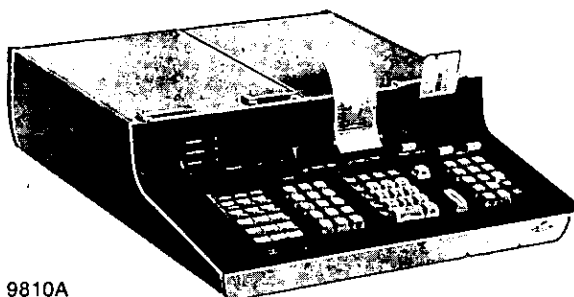
NEW

9810A

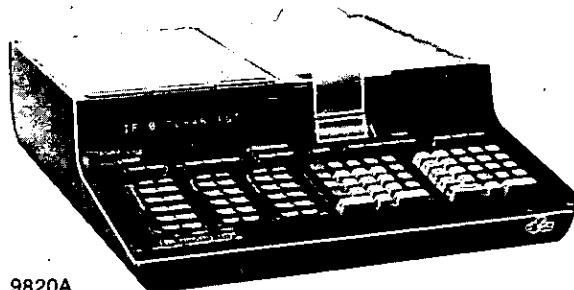

9820A

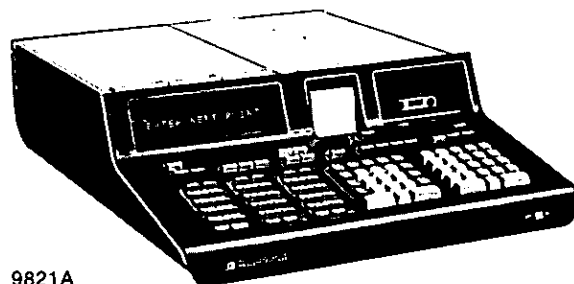

9821A

9800 Series programmable calculators

Hewlett-Packard's line of programmable desk-top calculators provides cost-effective solutions for a wide variety of business and scientific requirements. You pick the computing power and memory you need and then tailor the system to your application by choosing the appropriate peripherals.

Interfaces are also available which allow 9800 Series calculators to accept data from a large number of digital voltmeters, counters, and other instruments.

9810A, The programmable calculator for repetitive problems

Whatever your discipline, from physicist to financier, engineer to biochemist, there is a Hewlett-Packard 9810 Programmable Calculator that is right for you. The modular structure of the 9810 allows you to help design the calculator that best suits your needs! From keyboard to memory, peripherals to program packages, you can configure the 9810 to satisfy any situation—including a tight budget.

Easy programming

The calculator is programmed either by use of the keyboard or by magnetic cards. The program mode allows entry of program instructions, via the keyboard, into program memory. Programming consists of pressing keys in the proper sequence.

You can store programs or large amounts of data on handy magnetic cards for instant entry into your 9810.

9820A, Its natural, conversational language makes programming easy

Thanks to the 9820's natural, algebraic language and its conversational, alphanumeric display and alphanumeric printer, you key in most intricate mathematical problems in the same form you'd write them on paper. This allows you to easily solve complex interactive problems; such as, modeling electronic circuits, including schematics, parts specifications, and cost figures.

Peripheral and memory expandability

The 9820 is expandable through plug-in ROM's, added internal memory, and external peripherals, providing capabilities to match any type of application. The basic calculator has 173 registers. A 429- or 1453-register memory can be supplied in lieu of this, either with the original shipment or installed later by Hewlett-Packard field service personnel.

As an example of the 9820's power, the basic memory is sufficient to solve 17 simultaneous linear equations with 17 unknowns. With the 429- or 1453-register memory, the number of equations that can be solved are 34 and 71, respectively.

Built-in magnetic card reader

The magnetic card reader built into the basic 9820 allows you to make and reuse permanent recordings of programs and data. Recorded programs are easily protected against accidental re-recording by removing a perforated tab at the end of the card.

New 9821A, more straight talk and more memory

The HP 9821 Programmable Calculator brings together in one package the versatility of a desk-top calculator, the ease of the natural algebraic language, and the convenience of the tape cassette for program and data storage. With the 9821, you can design a system to meet your own specific needs in the business, technical, industrial, or scientific fields. This system allows you to write, edit, and use programs to solve your problems with unprecedented time savings and ease.

Peripheral and memory expandability

The basic calculator has 167 registers. Options for obtaining an initial configuration of 423, 935, or 1447 total registers are also available. Additional memory may be added later by HP field service personnel in increments of 512 registers (to a maximum of 1447 registers). As an example of the 9821's power, the basic memory is sufficient to solve 16 simultaneous linear equations with 16 unknowns (70 with the fully-expanded memory).

Built-in tape cassette unit

Both programs and data can be recorded onto and loaded from convenient tape cassettes, either manually or under program control. Each cassette has a capacity equivalent to approximately 8000 registers. Cassettes may be protected against accidental re-recording and/or secured against unauthorized use and duplication.

Model number and name

9810A Programmable Calculator	\$1975
9820A Programmable Calculator	\$3975
9821A Programmable Calculator	\$4975



9830A

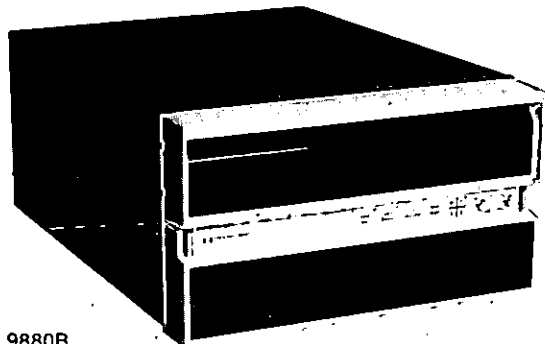

9880B

9830A, A complete data processing system programmed in BASIC

The Hewlett-Packard 9830 is a general purpose, programmable calculator designed for a wide range of applications.

The language of the 9830 is BASIC. This easy-to-use language couples simplicity with power and appeals to the new calculator owner as well as the experienced programmer. The 9830 automatically inherits a comprehensive range of proven software packages, including finance, mathematics, statistics, and education.

A minimum 9830 provides 3520 8-bit bytes (1760 words) of user read/write memory. This can be expanded to 15,808 bytes (7904 words). In addition, the user can select from a wide range of read-only-memory (ROM) plug-in blocks for increased computational capability or peripheral control, or both! The 9830 allows up to 16K bytes of add-on ROM for a total of eight plug-in blocks.

A broad range of peripherals is available with the 9830 calculator to allow the user maximum flexibility in putting together that specific system required to solve his problem.

The result is a cost-effective calculator that can meet your data handling problems today and continue meeting them as your needs expand.

Features

- Alpha Keyboard
- 32-Character, LED, Alphanumeric Display
- Built-In Tape Cassette
- BASIC Language
- 12 Significant Digits
- Full Trigonometric Capability
- Boolean Algebra Capability
- Special Function Keys
- Easy Editing
- Expandable User Memory
- Add-On Read-Only-Memory
- Formatted Output
- Broad Range of Peripherals

Programming in BASIC

The 9830 is programmed in BASIC, a formal, interactive language similar to FORTRAN. Depending on your needs, you may choose to do all your own programming. If you've already been working with BASIC, you can, with minor modifications, use your existing program. Since BASIC is a standard computer language, you will find there are many programs already written and available at nominal cost.

New mass memory subsystem

The HP 9880B Mass Memory Subsystem provides the HP 9830 calculator with the large data storage capability required for applications; such as, payroll, account maintenance, inventory control, patient records, credit verification, and large banks of data for structural design, statistical analysis, and many other scientific, industrial and commercial fields.

The memory media of this peripheral is a permanently installed memory platter and an interchangeable cartridge (HP 12869A), each having a capacity of 2.4 million bytes; this is the equivalent of more than 600,000 total items of data of 12 digits each.

One of the main advantages of this system is data safety and security. Master data can be recorded on the removable cartridge, transferred into the calculator for manipulation, stored temporarily on the fixed memory platter for further use by the calculator's program and verification prior to modifying the master data on the removable cartridge. Also, with this system, duplication of data files is easily accomplished. Year-to-date payroll data, inventory updating, account receivables and payables updating are just a few examples where this dual system offers great safety of the data base and affords the opportunity to verify the results prior to modification of master files. Should an error occur, it is easily corrected by repeating the operation since the initial data still resides on the removable memory cartridge.

In addition to providing a large amount of data storage, the 9880B Mass Memory Subsystem is fast. A 10×10 array can be transferred to the cartridge in about one second, and a typical 250-line program of 2000 words can be transferred in less than two seconds.

Model number and name

9830A Programmable calculator
9880B Mass memory subsystem

Price
\$6475
\$12,995

COMPUTATION**Calculator peripherals**

9800 Series, 2607A & 2895B (cont.)

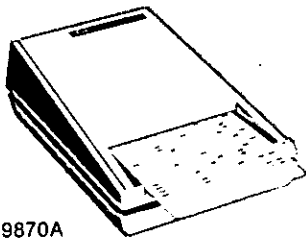
NEW

9870A

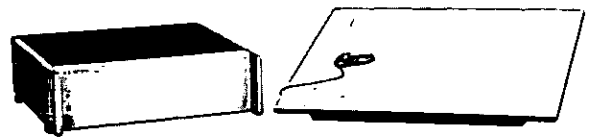

9864A

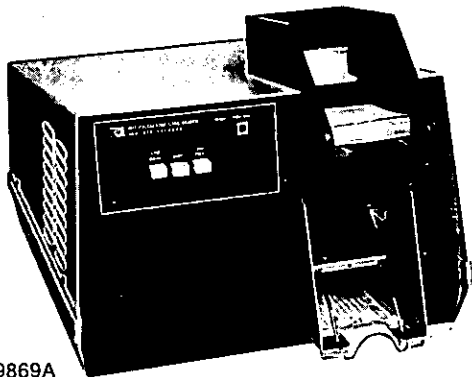

9869A

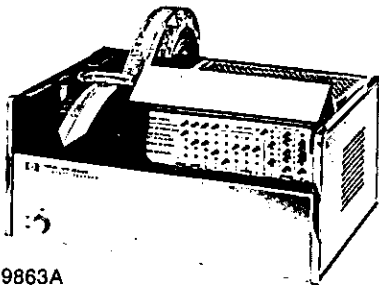

9863A

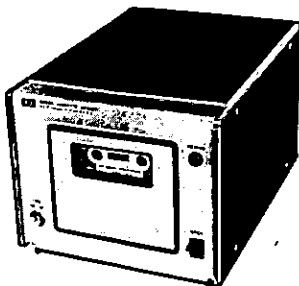

9865A

Calculator peripherals

Calculator peripherals are the input/output devices that let you tailor your programmable calculator to your specific computing requirement. All HP 9800 Series peripherals interface with all 9800 Series calculators on a plug-in basis. This makes it easy, not only to initially configure computing systems, but also to reconfigure them at some later date.

Input devices**New card readers**

The high-speed 9869A Hopper Card Reader handles 80-column punched cards as well as mark-sense cards. For smaller applications, the low-cost, hand-fed 9870A Card Reader optically reads mark-sense cards.

Interfacing

With plug-in interface cards, Series 9800 calculators take on the ability to accept data from a large number of digital voltmeters, counters, and other instruments. The 9868A I/O Expander allows you to plug up to 13 peripherals or test instruments into your calculator.

Paper tape readers

Data from analytical instruments, machine tools, and computer terminals goes directly into your calculator. The 9863A reads a wide variety of formats at 20 characters/second. The 2748B Tape Reader optically reads tapes at 300 characters/second.

Tape cassette

The high-speed 9865A Tape Cassette lets you easily store, update, and retrieve data and programs. A fast, bidirectional search feature lets you find any file on the tape without rewinding. The 9865A has a minimum capacity of 6,000 registers.

Digitizer

The 9864A Digitizer reads a curve or any irregular shape as a series of discrete points. Your HP calculator then prints out the dimensions of the line and the area of the contained shape.

Model number and name

Model number and name	Price
9869A Hopper Card Reader	\$2860
9870A Card Reader (hand fed)	\$550
9868A I/O Expander	\$1005
9863A Paper Tape Reader	\$1625
2748B Paper Tape Reader	\$1800
9865A Tape Cassette	\$1795
9864A Digitizer	\$4895

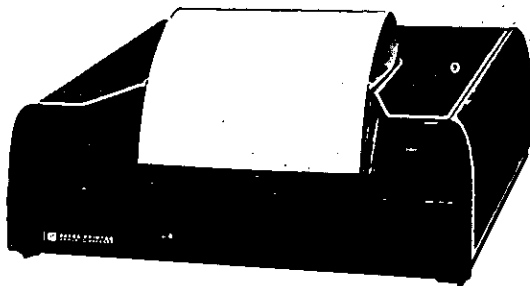

9866A

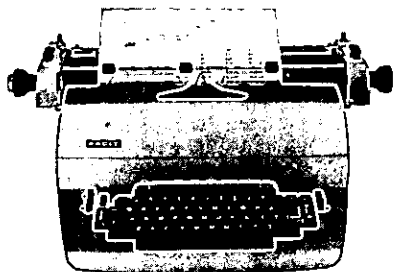

9861A

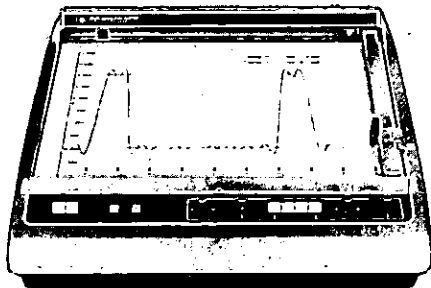

9862A

Output devices

Thermal printer

For high quality, hard-copy output, the 9866A Thermal Printer is hard to beat. Its 250 lines/minute speed is equivalent to 3,600 words/minute. It produces page-width, fully-formatted, alphanumeric text, tables, or simple plots.

Typewriter

The 9861A Typewriter has full alphanumeric capability, including uppercase/lowercase letters, punctuation marks, and symbols. Your HP calculator, operating through a peripheral control block, automatically controls such things as tab setting and clearing, ribbon color, and vertical or horizontal spacing.

New line printer

The 2607A Line Printer is a reliable, low-cost, 5 x 7 dot-matrix printer. Its unique print mechanism makes it quiet enough for any business environment and provides up to 6 consistent, clean copies. It prints at 200 lines/minute regardless of the line length and has full 132-column line width. It requires the HP 11287A Line Printer Interface Card.

Tape punch

The 2895B Tape Punch allows you to add a tape punch capability to your system. Compact and reliable, the 2895B punches tape at 75 characters/second.

X-Y Plotter

The 9862A X-Y Plotter with a peripheral control function block automatically scales your data, generates words as well as numbers, and sets up both axes, complete with labels and tick marks — all in your designated units.

New data communications

The HP 11285A Data Communications Interface allows a 9830 calculator to communicate with other 9830 calculators and computers via telephone lines and modems which meet EIA Specification RS-232-C. It can also interface to automatic dialers which meet EIA specification RS-366. The 11285A includes the 11284A Interface Cable and the 11296B Interface Control ROM.

Two new BASIC statements defined by the 11296B/F ROM enable the 9830 to write (TWRITE) messages in strings to or read (TREAD) messages from a remote terminal or computer via telephone lines. Other new BASIC statements allow configuring the 9830 as a terminal to conform to a variety of telecommunication environments. Asynchronous or synchronous data rates from 110 to 9600 bits/second are available, as well as programmable parity, automatic dialing and answering, programmable EOT and SYNC characters, and half- or full-duplex mode.

Two other ROM's may be added to further enhance the capabilities of the 9830 as a terminal. These are the 11297B Data Communications 2 ROM (binary synchronous) and the 11298B Data Communications 3 ROM (interactive).

The 11297B adds the IBM defined "Binary Synchronous Protocol" to the programmable read/write statements of the 11296B/F ROM. It also provides communication error detection and ASCII to EBCDIC conversion so that the 9830 can be programmed to look like a binary synchronous, remote-batch terminal to an IBM computer system for remote job entry.

The 11298B enables the 9830 to function like a teleprinter for low-speed, interactive communications; such as, time-sharing. The calculator can also transmit or receive BASIC language programs or "free text" which can include programs written in other languages; such as, FORTRAN.

Model number and name

Model number and name	Price
2607A Line Printer	\$7300
2895B Tape Punch	\$2575
9861A Typewriter	\$2420
9862A X-Y Plotter	\$2755
9866A Thermal Printer	\$2995
11285A Data Communications Interface and ROM	\$1500
11287A Line Printer Interface Card	\$200
11297B Binary Synchronous ROM	\$500
11298B Interactive ROM	\$500

COMPUTATION

Calculators, preprogrammed

HP-46 & HP-81

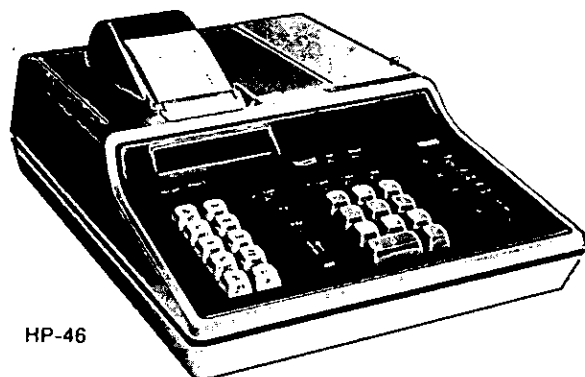
NEW

HP-46

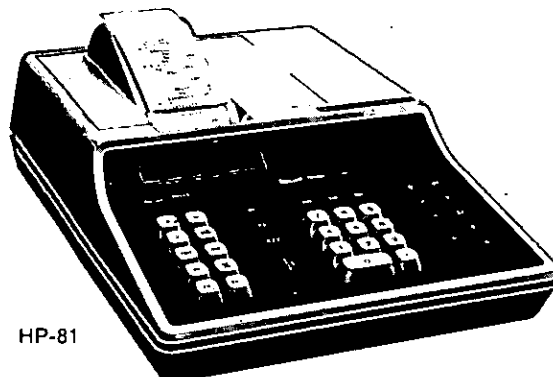

HP-81

HP-46, The desk-top slide rule with printer output

This desk-top counterpart to the HP-45 starts with the features users liked best in the HP-45: 48 high-level functions and operation, plus addition, subtraction, multiplication and division. Mean and standard deviation. Conversion of vectors to either polar or rectangular coordinates. And up to 10-digit accuracy.

Data storage registers

The HP-46 has nine data storage registers in addition to the operational stack. You can easily store data in any or all registers. It is simple to do storage arithmetic for such calculations as conversions and payroll. And for special problems, like statistics, additional answers are automatically recorded in certain registers.

Printer

With the HP-46, you also get a printout of every step of every operation for fast and easy rechecking. The alphanumeric impact printer lets you list the contents of the operational stack and registers, gives you error indications, and prints symbols, numbers, and letters in red (negative numbers) and black on standard paper tape.

LED display

The HP-46 has an optional LED display. With this option, you can use the display and the printer simultaneously or use the display only.

Capabilities

$1/x$	$\Delta\%$
y^x	Sine
x^2	Arc sine
\sqrt{x}	Cosine
LN X	Arc cosine
LOG X	Tangent
e^x	Arc tangent
10^x	Factorial
%	Mean

Standard deviation, register arithmetic, vector arithmetic, decimal degree mode, radian mode, and grad mode.

HP-81, The extra edge in money management

Now you can evaluate complex time/money relationships as easily as doing sums on an adding machine. No matter what your specialty, the computing power of the HP-81 gives you an extra edge in making business decisions. The HP-81 contains 63 fundamental business and financial functions, plus 10 preprogrammed functions, for instant solutions to thousands of business problems.

Capabilities

Primary: +, -, \times , \div ; multiply and divide by any constant; %, $\Delta\%$, $\text{Log}_{10}X$, Y^X , \sqrt{X} ; two 200-year calendars, 360/365.

Investment analysis: Discounted cash flow; discounted rate of return (for up to 9 uneven cash flows); compounded growth rate.

Depreciation: Straight line calculations; sum-of-the-digits calculations and schedule; declining balance schedule; diminishing balance schedule.

Loans: Accrued interest; present value; future value; interest per period; rule-of-78's prepayment; amortized loan schedule; APR odd-days' interest; APR given add-on interest; monthly payment for direct reduction loan.

Annuities: Future value of sinking fund; rate of interest for sinking fund; payment amount for sinking fund.

Bonds and notes: Bond price and yield; callable bond price and yield; note price and yield; coupon equivalent yield; discounted note.

Statistics: Linear regression trend line; expanded linear regression with uneven periods; coefficient of determination; mean and standard deviation.

Retail: Markup and price; cash discounts; proration; commissions.

LED display

The HP-81 has an optional LED display. With this option, you can use the display and the printer simultaneously or use the display only.

Buffered keyboard

With this option, you can enter data at top speed with no danger of overflowing the machine. Because all the keys are buffered, you can key in a new problem while the HP-81 is still solving the previous one.

Model number and name

HP-46 with printer	Price
HP-46 with printer and LED display	\$715
HP-81 with printer only	\$815
HP-81 with printer and LED display	\$925
HP-81 with printer and buffered keyboard	\$1025
HP-81 with printer, buffered keyboard, LED display	\$1150
HP-81 with printer, buffered keyboard, LED display	\$1250



The HP 3000 is a powerful disc-based computer system with multi-programming and multilingual capabilities. Users access system resources concurrently, through interactive terminals and batch devices.

Two state-of-the-art operating systems

Multiprogramming executive operating system (MPE/3000)

With MPE, the HP 3000 System provides full system and four-language capability (BASIC, FORTRAN, COBOL, and SPL — a comprehensive systems programming language) to all users at interactive terminals and batch devices. Programs may be executed from either batch or interactive terminals without modification. A powerful interactive text editor enables complete program file manipulation.

Multiprogramming executive for BASIC timesharing (MPET/3000)

With MPET, the HP 3000 System provides powerful BASIC timesharing for 16 or more interactive terminal users, and concurrently supports a multilingual (FORTRAN, COBOL, BASIC and SPL) batch background. The identical file system is used for timesharing and batch.

System organization

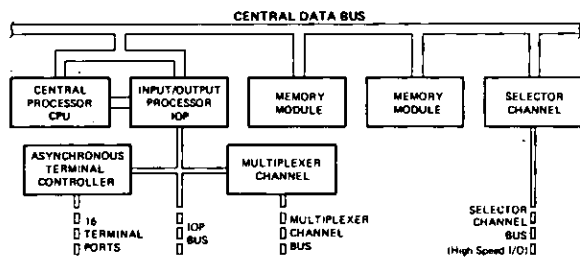

Central processor/memory

Architecture: Hardware-implemented stack; Separation of code and data; Nonmodifiable, re-entrant code; Variable-length code segmentation; Virtual memory for code; Dynamically relocatable programs.

Implementation: Microprogrammed CPU with 175 nanosecond microinstruction time; Built-in memory protection, parity checking, power-fail/auto restart.

Instructions: 170 powerful instructions, 16 bits in length; 16 and 32-bit integer, 32-bit and 48-bit floating point hardware arithmetic.

Memory: Addressable to 64K words (131,072 bytes); 17 bits (includes parity bit); Core with 980 ns cycle time.

I/O System: Privileged control of I/O; Concurrent I/O Operations; Three ways to implement I/O; Direct memory access by all channels; Device-independent I/O program execution; Independent parameters for flexible I/O.

Languages, software

BASIC/3000: Supports four numeric data types concurrently: real, integer, real extended precision, and complex.

Character string manipulation is provided. All digits, upper and lower case alphabetic characters, and all other printing and nonprinting ASCII characters can be stored in string variables.

Data files include BASIC FORMATTED files, ASCII and BINARY files. Data file security among different levels of users is furnished. Program segmentation capability is provided by CHAIN and INVOKE capabilities. An interactive debugging capability simplifies program check-out.

FORTRAN/3000: Based on ANSI STANDARD FORTRAN (X3.9-1966), has many extensions which expand the capabilities and in-

crease the power of the language. A new data type, "CHARACTER," allows FORTRAN/3000 users to directly manipulate strings up to 255 characters in length. FORTRAN/3000 also provides bit extract and deposit capability. Fixed format and free format representation for source-language-input are accepted.

Uniform access to disc files and to standard input/output devices is accomplished through the MPE/3000 file system.

COBOL/3000: A full implementation* of the ANSI standard, and conforms to the high-level Federal Standard in all categories.

Module	ANSI Rating	Federal Rating
Nucleus	High	High
Table Handling	High	High
Sequential Access	High	High
Random Access	High	High
SORT	High	High
Report Writer	Null	N/A
Segmentation	High	High
Library	High	High

*Every module except report writer.

SPL/3000: A high-level as well as a machine-dependent language. As a high level language, it is similar (but not equivalent) to ALGOL, and offers to the programmer the capability to produce the more usual coding sequences. The programmer can also easily exert control over machine-dependent functions of the computer system.

EDIT/3000: The interactive Text Editor which permits MPE Operating System users to create and manipulate program or text files.

IMAGE/3000: Provides the capabilities to describe data base structures through the use of a schema language, create data bases, and access and maintain data. Utilities are included for the dumping and restoring of data bases from magnetic tape.

QUERY/3000: Provides the ability to locate, report and update data values within an IMAGE/3000 data base.

SORT/3000: Provides the capability to sort and/or merge multiple files of sequential records into a sequential file.

STAR/3000: Provides simplified access to statistical functions of the HP Scientific Library through statistical analysis routines.

Ordering information and prices

HP 3000 Model 100: Includes 96K bytes of memory, 16-port terminal controller, system console, 600 cpm card reader, 200 lpm printer, 9-track 800 cpi magnetic tape unit, and 9.8M byte on-line storage.

With MPET Operating System: \$129,500
With MPE Operating System: \$134,500

Expansion equipment includes additional core memory, extended instruction set, terminals, additional on-line storage and on-line peripherals.

HP 3000 Model 200: Includes 128K bytes of memory, 16-port terminal controller, system console, 600 cpm card reader, 200 lpm printer, 9-track 800 cpi magnetic tape unit, 47M byte on-line storage, and 2M byte swap disc.

With MPE or MPET Operating System: \$176,000
Expansion equipment includes additional terminals and on-line peripherals.

Additional on-line peripherals available: Include a 600 lpm printer, 250 cpm card punch, 1200 cpm card reader, plotter interface, 75 cps paper tape punch, 500 cps punched-paper-tape reader, and a programmable controller (for interfacing to other on-line peripherals and to provide on-line data acquisition capabilities). Additional multiple-disc drives are available for increased storage.

COMPUTATION

HP 21MX Series computer systems

For end user and OEM applications

NEW

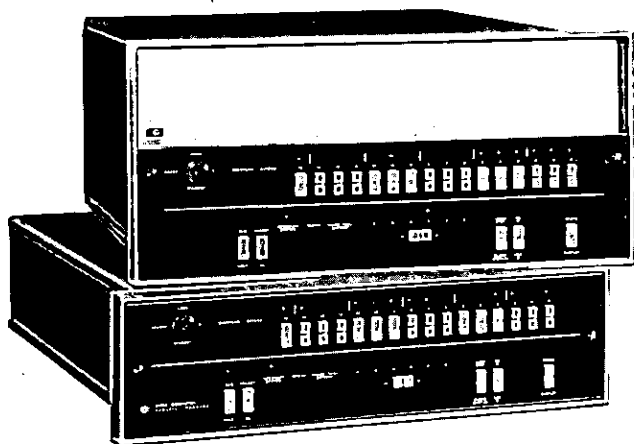

The HP 21MX Series offers a wide choice of semiconductor memory systems, user microprogrammable processors, and customized instruction sets. Independent selections from HP 21-M processors, HP 21-X memory systems, and common firmware enhancements make it possible to customize a computer mainframe to match a specific application.

Designed to take full advantage of 4K MOS RAM semiconductor technology, 21MX series processors feature 128 standard instructions (including floating point and data communications), 178 user accessible micro-orders, power fail interrupt, memory parity check, multilevel vectored priority interrupt structure, and up to four separate internal bootstrap loaders switch-selectable from the front panel.

Designed to cope with a wide range of power fluctuations and brownout conditions, an HP 21MX computer continues to operate normally while line voltage varies from nominal (110 V or 220 V) by as much as $\pm 20\%$, or while line frequency varies between 47 and 66 Hz, or even if power fails completely for $2\frac{1}{2}$ full power cycles.

A complete line of peripheral devices is also available including discs, magnetic tape units, card readers, line printers, plotters, paper tape devices, and terminals. Local HP Field Engineers can provide a detailed computer products catalog. OEM prices and discount schedules for quantity purchases are available.

Processors

HP 21-M/10

\$4150

Only $5\frac{1}{4}$ inches high, this powerful processor supports up to 32K of semiconductor memory in the mainframe and at the same time provides four powered I/O channels and full user microprogramming capability. The number of I/O channels may be increased to 36 by the addition of I/O extenders.

HP 21-M/20

\$5300

Supports up to 65K in an $8\frac{3}{4}$ inch mainframe, 9 powered I/O channels, optional memory protect system and full user microprogramming capability. I/O channels may be increased to 41 by the addition of I/O extenders.

Processor enhancements

Fast FORTRAN processor (12977A)

\$1500

Firmware microcode for more than a dozen instructions. Four word double precision operations, two and three-dimensional array addressing and other commonly used routines provide 2 to 30-fold increase in scientific program execution.

Memory systems

HP 21-X/1

Available in 8K and 16K modules, this high density, semiconductor memory system provides maximum memory expansion within the mainframe. Utilizes a high density 16-pin memory component.

Controller	\$650
8K module	\$2500
16K module	\$4600

HP 21-X/2

Available in 4K and 8K modules, this medium density, semiconductor memory system offers additional price advantage when maximum memory expansion is not required. Utilizes a 22-pin memory component.

Controller	\$500
4K module	\$1300
8K module	\$2150

Microprogramming option

Writable control store (12978A)

\$1250

Dynamically alterable, 256 24-bit word storage for microprograms. Enables access to additional high speed registers and read/write capability from memory.

Data communications interfaces

HP data communication interface cards permit HP 21MX Series and HP 2100 Series computer users to transmit data using a wide variety of privately-owned and common-carrier communication facilities. All communication interfaces conform to EIA specification RS-232, provide programmable character size, programmable parity checking and a variety of programmable or jumper selectable data rates. All interfaces can be operated under program or DMA control.

Asynchronous data set interface (12587B)

\$550

Provides two-way communications with Bell 103 or 202 Data Sets or equivalent. Operates from 26 to 3110 baud in simplex, half duplex or echoplex mode. Programmable character size is from 1 to 8 bits plus an optional parity bit.

Synchronous data set interface (12618A)

\$700

Provides two-way communications with devices such as a Bell 201A/B Data Set or equivalent. Operates up to 9600 baud in half or full duplex mode with fully independent transmit and receive channels. Programmable functions include parity checking, synchronization, special character recognition and character size.

Automatic dialer interface (12589A)

\$400

Permits automatic dialing of a computer generated phone number when used in conjunction with a Bell 801 Automatic Dialing Unit or equivalent. Can be used with either HP asynchronous or synchronous data set interfaces.

Asynchronous multiplexer (12920B)

\$2200

Provides interfacing for up to 16 communications devices at programmable rates from 57 to 2400 baud, with automatic speed detection at seven standard rates including the IBM 2741. Operates in full duplex, half duplex or echoplex modes with automatic answering and automatic break detection. Programmable functions include parity generation and checking, split speed operation and character length, from 5 to 12 bits.

Provides two-way communication between an HP computer and teleprinters, keyboard-display terminals, and Bell 103 Data Sets or equivalent.

Display terminal interface (12880A)

\$350

Provides local two-way communication with a keyboard/display terminal. Data rates from 110 to 9600 baud are automatically determined by the terminal external clock signal.

Hardwired serial interface (12889A)

\$750

Provides high-speed, asynchronous, long distance, point-to-point data transfer between two HP computers. Capable of transmitting up to 1000 feet at 2.5 million baud or up to 2400 feet at 1.25 million baud.

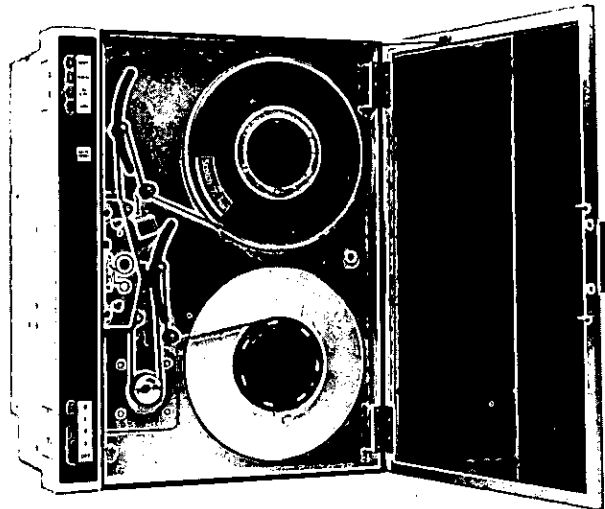

General purpose interfaces

HP general purpose interfaces are contained on individual plug-in/I/O cards. In addition to the appropriate data registers, each interface has independent flag and control logic, allowing two-way communication between an HP 21MX Series or an HP 2100 Series computer, and one or more external devices. All interfaces operate under either program or direct memory access control. A wide choice of interfaces allows external connection via floating contact closures, DTL/TTL, transistor or differential logic.

16-Bit relay register (12551B) \$515

Provides 16 floating contact closures and optional read-back circuitry for data verification.

16-Bit duplex register (12554A) \$450

Provides 16 input and 16 output transistor logic lines.

8-Bit duplex register (12597A) \$415

Provides 8 input and 8 output transistor logic lines.

Microcircuit interface (12566B) \$500

Provides 16 input and 16 output DTL/TTL compatible lines.

Universal interface (12930A) \$905

Provides 16 input and 16 output lines with differential transmitters and receivers for operation up to 500 feet. Can be operated in either a single or dual-channel mode.

Data source interface (12604B) \$875

Provides 32 input lines for sensing external voltages relative to an externally provided reference level.

Digital to analog converter (12555B) \$600

Provides two analog output channels ranging from 0 to +10 volts with 8-bits-per-channel resolution. Also provides two logic level outputs for external device control.

Magnetic tape subsystems

Magnetic tape subsystem (12972A) \$10,900

Phase Encoded format 7970E, 9-track tape drive subsystem. Provides 1600 cpi capability at speeds of 25, 37.5 or 45 ips.

Disc subsystems

HP disc subsystems are built around highly reliable field-proven moving head drives. All units are completely interfaced and boast exceptionally fast access times.

Cartridge disc subsystem (12960A) \$15,000

Compact 4.9 million byte 7900A dual platter disc subsystem. Controller handles up to 4 drives for a maximum capacity of 19.6 million bytes. This field-proven disc subsystem provides exceptionally fast (30 msec.) average access time with guaranteed interchangeability.

Disc file subsystem (12965A) \$29,900

Provides 23.4 million bytes of storage using a standard 11-high removable pack. Controller handles up to 2 drives for a maximum capacity of 46 million bytes. Average access time is 32 milliseconds.

7970 Series digital tape recorder

OEM, on-line, and off line applications

These units provide 800, 556, or 200 cpi NRZI and 1600 cpi phase-encoded electronics with the same superior operational and reliability characteristics usually associated with higher priced and more complex digital recorders. The 7970 was especially designed as a modular unit to enhance serviceability and reliability. All major transport assemblies are easily accessible for service and/or replacement, when required. The complete data electronics assembly is made up of plug-in type cards, neatly packaged in card cages within the 24-inch transport.

Model 7970B option configuration table (NRZI only)

Speed	9 Track	7 Track	7/9 Track
	RAW	RAW	R/O
21-37.5 ips	Std	133	140
37.6-45 ips	127	136	141

Model 7970E option configuration table

Speed (ips)	9 Track						7/9 Track	
	PE Only				PE/NRZI		PE/NRZI	
	RAW Slave	RAW Master	R/O Slave	R/O Master	R/O Slave	R/O Master	R/O Slave	R/O Master
21-37.5 ips	146	Std	148	149	158	159	160	161
37.6-45 ips	150	151	152	153	162	163	164	165

RAW = Read After Write
Master = initial PE unit
R/O = Read Only

Slave = additional PE unit
R/R = Read/Read

Tape speed range: 21 to 45 ips.

Reel diameter: up to 10 1/2" (26.7 cm).

Tape: computer grade.

Width: 0.5".

Thickness: 1.5 mils.

Tape tension: 8.5 ounces, nominal.

Tape format: IBM/ANSI compatible.

Rewind speed: 160 ips.

Start/stop travel: Read-After-Write: 0.187" ±0.020".

Power requirements: 115 or 230 (±10%) V ac, 48 to 60 Hz single phase. 400 VA, maximum (on high line).

Size: 610 × 483 × 400 mm (24" H, 19" W, 15 1/4" D). Depth from mounting surface: 305 mm (12").

Weight: 63.5 kg, maximum (140 lb).

Operating environment (hardware):

Ambient temperature: 0° to +55°C (+32° to 131°F).

Relative humidity: 20% to 80% noncondensing.

Altitude: 3048 meters (10 000 feet).

7970B-Std

\$6360

7970E-Std

\$8885

*For complete specifications and a list of accessories, request technical Data Sheet (7070B/C or 7970E). OEM prices and discount schedules are available.

COMPUTATION

HP 2000 series computer systems

Models S/110, S/210, S/250, S/310, 2000/E, 2000/F, M/230, M/260

NEW

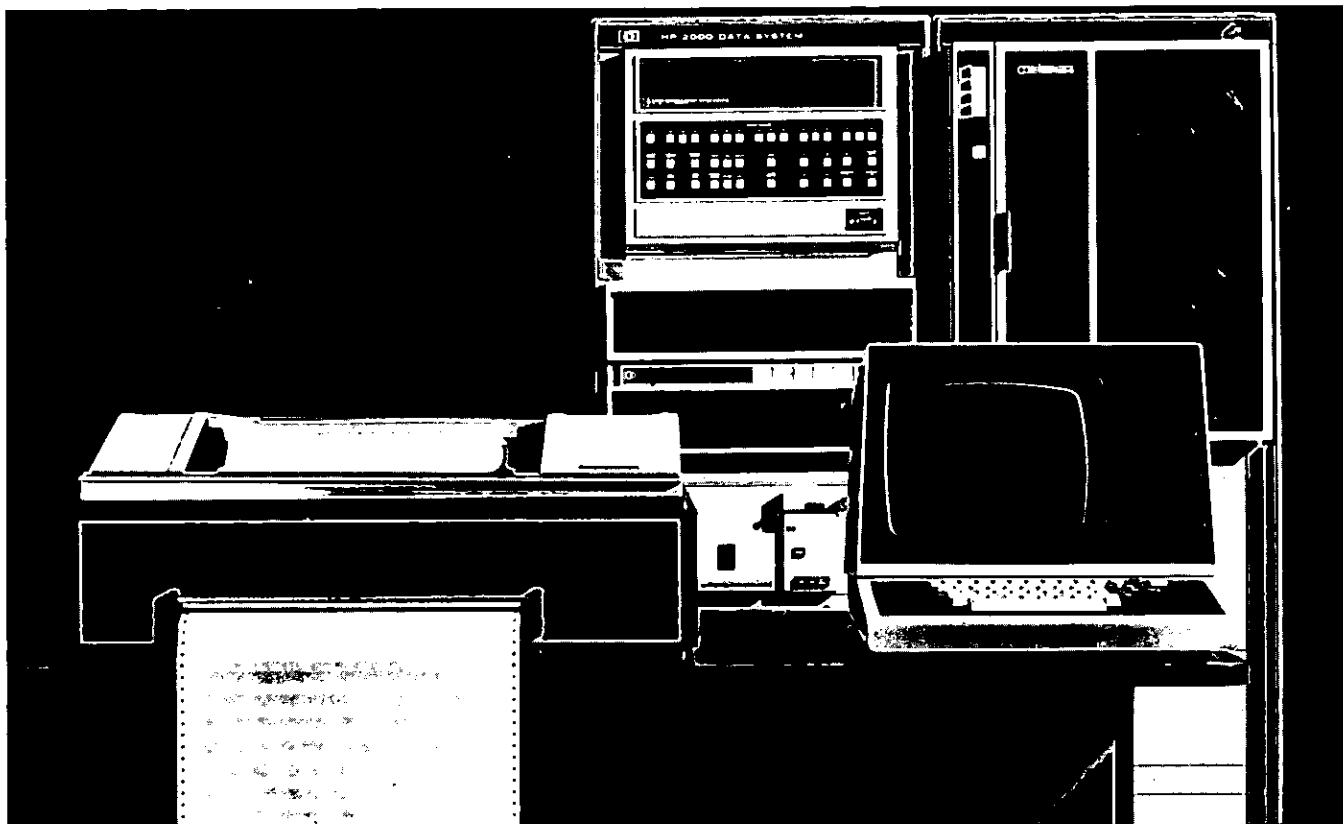

The HP 2000 Series computer systems are combinations of hardware and software configured to solve specific types of user problems. The 2000 series include scientific, management, and educational data systems.

Scientific data systems

S/110

Basic building block of all 2000 series systems. Employs the 2100S microprogrammable computer, with core-memory-only operation for computation, data acquisition, or as a satellite in a distributed computer network.

S/210

2100S computer with disc operating system for low cost computation in FORTRAN, ALGOL or Assembly language, in terminal or automatic batch mode.

S/250

2100S computer with Fast FORTRAN firmware for computation, and a disc-based data management software package to relieve the user from programming complex file processing routines. CRT console and line printer are also included for easy programming.

S/310

A 2100S Real Time Executive disc-based system, for multiprogramming computation (background/foreground), and real-time response to user data acquisition and control instrumentation.

2000/E

Low cost "starter set" timesharing system; supports 16 problem-solving terminals in BASIC language under TSB/E.

2000/F

Dual Processor (2100S) timesharing system for rapid response problem-solving in the Timeshared BASIC language, for up to 32 concurrent users.

Management data systems

M/230

Multiterminal Transaction Processing; communication oriented, computer system for on-line data entry and processing applications.

Up to 32 terminals are available with the standard Terminal Control Software. The system provides multiple user access, concurrent task independence, "real time" terminal response, high transaction throughput.

M/260

On-line, Dedicated Data Base Management; computer system for business applications, when the need is for accessing many records and files of interrelated data. Such applications normally demand large volumes of data, and have a need for concise reports, cross referencing of data, retrieving data on key parameters. The system with IMAGE software will handle up to 32 terminals with a data base from 5 to 94 million bytes.

Component products

Central processor (2100S): up to 32K words of core memory, dual channel direct memory access, hardwired extended arithmetic instructions, floating point hardware, power fail and automatic restart, memory parity check with interrupt, crystal controlled time base generator.

Disc memory (12960A): 4.9 megabyte capacity, removable cartridge, average access 30 milliseconds, transfer rate 312K bytes/sec.

Magnetic tape (12972A): 9 track, 1600 cpi, 45 ips, IBM/ANSI compatible, phase-encoded.

Paper tape reader (12925A): 50 cps, photoelectric, 8 level code.

System consoles:

(2752A): 10 cps, ASR-33 teleprinter, friction feed.

(2754A): 10 cps, ASR-35 teleprinter, tractor feed.

(2762A): 30 cps, form feed, tractor feed.

(2615A): 960 cps, CRT display.

Fast FORTRAN processor (12907A): 13 microcoded (firmware) FORTRAN subroutines; up to 20 times faster than software predecessors.

Line printer (12987A): 200 lpm, 132 column, 8 track form feed.

Terminal multiplexer (12920A): 16 asynchronous channels, EIA RS232, 57 to 2400 baud.

Disc operating system software (24307B DOS-III): disc based operating software; features batch processing, data communication and overlay management, privileged interrupt; supports up to 94M bytes on-line, system generation from dual platter disc, on-line disc duplication.

Timeshared basic software (TSB-E): 16 simultaneous users in BASIC language, automatic accounting, chaining, strings, security, random and sequential files, public and private libraries.

Timeshared basic software (TSB-F): same as TSB-E except 32 simultaneous users, disc storage to 188M bytes, magnetic tape/reloads, 16 open files, public, group and private libraries.

Real time executive software (RTE): disc-based multiprogramming (background/foreground) operating system, priority scheduling, FORTRAN IV, development concurrent with execution, overlays, easy-to-use directives editor and compilers, optional file manager.

Basic control system software (BCS): core based operating system with FORTRAN, ALGOL, single terminal BASIC. Paper tape-oriented.

IMAGE/2000 software (24376B): data base management software system that accesses data by key value (such as customer name), eliminates data redundancy, automatically links data, provides data security and privacy; provides subsystems to define, load, query, restructure and access a data base. The data base is expandable from 5M to 94M bytes.

Terminal control system software (24342A): multitask control program that provides task priority scheduling for up to 16 levels, overlapping of I/O transfers, minimal disc seeks, locking of I/O devices, simultaneous multiple user access to the same data base, minimal program overlay time.

COMPONENTS SUMMARY

COMPONENTS

MANAGEMENT

SCIENTIFIC

HARDWARE	PRODUCT NUMBER	M/230	M/260	S/110	S/210	S/250	S/310	2000/E	2000/F
Central Processor	2100S	16K	24K	8K	16K	24K	16K	16K	32K 8K
Disc Memory	12960A	5 Mb	5 Mb	—	5 Mb	5 Mb	5 Mb	5 Mb	5 Mb
Magnetic Tape	12972A	1600 bpi	1600 bpi	—	—	1600 bpi	—	—	800 bpi
Paper Tape Reader	12925A	500 cps	500 cps	500 cps	500 cps	500 cps	500 cps	500 cps	500 cps
System Console	2752A			10 cps	10 cps		10 cps		
	2762A		30 cps					30 cps	30 cps
	2615A	960 cps				960 cps			
Cabinets & Power	2860B	2 bays	2 bays	1 bay	1 bay	2 bays	1 bay	1 bay	2 bays
Fast FORTRAN Processor	12907A					X			
Line Printer	12987A					200 lpm			
Terminal Multiplexer	12920A	16 ch.						16 ch.	16 ch.

SOFTWARE

Disc Oper. System	24307B	X	X		X	X			
Timeshared BASIC	E 20856A							X	
	F 20854A								X
Real-Time Executive	2300E						X		
Basic Control System	20855A			X					
Data-Base Management	24376B		X			X			
Terminal Control	24342A	X							
	SYSTEM PRICE	\$48,950	\$53,950	\$15,750	\$30,950	\$59,950	\$36,050	\$34,950	\$64,750

COMPUTATION

Optical mark readers for direct data input

Models 7260A & 7261A

NEW

- Flexible card format

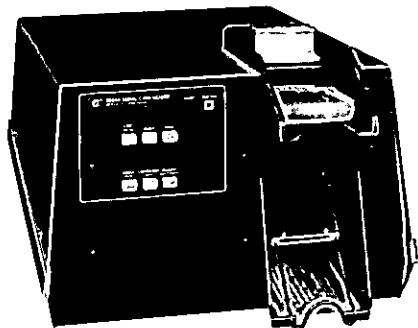

7260A

- High-speed operation

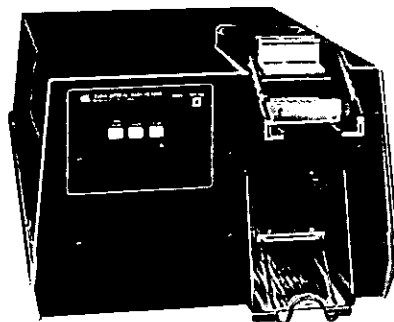

7261A

The Hewlett-Packard Models 7260A and 7261A Optical Mark Readers are desk-top data transmission instruments. The Readers optically (photo-reflectively) read standard 8.26 cm (3¼ in.) wide paper information processing cards. Card lengths from 18.73 cm to 28.26 cm (7½ in. to 11 in.), having 40 or 80-column marked or key-punched information using on-data or after-data clocking are accepted. With Option 003, the Readers can also read cards without clock marks. They can handle 300 processing cards at a time (up to 450 with Option 001) at feed rates of up to 300 cards per minute.

7260A Specifications

Code capacity: recognizes 128 characters Hollerith code. Other codes available on request.

Translation: translates to bit serial 7-level ASCII with even parity (odd parity available by changing internal jumper).

Operational modes: demand and continuous feed.

Parity: generates and transmits even parity (odd parity available by changing internal jumper).

Data rates: 100, 150, 300, 600, 1050, 1200, 2400 baud, switch selectable.

Form dimensions: standard tab card size 8.26 × 18.73 cm (3¼ × 7½ inches) or 8.26 × 28.26 cm (3¼ × up to 11½ inches).

Hopper capacity: 300 cards input, 450 cards output, 450-card input available. See Option 001.

Interface: RS-232C.

Interface connectors: 2 Cinch/Cannon DBM-25S - rear panel.

Dimensions: 61 × 36.8 × 26.7 cm (24 × 14½ × 10½ inches).

Weight: Net, 24.6 kg (54 lb). Shipping, 33.2 kg (73 lb).

Environmental: (exclusive of forms)

Storage temperature: -40°C to +75°C

Exposure power on: -20°C to +65°C

Meets specifications: 0°C to +55°C

Humidity: 5%-95% at 25°C to 40°C

Vibration: 10-55 Hz, .01 in. peak-to-peak excursions

Cards: From 20% to 75% RH at 73°F

AC power: (See Option 005 for 220/240 Vac operation) 100/120 Vac, +5% - 10%, selectable by rear panel switch 47.5 Hz - 66 Hz.

Average running VA: 300 VA

Main fuse: 4 A SB

Transformer fuse: 2 A SB

U.L. approval: The reader has U.L. and CSA approval and meets IEC specifications.

Options

Options	Price
001: 450-Card Hopper	\$25
002: Select Hopper	\$220
003: Encoder	\$220
004: Bell	\$55
005:	N/C
006: 50 Hz	N/C
016: Mute and Line	\$160
017: Nulls	\$55
018: Mnemonic Control	\$55
019: Image	\$25

7261A Specifications

Card code and output codes: the information from each card is converted by the Reader to a parallel 12-channel format.

Form dimensions: standard tab card size, 8.26 × 18.73 cm (3¼ × 7½ inches) or 8.26 × 28.26 cm (3¼ × up to 11½ inches).

Hopper capacity: 300 cards input, 450 cards output, 450-card input available. See Option 001.

Interface connector: 36 Pin Cinch Micro-Ribbon - rear panel.

Dimensions: 61 × 36.8 × 26.7 cm (24 × 14½ × 10½ inches).

Weight: Net, 24.5 kg (54 lb); shipping, 33.2 kg (73 lb).

Environmental: (exclusive of forms)

Storage temperature: -40°C to +75°C

Exposure power on: -20°C to +65°C

Meets specifications: 0°C to +55°C

Humidity: 5%-95% at 25°C to 40°C

Vibration: 10-55 Hz, .01 in. peak-to-peak excursions

Cards: From 20%-75% RH at 73°F

AC power: (see Option 005 for 220/240 V ac operation) 100/120 Vac, +5% - 10%, selectable by rear panel switch. 47.5 Hz - 66 Hz.

Average running VA: 300 VA

Main fuse: 4 A SB

Transformer fuse: 2 A SB

U.L. approval: The Reader has U.L. and CSA approval and meets IEC specifications.

Options

Options	Price
001: 450-Card Hopper	\$25
002: Select Hopper	\$220
003: Encoder	\$220
004: Bell	\$55
005: 220/240 V ac +5% - 10% (main fuse 2 A SB, Transformer 1 A SB)	N/C
006: 50 Hz	N/C

Model number and name

7260A Optical Mark Reader	\$3190
7261A Optical Mark Reader	\$2760
12986A with interface to HP 2100 series computers	\$3775
OEM and quantity discounts available.	
Service contracts available to meet your specific needs.	

Graphic plotter for computer applications

Model 7210A

- High speed graphics

- Complete status monitoring

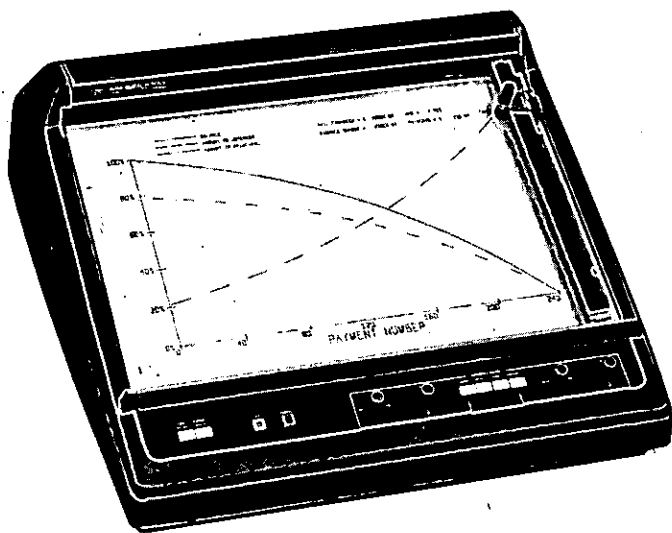

The Hewlett-Packard Model 7210A Digital Plotter is an output peripheral designed for use with computers and computer systems. The exceptional speed, resolution, and accuracy are available at the low cost normally associated with analog plotters, yet the 7210A does not require the higher system overhead of incremental plotters.

It can be added easily to either your computer or terminal. Accepting either Binary or BCD codes under full program control, the pen can make up to 20 moves per second at any angle. The internal microprocessor allows typical operation with less than 250 16-bit words of computer memory.

Any sheet type graph paper, up to 27.9 × 43.2 cm (11 × 17 inches), with or without preprinted grids, may be used. The Autogrip paper hold-down system solidly grips the paper. Four colors of ink are available in clean, disposable pens that can be changed quickly and easily.

7210A Specifications

Plotting surface: 25.4 × 38.1 cm (10 × 15 in.).

Plotting area: Front panel scaleable from 25.4 × 38.1 cm (0 × 0 to 10 × 15 in.).

Plotting maneuvers: Pen or position. Pen and position maneuvers are independent commands.

Vector generation: Automatic. A command to perform a position maneuver will cause the Plotter to traverse a straight line path to any specified point on the platen.

Vector length: Limited only by the plotting surface.

Vector speed: up to 30.5 cm/sec (12 in./second). The speed is dependent upon the slope of the line. Plotter will process up to 20 vectors/second.

Numerical code: Position data is received in BCD (8421) or Binary.

Plotting modes: Absolute coordinates and relative coordinates.

Numerical resolution: 1/10,000 (0.01%).

Plot accuracy: Better than 0.10 cm (0.04 inch) in 38.1 cm (15 inches).

Resettability: 0.18 mm (0.007 inch) max.

Writing method: Ink, disposable pens.

Paper size: Any size up to 27.9 × 43.2 cm (11 × 17 in.).

Power: 100 V, 115 V, 200 V, or 230 V ± 10% (choice of 4 positions at rear panel), 48 to 66 Hz, 100 watts maximum.

Weight: Net 18.1 kg (40 lb); Shipping 23.6 kg (52 lb).

Accessories supplied

	HP Part Number
1. Accessory Kit	07210-80010
1 Pkg Disposable Pens, Red (3)	5081-1190
1 Pkg Disposable Pens, Blue (3)	5081-1191
1 Pkg Disposable Pens, Black (3)	5081-1193
1 Slidewire Cleaner	5080-3605
1 Slidewire Lubricant	5080-3635
1 Fuse (for 230 V operation)	2110-0080
2. Operating Manual	07210-90000
3. Interface Manual	07210-90002
4. Mating Connector	
1 50 Pin Connector	1251-2771
1 Hood	1251-2769
2 Jackscrews	1251-2770
5. Dust Cover	4040-0477
6. Graph Paper, 20 sheets (English)	9270-1004
7. Graph Paper, 20 sheets (Metric)	9270-1024
8. Power Cord 2.3 m (7.5 ft)	8120-1348

Supplies available

Disposable Pens (package of 3)	HP Part Number
Red	5081-1190
Blue	5081-1191
Green	5081-1192
Black	5081-1193

Graph Paper (box of 100 sheets)

	Plot Area	HP Part Number
Linear	25 cm × 38 cm	9270-1024
Linear	10 in. × 15 in.	9270-1004
Linear	18 cm × 25 cm	9270-1023
Linear	7 in. × 10 in.	9270-1006
Semi-Log	10 in. × 2 cycle	9280-0159
Semi-Log	10 in. × 3 cycle	9280-0160
Semi-Log	2 cycle × 15 in.	9280-0169
Semi-Log	3 cycle × 15 in.	9280-0168
Log-Log	2 cycle × 3 cycle	9280-0167
Log-Log	3 cycle × 2 cycle	9280-0165
Log-Log	3 cycle × 4 cycle	9280-0171
Blank (with scaling points)	10 in. × 15 in.	9280-0180

Accessories available

	Price
17260A Plotter Stand (includes mounting plate)	\$85
17261A Mounting Plate	\$20
Carrying/Transit Case (P/N 9211-1377)	\$220
12935A Plotter Subsystem (7210A Interfaced to 2100 series computers)	\$4235

7210A

OEM Discounts Available

\$3400

PHYSICAL AND OPTICAL MEASUREMENTS

General information



5526A Laser Measurement System checking straightness of travel of a machine tool.

5526A Laser calibration system

The Hewlett-Packard 5526A Laser Calibration System utilizes a precisely-known wavelength of light to provide a portable, easily used dimensional measurement tool for such parameters as length, angle, straightness, squareness and flatness.

The 5526A Laser Calibration System is used in a wide variety of applications where very accurate physical measurements are required, such as characterizing the positioning accuracy and geometry of machine tools and measuring machines.

A wide variety of output devices are available to record the measurement data including digital printers and X-Y recorders. The Option 200 Laser/Calculator System allows the measurement data to be transferred directly from the Laser Calibration System to the 9820A Programmable Calculator and immediately processed by pre-written metrology programs. The reduced data is then presented in either printed format or plotted to provide report quality graphs of the measurements.

5501A Laser transducer

The 5501A Laser Transducer utilizes the same technology as the 5526A Laser Calibration System to provide a low-cost, built-in linear and angular measurement transducer.

The system is designed as a high accuracy and resolution positioning transducer for such applications as machine tools, measuring machines and integrated circuit manu-

facturing equipment. The modular configuration of the Laser Transducer allows using a single laser source to monitor up to 6 axes of motion simultaneously. This feature, plus numerous other design innovations, significantly lowers the cost of laser interferometer feedback. A range of output devices offers the choice of feedback control, digital display, or both. Although the Laser Transducer is designed for original equipment manufacturers (O.E.M.), simple installation techniques make it attractive for retrofit by end-users as well.

Digital thermometers

HP's 2801A, a research-type quartz thermometer, provides extremely precise, reliable measurements with resolution to 0.001°C over the range -80° to +250°C. A Model 2833B Oceanographic Temperature Sensor Assembly for the 2801A Quartz Thermometer is especially designed for use in rugged environments such as oceans, rivers, harbors and industrial fluids at pressures up to 10,000 psi. It meets all requirements for oceanographic investigations, for temperature profile and thermal pollution studies in rivers and harbors, for well-logging, factory effluent studies and other difficult industrial environments.

The 2802A Platinum Resistance Thermometer, a medium-priced thermometer with features usually found in more costly units, has two ranges; -200°C to +600°C

and -100°C to +200°C making it ideal for a wide variety of applications. Battery or BCD output accessories easily snap into place. In addition, the display unit may be used with other HP snap-in modules to make a voltmeter, a multimeter, a pre-amp ammeter, as well as other combinations offered by Hewlett-Packard.

Radiant flux meter

This complete, multi-purpose optical radiometer system is ideally suited for use in a wide variety of exacting applications involving the accurate measurement of radiant power density in the ultraviolet, visible and infrared regions of the electromagnetic spectrum.

A fully calibrated system, it reads directly in absolute radiometric units of watts per cm² at any wavelength and at any power level within the range of the detector.

Quartz pressure gauge

Precision pressure measuring capability and rugged construction make the HP 2811B Quartz Pressure Gauge (Probe and Signal Processor) ideal for applications requiring surface readout such as oil well logging, oceanographic research, and studies of subterranean hydrodynamics. An electronic frequency counter must be used to produce a digital display; any of various recorders, printers, computers or other data handling devices can be connected to the counter output.

PHYSICAL & OPTICAL MEASUREMENTS

Laser transducer for "build-in" applications
Model 5501A

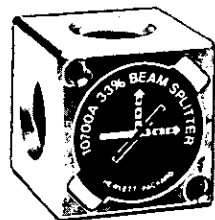
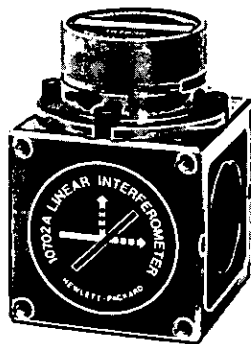
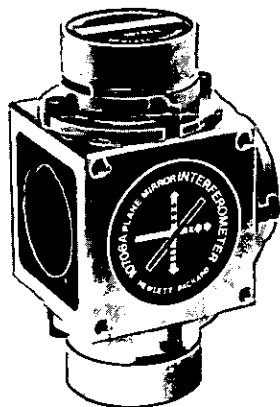
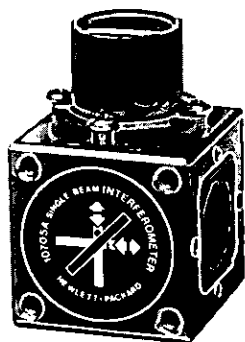
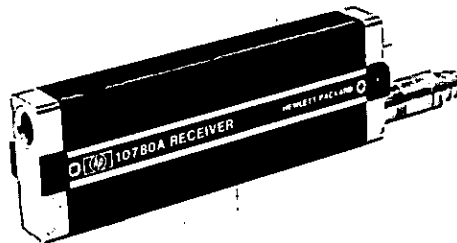
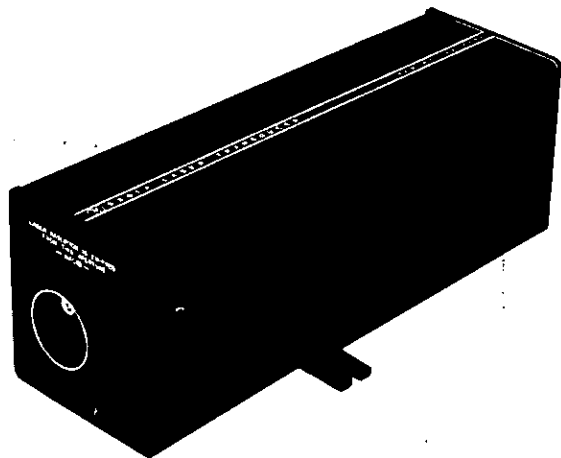

Systems description

The 5501A Laser Transducer is the basis of a linear displacement measuring system which brings the many advantages of interferometry to builders and users of accurate positioning equipment at a cost comparable with conventional devices. Using a single laser source, up to 6 axes of motion may be monitored simultaneously. This feature, plus numerous other design innovations, significantly lowers the cost of laser interferometer feedback. A range of output devices offers the choice of feedback control, digital display, or both. Although the Laser Transducer is designed for original equipment manufacturers (OEM.), simple installation techniques make it attractive for retrofit by end-users as well.

Specifications

Resolution: 6 microinches ($0.16 \mu\text{m}$) or 3 microinches ($0.08 \mu\text{m}$) using Plane Mirror Interferometer.

Accuracy: ± 0.5 parts per million.

Range: Up to 200 feet (60 meters) depending upon conditions (sum of axes for multi-axis configurations).

Number of axes: Up to six depending on system configuration and environmental conditions.

Maximum allowable signal loss: 95% (-13 dB).

Maximum lateral return beam offset: ± 0.2 ($\pm 5 \text{ mm}$).

Maximum allowable velocity: 720 in/min (18.3 meters/min) or 360 in/min (9.14 meters/min) using Plane Mirror Interferometer.

Optical accessories

Accessory	Price
10700A 33% Beam Splitter	\$300
10701A 50% Beam Splitter	\$300
10702A Linear Interferometer	\$1160
10703A Retroreflector	\$550
10704A Retroreflector	\$700
10705A Single Beam Interferometer	\$1425
10706A Plane Mirror Interferometer	\$2150
10707A Beam Bender	\$140

Electrical accessories

Accessory	Price
10740A Coupler	N/A
10741A Laser Transducer Interface	\$430
10742A Laser Transducer Counter	\$495
10743A Extender Board	\$125
10780A Receiver	\$290
10781A Pulse Converter	\$380
10782A Service Kit	\$750

Other options

Real time resolution extension by factors of six and ten are available along with modular power supplies and interfaces to Hewlett-Packard 9800 series Calculators.

5501A Laser Head

\$4750

PHYSICAL AND OPTICAL MEASUREMENTS

Laser system for dimensional measurements

Model 5526A

NEW



Model 5526A Laser/Display
System Base

Choice of options for
Length, Angle, Flatness,
Straightness Non-contact and 2 Axes

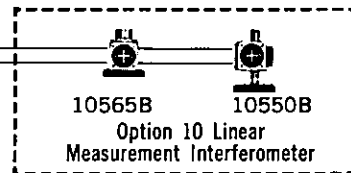

Configuration

The 5526A Laser Measurement System is a major advance in economical dimensional metrology. A choice of options allows the measurement of length, angle, flatness, straightness, squareness, parallelism and the capability of two measurements simultaneously. In addition, output options are available to reduce the data to printed or plotted format. The 5526A, which forms the base of the system, includes the 5500C Laser Head and the 5505A Laser Display. Measuring and output options are added to this base system to allow modular build-up of measurement capability.

General capabilities

The system is a highly accurate displacement measuring tool with a resolution of one millionth of an inch ($0.01 \mu\text{m}$) for linear measurements and 0.1 arc-second for angular measurements. Fully automatic tuning, instant warm-up and remote interferometric measurement techniques assure drift-free accuracy from the moment of switch-on. A laser tube lifetime in excess of 10,000 hours can be confidently expected and the unique optical heterodyning principle makes for practical, convenient measurements in adverse environments.

Measurement options

Option 010 linear Interferometer

This option consists of the 10565B Remote Interferometer and a 10550B Retroreflector. Since the Remote Interferometer is completely passive, it makes for an almost perfect linear measuring instrument. Complete thermal stability is assured since the laser head can be some distance away on a tripod. The small size of the Remote Interferometer allows easy fixturing and minimal distortion.

The Option 010 Linear Interferometer is ideal for any high accuracy and resolution linear measurement requirement such as machine tool calibration and metrology laboratory use.

Option 020 linear + angular flatness Interferometer

While including all the capabilities of the Option 010 Linear Interferometer, this option also provides angular measurement ability. The addition of passive optical modules allows fast, accurate measurements of pitch, yaw, or flatness. The option also includes two turning mirrors designed especially for rapid calibration of surface plates.

Option 030 straightness interferometer

This option converts the 5526A into an interferometric straight-edge. Lateral deviations from a perfectly straight line are displayed to a resolution of one millionth of an inch ($0.01 \mu\text{m}$) over an axial range of 10 feet (3 m). Unlike alignment lasers, the Hewlett-Packard system does not depend on the pointing stability of the laser beam for its reference, but instead uses two rigidly mounted plane mirrors and a special prism interferometer. A long range version (Option 31) is also

available with a resolution of ten millionths of an inch ($0.1 \mu\text{m}$) over an axial range of 100 feet (30 m).

Ideal for determining geometric characteristics of machine tools, the Straightness Option can also measure such parameters as parallelism and with an optional pentaprism, squareness.

Option 200 laser measurement/calculator system

The combination of the 5526A Laser Measurement System with the Model 9820 Calculator provides a complete problem solving system for a wide variety of measurements. In addition to the Calculator, the Option 200 consists of all measurement options for linear, angular, flatness, straightness, squareness and parallelism determination.

Data is transferred directly from the Laser Display to the Calculator during the measurement of machine tools or surface plates, eliminating tedious manual data recording and possible operator errors. A package of metrology applications programs developed especially for the Option 200 enables fast data reduction and plotting of measurements such as surface plate calibration, lead error analysis and geometry characteristics of machine tools and measuring machines, including straightness, parallelism and squareness. One important program included implements the NMTBA (National Machine Tool Builders Association) recommendations for accuracy and repeatability of numerically controlled machine tools.

No knowledge of calculator programming is required to operate the system. The Metrology Program Package has been prepared for the QC technician and can be run simply by following the step-by-step instructions displayed by the Calculator in an interactive manner.

5510A Automatic compensator

The 5510A Automatic Compensator provides accurate, continuous correction for variations in the refractive index of air and for temperature of the material being measured. Air temperature, pressure, humidity and material temperature are measured by rugged sensors designed especially for use in machine shops. Sensor readings can be observed at the Laser Display without disturbing the measurement.

Additional options

Other options to the 5526A Laser Measurement System are available including a Single Beam Interferometer which in conjunction with the non-Contact Converter measures displacement of reflective surfaces. The Plane Mirror Converter when added to the Remote Interferometer of Option 010 allows measurements from a plane mirror surface with relative insensitivity to mirror tilt. A Second Axis Add-on is available to allow the Laser System to make two simultaneous independent measurements.

Additional options include real time error plotting and a real time resolution extender for applications where 0.1 millionths of an inch ($0.001 \mu\text{m}$) is needed or where high resolution at a high update is required. A printer is also available.

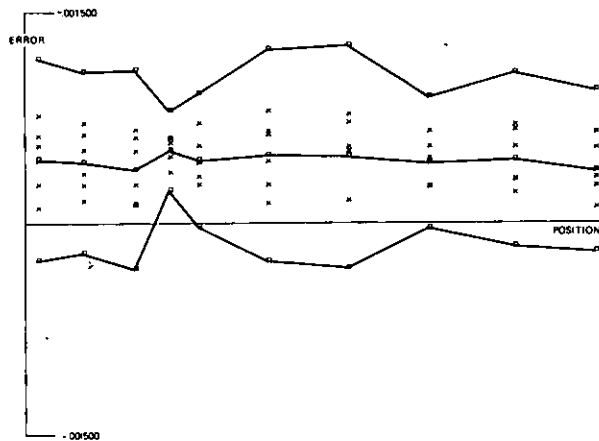

Option 200 NMTBA Accuracy Plot: Mean positioning error with $\pm 3\sigma$ confidence bands.

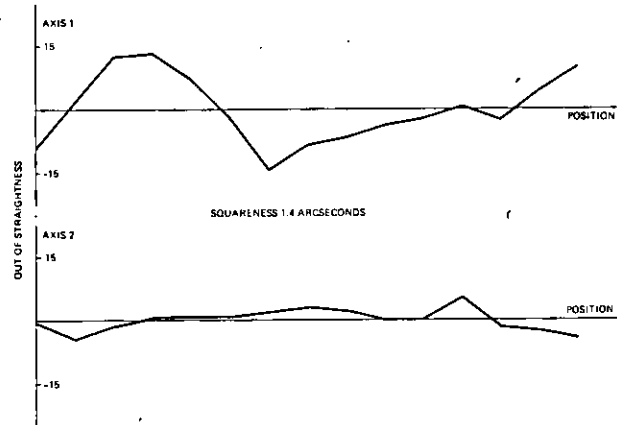

Option 200 straightness and squareness plot



Brief specification

5526A Laser/display

Laser: Helium-Neon type. Fully automatic tuning. Instant warmup.
Accuracy (for all linear displacement measurements): ± 0.5 parts per million ± 1 count (Metric ± 0.5 parts per million ± 2 counts).
Resolution: Normal and Smooth Modes:
Normal 0.000,01 in. Metric: 0.1 μm . Angular: 1 arc-sec. **X10** 0.000,001 in. Metric: 0.01 μm . Angular: 0.1 arc-sec.
Maximum allowable signal loss: 95% (-13 dB).
Maximum measuring velocity: 720 in/min (182 m/min).
Maximum lateral return beam offset: ± 0.2 inch (± 5 mm).
Atmospheric and material compensation: manual input from tables. 5510A Automatic Compensator optional.

Option 10 linear interferometer

Accuracy: as for 5526A Laser Display.
Maximum measuring range: up to 200 feet (60 m) depending on conditions.
Maximum lateral offset: The Remote Interferometer or the cube-corner retroreflector may be offset by up to ± 0.1 in. (± 2.5 mm) since a cube-corner displacement is doubled for the reflected beam.

Option 20 linear + angular/flatness interferometer

Linear specifications are as for Option 10.
Accuracy: ± 0.1 arc-second (± 1 count in last digit) up to ± 100 arc-seconds. ± 1 arc-seconds (± 1 count in last digit) up to ± 1000 arc-seconds. ± 4 arc-seconds per degree (± 1 count in last digit) up to ± 10 degrees using correction table.

Option 30 short range straightness interferometer

Accuracy:
Inch: ± 5 microinches/foot ± 1 count in last digit.
Metric: ± 0.4 micrometer/meter ± 2 counts in last digit.
Calibration: $\pm 3\%$ of reading. Can be calibrated out with the gain adjustment of an analog recorder, if used.
Resolution: As for 5526A Laser/Display.
Lateral range: ± 0.1 inch (± 2.5 mm).
Axial range: 10 feet (3 m).

Option 31 long range straightness interferometer

Accuracy: As for Option 030.
Calibration: $\pm 10\%$ of reading. Can be calibrated with the gain adjustment of an analog recorder, if used.
Resolution:
Normal: 0.0001 inch (1 μm).
X10: 0.00001 inch (0.1 μm).

5510A Automatic compensator

5526A/5510A System accuracy (worst case):

- For air temperature within range 68-85°F (20-30°C) 1.3 ppm ± 1 count (metric 1.3 ppm ± 2 counts).
- For air temperature within range 55-105°F (13-40°C) 1.5 ppm ± 1 count (metric 1.3 ppm ± 2 counts).

Model number and name

Model number and name	Price
5526A Laser/Display	\$10,750
Option 010 Linear Interferometer	\$3895
Option 020 Linear + Angular/Flatness Interferometer	\$5985
Option 030 Straightness Interferometer	\$3895
Option 200 Laser Measurement/Calculator System	\$32,215
5510A Automatic Compensator	\$3995



PHYSICAL & OPTICAL MEASUREMENTS

0.0001°C or °F resolution, direct measurement

Models 2801A, 2831A, 2833B, 2850A/B/C

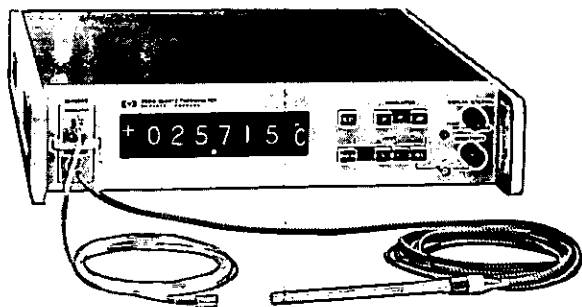

The method of temperature sensing employed in the 2801A Quartz Thermometer is based on the sensitivity of the resonant frequency of a quartz crystal to temperature change.

Temperature range of the 2801A Quartz Thermometer is -80 to $+250^{\circ}\text{C}$ (-112 to $+482^{\circ}\text{F}$). The quartz thermometer is considerably more linear than a platinum resistance thermometer: $\pm 0.05\%$ of span from -40 to $+250^{\circ}\text{C}$ compared with a typical figure of $\pm 0.55\%$ for the same range for platinum thermometers. Linearity of the quartz thermometer is superior to that of thermocouples and thermistors, which have an exponential characteristic. The excellent sensing characteristics of the quartz thermometer are supplemented by the advantages of direct digital readout (no bridge balancing, or reference to resistance or voltage-temperature tables or curves), immunity to noise and cable resistance effects, no reference junction, and good interchangeability between sensing probes.

The 2801A is equipped with two sensing probes for measuring temperature at either probe or the difference between the two. A 6-digit visual readout and recording output with a choice of pushbutton-controlled sample times provides resolution of 0.01, 0.001 or 0.0001°C or $^{\circ}\text{F}$. With Option 010 (100-second sample period) resolutions of 0.001, 0.0001 or 0.00001°C or $^{\circ}\text{F}$ can be obtained. Signal polarity indication is provided. The 2801A includes the capability for operation as a 300-kHz electronic counter.

Remote operation of probes

Each temperature sensing probe has a quartz crystal which is resonant at a frequency dependent upon temperature, and is driven by a 2830A Sensor Oscillator. The oscillators are transistorized devices enclosed in small die-cast aluminum housings. They are normally installed in the 2801A flushmounted in a front panel recess. A 12-foot cable connects each probe to its associated sensor probe; this cable forms part of the tuned circuit and cannot be altered in length. However, the sensor oscillators may be unplugged from the instrument and connected to it by standard 75-ohm coaxial cable up to 500 feet in length, with no loss in measurement accuracy. For greater distances, one or two 2831A Amplifiers may be used for a maximum of 4500 feet.

Oceanographic temperature sensor

The Model 2833B Oceanographic Temperature Sensor Assembly for the 2801A Quartz Thermometer is especially designed for use in rugged environments such as oceans, rivers, harbors and industrial fluids at pressures up to 10,000 psi. It combines the functions of a quartz crystal sensor and oscillator which are housed in a stainless steel pressure case approximately $5\frac{1}{8}$ inches long, with a maximum diameter of $\frac{7}{8}$ inch. A single coaxial cable transmits the temperature signal to, and the dc operating power from the 2801A.

The 2833B connects directly to the 2801A through the cable provided and gives a direct digital readout in $^{\circ}\text{C}$ or $^{\circ}\text{F}$. Operating range of the 2833B is -40 to $+120^{\circ}\text{C}$ (-40 to $+248^{\circ}\text{F}$) when used with the 2801A Quartz Thermometer. It may be used with as much as 5000 feet of cable with no loss of accuracy or sensitivity.

2801A Specifications

Temperature range: -80 to $+250^{\circ}\text{C}$ (-112 to $+482^{\circ}\text{F}$ with Option 001.)

Calibration accuracy: Thermometer-probe combination calibrated at factory to within 0.02°C (0.04°F) absolute, traceable to NBS.

Linearity: -40 to $+250^{\circ}\text{C}$: Better than 0.15°C (0.27°F) referred to best fit straight line through 0°C . -80 to -40°C : Better than 0.7°C (1.26°F) referred to same line as above. 0 to $+100^{\circ}\text{C}$: Better than 0.05°C (0.09°F) referred to best fit straight line through 0°C .

Stability:

Short term: Better than $\pm 0.0001^{\circ}$.

Long term: Zero drift less than $\pm 0.01^{\circ}\text{C}$ (0.018°F) at constant probe temperature for 30 days.

Ambient temperature effect: Less than 0.002°C per $^{\circ}\text{C}$ change.

Display: 6-digit in-line readout in $^{\circ}\text{C}$, or $^{\circ}\text{F}$. Decimal point, $^{\circ}\text{C}$ ($^{\circ}\text{F}$), and polarity indication included. Readout and units indication in ke in counter mode of operation. Storage feature holds display between readings.

Digital recorder output: BCD, 4-2-2-1, positive-true, for each digit, decimal point (exponent), polarity, and operating mode. 8-4-2-1 positive true optionally available.

External programming: Selected by contact closures or transistor circuit closures to ground. Measurement initiation, probe selection (T1, T2, or T1-T2), and resolution (0.01, 0.001, or 0.0001°) programmable.

Counter operation: Frequency Range: 2 Hz to 300 kHz. Resolution: 10, 1, and 0.1 Hz. Sensitivity: 0.5 to 10 V rms. Input impedance: 1 M, 50 pF shunt. Gate Time: 0.1, 1 and 10 sec.

Power required: 115/230 V $\pm 10\%$, 50 to 60 Hz, 85 W.

Instrument environment: Ambient temperatures from 0 to $+55^{\circ}\text{C}$ ($+32$ to $+130^{\circ}\text{F}$), at relative humidity to 95% at 40°C .

Weight: net 10.1 kg (22.5 lb), shipping 15.9 kg (35 lb).

Dimensions: 88 x 414 x 425 mm ($3\frac{1}{2}$ " x $16\frac{1}{8}$ " x $16\frac{1}{4}$ ").

2831A Amplifier specifications

Operating frequency: 28 to 29 MHz approximately.

Gain: 40 db approximately.

Power required: $+12$ to $+20$ dc, at about 8 mA (normally supplied by HP 2801A).

Connectors: Coaxial output connector mates with HP 2801A Quartz Thermometer.

2833B Oceanographic sensor specifications

Temperature range: -40 to $+120^{\circ}\text{C}$ (-40 to $+248^{\circ}\text{F}$).

Response time (step change): 63.2% of final value in 3 sec; 99.0% in 16 sec; 99.9% in 24 sec (flow at 2 fps).

2833B Options

001: 50' Waterproof Cable

002: 50' Armored Waterproof Cable with load-bearing termination

Above cable in lengths longer than 50'

Model number and name

2801A Quartz Thermometer. Includes 2 each 2830A oscillators and 2850 series sensors

2831A Amplifier for probe operation from 500-4500 ft

2833B Oceanographic Sensor

Price
N/C

\$265

Per ft \$1.50

\$3700

\$125

\$990

PHYSICAL & OPTICAL MEASUREMENTS

Platinum resistance thermometer

Model 2802A

NEW

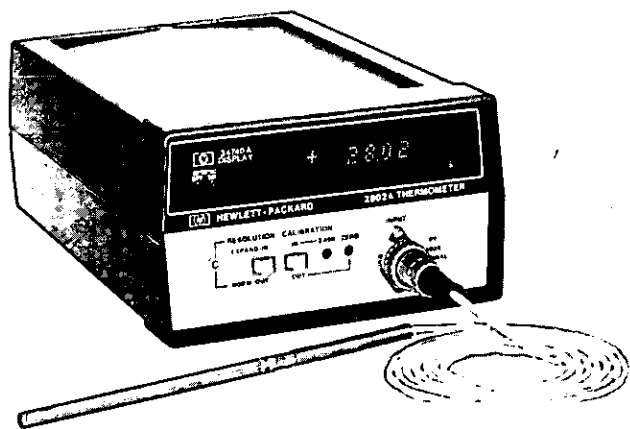

A platinum resistance thermometer, the HP 2802A offers performance and features found only in higher priced instruments. Some of these features include:

- ... Unique dual range
- ... Linear analog output
- ... Temperature, calibration, or overrange displayed
- ... Simple one-point calibration
- ... Battery operation and BCD output available

Description

Two modular units make up the HP 2802A Thermometer: a thermomodule (lower unit) which contains temperature measuring circuits, probe connections, and operating controls; an HP 34740A display unit with 4½ digit light-emitting diodes, which snaps into place on the thermomodule. Battery or BCD module accessories easily snap into place between the thermomodule and display unit. In addition, the display unit may be used with other HP snap-in modules to make a voltmeter, a multimeter, a pre-amp ammeter, as well as other combinations offered by Hewlett-Packard in this catalog under Digital Voltmeters.

A variety of probes can be used with the 2802A. All HP probes offered are interchangeable and meet high standard, in-house electrical specifications which allow them to provide maximum accuracy. The HP 2802A drives very low current through the platinum sensor, so self-heating is negligible. Less than 0.1 mW is dissipated. A four-wire technique used to measure sensor resistance eliminates errors due to connector or lead resistances.

Rugged cast aluminum cases with shock resistant slides and chemically resistant paint provide ample protection for the HP 2802A in just about any operating environment.

Specifications

These specifications are "total system specifications" meaning they apply to both the instrument and the probe working together (not just the best electronic specifications for the instrument by itself). HP

2802A Thermometer specifications relate directly to system performance under actual working conditions.

Ranges: -200 to +600°C and -100 to +200°C

Resolution: 0.1°C on -200 to +600°C range
0.01°C on -100 to +200°C range

Accuracy: ±(0.5°C ±0.25% of reading) on both ranges

Display: 4½ digits LED on HP 34740A Module

Stability: ±0.2°C for 7 days (23°C ±5°C ambient)

Linear Analog Output:

1 mV/°C on -200 to +600°C range (-0.2 V to +0.6 V F.S.)

10 mV/°C on -100 to +200°C range (-1.0 V to +2.0 V F.S.)

Voltage accuracy equal to that of digital display.

Output impedance 1 kΩ on both ranges.

Environmental standard: HP 2802A Thermometer operates within these specifications in environments of 0 to 50°C and up to 95% relative humidity over most of this temperature range. After calibration in some arbitrary ambient temperature, instrument calibration remains valid with ambient temperature changes up to 10°C.

Power requirements: Operates on any of four, single phase ac line voltages 100, 120, 220, or 240 volts rms (+5%, -10%), 48 to 440 Hz. Power dissipation is 8.7 volt-amperes.

Dimensions: Thermomodule with display unit is 159 mm wide, 98 mm high, 248 mm deep (6¼ × 3¾ × 9¾ in.); net weight is 2.27 kg (5 lb), shipping weight about 3.39 kg (7½ lb).

Thermometer options

2802A HP digital thermometer—Includes 4½ digit 34740A Display. Requires HP 18640 series probe and option 050 or 060. See list which follows.

050: 50 Hz, ac, single phase

060: 60 Hz, ac, single phase

001: HP digital thermomodule—Thermometer unit only, without display unit or probe. NOTE: Since thermomodule will not operate without display, this option is for those planning to use thermomodule with their own HP 34740A or HP 34750A Display Modules.

Probes

(NOTE: Time constant for probes measured in water flowing at 3 m per sec.)

18641A—13 cm stainless steel sheath, 6.4 mm diameter, with armored cable 1.83 m long. For -200 to +500°C, to +600°C short term (prevent cable movement above 250°C). Time constant 5 sec.

18642A—same as 18641A probe except with 1.83 m Teflon-insulated cable. Cable must be kept below 250°C.

18643A—13 cm stainless steel sheath, 0.64 cm diameter, with last 5.1 cm of sheath tip reduced to 0.32 cm diameter. For -200 to +500°C, to +600°C short term. Teflon cable 1.83 m long, must be kept below 250°C. Time constant 1.8 sec.

18644A PROBE KIT—includes platinum sensor cartridge, 1.3 × 0.25 cm diameter, having two nickel leads, 1 × 0.03 cm diameter, cable connector, wiring diagram for four-wire hookup. Time constant 0.5 sec.

Price

\$750

N/C

N/C

less \$325

\$165

\$150

\$180

\$105

PHYSICAL & OPTICAL MEASUREMENTS

0.01 psi resolution, 0-12 kpsi

Model 2811B

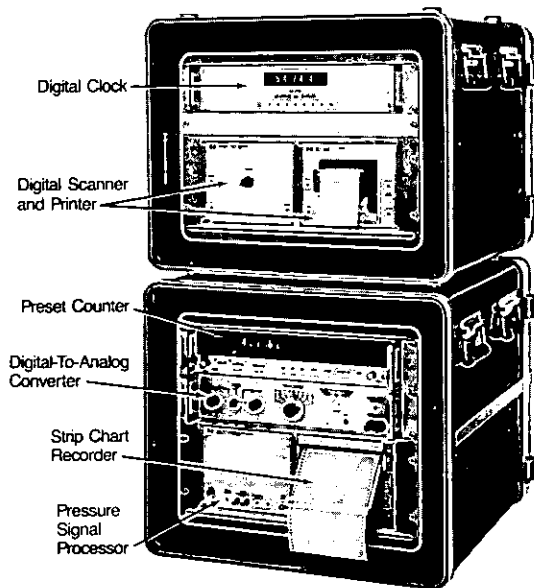
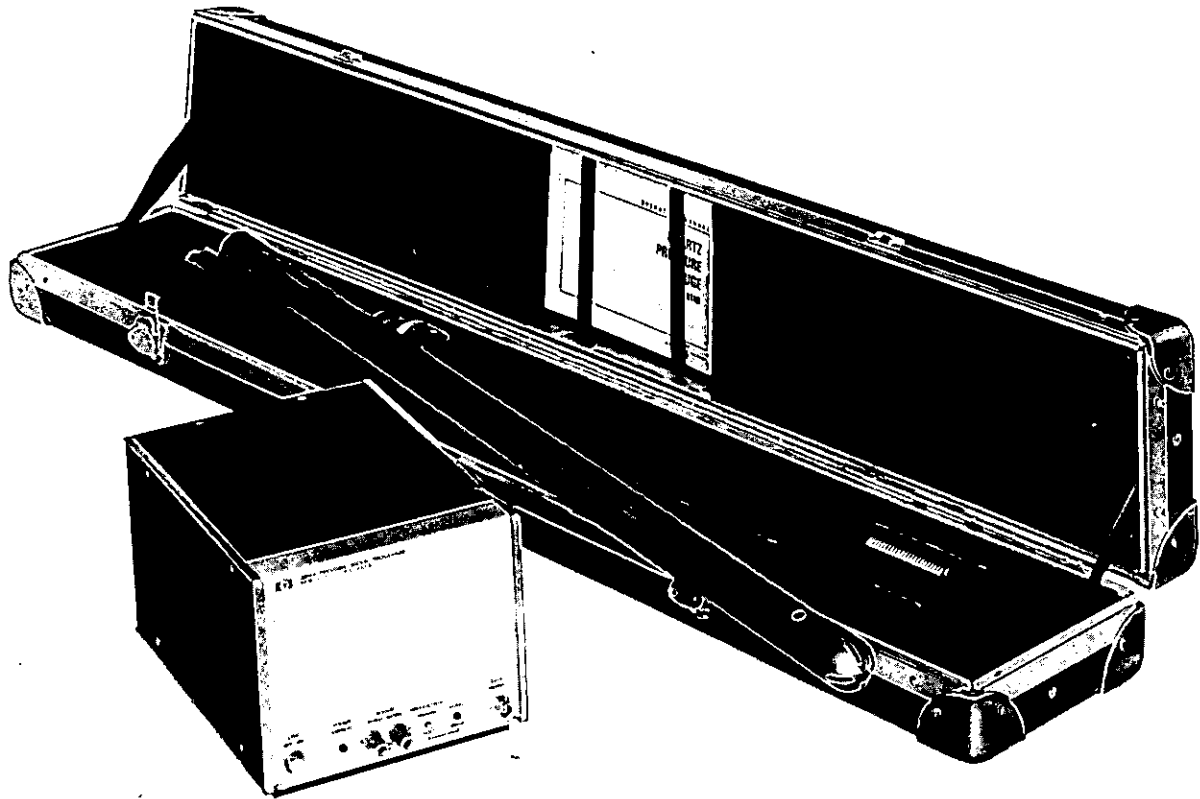

HP 2811B analog and digital recording Option 030 mounted in Option 031 field cases.

Description

The 2811B consists of a sensing probe and a signal processor interconnected by a standard electric line or cable. Probe and processor can be separated by as much as 6100 m (20,000 ft) of electric line without signal impairment. An electronic frequency counter must be used to produce a digital display; any of various recorders, printers, computers or other data handling devices can be connected to the counter output as shown in the drawing, "Pressure Gauge System Configurations."

A unique transducer, consisting of a natural quartz, crystal resonator whose frequency changes directly with applied pressure, is located in the sensor portion of the probe. It detects pressure changes as small as 0.0007 kg/cm^2 in ambient pressures up to 844 kg/cm^2 (0.01 psi in pressures up to 12,000 psia). It has higher resolution and more consistent accuracy over a wider dynamic range than instruments that are presently used in this application. Its high resolution is essentially constant, independent of operating pressure and temperature. The inherent stability of the quartz resonator practically eliminates hysteresis and zero drift, thus eliminating the need for frequent recalibration. In most cases, annual recalibration will be sufficient.

A single-conductor coaxial cable (electric line) connects the probe to the signal processor, furnishing all operating power to the probe and transmitting the measurement signal to the processor. The cable is not supplied, but standard one-conductor, armored electric line can be used in lengths up to 6100 m (20,000 ft).

Ruggedness and simplicity of the 2813B Quartz Pressure Probe greatly facilitate field use. Housed in a 3.65 cm ($1\frac{1}{8}$ " OD case made of 17-4PH stainless steel, the probe can withstand pressures in excess

Pressure Gauge System Configurations

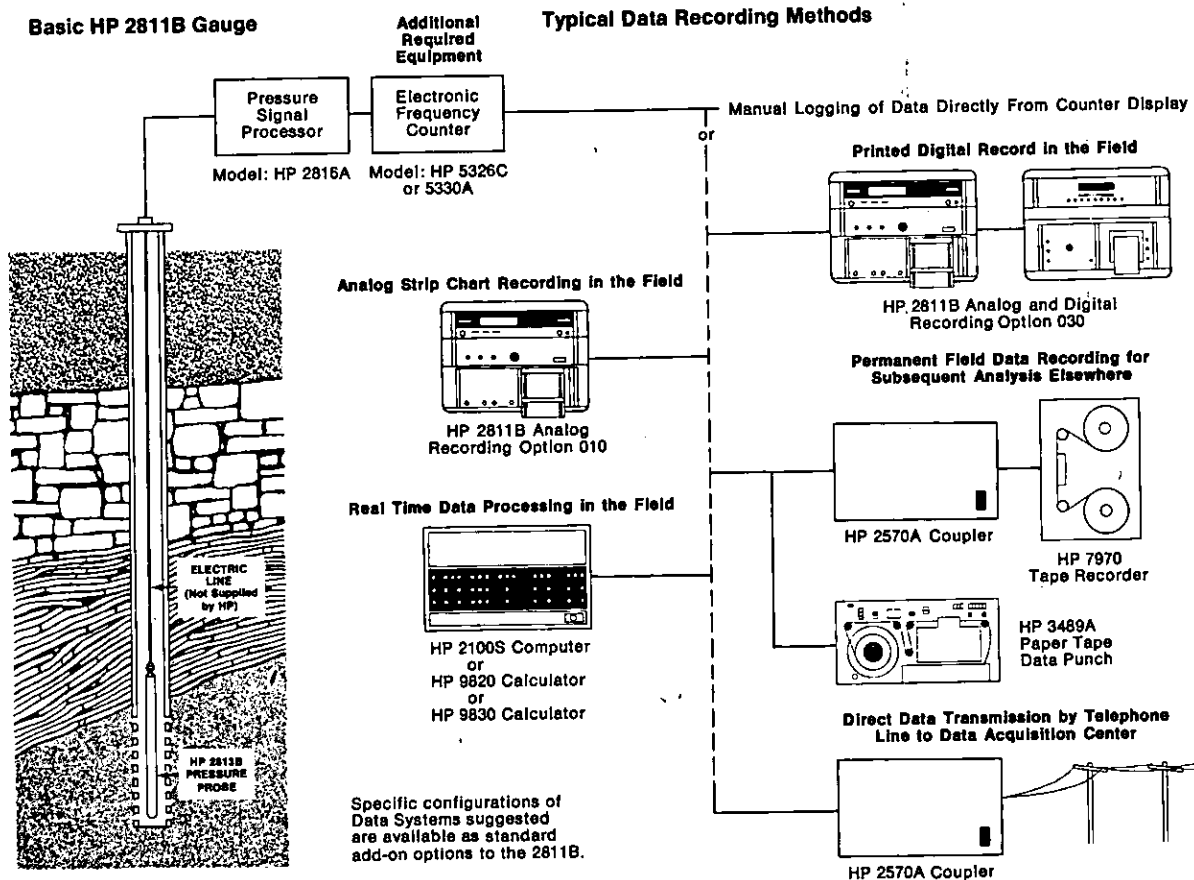

of 1400 kg/cm² (20,000 psia). It can be operated in flowing gas or liquid wells. Mechanical vibration has no direct effect on its performance.

The 2816A Pressure Signal Processor requires no adjustments or tuning during operation. An on/off switch and press-to-test switch are the only controls on the panel. Normal operation is indicated by two lamps, one indicating proper current supply to the probe and the other indicating proper signal return from the probe. Display is achieved by simply connecting the signal processor output to a general purpose digital frequency counter.

Operating principle

Inside the 2813B, the probe unit of the 2811B, are a quartz crystal pressure sensing oscillator and a reference oscillator. The frequency of the sensor oscillator, which varies with pressure, is subtracted from the frequency of the reference oscillator; the resulting pressure dependent difference frequency is transmitted up the cable to the signal processor.

The 2816A signal processor, the other part of the 2811B and located on the surface, is an amplifier, filter and multiplier which conditions the probe difference frequency to enable it to drive a general purpose digital frequency counter. The processed output frequency changes about 1500 Hz/kg/cm² (approx. 105 Hz/psi) which allows a resolution of 0.0007 kg/cm² (0.01 psi). The signal processor also supplies dc power to the probe in the wellbore via the electric line.

Specifications for basic 2811B probe and processor system

Operating pressure range: 0-844 kg/cm² (0-12,000 psia).

Calibrated pressure range: 14-774 kg/cm² (200-11,000 psia).

Within this range the pressure is expressed as a third degree function of the processor output frequency by the following equation: $P = G +$

$Hf + If^2 + Jf^3$; where G, H, I and J are provided as functions of temperature from 25° to 150°C (77° to 302°F).

Operating temperature range:

Probe: 0° to 150°C (32° to 302°F).

Signal processor: 0° to 55°C (32° to 131°F).

Sensitivity: 1500 Hz/kg/cm² (105 Hz/psi, nominal) at output of signal processor.

Resolution: <0.0007 kg/cm² (0.01 psi) when sampling for a 1-second period.

Precision: ±0.010 kg/cm² (0.15 psi) over entire range.

Accuracy (at thermal equilibrium) if operating temperature is known:

within 1°C (1.8°F): ±0.018 kg/cm² or ±0.025% of reading (±0.25 or ±0.025%R).

within 10°C (18°F): ±0.07 kg/cm² or ±0.1% of reading (±1 psi or ±0.1%R).

within 20°C (36°F): ±0.35 kg/cm² or ±0.25% of reading (±5 psi or ±0.25%R).

Linearity (without calibration): 1% maximum deviation from straight line through frequency at zero pressure and at 774 kg/cm² (11,000 psia).

Stability: Annual recalibration recommended.

Signal processor output: Nominal square wave with repetition rate between 490 KHz and 1.8 MHz; minimum peak-to-peak amplitude of 1.2 V across 600-ohm load.

Power requirements: 115/230 V ac (+10%, -25%) at 16 VA max., 48-66 Hz.

Probe connector: Mates with 1/16" OD Gearhart-Owen single conductor cable-head assemblies (Series 31-1000 and 31-1006) equipped with banana plug end (Part No. 31-1000-20).

Cable requirements: Single conductor coaxial with armored sheath (multiple conductor may also be used). Total round trip dc resistance

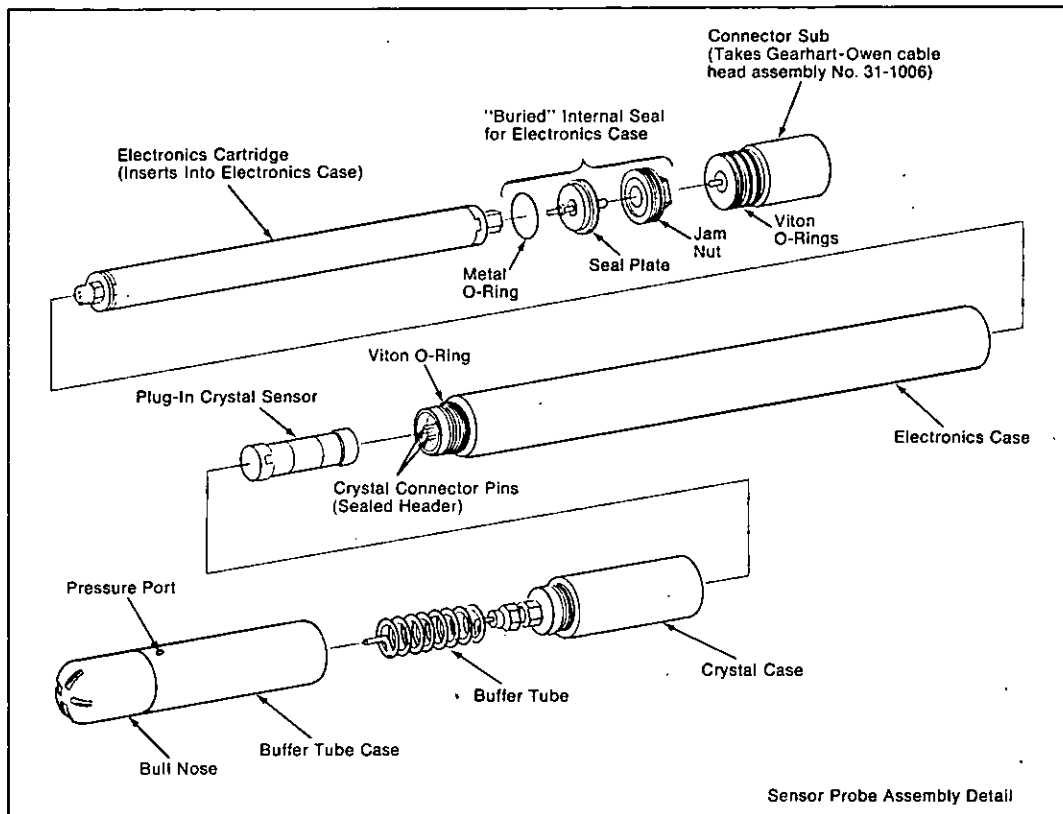

Sensor Probe Assembly Detail

<500 ohms; insulation breakdown voltage >50 V. No more than 40 db attenuation at 25 kHz for total line length.

Dimensions and weights

Probe:

Size: 3.7 cm (1 $\frac{1}{16}$ " OD by 100 cm (39 $\frac{3}{8}$ " long

Weight: 3.2 kg (7 lb)

Signal processor:

Size: 15.4 cm high \times 19.7 cm wide \times 27.9 cm deep (6 $\frac{1}{16}$ \times 7 $\frac{3}{4}$ \times 11")

Weight: 3.2 kg (7 lb)

Analog recording option 010/011 (including case):

Size: 65.7 cm high \times 57.2 cm wide \times 72.4 cm deep (25 $\frac{1}{2}$ \times 22 $\frac{1}{2}$ \times 28 $\frac{1}{2}$ "

Weight: 57 kg (125 lb)

Digital recording option 030/031 (including case and in addition to option 010/011):

Size: 65.7 cm high \times 52.8 cm wide \times 72.4 cm deep (25 $\frac{1}{2}$ \times 20 $\frac{1}{16}$ \times 28 $\frac{1}{2}$ "

Weight: 46 kg (105 lb)

Model number and name

Probe-gauge instrumentation

2811B Quartz Pressure Gauge: Includes 2813B Probe, 2816A Pressure Signal Processor, carrying case for probe, operator's manual, and calibration tables. For visual pressure indication, signal processor must be connected to electronic counter. Processor has nominal square wave output which will drive HP 5330A Preset Counter (see Options 010 and 011) or most general purpose counters which have a time base stability of $\pm 1 \times 10^{-6}$ per second or better and will accept a square wave input of 1 volt or more with a frequency range of 490 kHz to 1.8 MHz.

\$9980

2813B Quartz Pressure Probe: Probe only with carrying case and calibration tables

\$9125

2816A Pressure Signal Processor: Processor only with operator's manual

\$1085

5330A-H41 Preset Counter: Provides 6-digit display directly in pressure units from HP 2816A pressure signal processor

\$1670

Data logging options

010: Analog Recording Option: Provides continuous linearized digital display and analog data on a strip chart recorder. Includes HP 5330A Preset Counter, HP 580A Digital-to-Analog Converter, and HP 680A Strip Chart Recorder

\$4500

011: Field Case: Extremely rugged construction, into which Option 010 units can be factory or field mounted

\$775

012: Digital Clock: Displays hours, minutes, seconds. Also provides time marks on analog record

\$1330

013: Field Case: Similar to Option 011 into which digital clock Option 012 and units included in Option 010 can be factory or field mounted

\$850

030: Analog and Digital Recording Option: Provides linearized digital display, continuous analog recording, digital printing of pressure and time data with time marks on analog record. Digital printer will handle recording of up to four additional data channels.

Includes: 1) All units offered in Option 010, 2) HP 5055A Digital Printer and K10-5055B Scanner units, HP K22-5321B Digital Clock with hours/minutes/seconds display

\$8410

031: Set of Two Field Cases: Similar to Option 011 into which Option 030 units can be factory or field mounted

\$1390

032: Digital Clock "Days" Option: Adds "days" to digital clock described in Options 012 or 030 to provide days/hours/minutes/seconds display. Factory installed at time of purchase

\$105



Radiography, the art and science of making pictures with X-rays, has an important place in modern technology. It is one of the major nondestructive test methods available to industry, provides an indispensable tool in scientific investigations and is a valuable aid to law enforcement agencies. Hewlett-Packard makes a major contribution to these activities with X-ray equipment that offers a "better way" through advanced technology and design. This equipment makes radiographs easier and safer to take, provides portability for field use or offers stop-motion capability for the study of dynamic events.

Industrial Inspection

Industrial quality control and inspection procedures, especially in the field of electronics, benefit from nondestructive testing by radiography. The advantages of a testing method which does not harm the test objects are obvious. Radiography, therefore, offers benefits in design engineering, incoming inspection, production quality control, product reliability and failure analysis. X-rays are used to detect misregistration or plate-through problems in multi-layer P.C. boards; porosity, poor substrate bonding and wiring or lead location in transistors and integrated circuits; voids and other encapsulation problems in potted components; and solder balls or other defects in sealed relays.

Die casting is another industry that benefits from the nondestructive aspects and ability to "see inside" provided by radiography. Porosity, gas voids, tramp metal inclusion and other common defects can be easily detected and the cause determined. Expensive machining time can be avoided for castings found to be defective through X-ray inspection. The integrity of welds, alignment of connectors, inspection for proper assembly

and mechanical defects are further examples of tests which radiography performs for industry. The benefits of X-ray testing are reduced production costs, better quality assurance and product safety. The results are increased profits.

Scientific applications

Oceanography, geology, marine biology, paleontology, pathology, botany, forestry and agricultural research are a few examples

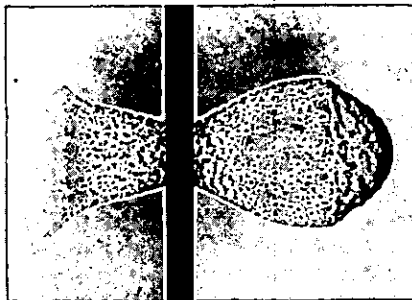

of scientific disciplines that use X-rays. Applications range from the study of the interior anatomy of fossils to determining the viability of seeds.

Law enforcement applications

Radiography aids many law enforcement groups, including crime labs and explosive ordnance demolition squads. Crime labs use X-rays to visualize certain types of latent fingerprints, for powder and lead splatter patterns in ballistics and for questioned-document examination. Medical examiners use X-rays for cause-of-death investigations and identification of remains. X-rays aid explosive ordnance demolition groups in examining parcels or mail to identify dangerous devices and to verify bomb circuitry.

These are among the many applications served by HP Faxitron® Cabinet X-Ray Systems. HP's shielded-cabinet and light-weight portable units offer a unique combination of high quality radiographic capability, simplicity of operation and convenience of use which is expanding the capabilities of scientific and industrial concerns throughout the world.

Pulsed radiation sources

Hewlett-Packard has pioneered in the design and manufacture of cold-cathode, flash X-ray tubes and systems. Cold-cathode tubes, based on the field emission principle, are combined with a pulse generator and appropriate control units. The systems produce nanosecond bursts of X-rays, electrons or

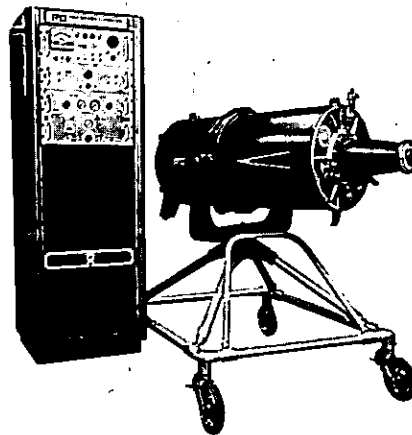

super radiant light (SRL). Output voltage and energy are provided by Marx-surge type energy storage modules charged in parallel and discharged in series through a pressurized spark gap switch mechanism.

A number of channels can often be operated from common controls enabling a series of stop motion radiographs at desired intervals.

Other capabilities include slow and fast cine-systems providing a series of motion picture-like radiographs at rates from 1 to 1000 frames/sec. These systems are custom designed from standard units.

HP pulse radiation systems yield a reproducible 5–10,000 ampere electron beam in air at energies of 400–2300 keV and pulse widths of 3–40 nanoseconds. Current densities of 12,500 amperes per cm² and dose rates up to 10¹⁵ Rads/second can be obtained. The systems are not used for radiation therapy or radiation of large areas because of rather high cost per Rad of radiation dose but their reproducibility, high dose rate output, ease of operation and instrumentation and small area requirements make them ideal for radiation chemistry or pulsed radiolysis studies as well as radiation effects studies, radiation biology and laser pumping.

Portable X-ray systems

Portable systems of light weight and small size are made possible by the field emission type tube. Hewlett-Packard markets several portable systems (Models 43846, 43802 and 43501A) which enjoy use in industrial and law enforcement applications.

For specific information and consultation regarding HP X-ray systems, see pages 556 and 557 of this catalog or contact Hewlett-Packard, 500 Linke Street, McMinnville, Oregon 97128, telephone: (503) 472-5101.

X-RAY SYSTEMS

Faxitron® high resolution cabinet X-ray systems

Models 43804, 43805, 43807 & 43808



43805

The Hewlett-Packard Faxitron® is a self-contained, radiation shielded cabinet X-ray system designed to give high resolution radiographs of small to medium-size objects of all types. Simple operating techniques and radiation safety features make the Faxitron® unusually convenient for X-ray inspection or quality control, reliability and failure analysis or other operations requiring nondestructive testing techniques.

Faxitron® systems consist of a self-rectified X-ray generator with appropriate control circuitry mounted in a radiation shielded cabinet which has the shape and appearance of a small oven. Cabinet doors are equipped with dual interlocks intended to prevent X-ray generation when the doors are open. A number of cabinet configurations are available to accommodate various object sizes. The cabinet is designed to reduce X-ray leakage to 0.5 mR/hr or less near the external surface in accordance with NBS Handbook 93 recommendations. Thus they can be used in occupied areas with no additional X-ray shielding.

The self-rectifying, thermionic X-ray tube (of HP manufacture) is regulated at 3 mA. Output voltage is continuously variable from 10 kVp to 110 kVp. A 130 kVp option provides additional penetration for thick samples. The 0.63 mm beryllium window allows full spectrum, soft X-ray output. A 0.25 mm beryllium window, standard on the Model 43805, allows even greater soft X-ray output at voltages under 30 kVp.

The Faxitron® Model 43804 is equipped with simple and convenient manual controls for selection of exposure time and output kilovoltage.

The Faxitron® Model 43805 features automatic exposure control, in addition to the standard manual controls. The automatic exposure control helps the operator select the optimum kilovoltage and determines the correct exposure time. An ionization chamber under the film shelf monitors the radiation penetrating the object and reaching the film, and terminates the X-ray when the proper exposure has been

reached. With the automatic control, good pictures are consistently obtained by inexperienced operators.

The Model 43807 is equipped with manual controls and variable 1 to 3 mA tube current for educational use. In other respects it is similar to the Model 43804.

The Model 43808 incorporates automatic exposure control along with the other features of the 43807.

Faxitron® models are also available in a free-standing table configuration with a 114 × 114 cm (45" × 45") radiation-shielded drawer for radiography of large flat objects. Drawer depths from 15 cm (6") to 60 cm (24") are available.

Specifications

Faxitron® lead-shielded cabinet X-ray systems; dual door interlocks; 64.8 cm (25.5") maximum focal distance; 0.50 mm X-ray source size; 10–110 kVp output; 115 V, 60 Hz.

43804

3 mA continuous current; manual controls; 0.63 mm beryllium window X-ray tube.

43805

3 mA continuous current; automatic and manual controls; 0.25 mm beryllium window X-ray tube; beam locator.

43807

1–3 mA variable current; manual controls; 0.63 mm beryllium window X-ray tube; instrumentation access port; external 60-minute timer.

43808

1–3 mA variable current; combination automatic and manual controls; 0.63 mm beryllium X-ray tube; instrumentation access port; external 60-minute timer.

Options

Opt. 001 dual cabinet: increases focal distance to 122 cm (48") to meet MIL Std. Specs, for decreasing distortion or for full coverage of a 14" × 17" film. Both doors are dual interlocked.

Opt. 004 130 kVp output: for increased penetration when radiographing thick or dense objects. Recommended for thicknesses greater than 6 mm (.25") of steel.

Opt. 007 filter-diaphragm teaching kit: for Models 43807 and 43808, aids in performing X-ray experiments. Consists of shelf/filter rack, 2 lead diaphragms (2 cm and 8 cm), 4 radiation filters (1/4, 1/2, 1 and 2 mm aluminum).

Opt. 011 extension collar: increases focal distance to improve resolution and increase field size. Use with Opt. 015.

Opt. 013 and 015 fluoroscopy: allows direct viewing of fluoroscopic images thru lead-glass window.

Opt. 030 radiation filter: 0.50 mm copper filter reduces scatter and improves definition on radiographs above 80 kV.

Opt. 031 processor: for developing 4" × 5" Polaroid® Land Film Packets. (Model 545 Land Film Holder).

Other options and accessories: control circuit voltage regulator, conduit access kit, AC accessory receptacle, remote control pendant, high current option and 230 V, 50 Hz options are also available.

Faxitron® Options

Option	Price
001: Dual Cabinet	\$365
004: 130 kV	\$700
007: Filter-Diaphragm Teaching Kit	\$220
011: Extension Collar, 15 cm (6")	\$150
013: 5" × 5", 1.5X Fluoroscopy	\$300
015: 8" × 10", 1.0X Fluoroscopy	\$325
030: Radiation Filter, 0.5 mm copper	\$20
031: Polaroid® Processor	\$75

Faxitron® Models:

43804	\$2860
43805	\$3485
43807	\$2950
43808	\$3870

X-RAY SYSTEMS



Portable X-ray systems

Models 43846, 43802 & 43501A

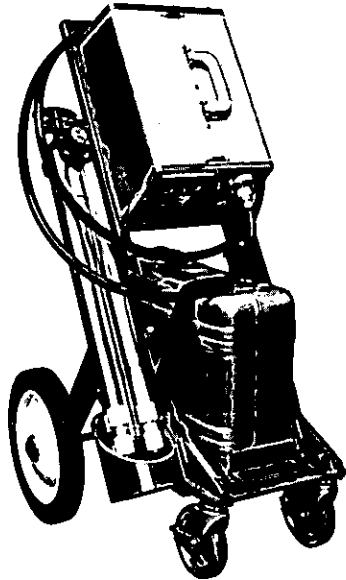

43802

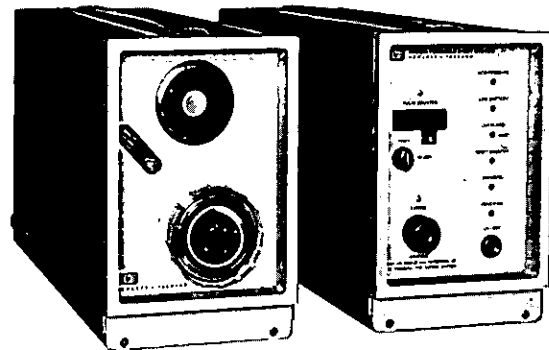

43501A

HP portable X-ray systems are convenient, reliable, lightweight units for use in field applications or in confined areas. All of these systems feature remote tubehead capability allowing use of a small X-ray tube at the end of a flexible coaxial cable.

They are used in law enforcement applications for identification of suspicious packages, inspection of internal construction of bombs and explosive devices, and for forensic pathology applications. Industrial applications include inspection of tubing, connectors and other devices in airframes or other areas of difficult access. Other applications include radiation effects studies using the short pulse, extremely high dose rate characteristics of the system.

These systems produce a train of intense, high energy X-ray pulses of short duration (typically 60 nanoseconds) and utilize the convenient, cold-cathode, field emission tube.

An exposure selector permits a choice of 1 through 99 pulses in a train, depending on exposure techniques desired.

The small tube permits a light, compact tubehead which is easily positioned in confined areas and is well shielded against stray leakage radiation. The tube is easily changed and can be used either in the pulser case or mounted in a remote tubehead at the end of a coaxial cable.

Circuitry is designed so that the X-ray beam quality and output remain constant despite input line voltage variations. These systems are particularly suited for field use or remote area use where power may be supplied by portable generators or battery packs.

Specifications

43846 Portable X-ray system

A 55-pound self-contained unit including high voltage pulser; electronic controls; X-ray tube (in pulser); 10' AC cord and trigger pendant with 10' coil-cord; 115 V, 60 Hz operation; pulser provides 60 nanosecond pulse.

Operating voltage (output): 100 and 150 kVp.

X-ray output per pulse @ 24": .6 mR/pulse @ 100 kV. 2.2 mR/pulse @ 150 kV.

Pulse repetition rate: 20/sec. @ 100 kV., 14/sec. @ 150 kV.

Focal spot size: 2.5 mm.

Inherent filtration (X-ray Beam): Exceeds 2.0 mm Al.

Input power requirements: 115 V, 50-60 Hz, 1200 watts surge, 11 watts standby.

System size: 19.1 × 24.8 × 50.8 cm (7½" × 9¾" × 20").

System weight: 25 kg (55 pounds).

43802 Mobile X-ray system

This system consists of the Model 43846 55-pound self-contained X-ray generator and tube, combined with Option #001: right-angle tubehead assembly with 15' coaxial cable; Option #009: mobile cart; Option #010: battery pack with inverter and charger and Option #008: light-weight tripod.

NEW: 43501A Portable X-ray system

A light-weight self-contained unit consisting of two cases (5¼" × 8¼" × 18") containing built-in battery converter power supply, high voltage pulser, internal tubehead, controls and trigger pendant cord. Built-in battery and charger. 150 kVp output on battery power alone.

Operating voltage (output): 150 kVp.

X-ray output per pulse: 1.5 mR @ 24".

Pulse repetition rate: 16 pulses/second when fully charged.

Focal spot size: 2.5 mm.

Inherent filtration (X-ray Beam): Exceeds 2.0 mm Al.

Tube life (warranty): 25,000 pulses or 6 months.

Output capacity per battery charge: 3,000 pulses @ 20°C (68°F).

Recharge time: 6 hours, maximum.

Optional operational mode: 115/230 V ac (through integral battery charging circuit.)

Total system weight: 26.5 kg (58½ pounds).

System size: Two cases 13.3 × 21.0 × 45.7 cm (5¼" × 8¼" × 18").

Set up time: Approximately 3 minutes.

Options

Options	Price
001: Tubehead assembly, right angle, with 15' cable	\$300
008: Tripod, light-weight, for mounting tubehead	\$125
009: Mobile cart, rigid (Model 43846 only)	\$830
010: Battery pack, including inverter and charger (Model 43846 only)	\$995
012: X-ray tube (spare)	\$150
013: Radiographic cassette, Model 43132, for 4" × 5" Polaroid® film (specify TI-2, Detail, Industrial or Hi-Plus screen).	\$160
014: Processor for developing 4" × 5" Polaroid® Land Film Packets (Model 545 Land Film Holder).	\$75
Portable X-ray systems	
43846 — Portable X-Ray Generator	\$3750
43802 — Mobile Cart X-Ray System	\$6000
43501A — Battery X-Ray System	\$5600

SOLID STATE COMPONENTS AND CIRCUITS

Transistor, diode & optoelectronic products

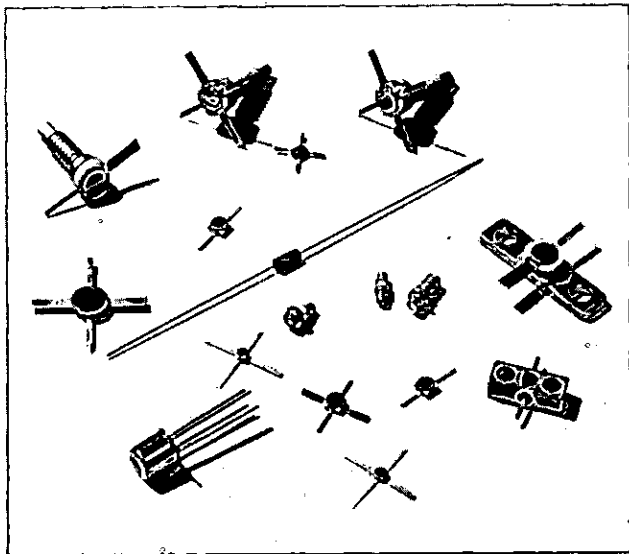

Low cost components, now available from Hewlett-Packard, offer exceptional performance in consumer, industrial, and other OEM equipment. With sophisticated semiconductor processing equipment, and the industry's most extensive hybrid thin-film microcircuit manufacturing facilities, Hewlett-Packard applies newly developed technologies to component manufacturing, offering high performance diodes, transistors, solid state numeric and alphanumeric readouts plus LEDs and other optoelectronic devices — in quantity at economically attractive prices.

Transistors

For RF and microwave oscillators, Hewlett-Packard has devices available that are useful to 8 GHz. The range of microwave transistors includes devices optimized for gain, low noise, and linear power output such that devices are available for the majority of microwave solid state designs.

Hewlett-Packard transistors fill all requirements for multistage VHF-UHF and microwave amplifiers: low-noise input stage, high-gain intermediate stages, and power output stage. Complete data sheet characterization and excellent processing uniformity make it possible to design your circuit by calculation instead of by trial-and-error.

Hewlett-Packard transistors are supplied in chip form, or in several stripline packages in either common-base or common-emitter configurations. The chips have unique moly-gold contact pads that don't deteriorate under high bonding temperatures, improving yields of thin-film hybrid microcircuits.

Look to Hewlett-Packard for further advancements in microwave transistor performance and pricing.

Diodes

Step recovery diodes: These are intended for use as comb generators and harmonic multipliers. When used as a comb generator, the abrupt termination of the diode's reverse recovery current generates voltage pulses up to tens of volts with pulse widths as narrow as 100 ps giving useful power at frequencies in excess of 20 GHz. By optimizing the circuit around any specific harmonic, high efficiency frequency multiplication can be accomplished.

Impatt diodes: A fundamental source of rf power at frequencies above 4 GHz is offered. CW devices can supply 2.5 W at 11 GHz with 10% efficiency, while pulse-optimized devices at the same frequency offer 14 W at 800 ns pulse width and 25% duty cycle.

Schottky barrier diodes: These metal semiconductor diodes combine extremely high retrification efficiency with pico second switching speeds, low series resistance, and low noise characteristics. This combination makes the Schottky an excellent mixer/detector diode.

At HF, VHF and UHF frequencies, HP delivers glass packaged Schottky performance in million piece quantities at economical prices. These same diodes have many digital circuit applications where switching speed is important such as clipping and clamping.

At microwave frequencies, their low noise and repeatable RF impedance lead to outstanding performance either as mixers or detectors. Package configurations include beam leaded devices as well as conventional ceramic and axial lead packages.

PIN diodes: These make super smart resistors for microwave design engineers. By controlling the DC bias, the RF resistance of a PIN diode can be varied from 1 ohm to about 10 k Ω . This unique property of the PIN diode makes it extremely useful as a switch, attenuator, modulator, phase shifter, limiter or AGC element at all frequencies from 1 MHz to microwave.

Integrated products

The combination of chip and beam lead diodes with hybrid thin-film circuit technology has led to an extensive product line of components for the conversion and control of RF signals.

SPST Switches covering the frequency range from 0.1 to 18 GHz are offered either in modules or with connectors. Absorptive Modulators with up to 70 dB of isolation at 18 GHz are available.

Other components include Limiters, Comb Generators, Mixer/Detectors, and Double Balanced Mixers.

High reliability testing

Many Hewlett-Packard components are SPACE QUALIFIED. The reliability of these devices is established by one of the finest high reliability testing facilities in the microwave component industry. Hewlett-Packard's High Reliability Test group maintains military approved JAN and JANTX parts in stock and can recommend Standard Screening programs, patterned after MIL-S-19500, for any HP component. Those who wish to design their own screening specifications can consult with and obtain quotations from Hewlett-Packard's staff of Reliability Engineers.

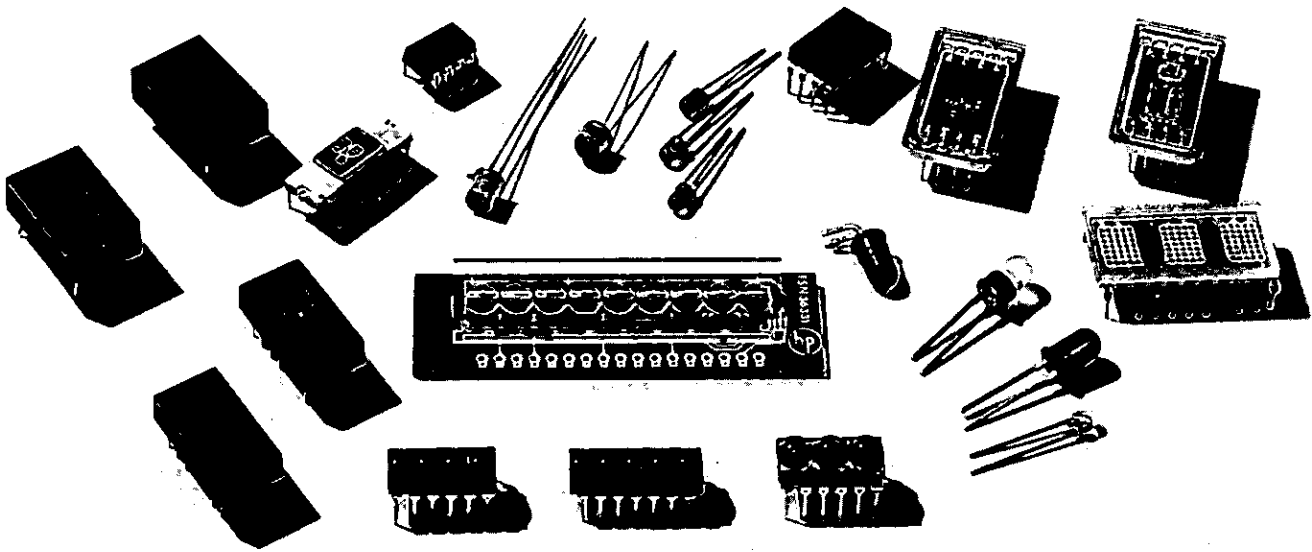

Solid state displays and optoelectronics

Hewlett-Packard offers a complete line of GaAsP and GaP discrete light emitting diodes (LEDs), numeric, and alphanumeric displays. These components provide solid state reliability to visible data transmission. As status indicators and solid state displays, these compact light emitting diodes are electrically compatible with monolithic integrated circuits, with useful life greater than 100,000 hours. HP offers visible emitters in red, yellow and green.

Low cost numeric displays, packaged single or clustered, with or without on-board electronics, are available in character heights from $\frac{1}{8}$ to $1\frac{1}{2}$ ". In addition, alphanumeric and hexadecimal displays are available in single or multi-digit packaging for a variety of applications. Small character, low power displays have been designed for portable instrumentation and calculator applications.

These light emitting diode (LED) displays are offered in plastic encapsulated or hermetic packages. Designed for low cost and ease of application, these displays are ideal for conventional indicator requirements as well as allowing many new applications in the display of information.

Discrete LED indicator lamps are designed for easy panel mounting with clips or direct PC board application. Both plastic and hermetic packages offer high brightness over a wide viewing angle with low power requirements. Hewlett-Packard offers a wide selection of leads, lens, brightness, and package combinations.

Hewlett-Packard offers high gain and high speed optically coupled isolators designed for analog and digital applications. These devices

operate up to 20 M bits with an isolation greater than 2500 volts. High speed and high gain is achieved using an advanced photo integrated-circuit construction. All devices are available in standard DIP packages.

Hewlett-Packard PIN photodiodes are excellent light detectors with an exceptionally fast response of 1 ns, wide spectral response from near infrared to ultra-violet, and wide range linearity (constant efficiency over 6 decades of amplitude). With dark current as low as 250 pA at 10 V, these detectors are especially well-suited for operation at low light levels.

Write for more information

Hewlett-Packard component capabilities are described in catalogs and data sheets available for the asking.

Diode and Transistor Designer's Catalog: This contains key parameters for our line of microwave transistors, Schottky, PIN, Step Recovery and IMPATT diodes, including chips and devices for hybrid integrated circuits.

Solid State Display and Optoelectronics Designer's Catalog: This contains key parameters for our broad line of LED readouts, LED lamps, new Optically Coupled Isolators and Detectors.

These catalogs, application notes and other literature, including prices, are as near as your phone. Call any Hewlett-Packard Sales Office.

ADDITIONAL HP CAPABILITIES

Medical applications

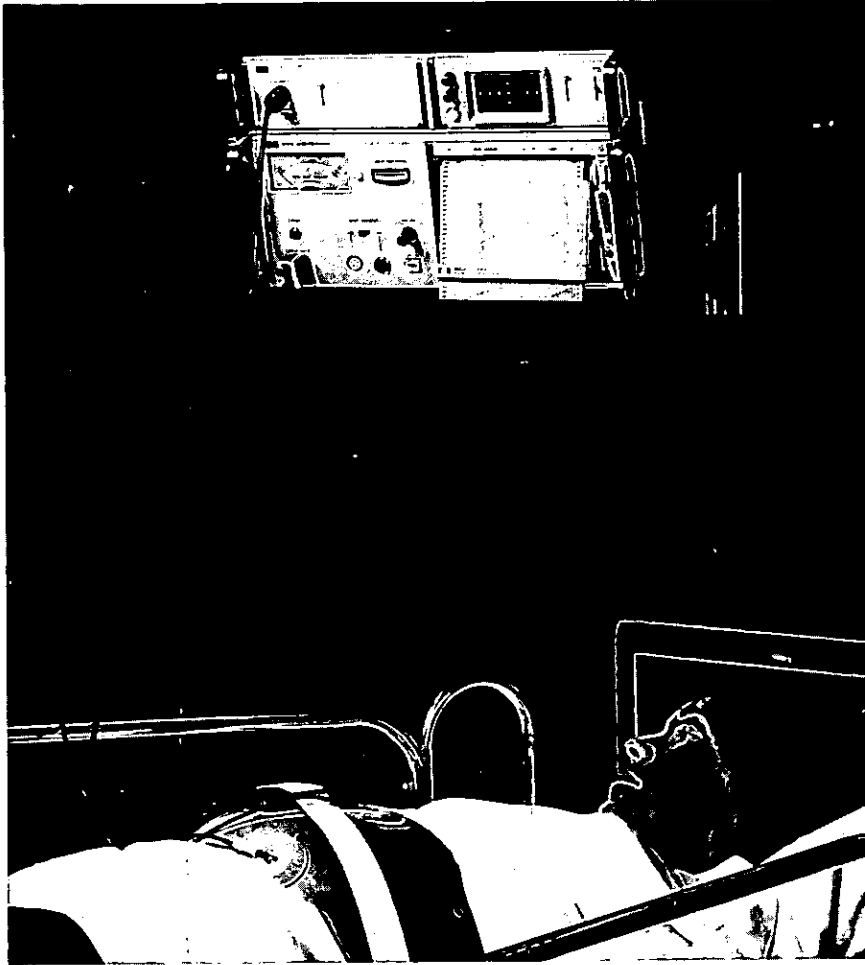

Modern obstetrical care in many hospitals now includes monitoring fetal heart rate and labor activity. State-of-the-art HP Abdominal ECG Processor, shown with HP Fetal Monitor, now offers an accurate external method of obtaining fetal heart rate.

Growth of experience

Today physicians and researchers are using more than 300 different HP medical products to acquire, display, record, store, and in some cases analyze, biomedical signals. This major instrumentation resource had its beginnings in blood pressure and metabolism equipment developed in the early 1920's by Sanborn Company, and has been steadily augmented during the last five decades. Sanborn became part of HP in 1961 and the combined experience and resources have now resulted in products and services for perinatal medicine, pulmonary function testing, anesthesiology, neurology, nuclear medicine, emergency care, radiology, pathology and intensive care monitoring. HP also serves medicine with a variety of application planning, maintenance and staff training services. In recent years, more than 800 hospital people re-

sponsible for maintaining monitoring and ECG instruments have gained valuable knowledge through training seminars conducted by HP.

Where HP instruments serve medicine

Cardiography applications: These involve HP instruments and systems for single- and three-channel ECG recording; ECG stress testing; computer-aided interpretation of ECGs; ECG recording with simultaneous registration of heart sound and pulse tracings; vectorcardiography; and ECG computer terminals for telephone transmission or tape recording of ECG data. Instrument/system highlights: briefcase-size portable ECG weighs less than 20 lb (9.1 kg) complete, operates on AC or batteries; 3-channel automated ECGs produce 12-lead records automatically in 10 sec.; ECG stress testing

system includes ECG, 3-channel memory scope, heart rate meter and defibrillator in mobile cart.

Cardiovascular and research applications: These use multi-channel heated stylus or optical recording systems, complete in all elements from transducers to data displays. System capability and flexibility comes from more than a dozen different interchangeable plug-in signal conditioners and a choice of scopes, meter and numerical displays, plus magnetic tape recorders for analog data storage and playback. With signal conditioners for DC signals, physiological pressures, flow, temperature, ECG, EEG, muscle potentials, heart rate, heart sounds, pressure and pulse waveforms, etc., these systems are widely used for clinical and research studies in cardiac catheterization laboratories, operating rooms and pulmonary labs, as well as medical and pharmaceutical research labs. The widely accepted Computerized Cath Lab Systems aid the physician by assimilating and rapidly calculating data on blood pressures and cardiac volumes, as well as preparing complete reports with much less time and effort. Other cardiovascular instruments include the HP Electromyograph for muscle and nerve diagnosis, and a Diagnostic Ultrasound unit for visualizing internal body structures.

Patient monitoring: An established part of modern intensive care of the coronary, general medical and post-operative patient in critical condition, patient monitoring is a major area of HP medical instrument contribution. Currently more than 40 modular instruments, systems, transducers, carts and a central station console are available, for monitoring the ECG, heart rate, pulse, cardiac arrhythmias, blood pressures, temperature, respiration rate, etc. For the patient on a ventilator, an HP respiratory monitor continuously measures expired airflow and digitally displays tidal volume or minute volume and respiration rate. Alarms warn if a valid breath is not detected within 22 seconds, and a bacterial filter helps reduce the possibility of cross-contamination. Central station instruments include non-fade scopes, numerical and meter displays, recorders and automatic alarms. For monitoring ambulatory patients, the HP ECG telemetry system transmits the ECG from a battery-powered unit worn by the patient, to receivers and displays at the central station. To provide accurate record keeping and instant retrieval of monitored data in many forms to aid diagnosis, the HP patient data management system links the monitoring system to an HP computer. Operation is simplified by direct keyboard communication with the system, and response by video-displayed messages, charts, graphs, etc. In addition, HP also offers a choice of mobile resuscitation systems which provide the specific combination of defibrillator, pacemaker, monitors and organized storage for medications needed by various medical, nursing and surgical services.



Cardiovascular research and clinical diagnosis utilize HP recording systems of many types, such as the multi-channel stress testing system shown in hospital laboratory use.

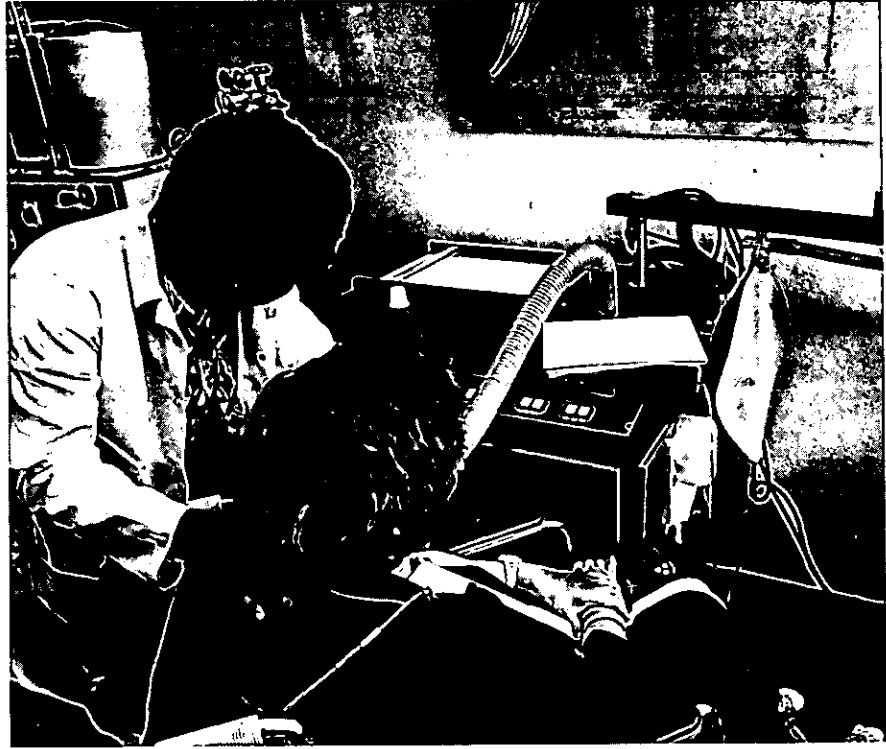

Automated pulmonary function testing allows more tests per hour, simplifies technique and improves quality of data. HP Analyzer shown calculates several measurements in 2 to 3 seconds, prints X-Y plot of washout curve, digitally displays other data on front panel.

Perinatal applications: These applications include instruments and systems for fetal/maternal and neonatal intensive care monitoring. Fetal monitors measure true beat-to-beat fetal heart rate and record it simultaneously with labor activity. Relating fetal heart rate to labor contractions gives valuable information for obstetrical diagnosis and management of labor and delivery, with the potential end-result of reduced fetal mortality and morbidity — i.e., "better babies." HP fetal monitors offer all of the methods of detecting fetal heart rate: internal scalp electrode; external heart sound, ultrasound, and the new state-of-the-art, unique abdominal ECG technique. Comprehensive fetal monitoring systems are analogous to intensive care monitoring systems, with central station display and recording capabilities. Neonatal intensive care monitoring systems employ heart rate and respiration rate monitors (e.g., cardiorespirographs), and also have recording and alarm features.

Pulmonary function testing: Pulmonary Function testing can be accomplished efficiently, with repeatable accuracy and virtually all data reduction and calculating chores performed automatically, with HP instru-

ments employing electronics and digital technology. A Pulmonary Function Analyzer automatically presets and calibrates itself, calculates vital capacity, FEV₁, FEV₃ and MEF_R in 2-3 seconds, prints an X-Y plot of single-breath N₂ washout with closing volume, and digitally displays FRC and ADS for a multiple-breath washout test. For pulmonary screening, a Lung Function Analyzer automatically prints peak flow, vital capacity, FEV₁ and FEV₃ four seconds after a single forced expiration. A Digital Pneumotach for flow and volume measurements, a Nitrogen Analyzer and fast X-Y Recorder combine to offer similar convenience and precision for pulmonary tests. For measuring arterial oxygen saturation non-invasively, with convenience, continuity and speed, the HP Oximeter offers unusual advantages. Optical transmission of the ear is measured using a patented multi-wavelength technique, and arterial O₂ saturation is numerically displayed within 30 seconds. Accuracy is unaffected by patient's ear thickness or skin pigmentation.

Radiology: In Radiology applications, HP now offers a group of high-performance X-ray machines with automatic exposure con-

trol. They include a 350 kV, field emission tube, chest X-ray system which improves soft tissue visibility throughout the entire chest, with considerably less radiation exposure to the patient; a complete system for X-raying the neonate in the nursery, with minimum distress to the infant and the most consistent radiograph; and Faxitron® cabinet X-ray systems for specimen radiography and for laboratory training of radiological technicians.

Hospital and independent clinical laboratories: For hospitals and clinical laboratories as well as medical research institutions, HP offers a full line of chemical analysis instruments. The wide variety available includes three different types of gas chromatographs, a high-pressure liquid chromatograph, and a gas chromatograph/mass spectrometer/data system. In addition, automatic liquid samplers for gas chromatographs and laboratory data handling systems for GC and LC are also available from HP chemical analysis product line Divisions.

Detailed information: For more detailed information on any HP medical instrument or system, please call or write Hewlett-Packard, indicating specific product(s) of interest.

INSTRUMENTATION FOR CHEMICAL ANALYSIS



Widely recognized as a leading supplier of electronic measuring instruments and data handling equipment for the engineer, Hewlett-Packard is also rapidly developing a similar position in analytical instrumentation for the scientist. HP's analytical products now include a full line of gas chromatographs, a liquid chromatograph, automatic sampling systems for GC, data handling devices and

systems for the analytical laboratory as well as mass and ESCA spectrometers and temperature measuring instruments.

Gas chromatographs

Although less than 20 years old, gas chromatography (GC) has taken over from classical methods of analysis the bulk of analytical work performed in laboratories around

the world. There is an excellent reason for the revolutionary popularity of the gas chromatograph in analytical chemistry: no other method gets more accurate results, at greater speed, and for less cost.

For the scientist whose interest is the chemical analysis of unknown samples, Hewlett-Packard offers four basic types of gas chromatographs.

Series 5830A reporting gas chromatographs: These are a complete analytical system. They have a built-in digital processor that operates the system throughout the analytical run, following precisely the instructions that you give it before the analysis, on an easy to use keyboard. The processor continuously monitors detector output; reduces it to peak areas and times according to a sophisticated integration algorithm; identifies the sample components and computes their concentrations; generates the chromatogram; and presents a complete analytical report, including a list of analysis conditions as well as the chromatogram and the component concentrations, on its own built-in printer/plotter.

5700A family of laboratory gas chromatographs: This family is comprised of Series 5710A dual column instruments and Series 5720A single column instruments. 5710A instruments are available with an isothermal oven temperature controller or a digital programmer, and can accommodate flame ionization, thermal conductivity, electron capture or flame photometric detector systems. Series 5720A instruments provide the same high performance and excellent precision as Series 5710A and are available with either flame ionization or thermal conductivity detectors. The modular design of these instruments makes possible the most economical GC at the highest performance level for laboratories that specialize in specific analyses such as drugs, pesticides, natural gas and air pollution.

Series 5750B research GC's: These multiple-detector instruments offer a high level of performance for a great variety of analyses. They are designed expressly for the research laboratory that requires an extremely versatile instrument.

Series 7610A high efficiency GC's: Their large oven accommodates glass U-tube columns for the analysis of materials that are difficult to chromatograph. These instruments incorporate other design features that make them especially effective with biological samples and thermally sensitive or polar materials.

Liquid chromatograph

Model 1010B high-speed liquid chromatograph: This instrument was specifically designed for modern high pressure operation. It allows a wide latitude in choice of detectors and is applicable to all modes of liquid chromatography. Automatic gradient and flow programming are available as options to the basic unit and the entire instrument is expandable to meet your growing analytical requirements. Detectors available for the Model 1010B are: differential refractometer, ultraviolet absorption, fluorescence, electrolytic conductivity and variable wavelength UV-visible.

Sampling systems

Model 7670A/7671A automatic samplers: These automate the measurement and

injection of samples into a gas chromatograph. Designed to be installed on either horizontal (7670A) or vertical (7671A) injection ports, these sampling devices operated unattended overnight and even over weekends reducing operating costs so significantly that even the smallest labs can justify the purchase.

Data handling

Since gas chromatography produces both qualitative and quantitative information on large numbers of complex samples in a very short time, its data output is so large that automatic methods for handling it are economical if not essential. Hewlett-Packard manufactures a variety of instruments and systems for automatic data handling.

The Model 3380A reporting integrator: The first instrument which provides all the functions that you need to get a complete answer from your gas or liquid chromatograph. In a single unified instrument, it records chromatograms, measures peak retention times and areas, and calculates the analysis results and prints the report. The 3380A does more than merely combine these three functions in a single cabinet. It also materially improves the quality of each function that it performs, because it conducts all of its operations under the constant control of its own built-in digital processor. As a result, the analytical report that it gives you is more complete than you can get from any combination of separate recorders and integrators or computing integrators or computer systems.

The Model 3352B laboratory data system: This turn-key system is ready to use when delivered, completely configured and pre-programmed for your laboratory. It can be expanded, as often as your needs require, to as many as 15 modules without obsoleting the modular hardware. Its powerful data analysis software looks backward at data already stored and forward to data just received to integrate total peak area. It corrects baseline drift, detects low, slow peaks and performs tangent skim calculations for peaks that appear on the tail of a solvent.

It lets you store as many as 248 analytical methods in computer memory and apply any one to any channel. All of the traditional calculation procedures — area %, normalization, internal standard, external standard — are available in software.

The Model 3373B electronic digital integrator: automatically measures the retention time and area of each peak on a chromatogram. It presents the data either on a built-in printer, on punched paper tape for use with time-share computers, or directly to a digital computer in real time.

Strip chart recorders: Several Hewlett-Packard recorders are available with special input circuitry for use in GC: Modules 7127A, 7128A, 7143A/B, 680. All solid state instruments, they offer a choice of one or two recording pens and five- or ten-inch calibrated charts.

Mass spectrometer

It is generally agreed among scientists that the most powerful tool for the qualitative and quantitative identification of unknown materials is the combination of a gas chromatograph and mass spectrometer. In the Hewlett-Packard system, these two instruments are fully integrated with a computer, further increasing their analytical power and operator convenience. All three components — gas chromatograph, mass spectrometer and computer — are manufactured and serviced world-wide by Hewlett-Packard.

HP mass spectrometers can be operated either manually or automatically. In the automatic mode, the Dual Disc Data System controls the operation of the spectrometer and accumulates the analytical data while it performs the necessary calculations. It does a mass scan in less than one second, fast enough to analyze every peak separated by the gas chromatograph, and stores all the analytical data for continuous GC/MS analyses as long as 10 hours. Data handling is enhanced by the ability to search a 12,807 spectral library and by powerful graphic display (CRT) software.

ESCA spectrometer

Electron spectroscopy for chemical analysis (ESCA) is a relatively new technique for measuring the binding energies of core and valence electrons in atoms and molecules. It has great potential in both structural and analytical chemistry, with applications in the study of surface chemistry, oxidation states, molecular structure and chemical analysis generally.

HP's 5950A ESCA Spectrometer advances the state-of-the-art in some extremely significant ways. It incorporates an X-ray monochromator and dispersion-compensated electron optics, each an entirely unique technological breakthrough. When combined with the 5950A's position-sensitive detector, these design features serve to eliminate the line-width of the exciting radiation without introducing any slits in the spectrometer. The result is an instrument that can be operated under optimum conditions of both sensitivity and resolution at all times.

The main performance characteristics of the 5950A include freedom from background and freedom from satellites as well as greatly improved resolution and sensitivity.

Thermometers

HP's 2801A, a research-type quartz thermometer, provides extremely precise, reliable measurements with resolution to 0.001°C over the range -80° to +250°C. The 2802A Platinum Resistance Thermometer, a medium-priced thermometer with features usually found in more costly units, has two ranges; -200°C to +600°C and -100°C to +200°C making it ideal for a wide variety of applications. Details about both thermometers are found under "Physical and Optical Measurements" in this catalog.

CIVIL ENGINEERING PRODUCTS

General information

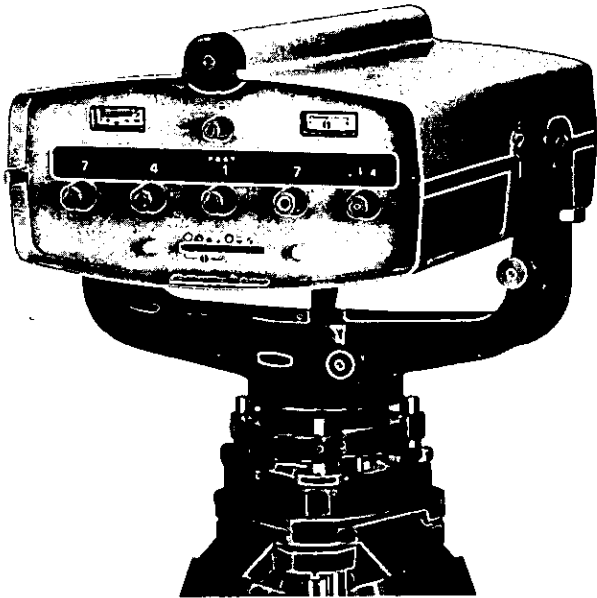

HP3800A Distance Meter

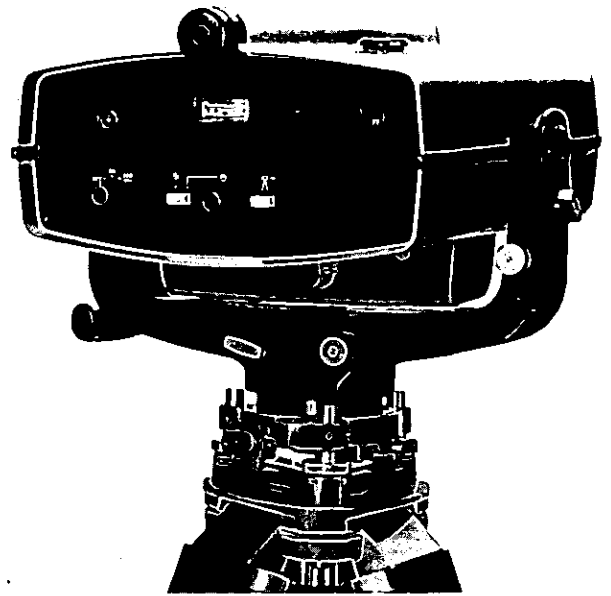

HP3805A Distance Meter



HP-65 Programmable Pocket Calculator with surveying routines and magnetic cards.

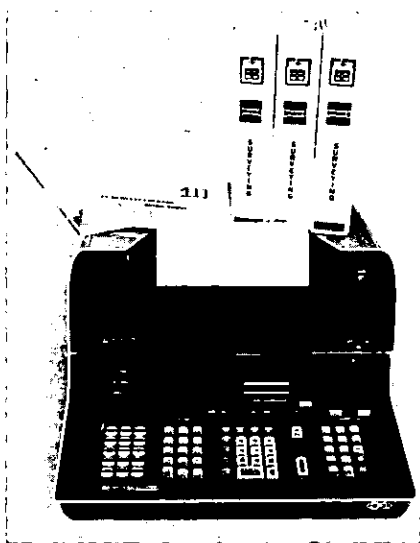

HP9810A Calculator, HP9866A Printer and surveying program library.

Hewlett-Packard, long recognized as the leading supplier of electronic measuring instruments for the engineer, has developed a similar position in electronic distance measurement and computation instrumentation for the surveyor. These instruments are briefly described on this page.

HP3800 Series distance meters

The Series 3800 Distance Meters are low cost, medium range, electro-optical distance measuring instruments employing an infrared light source. The HP3800A measures in feet, the HP3800B in metres. The HP3800's combine a range of 10,000 feet (3000 metres), high accuracy and ease of operation into one lightweight, rugged instrument. Use of graphic symbol notation on the operating panel serves as a constant reminder of the measurement sequence. A visual display of the total measured distance in feet or metres, corrected for atmospheric conditions, is accomplished in less than two minutes. Unique circuitry eliminates effects on measured distance caused by momentary beam interruptions. The compact HP3801 Power Unit with atmospheric correction dial and built-in charger gives long operating time and provision for operating from an external source.

HP3805A Distance meter

The HP3805A Distance Meter is a new low cost, short range, automatic readout, infrared light source instrument. The range of the

HP3805A is one mile (1600 metres) with the measured distance displayed in feet or metres at the flip of a switch. The HP3805A features a built-in computer to assure distance accuracy by taking a minimum of 3,000 readings for each measurement displayed. This instrument also has an internal self-check capability of verifying its electronic performance in the field or office, and automatic atmospheric correction. The optional battery pod that snaps into the bottom of the instrument provides cable free battery operation for a lightweight portable field system.

Hewlett-Packard's versatile distance meters are suited for such applications as boundary, subdivision, construction, control, geophysical and mine surveys. A short demonstration is all that is necessary for operator training on these instruments.

Surveying calculators

The Civil Engineering Division also markets Hewlett-Packard's full line of pocket, desk-top and programmable calculators filling the surveyor's requirements for distance measurement and computation instrumentation. Applications and programming specialists have developed surveying routines for the pocket calculators and libraries of surveying programs for the programmable models. For full specifications and details on Hewlett-Packard calculators and peripherals, see pages 531-538.

ORDERING INFORMATION



Shipping, prices, and terms of sale

Communicating with HP

HP is committed to providing convenient local support and the best possible attention to customer needs on a worldwide basis, and we now have more than 172 sales and service offices located in 65 countries. (A complete listing of our offices appears on the inside back cover of this catalog.)

Your entry point to the resources of Hewlett-Packard is through the local HP office nearest you. Our field engineers and order support specialists there are well-equipped to provide you with pre-sale assistance in product selection, as well as related business information such as current product availability and price delivered to your location.

HP field offices are tied into a sophisticated intra-company communications system. This not only means prompt transmission of orders to any of the 27 HP manufacturing locations — it also speeds the flow of regular messages among all HP field offices and factories. The objective, of course, is to provide the fastest possible response to your product interests.

Placing your order

Hewlett-Packard people at the field office nearest you will be pleased to provide assistance in selecting the HP equipment most appropriate to your needs, and to help you prepare your order.

The information in this catalog will, in many cases, be sufficient for you to decide to buy a particular HP product. In those instances, a telephone call to the nearest HP office will provide you with (1) information on product availability, and (2) the product's price, delivered to your location (since any budgetary prices provided with this catalog are FOB appropriate HP factory or warehouse facility, and do not include import surcharge, if any).

We want to be sure the product we deliver to you is exactly the one you want. Therefore, when placing your order, please specify the product's catalog (model, accessory, or part) number, as well as the product's name. Be as complete as possible in specifying exactly what you'd like, including standard options.

In the event you want special features or

capabilities such as different color or a non-standard power line voltage, ask your HP field engineer about availability and cost. of these "specials" first — and then, to prevent misunderstandings, include special instructions and specification details with your order.

Shipping methods

Inside the USA: Shipments to destinations in the USA are made directly from factories or local warehouses. Unless specifically requested otherwise, express or truck transportation is used, whichever is less expensive and most serviceable to you. Small items are sent parcel post. If fast delivery is needed, we gladly ship by air freight, air express, or air parcel post, when specified on your order, at prevailing rates. In many parts of the USA, a consolidated air freight service provides the speed of air transport at surface rates. Ask your HP field engineer for details.

Outside the USA: Shipments to destinations outside the USA are made from the appropriate Hewlett-Packard facility by either surface or air, as requested. Sea shipments usually require commercial export packaging at a nominal extra charge.

Budgetary prices

Price information which may be supplied with this catalog is designed to provide you with helpful budgetary guidance. Unless otherwise noted, prices are based on HP factory or warehouse shipping point, so please call your nearby HP field office to determine a product's delivered price at your location.

Any prices which appear printed on the product pages in blue ink apply only to domestic USA customers. They do not include an import surcharge on applicable products; such surcharge is to be added to the price shown.

Prices furnished with this catalog are net prices prevailing at the time of printing. Hewlett-Packard reserves the right to change prices, and those prices prevailing at the time an order is received will apply.

Quotations and pro forma invoices

Destination prices and other details you

may need to know before ordering can be quickly obtained via telephone. Just call your nearest HP office.

If you are an international customer requiring formal paperwork such as pro forma invoices or FAX, CIF, or C&F quotations, please contact the Hewlett-Packard office or representative serving your area. Exportation or importation assistance is also available.

Terms of sale

Inside the USA: Terms are net 30 days from invoice date. Unless credit with Hewlett-Packard has already been established, shipments will be made COD or on receipt of cash in advance.

Leasing and extended financial terms are available. However, the associated costs are not included in any product prices furnished with this catalog. Your nearby HP office will be pleased to discuss your requirements, and work with you in setting up an appropriate program.

Outside the USA: Terms for orders from customers outside the United States of America which are placed with the Hewlett-Packard Company, Hewlett-Packard S.A. or Hewlett-Packard Inter-Americas, are irrevocable letters of credit or cash in advance — unless other terms have been previously arranged. Terms for orders placed with authorized Hewlett-Packard representatives or distributors are mutually determined between the customer and the representative or distributor organization.

U.S. government sales

Most products in this catalog are covered on GSA federal supply schedule multi-award contracts.

Product changes

Although product information and illustrations in this catalog were current at the time it was approved for printing, Hewlett-Packard, in a continuing effort to offer excellent products at a fair value, reserves the right to change specifications, designs, and models without notice.

AFTER-SALE SERVICES

Warranty, certification, repair service, parts



With Hewlett-Packard, you get excellent products backed by a responsive customer service program

When you purchase a Hewlett-Packard product, you also receive the assurance that it will continue to perform to its published specifications today, tomorrow, next week — and

for a reasonable number of months and years in the future.

We firmly believe that our obligation to you as a customer goes much beyond just the

delivery of your new HP product. This philosophy is implemented by Hewlett-Packard in two basic ways: (1) by designing and building excellent products with good serviceabil-



ity, and (2) by backing up those products with a customer service program which can respond to your needs with speed and completeness.

The HP customer service program is one of the most important facets of our worldwide operations, providing a local service capability in virtually every one of our field offices (listed inside the back cover of this catalog.) Indeed, this customer service program is one of the major factors in Hewlett-Packard's reputation for integrity and responsibility towards its customers.

Warranty

As an expression of confidence in our products to continue meeting the high standards of reliability and performance that customers have come to expect, Hewlett-Packard products carry the following warranty:

All Hewlett-Packard products are warranted against defects in materials and workmanship. The period of coverage is specified in a warranty statement provided with each product. Hewlett-Packard will repair or replace products which prove to be defective during the warranty period. In some cases, reference is made to a requirement for preventive maintenance. No other warranty is expressed or implied. Hewlett-Packard is not liable for consequential damages.

Certification

Some customers are especially interested in the test and quality assurance programs that HP applies to its products. These Hewlett-Packard programs are documented in a Certificate of Conformance which is available upon request at the time of purchase. This certification states:

Products, materials, parts, and services furnished on this order have been provided in accordance with all applicable Hewlett-Packard specifications. Actual inspection and test data pertaining to this order is on file and available for examination.

Hewlett-Packard's calibration measurements are traceable to the National Bureau of

Standards to the extent allowed by the Bureau's calibration facilities.

The Hewlett-Packard Quality Program satisfies the requirements of MIL-Q-9858, MIL-I-45208, and MIL-C-45662.

Repair service

Help in maintaining your Hewlett-Packard equipment in first-rate operating condition is as close as a telephone call to the nearest Hewlett-Packard field office. Whether you want to repair an instrument yourself, or send it to a Hewlett-Packard facility for repair, recalibration, or overhaul, your local Hewlett-Packard field office can offer a complete range of technical assistance.

Local repair facilities are backed up by Regional Repair Centers, located in major industrial areas around the world. The Regional Repair Centers have more sophisticated test equipment, factory-trained specialists, and a full line of replacement parts.

If your equipment installation is fixed, and if justified by the type of service required, Hewlett-Packard will perform service at your facility.

You have access to all of Hewlett-Packard's extensive service network through your local Hewlett-Packard field office.

Replacement parts

Replacement parts play a key role in Hewlett-Packard's customer service program. Prompt product maintenance, whether it's performed in your shop or ours, depends on the ready availability of replacement parts. HP makes every effort to shorten parts delivery time and as a result, attempts to fill all replacement parts orders the same day they are received.

To sustain equipment operation in remote areas, or where equipment downtime is extremely critical, spare parts kits are available.

When ordering a replacement part, please specify the Hewlett-Packard part number listed in the table and give the complete name. If circumstances require your ordering a part without specifying the part number, please in-

clude in your order the instrument model number, its serial number, a complete description of the part, its function, and its location in the equipment.

Customer service agreements

Your instrument maintenance requirements in many cases may be handled most economically by entering into a Hewlett-Packard Customer Service Agreement. When you have a customer service agreement, HP assumes your maintenance responsibilities for a basic annual fee. This relieves you of having to hire your own trained maintenance specialist, of having to maintain replacement parts inventories, and of having to set up the administrative procedures needed for proper maintenance scheduling. Please contact your nearest HP office for details.

Service publications

The Operating and Service Manual supplied with each Hewlett-Packard test and measuring product contains maintenance, calibration, diagnostic and repair procedures, with troubleshooting charts and circuit diagrams. All replaceable parts are listed. Extra manuals are available at reasonable cost from your nearby Hewlett-Packard field office. Most operating and service manuals with changes and service notes are now available on COSATI standard, positive microfiche.

New or special calibration procedures, instrument modifications, and special repair procedures are described in detail in Hewlett-Packard Service Notes. This series of publications serves as a convenient means of updating operating and service manuals.

Bench Briefs, a periodic newsletter, has servicing tips, new modifications and other suggestions to help repair and maintenance personnel get maximum performance from Hewlett-Packard instruments. It describes new service notes and other company publications as they become available. To become a regular subscriber, ask your local HP field office to place your name on the mailing list.

HEWLETT-PACKARD INTERFACE BUS

Versatile interconnect system for instruments & controllers



HP Interface Bus: commitment to flexible, low-cost intercommunication.

Productivity improvement is emphasized almost everywhere, which has naturally led to an increased demand for programmable instruments and instrumentation systems of many kinds. It has also intensified the need for low-cost, versatile, high-performance inter-device communication links which may be commonly and uniformly used on a broad scale among system components.

Just such an interface system has now been developed at Hewlett-Packard, providing many of the attributes sought by instrument designers and systems users alike. And as you will note from the facing page, the Hewlett-Packard Interface Bus is much more than theoretical concept — in a very practical sense, it includes a growing list of Bus-compatible equipment (instruments, accessories, controllers, and complete systems) which are available to serve you right now.

What are the benefits?

Use of the HP Interface Bus (HP-IB) enables system designers and users to interconnect a wide variety of product capabilities, with minimum added engineering — and to conveniently configure simple bench-top systems, as well as larger and more complex instrumentation systems.

Among the specific benefits: (1) The HP-IB accommodates both high and low speed devices in the same system with equal ease, and thus permits selection of the best system components without undue constraints imposed by the interface. (2) Data codes, data rates, and data paths may be altered throughout the course of a test sequence to optimize system

performance. (3) Use of the ASCII code (preferred but not mandatory) simplifies system programming as well as generation and interpretation of data. And (4), the interface system provides direct data transfers between devices and allows multiple system component *listeners*, which reduces message traffic across the interface and speeds overall system performance.

The HP Interface Bus system, having these features and benefits, reduces both the initial system costs attributable to the interface, and those costs related to training and maintenance.

In addition, the HP-IB has been adopted as a major instrumentation interface standard within Hewlett-Packard. You may be assured we intend to add to the growing list of instruments, controllers, accessories, and pre-assembled systems utilizing the HP-IB concept — as well as providing assistance in the form of diagnostic equipment and training.

General description — how the HP Interface Bus works

The Hewlett-Packard Interface Bus* focuses on the most frequent communication needs within instrumentation systems: 15 or less interconnected devices, distances shorter than 20 meters (unless extended by HP's 59403A HP-IB Common Carrier Interface), data rates up to 1 megabyte per second, and

*The essential interface techniques as used in the Hewlett-Packard Interface Bus conform to a draft document now under consideration by the IEC as an international Recommendation.

relatively short messages carried among system components. Holding to these common parameters increases the feasibility of having a widely-used interface technique.

A key objective of the interface system is to permit interconnection of a broad spectrum of Hewlett-Packard products possessing stimulus, measurement, display, storage, and processor-related capabilities — all used in instrumentation systems. In addition, the interface system must be equally capable and effective in interconnecting a simple device such as a 10-digit remote display, or a complex device such as a computer used to control a large instrumentation system.

The Hewlett-Packard Interface Bus defines three major interface elements: *mechanical* (e.g., connectors), *electrical* (e.g., driver and receiver circuits), and *functional* (e.g., signal line and message transfer protocol) specifications. Only the device and system *independent* characteristics of these parameters are specified by the common interface definition to make the interface system widely applicable.

As mentioned earlier, the interface system accommodates up to fifteen devices (e.g., signal source, counter, voltmeter, printer, controller, etc.) interconnected over one contiguous bus — via a passive cable network containing the signal lines. Standard HP-IB cables are available in lengths of approximately 1, 2, and 4 meters (Models 10631A, B & C respectively) for ease in system assembly.

All information on 16 signal lines

The interface system contains a set of sixteen signal lines used to carry all information (addresses, universal commands, measurement data, program data, and status data) among the interconnected devices.

Eight "DIO" signal lines (Data Input Output, lines 1 through 8) carry coded messages in bit-parallel, byte-serial form to and from devices, with each byte being transferred from one *talker* to one or more *listeners*. Data flow is bidirectional in that the same signal lines are used to both input program data and to output measurement data from an individual device. Data is exchanged asynchronously between devices, enabling compatibility among a wide variety of products.

The other eight signal lines carry special control and status messages. Three of these dedicated lines: "DAV" (Data Valid), "NRFD" (Not Ready for Data), and "NDAC" (Not Data Accepted) are used to effect the transfer of each byte of coded data on the eight "DIO" (Data Input Output) signal lines. The five remaining dedicated signal lines: "IFC" (Interface Clear), "ATN" (Attention), "SRQ" (Service Request), "REN" (Remote Enable), and "EOI" (End or Identify) are used to manage an orderly flow of information across the interface.

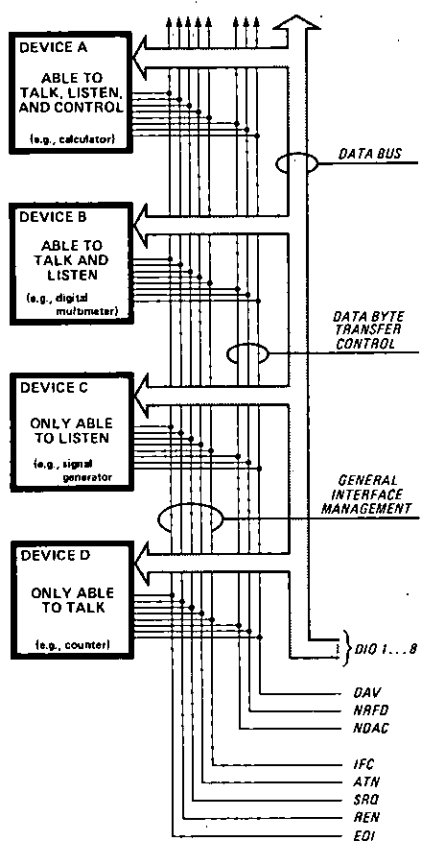

Defining operational responsibilities

The HP Interface Bus extends the concept of a common and widely useful interface system much further into instrument design than previous instrument interface concepts at Hewlett-Packard. While the HP-IB offers significant advantages, it must be recognized that it is not a universal panacea. Instant systems are neither the goal nor the net result. Interface-related operational capabilities (e.g., device dependent codes) are beyond the scope of the basic HP-IB definition. Helpful information to assist a customer in configuring and assembling an instrumentation system is contained in publications such as the "HP Interface Bus User's Guide" (included with certain HP-IB equipment, and available for purchase separately) — but overall operational responsibility for customer-assembled HP-IB systems rests with the customer. While the above operational capabilities are, of necessity, excluded from individual in-

struments, they are included in complete pre-assembled HP systems. Where there is sufficient demand, Hewlett-Packard offers standard HP-IB measurement systems such as the Model 3042A network analyzer (see page 420), and the Model 3050B automatic data acquisition systems (page 57). These pre-assembled systems are fully integrated and documented from a hardware and software point of view. Diagnostic and verification software is provided, and HP assumes full responsibility for overall system performance.

Instruments, accessories, and controllers for HP-IB use

An increasing number of Hewlett-Packard instruments applicable to instrumentation systems are now available for use with the HP Interface Bus — and are complemented by accessory devices specifically for HP-IB use, as well as HP calculators which may be used as controllers. Some of these products have been available since mid-1972, and substantiate the merits of this proven interface system.

Different configurations of signal sources, measuring and recording instruments, and Bus-compatible accessories can be assembled into stimulus, stimulus/response, or direct measurement systems — with applications in production testing, environmental measuring, and process control just to name a few.

Available instruments

Signal source and stimulus instruments compatible for HP-IB use include: Model 3320A/B and 3330A/B Frequency Synthesizers covering 0.01 Hz to 13 MHz (see pages 320 and 322); Model 8660A/B Synthesized Signal Generators covering 10 kHz to 2.6 GHz (page 348); and Model 8016A Word Generator having a 9 x 32 bit memory and a variable 0.5 Hz to 50 MHz bit rate (page 316). Measuring instruments include: Model 3490A Digital Multimeter (see page 47); Model 5345A Electronic Counter (page 252); Models 5340A and 5341A Microwave Counters (page 262); and the Model 5300B-series Electronic Counter system (page 270) when used with a 5312A module.

Measurement results can be captured and recorded by using the Model 5150A Alpha-numeric Thermal Printer (page 246).

Accessories

The following items provide specific enhancements to HP Interface Bus systems, and lend great versatility to the HP-IB concept. Most of them are described on pages 256 and 257: Model 59301A ASCII (HB-IB)-to-Parallel Converter; Model 59303A Digital-to-Analog Converter; Model 59304A Numeric Display; Model 59306A Relay Actuator; Model 59307A VHF Switch; Model 59308A Timing Generator; Model 59309A Digital

Clock; Model 59400A TTY Interface; Model 59403A Common Carrier Interface; and Model 59401A Bus System Analyzer.

Control via calculator or computer

Simple HP Interface Bus configurations (e.g., a two-instrument counter and printer setup for semi-automatic data logging) do not require the use of a controller such as a calculator or computer. However, the HP-IB also lends itself to more complex configurations where the power of HP calculators or computers may be important.

We will be pleased to discuss computer control with you if you are interested. In most cases, however, operator-oriented Hewlett-Packard programmable calculators are the ideal HP-IB controllers for customer-assembled systems, whenever some degree of data manipulation is required.

The Model 59405A HP-IB Calculator Interface package provides everything necessary for interconnecting an HP Model 9820A, 9821A, or 9830A calculator (see page 535) with up to 14 other HP-IB compatible devices. The 59405A uses only one I/O slot on the calculator, and it provides the necessary hardware and software for calculator operation of HP-IB instruments and accessories. Aids for problem diagnosis are also included.

When equipped with the Model 59405A package, HP calculators have five HP-IB operating modes: (1) *listen*; (2) *talk*; (3) *controller*; (4) *system controller*, the usual configuration and highest level of Bus control, being capable of initializing the Bus at any time; and (5) *service request monitor*.

HP-IB Calculator Interface details

Complete specifications and details are covered in the data sheet for the Model 59405A HP-IB Calculator Interface package, which has three configurations (depending upon which HP calculator is to be used): *59405A Option 020* for Model 9820A operation; programs on magnetic cards. *59405A Option 021* for Model 9821A operation; programs on cassettes. *59405A Option 030* for Model 9830A operation; programs on cassettes.

Each HP-IB Calculator Interface package includes the appropriate plug-in calculator ROM for I/O control, the I/O card, and an HP-IB interconnect cable approximately 4 meters long. Also included are a User's Guide which describes how to communicate with HP-IB instruments via the calculator, an operating manual, and verification and diagnostic programs (on cassettes or magnetic cards).

Model 59405A

51300

TRAINING/VIDEO TAPES

Technical training

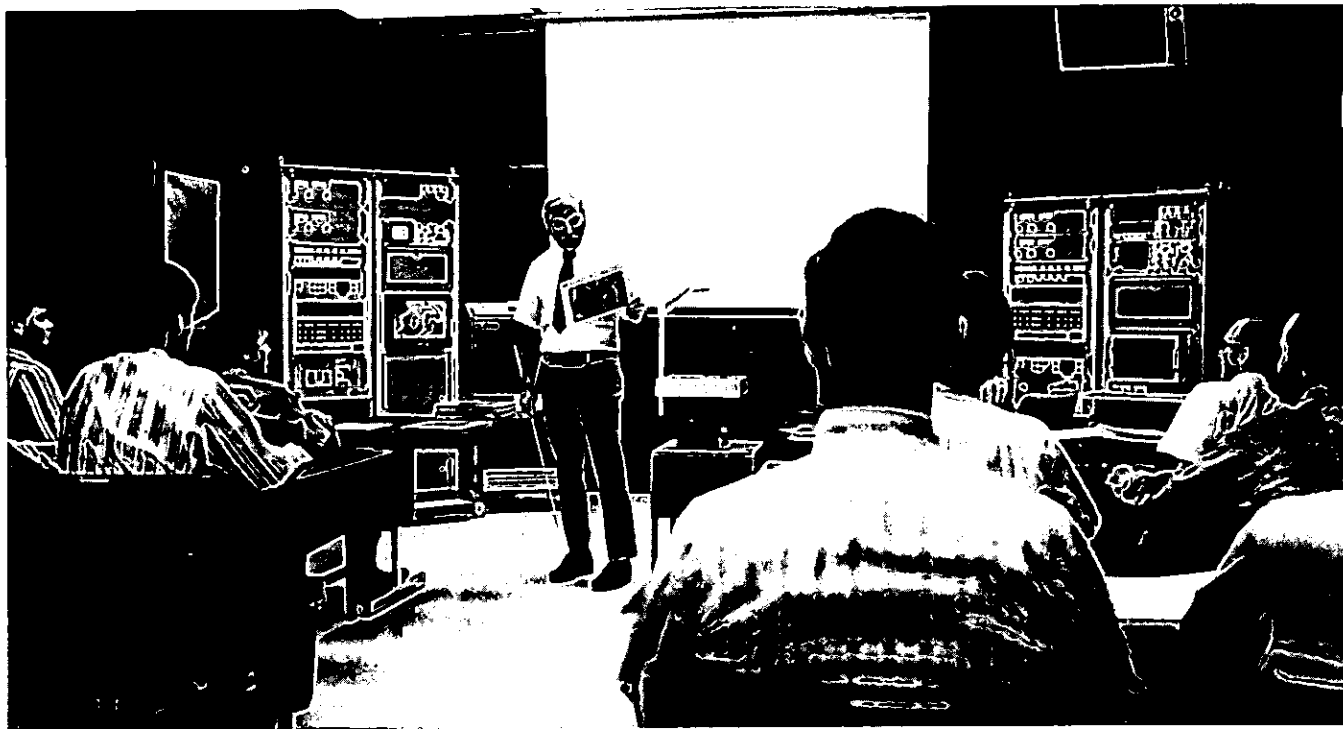

With Hewlett-Packard's extensive product line and worldwide customer mix there are two main avenues for technical customer training. These are live training sessions and video tapes. Live training sessions fall into three subcategories: *applications*, *service* and *tutorial*. *Application* seminars aimed at increasing your utilization of general purpose test instrumentation are often available at no charge. On the other hand, seminars on the operation of dedicated systems are more specific in nature and are generally charged for. *Service* seminars are available on a supply-and-demand basis and, as such, there is usually a nominal charge. *Tutorial* seminars, such as our Microwave Circuit Design Seminar (see example below), are frequently equivalent to graduate level instruction, and there is a corresponding charge for these programs.

MICROWAVE CIRCUIT DESIGN SEMINAR

Provides the designer of high-frequency circuits with:

1. A thorough understanding of modern microwave design concepts and
2. Competence in applying these concepts in his designs.

This will enable the designer to realize the performance potential that modern microwave technology offers.

He will learn linear design methods based on scattering parameters, and will learn to use time-shared computer programs to aid in the design and measurement of results.

For detailed information on all HP seminars, contact your Hewlett-Packard field engineer or call the Hewlett-Packard office nearest you—see the inside back cover.

HP video tapes A better way to learn

Part of the "extra value" which comes with each Hewlett-Packard product is our continuing commitment to provide Hewlett-Packard customers with useful training information in the areas of applications and service. In the past, this information has often been in the form of classroom seminars, either at your nearby Hewlett-Packard sales office or at one of our training facilities in California.

Now our capability is expanding by offering you both service and applications training via video tape. Video tape training is exceptionally convenient and readily available, ready for your own use at any time or any place, including within your own facilities.

Effective: Hewlett-Packard has found that video tape is a highly effective training medium. Video tapes can convey more information in *less time*, and with *higher retention*, than even the best live instruction. Hewlett-Packard programs are professionally produced and are based on measurable instructional objectives. They consider what the student already knows, emphasize what he needs to know, and omit what he does not need to know. Many video tapes utilize *split-screen* techniques, allowing students to watch a procedure on one part of the screen while observing its effect on another part. Most Hewlett-Packard video tapes are *100% visualized*, as opposed to conventional, partially visualized video tape "lectures."

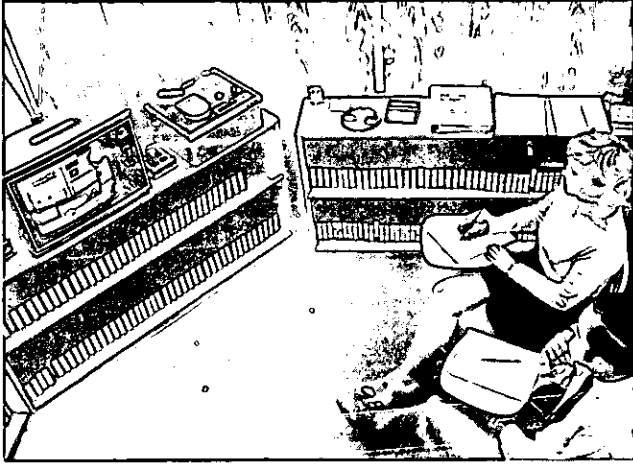

Flexible: With video tapes, you can *tailor* your training program to suit the many needs of your organization. You may select training programs for individuals with different backgrounds and specific needs, present effective programs to audiences of just one or hundreds, and offer a library of technical programs your staff members can easily consult on their own . . . for *new information* or for *refresher* purposes.

Faster: It has been our experience that Hewlett-Packard video programs *compress learning time* by a factor of up to 6-to-1. A video tape library also reduces the time needed to organize and schedule your training. You can schedule highly professional presentations anytime and anywhere, without arranging for outside instructors or juggling the detailed logistics that are often required for live training sessions. More effective training in one-sixth the time!

Convenient: Video tape programs come on small, *easy-to-file* magnetic tape reels or cassettes. Inexpensive playback equipment is easily operated by unskilled personnel. Programs may be viewed on small portable monitors or on full-screen TV sets. Video tapes can be quickly searched for specific information using "fast forward" or "fast rewind," and many recorders can stop on a single frame for more detailed study.

Time-Tested: All the video tapes offered in the Hewlett-Packard Videotape Catalog were developed to serve Hewlett-Packard's needs for a practical, low cost source of up-to-date training in a wide variety of subjects. Now, after having been tested in Hewlett-Packard training activities throughout the world, many of these video programs are available to help meet your training objectives.

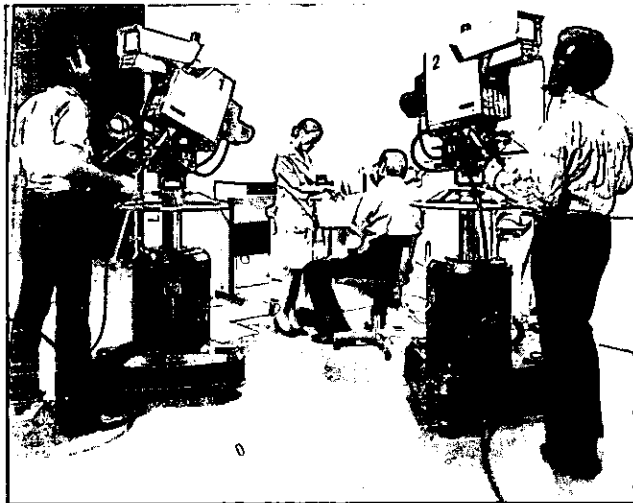

A best seller

Practical Transistors, a 15-program series for training electronics service technicians, is one of the most effective and widely used video tape courses of its kind.

The purpose of the series is to teach technical service personnel the truly practical aspects of transistor and other semiconductor circuitry. The programs avoid the use of complex mathematical equivalent circuits, and instead concentrate on presenting a clear and understandable look at the what, why and how of transistor circuits and the common techniques for troubleshooting them.

Throughout the tapes, ample use is made of demonstrations to compare measured with predicted results. Actual user experience has shown that the course is not only well received by technicians, but also creates a definite improvement in their troubleshooting and maintenance performance.

This Hewlett-Packard video tape course is in wide use throughout industry, colleges and universities, technical institutes, research organizations, vocational schools, and military training departments.

A supplementary textbook and a workbook, plus a complete set of homework problems and answers, is included with the nearly nine hours of video taped material (additional texts and workbooks are available at a nominal charge). Available in 1/2" or cassette formats (order 90100___). For complete details, ask for the free catalog *HP VIDEO TAPES: A Better Way to Learn* (HP 5952-0027).

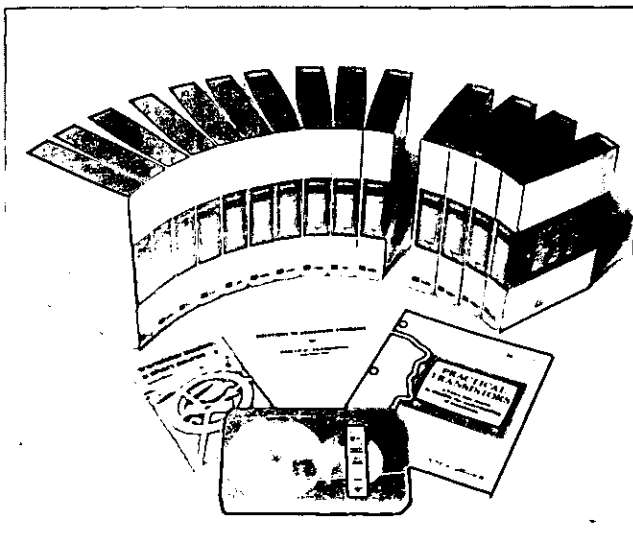

TRAINING/VIDEO TAPES

Video tapes (cont.)

A MINI INDEX

The following list of video tapes relates primarily to programs about electronic instruments and systems described in this catalog and does not include the many available programs on medical, calculators, data products, analytical, lasers and other applications. For a complete rundown about all of Hewlett-Packard's video tapes—including detailed program descriptions, formats, discount schedule, ordering instructions, language availability and prices—send for your free copy of *HP VIDEO TAPES: A Better Way to Learn* (HP 5952-0027) to:

Hewlett-Packard
Video Products
1819 Page Mill Road
Palo Alto, Ca. 94304

ANALYZERS

8050A Spectrum Analyzer Maintenance (90030—#616) 20 Minutes.

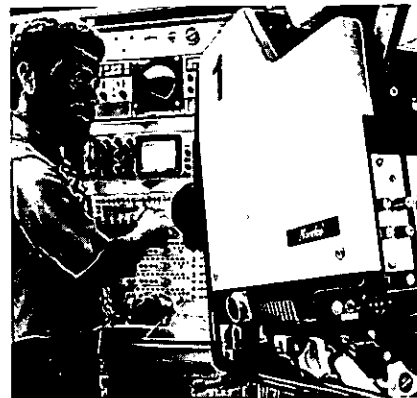
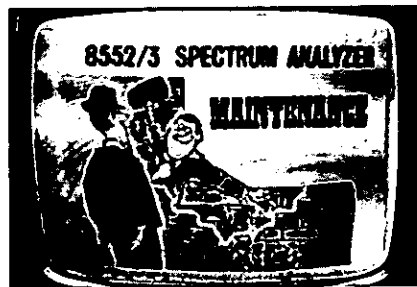
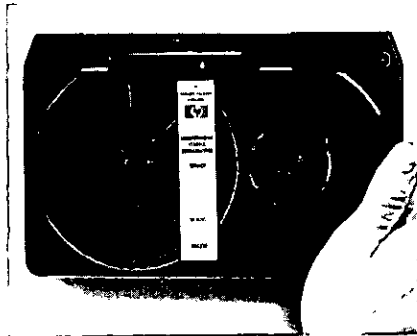

8554A Spectrum Analyzer (90060—#351) 40 Minutes.

8064A Spectrum Analyzer Service (90060—#632) 35 Minutes.

8064A Spectrum Analyzer Recalibration (90060—#663) 35 Minutes.

8552A/8553L Spectrum Analyzer Maintenance (90060—#321) 59 Minutes.

8552A/8553L Spectrum Analyzer Maintenance (90060—#339) 32 Minutes.

141T/8552B/8553B Spectrum Analyzer Operation (90030—#607) 26 Minutes.

141T/8552B/8554L Spectrum Analyzer Operation (90030—#646) 20 Minutes.

141T/8552B/8555A Spectrum Analyzer Operation (90030—#647) 28 Minutes.

141T/8552B/8555A Spectrum Analyzer Operation (90030—#697) 18 Minutes.

141T/8552B/8556A Spectrum Analyzer Operation (90030—#631) 20 Minutes.

Measuring AM Signals Using a Spectrum Analyzer (90030—#720) 16 Minutes.

5451 Fourier Series: Fourier Analysis (90030—#717) 17 Minutes.

5451 Fourier Series: Convolution, Correlation and Power Spectrum (90030—#718) 21 Minutes.

5451 Fourier Series: Windowing (90030—#719) 15 Minutes.

8407A Network Analyzer System (90030—#475) 29 Minutes.

8410A Network Analyzer System (90030—#473) 25 Minutes.

8410A/8411A Network Analyzer Service (90030—#490) 23 Minutes.

3590/3591 Wave Analyzer Maintenance (90030—#672) 28 Minutes.

Microwave Link Analyzer Operation (90030—#728) 19 Minutes.

Network Analysis (90060—#338) 43 Minutes.

OSCILLOSCOPES

Oscilloscope Basics (90060—#360) 36 Minutes.

Sampling Scopes (90060—#435) 37 Minutes.

Understanding HP Storage Scopes: Theory (90030—#449) 29 Minutes.

Understanding HP Storage Scopes: Service (90060—#359) 37 Minutes.

CRT Service and Troubleshooting (90030—#704) 18 Minutes.

180A Oscilloscope Front Panel and Operation (90060—#370) 47 Minutes.

180A Oscilloscope Delayed Sweep Applications (90030—#401) 23 Minutes.

183A Oscilloscope Mainframe Adjustments (90030—#503) 25 Minutes.

HP 1200A Oscilloscope Measurement Applications (90060—#731) 31 Minutes.

1700 Oscilloscope Series (Service 1): Controls and Operation (90030—#673) 14 Minutes.

1700 Oscilloscope Series (Service 2): Power Supply and Trigger Circuits (90030—#674) 20 Minutes.

1700 Oscilloscope Series (Service 3): 1710A Mechanical (90030—#797) 14 Minutes.

1700 Oscilloscope Series (Service 4):

1710A Electrical (90030—#798) 14 Minutes.

Basic Oscilloscope Measurements (90030—#820) 23 Minutes.

COUNTERS

5360A Computing Counter Applications (90060—#343) 58 Minutes.

5360A Computing Counter Maintenance (90030—#513) 27 Minutes.

5375A Computing Counter Keyboard (90060—#459) 39 Minutes.

SIGNAL GENERATORS & SYNTHESIZERS

746A Maintenance (90030—#408) 28 Minutes.

8660A Series Signal Generator Service (90030—#566) 23 Minutes.

8660A/B Synthesized Signal Generator (90030—#698) 21 Minutes.

Troubleshooting the 8660B DCU (90030—#726) 20 Minutes.

The Indirect Generation (90030—#759) 22 Minutes.

The 8640 Story: Chapter 1, Can You Turn Me On? (90060—#819) 31 Minutes.

RECORDERS

7123/7143 Strip Chart Recorder Service (90030—#478) 28 Minutes.

5050A/B Digital Recorder Maintenance (90060—#300) 43 Minutes.

7040 Family X-Y Recorders, Service (90210—) 30 Minutes.

METERS

3490 Multimeter Self-Test Troubleshooting (90030—#705) 22 Minutes.

432A Power Meter Maintenance (90060—#298) 60 Minutes.

COMMUNICATIONS TEST EQUIPMENT

Introduction to Pulse Code Modulation (90060—#874) 38 Minutes.

Demonstration of 3760A/3761A Bit Error Rate Measuring System (90030—#875) 20 Minutes.

SOUND MEASUREMENT & MONITORING

Akustik: Theory of Sound Measurement, Part 1 (90060—#233) 58 Minutes.

Akustik: Theory of Sound Measurement, Part 2 (90060—#234) 50 Minutes.

5061A Cesium Beam: Theory of Operation (90030—#716) 27 Minutes.

5061A Cesium Beam Tube Replacement (90030—#664) 30 Minutes.

CORRELATOR

3721A Correlator Applications (90030—#373) 23 Minutes.

I.C. TESTER

Big Benefits From the Little I.C. Troubleshooters (90030—#715) 14 Minutes.

CABLE FAULT LOCATING

Basics of Cable Fault Locating (90030—#751) 14 Minutes.

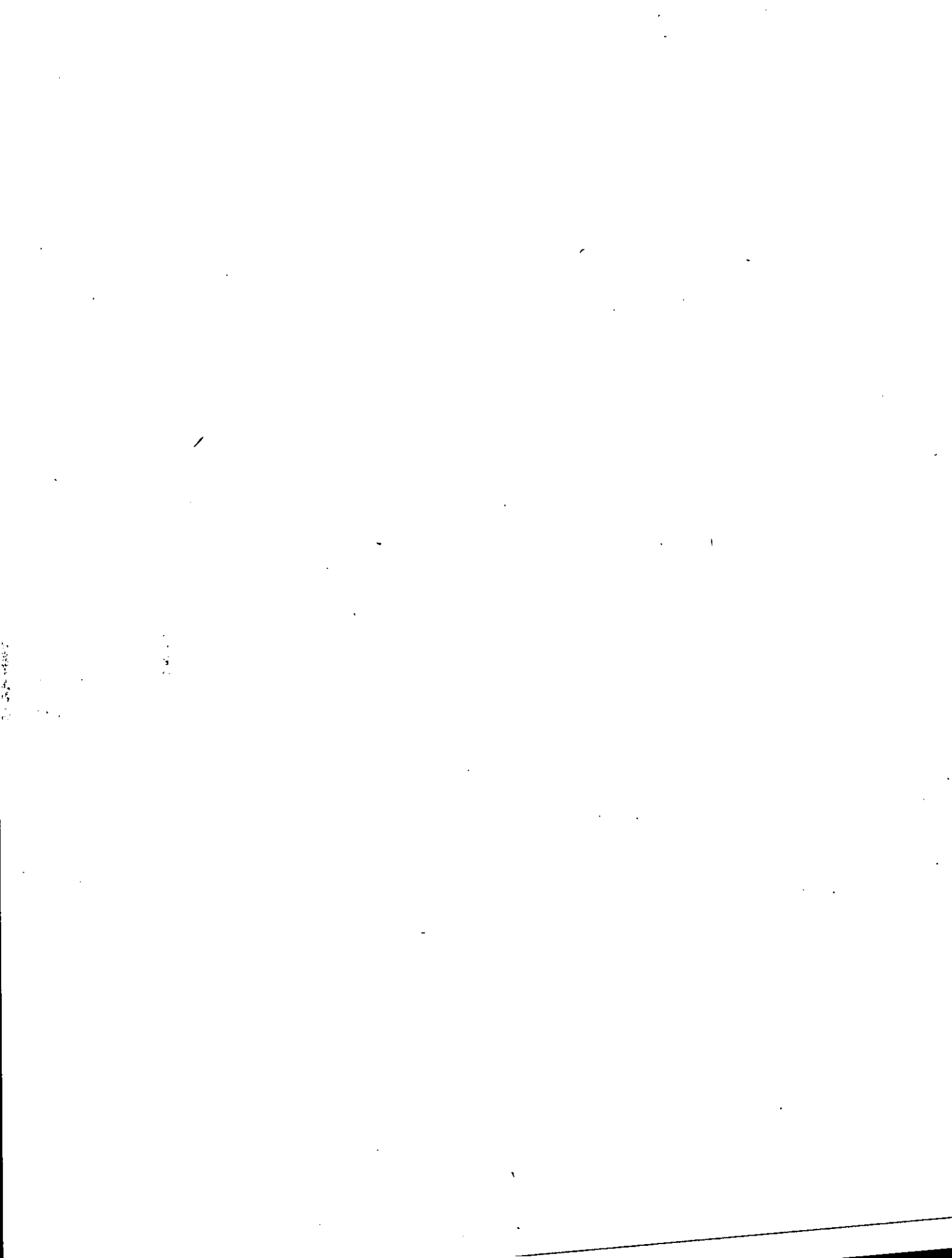





Printed in USA

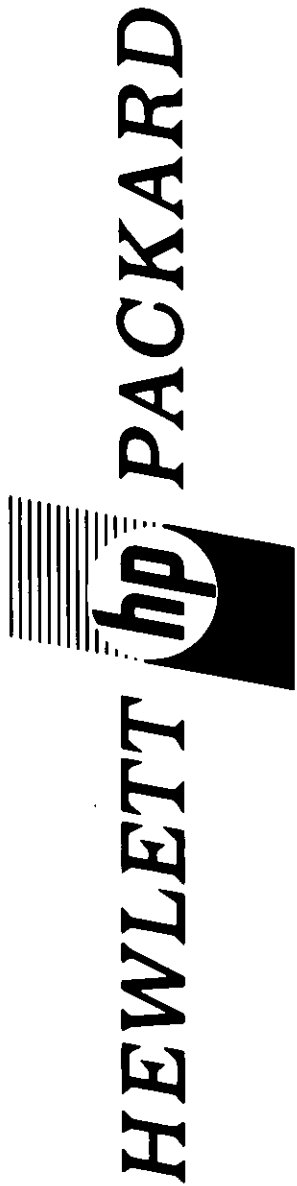

Sales and service from 172 offices in 65 countries.

Have you a need for additional information about HP products or do you have a measurement, computation or instrumentation problem that we may help you solve?

Complete one of the postpaid cards below and drop it in the mail. Or for an even more rapid response, contact your nearest HP Sales Office. Addresses and telephone numbers are listed inside the back cover.

Send me more information on HP model(s) _____

Contact me, (Tel: _____) I'd like to discuss _____

NAME _____ TITLE _____

COMPANY _____ TELEPHONE _____

NBR/BOX _____ STREET _____

CITY _____ STATE _____ ZIP _____

Send me more information on HP model(s) _____

Contact me, (Tel: _____) I'd like to discuss _____

NAME _____ TITLE _____

COMPANY _____ TELEPHONE _____

NBR/BOX _____ STREET _____

CITY _____ STATE _____ ZIP _____

FIRST CLASS
PERMIT
NO. 201
PALO ALTO
CALIFORNIA

No Postage Necessary if Mailed in the United States

Business Reply Mail

Postage will be paid by

HEWLETT-PACKARD
195 Page Mill Road
Palo Alto, California 94306

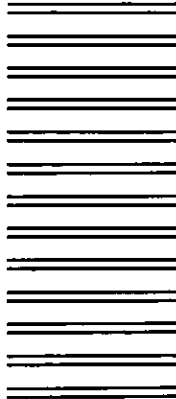

FIRST CLASS
PERMIT
NO. 201
PALO ALTO
CALIFORNIA

No Postage Necessary if Mailed in the United States

Business Reply Mail

Postage will be paid by

HEWLETT-PACKARD
195 Page Mill Road
Palo Alto, California 94306

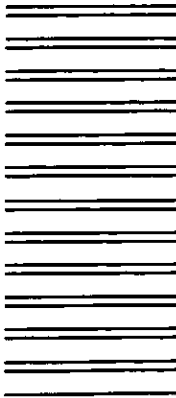



WORLD WIDE SALES & SERVICE OFFICES

UNITED STATES

ALABAMA 8290 Whitesburg Dr., S.E. P.O. Box 4207 Huntsville 35802 Tel: (205) 881-4591 TWX: 810-726-2204	COLORADO 5600 South Ulster Parkway Englewood 80110 Tel: (303) 771-3455 TWX: 910-935-0705	IOWA 1902 Broadway Iowa City 52240 Tel: (319) 338-9466 Night: (319) 338-9467	MISSOURI 11131 Colorado Ave. Kansas City 64137 Tel: (816) 763-8000 TWX: 910-771-2087	New York City Manhattan, Bronx Contact Paramus, NJ Office Tel: (201) 265-5000 Brooklyn, Queens, Richmond Contact Woodbury, NY Office Tel: (516) 921-0300	OKLAHOMA P.O. Box 32008 Oklahoma City 73132 Tel: (405) 721-0200 TWX: 910-830-6862	205 Billy Mitchell Road San Antonio 78226 Tel: (512) 434-8241 TWX: 910-871-1170
ARIZONA 2336 E. Magnolia St. Phoenix 85034 Tel: (602) 244-1361 TWX: 910-951-1331	CONNECTICUT 12 Lunar Drive New Haven 06525 Tel: (203) 389-6551 TWX: 710-465-2029	LOUISIANA P.O. Box 840 3239 Williams Boulevard Kenner 70062 Tel: (504) 721-6201 TWX: 810-955-5524	MARYLAND 148 Weldon Parkway Maryland Heights 63043 Tel: (314) 567-1455 TWX: 910-764-0830	OREGON 17890 SW Boones Ferry Road Tualatin 97062 Tel: (503) 620-3350 Tel: (914) 454-7330 TWX: 910-467-8714	PENNSYLVANIA 111 Zeta Drive Rochester 15238 Tel: (412) 782-0400 Night: 782-0401 TWX: 710-795-3124	UTAH 2890 South Main Street Salt Lake City 84115 Tel: (801) 487-0715 TWX: 910-925-5681
2424 East Aragon Rd. Tucson 85706 Tel: (602) 889-4661	FLORIDA P.O. Box 24210 2806 W. Oakland Park Blvd. FL Lauderdale 33307 Tel: (305) 731-2020 TWX: 510-955-4099	MARYLAND 6707 Whitestone Road Baltimore 21207 Tel: (301) 944-5400 TWX: 710-862-9157	NEW JERSEY W. 120 Century Rd. Paramus 07652 Tel: (201) 265-5000 TWX: 710-990-4951	5858 East Molloy Road Syracuse 13211 Tel: (315) 455-2485 TWX: 710-541-0482	1021 8th Avenue King of Prussia Industrial Park King of Prussia 19406 Tel: (215) 265-7000 TWX: 510-660-2670	2914 Hungary Springs Road Richmond 23228 Tel: (804) 285-3431 TWX: 910-956-0157
CALIFORNIA 1430 East Orangethorpe Ave. Footherton 92631 Tel: (714) 870-1000 TWX: 910-592-1288	P.O. Box 13910 6177 Lake Ellenor Dr. Orlando 32809 Tel: (305) 859-2900 TWX: 810-850-0113	4 Choke Cherry Road Rockville 20850 Tel: (301) 948-6370 Tel: 710-828-9685 710-828-0487	NEW MEXICO P.O. Box 8366 Station C 6501 Lomas Boulevard N.E. Albuquerque 87108 Tel: (505) 265-3713 TWX: 910-989-1665	1 Crossways Park West Woodbury 11797 Tel: (516) 921-0300 TWX: 510-221-2168	SOUTH CAROLINA 6941-O N. Tremholm Road Columbia 29260 Tel: (803) 782-6493	WASHINGTON Bellevue Office Pk. 1203-114th SE Bellevue 98004 Tel: (206) 454-3971 Tel: (206) 443-2446
3939 Lankershim Boulevard North Hollywood 91604 Tel: (213) 877-1282 TWX: 910-499-2170	GEORGIA P.O. Box 28234 450 Interstate North Atlanta 30328 Tel: (404) 434-4000 TWX: 810-766-4890	156 Wyatt Drive Las Cruces 88001 Tel: (505) 526-2485 TWX: 910-983-0550	NEW YORK 6 Automation Lane Computer Park Albany 12205 Tel: (518) 458-1550 TWX: 710-441-8270	NORTH CAROLINA P.O. Box 5188 1923 North Main Street High Point 27262 Tel: (919) 885-8101 TWX: 510-926-1516	*WEST VIRGINIA Charleston Tel: (304) 345-1640	WISCONSIN 9431 W. Beloit Road Suite 117 Milwaukee 53227 Tel: (414) 541-0550
6515 Arizona Place Los Angeles 90045 Tel: (213) 776-7500 TWX: 910-328-6148	HAWAII 2875 So. King Street Honolulu 96814 Tel: (808) 955-4455	MINNESOTA 3239 University Avenue St. Paul 55114 Tel: (612) 645-9461 TWX: 910-563-3734	1219 Campville Road Endicott 13760 Tel: (607) 754-0050 TWX: 510-252-0890	OHIO 16500 Sprague Road Cheviot 44130 Tel: (216) 243-7300 Night: 243-7305 Tel: (614) 423-9431	*TENNESSEE Memphis Tel: (901) 274-7472	TEXAS P.O. Box 1270 201 E. Arapaho Rd. Richardson 75080 Tel: (214) 231-6101 TWX: 910-867-4723
*Ridgecrest Tel: (714) 446-6165	ILLINOIS 5500 Howard Street Skokie 60076 Tel: (312) 677-0400 TWX: 910-223-3613	MICHIGAN 23855 Research Drive Farmington 48024 Tel: (313) 476-6400 TWX: 910-242-2900	330 Progress Rd. Dayton 45449 Tel: (513) 859-8202 TWX: 810-459-1925	1041 Kingsmill Parkway Columbus 43229 Tel: (614) 436-1041	TEXAS P.O. Box 27409 6300 Westpark Drive Suite 100 Houston 77027 Tel: (713) 781-6000 TWX: 910-881-2645	FOR U.S. AREAS NOT LISTED: Contact the regional office nearest you: Atlanta, Georgia ... North Hollywood, California ... Rockville, (4 Choke Cherry Rd.) New Jersey ... Skokie, Illinois. Their complete addresses are listed above.
2220 Watt Ave. Sacramento 95825 Tel: (916) 482-1463 TWX: 910-367-2092	INDIANA 3839 Meadows Drive Indianapolis 46205 Tel: (317) 546-4891 TWX: 810-341-3263				TEXAS P.O. Box 1270 201 E. Arapaho Rd. Richardson 75080 Tel: (214) 231-6101 TWX: 910-867-4723	*Service Only
9606 Aero Drive P.O. Box 23333 San Diego 92123 Tel: (714) 279-3200 TWX: 910-335-2000						

CANADA

ALBERTA Hewlett-Packard (Canada) Ltd. 11748 Kingsway Ave. Edmonton T5G 0K5 Tel: (403) 452-3670 TWX: 610-831-2431	BRITISH COLUMBIA Hewlett-Packard (Canada) Ltd. 837 E. Cordova Street Vancouver V6A 3R2 Tel: (604) 254-0531 TWX: 610-922-5059	MANITOBA Hewlett-Packard (Canada) Ltd. 513 Century St. St. James Winnipeg R3H 0L8 Tel: (204) 786-7581 TWX: 610-671-3531	NOVA SCOTIA Hewlett-Packard (Canada) Ltd. 800 Windmill Rd. Dartmouth NSC 1L1 Tel: (902) 469-7820	ONTARIO Hewlett-Packard (Canada) Ltd. 1785 Woodward Dr. Ottawa K2C 0P9 Tel: (613) 225-6530 TWX: 610-562-8968	QUEBEC Hewlett-Packard (Canada) Ltd. 275 Hymus Blvd. Pointe Claire H9R 1G7 Tel: (514) 697-4232 TWX: 610-422-3022 TLX: 05-821521 HPCL	Hewlett-Packard (Canada) Ltd. 2376 Galvani Street Ste-Foy G1N 4G4 Tel: (418) 688-8710
Hewlett-Packard (Canada) Ltd. 915-42 Avenue S.E. Suite 102 Calgary T2G 1Z1 Tel: (403) 287-1672				Hewlett-Packard (Canada) Ltd. 6877 Goreway Drive Mississauga L4V 1L9 Tel: (416) 678-9430 TWX: 610-492-4246		FOR CANADIAN AREAS NOT LISTED: Contact Hewlett-Packard (Canada) Ltd. in Mississauga

CENTRAL AND SOUTH AMERICA

ARGENTINA Hewlett-Packard Argentina S.A.C.e.l. Lavalle 1171-3° Piso Buenos Aires Tel: 35-0436, 35-0627, 35-0341 Tel: 012-1009 Cable: HEWPAK ARG	Hewlett-Packard Do Brasil I.E.C. Ltda. Praça Dom Feliciano, 78-8° andar (Cala 806/8) 9000-Porto Alegre-RS Tel: 25-84-70-DDD (0512) Cable: HEWPAK Porto Alegre	COLUMBIA Instrumentación Henrik A. Langebaek & Kier S.A. Carrera 7 No. 48-59 Apartado Aéreo 6287 Bogotá, D.E. Tel: 45-78-06, 45-55-46 Cable: AARIS Bogotá Tel: 44400INSTCO	MEXICO Hewlett-Packard Mexicana, S.A. de C.V. Torres Adalid No. 21, 11° Piso Col. del Valle México 12, D.F. Tel: (905) 543-42-32 Tel: 017-74-507	PANAMA Electrónico Balboa, S.A. P.O. Box 4929 Calle Samuel Lewis Ciudad de Panama Tel: 64-2700 Tel: 3431103 Curunda, Canal Zone Cable: ELECTRON Panama	PERU Compañía Electro Médica S.A. Ave. Enrique Canaval 312 San Isidro Casilla 1030 Lima Tel: 22-3900 Cable: ELMED Lima	MONTEVIDEO Tel: 40-3102 Cable: RADIUM Montevideo
BOLIVIA Stambuk & Mark (Bolivia) Ltda. Av. Mariscal, Santa Cruz 1342 La Paz Tel: 40626, 53163, 52421 Tel: 3560014 Cable: BUKMAR	Hewlett-Packard Do Brasil I.E.C. Ltda. Rua Siqueira Campos, 53, 4° andar Copacabana 2000-Rio de Janeiro-G8 Tel: 257-80-94-DDD (021) Tel: 2100 79 HEWPAK Cable: HEWPAK Rio de Janeiro	COSTA RICA Lic. Alfredo Gallegos Gardán Apartado 10159 San José Tel: 21-86-13 Cable: GALGUR San José	Hewlett-Packard Mexicana, S.A. de C.V. Lic. Constitución No. 2184 Moctezuma, N.L. Tel: 48-71-32, 48-71-84	PARAGUAY Z. J. Melamed S.R.L. Division: Aparatos y Equipos Medicos Division: Aparatos y Equipos Scientificos y de Investigacion P.O. Box 676 Chile, 482, Edificio Victoria Managua Tel: 4-5069, 4-6272 Cable: RAMEL	PUERTO RICO San Juan Electronics, Inc. P.O. Box 5167 Ponce de León 154 Pda. 3-PTA de Tierra San Juan 00906 Tel: (809) 725-3342, 722-3342 Cable: SATRONICS San Juan Tel: SATRON 3450 332	VENEZUELA Hewlett-Packard de Venezuela C.A. Apartado 50933 Edificio Segre Tercera Transversal Los Rucios Norte Caracas 107 Tel: 35-00-11 Tel: 21146 HEWPAK Cable: HEWPAK Caracas
BRAZIL Hewlett-Packard Do Brasil I.E.C. Ltda. Rua Frei Caneca, 1.152-Bela Vista 01307-São Paulo-SP Tel: 288-71-11, 287-81-20, 287-61-93 Tel: 309151/2/3 Cable: HEWPAK São Paulo	CHILE Calcagni y Metcalfe Ltda. Calle Lira 81, Oficina 5 Casilla 9418 Santiago Tel: 358613 Cable: CALMET	GUATEMALA IPESA Avenida La Reforma 3-48, Zona 9 Guatemala Tel: 63627, 64736 Tel: 4192 TELTRO GU	NICARAGUA Roberto Terán G. Apartado Postal 689 Edificio Terán Managua Tel: 3451, 3452 Cable: ROTERAN Managua		URUGUAY Pablo Ferrando S.A. Comercial e Industrial Avenida Italia 2877 Casilla de Correo 370	FOR AREAS NOT LISTED, CONTACT: Hewlett-Packard Inter-Americas 3200 Hillview Ave. Palo Alto, California 94304 Tel: (415) 493-1501 TWX: 910-373-1260 Cable: HEWPAK Palo Alto Tel: 034-8300, 034-8493

EUROPE

AUSTRIA Hewlett-Packard Ges.m.b.H Handelskz 52/3 P.O. Box 7 A-1205 Vienna Tel: (0222) 33 66 06 to 09 Cable: HEWPAK Vienna Tel: 75923 hewpak a	BELGIUM Hewlett-Packard Benelux S.A./N.V. Avenue de Col-Vert, 1, (Groenkaaglaan) B-1170 Brussels Tel: (02) 672 22 40 Cable: PALOBEN Brussels Tel: 23 494 paloben br	DENMARK Hewlett-Packard A/S Datavej 52 DK-3460 Birkerød Tel: (01) 81 66 40 Cable: HEWPAK AS Tel: 166 40 hp as	Hewlett-Packard A/S Torvet 9 DK-8600 Silkeborg Tel: (06) 82-71-66 Tel: 166 40 hp as Cable: HEWPAK AS	FINLAND Hewlett-Packard Oy Pulevardi 26 P.O. Box 185 SF-00120 Helsinki 12 Tel: (01) 907 13730 Cable: HEWPAK OY Helsinki Tel: 12-15363 hel	FRANCE Hewlett-Packard France Quartier de Courtabouff Boite Postale No. 6 F-91401 Orsay Tel: (1) 907 78 25 Cable: HEWPAK Orsay Tel: 60048	Hewlett-Packard France Agence Regional Chemin des Mouilles Boite Postale No. 12 F-69130 Ecully Tel: (78) 83 65 25 Tel: 31 617
---	--	--	--	---	---	--

Hewlett-Packard France
Zone Aéronautique
Avenue Clement Ader
F-31770 Colomiers
Tel: (61) 78 11 55
Telex: 51957

Hewlett-Packard France
Agence Régionale
Centre d'aviation générale
F-13721 Adroport de
Marignane
Tel: (91) 89-12-36
TWX: 41770 F

Hewlett-Packard France
Agence Régionale
63, Avenue de Rochester
F-35000 Rennes
Tel: (99) 36 33 21
Telex: 74912 F

Hewlett-Packard France
Agence Régionale
74, Allée de la Robertsau
F-67000 Strasbourg
Tel: (88) 35 23 20/21
Telex: 89141
Cable: HEWPACK STRBG

GERMAN FEDERAL REPUBLIC
Hewlett-Packard GmbH
Vertriebszentrale Frankfurt
Bernnerstrasse 117
Postfach 560 140
D-6000 Frankfurt 56
Tel: (0611) 50 04-1
Cable: HEWPACKSA Frankfurt
Telex: 41 32 49 Ira

Hewlett-Packard GmbH
Vertriebsbüro Böblingen
Herrenbergerstrasse 110
D-7030 Böblingen, Württemberg
Tel: (07031) 66 72 87
Cable: HEPAK Böblingen
Telex: 72 65 739 bbn

Hewlett-Packard GmbH
Vertriebsbüro Düsseldorf
Vogelsanger Weg 38
D-4000 Düsseldorf
Tel: (0211) 63 80 31/38
Telex: 85/86 533 hdd d

Hewlett-Packard GmbH
Vertriebsbüro Hamburg
Wendenstr. 23
D-2000 Hamburg 1
Tel: (040) 24 13 93
Cable: HEWPACKSA Hamburg
Telex: 21 63 032 hph d

Hewlett-Packard GmbH
Vertriebsbüro Hannover
Mellendorfer Strasse 3
D-3000 Hannover-Kirchfeld
Tel: (0511) 55 60 46
Telex: 092 3259

Hewlett-Packard GmbH
Vertriebsbüro Nuremberg
Hersbrucherstrasse 42
D-8500 Nuremberg
Tel: (0911) 57 10 66
Telex: 623 860

Hewlett-Packard GmbH
Vertriebsbüro München
Unterhachinger Strasse 28
ISAR Center
D-8017 Ottenbrunn
Tel: (089) 601 30 61/7
Telex: 52 49 85
Cable: HEWPACKSA München
(West Berlin)

Hewlett-Packard GmbH
Vertriebsbüro Berlin
Keith Strasse 2-4
D-1000 Berlin 30
Tel: (030) 24 90 86
Telex: 18 34 05 hpln d

GREECE
Kostas Karayannis
18, Ermou Street
GR-Athens 106
Tel: 3230-305 Sales/SVC
3230-305 Adm. Order Proc.
Cable: RAKAR Athens
Telex: 21 59 62 rkar gr

Hewlett-Packard S.A.
Mediterranean & Middle East
Operations
35 Kolokotroni Street
Platia Kefallarion
Gr-Kifissia-Athens
Tel: 8080337, 8080359,
8080429, 8018693

IRELAND
Hewlett-Packard Ltd
King Street Lane
Winnersh, Worthingham
GB-Berkshire RG11 5AR
Tel: Workingham 784774
Telex: 847178/848179

Hewlett-Packard Ltd.
The Graftons
Stamford New Road
GB-Altrincham, Cheshire
Tel: (061) 928-9021
Telex: 668068

ITALY
Hewlett-Packard Italiana S.p.A.
Via Amerigo Vespucci 2
I-20124 Milan
Tel: (2) 6251 (10 lines)
Cable: HEWPACKIT Milan
Telex: 32046

Hewlett-Packard Italiana S.p.A.
Vicolo Pastori, 3
I-35100 Padova
Tel: (49) 69 40 62
Telex: 32046 via Milan

Hewlett-Packard Italiana S.p.A.
Via Medaglia d'Onore, 2
I-56100 Pisa
Tel: (050) 500022
Telex: 32046 via Milan

Hewlett-Packard Italiana S.p.A.
Via G. Armetini 10
I-00143 Rome-Eur
Tel: (6) 5912544/5
Telex: 61514
Cable: HEWPACKIT Rome

Hewlett-Packard Italiana S.p.A.
Via San Quintino, 45
I-10121 Turin
Tel: (11) 53 82 64
Telex: 32046 via Milan

LUXEMBURG
Hewlett-Packard Benelux
S.A./N.V.
Avenue de Col-Vert, 1.
(Greenkraglaan)
B-1170 Brussels
Tel: (03/02) 72 22 40
Cable: PALOBN Brussels
Telex: 23 494

NETHERLANDS
Hewlett-Packard Benelux/N.V.
Weerdesteijn 117
P.O. Box 7825
NL-Amsterdam, 1011
Tel: (020) 5411522
Cable: PALOBN Amsterdam
Telex: 13 216 hepa nl

NORWAY
Hewlett-Packard Norge A/S
Nesveien 13
N-149
N-1344 Haslum
Tel: (02) 53 83 60
Telex: 16621 hpnas n

PORTUGAL
Telebra-Empresa Técnica de
Equipamentos Eléctricos S.a.r.l.
P.O. Rodrigo da Fonseca 103
R. do Boz 2531
P-Lisbon 1
Tel: (19) 68 60 72
Cable: TELECTRA Lisbon
Telex: 12598

SPAIN
Hewlett-Packard Española, S.A.
Jerez No. 3
E-Madrid 16
Tel: 438 26 00
Telex: 23515 hpe

Hewlett-Packard Española, S.A.
Milanesado 21-23
E-Barcelona 17
Tel: (3) 2036200-08,
(04)098/9
Telex: 52603 hpbe e

Hewlett-Packard Española, S.A.
Av Ramon y Cajal, 1
Edificio Sevilla I, planta *9
E-Seville
Tel: 64 44 54/58

SWEDEN
Hewlett-Packard Sverige AB
Englättsvägen 1-3
Fack
S-161 20 Bromma 20
Tel: (08) 730 0550
Cable: MEASUREMENTS
Stockholm
Telex: 10721

Hewlett-Packard Sverige AB
Magkargatan 9C
S-431 41 Mölndal
Tel: (031) 27 68 00/01
Telex: Via Bromma

SWITZERLAND
Hewlett-Packard (Schweiz) AG
Zürcherstrasse 20
P.O. Box 64
CH-8952 Schlieren Zurich
Tel: (01) 98 18 21/24
Cable: HPAG CH
Telex: 53933 hpag ch

Hewlett-Packard (Schweiz) AG
9, Chemin Louis-Pictet
CH-1214 Vernier-Geneva
Tel: (022) 41 4950
Cable: HEWPACKSA Geneva
Telex: 27 333 hpsa ch

TURKEY
Telekom Engineering Bureau
Saglik Sok No. 15/1
Ayaspaşa-Beyoglu
P.O. Box 437 Beyoglu
TR-Istanbul
Tel: 49 40
Cable: TELEMATON Istanbul

UNITED KINGDOM
Hewlett-Packard Ltd.
King Street Lane
Winnersh, Worthingham
GB-Berkshire RG11 5AR
Tel: Workingham 784774
Telex: 847178/848179

Hewlett-Packard Ltd.
"The Graftons"
Stamford New Road
GB-Altrincham, Cheshire
Tel: (061) 928-9021
Telex: 668068

Hewlett-Packard, Ltd.
c/o Makro
South Service Wholesale Centre
Amber Way
Halesowen Industrial Estate
GB-Halesowen, Worcs
Tel: Birmingham 7860

Hewlett-Packard Ltd.
4th Floor
Wedge House
799, London Road
GB-Thornton Heath CR4 6AL
Surrey
Tel: (01) 684 0105
Telex: 946825

Hewlett-Packard Ltd.
c/o Makro
South Service Wholesale Centre
Wear Industrial Estate
Washington
GB-New Town, County Durham
Tel: Washington 464001 ext. 57/58

Hewlett-Packard Ltd's registered
address for V.A.T. purposes
only:
70, Finsbury Pavement
London, EC2A1SX
Registered No. 690597

SOCIALIST COUNTRIES
PLEASE CONTACT:
Hewlett-Packard Ges.m.b.H.
Handelskai 52/3
P.O. Box 7
A-1205 Vienna
Ph: (0222) 33 66 06 to 09
Cable: HEWPACK Vienna
Telex: 75923 hewpak a

ALL OTHER EUROPEAN
COUNTRIES CONTACT:
Hewlett-Packard S.A.
7, rue du Bois-du-Lan
P.O. Box 349
CH-1217 Meyrin 1 Geneva
Switzerland
Tel: (022) 41 54 00
Cable: HEWPACKSA Geneva
Telex: 2 24 86

AFRICA, ASIA, AUSTRALIA

ANGOLA
Telebra
Empresa Técnica de
Equipamentos
Eléctricos, S.A.R.L.
R. Barbosa Rodrigues, 42-1ºDT
Casa Postal, 6487-Luanda
Tel: 35515/6
Cable: TELECTRA Luanda

AUSTRALIA
Hewlett-Packard Australia
Pty. Ltd.
31-41 Joseph Street
Blackburn, Victoria 3130
Tel: 89-6351, 89-6306
Telex: 31-024
Cable: HEWPARD Melbourne

Hewlett-Packard Australia
Pty. Ltd.
31 Bridge Street
Pymble,
New South Wales, 2073
Tel: 449 6566
Telex: 21561
Cable: HEWPARD Sydney

Hewlett-Packard Australia
Pty. Ltd.
97 Churchhill Road
Prospect 5082
South Australia
Tel: 44 8151
Cable: HEWPARD Adelaide

Hewlett-Packard Australia
Pty. Ltd.
Casablanca Buildings
196 Adelaide Terrace
Perth, W.A. 6000
Tel: 25-6800
Cable: HEWPARD Perth

Hewlett-Packard Australia
Pty. Ltd.
10 Woolley Street
P.O. Box 191
Dickson A.C.T. 2602
Tel: 49-8194
Cable: HEWPARD Canberra ACT

Hewlett-Packard Australia
Pty. Ltd.
5th Floor
Teachers Union Building
495-499 Boundary Street
Spring Hill, 4000 Queensland
Tel: 29-1544
Telex: AA-42133

CEYLON
United Electricals Ltd.
P.O. Box 681
60, Park St.
Colombo 2
Tel: 26696
Cable: HOTPOINT Colombo

CYPRUS
Kypronics
19 Gregorios & Xenopoulos Rd.
P.O. Box 1152
CY-Nicosia
Tel: 45628/29
Cable: KYPRONICS PANDEHIS

ETHIOPIA
African Salespower & Agency
Private Ltd., Co.
P.O. Box 718
58/59 Cunningham St.
Addis Ababa
Tel: 12285
Cable: ASACO Addisababa

HONG KONG
Schmidt & Co. (Hong Kong) Ltd.
P.O. Box 297
Connaught Centre
39th Floor
Connaught Road, Central
Hong Kong
Tel: 240168, 232735
Telex: HK4766
Cable: SCHMIDTICO Hong Kong

INDIA
Blue Star Ltd.
Kasturi Buildings
Jamsheji Tala Rd.
Bombay 400 020
Tel: 29 50 21
Telex: 3751
Cable: BLUEFROST

Blue Star Ltd.
Sahas
414/2 Vir Savarkar Marg
Prabhadevi
Bombay 400 025
Tel: 45 78 87
Telex: 4093
Cable: FROSTBLUE

Blue Star Ltd.
Band Box House
Prabhadevi
Bombay 400 025
Tel: 45 73 01
Telex: 3751
Cable: BLUESTAR

Blue Star Ltd.
14/40 Civil Lines
Kamper 208 001
Tel: 6 88 82
Cable: BLUESTAR

Blue Star Ltd.
7 Hare Street
P.O. Box 506
Calcutta 700 001
Tel: 23-0131
Telex: 655
Cable: BLUESTAR

INDONESIA
BERCA Indonesia P.T.
P.O. Box 496
1st Floor JL. Cikini Raya 61
Jakarta
Tel: 56038, 40369, 49886
Telex: 2895 Jakarta

IRAN
Multi Corp International Ltd.
Avenue Soraya 130
P.O. Box 1212
IR-Tehran
Tel: 83 10 35-39
Cable: MULTICORP Tehran
Telex: 2893 MCI TN

ISRAEL
Electronics & Engineering
Div. of Motorola Israel Ltd.
17 Aminadav Street
Tel-Aviv
Tel: 36941 (3 lines)
Cable: BASTEL Tel-Aviv
Telex: 33569

JAPAN
Yokogawa-Hewlett-Packard Ltd.
Ohashi Building
1-59-1 Yoyogi
Shibuya-ku, Tokyo
Tel: 03-370-2281/92
Telex: 232-2024YHP
Cable: YHPMARKET TOK 23-724

Yokogawa-Hewlett-Packard Ltd.
Nisei Ibaragi Bldg.
2-2-8 Kasuga
Ibaragi-Shi
Osaka
Tel: (0726) 23-1641
Telex: 5332-385 YHP OSAKA

Yokogawa-Hewlett-Packard Ltd.
Nakamo Building
No. 24 Kamisazuma-cho
Nakamura-ku, Nagoya City
Tel: (052) 571-5171

Yokogawa-Hewlett-Packard Ltd.
Nitto Bldg.
2-4-2 Shinohara-Kita
Kohoku-ku
Yokohama 222
Tel: 045-432-1504
Telex: 382-3204 YHP YOK

Yokogawa-Hewlett-Packard Ltd.
Chuo Bldg.
Rm. 603 3.
2-Chome
IZUMI-CHO
Mie, 310
Tel: 0292-25-7470

KENYA
Technical Engineering Services
P.O. Box 18311
Nairobi, Kenya
Tel: 57726
Cable: PROTON

KOREA
American Trading Company
Korea
I.P.O. Box 1103
Dae Kyung Bldg., 8th Floor
107 Sejong-Ro,
Chongro-Ku, Seoul
Tel: (4 lines) 73-8924-7
Cable: AMTRACO Seoul

LEBANON
Constantin E. Macridis
P.O. Box 7213
RL-Beirut
Tel: 220846
Cable: ELECTRONUCLEAR Beirut

MALAYSIA
MECOMB Malaysia Ltd.
2 Lorong 13/6A
Section 13,
Petaling Jaya, Selangor
Cable: MECOMB Kuala Lumpur

MOZAMBIQUE
A.M. Concalves, Lta.
162, 1º Apt. 14 Av. D. Luis
Caixa Postal 107
Lourenço Marques
Tel: 27091, 27114
Telex: 6-203 Negon Mo
Cable: NEGON

NEW ZEALAND
Hewlett-Packard (N.Z.) Ltd.
94-96 Dixon Street
P.O. Box 9443
Courtenay Place,
Wellington
Tel: 59-559
Telex: 3058
Cable: HEWPACK Wellington

Hewlett-Packard (N.Z.) Ltd.
Pakeranga Professional Centre
267 Pakeranga Highway
Box 51092
Pakeranga
Tel: 569-651
Cable: HEWPACK, Auckland

NIGERIA
The Electronics
Instrumentations Ltd.
NSB/770 Oyo Road
Oluseun House
P.M.B. 5402
Ibadan
Tel: 23225
Cable: THEITEIL Ibadan

The Electronics Instrumenta
tions Ltd. (TEIL)
16th Floor Cocoa House
P.M.B. 5402
Ibadan
Tel: 23225
Cable: THEITEIL Ibadan

PARISTAN
Mushko & Company, Ltd.
Osman Chambers
Abdullah Haroon Road
Karachi 3
Tel: 511027, 512927
Cable: COOPERATOR Karachi

Mushko & Company, Ltd.
38B, Satellite Town
Rawalpindi
Tel: 41924
Cable: FEMUS Rawalpindi

PHILIPPINES
Electromex, Inc.
6th Floor, Amalgamated
Development Corp. Bldg.
Ayala Avenue, Makati, Rizal
C.C.P.O. Box 1028
Makati, Rizal
Tel: 86-18-87, 87-76-77,
87-86-88, 87-18-15,
88-91-71, 83-81-12,
83-82-12
Cable: ELEMEX Manila

SINGAPORE
Mechanical & Combustion
Engineering Company Pte.
Ltd.
10/12, Jalan Kilang
Red Hill Industrial Estate
Singapore, 3
Tel: 647151 (7 lines)
Cable: MECOMB Singapore

Hewlett-Packard Singapore
(Pte.) Ltd.
Bld. 2, 6th FLOOR, Jalan
Bukit Merah
Redhill Industrial Estate
Alexandra P.O. Box 87,
Singapore 3
Tel: 633022
Cable: HPSG RS 21486

SOUTH AFRICA
Hewlett-Packard South Africa
(Pty.) Ltd.
Hewlett-Packard House
Daphne Street, Wendywood
Sandton, Transvaal 2001
Tel: 407641 (five lines)

Hewlett-Packard South Africa
(Pty.) Ltd.
Breecastle House
Cree Street
Cape Town
Tel: 2-6941/2/3
Cable: HEWPACK Cape Town
Telex: 0006 CT

Hewlett-Packard South Africa
(Pty.) Ltd.
641 Ridge Road, Durban
P.O. Box 99
Overport, Natal
Tel: 88-6102
Telex: 567954
Cable: HEWPACK

TAIWAN
Hewlett-Packard Taiwan
39 Chung Shiao West Road
Sec. 1 Overseas Insurance
Corp. Bldg. 7th Floor
Taipei
Tel: 389160.1.2, 375121,
Ext. 240-249
Telex: TP824 HEWPACK Taipei
Cable: HEWPACK Taipei

Hewlett-Packard Taiwan
38, Po-Ai Lane, San Min Chu,
Kaohsiung
Tel: 297319

THAILAND
UNIMEX Co., Ltd.
Elsom Research Building
Bangkok Sukumvit Ave.
Bangkok
Tel: 932387, 930338
Cable: UNIMEXA Bangkok

UGANDA
Uganda Tele-Electric Co., Ltd.
P.O. Box 4449
Kampala
Tel: 57279
Cable: COMCO Kampala

VIETNAM
Peninsular Trading Inc.
P.O. Box H-3
216 Hien-Vuong
Saigon
Tel: 20-805, 93398
Cable: PENTRA, SAIGON 242

ZAMBIA
R. I. Tibury (Zambia) Ltd.
P.O. Box 2792
Lusaka
Zambia, Central Africa
Tel: 73793
Cable: ARJAYTEE, Lusaka

MEDITERRANEAN AND
MIDDLE EAST COUNTRIES
NOT SHOWN PLEASE CONTACT:
Hewlett-Packard S.A.
Mediterranean and Middle
East Operations
35, Kolokotroni Street
Platia Kefallarion
GR-Kifissia-Athens
Tel: 21-6588
Cable: HEWPACKSA Athens

OTHER AREAS NOT LISTED, CONTACT:
Hewlett-Packard
Export Trade Company
3200 Hillview Ave.
Palo Alto, California 94304
Tel: (415) 493-1501
TWX: 910-373-1267
Cable: HEWPACK Palo Alto
Telex: 034-8300, 034-8493



HEWLETT  PACKARD

