

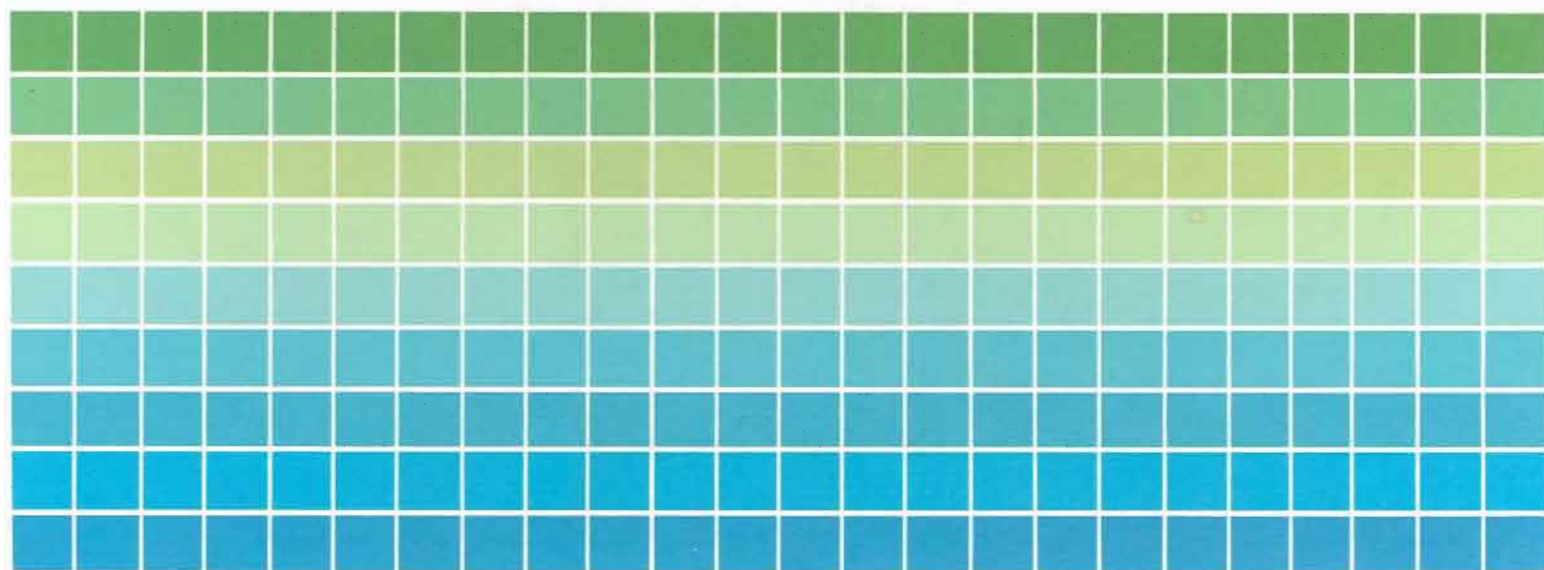

Measurement/Computation

ELECTRONIC INSTRUMENTS AND SYSTEMS

1983





## AT HEWLETT-PACKARD

Our business is the practical application of high technologies. HP applies its scientific and engineering resources to two fundamental areas: Measurement and Computation. The company makes more than 4500 products with broad application in the fields of science, engineering, business, industry, medicine, and education.

HP has manufacturing facilities in more than 30 cities throughout the world and has sales offices worldwide.

### Product Development

Traditionally, HP invests from eight to ten percent of its sales revenue in research and development. The largest share of these dollars support product development programs within HP's manufacturing divisions. This level of commitment enables the company to employ the latest technologies in developing innovative products that can be reliably produced, delivered, and supported on a continuing basis.

*Many of the page numbers below refer to the beginning of a catalog section.*



Amplifiers . . . . .	54	Digital Circuit Testers . .	122	DMM's/DVM's . . . . .	64
Analog VM's . . . . .	56	Digital IC Test Systems .	114	Electronic Counters . . .	284
Circuit Test Systems . . .	116	Displays . . . . .	222	F & T Standards . . . . .	211, 276
Component Testers . . . .	84	Distortion Analyzers . . .	520		



Amplifiers . . . . .	54	Microwave Link Analyzers . . . . .	570
Electronic Counters . . . . .	284	Microwave Semiconductors . . . . .	355
Frequency Synthesizers . . . . .	339	Microwave Test Equipment . . . . .	406
Microwave Counters . . . . .	290	Network Analyzers . . . . .	426



Accessories . . . . .	156	Digital IC Test Systems . . . . .	114
Circuit Test Systems . . . . .	116	IC Troubleshooters . . . . .	122
Data Generators/Analyzers . . . . .	164	Logic Analyzers . . . . .	134
Digital Circuit Testers . . . . .	122	Logic Troubleshooting Systems . . . . .	129



Digital Vibration Control System . . . . .	517	Plotters . . . . .	617
Fourier Analyzers . . . . .	515	Spectrum Analyzer . . . . .	508, 515



Circuit Test Systems . . . . .	116	Data Acquisition, Test & Control Systems . . . . .	34
Computers, Peripherals & Calculators . . . . .	579	Digital Multimeters . . . . .	64



Amplifiers . . . . .	54	Frequency Division Multiplexing . . . . .	558
Analyzers . . . . .	426, 460, 520	Frequency Synthesizers . . . . .	344
Cable Maintenance & Testers . . . . .	557	Microwave Counters . . . . .	290
Data Communications Testers . . . . .	542	Microwave Radio Testing . . . . .	570



Analyzers . . . . .	134, 164, 426, 460	Data Acquisition, Test & Control . . . . .	34
Circuit Test Systems . . . . .	110	Digital Voltmeters . . . . .	64
Component Testers . . . . .	84	Digitizers . . . . .	624
Computers & Peripherals . . . . .	559	Electronic Counters . . . . .	284



Business Computers . . . . .	601	Data Acquisition Systems . . . . .	34
Calculators . . . . .	581	Data Capture Terminals . . . . .	607
Computers, Peripherals . . . . .	579	Desktop Computers . . . . .	587, 593
CRT & Data Entry Systems . . . . .	602, 606	Digitizer . . . . .	624



Analytical Instruments for Chemistry . . . . .	654	Digital Education Products . . . . .	133
Cabinets . . . . .	642	Dimensional Measurement . . . . .	636
CRT Displays . . . . .	218	Frequency & Time Standards . . . . .	211, 276
		Medical Instrumentation . . . . .	656

**HP Computer Museum**  
**[www.hpmuseum.net](http://www.hpmuseum.net)**

**For research and education purposes only.**

## Customer Experience

Because HP products are functionally interrelated, the exchange of ideas throughout the company is continuous. A technological achievement in one product area often contributes to improved capabilities in other products and systems. Similarly, the wide range of customer needs improves HP's sensitivity and response. HP considers customer comments and suggestions essential to its continuing efforts to improve product quality and usefulness.

## Worldwide Support

All HP products come with complete documentation, including instructions for their most effective and efficient operation. Wherever they are sold, worldwide, HP products are supported by customer training programs, by system analyst and customer engineer assistance where required, and by a worldwide network of parts and repair centers for maintenance and service. To locate the HP office nearest you, please see the listing on pages 667-672.



Contents overleaf

Function Generators & Frequency Synthesizers . . . . . 329	HP-IL . . . . . 20	Oscillators . . . . . 310	Oscilloscopes . . . . . 174	Plotters . . . . . 617	Power Supplies . . . . . 228	Pulse Generators . . . . . 315	Recorders & Printers . . . . . 256	Signal Analyzers . . . . . 460	Signal Conditioners . . . . . 268	Sweep Oscillators . . . . . 370	Wave Analyzer . . . . . 522	Waveform Recorders . . . . . 170
--	--------------------	---------------------------	-----------------------------	------------------------	------------------------------	--------------------------------	------------------------------------	--------------------------------	-----------------------------------	---------------------------------	-----------------------------	----------------------------------

Oscilloscopes . . . . . 174	Plotters . . . . . 617	Power & Noise Figure Meters . . . . . 396	Recorders . . . . . 256	RF Impedance Meters . . . . . 90	RF Voltmeter . . . . . 63	Signal Analyzers . . . . . 460	Signal Generators . . . . . 345	Sweep Oscillators . . . . . 370	Transceiver Test Equipment . . . . . 528
-----------------------------	------------------------	---	-------------------------	----------------------------------	---------------------------	--------------------------------	---------------------------------	---------------------------------	--

Microprocessor Development System . . . . . 140	Plotters . . . . . 617	Signature Analyzers . . . . . 116, 126, 132, 515
---	------------------------	--

Digitizer . . . . . 624	Electronic Counters . . . . . 284	Frequency & Time Data Acquisition . . . . . 288	Graphics Tablet . . . . . 624	Hewlett-Packard Interface Bus . . . . . 22	Hewlett-Packard Interface Loop . . . . . 20	Logging Voltmeter . . . . . 70	Multiprogrammers . . . . . 50	Plotters . . . . . 617	Recorders & Printers . . . . . 256	Waveform Recorders . . . . . 170
-------------------------	-----------------------------------	---	-------------------------------	--	---	--------------------------------	-------------------------------	------------------------	------------------------------------	----------------------------------

Microwave Test Equipment . . . . . 406	Plotters . . . . . 617	Power & Noise Figure Meters . . . . . 396	Pulse Code Modulation (PCM) . . . . . 531	Pulse Generators . . . . . 315	Recorders . . . . . 256	Signal Generators . . . . . 345	Sweep Oscillators . . . . . 370	Telecommunications Test . . . . . 531	Transceiver Test Equipment . . . . . 528
--	------------------------	---	---	--------------------------------	-------------------------	---------------------------------	---------------------------------	---------------------------------------	--

Graphics Display System . . . . . 627	Graphics Tablet . . . . . 624	Measurement & Control Processor . . . . . 51	Multiprogrammers . . . . . 50	Oscilloscopes . . . . . 178	Plotters . . . . . 617	Power & Noise Figure Meters . . . . . 396	Sources . . . . . 164, 315, 329, 345, 370	Telecommunications Test . . . . . 531	Waveform Recorders . . . . . 170
---------------------------------------	-------------------------------	--	-------------------------------	-----------------------------	------------------------	---	---	---------------------------------------	----------------------------------

Disc Drives . . . . . 608, 610	DSN/Data Link . . . . . 606	Graphics Display Systems . . . . . 617, 627	Graphics Tablet . . . . . 624	Hard Copy Terminals . . . . . 612	Hewlett-Packard Interface Bus . . . . . 22	Hewlett-Packard Interface Loop . . . . . 24	Line Printers . . . . . 614	Multiprogrammers . . . . . 50	Plotters . . . . . 617	Recorders & Plotters . . . . . 256	Technical Computers . . . . . 587, 593, 597
--------------------------------	-----------------------------	---	-------------------------------	-----------------------------------	--	---	-----------------------------	-------------------------------	------------------------	------------------------------------	---

Microwave Semiconductors . . . . . 653	Optoelectronic Devices . . . . . 652	Pressure & Temperature . . . . . 638	Training & Video Tapes . . . . . 660	X-Ray Systems . . . . . 658
--	--------------------------------------	--------------------------------------	--------------------------------------	-----------------------------

## CONTENTS

<b>ALPHABETICAL INDEX</b> .....	<b>1</b>
<b>MODEL NUMBER INDEX</b> .....	<b>10</b>
Post-Sale Support Services .....	664
Publications .....	659
Information Request Card.....	back of catalog
Ordering Information .....	666
Sales & Support/Offices.....	667
Warranty.....	664

### PRODUCT SECTIONS:

Analytical Instruments for Chemistry .....	654	Medical Instrumentation .....	656
Amplifiers .....	54	Microwave Test Equipment .....	406
Analog Voltmeters.....	56	Network Analyzers .....	426
Cabinets.....	642	Oscillators .....	310
Cables & Adapters .....	640	Oscilloscopes .....	174
Cathode-Ray Tube Displays .....	216	Power & Noise Figure Meters .....	396
Circuit Test Systems .....	116	Power Supplies .....	228
Component Measurement .....	84	Pressure & Temperature .....	638
Computers, Peripherals & Calculators .....	579	Pulse Generators .....	315
Data Acquisition, Test & Control Systems ...	34	Recorders & Printers.....	256
Data Generators & Data Analyzers .....	164	Signal Analyzers .....	456
Digital Circuit Testers .....	122	Signal Generators .....	345
Digital Voltmeters .....	64	Sweep Oscillators .....	370
Dimensional Measurement .....	636	Solid State Components .....	652
Electronic Counters.....	284	Telecommunications Test Equipment.....	531
Function Generators & Frequency Synthesizers.....	329	Training/Video Tapes .....	660
Frequency & Time Standards.....	276	Transceiver Test Equipment .....	528
Hewlett-Packard Interface Bus (HP-IB) .....	22	Waveform Recorders .....	170
Hewlett-Packard Interface Loop (HP-IL)....	20	X-Ray Systems, Scientific & Industrial .....	658
Logic Analyzers.....	134		



Identifies products having the Hewlett-Packard Interface Bus (HP-IB) capability. HP-IB is our implementation of the IEEE Standard 488 and the identical ANSI Standard MC1.1, "Digital interface for programmable instrumentation." For the complete story, see pages 22-33.



Identifies products having Hewlett-Packard Interface Loop (HP-IL) capability. HP-IL provides serial loop interfacing for portable, battery-powered systems on the bench or in the field. See page 20.



Identifies newly introduced products or capabilities. New products are also indicated by **boldface** listings in the Model Number Index.

**Specifications** describe the product's performance.

Parameters that are described as **typical**, **nominal**, or **approximately** ( $\approx$ ) are supplemental characteristics intended to provide information useful to applying the product.



- A**
- AC**
- Digital Voltmeter ..... 64-83
  - Power Controller ..... 50
  - Probes ..... 71
  - Resistance Meter ..... 100
  - True RMS Voltmeters ..... 57, 69, 74-77
- Accessories**
- Cables/Connectors ..... 162, 640
  - Camera ..... 213
  - Connectors, Adapters ..... 162, 641
  - Graphics Software ..... 625, 630, 631
  - Logic Analyzer ..... 160
  - Modular Enclosures (System II) ..... 642-645
  - Network Analyzer ..... 452-457
  - Oscilloscope ..... 206
  - Overhead Transparency Kits ..... 626
  - PCM/TDM ..... 541
  - Signal Generator ..... 347
  - SLMS ..... 340, 560, 564, 567
  - Spectrum Analyzer ..... 483, 505
  - Transit Cases ..... 163, 648
  - Voltmeter ..... 206
- AC to DC Converter** ..... 270
- Active Probes** ..... 122, 296, 447
- Adapters**
- 50-75  $\Omega$  ..... 347, 443, 447, 505
  - Cables/Connectors ..... 640, 641
  - Detector ..... 424
  - Quasi-Peak ..... 483
  - Slotted Line Sweep ..... 416
- Air Line Extensions** ..... 420
- Alphanumeric LED Displays** ..... 652
- AM/FM Signal Generators** ..... 348, 350, 353, 356, 360
- AM/FM/ $\phi$ M Modulation Analyzer** ..... 523
- AM/FM/ $\phi$ M Signal Generator** ..... 352, 353
- AM/FM Test Source** ..... 524
- Amplifiers**
- Broadband Preamp ..... 54
  - Distribution ..... 282
  - Plug-Ins for Oscillographic Recorder ..... 258-261
  - Power Supply ..... 249
  - RF/Microwave ..... 55
- Analog Circuit Test System** ..... 120
- Analog-to-Digital Converter** ..... 31, 64-83, 171
- Cards, Multiprogrammer
    - High Speed ..... 50
    - Low Level ..... 50
- Analyzers**
- Audio ..... 465, 526
  - Audio Spectrum ..... 496
  - Automatic Network ..... 425, 431-432, 444, 458, 459
  - Automatic Spectrum ..... 468-514
  - Baseband ..... 571
  - Correlation ..... 515, 517
  - Data ..... 165
  - Data Line ..... 545
  - Digital Signal ..... 515, 517
  - Distortion ..... 465, 515, 517, 520, 522, 526
  - Fourier (FFT) ..... 508, 515, 517
  - Frequency Stability ..... 512, 519
  - Gain-Phase ..... 431, 434, 515
  - HP-IB ..... 222, 223
  - Logic ..... 134
  - Low Frequency Spectrum ..... 496, 515, 517
  - Mechanical Impedance ..... 515, 517
  - Microwave Link ..... 574
  - Modal ..... 515, 517
  - Modulation ..... 465, 515, 517, 523
  - Network ..... 426-434, 436-459
  - Primary Multiplex ..... 532
  - RF Impedance ..... 91
  - RF Signal Modulation ..... 523
  - Selective Level ..... 560
  - Spectrum ..... 468-514
  - Signature ..... 126
  - Structural Dynamics ..... 515
  - Telephone Line ..... 544
  - Timing/Hardware ..... 140
  - Transfer Function ..... 515, 517
  - Vibration ..... 506, 515, 517
  - Wave ..... 471, 522
- Applications Manual, Optoelectronics** ..... 652
- APC-3.5 series Adapters** ..... 455, 641
- APC-7<sup>®</sup> series Adapters** ..... 455, 641
- Assembler ROM** ..... 591
- Atomic Clock/Frequency Standard** ..... 277
- Attenuators**
- 75-Ohm General Purpose ..... 574
  - 600-Ohm Balanced & Unbalanced ..... 103
  - Coaxial, Fixed ..... 408
  - Coaxial, Microwave, OEM ..... 407
  - Waveguide ..... 407
- Automatic**
- Audio Distortion Analyzer ..... 526
  - Calibration DMM ..... 66, 72, 74
  - Capacitance Bridge ..... 101
  - Data Acquisition Systems ..... 34-49
  - Data Logger ..... 40, 44
  - LCR Meter ..... 86
  - Test Systems ..... 34-49, 425, 482
  - Network Analyzer ..... 425, 431-432, 444, 458, 459
  - Selective Level Meter ..... 560, 567
  - Synthesizer ..... 340-343, 348, 350, 353, 366
  - Spectrum Analyzer ..... 468-514, 517
  - Transceiver Test System ..... 528
- B**
- Balanced 2/4 Wire Audio Channel Selector ..... 533
  - Bar Code Decoder Board ..... 652
  - Bar Code Printer, Dot Matrix ..... 613
  - Bar Code Wand, Digital ..... 652
  - Bar Graph Array, LED ..... 652
  - Baseband Analyzer ..... 571
  - Baseband Analyzer System Software ..... 573
  - Battery Operated
    - Calculators/Computers ..... 582, 583
    - Counters ..... 302-308
    - DMM ..... 66-69, 307
    - Microwave Power Meter ..... 399
  - Beam Lead Diode ..... 653
  - BNC Series Adapters ..... 641
  - Board Tester, Analog ..... 120
  - Board Tester, Digital ..... 119
  - Breadboard Cards, Multiprogrammer ..... 50
  - Bridge, Directional ..... 422, 442, 447
  - Broadband Phase Comparator ..... 277
  - Business Computers ..... 588, 601
  - Broadband Sampling Voltmeter ..... 63

## C

Cabinet Identification	642	Communications Test Equipment	342, 343, 531-578
Cable Assemblies	640	Communications Test Set	546
Cable Maintenance & Construction	557	Comparator, Logic	124
Cables/Connectors	162, 640, 641	Comparator, Phase	277
Cables, HP-IB	29	Component Measurement	84-113
Calculators, Handheld Computers & Peripherals		Components	
Card Reader	583	Solid State	652
Financial Programmable	582	Component Testers	
Fully Programmable Printing	582	Digital IC Test System	114, 119
Memory Modules	583	Digital IC Test Interface Kit	115
Optical Wand	583	Computer-based Network Analyzer	425, 444, 458, 459
Printer/Plotter	583	Computer-based Spectrum Analyzer	482
Scientific Programmables	582, 583	Computer System Test	119
Calibration Data, Attenuators	409	Computers & Peripherals	579-635
Calibrators		A, L, E & F Series Computers	599
AM/FM (8901A)	523	Automatic Test Systems	53
Laser	636	Business Oriented Computer Systems	588-593, 601
Power Meter Calibrator for 432 Series		Computer Support	632-635
Power Meters	402	Data Capture Terminals	607
Range Calibrator for 435A Power Meter	399	Desktop	594-596
Capacitance Bridges; Meters	96	Disc Drives	589, 608, 610, 611
Cardiography/Cardiovascular Instrumentation	656	Disc/Tape Drives	611
Carrier Testing	558	Display Terminals, CRT	588, 600
Cases, Combining	646	DSN/Data Link	606
Cavity Frequency Meters	415	Flexible Disc Drives	608, 609
Cesium Beam Frequency Standard	277	Graphics Tablet	590, 624
Circuit Test Systems	116-121	Handheld Computers	583
Circuit Testers, Digital	119, 122-126, 129	HP-IL Peripherals	584, 585
Clip, Logic	124	Line Printer	590
Clock, Atomic	276	MicroWinchester Disc Drives	609
Clock, Digital	31	Modems	615
Clock, Thermal Printer	275	Modular Computer	588, 596
Coaxial Instrumentation		Personal	588, 589
Accessories	407-420, 641	Plotters	590, 617-623
Adapters	419, 455	Technical Computers	588, 589, 597-599
Air Lines	420	Thermal Graphics Printers	590, 609
Attenuators	407-411	Workstation Printers	613
Crystal Detectors	414, 415	Connector Adapters	641
Directional Bridge	422, 442, 447	Connectors, Microwave Precision	641
Directional Couplers	412	Converters	
Directional Detectors	413	A-to-D	31, 50, 171
Dual Directional Coupler	412	D-to-A	30, 50
Fixed Attenuators	408	DC to DC	254
Filters	308, 418, 423	Serial-to-Parallel	30
Frequency Meters	415	Counters, Electronic	284-309
Harmonic Mixer	418	Counter/Synchronizer	360
High Pass Filter	423	Counter/Timer	284-288, 294-308
Low-Pass Filters	308, 418, 423	Counter/Tracking Generator	498
Noise Sources	405	Digital Multimeter/Counter	45, 126, 306
Pad Attenuators	408	DVM	297, 300
Power Sensors	400, 403	F&T Data Acquisition System	288
Power Splitter	422, 437, 448	HP-IL to GPIO	585
Shorts	417	Low Cost	302-309
Sliding Load	417	Microwave	289-293
Slotted Line Carriage	416	Plug-In Adapter	287
Slotted Line	416	Portable, Battery Operated	302-308
Slotted Section	416	Pulsed RF	289
Step Attenuators	407, 410	Reciprocal	286, 294, 297, 302
Swept Slotted Line Systems	416	Time Interval	286, 294, 297, 300, 302, 305, 306
Switches	419	Time Interval Probes	296
Terminations	417	Universal	284-287, 294-308
Thermistor Mounts	403	Counter/Totalizer Card	50
Thermocouple Mounts	400	Couplers, Directional (Coax and Waveguide)	412, 413
Waveguide Adapters	420	CP/M® System (Series 80)	591
Comb Generator	505	CRT Displays	222-227
Combining Cases	646		



- Crystal Detectors ..... 414, 415  
 Crystal Oscillators ..... 281  
 Current Probe ..... 71  
 Current Tracer, Digital ..... 123
- D**
- D/A Converter ..... 30  
 D/A Converter Cards, Multiprogrammer ..... 50  
 Daisywheel Printer ..... 613
- Data**
- Acquisition Systems ..... 34-49, 288  
 Analyzers ..... 165  
 Capture Printer ..... 607  
 Capture Terminals ..... 607  
 Communications ..... 542, 591, 592  
 Coupler ..... 607  
 Error Analyzer ..... 556  
 Generators ..... 164-169, 540  
 Line Analyzers ..... 545  
 Link Adapter ..... 606  
 Logger ..... 40, 44  
 Terminals ..... 602  
 Transmission Test Set ..... 556
- DC**
- Millimeters ..... 60-62, 68  
 Voltage Source ..... 103  
 Voltmeters ..... 56-83
- DC-to-DC Converters ..... 254
- DC Power Supplies ..... 228-255
- Amplifier/Power Supply ..... 248  
 Autoranging ..... 238  
 Condensed Listing ..... 228  
 Constant-Current Sources ..... 248, 251  
 Digitally Controlled ..... 244-248  
 Dual Tracking ..... 233-237, 254  
 General Information ..... 228-232  
 General Purpose: 10-30 W Output ..... 233-235  
 General Purpose: 25-200 W Output ..... 236-239  
 General Purpose: 100-2000 W Output ..... 240-241  
 General Purpose: 300-11,000 W  
 Output ..... 238-241  
 High Voltage ..... 242  
 HP-IB Programmable ..... 244-248  
 Microprocessor ..... 254  
 Modular, DC-to-DC Converters ..... 254  
 Modular, Single Output, Series  
 Regulated ..... 254  
 Modular, Dual Output, Series  
 Regulated ..... 254  
 Modular, 200-600 W, Switching  
 Regulated ..... 254-255  
 Modular, 110 W Switching  
 Regulated ..... 254-255  
 Modular, Triple-Output Switching ..... 254-255  
 Multiprogrammer Control ..... 50  
 Precision Voltage Sources ..... 250  
 Programmable ..... 228-231, 244, 246, 247  
 Specifications Definitions ..... 232
- Decade Capacitors and Attenuators ..... 103  
 Degausser ..... 273, 277  
 Delay Generator ..... 321
- Desktop Computers and Peripherals ..... 587-592, 594-596,  
 630, 631  
 16-bit Parallel Interface ..... 594-595  
 BCD Input Interface ..... 591, 594, 595
- Color Video Interface ..... 595  
 Desktop Computers ..... 588, 589, 594-597  
 Disc Interface ..... 594  
 Flexible Disc Drives ..... 589, 608  
 General Interface ..... 590, 591  
 Graphics Tablet ..... 590, 624  
 HP-IB Interface ..... 591, 594, 595  
 HP-IL/Series 80 Interface ..... 585  
 Incremental Plotter Interface ..... 594  
 I/O Expander ..... 609  
 Intelligent Datacomm Interface ..... 594, 595  
 Interfacing Summary ..... 600  
 Micro Winchester Disc Drives ..... 589, 609  
 Multiprogrammer: I/O Expander & Converter ..... 50  
 Plotters, Graphics ..... 590, 617-623  
 Plotter/Printers ..... 581, 590  
 Plotter (Incremental) Interface ..... 594  
 Real Time Clock ..... 594  
 Serial Interface ..... 590  
 RS-232-C Serial Interface ..... 591, 594, 595  
 Thermal Graphics/Printers ..... 275, 590, 609  
 Two Channel DMA Controller Interface ..... 595
- Detectors**
- Adapter ..... 424  
 Coaxial, Microwave, OEM ..... 414  
 Crystal, Coaxial and Waveguide ..... 415  
 Error ..... 540  
 Error (Bell Compatible) ..... 537  
 Error (CEPT and CCITT compatible) ..... 536  
 Slotted Line ..... 416
- Development Station ..... 140  
 Development Systems, Logic ..... 140
- Digital**
- AC Voltmeters ..... 64-83  
 Analyzer, Logic ..... 134  
 Analyzer, Signature ..... 126  
 Board Tester ..... 116-121  
 Cassette Drive ..... 584  
 Circuit Test ..... 116-121, 126, 129  
 Current Tracer ..... 123  
 DC Voltmeters ..... 116-121  
 Education Course ..... 133  
 IC Tester ..... 114  
 IC Tester, Interface Kit ..... 115  
 IC Test System ..... 114  
 Impedance Meter ..... 96-98  
 LCR Meter ..... 86, 96, 100  
 Microprocessor Troubleshooting ..... 116-121, 126, 129  
 Multimeter ..... 68-83, 126, 585  
 Multimeter, Signature ..... 126  
 Noise Figure Meter ..... 404  
 PC Board Test System ..... 119  
 Pressure Gauge ..... 398, 638  
 Programmable Power Supplies ..... 244-248  
 Power Meter ..... 398  
 Signal Analyzers ..... 460-527  
 Signal Generators ..... 366  
 Signature Analyzer ..... 126, 129, 517  
 Spectrum Analyzers ..... 468-515, 517  
 Stimuli ..... 123  
 Storage Unit ..... 441, 449  
 Test Sets, Digital Logic ..... 129-130  
 Thermocouple Card, Multiprogrammer ..... 50  
 Thermometer ..... 639  
 -to-Analog Current Converter Card ..... 50





- to-Analog Voltage Converter Card ..... 50
  - Troubleshooting ..... 120-126, 129
  - Troubleshooting (Video Tape) ..... 661
  - Voltmeters ..... 64-83
  - Digital Electronics Programmable Calculator ..... 582
  - Digital Input/Analog Comparator Card ..... 50
  - Digital Input Card, Multiprogrammer
    - Common Ground ..... 50
    - Isolated Input ..... 50
  - Digital-to-Analog Converters ..... 30, 50, 247
  - Digital Output Card, Multiprogrammer ..... 50
  - Digitizing Oscilloscopes ..... 171, 178
  - Diodes ..... 653
  - Directional Bridge ..... 422, 442, 447
  - Disc Drives ..... 589, 610, 611
    - Flexible ..... 589, 608, 609
    - Micro Winchester ..... 589, 609
  - Disc/Tape Drives ..... 611
  - Displays
    - Cathode-ray Tube ..... 216
    - Computer Graphics System ..... 630
    - Display System ..... 222, 628
    - Graphics Generator (HP-IB Interface) ..... 222, 628
    - Imaging ..... 227
    - Instrumentation ..... 224-226
    - Large Screen ..... 223, 629
    - LED ..... 652
    - Tape Storage Module ..... 173
  - Distortion Analyzers ..... 515, 520, 522, 526
  - Distribution Amplifier ..... 282
  - Double Balanced Mixer ..... 418
  - Doublers, Frequency ..... 347, 365
  - Down Converter (1.7-14.5 GHz to 70/140 MHz) ..... 576
  - Drafting Plotters ..... 622
  - DSN/Data Link ..... 606
  - Dual Tracking, Power Supply ..... 233, 235, 236, 254
  - Dynamics Analyzer, Structural ..... 515
- E**
- Eight Channel Bank Amplifiers ..... 271
  - Eight-pen Plotters ..... 620
  - Emitters/Detectors ..... 652, 653
    - Optical Reflective Sensor ..... 652, 653
  - Electronic Counters ..... 284-309
  - EMI Measurement Accessory ..... 483
  - Emulators, Microprocessor ..... 130, 140
  - Error Measuring Set (1 kb/s-50 Mb/s) ..... 535
  - Error Measuring Set (1 kb/s-150 Mb/s) ..... 540
  - Error Measuring Set (Bell Compatible) ..... 537
  - Error Measuring Set (CEPT & CCITT Compatible) ..... 536
  - Error Rate Measurements ..... 534-537, 540
  - Exerciser, Microprocessor ..... 130
  - Extenders, HP-IB ..... 32
  - External Mixers ..... 484, 505
- F**
- Faxitron® X-Ray Systems ..... 658
  - FDM/Carrier Systems Testing ..... 558
  - FDM Network Surveillance Software ..... 563
  - Fiber Optics ..... 652
    - Multiplexer ..... 652
  - Filters
    - Bandpass ..... 347
    - Coaxial and Waveguide ..... 418, 423
    - High Pass ..... 423
    - Low Pass ..... 308, 418, 423, 492
  - Fixturer ..... 120
  - Flexible Disc Drives ..... 589, 608
  - Fourier Analyzer ..... 515, 517
  - FM Modulation Analyzer ..... 523
  - FM Signal Generators ..... 348, 350, 353, 356, 360
  - Frame Alignment Monitor & Error Detector ..... 534
  - Frequency
    - Counters ..... 284-309
    - Counter/Tracking Generator ..... 498
    - Doublers ..... 347, 365
    - Meters, Coaxial and Waveguide ..... 415
    - Response Test Set ..... 421
    - Stability Analyzer ..... 512, 519
    - Synthesizer, Microwave ..... 367
  - Frequency Reference Card, Multiprogrammer ..... 50
  - Frequency Standards ..... 276
    - Cesium ..... 277
    - Distribution Amplifier ..... 282
    - General Information ..... 276
    - Quartz ..... 281
    - Rubidium ..... 278
    - Standby Power Supplies ..... 283
  - Frequency and Time Standards ..... 276
  - Frequency Selective Meter and Tracking Oscillator ..... 343, 564
  - Frequency Stability Analyzer ..... 519
  - Frequency Synthesizers ..... 340-344, 348, 350, 353
  - Function Generators ..... 329-339, 341, 342
  - Functional Tester ..... 120
  - Fuseholder, RF ..... 347
- G**
- Gas Chromatograph ..... 654
  - GC/Mass Spectrometer Systems ..... 655
  - General Purpose Interface
    - HP-IL ..... 20, 21, 584, 585
  - General Purpose Integrator Preamp ..... 270
  - Generators
    - Data ..... 164-169, 329-334, 540
    - Function ..... 329-336
    - Graphics ..... 222, 628
    - Jitter ..... 538
    - Noise ..... 405
    - Pattern ..... 535
    - Pattern (Bell Compatible) ..... 537
    - Pattern (CEPT & CCITT Compatible) ..... 536
    - Pulse ..... 315-328
    - Signal ..... 345-368, 394, 395
    - Square Wave ..... 331, 337
    - Sweep ..... 334, 340-343, 370-395
    - Timing ..... 31
    - Tracking ..... 486, 490, 496, 498, 500, 503
  - Graphics
    - Generator (HP-IB Interface for displays) ..... 222, 628
    - Plotters ..... 590, 617-623
    - Printers ..... 590, 612, 613
    - Software ..... 592, 593, 625, 630
    - Tablet ..... 590, 624
    - Terminals ..... 603, 605
  - Group Delay (Network Analyzer) ..... 431, 432, 438, 458, 459
  - Guarded Digital Multimeter ..... 74
- H**
- Handheld Computers ..... 583
  - Harmonic Mixer (Coaxial and Waveguide) ..... 418

Hewlett-Packard Interface  
 Bus (HP-IB) ..... 22, 591  
 Hewlett-Packard Interface Loop . . . 21, 22, 66, 584, 585, 591  
 High Gain DC Preamplifier ..... 269  
 High Power Attenuators ..... 408  
 High Power Sensors ..... 400  
 High Resistance Meter ..... 100  
 High Speed A/D Converter Card, Multiprogrammer . . . . 50  
 High Speed System Voltmeter ..... 74, 80  
 How to Solder (Video Tape) ..... 663  
 How to Use an Oscilloscope (Video Tape) ..... 663  
**HP-IB**  
 Analog-to-digital converter ..... 31  
 Analyzers ..... 29  
 ASCII-to-parallel converter ..... 30  
 Cables ..... 29  
 Controlled Attenuator/Switch Driver ..... 410  
 Controlled Channel Selector ..... 533  
 Controllers ..... 593-597  
 Digital Clock ..... 31  
 Digital-to-Analog Converter ..... 30  
 Extenders ..... 32  
 General Information ..... 22-28  
 Graphics Tablet ..... 624  
 Multimeter/Voltmeters ..... 64-83  
 Relay Actuator ..... 30, 410  
 Timing Generator ..... 31  
 VHF Switch ..... 30  
**HP-IL** ..... 21, 22, 66, 584, 585  
**HP-IL Multimeter** ..... 66

**I**  
 IC Tester, Digital ..... 114  
 IC Test System, Digital ..... 114  
 I/O Expander ..... 609  
 Impedance Analyzer ..... 90-93  
 Impedance Meter ..... 94, 102  
 Impedance Transformers (50-75 Ω) ..... 447, 501  
 In-circuit Functional Tester ..... 120  
 Instrument Support ..... 664  
 Insulation Resistance Meter ..... 74, 100  
 Integrators, Reporting ..... 654  
 Interface Bus (HP-IB) ..... 22, 591  
 Interface Cards for Desktop Computers 590, 591, 594, 595  
 Interface Loop ..... 21, 22, 584, 585  
 Interface Kits  
 Logic Analyzer ..... 156  
 Multiprogrammer ..... 50  
 Interfacing Summary for Desktop Computers ..... 600  
 Interrupt Card, Multiprogrammer ..... 50

**J**  
 Jitter Generator & Receiver ..... 538

**K**  
 Kits, Overhead Transparency ..... 626  
 Kits, Rack Mounting ..... 163, 646

**L**  
 Laboratory Automation Systems ..... 654  
 Laboratory Strip Chart Recorders ..... 265  
 Laboratory X-Y Recorders ..... 258-263  
 Laser Measurement Systems ..... 636  
 Laser Printing System ..... 614  
 LCR Meter ..... 86, 96-98

LED Displays ..... 652  
 Light Bar Modules, LED ..... 652  
 Light Emitting Diodes ..... 652  
 Limiter ..... 289, 291, 293, 505  
 Liquid Chromatographs ..... 655  
 Log Level Preamp ..... 270  
 Logging Multimeter ..... 70  
**Logic**  
 Analyzer, Development System ..... 134  
 Analyzers ..... 134  
 Analyzer Accessories ..... 160  
 Analyzer Interface Kits ..... 156  
 Clip ..... 124  
 Current Tracer ..... 123  
 Comparator ..... 124  
 Development System ..... 140  
 Probes ..... 122  
 Pulser ..... 123  
 Signal Sources ..... 164, 315  
 Troubleshooting System ..... 125, 129  
 Low Distortion Generator ..... 337  
 Low Distortion Measurement ..... 520  
 Low Frequency Spectrum Analyzer ..... 496, 515, 517  
 Low Gain Preamplifier ..... 269  
 Low Level A/D Converter Card, Multiprogrammer . . . . 50  
 Low Resistance Meter ..... 74, 78, 100

**M**  
 Machinery Analyzer ..... 515, 517  
 Magnetic Tape Recorders, Analog ..... 272  
 Marker Generator ..... 373  
 Mass Spectrometers ..... 655  
 Measurement and Control System ..... 515, 517  
 Mechanical Impedance Analyzer ..... 515, 517  
 Medical Instrumentation ..... 656  
 Memory Card, Multiprogrammer ..... 50  
 Memory Modules (Series 80) ..... 589  
**Meters**  
 AC ..... 60-83  
 AC Resistance ..... 100  
 Capacitance ..... 96-103  
 Conductance ..... 96-103  
 Digital Multimeter ..... 64-83  
 Distortion ..... 520  
 Frequency ..... 415  
 Impedance ..... 86-98, 102  
 LCR ..... 86-89, 96-100  
 Milliammeter, AC ..... 62  
 Milliammeter, DC ..... 63, 68-82  
 Milliohmmeter ..... 68-83  
 Modulation ..... 523  
 Multifunction ..... 61, 64-83  
 Noise Figure ..... 404  
 Ohmmeter ..... 60, 64, 83, 100  
 Peak Power ..... 403  
 Power (RF/Microwave) ..... 398  
 Signature Multimeter ..... 126  
 Standing-Wave-Ratio (SWR) ..... 416  
 Susceptance ..... 86-95, 100, 101  
 True RMS ..... 57, 69, 70, 74, 83  
 Vector Impedance ..... 102  
 Microprocessor Exerciser ..... 130  
 Microprocessor Power Supplies ..... 255  
 Microprocessor Troubleshooting ..... 126, 129, 134  
 Microprocessor Training ..... 133  
**Microwave**  
 Counters ..... 289-293

# ALPHABETICAL INDEX

Diodes	653
Link Analyzers	574
Network Analyzers	425, 450, 458, 459
Noise Figure Meter	404
Power Measuring Equipment	396-403
Radio Testing	570
Signal Generators	361-368, 394, 395
Source Synchronizer	292
Spectrum Analyzers	474, 479, 486, 492, 502
Sweep Oscillators	370-395
Synthesizers	366
Test Equipment	416, 421-425
Transistors	653
Milliohmeter	68-83
Mixers, Double-balanced	418
Mixers, Coaxial and Waveguide	418, 484, 505
Modal Analysis	515, 518
Modems	590, 591, 615
Micro Winchester Disc Drives	609
Modular Power Supplies	253
Modular Spectrum Analyzers	488-504
Modulation Analyzer	426, 523
Modulator/Demodulator	578
Modulators, Absorptive	365, 369
Modulators, PIN	365, 369, 422
Modulation Test Source	524
Multi-frequency LCR Meter	86
Multimeter	64-83
Multimeter, Signature	126
Multiplex (Primary) Analyzer	532
Multiplexer	42, 45, 49, 652
Multipoint Cluster Controller	606
Multiprogrammers	50
<b>N</b>	
Network Analysis, General Information	426
Network Analyzers	421-430, 436-459
Accuracy Enhancement Program for 8409C	459
Automatic	425, 444, 458, 459
Automatic Scalar	425
Scalar	421, 425
Noise	
Analyzer/Modulation	426
Figure Meter	404
Generator	405
Normalizer, Data	441, 449
<b>O</b>	
<b>OEM</b>	
Computers	588, 589, 599
Displays, CRT	224-226, 630
Graphics Plotters	590, 618-623
HP-IL Converter	585
Instrumentation Tape Recorders	272-274
Microwave Attenuators	407, 409
Microwave Components	407, 408, 414, 419, 653
Microwave Crystal Detectors	414
Microwave Switches	419
Power Supplies	253
Series 80 Assembler Package	591
Strip Chart Recorders	265
X-Y Recorders	258-263
Ohmmeters	60, 64-83, 100
Operating & Transit Cases	648
Optical Shaft Encoders	652
Optocouplers	652
Optoelectronics	652
OR Monitors	657
Oscillators	
Audio	311, 312, 526
Function	331-334, 340
General Information	329
Low Distortion	312
Low Frequency	340
Sinewave	311
Squarewave	311, 331, 333, 340
Sweep	340, 370-395
Synthesized Sweep	394-395
Test	313
Oscillographic Recorders	266-271
Oscilloscopes	174
Accessories	206
Camera	213
Contrast Filters	210
Digital Waveform Storage	171, 178
Digitizing	171, 178
Measurement System	178
100 MHz Third-channel Trigger View	186
Time Interval Averaging	186
Delta Time	186
Fast Variable Persistence Storage	190
Variable Persistence Storage	189
200 MHz Delta Time Measurements	194
275 MHz Delta Time Measurements	194
275 MHz Delta Time Measurements	
with Microprocessor	195
275 MHz Fast Variable Persistence Storage	196
General Information	174
Inverter Power Supply for 1700	
Series Oscilloscopes	212
Light Shields	210
Low Frequency	203
Plug-In, 180 series	199
Rack Mount Slides and Adapters	210
Software, Oscilloscope Measurement System	178
Spectrum Analyzer Plug-In	488, 490, 492
Testmobiles	214
TV/Video Sync Retrofit Kit	211
Variable Persistence Storage	189
Viewing Hoods	210
Outside Plant Cable Test Equipment	613
Automatic Pair Identifiers	613
Cable Fault Locator	613
Conductor Fault Locators	613
Open/Split Locators	613
Pressurized Cable Leak Locators	613
Overhead Transparency Kits	626
<b>P</b>	
pA Meter	104
Pad, Coaxial Attenuator	408
Patient Monitors	657
Pattern Generator/Error Detector	535-537
PC Board Testers	116-121
PCM Test Equipment	531-541
PCM Test Systems	533
Peak Power Meter, Analog	403
Peak Power Meter, Digital	403
Perinatal Instrumentation	656



Personal Calculators & Handheld Computers	582-587	Printer, Thermal Instrumentation	275
Personal Computers	588, 589	Probes	
Personality Modules	152	Accessories	71, 122, 296
Phase Comparator	277	Active	296, 447, 505
Phase Meters	297, 436, 438, 446, 448	Digital Multimeter	71
Phase Modulation Analyzer	523	High Frequency	71
Phase Modulation, Signal Generator	352, 353	Logic	122
Phase Noise Measurement	350, 512, 519	Logic Analyzer	160
Phase Sensitive Demodulator	270	Miniature	206
PIN Modulators, Microwave	365, 369, 422	Slotted Line	416
PIN Photodiodes	652	Temperature	71, 212, 639
Plotter Accessories and Supplies	626	Time Interval	296
Plotter, Drafting	622	Voltage Divider	71
Plotter, Graphics	590, 617-623	Programmable Digitizers	171, 178
Plotter/Printers	580, 581, 590	Programmable Modulation Analyzer	523
Portable		Programmable ROM Drawer	591
Counters	302-309	Programmable Signal Source	344, 348, 350, 353, 366
Desktop Computers	588, 589	PROM Programmer	140, 590
Signal Generators	360	Pulse Adder, Splitter, Inverter	328
Spectrum Analyzers	488-493	Pulse Generators	315-328
Voltmeter	66-70	Accessories	323, 328
X-Ray Systems	658	Pulse/Function Generators	316, 334-338, 341, 342
Power Meter Calibrators	399, 402	Pulsers, Logic	123
Power Meter/Modulation Analyzer	523	<b>Q</b>	
Power Meters, RF & Microwave	396-403	Q-Meter	99
Power MOS FET	653	Quartz Frequency Standard	281
Power Sensors		Quasi-Peak Adapter	483
RF & Microwave	400	Quartz Pressure Gauge	638
Power Splitter	422, 437, 448	Quartz Thermometer	639
Power Supplies		<b>R</b>	
Amplifier/Power Supplies	248	Rack Mount Kits	163, 645, 646
Atomic Clock	283	Range Calibrator (for 435A Power Meter)	399
Condensed Listing	228	Readers, Card	583
Constant Current Sources	248, 251	Recorders	
Digitally Controlled	244, 246-248	Oscillographic	266-271
Dual Tracking	233-236, 254	Instrumentation Tape	272-274
Frequency Standards	283	Strip Chart	264-265
HP-IB Programmable	244-248	X-Y	258-263
Laboratory	228	Reflection/Transmission	
Microprocessor	255	Test Sets	422, 437, 442, 447, 453, 456, 458
Modular, DC to DC Converters	254	Reflectometer Bridge	422
Modular, Series Regulated	254	Relay Actuator (HP-IB)	30, 410
Modular/Switching Regulated	254	Relay Output Card, Multiprogrammer	50
Multiprogrammer Control	50	Resistance Meter	60, 64-83
Precision Voltage Sources	250	Retrofit, Signature Analysis	130
Programmable	244-248	Return Loss Kit	569
Specifications Definitions	232	Resuscitation Instrumentation	657
Standby	283	RF Impedance Analyzer	94
Power Supply/Amplifier	248	RF Spectrum Analyzers	476, 488, 490, 498, 500
Practical Transistors (Video Tape)	662	RF Test System	528
Preamplifiers	54, 262-266, 269-271, 296	RF Voltmeter	63
Precision Coaxial Connectors	641	RMS Voltmeter	57, 69-83
Precision Frequency Source	276	Rotary Air Line, Coaxial	420
Precision Oscillator	281	Rotary Joint, Coaxial	420
Precision Voltage Sources	250	Rotary Vane Attenuators, Waveguide	407
Preselector	503	Rubidium Frequency Standard	278
Pressure Gauge, Quartz	638	<b>S</b>	
Pressure Recording System	638	S-Parameter Test Sets	437, 442, 454
Primary Multiplex Analyzer	532	Scalar Network Analyzer	421, 425
Primary Multiplex Analyzer Systems	533	Scanner Cards, Multiprogrammer	50
Printer, Graphics	590, 612, 613	Selective Level Measuring Set	560
Printer, Line	590, 614	Selective Level Voltmeters	471, 560, 567
Printer/Printer Terminal	580, 582, 585, 612, 613	Selective Voltmeter	547, 560, 564
Printers, Letter Quality Daisywheel	590, 613		
Printers, Thermal Graphics	590, 609, 613		



# ALPHABETICAL INDEX

Self-Test Digital Multimeter	74-79
Semiconductor/Component Test System	106-111
Semiconductor Parameter Analyzer	112
Sensors, Microwave Power	400, 403
Series 80 Personal Computers	588-593
Series 80 Software	592, 593
Shorts, Coaxial	417
Shorts, Waveguide	417
Signal Analyzers	460-527
Audio	526
Automatic Spectrum	431, 432, 468, 482, 508
Digital	518
Distortion	520, 526, 547
General Information	460-467
Modular Spectrum	488-504
Modulation	523
Spectrum	460-518
Signal Conditioners	269-271
Signal Generators	
Accessories	347
Avionics	359
General Information	345
HF, VHF, UHF, SHF	348-368
Microwave	361-368
Programmable	348-355, 366
Pulse Modulator	365, 369
Synthesized	348-355, 366
Signal Sources	348-368
Signal Sources, Programmable	348-355, 366
Signature Analysis, Troubleshooting System	129
Signature Analysis	126
Signature Analysis Stimulus	130
Signature Analyzer, Digital	126
Signature Multimeter, Digital	126
Slotted Lines (Coaxial and Waveguide)	416
Sliding Load (Coaxial and Waveguide)	417
SLMS System Software	563
SMA, SMB, SMC Series Adapters	641
Snap-in Fiber Optic Link	652
Software, Graphics	592, 593, 625, 630
Software, Logic State Analyzer	140
Software, Oscilloscope Measurement System	178
Software, Series 80	592, 593
Software, Spectrum Analyzer System	482
Solid State	
Displays, Lamps, Arrays	652
Diodes, Transistors, Integrated Products, Power MOS FET's	653
Source, AM/FM Test	355
Source, Signal	348-368
Spectrophotometer, Diode Array	654
Spectrophotometric Detector, Hi Speed	654
Spectrum Analyzers, General Information	460-467
Spectrum Analyzers	460-517, 571
Spectrum Analyzer Preselector	503
Stability Analyzer, Frequency	512, 519
Standards: Frequency and Time	276
Standing Wave Ratio (SWR) Meter	416
Stepping Motor Control	50
Step Attenuators, Coaxial	407, 410
Storage-Normalizer	441, 449, 505
Strip Chart Recorders	264-265
Structural Dynamics	515
Sweep Oscillators, General Information	370-372
Sweep Oscillators	311, 313, 370-395, 577
Sweep Signal Generator	350-353
Sweeper Synthesizer	366
Swept Slotted Line	416
Switch Controller, HP-IB	410, 562
Switches	
Access, Distribution and Bi-directional	562
Actuators	42-49
HP-IB Driver	410
Coaxial, Microwave OEM	419
5-Port Coaxial	419
SPST	419
VHF Switch, HP-IB	30
Swivel Adapter	420
Synchronizer/Counter	360
Synthesized Function Generator	340
Synthesized Signal Generators	348-355, 366
Synthesized Signal Sources	348-355, 368, 517
Synthesized Sweep Oscillator	394
Synthesizer, Time	321
Synthesizers, Automatic	340-343, 348-355, 366-368
Synthesizers, Frequency	342, 343, 348-355, 368, 547, 564, 567
System, Logic Development	140
System I, System II Cabinets	642, 646
System, Digital Diagnostic	129
System Monitor	591
System Software, Baseband Analyzer	573
Systems Automatic Test	53
Systems Modem	615
Systems, Real Time Computer	599
<b>T</b>	
Tablet, Graphics	590, 624
Tape Degausser	273
Tape Drives	614
Tape Recorders, Analog Magnetic	272-274
Technical Computers	588, 589, 594-596, 599
I/O Summary	600
Telecommunications Test Equipment	531-578
Access Switch	562
Amplifier, Error Detector Input	541
Amplifier—IF	574
Attenuator—75 $\Omega$ General Purpose	574
Audio Channel Selector: HP-IB Controlled	533
Balanced 2/4-wire Audio Channel Selector	533
Baseband Analyzer	571
Baseband Analyzer System Software	573
Bi-directional Switch	562
Cable/Conductor Fault Locators	557
Cable Maintenance and Construction	
Test Equipment	557
Carrier Testing	558
Controller: Switch	562
Converter, 75 $\Omega$ Unbal/110 $\Omega$ Bal	541
Data Generator	540
Data Line Analyzers	545
Detector, Error	536, 537, 540
Down Converter	576
Error Measuring Set (1 kb/s-50 Mb/s)	535
Error Measuring Set (1 kb/s-150 Mb/s)	540
Error Measuring Set (Bell Compatible)	537
Error Measuring Set (CEPT and CCITT compatible)	536
Error Rate Measurements	534-537, 540
FDM Measurements	342, 343, 558-569
FDM Surveillance Software	563
Frame Alignment Monitor & Error Detector	534
HP-IB Controlled Channel Selector	533





# MODEL NUMBER INDEX

New product listings are printed in bold face type  
Dates in parentheses are references to recent HP Journal\* articles

<b>HP-10C Programmable Scientific</b> .....	<b>582</b>
HP-11C Advanced Programmable .....	582
HP-12C Advanced Financial Programmable .....	582
<b>HP-15C Advanced Programmable with Matrices</b> .....	<b>582</b>
<b>HP-16C Advanced Programmable for Digital Electronics and Computer Science</b> .....	<b>582</b>
HP-41C Handheld Computer (Jan. 1981) .....	583
HP-41CV Handheld Computer with 5X Memory .....	583
DTS-70 Digital Test Systems .....	119
HP-85A Personal Computer .....	588
<b>HP-86A Personal Computer</b> .....	<b>588</b>
<b>HP-87 Personal Computer</b> .....	<b>589</b>
HP-97 Programmable Printing Calculator .....	582

## 100

105A/B Quartz Frequency Standards .....	281
140T Spectrum Analyzer Mainframe .....	495
141T System Spectrum Analyzers .....	494
141T Spectrum Analyzer Mainframe .....	494
180 series Plug-in Oscilloscopes .....	199
180C, D High Writing Speed Oscilloscope Mainframes .....	199
180TR Rack-mount Display Mainframe .....	488, 490, 492
181AR, Variable Persistence Storage Mainframes .....	199
181T, TR Variable Persistence/Storage Display Mainframes .....	488, 490, 492
182T Large Screen Display Mainframe .....	488, 490, 492
197B Oscilloscope Camera .....	213

## 200

200CD Wide Range Oscillator .....	311
201C Audio Oscillator .....	311
204C Oscillator .....	311
204D Oscillator .....	311
209A Oscillator .....	311
214B Pulse Generator .....	322
239A Low Distortion Oscillator .....	312
HP 250 Business Computer System .....	601
281 series Coaxial-Waveguide Adapters .....	420
292 series Waveguide-Waveguide Adapters .....	420

## 300

334A Distortion Analyzer .....	520
339A Distortion Measuring Set .....	520
346B Noise Source .....	405
355 series Coaxial Step Attenuators .....	410
360 series Coaxial Low-pass Filters .....	418
362A series Waveguide Low-pass Filters .....	418
375 series Waveguide Variable Attenuators .....	418
382 series Waveguide Precision Variable Attenuators .....	407
393A Coaxial Variable Attenuator .....	407
394A Coaxial Variable Attenuator .....	407

## 400

400E & EL AC Voltmeters .....	58
400F & FL AC Voltmeter .....	58
400 GL AC Voltmeter .....	58
403B AC Voltmeter .....	59
410C Voltmeter .....	60
415E SWR Meter .....	416
420C Coaxial Crystal Detector .....	414
422A series Waveguide Crystal Detectors .....	415
423A/B Coaxial Crystal Detectors .....	414
424A series Waveguide Crystal Detectors .....	415
427A Voltmeter .....	61
428B Clip-on DC Milliammeter .....	62
432 series Power Meters .....	402

435B Power Meter .....	399
436A Power Meter .....	398
<b>436A-E40 Power Sensor Calibration System</b> .....	<b>399</b>
440A Detector Mount .....	416
442B Slotted Line RF Probe .....	416
444A Slotted Line Untuned Probe .....	416
447B Slotted Line Detector Probe .....	416
448B Slotted Line Sweep Adapter Probes .....	416
478A Coaxial Thermistor Mount .....	403
486A series Waveguide Thermistor Mounts .....	403
489A TWT Amplifier .....	55
491C TWT Amplifier .....	55
493A TWT Amplifier .....	55
495A TWT Amplifier .....	55

## 500

532 series Waveguide Frequency Meters .....	415
536A Coaxial Frequency Meter .....	415
537A Coaxial Frequency Meter .....	415
545A Logic Probe .....	122
546A Logic Pulser .....	123
547A Current Tracer .....	123
548A Logic Clip .....	124

## 600

618C SHF Signal Generator .....	364
620B SHF Signal Generator .....	364
626A SHF Signal Generator .....	364
628A SHF Signal Generator .....	364
651B/652A/654A Test Oscillators .....	313
680 Strip Chart Recorder .....	264

## 700

752 series Waveguide Directional Couplers .....	413
774D Coaxial Dual Directional Coupler .....	412
775D Coaxial Dual Directional Coupler .....	412
776D Coaxial Dual Directional Coupler .....	412
777D Coaxial Dual Directional Coupler .....	412
778D Coaxial Dual Directional Coupler .....	412
779D Coaxial Directional Coupler .....	412
786D Coaxial Directional Detector .....	413
787D Coaxial Directional Detector .....	413
788C Coaxial Directional Detector .....	413
789C Coaxial Directional Detector .....	413
796D Coaxial Directional Coupler .....	412
797D Coaxial Directional Coupler .....	412
798C Coaxial Directional Coupler .....	412

## 800

805C Coaxial Slotted Line .....	416
809C Slotted Line Carriage .....	416
810B series Waveguide Slotted Sections .....	416
816A Coaxial Slotted Section .....	416
817B Coaxial Swept Slotted Line System .....	418
<b>853A Spectrum Analyzer Display</b> .....	<b>488, 490, 492</b>
870A series Waveguide Slide Screw Tuners .....	418
895A General Purpose Power Supply .....	240

## 900

905A Coaxial Sliding Load .....	417
907A Coaxial Sliding Load .....	417
908A Coaxial 50-Ohm Termination .....	417
909A Coaxial 50-Ohm Termination .....	417
910 series Waveguide Terminations .....	417

\*A monthly publication of technical information from the HP Laboratories.



911A/C Coaxial Sliding Loads	417
914 series Waveguide Sliding Loads	417
920 series Waveguide Moving Shorts	417
923A Waveguide Sliding Short	417
930A Waveguide Shorting Switch	417
932A Waveguide Harmonic Mixer	418
934A Coaxial Harmonic Mixer	418
938A Frequency Doubler Set	365
940A Frequency Doubler Set	365

## 1000

HP 1000 Computers and Systems	597
<b>1000/6 Microsystem</b>	<b>598</b>
<b>1000/16 Computer System</b>	<b>598</b>
<b>1000/17 Computer System</b>	<b>598</b>
<b>1000/60 Computer System</b>	<b>598</b>
<b>1000/65 Computer System</b>	<b>598</b>
1006A Testmobile	214
1007A Testmobile	214
1008A Testmobile	214
<b>1040A Spectrophotometric Detector</b>	<b>654</b>
1051A & 1052A Combining Cases	646
1081B Liquid Chromatograph	655
1084B Liquid Chromatograph	655
1110B Current Probe	208
1111A AC Current Amplifier	208
1112A Inverter Power Supply	212
1117B Testmobile, Oscilloscope	215
1120A 500 MHz Active Probe	209
1121A AC Probe	447
1122A Probe Power Supply	208
1124A 100 MHz Active Probe	208
1200A/B Dual Channel Oscilloscope, 100 $\mu$ V/div	203
1201B Dual Channel Storage Oscilloscope, 100 $\mu$ V/div	204
1205B Dual Channel Oscilloscope, 5 mV/div	204
1220A Dual Channel Oscilloscope, 15 MHz	205
1222A Dual Channel, Delay Line Oscilloscope, 15 MHz	205
1304A 32 cm (13 in.) Display	226
1310B 48.3 cm (19 in.) Display	223, 629
1311B 35.6 cm (14 in.) Display	223, 629
1317B 43.2 cm (17 in.) Display	223, 629
1321B 53.3 cm (21 in.) Display	223, 629
1332A Small Screen Display	227
1335A Small Screen Display	227
1336S Small Screen Display	227
1340A Display Module	226
1345A Digital Display (Jan. 1982)	224, 225
1351A Graphics Generator	222, 628
1351S Computer Graphics Display System	222, 628
<b>1360 Graphics System</b>	<b>630</b>
1610B Logic State Analyzer	150
1611A Logic State Analyzer	152
1615A Logic Analyzer	148
1640B Serial Data Analyzer	552
1645A Data Error Analyzer	556
1645S Data Transmission Test Set	556
1700 series Oscilloscopes	186
1715A 200 MHz $\Delta$ Time Oscilloscope	194
1722B 275 MHz $\Delta$ Time Oscilloscope, with Microprocessor	195
1725A 275 MHz $\Delta$ Time Oscilloscope	194
1727A 275 MHz Oscilloscope (April 1982)	196
1740A 100 MHz Oscilloscope, Third-Channel Trigger View	186
1741A 100 MHz Oscilloscope, Variable Persistence Storage, Third-Channel Trigger View	189
1743A 100 MHz Crystal $\Delta$ Time Oscilloscope, Third Channel Trigger View	188
1744A 100 MHz Oscilloscope, Fast Variable Persistence Storage, Trigger View	189

<b>1745A 100 MHz Oscilloscope</b>	<b>186</b>
<b>1746A 100 MHz Oscilloscope</b>	<b>186</b>
1801A Dual Channel Vertical Amplifier, 50 MHz	200
1805A Dual Channel Vertical Amplifier, 100 MHz	200
1809A Four Channel Vertical Amplifier, 100 MHz	201
1821A Time Base/Delay Generator	201
1825A Time Base and Delay Generator	202
1950A Two Channel Expansion Module	184
1980A/B Oscilloscope Measurement System (Sept. 1982)	178

## 2000

2103LK Computer	599
<b>2106AK Board Computer</b>	<b>599</b>
<b>2107AK Board Computer</b>	<b>599</b>
2109EK Computer	599
2113E Computer	599
2117F Computer	599
<b>2137A Computer</b>	<b>599</b>
<b>2156A Computer</b>	<b>599</b>
<b>2178A/B Model 60 Computer Systems</b>	<b>598</b>
<b>2179A/B Model 65 Computer Systems</b>	<b>598</b>
<b>2186A/B Model 6 Microsystem</b>	<b>598</b>
<b>2196A/B Model 16 Computer Systems</b>	<b>598</b>
<b>2197A/B Model 17 Computer Systems</b>	<b>598</b>
2250 Measurement & Control Processor	51
<b>2333A Multipoint Cluster Controller</b>	<b>606</b>
2382A Office Display Terminal	600
<b>2601A Daisywheel Printer</b>	<b>590, 613</b>
2608S Line Printer	614
<b>2621B Interactive Display Terminal</b>	<b>600</b>
2622A Display Terminal	601
2623A Graphics Terminal	601
2624B Display Terminal	602
2626A Display Station (Mar. 1981)	602
<b>2626W Word Processing Workstation</b>	<b>602</b>
2631B Printer	590, 613
2631G #200 Factory Data Printer	613
2631G Graphics Printer	613
2635B Printer Terminal	613
2645A Display Station	603
<b>2647F Intelligent Graphics Terminal</b>	<b>603</b>
2648A Graphics Terminal	603
2671A Printer	590, 612
2671G Graphics Printer	590, 612
2673A Intelligent Graphics Printer	590, 612
2680 Laser Printing System	614
2804A Quartz Thermometer	639
2813B Quartz Pressure Probe	638
2816A Pressure Signal Processor	638
2820A Pressure Recording System	638

## 3000

HP 3000 Series 40, 44 & 64/Business Computer Systems	601
3040A Network Analyzer	431
3042A Network Analyzer	432
3044A/3045A Spectrum Analyzers	511
3046A/B Selective Level Measuring System	567
<b>3047A Spectrum Analyzer System</b>	<b>512</b>
3054A Automatic Data Acquisition/Control System (July 1981)	37
3054C Automatic Data Acquisition/Control System	39
3054DL Automatic Data Logger	40
<b>3056DL Data Logger</b>	<b>44</b>
3060A Circuit Test System	120
3074A/M Data Link Adapter	606



# MODEL NUMBER INDEX

New product listings are printed in bold face type

Dates in parentheses are references to recent HP Journal\* articles

3075A Desktop Data Capture Terminal	607	3771A Data Line Analyzer (CCITT)	545
3076A Wall-Mounted Data Capture Terminal	607	3771B Data Line Analyzer (BELL)	545
3077A Wall-Mounted Time Reporting Terminal	607	3777A HP-IB-controlled Channel Selector	533
3078A Data Coupler	607	3779C Primary Multiplex Analyzer (CEPT)	532
<b>HEDS-3200 Digital Bar Code Wand</b>	<b>652</b>	3779D Primary Multiplex Analyzer (Bell)	532
3310A Function Generator	331	3780A Pattern Generator/Error Detector	535
3310B Function Generator	331	3781A Pattern Generator (CEPT and CCITT Compatible)	536
3311A Function Generator	332	3781B Pattern Generator (BELL Compatible)	537
3312A Function Generator	333	3782A Error Detector (CEPT and CCITT Compatible)	536
<b>3314A Function Generator</b>	<b>334</b>	3782B Error Detector (BELL Compatible)	537
3325A Function Generator/Frequency Synthesizer/Sweeper	340	3783A Frame Alignment Monitor & Error Detector	534
3335A Frequency Synthesizer	342	3785A Jitter Generator & Receiver (CEPT)	538
3336A/B/C Synthesizer/Level Generator	343, 564	3785B Jitter Generator & Receiver (Bell)	538
3350 series Laboratory Automation Systems	654	3964A Instrumentation Tape Recorder	273
3388A Reporting Integrator	655	3968A Instrumentation Tape Recorder	273
3390A Reporting Integrator	655		
3400A RMS Voltmeter	57	<b>4000</b>	
3403C True RMS Voltmeter	83	4061A Semiconductor/Component Test System	106
3406A Broadband Sampling Voltmeter	63	4140B pA Meter/DC Voltage Source	104
<b>3421A Data Acquisition/Control Unit</b>	<b>42</b>	<b>4145A Semiconductor Parameter Analyzer</b>	<b>112</b>
3435A Digital Voltmeter	68	4191A RF Impedance Analyzer	90
3437A High Speed Digital Voltmeter	80	4192A LF Impedance Analyzer (Sept. 1981)	92
3438A 5-Function DMM; HP-IB	82	4193A Low Frequency Impedance Analyzer	94
3455A 6½ Digit DMM	78	4204A Oscillator	312
3456A Systems DVM (Apr. 1981)	74	4260A Universal Bridge	101
3466A 4½ Digit Autoranging DMM	69	4261A Digital LCR Meter	96
3467A Logging DMM	70	4262A Digital LCR Meter	97
<b>3468A 5½ Digit Multimeter (HP-IL)</b>	<b>66</b>	4265B Universal Bridge	101
<b>3468A Digital Multimeter</b>	<b>582</b>	4271B 1 MHz Digital LCR Meter	98
<b>3478A 5½ Digit Multimeter (HP-IB)</b>	<b>72</b>	4274A LCR Meter	86
3495A Scanner	49	4275A LCR Meter	86
3497A Data Acquisition/Control Unit	45	<b>4276A LCZ Meter</b>	<b>108</b>
3529A Magnetometer Probe	62	<b>4277A LCZ Meter</b>	<b>109</b>
3551A Transmission Test Set	546	4328A Milliohm-meter	100
3552A Transmission Test Set	546	4329A High Resistance Meter	100
3575A Gain/Phase Meter	434	4342A Q Meter	99
3580A Spectrum Analyzer	506	4440B Decade Capacitor	103
3581A Wave Analyzer	522	4800A Vector Impedance Meter	102
3581C Selective Voltmeter	547	4904A Cable Fault Locator	557
3582A Spectrum Analyzer	508	4905A Ultrasonic Leak Detector	557
3585A Spectrum Analyzer	468	4910G Open and Split Locator	557
3586A/B Selective Level Meter	564	<b>4918A Ultrasonic Leak Detector</b>	<b>557</b>
3586C Wave Analyzer	471	4930A Conductor Fault Locator	557
3702B IF/BB Receiver (70 MHz IF)	574	4935A Transmission Impairment Measuring Set	550
3710A IF/BB Transmitter (70 MHz IF)	574	4936A Transmission Impairment Measuring Set	551
3711A IF/BB Transmitter (70/140 MHz IF)	574	4940A Transmission Impairment Measuring Set	548
3712A IF/BB Receiver (70/140 MHz IF)	574	4943A Transmission Impairment Measuring Set	549
3717A 70 MHz Modulator/Demodulator	578	4944A Transmission Impairment Measuring Set	549
3724A Baseband Analyzer	571	4960/4961 Automatic Pair Identifier	557
3725A Display	571		
3726A Filter Mainframe	571	<b>5000</b>	
3730B Down Converter: RF to IF	576	5001A Microprocessor Exerciser (6800)	130
3736B RF Module (1.7 to 4.2 GHz)	576	<b>5001B Microprocessor Exerciser (6802, 6808)</b>	<b>131</b>
3737B RF Module (3.7 to 8.5 GHz)	576	5001C Microprocessor Exerciser (8085)	130
3738B RF Module (5.9 to 11.7 GHz)	576	5001D Microprocessor Exerciser (Z80)	130
3739B RF Module (10.7 to 14.5 GHz)	576	5004A Signature Analyzer	132
3743A IF Amplifier	574	5005A Signature Multimeter	126
3746A Selective Level Measuring Set (32 MHz)	560	<b>5005B Signature Multimeter</b>	<b>127</b>
3747A/B Selective Level Measuring Set (90 MHz)	560	5011T Logic Troubleshooting Kit	125
3750A Attenuator: 75 Ω	574	5015T Logic Troubleshooting Kit	125
3754A Access Switch	562	5021A Logic Troubleshooting Kit	125
3755A Switch Controller	562	5022A Logic Troubleshooting Kit	125
3756A 90 MHz Bi-directional Switch	562	5023A Logic Troubleshooting Kit	125
3757A 8.5 MHz Access Switch	562	5024A Logic Troubleshooting Kit	125
3762A Data Generator	540	5035A Basic Logic Lab	133
3763A Error Detector	540	5035T Logic Lab	133
3770B Telephone Line Analyzer	544	5036A Microprocessor Lab	133



5045A Digital IC Tester	114
5046A Digital IC Test System	114
<b>5046B Digital IC Test System</b>	<b>114</b>
5060 series Cooling Kits	647
5060 series Control Panel Covers	647
5060 series Filler Panels	646
5060 series Rack Adapter Frames	646
5060 series Rack Mounting Kits	646
K02-5060A Standby Power Supply	283
5061A Cesium Beam Frequency Standard	277
5061A with Option 004 Tube	277
E21-5061A Flying Clock (Cesium)	277
5065A Rubidium Frequency Standard	278
E21-5065A Portable Rubidium Time Standard	278
5085A Standby Power Supply	283
5087A Distribution Amplifier	282
5150A Thermal Printer	275
<b>5180A Waveform Recorder</b>	<b>171</b>
<b>5181A Display/Tape Storage Module</b>	<b>173</b>
5300A Counter Mainframe	306
5300B Counter Mainframe	306
5301A 10 MHz Counter Module	307
5302A 50 MHz Universal Counter Module	307
5303B 500 MHz Counter Module	307
5304A Timer/Counter Module	307
5305B 1300 MHz Counter Module	307
5306A Digital Multimeter/Counter	307
5307A Frequency Counter Module	307
5308A Timer Counter Module	308
5310A Battery Pack Module	308
5311B Digital-to-Analog Converter	308
5312A HP-IB Interface Module	308
5314A Universal Counter	305
5315A & 5315B Universal Counters	302
5316A Universal Counter (Sept. 1980)	302
5328A Universal Counter	300
5335A Universal Counter (Sept. 1980)	297
5340A Microwave Frequency Counter	293
5342A Microwave Frequency Counter	290
5343A Microwave Frequency Counter	290
<b>5344S Microwave Source Synchronizer</b>	<b>292</b>
5345A Electronic Counter	286
5355A Automatic Frequency Converter	289
5356A, B, C Frequency Converter Heads	289
5359A Time Synthesizer	321
5363B Time Interval Probes	296
5370A Universal Counter	294
5381A Frequency Counter	309
5382A Frequency Counter	309
5383A Frequency Counter	309
5390A Frequency Stability Analyzer	519
5391A Frequency and Time Data Acquisition System	288
5420B Digital Signal Analyzer	515
5423A Structural Dynamics Analyzer	515
5427A Digital Vibration Control System	518
5451C Fourier Analyzer	517
5501A Laser Transducer	636
5526A Laser Measurement System	636
<b>5527A Laser Transducer System</b>	<b>636</b>
<b>5528A Laser Measurement System</b>	<b>636</b>
5790A Gas Chromatograph	654
5880A Gas Chromatograph	654
<b>5985B GC/Mass Spectrometer</b>	<b>654</b>
5986A GC/Mass Spectrometer	655
5993C series GC/Mass Spectrometers	655
5995B GC/Mass Spectrometer	655

## 6000

6002A Extended Range DC Power Supply	246
6111A-6116A Precision DC Power Supplies	250
6012A Autoranging Power Supply	238
6024A Autoranging DC Power Supply	238
6034A 200 Watt Autoranging System Power Supply	244
6129C-6131C Digitally Controlled Voltage Sources	248
6140A Digital Current Source	248
6177C Precision DC Current Source	251
6181C Precision DC Current Source	251
6186C Precision DC Current Source	251
6200B-6209B DC Power Supplies	233-235
6212A-6218A DC Power Supplies	233-235
6227B Dual Tracking DC Power Supply	237
6228B Dual Tracking DC Power Supply	237
6234A Dual Output Power Supply	233-235
6235A Triple Output Power Supply	233-235
6236B Triple Output DC Power Supply	233-235
6237B Triple Output DC Power Supply	233-235
6253A Dual Output DC Power Supply	236
6255A Dual Output DC Power Supply	236
6259B DC Power Supply	240
6260B DC Power Supply	240
6261B DC Power Supply	240
6263B DC Power Supply	240
6264B DC Power Supply	240
6265B DC Power Supply	240
6266B DC Power Supply	240
6267B DC Power Supply	240
6268B DC Power Supply	240
6269B DC Power Supply	240
6271B DC Power Supply	240
6274B DC Power Supply	240
6281A DC Power Supply	236
6282A DC Power Supply	236
6284A DC Power Supply	236
6286A DC Power Supply	236
6289A DC Power Supply	236
6291A DC Power Supply	236
6294A DC Power Supply	236
6296A DC Power Supply	236
6299A DC Power Supply	236
6434B DC Power Supply	242
6438B DC Power Supply	242
6443B DC Power Supply	242
6448B DC Power Supply	242
6453A DC Power Supply	242
6456B DC Power Supply	242
6459A DC Power Supply	242
6464C DC Power Supply	242
6466C DC Power Supply	242
6469C DC Power Supply	242
6472C DC Power Supply	242
6475C DC Power Supply	242
6477C DC Power Supply	242
6479C DC Power Supply	242
6483C DC Power Supply	242
6515A High Voltage DC Power Supply	252
6516A High Voltage DC Power Supply	252
6521A High Voltage DC Power Supply	252
6525A High Voltage Power Supply	252
6824A DC Power Supply/Amplifier	249
6825A DC Power Supply/Amplifier	249
6826A DC Power Supply/Amplifier	249
6827A DC Power Supply/Amplifier	249
6940B Multiprogrammer	50
6941B Multiprogrammer Extender	50
6942A Multiprogrammer	50
6943A Multiprogrammer Extender	50

# MODEL NUMBER INDEX

New product listings are printed in bold face type  
 Dates in parentheses are references to recent HP Journal\* articles

## 7000

7004B X-Y Recorder	262
7010B X-Y Recorder	258
7015B X-Y Recorder	258
7034A X-Y Recorder	262
7035B X-Y Recorder	259
7044B X-Y Recorder	260
7045B X-Y Recorder	260
7046B X-Y Recorder	260
7047A X-Y Recorder	260
7130A Strip Chart Recorder, 2 Pen	265
7131A Strip Chart Recorder, 1 Pen	265
7132A Strip Chart Recorder, 2 Pen	265
7133A Strip Chart Recorder, 1 Pen	265
7220C 8-Pen Graphics Plotter	620
7220T 8-Pen Plotter/Paper Advance	620
7221C 8-Pen Graphics Plotter	620
7221T 8-Pen Plotter/Paper Advance	620
7402A 2-Channel Oscillographic Recorder	266
7404A 4-Channel Oscillographic Recorder	266
7414A 4-Channel Oscillographic Recorder	268
7418A 6 to 8 Channel Oscillographic Recorder	268
<b>7470A 2-Pen Graphics Plotter</b>	<b>590, 618</b>
7580A 8-Pen Drafting Plotter	622
<b>7585A 8-Pen Drafting Plotter</b>	<b>622-623</b>
7906 Disc Drive	610
7908 Disc/Tape Drive	611
<b>7911 Disc/Tape Drive</b>	<b>611</b>
<b>7912 Disc/Tape Drive</b>	<b>611</b>
7920 Disc Drive	610
7925 Disc Drive	610
<b>7933 Disc Drive</b>	<b>611</b>
7971A Tape Drive	614
7976 Magnetic Tape Subsystem	614

## 8000

8005B Pulse Generator	323
8007B Pulse Generator	326
8011A Pulse Generator	323
8012B Pulse Generator	324
8013B Pulse Generator	324
8015A Pulse Generator	325
8016A Word Generator	167
8018A Serial Data Generator	169
8080A Mainframe	328
8081A Repetition Rate Generator, 300 MHz	328
8082A Pulse Generator	327
8083A Output Amplifier, 300 MHz	328
8084A Word Generator, 300 MHz	328
8091A Repetition Rate Generator, 1 GHz	328
8092A Delay Generator/Freq. Divider	328
8093A Output Amplifier, 1 GHz	328
8111A 1 Hz-20 MHz Pulse/Function Generator	337
<b>8112A Programmable Pulse Generator</b>	<b>317</b>
8116A Pulse/Function Generator	338
8160A Programmable Pulse Generator	318
8161A Programmable Pulse Generator (Sept. 1981)	318
8165A Programmable Signal Source	344
8170A Logic Pattern Generator	168
<b>8180A Data Generator</b>	<b>165</b>
<b>8181A Data Generator Extender</b>	<b>165</b>
<b>8182A Data Analyzer</b>	<b>165</b>
<b>8340A Synthesized Sweep Oscillator</b>	<b>394</b>
8350A Sweep Oscillator	374-377
8403A Modulator	369
8404A Leveling Amplifier	373
8405A Vector Voltmeter	448
8406A Comb Generator	505
8407A Network Analyzer	446

8408B Automatic Network Analyzer	458
8409C Automatic Network Analyzer	459
8410C Network Analyzer Mainframe	450
8410S series Network Analyzers	457
8411A Harmonic Frequency Converter	451
8412B Phase-Magnitude Display	446, 451
8413A Phase Gain Indicator	456
8414B Polar Display	446, 451
8418B Auxiliary Power Supply	451
8443A Tracking Generator-Counter	498
8444A Tracking Generator	500
8444A Option 059 Tracking Generator	484, 486, 490, 503
8445B Automatic Preselector	503
8447 series Amplifiers	54
8450A Diode Array/Spectrophotometer	654
8470A/B Coaxial Crystal Detectors	414
8471A Coaxial Crystal Detector	414
8472A Coaxial Crystal Detector	414
8473B/C Coaxial Crystal Detectors	414
8477A Power Meter Calibrator	402
8478B Coaxial Thermistor Mount	403
8481A/H Power Sensors	400
8481B Power Sensor	400
8482A/H Power Sensors	400
8482B Power Sensor	400
8483A Power Sensor	400
8484A Power Sensor	400
8485A Power Sensor	400
8491A/B Coaxial Fixed Attenuators	408
8492A Coaxial Fixed Attenuator	408
8493A/B series Coaxial Fixed Attenuators	408
<b>8494A/B/G/H series Coaxial Step Attenuators</b>	<b>410</b>
8495A/B/D/G/H/K series Coaxial Step Attenuators	410
8496A/B/G/H series Coaxial Step Attenuators	410
8497K Coaxial Step Attenuator	410
8498A Coaxial Fixed Attenuator	408
8501A Storage-Normalizer	441
8502A & B Reflection Transmission Bridges	437, 442
8503A & B S-Parameter Test Sets	442
8505A Network Analyzer	438
8507B/C Automatic Network Analyzers	444
8552A Spectrum Analyzer—IF Section	494
8552B Spectrum Analyzer—IF Section	494
8553B Spectrum Analyzer, Tuning Section	498
8554B Spectrum Analyzer, Tuning Section	500
8555A Spectrum Analyzer, Tuning Section	502
8556A Spectrum Analyzer, Tuning Section	496
8557A Spectrum Analyzer	488
8558B Spectrum Analyzer	490
8559A Spectrum Analyzer	492
8565A Spectrum Analyzer	486
8566A Spectrum Analyzer	474, 479
8568A Spectrum Analyzer	474, 476
<b>8569B Spectrum Analyzer</b>	<b>484</b>
<b>8569B Option E30 External Mixer Kit</b>	<b>484</b>
8581B Automatic Spectrum Analyzer	482
8582B Automatic Spectrum Analyzer	482
8600A Digital Marker	373, 447
8601A Generator/Sweeper	373, 447
8614A Signal Generator	361
8616A Signal Generator	361
8620 System Sweep Oscillators	387, 577
8620C Sweeper Mainframe	387, 447
8640A,B AM/FM Signal Generators	356
8640B Option 004, Avionics Signal Generator	359

\*A monthly publication of technical information from the HP Laboratories.



8654A Signal Generator	360
8654B Signal Generator	360
8655A Synchronizer/Counter	360
8656A Signal Generator	348
8660A Synthesized Signal Generator	353
8660C Synthesized Signal Generator	353
8662A Synthesized Signal Generator (Feb. 1981)	350
<b>8663A Synthesized Signal Generator</b>	<b>352</b>
8671A Microwave Frequency Synthesizer	368
8672A Synthesized Signal Generator	366
<b>8672A-E24 MW Synthesized Generator (0.1 to 18 GHz)</b>	<b>366</b>
<b>8673A Microwave Synthesized Generator</b>	<b>366</b>
8683A/B Signal Generators	362
8684A/B Signal Generators	362
8709A/B Phase-lock Synchronizer	457
8717B Transistor Bias Supply	455
8721A Coaxial Directional Bridge	447
8731-8735 series PIN Modulators	369
8743B Reflection/Transmission Test Unit	453
8745A S-Parameter Test Set	452
8746B S-Parameter Test Set	454
8747A/B Waveguide series	
Reflection/Transmission Test Units	456
8748A S-Parameter Test Set	437
8750A Storage-Normalizer	424, 446, 449, 505
8754A Network Analyzer	436
8755C Frequency Response Test Set Plug-in	424
8755P Automatic Scalar Network Analyzer	425
8755S Frequency Response Test Sets	421
8761A & B Coaxial Switches	419
8801A Low Gain Preamplifier	269
8802A Medium Gain Preamplifier	269
8803A High Gain Preamplifier	269
8805A Carrier Preamplifier	269
8805B Carrier Preamplifier	269
8806B Phase Sensitive Demodulator	270
8807A AC/DC Converter	270
8808A Logarithmic Preamplifier	270
8809A Signal Coupler	270
8815A General Purpose Integrator	270
8820A DC Bank Amplifier	271
8821A DC Bank Amplifier	271
<b>8900C/D Peak Power Meter</b>	<b>403</b>
8901A Modulation Analyzer	523
8903A Audio Analyzer	526
<b>8953A Transceiver Test Set</b>	<b>529</b>
<b>8954A Transceiver Interface</b>	<b>530</b>
<b>8955A R.F. Test System</b>	<b>528</b>
<b>8956A System Interface</b>	<b>530</b>
8970A Noise Figure Meter	404
<b>9000</b>	
9111A Graphics Tablet	590, 624
<b>9121D/S 3.5 in.—Flexible Disc Drive</b>	<b>608</b>
<b>9130A Single Flexible Disc Drive (5¼")</b>	<b>589, 608</b>
<b>9134A Micro-Winchester Disc Drive</b>	<b>589, 609</b>
<b>9135A Combination Storage Unit</b>	<b>589, 609</b>
<b>9138A Mass Storage System</b>	<b>589, 609</b>
<b>9411B Switch Controller</b>	<b>53</b>
9412A Modular Switch	53
9413A VHF Switch	53
9414A Matrix Switch	53
9825B, T Desktop Computer	596
9826 Computer System	595
<b>9836A Desktop Computer</b>	<b>595</b>
9845B, C Desktop Computer	594
9872C 8-Pen Graphics Plotter	620
9872T 8-Pen Plotter/Paper Advance	620
9876A Thermal Graphics Printer	609
9878A I/O Expander	609
9885M/S Flexible Disc Drive (8")	609
9895A Flexible Disc Drive (8")	589, 608
9915A Modular Computer (July 1981)	596
<b>10000</b>	
10001A 10:1 Divider Probe	207
10001B 10:1 Divider Probe	207
10002A 50:1 Divider Probe	207
10002B 50:1 Divider Probe	207
10003A 10:1 Divider Probe	207
10004D 10:1 Divider Probe	207
10005D 10:1 Divider Probe	207
10006D 10:1 Divider Probe	207
10007B 1:1 Probe	207
10008B 1:1 Probe	207
10011B BNC Adapter Tip	210
10013A 10:1 Divider Probe	207
10014A 10:1 Divider Probe	207
10016B 10:1 Divider Probe	207
10017A Miniature Divider Probe	206
10018A Miniature Divider Probe	206
10019A Cable Assembly	209
10020A Resistance Divider Probe	207
10021A Miniature 1:1 Probe	206
10022A Miniature 1:1 Probe	206
10023A Temperature Probe (Mar. 1981)	71, 212
10024A IC Test Clip	210
10026A Miniature 1:1 Probe (50 Ω)	206
10027A Miniature 1:1 Probe (50 Ω)	206
10028A Jumper Cable	210
<b>10029A TV/Video Sync Retrofit Kit</b>	<b>63, 211</b>
10034A Probe Ground Lead Kit	209
10035A Probe Tip Kit	209
10036B Probe Tip Kit	60, 209
10037B Probe Tip Kit	209
10040A 10:1 Miniature Divider Probe	206
10041A 10:1 Miniature Divider Probe	206
10042A 10:1 Miniature Divider Probe	206
10066A HP-1B Probe Interface	159
10069A HP-1B Interface (1615A)	148
10080A Miniature 10:1 Probe	206
10081A Miniature 10:1 Probe	206
10082A Miniature 10:1 Probe	206
10083A Miniature 1:1 Probe	206
10084A Miniature 1:1 Probe	206
10100C 50 ohm Feedthrough Termination	210, 641
10100B 100 ohm Feedthrough Termination	210, 641
10110B BNC Male to Dual Banana Plug	641
10111A Shielded Banana Plug to BNC Female	641
10113A Triple Banana Plug to Dual BNC Female	641
10116A Light Shield for 1220 Series Oscilloscopes	210
10117A Panel Cover for 1220 Series Oscilloscopes	205
10119A Rack Mount Kit for 1220 Series Oscilloscopes	205
10140A Viewing Hood for 1700 Series Oscilloscopes	210
10166A Front Panel Cover (180A, 181A, 184A)	210
10173A RFI Filter and Contrast Screen for 1700 Series Oscilloscopes	210
10176A Viewing Hood for 12.7 cm (5 in.) Rect. CRT	210
10178A Metal Mesh Contrast Screen for 181 and 184 series Oscilloscopes	210
10221A 50 Ohm Probing Tee	209
10229A Retractable Hook Tip Adapter	210
10230C Clock Probe, Logic Analyzer	160
10231C Data Probe, Logic Analyzer	160
10233A Cable, 1645A to 5055A or 5150A	556
10235A Interface Cover for 1645A	556
10236A Trigger Bus Cable (1600S)	162
10237A Data Cable (1600S)	160



# MODEL NUMBER INDEX

New product listings are printed in bold face type

Dates in parentheses are references to recent HP Journal\* articles

10247A Clock Probe	160
10248C Data Probe	160
10250A TTL Trigger Probe	210
10257B Personality Module for 1611A (6800 $\mu$ P)	153
10258B Personality Module for 1611A (8080 $\mu$ P)	154
10259A Personality Module for 1611A (0F8 $\mu$ P)	154
10260A Personality Module for 1611A (Z80 $\mu$ P)	154
10261A Personality Module for 1611A (6502 $\mu$ P)	154
10262A Personality Module for 1611A (1802 $\mu$ P)	155
10263A Personality Module for 1611A (8085 $\mu$ P)	154
10264A GP Personality Module for 1611A (May 1980)	153
10266A Personality Module for 1611A (6809 $\mu$ P)	153
10275A PDP-11 UNIBUS Interface	158
10276A LSI-11 Interface	158
10277A,B,C General Purpose Interface	158
10278A HP 1000 series Interface	158
10279A NOVA 3 Interface	158
10280A microNOVA Interface	158
10281A HP-IB Interface (1640A)	158
10285A L-Series Logic Analyzer Interface	158
<b>10326A Time Interval Standard</b>	<b>67, 211</b>
10387A Interface, Type 303 Modems (1645A)	556
10388A Interface, CCITT V35 (1645A)	556
10389A Interface, Breakout Box (RS-232C) (1645A)	556
10407B Plug-in Extender (180 system)	210
10475A 3 in. Drawer for 1117B	215
10476A 8 in. Drawer for 1117B	215
10496A HP-IB Interface (1610B)	159
10501A Cable Assembly	640
10502A Cable Assembly	640
10503A Cable Assembly	640
10514A Double-balanced Mixer	418
10525T & 10525E Logic Probes	122
10526T Logic Pulser	123
10529A Logic Comparator	124
10533A BCD Interface Cable (5150A, 5300A)	308
10534A Double-balanced Mixer	418
10541A Reference Boards	124
10541B Preprogrammed Reference Boards	124
10548A Service Support Package	308
10590A Plug-in Adapter (5345A)	287
10595A Board Extender Kit (5345A)	287
10638A Degausser	277
10656A 5035A/T Texts & Lab Workbooks	133
10657A 5035A/T Component & Wire Kit	133
10819A Leather Carrying Case (5300A/B)	308
10833 A/B/C/D HP-IB Cables	29
10834A HP-IB Cable Adapter	29
10842A Extender Board Kit (5342/5343/5344S)	290
10844A Programming Interface Kit (5045A)	115
10845A Program Card (5045A)	115
10846A Program Card Coupon Book	115
10847A 5045A Service Kit	115
10851A/52A/53A/54A Rack Mount Kits (5300A/B)	308
10855A Broadband Preampifier	296
10856A Low Pass Filter Kit	308
<b>10871A Service Kit</b>	<b>171</b>
<b>10872A Parallel Interface</b>	<b>171</b>
<b>10873A Rack Mount Kit</b>	<b>171</b>
<b>10874A Slide Mount Kit</b>	<b>171</b>
<b>11000</b>	
11000A Cable Assembly	640
11001A Cable Assembly	640
11002A Test Leads	640
11003A Test Leads	640
11035A Cable Assembly	640
11036A AC Probe for 410C	60
11075A & 11076A Instrument Cases	647
11096B High Frequency Probe	71
11143A Cable Assembly	640
11170A/B/C Cable Assembly	640
11479A Caseless Version (9876A)	609
11500A/B Cable Assembly	640
11501A Cable Assembly	640
11509A Fuseholder	347
11511A Coaxial Short	417
11512A Coaxial Short	417
11515A Waveguide Adapter	420
11516A Waveguide Adapter	420
11517A Mixer	505
11518A-11520A Waveguide Taper Sections	505
11524A APC-7 to N (female) Adapter	641
11525A APC-7 to N (male) Adapter	641
11533A APC-7 to SMA (male) Adapter	641
11534A APC-7 to SMA (female) Adapter	641
11536A Probe Tee for 8405A	448
11540A Waveguide Stand	420
11542A-11548A Waveguide Holders	420
11549A Power Splitter for 8405A	448
11565A Coaxial Short	417
11566A Air Line Extension	420
11567A Air Line Extension	420
11570A Accessory Kit for 8405A	448
11581A Attenuator Set	408
11582A Attenuator Set	408
11583A Attenuator Set	408
11588A Swivel Adapter	420
11589A & 11590A Bias Networks	455
11599A Quick-Connect Adapter for 8745A	456
11600B Transistor Fixture	452
11602B Transistor Fixture	452
11604A Universal Extension for 8745A	452
11605A Flexible Arm for 8743A	456
11606A Rotary Air Line	420
11607A Small Signal Adapter for 8745A	456
11608A Transistor Fixture	454
11609A Cable Kit for 8410S	455
11610B Test Port Extension Cable	453
11650A Accessory Kit for 8410S	455
11652A Reflection/Transmission Kit for 8407A	447
11664A Detector for 8755	424
11664B Detector for 8755	424
11664C Detector Adapter for 8755	424
11665B Modulator for 8755	422
11666A Reflectometer Bridge for 8755	422
11667A DC-18 GHz Power Splitter	422
11668A 50 MHz High Pass Filter for 8755	423
11672A Service Accessory Kit for 8660A/C	353
11675B Leveling Cable Assembly for 784C	577
11678A Low Pass Filter Kit	423
11679A/B Extension Cables for 8755	423
11683A Range Calibrator	399
11684/5/6/8/9A Low Pass Filters	423
11687A Adapter, 50 to 75 $\Omega$	347
11690A Frequency Doubler	347
11691D Coaxial Directional Coupler	412
11692D Coaxial Dual Directional Coupler	412
11693A Limiter	505
11694A Matching Transformer, 50-75 $\Omega$	505
11697A/B/C Bandpass Filters	347
11708A Attenuator (for Calibrating 8484A)	400
11710B Down Converter	347
11712A Service Support Kit (for 8671A, 8672A)	367
11713A Attenuator/Switch Driver	410
11714A Service Support Kit (for 8662A, 8663A)	350
11715A AM/FM Test Source	525



# MODEL NUMBER INDEX

New product listings are printed in bold face type  
Dates in parentheses are references to recent HP Journal\* articles

18112A Laboratory Probe and Cal Module, 486 mm (19.1 in.) (2804A) .....	639
18115A Heavy Duty Probe and Cal Module, 29 mm (1.1 in.) (2804A) .....	639
18116A Heavy Duty Probe and Cal Module, 129 mm (5.1 in.) (2804A) .....	639
18117A Heavy Duty Probe and Cal Module, 179 mm (7.1 in.) (2804A) .....	639
<b>19000</b>	
<b>19800A Waveform Measurement Library</b> .....	<b>181</b>
19810A Sequence ROM .....	180
19811A Plot/Sequence ROM .....	180
19860A Digital Waveform Storage .....	179
<b>30000</b>	
33300 series Coaxial Step Attenuators .....	407
33311B/C Coaxial Switches .....	419
<b>33311B-C10 5-Port Switch</b> .....	<b>419</b>
33320 series Coaxial Step Attenuators .....	407
33330B, C Coaxial Crystal Detectors .....	414
<b>33340A/B Coaxial Attenuator</b> .....	<b>408</b>
34110A Carrying Case .....	71
34111A High Voltage Probe .....	71
34112A Touch-Hold Probe .....	71
37016A FDM Network Surveillance Software .....	563
37018A/B Baseband Analyzer System Software .....	573
37201A HP-IB Extender .....	32
37203A HP-IB Extender .....	32
37203L HP-IB Extender (Plug-In Card) .....	32
37213A Modem Card .....	615
37214A Modem Interface Card Cage .....	615
37215A Modem Interface Card .....	615
37216A Terminal Interface Card .....	615
37230A Short Haul Modem .....	615
37264A Band Defining Filter (for 3726A) .....	571
37265A Band Stop Filter (for 3726A) .....	571
37266A Band Pass Filter (for 3726A) .....	571
37267A Adapter Case (for 3726A) .....	571
37268A Dummy Plug-in (for 3726A) .....	571
37269A Front Panel Input Connector (for 3726A) .....	571
37461A Display .....	560
<b>39301A Fiber Optic Multiplexer</b> .....	<b>652</b>
<b>40000</b>	
43804 X-Ray System .....	658
43805 X-Ray System .....	658
43807 X-Ray System .....	658
<b>50000</b>	
<b>52126A Intel Multibus Interface</b> .....	<b>159</b>
<b>55005A Logic Troubleshooting System</b> .....	<b>129</b>
59301A ASCII-Parallel Converter .....	30
59303A Digital-to-Analog Converter .....	30
59306A HP-IB Relay Actuator .....	30
59307A HP-IB VHF Switch .....	30
59308A HP-IB Timing Generator .....	31
59309A HP-IB Digital Clock .....	31
59313A HP-IB Analog-to-Digital Converter .....	31
59401A Bus System Analyzer .....	29
59500A Multiprogrammer HP-IB Interface .....	50
59501A HP-IB Power Supply Programmer .....	31, 247
K70-59992 Rack Mount Adapter Kit (5342A, 5343A) .....	291
K34-59991A Broadband Linear Phase Comparator .....	277
<b>60000</b>	
61000 Modular Power Supplies (OEM) .....	253-254
61005C DC-to-DC Converter (single output) .....	253-254

61315D DC-to-DC Converter (triple output) .....	253-254
62000 & 63000 Modular Power Supplies (OEM) .....	253-254
62005A-62048G Modular Power Supplies .....	253-254
62212A-62215G Dual Output Modular Supplies .....	253-254
62410A Modular Supply Rack Mounting Tray .....	255
62411A Rack Tray Blank Front Panel .....	255
62412A Rack Tray Blank Rear Panel .....	255
62413A Rack Tray Cooling Unit (45 cfm) .....	255
62414A Rack Slide Kit (for standard cabinets) .....	255
62415A Rack Tray AC Distribution Panel .....	255
62605L, 62605M, 62615M 300-600 W Switching Power Supplies .....	253-254
63005C 110 W Switching Power Supply .....	253-254
63300F Modular Power Supplies .....	253-254
63315D Triple Output Switching Power Supply .....	253-254
64000 Logic Development System .....	140
64001S Logic Development System .....	140
64030A Development Station Cart .....	163
64100A Development Station .....	140
<b>64110A Development Station</b> .....	<b>140</b>
64200S Emulator, 8080/8085 .....	142
64210S Emulator, 6800 .....	142
<b>64220S Emulator, 8086/8088</b> .....	<b>140</b>
<b>64230S Emulator, Z8001/Z8002</b> .....	<b>140</b>
<b>64242S Emulator, 6800</b> .....	<b>140</b>
64250S Emulator, Z80 .....	142
<b>64262S Emulator, 8048</b> .....	<b>140</b>
64300A Logic Analyzer (Oct. 1980) .....	144
64500A PROM Programmer (Oct. 1980) .....	146
<b>64600S Hardware/Timing Analyzer</b> .....	<b>140</b>
<b>64620S Software/State Analyzer</b> .....	<b>140</b>
<b>64650A GP Preprocessor Module</b> .....	<b>140</b>
64940A Tape Cartridge Drive .....	140
65105A-65612A 50 Watt Modular Switching Power Supplies .....	253-255
<b>69280A Breadboard Card</b> .....	<b>50</b>
<b>69321B D/A Voltage Converter</b> .....	<b>50</b>
69322A Quad D/A Voltage Converter Card .....	50
69330A Relay Output Card .....	50
69331A Digital Output Card .....	50
69332A Open Collector Output Card .....	50
69335A Stepping Motor Control Card .....	50
69336B Scanner Card .....	50
69351B Voltage Regulator Card .....	50
69370A D/A Current Converter Card .....	50
69380A Breadboard Output Card .....	50
69422A High Speed A/D Converter Card .....	50
69423A Low Level A/D Converter Card .....	50
69430A Isolated Digital Input Card .....	50
69431A Digital Input Card .....	50
69433A Relay Output With Readback Card .....	50
69434A Event Sense Card .....	50
69435A Pulse Counter Card .....	50
69436A Process Interrupt Card .....	50
69480A Breadboard Input Card .....	50
69500A Unloaded Resistance Output Card .....	50
69501A-69513A Power Supply Control Cards .....	50
<b>69520A Power Supply Programming Card</b> .....	<b>50</b>
<b>69602B Timer/Pacer Card</b> .....	<b>50</b>
69700A-69706A Resistance Output Card .....	50
<b>69709A Power Supply Control Card</b> .....	<b>50</b>
69720A Digital-to-Analog Voltage Converter Card .....	50
69721A Digital-to-Analog Current Converter Card .....	50
69730A Relay Output Card .....	50
69731B Digital Output Card .....	50

\*A monthly publication of technical information from the HP Laboratories.



69735A Pulse Train Output/Stepping Motor Control Card	50	85030B Applications Pac for 8507B-9825T	445
69736A Timer/Pacer Card	50	85030C Applications Pac for 8507C-9845T	445
<b>69750A Scan Control/Pacer Card</b>	<b>50</b>	85031A APC-7 Calibration and Verification Kit for 8507B	445
69751A Analog-to-Digital Converter Card	50	85032A 50 $\Omega$ Type-N Calibration Kit	445, 455
<b>69752A 64 Channel FET Scanner Card</b>	<b>50</b>	85033A SMA Calibration Kit	445, 455
<b>69755A 16 Channel FET Scanner Card</b>	<b>50</b>	85033B APC-3.5 Calibration Kit	455
69770A Isolated Digital Input Card	50	85036A 75 $\Omega$ Type N Calibration Kit for 8507B	445
69771A Digital Input/Analog Comparator Card	50	<b>85040B Reflection/Transmission Test Set</b>	<b>456, 458</b>
69775A Counter/Totalizer Card	50	85650A Quasi-Peak Adapter	483
69776A Interrupt Card	50	85860A Software Pac for 8568A/9825/9866B Opt. 025/98034A	482
69790A Memory Card	50	85860B Software Pac for 8568A/9825T/9876A/98034B	482
69793A Breadboard Card	50	85861A Software Pac for 8566A/9825/9866B Opt. 025/98034A	482
<b>70000</b>		85861B Software Pac for 8566A/9825T/9876A/98034B	482
72021C HP-PLOT/2I Software	625	86200 series Sweeper Plug-ins for 8620C	392, 393
<b>80000</b>		86222A & B Sweeper Plug-ins for 8620C	389
82104A Card Reader (41C/CV)	583	86240A/B/C Sweeper Plug-ins for 8620C	391
82106A Memory Module (41C/CV)	583	<b>86251A 7.5-18.6 GHz Plug-in for 8620C</b>	<b>391</b>
82143A Printer/Plotter (41C/CV)	583	86290A, 86290B & 86290C Broadband Sweeper Plug-ins for 8620C	390
82153A Optical Wand (41C/CV)	583	<b>86720K Frequency Extension Retrofit Kit</b>	<b>368</b>
<b>82160A HP-IL Module</b>	<b>584</b>	<b>88100A Graphics Tablet System Tools</b>	<b>624</b>
<b>82161A Digital Cassette Drive</b>	<b>584</b>	<b>88101A Graphics Tablet System Tools</b>	<b>624</b>
<b>82162A Printer/Plotter</b>	<b>584</b>		
<b>82163A Video Interface</b>	<b>585</b>		
<b>82165A HP-IL GPIO Interface Converter</b>	<b>585</b>		
<b>82166A/B HP-IL Converter</b>	<b>585</b>		
82170A Quad Memory Module (41C/CV)	583		
<b>82180A Extended Functions/Memory Module</b>	<b>583</b>		
<b>82181A Extended Memory Module</b>	<b>583</b>		
<b>82182A Time Module</b>	<b>583</b>		
82500A Custom Modules	587		
82500B Custom Modules	587		
<b>82504A Custom Keyboards</b>	<b>587</b>		
82505A Custom Magnetic Cards	587		
<b>82900A CP/M System</b>	<b>591</b>		
82901M Flexible Disc Memory (5¼")	589, 608		
82902M Flexible Disc Memory (5¼")	589, 608		
82903A 16K Memory Module (Series 80 Computers)	589		
<b>82905B Printer</b>	<b>585, 590</b>		
<b>82907A 32K Memory Module</b>	<b>589</b>		
<b>82908A 64K Memory Module</b>	<b>589</b>		
<b>82909A 128K Memory Module</b>	<b>589</b>		
<b>82912A 9-Inch Monitor (86A)</b>	<b>588</b>		
<b>82913A 12-Inch Monitor (86A)</b>	<b>588</b>		
82928A System Monitor	591		
82929A Programmable ROM Drawer	591		
82936A ROM Drawer	591		
82937A HP-IB Interface Card	591		
<b>82938A HP-IL Interface</b>	<b>585, 591</b>		
82939A Serial Interface Card	591		
82940A GPIO Interface Card	591		
82941A BCD Interface Card	591		
82949A Printer Interface	591		
<b>82950A Series 80 Modem</b>	<b>591</b>		
83522A 0.01-2.4 GHz RF Plug-in for 8350A	380, 381		
83525A/B 0.01-8.4 GHz RF Plug-in for 8350A	380, 381		
83540A/B 2-8.4 GHz RF Plug-in for 8350A	382, 383		
83545A 5.9-12.4 GHz RF Plug-in for 8350A	382, 383		
83570A 18-26.5 GHz RF Plug-in for 8350A	384, 385		
83590A 2-20 GHz RF Plug-in for 8350A	378, 379		
83592A/B 0.01-20 GHz RF Plug-in for 8350A	378, 379		
83594A 2-26.5 GHz RF Plug-in for 8350A	378, 379		
83595A 0.01-26.5 GHz RF Plug-in for 8350A	378, 379		
<b>84811A Peak Power Sensor</b>	<b>403</b>		
85010B Basic Measurement Program Pac for 8501A/8505A & 9825T	445		
		90100A Practical Transistor Series (Videotape) VHS(SP)	662
		90100B Practical Transistor Series (Videotape) BETA I	662
		90100D Practical Transistor Series (Videotape) U-matic	662
		90301RA Understanding Microprocessors (Videotape) VHS(SP)	660
		90301RB Understanding Microprocessors (Videotape) BETA I	660
		90301RD Understanding Microprocessors (Videotape) U-matic	660
		90420A Digital Troubleshooting (Videotape) VHS(SP)	661
		90420B Digital Troubleshooting (Videotape) BETA I	661
		90420D Digital Troubleshooting (Videotape) U-matic	661
		98032A 16-bit Parallel Interface	594
		98033A BCD Input Interface	594
		98034B HP-IB Interface	594
		98035A Real Time Clock Interface	594
		98036A Serial Interface	594
		98040A Incremental Plotter Interface	594
		98041A Disc Interface	594
		98046B Intelligent Datacomm Interface	594
		98620A Two Channel DMA Controller/Interface	595
		98622A 16-Bit Interface	595
		98623A BCD Interface	595
		98624A HP-IB Interface	595
		98626A Serial Interface	595
		<b>98627A Color Video Interface</b>	<b>595</b>
		0960-0054 SMA-female short (50 ohm)	417
		0960-0055 SMA-male short (50 ohm)	417
		1250-XXXX Series Adapters and Connectors	401, 417, 641
		1250-1454 BNC Adapter Tip for HP Miniature Probes	210
		1251-2277 Dual Banana plug to BNC Female	641
		1251-2816 Dual Banana plug (for cable)	641
		1460-XXXX Series Cabinet Parts	643
		1490-XXXX Series Slide Kits, Casters	647, 651
		1494-XXXX Series Slide Kits	644
		5040-XXXX Series Rack Frames	646
		5060-0789 Cooling Kit	647
		5060-0796 Cooling Kit	647
		5060-XXXX Series Racking Accessories, Covers	646, 647
		5061-XXXX Series System II Cabinet Parts	642-645
		9211-XXXX Series Transit Cases	648-651



# HEWLETT-PACKARD INTERFACE LOOP

## Low Cost Interface for Battery-Operable Systems

### Hewlett-Packard Interface Loop (HP-IL)

The Hewlett-Packard Interface Loop, HP-IL, is a bit-serial interface designed for low cost, battery-operable systems. HP-IL allows the HP-41 to be used as a system controller, capable of transmitting and receiving data, and performing a wide variety of information management and instrument control functions.

In HP-IL systems, devices are connected by two-wire cables leading from the output port of one device to the input port of the next, until all devices form a closed loop. This loop structure provides a unique capability through: auto address assignment, device capability identification, power ON/OFF control, and error checking.

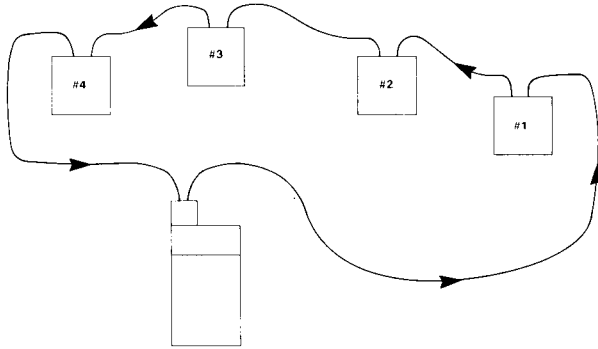

HP-IL System

#### Auto Address Assignment

In order to distinguish between devices in the loop, each device must have an address, a number from 1 to 30. The HP-41, as the controller, uses the address to specify and control the devices on the loop. HP-IL enables the HP-41 to assign addresses automatically, starting with the address 1 for the device next to the controller in the direction of the information transfer.

#### Device Capability Identification

Most HP-IL devices contain an accessory capability number that tells the HP-41 its device type, such as "printer" or "mass storage device". Upon execution of a PRINT command, the HP-41 polls each device on the loop until it finds the device that responds with the appropriate accessory ID number for printers. Device capability identification frees the user from having to know the address of each device on the loop. This feature also allows software to be run and written without regard to system orientation, address switches or preassigned addresses.

#### Power ON/OFF Control

Several HP-IL peripherals support STANDBY mode. Peripherals can be powered on or off, under program control, to conserve battery life. The power ON/OFF feature enables the use of an HP-IL system for remote applications.

#### Automatic Error Checking

HP-IL allows for automatic error checking of any data being transmitted on the loop. Because each character must return to the device that originally sent it, the device compares the returning character with a copy of the one that was sent. If the two do not match, an error message is generated.

#### Hold-Until-Ready Protocol.

HP-IL provides a simple means of coordinating the transfer of data. Some devices send and receive data at high rates while other devices work at a slower pace. In the HP-IL system, devices hold each piece of information until they are ready to receive another. When ready, they pass the information to the next device. By the time a piece of information makes a complete loop, all devices are ready to accept new information. This "hold-until-ready protocol" assures that fast and slow devices can operate in the same HP-IL system.

### The Versatility of HP-IL

HP-IL is an ideal, low cost interface option for those applications requiring low power and maximum portability. HP-IL also provides a link between battery-powered devices and more powerful computational products. Through HP-IL, an HP-41 Handheld Computer can pass information to a Series 80 personal computer. Another HP-IL product, the Converter, allows building an HP-IL interface into microprocessor-based products, making them compatible with an HP-IL device.

### HP-IB and HP-IL

HP-IL is not intended as a replacement for HP-IB, but rather as a low cost, low power alternative extending below the traditional scope of HP-IB in price and performance.

Although HP-IB and HP-IL serve the same basic function—interfacing controllers, instruments and peripherals—they differ in many respects.

1. Because of HP-IL's lower power consumption, it is usable with portable, battery-powered systems. Generally, HP-IB is not.
2. HP-IL system components will generally be low cost and have moderate performance; HP-IB system components are at the medium- to high-end of the performance spectrum and generally cost more.
3. HP-IL systems work at relatively low data rates. HP-IB systems work at relatively high data rates.
4. HP-IL allows device separations of up to 100 metres with shielded, twisted pairs (10 metres with zip cord). HP-IB requires extender hardware for long distance connections.

### The HP-IL Logo.

Just as the HP-IB interface is designated by the HP-IB symbol, Hewlett-Packard identifies the HP-IL interface with its own symbol. Wherever this logo appears, it indicates that that mainframe, peripheral, instrument, etc., is HP-IL compatible.



### HP-IL and the Future.

HP-IL adds a new dimension to Hewlett-Packard's instrumentation and computing capability. HP-IL enables battery-powered products to communicate with each other, and to communicate with Series 80 personal computers which can pass information along to larger computers. Watch for new HP-IL controllers, peripherals and instruments to be added to HP-IL's ongoing product line.

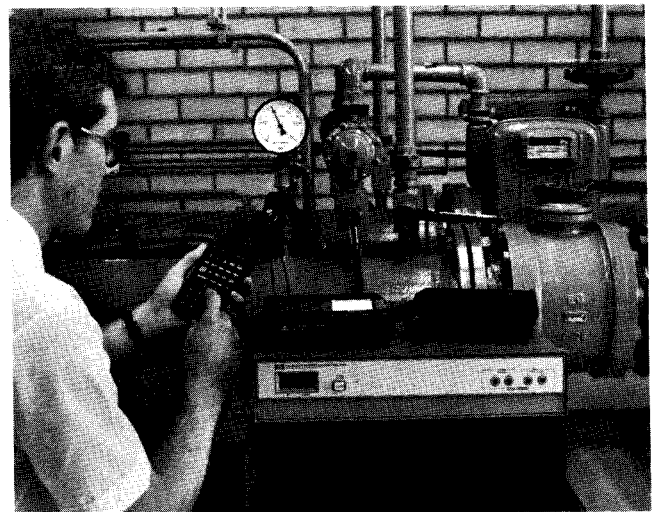

# HEWLETT-PACKARD INTERFACE LOOP

## Low Cost Interface for Battery-Operable Systems

21



### HP-IL Products and Applications Summary

Model	Application	See Page
HP-41 Handheld Computer (with HP 82160A HP-IL Interface Module)	Control: HP-IL Bench/Field Controller Computation: Field Data Collection	583-585
Series 80 Personal computers (with HP 82938A Interface)	HP-IL Bench Controller Field Data Analyses Control	589
HP 82161A Digital Cassette Drive	Field/Bench Program Storage Field/Bench Data Storage Field/Bench Data Logging Field Data Collection	584
HP 82162A Thermal Printer/Plotter	Field/Bench Hard Copy Data Logging Simple Plotting Computational Hard Copy	584
HP 82163A/B Video Interface	Bench Display Capability Demonstrations Instruction Program Debugging	585
HP 82165A GPIO Interface	Bench Conversion Between HP-IL and Parallel Digital Data Acquisition Interface From HP-IL to Most Computers	585

Model	Application	See Page
HP 82166A Prototyping Kit HP 82166B Volume Ten Pack	A component which can be built into a device, providing HP-IL capability.	585
HP 3468A Digital Multimeter	Bench/Field Automated Measurement Scientific Experimentation Lab Bench Experimentation & Trouble Shooting Bench/Field Automated Service & Diagnostic Tool	66
HP 82905B Impact Printer Opt. 248, 348, 448	Bench 80-Column Printer Utility Hard Copy Output (for program debugging, data output, and data presentations).	585, 590
HP 3421A Data Acquisition/Control Unit	Bench/Field Automated Measurement, Channel Selections and Control Lab Bench Experimentation and Control Portable Experimentation and Data Collection	42

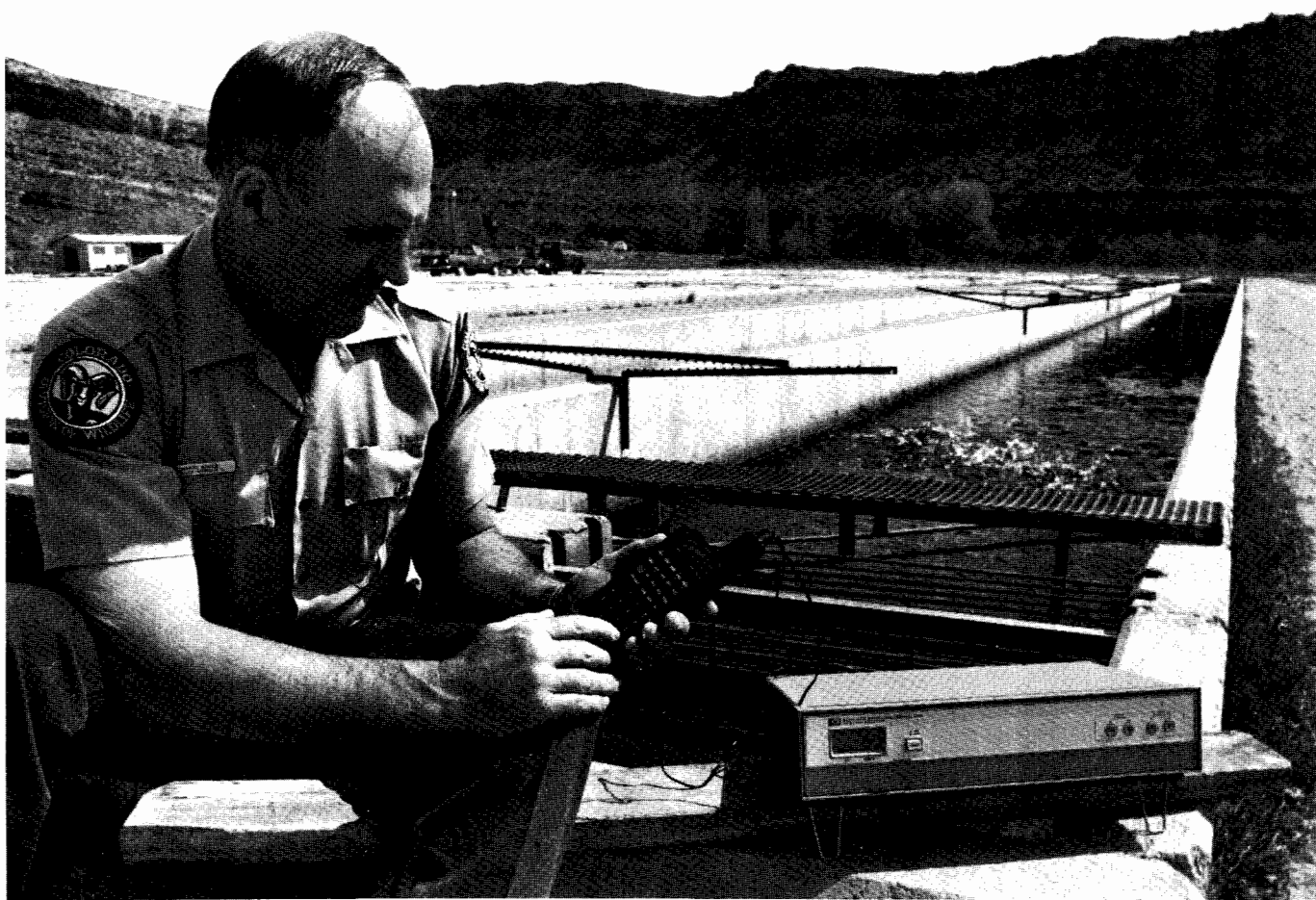



# HEWLETT-PACKARD INTERFACE BUS

## Versatile Interconnect System for Instruments and Controllers



- A versatile interconnect system that links instruments, desktop computers, minicomputers, and peripheral devices into automated measurement systems
- Very broad selection of HP-IB compatible instruments and accessory devices
- Wide choice of computers for the reduction, analysis, storage and management of measurement systems and resulting data
- The hardware, documentation and support that delivers the shortest path to a measurement system

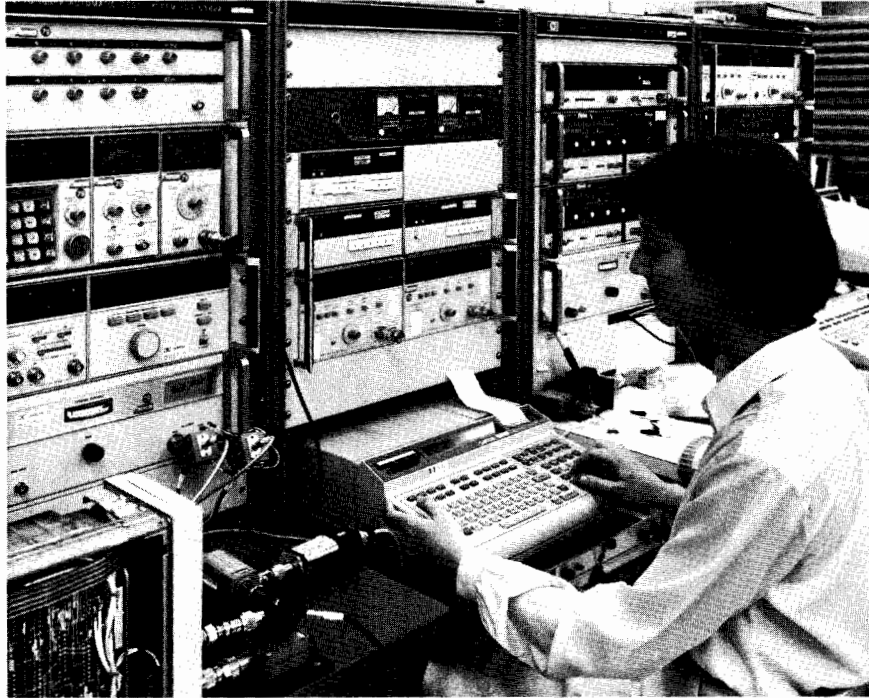

There are many applications where the measurement power of interactive instruments can be further enhanced by coupling them to desktop or minicomputers. Operating in a remote mode can provide more exact, error-corrected results as compared with conventional manual operation techniques.

Presently, three major parameters combine to reduce significantly the engineering development costs of configuring measurement systems:

- 1) The Hewlett-Packard Interface Bus, also known as "HP-IB";
- 2) Distributed computing through the growing number of "smart" instruments with internal microprocessors;
- 3) The broad choice of computers, ranging from "friendly" easy-to-program desktop computers to more sophisticated computer systems capable of managing multi-station instrument clusters and complex data bases.

### Relationship Between HP-IB and Other Interface Standards

Hewlett-Packard historically has been committed to the overall advancement of measurement technology, and has for some time been working on the problems of simplifying and standardizing means of instrumentation interfacing. An example of such an effort is the intimate involvement with the HP-IB from its conception at HP to its present status as a world instrumentation inter-

face standard (IEEE 488-1978 and IEC 625-1).

In mid-1972, Hewlett-Packard began to participate in various international standardization bodies. The U.S. Advisory Committee, composed of diverse interests represented by both users and manufacturers, first established initial goals—and then adopted the interface concept utilized by the HP Interface Bus as an appropriate starting point. A draft document was subsequently written and evaluated by members of the Committee, and then submitted as the U.S. Proposal to the IEC (International Electrotechnical Commission) Working Group in the autumn of 1972. Since then, the interface definition has undergone a number of minor changes to accommodate various needs at the international level.

In September 1974, the parent technical committee, IEC TC76, approved the main interface draft document for a formal ballot among the member nations of the IEC. Balloting took place in 1976, and IEC recommendation 625-1 was adopted. The IEC recommendation, using a different connector, is totally compatible with the present definition of the HP-IB.

Meanwhile, the IEEE Standards Board approved IEEE Standard 488-1975 "Digital Interface for Programmable Instrumentation", first published in 1975 and again published in 1978 with minor editorial

changes as IEEE Standard 488-1978. The IEEE standard is also fully compatible with the HP-IB. In January 1976, the American National Standards Institute adopted the IEEE Standard and published it as ANSI Standard MC 1.1.

The standardized interface concept is now well accepted. More than 1500 products, including more than 200 from HP, that use the HP-IB concepts articulated in IEEE 488 are today available from more than 250 manufacturers. As additional instrumentation interface standards evolve from the HP-IB, we will clearly indicate the relationship of the Hewlett-Packard Interface Bus to those standards—just as we have done with IEEE Standard 488, ANSI Standard MC 1.1 and IEC Publication 625-1.

### Why the HP Interface Bus Name?

As the list of HP products available with the "new digital interface" grew, our customers sought a convenient way to identify those products having the interface capability. In response, in 1974 we adopted the name "Hewlett-Packard Interface Bus" or simply "HP-IB". We will continue to use the identifying name and this symbol:



Both will be used with appropriate HP products so that their interface capabilities may be readily identified.

The Hewlett-Packard Interface Bus fully complies with IEEE Standard 488. As such, it incorporates the mechanical, electrical and functional specifications of the Standard. A fourth and vital element of any interface system is the operational aspect of a product at both the human-machine interface and machine-machine interface at the HP-IB port. HP-IB capability provides additional user benefits that are beyond the scope of IEEE Standard 488. Typical user conveniences such as high-level language implementation of interface functions, underscored program codes on the front panel of the instruments for easy programming, convenient data output formats, and designed-in "Learn Mode" capabilities. In addition there is complete support documentation in the form of programming and interfacing guides, application notes and operation manuals which illustrate the added benefits for users of products with HP-IB capability.

### Single Source Systems Approach

The decision to use a "system" instead of conventional manual methods must be based on an engineering evaluation of benefits versus costs. Among the many benefits associated with a systems approach:

- More consistent results in repeated measurements—a system is not subject to operator fatigue.
- Greater throughput because systems are generally faster.
- More thorough testing because system speed allows more parameters to be measured in a shorter time.
- Results expressed in engineering or scientific units, since many systems controllers are capable of on-line data manipulation.

- Greater accuracy because system errors can be measured automatically, stored and accounted for in the results.
- "Adaptive" data acquisition wherein a system can be programmed to branch to other measurements to help pinpoint when it senses an abnormal condition.
- Measurement results can be stored in computer memory or on hard copy.

It is our objective to facilitate the integration of instrumentation systems by providing users with instruments and computers designed for systems applications. Computers are designed with HP-IB options that allow easy hook-up to the bus and incorporate easy-to-use bus commands in their software. HP's policy when designing HP-IB compatible instruments is to eliminate interfacing ambiguities associated with controllers and instruments operating per the IEEE, ANSI and IEC standards by adopting consistent interface design guidelines.

Proper training on system components is very important for efficient utilization of any interface system. Therefore, we offer training at sales and service offices worldwide on HP desktop computers, computer systems and instruments as they relate to the HP-IB. (Refer to HP-IB Training, Page 28). In the area of HP-IB support documentation, we offer general interface technical descriptions, Operating and Service Manuals with programming information, Instrument/Controller Introductory Operating Guides, Quick Reference Guides and Application Notes. Technical assistance during system development is available from resident systems engineers specialized in desktop computers, computer systems and instruments at most local sales and service offices.

### How the HP Interface Bus Operates

All active interface circuitry is contained within the various HP-IB devices, and the interconnecting cable (containing 16 signal lines) is entirely passive. The cable's role is limited to that of interconnecting all devices in parallel, whereby any one device may transfer data to one or more other participating devices.

Every participating device (instrument, controller, accessory module) must be able to perform at least one of the roles of TALKER, LISTENER or CONTROLLER. A TALKER can transmit data to other devices via the bus, and a LISTENER can receive data from other devices via the bus. Some devices can perform both roles (e.g., a programmable instrument can LISTEN to receive its control instructions and TALK to send its measurement).

A CONTROLLER manages the operation of the bus system primarily by designating which devices are to send and receive data, and it may also command specific actions within other devices.

A minimum HP-IB system configuration consists of one TALKER and LISTENER, without a CONTROLLER. In this configuration, data transfer is limited to direct transfer between one device manually set to "talk only" and one or more devices manually set to "listen only" (e.g., a measuring instrument

talking to a printer, for semi-automatic data logging).

The full flexibility and power of the HP-IB become more apparent, however, when one device which can serve as CONTROLLER/TALKER/LISTENER (e.g., calculator or computer) is interconnected with other devices which may be either TALKERS or LISTENERS, or both (e.g., frequency synthesizers, counters, power meters, relay actuators, displays, printers, etc.), depending on the application. An HP-IB controller participates in the measurement by being programmed to schedule measurement tasks, set up individual devices so that they can perform these tasks, monitor the progress of the measurement as it proceeds, and interpret the results of the measurement. HP offers controllers which can be programmed in high-level languages such as BASIC, FORTRAN, HPL, and PASCAL.

### HP-IB Connections and Structure

The HP-IB has a party line structure where all devices on the bus are connected in parallel. The 16 signal lines within the passive interconnecting HP-IB cable are grouped into three clusters according to their function as follows:

- 1) Data Bus (8 signal lines)
- 2) Data Byte Transfer Control Bus (3 signal lines)
- 3) General Interface Management Bus (5 signal lines)

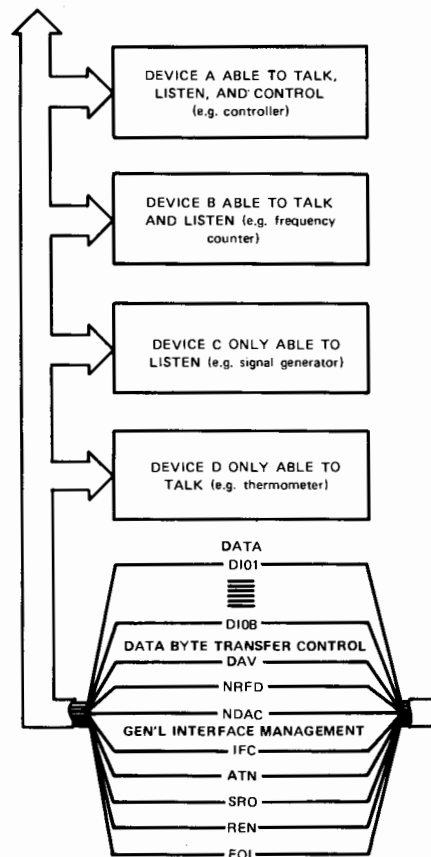

Interface connections and bus structure.

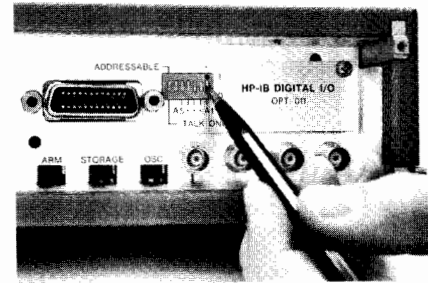

Rear panel switches are set so instrument will either be addressable by controller in a multi-device system, or will simply "talk only" to another device such as a printer.

The DATA BUS consists of eight signal lines which carry data in bit parallel, byte serial format across the interface. These signal lines carry addresses, program data, measurement data, universal commands and status bytes to and from devices interconnected in a system. Identification of the type of data present on the DIO signal lines is indicated by the ATN (attention) signal. When the ATN signal is true (asserted) either addresses or universal commands are present on the data bus and all connected devices are required to monitor the DIO lines. When the ATN message is false, then device dependent data (e.g., programming data) is carried between devices previously addressed to talk and listen.

Transfer of each byte on the Data Bus is accomplished via a set of three signal lines: DAV (data valid), NRFD (not ready for data), and NDAC (not data accepted). These signals operate in an interlocked handshake mode. Two signal lines, NRFD and NDAC, are each connected in a logical AND (wired OR) to all devices connected to the interface. The DAV signal is sent by the talker and received by potential listeners whereas the NRFD and NDAC signals are sent by potential listeners and received by the talker.

The General Interface Management Lines manage the bus to effect an orderly flow of messages. The IFC (interface clear) message places the interface system in a known quiescent state. SRQ (service request) is used by a device to indicate the need for attention or service and to request an interruption of the current sequence of events. REN (remote enable) is used to select between two alternate sources of device program data. EOI (end or identify) is used to indicate the end of a multiple byte transfer sequence or, in conjunction with ATN, to execute a polling sequence.

It is not possible in this limited space to go into detail on each signal line's role. But you should note that every HP-IB device need not be able to respond to all the lines. As a practical and cost-effective matter, each HP-IB device will usually be designed to respond only to those lines that are pertinent to its typical function on the bus. (Details appear in each device's operation manual.)

# HEWLETT-PACKARD INTERFACE BUS

Versatile Interconnect System for Instruments and Controllers



Individual Hewlett-Packard Products Available With HP-IB Capability

Products related to	Model	Product name/characteristics	Page
<b>Control and Computation</b>	85A/F	Personal Computer (uses 82937A Interface)	588
	86A	Personal Computer (uses 82937A Interface)	588
	87	Personal Computer (82937A Interface built-in)	589
	9825B/T	Desktop Computer (uses 98034B Interface)	595
	9826A	Desktop Computer	594
	9836A	Desktop Computer	594
	9845B/T	Desktop Computer System 45 (uses 98034B Interface)	593
	9915A	Modular Computer	595
	HP 1000 A600	Computer (2156A; uses 12009A Interface)	599
	HP 1000 A700	High Performance Computer (2137A; uses 12009A Interface)	599
	HP1000 E-series	Computers (2109E & 2113E use 59310B Interface)	599
	HP 1000 F-series	High-performance computers (2117F uses 59310B Interface)	599
	HP1000 L-series	Low cost computer (2103L uses 12009A Interface)	599
	3075A/3076A	Data Capture Terminals	607
	3078A	Data Coupler	607
	<b>Stimulus</b>	3314A	Function Generator: 0.01 Hz to 19.99 MHz
3325A		Synthesizer/Function Generator/Sweeper: 1 $\mu$ Hz to 21 MHz	340
3335A		Synthesizer/Level Generator: 200 Hz to 80 MHz	342
3336A/B/C		Synthesizer/Level Generator: 10 Hz to 20.9 MHz	343, 564
4140B		PA Meter/DC Voltage Source	104
5359A		Time Synthesizer: 1 ns accuracy; 50 ps increments, 100 ps jitter	321
6002A Option 001		DC Power Supply: 200 W autoranging. Listen only	246
6034A		System Power Supply: 200 W Autoranging w/status-readback	244
6129C Opt. P05 or J99		Precision Voltage Sources: $\pm$ 50 Vdc at 5 A (requires 59301A Converter)	248
6130C Opt. P05 or J99		Precision Voltage Source: $\pm$ 50 Vdc at 1A (requires 59301A Converter)	248
6131C Opt. P05 or J99		Precision Voltage Source: $\pm$ 100 Vdc at 0.5 A (requires 59301A Converter)	248
6140A Opt. P05 or J99		Precision Current Source: $\pm$ 100 mA at 100 Vdc (requires 59301A Converter)	248
6940B		Multiprogrammer (requires 59500A interface)	50
6942A		Multiprogrammer	50
8016A Option 001		Word Generator: 9 x 32 bit. Listen only	167
8018A Option 001		Serial Data Generator: 50 MHz, 2048-bit memory. Listen only	169
8112A		Programmable Low Cost Pulse Generator: 20 ns to 950 ms Period	317
8116A		Programmable Pulse/Function Generator: 1 mHz to 50 MHz	338
8160A		Programmable Pulse Generator: 20 ns to 999 ms period	318
8161A		Programmable Pulse Generator: 10 ns to 980 ms period	318
8165A		Programmable Signal Source: 0.001 Hz to 50 MHz	344
8170A		Logic Pattern Generator: 8 x 1024/16 x 512 bit	168
8180A		Data Generator: 50 MHz, 1024 bit/channel	165
8181A		Data Generator Extender	165
8340A		Synthesized Sweeper: 10 MHz–26.5 GHz	394
8350A		Sweep Oscillator: 10 MHz to 40 GHz	374
8620C Option 011		Sweep Oscillator: 10 MHz to 22 GHz	388
8656A		Signal Generator: 0.1 to 990 MHz	348
8660A, C Option 005		Synthesized Signal Generators: 10 kHz to 2.6 GHz. Listen only	353
8662A		Synthesized Signal Generator: 10 kHz to 1280 MHz.	350
8663A		Synthesized Signal Generator: 100 kHz to 2560 MHz.	352
8671A		Microwave Frequency Synthesizer: 2 to 6.2 GHz	368
8672A		Synthesized Signal Generator: 2 to 18 GHz	366
8672A-E24	Synthesized Signal Generator: 100 MHz to 18 GHz	368	
8673A	MW Synthesized Signal Generator: 2 to 26.5 GHz	366	
59501A	Power Supply Programmer: Isolated D-to-A Converter $\pm$ 10 Vdc @ 10 mA	247	
<b>Measurement</b>	436A Option 022	Power Meter: -70 dBm to +44 dBm, to 26.5 GHz	398
	853A	Spectrum Analyzer Display	488–493
	1610B Option 003	Logic State Analyzer: 64 x 32 bit memory	150
	1615A Option 001	Logic Analyzer: 256 x 24 bit memory	148
	1640B Option 001	Serial Data Analyzer: 2048 bit memory	552
	1980A/B	Oscilloscope Measurement System: dc to 100 MHz	178
	1980A/B Option 826	Waveform Measurement Library: Application Software for the HP 9826 & 9836.	181
	1980A/B Option 860	Digital Waveform Storage	179
	2250	Measurement & Control System	51
	2804A Option 010	Quartz Thermometer: 0.05°C accuracy	639
	3040A	Network Analyzer: 50 Hz to 13 MHz	431
	3044A	Spectrum Analyzer: 10 Hz to 13 MHz	511
	3437A	System Digital Voltmeter: high speed, 3½ digits	80
	3438A	Digital Voltmeter: low-cost, 3½ digits	82
	3455A	Digital Voltmeter: 5½ or 6½ digits, auto calibration	78



# HEWLETT-PACKARD INTERFACE BUS

Versatile Interconnect System for Instruments and Controllers



## Individual Hewlett-Packard Products Available with HP-IB Capability (Cont.)

Products related to	Model	Product name/characteristics	Page
Measurement (Cont.)	3456A	Digital Voltmeter: 3½ to 6½ digit voltmeter 1 nV sensitivity	74
	3478A	Digital Multimeter: 3½ to 5½ digits; 5 functions	72
	3582A	2-channel Real Time (FFT) Spectrum Analyzer: 20 mHz to 25.6 kHz	508
	3585A	Swept Spectrum Analyzer: 20 Hz to 40 MHz, 3 Hz BW, 0.4 dB amplitude accuracy	468
	3586A/B/C	Selective Level Meter: 50 Hz to 32.5 MHz	471, 564
	3717A	Wideband 70 MHz modem	578
	3724/25/26A	Baseband Analyzer	571
	3746A	32.5 MHz Selective Level Measuring Set: CCITT and Bell FDM Systems	560
	3747A	90 MHz Selective Level Measuring Set: CCITT FDM systems	560
	3747B	90 MHz Selective Level Measuring Set: Bell FDM systems	560
	3771A Option 005	Data Line Analyzer: CCITT measurement standards	545
	3771B Option 005	Data Line Analyzer: Bell measurement standards	545
	3779C	Primary Multiplex Analyzer: CEPT 2 Mb/s PCM systems	532
	3779D	Primary Multiplex Analyzer: Bell 1.5 Mb/s PCM systems	532
	3781A/3782A	Pattern Generator/Error Detector: CEPT and CCITT PCM/TDM systems	536
	3781B/3782B	Pattern Generator/Error Detector: Bell PCM/TDM systems	537
	3785A	Jitter Generator and Receiver: CEPT PCM/TDM systems	538
	3785B	Jitter Generator and Receiver: Bell PCM/TDM systems	538
	4140B	PA Meter/DC Voltage Source	104
	4145A	Semiconductor Parameter Analyzer	112
	4191A	RF Impedance Analyzer	90
	4192A	LF Impedance Analyzer	92
	4193A	Vector Impedance Meter	94
	4262A Option 101	Automatic LCR Meter	97
	4274A	Multifrequency LCR Meter: 10 steps, 100 Hz to 100 kHz	86
	4275A	Multifrequency LCR Meter: 10 steps, 10 kHz to 10 MHz	86
	4276A	LCZ Meter	108
	4277A	LCZ Meter	108
	4943A Option 010	Transmission Impairment Measurement System (TIMS)	545
	4944A Option 010	Transmission Impairment Measurement System (TIMS)	545
	5005B	System Signature Multimeter	126
	5180A	Waveform Recorder	171
	5312A	HP-IB interface (Talker) for 5300B Counter System	308
	5316A	Universal Counter: 0-100 MHz	302
	5328A Option 011	Universal Counter: to 512 MHz, 10 ns time interval	300
	5335A	Automatic Universal Counter: 200 MHz/1.3 GHz, 2ns Time Interval	297
	5340A Option 011	Automatic Microwave Counter: 10 Hz to 18 GHz	293
	5342A Option 011	Automatic Microwave Counter: 10 Hz to 18 GHz	290
	5343A Option 011	Microwave Frequency Counter: 10 Hz to 26.5 GHz	291
	5344S	Microwave Source Synchronizer .5 GHz to 18 GHz	292
	5345A Option 011,012	General Purpose Plug-In Counter	286
	5355A	Automatic Frequency Converter plug-in for 5345A	289
	5363B	Time Interval Probes	296
	5370A	Time Interval Counter: ±20 ps single-shot resolution	294
	5420A	Digital Signal Analyzer	515
	5423A	Structural Dynamics Analyzer	515
	5501A	Laser Transducer: for accurate positioning measurements	636
	5527A	Laser Transducer System	636
	5528A	Laser Measurement System	636
	6940B	Multiprogrammer (requires 59500A interface)	50
6942A	Multiprogrammer	50	
8182A	Data Analyzer: 50 MHz real-time capability; 1024 bit/channel	165	
8501A	Storage Normalizer for 8505A RF network analyzer	441	
8503A & 8503B	S-Parameter Test Set: 50 or 75 Ohm, for 8505A	442	
8505A	RF Network Analyzer: 500 kHz to 1.3 GHz	438	
8566A	Spectrum Analyzer: 100 Hz to 220 GHz	474, 479	
8568A	Spectrum Analyzer: 100 Hz to 1.5 GHz	474, 476	
8569B	Spectrum Analyzer: 10 MHz to 115 GHz	484	
8901A	Modulation Analyzer: 150 kHz to 1.3 GHz	523	
8903A	Audio Analyzer: 20 Hz to 100 KHz	526	
8954A	Transceiver Interface	530	
8956A	System Interface	530	
8970A	Noise Figure Meter: 10 to 1500 MHz	404	
85650A	Quasi-Peak Adapter	483	

### Individual Hewlett-Packard Products Available with HP-IB Capability (Cont.)

Products related to	Model	Product name/characteristics	Page
Switching Scanning Translation or Timing	2250	Measurement and Control Subsystem	51
	3421A	Scanner: to 30 channels; A/D converter	42
	3495A	Scanner: to 80 channels, low thermal; (to 40 relay channels)	49
	3497A	Data Acquisition Control Unit	45
	3754A	25 MHz Access Switch (requires 3755A switch controller)	562
	3756A	90 MHz Switch (requires 3755A)	562
	3757A	8.5 MHz Access Switch (requires 3755A)	562
	3777A	Telecommunications Channel Selector: up to 30 channels; dc to 110 kHz	533
	6940B	Multiprogrammer (requires 59500A interface)	50
	6942A	Multiprogrammer (no interface required)	50
	9411B	Switch Controller	53
	9412A	Modular Switch (requires 9411A switch controller)	53
	9413A	VHF Switch (requires 9411A)	53
	9414A	Matrix Switch (requires 9411A)	53
	11713A	Attenuator/Switch Driver (controls coax switches and step attenuators)	410
	37201A	HP-IB Extender Twisted-Pair or Modems	32
	37203A/L	HP-IB Extender: Coax and Fiber Optics	33
	59301A	ASCII-to-Parallel Converter: string to 16 characters	30
	59303A	Digital-to-Analog Converter	30
	59306A	Relay Actuator: for programmable switches, attenuators	30
59307A	VHF Switch: two 50 Ohm, bidirectional, dc to 500 MHz	30	
59308A	Timing Generator	31	
59309A	Digital Clock: month, day, hour, minute, second	31	
59313A	Analog-to-Digital Converter	31	
59501A	Power Supply Programmer: isolated D-to-A converter ± 10 V dc at 10 mA	247	
Storage	3964A Option 007	Instrumentation Tape Recorder: 4 channel Listen only	273
	3968A Option 007	Instrumentation Tape Recorder: 8 channel Listen only	273
	9121D/S	3.5" Flexible Disc: 540K bytes (Dual); 270K bytes (Single) of random access storage.	608
	9130A	5 1/4" Single Sided Flexible Disc: 270K bytes of random access storage. (For HP 86 only).	608
	82901M	5 1/4" Flexible Disc: 540K bytes random access storage (dual-drive).	608
	9895A	8" Flexible Disc: 2.36M bytes mass storage (dual-drive).	608
	9134A 9135A	5 1/4" Micro-winchester Disc: 4.6M bytes storage. Combination Storage Unit: 5 1/4" Winchester (4.6M bytes) plus 5 1/4" Flexible Disc (270K bytes back-up storage.)	609 609
9138A	Mass Storage System: 5 1/4" Winchester (4.6M bytes) and 8" Flexible Disc (2.36 M bytes storage.)	609	
Data Entry, Displays	1351S	Graphics Display System	628
	2608S	Line Printer: 400 lines/minute dot matrix	614
	2631B	Alphanumeric Dot Matrix Impact Printer: 132 columns	613
	2631G	Graphics Dot Matrix Impact Printer: 132 columns	612
	2671A	Alphanumeric Thermal Printer: 80 columns	612
	2671G	Graphics Thermal Printer: 80 columns	612
	2673A	Intelligent Graphics Printer: 80 columns	612
	5150A Option 001	Alphanumeric Thermal Printer: 20 Columns. Listen only	275
	7470A	Graphics Plotter: ISO A4 and 8 1/2 x 11 inch chart size	618
	7580A, 7585A	Large Format Drafting Plotters	622
	9111A	Graphics Tablet: graphics input	624
	9872C, 9872T 9876A	Graphics Plotter: multicolor (8 colors) programmable Thermal Graphics printer: 480 lines-per-minute	620 609
Interface Cabling	10833A-10833D	HP-IB Interconnection Cables	29
	10834A	HP-IB Interconnection Cable Adapter: 2.3 cm (.91 in)	29
HP-IB Extension	37201A	HP-IB Extender: Twisted Pair or modems	32
	37203A/L	HP-IB Extender: Coaxial or Fiber Optic Cable	33
Design and Servicing	10050A	HP-IB adapter for 1602A Logic State Analyzer	159
	10051A	Test Probe for 1602A Logic State Analyzer	159
	10066A	Probe Interface for 1610A/B and 1615 A Logic State Analyzers	159
	59401A	Bus System Analyzer	29



# HEWLETT-PACKARD INTERFACE BUS

## Versatile Interconnect System for Instruments and Controllers

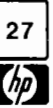

### Standard HP-IB Measurement Systems

Many application requirements can be satisfied with a standard HP-IB measurement system — a system assembled, tested, and

documented by Hewlett-Packard. Preconfigured systems save you design and setup time, and HP guarantees overall specified

system performance. Installation and service contracts are available from your local HP Sales and Service Office.

### Standard HP-IB Measurement Systems

Application	Model	Use Controller	System name/characteristic	Page
Data Logging, Acquisition, and Control	3054A	85/9825/9826 9835/9845	Fast, flexible, and precise data acquisition system with a wide choice of controllers	37
	3054C	1000	Computer based automatic data acquisition/control system	39
	3054DL	85	Complete data logger	40
	3056DL	85	Complete data logger	44
	5391A	9825	Frequency and Time Data Acquisition System: over 50,000 four-digit frequency and time interval measurements per second	288
Network Analysis	3042A	9825	Automatic Network Analyzer: complete amplitude and phase characterization, 50 Hz to 13 MHz. Group delay optional.	432
	8408B	85	Automatic Microwave Network Analyzer: 500 MHz to 18 GHz	458
	8409C	9845/9826	Automatic Microwave Network Analyzer: measures transmission and reflection parameters, 110 MHz to 18 GHz.	459
	8507B/C	9825/9845	Automatic RF Network Analyzers: measures complex impedance, transfer functions, group delay; 500 kHz to 1.3 GHz.	444
	8755P	85	Automatic Scalar Network Analyzer: measures insertion and return loss, 40 MHz to 18 GHz	425
Spectrum Analysis	3045A	9825	Automatic Spectrum Analyzer: same as 3044A, and includes the faster 9825 as computing controller.	511
	8581B	9825	Automatic Spectrum Analyzer: covers 100 Hz to 1.5 GHz; exceptional frequency tuning accuracy and resolution.	482
	8582B	9825	Automatic Spectrum Analyzer: covers 100 Hz to 22 GHz; exceptional frequency tuning accuracy and resolution.	482
Frequency Stability Analysis	3047A	9845/9836	Spectrum Analyzer System: high resolution and phase noise measurements	512
	5390A	9825	Frequency Stability Analyzer: short and long-term characterization of precision frequency sources, 500 kHz to 18 GHz.	519
Transceiver Testing	8953A	85/9826/9836	Transceiver Test Sets for AM and FM transceivers, 150 kHz to 990 MHz.	529
	8955A	9835/9845	RF Test System: for AM and FM transceivers, to 1000 MHz, transmitters to 120 W.	528
Circuit Testing	DTS-70	1000	Digital Test System: fast, accurate fault location on loaded printed circuit boards.	119
	3060A	9825	Analog and Digital Test System: Fast, accurate fault location on loaded printed circuit boards. Option 100 test microprocessors	120
Digital IC Testing	5046B	9826	Digital IC Test System: Reduces production costs through the isolation of faulty components prior to printed circuit board loading.	114
Network Surveillance	3046A/B	85	Frequency Division Multiplex (FDM) network surveillance system: automatic capability based on HP-85	567
Semiconductor/Component Testing	4061A	9835/9845 1000	Semiconductor/Component Test System: evaluation of fundamental characteristics of semiconductor and electronic components (I-V, HF, C-V, + quasi static C-V)	106
Pressure Recording	2820B	9825	Pressure recording system: displays, prints, and records pressure test data from oil and gas wells. Used with the 2813B Quartz Pressure Probe.	638
Power Sensor Calibration	436A-E40	85	Calibrates RF & MW power sensors; calculates measurement uncertainty. Good for metrology labs.	396





# HEWLETT-PACKARD INTERFACE BUS

## Versatile Interconnect Systems for Instruments and Controllers



### HP-IB Training and Support

Hewlett-Packard has field sales people trained in electronic instruments, desktop computers and computer systems to assist you in configuring HP-IB measurement systems. Also available for technical consultation are computing controller systems engineers and HP-IB instrumentation specialists.

HP-IB training courses on HP-IB controllers and instruments are listed below. Courses are conducted at selected Hewlett-Packard locations. For specific information on schedules and locations, contact your nearest HP office.

#### Instrumentation Systems

Course Name	Duration
• HPIB Programming on the 9826	5 days

#### Computer Systems

Course Name	Duration
• Instrument Interface with HP-IB	4 days

#### Desktop Computer Systems

Course Name	Duration
• HP BASIC Programming	4 days
• 9845 BASIC Operating and Programming	5 days
• BASIC Language I/O-Programming	4 days
• 9845 Image Data Base Management	5 days
• 9845 Advanced Graphics	4 days
• Engineering Graphics System for 9845	3 days
• 9826 Basic Language Operating and Programming	5 days
• 9826 PASCAL Programming	5 days
• HPL Operating and Programming	5 days
• HPL I/O Programming	4 days
• Series 80 Beginners Programming	2 days
• Series 80 General I/O Programming	3 days
• Series 80 Assemble Language	3 days

### Service and Warranty Considerations

Hewlett-Packard has dedicated measurement system service people who perform on-site maintenance on both customer configured systems as well as HP configured systems, irrespective of whether an HP desktop or minicomputer is used. Service contract coverage is available to meet your specific measurement system service needs and can be tailored to include extended warranty, calibration and extended hours of coverage. Contact your local sales and service office for further information on HP-IB service contract information.

Every HP-IB device and HP configured system carries a standard Hewlett-Packard warranty appropriate to that product. The warranty period for each product will be provided on request at the time of sale and is specified in documentation supplied with the product. HP takes responsibility for standard HP-IB systems performing as specified. However, software or interfacing which has not been provided by Hewlett-Packard as part of a standard system delivered by HP is not covered by this warranty.

In all cases, overall operational responsibility for those HP-IB systems assembled by a customer from individual HP-IB devices shall rest with the customer.

### HP-IB Specifications Summary

#### Interconnect Devices

Up to 15 maximum on one contiguous bus.

#### Interconnection Path

Star or linear bus network; total transmission path length 2 metres times number of devices or 20 metres, whichever is less. Operating distances can be extended; see pages 32 and 33.

### Message Transfer Scheme

Byte-serial, bit-parallel asynchronous data transfer using locked 3-wire handshake technique.

### Data Rate

One megabyte per second maximum over limited distance; 250-500 Kbytes per second typical over full transmission path (actual data rate depends on individual device characteristics).

### Address Capability

Primary addresses, 31 TALK and 31 LISTEN; secondary (2-byte) addresses, 961 TALK and 961 LISTEN. Maximum of 1 TALKER and up to 14 LISTENERS at a time.

### Control Shift

In systems with more than one controller, only one can be active at a time. A currently active controller can pass control to another, but only designated system controller can assume control over others.

### Interface Circuits

Driver and receiver circuits are TTL-compatible.

### Connector Lock Screw Compatibility

HP-IB products delivered now and in recent years are equipped with connectors having ISO metric-threaded lock screws, and stud mounts. (Very early HP-IB products have non-metric parts, but are readily distinguished from the metric by color: metric threaded parts are black and stamped with the letter "M" whereas non-metric parts have a shiny nickel finish). HP-IB Metric Conversion Kit (P/N 5060-0138) is available to convert these early instruments.

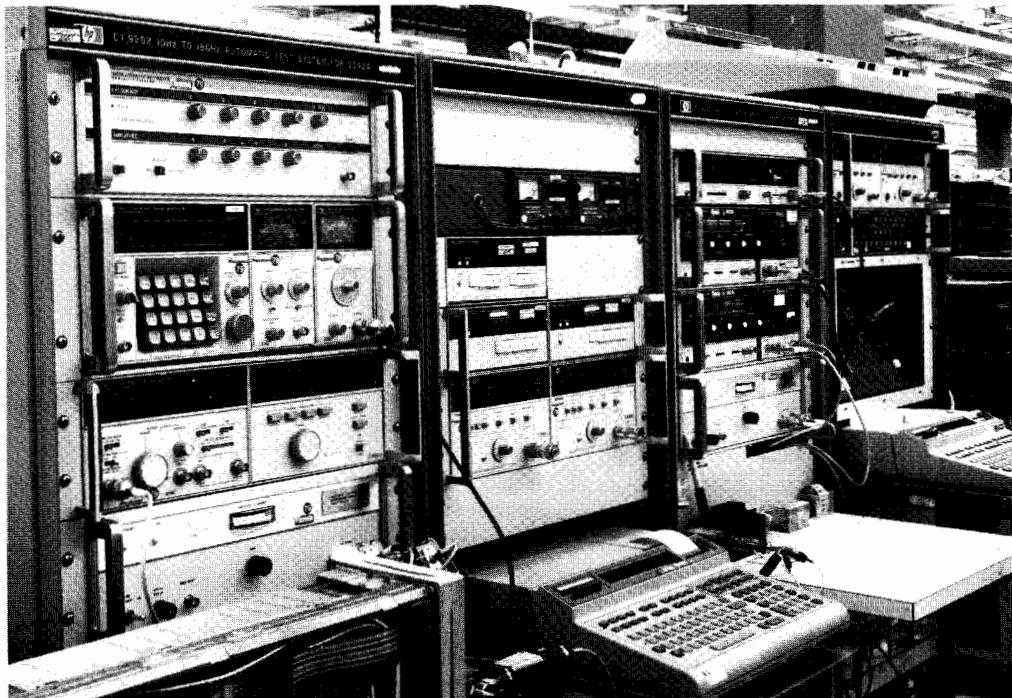



# HEWLETT-PACKARD INTERFACE BUS

## Versatile Interconnect System for Instruments and Controllers

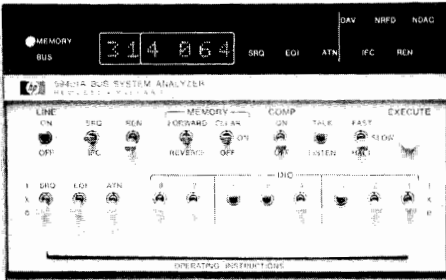

59401A

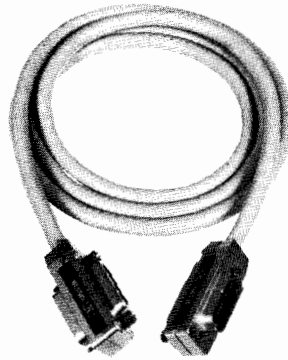

10833A/B/C/D

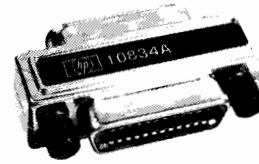

10834A

### 59401A Bus System Analyzer

The HP-IB (IEEE 488) concept has greatly simplified many of those things which have in the past made instrument interfacing a burdensome task. Even so, software errors can occur if the system designer does not completely understand the bus system or the capabilities of the instruments and other devices being interfaced. Hardware problems can occur if the instruments/devices are not functioning properly, or if they are not completely compatible with the bus standard.

The 59401 Bus System Analyzer is especially useful in design and service work. It simplifies and speeds up the diagnosis of software and hardware problems by allowing the user to see the status of all bus lines, including the actual characters on the bus data lines. Because the 59401A can also drive all bus lines, it can completely exercise another Talker, Listener or Controller—which is especially useful in verifying compatibility of new or user-designed products with the HP-IB.

There are several choices of analyzer operating speed. It may be operated at one character at a time (useful for software debugging), at 2 characters per second, or at regular bus speed. It may also be operated at a variable rate as determined by the external clock input.

The analyzer's 32 character memory can be used to store bus characters in the Listen mode, or to output characters to the bus in the Talk mode. When the analyzer is in the Compare mode, a stream of bus traffic may be stopped on a pre-selected character—and at that time, a trigger pulse is available, which is very useful when analyzing transient or timing problems related to the bus.

### 59401A Specifications

**Display:** monitors all bus lines. Represents data lines, any memory location, or DIO front panel switch settings; in octal code and ASCII character.

**Listen mode:** stores up to 32 characters of bus traffic in memory for real time and repetitive testing. In Compare mode, halts bus traffic when a selected character is present, and user can display any one of the previous 31 characters stored in memory.

**Timing:** accept <750 ns; ready <750 ns.

**Talk mode:** bus lines can be driven directly from front panel switches; memory can be loaded from front panel switches for driving bus with a 32 character sequence.

**Timing:** (1) data changed >500 ns before DAV pulled low; (2) ATN driven low >1  $\mu$ s before DAV pulled low; (3) DAV driven high <700 ns after NDAC is false; (4) DAV driven low <700 ns after NRFD is false, if conditions 1 and 2 are met.

**Operating speeds:** one character at a time, 2 characters per second, regular bus speed, or variable rate determined by external clock input; in either Listen or Talk mode.

**External clock input:** 1 standard power TTL gate input;  $\leq 10$  MHz repetition rate.

**Compare output:** provides 1 standard power TTL gate output (LOW TRUE) sync pulse when bus character is same as front panel switches.

**HP-IB load:** 1 bus load (capable of driving 14 other bus devices).

### General

**Temperature ranges:** operating, 0 to 50°C; storage, -40 to +75°C.

**Humidity:** 95% relative, 0 to 40°C.

**Power requirements:** 100, 120, 220, or 240 V +5%, -10%; 48 to 66 Hz;  $\leq 42$  VA.

**Size:** 145.5 H, 205.1 W, 495.3 mm D (5.730" x 8.075" x 19.500").

**Weight:** net, 5.64 kg (12.44 lb).

### Options and Accessories

**5061-0089** front handle kit

**10833B** 2 m (6.6 ft) bus cable, furnished

### 59401A Bus System Analyzer

### HP-IB Interconnection Cables

Cables for interconnecting HP-IB devices are available in four different lengths. The connector block at both ends of each HP-IB cable (photo above) has a plug on one side and a matching receptacle on the other, so that several cables may be conveniently connected in parallel, thus simplifying system interconnection. Lock screws provide for secure mounting of each connector block to an HP-IB instrument, or to another cable connector block.

*SPECIAL NOTE: HP-IB cables are not always included with individual HP-IB devices, particularly those that normally connect directly to an HP computing controller. (The HP-IB interface for HP computing controllers contains the necessary cable and connector). Product listings in this catalog should be checked to see if HP-IB cables are furnished.*

The 10833 series of cables feature an improved shielding design to help improve RFI levels in systems. This series of cables, with the RFI shielding, exhibits significantly lower radiated emissions than previous HP-IB cables.

The 10834A adapter is a shielded HP-IB to HP-IB adapter. It provides additional clearance between the HP-IB cable and the rear panel of the instrument. This allows easier access to switches, cables, and other connectors that may be in close proximity to the HP-IB connector.

### Ordering Information

**10833A** HP-IB Cable, 1m (3.3 ft)

**10833B** HP-IB Cable, 2m (6.6 ft)

**10833C** HP-IB Cable, 4m (13.2 ft)

**10833D** HP-IB Cable, 0.5m (1.6 ft)

**10834A** Adapter

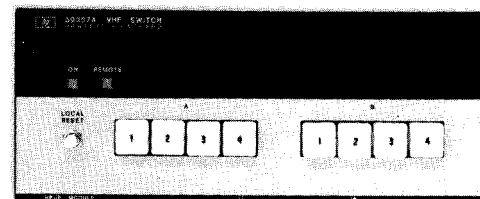
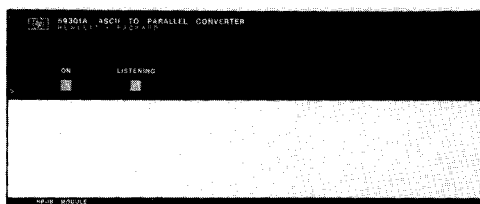
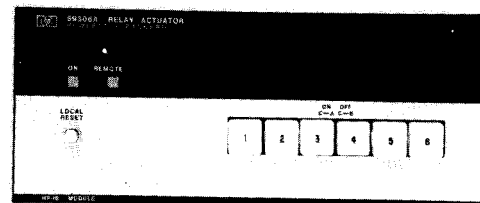
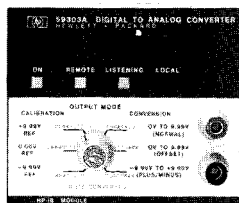

59301A

59307A

## HP-IB Accessory Modules

Modules in the HP 59300, 59400 and 59500-series are ideal building blocks for use with instruments to extend measurement capabilities. Modules listed here can be interconnected via the HP-IB to HP measuring instruments, signal sources and recording devices capable of operating directly on the HP-IB. In addition, these modules frequently serve as useful ways to interconnect with devices which are not themselves capable of direct HP-IB operation.

Instrument requirements differ. Some only output or accept data on the HP-IB. Others can be remotely programmed by ASCII characters sent along the HP-IB. These modules can work with instruments on any of these levels with or without a controller. Each module having controls can be operated stand-alone from its front panel, or it can be placed in automatic operation under program control.

Module provision for stand-alone, local operation also has important system benefits. The operator can set up and check out the system under manual control, avoiding otherwise complex and time consuming error tracing. Each module has status indicator lights that make it easy to monitor operation.

### 59301A ASCII-to-Parallel Converter

Accepts byte-serial ASCII characters from the HP-IB and converts them to parallel output. In operation, ASCII characters transmitted serially along the bus are converted into 4-bit characters with the first ASCII character received being interpreted as the most significant digit. A string of up to 16 characters terminated by linefeed is converted and placed upon the output lines. The linefeed character causes the 59301A to output a print command (strobe).

With the 59301A, instruments controlled via BCD can be operated using HP-IB. For example, the 59301A can be used with HP 6129C through 6131C and 6140A (Option J99) digitally-controlled power supplies for HP-IB programmable voltage and current. The 59301A can additionally be used to control other functions using its hexadecimal format.

#### General

**Size:** 101.6 mm H' x 212.9 mm W x 294.6 mm D (4" x 8.38" x 11.6").  
**Weight:** net 1.70 kg (3.78 lb), Shipping 2.33 kg (5.16 lb).

### 59301A ASCII-to-Parallel Converter

### 59303A Digital-to-Analog Converter

Accepts a string of serial ASCII characters and converts any three consecutive input digits to an analog output voltage, accurate to 0.1% in 30  $\mu$ s. Fully programmable via the HP-IB or manually operated from the front panel. A concentric control on the front panel makes it easy to select the digit group for conversion and the output mode. The

<sup>1</sup>Height includes feet. With feet removed height is 88.1 mm (3.45").

conversion switch is used to select the three digits of the character string that the DAC will change into analog voltage. The three output modes (NORMAL, OFFSET, and PLUS/MINUS) make the converter convenient for use directly with a variety of data logging devices, avoiding the need for auxiliary equipment to shift zero level or change polarity.

A primary application for the HP 59303A is to present on a logging device the data points being taken with a measuring instrument (like a frequency counter). A controller is not required for operation. Compatible logging devices include strip chart recorders, X-Y plotters, and displays.

#### General

**Size:** 101.6 mm H' x 105.9 mm W x 294.6 mm D (4" x 4.17" x 11.6").  
**Weight:** net 2.61 kg (5.80 lb), Shipping 3.17 kg (7.04 lb).

### 59303A Digital-To-Analog Converter

### 59306A Relay Actuator

Has six Form-C relays that provide for control of external devices either manually from front panel pushbuttons or remotely from the HP-IB. Relay contacts are specified to switch 24 V dc or 115 V ac at 0.5 A. Each relay can be programmed independently or multiple relays can be switched together. Front panel pushbuttons light to indicate the state of each relay.

The 59306A is ideal for providing control of microwave coaxial switches (HP 8761 A/B) as well as control of microwave programmable step attenuators (HP 8494 through 8496 G/H) using external dc power supplies.

#### General

**Size:** 101.6 mm H' x 212.9 mm W x 294.6 mm D (4" x 8.38" x 11.6").  
**Weight:** net 2.64 kg (5.87 lb), Shipping 3.23 kg (7.18 lb).

### 59306A Relay Actuator

### 59307A Dual VHF Switch

This module provides two single pole 4-throw switches controlled from front panel pushbuttons or remotely from the HP-IB. The 59307A is a dc to 500 MHz 50  $\Omega$  switch designed to maintain fast pulse transition times. The switches are independent and bidirectional for optimum use in multiplexing 50  $\Omega$  signal lines into measuring instruments. The 59307A is ideal to switch a standard delay, frequency, or voltage into a measurement loop for purposes of system calibration.

#### General

**Size:** 101.6 mm H' x 212.9 mm W x 294.6 mm D (4" x 8.38" x 11.6").  
**Weight:** net 2.64 kg (5.87 lb), Shipping 3.23 kg (7.18 lb).

### 59307A VHF Switch

# HEWLETT-PACKARD INTERFACE BUS

## Versatile Interconnect System for Instruments and Controllers



59309A

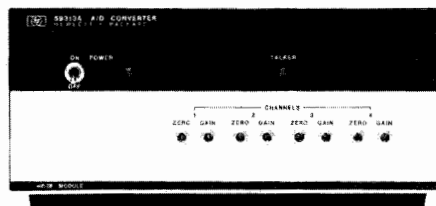

59313A

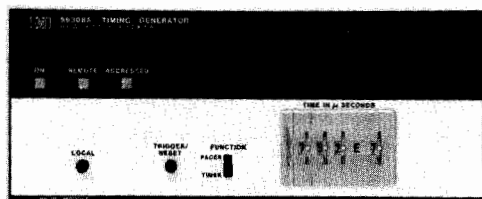

59308A

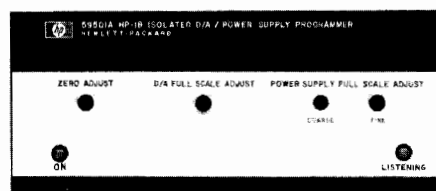

59501A

### 59308A Timing Generator

Provides a timing reference as either a Timer (digital delay generator) or a Pacer (precision time marker generator). In the Timer mode, a timing pulse is provided at a specified interval after a trigger is received. In the Pacer mode, a train of timing pulses of a specified period is provided on and after the receipt of a trigger.

The timing pulses are output on rear-panel BNC connectors and signal the HP-IB with appropriate signals. The timing can be set via the front panel thumbwheel switches, or via HP-IB. Times from 1  $\mu$ s to more than a day are available. Trigger inputs are available via HP-IB commands and rear panel connector. Outputs are available from both TTL and ECL levels, with switch selection of a squarewave or pulse output positive- or negative-going edge. Output pulses are 500 ns  $\pm$  100 ns wide, and rise time is <50 ns into 50  $\Omega$ .

#### General

**Size:** 101.6 mm H<sup>1</sup> x 105.9 mm W x 294.6 mm D (4" x 4.17" x 11.6").  
**Weight:** net 1.70 kg (3.78 lb), Shipping 2.84 kg (6.31 lb).

### 59308A Timing Generator

#### 59309A HP-IB Digital Clock

Displays month, day, hour, minute, and second, and upon command will output time via the interface bus. Time can be set into the clock by local control, or by remote commands received from the HP-IB. The clock accepts a small internal battery which can provide more than a day's standby in case of short power interruptions. Additionally, an auxiliary power supply such as the K10-59992 can sustain the clock for up to one year.

#### General

**Size:** 101.6 mm H<sup>1</sup> x 105.9 mm W x 294.6 mm D (4" x 4.17" x 11.6").  
**Weight:** net 1.70 kg (3.78 lb), Shipping 2.84 kg (6.31 lb).

#### 59309A HP-IB Digital Clock

<sup>1</sup>Height includes feet. With feet removed height is 88.1 mm (3.45").

### 59313A Analog-to-Digital Converter

Four channel converter allows analog data with a full scale range of up to  $\pm$  10 V dc to be digitized and transmitted via HP-IB to a computing controller.

On command from the controller, the instrument can be programmed to perform a single conversion or a series of internally-paced conversions in six selectable rates of up to 200 per second on one channel, or up to 50 per second on each of four channels. Sampling can also be initiated externally by a TTL transition or contact closure to ground. Included is a program-controlled reverse channel capable of driving small lamps, relays or TTL devices.

#### General

**Size:** 101.6 mm H<sup>1</sup> x 212.9 mm W x 345.4 mm D (4" x 8.38" x 13.6").  
**Weight:** net 5.45 kg (12.0 lb), Shipping 6.36 kg (14.0 lb).

### 59313A Analog-to-Digital Converter

#### 59501A Power Supply Programmer (Isolated DAC)

This single-channel digital-to-analog converter can control a wide range of power supplies (output voltage, or current), as well as other analog programmable devices. It may also be used as a low level signal source, depending on the speed of the controller. It has two output ranges (0-1 and 0-10 V dc in unipolar mode; -1 to +1 and -10 to +10 V dc in bipolar mode), as well as photo-isolators which electrically separate HP-IB control and data lines from power supply circuitry by up to 600 V dc. (Additional details on page 247)

#### General

**Size:** 101.6 mm H<sup>1</sup> x 212.9 mm W x 194.6 mm D (4" x 8.38" x 11.6").  
**Weight:** net 2.61 kg (5.80 lb), Shipping 3.17 kg (7.04 lb).

#### 59501A Power Supply Programmer

Model	Description	Dimensions—max. height x width x depth mm (inches)	Net Weight kg (lb)	Shipping Weight kg (lb)
59301A	ASCII-to-Parallel Converter	101.6 x 212.9 x 294.6 (4 x 8.38 x 11.6)	1.70 (3.78)	2.32 (5.16)
59303A	Digital-to-Analog Converter	101.6 x 105.9 x 294.6 (4 x 4.17 x 11.6)	2.61 (5.80)	3.17 (7.04)
59306A	Relay Actuator	101.6 x 212.9 x 294.6 (4 x 8.38 x 11.6)	2.64 (5.87)	3.23 (7.18)
59307A	VHF Switch	101.6 x 212.9 x 294.6 (4 x 8.38 x 11.6)	2.64 (5.87)	3.23 (7.18)
59308A	Timing Generator	101.6 x 212.9 x 294.6 (4 x 8.38 x 11.6)	2.10 (4.67)	3.83 (8.51)
59309A	HP-IB Digital Clock	101.6 x 105.9 x 294.6 (4 x 4.17 x 11.6)	1.70 (3.78)	2.84 (6.31)
59313A	Analog-to-Digital Converter	101.6 x 212.9 x 345.4 (4 x 8.38 x 13.6)	5.45 (12.0)	6.36 (14.0)
59401A	Bus System Analyzer	145.5 x 205.1 x 495.3 (5.73 x 8.08 x 19.5)	5.64 (12.44)	9.1 (20)
59501A	Power Supply Programmer	101.6 x 212.9 x 294.6 (4 x 8.38 x 11.6)	2.61 (5.80)	3.17 (7.04)

# HEWLETT-PACKARD INTERFACE BUS

## Versatile Interconnect System for Instruments and Controllers

Model 37201A



- Transparent extension of HP-IB systems
- Operation over twin-pair cable or modems
- Automatic error detection and correction
- High immunity to electrical interference
- Multi-point (multi-drop) capability
- Auto-dialler interface

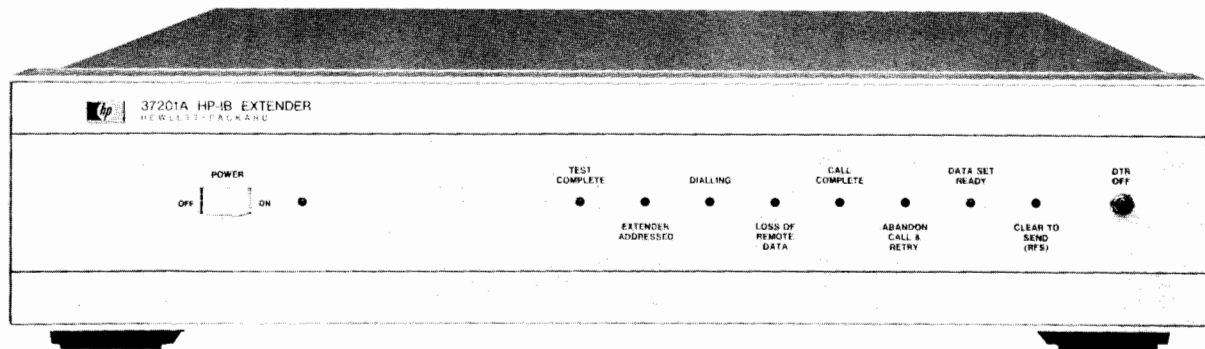

The 37201A HP-IB Extender overcomes the limited range available with direct HP-IB cable interconnections. Each 37201A converts parallel data from the interface bus into a serial bit stream, suitable for transmission to a remote site, and reconverts incoming serial data to bit-parallel HP-IB format. An HP-IB system can therefore be split into two or more discrete parts separated by HP-IB Extenders and a serial data link. A range of 1000 metres is obtainable if twin-pair cable is used for the transmission path, and virtually unlimited range is available if a modem link is used. Communication between Extenders is full duplex, allowing information to flow in both directions simultaneously.

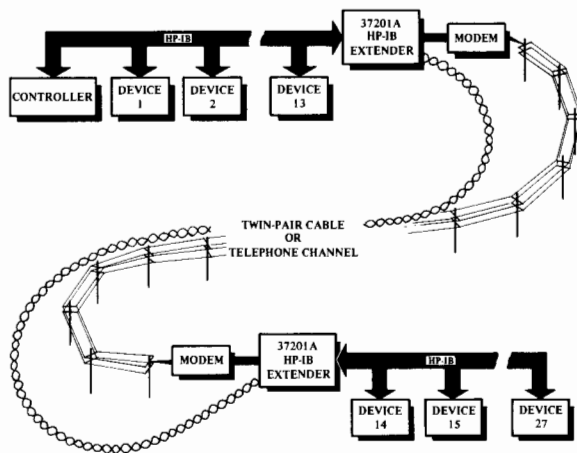

Point-to-point connection using twin twisted pair cable or full duplex modem link.

A pair of HP-IB Extenders provides a transparent interface between local and remote HP-IB devices. Program control of the 37201A is seldom necessary. Consequently, HP-IB Extenders can be added to an HP-IB system usually without any modification of software and without writing special routines to control the Extenders. The 37201A supports the full range of HP-IB functions with the exception of Parallel Poll and Pass Control.

Integrity of HP-IB data and control signals is assured by an automatic error-checking protocol, which retransmits any data corrupted in transmission. The 37201A is in general compliance with each of the following standards and supports their major capabilities:

- IEEE Standard 488-1978
- ANSI Standard MC1.1
- IEC Standard 625-1

### Twin-Pair Cable Operation

Twin twisted-pair cable provides a simple inexpensive transmission medium for distances up to 1000 metres. The serial data rate is nominally 20 kbit/s. Suitable cable is available as an accessory (HP Part Number 8120-1187). Transformer coupling within the 37201A gives a high degree of immunity from the effects of common mode signals. This, combined with the automatic error correction capability, makes the 37201A suitable for use in an electrically hostile environment.

### Modem Link Operation

The 37201A is designed to operate with a wide range of synchronous and asynchronous modems over private lines, leased lines, or the public switched (dial-up) telephone network. The data interface is compatible with EIA RS-232C and CCITT V.24 and V.28 standards. Asynchronous data rates provided are: 150, 300, 600, and 1200 bit/s. For synchronous modems, operation at any bit rate up to 19.2 kbit/s is possible. Besides operating in point-to-point mode, the 37201A can be used with modems in a multi-point (multi-drop) leased line configuration involving up to 31 remote sites. When operating over the public switched telephone network, connections may be dialled manually. Alternatively, an external auto-dialler may be used to make connections under program control. The 37201A has an RS-366/V.25 interface to permit operation with an auto-dialler.

The error checking/correcting communications protocol used in the 37201A protects against errors introduced by poor quality data circuits. It even provides immunity to major interruptions in the data link, such as dropouts, line breaks and modem sync loss, and recovers automatically without loss of data.

### 37201A HP-IB Extender

# HEWLETT-PACKARD INTERFACE BUS

## Versatile Interconnect System for Instruments and Controllers

Models 37203A, 37203L

33



- Transparent HP-IB extension up to 1000 metres
- HP-IB Transfer rate up to 50 k bytes/s
- Supports all HP-IB functions including Pass Control and Parallel Poll

- Electrical isolation plus error detection and correction protect HP-IB from transmission errors
- Transmission over single low-cost coaxial cable or, with Option 001, dual optical fiber

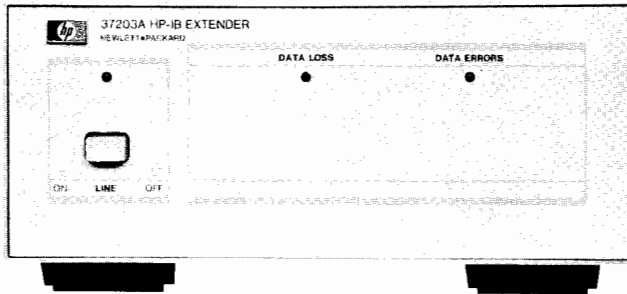

37203A

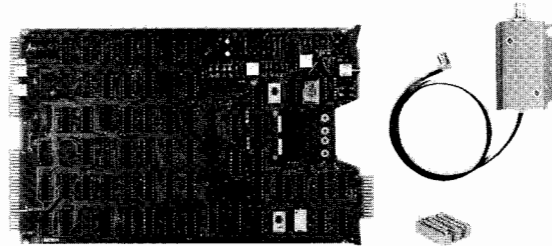

37203L



### 37203A HP-IB Extender

The 37203A HP-IB Extender overcomes the range limitations imposed by the cabling rules of the Interface Bus and provides high-speed, low-cost extension up to 1000 metres.

37203A's are used in pairs: each Extender serialises the normally parallel HP-IB information and transmits it to the other Extender where it is reconverted back to its original format. The transmission medium can be a single low-cost coaxial cable for both directions of transmission or, when Option 001 is fitted, dual optical fiber.

The 37203A is in general compliance with each of the following standards and supports their major capabilities

- IEEE Standard 488-1978
- ANSI Standard MC1.1
- IEC Standard 625-1

### 37203L HP-IB Extender

The 37203L is a repackaged version of the 37203A on an L-series computer card specifically designed for installation in the HP 2250A Measurement and Control Processor and HP 1000 L-series Computer. It operates in conjunction with a 37203A or another 37203L at the other end of the link. The transmission media and distances are the same as for the 37203A. The 37203L is supplied as a single circuit card together with two cable assemblies. Power is supplied from the 2250A or Computer mainframe. Operating characteristics are identical to those of the 37203A.

### Operating Characteristics (37203A/L)

#### Speed/Range

The table below shows the trade-off between maximum byte transfer rate and distance for coaxial cable and optical fiber.

Table 1. Nominal HP-IB Transfer Rates and Response Times

	Max HP-IB byte transfer rate (kbytes/sec)	Max SRQ propagation delay ( $\mu$ s)	Max Parallel Poll response time ( $\mu$ s)
Coaxial Cable			
Short* (at normal speed)	50	14	20
250m (max range at normal speed)	40	18	25
500m (max range at 1/4 speed)	14.2	55	75
1000m (max range at 1/16 speed)	2.75	200	270
Fiber Optics (opt 001)			
Short*	50	14	20
250m	39	20	25
1000m	25	30	40

\*For distances <250m, interpolate between Short and 250m.

### Parallel Poll Operation

The 37203A supports the Parallel Poll function but because of the absolute transmission delay, a guaranteed response cannot be delivered within 200 ns, as required by IEEE 488. Instead, the response from distant devices is returned as rapidly as possible to the polling controller.

### Error Detection and Correction

Data is transmitted across the link in frames. Each frame includes a cyclic redundancy check code which is rechecked when the frame is received. Any transmission errors which are detected cause the frame to be rejected. Data integrity is maintained by automatic retransmission of the rejected data frame. The presence of errors in the received data causes the DATA ERRORS indicator on the 37203A front panel to be illuminated.

### Transmission Over Coaxial Cable

The standard serial link between Extenders is a single coaxial cable which is used for transmission in both directions. Coaxial cable was chosen for this link because it is relatively inexpensive, easy to handle, and easy to obtain. The use of Belden type 9248B cable (or equivalent) is recommended.

### Transmission Over Optical Fiber

Option 001 of the 37203A/L provides the capability of operation over duplex optical fiber as a user-selectable alternative to coaxial cable. The use of optical fiber removes the metallic path between the Extenders and, therefore, eliminates all risk of electromagnetic pick-up on the link. Option 001 is recommended for use in severe electrical environments or where the use of electrical signalling is not acceptable. A further advantage of optical fiber is that it enables a higher byte transfer rate to be attained for transmission distances greater than 250m than is possible with coaxial cable (see Table 1).

### 39200 Series Fiber Optic Cables

**Operating temperature:** -20 to 70°C.

**Storage temperature:** -40 to 85°C.

**Relative humidity:** 95% at 70°C (max).

**Max. tensile force on cable:** 300N.

**Max. tensile force on connector/cable:** 100N.

**Min. bend radius:** 7 mm (0.3 in).

**Flexing:** 50000 cycles (180° bending at min bend radius).

**Crush load:** 20 kg (44 lb).

### Options (37203A/L)

**001:** Fiber Optic Interface

**301:** Rack Mount Adaptor (37203A only)

**302:** Dual Rack Mount Adaptor (37203 only)

### Ordering Information

37203A HP-IB Extender

37203L HP-IB Extender

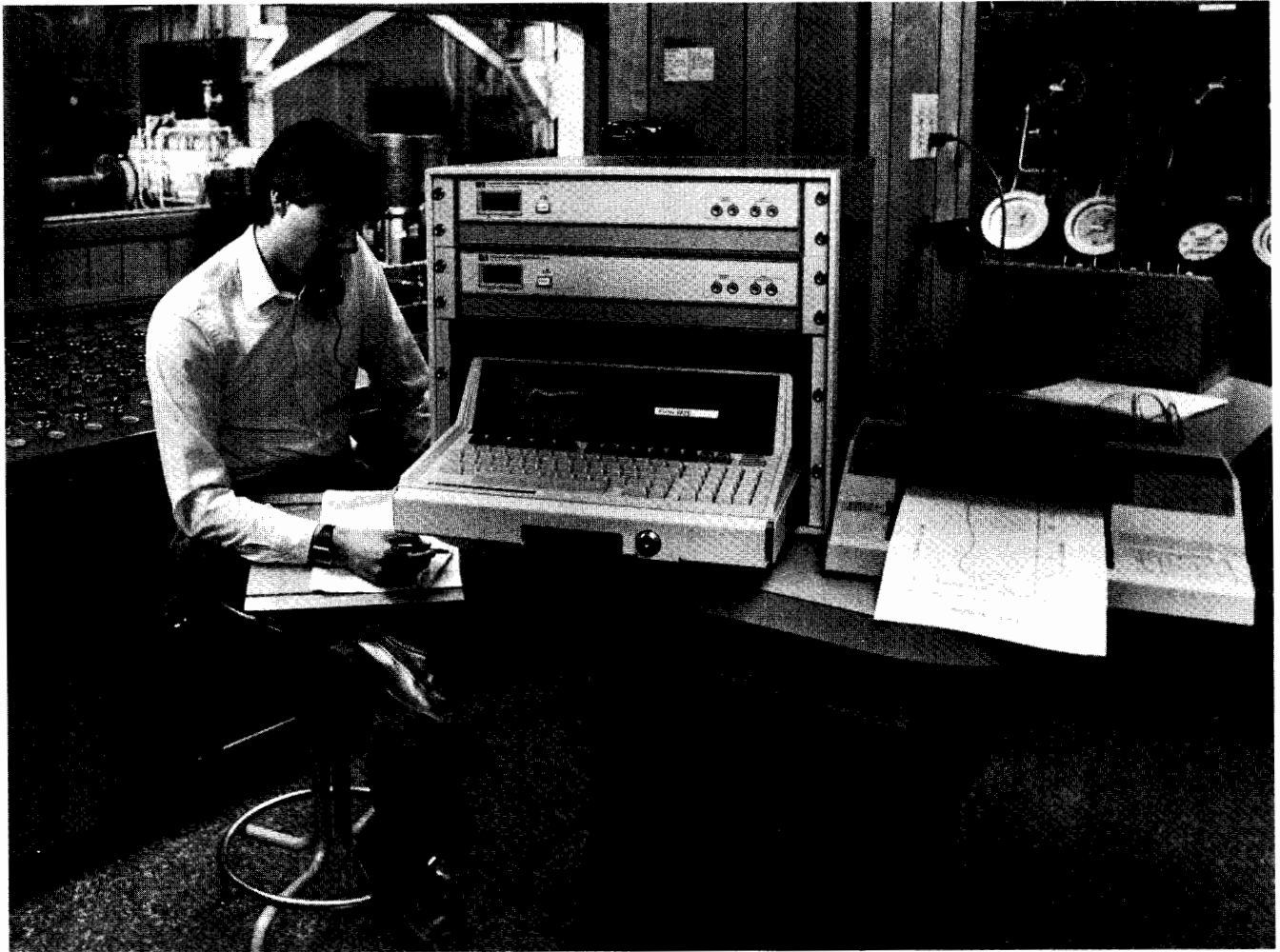

3056DL

Hewlett-Packard's automatic data acquisition and control equipment serves an ever-growing role as the world's industry strives to increase its productivity. More and more industries are discovering that automation is the key to remaining competitive and profitable. This section will outline some of the points that should be considered when evaluating automation solutions.

Industrial automation applications can be organized into three ideal categories: **Test**, **Measurement**, and **Control**.

### Test

The approach to industrial automation described as **Test** represents a situation where a product or device is being checked to its design standards. The variables to be measured and the requirements for accuracy and precision are well known. As an example of the **Test** philosophy, consider battery testing. A definite set of variables are measured (output voltage, voltage under load, output current charge capacity, etc.). Expected values and allowable tolerances for all inputs are known in a test application.

### Measurement

A measurement approach to industrial automation includes applications that evaluate or research a device, design or phenomenon. Unlike the **Test** approach, the measurement model is not known, in fact the quantities may not be understood. **Measurement** is the gathering of the data to construct a model of the unknown. As an example, scientists are researching ways to maximize food production by optimizing plant watering methods. These scientists might adopt a **Measurement** philosophy by attempting to characterize the response of crops to various watering strategies. Quantities they might need to measure include plant weight, growth, leaf temperature, etc. It is very likely that as they develop a model of how a plant reacts to different watering strategies they will want to measure other things, i.e., they will seek to improve their model.

### Control

A **Control** type of application is similar to a **Test** application in that the model or process is well understood. A **Control** system makes

a series of events take place, measures them and takes corrective action. Consider the sequence of events in a metal casting and curing operation. Because the parts may be used in aircraft, careful control and documentation of the process will be needed. For example, the controls on the curing oven will be set according to the particular part being produced. In addition, to comply with the documentation requirements the temperature of the curing oven must be recorded. To insure against costly rework or scrap, the control operation needs to sense other critical events and to take appropriate action.

The three classes of industrial automation described above are ideal and any real world application would probably be a composite of all three. However, they emphasize certain requirements that will help in recognizing what equipment is best suited to fit a specific automation application. The following sections will analyze test, measurement and control applications in regard to instrument and computer features.

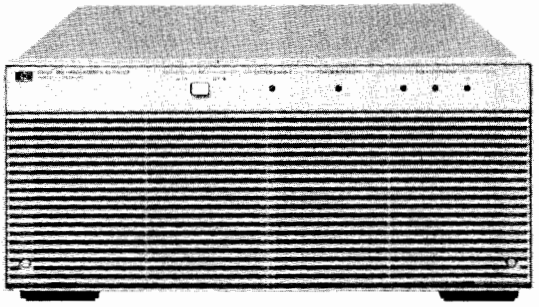

6942A

**Measurement Speed**

Maximizing measurement speed is often a characteristic of test and control applications where throughput and production efficiency are of great concern. As a general rule there is a trade-off between speed and accuracy—the longer something is measured, the more accurately it is measured. Or conversely, the faster an input is measured, the less accurate the measurement.

**Comparison of Analog Measurement Speed**

	Resolution	Maximum Readings/Second
3421A	1 part in 300,000	4
	1 part in 30,000	23
	1 part in 3000	38
3497A	1 part in 120,000	50
	1 part in 12,000	200
	1 part in 1,200	300
3054A/C	1 part in 1,200,000	48
	1 part in 120,000	210
	1 part in 12,000	330
6940B	1 part in 2000	5,000
	12 bit	7 (integrating converter)
	12 bit	20,000
6942A	12 bit	33,000
2240A	12 bit	20,000
2250A	14 bit	50,000
1000L	12 bit	55,000
M/C Cards		

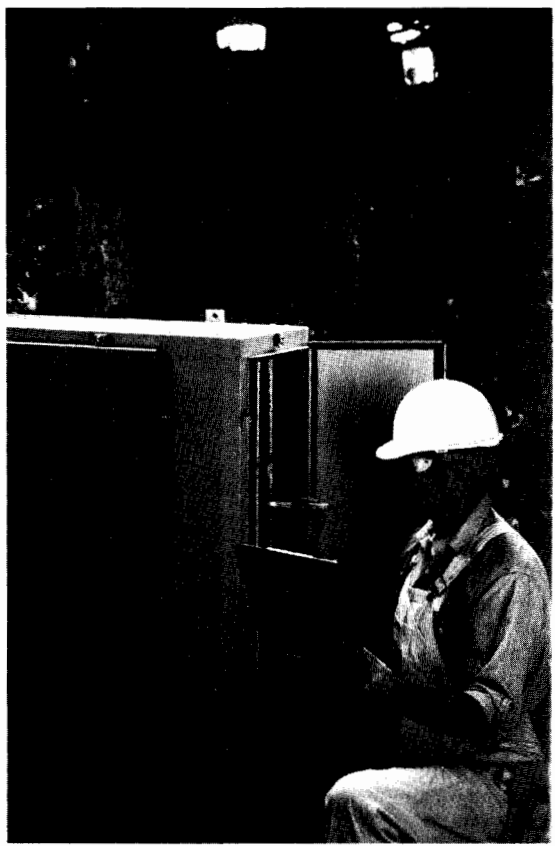

2250A

**Accuracy**

High accuracy, wide dynamic range and good resolution are the requirements for measurement applications. In these situations the input signal is frequently small and high accuracy is needed to aid in developing the most accurate model possible. In contrast, in control and production test applications the input is well characterized and therefore the demands of accuracy and resolution may not be as stringent.

**Comparison of Analog Measurement Performance**

	Sensitivity	Resolution	Accuracy
3421A	1 $\mu$ V	1 part in 300,000	.01%
3497A	1 $\mu$ V	1 part in 120,000	.007%
3054A/C	100 nV	1 part in 1,200,000	.0032%
6940B	10 $\mu$ V	12 bit	.20%
	50 $\mu$ V	12 bit	.15%
6942A	50 $\mu$ V	12 bit	.2%
2240A	10 $\mu$ V	12 bit	.5%
2250A	1.56 $\mu$ V	14 bit	.05%
1000L	625 $\mu$ V	12 bit	.1%
M/C Cards			

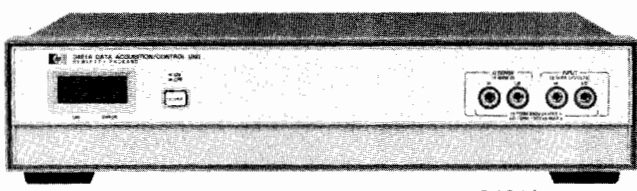

3421A

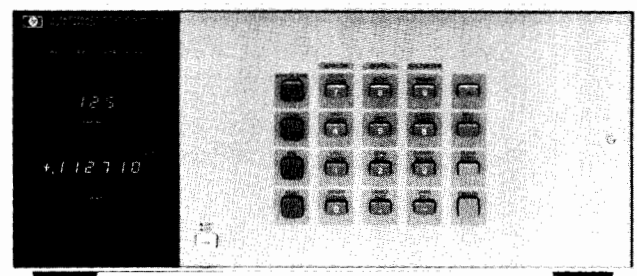

3497A



## Control Features

The Hewlett-Packard products considered in this section have capability to sense digital inputs, count pulse trains, close relays and provide programmable voltage and current outputs. Consider each product in regard to your particular application.

Instrument	Digital Input/Interrupt	Actuator Output	Programmable-Voltage & Current	Counter Input	Timer	Pulse Train Output
3497A	X	X	X	X	X	—
3054A/C	X	X	X	X	X	—
6940B	X	X	X	X	X	X
6942A	X	X	X	X	X	X
2240A	X	X	X	X	X	X
2250A	X	X	X	X	X	X
1000L	X	X	—	—	—	—
M/C Cards						
3421A	X	X	—	X	—	—

## Instrument Intelligence

Applications differ in how much they will require instruments to do independently of a computer.

**Measurement** applications are usually closely coupled to the computer and place few demands on the instrument. **Test** and **control** applications may have higher instrument intelligence requirements. In **Test** applications the instrument may operate stand alone from the computer and only report exceptions to the test limits. In **Control** applications it may be desirable for the instrument to operate separately from the computer to protect against computer or I/O link failure. Some products rely on more powerful micro-processors that can operate independently of the main computer. Other products, specifically the 6940 and 6942, rely on card to card cabling to provide additional capability.

Instrument	Relative Rating of Standalone Product Intelligence (doesn't include computer)	Intelligence	
		Reading Storage	Program Storage
3421A	Low	Yes	No
3497A	Low	Yes	No
3054A/C	Low	Yes	No
6940B	Low	No	No
6942A	Moderate	Yes	Yes
2240A	Moderate	Yes	Yes
2250A	High	Yes	Yes
1000L	N.A.	N.A.	N.A.
M/C Cards			

## Environment

Consideration of the operating environment is a very important step in choosing a measurement, test or control system. Any application can require that a test, measurement or control system operate in hot, dusty and corrosive environments. In addition, the

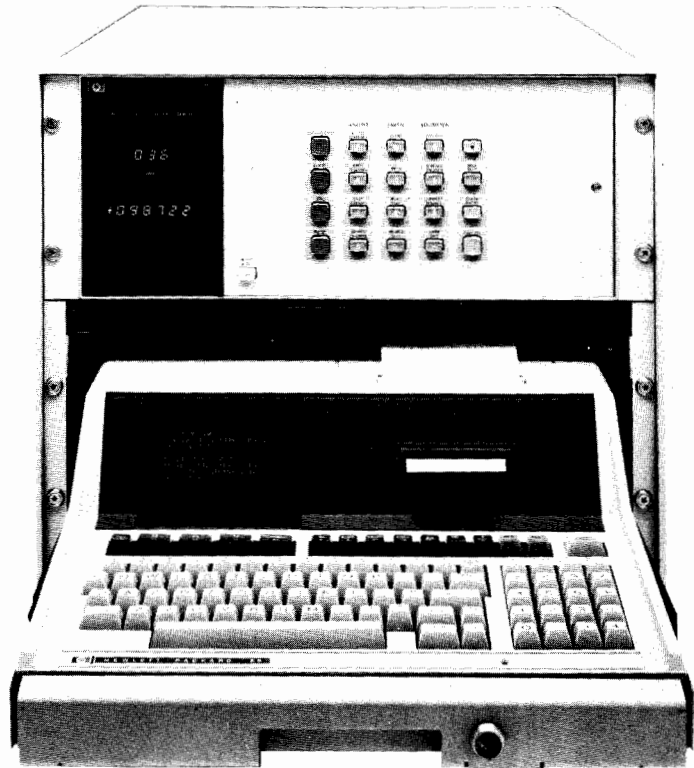

3054DL

electrical environment should also be considered in regard to the amount of electrical noise (both common and normal mode) present in the area.

While all Hewlett-Packard instruments are designed to operate in moderately harsh environments, the 2250A Measurement and Control Processor has been specially designed to tolerate more harsh industrial conditions. This includes elevated temperatures and high common mode voltages. Refer to the 2250A literature for additional information.

## Integrated Systems

In addition to providing the individual instruments and computers needed for automation, Hewlett-Packard also provides dedicated SYSTEMS that combine instruments, computers, and software with rack mounting and integration. Systems range from the 3054DL Data Logger which provides an easy to use software package for the first time user to the 3054A/C systems which provide utility subprograms that the customer can use to build his own program. Systems have the advantage of providing a

more complete solution and allowing the user to concentrate more on his automation task.

Base Instrument	System
3421A	3056DL Data Logger
3497A	3054DL Data Logger
3497A/3456A/3437A	3054C Automatic Data Acquisition/Control System
3497A/3456A/3437A	3054A Automatic Data Acquisition/Control System
6940B	Software Available
6942A	Software Available
2240A	9030 System
2250A	Software and Integration Available

Customized system integration is also available using the ATS/1000 system integration service. This service combines customer specified measurement and control equipment with HP 1000 computers. Integration ranges from simple racking and cabling to installation of the system and writing of software. (See page 597.)

For further information on these products, please refer to the following catalog pages. Separate technical brochures are also available on each product.

Automation Hardware	Catalog Page	Technical Brochure #
3421A	42	5953-6912
3497A	45	5952-8886
3054A	37	5952-8897
3054C	39	5952-8865
3054DL	40	5952-8862
3056DL	44	5953-6912
6940B	50	5952-4025
6942A	50	5952-4034
2240A	51	5953-4230
2250A	51	5953-4288
1000 L	53	5953-4260
M/C Cards		

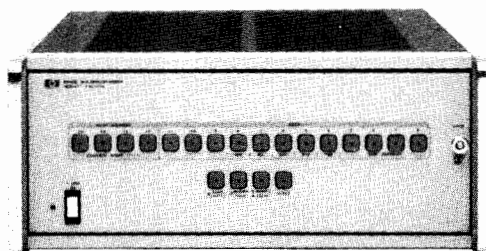

6940B



- Improve productivity in research and manufacturing
- Low cost data acquisition
- Precision transducer measurements and analysis
- 1000 analog channels and 1360 digital points
- Control functions for closed-loop applications

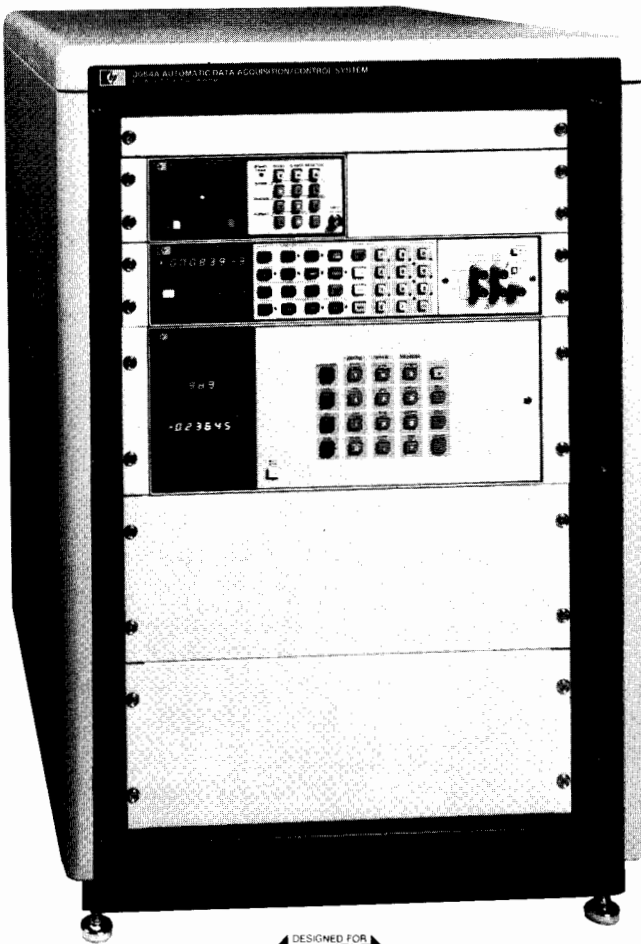

### Description

The 3054A is a computer-based automatic data acquisition and control system. The 3054A combines speed, precision and a variety of control functions with full computation and analysis capabilities. The 3054A offers flexibility, convenience, and performance to solve many data acquisition applications.

The system has the flexibility to make a wide variety of measurements, including outputs of thermocouples, strain gages, RTD's, flow meters, and other transducers. The 3054A also has digital inputs and outputs, voltage and current D/A converters for precision closed-loop control.

The 3054A offers the convenience of using instrumentation that is designed as a system. To help the user get started fast, the measuring system is rack-mounted and pre-tested. System specifications represent the summation of all instrument errors. An Introductory User's Guide is part of the system documentation package which enables the user to quickly learn how to use the system for his or her application.

The 3054A system performs by combining speed, accuracy and computational power. Measurement rates from 4500 readings/second to 48 readings/second are possible with resolutions from 3½ digits to 6½ digits. DC measurements of low level transducers can be made with 100 nanovolt resolution with greater than 150 dB of noise rejection. An HP desktop computer or mini-computer will automate the system, store data, linearize transducers, and provide computation and analysis.



9826A

The 3054A system is a powerful yet economic system for transducer measurements.

### System Configuration

The 3054A system includes:

**The 3497A Data Acquisition/Control Unit** is the instrument that provides the analog multiplexing, digital monitoring, and control functions using plug-in assemblies. The 20 Channel Reed Relay Assembly provides low level guarded switching with  $<2 \mu\text{V}$  of thermal offset. An isothermal connector is provided as an option to this assembly for thermocouple compensation. Digital input and output assemblies are available for monitoring and control. And you get specialized measurement and control using the Reciprocal Counter Assembly and the programmable D/A Converter Assemblies. Up to five of these optional plug-in assemblies can be contained in the 3497A mainframe. Expansion to more than five assemblies is provided by the 3498A Extender. Each 3498A can hold ten more assemblies. A total of thirteen extenders can be supported by one 3497A mainframe, giving a maximum of 1000 analog channels and 1360 digital channels.

System timing is accomplished through the non-volatile real time clock in the 3497A.

The optional DVM assembly for the 3497A has  $1 \mu\text{V}$  sensitivity, 5½ digit resolution, integration, and guarding—capability previously available only on stand-alone system DVMs. (Refer to page 45.)

**The 3456A Digital Voltmeter** is a 3½ to 6½ digit integrating voltmeter with high accuracy, 100 nanovolt sensitivity, and speed to 330 readings/second. Its DC and True RMS AC voltage and resistance measurement capability reduce the amount of signal conditioning necessary. The 3456A can detect 100 nanovolt changes in 100 mV signals at speeds of 48 readings/second. This capability is necessary for measuring thermocouples with the 3054A system to better than 0.01°C resolution. Common mode rejection of 140 dB makes the 3054A system particularly suited for repeatable low level measurements in the presence of noise.



## Model 3054A

The built-in memory of the 3456A can store both readings and sequences of measurement commands. The 3456A can store internally up to 350 readings or up to 1400 ASCII programming characters or combinations of both readings and programming characters. (See page 74.)

**The 3437A System Voltmeter** is a high speed 3½ digit DC voltmeter which provides precisely timed sample and hold readings. Use it to analyze repetitive signals up to 1 MHz or transients down to 1 msec. in a fraction of the time required by conventional means. (See page 80.)

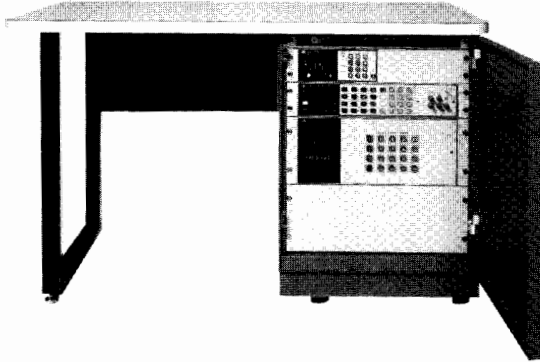

The variety of cabinet options with the 3054A can be configured to fit a wide range of applications.

### Power and Performance in Desktop Computers

The choice of four computers with the 3054A provides a wide range of capability and performance for automating data acquisition applications. The desktop computers supported with the 3054A are the HP 85F, 9826A, 9825B and 9845T. The computers automate the system by controlling the instruments and gathering the data over HP-IB. All four computers offer easy interaction to greatly simplify the writing and editing of programs. The friendly languages of the computers and the 3054A software package make it easy to get started. The presentation of data is very versatile when using a computer and external peripherals. Transducer data can be converted to engineering units, statistical analyses of the data can be performed and graphical representations of the data can be produced. The individual capabilities of each computer such as speed, memory size, and output devices should be considered for the different data acquisition applications.

### Software and Documentation

The system software is an integral part of the 3054A Automatic Data Acquisition/Control System. Specially written software and documentation packages are supplied for each of the four computers. This complete software package greatly simplifies programming and enables the user to get started fast.

The complete software and documentation package supplied with the 3054A includes:

- operational verification programs
- system sub-programming routines
- typical application programs

The system verification/diagnostic programs can be used to verify that the system is in operating condition at the time of installation. The programming of the 3054A is most effectively accomplished by combining the system sub-program with other system operations. Sample application programs are also provided for assistance in developing functional software.

### Racks and Cabinets

Other cabinets may be chosen besides the standard 30" rack for the 3054A. A 16" case is offered as a compact and portable package for the 3054A. A desk provides rack space for the instrument and a table top for software development. The 56" cabinet provides space for additional equipment and future expansion.

For more information on the 3054A, contact the local HP Field Engineer or nearest HP Sales Office.

### System Options

#### Input Assemblies for the 3497A

- 010:** 20 Channel, Low Thermal Relay Multiplexer Assembly
- 020:** Relay Multiplexer Assembly with Thermocouple Compensation
- 050:** 16 Channel, Isolated, Digital Input/Interrupt Assembly
- 060:** Reciprocal Counter Assembly
- 070:** 10 Channel, 120Ω Strain Gage/Bridge Assembly
- 071:** 10 Channel, 350Ω Strain Gage/Bridge Assembly

#### Output Assemblies for the 3497A

- 110:** 16 Channel Actuator/Digital Output Assembly
- 115:** 8 Channel High Voltage Actuator
- 120:** ± 10V Dual D/A Converter Assembly
- 130:** 0 to 20 mA or 4 to 20 mA Dual D/A Converter Assembly
- 140:** Breadboard card for custom designs
- 230:** U.S. Clock Format for the 3497A (Month:Day:Hours:Min:Sec)
- 231:** European Clock Format for the 3497A (Day:Month:Hours:Min:Sec)
- 260:** Delete Keyboard and Display on 3497A
- 261:** Delete 3437A SVM and HP-IB cable
- 262:** Delete 3456A DVM and HP-IB cable
- 280:** Add 5½ digit DVM and current source for the 3497A. NOTE: Only one DVM may be deleted from system, unless optional 3497A DVM assembly is added.
- 298:** Add 3498A Extender and connecting cables

#### Cabinet Options

- 400:** Delete 30" cabinet; rack-mounting hardware supplied
- 416:** Add 16" combining case with power strip; delete 30" cabinet
- 456:** Add 56" cabinet with fan and power strip; delete 30" cabinet
- 490:** Add 44530A systems desk with fan, power strip, and 23" rack space; delete 30" cabinet
- 496:** Add locking drawer, 8" high, for 85A
- 498:** Add locking drawer, 18" high

#### Software and Documentation Options

- 841:** Complete 3054A System Documentation—85A
- 842:** Complete 3054A System Documentation—9825B
- 844:** Complete 3054A System Documentation—9845T
- 801:** Complete 3054A System Documentation—9826A (BASIC)
- 804:** Complete 3054A System Documentation—9826A (HPL)

#### Basic 3054A System

# DATA ACQUISITION, TEST & CONTROL SYSTEMS

Automatic Data Acquisition/Control System

Model 3054C

39



- Precise measurement and analysis
- Execute multiple programs simultaneously
- Communicate to other computers in a distributed network

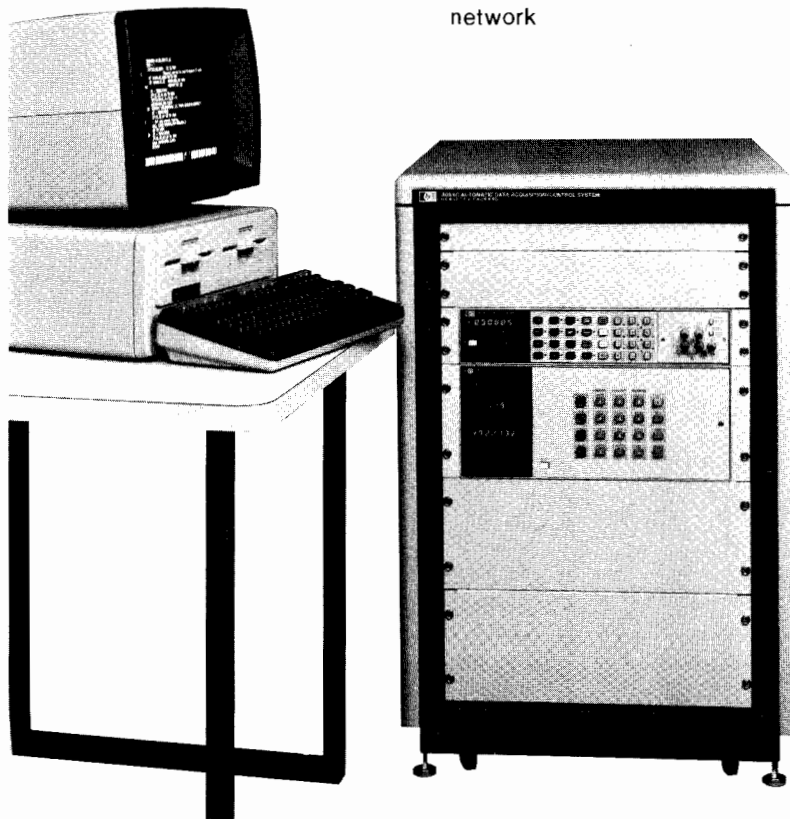

## Description

The 3054C Automatic Data Acquisition/Control System combines precise instrumentation with the power and versatility of HP 1000 computers. The 3054C is similar to the 3054A system except that the 3054C supports software compatible with the HP 1000 series of computers. The 1000 series of computers give you increased analysis capabilities and can be used to create multitasking, distributed, data acquisition and control networks. Distributed systems allow you to control instruments with one computer while another computer in the network analyzes or processes the data. The multitasking capability of the HP 1000 allows any computer in the network to simultaneously control instruments with one program while another program performs other, possibly unrelated, tasks.

### Instrumentation

The 3054C consists of a 3497A Data Acquisition/Control Unit and a 3456A Digital Voltmeter. The 3497A is a card cage instrument that can be custom configured to meet your needs. Assemblies are available for A/D conversion, multiplexing, strain gage/bridge completion, digital inputs/interrupts, counting, actuator outputs, and voltage and current D/A outputs. The 3456A is a very precise voltmeter and has the resolution and noise rejection required for measuring low levels in a noisy system environment.

### Computers

The 3054C software package is compatible with the HP 1000A, L, E, and F series of computers. These computers allow you to configure or expand your system as needed. The L series of computers offers the lowest cost solution for controlling the 3054C. The HP 1000 A series offers significantly more computing power at slightly more cost. The HP 1000 E and F series provides more versatility and the easiest program development. The 1000 A, E, and F series computers are recommended as host computers in a distributed system.

## Software

The 3054C software package consists of over 35 subroutines that can be used as building blocks to create a useful measurement program. The subroutines allow the user to write sophisticated programs without knowing instrument programming codes. Included in the 3054C software package are linearization programs for most thermocouples, 120 and 350 Ohm strain gages, thermistors and RTD's. The routines include error trapping to locate and identify system problems.

## System Configuration

The 3054C consists of the following. The computer, other computer peripherals and computer operating systems are ordered separately.

### 3054C

#### Instruments:

- 3497A Data Acquisition/Control Unit
- 3456A Digital Voltmeter

#### Software and Documentation

3054C Software package consisting of measurement, conversion, utility and HELP routines.

#### Rack/Integration

30" Rack (shown) is standard. Other racks are available. Integration includes HP-IB cables, instrument connecting cables and test assemblies.

#### Verification/Installation

The 3054C is installed and tested with the HP 1000 computer at the customer's site.

## Ordering Information

**Basic 3054C Automatic Data Acquisition/  
Control System**

# DATA ACQUISITION, TEST & CONTROL SYSTEMS

**Data Loggers**  
**Model 3054DL**

- 5½ Digit Measurement
- Graphics
- Data Analysis
- Graduated Software

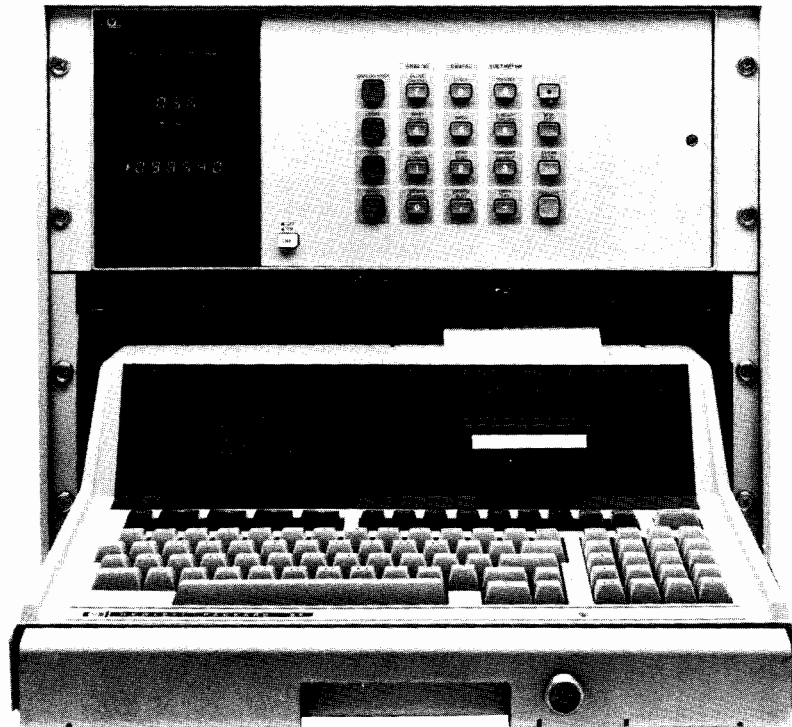

## Description

The 3054DL consists of a precise measurement unit housed inside an attractive locking cabinet. When you add the computational capability of the 85F scientific computer, the combination becomes more than just a data logger—it becomes a complete scientific measurement station with data and program storage, graphics and excellent measurement performance.

**The Measurement Unit** contains a 5½ digit digital voltmeter with a dc current source for ohms measurements as well as a 5-slot mainframe for optional plug-in assemblies. Each slot accepts either a counter, a low-thermal multiplexer, a thermocouple multiplexer, a digital input card or a digital output (alarm relay) card. Advanced noise-rejection techniques such as Multi-Slope Integration and Tree Switching compliment the 1 microvolt sensitivity of the voltmeter.

**The 85F Computer** is not only a system controller, it is a full function BASIC language scientific computer with data analysis capabilities, graphics CRT and printer, and a built-in tape cartridge for both data and program storage.

**Temperature Measurements**, whether made with thermocouples, RTD's or thermistors, are all specified in terms of total system accuracy. The thermocouple reference junction is located on the connector block and is read automatically via the data logger software.

**Resistance** can be measured in a 4-wire configuration to eliminate the effects of lead wire resistance.

**The Reciprocal Counter** accepts logic-level inputs and can operate in either a period measurement mode or a totalize mode.

**Digital Inputs and Digital (alarm relay) Outputs** are available for monitoring switch positions and controlling external devices.

### Graduated Software

The program, or "software" that instructs the measurement unit is stored on a magnetic tape cartridge in the 85F computer. This software flexibility allows you to choose any one of the three programming methods that fits your need best:

```

CHANNEL 01 FUNCTION SELECT

DCV--autoranging dc voltage
kΩ--autoranging resistance
J---type J thermocouple
K---type K thermocouple
T---type T thermocouple
SKIP--NO FUNCTION

-----
      J           K           T           SKIP
      DCV       kΩ
  
```

Level 1: Menu entry . . . no programming language required

```

COMMANDS:  HELP,NEW,GET,SAVE,LIST
           CHANGE,TIMING,RUN

channels function [/label]
[=linearization] [/limit.action]
[ ]
EXAMPLE:  1,3,6-9 10V/DEG K=-273+
100X,>100,DC4,0,<95,004,0

CHANNEL SETUP SAVED---THERMO
1: 1-87:J
?
-
  
```

Level 2: Line entry . . . no computer language required . . . just enter data logger information

```

10 SUBPROGRAM Busc1 hp85 rev A
80/07/17
20 P1=Min,P2=Max,P3=Offset,P4=
Min,P5=Max,P6=Tick
30 R3=512*(P1-P2) Min=Max
40 IF R3<0 THEN 230 Abort
50 ON ERROR GOTO 210
60 08=ABS(P2-P1) Range
70 07=IP(LGT(08)) Power
80 06=08/10^07 Norm
90 05=10*(06)^5+5*(06<5 AND 06)
=2)+2*(06<2 AND 06>1)+(06<=1)
100 04=05*10^(07-1) Inter
110 03=SGN(P1-P2) Direction to
round
120 03=(P1-P3)/10^07

```

**Subroutine**... enter a short BASIC program that uses prewritten subprograms

	Level 1	Level 2	Level 3
dc Volts, k ohms	X	X	X
J, K, T Thermocouples	X	X	X
E, R, S Thermocouples		X	X
B, Nn Thermocouples			X
385 Platinum RTD		X	X
2252 Thermistor		X	X
Labels	X	X	X
Limits, Alarms		X	X
Log 30 Channels	X	X	X
Log up to 100 Channels		X	X
Frequency, Totalize		X	X
Histograms, Graphs		X	X
Strip Chart		X	X
User Definable Functions		ax + b aebx a + blnx axb	Custom Program- ing, Up to 42 Functions
Customer Programs			X

**Graphic Presentation** is the key to understanding the data. From the graphic display to the program flexibility to the precise measurement capability, the 3054DL is the complete data logger.

**Graphical Plotting—It Tells the Whole Story**

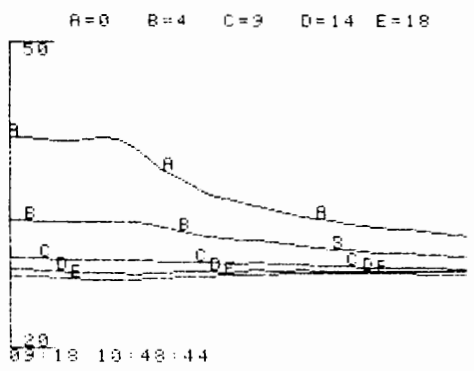

**3054DL Specifications**

The following specifications include all contact resistances, contact voltages and DVM errors. Accuracy specifications apply when the 3054DL is in an ambient environment of 23°C ± 5°, <85% R.H. Temperature coefficients are applied when the ambient temperature is 0 to 18°C or 28 to 50°C.

**DC Voltmeter (Use Option 010 or 020):**  
**Ranging:** Auto or fixed range  
**A/D Technique:** Integrating  
**Maximum Input Voltage:** Hi to Lo: ±120 V peak  
**Lo to Guard:** ±170 V peak  
**Any terminal to Chassis:** ±170 V peak

Range	Maximum Reading	Resolution	Accuracy (90 days) (%Rdg.+Counts)	Temperature Coefficient (%Rdg.+Counts)/°C	Z <sub>in</sub>
.1 V	.119999	1 μV	.007 + 5	.00025 + .15	>10 <sup>6</sup>
1 V	1.19999	10 μV	.006 + 2	.0002 + .02	>10 <sup>6</sup>
10 V	11.9999	100 μV	.006 + 1	.0002 + .01	>10 <sup>6</sup>
100 V	119.999	1 mV	.006 + 1	.00025 + .03	10 MΩ ± 0.5%

For >90 days, add 10 ppm/month to accuracy

**Normal Mode Rejection:** 60 dB (50 or 60 Hz ± .1%)  
**Effective Common Mode Rejection:**  
**ac:** 150 dB (50 or 60 Hz ± .1%)  
**dc:** 104 dB (100 Channels)

**Ohmmeter (Use Option 010 or 020):**  
**Type:** 2-wire or 4-wire  
**Current Source:** Floating

Range	Maximum Reading	1 Count Resolution	Current Through Unknown	Accuracy (90 days) (%Rdg.+Counts)	Temperature Coefficient (%Rdg.+Counts)/°C
100 Ω	119.999	1 mΩ	1mA	.032 + 5	.0028 + .15
1 kΩ	1.19999	10 mΩ	100 μA	.032 + 5	.0028 + .15
10 kΩ	11.9999	100 mΩ	10 μA	.032 + 5	.0028 + .15
100 kΩ	119.999	1 Ω	10 μA	.031 + 2	.0027 + .02

For >90 days, add 20 ppm/month to basic accuracy

**Options:**

- Option # (Choose up to 5 total option cards—3054DL capacity is 5 slots):**
- 010:** 20 channel guarded input relay card
- 020:** 19 channel guarded input relay card with thermocouple compensation. Measures JKERST thermocouples or dc volts
- 050:** 16 channel optically isolated digital input
- 060:** Frequency counter, totalizer
- 110:** 16 channel digital output actuator relay card
- 230:** Clock format: Mo:Day: Hr:Min:Sec
- 231:** Clock format: Day:Mo: Hr:Min:Sec
- 260:** Delete scanner display and controls
- Choose one power line option:**
- 315:** 100 Volts; 50 Hz
- 316:** 100 Volts; 60 Hz
- 325:** 120 Volts; 50 Hz
- 326:** 120 Volts; 60 Hz
- 335:** 220 Volts; 50 Hz
- 336:** 220 Volts; 60 Hz
- 345:** 240 Volts; 50 Hz
- 346:** 240 Volts; 60 Hz
- 400:** Delete locking cabinet with sliding drawer
- 841:** Add Level 3 software for custom data acquisition programs
- 910:** Extra set of Level 1 & 2 software (one set comes with 3054DL at no charge)
- Computer** (Order both items to complete the 3054DL)
- 85F:** Computer with CRT, printer, keyboard, graphics, magnetic tape drive, 82937A HP-IB I/O card, 00085-15003 I/O ROM, 82936A ROM Drawer
- 82903A:** 16K Memory Module
- 3054DL:** Includes 5½ digit DVM, current source, real time clock, HP-IB interface, sliding drawer and cabinet, software Levels 1 & 2, and pre-initialized data tape



## Data Acquisition/Control Unit Model 3421A

- Up to 30 differential channels, 56 single-ended channels
- Electronic calibration for repeatable answers
- Built-in 5½ digit A/D converter with 1  $\mu$ V sensitivity
- HP-IL (standard) and HP-IB (optional) with rear panel switch
- "Sleep mode" for extended battery life in remote locations
- Front terminals for convenient DCV, ACV, 2 & 4-wire ohms, frequency and temperature
- Display shows channels closed, digital states and self-test conditions

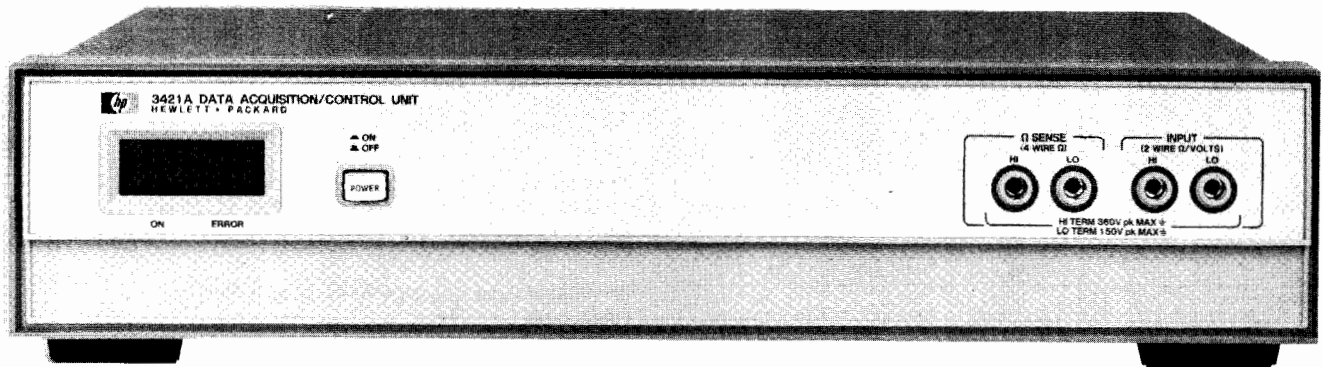

### Description

The HP 3421A Data Acquisition/Control Unit is the system that beats the high cost of data logging. Use it for that small data acquisition project with the assurance that it will quickly pay its own way.

The 3421A scans up to 30 channels, measuring DCV, ACV, 2- and 4-wire Ohms, Frequency, and Temperature. It also reads and writes digital information and stores up to 30 analog readings. The standard 3421A comes with an HP-IL interface for battery-powered flexibility or HP-IB for more computational power.

Up to three of the following assemblies may be added to the 3421A mainframe:

- 10-Channel analog multiplexer/actuator assembly with thermocouple compensation
- 8-bit input/8 bit output digital assembly
- Breadboard assembly for custom circuitry

### Measurement Integrity

With its 5½, 4½, 3½ digit A/D converter, the 3421A can resolve 1  $\mu$ V out of 300 mV to monitor thermocouples, strain gage bridges and other low-level transducers. Or it can read higher level signals by auto-ranging up to 300 volts DC.

### System Versatility

Each 3421A can scan up to 30 differential channels or 56 single-ended channels of analog information. The 3421A is battery-powered, with latching relays that will not change state when the AC line power is removed. Battery power gives the 3421A its own uninterrupted power supply.

All functions are remotely programmable via either HP-IL or HP-IB. Use HP-IL with the 41 CV handheld calculator as a self-contained battery-powered data logger, or use HP-IB with the HP 85F Personal Computer for more programming performance.

### Special 41C/CV ROM

To make the 3421A more convenient for benchtop or field use, a Data Acquisition Pac (HP 44468A) is available for the HP 41C/CV handheld computers. Using the HP-IL I/O, this Pac gives the HP 3421A an operational front panel from the computer's keyboard using "soft" keys defined by a keyboard overlay and special ROM. It also includes a data logger program complete with special keyboard overlay to allow the user to enter beginning-and-ending scan se-

quence, to define the functions to be measured, to automatically compensate for the most common types of thermocouples and to simplify storage of data. Prompting is done on the HP 41 handheld computer's LCD display. The HP 41C/CV can be equipped with an HP 82182A Time Module which allows the operator to specify at what time scanning sequences are to take place and at what interval measurements are to be made.

### The 41CV System

Combine the 41CV, the 3421A, the 82161A Digital Tape Drive, and the 82162A Printer/Plotter to make a portable low-cost data logger. The 44468A Data Acquisition Pac makes programming easy. It contains a 41CV Control ROM for the 3421A as well as two special 41CV keyboards. Each keyboard is dedicated to providing fast, simple function programming with the 41CV.

### The 85F System (The 3056DL)

The 3421A can also be combined with the 85F Personal Computer for even easier and more powerful data logging. Dedicated software enhances the system with Menu programming, Subroutine programming, instrument panel emulation and graphic analysis. It makes data logging as easy as answering a few questions on the CRT display.





Use thermocouples with the HP 3421A to measure the temperature of a bridge section to tell the best time to resurface the roadbed. Or use the DC voltage function to monitor the galvanic effect that causes steel reinforcing rods to corrode inside the concrete.

The HP 41CV handheld calculator can turn on the 3421A Data Acquisition/Control Unit, trigger it to scan a list of 30 channels, instruct the digital cassette to store all 30 readings on tape and then power down the entire system until the next time interval passes.

The 3421A is not limited to portable applications. It is equally useful in laboratory situations, where its 0.01% accuracy, 1 microvolt sensitivity and 5½ digit resolution assure you of reliable answers.

Digital inputs, actuator outputs and a breadboard assembly give the laboratory designer a great deal of instrument flexibility while HP-IB compatibility adds the option of a more powerful instrument controller.



### 3421A Mainframe Specifications

The 3421A mainframe comes with:

- A 5½, 4½, and 3½ digit integrating A/D converter
- Thermocouple compensation
- Type T thermocouple linearization built in
- HP-IL
- 30-reading storage buffer
- LCD 30 channel display with power and error indicators
- Electronic calibration
- Rechargeable battery
- High level command set

All specifications apply for relative humidity less than 85% at 30 degrees C.

#### DC Voltage

**Ranges:** 300 mV, 3 V, 30 V, 300 V, Autorange

**Basic accuracy:** ±(.009% Reading + 3 counts); 5½ digits

**Reading rates:** 2 to 35 readings/second

#### Resistance

**Ranges:** 300 Ω, 3 kΩ, 30 kΩ, 300 kΩ, 3 MΩ, 30 MΩ; Autorange

**Basic accuracy:** ±(.012% Reading + 3 counts); 5½ digits

**Reading rates:** 2 to 35 readings/second

#### AC Voltage

**Ranges:** 3 V, 30 V, (300 V with 44469A divider)

**Converter type:** Averaging

**Resolution:** 3½ or 4½ digits

**Basic accuracy:** 4½ digits; ±(0.5% Reading + 60 counts), 45 Hz to 500 Hz; ±(1% Reading + 60 counts), 30 Hz to 1 kHz

#### Counter

The counter is part of the mainframe circuit, and is multiplexed through the channel relays.

**Resolution:** 65,535 counts

**Frequency:** 1 Hz to 10 kHz

**Modes:** Frequency, Totalize

#### Thermocouple Thermometer

Type T thermocouple linearization is built in. For other thermocouple types, the reference junction temperature is available on each multiplexer assembly.

#### Option 020 10-Channel Multiplexer Assembly

Each multiplexer assembly has 10 relays. They can be configured as 10 multiplexers, 9 multiplexers plus one actuator, or 8 multiplexers plus two actuators. The actuators are capable of switching 252 VAC. One 3421A mainframe can accommodate up to 3 assemblies.

#### Option 040 Breadboard Assembly

The breadboard assembly is convenient for constructing custom circuitry. It comes complete with a manual describing the circuit that enables the 3421A to communicate directly with an 8-bit microprocessor.

#### Option 050 Digital I/O Assembly

Option 050 has 8 isolated input lines and 8 isolated output lines for both monitoring and controlling external digital devices.

### Ordering Information

#### Options

##### Input and I/O Assemblies

**020:** Ten Channel Multiplexer Assembly with thermocouple compensation, connector block.

**040:** Breadboard Assembly with connector block

**050:** 8 bit in, 8 bit out Digital I/O Assembly with connector block

**201:** Add HP-IB interface. Allows use of EITHER an HP-IB or HP-IL controller

##### 3421A/41CV System Options

**541:** Add 41CV for 3421A control. This option includes the HP 41CV handheld calculator, 44468A Data Acquisition Pac with 3421A/41CV Control ROM, 82160A HP-IL Interface Module for 41CV, and an 82182A Time Module

**561:** Add 82161A Digital Cassette Drive (HP-IL)

**562:** Add 82162A Printer/Plotter (HP-IL)

##### Power and Frequency Options

**315-346:** Line Power options from 100 V/50 Hz–240 V/60 Hz

##### Rack Mount and Manual Options

**401:** Side Handle Kit

**907:** Front Handle Kit

**908:** Rack Mount Kit

**909:** Rack Mount with Handle

**910:** Extra Manuals

##### Field Installation Kits

**44462A:** 10-Channel Multiplexer Assembly with thermocouple compensation, connector block

**44463A:** Extra connector block for above

**44464A:** Breadboard Assembly with connector block

**44465A:** 8 bit in, 8 bit out digital I/O assembly with connector block

**44466A:** Extra connector block for digital or breadboard assembly

**44468A:** Data Acquisition Pac for 41CV

**44469A:** Six 10:1 dividers for measuring 300 VAC (One pair comes standard with each Option 020)

##### Accessories

**34118A:** Test Lead Kit

### 3421A Data Acquisition/Control Unit





# DATA ACQUISITION, TEST & CONTROL SYSTEMS

## Data Logger Model 3056DL

- Up to 60 channels
- Graphics
- Data Stored on Tape
- Menu and Subroutine Software

- Adaptive Data Logging
- User Definable Functions
- Choose from 18 separate functions

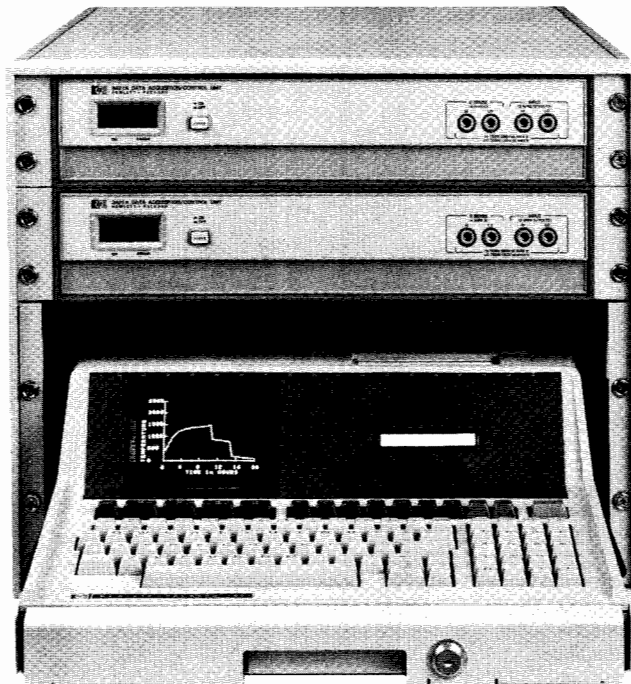

### Description

The 3056DL Data Logger merges the measurement capabilities of up to two 3421A Data Acquisition/Control Units with the programming versatility of the HP 85F computer. It comes in an attractive locking cabinet with two dedicated software packages and all necessary cables.

### The Hardware

Each 3421A Data Acquisition/Control Unit used in the 3056DL Data Logger has the accuracy and resolution for critical applications. The basic accuracy is .01%, with a 5½ digit A/D Converter, a sensitivity of one microvolt, signal conditioning for thermocouples, DCV, ACV, Ohms, and Frequency. Each has a scanning capacity of up to 30 channels as well as 30-reading storage buffer. The 3421A assures you of precise transducer measurements at a surprisingly low price.

The HP 85F Personal Computer communicates with the 3421A via either HP-IL or HP-IB. The 85F has the data logging features you need all in a single integrated package: keyboard, magnetic tape drive, graphics printer and CRT.

### The Software

Two levels of software come with each 3056DL Data Logger. The 3056DL Menu Software is ideal for the first-time user, yet powerful enough for an expert.

For the BASIC programmer, there are measurement subroutines in the 3056DL software. Integrate these subroutines into your own programming material to get the optimum speed and efficiency from the data logger.

### User Definable Functions

There are no less than 17 separate functions to choose from:

- DCV      •ACV      •Digital Read      •Actuate
- 2-Wire Ohms      •4-Wire Ohms      •Frequency      •4-20 mA
- Thermocouples: J•K      T•E      R•S
- 2-Wire RTD      •4-Wire RTD      •2.2K Thermistor

Each function is selected simply by pressing the appropriate key on the HP 85F computer.

When the 17 available functions are not adequate, you can generate your own linearization equation:  $mX+B$ , a 5th order polynomial, or even a BASIC subroutine that you write yourself.

### Adaptive Data Logging

When a specified channel exceeds its measurement limits, you can instruct the system to print to display a warning, or jump to a completely different measurement routine. For instance, you can scan slowly while the process you are monitoring is stable, and then adapt the scanning rate when an out-of-limit condition occurs. This "adaptive scanning" philosophy makes efficient use of data storage space and computer time.

### Ordering Information

#### Options

##### Input Assemblies

**020:** 10 Channel Multiplexer Assembly, connector block

**040:** Breadboard Assembly, connector block

**050:** Digital Assembly, connector block

##### Power Line Options

**315-346:** Options for 100 V/50 Hz through 240 V/60 Hz

##### Systems Options

**201\*:** Add HP-IB Interface to the 3421A (allows the use of EITHER HP-IB or HP-IL)

**202\*:** Two 3421A's (both HP-IL) for up to 60 channel capacity

**203\*:** Two 3421A's (both HP-IB) for up to 60 channel capacity

**400:** Delete 16 in. cabinet, locking drawer

**541:** Add 41CV, 44468A Data Acquisition Pac for 41CV, 82160A HP-IL Module and 82182A Time Module

**561:** Add 82161A HP-IL Digital Cassette Drive

**562:** Add 82162A HP-IL Printer/Plotter

**910:** Extra set of 3056DL manuals, pre-recorded tape cartridge

##### Computer

Order either the 85F or the 85F Option 006. To operate the 3056DL, you need all three items—the 85, the extra 16K memory module and the Advanced Programming ROM

**85F:** Personal computer with graphics CRTs and printer, tape drive, 16K memory, HP-IB Interface Card (82937A), I/O ROM (00085-15003) and drawer (82936A)

**85F/Opt 006:** Same as 85F, but with HP-IL Interface

**82903A:** Additional 16K Memory Module

**00085-15005:** Advanced Programming ROM

**3056DL Data Logger:** Includes one 3421A Data Acquisition/Control Unit with 5½ digit DVM, VDC, VAC, Ω, Counter, 30-reading storage, HP-IL Interface, sliding drawer and cabinet, software levels 1 and 2. Computer is ordered separately.

\* Select no more than one

- Relay Multiplexing
- DVM
- Real Time Clock
- Bridge Completion

- Digital Inputs/Outputs
- Counter
- Programmable D/A's
- Optional RS 232C Interface

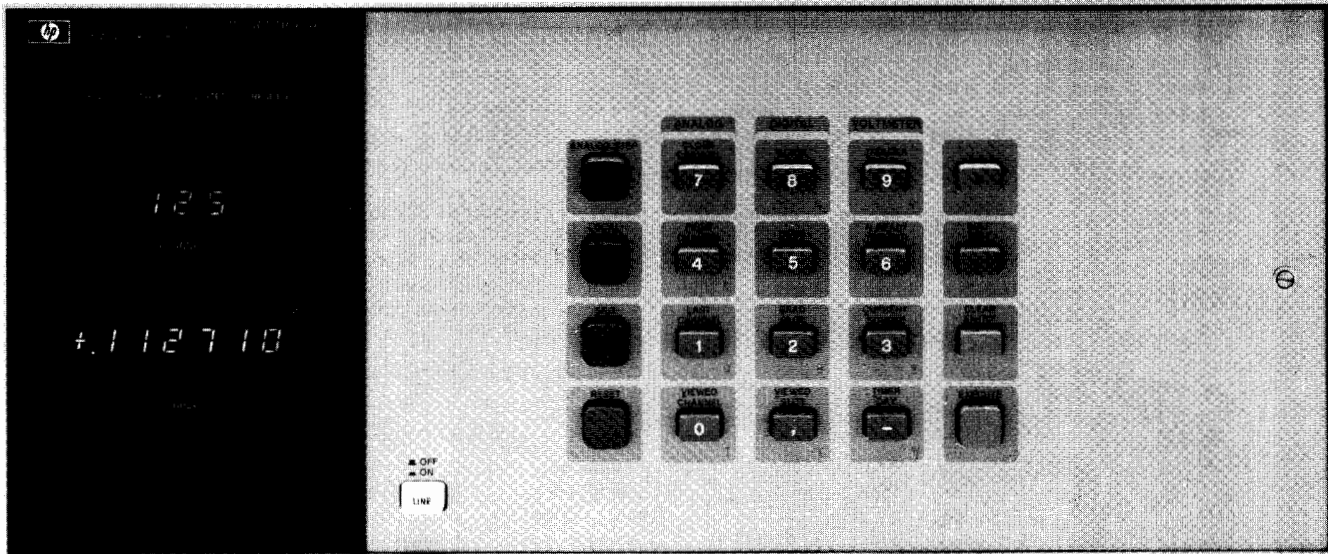

3497A

## Description

The 3497A Data Acquisition/Control Unit combines the capabilities of several instruments and is a basic building block of an automatic data acquisition and control system. The 3497A will be used in an HP-IB automated system and can be viewed as a precision measurement and control computer peripheral.

The 3497A has been designed to be a very versatile and very powerful instrument. A basic 3497A consists of a mainframe that includes a front panel keyboard and display, a non-volatile real time clock, and an HP-IB interface. Available as an option is a 5½ digit integrating digital voltmeter and current source that occupies a dedicated slot in the 3497A chassis. Capability is added to the 3497A by using any combination of plug-in assemblies. Available plug-in assemblies are:

- Relay Multiplexers with or without thermocouple compensation
- Digital Input/Interrupt
- Counters
- Strain gage/bridge completion
- Actuators
- Programmable voltage and current D/A's
- Breadboard Assembly

Up to 5 assemblies can be added to a 3497A and the 3498A Extender chassis can hold up to 10 more plug-in assemblies.

## High Performance

The 3497A DVM can resolve 1 microvolt signals and is ideal for the precise measurement of the outputs of thermocouples, strain gauges and other transducers. Included on the DVM is a programmable current source that allows four terminal resistance measurements. The multiplexer assemblies switch 3 wires (Hi, Lo, and Guard) and add less than 2 microvolts of thermal offset to the measured signal.

## Flexible Hardware Configuration

The 3497A card cage can hold 5 of any combination of the plug-in assemblies. This allows the multiplexing of up to 100 3-wire inputs to

the DVM in a single 3497A or a single 3497A might contain 60 multiplexer channels, 16 digital inputs, 16 actuator outputs, and a DVM. By using the 3498A Extender, up to 1000 analog channels and 1360 digital channels can be controlled, all at a single bus address.

## Ease of Use

The 3497A keyboard and display make the 3497A very easy to use and makes debugging of a 3497A based system easy. The calibration adjustments for the 3497A DVM are located behind a hinged front panel; this allows complete calibration of the DVM without removing it from the test rack. Connections to all of the 3497A assemblies are made using screw terminals, therefore eliminating the need for soldering.

## Automatic Data Acquisition and Control Systems

The 3497A is an integral part of the 3054A/C Automatic Data Acquisition and Control Systems. The 3054A consists of a 3456A Digital Voltmeter for high accuracy measurements, a 3437A Systems Voltmeter for high speed measurements and a 3497A for multiplexing, digital I/O and control. The 3054A includes software compatible with the HP 85, 9825, 9826, 9835 or 9845 computers. The 3054C is similar to the 3054A but it does not include the 3437A and the software is compatible with the HP 1000 series of computers. The 3497A is also a part of the 3054 DL data logger.

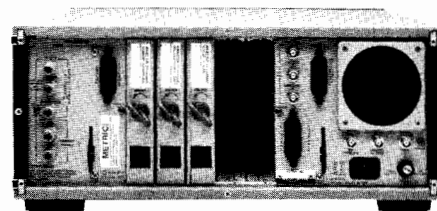



### Real Time Clock

The 3497A mainframe includes a quartz referenced non-volatile real time clock. In addition to providing timing data, the clock can measure elapsed time, interrupt at a pre-settable time, and output a programmable pulse train.

### Clock Format:

Month:Day:Hours:Minutes:Seconds (U.S. Format)

Day:Month:Hours:Minutes:Seconds (European Format)

Modes	Max. Time	Resolution	Accuracy
Real Time Mode:	1 year	1 second	$\pm (.005\%$ of time + .1 s)
Elapsed Time Mode:	10 <sup>6</sup> seconds	1 second	$\pm (.005\%$ of time + .1 s)
Time Alarm Mode:	24 hours	1 second	$\pm (.005\%$ of time + .1 s)
Time Interval Mode:	24 hours	1 second	$\pm (.005\%$ of time + .1 s)
Timer Output Mode:	1 second	100 $\mu$ s	$\pm .02\%$ of time

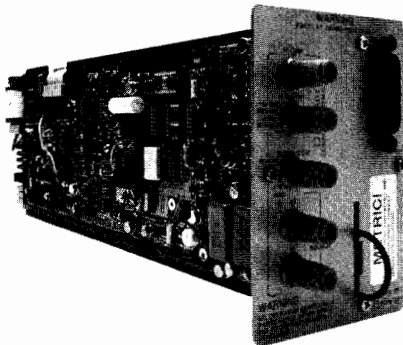

### Option 001—5½ Digit DVM and Current Source

The 3497A DVM assembly is a systems quality, 5½ digit, 1 micro-volt sensitive DC Voltmeter. The DVM is fully guarded and uses an integrating A/D conversion technique; this yields excellent common and normal mode noise rejection.

Included on the DVM assembly is a three level programmable current source. The current source, when used simultaneously with the DVM, can be used to make high accuracy four terminal resistance measurements with 1 milliohm resolution. Maximum speed is 300 readings per second in 3½ digit mode.

### Voltmeter Specifications

Range	Max. Display	5½ Digit Resolution	Accuracy 90 Days, 23°C $\pm$ 5°C 5½ Digits	Input Z
.10 V	$\pm .119999$	1 $\mu$ V	$\pm (.007\%$ RDG + 3 counts)	10 <sup>9</sup> $\Omega$
1.0 V	$\pm 1.19999$	10 $\mu$ V	$\pm (.006\%$ RDG + 1 count)	10 <sup>9</sup> $\Omega$
10.0 V	$\pm 11.9999$	100 $\mu$ V	$\pm (.006\%$ RDG + 1 count)	10 <sup>9</sup> $\Omega$
100.0 V	$\pm 119.999$	1 mV	$\pm (.006\%$ RDG + 1 count)	10 <sup>9</sup> $\Omega$

### Maximum Input Voltage

High to low: 120 V peak

Low to guard: 170 V peak

Guard to chassis: 170 V peak

Current source

Accuracy: 90 days

Range	23°C $\pm$ 5°C
10 $\mu$ A	2.5 nA
100 $\mu$ A	25.0 nA
1 mA	250 nA

Compliance:  $> +15$  volts

Isolation voltage: 170 volts peak

### General Information

Maximum reading rate: (readings/second)

Auto Zero	60 Hz Operation Digits Displayed			50 Hz Operation Digits Displayed		
	5½	4½	3½	5½	4½	3½
ON	25	100	150	20	83	125
OFF	50	200	300	40	166	250

Delay: 0 to 99.9999 sec. in 100  $\mu$ sec. steps

Buffer size: packed format: 100 readings; ASCII format: 60 readings

Number of readings per trigger: 1 to 999

### Measurement Speeds

For the 3497A DVM and the relay multiplexer, speeds are given for measurements on random channels (using software channel selection) and sequential channels (using external hardware increment). Speeds include I/O times to the indicated computers.

### 60 Hz operation (50 Hz Operation)

Number of Digits Selected		85	Computer		
			9826*	1000L	1000E,F
Sequential Channels using external increment	5½ digits	39 ( 33)	39	39 (25)	30 (25)
	4½ digits	97 ( 88)	103	108 (79)	88 (79)
	3½ digits	112 (107)	123	127 (99)	107 (99)
Random Channels using software	5½ digits	13 ( 15)	27	21 (16)	22 (16)
	4½ digits	14 ( 21)	51	31 (28)	35 (30)
	3½ digits	14 ( 23)	55	33 (29)	35 (32)

\*9826 speeds for BASIC operating system

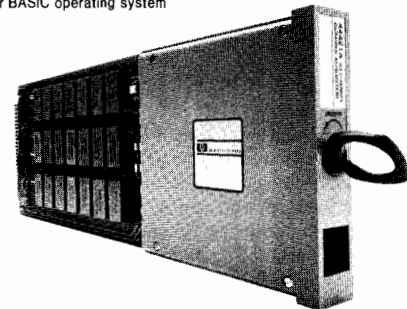

### Option 010—20 Channel Relay Multiplexer

This assembly uses reed relays to multiplex signals to the DVM or other instruments. Each assembly switches 20 channels, each channel consists of HI, Lo, and Guard lines. Two channels may be closed per assembly and relays may be closed in a random sequence or incremented between programmable limits. The low thermal offset of the relays make it suitable for measuring the outputs of strain gauges and other transducers. Each channel can be configured with a filter or current shunt for additional flexibility.

### Input Characteristics

Maximum input voltage:  $< 170$  V peak between any two input terminals

Maximum current: 50 mA per channel non-inductive

Maximum power: 1 VA per channel

Thermal offset: Direct Switched:  $< 1$   $\mu$ V Differential, Tree Switched:  $< 2$   $\mu$ V Differential

Closed channel resistance:

In series: 100  $\Omega$   $\pm$  10% in High, Lo and Guard

Relays contacts only:  $< 1$   $\Omega$  per contact

Open channel isolation:  $> 10^{10}$   $\Omega$  (Hi to Lo, 40°C,  $< 60\%$  R.H.)

Maximum switch rate: 475/second (using hardware increment)

Rated switch life at 1 VA: 10<sup>7</sup> operations

All relays are break-before-make

## Option 020—Relay Multiplexer with Thermocouple Compensation

The option 020 assembly uses the same relay multiplexer as option 010 but incorporates a special isothermal connector block to allow thermocouple compensation. Two types of compensation (selectable by the user) are available. A temperature-dependent voltage is generated for software compensation; this voltage is then used in a computer program to compensate the thermocouple voltage. Hardware compensation involves inserting a voltage in the measurement circuit that automatically compensates the thermocouple voltage.

### Reference Junction Compensation Comparison

	Software	Hardware
Compatible Thermocouples	Any mixture	One of the following types: B,E,J,K,R,S,T
Measurement channels available per assembly	19	20
Reference junction compensation accuracy (23° C ± 5° C)	.1°C	

## Option 050—16 Channel Isolated Digital Input/Interrupt

The option 050 assembly can sense up to 16 channels of digital data. The first 8 channels can also be used as interrupt lines to detect transient signals. The assembly can accept a wide range of input levels and all functions and masks are fully programmable. A five volt supply is provided for driving external contact closures and open collector outputs.

### Input signal characteristics:

Input Level	Low Voltage		High Voltage		Maximum Input Voltage Between High & Low Terminals	Minimum Input Current
	Maximum	Minimum	Maximum	Minimum		
5 V	0.8 V	2.4 V	30 V	400 μA		
12 V	3.0 V	7.0 V	42 V	1 mA		
24 V	6.0 V	13.0 V	42 V	2 mA		

**Maximum voltage:** ± 170 V peak between any terminal and chassis  
**Logic polarity:** Positive True (Negative True is Jumper Selectable)

### Interrupt Mode (Bits 0-7)

**Minimum pulse width:** 100 microseconds

**Triggering:** Each interrupt line is individually programmable for positive or negative edge triggering.

**Masking:** Each interrupt line may be enabled or disabled using a programmable mask.

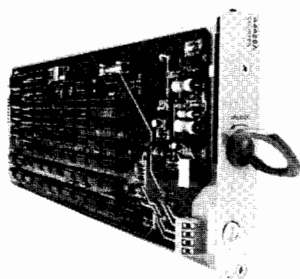

can also count up or down from a programmable start point. It can accept a wide variety of input signals including CMOS, open collector TTL and passive contact closures.

### Input Signal Characteristics:

#### Input Levels:

Input Level Range	V(Lo) (Maximum)		V(Hi) (Minimum)	
	Isolated	Non-iso	Isolated	Non-iso
5 V	1.0 V	1.0 V	4.2 V	4.2 V
12 V	1.8 V	2.7 V	10.3 V	8.0 V
24 V	2.6 V	6.0 V	18.4 V	16.5 V

(5 V level is standard, 12 and 24 volt levels are jumper selectable. Other voltages can be accepted using customer supplied resistors.)

**Input Circuit:** Switch selection of optically isolated or non-isolated input. Non-isolated input has 19.5 kΩ minimum input impedance.

**Maximum Isolation Voltage:** 170 V peak between any terminal and ground. Isolated mode only.

#### Period Mode:

**Maximum Input Frequency:** 100 kHz

**Minimum On Time:** 5 μs

**Minimum Off Time:** 5 μs

#### Range Characteristics:

Range	Least Significant Digit (LSD)	
	HP-IB	Display
9999.999 s	1 ms	10 ms
99.99999 s	10 μs	100 μs
0.9999999 s	100 ns	1 μs
.09999999 s	10 ns	1 μs

**Accuracy:** ± (.01% of reading + 2 LSDs + Trigger Error)

#### Pulse Width:

**Minimum Start to Stop time:** (Pulse Width): 18 μs

**Minimum Stop to Start Time:** 18 μs

#### Range Characteristics:

Range	Least Significant Digit (LSD)	
	HP-IB	Display
9999.999 s	1 ms	10 ms
99.99999 s	10 μs	100 μs
0.9999999 s	1 μs	1 μs
.0999999 s	1 μs	1 μs

**Accuracy:** ± (0.1% of reading + Trigger Error + (2 LSDs or 18 μs, whichever is greater)).

#### Totalize/Down Count Mode:

**Maximum Input Frequency:** 100 kHz

**Minimum Pulse Width:** 5 μs

**Range:** 0 to 999,999

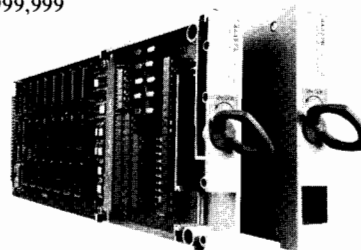

## Option 060—100 kHz Reciprocal Counter

This option can be used to measure mechanical and low frequency electronic signals. The counter can measure the period of signals up to 100 kHz and the pulse width of signals down to 18 μs. The counter

## Option 070—120 Ohm Strain Gage/Bridge Completion Assembly

## Option 071—350 Ohm Strain Gage/Bridge Completion Assembly



## Model 3497 (Cont.)

The option 070/071 assemblies may be used to provide bridge completion for measuring strain gages, RTD's pressure sensors and load cells. Each card uses an internal shared half bridge and can complete 10 channels of  $\frac{1}{4}$  and  $\frac{1}{2}$  and full bridges in any combination. When used with a +5 V excitation supply (such as the HP 6214A) and the 3497A DVM, the assembly provides .1  $\mu\text{E}$  sensitivity with 1  $\mu\text{E}$  accuracy. Provisions are made for shunt calibration and checking gage leakage and lead resistance.

### Specifications

Sensitivity (excitation voltage at 5 volts)			Accuracy	
Bridge Type	3497A DVM	3456A DVM	Range at Best Resolution	90 Day 23°C $\pm$ 5°C
$\frac{1}{4}$	.4 $\mu\text{E}$	.04 $\mu\text{E}$	42400 $\mu\text{E}$	25 $\mu\text{E}$
$\frac{1}{2}$	.2 $\mu\text{E}$	.02 $\mu\text{E}$	21200 $\mu\text{E}$	5 $\mu\text{E}$
Full	.1 $\mu\text{E}$	.01 $\mu\text{E}$	9500 $\mu\text{E}$	1 $\mu\text{E}$

### Excitation Supply Requirements:

**V max:** 5.4 Vdc; **I (out):** 250 mA per 10 channels (120 ohm gages)

### Option 110 16 Channel Actuator

### Option 115 8 Channel High Voltage Actuator

Option 110 consists of 16 mercury wetted form C (single pole-double throw) relays. Each relay can be individually closed and can switch one amp at 100 volts. The actuator assembly can be used to switch test fixture power or to actuate alarm bells. This flexibility of this assembly allows it to be used as a digital output or matrix switch.

Option 115 is an 8 channel high voltage actuator assembly that can switch voltages up to 252 VRMS and currents up to 2 amperes. The Option 115 assembly is ideal for switching power line voltages to small motors, alarm bells and lights, motor starters and solenoids.

### Option 110 and 115 Specifications

	Option 110	Option 115
Switch Form	C	A
Contact Type	Mercury Wetted	Dry
Number of channels	16	8
Maximum Voltage	100 V Peak	252 VRMS
		48 VDC
Maximum Current	1 amp	2 ARMS or DC
Maximum Power	100 VA	500 VA AC
		60 VA DC

### Option 120—Dual Voltage D/A

### Option 130—Dual Current D/A

Option 120 consists of two 0 to  $\pm 10$  V programmable voltage sources. These sources can be used to provide a programmable test stimulus or to control voltage programmed devices like power supplies and VCO's.

Option 130 consists of two 0 to 20 mA or 4 to 20 mA programmable current sources. These sources, especially when using the 4 to 20 mA range, can be used as transmitters in industrial current loops and can drive up to 600 ohms of total loop resistance.

### Option 120 Specifications:

**Output:** 13 bits including polarity

**Least Significant Bit:** 2.5 mV

**Output Range:** -10.2375 V to +10.2375 V

**90 Day Accuracy:**  $\pm .070\%$  of programmed value  $\pm 4.0$  mV

**Maximum Output Current:** 15 mA (output within specifications)

### Option 130 Specifications:

**Output:** 12 bits

**Least Significant Bit:** 5  $\mu\text{A}$  (0 to 20 mA range)

4  $\mu\text{A}$  (4 to 20 mA range)

**Output Range:** 0 to 20.475 mA or 4 to 20.380 mA (each source jumper selectable)

**90 Day Accuracy:**  $\pm 0.07\%$  of programmed value  $\pm 10.0$   $\mu\text{A}$

**Compliance Voltage:** 12.0 volts

### Option 140 Breadboard Card

Option 140 is a breadboard card compatible with the 3497A card-cage. Using this card, 3497A users can construct special purpose assemblies that communicate with the 3497A backplane.

### Option 232 RS232C Interface

Option 232 to the 3497A deletes the standard HP-IB interface and adds an RS232C (CCITT/V.24) compatible interface. The option 232 interface is also compatible with the new RS423 (CCITT/V.10) version of the RS449 interface.

The option 232 interface allows you to remotely locate the 3497A. HP technical brochure part number 5952-8884 contains additional information on 3497A option 232.

### Option 298—3498A Extender

The 3498A Extender chassis allows low cost expansion of 3497A-based systems. Each 3498A can hold up to ten 3497A plug-in assemblies. Use of one or more 3498A's requires a 3497A (for control); all required connecting cables are supplied with the 3498A.

**Number of slots per 3498A:** 10

**Maximum number of added analog multiplexer channels** (options 010, 020): 900 channels (45 assemblies)

**Maximum number of added non-analog acquisition assemblies** (options 050, 060, 110, 120, 130): 85 assemblies

**Maximum number of 3498A's per 3497A:** 13

### General

**Size** (3497A or 3498A): 190.5 mm H x 428.6 mm W x 520.7 mm D (7 $\frac{1}{2}$ " x 16 $\frac{7}{8}$ " x 20 $\frac{1}{2}$ ").

**Net weight:** 3497A, 20.4 kg (45 lbs.) and 3498A, 20.4 kg (45 lbs.) with assemblies in all slots.

**Shipping weight:** 3497A and 3498A maximum with assemblies in all slots are 26.3 kg (58 lbs.)

Operating temperature: 0°C to 55°C

Non-operating temperature: -40°C to 75°C

Humidity: to 95% at 40°C except as noted

Operating power: switch selection of 110, 120, 220 and 240 volts  $\pm 10\%$ , 48-66 Hz, 150 VA 3497A and 3498A.

### Ordering Information

Each 3497A can hold one DVM assembly (Opt 001) and up to 5 plug-in assemblies. Each 3498A (Opt 298) can hold 10 additional plug-ins. For plug-ins in excess of cardage capacity, order as 444XXX Field Installation Kits.

#### Required on every order:

- A Clock Format (Option 230 or 231)
- A Power Line Frequency and Voltage (Options 315 through 346)

**Opt 001:** 5 $\frac{1}{2}$  digit DVM and Current Source

**Opt 010:** 20 channel Relay Multiplexer Assembly

**Opt 020:** Relay Multiplexer Assembly with thermocouple compensation

**Opt 050:** 16 channel isolated Digital Input/Interrupt Assembly

**Opt 060:** 100 kHz Reciprocal Counter;

**Opt 070:** 120 Ohm Strain Gage/Bridge Completion Assembly

**Opt 071:** 350 Ohm Strain Gage/Bridge Completion Assembly

**Opt 110:** 16 channel Actuator/Digital Output Assembly

**Opt 115:** 8 Channel High Voltage Actuator Assembly

**Opt 120:** Dual Output Voltage DAC Assembly

**Opt 130:** Dual Output Current DAC Assembly

**Opt 140:** Breadboard Card

**Opt 230:** Clock Format (Month:Day:Hours:Min:Sec)

**Opt 231:** Clock Format (Day:Month:Hours:Min:Sec)

**Opt 232:** Delete HP-IB Interface, add RS232C Interface

**Opt 260:** Delete Keyboard and Display

**Opt 298:** Add 3498A Extender & connecting cables

### 3497A Data Acquisition/Control Unit

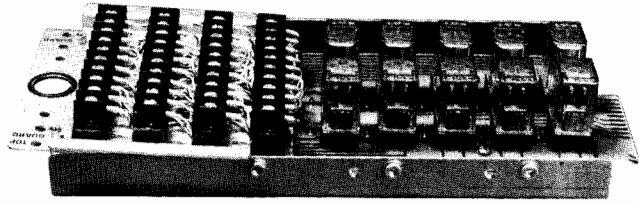
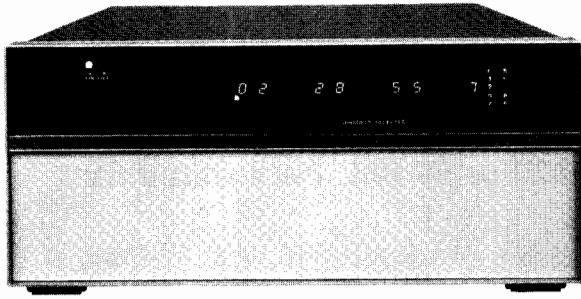

Option 002

### Description

#### General

The 3495A Scanner switches analog input signals to an appropriate measuring device (voltmeter). It can also control external devices with relay actuator closures. Ideal for many data logging and data acquisition applications, the scanner can be used for sequential or random scanning. Any Hewlett-Packard Interface Bus (HP-IB) compatible controller can be used to operate the Scanner. Any combination of four relay assemblies (discussed below) can be used per scanner mainframe. More than four assemblies requires additional scanner mainframes.

Five optional relay assemblies are available with the scanner, four low thermal assemblies and one actuator assembly.

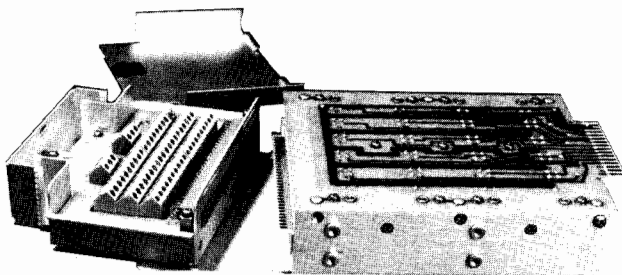

Option 004

#### Low Thermal Relay Multiplexer Assemblies

These assemblies are used to multiplex signals into a common detector, often a digital voltmeter. Typical applications are the multiplexing of low level dc voltages and resistances like the outputs of thermocouples, thermistors, strain gages and other transducers. Options 001 and 004 have 10 and 20 channels respectively. Options 003 and 005 have 9 and 19 channels respectively, an isothermal connector block and a thermistor to sense the temperature of the isothermal block. This gives options 003 and 005 thermocouple compensation capability.

#### Multiplexer Comparison

	Option 001	Option 003	Option 004/005
Number of Channels	10	9	20/19
Voltage Maximum	230 V Peak	42 V Peak	42 V Peak
Current Maximum	200 mA	200 mA	40 mA
Thermal Offset	<2 $\mu$ V	<2 $\mu$ V	<1 $\mu$ V
Isolation	>10 <sup>10</sup> Ohms	>10 <sup>7</sup> Ohms	>10 <sup>7</sup> Ohms
Switching Time	10 msec max.	10 msec max.	10 msec. max. 1 msec max. using 3495A high speed controller

#### Relay Actuator Assembly

**Applications:** process control, actuate visual or audio indicators, control high current relays, up to 2 X 5 X 2 Matrix switching.

**Ten Channel Relay Actuator Assembly:** This relay actuator assembly provides ten independently programmable 2-wire closures for controlling high current relays, distributing low current dc or ac voltages, or external control function. Each two-pole relay can switch currents up to 2 A rms. Any combination of channels on this assembly may be closed or opened simultaneously.

**Maximum contact ratings:** voltage: 100V rms; Current: 2 A rms; Maximum input voltage: 230V peak; Thermal offset: < 30  $\mu$ V differential EMF; Switching time: 40 ms max. (Caution: For use in circuits fused at 2 amperes or less and less than 200 VA).

#### General

**Operating temperature:** 0°C to +55°C

**Humidity range:** 95% R.H., 0°C to +40°C

**Power:** 100/120/220/240 +5%, -10%

48 to 66 Hz line operation, <100 VA

**Size:** 190.5 H x 428.6 W x 520.7 mm D (7.5" x 16.8" x 20.5").

**Weight:** Depends on options. Net: 18 kg (39.6 lbs.) maximum with four relay assemblies. Shipping: 22 kg (48.4 lbs.) maximum.

#### Option

**001:** Ten Channel Low Thermal Relay Assembly

**002:** Ten Channel Relay Actuator Assembly

**003:** Nine Channel Reference Assembly With Thermocouple Compensation

**004:** Twenty Channel Low Thermal Relay Assembly

**005:** Nineteen Channel Reference Assembly With Thermocouple Compensation

**100:** High Speed Control Board

#### Field Installation Kits

**44401A** Ten Channel Low Thermal Relay Assembly

**44402A** Ten Channel Relay Actuator Assembly

**44403A** Nine Channel Reference Assembly With Thermocouple Compensation

**44404A** Twenty Channel Low Thermal Relay Assembly

**44405A** Nineteen Channel Reference Assembly With Thermocouple Compensation

**44413A** High Speed Control Board

In addition, options 001 or 004 can be field modified to include thermocouple compensation by ordering the appropriate terminal connectors.

#### Additional terminal connectors for:

Ten Channel Low Thermal Relay Assembly 03495-64101

Ten Channel Relay Actuator Assembly 03495-64104

Nine Channel Thermocouple Reference Assembly 03495-64103

Twenty Channel Low Thermal Relay Assembly 03495A-64114

Nineteen Channel Thermocouple Reference Assembly 03495-64115

#### 3495A Scanner

# DATA ACQUISITION, TEST & CONTROL SYSTEMS

**Multiprogrammer: Computer Aided Test and Control**  
Models 6940B and 6942A

*Use the MULTIPROGRAMMER to implement customized solutions for your  
.....High Speed Data Acquisition  
.....Computer Aided Test  
.....Control Applications.  
First select the MULTIPROGRAMMER, 6940B or 6942A, best suited for  
your application.....*

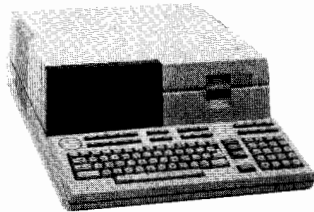

HP Desktop Computer

Then, Choose an HP Controller and Interface Kit ... Use either a Desktop or Minicomputer...

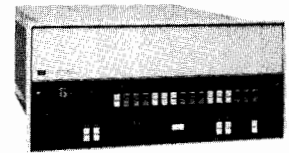

HP Minicomputer

Then select from a wide range of these MULTIPROGRAMMER CARDS for the MAINFRAMES ...

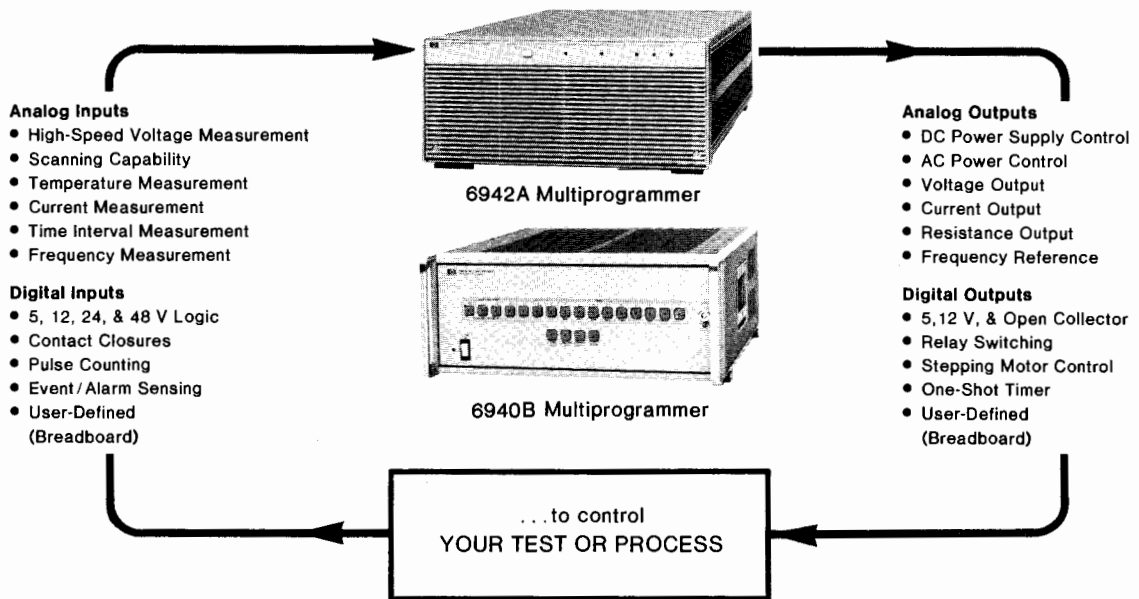

## Introduction

The Multiprogrammers' high speed makes them well suited for data acquisition and Computer Aided Test applications. Voltage measurements can be acquired at 33,000 readings per second from a single channel, or from several thousand channels using the Multiprogrammers' scanning capabilities. Digital data can be acquired at a 125 kHz rate. Thousands of Multiprogrammers are in use in Computer Aided Testing of electrical and mechanical devices. They improve quality and productivity throughout the manufacturing process in areas like incoming inspection, component test, subassembly test, final test, life test, and quality control test. Multiprogrammers are also used in the R&D environment to automate both short and long term experiments.

The Multiprogrammer Family gives you the choice of two mainframes: the 6940B and the 6942A. The 6940B is the lower cost solution. The 6942A is the latest addition to the family and offers simplified programming and some new, powerful I/O cards.

## Complete Technical Data

If you would like additional information on Multiprogrammer products we have a free, 68-page brochure on the 6940B and one on the

6942A. The brochures include detailed specifications, applications, programming, interfacing, and ordering information. Ask your HP Field Engineer for publication 5952-4077 (for the 6940B) or 5952-4078 (for the 6942A), or use the card at the rear of this catalog.

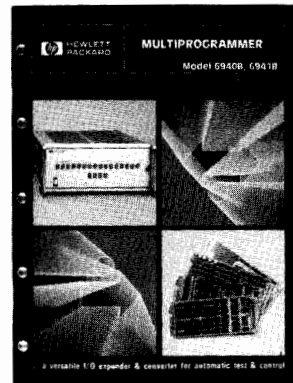

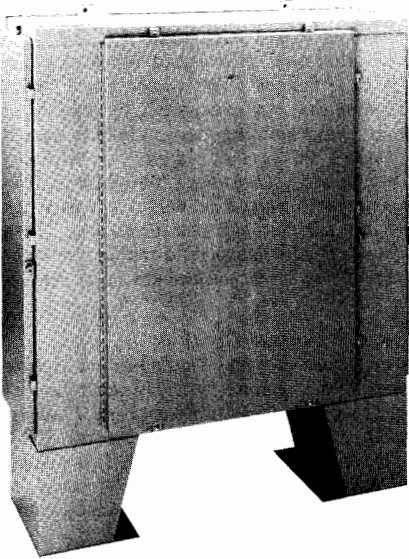

HP 2250N Measurement & Control Processor  
(Enclosed in NEMA-12 cabinet)

### Function/Applications

The HP 2250 Measurement and Control Processor is the nucleus of a family of HP automation systems that provide powerful capabilities for laboratory and industrial automation applications. The HP 2250's modular hardware structure gives you the versatility of selecting only the product you need for a cost-effective solution to your specific automation problem—yet you have the flexibility to expand your capabilities as your automation needs grow.

The HP 2250 operates in conjunction with an HP 1000 or HP 9800 series computer via the HP-IB, Hewlett-Packard Interface Bus, our implementation of IEEE Standard 488-1978 and identical ANSI Standard MC1.1. A single HP-IB cable connection is all that is required to link your computer to the HP 2250, creating a high-performance automation system. For those applications that require the 2250 to be remotely located, a coaxial cable or fiber optic HP-IB extender is available to extend the computer/2250 link up to 1000 metres.

The HP 2250 has a built-in LSI microcomputer and MCL/50 firmware, a software command set comprised of over 100 applications oriented mnemonic commands that can be used in many combinations to optimize measurement and control operations. MCL/50 Measurement and Control language software is easy to learn and use, allowing a user who is not a computer scientist to program his applications and control all 2250 function cards without tying up or intervention from the host computer. This decoupled operation facilitates a simpler and faster implementation of your automation solution, and results in more predictable and repeatable performance.

Measurement and control applications exist in many different environments—and the modular HP 2250 hardware is designed with the flexibility to meet the diverse requirements of these applications. A comprehensive set of high performance analog and digital function cards are available to interface to the broad range of sensors and actuators commonly found in laboratory and industrial environments today. Additionally, most function cards include provisions for on-board signal conditioning modules that permit accurate and reliable interfacing in demanding industrial applications. Also available are convenient industrialized field wiring assemblies accommodating up to 10 AWG wire.

### Special Features

- High-performance analog measurement capability includes
  - 14-bit resolution and 17-bit dynamic range
  - 0.08% accuracy from 0 to 50°C
  - 50,000 samples per second average throughput to disc
  - 45,000 samples per second paced throughput to disc
  - 350 Volt common mode protection
  - isolated voltage and current outputs
- Wide range of function cards are available, with 42 separate, plug-on signal conditioning modules.
- HP MCL/50 high level command set enables real-time task delegation and decoupled controller operation.
- Solid state output relay digital design is ruggedized to enable mechanical relay replacement.
- All I/O points can be floated or isolated.

- **HP 2250N**—an M&C processor packaged in a NEMA-12 steel enclosure that interfaces up to 480 analog/digital points. This rugged industrial cabinet is suitable for harsh manufacturing or outdoor environments and is sealed against dirt, oil, water. This configuration is designed for use with the HP 1000 L-Series computer and can either be remoted from the computer over the HP-IB optic cable or made part of a distributed plant network by plugging in the HP 1000L microcomputer.

In addition to the 2250N are other racking options that allow configured M&C systems of up to 2048 analog and digital points.

### Ordering Information and Related Products

- **HP 2250N** NEMA-Mounted Measurement and Control Processor
- **HP 2251AN/AR** Measurement and Control Unit
- **HP 2104AN/AR** Processor Unit
- **HP 25501A** 16-Channel High Speed Analog Input Card
- **HP 25502A** 32-Channel High Level Multiplexer Card
- **HP 25503A** 32-Channel Low Level Multiplexer Card
- **HP 25504A** 16-Channel Relay Multiplexer Card
- **HP 25510A** 8-Channel Isolated Voltage/Current Analog Output Card
- **HP 25511A** 32-Channel Digital Input Card
- **HP 25512A** 4-Channel Counter Card
- **HP 25513A** 32-Channel Digital Output Card
- **HP 25514A** 16-Channel Relay Output Card
- **HP 25515A** 4-Channel Pulse Generator Card
- **HP 25516A** 16-Point In/16-Point Out Digital Multi-function Card

For more information on the HP 2250 Measurement and Control Processor, I/O function cards, signal conditioning modules and accessories, contact your local HP Sales Representative, see pp. 667-672.



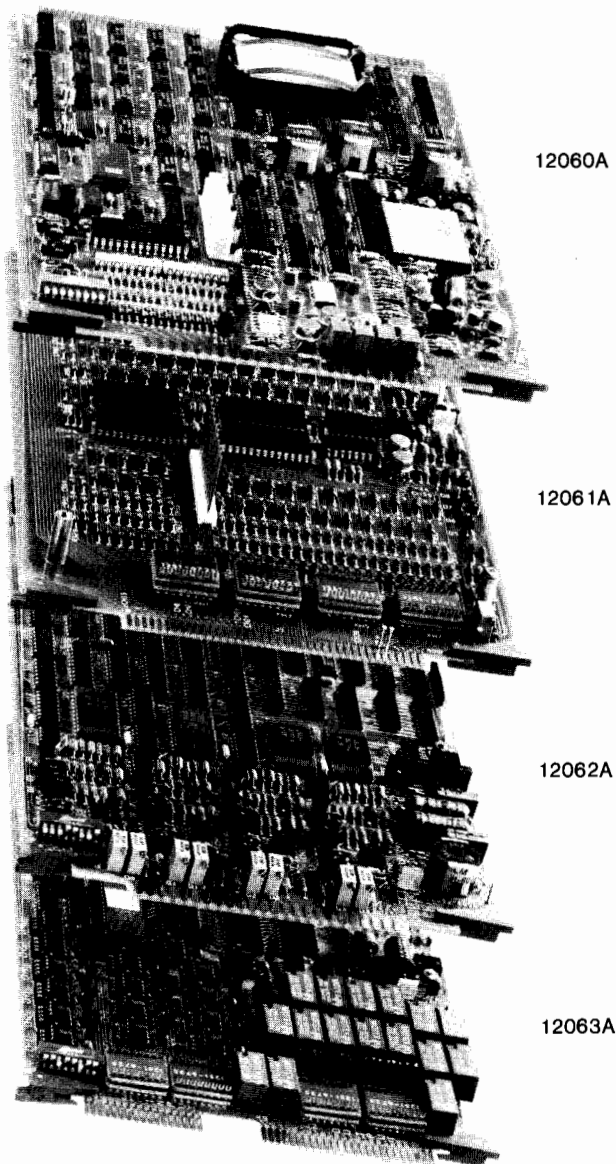

### Description

The 12060A, 12061A, 12062A, and 12063A are plug-in cards for HP 1000 L-Series Computers. They provide low cost, high performance, analog and digital I/O for use in distributed measurement and control applications. The A-series product in which these cards are used must have a 25 kHz power supply. Hood connectors with each card allow the user to build cables for connection to his application.

#### 12060A 8 Channel Analog Input Card

The 12060A is capable of acquiring up to 55,000 readings per second with 12-bit resolution. Auto scanning or single-channel sampling is possible to 55 kHz. Provisions for external pacing/triggering of sampling and scanning is provided. The 12060A includes four programmable full scale ranges from plus or minus 1.28 V to plus or minus 10.24 V. Maximum resolution is 0.625 mV on the 1.28 V range. A separate "zero reference" on the card allows the user to measure actual offset due to temperature drift, and correct readings on all channels for higher accuracy. The card has 8 differential channels.

#### 12061A 32 Channel Analog Input Expansion Card

The 12061A provides 32 additional differential inputs for the 12060A card. The 12061A card fastens directly onto the 12060A card, creating a two-board unit that occupies two I/O slots in an HP 1000 A-series computer. Programming information is passed from the 12060A directly to the 12061A; analog signals on the additional 32 channels are in turn passed back to the 12060A for digitizing. The 12061A includes removable plug-in headers so the user can add current sense resistors for current loop measurements. These headers allow the board to be adapted to the specific application without soldering components directly on the board and are easily removable for repair purposes.

#### 12062A 4 Channel Analog Output Card

The 12062A Analog Output Card provides 4 independent bipolar voltage outputs. Remote sensing per channel provides accurate output voltages to compensate for long distances of field wiring. Undedicated digital outputs may be used in pen up/down control, CRT display, or X-Y plotters. DMA compatibility provides fast analog updates on a per channel basis or between channels. Programmable time delay between DMA updates provides signal reconstruction capability with a full power bandwidth of 20 kHz.

#### 12063A 32 Channel Digital Multifunction Card

##### Input Characteristics

The 12063A provides 16 fully isolated digital inputs via voltage threshold opto-couplers. Input voltage levels are selectable by the user for each channel by installing the appropriately valued resistors on removable plug-in headers (8 resistors per header = 8 channels). These headers allow the board to be adapted to the specific application without soldering components directly on the board, and are easily removed for repair purposes. Plug-in opto-couplers (supplied) allow user selection of ac or dc coupling for each channel by merely installing the opto-coupler in the ac position or dc position. For ac coupling, a plug-on jumper is provided for each channel to select 60 Hz ac filtering of the rectified input if desired.

##### Event Detection

In addition to status, any input may be user programmed to function as an interrupt to be generated on the rising edge or falling edge of the input or both (whichever occurs first). This capability is easily activated by the user via loading the appropriate pattern into the three registers. The on-card microprocessor takes over to cause the interrupt to be generated when that event occurs. User programming is required to service the interrupt.

##### Debounce Delay

The same microprocessor also provides the user programmable debounce delay up to 246 msec on any input when monitoring contact closures, and may be used in both status mode and event sense mode.

##### Output Characteristics

Sixteen form C (SPDT) relay outputs are provided on the same card. Both the normally open (NO) and normally closed (NC) contacts are available to users. Two removable headers allow for arc suppression devices to be added by the user for each channel without soldering directly to the board. Each header handles 8 output channels. Plug-on jumpers select the arc suppression across the NO or NC contacts. An on-card isolated power supply derived from the 25 kHz ac supply in the A-Series processor provides coil power for the relays. This technique minimizes any coupling of relay contact noise in the computer itself. For ease of servicing, plug-in relays are used.

##### Ordering Information

12060A 8 Channel Analog/Digital Converter

12061A 32 Channel Analog Input Expansion

12062A 4 Channel Digital/Analog Converter

12063A 32 Channel Digital Multifunction Card

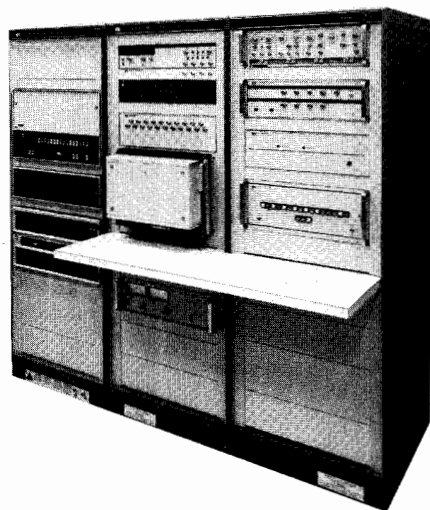

**Customized automatic test systems,  
integrated by Hewlett-Packard**

#### Switches for Automatic Test

HP-IB switch products used in HP automatic test systems are available individually for HP 1000 system users who manufacture their systems in-house or those who have complex switching requirements in their HP 1000-based automated test systems. These switches provide a commercially-available solution for connecting the system to the unit-under-test (UUT). Three types of switching units are available, all controlled by a single 9411B Switch Controller that provides micro-processor control of multiple switch mainframes.

- **9411B Switch Controller**

The 9411B is for use on HP 1000 Computer Systems and is controlled via the HP-IB. It provides control logic and relay power for the switch mainframes. It performs comprehensive self-test and fault isolation of all signal relays in the 9412A and 9414A switch cards.

- **9412A Modular Switch**

Provides high-density, multi-function switching of signals up to 10 MHz. A built-in 1768-pin (34 x 52) matrix interface panel improves signal performance and eliminates "spider web" cabling. The 9412A accommodates five types of switch cards in any combination up to a total of 25 cards.

- **9413A VHF Switch**

Provides modular, flexible high-frequency switching of pulse and video signals up to 500 MHz. The 9413A accommodates up to 12 coaxial switch modules.

- **9414A Matrix Switch**

Provides maximum flexibility for switching signals up to 10 MHz. Designed for high-density, high-performance switching, the 9414A allows any UUT pin to be switched to any instrument in the system. The 16-input matrix can be configured in 30-pin increments (UUT pins) up to 120 pins. A distribution bus allows several instruments to share four of the 16 matrix inputs, thus minimizing switching requirements.

#### ATS/1000 Integration Services

Previously, when building an automatic test system, users had only two choices: purchase an already-assembled "turn-key" system or purchase computers and instruments separately and assemble them on their own. As a result of our experience with more than 1000 HP automatic test system installations worldwide, HP offers two categories of system-building assistance, called ATS/1000 Integration Services.

An automatic test system can be purchased at various levels of completion, depending on how much assistance the user desires. At the lowest level, called Racking and Cabling Service, HP consolidates the equipment, designs cabinet layout and power distribution, then installs the equipment in cabinets. The user assumes responsibility for software configuration and testing.

With the highest level of service, Configuration/System Test, the user receives a fully-integrated, fully-installed system, ready for developing application programs. HP consolidates the equipment, installs it in cabinets, configures the operating software, and checks out the system on-site.

Integration service prices vary, depending on the complexity and size of the system. A typical system that contains \$100,000 of instrumentation typically requires \$30,000 to \$40,000 of integration services to be fully configured and tested.

#### Ordering Information

93283A ATS Racking and Cabling Service

93284A ATS Configuration/System Test Service

HP 9411B  
Switch  
Controller

HP 9413A  
VHF  
Switch

HP 9412A  
Modular  
Switch

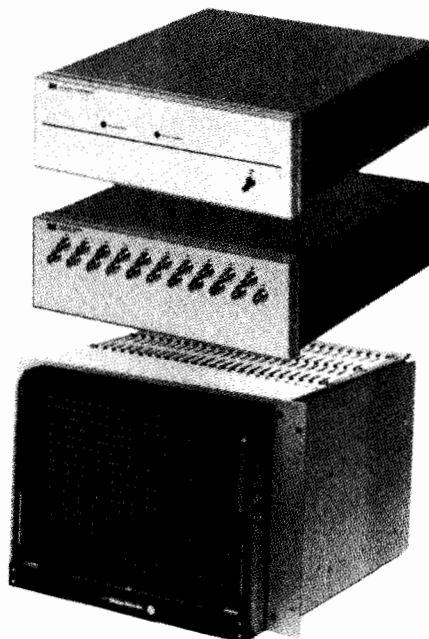

# AMPLIFIERS

## Wide Band Amplifiers

### Models 8447A/D/E/F

- Wide band
- Flat response
- Low noise

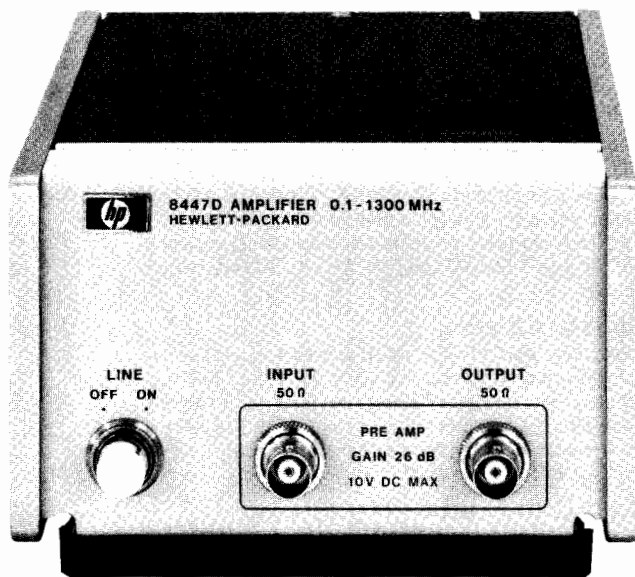

#### 8447D

The HP 8447 series of general purpose amplifiers combines high reliability and convenience.

#### High Performance

The performance of these amplifiers qualifies them for a number of uses: to improve the sensitivity of counters, spectrum analyzers, RF voltmeters, EMI meters, power meters and other devices without distortion or degradation of amplitude accuracy; to increase the maximum power available from a signal generator or sweeper.

#### Specifications

	8447A Preamp	8447D Preamp	8447E Power Amp	8447F Preamp-Power Amp
Frequency Range	0.1-400 MHz	100 kHz-1.3 GHz	100 kHz-1.3 GHz	100 kHz-1.3 GHz
Typical 3 dB Bandwidth	50 kHz-700 MHz	50 kHz-1.4 GHz	50 kHz-1.4 GHz	50 kHz-1.4 GHz
Gain (Mean)	20 dB ± 0.5 dB at 10 MHz	26 dB ± 1.5 dB (20°C-30°C)	22 dB ± 1.5 dB (20°C-30°C)	
Gain Flatness Across Full Frequency Range	± 0.5 dB	± 1.5 dB	± 1.5 dB	
Noise Figure	<5 dB	<8.5 dB	<11 dB typical	
Output Power for 1 dB Gain Compression	>+6 dBm	>+7 dBm typical	>+15 dBm	
Harmonic Distortion	-32 dB for 0 dBm output	-30 dB for 0 dBm output (typical)	-30 dB for +10 dBm output	
Typical Output for <-60 dB Harmonic Distortion	-25 dBm	-30 dBm	-20 dBm	
VSWR	<1.7	<2.0 input <2.2 output 1-1300 MHz	<2.2 1-1300 MHz	
Impedance	50 Ω	50 Ω	50 Ω	
Reverse Isolation	>30 dB	>40 dB	>40 dB	
Maximum DC Voltage Input	± 10 V	± 10 V	± 10 V	
Options Available	001	001, 010, 011	010	010

— 8447D AND 8447E COMBINED IN A SINGLE PACKAGE —

#### Broadband Frequency Coverage

The 8447 series offers an amplifier for nearly every application in the 100 kHz to 1.3 GHz frequency range. The wide bandwidths are compatible with other wideband instruments and accommodate wide-band spectra.

#### Options

A variety of options are available: Option 001 and Option 011 dual channel versions with BNC and Type N connectors respectively for operation with dual channel systems such as oscilloscopes or network analyzers (or the channels may be cascaded for increased gain); Type N connectors rather than the standard BNC connectors (Option 010).

#### General

**Weight:** net, 1.56 kg (3.4 lb). Shipping, 2.30 kg (5.1 lb).

**Size:** 85.8 H x 130 W x 216 mm D (3.4" x 5.1" x 8.5").

**Power requirements:** 110 or 230 V ac ± 10%, 48-440 Hz, 15 watts.

#### Ordering Information

8447A Preamp

8447D Preamp

8447E Power Amp

8447F Preamp-Power Amp

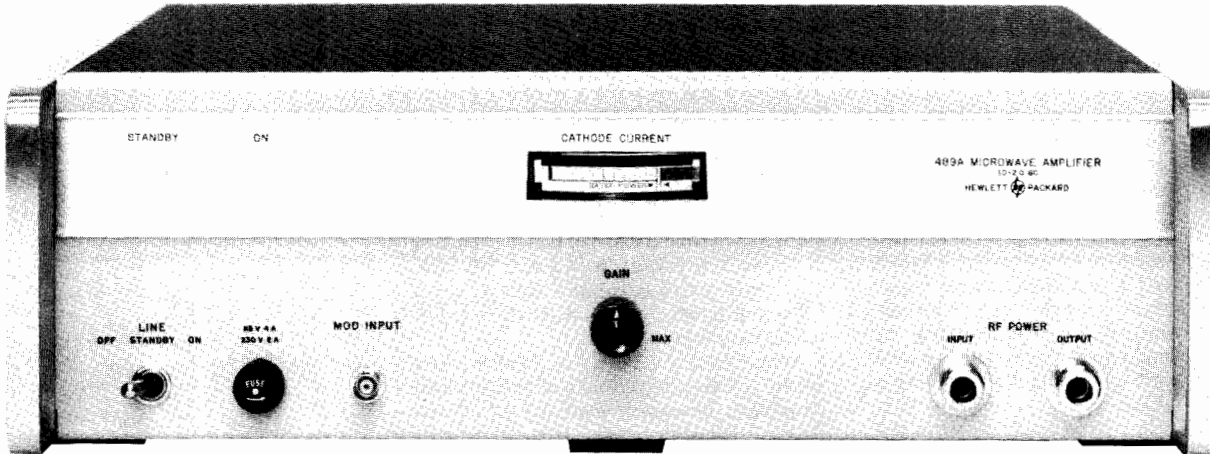

489A

### Microwave TWT Amplifiers

Amplification of frequencies from 1 to 12.4 GHz is accomplished in four ranges by the Hewlett-Packard medium-power, microwave amplifiers. Each delivers at least 1 watt for a 1-milliwatt input—a gain of at least 30 dB.

All four TWT amplifiers have provision for amplitude modulation, and since the internal modulation amplifier is dc-coupled, remote programming and power leveling are possible. Sensitivity is high for large output power changes from relatively small modulation signals, eliminating the need for an external modulation amplifier.

Cathode current in the TWT is monitored by a front panel meter and can be conveniently controlled by the GAIN adjustment for rated power output, or for reducing tube current to extend tube life when full output power is not required. The helix, collector, and anode current can be measured at an easily accessible test point board. Combined with the 8350 or 8620 Sweep Oscillator they make an excellent high power swept source.

#### Advantages

DC coupled modulation circuitry allows power leveling and remote programming.

Periodic-permanent-magnet focusing means fewer alignment problems.

#### Applications

Any one of the Hewlett-Packard TWT amplifier series is ideal for increasing the available RF power from a microwave sweep oscillator or signal generator when making antenna efficiency and antenna pattern measurements.

Also, they can easily extend the dynamic range of measurements up to 30 dB where RF substitution is employed in the measurement network.

RFI susceptibility tests often demand the high quality amplifying characteristics offered by this TWT amplifier series.

### 489A-495A Specifications

**Output power:** 1 watt for an input of  $\leq 1$  mW.

**Gain:** 30 dB at rated output.

**Input/output:** impedance, 50  $\Omega$ ; connectors, type N female.

**Noise figure:**  $\leq 30$  dB.

**Amplitude modulation:**

**Sensitivity (typically):** modulation input of  $> -20$  V peak reduces RF output by  $\geq 20$  dB from dc to 50 kHz.

**Frequency response (typically):** dc to 500 kHz (3 dB).

**Pulse response:**  $< 1$   $\mu$ s rise and fall times.

**Size:** 133 H x 426 W x 467 mm, (5.2" x 16.75" x 18.38").

**Weight:** net, 18 kg (40 lb). Shipping, 23.9 kg (53 lb).

	489A	491C	493A	495A
Frequency range (GHz)	1-2	2-4	4-8	7-12.4
Gain variation with freq. at rated output:	$\leq 6$ dB	$\leq 6$ dB	$\leq 6$ dB	$\leq 6$ dB
small signal: across any 10% of band	$\leq 5$ dB	$\leq 5$ dB	$\leq 5$ dB	$\leq 5$ dB
across full band	$\leq 12$ dB	$\leq 12$ dB	$\leq 12$ dB	$\leq 12$ dB for 300 MHz

#### Ordering Information

489A 1 to 2 GHz TWT Amplifier

491C 2 to 4 GHz TWT Amplifier

493A 4 to 8 GHz TWT Amplifier

495A 7 to 12.4 GHz TWT Amplifier

Opt 908: Rack Flange Kit (for all models)

### Selecting An Analog Voltmeter

Analog Voltmeters are used for many applications from general purpose bench or field use to special needs of true rms ac detection.

For measurements involving dc applications, select the instrument with the broadest capability meeting your requirements. For ac measurements involving sine waves with only modest amounts of distortion (<10%), the average-responding voltmeter can perform over a bandwidth extending to several megahertz. For high-frequency measurements (>10 MHz), the peak-responding voltmeter with the diode-probe input is the most economical choice. Peak-responding circuits are acceptable if inaccuracies caused by distortion in the input waveform can be tolerated. For measurements where it is important to determine the effective power of waveforms that depart from a true sinusoidal form, the True RMS-responding voltmeter is the appropriate choice.

Some analog voltmeters offer multiple functions such as dc and ac voltage plus resistance measurements.

### Analog Voltmeter Accuracy

Before we can discuss meter accuracy, we must have a familiarity with the various meter scales available. Many instruments have meter scales marked in both volts and decibel (dB) units. It should be noted that dB and

voltage are complements of each other. That is, if a voltage scale is made linear, the dB scale on the same meter face will be logarithmic or nonlinear. Likewise, if the dB scale is made linear, the voltage scale becomes nonlinear. The term "linear-log scale" is applied to an instrument that has a linear dB scale and, therefore, a nonlinear voltage scale. Several different types of meter faces are illustrated in Figure 1.

Analog meters usually have nonlinearities and/or offsets present in the attenuators and amplifiers. The meter movement itself can have nonlinearities even with individually calibrated meter scales. Nonlinearities cause percent of reading errors, and offsets cause percent of full scale errors.

Looking at instrument specification sheets, accuracy specifications are usually expressed in one of three ways: 1. percent of the full-scale value, 2. percent of the reading, 3. (percent of reading + percent of full-scale). The first is probably the most commonly used accuracy specification. The second (percent of reading) is more commonly applied to meters having a logarithmic scale. The last method has been used more recently to obtain a tighter accuracy specification on a linear-scale instrument.

Hewlett-Packard uses the two-part accuracy specification to take advantage of the upper-scale accuracy and yet maintain a reasonable specification for the lower portion of the scale.

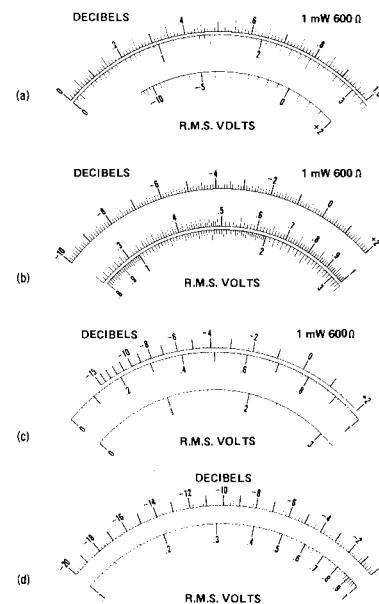

Figure 1. Four different types of meter scales available. (a) Linear 0-3 V and 0-10 V scales plus a dB scale. (b) Linear dB scale plus non-linear (logarithmic) voltage scales. (c) dB scale placed on larger arc for greater resolution. (d) Linear -20 to 0 dB scale useful for acoustical and communications applications.

### Analog Voltmeter Selection Chart

Model	AC VOLTMETERS	Voltage Range	Frequency Range; Typical Accuracy	Page
3400A	RMS VOLTMETER provides rms readings of complex signals. Has dc output for driving DVM's or recorders	1 mV to 300 V (12 ranges)	10 Hz to 10 MHz ±1% to ±5%	57
400E 400 EL	HIGH ACCURACY AC VOLTMETER has dc output (±0.5%) for driving recorder	1 mV to 300 V; -60 dB to +50 dB	10 Hz to 10 MHz ±1% to ±5%	58
400F 400 FL	FAST-RESPONSE AC VOLTMETER 100 kHz low-pass filter ac amplifier	100 μV to 300 V; -80 dB to +50 dB	20 Hz to 4 MHz; ±1% to ±4%	58
400GL	HIGH ACCURACY dB VOLTMETER 20 dB log scale (0 dB = 1 V)	-80 dB to +60 dB (8 ranges)	20 Hz to 4 MHz; ±0.2 dB to 0.4 dB	58
403B	RECHARGEABLE BATTERY AC VOLTMETER	1 mV to 300 V (12 ranges)	5 Hz to 2 MHz; ±2% to ±5%	59
3406A	SAMPLING RF VOLTMETER provides True RMS measurements when used with 3400A. Many accessories	1 mV to 3 V (8 ranges)	10 kHz to >1.2 GHz ±3% to ±13%	63
Model	MULTI-FUNCTION METERS	Voltage Range (Accuracy)	Resistance Range (Accuracy)	Page
427A	BATTERY-OPERATED MULTI-FUNCTION METER has 10 MΩ dc input impedance and 10 MΩ/20 pF ac input impedance	DC: ±100 mV to 1000 V (±2%) 9 ranges AC: 10 mV to 300 V 10 Hz to 1 MHz (±2%) 10 ranges	10 Ω to 10 MΩ mid-scale ±5%; from 0.3 to 3 on the meter scale (7 ranges)	61
410C	VERSATILE VOLTMETER has 100 MΩ dc input impedance and 10 MΩ/1.5 pF ac impedance	DC: ±15 mV to ±1500 V (±2%) 11 ranges AC: 0.5 V to 300 V 20 Hz to >700 MHz (±3% at 400 Hz) 7 ranges	10 Ω to 10 MΩ (center scale) 0 to midscale: ±5% or ±2% of midscale (whichever is greater) 11 ranges current: DC: ±1.5 μA to ±150 mA (±3%)	60
Model	CURRENT METERS	Current Range	Frequency Range	Page
428B	DC MILLIAMMETER with clip-on probe eliminates direct connection	1 mA to 10 A FS (9 ranges)	dc to 400 Hz	62

# ANALOG VOLTMETERS

## 10 Hz to 10 MHz True RMS Voltmeter

### Model 3400A



- 10 MHz bandwidth
- High crest factor for accurate pulse measurements
- Stable, linear DC output

- 1 mV full-scale sensitivity
- 10 MΩ input impedance
- Taut-band individually calibrated meter

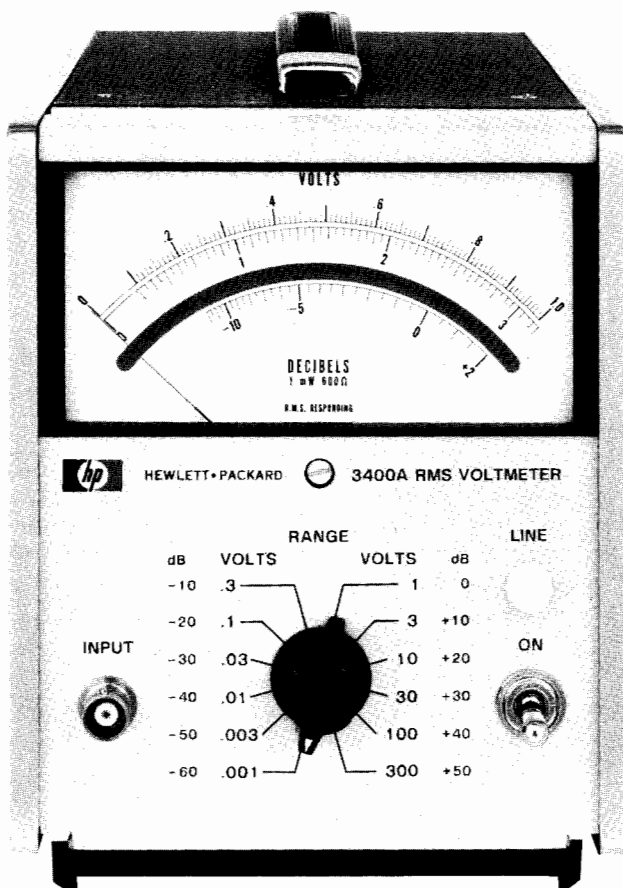

### Description

The Hewlett-Packard Model 3400A is a true root-mean-square (rms) voltmeter, providing a meter indication proportional to the dc heating power of the input waveform.

Six-decade frequency coverage makes the 3400A extremely flexible for all audio and most RF measurements and permits the measurement of broadband noise and fast-rise pulses.

Pulses or other non-sinusoids with crest factors (ratio of peak to rms) up to 10:1 can be measured full scale. Crest factor is inversely proportional to meter deflection, permitting up to 100:1 crest factor at 10% of full scale.

Permanent plots of measured data and higher resolution measurements can be obtained by connecting an X-Y plotter, strip chart recorder or digital voltmeter to the convenient rear-panel dc output. The dc output provides a linear 0 to 1 volt drive proportional to meter deflection.

### Specifications

**Voltage range:** 1 mV to 300 V full scale, 12 ranges.

**DB range:** -72 to +52 dBm (0 dBm = 1 mW into 600Ω).

**Frequency range:** 10 Hz to 10 MHz.

**Response:** responds to rms value (heating value) of the input signal for all waveforms.

**Meter accuracy:** % of full scale (20°C to 30°C)\*

10Hz	50Hz	1MHz	2MHz	3MHz	10MHz
±5%	±1%	±2%	±3%	±3%	±5%

**AC-to-DC converter accuracy:** % of full scale (20°C to 30°C)\*

10Hz	50Hz	1MHz	2MHz	3MHz	10MHz
±5%	±0.75%	±2%	±3%	±3%	±5%

\* TC: ±0.1% from 0°C to 20°C and 30°C to 55°C.

**Crest factor:** (ratio of peak to rms amplitude of input signal): 10 to 1 at full scale (except where limited by maximum input) inversely proportional to meter deflection (e.g., 20 to 1 at half-scale, 100 to 1 at tenth scale).

**Maximum continuous input voltage:** 500 V ac peak at 1 kHz on all ranges; 600 V dc on all ranges.

**Input impedance:** from 0.001 V to 0.3 V range: 10 MΩ shunted by <50 pF. From 1.0 V to 300 V range: 10 MΩ shunted by <20 pF. AC coupled input.

**Response time:** for a step function, <5 s to final value.

**AC overload:** 30 dB above full scale or 800 V p, whichever is less, on each range.

**Output:** negative 1 V dc into open circuit at full-scale deflection, proportional to meter deflection from 10-100% of full scale. 1 mA maximum; nominal source impedance is 1000Ω. Output noise <1 mV rms.

**Power:** 115 or 230 V ±10%, 48 to 66 Hz, 15 VA max.

**Size:** 159 H (without removable feet) x 130 W x 279 mm D (6.25" x 5.1" x 11"); 1/2 module.

**Weight:** net, 3.3 kg (7.3 lb). Shipping, 4.5 kg (10 lb).

**Accessories furnished:** 10110A Adapter, BNC to dual banana jack.

### Accessories Available

**11001A** Cable, 45 in. long, male BNC to dual banana plug

**11170A** Cable, 12 in., male BNC connectors

**11170B** Cable, 24 in., male BNC connectors

**11170C** Cable, 48 in., male BNC connectors

**11002A** Test lead, dual banana plug to alligator clips

**11003A** Test Leads, dual banana plug to probe and alligator clip

**11076A** Carrying Case

### Ordering Information

**3400A** Opt 001 spreads out the dB scale by making it the top scale of the meter.

Rear terminals in parallel with front panel terminals and linear log scale uppermost on the meter face are available on special order.

**3400A RMS Voltmeter**

# ANALOG VOLTMETERS

AC Voltmeter, 10 Hz to 10 MHz

Models 400E, EL, F, FL, GL

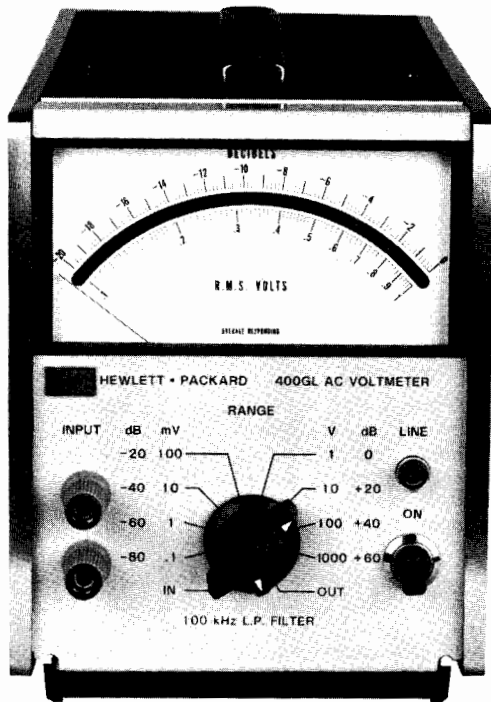

400GL

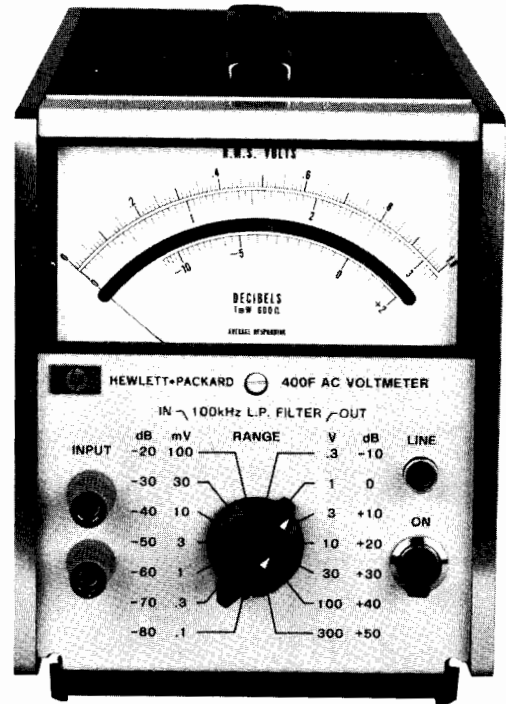

400F

## Specifications

	400E/EL*	400F/FL*	400 GL
Voltage range	1 mV to 300 V F.S. 12 ranges	100 $\mu$ V to 300 V F.S. 14 ranges	-80 dB to +60 dB F.S. 8 ranges
Frequency range	10 Hz-10 MHz	20 Hz-4MHz	20 Hz-4 MHz
Input impedance	10 M $\Omega$ on all ranges <25 pF to <12 pF depending on ranges	10 M $\Omega$ on all ranges <30 pF to <15 pF depending on ranges	10 M $\Omega$ on all ranges <30 pF to <15 pF depending on ranges
Accuracy*	$\pm$ (% reading + % range) <b>3 mV-300 V ranges</b> 10 Hz-40 Hz: $\pm$ (2.5 + 2.5) 40 Hz-2 MHz: $\pm$ (1 + 0) 2 MHz-4 MHz: $\pm$ (1.5 + 1.5)  <b>4 MHz-10 MHz</b> 3 mV range: $\pm$ (2.5 + 2.5) 10 mV-3V range: $\pm$ (3.0 + 2.0) for 4 MHz to 6 MHz $\pm$ (3.75 + 3.75) for 6 MHz to 10 MHz 10 V-30 V: $\pm$ (3.5 + 3.5)  <b>1 mV range</b> 10 Hz-40 Hz: $\pm$ (2.5 + 2.5) 40 Hz-500 kHz: $\pm$ (1 + 0) 500 kHz-4 MHz: $\pm$ (2.5 + 2.5)	(% reading + % range) (% reading) <b>300 <math>\mu</math>V-300 V ranges</b>  <b>F</b> 20 Hz-40 Hz: $\pm$ (2 + 2) 40 Hz-100 Hz: $\pm$ (1 + 1) 100 Hz-1 MHz: $\pm$ ( $\frac{1}{2}$ + $\frac{1}{2}$ ) 1 MHz-2 MHz: $\pm$ (1 + 1) 2 MHz-4 MHz: $\pm$ (2 + 2)  <b>100 <math>\mu</math>V range</b> 30 Hz-60 Hz: $\pm$ (2 + 2) $\pm$ 4 60 Hz-100 kHz: $\pm$ (1 + 1) $\pm$ 2 100 kHz-500 kHz: $\pm$ (1 + 1) $\pm$ 2 $\pm$ (1 + (+0, -7)) $\pm$ 1, -8	<b>+60 dB range</b> 20 Hz-40 kHz: $\pm$ 0.4 dB 40 kHz-100 kHz: $\pm$ 0.2 dB  <b>-60 dB thru +40 dB ranges</b> 20 Hz-40 Hz: $\pm$ 0.4 dB 40 Hz-500 kHz: $\pm$ 0.2 dB 500 kHz-2 MHz: $\pm$ 0.4 dB 2 MHz-4 MHz: +0.2, -0.8 dB  <b>-80 dB range</b> 30 Hz-60 Hz: $\pm$ 0.4 dB 60 Hz-100 kHz: $\pm$ 0.2 dB 100 kHz-500 kHz: +0.2, -0.8 dB
Recovery		<2 s for 80 dB overload	
Overload		**500 V rms ac, 300 V dc	**1200 V rms max. input; 1000 V dc max. input
Calibration		Responds to average value of input; calibrated in rms value of sine wave. Scale -10 to +2 dB between ranges, 100 divisions on 0 to 1 scale. The dB scale reads -10 to +2 dB; 10 dB between ranges.	Responds to average value of input; calibrated in rms value of sine wave. Linear -20 to 0 dB scale, 100 divisions. 20 dB per range. Log voltage scale.
Weight		Net, 2.7 kg (6 lb). Shipping, 4.1 kg (9 lb)	
Size		159 mm H (without removable feet) x 130 mm W x 297 mm D (6.25" x 5.13" x 11")	
Power		AC: 115 or 230 V +10%, 48 to 440 Hz, 6 VA max. DC: External batteries: + and - voltages between 35 V and 55 V	

\* NOTE: 400 EL same as 400E, and 400FL same as 400F, except for calibration. Linear dB scale -10 dB to +2 dB, 10 dB between ranges. Log voltage scales 0.3 to 1 and 0.8 to 3, 120 divisions from -10 dB +2 dB. 400 FL accuracy is % of reading in dB only.

\*\* AC overload voltage decreases with increasing frequency.

# ANALOG VOLTMETERS

## 5 Hz to 2 MHz AC Solid-State Voltmeter

Model 403B

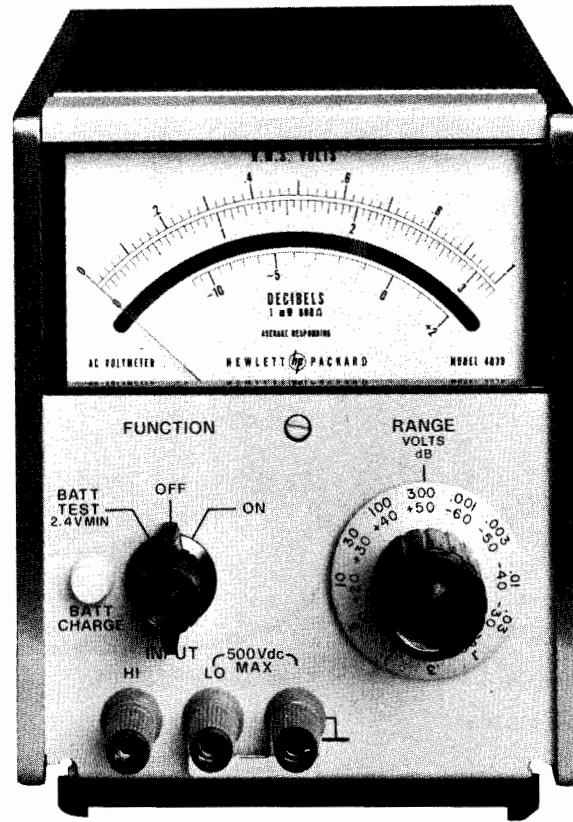

### Description

The Hewlett-Packard 403B AC Voltmeter is a versatile, general purpose instrument for laboratory and production work, yet is ideal for use in the field since it is solid-state, battery operated, and portable.

It measures from 100 microvolts to 300 volts, covering 5 Hz to 2 MHz. It operates from internal batteries and thus may be completely isolated from the power line and external grounds, permitting accurate measurements at power line frequency and its harmonics without concern for beat effects. Isolation from external ground also permits use where ground loops are troublesome. Turnover effect and waveform errors are minimized because the meter responds to the average

value of the input signal.

The 403B operates from an AC line as well as from the internal battery pack, and batteries recharge during AC operation. Battery charge may be easily checked with a front-panel switch to assure reliable measurements. Normally, about 60 hours of AC operation recharges the batteries; but an internal adjustment is provided which nearly doubles the charging rate. The Model 403B can be used while its batteries charge. A sturdy taut-band meter eliminates friction and provides greater precision and repeatability.

For improved resolution in dB measurements, the 403B Option 001 is available. This version spreads out the dB scale by making it the top scale of the meter.

### Specifications

Range	0.001 to 300 V rms full scale, 12 ranges, in a 1, 3, 10 sequence. -60 dB to +50 dB in 12 ranges with 10 dB steps.	
Meter	Responds to average value of input waveform, calibrated in the rms value of a sine wave.	
Frequency Range	5 Hz to 2 MHz	
Accuracy	Within $\pm 2\%$ ( $\pm 0.2$ dB) of full scale from 10 Hz to 1 MHz; within $\pm 5\%$ ( $\pm 0.4$ dB) of full scale from 5 to 10 Hz and from 1 to 2 MHz, except $\pm 10\%$ ( $\pm 0.8$ dB) from 1 to 2 MHz on the 300 V range (0 to 50°C).	
Input Impedance	2 M $\Omega$ ; shunted by <60 pF, 0.001 to 0.03 V ranges; <30 pF, 0.1 to 300 V ranges.	
Maximum Input	Fuse protected (signal ground can be $\pm 500$ V DC from chassis).	
Power	4 rechargeable batteries, 40 hr. operation per recharge, up to 500 recharging cycles; self-contained recharging circuit functions during operation from AC line.	AC line power: 115 V or 230 V ( $\pm 10\%$ ), 50-400 Hz, 2 VA
Size	159 mm H (without removable feet) x 130 mm W x 225 mm D (6.25" x 5.13" x 8.88").	
Weight	net, 2.9 kg (6.5 lb). Shipping, 3.6 kg (8 lb).	





# ANALOG VOLTMETERS

## General Purpose Multi-Function Voltmeter

Model 410C

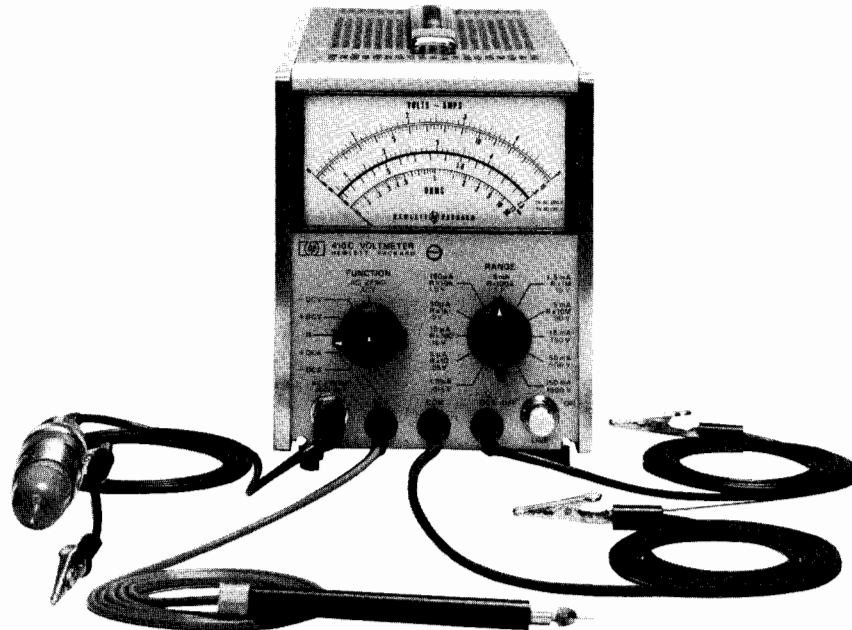

410C with 11036A

### Description

HP's Model 410C is a versatile general purpose instrument for use anywhere electrical measurements are made. This instrument measures dc voltages from 15 mV to 1500 V, dc current from 1.5  $\mu$ A to 150 mA, and resistance from 0.2  $\Omega$  to 500 M $\Omega$ . With a standard plug-in probe, ac voltages at 20 Hz to 700 MHz from 50 mV to 300 V and comparative indications to 3 GHz are attainable.

### Specifications

#### DC Voltmeter

**Voltage ranges:**  $\pm 15$  mV to  $\pm 1500$  V full scale in 15, 50 sequence (11 ranges).

**Accuracy:**  $\pm 2\%$  of full scale on any range.

**Input resistance:** 100 M $\Omega$   $\pm 1\%$  on 500 mV range and above, 10 M $\Omega$   $\pm 3\%$  on 150 mV range and below.

#### AC Voltmeter

**Voltage ranges:** 0.5 V to 300 V full scale in 0.5, 1.5, 5 sequence (7 ranges)

**Frequency range:** 20 Hz to 700 MHz.

**Accuracy:**  $\pm 3\%$  of full scale at 400 Hz for sinusoidal voltages from 0.5 V–300 V rms. The ac probe responds to the positive peak-above-average value of the applied signal. The meter is calibrated in rms.

**Frequency response:**  $\pm 2\%$  from 100 Hz to 50 MHz (400 Hz ref.); 0 to  $-4\%$  from 50 MHz to 100 MHz;  $\pm 10\%$  from 20 Hz to 100 Hz and from 100 MHz to 700 MHz.

**Input impedance:** input capacitance 1.5 pF, input resistance  $> 10$  M $\Omega$  at low frequencies. At high frequencies, impedance drops off due to dielectric loss.

**Safety:** the probe body is grounded to chassis at all times for safety. All ac measurements are referenced to chassis ground.

#### DC Ammeter

**Current ranges:**  $\pm 1.5$   $\mu$ A to  $\pm 150$  mA full scale in 1.5, 5 sequence (11 ranges).

**Accuracy:**  $\pm 3\%$  of full scale on any range.

**Input resistance:** decreasing from 9 k $\Omega$  on 1.5  $\mu$ A range to approximately 0.3  $\Omega$  on the 150 mA range.

**Special current ranges:**  $\pm 1.5$ ,  $\pm 5$  and  $\pm 15$   $\mu$ A may be measured on the 15, 50 and 150 mV ranges using the dc voltmeter probe, with  $\pm 5\%$  accuracy and 10 M $\Omega$  input resistance.

#### Ohmmeter

**Resistance range:** resistance from 10 $\Omega$  to 10 M $\Omega$  center scale (7 ranges).

**Accuracy:** zero to midscale:  $\pm 5\%$  of reading or  $\pm 2\%$  of midscale, whichever is greater;  $\pm 7\%$  from midscale to scale value of 2;  $\pm 8\%$  from scale value of 2 to 3;  $\pm 9\%$  from scale value of 3 to 5;  $\pm 10\%$  from scale value of 5 to 10.

#### Amplifier

**Voltage gain:** 100 maximum.

**AC rejection:** 3 dB at 0.5 Hz; approximately 66 dB at 50 Hz and higher frequencies for signals  $< 1600$  V p or 30 times full scale, whichever is smaller.

**Isolation:** impedance between common and chassis is  $> 10$  M $\Omega$  in parallel with 0.1  $\mu$ F. Common may be floated up to 400 V dc above chassis for dc and resistance measurements.

**Output:** proportional to meter indications; 1.5 V dc at full scale, maximum current, 1 mA.

**Output impedance:**  $< 3$   $\Omega$  at DC.

**Noise:**  $< 0.5\%$  of full scale on any range (p-p).

**DC drift:**  $< 0.5\%$  of full scale/yr at constant temperature.  $< 0.02\%$  of full scale/ $^{\circ}$ C.

**Overload recovery:** recovers from 100:1 overload in  $< 3$  s.

#### General

**Maximum input:** (see overload recovery). DC: 100 V on 15, 50 and 150 mV ranges, 500 V on 0.5 to 15 V ranges, 1600 V on higher ranges. AC: 100 times full scale or 450 V p whichever is less.

**Power:** 115 V or 230 V  $\pm 10\%$ , 50 Hz to 440 Hz, 15 VA (24 VA with 11036A ac probe).

**Size:** 165 mm H (without removable feet), x 130.2 mm W x 280 mm D (6 $\frac{1}{2}$ " x 5 $\frac{1}{8}$ " x 11") behind panel.

**Weight:** net, 3.6 kg (8 lb). Shipping, 6.35 kg (14 lb).

**Accessories furnished:** detachable power cord, 11036A AC probe.

#### Ordering Information

**410C** with HP 11036A Detachable AC probe

**410C** Option 002 (less ac probe)

# ANALOG VOLTMETERS

## Low-Cost Multi-Function Meter

Model 427A

61

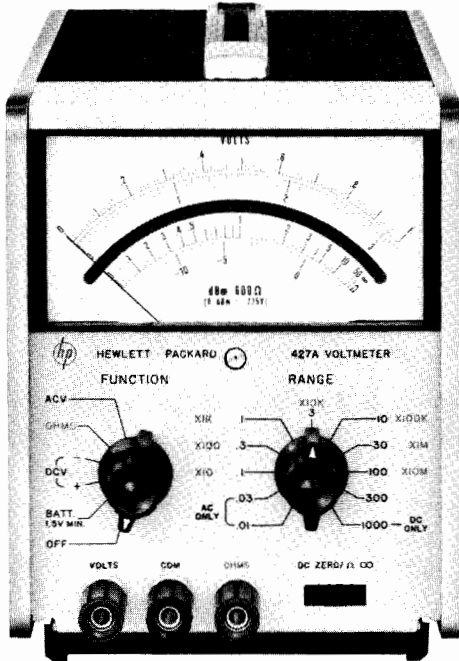

427A

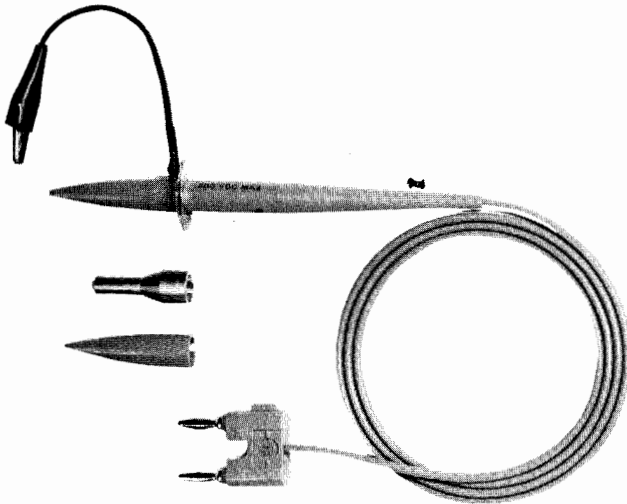

11096B

### Description

Hewlett-Packard's Model 427A is a portable, versatile, low cost multi-function meter which is valuable in any laboratory, production line, service department, or in the field. It is capable of measuring dc voltages from 100 mV to 1 kV full scale; ac voltage from 10 mV to 300 V full scale at frequencies up to 1 MHz (>500 MHz with the 11096B High Frequency Probe); and resistance from 10  $\Omega$  to 10 M $\Omega$  center scale.

The 427A will operate continuously for more than 300 hours on its internal 22.5 V dry cell battery. AC line and battery operation is available with option 001.

### Specifications

#### DC Voltmeter

**Ranges:**  $\pm 100$  mV to  $\pm 1000$  V in 9 ranges in 10 dB steps.

**Accuracy:**  $\pm 2\%$  of range.

**Input resistance:** 10 M $\Omega$ .

**AC normal mode rejection (ACNMR):** ACNMR is the ratio of the normal mode signal to the resultant error in readout. 50 Hz and above: >80 dB.

**Overload protection:** 1200 V dc.

#### AC Voltmeter

**Ranges:** 10 mV to 300 V in 10 ranges in 10 dB steps.

**Frequency range:** 10 Hz to 1 MHz.

**Response:** responds to average value, calibrated in rms.

**Accuracy:**

Frequency	Range	
		0.01 V to 30 V
10 Hz to 100 kHz	2% of range	
100 kHz to 1 MHz	2% of range	

**Input impedance:** 10 mV to 1 V range, 10 M $\Omega$  shunted by <40 pF; 3 V to 300 V range, 10 M $\Omega$  shunted by <20 pF.

**Overload protection:** 300 V rms momentarily, 1 V range and below; 425 V rms max above 1 V range.

#### Ohmmeter

**Ranges:** 10  $\Omega$  to 10 M $\Omega$  center scale in 7 decade ranges.

**Accuracy:**  $\pm 5\%$  of reading (from 0.3 to 3 on scale)

**Source current** (ohms terminal positive)

Range	Open circuit Voltage	Short circuit Current
X 10	0.1 V	10 mA
X 100	0.1 V	1 mA
X 1 k	1 V	1 mA
X 10 k	1 V	100 $\mu$ A
X 100 K	1 V	10 $\mu$ A
X 1 M	1 V	1 $\mu$ A
X 10 M	1 V	0.1 $\mu$ A

### General

**Input:** may be floated up to  $\pm 500$  V dc above chassis ground. Ohms input open in any function except ohms. Volts input open when instrument is off.

**Operating temperature:** 0°C to 50°C.

**Power:** >300 hr operation per battery.

**HP 427A.** 22.5 V dry cell battery, Eveready No. 763 or RCA VS102. HP 427A Option 001: battery operation or ac line operation, selectable on rear panel. 115 V or 230 V  $\pm 20\%$ , 50 Hz to 400 Hz, 0.7 VA max.

**Size:** (standard  $\frac{1}{2}$  module): 159 mm H (without removable feet) x 130 mm W x 203 mm D (6.25" x 5.13" x 8").

**Weight:** net, 2.4 kg (5.3 lb). Shipping, 3.2 kg (7 lb).

### Accessories Available

HP 11096B High Frequency AC Probe extends range to >500 MHz. With the 11096B, you can measure 0.25 to 30 V rms signals out to 500 MHz with better than  $\pm 1.2$  dB accuracy. Usable relative measurements can be made up to 1 GHz (3 dB point at 700 MHz). The 11096B is a peak-responding detector calibrated to produce a dc output proportional to the rms value of a sine wave input. Input impedance is 4 M $\Omega$  shunted by 2 pF.

### Options and Accessories

**11075A** High Impact Case. A rugged case for carrying, storing and operating the 427A

**11096B** High Frequency AC probe

**11001A** 45" test lead, dual banana plug to male BNC

**11002A** 60" test lead, dual banana plug to alligator clips

**11003A** 60" test lead, dual banana plug to pencil probe and alligator clip.

**10111A** BNC female to dual banana adapter

### Ordering Information

**427A** Multi-function Meter (includes batteries)

**427A Option 001** AC power supply & battery



# ANALOG VOLTMETERS

## 1 mA to 10 A Clip-On dc Milliammeter

Model 428B

- No circuit interruption
- No circuit loading



428B



3529A

### Description

Direct current from 1 milliamperes to 10 amperes full scale can be measured without interrupting your measured circuit or producing loading errors. With the HP Model 428B Clip-on Milliammeter, cutting wires for insertion of current meters and calculating current from voltage and resistance readings are eliminated. All that is required for fast, accurate readings is to clip around the wire and select the proper current range.

The 428B measures current by utilizing a clip-on transducer that converts the magnetic field around the conductor to an ac voltage proportional to dc current. This voltage is detected and displayed as direct current on the 428B's meter. Since there is no direct contact with the circuit being measured, complete dc isolation is assured.

The meter responds to dc current only and is therefore not susceptible to common mode currents. However, low frequency currents up to 400 Hz can be measured by connecting an oscilloscope or voltmeter to the convenient front panel output; or this output can be used to drive a strip chart recorder for permanent long term records.

For even greater sensitivity, several loops of the measured conductor can be put through the probe, increasing sensitivity by the same factor as the number of turns used.

### Specifications

**DC current range:** 1 mA to 10 A full scale, nine ranges.

**Accuracy:**  $\pm 3\%$  of full scale  $\pm 0.15$  mA, from 0°C to 55°C (when instrument is calibrated to probe).

**Probe inductance:**  $< 0.5 \mu\text{H}$ .

**Probe induced voltage:**  $< 15$  mV p (worst case at 20 kHz and harmonics).

**Output:** variable linear output level with switch position for calibrated 1 V into open circuit (corresponds to full scale deflection). 1.5 V

max. into open circuit in uncalibrated position.  $0.73 \pm .01$  V into 1 k $\Omega$  in calibrated position.

**Noise:** 1 mA range,  $< 15$  mV rms across 1 k $\Omega$ ; 3 mA range,  $< 5$  mV rms across 1 k $\Omega$ ; 10 mA through 10 A ranges,  $< 2$  mV rms across 1 k $\Omega$ .

**Frequency range:** dc to 400 Hz (3 dB point).

**AC rejection:** signals  $> 5$  Hz with pk value  $<$  full scale affect meter accuracy  $< 2\%$  (except at 40 kHz carrier frequency and its harmonics). On the 10 A range, ac pk value is limited to 4 A.

**Power:** 115 or 230 V  $\pm 10\%$ , 50 to 60 Hz, approx. 75 V A max.

**Operating temperature range:**  $-20^\circ\text{C}$  to  $+55^\circ\text{C}$ .

**Probe insulation:** 300 V maximum.

**Probe tip size:**  $\approx 0.5$  in. (12.7 mm) by  $0.66$ " (16.67 mm) aperture diameter 0.16 in. (3.97 mm).

**Size:** cabinet: 292 H x 191 W x 368 mm D (11.5" x 7.5" x 14.5").

**Weight:** net, 8.6 kg (19 lb). Shipping, 10.9 kg (24 lb).

### Accessories Available

**3529A Magnetometer Probe:** this probe measures magnetic field strength and direction. The component of magnetic field sensed is parallel to the cylindrical axis of the probe. Applications include the testing of magnetic materials for air shipment.

**Range:** 1 mG to 10 G full scale, nine ranges.

1 mG = 1 mA conversion factor.

**Accuracy:**  $\pm 3\%$  of full scale (0°C to  $+55^\circ\text{C}$ ) after calibration.

**Frequency range:** dc to 80 Hz (3 dB point).

**Weight:** net 0.45 kg (1 lb). Shipping 0.91 kg (2 lb).

### Ordering Information

3529A Magnetometer Probe

428B Analog Milliammeter (cabinet)

# ANALOG VOLTMETERS

10 kHz to 1.2 GHz RF Voltmeter

Model 3406A

63

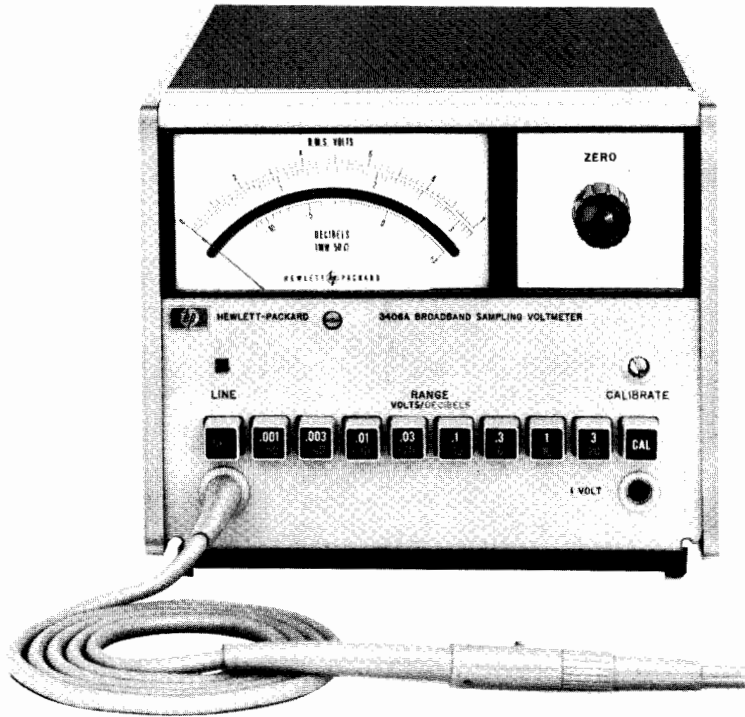

## Description

High frequency voltages can be measured easily with HP's 3406A Sampling Voltmeter. Employing sampling techniques, the HP 3406A has extremely wide bandwidth (10kHz to 1.2 GHz) with high input impedance. Signals as small as 50  $\mu$ V can be resolved. Full scale sensitivity from 1 mV to 3 V is selected in eight 10 dB steps and may be read directly from -62 dBm to +23 dBm. Accessory probe tips convert the HP 3406A for voltage measurements in applications such as receivers, amplifiers and coaxial transmission lines.

Measurement can be retained on the 3406A meter by depressing a pushbutton located on the pen-type probe. This is useful when measurements are made in awkward positions where the operator cannot observe the meter indication and probe placement at the same time.

## Specifications

**Voltage range:** 1 mV to 3 V full scale in 8 ranges; decibels from -50 to +20 dBm (0 dBm = 1 mW into 50  $\Omega$ ); average-responding instrument calibrated to rms value of sine wave.

**Frequency range:** 10 kHz to 1.2 GHz; useful sensitivity from 1 kHz to beyond 2 GHz.

**Full-scale accuracy (%) with appropriate accessory** (after probe is properly calibrated)

10 kHz	20 kHz	25 kHz	100 kHz	100 MHz	700 MHz	1 GHz	1.2 GHz
$\pm 13$	$\pm 8$	$\pm 5$	$\pm 3$	$\pm 5$	$\pm 8$	$\pm 13$	$\pm 13$

**Input impedance:** input capacity and resistance will depend upon accessory tip used. 100,000  $\Omega$  shunted by <2.1 pF at 100 kHz with bare probe; <10 pF with 11072A isolator tip supplied.

## Sample Hold Output

Provides ac signal whose unclamped portion has statistics that are narrowly distributed about the statistics of the input, inverted in sign

(operating into >200 k $\Omega$  load with <1000 pF). Output is 0.316 V at f.s. on any range.

**Noise:** <175  $\mu$ V rms referred to input.

**Accuracy (after calibration):** 0.01 V range and above: same as full scale accuracy of instrument. 0.001 V to 0.003 V range: value of input signal can be computed by taking into account the residual noise of the instrument. Jitter: meter indicates within  $\pm 2\%$  pk of reading 95% of time (as measured with HP 3400A True RMS Voltmeter).

**RMS crest factor:** 0.001 V to 0.3 V, 20 dB; 1 V, 13 dB; 3 V, 3 dB.

## Meter

**Meter scales:** linear voltage, 0 to 1 and 0 to 3; decibel, -12 to +3. Individually calibrated taut-band meter.

**Response time:** Indicates within specified accuracy in <3 s.

**Jitter:**  $\pm 1\%$  peak (of reading).

## General

**DC recorder output:** adjustable from 0 to 1.2 mA into 1000 ohms at full scale, proportional to meter deflection.

**Overload recovery time:** meter indicates within specified accuracy in <5 s (30 V p-p max.).

**Maximum input:**  $\pm 100$  V dc, 30 V p-p.

**RFI:** conducted and radiated leakage limits are below those specified in MIL-6181D and MIL-1-16910C except for pulses emitted from probe. Spectral intensity of these pulses is nominally 50 nV/ $\sqrt{\text{Hz}}$ ; spectrum, extends beyond 2 GHz.

**Temperature range:** Instrument, 0°C to +55°C; probe, +10°C to +40°C.

**Power:** 115 or 230 V  $\pm 10\%$ , 48 Hz to 66 Hz, 25 VA max.

**Size:** 159 mm H (without removable feet), x 197 mm W x 279 mm D (6.25" x 7.75" x 11");  $\frac{1}{2}$  module.

**Weight:** net, 5.4 kg (12 lb). Shipping, 6.8 kg (15 lb).

**Accessories:** refer to data sheet.

**3406A RF Voltmeter**

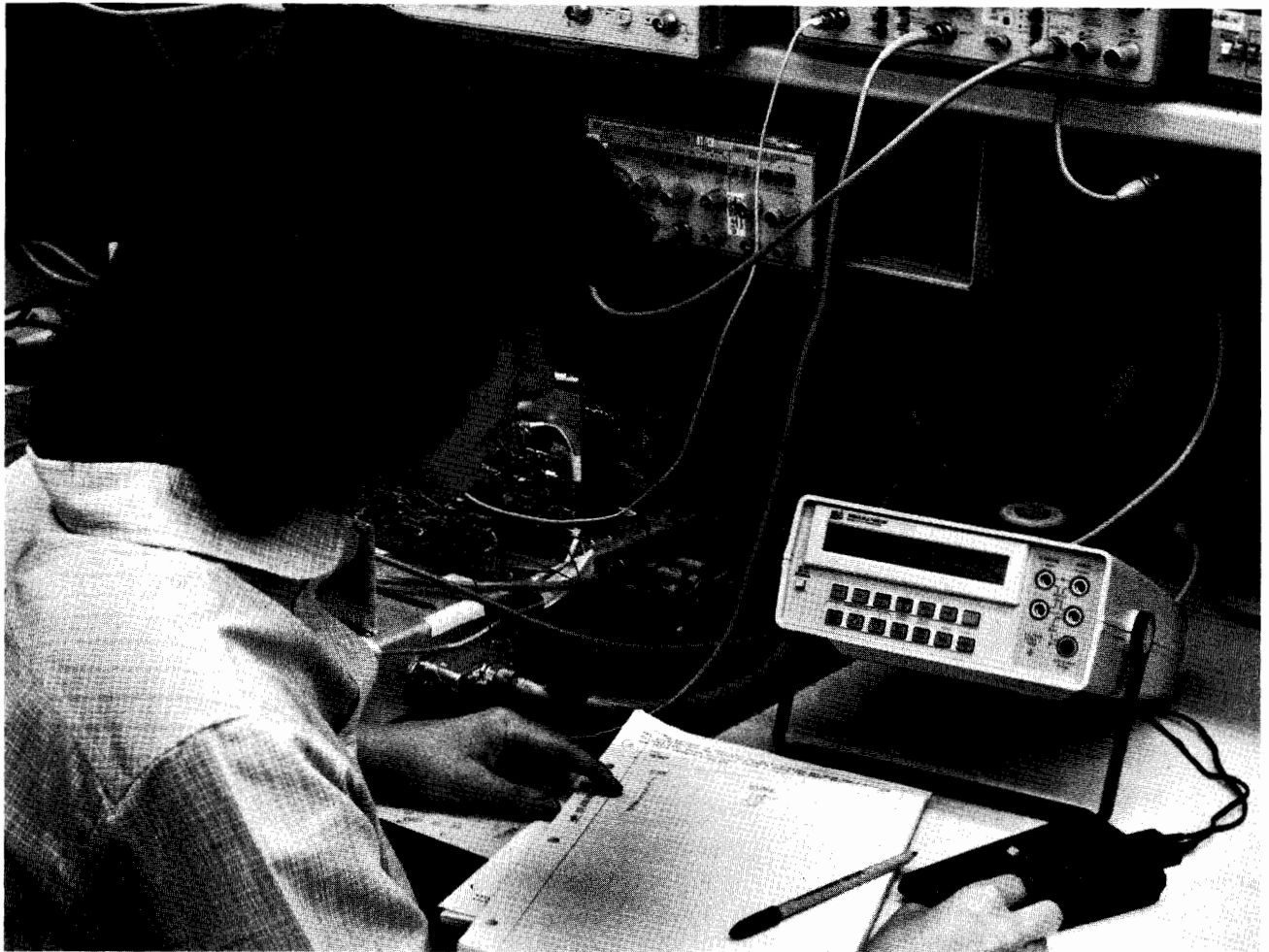

DVM's have historically been optimized for either a systems environment where speed is important or for bench applications where high accuracy, high resolution and low noise are paramount. In keeping with the precedent set by HP's high performance DVM, the 3456A, HP introduces two new DMM's—the 3468A and the 3478A. Both offer the classical trade-off between speed and accuracy by using the same multislope integration A/D technique introduced in the 3456A. Both offer  $3\frac{1}{2}$  to  $5\frac{1}{2}$  digit resolution. Both are full five function digital multimeters with dc volts, true rms ac volts, resistance, dc current, and true rms ac current. Both are completely programmable. Both offer complete, adjustment-free electronic calibration. The calibration constants are retained in non-volatile memory by a lithium battery capable of holding the calibration constants for more than ten years. And both the HP 3468A and 3478A are attractively low priced.

A new, low cost interface for peripheral and instrumentation is found in the HP 3468A. It is called HP-IL, the Hewlett-Packard Interface Loop. The new interface offers a low power, multidrop serial interface which allows interfacing between handheld

calculators like the 41C/CV and the series 80 Personal Computers and the HP 3468A DMM. All of this computational power can be applied to automate measurements on the bench or in a production environment.

With the power of a programmable calculator and the HP 3468A, software can easily be developed to analyze and store data for a customer's specific application. For example, if a customer needs to measure temperature, he can use the 41C/CV to linearize the transducer device and display the results in degrees C or F right on the display of the HP 3468A. With a simple 41C/CV program, the HP 3468A can display in dBm referenced to any impedance for audio and telecommunication applications. For applications such as resistor tolerance or performance testing of a device, the HP 3468A can easily be programmed to provide the measurements necessary for tolerance testing.

The new HP 3478A DMM offers high system performance at low cost bench prices. The HP 3478A measures dc volts, true rms ac volts, 2 and 4 wire ohms, and current with  $3\frac{1}{2}$ ,  $4\frac{1}{2}$ , or  $5\frac{1}{2}$  digit resolution. It measures dc voltage from 30 mV full scale with 100 nanovolt sensitivity up to 300 volts. This wide

dynamic range allows detection of low level signals or higher voltages and reduces the amount of signal conditioning necessary. The HP 3478A has a 300 kHz bandwidth and 4:1 crest factor to give customers confidence in true rms ac voltage measurements. Either 2-wire or 4-wire ohms measurements can be selected with a maximum range of 30 Mohms down to a 100 microhm sensitivity on the 30 ohm range. 4-wire ohms can be used for reducing errors caused by cable resistance and relay scanners in a customer's system or the 2-wire ohms can be used for convenience. Both .3 A and 3 A ranges of dc and true rms ac current are provided, completing the function capability of the HP 3478A.

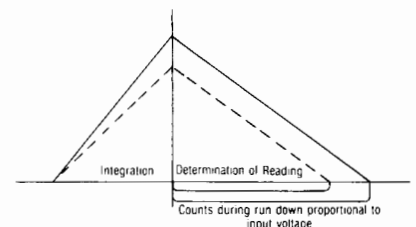

Figure 1. The classical dual-slope integration technique is limited in speed to how fast the zero crossing can be detected accurately. In addition, the final reading is not known until rundown has been completed. Note that the voltage remaining on the integrator's capacitor is proportional to input level.



### HP IC Technology Lowers the Cost of Multi-slope A/D Conversion

The A/D conversion technique pioneered by the HP 3456A has been refined with monolithic clip technology on the HP 3468A and 3478A to give high performance at very low cost. In addition, the reduced number of parts in the new multimeters means reduced service problems and lower cost of ownership. The basic design contributions of the multi-slope technique are:

1. Speed
2. Elimination of high speed logic in the zero comparator.
3. Keeping the run-up slopes steep to effectively extend the range of the comparator.

4. Completion of the A/D conversion during the measurement.
5. Conversion of the gain errors and timing errors into offset errors where they can be subtracted out.

In summary, the design emphasis of the new HP 3468A and 3478A lets the customer match his DMM needs to the performance level required. Either extremely high performance in resolution, speed, and accuracy with the HP 3456A or low cost for automated bench use with the HP 3468A & 3478A. The DMM Selection Chart below can help in the selection of the DVM for a bench or system application.

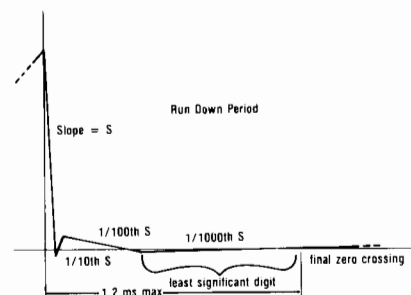

Figure 2. The Multi-slope II technique used in the 3456A Digital Voltmeter employs a four-slope rundown to successively establish the value of the four least significant digits in the final reading. Note that the final zero crossing which determines the least significant digits is done with the shallowest slope.

### BENCH DVM'S

DVM's	Features	dc Volts				ac Volts	Resistance			Current		General			
		Max. Input	Rdgs/Sec	Ranges	Sensitivity		Basic Accuracy	Bandwidth	Ranges	Sensitivity	Open Circuit Voltage	ac	dc	Ranging	Over-range
3435A 3½ digit p 68	<ul style="list-style-type: none"> <li>Accuracy</li> <li>10 milli Ω</li> </ul>	1200 V	4.7	100 mV to 1200 V	100 μV	±(.1% Rdg. + 1 count)	100 kHz	10 Ω to 10 MΩ	10 milli Ω	< 5 V	Yes	Yes	Auto/Manual	100%	Battery Power Opt 002
3466A 4½ digit p 69	<ul style="list-style-type: none"> <li>Autorange</li> <li>True RMS</li> <li>1 μV sensitivity</li> </ul>	1200V	4.7	10 mV to 1200 V	1 μV	±(.03% Rdg. + 1 count)	100 kHz True rms	10 Ω to 10 MΩ	1 milli Ω	< 5 V	Yes True rms	Yes	Auto/Manual	100%	Battery Power Trms/ac or dc
3467A 4½ digit p 70	<ul style="list-style-type: none"> <li>Temperature</li> <li>Printer/Timer</li> <li>4 channels</li> </ul>	350 V	4.5	20 mV to 350 V	1 μV	±(.03% Rdg. + 1 count)	100 kHz True rms	200 Ω to 20 MΩ	10 milli Ω	< 5 V			Auto/Hold	100%	Total Measurement Station
3468A 3½-5½ digit p. 66	<ul style="list-style-type: none"> <li>HP-IL</li> <li>5 Functions</li> <li>Low Cost</li> </ul>	300 V	32 (3.7 with 5½ digit)	.3 V to 300 V	1 μV	±(.0035% Rdg. + 2 counts)	300 kHz True rms	300 Ω to 30 MΩ	1 mΩ	<6.5 V	Yes True rms	Yes	Auto/Manual	N/A	Battery-Option 001 HP-IL

### SYSTEM DVM'S

DVM's	Features	dc Volts				ac Volts	Resistance			Current		General			
		Max. Input	Rdgs/Sec	Ranges	Sensitivity		Basic Accuracy	Bandwidth	Ranges	Sensitivity	Open Circuit Voltage	ac	dc	Ranging	Over-range
3438A 3½ digit p 82	<ul style="list-style-type: none"> <li>HP-IB</li> <li>Low Cost</li> </ul>	1200 V	4.7	200 mV to 1200 V	100 μV	±(.1% Rdg. + 1 count)	100 kHz	10 Ω to 10 MΩ	10 milli Ω	< 5 V	Yes	Yes	Auto/Manual	100%	Five function HP-IB
3437A 3½ digit p 80	<ul style="list-style-type: none"> <li>HP-IB</li> <li>High speed Sample/Hold</li> </ul>	20 V	5700	100 mV to 10 V	100 μV	±(.03% Rdg. + 2 counts)							Manual	100%	HP-IB Int. timer Sample/Hold Hold
3455A 5½, 6½ digit p 78	<ul style="list-style-type: none"> <li>HP-IB</li> <li>AutoCal</li> </ul>	1000 V	24	100 mV to 1000 V	1 μV	±(.002% Rdg. + 1 count)	1 MHz True rms	100 Ω to 10 MΩ	1 milli Ω	< 5 V			Auto/Manual	50%	HP-IB, guarded, 4 terminals, Math
3456A 3½, 4½, 5½, 6½ digit p 74	<ul style="list-style-type: none"> <li>High Performance</li> <li>Selective integration time</li> </ul>	1000 V	330 (48 with 6½ digits)	100 mV to 1000 V	100 nV	±(.0008% Rdg. + 2 counts)	250 kHz True rms	100 Ω to 1 GΩ	100 μΩ	< 9.5 V			Auto/Manual	20%	HP-IB, guarded, Statistics, Pass/Fail, Offset, % error
3478A 3½-5½ digit p. 72	<ul style="list-style-type: none"> <li>HP-IB</li> <li>5 Function</li> <li>Low Cost</li> </ul>	300 V	71 (4.4 with 5½ digits)	30 mV to 300 V	100 nV	±(.0034% Rdg. + 2 counts)	300 kHz True rms	30 Ω to 30 MΩ	100 μΩ	6.5 V	Yes True rms	Yes	Auto/Manual	N/A	HP-IB, 4 Wire Ω, Full 5 Functions
3497A 3½, 4½, 5½ digit p 45	<ul style="list-style-type: none"> <li>Selectable # of digits</li> <li>Built-in memory</li> </ul>	120 V	300 (50 with 5½ digits)	0.1 V to 100 V	1 μV	±(.002% Rdg. + 1 count)		Program. current source for ohms					Auto/Manual	20%	HP-IB, Guarded Built-in mem. Program. current source



- Five Functions
- HP-IL Programmable

- Electronic Calibration
- 5½ to 3½ Digits

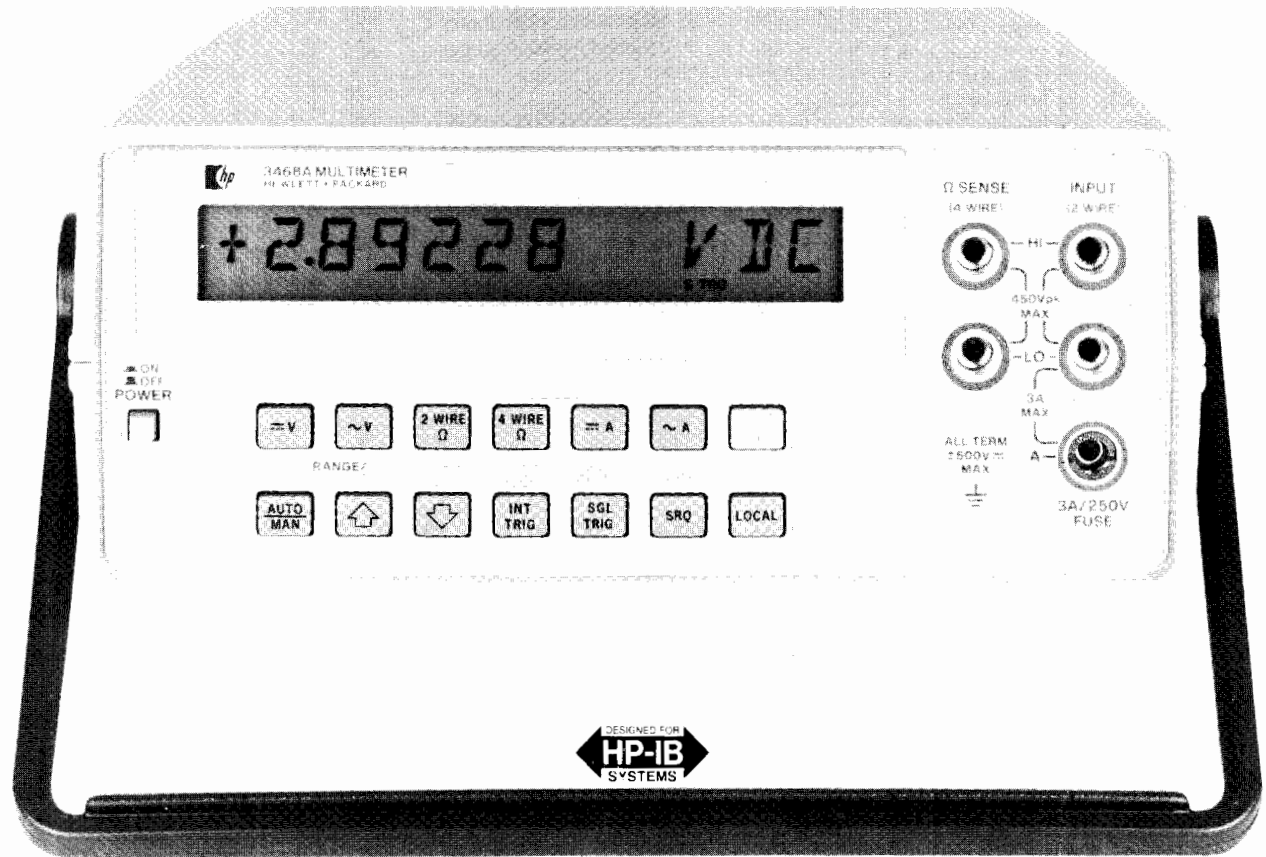

### Description

The 3468A is an autoranging 5½ to 3½ digit DMM with the five functions of dc volts, true RMS ac volts, 2 and 4-wire ohms, dc current and true RMS ac current. It interfaces with HP-IL (Hewlett-Packard Interface Loop) providing complete programmability of functions, ranges and modifiers. The 3468A can also be completely calibrated electronically without any adjustments either from the front panel or remotely in an automatic calibration system. It is available with a rechargeable battery and battery charging circuitry for portable measurements.

### HP-IL

The 3468A is fully programmable with HP-IL, a new two-wire serial interface, and the HP 41C/CV handheld calculators or the more powerful HP series 80 computers. HP-IL provides automatic measurements and adds computational power to a bench DMM. For example, to measure temperature, the HP 41 can linearize a transducer device and display the results in degrees C or degrees F right on the display of the 3468A. For audio and telecommunication applications, the 3468A can measure ac voltage and the HP 41 can convert to dBm referenced to any impedance. Or the HP 41 can be programmed to get data from the 3468A and perform a % error calculation, then display the results in percent on the 3468A display.

### High Performance

The 3468A has 5 functions with selectable 5½, 4½ or 3½ digit resolution. DC and true RMS ac voltage measurements are provided

from 0.3 volt full scale range with 1  $\mu$ V sensitivity up to 300 volts. The bandwidth of the true RMS ac converter is from 20 Hz to 100 kHz on all ranges and up to 300 kHz on the 30 V range. Either 2 or 4-wire ohms measurements can be selected with a maximum range of 30 M $\Omega$ . Both dc and true RMS ac current capability is provided up to 3 A. All functions on the 3468A incorporate a fast autoranging. The 3468A uses an integrating analog to digital conversion technique for high noise rejection. The selectable 3½, 4½ or 5½ digits of resolution allows flexibility for choosing speed or noise rejection.

### Electronic Calibration

Complete calibration of the 3468A is done electronically, either manually from the front panel or remotely in an automatic calibration system. There are no internal adjustments. Complete calibration of all functions is done without removal of the instrument's covers, thus saving valuable time and reducing cost. The calibration procedure for the 3468A involves connecting a calibration standard to the input, then pressing three keystrokes to store one calibration constant in CMOS RAM for each range and function. When the 3468A makes a measurement, each reading is corrected according to the calibration constants that have been stored. The internal CMOS RAM used in the 3468A is powered by a lithium battery to create a non-volatile memory capable of holding the calibration constants for more than ten years.

### Battery

The optional battery pack includes a rechargeable battery and the battery charger circuitry for up to five hours of continuous measurements.



## DC Voltage

### Input characteristics:

Range	Maximum Reading (5½ digit)	Resolution		
		5½ digit	4½ digit	3½ digit
.3 V	± 301000 V	1 µV	10 µV	100 µV
3 V	± 3.01000 V	10 µV	100 µV	1 mV
30 V	± 30.1000 V	100 µV	1 mV	10 mV
300 V	± 301.000 V	1 mV	10 mV	100 mV

**Input resistance:** .3 V, 3 V ranges: > 10<sup>10</sup> Ω  
30 V, 300 V ranges: 10 MΩ ± 1%

**Maximum input voltage** (non-destructive):

Hi to Lo: 301 Vrms or 450 V peak

Hi or Lo to Earth Ground: ± 500 V peak

**Measurement accuracy:** ± (% of reading + number of counts).  
Auto zero ON. 5½ digits.

### 5½ Digit Mode:

Range	TCal* ± 1°C 24 Hour	TCal* ± 5°C	
		90 Day	1 Year
.3 V	0.005 + 4	0.009 + 5	0.02 + 5
3 V	0.0035 + 2	0.007 + 2	0.018 + 2
30 V	0.005 + 3	0.009 + 3	0.02 + 3
300 V	0.0055 + 2	0.009 + 2	0.02 + 2

\*TCal is the temperature of the environment where the 3468A was calibrated. Calibration should be performed with the temperature of the environment between 20°C and 30°C.

**Temperature coefficient:** 0°C to 55°C, 5½ digits, auto zero ON.  
± (% of reading + number of counts)/°C.

Range	Temperature Coefficient
.3 V, 30 V	0.0008 + .5
3 V, 300 V	0.0007 + .05

**Noise rejection:** In dB, with 1 kΩ imbalance in Lo lead. AC rejection for 50, 60 Hz ± 0.1%. Auto zero ON.

Display	AC			DC CMR
	NMR	ECMR	CMR	
5½ digits	80	150	140	
4½ digits	59	130	140	
3½ digits	0	70	140	

### Reading rates:

**Maximum reading rate with HP 85A:** 32 readings/sec

**Maximum reading rate with 41 CV:** 2 readings/sec

## Resistance (2-wire Ω, 4-wire Ω)

### Input Characteristics:

Range	Maximum Reading (5½ digit)	Resolution		
		5½ digit	4½ digit	3½ digit
300 Ω	301.000 Ω	1 mΩ	10 mΩ	100 mΩ
3 kΩ	3.01000 kΩ	10 mΩ	100 mΩ	1 Ω
30 kΩ	30.1000 kΩ	100 mΩ	1 Ω	10 Ω
300 kΩ	301.000 kΩ	1 Ω	10 Ω	100 Ω
3 MΩ	3.01000 MΩ	10 Ω	100 Ω	1 kΩ
30 MΩ	30.1000 MΩ	100 Ω	1 kΩ	10 kΩ

**Input protection:** (non-destructive): ± 350 V peak

**Measurement accuracy:** ± (% of reading + number of counts).  
Auto zero ON. 5½ digit display. 4-wire ohms.

Range	TCal* ± 1°C 24 Hour	TCal* ± 5°C	
		90 Day	1 Year
300 Ω	0.004 + 4	0.012 + 4	0.017 + 5
3 kΩ–300 kΩ	0.004 + 2	0.011 + 2	0.016 + 2
3 MΩ	0.005 + 2	0.011 + 2	0.016 + 2
30 MΩ	0.036 + 2	0.066 + 2	0.078 + 2

**2-Wire ohms accuracy:** Same as 4-wire ohms, except add a maximum of 100 mΩ offset.

### Current through unknown:

Range	300 Ω	3 kΩ	30 kΩ	300 kΩ	3 MΩ	30 MΩ
Current	1 mA	1 mA	100 µA	10 µA	1 µA	100 nA

**Maximum open circuit voltage:** 6.5 V

## AC Voltage (true RMS responding)

### Input Characteristics:

Range	Maximum Reading (5½ digit)	Resolution		
		5½ digit	4½ digit	3½ digit
.3 V	± 301000 V	1 µV	10 µV	100 µV
3 V	± 3.01000 V	10 µV	100 µV	1 mV
30 V	± 30.1000 V	100 µV	1 mV	10 mV
300 V	± 301.000 V	1 mV	10 mV	100 mV

**Input impedance:** 1 MΩ ± 1% shunted by < 60 pF.

**Maximum input voltage** (non-destructive): 300 Vrms or 450 V peak.

**Measurement accuracy:** ± (% of reading + number of counts)  
Auto zero ON. 5½ digit display. Accuracy is specified for sinewave inputs only, > 10% of full scale.

**1 Year, TCal ± 5°C.**

Frequency	Ranges		
	.3V	3 V, 30 V	300 V
20-50 Hz	1.14 + 163	1.14 + 102	1.18 + 102
50-100 Hz	0.46 + 163	0.46 + 103	0.5 + 102
100 Hz-20 kHz	0.29 + 163	0.26 + 102	0.33 + 102
20-50 kHz	0.56 + 247	0.41 + 180	0.55 + 180
50-100 kHz	1.74 + 882	1.05 + 825	1.26 + 825
100 k-300 kHz	10.1 + 3720 (30 V range only)		

**Crest factor:** > 4:1 at full scale.

## DC Current

### Input characteristics:

Range	Maximum Reading (5½ digit)	Resolution		
		5½ digit	4½ digit	3½ digit
3 A	± 3.01000 A	10 µA	100 µA	1 mA

**Maximum input** (non-destructive): 3 A from < 250 V source; fuse protected.

**Measurement accuracy:** ± (% of reading + number of counts).  
Auto zero ON. 5½ digit display.

Range	TCal ± 5°C	
	90 Days	1 Year
3 A, < 1 A input	0.14 + 6	0.17 + 6
3 A, > 1 A input	1.0 + 30	1.0 + 30

## AC Current (true RMS responding)

### Input characteristics:

Range	Maximum Reading (5½ digit)	Resolution		
		5½ digit	4½ digit	3½ digit
.3 A	± .301000 A	1 µA	10 µA	100 µA
3 A	± 3.01000 A	10 µA	100 µA	1 mA

**Maximum input** (non-destructive): 3 A from < 250 V source; fuse protected.

**Measurement accuracy:** ± (% of reading + number of counts).  
Auto zero ON. 5½ digit display. Accuracy specified for sinewave inputs only, > 10% of full scale.

**1 Year, TCal ± 5°C**

Frequency	Ranges	
	.3 A	3 A
20-50 Hz	1.77 + 163	2.5 + 163
50-1 kHz	1.1 + 163	1.8 + 163
1 k-10 kHz	1.0 + 163	1.7 + 163
10 k-20 kHz	1.14 + 163	1.84 + 163

## General Information

**Operating temperature:** 0 to 55°C

**Humidity Range:** 95% R.H., 0 to 40°C

**Power:** AC line 48 to 440 Hz, 86 to 250 V, (see configuration)

**Battery:** (Opt 001) Rechargeable lead-acid; minimum continuous operation for 5 hours at 25°C; recharge time is 16 hours with 3468A off and 36 hours with 3468A on.

**Size:** 98.4 mm H x 238.1 mm W x 276.2 mm D (3.88 H x 9.38 W x 10.88 D).

**Weight:** 3468A—2.1 kg (4.63 lbs); 3468A with Opt 001—3.1 kg (6.83 lbs).

**Configuration:** Order one power and frequency option at no charge from below.

**Opt 315:** 100 V, 50 Hz; **Opt 335:** 220 V, 50 Hz

**Opt 316:** 100 V, 60 Hz; **Opt 336:** 220 V, 60 Hz

**Opt 325:** 120 V, 50 Hz; **Opt 345:** 240 V, 50 Hz

**Opt 326:** 120 V, 60 Hz; **Opt 346:** 240 V, 60 Hz

3468A DMM with HP-IL and Test Probes

3468A Opt 001, add Rechargeable Battery Pack



# DIGITAL VOLTMETERS

## 3 1/2 Digit, High Accuracy DMM

### Model 3435A

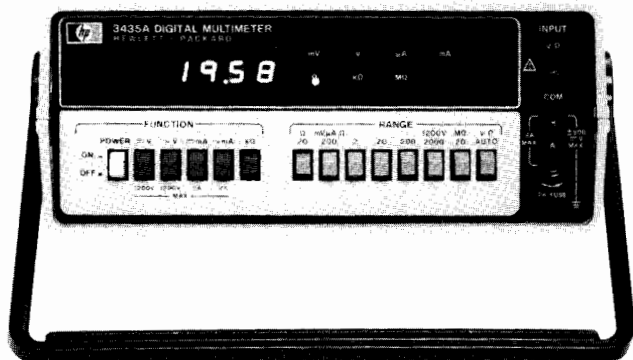

### Description

The 3435A is a 3 1/2 digit multimeter providing five functions of ACV, DCV, ACI, DCI and  $\Omega$ . It is available with rechargeable batteries or AC line power only. The 34112A Touch-Hold probe provides "eyes-on" probing of AC and DC voltages by holding the 3435A display using a button on the probe. The 3435A case is rugged with a detent position carrying handle which is used also as a tilt stand.

### Specifications

#### DC Voltmeter

<b>Ranges:</b>	200 mV	<b>Maximum display:</b>	$\pm 199.9$ mV
	2 V		$\pm 1.999$ V
	20 V		$\pm 19.99$ V
	200 V		$\pm 199.9$ V
	1200 V		$\pm 1199$ V

**Maximum input:** 1200 V (DC + Peak AC).

**Accuracy:** 1 year, 15 to 30°C.

Range	Specifications
200 mV	$\pm(0.1\%$ of reading + 2 counts)
2 V to 1200 V	$\pm(0.1\%$ of reading + 1 count)

**Temperature coefficient:** (0 to 15°C and 30 to 55°C)  $\pm(0.015\%$  of reading + 0.1 count)/°C.

**Input resistance:** 10 M $\Omega$   $\pm 1\%$ .

**Input type:** floating, 500 V maximum com. to ground.

**Normal mode rejection:** >40 dB at 50 Hz/60 Hz  $\pm 0.1\%$ .

**Response time:** <0.7 second to within 1 count of final value on one range. Add 1 second for each range change.

**Effective common mode rejection:** (1 k $\Omega$  unbalance) >120 dB at 50/60 Hz  $\pm 0.1\%$ .

#### AC Voltmeter

**AC converter:** avg. responding rms calibrated.

<b>Ranges:</b>	200 mV	<b>Maximum display:</b>	199.9 mV
	2 V		1.999 V
	20 V		19.99 V
	200 V		199.9 V
	1200 V		1199 V

**Maximum input:** 1700 V (DC + Peak AC), 10<sup>7</sup> volt-Hz max.

**Accuracy:** (with display of  $\geq 20$  counts) 1 year, 15 to 30°C.

Range	Specification
30 Hz–50 Hz	$\pm(1.5\%$ of reading + 3 counts)
50 Hz–20 kHz	$\pm(0.3\%$ of reading + 3 counts)
20 kHz–100 kHz	$\pm(1.5\%$ of reading + 10 counts)

**Temperature coefficient:** (0 to 15°C and 30 to 55°C)  $\pm(0.04\%$  of reading + 0.2 count)/°C.

**Input impedance:** resistance: 5 M $\Omega$ . Shunt capacitance: <50 pF.

### Ohmmeter

Ranges	Maximum display	Current through unknown
20 $\Omega$	19.99 $\Omega$	5 mA
200 $\Omega$	199.9 $\Omega$	5 mA
2 k $\Omega$	1.999 k $\Omega$	500 $\mu$ A
20 k $\Omega$	19.99 k $\Omega$	50 $\mu$ A
200 k $\Omega$	199.9 k $\Omega$	5 $\mu$ A
2000 k $\Omega$	1999 k $\Omega$	500 nA
20 M $\Omega$	19.99 M $\Omega$	50 nA

**Input protection:** 250 V rms.

**Accuracy:** 1 year, 15 to 30°C.

Range	Specifications
20 $\Omega$	$\pm(0.5\%$ of reading + 12 counts)
200 $\Omega$ –2000 k $\Omega$	$\pm(0.2\%$ of reading + 2 counts)
20 M $\Omega$	$\pm(0.8\%$ of reading + 2 counts)

**Temperature coefficient:** (0 to 15°C and 30 to 55°C)

Range	Specifications
20 $\Omega$ –2000 k $\Omega$	$\pm(0.04\%$ of reading + 0.2 count)/°C
20 M $\Omega$	$\pm(0.18\%$ of reading + 0.2 count)/°C

### DC Current and AC Current

<b>Ranges:</b>	200 $\mu$ A	<b>Maximum display:</b>	$\pm 199.9$ $\mu$ A
	2 mA		$\pm 1.999$ mA
	20 mA		$\pm 19.99$ mA
	200 mA		$\pm 199.9$ mA
	2000 mA		$\pm 1999$ mA

**Maximum input:** current: 2 amp (fuse protected). Voltage: 250 V.

**DC Current Accuracy:** 1 year, 15 to 30°C.

Range	Specifications
200 $\mu$ A to 200 mA	$\pm(0.3\%$ of reading + 2 counts)
2000 mA	$\pm(0.6\%$ of reading + 2 counts)

**AC Current Accuracy:** (with display of  $\geq 20$  counts)—1 year, 15 to 30°C.

Current Range	Frequency of Input Signal		
	30 Hz	50 Hz	10 kHz
2000 mA	$\pm(2\%$ of reading + 5 counts)	$\pm(1.2\%$ of reading + 5 counts)	
200 mA To 200 $\mu$ A	$\pm(1.7\%$ of reading + 5 counts)	$\pm(0.9\%$ of reading + 5 counts)	

### General

**Reading rate:** 2.4 – 4.7/s depending on input level.

**Ranging:** automatic or manual on ACV, DCV and ohms. Manual only on AC & DC current.

**Operating temperature:** 0 to 55°C.

**Humidity:** 95% RH, +15 to +40°C.

**Power:** AC line: 48–440 Hz; 86–250 V (see Ordering Information). Battery: rechargeable lead-acid 10 hours minimum continuous operation with full charge. Recharge time: 16 hours operating, 12 hours nonoperating.

**Size:** 3435A: 23.91 cm W x 9.84 cm H x 27.62 cm D (9.4" x 3.9" x 10.9").

**Weight:** 3435A: 2.41 kg (5.3 lb); 3435A Opt 001: 1.84 kg (4.1 lb).

### Ordering Information

**3435A** streamlined portable case with handle, AC line power. Batteries and charger included.

**3435A Opt. 001**, streamlined portable case, AC line power only.

**3435A Opt. 002**, Rack and Stack case, AC line power only. (Rack mount kit not included.)

All orders must include one of the power options: 86–106 V Opt. 100; 190–233 V Opt. 210; 104–127 V Opt. 115; 208–250 V Opt. 230.

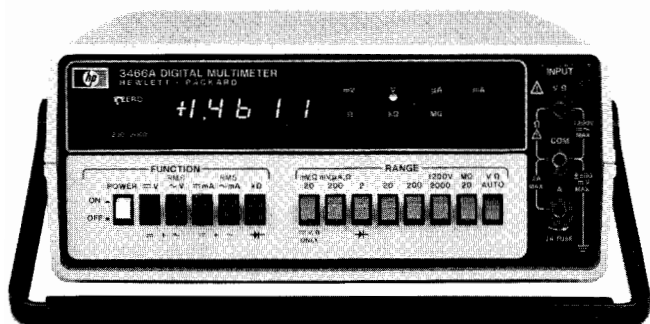

### Description

The 3466A is a 4 1/2 digit Multimeter with autoranging volts and ohms. Functional capability includes ACV, DCV, (AC + DC) V, ACI, DCI, (AC + DC) I,  $\Omega$ , and diode test. AC measurements are True-RMS with selectable AC or DC coupling. Available with rechargeable batteries or AC power only, it has 1  $\mu$ V DC and 1 m $\Omega$  sensitivity with zero adjustment on lowest ranges to compensate for external offsets.

### Specifications

#### DC Voltmeter

Voltage Range	Maximum Display
20 mV	$\pm 19.999$ mV
200 mV	$\pm 199.99$ mV
2 V	$\pm 1.9999$ V
20 V	$\pm 19.999$ V
200 V	$\pm 199.99$ V
1200 V	$\pm 1199.9$ V

**Maximum input:**  $\pm 1200$  V maximum DC and peak AC.

**Accuracy:** (1 yr., 18 to 28°C)

Range	$\pm$ (% of reading + # of counts)
20 mV	(.05 + 3)
200 mV	(.04 + 2)
2 V — 200 V	(.03 + 1)
1200 V, <700 V input	(.035 + 1)
1200 V, >700 V input	(.055 + 1)

**Input resistance:** 10 meg  $\Omega$   $\pm 0.5\%$  all ranges.

**Input type:** floating, 500 V maximum common to ground.

#### AC Voltmeter

**AC Converter:** True-RMS Responding True-RMS Calibrated

Range	Maximum Display
200 mV	199.99 mV
2 V	1.9999 V
20 V	19.999 V
200 V	199.99 V
1200 V	1199.9 V

**Maximum input:** (AC + DC):  $\pm 1200$  V DC;  $\pm 1700$  V (DC + Peak AC), AC:  $\pm 600$  V DC; 1700 V (Peak AC + DC),  $10^7$  V  $\cdot$  Hz.

**Crest factor:** 4:1 at Full Scale.

**Accuracy** (with display of  $\geq 10\%$  of range): 1 yr., 18 to 28°C sinusoid waveform.

**AC TRMS: (20 Hz to 100 kHz)**

Frequency Range	$\pm$ (% of reading + # of counts)
20 Hz to 30 Hz	(2 + 50)
30 Hz to 50 Hz	(1 + 30)
50 Hz to 10 kHz	(0.3 + 20)
10 kHz to 20 kHz	(1 + 40)
20 kHz to 100 kHz	(2 + 150)

**DC + AC TRMS:** DC + (20 Hz to 100 kHz).

### Ohmmeter

Ohms Range	Maximum Display	Current Through Unknown	Accuracy: 1 yr., 18 to 28°C $\pm$ (% of reading + # of counts)
20 $\Omega$	19.999 $\Omega$	5 mA	.08 + 2
200 $\Omega$	199.99 $\Omega$	5 mA	.08 + 2
2 k $\Omega$	1.9999 k $\Omega$	1 mA	.03 + 1
20 k $\Omega$	19.999 k $\Omega$	100 $\mu$ A	.03 + 1
200 k $\Omega$	199.99 k $\Omega$	10 $\mu$ A	.03 + 1
2000 k $\Omega$	1999.9 k $\Omega$	1 $\mu$ A	.04 + 1
20 M $\Omega$	19.999 M $\Omega$	100 nA	.15 + 1

**Input protection:** 250 V RMS or 350 V (DC + peak AC).

### DC Current and True RMS AC Current

Current Range	Maximum Display
200 $\mu$ A	$\pm 199.99$ $\mu$ A
2 mA	$\pm 1.9999$ mA
20 mA	$\pm 19.999$ mA
200 mA	$\pm 199.99$ mA
2000 mA	$\pm 1999.9$ mA

**Maximum input:** 2 amp rms from < 250 V source (fuse protected).

**DC Current Accuracy (1 yr., 18 to 28°C):**

Range	$\pm$ (% reading + # of counts)
200 $\mu$ A through 20 mA	(.07 + 2)
200 mA	(0.15 + 2)
2000 mA	(0.5 + 2)

**AC Current Accuracy:** (with display  $\geq 10\%$  of range) 1 yr., 18°C to 28°C, sinusoid waveform.

**AC TRMS:** 20 Hz to 10 kHz.

Range	Frequency	$\pm$ (% of reading + # of counts)
200 $\mu$ A–200 mA	20 Hz–30 Hz	2 + 50
	30 Hz–10 kHz	0.9 + 35
2000 mA	20 Hz–30 Hz	2 + 50
	30 Hz–10 kHz	1.2 + 20

**(DC + AC) TRMS:** DC + (20 Hz to 10 kHz).

### Diode Test

**Function:**  $\rightarrow$  (k $\Omega$ ). **Range:**  $\rightarrow$  (2k $\Omega$ ).

**Current source:** 1 mA  $\pm 1.5\%$ .

**Diode voltage drop displayed in volts:** 1.9999 volts maximum.

### General

**Reading rate:** 2.4 to 4.7/sec. depending on input level.

**Operating temperature:** (0 to 55)°C.

**Humidity:** 95% RH at +40°C.

**Power:** AC line; 48–440 Hz; 86–250 V.

**Battery:** rechargeable lead-acid 8 hours maximum continuous operation with full charge. Recharge time: 16 hours operating, 12 hours non-operating.

**Size:** 3466A: 98.4 mm H x 238.1 mm W x 276.2 mm D (3.88" x 9.38" x 10.88").

**Weight:** 3466A: 2.9 kg (6.31 lb). 3466A Opt 001: 2 kg (4.41 lb).

### Ordering Information

**3466A** streamlined portable case with handle, AC line power. Batteries and charger included. Test leads included.

**3466A Opt. 001**, streamlined portable case, AC line power only.

**3466A Opt. 002**, Rack and Stack case, AC line power only. (Rack mount kit not included.)

All orders must include one of the power options: 86–106 V Opt. 100; 190–233 V Opt. 210; 104–127 V Opt. 115; 208–250 V Opt. 230.

### 3466A Digital Multimeter

# DIGITAL VOLTMETERS

## 4½ Digit Logging Multimeter

Model 3467A

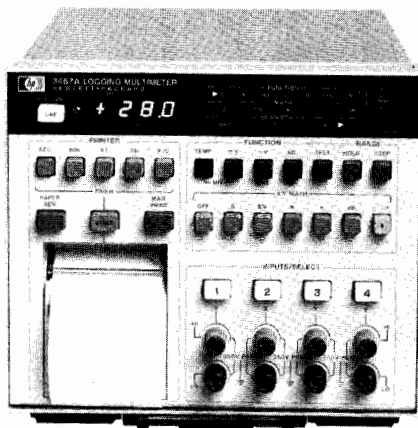

### Description

Hewlett-Packard's 3467A Logging DMM is a total measurement station, doing jobs that used to require several instruments. The HP 3467A combines a high performance 4½ digit DMM, four channel scanner, digital thermometer, math functions, and printer with timer in a single instrument. It simplifies setups and measurements and gives you a record of data in the units you need (°C, dB, etc.)... unattended or manually. The 3467A can be used to measure DC volts, resistance, true-rms AC volts, or temperature.

### Specifications

#### DC Voltmeter

Range	Maximum Reading
20 mV	± 19.999 mV
200 mV	± 199.99 mV
2 V	± 1.9999 V
20 V	± 19.999 V
200 V	± 199.99 V
350 V	± 349.9 V

**Maximum input:** ± 350 V from any terminal to ground and between any two terminals

**Accuracy:** 6 months, 18°C to 28°C (Assuming 30 minute warmup and use of zero adjustment):

Range	± (% of Reading + Number of Counts)
20 mV	0.05 + 10
200 mV	0.04 + 2
2 V - 200 V, 350 V	0.03 + 1

**Temperature coefficient:** (0° to 18°C, 28° to 50°C): ± (.003% of reading + 0.15 counts)/°C

**Input resistance:** 10 MΩ ± 5% on all ranges

**Normal mode rejection:** > 60 dB at 50/60 Hz ± 0.1%

**Effective common mode rejection (1 KΩ unbalance):** > 120 dB at 50/60 Hz ± 0.1%

#### Temperature Measurement

**Technique:** Temperature measurements using thermistors can be made directly in °C or °F, selectable by an internal switch.

**Thermistor linearization is included for the following thermistors:** YSI 44007, OMEGA 44007, FENWAL UUA 35J1 or equivalent. (One thermistor is furnished with each 3467A).

**Accuracy:** The accuracy specification includes ohmmeter accuracy, thermistor curve fit accuracy, and thermistor self-heating:

-80°C to + 80°C:	± 0.3°C
+80°C to +110°C:	± 0.5°C
+110°C to +150°C:	± 1.3°C

#### Ohmmeter

Range	Maximum Reading	Current Through Unknown
200 Ω	199.99 Ω	5 mA
2 KΩ	1.9999 KΩ	1 mA
20 KΩ	19.999 KΩ	100 μA
200 KΩ	199.99 KΩ	10 μA
2 MΩ	1.9999 MΩ	1 μA
20 MΩ	19.999 MΩ	100 nA

**Input Protection:** 250 V RMS or 350 V (DC + peak AC)

**Accuracy:** 6 months, 18°C to 28°C

**Range** ± (% of Reading + Number of Counts)

200 Ω	0.08 + 10
2 KΩ	0.03 + 3
20 KΩ-200 KΩ	0.03 + 1
2 MΩ	0.04 + 1
20 MΩ	0.15 + 1

**Temperature coefficient:** (0°C to 18°C, 28°C to 50°C)

**Range**

200 Ω	± (0.002% of reading + 1 count)/°C
2 KΩ-2 MΩ	± (0.002% of reading + 0.1 count)/°C
20 MΩ	± (0.01% of reading + 0.1 count)/°C

#### AC Voltmeter

**AC converter:** True RMS Responding; AC coupled

Range	Maximum Reading
200 mV	199.99 mV
2 V	1.9999 V
20 V	19.999 V
200 V	199.99 V
250 V	249.9 V

**Maximum input:** ± 350 V (DC + peak AC), 10<sup>7</sup> V·Hz from any terminal to ground and between any two terminals

**Crest factor:** 4:1 at full scale

**Accuracy:** Accuracy applies with readings of ≥ 9% of full scale; 6 months, 18°C to 28°C; sinusoidal waveform

**Frequency** ± (% of Reading + Number of Counts)

45 Hz-100 Hz	1 + 40
100 Hz -10 kHz	0.2 + 40
10 kHz-20 kHz	1 + 40
20 kHz-100 kHz	2 + 200

**Input impedance:** 2 MΩ ± 5% in parallel with < 100 pF

#### Printer and Timer

**Type:** Thermal Printer

**Print modes:** Manual: Initiates a printout of selected input channels; Automatic: Scans, measures and prints selected input channels at preset time intervals

**Time interval:** 1, 3, 6, 10, 18, 30, 60, or 180 seconds/minutes interval selectable via front panel pushbuttons

**Timer:** Internal 24-hour crystal controlled interval timer. Timer starts at 00:00:00 (HH:MM:SS). A time offset can be manually entered to synchronize the timer with the time of day.

**Timer accuracy:** Within 1 minute in 24 hours

#### General

**Reading rate:** Depends on input signal level. 2 to 4½ readings/second.

**Operating temperature:** 0°C to +50°C

**Thermal paper storage temperature:** -40°C to +30°C

**Humidity:** 95% R.H., +40°C without thermal paper  
60% R.H., +30°C with thermal paper

**Power:** 100/120/220/240 +5%, -10%

48 to 440 Hz line operation, < 25 VA

**Size:** 190.5mm H x 212.9mm W x 304.8mm D (7.5" x 8.4" x 12")

**Weight: Net:** 4.77 kg (10.5 lbs.); **Shipping:** 5.44 kg (12 lbs.)

**3467A Logging Multimeter** (includes 1 roll of thermal paper and a thermistor)

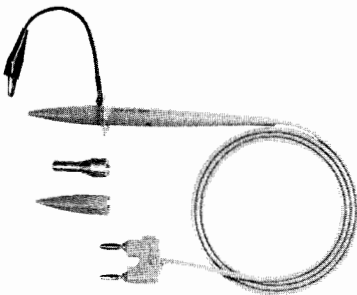

11096B High Frequency Probe

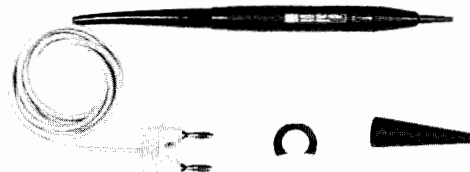

10023A Temperature Probe



34110A Soft Vinyl Carrying Case



34112A Touch-Hold Probe



34111A  
Hi-Voltage  
Probe

### 10023A Temperature Probe

The Model 10023A Temperature Probe provides the fast, accurate temperature measurements needed in a wide variety of thermal design, diagnostic, and testing applications. Surface temperature measurements are read directly in degrees Celsius on general purpose digital multimeters having an input impedance of  $\geq 10$  megohms. A pencil-like probe tip easily accesses small components and a press-to-read switch makes measurements easy.

The probe is a self-contained temperature-to-voltage transducer with a forward-biased diode chip providing calibrated linear output of  $1 \text{ mV}/^\circ\text{C}$ . The entire electronics assembly, including integrated circuits and battery is packaged in the probe barrel.

A standard dual banana plug output connector provides universal connection to digital voltmeters.

### 10023A Specifications

#### Electrical

**Measurement range:**  $-55^\circ\text{C}$  to  $+150^\circ\text{C}$ .

**Output:**  $1 \text{ mV}/^\circ\text{C}$ .

**Short term repeatability:**  $\pm 0.3^\circ\text{C}$  (minimum of 48 hrs).

**Accuracy:**  $\pm 2^\circ\text{C}$  from  $0^\circ\text{C}$  to  $100^\circ\text{C}$ , decreasing linearly to  $+2^\circ\text{C}$ ,  $-4^\circ\text{C}$  at  $-55^\circ\text{C}$  and  $+4^\circ\text{C}$ ,  $-2^\circ\text{C}$  at  $+150^\circ\text{C}$ .

**Maximum voltage at tip:** 600 V (dc + peak ac).

**Tip capacitance to ground:** approx 0.5 pF.

**Thermal response:**  $< 3 \text{ s}$  to settle within  $2^\circ\text{C}$  of final reading (liquid measurement) for a  $100^\circ\text{C}$  temperature change.

**DMM Input R:**  $\geq 10 \text{ M}\Omega$

#### General

**Operating environment (probe tip to approx 13 mm (0.5 in.) from probe tip):** temperature,  $-55^\circ\text{C}$  to  $+150^\circ\text{C}$ ; altitude, to 4600 m (15 000 ft); vibration, vibrated in three planes for 15 min. each with 0.38 mm (0.015 in.) excursion, 10 to 55 Hz.

**Operating environment (probe body):** temperature,  $0^\circ\text{C}$  to  $60^\circ\text{C}$  (battery limitation); humidity (non-condensing), to 95% relative humidity at  $+40^\circ\text{C}$ , altitude and vibration same as those for probe tip.

**Overall length:** approx 1.4 m (53 in.).

**Weight:** net, 85 g (3 oz); shipping, 312 g (11 oz).

**Battery life:** approx 50 hr (varies with ambient temperature).

**Accessories supplied:** one replacement battery (1420-0256), one sliding lock collar (10023-23201), and one probe tip cover (00547-40005).

### Ordering Information

10023A Temperature Probe

10023-60001 Replacement tip, includes pre-calibrated tip and matching compensation network

11096B High Frequency Probe

### 11096 B High Frequency Probe

Converts dc voltmeter with  $10 \text{ M}\Omega$  input to high-frequency ac voltmeter. Works with any dc voltmeter with  $10 \text{ M}\Omega$  input impedance.

### 11096B Specifications

**Voltage range:** 0.25 to 30 V rms.

**Transfer accuracy (when used with  $10 \text{ M}\Omega \pm 10\%$  dc voltmeter)**

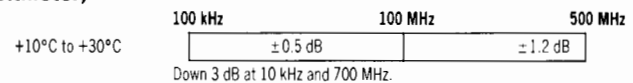

**Response:** peak responding. Calibrated to read rms value of sine wave.

**Input impedance:**  $4 \text{ M}\Omega$  shunted by 2 pF.

**Maximum input:** 30 V rms ac; 200 V dc.

**Cable length:** 4 feet long (1219 mm).

**Accessories furnished:** High-Frequency Adapter; Straight tip; Hook Tip; Ground Lead.

### 34110A Soft Vinyl Carrying Case

Carrying case for  $\frac{1}{2}$  rack size instruments. Inside dimensions of 25.4 cm x 22.9 cm x 10.2 cm or 10" D x 9" W x 4" T. Zipper flip top lid and zippered accessory pouch. Has shoulder carrying strap.

### 34111A DC Hi-Voltage Probe

1000:1 divider will accept up to 40 kV. Input  $Z = 10^9 \Omega$ . Divider accuracy meets specifications when connected to  $10 \text{ M}\Omega$  input resistance instrument.

#### Division ratio accuracy:

0-20 kV	$< 4\%$	Divider has interchangeable hook and pointed tip.
30-40 kV	$< 4\%$	
20-30 kV	$< 2\%$	

### 34112A Touch-Hold Probe

Allows user to hold DMM display by depressing button on probe body. Both AC and DC voltage up to 1200 V max. DC or AC RMS may be measured and held. Usable on the 3435A, 3438A, 3465A/B, and 3466A.

### Ordering Information

34110A Carrying Case for  $\frac{1}{2}$  Rack Size Instruments

34111A DC Hi-Voltage Probe

34112A Touch-Hold Probe

# DIGITAL VOLTMETER

## Low Cost 3½ to 5½ Digit HP-IB Multimeter

### Model 3478A

- 5 Measurement Functions
- Up to 71 Readings/sec

- Electronic Calibration
- 100 Nanovolt Resolution

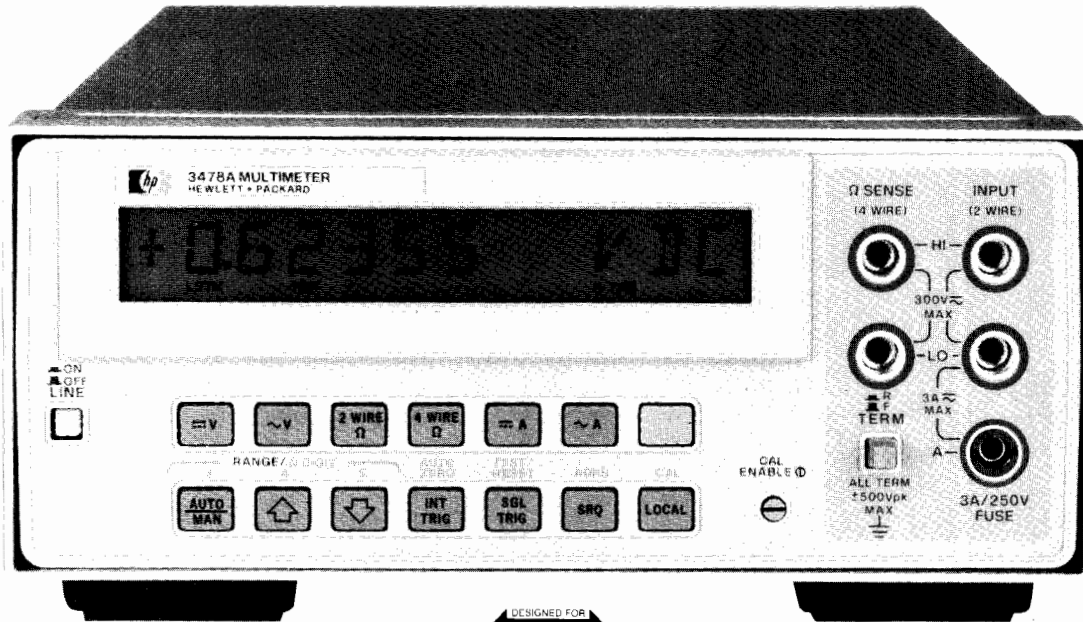

### Description

The 3478A provides a low cost, completely HP-IB programmable solution for system measurements. Selectable 3½ to 5½ digit resolution and 5 autoranging functions offer flexibility in automated testing. The 3478A can measure DCV, true RMS ACV, 2 and 4 wire ohms, and DC and AC current. Simple, fast electronic calibration eliminates all adjustments to provide a lower cost of ownership.

### Performance

Selectable speed and resolution provide the right capability for your measurement. The 3478A can perform production tests or acquire experimental data at 71 readings/sec with 3½ digit resolution, or take 33 readings/sec with 130 dB of noise rejection using 4½ digits. The 5½ digit mode offers 100 nVDC and 100 µΩ resolution for precise measurements. True RMS with 300 kHz bandwidth and 4:1 crest factor provides reliable measurements of AC signals. Fast autoranging makes the first reading useful and accurate.

### Designed for Systems

Switchable front/rear inputs permit flexible system connections. The Voltmeter Complete output and External Trigger input allow synchronization of the 3478A with a scanner for fast multiplexed measurements without the delay of software commands. The test program can automatically present messages or results on the alphanumeric liquid crystal display. The operator can then respond by pressing the 3478A's SRQ key to interrupt the controller and start the next test. Built-in self-test capability assures proper operation.

### Electronic Calibration

Complete calibration of the 3478A is accomplished without any internal adjustment or removing the instrument's covers. The simple and fast electronic calibration procedure lowers the cost of ownership. You only need to connect standards to the 3478A and store calibration constants in the 3478A's non-volatile memory. Calibration can be done manually from the front panel or automatically using HP-IB.

### Specifications

#### DC Voltage Input Characteristics:

Range	Maximum Reading (5½ digit)	Resolution		
		5½ digit	4½ digit	3½ digit
30 mV	±30.3099 mV	100 nV	1 µV	10 µV
300 mV	±303.099 mV	1 µV	10 µV	100 µV
3 V	±3.03099 V	10 µV	100 µV	1 mV
30 V	±30.3099 V	100 µV	1 mV	10 mV
300 V	±303.099 V	1 mV	10 mV	100 mV

**Input resistance:** 30 mV, 300 mV, 3 V ranges: > 10<sup>10</sup> Ω  
30 V, 300 V ranges: 10 MΩ ± 1%

**Maximum input voltage** (non-destructive): Hi to Lo: 303 Vrms or 450 V peak; Hi or Lo to Earth Ground: ± 500 V peak

**Maximum accuracy:** ± (% of reading + number of counts). Auto zero ON.

#### 5½ Digit Mode:

Range	TCal* ±1°C		TCal* ±5°C	
	24 Hour	90 Day	1 Year	
30 mV	0.027 + 35	0.03 + 41	0.04 + 41	
300 mV	0.005 + 4	0.0074 + 5	0.02 + 5	
3 V	0.0034 + 2	0.0059 + 2	0.019 + 2	
30 V	0.005 + 3	0.0074 + 3	0.02 + 3	
300 V	0.0055 + 2	0.0076 + 2	0.02 + 2	

**4½ and 3½ Digit Mode:** Accuracy is the same as 5½ digit mode for % of reading; use 1 count for number of counts on all ranges except 30 mV, use 4 counts.

**Temperature coefficient:** 0° to 55°C, 5½ digits, auto zero ON. ± (% of reading + number of counts) / °C

Range	Temperature Coefficient
30 mV	0.0028 + 5.0
300 mV	0.0005 + 0.5
3 V	0.0004 + 0.05
30 V	0.0006 + 0.5
300 V	0.0004 + 0.05



**Noise rejection:** In dB with 1 k $\Omega$  imbalance in Lo lead. AC rejection for 50, 60 Hz  $\pm$  0.1%. Auto zero ON.

Display	AC NMR	AC ECMR	DC CMR
5½ digits	80	150	140
4½ digits	59	130	140
3½ digits	0	70	140

**Maximum reading rates (readings/sec):**

Line Frequency	Auto Zero	Resolution		
		3½ digits	4½ digits	5½ digits
60 Hz	Off	71	33	4.4
	On	53	20	2.3
50 Hz	Off	67	30	3.7
	On	50	17	1.9

**AC Voltage (true rms)**

**Input characteristics:**

Range	Maximum Reading (5½ Digit)	Resolution		
		5½ Digit	4½ Digit	3½ Digit
300 mV	303.099 mV	1 $\mu$ V	10 $\mu$ V	100 $\mu$ V
3 V	3.03099 V	10 $\mu$ V	100 $\mu$ V	1 mV
30 V	30.3099 V	100 $\mu$ V	1 mV	10 mV
300 V	303.009 V	1 mV	10 mV	100 mV

**Input impedance:** 1 M $\Omega$   $\pm$  1% shunted by <60 pF

**Maximum input voltage (non-destructive):**

Hi to Low: 303 Vrms or 450 V peak

Hi to Lo to Earth Ground:  $\pm$  500 V peak

**Measurement accuracy:**  $\pm$  (% of reading + number of counts). Auto zero ON. 5½ digit display. Accuracy is specified for sinewave inputs only, >10% full scale.

**1 YEAR, T<sub>Cal</sub>\*  $\pm$  5°C**

Frequency	Ranges		
	300 mV	3 V, 30 V	300 V
20-50 Hz	1.14 + 163	1.14 + 102	1.18 + 102
50-100 Hz	0.46 + 163	0.46 + 103	0.5 + 102
100 Hz-20 kHz	0.29 + 163	0.26 + 102	0.33 + 102
20-50 kHz	0.56 + 247	0.41 + 180	0.55 + 180
50-100 kHz	1.74 + 882	1.05 + 825	1.26 + 825
100 k-300 kHz	10.1 + 3720 (30 V range only)		

\*T<sub>Cal</sub> is the temperature of the environment where the 3478A was calibrated. Calibration should be performed with the temperature of the environment between 20°C and 30°C.

**Crest Factor:** >4:1 at full scale

**Common mode rejection:** With 1 k $\Omega$  imbalance in Lo lead, >70 dB, at 60 Hz

**Maximum reading rates:** 3½ or 4½ digits, 1.4 readings/sec; 5½ digits, 1.0 readings/sec. First reading is correct within 70 counts of final value when triggered coincident with step input. Add 0.6 seconds for each range change.

**Resistance (2-wire  $\Omega$ , 4-wire  $\Omega$ )**

**Input Characteristics:**

Range	Maximum Reading (5½ Digit)	Resolution		
		5½ Digit	4½ Digit	3½ Digit
30 $\Omega$	30.3099 $\Omega$	100 $\mu\Omega$	1 m $\Omega$	10 m $\Omega$
300 $\Omega$	303.099 $\Omega$	1 m $\Omega$	10 m $\Omega$	100 m $\Omega$
3 k $\Omega$	3.03099 k $\Omega$	10 m $\Omega$	100 m $\Omega$	1 $\Omega$
30 k $\Omega$	30.3099 k $\Omega$	100 m $\Omega$	1 $\Omega$	10 $\Omega$
300 k $\Omega$	303.099 k $\Omega$	1 $\Omega$	10 $\Omega$	100 $\Omega$
3 M $\Omega$	3.03099 M $\Omega$	10 $\Omega$	100 $\Omega$	1 k $\Omega$
30 M $\Omega$	30.3099 M $\Omega$	100 $\Omega$	1 k $\Omega$	10 k $\Omega$

**Input protection (non destructive):** Hi to Lo:  $\pm$  350 V peak; Hi or Lo to Earth Ground:  $\pm$  500 V peak.

**Measurement accuracy:**  $\pm$  (% of reading + number of counts). Auto zero ON. 5½ digit display. 4-wire ohms.

Range	T <sub>Cal</sub> * $\pm$ 1°C		
	24 Hour	90 Day	1 Year
30 $\Omega$	0.023 + 35	0.027 + 41	0.034 + 41
300 $\Omega$	0.0045 + 4	0.012 + 5	0.017 + 5
3 k-300 k $\Omega$	0.0035 + 2	0.011 + 2	0.016 + 2
3 M $\Omega$	0.0052 + 2	0.011 + 2	0.016 + 2
30 M $\Omega$	0.036 + 2	0.066 + 2	0.078 + 2

**Current through unknown:**

Range	30 $\Omega$	300 $\Omega$	3 k $\Omega$	30 k $\Omega$	300 k $\Omega$	3 M $\Omega$	30 M $\Omega$
Current	1 mA	1 mA	1 mA	100 $\mu$ A	10 $\mu$ A	1 $\mu$ A	100 nA

**DC Current**

**Input Characteristics:**

Range	Maximum Reading (5½ Digit)	Resolution		
		5½ Digit	4½ Digit	3½ Digit
300 mA	$\pm$ 303.099 mA	1 $\mu$ A	10 $\mu$ A	100 $\mu$ A
3 A	$\pm$ 3.03099 A	10 $\mu$ A	100 $\mu$ A	1 mA

**Maximum input (non-destructive):** 3 A from <250 V source; fuse protected.

**Measurement accuracy:**  $\pm$  (% of reading + number of counts). Auto zero ON. 5½ digit display.

Range	T <sub>Cal</sub> * $\pm$ 5°C	
	90 Days	1 Year
300 mA	0.11 + 40	0.15 + 40
3 A (<1 A)	0.14 + 6	0.17 + 6
3 A (>1 A)	1.0 + 30	1.0 + 30

**Maximum burden at full scale:** 1 V (3 A range), 0.1 V (0.3 A range)

**AC Current (true rms responding)**

**Input Characteristics:**

Range	Maximum Reading (5½ Digit)	Resolution		
		5½ Digit	4½ Digit	3½ Digit
300 mA	303.099 mA	1 $\mu$ A	10 $\mu$ A	100 $\mu$ A
3 A	3.03099 A	10 $\mu$ A	100 $\mu$ A	1 mA

**Maximum input (non-destructive):** 3 A from <250 V source; fuse protected.

**Measurement accuracy:**  $\pm$  (% of reading + number of counts). Auto zero ON. 5½ digit display. Accuracy is specified for sinewave inputs only, >10% of full scale.

**1 YEAR, T<sub>Cal</sub>\*  $\pm$  5°C**

Frequency	Ranges	
	300 mA	3 A
20-50 Hz	1.54 + 163	2.24 + 163
50-1 kHz	0.81 + 163	1.50 + 163
1 k-10 kHz	0.72 + 163	1.42 + 163
10 k-20 kHz	0.86 + 163	1.56 + 163

**Maximum burden at full scale:** 1 V (3A range)

**General**

**Operating temperature:** 0 to 55°C

**Humidity range:** 95% R.H., 0 to 40°C

**Power:** AC line 48 to 440 Hz; 86 to 250 V, 25 VA max.

**Size:** 102 mm H x 215 mm W x 356 mm D (4" x 8" x 14"); 3½ in. H without feet.

**Weight:** 3 kg (6.5 lbs.)

**Ordering Information**

Choose one N/C power option:

**Opt 315:** 100 V, 50 Hz; **Opt 335:** 220 V, 50 Hz

**Opt 316:** 100 V, 60 Hz; **Opt 336:** 220 V, 60 Hz

**Opt 325:** 120 V, 50 Hz; **Opt 345:** 240 V, 50 Hz

**Opt 326:** 120 V, 60 Hz; **Opt 346:** 240 V, 60 Hz

**Opt 907:** Front Handle Kit (P/N 5061-0088)

**Opt 908:** Rack Mount Kit (P/N 5061-0072)

**Opt 910:** Extra Manuals

**Model 3478A Multimeter**

# DIGITAL VOLTMETERS

3½ to 6½ Digit DVM for Bench/System Applications

Model 3456A

- Up to 330 rdgs/sec
- 100 nanovolt resolution
- Transfer standard performance
- 100 micro-ohm to 1.0 gigaohm measurement capability
- Offset Compensated Ohms (OC Ω)
- Fast AC

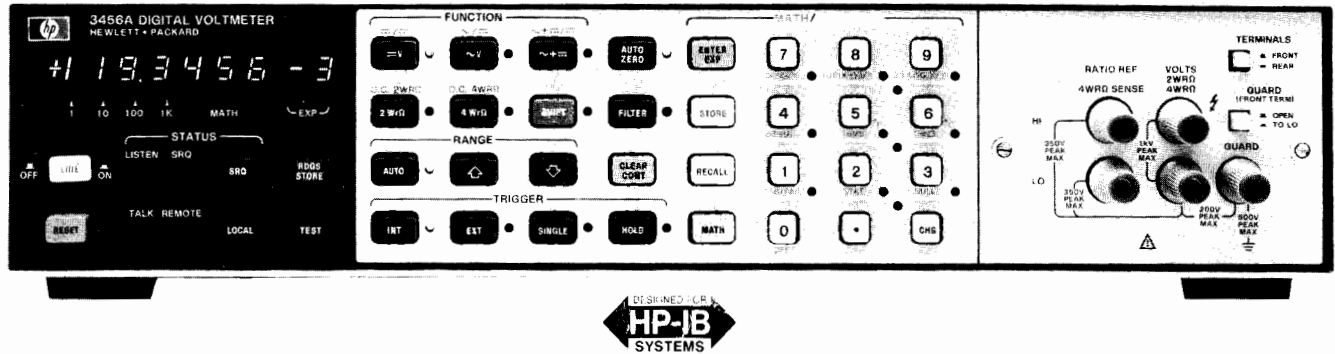

## Description

This microprocessor-based, fully guarded, integrating Digital Multimeter is designed for bench or systems. The HP Model 3456A measures dc, true RMS ac voltage and resistance.

Five full scale dc ranges from 0.1 volt to 1000 volts are provided. Measurement speed and accuracy can be enhanced for a specific application, using the HP 3456A's selectable integration time (up to 100 power line cycles) and settling time. An operator can select up to 330 readings/second for high speed bursts or one reading every fifteen minutes for periodic measurements. Resolution of 100 nanovolts at 48 readings/second (6½ digits) to 10 microvolt resolution at 330 readings per second (3½ or 4½ digits) can be selected.

Because the HP 3456A uses an integration technique with features such as "Program Memory" and "Reading Store", the operator can obtain the fastest possible reading rate with the most noise rejection. The first reading is correct, every time. The HP 3456A built-in memory is divided into two parts (Program and Reading Store). This feature lets the operator choose the length of program and the number of readings to be stored. For example, one could store an instrument command string 8 bytes long in program memory with room for 348 stored readings. The size of the HP 3456A memory is 1400 bytes long.

Transfer standard performance is assured with the HP 3456A. With good repeatability and 100 nanovolt sensitivity, accuracy on the ten volt range is ± 0.0008% + 2 counts over a 24-hour period at 23°C ± 1°C.

Four full-scale, true TRMS ac voltage ranges are provided, with reading speeds up to 12 per second speed over a 20 Hz to 250 kHz frequency range with 1 microvolt resolution (6 digits). Best accuracy is 0.05%. Crest factor is greater than seven at full scale.

## Offset Compensated Ohms

A technique called Offset Compensated Ohms is incorporated in the 3456A. The DMM compensates for any resistance inaccuracies that may be caused from thermally produced offset voltages in the circuit under test. In the ohms function, the instrument first measures the voltage drop across the circuit under test. The voltage measured is stored in the DMM. Simultaneously, the DMM supplies a fixed current through the circuit under test and measures the voltage drop. Since the thermal error first stored in the DMM's memory, it is automatically eliminated from the measurement.

The measurement range is from 1 mΩ to 1.2 GΩ, using either 2 or 4 wire connections.

## System DMM

Standard on the 3456A is an isolated HP-IB (IEEE-488) I/O for the systems operation. The front panel indicators on the 3456A display range, function and HP-IB status during remote operation. Also on the front panel is a SRQ (Service Request) button which can be

used to flag or interrupt a computer. With the 3456A's program memory and reading storage capability, system programmers and operators can use only one desktop or minicomputer to control numerous test stations, each containing a 3456A. By depressing the 3456A numerical entry keys and SRQ, the computer can be instructed to transfer a measurement sequence to the 3456A. The 3456A can take measurements and store them while a computer continues its operation as before the SRQ interrupt.

Another system feature of the 3456A is its hardware scanner advance capability for scanned or multiplexed system applications. As soon as the 3456A's measurement cycle is complete, a TTL signal is available to trigger an HP 3495A Scanner or 3497A Acquisition/Control Unit to advance to their next channel. Up to 330 channels can be scanned per second without computer interaction.

## Bench DMM

With a 2 ppm stability, the HP 3456A is a true transfer standard offering either 100 nanovolt sensitivity or 0.001% accuracy. Other standard features include fast autorange and easy-to-use math functions. The user can scale, limit test, null and make measurements in percent error, dB and dBm, as well as thermistor compensation in degrees F and C. A statistics function key (STAT) enables the operator to improve the 3456A's sensitivity, resolution and accuracy by averaging. Averaging reduces random noise fluctuations and improves sensitivity by a factor of the square root of the number of measurements. For example, for low level signals after 100 measurements, the actual sensitivity of the 3456A is approximately 10 nanovolts instead of 100 nanovolts. In addition, STAT enables the operator to recall the maximum (upper), minimum (lower), and variance.

Calibration of the HP 3456A is fast and convenient since all routine adjustments are accessible from a concealed door in the front panel. Should service be necessary, built-in diagnostics and PC Board modules make the HP 3456A easy to service.

## Specifications

### DC Voltage

#### Input characteristics:

RANGE	MAXIMUM READING (5½ digit)	6½ digit	RESOLUTION 5½ digit	4½ digit	INPUT IMPEDANCE	MAXIMUM INPUT VOLTAGE
0.1 V	119.999 V	100 nV	1 μV	10 μV	>10 <sup>10</sup> Ω	±1000 V peak
1.0 V	1.19999 V	1 μV	10 μV	100 μV	>10 <sup>10</sup> Ω	
10.0 V	11.9999 V	10 μV	100 μV	1 mV	>10 <sup>10</sup> Ω	
100.0 V	119.999 V	100 μV	1 mV	10 mV	10 MΩ ± 5%	
1000.0 V	1000.00 V	1 mV	10 mV	100 mV	10 MΩ ± 5%	

Guard to chassis: ± 400 V peak  
Guard to low: ± 200 V peak

**Measurement accuracy:**  $\pm$  (% of Reading + Number of Counts).  
Auto-zero on and filter off.

24 hour: 23°C  $\pm$  1°C

RANGE	6½ digit ( $\geq 10$ PLC) <sup>a</sup>	6½ digit (1 PLC)	5½ digit (.1 PLC)	4½ digit (.01 PLC)
0.1 V	.0022 + 24	0.0024 + 32	0.007 + 14	0.06 + 3
1.0 V	0.0009 + 4	0.0012 + 5	0.007 + 3	0.06 + 2
10.0 V	0.0008 + 2	0.0011 + 3	0.007 + 2	0.06 + 2
100.0 V	0.0011 + 3	0.0014 + 4	0.007 + 2	0.06 + 2
1000.0 V <sup>1</sup>	0.0011 + 2	0.0013 + 3	0.007 + 2	0.06 + 2

<sup>a</sup>Add .02  $\frac{\text{Input Voltage}}{1000}$  % to % of reading.

90 day: 23°C  $\pm$  5°C

RANGE	6½ digit ( $\geq 10$ PLC) <sup>a</sup>	6½ digit (1 PLC) <sup>a</sup>	5½ digit (.1 PLC)	4½ digit (.01 PLC)
0.1 V	0.0034 + 24	0.0035 + 32	0.008 + 14	0.06 + 3
1.0 V	0.0024 + 4	0.0025 + 5	0.007 + 3	0.06 + 2
10.0 V	0.0023 + 2	0.0024 + 3	0.007 + 2	0.06 + 2
100.0 V	0.0026 + 3	0.0027 + 4	0.007 + 2	0.06 + 2
1000.0 V <sup>1</sup>	0.0024 + 2	0.0025 + 3	0.007 + 2	0.06 + 2

<sup>a</sup>Integration Time in Power Line Cycles (PLC). For 5½ digits, multiply counts by 0.1. For 4½ digits, multiply counts by 0.01.

> 90 days: 23°C  $\pm$  5°C

Add  $\pm$ .0006% of Reading/month to 90 day accuracy.

**Temperature coefficient:**  $\pm$  (% of Reading + Number of Counts)/°C

RANGE	5½ Digit Display				
	0.1V	1.0V	10.0V	100.0V	1000.0V
Temp Coef.	0.0002 +0.2	0.0002 +0.02	.0002 +0.02	0.0002 +0.02	0.0002 +0.02

For 6½ digits, multiply counts by 10. For 4½ digits, multiply counts by .1

**Auto-zero OFF:** (5½ digit). For a stable environment  $\pm$  1°C, add 10 counts for 0.1 V range, 1 count for 1 V and 100 ranges, and .1 count for 10 V and 1000 V ranges. For 6½ digits, multiply counts by 10. For 4½ digits, multiply counts by .1.

**Filter ON:** Rejection is >60 dB at 50 Hz. Add 2  $\mu$ V for .1 V, 1.0 V and 10 V range and 200  $\mu$ V for 100 V and 1000 V range.

**Response time:**

**Filter OFF:** for preprogrammed settling times (0.0 seconds), error is <.005% of input voltage step.

**Filter ON:** for preprogrammed settling times (.65 seconds), error is <.01% of input voltage step.

	NOISE REJECTION (dB) (1 k $\Omega$ unbalance in Lo)		
	AC <sup>3</sup>	AC <sup>3</sup>	DC
	NMR	ECMR	ECMR
.01 PLC or .1 PLC	0	90	140
$\geq 1$ PLC	60	150	140
$\geq 1$ PLC with filter	120	160	140

<sup>3</sup>For 50, 60 Hz (depending on option)  $\pm$  .09%

	MAXIMUM READING RATES (RDGS/S)			
	Remote		Bench	
	60 Hz	50 Hz	60 Hz	50 Hz
4½ digit	330	290	200	167
5½ digit	210	180	150	125
6½ digit	48	40	46	38

For more detail, see "Reading Rates"

**AC RMS Voltage (ac, ac + dc)**

Input characteristics:

RANGE	MAXIMUM READING (5½ digit)	RESOLUTION			INPUT IMPEDANCE	MAXIMUM INPUT VOLTAGE
	6½ digit	5½ digit	4½ digit			
1.0 V	1.19999 V	1 $\mu$ V	10 $\mu$ V	100 $\mu$ V	1 M $\Omega$ $\pm$ 5% shunted by <90 pF	$\pm$ 1000 V peak (700 V rms) 10 <sup>6</sup> VHZ
10.0 V	11.9999 V	10 $\mu$ V	100 $\mu$ V	1 mV		
100.00 V	119.999 V	100 $\mu$ V	1 mV	10 mV		
1000.0 V	700.00 V	.1 mV	10 mV	100 mV		

**Measurement accuracy:**  $\pm$  (% of Reading + Number of Counts). Auto-zero on, >1% of scale, and DC component <10% of AC component.

24 hour: 23°C  $\pm$  1°C

Filter OFF	FREQUENCY IN HZ					
	Filter ON	20 to 30	400-20k 30-20k	20k to 50k	50k to 100k	100k to 250k
6½ digit ( $\geq 1$ PLC) <sup>a</sup>		.33 + 300	.05 + 440	.15 + 1500	.53 + 2700	5.0 + 6300
5½ digit (.1 PLC)		.34 + 33	.06 + 44	.16 + 150	.54 + 270	5.0 + 630
4½ digit (.01 PLC)		.39 + 5	.11 + 6	.21 + 17	.59 + 29	5.1 + 65

90 day: 23°C  $\pm$  5°C<sup>a</sup>

Filter OFF	FREQUENCY IN HZ					
	Filter ON	20 to 30	400-20k 30-20k	20k to 50k	50k to 100k	100k to 250k
6½ digit ( $\geq 1$ PLC) <sup>a</sup>		.35 + 500	.07 + 700	.17 + 1700	.55 + 2900	5.0 + 6500
5½ digit (.1 PLC)		.36 + 53	.08 + 73	.18 + 173	.56 + 293	5.0 + 653
4½ digit (.01 PLC)		.41 + 7	.13 + 9	.23 + 19	.61 + 31	5.1 + 67

> 90 days: 23°C  $\pm$  5°C (5½ digit)

Add  $\pm$  (.004% of Reading + 12 counts)/month to 90 day accuracy. For 6½ digit, multiply counts by 10. For 4½ digit, multiply counts by .1.

<sup>a</sup>Frequencies >100 kHz are specified for 1.0 V and 10 V ranges only.

<sup>2</sup>Integration Time in Power Line Cycles (PLC). For 5½ digits, multiply counts by 0.1. For 4½ digits, multiply counts by 0.01.

**Guard to Chassis:**  $\pm$  500 V peak

**Guard to Low:**  $\pm$  200 V peak

**Temperature coefficient:**  $\pm$  (% of Reading + Number of Counts)/°C. (5½ digit)  $\pm$  (.008 + 6)/°C for DC component <10% AC component. Otherwise add  $\pm$  (.008 + 12)/°C. For 6½ digit, multiply counts by 10. For 4½ digit, multiply counts by .1.

**DC Component > 10% of AC Component:** (5½ digit) Add  $\pm$  (.05% of Reading + 50 counts) to accuracy. For 6½ digit, multiply counts by 10. For 4½ digit, multiply counts by .1. For signals with no ac component, use the 1 kHz ac spec.

**Crest factor:** > 7:1 at full scale.

**Common mode rejection (1 k $\Omega$  unbalance in Lo):** > 90dB dc to 60 Hz.

**Auto-zero OFF:** For stable environment  $\pm$  1°C no accuracy change.  
**Response time:** for preprogrammed settling times, error is <.1% of input voltage step.

**Filter OFF:** 0.06 seconds

**Filter ON:** .80 seconds



# DIGITAL VOLTMETERS

3 1/2 to 6 1/2 Digit DVM for Bench/System Applications

Model 3456A

**Resistance** (2 Wr $\Omega$ , 4 WrOC $\Omega$ , 4 WrOC $\Omega$ )

**Input characteristics:**

RANGE	MAXIMUM READING (5 1/2 digit)	6 1/2 digit	RESOLUTION 5 1/2 digit	4 1/2 digit	CURRENT THROUGH UNKNOWN	MAXIMUM VALID READING VOLTAGE	MAXIMUM OPEN CIRCUIT VOLTAGE
100 $\Omega$	119.999 $\Omega$	100 $\mu\Omega$	1 m $\Omega$	10 m $\Omega$	1 mA	.12 V	5.5 V
1 k $\Omega$	1199.99 $\Omega$	1 m $\Omega$	10 m $\Omega$	100 m $\Omega$	1 mA	1.2 V	5.5 V
10 k $\Omega$	11.9999 k $\Omega$	10 m $\Omega$	100 m $\Omega$	1 $\Omega$	100 $\mu$ A	1.2 V	5.5 V
100 k $\Omega$	119.999 k $\Omega$	100 m $\Omega$	1 $\Omega$	10 $\Omega$	50 $\mu$ A	6 V	9.5 V
1 M $\Omega$	1199.99 k $\Omega$	1 $\Omega$	10 $\Omega$	100 $\Omega$	5 $\mu$ A	6 V	9.5 V
10 M $\Omega$	11.9999 M $\Omega$	10 $\Omega$	100 $\Omega$	1 k $\Omega$	500 nA	6 V	9.5 V
100 M $\Omega$	119.999 M $\Omega$	100 $\Omega$	1 k $\Omega$	10 k $\Omega$	$\leq 500$ nA <sup>1</sup>	5 V	5.5 V
1 G $\Omega$	1000.00 M $\Omega$	1 k $\Omega$	10 k $\Omega$	100 k $\Omega$	$\leq 500$ nA <sup>1</sup>	5 V	5.5 V

<sup>1</sup>Ohms source is a 500 nA current source in parallel with a 10 M $\Omega$  resistance.

**Non-destructive overload:** 350 V peak

**Measurement accuracy:**  $\pm$  (% of Reading + Number of Counts).

Auto-zero on, filter off, and 4-wire ohms.

**24 hour: 23°C  $\pm$  1°C**

RANGE	6 1/2 digit ( $\geq 10$ PLC) <sup>a</sup>	6 1/2 digit (1 PLC)	5 1/2 digit (.1 PLC)	4 1/2 digit (.01 PLC)
100 $\Omega$	0.003 + 24	0.003 + 32	0.009 + 14	0.07 + 3
1 k $\Omega$	0.002 + 4	0.003 + 5	0.008 + 3	0.07 + 2
10 k $\Omega$	0.002 + 4	0.003 + 5	0.008 + 3	0.07 + 2
100 k $\Omega$	0.002 + 2	0.003 + 3	0.008 + 2	0.07 + 2
1 M $\Omega$	0.006 + 2	0.006 + 3	0.012 + 2	0.07 + 2
10 M $\Omega$	0.041 + 2	0.041 + 3	0.07 + 2	0.12 + 2
100 M $\Omega$	1.3 + 1	1.3 + 1	1.5 + 1	1.5 + 1
1 G $\Omega$	11 + 1	11 + 1	13 + 1	13 + 1

**90 day: 23°C  $\pm$  5°C**

RANGE	6 1/2 digit ( $\geq 10$ PLC) <sup>a</sup>	6 1/2 digit (1 PLC) <sup>a</sup>	5 1/2 digit (.1 PLC)	4 1/2 digit (.01 PLC)
100 $\Omega$	0.004 + 24	0.004 + 32	0.01 + 14	0.07 + 3
1 k $\Omega$	0.003 + 4	0.004 + 5	0.009 + 3	0.07 + 2
10 k $\Omega$	0.003 + 4	0.004 + 5	0.009 + 3	0.07 + 2
100 k $\Omega$	0.003 + 2	0.004 + 3	0.009 + 2	0.07 + 2
1 M $\Omega$	0.007 + 2	0.007 + 3	0.013 + 2	0.07 + 2
10 M $\Omega$	0.042 + 2	0.042 + 3	0.07 + 2	0.12 + 2
100 M $\Omega$	1.8 + 1	1.8 + 1	2.0 + 1	2.0 + 1
1 G $\Omega$	16 + 1	16 + 1	18 + 1	18 + 1

<sup>a</sup>Integration Time in Power Line Cycles (PLC). For 5 1/2 digits multiply counts by 0.1. For 4 1/2 digits multiply counts by 0.01.

**>90 days: 23°C  $\pm$  5°C**

Add  $\pm$  .0004% of Reading/month to 90 day accuracy.

**2-Wire Ohms accuracy:** Same as 4-wire ohms except add a maximum of .2 ohm offset.

**Auto-Zero OFF accuracy:** (5 1/2 digit). For a stable environment  $\pm$  1°C, add 10 counts for 100  $\Omega$  range, 1 count for 1 k $\Omega$  and 10 k $\Omega$  range, and .2 counts for  $\geq 100$  k $\Omega$  range. Changes in lead resistance are not corrected in 4-wire ohms. For 4 1/2 digit, multiply counts by .1. For 6 1/2 digit, multiply counts by 10.

RANGE	MAXIMUM LEAD RESISTANCE FOR 4-WIRE OHMS	MAXIMUM OFFSET VOLTAGE FOR OFFSET COMPENSATED OHMS	PREPROGRAMMED SETTling TIME IN SECONDS
100 $\Omega$	10 $\Omega$	.01 V	0
1 k $\Omega$	100 $\Omega$	.1 V	0
10 k $\Omega$	1000 $\Omega$	.1 V	0
100 k $\Omega$	1000 $\Omega$	.5 V	.0008
1 M $\Omega$	1000 $\Omega$		.008
10 M $\Omega$	1000 $\Omega$		.08
100 M $\Omega$	1000 $\Omega$		.08
1 G $\Omega$	1000 $\Omega$		.08

**Offset compensated ohms accuracy:** same as 2-wire and 4-wire except maximum reading may be reduced by 9% for large offset voltages.

**Response time:** with preprogrammed settling time and  $< 200$  pF of capacitance, first reading is in specification.

**Filter is not operational in ohms.**

**Temperature coefficient:** (5 1/2 digits)  $\pm$  (% of Reading + Number of Counts)/°C

RANGE	100 $\Omega$	100 k $\Omega$	1 M $\Omega$	10 M $\Omega$	100 M $\Omega$	1 G $\Omega$
Temp Coef.	.0004 +2	.0004 +02	.0004 +004	.0010 +004	.16 +0	1.6 +0

4 1/2 digit: multiply counts by .1; 6 1/2 digit: multiply counts by 10.

### MAXIMUM READING RATES (RDGS/S) (100 TO 10 k $\Omega$ RANGES)

	Remote		Bench	
	60 Hz	50 Hz	60 Hz	50 Hz
4 1/2 digit	330	290	200	167
5 1/2 digit	210	180	150	125
6 1/2 digit	48	40	46	38

For more detail, see "Reading Rates"

### Ratio

**Type:** DC/DC, AC/DC, or (AC + DC)/DC

**Method:** 4-wire with Volts Lo input common

$$\text{Ratio} = \frac{\text{Signal Voltage}}{\text{Ref. Hi Voltage} - \text{Ref. Lo Voltage}}$$

**Signal measurement:** Same as DC Volts, AC Volts, or AC + DC Volts

**Reference measurement:** Automatically selects .1 V, 1 V, or 10 V DC. Volts range and a 0.0 msec. settling time. Filter is off.

**Maximum reference voltages:**

Ref. Hi:  $\pm 12$  V

Ref. Lo:  $\pm 9\%$  of Ref. Hi

Ref. Hi-Ref. Lo:  $\pm 11.9999$  V

Protection:  $\pm 350$  V peak

**Accuracy:** Total % signal error + total % reference error (same as .1 V, 1 V, or 10 V DC volts)

### Reading Rate

Reading rates are with autorange, math, display and filter off. Output is to internal memory using internal trigger and packed mode. Packed output in place of internal memory adds .35 ms; ASCII output adds 2.3 ms.

**Rates vs. integration time and Auto-Zero:** DC volts and 100  $\Omega$  thru 10 k $\Omega$  ranges with preprogrammed settling times ( $\approx 0.0$  sec.). Also, AC or AC + DC Volts and 100 k $\Omega$  thru 10 k $\Omega$  ranges with 0.0 sec. delay.

**RATES**

INTEGRATION TIME IN POWER LINE CYCLES (PLC)	Auto Zero OFF		Auto Zero ON	
	60 Hz	50 Hz	60 Hz	50 Hz
0.01 (4½ digit)	330	290	210	180
0.10 (5½ digit)	210	180	120	100
1.00 (6½ digit)	48	40	25	20
10.00 (6½ digit)	5.8	40	2.9	2.4
100.00 (6½ digit)	.57	.47	.29	.24

**Memory**

**Reading Store:** Can store up to 350 readings.

Can be recalled from HP-IB interface or front panel

**Program memory:** Can execute an internal program which controls instrument configuration and measurement sequence. Program is input from the HP-IB interface with up to 1400 ASCII characters.

**Memory size:** Total size is 1400 bytes. Memory used is 1 byte per ASCII character + 4 bytes per reading stored.

**Math Function Specifications**

**General:** Math function specifications do not include error in X (instrument reading) or in entered values (R, L, U, Y, Z). Range of values input or output is  $0.000000 \times 10^{-9}$  to  $\pm 1999999 \times 10^9$ . Out of range values send "OL" to display and  $+1999999 \times 10^9$  to HP-IB.

**Pass/Fail:** Displays "HI" for values upper limit (U), "LO" for values lower limit (L), and X for values between the limits, with no introduced error. SRQ mask can be programmed to respond to out-of-limit conditions.

**Maximum execution time:** 20 ms

**Statistics:**

$$\text{Mean (M)} = X_1 + \frac{1}{C} \sum_{i=1}^C (X_i - X_1)$$

$$\text{Variance (V)} = \frac{\sum_{i=1}^C (X_i - X_1)^2 - \frac{1}{C} \left[ \sum_{i=1}^C (X_i - X_1) \right]^2}{C - 1}$$

Maximum (U) and Minimum (L) are the most positive and negative instrument readings, respectively. X is displayed during calculation of statistics.

$X_1$  is the first reading taken after enabling statistics and is stored in the Z register. The number of readings taken (C) is stored in the count register.

$$\text{Accuracy of Mean: } < \pm \frac{C(U-L)}{10^{11}} + 1 \text{ LSD}$$

$$\text{Accuracy of Variance: } < \pm \frac{C(U-L)^2}{10^8} + 1 \text{ LSD}$$

**Maximum execution time:** 50 ms

**Null:**  $X - X_1$  ( $X_1$  is the first valid reading taken after enabling null and is stored in the Z register).

**Maximum execution time:** 15 ms

**dBm(R):**  $10 \log \left| \frac{x^2/R}{1 \text{ mW}} \right|$  R is the user-entered impedance.

**Output range:** -280 to +340 dBm

**Accuracy:**  $\pm .001$  dBm

**Maximum execution time:** 150 ms

**Thermistor (F):** Converts resistance of thermistor HP0837-0164, YSI 44007, Omega UUA35J3, and Fenwal UUA35J1 to temperature in °F.

**Output range:** -112 to 302°F

**Accuracy:**  $-103 \leq T \leq +266^\circ\text{F}$ :  $\pm .11^\circ\text{F}$  max.

$-112 \leq T \leq +302^\circ\text{F}$ :  $\pm .27^\circ\text{F}$  max.

Accuracy specification does not include any inaccuracies in the actual thermistor used.

**Maximum execution time:** 100 ms

**Scale:** (X-Z)/Y

**Accuracy:**  $\pm 1$  LSD

**Maximum execution time:** 60 ms

**dB:**  $20 \log \frac{X}{Y}$

**Output Range:** -620 to +620 dB

**Accuracy:** .001 dB

**Maximum execution time:** 100 ms

**% Error:**  $100 \times (X-Y)/Y$

**Accuracy:**  $\pm 1$  LSD

**Maximum execution time:** 60 ms

**General**

**Operating Temperature:** 0 to 50°C

**Warmup time:** one hour to meet all specifications

**Humidity range:** 95% R.H., 0 to 40°C

**Storage temperature:** -40 to +75°C

**Power:** 100/120/240 V  $\pm 5\%$ , -10%, 48 Hz to 66 Hz line operation, 60 VA; 220 V  $\pm 10\%$ , 48 Hz to 66 Hz line operation, 60 VA.

**Size:** 88.9 mm H x 425.5 mm W x 527.1 mm D (3½" x 16¾" x 20¾")

**Weight:** Net, 10.49 kg (23.13 lbs.); Shipping, 13.35 kg (29.38 lbs.)

**Ordering Information**

**10631A:** 1 Meter (39.37 in.) HP-IB Cable

**10631B:** 2 Meter (78.74 in.) HP-IB Cable

**10631C:** 4 Meter (157.48 in.) HP-IB Cable

**10631D:** 0.5 Meter (19.69 in.) HP-IB Cable

**03456-90001:** Operating information supplement (one furnished with 3456A)

**11000A:** Test Leads, dual banana both ends

**11002A:** Test Leads, dual banana to probe and alligator

**34111A:** High Voltage Probe, 40 kV

**Opt 050:** Noise rejection for 50 Hz

**Opt 060:** Noise rejection for 60 Hz

**Front Handle Kit (Opt 907)** Pt. #5061-0088

**Rack Mount Kit (Opt 908)** Pt. #5061-0074

**Rack Mount Kit (Opt 909)** Pt. #5061-0075

**Extra Operating and Service Manual (Opt 910)**

**Model 3456A Digital Voltmeter**

# DIGITAL VOLTMETERS

## 5½ / 6½-Digit DVM with Auto Cal

### Model 3455A

- AutoCal
- Self test
- Bench / system

- AC/DC/OHMS
- High speed
- Removable reference

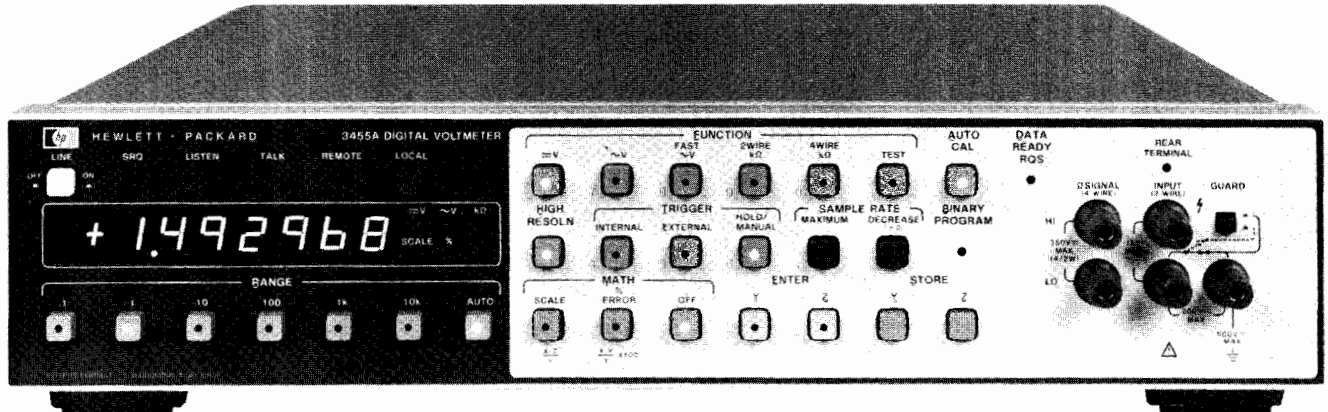

### Description

Hewlett-Packard's 3455A Digital Voltmeter is a microprocessor controlled 5½- or 6½-digit integrating voltmeter for bench or systems applications. The standard instrument measures DC volts, AC volts, and resistance. HP-IB I/O for systems applications is also standard.

### Measuring Speed

The 3455A is fully guarded and has greater than 60 dB normal mode noise rejection at reading rates of up to 24 readings per second on all DC ranges. Ohms reading rates are up to 12 readings/second and an AC fast mode gives reading rates of up to 13 readings/second at frequencies above 300 Hz. (Readings/seconds given for 60 Hz operation and high resolution off.)

### Performance

DC measurements can be made with up to 1µV sensitivity. Ohms measurements are made with either a 2-wire and 4-wire mode. The High Resolution (6½-digit) mode gives DC and Ohms measurements with greater than 1 part per million resolution.

### True rms

The standard true rms converter gives AC measurements from 30 Hz to 1 MHz. Complex signals with crest factors of up to 7:1 at full scale can be measured.

### Math

The math functions provide computational capability. The Scale mode ( $\frac{X-Y}{Y}$ ) allows the user to offset, take ratios, or scale readings to give readouts in physical units. The % Error mode ( $\frac{X-Y}{Y} \times 100\%$ ) converts readings into percentage change from Y which is entered as a reference. For the math functions X is the present reading, Y and Z are previously entered readings or numbers entered from the front panel or by remote program.

### Auto Cal

The auto cal feature gives the user accurate DC volts and ohms measurements and simplifies calibration of these functions. The DC and ohms operating circuits are checked against internal references and any errors are corrected digitally. All dc and ohms adjustments are in a removable reference assembly.

### Serviceability

Routine maintenance and calibration has been simplified with the removable reference assembly. Calibration of DC and ohms functions can be done by replacing the reference assembly with a recently calibrated one. Extra reference assemblies are available as HP accessory number 11177A. A spare assembly is ideal for one or more 3455A's. Calibrate DC and ohms in a 3455A without removing it from the bench or system. Just return the extra reference assembly to the cal lab or HP for calibration and have it back in time to calibrate the 3455A next time.

The self-test feature is used to aid in troubleshooting as well as verifying operation of the 3455A. Test verifies proper operation of the DC measuring circuits by comparing their parameters against predetermined limits. If a problem is found, the display is used to assist in finding the problem area by indicating which parameter is in error. Detailed troubleshooting can then be used to quickly isolate the problem.

### Specifications

#### DC Voltage

Ranges		Maximum Display	
0.1	—	±0.149999 V	—
1	1	±1.49999 V	±1.499999 V
10	10	±14.9999 V	±14.99999 V
100	100	±149.999 V	±149.9999 V
1000	1000	±1000.00 V	±1000.000 V

### Performance

#### (High Resolution Off)

#### Accuracy ± (% of reading + counts)

24 hrs: 23°C ± 1°C		
Range	High Resolution Off	High Resolution On
0.1 V	0.004 + 4	—
1 V	0.003 + 1	0.003 + 4
10 V	0.002 + 1	0.002 + 3
100 & 1000 V	0.004 + 1	0.004 + 3
90 days: 23°C ± 5°C		
Range	High Resolution Off	High Resolution On
0.1 V	0.007 + 4	—
1 V	0.006 + 1	0.006 + 4
10 V	0.005 + 1	0.005 + 3
100 & 1000 V	0.007 + 1	0.007 + 3

**Input Characteristics**

**Input resistance:** 0.1 V through 10 V range: > 10<sup>10</sup> ohms. 100 V and 1000 V range: 10 megohm ± 0.1% with Auto Cal. "off."

**Maximum input voltage**

**High to low input terminals:** ± 1000 V peak.

**Guard to chassis:** ± 500 V peak.

**Guard to low terminal:** ± 200 V peak.

**Normal mode rejection (NMR):** NMR is the ratio of the peak normal-mode voltage to the peak error voltage in the reading.

**NMR at 50 or 60 Hz ± 0.1%:** > 60 dB.

**Effective common mode rejection (ECMR):** ECMR is the ratio of the peak common-mode voltage to the resultant peak error voltage in the reading.

**ECMR with 1 kΩ unbalance in low lead at**

**DC:** > 140 dB.

**50 Hz or 60 Hz ± 0.1%:** > 160 db.

**AC Voltage (rms Converter)**

(High Resolution On or Off)

**Ranges:** 1.00000 V      **Maximum Display:** 1.49999 V

10.0000 V              14.9999 V

100.000 V             149.999 V

1000.00 V             1000.00 V

**Range selection:** Manual, Automatic or Remote.

**Function selection:** ACV or Fast ACV.

**Input Characteristics**

**Input impedance**

**Front terminals:** 2 MΩ ± 1% shunted by less than 100 pf.

**Rear terminals:** 2 MΩ ± 1% shunted by less than 75 pf.

**Maximum input voltage**

**High to low terminals:** ± 1000 volts peak.

Subject to a 10<sup>3</sup> volts—Hz limitation.

**Guard to chassis:** ± 500 V peak.

**Guard to low terminal:** ± 200 V peak.

**Response Time**

**ACV and FAST ACV**

First reading to < 0.1% of step size when triggered coincident with step change when on correct range (for AC signals with no DC component).

**Performance (rms Converter)**

**Accuracy:** ± [% of reading + counts]<sup>1</sup> (AC Coupled)<sup>2</sup>

Fast ACV	300 Hz to 20 kHz	20 kHz to 100 kHz	100 kHz to 250 kHz	250 kHz to 500 kHz	500 kHz to 1 MHz
	30 Hz to 20 kHz				
24 hours 23°C ± 1°C	0.04 + 40	0.40 + 80	1.80 + 200	4.0 + 400	5.00 + 2600
90 days 23°C ± 5°C	0.05 + 50	0.50 + 100	2.00 + 250	5.00 + 500	6.00 + 3100

<sup>1</sup>Guard must be connected to low. Specifications are only for input levels above 1% of range. For AC coupled inputs < 1% of full scale: add 20 counts to above accuracy table, except for AC coupled inputs above 50 kHz and < 5% of full scale: add 170 counts to above accuracy table. See footnote 2 for AC/DC coupled inputs.

<sup>2</sup>For any AC/DC coupled input: add (0.05% of reading + 20 counts) to above accuracy table, except for an AC/DC coupled input above 50 kHz and < 5% of full scale: add 170 counts to above accuracy table.

<sup>3</sup>Frequencies of greater than 100 kHz are specified for the 1 V and 10 V ranges only.

<sup>4</sup>Accuracy is not specified if the volt-hz product exceeds 10<sup>7</sup>. For inputs > 500 V, multiply the above tabled accuracy by  $\frac{1500 + V_{in}}{1000}$ .

**Ohms**

Ranges		Maximum Display	
High Resolution Off	High Resolution On	High Resolution Off	High Resolution On
0.100000 kΩ	—	0.149999 kΩ	—
1.00000 kΩ	1.00000 kΩ	1.49999 kΩ	1.49999 kΩ
10.0000 kΩ	10.0000 kΩ	14.9999 kΩ	14.9999 kΩ
100.000 kΩ	100.000 kΩ	149.999 kΩ	149.999 kΩ
1000.00 kΩ	1000.00 kΩ	1499.99 kΩ	1499.99 kΩ
10000.0 kΩ	10000.0 kΩ	14999.9 kΩ	14999.9 kΩ

**Range selection:** Manual, Automatic, or Remote.

**Performance**

**Function selection:** 2-wire kΩ or 4-wire kΩ.

**Accuracy** ± (% of reading + counts) 4-wire kΩ

24 hours: 23°C ± 1°C		
Range	High Resolution Off	High Resolution On
0.1 kΩ	0.003 + 4	—
1 kΩ	0.003 + 1	0.0025 + 4
10 kΩ	0.005 + 2	0.0045 + 4
100 kΩ	0.002 + 2	0.0020 + 5
1000 kΩ	0.012 + 5	0.0120 + 4
10,000 kΩ	0.10 + 5	0.1000 + 4
90 days: 23°C ± 5°C		
Range	High Resolution Off	High Resolution On
0.1 kΩ	0.005 + 5	—
1 kΩ	0.005 + 1	0.0035 + 5
10 kΩ	0.007 + 2	0.0060 + 5
100 kΩ	0.004 + 2	0.0035 + 6
1000 kΩ	0.014 + 5	0.0135 + 5
10,000 kΩ	0.100 + 5	0.1000 + 5

2-wire kΩ: all accuracy specifications are the same as 4-wire kΩ except add 0.0004 kΩ to all readings.

**Input Characteristics**

**Maximum voltage generated across unknown:** < 5 volts for open circuit; < 4.7 volts for valid reading.

**Signal source driving unknown (nominal):** 0.1 kΩ, 1 kΩ & 10 kΩ ranges.

**Overload Protection**

**Non-destruction:** ± 350 V peak.

**Maximum reading rates for remote operations.**

(Readings/Sec)

Function	High Resolution ON		High Resolution OFF	
	50 Hz	60 Hz	50 Hz	60 Hz
DCV	5	6	22	24
Ohms	2.5	3	11	12
ACV (rms)			1.1	1.3
Fast ACV (rms)			12	13
ACV (Ave)			1.1	1.3
Fast ACV (Ave)			12	13

**Math**

**Scale ( $\frac{X-Z}{Y}$ ):** X is present reading. Y and Z are previously entered readings, or numbers entered from the front panel or by external program.

**Maximum number (entered or displayed):** ± 199,999.9.

**Accuracy:** ± (Accuracy of X reading ± 1 digit of displayed answer). This assumes no "Y" or "Z" error.

**%Error ( $\frac{X-Z}{Y} \times 100\%$ ):** X is present reading. Y is a previously entered reading, or number entered from the front panel or by external program.

**Maximum number (entered or displayed):** ± 199,999.9.

**Accuracy:** ± (Accuracy of X reading ± 1 digit of displayed answer). This assumes no "Y" error.

**How to enter numbers in "Y" or "Z"**

**From a current displayed reading:** press STORE "Y" or "Z".

**From front panel:** Press ENTER "Y" or "Z". The front panel is now set for numerical entry. These numbers are in blue next to the keys. Enter number and press STORE "Y" or "Z".

**By remote program:** send program codes for equivalent front panel operations.

**General**

**Power:** 100 V, 120 V, 240 V +5% -10%, 48 Hz to 400 Hz line operation; < 60 VA with all options.

**Size:** 88.9 H x 425.5 W x 527.1 mm D (3.5" x 16.75" x 20.75").

**Weight:** net, 9.38 kg (20.7 lb). Shipping, 11.8 kg (26 lb).

**Options**

**001:** Average converter

**3455A Digital Voltmeter**

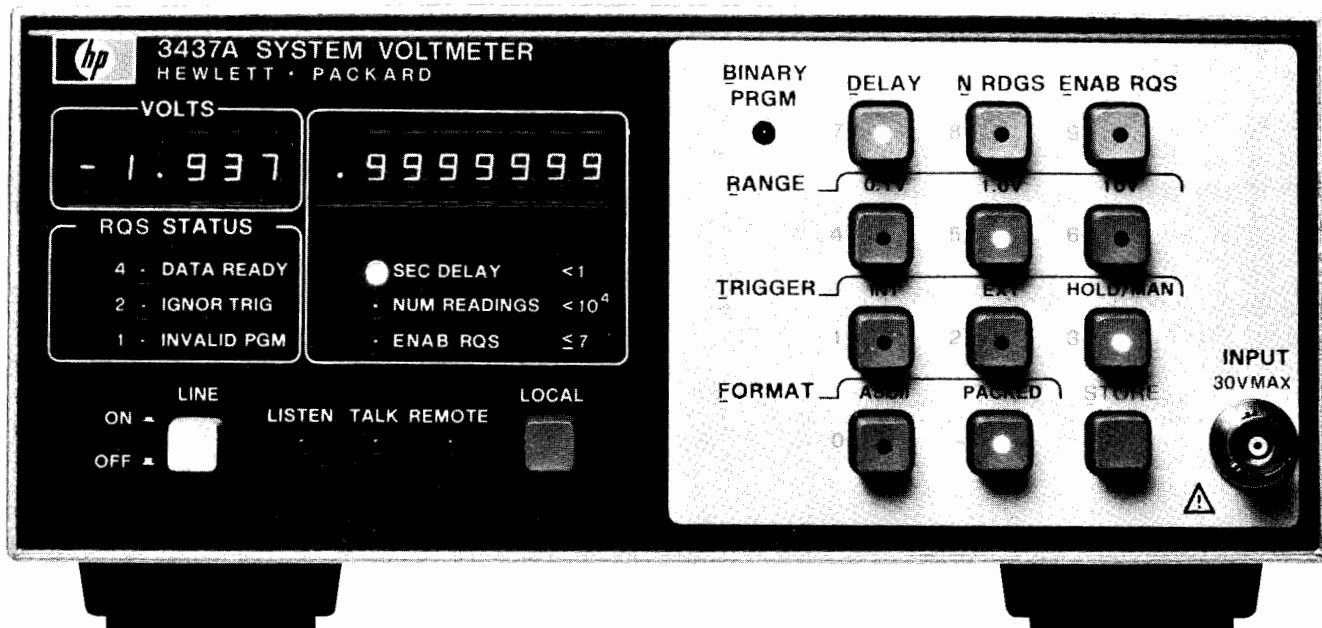

**Description**

The Hewlett-Packard 3437A System Voltmeter has been designed to be used in systems. It is a 3½ digit high speed dc voltmeter with sample and hold. The standard unit measures DC volts, provides trigger delay, burst reading capability and Hewlett-Packard Interface Bus (HP-IB).

There are three DC floating input ranges: 0.1V, 1.0V and 10.0V full scale with a maximum display of "1999." Sample and Hold allows the 3437A to be an instantaneous reading voltmeter. The trigger delay can be set from 0.1µs to 1.0 second and the number of readings can be set from 0 to 9999 readings.

**Typical Operation**

**Example:** set Delay to 1 ms and Number of Readings is set to 1000. The 3437A will now take 1000 readings spaced 1 ms apart upon receiving one trigger.

**Data Output**

All front panel switches are programmable from the HP-IB. Two data output formats are available: (1) ASCII output (Serial ASCII characters) and (2) Packed output (two 8-bit bytes on the HP-IB to send the complete reading).

**High Speed**

The Packed output mode allows more data to be stored in the calculator or computer as well as increasing the maximum reading rate from 3000 readings/second to greater than 5000 readings/second.

**Systems Capability**

The user may select the mode for which the voltmeter requests service from the controller. Request Service can be programmed manually or automatically to request service for: (1) Data Ready, (2) Trigger Ignore, or (3) Invalid Program. Any combination of these three can be selected.

**Applications**

**Waveform analysis**—The 3437A can be used to analyze a wide variety of waveforms. The delay and burst reading capability allows frequency, positive or negative peak values, RMS value and harmonic distortion to be measured. The accuracy of these measurements is comparable to more traditional measurement techniques.

**Transient signal analysis**—The 3437A is capable of measuring transient signals because of the wide bandwidth input (>1 MHz), high measuring speed and sample-and-hold.

**Fast AC measurements**—Sinusoidal signals of known frequency can be measured in less than one cycle of the signal. Very low frequency measurements can be made more quickly than with conventional techniques.

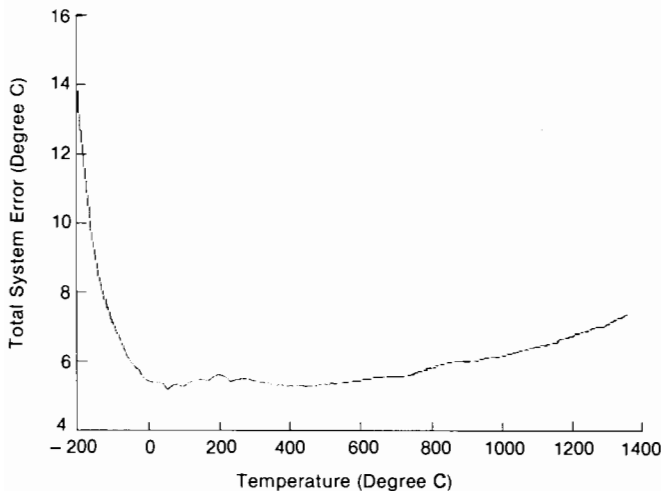

Figure 1 shows the performance of a 3437A when used to measure J type thermocouples. The 3437A can be used to measure multiple thermocouples at up to 4800 channels per second. Thermocouple linearization routines are provided in the 3054A Data Acquisition and Control System software.

**High speed scanning:** multiple input measurement applications can be satisfied with the 3437A and the HP 3497A Data Acquisition/Control Unit. Reading rates of up to 475 channels/second can be attained.

**Bench measurements:** in addition to systems applications, the 3437A can be used to improve oscilloscope amplitude and measurement accuracy.

### Data-Sheeted Systems

The 3437A is a component of the 3054A Automatic Data Acquisition and Control System. The 3054A includes the 3437A for high speed measurements, the 3456A Digital Voltmeter for high accuracy measurements and the 3497A Data Acquisition/Control Unit for multiplexing and control outputs. The 3054A includes an extensive software package to support the 3437A when used for thermocouple measurements, high speed scanning, and waveform digitization. The 3437A is also a component of the 3052A Data Acquisition System.

## Specifications

### DC Volts

Ranges	Max. Display	Overload Reading
10 V	±19.98	±99.99
1 V	±1.998	±9.999
0.1 V	±.1998	±.9999

**Ranging:** Manual or Remote.

### Performance

#### Static accuracy (90 days, 23°C ± 5°C)

- 10 V range:** ±(0.05% of reading + 1.6 counts.)
- 1 V range:** ±(0.03% of reading + 1.6 counts.)
- 0.1 V range:** ±(0.06% of reading + 1.8 counts.)

#### Static accuracy (1 year, 23°C + 5°C)

- 10 V range:** ±(0.05% of reading + 2 counts.)
- 1 V range:** ±(0.03% of reading + 2 counts.)
- 0.1 V range:** ±(0.06% of reading + 2.2 counts.)

**Static accuracy temperature coefficient (0°C–50°C):** ±(0.002% reading + 0.05 counts) / °C.

### Input Characteristics

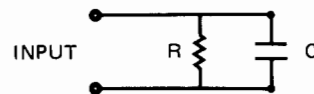

**10 V range:**  $R = 1 \text{ M}\Omega \pm 20\%$ ;  $C < 75 \text{ pF}$ .

**1 V range:**  $R > 10^6 \Omega$ ;  $C < 75 \text{ pF}$ .

**0.1 V range:**  $R > 10^6 \Omega$ ;  $C < 75 \text{ pF}$ .

**Maximum input voltage high to low on all ranges:**  $< \pm 30 \text{ V peak}$ .

**Maximum voltage low to chassis:**  $\pm 42 \text{ V peak}$ .

**Number of Readings (N Readings):** 0 to 9,999.

Readings are not internally stored.

For  $N = 0$  the 3437 operates in delay mode only.

**Maximum reading rate (Remote, N Rdgs. > 1, and a zero delay listener\*)**

**ASCII:** 3600 Readings/s.

**PACKED:** 5700 Readings/s.

Actual Reading Rate is given by

$$\text{ASCII: } \frac{3600 + \text{listen rate}}{3600 (\text{listen rate})}$$

$$\text{ASCII: } \frac{3600 + \text{listen rate}}{3600 + \text{listen rate}}$$

Listen rate is the maximum speed at which the listener can accept 7 data bytes.

$$\text{PACKED: } \frac{5700 + \text{listen rate}}{5700 + \text{listen rate}}$$

$$\text{PACKED: } \frac{5700 + \text{listen rate}}{5700 + \text{listen rate}}$$

Listen rate is the maximum speed at which the listener can accept 2 data bytes.

### Delay

**N Rdgs. = 0 or 1**

**DELAY (setting):** 0 to 0.999 999 9 sec. in 0.1  $\mu\text{s}$  steps.

**N Rdgs. > 1 (Remote and a zero delay listener)**

**ASCII:**  $0.0002778 \text{ s} \leq \text{DELAY} \leq 0.9999999 \text{ s}$ .

**PACKED:**  $0.0001754 \text{ s} \leq \text{DELAY} \leq 0.9999999 \text{ s}$ .

Minimum delay is a function of listener delay related by:

**ASCII:**  $277.8 \mu\text{s} + \text{listener delay}$ .

**PACKED:**  $175.4 \mu\text{s} + \text{listener delay}$ .

**Accuracy (EXT. TRIG to DELAY OUT, 0°C to 50°C)**

**Delay offset:**  $100 \text{ ns} \pm 25 \text{ ns}$  (with  $< 150 \text{ pF}$  cable capacitance)

**Delay accuracy:**  $\pm 0.008\%$  DELAY Setting + Delay offset.

**Delay repeatability (jitter) for N Rdgs = 0 or 1**

DELAY of 0 or 0.1  $\mu\text{s}$ : 2 ns

DELAY of 0.2  $\mu\text{s}$  to 50 ms:  $10 \text{ ns} + 0.0002\%$  DELAY setting.

DELAY of  $> 50 \text{ ms}$ :  $\pm 110 \text{ ns}$ .

**Input bandwidth (3 dB)**

**10 V range:** 1.0 MHz.

**1 V range:** 1.1 MHz.

**0.1 V range:** 40 kHz.

### Settling Time:

**10 V range:** 10 V Range with 10 V step input:

Reading settles to within 30 mV of final value in 7.5  $\mu\text{s}$  or to within 200 mV of final value in 700 ns.

**1 V range:** 1 V Range with 1 V step input:

Reading settles to within 3 mV of final value in 1.5  $\mu\text{s}$  or to within 20 mV of final value in 700 ns.

**0.1 V range:** 0.1 V Range with .1 V step input

Reading settles to within 200  $\mu\text{V}$  of final value in 25  $\mu\text{s}$ .

### General

**Operating temperature:** 0 to 55°C.

**Storage temperature:**  $-40^\circ\text{C}$  to  $75^\circ\text{C}$ .

**Humidity range:**  $< 95\%$  R.H.,  $0^\circ\text{C}$  to  $40^\circ\text{C}$ .

**Power:** 100 V, 120 V, 220 V, 240 V +5%, -10%, 48 Hz to 440 Hz line operation,  $< 42 \text{ VA}$  with all options.

**Size:** 88.9 mm H x 212.7 mm W x 527.1 mm D ( $3\frac{1}{2}''$  x  $8\frac{3}{8}''$  x  $20\frac{3}{4}''$ ).

**Weight:** net, 5.6 kg (12 lb 4 oz). Shipping, 7.6 kg (16 lb 12 oz).

### 3437A System Voltmeter

# DIGITAL VOLTMETERS

## HP-IB 5 Function DMM

### Model 3438A

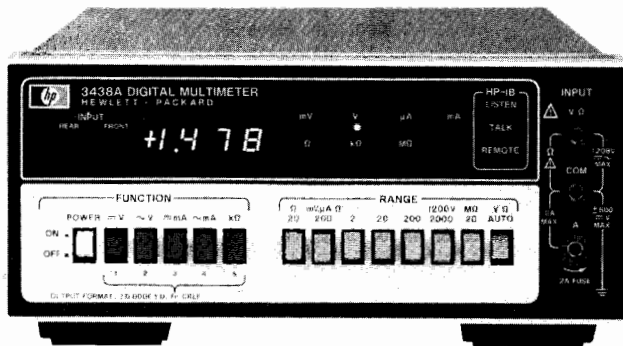

### Description

The 3438A is an autoranging 3½ digit Multimeter with 5 functions of ACV, DCV, ACI, DCI, and  $\Omega$ . It interfaces to the HP-IB providing both addressable and talk-only modes. The addressable mode allows triggering either from the Computer or Controller (remote) or internally (local). Function and range are selected manually on the front panel with autoranging of volts and ohms.

### Specifications

#### DC Voltmeter

Ranges:	Maximum display:
200 mV	$\pm 199.9$ mV
2 V	$\pm 1.999$ V
20 V	$\pm 19.99$ V
200 V	$\pm 199.9$ V
1200 V	$\pm 1199$ V

**Maximum input:** 1200 V (DC + peak AC).

**Accuracy:** (1 year, 15 to 30°C)

Range	Specifications
200 mV	$\pm (0.1\% \text{ of reading} + 2 \text{ counts})$
2 V to 1200 V	$\pm (0.1\% \text{ of reading} + 1 \text{ count})$

**Temperature coefficient:** (0 to 15°C and 30 to 55°C)  $\pm (0.015\% \text{ reading} + 0.1 \text{ count})/^\circ\text{C}$ .

**Input resistance:** 10 meg  $\Omega \pm 1\%$ .

**Input Type:** floating, 500 V maximum com. to ground.

**Normal Mode Rejection:** >40 dB at 50 Hz and 60 Hz  $\pm 0.1\%$

**Effective common mode rejection:** (1 k $\Omega$  unbalance) > 120 dB at 50/60 Hz  $\pm 0.1\%$ .

**Response time:** <0.7 seconds to within 1 count of final value on one range. Add 1 second for each range change.

#### AC Voltmeter

**AC Converter:** (average responding RMS calibrated)

Ranges:	Maximum display:
200 mV	199.9 mV
2 V	1.999 V
20 V	19.99 V
200 V	199.9 V
1200 V	1199 V

**Maximum input:** 1700 V (DC + Peak AC), 10<sup>7</sup> Volt-Hz max.

**Accuracy (with display of  $\geq 20$  counts)** 1 year, 15 to 30°C

Frequency	Specifications
30 Hz-50 Hz	$\pm (1.5\% \text{ of reading} + 3 \text{ counts})$
50 Hz-20 kHz	$\pm (0.3\% \text{ of reading} + 3 \text{ counts})$
20 kHz-100 kHz	$\pm (1.5\% \text{ of reading} + 10 \text{ counts})$

**Temperature coefficient:** (0 to 15°C and 30 to 55°C)  $\pm (0.04\% \text{ of reading} + 0.2 \text{ count})/^\circ\text{C}$ .

#### Ohmmeter

Ranges	Maximum display	Current through unknown
20 $\Omega$	19.99 $\Omega$	5 mA
200 $\Omega$	199.9 $\Omega$	5 mA
2 k $\Omega$	1.999 k $\Omega$	500 $\mu\text{A}$
20 k $\Omega$	19.99 k $\Omega$	50 $\mu\text{A}$
200 k $\Omega$	199.9 k $\Omega$	5 $\mu\text{A}$
2000 k $\Omega$	1999 k $\Omega$	500 nA
20 M $\Omega$	19.99 M $\Omega$	50 nA

**Input protection:** 250 V RMS.

**Accuracy** (1 year, 15 to 30°C)

Range	Specifications
20 $\Omega$	$\pm (0.5\% \text{ of reading} + 12 \text{ counts})$
200 $\Omega$ to 2 M $\Omega$	$\pm (0.2\% \text{ of reading} + 2 \text{ counts})$
20 M $\Omega$	$\pm (0.8\% \text{ of reading} + 2 \text{ counts})$

**Temperature coefficient** (0 to 15°C and 30 to 55°C)

Range	Specifications
20 $\Omega$ -2 M $\Omega$	$\pm (0.04\% \text{ of reading} + 0.2 \text{ counts})/^\circ\text{C}$
20 M $\Omega$	$\pm (0.18\% \text{ of reading} + 0.2 \text{ counts})/^\circ\text{C}$

#### DC Current and AC Current

Ranges:	Maximum display:
200 $\mu\text{A}$	$\pm 199.9$ $\mu\text{A}$
2 mA	$\pm 1.999$ mA
20 mA	$\pm 19.99$ mA
200 mA	$\pm 199.9$ mA
2000 mA	$\pm 1999$ mA

**Maximum input:** current: 2 amp (fuse protected) voltage: 250 V

**DC Current Accuracy:** (1 year, 15 to 30°C)

Range	Specifications
200 $\mu\text{A}$ to 200 mA	$\pm (0.3\% \text{ of reading} + 2 \text{ counts})$
2000 mA	$\pm (0.6\% \text{ of reading} + 2 \text{ counts})$

**AC Current Accuracy (With display of  $\geq 20$  counts)** 1 year, 15 to 30°C

Current Range	Frequency of Input Signal	
	30 Hz	50 Hz
2000 mA	$\pm (2\% \text{ of reading} + 5 \text{ counts})$	$\pm (1.2\% \text{ of reading} + 5 \text{ counts})$
200 mA to 200 $\mu\text{A}$	$\pm (1.7\% \text{ of reading} + 5 \text{ counts})$	$\pm (0.9\% \text{ of reading} + 5 \text{ counts})$

#### HP-IB

**Data output format:**

$\pm X.XXX$  E $\pm X$ , Fn CR LF (13 byte, fixed)

DISPLAY EXPONENT FUNCTION

**Function Code:** DCV, 1; ACV, 2; DCI, 3; ACI, 4;  $\Omega$ , 5

**Overload Indication:**  $\pm 1.XXX$  E + 9

**Talk Modes (Selected by internal switch)**

**Addressed to Talk**

**Local:** continuously sampling input; outputs on Bus when addressed to talk.

**Remote:** samples input only on command from controller.

**Talk only (used without controller)**

**Input:** switch selectable, front or rear.

**Reading rate:** is function of input level and ranging (2.5 to 4.7/sec. if in proper range).

#### General

**Ranging:** automatic or manual on ACV, DCV, and ohms. Manual only on AC & DC current.

**Operating temperature:** (0 to 55)°C.

**Humidity:** 95% RH at +40°C.

**Power:** 48-440 Hz, 12 watts; 86-106 V Opt 100; 104-127 V Opt 115; 190-233 V Opt 210; 208-250 V Opt 230.

**Size:** 85.7 mm H x 209.6 mm W x 282.2 mm D (3.4" x 8.25" x 11.5").

**Weight:** 2.8 kg (6.2 lb).

**3438A Digital Multimeter**

Opt 100, 115, 210, or 230 (specify one)



- DC and 2 Hz to 100 MHz
- 3½ digit



## Description

The Model 3403C is usable from dc to 100 MHz. True rms is especially valuable for measurements of noise, multiplexed signals, modulated waves and signals with high harmonic content.

### dB Display

The dB display option provides readings directly in dB, a major convenience to ac users. The dB reference to which the measurement is made is conveniently adjustable from the front panel to provide referenced dB measurements, or to provide a convenient means to offset the reading by as much as 13 dB for unreferenced measurements.

## Specifications

### Ranges

**Full range display:** 10.00 mV (ac only); 100.0 mV; 1.000 V; 10.00 V; 100.0 V; 1000 V.

**Overrange:** >90% on all ranges except as limited by max input voltage.

**Ranging information:** front panel annunciators indicate overrange (approximately 190% of full range), or underrange (approximately 17% of full range) conditions.

### Performance

#### AC Frequency Range

**Slow response:** 2 Hz to 100 MHz.

**Fast response:** 25 Hz to 100 MHz.

#### Response Time

**Fast response:** 1 s.

**Slow response:** 10 s.

Instrument reads final reading  $\pm 0.1\%$  of input change in stated response time.

#### Display Rate

**Fast response:** 4 readings per s.

**Slow response:** 2 readings per s.

#### Functions

**DC:** responds to dc component of input signal.

**AC:** responds to true rms value of ac coupled input signal.

**AC+DC:** responds to true rms value of dc and ac input signal; reading is  $\sqrt{(dc)^2 + (ac \text{ rms})^2}$

**Temperature coefficient:**  $\pm (0.1 \times \text{reading accuracy} / ^\circ\text{C})$  outside the  $25^\circ\text{C} \pm 5^\circ\text{C}$  temperature range.

**Accuracy:** 90 days ( $25^\circ\text{C} + 5^\circ\text{C}$ , <95% RH, 17% of range to 190% of range).

\*Data from accuracy charts.

READING ACCURACY =  $\pm(\% \text{ OF RANGE} + \% \text{ OF READING})^{**}$

RANGE	% OF RANGE (VOLTS)			% OF READING (VOLTS)						
	DC	DC-AC	AC	DC	2 Hz	25 Hz	100 kHz	1 MHz	10 MHz	100 MHz
1000V	.3	.3	.3	.2	.4*	.2				
100V	.2	.2	.2	.2	.4*	.2	1			
10V	.2	.2	.2	.2	.4*	.2	.5	1		
1V	.2	.2	.2	.2	.4*	.2	.5	1	2.5	10
100mV	.6	.6	.2	.2	.4*	.2	.5	2	2.5	10
10mV		.2	.4			.3	1.2	3		

CAUTION: frequencies and ranges in this area may result in invalid readings without ranging indication.

\* DC + AC function and slow response time only

\*\* % of reading specification is representative of typical flatness.

## Input Characteristics

**Input impedance:** (<10 MHz):

**1 V to 1000 V range:**  $10 \text{ M}\Omega \pm 10\%$  shunted by  $24 \text{ pF} \pm 10\%$ .

**10 mV and 100 mV range:**  $20 \text{ M}\Omega \pm 10\%$  shunted by  $20 \text{ pF} \pm 10\%$ .

## Maximum Input Voltage

**High to low:** 1000 V rms, 1500 peak or  $10^\circ \text{ V-Hz}$  on any range. Maximum dc voltage in ac mode: 500 V dc.

**Low to chassis:**  $\pm 500 \text{ V dc}$ , when floated with special banana to BNC adapter.

## Options:

### Autoranging (3403C option 001)

**Automatic ranging:** uprange at approximately 190% of full range; downranges at approximately 17% of full range.

**Autorange time:** fast response: 1 s per range change. Slow response: 10 s per range change.

**Remote control + digital output + autoranging (3403C option 003):** Provides remote control of all front panel functions, ranges, digital output and autoranging.

### dB display (3403C option 006)

**Measurement range:** 108 dB ( $-48 \text{ dBV}$  to  $+60 \text{ dBV}$ ).

**Calibrated dB reference:** 0 dB = 1.000 V; reference level may be set for 0 dBm (600 $\Omega$ ) by adjusting front panel dB calibration adjustment.

**Variable dB reference:** reference level may be shifted downward from calibrated position >13 dB.

## General

### Operating Conditions

**Temperature range:**  $0^\circ\text{C}$  to  $50^\circ\text{C}$ .

**Humidity:** <95% RH.

### Recorder Output

**Output voltage:** 1 V dc open circuit for full range input.

**Output resistance:**  $1 \text{ k}\Omega \pm 10\%$ .

**Power:** 115 V or 230 V  $\pm 10\%$ , 48 Hz to 440 Hz, 35 VA max. (including all options).

**Input terminals:** BNC front panel connector standard for low to high terminals; rear panel connector available by internally reversing position of ac converter module.

**Weight:** including all options: net, 5 kg (11 lb). Shipping, including all options: Net, 7.2 kg (16 lb).

**Size:** 127 H x 234.9 W x 196.8 mm D (5" x 9.25" x 7.75").

**Accessories furnished:** floating adapter-banana to BNC.

## 3403C True RMS Voltmeter

**Opt 001** autoranging

**\*Opt 003** remote control + digital output + autoranging

**\*Opt 006** dB display

\*Options 003 and 006 are available only as factory installed options.



# COMPONENT MEASUREMENT

## General Information

C, R, L, D, Q, Z,  $\theta$  and IC's

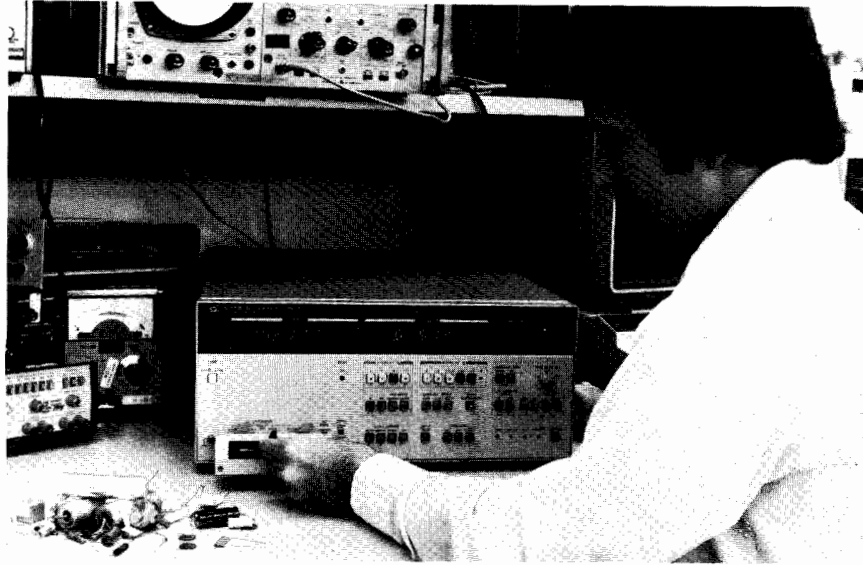

Instrument	Frequency				Q or 1/D		C in farads, L in henries or R in ohms						Basic Accuracy			Page		
	1 DC Hz	1 kHz	1 MHz	1 GHz	10 <sup>0</sup>	10 <sup>3</sup>	10 <sup>-15</sup>	10 <sup>-12</sup>	10 <sup>-9</sup>	10 <sup>-6</sup>	10 <sup>-3</sup>	10 <sup>0</sup>	10 <sup>3</sup>	10 <sup>7</sup>	0.1%		1%	10%
Multi-frequency LCR Meter 4274A		•	•						C				R		•			86
Multi-frequency LCR Meter 4275A		•	•						C				R		•			86
LCZ Meter 4276A		•	•						C				R		•			108
LCZ Meter 4277A		•	•						C				R		•			108
RF Impedance Analyzer 4191A					10 <sup>-1</sup>				C				R, Z		•			90
LF Impedance Analyzer 4192A									C				Z, R		•			92
Vector  Z  Meter 4193A													Z		•			94
Digital LCR Meter 4261A		•	•						C				R		•			96
Digital LCR Meter 4262A		•	•						C				R		•			96
1 MHz LCR Meter 4271B			•						C				R		•			98
Q Meter 4342A			•						C				L			•		99
Miliohm Meter 4328A			•										R			•		100
High Resistance Meter 4329A	•								10 <sup>6</sup>				R			•		100
Universal Bridge 4260A	•		•						C				R		•			101
Universal Bridge 4265B			•						C				R		•			101
Vector  Z  Meter 4800A			•						C				L, Z		•			102
pA Meter/DC Voltage Source 4140B*	•								C				I		•			104
Semiconductor Parameter Analyzer 4145A	•												I, V		•			112
Semiconductor/Component Test System 4061A	•		•						C				I, V		•			106
Digital IC Tester 5045A/5046A	Functional and DC Parameter measurements on TTL, CMOS, ECL, HTL, and DTL logic families.																	114

\*I in amperes, V in volts; (V is test voltage).



## Impedance $|Z|$ , $\theta$ , C, R, L, D & Q

Hewlett Packard's family of component measurement instruments covers the impedance range from less than one milliohm to greater than  $10^{16}$  ohms. Instruments range from the traditional manual null measurement technique to the completely automatic, microprocessor controlled, systems oriented type.

The basic characteristics of each instrument are summarized in the selection guide on the preceding page. This guide is convenient for selecting the most suitable instrument for a particular application or for considering trade-offs of key characteristics.

### Impedance Considerations

Impedance measuring instruments can be categorized, according to the technique used, into the bridge, voltage/current and Q methods. In the bridge technique, circuit conditioning required to achieve a balance or null condition is detected and processed to indicate the measured value. The voltage/current method essentially uses Ohm's Law in that a constant voltage or current is applied to the unknown and the converse current or voltage is indicative of the unknown value. The Q method utilizes unique characteristics of the series resonant circuit to determine Q, and indirectly L, C and R.

Traditionally, the bridge has been the most accurate measurement technique. Two examples are the low-cost, manual HP 4265B Universal Bridge and the semi-automatic HP 4260A Universal Bridge. Today's technology yields automatic, digital readout bridges with accuracy exceeding the less sophisticated manual bridges. The HP 4271B 1 MHz LCR Meter uses a state-of-the-art four terminal pair arrangement to eliminate the mutual inductance of the test leads—a principle consideration at 1 MHz.

In the past, the voltage/current technique utilized analog meter readouts for speed and convenience, but offered less accuracy than the bridge method. With recent advances in technology, this is no longer the case. The new fully automatic digital instruments using the voltage/current method offer accuracy exceeding all but the most sophisticated manual bridges.

The first of these instruments introduced by Hewlett-Packard was the 4261A. It offers fully automatic L, C, R and D measurements at two test frequencies with excellent accuracy. The HP 4262A is the first of a new generation of microprocessor-based instruments, featuring three test frequencies and automatic self-test capability.

### New Generation Component Measurements

Many of these measurements have been either not practical, very difficult, or very costly to make with earlier instruments that were designed to make measurements only under relatively limited test conditions. However, Hewlett-Packard now offers a new generation of instruments to change the measuring concept of evaluating electronic components, devices and circuits—that is, "testing and evaluating under actual working conditions."

The addition of the HP 4274A and 4275A will allow the user to test components under

actual operating conditions. Both instruments feature variable test signal levels, ten spot frequencies, self test capability, digital offset to compensate for test leads and fixtures, and vector/phase angle measurements.

The HP Models 4276A and 4277A LCZ Meters are the latest additions to HP's lineup of component measuring instruments. Both instruments are capable of high speed LCZ measurements under real-world frequency conditions and both have an optional comparator for fully automatic bin sorting. These features, along with  $4\frac{1}{2}$  digit resolution and a basic measurement accuracy of 0.1%, make the 4276A and 4277A ideal for either production line or R & D applications.

Impedance analysis and network analysis can be performed accurately and efficiently using the HP Model 4191A RF Impedance Analyzer and the new HP Model 4192A LF Impedance Analyzer.

In the frequency range of 1 MHz to 1000 MHz, the 4191A measures 14 parameters including  $|Z|$ ,  $|Y|$ ,  $\theta$ , R, X, G, B, L, C, D, and Q, reflection coefficient  $|\Gamma|$ ,  $|\Gamma_x|$ , and  $|\Gamma_y|$  plus deviation  $\Delta$  and  $\Delta\%$  for all parameters. The 4192A measures all the preceding parameters plus Group Delay in the frequency range from 5 Hz to 13 MHz.

Both 4191A and 4192A have built-in frequency synthesizers and dc bias sources, including internal sweep of both frequency and bias voltage. Basic measuring accuracy for the 4191A (1 MHz to 1000 MHz) is 1%. Basic accuracy for the 4192A (5 Hz to 13 MHz) is 0.3%.

The addition of the HP 4193A enables in-circuit measurements of impedance magnitude and phase. The 4193A features a built-in 4 digit synthesizer, sweepable from 400 kHz to 110 MHz. This also offers in-circuit and component impedance evaluation at actual operating frequencies.

### Semiconductor Measurements

The 4140B pA Meter/DC Voltage Source is a highly accurate test instrument designed for basic DC characteristics measurements such as leakage current, current-voltage characteristics, quasi-static C-V measurements and those others especially required by the semiconductor industry for new device development and for improvement of production yields.

The 4140B is also usable for making measurements on electric components and equipment such as for measuring leakage current or insulation resistance to improve product reliability.

The 4140B consists of a very stable picoampere meter with a synchronized, dual programmable DC voltage supply— $V_A$  and  $V_B$  ( $V_A$  includes staircase capability and ramp voltage generation).

The new HP Model 4145A Semiconductor Parameter Analyzer provides complete dc characterization of semiconductor devices and materials. It is a fully automatic, high performance, programmable test instrument designed to measure, analyze, and graphically display a wide range of semiconductor dc characteristics, such as  $h_{FE}$ ,  $g_m$ , and  $V_{th}$ .

Device stimulus and parameter measurement are performed by four programmable

stimulus/measurement units (SMU), providing automatic, high speed measurements and eliminating instability resulting from connection changes at the DUT. The 4145A also has two voltage sources and two voltage monitors for measurement applications which require more than the four SMUs.

Measurement results are displayed on a built-in 6-inch CRT, and can be dumped directly on to an external digital printer/plotter. A built-in flexible disc drive allows storage of measurement set-ups and measurement results.

### Integration into HP-IB System

Adding the HP-IB option to a component measuring instrument enables the instrument to be incorporated into an HP-IB system. This permits high speed measurement of many components along with arithmetic processing of measurement data and greatly increases the efficiency of production line testing of discrete components, of quality assurance tests, or of laboratory evaluations.

For more comprehensive semiconductor measurement, Hewlett-Packard has provided the Model 4061A Semiconductor/Component Test System. The 4061A is a dedicated HP-IB system that performs efficient, automatic evaluation of the fundamental characteristics of semiconductor and electronic components. The 4061A is especially useful for new component/material development, quality control, and in the early stages of semiconductor manufacture, for monitoring and controlling the wafer process.

A wide range of characteristics measurements can be done, including doping profile, surface charge density, minority carrier lifetime and threshold voltage. Software for seven typical applications are provided with the system.

The 4061A employs a unique switching sub-system that controls DUT connection between the LCR meter and pA Meter. This insures that both impedance and current characteristics can be measured without changing the system set-up.

### Summary

To assist in the selection of an impedance meter suitable for your needs, the following guidelines may be used:

- (1) Choose an instrument capable of measuring your device under frequency, signal level, and dc bias conditions identical to those of the intended application.
- (2) Consider the environmental parameters (lead resistance and inductance, stray capacitance, temperature variations, ...) that will affect your measurement and choose a measurement technique that will tend to counteract them.
- (3) Then select the instrument with the broadest measurement capability within accuracy and cost constraints.

Hewlett-Packard's impedance measuring instruments have been used in numerous diverse applications. If you have an unusual application or need assistance, contact your nearest Hewlett-Packard sales office for information.



# COMPONENT MEASUREMENT

## Multi-Frequency LCR Meters

Models 4274A & 4275A

- Test frequencies - 100 Hz to 100 kHz
- Test signal level - 1 mV to 5 Vrms
- High Resolution - 5 1/2 digit: D=0.00001
- Measure L/C - D/Q/ESR/G;  $|Z| - \theta$ , R-X/B/L/C;  $\Delta LCRZ$ ,  $\Delta\%$
- 0.1% basic accuracy

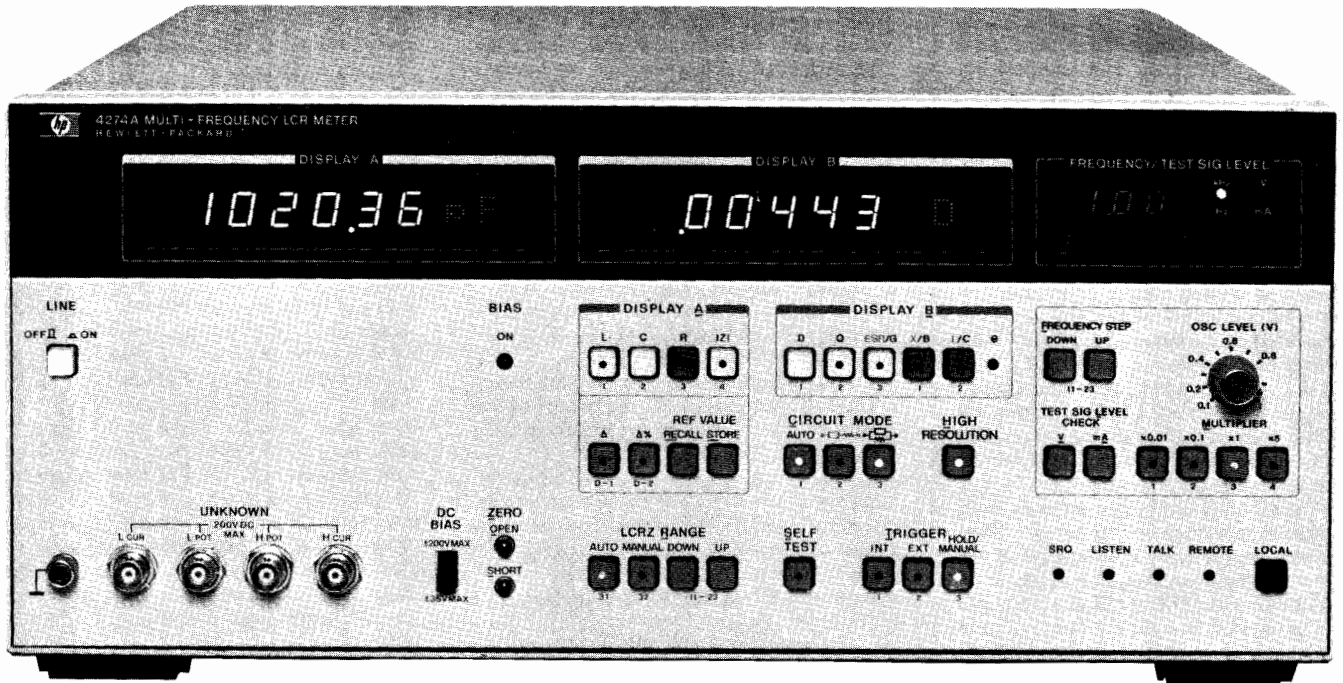

4274A



### Description

The 4274A and 4275A Multi-frequency LCR Meters are the most recent additions to Hewlett-Packard's new generation of micro-processor-based impedance measuring instrumentation. Both instruments offer a new measuring concept for the evaluation of LCR components, complex components, electronic circuits "tested under actual working conditions", and semiconductor materials. A measurement under conditions similar to the intended use contributes to the improvements in quality and reliability of electronic components, devices and circuits.

### Multi-Frequency Capability

To insure the high reliability in circuits and devices, it is most important that they be measured and evaluated at test signals similar to those of actual operating conditions.

The 4274A covers the wide frequency range of 100 Hz to 100 kHz in 11 spot frequencies and the 4275A has 10 spot frequencies from 10 kHz to 10 MHz, in 1-2-4 step sequence with 1-3-5 as an option. This feature produces the frequency characteristics of components or devices. In addition, two optional special frequencies (for example: 455 kHz and 10.7 MHz) are available within the frequency range of each instrument. This wide frequency range selection offers evaluation of circuit design with a continuously variable test signal over the range of 1 mV to 5 Vrms (to 1 Vrm for the 4275A), and with internal dc bias optionally available with 1 mV maximum resolution. The test voltage or current values can be monitored on the 3-digit display for accurately setting the actual conditions under which the device-under-test will operate.

### Multi-Parameter Measurements

The 4274A and 4275A measure equivalent series resistance (ESR), impedance ( $|Z|$ ), phase angle ( $\theta$ ), reactance (X), susceptance (B), and conductance (G), in addition to the conventional L,C,R,D and Q parameters in certain combinations with a dual 5 1/2 digit display, and an HP-IB option for systems integration.

This wide selection of 11 parameters provides for more accurate evaluation of electronic materials or components with high measurement speed for most needed combined parameters; for example, the C-G measurement of semiconductors, an R-X measurement in circuit design, or the C-ESR or  $|Z|-\theta$  measurement of tantalum capacitors.

In addition, a deviation measurement capability ( $\Delta, \Delta\%$ ) for the L.C.R. and  $|Z|$  functions displays the difference between the actual value and a stored reference, either as a difference value or in percent. Deviation applications include, for example, a temperature dependence measurement of devices in environmental tests.

### Reliable Measurements With 5 1/2 Digit Resolution

The 4274A and 4275A measure only the value of the component and/or device under test, with 5 1/2 resolution and 0.1% basic accuracy by reducing the possibility of errors due to self or mutual inductance, stray capacitance and/or residual inductance in the test leads or test fixture used. This measurement is obtained by a state-of-the-art four terminal pair configuration and a built-in automatic ZERO-offset capability to compensate for these errors.

# COMPONENT MEASUREMENT

## Multi-Frequency LCR Meters

Models 4274A & 4275A

87



- Test frequencies - 10 kHz to 10 MHz
- Test signal level - 1 mV to 1 Vrms
- 0.1% basic accuracy

- High Resolution - 5½ digit;  $D=0.00001$
- Measure L/C - D/Q/ESR/G;  $|Z| - \theta$ ,  
R-X/B/L/C;  $\Delta LCRZ$ ,  $\Delta\%$

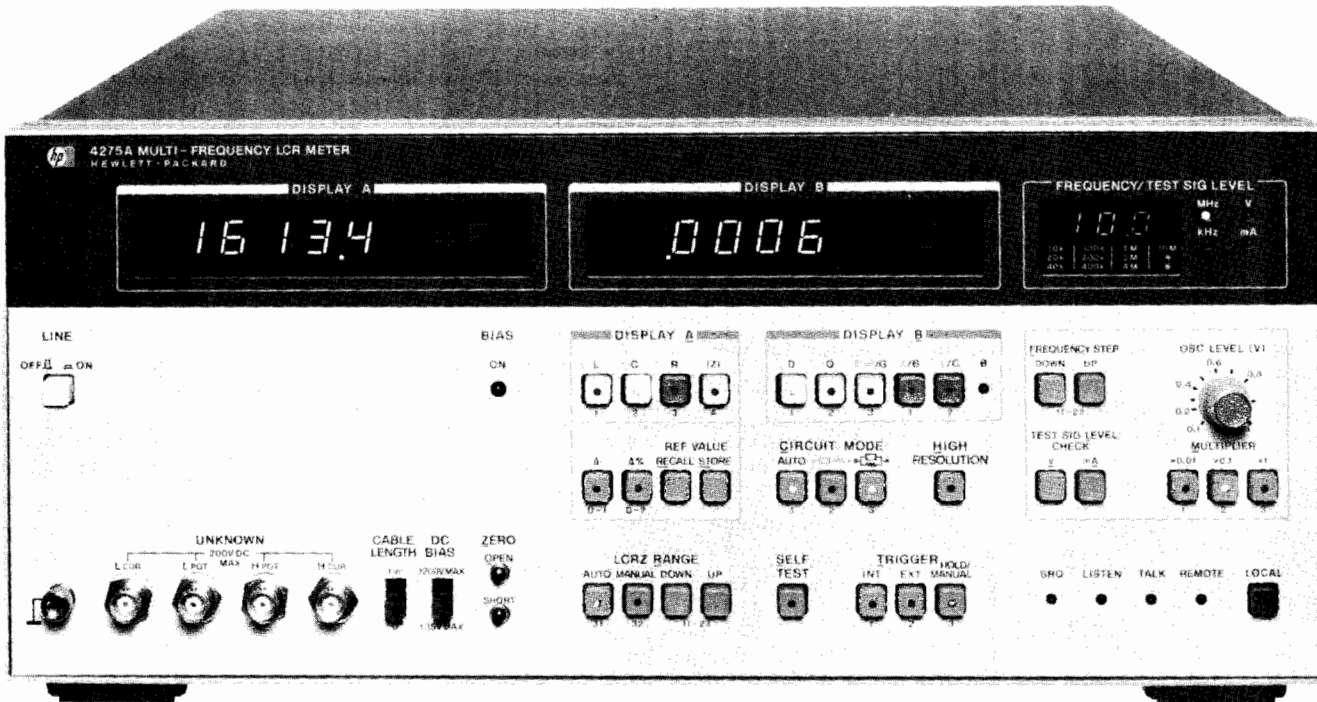

4275A



The fast measurement speed, high resolution, and high accuracy can make major contributions for the component manufacturer and user who is concerned about reducing his costs, improving quality, and throughput efficiency. In these areas, the 4274A and the 4275A are ideal for D-measurements of film capacitors or insulation material (with the high resolution of 0.00001), the C-G measurements of semiconductors (with maximum resolutions of 0.001 pF, 0.1 nS, respectively), and for the low impedance measurement of aluminum electrolytic capacitors (with a maximum resolution of 0.001 m $\Omega$ ).

### Automatic Semiconductor and Component Measurements With HP-IB

Integrating the 4274A and the 4275A into an HP-IB controlled system is an excellent method for improving efficiency and cost savings both in the laboratory and on the production line. These automatic measurement systems are assembled by connecting the HP-IB cables between the instruments to be utilized for a specific task.

A system built around the 4274A and/or 4275A allows the user to obtain useful data for many diverse applications. For example, the evaluation of semiconductors based on the frequency dependence of its C-V characteristics that requires a wide range and fast measurement speeds is easily accomplished with these instruments. The four-terminal pair input configuration and the automatic zero offset capability insures that the measured data is accurate, even in a systems environment.

### Sample Applications Semiconductor Measurements

The evaluation of a semiconductor can be done with a C-V or G-V measurement with the multi-spot frequencies featured in the 4274A

and 4275A, (with C resolution of 0.001 pF and G resolution of 0.1 nS), their two programmable bias sources (maximum resolution 1 mV) and their continuously variable test signal levels (from 1 mVrms).

Of significant use is the evaluation of the doping process and the measurement of the characteristics of MOS or bipolar semiconductor materials which employ a C or G measurement with varying dc bias voltage.

A sample plot of a semiconductor measurement is shown in the figure below. Such measurements at high speed can offer high reliability and high throughput efficiency in the semiconductor manufacturing processes.

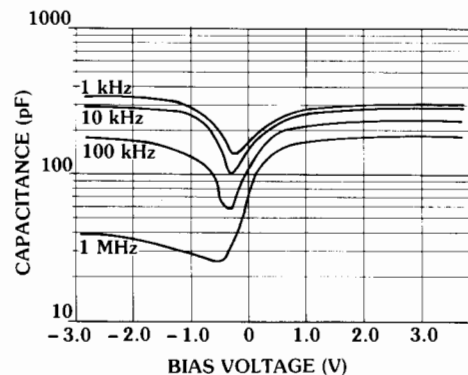

# COMPONENT MEASUREMENT

## Multi-Frequency LCR Meters

Models 4274A & 4275A (Cont.)

### Common Specifications (4274A & 4275A)

#### Parameters measured:

L: inductance C: capacitance	Q: =1/D ESR: equivalent series resistance	θ: phase angle Δ: deviation for L, C, R, Z, Δ%: % of deviation
R: resistance Z: impedance D: dissipation factor	G: conductance X: reactance B: susceptance	Test frequency Test signal level (voltage or current)

#### Parameter combinations:

Display A	Display B	
L	D / Q / ESR	D / Q / G
C		
R	X / L	B / C
Z	θ	

#### Measurement frequencies, test signal levels, and full scale range:

MODEL	4274A	4275A
Measurement frequencies	100 Hz–100 kHz, 11 spots (100 Hz, 120 Hz, 200 Hz, 400 Hz, 1 kHz, 2 kHz, 4 kHz, 10 kHz, 20 kHz, 40 kHz, 100 kHz; ±0.01%)	10 kHz–10 MHz, 10 spots (10 kHz, 20 kHz, 40 kHz, 100 kHz, 200 kHz, 400 kHz, 1 MHz, 2 MHz, 4 MHz, 10 MHz; ±0.01%)
Test signal levels	4-ranges (1 mVrms–5 Vrms) continuously variable	3-ranges (1 mVrms–1 Vrms) continuously variable
Full scale range	L: 100.00 nH – 1000.0 H C: 1.0000 pF – 1.00 F R,  Z , ESR, & X: 100.00 MΩ – 10.000 MΩ D: 0.00001 – 9.9999 Q (1/D): 0.01 – 9900 G & B: 1.0000 μS – 100.00 S θ: 0 – ±180°	L: 100.00 nH – 10.00 H C: 1.0000 pF – 100.00 μF R: 1.0000 Ω – 10.000 MΩ D: 0.00001 – 9.9999 Q: 0.01 – 9900 S: 1.0000 μS – 10.00 S θ: 0 – ±180°

**Accuracy (4274A only):** Typical C–D, L–D, R–X and |Z|–θ measurement accuracy values are given below.

**Displays:** Dual 5½-digit and single 3-digit; maximum display 199999 (full scale and overrange in high resolution mode), and 4½-digit: maximum display 19999 in normal mode. (Number of digits depends on measurement frequency, test level, and range).

**Circuit modes:** Series equivalent circuit and parallel equivalent circuit. Automatic selection available in AUTO mode.

**Deviation measurement:** Difference between recallable stored reference and displayed is deviation value (count or percent).

Display range: –199999 to +199999 counts in AUTO range. –19999 to +199999 counts in MANUAL range (the sample should be measurable at the selected range). % Display range: –199.99% to +199.99%

**Ranging:** AUTO or MANUAL (UP/DOWN)

**Trigger:** Internal, External or Manual.

**Measurement terminals:** Four-terminal pair with guard.

**Auto zero adjustment:** Automatic normalization of the readout offset due to residuals of the test fixture by pushbutton operation.

**Normalization range:** C < 20 pF, L < 2000 nH, R < 0.5 Ω, G < 5 μS.

**Self test:** Automatic operational verification check indicates pass or fail condition.

**HP-IB data output and remote control:** Standard.

**Memory back-up for storing measurement conditions:** Standard.

**Range:** full scale range, accuracy: % of reading + counts (D: accuracy: % of reading + absolute D value + count)

FREQUENCY RANGE	C–D/Q	L–D/Q	R–X	Z –θ
	D-range: 0.00001–9.9999 Q-range: 0.01–9900 (=1/D) (C & D accuracies apply only when C: full scale and D: ≤ 0.1)	D-range: 0.00001–9.9999 Q-range: 0.01–9900 (=1/D) (L & D accuracies apply only when L: full scale and D: ≤ 0.1)	(R accuracies apply only when R: full scale) (X accuracies apply only when R: 1/10 of full scale and X: full scale)	θ-range: –180° – +180.00° ( Z  & θ accuracies apply only when  Z : full scale)
100 Hz 120 Hz	C: 1000 pF–1000 mF, 0.1% + 3 D: 0.33% + 0.0008 + 1	L: 100 μH–10 kH, 0.1% + 3 D: 0.33% + 0.0013 + 1	R: 100 mΩ–10 MΩ, 0.1% + 3 X: 100 mΩ–10 MΩ, 0.1% + 13	Z : 100 mΩ–10 MΩ, 0.1% + 3 θ: ±0.1°
200 Hz	C: 1000 pF–1000 mF, 0.1% + 2 D: 0.32% + 0.0007 + 1	L: 100 μH–10 kH, 0.1% + 3 D: 0.32% + 0.0012 + 1	R: 100 mΩ–10 MΩ, 0.1% + 3 X: 100 mΩ–10 MΩ, 0.1% + 13	Z : 100 mΩ–10 MΩ, 0.1% + 3 θ: ±0.1°
400 Hz	C: 100 pF–100 mF, 0.14% + 1 D: 0.34% + 0.0013 + 1	L: 100 μH–10 kH, 0.1% + 3 D: 0.31% + 0.0011 + 1	R: 100 mΩ–10 MΩ, 0.1% + 3 X: 100 mΩ–10 MΩ, 0.1% + 13	Z : 100 mΩ–10 MΩ, 0.1% + 3 θ: ±0.1°
1 kHz	C: 100 pF–100 mF, 0.1% + 3 D: 0.33% + 0.0008 + 1	L: 10 μH–1000 H, 0.1% + 3 D: 0.33% + 0.0013 + 1	R: 100 mΩ–10 MΩ, 0.1% + 3 X: 100 mΩ–10 MΩ, 0.1% + 13	Z : 100 mΩ–10 MΩ, 0.1% + 3 θ: ±0.1°
2 kHz	C: 100 pF–100 mF, 0.1% + 2 D: 0.32% + 0.0007 + 1	L: 10 μH–1000 H, 0.1% + 3 D: 0.32% + 0.0012 + 1	R: 100 mΩ–10 MΩ, 0.1% + 3 X: 100 mΩ–10 MΩ, 0.1% + 13	Z : 100 mΩ–10 MΩ, 0.1% + 3 θ: ±0.1°
4 kHz	C: 10 pF–10 mF, 0.14% + 1 D: 0.34% + 0.0013 + 1	L: 10 μH–1000 H, 0.1% + 3 D: 0.31% + 0.0011 + 1	R: 100 mΩ–10 MΩ, 0.1% + 3 X: 100 mΩ–10 MΩ, 0.1% + 13	Z : 100 mΩ–10 MΩ, 0.1% + 3 θ: ±0.1°
10 kHz	C: 10 pF–10 mF, 0.1% + 3 D: 0.33% + 0.0008 + 1	L: 1 μH–100 H, 0.1% + 3 D: 0.33% + 0.0013 + 1	R: 100 mΩ–10 MΩ, 0.1% + 3 X: 100 mΩ–10 MΩ, 0.1% + 13	Z : 100 mΩ–10 MΩ, 0.1% + 3 θ: ±0.1°
20 kHz	C: 10 pF–10 mF, 0.1% + 2 D: 0.32% + 0.0007 + 1	L: 1 μH–100 H, 0.1% + 3 D: 0.32% + 0.0012 + 1	R: 100 mΩ–10 MΩ, 0.1% + 3 X: 100 mΩ–10 MΩ, 0.1% + 13	Z : 100 mΩ–10 MΩ, 0.1% + 3 θ: ±0.1°
40 kHz	C: 1 pF–1000 μF, 0.14% + 1 D: 0.34% + 0.0013 + 1	L: 1 μH–100 H, 0.1% + 3 D: 0.31% + 0.0011 + 1	R: 100 mΩ–10 MΩ, 0.1% + 3 X: 100 mΩ–10 MΩ, 0.1% + 13	Z : 100 mΩ–10 MΩ, 0.1% + 3 θ: ±0.1°
100 kHz	C: 1 pF–1000 μF, 0.1% + 3 D: 0.33% + 0.0008 + 1	L: 100 nH–10 H, 0.1% + 3 D: 0.33% + 0.0013 + 1	R: 100 mΩ–10 MΩ, 0.1% + 3 X: 100 mΩ–10 MΩ, 0.1% + 13	Z : 100 mΩ–10 MΩ, 0.1% + 3 θ: ±0.1°

(Conditions: Warm-up time ≥ 30 minutes, environment temperature: 23°C ± 5°C) Refer to technical data sheet for accuracy details.



**Accuracy (4725A only):** Typical C-D, L-D, R-X and  $|Z|-\theta$  measurement accuracy values are given below.

**Range:** full scale range, accuracy: % of reading + counts (D accuracy: % of reading + absolute D value + count)

Frequency Range	C - D/Q	L - D/Q	R - X	$ Z -\theta$
	D-range: 0.00001 - 9.9999 Q-range: 0.01-9900 (= 1/D) (C & D accuracies apply only when C: full scale and D: $\leq 0.1$ )	D-range: 0.00001 - 9.9999 Q-range: 0.01 = 9900 (= 1/D) (L & D accuracies apply only when L: full scale and D: $\leq 0.1$ )	(R accuracies apply only when R: full scale) (X accuracies apply only when R: 1/10 of full scale and X: full scale)	$\theta$ -range: $-180.00^\circ$ - $+180.00^\circ$  (Z & $\theta$ accuracies apply only when Z: full scale)
10 kHz	C: 10 pF - 100 $\mu$ F, 0.1% + 3 D: 0.33% + 0.008 + 1	L: 10 $\mu$ H - 100H, 0.1% + 3 D: 0.33% + 0.0013 + 1	R: 1000 m $\Omega$ - 10 M $\Omega$ , 0.1% + 3 X: 1000 m $\Omega$ - 10 M $\Omega$ , 0.1% + 13	$ Z $ : 1000 M $\Omega$ - 10 m $\Omega$ , 0.1% + 3 $\theta$ : $\pm 0.1^\circ$
20 kHz	C: 10 pF - 100 $\mu$ F, 0.1% + 2 D: 0.32% + 0.0007 + 1	L: 10 $\mu$ H - 100 H, 0.1% + 3 D: 0.32% + 0.0012 + 1	R: 1000 m $\Omega$ - 10 M $\Omega$ , 0.1% + 3 X: 1000 m $\Omega$ - 10 M $\Omega$ , 0.1% + 13	$ Z $ : 1000 M $\Omega$ - 10 m $\Omega$ , 0.1% + 3 $\theta$ : $\pm 0.1^\circ$
40 kHz	C: 1 pF - 10 $\mu$ F, 0.14% + 1 D: 0.34% + 0.0009 + 1	L: 10 $\mu$ H - 100 H, 0.1% + 3 D: 0.31% + 0.0011 + 1	R: 1000 m $\Omega$ - 10 M $\Omega$ , 0.1% + 3 X: 1000 m $\Omega$ - 10 M $\Omega$ , 0.1% + 13	$ Z $ : 1000 M $\Omega$ - 10 m $\Omega$ , 0.1% + 3 $\theta$ : $\pm 0.1^\circ$
100 kHz	C: 1 pF - 10 $\mu$ F, 0.1% + 3 D: 0.33% + 0.0009 + 1	L: 1 $\mu$ H - 10 H, 0.1% + 3 D: 0.33% + 0.0013 + 1	R: 1000 m $\Omega$ - 10 M $\Omega$ , 0.1% + 3 X: 1000 m $\Omega$ - 10 M $\Omega$ , 0.1% + 13	$ Z $ : 1000 M $\Omega$ - 10 m $\Omega$ , 0.1% + 3 $\theta$ : $\pm 0.1^\circ$
200 kHz	C: 10 pF - 10 $\mu$ F, 0.1% + 2 D: 0.32% + 0.0007 + 1	L: 1 $\mu$ H - 1000 mH, 0.2% + 3 D: 0.53% + 0.0023 + 1	R: 1000 m $\Omega$ - 1 M $\Omega$ , 0.2% + 3 X: 1000 m $\Omega$ - 1 M $\Omega$ , 0.2% + 13	$ Z $ : 1000 M $\Omega$ - 1 m $\Omega$ , 0.2% + 3 $\theta$ : $\pm 0.1^\circ$
400 kHz	C: 1 pF - 1000 nF, 0.14% + 1 D: 0.34% + 0.0025 + 1	L: 1 $\mu$ H - 1000 mH, 0.2% + 3 D: 0.51% + 0.0021 + 1	R: 1000 m $\Omega$ - 1 M $\Omega$ , 0.2% + 3 X: 1000 m $\Omega$ - 1 M $\Omega$ , 0.2% + 13	$ Z $ : 1000 M $\Omega$ - 1 m $\Omega$ , 0.2% + 3 $\theta$ : $\pm 0.1^\circ$
1 MHz	C: 1 pF - 1000 nF, 0.1% + 3 D: 0.33% + 0.0008 + 1	L: 100 nH - 100 mH, 0.2% + 3 D: 0.55% + 0.0025 + 1	R: 1000 m $\Omega$ - 1 M $\Omega$ , 0.2% + 3 X: 1000 m $\Omega$ - 1 M $\Omega$ , 0.2% + 13	$ Z $ : 1000 M $\Omega$ - 1 m $\Omega$ , 0.2% + 3 $\theta$ : $\pm 0.1^\circ$
2 MHz	C: 10 pF - 100 nF, 0.3% + 3 D: 0.55% + 0.0025 + 1	L: 1 $\mu$ H - 10 mH, 0.5% + 5 D: 1.0% + 0.0033 + 1	R: 10 $\Omega$ - 100 k $\Omega$ , 0.5% + 5 X: 10 $\Omega$ - 100 k $\Omega$ , 0.5% + 15	$ Z $ : 10 $\Omega$ - 100 k $\Omega$ , 0.5% + 5 $\theta$ : $\pm 0.2^\circ$
4 MHz	C: 1 pF - 10 nF, 1% + 20 + 0.002 pF D: 3.3% + 0.01 + 1	L: 1 $\mu$ H - 10 mH, 1% + 5 D: 2.0% + 0.0063 + 1	R: 10 $\Omega$ - 100 k $\Omega$ , 2% + 7 X: 10 $\Omega$ - 100 k $\Omega$ , 2% + 105	$ Z $ : 10 $\Omega$ - 100 k $\Omega$ , 2% + 7 $\theta$ : $\pm 0.8^\circ$
10 MHz	C: 1 pF - 10 nF, 2% + 20 + 0.002 pF D: 4% + 0.011 + 1	L: 100 nH - 1 mH, 2% + 7 D: 3.1% + 0.002 + 1	R: 10 $\Omega$ - 100 k $\Omega$ , 2% + 7 X: 10 $\Omega$ - 100 k $\Omega$ , 2% + 105	$ Z $ : 10 $\Omega$ - 100 k $\Omega$ , 2% + 7 $\theta$ : $\pm 0.8^\circ$

(Conditions: Warm-up time  $\geq$  30 minutes, environment temperature:  $23^\circ\text{C} \pm 5^\circ\text{C}$ ) Refer to technical data sheet for accuracy details.

## General Information

### Test signal level monitor:

Model	Range		Accuracy
	Voltage	Current	
4274A	0.001 V - 5.00 Vrms	0.001 mA - 100 mArms	$\pm$ (3% of reading + 1 count)
4275A	0.001 V - 1.00 Vrms	0.001 mA - 10.0 mArms	$\pm$ (3% of reading + 1 count) at $< 1$ MHz  $\pm$ (10% of reading + 2 counts) at $\geq 1$ MHz

**Measurement time:** (typical) 140-180 ms ( $> 1$  kHz); 140-210 ms  $\leq 1$  kHz (Measurement time depends on range, sample value and offset adjustment value).

**Z -  $\theta$  measurement time:** 170-210 ms  $> 1$  kHz; 170-240 ms  $\leq 1$  kHz.

**High resolution mode:** Approximately 8 times the normal measurement time.

**Auto ranging time:** 100 ms - 300 ms per range change.

## Options

**Opt 001:** 0 to  $\pm 35$  internal dc bias

Range	Steps	Accuracy
$\pm$ (.000 - .999) V	1 mV	$\pm$ (0.5% of reading + 1 mV)
$\pm$ (1.00 - 9.99)	10 mV	$\pm$ (0.5% of reading + 2 mV)
$\pm$ (10.0 - 35.0)	0.1 V	$\pm$ (0.5% of reading + 20 mV)

**Control:** 16023B DC Bias Controller or remote control with HP-IB (opt 101)

**Opt 002:** 0 -  $\pm 99.9$  V internal dc bias (for  $C \leq 0.1$   $\mu$ F)

**Range:**  $\pm$  (00.0 - 99.9) V, 0.1 V steps

**Accuracy:**  $\pm$  (2% of reading + 40 mV)

**Control:** Same as Opt 001

**External dc bias:**  $\pm 200$  V maximum.

**Bias monitor:** Rear panel BNC connector monitors internal or external input bias.

**Opt 004:** Frequency steps in 1-3-5 sequence.

**Special options:** Up to two additional test frequencies can be added in the frequency range of the 4274A (100 Hz to 100 kHz) or 4275A (10 kHz to 10.7 MHz). The following special test frequencies are available and others are available on request:

Option number	Frequency	Option number	Frequency
F01	15.7 kHz	F14	25.2 kHz
F02	32.8 kHz	F15	79.6 kHz
F03	455 kHz	F16	252 kHz
F04	3.58 MHz	F17	796 kHz
F05	4.19 MHz	F18	2.52 MHz
F06	10.7 MHz	F19	7.96 MHz
F11	15.75 kHz	F21	15.625 kHz
F13	62.5 kHz	F25	63.18 kHz

## Accessories

**16047A:** Direct coupled test fixture. Furnished accessory with the 4274A and 4275A.

**16023B:** DC Bias Controller, for control of dc bias Opt 001 or 002 Internal Bias Supply when HP-IB option is not installed. Control range 0 to  $\pm 99.9$  V by setting thumbwheel switch.

**16034B:** Test Fixture for chip components

**16047B:** Test Fixture with Safety Cover

**16047C:** Test Fixture for high frequencies

**16048A:** Test leads, BNC

**16048B:** Test leads, RF miniature

**16048C:** Test leads with Alligator Clips

**16380A:** Standard Air Capacitor Set, includes 1 pF, 10 pF, 100 pF and 1000 pF standard capacitors usable to 10 MHz.

## Options

**Opt 001:** 0 to  $\pm 35$  internal dc bias, max resolution; 1 mV steps

**Opt 002:** 0 to  $\pm 99.9$  V internal dc bias, resolution: 100 mV steps.

**Opt 004:** Frequency steps in 1-3-5 sequence

**Opt F01-F27:** Special test frequencies (each)

## Ordering Information

**4274A** 100 Hz - 100 kHz Multi-Frequency LCR Meter

**4275A** 10 kHz - 10 MHz Multi-Frequency LCR Meter

# COMPONENT MEASUREMENT

## RF Impedance Analyzer

Model 4191A

- 1-1000 MHz variable test frequency with sweep capability
- Direct reading of  $|Z| - \theta$ ,  $|Y| - \theta$ ,  $|\Gamma| - \theta$ ;  
 $L \cdot C - R \cdot G \cdot D \cdot Q$   
 $R - X, G - B, \Gamma_x - \Gamma_y$
- High resolution—4½ digit max
- Wide measuring range—1 mΩ – 100 kΩ ( $|Z|$ )
- Versatile easy-to-use test fixtures

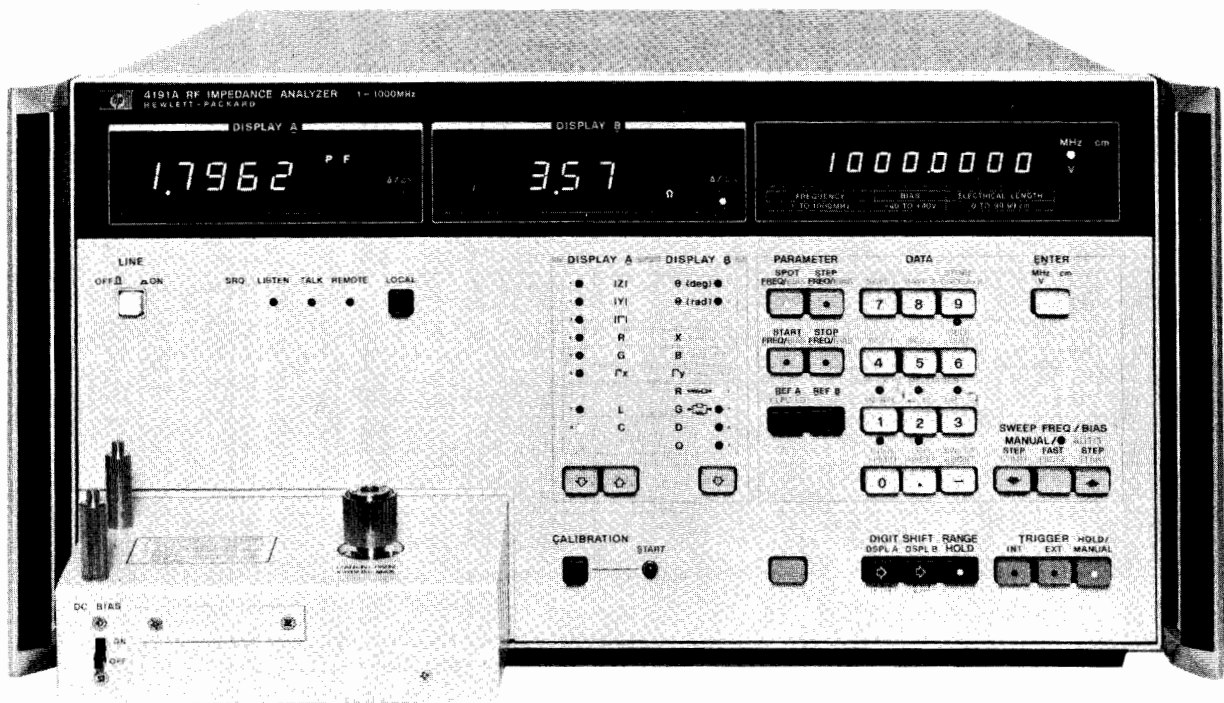

4191A (Shown with Opt 907 Handles)



### Description

The HP Model 4191A RF Impedance Analyzer measures 14 parameters with a maximum resolution of 4½ digits. The internal synthesizer provides variable frequencies from 1 MHz through 1000 MHz covering the UHF, VHF and video bands with automatic sweep capability. An internal dc bias supply with auto sweep function covers the voltage range of ±40 V in 10 mV steps.

The 4191A permits reliable measurements over a wide measuring range. Its outstanding repeatability, frequency response and accuracy are made possible by unique error correction capability and specially designed test fixtures. These features allow the 4191A to be used in evaluation of electronic materials, components and circuitry.

The internal synthesizer provides a maximum resolution of 100 Hz (Opt 002) with an accuracy of 3 ppm, allowing small changes in the resonant frequency of the device under test to be easily detected. The swept frequency capability aids in the analysis of frequency characteristics of the device.

Two complete front panel settings (parameter selection and the sweep control) can be stored in a non-volatile memory and recalled at any time with a single key operation. This, together with the standard HP-IB interface, makes the 4191A extremely efficient either as a stand-alone or systems instrument.

These unique features permit very wide applications in: (1) semiconductor testing such as surface state evaluation at high frequencies (C-V/G-V and conductance  $G/\omega$ ) characteristics, (2) resonator, filter, and magnetic and dielectric materials testing, (3) evaluation of LCR components such as high frequency chip and leaded components, and (4) testing of communications related components such as cables, connectors, etc.

### Specifications

**Parameter measured:**  $|Z| - \theta$ ,  $|Y| - \theta$ ,  $|\Gamma| - \theta$   
 $R - X, G - B, \Gamma_x - \Gamma_y$   
 $L - R \cdot G \cdot D \cdot Q, C - R \cdot G \cdot D \cdot Q$

**Display:** 4½ digit, max display 19999 counts

**Deviation measurement** (deviation from stored reference):

$\Delta$ : -19999 to +19999 counts

$\Delta\%$ : -1999.9 to +1999.9%

**Measuring signal** (23 ± 5°C):

**Frequency range:** 1 MHz to 1000 MHz

**Frequency step:** Standard: 100 kHz, 1-500 MHz  
 200 kHz, 500-1000 MHz

Opt 002: 100 Hz, 1-500 MHz  
 200 Hz, 500-1000 MHz

**Frequency accuracy:** ± 3 ppm

**Signal level (into 50Ω):** -20 ± 3 dBm

**Frequency control:** spot and swept

**Measuring mode:**

**Spot measurement:** at specific frequency (or dc bias)

**Swept measurement:** manual or automatic sweep from start to stop frequency (or dc bias) at step frequency (or dc bias) rate in linear or logarithmic form.

**Auto calibration:**

Automatic error compensation referenced to connected terminations (0 Ω, 50 Ω, 0 S)

**Calibration frequency:** 51 frequencies between start and stop frequencies.

**Electrical length compensation:** automatic compensation for electrical length of test fixtures.

Compensating range: 0 to 99.99 cm.

**DC Bias:**

**Internal DC Bias**

Voltage range: -40 to +40 V, 10 mV step  
 Setting accuracy: 0.1% of setting +10 mV  
 Bias control: spot and swept

**External DC Bias**

Voltage range: -40 to +40 V  
 Max allowable current: 100 mA

**Key status memory:** 2 sets of measuring conditions can be stored and recalled at any time. These conditions are kept in storage even when LINE is turned off.

**Ranging:** Auto/Range hold

**Trigger:** Internal, External or Manual

**Self-Test:** Automatic internal program test

**HP-IB Data output and remote control:** Standard

**Measuring Range, Resolution and Accuracy:**

Specified at APC-7 UNKNOWN connector for reflect coefficient measurement at measuring frequency and ambient temperature (0 - 55°C) where calibration is performed after the warm-up time of 40 minutes. Refer to General Information for temperature coefficient and typical measuring range/resolution and accuracies of other measuring parameters (see data sheet for detailed specifications).

**$|\Gamma| - \Theta/\Gamma_x - \Gamma_y$  Measurement**

**Measuring range:**

$|\Gamma|, \Gamma_x, \Gamma_y$ : 0.0001 to 1.0000  
 $\Theta$ : 0° to ±180.00° (0 to ±π rad.)  
 $|\Gamma|, \Gamma_x, \Gamma_y$  resolution: 0.0001  
 $|\Gamma|, \Gamma_x, \Gamma_y$  Accuracy (see graph below):

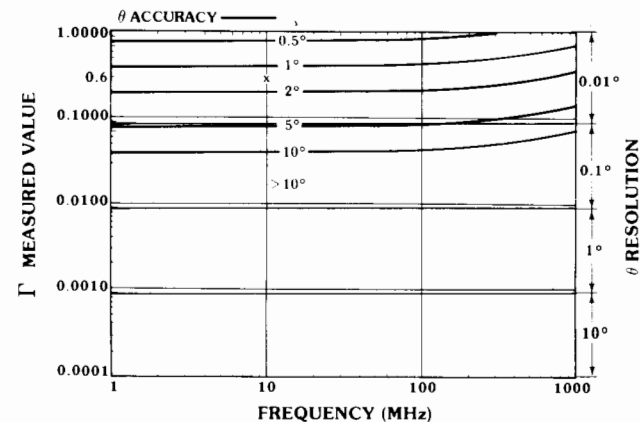
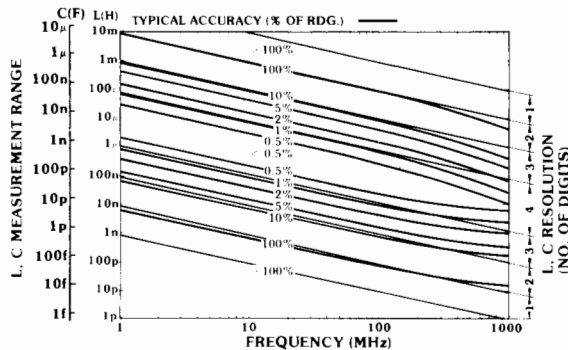
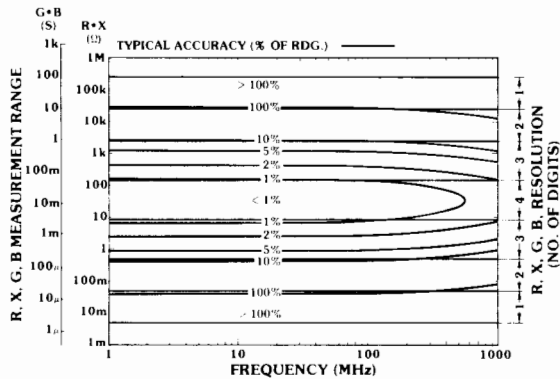
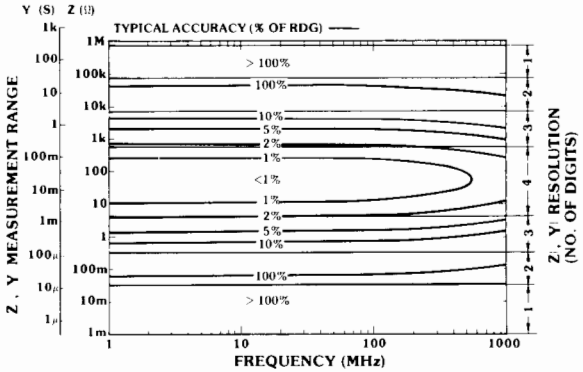
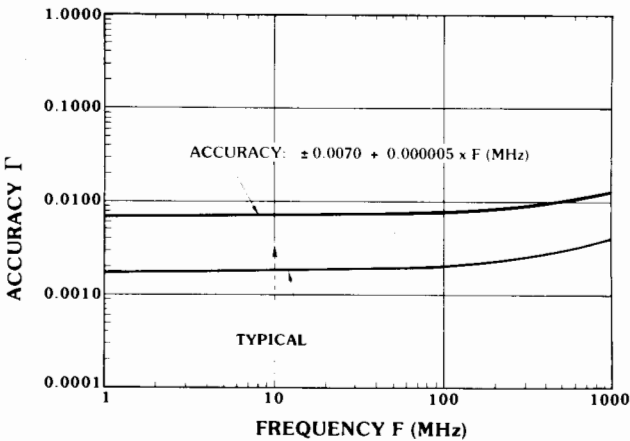

**General**

Temperature coefficient for  $|\Gamma|, \Gamma_x,$  and  $\Gamma_y$ : 0.0001/°C (23 ± 5°C)

Measuring time: 800 ms or 250 ms (high speed mode)

Frequency switching time: ≤ 200 ms

Temperature: 0 - 55°C, < 95% RH

Power: 100, 120, 220 V ± 10%, 240 V + 10% - 5%, 48 - 66 Hz, 150 VA max.

Size: 425.5 mm W x 230 H x 574 mm D (16.75" x 9" x 22.6").

Weight: Approx. 24 Kg. (52.8 lbs.)

Accessories furnished: accessory case (with reference terminations included).

**Accessories Available**

- 16091A Coaxial Fixture Set
- 16092A Spring Clip Fixture
- 16093A Binding Post Fixture
- 16093B Binding Post Fixture
- 16094A Probe Fixture

**Options**

- 002: 100 Hz/200 Hz resolution synthesizer
- 004: Recorder Outputs

**4191A RF Impedance Analyzer**



# COMPONENT MEASUREMENT

## LF Impedance Analyzer (5 Hz to 13 MHz)

Model 4192A

- 5 Hz to 13 MHz Variable Measuring Frequency
- Gain-Phase Measurement: Amplitude, Phase and Delay
- Floating or Grounded Devices

- Impedance Measurement:  $|Z| \cdot |Y| \cdot \theta \cdot R \cdot X \cdot G \cdot B \cdot L \cdot C \cdot D \cdot Q \cdot \Delta \cdot \Delta\%$
- Standard HP-IB

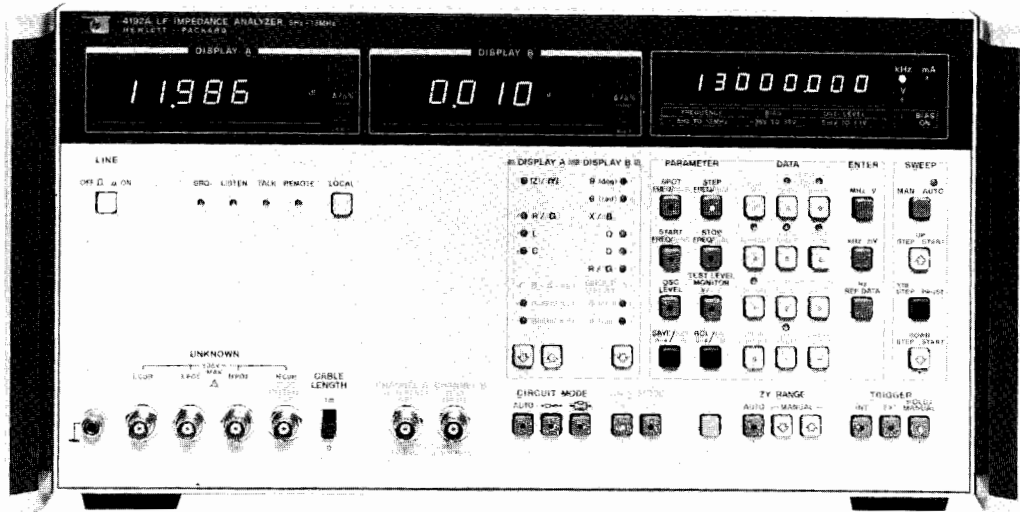

### Description

The 4192A LF Impedance Analyzer performs both network analysis and impedance analysis on devices such as telecommunication filters, audio/video electronic circuits, and basic electronic components. Both floating and grounded devices can be tested.

### Automatic Swept Frequency Measurement of All Impedance Parameters

The 4192A can measure 11 impedance parameters ( $|Z|$ ,  $|Y|$ ,  $\theta$ ,  $R$ ,  $X$ ,  $G$ ,  $B$ ,  $L$ ,  $C$ ,  $D$ ,  $Q$ ) over a wide range  $|Z|$ : 0.1 m $\Omega$  to 1 M $\Omega$ ;  $|Y|$ : 1 nS to 10 S).

The built-in frequency synthesizer can be set from 5 Hz to 13 MHz with a maximum resolution of 1 mHz. This feature allows accurate characterization of high Q devices such as crystals. Test signal level is variable from 5 mV to 1.1 V with 1 mV resolution. Also, an internal dc bias voltage source provides  $\pm 35$  V at 10 mV increments. Thus, the 4192A can evaluate components and entire circuits near actual operating conditions.

### Specifications (Complete specifications on data sheet)

#### Measuring signal (23 $\pm$ 5°C)

**Frequency range:** 5 Hz to 13 MHz

**Frequency step:** 0.001 Hz (5 Hz to 10 kHz), 0.01 Hz (10 kHz to 100 kHz), 0.1 Hz (100 kHz to 1 MHz), 1 Hz (1 MHz to 13 MHz).

**Frequency accuracy:**  $\pm 50$  ppm

**OSC level:** 5 mV to 1.1 Vrms variable into 50  $\Omega$  (amplitude-phase measurement) or open circuit (impedance measurement).

**OSC level step:** 1 mV (5 mV to 100 mV), 5 mV (100 mV to 1.1 V)

**OSC level accuracy:** 5 Hz to 1 MHz:  $\pm(5 + 10/f)\%$  of setting  $\pm 2$  mV where f is in Hz. 1 MHz to 13 MHz:  $\pm(4 + 1.5 \times F)\%$  of setting  $\pm 2$  mV where F is in MHz.

**Level monitor** (impedance measurement): Current through or voltage across sample can be monitored

**Control:** spot and sweep via front panel or HP-IB

#### Measuring Mode

**Spot measurement:** at specific frequency (or dc bias)

**Swept measurement:** manual or automatic sweep from START to STOP frequency (or dc bias) at selected STEP frequency (or dc bias) rate

**Sweep Mode:** linear or logarithmic (frequency only)

**Recorder outputs:** output dc voltage proportional to each measured value, and frequency or dc bias.

**Maximum output voltage:**  $\pm 1$  V

**Output voltage accuracy:**  $\pm 0.5\%$  of voltage  $\pm 20$  mV

**Key status memory:** 5 sets of measuring conditions can be stored and recalled at any time.

**HP-IB data output and remote control:** standard

**Self-test:** automatic introspective testing

**Trigger:** internal, external or manual

### Amplitude—Phase Measurement

**Parameter measured:** relative amplitude B-A (dB) and phase  $\theta$  (degrees or radians), B-A and group delay, absolute amplitude A (dBm or dBV) or B (dBm or dBV), and deviation ( $\Delta$ ,  $\Delta\%$ ) of all parameters

**Reference amplitude:** 0 dBV = 1 Vrms, 0 dBm = 1 mW (with 50  $\Omega$  termination)

**OSC output resistance:** 50  $\Omega$

**Channels A and B:** input impedance: 1 M $\Omega$   $\pm 2\%$ , shunt capacitance: 25 pF  $\pm 5$  pF

### Display range and resolution:

**B-A:** 0 to  $\pm 100$  dB\*, 0.001 dB (0 to  $\pm 20$  dB), 0.01 dB ( $\pm 20$  to  $\pm 100$  dB)

$\theta$ : 0 to  $\pm 180^\circ$ , 0.01 $^\circ$

**Group delay:** 0.1 ns to 19 s, max. resolution 4 1/2 digits

**A or B:**  $+0.8$  to  $-100$  dBV\*, 0.001 dB ( $> -20$  dB), 0.01 dB ( $< -20$  dB),  $+13.8$  to  $-87$  dBm, 0.001 dB ( $> -20$  dBm), 0.01 dB ( $< -20$  dBm)

**Measuring accuracy (23  $\pm$  5°C):** Specified at BNC unknown terminals after 30 minute warmup (test speed: normal or average)

### B-A (Relative Amplitude) and $\theta$ (Phase) Measurement:

Determined by sum of channel A and B accuracies given below (accuracy of each channel changes according to absolute input level)

\*Accuracy of relative and absolute gain measurements is specified from 0 dB to  $\pm 80$  dB.

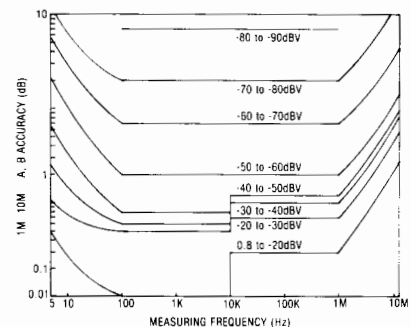

FIGURE 1: GAIN MEASUREMENT ACCURACY

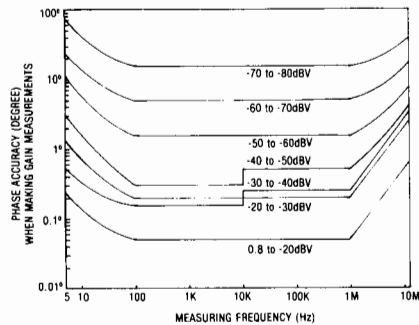

FIGURE 2: PHASE ACCURACY WHEN MAKING GAIN MEASUREMENTS

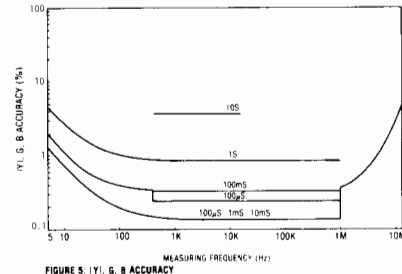

FIGURE 5: |Y|, G, B ACCURACY

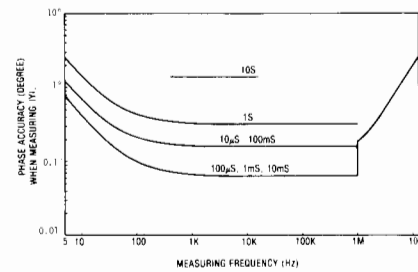

FIGURE 6: PHASE ACCURACY WHEN MEASURING |Y|

**Impedance Measurement**

**Parameter measured:**  $|Z| - \theta, |Y| - \theta, R - X, G - B, L - D \cdot Q \cdot R \cdot G, C - D \cdot Q \cdot R \cdot G$  and deviation ( $\Delta, \Delta\%$ ) of all parameters

**Display:** 4 1/2 digits, max. display 12999 counts

**Circuit mode:** Series equivalent circuit ( ) and parallel equivalent circuit ( ). Automatic selection available.

**Auto ZERO adjustment:** Automatic normalization of the readout offset due to residuals of the test fixture by pushbutton operation (at spot frequency)

**Measuring range and accuracy (23 ± 5°C):** Specified at BNC unknown terminals after 30 minute warmup when OSC level is more than 0.3 V and when auto ZERO adjust is performed (test speed: normal or average). Accuracy given below is only valid when the measured value is equal to full scale of each range.

**|Z| - θ, R - X Measurement:** Range:  $|Z|, R, X: 0.1 \text{ m}\Omega$  to 1.2999 MΩ;  $\theta: -180.00^\circ$  to  $+180.00^\circ$ . Accuracy: R accuracy ( $D \geq 10$ ); X accuracy ( $D \leq 0.1$ )

**L - D · Q, C - D · Q Measurement:** (automatically calculated from measured Z/Y values)

Parameter	Measuring Range*	Basic Accuracy
L	0.01 nH to 1000 H	0.27%
C	0.1fF to 199** mF	0.15%
D(1/Q)	0.0001 to 19.999	0.001 (C-measurement) 0.003 (L-measurement)

\*Varies with measuring frequency except for D(1/Q)  
\*\*Accuracy of C ranges over 100 mF is not specified.

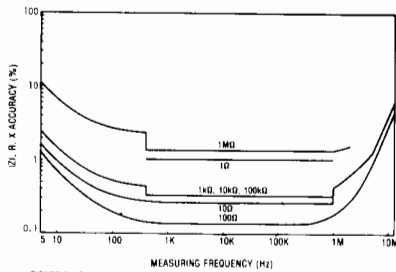

FIGURE 3: |Z|, R, X ACCURACY

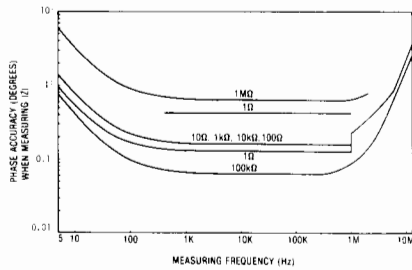

FIGURE 4: PHASE ACCURACY WHEN MEASURING |Z|

**|Y| - θ, G - B Measurement:** Range:  $|Y|, G, B: 1 \text{ nS}$  to 12.999 S;  $\theta: -180.00^\circ$  to  $+180.00^\circ$ . Accuracy: G accuracy ( $D \geq 10$ ); B accuracy ( $D \leq 0.1$ ).

**Internal DC Bias:** Standard (Impedance Measurement only)

**Voltage range:** -35 V to +35 V, 10 mV step

**Setting accuracy (23 ± 5°C):** 0.5% of setting +5 mV

**Bias control:** spot and swept, using front panel controls or HP-IB

**General**

**Measuring time (high speed mode):**

**B-A and θ, A or B:** 88 to 127 ms ( $\geq 400 \text{ Hz}$ )

**Impedance parameters:** 58 to 91 ms ( $\geq 1 \text{ kHz}$ )

**Test level monitor range (impedance measurement):**

**Voltage:** 5 mV to 1.1 V

**Current:** 1 μA to 11 mA

**Operating Temperature:** 0 to 55°C,  $\leq 95\% \text{ RH}$  at 40°C

**Power:** 100, 120, 220 V ± 10%, 240 V + 5% to -10%, 48 to 66 Hz, 100 VA max.

**Size:** 425.5 mm W x 230 mm H x 574 mm D (16.75" x 9" x 22.6").

**Weight:** Approx. 19 kg (41.9 lbs.)

**Furnished accessories and parts:** 16047A test fixture, 50 Ω feed thru terminations (2 ea.), power splitter, BNC cables (2 ea.), BNC adapter

**Accessories available:**

16095A Probe Fixture

16096A 2-port Component Test Fixture

16097A Accessory Kit

16047C 2-terminal Test Fixture

16048B Test Leads (miniature connector)

16048C Test Leads with alligator clip

4274A/4275A's test fixtures/leads are usable with 4192A

4192A LF Impedance Analyzer

# COMPONENT MEASUREMENT

## Vector Impedance Meter (400 kHz to 110 MHz)

### Model 4193A

- 400 kHz to 110 MHz Spot or Swept Frequency
- Measure Impedance Magnitude (10 mΩ to 100.0 kΩ) and Phase (−180.0° to +180.0°)
- Test Components In-Circuit and Out-of-Circuit
- Fixtures Include Low-grounded Probe, Spring Clip Fixture and Binding Post Fixture
- Standard HP-IB and Analog Outputs

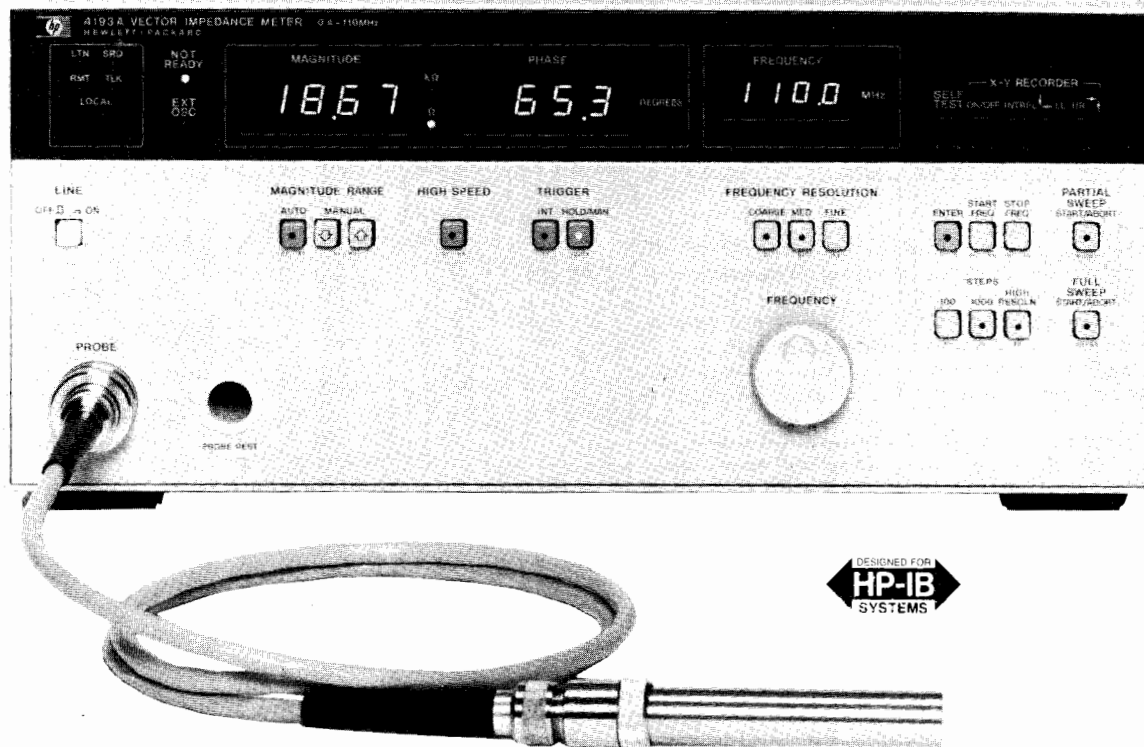

### Description

The HP Model 4193A Vector Impedance Meter measures impedance magnitude and phase. An internal oscillator provides test signals from 400 kHz to 110.0 MHz. The test signal is constant current between 10 μA and 100 μA, depending on |Z| range.

#### Reliable and Accurate Impedance Measurement

The 4193A can measure and display impedance magnitudes from 10 mΩ to 100.0 kΩ. Impedance phase is displayed from +180.0° to −180.0°. Accuracy is as good as 3.0% of reading (magnitude) and 3.6° (phase).

Also, the 4193A's 3½ digit resolution makes it easy to see small changes in measurement results during adjustment procedures, for example.

#### Frequency Sweep for Complex Component Testing

When testing complex components like ceramic resonators, it is useful (1) to sweep frequency to get the big picture and (2) identify critical impedance points like series resonant point. This requires both swept measurement and measurements at individual "spot" frequencies. The 4193A can do both.

The 4193A can be tuned to any individual frequency from 400 kHz to 110.0 MHz with maximum resolution of 1 kHz. If greater frequency resolution is required, it can be provided by connecting an external synthesized source like the HP 3335A or 8656A to the 4193A EXT OSC input.

Flexible internal frequency sweep is an exciting 4193A feature. Frequency can be swept linearly over any portion of the 4193A frequency range—or swept logarithmically over the entire 400 kHz to 110.0 MHz range.

#### Test In-Circuit and Out-of-Circuit Components

Several test fixtures help adapt the 4193A to your device under test. For example, the handy L-ground probe is useful for in-circuit test-

ing. The 16099A Test Fixture Adapter and three associated fixtures help connect to out-of-circuit devices of various sizes and shapes.

#### Easy to Use—Both Manually and Under HP-IB Control

The 4193A front panel is amazingly simple. In just a few minutes you can become an expert operator. This is a big time saver over most other impedance meters which are usually much more difficult to operate. Plus, the 4193A has standard HP-IB, making it a good choice for automated testing in R&D, incoming inspection, production and product assurance.

### Specifications

#### Test Signal Output Specifications:

test signal is output from the furnished low-ground probe.

**Frequency range:** 400 kHz to 110.0 MHz

**Frequency resolution:**

400 kHz to 9.999 MHz: 1 kHz resolution

10.00 MHz to 99.99 MHz: 10 kHz resolution

100.0 MHz to 110.0 MHz: 100 kHz resolution

**Frequency accuracy:** ±0.01% of setting after calibration.

**Frequency stability:** ±100 ppm per month (0 to 55°C)

**Frequency control:**

**Spot:** spot frequency is set using coarse, medium and fine controls

**Full sweep:** logarithmic sweep at 43 points over full range of 400 kHz to 110 MHz

**Partial sweep:** linear sweep from selected START to STOP frequency. Number of steps is selected as 100, 1000 or "HIGH RESOLN". When "HIGH RESOLN" steps is selected, the operator must also select "coarse", "medium" or "fine" resolution.

**EXT OSC:** Increase frequency resolution by connecting an external frequency synthesizer like the HP 3335A or 8656A.

**Input signal level:** 0 dBm to +5 dBm  
**Input impedance:** 50 ohms ± 10%  
**Frequency range:** 400 kHz to 110 MHz

**Test level:** constant current source

Z  Range	Current in µA ± 20%	Voltage <sup>1</sup> Across DUT in µVrms
10 Ω	100	1
100 Ω	100	10
1 kΩ	100	100
10 kΩ	50	500
100 kΩ	10	1000

<sup>1</sup>Voltage across DUT depends on |Z| of DUT. The voltage shown is across a |Z| of range value. For example, 1 Vrms would appear across |Z| of 10 Ω on the 10 Ω range.

**Impedance Measurement Specifications:**

**Input Configuration:** low-grounded probe (furnished)

**Residual impedance of probe** (at probe tip)

**Resistance:** <0.55 Ω  
**Inductance:** <(4.9 + 10/f) nH where f is measuring frequency in MHz  
**Capacitance:** <0.11 pF

**Digital display of impedance:** 3½ digits

**|Z|:** 0 to 1999 counts (0 to 1200 counts on 100 kΩ range)

**θ:** -1800 to +1800 counts

**Measurement trigger:** internal, external, and manual

**Measurement range control:** auto, hold, and manual

**Measurement range:**

**|Z|:** Five decade ranges: 10 Ω, 100 Ω, 1 kΩ, 10 kΩ, 100 kΩ

**minimum |Z|** (sensitivity): 10 mΩ

**maximum |Z|:** 100.0 kΩ

**θ:** One range: -180.0° to +180.0°

**Recorder output:** dc voltage proportional to measured |Z|, θ and measurement frequency.

**Output voltage:** accuracy specification for all recorder output voltages is ±(1% + 20 mVdc)

**|Z|:** 0 Vdc (0000 display counts) to +1 Vdc (1999 display counts)

**θ:** -1 Vdc (-180.0°) to +1 Vdc (+180.0°)

**Frequency:**

**Full sweep:** 0 Vdc (400 kHz) to +1 Vdc (110 MHz), log sweep

**Partial sweep:** 0 Vdc (START frequency) to +1 Vdc (STOP frequency), linear sweep

**HP-IB remote control and data output:** standard

**Self-test:** standard

**General Information**

**Test Signal Output**

**Frequency settling time:** 5 ms to 300 ms. Best case is when (Δf/f)% is less than 10% (below 10 MHz) and less than 1% (above 10 MHz).

**Signal purity:**

**Spurious:** -60 dBc (dBc is dB below carrier)

**Harmonics:** -30 dBc

**Residual FM:** measured in a 100 Hz band centered on the carrier  
**400 kHz to 1 MHz:** 40 Hz p-pFM

**1 MHz to 110 MHz:** 100 Hz p-pFM

**Impedance Measurement**

**Measuring speed:** assumes range is fixed; recorder output is OFF

**HI SPEED:** approximately 150 msec per measurement

**NORMAL:** approximately 1 sec per measurement

**Ranging time:** approximately 400 msec per range plus one measuring interval (e.g., 1 sec in normal mode)

**Temperature coefficient at 23°C ± 5°C**

**|Z|:** 2 mΩ/°C

**θ:** 0.02°/°C

**|Z| and θ Measurement Accuracy: in the Table below, "f" is in MHz**

Range	Accuracy	Measuring Frequency in Megahertz		
		1	10	40
10 Ω Range	Z  Accuracy	±[(5.7 + 0.56/f)% rdg + 9 counts]	±(6.3% rdg + 6 counts)	±[(4.5 + 0.18f)% rdg + 4 counts]
	θ Accuracy	±(1.7 + 1.8/f + 35/ Z counts) deg	±(3.3 + 0.20f + 35/ Z counts) deg	
100 Ω Range	Z  Accuracy	±[(2.4 + 0.56/f)% rdg + 4 counts]	±(3.0% rdg + 4 counts)	±[(2.6 + 0.037f)% rdg + 4 counts]
	θ Accuracy	±(1.5 + 1.9/f + 35/ Z counts) deg	±(3.3 + 0.035f + 35/ Z counts) deg	
1 kΩ Range	Z  Accuracy	±[(3.2 + 0.56/f)% rdg + 4 counts]	±(3.7% rdg + 4 counts)	±[(2.7 + 0.11f)% rdg + 4 counts]
	θ Accuracy	±(1.6 + 1.8/f + 35/ Z counts) deg	±(3.3 + 0.11f + 35/ Z counts) deg	
10 kΩ Range	Z  Accuracy	±[(2.9 + .56/f)% rdg + 4 counts]	±[(3.2% + 0.29f)% rdg + 4 counts]	±[(.74 + .53f)% rdg + 4 counts]
	θ Accuracy	±(2.1 + 1.9/f + 35/ Z counts) deg	±(3.1 + 0.53f + 35/ Z counts) deg	±(8.3 + .01f + 35/ Z counts) deg
100 kΩ Range	Z  Accuracy	±[(3.3 + 0.56/f)% rdg + 4 counts]		
	θ Accuracy	±(3.0 + 1.9/f + 35/ Z counts) deg		Not specified

**Guideline for use of the |Z| and θ Accuracy Table**

- "f" is in MHz.
- "rdg" is display reading, for example, 50.0 ohms.
- "counts" is display counts in the |Z| display.
- "deg" is degrees of arc.

**Example:** Calculate the |Z| and θ accuracy for a device which gives 4193A readings of |Z| = 50.0 Ω and θ = -45.0°. Assume an 0.9 MHz test frequency 100 Ω range, and normal measuring mode.

$$|Z| = 50.0 \Omega \pm [(2.4 + \frac{.56}{f}) \% \text{ of rdg} + 4 \text{ counts}]$$

$$|Z| = 50.0 \Omega \pm [(2.4 + \frac{.56}{.9}) * \frac{50.0 \Omega}{100\%} + .4 \Omega]$$

$$|Z| = 50.0 \Omega \pm 1.91 \Omega$$

$$\theta = -45.0^\circ \pm (1.5 + \frac{1.9}{f} + \frac{35}{|Z|\text{counts}}) \text{ deg}$$

$$\theta = -45.0^\circ \pm (1.5 + \frac{1.9}{.9} + \frac{35}{500}) \text{ deg}$$

$$\theta = -45.0^\circ \pm 3.68^\circ$$

**Operating temperature/humidity:** 0 to 55°C, 95% RH @ 40°C. Note that measurement error in 0°C to 55°C temperature range is typically double the error in the 23°C ± 5°C range.

**Power:** 100/120/220 V ± 10%, 240 V -10% to +5%, 48 to 66 Hz, Max 150 VA

**Size:** 426 mm W x 178 mm H x 498 mm D, (16.75" x 7" x 19.6").

**Weight:** 18 kg (40 lbs.)

**Accessories furnished:** low-ground probe kit includes probe, spare pins, spare clips, BNC adapter, component mounting adapter, probe socket and accessory case.

**Accessories Available**

**16099A** Test Fixture Adapter: (used with 16092A, and 16093A/B)

**16092A** Spring Clip Fixture: (used with 16099A)

**16093A** Binding Post Fixture: (used with 16099A)

**16093B** Binding Post Fixture: (used with 16099A)

**4193A Vector Impedance Meter**



# COMPONENT MEASUREMENT

## Digital LCR Meters

Models 4261A and 4262A

- Automatic balancing, ranging & circuit mode selection
- Test frequencies: 4261A...120 (100) Hz and 1 kHz  
4262A...120 (100) Hz, 1 kHz and 10 kHz
- Versatile accessories and options
- High reliability

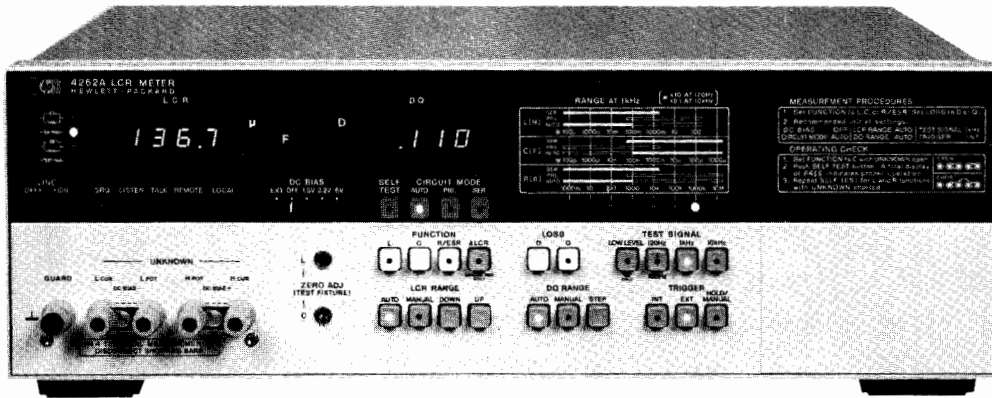

4262A



4261A

### Description

The HP 4261A and 4262A are 3½ digital LCR meters that meet today's requirements for component measurements. Both instruments feature fully automatic operation over wide measuring range. Simply select the measuring functions and one of the test frequencies, and then insert the device to be measured. The instrument does the rest—automatically selecting the proper measuring range and equivalent circuit mode. The HP 4261A and 4262A basic features are summarized in the table below.

	4261A	4262A
Test Frequency	120 (100) Hz, 1 kHz	120 (100) Hz, 1 kHz, 10 kHz
Signal Level	1 V, 50 mV (Cp)	1 V, 50 mV (Cp)
Parameters Measured	C-D L-D R	C-D • Q L-D • Q R (ESR) Δ (Deviation)
HP-IB	NO	YES (OPT.)
Digital Comparison	NO	YES (OPT.)
BCD Output	YES (OPT.)	YES (OPT.)

In addition to automatic measurements, the 4261A and 4262A provide high accuracy (0.2% reading), internal DC bias, and series and parallel equivalent circuit modes.

These relatively low cost and easy to use LCR meters are capable of a wide range of applications—measuring electrolytic/ceramic capacitors, filter coils, pulse transformers, internal resistance of dry cells and semiconductor junction capacitance, as well as ordinary LCR components. Extended features of these reliable instruments include optionally available HP-IB and BCD data output capabilities and a comparison option which is convenient for production line applications.

**Specifications** (Refer to Data Sheet for complete specifications)

Measurement ranges and accuracies: See table on next page. Accuracy applies over a temperature range of 23°C ± 5°C (at 0° to 55°C, error doubles). 10 kHz and Q specifications are given only for the 4262A.

	4261A	4262A
Parameters measured	L-D, C-D R	L-D • Q, C-D • Q R (ESR), Δ LCR
Display	3 • ½ digits max. display 1900	3 • ½ digits max. display 1999
Test frequency	120 (100) Hz, 1 kHz ± 3%	120 (100) Hz, 1 kHz 10 kHz ± 3%
Test signal level (typical)	1 V, 50 mV (Cp mode only)	
DC bias	INT	1.5 V, 2.2 V, 6 V ± 5%, selectable
	EXT	0 to +30 V
Equivalent circuit modes	auto, parallel, series	
Ranging modes	LCR	auto, manual
	DQ	—
Trigger	internal, external, manual	
Measuring terminal	5-terminal configuration	

**Deviation measurement (4262A):** Displays the difference between a stored value (that is, measured value when Δ LCR switch is depressed) and subsequent measured data.

**Offset adjustments (4262A):** Front panel adjustments to compensate for stray capacitance and residual inductance of the test fixture.  
C: 0 to 10 pF      L: 0 to 1 μH

**Self-test (4262A):** Automatically checks the 4262A's basic functions.

### General

**Measuring time (typical):** for a 1000 count measurement on a low loss component on a fixed range:

1 kHz, 10 kHz: C/L 220-260 ms, R 120-160 ms

120 (100) Hz: C/L 900 ms, R 700 ms

**Ranging time:**

1 kHz, 10 kHz: 180 ms/range step

120 (100) Hz: 670 ms/range step

**Reading rate:** INT (internal trigger) approximately 30 ms between end of measurement cycle and start of the next cycle. EXT (External trigger) measuring cycle is initiated by a remote trigger input.

## C-D/C-Q Measurement

Range	C	120 (100) Hz 1 kHz 10 kHz	1000 pF 100.0 pF 10.00 pF	10.00 nF 1000 pF 100.0 pF	100.0 nF 10.00 nF 1000 pF	1000 nF 100.0 nF 10.00 nF	10.00 μF 1000 nF 100.0 nF	100.0 μF 10.00 μF 1000 nF	1000 μF 100.0 μF 10.00 μF	10.00 mF 1000 μF 100.0 μF	
	D	0.001 to 1.900 (4261A), 0.001 to 19.9 (4262A)									
	Q* <sup>1</sup>	0.050 to 1000 (4 ranges, 4262A)									
C Accuracy * <sub>2</sub>		0.2% + 1* <sub>3</sub>									
		At 120 (100) Hz, 1 kHz			0.3% + 2			0.5% + 2		1% + 2** <sub>4</sub>	
		At 10 kHz						1% + 2		5% + 2	
D (1/Q) Accuracy * <sub>3</sub>		0.2% + (2 + 200/Cx)					At 120 (100) Hz, 1 kHz				
		0.5% + (2 + 200/Cx)					At 10 kHz				
		At 120 (100) Hz, 1 kHz			0.3% + (2 + Cx/500)			1% + (5 + $\frac{Cx}{500}$ )			
		At 10 kHz			0.5% + (2 + Cx/500)			1% + (5 + $\frac{Cx}{500}$ )		5% + (5 + $\frac{Cx}{500}$ )	

\*<sup>1</sup>Calculated as the reciprocal of D.\*<sub>2</sub> ± (% of reading + number of counts), Cx is capacitance readout in counts. Accuracies in this table apply when D < 1.900.\*<sub>3</sub> Add 0.2 pF for 4261A.\*<sub>4</sub> (5% + 2 counts) at 1 kHz.

## L-D/L-Q Measurement

Range	L	120 (100) Hz 1 kHz 10 kHz	1000 μF 100.0 μH 10.00 μH	10.00 mH 1000 μH 100.0 μH	100.0 mH 10.00 mH 1000 μH	1000 mH 100.0 mH 10.00 mH	10.00 H 1000 mH 100.0 mH	100.0 H 10.00 H 1000 mH	1000 H 100.0 H 10.00 H	
	D	0.001 to 1.900 (4261A), 0.001 to 19.9 (4262A)								
	Q* <sup>1</sup>	0.050 to 1000 (4 ranges, 4262A)								
L Accuracy * <sub>2</sub>		At 120 (100) Hz, 1 kHz			0.3% + 2			1% + 2		
		At 10 kHz						1% + 2		5% + 2
		0.2% + 2* <sub>3</sub>					At 120 (100) Hz, 1 kHz			
		0.3% + 2		0.2% + 2			At 10 kHz			
D (1/Q) Accuracy * <sub>2</sub>		At 120 (100) Hz, 1 kHz			0.3% + (3 + Lx/500)			1% + (3 + Lx/500)		
		At 10 kHz			0.5% + (3 + Lx/500)			1% + (3 + Lx/500)		5% + (5 + $\frac{Lx}{500}$ )
		0.2% + (3 + 200/Lx)					At 120 (100) Hz, 1 kHz			
		0.5% + (3 + 200/Lx)					At 10 kHz			

\*<sup>1</sup>Calculated as the reciprocal of D.\*<sub>2</sub> ± (% of reading + number of counts), Lx is inductance readout in counts. Accuracies in this table apply when test signal level is 1 V and D < 1.900.\*<sub>3</sub> Add 0.2 μH for 4261A.R (ESR)\*<sup>1</sup> Measurement

Range	120 (100) Hz 1 kHz 10 kHz	1000 mΩ	10.00 Ω	100.0 Ω	1000 Ω	10.00 kΩ	100.0 kΩ	1000 kΩ	10.00 MΩ	
Accuracy * <sub>2</sub>		0.2% + 1					0.3% + 2* <sub>3</sub>			

\*<sup>1</sup>ESR measuring range is from 1 mΩ to 19 kΩ (typical). These values vary depending on the series capacitance or inductance value of the device under test.\*<sub>2</sub> ± (% of reading + number of counts).\*<sub>3</sub> ± (5% + 2 counts) on 10.00 MΩ range at 10 kHz.

	4261A	4262A
Operating Temperature and humidity	0°C to 55°C 95% RH at 40°C	
Power requirements	100/120/220/240 V ± 10%	100/120/220 V ± 10%, 240 V + 5%
Power Consumption	48–66 Hz	–10%, 48–66 Hz
Size	≤25 VA	≤55 VA
Weight (approx.)	132.6 H x 213 W x 427 mm D (5 • 1/4" x 8 • 3/8" x 16 • 5/8")	147 H x 426 W x 345 mm D (5 • 3/8" x 16 • 3/8" x 13 • 3/8")
	7.5 kg (16.51 lbs)	8 kg (17.51 lbs)

**Accessories available:** **16061A:** Test fixture, direct couple, 5-terminal; **16062A:** Test leads with alligator clips, 4-terminal (for low impedance measurements); **16063A:** Test leads with alligator clips, 3-terminal (for high impedance measurements).

**Ordering information (4261A)**

16061A Test Fixture

16062A Test Leads

16063A Test Leads

Opt 001: BCD Output (Simultaneous)

Opt 002: BCD Output (Alternately)

Opt 003: BCD Remote Control

Opt 910: Extra Manual

4261A Digital LCR Meter

**Options available:**

Option	4261A* <sup>1</sup>	4262A* <sup>2</sup>
001	BCD data output (L/C/R and D simultaneously)	BCD data output
002	BCD data output (L/D, C/D, R alternately)	—
003	BCD remote control	—
004	—	Digital comparator
101	—	HP-IB

\*<sup>1</sup>Options 001 and 002 are mutually exclusive.\*<sup>2</sup>Option combinations 101/001 and 101/004 can not be ordered.**Ordering information (4262A)**

Opt 001: BCD Output

Opt 004: Digital Comparator

Opt 010: 100 Hz Test Frequency

Opt 101: HP-IB Interface

Opt 908: Rack Flange Kit

Opt 910: Extra Manual

16061A Test Fixture

16062A Test Cables

16063A Test Cables

4262A Digital LCR Meter

# COMPONENT MEASUREMENT

## 1 MHz Digital LCR Meter

Model 4271B

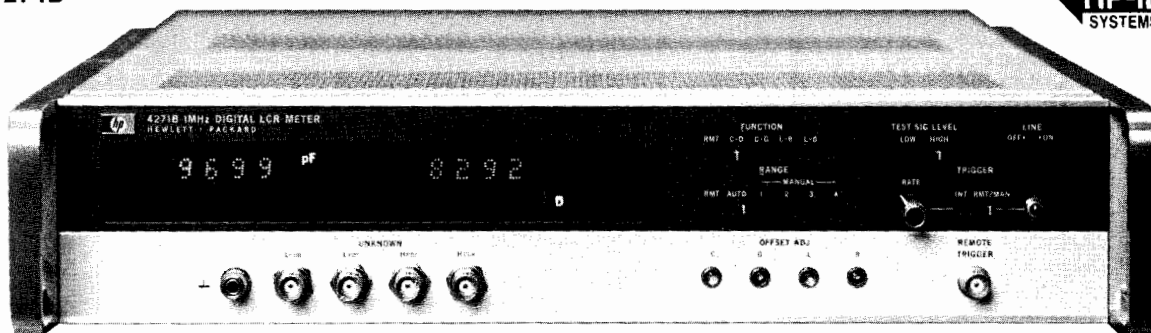

### Description

The HP 4271B 1 MHz LCR Meter meets the requirements of the lab, manufacturing and where automatic high speed and accuracy measurements are essential. The four-pair measurement technique

has the advantage of reducing errors due to residual inductance, stray capacitance, and electromagnetic coupling of leads. Offset adjustments are provided to cancel the residuals of the test fixtures.

Typical applications include microcircuit measurements, C-V characteristics of semiconductor devices and passive component tests.

### Specifications

**Full scale ranges and accuracy:** (When conductance reading is less than 100 counts and resistance reading is less than 1000 counts.) Accuracy listed in the following table applies over a temperature range of 23°C ± 5°C.

**Capacitance and conductance/dissipation factor: using parallel equivalent circuit.**

Range	Test Sig Level	Capacitance: (Overrange 90%)		Conductance: (Overrange 90%)		Dissipation Factor*: (Overrange 60%)	
		Full Scale Display	Accuracy**	Full Scale Display	Accuracy**	Full Scale Display	Accuracy**
1	HIGH	10.000 pF	0.1 + 7	100.00 μS	0.2 + (7 + N <sub>C</sub> /1000)	1.0000	1.0 + (10 + 20000/N <sub>C</sub> )
	LOW		0.2 + 8		0.3 + (7 + 2 N <sub>C</sub> /1000)		1.0 + (15 + 30000/N <sub>C</sub> )
2	HIGH	100.00 pF	0.1 + 3	1000.0 μS	0.2 + (3 + N <sub>C</sub> /1000)	1.0000	1.0 + (10 + 10000/N <sub>C</sub> )
	LOW		0.2 + 4		0.3 + (3 + 2 N <sub>C</sub> /1000)		1.0 + (15 + 20000/N <sub>C</sub> )
3	HIGH	1000.0 pF	0.1 + 2	10.000 mS	1.2 + (2 + 2 N <sub>C</sub> /1000)	1.0000	10 + (10 + 10000/N <sub>C</sub> )
	LOW		0.2 + 3		1.2 + (2 + 2 N <sub>C</sub> /1000)		1.0 + (15 + 20000/N <sub>C</sub> )
4***	LOW	10.000 nF	0.4 + 3	100.00 mS	1.2 + (2 + 2 N <sub>C</sub> /1000)	1.0000	1.0 + (15 + 30000/N <sub>C</sub> )

**Inductance and resistance/dissipation factor: using series equivalent circuit.**

Range	Test Sig Level	Inductance: (Overrange 90%)		Resistance: (Overrange 90%)		Dissipation Factor*: (Overrange 90%)	
		Full Scale Display	Accuracy**	Full Scale Display	Accuracy**	Full Scale Display	Accuracy**
1***	LOW	1000.0 nH	1.0 + 15	10.000 Ω	1.2 + (8 + 2 N <sub>L</sub> /1000)	1.0000	1.0 + (20 + 30000/N <sub>L</sub> )
	HIGH		0.6 + 4		1.2 + (2 + 2 N <sub>L</sub> /1000)		1.0 + (15 + 10000/N <sub>L</sub> )
2	LOW	10.000 μH	0.6 + 6	100.00 Ω	1.2 + (2 + 2 N <sub>L</sub> /1000)	1.0000	1.0 + (20 + 20000/N <sub>L</sub> )
	HIGH		0.2 + 4		0.3 + (2 + 2 N <sub>L</sub> /1000)		1.0 + (15 + 10000/N <sub>L</sub> )
3	LOW	100.00 μH	0.3 + 6	1000.0 Ω	0.5 + (2 + 2 N <sub>L</sub> /1000)	1.0000	1.0 + (20 + 20000/N <sub>L</sub> )
	HIGH		0.2 + 4		0.3 + (2 + 2 N <sub>L</sub> /1000)		1.0 + (15 + 20000/N <sub>L</sub> )
4	LOW	1000.0 μH	0.3 + 6	10.000 kΩ	0.5 + (2 + 2 N <sub>L</sub> /1000)	1.0000	1.0 + (20 + 30000/N <sub>L</sub> )
	HIGH		0.2 + 4		0.3 + (2 + 2 N <sub>L</sub> /1000)		1.0 + (15 + 20000/N <sub>L</sub> )

\*When reading of L or C is more than 1500 counts.

**Test frequency:** 1 MHz ± 0.01%

**Test signal level:**

RANGE	C measurement		L measurement	
	HIGH	LOW	HIGH	LOW
1	0.5 V rms ± 10%	20 mV rms ± 10%	2 mA rms ± 20%	2 mA rms ± 20%
2			5 mA rms ± 10%	200 μA rms ± 10%
3			500 μA rms ± 10%	20 μA rms ± 10%
4			20 mV rms ± 20%	20 mV rms ± 20%

**Display:** dual 4½ digit LED displays.

**Ranging:** automatic and manual. Remote control with Opt 101.

**Measurement terminals:** four-terminal pair construction.

**Offset adjustment ranges:** capacitance ≤ 1 pF, conductance ≤ 1 μS, inductance ≤ 100 nH, resistance ≤ 100 mΩ.

**DC bias (optional)**

**Internal source:** available; Opt 001, 00.0 V to 39.9 V, 0.1 V steps.

**External source:** ± 200 V max to BNC connector.

**General**

**Measuring Speed**

**Fixed range:** 100 ms to 250 ms for C-G and L-R measurement.

160 ms to 400 ms for C-D and L-D measurements.

**Autorange:** 100 ms/range step added to above values.

**Power:** 100/120/220 V ± 10%, 240 V + 5% - 10%, 48-66 Hz, 80 VA max.

\*\* ± (% of reading + counts), N<sub>C</sub> and N<sub>L</sub> are capacitance and inductance readouts in count.

\*\*\*Test Level is low on range 4 for C and range 1 for L measurements.

**Size:** 88 mm H x 425 mm W x 496 mm D (3<sup>15</sup>/<sub>32</sub>" x 16<sup>3</sup>/<sub>16</sub>" x 19<sup>9</sup>/<sub>16</sub>".)

**Weight:** 10 kg (22 lb).

**Accessory furnished:** 16038A Test Fixture for radial and axial lead components.

### Ordering Information\*

**16022A** General Purpose Test Fixture

**16023A** DC Bias Voltage Controller (used with Opt 001)

**16032A** Test Leads (BNC)

**16033A** Test Leads with miniature coaxial connectors

**16034A** Test Fixture for chip capacitor measurement

**16039A** Test Fixture with "D" offset.

**Opt 001:** DC Bias supply; 0.0 V to 39.9 V

**Opt 002:** C/L BCD output; may be used with Opt 003 for simultaneous outputs +8421 Code

**Opt 003:** G/R/D BCD output. +8421 Code (see Opt 002)

**Opt 004:** Parameter Serial BCD output

**Opt 101:** HP-IB Data Output and Remote Control

**Opt 908:** Rack Flange Kit

**Opt 910:** Extra manual

Combined use of Opt 001 and Opt 101 not allowed.

**4271B 1 MHz Digital LCR Meter**

\*HP-IB cable not supplied. See page 29.

- Frequency range: 22 kHz to 70 MHz
- Q range: 5 to 1000

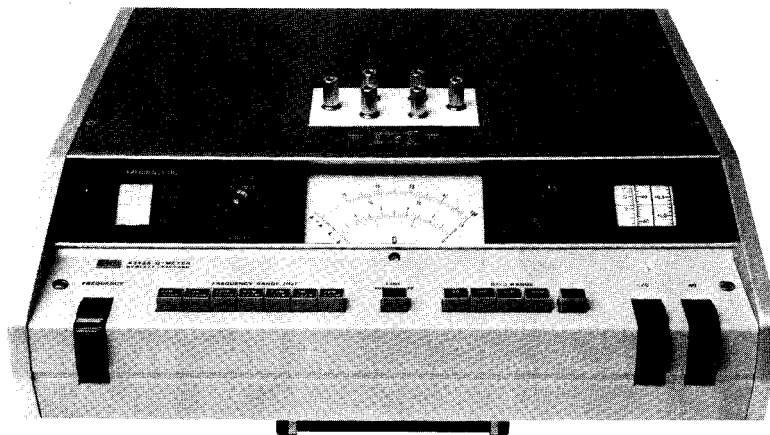

## Description

The direct-reading expanded scale of the 4342A permits measurement of Q from 5 to 1000 and readings of very small changes in Q resulting from variation in test parameters. The 4342A is solid state with the elimination of specially matched, fragile thermocouple components.

The 4342A will measure dissipation factor and dielectric constant of insulating materials. The Q meter can measure coefficient of coupling, mutual inductance, and frequency response of transformers. RF resistance, reactance, and Q of resistors and capacitors can also be determined.

Push button operation of frequency range and Q/ $\Delta$ Q range selection provides straightforward measurement. Automatic indication of meter scales, frequency dials and frequency multipliers are featured, adding to simplicity and reading speed.

## Specifications

### RF Characteristics

**RF range:** 22 kHz to 70 MHz in 7 bands: 22 to 70 kHz, 70 to 220 kHz, 220 to 700 kHz, 700 to 2200 kHz, 2.2 to 7 MHz, 7 to 22 MHz, 22 to 70 MHz.

**4342A Opt 001:** 10 kHz to 32 MHz in 7 bands: 10 to 32 kHz, 32 to 100 kHz, 100 to 320 kHz, 320 to 1000 kHz, 1 to 3.2 MHz, 3.2 to 10 MHz, 10 to 32 MHz.

**RF accuracy:**  $\pm 1.5\%$  from 22 kHz to 22 MHz;  $\pm 2\%$  from 22 MHz to 70 MHz;  $\pm 1\%$  at "L" point on frequency dial.

**4342A Opt 001:**  $\pm 1.5\%$  from 10 kHz to 10 MHz;  $\pm 2\%$  from 10 MHz to 32 MHz;  $\pm 1\%$  at "L" point on frequency dial.

**RF increments:** approximately 1% resolution.

### Q Measurement Characteristics

**Q range:** 5 to 1000 in 4 ranges: 5 to 30, 20 to 100, 50 to 300, 200 to 1000.

**Q accuracy:** % of indicated value: (at 25°C)

	4342A & 4342A Opt. 001	4342A
Q \diagdown Freq.	22 kHz-30MHz	30 MHz-70 MHz
5-300	$\pm 7$	$\pm 10$
300-600	$\pm 10$	$\pm 15$
600-1000	$\pm 15$	$\pm 20$

**Q increments:** upper scale: 1 from 20 to 100; lower scale: 0.5 from 5 to 30.

**$\Delta$ Q range:** 0 to 100 in 4 ranges: 0 to 3, 0 to 10, 0 to 30, 0 to 100.

**$\Delta$ Q accuracy:**  $\pm 10\%$  of full scale.

**$\Delta$ Q increments:** upper scale: 0.1 from 0 to 10; lower scale: 0.05 from 0 to 3.

### Inductance Measurement Characteristics

**L range:** 0.09  $\mu$ H to 1.2 H, direct reading at 7 specific frequencies.

**L accuracy:**  $\pm 3\%$  after substitution of residuals (approx. 10 nH).

### Resonating Capacitor Characteristics

**Capacitor range:** main dial: 25 to 470 pF; vernier dial  $-5$  to  $+5$  pF.

**Capacitor accuracy:** main dial:  $\pm 1\%$  or 1 pF, whichever is greater; vernier dial  $\pm 0.1$  pF.

**Capacitor increments:** main dial: 1 pF from 25 to 30 pF; 2 pF from 30 to 200 pF; 5 pF from 200 to 470 pF; vernier dial: 0.1 pF.

### General

#### Rear Panel Outputs

**Frequency monitor:** 170 mV rms min. into 50  $\Omega$ .

**Q analog output:** 0 to 1 V  $\pm 50$  mV dc after 15 minutes warmup, proportional to meter deflection. Output impedance approximately 1 k $\Omega$ .

**Over limit signal output:** contact closure at the rear panel. Relay contact capacity 0.5 A/15 VA.

**Over limit display time:** selectable, 1 s or continuously on, after limit exceeded.

**Temperature range:** 0°C to 50°C.

**Power:** 115 or 230 V  $\pm 10\%$ , 50-400 Hz, 25 VA max.

**Size:** 129 mm H x 425 mm W x 414 mm D ( $5\frac{1}{16}$ " x  $16\frac{3}{4}$ " x  $16\frac{3}{16}$ ").

**Weight:** net, 14 kg (31 lb). Shipping, 18.45 kg (41 lb).

#### Accessories available:

HP 16014A: Series Loss Test Adaptor is designed for measuring low-value inductors and resistors and high-value capacitors.

HP 16462A: Auxiliary Capacitor is designed to extend the Q and L measurement capability of the 4342A Q Meter. It is especially useful for measuring small inductors at low frequencies.

HP 16470A Reference Inductors: A range of 20 inductors (any of which can be supplied separately) which can be used with the 4342A Q Meter when measuring the RF characteristics of capacitors, resistors, or insulating materials.

HP 16470B Stable Inductors: A set of 4 inductors (any of which are separately available) which can be used to compensate indicated Q values and/or instrumental variation in the maintenance of the 4342A Q Meter. They are useable over a range of 800 kHz to 50 MHz with excellent long-term temperature stability.

### Options and Accessories

**Opt 001:** Frequency Range

**Opt 910:** Extra Manual

**16014A** Series Loss Test Adaptor

**16462A** Auxiliary Capacitor

**16470A** Reference Inductors, set of 20

**16470B** Stable Inductors, set of 4

**16470C** Complete set of 24 Inductors (16470A + 16470B)

### 4342A Q Meter





# COMPONENT MEASUREMENT

## Milliohmmeter/High Resistance Meter

Model 4328A/4329A

- 20  $\mu\Omega$  resolution on 1 m $\Omega$  range
- Four terminal measurement
- Low test voltage

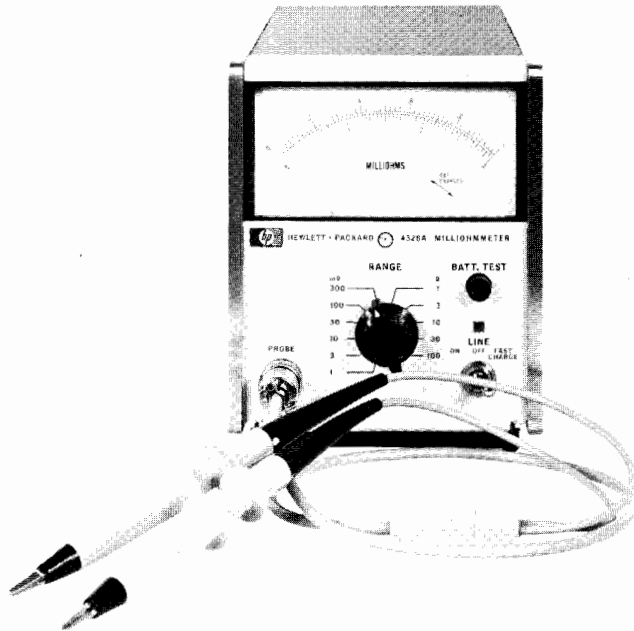

4328A

### Description

HP's 4328A Milliohmmeter is a high sensitivity portable instrument for measurement of low resistances. The 1 m $\Omega$  to 100  $\Omega$  measuring range and 20  $\mu\Omega$  resolution make the 4328A ideal for measuring the contact resistance of switches, relays, and connectors and the resistivity of conductors and semiconductors. Series reactances of up to twice the full scale resistance will not affect the accuracy. The maximum voltage across a sample, with the instrument at the proper range, is less than 200  $\mu$ V peak. Even at incorrect range settings, the voltage across the sample will not exceed 20 mV peak.

The special probes that allow four-terminal measurement in two probes are furnished with the 4328A.

The basic 4328A is line operated but Opt 001 permits operation from rechargeable batteries for 15 continuous hours.

### Specifications

- Range:** 0.001 to 100 ohms full scale in a 1, 3 sequence.  
**Accuracy:**  $\pm 2\%$  of full scale. No additional error is caused by series reactance of samples up to two times full scale.  
**Measuring frequency:** 1000 Hz  $\pm 100$  Hz.  
**Voltage across sample:** 200  $\mu$ V peak at full scale.  
**Maximum voltage across sample:** 20 mV peak.  
**Superimposed dc:** 150 V dc maximum (external source).  
**Recorder output:** 0.1 V dc output at full scale, output resistance approx. 1 k $\Omega$ .  
**Applied current (mA):** Constant by range, 150/(full scale value in milliohms).

#### General

- Power requirements:** 115/230 V  $\pm 10\%$ , 50 to 60 Hz, 1.5 VA.  
**Weight:** 3.2 kg (7 lb).  
**Size:** 155 mm H x 130 mm W x 279 mm D (6 $\frac{3}{32}$ " x 5 $\frac{1}{8}$ " x 11").  
**Accessories furnished:** Model 16005A Probe, 16006A Probe and 16007A/B Test Leads. 16143A Probe Cable.

#### Ordering Information

- 4328A** Milliohmmeter  
**Opt 001:** Rechargeable battery operation  
**Opt 910:** extra manual

- Wide range: 500 k $\Omega$  to  $2 \times 10^{16} \Omega$
- Selectable test voltages: 10 V to 1000 V



4329A

### Description

The HP 4329A is a solid-state insulation resistance meter designed for easy, accurate and direct readings of the very high resistance values typically found in synthetic resins, porcelain, insulating oils and similar materials. It is also useful for measurements in electrical components like capacitors, transformers, switches and cables. Seven fully regulated dc test voltages (between 10 and 1000 V) are provided as test sources.

The HP 4329A is instantly convertible from ungrounded-to-grounded-sample operation via a simple relocation of the front panel ground strap from "guard" to "+" position.

The HP 4329A also has a current measurement capability. Minute currents as low as 0.05 pA can be readily measured.

The HP 16008A Resistivity Cell, designed for use with the HP 4329A, can safely, rapidly and conveniently measure the volume and surface resistivity of sheet insulation materials (maximum sample size: 125 mm W x 125 mm D x 17 mm H).

### Specifications

#### Resistance Measurement

- Range:** 500 k $\Omega$  to  $2 \times 10^{16} \Omega$ . (Depends on the test voltage).  
**Accuracy:** total accuracy is determined by test voltage and range used. At low resistance end of each scale, accuracy is  $\pm 3\%$ , near center scale  $\pm 5\%$ , and near the specified upper limit on the meter scale (a quarter of full scale), accuracy is  $\pm 10\%$ . Accuracy is not specified above these limits. On all voltage ranges, if multiplier is set to Rmax., an additional  $\pm 3\%$  is included.  
**Test Voltage:** 10 V, 25 V, 50 V, 100 V, 250 V, 500 V and 1000 V  $\pm 3\%$ .

#### Current Measurement

- Range:**  $5 \times 10^{-14}$  to  $2 \times 10^{-5}$  A in 8 ranges.  
**Accuracy:**  $\pm 5\%$  of full scale deflection (there can be an additional  $\pm 3\%$  error at the top decade).

#### General

- Recorder output:** 0 to 100 mV dc, proportional to meter deflection; 1 k $\Omega$  output resistance.  
**Power:** 115/230 V  $\pm 10\%$ , 50-60 Hz, approximately 3 VA.  
**Size:** 166 mm H x 198 mm W x 224 mm D (6 $\frac{1}{2}$ " x 7 $\frac{25}{32}$ " x 8 $\frac{25}{32}$ ").  
**Weight:** 3.5 kg (7.7 lb).  
**Accessory furnished:** HP 16117A Low Noise Test Leads.  
**Accessory available:** Model 16008A Resistivity Cell.

#### Ordering Information

- 16008A** Resistivity cell  
**4329A** High resistance meter  
**Opt 910:** extra manual



4260A

### 4260A Description

Measurements of C, R, L, D and Q are easily made with Hewlett-Packard's Model 4260A Universal Semi-Automatic Impedance Bridge.

Nulling is easily accomplished with a unique auto-balance circuit. Illuminated pointers (<CRL>) automatically indicate whether a null is up- or down-scale. Both range and CRL controls can be set watching these pointers.

Components may be biased by connecting a battery to rear terminals. An external oscillator and detector can be used for measurements in the 20 Hz-20 kHz range.

### Specifications

Model		4260A			4265B	
Full scale ranges	C	1000 pF to 1000 μF, 7 ranges			1000.0 pF to 1000.0 μF, 7 ranges	
	L	1000 μH to 1000 H, 7 ranges			1000.0 μH to 1000.0 H, 7 ranges	
	R	10 Ω to 10 MΩ, 7 ranges			1000.0 mΩ to 1.0000 MΩ, 7 ranges	
Range	C	1 pF to 1 nF	1 nF to 100 μF	100 μF to 1000 μF	all ranges except →	1000.0 μF range only
	L	1 μH to 1 mH	1 mH to 100 H	100 H to 1000 H	all ranges except →	1000.0 μH range only
	R	10 mΩ to 10 Ω	10 Ω to 1 MΩ	1 MΩ to 10 MΩ	all ranges except →	1000.0 mΩ range only
Accuracy (% of reading)		±(2% + 1 digit)	±(1% + 1 digit)	±(2% + 1 digit)	±(0.2% of reading + 0.01% of F.S.)	±(0.4% of reading + 0.01% of F.S.)
D	Range	LOW D (series C)		HIGH D (parallel C)	series C	parallel C
	Accuracy	0.001 to 0.12		0.05 to 20	0.001 to 1	0.1 to 1000
Q	Range	LOW Q (series L)		HIGH Q (parallel L)	series L	parallel L
	Accuracy	0.05 to 20		8 to 1000	0.001 to 10	1 to 1000
Oscillator		internal: 1 kHz ± 2%, 100 mV rms ± 20% external: 20 Hz to 20 kHz, ≤ 2 V rms.			internal: 1 kHz ± 15 Hz, ≤ 0.4 V rms external: 50 Hz to 10 kHz or dc for R-measurement; ≤ 4 V rms	
DC bias		Voltage ≤ 6 V, current ≤ 10 mA			Voltage ≤ 250 V, current ≤ 10 mA	

### General (4260A)

**Power:** 115 or 230 volts ± 10%, 50-60 Hz, approx. 7 VA.  
**Size:** 166 mm H x 198 mm W x 279 mm D (6.5" x 7.8" x 11").  
**Weight:** Net, 5 kg (11 lb). Shipping, 6.8 kg (15 lb).

### Options

Opt 910: Extra Manual

4260A Universal Bridge

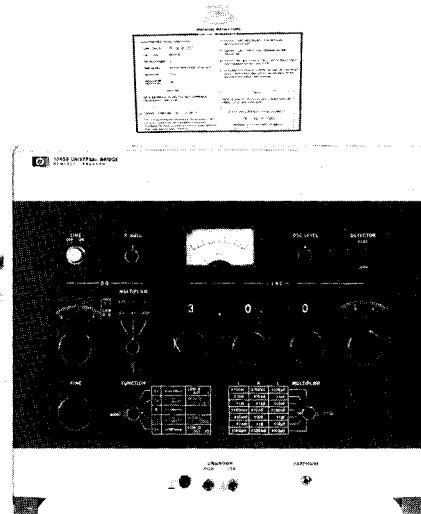

4265B

### 4265B Description

Hewlett-Packard's Model 4265B Universal Bridge provides an economical way to make precision measurements of L, C, or R and D or Q. Components can be measured in ranges of 0.1 μH to 1111 H in inductance, 0.1 pF to 1111 μF in capacitance and 0.1 mΩ to 1.111 MΩ in resistance with a basic measurement accuracy of 0.2% of reading for L, C, and R.

Measurement frequency range is 50 Hz to 10 kHz with an external oscillator, and 1 kHz with internal oscillator.

### General (4265B)

**Power:** 100/120/200/240 V ± 10%; 48 to 440 Hz, 5 VA.  
**Size:** 376 mm H x 393 mm W x 115 mm D (14.8" x 15.5" x 4.5").  
**Weight:** Net, 5.5 kg (12.1 lb). Shipping, 7.1 kg (15.7 lb).

### Ordering Information

16029A Test Fixture

Opt 910: Extra Manual

4265B Universal Bridge



# COMPONENT MEASUREMENT

## Vector Impedance Meter

Model 4800A

- Measures impedance, magnitude and phase
- 5 Hz to 500 kHz
- Analog outputs for impedance magnitude, phase, and frequency

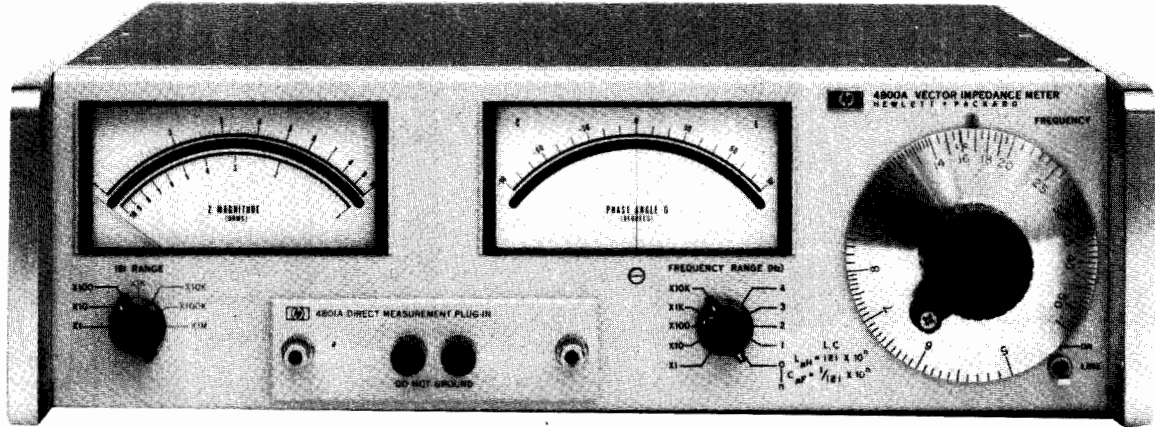

### Description

Vector impedance is a quantity involving both magnitude and phase and can be graphically illustrated by a vector in the  $Z, \theta$  plane. Vector impedance describes the ratio of voltage to current and phase difference between the two.

Impedance of components, complex networks, and other two-terminal devices is measured by simply connecting the "unknown" to HP's 4800A Vector Impedance Meter, selecting the desired test frequency, and adjusting the impedance range switch. Both impedance magnitude in ohms and phase in degrees are read directly. HP's Vector Impedance Meter eliminates all the tedium of traditional techniques for measuring complex impedance. It is a complete system calibrated to read the complex impedance as measured between the terminals.

HP's Vector Impedance Meter measures impedance from 1 ohm to 10 megohms over a phase range of  $-90^\circ$  to  $+90^\circ$ . Frequency adjusts from 5 Hz to 500 kHz in 10 decade ranges. Three controls: impedance range switch, frequency range switch, and frequency dial, are arranged on the front panel to assure simple operation.

Besides measuring vector impedance, HP's 4800A conveniently measures components. At frequencies that are decade multiples of  $1/2\pi$ , as marked on the frequency dial,  $L$  and  $1/C$  are read directly if the phase is approximately  $\pm 90^\circ$  respectively.  $R$  is equal to the impedance magnitude at frequencies where the phase is approximately  $0^\circ$ . The vector impedance meter also yields  $Q$  of circuits and inductors by using either  $f_0/\Delta f$ ,  $R_p/\omega L$  or the  $\omega L/R_s$  technique. A vector impedance calculator is furnished with each instrument for quick determination of equivalent series resistance, reactance, inductance, capacitance, and  $Q$ .

HP's 4800A is equipped with analog outputs for three parameters: impedance magnitude, impedance phase, and frequency. These outputs may be used in conjunction with a two-pen X-Y recorder to provide permanent traces. The rear panel provision for an external oscillator input makes possible swept frequency characterization of "unknowns". The impedance meter can be swept over any decade range of frequency and impedance within the range of the instrument. Analog outputs can also be connected to a digital voltmeter for a high resolution, digital readout with excellent repeatability.

### Specifications

#### Frequency characteristics

**Range:** 5 Hz to 500 kHz in five bands: 5 to 50 Hz, 50 to 500 Hz, 0.5 to 5 kHz, 5 to 50 kHz, 50 to 500 kHz.

**Accuracy:**  $\pm 2\%$  from 50 Hz to 500 kHz,  $\pm 4\%$  from 5 to 50 Hz,  $\pm 1\%$  at 15.92 on frequency dial from 159.2 Hz to 159.2 kHz,  $\pm 2\%$  at 15.92 Hz.

**Monitor output:** level: 0.2 V rms minimum; source impedance: nominally 600 ohms in series with 50  $\mu\text{F}$ .

#### Impedance measurement characteristics

**Range:** 1 ohm to 10 megohms.

**Meter scale range:** 1 ohm to 10 ohms times impedance range.

**Impedance ranges:** X1, X10, X100, X1 k, X10 k, X100 k, X1 M.

**Accuracy:**  $\pm 5\%$  of reading.

#### Phase angle measurement characteristics

**Range:**  $0^\circ$  to  $\pm 90^\circ$ .

**Accuracy:**  $\pm 6^\circ$ .

**Calibration:** increments of  $5^\circ$ .

#### Direct inductance measurement capabilities

**Range:** 1  $\mu\text{H}$  to 100,000 H, direct reading at decade multiples of 15.92 Hz.

**Accuracy:**  $\pm 7\%$  of reading for  $Q$  greater than 10 from 159.2 Hz to 159.2 kHz,  $\pm 8\%$  of reading for  $Q$  greater than 10 at 15.92 Hz.

#### Direct capacitance measurement capabilities

**Range:** 0.1 pF to 10,000  $\mu\text{F}$ , direct reading at decade multiples of 15.92 Hz.

**Accuracy:**  $\pm 7\%$  of reading for  $D$  less than 0.1 at 159.2 Hz to 159.2 kHz,  $\pm 8\%$  of reading for  $D$  less than 0.1 at 15.92 Hz.

#### Measuring terminal characteristics

**Configuration:** electrical: both terminals above ground, ground terminals provided for shielding convenience; mechanical: binding posts spaced  $3/4$ " at centers.

**Waveshape:** sinusoidal.

**External oscillator requirements:** 0.9 V  $\pm 20\%$  into 20 k $\Omega$ .

#### Recorder outputs

**Frequency:** level: 0 to 1 V nominal; source impedance: 0 to 1000 ohms nominal; proportional to frequency dial rotation.

**Impedance:** level: 0 to 1 V nominal; source impedance: 100 ohms nominal.

**Phase angle:** level: 0  $\pm 0.9$  V nominal; source impedance: 1000 ohms nominal.

**Accessories furnished:** 13525A Calibration Resistor, 00610A Terminal Shield.

**Dimensions:** 426 mm W x 133 mm H x 467 mm D (16 $3/4$ " x 5 $1/4$ " x 18 $3/8$ ").

**Weight:** net, 10.8 kg (24 lb); shipping, 13.5 kg (30 lb).

**Power:** 115 or 230 V  $\pm 10\%$ , 48 to 440 Hz, 29.7 VA.

#### 4800A Vector Impedance Meter

**Opt 908:** Rack Flange kit

**Opt 910:** Extra operating and service manual

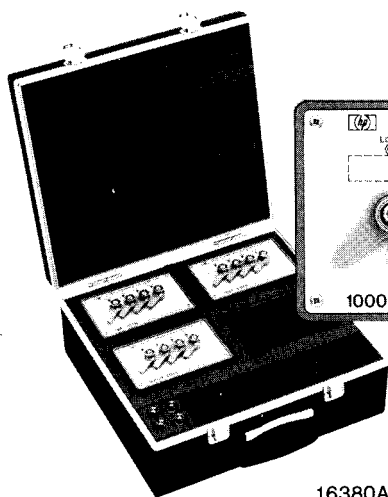

16380A

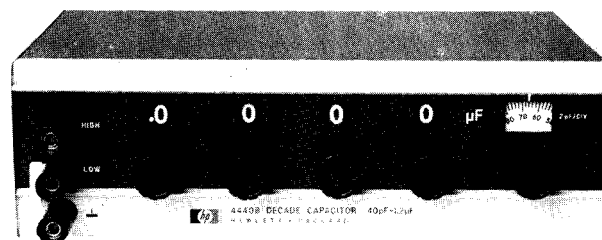
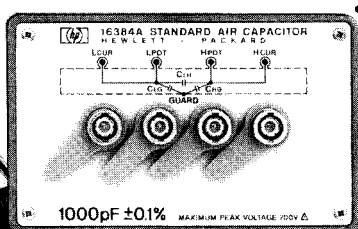

4440B

### 16380A Description

The HP 16380A is a set of four air-dielectric four-terminal pair configuration capacitors with values of 1, 10, 100 and 1000 pF. These standard capacitors have excellent capacitance stability ( $\leq 300$  ppm/year) and frequency characteristics (100 Hz to 10 MHz). Each unit is supplied with test certification to 0.01% calibration accuracy at 1 kHz. This permits direct calibration of capacitance and LCR meters to an accuracy of 0.1%.

The 16380A can be easily adapted to 3, 4 and 5 terminal configurations, allowing it to be used for calibration of all Hewlett-Packard LCR meters.

### 16380A Specifications (at 1 kHz, $23 \pm 5^\circ\text{C}$ )

	16381A	16382A	16383A	16384A
Capacitance	1 pF	10 pF	100 pF	1000 pF
Accuracy	$\pm 0.1\%$			
Dissipation Factor	$\leq 0.0001$			
Dimensions	112 mm H x 142 mm W x 88 mm D			
Weight	1.4 kg each, Case: 8.6 kg			

### General

#### Frequency Characteristics

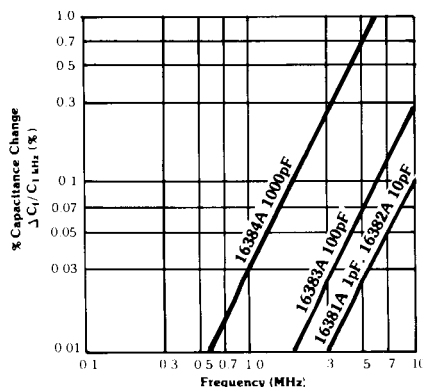

**Temperature coefficient (typ.):** +40 ppm/ $^\circ\text{C}$  (1 pF), +30 ppm/ $^\circ\text{C}$  (10 p, 100 p, 1000 pF)  
**Calibration accuracy:**  $\pm 0.01\%$  (certification at 1 kHz supplied).  
**Stability:** 300 ppm/YR (at 1 kHz and  $23 \pm 5^\circ\text{C}$ )

### 4440B Description

The Hewlett-Packard 4440B Decade Capacitor is a high accuracy instrument providing usable capacitances from 40 pF to 1.2  $\mu\text{F}$ . Its 0.25% accuracy makes it an ideal aid for circuit design or as a working standard.

The use of silvered-mica capacitors in all four decades provides higher accuracy, lower dissipation factor and good temperature coefficient. An air capacitor vernier provides 100 pF (from 40 pF to 140 pF) with resolution of 1 pF. Capacitors are housed in a double shield in such a way that increased capacitance from two terminals to three terminals is held to 1 pF.

### 4440B Specifications

**Capacitance:** 40 pF to 1.2  $\mu\text{F}$  in steps of 100 pF with a 40 pF to 140 pF variable air capacitor providing continuous adjustment to better than 2 pF between steps.

**Direct reading accuracy:**  $\pm (0.25\% + 3 \text{ pF})$  at 1 kHz for three-terminal connection.

**Resonant frequency:** typical values of the resonant frequency are 450 kHz at 1  $\mu\text{F}$ , 4 MHz at 0.01  $\mu\text{F}$  and 40 MHz at 100 pF

**Dissipation factor:** for  $C > 1040 \text{ pF}$ , 0.001 MAX at 1 kHz.  
 for  $C < 1040 \text{ pF}$ , 0.005 MAX at 1 kHz.

**Temperature coefficient:**  $< +70 \text{ ppm}/^\circ\text{C}$ .

**Insulation resistance:** 5 G $\Omega$  minimum, after 5 minutes at 500 V dc.

**Maximum voltage:** 500 V peak.

**Weight:** net 2.5 kg (5 1/2 lb); shipping 3.6 kg (8 lb).

**Size:** 76 mm H x 264 mm W x 152 mm D (3" x 11" x 6").

### Ordering Information

16380A Standard Air Capacitor Set  
 4440B Decade Capacitor

# COMPONENT MEASUREMENT

## pA Meter/DC Voltage Source

Model 4140B

- 3 basic semiconductor measurements:  
I, I-V and Quasi-Static C-V measurements
- Two programmable voltage sources
- Basic accuracy: 0.5%
- High resolution:  $1.000 \times 10^{-12}$
- HP-IB Standard

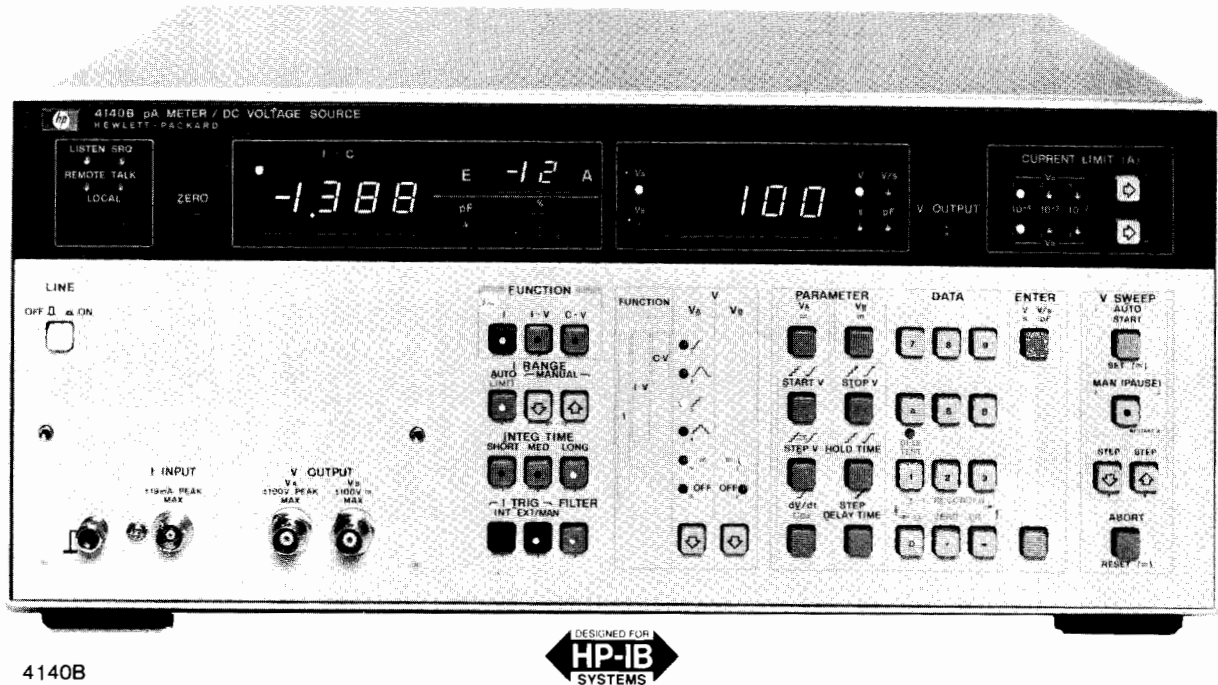

### Description

The 4140B pA Meter/DC Voltage Source is another in Hewlett-Packard's new generation of Component Measurement instrumentation. It consists of an extremely stable picoampere meter and two programmable dc voltage sources, one of which operates as a ramp and staircase generator as well as a dc source. These features make the 4140B ideal for making dc characteristic measurements such as leakage current, current-voltage characteristics and quasi-static C-V measurements required by the semiconductor industry for new product development and for improving production yields. It is equally useful in measurements of electronic components and materials to determine leakage currents or insulation resistances.

The 4140B can contribute to the development, production and quality control of semiconductor devices and to the improvement in the reliability of electronic components and equipment.

### Stable pA Measurements

Stable picoampere measurements can be made with the 4140B with a maximum resolution of  $10^{-15}$ A. This is made possible by a new measurement technique in conjunction with an offset current capability, low noise test leads, and an electrostatic and light shielded test fixture. These features provide both stable and fast picoampere measurements.

This measurement technique is very useful in making small leakage current measurements and determining dc parameters of semiconductor devices or measuring the insulation resistance and leakage current for dielectric absorption measurements necessary in the analysis of capacitors or insulation materials.

### Synchronized I-V Measurements

The 4140B makes automatic, synchronized current-voltage measurements that have required a large instrumentation system in the past.

The two voltage sources in the 4140B operate over a range of  $-100$  V to  $+100$  V with a maximum resolution of 10 mV. One operates only as a stable dc source while the other generates a staircase voltage, a precise ramp or a stable dc level.

By adding precise, programmable timing capability, we can now make fast, accurate I-V and C-V measurements. Device stabilization times, (time between the applied voltage and the subsequent current

measurement) can now be programmed from the front panel of the 4140B or via the HP-IB bus.

### Quasi-static C-V Measurements

Automatic quasi-static C-V measurements are easily accomplished by the ramp voltage capability of the 4140B. This measurement is highly significant in evaluating basic semiconductor characteristics.

The 4140B operates over a capacitance range of 0.1 pF to 1999 pF with a dc voltage ramp rate of 1 mV/s to 1 V/s in 1 mV/s increments. Capacitance, which is calculated from the measured current divided by the ramp rate, can also be provided as a percent of the capacitance of the oxide film ( $C_{ox}$ ) over a range of 0.0 to 199.9%. By providing the output voltage at each capacitance measurement point, we have the dc (quasi-static) C-V characteristics of the device under test.

### HP-IB Capability

Interfacing the 4140B to an HP-IB system improves measurement efficiency and takes advantage of its high speed (approx 5 ms) measurement rate. Such a system will minimize measurement time of dc parameters of semiconductors and the insulation resistance and leakage current of electric components and materials. This allows rapid feedback to production for fast evaluation of a new device in the development stage.

### Specifications

**Measurement functions:** I, I-V and C-V

**Voltage sources:** two separate sources ( $V_A$  and  $V_B$ )

$V_A$ :  $\pm 100$  V programmable source/function generator

$V_B$ :  $\pm 100$  V programmable DC voltage source

**Measurement Function/Source Selection:**

Function	$V_A$	$V_B$
I		--- (DC)
I-V		--- (DC)
C-V		--- (DC)

**Voltage sweep:** auto or manual (pause)

**Current measurements:**

**Displays:** current, 3½ digits with 2 digit annunciator. Voltage, 3½ digits.

**Measurement range:** ± 1.000 × 10<sup>-12</sup>A to 1.000 × 10<sup>-2</sup>A full scale in 11 ranges.

**Overrange capability:** 99.9% on all ranges.

**Range selection:** auto (lowest current range is selectable), and manual

**Measurement accuracy/Integration time:**

Range	Accuracy* ± (% of rdg. + counts)	Integration Time** (ms)		
		Short	Medium	Long
10 <sup>-2</sup> – 10 <sup>-9</sup>	0.5 + 2	20	80	320
10 <sup>-10</sup>	2 + 2			
10 <sup>-11</sup>	5 + 3	80	320	1280
10 <sup>-12</sup>	5 + 8	160	640	2560

\* Accuracy for long integration time. 23°C ± 5°C, humidity ≤ 70%. For short and medium integration time, see reference data section.

\*\* Integration times specified at 50 Hz. For 60 Hz operation, multiple time by %.

**Zero offset:** cancels leakage current of test leads or test fixtures.

**Offset range:** 0 to ± 100 × 10<sup>-15</sup>A.

**Trigger:** INT, EXT and HOLD/MAN

**Input terminal:** triaxial

**Capacitance-voltage (C-V) measurement**

**Measurement ranges:** 0.0 pF – 100.0 pF and 200 pF – 1000 pF F.S. in two ranges; 99.9% overrange

**Ranging:** auto

**%C:** capacitance change of device under test is displayed as a percent of the set value of the oxide capacitance (C<sub>ox</sub> = 100%)

**%C range:** 0.0% – 199.9%

**Cox setting ranges (2 ranges):** 0.1 pF – 199.9 pF and 200 pF – 1999 pF

**Capacitance calculation accuracy:** accuracy is dependent on accuracy of both the current measurement and ramp voltage.

**Zero offset:** cancels stray capacitances of test fixtures and test leads.



**Offset range:** 0 to 100 pF

**High speed I data output:** available with HP-IB interface only. Outputs current measurement data at 4 ms intervals (max rate).

**DC voltage sources**

**Output modes, V<sub>A</sub>:**

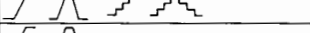
**V<sub>B</sub>:**

Function	V <sub>A</sub>	V <sub>B</sub>
I		(DC)
I-V		(DC)
C-V		(DC)

**Voltage ranges (V<sub>A</sub> and V<sub>B</sub>):** 0 to ± 10.00 V and 0 to ± 100.0 V in 2 ranges, auto range only.

**Maximum current:** 10 mA, both sources.

**Voltage sweep:** auto and man (Pause), up/down step in manual (Pause) mode. Sweep abort standard

**Operating parameter setting ranges:**

**Start voltage and stop voltage:** 0 – ± 10.00 V, 0.01 V steps; 0 – ± 100.0 V, 0.1 V steps

**Step voltage:** 0 – ± 10.00 V, 0.01 V steps; 0 – ± 100.0 V, 0.1 V steps

**Hold time:** 0 – 199.9 seconds in 0.1 s increments; 0 – 1999 seconds in 1.0 s increments

**Step delay time:** 0 – 10.00 seconds in 0.01 s increments; 0 – 100.0 seconds in 0.1 s increments

**Ramp rate (dV/dt):** 0.001 V/s – 1.000 V/s in 0.001 V/s increments

**Accuracy (at 23°C ± 5°C):**

**Output voltage:** ± 10 V, ± (0.07% + 11 mV); ± 100 V, ± (0.09% + 110 mV)

**Ramp rate:** typically 0.5%, 0 – ± 10 V; < 5 %, > 10 V.

**Current limit:** 100 μA, 1 mA and 10 mA, ± 10% (V<sub>A</sub> and V<sub>B</sub>)

**Output terminals:** BNC; L-GND

## Reference Data

### Current Measurement

#### Current measurement accuracy\*

Range	Integration Time	
	Short	Medium
10 <sup>-2</sup> – 10 <sup>-8</sup>	0.5 + 3	0.5 + 2
10 <sup>-9</sup>	0.5 + 3	0.5 + 3
10 <sup>-10</sup>	2 + 4	2 + 3
10 <sup>-11</sup>	5 + 10	5 + 4
10 <sup>-12</sup>	5 + 20	5 + 10

\* ± (% of rdg. + counts), 23°C

**Current ranging times\*:** 21 ms to 3.8 sec. (longer ranging time needed for large changes in input signal level, especially on lowest current ranges).

\*When FILTER is on, current ranging time increases 60 ms (50 Hz power line) or 50 ms (60 Hz power line)

**Warm-up time:** ≥ 1 hour

**Common mode rejection ratio:** ≥ 120 dB (≤ 2 counts)

#### Analog Output I, C and V<sub>A</sub>

**Accuracy:** ± (0.5% + 20 mV)

**Low pass filter:** 3 position: OFF, 0.22 s ± 20% and 1 s ± 20% applied to both V<sub>A</sub> and I/C data outputs

**Pen lift output:** TTL low level (≤ 0.8V) during sweep period in I-V and C-V functions

**Recorder output scaling:** pushbutton scaling of lower left and upper right limits of X-Y recorder

#### HP-IB Interface\*

**Remote controlled functions:** measurement function, current range, integration time, I data output trigger, voltage sweep controls, current limit, V<sub>A</sub> and V<sub>B</sub> voltages, zero (offset), self test and parameter settings (voltages, sweep/hold/delay times)

**Data output:**

Measured data (I, C and V<sub>A</sub>),

Voltage setting (V<sub>A</sub> and V<sub>B</sub>),

Parameter settings

\*HP-IB cables not supplied; see page 29.

#### General Information

**Power:** 100, 120, 220, V ± 10%, 240 V +5% – 10%; 48-66 Hz, 135 VA max with any option

**Size:** 426 mm W x 177 mm H x 498 mm D (16.5" x 7" x 19.6").

**Weight:** 14.4 kg (31.7 lbs.)

#### Accessories Furnished

**16053A test leads:** Consists of one triaxial cable, two each BNC-BNC cables and one connection plate with mating female panel-mount connectors. Cables are one meter in length.

**16055A test fixture:** for general device measurements. Provides electrostatic and light shielding for stable pA measurements.

#### Accessories Available

**16054A connection selector:** provides a simple method to select appropriate connection of low lead for the pA meter section.

**16056A current divider (10:1):** for use only on the 10 mA range to extend the measurement capability to 100 mA.

#### Ordering Information

##### Accessories

**16053A** Test Leads (furnished)

**16054A** Connection Selector

**16055A** Test Fixture (furnished)

**16056A** Current Divider (10:1)

##### Options

**Opt 907** Front Handle Kit (P/N 5061-0090)

**Opt 908** Rack Flange Kit (P/N 5061-0078)

**Opt 909** Rack & Handle Kit (P/N 5061-0084)

**Opt 910** Extra Manual

**4140B pA Meter/DC Voltage Source**



# COMPONENT MEASUREMENT

## Semiconductor/Component Test System

Model 4061A

- Ready to use—supplied with 7 turn-key application pacs
- Reliable impedance and current measurements with one probing
- Productivity improvement through accurate and fast measurement over wide range

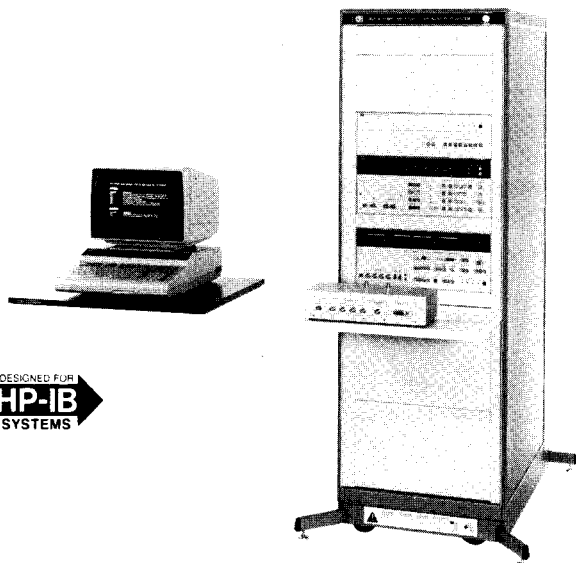

### Description

The 4061A Semiconductor/Component Test System is a dedicated system for making efficient, automatic evaluation of the fundamental characteristics of semiconductor and electronic components required in R & D and production areas. This system employs reliable, accurate measurements and high speed data processing to perform more reliable evaluations with speed and less manpower. The 4061A is supplied with 7 sophisticated applications programs and is flexible in both software and hardware. Thus, the system can output measurement results in nearly any required data format.

The switching subsystem, designed especially for use with the 4061A, allows both impedance and current measurement without changing DUT connection. Using this new switching subsystem, and by making impedance measurements, the 4061A performs evaluation of Doping profile, Oxide capacitance, Flat band condition, Threshold voltage, Surface charge, and Minority carrier life time/surface generation velocity. The 4061A also measures leakage current and reverse/forward current-voltage characteristics. Surface state density evaluation, using both high (e.g., 1 MHz) and low frequency (Quasi-static) C-V measurements and data processing are also possible by making modifications to system software.

The system offers significant improvement in both yield and quality in production through fast and reliable measurements and evaluations. It is also a valuable evaluation tool for the development of new materials and devices. The 4061A provides the flexibility to meet the future measurement requirements of the electronics industry.

### System Configuration

The 4061A consists of the following:  
 4140B pA Meter/DC Voltage Source  
 4275A Multi-frequency LCR Meter  
 Switching Subsystem  
 9835A System Controller  
 98034B HP-IB Card  
 98035A Real Time Clock  
 29402C 56-inch Rack Cabinet

### Impedance Measurement

The 4275A Multi-frequency LCR Meter offers excellent flexibility in measuring the impedance characteristics of semiconductors, LCR components and electronic materials. The 4275A's flexibility enables tests to be performed at test frequencies, test signal levels and DC bias voltage equivalent to, or very near actual operating conditions.

The 4275A offers up to 5½ digit resolution, wide measurement range (0.01 fF to 199.999  $\mu$ F) basic accuracy of 0.1% over a 10 kHz to 10 MHz frequency range.

### Current Measurement

The 4140B pA Meter/DC Voltage Source offers stable current from 0.001 pA to 20 mA. Two programmable  $\pm 100$  VDC voltage sources are also built in. Fast, accurate I-V characterization of FETS and diodes are made easy using microprocessor timing control between the voltage sources and pico-ammeter. The 4140B also performs reliable quasi-static C-V measurement with high sensitivity and stability by using a highly linear ramp biasing technique.

### Switching Subsystem

The switching subsystem remotely changes DUT connection between the 4275A and 4140B. Thus, with one probing, the measurement cabling is automatically controlled and wide measurement range for both impedance measurements, up to 1 MHz, and current measurements, down to 0.001 pA are guaranteed.

This switching subsystem includes an 8 bit data I/O function with 2 bit interrupt input for interface versatility. Non-HP-IB products such as IC probers, temperature controls, or component handlers can be interfaced through this 8 bit I/O. Of course, other HP-IB compatible products can be interfaced, allowing greater flexibility in both measurement and data processing.

### Controller

The standard System controller is the HP 9835A with basic 64 k byte memory. The 9835A controls measurements and performs complex data manipulation. The derivation of the semiconductor characterization parameters and general data analysis such as statistical evaluation of the measurement result can be obtained immediately after measurement.

### System Software

System software consists of 7 turn-key application programs, 28 system subroutines, and 4 diagnostics. The application software is ready to use to perform basic semiconductor characterizations and component impedance evaluations. System subroutines are usable as major program subroutines to expand system measurement and data processing capabilities. The diagnostics isolate parts of the system not operating properly and can be used to verify system operation before making measurements.

### Furnished Application Software

Semiconductor high/low frequency C/V characteristics, I-V characteristics, C-t characteristics and Zerst analysis, Impedance Frequency/Bias characteristics, Ideal C-V curve.

### Semiconductor Applications

#### C-V Characteristics

The 4061A measures the C-V characteristics of MIS structures. Both high frequency C-V (10 kHz to 1 MHz) and low frequency C-V (quasi-static) characteristics are easily measured. Using data from the C-V characteristics measurement, a doping profile is easily obtained.

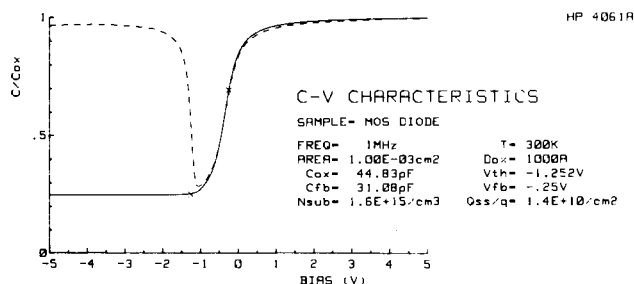

The 4061A performs the Zerst analysis using the C-t measurement data. This analysis is an effective evaluation method for obtaining the semiconductor minority carrier generation characteristics.

### I-V and DC Characteristics

Total synchronization between the application of the voltage and the current measurement is automatically accomplished by the 4061A. This permits the accurate (0.5%) and high speed (35 ms on the 1 nA range) measurements necessary to measure small leakage currents in MOS structures, FET's, and diode static characteristics.

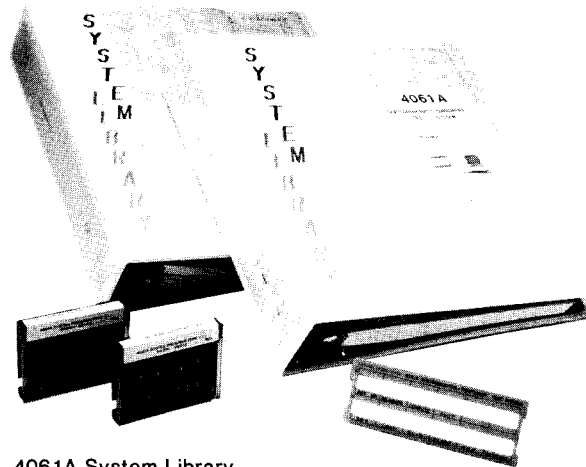
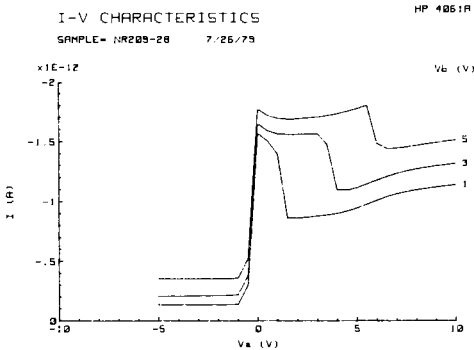

4061A System Library

### Specifications

For detailed specifications on each of the instruments used in the 4061A, refer to the individual data sheets.

#### Impedance Measuring Section (4275A)

These specifications are for the 4275A connected directly to the device-under-test (DUT).

**Display:** 4½ digits; 5½ digits in high resolution mode

**Frequency:** 10 kHz to 10 MHz; 10 spot frequencies in a 1-2-4 step sequence.

**Oscillator level:** 1 mVrms continuously variable into open circuit. Output impedance approximately 100 ohms.

**Measurement parameters:** C-D•Q•ESR•G, L-D•Q•ESR•G, R-X•B•L•C, |Z|-θ

**Measurement ranges:**

**C:** 0.01 fF to 199.99 μF

**L:** 1 pH to 19.999 H

**|Z|, R, X:** 0.01 mΩ to 19.999 MΩ

**G, B:** 0.01 nS to 19.999 S

**D:** 0.0001 to 9.9999

**Q:** 0.01 to 9900

**Basic accuracy:** ±0.1%

**Measurement time:** Approximately 140 ms to 210 ms

**DC Bias (4275A Option 001):** 0 to ±35 V, 1 mV maximum resolution.

#### Current Measurement Section (4140B)

These specifications are for the 4140B connected directly to the device-under-test.

**Measurement functions:** I, I-V, and C-V. Synchronized measurements of Current-Voltage (I-V) and Quasi-Static (C-V) are automatically performed.

### Current measurement:

**Display:** 3½ digit

**Range:** ±0.001 × 10<sup>-12</sup> A to 1.999 × 10<sup>-2</sup> A

**Basic accuracy:** ±0.5%

**Measurement time:** approximately 5 ms to 9 s

### DC Voltage sources: V<sub>A</sub> and V<sub>B</sub>

**Output mode:** V<sub>A</sub>; V<sub>B</sub>;

**Range:** Both sources, 0 to ±10 V in 10 mV steps; 0 to ±100 V in 100 mV steps; Ramp Rate, (V<sub>A</sub> only), 0.001 V/s to 1 V/s

### Capacitance-Voltage (C-V Measurement)

**Measurement ranges:** 0.0 pF to 199.9 pF and 200.0 pF to 1999 pF F.S. in two ranges; 99.9% overrange.

### Switching Subsystem

The switching subsystem consists of a switch control module and switching module with interconnecting cables.

Function: Switches connection from DUT to either Multi-frequency LCR Meter or the pA Meter/DC Voltage source.

**System Measurement Range** (Only deviations from individual instrument specifications are listed.)

#### Impedance measurements (4275A)

**Frequency range:** 1 MHz

**Measurement parameters:** C-G

**Capacitance:** ≤200 pF (With D≤0.1)

Accuracy: (Accuracy of 4275A) × 1.5 + ΔC (at 25°C + 5°C).

$$\Delta C = 1.4 \times 10^{-3} C x f^2 \text{ (pF)} + 5 \text{ counts}$$

**Conductance:** ≤12 mS (D ≤0.1)

\*Accuracy: (Accuracy of 4275A) × 1.5 + ΔG (at 25°C + 5°C)

$$\Delta G = 6 \times 10^{-3} C x f \text{ (S)} + 5 \text{ counts}$$

\*After 1 hour warmup and at DUT terminal of switching module f: frequency in MHz

Cx: Measured capacitance value in pF

At 5°C to 40°C, ΔC and ΔG doubles (Example: Assume Cx = 1000 pF and f = 1 MHz). C = (1.4 × 10<sup>-3</sup> × 10<sup>3</sup> × (1)<sup>2</sup>) pF + 5 counts = 1.4 pF + 5 counts

#### Current Measurements (4140B)

**Accuracy:** (Accuracy of 4140B) × 1.5 + 5 counts

After one-hour warmup and at DUT terminal of switching module

#### Controller (9835A)

**Internal storage:** 64 kbytes

**Dynamic range:** 10<sup>99</sup> to 10<sup>-99</sup>, 0, -10<sup>-99</sup> to -10<sup>99</sup>

**Internal calculation range:** 10<sup>511</sup> to 10<sup>-511</sup>, 0, -10<sup>-511</sup> to -10<sup>511</sup>

**CRT display:** 80 characters per line; 25 lines

**Data cartridge capacity:** 217 kbytes

### Available Options

**Option 001:** ±100 V internal dc bias; 4275A internal bias is changed to ±100 V with 0.1 V resolution

**Option 002:** 1-3-5 frequency step; 4275A frequency steps are in a 1-3-5 sequence

**Option 030:** European date format; 98035A output format is changed to (day, month, hour, minutes, seconds)

### General Information

**Operating temperature:** 5°C to 40°C

**Relative humidity:** 70% at 40°C

**Power:** 100, 120, 220, and 240 V, +5% to 10%, 48 to 66 Hz, 690 VA Max (520 VA without the 9835A)

**Size:** Rack Cabinet, 535 mm W x 1635 mm H x 770 mm D (21" x 64.4" x 30.3"); 9835A: 384 mm W x 358 mm H x 496 mm D (15" x 14" x 19.5").

**Weight:** Rack Cabinet, approximately 125 kg (275 lbs.); 9835A, approximately 22.3 kg (49 lbs.); Standard System, approximately 190 kg (417 lbs.).

### Ordering Information

**Option 001:** ±100 V dc Bias for 4275A

**Option 002:** 1-3-5 Frequency Steps for 4275A

**Option 030:** European Date Format

**4061A Semiconductor/Component Test System**





# COMPONENT MEASUREMENT

## LCZ Meters

Models 4276A & 4277A

Model 4276A

- 3-digit frequency setting: 100 Hz to 20 kHz (801 spots)
- High speed measurements (1 kHz): 95 ms/meas (4-digit display resolution); 60 ms/meas (3-digit display resolution)

- Measure L/C-D/Q/ESR/G,  $|Z| - \theta$ , L/C only
- 10-bin component sorting-Comparator/Handler Interface (optional)
- 0.1% basic accuracy over impedance range of 100 m $\Omega$  to 10 M $\Omega$

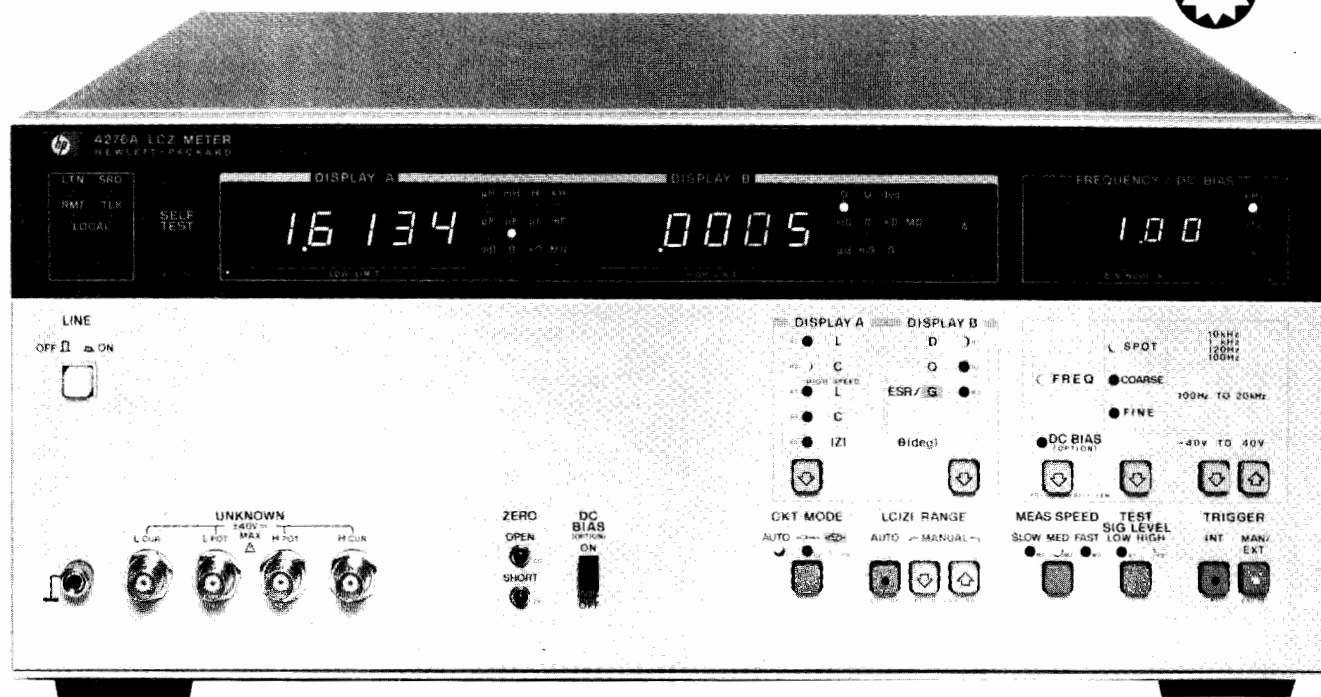

4276A



### Description

HP's 4276A and 4277A LCZ Meters are general purpose impedance measuring instruments designed to measure circuit components such as capacitors and inductors using frequency and DC bias conditions identical to those of the intended application. Both 4276A and 4277A feature variable test frequency (100 Hz - 20 kHz and 10 kHz - 1 MHz respectively), optional DC bias variable from 0 to  $\pm 40$  V, multiple parameters (L • C •  $|Z|$  • D • Q • ESR • G •  $\theta$ ) with fully automatic high speed measurements, and 4½ digit resolution. The 4276A has an impedance range of 100 m $\Omega$  to 10 M $\Omega$ ; and the 4277A, 10  $\Omega$  to 1 M $\Omega$ .

Both instruments are ideal for production line, quality control, and circuit design applications, and are versatile enough for stand-alone use or systems use under HP-IB control (standard). An optional comparator/component handler interface for 10-bin sorting with measurement speed of better than 100 ms make the 4276A/4277A a good choice for production line testing of discrete components.

### Variable Test Parameters: Frequency, Bias, Signal Level

HP's 4276A and 4277A offer variable test frequency, optional internal DC bias, and selectable test signal level (HIGH and LOW). This makes it possible to measure components under conditions almost identical to those of the intended circuit.

The 4276A (100 Hz to 20 kHz) and the 4277A (10 kHz to 1 MHz)

provide 801 and 701 test frequencies, respectively. Test frequencies of both instruments are linearly spaced along a logarithmic scale. The most commonly used test frequencies for production line measurements—100 Hz, 120 Hz and 1 MHz, all of which are specified in MIL/IEC standards are included. Frequency setting resolution is 3 digits.

Both instruments feature selectable test signal levels—1 V/50 mV (4276A) and 1 V/20 mV (4277A)—and both can be equipped with an optional internal DC bias source that is variable from 0 to  $\pm 40$  V in 10 mV (0 to 10 V) or 100 mV (10 to 40 V) steps. Thus, bias conditions that suit the measurement and the DUT can be selected, an important consideration for semiconductor C/V measurements.

The above features satisfy most impedance measurement requirements for component development and circuit design. HP-IB enhances these features.

### High Speed Measurements

The 4276A and 4277A provide high speed measurements with 3½ to 4½ digits resolution. The time required for a C-D measurement, for example, is 95 ms (4-digit) or 60 ms (3-digit) at 1 kHz, and 70 ms (4-digit) or 50 ms (3-digit) at 1 MHz. Even at 120 Hz, a measurement time of 170 ms (4-digit) or 150 ms (3-digit) is possible. Also, when the instrument is set to L only or C only measurement mode, measurement time is 45 ms (4-digit) or 35 ms (3-digit) at 1 kHz (if D is less than 0.002), and 40 ms (4-digit) or 30 ms (3-digit) at 1 MHz (if D is less than 0.01).

# COMPONENT MEASUREMENT

LCZ Meters

Models 4276A & 4277A

109



Model 4277A

- 3-digit frequency setting: 10 kHz to 1 MHz (701 spots)
- High speed measurements (1 MHz): 70 ms/meas (4-digit display resolution; 60 ms/meas (3-digit display resolution))

- Measures L/C-D/Q/ESR/G,  $|Z| - \theta$ , L/C only
- 10-bin component sorting-Comparator/Handler Interface (optional)
- 0.1% basic accuracy over impedance range of 10  $\Omega$  to 1 M $\Omega$

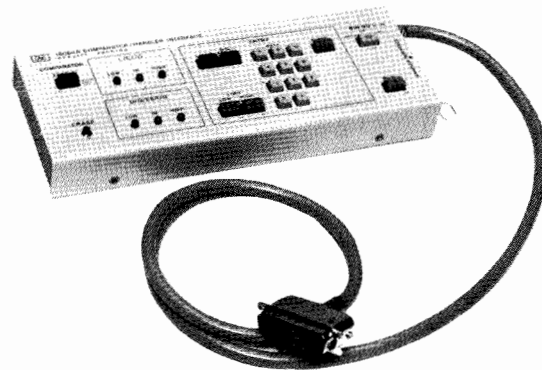
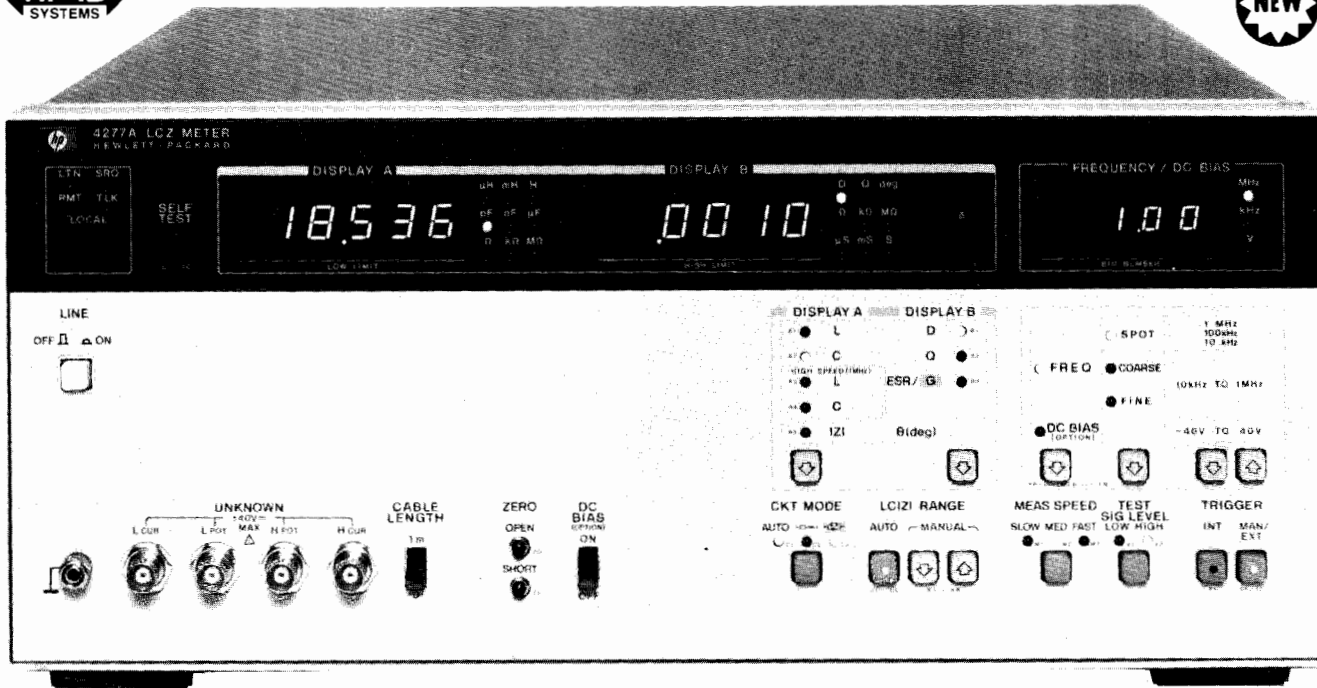

Option 002 Comparator/Handler Interface

Such high speeds considerably improve the efficiency and increase the throughput of high volume measurements like outgoing inspection on the production line and incoming inspection by component end users. If an HP-IB system is configured, measurement efficiency is further improved because HP-IB is capable of packed binary data output format, which can be processed much faster than the usual ASCII format. Even when the HP-IB capability is not used, the 4276A/4277A can increase production line throughput if the optional comparator/handler interface is used.

### Optional Ten-Bin Component Sorting

A 10-bin Comparator/Handler Interface (option 002) is available. Nine sets of bin limits (high and low) can be input for L, C or  $|Z|$ . Also, high and low limits for D, Q, ESR, or G can be set to provide go/no-go testing.

Multiple bin sorting is especially beneficial on the production line and in incoming inspection. Test costs can be significantly reduced using the 4276A/4277A's high speed measuring capability. When the optional handler interface is used for automatic component sorting, measurement efficiency is better than that when using HP-IB. This is because time for data handshake is not needed.

Output data from the handler interface is at TTL or open collector level, which improves system noise immunity. Particularly,

three lines—external trigger and measurement complete signals—are photo-isolated, so a reliable sorting system free from noise can be constructed.

Measurement reliability is improved by other comparator features like front panel lock-out and auto zeroing of fixture residuals.

Plus, all comparator/handler interface functions can be HP-IB controlled. So a fully automatic component sorting system can be constructed for the use in outgoing/incoming inspection.

**Specifications** (refer to data sheet to complete specifications (Common to 4276A and 4277A))

**Parameters measured:** C-D-Q-ESR-G  
L-D-Q-ESR-G  
C only, L only

$|z| - \theta$  and  $\Delta$ (deviation for any parameter)

**Display:** 4½ digits (max), maximum display 19999

# COMPONENT MEASUREMENT

## Models 4276A & 4277A (Cont.)

**Measurement circuit modes:** Auto, Parallel, and Series  
**Frequency control modes:** SPOT (100 Hz, 120 Hz, 1 kHz, 10 kHz, 100 kHz, 1 MHz), COARSE (10 freqs/decade), and FINE (max. freq. resolution).

**Test signal level (unknown terminal open):**

	HIGH	LOW
4276A	1 Vrms ± 10%*	50 mV ± 20%*(Cp only)
4277A	1 Vrms ± 10%	20 mV ± 15%

\* at 1 kHz only

**Output impedance:** 100 Ω  
**Ranging modes:** Auto and Manual (up-down)  
**Trigger:** Internal, External or Manual  
**Measurement terminals:** 5-terminal (4276A)  
 4-terminal pair (4277A)  
**Measurement speed modes:** FAST, MED, and SLOW  
**Offset adjustments:** Front panel OPEN and SHORT adjustments to compensate for residual impedance and stray admittance of the test fixture.  
**Test frequencies:** 4276A - 100 Hz to 20 kHz ± 0.01% (801 points)  
 4277A - 10 kHz to 1 MHz ± 0.01% (701 points)

### Step frequency:

Test Frequency	Step Frequency
100 Hz-200 Hz	1 Hz
202 Hz-500 Hz	2 Hz
505 Hz-1 kHz	5 Hz
1.01 kHz-2 kHz	10 Hz
2.02 kHz-5 kHz	20 Hz
5.05 kHz-10 kHz	50 Hz
10.1 kHz-20 kHz	100 Hz
20.2 kHz-50 kHz	200 Hz
50.5 kHz-100 kHz	500 Hz
101 kHz-200 kHz	1 kHz
202 kHz-500 kHz	2 kHz
505 kHz-1 MHz	5 kHz

### Compensation frequencies:

**4276A:** 100, 200, 500, 1k, 2k, 5k, 10k, 16k, 20 kHz  
**4277A:** 10k, 20.2k, 50.5k, 100k, 202k, 505k, 700k, 900k, 1 MHz  
 Compensation at other frequencies is automatically done using second degree interpolation.

### Offset ranges:

	4276A	4277A
OPEN	C ≤ 20 pF G ≤ 0.2 μS	C ≤ 20 pF G ≤ 2 μS
SHORT	Z  ≤ 2 Ω	L ≤ 2 μH R ≤ 2 Ω

### HP-IB Interface

**Remote control:** All front panel control settings and 16064A (Comparator/Handler Interface) settings can be controlled using HP-IB.  
**Data Output:** Parameter measured, equivalent circuit, display status, measured values and decision output of comparator.  
**Output format:** ASCII and packed binary.  
**Self test:** Checks 4276A/4277A's basic operation.

**Measurement Accuracy and Range:** Specified at the front panel unknown connectors when all of the following conditions are satisfied:

- (1) warmup time ≥ 30 min.
- (2) test signal level is set to HIGH (1 Vrms)
- (3) measurement speed mode: MED or SLOW
- (4) ambient temperature is 23°C ± 5°C
- (5) cable length switch is set to Om (4277A)
- (6) OPEN and SHORT adjustments have been made
- (7)  $D \leq 0.1$  (L-D•Q, C-D•Q, and |Z| - θ measurements)  
 $D \leq 0.002$  (4276A) L only and C only measurement  
 $D \leq 0.01$  (4277A)

Accuracies given in Tables 1 through 6 are read as ±(% of reading + number of counts) for L, C, and |Z|, and ±(number of degrees + number of counts) of θ.

**C-D/C-Q (1/D) Measurement Accuracy:** Accuracies for C measurements are given in Table 1 (frequencies other than 100, 120, 1k, and 1 MHz) and Table 2 (100, 120, 1k and 1 MHz only). The 4277A's C accuracies in the tables are for the full scale value of each C range.

**C only measurements can be made under the following conditions:**

	Test Frequency	Measurement Range	D
4276A	All frequencies	All ranges except for the two highest ranges at each frequency	≤ 0.002
4277A	1 MHz	1 pF - 10 nF	< 0.01

(Refer to the 4276A/4277A data sheet for complete accuracy specifications, including D/Q accuracies)

**L-D/L-Q (1/D) Measurement:** Accuracies for L measurements are given in Table 3 (for frequencies other than 1k, 10k, 100k, and 1 MHz) and Table 4 (for 1k, 10k, 100k, and 1 MHz). The 4276A's L accuracies given in the tables are for the full scale value of each L range.

**L only measurement can be made under the following conditions:**

	Test Frequency	Measurement Range	D
4276A	All frequencies	All ranges except for the two highest ranges at each frequency	≤ 0.002
4277A	1 MHz	1 μH - 100 μH	< 0.01

(Refer to the 4276A/4277A data sheet for complete accuracy specifications, including D/Q accuracies)

**|Z| - θ Measurement:** Accuracies for |Z|/θ measurements are given in Table 5 (4276A) and Table 6(4277A). Accuracies given in the tables are for the full scale value of each |Z| range.

### DC Bias

**Internal DC bias (Opt.): 0 to ± 40 V**

Bias Voltage	Voltage Step	Accuracy (at 23 ± 5°C)
-40.0 to -10.0 V	0.1 V	±(1% of reading + 35 mV)
-9.99 to -0.01 V	0.01 V	±(1% of reading + 10 mV)
0.00 to 9.99 V	0.01 V	±(0.3% of reading + 10 mV)
10.0 to 40.0 V	0.1 V	±(0.5% of reading + 35 mV)

**Output resistance:** 1020 Ω ± 10% (4276A)

1040 Ω ± 10% (4277A)

**Control:** Front Panel or via HP-IB

**External DC bias via rear panel:** 0 to ± 40 V

**Memory Backup** (approx. two weeks):

**Memory Contents:** all front panel key settings, excluding BIAS, offset values, reference for deviation and comparator limit data.

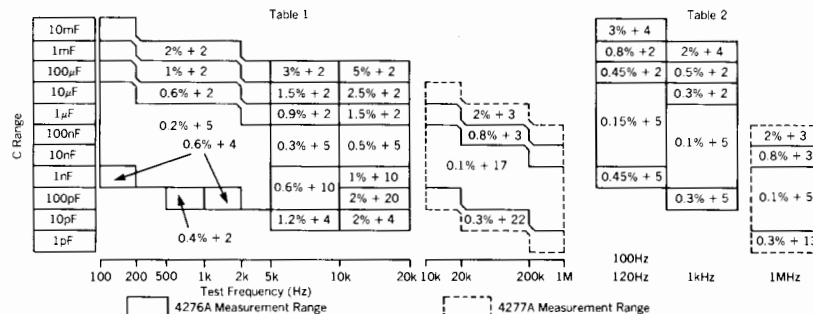





## Model 4145A

- Fully automatic, high speed dc characterization of semiconductor devices and materials
- Four programmable stimulus/measurement units capable of high resolution, wide range sourcing and sensing ... I: 1 pA~100 mA, V: 1 mV~100 V
- Built-in graphics analysis functions
  - marker and cursor provide direct numeric readouts
  - line function for automatic calculation of line gradient and X-Y axes intercept values
- Built-in flexible disc drive for permanent storage of user programs and measurement results

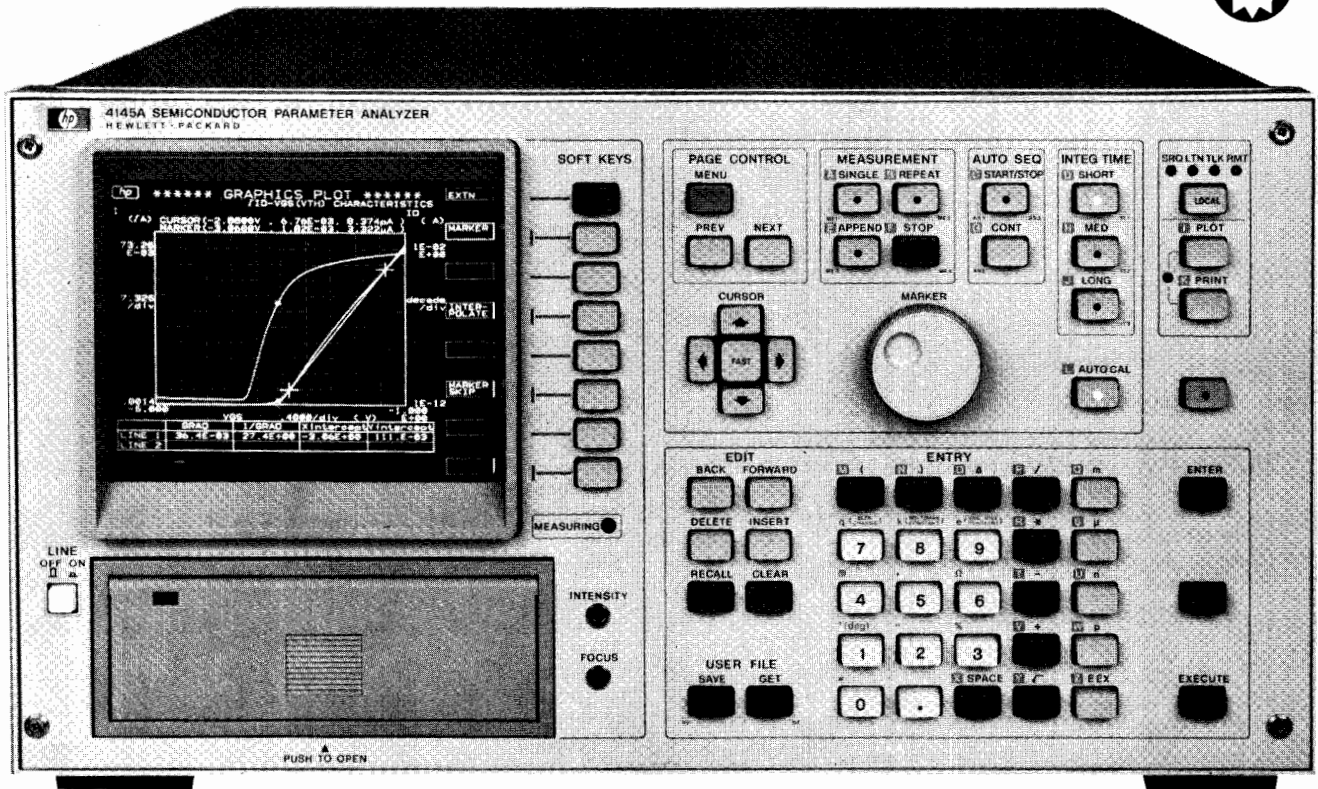

### Description

Designed for production line and laboratory use, the HP 4145A is the electronics industry's first stand-alone instrument capable of complete dc characterization of semiconductor devices and materials. It stimulates voltage and current sensitive devices, measures the resulting current and voltage responses, and displays the results in a user-selectable format (graph, list, matrix or schmo) on a built-in CRT display. An on-board programmable calculator provides real-time calculation of voltage/current dependent parameters, such as the current gain ( $h_{FE}$ ) and transconductance ( $g_m$ ) of transistors, which also can be displayed on the CRT. A number of powerful graphic analysis tools—marker, cursor, line function, interpolation—enhance the 4145's basic capabilities and provide fast, accurate analysis of semiconductor devices, leading to increased production yields and improved device quality.

Four built-in stimulus/measurement units (SMUs) are the heart of the 4145A. Each SMU can be independently programmed to function as either a voltage source/current monitor or a current source/voltage monitor. Thus, a bipolar transistor, for example, can be completely characterized in common-base, common-emitter, and common-collector configurations without changing connections—only changing the SMUs' operating modes is required. The HP 4145A is also equipped with two voltage sources and two voltage monitors for measurements on devices having more than four terminals, such as ICs.

The HP 4145A can be controlled from the front panel, via the HP-

IB (standard), or by measurement setups stored on flexible discs.

Displayed information—measurement setups, auto-sequence programs, measurement results—can be dumped directly onto an external digital printer/plotter to obtain publication quality hard copies. Also, measurement results can be sent via the HP-IB to a computer for further processing.

### Auto Sequence Programs

Measurement programs stored on a 4145A flexible disc can be linked by an auto sequence program, making it possible to perform a series of measurements with just one keystroke.

### Four User-Selectable Display Formats to Suit the Evaluation

Measurement results can be displayed in one of four display formats: GRAPHICS, LIST, MATRIX or SCHMO. After measurement has been made and the results displayed, the softkeys can be used to access various analysis functions for complete device evaluation. These functions include MARKER for numeric readout of measured value at any point along a plotted curve, CURSOR for numeric readout of measured value at any point along a plotted curve, CURSOR for numeric readout of value at any graphic point and for line positioning, STORE /RECALL for overlay comparisons, AUTO SCALE for optimum graphic scaling, and LINE FUNCTION for direct readout of line gradient and X-Y axes intercept values.



## Specifications

### Measurement

**Stimulus Measurement Unit (SMU):** Four SMUs are built into the HP 4145A. Each SMU can be programmed to source voltage and monitor current, or conversely to source current and monitor voltage. Each SMU can also be programmed to COM mode. This sets voltage at 0 volts and current compliance at 105 mA.

**Output/Measurement Resolution:** Voltage, 4½ digits. Current, 4 digits

**Voltage measurement input resistance/Current source output resistance:**  $\geq 10^{12} \Omega$

**Maximum capacitive load:** 1000 pF

**SMU voltage range, resolution and accuracy:**

Voltage Range	Resolution	Accuracy <sup>1,2</sup>	Max. Current
± 20 V	1 mV	±(0.1% of reading + 0.05% of range + $0.4 \times I_{out}^*$ )	100 mA
± 40 V	2 mV		50 mA
± 100 V	5 mV		20 mA

\* $I_{out}$  is SMU output current in amps.

**SMU current range, resolution and accuracy:**

Current Range	Resolution	Accuracy <sup>1,2</sup>	Max. Voltage
± 100 mA	100 $\mu$ A	$\pm [0.3\% + (0.1 + 0.2 \times V_{out}/100)\%]$	20 V ( $I > 50$ mA) 40 V ( $20 \text{ mA} < I \leq 50$ mA) 100 V ( $I \leq 20$ mA)
± 10 mA	10 $\mu$ A		100 V
± 1000 $\mu$ A	1 $\mu$ A		
± 100 $\mu$ A	100 nA		
± 10 $\mu$ A	10 nA		
± 1000 nA	1 nA	$\pm [0.5\% + (0.1 + 0.2 \times V_{out}^*/100)\%]$	
± 100 nA	100 pA		
± 10 nA	10 pA	$\pm [1\% + (0.1 + 0.2 \times V_{out}^*/100)\% + 5 \text{ pA}]$	
± 1000 pA	1 pA**		

\* $V_{out}$  is SMU output voltage in volts.

\*\* 50 fA resolution in current monitor mode.

- Accuracy specifications are given as  $\pm$  % of reading or setting value  $\pm$  % of range.
- Accuracy tolerances are specified at 25°C  $\pm$  5°C, after a 40 minute warm-up time, with AUTO CAL on, and specified at the rear panel connector terminals referenced to SMU common. Tolerances are doubled for the extended temperature range of 10°C to 40°C.

### SMU Voltage/Current Compliance:

**Maximum Voltage compliance:** 20 V, 40 V, or 100 V, depending on the output current range.

**Maximum current compliance:** 20 mA, 50 mA, or 100 mA, depending on the output voltage range.

**Compliance setting resolution:** Same as current and voltage output/measurement resolution. Maximum current compliance resolution, however is 50 pA.

**Compliance accuracy:** Voltage compliance accuracy is the same as voltage output/measurement accuracy. Current compliance accuracy is current output/measurement accuracy  $\pm$  (1% of range + 10 pA).

**Voltage/Current Sweep Characteristics:** Output from up to three SMUs or voltage sources can be swept in one of three modes: VAR1, VAR2, or VAR1'.

**VAR1:** Linear or logarithmic staircase sweep

**VAR2:** Linear staircase sweep. Output from the VAR2 source is incremented after completion of each VAR1 sweep.

**VAR1':** Output from the VAR1' source is synchronized with VAR1 but at levels proportional to a user-selectable ratio or offset relative to VAR1.

**Ratio:**  $\pm 0.01$  to  $\pm 10$

**Offset:** Any value that will not cause VAR1' to exceed maximum allowable output.

**Hold time:** 0 to 650 seconds,  $\pm$  (0.5% + 9 ms) with 10 ms resolution

**Delay time:** 0 to 6.5 seconds,  $\pm$  (0.1% + 5 ms) with 1 ms resolution

### Voltage Sources (Vs) Characteristics:

**Number of sources:** Two

**Output resistance:**  $\geq 0.2 \Omega$

**Maximum capacitive load:** 1000 pF

### Voltage output range, resolution and accuracy:

Output Voltage Range	Resolution	Accuracy	Max. Output Current
± 20 V	1 mV	±(0.5% of setting + 10 mV)	10 mA

### Voltage Monitors (Vm) Characteristics:

**Number of monitors:** Two

**Input resistance:** 1 M $\Omega$   $\pm$  1% shunted by 150 pF  $\pm$  10%

**Voltage measurement range, resolution and accuracy:**

Measurement Voltage Range	Resolution	Accuracy
± 2 V	100 $\mu$ V	±(0.5% of reading + 10 mV)
± 20 V	1 mV	±(0.2% of reading + 10 mV)

### Characteristics Common to SMUs, Voltage Sources & Voltage Monitors:

**Maximum allowable terminal voltage:** 100 V peak across SMU and  $V_m$  input terminals, or SMU and  $V_S$  output terminals, or between those terminals and guard; and 42 V maximum from Common to Ground.

### Display

CRT size and screen resolution: 152.4 mm (6 inch) diagonal. 2048 x 2048 points.

**Display modes:** Graphics, Schmo, List and Matrix

**External CRT analog output:** X, Y and Z outputs of 0 to 1 Vdc into 600  $\Omega$

### Analysis

**Calculation:** Two user functions can be input and keyboard calculations can be done using the following 11 operators: +, -, \*, /,  $\sqrt{\quad}$ , EXP, LOG, LN, \*\* (power), ABS (absolute) and  $\Delta$  (differential).

**Constants available on the keyboard:**

**q:** Electron charge ( $1.602189 \times 10^{-19}$  coulomb)

**k:** Boltzmann's Constant ( $1.380662 \times 10^{-23}$  J/ $^\circ$ K)

**e:** Dielectric constant of vacuum ( $8.854185 \times 10^{-12}$  F/m)

**Analysis functions:** Overlay comparison with STORE/RECALL, Marker, Interpolate, Cursor, Auto scale, Zoom function ( $\leftarrow$ ,  $\rightarrow$ ,  $\updownarrow$ ,  $\updownarrow$ ), Line and Move Window.

### General Specifications

**Operating temperature range:** +10°C to +40°C;  $\leq 70\%$  RH at 40°C, permissible temperature change  $\leq 1^\circ\text{C}/5$  min.

**Power requirements:** 100/120/220 V  $\pm 10\%$ ; 240 V - 10% + 5%; 48 to 66 Hz; 270 VA max.

**Dimensions:** 425.5 mm W x 230 mm H x 612 mm D (16.75" x 9.06" x 24.1")

**Weight:** 27 kg (59 lbs) approximately.

### Reference Data

**SMU measurement time:** Measurement time = response time + ranging time + integration time.

**SMU response time:**

Current Range	Setup/Setting Time	SMU Wait Time
100 nA to 100 mA 1 nA and 10 nA	2.7 ms	0.2 ms 47.5 ms

**Ranging time:** varies from 4 ms to 74 ms

**Integration time:** SHORT, MED and LONG

	SHORT	MED	LONG
50 Hz	3.6 ms	20 ms	320 ms
60 Hz		16.7 ms	267 ms

### Accessories Furnished

16058A Test Fixture

04145-60001 Connector Plate

04145-61622 Triaxial Cable (3m), 4 ea.

04145-61630 BNC Cable (3m), 4 ea.

04145-61623 Shorting Connector

04145-61100 5 System Discs with a Head Cleaning Disc (P/N9164-0168)

### Ordering Information

HP 4145A Semiconductor Parameter Analyzer

# COMPONENT MEASUREMENT

## Digital IC Tester Models 5045A, 5046B

- Large program library
- Test IC's to 24 pins
- Printed record of IC failures
- Modify existing device programs
- Generate one-of-a-kind device programs
- Change test parameters quickly, simply

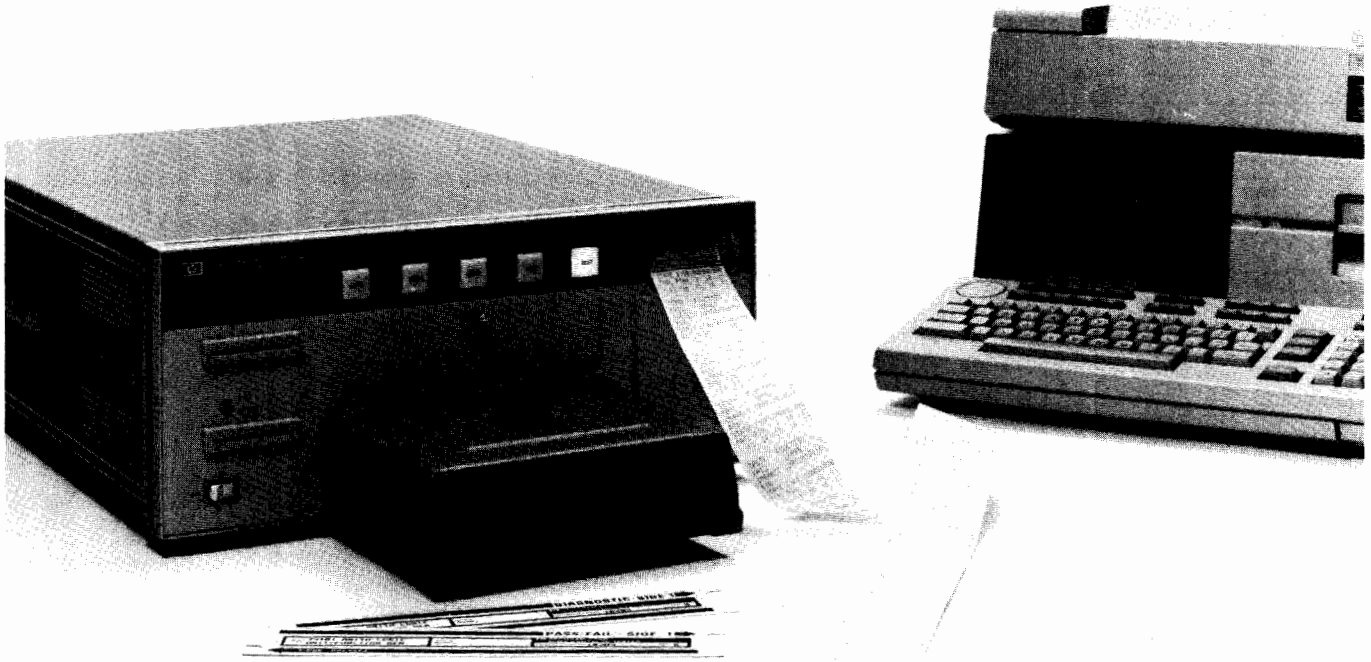

### 5045A Digital IC Tester

The HP 5045A Digital IC Tester is well suited for high volume incoming inspection of digital integrated circuits, simple enough to be used by an unskilled operator. To test a device, all that's required is a preprogrammed magnetic card. Insert the card into the front panel slot, and the tester is ready to provide complete DC parametric and functional verification. Test programs may be selected from an extensive list contained in our program catalog.

Permanent test results of individual IC failures are available on the standard thermal printer. Lot statistics are tabulated as testing proceeds, and are available from the printer. These are useful in documenting parts returned to manufacturers.

#### Test All These Families

##### TTL (all versions), CMOS, ECL

Universal pin electronics permit each pin of the 5045A to act as a forced voltage or current driver for inputs, outputs, open circuit, and power supplies. This provides the flexibility and capability needed to test combinatorial and sequential circuits, from gates to RAMs. Devices with power supply voltages up to 15 volts ( $-7.5$  V to  $+7.5$  V) may be tested. As testing requirements expand, your 5045A may be easily and inexpensively updated by adding new program cards. The nominal cost of these cards means that your cost-of-ownership remains low while your testing ability is kept current.

### 5046B Digital IC Test System

The HP 5046B Digital IC Test System is a fully programmable system consisting of the 5045A IC Tester, 9826A Controller and 2671G Printer. The System provides fast voltage and current test parameter changes with a few simple keystrokes. This ease of programming provides the ability to write or change IC test programs to meet your special testing needs. Evaluation and characterization capabilities are tailored to meet the needs of incoming QA departments as well as component evaluation.

#### Programming

You may apply the exact voltage and current you want for both the low and high states for any test. It's like having 24 programmable supplies available for a 24-pin IC. This capability is easily accessed using just a few lines of code. There are multiple programming methods to choose from, so you can apply just the right pattern for the device under test. You can key in all the 1's and 0's line-by-line, or write a short program block that automatically generates the device truth table. For ROMs, the system memorizes the output states of a known good device and automatically makes them part of the test program. Whether an input or output, test pattern coding is simple, direct, and provides a complete test for the device. Up to 16 separate detailed tests may be programmed to meet your exacting testing requirements.

### DC Parametric and Functional Tests

The 5045A thoroughly tests devices both functionally and parametrically to ensure that defective components don't get loaded into your PC boards. Functional tests check the ability of the device to operate correctly, according to its truth table, as an appropriate input stimulus is applied. DC parametric tests check the voltage and current on devices' inputs and outputs under various conditions specified by the manufacturer. These tests eliminate almost all defective devices and avoid the expense of finding and replacing these bad circuits once they have been soldered into PC boards and perhaps become part of a complex system.

### Economical ROM Testing

To test the many different truth tables which may be programmed into ROMs of the same generic type, it is not necessary to buy a card for each one. A single card containing stimulus information for the generic ROM type is loaded into the 5045A and the unique truth table of a known good ROM is "memorized" by the 5045A. The complete program is then recorded on a blank card for further use. Duplicates of any card may be made from the original by programming the 5045A, pressing "write", and then inserting a blank card. ROMs up to 64K bits may be tested.

### Automatic IC Handlers

The 5045A is designed to work with automatic IC handlers needed for high volume testing. The Kelvin contacts, as well as the special circuits which generate the fast rise and fall times for testing digital circuits, are in a removable test head which can be placed within inches of the IC being tested. Problems caused by long cables between handler and tester (ringing, oscillation, slow rise/fall times) are eliminated.

HP, in cooperation with major automatic handler manufacturers, has designed custom interface kits for popular handlers. So interfacing the 5045A or 5046B and an automatic IC handler requires nothing more than plugging the two together.

### Printer Gives Permanent Copy of Test Results

A built-in thermal printer provides useful test information: A) It tells whether a program is loaded correctly and what program it is. B) It records the number of failed and passed IC's. C) It provides failure analysis information for each failed IC. In its failure analysis modes, the printer provides very detailed information; a special voltage/current printout, for example. This makes the printer a digital multimeter.

### Failure Statistics

Failure Statistics are valuable when making decisions on the relative acceptability of a group of devices. This information may be used as a vendor tracking tool. The 5045A and 5046B aid you in this determination by tabulating the number of devices that have PASSED and FAILED since the tester was programmed. General pass/fail statistics are available on the standard 5045A printer. Detailed lot statistics are available using the 5046B's **FAILURE STATISTICS** program.

### Condensed Accessories

**10844A/B:** programming interface retrofit kit; contains all necessary parts, cables, interface board, and instructions to modify the 5045A for use in the 5046 Digital IC Test System. Order 10844A for use with 9825B and 10844B for use with 9826/9836.

**10845A:** preprogrammed magnetic card for any device listed in the **PROGRAM CATALOG**; min. order, 10 programs.

**10846A:** book containing ten coupons, each redeemable for one IC program listed in the **IC PROGRAM CATALOG**. Coupons are mailed to factory, programs sent by return mail. Coupons expire after 2 years.

**10847A:** service kit, allows fault isolation and rapid repair of the 5045A through board replacements, thereby reducing downtime. The kit includes: all CPU boards, two pin-drivers, card reader and interface, printer interface and solenoid, front panel control, diagnostic program card kit and accessories, and carrying case.

### Programming Tools

The 5046B system software is stored on one standard 9826A Disk. The programs are accessible using the special function keys on the desktop computer. The software package contains the following programs:

The **EDITOR** provides the capability to: 1) Enter IC test programs from the 9826A keyboard. 2) Read and store source programs from the 9826A disk. 3) Provide on-line editing to modify source programs.

The **COMPILER** provides the capability to: 1) Do syntax checking on source program statements. 2) Convert the source program into an object program. 3) Output the object program to the 5045A IC Tester.

The **DECOMPILER** provides the capability to: 1) Read an object program from the 5045A IC Tester. 2) Generate the corresponding source program.

The **PROGRAM ANALYZER** is used for error checking and debugging of source programs. It interrogates the 5045A processor as it executes a test program, then prints the following: 1) Listing of actual test sequence. 2) Programmed test parameters for each pin in each test. 3) The logical 1's and 0's for each pin in each test.

The **FAILURE STATISTICS** program provides the following: 1) Printout of failure by pin for each specific test failed. 2) Summary of failures and failure percentage for each test in the program.

The **FAILURE STATE MONITOR** program interacts with the 5045A while an IC is being tested. When a failure is encountered, it displays the state (vector) in which the IC failed.

The **DATA LOG** and **HISTOGRAM** programs provide detailed pin-by-pin voltage and current performance characteristics on IC devices. This provides the ability to carefully evaluate an IC's characteristics and design margins for usability in a company's products. Data is readily available on the 5046B's system printer in a large, readable format.

The **STORE** and **RETRIEVE** functions provide the capability to store and retrieve up to 75 compiled programs on each floppy disk. This capability eliminates the need to load and store program cards manually for use with the 5045A.

### Ordering the Preprogrammed Magnetic Cards

The 5045A is programmed by prerecorded magnetic cards available from HP. These cards, covering the most common device types, are listed in our **IC PROGRAM CATALOG (HP Pub. # 5952-7662)**. This catalog contains a wide variety of logic families and includes the majority of common device types. When additional programs are needed after the original purchase, they may be ordered through your local HP sales office or by mail with a prepaid coupon.

## Condensed Specifications

### Universal Pin Drivers

The same circuit drives or monitors each pin whether an input, output, power supply, clock, or open. Voltages and currents are individually programmable for each pin. No external fixtures required. **VOLTAGE** applied to the device under test:

Range	Accuracy
-7.5 V to <-1.875 V	±25 mV
-1.875 V to +1.875 V	±15 mV
>+1.875 V to +7.5 V	±25 mV

**CURRENT** applied to the device under test:

Range	Accuracy*
-200 mA to <-2.5 mA	±0.4 mA or ±6%
-2.5 mA to +2.5 mA	±10 μA or ±6%
>2.5 mA to 200 mA	±0.4 mA or ±6%

\*whichever is greater

**Slew rate:** ≥33.3 volts/μs.

### Ordering Information

**5045A** Digital IC Tester  
**5046B** Digital IC Test System



# CIRCUIT TEST SYSTEMS

Production Testing of Electronic Printed  
Circuit Board Assemblies



The decade of the 1980's will place new demands on production managers to cut costs, improve productivity, and increase quality. Automatic test equipment will become a key strategy in achieving these three goals. Implementing a specific ATE solution, however, requires careful assessment of the production environment to ensure the best allocation of your test resource dollars.

## Failures Are Expensive

Evidence suggests that the cost of finding a failure in electronic equipment increases by a factor of ten at each stage in the production process. Detecting a bad component at the board level costs \$5. The charge to locate a failure at the system level increases to \$50. Once the system makes it into the field, the expense becomes \$500. While the economic costs are surprisingly high, the intangible costs can be even greater. Defects at the

board level dislocate the smooth flow of production, and may lead to bottlenecks. Failures which occur during final testing of the system can force late deliveries and frustrate efforts to achieve shipment linearity. Once the product has left your front door, failures will undermine customer goodwill and a corporate reputation for quality.

Since the cost of identifying faults increases dramatically at each step in production, you want to catch faults as early as possible. It doesn't necessarily follow that 100% incoming inspection is the answer. Your real goal is high turn-on rates in final test. To achieve high turn-on rates requires boards that are as close as possible to being defect-free. As the diagram shows, high-yield PC boards are a function of both good parts and good processes.

A number of problems can occur during the PC board assembly process that will lead

to faults. The fault spectrum includes open or shorted traces on the board itself, wrong and misloaded parts, poor solder joints, and damage to components as the board is assembled. With no testing at the board level, such process faults can lead to unacceptably low turn-on rates at final test. With a good board

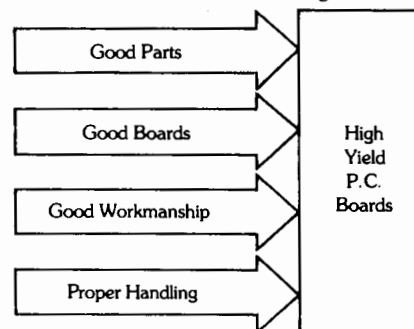

yield of 60% even a simple product with five boards would overload final test. The laws of statistics predict that nine out of ten systems would fail. Clearly, a good place for thorough testing is at the board level because it represents the first opportunity to locate faults across the entire fault spectrum. But is automatic test equipment worth the investment?

**The ATE Advantage**

Automatic test equipment will save you money by unlocking productivity and improving quality. Productivity is increased because labor-intensive manual testing is replaced by computer-aided testing. In addition, component-level diagnostic information provided by the ATE reduces rework costs.

As your production throughput increases, so does your capacity. At the same time, delivery is improved, providing you with a real competitive advantage.

ATE will also help you to achieve your quality goals. Higher quality lowers warranty costs and preserves customer goodwill. Quality, it has been said, isn't tested in but is built in. Quite true. But to improve quality you have to know what to look for. ATE provides the critical feedback you need to diagnose quality problems and to correct them. Design errors, for example, can be distinguished from flaws in the assembly process. You can also detect slips in vendor quality and work with them to find a solution.

Your production operation is unique from any other. To determine if ATE makes sense you have to compare your total cost of ownership with the savings which accrue from using ATE. Return on investment calculations very often show that the test equipment will pay for itself in a year or less.

**Choosing a Circuit Board Tester**

There are no simple answers to selecting an automatic circuit test system. Broadly speaking, you have to consider your production fault spectrum, hardware performance, software quality, and the level of service support you require from the ATE manufacturer. There is a broad range of questions that must be considered in each of these areas:

Will the system test for the spectrum of faults you expect to encounter? Can it test present and future board types? Can the system verify that it is operating properly? Can

it diagnose its own failures? Is the system easy to service? How good is the system's software? Can the ATE vendor provide prompt, on-site service when you need it?

The diagram illustrates the typical types of faults you can expect to occur at various stages of the production process. The market place has many potential test solutions. You can choose from simple shorts testers to equipment that measures individual components on printed circuit cards to systems that verify the dynamic performance of complete boards.

Three general types of loaded board testers are now being used: in-circuit testers, functional testers, and combination in-circuit/functional testers. The in-circuit test system locates faults by checking components and circuit paths without energizing the board. With functional testers, faults are found by exercising the board in a manner that emulates its use in the final product.

**In-Circuit Board Testers**

In-circuit testers contact board nodes through a bed-of-nails fixture. Spring loaded pins contact internal points on the loaded board. Components can be isolated using electrical guarding techniques and then tested for value, placement, and component type. In-circuit testers make excellent pre-screening tools prior to functional testing. They are well-suited for detecting manufacturing and workmanship-related faults which for some boards account for up to 80% of all faults. In many cases, workmanship errors are a simple test for an in-circuit tester but to identify the same defect with a functional tester can be time-consuming. An example of this is a short circuit caused by the wave soldering process. In-circuit testing has access to nodes in-circuit, so a simple shorts test will identify the flaw. On the other hand, most functional test systems require computer diagnostics and a guided probe to correctly identify faults.

Another characteristic of the in-circuit tester is simple test program generation. The actual functioning of the PC board is irrelevant to the in-circuit tester. Tests are at the component level only. The tester steps through the program from component to component and specific characteristics of each part are examined.

**Functional Board Testers**

Functional test systems emulate the electrical environment of the board under test. Stimulus sources act as input signals to the circuit, while detectors measure the output and compare it to the expected response. The major characteristic of functional testing is the go/no-go nature of the test. PC boards with many faults require high fault diagnosis times which reduce the test system's capacity.

**Combined Test Systems**

Individually in-circuit testers and functional testers offer advantages and disadvantages. Together they are complementary testing approaches. The spectrum of faults not covered by the in-circuit tester will usually be covered by the functional tester.

As product complexity increases, the need for high yield PC boards also increases. With high yield boards, final product test times are minimized, resulting in lower overall testing costs. High yield can be obtained by combining functional testing with in-circuit testing, as the diagram at the top of the next page shows. This combination produces yields of 90-99%.

Some test systems can execute both in-circuit and functional testing. They combine the best features of each approach into one stand-alone system. Testers that blend in-circuit with functional test capability not only can check for shorts and component errors, but also can validate the dynamic operational performance of the PC board circuitry.

HP's electronic manufacturing experience has led to the development of two major automatic board test products, the HP 3060A and the DTS-70. Each system approaches the problem of PC board testing differently, focusing on the various types of boards being manufactured. The HP 3060A is a combined in-circuit and functional test system for testing both analog and microprocessor-based boards, while the DTS-70 Digital PC Board Test System is a functional tester whose simulator-based architecture can perform testing to a known level of fault coverage.

HP's 3060A Board Test System is an advanced system that combines the latest in-circuit testing technology with functional testing. It can handle the toughest testing problems.

**In-Circuit Testing**

There are a number of challenges to making accurate in-circuit component measurements. Parallel paths must be nullified. Components with both real and reactive characteristics must be measured correctly. Readings must be accurate over a wide dynamic range. And both active and passive parts must be tested.

The 3060A utilizes advanced in-circuit testing techniques that allow you to isolate components in commonly found but difficult to measure circuit configurations. For example, a .01  $\mu$ F capacitor can be measured to an accuracy of 4% even when shunted by a 1 K $\Omega$  resistor. The key to this measurement is phase-synchronous detection, a valuable tool for measuring parts with significant real and reactive characteristics.

HP's instrumentation expertise has allowed us to make some real contributions to

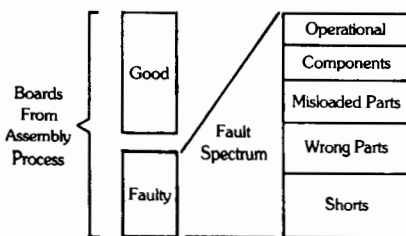

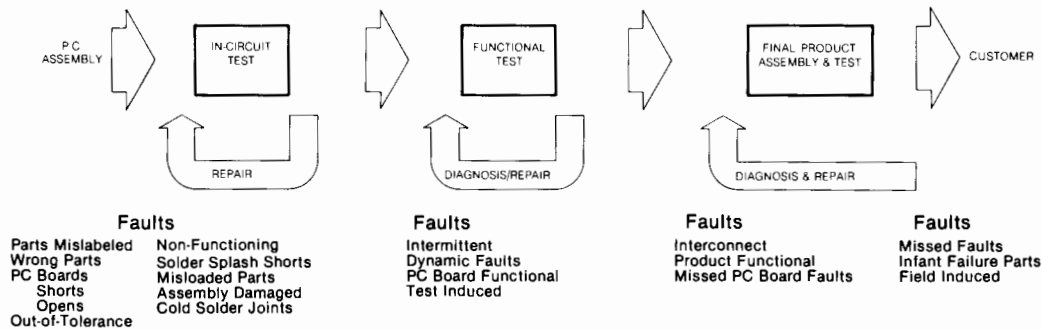

in-circuit testing. True six-wire measurements, phase-synchronous detection, and measurement enhancement algorithms combine to yield fault coverage beyond traditional in-circuit methods.

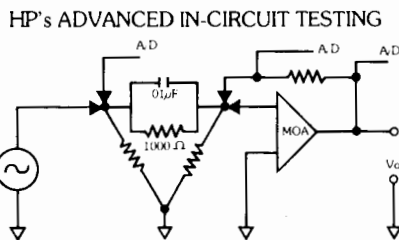

### Why In-circuit Testing Isn't Enough

In-circuit testing is a powerful approach. But today's complex products require more than in-circuit testing. Higher PC board yields are necessary to maintain acceptable yield at final test. Functional testing verifies the dynamic characteristics of the circuit under test, and catches the faults that in-circuit testing will not find. The addition of advanced in-circuit testing and functional testing adds an increment to your board yield shown below.

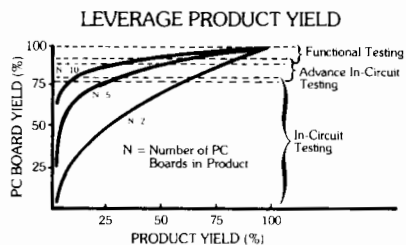

In a five-board product, increasing the yield from 75% to 98% increases final test yield from 23% to 90%. The HP 3060A combines in-circuit testing and functional testing into one powerful system, minimizing your capital investment.

### Functional Testing Makes The Difference

The standard 3060A has a wide range of sources and detectors useful for testing an-

alog and digital circuitry. It incorporates board level stimulus/response testing to check components like operational amplifiers, DAC's, and optoelectronic devices. Circuit parameters such as frequency and period can be measured and adjustments made. The 3060A's functional testing capabilities extend to analog, digital, and combined circuits. For example, the 3060A can test a DAC by applying digital patterns and then monitoring the analog output voltages.

### Signature Analysis

The big news in board testing is the micro-processor. Conventional testers require massive data storage to test such circuits. But the HP 3060A uses an HP-developed technique called Signature Analysis to test micro-processor boards. The HP 3060A collects lengthy bit streams at each node and compresses them into four-character hexadecimal codes. These codes can be compared to expected responses during a test. The HP 3060A's Digital High Speed Functional Test (DHSFT) option implements the Signature Analysis approach.

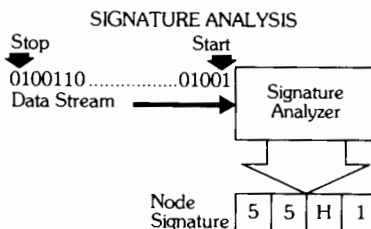

### Real-Time Support

A board tester represents a potential bottleneck in the production process. If a system fails, you need immediate help in bringing it back up. HP has a worldwide network of Customer Engineers dedicated to keeping your system up and running. You can count on rapid response to on-site service calls and spare part requests. When you need technical applications advice, HP's System Engineering Organization is available at modest cost to help you get the highest returns from your HP board test solution. You are buying more than a piece of hardware; you are buying a partner you can count on.

### Large-Scale Digital Testing

Large, complex logic boards will benefit from the use of HP's DTS-70 Digital PC Board Test System. As a simulation-based tester, it tells you how effective your test programs are and what portions of the circuit are not completely tested. The DTS-70 is a useful R&D design tool that can help you design better products. Your test engineers will value its ability to model feedback loops, find open traces, and identify intermittent faults.

The DTS-70's power and flexibility come from its controller, the HP 1000 Computer System. Its Real-Time Executive operating system allows you to simultaneously test boards and develop new programs. As your testing needs expand, you can add test stations and programming terminals without having to add additional computing power. The operating system is compatible with database management software to help you keep track of test data. The DTS-70 will also fit into your local area networks.

	3060A	DTS-70
In-Circuit	X	
Bed-of-Nails	X	
Edge Connector		X
Functional Analog	X	X
Functional Digital	X	X
Signature Analysis	X	
Board Simulator		X
HP-IB	X	X
Controller	HP 9825T	System 1000

### Two Million Boards Worth of Experience

HP circuit test products evolved out of our own internal experience with board testing. The HP 3060A, for example, is really a third-generation product. Today, HP uses more than 150 in-house ATE systems within our own plants.

Your production operation is unique, but we can help you characterize it by comparing the cost of testing, or not testing at each level to arrive at your best resource allocation. Let us help you answer these key test questions.

- High Speed, High Volume Digital Testing
- Isolate Faults Quickly and Easily
- Eliminate Production Bottlenecks

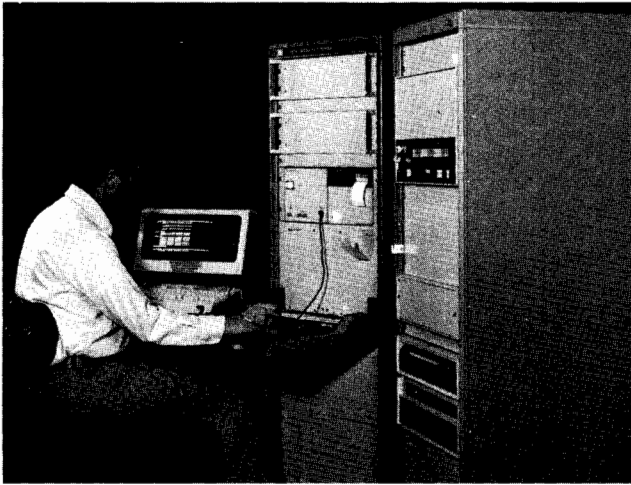

### Description

The DTS-70 Digital Printed Circuit Board Test System can solve your digital board testing needs. The DTS-70 can test your boards and isolate faulty components in seconds. Typical tests take only a few seconds and isolation of the failed component typically takes less than a minute. All this testing is performed to a known level of test effectiveness. The TESTAID board simulation software, provided with the system, enables you to determine the overall effectiveness of your testing process, a benefit not possible on hardware comparison testers. The FASTRACE fault isolation software guides your test operator to probe for the faulty component quickly and easily, all but eliminating costly manual troubleshooting.

The DTS-70 System is a complete system consisting of the 9571A Test Station, the HP System 1000 computer and a complete software package. The 9571A Test Station comes complete with digital test unit, programmable power for your board under test, and fault isolation probe. The test station is expandable to do added analog testing that may be required. The field proven HP System 1000 includes the 21 MX Series E computer and 7906A disk. The HP System 1000 provides both testing and software test generation expandability through the Real Time Executive operating system. The TESTAID simulator software and FASTRACE fault isolation software provide powerful test generation capability and advanced fault isolation which even enables you to isolate intermittent faults.

The DTS-70 is a test system with the capability, expandability, and reliability you expect from HP.

### No More Production Down-Time to Develop Test Programs

The multi-terminal capability of the DTS-70 allows you to generate test programs without shutting down testing on your production line. No longer do you have to choose between production shut downs and spending tens of thousands of dollars for off-line test generation capability. All you need is a relatively inexpensive terminal. Need more programming capability to keep up with new boards? Add up to six terminals to the DTS-70 for use as programming stations.

### High Speed, High Volume Digital Testing

Test complex boards in only seconds compared to the minutes or even hours necessary for manual test and fault isolation. The DTS-70 is capable of testing tens of thousands of PC assemblies a month for high throughput requirements.

### Isolate Faults Quickly and Easily

Troubleshooting and isolation of faulty components is done automatically. The computer instructs your test operator to isolate the fault in seconds using the guided probe. Avoid time-consuming manual fault diagnosis and reduce the need for highly skilled technicians.

### Eliminate Production Bottlenecks

The DTS-70 can test those complex boards that are so hard to troubleshoot at your final product test station and which hold up your shipments. The DTS-70 is capable of testing complex boards with over 200 MSI components.

### How Effective Is Your Test?

Only a simulator-based tester such as the DTS-70 can tell you how effective your tests are. The DTS-70 not only tells you how effective your test is, but also which nodes on the board need further attention. This has improved test quality over manual functional test generation methods by factors of two or more.

### Model Your Designs in R & D

Catch costly design and testability problems before they become designed-in problems. The DTS-70 TESTAID simulator software models the behavior of your designs, points out testing trouble spots, and predicts race and hazard conditions to your designers. Simulation at the design stage can prevent marginal designs and designed-in problems from reaching your end-users, preventing high warranty costs or costly on-site repairs.

### Worldwide Service

The DTS-70 Digital Test System is designed and manufactured by Hewlett-Packard and is backed up by HP worldwide support. HP recognizes that in a high volume production environment, each hour of operation affects a large portion of your profit dollars. When you take delivery of a DTS-70 system, the following support is available to you, worldwide, to keep your system working for you.

### Installation

Installation services will be provided with each purchase of a DTS-70 Test System. These services consist of site preparation data in advance of system delivery and installation when your system arrives.

### Warranty

A complete warranty program covers the entire DTS-70 system for 90 days beyond the system installation date. This warranty provides complete repair service during the warranty period.

### Customer Assistance Agreements

For system support beyond the warranty period, Customer Assistance Agreements are offered for hardware support and software support. You may select these services together or you may tailor a service program to match your individual needs. With the exception of extremely remote areas, these support programs are available throughout HP's worldwide service organization.

### Training

A digital test programming course is included for customer personnel responsible for developing test programs. This 10-day course teaches system operation, FASTRACE fault isolation and emphasizes use of TESTAID to generate digital test programs. Two enrollments are provided with the purchase of a DTS-70 system.

### Documentation

Every DTS-70 System is delivered with a complete set of operating and service documentation. The documentation set includes system level manuals, instrument level manuals, software manuals and quick reference guides.

### Field Support Package

For those DTS-70 users who choose to do their own servicing, HP offers special field support packages in the form of service kits that contain replacements assemblies. These service kits are designed to allow a user to support his DTS-70 system. For more information on these field support packages, contact your local HP field engineer.

### Ordering Information

DTS-70  
(Depends Upon Test Configuration)



# CIRCUIT TEST SYSTEMS

## In-Circuit/Functional Test System

### Model 3060A

- Precision in-circuit measurements
- Analog, digital functional testing
- Automatic program generation
- World-wide support
- Test microprocessor boards

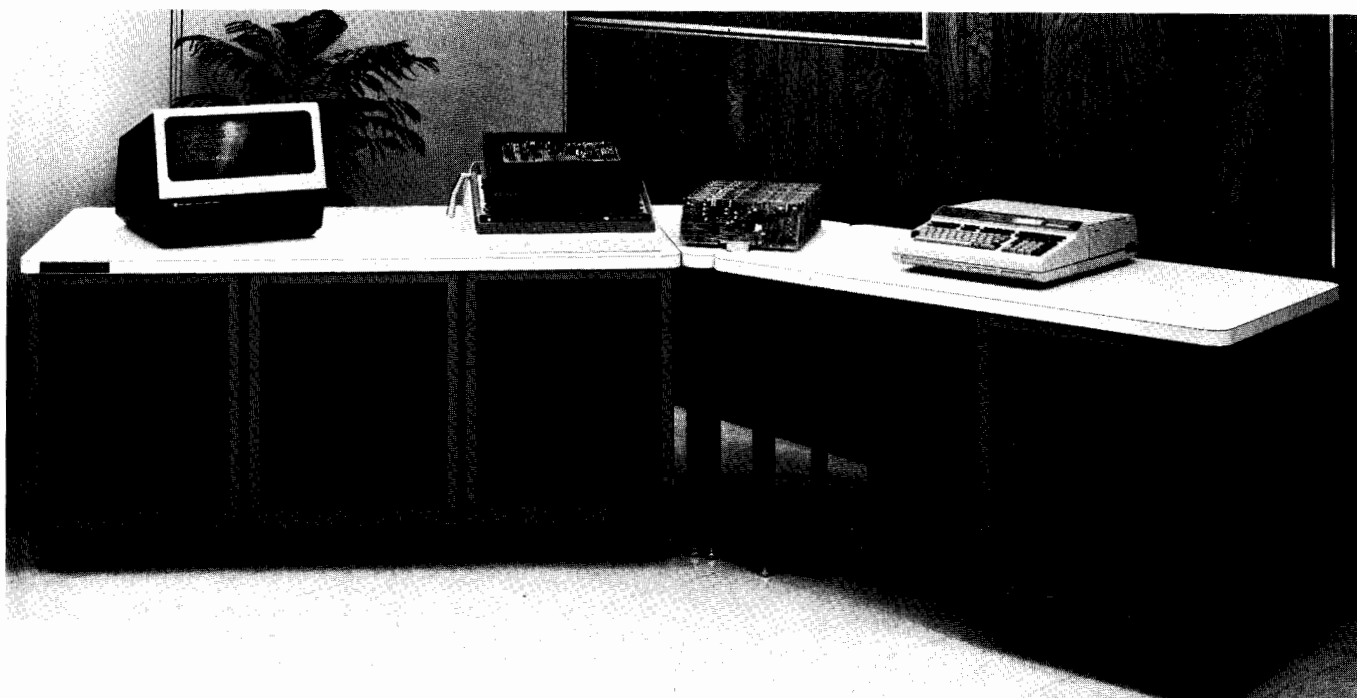

#### Description

The HP 3060A Board Test System combines advanced in-circuit measurement techniques with functional testing to increase your manufacturing productivity and reduce your costs. Because the 3060A represents the power of two systems in one, precious capital investment dollars are conserved. Board handling is minimized and throughput is increased.

The 3060A Board Test System contributes exceptional performance. It is the only test system on the market that offers you the precision of true six-wire guarding. A broad selection of signal sources and detectors gives the flexibility to functionally exercise your analog and/or digital PC boards under actual operating conditions. Signature analysis lets you tackle microprocessor-based boards with ease. Combine these hardware features with automatic program generation software and you have a system offering unparalleled performance.

#### State-of-the-Art Hardware

The HP 3060A combines the best of in-circuit and functional testing hardware. Making accurate in-circuit component measurements in the presence of parallel paths, reactive parts, and production-floor EMI requires care. The HP 3060A delivers unsurpassed accuracy with true six-wire guarding, phase-synchronous detection, and measurement enhancement algorithms. Six-wire guarding is an advanced in-circuit measurement technique that dramatically extends the range of circuit configurations that can be tested by eliminating measurement errors introduced by the test equipment. Measurement enhancement software corrects for voltage offsets, thermal EMF's, bias currents, and source loading. Phase-synchronous detection separates real and imaginary components in a reactive network or within a single part.

Functional testing simulates operating conditions the board is expected to encounter. A wide range of internal sources and detectors is built into the HP 3060A. In addition, you can add external sources and detectors to meet special test requirements. Both analog and digital stimuli can be used simultaneously to test even the most complex hybrid circuits like phase-locked loops and digital-to-analog converters.

#### Microprocessor Testing

The HP 3060A Board Test System can execute stored pattern test-

ing of digital circuits as well as dynamic testing of microprocessor-based PC boards. The High Speed Digital Functional Test Option (Option 100) uses Signature Analysis techniques to test microprocessor circuits. Option 100 easily handles bi-directional buses and circuits with memory and peripheral chips. Stimulus data can be applied at rates up to 2 MHz. Measurements on externally clocked data can be made up to 10 MHz. Option 100 represents a powerful, low-cost solution to digital functional testing.

#### Networking Capability

Factories of the future will integrate production and testing by linking them together into a computer-based communication network. The real-time feedback provided by such a network enhances the production manager's ability to monitor and control the entire process. HP has developed both computer and instrument solutions for factory automation. As a major computer maker, HP has been at the forefront in developing a total concept of automated manufacturing and testing called the Manufacturer's Productivity Network (MPN). The HP 3060A Board Test System forms an integral part of MPN's distributed test system network. At HP we are committed to providing you with a full solution to your productivity needs.

#### Automatic Program Generation

Software seems to be an area where gains in productivity come all too infrequently. In answer to the problem, the 3060A software includes a time-saving program that automatically creates an in-circuit test program from a description of the board to be tested. Called IPG, for In-circuit Program Generator, this powerful software tool significantly reduces the time it takes to write a test program. IPG selects optimum guard locations based on an analysis of all parallel paths. It identifies where remote sensing is required. IPG not only generates source code, but also generates a fixture map and wiring list helpful in constructing the test fixture. In addition, IPG performs a measurement analysis that indicates the accuracy with which each component can be measured.

#### Data Logging

Data logging makes it easy to process failure messages and yield data. The data logging software allows you to store failure data



in the local controller. You can also transfer the data over a local area network link to a central computer. The software includes programs that do yield analysis and failure histograms. The histograms identify which parts fail and how often they fail. In addition, the software helps the user in characterizing the failure modes of different parts so that vendor and process problems are quickly spotted.

### Self-Test

The HP 3060A includes both confirmation and diagnostic routines. The confirmation software allows the operator to verify that all system functions are working properly. The system confirmation software provides you with a high level of confidence that the 3060A is testing your board accurately.

The diagnostic program aids in isolating system faults to replaceable assemblies. Customers who perform their own maintenance and service will find the diagnostic software particularly beneficial.

### Worldwide Support

The real test of an ATE vendor comes after the sale. When every PC board is channeled through a board test operation, the failure of the test system creates a production bottleneck. You have to get the system up and running again with minimal delay. HP has a network of Customer Engineers on call the world over. They are experts with special training and experience to bring your system back into operation as quickly as possible. HP's Customer Engineers provide real-time support.

For customers who require technical applications support, HP Systems Engineers are available for consultation.

### A Complete Testing Solution

The HP 3060A Board Test System is a complete solution to your testing requirements. Sophisticated hardware provides the measurement accuracy you need to ensure high yields at final test. System software dramatically increases programmer productivity. And HP's real-time support helps you get the maximum return on your capital investment dollar. You're getting more than a test system. You're getting an experienced partner in your productivity efforts.

### Fixturing Products

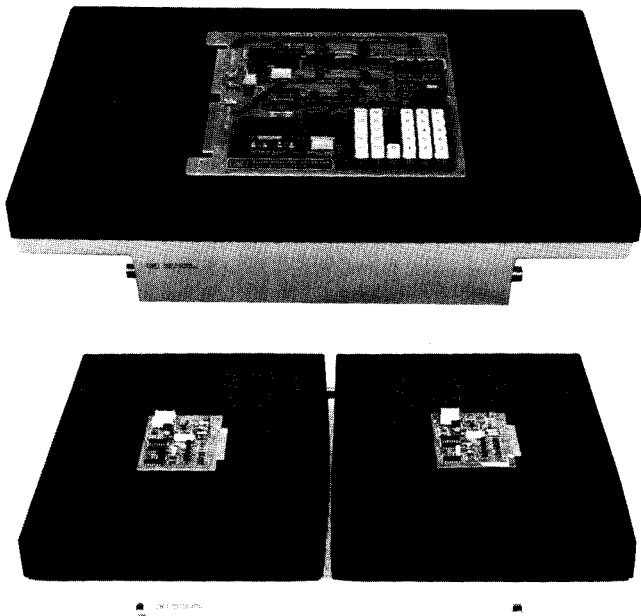

A reliable, high quality bed-of-nails test fixture is critical in order to achieve valid test results. The fixture is a mechanical interface that provides the test electronics access to the board under test by means of spring loaded contacts. Since all test signals to and from the board must be routed through the fixture, the performance of the test system can depend substantially on the performance of the test fixture. Hewlett-Packard has developed a set of fixturing products designed to meet your most severe requirements for performance, quality, and long-term reliability.

### Description

The new vacuum-actuated test fixtures have a dual vacuum plate design that creates a guided probe system. The spring probes are equipped to allow wire-wrap interconnections, and are easily replaceable. A patch panel interfaces the probes to the HP 3060A relay matrix, while the frame bar assembly provides for precise alignment with the scanner's paddle pins. The entire lightweight fixture is enclosed by a molded plastic case. An optional extender with breadboard allows you to add your own custom test circuitry to the fixture.

### Performance

Special attention has been paid to the design of the new fixturing products to ensure performance. The patch panel is made of a material that exhibits very high isolation resistance, matching the characteristics of the vacuum plates. The very low leakage currents that result will not significantly affect the in-circuit measurement. In addition, the spring probes exhibit low series resistance and can handle up to three amperes of current. Wire wrap construction provides for high quality, reliable connections.

Attention has been paid not only to electrical performance but to mechanical performance as well. For example, the fixtures contain dual vacuum plates. Since the spring probes are guided through two plates instead of one, there is a high degree of precision in their alignment. In addition, the fixtures has been designed to significantly reduce vacuum requirements. Low leakage probe sockets together with an improved vacuum seal made of durable thermoplastic rubber help achieve an air-tight construction.

### Quality

A case of high impact plastic totally encloses the test fixture wiring, eliminating the possibility of their accidental damage and contamination. The improved vacuum seal serves to muffle the acoustic noise level for smooth, quiet operation.

The fixture kits are designed for ease of assembly and modification. No adhesives are required at any point in the assembly process, neither to attach the seals or to insert the sockets. The test head is hinged and can be locked in either the down position or the up position for easy access to wiring. The probes are simple to replace when they become damaged or worn out. Once assembly is completed, a fixture verification software package aids you in debugging the initial construction and is also useful for repairing and troubleshooting the kits already in production.

### Three Choices

There is a kit for relatively small boards up to a size of 25.4 x 33 cm (10" x 13"). For larger boards, there is a kit that will accommodate sizes up to 33 x 55.9 cm (13" x 22"). In addition, there is a dual fixture kit that will allow you to increase your throughput by testing boards in tandem. Each side of the dual fixture will accept a small size PC board. All three of the fixturing products are fully compatible with the HP 3060A Board Test System, and are available as either options or accessories.

### Ordering Information

**Option 042** or 44538A - Small Kit

**Option 043** or 44539A - Large Kit

**Option 044** or 44540A - Dual Kit

**3060A Board Test System**  
(depending upon configuration)

# DIGITAL CIRCUIT TESTERS

## Logic Probes

Models 545A, 10525T, & 10525E

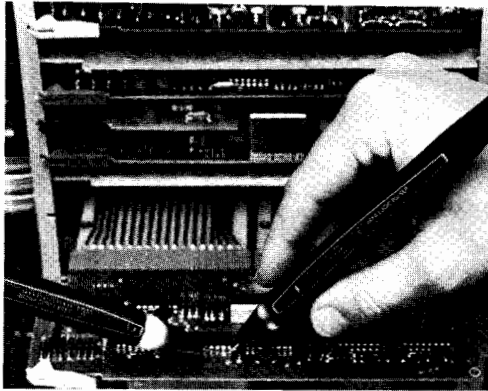

545A/546A

### Logic Probes

Logic Probes greatly simplify tracing logic levels and pulses in IC circuits to find nodes stuck HIGH or LOW, intermittent pulse activity, and normal pulse activity. That's because they instantly show whether the node probed is high, low, bad level, open circuited, or pulsing.

Logic Probes require a simple connection to the circuit under test's power supply, and they're ready to use. The strain-relieved power cord, and line-voltage protected tip insure long life and durability. High input impedance protects against circuit loading, not just in the HIGH state, but for logic LOWs as well.

#### 545A TTL/CMOS Logic Probe

The HP Model 545A Logic Probe contains all the features built into other HP probes, plus switch-selectable, multi-family operation and built-in pulse memory. Employing the same straightforward one-lamp display as our other probes, the 545A operates from 3 to 18 volts in CMOS applications or from 4.5 to 15 V dc supplies in the TTL mode while maintaining standard TTL thresholds.

The probe's independent, built-in pulse memory and LED display help you capture hard to see, intermittent pulses. Just connect the probe tip to a circuit point, reset the memory, and wait for the probe to catch those hard to find glitches. The memory captures and retains a pulse until reset.

The hand-held 545A is light, rugged, overload protected, and very fast: 80 MHz in TTL, 40 MHz in CMOS. It also employs handy power supply connectors that enable you to easily hook up to supply voltage almost anywhere in the unit under test.

#### 10525T Logic Probe

The Model 10525T Logic Probe provides TTL/DTL trouble-shooting at low cost. Ideally suited to 5 volt logic applications, the 10525T has high input impedance, overload protection, and 50 MHz data rate capability.

#### ECL Logic Probe

The HP Model 10525E Logic Probe extends time-proven, cost-saving logic probe troubleshooting techniques to high-speed ECL logic.

Operation of the ECL probe is analogous to that of the 10525T except the 10525E's high speed circuitry stretches single shot phenomena so that single pulses as narrow as 5 nanoseconds may be observed.

The 10525E may be powered directly from any -5.2 volt source and its high input impedance minimizes circuit loading.

#### Ordering Information

545A Logic Probe  
10525T Logic Probe  
10525E Logic Probe

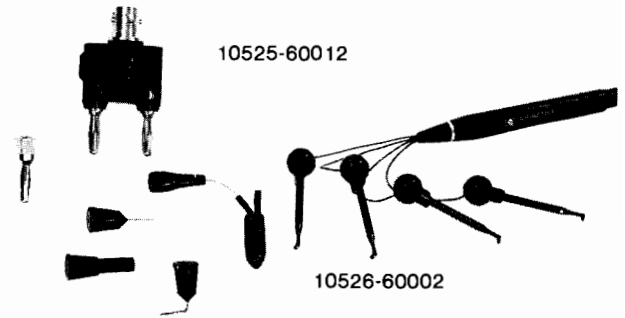

### 545A Probe Specifications

**Input current:**  $\leq 15 \mu\text{A}$  (source or sink).

**Input capacitance:**  $\leq 15 \text{ pF}$ .

#### Logic thresholds

\*TTL: Logic one 2.0 + 0.4, -0.2 V dc. Logic zero 0.8 + 0.2, -0.4 V dc.

CMOS: 3-10 V dc supply

Logic one:  $0.7 \times V_{\text{supply}} \pm 0.5 \text{ V dc}$ .

Logic zero:  $0.3 \times V_{\text{supply}} \pm 0.5 \text{ V dc}$ .

CMOS:  $\geq 10-18 \text{ V dc supply}$ .

Logic one:  $0.7 \times V_{\text{supply}} \pm 1.0 \text{ V dc}$ .

Logic zero:  $0.3 \times V_{\text{supply}} \pm 1.0 \text{ V dc}$ .

**Input minimum pulse width:** 10 ns using ground lead (typically 20 ns without ground lead).

#### Input maximum pulse repetition frequency:

TTL, 80 MHz. CMOS, 40 MHz.

**Input overload protection:**  $\pm 120 \text{ V}$  continuous (dc to 1 KHz);  $\pm 250$  for 15 seconds (dc to 1 kHz).

**Pulse memory:** indicates first entry into valid logic level; also indicates return to initial valid level from bad level for pulse  $\geq 1 \mu\text{s}$  wide.

#### Power Requirements

TTL: 4.5 to 15 V dc\*.

CMOS: 3 to 18 V dc.

Maximum current: 70 mA.

Overload protection:  $\pm 25 \text{ V dc}$  for one minute.

**Accessory included:** Ground Clip (HP Part No. 00545-60105).

\* $\pm 5 \pm 10\%$  V dc power supply; usable to +15 V dc with slightly increased logic low threshold.

### 10525T Probe Specifications

**Input impedance:**  $> 25 \text{ k}\Omega$  in both the high and low state ( $< 1$  low power TTL load).

**Logic one threshold:** 2.0 V +0.4, -0.2 V.

**Logic zero threshold:** 0.8 V +0.2 V, -0.4 V

**Input minimum pulse width:** 10 ns.

**Input maximum pulse repetition frequency:** 50 MHz.

**Input overload protection:**  $\pm 70$  volts continuous,  $\pm 200$  volts intermittent, 120 V ac for 30 seconds, 240 V ac for 10 seconds.

**Power requirements:** 5 V +10%, -5% at 60 mA, internal overload protection for voltages from +7 to -15 volts. Includes power lead reversal protection.

**Accessories included:** BNC to alligator clips; ground clip.

### 10525E ECL Probe Specifications

**Input impedance:** 12 k $\Omega$  in both the high and low state.

**Logic one threshold:** -1.1 V  $\pm 0.1 \text{ V}$ .

**Logic zero threshold:** -1.5 V  $\pm 0.1 \text{ V}$ .

**Input minimum pulse width:** 5 ns.

**Input maximum pulse repetition frequency:** 50 MHz (typically 100 MHz at 50% duty cycle).

**Input overload protection:**  $\pm 70$  volts continuous, 200 volts intermittent, 120 V ac for 30 seconds.

**Power requirements:** -5.2 V  $\pm 10\%$  at 80 mA; supply overload protection for voltages from -7 to +400 volts.

**Accessories included:** BNC to alligator clips, ground clip.

#### Accessories Available

00545-60104 Tip Kit for 545A Probe  
10525-60012 Tip Kit for 10525T Probe, 10526T Pulser  
10525-60015 Pulse Memory for 10525T Probe

# DIGITAL CIRCUIT TESTERS

Logic Pulsers, Digital Current Tracer

Models 546A, 547A, & 10526T

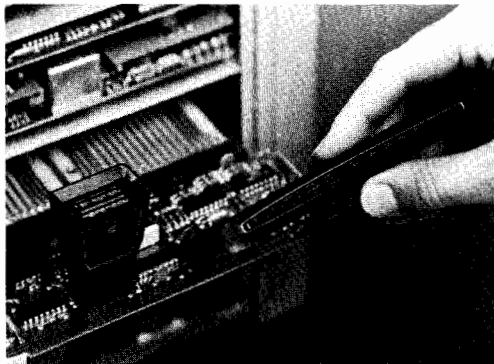

548A/546A

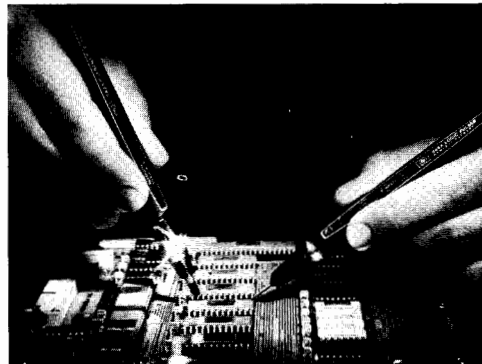

547A/546A

## Logic Pulser

The Logic Pulser solves the problem of how to pulse IC's in digital circuits. Merely touch the Pulser to the circuit under test, press the pulse button and all circuits connected to the node (outputs as well as inputs) are briefly driven to their opposite state. No unsoldering of IC outputs is required. Pulse injection is automatic, high nodes are pulsed low and low nodes, high, each time the button is pressed.

Ability to source or sink up to 0.65 Amperes insures sufficient current to override IC outputs in either the high or low state. Output pulse width is limited so the amount of energy delivered to the device under test is never excessive. Additionally, the Pulser output is three-state so that the circuit under test is unaffected until the Pulser is activated.

## 546A Logic Pulser

Automatic polarity pulse output, pulse width, and amplitude make for easy multi-family operation when you use the 546A Logic Pulser. But, the real surprise comes when you code in one of its six ROM-programmable output patterns (single pulses; pulse streams of either 1, 10, or 100 Hz; or bursts of 10 or 100 Hz; or bursts of 10 or 100 pulses). This feature allows you to continually pulse a circuit when necessary, or it also provides an easy means to put an exact number of pulses into counters and shift registers. Used with our multi-family IC Troubleshooters, the 546A acts as both a voltage and current source in digital troubleshooting applications.

## 10526T Logic Pulser

The economical 10526T provides dependable single-shot operation in TTL/DTL applications. Just press the pulse button, and the pulser delivers a single powerful pulse of the correct pulse width, polarity and amplitude.

## 546A Pulser Specifications

### Output

Family	Output Current	Pulse Width	Typical Output Voltage	
			HIGH	LOW
TTL/DTL	≤650 mA	≥0.5 μs	≥3 V dc	≤0.8 V dc
CMOS	≤100 mA	≥5.0 μs	V (supply) - 1 V dc	≤0.5 V dc

**Power supply requirements:** TTL; 4.5 to 5.5 V dc at 35 mA, CMOS; 3 to 18 V dc at 35 mA, protected to 25 V dc for 1 min.

### Accessories Available

00545-60104: Tip Kit for 546A Pulser, 545A Probe  
10525-60012: Tip Kit for 10526T Pulser, 10525T Probe  
10526-60002: Multi-Pin Stimulus Kit

### Ordering Information

546A Logic Pulser  
10526T Logic Pulser

## Digital Current Tracer

The 547A Current Tracer precisely locates low-impedance faults in digital circuits by locating current sources or sinks. For example, on a bad node the Tracer can verify that the driver is functioning and also show where the problem is by tracing current flow to the source or sink causing the node to be stuck. The Tracer is designed to troubleshoot circuits carrying fast rise-time current pulses. The Tracer senses the magnetic field generated by these signals in the circuit and displays transitions, single pulses, and pulse trains using a simple one-light indicator. Because it is not voltage sensitive, the Tracer operates on all logic families having current pulses exceeding 1 mA, including CMOS, where even lightly loaded outputs can have up to 2 to 3 mA of instantaneous charging current.

To use the Tracer, align the dot on its tip at a reference point, usually the output of a node driver. Set the sensitivity control to indicate the presence of AC current activity. As you probe from point to point or follow traces, the lamp will change intensity; when you find the fault the Tracer will indicate the same brightness found at the reference point.

## 547A Current Tracer Specifications

### Input

**Sensitivity:** 1 mA to 1 A.

**Frequency response:** light indicates single-step current transitions; single pulses ≥50 ns in width; pulse trains to 10 MHz (typically 20 MHz for current pulses ≥10 mA).

**Risetime:** light indicates current transitions with risetime ≤200 ns at 1 mA.

### Power Supply Requirements

**Voltage:** 4.5 to 18 V dc.

**Input current:** ≤75 mA.

**Maximum ripple:** ±500 mV above 5 V dc.

**Overvoltage protection:** ±25 V dc for one minute.

## 10526T Pulser Specifications

**Output high pulse voltage:** >2 V at 0.65 A (1 A typical at V<sub>ps</sub> = 5 V, 25°C).

**Output low pulse voltage:** <0.8 V at 0.65 A (1 A typical at V<sub>ps</sub> = 5 V, 25°C).

**Output impedance, active state:** <2 ohms.

**Output impedance, off state:** >1 Megohm.

**Pulse width:** 0.3 μs nominal.

**Input overload protection:** ±50 volts continuous.

**Power supply input protection:** ±7 volts (includes power lead reversal protection).

**Power requirements:** 5 V ±10% at 25 mA.

**Accessories included:** BNC to alligator clips, ground clip.

547A Digital Current Tracer



# DIGITAL CIRCUIT TESTERS



Logic Clip, Logic Comparator  
Models 548A & 10529A



## Logic Clip

The Logic Clip is an extremely handy service and design tool which clips onto dual-in-line package (DIP) ICs, instantly displaying the states of up to 16 pins. Each of the clip's 16 LEDs independently follows level changes at its associated pin. Lit diodes are logic High, extinguished diodes are Low.

The Logic Clips's rel value is in its ease of use. It has no controls to set, needs no power connections, and requires practically no explanation as to how it is used. The clip has its own gating logic for locating ground and  $V_{CC}$  pins and its buffered inputs reduce circuit loading.

The Logic Clip is much easier to use than either an oscilloscope or a voltmeter when you are interested in whether a circuit is in the high or low state, rather than its actual voltage. The Clip, in effect, is 16 binary voltmeters, and the user does not have to shift his eyes away from his circuit to make the readings.

The intuitive relationship of the input to the output—lighted diodes corresponding a high logic states—greatly simplifies the troubleshooting procedure. The user is free to concentrate his attention on his circuits, rather than on measurement techniques. Also, timing relationships become especially apparent when clock rates can be slowed to about 1 pulse per second.

When used in conjunction with the Logic Pulser, the Logic Clip offers unparalleled analysis capability for troubleshooting sequential used to inject pulses between gates allowing it to supply signals to the IC under test absolutely independent of gates connected to the IC. All outputs may then be observed simultaneously on the Logic Clip. Deviations from expected results are immediately apparent as the Pulser steps the IC through its truth table.

## 548 Multi-family Logic Clip

Fully automatic and protected to 30 V dc, and employing bright individual LEDs in its display, the 548A brings multi-family operation to the HP line of IC Troubleshooters. The Clip can be externally powered, if desired, using a simple power connector.

## 548A Specifications

**Input threshold:**  $(\geq 0.4 \pm 0.06 \times \text{Supply Voltage}) = \text{Logic High}$ .

**Input impedance:** 1 CMOS load per input.

**Input protection:** 30 V dc for 1 minute.

**Supply voltage:** 4-18 V dc across any two pins.

**Auxiliary supply input:** 4.5 to 20 V dc applied via connector. Supply must be  $\geq 1.5$  V dc more positive than any pin of IC under test.

**Supply current:**  $< 55$  mA.

548A Logic Clip

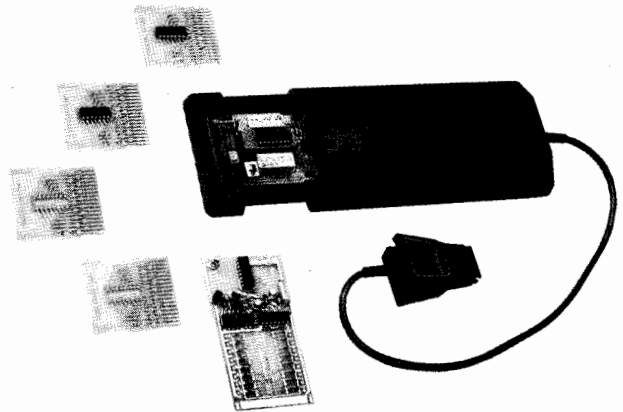

## Logic Comparator

The Model 10529A Logic Comparator clips onto powered TTL or DTL ICs and detects functional failures by comparing the in-circuit test IC with a known good reference IC inserted in the Comparator. Outputs of the particular IC to be tested are selected via 16 miniature switches which tell the Comparator which pins of the reference IC are inputs and which are outputs. Any logic state difference between the test IC and reference IC is identified to the specific pin(s) on 14- or 16-pin dual in-line packages on the Comparator's display. A lighted LED corresponds to a logic difference. Intermittent errors as short as 300 nanoseconds (using the socket board) are detected, and the error indication on the Comparator's display is stretched for a visual indication. A failure on an input pin, such as an internal short, will appear as a failure on the IC driving the failed IC; thus a failure indication actually pinpoints a malfunctioning node. A test board is supplied to exercise all of the circuitry, test leads, and display elements to verify proper operation.

**10541A:** twenty additional blank reference boards; identical to the 10 boards provided with the Logic Comparator.

**10541B:** twenty preprogrammed reference boards. The 10541B includes the following ICs; 7400, 7402, 7404, 7408, 7410, 7420, 7430, 7440, 7451, 7454, 7473, 7474, 7475, 7476, 7483, 7486, 7490, 7493, 74121, 9601.

## 10529A Comparator Specifications

**Input threshold:** 1.4 V nominal (1.8 V nominal with socket board), TTL or DTL compatible.

**Test IC loading:** outputs driving Test IC inputs are loaded by 5 low-power TTL loads plus input of Reference IC. Test IC outputs are loaded by 2 low-power TTL loads.

**Input protection:** voltages  $< -1$  V or  $> 7$  V must be current limited to 10 mA.

**Supply voltage:** 5 V  $\pm 5\%$ , at 300 mA.

**Supply protection:** supply voltage must be limited to 7 V.

**Maximum current consumption:** 300 mA.

### Sensitivity

**Error sensitivity:** 200 ns with reference board or 300 ns with socket board. Errors greater than this are detected and stretched to at least 0.1 seconds.

**Delayed variation immunity:** 50 ns. Errors shorter than this value are considered spurious and ignored.

**Frequency range:** maximum operational frequency varies with duty cycle. An error existing for a full clock cycle will be detected if the cycle rate is less than 3 MHz.

**Accessories included:** 1 test board; 10 blank reference boards; 1 programmable socket board; 1 carrying case.

### Accessories Available

**10541A:** Twenty Blank Reference Boards

**10541B:** Twenty Pre-programmed Boards

10529A Logic Comparator

# DIGITAL CIRCUIT TESTERS



## Logic Troubleshooting Kits

Models 5011T, 5015T, 5021A, 5022A, 5023A & 5024A

- Complete multi-family kits
- Stimulus-response capability
- In-circuit fault finding

- In-circuit analysis
- Dynamic and static testing
- Multi-pin testing



5011T

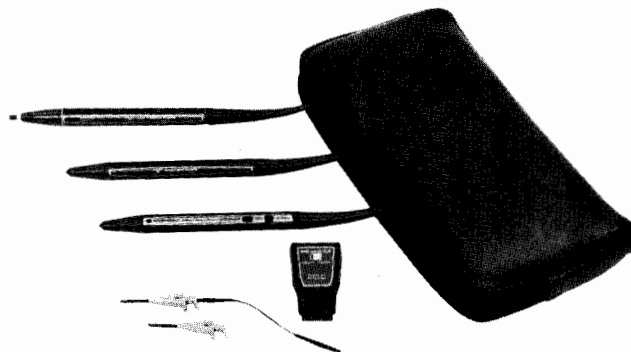

5022A

FAULT	STIMULUS	RESPONSE	TEST METHOD
Shorted Node <sup>1</sup>	Pulser <sup>2</sup>	Current Tracer	<ul style="list-style-type: none"> <li>• Pulse shorted node</li> <li>• Follow current pulses to short</li> </ul>
Stuck Data Bus	Pulser <sup>2</sup>	Current Tracer	<ul style="list-style-type: none"> <li>• Pulse bus line(s)</li> <li>• Trace current to device holding the bus in a stuck condition</li> </ul>
Signal Line Short to Vcc or Ground	Pulser	Probe, Current Tracer	<ul style="list-style-type: none"> <li>• Pulse and probe test point simultaneously</li> <li>• Short to Vcc or Ground cannot be overridden by pulsing</li> <li>• Pulse test point, and follow current pulses to the short</li> </ul>
Supply to Ground Short	Pulser	Current Tracer	<ul style="list-style-type: none"> <li>• Remove power from circuit under test</li> <li>• Disconnect electrolytic bypass capacitors</li> <li>• Pulse across Vcc and ground using accessory connectors provided</li> <li>• Trace current to fault</li> </ul>
Internally Open IC	Pulser <sup>2</sup>	Probe	<ul style="list-style-type: none"> <li>• Pulse device input(s)</li> <li>• Probe output for response</li> </ul>
Solder Bridge	Pulser <sup>2</sup>	Current Tracer	<ul style="list-style-type: none"> <li>• Pulse suspect line(s)</li> <li>• Trace current pulses to the fault</li> <li>• Light goes out when solder bridge passed</li> </ul>
Sequential Logic Fault in Counter or Shift Register	Pulser	Clip	<ul style="list-style-type: none"> <li>• Circuit clock de-activated</li> <li>• Use Pulser to enter desired number of pulses</li> <li>• Place Clip on counter or shift register and verify device truth table</li> </ul>

1. A node is an interconnection between two or more IC's.  
2. Use the Pulser to provide stimulus or use normal circuit signals, whichever is most convenient.

### Accessories Available

**00545-60104:** Tip Kit for 545A Probe, and 546A Pulser

**10525-60012:** Tip Kit for 10525T Probe, 10526T Pulser

**10525-60015:** Pulse Memory for 10525T Probe

**10526-60002:** Multi-pin Stimulus Kit for Logic Pulsers

**10529-60006:** External Reference Kit for 10529A Comparator

**10541A:** Twenty blank reference boards for 10529A Comparator

**10541B:** Twenty pre-programmed reference boards for 10529A Comparator

Used individually, each of HP's IC Troubleshooters provide their own unique and important troubleshooting function. Together they become invaluable stimulus-response testing partners that help pinpoint faults and ensure fast non-destructive repair of digital circuits.

To help you take advantage of the usefulness of the IC Troubleshooters, HP has packaged them into kits which offer both ordering convenience, and cost savings. Also, applications information is available, such as AN 163-2, "New Techniques of Digital Troubleshooting", to help users derive maximum benefit from these instruments.

The table shows a series of typical node and gate faults and the combination of tools used to troubleshoot the circuit. As with all sophisticated measuring instruments, operator skill and circuit knowledge are key factors once the various clues, or "bits" of information are obtained using the IC Troubleshooters.

To accomplish troubleshooting at the node and gate level, both stimulus (Pulser) and response (Probe, Tracer, Clip and Comparator) instruments are needed. Moreover, instruments with both voltage and current troubleshooting capability help isolate electrical faults where the precise physical location is hard to identify.

The 547A Current Tracer, the latest and most sophisticated of these troubleshooters, lets you "see" current flow on nodes and buses that otherwise appear stuck at one voltage level. Used with the 546A Pulser, stimulus-response testing is now also possible in the current domain.

### IC Troubleshooter Kits Ordering Information

Kit	H mm (in)	W mm (in)	D mm (in)	Net Wt kg (lbs, oz)	Ship Wt kg (lbs, oz)
5011T	82.6 (3.25)	203 (8)	311 (12.25)	1.49 (3.5)	2.11 (4.11)
5015T	64 (2.5)	133 (5.25)	286 (11.25)	0.63 (1.6)	0.74 (1.10)
5021A	64 (2.5)	146 (5.75)	298 (11.75)	0.51 (1.2)	0.62 (1.6)
5022A	64 (2.5)	146 (5.75)	298 (11.75)	0.65 (1.7)	0.76 (1.11)
5023A	225 (8.88)	200 (7.88)	337 (13.25)	1.63 (3.10)	2.19 (1.14)
5024A	64 (2.5)	146 (5.75)	298 (11.75)	0.60 (1.5)	0.71 (1.9)

### IC Troubleshooter Kits Selection Guide

	545A TTL/CMOS Probe	546A TTL/CMOS Pulser	547A TTL/CMOS Current Tracer	548A TTL/CMOS Clip	10525T TTL Probe	10526T TTL Pulser	10529A TTL Comparator
5011T Kit				X	X	X	X
5015T Kit				X	X	X	
5021A Kit	X	X		X			
5022A Kit	X	X	X	X			
5023A Kit	X	X	X	X			X
5024A Kit	X	X	X				

# DIGITAL CIRCUIT TESTERS

## Signature Multimeter, Combines Counter and Multimeter Functions with Signature Analysis Model 5005A/B

- Digital and analog measurement capability optimized for digital troubleshooting
- Easy to use single probe measurement of logic signals, voltage, and frequency
- 25 MHz, multiple logic family Signature Analysis with qualified clocking mode
- Compact and portable (5005A)

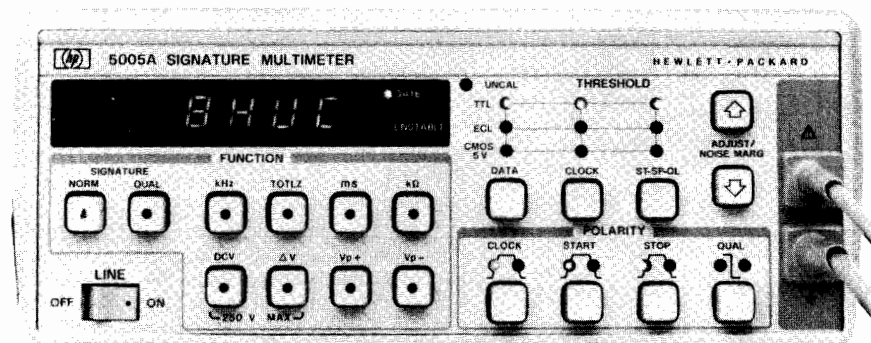

5005A Signature Multimeter

### Description

Total checkout of a digital system often requires characterizing both digital data activity and analog signal parameters. A typical troubleshooting procedure may specify a digital multimeter for checking power supplies and circuit board integrity (shorts and opens), a universal counter to measure clock frequencies and time intervals between signals, and a means to verify the analog integrity of active digital signals. The 5005 Signature Multimeter offers, in a single instrument, a measurement set optimized for these types of digital troubleshooting applications.

Two versions, the 5005A for manual applications and the 5005B for automatic test system applications, share common performance capabilities. Their feature set includes:

- Field proven Signature Analysis (for multiple logic families).
- Digital multimeter (DC volts, resistance and differential voltage).
- Frequency counter (frequency, totalize, time interval).
- Voltage threshold (upper voltage peak, lower voltage peak).
- Multifunction probe.

### Signature Analysis

HP's patented Signature Analysis technique enables the 5005 to generate a compressed, four digit "fingerprint" or signature of the digital data stream at a logic node. Any fault associated with a device connected through the node will force a change in the data stream and, consequently, produce an erroneous signature. A more in-depth discussion of Signature Analysis can be found in the HP Application Note Series 222.

Specific features of the 5005 Signature Analyzer include:

- Multiple logic family compatibility—preset threshold levels for TTL, CMOS, and ECL or adjustable thresholds (+12.5 V to -12.5 V) assure coverage of a wide variety of logic device types.
- 25 MHz clock frequency—extends Signature Analysis to high speed circuits such as CRT controllers.
- Qualified signature mode—speeds fault isolation in complex products by windowing signature collection to specific modules or devices without requiring major test setup changes. This simplifies the engineering involvement in hardware and software testability and accelerates test procedure preparation.

### Digital Multimeter

Certain digital problems result from analog circuit failures: a low power supply voltage, an open shorted circuit path, a faulty A/D or D/A converter. Each may contribute to a system failure. The 5005 contains a 4½ digit DC voltmeter, ohmmeter, and differential voltmeter, each with performance geared toward analog measurements necessary in digital troubleshooting.

The implementation of each multimeter function emphasizes simplicity and convenience. Automatic internal self calibration and auto-ranging maximize troubleshooting efficiency by eliminating unnecessary interaction with the instrument. Improvements in display interpretation also aid troubleshooting. The ohmmeter, for example, when measuring an open circuit, produces an "OPEN" indication on the display rather than the typical overload display.

### Frequency Counter

The counter within the 5005 provides totalize and frequency measurements to 50 MHz, and time interval measurements to 100 nanosecond resolution. Intended to extend the digital troubleshooting capabilities of the Signature Analysis (synchronous measurements), the counter functions provide the ability to characterize one-shots and timers through time interval measurement; test interrupt lines, reset lines, and asynchronous communication interfaces (RS-232) through totalize, and verify clock and clock driver circuitry through frequency measurement.

### Voltage Threshold

Logic level degradation is a common and troublesome malfunction in digital products. Isolating this failure typically requires displaying and interpreting the waveform. The 5005's peak voltage measurement mode provides a simple, direct method of measuring logic high and logic low voltage of active digital signals.

The peak voltage measurement mode allows the 5005 to characterize and display either the greatest (positive peak) or lowest (negative peak) voltage measured at the probe. Selection of either positive peak or negative peak mode displays the appropriate measured threshold for comparison against the specifications of the logic family.

- Complete HP-IB programmability of every function
- Measurement trigger switch in probe
- Rack and stack enclosure (5005B)
- Programmable audible beeper

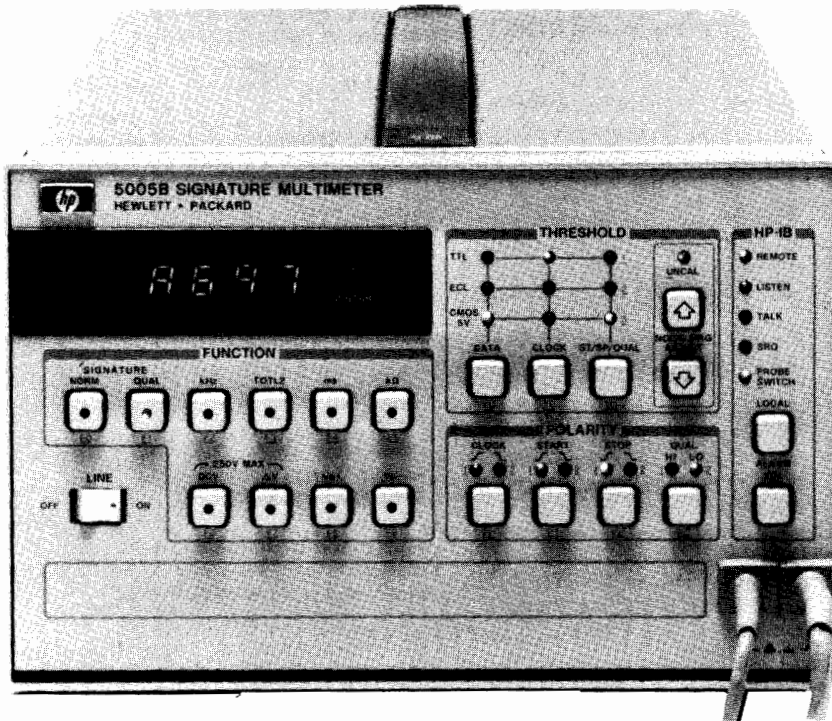

5005B Programmable Signature Multimeter

### Multifunction Probe

Several measurement functions incorporated into a single instrument can provide optimal troubleshooting efficiency only when each function is easy to use. The operator, when troubleshooting, must be able to measure the analog signal parameters and digital functional characteristics of a node without requiring time consuming and error-prone probe or instrument setup changes. The 5005 multifunction probe solves this problem by providing automatic access to the Signature Analyzer, multimeter, and counter functions through a single probe. All signal multiplexing to the appropriate measurement function is accomplished inside the 5005.

This efficient probing scheme becomes particularly important in automatic applications. The 5005B takes advantage of the several functions available in the multifunction probe. A switch, located on the side of the probe, allows the operator to trigger automatic measurement. The instrument controller can then characterize both the analog parameters and functional digital operation of a circuit node while the operator probes the same point. This greater automatic measurement efficiency translates into increased troubleshooting productivity.

### HP-IB Programmability

Complete programmability makes the 5005B an ideal choice for automatic digital testing and troubleshooting. Every 5005B measurement and control function can be programmed through the HP-IB interface. This flexibility allows the automatic test system designer full access to the many measurement functions in the instrument.

Simplified programming enhances the automatic testing and troubleshooting productivity improvements inherent in the 5005B. Straightforward commands and data output formats aid in accelerating test program development. A measurement trigger switch located in the probe allows direct operator communication to the controller. Audible feedback, supplied by the beeper in the 5005B, can then indicate the completion of the measurement cycle. This closed-loop communication (controller-to-operator) aides in improving troubleshooting efficiency.

### Portability

The 5005A offers a compact portable solution for manual troubleshooting of digitally based products. Its compact package, complete measurement capabilities and multifunction probe, make it invaluable as a bench or field service tool. This complete measurement set, combined into a single instrument, insures you always having the necessary troubleshooting capabilities in hand.

The identical feature set between the 5005A and 5005B also simplifies going from automatic to manual troubleshooting procedures. Consistent front panel function key arrangements and performance specifications allow direct translation of test or troubleshooting procedures. Your investment in an automatic procedure provides an additional return when expanding into a manual troubleshooting environment.

# DIGITAL CIRCUIT TESTERS

**Signature Multimeter, Combines Counter and Multimeter Function with Signature Analysis**  
**Model 5005A/B (Cont.)**

## 5005A/B Specifications

### Signature

**Display:** 4 digits. Characters 0-9, ACFHPU.

**Fault detection accuracy:** 100% probability of detecting single-bit errors; 99.998% probability of detecting multiple-bit errors.

**Minimum gate length:** 1 clock cycle (1 data bit) between START and STOP.

**Maximum gate length:** no limit.

**Minimum timing between gates:** 1 clock cycle between STOP and START.

### Data probe timing:

**Setup time:** 10 ns (data to be valid at least 10 ns before selected clock edge.)

**Hold time:** 0 ns (data to be held until occurrence of selected clock edge.)

### START, STOP, QUAL timing:

**Setup time:** 20 ns (signals to be valid at least 20 ns before selected clock edge.)

**Hold time:** 0 ns (signals to be held until occurrence of selected clock edge.)

### CLOCK timing:

**Maximum clock frequency:** 25 MHz.

**Minimum pulse width:** 15 ns in high or low state.

**Qualify mode:** allows data clock qualification by an external signal. DATA probe input impedance  $\approx 50$  k $\Omega$  to the average value of "0" and "1" threshold settings ( $\pm 6$  V max); 15 pF.

**START, STOP, CLOCK, QUAL input impedance  $\approx 100$  k $\Omega$ ; 15 pF.**  
**Front panel indicators:** flashing GATE light indicates detection of valid START, STOP, CLOCK conditions. Flashing UNSTABLE light indicates a difference between 2 successive signatures, and possible intermittent faults.

### Frequency

**Display:** 5 digits.

**Ranges:** 100 kHz, 1 MHz, 10 MHz, 50 MHz, autoranged.

**Resolution:** 1 LSD (1 Hz on 100 kHz range).

**Accuracy:**  $\pm 0.01\%$  of reading  $\pm 1$  count.

Minimum pulse width  $\approx 10$  ns in high or low state.

Gate time  $\approx 1$  s, fixed.

Input impedance  $\approx 50$  k $\Omega$  to the average value of "0" and "1" threshold settings ( $\pm 6$  V max); 15 pF.

### Totalizing

**Display:** 5 digits.

**Range:** 0-99,999 counts.

**Resolution:** 1 count.

Maximum input frequency  $\approx 50$  MHz, with a minimum pulse width of 10 ns, and minimum pulse separation of 10 ns.

Minimum START/STOP pulse width  $\approx 20$  ns.

DATA input impedance  $\approx 50$  k $\Omega$  to the average value of "0" and "1" threshold settings ( $\pm 6$  V max); 15 pF.

START, STOP input impedance  $\approx 100$  k $\Omega$ ; 15 pF.

### Time Interval

**Display:** 5 digits.

**Ranges:** 10 ms, 100 ms, 1 s, 10 s, 100 s, autoranged.

**Resolution:** 1 count (100 ns on 10 ms range).

Accuracy  $\pm 0.01\%$  of reading  $\pm 2$  counts.

Minimum START/STOP pulse width  $\approx 20$  ns.

START, STOP input impedance  $\approx 100$  k $\Omega$ ; 15 pF.

### Resistance

**Display:** 4 or 5 digits, depending on range.

**Ranges:** 30 k $\Omega$ , 300 k $\Omega$ , 1 M $\Omega$ , 3 M $\Omega$ , 10 M $\Omega$ , autoranged.

**Accuracy:** (at 15°C-30°C).

RANGE	FULL SCALE	ACCURACY	DISPLAY RESOLUTION
30 k $\Omega$	29.999 k $\Omega$	$\pm 1\%$ of reading $\pm 2 \Omega$	1 $\Omega$
300 k $\Omega$	299.99 k $\Omega$	$\pm 1\%$ of reading	10 $\Omega$
1 M $\Omega$	999.9 k $\Omega$	$\pm 1\%$ of reading	100 $\Omega$
3 M $\Omega$	2999. k $\Omega$	$\pm 10\%$ or reading	1 k $\Omega$
10 M $\Omega$	10000. k $\Omega$	$\pm 10\%$ of reading	10 k $\Omega$

Input impedance  $\approx 20$  k $\Omega$  to  $\pm 2$  V

### DC Voltage

**Display:**  $4\frac{1}{2}$  digits.

**Ranges:**  $\pm 25$  V,  $\pm 250$  V, autoranged; referenced to earth ground.

**Accuracy:** (at 15°C-30°C).

RANGE	ACCURACY	RESOLUTION
25 V	$\pm 0.1\%$ of reading $\pm 2$ mV	1 mV
250 V (<100 V)	$\pm 0.25\%$ of reading $\pm 20$ mV	10 mV
250 V ( $\geq 100$ V)	$\pm 0.25\%$ of reading $\pm 20$ mV	100 mV

Input impedance  $\approx 10$  M $\Omega$ .

### Differential Voltage

**Reading:** reads input voltage present at the probe and displays difference between it and voltage at the time  $\Delta V$  key was depressed.

**Specifications:** same as for DCV, above. Voltage range is determined by larger of 2 compared voltages.

### Peak Voltage

**Display:**  $3\frac{1}{2}$  digits.

**Range:** 0- $\pm 12$  Vp.

**Resolution:** 50 mV.

**Accuracy:**  $\pm 2\%$  of reading  $\pm 5\%$  of p-p signal  $\pm 100$  mV.

Minimum peak duration  $\approx 10$  ns.

Maximum time between peaks  $\approx 50$  ms.

Input impedance  $\approx 100$  k $\Omega$ ; 15 pF.

### Signature Analyzer Logic Thresholds

Preset thresholds: TTL, ECL, CMOS.

**Adjustable thresholds:** each preset threshold can be adjusted.

**Range:**  $\pm 12.5$  V, in 50 mV steps.

**Accuracy:**  $\pm 2\%$  of setting,  $\pm 2$  V

Logic threshold circuitry is operative during NORM, QUAL, kHz, TOTLZ and ms measurements.

### General

**Data probe tip:** acts as high-speed logic probe in the NORM, QUAL, kHz and TOTLZ modes. Lamp indicates high, low, bad-level and pulsing states.

Minimum detected pulse width is 10 ns.

### Data probe protection:

**Continuous overload:**

**DCV,  $\Delta V$ , k $\Omega$  modes only:**  $\pm 250$  V AC/DC.

**All other modes:**  $\pm 150$  V AC/DC, 20 V rms at input frequencies  $> 2$  MHz.

**Intermittent overload:**  $\pm 250$  V AC/DC, up to 1 min, for all modes.

### Timing pod protection:

**Continuous overload:**  $\pm 100$  V AC/DC, 20 V rms at input frequencies  $> 2$  MHz.

**Intermittent overload:**  $\pm 140$  V AC/DC, up to 1 min.

**Auxiliary power supply:** three rear-panel connectors supply 5 V at 0.7A total for accessories (5005A only)

**Operating temperature:** 0°C to +55°C.

**Power:** selectable 100 V, 120 V, 220 V or 240 V AC line (+5%-10%), 5005A-48-440 Hz, 35 VA maximum.

5005B-48-66 Hz, 35 VA maximum.

**Weight:** 5005A-Net: 3.5 kg, (8.0 lb.) Shipping: 10 kg, (22.5 lb.).

5005B-New: 5.5 kg, (12.0 lb.) Shipping: 8.7 kg, (19 lb.).

**Size:** 5005A-90 mm H x 215 mm W x 410 mm D (3 $\frac{1}{2}$ " x 8 $\frac{1}{2}$ " x 16"), excluding handle.

5005B-133 mm H x 212 mm W x 432 mm D (5 $\frac{1}{4}$ " x 8 $\frac{3}{8}$ " x 17"), excluding handle.

5005A Signature Multimeter

5005B Signature Multimeter

Option 910 Additional Manual:



- Automated digital troubleshooting using Signature Analysis
- Automatic test construction and documentation generation
- Backtrace and signature matching troubleshooting modes
- No programming or device libraries required

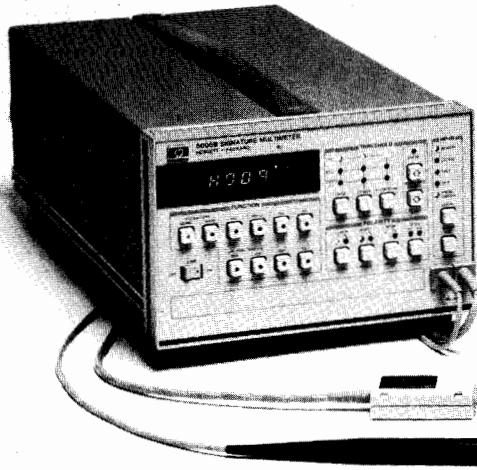

## Description

The 55005A Logic Troubleshooting System represents a significant advance in automated digital test construction, documentation, and directed troubleshooting using Signature Analysis. It consists of an HP 85 Computer, 5005B Signature Multimeter, system software, optional flexible disc drive, and optional printer. These components together provide a significant productivity improvement when applied to troubleshooting digital products.

## Test Construction

Circuit characterization is greatly simplified by the 55005A's LEARN mode. All information necessary for troubleshooting a product is generated during the signature collection phase of LEARN mode. The operator only needs to know the device number, input/output status of each device pin, and the circuit connection points. Automatic signature collection, through the 5005B Signature Multimeter, and directed softkey inputs provide the data required to build a troubleshooting data base. This eliminates the requirement for device libraries or special programming.

Test construction utilizes the data base compiled in the LEARN mode. Signature and circuit connection information comprise the basic lists for backtrace and signature matching modes of troubleshooting. These lists are automatically generated by the 55005A software.

## Documentation

Troubleshooting a digitally based product requires sound documentation. The 55005A system generates a complete set of documentation for effective Signature Analysis troubleshooting. Three forms of printed documentation, or reports, can be generated by the 55005A system. Two of these reports, report-by-part and report-by-node, list the correct signatures for each respective circuit point. These reports comprise the basic documentation found in products designed for Signature Analysis troubleshooting. A third report, the troubleshooting tree, provides an innovative way to perform manual backtracing through a circuit. This troubleshooting tree provides a means, by fol-

lowing through a set of special signature lists, to backtrace systematically through a circuit.

## Troubleshooting

Major improvements in troubleshooting productivity translate into recurring manufacturing and service savings. Two troubleshooting modes in the 55005A provide these productivity improvements for both highly skilled technicians and lower skill level personnel.

Higher skill level operators benefit from the 55005A's ability to indicate if a probed signature matches a correct signature existing in the unit under test's data base. This allows the operator to troubleshoot a product efficiently using knowledge of the circuit's operation, technical experience and intuition. Enhanced productivity results from this extension of the technician's efficiency.

A guided backtrace mode in the 55005A aids the lower skill level person in troubleshooting digital products. All probing and measuring is controlled by the software program. The operator repeatedly probes the circuit, as directed by the controller, until the 55005A system locates the faulty node. A full report printout of probing history, location of the faulty node, and circuit points connected to the bad node occurs upon locating the fault. This report can then assist a technician in repairing the circuit assembly.

## Configuration

Three system configurations (development, troubleshooting, and basic configuration) cover a variety of troubleshooting applications. Service support engineering, manufacturing, and field service organizations can select a system configuration which meets their exact needs. A full development system, for example, could support the troubleshooting procedure and documentation generation requirements found in a service support group. Manufacturing and field service would benefit from the cost savings and optimized performance available in the troubleshooting system configuration. Each system offers the flexibility to upgrade to higher performance configurations when the need arises.



# DIGITAL CIRCUIT TESTERS

Microprocessor Exerciser, 6800, 6802, 6808, 8085 and Z-80 Support

Model 5001A, B, C, and D

- External stimulus for Signature Analysis troubleshooting
- Over 50 preprogrammed tests

- Full I/O wraparound testing
- Unique memory overlay for preprogrammed tests

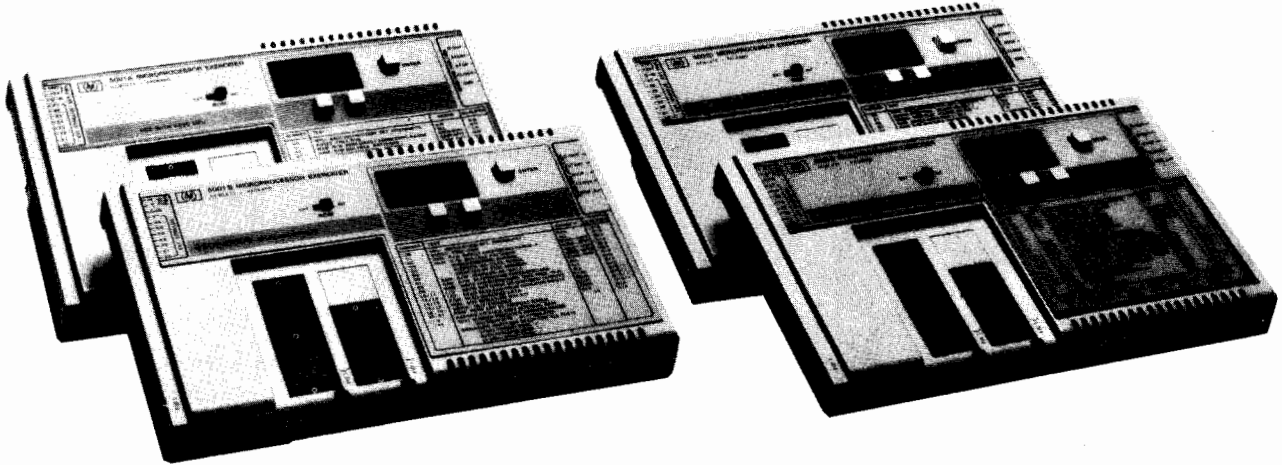

5001 Microprocessor Family

## Description

The HP 5001 series of Microprocessor Exercisers offers a new alternative to add enhanced testability, in microprocessor-based products. Used in conjunction with a Signature Analyzer, the HP 5001 provides an external source of either preprogrammed or custom test stimulus to the microprocessor or input ports of a system. The operator simply removes the microprocessor from the system under test, connects the HP 5001 Microprocessor Exerciser, and utilizing the three button front panel, selects the test program to execute.

### Preprogrammed Test Stimuli

Front panel switches on the 5001 allow selection of over 50 preprogrammed tests which are stored in its ROM. These test stimuli include:

- A test of the microprocessor instruction set and interrupts.
- A free-run test for address and data bus integrity.
- ROM read tests.
- RAM read-write tests.
- Output port pattern tests.
- Input port pattern tests.

The 5001 utilizes the microprocessor of the product under test to repetitively execute preprogrammed stimuli.

### Custom Test Stimuli

The 5001 can be utilized to run custom programs for those portions of the product under test which require stimulus beyond that provided by the preprogrammed routines. It has a socket which allows instructions to be executed from a custom programmed ROM. The user writes stimulus programs, generates a PROM containing the appropriate microprocessor code and places it into the 5001 to execute up to 2 Kbytes of external stimulus. Typical custom tests could include:

- Configuration and stimulus for PIA's.
- Pattern stimuli for sequential logic outboard of output ports.
- Go/no go functional tests.

### Memory Overlay

A unique memory overlay scheme makes all preprogrammed tests and custom ROM programs independent of the system under test

memory map. A product may use its entire memory space without reserving ROM space for test programs. Additionally, this feature allows all programs to run independently of memory faults in the system under test.

### Single Signature Tests

Certain preprogrammed stimuli are designed to provide pass/fail information on the microprocessor, RAM and ROM through a single signature. For example, to save troubleshooting time a particular RAM test requires collecting only a single signature to verify a RAM rather than collecting signatures of all RAM pins.

### Qualified Stimuli

Some stimuli utilize a "qualify" line to optimize testing by dynamically modifying the effective address range of the preprogrammed test. For example, the output port tests call for the qualify line to be connected to the chip-enable pin of the port to be tested. The microprocessor searches its address field until that chip is enabled (and the qualify line asserted) then writes all possible patterns to that port, repetitively.

### Bus Signatures

The 5001 can read data from the product under test, as well as write patterns into it. Certain stimuli utilize this feature to read bus data, serialize it, and output a single bit stream. This "bus signature" saves time and reduces the potential errors in probing several separate points on a bus.

### Input Port Stimuli

The 5001 has eight output lines under microprocessor control. These can be used to stimulate input ports or circuitry within the product under test without requiring additional equipment, connectors, or fixtures. Reading the results into the 5001 allows full wrap-around testing of the product under test.

### SA Interface

A signature analyzer port on the 5001 allows quick and easy connection of START, STOP, CLOCK, and ground. Full control of these signals through either preprogrammed tests or through the custom test ROM saves time by reducing equipment setup changes.

- Support for the 6800, 6802, 6808, 8085 and Z-80 microprocessors
- External ROM socket for customer stimulus

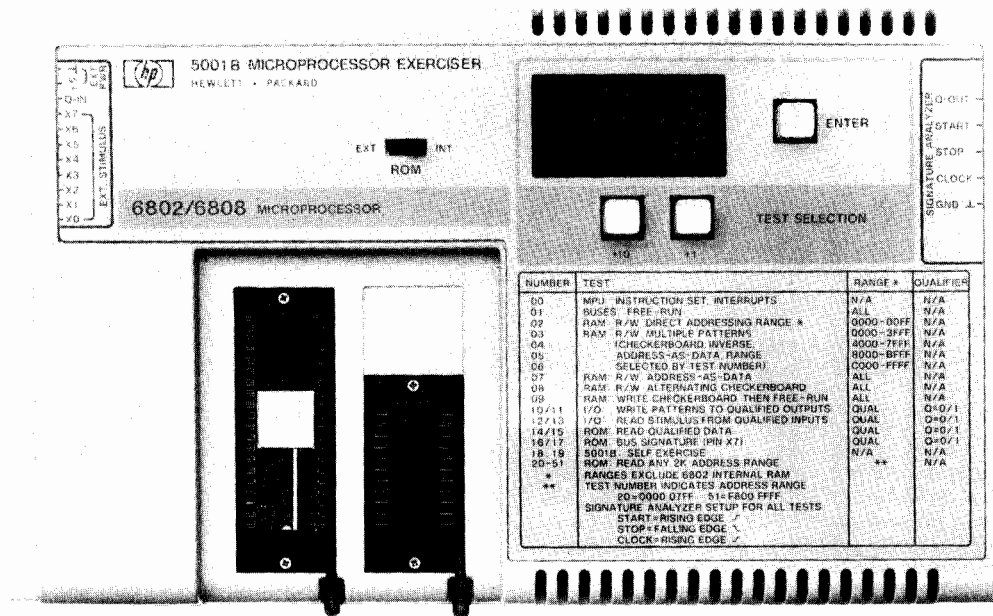

5001B Microprocessor Exerciser (6802 and 6808)



## Specifications

Model Number	Micro-processor	Max Clock Frequency (fmax)		ROM Spec for fmax	
		External ROM	Internal ROM	tacc	tco
5001A	6800	2.0 MHz	1.5 MHz	250 ns	190 ns
5001B	6802; 6808	2.0 MHz	1.5 MHz	250 ns	190 ns
5001C	8085A	6.25 MHz	6.25 MHz	557 ns	256 ns
5001D	Z-80A	4.0	4.0 MHz	335 ns	245 ns

t<sub>acc</sub>-maximum address-to-output delay.  
t<sub>co</sub>-maximum chip select-to-output delay.  
External ROM type-Intel 2716 EPROM or equivalent.  
Minimum clock rate-as specified by manufacturer.  
5001C Internal Crystal (switch selectable)-4 MHz.

## General Specifications

**Operating Temperature:** 0-55°C.  
**Power Requirements:** +5 V DC ± 5%  
**5001A:** 550 mA Nominal.  
**5001B:** 550 mA Nominal.  
**5001C:** 500 mA Nominal.  
**5001D:** 550 mA Nominal.

Excluding the microprocessor and external custom ROM.

**Shipping Weight:** 1.36 kg (3 lbs).

**Dimensions:** 235 mm L x 140 mm W x 26 mm H (9¼" x 5½" x 1").

## Ordering Information:

**5001A** Microprocessor Exerciser for 6800 Systems

**5001B** Microprocessor Exerciser for 6802/6808 Systems

**5001C** Microprocessor Exerciser for 8085 Systems

**5001D** Microprocessor Exerciser for Z-80 Systems

**Option 910:** Extra Manual

Accessories include: microprocessor interface ribbon cable, external stimulus port cable, external power cable, 11 test point grabbers, protective carrying case, and operating and programming manual.





# DIGITAL CIRCUIT TESTERS

Signature Analyzer, A Digital Troubleshooting Tool  
Model 5004A

- Full at speed testing of digital products
- Reduced skill level necessary to troubleshoot microprocessor-based products to component level
- High confidence testing (>99.998%)
- Reduce warranty and service support costs

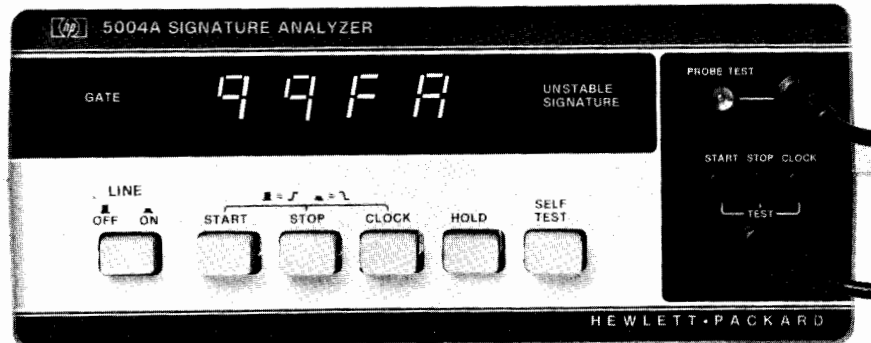

## The Product

The HP5004A Signature Analyzer is a tool for production and service troubleshooting of complex logic circuits. It recognizes and displays unique digital signatures associated with data nodes in a circuit under test. By comparing these actual signatures to the correct ones, a technician can back-trace to a faulty node. In microprocessors and high speed digital state machines, where data streams are long and complex, the 5004A Signature Analyzer, unlike conventional measurement tools, allows full at-speed component-level troubleshooting.

## The Technique

HP's patented Signature Analysis technique enables the 5004A to display a compressed, four-digit "fingerprint" of the data stream present at a node. This signature is generated from a linear feedback shift register in the 5004A, and is unique for a specific good node. Any fault associated with a device on that node will force a change in the data stream and, therefore, result in an erroneous signature.

Troubleshooting requires only the skill to follow a test procedure comparing measured signatures in a circuit to correct signatures noted within the product documentation. (The resulting probability of detecting an erroneous data stream is 99.998%, the probability of detecting a single-bit error in a data stream is 100%.) Signature Analysis also detects time-related faults, such as mid-cycle displaced bits, which are not detectable by traditional transition and ones counting techniques.

## The Application

For a product which has been setup for Signature Analysis, troubleshooting typically consists of:

- Switching the product to be tested into a test mode of operation.
- Attaching the 5004A's START, STOP, CLOCK and GND leads to the test points of the product to be tested (no board or component removal required).
- Probing circuit nodes and observing the signatures displayed on the 5004A.
- Comparing them to correct signatures preprinted on a schematic or troubleshooting procedure for the product under test.
- Isolating a faulty node by observing an erroneous signature.
- Tracing signatures back through gates and memory elements, until an element with correct inputs and faulty outputs is isolated.
- Replacing only the faulty component.

These steps can be performed quickly on-site, at a field service facility, or on a production line.

Additional information on Signature Analysis is available in the HP Application Note Series 222.

## 5004A Specifications

**Display:** 4 digits. Characters 0-9, ACFHPU.

**Fault detection accuracy:** 100% probability of detecting single-bit errors; 99.998% probability of detecting multiple-bit errors.

**Minimum gate length:** 1 clock cycle (1 data bit) between START and STOP.

**Maximum gate length:** no limit.

**Minimum timing between gates:** 1 clock cycle between STOP and START.

**Data probe tip:** acts as high-speed logic probe. Lamp indicates high, low, bad-level and pulsing states. Minimum detected pulse width is 10 ns.

### Data probe timing:

**Setup time:** 15 ns (data to be valid at least 15 ns before selected clock edge.)

**Hold time:** 0 ns (data to be held until occurrence of selected clock edge.)

### START, STOP timing:

**Setup time:** 25 ns (signals to be valid at least 25 ns before selected clock edge.)

**Hold time:** 0 ns (signals to be held until occurrence of selected clock edge.)

### CLOCK timing:

**Maximum clock frequency:** 10 MHz.

**Minimum pulse width:** 50 ns in high or low state.

### Logic thresholds:

**Data input:** Logic one: 2.0 V, +.1-4  
Logic zero: .8 V, +.4-0

**START, STOP, CLOCK inputs:** single threshold, 1.4 V  $\pm$  .6 (.1 V Hysteresis).

**Input impedance:** all inputs, 50 k $\Omega$  to 1.4 V, shunted by 7 pF.

**Overload protection:** all inputs:  $\pm$ 150 V continuous.  $\pm$ 250 V intermittent. 250 V AC for 1 minute.

**Operating environment:** temperature: 0-55°C. Humidity: 95% RH at 40°C.

**Power:** 25 VA max. See options below for power line voltage and frequency.

**Weight:** net: 2.5 kg 5.5 lbs. Shipping: 5 kg 11 lbs.

**Size:** 90 mm H x 215 mm W x 300 mm D (3½" x 8½" x 12"), excluding handle.

### Supplemental characteristics:

**Front panel indicators:** flashing GATE light indicates detection of valid START, STOP, CLOCK conditions. Flashing UNSTABLE light indicates a difference between 2 successive signatures, and possible intermittent faults.

## Ordering Information

5004A Signature Analyzer:

Option 910 Additional Manual:

Orders must specify one of these power line options

Option 100: 100 V AC line, +5%, -10%, 48-440 Hz

Option 120: 120 V AC line, +5%, -10%, 48-440 Hz

Option 220: 220 V AC line, +5%, -10%, 48-66 Hz

Option 240: 240 V AC line, +5%, -10%, 48-66 Hz

- Complete introductory course in practical digital electronics.

- Covers hardware, software and troubleshooting in one course.

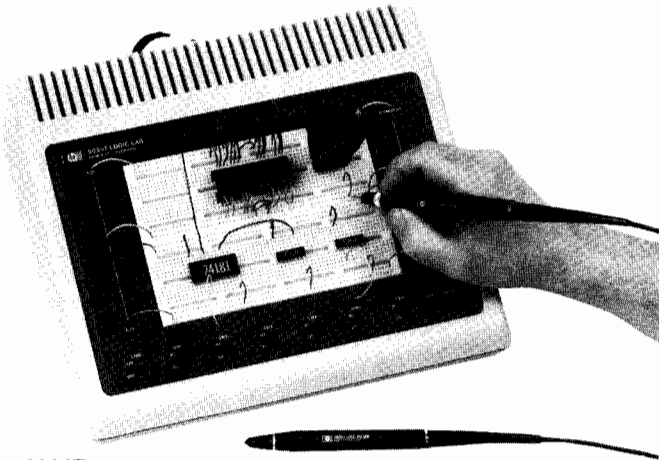

5035T

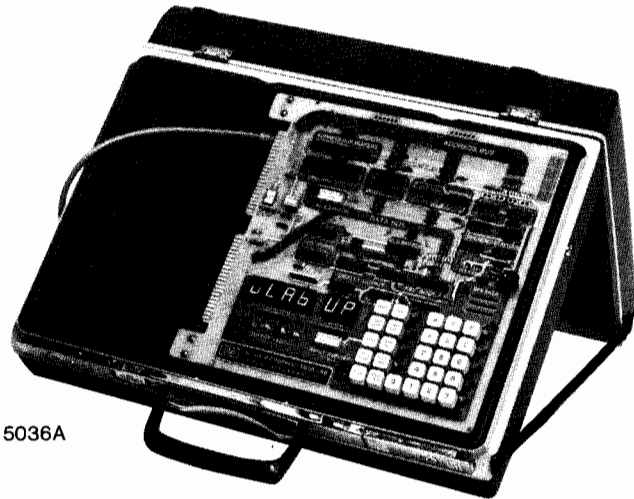

5036A

## 5035T Complete Logic Lab

Learn logic...the practical way. HP's model 5035T Logic Lab combines theory and lab so you'll learn digital logic quickly, enjoyably, and memorably. Start by building simple circuits and work up to a complete digital clock. Logic labs have been adopted by schools, industrial firms and individuals who want to keep up with the changing world of electronics, and enjoy doing it.

### 5035T Lab Includes

**5035A Mainframe** with removable breadboard (see below)  
**"Practical Digital Electronics"—An Introductory Course**

- Complete textbook
- 26 Experiment Workbook

### TTL/DTL Test Instruments

- 10525T Logic Probe
- 10526T Logic Pulser
- 548A Logic Clip

### Wire and Component Kit

- 32 TTL, MSI, LSI ICs
- 285 Pre-stripped Wires
- 4 Large LED Numerical Displays
- IC Remover

## 5035A Logic Lab Mainframe

The 5035A Logic Lab Mainframe brings convenience and flexibility to breadboarding by allowing solderless connection of new circuit ideas. Fully self-contained, the mainframe has a 5-volt 1-amp power supply, two clocks, four LED indicators, six data switches, two 5-volt BNC connectors, and a handy removable breadboard. To use it, just connect circuits using standard 24-gauge wire, then power up either one or several breadboards to verify new circuit ideas quickly and easily before incurring PC board layout and rework charges.

### Accessories Available

- 1258-0121:** Additional breadboard assembly
- 1540-0258:** Heavy duty, padded vinyl carrying case
- 05035-60006:** Wire interconnect kit
- 10656A:** Set of 10 "Practical Digital Electronics", An Introductory Course—Text and Lab Workbook
- 10657A:** Additional component and wire kit

### Ordering Information

- 5035T** Complete Logic Lab
- 5035A** Logic Lab Mainframe

## 5036A Microprocessor Lab

### Staying Current with Technology

The microprocessor presents a repair problem due to its complexity, and because it is used in so many diverse products. Little imagination is required to anticipate field repair problems with microprocessor-based products like traffic controllers, typesetters, POS terminals, medical instrumentation, etc.

There are scientists and engineers who can contribute to solving this problem by learning about both the hardware and software in microprocessor systems, and there is a virtual army of technicians who need to learn to troubleshoot them. The 5036A Microprocessor Lab provides both the hardware and software basics and vital troubleshooting information needed to solve the microprocessor puzzle.

The 5036A course book, *Practical Microprocessors*, covers both hardware and software in detail in separate chapters containing summaries, hands-on experiments and quizzes. Once these chapters are completed, the course builds up to a series of troubleshooting experiments employing recommended troubleshooting instruments that challenge the user and reinforce microprocessor operating concepts. The book also contains information on the use of oscilloscopes, signature analyzers, logic analyzers, and logic probes for troubleshooting microprocessor-based products.

### 5036A Major Features

- Color PC board graphics illustrate system block diagrams to enhance learning.
- Multiple-experiment troubleshooting chapter highlights IC Troubleshooters such as 545A Probe, 546A Pulser, 547A Current Tracer and 5004A Signature Analyzer.
- Plug-in jumpers create real hardware faults that allow realistic troubleshooting practice.
- Complete resident software.
- Dual 5-Volt power supplies, plus edge connectors for expandability.
- LED monitors on all data, address, status and output lines.

### Ordering Information

**5036A** Microprocessor Lab and Power Supply mounted in briefcase, plus *Practical Microprocessors* text and lab book, in English (German, French and Italian editions are available in those countries).

### Recommended Accessories for Troubleshooting Experiments:

- 5024A** Logic Troubleshooting Kit
- 5004A** Signature Analyzer



### Introduction

More and more products include logic circuits and microprocessors as an integral, and sometimes major, component. While the number of uses for logic is rapidly expanding, the available talent pool of digital designers and developers is also growing, but not at a rate great enough to meet the need created, by even more rapid increase in potentials for logic-based products. One solution to this apparent dilemma is to provide logic designers and developers with the tools that make them more productive.

Hewlett-Packard logic analyzers and Model 64000 Logic Development System are a family of instruments that support the entire cycle of design, production, testing and troubleshooting of logic products. Analyzers and the modular development system add to productivity by providing effective tools to accomplish the many tasks in building digital products. An additional benefit is that these logic instruments are convenient and easy to

use; the user can give maximum effort to creative functions or analysis, rather than to the tool.

### Logic Design

Model 64000 Logic Development System provides advanced software development, real-time emulation, state analysis, and timing analysis. These functions may be used separately, combined, or interactively to provide support tools for all phases of developing microprocessor-based products. A flexible system, Model 64000 can be configured as an integrated cluster of development stations sharing a hard disc and printer, a stand-alone unit for emulation and/or analysis using a dual flexible disc drive, or as an emulation/analysis terminal to a computer. In any setup, the 64000's directed-syntax softkeys result in quicker learning for new users and faster response for experienced users. Emulation support is available for popular microprocessor families.

### Logic Analysis

Hewlett-Packard logic analyzers are powerful measurement tools for today's complex digital systems. They are essential during the critical phase of integration of hardware and software. Costly design errors can be avoided by optimizing code and fine-tuning the total product performance. When the digital products are in production or operational, a logic analyzer is the troubleshooting tool that quickly isolates a problem and decreases downtime. Hewlett-Packard logic analysis products range from the powerful software and hardware analysis subsystems of the 64000 system to the more traditional family of 1600 series benchtop logic analyzers.

Model 1611A Logic State Analyzer is a dedicated analyzer with processor-specific modules for seven microprocessors, and a 36-bit wide general purpose interface. When a processor-specific module is installed, connection to the system under test is as simple as plugging in a probe, and the system ac-

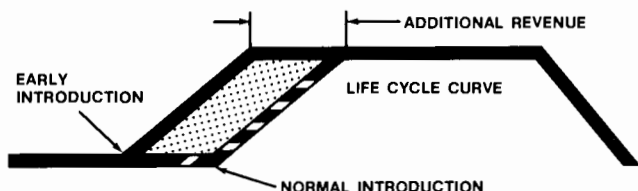

**Figure 1.** Reducing the development time of a microprocessor-based product puts the product on the market faster. This extends the life cycle of the product, and generates additional income.

tivity is displayed conveniently in mnemonic code. Model 1610B Logic State Analyzer is a software analysis instrument for software test, debug, and performance analysis. When integrating hardware and software, or isolating glitches and timing malfunctions, Model 1615A Logic Analyzer offers interactive state and timing analysis capabilities to correlate synchronous state flow with asynchronous control signals.

### Productivity through Appropriate Tools

Design aids and support tools for digital products have value only if they accomplish at least one of two ends: (1) provide a necessary function not available otherwise, or (2) make it possible to do a task more quickly or more effectively. As logic circuits and microprocessor products become more complex, the instruments needed to create and test them become correspondingly more complex.

Selecting instruments can also be a complex process. For example, when planning a microprocessor product, some teams research the available microprocessor alternatives first and then try to fit the available tools to their applications. A wiser course of action is selecting a development system first because it has a major impact on development time, product quality, design team productivity, system documentation, and long-term product support. Instrument selection is simplified by beginning at the end: first determine what is to be accomplished with a instrument or system. Feature sets should be compiled only after analyzing the application environment. This method avoids purchasing instruments that sit on a shelf or tools that lack the power to do the job.

Application environments for logic development systems and analyzers can be divided into two major categories, team applications and stand-alone applications.

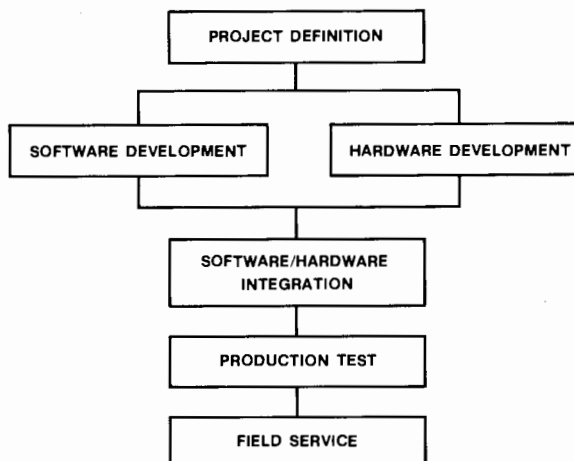

**Figure 2.** Development cycles for logic products include these basic steps, whether developed by a single designer or a team of designers.

### Team Approaches

Teams that produce any product have always faced the dual constraints of timeliness and quality, and as the processor-based products proliferate in number and kind, logic product manufacturers are increasingly aware of both factors. Products that go to market earlier have a longer life cycle and generate more income against an equivalent development cost. Adding quality to the product assures lower maintenance and warranty costs, more customer satisfaction, and a longer life span at the other end of the cycle. Better products produce added income.

Added to the market pressures, the complexity and magnitude of new logic products make it natural to use the team approach in design and development. The desired result is a compressing of the total development time.

Major milestones for a development team are setting design criteria, developing hardware and software in parallel, integrating hardware and software, optimizing product operation, and documenting the processes for subsequent use by quality control, production, and service. Hewlett-Packard's answer to team development for microprocessor-based and other logic products is the 64000 Logic Development System.

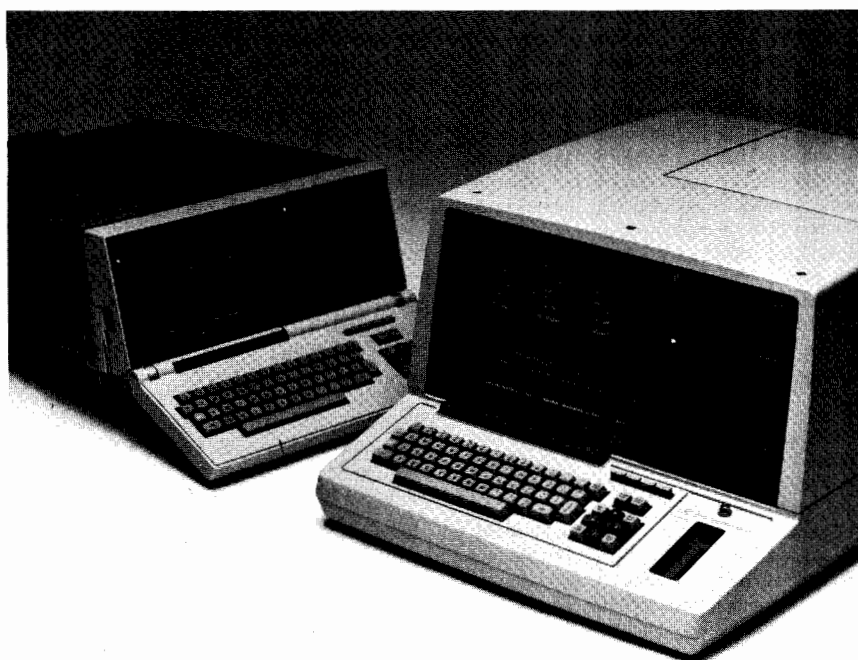

**Figure 3.** Work stations for the 64000 Logic Development System are Model 64100A Development Station and Model 64110A Development Station. The transportable 64110A station includes integral dual flexible disc drives.



```

"8086"
$HEAP = 0$
PROGRAM BIRDIE;
$EXTENSIONS$
$ALIGN$

CONST
  COLS = 8;
  ROWS = 16;
  WAITRE = 100H;
  U_WING = "\ /";
  D_WING = "- \";

TYPE
  ROW_TYPE = ARRAY[1..COLS] OF CHAR;
  SCREEN_TYPE = ARRAY[1..ROWS] OF ROW_TYPE;
  STRING = PACKED ARRAY[0..8] OF CHAR;

VAR
  $GLOBVAR ON$
  GUN:BYTE;
  UPITY:BOOLEAN;

PROCEDURE WRITE (VAR DEST : ROW_TYPE ; S : STRING);

VAR
  COUNT : INTEGER;

BEGIN
  FOR COUNT := 1 TO (COLUMN - 1) DO
    DEST[COUNT] := " ";
  FOR COUNT := 1 TO INTEGER(BYTE(S[0])) DO
    DEST[COLUMN+COUNT-1] := S[COUNT];
  FOR COUNT := (COLUMN+INTEGER(BYTE(S[0]))) TO COLS DO
    DEST[COUNT] := " ";
END;

```

**Figure 4.** Compilers for the 64000 System allow the software designer to use a high-level programming language, Pascal or C, to create algorithms logically without concern for processor-dependent steps.

### Setting Design Criteria

The initial step is defining what the product is to be. Microprocessor products sufficiently complex to require a team effort should be described and defined in some detail before beginning any programming or circuit building. The convenient editor function of a Model 64000 System cluster or development station can act as a "documentation system" for even the first steps in setting design criteria. Design criteria are entered in a file available to each member of the design team, and as additions and amendments are made, earlier versions are stored or discarded. The final, agreed-upon, paper design remains available throughout the development process, avoiding duplicated efforts, misunderstandings which can result in incompatible components, and costly oversights. Once actual hardware and software is being produced, changes of design criteria are sometimes unavoidable; if the team is using a 64000 Logic Development System, a message function and common criteria files keep all team members informed of the new changes.

### Developing Software and Hardware

Typically, after the design criteria are set the development task is divided between a hardware team and a software team, and then tasks are further divided between members of each team. With a 64000 System cluster, emulation and software development functions can be conducted simultaneously at different development stations on the same system.

For the software developer, the 64000 editor is a major benefit. Like all the 64000 functions, it uses the convenient, syntax-driven softkeys. Editing, assembly, compiling, and linking are all done with softkeys and the

ASCII keyboard. Programs may be written in a high level language, Pascal or C, and then compiled for the target microprocessor. When a program is linked, modules of high-level language and assembler language can be combined. This gives the programmer the flexibility to program some code in the assembly language for tighter, more efficient code in frequently called routines, and still keep the ease and speed gained by programming in a high-level language.

Emulators serve both hardware and software engineers. A universal development system, the 64000 Logic Development System presently offers support for many popular 8-bit and 16-bit microprocessors: 8080, 8085, Z80, 6800, 6802, 6808, Z8001, Z8002, 68000, 8048, 8086, and 8088. Additional new emulators will be introduced during the year. When software modules are completed, they can be executed on an emulator even if no hardware for the product exists. As hardware units are completed, they can be combined with the emulator performing the functions of the missing hardware. Each emulator has a real-time run mode to permit checking timing relationships, handshake and control signals, and electrical specifications as new hardware modules are completed and added to the prototype system.

### Integrating Hardware and Software

As the subunits of the microprocessor product are completed and tested, they are combined, and hardware and software are run in concert. At this point, there is a need to verify that all modules are performing as expected, and that the hardware and software execute smoothly when combined. Rarely is this true. The required tool is the logic analyzer. Model 64600S Hardware/Timing Analyzer and Model 64620S

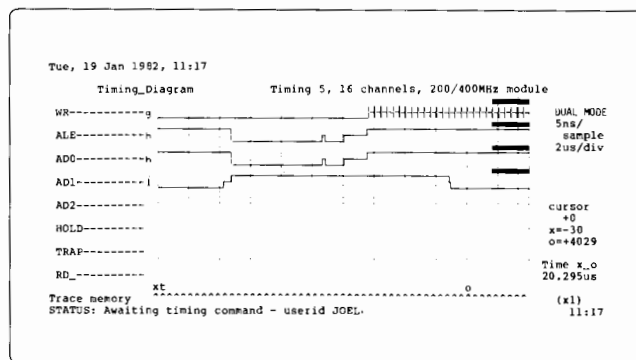

**Figure 5.** Dual threshold measurements with Model 64600S Hardware Analysis subsystem produce a display of trilevel waveforms that aid in locating marginal signals and slow transitions.

Software/State Analyzer subsystems are available to streamline the troubleshooting and debugging required at integration.

### Hardware Analyzer

Model 64600S Timing Analyzer offers sophisticated timing analysis for 8 or 16 input lines. Four measurement modes (wide sample at 200 MHz, fast sample at 400 MHz, glitch, and dual threshold) allow the hardware engineer to check critical timing relationships and locate marginal operation areas in the new hardware. As a subsystem of the 64000 System, the timing analyzer is also operated with the friendly softkeys, taking full advantage of the familiar development station. Measurements can be specified in the traditional manner, or labels from a symbol table generated during earlier linking and assembling, together with any additional labels and symbols defined, can be accessed to easily pinpoint critical points of program flow to monitor system activity. Resource sharing within the analyzer focuses the full power of the subsystem on each measurement mode as it is called up by softkey commands. For example, the wide sample mode monitors all lines of a 16-line configuration, but, by swapping resources, the fast sample mode monitors eight of the lines at double the sample rate to perform first-level parametric measurements. Glitch mode also uses resources of the additional lines to capture and store glitches as narrow as 3 ns. The dual threshold mode produces a trilevel display which clearly identifies marginal signals and slow transitions. Triggering is flexible, allowing time duration violations as well as patterns to initiate a measurement. Both analyzers are transparent to the target system and measurements reflect real-time activity.

```

Format Specification      State 2, 60 channel, 8085 interface
symbol map ADDR_MAP

Symbol      Range      Value
CONST_1    55
SPACE      100
DISP_PORT  289
KBRD_PORT  388
COLD_STRT  0 thru 7      start
MON_ENTRY  8 thru F      start
BEEP_ENTR  10 thru 17     start
MON_TABLE  18 thru 3F     start
POWER_UP   40 thru F2     start
MONITOR_1  F3 thru 1A     start
KEY_INPUT  14B thru 1C7   start
DISPLAY    1C8 thru 29E   start

STATUS: Awaiting state command      userid _____ 12:45
display symbol_map ADDR_MAP

display define modify _____ show execute ---ETC---

```

**Figure 6.** Symbol tables may be entered manually or the table created by the linking operation may be accessed; then the defined labels can serve as parameters when setting up measurements with the 64620S Software Analysis subsystem.

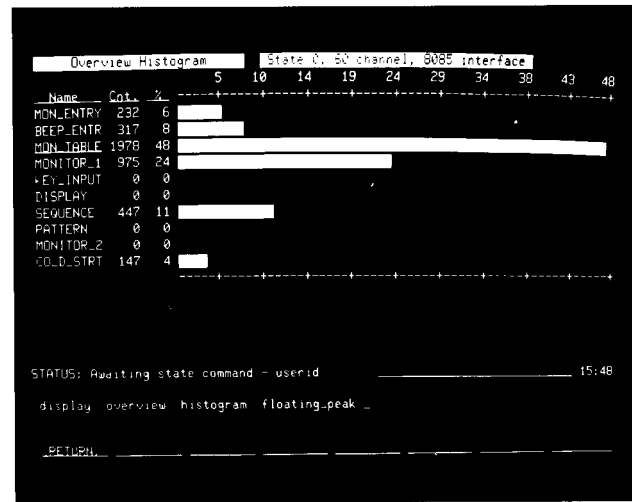

**Figure 7.** One mode of the overview function of the Software Analyzer displays a histogram of system activity for a macro view of program flow.

## Software Analyzer

Model 64620S Logic State/Software Analysis Subsystem is assembled modularly, also. With a choice of 20 to 120 channels in 20-channel or 40-channel increments, the software analyzer accommodates multiprocessor systems as well as the simpler, single 8-bit microprocessor applications. Directed-syntax softkeys lead the user through trace specifications, from simple to intricate. Symbol tables can be used directly or amended to define trace parameters with the now familiar labels and landmarks, or trace points can be identified directly by numerical memory addresses. Resource sharing in the software analyzer is distributed across the trigger, qualify, and store functions. A trigger sequence as deep as 15 terms may be used, or up to three windows can be defined for collecting state flow. The overview function provides histograms and graphs for performance analysis. As many as eight separate events (addresses, symbols, or ranges) can be analyzed for relative frequency or elapsed time. Memory for the overview function is 4096 collected states.

Considered separately, either the software/state or hardware/timing analysis subsystems contribute to resolving problems encountered in integrating hardware and software, quickly and easily. But the capability valued by experienced users is the interactive capacity. Any combination of analysis subsystems and emulation subsystems installed in one development station can be connected across the Intermodule Bus (IMB) and used interactively. For multiprocessor systems, the processors can be run simultaneously and monitored as a total system rather than disconnecting and reconnecting probes to check activity of each mi-

croprocessor in turn. Two timing analyzers in conjunction can be set to monitor the relationships between peripheral control lines and CPU I/O lines. Two state analyzers more than double the possible combinations of trigger, store, count, sequence, and enable functions. If two microprocessors are part of a multiprocessor product, the measurements of the new system can be viewed in both disassembled codes. Since either analysis subsystem can trigger or enable the other, synchronous program activity can be related to signals on the asynchronous control lines. This is a powerful set of measurement capacities for the integration stage when the newly developed software and hardware are run together. Software/hardware analysis combinations are particularly of value for troubleshooting malfunctions at any time in the product's life. With both measurements available simultaneously, it is simple and quick to determine whether some portion of the software fails under unique operating conditions, or a portion of the circuits operate marginally and fail intermittently.

The greatest benefit realized by applying the IMB is freedom to move smoothly between functions. For example, suppose the hardware analysis uncovers a disruptive glitch or a marginal signal. Without leaving the development station, the operator can return to the emulation mode and evaluate the impact of these conditions on the execution of code modules that could be affected. Should the software analyzer disclose a piece of erroneous code, or, through the overview function, identify an inefficient subroutine, the operator can return directly to the software development phase with a few strokes of the softkeys. In the development mode, new code can be written in assembly or high-

level language. Again, a few strokes of the softkeys translates the new code into all the pertinent files, avoiding the temptation to try a bit of code, and failing to integrate the "patch" into the larger program. Softkeys are then used again to return to the analysis operation. The savings in time for breakdown and setup alone make the pairing of software development and software/hardware functions in one station an obvious money-saver.

One final step remains before the initial development of the microprocessor product is complete. Circuits and code must be checked one more time for optimal performance. Since both hardware and software exist and run together, inefficient operation can be isolated with the overview functions of the software analyzer. Routines that run too long, service routines that are called frequently, or modules that appear in the wrong sequence can be located. If a code module occurs too often, "tightening up" the code by writing it in assembly language rather than high-level language reduces operation time.

Software and hardware optimization is not limited to the final stages of development; the overview function of the software analyzer is available at any time, for streamlining system operation module by module, or revamping products already in production.

## Documentation

No product is complete without documentation. A completed prototype is just the first milestone before a processor-based product is passed on to the consumer. Consider the people who can profit from information about the product beyond program listings and circuit diagrams: production, test, quality control, marketing, manual writing, service,



# LOGIC ANALYZERS

## Software Development and Real-Time Analysis



**Figure 8.** Model 64110A Development Station can be used at field sites and in product service for troubleshooting and service routines.



**Figure 9.** The logic state analyzer is an excellent troubleshooting tool for hybrid logic circuits, and is frequently used to supplement the development system for digital measurements.

and eventually, the customer. On a hard-disc based 64000 System cluster, the design team can maintain a separate file for documentation, beginning with the initial design specifications. Keeping the documentation file updated is convenient, because text is entered with the same keyboard used for all functions. In this way, the documentation required for production is almost complete when the prototype is finished. The documentation file may be printed out, or, if other development systems or stations are used in other functional areas, the file may be transmitted via an RS-232-C interface.

### One-Person Applications

Not every project calls for a team of technical people. There are many applications for logic instruments which require only one person, or two or three people part-time. Servicing microprocessor products in remote locations is best accomplished with a portable unit. Modifying an earlier existing design might require only one or two engineers. Production may need only a single station with access to the common data base on occasion. Despite a growing need for instrument systems to support team projects, there still remains a large body of applications that are better suited for stand-alone instruments.

### One-Station Development Projects

Features of the 64000 System are not restricted to a multistation setting. either Model 64110A Development Station or Model 64100A Option 041 Development Station operates independently with a dual flexible disc drive. Emulation or analysis subsystems are installed in the card cage of the station; Model 64110A has five option card slots, and Model 64100A has ten option card slots. A single station provides a base for all development, emulation, and analysis functions. One

engineer at a bench can perform all the steps in creating a microprocessor-based product. Communication to a large computer or a 64000 cluster is possible through RS-232-C (V.24) communication links. Software can be exchanged between 64000 stations or clusters via RS-232-C or by simply exchanging flexible discs.

### Troubleshooting

At a time when phrases like "cost effective", "productivity improvement", and "benefit analysis" have real meaning to the engineer in the lab as well as the accountant, it is important to take note of the powerful measurement sets available with stand-alone logic analyzers. The larger, integrated "electronic workbenches" are not always the only solution to an instrument need. Logic analyzers are well established as tools to troubleshoot general logic circuits and microprocessor buses and control lines.

Hewlett-Packard offers three stand-alone logic analyzers and a 64000 System station with a dual flexible disc drive can be configured as a state/software analyzer, timing/hardware analyzer, or a state/timing analyzer. Selecting a logic analyzer is a matter of matching the analyzer feature set to the tasks. Logic analyzers provide a window on system activity by providing a nonintrusive, real-time view of the system buses and control lines.

A logic analyzer supplements a development system. When the major part of a development program is complete, a separate logic analyzer can be used for the last few bits of fine tuning while the development system is turned over to the next major development project. Test routines defined during initial design can be carried out with stand-alone analyzers in production, quality control, or service at remote sites.

For hybrid logic circuits not related to a specific microprocessor, the stand-alone analyzer is an excellent troubleshooting aid. Since much of the power of any development system is focused on interpreting the target microprocessor code, such power is extraneous to the problem of troubleshooting logic systems not directly related to the processor.

### Taking Advantage of Computer Systems

Development stations for the 64000 System can be used, via the RS-232-C (V.24) ports, as terminals for compatible, large mainframe computers. Communication is through files which may be uploaded to or downloaded from the computer. The development station can be used passively, as one more terminal to enter files into the computer for storage or data processing. Data collected by 64000 System emulation or analysis subsystems can be entered in the computer for processing, using the computer's utility programs for extensive statistical analysis.

A common application of the 64000 development station as a terminal is to take advantage of a software development system resident on the computer. The need for software development aids preceded the advent of microprocessor development systems; consequently, many organizations created their own using existing computers. With the development station as a terminal, the organization can retain their established, familiar software development aids and still access the advanced emulation and analysis capabilities of the 64000 Logic Development System.

### Beyond Development

Applications for logic analyzers and the 64000 Logic Development System are not

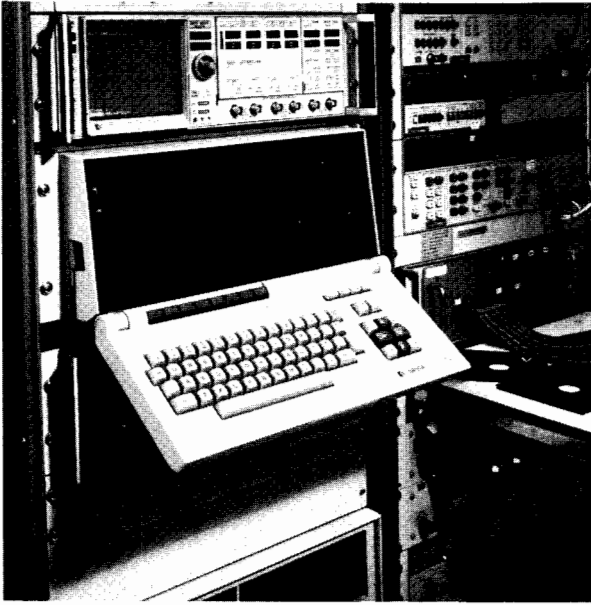

**Figure 10.** Logic analyzers or the 64110A Development Station can be used for automated applications.

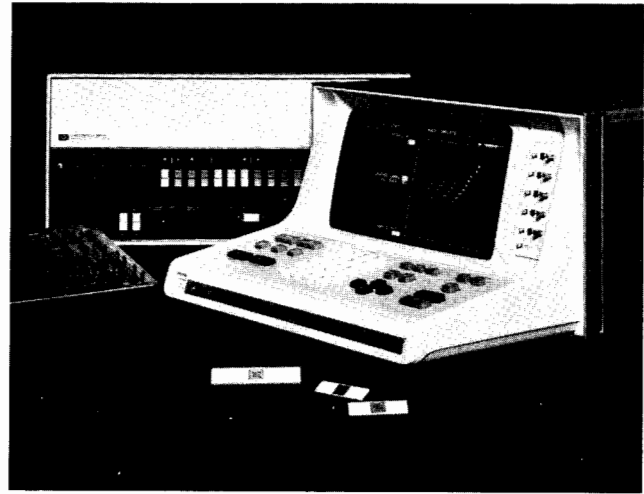

**Figure 11.** Minicomputer interfaces and logic analyzers monitor system buses nonintrusively in real-time.

limited to the laboratory. Data and information accumulated during design and development should not be put on a shelf, leaving the people in production, testing, quality control, and service to rediscover facts already known. By sharing the large, common data base of the 64000 System with the functional groups that begin their work after the processor-based products are fully defined and developed, duplicated efforts can be eliminated, and many potential pitfalls can be avoided. With good planning and design, provision for physical connections and simple checking routines for logic analyzers are built into the product for quick troubleshooting and efficient maintenance even after the product is in use.

#### Production

Production processes impose a different set of pressures and constraints than those present in an R & D lab. Speed, automation, and efficiency are paramount. There is no allowance for a little extra time to cope with a tricky little connection. The 64000 System is at home in production, too; the common data base and convenient, friendly development station smooth the transition from prototype to production line. Logic analyzers with HP-IB interfaces are combined with desktop computer/controllers for automated monitoring, and off-line, analyzers are used to troubleshoot faulty units.

#### Inspection and Quality Control

Inspection and quality control departments must make judgments about a product's performance against two sets of criteria: (1) the specifications established by the design people, and (2) the standards imposed by the marketplace. Ideally, the standards required by end users are a subset of the standards set by the lab; but, in either case, the work of inspection and QC is easier and more effective when they have a full history of the product from the teams that developed it. For products developed on the Logic Development

System, this history is available on the common data base. Work loads in these departments determine whether a 64000 System cluster or an independent, flexible disc-driven station configured for hardware and software analysis is the best instrument solution.

Logic analyzers are important tools for verifying performance on any logic products. Nonintrusive, real-time monitoring allows inspection and quality control people to do more than simply accept or reject end products. Cost savings result when rejected products can be classified by failure type and degree, and many products can be made acceptable with only minor fixes. A strong inspection/quality control program will also uncover production line problems early, avoiding costly, high rejection rates or even more costly failures at the customer's site.

#### Field Testing

Logic analyzers and the development system are needed for two major applications in field testing. First, service personnel often have the responsibility to generate the tests and troubleshooting algorithms for eventual field test. This application, like production and inspection, benefits by having all the information related to the product, beginning with the original design specifications. Actual field tests are easier if there is access to logic analyzers, either directly with a transportable analyzer, or indirectly through communication links back to a logic analyzer or development system.

#### Updating Products

As the availability of electronic components grows rapidly, both in kind and number, it is often practical, and sometimes necessary, to redesign existing products around new components. On one hand, there is advantage of having all the basic problems defined and solved. On the other hand, there are the disadvantages of being bound by the constraints of an earlier design. Sometimes, updating the product is simply a matter of

exchanging the old component with a new one. When simple exchanges are not adequate, the design aids and tools needed are the same ones used for new designs. Failure to provide rework teams with adequate design instruments is a false economy, as the losses due to failed components or dissatisfied customers can be extensive.

### Selecting Logic Systems Instruments

If you are considering a 64000 Logic Development System or one of the Hewlett-Packard logic analyzers, you are probably concerned with the design, production, or service of a logic product. In the last analysis, the common ingredient in all electronic products is people. Then it follows that to produce a good product economically and in a timely manner, it is important to provide people with the tools that are effective and convenient, tools that enhance their skills and capabilities.

In selecting instruments and systems, you want to avoid erring in either direction. You don't want to pay for features that will never be used, and you don't want to handicap your people with inadequate tools. Take a good look at your needs first. Determine what functions are important now, next year, and five years from now. Then select the instruments that have the features you need in your applications.

After defining the class of instruments for today's and tomorrow's needs, evaluate the other factors you always consider in any purchase: reliability, service, and quality.

Hewlett-Packard's 64000 Logic Development System and Model 1600 Series of Logic Analyzers are themselves microprocessor-controlled products. The engineers who design, develop, produce, and service the Logic Systems instruments offer instruments that they use, too. These are instruments built for the engineer at the "next bench".





# LOGIC ANALYZERS

Logic Development System

Model 64000



64000 Logic Development System

## Introduction

Model 64000 Logic Development System is a member of the newest generation of engineering tools for designing and developing microprocessor-based products. As electronic building blocks become more complex and more powerful, the tools for building electronic products are changing accordingly. A few years ago, the terms computer-aided engineering (CAE) and computer-aided design (CAD) began to appear with increasing frequency; but, initially, applications of computers to design and engineering were few and largely experimental. Applications of CAD and CAE have taken two routes. Large main-frame computers have been called into service for small problems at first. Eventually, more software was developed and peripherals added, and the computer became a CAD/CAE resource. The other route was to determine the engineering task to be performed, and, building from that base to create dedicated, special-purpose computers. The 64000 System was planned and implemented through the second approach. Initial design criteria outlined all the functions needed to design and develop microprocessor-based products. Now, the 64000 System offers a complete set of necessary tools for hardware and software development: software development, emulation, and analysis.

Flexible is the key word for the 64000 Logic Development System. The system is not sold as a single unit with add-ons, but rather, the 64000 System is configured for each application, beginning with one or more development stations, and additional subsystems and peripherals as needed. A large system can be assembled with a compatible hard disc, printer, six development stations (the maximum number of stations for a single system cluster), and one or more emulation or analysis subsystems installed in each station. At the lower end of the spectrum of configuration, a single 64110A Development Station, driven from the integral, dual flexible disc drives with a single subsystem could serve as an independent, stand-alone emulator or logic analyzer, or as a software development station. Each development station, Model 64100A Development Station with ten option card

slots or Model 64110A Development Station with five option card slots, has a separate operating system with a powerful 16-bit host processor. Both stations present the same operating environment to the user, so changing stations does not require relearning. Reconfiguring a system by adding stations adds computing power rather than degrading system response, because the 64000 System in a cluster operates as a distributed processing network. Functions may be added as they are required. A further dimension of flexibility is apparent in the variety of popular microprocessors that are supported. Emulators, assemblers, and compilers are available for popular 8-bit and 16-bit microprocessors. A user-definable assembler makes it possible to develop software for new or proprietary microprocessors.

Commonality is the other basic strength of the 64000 Logic Development System. Flexibility is a function of the freedom to select and assemble the 64000 System hardware and functions, and the easy transition between installed operating modes; but, in any configuration and under any operating mode, the user always executes actions on the convenient ASCII keyboard and syntax-driven softkeys. Additional commonality is reflected in the common data base available to all users of a single system, whether the system is a hard disc-based cluster or a single development station. With a communication link to other 64000 clusters, the common data base is shared by all teams working on the same project. The value of a common data base cannot be overstated. Most microprocessor products are designed and developed by groups of engineers, hardware and software; with many pressures forcing a timely introduction of a new product, few manufacturers can afford to relegate a new product to one or two engineers over an extended period. A common data base accessed from the work station simplifies intrateam communication, leading to smoother work flow and improved efficiency.

Flexibility, commonality, and friendliness of the 64000 System sum up to improved productivity. Flexibility fosters a wise use of available capital by investing equipment money for tools that are needed now while still leaving future options open as applications change. A

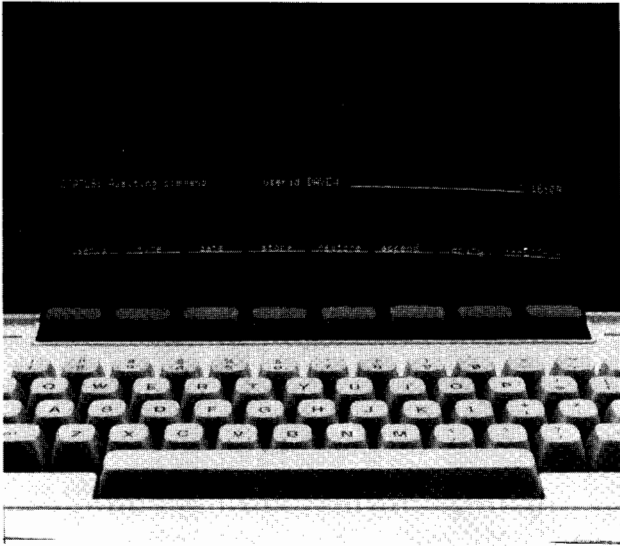

**Figure 1.** Eight softkeys at the top of the 64000 development station keyboard are labeled on the station display. With directed syntax, the labels change as new functions are entered.

common data base keeps all team members informed of project status, current changes, and design criteria, all the time. By using the efficient communication avenues of the common data base, time is saved that could be lost to reworking incompatible components. "Friendly" is a description applied generously in the electronics industry. The friendliness of the 64000 System is a direct consequence of the syntax-driven softkeys (figure 1). Syntax errors rarely occur, as the software-labeled softkeys guide the user in selecting acceptable sequences. Commands are displayed as complete words, and error messages are written out rather than indexed by number. New users learn to use the 64000 capabilities quickly, and experienced users like the speed of using a labeled softkey rather than typing in cryptic commands dug out of a large manual. Taken together, these attributes of the 64000 Logic Development System reduce development costs because hardware and software designers can do a better job in less time.

### What Is the 64000 Logic Development System?

Model 64000 Logic Development System is a universal development system that supports the design and development of microprocessor-based products. "Universal" distinguishes the 64000 System from a "dedicated" microprocessor development system which supports a single-vendor microprocessor families; the 64000 provides emulators and related design aids for more than a dozen microprocessors. Primary functions are software development, emulation, and logic analysis for hardware and software. These functions may be installed in a multistation cluster or stand-alone station. The versatile system architecture allows the development system to be configured for a variety of environments, as well as insulating the system against obsolescence.

### System Architecture

Model 64000 Logic Development System can be established as a single development station, a multistation cluster, or as a terminal to a large mainframe computer. The basic component, the development station, is available in two stations: Model 64100A Development Station and Model 64110A Development Station. Most of the flexibility of the system is due to the adaptive architecture of the development stations. Development stations house the subsystems, and each station contains a host processor.

Development stations are the work bench for 64000 System users, and the convenient access point to all the powerful system functions. Each station contains

- High-performance, 16-bit, host processor



**Figure 2.** Model 64110A Development Station, with integral, dual flexible disc drives, has a hinged keyboard and adjustable legs, for easy use in a wide variety of environments.

- ROM and RAM memories dedicated to the operating system
- Modular power supply
- Full ASCII keyboard and cursor controls
- Eight software-driven softkeys with guided syntax
- Optional local mass storage
- Card cage with five or ten slots for subsystem option cards
- RS-232-C (V.24) interface.

Model 64100A Development Station is the larger station. The card cage reserves three slots for the host processor operating system and has ten additional slots to accommodate subsystem options. An optional PROM programmer can be installed directly in the station next to the keyboard; PROM interfaces are available for most common PROMs. Local mass storage can be added by installing a tape cartridge drive unit or a dual flexible disc drive unit.

Model 64110A Development Station (figure 2), transportable version, has a dual flexible disc drive unit which makes the 64110A station ideal for stand-alone applications. The operating host processor system occupies the first two slots of the card cage, and the remaining five slots are available for system options and subsystems. Adjustable cabinet legs and fold-up keyboard make the station comfortable to use in any position - on a desk, standing on end, or rack-mounted.

An important architectural feature of the development stations is the multiple bus structure. The operating system and station CPU communicate with the option-card slots via the development station bus. This bus carries address, data, and control signals, and supplies power to all card slots. Cards which comprise a specific subsystem, e.g., an emulation subsystem, communicate via separate, high-speed subsystem buses. Another bus, the intermodule bus (IMB) is the link for interactive emulation and/or logic analysis. An I/O display control bus provides the quick response required by the interactive display. Since buses are not shared, the host system does not intrude on emulation or analysis operations to conduct "housekeeping" tasks, allowing a real-time run mode for either subsystem.

Logic Development System clusters network up to six stations with a compatible Hewlett-Packard disc and printer. Distributed processing maintains a fast system response time which does not deteriorate as new stations are added. Any of several high-speed printers provide hard copy output. A hard disc drive selection include drives from Multiaccess Controller (MAC) family or several Winchester disc drives with integrated tape backup units. Disc storage memory capacities range from 5 Mbytes to 960 Mbytes. Sharing the high-performance peripherals adds the speed, power, and capacity of hard discs and printers, but the cost is distributed across several stations.

Stand-alone stations for emulation, analysis, software development, or terminal mode typically run on the dual flexible disc drives; i.e.,

```

"8086"
$RECURSIVE OFF$

#define cols 8
#define rows 16
#define waitre 0X100
#define u_wing "\ \ /"
#define d_wing "/- \\"
#define space ' '
#define true 1
#define false 0

typedef char string[];
int column = 0;
int hits = 0;
int tries = 0;
int downer = -1;
int rocket_pow = -1;
int row = Rows - 1;
int waiter = waitre;
short gun = 0;
string up_wing = u_wing;
string downer_wing = d_wing;
char *bird = downer_wing;

write (dest, s)
    string dest, s;
{
    int count;

    for (count = 0 ; count < column ; count++)
        dest[count] = space;
    for (count = 0 ; s[count] != '\0' ; count++)
        dest[column+count] = s[count];
    count += column;
    while (count < cols)
        dest[count++] = space;
}

```

Figure 3. Programming for selected 8-bit and 16-bit microprocessors can be done in high-level programming languages with 64000 System Pascal and C compilers.

either Model 64110A or Model 64100A option 041 Development Station is used. This frees the station for specific applications, at sites in production, testing, or field, without sacrificing the friendly interface and extensive tools of the 64000 System. If communication with a central 64000 cluster is desirable, an RS-232-C (V.24) link can be set up to transfer files. Flexible discs or tape cartridges also serve as media for information exchange between systems. As an ASCII terminal to a large computer, the development station can access the storage and computing power of the larger mainframe.

The architectural features of the 64000 System, for networking and independent modes, and within the development station itself, create the flexibility so important to today's electronics industry. A single station or a cluster can keep pace with the changing needs of a project or an organization.

### Software Development

A microprocessor-based product is a union of hardware and software. As circuits and processors become more complex, more code is generated to direct the system activity of the final products. Obviously, any design tools that enhance the software designer's work result in reduced development costs and better products. The software development feature set of the 64000 Logic Development System focuses on the tools and conveniences valued by software designers:

- Softkeys for one command, one stroke action
- Directed syntax
- Sophisticated editor
- Assemblers for 8-bit and 16-bit microprocessors
- User-definable assembler for proprietary processors
- Pascal and C compilers for high-level languages
- Fast, linking, assembly, and compiling
- Linker combines any relocatable code-assembly, high-level language, and/or external library files

Software development tools of the 64000 System are structured to make good programming practices easy. For example, a common problem software engineers encounter is a need to rewrite a small piece of code in a module completed earlier. Perhaps a performance test disclosed an I/O access routine using too much code space; a code error is uncovered that was missed; or a software module that ran well by itself does not meet specifications of modified hardware. After reducing the code, correcting the error, or rewriting the routine to conform to the new specifications, the new code can be checked with the

emulator or analysis. When the code is amended, there is a temptation to continue the interrupted sessions, without recompiling, assembling, and linking the new "patch" of code. This is less likely to occur with the 64000 System, as the processes are completed so quickly that transcribing the change into all levels of code is easy and convenient.

Functions of the softkeys are software driven; the directed syntax virtually eliminates the possibility of errors in syntax. As programming proceeds, labels for each of the eight softkeys appear on the CRT display directly above the keys. These labels list all the legal commands that can be executed next. Commands are listed in the sequence selected in the command display space just above the softkey labels. Pressing the "return" key causes all commands in the command line to be executed. Error messages are written out completely rather than as error codes to be looked up in a manual.

Editing text and code is easy with the sophisticated editor function. Since programmers typically spend 50 percent or more of their time in editing, any time saved in editing has a major positive impact on meeting project deadlines. Editor functions are transparent to the user, but the status line keeps the user informed about what is happening. Characters or lines are added or deleted with equal ease, with softkeys, overwriting, or special functions keys.

In the edit mode, a display cursor is moved by the cursor keys on the right side of the ASCII keyboard. Keys nested with the cursor keys are used to roll the displayed text or code up or down and left or right. The alphanumeric character keys for entering parameters and writing text are arranged in the standard, familiar "typewriter" format.

Assemblers are entered into the 64000 System mass storage from tape cartridge or flexible disc. Once resident on the system, the assembler can be called into the station's host memory with softkey commands. When code space is restricted or when more control is needed for a particular hardware function, many software designers prefer to program in assembly language. Assemblers are available for a wide variety of microprocessors. For other microprocessors, a user-definable assembler can be used to create a new table-driven assembler for the new microprocessor.

Model 64000 supports compilers for Pascal and C languages for major 8-bit and 16-bit processors. Pascal is best suited to writing applications programs, while C is best suited for systems programs (figure 3).

The high-speed linker is a key element of the efficient programming tools of the 64000. The linker unites modules into a single program. Modules may be relocatable assembly modules, compiled high-level language modules, and external library files. This linking capability frees the design engineer to program at any level, using the most effective language for each component code unit. Despite its apparent simplicity, the linker function is a major factor in facilitating programming. Effective routines are reused rather than rewritten. High-level languages are better suited to top-down programming techniques, but assembly language programming can be inserted to fine tune critical portions of code.

Software development on the 64000 System flows quickly, because the system adapts to the software designer's needs. The designer can concentrate on the design task and not on the constraints of the design tool.

When software has been created and tested, PROM programmers convert the software to firmware. When a PROM programmer option is added to a 64000 System, an interface module is installed in the 64100A Development Station, to the right of the keyboard and the PROM programmer control card is installed in the card cage. Interface modules are available for most of the common PROMs. The PROM programmer is a convenient option for downloading software to PROMs right at the development station.

### Emulation

Emulation is one of the significant contributions of development systems to the process of creating microprocessor-based products. Emulation has become a standard technique to check and debug both hardware and software during all stages of developing a microprocessor system. An emulator should conform to the characteristics, operating modes, and specifications of the microprocessor it supports. The 64000 Logic Development System offers emulation subsystems for



**Figure 4.** Emulation subsystems are available for a variety of 8-bit and 16-bit microprocessors. Emulation pods are shown for some of the supported processors.

8-bit and 16-bit microprocessors (figure 4). Periodically, new emulators are introduced to support new microprocessors that come into general use. Presently, emulation subsystems are provided for a variety of microprocessors including:

8080	8048/8049	6800
8085	Z80	6802
8086	Z8001	6809
8088	Z8002	68000

Emulation subsystems for the 64000 System consist of a control card and an emulator pod assembly. Memory for the emulator, ordered separately, requires at least two card slots in the card cage, one for a control card and one for the memory card; emulation memory (8 kbytes to 960 kbytes) is implemented with high-speed static RAM.

Emulation is the tool that lets designers check their modules as they are developed, rather than when software and hardware are completed in totality. Even before any hardware is built, software modules can be run and debugged on the emulator. Basically, the emulation process is run by software control of emulator memory space and the target system memory space. From the development station, the engineer designates the memory blocks from both the emulator and target system that apply to the emulation session. The emulator/target system runs as a single unit, as the sequence of program steps is what operates the unit, and the memory source is not relevant. Since much of the debugging is done as modules are added, the problems at the final integration of hardware and software are far fewer.

Emulators completely change the process of developing logic products. Features of 64000 emulation subsystems meet the needs of hardware and software designers:

- Software control of mapping memory blocks to emulation and target system memories
- Real-time mode for emulation without inserted wait states
- Simulated I/O using 64000 resources
- Functionally transparent emulation mode
- High-speed emulation memory
- Support for 8-bit and 16-bit microprocessors

A paramount consideration in judging a microprocessor emulator is the degree to which the emulated activity matches the actual system activity in the completed product. An ideal emulator would be functionally and electrically transparent to the target system. Since complete transparency is not possible, 64000 emulators accent functional transparency. For example, each emulator offers at least one mode in which the emulator microprocessor runs at the same speeds as the microprocessor in the final product. Some problems can only be detected when a system runs at full speed. Emulation at operational

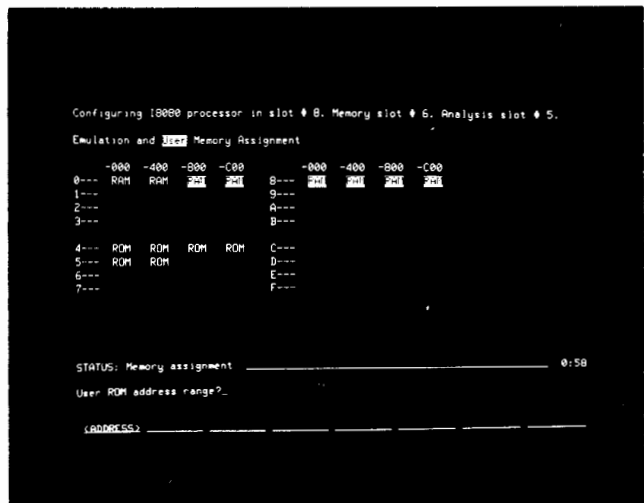

**Figure 5.** Memory for emulation is assigned by blocks to emulation memory and target system memory. Blocks may be designated as RAM, ROM, or illegal memory.

speeds is achieved with a high-speed emulation memory, and separate buses for the emulation subsystem and the host system. Each emulator has at least one run mode that does not require inserted wait states. Another factor in functional transparency is that the emulator should not use resources reserved to the target system. For 8-bit emulators of the 64000 System, this criterion is completely met. However, complexity of the 16-bit microprocessors is necessarily reflected in complexity of the 16-bit processor emulators. Consequently, these emulators share some of the target system by using one or more control signals of the target processor; this relation is clearly defined, and designers can select alternative control signals when checking activity related to the shared control signals, for a piece-wise functional transparency. None of the emulator functions are hidden from the designer; this open approach lets the designer make sound judgments on the degree to which emulator activity corresponds to the eventual product performance. Some modifications to emulator operation are possible for specific cases.

The emulation processor is run from two memories: emulation memory and target system memory. Memory is assigned to either memory by blocks of memory address space (figure 5); the processor runs as if only one memory space existed. Blocks of emulation memory can be defined as RAM, ROM or illegal. As modules of software are completed, they can be tested on the emulator and/or the completed target hardware. When a module has been tested and debugged, it can be downloaded to a PROM for the target product prototype.

One of the important advantages of an emulator is the control over the microprocessor during the development phase. The microprocessor can be run, halted, or single-stepped from the development station keyboard. During emulation, it is possible to examine the contents of the target memory and the microprocessor registers, modify the contents of either, and then continue the emulation run.

Before the advent of emulators, most of the emulation tasks were accomplished with a variety of instruments and software techniques. While many of the techniques were innovative, compared to present-day emulators, they were cumbersome, time-consuming, incomplete, and often intrusive. Emulators have become standard tools because they are much easier to use, offer more features, and save valuable designer time. The 64000 emulators add one more dimension of user friendliness, because all emulation commands are entered via direct-syntax softkeys of the development station.

An internal logic analyzer may be added to the emulator subsystem to monitor activity on the emulation bus. These analyzers perform real-time traces of address, data, and control signals. Displays are in the mnemonics of the microprocessor or an appropriate numerical base.

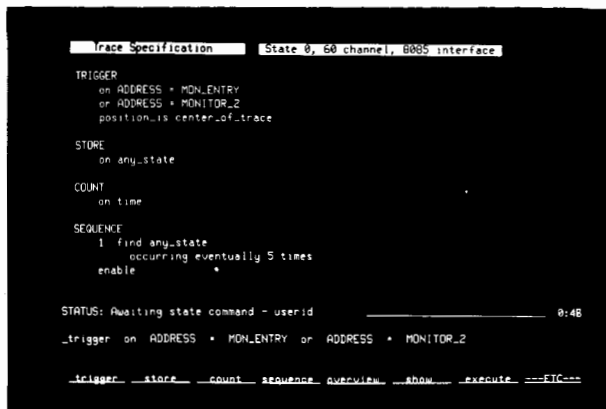

**Figure 6.** Setting up a measurement with Model 64620S Logic State/Software Analyzer subsystem is accomplished with the trace specification display and softkeys.

Trigger points, the reference point for collecting a trace, are defined from any combination of address, data, or control line information. In symbolic debugging, symbols or Pascal/C line numbers can be used in defining trigger points. A restart term and multiple occurrences can be added to the trigger parameters. Events captured can be qualified so only particular types of events are stored. Elapsed time or event counts can be measured from the trigger point or between stored events. The internal analyzer is on a single card, and no extra cables are required. Signal outputs for external instruments can be transmitted at a trigger point, or at the completion of a measurement trace.

The emulation subsystem can be used interactively with the software development functions, a hardware/timing analyzer, or a software/state analyzer subsystem. It can be used with a second emulator subsystem for multiprocessor applications.

The microprocessor marketplace offers a wide choice of processors. Two apparently similar products may call for two different microprocessors. Any given application might work equally well with any one of several microprocessors. An investment in a 64000 System is not lost if the next project requires another microprocessor. A universal development system, the 64000 Logic Development System offers the benefits of a friendly terminal and increased productivity without locking the users into a single microprocessor family for all applications.

### Software and Hardware Analysis

Logic analysis extends the 64000 support for microprocessor products across the entire product life cycle. As the first modules are completed, the Logic Timing/Hardware Analyzer and Logic State/Software Analyzer are used for debugging and troubleshooting. The analyzers are in greatest demand for integrating software and hardware, and continue to serve well throughout initial tests and quality control. Automated stations are needed for production, and stand-alone stations provide state-of-the-art logic analysis for quick and efficient field service. With logic analysis, the 64000 System is a complete tool for microprocessor-product development.

### Software Analysis

Less than a decade ago, engineers who were acquiring new skills for emerging data domain applications were delighted with a new instrument, the logic analyzer. With the logic analyzer they could see the program flow on parallel lines as wide as 16 bits, listed in sequence in 1's and 0's. Since then, data domain applications have grown exponentially in every dimension - kind, size, number, complexity, and amount of code. Mode 64620S Logic State/Software Analysis subsystem can generate a state trace list in 1's and 0's, triggered by a single binary pattern 16 bits wide; it will also generate a mnemonic state listing of patterns up to 120 bits wide, or only I/O writes to a range of addresses or a single address (STORE) together with the number of events occurring between each listed state. The trace speci-

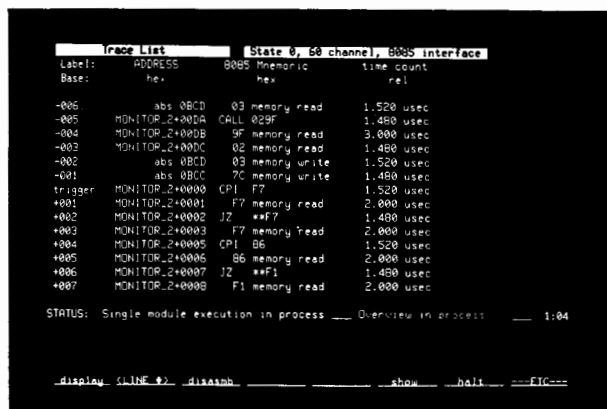

**Figure 7.** A listing of the state flow may be viewed in the mnemonics of the microprocessor code. Time and state counts are valuable analysis aids.

fication, shown in figure 6, is very complex, but not atypical in the detail required to pinpoint data flow for analysis in today's microprocessor applications. Applying the power of the software analyzer is made simple with directed syntax and softkeys of the development station.

Model 64620S Logic State/Software Analysis subsystem is composed of a control card, one to three data acquisition cards, and general-purpose or dedicated probes. There are two types of data acquisition cards; one card has 40 input channels, and the other has 20 input channels with overview circuits. Installed in a 64100A development station or the transportable 64110A station, a state-of-the-art software analyzer with 20 to 120 input channels is created. The analyzer keeps pace with system clocks at rates which produce data transfer rates up to 10 MHz. Major contributions of the software analyzer are:

- Symbolic tracing for easier measurements and better communications
- Enhanced sequencing and windowing power for finer-grained trigger and trace specifications.
- Extensive overview capability for performance analysis

Measurements with the software analyzer are in two categories, synchronous state traces (figure 7) and overview graphics. Trace lists are formatted and disassembled automatically when a preprocessor and dedicated, processor-specific interface are used. Any convenient format can be set up or rearranged quickly with softkeys. Performance analysis techniques with the overview function provide a macro view of system activity to locate bottlenecks, isolate inefficient code modules, or optimizing program flow. Overview events can be defined for up to 15 ranges, values, or time intervals. The displays are graphs or histograms (bar graphs) of execution times, event counts, or occurrences. Once an area is identified for closer analysis, a few keystrokes set the analyzer up for a detailed view.

Symbolic tracing begins by defining a symbol table, or by adding to a symbol table drawn from the linking function. Symbols are alphanumeric labels assigned to absolute addresses, ranges, or procedure names. Once defined, symbols are integrated in the 64000 software for use as softkey labels. Thereafter, a softkey defines, for example, an entry address for a subroutine, and the user saves the time that would be spent looking up the absolute memory address of that routine in the most recent software revision.

Flexible triggering, a major strength of the software analyzer, is enhanced by sharing resources between trigger, store, and count functions. A convenient default trigger specification triggers the analyzer on any state, stores states, and counts time. If all resources are assigned to only one function, the trigger can include eight ORed functions. Trigger patterns may be values, ranges, "don't care" terms, or NOT terms. Storing monitored state flow may be set to begin before, after, or about the trigger point. Events stored may be all states, or qualified to include only states of a specified type or in a given range.

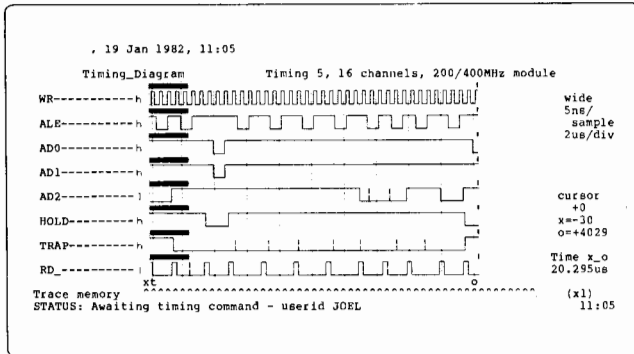

**Figure 8.** In fast sample mode, Model 64600S Logic Timing/Hardware Analyzer captures timing information at rates up to 400 MHz.

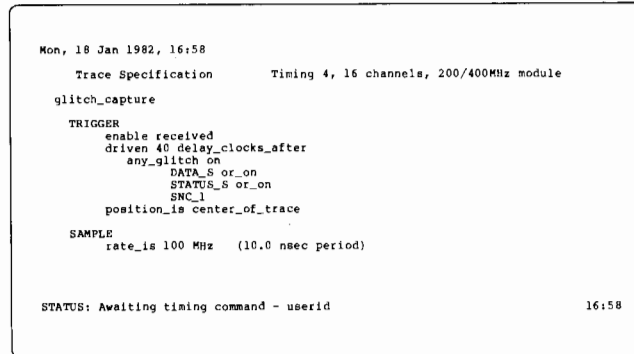

**Figure 9.** Triggering specifications for the Timing Analyzer may be set for patterns, durations, transitions, glitch occurrences, and combinations of specifications for flexible triggering.

Event or time interval counts can be taken between stored states or from the trigger point.

A sequencer is superimposed on the trigger/store/count functions. The sequencer windows the other trigger specifications. A basic sequence can have up to 15 separate terms followed by a restart term to reinitiate the search for the sequence. Each term can be specified to be "immediately followed by" or "eventually followed by" the next sequence term. The windowing capability is a subset of the sequencer. Windows are formed by enable/disable terms.

At the highest level is a master enable function. The master enable initiates the analyzer as a whole. Master enable may be a specific event, a sequence, or a signal from another analyzer or emulator subsystem in the same development station across the intermodule bus.

Even a brief description of 64620S Software Analyzer functions reveal the power, functionality, and flexibility of the analyzer. But, due to softkeys and microprocessor-specific interfaces, using the analyzer is simple, quick, and easy.

A general purpose preprocessor with a microprocessor-specific module simplifies connections to the target system. It replaces three data pods and one clock pod. Lines not needed for monitoring the microprocessor are available for probing other lines in the target system. The 20-channel data cables and 8-channel clock cable plug directly into the preprocessor and the preprocessor has a convenient target processor socket. Bus signals are conditioned for the analyzer, signals may be demultiplexed, and STIMULUS and HALT signals may be controlled by the analyzer. Inverse assemblers translate the signals into the processor's mnemonic code; the appropriate inverse assembler is called automatically from 64000 mass storage whenever a processor-specific module is installed in the preprocessor. The preprocessor is also compatible with the interfaces for a wide variety of minicomputer families.

#### Hardware Analysis

Model 64600S Logic Timing/Hardware Analysis subsystem may be installed in either development station with 8 or 16 input channels for asynchronous timing analysis. Four modes of measurement and flexible triggering specifications adapt Model 64600S Hardware Analyzer for the complex and detailed timing measurements needed in today's digital systems. Basic units of the analyzer are a control card and one or two 8-channel data acquisition cards and probes. The primary strengths of the hardware analyzer are:

- Four measurement modes
  - Wide sample to 200 MHz
  - Fast sample to 400 MHz
  - Glitch capture for 3 ns glitches
  - Dual threshold to check marginal signals
- Sophisticated, flexible triggering
- Symbolic signal identification

Default measurement mode is the wide sample mode for all of the input channels at selected sampling speeds from 2 Hz to 200 MHz. Maximum measurement resolution is 5 ns including up to 1.5 ns of skew. Memory is 4060 samples deep. The other three modes use resource sharing to achieve additional power; half of the installed input channels are traded off when fast sample mode, glitch capture mode, or dual sample mode is evoked. Fast sample captures asynchronous events up to a 400 MHz sample rate; the memory space is doubled (figure 8). At these speeds, first-level parametric measurements are feasible. The glitch capture mode identifies glitches with a separate glitch detection circuit that is activated by a signal that crosses threshold two or more times within a single sample period for completely asynchronous action. Glitches are displayed as short, dashed vertical lines on the timing display traces, and noted with a "g" on the corresponding word listing. Dual threshold mode displays trilevel waveforms that show the time the signal is above, below, or within a specified voltage level range. This mode identifies marginal signal levels and slow transitions, which are frequent causes for intermittent hardware problems.

Symbolic signal identification is also available in the hardware analyzer. Signals may be conveniently labeled to identify single lines or groups of lines with the corresponding inputs. Once defined, the labels become part of the softkey labels software, convenient for defining measurements and displaying data.

Speed, memory depth, and measurement modes give the hardware analyzer its power; finesse is a function of the versatile triggering parameters (figure 9). Pattern triggers are specified in binary, octal, or hexadecimal. A Boolean NOT condition of a specified pattern triggers a timing trace when the specified lines deviate from a set pattern. The occurrence of a glitch on one or more lines can serve as a trigger, or can be combined with a pattern specification in logical AND or logical OR combinations. Patterns may include "don't care" entries. Transition triggering specifies a trigger point as a set of signals entering or leaving a defined state. Time interval specifications can be defined for specified patterns, and the analyzer triggered if the pattern persists longer than a prespecified time interval, or if it does not persist long enough. When 16 input channels are available, a trigger on inputs of one probe pod can arm the analyzer to search for another trigger specification on the second probe pod, a powerful sequential triggering capability.

Timing analyzers have traditionally been considered tools for hardware engineers. Model 64600S Hardware Analyzer is a subsystem of the 64000 System, and many timing tests can be run by designers who are less sophisticated in circuits, but need to check handshake signals or locate protocol violations. For experienced users, the simplified operation of the hardware analyzer eliminates repetitive, time-consuming tasks and allows them to do more analysis in less time.



# LOGIC ANALYZERS

Logic Development System

Model 64000



**Figure 10.** By combining a hardware analyzer and software analyzer via the Intermodule Bus (IMB), one analyzer can trigger or arm the second analyzer for interactive measurements.

### Interactive Analysis

The intermodule bus (IMB) can combine logic analyzers and/or emulators. Combining logic hardware and software analyzers with the IMB creates a simultaneous state/timing analyzer, which is particularly useful during integration phases (figure 10). Malfunctions are generally expected when hardware and software first run together, but it is not always apparent whether the cause of the malfunction lies in the circuits, the code, or both. Cross-triggering and arming the analyzers is far more efficient than attempting to troubleshoot the same problems with two separate analyzers. Additionally, interactive troubleshooting algorithms are possible on the combined analyzers that are not possible otherwise. Adding an emulator to the IMB makes it easy to switch between emulation and analysis modes. Combining emulation via IMB is a valuable capability for developing multiple processor systems.

### Terminal Mode

An RS-232-C (V.24) interface and terminal mode software adds a 64000 System development station to existing computer networks (figure 11). When a development system already exists on a minicomputer or large mainframe-based system, the terminal mode adds 64000 System functions, but retains full use of the existing, in-house capabilities. As code is completed on the existing system, it can be downloaded to the 64000 development station for testing, troubleshooting, and PROM programming. Code can also be uploaded.

### How is the 64000 Used?

Model 64000 Logic Development System is the complete system for developing microprocessor-based products. From the very first outlines of design specifications through final delivery to the end user, the 64000 System provides a common data base which can be accessed by everyone associated with the product. Engineers and technicians working with the product after the prototype is built don't have to guess what should happen on the basis of out-of-date listings, inaccurate after-the-fact flowcharts, and scanty notes. They know. The final code revision and complete documentation can be passed on with the product. Not only does everyone work from the same data base, they all use the same stations. There is no need to alter routines and procedures to adapt to a new instrument after each major step; the user interface is the same for every step. An implementation of the "electronic work bench concept", the 64000 System provides common links as the processor product moves through the phases of design, development, production, and test.

Universal microprocessor support frees the 64000 System user in matching processors to products. With a dedicated development system, a processor is chosen first, and the tools are chosen to match the processor. Once a dedicated development system is purchased, subsequent products are likely to be tied to the same processor family, even if it means designing around limitations of the processor in new appli-

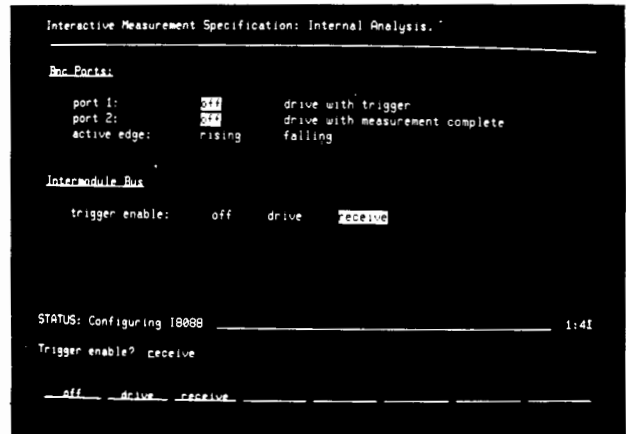

**Figure 11.** With the RS-232-C (V.24) interface, a development station can be used with a large mainframe-based computer, as a terminal, analysis station, or emulation station.

cations. It appears more economical to adapt to existing development aids than to purchase a second development system. With universal support, the optimum processor can be selected for each product. It becomes practical to assemble critical components of the projected product using two different microprocessors, and evaluate the relative merits of the processor through interactive emulation and analysis. Multiprocessor applications with processors from different families for different functions are feasible with the 64000 System. The 64000 System even offers many support tools for proprietary chips and recently introduced microprocessors through user-defined assemblers, host Pascal, and the general purpose preprocessor for the software analyzer.

The 64000 is a friendly system, friendly in many dimensions. New users become proficient in little time, typically, less than a day, and experienced users progress quickly to take full advantage of the advanced applications of the 64000 System. The 64000 System responds quickly due to distributed processing, and details of routine tasks are performed by the system, not the user. Yet, none of the functions are hidden; the display always describes current system activity, and error messages and commands are fully spelled out. Softkeys as implemented in the 64000 System are virtually self-explanatory; frequent references to manuals to decipher a code are eliminated. With softkeys, typing is used to create new code and text, and not for entering commands. Directed syntax displays the possible choices for the next command and avoids the inconvenience of entering a command string in the wrong sequence. Friendliness of the 64000 System is not limited to one or two functions. A programmer who used the system to create code will find it simple to use the software analyzer; a circuit designer familiar with the emulation subsystem can easily transfer to the hardware analyzer. Model 64000 Logic Development System encourages the user to focus on good design and development.

The 64000 System adapts to a number of environments. As a design aid for a team, the 64000 System configuration is the cluster: one to six development stations sharing a high-performance hard-disc memory and high-speed printer. Subsystems are installed in stations as needed, software development, emulation, and analysis. With dual flexible-disc drives, either development station can be as used a stand-alone station for any of the major functions. Stand-alone units serve well in production and service environments, remote from a design cluster. Another stand-alone function employs a 64000 station in the terminal mode to a computer. Model 64110A, with hinged keyboard and adjustable legs, can be moved to remote locations, and used as an advanced logic analyzer for servicing products or performing production tests.

Open-ended architecture and modular structure add one more form of flexibility: the 64000 System can be purchased in functional units, and enhanced across time. The immediate advantage is that capital equipment expenditure can be spread across several budgets. Stations, subsystems, and peripherals are added as needed. One approach is to begin with a small cluster of two or three development



**Figure 12.** Subsystems may be added to Model 64100A (or 64110A) Development Stations as they are needed. New system configurations for clusters or stand-alone stations may be made at any time.

stations, printer, hard-disc sufficient to accommodate foreseeable growth, and one or two emulator subsystems. Logic software and hardware analysis subsystems are added later when the project is sufficiently complete and analysis is more critical. As new projects come on-line, more stations and new emulators can be added. The initial 64000 System equipment could be one or two 64110A development stations with an emulation subsystem in one and an analyzer subsystem in the other. By adding functions and stations as they are required, 64000 System users take full advantage of the resources they need, without supporting expensive apparatus that lies idle because it is not immediately applicable (figure 12).

### Why Standardize on the 64000 System?

When all the factors and features of the 64000 Logic Development System are summed, the real consequence of the 64000 System is improved productivity. The basic resource of a technological organization is the pool of technical and professional talent; in short, the people. Ease of use, common data base, quick response, and a single work station for all functions, translate into a marked savings of valuable technical time. Less time is spent in learning to use the system. Less time is wasted waiting for the system to process and respond. Less time is needed for communication between team members and between teams. Less time is lost in searching for the most current revision. Less time is devoted to coping with complex, unwieldy tools. The time saved is used in the "real" work of the engineer, the work that uses the skills and knowledges of technical people.

Lower development costs, shorter design-to-production cycles, and better designs are achieved with the 64000 System. In the competitive markets for microprocessor-based products, the extra advantages gained with the 64000 System can be the difference between an adequate product and an outstanding product. Here is a development system that solves the problems of software and hardware engineers, a cost-effective "electronic bench" for the entire product life cycle.

The evolution of the 64000 Logic Development System is clear evidence of the on-going Hewlett-Packard commitment to maintaining an effective system. Introduced with four emulators for 8-bit microprocessors, the choice of emulators now includes support for 16-bit microprocessors. Assemblers have been added, and the user-definable assembler is available to give access to the powerful 64000 software development aids for virtually any processor. Two Pascal compilers were added shortly after introduction; now a wider selection of Pascal compilers exists, and C compilers are available. A transportable development station makes it more convenient to carry the 64000 feature set to field environments, and the dual flexible disc drives integral to the new Model 64110A Station may also be installed in the standard development station, Model 64100A. A major extension of 64000 capabilities, the hardware and software analyzer broadens the range of application areas for the 64000 System, and makes possible the powerful interfunction measurements.



**Figure 13.** Software for the 64000 Logic Development System is available on flexible discs or tape cartridges.

Hewlett-Packard's commitment to the 64000 System includes a concern for 64000 users. New subsystems and capabilities are accommodated in existing 64000 Systems. New products are enhancements, not replacements.

Making the 64000 Logic Development System the basis for designing and developing microprocessor-based products results in immediate and long-term benefits. The 64000 System is an integrated development solution, a single system that supports many microprocessors. There is one interface for all operations. Modular design and compatibility protect the 64000 System from obsolescence, and let the system increase by steps as users' needs change. For better productivity and efficient capital equipment spending, the 64000 Logic Development System makes good sense.

### Selecting a Logic Development System

Model 64000 Logic Development System is complex and often represents a major investment. All system software is ordered separately (figure 13). It is strongly recommended that an HP Instrument Sales Representative be contacted for suggested system configurations and applications. Prices for selected components follow.

#### Ordering Information

- 64100A** Development Station
  - Opt 040** Cartridge Tape Drive
  - Opt 041** Dual Flexible Disc Drive
- 64110A** Development Station with Dual Disc Drive
- 642XXS** Emulation Subsystem, 8-bit  $\mu$ P
- 642XXS** Emulation Subsystem, 16-bit  $\mu$ P
- 64300A** Internal Logic Analyzer for Emulation Bus, 8-bit  $\mu$ P
- 64302A** Internal 48-Channel Logic Analyzer for Emulation Bus, 16-bit  $\mu$ P
- 645XXA** PROM Programmer (64100A)
- 64600S** Logic Timing/Hardware Analysis Subsystem, 8 channels
  - Opt 010** 16 channels
- 64620S** Logic State/Software Analysis Subsystem, 20 channels and overview
  - Opt 010** 40 channels
  - Opt 011** 60 channels and overview
  - Opt 012** 80 channels
  - Opt 013** 100 channels and overview
  - Opt 014** 120 channels
- 64650A** General Purpose Preprocessor
- 646XXA** Processor-Specific Interface Modules
- 648XXA** Pascal or C Compiler, 8-bit  $\mu$ P
- 648XXA** Pascal or C Compiler, 16-bit  $\mu$ P
- 648XXA** Assembler/Linker, 8-bit  $\mu$ P
- 648XXA** Assembler/Linker, 16-bit  $\mu$ P
- 64851A** User-Definable Assembler



# LOGIC ANALYZERS

## Simultaneous Time, State & Glitch Information

### Model 1615A

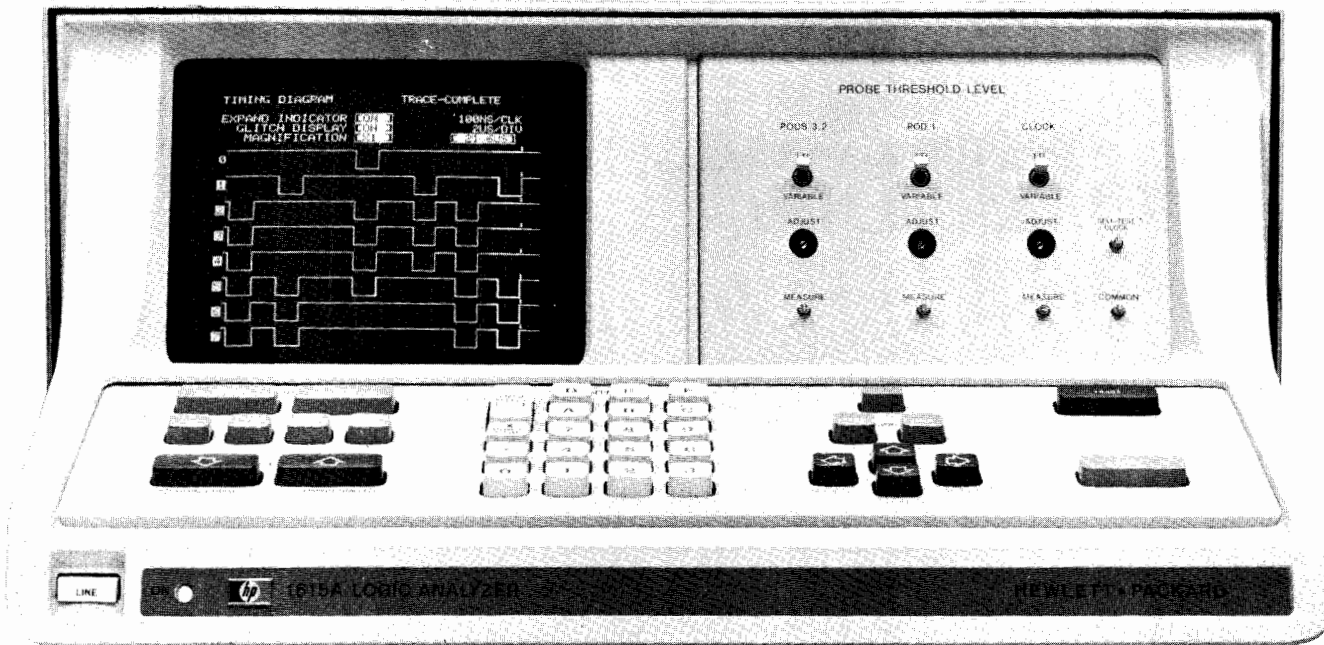

1615A



### 1615A Description

Hewlett-Packard's Model 1615A Logic Analyzer is two instruments in one, a timing analyzer and a state analyzer, for design and troubleshooting of digital systems. With Model 1615A, you can make timing measurements, state measurements, or both simultaneously. Using simple keyboard entries, the 1615A can be configured as an 8-bit timing analyzer, a combined 8-bit timing and 16-bit state analyzer, or 24-bit state analyzer, each with a memory 256 words deep. Powerful triggering capability, synchronous and asynchronous data capture modes, six clock qualifiers, and sophisticated delay functions assure that the timing and data information you need is collected.

The menu system simplifies measurement setups and eliminates the need for a complex, crowded keyboard. Mode of operation, state, time, or dual, is set with the Format Specification menu, and the test parameters are set with the Trace Specification menu. Each menu is an interactive display and parameters are either selected from a defined set or entered directly from the keyboard.

### Asynchronous Measurements

The 1615A makes asynchronous measurements in the time mode of operation. The trace point (trigger) may be placed at the beginning or end of the trace list, so you can view activity either preceding or following the trace point you specify. Either an external or internal clock may be selected. Up to three ORed trigger states can be entered, or using ON NOT as a trigger condition, any condition other than the one named will act as a trace point. NOT triggering is convenient for monitoring a status word for change, or, with a "don't care" trigger state in end mode, and an external clock, a system crash results in capture of the 256 events preceding the crash. A time or clock delay can be added to trigger conditions.

The 8-bit mode is truly asynchronous in pattern recognition. The pattern duration may be set from 15 to 2000 ns, and when a specified pattern exists for the duration selected, it will be registered by the analyzer even if it was not true when the clock occurred. This feature always produces positive triggering, even with narrow patterns or very slow clocks. Glitches are treated as separate parameters, stored in a separate memory, and displayed uniquely, even when they occur at data transitions. Glitches can be added to trigger conditions.

Tracing in the 8-bit mode produces an eight-line timing diagram. Short, vertical bars between the timing lines indicate the location of the trace point. A few quick keystrokes arrange the channels in any order you wish and channels not needed can be turned off. When the glitch display is turned on, glitches are shown as bright vertical bars or as brightened edges if they occur at a data transition. Any part of the display may be selected to be magnified by a factor of ten for a better display resolution. The expand indicator serves a dual purpose as it is also used to display readout of the time between any two selected points of the display.

### Simultaneous Timing and State Measurements

Model 1615A captures asynchronous and synchronous activity simultaneously. Consequently, timing information can be traced relative to the occurrence of a specific state, or state flow can be monitored relative to a specific timing condition. Now you can monitor those critical "ripple through" paths and relate activity directly to program execution, or watch activity on both sides of an asynchronous I/O port. The 1615A dual mode of operation is the 16-bit and 8-bit mode, selected on the Format menu. Four interactive modes are offered on the Trace Specifications menu: 8-Bit Triggers/Arms 16-Bit and 16-Bit Triggers/Arms 8-Bit.

### Synchronous Measurements

The quickest way to find faults in a state machine is monitoring program execution, because any malfunction in the machine is reflected by a corresponding deviation in program sequence. Model 1615A is a powerful state analyzer in the 24-bit mode of operation. The 24 lines may be grouped by up to three labels, and each label group is then treated as a separate variable. Logic polarity and numerical base (hexadecimal, decimal, octal, or binary) is assigned to each label set. The 24-bit trigger may be placed at the beginning or end of the 256-word trace list; any bits not required for the trigger word may be set to X for "don't care." Six clock qualifiers may be used and are set to 1, 0, or X from the keyboard in one or two ORed fields. Delays to 999 999 may be entered for number of states or number of trigger occurrences. The display is either a sequential list of monitored states or only trigger words.



## HP-IB Interface Bus for Measurement Systems Applications (Opt 001)

Hewlett-Packard Interface Bus (HP-IB) is HP's implementation of IEEE Standard 488-1978. An HP-IB configuration is available for Model 1615A on initial order as Option 001, or can be installed at a later date with Model 10069A HP-IB Interface Field Kit. With HP-IB, the 1615A can be configured for automatic functional testing of digital systems. Combined with a controller, such as HP Model 9825A, data captured by the logic analyzer can be transferred to the controller for automatic analysis. Hard copy of menus, data lists and timing diagrams can be produced by a variety of HP-IB compatible printers and plotters. In the laboratory, the speed and ease with which data is accumulated, summarized, and documented in hard copy lets you spend more time on analysis and design and less time in data collection. In production, automated testing reduces time and cost for making extensive tests on systems and subassemblies. Test programs with built-in operator instructions decrease testing costs even further by cutting training costs and providing uniform test procedures.

### 1615A Specifications

#### Operating Modes

**24 Bit (State):** for asynchronous monitoring of one or more buses with combined width up to 24 bits.

**8 Bit (Time):** for asynchronous monitoring of control line activity or any asynchronous data lines.

#### 16 Bit & 8 Bit (simultaneous State and Time)

**16 Bit Triggers 8 Bit:** 16-bit state trigger point is reference point for acquisition of 8-bit timing data.

**16 Bit Arms 8 Bit:** sequential trigger, 16-bit state trigger point initiates search for 8-bit timing trigger.

**8 Bit Triggers 16 Bit:** 8-bit timing trigger is reference point for acquisition of 16-bit state data.

**8 Bit Arms 16 Bit:** sequential trigger, 8-bit timing trigger point initiates search for 16-bit state trigger.

#### Clock, Qualifier, and Data Inputs

**Repetition rate:** to 20 MHz.

**Input RC:** 100 k $\Omega$  shunted by  $\leq 5$  pF at probe body.

**Input threshold:** TTL, fixed,  $\approx +1.4$  V; variable  $\pm 10$  Vdc.

**Maximum input:**  $-40$  V to  $+40$  V.

**Dynamic range:**  $-15$  V to  $+15$  V.

#### Minimum Input

**Swing:** 0.6 V

**Clock pulse width:** 20 ns at threshold level.

**Setup time:** data must be present 20 ns prior to clock transition.

**Hold time:** time data must be present after clock transition, zero.

#### Synchronous Operation

**Trigger delay:** to 999 999 clocks.

**Trigger occurrence:** to 999 999.

#### Asynchronous Operation

**Sample rate:** 2 Hz to 20 MHz.

**Data skew:** 9 ns max.

**Minimum detectable glitch:** 5 ns with 30% peak overdrive or 250 mV, whichever is greater.

**Glitch trigger:** on any selected channel(s), if a glitch is captured, the glitch is ANDed with the asynchronous pattern trigger.

**External trigger pulse width:** 5 ns min with 30% peak overdrive or 250 mV, whichever is greater.

**Pattern trigger:** any 8-bit pattern. Trigger duration required is selectable 15, 50, 100, 200, 500, 1000, or 2000 ns  $\pm 15$  ns or 15%, whichever is greater.

**Delay time:** to 1 048 575 x sample period.

#### Trigger Outputs (Rear Panel)

##### 16/24 Bit Trigger Output

**Level:** high,  $\geq 2$  V into 50 $\Omega$ ; low,  $\leq 0.4$  V into 50 $\Omega$ .

**Pulse duration:**  $\approx 25$  ns.

**Delay from input clock:**  $\approx 85$  ns.

##### 16/24 Bit Trace Point Output

**Level:** high,  $\geq 2$  V into 50 $\Omega$ ; low,  $\leq 0.4$  V into 50 $\Omega$ .

**Pulse duration:** starts at beginning of trace and ends at trigger point (pattern trigger plus delay).

**Delay from input clock:**  $\approx 85$  ns.

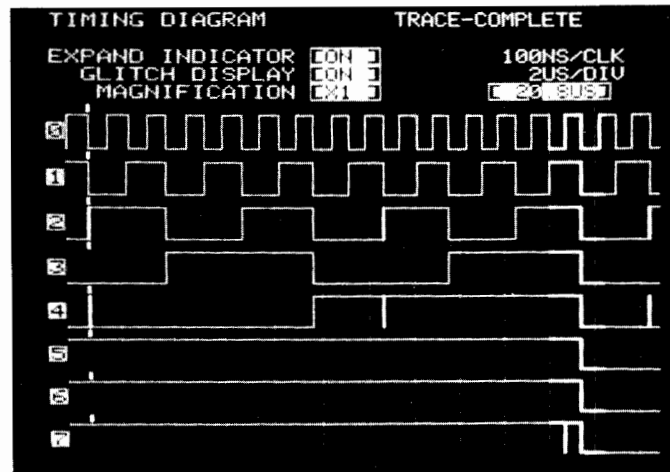

The 1615A displays timing information for up to eight lines and glitches which are displayed as vertical bars or brightened edges when they occur at a transition. A trigger point is indicated by a short vertical bar on each timing line, and is shown at the far left of this display. In addition, the sampling clock period and time per division are displayed.

#### 8 Bit Pattern Output

**Level:** high  $\geq 2$  V into 50 $\Omega$ ; low  $\leq 0.4$  V into 50 $\Omega$ .

**Pulse duration:** pattern duration minus asynchronous trigger duration width.

**Delay from pattern at probe:**  $\approx 75$  ns plus synchronous trigger duration width.

#### General

**Memory depth:** 256 data transactions (in timing display mode, 249 samples are displayed).

**Power:** 100, 120, 220, 240 Vac;  $-10\%$  to  $+5\%$ ; 48 to 66 Hz; 230 VA max.

**Size:** 189 H x 426 W x 664 cm D ( $7\frac{7}{16}$ " x  $16\frac{3}{4}$ " x  $26\frac{1}{8}$ ").

#### Operating Environment

**Temperature:**  $0^{\circ}\text{C}$  to  $+55^{\circ}\text{C}$ .

**Humidity:** up to 95% relative humidity at  $+40^{\circ}\text{C}$ .

**Altitude:** to 4600 m (15 000 ft).

**Vibration:** vibrated in three planes for 15 min. each with 0.3 mm (0.015 in.) excursions, 10 to 55 Hz.

**Weight:** net, 19.1 kg (42 lb); shipping, 23.6 kg (52 lb).

**Accessories supplied:** three 8-bit Model 10248C data probes and one Model 10248C clock probe with probe leads and tips (three probes for data and one probe for clock, qualifiers, and external trigger), one 2.3 m (7.5 ft) power cord, and one Operating and Service Manual.

#### Ordering Information

##### 1615A Logic Analyzer

**Opt 001:** HP-IB Interface

**Opt 002:** add 10277B Opt 001 GP Probe Interface

**Opt 003:** add 10275A UNIBUS Interface and 10277B Opt 001

**Opt 004:** add 10276A Q-Bus Interface and 10277B Opt 001

**Opt 005:** add 10278A HP 1000 M/E/F Series Interface and 10277B Opt 001

**Opt 006:** add 10279A NOVA 3 Interface and 10277B Opt 001

**Opt 007:** add 10280A microNOVA Interface and 10277B Opt 001

**Opt 008:** add 10285A HP 1000 L Series Interface and 10277B Opt 001

**Opt 009:** add 52126A Multibus Interface and 10277B Opt 001

**Opt 010:** add 10066A HP-IB Probe Interface

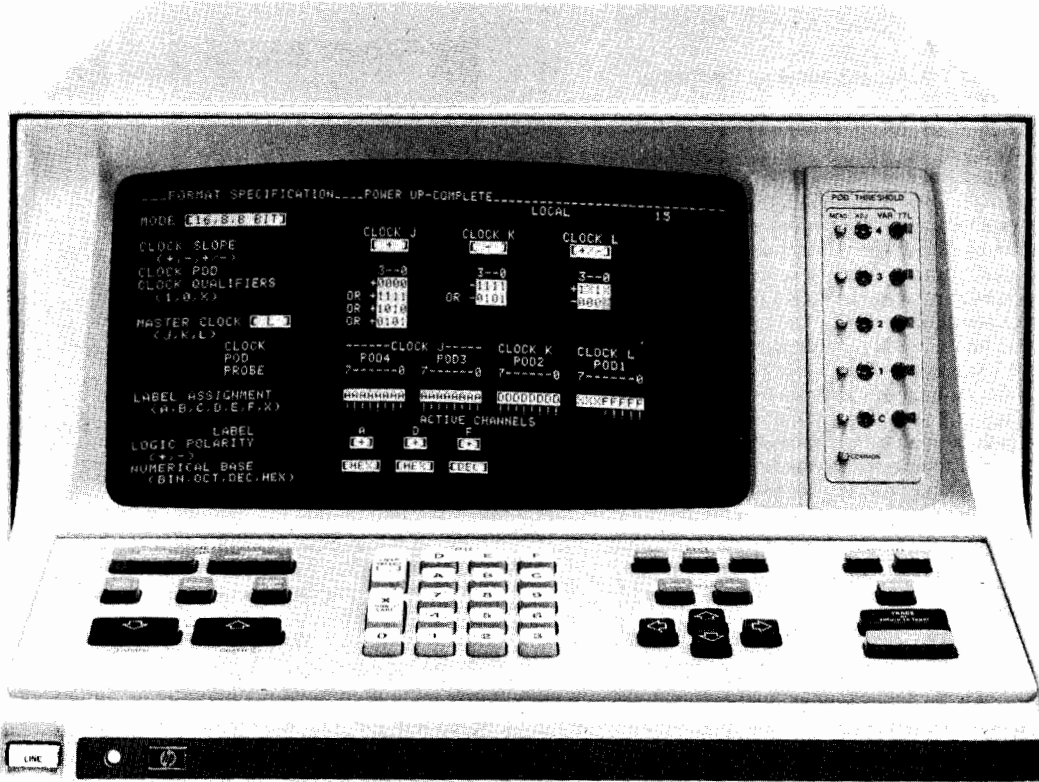

1610B



**1610B Description**

Model 1610B Software/Logic State Analyzer offers powerful software and state flow measurements in microprocessor-based systems, minicomputers, and general digital circuits. Nonintrusive and real-time analysis lets you realize major improvements in debugging, testing, and performance analysis activities.

The versatile 1610B analyzer is an effective measurement tool for a wide range of analysis problems in complex software environments.

- Software debugging to monitor
  - Control signals
  - Program data flow
- State flow testing to determine
  - Elapsed time and occurrence counts
  - Program statement, branch, and path execution
  - Input-output values
- Performance measurements to correct
  - System time and volume bottlenecks
  - Operating inefficiencies
- System bus flow measurements to observe
  - Functional timing relationships
  - Event sequences by time and occurrence
  - Sequential logic flow

**Flexible Feature Set**

Software and hardware engineers use the 1610B Software/Logic State Analyzer to gain a window on program flow at data rates up to 10 MHz. A selective view of synchronous data flow speeds analysis for shorter development time and quicker troubleshooting.

An interactive display with a menu format allows you to enter parameters for each measurement conveniently. There are 32 input channels, sufficient for 8-bit, 16-bit, or 32-bit processors. One or both edges of each of the three clocks, together with control line qualifiers,

are specified to define what state flow distinguishes a single event, in simple or multiplexed systems.

Flexible triggering is the key feature when tracing state flow that occurs deep in nested loops or complex branching routines. Up to seven words in sequence, each identified once or a specified number of times, can be selected to define the precise point at which monitoring is initiated. For a detailed analysis, a state by state trace list is used; for a general view of an area of program flow, the analyzer is set to sample every nth event or only events of a specific class or range. A graph of data by order of occurrence provides a quick overview of real-time system activity. Time and event counts can be included in any measurement, so you can run benchmark studies, time a program loop, or check the frequency of service interrupts.

**Performance Analysis**

Performance analysis aids you in making design evaluations, tradeoffs, and more efficient subroutines. You can make many evaluations using only the 1610B analyzer, but for more complex techniques and statistics, added computational power is gained by combining the 1610B with an external controller (e.g., an HP desktop computer) over the optional HP-IB interface. Histograms, Gantt charts, and linkage charts help you in finding bottlenecks and judging design alternatives. The analyzer-controller combination is also valuable for automatic operating modes, production tests, and maintenance. Printers, plotters, and additional memory are other enhancements for the 1610B logic analyzer that can be used.

**Minicomputer Interfaces**

Interfaces for minicomputers are available for seven minicomputer families. Refer to page 159. The interfaces make setup as simple as plugging in the analyzer probe pods, and provide active circuits to preprocess the computer signals for the analyzer or for your special analysis needs.

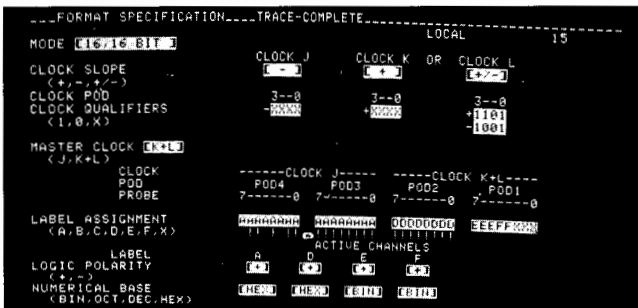

Model 1610B offers up to three clocks, used independently or in ORed combinations. For active clocks, either or both edges can be used and each clock can be qualified with up to four minterms.

SEQUENCE	A HEX	C BIN	B OCT	E DEC	TIME DEC
SEQUENCE	2987	000	205	1	
SEQUENCE	298E	000	206	1	1 009 S
SEQUENCE	29A5	000	206	1	08 00 MS
START	29A1	000	000	1	6 049 MS
+01	29A2	000	232	1	4 0 US
+02	29A3	000	000	1	2 0 US
+03	29A4	000	232	1	4 0 US
+04	29A5	000	002	1	2 0 US
+05	29A6	000	200	1	4 0 US
+06	29A7	000	002	1	2 0 US
+07	29A8	000	046	1	2 0 US
+08	29A9	000	004	1	2 0 US
+09	29AA	000	212	1	6 0 US
+10	29AB	000	000	1	0 0 US
+11	29AC	000	204	1	0 0 US
+12	29AD	000	002	1	0 0 US
+13	29AE	000	316	1	0 0 US
+14	29AF	000	000	1	0 0 US
+15	29B0	000	304	1	0 0 US
+16	29B1	000	010	1	2 0 US

Trace list displays the label and numerical bases, as well as the sequence requirements and resulting state flow. This example also shows time in the relative mode.

## 1610A and 1610B Specifications

### Clock and Data Inputs

**Repetition rate:** to 10 MHz.

**Input RC:** 100 k $\Omega$  shunted by approx 5 pF at probe body.

**Input threshold:** TTL, fixed at  $\approx +1.5$  V; variable,  $\pm 10$  Vdc.

**Max input:**  $-40$  V to  $+40$  V.

**Dynamic range:**  $-15$  V to  $+15$  V.

### Min Input

**Swing:** 0.6 V.

**Clock pulse width:** 20 ns at threshold level.

**Edge-to-edge timing:** master active edge to master active edge, 100 ns; master active edge to next slave active edge, 20 ns; slave active edge to slave active edge, zero.

**Data setup time:** time data must be present prior to clock transition, 20 ns.

**Hold time:** time data must be present after clock transition, zero.

### Trigger and Meas Enable Outputs

**Trigger output (rear panel):** a 50 ns  $\pm$  10 ns positive TTL level trigger pulse is generated each time the trace position is recognized. If the trace position includes a word sequence, the pulse occurs when the last word is found. Trigger outputs continue until a new specification is traced or the Stop key is pressed. Pulse rep-rate is 0 to 10 MHz depending on input data rates. In continuous or compared trace modes, the internal display process blanks out pulses for 100  $\mu$ s at rep-rates of  $< 20$  Hz.

**Measurement enable output (rear panel):** Two BNC rear panel outputs for TTL-level measurement enable. One BNC outputs a signal which goes high and remains high when the analyzer is looking for a trace position and goes low when a trace position is recognized or Stop key is pressed. Other BNC goes low and remains low when the analyzer is looking for a trace position and goes high when a trace position is recognized or Stop key is pressed.

**Delay from input clock:**  $\leq 150$  ns.

### General

**Memory depth:** 64 data transactions; 20 transactions are displayed on screen, roll keys permit viewing all 64 data transactions.

**Time interval:** resolution, 100 ns; accuracy, 0.01%. Maximum time, 429.4 seconds.

**Events count:** 0 to  $2^{32}$  - 1 events.

**Power:** 100, 120, 220, 240 Vac;  $-10\%$  to  $+5\%$ ; 48 to 63 Hz; 260 VA max.

**Rear panel BNC output:** 5 V, 100 mA output for logic probe or other accessories.

**Size:** 230 H x 425 W x 752 mm D (9 $\frac{1}{16}$ " x 16 $\frac{3}{4}$ " x 29 $\frac{5}{8}$ ").



When the HP-IB Interface is used with a controller, data collected by the analyzer are transferred to the controller. In this example, the controller counts the events in each address range, and displays the results as a histogram on the 1610 CRT.

### Operating Environment

**Temperature:**  $0^{\circ}\text{C}$  to  $+55^{\circ}\text{C}$  ( $+32^{\circ}\text{F}$  to  $+132^{\circ}\text{F}$ ).

**Humidity:** up to 95% relative humidity at  $+40^{\circ}\text{C}$  ( $+104^{\circ}\text{F}$ )

**Altitude:** to 4600 m (15 000 ft).

**Vibration:** vibrated in three planes for 15 min. each with 0.25 mm (0.010 in.) excursions.

**Weight:** net, 23.8 kg (52.5 lb); shipping, 29.4 kg (65 lb).

**Accessories supplied:** five 10248C data probes; one 2.3 m (7.5 ft) power cord, one Operating manual, and one Service manual.

### Ordering Information

**1610B Logic State Analyzer**

**Opt 003:** HP-IB Interface

**Opt 004:** adds 9876A Thermal Printer

**Opt 005:** adds 10277A/B Opt 001 GP Probe Interface

**Opt 006:** adds 10275A UNIBUS Interface and 10277A/B Opt 001

**Opt 007:** adds 10276A-Q-Bus Interface and 10277A/B Opt 001

**Opt 008:** adds 10278A HP 1000 M/E/F Series Interface and 10277A/B Opt 001

**Opt 009:** adds 10279A NOVA 3 Interface and 10277A/B Opt 001

**Opt 010:** adds 10280A microNOVA Interface and 10277A/B Opt 001

**Opt 011:** adds 10285A HP 1000 L Series Interface and 10277A/B Opt 001

**Opt 012:** adds 52126A Multibus Interface and 10277A/B Opt 001

**Opt 015:** adds 10066A HP-IB Probe Interface

**10496A HP-IB Interface Kit**



# LOGIC ANALYZERS

## Analysis of Microprocessor Based Systems

Model 1611A

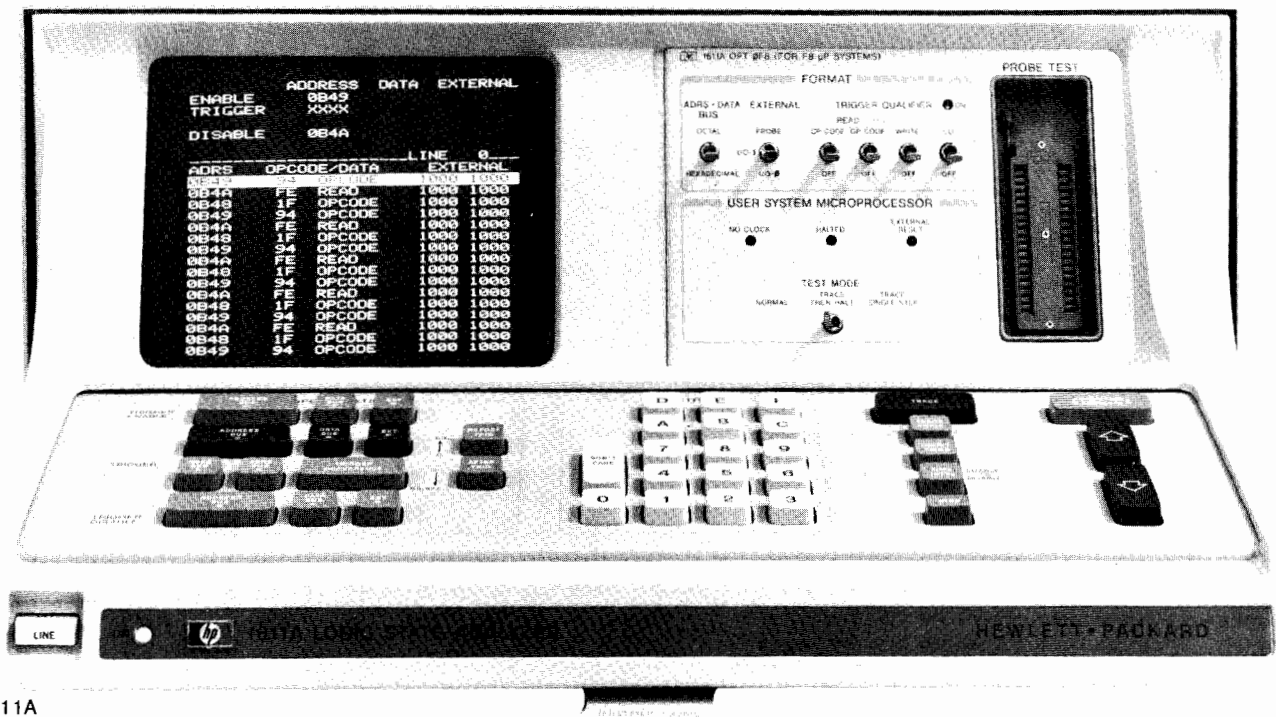

1611A

### 1611A Description

Hewlett-Packard's Model 1611A Logic State Analyzer quickly locates those elusive software and hardware problems in microprocessor systems. This stand-alone logic state analyzer saves time in design and troubleshooting for earlier operation, shorter down time for maintenance, and lower development and production costs. There are now nine personality modules available for the 1611A; eight of the personality modules can perform a complete inverse assembly of code from buses of eight major processor families, while the ninth personality module is a general purpose module. Programs are debugged on operating hardware with real-time viewing of the system's actual operation for analysis. Extensive triggering capability allows you to capture 64 pertinent transactions on data and address buses as well as external lines. Model 1611A is passive to the system under test, adding small capacitance and drawing only a small amount of current. Data entry may be hexadecimal or octal base, with binary base for control lines.

The keyboard is divided into four functional areas, data registration, entry, execute, and display. Specific events in program execution can be pinpointed with the ability to trigger on address, data, external signals, or any combination of the three. A direct readout of elapsed time or number of events between specified states, as well as minimum and maximum times or counts, can be obtained. Selective triggering is further refined by range triggering, selective store, sequential triggering and trace triggers. In effect, you "edit" the data, collecting only the transactions needed for analysis. Model 1611A performs a self-test during turn-on and displays the results.

### Dedicated Personality Modules

The eight dedicated personality modules reduce setup time as input parameters are already matched to proper trigger levels and clock slopes of the microprocessor. Connection to the system is quick and easy with a "clothespin" clip, or the 40-pin connectors for address and data and eight auxiliary leads with individual miniature probes for related control lines. You can view microprocessor transactions in mnemonic language or absolute code on the 32-bit wide display. Halting or single-stepping the microprocessor is possible with any of the dedicated personality modules.

### General Purpose Personality Module

Using the general purpose personality module makes the 1611A a conventional logic state analyzer for microprocessors. All but the device-specific capabilities of the dedicated modules are retained, and you can monitor virtually any microprocessor which has accessible test points. With a display up to 36 bits wide, you can observe activity on several buses simultaneously on 8-bit or 16-bit microprocessors. Seven clocks allow multiplexed information to be latched into the 1611A at the appropriate time for display. The listing is displayed in absolute code in hexadecimal or octal for address and data buses, and in same base or binary for the external and auxiliary lines. Connection to the system under test is universal, with two pods, individual leads, and miniature probes for all inputs.

ADDRESS		DATA	EXTERNAL	
TRIGGER		000F		
PRE-TRIGR=7				
-----LINE 0-----				
ADRS	OPCODE/DATA	EXTERNAL		
0009	LD C,B	0000	0000	
000A	LD L,00	0000	0000	
000C	LD H,D	0000	0000	
000D	LD A,<HL>	0000	0000	
0400	00 READ	0000	0000	
000E	LD H,B	0000	0000	
000F	LD <HL>,A	0000	0000	
3400	00 WRITE	0000	0000	
0010	INC L	0000	0000	
0011	JP NZ,000C	0000	0000	
000C	LD H,D	0000	0000	
000D	LD A,<HL>	0000	0000	
0401	31 READ	0000	0000	
000E	LD H,B	0000	0000	
000F	LD <HL>,A	0000	0000	
3401	31 WRITE	0000	0000	

Inverse assembly of the data on the data buses is possible with the eight dedicated personality modules. This mnemonic display is in the familiar assembler format for easy interpretation.



ENABLE TRIGGER	ADDRESS	DATA	EXTERNAL
	29C3	XXXX	
DISABLE	29B6		

---

ADRS	OPCODE/DATA	EXTERNAL

TIME =	98 MICROSECONDS
MAX =	280 MICROSECONDS
MIN =	90 MICROSECONDS

The time interval mode and the ability to select enable and disable trigger conditions allows direct measurements of execution time in loops, subroutines, and responses to interrupts. The 1611A can record the time for one measurement or provide the minimum and maximum values along with the last measurement from repeated measurements.

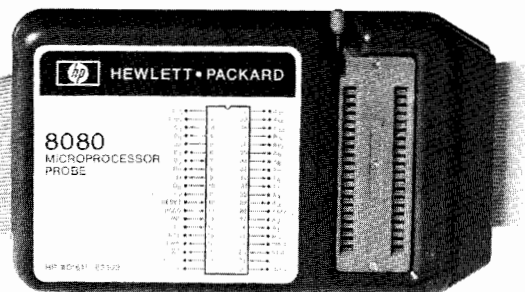

Connection with dedicated personality probes is with a 40-pin dual in-line package clip or the microprocessor may be relocated to the probe body and the probe connected to the system with a 40-pin connector.

### Configuration

The flexibility and convenience of Model 1611A are a function of the nine personality modules. On initial order, the 1611A is fitted with the module of your choice. Subsequently, to change the configuration, a new personality module can be installed on site in about 15 minutes. Each module consists of two or three printed circuit boards, an insert for the front panel, and the accompanying microprocessor probe. Dedicated personality modules are available for eight microprocessor types: 6800, 6809, 8080, F8, Z80, 6502, 1802, and 8085. The general purpose personality module features flexibility, and can be used to troubleshoot most microprocessors manufactured now or in the foreseeable future.

### Option 001 (General Purpose Personality Module)

**Note:** Model 10264A personality module may be ordered separately for installation in a 1611A to provide Option 001 capability.

#### Inputs

**Input current:** 200  $\mu$ A, logic 0 (low);  $\approx$  20  $\mu$ A logic 1 (high).

**Threshold:** 2 V min, logic 1 (high); 0.7 V max, logic 0 (low). All inputs have hysteresis.

**Input capacitance:**  $\approx$  20 pF.

#### Clock

**Clock rate:** dc to 2.8 MHz max (2.2 MHz max if installed in a 1611A with serial number prefix of 1723A or below). Min pulse width is 30 ns. No clock should occur until at least 100 ns after the master clock. The NO CLOCK indicator lights if the period between clocks exceeds 4 ms.

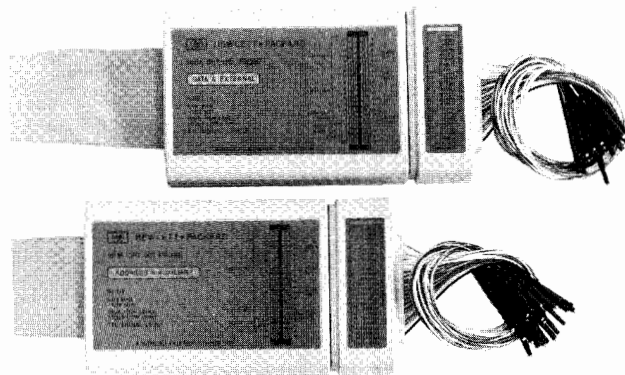

External probes used with the general purpose personality module can obtain signals from up to 36 test points, whether the lines are dedicated or multiplexed.

### Setup and Hold Times

**Setup time:** 80 ns relative to specified clock edge.

**Hold time:** zero.

### Option A68 (6800 Microprocessors)

**Note:** Model 10257B personality module may be ordered separately for installation in a 1611A to provide Opt A68 capability.

#### Microprocessor Compatibility

**Motorola:** 6800, 68A00, 68B00, 6802.

**AMI:** 6800.

**Note:** The 1611A Opt A68 is compatible with any microprocessor that meets specifications of the Motorola 6800.

#### Clock and Data Inputs

**Clock rate:** 70 kHz to 2.0 MHz; (70 kHz to 1.66 MHz with 10257B installed in 1611A with serial number prefix below 1723A).

#### Input Loading

**A<sub>0</sub>-A<sub>15</sub>, R/W, VMA:**  $\approx$  1 M $\Omega$  shunted by  $\approx$  40 pF, including capacitance of 30.4 cm (12") cable;  $\approx$  30 pF with 7.6 cm (3") cable.

**D<sub>0</sub>-D<sub>7</sub>, BA:** 20  $\mu$ A max with  $V_{in} = 2.7$  V; -0.2 mA max with  $V_{in} = 0.4$  V.

**HALT:** 120  $\mu$ A max with  $V_{in} = 2.7$  V; -0.2 mA max with  $V_{in} = 0.4$  V.

**$\Phi$ 2:** 0.2 mA max with  $V_{in} = 5$  V; -0.4 mA max with  $V_{in} = 0.4$  V.

**Threshold:** 2.4 V to 5.5 V, logic 1 (high); -0.8 V to 0.8 V, logic 0 (low).

**Halt output:** TTL open-collector compatible output capable of sinking at least 8 mA when active.

### Option A09 (6809 Microprocessors)

**Note:** Model 10266A personality module may be ordered separately for installation in a 1611A to provide Opt A09 capability.

#### Microprocessor Compatibility

**Motorola:** MC6809, MC6809E, MC68A09, MC68A09E, MC68B09, MC68B09E.

**Note:** The 1611A Opt A09 is compatible with any microprocessor that meets specifications of the Motorola 6809.

#### Clock and Data Inputs

**Clock rate:** 80 kHz to 2 MHz (70 kHz to 1.66 MHz with 10266A installed in 1611A with serial number prefix below 1723A).

#### Input loading

**A<sub>0</sub>-A<sub>15</sub>, R/W:**  $\approx$  1 M $\Omega$  shunted by  $\approx$  40 pF including capacitance of 30.4 cm (12") cable;  $\approx$  30 pF with 7.6 cm (3") cable.

**D<sub>0</sub>-D<sub>7</sub>, BA, BS:** 20  $\mu$ A max with  $V_{in} = 2.7$  V; -0.2 mA max with  $V_{in} = 0.4$  V.

**HALT:** 120  $\mu$ A max with  $V_{in} = 2.7$  V; -0.2 mA max with  $V_{in} = 0.4$  V.

**E-Clock:** 0.2 mA max with  $V_{in} = 5$  V; -0.4 mA max with  $V_{in} = 0.4$  V.

**Threshold:** 2.4 V to 5.5 V, logic 1 (high); -0.8 V to 0.8 V, logic 0 (low).



### Option A80 (8080 Microprocessors)

**Note:** Model 10258B personality module may be ordered separately for installation in a 1611A to provide Opt A80 capability.

#### Microprocessor Compatibility

**Intel:** 8080, 8080A, 8080A-1, 8080A-2.

**AMD:** 9080A, 9080A-1, 9080A-2, 9080A-4.

**NEC:**  $\mu$ PD8080,  $\mu$ PD8080A-E.

**TI:** TMS8080, TMS8080A.

**National:** INS8080A.

**Note:** The 1611A Opt A80 is compatible with any microprocessor that meets specifications of the Intel 8080A.

#### Clock ( $\Phi$ 2 only)

**Repetition rate:** 300 kHz to 4 MHz.

**Width:** 75 ns min for either high or low state.

**Input resistance:**  $\approx$  12 k $\Omega$ .

**Input capacitance:**  $\approx$  25 pF, includes capacitance of 30.5 cm (12") cable,  $\approx$  15 pF with 7.6 cm (3") cable.

**Threshold:** 9 to 13 V, logic 1 (high); -1 to 0.8 V, logic 0 (low).

#### Data, Address, Wait, Ready, HLDA, INTE, SYNC

**Input resistance:**  $\approx$  1 M $\Omega$ .

**Input capacitance:**  $\approx$  25 pF, includes capacitance of 30.5 cm (12") cable,  $\approx$  15 pF with 7.6 cm (3") cable.

**Threshold:** 3 V to 6 V, logic 1 (high); -1 to 0.8 V, logic 0 (low).

**Ready output:** TTL open-collector compatible output capable of sinking at least 8 mA when active.

### Option A85 (8085 Microprocessors)

**Note:** Model 10263A personality module may be ordered separately for installation in a 1611A to provide Option A85 capability.

#### Microprocessor Compatibility

**Intel:** 8085, 8085A, 8085A-2.

**AMD:** AM9085.

**Siemens:** 8085.

**NEC:**  $\mu$ PD8085.

**Note:** The 1611A Opt A85 is compatible with any microprocessor that meets specifications of the Intel 8085.

#### Clock, Data, Address, Status, and Control Inputs

**Clock rate:** 300 kHz to 5 MHz.

**Threshold:** 2 V to 5.5 V, logic 1 (high); -0.5 V to 0.8 V logic 0 (low).

#### Input Current

**Clock and Control:**  $\approx$  50  $\mu$ A max with  $V_{in} = 2.7$  V; -0.4 mA max with  $V_{in} = 0.5$  V.

**Data, Address, and Status:**  $\approx$  20  $\mu$ A max with  $V_{in} = 2.7$  V; -0.2 mA max with  $V_{in} = 0.4$  V.

**Input capacitance:**  $\approx$  25 pF including capacitance of 30.5 cm (12") cable;  $\approx$  15 pF with 7.6 cm (3") cable.

**Ready output:** TTL compatible open-collector output capable of sinking at least 8 mA when active.

### Option 0F8 (F8 Microprocessors)

**Note:** Model 10259A personality module may be ordered separately for installation in a 1611A to provide Option 0F8 capability.

#### Microprocessor Compatibility

**Fairchild:** F8 (3850).

**Mostek:** F8 (3850).

**Note:** The 1611A Opt 0F8 is compatible with any microprocessor that meets specifications of the Fairchild F8.

#### Clock and Write

**Clock rate:** 100 kHz to 2 MHz.

**Width:** 180 ns min for either high or low state.

**Input current:**  $\approx$  50  $\mu$ A, logic 0 (low) and logic 1 (high).

1611A OPT 001 (FOR 8 OR 16 BIT PROCESSOR SYSTEMS)

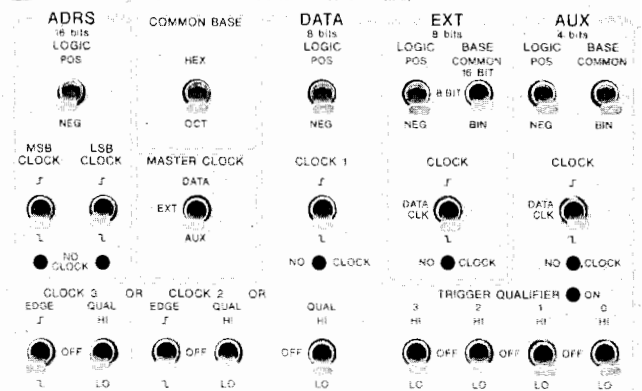

Opt 001 General Purpose Personality Module

**Input capacitance:**  $\approx$  25 pF, includes capacitance of 30.4 cm (12") cable;  $\approx$  15 pF with 7.6 cm (3") cable.

**Threshold:** 2.4 V to 5.5 V, logic 1 (high); -0.8 to 0.8 V, logic 0 (low).

**Write period:** either 4 or 6 times the clock period.

**Write pulse width:** max = clock period, min = clock period - 100 ns.

#### ROMC

**Input current:**  $\approx$  22  $\mu$ A, logic 0 (low);  $\approx$  40  $\mu$ A, logic 1 (high).

**Input capacitance:**  $\approx$  25 pF, includes capacitance of 30.4 cm (12") cable;  $\approx$  15 pF with 7.6 cm (3") cable.

**Threshold:** 2 V min, logic 1 (high); 0.7 V max, logic 0 (low).

#### Data, I/O0, I/O1, EXT RES

**Input current:**  $\approx$  200  $\mu$ A, logic 0 (low);  $\approx$  20  $\mu$ A, logic 1 (high).

**Input capacitance:**  $\approx$  25 pF, includes capacitance of 30.4 cm (12") cable;  $\approx$  15 pF with 7.6 cm (3") cable.

**Threshold:** 2 V min, logic 1 (high); 0.7 V max, logic 0 (low).

#### Halting

The F8 CPU must be placed in the 1611A Probe socket to halt or single-step the F8 microprocessor.

### Option Z80 (Z80 Microprocessors)

**Note:** Model 10260A personality module may be ordered separately for installation in a 1611A to provide Option Z80 capability.

#### Microprocessor Compatibility

**Zilog:** Z80, Z80A.

**Mostek:** 3880 (Z80), 3880N-4 (Z80A).

**Note:** The 1611A Opt Z80 is compatible with any microprocessor that meets specifications of the Zilog Z80.

#### Clock, Data, Address, and Control Inputs

**Clock rate:** 500 kHz to 4 MHz.

**Input current:**  $\approx$  200  $\mu$ A, logic 0 (low);  $\approx$  20  $\mu$ A, logic 1 (high).

**Input capacitance:**  $\approx$  25 pF, includes capacitance of 30.4 cm (12") cable;  $\approx$  15 pF with 7.6 cm (3") cable.

**Threshold:** 2 V min, logic 1 (high); 0.7 V max, logic 0 (low).

**Wait output:** TTL open-collector compatible output capable of sinking at least 8 mA when active.

### Option A65 (6502 Microprocessors)

**Note:** Model 10261A personality module may be ordered separately for installation in a 1611A to provide Option A65 capability.

#### Microprocessor Compatibility

**MOS Technology:** MCS6502, MCS6502A.

**Rockwell:** R6502, R6502A, R6512, R6512A.

**Synertek:** SY6502.

**Note:** The 1611A Opt A65 is compatible with any microprocessor that meets specifications of the MOS Technology MCS6502.

1611A OPT A80 (FOR 8080  $\mu$ P SYSTEMS)

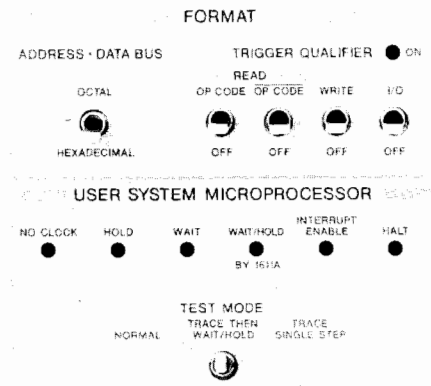

PROBE TEST

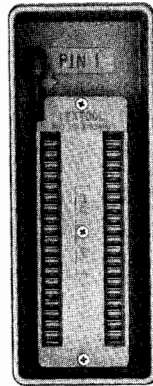

Opt A80 8080 $\mu$ P Personality Module

### Clock and Data Inputs

**Clock rate:** 70 kHz to 2 MHz.

### Input Loading

**A0-A15, R/W, Sync:**  $\approx 1\text{ M}\Omega$  shunted by  $\approx 40\text{ pF}$ , including capacitance of 30.4 cm (12") connecting cable,  $\approx 30\text{ pF}$  with 2.6 cm (3") cable.

**D0 - D7:** 20  $\mu\text{A}$  max with  $V_{in} = 2.7\text{ V}$ ;  $-0.2\text{ mA}$  max with  $V_{in} = 0.4\text{ V}$ .

**Rdy:** 120  $\mu\text{A}$  max with  $V_{in} = 2.7\text{ V}$ ;  $-0.2\text{ mA}$  max with  $V_{in} = -0.4\text{ V}$ .

$\Phi 2$ : 0.2 mA max with  $V_{in} = 5\text{ V}$ ;  $-0.4\text{ mA}$  max with  $V_{in} = 0.4\text{ V}$ .

**Threshold:** 2.4 to 5.5 V, logic 1 (high);  $-0.8\text{ V}$  to 0.8 V logic 0 (low).

**RDY output:** TTL compatible open collector output capable of sinking at least 8 mA when active.

### Option A18 (1802 Microprocessors)

**Note:** Model 10262A personality module may be ordered separately for installation in a 1611A to provide Option A18 capability.

### Microprocessor Compatibility

**RCA<sup>®</sup>:** CDP1802D, CDP1802CD. Example of RCA acceptable operating conditions at  $+25^\circ\text{C}$  with a shunt capacitance of 50 pF are:

$V_{cc}$	$V_{dd}$	CLOCK SPEED
5	5	2 MHz
5	10	4 MHz
10	10	5 MHz

**Note:** The 1611A Opt A18 is compatible with any microprocessor that is functionally identical to the RCA 1802. Microprocessor operating conditions (clock rate, supply voltages and signal timing) must be compatible with the 10262A setup and hold specifications.

<sup>®</sup>Registered Trade Mark RCA Corp.

### Clock and Data Inputs

**Input loading, MA 0—MA 7, Bus 0—Bus 7, TPA, TPB, XTAL, SCO, SC1, MRD, MWR, NO, N1, N2, WAIT, CLEAR:**  $\approx 32\text{ k}\Omega$  shunted by  $\approx 25\text{ pF}$  including the capacitance of a 30.5 cm (12") cable or  $\approx 15\text{ pF}$  with a 7.6 cm (3") cable.

**Threshold:** automatically adjusted internally to  $\approx V_{DD}/2$ .

**Wait output:** series current limit. Open collector output series with current limited to 10 mA.

**Waiting:** with the Test Mode Switch in TRACE THEN WAIT or TRACE SINGLE STEP with the CPU in the 1611A probe socket, the 1611A will cause the CPU to wait. If the CPU is not in the probe socket, waiting cannot be guaranteed.

## 1611A Specifications

### General

#### External Probe Inputs

**Current:**  $\approx 50\text{ }\mu\text{A}$  logic 0 or logic 1

**Capacitance:**  $\approx 25\text{ pF}$  at probe tip.

**Threshold:** 2.4 V to 5.5 V logic 1 (high);  $-0.8$  to 0.8 V logic 0 (low).

**Hold time:** zero, relative to appropriate strobe edge.

#### Outputs

**Low:**  $< 0.4\text{ V}$  into 50  $\Omega$ .

**High:**  $> 2.0\text{ V}$  into 50  $\Omega$  (nominally 3.9 V into an open circuit).

**Trigger:** duration  $\approx 75\text{ ns}$  in RZ format; delay  $\approx 350$  to 400 ns after the appropriate strobe edge during the cycle that defines a valid trigger.

**Trace Point ( ):** provides a positive edge  $\approx 350$  to 400 ns after the appropriate strobe edge during the cycle that defines the specific valid trigger to be displayed on the 1611A. If the 1611A Delay is set so that the trigger word is not displayed, Trace Point output occurs for the cycle that defines the valid word immediately preceding the first displayed word.

**Trace Point ( ):** complement of Trace Point ( ).

**Memory depth:** 64 data transactions; 16 transactions are displayed at one time, roll keys permit viewing of all 64 transactions.

**Time interval:** accuracy,  $0.1\% \pm 1\text{ }\mu\text{s}$ . Max time,  $(2^{24}-1)\text{ }\mu\text{s}$  (16.7 s).

**Events count:**  $2^{24}-1$  events (16.7 million) max.

**Logic probe output power:** 5 V dc at 0.1 A max.

**Power:** 100, 120, 220, 240 V ac;  $-10\%$   $+5\%$ ; 48 to 440 Hz; 120 VA max.

**Size:** 189 H x 426 W x 572 mm D (7  $\frac{7}{16}$ " x 16  $\frac{3}{4}$ " x 22  $\frac{1}{2}$ ").

**Operating environment:** temperature,  $0^\circ\text{C}$  to  $+55^\circ\text{C}$  ( $+32^\circ\text{F}$  to  $132^\circ\text{F}$ ); humidity, to 95% relative humidity at  $+40^\circ\text{C}$  ( $+104^\circ\text{F}$ ); altitude to 4600 m (15 000 ft); vibrated in three planes for 15 min. each with 0.38 mm (0.015 in.) excursions, 10 to 55 Hz.

**Weight:** net, 15 kg (33 lb); shipping, 19.5 kg (43 lb).

### Accessories Supplied

**With 1611A:** external 8-bit probe; one 2.3 m (7.5 ft) power cord; and one Operating and Service Manual.

**With Dedicated Module:** one 40-pin clip with 30.5 cm (12") cable; one 40-pin male socket with 30.5 cm (12") cable; and one 40-pin male socket with 7.6 cm (3") cable.

**With General Purpose Module:** two universal probes with individual leads, and miniature probe tips for each input.

### Ordering Information

**1611A Opt 001** Logic State Analyzer, General Purpose

**1611A Opt 002** adds Model 10277D GP Probe

Interface; order with 1611A Opt 001 only

**1611A Opt A68** Logic State Analyzer for 6800  $\mu\text{P}$

**1611A Opt A09** Logic State Analyzer for 6809  $\mu\text{P}$

**1611A Opt A80** Logic State Analyzer for 8080  $\mu\text{P}$

**1611A Opt A85** Logic State Analyzer for 8085  $\mu\text{P}$

**1611A Opt 0F8** Logic State Analyzer for F8  $\mu\text{P}$

**1611A Opt Z80** Logic State Analyzer for Z80  $\mu\text{P}$

**1611A Opt A65** Logic State Analyzer for 6502  $\mu\text{P}$

**1611A Opt A18** Logic State Analyzer for 1802  $\mu\text{P}$

### Personality Modules for Field Installation

**10257B** for 6800  $\mu\text{P}$

**10258B** for 8080  $\mu\text{P}$

**10259A** for F8  $\mu\text{P}$

**10260A** for Z80  $\mu\text{P}$

**10261A** for 6502  $\mu\text{P}$

**10262A** for 1802  $\mu\text{P}$

**10263A** for 8085  $\mu\text{P}$

**10264A** General Purpose

**10266A** for 6809  $\mu\text{P}$



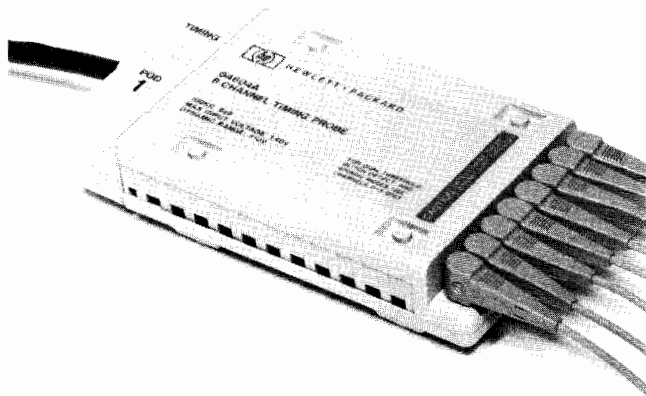

64604A 8-Channel Timing Probe

### Development System Probes, Cables, and Interfaces

Model 64000 Logic Development System probes, cables, and interfaces feature flexibility and ease of use. Connections to a system under test may be as simple as plugging probe pods into the General Purpose Preprocessor with any processor-specific interface module installed, and plugging the interface probe directly onto the target processor. Cables within and between subsystems snap on top of the cards that comprise the subsystem(s).

Alternatively, the individual input lines of the analyzers can be attached with separated leads to check peripheral buses, wire-wrap boards, or proprietary microprocessors.

### Hardware and Software Analyzer Probes

One probe pod is used with each 8-channel data acquisition board of Model 64600S Logic Timing/Hardware Analyzer. Each data probe pod for Model 64620S Logic State/Software Analyzer has 20 input channels; the clock probe pod accommodates up to eight clock and/or qualifier lines.

### Model 64604A 8-Channel Timing Probe

Input of the timing analyzer probes consists of a compensated R-C network that provides a low input capacitance required for high-frequency probing. Each of the eight probe leads snaps on the pod body. Miniprobe tips also accept pincer tips, ground leads, IC test clips, or a variety of accessories available for oscilloscope probes. (Refer to pages 204 to 212.)

**Input RC:** 100 k $\Omega$   $\pm$  2% shunted by < 6 pF.

**Dynamic range:**  $\pm$  10 V.

**Maximum input:**  $\pm$  40 V.

**Threshold accuracy:**  $\pm$  50 mV or  $\pm$  2%, whichever is greater.

**Hysteresis:**  $\approx$  50 mV.

#### Drive requirements

**Minimum input amplitude:** 600 mV, p-p.

**Minimum input overdrive:** 20 mV or 25% of input amplitude, whichever is greater.

**Minimum pulse width:** 3 ns at threshold.

### Model 64635A 20-Channel Data Probe

Logic state/software analyzer probes adapt to a variety of applications. Connections may be by individual leads or a standard 25-pin connector. There are 20 input channels for each Model 64635A Data Probe.

**Input RC:** 100 k $\Omega$  shunted by < 14 pF at probe lead tips.

**Dynamic range:** threshold  $\pm$  10 V.

**Maximum input:**  $\pm$  40 V.

**Threshold adjustment:** preset for TTL and ECL logic families or set in 0.1 V increments.

**Data setup time:** minimum 30 ns prior to active clock edge.

**Data hold time:** zero.

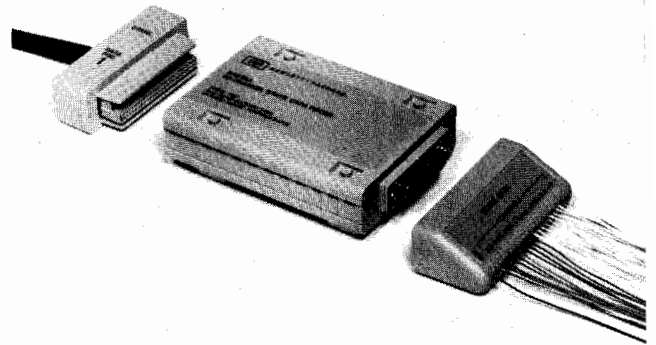

64635A 20-Channel State Data Probe

### Model 64636A 8-Channel Clock Probe

Model 64636A clock Probe for the logic state/software analyzer has eight input lines for edge-sensitive clocks and/or edge-sensitive qualifiers. Up to eight inputs can be logically ORed and ANDed with levels to define valid data states.

**Input RC:** 100 k $\Omega$  shunted by < 10 pF at probe lead tips.

**Dynamic range:** threshold  $\pm$  10 V.

**Maximum input:**  $\pm$  40 V.

**Threshold adjustment:** preset for TTL and ECL families or set in 0.1 V increments.

#### Clock rate

**Unqualified pulse rate:** 25 MHz max.

**Qualified data strobe:** 10 MHz max.

**Clock pulse width:** 20 ns min.

**Clock qualifier setup time:** 20 ns min prior to active clock edge.

**Clock qualifier hold time:** zero.

### Subsystem Cables

There are three types of cables for the logic analysis subsystems of the 64000 Logic Development System. Model 64963A Timing Analysis Bus Cable is available as a 2-position cable for an 8-channel timing analysis subsystem and a 3-position cable for a 16-channel analysis subsystem. For the state analysis subsystem, Model 64962A State Analysis Bus Cable with 2-position, 3-position, or 4-position cable is used. The Intermodule Bus (IMB) cable, Model 64964A, links analysis and/or emulation subsystems installed in the same development station for powerful, interactive applications.

### Control and Data Acquisition Cards

When reconfiguring a development station for new applications, additional control cards or data acquisition cards may be required. Basis for a timing analysis subsystem is Model 64601A Timing Analysis Card and one or two Model 64602A 8-channel timing cards. A state analysis subsystem contains one Model 64621A State Analysis Control Card and up to three data acquisition cards: Model 64622A 40-channel data Acquisition Card and Model 64623A 20-Channel Data Acquisition Card. The overview function is available only on the 20-channel Model 64623A card. Refer to power requirement tables when installing new logic analysis subsystems to assure that the subsystems may be accommodated by the development station used.

### Ordering Information

**64601A** Timing Analysis Control Card

**64602A** 8-Channel Timing Card

**64604A** 8-Channel Timing Probe

**64621A** State Analysis Control Card

**64622A** State Analysis 40-Channel Data Acquisition Card

**64623A** State Analysis 20-Channel Data Acquisition Card with Overview

**64635A** State Analysis 20-Channel Data Probe

**64636A** State Analysis 8-Channel Clock Probe

**64962A** State Analysis Bus Cable, 2 position

**64963A** Timing Analysis Bus Cable, 2 position

**64964A** Intermodule Bus Cable, 2 position

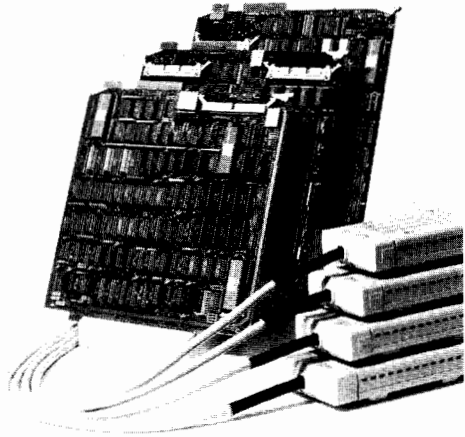

64620S Software Analyzer

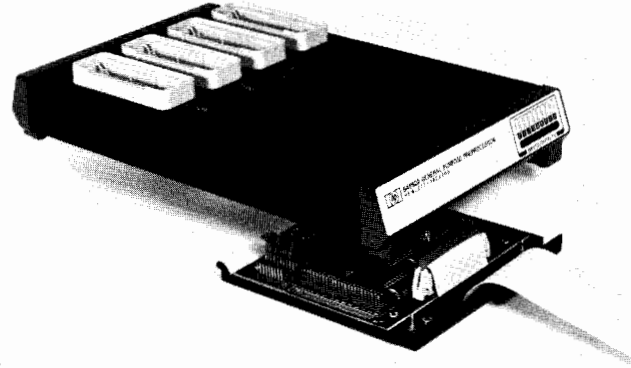

64650A GP Preprocessor

### Software Analyzer Probe Interfaces

Model 64650A General Purpose Preprocessor is a multifunction probe for Model 64620S Software Analysis subsystem. It accommodates three 20-channel data probe pods and the clock probe pod. Plug-in, processor-specific or a user-definable interface module is installed to condition signals for the analyzer and provide simple connections to a target system. Lines are available for general purpose probing, and stimulus and halt lines control the processor. Interface software translates the processor instruction set for mnemonic trace displays, and automatically formats the analyzer measurements. The General Purpose Preprocessor may also be used with logic analyzer/minicomputer interfaces; refer to page 159.

#### 64650A Specifications

**Channel width:** 60 channels.

**Qualified clock rate:** 10 MHz max.

#### Input

**RC:** 100 k $\Omega$  shunted by < 20 pF at interface module connector.

**Maximum:**  $\pm 40$  V.

**Dynamic range:** threshold  $\pm 10$  Vdc in 0.1 V increments.

**Minimum signal swing:** 600 mV.

**Minimum clock pulse width:** > 20 ns.

#### Setup and hold times

**Clock qualifier setup time:** 20 ns min.

**Clock qualifier hold time:** zero.

**Data setup time:** 37 ns min; when clocked by the preprocessor, 23 ns min.

**Data hold time:** zero; when clocked by the preprocessor, 7 ns min.

#### Power

**Consumption:** 0.8 A max at +5 V; 2.5 V max at -5.2 V.

**Available for interface module:** 1.0 A max at 5 V.

**Note:** all power supplied by the software analyzer subsystem.

#### Environmental

**Temperature:** operating, 0° to 55°C (+32° to +131° F); nonoperating, -40° to +75°C (-40° to +167° F).

**Altitude:** operating, 4600 m (15 000 ft); nonoperating, 15 300 m (50 000 ft).

**Humidity:** operating, to 90% noncondensing; avoid sudden, extreme temperature changes that could cause condensation within the instrument.

#### Preprocessor Interface Modules

The preprocessor interface module is plugged into the preprocessor pod to complete the interface to the target microprocessor. Processor-specific modules provide circuits for a dedicated interface, to demultiplex bus signals, carry stimulus and halt signal lines from the analyzer, and transmit processor state flow to the analyzer. Cable and a low profile, dual-in-line probe/chip carrier connects the interface module to the target system microprocessor. The associated software for the module is loaded into 64000 system mass storage, and is automatically transferred to the software analyzer whenever the module is installed in the preprocessor; this software disassembles processor signals for a mnemonic trace display and formats the analyzer dis-

plays appropriately. Interface modules are available for popular microprocessors.

A general purpose interface module for proprietary and other microprocessors is used to design custom interfaces. Wire-wrap boards with chip sockets are the basis for routing system signals, and the associated software is used to generate the user-defined mnemonic tables for a inverse assembly language. A wide variety of probe/chip carriers are available.

#### Interface Module Specifications

Model No.	Microprocessor Compatibility	Max Clock Speed	Power Consumption at +5 Vdc
64651A	User-definable	10 MHz	0.30 A
64653A	8086, 8088	10 MHz	0.45 A
64655A	8085, 8085A, 8085A-2	5 MHz	0.25 A
64670A	MC68000	10 MHz	0.40 A
64680A	Z8001	6 MHz	0.50 A
64681A	Z8002	6 MHz	0.50 A
64683A	Z80	6 MHz	0.30 A

**Signal line loading:** one LS TTL load for all monitored signal lines and  $\approx 35$  pF capacitance.

**Outputs:** STIMULUS and HALT are LS TTL open collector active-low outputs; max sinking current, 6 mA.

**Input:** ACK, acknowledge for STIMULUS line active low, TTL level.

**Environmental:** conforms to specifications for Model 64650A General Purpose Preprocessor.

#### Ordering Information

**Note:** Software is ordered separately for Preprocessor Interface Modules. The appropriate software has the same model number as the interface module, with a different suffix; an AF suffix indicates a flexible disc software medium, and an AT suffix indicates a tape cartridge software medium. Only one software package is required for any number of interface modules with the same model number.

**64650A** General Purpose Preprocessor

**64651A** General Purpose Interface Module

**64856AF/AT** Inverse Assembly Language Software

**64653A** 8086/8088 Preprocessor Interface Module

**64653AF/AT** 8086 Interface Software

**64655A** 8085 Preprocessor Interface Module

**64655AF/AT** 8085 Interface Software

**64670A** 68000 Preprocessor Interface Module

**64670AF/AT** 68000 Interface Software

**64680A** Z8001 Preprocessor Interface Module

**64681A** Z8002 Preprocessor Interface Module

**64681AF/AT** Z8001/Z8002 Interface Software

**64683A** Z80 Preprocessor Interface Module

**64683AF/AT** Z80 Interface Software

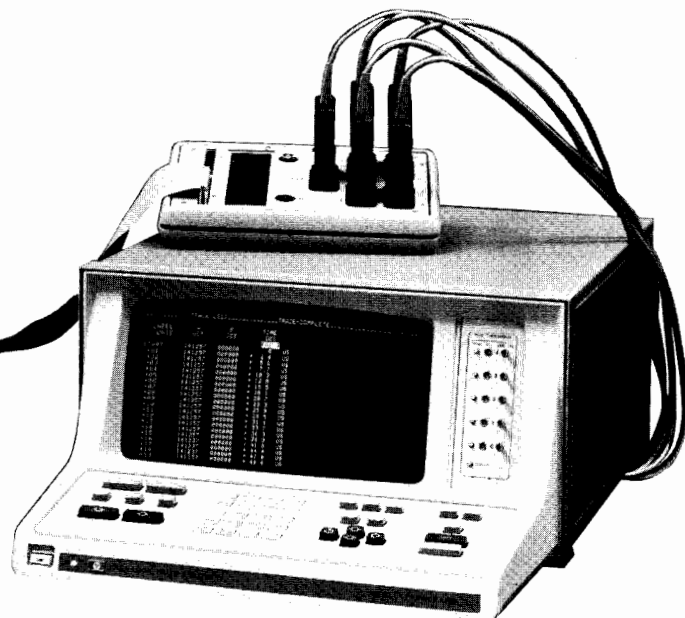
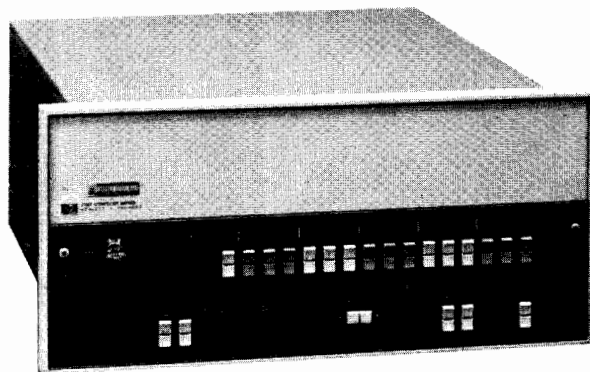

1610A with Interfaces

### Interfaces

Three categories of interfaces are available for Hewlett-Packard logic analyzers: (1) general purpose, (2) minicomputer, and (3) HP-IB. The general purpose interfaces simplify the mechanical connections between the logic analyzer and the system under test, and provide some preprocessing capabilities to adapt and qualify signals from the system. Seven minicomputer interfaces give you access to address, data, and control line signals from specific minicomputers. Because these are dedicated interfaces, minicomputer interfaces have even more flexibility for preprocessing and selecting the signals you want

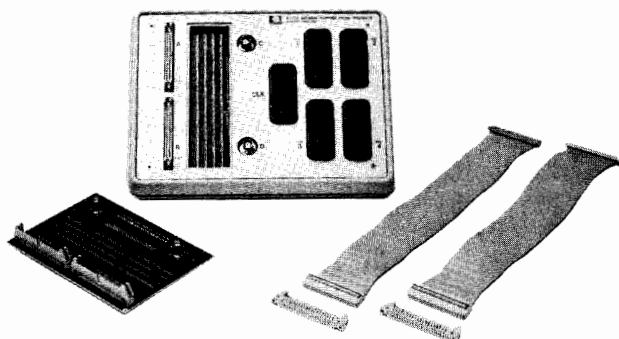

10277A General Purpose Probe Interface

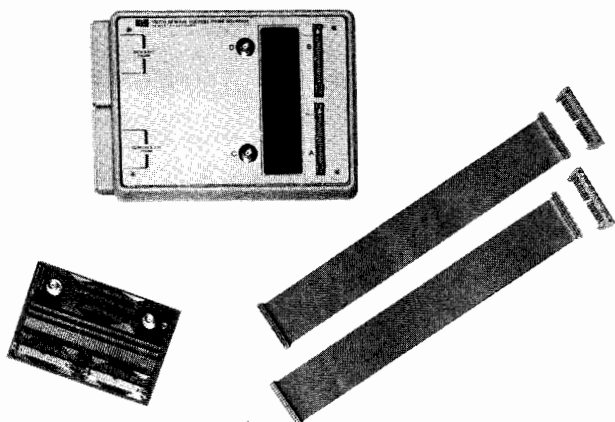

10277D General Purpose Probe Interface

to monitor of the many active lines in the typical minicomputer. An HP-IB interface may be a monitor only or an active interface that adds the logic analyzer to a larger measurement system.

### 10277A/B/C/D General Purpose Probe Interface

For convenient connections between your analyzer and a digital system, Model 10277A/B/C/D has dedicated sockets for the analyzer probe pods, and cables with 40-pin connectors for the system under test. Wire-wrap boards in the interface carry active circuits to preprocess the system signals for the logic analyzer. These interchangeable boards can be set up for a variety of analysis modes, such as serial-to-parallel conversion, sorting out signals on multiplexed buses, generating ORed clocks from multiclock systems, etc. Analysis modes can be changed quickly by simply swapping boards. Option 001 for Models 10277A/B replaces one wire-wrap board with a prewired board that directly accesses address and data lines. The appropriate 10277 interface can be used with Models 1600S, 1610A/B, 1611A, and 1615A logic analyzers.

### 10277A/B/C/D Interface Specifications

**Input connectors:** two 40-pin connectors to interface with a system. Two BNC connectors on the wire-wrap boards allow external signals or power to user-constructed circuits on the board.

**Output connectors:** four data connectors for HP logic analyzers with Model 10248 or 10231 data probes. One clock connector for Models 10247, 10230, or 10248B Opt. 001 clock probes. Model 10277D has two plugs for the two 40-pin connectors of the HP 1611A Logic State Analyzer.

**Weight:** net, 0.75 kg (1.7 lb); shipping, 2 kg (4.4 lb).

**Accessories supplied:** two removable interconnection wire-wrap boards (HP P/N 10277-66501 for Models 10277A/B/C, HP P/N 10277-66507 for Model 10277D), two 36 mm (1.4 in.) ribbon cables with 40-pin female connectors on each end (HP P/N 10277-61601), and two 40-pin male connectors (HP P/N 1251-3004).

### Ordering Information

10277A Interface for 1610A

10277B Interface for 1610B or 1615A

Opt 001 (10277A/B only) replaces one wire-wrap board (HP P/N 10277-66501) with a prewired board (HP P/N 10277-66505) for connection to minicomputer interfaces; replaces 35.5 (1.4 in.) cable (HP P/N 10277-61601) with a 91.5 cm (3 ft) cable (HP P/N 10277-61602)

10277C Interface for 1600A or 1607A

10277D Interface for 1611A

10277-66501 Wire-wrap Board with Connectors (two supplied with Model 10277 Interface)

10277-66505 Prewired Wire-wrap Board

### Minicomputer Interfaces

Interfaces for HP logic analyzers are available for seven minicomputer families. Minicomputer interfaces provide a simple, rapid connection between logic analyzers and the system under test, and preprocess system activity to produce signals suitable for the analyzers. The one or two printed circuit boards of each interface connect directly to the minicomputer mainframe or system bus to transparently monitor address and data buses and control lines. Interface boards have switches to qualify signals so that only particular activities can be monitored, as, for example, only reads, or only DMA outputs. Active circuits on the board assure transparent monitoring with buffering as required, and generate clock signals for the logic analyzer.

These interfaces can also be used with Model 64650A General Purpose Preprocessor for Model 64620S Logic State/Software Analyzer subsystem. Ribbons from the minicomputer interfaces plug into the General Purpose Preprocessor, which has sockets for the 64620S probe pods. While the software analyzer is targeted to microprocessor systems, the analysis functions and features are readily adapted to analysis of bus activity on the minicomputers to take advantage of the analysis power of Model 64620S

### Minicomputer/Logic Analyzers Interfaces

INTERFACE MODEL	COMPUTER	NET WEIGHT kg (lb)	SHIPPING WEIGHT kg (lb)
10275A	PDP-11 (Digital Corp)	0.28 (0.6)	0.60 (1.3)
10276A	LSI-11 (Digital Corp)	0.2 (0.4)	0.32 (0.7)
10278A	HP 1000 M/E/F Series	0.8 (1.8)	1.40 (3)
10279A	NOVA 3 (Data General)	0.23 (0.5)	0.45 (1)
10280A	microNOVA (Data General)	0.23 (0.5)	0.45 (1)
10285A	HP 1000 L-Series	0.23 (0.5)	0.45 (1)
52126A	Intel MULTIBUS	0.23 (0.5)	0.45 (1)

### HP-IB Interface Kits

Logic analyzer HP-IB interfaces allow you to add the measurement set of the analyzers to a system with other HP-IB compatible instruments for automated monitoring, higher-level analysis, and documentation. Refer to pages 22-23 for an overview of instruments available with HP-IB capability. HP-IB interfaces may be ordered as options or field kits.

For factory-installed HP-IB interfaces, order Option 003 for Model 1610B Logic State Analyzer, and Option 001 for Model 1615A Logic Analyzer on the original order. The user-installed kits use Model 10496A HP-IB Interface Kit for the 1610B analyzer and Model 10069A HP-IB Interface Kit for the 1615A analyzer. Adding a printer or printer/plotter provides hard copy of the analyzer setups and measurements. Adding a desktop computer as a controller provides a system for performance analysis.

### Performance Analysis

Using the second-generation logic analyzers with HP-IB capability and a smart controller creates a measurement system for higher-level evaluations of system performance. Model 1610A/B Logic State Analyzer or Model 1615A Logic Analyzer may be used to acquire data and provide front end storage. Data is sent across the HP-IB to an intelligent controller for post-processing. Model 9825A/35A/45A Desktop Computers or any HP-IB compatible computer can be programmed for user-defined tests and routines. The post processing results can then be displayed on a graphics terminal, printer/plotter, or the logic analyzer display. Typical analysis formats include histograms of system activity by frequency or time, software execution time profiles, or matrices of branching probabilities.

For Model 64620S Logic State Analyzer subsystem, performance analysis measures are provided by the 20-channel input card, Model 64623A, which includes the overview function. Histograms and graphs generated by the overview function provide the basic performance analysis data. No separate controller is required.

### HP-IB Monitors

Model 10066A HP-IB Probe Interface is used with the 1610A/B Logic State Analyzer or 1615A Logic Analyzer to transparently monitor the 16 HP-IB lines. The interface connects directly to the bus and has pod sockets for the analyzer probes. Protocol violations in the

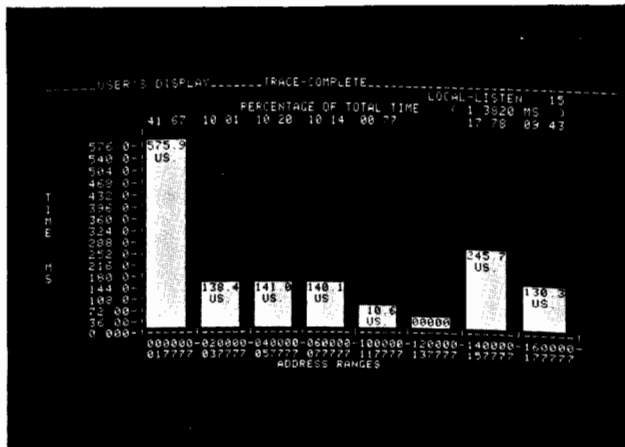

A logic analyzer with HP-IB interface and an intelligent controller are used for higher-level performance analysis. This histogram of occurrence counts is displayed on a 1610 Logic State Analyzer.

handshake sequences set a flag for the analyzer and flash an LED on the interface. A clock source switch gives you a choice of acquiring talker asserted data (DAV), listener accepted data (NDAC), or parallel poll sequences. A pushbutton on the interface displays on the analyzer the state of quiescent lines on a quiet or stalled HP-IB bus.

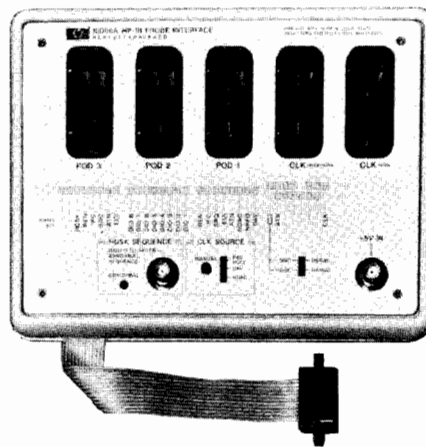

### 10066A HP-IB Probe Interface

#### 10066A HP-IB Probe Interface Specifications

**Input load:** <400  $\mu$ A source or logic analyzer probe load.

**Input Threshold:** TTL fixed at approx 1.5 V.

**Maximum input:**  $\leq$ 5.5 V or logic analyzer spec.

#### Minimum input

**Voltage:**  $\geq$ 0.5 V or logic analyzer spec.

**Setup time:** time data stable prior to clock edge, 20 ns.

**Hold time:** time data stable following clock edge, 50 ns.

**Power:** +5 V, 100 mA max.

#### Ordering Information

**10066A** HP-IB Probe Interface, 1610A/B and 1615A

**10069A** HP-IB Interface Kit for 1615A

**10275A** PDP-11 UNIBUS Interface\*

**10276A** LSI-11 Q-Bus Interface\*

**10278A** HP 1000 M/E/F Series Interface\*

**10279A** NOVA 3 Interface\*

**10280A** microNOVA Interface\*

**10285A** HP-1000 L-Series Interface\*

**10496A** HP-IB Interface Kit for 1610B

**52126A** Multibus Interface\*

\*Opt 001: adds 10277A/001 GP Interface

\*Opt 002: adds 10277B/001 GP Interface



# LOGIC ANALYZERS

## Accessories

### Probes and Probe leads

Hewlett-Packard offers a large line of accessories to give you optimal flexibility in integrating stand-alone logic analyzers into your digital design and troubleshooting applications.

	Page		Page
Data/Clock Probes	160	Probe Leads	161
Microprocessor Probes	160	Cables	162
Trigger Probes	160	Connectors	162
Miniature Probes	160	Testmobiles, Accessories	163

### Logic Analyzer Probes

Most of the probes in this section are supplied with the appropriate logic analyzers. Be sure to check the list of accessories supplied with the logic analyzers you have or will have purchased. The descriptions of these probes are included for your convenience in selecting replacement parts.

Probe Model Number	Logic Analyzer											
	1600S*	1600A*	1607A*	1601A*	1602A*	1610A*	1610B	1611A	1615A	1620A*	1640B	10254A* Converter
10231C Data Probe	6	3	3	2						3		1
10230C Clock Probe	2	1	1	1						1		
10248C Data Probe						4	5	4				
10247A Clock Probe						1						
10250A (TTL) Trigger Probe					1							

\*No longer in production

### Models 10231C Data Probe and 10230C Clock Probe

These probes are generally used with Model 1600S Logic Analyzer system, which is comprised of Models 1600A and 1607A Logic Analyzers. Each analyzer requires three data probes and one clock probe. These probes are also used with Model 10254A Serial-to-parallel Converter, Model 1620A Pattern Analyzer, and Model 1601A Logic Analyzer. Individual probes are connected to each data or clock pod through a quick-disconnect ganging bar for flexibility in connecting to a system.

### Models 10248C Data Probe and 10247A Clock Probe

Models 10248C Data Probes are used with Models 1610A/B and 1615A Logic Analyzers. Each data probe is an 8-bit probe, Model 10247A Clock Probe is a one-bit probe used with the 1610A Logic State Analyzer.

### Probe Clip Set (HP P/N 5061-3611)

For convenience in using Model 10248 probes, the Probe Clip Set (HP P/N 5061-3611) permits you to stack the probes without damage. This set is provided on initial order with Models 1610A/B and 1615A Logic Analyzers. The set includes four holders for probes.

### Model 1611A Microprocessor Probes

Use the following chart to order replacement microprocessor probes for the various personality modules for Model 1611A Logic State Analyzer; remember that the appropriate microprocessor probe is provided on initial order of personality modules, whether the modules are ordered as options or separate modules.

Micro-Processor Family	1611A Option Number	Personality Modules: Model No.	Module Model Price	Probe Part No.
MOTOROLA 6800	A68	10257B	\$1700	01611-62106
MOTOROLA 6809	A09	10266A	\$1700	01611-62114
INTEL 8080A	A80	10258B	\$1700	01611-62107
FAIRCHILD F8	OF8	10259A	\$1900	01611-62104
ZILOG Z80	Z80	10260A	\$1700	01611-62105
ROCKWELL 6502	A65	10261A	\$1900	01611-62108
RCA 1802	A18	10262A	\$1900	01611-62109
INTEL 8085	A85	10263A	\$1700	01611-62112
GENERAL PURPOSE	001	10264A	\$3200	01611-62110

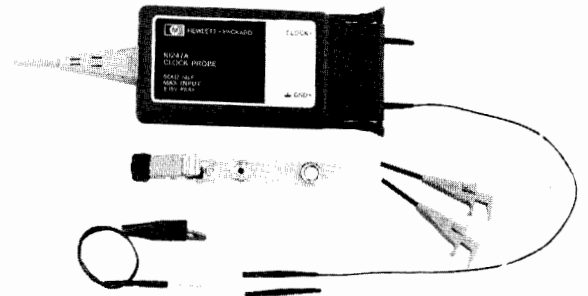

10247A Clock Probe

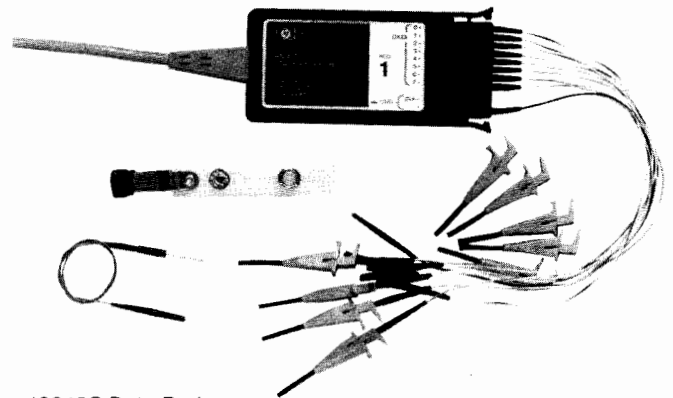

10248C Data Probe

### Trigger Probes

#### Eight-bit External Probe (HP P/N 01611-62101)

The 8-bit external probe (HP P/N 01611-62101) permits connections in a system external to the microprocessor bus for tracing related events or for additional trigger qualifications on Model 1611A Logic Analyzer.

**Resistance:** 1 M $\Omega$ .

**Capacitance:** 25 pF at probe tip.

**Threshold:** +2.4 V to +5.5 V, logic 1 (high); -0.8 V to +0.8 V at logic 0 (low).

**Setup time:** 250 ns prior to falling edge of appropriate strobe.

**Hold time:** zero (after falling edge of strobe).

**Accessories supplied:** one ganging bar, eight data leads, one ground lead, and nine probe tips.

### Miniature Probes

The Hewlett-Packard series of miniature probes give you easy access to test points in densely populated digital circuits. The basic probe, a small (2.4 mm diameter, 25 mm long) cylinder with a needle-like tip, provides access to test points while reducing the possibility of shorting to adjacent leads. This series of probes consists of 10:1 high impedance divider probes, 1:1 probes for instruments with high impedance inputs, and 1:1 probes for 50 ohm inputs.

For a more complete description of the miniature easy IC probes and accessories, refer to page 206, Oscilloscope Probes and Other Accessories.

### Ordering Information

**10230C** Clock Probe

**10231C** Data Probe

**10247A** Clock Probe

**10248C** Data Probe

**01611-62101** 8-bit External Probe

**5061-3611** Probe Clip Kit

## Probe Leads and Probe Lead Kits

Probe leads are provided with every logic analyzer probe. For replacement or special applications, available leads are listed in the next three tables. The last table lists the quick disconnect probe lead kits which are available.

### Quick Disconnect Probe Pod Leads

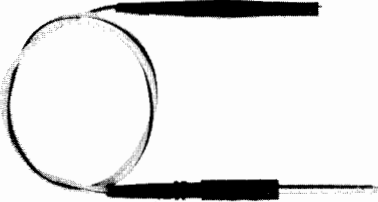

PART NUMBER	LEAD END	LENGTH mm (in.)	COLOR
5061-1215	PIN	305 (12)	BLACK
5061-1251	PIN	152 (6)	BLACK
10231-61624	PIN	610 (24)	BLACK
10231-61625	ALLIGATOR	305 (12)	BLACK
5061-1227	PIN	305 (12)	RED
5061-1216	PIN	305 (12)	YELLOW
5061-1217	PIN	305 (12)	WHITE/BLACK
5061-1218	PIN	305 (12)	WHITE/BROWN
5061-1219	PIN	305 (12)	WHITE/RED
5061-1220	PIN	305 (12)	WHITE/ORANGE
5061-1221	PIN	305 (12)	WHITE/YELLOW
5061-1222	PIN	305 (12)	WHITE/GREEN
5061-1223	PIN	305 (12)	WHITE/BLUE
5061-1224	PIN	305 (12)	WHITE/VIOLET

### Threaded Probe Pod Leads

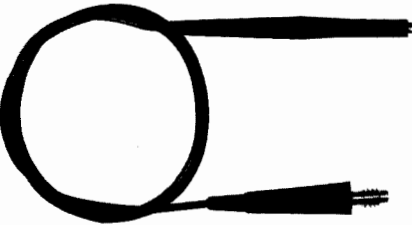

PART NUMBER	LEAD END	LENGTH mm (in.)	COLOR
10231-61606	PIN	305 (12)	BLACK
10231-61602	PIN	305 (12)	RED
10231-61605	PIN	305 (12)	YELLOW
10231-61604	PIN	305 (12)	GREEN
10231-61608	PIN	305 (12)	WHITE/BLACK
10231-61612	PIN	305 (12)	WHITE/BROWN
10231-61613	PIN	305 (12)	WHITE/RED
10231-61614	PIN	305 (12)	WHITE/ORANGE
10231-61615	PIN	305 (12)	WHITE/YELLOW
10231-61616	PIN	305 (12)	WHITE/GREEN

### "Single-ended" Probe Pod Leads (Prepared for soldering)

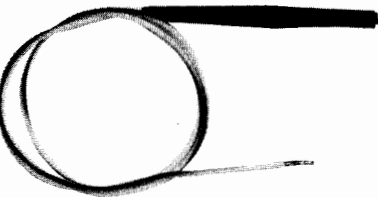

PART NUMBER	LEAD END	LENGTH mm (in.)	COLOR
5061-1231	PIN	305 (12)	BLACK
5061-1232	PIN	305 (12)	YELLOW
5061-1233	PIN	305 (12)	WHITE/BLACK
5061-1234	PIN	305 (12)	WHITE/BROWN
5061-1235	PIN	305 (12)	WHITE/RED
5061-1236	PIN	305 (12)	WHITE/ORANGE
5061-1237	PIN	305 (12)	WHITE/YELLOW
5061-1238	PIN	305 (12)	WHITE/GREEN
5061-1239	PIN	305 (12)	WHITE/BLUE
5061-1240	PIN	305 (12)	WHITE/VIOLET
5061-1241	PIN	305 (12)	GRAY/BLACK
5061-1242	PIN	305 (12)	GRAY/BROWN
5061-1243	PIN	305 (12)	GRAY/RED
5061-1244	PIN	305 (12)	GRAY/ORANGE
5061-1245	PIN	305 (12)	GRAY/YELLOW
5061-1246	PIN	305 (12)	GRAY/GREEN
5061-1247	PIN	305 (12)	GRAY/BLUE
5061-1248	PIN	305 (12)	GRAY/VIOLET

### NUMBER OF KITS REQUIRED BY LOGIC ANALYZER MODELS

	ANALYZER MODEL NUMBER								
	1600A*	1607A*	1601A*	1602A*	1610B	1611A	1615A	1620A*	10254A*
Quick Disconnect Kits 10231-68703 Data	3	3	2			1		3	1
10247-68701 Clock					1				
10248-69501 Data					4		3		
Threaded Probe Leads 10230-68701 Clock	1	1	1					1	
Threaded Probe Leads 10231-68702 Data	3	3	2					3	1
Kit of 10 Miniature Probe Tips 10230-68702	3	3	2	2	4	1	4	3	1

(Order single tips as HP P/N 10230-62101).

\*No longer in production.

Analyzer / Converter Cables  
10254-61601

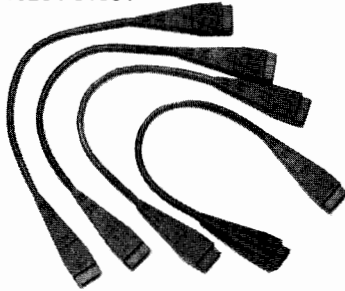

Trigger Bus Cable  
10236A



Test Cable  
01611-61612

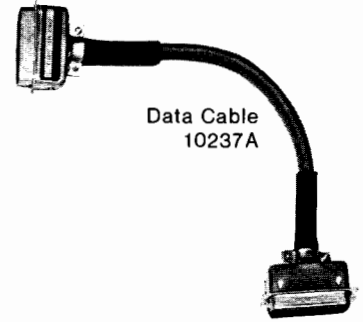

Data Cable  
10237A

Test Cable, Clip  
01611-61609

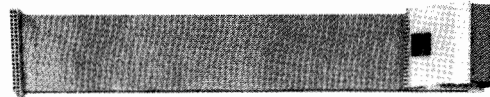

Test Cable, Plug  
01611-61610

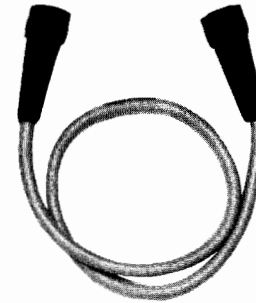

Analyzer / Printer Cable  
09866-61630

### Cables

The following cables are supplied with the respective instruments and options on initial order. They are included for convenience in ordering replacement parts.

#### Models 10236A Trigger Bus Cable and 10237A Data Cable

These cables connect the 1600A and 1607A Logic Analyzers to double the 16-bit word capacity to 32-bit word width. Model 10236A Trigger Bus cable also provides the connection of Model 10254A Serial-to-parallel Converter to the 1600A or 1607A Analyzers. The appropriate number of cables are supplied with the 1600S and 10254A.

#### Models 1600S Logic Analyzer / 10254A Serial-to-parallel Converter Interconnecting Cable (HP P/N 10254-61601)

These interconnecting cables transmit the clock and data output of the 10254A Serial-to-parallel Converter to 1600A or 1607A Logic Analyzer. Four cables are needed and are supplied with Model 10254A.

#### Models 1610A/B Logic Analyzers and 9876A Printer Cable

A cable is available to connect the 1610A/B Logic Analyzer to either Model 9876A or 9866A/B Thermal Printer. This cable, HP P/N 09866-61630, is provided with Option 004 for the 1610A/B. The two end connectors can be ordered alone, vendor Burndy, P/N BTO 6B ( ) 14-19PAA143.

#### Model 1611A Logic Analyzer Cables

Three test cables are supplied with Model 1611A Logic Analyzer, and provide the connections between the Analyzer's microprocessor

probe and the microprocessor under test. Any of these three cables can be used to connect the microprocessor to the 1611A input.

### Connectors

#### Model 1602A Analyzer Probe Connectors

Several kits and units are available to make more convenient connectors for Model 1602A Logic Analyzer. HP P/N 01602-68701 is an assembly of quick disconnect pod with a printed circuit board and 30.5 cm (12 in.) leads; no slip-on probe tips are included. HP P/N 01602-68702 includes the quick disconnect plastic pod halves and a printed circuit board, but no leads are included. An unloaded printed circuit board, HP P/N 01602-26506, is available for use with the quick disconnect plastic pods. This probe/system interface is a standard two row, edge connector which is easily added to your instrument during development.

#### Ordering Information

- 10236A Trigger Bus Cable
- 10237A Data Cable
- 01602-68701 Probe Connector with Leads
- 01602-68702 Quick Disconnect Kit
- 01602-26506 Unloaded PC Board
- 01611-61609 30.5 cm (12 in.) Test Cable with a 40-pin female connector and 40-pin clip
- 01611-61610 30.5 cm (12 in.) Test Cable with a 40-pin female connector and 40-pin plug
- 01611-61612 10.2 cm (4 in.) Test Cable with a 40-pin female connector and a 40-pin plug
- 09866-61630 Printer Cable
- 10254-61601 Cable, each

### Probe/System Connector Kit

The Hewlett-Packard probe/system connector kit (HP P/N 5061-1263) includes five plastic connector bodies (HP P/N 01610-87601) and fifty connector pins (HP P/N 01610-06101). By incorporating these connectors into your system during initial design, you have easy access to signals necessary for testing with an HP Logic Analyzer. Alternatively, these connectors can be installed on an interface board which can then be connected to a system with a ribbon cable.

Connectors can be mounted on an exterior surface of an internal circuit board with only a portion of the body extending through an external panel. Two notches in the connector body mate with the feet of the Analyzer probes to assure proper alignment.

If you want to solder wires directly to probe connector pins, order hollow pins, HP P/N 1251-4305. When soldering pins to the printed circuit board, a dummy fixture or other probe should be used to keep the pins parallel. A dummy probe can be fabricated using a pod cover (HP P/N 5040-8125), four screws (HP P/N 0624-0306), and the pod housing for a logic probe. For probe models 10230C, 10231C, and 10247A use pod housing HP P/N 5040-8010; for probe models 10248A/B/C, 10248B Opt 001, and HP P/N 01611-62101 use pod housing HP P/N 5040-8011.



64030A Development Station Cart and 1610B Logic Analyzer

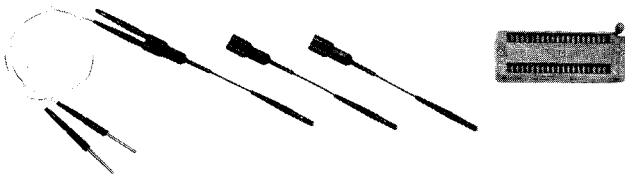

5061-3613 Demultiplexing Adapters  
1200-0623 40-pin Socket

### Special Connectors

HP P/N 5061-3613 Demultiplexing Adapter is a 95 mm (3.7 in.) 2-for-1 adapter which can route a system signal to two monitoring lines. In combination with clock qualifiers, these leads allow you to monitor multiplexed pins on microprocessors and display the two signals in parallel on the logic analyzer display.

HP P/N 1200-0623 is a 40-pin, zero insertion force socket for use in a circuit board for damage-free insertion and removal of microprocessors and 40-pin DIPs. HP P/N 1200-0682 is a socket for Model 1611A Logic Analyzer microprocessor probe cable, and prevents header breakage. This socket also protects the pins for any 40-pin DIP that is removed or replaced frequently.

### Accessories and Testmobiles

#### Testmobiles

Four styles of testmobiles can be used with your logic analyzer: Models 1006A, 1007A, 1008A, and 1117B. A variety of options are available for add-on drawers and shelves. Refer to page 214.

For the 64100A Development Station and logic analyzers with horizontal keyboards, Model 64030A Development Station Cart is a convenient, 690 mm. (27 in.) high table-level working surface which rolls easily on ball casters. A large recessed shelf under the table top provides convenient storage space for manuals and parts. The wheel base matches the 600 mm x 760 mm. (24 in. x 30 in.) table-top for stability.

#### Adapter Plate

An adapter plate, HP P/N 5061-1213, can be used to fasten Model 1740 and 1720 Series Oscilloscopes to the Model 1607A Logic Analyzer, the 1600A Logic Analyzer to the 1607A Logic Analyzer, or either of these two analyzers to Model 10254A Serial-to-Parallel Converter. This part consists of an aluminum plate and a strap for the top unit.

#### Rack Mount Slides and Adapter

Hardware is available to install some logic analyzers in standard 483 mm (19 in.) racks. Model 10491B Rack Mount Adapter can be used with Model 1600A Logic Analyzer. Fixed slides (HP P/N 1490-0714) and pivot slides (HP P/N 1490-0719) can be used in conjunction with this rack adapter.

### Transit Cases

Transit cases are available for some of the logic analyzers. A standard transit case (HP P/N 9211-2459) can be used for Model 1600A Logic Analyzer, and it is also suitable for the 1700 Series Oscilloscopes. The transit case for Model 9866A/B Printer is HP P/N 9211-0839. To add wheels to these cases, order Field Kit HP P/N 1490-0913.

For all other analyzers, have your Field Engineer contact the HP Corporate Parts Center where a specialist is available to advise the best solution for transporting your analyzer.

### Pouches

Three pouches are available for use with logic analyzers: HP P/N 1540-0325 is a large pouch which will hold all of the accessories for Model 1610A/B, 1611A, or 1615A Logic Analyzer. HP P/N 1540-0320 is a small pouch for the 10230/10248 probes. HP P/N 1540-0440 is a medium pouch for Model 1611A Logic Analyzer probe.

### Keyboard Covers

A hard, protective keyboard cover (HP P/N 5040-0588) is available to fit the keyboards of Models 1611A and 1615A Logic Analyzers. Front panel cover for Model 1600A is HP P/N 5040-0516.

### Ordering Information

1006A Testmobile  
1007A Testmobile  
1008A Testmobile  
1117B Testmobile  
10491B Rack Mount Adapter (1600A)  
64030A Development Station Cart  
0624-0306 Screw, each  
1200-0623 40-Pin Socket  
1200-0682 Socket for 1611A  
1251-4305 Hollow Connector Pin, each  
1490-0714 Fixed Slides  
1490-0719 Pivot Slides  
1490-0913 Field Kit, Wheels  
1540-0320 Small Pouch  
1540-0325 Large Pouch  
1540-0440 Medium Pouch  
5040-0516 Panel Cover (1600A)  
5040-0588 Keyboard Cover  
5040-8010 Pod Housing  
5040-8011 Pod Housing  
5040-8125 Pod Cover  
5061-1213 Adapter Plate  
5061-1263 Probe System Connector Kit  
5061-3613 Demultiplexing Adapter  
9211-2459 Transit Case (1600A)  
01610-87601 Connector Body  
01610-06101 Connector Pin, each



# DATA GENERATORS & DATA ANALYZERS

## General Information

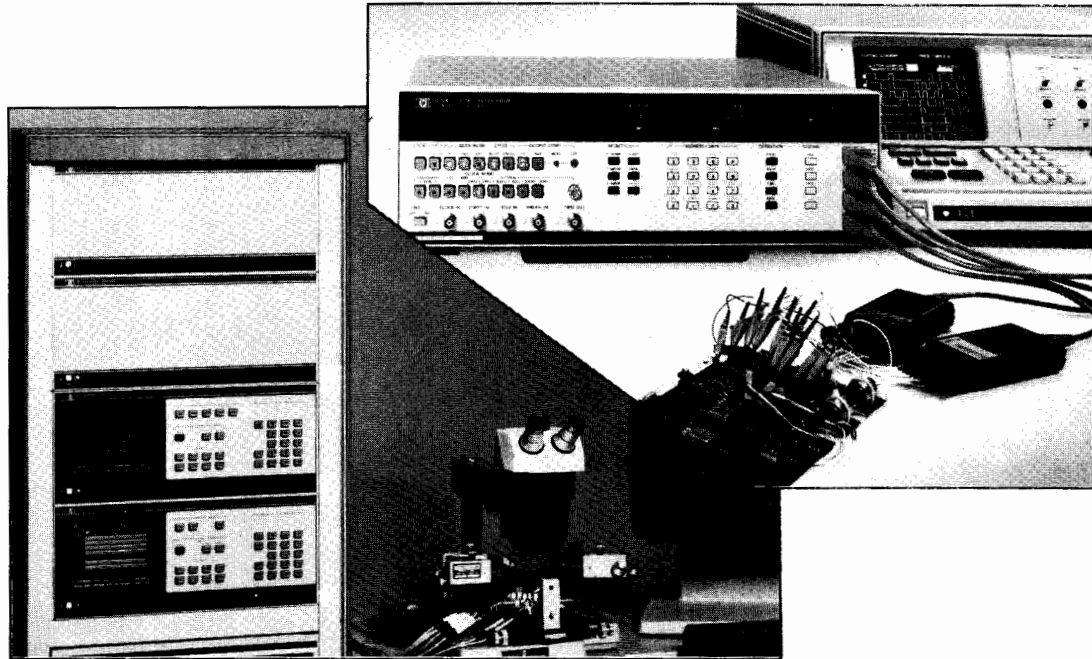

### Engineering Efficiency

HP's data generators and data analyzers\* are engineering tools which enhance, and, at the same time, simplify the evaluation of digital hardware. Enhanced because at-speed testing assures performance. Simpler because bench-top transportability plus front panel and HP-IB access mean quick set-up and fast response to engineering problems. Variable parameters and programmable data save time and equipment because they make dedicated solutions and unwieldy arrays of many different instruments unnecessary.

\*Although oriented towards software problems, stand-alone Logic Analyzers are also summarized because of their hardware capabilities. Refer as well to the 64000 Logic Development System (p. 140) when sophisticated software analysis is needed as well as powerful asynchronous timing analysis.

### Independence

Data generators and analyzers functionally test digital devices under real conditions independent of supporting hardware or large test systems. Models with variable timing and levels permit full characterization, are convenient and need no additional equipment.

Project times are consequently shortened because parallel development is feasible, and problems are detected earlier in design and Selection Chart

production engineering phases. Equipment accessibility makes QA and materials engineering less dependent on other areas, and at-speed module testing enhances system assurance.

Long term investment is ensured through flexibility. Pulse performance and choice of levels ensure suitability for all common logic families, and quality connectors mean swift adaptation to an IC, IC prototype, bread-board, board, module, etc., with specified performance at the device.

Separate packaging saves equipment and promotes mobility because the generators and analyzers can be paired to match input and output needs. Also, separate use is feasible for either multi-channel output devices which are essentially stimulus-independent, or multi-channel input devices with "simple" outputs which can be effectively monitored with an oscilloscope or voltmeter.

### Comprehensive

Data generators include the Serial generators 8018A, for PCM and similar applications, and the sub-nanosecond 8080A. Multi-channel requirements are met by the 8170A, with additional capability for hand-shake devices, and the 8016A with variable timing. High pin-count requirements are solved by the 8180A which has extensive timing capa-

bility and can be configured to the number of channels needed.

Analyzers embrace serial link applications with the 1640B and multi-channel needs. Software and target-system hardware are addressed by the 1611A for specific micro-processors. For mini-computers, the 1610B has advanced sequential triggering and measures software real-time performance. The 1615A is for general device analysis and troubleshooting, especially when interactive time and state measurements are needed. At-speed functional and ac-parametric testing is covered by the 8182A which is extendible for high pin counts on all types of digital hardware.

### Direct Measurement of ac Parameters

Performance credibility demands full specification of all timing and level criteria. With variable analog timing and levels, the 8180A Data Generator and 8182A Analyzer form a compact, comfortable solution for all engineering investigations. Parameters such as setup, hold and propagation times, sensitivity and dynamic fanout capability are measured directly. High resolution allows the exact pulse shape to be delivered, and precise sampling.

APPLICATION	Model Page	GENERATORS					ANALYZERS				
		8080 A 328	8018 A 169	8016 A 167	8170 A 168	8180 A/8181 A 165	8182 A 165	1640 B 552	1611 A 152	1610 B 150	1615 A 148
Functional Test only		ECL, EPL, CMOS Hardware	ECL, TTL, CMOS Serial Digital Hardware	ECL, TTL Digital Hardware	TTL, CMOS Digital Hardware, I/O	ECL, TTL, CMOS and Mixed Logic IC's, Prototypes, Breadboards, Boards and Modules	RS232 Hardware, Software.	TTL, $\mu$ P Systems, Software.	TTL Mini-Computer, Software.	TTL Digital Hardware, Software.	
Data Rate (Bits/s)		300 M	50 M	50 M	2 M	50 M	50 M	19.2k $\mu$ P-Dependent	10 M	20 M	
Channels		1-4	2, serializable	9, serializable	16	8-64	8-32	1	36	32	24
Bits/Channel		64	1k + prbs	32	1 - 4k	1k	1k	2k	64	64	256
Variable Parameters		Level, Delay, Width	Level	Delay Width	—	Levels, Delays, Widths	Thresholds, Sampling Delay, Real-time Window	—	—	Threshold	Threshold

# DATA GENERATORS & DATA ANALYZERS

Data Generator/Analyzer System

Models 8180A, 8181A, 8182A



- Digital ac parametric and functional characterization
- 50 MHz, 1 kbit/channel
- Direct measurements, 100 ps/10 mV resolution

- Variable sampling point delay in synchronous operation
- Real-time data comparison
- Convenient softkey operating concept with live keyboard

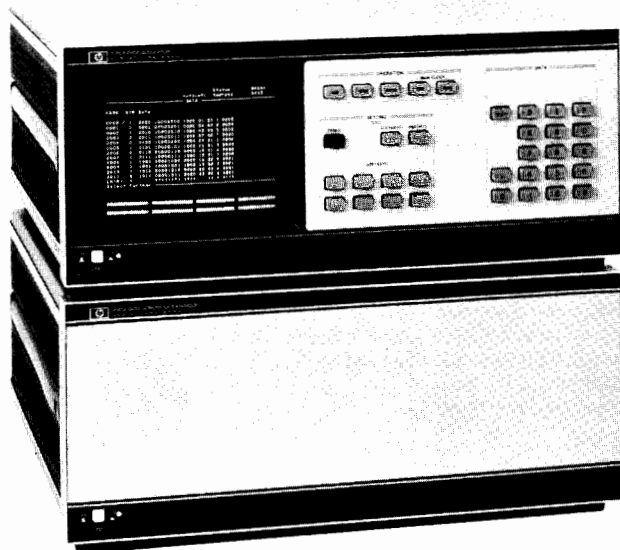

Upper: 8180A Data Generator

Lower: 8181A Data Generator Extender  
Up to 64\* channels with 8180A and two 8181A's.



An affordable engineering tool for at-speed characterization of digital hardware.

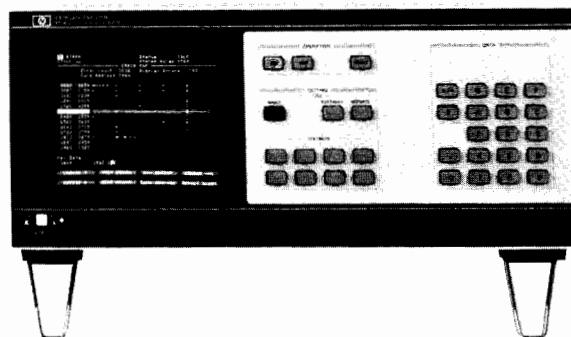

8182A Data Analyzer (up to 32\* channels)

\*Number of channels can be doubled by twin operation.

This compact, benchtop system is designed for manual and automatic engineering investigations on all types of digital hardware. It also upgrades ATS to at-speed testing. Features such as the same high resolution for generator and analyzer, and matched control signals, guarantee the viability of these measurements. Modularity promotes cost-effectivity because the number of channels can be increased without loss of speed or memory.

The same guided operating concept speeds familiarization, and common HP-IB syntax and free format accelerate programming. Live keyboards give rapid parameter access without changing software. Data entry is simplified by the selectable patterns and extensive edit features. Choice of codes and the arbitrary order of channels in the display ensure clarity for error-free operation. Mixed logic needs are solved because up to 6 different levels can be assigned to any number of individual channels.

**Data Generator** Timing capabilities include individual delay and width on two clock channels for dual-phase applications, and on RZ data channels for setup and hold time measurements. 8181A Extender group delay allows separate timing of e.g. simulated address lines.

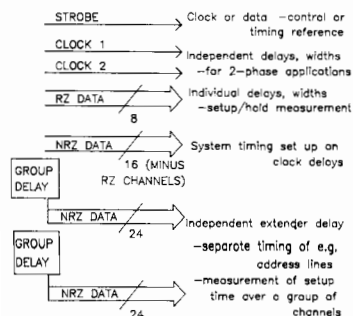

High-speed pulses and clean shape provide performance for all common logic. Variable, high resolution, levels allow worst-case conditions to be measured. The segmentable memory allows initiating and loop data (with exit on external command) to be set up.

**Data Analyzer** In addition to at-speed analysis, comparison and glitch detection, the 8182A also measures the output timing because the sampling point delay is variable. For investigations in e.g. the setup/hold interval, a real-time compare mode examines data stability throughout a programmable window; any deviation from the expected state is displayed and error signals permit operations such as 'stop on error' for trapping sporadic faults.

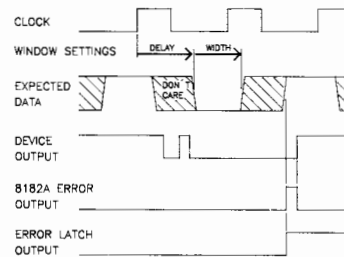

Real-time compare mode checks validity of each output data transfer.

Dual threshold mode checks out high and low levels simultaneously to verify dynamic performance at a glance.

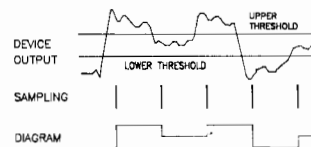

# DATA GENERATORS & DATA ANALYZERS

## Data Generator/Analyzer System

Models 8180A, 8181A, 8182A (Cont.)

### Specifications

Specifications apply for operating temperatures from 0°C to 50°C.

#### 8180A/8181A Data Generator/Extender

##### Memory and Channels

**Memory depth:** 1024 bit/channel.

**Number of channels:** up to 64 using 8180A with two 8181A Extenders. Up to 128 channels with 2 sets of equipment in twin operation.

##### 8180A Channels

**RZ (return-to-zero) channels:** independent variable delay and width in each of up to 8 channels.

**NRZ (non-return-zero) channels:** Up to 16 channels minus the number of RZ channels. Fixed timing.

**Strobe channel:** NRZ data or clock. Fixed timing.

**Clock channels:** independent delay and width in each of 2 channels. Clock 1 can be selected to run continuously in Break state (see 'Cycle modes').

##### 8181A Channels

**NRZ:** up to 24 channels. Fixed timing within an Extender, group delay with respect to 8180A.

##### Memory Segmentation

**Active Segment:** user-defined by first and last addresses (FAD, LAD) in the range 0 to 1023. Store/recall allows 10 different FAD/LAD pairs to be stored.

**Initializing segment:** segment 0 to FAD initializes DUT.

##### Memory Loading

**Codes:** bin, oct, hex, dec (address codes: oct, hex, dec).

**Entry:** Keyboard or HP-IB.

**Displayed channel order:** user-defined.

**Line edit:** insert, delete, macro.

**Channel edit:** clear, set, copy, prbs, counts, entry mask.

##### Cycle Modes

Single, Auto, Initialization + Auto, Gated, Initialization + Gated. (Initialization data is output at the beginning of the first cycle only).

**Break state:** implemented by manual or external BREAK command or by strobe channel bit. Data is held at current address. Manual or external RUN command cause same cycle to continue.

**Stop state:** implemented by manual or external STOP command. Data is held at current address and the cycle is terminated. Manual or external RUN command trigger a new cycle.

##### Timing

**Clock period:** 20 ns to 950 ms (1.05 Hz to 50 MHz). Ext clock 0 to 50 MHz.

**Delay (relative to strobe channel):** 0.0 ns to 950 ms, max 90% period - 18 ns.

**Width:** 10.0 ns to 950 ms, max 90% period - 8 ns.

**Skew:**  $\leq 2$  ns for NRZ channels and RZ channels programmed for zero delay.

**Resolution:** 3 digits (best case 100 ps).

**Accuracy:**  $\pm 5\%$  of programmed value  $\pm 1$  ns.

**Jitter:**  $\leq 0.2\%$  + 100 ps (+additional 50 ps for delay and width).

##### Outputs

**Output Impedance:** 50 Ohm.

**Data and Clock:** 4 different high level/low level pairs can be defined and assigned to any number of individual outputs. Each channel has independent normal/complement switching. Common 'off'.

**Read-out:** can be selected for 50-Ohm or high-impedance load (common selection for all channels).

	50-Ohm load	High-impedance load
<b>High level:</b>	-1.50 to +5.50 V	-1.00 to +17.0V
<b>Low level:</b>	-2.00 to +5.00 V	-2.00 to +16.0 V
<b>Resolution:</b>	3 digits (10 mV)	3 digits (best case 20 mV)
<b>Amplitude:</b>	0.5 to 5.5 V	1.0 to 17 V

##### Transitions

**10% to 90%:**  $(3 + 0.2 | \text{ampl} |)$  ns  $(3 + 0.5 | \text{ampl} |)$  ns

**20% to 80% at ECL levels:** 1.5 ns.

**Strobe:** ECL/TTL selectable.

##### Tri-State

For bi-directional applications, 4-channel Tri-state Pods (Accessory 15413A) are available. The tri-state is implemented by an external signal common to all 4 channels. Tri-state unit 15414A energises up to 6 pods. Level programming remains active.

#### 8182A Data Analyzer

##### Memory and Channels

**Memory depth:** 1024 bit/channel.

**Number of channels:** up to 32. Can be doubled by twin operation of two 8182A's.

**Expected data memory:** 1024 bit/channel, segmentable.

**Codes:** bin, oct, hex (address code: dec).

**Entry:** Keyboard, HP-IB or read-in from DUT.

**Displayed channel order:** user-defined.

**Line edit:** word mask (don't care), insert, delete.

**Channel edit:** clear, set, copy, mask (don't care), exchange.

##### Modes

**Analysis/Store-and-Compare:** synchronous sampling with variable analog sampling point delay or asynchronous sampling. Comparison with expected data, if required.

**Displays:** state list, diagram or error map.

**Glitch detection:** down to 5 ns. Memory depth is halved when glitch detection is selected.

**Trigger condition:** can be selected to start or stop analysis.

**Real-Time Compare:** comparison of actual with expected data throughout a time window. Window has variable analog delay and width. Real-time and latched error output signals are provided.

**Display:** error map.

**Trigger condition:** starts comparison.

##### Timing

**External clock:** 0 to 50 MHz.

**Delay (relative to external clock):** 0.0 ns to 1 s, max 95% period - 1 ns.

**Compare window width:** 10.0 ns to 1 s, max 95% period - 9 ns.

**Channel skew:**  $\leq 2$  ns.

**Resolution:** 3 digits (best case 100 ps).

**Accuracy:**  $\pm 5\%$  of programmed value  $\pm 1$  ns.

**Internal clock:** 1 Hz to 50 MHz. (1-2-5 steps).

##### Inputs

**Data:** 6 different thresholds or dual threshold pairs can be defined and assigned to any number of individual inputs. Each measuring channel selected for dual threshold operation occupies two normal channels.

**Clock:** programmable threshold and selectable slope (positive, negative, both).

**Input Impedance:** 1 M $\Omega$ ,  $< 7$  pF.

**Control Signals:** (100 k $\Omega$ /50  $\Omega$  selectable input impedance)

**Trigger Arm and Ext Stop Signals:** independent programmable thresholds and selectable slope (positive, negative, don't care).

**Trigger Qualifier and Clock Qualifier signals:** independent programmable thresholds and selectable levels (high, low, don't care).

**Threshold range:** -10.0 to +10.0 V.

**Dynamic range:** threshold  $\pm 10$  V.

**Resolution:** 3 digits (best case 10 mV).

##### Trigger

Trigger arm, word and qualifier, digital filter (1 to 16), clock and qualifier, delay (0 to 65535).

##### Ordering Information

**8180A Data Generator\*** (includes 8 NRZ channels)

**Opt 001** 4 additional NRZ channels

**Opt 002** 4 additional RZ channels

**8181A Data Generator Extender\*** (includes 8 NRZ channels)

**Opt 001** 4 additional NRZ channels

**8182A Data Analyzer\*** (includes 8 channels)

**Opt 001** 8 additional channels

Refer to publications for more detailed information, accessories, plus front handle kit, etc. Publications available: Product Brochure (5952-9548), Application Note 319 (5952-9549), 8180A/8181A Technical Data (5952-9550), 8182A Technical Data (5952-9551).

\*HP-IB cables not included, see page 29.

# DATA GENERATORS & DATA ANALYZERS

## 9-Bit Parallel, 32-Bit Serial, 50 MHz Word Generator

Model 8016A

167



- 2 complementary outputs per channel, RZ/NRZ formats
- Channel serializer
- Variable RZ width, 4 delay channels
- TTL/ECL output levels selectable

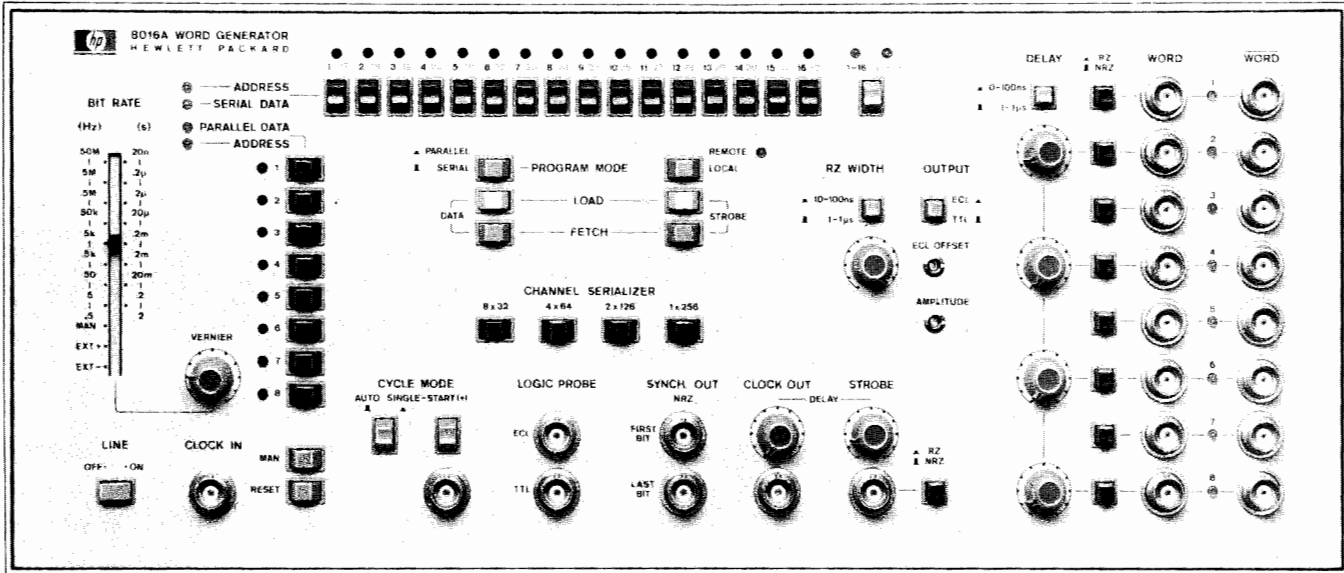

Option 001



The 8016A is a 9-channel data generator capable of serialization up to 256 bits. For the digital designer the 8016A is a natural companion to multichannel data display devices such as logic analyzers. As a bench or systems component, the 8016A provides programmable digital patterns plus adjustable timing parameters necessary for testing ICs and circuit boards.

### Functional Test

Bit pattern programmability combined with fast cycle time (50 MHz clock) make the 8016A especially effective in simulating worst case conditions, e.g. high speed IC testing. The 8016A saves time in component evaluation environments because test setups can be rapidly built and reconfigured to meet the demands of testing small quantities of a wide variety of IC types.

### Parametric Test

Complete testing of digital circuits and systems requires not only digital patterns for functional test but control of the analog parameters of the pulses as well. Adjustable pulse widths, levels, and inter-channel delays contribute to measurements such as setup and hold times, clock pulse width sensitivities, and system sensitivity to propagation delay variations. To meet these testing requirements, the 8016A includes 6 independent delay circuits. Output levels of the 8016A's 50  $\Omega$  output amplifiers are selectable for ECL or TTL test specifications and can be adjusted. In addition, a choice of RZ or NRZ formats with variable RZ pulse width is provided.

### Specifications

**Data Capacity:** 8 data channels plus 1 strobe channel, each 32 bits. 8 data channels can be serialized as four 64-bit channels, two 128-bit channels or a single 256-bit channel.

**Data Loading:** address channel, enter 32 serial bits in that channel. Alternatively, address parallel word, enter (max 8) bits in that word. Addressing/entry by pushbuttons/LEDs or via HP-IB (option 001).

**Data Outputs** (50  $\Omega$  source into 50  $\Omega$  load).

**Format:** independent RZ/NRZ selection in each channel.

**RZ Width:** single continuous adjustment in ranges 10-100 ns, 0.1-1  $\mu$ s.

**Width jitter:**  $\leq 0.2\% + 50$ ps

**Component:** Simultaneous normal and complement outputs for each channel.

**Delay:** channels 2, 4, 6, 8 can be delayed independently within the ranges 0-100 ns, 0.1-1  $\mu$ s with respect to odd channels.

**Jitter:**  $\leq 0.1\% + 5$  ps

**Skew (undelayed):**  $\pm 1$  ns

**Levels:** ECL/TTL selectable

**Transition Times:**  $\leq 3.0$  ns (ECL  $\leq 2.5$  ns)

**Bit Rate**

**Internal:** 0.5 Hz to 50 MHz.

**External:** dc to 50 MHz, or manual.

### Data Cycling

**Auto:** Sequence recycles continuously.

**Single Cycle:** Sequence is triggered/gated by external pulse/level.

### General

**Operating temperature:** 0°C to +50°C.

**Power:** 100/120/220/240 Vrms; +5%, -10%; 48 Hz to 66 Hz, 200 VA (maximum)

**Weight:** net, 14.5 kg (32 lb). Shipping 16 kg (35.3 lb).

**Size:** 177 H x 426 W x 422 mm D (7" x 16.8" x 16.6").

### Ordering Information

8016A Word Generator

**Opt 001:** HP-IB for data loading\*

**Opt 907:** Front Handle Kit (Part No. 5061-0090)

**Opt 908:** Rack Flange (Part No. 5061-0078)

**Opt 909:** Opt 907, 908 combined (Part No. 5061-0084)

**Opt 910:** Additional Operating and Service Manual

\*HP-IB cables: Refer to page 29.

# DATA GENERATORS & DATA ANALYZERS

## Logic Pattern Generator for Bus Stimulation

Model 8170A

- 8k memory (32k option)
- 8 bit / 16 bit parallel output
- 2 wire / 3 wire handshake capability
- Internal and external addressing

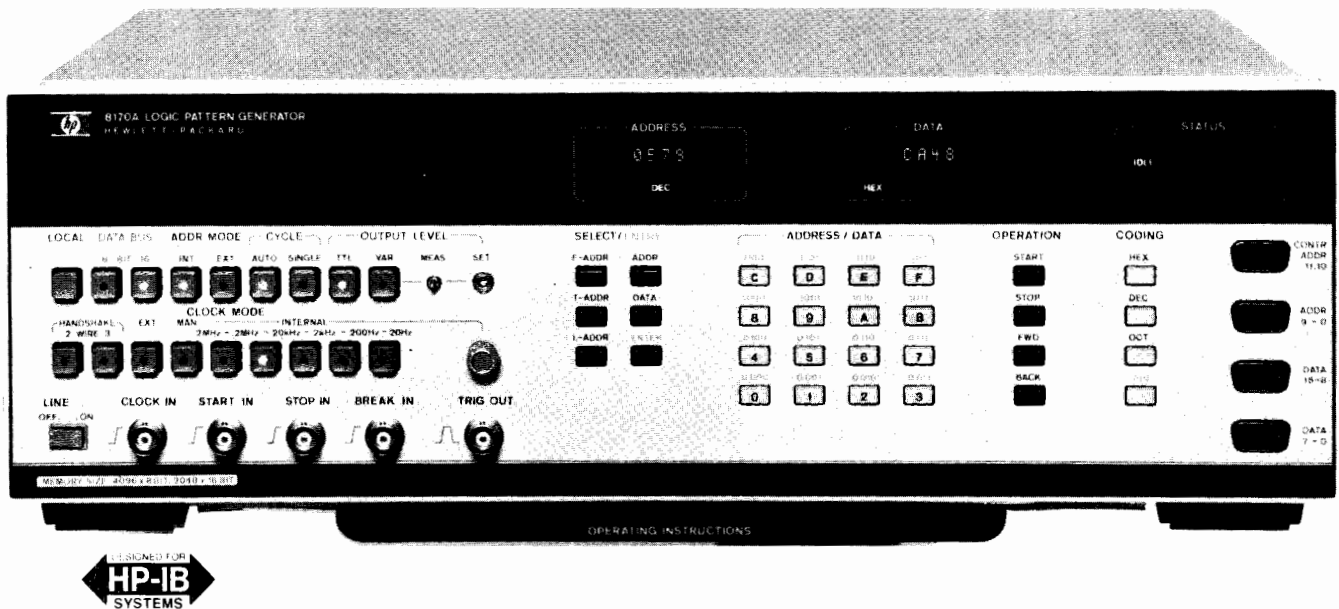

Parts, memories and peripherals can be verified at all stages in design and production because the 8170A allows testing in isolation from the system. Busses or devices can be stimulated synchronously or asynchronously with data from the 8170A's memory. Address outputs (Option 002) allow writing into a RAM for subsequent comparison on e.g. a logic analyzer. In external address mode, software can be setup, verified and modified in the 8170A before committing ROM's.

The 8170A memory can be programmed manually, via HP-IB or by selecting one of the fixed patterns. User codes can be used directly because conversion is handled automatically.

### Specifications

**Memory:** 8 kbit (32 kbit Opt 001). 8- or 16- bit width, selectable. Freely programmable or selectable patterns (Set/reset/prbs/count up/down).

#### Address Modes

**Internal:** Ascending sequence between user-defined addresses.

**External:** 10-line address plus 4 enable lines. Max rate 2 Mbit/s.

#### Clocking

**Internal:** 20 Hz to 2 MHz in 5 ranges.

**External:** dc to 2 MHz.

**Manual:** forward/backward data stepping.

**Handshake:** 2-wire/3-wire (IEEE 488) selectable.

#### Cycle Modes (applies to Int Address mode)

**Auto Cycle:** Data cycled continuously.

**Single Cycle:** Data is cycled once per Start In command.

#### Outputs

**Data:** 8 or 16 lines, selectable. Pos/neg true selectable.

**Control:** Data Valid. Pos/neg true selectable.

**Status:** 2 lines indicate whether data is clocked, static or off.

**Levels:** TTL or adjustable +3 V to +15 V.

**Address (via Opt 002 pod):** 10 lines, +2.4 V true, +0.5 V false.

### Inputs

**Address:** 10 lines (12 lines in Opt 001).

**Control:** Ready For Data and Data Accepted lines.

**Enable:** 4 lines.

**Levels:** High +2.0 V, low +8.0 V.

**Remote Control:** HP-IB, RS-232C (CCITT V.24).

### General

**Power:** 100/120/220/240 V rms; +5%, -10%; 48-66 Hz, 110 VA max.

**Operating Temperature:** 0°C to 55°C.

**Weight:** net 11 kg (24.3 lbs), shipping 15 kg (33.2 lbs).

**Dimensions:** 133 H x 426 W x 422 mm D (5.2" x 16.8" x 16.6").

### Ordering Information

**8170A Logic Pattern Generator\***

**Opt 001:** 32 kbit Memory

**Opt 002:** Address Driver Pod (Model 15452A)

**Opt 907:** Front Handle Kit (part number 5061-0089)

**Opt 908:** Rack Mount Kit (part number 5061-0077)

**Opt 909:** Opt 907, 908 combined (p/n 5061-0083)

**Opt 910:** Extra Operating and Service Manual

**15457A Pod Connector** (Pods can be easily plugged into DUT when this accessory is wired in)

**15459A 1.5 m pod extension cable**

### Supplied Accessories

**15453A Address input pod**

**15454A Control Pod**

**15455A Data Pod (D0-D7)**

**15456A Data Pod (D8-D15)**

**15458A Snap-on Assembly (one per pod)**

**10230-62101 Hook-on Clip**

\*HP-IB cables not furnished, see page 29.

# DATA GENERATORS & DATA ANALYZERS

## 50 MHz Serial Data/PRBS Generator

Model 8018A

169



- 2048 bit, dual channel memory
- Variable word and pattern length

- TTL, ECL, CMOS compatible
- Programmable, prbs and mixed data

Option 001

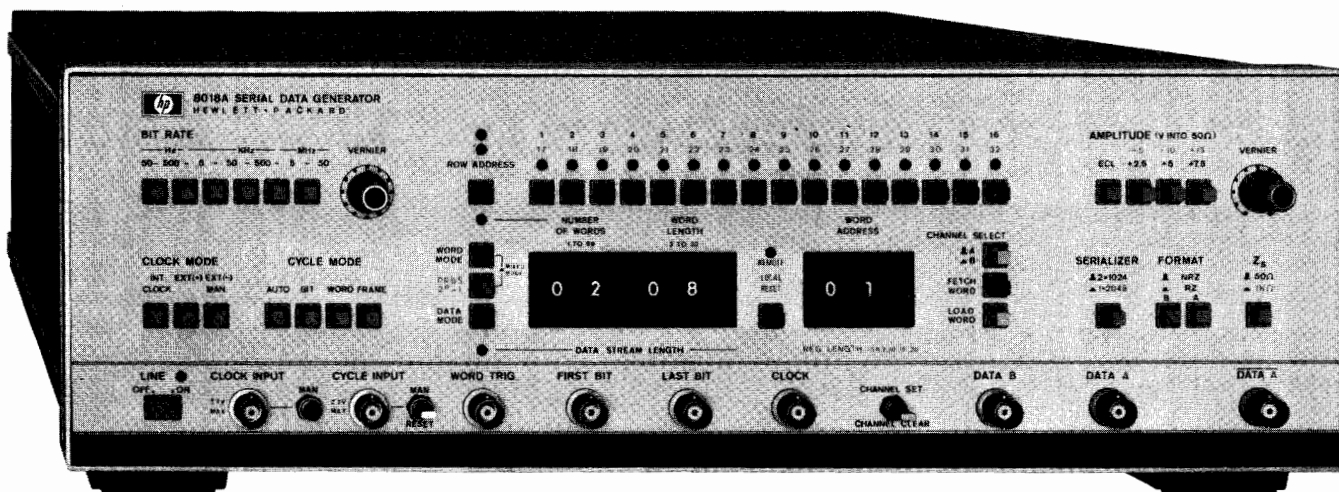

With 2048 programmable bits, and a choice of pseudo-random binary sequences (prbs) ranging to over 1 Mbits, the 8018A is a powerful stimulator for serial digital systems and devices requiring high bit rate and fast pulses. Even preamble-data-post-amble data link patterns are feasible by combining prbs and programmed data. Useful synch outputs simplify testing by locking scope or analyzer to unique points in the data stream.

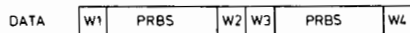

For data link patterns, mixed mode inserts a prbs after each odd word.



For dual-channel applications, the memory splits so that the outputs have independent 1 Kbits of data.

A high performance output amplifier adds to the 8018A's wide applicability. It delivers clean, 6 ns pulses with repetition rates from dc to 50 Mbits/s. Output amplitude is variable up to 15 volts into 50  $\Omega$ . This enables you to directly drive logic circuits ranging from TTL to CMOS. Output levels for emitter-coupled-logic (ECL) are also provided.

To handle patterns for repetitive tests more conveniently, data can be loaded via HP-IB (Option 001).

## Specifications

### Data Capacity and Modes

**Programmable memory:** 2 channels, each 1 kbit, serializable. Thumbwheel switches define data stream length or frame length (N words of Mbits), and set up synch signals accordingly.

**Prbs:** pseudo-random binary sequences of 511, 1023, 32767 and 1048575 bits. Synch pulse at beginning of sequence.

**Mixed:** prbs is inserted after every odd-numbered programmable word.

## Data Outputs

**Channel A:** Simultaneous normal and complement outputs. ECL levels or variable +15 V amplitude. Selectable 50  $\Omega$ /1 k $\Omega$  output impedance, RZ/NRZ format.

**Data length:** up to 1024 bit or (serialized with B data) 1025 to 2048 bit.

**Transitions (50  $\Omega$  into 50  $\Omega$ ):**  $\leq 6$  ns (ECL  $\leq 5$  ns)

**Preshoot, overshoot, ringing:**  $\leq 10\%$  (ECL  $\leq 15\%$ )

**Channel B:** normal output, 2.4 V (50  $\Omega$  into 50  $\Omega$ ), up to 1024 bits, RZ/NRZ selectable.

## Bit Rate

**Internal:** 50 Hz to 50 MHz (40 MHz in Mixed mode), jitter 0.2%

**External:** dc to 50 MHz (40 MHz in Mixed mode) or manual.

## Data Cycling

**Auto:** Sequence recycles continuously.

**Bit:** bits are triggered/gated by external pulses/level.

**Word:** words are triggered/gated by external pulses/level.

**Frame:** sequence is triggered/gated by external pulses/level.

**Manual:** switch triggers single bits/words/frame.

## General

**Power:** 100/120/220/240 V rms; +5%, -10%; 48 to 440 Hz. 230 V A max.

**Temperature Range:** 0°C to 50°C.

**Weight:** net 12 kg (26.5 lbs); shipping 16 kg (35.3 lbs).

**Size:** 133 H x 426 W x 422 mm D (5.2" x 16.8" x 16.6").

## Ordering Information

8018A Serial Data Generator

**Opt 001:** HP-IB for data loading\*

**Opt 907:** Front Handle Kit (Part No. 5061-0089)

**Opt 908:** Rack Flange Kit (Part No. 5061-0077)

**Opt 909:** Opt. 907, 908 combined

(Part No. 5061-0083)

**Opt 910:** Extra Operating and Service Manual

\* HP-IB cables: refer to page 29.



## Introduction

Waveform recorders provide extensive measurement capability, combining important features of storage oscilloscopes and digital voltmeters. They sample analog input waveforms, convert the samples to digital form, and store these digital representations of waveforms in memory. Waveform recorders are ideal for recording transients. Because they are built around high-speed analog-to-digital converters (ADC's), they capture waveform information in a single-shot manner. They also make a contribution in recording repetitive waveforms, because they provide accurate voltage information. For repetitive signal recording, equivalent time sampling systems based on low-speed ADC's (e.g. 1980/19860 Oscilloscope Measurement System) are also available, and often have much higher input bandwidths than do waveform recorders.

A major advantage of waveform recorders is their ability to record information before a trigger occurs. When a waveform recorder is armed for triggering, digitized samples flow into memory. At the time of the trigger, waveform information which is already in memory may be saved; thus, "pre-trigger" recording is possible. For example, the first transient shown was recorded on a storage scope. Notice that no pre-trigger information is available. When a waveform recorder set in pre-trigger mode captures the same transient, a display of the waveform shows information prior to the trigger point, and values such as rise times and voltages can be calculated using the stored digital information.

Digital storage of waveform data provides several other advantages. Waveforms can be

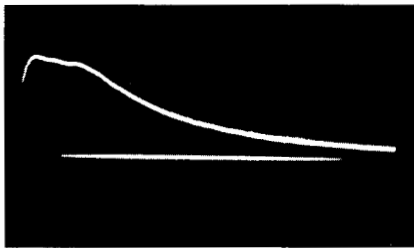

Transient recorded by storage scope contains no pre-trigger information.

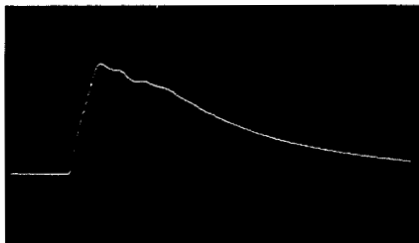

Transient captured by 5180A Waveform Recorder shows initial pre-trigger voltage change.

re-created on a CRT display, or a portion of a waveform may be expanded in the display to show detail. In addition, digitized waveforms can be saved permanently on tape or disk, or processed by digital computer.

## Selecting A Waveform Recorder

In determining whether or not a waveform recorder will work in a given application or solve a particular problem, the first features to consider are the instrument's maximum sampling rate, and its voltage resolution in terms of number of bits. However, these hardware specifications don't tell the whole story: as a waveform recorder samples more rapidly changing signals, the accuracy of the digitized output values decreases. To determine whether a waveform recorder is adequate, then, some measure of its "dynamic performance" is needed.

### Dynamic Performance

Hewlett-Packard has made an important contribution in this area, by developing tests for measuring how well the digital output codes from a waveform recorder represent an analog input waveform. These dynamic performance tests determine the degradation in a waveform recorder's performance as the sampling rate and the frequency of the input signal increase.

The dynamic performance tests: 1) identify digital codes which are missing or which occur too frequently; 2) measure harmonic distortion caused by nonlinearities in the ADC transfer function; 3) determine the number of bits of information which are reliable (effective bits). These tests (and others) are described in detail in Product Note 5180A-2 "Dynamic Performance Testing of Analog-to-Digital Converters."

Other features to consider in selecting a waveform recorder include:

### Input Channels

**Number of channels:** when more than one waveform must be recorded at a time, multiple input channels are necessary. Simultaneous waveform recording may then be provided by two ADC's, or by a single ADC alternating sampling between the two input channels.

**Voltage range selection:** variable input voltage ranges make it possible to obtain maximum resolution on small or large amplitude signals. In addition, waveform recorders may provide selectable input voltage offsets, so the input voltage range can be centered around a signal with a DC offset.

### Triggering

**Precise trigger level selection:** trigger level in a waveform recorder should be accurately and reliably selectable.

**Reliable triggering:** it is essential that triggering be dependable in waveform recorders, since these instruments are optimized for capturing transients which are often non-repeatable.

### Memory

**Sufficient memory size:** the number of memory words required for a given input signal depends on both the duration of the signal and the required sampling rate.

**Change sampling rate during recording:** when a portion of signal has a large information content compared to the rest of the signal, the ability to change sampling rate during a recording makes it possible to conserve memory space. This is done by sampling at a high rate where the information content is greater, and switching to a lower rate where the input signal contains less information.

**Segmentable into multiple records:** waveform recorders with memory which can be divided into independent records make it possible to record and store more than one waveform.

### Display Features/Benchtop or Manual Measurements

**Cursors:** cursors make it possible to select points of interest in a displayed waveform.

**Voltage and time indicators:** direct readout of voltages and times in any location on a displayed waveform eliminates the need to estimate these values.

**Zoom:** expanding a portion of a stored waveform in the display makes it possible to see detail.

**Number of display traces:** two or more display traces allow waveform comparison.

### Operating Convenience Features

**Preset/Autoset:** a preset command automatically selects known values for all front panel functions. An autoset command automatically optimizes front panel functions values for a repetitive input waveform.

**Save/Recall front panel setups:** the ability to save and recall often-used front panel setups is another important convenience feature. It saves time in re-selecting function values, makes measurements more repeatable, and reduces operator error.

**Direct output to hardcopy device:** an output which interfaces directly to an X-Y recorder or digital plotter is an important convenience feature, particularly when a measurement setup does not include a controller.

### Programmability/Systems Features

**Data output capability:** when it is necessary to process stored waveform data by computer, some form of digital data output is essential. It is helpful if front panel settings can also be transferred to a computer, to eliminate the need for entering these values manually and the associated increased chance for error.

**Full programmability of all functions:** as an enhancement to the systems capability of a waveform recorder, full programmability of front panel settings makes modification of these values very convenient.



- Fully programmable via HP-IB
- Convenient for benchtop measurements

- 20 MHz maximum sampling, 10 Bit resolution
- Excellent dynamic performance

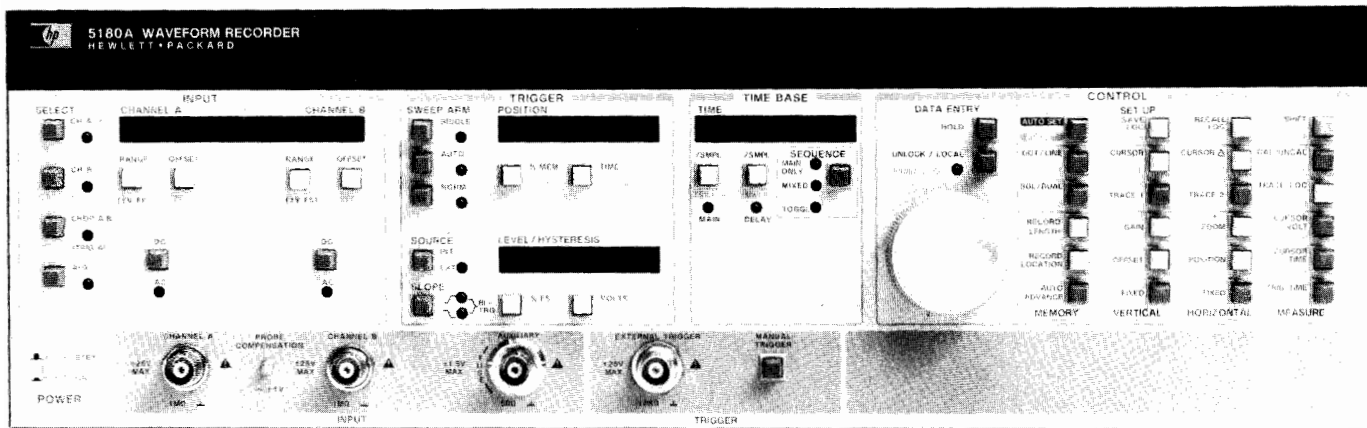

## Introduction

Hewlett-Packard's new waveform recorder, the 5180A, samples analog signals at a maximum rate of 20 MHz, and converts these samples to digital form. Thus, the 5180A is like a 3-digit voltmeter, taking up to 20 million readings per second, and storing 16 thousand of the resulting digital values in memory. The 5180A's versatile feature set makes this data convenient to record, and improves reliability of the results.

## Dynamic Performance

The 5180A Waveform Recorder offers superb dynamic performance, which is specified in the instrument's data sheet. Hewlett-Packard's 5 GHz integrated circuit process makes this exceptional dynamic performance possible. The hybrid IC's used in the 5180A provide accurate representations of input waveforms, reliability, and confidence.

## Input Channels

The 5180A has two high-impedance input channels, A and B, and a third "auxiliary" 50 ohm input channel. Either the A or B channel used alone allows sampling at a maximum 20 MHz rate, or the two channels will alternate sampling in chop mode, with a maximum sampling rate of 5 MHz per channel. The auxiliary channel offers up to 20 MHz sampling rate.

Input voltage range is selectable for the A and B channels independently, between  $\pm 100$  mV and  $\pm 10$  V. In addition, voltage offset may be added to the input signal. The available offset range is the same as the selected input voltage range. Since it has no input amplifier, the auxiliary channel input voltage range is  $\pm 1$  V. This channel inputs directly to the ADC, and consequently has slightly better accuracy than either high impedance channel.

## Triggering

Trigger level in the 5180A is precisely selectable in digital form; a digital readout on the display indicates the currently selected trigger level. In addition, the trigger slope may be rising, falling, or bi-directional. Triggering may be based on the input waveform (internal), or an external trigger source may be supplied.

The 5180A uses a precise digital trigger when internal triggering is selected. This trigger compares the selected trigger level (in 10-bit digital form) to the 10-bit output of the ADC following each waveform sample. The first waveform sample meeting triggering conditions becomes the trigger point. In addition, digital triggering makes selectable hysteresis possible. By specifying an appropriate hysteresis region, triggering on noise can be eliminated, which allows extremely reliable triggering.

Another triggering feature provided by the 5180A is pre- or post-trigger recording. At the time of the trigger, the 5180A is capable of saving up to 100% of the waveform data which is already

## Literature Available for 5180A Waveform Recorder

- 5180A Data Sheet (Pub. 02-5952-7626) 20 pp.
- 5180A Brochure (Pub. 02-5952-7644) 4 pp.
- PN 5180-1 *Understanding the 5180A Waveform Recorder* (Pub. 02-5952-7623) 60 pp.
- PN 5180-2 *Dynamic Performance Testing of Analog to Digital Converters* (Pub. 02-5952-7629) 48 pp.
- PN 5180-3 *General Purpose Subroutines for the 5180A Waveform Recorder (using the 9825 controller)* (Pub. 02-5952-7643) 48 pp.
- AN 313-1 *Troubleshooting Microprocessor-Based Systems Using the 5180A Waveform Recorder and a Logic Analyzer* (Pub. 02-5952-7634)
- AN 313-2 *Using the 5180A Waveform Recorder with a Spectrum Analyzer for new Time-Domain Measurement Capability* (Pub. 02-5952-7635)
- AN 313-3 *Using the 5180A Waveform Recorder to Measure Microwave VCO Settling Time and Post Tuning Drift* (Pub. 02-5952-7636)
- AN 313-4 *Extending the Frequency Range and Increasing the Effective Sample Rate of the 5180A Waveform Recorder* (Pub. 02-5952-7637).
- AN 313-5 *Power Supply Testing with the 5180A Waveform Recorder* (Pub. 02-5952-7647).
- AN 313-6 *Recording Sonar and Other Signals Using the 5180A's Toggle Mode* (Pub. 02-5952-7641).
- Programming Note 5180A/9825-1 *Introductory Operating Guide for the 5180A Waveform Recorder with the 9825 Desktop Computer* (Pub. 02-5952-7630).
- Programming Note 5180A/85-1 *Introductory Operating Guide for the 5180A Waveform Recorder with the HP 85 Personal Computer* (Pub. 02-5952-7633).
- Programming Note 5180A/9826-1 *Introductory Operating Guide for the 5180A Waveform Recorder with the 9826 Computer System* (Pub. 02-5952-7664).



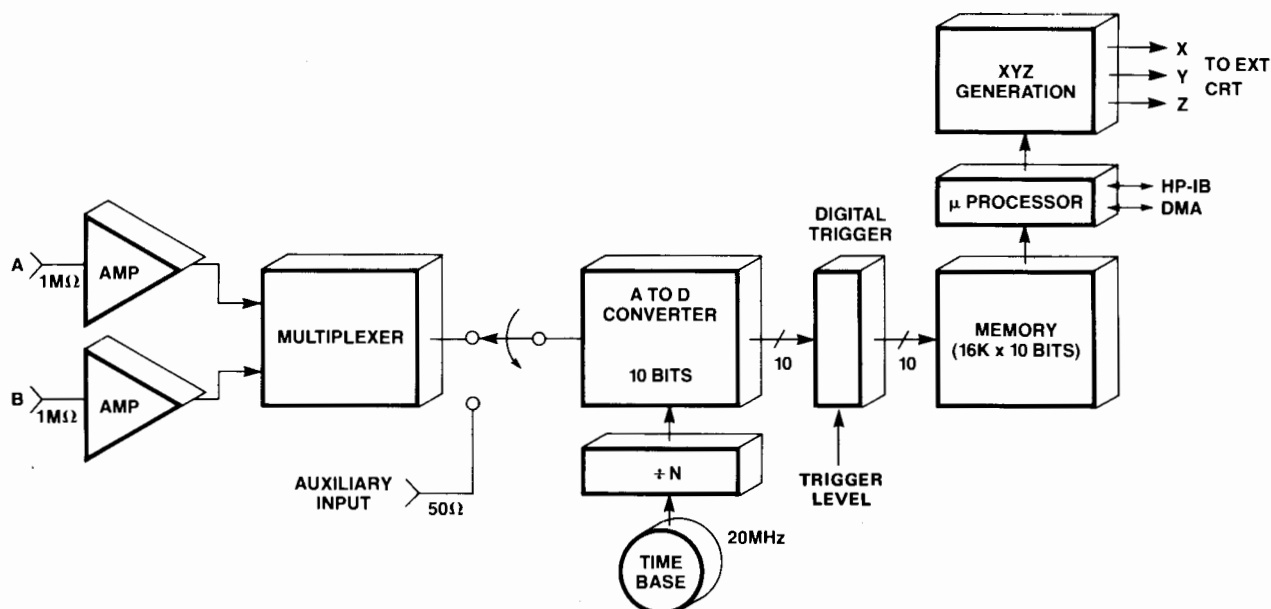

Available inputs to the 5180A include two high impedance input channels with selectable voltage ranges. In addition, the 5180A offers a 50 ohm auxiliary input, which sends signals directly into the ADC.

The 5180A's signal sampling rate is obtained by selecting the value of N which will divide down the 20 MHz internal timebase. The 5180A determines the trigger point by comparing the selected trigger level to the output of the ADC.

When data has been placed in the 5180A's memory, it can be output in digital form via HP-IB or direct memory access (DMA), or in analog form via XYZ outputs.

stored in memory. This "pre-trigger" feature makes it possible to record waveform information such as the initial rise of a transient which occurs before the trigger. If, on the other hand, a convenient trigger signal occurs some time before recording should begin, the "post-trigger" feature enables the 5180A to wait for a precise amount of time after the trigger before starting to save data. This precise delay may be as long as 1 million sample time intervals.

#### Memory

Two timebases, main and delay, allow the 5180A to change sampling rate once or twice during a recording. The 5180A can sample at the main timebase rate only, or switch from the main rate to delay rate, or from main to delay and back to main while recording into each memory record. The main and delay timebase rates are independently selectable, between 50 ns/sample (20 MHz rate) and 50 ms/sample (20 Hz rate).

The 5180A provides 16K words of high-speed memory. For the maximum 20 MHz sampling rate, this allows a total recording time of 819  $\mu$ s. If the entire memory is not required for a single waveform, the memory may be segmented into as many as 32 separate records.

When the memory is segmented into multiple records, a special feature of the 5180A enables it to automatically move to the next memory record when it has filled the current one. This feature, "auto advance", makes it possible to quickly record successive signals, and to record multiple signals when the 5180A is unattended. In addition, the "trigger time" of each successive record is available with respect to a user-selected zero time.

#### Display Features/Benchmark or Manual Measurements

Two cursors are available on the 5180A. These can be used to make voltage and time difference measurements, and to select points around which to expand either horizontally or vertically in the display. The 5180A has two display traces, each of which can display the waveform from a single memory record. When both traces are used, both cursors may be placed on one trace, or they may be placed on separate traces.

#### Operating Convenience Features

The 5180A's "Preset" key sets all front panel functions to known values. These values were selected to be optimal for recording tran-

sients about which little information is available. An "Autoset" key selects front panel function values for a repetitive input waveform. Often-used front panel setups can be stored in the 5180A's four "Save Locations" and later conveniently recalled for use.

Another convenience feature offered by the 5180A is direct HP-GL output to digital plotters as well as analog output to X-Y recorders. These hardcopy devices need only be connected by cables; no controller is required.

#### Programmability/Systems Features

The 5180A's front panel function values are fully programmable via HP-IB. Digital data may be output from or input to the 5180A in either binary or ASCII via HP-IB. Also, high-speed digital data transfer is available using direct memory access (DMA).

#### External Timebase Input

An external timebase signal between 1 and 20 MHz may be input to the 5180A and used instead of the instrument's 20 MHz internal timebase. This feature makes it possible to synchronize sampling with another signal, or to lengthen the 5180A's minimum sample interval from 50 ms to up to 1 second. The external timebase capability is also useful in a number of other applications, including:

**Effective sample rates up to 20 GHz for repetitive input waveforms:** a technique similar to that of a sampling scope enables the 5180A to "step through" an input waveform, obtaining high effective sample rates on waveforms containing frequencies up to 70 MHz.

**Increasing number of input channels using multiple 5180A Waveform Recorders:** samples from several 5180A Waveform Recorders may be synchronized by driving the external timebase inputs using synchronous sources.

**Increasing real sample rates using more than one 5180A Waveform Recorder:** to obtain real sampling rates higher than 20 MHz, even for transient waveforms, samples of the waveform taken by more than one 5180A may be interleaved.

**Recording "Burst" data using a precisely controlled timebase input:** by using a "burst" timebase input to a 5180A Waveform Recorder, data which occurs in bursts may be recorded without wasting memory space.



- Display Waveforms Recorded in 5180A Memory
- Permanently Record Digitized Waveforms on Tape



5181A, companion instrument to 5180A Waveform Recorder, shown with 5180A



### Summary of 5180A Specifications\*

#### Channel A and B Inputs

**Input Voltage Range:**  $\pm 100$  mV to  $\pm 10$  V.

**Input Offset Voltage:**  $\pm$  Selected Voltage Range.

**Amplifier Bandwidth (-3 dB):** dc to 40 MHz (dc coupling).  
10 Hz to 40 MHz (ac coupling).

**Input Impedance (NOMINAL):**  $1\text{ M}\Omega \parallel <30\text{ pF}$  (10-V range).  
 $1\text{ M}\Omega \parallel <35\text{ pF}$  (other ranges).

**Damage Level:**  $\pm 12$  V above 1 kHz.

#### Dynamic Performance:

	Voltage Range	Input Signal	Test Frequency	
			1 MHz	10 MHz
Fourier Transform (unwanted signal level)	$\pm 1$ V	2 Vp-p	$\leq -50$ dBc	$\leq -46$ dBc
Differential Nonlinearity	$\pm 1$ V	2.2 Vp-p	$\leq 3$ LSB	$\leq 4$ LSB
Missing Codes	$\pm 1$ V	2.2 Vp-p	None	None
Effective Bits	$\pm 1$ V	2 Vp-p	$\geq 7.8$ bits	$\geq 7.5$ bits
S/N Ratio	$\pm 1$ V	2 Vp-p	$\geq 48.6$ dB	$\geq 46.8$ dB

#### Auxiliary Input

**Input Voltage Range:**  $\pm 1$  V

**Amplifier Bandwidth (-3 dB):** dc to 70 MHz

**Input Impedance (NOMINAL):**  $50\ \Omega$

**Damage Level:**  $\pm 1.5$  V

#### Triggering

**Internal Trigger:** level selectable over input voltage range.

**External Trigger:** level selectable over  $\pm 2.5$  V range.

**Trigger Position:** -100% to +9999% of memory.

#### Timebase

**Internal Timebase:** 20 MHz internal timebase allows sample rates between 50 ns and 50 ms in a 1-2-5 sequence.

**External Timebase:** external timebase signals between 1 MHz and 20 MHz may be used.

#### Memory

**Size:** 16,384 words.

**Bits/Word:** 10 bits.

**Segmentation:** memory may be divided into 1, 2, 4, 8, 16, or 32 equal-length records.

#### Outputs

**XYZ CRT Monitor Outputs:** X, Y deflection voltages (NOMINAL) -1 to 0V into  $50\ \Omega$ . X requires 1 MHz bandwidth input; Y requires 5 MHz bandwidth input. Z voltage (NOMINAL) is 0 to 2 V into 1 K $\Omega$  (0 to 1V into  $50\ \Omega$ ), selectable positive or negative going blanking pulse. Z requires 1.25 MHz bandwidth input.

**HP-IB:** all front panel function values selectable via HP-IB. Data I/O in ASCII or binary; maximum 3 Kbyte/second rate, depending on controller. "Talk only" to HP-GL plotters available even if no controller is used.

**DMA:** direct memory access allows fast parallel data transfer; maximum 1M word/second, depending on controller.

**Trigger Output:** positive going signal from -0.6 V to 0 V into  $50\ \Omega$  synchronous with 5180A trigger.

#### General

**Operating Temperature:**  $0^\circ\text{C}$  to  $55^\circ\text{C}$ .

**Power Requirements:** 100/120/220/240 volts +5%, -10%; 48 to 66 Hz. Max power dissipation 400 VA.

**Weight:** 22 kg (48 lbs.) net; 25 kg (53 lbs.) shipping.

**Size:** 142 mm H x 426 mm W x 574 mm D ( $5\frac{5}{8}$ " x  $16\frac{3}{4}$ " x 23").

#### Ordering Information

##### 5180A Waveform Recorder

10871A Service Kit (for 5180A)

10872A Parallel Interface (DMA Interface for use with 5180A and 9825/35/45 controller)

10873A Rack Mount Kit (for 5180A)

10874A Slide Mount Kit (for 5180A)

\*See 5180A Waveform Recorder Data Sheet for more information.

### 5181A Display/Tape Storage Module

#### Introduction

The 5181A Display/Tape Storage Module, a companion instrument to the 5180A Waveform Recorder, provides a high resolution CRT for waveform display and a dedicated controller for recording digitized waveforms onto magnetic tape.

The display portion of the 5181A uses an HP 1332A Small Screen Display. The controller is an HP 9915A Modular Computer with special front panel keys which enable data transfer (between the 5180A and the 5181A) and data storage.

When waveform data is sent to or from the 5180A, the 5181A also transfers the current complete 5180A front panel setup, so that the conditions used for recording each waveform are saved along with the waveform. Digitized waveforms which have been stored on tape by the 5181A may be read directly by an HP 9915A, HP 85, HP 9835, or HP 9845 controller for custom data analysis.

### 5181A Specifications

#### Data Storage

**Tape Capacity:** four 16,384-word files per tape, plus space for up to 128 complete front panel setups.

#### Display

**Viewing Area:** 9.6 x 11.9 cm.

**Quality Viewing Area:** 8.5 x 10.8 cm.

**Spot Size:**  $\leq 0.30$  mm within quality viewing area.

**Resolution:** 31.5 lines/cm.

#### General

**Operating Temperature:**  $0^\circ$  to  $55^\circ\text{C}$ .\*

**Power Requirements:** 100/120/220/240 volts + 5%, -10%, 48-66 Hz. Maximum Power Dissipation: 100 VA.

**Weight:** 14.9 kg (32 lbs., 12 oz.) net.

**Size:** 142 mm H x 426 mm W x 574 mm D ( $5\frac{5}{8}$ " x  $16\frac{3}{4}$ " x 23").

#### Ordering Information

##### 5181A Display/Tape Storage Module

(includes handles)

**Option 908 Rack Mount Kit** (for mounting without handles)

**Option 913 Rack Mount Kit** (for mounting with handles)

\*Tape cartridges are not recommended for use above  $40^\circ\text{C}$ .

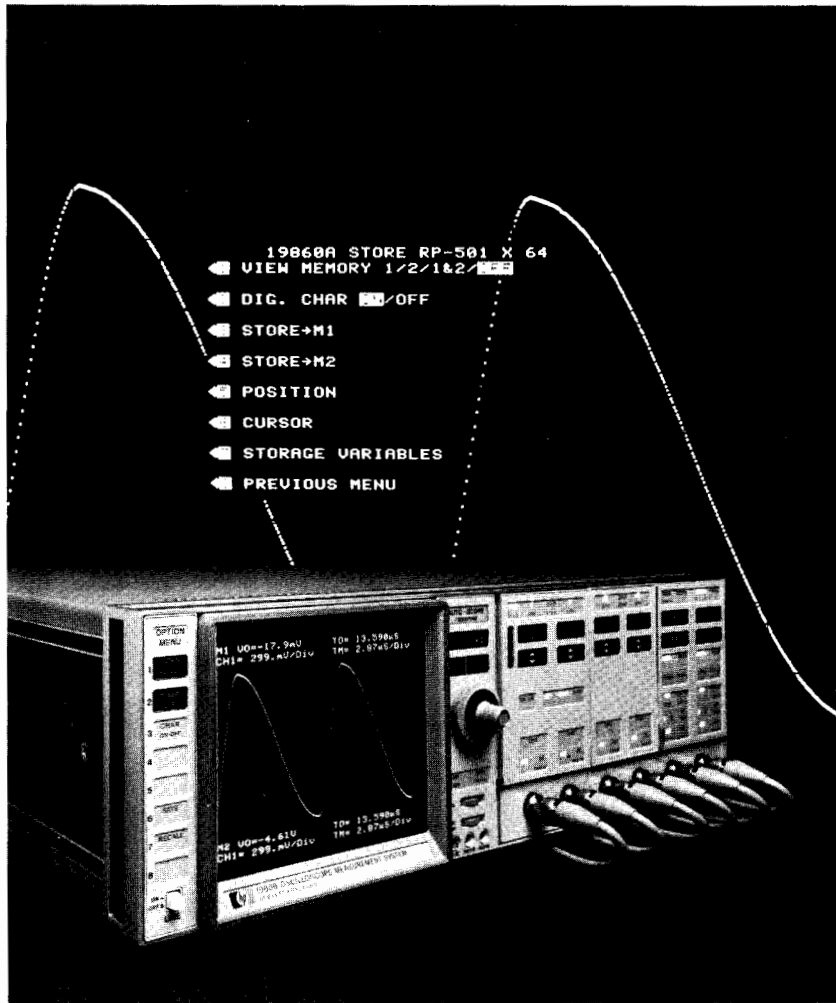

## Introduction

The oscilloscope—the most general purpose and basic tool of the electronic industry—has evolved into an even more powerful and versatile measurement tool. Hewlett-Packard technological innovations provide expanded levels of performance in all three primary oscilloscope application areas: waveform viewing, timing analysis, and instantaneous voltage measurement.

## Waveform Viewing

Many measurement applications involve signals that ordinarily result in very faint traces. Hewlett-Packard's variable persistence oscilloscopes solve this problem by operating similar to conventional repetitive sweep instruments except that signals are displayed as bright, high contrast, flicker-free traces. Also, there is no waiting for storage operation which makes it easy to view a high speed, randomly occurring glitch in the presence of a repetitive signal.

Hewlett-Packard's 1980A/B Oscilloscope Measurement System includes a built-in feature, called Auto-Scope, which automatically sets intensity, deflection factors, sweep speeds, trace position, and signal conditioning necessary to obtain a display of the input

signals. This allows an operator to obtain a display rapidly without adjusting individual controls and provides a starting point for test procedures.

The Model 1980A/B is a fully programmable oscilloscope. In production test applications, the 1980A/B provides the user with the best of both worlds: the powerful diagnostic ability of an oscilloscope waveform display plus the tremendous productivity gains associated with a fully automated instrument operation.

## Timing Analysis

The ever increasing use of digital circuits in today's products and systems has resulted in a need for more convenient and accurate time interval measurements. Digital circuits fail to function properly for a variety of reasons, but often the problem is caused by a timing error. Hewlett-Packard's family of time interval oscilloscopes are designed to track down and help the user identify elusive timing violations such as clock phasing discrepancies, setup and hold time violations for a flip-flop, or unexpected propagation delays.

The HP Model 1743A offers time interval averaging measurements that provide accuracies of 0.002% of reading and 100 pico-

second resolution. The 1743A's technology also offers several innovative measurement capabilities: a triggered measurement mode in which the time interval reading will track changes in the input signal without operator intervention and a "first pulse" feature that enables the leading edge of the signal starting the oscilloscope main sweep display to be used as a reference for precise time interval measurements.

The 275 MHz 1722B, 1725A, and 1727A; 200 MHz 1715A; and 100 MHz 1746A all offer the Hewlett-Packard pioneered two-marker time interval measurement system. For repetitive measurement applications, the HP-IB controlled 1980A/B Oscilloscope Measurement System offers a powerful repertoire of time interval measurement facilities.

## Instantaneous Voltage Measurement

The modern oscilloscope is such a powerful waveform viewing, diagnostic, and timing analysis instrument that many users tend to forget its ability to make instantaneous voltage measurements on extremely complex, wide bandwidth signals. The HP Model 19860A Digital Waveform Storage enhancement to the 1980A/B Oscilloscope Measurement System provides from one to 501 instantaneous voltage measurements on any viewable signal with resolution of one part in a thousand. These voltage measurements are available for on-screen viewing, waveform plotting, or supplied via HP-IB for computer analysis.

The HP Model 1722B Oscilloscope enables the user to combine on-screen cursors and a built-in microprocessor to obtain dc voltage, waveform voltage, and percent amplitude measurements.

## Selecting an Oscilloscope

When selecting an oscilloscope, you will need to match your present and future measurement needs with the oscilloscope feature set. Price is always a consideration and incremental cost must be weighed against incremental measurement capability. In many cases, ease-of-use should be considered along with measurement accuracy and the overall feature set. Some of the major feature decisions include:

- Bandwidth
- Number of channels
- Rack or cabinet configuration
- Portability
- Plug-in versatility
- Vertical and horizontal accuracy
- Convenience
- Price
- Time interval capability
- Variable persistence storage
- HP-IB programmability
- Digital waveform storage

Hewlett-Packard manufactures several oscilloscope families. Each family optimizes a different combination of the considerations previously listed. Refer to the Oscilloscope Selection Chart on page 177 for feature sets and page references.



### The 1980A/B

Hewlett-Packard's Oscilloscope Measurement System is a revolutionary, fully programmable, HP-IB compatible instrument with digital waveform storage that makes significant contributions in viewing, measuring, and processing time domain waveforms. These contributions are achieved by using a computer architecture with instrument operation controlled by a microprocessor. The computer architecture permits physical separation of the analog measurement circuits and the front panel controls which allow the front panel to be laid out in a logical hierarchy. A single, digitally-encoded rotary control replaces the numerous rotary controls on other instruments which simplifies operation.

### HP-IB Programmable

With complete digital control of instrument operation, computer control through an HP-IB interface is easily accomplished. A computer can establish front panel settings and can communicate with an operator by writing instruments on the CRT through its character generator. When this automated capability is used in repetitive testing, complete step-by-step procedures can quickly direct operators through complex tests. Additionally, the computer can lock out controls to prevent inadvertent actuation which would result in time-consuming, erroneous measurements. Furthermore, front panel setup and variable functions (e.g., deflection factors, sweep speeds, etc.) can be read by the computer for calculation, evaluation, and, if desired, print out for permanent record. With computer control, today's complex products can be more extensively tested to assure high quality while reducing both measurement time and cost.

### Digital Waveform Storage

With the addition of the Model 19860A Digital Waveform Storage capability, com-

pletely automatic measurements under computer control are possible. For example, a waveform can be automatically scaled by the Auto-Scope routine resident in the 1980 operating system. The displayed signal can then be digitized, stored, and sent to a computer for analysis.

### Waveform Measurement Library

The newest enhancement to the 1980A/B is the HP 19800A – a software package that supplies the measurement programs, subprograms, and development aids you need to make completely automatic time-domain measurements. Linking the 1980 to HP computers, the 19800A provides measurement capability on the day the system arrives and reduces the time needed to develop software for specific applications. The 19800A is able to set up the 1980 to digitize, store, and transfer waveforms to the computer, to compare and characterize many kinds of waveforms, and to output results and plot waveforms. By automating measurements traditionally made manually, the 19800A can improve measurement quality and reduce the required skill level of the operator. The following areas described can all be made more productive by incorporating the 19800A into the 1980/860 system.

### Automatic Test System

The 1980/860 system can greatly improve the efficiency of test systems by completely automating time domain measurements. This fully programmable system can be set up to acquire a signal, digitize it, and transfer it to a computer for automatic analysis to provide complete answers without operator intervention. A series of standard signals may be digitized and stored in a computer to build a library of references for automatic testing. Now, as tests are performed, signals are automatically compared in software.

Test procedures are easily developed because the 1980 uses a "learn string" to define all setup information. All that is required is to store a reference waveform along with the learn string that was used to set up the instrument. When the test is performed, the stored information is simply sent back to the 1980 and text may be written on the CRT to explain the adjustments.

### Semiautomatic Testing

In applications where operator interaction is necessary, such as circuit setup, calibration, or troubleshooting, the measurement system can improve productivity by eliminating operator front panel setup time and possible errors. A controller can set up front panel controls and write a reference waveform with text on the CRT to direct an operator through a calibration sequence. The operator only has to make circuit adjustments so that a real time waveform is positioned between two reference waveforms. All of the information for text, instructions, reference waveforms, and front panel setup, can be stored in a data base on tape or disc files.

Furthermore, the 1980 front panel controls can be redefined in a programmable station. For example, the rotary control could be redefined to control the adjustment of another instrument as directed by instructions on the CRT. In a similar fashion, the soft keys could be redefined with the appropriate instructions adjacent to them to control the modes of operation of other instruments in a programmable system.

The start and stop cursors can also be used to improve measurement efficiency by taking advantage of operator interaction. For instance, after a waveform is captured, the operator can position the cursors on critical points of a waveform that would normally require considerable controller software to define automatically. The cursor positions can then be read by the controller with the necessary computations quickly accomplished.

### Bench Operation

In bench applications with a controller, an engineer can easily develop and maintain a data base to log the results of design changes. When combined with other programmable instruments, long tests can be automatically accomplished to record any changes in circuit response with design changes. Also, with the appropriate controller software, answers to frequent measurements can be obtained with the press of one of the 1980 soft keys.

Without a controller, the 1980/860 can be used as a traditional oscilloscope with the added benefits of the easy-to-use front panel and software features. The Auto-Scope capability acquires a signal with the press of one key reducing the time for initial instrument setup. Frequently used front panel setups can be saved in eight local registers and quickly recalled to reduce measurement time and improve productivity. Slow repetition rate fast signals can be captured and displayed as bright, nonfading signals by the digital waveform storage capability.

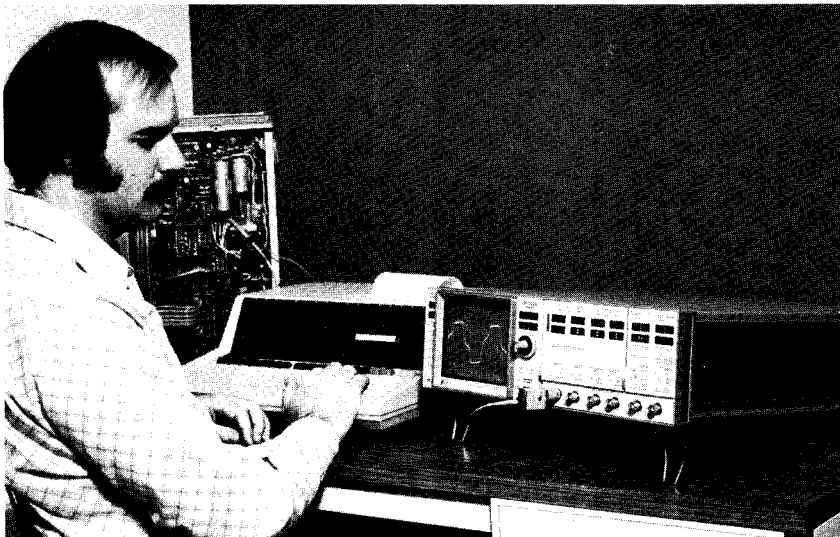

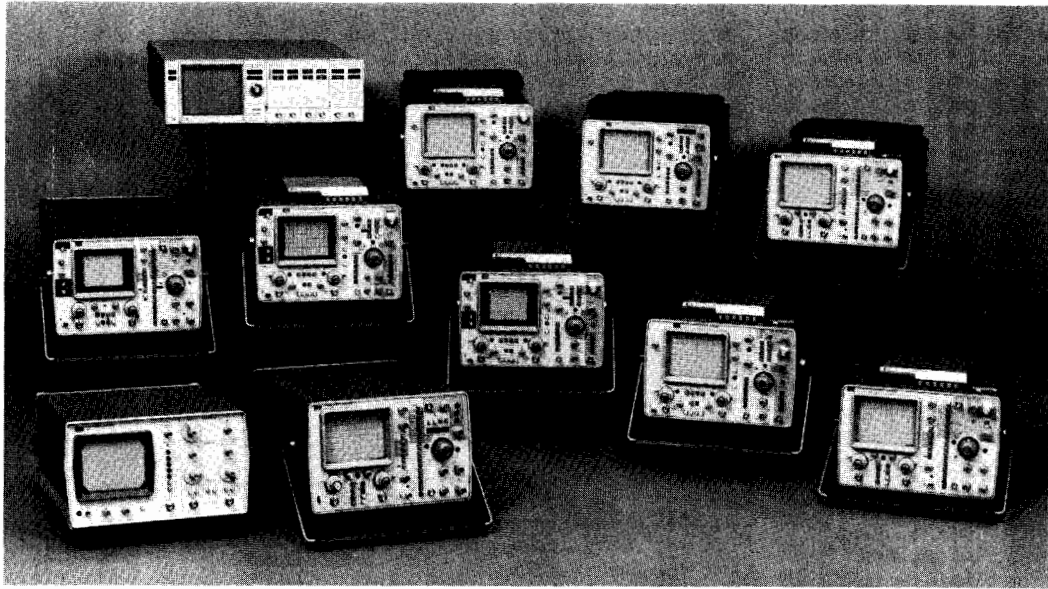

### The 1700 Series

#### A Family of Solutions

The 1700 family of oscilloscopes provides a wide selection of quality instruments for lab, production, and service applications. The product line is composed of oscilloscopes ranging in bandwidth from 100 to 275 MHz, with both conventional and variable persistence/storage CRTs available in each bandwidth category.

#### The 1740 Series

This series offers a selection of five oscilloscopes in the 100 MHz category; 1740A, 1741A, 1743A, 1744A, 1745A, 1746A. All of the 1740 series are dual channel, offer a third channel trigger view, vertical sensitivity to 1 mV (at reduced bandwidth), as well as selectable input impedance (50 $\Omega$ /1M $\Omega$ ). Models 1741A and 1744A offer the additional capability of variable persistence/storage.

#### Large Screen 1740's

The 1745A and 1746A offer a large screen 9.5 x 12 cm CRT which has 43% more viewing area than the standard 8 x 10 cm CRT. The trace is crisp and bright as in the 1740A which increases resolution for more accurate measurements, especially in three-channel timing measurements with trigger view. The large screen also enhances the viewability of the screen, providing more of what an oscilloscope is used for—seeing a picture of what is happening in the circuit.

#### High Frequency 1700's

For high frequency applications, there is a selection of four oscilloscopes ranging from 200 to 275 MHz with both conventional and variable persistence/storage CRTs; 1715A, 1725A, 1722B, and 1727A. These instruments are all delta time oscilloscopes, which are ideal for use in the design, manufacture,

and testing of high speed computers, peripherals with fast interface logic, high speed digital communications, and high frequency RF and analog applications.

#### Variable Persistence/Storage

The 100 MHz 1741A and 1744A combine with the 1727A to form an excellent selection of variable persistence/storage oscilloscopes. HP's advanced CRT technology permits high variable persistence writing speeds with blind times identical to conventional oscilloscopes. Extremely fast variable persistence and stored writing speeds are available on the 1744A and the 1727A with the HP developed expansion storage technique. These capabilities combine with an auto-intensity circuit to create an instrument that is extremely general purpose. In fact, more and more of these oscilloscopes are being used as a "one oscilloscope solution" to solve the wide variety of measurements encountered every day, rather than the special purpose tool of the past.

#### Delta Time Measurements

All 1700 series instruments have delayed sweep time bases for differential timing measurements. Several of these instruments also have the Hewlett-Packard developed time interval measurement capability known as delta time. This delta time system incorporates two intensified markers that define the start and stop events and makes time interval easier and more accurate than single marker systems. Furthermore, the interval can be read directly on the heliodial, an optional DMM, or on some models the built-in LED display.

#### 1700 Series Options

DMM/Temperature Probe—DMM and

temperature probe are available on the 1740A, 1741A, 1715A, 1725A, and 1727A. This is a 3½ digit auto-ranging and auto-zeroing DMM built into the top cover of the instrument capable of displaying time intervals on delta time oscilloscopes, as well as supplying the five basic measurements: ac and dc volts, ac and dc current, and resistance. By adding a Model 10023A Temperature Probe to the DMM, fast, accurate temperature measurements are accomplished easily with its "pencil-like" tip that easily accesses components.

TV Sync—Hewlett-Packard's Option 005 offers triggering capability on composite video waveforms that have negative sync pulses. The option features a variety of display enhancements including field selection, line scan, and single line scan. This option is available on the 1740A, 1741A, 1715A, 1725A, 1745A, and 1746A.

#### Probes

Probing is an extremely important and often overlooked part of making a measurement. Hewlett-Packard offers a full line of probes to complement HP oscilloscopes for maximum signal fidelity and minimum circuit disturbance.

For IC probing in densely packed printed circuit boards, HP offers miniature probes in high impedance and 50  $\Omega$  versions. These small, lightweight probes fit in the hand much like a pencil and easily clip on IC pins. Also, the 10024A IC test clip clamps on 14- or 16-pin DIP's for easy access with the miniature probes.

In addition, HP offers passive resistive divider, active, current, and logic triggering probes to meet your measurement needs fully.



## Low Frequency 500 kHz

Low frequency oscilloscopes, such as HP's 1200B, 1201B, and 1205B, which have 500 kHz bandwidth, are used in education, medicine, system monitors, engineering, production, and some field service applications. The 1200 series oscilloscopes offer 100  $\mu$ V and 5 mV sensitivity, differential inputs, solid state, and lightweight construction, as well as reliable operation.

## 15 MHz

In the dc to 15 MHz range, Models 1220A and 1222A dual-channel oscilloscopes are ideal for industrial and educational applications. Logical front panel layout, large 8 x 10 cm internal graticule, and automatic triggering assure easy operation in all environments. Model 1222A has all of the features of the 1220A plus a delay line that allows viewing of the leading edge of the signal that triggered the sweep.

## Accessories

Hewlett-Packard offers a full line of quality accessories designed to meet a wide variety of applications. Several models of test-modules offer convenient portability for your oscilloscopes or instrumentation systems. Portable power supply, camera, adapters, and terminations round-out the accessories which will help you get the most out of your oscilloscope investment.

## Completing the Oscilloscope Solution . . .

### Support Literature

A comprehensive selection of support literature is available on the oscilloscope product line. Application notes, product notes, programming guides, and data sheets help you get the maximum measurement capability out of your particular oscilloscope.

## Seminars

Seminars are an excellent vehicle to help engineers and technicians learn more about their Hewlett-Packard oscilloscope, whether the information concerns applications, operation, programming, or maintenance.

Maintenance training classes are offered several times each year at the Colorado Springs Division. These seminars, directed towards calibration and repair technicians, teach operation, circuit theory, calibration, and troubleshooting to the component level. A nominal fee is charged to cover study materials, manuals, etc. Contact your HP field engineer for information about a specific instrument seminar.

Operation/application seminars are also arranged on an individual basis by field engineers as a pre- and post-sales enhancement. These seminars inform engineers and technicians about special considerations in respect to specific applications and modes of operation: probing, bandwidth time base errors, and variable persistence storage.

The automation of waveform measurements using the HP 19800A Waveform Measurement Library with the 1980A/B is the topic of a waveform measurement system seminar. This seminar, offered to help you maximize productivity by helping you understand the capabilities of the 1980A/B and its software, will teach waveform processing techniques, how to modify the 1980A's measurement programs, and how to assemble the subprograms into application programs. This seminar will also cover the two measurement tools of the 1980A/B system—the 1980A/B's Trigger Flag and the 19860A Digital Waveform Storage option—and how they work together to produce a total solution to time-domain measurement needs. The

seminar will also teach you how to interface the 19800A with other HP software products so that your system will reach beyond the time-domain. The 19800A seminar combines a tutorial with supervised hands-on workshops. The course is given by HP Systems Engineers at the customer's facility and on the customer's equipment. For further information, contact your local HP sales office.

## Reliability/Quality

Hewlett-Packard oscilloscopes maintain the high standard of quality that is present throughout the company. Two programs insure that this quality remains an integral part of Hewlett-Packard oscilloscopes: 1) an overall reliability program and 2) an internal quality program.

The overall reliability program stresses "designing reliability in." This comprehensive program starts at the lab prototype stage, where temperature and environmental tests identify marginal components and even potential design problems. The program continues throughout the entire development cycle of a product and ends with a full environmental and life test prior to release.

The internal quality program emphasizes "do it right the first time" and affects all areas of operation: production, shipping, order processing, service, and the lab.

In production, quality starts with the inspection of incoming parts. Printed circuit boards go through extensive testing including functional and parametric component testing, power cycling to weed out early failures and to increase the reliability of the boards going to final assembly. There, quality teams monitor assembly and calibration procedures to ensure that HP oscilloscopes maintain their reputation for high quality.

## Oscilloscope Selection Chart

Characteristics	1700 Series										180 Series	1220A 1222A	1200 Series			**1980A/B
	1715A	1722B	1725A	1727A	1740A	1741A	1743A	1744A	1745A	1746A			1200B	1201B	1205B	
Bandwidth	200 MHz	275 MHz	275 MHz	275 MHz	100 MHz	100 MHz	100 MHz	100 MHz	100 MHz	100 MHz	50 MHz, 100 MHz	15 MHz	500 kHz	500 kHz	500 kHz	100 MHz
Deflection Factors/Div.	5 mV to 5 V	10 mV to 5 V	10 mV to 5 V	10 mV to 5 V	1 mV <sup>2</sup> to 20 V	1 mV <sup>2</sup> to 20 V	1 mV <sup>2</sup> to 20 V	1 mV <sup>2</sup> to 20 V	1 mV <sup>2</sup> to 20 V	1 mV <sup>2</sup> to 20 V	5 mV Min.	2 mV to 10 V	0.1 mV to 20 V	0.1 mV to 20 V	5 mV to 20 V	2 mV to 10 V
Sweep Speeds/Div.	1 ns to 0.5 s	1 ns to 0.5 s	1 ns to 0.5 s	1 ns to 0.5 s	5 ns to 2 s	5 ns to 2 s	5 ns to 2 s	5 ns to 2 s	5 ns to 2 s	5 ns to 2 s	5 ns to 1 s	10 ns to 0.5 s	0.1 $\mu$ s to 5 s	0.1 $\mu$ s to 5 s	0.1 $\mu$ s to 5 s	5 ns to 1 s
Channels	2	2	2	2	2	2	2	2	2	2	2, 4	2	2	2	2	2, 4
Time Measurements	•	•	•	•												•
Variable Persistence Storage				•		•		•			•			•		
3rd Channel Trigger View					•	•	•	•	•	•						•
TV Sync	Opt	10029A	Opt	10029A	Opt	Opt	10029A	10029A	Opt	Opt		•				
Differential Inputs											•		•	•		
Optional Logic State Switch	•	•	•		•	•	•		•	•						
LED Readout/DMM	Opt	•	Opt	Opt	Opt	Opt	•		Opt	Opt						•
Large CRT									•	•						•
Page	194	195	194	196	186	189	187	190	186	186	202	205	203	203	203	178

\*With X5 vertical magnification at reduced bandwidth.

\*\*Fully programmable, HP-IB.

# OSCILLOSCOPES

## Oscilloscope Measurement System

Models 1980A/B

- Fully HP-IB Programmable
- Expandable Measurement Capability
- Easy-to-Use Front Panel
- On Site Calibration
- Auto-Scope Automatically Scales Waveforms
- CRT Text for Operator Instructions
- Optional Digital Waveform Storage
- Optional Waveform Measurement Library

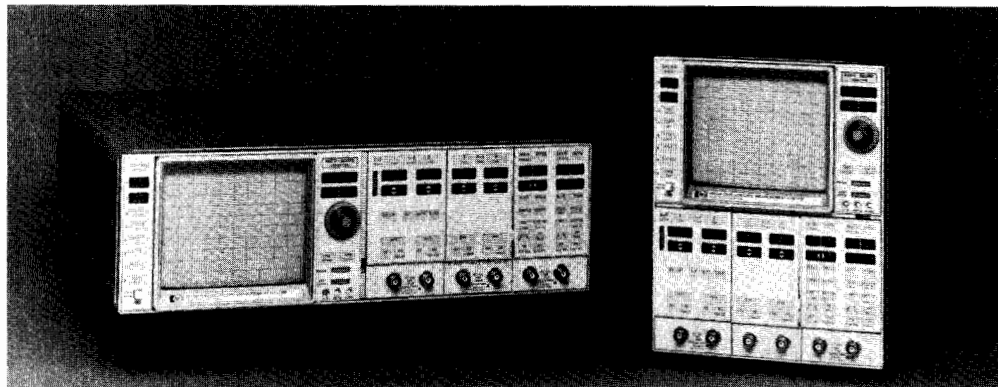

### Introduction

Hewlett-Packard's Model 1980A/B Oscilloscope Measurement System is a revolutionary, fully programmable, time domain instrument based on a computer architecture. This automated, HP-IB compatible instrument makes significant contributions in viewing, measuring, and processing time domain waveforms. Improved measurement capability is achieved with the computer architecture design that permits internal operation to be controlled by a microprocessor. This results in an easy-to-use instrument with an extensive feature set. Internally, the instrument is divided into eight independent functional blocks that interface with each other over a bus structure. This extensive digital control permits many features not in other oscilloscopes, including programmable hardware and firmware expansion, an easy-to-use front panel, autoranging, and complete programmability.

### Enhancements

The basic instrument contains provisions for expanded measurement and control capabilities in the form of additional hardware or firmware. Hardware expansion modules, such as the two-channel 1950A, fit into a front panel compartment and contain analog and digital interfaces for measurement integrity and programmability. Firmware expansion is through the addition of up to four preprogrammed 4k ROMs that provide either additional control capabilities or data manipulation. Digital waveform storage is another form of enhancement that provides completely automatic measurement capability. To access this capability most rapidly, the 1980 now has a software package, the Waveform Measurement Library, that will greatly reduce software development time.

### The 1980A/B Oscilloscope Measurement System

In its basic configuration, the 1980 offers two 100 MHz analog measurement channels with continuous 2 mV to 10 V/div deflection factors, two independent and continuous main and delayed sweeps from 5 ns to 1 s/div, main or delayed trigger view, both delta time and voltage measurements, an Auto-Scope feature for automatic signal scaling, and many other features. These capabilities are combined with an innovative front panel design with color-coded keys and a single rotary control. The internal microprocessor scans the front panel for any key activation and variable control changes and then sets the instrument. Because these functions are controlled digitally by the microprocessor, they can also be programmed quite easily through the HP-IB interface. This programmability allows instrument setup to be done automatically by a computer which eliminates errors and greatly reduces setup time.

### Full Programmability

Remote programmed operation is through the standard HP-IB port that interfaces through the internal digital bus with all functional blocks. This remote operation allows programming all measurement parameters (i.e., deflection factors, sweep speeds, etc.),



SIMPLIFIED BLOCK DIAGRAM OF 1980A/B ARCHITECTURE

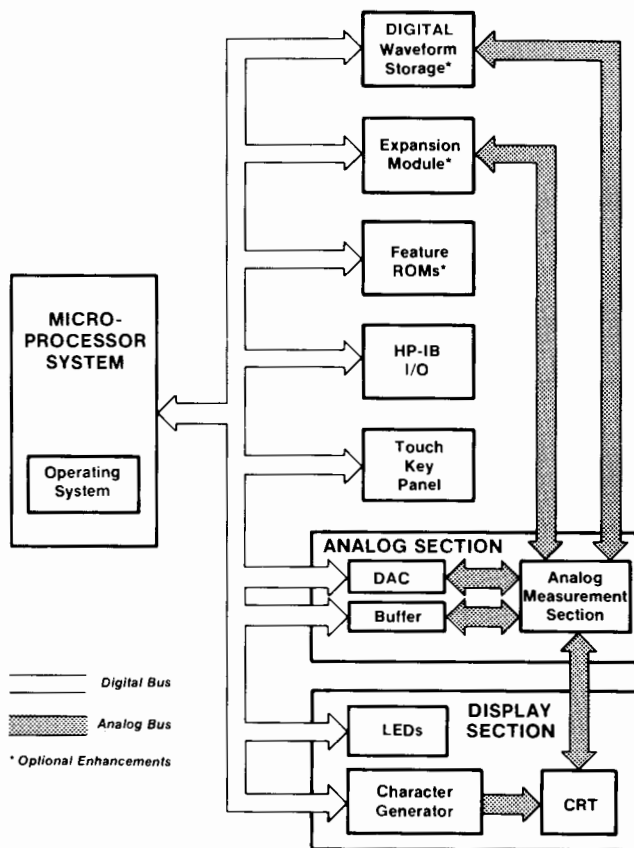

touch key setup, writing of instructions on the CRT through an ASCII character generator, and accessing of all installed enhancements. Conversely, the front panel status, measurement parameters, and, when installed, digitally stored waveforms may be read by a computer.

**Front Panel**

The internal computer architecture made it possible to incorporate an extremely easy-to-use, space efficient, touch key panel which is arranged in a logical manner. The front panel controls are simply contact closures which are constantly scanned by the microprocessor for actuation. A single, digitally encoded rotary control is used to control all variable functions to further simplify the front panel. An increase of control functions without an increase of density is achieved with shifted function keys that access secondary functions or protect certain modes.

The front panel is divided into five operating sections which are arranged for efficient operation and fast familiarization. The top row of keys controls the basic operating modes; dark keys in the second and third rows are variable functions that are assigned to the rotary control for adjustment. The remaining keys are setup functions used to establish input signal and trigger conditioning.

**Menus**

A series of keys to the left of the CRT are designated as soft keys which access a series of menus. When the Option Menu key is pressed, a listing of self-tests and installed firmware and/or hardware enhancements is displayed. Accessing the desired test only requires pressing the indicated soft key which then displays a menu for that function. The menus include instrument preset, front panel calibration, automatic delay and input amplifier balancing, confidence tests, and front panel setting of HP-IB address and operating modes. The menus are automatically updated as hardware and firmware enhancements, such as the 19860A Digital Waveform Storage, are added.

**Calibration**

The computer architecture and microprocessor based operating system provide a new method of calibration. This calibration can be performed from the front panel in less than 45 minutes, without removing the covers and with little or no test equipment. Calibration can now be performed on-site without the need for removal to a calibration lab. In production environments, a more accurate calibration is achieved with the 1980A/B in its test bay or rack thermal operating environment.



Self-contained instructions guide the calibrator through the entire 1980A/B calibration.

The 1980 can be calibrated using its internal calibrator signal with some degradation of accuracy but without the need of any external test equipment. Additionally, calibration requires no or minimal reference to a service manual since the complete step-by-step calibration procedure is displayed on the CRT. When stepping through the calibration procedure, offsets and variances are stored as calibration fac-

tors in nonvolatile RAM. When variable function adjustments are made for new measurements, the software calibration factors are used to assure that only calibrated measurements are made.

A rear panel slide switch prevents unauthorized access to the internal calibration factors. Placing a calibration sticker over the recessed switch insures that the calibration is retained. This innovative front panel calibration capability greatly reduces calibration time and the need for specialized test equipment.

**19860A Digital Waveform Storage**

Adding the Model 19860A Digital Waveform Storage to the 1980 makes waveform acquisition and analysis completely automatic. The 1980/19860A combination greatly reduces measurement time by eliminating operator involvement in complex, repetitive measurements. Repetitive events to 100 MHz or single-shot events to 5 kHz (10 points per period) may be captured, displayed, and sent over HP-IB to a computer for analysis.

In the repetitive mode, signals are sampled at discrete points on successive sweeps with the delay generator used as the sample clock. The number of horizontal data points can be selected in steps of 1, 3, 6, 11, 21, 101, 251, or 501 points which allows the optimum choice between acquisition time and resolution. In the single-shot mode, signals are captured in one sweep with the sample clock provided by the crystal controlled processor clock. The number of data samples is selectable in the same manner as the repetitive mode.

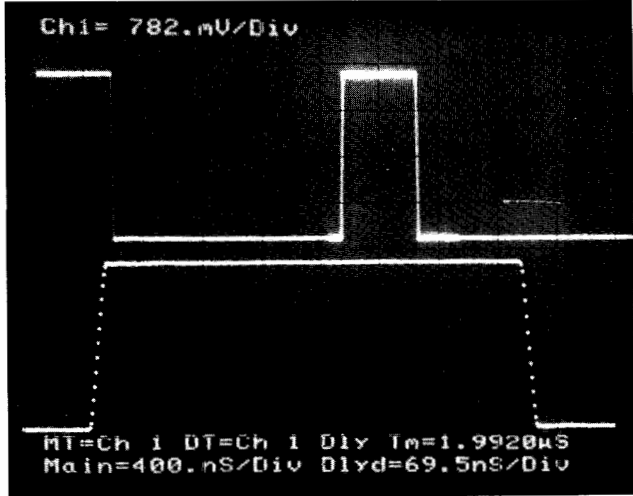

The intensified portion of the waveform is digitized with all 501 horizontal points.

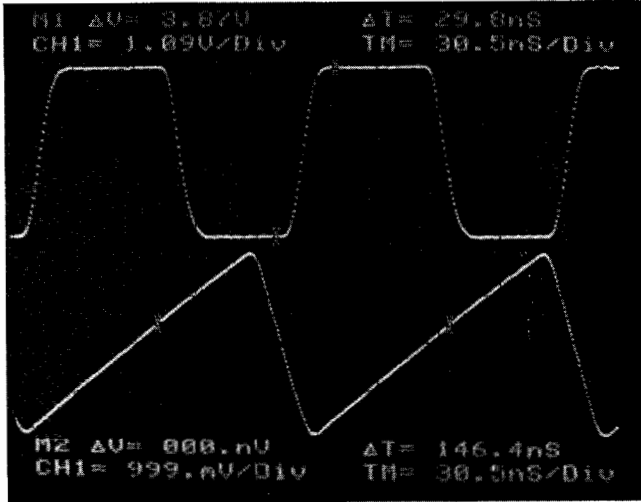

Cursors may be manually or automatically set to assist the operator, or read by a computer to aid in computation.





# OSCILLOSCOPES

## Oscilloscope Measurement System

Models 19860A, 19811A, 19810A

In either acquisition mode, the waveform acquisition window is defined by the main, delayed, or intensified horizontal display mode. In main or delayed mode, the full ten displayed divisions are digitized and stored. In the intensified mode, the intensified marker is digitized and displayed as a full ten divisions for immediate expansion of a critical portion of a waveform. Digitizing of the intensified marker makes it easy to define the portion of a signal to be acquired with a full 501 points of resolution.

### Noise Reduction

In the repetitive mode, averaging can be selected to capture repetitive signals containing random noise. The number of averages per data point can be selected in a 2, 4, 8, 16, 32, or 64 sequence. In the single-shot mode, noise reduction is achieved by selecting a 1 MHz low pass filter.

### Waveform Display

Real time waveforms including trigger view can be displayed along with either or both stored waveforms. With a two-channel expansion module installed, a total of seven (four real time, two stored, and trigger view) different waveforms may be displayed simultaneously. Also, stored waveform intensities may be adjusted independent of real time trace or character intensities for added viewing convenience.

### Cursors

One or two cursors may be activated on each of the stored waveforms with voltage and time values displayed on the CRT. With one cursor active, a voltage value with respect to signal ground is displayed along with a time value representing the time from main sweep start to the cursor position. With two cursors active, delta time and delta voltage values between cursors are displayed.

### Local Operation

Full control of the digitizer is available from the front panel by entering the 1980 menus. The digitizer has three comprehensive menus for selection of control functions such as sample density, averages per data points, cursor positioning, and waveform storage and display.

### Automatic Operation

All of the digitizer capabilities can be controlled through the HP-IB interface by a computer which makes completely automatic signal acquisition and analysis possible. Because of the internal configuration of the 1980, the 19860A uses the system HP-IB interface and does not require a separate address which simplifies programming. In addition, the digitizer can transfer waveform data in either ASCII or Binary format to optimize data transfer and computation times for different controllers. Waveform data can also be sent from a controller to the 1980 for display as a reference or limits.

### Feature ROMs

Two Feature ROMs are available to aid measurement capabilities. Model 19811A Plot/Sequence ROM provides a convenient method of obtaining records of waveforms and performing redundant measurements. The 19811A contains two separate programs, one plots waveform data from a 19860A digital waveform storage memory to HPGL "listen only" plotters without the need for a controller and the other directs the 1980A/B to perform sequential operations.

The plot program talks directly to an HPGL listen only plotter over the HP-IB interface when the 1980A/B is in the talk only mode. Operation of the plot program is accessed through the 19811A menu which allows waveforms stored in memory one or two, a graticule, and measurement parameters to be plotted for permanent record. Cursor locations may also be plotted to highlight points on complex waveforms.

The sequence portion of the ROM provides the capability of storing sequences of 1980A/B keystrokes. These sequences are then recalled by pressing a key on any of the 10080 series probes. Sequences can be programmed to set up the 1980/19860A system for repetitious measurements which reduces the possibility of setup errors while reducing total test time. For example, a program could include a series of keystrokes to set up the front panel for displaying a signal, digitize and store the signal, and then, using the plot program, output the stored waveform to a plotter. All of this automated measurement capability is accomplished by pressing one button on the oscilloscope probe. If the digital waveform storage capability is not added to a 1980A/B, the sequencing capability is available in the Model 19810A Sequence ROM.

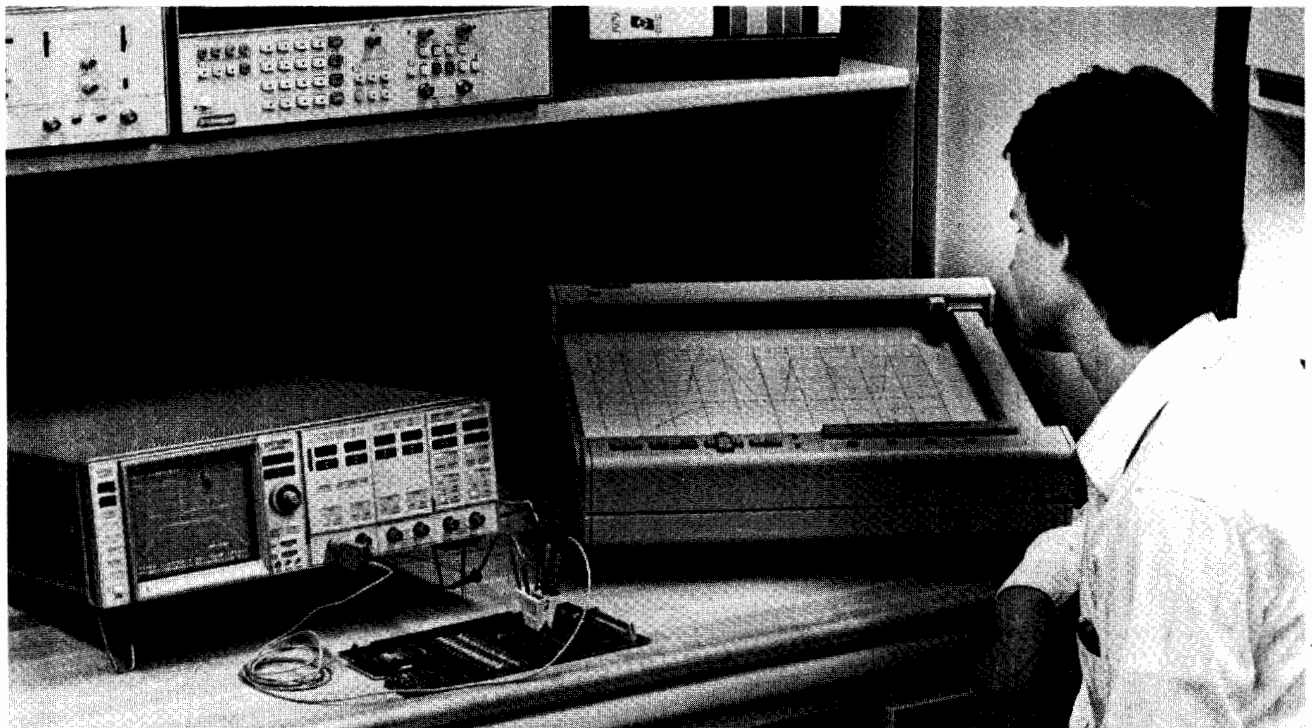

Design engineers can obtain multiple color hard copy by using the 19811A Plot/Sequence ROM. No computer is required.

- Immediate Measurement Capability
- Automatic Waveform Characterization
- Works with Powerful HP Computer Systems

- Improves Quality of Measurements
- Easy to Use Subprogram Library
- Program Development Aids

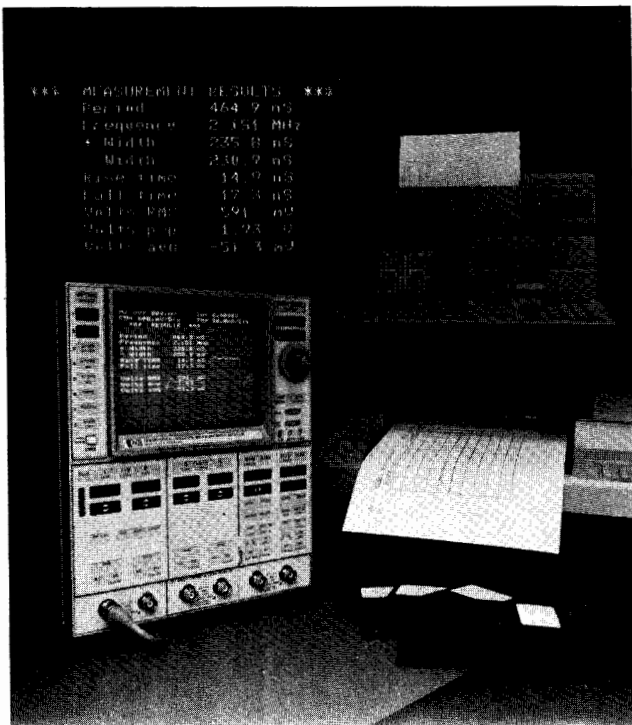

The HP 19800A Waveform Measurement Library links the 1980A to an HP computer for completely automatic time-domain measurements.

### 19800A Waveform Measurement Library

Coupling Hewlett-Packard's Model 19800A Waveform Measurement Library with the HP 1980A/B Oscilloscope Measurement Systems and an HP computer increases productivity by automating time-domain measurements traditionally made manually. With the HP 19800A, the quality of measurements is improved because the computer performs many of the functions normally done by an oscilloscope's operator. For example, through the 19800A's Waveform Setup subprograms, the computer can set up the front panel of the oscilloscope completely without an operator. Measurements usually made by counting graticule lines can be made automatically with the Waveform Characterization subprograms. The Waveform Comparison subprograms obsolete the traditional grease pencil by judging whether waveforms are acceptable or not. By improving the quality of measurements and reducing the required skill level of the operator, the overall productivity of a system can be dramatically increased.

The HP 19800A Waveform Measurement Library is designed to work together with the HP 1980A/B and HP computers to provide a complete time-domain measurement solution. The 1980A/B is a fully programmable, 100 MHz, time-domain instrument. Its continuously calibrated verniers and HP-IB programmability make the 1980A/B exceptionally versatile in viewing, measuring, and processing time-domain waveforms. With large memories, powerful high-level language, built-in mass storage and versatile I/O, HP's personal and desktop computers provide a friendly environment in which to solve technical problems. With the HP 1980A/B and an HP computer, the HP 19800A provides first-day measurement capability, a flexible subprogram structure, and easy to use program development aids.

The HP 19800A Waveform Measurement Library consists of three parts that together reduce total software development time:

1. The Measurement Program, which requires no additional programming before it can be used, provides completely automatic time-domain measurements on the day the system arrives. Capable of performing waveform characterization, this Measurement Program meets the measurement needs of a variety of environments.

2. The Library Subprograms are the foundation of the HP 19800A's measurement capability. Conceptually similar to TTL components in circuit design, these subprograms can be used as building blocks and assembled to solve specific applications.

3. The Program Development Aids include complete documentation for the Measurement Programs and the Library Subprograms, instructions for developing programs with the Library Subprograms, and an Autoloader that links the needed subprogram "building blocks" together automatically.

By performing waveform characterization and waveform comparison, the HP 19800A Waveform Measurement Library provides an extremely versatile set of time-domain measurements. The HP 19800A can automatically characterize waveform parameters such as peak-to-peak voltage, rms voltage, frequency, pulse width, rise time, and fall time. Time interval measurements can be made on complex waveforms or between two different waveforms. Waveform comparison is a measurement technique that allows a computer to perform qualitative time-domain measurements. To perform a waveform comparison, the waveform under test must be compared to limits established for it. These limits can be derived from an ideal waveform generated by the computer or from a known "good" waveform. In this way, the computer, not the operator, can make the necessary judgments. Because the HP 19800A can automatically characterize and compare waveforms, it creates a new standard in the automation of time-domain measurements.

### Measurement Program

The HP 19800A's measurement program accesses the library's measurement capabilities without requiring any additional programming. It is a complete program that makes time-domain measurements by characterizing waveforms and providing results from the day the system arrives. The measurement program also illustrates how the library subprograms can be assembled to solve specific applications.

# OSCILLOSCOPES

## Measurement Systems

Model 19800A

19800A cont.

### Measurement Program

The HP 19800A's measurement program accesses the library's measurement capabilities without requiring any additional programming. It is a complete program that makes time-domain measurements by characterizing waveforms and providing results from the day the system arrives. The measurement program also illustrates how the library subprograms can be assembled to solve specific applications.

The Automatic Waveform Measurement Program characterizes many different kinds of waveforms. After you select the desired channel and signal coupling, the computer instructs the 1980A/B's Auto-Scope to scale the signal. After the signal is digitally stored and transferred to the computer, the computer examines the waveform data to determine whether there is sufficient information to characterize the waveform. If there is not sufficient information within the waveform data for the measurement, the waveform is automatically rescaled to improve the measurement resolution. For example, in top photo, a waveform is displayed which has a relatively fast rise time. Since there are no sample points on the rising edge, the waveform is rescaled without operator intervention to improve the measurement (bottom photo).

### Library Subprograms

The library subprograms, a collection of routines that perform many different functions, are the key to the HP 19800A's measurement capability. The subprograms can be mixed and matched to solve a variety of different applications and are designed to be an easy to use, flexible approach to solving time-domain measurement problems.

The library subprograms consist of 36 subprograms which can be divided into five functional groups: Waveform Setup, Waveform Data Management, Waveform Characterization, Waveform Comparison, and General Utilities.

1. Waveform Characterization subprograms provide an extensive and versatile set of parametric, time-domain measurements. Three of the subprograms use the 1980A/B's Trigger Flag to make voltage and timing measurements. The remainder make these measurements using waveform data from the HP 19860A. Specific subprograms are included to measure the voltage at a given point, the voltage difference between two points, and the average or rms voltage of a waveform. Also included are subprograms that make time interval measurements such as rise time, fall time, pulse width, and pulse period. Delta time measurements can be made between two waveforms or between two points on the same waveform. In order to make these measurements automatically, there are two subprograms included that define transition levels of a waveform and locate where the transitions occur. With the first subprogram, the transition levels are defined using a histogram that ignores ringing and overshoot on the top and base of a pulse. The second subprogram locates only complete transitions of the waveform and ignores glitches or incomplete transitions.

2. Waveform Comparison subprograms provide an efficient and flexible means of performing limit tests on waveform parameters. The measurement is done by first defining limit waveforms, and then comparing it to the waveform under test. The limit waveforms can be defined either by specifying a set of line segments across the 1980A/B's CRT or by specifying a voltage and time tolerance around a known "good" waveform. After the waveform under test is compared to a limit waveform, a pass/fail result is returned to the main program. Using the 1980A/B's Trigger Flag, the library subprograms can also compare the amplitude or event timing of waveforms.

3. The Waveform Setup subprograms reduce test time and eliminate operator setup errors by automatically setting up the 1980A/B. To view a waveform, a window must be defined in the voltage and time plane by adjusting the oscilloscope's controls. These subprograms define the waveform window in terms oriented to the user rather than to the oscilloscope; the voltage window can be defined in terms of a minimum and maximum voltage, while the time window can be defined in terms of a start time and duration. The Waveform Setup subprograms then translate the specified window into oscilloscope terms (e.g., vertical sensitivity and sweep speeds) and set up the 1980A/B to display the window. The criteria which these routines use

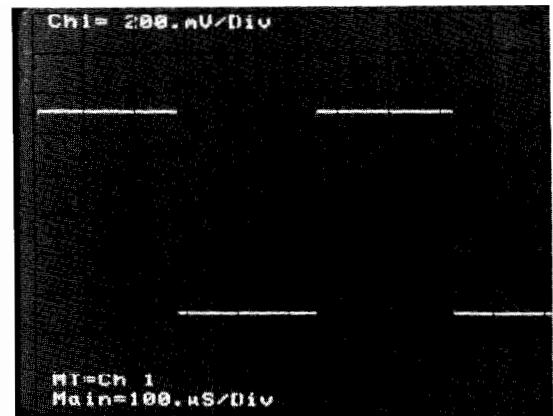

There is not enough resolution on the rising edge of the waveform for the measurement to be made (top photo).

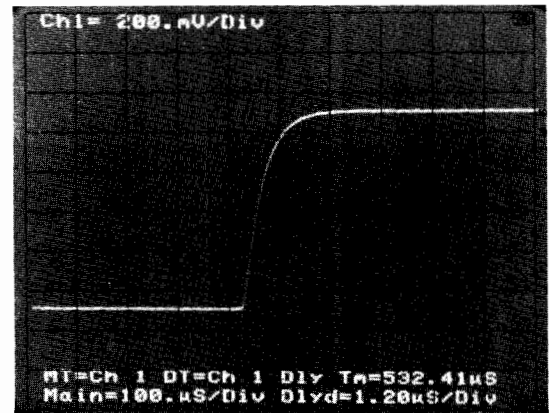

The computer has automatically rescaled the waveform, and there is now enough information to measure the rise time (middle photo).

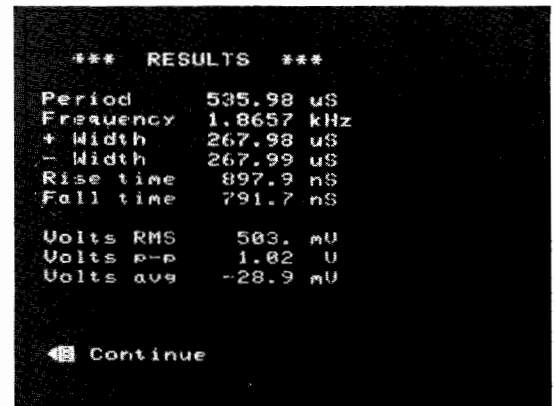

An example of the results obtained when using the Automatic Waveform Measurement Program (bottom photo).

to perform the setups can be either user-defined or defined dynamically by a program based on previous waveform data. This group of subprograms also includes an automatic scaling subprogram that redefines the waveform window for a given measurement. If there is not sufficient information within the waveform data for the measurement, the automatic scaling subprogram rescales the waveform without operator intervention to obtain better resolution for the measurement.

4. Waveform Data Management subprograms control the HP 19860A Digital Waveform Storage option and direct the movement of waveform data records. The subprograms control the interaction between the computer, the 19860A, and the mass storage medium. They can also create and control a waveform data base where permanent records of waveforms can be stored.

5. General Utilities subprograms manage the interaction between the user and the system. These subprograms initialize HP-IB, help debug programs under development, output results, plot waveforms, manage 1980A/B key closures, and control instrument setup data.



## 1980A/B Specifications

### Operating Modes

Voltage vs time (V vs T); channel 1 vs 2 (1 vs 2); monitor mode for logic state display with HP Model 1607A (X • Y • Z).

### Vertical Display Modes (V vs T)

Channel 1; channel 2; channels 1 and 2 displayed on alternate sweeps (ALT); channels 1 and 2 displayed by switching between channels at approx 400 kHz rate with blanking during switching (CHOP); automatic selection of alternate for sweep speeds > 1 ms/div and chop for sweep speeds ≤ 1 ms/div (AUTO-CHOP/ALT); channel 1 plus 2 algebraic addition (1 + 2), channel 1 and/or 2 may be inverted; and either main or delayed trigger signal.

### Vertical Amplifiers (2)

**Bandwidth:** 3 dB down from a 5 div reference signal (0 to +40°C).

**DC coupled:** dc to 100 MHz in 50 Ω and 1 MΩ input modes.

**AC coupled:** <10 Hz to ≥100 MHz.

**Bandwidth limit:** limits upper bandwidth to approx 20 MHz.

**Input coupling:** ac, dc, 50 Ω (dc), ground. Ground position disconnects input connector and grounds amplifier input.

**Input RC:** ac or dc, 1 MΩ ±2% shunted by approx 16 pF; 50 ohm (dc), 50 Ω ±3%.

**Maximum input voltage:** 50 ohm, 5 V rms; 1 megohm, ac or dc coupled, 250 V (dc + peak ac) at ≤1 kHz.

**Deflection factor:** range, 2 mV/div to 10 V/div; accuracy, ±3%; 3 digits of resolution.

**Vertical position:** range, baseline can be adjusted ±15 major div from center graticule line (possible 10 div off screen); accuracy, ±(2% of reading + 0.3 major div).

**ΔV (Channel 1 or 2):** range, ±15 times the deflection factor selected for that channel; accuracy, ±4% (for a Δ ≤ 10 major div).

### Channel 1 + 2

**Amplifier:** bandwidth and deflection factors are unchanged.

**Differential (Channel 1-2 or Channel 2-1):** CMR is at least 20 dB from dc to 20 MHz with common mode signal amplitude equivalent to 10 div and one channel adjusted for optimum rejection.

**Trigger view:** displays internal or external trigger signal for either main or delayed sweep.

### Horizontal Display Modes (V vs T)

Main, Main Intensified, Delayed, and Dual. Dual simultaneously displays main intensified and delayed sweep.

### Main and Delayed Time Bases

**Range:** 5 ns/div to 1 s/div; 3 digits of resolution.

#### Accuracy\*

Speed	Accuracy*
5 ns/div to 9.99 ns/div (center 8 div)	±3%
10 ns/div to 9.99 ms/div (first 10 div)	±3%
10 ms/div to 1 s/div (first 10 div)	±4%

\*Within ±10°C of the temperature at which the instrument was calibrated. For temperatures beyond the ±10°C range and within 0 to +55°C, add 1% and 2% from 0.5 s/div to 1 s/div.

### Sweep Delay

**Time delay:** range, 0 to 9.9999 s; resolution, displayed, 5 digits; HP-IB, 100 ps at any delay, possible 11 digits.

#### Accuracy\*

Sweep Speed	Delay or Time Interval	
	<200 μs	≥200 μs
5 ns/div to 9.99 ns/div	±(2 ns + 0.1% of reading)	±(0.05% of reading)
≥10 ns/div	±(2 ns + 0.1% of reading + 1% of dly'd s/div x 10 div)	±(0.05% of reading + 1% of dly'd s/div x 10 div)

\*Within one hour of a Delay Self-Calibration and in constant ambient temperature.

**Delay jitter:** 0.002% of delay time; at 10 MHz ±10 kHz, 0.01% of delay time.

**Time interval (ΔT):** in Intensified, Dual, or Delayed Horizontal Display modes, a zero time reference can be set anywhere in the delay range and a Δt measurement made from that point.

**Resolution, Accuracy:** same as Time delay.

**Frequency (1/ΔT):** calculates and displays reciprocal of time interval measurement; resolution, same as ΔT. As frequency increases, insignificant digits are truncated; accuracy, same as Time delay.

**Digital delay:** range, 0 to 10<sup>8</sup> - 1 events; resolution, 1 event; maximum rep rate, 15 MHz with a 50% duty cycle.

### Triggering (Main and Delayed Time Bases)

#### Main Sweep

**Triggered:** specified level and slope generates a sweep.

**Auto-triggered:** baseline displayed in absence of a trigger signal; triggering is same as triggered above approx 10 Hz.

**Single:** sweep occurs once with same triggering as Triggered mode.

#### Delayed Sweep

**Auto sweep after delay:** delayed sweep starts at end of delay time.

**Triggered sweep after delay:** sweep can trigger after delay.

**Digital delay:** delayed sweep starts a specified number of events after start of main sweep.

**Sources:** selectable from channel 1, channel 2, enhancement module, or external. Line frequency triggering for main sweep only. Main and delayed independently selectable.

#### Internal Trigger Level

**Range:** ±20 major divisions from center horizontal graticule line.

**Resolution:** 0.02 major divisions; coarse or fine slew rates.

**Accuracy:** ±(3% of reading + 0.4 major div).

#### External Trigger Level

**Range:** ±1.2 V from ground reference; in ÷ 10, ±12 V.

**Resolution:** ±1, 2 mV; ÷ 10, 20 mV; coarse or fine slew rates.

**Accuracy:** ±(3% of reading + 40 mV); ÷ 10, ±(3% of reading + 400 mV).

#### Line Trigger Level

**Range:** ±20 relative units.

**Resolution:** steps of 0.02; fine or coarse slew rates.

**Slope:** positive or negative slope within trigger signal range.

#### Sensitivity

**Internal:** <10 mV/div, at least 1.4 div from dc to 25 MHz increasing to 3 div at 100 MHz; ≥10 mV/div at least 0.7 div from dc to 25 MHz increasing to 1.5 div at 100 MHz.

**External:** ÷10, at least 500 mV p-p from dc to 25 MHz increasing to 1.2 V p-p at 100 MHz; ÷1, at least 50 mV p-p from dc to 25 MHz increasing to 120 mV p-p at 100 MHz.

**Coupling (internal and external):** ac, attenuates signals <10 Hz; dc, direct coupled; HF rej, attenuates signals above approx 35 kHz; LF rej, attenuates signals below approx 35 kHz.

#### External Trigger Inputs (Main and Delayed)

**Input RC:** ac or dc, 1 MΩ ±2% shunted by approx 15 pF; 50 Ω (dc), 50 Ω ±3%.

**Maximum input voltage:** 50 Ω (dc), 5 V rms; 1 MΩ, ac or dc coupled, 250 V (dc + peak ac) at ≤1 kHz.

### 1 vs 2 Operation

**Bandwidth:** Y-axis (channel 1), same as channel 1 in V vs. T; X-axis (channel 2), dc to 4 MHz.

**Phase difference:** ≤3° dc to 100 kHz.

**Deflection factors:** same as Vertical Amplifiers.

### Cathode Ray Tube and Controls

**Type:** post-accelerator, approx 22 kV accelerating potential, aluminumized P31 phosphor.

**Graticule:** 10 x 10 div internal graticule; 0.2 subdivision markings on major horizontal and vertical axes; 10 x 12 cm display area.

**Trace and character intensity:** adjustable in relative steps of 1 from 0 to 99.

### General

**Bus Compatibility:** as defined in IEEE Std 488-1978 is SH1, AH1, T5, TE0, L3, LE0, SR1, RL1, PP0, DC0, DT1, C0, and E2.

**Power:** 100, 120, 220, 240 Vac, +5 to -10%; 48 to 440 Hz; 300 VA max with expansion module and plug-in ROMs, standard, 200 VA max.

**Weight:** net, approx 18.2 kg (40 lb); shipping, approx 24.1 kg (53 lb).

**Dimensions:** (1980A) 278 H x 213 W x 543 mm D (10.9 x 8.4 x 21.4 in.). (1980B) 143 H x 427 W x 543 mm D (5.6 x 16.8 x 21.4 in.).

**Operating environment:** temperature, 0° to +55°C; humidity, to 95% relative at +40°C; altitude, to 4600 m (15000 ft); vibration, vibrated in three planes for 15 min each with 0.38 mm (0.015 in.) excursion, 10 to 55 Hz.

**Accessories furnished:** one blue light filter HP P/N 01980-02701; one 2.3 m (7.5 ft) power cord; one expansion module panel cover, HP P/N 01980-24106; two Operating/Programming Manuals; one service manual; one binder with divider tabs; two 10081A, 10:1 divider probes approx 2 m (6 ft) long.

### 1950A Specifications

#### Vertical Display Modes

Channel 3 and 4 independently selected; channel 3 vs 2; channel 3 + 4; either or both channels may be inverted.

#### Vertical Amplifiers

**Bandwidth:** same as 1980.

**Input RC:** same as 1980, channels 1 and 2.

**Deflection factors:** 2 mV/div to 10 V/div, ±3%, 3 digit resolution.

**ΔV (Channel 3 or 4):** same as 1980, channels 1 and 2.

#### General

**Operating environment:** same as 1980A/B.

**Weight:** net, approx 1.5 kg (3.3 lb); shipping, 2.2 kg (4.8 lb).

**Power:** supplied by 1980.

**Accessories furnished:** one operating and service manual; two 10081A, 10:1 divider probes, approx 2 m (6.6 ft) long.

### 19860A Digital Waveform Storage Specifications

#### Vertical

**Analog bandwidth:** dc to 100 MHz; ac coupled lower limit is <10 Hz; 3 dB down from a 5 div reference; 0 to 40°C.

**Acquisition window:** > ±4.5 div from center horiz graticule line.

**Matching of data to CRT graticule lines:<sup>1</sup>** ±2% of full scale.

**Matching of digitized to real time traces:<sup>1</sup>**

Sine Wave, Percent of Full-Scale		
10 Hz	1 kHz	1 MHz
±1.5%	±1.5%	±2.5%

Excludes first data point. In repetitive mode, trigger rep rate must be 1 Hz or faster. In single sweep mode, trigger must occur within 1 s of digitize command, otherwise exclude first five data points. Data for this specification is acquired using the Auto-Cal default mode of a full Auto-Cal.

**Absolute accuracy of data:** ±(accuracy of vertical channel + matching of digitized trace to real time trace + matching of data to graticule line).

**DC offset:** <0.2 div from real time trace at time of data acquisition.

<sup>1</sup>Full scale is ten divisions.

### RMS noise<sup>2</sup>

	2 mV/div to 9.99 mV/div	10 mV/div to 10 V/div
Normal	0.75% of fs	0.5% of fs
8 Averages or Filtered	0.4% of fs	0.25% of fs

<sup>2</sup>Measured by grounding the vertical input, digitizing, and calculating the RMS value of the data.

### Horizontal

**Acquisition window:** Main Horizontal Display mode (Main s/div x 10 div); in Intensified and Delayed (Delayed s/div x 10 div). In Intensified and Delayed, the acquisition window can be delayed 0 to 9.9999 s from Main trigger point.

**Time offset from real time trace:** -(25 ± 5 ns).

**Timing accuracy:** ±(2 ns + 0.2% of the acquired time window).

**Jitter:** 0.002% of delay time + 1 ns; at 10 MHz ± 10 kHz, 0.01% of delay time + 1 ns.

### Operating Characteristics

**Repeatability of data:** approx 2% for waveforms acquired within 8 hours and within 20°C to 30°C. To optimize repeatability of waveform data, use either a minimum of 8 averages or filtered mode, for signals <100 Hz use dc or 50 Ω dc input coupling.

**Vertical resolution:** 10 bits, approx 0.1% of full scale.

**Auto-Cal:** pre-acquisition calibration of sampling efficiency that also sets offset and gain data correction factors. Offset and gain factors are used for post-acquisition data correction to match a digitized trace to a real time trace.

**Sample density:** selectable 1, 3, 6, 11, 21, 51, 101, 251, 501 points at any sweep speed.

**Minimum time between points:** repetitive, 100 ps, clocked by 1980 delay generator; single-shot, 19.8 μs, clocked by 1980 processor clock.

**Acquisition mode:** repetitive, 999 μs/div to 5 ns/div, two sweeps per point; single-shot, 1 s/div to 1 ms/div, one sweep per waveform.

**Averaging:** each sample point may be averaged 2, 4, 8, 16, 32, or 64 times in repetitive mode to reduce noise; N + 1 sweeps required per point, where N = number of averages.

**Filter:** approx 1 MHz low pass filter selectable in single-shot.

**Cursors:** start and stop cursors for memories (M1 and M2) to measure voltage from center graticule line, time from main trigger point, or ΔV and ΔT measurements on stored waveforms.

### General

**Operating environment:** same as 1980B.

**Weight:** net, 0.4 kg (13 oz); shipping, 0.9 kg (2 lb).

### 19800A Product Description

#### Library Subprograms

Functional Group	Name	Description
Waveform Setup	Setver	Defines vertical window by setting up deflection factor and vertical pos.
	Sethrz	Defines horizontal window by setting up horizontal mode, delay time, main and delayed sweep speeds.
	Settrg	Defines trigger by setting up trigger source, coupling, and level.
	Setflg	Sets up trigger flag parameters such as trigger flag mode and sweep wait time.
	Autsc1	Evaluates current waveform data and automatically rescales the horizontal or vertical window of a waveform if there is insufficient data for the desired measurement.



## 19800A Product Description (cont.)

### Library Subprograms

Functional Group	Name	Description
Waveform Data Management	Wfdgtz	Stores a waveform from the specified channel using the HP 19860A.
	Wfmove	Moves waveform data from the specified source to the specified destination. The source/destination may be the 19860A memory 1 or 2, the mass storage medium, or the computer.
Waveform Characterization	Topbas	Performs max-min search; uses histogram to determine the top and base of a waveform.
	Findge	Searches for complete transition of the waveform through three specified transition levels.
	Wfvolt	Converts a waveform data quantization level to volts.
	Wftime	Converts a sample point number to seconds.
	Wfp-p	Returns a delta voltage measurement such as peak-to-peak voltage.
	Wfave	Computes the average voltage of a waveform over one period.
	Wfrms	Computes the rms voltage of a waveform over one period.
	Wfper	Computes the period of a waveform.
	Wfwidth	Computes the pulse width of a waveform.
	Wfedge	Computes the rise time or fall time of a waveform.
	Intrpo	Performs a linear interpolation on waveform data.
	Deltat	Performs delta time measurements on the same waveform or between two different waveforms.
	Tfcal	Calibrates the offset and hysteresis in the specified trigger path.
	Tfdc	Finds a dc voltage level using the trigger flag.
	Tfpeak	Finds the positive or negative peak voltage using the trigger flag.
Tftime	Finds the time of a specified voltage level.	
Waveform Comparison	Windo1	Creates a waveform window from user-defined inputs.
	Windo2	Creates a waveform window from a specified voltage tolerance.
	Wfcomp	Compares the waveform under test to a waveform window previously defined.
	Tfcomp	Compares amplitude or event-timing to previously measured waveform using the trigger flag.
General Utilities	Init80	Initializes the measurement system and confirms the instrument configuration.
	Warn80	Provides warnings and error messages for the measurement system.
	Outres	Outputs the result of a measurement to a specified destination.
	Outbld	Formats the result in engineering notation with the user-defined prefix and units.
	Wfplot	Plots the waveform data to the internal graphics.
	Kywait	Waits for 1980A/B key closures and reports the key pressed.
	Kyprss	Intercepts 1980A/B key closures to allow selective enablement/disablement of the 1980A/B front panel.
	Sigtst	Tests to see if the 1980A/B is triggered.
	Stmove	Moves instrument setup data from the specified source to the specified destination. The source/destination may be the 1980A/B, the mass storage medium, or the computer.

### Ordering Information

**1980A** Oscilloscope Measurement System (Cabinet)

**1980B** Oscilloscope Measurement System (Rack)

**Opt 150:** Model 1950A Expansion Module

**Opt 810:** Model 19810A Sequence ROM

**Opt 811:** Model 19811A Plot/Sequence ROM

**Opt 826:** 19800A Software for the HP9826 and HP9836 Computer Systems

**Opt 860:** Digital Waveform Storage

**Opt 907 (1980B):** front handle kit (P/N 5061-0089)

**Opt 908 (1980B):** rack flange kit (P/N 5061-0077)

**Opt 909 (1980B):** rack flange and front handle kit (P/N 5061-0083)

**Opt 910:** adds two operating/programming manuals, a service manual, and a binder with divider tabs

**Opt 914:** adds one operating/programming manual, a binder, and divider tabs

**50013A Opt 010:** Waveform Measurement System Seminar (contact your local HP sales office)

**1950A** 100 MHz, 2-Channel Expansion Module

**Opt 910:** adds one operating/service manual

**19800A** Waveform Measurement Library

**Opt 826:** Software for the HP9826 and HP9836 Computer Systems

**19810A** Sequence ROM

**19811A** Plot/Sequence ROM

**19860A** Digital Waveform Storage

**Opt 910:** adds one operating/service manual

# OSCILLOSCOPES

## 100 MHz Delta Time, Time Interval Averaging

Models 1740A, 1743A, 1745A, 1746A

- Delta time measurements
- Optional built-in DMM for increased accuracy & flexibility
- Dual channel, 5 mV/div to 100 MHz
- 3rd channel trigger view and selectable input impedance

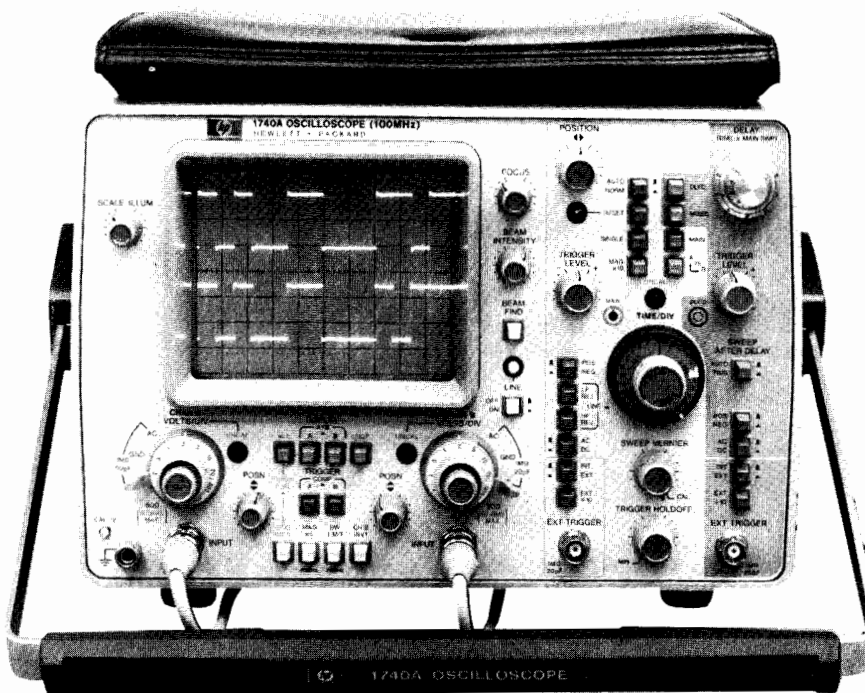

### Description

The 1740 series of 100 MHz, dual-channel oscilloscopes have proven to be highly reliable measurement tools by passing the most complete testing program possible—years of use by satisfied customers. This reliable performance coupled with versatile measurement sets offer exceptional value for your time interval and general purpose oscilloscope needs over the long term.

The 1740s provide several measurement features which users have found to be particularly valuable. Both vertical channels provide 1 mV/div deflection factors with dc to 40 MHz bandwidth performance; the full 100 MHz performance is achieved with deflection factors of 5 mV/div to 20 V/div. Third channel trigger view, first offered in the 1740A, permits viewing of the trigger signal plus simultaneous viewing and timing of the external trigger signal with both vertical channels. A X10 horizontal magnifier provides main and delayed sweep speeds to 5 ns/div... to allow full use of the 1740A's 100 MHz bandwidth amplifiers. These amplifiers have a Gaussian roll-off characteristic for accurate pulse response.

In addition, the 1740s offer a TV/video sync option that allows a variety of measurements to be made on complex video waveforms. There is also an optional auto-ranging DMM with 3½ digit resolution for ac/dc voltage, ac/dc current, and resistance measurements.

### Individual Characteristics

#### 1740A

The 1740A, which is the basic building block of the 1740 series, is a highly reliable general purpose 100 MHz oscilloscope. In addition to the family characteristics of the 1740 series, the 1740A uses a single-marker delayed sweep for time interval measurements.

The 1740A's front panel is laid out in a clear logical manner and has a color coding scheme that simplifies operation. The blue buttons control the display functions, while all trigger function buttons are green. Other controls are light gray or white, and the delayed sweep functions are highlighted with a shaded background.

To the oscilloscope user, the most critical component in the instrument is the cathode ray tube (CRT). The 8 × 10 cm CRT used in the 1740A has been perfected to the point where it has been described as

having "the brightest, crispest trace in the industry." Since the CRT is also the most expensive part of an oscilloscope, it is imperative that it be extremely reliable. With the 1740A, HP's CRT improvements have led to less than 1.4 failures per year per 1000 instruments — believed to be the best reliability record of any comparable CRT in industry.

#### 1745A/1746A

Both the HP model 1745A and 1746A oscilloscopes add a large screen CRT and a revised front panel to the time-tested instrument design of the 1740A. The new CRT offers a 43% larger viewing area while maintaining the same high standards of the 1740A trace quality. This provides more resolution for more accurate measurements, especially with multi-channel measurements that use third channel trigger view.

Voltage measurements are also simplified. The CRT graticule is 10 x 10 divisions instead of the more traditional 8 x 10 divisions. Full-scale voltage display is ten times the deflection factor - greatly reducing the amount of mental arithmetic required of the user.

The 1745A and 1746A both offer a neutral gray contrast screen which is heat-treated with a proprietary antireflection coating. You obtain bright, sharp trace definition without annoying light reflections. In keeping with the new CRT's contrast screen color, the color coding of the controls has also been changed. The dark buttons control the display functions while all trigger functions are medium gray. Miscellaneous functions are light gray and all delayed sweep functions are highlighted with a lightly shaded background.

The 1745A uses the familiar single-marker delayed sweep to perform time interval measurements. The 1746A adds HP's dual-marker delta time measurement capability for faster and more accurate timing measurements. When combined with the optional DMM, a direct readout of time interval measurements is provided in the LED display.

In the delta time mode, start and stop markers are alternately displayed on the intensified sweep. When the delayed sweep mode is selected, the region of the intensified markers is expanded and alternately displayed with the increased resolution of the faster delayed sweep. The waveforms are then positioned by adjusting the

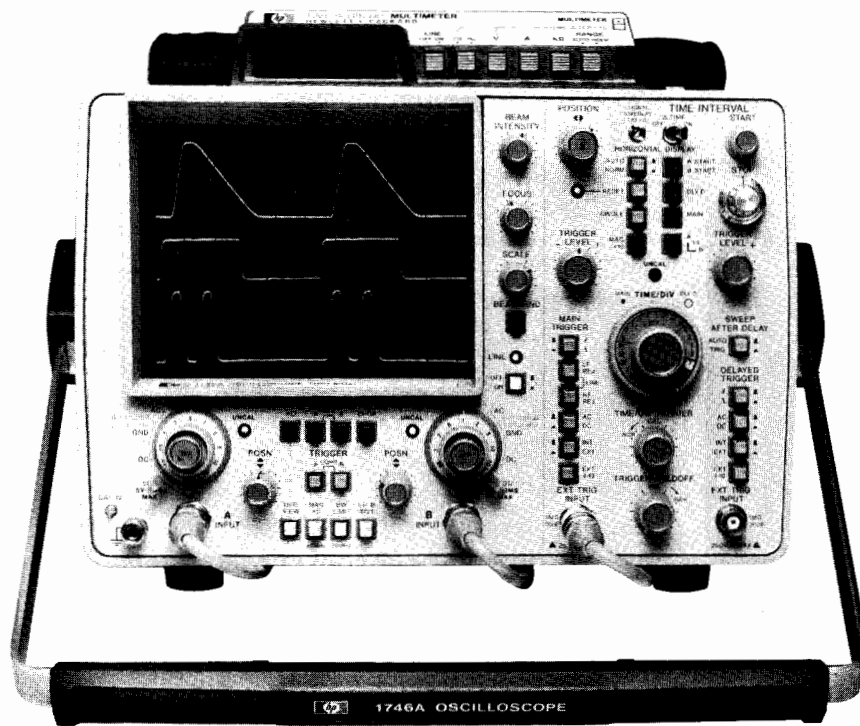

start and stop controls to make the measurements. For example, to make a pulse width measurement, the rising and falling edges are crossed at the 50% point. The answer is then obtained in one of three ways.

- 1) Multiply the helical stop control setting by the main sweep speed to obtain the answer. With this method, accuracy is approximately the same as with the single-marker method.
- 2) The 1746A has a rear panel voltage output which is scaled to represent the time interval between the start and stop markers. Using an external DMM to measure this voltage yields a direct readout of the time interval. This method is both easier and more accurate, approaching accuracies of  $\pm 0.5\%$ .
- 3) When the Option 034/035 DMM is added to the 1746A, the scaled voltage is measured directly by selecting the DMM time interval mode. Again measurement convenience is improved with accuracy approaching  $\pm 0.5\%$ .

In the dual-marker mode, time interval measurements can be made from Channel A to Channel B or from Channel B to Channel A when the alternate display mode is selected. A convenient switch lets you select whether the start marker is on Channel A or B.

In the three channel trigger view mode, the start marker is displayed on the trigger channel with time-coincident stop markers on each of the other two channels. This allows direct readings of time intervals between events on either channel and the external trigger input signal. Because there is a fixed delay ( $< 3.5$  ns) between the external trigger and vertical signals, the accuracy of this time interval measurement can be improved by measuring this fixed delay and using it as a correction factor in subsequent measurements.

### 1743A

The 1743A adds to the feature set of the 1740A a delta time system based on a 100 MHz crystal oscillator rather than the traditional analog reference ramp. A time interval averaging technique increases both the accuracy and resolution of repetitive waveform measurements. This technique measures the time interval by accumulating counts from the 100 MHz crystal oscillator with a fundamental accuracy of  $\pm 1$  clock period ( $\pm 10$  ns from a 100 MHz clock). However, by using a time interval averaging technique, the resolution of the measurement is increased by N, where N is the number of averages. At the three fastest sweep speeds, 10,000 intervals are averaged to

produce a measurement with a 100 ps resolution. The averaged time interval measurement is directly displayed on five-digit LED readout.

Time interval measurements relative to the leading edge of the first pulse in the main sweep display can be made with the 1743A. This first pulse measurement capability permits measurements between the trigger signal and the other two channels. In the trigger view mode, the start marker is on the trigger channel with the stop marker on each of the two channels at the same point in time. This allows timing measurements from the leading edge of an asynchronous signal, such as a strobe or flag, to resulting activity on Channels A and B.

The triggered delay mode of the 1743A offers excellent pulse width, period, and propagation delay measurement capability. The triggered delta sweep mode automatically performs the desired measurements without any of the complex operations usually needed with delayed sweep measurements. By selecting the appropriate start and stop slopes (one positive and one negative for width measurements and both the same for period measurements) you can conveniently read out the period or width measurement while directly viewing the exact trigger level at which the measurement is being made.

Also available is the ability to make duty cycle measurements quickly. In the intensified mode, measure the pulse width and period with the direct LED readout. Then a simple ratio calculation provides an accurate answer.

### Family Characteristics

#### Third Channel Trigger View

In many measurements, especially in digital applications, it is desirable to trigger the main sweep externally using a signal synchronous with the displayed waveforms. The third channel trigger view offers several measurement conveniences in timing applications:

- 1) The trigger threshold can be viewed relative to the trigger waveform for either an internal or external trigger source. Trigger threshold is the center horizontal graticule line and the trigger point is selected by positioning the trigger waveform vertically on the reference graticule line using the Main Sweep Trigger Level control. This also allows you to view the shape of the trigger waveform to verify that the correct signal is used as the trigger source and that the trigger threshold is not set to portions of a waveform containing irregularities and reflections.





# OSCILLOSCOPES

100 MHz Delta Time, Time Interval Averaging

Models 1740A, 1743A, 1745A, 1746A

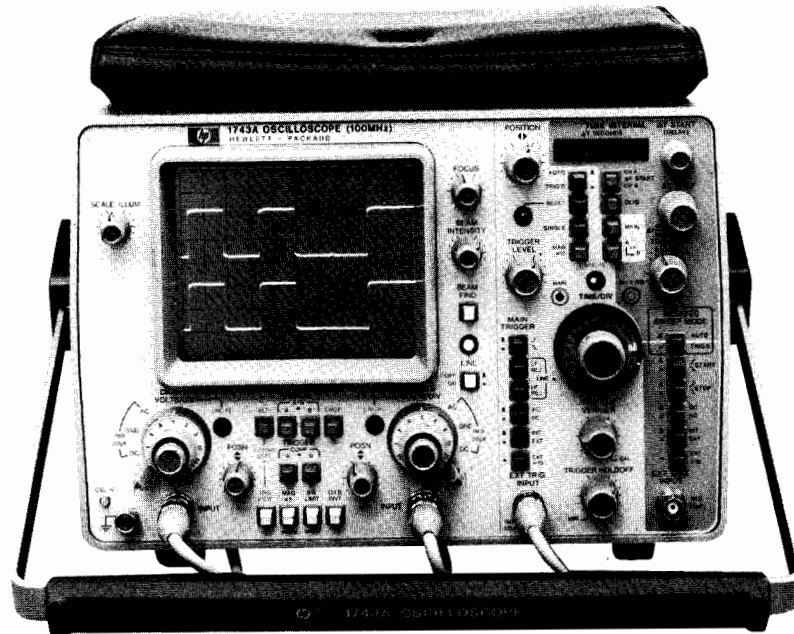

2) With trigger view, three channels of information are displayed so that timing relationships can be analyzed. The displayed trigger signal has a specified delay of  $<3.5$  ns relative to the two vertical channels.

### Stable Flexible Triggering

Stable internal triggering to greater than 100 MHz requires only one division of vertical deflection. The internal trigger signal is picked off immediately after the attenuator which assures a stable display regardless of changes in position, vernier, or polarity controls. Easy to use pushbutton trigger controls assure you of the desired signal conditioning for your measurement applications. In the external trigger mode, signals of only 100 mV trigger the oscilloscope to 100 MHz (only 50 mV to 50 MHz). In the composite trigger mode, the oscilloscope internally triggers on asynchronous signals without the need to overlap the traces vertically or use additional conditioning controls.

### Vertical Amplifiers

Vertical deflection factors from 5 mV/div to 20 V/div assure that the majority of signals can be easily displayed. For low level signals, a times five magnifier offers dual-channel deflection factors of 1 mV/div and 2 mV/div to 40 MHz.

### Optimum Signal Termination

For maximum measurement flexibility, switchable 50  $\Omega$  and 1 M $\Omega$  inputs are provided. The internal 50  $\Omega$  input with low reflections is useful for measurements requiring a 50  $\Omega$  termination for accurate pulse reproduction.

### Serviceability

Innovations in circuit design along with custom intergrated hybrid circuits reduce calibration time because of a minimum of adjustments. Wire harnesses and interconnection cables between boards are reduced with an interface board which connects the main boards together. This interface board helps to reduce service time and reassembly errors normally encountered with instruments containing many cables. These oscilloscopes, with the exception of the high writing speed 1744A, do not require a fan or ventilating holes for convection cooling which reduces the amount of dust and dirt that can accumulate internally.

### Optional Measurement Capability

#### TV Sync Option (1740A, 1745A, 1746A)

With this option you can trigger on composite video for analysis of

fields, test signals, timing relationships, lines, or segments of lines. This capability is provided through a TV sync separator circuit that triggers the main sweep on the vertical interval of a composite video waveform and triggers the delayed sweep on individual horizontal lines.

### Video Waveform Display

To aid in viewing specific portions of composite video waveforms, the TV sync option includes field select, TV line scan, and single line scan capabilities. Field selection is easily accomplished by pressing the Field Select button which automatically displays the alternate field in the frame. The TV Line Scan control allows you to position the intensified marker to the desired location for expansion. When switched to delayed sweep, individual lines are easily inspected and measured. For precise control of highly expanded line segments, single line scan lets you examine one line in detail.

The TV/Video Sync option is installed on the top cover and provides its own signal input with a 75  $\Omega$  termination to match most video systems. The input also provides a TV clamp which combines ac coupling and negative clamping to eliminate position shift due to varying levels for video information.

Three signal outputs on the back panel of the TV/Video Sync option provide access to the video signal, the main trigger signal, and the delayed trigger signal. These signals are routed to a vertical channel, the main trigger input, and the delayed trigger input to view video signals. The main and delayed trigger signals can also be used to sync other instruments on the video signal.

### Optional Digital Multimeter (1740A, 1745A, 1746A)

Adding an optional 3 $\frac{1}{2}$  digit autoranging DMM improves the convenience of your basic measurement capabilities. With the optional DMM, you can make the five most common measurements: ac and dc voltage, ac and dc current, and resistance. The DMM has autoranging so that readings always have the same multiplier: voltage in volts, current in amperes, and resistance in kilohms. In addition, the DMM has auto-zero which eliminates the need to zero the instrument prior to a test and auto-polarity for measuring either positive or negative voltages without reversing test leads.

In the 1746A, the optional DMM improves the accuracy and convenience of delta time measurements. A switch on the 1746A lets you select DMM operation or direct delta time readout.

- 200 cm/ $\mu$ s variable persistence & stored writing speed
- Minimum blind time, auto-intensity circuit

- Dual channel, 5 mV/div to 100 MHz
- 3rd channel trigger view and selectable input impedance

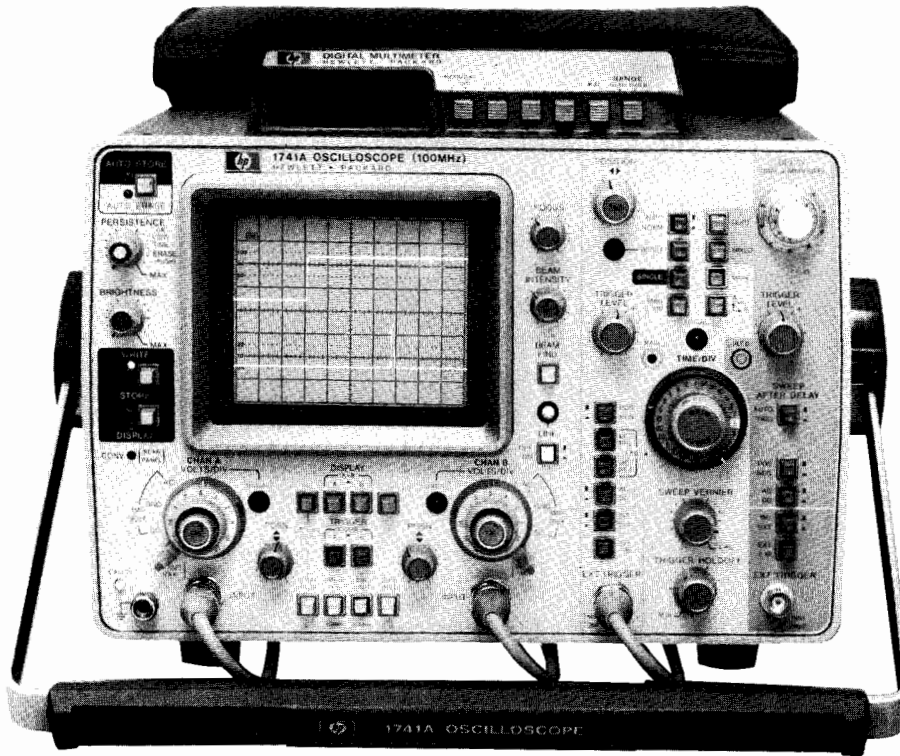

1741A Opt 034

### 1741A, 1744A Variable Persistence/Storage

Hewlett-Packard Variable Persistence/Storage Oscilloscopes provide a "one oscilloscope" solution to the wide variety of measurements encountered daily. The versatility results from the multitude of operating modes available; starting with minimum persistence, which approximates conventional operation, through continuous persistence settings, all the way to automatic storage. The adjustable persistence control provides the ability to match signal and persistence characteristics resulting in excellent display characteristics over a wide range of conditions.

### Applications

These oscilloscopes provide a clear display of virtually any signal; however, they are especially useful in certain applications. Low repetition rate signals at fast sweep speeds produce very low light output on conventional CRTs and normally require the use of a viewing hood to obtain a viewable display. The variable persistence mode solves this problem by integrating several sweeps to amplify the light output, thereby producing bright, clear traces. This "light-integrating" capability is also useful in eliminating flickering displays, which are the result of low repetition rates and slow sweep speed signals. These signals are annoying to view and even more difficult to measure; however, the display is improved by matching signal and persistence characteristics.

Single-shot events are also captured easily by using the auto-store mode, which, once set, will wait and capture a sweep after the first trigger event. During operation of the oscilloscope, any display on the CRT can be saved at the touch of a button, no matter what mode the instrument is in.

### Writing Speed and Blind Time

In all Hewlett-Packard storage oscilloscopes, the advanced technology used allows signals to be captured at the maximum writing speed in both variable persistence and single-shot modes (1741A-200 cm/ $\mu$ s; 1744A-1800 cm/ $\mu$ s; 1727A-2000 cm/ $\mu$ s). These fast writing

speeds are achieved without reduced scans or excessive blind times. Operating in the variable persistence mode, high speed signals can be displayed without the transfer or erase time (typically 1 second) necessary in other storage techniques. The probability of displaying a random event is increased by decreasing the blind time by a factor of 1000 or more in most situations.

### A Comparison - Fast Writing Modes

#### 1. HP's Variable Persistence Mode

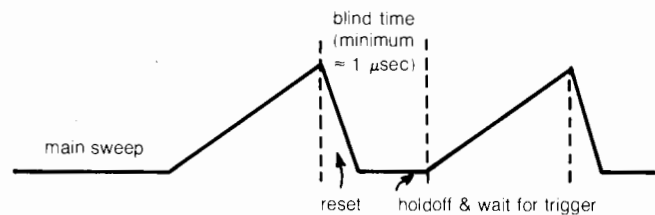

#### 2. Transfer Techniques Not Used in HP Variable Persistence/Storage Oscilloscopes

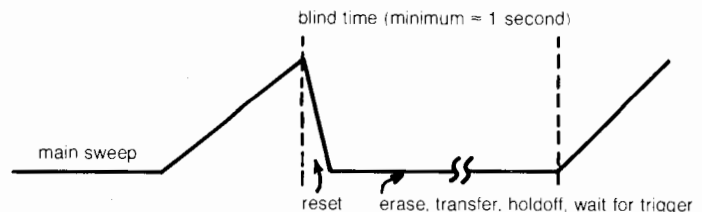



# OSCILLOSCOPES

## Variable Persistence/Storage

Models 1741A, 1744A, 1727A

- 1800 cm/ $\mu$ s (1744A) variable persistence & stored writing speed
- Minimum blind time, auto-intensity circuit
- Dual channel 5 mV/div to 100 MHz
- 3rd channel trigger view and selectable input impedance

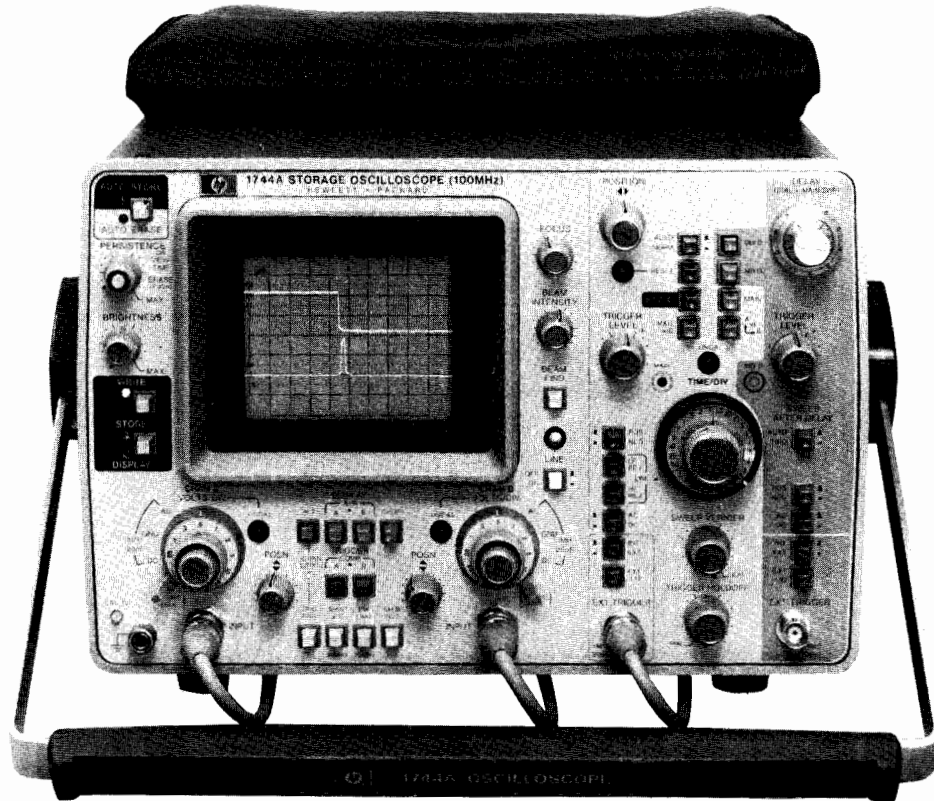

1744A

### 1741A, 1744A 1727A Operation

An auto-intensity circuit in all of these variable persistence/storage oscilloscopes simplifies operation. This circuit permits sharp, flicker-free, non-blooming traces to be obtained in the variable persistence mode under almost all operating conditions. There is a variety of settings available in the variable persistence mode; however, there is an easily set reference position that will provide a viewable trace: Intensity—max, Persistence—min, Brightness—min. From this position, Intensity can be decreased and Persistence can be increased as necessary.

In addition to the variable persistence mode, storage LEDs provide positive identification of storage operating modes. The auto-erase mode periodically takes individual "snapshots" of an input signal. In this mode, Persistence is internally set to maximum and the persistence control regulates how frequently a new "snapshot" is captured and displayed when two or more channels are displayed. The required number of sweeps are captured before a new cycle is initialized. This mode offers "hands-off" operation for probing circuits and a convenient method of quickly setting the focus and intensity for single-shot events.

The auto-store mode makes single-shot events easy to capture and reduces the possibility of recording the wrong event by automatically switching to the normal trigger mode. The oscilloscope automatically switches from a "write" mode to a

"store" mode after the sweep of the single-shot event for maximum trace retention time. A "store" LED indicates that the event is captured and one press of the Store/Display button displays the stored trace.

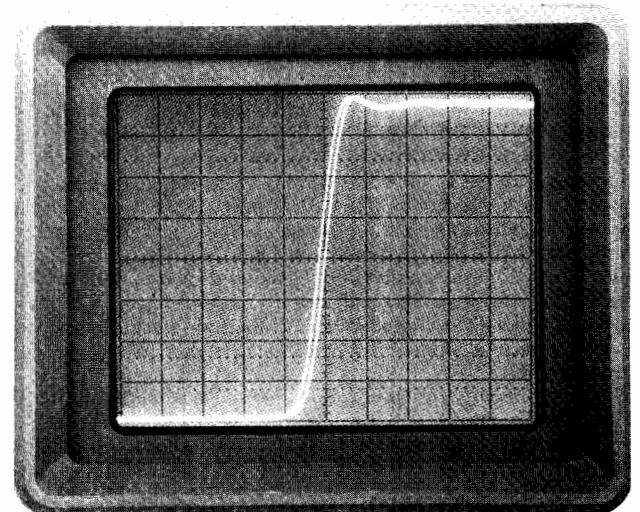
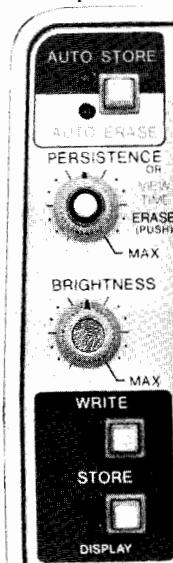

Exceptionally fine trace in the variable persistence mode permits high resolution timing measurements as shown with this dual trace, alternate sweep display at a sweep speed of 5 ns/div.

### 1741A Auto-Camera Option

The Auto-Camera Option 003 combines with Model 1741A to form a powerful method of obtaining photographic records, especially in long-term monitoring applications where hours of "babysitting" time can be saved. Setup involves mounting a Model 197B camera on the 1741A and selecting the auto-store mode. When the trigger signal is received, the oscilloscope sweeps and switches automatically to the store mode. Control circuits then command a display of the stored trace and actuate the camera shutter. After the first exposure of the waveform, the 1741A executes an erase cycle and, at the same time, the camera takes a second exposure to superimpose the graticule on the photograph.

### Optional Parametric Measurements

A new dimension of measurement capability is added to the 1741A with Option 002, triggered A vs B mode. Many non-time related displays commonly encountered in engineering problems, such as the Lissajous pattern, are clearly and accurately displayed. Option 002 adds a variable delay line in the horizontal axis which eliminates phase error and enables the 1741A to produce matched phase response up to the 5 MHz bandwidth of the horizontal section.

The display of parametric measurements is also enhanced by using main sweep to window several cycles of an event and then selecting delayed sweep, A vs B mode to examine each cycle. This triggered technique eliminates the bright spots caused by inactivity in the A vs B mode and removes any confusion created by having unnecessary information on the display.

### Expansion Storage 1744A

The ability to capture signals at the maximum bandwidth of the 1744A vertical deflection system is achieved with expansion storage CRT technology. This fast writing speed is achieved by combining a miniature precision storage mesh with an electronic lens system that magnifies and projects the stored image. The storage mesh is about one-fifth the size of the viewing screen and is capable of storing sharp waveform images. An electron cloud from a flood gun projects the image through the electronic lens system into the CRT phosphor for viewing. The extremely fast writing speeds provided by the expansion mesh technology are available in both variable persistence and storage modes. Operation is enhanced with an automatic focus circuit and maintains a crisp display with changes in intensity while an auto-intensity circuit helps to maintain a constant beam current to the storage surface over a wide range of sweep speeds.

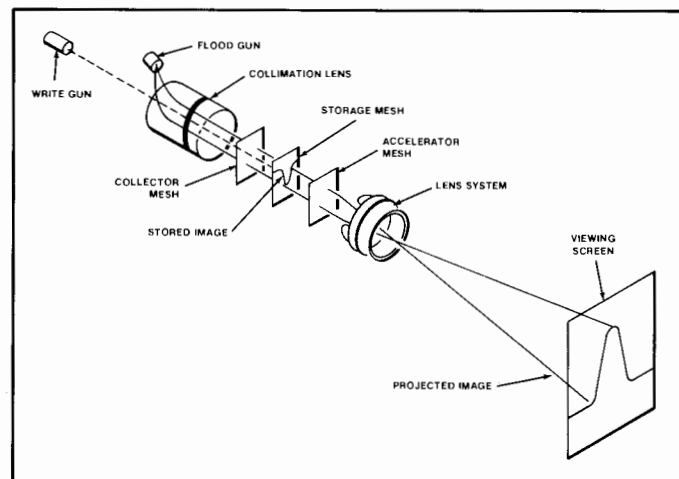

### Expansion Storage CRT

Expansion storage combines a miniature precision storage mesh with an electronic lens system that magnifies and projects the stored image.



Long term monitoring of circuits to capture random events is simplified with the 1741A Auto-camera Option 003. You can set up the oscilloscope/camera, leave them unattended, and automatically capture single-shot events

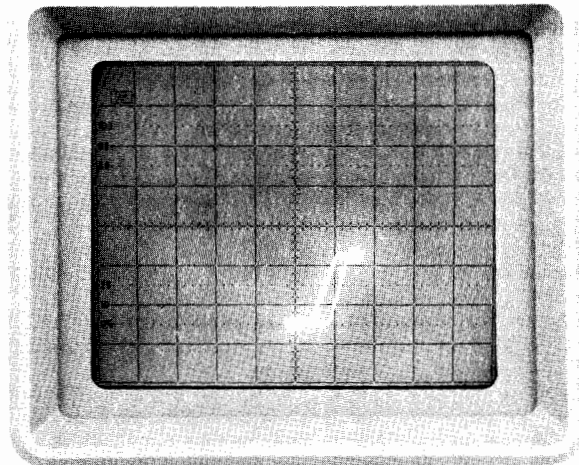

without triggered X, Y

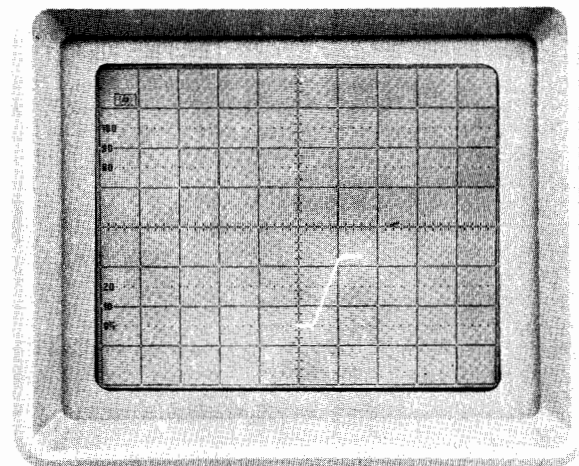

with triggered X, Y

1741A Triggered A vs B Option 002. The display of signals (top trace) in main sweep, A vs B mode shows total signal parameters. With delayed sweep A vs B, the display can be qualified (lower trace) to show only changing parameters which eliminates the bright dots caused by stationary values and confusion caused by unnecessary information.



Models 1740A, 1741A, 1743A, 1744A, 1745A, & 1746A (cont.)

## 1740A, 1741A, 1743A, 1744A, 1745A, 1746A

### Specifications

#### Vertical Display Modes

Channel A; channel B; A and B displayed alternately on successive sweeps (ALT); A and B displayed by switching between channels at  $\approx 250$  kHz rate with blanking during switching (CHOP); A plus B (algebraic addition); and trigger view.

**Vertical Amplifiers (2)** Bandwidth and rise time at all deflection factors from  $0^\circ\text{C}$  to  $+55^\circ\text{C}$ .

**Bandwidth:** 3 dB down from 8 div reference signal; 3 dB down from 6 div reference signal for 1741A, 1744A; 3 dB down from 10 div reference signal for 1745A, 1746A.

**DC-coupled:** dc to 100 MHz in both 50  $\Omega$  and 1 M $\Omega$  input modes.

**AC-coupled:**  $\approx 10$  Hz to 100 MHz.

**Bandwidth limit:** limits upper bandwidth to  $\approx 20$  MHz.

**Rise time:**  $\leq 3.5$  ns measured from 10% to 90% points of a 6 div (5 div, 1744A, 1745A, 1746A) input step.

#### Deflection Factor

**Ranges:** 5 mV/div to 20 V/div (12 calibrated positions) in 1, 2, 5 sequence, attenuator accuracy  $\pm 3\%$ .

**Vernier:** extends deflection factor to  $\geq 50$  V/div.

**Polarity:** channel B may be inverted.

**Input coupling:** selectable ac or dc, 50  $\Omega$  (dc), or ground.

**Input RC (selectable):** ac or dc, 1 M $\Omega$   $\pm 2\%$  shunted by  $\approx 20$  pF; 50  $\Omega$ , 50  $\Omega$   $\pm 3\%$ , SWR  $\leq 1.4$  at 100 MHz.

**Maximum input:** ac or dc, 250 V (dc + peak ac) or 500 V p-p at  $\leq 1$  kHz; 50  $\Omega$ , 5 V rms.

#### A + B Operation

**Amplifier:** bandwidth and deflection factors are unchanged; channel B may be inverted for A-B operation.

**Differential (A-B) common mode:** CMR is at least 20 dB from dc to 20 MHz. Common mode signal amplitude equivalent to 8 div (6 div, 1744A; 10 div for 1745A, 1746A) with one vernier adjusted for optimum rejection.

#### Vertical Magnification (X5)

**Bandwidth:** 3 dB down from 8 div (6 div, 1744A; 10 div for 1745A, 1746A) reference signal.

**DC-coupled:** dc to  $\approx 40$  MHz; dc to  $\approx 30$  MHz for 1741A, 1744A.

**AC-coupled:**  $\approx 10$  Hz to 40 MHz;  $\approx 10$  Hz to 30 MHz for 1741A, 1744A.

**Rise time:**  $\leq 9$  ns,  $\leq 12$  ns for 1741A, 1744A (measured from 10% to 90% points of 8 div, 5 div 1744A, 1745, 1746A input step).

**Deflection factor:** increases sensitivity of 5 and 10 mV settings by a factor of 5 with max sensitivity of 1 mV on channels A and B.

#### Trigger Source

Selectable from channel A, channel B, composite, or line frequency.

#### Trigger View

Displays internal or external trigger signal. In Alternate or Chop mode, channel A, channel B, and the trigger signals are displayed. In channel A or B mode, trigger view overrides that channel. Internal trigger signal amplitude approximates vertical signal amplitude. EXT trigger signal deflection factor is 100 mV/div or 1 V/div in EXT  $\div 10$ . Triggering point is approx center screen. With identically timed signals to a vertical input and the EXT trigger input, trigger signal delay is  $\leq 3.5$  ns.

#### Horizontal Display Modes

Main,  $\Delta$ time with channel A or B start (1746A, 1743A), main intensified, mixed (except 1743A, 1746A), delayed, mag X10, and A vs. B.

#### Main and Delayed Time Bases

##### Ranges

**Main:** 50 ns/div to 2 s/div (24 ranges) in 1, 2, 5 sequence.

**Delayed:** 50 ns/div to 20 ms/div (18 ranges) in 1, 2, 5 sequence.

##### Accuracy

Sweep Time/div	*Accuracy		Temp Range
	X1	X10	
50 ns to 20 ms	$\pm 3\%$	$\pm 4\%$	$0^\circ\text{C}$ to $+15^\circ\text{C}$
	$\pm 2\%$	$\pm 3\%$	$+15^\circ\text{C}$ to $+35^\circ\text{C}$
	$\pm 3\%$	$\pm 4\%$	$+35^\circ\text{C}$ to $+55^\circ\text{C}$

\*Add 1% for 50 ms to 2 s ranges

**Main sweep vernier:** extends slowest sweep to at least 5 s/div.

**Magnifier (X10):** extends fastest sweep to 5 ns/div.

#### Calibrated Sweep Delay (except 1743A)

**Delay time range:** 0.5 to 10X Main Time/div settings of 100 ns to 2 s (min delay 150 ns).

#### Differential Time Measurement Accuracy

(Using one intensified marker and helical control)

Main Time Base Setting	Accuracy* ( $+15^\circ\text{C}$ to $+35^\circ\text{C}$ )
100 ns/div to 20 ms/div	$\pm(0.5\%$ of reading $+0.1\%$ of fs)
50 ms/div to 2 s/div	$\pm(1\%$ of reading $+0.1\%$ of fs)

\*Add 1% for temperature from  $0^\circ\text{C}$  to  $+15^\circ\text{C}$  and  $+35^\circ\text{C}$  to  $+55^\circ\text{C}$ .

**Delay jitter:**  $<0.002\%$  (1 part in 50 000) of max delay in each step from  $+15^\circ\text{C}$  to  $+35^\circ\text{C}$ ;  $<0.005\%$  (1 part in 20 000) from  $0^\circ\text{C}$  to  $+15^\circ\text{C}$  and  $+35^\circ\text{C}$  to  $+50^\circ\text{C}$ .

#### Differential Time Measurement Accuracy (1746A)

(Using  $\Delta$ time dual intensified markers)

Main Time Base Setting	Accuracy* ( $+15^\circ\text{C}$ to $+35^\circ\text{C}$ )		
	Opt 034/035	External DVM***	Helical
100 ns** to 20 ms/div	$\pm(0.5\%$ of reading $+0.05\%$ of fs)	$\pm(0.5\%$ of reading $+0.05\%$ of fs)	$\pm(0.5\%$ of reading $+0.1\%$ of fs)
50 ms to 2 s/div	$\pm(1\%$ of reading $+0.1\%$ of fs)	$\pm(1\%$ of reading $+0.1\%$ of fs)	$\pm(1\%$ of reading $+0.1\%$ of fs)

\*Add 1% for temperatures from  $0^\circ\text{C}$  to  $+15^\circ\text{C}$  and  $+35^\circ\text{C}$  to  $+55^\circ\text{C}$ .

\*\*On 100 ns/div range, specification applies after first cm of main sweep.

\*\*\*Add DVM accuracy.

#### Time Interval ( $\Delta$ Time) 1746A

**Function:** measures time interval between two events on channel A (A display); two events on channel B (B display); or two events starting from an event on either channel A or B and ending with an event on either channel A or B (alternate display).

**Time interval output voltage:** varies from 50 V to 100 mV full scale. Full scale output voltage can be determined by multiplying the number on the Time/Div dial by 10 V (e.g., 0.05 s, 0.05 ms, or 0.05  $\mu\text{s}$  per div gives 0.5 V output full-scale).

**Stability ( $0^\circ\text{C}$  to  $+55^\circ\text{C}$ ):** short-term 0.005%. Temperature,  $\pm 0.03\%/^\circ\text{C}$  deviation from calibration temperature range.

#### Crystal Referenced $\Delta$ Time (1743A)

**Delay time range:** 0 to 10 X Main Time/Div settings of 100 ns to 2 s.

#### Differential time measurement accuracy

**Accuracy:**  $\pm 0.002\%$  of reading  $\pm 1$  count from  $+15^\circ\text{C}$  to  $+35^\circ\text{C}$ ;  $\pm 0.005\%$  of reading  $\pm 1$  count from  $0^\circ\text{C}$  to  $+15^\circ\text{C}$  and  $+35^\circ\text{C}$  to  $+55^\circ\text{C}$ .

#### Time Resolution of $\pm 1$ Count

Sweep Ranges/div	$\pm 1$ Count	Averages
0.1 $\mu\text{s}$ , 0.2 $\mu\text{s}$ , 0.5 $\mu\text{s}$	$\pm 100$ ps	10 000
1 $\mu\text{s}$ , 2 $\mu\text{s}$ , 5 $\mu\text{s}$	$\pm 1$ ns	1 000
10 $\mu\text{s}$ , 20 $\mu\text{s}$ , 50 $\mu\text{s}$	$\pm 10$ ns	100
0.1 ms, 0.2 ms, 0.5 ms	$\pm 100$ ns	direct

**Readout:** 5 digit LED plus exponent.

**Crystal Aging:** 0.0005% per year.

**Delay jitter:** same as other 1740 series oscilloscopes.

#### Triggering

##### Main Sweep

**Normal:** sweep is triggered by internal or external signal.

**Automatic:** baseline displayed in absence of input signal. Above  $\approx 40$  Hz, triggering is same as normal.

**Single:** sweep occurs once with same triggering as Normal. Reset arms sweep and lights indicator (1741A, 1744A). Single sweep is also initiated with Erase, sweep is armed after the erase cycle.

**Internal:** dc to 25 MHz on signals  $\geq 0.3$  div vertical deflection, increasing to 1 div vertical deflection at 100 MHz in all display modes (required signal level is increased by 2 when in Chop mode and by 5 when X5 vertical magnifier is used).

**External:** dc to 50 MHz on signals of 50 mV p-p or more, increasing to 100 mV p-p at 100 MHz (required signal level is increased by 2 when in Chop mode).

##### Delayed Sweep (Sweep After Delay)

**Auto:** delayed sweep starts at end of delay period.

**Trig:** delayed sweep armed and triggerable at end of delay period.

**Internal:** same as Main Sweep except 1743A is dc to 25 MHz on signals causing 1 div or more vertical deflection, increasing to 2 div of vertical deflection at 100 MHz.

**External:** same as Main sweep except 1743A is dc to 50 MHz on signals 100 mV p-p increasing to 200 mV p-p at 100 MHz.



**External input RC:**  $\approx 1$  M $\Omega$  shunted by  $\approx 20$  pF; max external input, 250 V (dc + peak ac) or 500 V p-p at  $\leq 1$  kHz.

**Level and slope:** internal, at any point on positive or negative slope of displayed waveform; external, continuously variable from +1 V to -1 V on either slope of trigger signal, +10 V to -10 V in  $\div 10$ .

**Coupling:** ac, dc, LF REJ, or HF REJ.

**Trigger holdoff (main sweep):** increases sweep holdoff, all ranges.

### Calibrated Mixed Time Base (except 1743A, 1746A)

Dual time base in which the main time base drives the first portion of sweep and the delayed time base completes the sweep at the faster delayed sweep. Also operates in single sweep mode. Accuracy, add 2% to main time base accuracy.

### A vs B Operation

**Bandwidth:** channel A (Y-axis), same as channel A; channel B (X-axis), dc to 5 MHz.

**Deflection factor:** 5 mV/div to 20 V/div (12 cal positions) in 1, 2, 5 sequence; phase difference between channels,  $< 3^\circ$ , dc to 100 kHz (75 kHz, 1743A).

### Cathode Ray Tube and Controls (1740A, 1743A)

**Type:** 12.7 cm (5 in.) rectangular CRT, post accelerator,  $\approx 15$  kV accelerating potential, aluminized P31 phosphor.

**Graticule:** 8  $\times$  10 div (1 div = 1 cm) internal nonparallax graticule, 0.2 subdivision markings on major horizontal and vertical axes and markings for transition time measurements. Internal floodgun graticule illumination.

**Beam finder:** returns trace to CRT screen.

**Z-axis input (intensity modulation):** +4 V,  $\geq 50$  ns wide pulse blanks trace of any intensity, usable to  $\leq 10$  MHz for normal intensity. Input R, 1 k $\Omega$   $\pm 10\%$ . Max input  $\pm 20$  V (dc + peak ac).

**Rear panel controls:** astigmatism and trace align.

### Cathode Ray Tube and Controls (1745A, 1746A)

**Type:** Hewlett-Packard, 15.6 cm (6.15 in.) rectangular CRT, post accelerator, approximately 21 kV accelerating potential, aluminized P31 phosphor.

**Graticule:** 10  $\times$  10 div; 1 vertical div = 0.95 cm, 1 horizontal div = 1.2 cm; internal nonparallax graticule with 0.2 subdivision markings on major horizontal and vertical axes, markings for rise time measurements. Internal flood gun graticule illumination.

**Beam finder:** returns trace to CRT regardless of horizontal, vertical, or intensity settings.

**Z-axis input (intensity modulation):** +4 V,  $> 50$  ns width pulse blanks trace of any intensity, usable to  $\leq 10$  MHz for normal intensity; input R, 1 k $\Omega$   $\pm 10\%$ ; maximum input  $\pm 20$  V (dc + peak ac),  $\leq 1$  kHz.

**Rear panel controls:** astigmatism and trace align.

### Cathode Ray Tube and Controls (1741A)

**Type:** 12.7 cm (5 in.) rectangular CRT, post accelerator,  $\approx 7.5$  kV accelerating potential, aluminized P31 phosphor.

**Graticule:** 8  $\times$  10 div (1 div = 0.85 cm) internal, nonparallax graticule, 0.2 subdivision markings on major horizontal and vertical axes, with markings for transition time measurements. Graticule illumination is achieved with Persistence control set to min.

**Beam finder:** returns trace to CRT screen.

**Z-axis input (intensity modulation):** same as 1740A.

**Operating modes:** write, store, display, auto-store, auto-erase, and conventional (rear panel control).

**Persistence:** variable,  $\approx 100$  ms to 1 min; conventional,  $\approx 40$   $\mu$ s.

**Writing speed, variable persistence and storage:**  $\geq 200$  cm/ $\mu$ s (235 div/ $\mu$ s) over center 7  $\times$  9 div (with viewing hood).

**Storage time:** display mode, at least 10 s at 22°C; store mode, at least 30 s at 22°C.

**Brightness:**  $\approx 170$  cd/m $^2$  (50 fl) increasing to  $\approx 340$  cd/m $^2$  (100 fl) depending on brightness control setting.

**Erase time:**  $\approx 300$  ms.

**Rear panel controls:** astigmatism, trace align, conventional push-button, and view time.

### Cathode Ray Tube and Controls (1744A)

**Type:** 12.7 cm (5 in.) rectangular CRT, post accelerator,  $\approx 10$  kV accelerating potential, aluminized P31 phosphor.

**Graticule:** 8  $\times$  10 div (1 div = 0.72 cm) internal graticule, 0.2 subdivision markings on major horizontal and vertical axes, with markings for transition time measurements. Graticule illumination is achieved with Persistence control set to min.

**Beam finder, Z-axis input (intensity modulation):** See 1740A.

**Operating modes:** write, store, display, auto-store, and auto-erase.

**Writing speed, variable persistence and storage:**  $\geq 1800$  cm/ $\mu$ s (2500 div/ $\mu$ s) over center 6  $\times$  8 div (with viewing hood).

**Storage time:** store mode, at least 30 s; view mode, at least 10 s; wait time, at least 60 s, at 22°C.

**Persistence:** variable (100 ms min).

**Erase time:**  $\approx 300$  ms.

**Rear panel controls:** astigmatism and trace align.

### General

**Rear panel outputs:** main and delayed gates, 0.8 V to  $\geq +2.5$  V capable of supplying  $\approx 5$  mA.

### Amplitude Calibrator (0°C to +55°C)

**Output Voltage:** 1 V p-p into  $\geq 1$  M $\Omega$ , 0.1 V p-p into 50  $\Omega$ ; accuracy,  $\pm 1\%$ .

**Rise time:**  $\approx 0.1$   $\mu$ s.

**Frequency:**  $\approx 1.4$  kHz.

**Power:** 100, 120, 220, 240 V ac  $\pm 10\%$ ; 48 to 440 Hz; 100 VA max.

**Weight:** (1740) net, 13 kg (28.6 lb); shipping 15.7 kg (34.6 lb). (1741, 1743, 1744) net 13.8 kg (30.5 lb); shipping 17.7 kg (39 lb).

**Operating environment:** temperature 0°C to +55°C; humidity to 95% relative humidity at +40°C; altitude, to 4600 m (15,000 ft); vibration, vibrated in three planes for 15 min. each with 0.254 mm (0.010 in.) excursion, 10 to 55 Hz.

**Size:** (1740A, 1745A) 197 H  $\times$  335 W  $\times$  597 mm D (7.8"  $\times$  13.2"  $\times$  23.5") with handle, 492 mm D (19.4 in.) without; (1741A) 616 mm D (24.3 in.) with handle, 552 mm D (21.7 in.) without; (1746A) 570 mm D (22.4 in.) with handle, 502 mm D (19.8 in.) without; (1743A) 613 mm D (24.1 in.) with handle, 549 mm D (21.6 in.) without; (1744A) 635 mm D (25 in.) with handle; 511 mm D (20.1 in.) without.

**Accessories furnished:** one blue light filter HP P/N 01740-02701, one front panel cover, one 2.3 m (7.5 ft) power cord, one vinyl accessory storage pouch, one Operators Guide and one Service Manual, two Model 10041A 10:1 divider probes  $\approx 2$  m (6.6 ft) long. The 1741A and 1744A also include one Model 10173A RFI filter and contrast screen, and one Model 10140A viewing hood.

### Options and Accessories

**001:** fixed power cord (U.S. only).

**002 (1741A):** Triggered A vs B Mode; phase shift  $\leq 2^\circ$ , dc to 5 MHz; internal triggering on channel B.

**003:** Auto Camera (1741A)

**005 (except 1743A, 1744):** TV sync

**034 (except 1743A, 1744A):** built-in DMM (60 Hz)

**035 (except 1743A, 1744A):** built-in DMM (50 Hz)

**091:** two 3 m (9.8 ft) 10042A 10:1 probes in lieu of 10041A probes

**096:** two 1.8 m (6 ft) 10006D 10:1 probes in lieu of 10041A probes.

**112:** includes 1112A Inverter Power Supply, a portable power source for 1700 series oscilloscopes.

**910:** extra set of product manuals.

**Multimeter kit:** HP P/N 01742-69501 (1746A), 01741-69502 (1741A), or 01740-69503 (1740A, 1745A) adapts standard oscilloscope to an Option 034/035 with built-in LED readout. Kit includes a multimeter, top oscilloscope cover, vinyl storage pouch, and mounting hardware.

### Ordering Information

**1740A** 100 MHz Oscilloscope

**1741A** 100 MHz Storage Oscilloscope

**1743A** 100 MHz  $\Delta$ Time Oscilloscope

**1744A** 100 MHz Storage Oscilloscope

**1745A** 100 MHz Large Screen Oscilloscope

**1746A** 100 MHz Large Screen Oscilloscope

# OSCILLOSCOPES

200/275 MHz Delta Time, 275 MHz Storage

Models 1715A, 1722B, 1725A, & 1727A

- 200 MHz (1715A) and 275 MHz (1725A) bandwidths
- Two marker delta time measurements
- Optional DMM
- Selectable input impedance

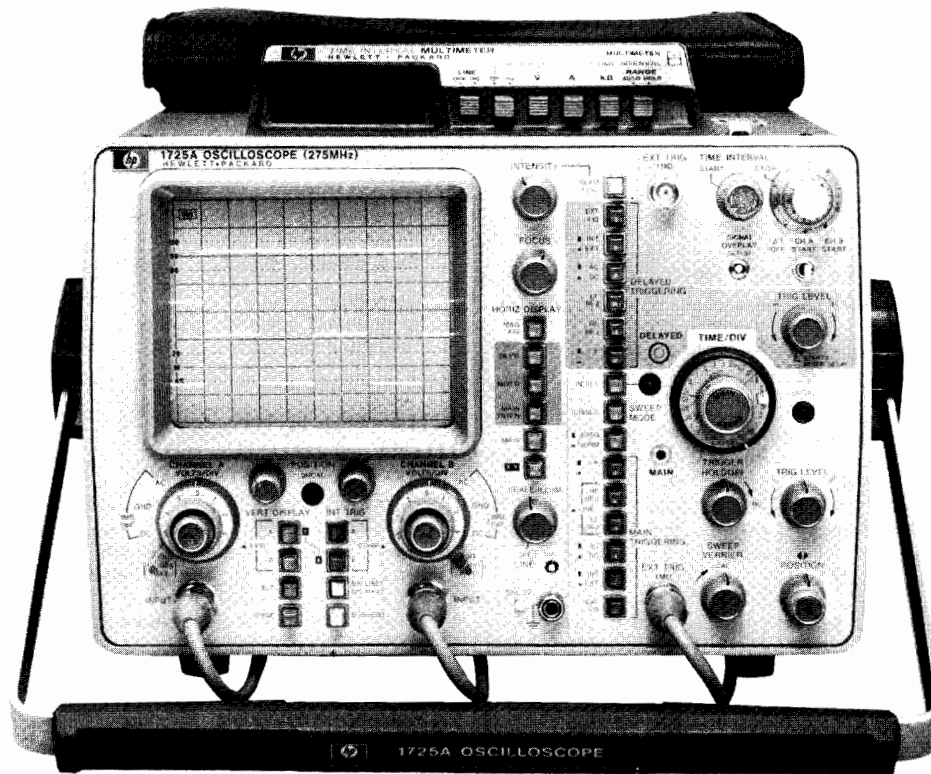

1725A Opt 034

Hewlett-Packard's Models 1725A, 275 MHz, and 1715A, 200 MHz oscilloscopes offer delta time measurements with an optional DMM for direct delta time readout and current, voltage, or resistance measurements. The large 8 x 10 cm CRT provides easy viewing of dual trace signals on which timing measurements can be made conveniently and accurately using the Hewlett-Packard developed delta time technique. For easier percentage measurements, reference lines of 0% and 100% amplitude are 5 divisions apart and markings for 10%, 90%, 20%, and 80% are also provided for easier transition time measurements. Vertical deflection factors of 10 mV/div to 5 V/div over the full bandwidth (5 mV/div to 150 MHz in the 1715A) and a selectable 50 ohm or 1 megohm input offer the high performance required for both laboratory and field applications.

### Delta Time Measurements

These oscilloscopes offer two methods for making timing measurements. One is the familiar single marker delayed sweep, using the calibrated delay control to accurately measure time relationships; the second is a system of dual intensified markers which significantly improves accuracy while conveniently reducing the time necessary to make a measurement. The latter, better known as the Delta Time measurement method, incorporates a system of two intensified markers which are two delayed sweeps displayed alternately.

The Delta Time measurement technique is to select the Main Intensified mode and position the first marker at  $t_1$  with the Time Interval Start control and position the second marker at  $t_2$  with the Time Interval Stop control. The difference between the two selected points is then read directly on the optional DMM or on the calibrated delay time control, or is available as a rear panel scaled voltage output compatible with most DVM's. Units of seconds, milliseconds, or microseconds are read on the Main Time/Div control.

For increased precision, Delayed Sweep mode is selected where the two intensified portions are displayed alternately. Maximum accuracy is achieved by superimposing the start and stop points using the

Time Interval Stop control. Even without an external voltmeter and using only the Time Interval Stop control, this optical nulling technique reduces the chance of error in time interval measurements.

The Delta Time technique makes timing measurements such as transition times, propagation delay, clock phasing, and other high speed digital timing measurements faster and with more repeatability than with standard delayed sweep oscilloscopes. Time interval measurements can be made between two events on channel A, two events on channel B, or between two events on alternate channels.

### Optional Digital Multimeter

Adding an optional multimeter to the 1715A or 1725A improves the accuracy and convenience of delta time measurements as well as improving basic measurement capabilities. A switch on the instrument allows selection of direct delta time measurements or DMM operation. The DMM mode provides the five most common measurements: ac and dc voltage, ac and dc current, and resistance. This versatile DMM includes autopolarity, autozeroing, and autoranging to make direct convenient measurement. Using a Model 10023A Temperature Probe with the DMM, fast, accurate temperature measurements are easy to make. The pencil-like tip accesses small components and the temperature is displayed directly in degrees Celsius on the DMM.

### Optional TV Sync

A TV sync option (005) is available for the 1715A and 1725A. This option provides external main and external delayed triggers to the instrument. A sync separator derives these triggers from the composite video which allows the analysis of fields, test signals, timing relationships, lines, or segments of lines. This added TV sync capability in a high frequency oscilloscope offers the ability to view either video signals or the fast transitions and timing relationships of high speed logic in today's video systems. For more information, ask your local HP Field Engineer for the 1715A/1725A TV Sync Data Sheet.

- 275 MHz bandwidth
- Microprocessor calculated delta time measurements
- Direct LED readout with 20 ps resolution
- Selectable input impedance

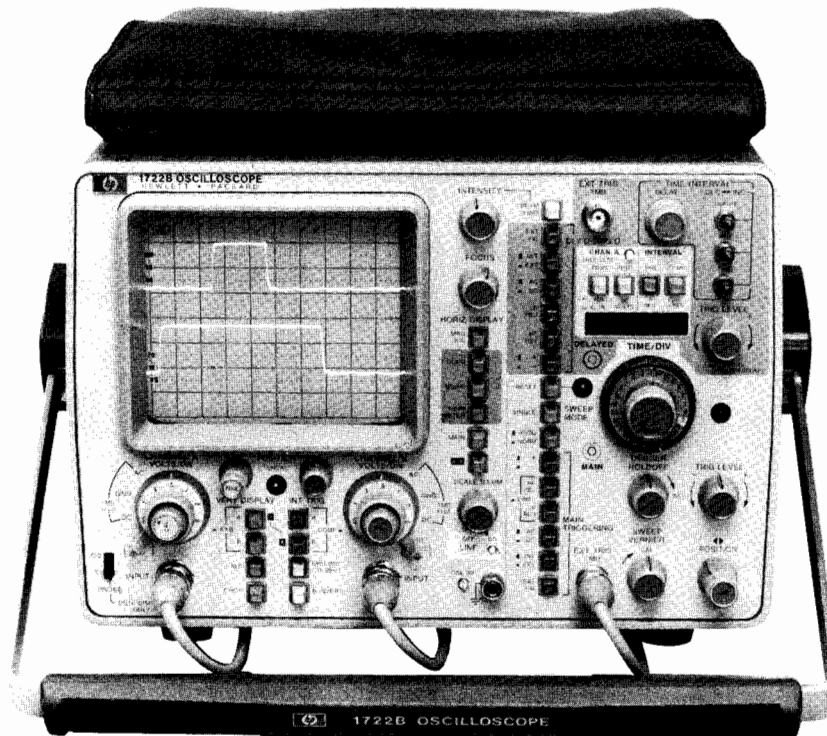

1722B

## 1722B Description

Model 1722B is a 275 MHz bandwidth, 1 ns/div sweep speed, dual channel oscilloscope with a built-in microprocessor and five function LED display for precise real time measurements. In addition to the conventional volts versus time CRT display, the microprocessor gives you direct readout of delta time, frequency, dc voltage, instantaneous waveform voltage, and percent amplitude. The 1722B's outstanding repeatability and 20 ps resolution make it ideal for clock phasing measurements in large computer timing applications.

### Delta Time Measurements

Delta time measurement, developed by Hewlett-Packard, is used in the Time Interval mode for making accurate time interval measurements including transition time, pulse duration (width), period, and propagation delay. Time interval measurements can be made between two events on Channel A, two events on Channel B, or between an event beginning on Channel A and ending on Channel B.

The delta time measurement technique is to select Main Intensified mode and set the first intensified marker to  $t_1$ . The second intensified marker is positioned by using the DEC → INC controls (coarse, medium, or fine) which causes the microprocessor to develop the voltage to position the second marker. While developing the voltage ( $t_2 - t_1$ ) to separate the two markers, the microprocessor drives and updates the 3 1/2 digit LED display. Time interval measurements are automatically scaled for the proper sweep speed and displayed in units of seconds (exponent 0), milliseconds (exponent -3); microseconds (exponent -6); or nanoseconds (exponent -9).

Additional precision is obtained by switching to the Delayed Sweep mode where the two intensified markers are expanded and displayed alternately. Maximum accuracy is quickly obtained by overlapping the two expanded sweeps using the DEC → INC controls. Superimposing the start and stop points of the measured time interval provides a more accurate digital readout by nulling any amplifier or CRT nonlinearities. Separate portions of a sweep can be magnified and examined simultaneously, enabling you to view two events separated in time while maintaining their relative time relationship.

The microprocessor not only keeps track of the distance between the two markers but automatically expands the measurement resolution by a factor of 10 whenever the two markers are within 1 div of each other. The microprocessor also interrogates the function switches to help prevent inaccurate measurements.

### 1/Time (Frequency) Measurements

The 1722B gives an automatic 3 or 4 digit display of the reciprocal of time, eliminating the need for calculations when setting up clock frequencies and measuring the frequency or repetition rate of a waveform.

### DC Voltage Measurements

The Input (dc volts) mode provides a direct digital display of the average value of a waveform at the input to channel A. The built-in DVM measurement is made using a successive approximation algorithm controlled by the microprocessor. This allows you to establish a reference level with respect to any voltage and enables differential dc measurements.

### Instantaneous Voltage Measurements

In the Position mode you can measure the voltage at any point on a waveform in channel A without needing to count divisions from a base line and multiply by the attenuator setting. The measurement mode is useful for measuring peak voltages, crossover, and threshold points in logic circuits, or for any time you need to know a precise voltage at a particular point on a waveform.

### Percentage Measurements

Percentage measurements are made in the Position mode with the channel A vernier out of the Cal position to establish 5 div separation between the 0% and 100% points. By positioning the desired 0% point on a convenient graticule line, zeroing the LED display, and then positioning the waveform to the 100% point, percent amplitude of any point on the waveform with respect to the 100% point is measured by positioning that point at the reference graticule and reading the LED display. Relative amplitude measurements such as pulse overshoot, ringing, preshoot, and percent amplitude modulation on an rf carrier are easily measured using this measurement mode.



# OSCILLOSCOPES

## 275 MHz Variable Persistence/Storage

Models 1715A, 1725A, 1722B, 1727A

- 2000 cm/ $\mu$ s Variable Persistence and Stored Writing Speed
- Minimum Blind Time, Auto Intensity Circuit
- 275 MHz bandwidth, 10 mV/div with 1 M $\Omega$  or 50  $\Omega$  input
- Delta Time and Optional DMM

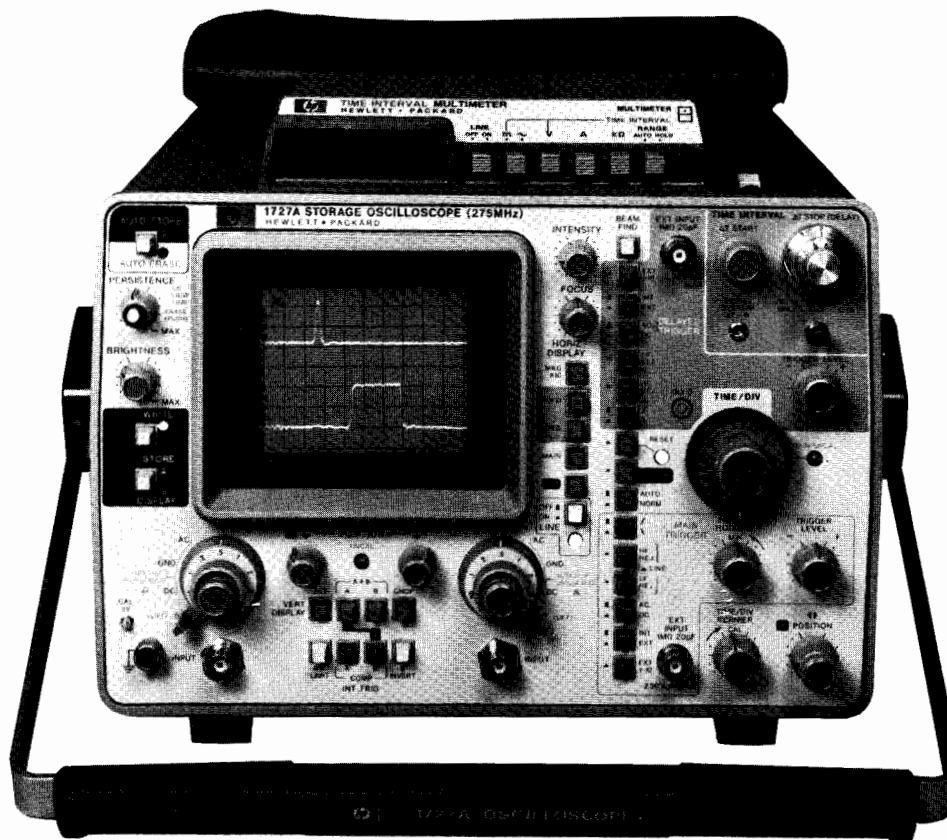

1727A Opt 034

### 1727A Description

Hewlett-Packard's 275 MHz, Model 1727A Variable Persistence/Storage Oscilloscope offers 2000 cm/ $\mu$ s writing speed in both the variable persistence and single shot storage modes. The fast writing speed and large display area make the 1727A ideal for viewing and analyzing narrow pulses in the physical sciences as well as glitches and noise pulses in digital environments. Signals with rise times as fast as 1.27 ns (4 div) can be captured and displayed in the single-shot mode.

Conveniently grouped variable persistence storage controls, front panel color coding, LED indicators, and automatic operating modes make the 1727A one of the easiest to use, high-speed storage oscilloscopes available today. Additional features which provide exceptional versatility and ease of use include dual marker delta time measurements; an auto-intensity circuit to simplify the setup of a sharp, non-blooming trace; and selectable input impedance (1 M $\Omega$ /50  $\Omega$ ) for both general purpose probing and high fidelity, high frequency signal capture with the built-in 50 ohm impedance matching.

### Expansion Storage

The expansion storage CRT (refer to 1744A for illustration) has a miniature storage mesh, about the size of a postage stamp, and an electronic lens system to present well defined, sharp traces at the high writing speed of 2000 cm/ $\mu$ s in a variety of operating modes. The fast CRT writing speed is obtained over the full display quality area. Other convenience features include an automatic focus circuit that maintains a crisp display with changes in intensity, and an auto intensity circuit that minimizes blooming and reduces operator concern about CRT damage.

### Variable Persistence Is General Purpose

The ability to write at 2000 cm/ $\mu$ s in the variable persistence mode makes the 1727A a general purpose instrument. Using the

variable persistence mode, the effective writing speed can be increased by integrating repetitive signals. With the 1727A, only two or three repetitions of a signal in a 10 second time period are needed to view any signal compatible with the vertical and horizontal specifications. For example, a 275 MHz sine wave with an amplitude of 8 divisions at a sweep speed of 1 ns/div has a maximum spot velocity of 5028 cm/ $\mu$ s and only requires about three repetitions for viewing.

The following table is a quick reference guide for determining the single-shot signals that can be captured by a 1727A.

Amp p-p	Sine Wave MHz	Observed Pulse Tr	Sweep Speed ns/div	Req Writing Speed cm/ $\mu$ s
4 div		1.27 ns	1	1952
4 div		1.27 ns	10	1816
3 div	275		1	2000
3 div	275		10	1867
4 div	200		1	1948
4 div	200		10	1811

### Delta Time Measurements

In the variable persistence mode, the 1727A can make delta time measurements using the two marker delta time system. This delta time system simplifies time interval measurements while improving both accuracy and resolution. In the delta time mode, Start and Stop markers are alternately displayed on the main intensified sweep. The time interval between these markers can be displayed on the optional DMM or is available as a scaled voltage output, on the rear panel, that is compatible with most DVMs. Time interval measurements may also be made without a DVM using the helidial for determining the measurement.



## 1715A, 1722B, 1725A, 1727A Specifications

### Vertical Display Modes

Channel A; channel B; A and B displayed alternately on successive sweeps (ALT); A and B displayed by switching between channels at  $\approx 1$  MHz rate with blanking during switching (CHOP); A plus B (algebraic addition); X-Y (A vs. B).

### Vertical Amplifiers (2)

**Bandwidth:** (3 dB down from 6 div reference signal).

**DC-coupled:** (1722B, 1725A, 1727A) dc to 275 MHz, (1715A) dc to 200 MHz 10 mV/div to 5 V/div (to 150 MHz at 5 mV/div, 1715A), in both 50  $\Omega$  and high Z input modes.

**AC-coupled:** lower limit  $\approx 10$  Hz.

**Bandwidth limit:** limits upper bandwidth to  $\approx 20$  MHz.

**Rise time:** (1722B, 1725A, 1727A)  $< 1.3$  ns; (1715A)  $< 1.75$  ns 10 mV/div to 5 V/div,  $< 2.3$  ns at 5 mV/div.

**Deflection factor:** ranges, 10 mV/div to 5 V/div (9 calibrated positions) in 1, 2, 5 sequence,  $\pm 2\%$  attenuator accuracy; 5 mV/div to 5 V/div (10 calibrated positions) in 1715A; Vernier, extends max deflection factor to  $\geq 12.5$  V/div.

**Polarity:** channel B may be inverted.

**Input coupling:** selectable, ac or dc, 50  $\Omega$  (dc) or ground.

**Input RC (selectable):** ac and dc, 1 M $\Omega$   $\pm 2\%$  shunted by  $\approx 11$  pF; 50  $\Omega$ , 50  $\Omega$   $\pm 2\%$ ; SWR (1722B, 1725A, 1727A)  $\leq 1.3$  on 10, 20, and 50 mV ranges,  $< 1.15$  on all other ranges; SWR (1715A)  $\leq 1.3$  on 5, 10, 20, and 50 mV ranges and  $< 1.15$  on all other ranges.

**Max input:** 1 M $\Omega$ ,  $\pm 250$  V (dc + pk ac) at  $\leq 1$  kHz; 50  $\Omega$ , 5 V rms.

**A+B operation:** amplifier, bandwidth and deflection factors are unchanged; channel B may be inverted for A-B operation; Differential (A-B) Common Mode, CMR is  $\geq 40$  dB from dc to 5 MHz decreasing to 26 dB at 50 MHz. Common mode signal amplitude equivalent to 12 div with one vernier adjusted for optimum rejection.

### Channel A Input-dc Volts (1722B)

**X1 range:** 95 mV to 47 V fs vertical deflection (10 mV/div to 5 V/div).

**X10 range:** 0.95 V to 470 V full scale vertical deflection (100 mV/div to 50 V/div with X10 probe).

**Accuracy:**  $\pm 0.5\%$  reading  $\pm 0.5\%$  full scale (fs = 10 cm),  $+20^\circ\text{C}$  to  $+30^\circ\text{C}$ ; Stability, temperature coefficient,  $< \pm 0.02\%/^\circ\text{C}$ .

**Input impedance:** X1 range, 1 M $\Omega$  shunted by  $\approx 11$  pF; X10 range (with X10 probe) 10 M $\Omega$  shunted by  $\approx 10$  pF.

**Sample rate:**  $\approx 2/s$ , response time  $\leq 1$  s.

### Channel A Position - Volts (1722B)

(Channel A vernier in CAL detent.)

**Measurement:** dc substitution method using channel A position control to determine voltage of any point on displayed waveform using any graticule line as reference.

**Bandwidth:** dc to 275 MHz ( $\leq 3$  dB down from 6 div ref signal).

**Dynamic range:**  $\pm 6$  cm from ground referenced to center screen.

**Accuracy:**  $\pm 1\%$  reading  $\pm 0.5\%$  of full scale (10X the volts/div range) measured at dc.

### Channel A Position - % (1722B)

(Channel A vernier out of CAL detent.)

**Measurement:** dc substitution method using channel A position control to determine percent of any waveform point with respect to user defined 0 and 100% points. Accuracy  $\pm 1\%$ .

**Range:** 0 to  $\pm 140\%$  (set with vernier so that 100% equals 5 div).

### Vertical Output (Rear Panel)

**Amplitude:** one div of vertical deflection produces  $\approx 100$  mV output, dc to 50 MHz in 1722B, 1725A, 1727A, dc to 25 MHz in 1715A.

**Cascaded deflection factor:** 1 mV/div with both vert channels set to 10 mV/div. Bandwidth, dc to 5 MHz (with bandwidth limit). Source resistance  $\approx 100\Omega$ ; selection, trig source set to A selects channel A output, to B selects channel B output.

### Horizontal Display Modes

Main, main intensified (1715A, 1722B, 1725A), delayed, mixed, X-Y, and mag X10. The 1727A main intensified mode is automatically selected whenever the delayed time base is turned on.

### Main Time Base

#### Sweep

**Ranges:** 10 ns/div to 0.5 s/div (24 ranges) 1, 2, 5 sequence.

#### Accuracy

Main Sweep Time/Div	Accuracy (0°C to +55°C)	
	X1	X10
10 ns to 50 ns	$\pm 3\%$	$\pm 5\%$
100 ns to 20 ms	$\pm 2\%$	$\pm 3\%$
50 ms to 0.5s	$\pm 3\%$	$\pm 3\%$

**Vernier:** extends slowest sweep to at least 1.25 s/div.

**Magnifier:** extends fastest sweep to 1 ns/div.

#### Sweep Mode

**Normal:** sweep is triggered by internal or external signal.

**Automatic:** baseline displayed in absence of input signal. Triggering is same as normal above  $\approx 40$  Hz.

**Single:** in Normal, sweep occurs once with same triggering as Normal, reset arms sweep and lights indicators; in Auto, sweep occurs once each time Reset is pressed (1727A). Erase pushbutton arms sweep, lights indicator, and performs the Reset function immediately following the erase cycle.

#### Triggering

**Source:** channel A, B, Comp, or line frequency.

**Internal:** dc to 100 MHz on signals causing  $\geq 0.5$  div vertical deflection, increasing to 1 div of vert deflection at 300 MHz (200 MHz, 1715A) in all display modes. Line freq. triggering selectable.

**External:** dc to 100 MHz on signals  $\geq 50$  mV p-p increasing to 100 mV p-p at 300 MHz (200 MHz, 1715A). Max input,  $\pm 250$  V (dc + peak ac) at  $\leq 1$  kHz. Input RC  $\approx 1$  M $\Omega$  shunted by  $\approx 15$  pF.

#### Trigger Level and Slope

**Internal:** at any point on the vertical waveform displayed.

**External:**  $+1.0$  V to  $-1.0$  V ( $+10$  V to  $-10$  V in  $\div 10$  mode).

**Coupling:** AC, DC, LF REJ, or HF REJ.

**Trigger holdoff:** variable, to  $> 1$  sweep from 10 ns/div to 50 ms/div.

### Main Intensified

**Delayed sweep:** intensifies that part of main time base to be expanded to full screen in delayed mode.

**Delta time mode:** intensifies two parts of main time base that are expanded in delayed mode.

### Delayed Time Base

#### Sweep

**Ranges:** 10 ns/div to 20 ms/div (20 ranges) in 1, 2, 5 sequence.

**Accuracy:** same as main time base.

#### Triggering

**Internal:** same as main time base, no Line Frequency triggering.

**Starts after delay:** sweep starts at end of delay period.

**Trigger:** with delayed trigger level control out of detent (starts after delay) delayed sweep is triggerable at end of delay period.

**Delay time range:** 0.5 to 10X Main Time/Div settings of 20 ns to 0.5 s (min delay 50 ns).

External triggering, external input RC, max external input, trigger level and slope, and coupling are same as main time base.

### Differential time accuracy (1715A, 1725A, 1727A)

Main Time Base Setting	Accuracy (+15°C to +35°C)
50 ns/div to 20 ms/div	$\pm (0.5\% \text{ of reading} + 0.1\% \text{ of full scale})$
20 ns/div	$\pm (1\% \text{ of reading} + 0.2\% \text{ of full scale})$
50 ms/div to 0.5 s/div	$\pm 3\%$

**Delay jitter:**  $< 0.005\%$  of max delay in each step.

**Stability (0°C to +55°C):** short term 0.005%. Temperature,  $\pm 0.03\%/^\circ\text{C}$  deviation from calibration temperature range.



## Models 1715, 1722B, 1725A &amp; 1727A (cont.)

**Time Interval ( $\Delta$  Time Mode—1715A, 1725A, 1727A)**

**Function:** measures time interval between two events on channel A (A display), on channel B (B display), or starting from an event on either A or B and ending with an event on either A or B (alt display).

**Time interval output voltage:** from 50 V to 100 mV full-scale.

**Accuracy:** Time Interval Accuracy plus DVM accuracy.

Main Time Base Setting	Accuracy (+20°C to +30°C)
100 ns/div to 20 ms/div	$\pm 0.5\%$ of reading $\pm 0.05\%$ of fs
50 ns/div*	$\pm 0.5\%$ of reading $\pm 0.1\%$ of fs
20 ns/div*	$\pm 0.5\%$ of reading $\pm 0.2\%$ of fs
50 ms/div to 0.5 s/div	$\pm 3\%$

**Time Interval Measurements (1722B)**

**Time interval delay:** continuously variable from 10 ns to 5 s.

**Delay jitter:** refer to Time Interval Measurements, Stability.

**Time Interval Measurement (Time)**

**Function:** measures time interval between two events on channel A (A display), on channel B (B display), or between two events starting from an event on A and one ending on channel B (alt display).

**Time Interval Accuracy**

Main Time Base Setting	Accuracy (+20°C to +30°C)
100 ns/div to 20 ms/div	$\pm 0.5\%$ of measurement $\pm 0.02\%$ of full scale (for measurements < 1 cm). For measurements > 1 cm, $\pm 0.5\%$ of measurement $\pm 0.05\%$ of full scale.
50 ns/div*	$\pm 0.5\%$ of measurement $\pm 0.06\%$ of full scale.
20 ns/div*	$\pm 0.5\%$ of measurement $\pm 0.15\%$ of full scale.
50 ms/div to 0.5 s/div.	$\pm 3\%$

\*Starting after 60 ns of sweep.

**Resolution:** intervals < 1 cm, > 0.01% of full scale; intervals > 1 cm, 0.1% of full scale; max display resolution, 20 ps.

**Stability (0° to +55°C):** short term, < 0.01%. Temperature,  $\pm 0.03\%/^{\circ}\text{C}$  deviation from calibration temperature range.

**Reciprocal of Time Interval Measurement (1/time)**

**Accuracy, resolution, stability:** see time interval measurements.

**Mixed Time Base**

Dual time base in which the main time base drives the first portion of sweep and the delayed time base completes the sweep.

**X-Y Operation****Bandwidth:**

Y-axis (channel A), same as channel A;

X-axis (channel B), dc to > 1 MHz.

**Deflection factor:** 10 mV/div to 5 V/div, 9 cal positions (5 mV/div to 5 V/div, 10 cal positions, 1715A) in 1, 2, 5 sequence.

**Phase difference:** < 3°, dc to 1 MHz (3 MHz, 1722B).

**Cathode-ray Tube and Controls (1715A, 1722B, 1725A)**

**Type:** post accelerator,  $\approx 20.5$  kV, aluminized P31 phosphor.

**Graticule:** 8 x 10 div internal graticule, 0.2 subdiv markings on major horiz and vert axes, 1 div = 1 cm. Internal floodgun illum.

**Beam finder:** returns trace to CRT screen.

**Intensity modulation (Z-axis):** +8 V,  $\geq 50$  ns width pulse blanks trace of any intensity, usable to 20 MHz for normal intensities. Input R, 1 k $\Omega$   $\pm 10\%$ . Max input,  $\pm 10$  V (dc + peak ac).

**Auto-focus:** maintains beam focus with variations of intensity.

**Intensity limit:** limits beam current to simplify operation. Circuit response time ensures full writing speed.

**Cathode-ray Tube and Controls (1727A)**

**Type:** post accelerator,  $\approx 9.5$  kV, aluminized P31 phosphor.

**Graticule:** 8 x 10 div internal graticule, 0.2 subdivision markings on major horiz and vert axes, 1 div = 0.72 cm.

**Beam finder:** returns trace to CRT screen.

**Intensity modulation (Z-axis):** +4V,  $\geq 50$  ns width pulse blanks trace of any intensity, usable to 20 MHz for normal intensities. Input R, 1 k $\Omega$   $\pm 10\%$ . Max input,  $\pm 20$  V (dc + peak ac).

**Operating modes:** write, store, display, auto-store, and auto-erase.

**Writing speed, variable persistence and storage:**  $\geq 2000$  cm/ $\mu\text{s}$  (2775 div/ $\mu\text{s}$ ) over center 6 x 8 div (with viewing hood).

**Storage time (at 22°C):** display mode, at least 10 s; store mode, at least 30 s; wait time, at least 60 s.

**Persistence:** variable,  $\geq 100$  ms.

**Erase time:**  $\approx 300$  ms.

**Intensity limit:** limits beam current to simplify operation. Circuit response time ensures full writing speed.

**Auto-focus:** maintains beam focus with variations of intensity.

**General**

**Rear panel control:** astigmatism and trace align (both X and Y).

**Rear panel outputs:** main and delayed gates,  $-0.7$  V to +1.3 V capable of supplying  $\approx 3$  mA; and vertical output.

**Calibrator:** type, 1 kHz  $\pm 15\%$  ( $\pm 10\%$ , 1722B) square wave; 3 V p-p  $\pm 1\%$ , < 0.1  $\mu\text{s}$  transition time.

**Power:** 100, 120, 220, and 240 Vac,  $-10\% + 5\%$ ; 48 to 440 Hz; 110 VA max.

**Weight**

**1715A, 1725A:** net, 12.9 kg (28.5 lb); shipping, 17.9 kg (39.5 lb).

**1722B:** net 13.6 kg (30 lb); shipping, 19.5 kg (43 lb).

**1727A:** net, 15.9 kg (35 lb); shipping, 20 kg (44 lb).

**Operating environment:** temp, 0°C to +55°C; humidity, to 95% rel humidity at +40°C; altitude, to 4600 m (15,000 ft); vibration, in three planes for 15 min. each with 0.254 mm excursion, 10 to 55 Hz.

**Size:** (1715A, 1725A, 1722B) 197 H x 335 W x 570 mm D (7.75" x 13.8" x 22.4") with handle; (1715A, 1725A) 502 mm D (18.88 in. without handle; (1722B) 510 mm (20.06 in.) without handle; (1727A) 197 H x 335 W x 652 mm D (7.75" x 13.8" x 25.69") with handle; 595 mm (23.38 in.) without handle.

**Accessories furnished:** one blue light filter; one panel cover; two 10017A 10:1 divider probes with 1722B, 1725A, 1727A; two 10018A 10:1 divider probes with 1715A; one 2.3 m (7.5 ft) power cord; one vinyl storage pouch; one Operating and Service Manual. The 1727A includes one Model 10173A RFI filter and contrast screen, and one Model 10140A viewing hood.

**Options and Accessories**

**001:** U.S. fixed line cord

**003:** probe power supply with two rear panel jacks for use with HP 1120A or 1124A active probes.

**034 (except 1722B):** built-in DMM (60 Hz)

**035 (except 1722B):** built-in DMM (50 Hz)

**091 (except 1715A):** two 2 m (6.6 ft) 10018A, 10:1 probes substituted for two 10017A miniature probes

**091 (1715A):** two 1 m (3.3 ft) 10017A, 10:1 probes substituted for two 10018A miniature probes

**092:** two 1.8 m (6 ft) 10016B, 10:1 probes substituted for two miniature probes

**112:** includes 1112A Inverter Power Supply.

**910 (except 1727A):** additional set of manuals

**910 (1727A):** additional set of manuals

**Time interval multimeter kit:** (HP P/N 01715-69501 for 1715A or 1725A, HP P/N 01727-69501 for 1727A) adapts a standard Model 1715A, 1725A, or 1727A to an Opt 034/035, built-in, LED readout, delta time oscilloscope. Included are a multimeter, an oscilloscope cover, a vinyl storage pouch, and mounting hardware.

**Ordering Information**

**1715A** 200 MHz Oscilloscope

**1722B** 275 MHz Oscilloscope with Microprocessor

**1725A** 275 MHz Oscilloscope

**1727A** 275 MHz Storage Oscilloscope

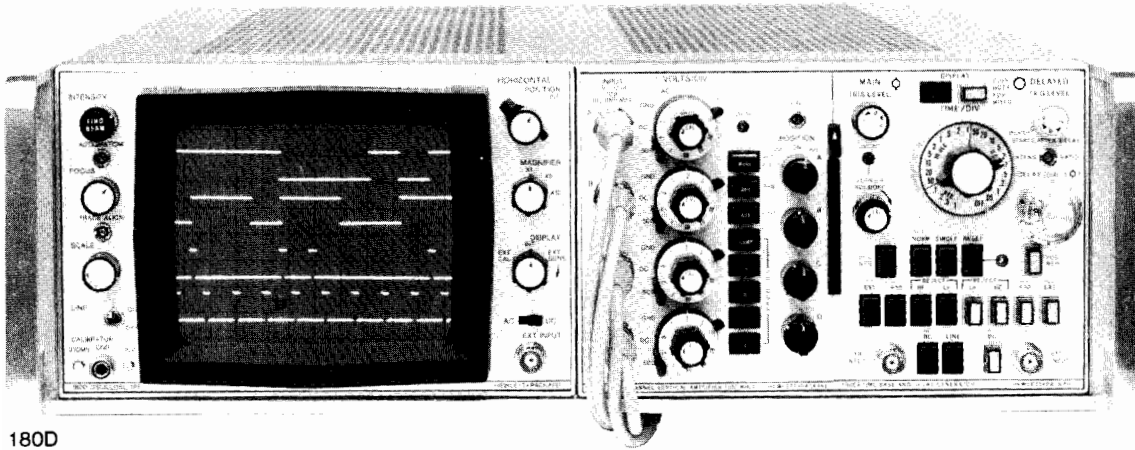

180D

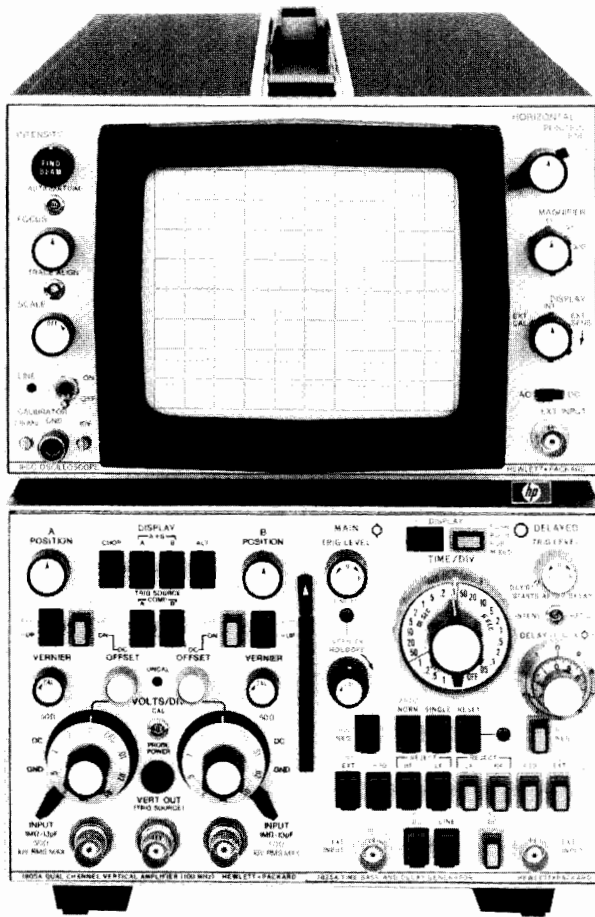

180C

## 180C/D, 181AR Specifications

### Cathode-ray Tube and Controls

**Type:** post accelerator, 15 kV (180), 8.5 kV (181); aluminized P31 phosphor.

**Graticule:** 8 × 10 div internal graticule, 0.2 div subdivisions on major axes; (180) 1 div = 1 cm, (181) 1 div = 0.95 cm.

**Beam finder:** returns trace to CRT screen.

**Intensity modulation (external input):** input,  $\approx +2$  V,  $\geq 50$  ns pulse width blanks trace of normal intensity; input  $R \approx 50$  k $\Omega$ ; Max input,  $\pm 20$  V (dc + peak ac) at  $\leq 1$  kHz.

### Persistence, Storage, 181AR

**Persistence:** normal,  $\approx 40$   $\mu$ s; variable,  $<0.2$  to  $>1$  min.

**Writing speed:** write,  $>20$  cm/ms; max write,  $>5$  cm/ $\mu$ s.

**Brightness:**  $>342.6$  cd/m<sup>2</sup> (100 fl).

**Storage time:** from Write to Store, reduced intensity for  $>1$  hr; to View, normal intensity for  $>1$  min. From max Write to Store, reduced intensity for  $>5$  min.; to View, normal intensity for  $>15$  s, pushbutton erasure takes  $\approx 300$  ms.

### Horizontal Amplifier

#### External Input

**Bandwidth:** dc-coupled, dc to 5 MHz; ac-coupled, 5 Hz to 5 MHz.

**Deflection factor:** 1 V/div, X1; 0.2 V/div, X5 (180, 181); 0.1 V/div, X10; accuracy,  $\pm 5\%$ ; dynamic range  $\pm 20$  V.

**Max input:** 600 V dc (ac-coupled input).

**Input RC:**  $\approx 1$  M $\Omega$  shunted by  $\approx 30$  pF.

**Sweep magnifier:** X10, X5 (180, 181); overall accuracy,  $\pm 5\%$ .

**Calibrator:**  $\approx 1$  kHz square wave,  $<3$   $\mu$ s rise time; 250 mV p-p and 10 V p-p into 1 M $\Omega$ ,  $\pm 1\%$ .

### Outputs

Four rear panel emitter follower outputs for main and delayed gates, main and delayed sweeps. Max current available,  $\pm 3$  mA. Will drive impedances  $\geq 1000$  ohms without distortion.

### General

**Operating environment:** temperature, 0° to 55°C (+32°F to +130°F); humidity, to 95% relative humidity at 40°C (104°F); altitude, to 4600 m (15000 ft); vibration, vibrated in three planes for 15 min. each with 0.254 mm (0.010 in.) excursion, 10 to 55 Hz.

#### Size

**180C:** 289 H x 200 W x 540 mm D behind panel (11.4" x 7.9" x 21.3").

**180D, 181AR (rack):** 133 H x 425 W x 543 mm D overall (5.2" x 16.7" x 21.4") 493 mm (19.4") D behind rack mount tabs.

#### Weight (without plug-ins)

**180C (cabinet):** net, 10.4 kg (23 lb); shipping, 15.4 kg (34 lb).

**180D (rack):** net, 11.8 kg (26 lb); shipping, 17.2 kg (38 lb).

**181AR (rack):** net, 11.8 kg (26 lb); shipping, 17.2 kg (38 lb).

**Power:** 115 or 230 V,  $\pm 10\%$ , 48 to 440 Hz; max mainframe power, 200 VA, (181) 225 VA.

#### Accessories Supplied

**180, 181:** 2.3 m (7.5 ft) power cord, blue plastic light filter (HP P/N 5060-0548), Model 10178A mesh contrast filter (181), one Operating and Service Manual. A rack mount kit (HP P/N 5060-0552) and 2 clip-on probe holders (HP P/N 5040-0464) are supplied with the 180D, 181AR rack models.

# OSCILLOSCOPES

## 180 Vertical Plug-Ins

Models 1805A & 1801A

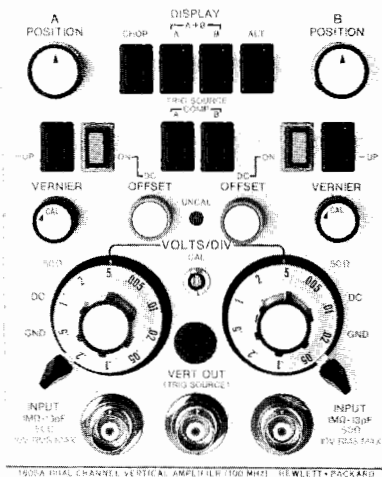

1805A, 100 MHz 2 channel

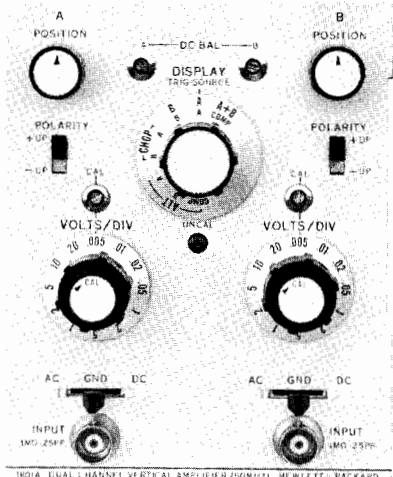

1801A, 50 MHz 2 channel

### 1805A, 1801A Specifications

#### Modes of Operation

Channel A; Channel B; A and B displayed alternately on successive sweeps (ALT); A and B displayed by switching between channels at approx 400 kHz rate (CHOP) with blanking during switching; A plus B (algebraic addition).

#### Each Channel (2)

**Bandwidth:** measured with or without 10014A probe (1805A), 10004D probe (1801A), 3 dB down from 8 div ref signal from a terminated 50  $\Omega$  source.

**DC-coupled:** (1805A) dc to 100 MHz, (1801A) dc to 50 MHz.

**AC-coupled:** (1805A)  $\approx$  10 Hz to 100 MHz, (1801A)  $\approx$  8 Hz to 50 MHz.

**Rise time:** (1805A) < 3.5 ns (measured with or without 10014A probes, 10% to 90% points of 6 div input step from a terminated 50  $\Omega$  source); (1801A) < 7 ns (measured with or without 10004D probe, 10% to 90% points of 8 div input step from a terminated 50  $\Omega$  source).

#### Deflection Factor

**Ranges:** (1805A) 5 mV/div to 5 V/div (10 cal positions) in 1, 2, 5 sequence;  $\pm$  2% attenuator accuracy. (1801A) 5 mV/div to 20 V/div (12 positions) in 1, 2, 5 sequence;  $\pm$  3% attenuator accuracy.

**Vernier:** extends max deflection factor  $\geq$  12.5 V/div (1805A),  $\geq$  50 V/div (1801A).

**Polarity:** + up or - up selectable.

**Input coupling:** (1805A) ac, dc, 50  $\Omega$  (dc), or ground; (1801A) ac, dc, or ground.

**Input RC:** (1805A) ac and dc, 1 M $\Omega$   $\pm$  1% shunted by  $\approx$  13 pF; 50  $\Omega$ , 50  $\Omega$   $\pm$  2%; SWR < 1.2 at 100 MHz on all ranges. (1801A)  $\approx$  1 M $\Omega$  shunted by  $\approx$  25 pF.

**Max input:** (1805A) ac and dc,  $\pm$  300 V (dc + peak ac) at  $\leq$  1 kHz;  $\pm$  150 V (dc + peak ac) on 5 mV/div range at  $\leq$  1 kHz; 50  $\Omega$ , 10 V rms, dc-coupled. (1801A) dc-coupled  $\pm$  350 V (dc + peak ac) at  $\leq$  10 kHz;  $\pm$  150 V (dc + peak ac) on 5 mV/div range at  $\leq$  1 kHz; ac-coupled,  $\pm$  600 V dc.

**Dynamic range (1805A):** 6 div at 100 MHz to 16 div at  $\leq$  15 MHz.

**Positioning range (1805A):** 16 div.

**A + B operation:** amplifier bandwidth and deflection factors unchanged; either channel may be inverted for  $\pm$  A  $\pm$  B operation. Differential input (A-B) common mode, (1805A) CMR  $\geq$  40 dB dc to 1 MHz for common mode signals  $\leq$  16 div,  $\geq$  20 dB at 50 MHz for signals  $\leq$  6 div; (1801A) CMR  $\geq$  40 dB at 5 mV/div and  $\geq$  20 dB on other ranges, dc to 1 MHz, for common mode signals  $\leq$  24 div.

**Offset (1805A):**  $\pm$  200 div of offset.

#### Triggering (1805A)

**Source:** selectable from channel A, channel B, or a composite (Comp) signal from A and B in any display mode. Composite is A and B signals switched for Alt and Chop modes and added for A and B mode. Vernier and position controls do not affect A, B, or composite trigger signals. A and B signals are independent of polarity selection.

#### Frequency

Time Base Plug-in	Trigger Frequency*	Required Vertical Deflection
1825A	dc-50 MHz	$\frac{1}{2}$ div
	dc-100 MHz	1 div
1821A	dc-50 MHz	1 div

\*all display modes except Chop, dc to 100 kHz in Chop.

#### Triggering (1801A)

**Source:** for channel A or B, on signal displayed; Chop selectable from A or B; Alt selectable from A, B, or Comp (A and B switched).

**Frequency:** dc to > 50 MHz on signals causing  $\geq$  0.5 div vert deflection in all display modes except Chop which is dc to 100 kHz.

#### Vertical Signal Output (1805A)

**Bandwidth:** > 50 MHz into 50  $\Omega$ .

**Amplitude:** > 50 mV for each div of display into 50  $\Omega$  with usable amplitudes up to 500 mV p-p.

**Source impedance:**  $\approx$  50 ohms.

#### General

**Operating environment:** same as 180 C/D mainframes.

#### Weight

**1805A:** net 2.3 kg (5 lb); shipping, 3.6 kg (8 lb).

**1801A:** net 1.8 kg (4 lb); shipping, 3.6 kg (8 lb).

**Accessories supplied:** (1805A) two 10014A 10:1 divider probes  $\approx$  1.1 m (3.5 ft), one Operating and Service Manual. (1801A) two 10004D, 10:1 divider probes,  $\approx$  1.1 m (3.5 ft), one Operating and Service Manual.

**Recommended probes:** (1805A) full performance maintained by 10014A, 10016B passive probes, 10017A, 10018A miniature passive probes, 10026A, 10027A miniature 50  $\Omega$  probes, 10020A resistive divider probe kit, and the 1120A active probe; (1801A) full performance maintained by 10004D, 10005D, and 10006D passive probes and 10041A, 10042A miniature passive probes.

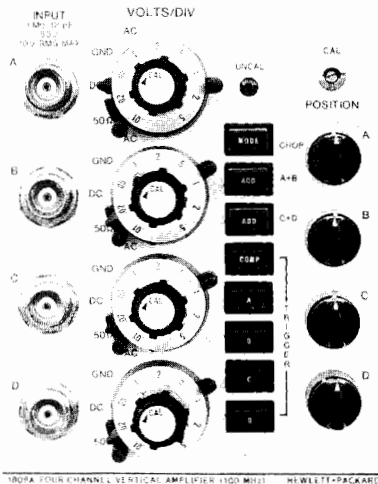

1809A, 100 MHz 4 channel

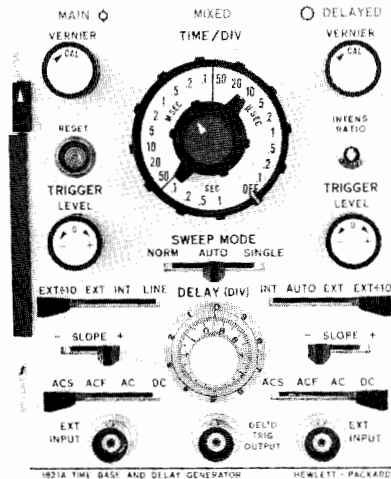

1821A, 50 MHz triggering

### 1809A Specifications

#### Modes of Operation

Channels A, B, C, or D or any combination displayed alternately on successive sweeps (ALT) or chopped (CHOP) with blanking during switching; either A and B or C and D may be algebraically added ( $\pm A \pm B$ ) or ( $\pm C \pm D$ ). Approx chop rate for two channels displayed is 1 MHz, 3 channels is 667 kHz, 4 channels is 500 kHz.

#### Each Channel (4)

**Bandwidth:** (measured with or without 10014A probe, 3 dB down from a terminated 50  $\Omega$  source)

**DC-coupled:** dc to 100 MHz.

**AC-coupled:**  $\approx 10$  Hz to 100 MHz.

**Rise time:**  $< 3.5$  ns. Measured with or without 10014A probe, 10% to 90% of 6 div input step from a terminated 50  $\Omega$  source.

#### Deflection Factor

**Ranges:** from 0.01 V/div to 5 V/div (9 cal positions) in 1, 2, 5 sequence. Attenuator accuracy,  $\pm 2\%$ .

**Vernier:** extends max deflection factor to  $\geq 12.5$  V/div.

**Input coupling:** ac, dc, 50  $\Omega$  (dc), or ground.

**Input RC (selectable):** ac or dc, 1 M $\Omega$ ,  $\pm 1\%$  shunted by  $\approx 12$  pF; 50  $\Omega$ , 50  $\Omega \pm 2\%$ . SWR, 1.3 at 100 MHz on all ranges.

**Max input:** ac and dc,  $\pm 300$  V (dc + peak ac) at  $\leq 1$  kHz,  $\pm 150$  V (dc + peak ac) on 10 mV/div range at  $\leq 1$  kHz; 50  $\Omega$ , 10 V rms.

**Polarity:** any channel may be inverted ( $\pm A$ ,  $\pm B$ ,  $\pm C$ ,  $\pm D$ ).

#### Algebraic Addition (A + B), (C + D)

**Amplifier:** bandwidth and deflection factors are unchanged, any channel may be inverted for ( $\pm A \pm B$ ) or ( $\pm C \pm D$ ) operation.

**Differential input (A - B) or (C - D) common mode:** CMR is  $\geq 20$  dB from dc to 80 MHz on all ranges.

#### Triggering

**Source:** selectable from channel A, B, C, D, or composite (on displayed signals) in all display modes.

#### Frequency

Time Base Plug-in	Trigger Frequency*	Required Vertical Deflection
1825A	dc-50 MHz dc-100 MHz	$\frac{1}{2}$ div 1 div
1821A	dc-50 MHz	1 div

\*All display modes except Chop, dc to 100 kHz in Chop.

#### General

**Operating environment:** same as 180C/D mainframes.

**Weight:** net, 3.2 kg (7 lb); shipping, 4.5 kg (10 lb).

**Accessories supplied:** one Operating and Service Manual.

#### Recommended Probes

Models 10014A, 10016B, 10017A, and 10018A for 1 M $\Omega$  mode.  
Models 10020A, 10026A, and 10027A for 50  $\Omega$  input mode.

### 1821A Specifications

#### Main Time Base

##### Sweep

**Ranges:** from 0.1  $\mu$ s/div to 1 s/div (22 positions) in 1, 2, 5 sequence;  $\pm 3\%$  accuracy with vernier in CAL position.

**Vernier:** extends slowest sweep to at least 2.5 s/div.

**Magnifier:** (mainframe) expands fastest sweep to 10 ns/div.

##### Sweep Mode

**Normal:** triggered by an int, ext, or power line signal.

**Automatic:** baseline displayed in absence of input signal. Above  $\approx 40$  Hz triggering same as normal.

**Single:** sweep occurs once with same triggering as normal.

#### Trace Intensification

In Main sweep mode, intensifies that part of Main time base to be expanded to full screen on Delayed time base.

#### Delayed Time Base

Sweeps after a time delay set by Main and Delay controls.

##### Sweep

**Ranges:** from 0.1  $\mu$ s/div to 50 ms/div (18 positions) in 1, 2, 5 sequence;  $\pm 3\%$  accuracy with Vernier in CAL position.

**Vernier:** continuously variable between all ranges; extends slowest sweep to at least 125 ms/div.

#### Triggering

(Main and Delayed time base)

**Internal:** refer to vertical plug-in specifications.

**External:** dc to 50 MHz on signals 0.5 V p-p or more, increasing to 100 MHz on signals 1 V p-p or more.

**Line:** power line frequency signal (main only).

**Level and slope:** internal, at any point on the vertical waveform displayed; external, continuously variable from +3 V to -3 V on either slope of the sync signal, from +30 V to -30 V in  $\pm 10$ .

**Automatic (delayed only):** triggered at end of set time delay.

**Coupling:** ac, dc, ACF (ac-fast), or ACS (ac-slow).

##### Delay (before start of Delayed sweep)

**Time:** continuously variable from 0.1  $\mu$ s to 10 s.

**Accuracy:**  $\pm 1\%$  of differential delay  $\pm 2$  minor divisions of delay dial. Time jitter is 0.005% of max delay of each step.

**Trigger output:** (at end of Delay time)  $\approx 1.5$  V with  $> 50$  ns rise time from 1000  $\Omega$  source resistance.

#### Mixed Time Base

Dual time base in which Main time base drives first portion of sweep and delayed time base completes sweep at up to 1000 times faster.

#### General

**Operating environment:** same as 180 C/D mainframes.

**Weight:** net, 1.8 kg (4 lb); shipping, 3.6 kg (8 lb).

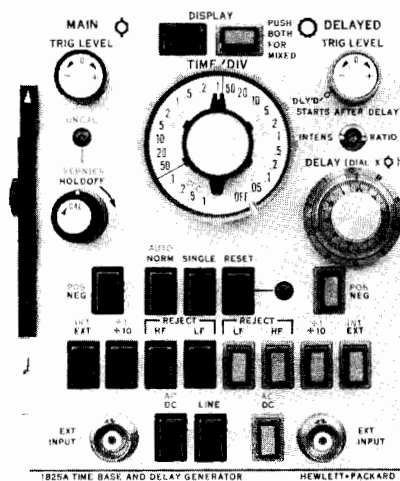

1825A, 100 MHz triggering

## 1825A Description

Model 1825A time base and delay generator provides sweep speeds ranging from 0.05  $\mu\text{s}/\text{div}$  to 1 s/div in 23 positions. Delay times are continuously variable from 50 ns to 10 s and are accurate to 0.75% with extremely low jitter of 1 part in 50 000. Also, a calibrated mixed sweep mode is provided. A mainframe X10 magnifier increases sweep-speed capability to 5 ns/div with 5% accuracy.

One knob control makes triggering easy in main, delayed, and mixed modes. Stable, accurate time displays are provided in main, delayed, and mixed modes with the highly sensitive 50 mV external trigger capability at 50 MHz which increases to only 150 mV at 150 MHz. Trigger synchronization is maintained when switching between main, delayed, and mixed modes, further simplifying use.

Front panel controls are logically arranged for quick familiarization and easy use. Pushbuttons eliminate front panel clutter and reduce the possibility of errors. Easy-to-operate pushbuttons establish main, delayed, and mixed modes of operation.

Trigger level controls on main and delayed sweeps allow selection of the triggering point on the desired portion of the signal for almost every measurement application. Also, the  $\div 10$  function provides a wide dynamic range of triggering in both external and internal modes of operation.

External trigger sensitivity of 50 mV on both main and delayed sweeps allows a 10:1 divider probe to be used to reduce circuit loading at trigger pick-off points and reduces the possibility of circuit malfunction caused by the measuring instrument.

## 1825A Specifications

### Main Time Base

#### Sweep

**Ranges:** 0.05  $\mu\text{s}/\text{div}$  to 1 s/div (23 positions) in 1, 2, 5 sequence;  $\pm 3\%$  accuracy with vernier in CAL position.

**Vernier:** extends slowest sweep to at least 2.5 s/div.

**Magnifier:** (on mainframe) expands fastest sweep to 5 ns/div, accuracy  $\pm 5\%$  (main or delayed).

#### Sweep Mode

**Normal:** sweep is triggered by an internal, external, or power line signal.

**Automatic:** baseline displayed in absence of trigger signal. Triggering is same as normal except low frequency limit is 40 Hz.

**Single:** in Normal, sweep occurs once with same triggering as Normal (reset pushbutton arms sweep and lights indicator); in Auto, sweep occurs once each time reset pushbutton is pressed.

## Trace Intensification

In Main sweep mode, intensifies that part of main time base to be expanded to full screen in delayed time base mode. Rotating time base switch from OFF position activates intensified mode.

## Delayed Time Base

Delayed time base sweeps after a time delay set by Main time base and Delay controls. Delayed time base is triggered on first trigger pulse after set delay or automatically triggers after set delay when delayed level control is in detent position.

**Sweep ranges:** 0.05  $\mu\text{s}/\text{div}$  to 20 ms/div (18 positions) in 1, 2, 5 sequence;  $\pm 3\%$  accuracy.

## Triggering

(Main and Delayed time base)

**Internal:** refer to vertical amplifier plug-in specifications.

**External:** dc to 50 MHz on signals 50 mV p-p or more increasing to 100 mV p-p at 100 MHz and 150 mV p-p at 150 MHz.

**Line:** power line frequency signal (Main only).

### Level

**Internal:** at any point on the vertical waveform displayed.

**External:** continuously variable from +2 V to -2 V on either slope of trigger signal, from +20 V to -20 V in  $\div 10$  setting.

**Slope:** pushbutton selects either positive or negative slope of trigger signal.

**Coupling:** ac, dc, HF Reject, or LF Reject. AC, attenuates signals below  $\approx 20$  Hz; LF reject, attenuates signals below  $\approx 15$  kHz; HF reject, attenuates signals above 15 kHz.

**Trigger holdoff:** time between sweeps continuously variable, exceeding one full sweep on all ranges (Main only).

**Delay** (before start of delayed sweep)

**Time:** continuously variable from 50 ns to 10 s.

**Accuracy:**  $\pm 0.75\%$  of differential delay  $\pm 2$  minor divisions of delay dial.

**Time jitter:**  $\pm 0.002\%$  of max delay on each range.

## Calibrated Mixed Sweep

Combines Main and Delayed Sweeps into one display. Sweep is started by the Main time base and is completed by the faster Delayed time base.

## Ordering Information

### 180C Cabinet Style Main Frame

**Opt 010:** deletes rear panel outputs for main and delayed gates and main and delayed sweeps

**Opt 910:** additional Operating and Service Manual

### 180D Rack Style Mainframe

**Opt 010:** (see 180C Option 010)

**Opt 910:** additional Operating and Service Manual

### 181AR Storage Mainframe, Rack Style

**Opt 910:** additional Operating and Service Manual

### 1805A 100 MHz Dual Channel Vertical Amplifier

**Opt 910:** additional Operating and Service Manual

### 1801A 50 MHz Dual Channel Vertical Amplifier

**Opt 001:** Channel B output and X5 magnifier

**Opt 090:** 1.8 m (6 ft) 10006D probes in lieu of 10004D

**Opt 091:** 3 m (10 ft) 10005D probes in lieu of 10004D

**Opt 910:** additional Operating and Service Manual

### 1809A 100 MHz 4 Channel Vertical Amplifier

**Opt 910:** additional Operating and Service Manual

### 1821A Time Base and Delay Generator

**Opt 910:** additional Operating and Service Manual

### 1825A Time Base and Delay Generator

**Opt 910:** additional Operating and Service Manual

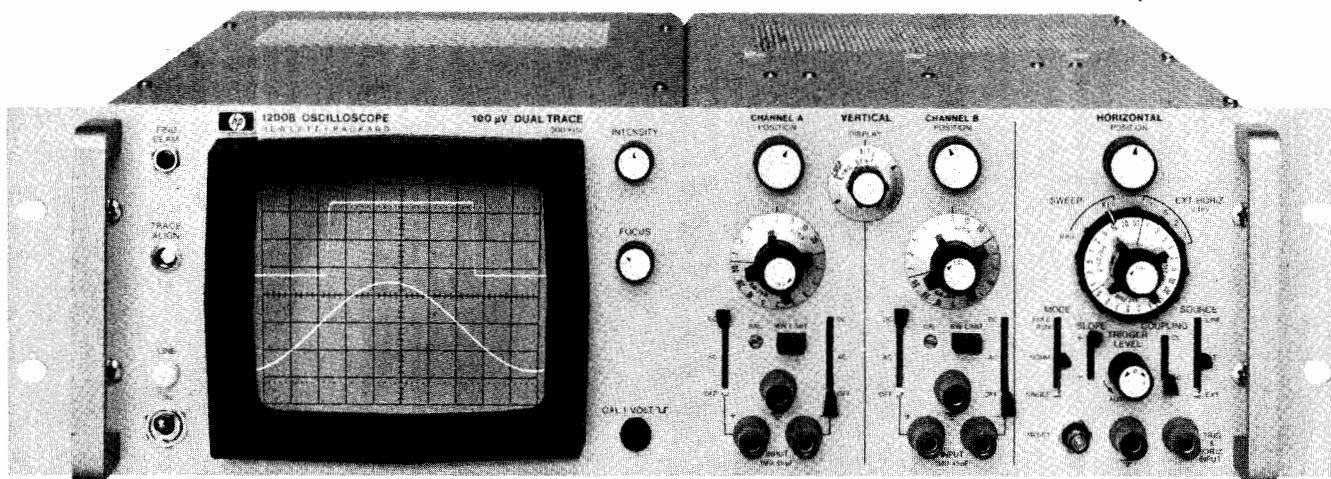

1200B

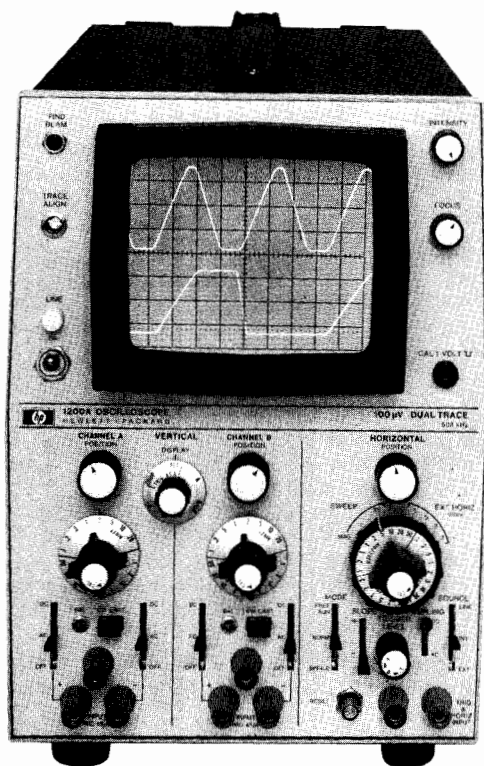

1200A

### 1200A/B, 1201B, 1205B Specifications

#### Vertical Amplifiers

**Modes of operation:** channel A; channel B; channels A and B (either Chop or Alternate triggered by channel A), Chop frequency is  $\approx 100$  kHz; channel A vs B (A-vertical, B-horizontal).

**Bandwidth:** dc-coupled, dc to 500 kHz; ac-coupled, 2 Hz to 500 kHz. Bandwidth limit switch (1200 and 1201) selects upper bandwidth to  $\approx 50$  kHz or 500 kHz.

**Rise time:** 0.7  $\mu$ s max.

#### Deflection Factor

**Ranges (1200 and 1201):** from 0.1 mV/div to 20 V/div (17 positions) in 1, 2, 5 sequence.

**Ranges (1205):** from 5 mV/div to 20 V/div (12 positions) in 1, 2, 5 sequence.

**Attenuator accuracy:**  $\pm 3\%$  with vernier in Cal.

**Vernier:** extends max deflection factor to at least 50 V/div.

**Noise (1200 and 1201):**  $< 20$   $\mu$ V measured tangentially at full bandwidth.

**Input:** differential or single-ended on all ranges.

#### Common Mode

**Frequency:** dc to 10 kHz.

#### Rejection ratio

**1200 and 1201:** 100 dB (100 000 to 1) with dc-coupled input on 0.1 mV/div range, decreasing by  $< 20$  dB per decade of deflection factor to at least 40 dB on the 0.2 V/div range; CMR is at least 30 dB on 0.5 V/div to 20 V/div ranges. Max signal is  $\pm 10$  V (dc + peak ac) on 0.1 mV/div to 0.2 V/div ranges;  $\pm 400$  V (dc + peak ac) on all other ranges.

**1205:** 50 dB with dc-coupled input on 5 mV/div to 0.2 V/div ranges; CMR  $\geq 30$  dB on the 0.5 V/div to 20 V/div ranges. Max signal is  $\pm 3$  V (dc + peak ac) on 5 mV/div to 0.2 V/div ranges;  $\pm 300$  V (dc + peak ac) on all other ranges.

**Input coupling:** selectable AC, DC, or OFF for + and - inputs.

**Input RC:**  $\approx 1$  M $\Omega$  shunted by  $\approx 45$  pF.

**Max input:** refer to Common Mode Rejection Ratio.

**Internal trigger source:** on channel A signal for A, Chop, and Alternate displays, on channel B signal for B display.

**Isolation:**  $> 80$  dB between channels at 500 kHz, with shielded input connectors.

**Phase shift:** A vs B mode,  $< 1^\circ$  to 100 kHz with verniers in Cal.

#### Time Base

##### Sweep

**Ranges:** from 1  $\mu$ s/div to 5 s/div (21 positions) in 1, 2, 5 sequence;  $\pm 3\%$  accuracy with vernier in Cal.

**Vernier:** extends slowest sweep to at least 12.5 s/div.

**Magnifier:** direct reading X10 magnifier expands fastest sweep to 100 ns/div with  $\pm 5\%$  accuracy.

##### Automatic Triggering

Baseline is displayed in absence of an input signal.

**Internal:** 50 Hz to  $> 500$  kHz on most signals causing 0.5 div or more vert. deflection. Triggering on line frequency also selectable.

**External:** 50 Hz to above 1 MHz on most signals  $\geq 0.2$  V p-p.

**Trigger slope:** positive or negative slope on internal, external or line trigger signals.

##### Amplitude Selection Triggering

**Internal:** dc to 500 kHz on signals causing  $\geq 0.5$  div vert. deflection.

**External:** dc to 1 MHz on signals  $\geq 0.2$  V p-p. Input impedance  $\approx 1$  M $\Omega$  shunted by  $\approx 20$  pF.

**Trigger level and slope:** internal, at any point on vertical waveform displayed; or continuously variable from +100 V to -100 V on either slope of the external trigger signal.

**Trigger coupling:** dc or ac for external, line, or internal triggering. Lower ac cutoff is 2 Hz for external; 5 Hz for internal.

**Single sweep:** selectable by front panel switch. Reset switch with armed indicator light.

**Free run:** selectable by front panel switch.

**Max input:**  $\pm 350$  V (dc + peak ac).



# OSCILLOSCOPES

## 500 kHz General Purpose

### Models 1200A/B, 1201B & 1205B (cont.)

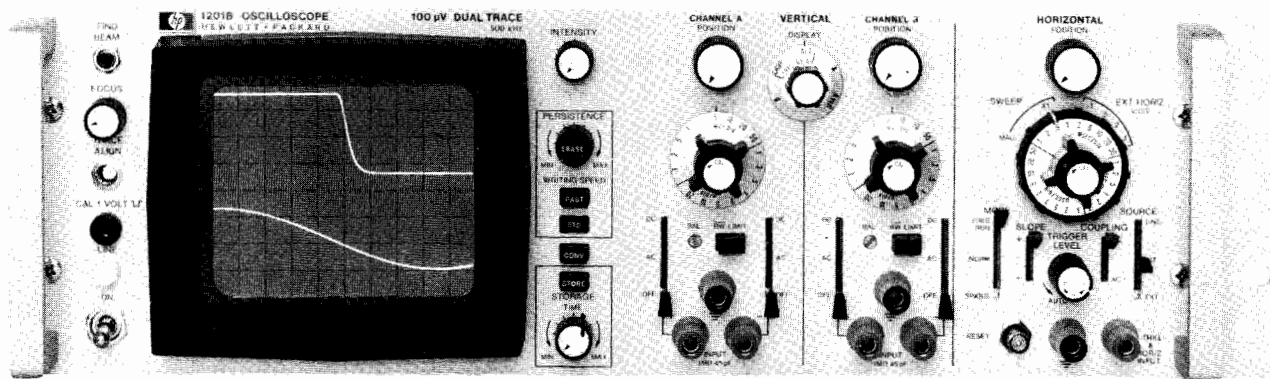

1201B

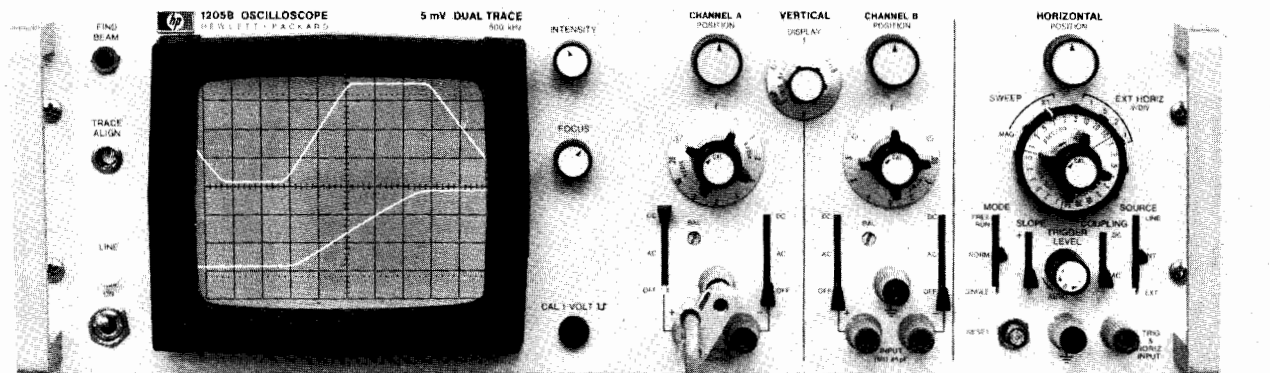

1205B

#### Horizontal Amplifier

**Bandwidth:** dc-coupled, dc to 300 kHz; ac-coupled, 2 Hz to 300 kHz.

**Deflection factor:** ranges, 0.1 V/div, 0.2 V/div, 0.5 V/div, and 1 V/div. Vernier, extends max deflection to at least 2.5 V/div.

**Max input:**  $\pm 350$  V (dc + peak ac).

**Input RC:**  $\approx 1$  M $\Omega$  shunted by  $\approx 20$  pF.

**Input:** single-ended on all ranges.

#### Cathode-ray Tube and Controls

**Beam finder:** returns trace to CRT screen.

**Intensity modulation:** +2 V signal blanks trace of normal intensity, +8V signal blanks any intensity trace. DC-coupled rear panel input; amplifier rise time,  $\approx 200$  ns; input R  $\approx 5$  k $\Omega$ .

#### Standard CRT, 1200, 1205

**Type:** mono-accelerator,  $\approx 3000$  V accelerating potential, P-31 phosphor standard.

**Graticule:** 8  $\times$  10 div internal graticule, 0.2 subdivision markings on horizontal and vertical major axes; 1 div = 1 cm.

#### Variable Persistence Storage CRT, 1201

**Type:** post-accelerator, variable persistence storage tube;  $\approx 10.5$  kV accelerating potential; aluminumized P-31 phosphor.

**Graticule:** 8  $\times$  10 div internal graticule, 0.2 subdivision markings on major axes; 1 div = 0.95 cm.

#### Persistence Storage Characteristics

(Referenced to a centered 7  $\times$  9 div area in STD mode and to a centered 6  $\times$  8 div area in FAST mode.)

**Persistence:** conventional,  $\approx 40$   $\mu$ s; variable, continuously variable from 0.2 s to  $> 1$  min., STD mode; from 0.2 s to 15 s, FAST mode.

**Storage writing speed:** STD, 20 div/ms; FAST, 0.5 div/ $\mu$ s.

**Brightness:** 343 cd/m<sup>2</sup> (100 fl) in write mode.

**Storage time:** STD writing speed variable from  $\approx 1$  min. to  $> 1$  hr. FAST writing speed, variable from  $\approx 15$  s to  $> 15$  min.

**Erase:** pushbutton erasure takes  $\approx 1.2$  s. Write gun is blanked and sweep is reset until erasure is completed.

#### General

**Calibrator:** 1 V  $\pm 1.5\%$  line frequency square wave.

**Size:** 1200A, 298 mm H  $\times$  211 mm W  $\times$  475 mm D (11.7"  $\times$  8.3"  $\times$  18.7") 133 H  $\times$  483 W  $\times$  466 mm D overall, 423 mm D behind front panel (5.2"  $\times$  19"  $\times$  18.4"; 16.7").

**Power:** 115/230 V  $\pm 10\%$ , 48 to 440 Hz, 150 VA max.

#### Weight

**1200A:** net, 11.3 kg (25 lb); shipping, 15.6 kg (34.5 lb).

**1200B, 1205B:** net, 10.2 kg (22.5 lb); shipping, 15.9 kg (35 lb).

**1201B:** net, 12.5 kg (27.5 lb); shipping, 18.1 kg (40 lb).

#### Vertical Output Signal Specifications (Opt 015)

**Output:** 0.3 V/div  $\pm 10\%$ , 0 V offset unaffected by position setting.

**Bandwidth:** dc to 500 kHz.

**Dynamic range:**  $\pm 3.5$  V.

**Max slewing rate:** 12 V/ $\mu$ s with 300 pF load.

**Min load RC:** 10 k $\Omega$  shunted by  $\approx 300$  pF.

**Source impedance:**  $\approx 300$   $\Omega$ .

#### Options

**006:** rear input terminals wired in parallel with front panel vertical and horizontal input terminals. Vertical input shunt capacitance is increased to  $\approx 100$  pF. Horizontal input shunt capacitance is increased to  $\approx 75$  pF.

**009:** storage model only, remote erase through rear panel banana jack, shorting to ground provides erasure (not compatible with Opt 006).

**015:** vertical channel signal outputs through rear panel connectors.

**910:** additional Operating and Service Manual

**1200A/B or 1201B**

**1205B**

#### Ordering Information

**1200A or 1200B** Dual Channel, 100  $\mu$ V Oscilloscope

**1201B** Dual Channel, 100  $\mu$ V Storage Oscilloscope

**1205B** Dual Channel, 5 mV Oscilloscope

- X-Y Operation
- TV Sync
- Auto or Normal trigger selection

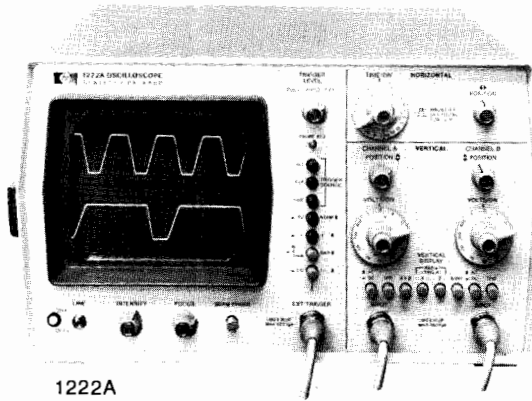

### 1220A, 1222A Specifications

#### Modes of Operation

Channel A; channel B; channel B inverted (1222A); channel A  $\pm$  B (1222A); channels A and B displayed alternately on successive sweeps (Alt); triggering by A channel; channels A and B displayed by switching between channels at approx 200 kHz rate with blanking during switching (Chop). Automatic selection of alternate or chop mode—chop, at speeds from 0.5 s/div to 1 ms/div, alternate, 0.5 ms/div to 0.1  $\mu$ s/div.

#### Vertical Amplifiers (2)

**Bandwidth** (3 dB down from 50 kHz, 6 div reference signal from a terminated 50  $\Omega$  source.)

**DC-coupled:** dc to 15 MHz.

**AC-coupled:** lower limit is  $\approx$  2 Hz.

**Rise time:**  $\approx$  23 ns (measured from 10% to 90% points of 6 div input step from a terminated 50  $\Omega$  source).

#### Deflection Factor

**Ranges:** from 2 mV/div to 10 V/div (12 calibrated positions) in 1, 2, 5 sequence.  $\pm$ 3% accuracy with vernier in cal position on 20 mV/div to 10 mV/div ranges,  $\pm$ 5% on 2 mV/div, 5 mV/div, and 10 mV/div ranges.

**Vernier:** extends max deflection factor to at least 25 V/div.

**Polarity (1222A):** Channel B may be inverted.

**Signal delay (1222A):** input signals are delayed sufficiently to view leading edge of input signal without advanced external trigger.

**Input RC:** AC or DC,  $\approx$  1 M $\Omega$  shunted by  $\approx$  30 pF.

**Input coupling:** ac, dc, or GND.

**Maximum input:**  $\pm$ 350 V (dc + peak ac) at  $\leq$  1 kHz.

**A + B operation (1222A):** bandwidth and deflection factors are unchanged; channel B may be inverted for A - B operation.

**Differential (A - B) common mode (1222A):** CMR is at least 30 dB from dc to 1 MHz.

#### Time Base

**Sweep ranges:** from 0.1  $\mu$ s/div to 0.5 s/div (21 ranges) in 1, 2, 5 sequence;  $\pm$ 4% accuracy over full scale with Magnifier/Expander in calibrated position.

**Sweep trigger mode:** normal, sweep is triggered by internal or external signal; automatic, bright baseline displayed in absence of input signal, above  $\approx$  10 Hz, triggering same as normal.

#### Triggering

**Internal:**  $\approx$  2 Hz to 15 MHz on signals with  $\geq$  1 div vertical deflection.

**External:**  $\approx$  2 Hz to 15 MHz on signals of 0.1 V p-p or more.

**External input RC:**  $\approx$  1 M $\Omega$  shunted by  $\approx$  30 pF.

**Line:** triggers on line frequency.

**TV sync:** separator for + or - video, requires 1 div of video signal to trigger, automatic frame (0.5 s/div to 100  $\mu$ s/div) and line select (50  $\mu$ s/div to 0.1  $\mu$ s/div). Usable also as a low pass filter.

- A  $\pm$  B Operation (1222A)
- Delay line (1222A)

#### Level and Slope

**Internal:** at any point on the positive or negative slope of the displayed waveform.

**External:** continuously variable from +0.5 V to -0.5 V on either slope of the trigger waveform; +10 extends trigger range to +5 V to -5 V.

#### Calibrated X-Y Operation (1222A)

Operation is via channel A (X-axis) and channel B (Y-axis).

**Bandwidth:** X-axis dc to 1 MHz, otherwise see Vertical Amplifiers Bandwidth specifications.

**Accuracy:** see Vertical Amplifiers Deflection Factor specifications. X-Y phase shift  $<$  3 $^\circ$  at 100 kHz.

#### Cathode-ray Tube and Controls

**Type:** mono-accelerator,  $\approx$  2 kV accelerating potential, P31 phosphor.

**Graticule:** 8  $\times$  10 cm internal graticule; 0.2 cm subdivisions on major horizontal and vertical axes.

**Beam finder:** returns trace to CRT screen.

**Intensity modulation:** +5 V (TTL compatible) 2 Hz to 1 MHz blanks trace of any intensity. Input R  $\approx$  1 k $\Omega$ . Max input, 7 V rms, ac-coupled.

#### External Horizontal Input (1220A)

**Bandwidth:** dc to 1 MHz.

**Coupling:** dc

EXPANDER	X MODE ATTENUATOR	DEFLECTION FACTOR
Cal.	1:1	1 V/div
Cal.	1:10	10 V/div
cw	1:1	100 mV/div

Continuous adjustment between ranges by Expander.

**Input RC:**  $\approx$  1 M $\Omega$  shunted by  $\approx$  30 pF.

**X-Y Phase shift:**  $<$  3 $^\circ$  at 100 kHz.

#### General

**Probe adjust:**  $\approx$  0.5 V p-p, 1 kHz square wave for adjusting probe compensation.

**Power:** 100, 120, 220, 240 V,  $\pm$  10%, 60 VA max.

#### Weight

**1220A:** net, 7.3 kg (16 lb); shipping 10 kg (22 lb).

**1222A:** net, 7.3 kg (16 lb); shipping 10 kg (22 lb).

**Size:** 181 H  $\times$  311.2 W  $\times$  412.8 mm D (7.13"  $\times$  12.25"  $\times$  16.25").

**Accessories furnished:** one blue light filter, one power cord, one fuse for 100 V, 120 V, 220 V or 240 V operation, and one Operating and Service Manual.

#### Environment

**Operating temperature:** 0 $^\circ$ C to +45 $^\circ$ C (+32 $^\circ$ F to 113 $^\circ$ F).

**Non-operating temperature:** -40 $^\circ$ C to +75 $^\circ$ C (-40 $^\circ$ F to +167 $^\circ$ F).

**Relative humidity:** to 95% at +40 $^\circ$ C (+104 $^\circ$ F).

**Altitude:** to 4600 m (15 000 ft).

**Vibration:** vibrated in three planes for 15 minutes each with 0.254 mm (0.01 in.) excursion, 10 to 55 Hz.

#### Accessories Available

**10116A:** Light Shield.

**10117A:** Front Panel Cover

**10119A:** Rack Mount Kit

**Note:** Probes are not supplied

**10013A:** 10:1 Divider Probe recommended

#### Ordering Information

**1220A** Dual Channel Oscilloscope

**Opt 910:** extra Operating and Service Manual

**1222A** Dual Channel Oscilloscope

**Opt 910:** extra Operating and Service Manual

# OSCILLOSCOPES

## Probes and Other Oscilloscope Accessories

### Miniature Oscilloscope Probes

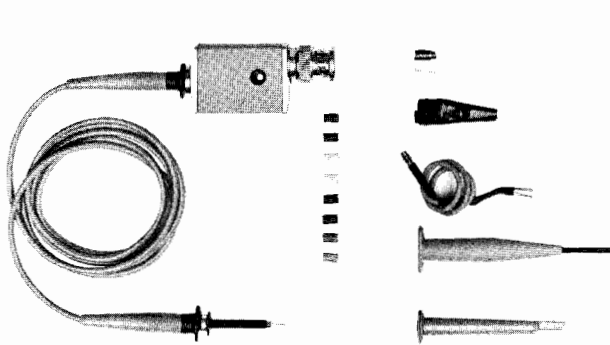

10017A, 10018A, 10040A, 10041A, 10042A

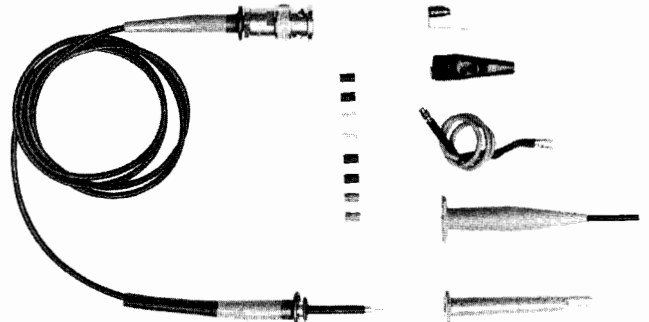

10026A, 10027A

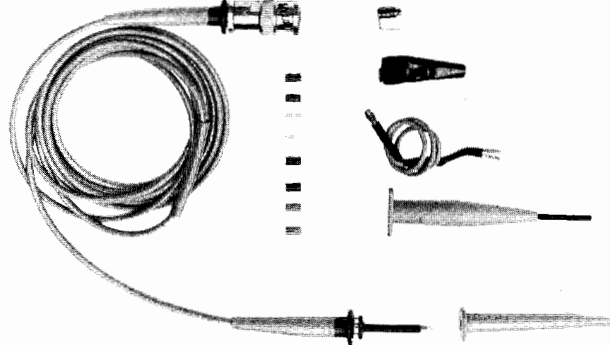

10021A, 10022A

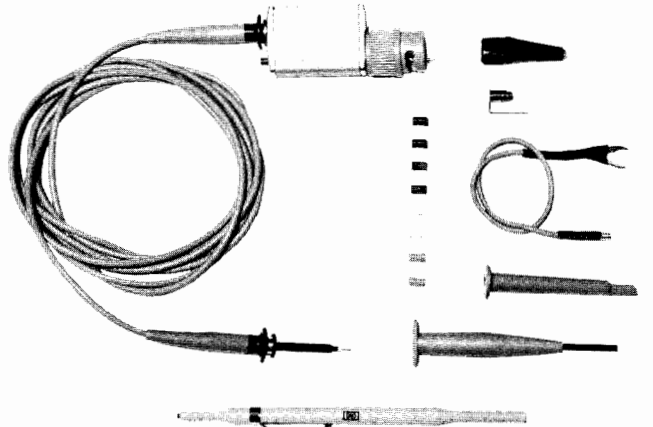

10080A, 10081A, 10082A, 10083A, 10084A

*OSCILLOSCOPE/MINIATURE PROBE COMPATIBILITY AND PROBE CHARACTERISTICS							
HP Oscilloscope/ Plug-in Model No. and Bandwidth	Probe Model No.	Approx Overall Length in Metres (ft)	Division Ratio	Input R	Shunt Capacitance	Compensates Oscilloscope Input	Max DC Volts
1725A/275 MHz 1722B/275 MHz 1727A/275 MHz	10017A	1 m (3.3)	10:1	1 MΩ	8 pF	9 to 14 pF	300
1715A/200 MHz 1809A/100 MHz 1805A/100 MHz	10018A	2 m (6.6)	10:1	1 MΩ	10 pF	9 to 14 pF	300
1740A, 1741A, 1743A, 1744A, 1745A, 1746A 100 MHz	10040A	1 m (3.3)	10:1	1 MΩ	9 pF	20 to 30 pF	300
	10041A	2 m (6.6)	10:1	1 MΩ	12 pF	20 to 26 pF	300
	10042A	3 m (9.8)	10:1	1 MΩ	15 pF	20 to 24 pF	300
1908A/B/100 MHz	10080A**	1 m (3.3)	10:1	1 MΩ	9 pF	10-20 pF	300
	10081A**	2 m (6.6)	10:1	1 MΩ	12 pF	12-20 pF	300
1950A/100 MHz	10082A**	3 m (10)	10:1	1 MΩ	14 pF	14-18 pF	300
	10083A**	1 m (3.3)	1:1		45 pF		300
	10084A**	2 m (6.6)	1:1		68 pF		300
	10021A	1 m (3.3)	1:1		36 pF		300
All Scopes with high Z inputs (may reduce bandwidth)	10022A	2 m (6.6)	1:1		62 pF		300
	10026A	1 m (3.3)	1:1	50 Ω			100
All Scopes with 50 Ω inputs and with a 50 Ω source impedance	10027A	2 m (6.6)	1:1	50 Ω			100

**Accessories supplied with each probe:** one retractable hook tip, one IC probe tip adapter, one alligator clip, one 20 cm (8 in.) ground lead, eight color-coded indicator sleeves, one grounding spring, and one Operating Note.

\*These miniature probes may be used with other oscilloscopes and test instruments with the proper input capacitance with no noticeable bandwidth degradation. However, due to variations of input characteristics, the probes may require recalibration for optimum performance.

\*\*The 10080 Series miniature probes include a Feature Enable pushbutton for exclusive use with the 1980 Oscilloscope Measurement System.

### Standard probes

For measurements in standard circuits where miniature probes are not a requirement, Hewlett-Packard offers a wide selection of standard size probes.

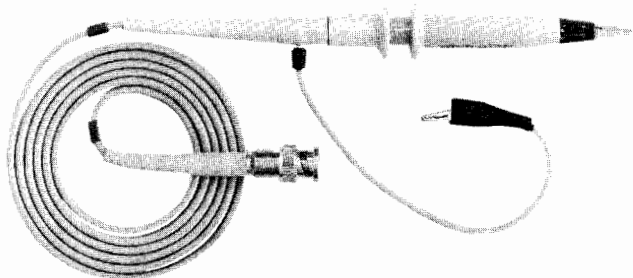

10001-10003A

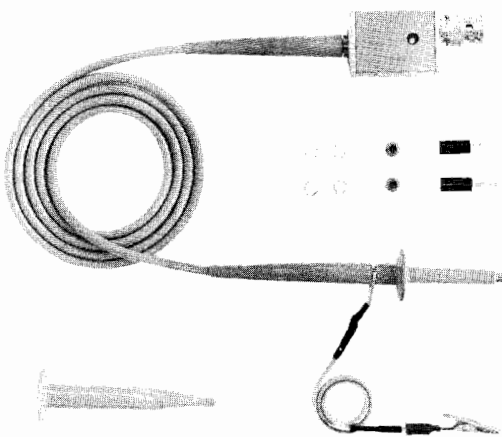

10004D-10006D, 10014A, 10016B

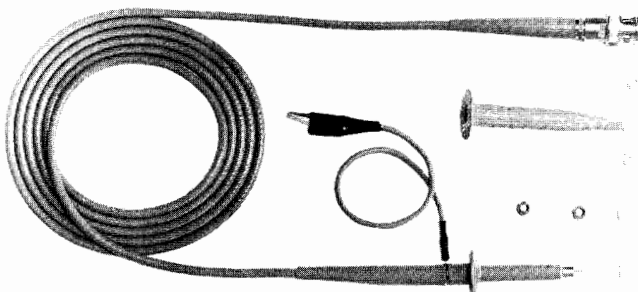

10007B, 10008B

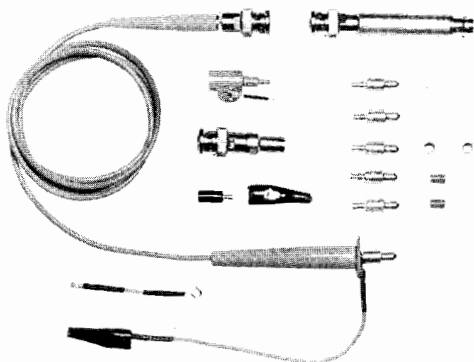

10020A

### Standard Probe Instrument Compatibility

Scope/ Plug-in	1200 Series	1220 Series	1715A 1725A 1722B 1727A	1740A thru 1744A	1801A	1805A 1809A
Probe						
10001A	X	X		L	L	
10001B	X	X		L	L	
10002A	X	X		L	L	
10002B	X	X		L	L	
10003A	X	X		L	L	
10004D		X		X	X	
10005D		X		L	X	
10006D		X		X	X	
10007B	X	X	L	L	L	L
10008B	X	L	L	L	L	L
10013A	X	X			L	
10014A			X			X
10016B			X			X
10020A			X	X		X
1120A			X	X		X
1124A			L	L		L

Notes:  
X Indicates that probe will maintain the bandwidth of the instrument.  
L Indicates that probe may limit the bandwidth of the instrument.

### Standard Divider Probe Characteristics

Model No.	Division Ratio	Resistance (M Ω)	Shunt Capacitance (pF)	Compensates Scope Input C (pF)	Max DC Volts	Overall Length m (ft)
10001A	10:1	10	10	15-55	600	1.5 (5)
10001B	10:1	10	20	15-45	600	3 (10)
10002A	50:1	9	2.5	15-55	1000	1.5 (5)
10002B	50:1	9	5	15-55	1000	3 (10)
10003A	10:1	10	10	15-55	600	1.3 (4)
10004D	10:1	10	10	20-30	500	1.1 (3.5)
10005D	10:1	10	17	20-30	500	3 (10)
10006D	10:1	10	14	20-30	500	1.8 (6)
10007B	1:1	—	40	—	600	1.1 (3.5)
10008B	1:1	—	60	—	600	1.8 (6)
10013A	10:1	10	13	24-45	500	1.8 (6)
10014A	10:1	10	10	9-13	500	1.1 (3.5)
10016B	10:1	10	14	9-13	500	1.8 (6)

### 10020A Resistive Dividers

Division Ratio	Input R* (ohms)	Division Accuracy	Max V** (rms)	Input C (pF)
1:1	50	—	6	—
5:1	250	± 3%	9	<0.7
10:1	500	± 3%	12	<0.7
20:1	1000	± 3%	15	<0.7
50:1	2500	± 3%	25	<0.7
100:1	5000	± 3%	35	<0.7

\*When terminated in 50 ohms.  
\*\*Limited by power dissipation of resistive element.

Probe length (overall): ≈ 1.2 m (4 ft).

Weight: net, 0.45 kg (1 lb); shipping, 1.4 kg (3 lb).

Accessories supplied: blocking capacitor, BNC adapter tip, 6-32 adapter tip, alligator tip, probe handle, cable assy's 5.1 cm (2 in.) & 15.2 cm (6 in.) ground, spanner tip, insulating caps, colored sleeves.

### 10020A Resistive Divider Probe Kit

# OSCILLOSCOPES

## Probes and Other Oscilloscope Accessories (Cont.)

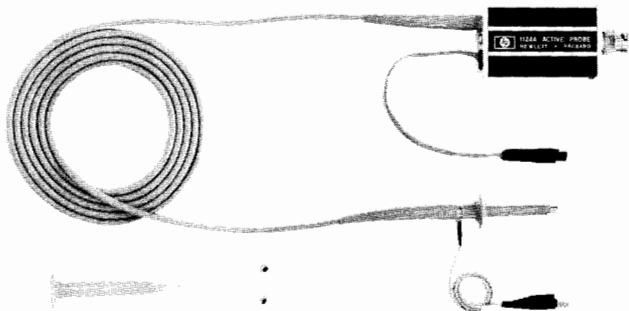

1124A

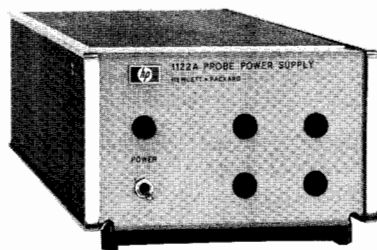

1122A

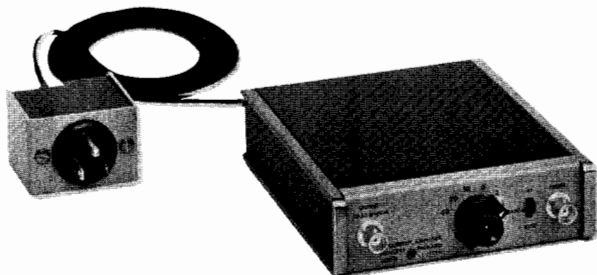

1111A

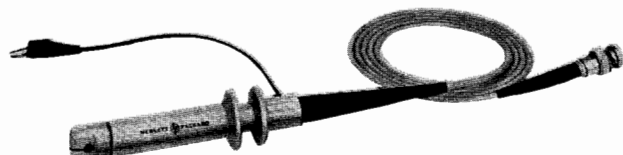

1110B

### 1124A 100 MHz Active Probe

Model 1124A Active Divider Probe provides high voltage, general purpose probing capabilities for instruments having 50 ohm inputs without selectable high impedance inputs. This 10 megohm 10 pF probe allows direct measurements of 100 volts, in the 100:1 division ratio mode, from dc to 100 MHz. In the 10:1 division ratio mode, input voltage range is  $\pm 10$  volts. Power is supplied by instruments with probe power jacks or the 1122A probe power supply.

#### 1124A Specifications

(Measured when connected to a 50  $\Omega$  load.)

**Bandwidth:** (measured from a terminated 50  $\Omega$  source) dc-coupled,

dc to 100 MHz; ac-coupled, 2 Hz to 100 MHz.

**Pulse response:** (measured from a terminated 50  $\Omega$  source) transition time,  $< 3.5$  ns; perturbations, 5% p-p. Measured with pulse transition time of  $> 2.5$  ns.

**Attenuation ratio:** 10:1  $\pm 5\%$ ; 100:1  $\pm 5\%$ .

**Dynamic range:** X10,  $\pm 10$  V; X100,  $\pm 100$  V.

**Input RC:** 10 M $\Omega$  shunted by  $\approx 10$  pF.

#### Maximum safe input

**DC-coupled:** X10,  $\pm 300$  V (dc + peak ac)  $\leq 100$  MHz; X100,  $\pm 500$  V (dc + peak ac)  $\leq 100$  MHz.

**AC-coupled:** X10,  $\pm 300$  V (dc + peak ac)  $\leq 100$  MHz. DC component must not exceed  $\pm 200$  V; X100,  $\pm 500$  V (dc + peak ac)  $\leq 100$  MHz. DC component must not exceed  $\pm 200$  V.

**Accessories supplied:** one 20.3 cm (8 in.) ground lead, one retractable hook tip, and two probe tip insulating caps.

**Power:** supplied by instruments with probe power jacks or Model 1122A probe power supply.

**Weight:** net, 0.2 kg (5 oz.); shipping, 0.91 kg (2 lb).

**Length:**  $\approx 1.5$  m (5 ft) overall.

**Available accessory:** 10131B 91.4 cm (36 in.) extender cable (refer to 1122A Probe Power Supply). Required for use with HP 1700 oscilloscopes with probe power option.

### 1122A Probe Power Supply

Model 1122A is a regulated power supply that provides all power requirements for simultaneous operation of up to four active probes.

#### 1122A Specifications

**Probe driving capability:** up to four HP active probes.

**Power output:**  $-12.6$  V and  $+15$  V,  $\pm 3\%$ .

**Power input:** 115 V or 230 V  $\pm 10\%$ , 48 to 440 Hz, 40 W (with four probes).

**Weight:** net, 2.7 kg (6 lb); shipping, 3.6 kg (8 lb).

**Accessories supplied:** four Model 10131B 91.4 cm (36 in.) extender cables.

### 1111A AC Current Amplifier

**Deflection factor:** (with a 50 mV/div oscilloscope deflection factor) in X1, 1 mA/div to 50 mA/div; in X100, 100 mA/div to 5 A/div; 1, 2, 5 sequence in X1 or X100.

**Accuracy:** in X1,  $\pm 3\%$ ; in X100,  $\pm 4\%$ .

**Rise time:** 18 ns.

**Noise:**  $< 100$   $\mu$ A p-p, referenced to input signal.

**Maximum ac current:** above 700 Hz, 50 A p-p; below 700 Hz, decreases at 1.4 A/20 Hz.

**Output impedance:** 50  $\Omega$ .

**Size:** 38.1 H x 130.2 W x 152.4 mm D (1 1/2" x 5 1/8" x 6").

**Weight:** net,  $\approx 0.9$  kg (2 lb); shipping, 1.4 kg (3 lb).

**Power:** 115 or 230 V  $\pm 10\%$ , 50 to 440 Hz, 1.5 W.

### 1110B Current Probe

**Sensitivity:** without 100  $\Omega$  termination, 1 mV/mA; with 100  $\Omega$  termination, 0.5 mV/mA.

**Accuracy:**  $\pm 3\%$ .

#### Bandwidth

**Lower -3 dB point:** without 100  $\Omega$  termination,  $\approx 1700$  Hz; with 100  $\Omega$  termination,  $\approx 850$  Hz.

**Upper -3 dB point:** with 4 pF capacitive load,  $\approx 45$  MHz; with 30 pF capacitive load  $\approx 35$  MHz.

**Rise time:** with 4 pF capacitive load,  $\approx 7$  ns; with 30 pF capacitive load,  $\approx 9$  ns.

**Insertion impedance:**  $\approx 0.01$   $\Omega$  shunted by 1  $\mu$ H; capacitance to ground  $< 3$  pF.

**Maximum dc current:** 0.5 A.

**Maximum ac current:** 15 A p-p above 4 kHz; decreasing below 4 kHz at 3.8 A/kHz rate.

**Weight:** net, 0.5 kg (1 lb); shipping, 0.9 kg (2 lb).

**Dimensions:** probe aperture, 3.9 mm (3/32 in.) diameter; overall length, 1.5 m (5 ft).

#### Ordering Information

1122A Probe Power Supply

1124A 100 MHz Active Probe

1111A Current Amplifier

1110B Current Probe

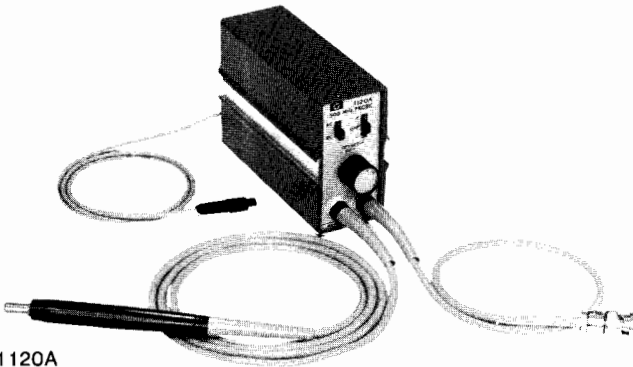

1120A

### 1120A 500 MHz Active Probe

For probing high source impedances at high frequencies, the Model 1120A 1:1 active probe provides a probe tip impedance of 100 k $\Omega$  shunted by approx 3 pF at 100 MHz. When used with the 10:1 or 100:1 divider tips, the shunt capacitance is <1 pF at 100 MHz. The 50 ohm output provides the optimum impedance match and measurement accuracy for oscilloscopes, spectrum analyzers, counters, and network analyzers with 50 ohm inputs. Power is supplied by instruments with probe power jacks or the 1122A probe power supply.

### 1120A Specifications

(Measured with output connected to a 50  $\Omega$  load.)

**Bandwidth:** (measured from a terminated 50  $\Omega$  source) dc-coupled, dc to >500 MHz; ac-coupled, <1.5 kHz to >500 MHz.

**Pulse response:** (measured from a terminated 50  $\Omega$  source) transition time, <0.75 ns; perturbations, < $\pm$ 6% measured with 1 GHz sampler.

**Dynamic range:**  $\pm$ 0.5 V with  $\pm$ 5 V dc offset.

**Noise:**  $\approx$  2.5 mV (measured tangentially).

**Input RC:** 100 k $\Omega$ , shunt capacitance  $\approx$  3 pF at 100 MHz; with 10:1 or 100:1 dividers, shunt capacitance is <1 pF at 100 MHz.

**Maximum input:**  $\pm$  80 V.

**Weight:** net, 1.8 kg (4 lb); shipping, 3.2 kg (7 lb).

**Power:** supplied by oscilloscopes with probe power jacks or a Model 1122A probe power supply.

**Length:** 1.2 m (4 ft) overall; with Option 001, 1.8 m (6 ft).

### Accessories Furnished

**Model 10241A 10:1 divider:** increases input R to  $\approx$  1 M $\Omega$  shunted by <1 pF at 100 MHz.

**Model 10243A 100:1 divider:** increases input R to  $\approx$  1 M $\Omega$  shunted by <1 pF at 100 MHz.

**Model 10242A bandwidth limiter:** reduces bandwidth to  $\approx$  27 MHz shunted by  $\approx$  6 pF and reduces gain <2%.

**Also included:** slip-on hook tip, 6.4 cm (2.5 in.) ground lead, spare probe tips, a slip-on BNC probe adapter, and a probe divider adjustment tool (PN 5020-0570).

### 10034A Ground Lead Kit

Model 10034A probe adapter kit consists of an assortment of 6-32 screw-on tips, and two ground lead cables which allow many methods of connecting the ground leads in a circuit. A 6-32 to slip-on adapter allows these tips to be used on 10004D-10006D, 10007B, 10008B, 10013A, 10014A, 10016B, and 1124A probes. The kit consists of one 15.2 cm (6 in.) and one 30.5 cm (12 in.) ground lead, one hook tip, one alligator tip, one pin tip, one tip for 0.6 mm (0.025 in.) square pins, one banana tip, and one slip-on to 6-32 adapter.

### Ordering Information

**1120A 500 MHz Active Probe**

**1120A Opt 001, 1.8 m (6 ft) length**

**10221A 50 ohm Probing Tee**

**10034A Ground Lead Kit**

### 10035A Probe Tip Kit

The tips in this kit are designed to be used with probes that accept a No. 6-32 screw-on tip which include: Models 10001A/B, 10002A/B, and 10003A. A slip on to 6-32 adapter allows these tips to be used with other probes with pin tips. The adapter is supplied with 10004D through 10006D, 10014A, 10016B, 10020A Probes, and 10034A Ground Lead Kit. Model 10035A Probe Tip Kit contains a pincer jaw, banana tip, pin tip, and spring tip.

### 10036B Probe Tip Kit

The tips in this kit extend the usefulness of standard probes that accept slip-on tips, and the Easy IC Miniature Probes. Included in the kit are two slip-on to 6-32 adapters and three bushing adapters that provide the flexibility to use the supplied tips with both types of probes. The adapters also allow use of other 6-32 probe tips with the probes. Model 10036B includes an assortment of tips for the following: 2.0 mm (0.08 in.) jack; 0.6 mm (0.025 in.) and 1.14 mm (0.045 in.) square pin; 1.0 mm-1.6 mm (0.040-0.062 in.) dia pin.

### 10037B Probe Tip Kit

Model 10037B Probe Tip Kit contains six 0.64 mm (0.025 in.) square female (white) tips for standard probes that accept slip-on tips, and the Easy IC Miniature Probes. Also included are six bushings that adapt HP miniature probes to the supplied tips.

### Miniature Probe Accessories

#### 10091A BNC to Square Pin Cable Assembly

Model 10091A cable assembly is designed for connecting test equipment to 0.64 mm–0.76 mm (0.025 in.–0.030 in.) square pin signal nodes or to integrated circuits through the 10024A IC Test Clip. This adaptable cable assembly is primarily used as:

a. A signal pick-off device for applying circuit signals to the input of test equipment such as oscilloscopes, voltmeters, etc. An application is the checking of voltages on computer back plane pins.

b. A signal insertion cable for inserting signals into suspected faulty circuits from power supplies, pulse generators, etc. Used in conjunction with Model 10024A IC Test Clip, signals are easily inserted into the proper IC leads.

For applications requiring greater separation between the circuit nodes and the instrumentation, the 10091A may be extended by using a BNC to BNC adapter (HP P/N 1250-0080) and a 50 ohm test cable such as the 122 cm (48 in.) Model 11170C. And when the test equipment hookup requires a dual banana plug, BNC to Dual Banana Plug Adapter (HP P/N 1251-2277) is available.

#### 10017-67603 Coaxial Adapter Cable

HP P/N 10017-67603 is a 230 mm (9 in.) 50 ohm slip-on adapter cable for miniature and standard HP probes that provides a coaxial interface to 0.64 mm (0.025 in.) square pin circuit nodes. The cable is ideal for probing computer back planes as well as wire wrap terminals. HP P/N 10017-67604 mini to standard probe adapter allows the cable to slip directly onto the HP Easy IC Miniature Probe tip with the insulating barrel removed.

#### 10017-67604 Mini to Standard Probe Adapter

HP P/N 10017-67604 allows standard size slip-on probe tip accessories to be used with HP miniature probes. With the retractable insulating barrel removed from the miniature probe and replaced with the 10017-67604 adapter, the probe slides directly into the standard size probe tip accessories.

### Ordering Information

**10035A Probe Tip Kit**

**10036B Probe Tip Kit**

**10037B Probe Tip Kit**

**10019A Cable Assembly**

**10017-67603 Coaxial Adapter Cable**

**10017-67604 Mini to Standard Probe Adapter**

### Miniature Probe Accessories

#### 10024A IC Test Clip

Model 10024A IC Test Clip provides easy probing of dual in-line packages and includes four insulated circuit interface pins. Additional circuit interface pins are available (see Ordering Information) in packages of twelve pins. Each pin has a tip on each end so that probes such as those on HP Logic Analyzers can be connected for fast, functional checks of circuit operation.

#### 10036B and 10037B Probe Tip Kits

Models 10036B and 10037B probe tip kits increase probing versatility with an assortment of 6-32 screw-on tips. Slip-on to 6-32 adapters are included for compatibility with the miniature probes.

#### 10028A Jumper Cable

Model 10028A 50 ohm 610 mm (24 in.) miniature probe/jumper cable is designed primarily for bypassing suspected faulty circuits in densely populated IC circuits. The basic tip on either end of the cable inserts directly into a 10024A IC Test Clip, allowing easy temporary connections between IC's without the danger of shorting between pins. The cable can also be used as a 50 ohm 1:1 probe to insert signals from an external source or as an input source to an external measuring device. For the latter uses, Probe Tip to BNC Adapter (HP P/N 1250-1454) is available.

#### Digital Trigger Probes

Model 10250A (TTL) 4 bit Trigger Probe is a useful service, production, and design troubleshooting tool that offers digital pattern triggering to enhance the use of oscilloscopes, logic analyzers, and other test equipment. The four inputs may be switched to HI, LO, or OFF (don't care) for convenient selection of the trigger point. No separate power supply is needed because probe power is obtained from the circuit under test.

### Probe Accessories

#### Terminations

**10100C:** 50  $\Omega$   $\pm$  1% BNC male to BNC female feedthrough termination.

**10100B:** 100  $\Omega$   $\pm$  2  $\Omega$  BNC male to BNC female feedthrough termination.

#### Standard Probe Tip Adapters

**10011B slip-on to BNC probe tip adapter:** for probes 10004D-10006D, 10007B, 10008B, 10013A, 10014A, 10016B, and 1124A.

**10229A hook tip adapter:** retractable pincer tip provides firm connection to circuit nodes. Supplied with 1120A probe. Recommended accessory for 10020A Resistive Divider Kit.

**HP P/N 10004-69515 IC probe tip adapter:** retractable pincers provide convenient connection to dual in-line packages for probes 10004D-10006D, 10007B, 10008B, 10013A, 10014A, 10016B, and 1124A. Supplied with 10004D, 10005D, 10006D, 10014A, and 10016B.

#### Ordering Information

**10024A** IC Test Clip for easy probing of dual in-line packages; includes 4 insulated circuit interface pins

**10024-69501** Interface Pin Kit for 10024A; includes 12 interface pins

**1250-1454** BNC to probe adapter permits the miniature probes to be connected to BNC connectors to maintain fast pulse response.

**10036B** Probe Tip Kit

**10037B** Probe Tip Kit

**10028A** Jumper Cable

**10250A** Trigger Probe (TTL)

**10229A** Retractable Hook Tip Adapter

**10004-69515** IC Probe Tip Adapter

**10011B** BNC Probe Tip Adapter

**10100C** 50  $\Omega$  Feedthrough Termination

**10100B** 100  $\Omega$  ( $\pm$  2  $\Omega$ ) Feedthrough Termination

### Servicing and Viewing Accessories

#### Plug-in Extender

**Model 10407B:** 180 system extender (metal frame extends both plug-ins). Allows calibration while a unit is operating.

#### Viewing Hoods

**10116A:** collapsible light shield for 1220 series oscilloscopes.

**10140A:** collapsible viewing hood for 1700 series oscilloscopes.

**10176A:** viewing hood for 12.7 cm (5 in.) rectangular CRT bezels.

#### Light Filters

**10173A:** RFI filter and contrast screen for 1700 series oscilloscopes.

**10178A:** metal mesh contrast screen for 181AR oscilloscopes.

**Amber plastic filter:** HP P/N 5020-0530, for 12.7 cm (5 in.) rectangular CRT (180 style).

**Smoke gray plastic filter:** HP P/N 5020-0567, for 12.7 cm (5 in.) rectangular CRT (180 style).

**Blue plastic filter:** HP P/N 5060-0548, for 12.7 cm (5 in.) rectangular CRT (180 style).

**Blue light filter:** HP P/N 01740-02701 for 1700 series oscilloscopes.

#### Rack Mount Slides and Adapters

##### 1700 series oscilloscopes

**10491B rack mount adapter:** adapts 1700 series oscilloscopes to standard 483 mm (19") rack; 222 mm (8 $\frac{3}{4}$ ") high, 540 mm (21 $\frac{1}{4}$ ") deep. Requires fixed slides (HP P/N 1490-0714) or pivoted slides (HP P/N 1490-0719) for slide mounting.

##### 180 and 181 rack style oscilloscopes

A slide adapter is required to secure an oscilloscope to the slides.

**Fixed slides:** HP P/N 1490-0714, 55.9 cm (22").

**Pivot slides:** HP P/N 1490-0719, 55.9 cm (22").

**Slide adapter:** HP P/N 1490-0768 (required for all slides).

#### Front Panel Covers

**10166A:** provides front panel protection for 180C oscilloscope.

**HP P/N 5040-0516:** provides front panel protection for 1700 series oscilloscopes.

#### Ordering Information

**10407B** Plug-in Extender

**10116A** Light Shield for 1220 series oscilloscopes

**10140A** Viewing Hood for 1700 series (8 x 10 div. CRT)

**10166A** Front Panel Cover for 180C oscilloscope

**10176A** Viewing Hood for 12.7 cm (5 in.) rect. CRT

**10173A** RFI Filter and Contrast Screen for 1700 series oscilloscopes (8 x div. CRT)

**10178A** Metal Mesh Contrast Screen for 181AR oscilloscopes

**5020-0530** Amber Plastic Filter for 12.7 cm (5 in.) rectangular CRT

**5020-0567** Smoke Gray Plastic Filter for 12.7 cm (5 in.) rectangular CRT

**5060-0548** Blue Plastic Filter for 12.7 cm (5 in.) rectangular CRT

**01740-02701** Blue Light Filter for 1700 series oscilloscopes (8 x 10 div. CRT)

**10491B** Rack Adapter for 1700 series oscilloscopes.

**1490-0714** Fixed slides for 180, 181 rack style oscilloscopes and 10491B

**1490-0719** Pivoted Slides for 180, 181 rack style oscilloscopes and 10491B

**1490-0768** Slide Adapter, required for securing slides to 180, 181 rack style oscilloscopes

**5040-0516** Front Panel Cover for 1700 series oscilloscopes.

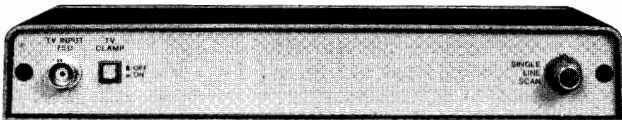
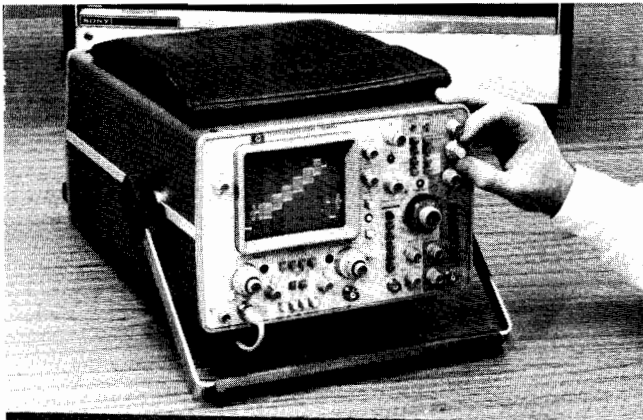

The HP 10029A TV/video sync retrofit kit can be added to any 1700 series oscilloscope for the display of composite video waveforms.

#### Video Sync Retrofit Kit for 17XX Series

Any 1700 series oscilloscope can easily display composite video waveforms with the addition of the HP 10029A retrofit kit module. Consisting of a user-installable module, the retrofit kit mounts on the instrument top cover. Power for the module is received from the instruments; no other internal modifications are required in the oscilloscope.

The HP 10029A module operates completely external to the oscilloscope — BNC cables provide the necessary connections. Composite video waveforms are input to the module that provide a 75 ohm input for impedance matching to most video signal sources. A vertical output signal (video) provides a method for connecting the signal to the instrument's vertical input channel. With the trigger signals from the TV/video sync module and proper use of the oscilloscope's standard controls, specific portions of the composite video waveform can be selected for viewing.

Field selection is easily accomplished with one button, and a single line scan control on the module enables you to examine an individual horizontal line precisely.

#### Specifications

Input Impedance: 75  $\Omega$   $\pm$  3%. In TV clamp, ac coupled with negative clamping to ground.

Maximum Input: 75  $\Omega$  or TV clamp mode, 5 V rms.

#### Outputs

Main Trigger: 0.75 to <1 V square wave with main trigger slope (POS/NEG) selecting the alternate field in the frame.

Delayed Trigger: 0.75 to <1 V square wave. Delayed trigger slope selection must be set to NEG (with delayed sweep set in the "TRIG'D" mode) to engage single line scan.

TV Vertical: maintains minimum 20 MHz bandwidth.

#### Ordering Information

10029A TV/Video Sync Retrofit Kit

#### HP 10326A Time Interval Standard

The HP Model 10326A Time Interval Standard is a signal source that provides a dual-channel time interval reference. The two channels, OUTPUT and  $\overline{\text{OUTPUT}}$ , offer a selectable square wave output with waveform periods of 5, 10, 20, 50, or 100 nanoseconds. These output signals can be delivered to probe tips or BNC connectors with the 10326A's accessory kit.

The waveform period accuracy of any selected square wave output is  $\pm$  5 picoseconds. This accuracy results from the purity of the crystal oscillator's frequency spectrum and the accuracy of the oscillator's frequency. Low subharmonic distortion permits short time intervals of a single period to be presented with a high degree of stability. Timing relationships between rising and falling edges in any combination are specified between output channels.

The waveform period accuracy and known timing relationships between edges of OUTPUT and  $\overline{\text{OUTPUT}}$  are convenient signals to evaluate system performance. Low subharmonic distortion of output signals is ideal for calibration and other applications which require extremely stable waveforms for timing analysis.

Specifications (See data sheet No. 5953-3911 for complete details.)

**Signal Outputs:** OUTPUT,  $\overline{\text{OUTPUT}}$ , Trig Out; Square Wave Period (selectable) 5 ns, 10 ns, 20 ns, 50 ns, 100 ns.

Rise Time (20–80%): OUTPUT,  $\overline{\text{OUTPUT}}$   $\leq$  1.25 ns.

#### Operating Characteristics (Typical Values)

Square Wave Amplitude (OUTPUT,  $\overline{\text{OUTPUT}}$ , Trig Out)  $\approx$  0.38 V p-p (fixed) into a 50 ohm load; warm-up time, 1 minute.

#### General

**Weight:** net, approx. 2.95 kg (6.5 lb.); shipping, approx. 5.77 kg (12.7 lb.).

**Dimensions:** 9.53 mm (3.75 in.) high; 21.27 mm (8.375 in.) wide; 27.94 mm (1.1 in.) deep.

**Accessories Furnished:** one BNC/probe adapter kit (HP P/N 10326-69501), one 2.3 m (7.5 ft.) power cord, and one operating and service manual.

#### Ordering Information

10326A Time Interval Standard

Option 001 - delete Accessory Kit



The HP Model 10326A Time Interval Standard.





# OSCILLOSCOPES

## Probes and Other Accessories (Cont.)

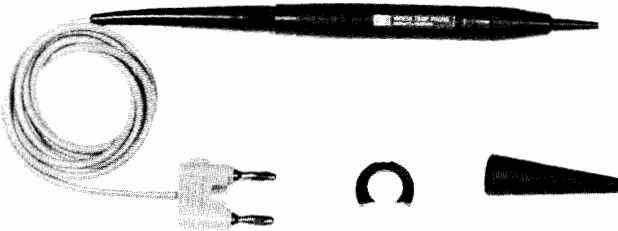

10023A

### 10023A Temperature Probe

The Model 10023A Temperature Probe provides fast, accurate temperature measurements in a variety of thermal design, diagnostic, and testing applications. Surface temperatures are read directly in degrees Celsius on multimeters (DMM) having an input impedance of  $\geq 10$  megohms. A pencil-like probe tip easily accesses small components and a press-to-read switch make measurements easy; just press the button, touch the surface to be measured, and read its temperature directly on the DMM.

The probe is a self-contained temperature-to-voltage transducer with a forward-biased diode chip bonded to a small ceramic substrate in the probe tip. A calibrated, linear output of  $1 \text{ mV}/^\circ\text{C}$  is assured by individually characterizing each diode in a precision thermal reference bath. An integrated circuit resistor network is then laser trimmed to match each diode to its electronic compensation circuit.

The entire electronics assembly, including the battery, is packaged in the probe barrel. A standard dual banana plug output connector provides universal readout through most digital voltmeters including the built-in DMMs on HP's Option 034/035, 1700 Series oscilloscopes.

### 10023A Specifications

#### Electrical

**Measurement Range:**  $-55^\circ\text{C}$  to  $+150^\circ\text{C}$ .

**Output:**  $1 \text{ mV}/^\circ\text{C}$ .

**Short Term Repeatability:**  $\pm 0.3^\circ\text{C}$  (minimum of 48 hrs).

**Accuracy:**  $\pm 2^\circ\text{C}$  from  $0^\circ\text{C}$  to  $100^\circ\text{C}$ , decreasing linearly to  $+2^\circ\text{C}$ ,  $-4^\circ\text{C}$  at  $-55^\circ\text{C}$  and  $+4^\circ\text{C}$ ,  $-2^\circ\text{C}$  at  $+150^\circ\text{C}$ .

**Maximum Voltage at Tip:** 600 V (dc + peak ac).

**Tip Capacitance to Ground:** approx 0.5 pF.

**Thermal Response:**  $< 3 \text{ s}$  to settle within  $2^\circ\text{C}$  of final reading (liquid measurement) for a  $100^\circ\text{C}$  temperature change.

**DMM Input R:**  $\geq 10 \text{ M}\Omega$ .

#### General

**Operating Environment probe tip to approx 13 mm (0.5 in.) from probe tip:** temperature,  $-55^\circ\text{C}$  to  $+150^\circ\text{C}$ ; altitude, to 4600 m (15,000 ft); vibration, vibrated in three planes for 15 min. each with 0.38 mm (0.015 in.) excursion, 10 to 55 Hz.

**Operating Environment (probe body):** temperature,  $0^\circ\text{C}$  to  $60^\circ\text{C}$  (battery limitation); humidity (non-condensing), to 95% relative humidity at  $+40^\circ\text{C}$ , altitude and vibration same as those for probe tip.

**Overall Length:** approx 1.4 m (53 in.).

**Weight:** net, 85 g (3 oz); shipping, 312 g (11 oz).

**Battery Life:** approx 50 hr (varies with ambient temperature).

**Low Battery Indication:** probe output indicates approx  $-70^\circ\text{C}$  on DMM. First indication of a low battery condition is a decreasing indication of  $1^\circ$  to  $2^\circ\text{C}/\text{minute}$  with probe tip at a constant temperature.

**Accessories Supplied:** one replacement battery (1420-0256), one sliding lock collar (10023-23201), and one probe tip cover (00547-40005).

**Replacement Batteries:** batteries may be purchased locally using the following part numbers, RAY-O-VAC<sup>®1</sup>, RS 312-G or T-312-G; DURACELL<sup>®2</sup> 10L125; or batteries with similar specifications.

<sup>®1</sup> RAY-O-VAC is a registered trademark of ESB, Inc.

<sup>®2</sup> DURACELL is a registered trademark of P. R. Mallory & CO.

#### Ordering Information

10023A Temperature Probe

10023-60001 Replacement Tip, includes pre-calibrated tip and matching compensation network

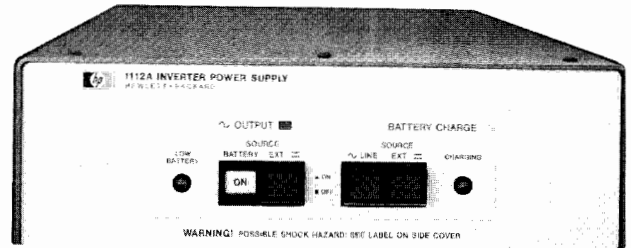

### 1112A Inverter Power Supply Specifications

#### Output

**Voltage:** 120 or 240 V ac, peak-to-peak output is fixed at 285 V; rms value changes with load; minimum usable load, 20 W.

Load	120 V Range		240 V Range	
	400 Hz	60 Hz*	400 Hz	60 Hz*
65 W	$\geq 96 \text{ V rms}$	$\geq 99 \text{ V rms}$	$\geq 192 \text{ V rms}$	$\geq 198 \text{ V rms}$
20 W	$\leq 126 \text{ V rms}$	$\leq 126 \text{ V rms}$	$\leq 250 \text{ V rms}$	$\leq 250 \text{ V rms}$

\*With Option 060

**Waveform:** duty cycle is 50% for loads of 40 W, increasing to 65% as the load decreases to 20 W.

**Frequency:**  $400 \text{ Hz} \pm 10\%$  (Opt 060,  $60 \text{ Hz} \pm 0.5 \text{ Hz}$ ).

**Max power:** 65 W nominal, compatible with line voltage and 60 to 70 VA load requirements of HP 1700 series oscilloscopes.

**Operating time:**  $\approx 140$  watt hours with a fully charged battery pack at  $25^\circ\text{C}$ .

**Input power:** External dc source; 11.5 V to 50 V (Opt 060, 12 V to 50 V), at least 90 watts; External ac source; 100 V to 120 V or 220 V to 240 V,  $+5\%$ ,  $-10\%$ ; 48 to 66 Hz; 250 VA max; ac feedthrough operation; output voltage and frequency is the same as the input; output power, 120 VA max.

**Battery charging:** AC input; full charge in 14 hrs at  $+25^\circ\text{C}$  with 120 V rms input (80% in 8 hrs); dc input: full charge in 24 hrs at  $+25^\circ\text{C}$  with 18 watts input.

#### General

**Size:** 92 H x 273 W x 403 mm D ( $3\frac{5}{8}$ " x  $10\frac{3}{4}$ " x  $15\frac{7}{8}$ ").

**Weight:** net, 9.1 kg (20 lb) with battery pack, 4.5 kg (10 lb) without battery pack; shipping, 10. kg (22 lb) with battery pack, 5.4 kg (12 lb) without battery pack.

**Compatibility:** HP 1700 Series Oscilloscopes. For compatibility with other instruments call your HP Field Engineer.

**Operating environment:** temperature, 0 to  $+55^\circ\text{C}$  ( $+32^\circ\text{F}$  to  $+130^\circ\text{F}$ ), non-operating  $-40^\circ\text{C}$  to  $+55^\circ\text{C}$  ( $-40^\circ\text{F}$  to  $+130^\circ\text{F}$ ); humidity, to 95% relative humidity at  $+40^\circ\text{C}$  ( $+104^\circ\text{F}$ ); altitude, to 4600 m (15,000 ft); vibration, vibrated in three planes for 15 min. each with 0.38 mm (0.015 in.) excursion, 10 to 55 Hz.

**Accessories supplied:** one Model 10421A battery pack, one mounting bracket kit, one 2.3 m (7.5 ft) power cord, one 2.1 m (7 ft) grounding cable, and one operating and service manual.

#### 1112A Accessories

**10421A Battery Pack:** the battery pack consists of 30 size "D" nickel cadmium cells and includes temperature sensors to reduce the possibility of cell damage during charging (supplied with 1112A).

**Weight:** net, 4.4 kg (10 $\frac{3}{4}$  lb); shipping, 5.3 kg (11 $\frac{3}{4}$  lb).

**01112-61605 Grounding cable:** grounds inverter and oscilloscope chassis (supplied with 1112A).

**01112-69501 Mounting bracket kit:** for mounting the 1112A on top or bottom of 1700 series oscilloscopes (supplied with 1112A).

#### Ordering Information

1112A Inverter power supply (400 Hz)

Opt 001: without battery pack

Opt 002: without mounting bracket kit

Opt 060: 60 Hz output frequency, internal battery operation reduced to 120 watt hours

10421A Battery pack

01112-61605 Grounding cable

01112-69501 Mounting bracket kit

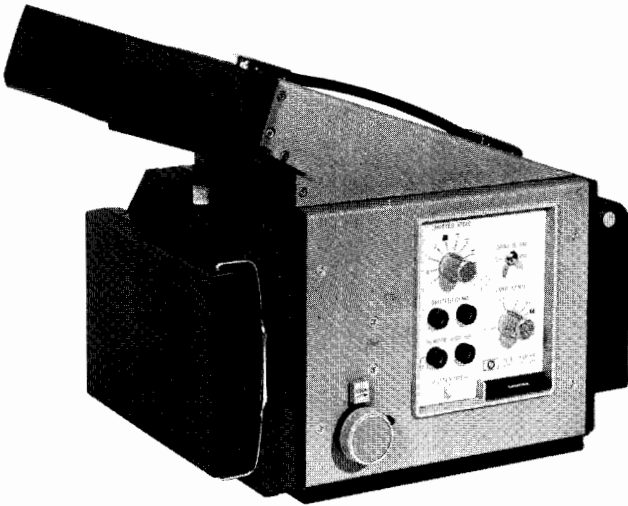

## Introduction

Model 197B is a versatile, general purpose instrument for cathode-ray tube photographic recording. The camera features lift-off mounting and swing-away hinging by pressing a single latch release button. Interchangeable film backs enable capture of CRT display information on a complete spectrum of Polaroid® or conventional sheet, pack, or roll film. All controls are located outside of the camera for easy reading and fast adjustment during setup. A low-angle viewing port provides a direct view of the display through a flexible facemask while the camera is in the photographic position.

A combination split-image focusing plate and image reduction ratio scale is included and is stored in a convenient pocket underneath the camera. The reduction ratio scale provides 1:1, 1:0.9, and 1:0.7 reference settings for displays with one centimetre graticule spacing. Corner marks on the focusing plate allow the usable film area to be accurately identified. The optional Graflok® back is equipped with a ground glass focusing plate and a snap-out viewing hood.

Model 197B camera incorporates an electronically controlled shutter with eight exposure times from 1/30 to 4 seconds. Time (T) and bulb (B) control settings are also provided. The camera lens opening is continuously adjustable from f/1.9 to f/16. The 75 mm, high transmission lens provides high resolution, low distortion photographs for capturing a wide range of images.

## Camera Mounting

On initial order, the 197B can be configured, with different camera adapters, to directly mount on a variety of instruments as listed in the 197B Camera Compatibility Table. Each camera adapter is attached to the camera body with a piano hinge and is an integral part of the camera. Model 197B includes a 10376A adapter which directly interfaces to HP 1700 series oscilloscopes with 8 x 10 division CRTs. Model 197B Option 002 includes a 10378A adapter which directly interfaces to HP 180 series oscilloscopes. Model 197B Option 006 includes a 10375A adapter which directly interfaces with the majority of HP small screen CRT displays.

By using camera bezel adapters, various camera configurations can be adapted to other instruments not directly compatible with the camera adapter. For mounting a variety of cameras to instruments both current and those no longer in production, refer to the 197B Camera Data Sheet. Copies of the 197B Data Sheet can be obtained from your local HP field office or by writing: Inquires Manager, Hewlett-Packard Company, 1507 Page Mill Road, Palo Alto, California 94304.

## 197B Characteristics

**Reduction ratio:** continuously adjustable from 1:1 to 1:0.7. Reference scale provided on focus plate.

**Lens:** 75 mm, f/1.9 high transmission lens; aperture, f/1.9 to f/16.

197B Camera Compatibility				
Instrument	197B	Opt 002	Opt 006	Opt 009
<b>Oscilloscopes</b>				
1200/01/05		X		
1740 Series except 1745A/46A	X			
1745A/46A				X
1715A/22B/25A/27A	X			
180/181		X		
1980			X	
<b>Displays</b>				
1332/33/35/36/40			X (3)	
<b>Network Analyzers</b>				
8412A		X (4)		
8414A		X		
8505A			X (3)	
8754A		(1)		
<b>Signal Analyzers</b>				
140T/180TR		X (2)		
141T/181T/TR		X		
182T		Add 10367A (2)		
3580A		X		
3582A/85A			X (3)	
3720A/21A		X		
5420A/23A			X (3)	
8565A/66A/68A			X (3)	

### Notes:

1. Model 8754A CRT has P39 phosphor. Ultraviolet light does not excite P39 phosphor and will not illuminate an internal graticule. However, the 197B Opt 002 physically fits on the 8754A.
2. These instruments have P39 phosphor with internal graticule illumination supplied by internal CRT floodguns.
3. These instruments have Lexan CRT faceplates that attenuate ultraviolet light and will not allow illumination of an internal graticule. Instruments with internal floodguns provide internal graticule illumination.
4. Model 8412A CRT has P7 phosphor and the ultraviolet camera light source does not illuminate the phosphor very well, and there is no internal CRT floodgun for graticule illumination.

**Shutter speeds:** 1/30, 1/15, 1/8, 1/4, 1/2, 1, 2, 4 seconds, Time and Bulb; shutter has a sync contact closure output for triggering external equipment and an input jack for remote operation.

**Camera back:** 83 mm x 108 mm (3.25" x 4.25") Polaroid pack back (Graflok back is available, see Options).

**Mounting:** lift on/off mounting with positive lock, swing-away hinging to left.

**Viewing:** low-angle, direct viewing through a flexible facemask.

**Shutter open indicator:** illuminated whenever shutter is open.

**Ultraviolet illumination:** light source and lens filter provide graticule illumination and photographic speed enhancement.

**Focus:** adjustable with lock; split-image focusing plate provided.

**Size:** 267 H x 194 W x 356 mm D (10.5" x 7.6" x 14").

**Weight:** net, 4.5 kg (10 lb); shipping, 7.3 kg (16 lb).

**Power:** switch selectable 115 Vac  $\pm$  10% or 230 Vac  $\pm$  10%, 48 to 66 Hz\*, 10 VA max.

**Accessories furnished:** comb. split image focusing plate reduction ratio scale, 2.3 m (7.5 ft) power cord, and instruction manual.

## 197B Options & UV Kit

**001:** deletes ultraviolet illumination feature

**002:** replaces 197B adapter with 10378A adapter.

**003:** Graflok back in place of pack back

**006:** replaces 197B adapter with 10375A adapter.

**007:** meets UL listing requirements for medical and dental electronic equipment.

**009:** Camera Bezel Adapter for 1745A and 1746A oscilloscopes.

**910:** additional manual

**10367A** Camera Bezel Adapter for 182T

**Ultraviolet Light Kit** (P/N 00197-69507) for field installation of ultraviolet illumination feature.

## 197B Camera

\*Camera operates from 48 to 440 Hz, but does not meet the ac line to chassis leakage requirements of UL 544 listing above 66 Hz.



# OSCILLOSCOPES

Testmobiles: Save Bench Space, Easily Moved

Models 1006A, 1007A, 1008A & 1117B

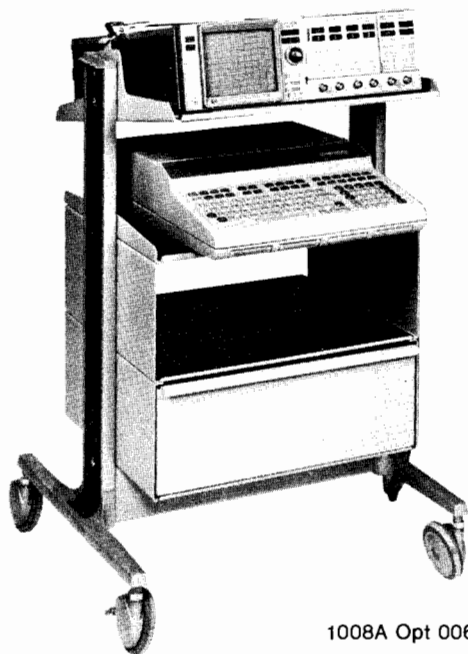

1008A Opt 006



1006A

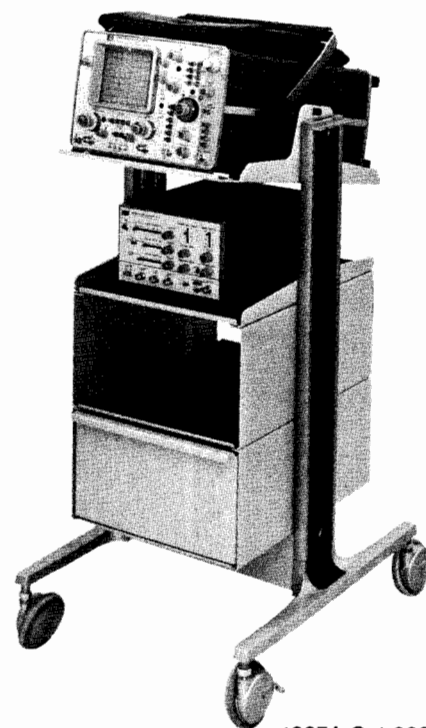

1007A Opt 006

## Introduction

Hewlett-Packard Testmobiles offer convenient portability for your oscilloscopes or instrumentation systems. The top tray on these testmobiles may be tilted to position your instrument for easy operation. The selection of testmobiles range from a basic model such as the 1006A, designed to hold a single oscilloscope or other instrument, to a testmobile such as the 1008A or 1117B that can be adapted to provide a complete mobile test system. Refer to the testmobile/instrument compatibility chart for assistance in selecting the testmobile that will best fit your requirements.

## Testmobile / Instrument Compatibility

Testmobile Model Number	Instrument
1006A 1007A	All Hewlett-Packard 180, 1200, 1220, and 1700 Series cabinet style oscilloscopes, or other instruments that meet the height and weight requirements.
1008A	Hewlett-Packard instruments that are configured to be mounted in a standard 48.3 cm (19 in.) rack and meet the testmobile height and weight requirements.
1117B	All instruments listed above.



1006A

## 1006A Description

This is a sturdy general purpose testmobile for cabinet style oscilloscopes and other instruments (see compatibility chart). The tilt tray adjusts  $\pm 30^\circ$  in  $10^\circ$  increments. A base tray and an accessory rack add space for other instruments and accessories; and a convenient bracket holds three HP probes. Large rear wheels allow easy movement and locking front casters hold the testmobile in position. A five outlet power strip accessory is available for mounting under the tilt tray or beneath the accessory rack.

## 1007A, 1008A Description

These versatile testmobiles provide a sturdy, lightweight, stable platform for your oscilloscope or instrumentation system (see compatibility chart). Large angled wheels with a wide track move quietly and smoothly over most surfaces. The top trays are table-top height and can be tilted to a convenient viewing angle between  $30^\circ$  above and  $30^\circ$  below the horizontal position with a total of seven detent positions in  $10^\circ$  increments. The caps on each side rail are designed to conveniently hold three probes to reduce the possibility of damaging probes not in use.

## 1007A, 1008A Options

Many options are available so that the 1007A or 1008A can be easily tailored to your specific requirements. Refer to the option photographs with description to select the testmobile best suited to your requirements. Options apply to either the 1007A or 1008A. Option 008, U.S. only five outlet power strip option, is also available for convenient instrument operation.

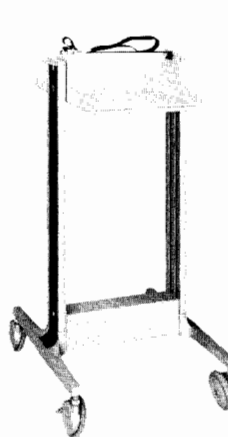

Basic Testmobile

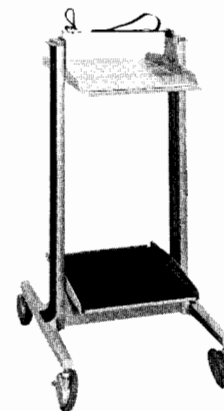

Opt 001: storage shelf  
load limit: 18 kg (40 lb).

## Testmobiles: Save Bench Space, Easily Moved

Models 1006A, 1007A, 1008A & 1117B (cont.)

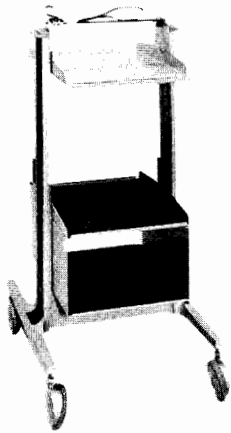

**Opt 002:** storage shelf and lower cabinet; load limit 18 kg (40 lb) ea.

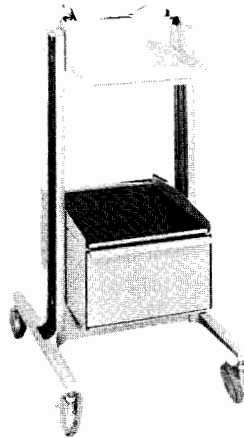

**Opt 003:** 15 cm (6 in.) lockable drawer with shelf on top; load limit 11 kg (25 lb) in drawer and 18 kg (40 lb) on shelf.

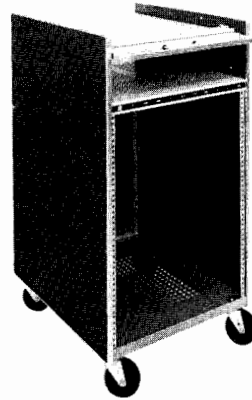

1117B

### 1117B Description

Model 1117B provides a mobile test station for cabinet and rack model instruments, with tilt tray angles from  $-15^{\circ}$  to  $+30^{\circ}$  in  $7\frac{1}{2}^{\circ}$  increments for easy viewing. In addition, other instruments can be mounted in the standard EIA racks of the lower compartment. Rack mounting height is 62.2 cm (24 $\frac{1}{2}$  in.), depth is 58.4 cm (23 in.), and power distribution is provided with a built-in four outlet power strip. Optional accessory drawers 7.6 cm (3 in.) and 20.3 cm (8 in.) deep are available to provide convenient storage space. The drawers may be installed in many vertical positions of the lower compartment, allowing room for other rack mounted equipment.

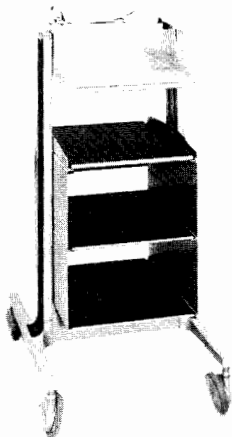

**Opt 004:** two storage cabinets with shelf on top; combined load limit, cabinets and shelf, 45 kg (100 lb).

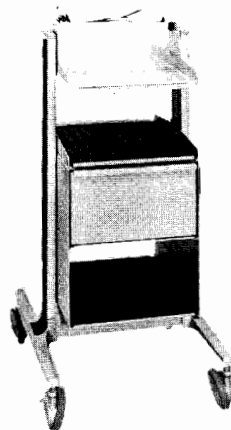

**Opt 005:** storage cabinet and drawer in upper position with shelf on top; load limit 18 kg (40 lb) ea on shelf and in cabinet, 11 kg (25 lb) in drawer.

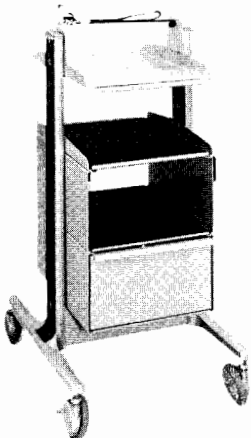

**Opt 006:** storage cabinet with shelf on top and drawer in lower position; load limit 18 kg (40 lb) ea on shelf and in cabinet, 11 kg (25 lb) in drawer.

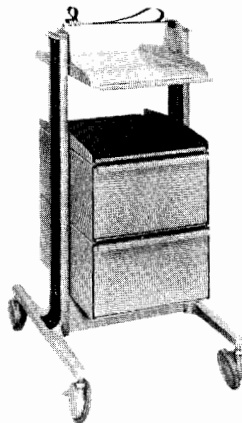

**Opt 007:** two lockable drawers with shelf on top; load limit 18 kg (40 lb) on shelf, 11 kg (25 lb) ea drawer.

### Specifications

(see Testmobile data sheet for complete specifications)

	1006A	1007A	1008A	1117B
Height	841 mm (33 $\frac{1}{8}$ in.)	930 mm (36 $\frac{1}{2}$ in.)	930 mm (36 $\frac{1}{2}$ in.)	1003 mm (39 $\frac{1}{2}$ in.)
Overall width	502 mm (19 $\frac{3}{4}$ in.)	584 mm (23 in.)	759 mm (29 $\frac{7}{8}$ in.)	511 mm (20 $\frac{1}{2}$ in.)
Width of tray	322 mm (12 $\frac{7}{16}$ in.)	321 mm (12 $\frac{5}{16}$ in.)	473 mm (18 $\frac{5}{8}$ in.)	
Tilt tray angle	$\pm 30^{\circ}$	$\pm 30^{\circ}$	$\pm 30^{\circ}$	$-15^{\circ}$ to $+30^{\circ}$
Weight	net	11.8 kg (26 lb)	11 kg (25 lb)	13 kg (28 lb)
	shipping	14.5 kg (32 lb)	19 kg (41 lb)	22 kg (48 lb)
Max load on tilt tray	23 kg (50 lb)	34 kg (75 lb)	45 kg (100 lb)	45 kg (100 lb)
Max load below tilt tray	23 kg (50 lb)	see Option descriptions	see Option descriptions	56.7 kg (125 lb)

### Optional Accessories

**10475A** 7.6 cm (3 in.) drawer for 1117B testmobile

**Weight:** net, 4.1 kg (9 lb); shipping, 5.9 kg (13 lb).

**10476A:** 20.3 cm (8 in.) drawer for 1117B testmobile

**Weight:** net, 5.4 kg (11 lb); shipping, 8.2 kg (18 lb).

**01008-61201** Probe Pod Holder holds three small Logic Analyzer probe pods such as 10230 and 10248

**01008-61202** Probe Pod Holder holds one small and one large Logic Analyzer probe for 1611A

**01008-68701** Rack Mount Kit for 1008A, 13.3 cm (5 $\frac{1}{4}$  in.) high for mounting under the tilt tray

**01008-68702** Rack Mount Kit for 1008A, 19 cm (7 $\frac{1}{2}$  in.) high for mounting under the tilt tray

**01007-60008** Power Strip kit adds Opt 008 power strip to all versions of 1006A, 1007A, 1008A testmobiles

### Ordering Information

#### 1006A Testmobile

**Opt 008** Power Strip

**1007A, 1008A** Testmobiles

(see 1007A, 1008A Options for option descriptions)

**Opt 001:** storage shelf

**Opt 002:** storage shelf, lower cabinet

**Opt 003:** storage shelf, locking drawer

**Opt 004:** two storage cabinets, shelf

**Opt 005:** upper drawer, lower storage

**Opt 006:** lower drawer, upper storage

**Opt 007:** two locking drawers

**Opt 008:** power strip (5 outlet)

**1117B** Testmobile (includes power strip)

# CATHODE-RAY TUBE DISPLAYS

Instrumentation, Computer Graphics & Imaging Applications

1300 Series

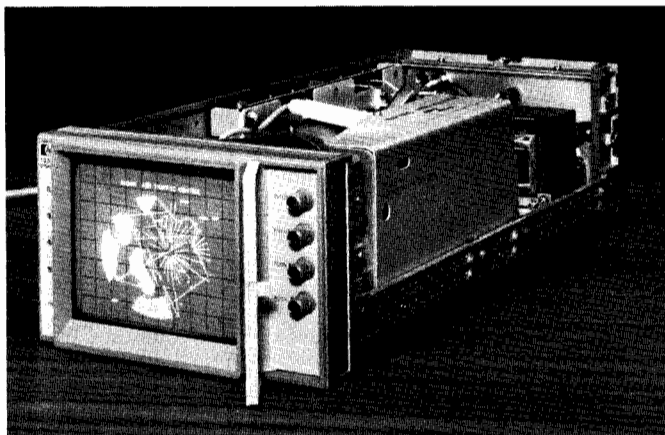

## Introduction

Selecting a graphics display is no longer a simple choice between an electrostatic or an electromagnetic cathode-ray tube (CRT). The trend to microcomputer and minicomputer control of instruments and systems is generating needs to display more complex pictures. Reduced memory costs are making it possible to design a greater variety of digital displays using either electrostatic or electromagnetic CRTs.

## Electrostatic CRT

The heart of HP graphics displays is an electrostatic CRT. Also included are X- and Y-axes deflection amplifiers, a Z-axis (video) amplifier, and both high and low voltage power supplies. HP small screen displays are available with or without cabinets. In addition, several rack and bench type cabinet configurations are available, giving your designer a high degree of flexibility in incorporating HP displays into your instrument or system.

The primary attributes of the electrostatic CRT are high writing speed and low power requirements. The deflection plates are voltage driven whereas electromagnetic CRTs are current driven, through a yoke and tuned circuit in raster-scan displays. Vector writing speeds of electrostatic CRT displays are typically ten times faster than high-performance electromagnetic CRT displays.

Power requirements become a significant consideration with large screen displays. All HP large screen displays meet environmental specifications without a fan. The maximum power of any HP display is 185 watts. This can be a benefit in reducing system cooling requirements.

## Digital interfaces

Model 1351A Graphics Generator provides a convenient digital interface between computers and controllers and the analog inputs in the majority of HP graphic displays. Model 1351A converts digital inputs to analog outputs capable of driving HP's large screen displays. The very high resolution of these displays, combined with the 1351A's 8k vector/character generating capability, provide the complex drawing capability needed in computer aided graphics systems such as CAD/CAM.

Model 1345A is a high performance display that has a built-in digital interface and it is ideal for microprocessor-based instrumentation and system applications. The 1345A represents a new concept in instrumentation displays with its 16-bit TTL I/O. The advantage of the 16-bit I/O is that digital interfacing to a microprocessor based system provides a convenient, high performance interface. With the many peripheral interfacing adapters (PIAs) that are available, interfacing a digital system to the 1345A can be accomplished in a fraction of the time required for interfacing displays with analog inputs. The 16-bit I/O also operates with 8- or 16-bit microprocessors which assures compatibility with present and future instrument systems.

## Imaging Applications

HP CRT displays have been used to present continuous-tone images both for direct viewing and photographic recording for many years. One of the first applications was to produce high-speed, random dot images from gamma cameras used in nuclear medicine. HP's advanced technology makes it possible to manufacture CRTs with highly uniform light output which is essential in assuring the diagnostic accuracy of gamma camera pictures.

## Measurement Instruments

Most measurement instruments that produce line drawing pictures operate in real-time. Because of the need for high writing speed they usually include an electrostatic CRT display. The HP Model 1340A and 1345A meet the needs of measurement instrument designers. The modular package makes them physically easy to incorporate into an instrument or system. Integrated circuit amplifiers provide flexibility when electrically integrating the 1340A with an instrument. DC voltage levels control X and Y amplifier gain and position as well as intensity. Either controls supplied with the 1340A or circuits in your instrument can be used to control the display. Model 1345A has a digital interface which makes it ideally suited to integrate into digitally controlled systems. CRT performance meets the picture drawing needs of both analog and digitally controlled instruments.

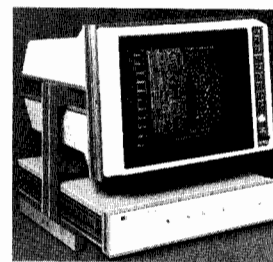

## Measurement Systems

The capability of the 1351S to update a portion of the picture without redrawing the entire display is extremely useful in measurement systems.

Radar and sonar system designers can benefit from the speed and versatility of HP graphics display systems. Most of these systems display continually changing pictures which the operator uses to make tactical decisions. He cannot afford to wait a significant length of time for pictures to be updated. Consequently, the high refresh rate of the 1351A and the high speed and resolution of HP's large screen displays make them good choices for such applications.

Analytical chemistry systems often need large screen, high resolution pictures to display various spectra. The 1351S and its 1020 x 1020 addressable resolution is an excellent match for analytical instrument specifications. Its memory versatility enables the system operator to store several spectra and quickly display various sequences of data for comparative analysis. All this can be done at ambient light levels because of the brightness of the 1351S Display System.

Some medical research and data acquisition systems require simultaneous display of several traces. It is possible to continuously update HP large screen displays through the 1351A Graphics Generator to simulate a multiple-trace cart recorder. Simulation systems usually operate in a real-time mode and require fast picture writing speeds. The 1351S is being used in several simulation systems because it can display changes in the picture at rates faster than operator response times. Other benefits for simulation systems are the capability to operate multiple displays and to use a variety of CRT sizes.

## Computer Graphics

Computer graphics is one of the most rapidly growing branches in the computer field. Graphics is an extremely effective medium for communication between man and computer; the eye is able to absorb information in graphical form much faster than it can interpret information in tabular form.

Large-screen displays are well-suited to computer graphics applications, particularly in the areas of Computer-Aided Design (CAD) and Computer-Aided Manufacturing (CAM). Many CAD/CAM systems make use of interactivity which allows the operator to draw and manipulate objects or elements by means of an input device like a tablet or light pen. The result of the action is seen in real-time on the display screen. To the user it appears that the picture is changing instantaneously in response to his commands.

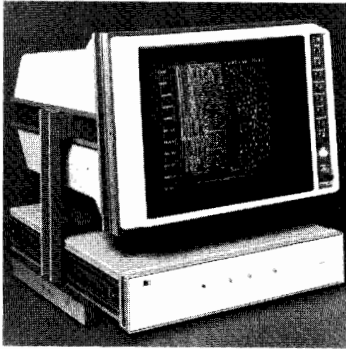

## Graphics Systems and Displays

Pages 222 and 223

Large screen displays and display systems with high speed and resolution for instrumentation, process control, simulation, design graphics, and general graphical display.

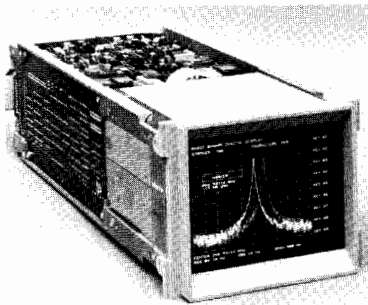

## Instrumentation Displays

Pages 224 to 226

Analog and digital display modules suitable for instrumentation applications, including microprocessor-based OEM instruments.

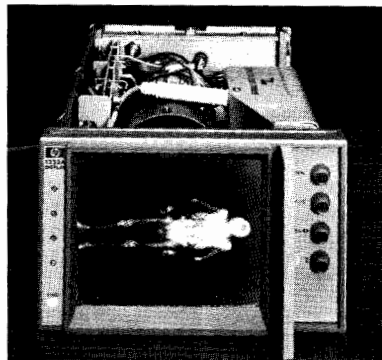

## Imaging

Page 227

Displays suited for continuous-tone imaging applications, such as medical ultrasound, radar, remote sensing of destructive environments.



## Computer Graphics Systems and Peripherals

Pages 627 to 631

Systems and peripherals oriented toward computer-generated graphics for OEM and end-user computer-aided design applications.



# CATHODE-RAY TUBE DISPLAYS

## Performance Specifications

1300 Series

CATHODE-RAY TUBE	1332A	1335A		1336S	1340A
		Conventional	Storage		
Viewing Area	≈9.6 x 11.9 cm (3.8 x 4.7 in.)	≈7.1 x 9 cm (2.8 x 3.6 in.)		≈8 x 10 cm (3.2 x 3.9 in.)	≈9.6 x 11.9 cm (3.8 x 4.7 in.)
Quality Area	≈8.4 x 10.8 cm (3.3 x 4.3 in.)	≈7.1 x 8.9 cm (2.8 x 3.5 in.)		≈6.4 x 8 cm (2.5 x 3.2 in.)	≈9.6 x 11.9 cm (3.8 x 4.7 in.)
Graticule	8 x 10 div 1 div = 1.2 cm	8 x 10 div 1 div = 0.89 cm		None	8 x 10 div 1 div = 1.2 cm
Spot Size (within quality area)	≤0.30 mm	≤0.25 mm	See "Resolution"	See "Resolution"	≤0.46 mm
Resolution	31.5 lines/cm (80 lines/in.)	39 lines/cm (99 lines/in.)	20 lines/cm (51 lines/in.)	140 lines/cm (356 lines/in.) (center screen); 80 lines/cm (203 lines/in.) (quality area)	≈22 lines/cm (55 lines/in.)
Light Output (at 0.25 cm/μs, 60 Hz refresh, unless otherwise noted)	170 cd/m <sup>2</sup> (50 fl)	68 cd/m <sup>2</sup> (20 fl)	680 cd/m <sup>2</sup> (200 fl)	2 μW/cm <sup>2</sup> steradian (4 x 4 cm raster)	Not Specified
Light Output Uniformity	Not Specified	Not Specified	Not Specified	≤16% overall ≤6%/cm	Not Specified
Light Output Stability	<10%/hr	<10%/hr	Not Specified	<5%/hr	Not Specified
Writing Speed (Storage)	N/A	N/A	≥50 cm/ms	N/A	N/A
Dot Writing Time (Storage)	N/A	N/A	≤1 μs	N/A	N/A
Storage Time	N/A	N/A	<1 minute (Write Mode)	N/A	N/A
<b>X &amp; Y AXES AMPLIFIERS</b>	<b>1332A</b>	<b>1335A</b>		<b>1336S</b>	<b>1340A</b>
Deflection Factor Range	80–200 mV/div	80–200 mV/div		100–200 mV/cm 0.5–2.0 V/cm	80–200 mV/div, 0.4–1.0 V/div
Settling Time	≤300 ns	≤300 ns		≤500 ns	≤300 ns
Linearity	≤3%	≤3%		≤3%	≤5%
Dynamic Range	Up to ½ screen diameter off screen in any direction.				
Drift	≤1 mm in 24 hours.				
<b>Z-AXIS AMPLIFIER</b>	<b>1332A</b>	<b>1335A</b>		<b>1336S</b>	<b>1340A</b>
Blanking Range (Internal Adjust.)	1 V–2.5 V p-p	1 V–2.5 V p-p		1 V–2.5 V p-p, 5 V–25 V p-p	1 V–2 V p-p
Rise Time	≤25 ns	≤25 ns		≤25 ns	≤25 ns
X, Y, Z INPUTS	Single-ended BNC	Single-ended BNC		Differential, Separate BNC's	Single-ended BNC
Input RC	≈1 MΩ, ≤60 pF (50 Ω Optional)	≈1 MΩ, ≤60 pF (50 Ω Optional)		≥10 kΩ, <70 pF (50 Ω selectable)	≥1 MΩ, <40 pF (50 Ω selectable)
Maximum Input	±50 V	±50 V		±50 V	±50 V
Line Power at 60 Hz, 120 VRMS	≈24 W	≈35 W		≈100 W	≈30 W
UL Medical & Dental Listing	Optional	Optional		Standard	Optional
UL Medical & Dental Component Recog.	Standard	Standard		N/A	Optional

**Note:** These are condensed specifications; refer to applicable data sheet for complete specifications, including options and accessories.

### Common Specifications

#### Operating Environment

**Temperature:** 0°C to +55°C (+32°F to +131°F), operating; –40°C to +70°C (–40°F to +158°F), non-operating.

**Humidity:** to 95% RH at +40°C (+104°F).

**Altitude:** to 4600 m (15 000 ft), operating; to 6300 m (20 669 ft), non-operating.

**Shock:** 30 g peak, ½ sine wave, 11 ms duration.

**Vibration:** 15 min. in each plane at 0.38 (0.015 in.) mm p-p excursion, 5–55 Hz, 1 min./octave, 10 min. at each resonant frequency

(except 1332A, 1335A: 15 min. in each plane, 0.25 mm (0.010 in.) p-p excursion, 10–55 Hz).

**Primary line voltage:** 100, 120, 220, or 240 Vac, +5%, –10% (1336S: +5%, –20%).

#### Ordering Information

**1332A** Small Screen Display

**1335A** Small Screen Display

**1336A** Display Module

**1336P** Power Supply Module

**1336S** Display System (includes 1336A, 1336P)

**1340A** Display Module (with control panel)

OEM and quantity discounts available.



CATHODE-RAY TUBE	1304A*	1310B	1311B	1317A	1321B
Viewing Area	≈20 x 25 cm (7.9 x 9.8 in.)	≈28 x 38 cm (11 x 15 in.)	≈21.6 x 27.9 cm (8.5 x 11 in.)	≈25.4 x 34.5 cm (10 x 13.5 in.)	≈43.2 x 30.5 cm (17 x 12 in.)
Quality Area	≈20 x 25 cm (7.9 x 9.8 in.)	≈28 x 38 cm (11 x 15 in.)	≈21.6 x 27.9 cm (8.5 x 11 in.)	≈25.4 x 34.3 cm (10 x 13.5 in.)	≈43.2 x 30.5 cm (17 x 12 in.)
Spot Size (center screen) (corners)	(0.02 in.)	≤0.51 mm (0.02 in.) ≤0.70 (0.0275 in.)	≤0.43 mm (0.017 in.) ≤0.51 (0.02 in.)	≤0.51 mm (0.02 in.) ≤0.76 (0.03 in.)	≤0.51 mm (0.02 in.) ≤0.70 mm (0.0275 in.)
Resolution (center screen) (corners)	≤20 lines/cm (50 lines/in.)	≤20 lines/cm (50 lines/in.) ≥14 lines/cm (36 lines/in.)	≤24 lines/cm (61 lines/in.) ≥20 lines/cm (51 lines/in.)	≤19.7 lines/cm (50 lines/in.) ≥13 lines/cm (33 lines/in.)	20 lines/cm (51 lines/in.) ≥14 lines/cm (36 lines/in.)
Light Output (at 0.25 cm/μs, 60 Hz refresh)	19.2 cd/m <sup>2</sup> (5.6 fl)	84 cd/m <sup>2</sup> (24.5 fl)	84 cd/m <sup>2</sup> (24.5 fl)	84 cd/m <sup>2</sup> (24.5 fl)	84 cd/m <sup>2</sup> (24.5 fl)

X & Y-AXES AMPLIFIERS	1304A	1310B	1311B	1317B	1321B
Deflection Factor Range (approx.)	80-120 mV/div, 1 div = 20 mm (0.8 in.)	(Vertical) 35.8-60.9 mV/cm, 90-153 mV/in. (Horizontal) 26.2-45.9 mV/cm, 67-117 mV/in.	(Vertical) 46.3-81 mV/cm, 118-207 mV/in. (Horizontal) 35.8-60.9 mV/cm, 90-153 mV/in.	(Vertical) 39-69 mV/cm, 100-175 mV/in. (Horizontal) 33-58 mV/cm, 83-147 mV/in	(Vertical) 33-58 mV/cm, 83-147 mV/in. (Horizontal) 28.1-49.2 mV/cm, 71-125 mV/in
Settling Time	≤300 ns	≤500 ns	≤500 ns	≤500 ns	≤500 ns
Repeatability error	<0.15%	<0.15%	<0.15%	<0.15%	<0.15%
Linearity	≤3%	≤1%	≤1%	≤1%	≤1%
Dynamic Range	Up to ½ screen diameter offscreen in any direction				
Drift	≤2.5 mm in 24 hours	8.9 mm in 24 hrs	6.3 mm in 24 hrs	8.9 mm in 24 hrs	10.2 mm in 24 hrs

Z-AXIS AMPLIFIER	1304A	1310B	1311B	1317B	1321B
Blanking Range	Internally adjustable from 1 V to 2.5 V p-p.				
Rise Time	≤25 ns	≤25 ns	≤25 ns	≤25 ns	≤25 ns
X, Y, Z INPUTS	Differential, separate BNC's	Single-ended BNC	Single-ended BNC	Single-ended BNC	Single-ended BNC
Input RC	≥100 kΩ, ≤65 pF (50 Ω selectable)	(X, Y inputs) 50Ω or ≈10 kΩ/ ≈40 pF (Z input) 50Ω or ≈10 kΩ/ ≈60 pF	(X, Y inputs) 50Ω or ≈10 kΩ/ ≈40 pF (Z input) 50Ω or ≈10 kΩ/ ≈60 pF	(X, Y inputs) 50Ω or ≈10 kΩ/ ≈40 pF (Z input) 50Ω or ≈10 kΩ/ ≈60 pF	(X, Y inputs) 50Ω or ≈10 kΩ/ ≈40 pF (Z input) 50Ω or ≈10 kΩ/ ≈60 pF
Maximum Input	(High Z) ±50 V (50 Ω) ±2.5 V	(High Z) ±50 V (50 Ω) ±5 V	(High Z) ±50 V (50 Ω) ±5 V	(High Z) ±50 V (50 Ω) ±5 V	(High Z) ±50 V (50 Ω) ±5 V
TTL Blanking Input (rear panel BNC)	Optional	Standard	Standard	Standard	Standard
Primary Line Voltage	100, 120, 220 or 240 Vac +5%, -20%	100, 120, 220 or 240 Vac +5%, -20%	100, 120, 220 or 240 Vac +5%, -20%	100, 120, 220 or 240 Vac +5%, -10%	100, 120, 220 or 240 Vac +5%, -10%
Maximum Power	≈85 W	≈185 W	≈185 W	≈165 W	≈185 W
UL Medical and Dental Listing	Optional	Optional	Optional	Optional	Optional

Note: These are condensed specifications; refer to applicable data sheet for complete specifications, including options and accessories.

## Common Specifications

### Operating environment

**Temperature:** 0°C to 55°C (+32°F to +131°F), operating; -40°C to +70°C (-40°F to +158°F), non-operating.

**Humidity:** to 95% RH at +40°C (+104°F).

**Altitude:** to 4600 m (15 000 ft), operating; to 7600 m (25 000 ft), non-operating (15 300 m, 50 197 ft for 1304A).

**Vibration:** 15 min. in each plane, 0.25 mm (0.010 in.) p-p excursions (0.38 mm, 0.015 in. for 1304A, 1338A), 5 to 55 Hz; 1 min./octave, 10 min. at each resonant frequency.

### Ordering Information

\*1304A 32 cm (14 in.) Display

1310B 48 cm (19 in.) Display

1311B 36 cm (14 in.) Display

1317B 43 cm (17 in.) Display

1321B 53 cm (21 in.) Display

\*Not recommended for high speed, high resolution computer graphics applications.





# CATHODE-RAY TUBE DISPLAYS

## Digital Display Specifications

Models 1345A, 1351A

GENERAL	1345A	1351A
<b>Input Power</b>	+15 Vdc $\pm$ 5% Regulated; $\leq$ 1.05A, $\leq$ 10 mV p-p ripple. -15 Vdc $\pm$ 5% Regulated; $\leq$ 0.3A, $\leq$ 10 mV p-p ripple. +5 Vdc $\pm$ 5% Regulated; $\leq$ 0.75A, $\leq$ 50 mV p-p ripple.	Selectable 100, 120, 220, or 240 Vac, +5%, -10%, 48 Hz -440 Hz, max power 120 VA (X95W). Average power dissipation at 60 Hz, 120 V $\approx$ 90 W w/o options.
<b>PROGRAMMING INPUT</b>	<b>1345A</b>	<b>1351A</b>
<b>Interface(s)</b>	16-bit TTL	HP-IB 16-bit binary (option 002) RS-232C (option 001) Rear Panel, conforms to IEEE 488-1978 (HP-IB only).
<b>CHARACTER GENERATOR</b>	<b>1345A</b>	<b>1351A</b>
<b>Character Set</b> <b>Character Sizes</b> <b>Character Orientation</b>	Full ASCII 4 Programmable 4 Programmable	Modified full ASCII 4 Programmable 2 Programmable
<b>VECTOR GENERATOR</b>	<b>1345A</b>	<b>1351A</b>
<b>Resolution</b> <b>Intensities</b> <b>Line Types</b> <b>Writing Speeds</b>	0-2048 X, 0-2048 Y 3 Programmable 4 Programmable 4 Programmable	0-1020 X, 0-1020 Y 3 Programmable 3 Programmable
<b>ANALOG OUTPUTS</b>	<b>1345A</b>	<b>1351A</b>
<b>Levels</b>	X, Y, Z; 0-1 Vdc, into 600 $\Omega$ , 0-5 MHz bandwidth	X, Y, Z; 0.2 V-1.2 V into 50 $\Omega$ (X and Y). -1 V to 1 V into 50 $\Omega$ (Z). Logic Control (Intensity) TTL into 50 $\Omega$ . Rear Panel BNCs for X, Y, Z axes. Auxiliary intensity control connector.
<b>CONNECTORS</b>		
<b>DATA ACCEPTANCE</b>	<b>1345A</b>	<b>1351A</b>
	$\approx$ 10 k-667 k words/sec (dependent on 1345A, user processor)	$\approx$ 6.25 words/sec (RS-232C @ 50 baud)-500 k words/sec (16 bit I/O).
<b>CATHODE RAY TUBE</b>	<b>1345A</b>	<b>1351A</b>
<b>Type</b> <b>Phosphor</b> <b>Screen Size</b> <b>Viewing area</b>  <b>Brightness</b>	Electrostatic P31 16 cm diag. 119° cm; 9.6 cm vert. x 12.5 cm horiz. 3170C d/m @ 2.54 mm/s writing rate, full brightness, 60 Hz refresh rate.	N/A

**Note:** These are condensed specifications; refer to applicable data sheet for complete specifications, including options and accessories.

### COMMON SPECIFICATIONS

#### Operating environment

**Temperature:** 0°C to +55°C (65°C for 1345A) operating; -40°C to +70°C non operating.

**Humidity:** to 95% relative humidity at +40°C (50°C for 1345).

**Altitude:** to 4600 m operating; 7600 m (15 300 m for 1345A) non-operating.

#### Ordering information

1345A Digital Display

1351A Graphics Generator

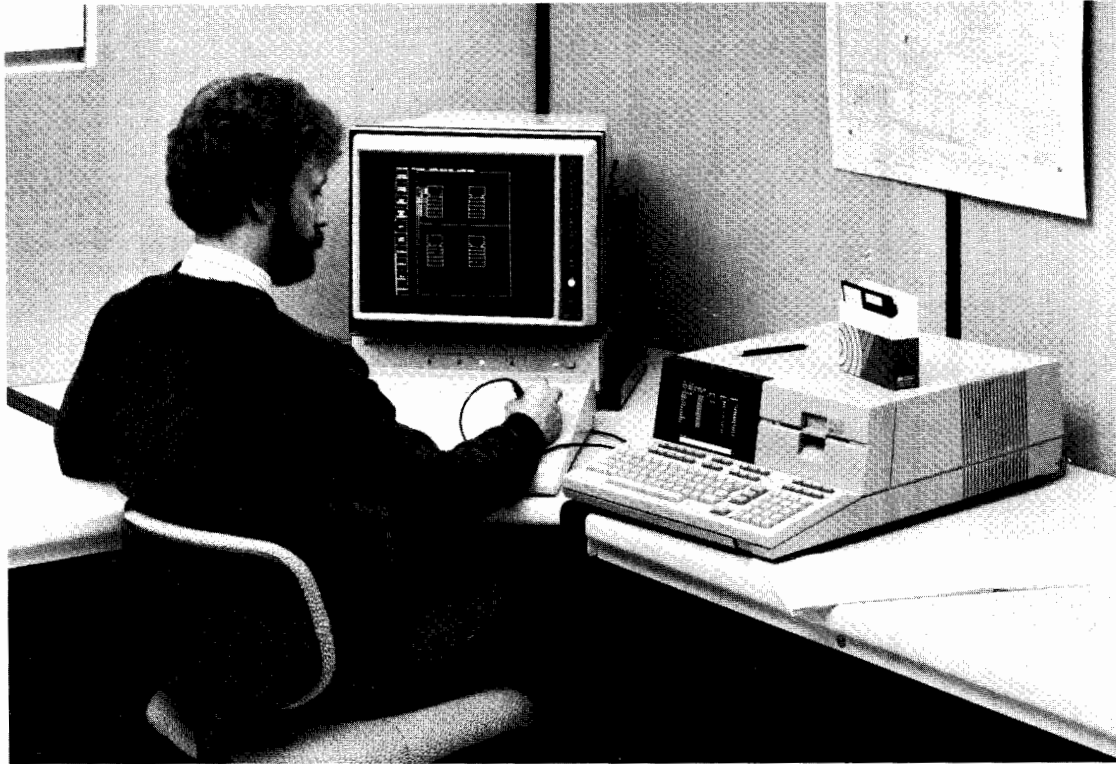

## Introduction to Softcopy Graphics

The need to display and update graphical data in real-time is of primary importance in a number of computer-driven applications. It is also necessary in many applications to display the data quickly, and with high resolution. To meet these needs, Hewlett-Packard offers a number of CRT displays and display systems for engineering and scientific disciplines. Depending on the particular HP display or display system chosen, available features are programmable intensity levels, programmable line types, large screens, character generation, and choice of interface.

### What is Softcopy Graphics?

Softcopy Graphics uses some volatile device to display the graphical information, in most cases a CRT display. Unless the picture is stored by some means, it is lost when the system is turned off. Because information is not stored by the device, softcopy graphical displays are particularly suited to interactive computer graphics systems.

### Softcopy or Hardcopy?

Both hard and softcopy graphics have appropriate applications. While plotters and other hardcopy devices provide a permanent record of the picture, they cannot react in real-time. Since it takes a hardcopy device some length of time to plot, making changes to a picture, while using a plotter as a peripheral in an interactive graphics system, would be a time-consuming task. On the other hand, a CRT display can show changes to the picture in real-time, allowing the operator to alter the graphical data and see the results immediately. Because the display is not a permanent storage device, changes can be made while errors are erased from the screen. When all changes are complete, the finished picture can be "dumped" to a hardcopy peripheral for retainment.

Softcopy graphics is also essential in areas where decisions are made on the basis of rapid input of information. Radar display is an example. In such an application, high display resolution as well as

high speed data-updating capability are needed to show and update complex pictures quickly.

Electronic instrumentation makes use of softcopy graphics in a number of areas such as oscilloscopes, spectrum analyzers, waveform analyzers, and logic analyzers. Because of the ability of graphics to portray large amounts of data in a form that is easily and quickly assimilated, such instruments use CRT displays.

### Choice of Interface

Several HP displays and display systems give the user a choice of three interfaces: HP-IB, RS-232C, and 16-bit parallel. The HP 1351A Graphics Generator can take digital information from one of the three interfaces mentioned above and change it to X, Y, and Z analog voltages necessary to drive HP large screen displays. In addition, the 1345A Digital Display Module can accept commands via 16-bit parallel and is suited for OEM instrumentation graphics.

### Applications

- Schematic generation
- Engineering design and evaluation (mechanical, electrical, chemical, etc.)
- Radar/Sonar control/Monitoring
- Real-time instrumentation systems (data acquisition/analysis, production testing)
- Architectural design
- Interactive computer graphics systems

### Advantages

- High resolution
- High drawing and update speed
- Bright, crisp vectors and characters
- Choice of screen sizes
- Digital and analog display interface available

# CATHODE-RAY TUBE DISPLAYS

## Instrumentation Graphics Systems

### Model 1351S

- Computer/Calculator Compatible Digital Interface
- Fast Display Updating
- High Resolution Graphics

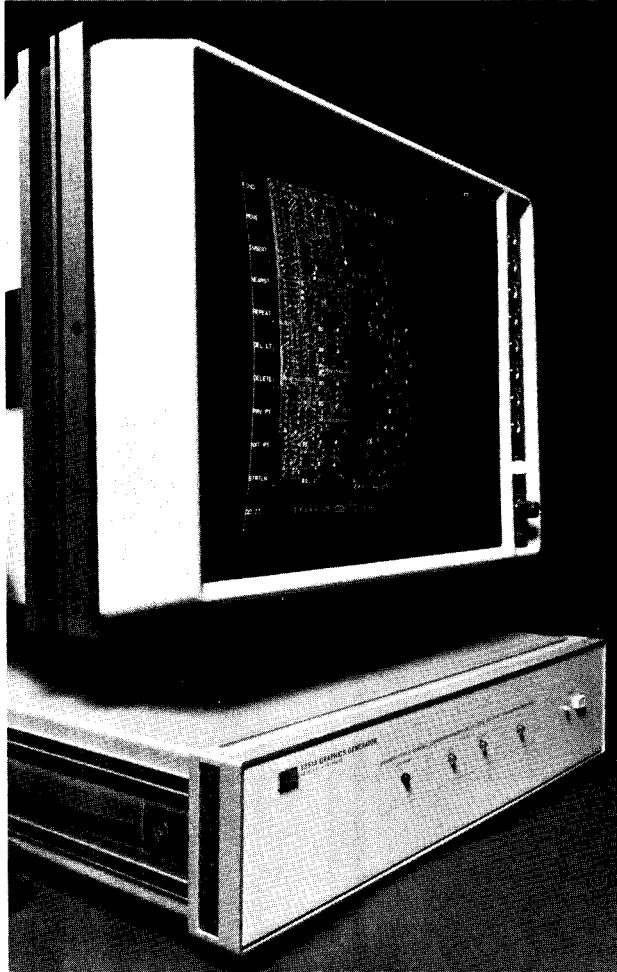

The 1351S Display System includes a 1351A Graphics Generator, a 1311B X-Y Display, a tilt stand which holds the display & provides space below for the generator, an interconnect cable, and a binder for instruction manuals.

The 1351S Graphics System provides a high resolution, real-time method of generating bright line vectors and/or alphanumeric characters. This cost-effective system includes a high quality, large-screen electrostatic CRT display (with programmable binary Z-axis control) and the 1351A Graphics Generator. The system gives bright graphics in minicomputer or desk-top computer systems with a resolution of 1020 x 1020 addressable points on the CRT screen. In addition, it provides the fast information throughput, rapid picture manipulation, and complex vector drawing capability needed in interactive computer graphics for computer-aided design/ computer-aided manufacturing (CAD/CAM) systems, and radar/simulation.

Digital information is received by the Graphics Generator from the standard HP-IB interface or an optional RS-232-C or 16-bit parallel interface bus and stored in internal refresh memory. Analog outputs in the form of vectors and characters are then generated and sent to the display where uniformly bright, sharp lines and alphanumerics are produced at high writing speeds. The display is continuously refreshed by the 1351A, freeing the host computer or controller to collect or process other data.

The 1351A has 64 memory files which are selectable in size, separately addressable and erasable, and can be directed to flash selected information on and off. Variable vector drawing speeds provide three intensity levels for highlighting of selected information. This allows the programmer to highlight on-screen menus, cursors and grids, as well as enhance 3-D drawings, add perspective, or otherwise improve visual clarity and meaning. The 1351A can also produce seven intensity levels for data differentiation via a Binary Z Control on the large screen display. The Binary Z Control feature is standard on HP directed-beam large screen displays.

Each digital word in the 1351A can be a vector coordinate or an upper or lower case ASCII character. A character ROM generates each ASCII character while using only one word of RAM in the 1351A memory, making more RAM available for other display information. Each character can be programmed to be displayed in four different sizes with two orientations (horizontal and 90 degree rotation).

#### RS-232-C or 16-Bit Parallel Optional Interface

The 1351A has a flexible interface structure to allow one of three specific interfaces to be used. Changing from one interface type to another is accomplished by changing the plug-in interface card. An HP-IB interface is standard with optional RS-232-C and 16-bit parallel interfaces available.

Advantages of the 1351A RS-232-C interface are:

Software compatible with most teletypewriter system handlers.

Increased transmission distances.

Special high-speed transmission rate of 57K baud.

Advantages of the 1351A 16-bit parallel interface are:

High speed data transfer rate of 500K 16-bit words/sec.

Vector transfer rate of up to 250K vectors/sec.

#### Applications

The 1351S is ideally suited for minicomputer and calculator applications which require high speed and/or high resolution displays. Typical applications include:

- Radar and Sonar
- Fire Control
- Integrated Circuit Layout
- Production Testing and Calibration
- Process Control
- Flight Instrument Simulation
- Structural Design
- Computer-Aided Design
- Interactive Graphics
- Analytical Chemistry Scans
- Spectrum Analysis

#### Options and Accessories

- 001: RS-232-C interface in lieu of standard HP-IB
- 002: 16-bit parallel interface in lieu of standard HP-IB
- 010: Short tilt stand for 1311B
- 024: 10-metre cable in lieu of 1-metre cable
- 184: 10184B Binary Cassette tape for 9825A/B
- 510: 1310B, 19 in. X-Y display in lieu of 1311B
- 517: 1317B, 17 in. X-Y display in lieu of 1311B
- 521: 1321B, 21 in. X-Y display in lieu of 1311B
- 604: P-4 phosphor display, no graticule
- 639: P-39 phosphor display, no graticule
- 908: Rackmount hardware for 1351A and 1311B
- 909: Rackmount hardware for 1351A and 1310B
- 910: Extra set of manuals

#### Ordering Information\*

- 1351S Display System (includes 1311B display)
- 1351A Graphics Generator (supplied with 1351S)

\*An HP-IB cable is not supplied and must be ordered separately.

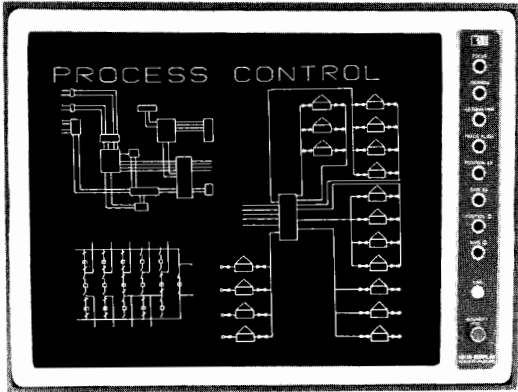

Complex processes such as valve closures and temperature or pressure changes can be shown in real time as in this computer generated 1311B display.

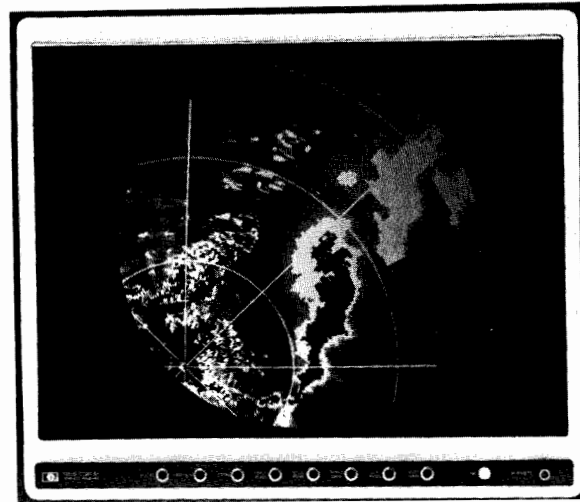

The low power consumption and high reliability of the 1310B are important benefits for remote locations such as shown in this weather radar application.

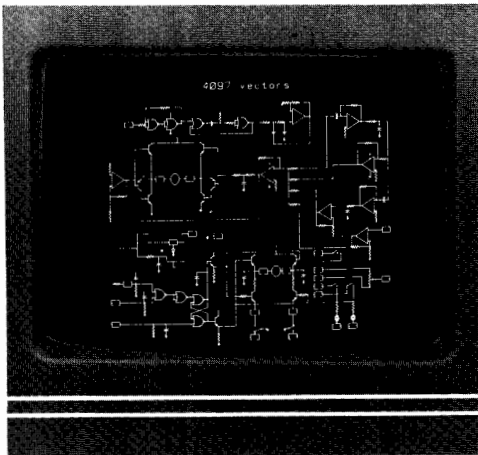

Ideal for standard rack mounting, the 1317B easily displays complex schematics.

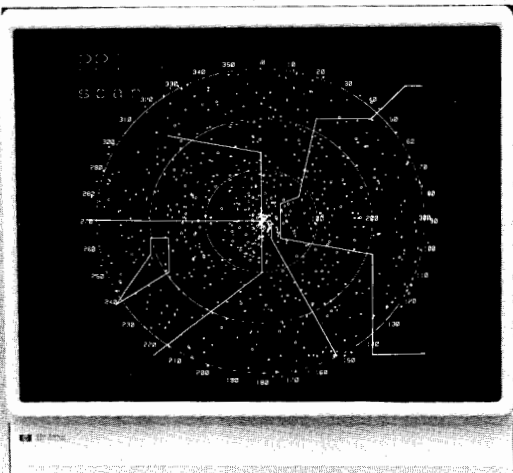

The 1321B can provide densely populated displays such as this PPI scan for simulation, training, or analysis of data. Small image resolution is maintained over the entire screen area.

### Description

Hewlett-Packard's Models 1310B, 1311B, 1317B, and 1321B Large Screen Displays offer the high writing speed, fast settling time, brightness and contrast needed for the display of high density graphics information. These displays are ideal computer peripherals with the high picture quality and dynamic performance required for complex computer generated graphics. Any on-screen movement can be made in less than 500 ns, including settling time. This high speed performance is particularly useful in radar and simulation, where many symbols must be moved about almost simultaneously. It is also useful in computer-aided design (CAD) applications which require complex, high density drawing capability.

These high resolution displays remain exceptionally well focused in all parts of the screen which solves such difficult display problems as writing many characters around the picture edges, while showing great detail in curves, graphs, or diagrams. Excellent image quality is further assured with features such as a contrast control circuit which provides constant contrast with variations in intensity, and a flat, optical quality glass contrast filter which eliminates trace diffusion and minimizes glare.

The 1310B, 1311B, 1317B, and 1321B are electrically almost identical, but offer a wide range of sizes and configurations to fit almost any high-speed, large screen OEM display requirements. The 1321B has the highest overall resolution (screen area divided by spot size) of any HP CRT display, making it the choice for applications where maximum information density is the main consideration. The 1317B is ideal for standard 48.3 cm (19 in.) rack-mount applications requiring the largest possible screen area in the minimum vertical rack space. For table-top applications such as remote monitors, Models 1310B and 1311B offer an attractively styled enclosure with a tilt stand. Both displays may be ordered without the tilt stand (Opt 001) for mounting in standard 48.3 cm (19 in.) racks or custom designed enclosures.

### Ordering Information

For information on options and accessories, refer to the applicable Large Screen CRT data sheet.

**1310B** 48 cm (19 in.) Display

**1311B** 36 cm (14 in.) Display

**1317B** 43 cm (17 in.) Display

**1321B** 53 cm (21 in.) Display

OEM discounts available

# CATHODE-RAY TUBE DISPLAYS

## Instrumentation Display Modules

### Model 1345A

- 16-bit TTL I/O
- 11-bit Addressable Resolution (2048 by 2048)
- Random Vector Plotting
- Internal Character Generation
- Programmable Intensity, Speed and Line Type
- Modular Construction

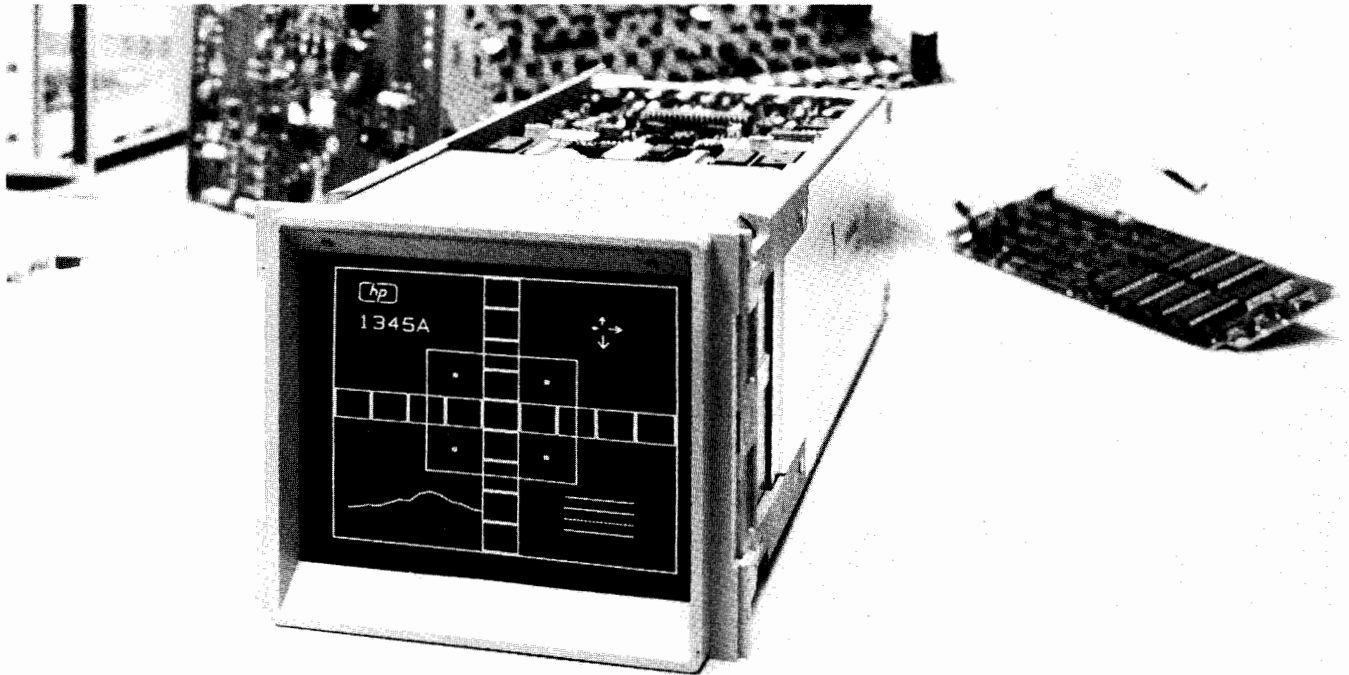

#### Description

Hewlett-Packard's Model 1345A is a high performance digital display for microprocessor-based instrumentation and system applications. This display module features a 16-bit digital interface for compatibility with today's digital instrumentation architectures. An electrostatic deflection CRT supplies fast writing rates with high resolution, and at low power. The 1345A's small package takes a minimum of space which makes it easier to design into an instrument or system.

The 1345A produces exceptional quality vector graphics in response to digital commands from a user processor. The 2048 x 2048 point addressability on the CRT provides high resolution graphics and allows for excellent positional discrimination of its crisp, well focused electron beam. Picture quality is further enhanced by programmable intensity, speed, line type, programmable graph mode, and internal character generation.

#### The Digital Display

Instruments and instrumentation systems are incorporating more and more digital control circuits and as a result require displays with a direct digital interface. Model 1345A solves this problem by combining a high performance display with a digital interface. This digital interface accepts digital information directly from a data bus and directly displays it as high quality graphics information. The binary interface in the 1345A assures flexibility and compatibility by allowing the use of 8-bit or 16-bit microprocessors.

#### Interfacing

The 1345A represents a new concept in instrumentation displays with its 16-bit TTL I/O. The advantage of this interfacing method is that interfacing to a microprocessor-based system is faster and easier. With the many peripheral interface adapters (PIAs) that are available, interfacing a processor to the 1345A can be accomplished in a fraction of the time required for interfacing displays having analog inputs. The 16-bit I/O allows operation with 8-bit or 16-bit micro-

processors which assures that the 1345A will be compatible with present and future instrument systems. Ease of interfacing and the resulting savings in design time makes the 1345A ideally suited for incorporation in today's digital instrumentation systems.

#### Operation

Model 1345A is a high performance display that generates and displays information derived from digital information received through its I/O port. It provides the fast information throughput, rapid picture manipulation, and complex vector drawing capability needed in instrumentation systems.

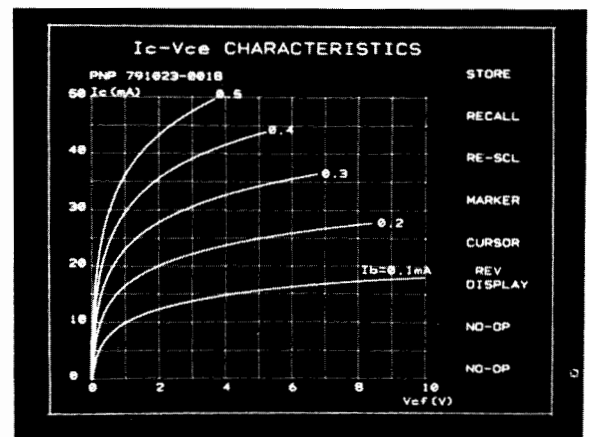

In standard configuration, the 1345A displays a picture which is defined by commands and data transmitted over the digital I/O. Vectors are drawn automatically by defining end points, at any one of the four programmable writing speeds. Vector end points can be defined anywhere on the CRT screen with 2048 by 2048 point resolution. This high resolution allows very smooth curves and precise detail to



be presented on the 1345A CRT. Furthermore, there are three programmable intensities, plus blanking, which are useful for maintaining a consistent picture intensity with different length vectors or can be used to highlight important information. The programmable intensity levels and writing speeds can also be combined to provide up to 12 different intensities.

A programmable delta X increment simplifies the generation of complex graphs and saves system memory space. In this mode, the X increment is stored once with only the Y values being updated and stored in memory.

Display refresh is provided by the system which gives flexibility with variations in the amount of memory used for different pictures. This method of refresh provides the ability to define the refresh cycle and eliminates flicker when there might be a conflict between a standard (or predetermined) refresh cycle and the time required to draw a picture.

A modified ASCII character set is stored in an internal ROM and the display can be programmed to supply characters in four sizes and four degrees of rotation. Since the vector data for the characters is contained in ROM, only one word of RAM is needed for each character, which makes more words of RAM available for other uses. Characters can be written in about 15  $\mu$ s which allows up to 1000 characters to be written without flicker.

An optional 4k by 16-bit vector memory can be installed that serves as an auxiliary read/write memory for the system processor. This vector memory automatically refreshes the display and frees the system processor for other functions. An addressable pointer in the memory allows portions of a picture to be quickly updated without the need for changing the entire memory. Additionally, an internal jump capability allows the system processor to suppress portions of a picture, such as graticules or labels, by directing the vector memory to skip past them. When desired, suppressed data can be added to a picture with only one or two commands from the system processor.

### Applications

In spectrum analyzers, the 1345A's high data acceptance and vector drawing rates allow complex traces to be generated as rapidly as new data is acquired. Multiple programmable intensity levels aid in visualization by discriminating between complex overlapping traces. The high resolution of 2048 by 2048 points along with a crisp trace allows fine details to be displayed so that the measurement capabilities of high technology systems are not compromised.

In medicine, monitoring of physiological parameters requires faithful preservation of input signals for accurate diagnosis; this is assured with the display's high resolution. The speed of the 1345A allows the entire picture, even with several waveforms displayed, to be updated in real-time as rapidly as new data is acquired. The low power

requirement, light weight, and rugged construction also makes the 1345A ideal for use in portable or mobile equipment.

In airborne applications, there are extreme demands on electronic equipment in terms of volume, mass, power, and rugged construction. The 1345A meets these challenges without any compromise in speed of information updating or picture quality and brightness.

### Mechanical Construction

The 1345A module is a unitized structure, which is independently rugged without a cabinet. The display integrates easily into almost any instrument or system console design. If you wish to simplify the cabinet design for your system, there are several OEM cabinets for the 1345A. These are attractively styled and accommodate circuitry for a variety of instrument applications.

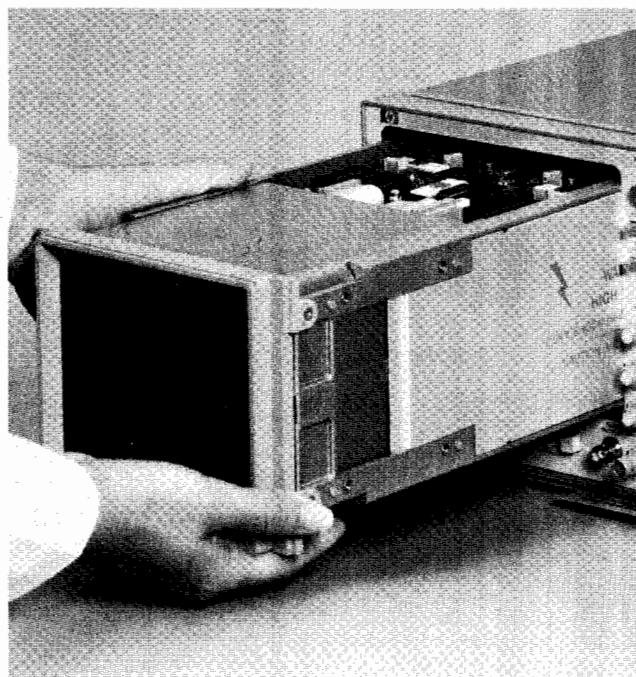

### Ordering Information

(OEM and quantity discounts available; contact your local Hewlett-Packard office for additional information.)

Model 1345A Digital Display Module

### Options

- 001:** Remote focus and intensity controls with cables
- 323:** Output Cable Kit.  
61 cm (24") X, Y and Z coaxial cable with mating connectors for 1345A on one end.
- 325:** Input Cable Kit.  
76 cm (30") Data Cable; 91 cm (36") Power Cable; Mating connectors for 1345A on one end, stripped other end.
- 400:** Metric Hardware.
- 500:** Deletes Service Manual.
- 564:** Blue Contrast Filter replaces Neutral Density Filter.
- 704:** 4k Word/Vector Memory.
- 910:** Extra Manual.

### Accessories

197B Option 006 Camera.

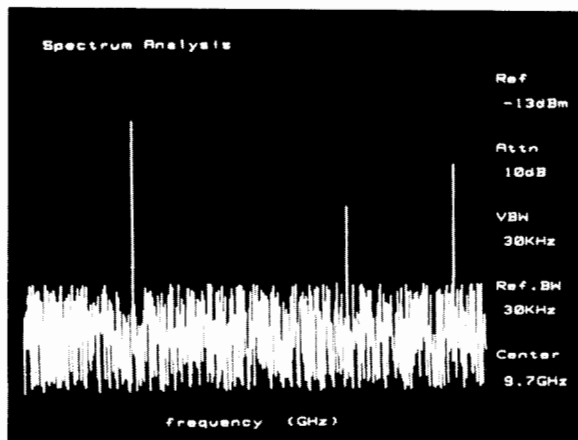

# CATHODE-RAY TUBE DISPLAYS

Instrumentation Analog Displays

Models 1304A & 1340A

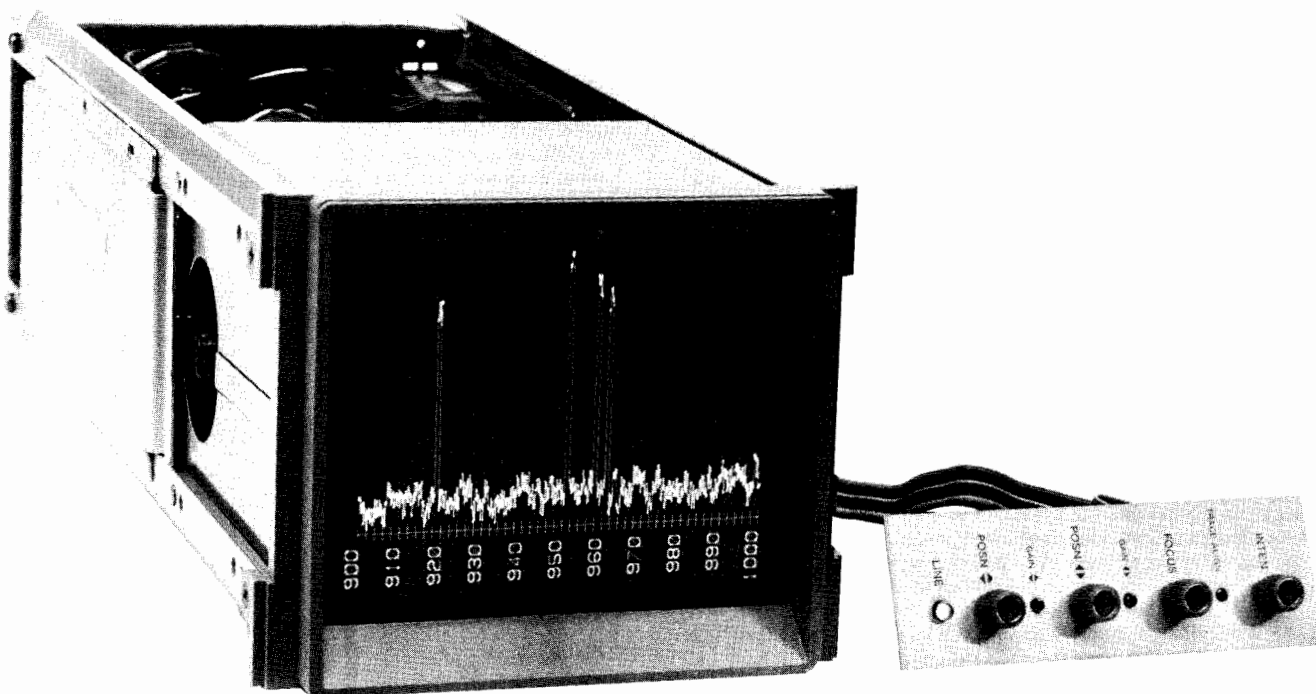

1304A Option 631

## 1304A Description

The 1304A is a moderately-priced, large screen display that has high writing speed and fast settling time. Both X and Y amplifiers have full differential input with internal switches to enable the user to select one, five, or ten volt full scale input at either 50  $\Omega$  or 100  $\Omega$  impedance. This makes the 1304A well suited for general purpose use or as a component in production test systems.

The 1304A can be used as an auxiliary display in measurement systems and analytical instruments while providing an excellent price/performance ratio. If optimum picture resolution is required, the Model 1311B, with the same 14-inch CRT size as the 1304A, is recommended.

## 1340A Description

Model 1340A modular 15.3 cm display offers flexibility and cost-effectiveness for OEM system designers with a basic display module that is rugged and easy to integrate into an instrument or system console. A variety of cabinet configurations offer benefits to engineers and scientists who either want to add a display to an instrument or who are designing an instrument around the display.

Integrated circuits contain most of the X, Y, and Z amplifier components, improving reliability as well as reducing cost, X and Y attenuators, input impedance, polarity, and bandwidth limiting are internally switch selectable. This provides flexibility to designers and for inventory control when using the 1340A in more than one instrument or system.

A dc supply option deletes the power transformer, rectifiers, and power cable, allowing power to be supplied from your own instrument or system. Two voltages are required: regulated +20 Vdc and regulated -15 Vdc.

## Mechanical Construction

The 1340A module is a unitized structure, which is independently

rugged without a cabinet. The display integrates easily into almost any instrument or system console design. If you wish to simplify the cabinet design of your system, there are several OEM cabinets for the 1340A. In addition, an option is available to make the 1340A a free-standing display for use with instruments that do not have a built-in display.

## Serviceability

Ease of service is designed into the 1340A. The mechanical construction gives easy accessibility, while the electrical design uses IC's to reduce the number of components that can fail.

## Applications

**1304A:** The high writing speed of the 1304A allows it to be used where electromagnetic CRT displays are too slow, as in multiple-bed patient monitoring systems with four to eight heart rates shown on the CRT.

**1340A:** The price/performance ratio of the 1340A makes it ideal for almost every instrumentation system. Resolution, viewing area, and brightness are suitable for spectrum, network, and logic analyzers, as well as a number of non-destructive test systems or instruments. The dc power option simplifies integration into a system and reduces weight, a benefit with portable equipment or other systems that require minimum size and weight.

The 1340A may also be used as a basic display for communication system analyzers, chemical and scientific analysis systems, and some medical diagnostic systems. It provides an economical operator interface in special production test systems.

## Ordering Information

For a complete list of options refer to the 1304A and 1340A data sheets.

**1304A** Large Screen Display

**1340A** Analog Display Module (with control panel)

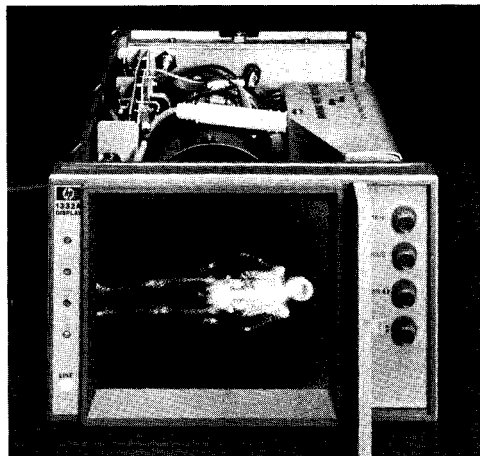

1332A

Models 1332A, 1335A, and 1336S are high-quality cathode-ray tube displays designed to satisfy a wide range of OEM medical and electronic instrument display needs. They provide optimum performance when used as continuous tone imaging displays. Continuous tone images are so called because the image space in the X-Y plane is filled with a continuum of brightness levels ranging from black to maximum brightness, where the brightness represents some physical parameter such as radar return amplitude, ultrasonic reflectivity of body tissues, etc., having a varying spatial distribution of magnitude. Spot size is relatively independent of intensity settings or Z-axis input signals, eliminating the need to refocus at each intensity setting.

#### Bright for Easy Viewing

**Model 1332A:** has a large 9.6 x 11.9 cm display area with the resolution and picture quality required for medical diagnosis systems plus a bright display for differentiating between many gray shades, or for viewing in brightly lighted areas. Option 530 provides even greater brightness with up to 500 cd/m<sup>2</sup> line brightness at slightly lower resolution.

#### Variable Persistence, Storage

**Model 1335A:** is a high resolution 8 x 10 cm storage display which offers medical and instrumentation OEM users a variable persistence storage CRT display with outstanding performance and picture quality.

Persistence is continuously adjustable with a front panel control from approximately 0.20s to > 1 minute. This mode allows you to increase the persistence to match the refresh rate.

The storage CRT is preset to store dots having a Z-axis width of 1  $\mu$ s or greater for up to 30 minutes. Stored resolution is over 20 lines per cm (50 lines per in.) and stored traces are retained for up to 1 minute in WRITE mode, 30 minutes in STORE mode.

ERASE, STORE, WRITE, CONVENTIONAL, and VARIABLE PERSISTENCE modes can be selected with the manual front panel controls, or by remote program inputs.

#### Resolution up to 140 lines/cm

**Model 1336S:** consists of an 8 x 10 cm display module (1336A) and a separate power supply module (1336P) for mounting flexibility. The display offers a choice of 140 lines/cm or 90 lines/cm (Option 005) resolution for high-resolution imaging requirements such as multi-imaging for nuclear or ultrasound medical diagnostic systems.

#### Safety

Models 1332A, 1335A (Opt 330), and 1336S are listed with Underwriters Laboratories in accordance with the UL 544 Medical Safety Standard which defines detailed patient protection requirements. Regular inspection of our production facility by UL assures

you that this patient protection is built into the display that you purchase.

#### Electronics

##### Models 1332A, and 1335A

The X and Y amplifiers have 70 ns rise time (bandwidth is 5 MHz) and the Z-axis blanking amplifier has a 25 ns rise time. When faster X and Y amplifier response is required, Model 1332A has an Option available to obtain 25 ns rise times. All amplifiers are fully differential and operate at low power levels for stable, drift-free performance over wide ranges of operating temperatures.

The time required to make any size movement on the CRT, including the response time for the amplifiers to settle within one spot diameter of final position, is less than 300 ns (1336A: 500 ns). All amplifiers are fully differential and operate at low power levels for stable operation and minimum warm-up time. A regulated dc CRT filament supply assures a stable light output.

An optional TTL blanking input unconditionally overrides any analog Z-axis input and the intensity control, and can be used to provide CRT protection in the event of CRT failure.

#### Cabinet Sizes

Models 1332A, and 1335A are 13.3 cm (5¼ in.) high, half rack width, 49.5 cm (19½ in.) long packages that can be combined with identical empty modules to form an attractive full width horizontal or vertically stacked OEM instrument. The 1336A Display Module has the same dimensions and the 1336P Power Supply Module has the same height and width but is 33.5 cm (13¼ in.) deep. If the 1336A/P are to be mounted together, 1336P Option 018 may be ordered to provide the same cabinet depth as the 1336A, with locking hardware to form a standard EIA rack width unit.

#### Options and Accessories

A wide range of options is available for tailoring the display to specific requirements; refer to data sheets for complete listing. Accessories available include rack mounting kits, OEM half module frames and rack slides. For convenient system interconnection, Model 10488A 3.6 m (12 ft) Display Cable is available as an accessory. Model 197B Option 006 camera is adapted for direct recording of 1332A, 1335A, and 1336S displays. Refer to individual display data sheets for complete description of accessories.

#### Ordering Information

**1332A** Small Screen Display

**1335A** Small Screen Display

**1336A** Display Module

**1336P** Power Supply Module

**1336S** Display System (includes 1336A, 1336P)

**1336A or 1336S Opt 005**

**10183** Light Shield for 1332A, 1335A, 1340A, 1338A

OEM and quantity discounts available.



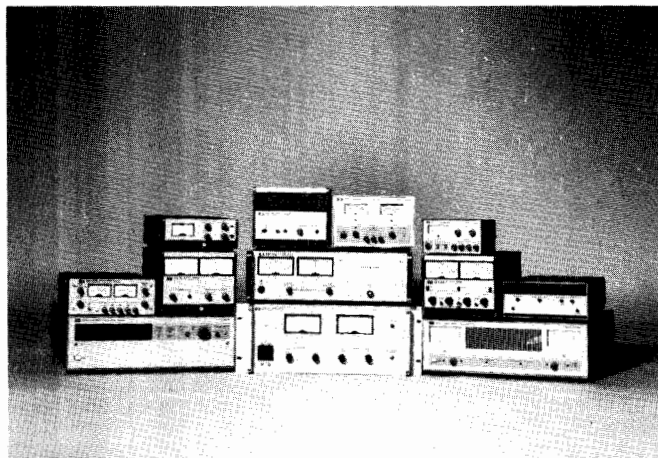

### Introduction

Hewlett-Packard's extensive variety of power supplies serve a wide range of applications. For circuit and device development, there are laboratory supplies. For industrial needs, these are high power units. The HP-IB power sources manufactured by Hewlett-Packard are used in automated systems, and OEM Modular Power Supplies are designed for incorporation into other products. Through technological innovations, Hewlett-Packard strives to offer advanced capabilities, high reliability, and good value in both system and bench power supply families.

### Regulation Techniques

The regulation technique used in a power supply defines its performance specifications, size, and efficiency. HP power supplies are designed using one of four proven regulation techniques: Series, SCR, SCR preregulator/series regulator, and switching.

**Series Regulation:** this technique exhibits good regulation, low ripple and noise, and fast transient response. However, it is relatively inefficient. This results in greater power usage, large size, and more generated heat than the other methods. For this reason, series regulation is most useful for lower power units. These power supplies are used in laboratory and test applications, where stable, precise, dc power is needed.

**SCR Regulation:** This technique is more efficient than series regulation, so the power supplies have lower power usage, smaller heat sinks, and less generated heat. However, the regulation, (PARD ripple and noise), and transient response specifications are better with series regulation than with SCR regulation. Power supplies with SCR regulation are especially useful for high power industrial applications, where fine regulation is not necessary, and the lower cost/watt is important.

**SCR Preregulation/Series Regulator:** this technique combines the best qualities of series and SCR regulation. As can be seen in the table, the operating specifications are much better than with SCR regulation. SCR preregulation does not detract from the excellent characteristic of series regulation, except for slower transient response. The efficiency is higher than that with series regulation, but not quite as high as with SCR regulation alone. These power supplies are used in similar laboratory and test applications as series regulated power supplies, but at power levels greater than 75 watts.

**Switching Regulation:** this technique provides high efficiency, and operating specifications similar to series regulation (see table). These power supplies also tend to be small and lightweight.

For high quality modular  
OEM power supplies,  
see page 253 . . .

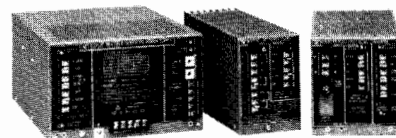

- 50-550 Watts
- Up to six outputs
- Many meet FCC and VDE, EMI and safety regulations.

### Example Power Supply Comparison for a 40 V, 25 A, 1000 Watt Application

Regulation Technique	Model Number	PARD (ripple and noise) rms/p-p	Load Effect	Load Transient Recovery	Typical Efficiency
Series with SCR preregulation	6268B 40 V @ 30 A	1 mV/5 mV	.01% + 200 $\mu$ V (4.2 mv at 40 V)	50 $\mu$ s, 10 mV	60%
Switching (autoranging)	6012A 60 V @ 50 A	5 mV/50 mV	.01% + 5 mv (9 mV at 40 V)	2 ms, 100 mv	75%
SCR	6434B 40 V @ 25 A	40 mV/500 mV	40 mV	200 ms, 200 mv	70%

### Autoranging—the best value

An autoranging power supply can provide maximum rated power over a wide range of voltage and current without external intervention. For example, the graph of general purpose power supplies maximum output points on the following page shows a few units which have continuous curves rather than single points. These power supplies provide more application flexibility than conventional units of the same power rating. The autoranging capability is implemented either with switching regulation (6024A, 6012A, 6034A) or series regulation (6002A). For either bench or system use, autoranging usually provides the best value, at up to 1000 watts.

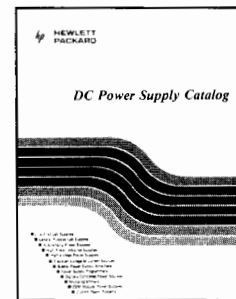

For more details concerning Hewlett-Packard power supplies, ask your HP Field Engineer for a *DC Power Supply Catalog*, or fill in the card at the back of this catalog.



### Special Purpose Bench Power Supplies

#### Bipolar Power Supply/Amplifiers (page 249)

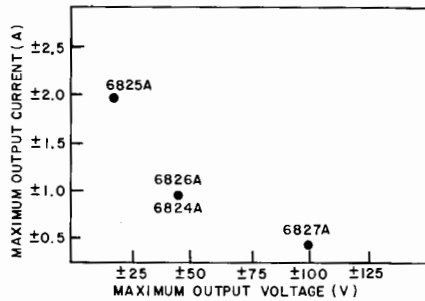

These versatile units can be used as either power supplies or amplifiers. They have bipolar voltage output and can source or sink current. Models 6825A-6827A offer a signal to noise ratio of approximately 80db at full output with low distortion, and frequency response of up to 40 kHz.

#### Precision Voltage Sources (page 250)

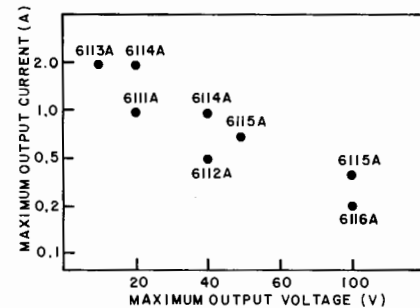

The 6114A and 6115A offer 0.0005% regulation in constant voltage mode and 0.01% in constant current mode. Models 6111A, 6112A, 6113A and 6116A offer 0.001% regulation of voltage. The precision voltage sources have less than 40  $\mu$ V rms or less. Their many applications include working voltage standards, and high stability lab supplies.

#### High Voltage Power Supplies (page 252)

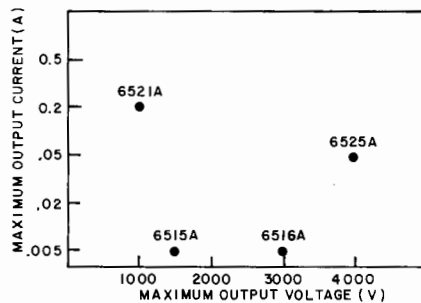

These supplies provide 0.005% or 0.01% regulation, and less than 2mV rms ripple and noise. Models 6521A and 6525A provide 0.002% resolution; model 6515A provides 0.006%, and the 6516A provides 0.03%. These units have enough output current to power devices such as TWT's, klystrons, magnetrons and electron beam welding devices. These power supplies are not remotely programmable.

#### Precision Current Sources (page 251)

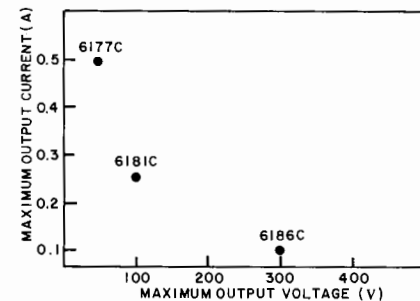

These accurate, stable high-resolution units are optimized for constant current operation. They are especially useful for semiconductor testing and development. Ripple and noise is less than 0.002% of full scale output current, and resolution is 0.03% of range.

### System Power Supplies

The correct solution for a particular system application depends upon many factors including: the number of different voltage or current outputs needed simultaneously, the power supply specifications required and the degree of programmability desired.

If multiple outputs are needed, approaches are available which are more cost effective than complete duplication of single output system power supplies. These are discussed in the section entitled "Multiple Output System Power Supplies" on the following page.

Some systems require power supplies with specific features enhanced. These special purpose system supplies are described on the following page.

Many automatic test applications require more than programmable voltage or programmable current. If capabilities such as readback of output voltage or current, programmable OVP level, and status readback are desired, the 6034A Autoranging System Supply should be

used. The 6034A is the best solution for most system power supply applications up to 200 watts.

Hewlett-Packard offers a wide variety of general purpose system power supplies, which meet the needs of many diverse laboratory and industrial applications. They range in power to 11,000 watts. To find the model which meets your maximum voltage and current needs, use the graph on the following page. Most of the models listed are used with the 59501A HP-IB Power Supply Programmer. When choosing a system power supply, keep in mind the benefits of autoranging discussed on page 228.

#### 59501A Power Supply Programmer

The 59501A is an HP-IB Isolated Digital to Analog Converter. It can be used to program the current or voltage output of many Hewlett-Packard power supplies. Specifications of the 59501A Power Supply Programmer can be found on page 247.

### Single Output System Power Supplies

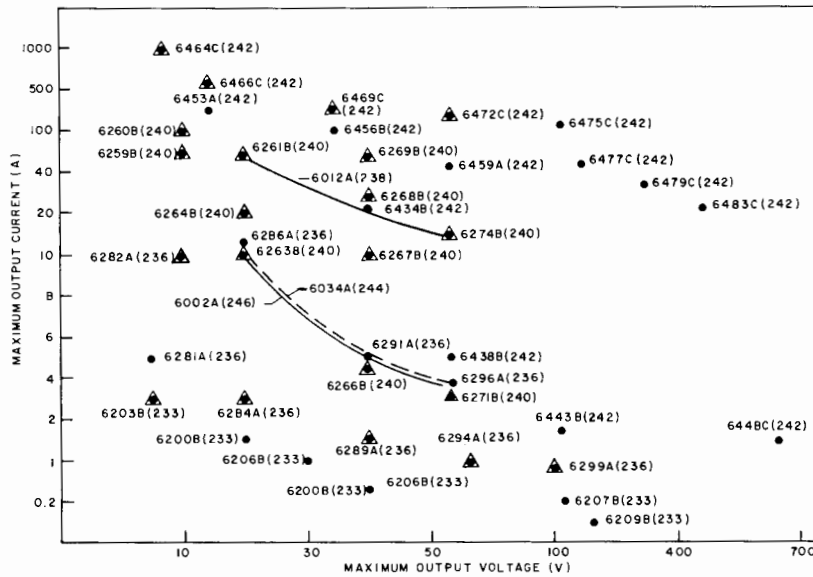

**MAXIMUM OUTPUT POINTS**  
 ● PROGRAMMED WITH THE 59501A POWER SUPPLY PROGRAMMER  
 NOTE: MODELS 6434B-6448B AND 6466C-6483C MUST BE ORDERED WITH SPECIAL OPTION J30 TO BE PROGRAMMED WITH THE 59501A.  
 △ MAY BE PROGRAMMED WITH THE 6942A OR 6940B INSTEAD OF THE 59501A

**MAXIMUM OUTPUT CURVES**  
 (FOR AUTORANGING POWER SUPPLIES)  
 — OR —  
 6012A PROGRAMMED WITH THE 59501A POWER SUPPLY PROGRAMMER  
 6034A AND 6002A DIRECTLY PROGRAMMED

To choose a power supply using the graph above, first locate the point which corresponds to the voltage and current ratings needed, then find the model number printed closest to that point. More details

concerning that particular power supply can be found on the page which is listed in parentheses next to the model number.

### Special Purpose System Power Supplies

#### Precision System Supplies

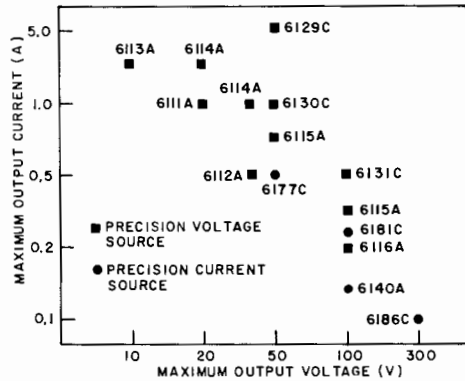

#### Bipolar System Supplies

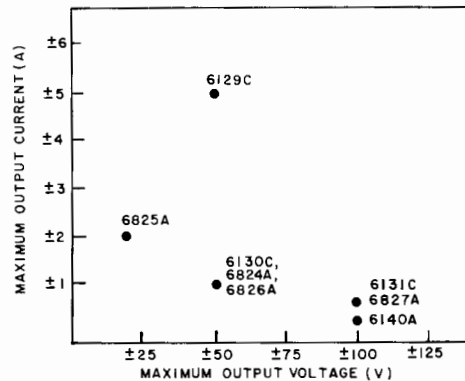

The 6129C-6131C voltage sources and 6140A current source (page 248) offer fast accurate, high resolution, bipolar output. They are used with the 59301A ASCII to Parallel Converter.

The 6111A-6116A voltage sources (page 250) and 6177C-6186C current sources (page 251) are high stability, moderate resolution, system power sources, when programmed with the 59501A Power Supply Programmer.

The 6129C-6131C voltage sources and 6140A current source (page 248) offer fast, accurate, high resolution, bipolar output. These supplies are programmed with the 59301A ASCII to Parallel Converter.

The 6824A-6827A Bipolar Power Supply/Amplifiers (page 249) are programmed with the 59501A Power Supply Programmer. They are fast bipolar system supplies.

### Multiple Output System Power Supplies

When more than one power supply output is needed, there are two cost effective system approaches which can be used. A dual output power supply can be used to replace two single output units, and a Multiprogrammer (6940B or 6942A) can be used to program multiple power supplies. The Multiprogrammer solution is generally cost effective when four or more power supply outputs are needed.

The following power supplies can be programmed with either the 59501A Power Supply Programmer or the Multiprogrammers:

Model #	OUTPUT 1		OUTPUT 2		Page
	Volts	Amps	Volts	Amps	
6205C	0-20 & 40	0-0.6 & 0.3	0-20 & 40	0-0.6 & 0.3	233
6227B	0-25	0-2	0-25	0-2	236
6228B	0-50	0-1	0-50	0-1	236
6253A	0-20	0-3	0-20	0-3	236
6255A	0-40	0-1.5	0-40	0-1.5	236

Multiprogrammers and the associated resistance output cards can be used to program many of the Hewlett-Packard power supplies. A Multiprogrammer can control the voltage or current outputs of the power supplies marked with a  $\Delta$  on the single output graph above, models 6111A-6115A, and the dual output power supplies listed in the table at the left, when the supplies are equipped with Option 040. The Multiprogrammers have many other capabilities including digital inputs and outputs, voltage and current DAC's, thermocouple measurements, relays, and A/D's. See page 50 for more information concerning the 6940B or 6942A Multiprogrammers.

Full feature programming cards are used with the auto-ranging power supplies 6024A (200 watts) and 6012A (1000 watts). For use with these cards, the power supplies should be equipped with Option 002. The 69520A Power Supply Programming Card used in a 6940B provides voltage and current programming, status readback, and OVP set and reset. The 69709A card, used in the 6942A provides the above capabilities plus output voltage and current readback.

### Power Supply Terms

**Ambient temperature:** the temperature of the air immediately surrounding the power supply.

**Auto-parallel operation:** a master-slave connection of the outputs of two or more supplies used for obtaining a current output greater than can be obtained from one supply.

**Autoranging power supply:** a power supply that can provide maximum rated power over a wide range of voltage and current without external intervention to change range.

**Auto-series operation:** a master-slave connection of the outputs of two or more supplies used for obtaining a voltage greater than can be obtained from one supply.

**Auto-tracking operation:** a master-slave connection of two or more supplies each of which has one of its output terminals in common with one of the output terminals of all of the other supplies.

**Complementary tracking:** a master-slave interconnection of two supplies in which the voltage of the slave is equal to or proportional to that of the master and of opposite polarity with respect to a common point.

**Compliance voltage:** the output voltage of a power supply operating in the constant-current mode.

**Constant-current (CC) power supply:** a power supply that stabilizes output current with respect to changes in influence quantities. Thus, for a change in load resistance, the output current remains constant while the output voltage changes by whatever amount necessary to accomplish this.

**Constant-voltage (CV) power supply:** a power supply that stabilizes output voltage with respect to changes in influence quantities. Thus, for a change in load resistance, the output voltage remains constant while the output current changes by whatever amount necessary to accomplish this.

**Constant-voltage/constant-current (CV/CC) power supply:** a power supply that operates as a constant voltage power supply or a constant-current power supply depending on load conditions. It acts as a constant-voltage source for comparatively large values of load resistance and as a constant-current source for comparatively small values of load resistance.

**Constant-voltage/current-limiting (CV/CL) power supply:** a power supply similar to a constant-voltage/constant current supply except that at comparatively small values of load resistance, its output current is limited instead of being stabilized.

**Crowbar:** see overvoltage protection.

**Current limiting:** the action of limiting the output current of a constant-voltage supply to some predetermined maximum value (fixed or adjustable) and automatically restoring the output voltage to its normal value when the overload or short circuit is removed. There are three types of current limiting: 1) by constant-voltage/constant-current crossover, 2) by decreasing the output voltage as the current increases, 3) by decreasing both voltage and current as the load resistance decreases (referred to as foldback or cutback current limiting).

**Drift:** the maximum change of an output voltage or current during an 8-hour period following a 30-minute warmup, with all influence and control quantities maintained constant during the warm-up time and the period of drift measurement. Drift includes both periodic and random deviations over the bandwidth from zero frequency (dc) to a specified upper frequency limit (usually 20 Hz).

**Load effect:** formerly known as load regulation, load effect is the change in the steady-state value of the stabilized output voltage or current resulting from a full-load change in the load current of a constant-voltage supply or the load voltage of a constant-current supply, with all other influence quantities maintained constant.

**Load effect transient recovery time:** the time interval between a specified step change in the load current of a constant-voltage supply (usually a full-load or 5-amp change, whichever is smaller) or in the load voltage of a constant-current supply and the instant when the stabilized output quantity returns to and stays within the specified transient recovery band.

**Master-slave operation:** a method of interconnecting two or more supplies such that one of them (the master) serves to control the others (the slaves). The outputs of the slave supplies always remain equal to or proportional to the output of the master. The outputs of the

master supply and of one or more slaves may be connected in series, in parallel, or with just their negative or positive output terminals in common. (See also complementary tracking.)

**Nominal value:** the value that exists "in name only," not the actual value. For example, in the case of a power supply with a calibrated output control, the nominal value is the value indicated by the control setting. For a supply with a fixed output, the nominal output is the output indicated on the nameplate. The nominal value of a 120-volt  $\pm 10\%$  line voltage is 120 volts.

**Output impedance:** the complex ratio of a sinusoidal voltage and sinusoidal current at the output terminals, the one being caused by the other and being of external origin.

**Overcurrent protection:** protection of the power supply and/or connected equipment against excessive output current.

**Overtemperature protection:** protection of the power supply or parts of it against temperatures exceeding specified values.

**Overvoltage protection:** protection of the power supply and/or connected equipment against excessive output voltage. Overvoltage protection is usually by means of a crowbar protection circuit, which rapidly places a low resistance shunt across the supply's output terminals to reduce output voltage to a low value if a predetermined voltage is exceeded. A supply equipped with an overvoltage crowbar must also be protected by a means of limiting or interrupting output current.

**PARD (acronym for periodic and random deviation):** the term PARD replaces the former term ripple and noise. PARD is the periodic and random deviation of a dc output voltage or current from its average value, over a specified bandwidth (20 Hz to 20 MHz; except Models 6515A-6525A: 1 Hz to 20 MHz) and with all influence and control quantities maintained constant).

**Programming speed:** the maximum time required for the programmed output voltage or current to change from a specified initial value (usually zero or maximum output) to a value within a specified tolerance band of a specified newly programmed value (for most models 99.9% or 0.1% of maximum output, respectively; 99% and 1% for the 6111A-6116A, 6177C-6186C, and 6428B-6483C) following the onset of a step change in an analog programming signal, or the gating of a digital signal.

**Remote control:** also referred to as remote programming, remote control is the setting of the power supply voltage, current, or other function by means of an external control quantity such as a variable resistance, voltage, or current, or a digital signal.

**Remote sensing:** remote sensing, or remote error sensing, is a means by which a power supply monitors the stabilized voltage directly at the load using extra sensing leads. The resulting circuit action compensates for voltage drops in the load leads (up to a specified limit).

**Resolution:** for a bench supply, the smallest change in output voltage or current that can be obtained using the front panel controls. For a system supply, the smallest change that can be obtained either using the front panel controls, or a computer.

**Reverse voltage protection:** protection of the power supply against reverse voltage applied at the output terminals.

**Slave operation:** see master-slave operation.

**Source effect:** formerly known as line regulation, source effect is the change in the steady-state value of the stabilized output voltage on current resulting from any change in the source voltage within its specified range, with all other influence quantities maintained constant. Source effect may be measured at any output voltage and current within rating.

**Temperature effect coefficient:** the maximum steady-state change in a power supply's output voltage or current per degree Celsius following a change in the ambient temperature within specified limits, with all other influence quantities maintained constant.

**Voltage limiting:** the action of limiting the output voltage of a constant-current supply to some predetermined maximum value (fixed or adjustable) and automatically restoring the output current to its normal value when the load conditions are restored to normal. There are two types of voltage limiting: 1) by constant-voltage/constant-current crossover, 2) by decreasing the output current as the voltage increases.

**Warm-up time:** the time interval after switching on a power supply until it complies with all performance specifications.



- 6212B-6218B . . . 10 watts output
- Compact, impact-resistant stackable case
- Short-circuit proof

- 6200B-6209B . . . 30 watts output
- Auto series, parallel, and tracking
- Remote sensing

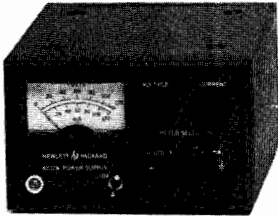

Single Output: 6212B-6218B

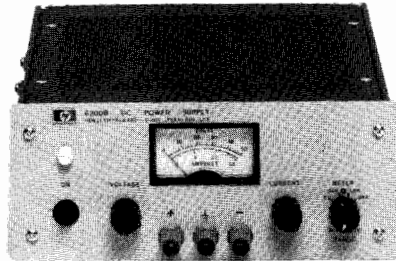

Single Output: 6200B-6209B

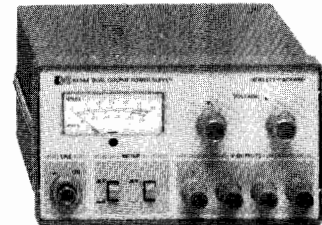

Dual Output: 6234A

### Description—Single Output Models

#### Models 6212B-6218B

These popular low-cost CV/CC bench supplies are designed for general laboratory use and are equipped with front-panel mounted voltage and current controls, a combination volt/ammeter, and output binding posts. Output voltage and current are continuously variable, via coarse and fine controls from 0 to 15% above the maximum rated output. A switch selects either output voltage or current for display on the panel meter.

Load connections are made via three binding posts. Either the + or the - post may be grounded through an adjacent GND terminal or the supply may be operated floating at up to 300 volts above ground.

The supplies can also be operated as constant current sources with 500  $\mu$ A load regulation. All of these models can be connected in series or parallel.

The molded, impact-resistant case includes an interlocking feature for stacking several units vertically, thus minimizing bench space required for multiple supplies. Alternatively, up to three units can be mounted side by side in a 19" rack using Rack Mounting Kit 14521B. These supplies measure 86 H x 133 W x 368 mmD (3.40" x 5.25" x 8") and weigh 2 kg (4.4 lb).

#### Models 6200B-6209B

This series of low-cost bench supplies includes five models covering an output voltage range from 0–7.5 V to 0–320 V. All models are equipped with ten-turn voltage and current controls, (except the 6206B, which does not have a current control), volt/ampere meter, meter function/range switch, and front and rear output terminals. In addition, on the dual-range models (6200B and 6206B), an output range switch permits the selection of either a high or a low output voltage range.

The constant voltage/current limiting supply, 6206B, is short-circuit protected by a fixed current limiting circuit which is activated at approximately 110% of rated load current. The current-limit point can be reduced by changing the value of a single internal resistor. For the constant voltage/constant current supplies, ten-turn current controls allow the current-limit point to be set to any value within the current rating. Using these controls the CV/CC supplies can also be operated as constant-current sources.

Units may be bench operated or rack mounted individually or in pairs using accessory rack mounting hardware.

All models in this group of supplies measure 89 H x 216 W x 317 mm D (3.50" x 8.50" x 12.50") and weigh 4.5 kg (10 lb).

### Description—Dual Output Models

#### Model 6234A

Model 6234A is a low-cost, dual-output bench power supply with two independently adjustable and isolated power sources in one compact unit. Both of the dc power sources are of the constant voltage/current limit type with each output voltage being adjustable continuously over a 0 to 25 V range. The maximum current available per output is 0.2 A and is limited automatically to prevent over-load.

The HP 6234A offers considerable flexibility to the user with output voltages that can be arranged to provide identical or different voltages in any polarity combination with respect to 0 or other common positive or negative voltage points. The outputs can also be connected in series to provide up to 50 V at 0.2 A. Both sources are fully isolated to permit either of the output terminals to be grounded.

With pushbutton switches, users can select either voltage or current for each output to be monitored on the unit's meter. Other features include two multiple-turn controls for precise voltage setting, regulation to 0.01% and ripple and noise of less than 200 microvolts rms.

With dimensions of only 93 mm high, 157 mm wide and 210 mm deep (3.64" x 6.17" x 8.25"), the HP 6234A supply takes up a minimum amount of bench space. Its weight is 2.3 kg (5 lbs.). The unit can be powered from a 115 V or an optional 230 V, 47-63 Hz ac input, (Option 028).

#### Model 6205C

This low-cost bench supply is equipped with ten-turn output voltage controls, volt/ampere meter, meter function/ range switch, and front and rear output terminals. In addition, an output range switch permits the selection of either a high or a low output voltage range.

Model 6205C combines the versatility of a dual power supply with the flexibility of auto-parallel and auto-series operation to extend the output ratings of this supply to 20 V/1.2 A, 40 V/0.6 A, and 80 V/0.3 A. In addition, using the supply's auto-tracking capability, opposite

# POWER SUPPLIES

Laboratory: Single & Multiple Output, 10 W to 38 W

Models 6200B-6218B and 6234A-6237B

- Dual output to 24 watts
- Short-circuit proof
- Independent voltage controls

- Triple output to 38 watts
- Short circuit proof
- Tracking  $\pm 20$  volt outputs

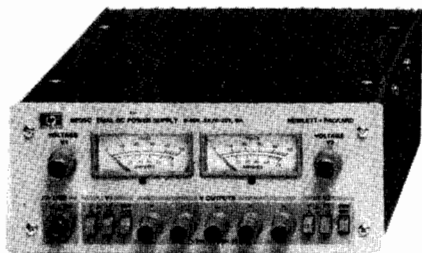

Dual Output: 6205C

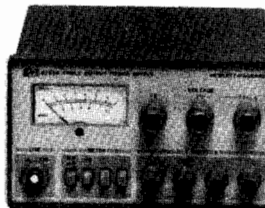

Triple Output: 6235A



Triple Output: 6236B, 6237B

polarity voltages ( $\pm 20$  V,  $\pm 40$  V) can conveniently be obtained from this one supply.

This constant voltage/current limiting supply is short-circuit protected by a fixed current limiting circuit which is activated at approximately 110% of rated load current. The current-limit point can be reduced by changing the value of a single internal resistor. Units may be bench operated or rack mounted individually or in pairs using accessory rack mounting hardware.

## Description—Triple Output Models

### 6235A

This compact, low-cost, three-in-one power supply is a handy addition to the lab bench where single or multiple voltages are needed for designing and testing breadboards and prototypes. The Hewlett-Packard Model 6235A delivers three adjustable dc output voltages: 0 to +6 V at 1 A, 0 to +18 V at 0.2 A, and 0 to -18 V at 0.2 A. A single 0 to 36 volt output at 0.2 A can also be obtained by connecting across the +18 V and -18 V terminals.

The controls, meter, and binding posts are conveniently arranged on the front panel. One voltage control simultaneously adjusts the +18 V and -18 V outputs, which track one another and can be used to power operational amplifiers and other circuits requiring balanced positive and negative voltages. The supply's dual outputs have added versatility with an adjustable tracking ratio control (TRACK) that can set the negative output to a lower voltage than the positive output. Once the tracking ratio control has established a voltage ratio between the positive and negative outputs, the ratio remains constant as the +18 V voltage control is adjusted. A third control sets the 0 to +6 V output voltage.

The supply is a constant voltage/current limit type with each output voltage continuously adjustable over its range, while the maximum current available is automatically limited to prevent overloading. The power supply's outputs share a common terminal and are isolated from chassis ground so that any output terminal can be grounded if desired. Each output voltage or current can be quickly selected and monitored with the push-button meter switches.

Model 6235A measures 89 H x 157 W x 210 mm D (3.5" x 6.17" x 8.25") and weighs 2.3 kg (5 lb).

### 6236B and 6237B

Microprocessors, digital and linear integrated circuits, and displays used in lab development frequently require triple output power supplies for operating prototypes. The 6236B and 6237B are valued additions to the design bench due to their multiple output voltages, small size, ease of operation and application-related performance.

These compact constant voltage/current limiting supplies combine 0 to  $\pm 20$  V tracking outputs rated at 0.5 amps with a single output rated at 0 to +6 volts at up to 2.5 amps in the 6236B, and 0 to +18 volts at 1 amp in the 6237B.

Controls, meters, and binding posts are logically arranged on a neatly laid out front panel. One voltage control simultaneously adjusts the 20 V and -20 V outputs, which track within 1% to power operational amplifiers and circuits requiring balanced voltages. A tracking ratio control can disable the 1:1 tracking feature and set the negative output to a lower voltage than that of the positive output. Once the tracking ratio control has established a voltage ratio between the positive and negative outputs, the ratio remains constant as the  $\pm 20$  V voltage control varies both outputs. Another voltage control sets the 0 to +6 V (6236B) or 0 to +18 V (6237B) output.

All outputs are protected against overload and short-circuit damage by fixed current limiting circuits. For any overload condition, the +20 V and -20 V outputs in both models are limited to 0.55 amps and the +18 V output in the 6237B is limited to 1.1 amps. The overload protection circuit for the +6 V output in the 6236B has a current foldback characteristic that reduces the maximum available current from about 2.75 amps at a 6 V terminal voltage to 1 amp at zero volts (or short circuited). This foldback limiting characteristic maximizes the available current in the important 5 to 6-volt range while minimizing dissipation during overloads.

Another protective feature safeguards sensitive load circuitry by preventing an output voltage overshoot when the supply is turned on or off.

Separate dual-range panel meters allow both the voltage and current of any output to be monitored simultaneously. A three-position switch selects the output which the meters will monitor.

Both models measure only 89 H x 216 W x 319 mm D (3.5" x 8.5" x 12.5") and weigh 4.3 kg (9.5 lb).

# POWER SUPPLIES

**General Purpose: Laboratory Bench Applications**  
Models 6200B-6218B and 6234A-6237B



## Specifications

RATINGS		PERFORMANCE							GENERAL	
DC Output		Model	Load Effect	Source Effect	PAR rms/p-p	Control Mode and Resolution	Remote Control Coefficients	Power* 115 V ac ± 10%	Options	
Volts	Amps									
<b>SINGLE OUTPUT—10 WATTS</b>										
0-10	0-1	6214B	4 mV	4 mV	200 $\mu$ V/1 mV	CV/CC 5mV/75 $\mu$ A	**	48-440 Hz 0.3 A, 28 W	28	
0-25	0-0.4	6216B	4 mV	4 mV	200 $\mu$ V/1 mV	CV/CC 5mV/20 $\mu$ A	**	48-440 Hz 0.3 A, 28 W	28	
0-50	0-0.2	6218B	4 mV	4 mV	200 $\mu$ V/1 mV	CV/CC 10mV/10 $\mu$ A	**	48-440 Hz 0.3 A, 28 W	28	
0-100	0-0.1	6212B	8 mV	4 mV	200 $\mu$ V/1 mV	CV/CC 20mV/10 $\mu$ A	**	48-440 Hz 0.3 A, 28 W	28	
<b>SINGLE OUTPUT—UP TO 30 WATTS</b>										
0-7.5	0-3	6203B	5 mV	3 mV	200 $\mu$ V/1 mV	CV/CC 5 mV/2 mA	200 $\Omega$ /V ± 1% 500 $\Omega$ /A ± 10%	48-440 Hz 0.9 A, 70 W	11, 28	
Dual range 0-20 or 0-40	0-1.5 0-0.75	6200B	0.01% + 4 mV	0.01% + 4 mV	200 $\mu$ V/1 mV	CV/CC 10 mV/2 mA	200 $\Omega$ /V ± 1% 0.5 k $\Omega$ /A ± 10% or 1 k $\Omega$ /A ± 10%	48-440 Hz 0.9 A, 70 W	11, 28	
Dual range 0-30 or 0-60	0-1 0-0.5	6206B	0.01% + 4 mV	0.01% + 4 mV	200 $\mu$ V/1 mV	CV/CL 10 mV/*	300 $\Omega$ /V ± 1%	48-440 Hz 1 A, 66 W	11, 28	
0-160	0.2	6207B	0.02% + 2 mV	0.02% + 2 mV	500 $\mu$ V/40 mV	CV/CC 25 mV/500 $\mu$ A	300 $\Omega$ /V ± 1% 75 k $\Omega$ /A ± 10%	48-63 Hz 1 A, 60 W	28	
0-320	0-0.1	6209B	0.02% + 2 mV	0.02% + 2 mV	1 mV/40 mV	CV/CC 40 mV/200 $\mu$ A	300 $\Omega$ /V ± 1% 150 k $\Omega$ /A ± 10%	48-63 Hz 1 A, 60 W	28	
<b>DUAL OUTPUT—10 WATTS</b>										
Dual output 0-25 and 0-25	0.2 0.2	6234A	0.01% + 1 mV	0.01% + 1 mV	200 $\mu$ V/1 mV	CV/CL	**	104-127 Vac 47-63 Hz 0.26A, 35 W	28	
<b>DUAL OUTPUT—24 WATTS</b>										
Two dual ranges 0-20/0-40 and 0-20/0-40	0-0.6/0.3 0-0.6/0.3	6205C	0.01% + 4 mV	0.01% + 4 mV	200 $\mu$ V/1 mV	CV/CL 10 mV/*	200 $\Omega$ /V ± 1%	48-440 Hz 0.5 A, 50 W	11, 28 40	
<b>TRIPLE OUTPUT—13 WATTS</b>										
Triple output 0 to 6 and 0 to 18 and 0 to -18	0-1 0-0.2 0-0.2	6235A	8 mV 10 mV 10 mV	8 mV 15 mV 15 mV	1 mV/5 mV 1 mV/5 mV 1 mV/5 mV	CV/CL	** ** **	47-63 Hz 0.26 A, 35 W	28	
<b>TRIPLE OUTPUT—35 WATTS</b>										
Triple output 0 to +6 and 0 to +20 and 0 to -20	2.5 0.5 0.5	6236B	0.01% + 2 mV	0.01% + 2 mV	350 $\mu$ V/1.5 mV	CV/CL 70 mV/*	**	104-127 Vac 47-63 Hz 1.2 A, 112 W	100 220 240	
<b>TRIPLE OUTPUT—38 WATTS</b>										
Triple Output 0 to +18 and 0 to +20 and 0 to -20	1 0.5 0.5	6237B	0.01% + 2 mV	0.01% + 2 mV	350 $\mu$ V/1.5 mV	CV/CL 70 mV/*	**	104-127 Vac 47-63 Hz 1.2 A, 112 W	100 220 240	

\*fixed current limit  
\*\*remote control not available

## Option Descriptions

**011:** internal overvoltage protection crowbar. Protects delicate loads against power supply failure or operator error. Dual output models have dual crowbars.

6200B, 6203B, 6206B  
6205C

**028:** 230 V ac ± 10%, single phase input. Consists of reconnecting power transformer taps, and other components where necessary.

**040:** Multiprogrammer interface. Prepares 6205C power supplies for resistance programming by the 6940B or 6942A Multiprogrammer

**100:** 87-106 Vac, 47-63 Hz, single phase input

**220:** 191-233 Vac, 47-63 Hz, single phase input

**240:** 208-250 Vac, 47-63 Hz, single phase input

**910:** one additional operating and service manual is shipped with each power supply

6200B-6235A

6236B-6237B

### Accessories

**14513A:** rack kit for one 6200-6209B, 6236B, or 6237B supply

**14523A:** rack kit for two of the above power supplies

**14521B:** rack kit for one, two or three 6212B-6218B power supplies





# POWER SUPPLIES

General Purpose: 25–200 W Output

Models 6227B–6299A

- Constant voltage / constant current operation
- Remote sensing and programming
- Auto-series, -parallel, & -tracking operation

- Front and rear output terminals
- Floating output—use as positive or negative source
- Bench or rack mounting

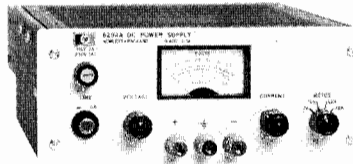

6281A, 6284A, 6289A,  
6294A, 6299A

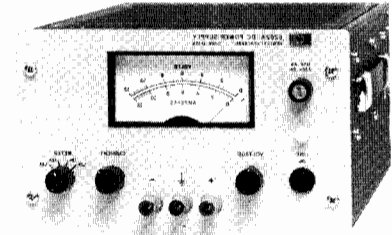

6282A, 6286A,  
6291A, 6296A

## Description

### 6281A–6299A Single Output

This series of medium-power constant voltage/constant current power supplies is available in two power ranges: 37–75 watts (packaged in 3½-inch high half-rack cases), and 100–200 watts (packaged in 5¼-inch high half-rack cases). All models except 6294A and 6299A have separate coarse and fine voltage and current controls that allow the voltage and current outputs to be varied from zero to the maximum rated values. The latter two models have ten-turn voltage controls. Crossover from constant voltage to constant current operation occurs automatically when the load current exceeds the value established by the current control settings. A four-position meter function switch selects either of two output voltage or output current ranges (X1, X0.1) for display on the panel meter.

The 37–75 watt models are of the series-regulated type. They have excellent regulation and ripple characteristics and include a special output-capacitor discharge circuit for improved programming speed. The 100–200 watt models employ a series-regulator/SCR-preregulator configuration to achieve the high efficiency necessary for a convection-cooled package of this size. They also have excellent regulation, low ripple and noise, and moderate programming speeds.

### 6253A and 6255A Dual Output

These versatile dual-output models each contain two identical, independently adjustable 60 watt power supplies in a full-rack width case. The regulator, voltage and current control, and metering circuits of each section of the supply are electrically identical to those of the individual 37–75 watt models described above.

By combining the versatility of a dual power supply with the flexibility of auto-series and auto-parallel operation, twice the maximum rated output voltage or current of each section can be obtained from the one supply. In addition, using the supply's auto-tracking capability, opposite-polarity voltages ( $\pm 20$  V for Model 6253A or  $\pm 40$  V for Model 6255A) are possible.

### 6227B and 6228B Dual Output

These versatile lab supplies each house two identical 50 W regulated power supplies. A convenient front panel switch selects either independent or tracking operation. In the track mode, the right supply tracks the left within  $0.2\% \pm 2$  mV. The tracking mode is especially useful for powering operational amplifiers, push-pull stages, deflection systems, or any application where plus and minus voltages must track with insignificant error. The independent mode permits operation of the two supplies individually, in auto-parallel or in auto-series.

## Specifications

RATINGS			PERFORMANCE							
DC Output			Load Effect		Source Effect		PAR (rms/p-p)		Drift (stability)	
Volts	Amps	Model	Voltage	Current	Voltage	Current	Voltage	Current	Voltage	Current
0–7.5	0–5	6281A	5 mV	0.01% + 250 $\mu$ A	0.01% + 2 mV	0.01% + 250 $\mu$ A	200 $\mu$ V/1 mV	4 mA rms	0.1% + 2.5 mV	0.1% + 12.5 mA
0–10	0–10	6282A	0.01% + 1 mV	0.05% + 1 mA	0.01% + 1 mV	0.05% + 1 mA	500 $\mu$ V/25 mV	5 mA rms	0.1% + 2.5 mV	0.1% + 25 mA
0–20	0–3	6253A*	0.01% + 4 mV	0.01% + 250 $\mu$ A	0.02% + 2 mV	0.01% + 250 $\mu$ A	200 $\mu$ V/1 mV	2 mA rms	0.1% + 2.5 mV	0.1% + 7.5 mA
0–20	0–3	6284A	0.01% + 4 mV	0.01% + 250 $\mu$ A	0.01% + 2 mV	0.01% + 250 $\mu$ A	200 $\mu$ V/1 mV	2 mA rms	0.1% + 2.5 mV	0.1% + 7.5 mA
0–20	0–10	6286A	0.01% + 1 mV	0.05% + 1 mA	0.01% + 1 mV	0.05% + 1 mA	500 $\mu$ V/25 mV	5 mA rms	0.1% + 2.5 mV	0.1% + 25 mA
0–25	0–2	6227B*	0.01% + 1 mV	0.01% + 250 $\mu$ A	1 mV	100 $\mu$ A	250 $\mu$ V/4 mV	250 $\mu$ A/2 mA	0.2% + 2 mV	0.2% + 3 mA
0–40	0–1.5	6255A*	0.01% + 2 mV	0.01% + 250 $\mu$ A	0.01% + 2 mV	0.01% + 250 $\mu$ A	200 $\mu$ V/1 mV	500 $\mu$ A rms	0.1% + 2.5 mV	0.1% + 4 mA
0–40	0–1.5	6289A	0.01% + 2 mV	0.01% + 250 $\mu$ A	0.01% + 2 mV	0.01% + 250 $\mu$ A	200 $\mu$ V/1 mV	500 $\mu$ A rms	0.1% + 2.5 mV	0.1% + 4 mA
0–40	0–5	6291A	0.01% + 1 mV	0.05% + 1 mA	0.01% + 1 mV	0.05% + 1 mA	500 $\mu$ V/25 mV	3 mA rms	0.1% + 2.5 mV	0.1% + 12.5 mA
0–50	0–1	6228B*	0.01% + 1 mV	0.01% + 250 $\mu$ A	1 mV	100 $\mu$ A	250 $\mu$ V/4 mV	250 $\mu$ A/2 mA	0.2% + 2 mV	0.2% + 1.5 mA
0–60	0–1	6294A	0.01% + 2 mV	0.01% + 250 $\mu$ A	0.01% + 2 mV	0.01% + 250 $\mu$ A	200 $\mu$ V/1 mV	500 $\mu$ A rms	0.1% + 2.5 mV	0.1% + 2.5 mA
0–60	0–3	6296A	0.01% + 1 mV	0.05% + 1 mA	0.01% + 1 mV	0.05% + 1 mA	500 $\mu$ V/25 mV	3 mA rms	0.1% + 2.5 mV	0.1% + 7.5 mA
0–100	0–0.75	6299A	0.01% + 2 mV	0.01% + 250 $\mu$ A	0.01% + 2 mV	0.01% + 250 $\mu$ A	200 $\mu$ V/1 mV	500 $\mu$ A rms	0.1% + 2.5 mV	0.1% + 2 mA

\*Models 6227B, 6228B, 6253A, and 6255A contain two identical, independently-adjustable power supplies.

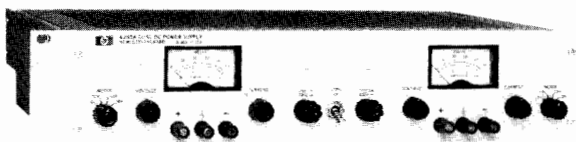

6253A, 6255A



6227B, 6228B

Each side of the dual supply can be operated as a constant voltage or constant current source, and each has its own crowbar for overvoltage protection. In the tracking mode, an overvoltage condition in either supply trips both crowbars. The power supply outputs are isolated up to 300 V from output to chassis or output to output.

### Specifications—General

**Load effect transient recovery:** time, 50  $\mu$ s. Level, 15 mV.

**Meter accuracy:** 3% of full scale.

**Power:** standard input voltage is 115 V ac  $\pm$  10%. Order Option 028 for 230 V ac  $\pm$  10% operation. Input power frequency, maximum input current, maximum power consumption are:

6227B and 6228B, 48–63 Hz, 2.7 A, 260 W;

6253A, 48–440 Hz, 2.6 A, 235 W; 6255A, 48–440 Hz, 2.6 A, 235 W;

6281A, 48–440 Hz, 1.3 A, 118 W; 6282A, 57–63 Hz, 3.5 A, 200 W;

6284A, 48–440 Hz, 1.5 A, 128 W; 6286A, 57–63 Hz, 5.5 A, 320 W;

6289A, 48–440 Hz, 1.3 A, 110 W; 6291A, 57–63 Hz, 5.5 A, 280 W;

6294A, 48–440 Hz, 1.3 A, 114 W; 6296A, 57–63 Hz, 4.5 A, 250 W;

6299A, 48–440 Hz, 1.5 A, 135 W.

**Size:** 6227B, 6228B: 155 H x 197 W x 309.55 mm D (6 $\frac{3}{32}$ " x 7 $\frac{25}{32}$ " x 12 $\frac{3}{16}$ ").

6253A, 6255A: 87 H x 483 W x 403 mm D (3 $\frac{3}{16}$ " x 19" x 15 $\frac{7}{8}$ ").

6281A, 6284A, 6289A, 6294A, 6299A: 87 H x 209 W x 398 mm D (3 $\frac{3}{16}$ " x 8 $\frac{3}{32}$ " x 15 $\frac{7}{8}$ ").

6282A, 6286A, 6291A, 6296A: 131 H x 210 W x 435 mm D (5 $\frac{1}{32}$ " x 8 $\frac{1}{4}$ " x 17 $\frac{1}{8}$ ").

### Option Descriptions

**005:** 50 Hz ac input: optimizes power supplies that require adjustment/modification for 50 Hz operation.

**010:** Chassis slides. Enable convenient access to rack-mounted power supply for maintenance

**011:** Internal overvoltage protection crowbar. Protects sensitive loads against power supply failure or operator error. Monitors the output voltage and places a virtual short circuit (conducting SCR) across load after preset trip voltage is exceeded.

6281A, 6284A, 6289A, 6294A, 6299A

6282A, 6286A, 6291A, 6296A

6253A, 6255A

**028:** 230 V ac  $\pm$  10%, single-phase input. Factory modification reconnects the multi-tap input power transformer for 230 V operation.

**040:** Interfacing for Multiprogrammer operation. Prepares standard HP power supplies for resistance programming by the HP 6940B or 6942A. Price per output.

**910:** one additional operating and service manual shipped with the power supply

6253A, 6255A, 6227B, 6228B

6281A, 6282A, 6284A, 6286A, 6289A, 6291A, 6294A, 6296A, 6299A

### Accessories

**14513A:** 3.5 in. high rack kit for one 6281A, 6284A, 6289A, 6294A, 6299A

**14523A:** 3.5 in. high rack kit for two above supplies

**14515A:** 5.25 in. high rack kit for one 6282A, 6286A, 6291A, 6296A

**14525A:** 5.25 in. high rack kit for two above supplies

**5060-8760:** blank filler panel for 6227B, 6228B

**5060-8762:** adapter frame for rack mounting one or two 6227B, 6228B

### Specifications, continued

REMOTE CONTROL FEATURES								GENERAL				
Resistance Coefficient		Voltage Coefficient		Speed, UP*		Speed, DOWN*		Overvoltage		Weight		
Voltage	Current	Voltage	Current	NL	FL	NL	FL	Range	Margin	Net	Shipping	Options $\Delta$
200 $\Omega$ /V $\pm$ 1%	200 $\Omega$ /A $\pm$ 10%	1 V/V $\pm$ 1%	0.2 V/A $\pm$ 10%	1 ms	2 ms	10 ms	6 ms	2.5–10 V	4% + 2 V	6.4 kg/14 lb	7.2 kg/16 lb	1, 28, 40
200 $\Omega$ /V $\pm$ 1%	100 $\Omega$ /A $\pm$ 10%	1 V/V $\pm$ 1%	100 mV/A $\pm$ 10%	70 ms	200 ms	9 s	40 ms	1–13 V	7% + 1 V	11.3 kg/25 lb	13.6 kg/30 lb	5, 11, 28, 40
200 $\Omega$ /V $\pm$ 1%	500 $\Omega$ /A $\pm$ 10%	1 V/V $\pm$ 1%	0.33 V/A $\pm$ 10%	30 ms	80 ms	400 ms	100 ms	2.5–23 V	4% + 2 V	12.7 kg/28 lb	17.7 kg/39 lb	10, 11, 28, 40
200 $\Omega$ /V $\pm$ 1%	500 $\Omega$ /A $\pm$ 10%	1 V/V $\pm$ 1%	0.33 V/A $\pm$ 10%	30 ms	80 ms	400 ms	100 ms	2.5–23 V	4% + 2 V	6.4 kg/14 lb	7.2 kg/16 lb	1, 28, 40
200 $\Omega$ /V $\pm$ 1%	100 $\Omega$ /A $\pm$ 10%	1 V/V $\pm$ 1%	100 mV/A $\pm$ 10%	150 ms	150 ms	9 s	70 ms	2–22 V	7% + 1 V	10.8 kg/26 lb	13.1 kg/29 lb	5, 11, 28
200 $\Omega$ /V $\pm$ 1%	500 $\Omega$ /A $\pm$ 10%	1 V/V $\pm$ 1%	5 V/A $\pm$ 10%	40 ms	200 ms	400 ms	75 ms	5–28 V	7% + 1.5 V	11 ka/24 lb	12.9 kg/28 lb	40
200 $\Omega$ /V $\pm$ 1%	500 $\Omega$ /A $\pm$ 10%	1 V/V $\pm$ 1%	0.66 V/A $\pm$ 10%	15 ms	45 ms	200 ms	40 ms	2.5–44 V	4% + 2 V	12.7 kg/28 lb	17.7 kg/39 lb	10, 11, 28, 40
200 $\Omega$ /V $\pm$ 1%	500 $\Omega$ /A $\pm$ 10%	1 V/V $\pm$ 1%	0.66 V/A $\pm$ 10%	15 ms	45 ms	200 ms	40 ms	2.5–44 V	4% + 2 V	6.4 kg/14 lb	7.2 kg/16 lb	1, 28, 40
200 $\Omega$ /V $\pm$ 1%	200 $\Omega$ /A $\pm$ 10%	1 V/V $\pm$ 1%	200 mV/A $\pm$ 10%	275 ms	275 ms	13 s	275 ms	6–43 V	7% + 1 V	11.3 kg/25 lb	12.7 kg/28 lb	5, 11, 28
200 $\Omega$ /V $\pm$ 1%	1 k $\Omega$ /A $\pm$ 10%	1 V/V $\pm$ 1%	1 V/A $\pm$ 10%	50 ms	350 ms	1 s	50 ms	5–55 V	7% + 1.5 V	11 ka/24 lb	12.9 kg/28 lb	40
300 $\Omega$ /V $\pm$ 1%	1 k $\Omega$ /A $\pm$ 10%	1 V/V $\pm$ 1%	1 V/A $\pm$ 10%	25 ms	80 ms	2 s	175 ms	5–65 V	4% + 2 V	5.9 kg/13 lb	6.8 kg/15 lb	1, 28, 40
300 $\Omega$ /V $\pm$ 1%	500 $\Omega$ /A $\pm$ 10%	1 V/V $\pm$ 1%	333 mV/A $\pm$ 10%	600 ms	600 ms	5 s	200 ms	9–66 V	7% + 1 V	11.3 kg/25 lb	12.7 kg/28 lb	5, 11, 28
300 $\Omega$ /V $\pm$ 1%	1 k $\Omega$ /A $\pm$ 10%	1 V/V $\pm$ 1%	1.3 V/A $\pm$ 10%	25 ms	200 ms	1.5 s	200 ms	20–106 V	4% + 2 V	5.9 kg/13 lb	6.8 kg/15 lb	11, 28, 40

\*UP = increasing output voltage. NL = No output load current. FL = Full rated output load current.



# POWER SUPPLIES

General Purpose: Autoranging—200 & 1000 W Output

Models 6012A and 6024A

- Autoranging output
- High efficiency, compact and lightweight
- Fast remote programming

- Designed for system applications
- Ten-turn voltage and current controls
- Operating mode status indicators

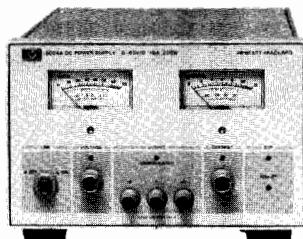

6024A—200 watts

## Autoranging power supply description

The model 6012A and 6024A set a new technological standard for laboratory and system dc power supplies. They are the first in a new generation of power supplies from Hewlett-Packard, combining state of the art advances in both component and circuit design. The result is increased performance and flexibility and friendlier operation both on the bench and in automated test and control systems.

Conventional dc power supplies have an output characteristic which is described by a rectangle. The flexibility provided by an autoranging power supply is revealed when its output characteristic is compared to that of a conventional supply. A conventional power supply can provide its maximum output power at only one combination of voltage and current. Autoranging power supplies provided maximum output power capability over a wide and continuous range of voltage or current. This function is performed automatically, requiring no range selection by the operator.

Using the model 6024A as an example, you would have to combine a 20-volt 10-amp supply, a 40-volt 5-amp supply, and a 60-volt 3-amp supply in order to approximate the same capability as the 6024A. (See output curves on next page.) The autoranging feature of these power supplies makes them convenient and cost-effective units capable of satisfying many different dc requirements.

### In the lab . . . .

Both models have many features that make them versatile. Mode indicators, adjustable overvoltage protection, 10-turn pots, amplified current monitor, and voltage and current meters are some of the features. A barrier strip at the rear of the supply provides the necessary terminals for current monitoring, remote programming, and remote sensing.

In auto-parallel operation, up to three units of the same model may be connected in parallel to increase the total output current capability while maintaining control from one master power supply. In auto-series operation up to four units may be connected in series to increase the total output voltage to 240 V while maintaining control from one master power supply.

Several LEDs on the front panel indicate the operating status without any additional measurement or control changes. Two 10-turn potentiometers on the front panel provide high resolution control of output voltage and current. A secondary scale on the voltmeter indicates maximum "Amperes Available". Likewise, the ammeter has a secondary scale to indicate the "Volts Available". The secondary scales are calibrated to follow the maximum output power curve and let the user know approximately how much power margin is available at any operating point.

Because of the delicate nature of many loads several types of protection have been included. When operating in constant-voltage mode, a current limit can be set. Similarly, when operating in constant-current mode, a voltage limit can be set.

### In the system . . . .

System designers frequently need a variety of fixed and programmable power supplies. By standardizing on autoranging power supplies, the system designer can reduce the number of different models required along with their resultant documentation and support.

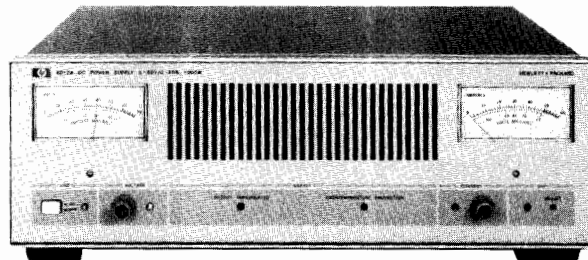

6012A—1000 watts

The standard models can be programmed either with a resistance or a voltage input. Full scale output voltage and current have been normalized to 2500 ohms or 5.0 volts. Both models contain an active down programming circuit. This circuit provides an improvement of up to 15 to 1 in down programming speed over conventional power supplies of similar ratings. Sensing terminals are provided at the rear of the power supply for applications where the load may be located some distance from the supply. When using remote sensing, the power supply maintains regulation at the load rather than at the rear terminals of the supply. The amplified current monitor provides a 0–5 volt output which is directly proportional to the output current.

Some of the most important benefits of using these supplies in systems results from the switching technology employed. A switching frequency of 20 kHz is used which allows most power handling components, as well as the filter capacitors, to be substantially reduced in size. This contributes to the reduced size and weight of the supply. Typical operating efficiency is 75%, which reduces the amount of cooling necessary for the overall system and enables the system to use less power.

### Option 002

The optional interface (002) provides a convenient means of integrating these supplies into a custom designed system or one controlled by an HP Multiprogrammer. A 69520A programmer card in conjunction with the option 002 card allows these supplies to be controlled by a 6940B Multiprogrammer. Similarly, the model 69709A programmer card is required when controlling the power supply by a 6942A Multiprogrammer.

The interface features are available through a 37-pin connector on the back of the power supply, and include:

**Remote programming:** Both the output voltage and current can be remotely programmed. In addition to external voltage and resistance programming, the interface provides current programming of output voltage and current.

**Status readback:** Six optically isolated status lines provide digital outputs to indicate the following states: constant-voltage, constant-current, unregulated output, ac line fault, overtemperature, and over-voltage.

**Remote shutdown:** There are two methods to remotely disable the output. The first method, utilizing two inputs, allows one input to be pulse "set" and the other to be pulse "reset." The second method uses one input whose level determines the output condition. These input lines are TTL compatible and optically isolated to prevent ground loops.

**Output bias supplies:** Three bias supplies are available with +5V, +15V, and –15V to power DAC's and other user supplied circuitry.

**Voltage and current readback:** For convenience, both are brought through the option connector.

## DC Output

		6024A	6012A
Model	Voltage	0-60 V	0-60 V
	Current	0-10 A	0-50 A
Load effect: (Load regulation)	Voltage	0.01% +3 mV	0.01% +5 mV
	Current	0.01% +3 mA	0.01% +5 mA
Source effect: (Line regulation)	Voltage	0.01% +2 mV	0.01% +3 mV
	Current	0.01% +2 mA	0.01% +5 mA
PARD: (Ripple and noise) rms/p-p, 20 Hz to 20 MHz	Voltage	3 mV / 30 mV	5 mV / 50 mV
	Current	5 mA rms	25 mA rms
Temperature coefficient: $\Delta$ /°C after 30 minute warmup	Voltage	0.01% +1 mV	0.01% +2 mV
	Current	0.03% +1 mA	0.01% +3 mA
Drift: (Stability) change in output over an 8 hour interval	Voltage	0.03% +3 mV	0.03% +5 mV
	Current	0.03% +3 mA	0.03% +5 mA
Load effect transient recovery response:	Time	1 ms	2 ms
	Level	75 mV	100 mV
Resolution: (Minimum adjustment of front panel controls)	Voltage	20 mV	20 mV
	Current	5 mA	20 mA
Remote resistance programming accuracy: (2500 ohms necessary for full scale output)	Voltage	0.08% +1 mV	1% +3 mV
	Current	2.4% +1 mA	2.5% +10 mA
Remote voltage programming accuracy: (5.0 volts necessary for full scale output)	Voltage	0.2% +1 mV	0.3% +3 mV
	Current	0.9% +1 mA	1% +10 mA
Programming response time: Maximum time for output voltage to change from 2 V to 60 V or 60 V to 2 V and settle within 200 mV	Up full load	200 ms	120 ms
	Up no load	200 ms	120 ms
	Down full load	300 ms	400 ms
	Down no load	600 ms	1.2 s
Overvoltage trip point range:		2-63 V	2-63 V
Amplified current monitor: 0-5 V represents zero to rated current output	Accuracy	0.9% +7 mV	1% +10 mV
	Output impedance	10 K $\Omega$ nom.	10 K $\Omega$ nom.
RFI specifications:		Meets VDE 0871 / 6.78 Level A	
Safety specifications:		Comply with IEC 348, VDE 0411, CSA 556B, CSA 22.2 #0-1975	
DC output isolation:		$\pm$ 240 Vdc from ground	
Temperature rating: (fan cooled)	Operating	0-50°C	
	Storage	-40 to +75°C	
AC input: (48-63 Hz) (Standard)	Voltage	104-127 Vac	
	Current	5.3 A rms max.	24 A rms max.
Weight:	Net	5.4 Kg (12 lbs)	15 Kg (33 lbs)
	Shipping	7.3 Kg (16 lbs)	16 Kg (35 lbs)

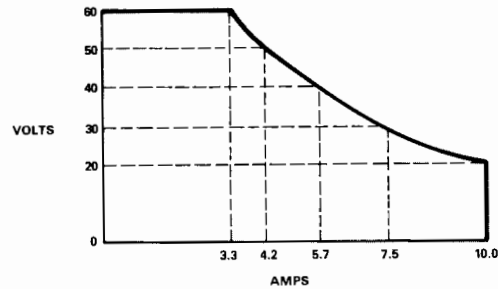

Autoranging operating area for the 6024A

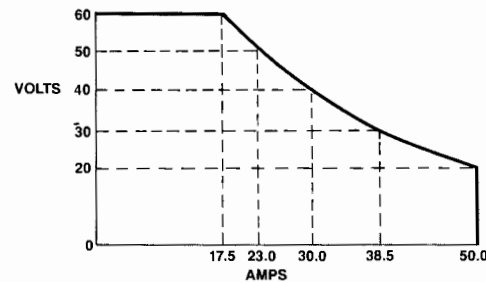

Autoranging operating area for the 6012A

## System Interface Specifications

		6024A	6012A
Sink current necessary for full scale output of voltage:	Voltage	2 mA	2mA
	Accuracy	0.3% +7 mV	0.4% +9 mV
Sink current necessary for full scale output of current:	Current	2 mA	2 mA
	Accuracy	1% +2 mA	1.1% +15 mA
Isolation: (Between status and control lines equipment ground, and power supply output)	Voltage	600 Vdc	600 Vdc

## Multiprogrammer Interface Cards

Model 69520A (for 6940B Multiprogrammer)			
Programming resolution	Voltage	60 mV	60 mV
	Current	10 mA	50 mA
Model 69709A (for 6942A Multiprogrammer)			
Programming Resolution	Voltage	60 mV	60 mV
	Current	10 mA	50 mA

## Accessories

**5061-0057:** Rack mounting adapter kit for one 6024A

**5061-0094:** Cabinet lock-together kit to connect two 6024As

**5061-0077:** Rack flange kit to mount two locked 6024As

## Options

**002:** System interface

**100:** 87-106 Vac, 48-63 Hz

**220:** 191-233 Vac, 48-63 Hz

**240:** 208-250 Vac, 48-63 Hz

**910:** Extra operating and service manual

**6024A** Autoranging Power Supply

**6012A** Autoranging Power Supply

# POWER SUPPLIES

General Purpose: 120–2000 W Output

Models 6259B-6274B & 895A

- Built-in overvoltage protection\*
- Constant voltage/constant current operation
- Remote programming and sensing

- Remote sensing
- Auto-series, -parallel, and -tracking operation
- $\leq 50 \mu\text{s}$  load transient recovery

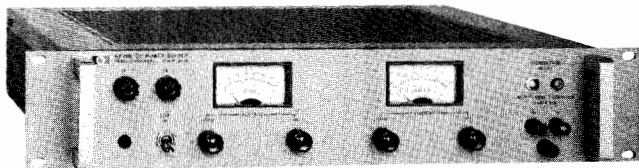

6263B, 6266B, 6271B

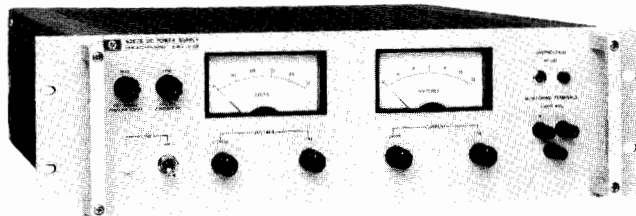

6264B, 6267B

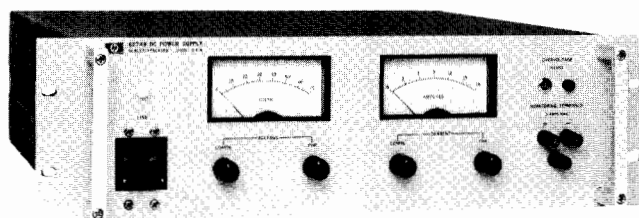

6274B

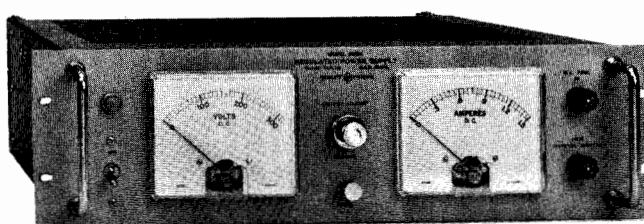

895A

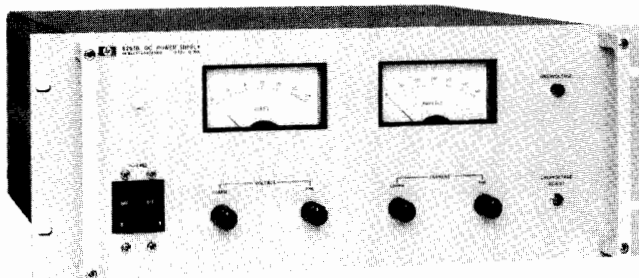

6259B, 6260B, 6261B, 6268B, 6269B

## Description

### Models 6259B-6274B

This series of high-performance constant voltage/constant current supplies includes twelve models with output rating from 10 to 60 V. All models employ a transistor series-regulator/triac-preregulator circuit to achieve high efficiency, excellent regulation, low ripple and noise, and moderate programming speeds in a compact full-rack width package.

Separate coarse and fine voltage and current controls allow the voltage and current outputs to be varied from zero to the maximum rated value, crossover from constant voltage to constant current operation occurs automatically when the load current exceeds the value established by the current control settings.

Additional features include built-in overvoltage crowbar protection; remote error sensing; and auto-series, auto-parallel, and auto-tracking operation. The crowbar trip point adjustment and associated overvoltage indicator are conveniently located on the front panel.

## Specifications†

RATINGS			PERFORMANCE							
DC Output		Model	Load Effect		Source Effect		PARD (rms/p-p)		Drift (stability)	
Volts	Amps		Voltage	Current	Voltage	Current	Voltage	Current	Voltage	Current
0-10	0-50	6259B	0.01% + 200 $\mu\text{V}$	0.02% + 1 mA	0.01% + 200 $\mu\text{V}$	0.02% + 1 mA	500 $\mu\text{V}/5 \text{ mV}$	25 mA rms	0.03% + 2 mV	0.03% + 10 mA
0-10	0-100	6260B	0.01% + 200 $\mu\text{V}$	0.02% + 2 mA	0.01% + 200 $\mu\text{V}$	0.02% + 2 mA	500 $\mu\text{V}/5 \text{ mV}$	50 mA rms	0.03% + 2 mV	0.03% + 20 mA
0-20	0-10	6263B	0.01% + 200 $\mu\text{V}$	0.02% + 500 $\mu\text{A}$	0.01% + 200 $\mu\text{V}$	0.02% + 500 $\mu\text{A}$	200 $\mu\text{V}/10 \text{ mV}$	3 mA rms	0.03% + 500 $\mu\text{V}$	0.03% + 6 mA
0-20	0-20	6264B	0.01% + 200 $\mu\text{V}$	0.02% + 500 $\mu\text{A}$	0.01% + 200 $\mu\text{V}$	0.02% + 500 $\mu\text{A}$	200 $\mu\text{V}/10 \text{ mV}$	5 mA rms	0.03% + 500 $\mu\text{V}$	0.03% + 6 mA
0-20	0-50	6261B	0.01% + 200 $\mu\text{V}$	0.02% + 1 mA	0.01% + 200 $\mu\text{V}$	0.02% + 1 mA	500 $\mu\text{V}/5 \text{ mV}$	25 mA rms	0.03% + 2 mV	0.03% + 10 mA
0-40	0-5	6266B	0.01% + 200 $\mu\text{V}$	0.02% + 500 $\mu\text{A}$	0.01% + 200 $\mu\text{V}$	0.02% + 500 $\mu\text{A}$	200 $\mu\text{V}/10 \text{ mV}$	3 mA rms	0.03% + 500 $\mu\text{V}$	0.03% + 3 mA
0-40	0-10	6267B	0.01% + 200 $\mu\text{V}$	0.02% + 500 $\mu\text{A}$	0.01% + 200 $\mu\text{V}$	0.02% + 500 $\mu\text{A}$	200 $\mu\text{V}/10 \text{ mV}$	3 mA rms	0.03% + 2 mV	0.03% + 3 mA
0-40	0-30	6268B	0.01% + 200 $\mu\text{V}$	0.02% + 2 mA	0.01% + 200 $\mu\text{V}$	0.02% + 2 mA	1 mV/5 mV	20 mA rms	0.03% + 2 mV	0.03% + 5 mA
0-40	0-50	6269B	0.01% + 200 $\mu\text{V}$	0.02% + 2 mA	0.01% + 200 $\mu\text{V}$	0.02% + 2 mA	1 mV/5 mV	25 mA rms	0.03% + 2 mV	0.03% + 10 mA
0-60	0-3	6271B	0.01% + 200 $\mu\text{V}$	0.02% + 500 $\mu\text{A}$	0.01% + 200 $\mu\text{V}$	0.02% + 500 $\mu\text{A}$	200 $\mu\text{V}/10 \text{ mV}$	3 mA rms	0.03% + 500 $\mu\text{V}$	0.03% + 3 mA
0-60	0-15	6274B	0.01% + 200 $\mu\text{V}$	0.02% + 500 $\mu\text{A}$	0.01% + 200 $\mu\text{V}$	0.02% + 500 $\mu\text{A}$	200 $\mu\text{V}/20 \text{ mV}$	5 mA rms	0.03% + 2 mV	0.03% + 5 mA
0-320	0-1.5	895A	0.007% or 20 mV	—	0.007% or 20 mV	—	1 mV rms	—	0.1% + 5 mV	—

\*These six features apply to models 6259B-6274B, but not to model 895A.

†Refer to page 232 for complete specification definitions.



Auto-series, auto-parallel, and auto-tracking connections should ordinarily include no more than three supplies. If a specific application requires the use of more than three supplies in any of the three connections, consult your local HP Field Engineer for additional information.

All dc output, ac input, sensing, control, and programming connections are made to rear-panel terminals. Either the positive or negative output terminal may be grounded or the supplies may be operated floating at up to 300 volts above ground. Models 6263B, 6264B, 6266B, 6267B, and 6271B are convection cooled. All other models in this series employ cooling fans. Models which output more than 200 watts are equipped with terminal blocks for ac input and are not shipped with line cords.

### Model 895A

Model 895A is a general purpose constant/voltage/current/limit supply. Output voltage is adjustable from 0-320 V via a front panel 10-turn potentiometer with concentric lock and a single-turn fine control. Separate voltage and current meters provide continuous indication of power supply outputs. High performance specifications include 0.007% line and load regulation and 1 mV rms ripple and noise. Remote sensing and programming are standard features. The 895A is equipped with a terminal block for ac input and is not shipped with a line cord.

### Specification—General

**Load effect transient recovery:** time—50  $\mu$ s. Level—10 mV (895A—time—100  $\mu$ s. Level—20 mV)

**Resolution:** voltage control—less than 0.02%. Current control—less than 0.15%.

**Temperature coefficient per °C:** 0.01% of output plus 200  $\mu$ V (895A—0.03% + 1.5 mV).

**Temperature ratings:** operating, 0 to 55°C; Storage, -40 to 75°C.

**Remote control programming:** these power supplies are capable of being programmed in constant voltage and constant current operation by using an external resistance or dc voltage with coefficients as shown in the table below.

Rear terminal wiring configurations for remote control operation are specified in the operating and service manual supplied with the power supply. For remote control programming procedures and timing considerations, contact your local HP field engineer.

**Power:** input voltage is 115 V ac or 230 V ac  $\pm$  10%, 57-63 Hz. For other input voltage and frequency options available, see option listing below. Standard input voltage, maximum input current, and maximum power are:

6259B, 230 V ac, 6 A, 850 W;  
 6260B, 230 V ac, 12 A, 1600 W; 6261B, 230 V ac, 12 A, 1500 W;  
 6263B, 115 V ac, 4.5 A, 350 W; 6264B, 115 V ac, 8 A, 600 W;  
 6266B, 115 V ac, 4 A, 325 W; 6267B, 115 V ac, 8 A, 550 W;  
 6268B, 230 V ac, 12 A, 1600 W; 6269B, 230 V ac, 18 A, 2500 W;  
 6271B, 115 V ac, 4 A, 300 W; 6274B, 115 V ac, 15 A, 1200 W;  
 895A, 115 V ac, 8.7 A, 585 W.

**AC line connections:** three wire, five foot ac power cord included—6263B, 6266B and 6271B.

Three terminal barrier strip provided on power supply for ac power connections—6259B, 6260B, 6261B, 6264B, 6267B, 6268B, 6269B, 6274B and 895A.

### Size:

6263B, 6266B, 6271B: 83.7 H x 483 W x 479.4 mm D (3.296" x 19" x 18.875").

6264B, 6267B, 6274B: 127 H x 483 W x 479.4 mm D (5.00" x 19" x 18.875").

6259B, 6260B, 6261B, 6268B, 6269B: 173 H x 483 W x 479.4 mm D; (6.812" x 19" x 18.875").

895A: 128.6 H x 483 W x 463.6 mm D (5.062" x 19" x 18.25").

### Option Descriptions

**005:** 50 Hz ac input: optimizes power supplies that require adjustment/modification for 50 Hz operation.

**010:** chassis slides. For access to rack mounted power supplies. 6263B, 6264B, 6266B, 6267B, 6271B, 6274B 6259B, 6260B, 6261B, 6268B, 6269B

**016:** 115 V ac  $\pm$  10% single phase input. Consists of replacing power transformer and circuit breaker, and reconnecting bias transformer, RFI choke and fans.

**022:** voltage and current programming adjust. Allows the V and I programming coefficients and zero output to be conveniently adjusted to 0.1% accuracy via access holes in the rear panel. Consists of four potentiometers and resistors located inside the rear panel.

**026:** 115 V ac  $\pm$  10%, single phase input. Consists of replacing the input circuit breaker and reconnecting the power transformer, bias transformer, RFI choke, and fans.

**027:** 208 V ac,  $\pm$  10%, single phase input. Consists of reconnecting power transformer taps, and other components where necessary.

**028:** 230 V ac  $\pm$  10%, single phase input. Consists of reconnecting power transformer taps, and other components where necessary.

**040:** Multiprogrammer interface. Prepares standard HP power supplies for resistance programming by the 6942A or 6940B Multiprogrammers. This option includes Option 022, special calibration, and protection check-out procedures (where required).

**910:** one additional operating and service manual shipped with each power supply. 6259B-6274B 895A

**J10:** special option for 220 V 50 Hz operation for the 895A.

### Specifications, continued

REMOTE CONTROL FEATURES								GENERAL				
Resistance Coeff.		Voltage Coeff.		Speed Up*		Speed Down*		Overvoltage		Weight		Options
Voltage	Current	Voltage	Current	NL	FL	NL	FL	Range	Margin	Net	Shipping	
200 $\Omega$ /V $\pm$ 1%	4 $\Omega$ /A $\pm$ 10%	1 V/V $\pm$ 1%	10 mV/A $\pm$ 10%	70 ms	70 ms	200 ms	100 ms	2-12 V	5% + 2V	31.3 kg/69 lb	35.3 kg/78 lb	5, 9, 10, 15, 22, 26, 27, 40
200 $\Omega$ /V $\pm$ 1%	2 $\Omega$ /A $\pm$ 10%	1 V/V $\pm$ 1%	5 mV/A $\pm$ 10%	70 ms	70 ms	200 ms	75 ms	2-12 V	5% + 2V	43.9 kg/97 lb	48 kg/106 lb	5, 9, 10, 15, 16, 22, 27, 40
200 $\Omega$ /V $\pm$ 1%	100 $\Omega$ /A $\pm$ 10%	1 V/V $\pm$ 1%	50 mV/A $\pm$ 10%	150 ms	150 ms	7 s	350 ms	2-23 V	5% + 1V	15.4 kg/34 lb	18.6 kg/41 lb	5, 9, 10, 15, 22, 27, 28, 40
200 $\Omega$ /V $\pm$ 1%	10 $\Omega$ /A $\pm$ 10%	1 V/V $\pm$ 1%	25 mV/A $\pm$ 10%	140 ms	140 ms	10 s	150 ms	2.5-23V	5% + 1V	21.3 kg/47 lb	24.5 kg/54 lb	5, 9, 10, 15, 22, 27, 28, 40
200 $\Omega$ /V $\pm$ 1%	4 $\Omega$ /A $\pm$ 10%	1 V/V $\pm$ 1%	10 mV/A $\pm$ 10%	150 ms	150 ms	250 ms	250 ms	2-23 V	5% + 2V	35.3 kg/78 lb	39.4 kg/87 lb	5, 9, 10, 15, 22, 26, 27, 40
200 $\Omega$ /V $\pm$ 1%	200 $\Omega$ /A $\pm$ 10%	1 V/V $\pm$ 1%	100 mV/A $\pm$ 10%	275 ms	275 ms	13 s	1.5 s	2.5-45 V	5% + 1V	15.4 kg/34 lb	18.6 kg/41 lb	5, 9, 10, 15, 22, 27, 28, 40
200 $\Omega$ /V $\pm$ 1%	100 $\Omega$ /A $\pm$ 10%	1 V/V $\pm$ 1%	50 mV/A $\pm$ 10%	275 ms	275 ms	13 s	750 ms	2.5-45 V	5% + 1V	17.7 kg/39 lb	20.8 kg/46 lb	5, 9, 10, 15, 22, 27, 28, 40
200 $\Omega$ /V $\pm$ 1%	6 $\Omega$ /A $\pm$ 10%	1 V/V $\pm$ 1%	16.7 mV/A $\pm$ 10%	300 ms	300 ms	1 s	650 ms	4-45 V	5% + 1V	34.4 kg/76 lb	38.1 kg/84 lb	5, 9, 10, 15, 22, 26, 27, 40
200 $\Omega$ /V $\pm$ 1%	4 $\Omega$ /A $\pm$ 10%	1 V/V $\pm$ 1%	10 mV/A $\pm$ 10%	350 ms	350 ms	1 s	600 ms	4-45 V	5% + 1V	40.3 kg/89 lb	44 kg/98 lb	5, 9, 10, 15, 22, 27, 40
300 $\Omega$ /V $\pm$ 1%	300 $\Omega$ /A $\pm$ 10%	1 V/V $\pm$ 1%	167 mV/A $\pm$ 10%	600 ms	600 ms	7 s	2 s	6-66 V	5% + 1V	15.4 kg/34 lb	18.6 kg/41 lb	5, 9, 10, 15, 22, 27, 28, 40
300 $\Omega$ /V $\pm$ 1%	67 $\Omega$ /A $\pm$ 10%	1 V/V $\pm$ 1%	33.3 mV/A $\pm$ 10%	600 ms	600 ms	40 s	800 ms	6-66 V	5% + 1V	21.7 kg/48 lb	24.5 kg/54 lb	5, 9, 10, 15, 22, 27, 28, 40
300 $\Omega$ /V	—	—	—	—	—	—	—	NA	NA	22.6 kg/50 lb	29.4 kg/65 lb	J10

\*Up = increasing output voltage. NL = No output load current. FL = Full rated output load current

# POWER SUPPLIES

General Purpose: 300—11,000 W Output  
Models 6434B—6483C

- Outstanding value—low cost/watt
- Up to 75% efficiency at full output
- Constant voltage/current operation

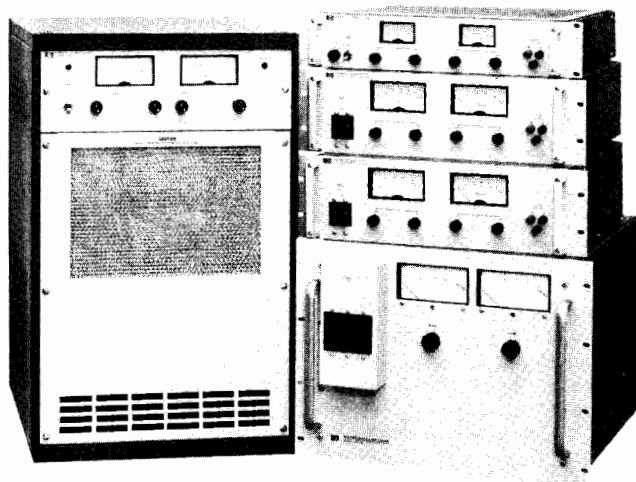

6434B—6483C

## Description

This series of SCR-regulated power supplies is designed for medium to high-power applications requiring a fixed or variable dc source with moderate regulation and ripple. For supplies with better regulation, faster response time, and lower ripple, see models 6259B—6274B and 895A, on page 240.

## Operating Features

All supplies in this series are of the constant voltage/constant current type. Large easy-to-read panel meters continuously monitor output voltage current.

Input and output power, remote sensing, remote programming, and auto-series, -parallel, and -tracking connections are made to bus bars and terminal blocks on the rear panel.

## Protective Features

In addition to the overload protection inherent in constant voltage/constant current operation, there are many other built-in protective features included in these supplies. The features vary within the three model classifications as follows:

**6434B—6448B:** (1) Reverse voltage protection. (2) Fused ac input.

**6453A, 6456B, 6459A:** (1) AC line loss protection circuit monitors 3-phase input and cuts off SCR's and opens output bus if a phase drops out; operation resumes when ac input returns to normal. (2) 3-phase input circuit breaker. (3) Optional internal crowbar (Option 006) protects load from overvoltage condition.

**6464C—6483C:** (1) High-temperature protection thermostat opens input to power transformer and lights front panel indicator if supply overheats. (2) Prolonged overload protection circuit is activated and lights front panel indicator if output current exceeds approximately 115% of maximum rating. (3) Optional internal crowbar (except on 6464C) protects load from overvoltage condition. (4) Turn-on circuit limits peak line current during start-up into low impedance loads. (5) Phase-balance circuit permits operation with line-to-line input voltage imbalance up to 8%. (6) Overcurrent and overvoltage circuits of master slave supplies used in auto-series, -parallel, or -tracking operation can be interlocked.

## Auto-Series, -Parallel, -Tracking Operation

Supplies may be connected in auto-series, or auto-tracking. (Except 6448B and 6483C, which cannot be connected in auto-series.)

Up to three lower power models (6434B—6448B) may be connected in any of the above configurations. Higher-power model (6453A/6483C) interconnection should ordinarily include no more than two supplies.

## Remote Programming

The voltage and current outputs of the supplies can be programmed by a remote resistance, or for most models, a remote voltage source. Programming speeds and coefficients are detailed in the specifications table.

## AC Power Requirements

The ac power requirements vary with the three model classifications (see option listings). When powered from a 50 Hz source (possible with option 005), the rms ripple and transient response specifications increase by 50%. The p-p ripple specification is unchanged by line frequency.

## Specifications†

RATINGS			PERFORMANCE						
DC Output		Model	Load Effect		Source Effect		PARD $\Delta$ rms/p-p	Temperature Coefficient	Drift
Volts§	Amps§		Voltage	Current	Voltage	Current			
0-8	0-1000	6464C	0.05% + 5 mV	0.1% + 1 A	0.05% + 5 mV	0.1% + 1 A	80 mV/1 V	0.03% + 100 $\mu$ V	0.03% + 1 mV
0-15	0-200	6453A	0.2% + 10 mV††	1% or 2 A††	0.2% + 10 mV††	1% or 2 A††	150 mV rms	0.05% + 2 mV	0.25% + 10 mV
0-16 or 18	0-600 or 500*	6466C	0.05% + 5 mV	0.1% + 0.6 A	0.05% + 5 mV	0.1% + 0.6 A	180 mV/1 V	0.03% + 200 $\mu$ V	0.2% + 1 mV
0-36	0-100	6456B	0.2% + 10 mV††	1% or 1 A††	0.2% + 10 mV††	1% or 1 A††	180 mV rms	0.05% + 2 mV	0.25% + 10 mV
0-36	0-300	6469C	0.05% + 5 mV	0.1% + 0.3 A	0.05% + 5 mV	0.1% + 0.3 A	180 mV/1 V	0.03% + 400 $\mu$ V	0.15% + 1 mV
0-40	0-25	6434B	40 mV	200 mA	18 mV	200 mA	40 mV/500 mV	0.03% + 5 mV	0.1% + 20 mV
0-60	0-5	6438B	60 mV	50 mA	30 mV	50 mA	120 mV/400 mV	0.03% + 10 mV	0.1% + 30 mV
0-64	0-50	6459A	0.2% + 10 mV††	1% or 0.5 A††	0.2% + 10 mV††	1% or 0.5 A††	160 mV rms	0.05% + 2 mV	0.25% + 10 mV
0-64	0-150	6472C	0.05% + 100 mV	0.1% + 0.15 A	0.05% + 100 mV	0.1% + 0.15 A	160 mV/2 V	0.03% + 4 mV	0.15% + 16 mV
0-110	0-100	6475C	0.05% + 100 mV	0.1% + 0.1 A	0.05% + 100 mV	0.1% + 0.1 A	200 mV/2 V	0.03% + 5 mV	0.15% + 20 mV
0-120	0-2.5	6443B	120 mV	25 mA	60 mV	25 mA	240 mV/400 mV	0.03% + 20 mV	0.1% + 60 mV
0-220	0-50	6477C	0.05% + 100 mV	0.1% + 50 mA	0.05% + 100 mV	0.1% + 50 mA	330 mV/2 V	0.03% + 8 mV	0.15% + 35 mV
0-300	0-35	6479C	0.05% + 100 mV	0.1% + 35 mA	0.05% + 100 mV	0.1% + 35 mA	330 mV/3 V	0.03% + 11 mV	0.15% + 45 mV
0-440, 500 or 600	0-25, 20, 15*	6483C	0.05% + 100 mV	0.1% + 35 mA	0.5% + 100 mV	0.1% + 35 mA	600 mV/5 V	0.03% + 20 mV	0.15% + 80 mV
1-600	5 mA-1.5 A	6448B	1 V	40 mA	600 mV	15 mA	600 mV/2 V	0.03% + 100 mV	0.1% + 300 mV

†Refer to page 232 for complete specification definitions.

††Specified for combined line and load regulation.

Δ For operation with a 50 Hz input (possible only with Option 005), the rms ripple and transient response specifications are increased by 50%.

\* The output current rating is given in the same order corresponding with the voltage rating.

§ Under light loading conditions, power supply may not meet all published specifications. The graph on the next page defines the permissible operating regions for CV and CC modes of operation.

For operation with a 50 Hz input (possible only with Option 005), output current is linearly derated from 100% at 40°C to 80% at 50°C.

POWER SUPPLY OUTPUT RESTRICTIONS AS A FUNCTION OF LOADING

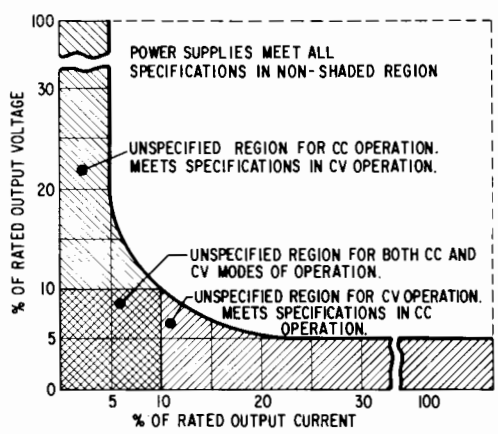

An ac input option must be specified when ordering.

**Line Cords**

Line cords are not supplied with models 6453A-6483C.

**Size**

**Models 6438B and 6443B:** 89 H x 483 W x 445 mm D (3.5" x 19" x 17.5").

**Models 6434B, & 6448B:** 133 H x 483 W x 432 mm D (5.25" x 19" x 17").

**Models 6453A, 6456B, & 6459A:** 356 H x 483 W x 500 mm D (14" x 19" x 19.7").

**Models 6464C, 6466C, 6469C, 6472C, 6475C, 6477C, 6479C, & 6483C:** 705 H x 483 W x 715 mm D (27.75" x 19" x 28.12").

**Option Descriptions**

**6434B-6448B**

**Std:** 115 V ac, ± 10%, single phase, 57-63 Hz

**005:** realignment for 50 Hz operation

**010:** chassis slides

**027:** 208 V ac, ± 10%, single phase, 57-63 Hz

**028:** 230 V ac, ± 10%, single phase, 57-63 Hz

**910:** one extra operating and service manual shipped with each power supply

**6453A, 6456B, 6459A**

An ac input option must be specified when ordering.

AC input connections are by means of a 4-conductor connector at rear of unit. A matching Hubbell No. 7413G plug (HP part number 1251-1570) is furnished.

**001:** 208 V ac, ± 10%, 3-phase, 15.5 A/phase, 57-63 Hz

**002:** 230 V ac, ± 10%, 3-phase, 14 A/phase, 57-63 Hz

**003:** 460 V ac, ± 10%, 3-phase, 7 A/phase, 57-63 Hz

**005:** realignment for 50 Hz operation

**006:** internal overvoltage protection crowbar

**010:** chassis slides

**031:** 380 V ac, ± 10%, 3-phase, 8.5 A/phase, 57-63 Hz

**032:** 400 V ac, ± 10%, 3-phase- 8.0 A/phase, 57-63 Hz

**910:** one extra operating and service manual shipped with each power supply

**6464C-6483C**

An ac input option must be specified when ordering.

AC input connections are by means of enclosed 4-wire terminal block

**001:** 208 V ac, ± 10%, 3-phase, 55 A/phase, 57-63 Hz

**002:** 230 V ac, ± 10%, 3-phase, 50 A/phase, 57-63 Hz

**003:** 460 V ac, ± 10%, 3-phase, 25 A/phase, 57-63 Hz

**005:** realignment for 50 Hz operation

**006:** internal overvoltage protection crowbar

6477C, 6479C, 6483C

6466C

6469C

6472C, 6475C

**023:** rack mounting attachments for standard 19" rack

**031:** 380 V ac, ± 10%, 3-phase, 30 A/phase, 57-63 Hz

**032:** 400 V ac, ± 10%, 3-phase, 28.5 A/phase, 57-63 Hz

**040:** prepares power supply to be programmed with resistance by a 6940B or 6942A.

**910:** one extra operating and service manual shipped with each power supply

**Accessory**

**14545A:** casters for 6464C-6483C—set of four

**Specifications, continued**

REMOTE CONTROL										GENERAL			
Resolution		Load Transient Recovery $\Delta$	Resistance Coefficient		Voltage Coefficient†		Up		Down		Net Weight		Options
			Voltage	Current	Voltage	Current	NL	FL	NL	FL	Kg	lb	
V	C												
8 mV	1 A	100 ms, 500 mV	200 $\Omega$ /V $\pm$ 2%	1 $\Omega$ /A $\pm$ 2%	1 V/V $\pm$ 1%	6.2 mV/A $\pm$ 7%	1.6 s	0.6 s	6 s	0.1 s	235	518	1, 2, 3, 5, 23, 31, 32, 40
65 mV	1 A	50 ms, 150 mV	200 $\Omega$ /V $\pm$ 2%	1 $\Omega$ /A	0.4 V/V	30 mV/A	1 s	0.5 s	20 s	0.2 s	108	238	1, 2, 3, 5, 6, 10, 31, 32
18 mV	0.5 A	100 ms, 500 mV	200 $\Omega$ /V $\pm$ 2%	1.66 $\Omega$ /A $\pm$ 2%	1 V/V $\pm$ 1%	10.3 mV/A $\pm$ 7%	1.6 s	0.6 s	15 s	0.2 s	226	500	1, 2, 3, 5, 6, 23, 31, 32, 40
90 mV	0.5 A	50 ms, 300 mV	200 $\Omega$ /V $\pm$ 2%	2 $\Omega$ /A	166 mV/V	60 mV/A	1 s	0.5 s	60 s	0.5 s	108	238	1, 2, 3, 5, 6, 10, 31, 32
36 mV	0.3 A	100 ms, 500 mV	200 $\Omega$ /V $\pm$ 2%	3.33 $\Omega$ /A $\pm$ 2%	1 V/V	20.6 mV/A $\pm$ 7%	1.6 s	3 s	20 s	0.5 s	226	500	1, 2, 3, 5, 6, 23, 31, 32, 40
10 mV	12.5 mA	200 ms, 200 mV	200 $\Omega$ /V $\pm$ 2%	12 $\Omega$ /A	1 V/V	**	0.3 s	1.2 s	75 s	1.2 s	30.4	67	5, 10, 27, 28
9 mV	2.5 mA	200 ms, 300 mV	300 $\Omega$ /V $\pm$ 2%	60 $\Omega$ /A	1 V/V	**	0.5 s	2.5 s	200 s	2.5 s	14	31	5, 10, 27, 28
100 mV	0.25 A	50 ms, 600 mV	300 $\Omega$ /V $\pm$ 2%	4 $\Omega$ /A	94 mV/V	120 mV/A	1 s	0.5 s	45 s	0.7 s	108	238	1, 2, 3, 5, 6, 10, 31, 32
64 mV	0.15 mA	100 ms, 750 mV	300 $\Omega$ /V $\pm$ 2%	6.7 $\Omega$ /A $\pm$ 2%	1 V/V $\pm$ 3%	41.2 mV/A $\pm$ 7%	1.4 s	2.5 s	55 s	0.7 s	226	500	1, 2, 3, 5, 6, 23, 31, 32, 40
22 mV	0.1 A	100 ms, 1 V	300 $\Omega$ /V $\pm$ 2%	10 $\Omega$ /A $\pm$ 2%	1 V/V $\pm$ 3%	62 mV/A $\pm$ 7%	1.5 s	2 s	80 s	0.7 s	226	500	1, 2, 3, 5, 6, 23, 31, 32
30 mV	1.3 mA	200 ms, 600 mV	300 $\Omega$ /A $\pm$ 2%	120 $\Omega$ /A	1 V/V	**	0.5 s	2 s	210 s	2 s	14	31	5, 10, 27, 28
44 mV	50 mA	100 ms, 2 V	300 $\Omega$ /V $\pm$ 2%	20 $\Omega$ /V $\pm$ 2%	1 V/V $\pm$ 3%	124 mV/A $\pm$ 7%	1.5 s	2 s	95 s	1 s	226	500	1, 2, 3, 5, 6, 23, 31, 32
60 mV	35 mA	100 ms, 3 V	300 $\Omega$ /V $\pm$ 2%	28.6 $\Omega$ /A $\pm$ 2%	1 V/V $\pm$ 3%	177 mV/A $\pm$ 7%	1.5 s	2 s	75 s	1.6 s	226	500	1, 2, 3, 5, 6, 23, 31, 32
60 mV	25 mA	100 ms, 5 V	300 $\Omega$ /V $\pm$ 2%	40 $\Omega$ /A $\pm$ 2%	1 V/V $\pm$ 3%	0.25 V/A $\pm$ 7%	1.5 s	2 s	120 s	2 s	226	500	1, 2, 3, 5, 6, 23, 31, 32
60 mV	0.75 mA	200 ms, 3 V	300 $\Omega$ /V $\pm$ 2%	600 $\Omega$ /A	1 V/V	**	0.2 s	1 s	45 s	2 s	27.6	61	5, 10, 27, 28

$\Delta$ For operation with a 50 Hz input (possible only with Option 005), the rms ripple and transient response specifications are increased by 50%.

\*\*This feature is not available.

\*An ac input option must be specified when ordering these 3-phase models.

†Special Option J30 must be ordered with models 6434B-6448B and 6466C-6483C to be programmed with a 59501A Power Supply Programmer. Contact your local HP Field Engineer for ordering instructions.



# POWER SUPPLIES

## 200 Watt System Power Supply

- HP-IB programming of voltage, current and OVP
- HP-IB measurement of voltage and current
- Full operating status readback
- Autoranging output
- Service request capability
- Self-test and diagnostics

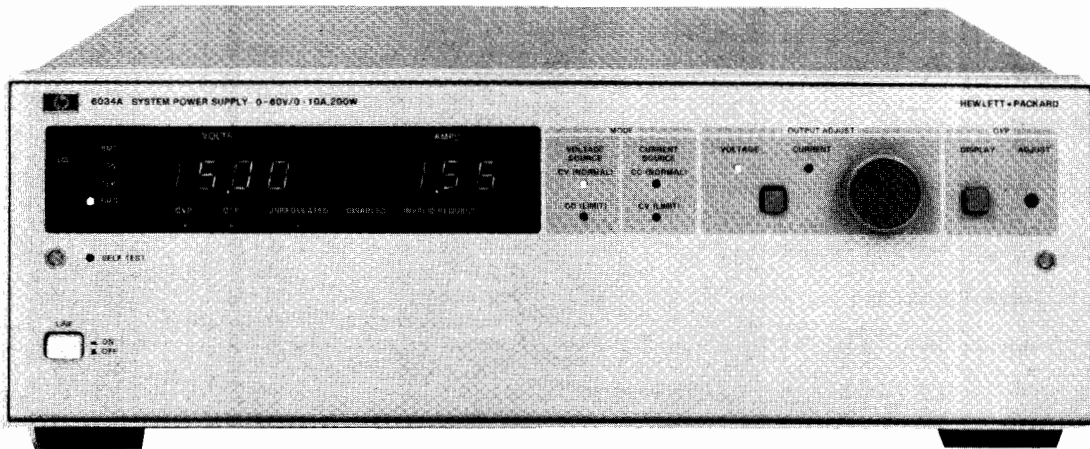

### Description

The 6034A DC power supply has a combination of features and specifications that characterize it as a comprehensive solution to HP-IB system power supply applications. The 6034A combines FET switching technology with an internal microprocessor-based HP-IB programmer to achieve the first bidirectional programmable autoranging dc power supply.

FET switching technology provides laboratory-grade performance specifications and autoranging capability in a compact lightweight package. The high electrical efficiency, obtained through the use of flyback switching, reduces your overall system cooling requirements. The microprocessor-based HP-IB interface provides a friendly programming format. Output voltage and current can be programmed directly in volts and amperes with 12-bit resolution. Information regarding the output and load is available through remote metering over the HP-IB.

As an autoranging power supply, the 6034A can provide maximum rated power over a wide range of voltage and current without the operator having to program the proper range.

Eight status parameters can be read back via the HP-IB to enhance system versatility. These status parameters permit identification of the operational mode and fault conditions of the 6034A. They also can be used to initiate corrective action for fault conditions without operator intervention. The overvoltage trip point can be programmed directly in volts with 8-bit resolution, or set with a front panel adjustment. Other protection oriented features include soft voltage and current limits, and overtemperature protection. Soft limit protection allows the user to program limits such that only voltage and current values within these limits will be accepted by the power supply.

### System Applications

The 6034A incorporates many system features that can significantly reduce the time needed for hardware and software development. These features include friendly programming of voltage, current, and overvoltage protection, readback of voltage or current, full service request interrupt capability and operating status readback. The following two applications illustrate the power and flexibility of the 6034A.

### Automatic PC Board Test

The interactive nature of the 6034A is of particular value in a PC board test system. For example, voltage can be programmed along with a current limit to protect board tracks. Either a constant voltage or constant current can be programmed as the normal operating mode via the HP-IB. If the board under test has a rail to rail short as a result of a defective component or bridged tracks, the current limit setting will prevent damage to the PC board's power distribution system and components. Utilizing the status readback capabilities of the 6034A when constant voltage (CV) has been defined as the normal operating mode of the supply, the shorted component or bridged track can cause the 6034A to initiate a service request (SRQ). The mode crossover condition can then be relayed to the controller through a serial poll. A remote voltage reading can also be taken across the load and sent back to the controller. If the voltage is close to zero, the controller can display the "shorted load" condition to the system operator. Conversely, if a remote measurement is taken and the supply is found to be in normal mode with a current value of zero the controller can reveal the "open load" condition to the operator. Software can also set up an operating power region for a particular board, and the 6034A coupled with that software can determine whether the board under test is drawing power within the anticipated boundaries.

### Incoming Inspection of Electronic Components

The forward characteristics of a rectifier diode can be evaluated by the 6034A for incoming inspection.

The controller compares characteristics tested by the 6034A with established standards and rejects out-of-spec units. The system can then plot individual device E-I characteristics, or reduce the data on an entire lot of devices to graphical or statistical form.

Without the 6034A, a current shunt and an HP-IB voltmeter would be required to implement this test system. However, with the 6034A, both stimulus and response are effected through a single system component, thereby reducing your system hardware costs and rack space requirements. Also, the microprocessor-based architecture of the 6034A offers an easy programming format.

### Specifications

All performance specifications are measured at the rear terminals with a resistive load and at 25°C ± 5°C.

**DC Output:** Voltage and current output can be programmed with the HP-IB or the front panel control over the following ranges:

**Voltage:** 0-60 V      **Current:** 0-10 A

Maximum available output power from 20 V to 60 V is indicated below.

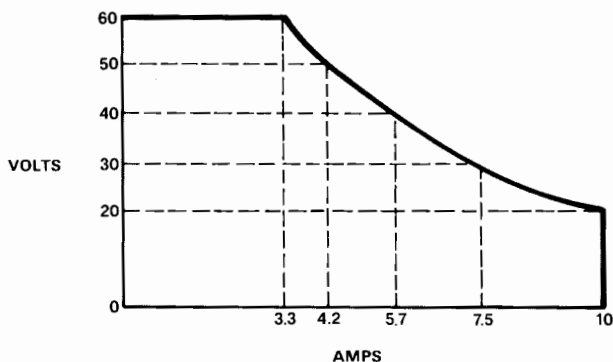

#### Load Effect: (Load Regulation):

**Voltage:** ±0.01% ± 3 mV

**Current:** 0.01% + 3 mA

#### Source effect:

**Voltage:** 0.01% + 2 mV

**Current:** 0.01% + 2 mA

**PARD:** (Ripple and Noise) RMS/p-p, 20 Hz to 20 MHz:

**Voltage:** 3 mV/30 mV

**Current:** 5 mA RMS

**Temperature coefficient:** Δ/°C after 30 minute warmup:

**Voltage:** ±0.009% ± 0.7 mV

**Current:** ±0.009% ± 0.8 mA

**Load transient recovery time:** Less than 1 ms is required for output voltage recovery (in constant voltage operation) to within 75 mV of the nominal output following a change in output current from 90% to 100% or 100% to 90% of maximum current.

#### Programming resolution:

**Voltage:** 15 mV (12 bits)

**Current:** 2.5 mA (12 bits)

#### Programming accuracy (25 ± 5°C):

**Constant Voltage:** ±0.07% ± 28 mV

**Constant Current:** ±0.085 ± 12.5 mA

**Output impedance:** Typical value is 1 mΩ in series with 30 μH, but less than 1 Ω for all frequencies less than 1 MHz.

**Drift:** (Stability) change in output over an 8 hour interval with fixed conditions after 30 minute warmup.

**Voltage:** ±0.03% ± 3 mV

**Current:** ±0.03% ± 3 mA

#### Programmable time delay:

**Range:** 0-65,535 ms

**Resolution:** 1 ms

**Accuracy:** ±5% nominal

**Amplified current monitor:** Scale Factor 0-5 V monitor output for 0-10 A output current:

**Accuracy:** 0.1% + 7 mV typical

**Output Impedance:** 10 kΩ nominal

**RFI Specifications:** Meets VDE 0871/6.78 Level A

**Programming response time:** Maximum time for output voltage to change from 0 V to 60 V or 60 V to 2 V and settle within a 60 mV band (0.1% of maximum rated output):

		Band:	60 mV(*)	15 mV(**)
<b>Up:</b>	Full Load	(18 Ω)	200 ms	225 ms
	No Load		200 ms	225 ms
<b>Down:</b>	Full Load	(18 Ω)	300 ms	450 ms
	No Load		600 ms	750 ms

\*Max, \*\*(Typical)

#### Front panel meters:

**Output Voltage:** Low Range: ±20.00 V

High Range: ±200.0 V

**Range switch points:** Up: above 19.99 V ± 0 V

Down: below 17.5 V nominal

**Resolution:** Low Range: 10 mV

High Range: 100 mV

**Accuracy:** Low Range: ± 20 mV ± 0.07%

High Range: ± 200 mV ± 0.09%

**Temperature coefficient:** ±.01%/°C

#### Output current:

**Range:** ±19.99 A

**Resolution:** 10 mA

**Accuracy:** ± 17 mA ± 0.1%

**Temperature coefficient:** ± 0.01%/°C ± 0.7 mA/°C

#### OVP Setting: (with reference to A2, not to -S)

**Range:** 200.0 V

**Resolution:** 100 mV

**Accuracy:** 0.5% + 150 mV (at 0.0 A load current)

#### Remote Meters:

##### Output voltage:

**Range:** 0-60 V

**Resolution:** 15 mV

**Accuracy:** ± 0.08% ± 35 mV

**Temperature coefficient:** ± 0.007%/°C ± 0.35 mV/°C

##### Output current:

**Range:** 0-10 A

**Resolution:** 2.5 mA

**Accuracy:** ± 0.125% ± 8.5 mA

**Temperature Coefficient:** ± 0.006%/°C ± 0.6 mA/°C

**Settling time:** < 200 ms

#### Overvoltage protection:

**Local OVP adjustment:** The lower of the two OVP trip points will dominate.

**Range:** 1.7 V to 64.5 V

**Resolution:** 0.2 V

##### Remote OVP adjustment:

**Range:** 2.0 V to 64.5 V (the OVP trip point = 2 V + 1.04 × soft voltage limit)

**Resolution:** 0.25 V

**Accuracy:** ± 0.7 V. The OVP circuit will trip when the voltage between the + output and the outboard side of the current monitoring resistor equals the set voltage. This could be as much as 1.35 V above the voltage between the ± S terminals.

**Temperature coefficient:** 250 PPM/°C

**DC Output isolation:** ± 240 Vdc from ground.

**Temperature rating:** Operating 0-55°C

**Storage:** -40 to 75°C, Fan cooled

**AC Input:** 87 to 106 Vac Option 100

104 to 127 Vac Option 120

191 to 233 Vac Option 220

208 to 250 Vac Option 240

All are 48 to 63 Hz

(Two internal switches and one internal jumper permit line voltage selection except for Option 100)

325 watts @ 200 watts output

600 VA @ 200 watts output

**Weight:** Net 9.9 kg (20 lbs) Shipping: 10.4 kg (23 lbs)

#### Ordering Information

6034A System Power Supply

**Opt 100 (100 Vac input. Max 50 V, 150 W output)**

**Opt 120, 220 and 240**

**Opt 907:** front handle kit (part No. 5061-0089)

**Opt 908:** rack flange kit (part No. 5061-0077)

**Opt 909:** Opt. 907, 908 combined (part No. 5061-0083)

**Opt 910:** additional operating and service manual

# POWER SUPPLIES

## 200 Watt System Power Supply

### Model 6002A

- 200 watt autoranging dc output
- Constant-voltage/constant-current operation
- HP-IB programming option

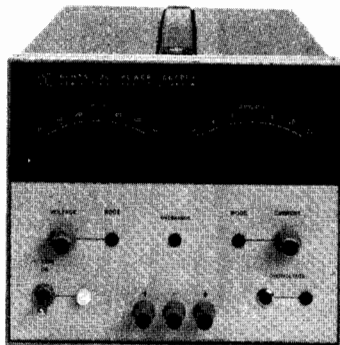

6002A

### Description

The 6002A dc power supply offers an exceptional combination of performance and flexibility. It employs a unique control concept which provides for an autoranging output with the performance characteristics of linear regulation. The 6002A is a 200 watt CV/CC power supply, which may be remotely programmed via the HP-IB, when equipped with Option 001.

As an autoranging power supply, the 6002A can provide 200 watts over a wide range of voltage and currents without external intervention. This allows it to take the place of multiple conventional power supplies. For example, the 6002A can replace both a 50 volt, 4 amp supply and a 20 volt, 10 amp supply.

### Autoranging Output Characteristic

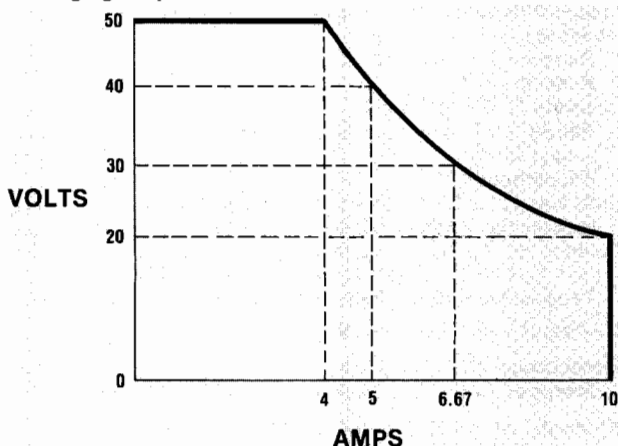

### System features/remote control

Analog programming of output voltages and current can be accomplished through the use of remotely controlled resistance or voltage applied to rear panel terminals. Additional control terminals are provided for remote load voltage sensing, auto-series or parallel operation, and for remotely activating the crowbar circuit. A pulse output from the crowbar terminal indicates the overvoltage circuit has been self-activated. A voltage step change appearing on terminal indicates a changeover to or from constant-current operation.

### HP-IB option

Digital programming via Option 001 permits control of output voltage or current by the Hewlett-Packard Interface Bus (HP-IB). Two programmable ranges allow better resolution below 10 volts or 2 amps. The selection of HP-IB control of either voltage or current is done by rear panel switches. The IEEE 488 interface functions supported by the 6002A with Option 001 are basic listener (L2) and acceptor handshake (AH1). Complete explanation of these interface functions is available in the IEEE Std. 488-1978.

- Built-in overvoltage protection crowbar
- CV/CC operating status indicators
- Remote analog programming and sensing

### Choosing a system power supply

Hewlett-Packard offers many solutions for 200 watt system power supply applications. Depending upon the specific application needs, either the 6034A (page 244) or the 6002A will offer the best solution. The 6034A offers complete and friendly remote programming including voltage, current, and OVP trip level. The output voltage or current can be read back over the HP-IB, and interrupts can be generated on preset conditions. The 6002A offers particularly good performance in the areas of ripple and noise and load transient recovery. The programmability and power supply specification needs should be weighed when choosing the system power supply most suited to a particular application.

### Specifications

**DC output:** voltage and current output can be adjusted over the ranges indicated by front panel controls, analog programming, or an optional HP-IB interface.

**Voltage:** 0-50 V. **Current:** 0-10 A.

Maximum 200 Watts output from 20 V to 50 V.

**Load effect:** Constant-voltage, 0.01% +1 mV. Constant-current, 0.01% + 1 mA.

**Source effect:** CV, 0.01% +1 mV; CC, 0.01% + 1 mA.

**PARD (ripple and noise):** rms/p-p, 20 Hz to 20 MHz; CV, 1 mV/10 mV; CC, 5 mA rms.

**Temperature coefficient:** CV, 0.02% +200  $\mu$ V/ $^{\circ}$ C; CC 0.02% +5 mA/ $^{\circ}$ C.

**Drift:** CV, 0.05% +1 mV/8 hrs; CC, 0.05% +5 mA/8 hrs.

**Load transient recovery:** 100  $\mu$ s for output voltage to recover within 15 mV of nominal voltage setting following a load current change of 50% to 100% or 100% to 50% of full load current.

**Response time:** maximum time for output voltage to change between 0 to 99.9% or 100% to 0.1% of maximum rated output voltage. Up Programming: no load, 100 ms; full load, 100 ms. Down Programming: no load, 400 ms; full load, 200 ms.

**Overvoltage protection:** trip voltage adjustable from 2.5 V to 60 V.

**DC output isolation:** 150 V dc.

**Power:** 100, 120, 220, or 240 V ac (-13%, +6%), 48-63 Hz.

**Temperature rating:** 0 $^{\circ}$ C to 55 $^{\circ}$ C operating, -40 $^{\circ}$ C to +75 $^{\circ}$ C storage. Supply is cooled by built-in fan.

**Size:** 180 H x 212 W x 422 mm D (6.97" x 8.36" x 16.6").

**Weight:** net, 14.5 kg (32 lb). Shipping, 15.9 kg (35 lb).

### HP-IB Option

**Programmable ranges:** high: 0-50 V or 0-10 A, low: 0-10 V or 0-2 A.

**Programming speed:** same as response time.

**Accuracy:** Hi range: CV, 0.2% +25 mV; CC, 0.2% +25 mA. Lo range: CV, 0.2% + 10 mV; CC, 0.2% +25 mA.

**Resolution:** Hi range: CV, 50 mV; CC, 10 mA. (12 bit) Lo range: CV, 10 mV; CC, 2 mA. (12 bit)

**Isolation:** 250 Volts dc from bus data lines to power supply.

### Accessories

**5061-0060:** rack mounting adapter kit for one 6002A

**5061-0094:** cabinet lock-together kit to connect two 6002A's

**5061-0078:** rack flange kit to mount 2 locked 6002A's

### Options

**001:** HP-IB interface

**910:** one extra operating and service manual

### 6002A Autoranging DC Power Supply



- HP-IB power supply control
- HP-IB-to-power-supply isolation
- Programmable range

- Programmable 10-volt DC output
- Unipolar/Bipolar operation
- Fast digital to analog conversion

### Specifications

#### Digital to Analog Converter

**DC output voltage:** programmable in high or low ranges within the voltage limits shown below. Output mode is unipolar or bipolar and is selected by a rear panel switch.

**Unipolar:** 0 to 9.99 V (low range, 0 to 9.999 V).

**Bipolar:** -10 to +9.98 V, (low range, -1 to +0.998 V).

**DC output current:** 10 mA maximum.

**PARD (ripple and noise):** 2 mV rms/10 mV p-p.

**Resolution:** unipolar, 10 mV (low range, 1 mV). Bipolar, 20 mV (low range, 2 mV).

**Accuracy:** specified at 23°C ± 5°C.

**Unipolar:** 0.1% + 5 mV (low range, 0.1% + 1 mV).

**Bipolar:** 0.1% + 10 mV (low range, 0.1% + 2 mV).

**Stability:** change in output over 8 hour interval under constant line, load, and ambient following a 30 minute warm-up. Stability is included in accuracy specification measurements over the temperature range indicated.

**Unipolar:** 0.04% + 0.5 mV (low range, 0.04% + .1 mV).

**Bipolar:** 0.04% + 1 mV (low range, 0.04% + .2 mV)

**Temperature coefficient:** unipolar, 0.01%/°C + 0.5 mV/°C (low range, 0.1%/°C + 0.1 mV/°C). Bipolar, 0.01%/°C + 0.5 mV/°C (low range, 0.01%/°C + 0.1 mV/°C).

**Zero adjust:** plus or minus 250 millivolts.

**D/A Full scale adjust:** plus or minus 5%.

**Programming speed:** the time required for output to go from zero to 99% of programmed output change is 250 μs (measured with resistive load connected to output terminals).

#### Power Supply Programming

**Programming network specifications:** in the following specifications, M represents the calibrated full scale value of the supply being programmed and P is the actual programmed output. The full scale value (M) can be any value within the supply's output range and is calibrated with the 59501A programmed to its maximum high range output.

**Accuracy:** specified at 23°C ± 5°C.

**Unipolar:** 0.05% M + 0.25% P (low range, 0.01% M + 0.25% P).

**Bipolar:** 0.1% M + 0.25% P (low range, 0.02% M + 0.25% P).

**Isolation:** 600 V dc between HP-IB data lines and output terminals.

**Temperature coefficient:** 0.005% M/°C + 0.015% P/°C (low range, 0.01% M/°C + 0.015% P/°C).

**Programming resolution:** 0.1% M (low range, 0.01% M).

**Programming speed:** D/A programming speed plus the programming speed of the power supply.

#### General

**Temperature range:** operation: 0 to 55°C, Storage: -40 to 75°C.

**Power:** 100, 120, 220, or 240 Vac (+6% -13%) 47-63 Hz, 10 VA (selectable on rear panel).

**Size:** 101.6 H x 212.9 W x 294.6 mm D (4" x 8.38" x 11.6")

**Weight:** Net 1.36 kg (3 lb). Shipping 1.81 kg (4 lb).

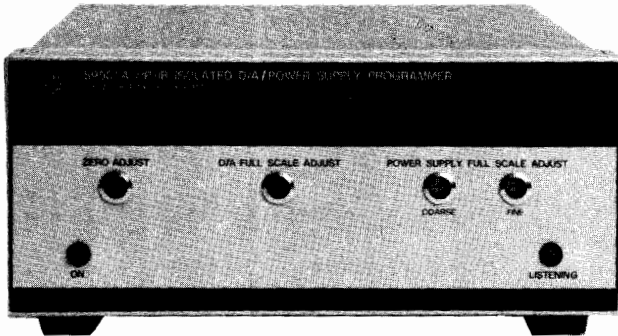

### Description

The 59501A is an isolated digital-to-analog converter designed to provide a convenient interface between the Hewlett-Packard Interface Bus and HP power supplies. With the 59501A, a wide range of DC voltages and currents becomes automatically controllable via the HP-IB. With proper wiring, the built-in isolation devices protect other instrumentation on the HP-IB from damage that could be caused by power supply outputs. In addition, an internal control circuit holds the output level near zero until programmed data is received. A programmable High/Low range control improves resolution by ten-to-one.

Power supply control is accomplished through the 59501A's programmable output voltage and programming network (see below). By making the appropriate connections between the 59501A's rear terminals and the remote programming terminals on the supply, the output voltage (or current) of the supply can be programmed from zero to its full rated output. The 59501A front panel controls provide fast and easy calibration of power supply outputs. The Zero Adjust enables the user to correct for small offsets in power supply response to programmed inputs. The Power Supply Full Scale Adjust (part of programming network) enables the user to set the maximum output desired from the power supply when the 59501A is programmed to its maximum value. For example, this adjustment would normally be used to calibrate the maximum programmable output of a 320Vdc power supply to 320 volts. However, it could also be used to set the maximum to 200 volts.

The 59501A also can be used directly as a low level DC signal source. Unipolar and bipolar output modes are available with output voltages programmable from zero to 9.99 volts, or minus 10.0 to plus 9.98 volts. Output current up to 10 milliamps is available and is automatically limited to protect the 59501A and user equipment. The 59501A produces a full scale voltage change in approximately 250 μs from the time the digital data is received.

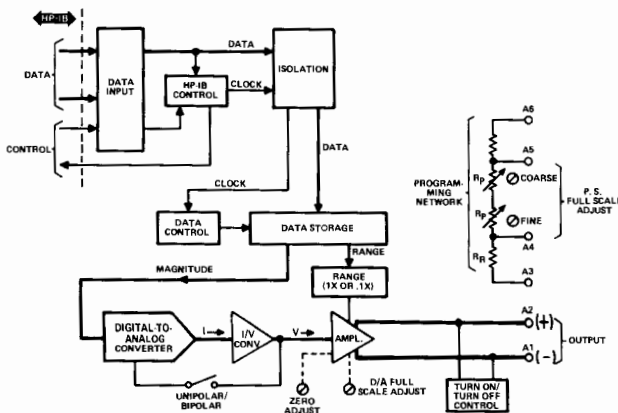

Several programming notes are available to assist in operating the 59501A Power Supply Programmer with the HP desktop computers

#### Accessories

5061-0072: rack mounting adapter kit for one 59501A

5061-0094: cabinet lock-together kit to connect two 59501A's

5061-0074: rack flange kit to mount two locked 59501A's

#### Ordering Information

59501A HP-IB Isolated D/A Power Supply Programmer

# POWER SUPPLIES

## Precision Bipolar System Supplies

Models 6129C-6131C & 6140A

- HP-IB compatible options P05 and J99 with the 59301A
- Fast, accurate, high resolution programming
- Bipolar Output

- Current sink or source
- Programmable current latch (on voltage sources) or voltage limit (on current sources)
- Isolated output

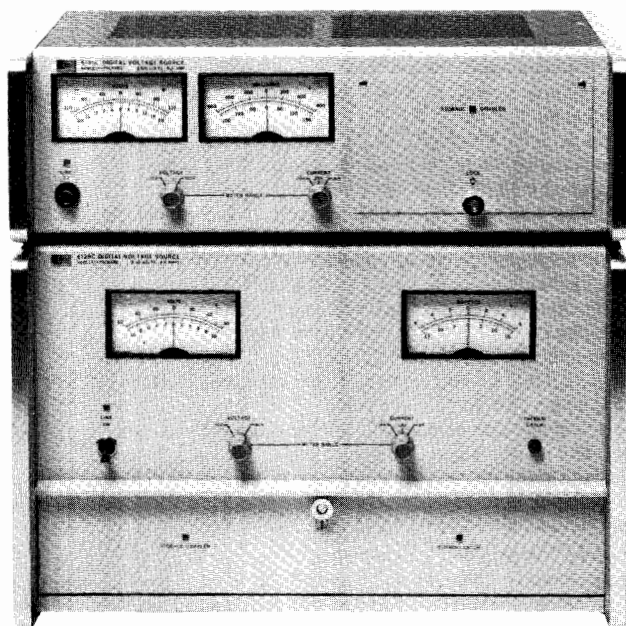

### Description

The family of Precision Bipolar System Supplies consists of three voltage sources (6129C, 6130C and 6131C) and one current source (6140A). They provide easy, fast and accurate programming of their dc outputs, with many features oriented specifically towards efficient integration in automatic systems.

#### HP-IB

These system power supplies, when ordered with either option P05 or J99, may be programmed on the HP-IB via the 59301A ASCII to parallel converter.

#### Isolation

All digital inputs are completely isolated from the analog outputs.

#### Programmable Current Limit (Voltage Source)

Valuable loads can be protected by a user programmable current latch. Output power goes to zero when the latch circuit is tripped. The reaction time to the latch can be adjusted, if desired, to avoid tripping when reprogramming with a capacitive load. There is also a fixed current limit at 110% of rated current output.

#### Current Monitoring Terminals (Voltage Sources)

A voltage is available at the rear barrier strip which is proportional to the output current.

#### Analog Input

An ac signal may be injected into the output amplifier to simulate various noise and ripple conditions.

#### Precision Bipolar System Current Source

The 6140A Current Source has features which correspond to the voltage sources. It has a programmable voltage limit, voltage monitoring terminal, as well as isolation, HP-IB options, and analog input capabilities.

#### Accessories Furnished:

- 1251-0086 50-contact rear plug.
- 5060-7948 Plug-in extender board for voltage source.
- 5060-7948/5060-7982 Two plug-in extender boards for current source.

### Specifications

	Binary Instruments Option J20 & P05		BCD Instruments Option J99	
	X1 Range	X10 Range	X1 Range	X10 Range
6129C				
Output	±16.384 V, 5 A	±50.00 V, 5 A	±9.999 V, 5 A	±50.00 V, 5 A
Accuracy	1.5 mV	15 mV	1.5 mV	15 mV
Resolution	0.5 mV	5 mV	1 mV	10 mV
6130C				
Output	±16.384 V, 1 A	±50.00 V, 1 A	±9.999 V, 1 A	±50.00 V, 1 A
Accuracy	1 mV	10 mV	1 mV	10 mV
Resolution	0.5 mV	5 mV	1 mV	10 mV
6131C				
Output	±16.384 V, 0.5 A	±100.00 V, 0.5 A	±9.999 V, 0.5 A	±99.99 V, 0.5 A
Accuracy	1 mV	10 mV	1 mV	10 mV
Resolution	0.5 mV	5 mV	1 mV	10 mV
6140A				
Output	±16.384 mA, 100 V	±163.84 mA, 100 V	±9.999 mA, 100 V	±99.99 mA, 100 V
Accuracy	1 μA ±0.01%	10 μA, ±0.01%	10 μA, ±0.01%	10 μA, ±0.01%
Resolution	0.5 μA	5 μA	1 μA	10 μA

### Options

#### AC Power Option

**028:** transformer tap change for 230 V ac ±10%, single-phase input on 6130C and 6131C. (6129C and 6140A are 115/230 switch selectable)

#### Standard Interface Options

**P05:** 16 bit binary programming format with modifications to interface to the 59301A, and be programmed on the HP-IB. In addition to power supply modifications, a cable to connect the supply to the 59301A, and programming documentation are included.

**J99:** 4 digit BCD programming format, otherwise similar to Opt. P05. A cable, and programming documentation, are included.

**J20:** 16 bit binary interface for 12661A I/O programmer card for Hewlett-Packard computers.

#### Accessories Available

**14533B:** Pocket programmer permits manual programming of all input functions by switch closure

**14534A:** Pocket programmer extension cable (3 ft)

**14535A:** HP computer interface kit includes 12661A computer I/O card, 14539A cable, verification software and RTE Driver. Up to eight PBSS's may be controlled from one 14535A

**14539A:** Cable connects the first PBSS in a chain of up to eight instruments to the 12661A programming card for Hewlett-Packard computers

**14536A:** Chaining cable connects an additional PBSS to the existing chain of PBSS's

#### Ordering Information\*

**6129C:** Digital Voltage Source

**Opt 908:** Rack Flange Kit

**6130C, 6131C:** Digital Voltage Source

**6140A:** Digital Current Source

**Opt 908:** Rack Flange Kit

**Opt 910:** One extra operating and service manual shipped with each power supply

\*An interface option must be ordered.

- High speed remote programming
- Overload protection
- Wide-band response

- Bipolar voltage
- Current sink or source



6825A-6827A

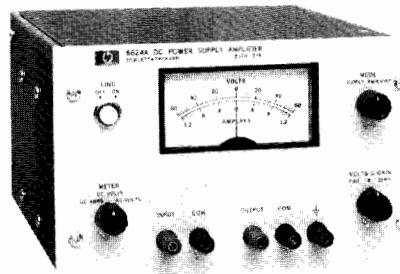

6824A

## Description

The Power Supply/Amplifier is a general-purpose instrument useful in any laboratory engaged in research and development of electronic systems, circuitry, or components. The unit can be operated in one of two basic operating modes: power supply or amplifier. Terminals at the rear permit access to various internal control points to further expand the operational capabilities of the instrument. The resulting flexibility lends the Power Supply/Amplifier to an almost unlimited number of applications.

### Models 6825A through 6827A

These models feature dual-range output and constant-voltage/constant-current operation. Output voltage and current as a dc supply, or gain as a power amplifier, are remotely controllable and are compatible with Hewlett-Packard Multiprogrammer Systems.

As a dc power supply, the unit can furnish a bipolar, constant-voltage or constant-current output. It can be remotely programmed with a resistance, voltage, or current and its high speed programming characteristics adapt it to a wide variety of laboratory and production testing applications. The supply can sink, as well as source, current permitting it to serve as a variable load device.

As a direct-coupled power amplifier, each unit offers a signal-to-noise ratio of approximately 80 dB at full output with low distortion and a frequency response up to 40 kHz in the fixed gain mode.

### Model 6824A

Although this model does not provide quite the level of performance and flexibility of Models 6825A through 6827A, it is lower in cost and is suitable for many applications.

As a power supply, this unit offers constant-voltage/current-limiting operation, remote programming, and Auto-Series, Auto-Parallel operation.

As a power amplifier, the unit exhibits a high signal-to-noise ratio with a 20 dB gain from dc to 10 kHz. It is useful in servo systems, as a pulse or oscillator amplifier, for motor control, and a variety of other applications.

### General Specifications

**Temperature:** operating, 0 to 55°C, storage, -40 to +75°C.

**Power:** 6824A, standard input voltage is 104-127 V ac, 48-63 Hz. Order Option 028 for 230 V ±10% operation. 6825A & 6826A, 6827A, switchable, 100, 120, 220, or 240 V ac, -13% +6%, 48-63 Hz, 150 W.

**Size:** 6824A, 131 H x 209 W x 303 mm D (5<sup>1</sup>/<sub>32</sub>" x 8<sup>7</sup>/<sub>32</sub>" x 11<sup>15</sup>/<sub>16</sub>" ). 6825A, 6826A & 6827A, 155 H x 198 W x 316 mm D (6<sup>3</sup>/<sub>32</sub>" x 7<sup>25</sup>/<sub>32</sub>" x 12<sup>7</sup>/<sub>16</sub>" ).

**Weight:** 6824A, 7.7 kg (17 lb), 6825A, 6826A & 6827A, 8.2 kg (18 lb).

## Specifications

RATINGS		POWER SUPPLY PERFORMANCE							POWER AMPLIFIER PERFORMANCE						
DC Output		Model	PAR (rms/p-p)		Transient Recovery		Resolution		Voltage Gain		Frequency Response, +1, -3 dB		Distortion at full output		Options
Volts	Amps		Voltage	Current	Time	Level	Voltage	Current	Fixed	Variable	Fixed Gain	Variable Gain	100 Hz	10 kHz	
-5 V to +5 V / -20 V to +20 V	0-2.0 A Both Ranges	6825A	10/30 mV	5/15 mA	100 μs	20 mV	40 mV	6 mA	1X 4X	0-2X 0-8X	dc -40 kHz	dc -15 kHz	0.1% THD	0.5%	9
-5 V to +5 V / -50 V to +50 V	0-1.0 A Both Ranges	6826A	6/35 mV	0.8/5 mA	100 μs	50 mV	100 mV	3 mA	1X 10X	0-2X 0-20X	dc -40 kHz	dc -15 kHz	0.1% THD	0.5%	9
-10 V to +10 V / -100 V to +100 V	0-0.5 A Both Ranges	6827A	10/50 mV	0.4/5 mA	100 μs	100 mV	200 mV	1.5 mA	2X 20X	0-4X 0-40X	dc -30 kHz	dc -15 kHz	0.1% THD	1%	9
-50 V to +50 V	0-1.0 A	6824A	10 mVrms	—	100 μs	0.02% +5 mV	—	—	—	0-10X	—	dc -10 kHz	0.1% THD	—	9.28

### Options Descriptions

**009:** ten-turn output controls 6824A  
6825A-6827A

**028:** 230 V ac ± 10%, single phase input

**910:** one additional manual shipped with each power supply 6824A, 6825A  
6826A, 6827A

### Accessories

**5060-8762:** adapter frame for rack mounting one or two 6825A-6827A units

**5060-8760:** blank filler panel to be used with above units

**14515A:** rack mounting kit for one 6824A

**14525A:** rack mounting kit for two 6824A's

# POWER SUPPLIES

## Special Purpose: Precision Voltage Sources

Models 6111A-6116A

- 6114A, 6115A...CV/CC operation
- .025% output voltage accuracy
- Overvoltage crowbar



6114A, 6115A

- 6111A-6113A, 6116A...CV/CL operation
- 0.1% output voltage accuracy
- Thumbwheel voltage control

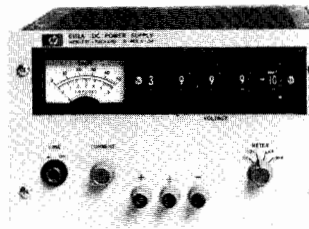

6111A, 6112A,  
6113A, 6116A

### Description

#### 6114A, 6115A High Performance Precision Source

These 40 watt precision power supplies are ideal for applications where an accurate, highly stable, and easy-to-use source of dc voltage is required. Both models feature automatic dual range operation. For example, model 6114A can supply 0-20 V at 0-2 A, and 20-40 V at 0-1 A, without manual range switching. Automatic output current range crossover occurs when the supply is providing greater than one-half of the maximum rated output voltage. Pushbutton voltage controls on models 6114A and 6115A allow the output voltage to be set rapidly and accurately. A front-panel control allows the output current to be set to any desired value within the maximum rating. Using this control, the supplies can be operated as constant current sources with 0.01% current regulation.

**Power:** 104-127 or 208-250 V ac selected by switch, 48-440 Hz, 150 VA maximum.

**Size:** 166 H x 197 W x 336 mm D (6.5" x 7.75" x 13.25").

**Weight:** net, 7.7 kg (17 lb). Shipping, 9.5 kg (21 lb).

#### 6111A, 6112A, 6113A and 6116A

Although these 20 watt precision power supplies do not provide quite the level of performance and flexibility of models 6114A and 6115A, they are lower in cost and are suitable for many precision power applications. Output voltage is adjusted by a five-decade thumbwheel voltage programmer for convenient and precise adjustment of output voltage. A single-turn current control allows full-range adjustment of the current-limit point.

**Power:** 115 V ac  $\pm 10\%$ , 43-63 Hz, 0.5 A, 52 W (for 230 V, order Opt. 028).

**Size:** 133 H x 216 W x 318 mm D (5.25" x 8.5" x 12.5").

**Weight:** net, 5 kg (11 lb). Shipping, 6.8 kg (14 lb).

### Ordering Information

#### Option Descriptions

**009:** ten-turn output controls. replaces single-turn output voltage and current controls.

**011:** internal overvoltage, protection crowbar. Protects delicate loads against power supply failure or operator error.

**015:** three-digit graduated turns-counting dial and ten-turn controls for output voltage and current (where applicable and available). Improves resettability of power supply output.

**028:** 230 V ac  $\pm 10\%$ , single-phase input. Consists of reconnecting power transformer taps, and other components where necessary.

**040:** Multiprogrammer interface. Prepares standard HP power supplies for resistance programming by the 6940B or 6942A Multiprogrammer.

**910:** one additional operating and service manual shipped with each voltage source.

#### Accessories

**14515A:** 5.25 in. high rack kit for one supply

**14525A:** 5.25 in. high rack kit for two supplies

**14515A:** and **14525A** rack kits apply to the following models: 6111A-6113A, 6116A

**5060-8762:** adapter frame for rack mounting one or two 1/2 rack width units. This frame applies to the following models: 6114A, 6115A

**5060-8760:** blank filler panel. This 1/2 rack width panel applies to the following models: 6114A, 6115A

### Specifications†

RATINGS—DC Output			PERFORMANCE							General	
Volts	Amps	Model	Accuracy	Resolution	PARD (rms/p-p)	Source Effect	Load Effect	Temperature Coefficient	Drift (Stability)	Overvoltage Protection	Options
0-10	0-2	6113A	0.1% + 1 mV	20 $\mu$ V	40 $\mu$ V/100 $\mu$ V	0.001%	0.001% + 100 $\mu$ V	0.001% + 10 $\mu$ V	0.01% + 100 $\mu$ V	Opt 11. 3-13 V	11, 28, 40
0-20	0-1	6111A	0.1% + 1 mV	200 $\mu$ V	40 $\mu$ V/100 $\mu$ V	0.001%	0.001% + 100 $\mu$ V	0.001% + 10 $\mu$ V	0.01% + 100 $\mu$ V	Opt 11. 2.5-23 V	11, 28, 40
0-20, 20-40	0-2, 0-1	6114A	0.025% + 1 mV	200 $\mu$ V	40 $\mu$ V/200 $\mu$ V*	0.0005% + 40 $\mu$ V	0.0005% + 100 $\mu$ V	0.001% + 15 $\mu$ V	0.0015% + 15 $\mu$ V	STD. 0.5-45 V	9, 15
0-40	0-0.5	6112A	0.1% + 1 mV	200 $\mu$ V	40 $\mu$ V/100 $\mu$ V	0.001%	0.001% + 100 $\mu$ V	0.001% + 10 $\mu$ V	0.01% + 100 $\mu$ V	Opt 11. 2.5-44 V	11, 28, 40
0-50, 50-100	0-0.8, 0-0.4	6115A	0.025% + 1 mV	200 $\mu$ V	40 $\mu$ V/200 $\mu$ V*	0.0005% + 100 $\mu$ A	0.0005% + 50 $\mu$ V	0.001% + 15 $\mu$ V	0.0015% + 15 $\mu$ V	STD. 0.5-110 V	9, 15
0-100	0-0.2	6116A	0.1% + 1 mV	200 $\mu$ V	40 $\mu$ V/100 $\mu$ V	0.001%	0.001% + 100 $\mu$ V	0.001% + 10 $\mu$ V	0.01% + 100 $\mu$ V	Opt 11. 20-106 V	11, 28

† Refer to page 232 for complete specification definitions.

\* \* Specified with final decade pot set to zero. If pot is set to value other than zero, pot wiper jump effect may cause drift of 0.0015% + 200  $\mu$ V (90-day).

\* 200  $\mu$ V p-p noise is typical with a maximum 400  $\mu$ V p-p spike of less than 1  $\mu$ s duration occurring repetition rate of twice power line frequency under worst case conditions of high line, full output voltage. When operated at 400 Hz input, peak-to-peak ripple is less than 10 mV.



- Continuously variable voltage limit
- Output useful to micro-ampere region



6177C, 6181C

6186C

- High output impedance—no output capacitor

voltage to vary from zero to maximum.

**Source effect (line regulation):** less than 25 ppm of output + 5 ppm of range switch setting for any change in the line voltage between 104 and 127 V ac at any output current and voltage within rating.

**Load effect transient recovery:** less than 800  $\mu$ s for recovery to within 1% of nominal output current following a full load change in output voltage. (On 6186C, recovery time for 100 mA/10 mA/1 mA ranges is 1 ms/1.6 ms/4 ms, respectively.)

**Temperature coefficient:** output change per degree C is less than 75 ppm of output current +5 ppm of range switch setting.

**Drift (stability):** less than 100 ppm of output current +25 ppm of range switch setting. Stability is measured for eight hours after one hour warm-up under conditions of constant line, load, temperature, and output setting.

**Resolution:** 0.03% of range switch setting.

**Temperature rating:** operating 0, to 55°C, storage, -40 to +75°C.

### Accessories

5060-8764: rack adapter for rack mounting one or two 6177C or 6181C supplies

5060-8762: rack adapter for rack mounting one or two 6186C supplies

5060-8530: filler panel for Models 6177C, 6181C

5060-8760: filler panel for Model 6186C

### Options

**015:** three-digit graduated turns-counting current control replaces front panel current knob

**028:** 230 V ac  $\pm$ 10%, single-phase input. Models 6177C and 6181C only

**910:** one additional operating and service manual

### Ordering Information

6177C, 6181C Constant Current Source

6186C Constant Current Source

## Description

These solid-state constant-current sources are ideal for semiconductor circuit development, component testing, and precision electroplating applications.

Their high-speed remote programming characteristics make these supplies useful in testing and sorting semiconductors, resistors, relays, meters, etc. The ability to superimpose ac modulation on the dc output permits the supplies to be used for measurement of dynamic or incremental impedance of circuit components.

## Specifications

**Load effect (load regulation):** less than 25 ppm of output + 5 ppm of range switch setting for a load change which causes the output

Model		6177C	6181C	6186C	
Output Current ††		0-500 mA	0-250 mA	0-100 mA	
Voltage Compliance $\Delta$		0-50 V dc	0-100 V dc	0-300 V dc	
Output Ranges	A	0-5 mA	0-2.5 mA	0-1 mA	
	B	0-50 mA	0-25 mA	0-10 mA	
	C	0-500 mA	0-250 mA	0-100 mA	
AC Input		115 V ac $\pm$ 10%, 48-63 Hz; 0.6 A, 55 W at 115 V ac For 230 V ac see Option 028	115 V ac $\pm$ 10%, 48-63 Hz; 0.6 A, 55 W at 115 V ac For 230 V ac see Option 028	115/230 V ac, 48-63 Hz; 0.9 A, 90 W at 115 V ac 115/230 V ac switch	
Constant Current	Voltage Control (accuracy: 0.5% of output current +.04% of range)	Range A	200 mV/mA	1 V/mA	10 V/mA
		Range B	20 mV/mA	100 mV/mA	1 V/mA
		Range C	2 mV/mA	10 mV/mA	100 mV/mA
Remote Programming	Resistance Control 1% of output control +0.04% of range)	Range A	400 ohms/mA	2 k $\Omega$ /mA	10 k $\Omega$ /mA
		Range B	40 ohms/mA	200 ohms/mA	1 k $\Omega$ /mA
		Range C	4 ohms/mA	20 ohms/mA	100 k $\Omega$ /mA
Voltage Limit Remote Programming	Voltage Control (Accuracy: 20%)		1 V/V	1 V/V	1 V/V
		Resistance Control	870 ohms/V	435 ohms/V	820 ohms/V
		Accuracy	25%	25%	15%
Typical Output Impedance (R in parallel with C)*	Range A	R = 330 Meg, C = 500 pF	R = 1330 Meg, C = 10 pF	R = 10,000 Meg, C = 900 pF	
	Range B	R = 33 Meg, C = 0.005 $\mu$ F	R = 133 Meg, C = 100 pF	R = 1,000 Meg, C = 700 pF	
	Range C	R = 3.3 Meg, C = 0.05 $\mu$ F	R = 13.3 Meg, C = 1000 pF	R = 100 Meg, C = 1500 pF	
PARD (Ripple and Noise): rms/p-p (20 Hz to 20 MHz) with either output terminal grounded	Range A	1.6 $\mu$ A rms/40 $\mu$ A p-p	0.8 $\mu$ A rms/20 $\mu$ A p-p	0.2 $\mu$ A rms/5 $\mu$ A p-p	
	Range B	16 $\mu$ A rms/200 $\mu$ A p-p	8 $\mu$ A rms/100 $\mu$ A p-p	2 $\mu$ A rms/50 $\mu$ A p-p	
	Range C	160 $\mu$ A rms/1 mA p-p	80 $\mu$ A rms/500 $\mu$ A p-p	20 $\mu$ A rms/500 $\mu$ A p-p	
Programming Speed: from 0 to 99% of range switch setting with a resistive load ** (Output Current Modulation)		6 ms	6 ms	10 ms	
Dimensions:		7.75" (W) x 3.44" (H) x 12.38" (D) 197 mm (W) x 88 mm (H) x 315 mm (D)	7.75" (W) x 3.44" (H) x 12.38" (D) 197 mm (W) x 88 mm (H) x 315 mm (D)	7.75" (W) x 3.44" (H) x 12.38" (D) 197 mm (W) x 158 mm (H) x 315 mm (D)	
Weight: (Net/Shipping)		4.53 kg (10 lb)/5.9 kg (13 lb)	4.53 kg (10 lb)/5.9 kg (13 lb)	5.9 kg (13 lb)/7.7 kg (17 lb)	

\* This network is a simplified representation of a complex network. The formula  $Z = R X_c / \sqrt{R^2 + X_c^2}$  is used for frequencies up to 1 MHz by substituting the values given for R and C. Above 1 MHz, the output impedance is greater than the formula would indicate.

\*\* Output current can be modulated 100% up to 50 Hz; percent modulation decreases

linearly to 10% at 500 Hz.

†† For operation above 40°C the maximum output current must be reduced linearly to 80% of rating at 55°C (maximum temperature).

$\Delta$  Minimum voltage obtainable with voltage limit control is 0.5 V.



# POWER SUPPLIES

## Special Purpose: High Voltage Output

Models 6515A-6525A

- Short circuit proof
- Precise voltage control—four decade thumbwheel or switch and vernier
- Convection cooling

- Floating output—can be used as a positive or negative source
- Front-panel meters
- Bench or rack mounting

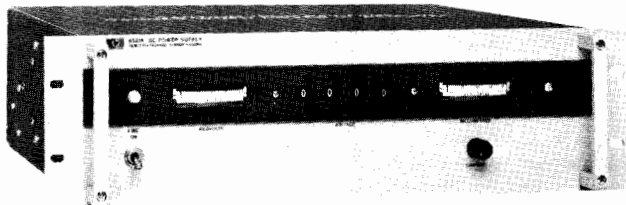

6521A, 6525A

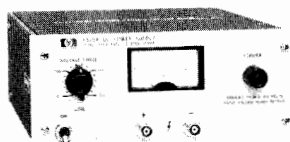

6515A

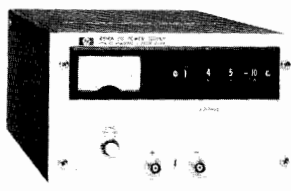

6516A

### Description

#### 6521A, 6525A

This series of high performance power supplies has broad application both in the laboratory and in the system. They have sufficient output current to power devices such as TWT's, klystrons, magnetrons, backward-wave oscillators, high-power gas lasers, electron-beam welding devices, etc. Output voltage is set easily and precisely by a three-decade thumbwheel switch plus a thumbwheel vernier providing 0.002% resolution. In constant voltage operation, a single-turn current control allows the current limit point to be set to any value within the current rating. In constant current operation, the current control varies the output current while the voltage controls (thumbwheels) provide an adjustable voltage limit. The supplies are protected against reverse voltage that could be generated by an active load. Protection from reverse current requires pre-loading the supply with a dummy load to ensure that the supply outputs current through the entire operating cycle of the load. Either the positive or negative terminal may be grounded or the supply may be operated floating at up to 200 V above ground.

**Power:** 115 V ac  $\pm$  10%, 48-440 Hz, 4 A, 270 W (230 V ac available on special order).

**Weight:** net, 19 kg (42 lb). Shipping, 28.5 kg (63 lb).

**Size:** 133 H x 483 W x 457 mm D (5.25" x 19" x 18").

#### 6515A and 6516A

These high-voltage power supplies are lower in cost and output power than the 6521A-6525A supplies. Their small size, low price, and short-circuit-proof operation make them excellent high-voltage laboratory supplies, or high-voltage systems supplies for lower current requirements.

Model 6515A employs a sixteen-position rotary switch and a ten-turn vernier control to adjust the output voltage. The rotary switch selects output voltage increments from 1 to 1500 V in 100-volt steps; the vernier control permits fine adjustment (100 mV resolution) over any 100-volt span. Model 6516A uses a three-decade thumbwheel switch plus a thumbwheel vernier for convenient and precise (1.0 V resolution) output voltage control.

Non-adjustable current-limit protection is provided on both models. On Model 6516A, the current-limit point is fixed at approximately 8 mA. On Model 6515A, the current limit value varies with the selected output voltage range as follows (voltage range/current limit): 0-300 V/7.5 mA, 400-700 V/65 mA, 800-1100 V/32 mA, 1200-1500 V/25 mA. Both supplies are protected against reverse voltage that could be generated by an active load. Pre-loading is necessary to protect the supplies from reverse current. Either the positive or negative terminal may be grounded or the supply may be operated floating at up to 1000 V above ground. Units are packaged in half-rack-width cases. They may be bench operated or mounted individually or in pairs using accessory rack-mounting kits.

**Power:** 6515A: 115 V ac  $\pm$  10%, 60  $\pm$  0.3 Hz, 016 A, 19 W. (230 V ac available on special order) 6516A: 115 V ac  $\pm$  10%, 57-63 Hz, 1 A, 40 W.

**Weight:** 6515A: net, 4.1 kg (9 lb). Shipping, 5.0 kg (11 lb). 6516A: net, 7.7 kg (17 lb). Shipping, 9.5 kg (21 lb).

**Size:** 6515A, 89 H x 216 W x 299 mm D (3.50" x 8.50" x 11.75"). 6516A, 133 H x 216 W x 406 mm D (5.25" x 8.50" x 16").

### Option Descriptions

**015:** three-digit graduated turns-counting dial and ten-turn controls for output voltage and current (where applicable and available). Improves resettability of power supply output.

Option 015 applies only to the 6515A.

**019:** 230 V ac  $\pm$  10%, 50  $\pm$  0.3 Hz, single phase input. Consists of replacing input transformer, line cord and fuse.

Option 019 applies only to models 6515A  
6516A

**J08:** model 6521A may be operated on 230 V ac, 48-63 Hz, only through the use of an external accessory 230 V to 115 V step-down transformer. Suitable transformer with built-in receptacle, line cord and grounding-type plug may be ordered with the power supply as a Special Option. Contact your local HP Field Engineer for ordering information.

**J13:** same as J08, for model 6525A

**910:** one additional operating and service manual shipped with each power supply

### 6515A-6521A 6525A

#### Accessories

**14513A:** rack kit for one 6515A

**14523A:** rack kit for two 6515A's

**14515A:** rack kit for one 6516A

**14525A:** rack kit for two 6516A's

RATINGS			PERFORMANCE										GENERAL	
DC Output		Model	Load Effect		Source Effect		PARD (rms/p-p)		Drift		Resolution		Options	
Volts	mA		Voltage	Current	Voltage	Current	Voltage	Current	Voltage	Current	V	C		
0-1000	0-200	6521A	0.005% or 20 mV	2% or 1 mA	0.005% or 20 mV*	1 mA	1 mV/150 mV	2 mA rms	0.036% + 3 mV	0.25% + 0.5 mA	20 mV	0.6 mA	J08	
0-1600	5	6515A	0.01% or 16 mV*	**	0.01% or 16 mV*	**	2mV/15 mV	**	0.05% + 5 mV	**	100 mV	**	15, 19	
0-3000	6	6516A	0.01% or 16 mV*	**	0.01% or 16 mV*	**	1 mV/15 mV	**	0.05% + 5 mV	**	1 V	**	19	
0-4000	0-50	6525A	0.005% or 20 mV*	2% or 1 mA*	0.005% or 20 mV	1 mA	1 mV/150 mV	500 $\mu$ A rms	0.036% + 3 mV	0.25% + 0.12 mA	80 mV	0.15 mA	J13	

\*whichever is larger.

\*\* This feature is not available.

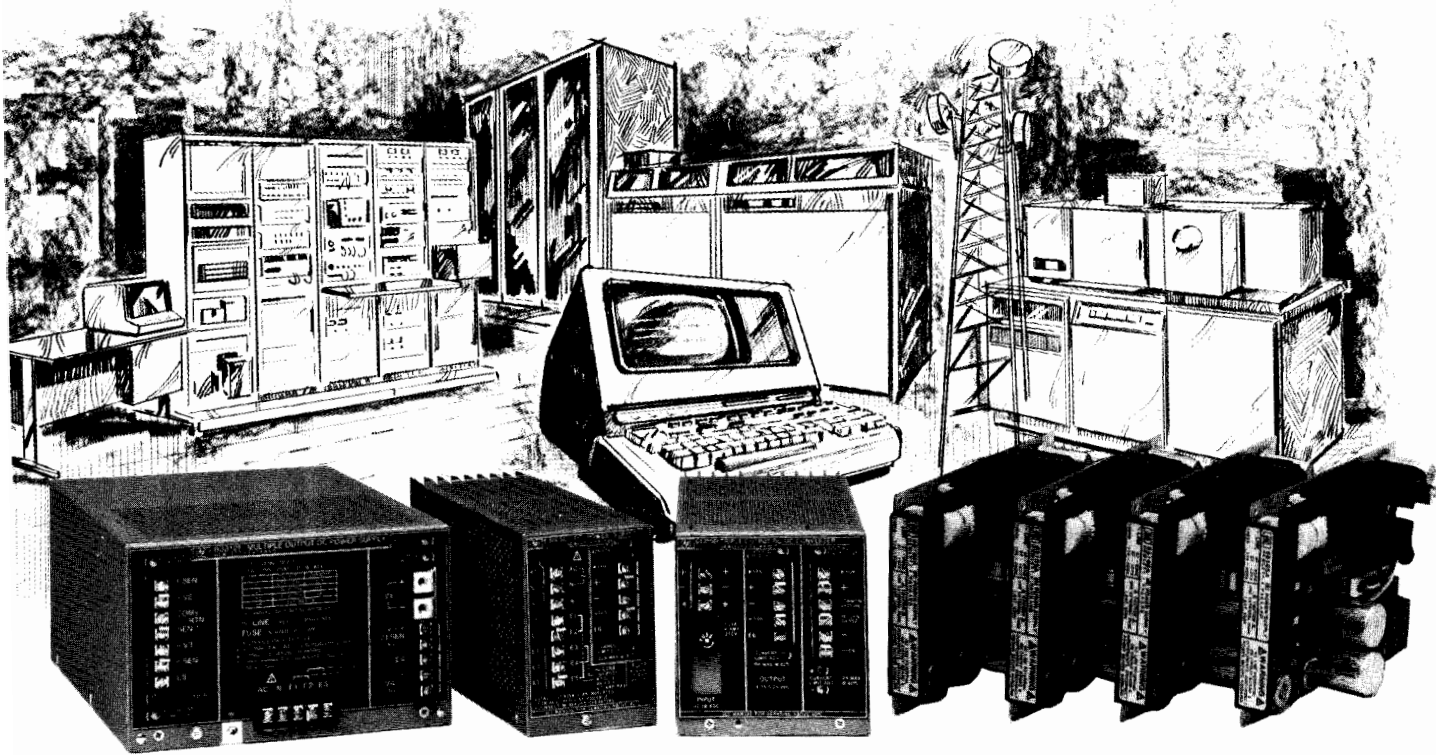

The selection of a power supply for today's electronic system requires careful evaluation. Sophisticated system electronics have placed new demands on the supply and, as always, the power supply is the very heart of the system. If it stops delivering power, the system stops. In your selection consider not only the obvious technical and cost considerations, but also the less tangible product factors that are provided for your OEM dollar.

**Quality**

Hewlett-Packard OEM supplies are thoroughly proven before they are introduced. Each product goes through a development cycle consisting of Engineering Breadboard, Lab Prototype and Production Pilot Runs. At each phase the units are evaluated for safety, specification compliance, environmental performance, workmanship, and serviceability. Before introduction as new products, all models undergo formal environmental testing in multiple tests including hi-pot, altitude, operating temperature, humidity, vibration, shock, EMC, this many tests again and more.

**MTBF**

We employ a comprehensive and conservative method of determining Mean Time Between Failure (MTBF). A component data base is maintained to provide actual component failure statistics and the MTBF is adjusted to reflect the actual working environment in which the components operate. Calculated MTBF objectives are confirmed with life tests.

As an illustration of HP's commitment to reliability, the 395,000 unit hours of life-test data for the 65105A, 50 Watt power supply

is presented below per MIL-781B, Test Plan III. The data demonstrates with 90% confidence a 25,000 hour MTBF at 50°C and more than 100,000 hours at room ambient conditions.

**Life Test Acceptance Curve—  
65105A**

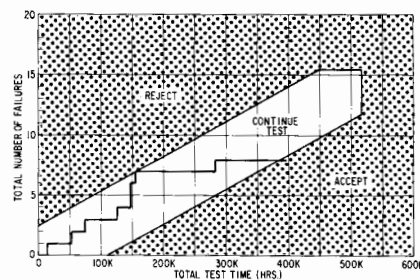

The 395,000 unit-hours represents a full year of testing 58 power supplies. It predicts an operating life of more than 20 years in typical applications. It's part of our commitment to you.

**Safety**

To assist you in complying with safety regulations, all HP modular power supplies are designed to meet UL specifications. New products are also designed to meet interna-

tional safety regulations (e.g. VDE 0730). HP modular power supplies are UL listed, and a UL yellow card number will be provided upon request.

**Service Support**

Hewlett-Packard's service support is a major factor in the lasting value of our products. HP is ready to respond to your service needs with extensive world-wide service and spare parts facilities. Staffed by competent technical personnel, these facilities provide fast turn-around-time. All units are shipped with complete Operating and Service Manuals.

**Special Designs**

In some applications off-the-shelf power supplies will not meet your needs. In these instances, our Specials Engineering is ready to provide product modifications, assembled power systems, or applications assistance to help with your specific requirements. Just let your HP Field Engineer know.

**Make or Buy**

A crucial question in the make-or-buy decision is whether or not you want to expend the technical and financial resources to design and manufacture your own supplies.

It is important not to underestimate the difficulty involved in a power supply design. When evaluating your technical capabilities keep in mind that modern power supplies are state-of-the-art components. Much time will be required for electrical and mechanical design, prototypes and evaluation, and your engineers will be diverted from other more productive tasks.

**Switching Supplies, AC to DC**

**50 Watts Card**

Model	Output Voltage (Vdc)	Maximum Current (A <sub>dc</sub> )	
		40°C	50°C
65105A	5	10.0	10.0
65112A	12	4.2	4.2
65115A	15	3.3	3.3
65312A	5	10.0	10.0
	+12	1.5	1.5
	-15	1.0	1.0
65315A	5	10.0	10.0
	+15	1.0	1.0
	-15	1.0	1.0
65317A	5	10.0	10.0
	+18	1.0	1.0
	-18	1.0	1.0
65512A	5	10.0	10.0
	+16	1.0	1.0
	-16	1.0	1.0
	+15 to 12	0.3-1.0	0.3-1.0
	-5 to -12	0.3-1.0	0.3-1.0
65612A	5	10.0	10.0
	+16	1.0	1.0
	-16	1.0	1.0
	+5 to 12	0.3-1.0	0.3-1.0
	-5 to -12	0.3-1.0	0.3-1.0
	-5 to -12	0.1-0.3	0.1-0.3

**110 Watts, Convection Cooled**

63005E	5	22	18
63315E	5	18	15
	+15	2	1.6
	-15	2	1.6

**300 Watts, Fan Cooled**

62605L	5	60	50
--------	---	----	----

**500 Watts, Fan Cooled**

62605M	5	100	87
62615M	15	35	30

**550 Watts Fan Cooled**

Model	Output Voltage (Vdc)	Maximum Current (A <sub>dc</sub> )	
		40°C	50°C
63312F	5	50	42
	+12 to 15	10	8
	-12 to 15	10	8
63330F	5	50	42
	12 to 15	10	8
	12 to 15	10	8
63331F	5	85	70
	+12	5	4
	-12	5	4
63340F	5	50	42
	12 to 15	10	8
	12 to 15	10	8
	5	5	4
63341F	5	35	29
	24	5	4
	12	10	8
	12	6	5
63350F	5	35	29
	24	5	4
	-12	9	7
	12	6	5
	-5	1	1

**Linear Supplies, AC to DC**

**10-20 Watts, Convection Cooled**

62005A	5	2.0	2.0
62012A	12	1.5	1.5
62015A	15	1.25	1.25
62024A	24	0.75	0.75

**40-90 Watts, Convection Cooled**

62005E	5	8	8
62012E	12	6	6
62015E	15	5	5
62024E	24	3.75	3.75

**80-200 Watts, Convection Cooled**

62005G	5	16	16
62012G	12	12	12
62015G	15	10	10
62024G	24	7.5	7.5

**30-140 Watts, Dual Output, Convection Cooled**

62212A	±12	1.41/1.25	—
62215A	±15	1.25/1.1	—
62212E	±12	3.3/3	—
62215E	±15	3/2.75	—
62212G	±12	6/5	—
62215G	±15	5.2/4.5	—



- 65000A-Series Power Supplies
- 50 Watts, Up to 6 Outputs, 200 kHz Switching

- 63300F-Series Power Supplies
- 550 Watts, 3-5 Outputs

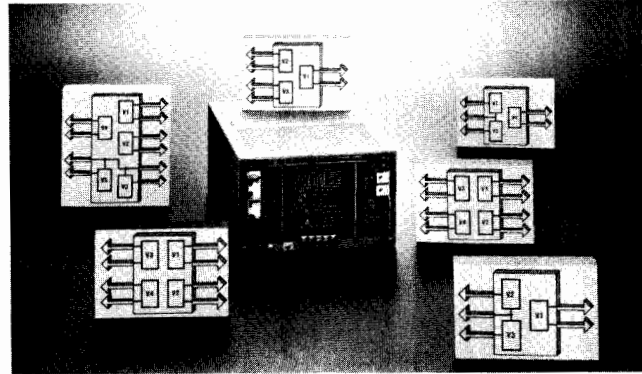
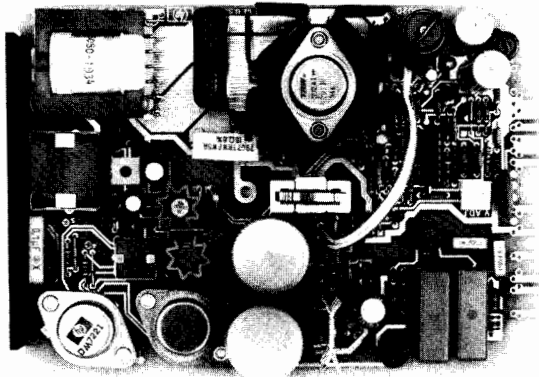

Breakthrough technology makes possible the 65000A Series of 50 watt power supplies. By using power MOS FET's and 200 kHz sinewave power conversion, they are smaller and lighter and provide increased reliability over conventional switching power supplies—more than 100,000 hours MTBF for single output models, verified by 395,000 hours of life tests.

The series includes eight models in three sizes as listed on page 254. The first output listed is the main output. It is 0.1% regulated and delivers up to 10 amperes. The second and third outputs are semi-regulated. Other outputs are 2% regulated and adjustable. All auxiliary outputs share a common return but are isolated from the main output.

- Proven Reliability—100,000 hours MTBF
- Worldwide Operation
  - 87 to 127 V ac or 174 to 250 V ac input, 47–63 Hz
- Meets International Safety Specifications
  - VDE 0730 Part 2P certified (65512A & 65612A only)
  - UL 114 & UL 478 recognized
  - CSA 22.2 #154 & #143 certified
  - Designed to IEC 348
- Overvoltage and Short Circuit Protection
- Up to 1 watt per cubic inch

### Linear regulated

### Description

Single and dual output modular power supplies are offered in this series of linear regulated modules. Packaged in modules which are 1/8, 1/4, and 1/2-width fractions of the standard 19-inch rack system, and with uniform height and depth, they provide design flexibility. Modular combinations mounted in the HP 62410A tray developed power systems for rack installations, or the modules may be mounted individually in equipment.

Protection from overcurrent, overtemperature, reverse voltage, and open remote voltage sensing terminals is standard on all models. A built-in overvoltage protection crowbar is optional. Output voltage tracking accuracy is within  $\pm 1\%$  on the dual output models.

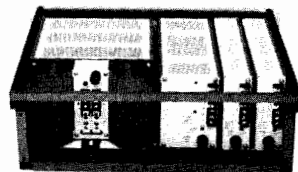
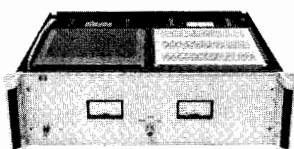

### Power Systems

- Custom designed systems are available assembled, tested and documented by Hewlett-Packard
- System component units for "do it yourself" power system solutions

### Custom Systems

Custom power systems can be assembled by installing suitable combinations of single and dual-output linear supplies and switching regulated supplies in rack mounting trays. If desired, Hewlett-Packard will assemble, wire, and test complete power supply systems to customer specifications using these modular power supplies and rack mounting accessories. Meters, switches, input and output connectors, and other components will be installed to meet your specific needs. Consult your local Hewlett-Packard Field Engineer for price and delivery information.

The need for more features and the needs for end-product compliance with new safety and EMI regulations are placing more demands on your power supply. To help meet these demands, HP has a family of multiple-output switching power supplies. These supplies provide up to 85 amperes with voltages ranging from 5 to 24 volts, isolated or tracking. The basic design has the flexibility to allow modification to meet your requirements when the total power from all outputs combined is under 550 watts.

Consider the following features:

- Worldwide operation
  - 87 to 127 V ac or 174 to 250 V ac input, 47–63 Hz
- Internal EMI filter—meets VDE 0871 Level A
- Meets international safety specifications:
  - VDE 0730 Part 2P (63312F only VDE certified)
  - UL 114, UL 478 recognized
  - CSA 22.2 #154, #143 certified
  - IEC 65, IEC 348
- Standard protection features include
  - Overvoltage and overcurrent protection on each output
  - Overtemperature protection
  - Output power limiting
  - Low line voltage protection
- Systems-oriented
  - Remote on-off of each output
  - Brownout proof down to 87 V ac input
  - Carry over time of 50 ms at full load, 120 V ac
  - Extra 15 mV, 50 mA output for external circuitry

OEM modular power supply Data Sheets are available from your local HP Field Engineer.

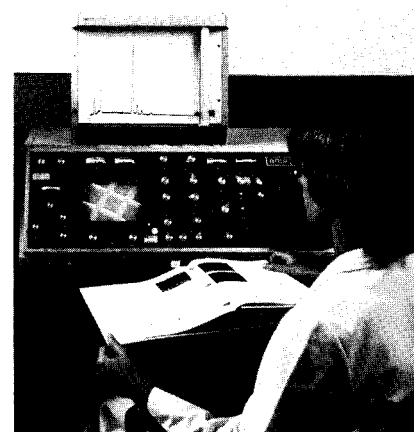
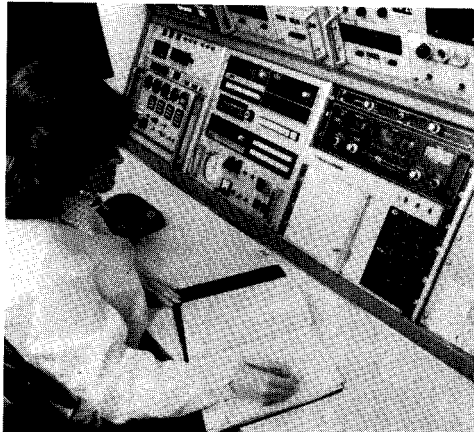

### Introduction

Hewlett-Packard offers a wide selection of recorders that capture and display data accurately, quickly, and consistently. This recorder line provides a choice of performance features to meet a variety of applications, including manufacturing, business, education, laboratory, and medical needs. Some of the criteria for selecting a recording device to satisfy present and future requirements are discussed below.

A major area of consideration for any precision instrument is reliability and serviceability. HP maintains the same high level of reliability for the entire recorder line, through rugged construction and extensive performance and environmental testing. Service is ensured by a responsive customer service program available through the worldwide network of HP sales and support offices.

### Selecting an X-Y Recorder

X-Y recorders plot Cartesian coordinate graphs from low frequency analog signals. There are three factors to consider in selecting an X-Y recorder in addition to reliability: static performance, dynamic performance, and features.

**Static performance:** Static performance relates to a recorder's response to dc voltages and very low frequency input signals. It includes accuracy and resolution. Accuracy is the degree of distortion of the recorded signal. Accuracy and resolution of the trace are functions of the electronic and mechanical characteristics of the recorder and also of its dynamic performance. The type of input signal will determine the range of sensitivity (input voltage) required.

**Dynamic performance:** Dynamic performance is a function of two characteristics: slewing speed and acceleration. Slewing speed is defined as the maximum speed attainable by the pen along either the X- or Y-axis. Its main contribution is the ability to record high amplitude, low frequency signals. Acceleration is defined as the peak pen acceleration when the pen responds to a step input. Acceleration's main contribution is the ability to respond to low amplitude, high frequency signals. As an instrument's rated acceleration decreases, response is more and more limited by acceleration, and slewing speed becomes less significant. High dynamic performance is essential to the capture of rapid, transient signal inputs. The types, speed, frequency, and range of the input signals determine the required dynamic performance characteristics.

**Features:** The importance of other features is determined by the application in which the recorder will be used. In some cases there is a trade off. Unit size is one example. The larger the unit, the easier it is to scale for recognition and interpretation of the trace, but the more space is required to house the recorder. Selecting a 1- or 2-pen system depends on whether one or two independent variables are being recorded versus another variable. Use of a time base feature is determined by the need to record the variable or variables versus time.

Other standard or optional features available on all HP X-Y recorders include electrostatic holddown, zero offset, and rack mounts.

### Selecting a Strip Chart Recorder

Strip chart recorders produce permanent records of slowly varying analog signals versus time. Selection criteria should include chart speeds and writing system.

**Chart speeds:** Recording speeds vary with each recorder capable of performing at multiple, user-selected speeds. Fast speeds capture rapid, close signals, and slow speeds are ideal for long-term recording and paper economy. The range selected will vary, based on your requirements and data input volume.

**Writing systems:** A thermal writing system, which seldom requires pens to be changed, is ideal for long-term unattended operation; an ink writing system contains durable stainless steel or convenient disposable pens. Both systems provide a clean, distinct trace. All 2-pen models permit both channels to use the full resolution of the chart width simultaneously, as the pens can overlap on the same chart without interference.

**Features:** Standard features on all models include chart tables that tilt at three angles, front-panel thumbwheels that advance chart paper, chart storage, and user-oriented manuals. The series offers models with 1 and 2 pens, modular construction, compact size, event marker options, and remote capability.

### Selecting an Oscillographic Recorder

Direct writing oscillographs accurately record analog signals in excess of 100 Hz, whereas strip chart recorders are limited to about 1 Hz. Oscillographic recorders utilize a 40 to 50 mm channel width as opposed to the 125 or 250 mm channel width of the typical strip chart recorder. The selection of a specific oscillograph is dictated in large part by the number of channels and the type of writing system.

**Number of channels:** Generally available in 2, 4, or 8 channels, the number of channels you select on your oscillograph should be determined by your current and projected requirements. All channels provide precise time correlation relative to the other channels. As the number of channels increases, the cost per channel decreases.

**Writing system:** The writing system is a prime example of high durability, an area in which Hewlett-Packard oscillographs excel. Tungsten carbide ink-writing pen tips and ceramic thermal pen tips can last the life of the recorder. The pen structure is stainless steel to eliminate fatigue failures, including the types that are caused by sustained violent signals. The HP pen system frees you from the problems of pen adjustment, pen lapping, and pen placement.

**Features:** Other features include a high pen resonance frequency, remote chart speed control, accessible preamplifier outputs, environmental specifications, and the same 5-pin shielded input connectors on all preamplifiers.

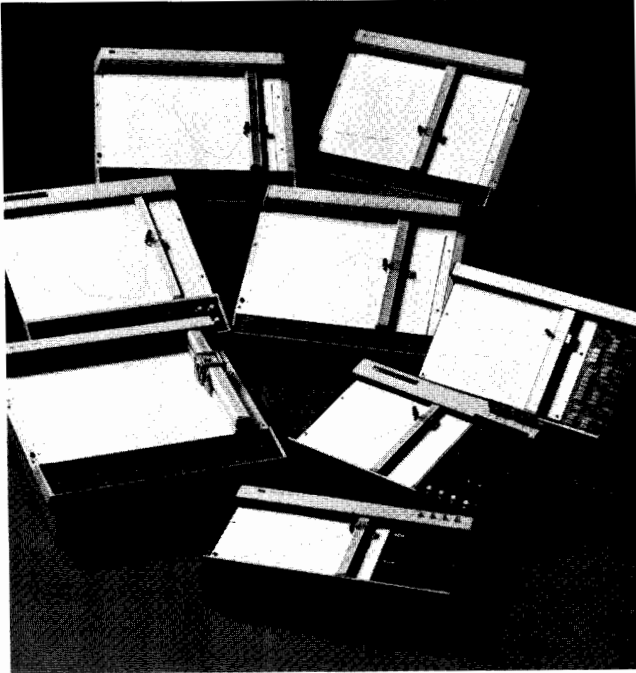

The following tables provide information to help identify the best type of recorder for present and future needs. Once the recorder is identified, full information for the unit can be found in this catalog. The appropriate catalog page numbers are listed on the tables.

### Review of HP's Laboratory X-Y Recorders

All of HP's X-Y recorders have electrostatic holddown, disposable fiber-tip pens, offsettable zero, convenient front-panel inputs and controls, easy paper alignment, rack mount capability, an optional or standard time base, and components designed for rugged use, long life, and long-term alignment.

#### X-Y Recorders

Chart Size	Dynamic Performance	Sensitivity	Special Features	Model Number	Page Number
Large chart 28 x 42 cm (or 11 x 17 in.)	Very high	High	TTL remote control	7045B	260
	Very high	High	2 pens, TTL remote control	7046B	260
	High	Very high	TTL remote control	7047A	260
	High	High	TTL remote control	7044B	260
	High	High	Uses 17170-series plug-ins	7004B	262
Small chart 22 x 28 cm (or 8.5 x 11 in.)	High	Medium	TTL remote control, time base	7015B	258
	High	High	Uses 17170-series plug-ins	7034B	262
	Low	Medium		7035B	259

### Review of HP's Laboratory Strip Chart Recorders

Standard features include chart tables that tilt at three angles, front-panel chart advance thumbwheels, and chart storage. All have ink writing systems; thermal writing options are available on some

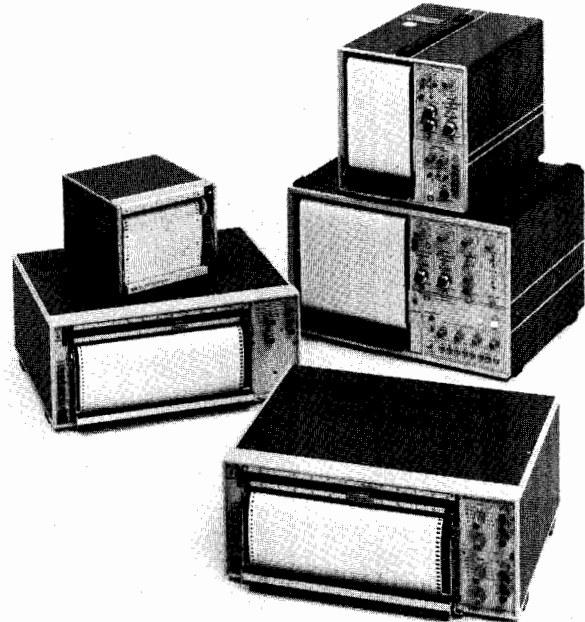

models. Two-pen models permit both channels to use the full resolution of the chart width simultaneously.

#### Strip Chart Recorders

Grid Width	Chart Speeds	Special Features	Model No.	Page No.
25cm (10 in.)	8 speeds plus remote control (speed proportional to input pulse rate)	2 pens, thermal writing option, TTL remote control	7132A*	265
25 cm (10 in.)	8 speeds plus remote control (speed proportional to input)	1 pen, thermal writing option, TTL remote control	7133A*	265
12 cm (5 in.)	8 speeds	1 pen, compact	680	264

\*For OEM applications, single-range, single-speed models are available (7130A and 7131A).

### Review of HP's Oscillographic Recorders

HP's oscillographic recorders free you from pen adjustment, lapping, and replacement problems through a combination of tungsten or ceramic tips and trouble-free mechanical design. The recorders provide single high-resonant frequency, consistent and uniform traces, and smooth pen response. Other standard features include remote chart speed control, accessible preamplifier outputs, and common-type shielded input connectors on all preamplifiers.

#### Oscillographic Recorders

Number of Channels	Writing Method	Number of Chart Speeds	Special Features	Model No.	Page No.
8	Thermal	8, 16 optional	Uses 8800-series plug-ins	7418A	268
4	Thermal	8, 16 optional	Uses 8800-series plug-ins	7414A	268
4	Ink, low pressure	6, 12 optional	Uses 17400-series plug-ins	7404A	266
2	Ink, low pressure	4, 7 optional	Uses 17400-series plug-ins	7402A	266



# RECORDERS & PRINTERS

## Low-cost, Flexible X-Y Recorders

### Models 7010B, 7015B

- Low cost of ownership
- Choice of optional features

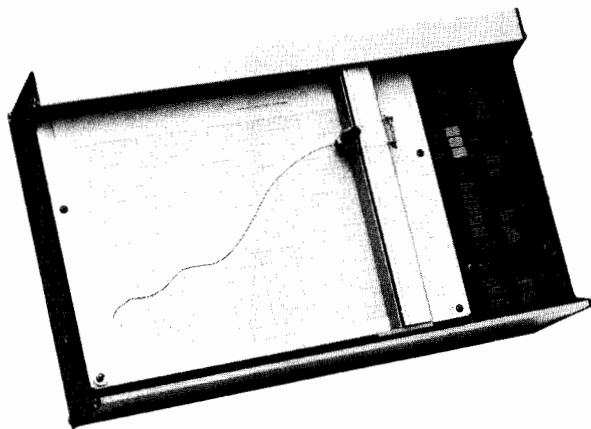

- Low price
- Full capability



7010B  
Control  
Panel

### Models 7010B and 7015B X-Y Recorders

The 7010B and 7015B are low-cost, one-pen X-Y recorders that allow charting on paper sizes up to ISO A4 or 216 x 280 mm (8.5 x 11 in.). All paper sizes up to the maximum are held securely by the trouble-free electrostatic paper hold-down. The units are mounted in sturdy cases made from single castings, assuring mechanical alignment and long life, even in rugged environments. Designed for the OEM market, the 7010B recorder features low cost, compact design, and a selection of options. The 7015B provides recording for a wide range of laboratory uses where there is a need for full capability at reasonable cost.

The 7010B, for OEM applications, features electrical and mechanical flexibility by providing a choice of X- and Y-axis sensitivities and X-axis sweep options. In addition, there are optional time base sweeps with remote TTL triggering, input filters, electric pen lift with TTL remote control, control panel, and carrying case.

The 7015B has a full complement of capabilities. The standard features include an internal time base with sweep selections from 5 seconds to 20 minutes. The time base provides automatic pen control and accepts remote triggering from sweep start and reset. Also included are matched input filters, remote pen lift, and TTL-level remote control. The 7015B accepts TTL-level and low current (5 mA) contact closure for easy interface with external equipment.

### 7010B, 7015B Performance Specifications

#### Input voltage:

**7010B:** Single range, metric: 50 mV/cm, English: 0.1 V/in.

**7015B:** Metric: 5 mV/cm, 50 mV/cm, 500 mV/cm, English: 0.01 V/in., 0.1 V/in., 1 V/in.; vernier adjustable overlapping all ranges

#### Time base:

**7015B:** Metric: 0.1, 0.5, 1, 5, 10, 50 s/cm, English: 0.5, 1, 5, 10, 50, 100 s/in.; remote sweep start and reset via TTL level or contact closure

#### Input types:

**7010B:** Floating rear connector on circuit board

**7015B:** Floating binding posts or circuit board rear connector

**Input resistance:** 1 M $\Omega$  constant

**Normal mode rejection:** 7015B: greater than 50 dB at 50 and 60 Hz (40 dB/decade roll-off above 60 Hz)

**Common mode rejection:** 100 dB dc, 90 dB ac (decreases 20 dB/decade step in attenuation); measured with 1 k unbalance in HI terminal on most sensitive range

**Common mode voltage:** 40 V dc and peak ac maximum (conforms to IEC 348)

7015B

**Accuracy:** 7010B:  $\pm 0.3\%$  of full scale at 25°C (includes linearity and resettability). 7015B: add  $\pm 0.2\%$  of deflection when not on most sensitive range; temperature coefficient:  $\pm 0.2\%/^{\circ}\text{C}$ ; time base: 1.5%  $\pm 0.1\%/^{\circ}\text{C}$

**Resettability:** Less than 0.2% of full scale

**Overshoot:** Less than 2% of full scale

**Slewing speed:** Greater than 50 cm/s (20 in./s)

**Zero set:** 7015B: Zero may be placed anywhere on writing area or electrically off-scale up to one full scale from zero index; adjustment by 10-turn high resolution control

**Environment:** Operating temperature 0°C to 55°C; 95% RH (40°C)

### 7010B, 7015B General Specifications

**Writing system:** Fiber-tipped disposable pen

**Writing area:** 18 x 25 cm (7 x 10 in.)

**Platen size:** Holds up to ISO A4 (21 x 30 cm) and 8.5 x 11 in.

**Size:** 267 H x 432 W x 135 mm D (10.5" x 17" x 5")

#### Pen lift:

**7010B:** Manual (optional TTL remote control)

**7015B:** Electric (remote via TTL level or contact closure)

**Power:** Switch selectable for 100, 120, 220, 240 V ac  $\pm 5 - 10\%$ ; 47.5 to 440 Hz; 70 VA maximum

**Weight:** Net, 7.2 kg (16 lb); shipping, 10 kg (22 lb)

### 7010B Options

**001** Metric calibration

**002** Control panel

**003** Electric pen lift

**004** Deletes recorder case

**005** X-axis single sensitivity 5 mV/cm (10 mV/in.)

**006** X-axis single sensitivity 0.5 V/cm (1 V/in.)

**007** Y-axis single sensitivity 5 mV/cm (10 mV/in.)

**008** Y-axis single sensitivity 0.5 V/cm (1 V/in.)

**009\*** X-axis sweep rate of 0.5 s/cm (1 s/in.)

**010\*** X-axis sweep rate of 5 s/cm (10 s/in.)

**011** Carrying case (not for shipping use)

**012** Input filter (both axes)

**013** Rear connector (37-pin subminiature "D")

**908** Rack mount

\*Options 009 and 010 include electric pen lift

### 7015B Options

**001** Metric calibration

**004** Carrying case (not for shipping use)

**908** Rack mount

### Ordering Information

**7010B** OEM X-Y Recorder

**7015B** Lab X-Y Recorder

OEM discounts available

# RECORDERS & PRINTERS

## General Use X-Y Recorder, Plus Time Base

Models 7035B, 17108A Time Base

259



- Precision recording
- Time base available
- Floating guarded inputs

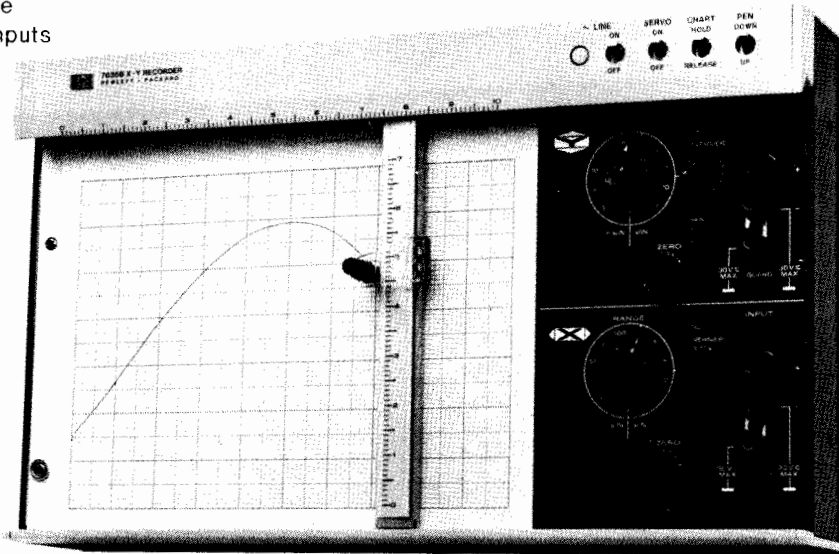

7035B

### Model 7035B X-Y Recorder

The 7035B combines precision with low cost and general-use design to provide users with one X-Y recorder that serves most recording needs where medium dynamic performance is a requirement. Compact in design, the 7035B is well adapted to rack mounting with the addition of only two optional wing brackets. Other features are silent, trouble-free electrostatic paper holddown for paper sizes up to 216 x 280 mm (8.5 x 11 in.); floating guarded inputs to help eliminate the common mode voltage effects that are troublesome when recording from low level sources; and disposable pens with self-contained ink supply to allow simple, one-step replacement of ink, tip, and color.

Input connectors on the 7035B accept both open wire and plug-type connectors. In addition, the recorder provides five calibrated ranges (0.4 mV/cm to 4 V/cm) for each axis; signal scaling for full-scale deflection, and high input impedance (1 megohm, except the first two ranges).

### Model 17108A Time Base

The 17108A is a self-contained external time base that operates on either axis of the 7035B. By simply plugging in the 17108A, the 7035B is provided with five sweep speeds from 0.2 to 20 s/cm (0.5 to 50 s/in.). This module, powered by a single self-contained battery, is controlled by its own six-position range switch and three-position mode switch.



17108A Option 002 mounted on recorder

### 17108A Specifications

**Sweep speeds:** 0.2, 0.4, 2, 4, 20 s/cm (0.5, 1, 5, 10, 50 s/in.)  
**Accuracy:** 5% of recorder full scale  
**Linearity:** 0.5% of full scale (20°C to 30°C)  
**Output voltage:** 0 to 1.5 V  
**Power:** Replaceable mercury battery (100 hr)

### 7035B Performance Specifications

**Input ranges:** 0.4, 4, 40, 400 mV/cm and 4 V/cm (1, 10, 100 mV/in.; 1 and 10 V/in.). Continuous vernier between ranges

**Input types:** Floating guarded signal pair; rear connector

**Input resistance:**

Range		Input resistance
0.4 mV/cm	(1 mV/in.)	Potentiometric (essentially infinite at null)
Variable		11 kΩ
4 mV/cm	(10 mV/in.)	100 kΩ
Variable		100 kΩ
40 mV/cm & above	(100 mV/in. & above)	1 MΩ

**Normal mode rejection:** >30 dB at 60 Hz; then 18 dB/octave

**Maximum allowable source impedance:** 20 kΩ on the most sensitive range; no restrictions on other ranges.

**Accuracy:** ±0.2% of full scale

**Linearity:** ±0.1% of full scale

**Resetability:** ±0.1% of full scale

**Zero set:** Zero may be set up to one full scale in any direction from zero index. Lockable zero controls.

**Slewing speed:** 50 cm/s (20 in./s) nominal at 115 V.

**Common mode rejection:** 130 dB at dc & 100 dB at line frequency with up to 1 kΩ between the positive input and guard connection point and attenuator on most sensitive range. CMR decreased 20 dB per decade step in attenuation.

### 7035B General Specifications

**Electrostatic paper holddown:** Grips 216 x 280 mm (8.5 x 11 in.) charts or smaller. Special paper not required.

**Pen lift:** Electric pen lift capable of being remotely controlled.

**Size:** 265 H x 445 W x 121 mm D (10.5" x 17.5" x 4.8").

**Weight:** Net, 8 kg (18 lb). Shipping, 10.9 kg (24 lb).

**Power:** 115 or 230 V ±10%, 50 to 60 Hz, approximately 45 VA

### 7035B Options

**001** Metric calibration

**003** Retracting potentiometer on X-axis 5 kΩ ±3%

**908** Rack mount

### 17108A Options

**002** 17108A Metric calibration

### Ordering Information

**7035B** General purpose X-Y recorder

**17108A** Time base plug-in



# RECORDERS & PRINTERS

## High Performance General-Use X-Y Recorders

Models 7044B, 7045B, 7046B, 7047A

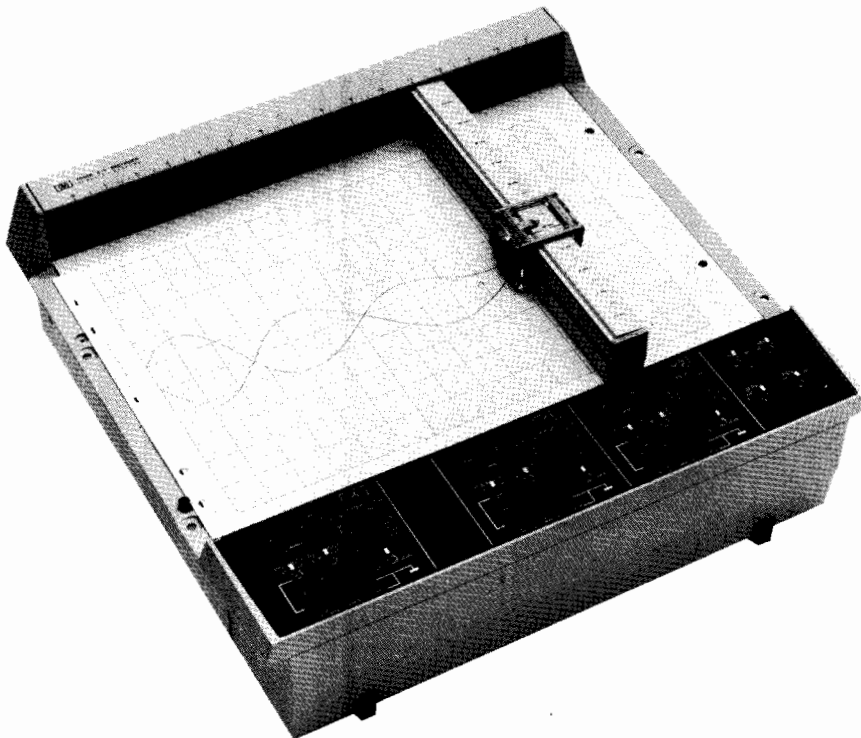

Maximum general-use capability need? Two pens to draw two or three simultaneous variables? . . . **Choose the 7046B**



Relatively low frequency requirements? A dedicated application? Flexible needs for basic recording? . . . **Choose the 7044B**



Multi-users and many applications? Fast pen response? No need to plot two simultaneous Y variables? . . . **Choose the 7045B**

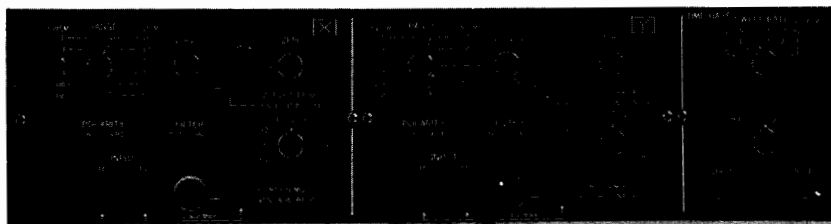

High-sensitivity low-signal application such as electrochemistry? High noise levels? . . . **Choose the 7047A**

### The 7044B, 7045B, 7046B, 7047A

This series of general-use X-Y recorders has been designed to satisfy both current and future laboratory applications. The high-level performance and reliability of these recorders are the results of a design philosophy that has evolved through 30 years of Hewlett-Packard experience as a leading manufacturer of X-Y recorders.

Whether the buyer purchases the one-pen (X or T vs Y) 7044B, 7045B or 7047A or the two pen (X or T vs Y1 & Y2) 7046B, the recorder will provide the following quality features:

**Very high dynamic performance:** With a combination of high slewing speed and acceleration, these recorders can capture fast changing signals that an ordinary recorder might miss. For example, the 7045B will, typically, record a signal from dc to 10 Hz at 2 cm peak-to-peak amplitude on either axis.

**TTL remote control:** With TTL or simple contact closure to ground, a rear connector offers easy interface to measurement systems. TTL provides remote control of sweep, start and reset, pen lift, servo mute, and chart hold. Pen lift, the most important action to be controlled remotely, is also available from a convenient rear-mounted banana jack connector (not 7047A).

**Wide chart size range:** Accepts ISO A3, ISO A4, 8.5 x 11 in., 11 x 17 in., and any paper size under the maximum limit (ISO A3 or 11 x 17 in.). With this capability these recorders can fill a variety of charting needs.

**Environmental specifications:** Each unit is designed to meet exacting Hewlett-Packard environmental specifications. For example, these units meet performance specifications through a temperature range of 0°C to 55°C and at relative humidities up to 95 percent. They also conform to rugged shock and vibration specifications.

**Other user-oriented features:** With this X-Y recorder line, the two design objectives were to produce precision instruments and to make these units easy to use. Major features include:

- Polarity reverse switch that eliminates need to reverse input leads
- Response switch on 7045B and 7046B that allows recorder response to be slowed to simplify initial set up
- Separate rear connector that provides a convenient remote pen lift control connection (not 7047A)
- Built-in hardware that simplifies table or rack mounting



## 7044B, 7045B, 7046B, and 7047A Specifications

### Performance Specifications

	7044B HIGH SPEED	7045B VERY HIGH SPEED	7046B 2-PEN, VERY HIGH SPEED	7047A VERY HIGH SENSITIVITY
Type of input	Front and rear input. Floating, guarded. Polarity reversal switch on front panel.			Front input only. Floating, guarded. Common mode driver circuit eliminates need to connect CMV to recorder, if CMV <10 V peak.
Input ranges	0.25, 0.5, 1, 2.5, 5, 10, 25, 50, 100, 250, 500 mV/cm. 1, 2.5, 5 V/cm. (0.5, 1, 2, 5, 10, 20, 50, 100, 200, 500 mV/in. 1, 2, 5, 10 V/in.) Continuous vernier between ranges.			0.02, 0.05, 0.1, 0.5, 1, 5 mV/cm; 0.01, 0.05, 0.1, 0.5, 1, 5 V/cm. (0.05, 0.1, 0.5, 1, 5, 10 mV/in.; 0.05, 0.1, 0.5, 1.5, 10 V/in.) Continuous vernier between ranges.
Input resistance	1 megohm constant on all ranges			
Source resistance	10 k $\Omega$ maximum on all ranges			10 k $\Omega$ max except 0.02 mV/cm, 0.05 mV/cm, and 0.1 mV/cm (0.05 mV/in. and 0.1 mV/in.) ranges are 2 k $\Omega$ max.
Accuracy	$\pm 0.2\%$ of full scale (includes linearity and deadband) at 25°C. Temp coefficient $\pm 0.01\%$ per °C			
Range accuracy	$\pm 0.2\%$ of full scale $\pm 0.2\%$ of deflection (includes linearity and deadband) at 25°C. Temp coefficient $\pm 0.01\%$ per °C.			
Deadband	0.1% of full scale			
Common mode rejection	110 dB and 90 dB ac (exceeds 130 dB dc and 110 dB ac under normal lab environmental conditions) with 1 k $\Omega$ between HI and LO terminals. CMV applied between ground and LO, and attenuator on most sensitive range. CMR decreases 20 dB per decade step in attenuation.			130 dB dc and 130 dB ac with 1 k $\Omega$ imbalance in HI or LO terminal (exceeds 150 dB under normal conditions). CMR decreases 20 dB per decade step in attenuation from most sensitive range.
Normal mode rejection	Internal filter not available			30 dB min at line frequency with FILTER IN. (50 dB typical at 60 Hz and 40 dB at 50 Hz.)

### Dynamic Performance Specifications

Slewing speed	50 cm/s (20 in./s), min.	97 cm/s (38 in./s) typical under normal lab conditions. 76 cm/s (30 in./s) minimum.		
Acceleration peak—Y axis	2540 cm/s <sup>2</sup> (1000 in./s <sup>2</sup> )	7620 cm/s <sup>2</sup> (3000 in./s <sup>2</sup> )	6350 cm/s <sup>2</sup> (2500 in./s <sup>2</sup> )	7620 cm/s <sup>2</sup> (3000 in./s <sup>2</sup> )
—X axis	1270 cm/s <sup>2</sup> (500 in./s <sup>2</sup> )	5080 cm/s <sup>2</sup> (2000 in./s <sup>2</sup> )	3800 cm/s <sup>2</sup> (1500 in./s <sup>2</sup> )	5080 cm/s <sup>2</sup> (2000 in./s <sup>2</sup> )
Overshoot	2% of full scale maximum.	1% of full scale maximum.		

### Offset Specifications

Zero offset	Zero may be placed anywhere on the writing area or electrically off scale up to one full scale from zero index.	11 calibrated scales of zero offset in both axes. Switchable in steps of full scale from +1 to -10.		
Offset accuracy at 25°C (applies to calibrated unit)	Not applicable	$\pm 0.1\%$ of full scale times N where N = number of scales of offset.		
Temperature coefficient	Not applicable	$\pm 0.004\%$ of full scale times N per °C.		

### Time Base Specifications

Time base	8 speeds: 0.25, 0.5, 1, 2, 5, 10, 25, 50 s/cm (0.5, 1, 2, 5, 10, 20, 50, 100 s/in.)	6 speeds: 0.1, 0.5, 1, 5, 10, 50 s/cm (0.5, 1, 5, 10, 50, 100 s/in.) switchable to X or Y axis.		
Time base accuracy	1.0% at 25°C. Temp coefficient at $\pm 0.1\%/C^\circ$			

### General Specifications

Power	100, 120, 220, 240 Vac +5 -10%; 48 to 440 Hz; 135 VA	100, 120, 220, 240 Vac +5 -10%; 48 to 440 Hz; 230 VA	100, 120, 220, 240 Vac +5 -10%; 48 to 440 Hz; 230 VA	100, 120, 220, 240 Vac +5, -10%; 48 to 66 Hz; 180 VA
Pen lift	Electric (remote via TTL level)			
Writing area	25 x 38 cm (10 x 15 in.)			
Weight	Net 13.7 kg (30 lb)		Net 16 kg (35 lb)	Net 18.6 kg (41 lb)
Size	400 H x 483 W x 165 mm D (15.8" x 19" x 6.5").		441 H x 483 W x 173 mm D (17.4" x 19" x 6.8").	

### 7044B, 7045B Options

- 001 Time base
- 002 Event marker
- 006 Metric calibration

### 7046B Options

- 001 Time base
- 002 Event marker
- 007 Metric calibration
- 085 VDE certification (VDE specification DIN 57411)

### 7047A Options

- 001 Metric calibration
- 002 Event marker

### Ordering Information

- 7044B High speed recorder
- 7045B Very high speed recorder
- 7046B 2-pen, very high speed recorder
- 7047A Very high sensitivity, high speed recorder
- OEM discounts available



# RECORDERS & PRINTERS

## High Performance Modular X-Y Recorders

Models 7034A, 7004B, with 17170 Series Preamps

- High dynamic performance
- Plug-in flexibility
- Guarded inputs

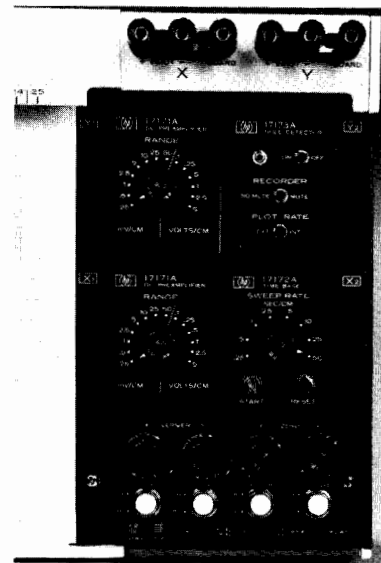
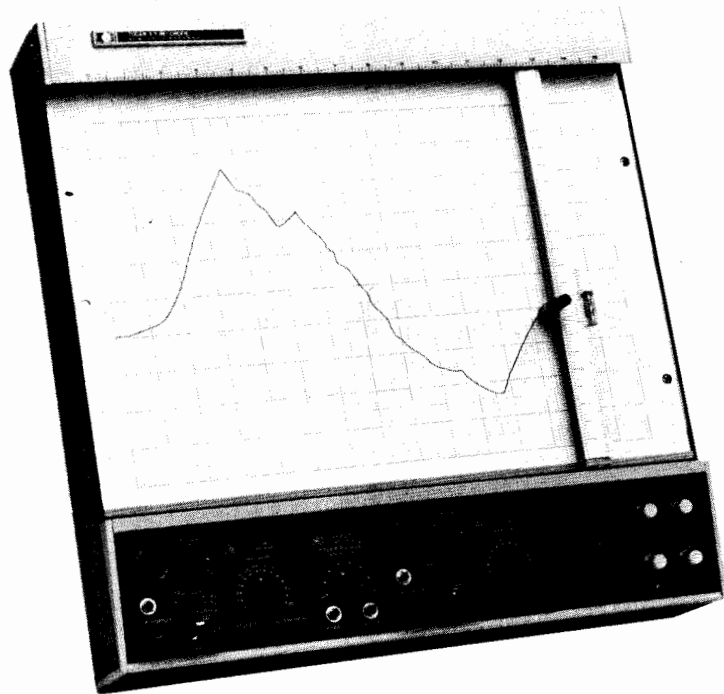

7004B

7034A

### Models 7034A and 7004B X-Y Recorders

The 7034A and 7004B X-Y recorders provide high dynamic performance, plus plug-in flexibility. Precision recordings of rapidly changing input signals are assured because the recorders have excellent dynamic performance, high slewing speed (greater than 75 cm/s), and high peak acceleration (3800 cm/s<sup>2</sup>). With this high peak acceleration, the pen can follow quick, small input changes, accelerating to 76 cm/s in less than 50 ms.

Both the 7034A and 7004B can be reconfigured for many different recording needs by simply plugging in different preamp modules. The variety of signal conditioner modules permits the user to reconfigure the recorder not only for a specific purpose, but also to one of these three basic types:

- **Basic systems recorder**—50 mV/cm (100 mV/in.). Available with dc coupler (17170A).
- **General-purpose recorder**—High-sensitivity X-Y available with dc preamps (17171A). Can have X-T or Y-T, available with dc (17171A), plus time base (17172A).
- **Specialized recorder**—Point plotting available with null detector (17173A) and “two-pen” simulation available with scanner (17176A).

In addition, other features may be added with other modules.

### Additional Features

The 7034A and 7004B have front and rear guard terminals available for signal inputs. This guarding helps eliminate the common mode voltage effects that are particularly troublesome when recording from low level sources, such as thermocouples and strain gauges. In addition, the recorders are equipped with a silent, trouble-free electrostatic holddown that secures all paper sizes up to 210 x 280 mm (8.5 x 11 in.) on the 7034A and 280 x 432 mm (11 x 17 in.) on the 7004B. Disposable ink pens are designed to provide clean, crisp, and continuous traces; self-contained ink supplies and fiber

tips eliminate ink handling and pen cleaning. Other features include a Record/Setup switch, single-locking rear connector, easily accessible slidewires, knob locks, five-way binding posts, locking feet, tilt stand, and optional rack mounting brackets.

### Model 17012B/C Point Plotter

The 7004B or 7034A, equipped with 17012B or 17012C respectively, point plot when used with an appropriate plug-in. Plotting rate is 50 points per second. Power is supplied from the recorder.

### 7034A and 7004B Performance Specifications

**Plug-ins:** Accept 4 single-width, 2 per axis

**Type of input:** Floating and guarded signal pair. Available through front panel or rear connector.

**Zero set:** May be set  $\pm 1$  fs from zero index

**Zero check switches:** Pushbutton in each axis allows verification of recorder's zero position without removal or shorting of input signal.

**Mainframe accuracy:**  $\pm 0.2\%$  of full scale

**Range vernier:** Lockable, covers 2.5 times range setting

**Slewing speed:** More than 75 cm/s (30 in./s) independent of line voltage and frequency

**Acceleration (peak):** More than 3800 cm/s<sup>2</sup> (4 g)

**Reference stability:** Better than 0.003%/°C

**Terminal-based linearity:**  $\pm 0.1\%$  of full scale

**Resettability:**  $\pm 0.05\%$  of full scale

### 7034A, 7004B General Specifications

**Electrostatic paper holddown:** Grips charts up to size of platen

**Pen lift:** Local and remote control (contact closure or TTL)

**Size:**

**7004B:** 445 H x 445 W x 121 mm D (17.5" x 17.5" x 4.8").

**7034A:** 267 H x 445 W x 121 mm D (10.5" x 17.5" x 4.8").

**Weight:**

**7004B:** Net 10.9 kg (24 lb). Shipping 14.5 kg (32 lb).

**7034A:** Net 7.7 kg (17 lb). Shipping 10.2 kg (23 lb).

**Power:** 115 or 230 V ac  $\pm 10\%$ , 50 to 400 Hz, approximately 85 VA (dependent on plug-in)

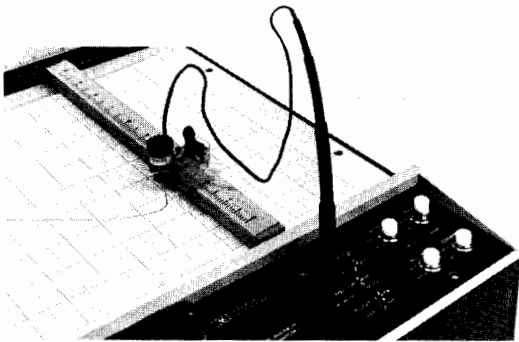

17012B/C

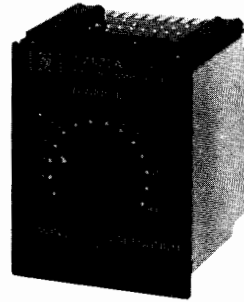

17171A

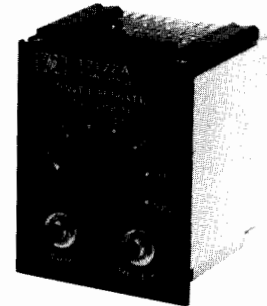

17172A

## 17170 Series Preamp Specifications

### 17170A DC Coupler

**Input range:** Single, fixed calibration range of 50 mV/cm (100 mV/in.)

**Input resistance:** 1 M $\Omega$  constant

**Common mode rejection:** 120 dB at dc & 70 dB at 50 Hz & above with 100  $\Omega$  between low side & guard connect point with source impedance 10 k $\Omega$  or less

### 17171A DC Preamplifier

**Input ranges:** 0.25, 0.5, 1, 2.5, 5, 10, 25 mV/cm, 0.05, 0.1, 0.25, 0.5, 1, 2.5, 5 V/cm (0.5, 1, 2, 5, 10, 20, 50, mV/in., 0.1, 0.2, 0.5, 1, 2, 5, 10 V/in.)

**Input resistance:** 1 M $\Omega$

**Common mode rejection:** 120 dB at dc & 100 dB at 50 Hz & above with 100  $\Omega$  between low side & guard connect point at 0.25 mV/cm (0.5 mV/in.). CMR on others decreases 20 dB/decade step in attenuation.

**System accuracy:**  $\pm 0.2\%$  full scale

### 17172A Time Base

**Sweep speeds:** 0.25, 0.5, 1, 2.5, 5, 10, 25, 50 s/cm (0.5, 1, 2, 5, 10, 20, 50 100 s/in.)

**System accuracy:**  $\pm 1\%$  of fs on 6 fastest ranges,  $\pm 2.5\%$  on remaining two

### 17173A Null Detector (17012B/C Required)

**Plot rate:** Up to 50 points/s

**Enable/disable:** Required disable voltage +3 V min to +20 V max  
**Required enable voltage:** -0 V dc or no connect. Other voltage combinations available on request

**Muting:** Local or remote

**Plotting accuracy:**  $\pm 0.25\%$  of full scale

### 17174B DC Offset

**Offset:** <1 mV to approximately 1V

**Controls:** 2 lockable, 10-T high resolution controls (<1 mV to approximately 10 mV & <1 mV to approximately 1 V). An offset polarity switch allows upscale or downscale zero offset

**Offset voltage stability:**  $>0.005\%/^{\circ}\text{C}$

### 17175A Filter

**Input ranges:** -5 to +45 V dc, 10 V ac max p-p

**Maximum source impedance:** 1 k $\Omega$ ; higher impedance decreases filter response

**Rejection:**  $>55$  dB at 50 Hz & higher (0.25 s rise time) or  $>70$  dB at 50 Hz & higher (1 s rise time). Front panel selection

### 17176A Scanner (17012B/C Required)

**Input:** Front panel miniature binding posts isolated from ground (high & low only). Mainframe input: utilizes existing input connectors

**Attenuator:** Fixed attenuator in decade steps from X1 to X0.001. Variable attenuator provides continuous coverage

**Input impedance:** 100 k $\Omega$

**Accuracy:** 0.2% of full scale

**Scan Rate:** Adjustable from 0.1 to 4 s/scan

### 17178A DC Attenuator

**Input ranges:** 0.05, 0.1, 0.25, 0.5, 1, 2.5, 5, 10 V/cm (0.1, 0.2, 0.5, 1, 2.5, 10, 20 V/in.)

**Input resistance:** 1 M $\Omega$

**Common mode rejection:** 120 dB at dc & 70 dB at 50 Hz & above with 100  $\Omega$  between low side & point where guard is connected (at 50 mV/cm or 100 mV/in.). Other ranges CMR decreases 20 dB/decade step in attenuation.

**System accuracy:**  $\pm 0.2\%$  of full scale

### 7004B Options

001 Metric scaling and calibration

002 X-axis retransmitting potentiometer 5 k $\Omega$   $\pm 0.1\%$  linearity

908 Rack mount kit

### 7034A Options

001 Metric scaling and calibration

908 Rack mount kit

### 17012B/C Point Plotter Options

001 6-symbol plotting capability

### 17171, 17172, 17177, 17178 Options

001 Metric scaling

### 17173A Preamp Options

001 +3 to 20 V enable, 0 V disable

002 -3 to -20 V disable, 0 V enable

003 -3 to -20 V enable, 0 V disable

### Ordering Information

7004B X-Y recorder

7034A X-Y recorder

17170A DC coupler plug-in

17171A DC amplifier plug-in

17172A Time base plug-in

17173A Null detector

17174B DC offset plug-in

17175A Filter plug-in

17176A Scanner plug-in

17178A DC attenuator plug-in

17012B/C Point plotter



# RECORDERS & PRINTERS

## Compact, Wide-Range Strip Chart Recorder

Model 680

- Low-cost, high quality recording
- User-selectable speeds and spans
- Metric or English recording
- Compact design

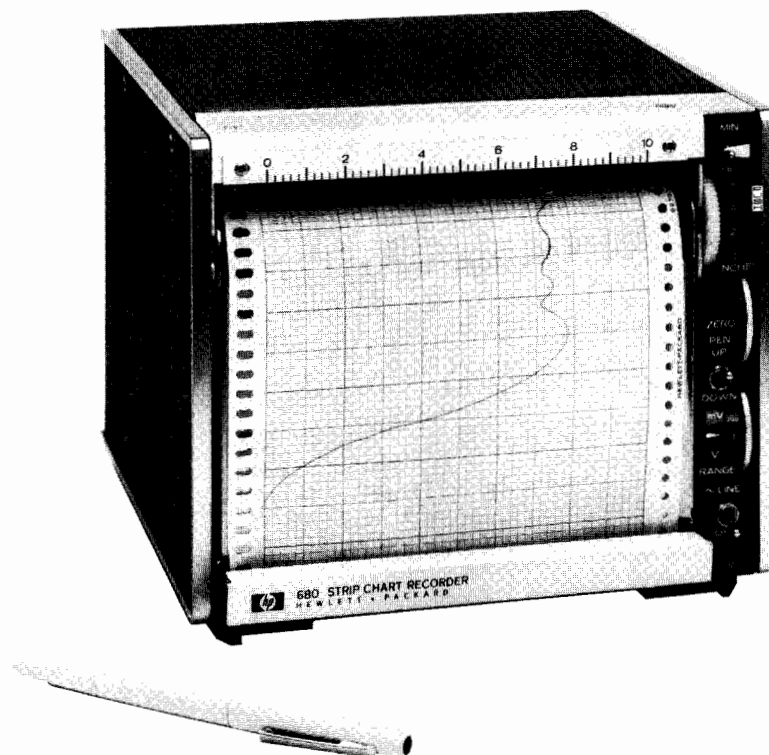

680

### Model 680 Strip Chart Recorder

The compact 680 produces quality recordings on a 12 cm or 5 in. wide grid. The versatility of the 680 is demonstrated by the wide range of user-selectable speeds and spans, providing one small unit that fills many metric or English recording needs. Major areas of versatility include: ten selectable voltage spans from 6 mV to 120 V (5 mV to 100 V for English recording) to magnify specific data; eight selectable speeds from 2.5 cm/hr to 20 cm/min (1 in./hr to 8 in./min for English recording) to use the most compatible speed with the data input rate; and two ink writing systems to provide a steel pen for maximum durability or optional disposable fiber and capillary tips to help prevent possible clogging due to noisy data. The 680 also provides a remote electric pen lift, full-scale zero adjustment, and standard input filter to eliminate the effects of signal noise. Primary uses of the 680 are as a monitor for instrumentation with dc outputs and for digital devices using digital-to-analog converters.

### 680 Performance Specifications

**Spans:** Ten calibrated spans; metric—6, 12, 60, 120, 600 mV; 1, 2, 6, 12, 60, 120 V (English—5, 10, 50, 100, 500 mV; 1, 5, 10, 50, 100 V)

**Input type:** Floating; (40 Vdc and peak ac maximum, conforms to IEC 348) single-ended rear connector

**Maximum DC common mode voltage:** 500 V

**Input resistance:** 166 k $\Omega$ /V (200 k $\Omega$ /V, English) full scale, through 10 V span; 2 M $\Omega$  on all others

**Common mode rejection:** DC 100 dB on most sensitive range. Decreases 20 dB per decade step in attenuation

**Accuracy:**  $\pm 0.2\%$  of full scale

**Response time:** Maximum, 0.5 s full scale

**Resettability:** 0.1% of full scale

**Chart speed:** Synchronous motor driver; metric—2.5, 5, 10, 20 cm/min; 2.5, 5, 10, 20 cm/hr (English—1, 2, 4, 8 in./min and in./hr). With option 008 (gear ratio 16:1 instead of 60:1) chart speeds are divided by 16.

**Zero set:** Adjustable over full span

### 680 General Specifications

**Writing mechanism:** Ink

**Pen lift:** Electric, controlled by local switch or remote contact closure

**Power:** 115/230 V, 60 Hz, 22 VA

**Weight:** Net, 5 kg (11 lb); shipping 7.6 kg (17 lb).

**Size:** 165 H x 197 W x 219 mm D (6.5" x 7.8" x 8.6").

### 680 Options

001 Retransmitting potentiometer

002 Event marker

003 High-low limit switches

008 16/1 speed reducer (replaces 60/1)

009 Remote chart on-off

010 50 Hz operation

014 Glass door with lock

018 Disposable pen tips

026 Metric calibration

H01 Additional span: 1.2 mV metric, 1 mV English

H02 100 k $\Omega$  input resistance

### Ordering Information

680 Strip chart recorder

OEM discounts available

# RECORDERS & PRINTERS

## Laboratory-use Strip Chart Recorders

Models 7132A, 7133A, 7130A, 7131A

265



- One-pen or two-pen recording
- Disposable pens or thermal writing
- User-selectable voltage spans
- OEM models available

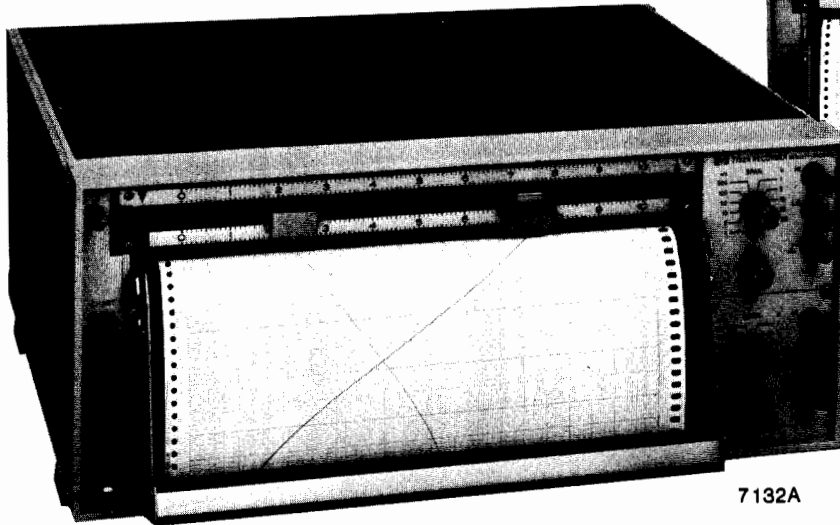

7132A

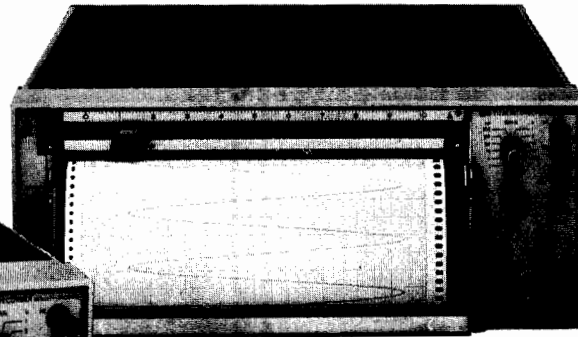

7133A

### Models 7132A and 7133A Strip Chart Recorders

The two-pen 7132A and one-pen 7133A are designed with a stepper motor chart drive for metric or English recording. This drive allows the chart advance to be controlled by an external pulse input, or by front-panel pushbuttons. When controlled by an external pulse, the chart speed is changed by variation in the rate at which pulses are applied to the motor, allowing the chart advance to be synchronized to an external event. Both recorders are manufactured with a belt-driven modular servo system for quiet, reliable operation. This modular design cuts maintenance costs by reducing the time necessary for routine inspections and maintenance. In addition, both recorders ensure longer pen life by reducing the amplifier gain automatically if the pen is driven off scale.

The power of the 7132A and 7133A is demonstrated by these features: 11 selectable voltage ranges from 1 mV to 100 V in 1, 5, and 10 steps, plus front-panel control for overlapping span adjustment; 8 selectable chart speeds from 15 cm/min to 2.5 cm/hr (6 in./min through 1 in./hr), plus external impulse control; and two writing systems: disposable ink pens or optional thermal writing for unattended operation.

Other options include right-hand zero (option 014) to deflect the pen from right to left for recording positive voltage, and event markers (options 037, 038, and 537) to mark the position of important events on either margin.

### Model 7130A, 7131A OEM Strip Chart Recorders

The two-pen 7130A and one-pen 7131A are 25 cm (10 in.) strip chart recorders designed primarily for the OEM market. Providing a large range of voltage span and chart speed options, these units are designed with the ruggedness, compactness, and performance required by OEM users. For a list of specifications and options, contact your HP sales representative.

### 7132A, 7133A Performance Specifications

**Input ranges:** Eleven ranges from 1 mV to 100 V full scale in 1-5-10 sequence with overlapping vernier

**Input type:** Floating (40 V dc and peak ac maximum, conforms to IEC 348), single ended, front connector

**Input resistance:** 1 megohm on all ranges

**Maximum source resistance:** 10 k $\Omega$  (to within rated response)

**Normal mode rejection (at line frequency):** >40 dB

**Common mode rejection:** >120 dB dc and 100 dB ac

**Accuracy:**  $\pm 0.2\%$  of full scale (includes linearity and deadband) at 25°C. Temp coefficient  $\pm 0.01\%$  per °C

**Range accuracy:**  $\pm 0.2\%$  of full scale  $\pm 0.2\%$  of deflection (includes linearity and deadband) at 25°C. Temp coefficient  $\pm 0.01\%$  per °C

**Deadband:** 0.1% of full scale

**Response time:** Less than 0.5 second

**Overshoot:** Less than 2% of full scale

**Chart speeds:** 2.5, 5, 10, 15 cm/min, and cm/hr (1, 2, 4, 6 in./min, and in./hr)

**Chart speed accuracy:**  $\pm 0.08\%$  plus line frequency accuracy

**Zero set:** Provides three full scales of offset

**Environmental (operating):** 0 to 55°C, less than 95% relative humidity (40°C)

### 7132A, 7133A General Specifications

**Writing mechanism:** Disposable ink pens (thermal writing optional)

**Grid width:** 25 cm (10 in.)

**Chart length:** 24 m (80 ft)

**Pen lift:** Solenoid operated with remote capabilities

**Power:** 115/230 V  $\pm 10\%$ , 50 or 60 Hz, 120 VA

**Size:** 184 H x 432 W x 340 mm D (7.3" x 17" x 13.4")

**Weight:** Net, 13 kg (28 lb). Shipping, 19 kg (42 lb).

### 7132A, 7133A Options

**001** Metric calibration

**014** Right-hand zero (hard)

**037** Right-hand event marker (not compatible with option 054)

**038** Thermal event marker (option 054 required)

**050** 50 Hz line power

**054** Thermal writing (for pen speed below 5 in./sec):  
on 7132A  
on 7133A

**060** 60 Hz line power

**537** Left-hand event marker, 7132A only (not compatible with option 054)

**908** Rack mounting brackets

### Ordering Information

**7132A** Two-pen laboratory recorder

**7133A** One-pen laboratory recorder

**7130A** Two-pen OEM recorder

**7131A** One-pen OEM recorder

OEM discounts available

# RECORDERS & PRINTERS

## Oscillographic Recorders with Plug-In Preamps

Models 7402A and 7404A with 17400A Series Preamps

- Records from dc to 150 Hz
- Draws traces with instant dry ink

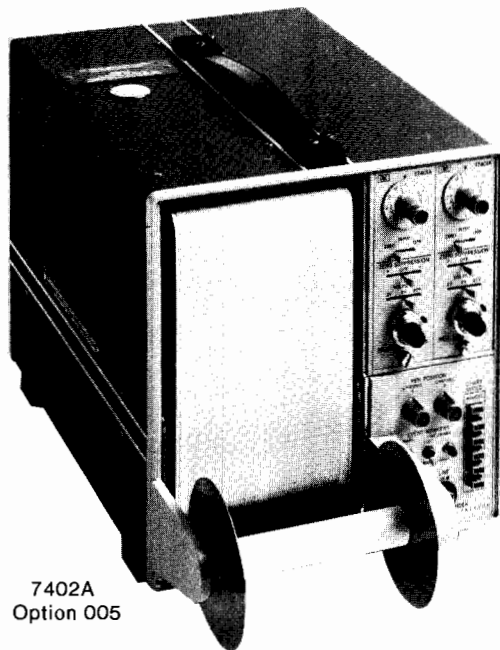

7402A  
Option 005

- Provides pens designed for long-life
- Allows configuration flexibility with plug-in modules

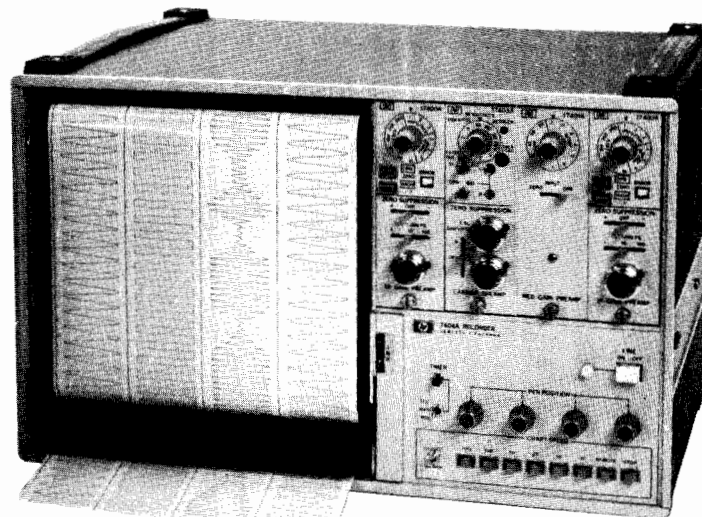

7404A

### Models 7402A and 7404A Oscillographic Recorders

The 2-channel 7402A and 4-channel 7404A are direct-writing oscillographic recorders capable of recording signals from dc through 150 Hz. Additional flexibility is provided with a choice of plug-in signal conditioner modules that can be changed easily by the user to configure the units to meet a variety of specific requirements.

### Long-life Pens

Both recorders are equipped with pens designed to last for the life of the recorder. The pen body is made of stainless steel to eliminate failure from metal fatigue, even when subjected to sustained and violent signals. The pen tips are formed of tungsten carbide, a metal with extremely low wear characteristics. The combination of durable metals in this HP pen design provides a stability that frees the user from tip lapping, pen adjustment, or replacement.

The low pressure ink system produces a solid black trace that dries as it draws. The consistency of the trace, even at high chart speed, provides a smudge-proof, blot-proof permanent presentation of the charted data.

### Other Mainframe Features

All plug-in module outputs are available from the rear of the mainframe. The output voltage (0 to  $\pm 5$  V) can be used as signal input to other monitoring/recording instruments. The rear panel also implements remote selection of chart speeds, including Stop, using a contact closure or TTL level change.

Both the 7402A and 7404A are designed and tested to operate in extremely adverse environments. This includes vibration (5-55 Hz, 0.01 in. peak-to-peak); operating temperatures (0-55°C); and humidity (95% at 40°C).

Both units also are designed with a single high resonant pen frequency, approximately 800 Hz, that is well above the range of the recorder. This capability ensures proper pen response at higher operating frequencies without unwanted perturbations.

### User Plug-in Modules

Either recorder can be reconfigured by the user with a simple change of plug-in signal conditioner module. The range of modules to change both voltage and transducer compatibility are:

**17400A high gain preamplifier**—Maximum sensitivity of 1  $\mu$ V/div (50  $\mu$ V span) and 21 calibrated ranges. Input is differential, floated, and guarded. Module provides calibrated zero suppression.

**17401A medium gain preamplifier**—Maximum sensitivity of 1 mV/V/full scale (50 mV span) and 12 calibrated ranges. Input is differential and balanced to ground. Calibrated zero suppression is optional.

**17402A low gain preamplifier**: Maximum sensitivity of 20 mV/div (1 V span) and 8 calibrated ranges. Inputs are single ended from both the front and rear connectors.

**17403A ac carrier preamplifier**: Maximum input sensitivity of 0.1 mV/V/full scale. Accepts inductive and resistive transducers, such as strain gauges, LVDTs, etc. Module supplies an excitation voltage of 5 V at 2.4 kHz, 15 calibrated range steps, and calibrated zero suppression. When module is used, a 2.4 kHz carrier frequency oscillator (Option 011) must be ordered with the mainframe.

### 7402A, 7404A Specifications

#### Analog channels:

7402A: 2 channels

7404A: 4 channels

**Chart description:** 84 m (275 ft) long with 50 div, full scale

7402A: 50-mm-wide channels

7404A: 40-mm-wide channels

**Chart speed:** Controlled by front panel, rear panel TTL or contact closure

7402A: 1, 5, 25, 125 mm/s

7404A: 5, 10, 25, 50, 100, 200 mm/s and mm/min

**Chart speed accuracy (25°C):**  $\pm 0.5\%$  plus power line frequency variation

**Chart weave:**  $\pm 0.25$  mm maximum

**Zero adjustment:**  $\pm 30$  div from grid center

**Writing system:** Black ink with rectilinear presentation; 55 cc throwaway ink cartridge

**Operating environment:** 0-55°C and up to 95% humidity maximum from 25-40°C for mm/s speeds and up to 80% humidity for mm/min speeds

**Power:** 100, 120, 220, 240 Vac

7402A: +5%, -10%, 60 Hz, 140 VA

7404A:  $\pm 10\%$ , 60 Hz, 300 VA

**Weight:**

7402A: 18.2 kg (40 lb.); shipping: 26.9 kg (59 lb)

7404A: 31.4 kg (69 lb.); shipping: 43.2 kg (95 lb)

**Size:**

7402A: 284 H x 253 W x 384 mm D (11.1" x 9.9" x 15.1").

7404A: 290 H x 438 W x 384 mm D (11.4" x 17.3" x 15.1").

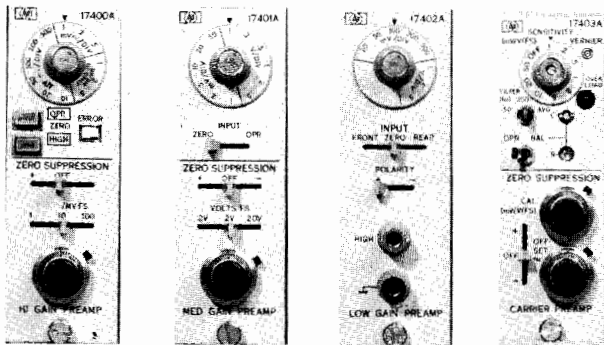

Preamps for 7402A and 7404A

## 17400A Series Specifications

### 17400A High Gain

**Input ranges:** 1, 2, 5, 10, 20, 50, 100, 200, 500  $\mu\text{V}/\text{div}$  and  $\text{mV}/\text{div}$ ; 1, 2, 5  $\text{V}/\text{div}$  continuous vernier between ranges

**Input type:** Differential, floated and guarded through rear connector  
**Common mode rejection:** 150 dB dc and 140 dB at line frequency with 1  $\text{k}\Omega$  source imbalance; 90 dB dc and 80 dB at 60 Hz on 10  $\mu\text{V}/\text{div}$  and above

**Frequency response (10-division deflection):** 3 dB at 110 Hz on 10  $\mu\text{V}/\text{div}$  range and above

**Typical rise time:** 7.5 ms (10 to 90% of full scale deflection)

**Overshoot:** Less than 2% of full scale

**Accuracy:**  $\pm 1\%$  of full scale; includes linearity (calibrated range, 25°C, temp coefficient 0.06%/°C)

**Range accuracy:**  $\pm 1\%$  of full scale;  $\pm 0.2\%$  of reading (25°C, temp coefficient 0.06%/°C). Linearity is included

**Zero suppression:** 1, 10, 100 V on 10  $\text{mV}/\text{div}$  range and above; other ranges 1, 10, 100 mV. Continuous calibrated 10-turn vernier between suppression steps

**Zero suppression accuracy:**  $\pm 0.5\%$  of setting or of full scale, whichever is greater

### 17401A Medium Gain

**Input ranges:** 1, 2, 5, 10, 20, 50, 100, 200, 500  $\text{mV}/\text{div}$ ; 1, 2, 5,  $\text{V}/\text{div}$ . Continuous 10-turn vernier between ranges

**Input type:** Balanced to ground. Inputs through rear connector

**Input resistance:** 1  $\text{M}\Omega$

**Common mode rejection:** Greater than 50 dB to line frequency. 100  $\Omega$  source imbalance

**Frequency response (10-division deflection):**

7402A: 3 dB at 140 Hz

7404A: 3 dB at 150 Hz

**Typical rise time:** 7.5 ms (10 to 90% of full scale deflection)

**Overshoot:** Less than 2% of full scale

**Accuracy:**  $\pm 1\%$  of full scale; includes linearity (calibrated range, 25°C, temp coefficient 0.06%/°C)

**Range accuracy:**  $\pm 1\%$  of full scale;  $\pm 0.2\%$  of reading (25°C, temp coefficient 0.06%/°C). Linearity is included

**Zero suppression:**

**Optional:** 0.2, 2, 20 V. Continuous calibrated 10-turn vernier between ranges

**Zero suppression accuracy:**  $\pm 0.5\%$  of setting or of full scale, whichever is greater.

### 17402A Low Gain

**Input ranges:** 20, 50, 100, 200, 500  $\text{mV}/\text{div}$ ; 1, 2, 5  $\text{V}/\text{div}$ . Continuous 10-turn vernier between ranges

**Input type:** Single ended. Inputs through front or rear connector.

**Input resistance:** 1  $\text{M}\Omega$  minimum

**Frequency response (10-division deflection):**

7402A: 3 dB at 140 Hz

7404A: 3 dB at 150 Hz

**Typical rise time:** 7 ms (10 to 90% of full scale deflection)

**Overshoot:** Less than 2% of full scale

**Accuracy:**  $\pm 1\%$  of full scale (calibrated range, 25°C, temp coefficient 0.06%/°C). Linearity is included

**Range accuracy:**  $\pm 0.2\%$  of reading. Linearity is included (25°C, temp coefficient 0.06%/°C)

### 17403A Carrier

**Input ranges:** 0.1, 0.2, 0.5, 1, 2, 5, 10, 20, 50  $\text{mV}/\text{V}/\text{full scale}$ . Continuous vernier between ranges. Sensitivities shown above also divisible by 100

**Input type:** Differential, floating

**Common mode rejection:** 120 dB dc to line frequency with 1  $\text{k}\Omega$  source imbalance

**Frequency response (10-division deflection):**

7402A: 3 dB at 140 Hz

7404A: 3 dB at 150 Hz

**Typical rise time (10 to 90% of full scale deflection):** 7.5 ms with preamp filter switch to 50 or 200; 1 s with switch to AVG

**Overshoot:** Less than 2% of full scale

**Accuracy:**  $\pm 0.6\%$  of full scale (calibrated range, 25°C, temp coefficient 0.06%/°C)

**Range accuracy:**  $\pm 0.2\%$  of reading (25°C, temp coefficient 0.06%/°C). Linearity is included

**Zero suppression:** 10-turn controls from 1 to 100% of full scale

**Zero suppression accuracy:**  $\pm 0.5\%$  of setting or of full scale, whichever is greater

**Drift (zero line referenced to input):**  $\pm 0.2 \mu\text{V}/\text{V}/\text{week}$ , including excitation drift

**Balance control (R balance):**  $\pm 5 \text{ mV}/\text{V}$ . Temp coefficient  $\pm 1.8 \mu\text{V}/\text{V}/^\circ\text{C}$

**Quadrature rejection:** 40 dB at 2.4 Hz. Quadrature tolerance: 2.1

**Transducer excitation:**

**Full bridge:** 5.0 V rms  $\pm 5\%$ , 2.4 kHz  $\pm 3\%$

**Half bridge:** One-half full bridge

**Excitation load resistance:** 100  $\Omega$  minimum; unlimited short circuit duration

### 7402A Options

001 Event marker, left hand

003 Event marker, left hand & event marker/timer, right hand for 1 s intervals

004 50 Hz power line operation

005 Paper take up, external

008 Event marker/timer, right hand, for minutes & seconds. Not compatible with Options 001 or 003

009 60:1 speed reducer

010 Hard cover. Not compatible with Options 005 or 908

011 2.4 kHz oscillator for 17403A

016 White paint

908 Rack mount adapter

### 7404A Options

004 50 Hz power line operation

005 Paper take up, external

010 Hard cover. Not compatible with Options 005, 012 or 908

011 2.4 kHz oscillator for use with 17403A

012 Rack mount adapter for 1064A

013 Channel 2 event marker

014 Channel 3 event marker

015 Channel 4 event marker

016 White paint

908 Rack mount adapter

### Ordering Information

Specify Option 016 for no charge white paint on preamps

7402A Mainframe (less preamps)

7404A Mainframe (less preamps)

17400A High-gain preamplifier

17401A Medium-gain preamplifier

**Option 001:** (zero suppression) for 17401A

17402A Low-gain preamplifier

17403A AC carrier preamplifier



# RECORDERS & PRINTERS

## Four and Eight-Channel Oscillographic Recorders

Models 7414A, 7418A & 8800 series signal conditioners

- Thermal writing for low maintenance
- Z-fold paper for easy review/storage

- Available in benchtop configuration, mobile cart, upright cabinet

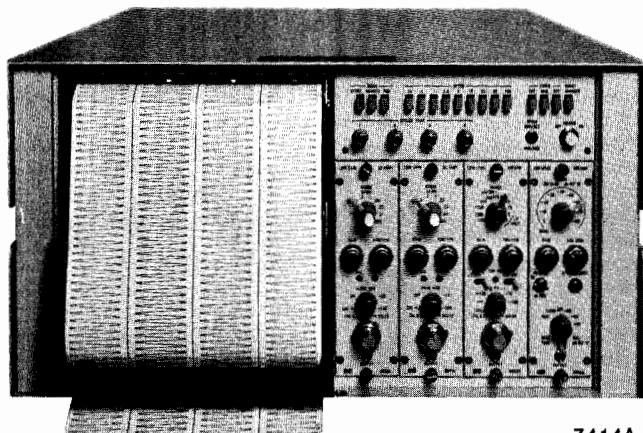

7414A

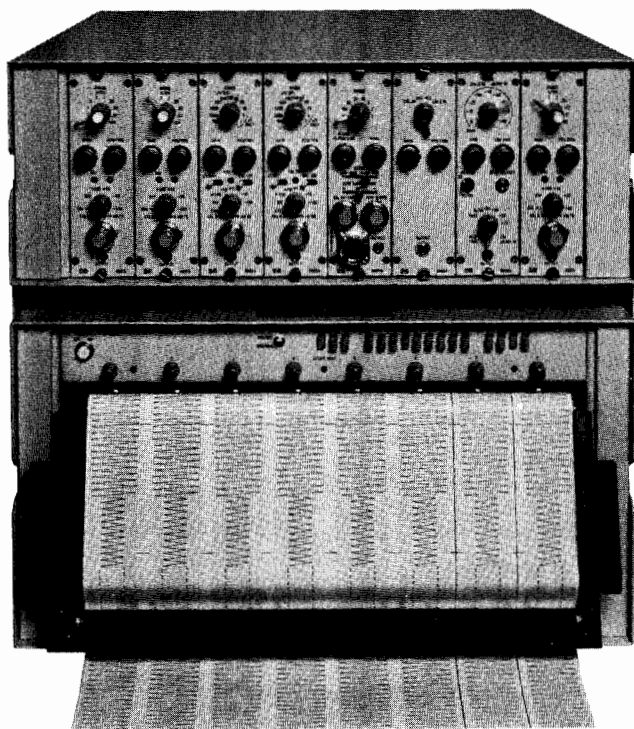

7418A with Options 030 and 003

Models 7414A 4-Channel and 7418A 8-Channel Oscillographic Recorders provide permanent reproducible records of multichannel, real-time data. A complement of 8800 Series Plug-in Signal Conditioners results in a system capable of meeting many measurement requirements in a reliable, versatile manner.

Thermal writing tips feature long stylus life and rectilinear presentations. A Z-fold chart paper pack loads easily, allows for convenient data review and storage. Two markers are supplied. The timer marker can be selected for one-second or one-minute marks. The event marker can be activated remotely or by front panel pushbutton.

### 7414A, 7418A, 8800 Series Plug-in Specifications

#### 7414A General Specifications

**Chart speeds:** 0.25, 0.5, 1.0, 2.5, 10, 25, 50, 100 mm/s. Speed regulation  $\pm 1\%$ . Paper weave less than 0.5 mm. Speed selected via front panel pushbuttons. Optional speeds in mm/min.

**Limiting:** electrical limiting keeps stylus within channel.

**Markers:** Event (local or remote control) between ch 3 and 4. (Timer (1 min or 1 s selectable) between ch 1 and 2.

**Chart paper:** four 40 mm wide channels each with 50 div; time lines every 1 mm; heat sensitive Z-fold Permapaper® with green grid lines available in packs of 500 sheets, each 30 cm (12"). (Part number 9270-0878).

**Paper loading:** no threading required.

**Remote operation:** rear panel connector provides for remote chart drive and event marker activation.

**Power:** 115/230 V ac  $\pm 10\%$ , 60 Hz, 350 VA (includes plug-ins) 50 Hz optional.

**Size:** 266.7 H x 482.6 W x 577.9 mm D (10½" x 19" x 22¾"). Projection: 76.2 mm (3") from rack front.

**Weight:** net, 50.5 kg (112 lb). Shipping, 59.5 kg (132 lb).

#### 7418A General Specifications

**Chart speeds:** 0.5, 1, 2.5, 5, 10, 25, 50, 100, 200 mm/s. Speed regulation  $\pm 1\%$ . Paper weave less than 0.5 mm. Speed selected via front panel pushbuttons (or remote). Optional speeds in mm/min.

**Chart Paper:** Eight 40 mm wide channels each with 50 divisions; time lines every 1 mm. Heat sensitive Chemical Thermal Paper standard for all system recorders except option 050. Permapaper® for Option 050 recorders only. Chemical Thermal Paper available in packs of 400 sheets, each 30.1 cm (12") long x 40.2 cm (15.8") wide (part number 9270-0563 red grid). Permapaper available in packs of 500 sheets, each 30.1 cm (12") long x 40.2 cm (15.8") wide (part number 9270-0946 green grid).

**Remote operation:** rear panel connector provides for chart drive and event marker, optional extra markers. Remote connector supplies -20 V.

**Power:** 115/230 V ac  $\pm 10\%$ , 60 Hz. Recorder only 575 VA; system plug-ins 695 VA.

**Size:** rack: 266.7 H x 482.6 W x 577.9 mm D (10½" x 19" x 22¾"). Projection: 76.2 mm (3") from front of rack.

**Weight:** 50 kg (110 lb) including driver amplifiers.

• Plug-in versatility for 7414A/7418A

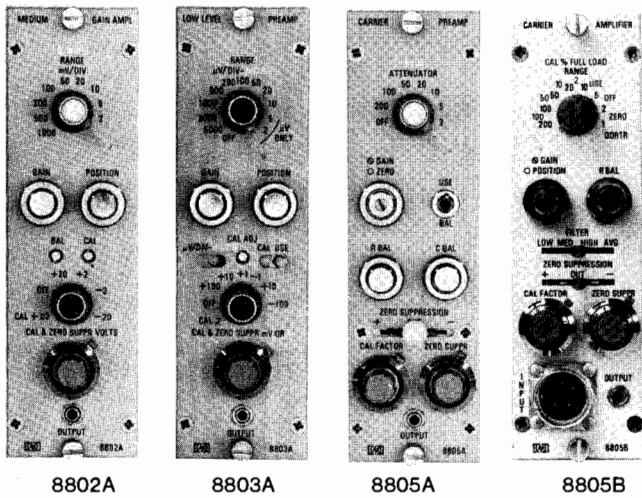

#### 8801A Low Gain DC Amp

**Input ranges:** 5, 10, 20, 50, 100, 200, 500, 1000, 2000, 5000 mV/div; accuracy  $\pm 1\%$ .

**Max sensitivity:** 5mV/div (gain 20).

**Max fs input:** 250V.

**Input circuit & input frequency range:** resist. 500 k $\Omega$   $\pm 1\%$  each side bal to gnd; parallel with approx. 100 pF

**Rise time (10 div, 10-90%, 4% overshoot):** 5 ms.

**Calibration (referred to input):** 100 mV,  $\pm 1\%$ , internal.

**Output frequency response (-0.5 dB at 50 div):** 50 Hz.

**Zero suppression:**  $\pm 10$  and  $\pm 100$  V for single-ended or diff. signals. 10-T pot sets precise values of zero suppression voltages;  $\pm 50$  V max suppress on 5, 10, 20 mV/div ranges; max error of suppression  $\pm 0.5\%$  of suppression range, and 1% of indicated suppression.

**Output noise, max (less trace width):** 0.2 div, p-p.

**Zero drift, 20° to 40°C, 103 to 127 V (less trace width):** temp—1.25 div/10°C, 0.5 div/hr, constant ambient. Line voltage—0.15 div.

**Common mode rejection and tolerance:** 48 dB min, dc to 150 Hz;  $\pm 50$  V max on other ranges for  $<1\%$  change in differential sensitivity.

**Output linearity (less trace width):** 0.25 div, after calibration for zero error to center scale +20 div.

#### 8802A Medium Gain DC Amp

**Input ranges:** 1, 2, 5, 10, 20, 50, 100, 200, 500, 1000 mV/div; accuracy  $\pm 1\%$ .

**Max sensitivity:** 1 mV/div (gain 100).

**Max fs input:** 50 V.

**Input circuit and input frequency range:** resist 180 k $\Omega$   $\pm 1\%$ , each side bal to gnd, parallel with approx 100 pF.

**Rise time (10 div, 10-90%, 4% overshoot):** 5 ms.

**Calibration (referred to input):** 20 mV,  $\pm 1\%$ , internal.

**Output frequency response (-0.5 dB at 50 div):** 50 Hz.

**Zero suppression:**  $\pm 2$  V and 20 V for single-ended or differential signals; 10-T pot sets precise values of zero suppression voltages;  $\pm 12.5$  max suppression on 1, 2, 5 mV/div ranges; max error of suppression  $\pm 0.5\%$  of suppression range and 1% of indicated suppression.

**Output noise, max (less trace width):** 0.2 div, p-p.

**Zero drift, 20° to 40°C, 103 to 127 V (less trace width):** same as 8801A.

**Common mode rejection and tolerance:** 48 dB min dc to 60 Hz, 1000 mV/div range; 48 dB min. dc to 150 Hz other ranges  $\pm 12.5$  V on 1, 2, 5 mV/div ranges;  $\pm 125$  V on 10, 20, 50 mV/div ranges;  $\pm 500$  V max other ranges for less than 1% change in differential sensitivity.

**Output linearity (less trace width):** same as 8801A.

#### 8803A High Gain DC Amp

**Input ranges:** 1, 2, 5, 10, 20, 50, 100, 200, 500, 1000, 2000, 5000  $\mu$ V/div; 10, 20, 100, 200, 500, 1000, 2000, 5000 mV/div; accuracy  $\pm 1\%$  on 5000  $\mu$ V/div to 20  $\mu$ V/div ranges,  $\pm 2\%$  on 10  $\mu$ V/div to 1  $\mu$ V/div; accuracy of x 1000 attenuator  $\pm 1\%$ .

**Max sensitivity:** 1  $\mu$ V/div (gain 100,000)

**Max fs input:** 250 V.

**Input circuit and input frequency range:** 1 M $\Omega$  min on  $\mu$ V range, independent of gain; 5 M $\Omega$  on mV range; floating and guarded.

**Rise time (10 div, 10-90%, 4% overshoot):** 5 ms. 6% overshoot.

**Calibration (referred to input):** 200  $\mu$ V  $\pm 1\%$  internal on  $\mu$ V/div range; 200 mV  $\pm 1\%$  internal on mV/div range.

**Output frequency response (-0.5 dB at 50 div):** 50 Hz.

**Zero suppression:**  $\mu$ V ranges  $\pm 1$ ,  $\pm 10$ ,  $\pm 100$  mV; mV ranges  $\pm 1$ ,  $\pm 10$ ,  $\pm 100$  V, 10-T pot sets precise values of zero suppression voltages; accuracy  $\pm 1\%$  suppression range.

**Output noise, max (less trace width):** 1.5 mm p-p at 1  $\mu$ V/div; 0.1 div, p-p min gain.

**Zero drift, 20% to 40%, 103 to 127 V (less trace width):** temp— $\mu$ V range 1  $\Omega$ V/10° referred to input,  $\pm 0.26$  div/10° C for 0 output &  $\pm 0.65$  div/10° C for fs output. mV range, 1 mV/10° C referred to input,  $\pm 0.26$  div/10° C for 0 output. Line voltage 0-0.07 div; fs 0.35 div.

**Common mode rejection and tolerance:**  $\mu$ V range, max source unbal of 1 k $\Omega$ ; 160 dB min at dc, 120 dB min at 60 Hz; mV range, max source unbal of 500 k $\Omega$ ; 100 dB min at dc, 60 dB min at 60 Hz dc. 300 V pk; 60 Hz. 1  $\mu$ V/div, 10 V rms; 2  $\mu$ V/div, 20 V rms; 5  $\mu$ V/div, 50 V rms; 10  $\mu$ V/div and 10 mV/div, 100 V rms; 20  $\mu$ V to 5000  $\mu$ V/div and 20 mV to 5000 mV/div, 200 V rms.

**Output linearity (less trace width):** 1 mV range 0.35 div, others 0.25 div after calibrating for zero error at center scale and +20 div.

#### 8805A/B Carrier Preamp

**Input ranges:** X1, 2, 5, 10, 20, 50, 100, 200; accuracy  $\pm 2\%$ .

**Max sensitivity:** 10  $\mu$ V rms/div (gain 10,000 rms ac to dc)

**Max fs input:** 100 mV rms.

**Input circuit and input frequency range:** input impedance—8805A approx 10 k $\Omega$ ; 8805B 1 M $\Omega$   $\pm 10\%$ ; single-ended. Min load resistance across excitation 100  $\Omega$ . Max impedance in series with input (transducer output impedance) 5 k $\Omega$ . Excitation—floating source 5 V rms nominal at 2400 Hz  $\pm 2\%$ . Internal switch allows use with full or half bridge transducer.

**Rise time (10 div, 10-90%, 4% overshoot):** 5.6 ms.

**Calibration (referred to input):** 2%  $\pm 0.02\%$  of transducer fs output. Adjust by Cal Factor control; accuracy  $\pm 55$   $\mu$ V/V out of 10mV/V. 8805B switchable Cal voltage to 2%, 10%, 50%, or 100%  $\pm 1\%$  of fs.

**Output frequency response (-0.5 dB at 50 div):** 50 Hz.

**Zero suppression:** 0-100% of transducer full load rating, for transducers having Cal Factor up to 10 mV/V at full load, 10-T pot with calibration dial; accuracy—1 dial div  $\pm 0.5\%$  of suppress range. Zero Supp Polarity switch, Separate R Bal control allows bucking of in-phase unbal to  $\pm 3$  mV/V regardless of Cal Factor.

**Output noise, max (less trace width):** approx. 0.2 div, p-p.

**Zero drift, 20% to 40%, 103 to 127 V (less trace width):** temp—0.45 div/10° C; Line voltage—0.25 div.

**Common mode rejection and tolerance:** quadrature rejection and tolerance:  $>40$ dB. Tolerance error:  $<\pm 2\%$  fs when quadrature voltage equal to twice in-phase signal required for center to edge deflection on chart. C Balance control permits bucking of transducer's quad unbalance of up to  $\pm 5$  mV/V. The 8805B has automatic C balance.

**Output linearity (less trace width):** 0.4 div after calibrating for zero error at center scale and +20 div.



# RECORDERS & PRINTERS

## Four and Eight-Channel Oscillographic Recorders

Models 7414A, 7418A & 8800 series signal conditioners (cont.)

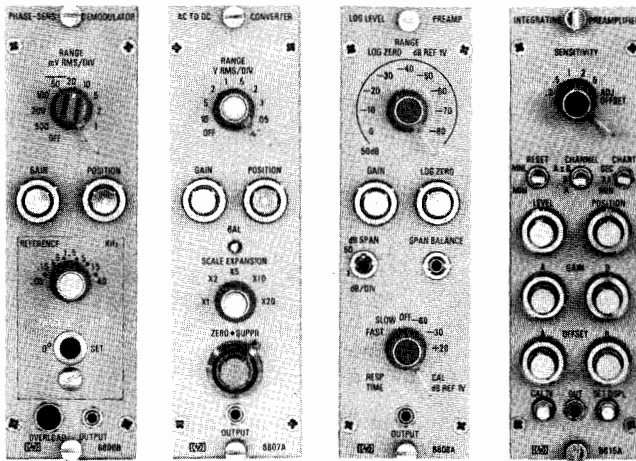

8806B Opt. 002

8807A

8808A

8815A Opt. 002

### 8806B Phase Sensitive Demodulator

Must be purchased with minimum of one of the four available options.

**Input ranges:** sig input—0.5, 1, 2.5, 10, 20, 50, 100, 200, 500 mV/div;  $\pm 1\%$ , 50 Hz to 10 kHz;  $\pm 2\%$ , 10 kHz;  $\pm 3\%$ , 20 kHz to 40 kHz. Reference voltage—3 to 20 rms, 20 to 133 V rms.

**Max sensitivity:** 0.5 mV rms/div (gain 200 rms ac to dc).

**Max fs input:** 25 V rms full scale.

**Input circuit and input frequency range:** signal input—transformer isolated, floating point and guarded; resistance approx 1 M $\Omega$ . Reference input: differential, transformer coupled; resistance approx 500 k $\Omega$  each side to ground, may be used single ended. 50 Hz to 40 kHz in 6 bands with variable frequency plug-in (Opt. 002); 60 Hz (Opt. 003), 400 Hz (Opt. 004) and 5 kHz (Opt. 005) fixed frequency phase shifter plug-in; special order phase shifter plug-ins 50 Hz to 40 kHz. Note: must order with frequency plug-in.

**Rise time (10 div, 10-90%, 4% overshoot):** 5 ms (5 kHz ref).

**Calibration (referred to input):** 1 V rms internal at carrier reference frequency;  $\pm 1\%$  50 Hz to 10 kHz;  $\pm 2\%$  10 kHz to 20 kHz;  $\pm 3\%$  20 kHz to 40 kHz.

**Zero suppression:** none. Phase shifter plug-ins allow control of reference phase over 360°. Fixed frequency: 0° to 90° dial; 2° graduations; any of 4 quadrants by panel switches; dial accuracy within  $\pm 3^\circ$ . Variable frequency: adjust thru 360°.

**Output noise, max (less trace width):**  $7 \mu\text{V} \times \text{sq root of frequency response}$ , referred to input.

**Zero drift, 20° to 40°C, 103 to 127 V (less trace width):** temp: 0.5 div/10°C; Line voltage: 0.25 div.

**Common mode rejection and tolerance:** CM: >40 dB up to 10 kHz 500 V rms, max. Quadrature tolerance: equal to amplitude of a fs, in-phase signal.

**Output linearity (less trace width):** 0.4 div after calibrating for zero error at center scale and +20 div.

### 8807A AC to DC Converter

**Input ranges:** 0.02, 0.05, 0.1, 0.2, 0.5, 1, 2, 5, 10 V rms/div,  $\pm 2\%$  (midband). Scale expansion: X1, 2, 5, 10, 20,  $\pm 2\%$ .

**Max sensitivity:** 1 mV rms/div (gain 100 rms ac to dc). 20 mV rms/div with X1 scale expansion.

**Max fs input:** 500 V rms.

**Input circuit and input frequency range:** approx 1 M $\Omega$  resistive in parallel with 10 pF and stray cable capacitance; floating and guarded. Standard model: 330 Hz to 100 kHz; Opt 001: 50 Hz to 100 kHz.

**Rise time (10 div, 10-90%, 4% overshoot):** 11.2 ms. Opt 001: 70 ms, approx 10% overshoot.

**Calibration (referred to input):** 1 V internal  $\pm 1\%$ ; approx 500 Hz.

**Output frequency response (-0.5 dB at 50 div):** 54 Hz (3 dB at 10 div). Opt 001—9Hz.

**Zero suppression:** up to 100% of fs on any range can be suppressed;

10-T pot with calibrating dial. Scale expansion: 5, 10, 20, or 50% of fs can be expanded to cover full chart.

**Output noise, max (less trace width):** baseline offset/noise: 2 mV rms referred to input  $+0.025 \text{ div} \times \text{scale expansion}$

**Zero drift, 20° to 40°C, 103 to 127 V (less trace width):** temp 0.03 div/10°C  $\times \text{scale expansion} + 0.35 \text{ div}/10^\circ\text{C}$ ; at constant ambient 0.005 div/hr  $\times \text{scale expansion}$ . Line voltage 0.005 div  $\times \text{scale expansion} + 0.1 \text{ div}$ .

**Common mode rejection and tolerance:** 60 dB min at 60 Hz; 40 dB min at 400 Hz with up to 10 K source unbalance;  $\pm 500 \text{ V pk}$ .

**Output linearity (less trace width):** 0.55 div  $+0.05 \text{ div} \times \text{scale expansion}$ , 330 Hz to 5 kHz; Opt 001: 60 Hz to 5 kHz, after calibration for zero error at lower and upper ends of printed coordinates.

### 8808A Log Level Preamp

**Input ranges:** 50 dB span: bottom scale -80, -70, -60, -50, -40, -20, -10, and 0 dB below 1 V (i.e. 100  $\mu\text{V}$ , 320  $\mu\text{V}$ , 1, 3.2, 10, 32, 100, 320 mV and 1 V). 100 dB span bottom scale -80, -70, -60, and -50 dB below 1 V.

**Max sensitivity:** 100  $\mu\text{V}$  rms sine wave corresponds to bottom scale output, -80 dB below 1 V.

**Max fs input:** 320 V rms.

**Input circuit and input frequency range:** single ended, resistance 1 M $\Omega$  min. 5 Hz to 100 kHz for <3 dB down from the midband level on "Slow" response range; 500 Hz to 100 kHz on "Fast" response range.

**Rise time (10 div, 10-90%, 4% overshoot):** fast: 20.5 rms (875 dB/s) Slow: 2 s (9 dB/s).

**Calibration (referred to input):** internal from oscillator at approx 500 Hz. -80, -30, and  $\pm 20 \text{ dBV} = \text{dB ref. to } 1 \text{ V}$  (100  $\mu\text{V}$ , 32 mV and 10 V) -80  $+20 \text{ dBV}$  internally adjustable: -30 dBV accuracy  $\pm 0.25 \text{ dB}$  (at 115 V line at 25°C).

**Output noise, max (less trace width):** 50 dB range: 0.8 div, p-p, 100 dB range: 0.4 div, p-p (max noise at bottom of recording chart).

**Output linearity (less trace width):** departure from log characteristics 50 dB: 1.25 div, 100 dB: 1 div, after calibrating for zero error at lower and upper ends of printed coordinates.

### 8809A Signal Coupler

**Input ranges:** continuously adjustable from 20 to 50 mV/div.

**Max sensitivity:** 30 mV/div (gain 3.33).

**Max fs input:** 0 to +2.5 V or 0 to -2.5 V.

**Input circuit and input frequency range:** switch selected: 1500  $\Omega$   $\pm 2\%$  or 100 k $\Omega$  min, incremental; single ended.

**Rise time (10 div, 10-90%, 4% overshoot):** 5 ms.

**Calibration (referred to input):** 600 mV  $\pm 2\%$ , internal.

**Output frequency response (-0.5 dB at 50 div):** 50 Hz.

**Output noise, max (Less trace width):** 0.1 div, p-p.

**Zero drift, 20° to 40°C, 103 to 127 V (less trace width):** temp: 0.4 div/10°C at 30 mV sensitivity. Line voltage: 0.3 div.

**Common mode rejection and tolerance:** 50,000: 1 at dc.

**Output linearity (less trace width):** 0.4 div after calibrating for zero error at center scale and +20 div.

### 8815A Opt 002 General Purpose Integrator

**Sensitivity ranges:** 0.2, 0.5, 1, 2, 5. Sensitivity setting of 1 results in the following integrator outputs:

**Seconds integrator:** 1 volt per volt-second input (0.1 volt-seconds per recorded division, or 5 volt-seconds full scale).

**Minute integrator:** 1 volt per 60 volt-seconds input (6 volt-seconds per recorded division or 300 volt-seconds full scale). For other sensitivity settings, divide the above volt-second values by the sensitivity switch setting.

**Offset control:**  $\pm 2.8$  volts referred to input. Can be used with switch-selectable rectifier to rectify (or ignore) portions of roughly sinusoidal inputs.

**Drift:** seconds integrator,  $\pm 5 \text{ mV/s}$ , referred to output; minute integrator,  $\pm 15 \text{ mV/min.}$ , referred to output.

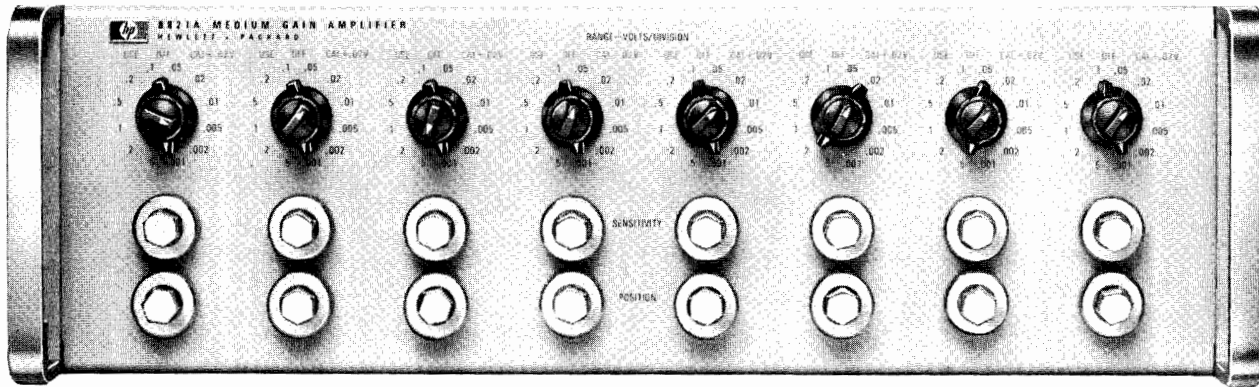

8821A

### 8820A Eight Channel Bank Amplifier

**Max sensitivity:** 0.05 V/div (Amplifier Gain 2).

**Max fs input:** 250 V (edge to edge).

**Input ranges (attenuation):** 0.05, 0.1, 0.2, 0.5, 1, 2, 5 V/div. Attenuator accuracy  $\pm 2\%$ .

**Input circuit:** single ended, 1 M $\Omega$  min.

**Frequency response:** dc to  $< 0.5$  dB down at 50 Hz (50 div. p-p); dc to  $< 3$  dB down at 100 Hz (10 div. p-p).

**Rise time (10 div, 10-90%, 4% overshoot):**  $< 6$  ms.

**Output linearity (less trace width):** linear within  $\pm 0.25$  div. after setting mechanical zero of stylus to within  $\pm 1$  div of chart center and calibrating for zero error at center scale and  $\pm 20$  div.

**Drift, 20° -40°, 115 V  $\pm 10\%$ , 60 Hz (less trace width):** temp:  $< 0.55\%/10^\circ\text{C}$ ; Line voltage:  $< \pm 0.2$  div.

**Calibration:** 1 V  $\pm \%$  calibration voltage for all channels.

**Temp rating:** operating: 0°C to +55°C; storage: -40°C to 75°C.

### 8821A Eight Channel Bank Amplifier

**Max sensitivity:** 0.001 V/div (Amplifier Gain 100).

**Max fs input:** 250 V (edge to edge).

**Input ranges (attenuation):** 0.001, 0.002, 0.005, 0.010, 0.020, 0.050, 0.1, 0.2, 0.5, 1, 2, 5 V/div. Attenuator accuracy (dc)  $\frac{1}{2}\%$  on 0.001 to 0.050 V/div ranges; 1% on 0.1 to 5 V/div ranges.

**Input circuit:** balanced, floating and guarded, 9 M $\Omega$  constant for all gain settings (0.001 to 0.050 V/div); 4.5 m $\Omega$  each side to ground (0.1 to 5 V/div).

**Common mode rejection:** 100 dB at 60 Hz, 0.001 V/div sensitivity, 1 k $\Omega$  source unbalance decreases to 66 dB at 0.05 V/div, 66 dB at 60 Hz, 0.01 to 5 V/div sensitivity. 1 k $\Omega$  source unbalance.

**Common mode tolerance:**  $\pm 20$  V on 0.001 to 0.05 V/div ranges (6 most sensitive);  $\pm 250$  V on 0.1 to 5 V/div ranges (6 least sensitive).

**Frequency response:** dc to  $< 0.5$  dB down at 50 Hz (50 div, p-p); dc to  $< 3$  dB down at 200 Hz (10 div p-p).

**Rise time (10 div, 10-90%, 4% overshoot):**  $< 6$  ms.

**Output linearity (less trace width):** same as 8820A.

**Drift, 20° to 40°C, 115 V  $\pm 10\%$ , 60 Hz (less trace width):** same as 8820A.

**Calibration:** +0.02 V  $\pm 1\%$  on 6 most sensitive ranges. Simulates +2 V  $\pm 2\%$  at input on 6 least sensitive ranges.

**Temperature rating:** same as 8820A.

### Ordering Information

**7414A** 4-channel Oscillographic Recorder

**Opt 001:** rack mount kit with slides and mounting hardware; delete case.

**Opt 008:** 50 Hz operation

**Opt 015:** extra Event Marker, between channels 2 & 3

**Opt 025:** 60:1 speed reduction (50 Hz), requires Opt 008

**Opt 026:** 60:1 speed reduction (60 Hz)

**Opt 054:** installed in mobile cart. Rack space: 53 cm (21 in). Cart height: 102 cm (40.75 in). Includes paper takeup drawer.

### 7418A 6 to 8-channel Oscillographic Recorder

**Opt 001:** 6 channel Hot-tip Thermal Recorder only; includes takeup tray. Plug-in preamplifiers require Opt 030 Power Supply; for 8-channel Bank Amplifiers (Power Supply included) select Opt 031 or 032

**Opt 002:** rack mount kit

**Opt 003:** bench-top configuration

**Opt 004:** 160 cm (63 in) rack space cabinet. Cabinet height: 177 cm (72.5 in). Includes paper takeup drawer.

**Opt 006:** Portable Cart with 71 cm (28 in) rack space, includes Opt. 002. Cart height: 126 cm (50.5 in).

**Opt 008:** 50 Hz operation

**Opt 009:** 230 V ac operation

**Opt 014:** extra Event Marker between channels 4 & 5

**Opt 015:** extra Event Marker between channels 5 & 6

**Opt 025:** 60:1 speed reduction (50 Hz), requires Opt 008

**Opt 026:** 60:1 speed reduction (60 Hz)

**Opt 030:** 8848A plug-in Preamplifier Power Supply, required for operation of 8800 preamplifiers

**Opt 031:** 8820A 8-channel Low Gain Bank Preamplifier

**Opt 032:** 8821A 8-channel Medium Gain Bank Preamplifier

**Opt 035:** rack mount kit for HP 29400 series cabinet

**Opt 050:** recorder equipped for permapaper operation only

**8801A** Low Gain Preamplifier

**8802A** Medium Gain Preamplifier

**8803A** High Gain Preamplifier

**8805A** Carrier Preamplifier

**Opt 002:** Harmonic Filter Kit, required when 267, 268, 270, or 1280B, C transducers are used

**8805B Opt 012** Carrier Preamplifier without Harmonic Filter

**8806B** Phase Sensitive Demodulator Preamplifier. Requires one of following plug-ins:

**Opt 002:** Variable Frequency Phase Shifter plug-in, 50 Hz to 40 kHz

**Opt 003:** 60 Hz Phase Shifter plug-in

**Opt 004:** 400 Hz Phase Shifter plug-in

**Opt 005:** 5 kHz Phase Shifter plug-in

**8807A** AC/DC Converter Preamplifier

**Opt 001:** 50 Hz to 100 kHz Signal Filter

**Opt 002:** DC Plug-in

**8808A** Logarithmic Preamplifier

**8809A** Signal Coupler Preamplifier

**8815A Opt 002** General Purpose Integrator

**Opt 003:** Sample and hold (for digital display readouts)

**8820A** Low Gain Bank Preamplifier (8-channel)

**8821A** Medium Gain Bank Preamplifier (8-channel)

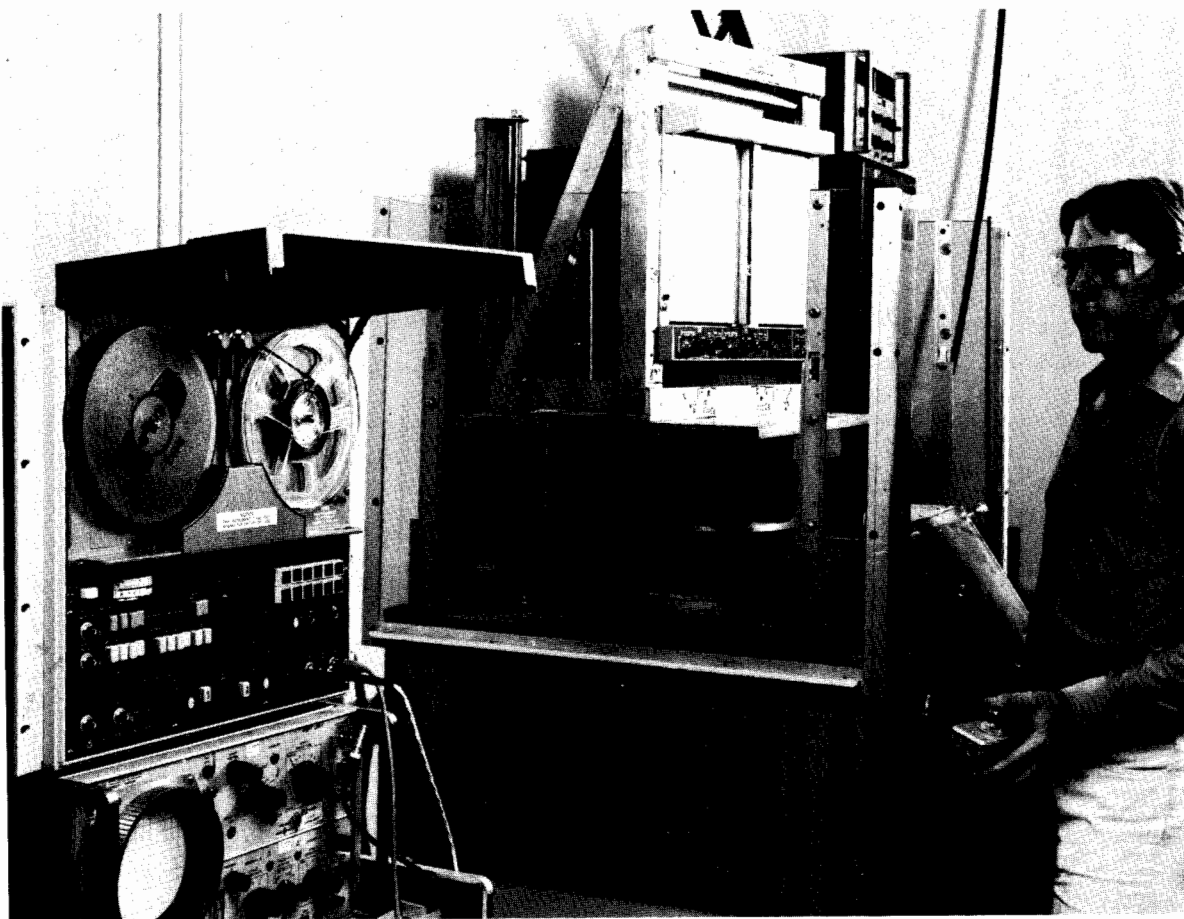

### Introduction

Instrumentation tape recorders (ITR's) are used to record, store, and reproduce test data for many and varied applications. The main reasons for using ITRs are economy, accurate data recording and reproduction, and long-term data storage. ITRs manufactured by Hewlett-Packard are 4 or 8-channel recorders using 1/4-inch tape. They are designed specifically for applications under 64 kHz. ITR recording provides nondestructive reproduction so data can be reproduced repeatedly without degrading the quality, and time-base can be contracted or expanded. Data is contracted by using faster tape speeds to reproduce slow-speed data or expanded by doing the reverse to produce, for example, lower frequency data for use on a graphics recorder.

### ITR Characteristics

**Direct Record/Reproduce Electronics:** Direct electronics accept frequencies above 100 Hz (approximate) and record the amplitude of the input signal on the tape as a proportional magnetic flux intensity. Because direct electronics require a "linear" relationship, changing tape type (as from 3M 890 to 3M 990) generally necessitates the re-equalization of each direct channel. Direct electronics also require that each recorded tape be degaussed (erased) fully before being reused.

**FM Record/Reproduce Electronics:** FM electronics accept very low frequencies, including dc. In FM, the amplitude of the input signal is recorded as a frequency deviation from a "center" frequency, the maximum input amplitude being recorded as a 40% deviation. Because amplitude is converted to a frequency, FM tends to be insensitive to tape drop-outs, but sensitive to speed irregularities such as flutter. With FM, tape types can be changed without re-equalizing the channel. Since FM records to saturation, tape can be reused without degaussing with only a small (10 to 15 dB) loss in signal-to-noise ratio.

**Common Frequency Range:** FM and direct have a common segment of the frequency range in which either type of electronics can function. On Hewlett-Packard's ITRs this range is approximately 100 Hz to 5 kHz. The advantages of using direct electronics in this range are high frequency response at slow tape speeds and a general insensitivity to flutter. The advantages of FM are dc response and a general insensitivity to tape drop-outs.

**Tape Speed Control:** The tape speed is usually controlled by a phase-lock servo system in one of two ways. The more common method uses the servo system to control the

rotational speed of the tape capstan, employing a tachometer mounted on the capstan's shaft to monitor the speed. With this method, tape speed control is limited to approximately  $\pm 0.2\%$ , because of capstan irregularities, tape slippage, and tape stretching. The less common, but more precise, method uses a frequency reference placed on one track during recording as the speed reference for the phase-lock servo during reproduce. Tape servo generates a reproduce speed that is virtually identical to the record speed; the time difference between events in record and reproduce is indicated by the time base error specification (which assumes continuous phase-lock operation). The time base error figure represents a short-term specification, because drop-outs, etc., may cause momentary loss of phase lock.

**Flutter:** This is a short-term tape speed variation. It produces time base perturbations in direct electronics and noise in FM.

**Signal-to-noise ratio:** This is the ratio of maximum to minimum recordable amplitude expressed as a voltage ratio in dB. Basically, it represents the usable dynamic range.

**Tape Selection:** It is recommended that instrumentation tape such as 3M 890 always be used. Use of other quality tape may adversely affect head wear, signal-to-noise ratio, etc.

# RECORDERS & PRINTERS

## Instrumentation Tape Recorders and Degausser

Models 3964A, 3968A, and 13064A Degausser

273



- Continuing savings by recording on 1/4-inch tape
- Choice of 4 or 8-channel recorders
- Selection of FM or Direct electronics

- Six tape speeds, including 15/32 ips
- Remote control (TTL or optional HP-IB)
- Switch selection of tach or tape servo

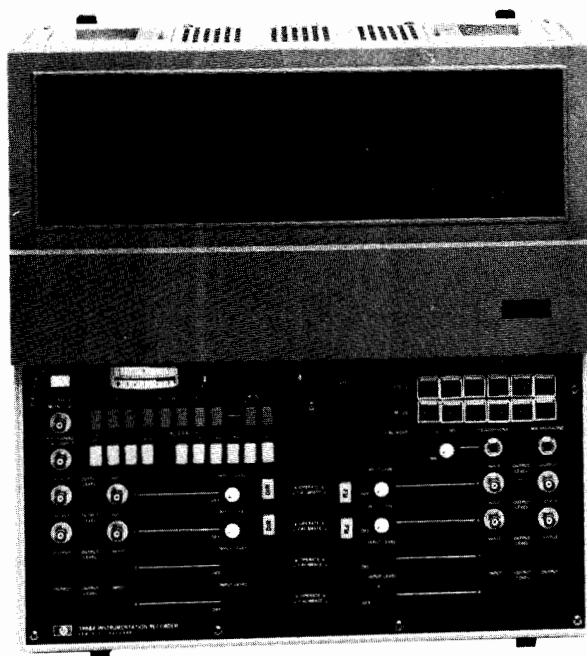

3968A



3964A

### Models 3964A and 3968A ITR's, 13064A Degausser

The 4-channel 3964A and 8-channel 3968A are quality instrumentation tape recorders (ITRs) that provide cost-saving operation by using 1/4-inch tape for a wide variety of recordings. Medical versions of the 3964A and 3968A (Options 009 and 010) are available. These versions include a UL 544 medical listing making them useful in hospitals, medical offices, and research facilities.

The 13064A bulk tape degausser erases a complete roll of tape cleanly in seconds. A thoroughly clean tape is necessary to obtain maximum signal-to-noise ratio.

Both the 3964A and the 3968A are precision-built ITRs with features that cut costs, enhance the usefulness of the units, and simplify recording tasks in laboratory, medical, production, and field use.

### 3964A, 3968A Features

**Cost-saving 1/4-inch tape:** Provides continuing savings for the life of the recorder. By using 1/4-inch tape, rather than 1/2-inch tape, users can save over 50 percent on tape costs.

**AC/DC calibrator:** Provides an internal voltage source that simplifies the set up of input and output levels for each data channel. Six voltages, ac or  $\pm$  dc, can be pushbutton selected, applied, and monitored to check out each channel. In addition, there is an external connector to allow the use of scopes or other monitoring devices.

**Tach or tape servo control:** Tach-servo and tape-servo systems are switch selectable.

**Flutter compensation:** Improves the signal-to-noise ratio in FM by up to 12 dB in a vibrating environment. When switched on, flutter-generated noise introduced during record and reproduce is subtracted from all FM data channels during reproduce to improve performance. One FM channel is used for flutter compensation; this same channel can also be used for tape servo control, saving a data channel for recording when both flutter compensation and tape servo are required.

**Voice capability:** Provides voice annotation capability on the fourth channel of the 3964A or the eighth channel of the 3968A, using the press-to-talk microphone. The voice channel accepts data only, voice only, or data with a voice interrupt. Microphone, speaker, and headphone jack are provided with both recorders.

**FM electronics-to-electronics (e-e) mode:** Transfers the input signal automatically to output, bypassing the record/reproduce heads. This occurs when tape is below record/reproduce speed or in Fast Forward, Rewind, or Stop mode. E-E allows the unit to be set and calibrated without using tape.

### Instrumentation Tape Recorder Notes

These technical application notes are available, at no charge, from your Hewlett-Packard sales office:

Topic	Application Note No.	Part Number
Dropouts	213-1	5952-2841
Crosstalk	213-2	5952-2844
Interchannel Time Displacement Error	213-3	5952-2848

### 3964A, 3968A Transport Specifications

**Tape width:** 1/4 inch (6.3 mm)

**Reel size:** Standard 7-inch (18 cm) plastic reel, totally enclosed by reel cover

#### Heads:

**3964A:** One 4-track record and one 4-track reproduce

**3968A:** One 8-track record and one 8-track reproduce

Tape Speed* (ips)	15	7 1/2	3%	1%	15/16	15/32
Flutter (% p-p)	0.35	0.35	0.40	0.50	0.70	1.5
Time base error (s)*	$\pm 4$	$\pm 5$	$\pm 7.5$	$\pm 15$	$\pm 25$	$\pm 50$
Start time (s) (typical)	3	1.5	0.9	0.5	0.5	0.5
Tape speed accuracy (s)	0.2	0.2	0.2	0.2	0.2	0.2

\*Tape servo operation

**Tape motion controls:** Pushbutton selectable Forward Record, Reverse Record, Forward Play, Reverse Play, Fast Forward, Fast Rewind, and Stop

**EOT sensing:** Tape drive stops automatically at the end of tape (EOT)

**Reel revolution counter:** 4-digit counter with pushbutton reset



# RECORDERS & PRINTERS

## Instrumentation Tape Recorders & Degausser

Models 3964A, 3968A, 13064A Degausser (Cont.)

### FM Record/Reproduce Specifications<sup>1</sup>

Tape Speed (ips)	Passband <sup>2</sup> (Hz)	Signal-to-noise <sup>3</sup> Ratio	
		3964A	3968A
15	dc-5000	48	46
7 <sup>1</sup> / <sub>2</sub>	dc-2500	48	46
3 <sup>3</sup> / <sub>4</sub>	dc-1250	48	46
1 <sup>7</sup> / <sub>8</sub>	dc-625	46	46
1 <sup>5</sup> / <sub>16</sub>	dc-312	44	44
1 <sup>5</sup> / <sub>32</sub>	dc-156	40	40

- Based on use of 3M-890 tape or equivalent
- Frequency response over passband is  $\pm 1.0$  dB referenced to 10% of upper band edge frequency
- Signal measured with carrier deviation  $\pm 40\%$  of upper passband without flutter compensation. Output filters of reproduce amplifiers selected for constant amplitude response. May also be selected for linear phase (transient) response

**Flutter compensation:** Can improve signal-to-noise by up to 4 dB under static conditions and as much as 12 dB under conditions of vibration. Selected by rear panel switch.

**Distortion:** Total harmonic distortion  $< 1.2\%$  @ 15 to 1% ips,  $< 2\%$  @ <sup>15</sup>/<sub>16</sub> to <sup>15</sup>/<sub>32</sub> ips.

**Linearity:**  $\pm 1.0\%$  of peak-to-peak output for best straight line through zero at  $\pm 40\%$  deviation

**DC drift:**  $\pm 0.1\%$  (max) of full scale output per °C

**Input level:** 1 V to 30 V (peak-to-peak); continuously adjustable

**Input impedance:** 100 k $\Omega$  nominal, shunted by  $< 100$  pF single-ended

**Output level:** 1 to 5 V (peak-to-peak); continuously adjustable

**Load impedance:** Minimum load impedance 660  $\Omega$

### Direct Record/Reproduce Specifications<sup>1</sup>

Tape Speed (ips)	Passband ( $\pm 3$ dB) <sup>2</sup>		S/N Ratio (dB) <sup>3</sup>	
	3964A	3968A	3964A	3968A
15	70-64000 Hz	500-64000 Hz	38	36
7 <sup>1</sup> / <sub>2</sub>	50-32000 Hz	250-32000 Hz	38	36
3 <sup>3</sup> / <sub>4</sub>	50-16000 Hz	100-16000 Hz	38	36
1 <sup>7</sup> / <sub>8</sub>	50-8000 Hz	100-8000 Hz	38	36
1 <sup>5</sup> / <sub>16</sub>	50-4000 Hz	100-4000 Hz	38	35
1 <sup>5</sup> / <sub>32</sub>	50-2010 Hz	100-2000 Hz	37	35

- Based on the use of 3M-890 tape or equivalent
- Reference to 10% of upper band edge
- Referenced to a 500 Hz sine wave with a maximum of 1% third harmonic distortion when reproduced at 3<sup>3</sup>/<sub>4</sub> ips

**Input level:** 1 V to 30 V (p-p); continuously adjustable

**Input impedance:** 100 k $\Omega$  nominal, single-ended

**Output level:** 0.5 to 5 V (p-p); continuously adjustable

**Load impedance:** Minimum load impedance 600  $\Omega$

**Calibrator:** Internal signal source, peak ac and  $\pm$  dc levels of 0, 1.0, 1.414, 2.5, 5.0, and 10.0 volts  $\pm 2\%$

**Meter modes:** Peak ac or dc, input or output

### 3964A, 3968A General Specifications

#### Size:

**3964A:** 400 H x 427 W x 256 mm D (15.7" x 16.8" x 10.1").

**3968A:** 445 H x 427 W x 256 mm D (17.5" x 16.8" x 10.1").

**Weight:** 3964A: 29.5 kg (65 lb). 3968A: 31.3 kg (69 lb)

**Power requirements:** 100, 120, 220, or 240 V,  $\pm 5\%$ ,  $-10\%$ , 48-440 Hz; 110 W average (except Opt 009, 010, 48-66 Hz)

**Temperature:** storage,  $-40^{\circ}\text{C}$  to  $75^{\circ}\text{C}$ ; operating,  $0^{\circ}\text{C}$  to  $55^{\circ}\text{C}$ ; tape limit,  $10^{\circ}\text{C}$  to  $40^{\circ}\text{C}$

**Altitude:** Storage, 15240 m (50000 ft); operating, 4500 m (15000 ft)

**Humidity:** The system, excluding tape limitations, will operate from 10% to 95% RH ( $25^{\circ}\text{C}$  to  $40^{\circ}\text{C}$ ), non-condensing

**Shock:** 30 g maximum (11 ms) non-operating

**Mounting:** Rack mounting kit for equipment racks, 19-inch



13064A

### 13064A Tape Degausser Specifications

**Tape size:** 1/4-inch (6.33 mm) tape on reels up to 10 1/2 inch (266 mm) in diameter

**Erase:** 60 dB minimum

**Duty Cycle:** one minute ON - three minutes OFF

**Size:** 67 H x 133 W x 171 mm D (2.6" x 5.25" x 6.75").

**Weight:** approximately 4.3 kg (9.5 lb)

**Power requirements:** 115 V ac  $\pm 10\%$ , 50-60 Hz (Opt 001); 230 V ac  $\pm 10\%$ , 50-60 Hz (Opt 002)

### 3964A, 3968A Options

#### Record/Reproduce Channel Data Card Options.

Option provides one data card. Specify one option for each channel, up to 4 for 3964A, up to 8 for 3968A.

**001** FM data card, standard

**030** FM data card, medical (must order Opt 009 or 010)

**002** Direct data card, standard

**031** Direct data card, medical (must order Opt 009 or 010)

#### Medical ITR Options

**009** Medical version with white paint

**010** Medical version with standard paint

#### Other Options

Specify no more than one of each option per mainframe

**003** Rear panel with BNC input/output connectors for each channel.

**3964A**

**3968A**

**004** Locking knob set (screwdriver adjustable)

**005** Metric speed annotation on pushbuttons

**007** HP-IB remote control of speeds and mode

**024** Loop adapter (accommodates 5 to 30-ft loop)

**026** Slides for 19 in. racks

**027** Slides for HP cabinets

**041** IRIG servo reference frequency

**070** Overlap. For two units. Provides automatic play/record commands for second recorder when first unit tape is low

### Ordering Information

**3964A** 4-channel instrumentation tape recorder

**3968A** 8-channel instrumentation tape recorder

**13064A** Tape degausser (specify Option 001 for 115 V ac or 002 for 230 V ac, N/C for options)

**13107A** Transit case for 3964A

**13106A** Transit case for 3968A



- Silent operation
- Optional scanner and clock
- Alphanumeric

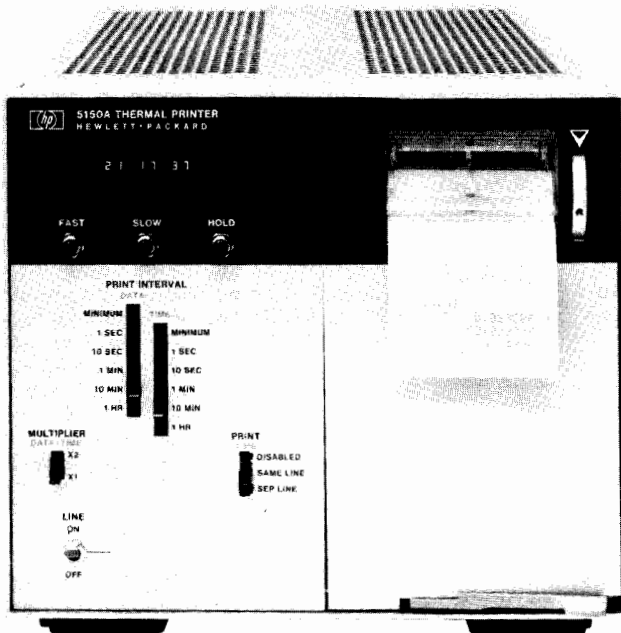

5150A Opt 004

### General

The 5150A Thermal Printer is a versatile instrumentation printer designed to accept and record up to 20 columns of data from most HP digital instruments. Because it uses a thermal printing technique, it is extraordinarily quiet while in operation. Two input interfaces are available (one must be specified with the order) to allow data input from the HP Interface Bus (use Option 001) or from BCD-coded sources (use Option 002). Other options which add to the flexibility of this printer are the Option 003 Scanner, which can sequentially address and interrogate up to 13 instruments on the HP-IB, and the Option 004 Clock, which can be used with either the HP-IB or BCD Interfaces.

### Opt 001 HP-IB Interface

With Option 001 installed, the printer can accept up to 20 ASCII characters per line via the HP-IB. Inputs are interpreted according to the 64 member upper-case ASCII character set. With this interface, the printer can also serve as an "addressable listener" in a controller-based HP-IB system. HP-IB cable not supplied.

### Opt 002 BCD Interface

With Option 002 installed, the printer will accept 10 columns of TTL-level BCD data. Two Options 002's may be installed for 20-column print-out from one or two sources. The standard 16-member character set consists of 0 through 9, +, -, V, A, R, and [blank]. Special characters set which draw from the 64-character upper-case ASCII set may also be specified.

### Opt 003 Scanner

With both Options 001 and 003 installed, the printers can log data from up to 13 instruments on the HP-IB. Operation is asynchronous; that is, the printer will address the lowest address instrument, wait for data, print, then go to the next instrument.

### Opt 004 Clock

Used with either the HP-IB Interface or BCD Interface, this option gives the printer two additional capabilities: it can control the elapsed time between successive data printouts, and it can print the time of day immediately following each data printout. When used with the Option 003 Scanner, the clock controls the elapsed time between the initiation of successive scans.

## Specifications

**Character printer:** 5 × 7 dot matrix.

**Printing rate:** 3 lines per second.

**Line spacing:** approximately 2.5 lines per cm. (6 lines per inch).

**Paper advance mechanism:** direct drive, stepping motor.

**Paper:** thermal sensitive, in rolls (one roll supplied).

**Operating environment:** 0°C to 50°C temperature; 95% relative humidity.

**Power:** 100, 120, 220, or 240 volts, 48 to 440 Hz (50 or 60 Hz only for Opt 004), 100 VA.

**Dimensions:** half-rack module, 178 mm H x 216 mm W x 356 mm D (7" x 8½" x 14¼").

**Weight:** approx. 7 kg (16 lb) (5150A +1 option).

### HP-IB Interface (Opt 001)

**Columns:** 20.

**Printed character set:** 64 ASCII characters (columns 2, 3, 4, and 5 of ANSI X3.4-1968, except "I" in column 5, row 14).

**Input Logic Levels:** TTL (low <0.4 V, high >2.5 V).

**Data format:** byte-serial with storage, compatible with HP-IB.

**Inhibit (output):** holds NRD line of HP Interface Bus low following receipt of either CR or LF (selectable) until print is completed. This interval is approx. 250 ms minimum, or the duration of Option 004 Clock data print interval with clock in Hold mode.

### BCD Interface (Opt 002)

**Columns:** 10 (20 columns with two Options 002's installed).

**Character set:** 0 through 9, +, -, V, A, R, and [blank].

**Input logic levels:** TTL (low <0.4 V, high >2.5 V).

**Data format:** parallel BCD (8421); switch selects + or - true logic.

**Print command:** pos. or neg. TTL transition; 2 kΩ input impedance.

**Inhibit (output):** + or -, same levels as above; remains at true level until print is completed (approx. 250 ms minimum) or during Option 004 Clock data print interval with clock in Hold mode.

### Scanner (Opt 003)

**Instruments scanned:** 1 to 13.

**Cycle time of scan:** limited by the slowest of (a) response of instruments scanned, (b) 3 samples per second, or (c) Data Print Interval setting on Option 004 Clock.

**Compatibility:** HP Interface Bus (utilizes ASCII code).

**Identifier:** labels data line of each instrument with letters A-M.

**Protect feature:** bypasses non-responding instrument after 3 sec.

### Clock (Opt 004)

**Data print interval:** selectable by front panel switches: minimum, 1 s, 2 s, 10 s, 20 s, 1 min, 2 min, 10 min, 20 min, 1 hr, 2 hrs. Print interval will be that of input device if it is slower than the selected interval.

**Time print interval:** selectable by front panel switch, same intervals as above (intervals shorter than data interval prevented).

**Time print format:** selectable by front panel switch: disabled, same as data, or separate line from data.

**Display:** six-digit, seven-segment LED display of hours, minutes, seconds (00:00:00 to 23:59:59); settable via front panel switches.

**Time base:** line frequency (50 or 60 Hz, selectable by jumper).

### Operating Supplies/Accessories

**9281-0401** 6-Roll box of paper, 76 meters (250 feet) each

**10533A** BCD Interface Cable for 5300A

**10833A** Interface Bus Cable, 1 meter

**10833B** Interface Bus Cable, 2 meters

**10833C** Interface Bus Cable, 4 meters

**10833D** Interface Bus Cable, .5 meter

### Options

**001:** HP-IB Interface

**002:** BCD Interface

**003:** Scanner

**004:** Clock

**005:** BCD Interface Cable (562A-16C)

**910:** Extra manual

**5150A Thermal Printer**







Hewlett-Packard offers frequency standards and clocks which provide accurate frequency, time interval and timekeeping capabilities. Further, Hewlett-Packard standards provide means for comparing these quantities against national standards such as the National Bureau of Standards (NBS) and the U.S. Naval Observatory. Units of frequency or time cannot be kept in a vault for ready reference. They must be generated for each use, hence be regularly compared against recognized primary standards.

Frequency standards and clock systems manufactured by Hewlett-Packard are used for control and calibration at observatories, national centers for measurement standards, physical research laboratories, missile and satellite tracking stations, communication systems, radio navigation systems, manufacturing plants and radio monitoring and transmitting stations.

### Types of Frequency Standards

At the present time, three types of frequency standards are in common use. These are:

1. The cesium atomic beam controlled oscillator.
2. The rubidium gas cell controlled oscillator, and
3. The quartz crystal oscillator.

Hewlett-Packard manufactures all three types of frequency standards. Of these three standards, the first is a primary frequency standard and the last two are secondary frequency standards. The distinction between a primary standard and a secondary standard is that the primary standard does not require any other reference for calibration; whereas the secondary standard requires calibrations both during manufacturing and at intervals during use depending on the accuracy desired.

### Cesium Beam Frequency Standard

Cesium beam standards are in use wherever the goal is a very high accuracy primary frequency standard. In fact, the NBS frequency standard itself is of the cesium beam type. The cesium beam standard is an atomic resonance device which provides access to one of nature's invariant frequencies in accord with the principles of quantum mechanics. The cesium standard is a true primary standard and requires no other reference for calibration.

### Rubidium Frequency Standard

Rubidium frequency standards feature a high order of both short-term and long-term frequency stability. These are both important in certain fields such as deep-space communications, satellite ranging, and doppler radar.

Rubidium standards are similar to cesium beam standards in that an atomic resonant element prevents drift of a quartz oscillator through a frequency lock-loop. Yet the rubidium gas cell is dependent upon gas mixture and gas pressure in the cell. It must be calibrated and then it is subject to a small degree of drift. The drift is typically 100 times less than the best quartz crystal standard.

TABLE 1 Comparison of Frequency Standards

Standard	Principal construction feature	Principal advantage
Cesium Atomic Beam Resonator Controlled Oscillator.	Beam of free cesium atoms, spatially state selected, is subjected to a microwave signal at resonance frequency.	High intrinsic reproducibility and long-term stability. Designated as primary standard for definition of time interval.
Rubidium Gas Cell Resonator Controlled Oscillator.	Gas buffered resonance cell with optically pumped state selection.	Compact and light weight. High degree of short-term stability.
Quartz Crystal Oscillator.	Piezoelectrically active quartz crystal with electronic stabilization.	Very compact, light and rugged. Inexpensive.

### Quartz Crystal Oscillators

Quartz oscillators are used in virtually every frequency control application including atomic standards. The excellent short-term stability and spectral purity of the quartz oscillators used in Hewlett-Packard atomic standards contribute to the high quality of the output signal of these standards. For less demanding applications where some long-term drift can be tolerated, quartz oscillators are used as independent frequency sources.

### Frequency Standards and Clocks

Frequency standards and clocks have no fundamental differences—they are based upon dual aspects of the same phenomenon. Time and frequency are intangible quantities which can be measured only with respect to some physical quantity. The basic unit of time, the second, is defined as the duration of 9,192,631,770 periods of transition within the cesium atom. Conversely an unknown frequency is determined by counting the number of cycles over the period of a second. The Master Clock at the U.S. Naval Observatory, one of the world's most accurate clocks, is made of an ensemble of more than a dozen Hewlett-Packard cesium beam frequency standards. The USNO directly controls the distribution of precise time and time interval (frequency) from Naval radio stations, Loran-C (operated by U.S. Coast Guard), Omega and Satellite Navigation Systems. Hewlett-Packard portable cesium standards, "flying clocks," are used to periodically check the synchronization between these stations and the Master Clock.

Hewlett-Packard cesium beam standards are widely used to drive precision clocks because of the extremely good long-term stability and reliability of this primary standard. If a quartz oscillator or other secondary standard is used, it must be evaluated for rate of drift and be corrected periodically.

### Time Scale

The time interval of the atomic time scale is the International Second, defined in October 1967 by the Thirteenth General Conference of Weights and Measures. Since January 1972 the frequency offset between UTC and Atomic Time has been zero and the UTC time scale is kept in synchronism with the rotation of the earth to within  $\pm 0.9$  second by step-time adjustments of exactly 1 second, when needed (see Hewlett-Packard Application Note 52-2).

The U.S. National Bureau of Standards (NBS) and USNO provide the official basis for Standard Time for the United States. The UTC signal is broadcast from the NBS stations WWV and WWVB and by several other stations throughout the world. (See Hewlett-Packard Application Note 52-1, Fundamentals of Time and Frequency Standards, for a list of stations broadcasting time signals).

### Standby Power Supplies

Minimum down-time, important for any system, is vital to a time standard. Its worth depends directly on continuity of operation. Noninterrupted operation is also important to ultra-precise quartz oscillators.

Hewlett-Packard standby power supplies ensure continued operation despite line interruptions, and operate over a range of ac line voltage to supply regulated dc to operate frequency standards and frequency dividers and clocks. The batteries in the supplies assume the full load immediately when ac power fails.

### Hewlett-Packard Time and Frequency Standard

The Hewlett-Packard House Standard at the Santa Clara Division consists of an ensemble of four Hewlett-Packard Cesium Beam Standards each with the Option 004 High Performance Tube.

The standard is compared to the U.S. Naval Observatory Master Clock in Washington, D.C. by means of Loran C and TV Line 10 measurements through the USASTRAT-COM satellite system. It is also compared with the U.S. National Bureau of Standards Frequency Standard (NBS FS) at Boulder, Colorado by means of Loran-C through the Naval Observatory. The frequency uncertainty of the standard is within a few parts in  $10^{13}$  with respect to the standards maintained by the NBS and the USNO.

Time is maintained relative to the Naval Observatory and the National Bureau of Standards master clocks to an accuracy of better than  $\pm 1.0$  microseconds. This accuracy is verified with flying clock trips from the Naval Observatory to both Hewlett-Packard Santa Clara Division and Hewlett-Packard Geneva. Both locations have been designated U.S. Naval Observatory Time Reference Stations.

#### 5061A

- Primary standard,  $\pm 1 \times 10^{-11}$  accuracy
- Proven reliability
- World-wide usage

#### 5061A, Opt 004

- Accuracy  $\pm 7 \times 10^{-12}$
- Settability  $\pm 1 \times 10^{-13}$
- Time domain stability  $5 \times 10^{-12}$  (1 s avg)



5061A

#### 5061A Cesium Beam Standard

The first Hewlett-Packard Cesium Beam Standard, the 5060A, was introduced in 1964. This was followed in 1967 with the improved 5061A and in 1973 with the high performance beam tube option for the 5061A. Since this time the accuracy and reliability of Hewlett-Packard cesium beam standards has been demonstrated and these standards have become the world-wide standard for frequency and time keeping. The 5061A has provision for an optional digital divider and reliable, easy-to-read LED clock (Option 001) and for a battery with 1/2 hour standby power capacity with automatic charging (Option 002).

**Reliability and warranty:** over 60 million operation hours have proven the performance and reliability of Hewlett-Packard cesium beam standards in various world-wide applications. The units have provided dependable microsecond accuracy in aircraft, ship and fixed environments.

A three-year warranty on the 5061A standard cesium beam tube is provided as a result of proven field reliability over an extended period. This warranty includes replacement of the cesium beam tube if it should fail within the warranty period. Typically, beam tube life has been in excess of five years.

#### 5061A with Opt 004, High Performance Cesium Beam Tube

The Hewlett-Packard Model 5061A primary frequency standard with the Option 004 Cesium Beam Tube offers increased stability and accuracy in the instrument which has become the worldwide standard of frequency and time keeping since its introduction in 1967. Improvements in magnetic shielding, ruggedization and environmental performance permit improved performance and expansion of navigation and communication systems that have been made practical by the 5061A.

The design concept of the high performance beam tube includes unique HP designed dual beam optics with higher beam intensity to accomplish better short term stability and greater immunity to effects of shock and vibration. A 50 percent increase in resonance cavity length without change in the overall beam tube size contributes to better accuracy and settability because of the high Q of the narrower resonant line width. This tube retains the unique cesium standard feature of virtually no long term instability or aging.

The intrinsic accuracy is improved to  $\pm 7 \times 10^{-12}$  which provides an excellent reference standard without need of calibration. If desired, as in many timekeeping applications, two or more units may be calibrated to determine the difference in rate or may be adjusted to the same frequency. With the improved settability specifications of  $1 \times 10^{-13}$  small changes in frequency are accomplished rapidly and accurately. A provision for degaussing the tube without adversely affecting the instrument operation allows removal of any residual magnetic field in the tube. This is important in achieving the settability performance.

The short term stability specification is improved by a factor of ten with this tube. The  $5 \times 10^{-12}$  (1 s avg.) performance compares very favorably with that of rubidium type standards which are noted for their excellent short term stability. An important advantage from the better short term stability is the capability to make measurements to 1 sigma precision of  $1 \times 10^{-12}$  in about one minute compared to the two hours required previously. The 5061A with the Option 004 High Performance Tube has the same high reliability as the 5061A with the standard tube. The new high performance tube is warranted for one year, but is designed to have the same long life as the standard tube.

#### 10638A Degausser

The Model 10638A Degausser is designed for use with the Option 004 High Performance Beam Tube to achieve settability of  $\pm 1 \times 10^{-13}$  and reproducibility of  $\pm 3 \times 10^{-12}$ . The degausser removes residual magnetic fields in the beam tube which slowly decay and cause a small frequency change. The degausser should be used when initially setting up the 5061A with Option 004 or after the instrument has been moved or adjusted.

#### K34-59991A Broadband Linear Phase Comparator

The K34-59991A accurately compares the phase relationship of the output signals of two frequency standards having the same nominal frequency between 100kHz and 10MHz. The comparator output signal is suitable for driving a stripchart recorder, thus allowing long-term monitoring of the frequency standards' output differences. By using this comparator, very small frequency differences can be detected and adjustments can be made to the frequency standards to correct for timekeeping errors.

#### E21-5061A Flying Clock

The E21-5061A consists of a 5061A Cesium Beam Standard with Option 001 LED Clock and K02-5060A Power Supply joined together to make one portable unit. The power supply, which can be operated from 6 or 12 V dc, 24 to 30 V dc, or 115/230 V  $\pm 10\%$ , 50 to 400 Hz, will provide approximately 7 hours standby power (from sealed nickel-cadmium batteries) for the 5061A Cesium Beam Standard.

This wide range of operating power capabilities enable the E21-5061A to operate on local power in virtually any country in the world. Operation is approved aboard commercial aircraft. The seven hours standby capability make it possible to travel where there is no power available and, of course, allow the E21-5061A to conveniently be transported between power sources and operated in almost any air or surface vehicle as a "flying clock" (see Hewlett-Packard Journal, August 1966 and December 1967).

The Option 004 tube, because of the improved shielding, offers a significant increase in accuracy under the varying earth's magnetic field conditions experienced by flying clocks and is a desirable addition to the E21-5061A. In addition, the better short term stability permits more accurate and rapid comparison of standards. The Option 002 Battery may also be added to increase standby capability.



# FREQUENCY & TIME STANDARDS

## Atomic Frequency Standards

Models 5061A, 5065A (Cont.)

- Compact, high reliability, proven performance
- Long term drift rate  $< 1 \times 10^{-11}/\text{mo}$
- Time domain stability  $< 5 \times 10^{-13}$  (100 s avg)

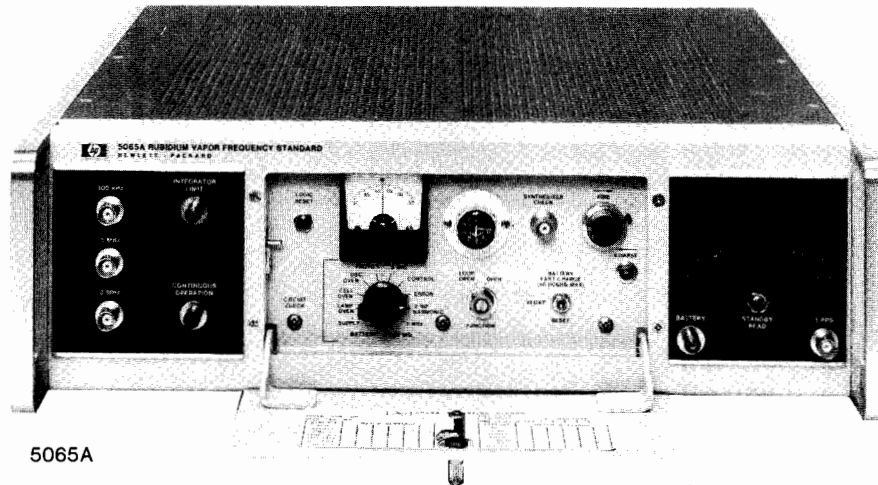

5065A

### 5065A Rubidium Frequency Standard

The HP Model 5065A is an atomic-type secondary frequency standard which uses a rubidium vapor resonance cell as the stabilizing element. As a result, it has long-term stability of better than  $1 \times 10^{-11}$  per month which exceeds that of high quality quartz oscillator frequency standards by 50 to 100 times. Furthermore, it has excellent short-term stability. These features contribute to its desirability as a coherent signal source, as a master oscillator for radio and radar systems where special requirements for stability and/or narrow bandwidth must be met, as a precision time keeper where the better performance of a cesium beam primary standard is not required, and as a house frequency standard for improved accuracy with fewer NBS calibrations compared to that required with quartz standards.

Front panel controls and circuit check meter of the 5065A are protected by a panel door. The magnetic field control provides fine frequency adjustment with which the frequency can be set to a precision of better than  $2 \times 10^{-12}$  without reference to a chart. The 5 MHz low noise quartz oscillator is phase-locked to the atomic frequency and provides the standard 5 MHz, 1 MHz, and 100 kHz outputs. The circuit check meter with selector switch monitors key voltages and currents for routine maintenance readings, calibration procedures, and fault finding.

The 5065A is designed for assured operation—to give the user confidence that the standard output signals are correct and locked to the atomic frequency. Logic within the unit maintains power to a “continuous” operation light on the front panel. If operation is interrupted, even momentarily, for any reason the light goes out and stays out until manually reset. An integrator limit light warns when the frequency correcting servo loop is approaching the limit of its dynamic range.

The HP Model 5065A is contained in a small-size package and is lightweight in comparison to a cesium beam standard. Additionally the rubidium resonance cell is much more frequency stable than quartz oscillators while subjected to shock and vibration, EMC, humidity, and magnetic field effects.

**Reliability and warranty:** the most significant module in the HP 5065A in terms of performance is the Rubidium Vapor Frequency Reference (RVFR). This temperature controlled, magnetically shielded unit includes the Rb gas cell and a photo sensitive detector

designed for maximum possible reliability. Field experience, including several million hours of operation, have demonstrated this reliability and the module is now warranted for a period of three years. This increased warranty protects the owner in the event of random failure.

The Option 001 Digital Clock has an easy to read LED time-of-day display. The olive black upper panel provides a dark background around the readout for excellent contrast and readability. Initial clock setting is accomplished by means of pushbuttons easily accessible by removing the top cover. The LED display offers high reliability, freedom from errors due to mechanical shock, and performance over the full environmental range of the 5065A. A sync button on the digital divider permits automatic synchronization of this 1 PPS pulse to an external pulse. The clock 1 PPS is adjustable in decade steps from  $1 \mu\text{s}$  to 1 s, with respect to the synchronized reference, with 6 thumbwheel switches. A screwdriver adjustment allows fine continuous adjustment over a range of  $1 \mu\text{s}$ .

To conserve battery power, the display is not illuminated when ac power is not available. A STANDBY READ pushbutton below the display is used for readout when operating on the internal battery or external dc.

The Option 002 Standby Battery provides the 5065A with a minimum of 10 minutes standby power at  $25^\circ\text{C}$ . Switchover from line to battery is automatic so there is no interruption of operation if ac line power should fail. A front panel ac interruption light warns when ac power has failed or has been disconnected. Fast or float charging rates may be selected when ac power is available.

The Option 003 combines the Option 001 Clock and Option 002 Battery and should be specified if both Options 001 and 002 are required.

### E21-5065A Portable Time Standard

E21-5065A Portable Time Standard is a complete system for precision timekeeping and for transporting time from one location to another. It consists of the 5065A Rubidium Standard with digital clock and divider (Option 001) and the K02-5060A Power Supply with 6 or more hours standby capability. The component units are held together by side bars, and the interconnecting cables are protected by a back cover.



## Specifications

Instrument:	5061A Option 004	5061A	5065A
<b>Type of Standard:</b>	Cesium	Cesium	Rubidium
<b>Accuracy:</b> maintained in magnetic field to 2 gauss and over temperature range of:	$\pm 7 \times 10^{-12}$ 0 to 50°C	$\pm 1 \times 10^{-11}$ 0 to 50°C	
<b>Stability:</b> <b>Long Term:</b> <b>Short Term 5 MHz<sup>(2)</sup>:</b>	Averaging time: 0.01 $\pm 3 \times 10^{-12(1)}$ $1.5 \times 10^{-10}$ $5 \times 10^{-12}$ $2.7 \times 10^{-12}$ $8.5 \times 10^{-13}$	$\pm 5 \times 10^{-12(1)}$ $1.5 \times 10^{-10}$ $5.6 \times 10^{-11}$ $2.5 \times 10^{-11}$ $8 \times 10^{-12}$	$\pm 1 \times 10^{-11}$ /month $1.5 \times 10^{-10}$ $5 \times 10^{-12}$ $1.6 \times 10^{-12}$ $5 \times 10^{-13}$
<b>SSB Phase Noise</b> <b>Signal (1 Hz BW)</b> <b>Offset from signal:</b>	Hz: $10^{-3}$ $10^{-2}$ $10^{-1}$ 0 $10^1$ $10^2$ $10^3$	-28 dB -48 dB -48 dB -82 dB -120 dB -125 dB -140 dB	-25 dB -52 dB -72 dB -93 dB -120 dB -126 dB -140 dB
<b>Reproducibility<sup>(4)</sup></b>	$\pm 3 \times 10^{-12(3)}$	$\pm 5 \times 10^{-12}$	
<b>Settability (frequency)<sup>(5)</sup>:</b>	$\pm 1 \times 10^{-13(3)}$	$\pm 7 \times 10^{-13}$	$\pm 2 \times 10^{-12}$
<b>Warm-up:</b>	At 25°C 30 Min.	At 25°C 45 Min.	At 25°C $1 \times 10^{-10}$ 1 hr. $5 \times 10^{-11}$ 4 hrs.
<b>Sinusoidal Outputs:</b> <b>Output Voltage</b>	5 MHz, 1 MHz, 100 kHz, Front & Rear BNC 1 V into 50 ohms		
<b>Harmonic Distortion:</b> (below rated output) <b>Non-Harmonic related output:</b> (below rated output) <b>Under vibration or AC Mag Field:</b> <b>Signal-to-Phase Noise Ratio in 30 kHz noise BW (1 and 5 MHz):</b>	>40 dB >80 dB >60 dB >87 dB	>40 dB >80 dB >60 dB >87 dB	>40 dB >80 dB >60 dB >87 dB
<b>Environmental</b> <b>DC Magnetic Field Stability:</b>  <b>AC Magnetic Field:</b> 50, 60 and 400 Hz $\pm 10\%$  <b>Temperature, operating with Option 001 or 002</b> <b>Freq. change from 25°C:</b>	$< \pm 2 \times 10^{-13}$ 2 Gauss Field $< 2 \times 10^{-12}$ for 2 Gauss peak 0 to 50°C $< 5 \times 10^{-12}$	$< \pm 2 \times 10^{-12}$ 2 Gauss Field $< 2 \times 10^{-12}$ for 2 Gauss peak 0 to 50°C $< 5 \times 10^{-12}$	$< \pm 5 \times 10^{-12}$ 1 Gauss Field $< 5 \times 10^{-12}$ for 1 Gauss peak 0 to 50°C $< 4 \times 10^{-11}$
<b>Temperature, non-operating without options:</b> <b>with Option 001:</b> <b>with Option 002</b>	-40°C to 75°C -40°C to 75°C -40°C to 50°C	-40°C to 75°C -40°C to 75°C -40°C to 50°C	-40°C to 75°C -40°C to 75°C -40°C to 50°C

**NOTES:**

- (1) For life of beam tube.
- (2) Short-term stability for the 5061A with both standard and high performance tubes is given for the normal loop time constant. For improved short-term stability in controlled environments the long time constant may be used.
- (3) With 10638 Degausser.
- (4) Degree to which an oscillator will produce the same frequency from one occasion to another without recalibration.
- (5) Degree to which frequency can be set to agree with a reference frequency.

# FREQUENCY & TIME STANDARDS

## Atomic Frequency Standards

Models 5061A, 5065A (Cont.)

Instrument	5061A Opt 004	5061A	5065A
Vibration: with isolators:	MIL-STD-167-1 MIL-T-21200	MIL-STD-167-1 MIL-T-21200	MIL-STD-167-1
Shock:	MIL-E-5400, Class 1 (30G)		
	1-MIL-T-21200, C.1		MIL-T-21200, C.1
EMC:	MIL-STD-461, Notice 3, Class A		
<b>General</b>			
Power: AC:	50, 60 or 400 Hz $\pm$ 10%, 115/230 V $\pm$ 10%		
DC:	43 W 22 to 30 V 27 W	43 W 22 to 30 V 27 W	49 W 23 to 30 V 35 W
Option 001: add (AC/DC)	10/7.5 W	10/7.5 W	10/7.5 W
002: add (AC/DC)	22/4.5 W	22/4.5 W	6/0 W
010: add (AC/DC)			
Dimensions ( H x W x D): mm: inches:	221 x 425 x 416 8.7 x 16.7 x 16.4	221 x 425 x 416 8.7 x 16.7 x 16.4	133 x 425 x 416 5.2 x 16.7 x 16.4
Weight: (lb/kg)	70/31.8	67/30.5	34/15.4
Option 001: add (lb/kg)	2/0.9	2/0.9	2/0.9
002: add (lb/kg)	5/2.3	5/2.3	3.5/1.6
<b>Option 001, Clock</b>			
1 PPS Outputs: Master:			
Clock:	Front & Rear BNC	Front & Rear BNC	Front & Rear BNC
Amplitude:	10 V peak into 50 $\Omega$ load		
Width:	20 $\mu$ s min	20 $\mu$ s min	20 $\mu$ s min
Rise Time:	<50 ns	<50 ns	<50 ns
Fall Time:	<2 $\mu$ s	<2 $\mu$ s	<2 $\mu$ s
Jitter, pulse-to-pulse:	<5 ns, rms	<5 ns, rms	<5 ns, rms
Synchronization:	Automatic, 10 $\pm$ 1 $\mu$ s delay	Automatic, 10 $\pm$ 1 $\mu$ s delay	Auto., 10 $\pm$ 1 $\mu$ s delay
Clock pulse adjustment range:	1 $\mu$ s to 1 s	1 $\mu$ s to 1 s	1 $\mu$ s to 1 s
Clock display:	Solid State Digital		
Option 002, Standby Power Supply Capacity at 25°C with Option 001 Clock:	30 Minutes	30 Minutes	10 Minutes
Recharge, Fast/Float:	Automatic, fast charge		Switch

### Ordering Information

#### 5061A Cesium Beam Frequency Standard

- Opt 001: Clock
- Opt 002: Standby Power Supply
- Opt 003: Clock and Standby Power Supply
- Opt 004: High Performance Beam Tube
- Opt 908: Rack Flange Kit

#### E21-5061A Flying Clock

Consists of: 5061A with Opt 001 (not included in E21 price) and K02-5060A Standby Power Supply.

Weight: 64 kg (141 lb).

Size: 425 H x 405 W x 546 mm D (16.7" x 15.9" x 21.5") (includes handles).

#### 10638A Degausser

Weight: 1.2 kg (3 lb).

Size: 130 H x 77 W x 279 mm D (5.1" x 3" x 11").

#### 5065A Rubidium Frequency Standard

- Opt 001: Clock
- Opt 002: Standby Power Supply
- Opt 003: Clock and Standby Power Supply
- Opt 908: Rack Flange Kit

#### E21-5065A Portable Time Standard

Consists of: 5065A with Opt 001 (not included in E21 price) and K02-5060A Standby Power Supply.

Weight: 50 kg (110 lb).

Size: 425 H x 405 W x 546 mm D (16.7" x 15.9" x 21.5") (includes handles).

- High spectral purity
- Well-buffered outputs
- Aging  $< 5 \times 10^{-10}$  per day

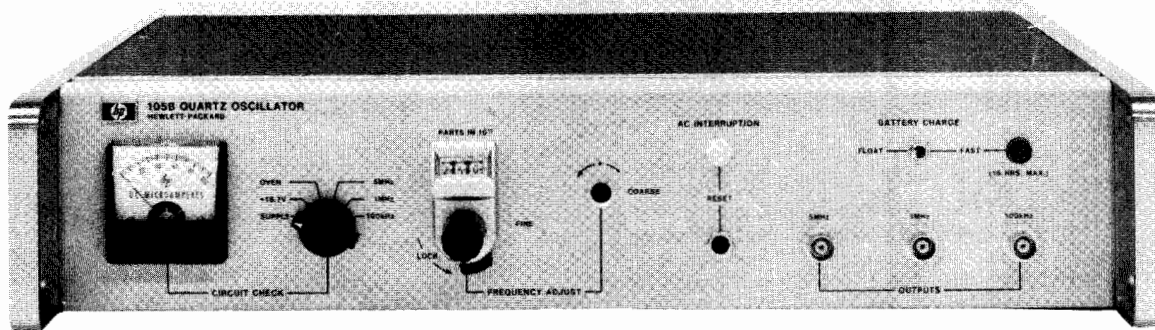

105B

Models 105A and B Quartz Oscillators provide state-of-the-art performance in precision frequency and time systems because of their excellent long and short term stability characteristics, spectrally pure outputs, unexcelled reliability, and ability to operate under a wide range of environmental conditions. They fill a need for a small and economical yet highly stable precision quartz oscillator for frequency and time standards. Both models can be operated from the ac line; the 105B has a built-in 8-hour standby battery for uninterrupted operation should line power fail. Both have 5 MHz, 1 MHz and 100 kHz buffered sinusoidal outputs with excellent short term stability (5 parts in  $10^{12}$  rms for 1 s averaging time) and aging rate ( $< 5$  parts in  $10^{10}$  per day).

The 105A/B features rapid warm-up. Typically, the oscillator will be within 5 parts in  $10^9$  of the final frequency in 15 minutes after an "off" period of 24 hours. The basis of these oscillators is an extremely stable "SC" cut quartz crystal developed by Hewlett-Packard. New technologies in the crystal mounting and packaging have resulted in a cleaner crystal which in turn has a lower aging rate. The crystal, oscillator and AGC circuit are all enclosed in a proportional oven which reduces the temperature effects on these components and circuits.

Particular care was taken to provide a spectrally pure 5 MHz output which, when multiplied high into the microwave region, provides signals with spectra only a few cycles wide. Spectra less than 1 Hz wide can be obtained in X-band (8.2 to 12.4 GHz). The stability and purity of the 5 MHz output make it suitable for doppler measurements, microwave spectroscopy, and similar applications where the reference frequency must be multiplied by a large factor.

### Specifications

**Outputs:** 5 MHz, 1 MHz, 100 kHz; 1 V rms into 50  $\Omega$  front and rear connectors.

**Clock output:** 1 MHz or 100 kHz; 0.5 V rms into 1 k $\Omega$ , rear connector. Normally supplied wired for 1 MHz output.

#### Frequency Stability

**Aging rate:**  $< 5 \times 10^{-10}$  per 24 hours.

**Short-term stability:** for 5 MHz output only.

$\tau$ (sec)	$\sigma_{\Delta f}/f(2,\tau)$
$10^{-2}$	$1.5 \times 10^{-10}$
$10^{-1}$	$1.5 \times 10^{-11}$
$10^0$	$5 \times 10^{-12}$

**Temperature:**  $< 2.5 \times 10^{-9}$  total change  $0^\circ\text{C}$  to  $50^\circ\text{C}$ .

**Load:**  $\pm 1 \times 10^{-10}$  open to short circuit, 50  $\Omega$  R, L or C load change.

**Supply voltage:**  $\pm 5 \times 10^{-11}$  for 22–30 V dc from 26 V dc reference and for 115/230 V  $\pm 10\%$ .

**Warm-up (at  $25^\circ\text{C}$ ):** to within  $5 \times 10^{-9}$  of final frequency in 15 min.

**Distortion (5 MHz, 1 MHz, 100 kHz) below rated output**

**Harmonic:**  $> 40$  dB.

**Non-harmonic:**  $> 80$  dB.

#### Frequency Adjustments

**Fine:**  $\pm 5 \times 10^{-8}$  range with digital dial reading parts in  $10^{10}$ .

**Coarse:**  $1 \times 10^{-6}$  front panel screwdriver control.

**Phase locking:** external +5 V to  $-5$  V allows  $> 2 \times 10^{-8}$  frequency control for locking to external source.

#### Environmental

**Temperature, operating:**  $0^\circ\text{C}$  to  $+50^\circ\text{C}$ .

**Temperature, storage:**  $-40^\circ\text{C}$  to  $+75^\circ\text{C}$  ( $+50^\circ$  for 105B).

**Altitude:** 15.24 km (50,000 ft.).

**Shock:** MIL-T-21200 (30 Gs).

**Vibration:** MIL-STD-167 and MIL-T-21200.

**Electromagnetic compatibility (EMC):** MIL-I-6181D.

**Standby supply capacity:** model 105B only, 6 hours at  $25^\circ\text{C}$  ambient temperatures.

**Power requirements:** 115/230 V  $\pm 10\%$ , 50–400 Hz at 18 W (70 W warm-up) for 105A. For 105B add 1 W for float charge and 12 W for fast charge. 22–30 V dc at 8 W (16 W warm-up).

**Size:** 88 H x 425 W x 286 mm D ( $3^{15}/_{32}$ " x  $16^{3}/_{4}$ " x  $11^{1}/_{4}$ ").

**Weight:** 105A—net, 8 kg (16 lb). Shipping, 10.5 kg (23 lb). 105B—net, 11 kg (24 lb). Shipping, 14 kg (31 lb).

#### Options

**908:** Rack Flange Kit

**910:** Extra manual

#### Ordering Information

**105A** Quartz Oscillators

**105B** Quartz Oscillators



# FREQUENCY & TIME STANDARDS

## Distribution Amplifier

Model 5087A

- Versatile with 3 input and 12 output channels
- Low noise, high stability, and isolation

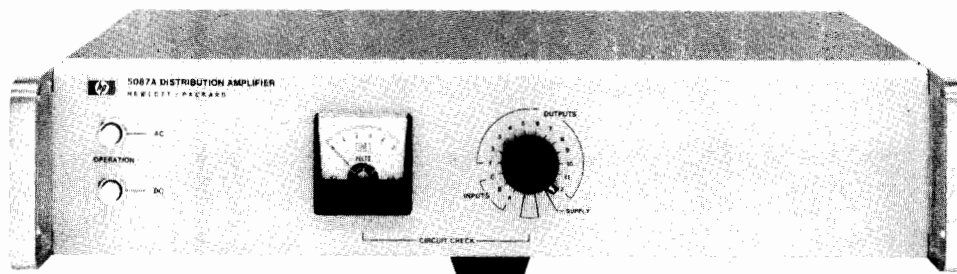

The Hewlett-Packard Model 5087A Distribution Amplifier provides the isolation and flexibility required for distribution of the output of high quality frequency standards. Low distortion and excellent isolation make it ideal for providing multiple outputs from atomic or crystal frequency standards. The 3 input channels will accept 10 MHz, 5 MHz, 1 MHz or 100 kHz in any combination. The number of outputs for each channel is selectable up to a total of 12 outputs. The output levels are individually adjustable from 0 to 3 V rms. All input and output levels are monitored on a front panel meter.

The Distribution Amplifier features plug-in modular construction, short circuit isolation, exceptional phase stability, low noise and cross-talk, and uninterrupted switchover to standby dc in event of ac power failure.

The shielding around each input and output plug-in amplifier assures minimum noise and crosstalk. The tuned output amplifiers provide clean signals and high channel-to-channel isolation.

The instrument is designed for maximum versatility and can be supplied to meet a wide variety of special requirements. The standard configuration of input and output amplifiers is shown in Figure 1.

Several other commonly used configurations are also available and special combinations of the various input and output modules can be supplied. Input and output amplifiers can be added or the configuration easily changed at any time.

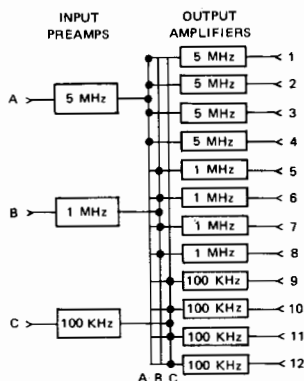

Figure 1. 5087A Distribution Amplifier with Option 031, Standard Configuration input and output amplifiers.

### Specifications

**Inputs:** (up to three, rear panel BNC).

**Frequencies:** 10 MHz, 5 MHz, 1 MHz or 100 kHz.

**Level:** 0.3 to 3.0 V rms, 50 ohms.

**Outputs:** (up to 12 rear panel BNC).

**Frequencies:** 10 MHz, 5 MHz, 1 MHz or 100 kHz.

**Level:** 0–3 V into 50 ohms (screwdriver adjustment).

**Harmonic distortion:** >40 dB below rated output.

**Non-harmonic distortion:** >80 dB below rated output

### Isolation

**Load** (open or short on any other channel)

**Amplitude change:** 0.1 percent.

**Phase change:** <0.1 ns at 5 or 10 MHz.

<0.5 ns at 1 MHz.

<5.0 ns at 100 kHz.

**Injected signal:** 1 V signal up to 50 MHz applied to any output except 10 MHz, will be down more than 60 dB in all other outputs; 10 MHz output channel will be down more than 50 dB.

**SSB phase noise (5 MHz):** >145 dB below signal in 1 Hz BW for frequencies > 1 kHz from carrier.

**Short term stability degradation (5 MHz):** < 1 x 10<sup>-12</sup> in 10 kHz band. (1 s average).

### Environmental

**Temperature:** MIL-E-16400, Class 4.

**Operating:** 0–50°C; storage: –62° to +75°C.

### Stability:

**Amplitude:** ±0.5 dB, 0° to 50°C.

**Phase:** <0.1 ns/°C., 5 and 10 MHz.

**EMC:** MIL-STD-461A.

**Humidity:** 95% at 40°C.

**Vibration:** MIL-STD-167.

**Altitude:** up to 30,000 ft.

**Shock:** MIL-T-21200, Class 1 and MIL-E-5400 (30 Gs).

### General

**Power:** 115 or 230 V ±10%, 48 to 440 Hz, 20 VA, max, or 22–30 V dc, 500 milliamperes, max.

**Dimensions:** 88 H x 425 W x 286 mm D (3.5" x 16.7" x 11.3").

**Weight:** typical, Opt 031–Net 7 kg (15 lb).

### Options

**Normal configurations** (input and output amplifiers)

**031:** 5, 1 and 0.1 MHz inputs and 4 outputs at each frequency

**032:** Single 5 MHz input and 12 outputs

**033:** Single 10 MHz input and 12 outputs

**034:** Single 5 MHz input, 4 each outputs at 5, 1 and 0.1 MHz

### Special Configurations

**Input preamplifiers** (up to 3 total)

**004:** Input Preamplifier (0.1 to 10 MHz)

**005:** 5 to 1 MHz Input Divider

**006:** 1 to 0.1 MHz Input Divider

**011:** 5 to 10 MHz Input Doubler

**013:** 10 to 5 MHz Input Divider

**014:** 10 to 1 MHz Input Divider

**Output amplifiers** (up to 12 total)

**001:** 5 MHz Output Amplifier

**002:** 1 MHz Output Amplifier

**003:** 0.1 MHz Output Amplifier

**012:** 10 MHz Output Amplifier

**908:** Rack Flange Kit

5087A: Distribution Amplifier Mainframe



- 12 Amp-hr capacity
- Sealed nickel-cadmium cells
- Used in "flying clocks"

- 18 Amp-hr capacity
- Vented nickel-cadmium cells

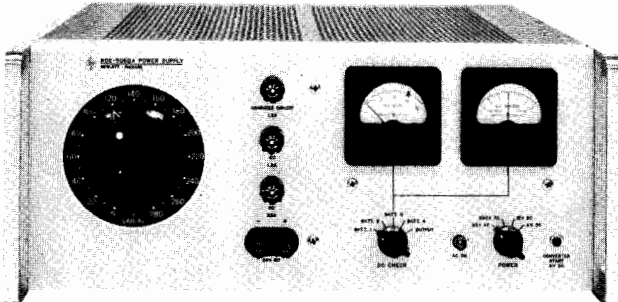

K02-5060A

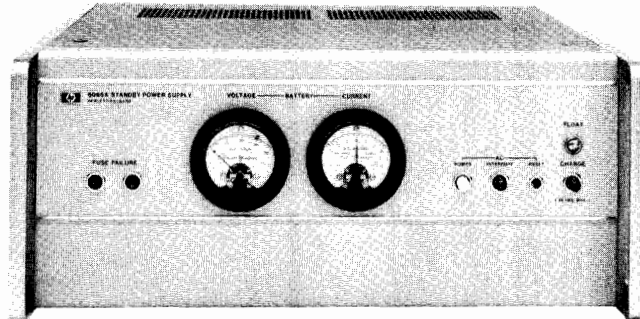

5085A

The HP Models 5085A and K02-5060A Standby Power Supplies furnish dc power to keep frequency or time standard systems operating during extended interruptions of ac line power. For applications where it is essential to maintain continuous operation and avoid loss of precise time, the use of a standby power supply is an absolute necessity. These units are designed for use with the Hewlett-Packard Cesium Beam Standards, Rubidium Vapor Standards, Quartz Oscillators and other equipment which will operate from 22 to 30 V dc. No switching is used in transferring power from line to battery operation and back again thus assuring uninterrupted operation.

### HP K02-5060A

The K02-5060A is a very versatile unit which was designed specifically as a portable power supply for the 5061A and 5065A "Flying Clocks" where it is necessary to operate from a wide range of power sources along with the standby capability to maintain continuous operation where no external power is available. A special inverter permits operation from a 6 or 12 V dc car battery in addition to the 115/230 V ac and 24-30 V dc capability. The 12 ampere-hour standby batteries are the sealed, nickel-cadmium type and thus spill-proof. Mounting hardware is available to attach the K02-5060A to either the 5061A or 5065A Standards to make a portable standard, the E21-5061A or E21-5065A.

### HP5085A

The HP 5085A is intended for installation where 115 or 230 V ac is available. Vented nickel-cadmium batteries with an 18 ampere-hour guaranteed capacity (derated from 25) are used. They provide about 10 hours of standby power for the 5061A Cesium Standard or 5065A Rubidium Standard (at average ambient temperature of 25°C).

Front panel lights indicate mode of operation, report fuse failure, and ac interrupt. A float-charge switch permits rapid recharge after an ac power failure.

### K02-5060A Specifications

#### Input and Output Voltages

Input	Output
6 or 12 V dc	0-230 V, 60 Hz nominal
115 or 230 V ac, 50-400 Hz	0-230 V ac
24-30 V dc	24-30 V dc

Standby battery, 26 ± 4 V dc available at all times.

AC and both dc inputs may be connected simultaneously.

**Output current:** 0.5A ac, 2 A dc.

**Standby capacity:** 12 ampere-hour at 25°C, 7 hours standby when used in E21-5061A, 6 hours in E21-5065A.

**Recharging:** 1.6 hours recharging time required for each ampere hour of discharge.

**Alarm indicator:** external power failure.

**Panel meters:** voltmeter, ammeter indicating voltage and current of 4 internal batteries and load.

**Battery:** four paralleled rechargeable battery packs each containing 20 sealed nickel-cadmium cells. Packs may be removed individually without interfering with power supply operation.

#### Temperature

**Operating:** 0 to 50°C.

**Storage:** -40 to 60°C

**Size:** 177 H × 425 W × 416 mm D (7" × 16.7" × 16.4").

**Weight:** net, 30.5 kg (67 lb).

### 5085A Specifications

**Output voltage:** 24 ± 2 V dc at rated current.

**Output current:** 2 amperes (2.5 A for 30 min.).

**Standby capacity:** (at 25°C) 18 amp-hrs. after 48 hours charge.

**Alarm indicators:** panel lamps indicate: (1) FUSE FAILURE, (2) AC POWER, (3) AC INTERRUPT, (4) CHARGE.

**Remote alarm provisions:** SPDT relay contacts provided at rear terminals for operating remote alarm from separate power system.

**Panel meters:** battery voltage and charge/discharge current.

**Power requirements:** 115 or 230 ± 10% V ac; 50 to 400 Hz (2.0 A max. at 115 V line).

**Battery (supplied):** vented nickel-cadmium 25 ampere-hour capacity derated to 18 ampere-hours. Periodic maintenance required.

**Additional (external) battery provision:** rear connector.

#### Temperature

**Operating:** 0 to 50°C.

**Storage:** -40 to 75°C.

**Size:** 177 H × 425 W × 416 mm D (7" × 16.7" × 16.4").

**Weight:** net, 34.1 kg (75 lb). Shipping, 45.9 kg (101 lb) including battery. Option 001 (no batteries) is 22.8 kg (50 lb) less.

### Ordering Information

5085A (complete with batteries)

Opt 001: without batteries

Opt 908: Rack Flange Kit

K02-5060A

Opt 908: Rack Flange Kit



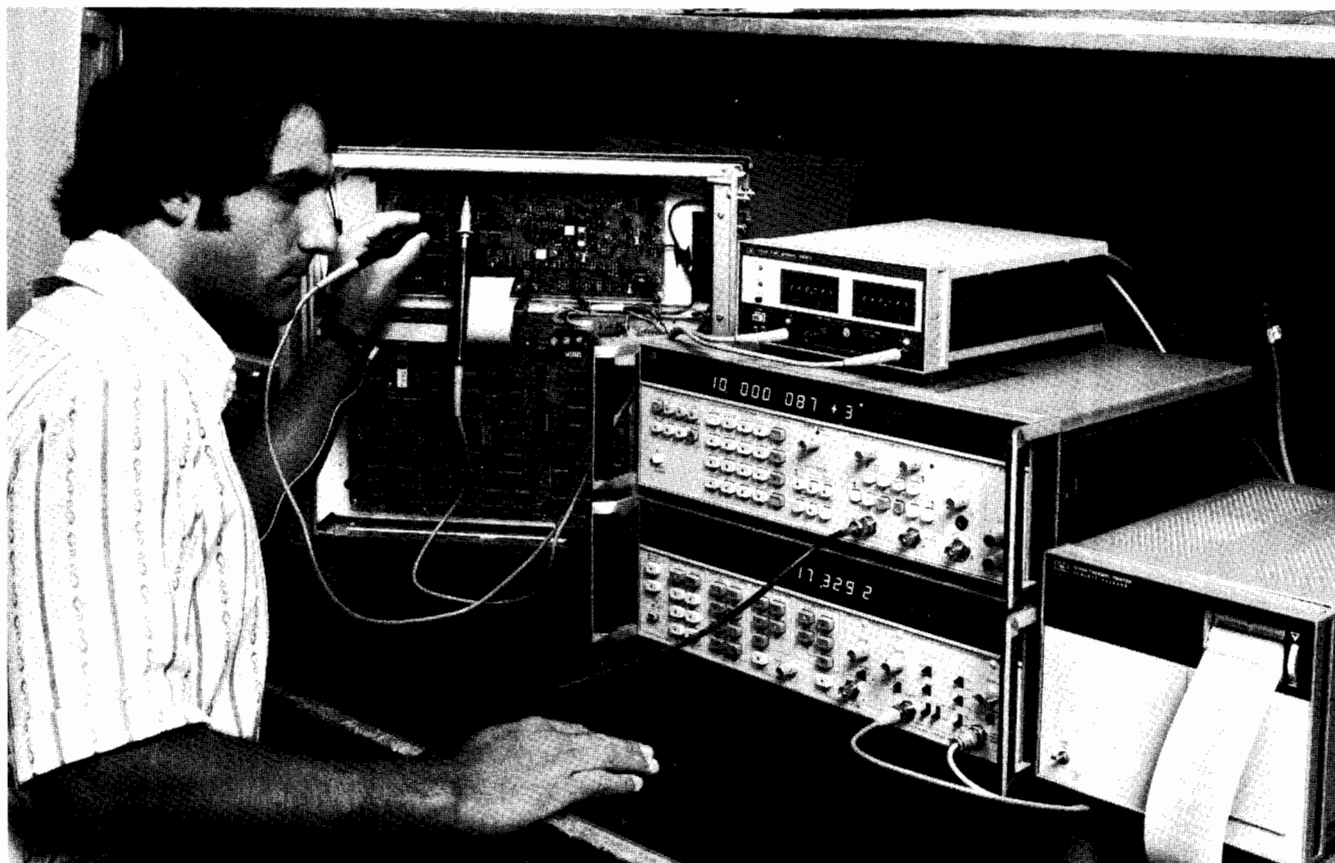

### Introduction

HP introduced its first digital electronic counter in 1952. That product, the 524A, could measure frequencies to 10 MHz and time intervals as short as 100 ns. Thirty years later HP counters measure frequencies as high as 40 GHz and time intervals as short as 20 picoseconds, the time it takes light to travel six millimeters.

Applications for counters exist throughout the electronics industry, in all phases of engineering, production, and service. Today's counters make a variety of measurements, which are summarized below.

### Frequency

In this fundamental measurement, the counter totalizes cycles of the unknown signal for a precisely known length of time. Using high speed custom ECL parts, counters today measure frequency to 500 MHz directly and to 40 GHz with down conversion. The measurement quality is closely linked to the timebase and HP counters feature a variety of high stability oscillators to match the requirements of the application.

### Period

The inverse of frequency measurement is available on most products to provide high resolution measurements of low frequency.

### Totalize

This measurement is similar to frequency except that the user controls the time interval over which the measurement takes place. Applications for totalize range from mechanical systems to high speed electronics R & D. The

ability of the 5345A to totalize at a 500 MHz rate represents the current state of the art for this measurement.

### Ratio

Some counters have the ability to compute and display the ratio of two input frequencies. The major application is the measurement of harmonically related signals.

### Scaled Output

A divide by N version of the input signal is available at the timebase output of the 5328A for specialized applications.

### Time Interval

The importance of digital techniques throughout the electronics industry makes high resolution measurement of time interval increasingly useful. Seven HP counters make time interval measurements including the 5370A which uses phase locked vernier interpolation to measure time interval as short as 20 picoseconds. Time interval averaging, a technique pioneered by HP, improves the resolution of time interval measurements made on repetitive signals over the single shot resolution of the counter. Another product, the 5363B Time Interval Probe, aids time interval measurements by expanding the dynamic range of trigger levels and reducing uncertainties caused by trigger level errors.

### Pulse Parameters

On the 5335A counter the measurement hardware is combined with the power of a microprocessor to make complex measure-

ments easier and faster. At the touch of a few keys the 5335A automatically measures phase, slew rate, duty cycle, rise/fall times, and computes statistics.

### Reciprocal Counting

Six HP counters (the 5300A/5307A, 5315A/B, 5316A, 5335A, 5345A and 5370A) measure frequency by counting the internal clock for a known number of periods of the input signal and computing frequency. This technique, known as reciprocal counting, makes the resolution of the measured frequency proportional to the frequency of the timebase rather than the one Hertz in one second resolution of conventional counters. The graph below compares the measurement resolution of the 5345A universal counter which uses the reciprocal technique to conventional counters. Note that for frequencies below the 500 MHz internal clock frequency, the 5345A delivers significantly more resolution in the same one second gate time.

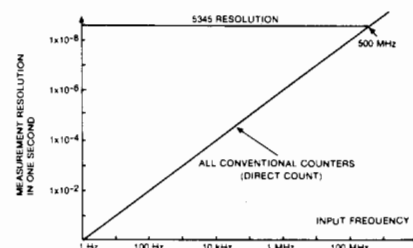



### Categories of Frequency Counters

While counters can potentially offer all of the capabilities described above, they essentially fall into three categories, frequency counters, universal counters, and microwave counters.

Frequency counters offer basic frequency measurement and often additional features such as totalize, period and ratio. They are designed for people with specific applications and the wide variety of products in this area insure that one is available to economically match most applications.

Universal counters provide time interval measurement capability in addition to the other measurements found in frequency counters. The 5314A is the most economical of HP universal counters and features 100 MHz frequency and 100 nanosecond time interval. At the other extreme the 5370A measures time intervals of 20 picoseconds single shot. In between, the 5315A/B, 5316A, 5328A, 5335A, and 5345A offer a range of capabilities that are more fully described in the comparison chart below.

HP microwave counters make high accuracy frequency measurements at frequencies up to 40 GHz. The 5343A automatically

measures frequencies to 26.5 GHz with one Hertz resolution and wideband FM tolerance. For pulsed RF or CW microwave applications, the 5355A plug-in for the 5345A is a complete solution to 40 GHz.

The 5344S Microwave Source Synthesizer is a recent addition to the HP Microwave Counter family. When used with microwave sweepers such as the HP 8350A, the 5344S greatly improves the frequency accuracy for network measurements.

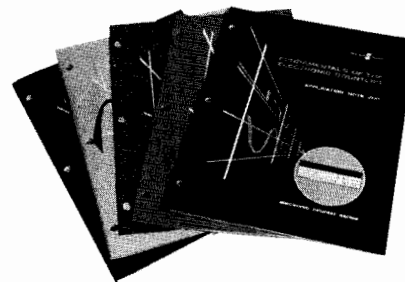

### HP Interface Bus

Most HP counters are compatible with the HP Interface Bus, the Hewlett-Packard implementation of IEEE-488, when equipped with the HP-IB option (standard on the 5316A, 5335A and 5370A).

For applications requiring a large number of time or frequency measurements, frequent changes of the front panel settings, or automatic data reduction, storage and output, HP-IB counters are compatible with the 9800 series of desktop computers, the HP-1000 minicomputer or any IEEE-488 controller.

The 200 series of application notes, shown above, explains in detail the operation and application of HP's frequency counters. Topics include:

- Fundamentals of Electronic Counters 200
- Fundamentals of Microwave Counters 200-1
- Fundamentals of Quartz Oscillators 200-2
- Fundamentals of Time Interval Measurements 200-3
- Understanding Counter Specifications 200-4

These notes are available from all HP sales offices.

Category	Model	Type	Digits	Sensitivity	Frequency	Time Interval	Features	Options	Page
Frequency Counters	5300B/5301A	Conventional	7	25 mV	10 MHz	—	Yes <sup>1</sup>	T	306
	5300B/5303B	Conventional	8	100 mV	500 MHz	—	Yes <sup>1</sup>		306
	5300B/5305B	Conventional	8	20 mV	1300 MHz	—	Yes <sup>1</sup>		306
	5300B/5306A	Conventional	7	50 mV	10 MHz	—	Yes <sup>1</sup>	DMM	306
	5300B/5307A	Reciprocal	6	10 mV	2 MHz	—	Yes <sup>1</sup>		306
	5381A	Conventional	7	25 mV	80 MHz	—	—		309
	5382A	Conventional	8	25 mV	225 MHz	—	—		309
	5383A	Conventional	9	25 mV	520 MHz	—	—		309
	Universal Counters	5300B/5302A	Conventional	7	25 mV	50 MHz	100 ns	Yes <sup>1</sup>	P,R,T
5300B/5304A		Conventional	7	25 mV	10 MHz	100 ns	Yes <sup>1</sup>	P,T	306
5300B/5308A		Conventional	8	25 mV	75 MHz	100 ns	Yes <sup>1</sup>	P,R,T	306
5314A		Conventional	7	25 mV	100 MHz	100 ns	—	P,R,T	305
5315A		Reciprocal	8	10 mV	100 MHz	100 ns	—	P,R,T	302
5315B		Reciprocal	8	10 mV	100 MHz	100 ns	—	P,R,T <sup>2</sup>	302
5316A		Reciprocal	8	10 mV	100 MHz	100 ns	Yes <sup>3</sup>	P,R,T	302
5328A		Conventional	8	25 mV	100 MHz	100 ns	Yes	P,R,T	300
5335A		Reciprocal	12	25 mV	200 MHz	2 ns	Yes <sup>3</sup>	P,R,T <sup>3</sup>	297
5345A		Reciprocal	11	20 mV	500 MHz	2 ns	Yes	P,R,T	286
5370A		Reciprocal	12	20 mV	100 MHz	20 ps	Yes <sup>3</sup>	P,Statistics	294
Microwave	5340A	Conventional	8	-35 dBm	18 GHz	—	Yes		293
	5342A	Conventional	11	-25 dBm	18 GHz	—	Yes	Amplitude, D to A	290
	5343A	Conventional	11	-33 dBm	26.5 GHz	—	Yes		290
	5355A	Conventional	11	-15 dBm	1.6 GHz	2 ns	Yes	P,R,T	289
	5356A/B/C	Conventional	11	-20 dBm	18/26.5/40 GHz	2 ns	Yes	P,R,T	289

P Period  
R Ratio  
T Totalize

Counting Technique

Number of Digits

Sensitivity

Frequency

Single Shot Time Interval



Other

Page Number

1. Talk only, not fully programmable
2. Offset and normalize—Option 006
3. Pulse characteristics, phase, math, statistics
5. HP-IB is standard

# ELECTRONIC COUNTERS

## 500 MHz Plug-In Counter

Model 5345A

- DC to 500 MHz direct counting
- 2 ns single shot T.I. resolution
- Averaging to 2 ps resolution
- 20 mV sensitivity to 500 MHz
- Plug-in measurements to 40 GHz
- Full HP-IB programming optional

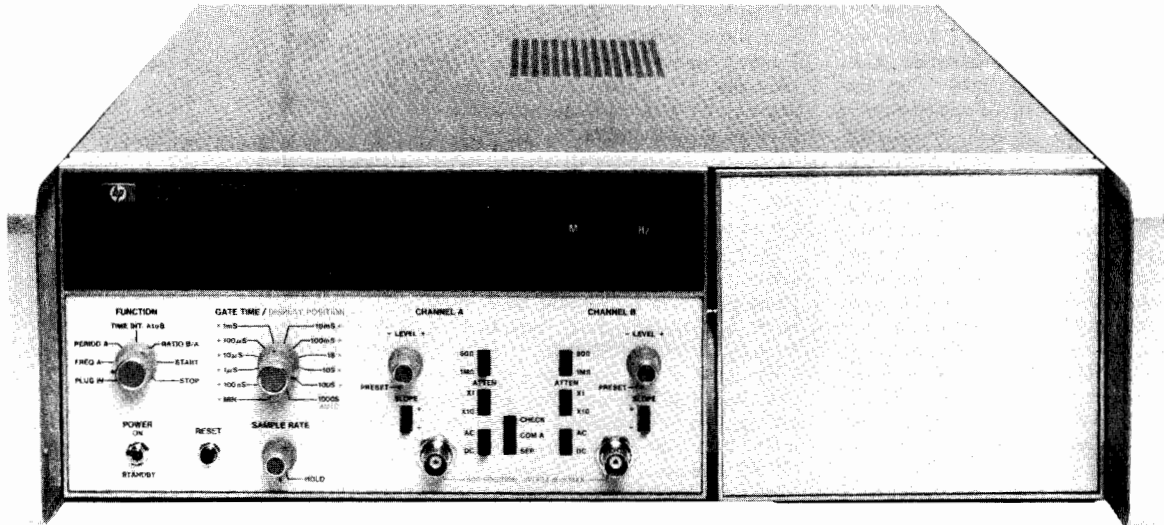

The 5345A Electronic Counter represents one of the most advanced general purpose instruments in the Hewlett-Packard Counter Product Line. Utilizing monolithic bipolar integrated circuit technology especially designed and manufactured at Hewlett-Packard, this instrument provides unsurpassed power, versatility and flexibility in frequency and time measurements. The 5355A plug-in (p. 289) extends the capability and frequency range of the 5345A mainframe.

### Input Signal Conditioning

The fully optimized front end includes switchable 50 Ω/1 MΩ input impedance, DC/AC coupling, and slope selection. The sensitive wideband amplifiers assure measurements on even the lowest level sinusoidal and digital signals. Also featured is an extremely wide linear dynamic range of -2 to +0.5 Vdc.

Frequency measurements are made direct from dc to 500 MHz. Using the reciprocal technique, 9 digits of resolution occur in a one second gate time over the entire frequency range. This means a 1 MHz input can be resolved to  $2 \times 10^{-9}$  (= 0.002 Hz) in one second.

This high resolution in a short period of time can be traded for greater measurement speeds. Using a 100 μs gate with a resolution of  $2 \times 10^{-5}$  the measurement can now be made 5000 times a second. Up to 9000 readings a second can be output to the Interface Bus using the computer dump mode.

### Measurement Speed

Mode of Operation	Readings per Second
Normal Operation (Max sample rate)	10
Externally armed	500
Externally gated	500
Computer dump	9,000

### Time Interval

Single-shot time interval resolution is 2 ns. Time interval averaging on repetitive inputs can improve resolution to 2 ps. Due to a modulated clock technique, true averaging occurs under all conditions. Also helpful in time interval applications is knowing where triggering on the input signal occurs. This can be determined by simply measuring the DC trigger levels at rear panel BNCs.

### External Gating Capability

Via the rear panel gate control input, the operator can determine at what point in real time and for how long the measurement is to be made. The major application is in the measurement of pulsed RF signals, using frequency averaging to improve resolution (see Figure 1).

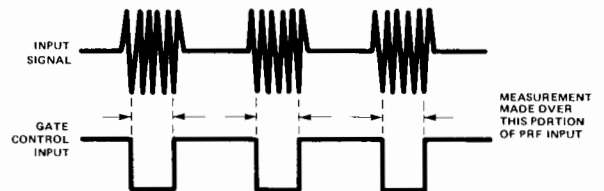

Figure 1. Frequency Averaging to Increase Resolution

External gating can also provide more versatility in time interval and totalize modes. For example, this capability allows the user to select only the desired portion of an input pulse train for a totalize measurement, as in figure 2. Time Interval measurements, such as those in figure 3, can also be made.

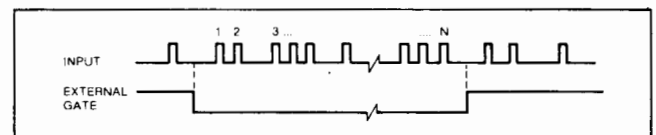

Figure 2. Selecting a Portion of a Pulse Train

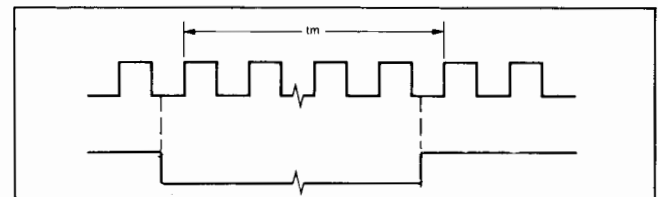

Figure 3. Using EXT GATE to Measure Tm



### Ratio/A ± B Modes

Ratio and A ± B functions are included, being extremely useful for comparison between reference and test signals applied to the two mainframe inputs. Typical applications include bit error rate and synthesizer testing. Allowing high speed measurements, the frequency or bit rate of either channel can vary from DC to 500 MHz.

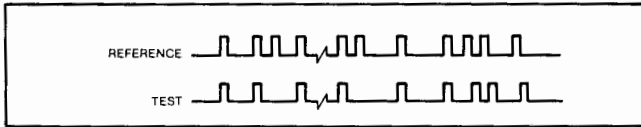

Figure 4. Comparison Measurements

In A-B mode, any difference between the total number of events accumulated in each channel is indicated by the 5345A display after the measurement is completed. In A+B mode, all transitions of a 1 gigabit NRZ signal can be measured by setting the "A" trigger slope to "+" and the "B" slope to "-".

### Hewlett-Packard Interface Bus

Option 011 provides HP-IB control for all measurement functions, sample rate, gating and display position commands. Adding complete systems programmability, option 012 also includes remote slope and trigger level control.

## 5345A Condensed Specifications

### Frequency/Period Measurements

Range: 0.00005 Hz to 500 MHz.

Accuracy:  $\pm \frac{2 \times 10^{-9}}{\text{gate time}} \pm \text{trigger error} \pm \text{time base error}$ .

Gate time: 1000 seconds to 100 nanoseconds in decade steps; <50 ns in MIN position.

### Time Interval/Time Interval Average

Range: 10 n to 20,000 sec.

Minimum dead time: 10 n.

Trigger pulse width: 1 nsec minimum width input at minimum voltage input.

### Accuracy:

Time interval:  $\pm \text{trigger error} \pm 2 \text{ ns} \pm \text{time base error}$ .

### Time interval averaging:

$\frac{\text{trigger error} \pm 2 \text{ nsec}}{\sqrt{\text{intervals averaged}}} \pm 0.7 \text{ ns} \pm \text{time base accuracy}$

Not affected by harmonics of clock frequency.

### Resolution:

Time interval: 2 ns.

### Time interval average:

$\pm \frac{2 \text{ ns}}{\sqrt{\text{intervals averaged}}} \pm 2 \text{ picoseconds}$ .

### Ratio B/A

Range: both channels accept dc to 500 MHz.

Accuracy:  $\pm \text{LSD} \pm \text{trigger error}$ .

### Start/Stop

Range: both inputs dc to 500 MHz.

Modes: A, A ± B determined by rear panel switch.

### Scaling

Range: dc to 500 MHz.

Scaling factor: selectable by GATE TIME setting. Scaling factor equals GATE TIME setting/10<sup>-9</sup> seconds.

Input: input signal through channel A.

Output: output frequency equals input frequency divided by scaling factor.

### Input Channels A and B

Range: 0 to 500 MHz dc coupled 50 Ω and 1 MΩ; 4 MHz to 500 MHz ac coupled, 50 Ω; 200 Hz to 500 MHz ac coupled, 1 MΩ.

Impedance: selectable, 1 MΩ shunted by less than 30 pF or 50 Ω (nominal).

Sensitivity: X1, 20 mV rms sine wave and 60 mV peak-to-peak pulse. X10, 250 mV rms sine wave and 750 mV peak-to-peak pulse.

Dynamic range: 50 Ω & 1 MΩ: 20 mV to 250 mV rms sine wave (X1); 250 mV to 2.0 V rms (X10).

Trigger level: adjustable over ±1.3 V dc.

Output: rear panel BNC connectors bring out CHAN A TRIG LEVEL and CHAN B TRIG LEVEL for convenient DVM monitoring.

### Common Input

Range: ac coupled 50 Ω, 4 MHz to 400 MHz; ac coupled 1 MΩ, 300 Hz to 400 MHz.

Impedance: 50 Ω remains 50 Ω; 1 MΩ becomes 500 kΩ shunted by <60 pF.

Sensitivity: 50 Ω: 40 mV rms; 1 MΩ: No change.

Dynamic range: 50 Ω: 40 mV to 500 mV rms (X1); 500 mV to 4 V rms (X10); 1 MΩ: No change.

### Time Base

#### Standard high stability oven.

Frequency: 10 MHz

Aging rate:  $<5 \times 10^{-10}$  per day.

Short term:  $<1 \times 10^{-11}$  for 1 sec average.

Temperature:  $<7 \times 10^{-9}$ , 0°C to 55°C.

#### Opt 001:

Frequency: 10 MHz

Aging rate:  $<3 \times 10^{-7}$  per month.

Short term:  $<2 \times 10^{-9}$  rms for 1 sec.

Temperature:  $<2 \times 10^{-6}$ , 25°C to 35°C.

$<5 \times 10^{-6}$ , 0°C to 55°C.

Line voltage:  $<1 \times 10^{-8}$ , ±10% from nominal.

External frequency standard input: input voltage >1.0 V rms into 1 kΩ required from source of 1, 2, 2.5, 5 or 10 MHz  $\pm 5 \times 10^{-8}$  ( $\pm 5 \times 10^{-6}$  for opt. 001).

Frequency standard output: >1 V rms into 50 Ω at 10.0 MHz sine wave.

### General

Display: 11 digit LED display and sign. Annunciator displays ksec to nsec, k to n, μHz to GHz. Decimal point is positioned with DISPLAY POSITION control or positioned after the first, second or third most significant digit if DISPLAY POSITION is in AUTO. Leading zeros are suppressed.

Overflow: asterisk is illuminated when display is overflowed.

Sample rate: continuously variable from <0.1 sec to >5 sec with front panel control. In HOLD position the last reading is maintained until the counter is reset.

External arm input: counter can be armed by a -1.0 V signal applied to the rear panel 50 Ω input.

External gate input: same conditions as for EXT ARM.

Gate output: >1 volt into 50 Ω.

Operating temperature: 0°C to 55°C.

Power requirements: 100/120/220/240 V rms +5% -10% 48 to 66 Hz, maximum power 250 VA.

Weight: 17 kg (37 lb).

Size: 132.6 H x 425 W x 495 mmD (5.22" x 16.75" x 19.5").

### Options and Accessories

001: Room Temperature Time Base

010: HP-IB Talk Only

011: HP-IB includes remote programming

012: HP-IB similar to OPT 011, but also includes slope and trigger level controls

908: Rack Flange Kit, number 5060-8740

10595A Board Extender Kit: For troubleshooting

K13-59992A: State machine tester to aid troubleshooting the arithmetic processor

K15-59992A: Standby power unit: Plug-in maintains oscillator operation without line voltage

### 5345A Plug-In Counter

#### 10590A Plug-In Adaptor

The 10590A allows the user to interface any of the obsolete 5245 series of plug-ins (except the 5264A) to the 5345A counter.

#### 10590A Plug-In Adapter

# ELECTRONIC COUNTERS

## Frequency and Time Data Acquisition System

### Model 5391A

- Capable of 100,000 measurements / second

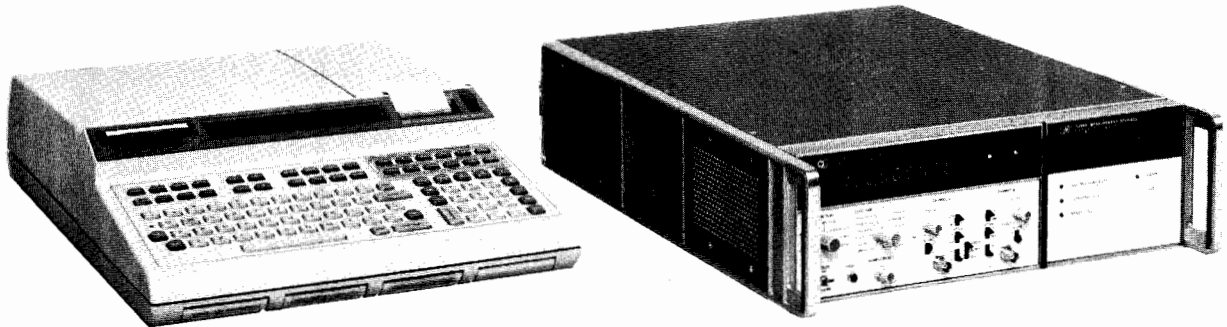

5391A Frequency and Time Data Acquisition System

### General

The HP5391A Frequency and Time Data Acquisition System combines the power of the HP5345A Universal Counter with the speed and storage capability of the HP5358A Measurement Storage Plug-In to allow you to make and store frequency or time measurements at rates as high as 100,000 measurements per second. The 5391A can help you characterize pulse width jitter by measuring and storing each pulse width and then computing statistical parameters such as min, max, mean, and standard deviation. Other application areas include nuclear time of flight studies, explosive testing and characterization, and frequency profile measurements.

The 5391A is a compact HP-IB system consisting of the 5345A Universal Counter with the 5358A Measurement Storage Plug-In, the 9825B Computing Controller, and a versatile software package providing utility application routines and diagnostic service routines.

### Application Example

Frequencies, periods, ratios, and time intervals may be measured and stored by the 5391A. A typical application, shown in the figure, is to measure and store every pulse width in a burst of pulses:

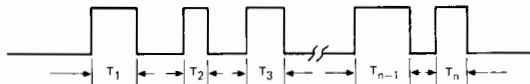

The 5345A counter makes a single shot time interval measurement (2 nanosecond resolution) for each pulse width. During the dead time between successive time intervals, the 5345A transfers the data to the 5358A Measurement Storage Plug-In. The time required for this transfer is  $7 \mu s + 1 \mu s/\text{digit transferred}$ . The graph plots transfer time required versus the time interval measured. If the dead time immediately following a measured time interval is greater than the required transfer time, the 5391A can make the measurement.

The 5391A, with its 9825B Controller, is capable of making and storing up to 1200 consecutive measurements for time intervals less than 2 milliseconds. Above 2 milliseconds, the 8K memory of the 5358A will limit the number, depending on the time interval.

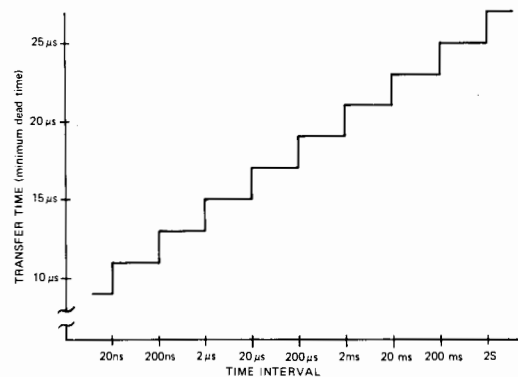

When the desired number of measurements in a run exceeds the maximum allowable, the maximum is taken and then stored as a block on the 9825B cassette. Subsequent blocks of measurements are taken and stored on cassette until the total desired number of measurements has been accumulated. The time required to transfer the measurement data from the 5358A to the 9825B and store it on cassette is on the order of seconds. During this time, no measurements can be made. The total number of measurements is program selectable from 1 to 9999.

### Systems Options

**325:** Deletes 9825B Controller (as well as HP-IB Interface)

### Ordering Information

- 5391A Basic System Includes:**
- 5345A Option 011 Electronic Counter
  - 5358A Measurement Storage Plug-in with 8K bytes of memory
  - 9825B Computing Controller (Includes 32K Bytes of Memory, and all needed ROMs)
  - 98034A HP-IB Interface System Software Cartridge
  - System and Instrument Manuals

### 5391A Basic System



- Fully automatic to 40 GHz
- Pulsed RF or CW measurement
- 60 ns minimum pulse width
- User definable offsets from front panel

### Specifications

#### Input Specifications (Pulse and CW Mode)

	5356A	5356B	5356C
<b>Frequency Range</b>	1.5-18 GHz	1.5-26.5 GHz	1.5-40 GHz
<b>Sensitivity:</b> 1.5-12.4 GHz 12.4-18 GHz 18-26.5 GHz 26.5-34 GHz 34-40 GHz	-20 dBm -15 dBm — — —	-20 dBm -15 dBm -15 dBm — —	-25 dBm -20 dBm -20 dBm -15 dBm -10 dBm
<b>Maximum Input</b> 1.5-12.4 GHz 12.4-18 GHz 18-26.5 GHz 26.5-40 GHz	+5 dBm +5 dBm — —	+5 dBm +5 dBm +5 dBm —	+5 dBm +15 dBm +15 dBm +15 dBm
<b>Damage Level*</b>	+25 dBm peak	+25 dBm peak	+25 dBm peak
<b>Impedance</b>	50 Ω NOMINAL	50 Ω NOMINAL	50 Ω NOMINAL
<b>SWR:</b> 1.5-10 GHz 10-18 GHz 18-26.5 GHz 26.5-34 GHz 34-40 GHz	<2:1 TYPICAL <3:1 TYPICAL — — —	<2:1 TYPICAL <3:1 TYPICAL <3:1 TYPICAL — —	<2:1 TYPICAL <3:1 TYPICAL <3:1 TYPICAL <3:1 TYPICAL <5:1 TYPICAL
<b>Connector</b>	N Male	SMA Male	APC 3.5 Male

\* see Option 006 for higher damage protection.

#### CW Mode

	5356A/B/C Auto Mode	5356A/B/C Man Mode
<b>FM Tolerance</b>	15 MHz p-p (60 MHz p-p in special FM mode) rate: dc -10 MHz	80 MHz p-p rate: dc -10 MHz
<b>AM Tolerance</b>	Any modulation index provided the minimum signal level is greater than the counter sensitivity.	
<b>Multiple Signal Discrimination</b>	Automatic Amplitude Discrimination (AAD). Automatically measures largest signal provided signal is 8 dB (TYPICAL) greater than any signal within 500 MHz and 20 dB (TYPICAL) greater than any signal over the full frequency range of the head.	
<b>Acquisition Time</b>	5356A/B = 400 ms 5356C = 1.4 s	15 ms
<b>LSD Displayed</b>	1 Hz ÷ 5345A Gate Time	
<b>Resolution</b>	± 2 x LSD ± 10 <sup>-10</sup> rms x FREQ	
<b>Accuracy</b>	± 2 x LSD ± 1 x 10 <sup>-10</sup> rms x FREQ ± time base error x FREQ	

#### Pulse Mode

	5356A/B/C Input Auto Mode	5356A/B/C Input Man Mode
<b>FM Tolerance</b>	50 MHz p-p Chirp	80 MHz p-p Chirp
<b>Acquisition Time</b>	5356A/B/C Input Man Mode: 0 5356A/B Input Auto Mode: 100 μs ÷ (EXT GATE WIDTH x PRF) + 650 ms for EXT GATE ≤ 100 μs (2 ÷ PRF) + 650 ms for EXT GATE > 100 μs 5356C Input Auto Mode: (8 ÷ PRF) + 1.55s + 100 μs ÷ (EXT GATE WIDTH x PRF) for EXT GATE ≤ 100 s. (10 ÷ PRF) + 1.55 s for EXT GATE > 100 μs.	
<b>Pulse Width</b> Min: Max:	100 ns 20 ms	75 ns 20 ms
<b>Pulse Repetition Frequency</b> Min: Max:	50 Hz 2 MHz	50 Hz 2 MHz
<b>Minimum ON/OFF RATIO</b>	25 dB TYPICAL	
<b>Maximum Video Feed-Through</b>	15 mV p-p TYPICAL for rf burst rise and fall times > 10 ns	
<b>Minimum EXT GATE WIDTH</b>	20 ns	
<b>LSD Displayed</b>	1 Hz ÷ 5345A GATE TIME	
<b>Resolution</b>	± 2 x LSD ± rms jitter*	
<b>Accuracy</b>	± 2 x LSD ± rms jitter* ± $\frac{.04}{\text{EXT GATE WIDTH}} \pm 3 \text{ KHz}$ ± Time base error X FREQ	

\* rms jitter = 100 Hz rms + 1 ÷ √(5345A GATE TIME) (EXT GATE WIDTH)

For EXT GATE signals generated by the 5355A, the EXT GATE WIDTH equals the input PULSE WIDTH minus 30 ns (TYPICAL) for the 5356A/B/C input and equals input PULSE width minus 65 ns (TYPICAL) for the 5355A 0.4-1.5 GHz input.

5355A

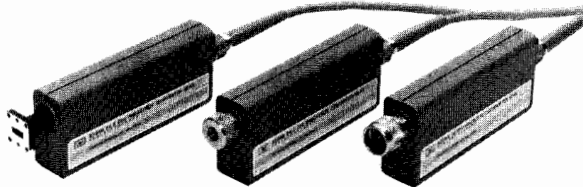

5356A/B/C

The 5355A automatic frequency converter plug in, together with the 5356A, 5356B, or 5356C frequency converter head, provides pulsed and CW frequency measurement capability to 18/26.5/40 GHz for the 5345A counter. A 0.4-1.5 GHz prescaled input offers pulsed and CW measurement for the lower microwave range even without one of the heads. The 5355A's internal microprocessor controls the measurement algorithm, computes the input microwave frequency, and displays it on the eleven digit 5345A display.

Superior pulsed RF performance is provided with selectable resolution to 100 Hz and better, with accuracy to 3 kHz. Internal pulse detection circuitry sets the counters gate for maximum resolution for any pulse width down to 75 ns. External gating allows samples as small as 20 nsec for performing dynamic frequency profiling of "CHIRPS" and other FM on the RF burst. This is also an excellent CW microwave counter, providing 1 Hz resolution in 1 second. Automatic amplitude discrimination and 60 MHz FM tolerance allows this counter to correctly measure carrier frequencies in the most difficult transmitted signals.

Microprocessor control provides automatic operation and diagnostic routines for quick easy failure isolation. The front panel keyboard provides user definable offsets including an mx ± b offset mode for receiver testing, where the local oscillator can be measured directly then multiplied by the appropriate harmonic number. Offsetting this by the receiver's IF allows the counter to conveniently display the tuned receiver frequency.

### Ordering Information

5355A Automatic Frequency Converter Plug-In (HP-IB Standard)

5356A 18 GHz Frequency Converter Head

Option 001 High Pass Filter

Option 006 Limiter Input Protection (+39 dBm)

5356B 26.5 GHz Frequency Converter Head

Option 001 18-26.5 GHz Waveguide Input

Option 006 Limiter Input Protection (+39 dBm)

5356C 40 GHz Frequency Converter Head

Option 001 26.5-40 GHz Waveguide Input

# ELECTRONIC COUNTERS

## Automatic Microwave Counters

Models 5342A & 5343A

- Microprocessor Controlled
- Automatic Measurement to 18 GHz / 26.5 GHz
- Wide FM Tolerance

- Simultaneous Display of Input Level
- High Sensitivity
- Automatic or Manual Operation



5342A



### Description

The 5342A and 5343A Microwave Counters provide Automatic Frequency Measurement up to 18 or 26.5 GHz in highly portable packages. The 5342A extends to 24 GHz optionally.

The powerful and versatile microprocessor controlled keyboards can accomplish offset tasks as a standard feature as well as providing user interactive diagnostic information. The eleven-digit display is sectionalized for easy readout to one hertz resolution.

Both units utilize the Harmonic Heterodyne down conversion technique which combines the best performance features of the Heterodyne Converter and Transfer Oscillator Techniques. Now Wide FM Tolerance is achievable along with high input sensitivity and automatic amplitude discrimination. This allows the counter to automatically measure the largest signal present within the counters' spectrum while ignoring all others.

### Amplitude Measurements (Option 002) (5342A Only)

Option 002 adds the ability to measure the input level of the incident sinewave signal. The instrument then displays this level in dBm. The eleven-digit LED display simultaneously presents frequency to 1 MHz resolution and amplitude to 0.1 dBm resolution. An added benefit from Option 002 is that dynamic range is extended so that frequency measurements to +22 dBm are accomplished. This extended dynamic range is also available without the amplitude measurement capability by ordering Option 003 (5342A only).

### FM Tolerance

The ability to measure a carrier frequency while being frequency modulated has broad appeal in the communications industry and elsewhere. The 5342A can tolerate 50 MHz peak-to-peak worst case FM in the wide mode, or the normal mode with accompanying faster acquisition time can be selected which gives 20 MHz peak-to-peak worst case FM. The 5343A offers a selection of three (3) acquisition times including a 200 ms "fast" acquisition time with 6 MHz peak-to-peak worst case FM Tolerance.

### Offset Functions

The power and versatility of the microprocessor controlled keyboard allows the user to perform offset functions by means of a few key strokes. Frequency values to 1 Hz resolution can be added to or subtracted from the measured frequency for IF offset application and also for monitoring variances about a given frequency. The 5343A also offers an  $m \times \pm b$  mode for receiver testing where the measured local oscillator can be multiplied by the appropriate harmonic number. Adding the IF as an offset has the counter displaying the received frequency.

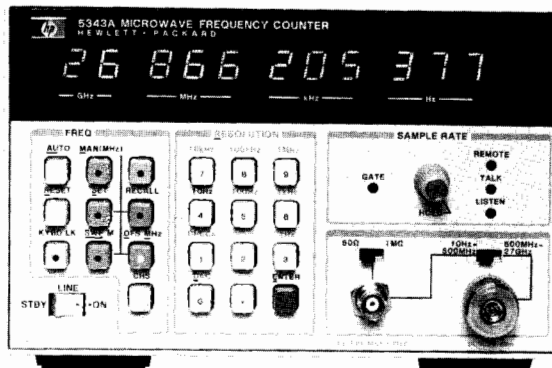

5343A



With Option 002 installed (5342A) this offset capability can be applied to the amplitude measurements. These offset values can be recalled to the display at any time for reviewing.

### Digital-To-Analog Converter (Option 004)

The ability to convert any three consecutive displayed digits (frequency or amplitude) into an analog voltage output on the rear panel is added by Option 004. This makes the monitoring of microwave oscillator frequency drift easy to make with only a strip chart recorder.

### Microwave Limiter (Option 006)

High input level protection is available with Option 006. It provides built-in microwave limiter protection for CW input signals up to +39 dBm (8 watts). This option is very useful for high input level environments where expensive input circuitry of the counter could be damaged.

### HP Interface Bus For Systems Use (Option 011)

The full power of HP-IB (IEEE 488) is brought to fruition with the addition of Option 011. Front and rear panel controls can now be remotely programmed and measurement results can be outputted to HP-IB-compatible instruments, calculators, or computers. This interface also can select a given frequency in the manual mode and reduce acquisition time to typically less than 80 msec.

### 5342A Specifications

#### Signal Input

##### Input 1

**Frequency range:** 5342A: 500 MHz to 18 GHz  
5343A: 500 MHz to 26.5 GHz

**Sensitivity:** 5342A: 500 MHz to 12.4 GHz: -25 dBm  
12.4 GHz to 18 GHz: -20 dBm  
5343A: 500 MHz to 12.4 GHz: -33 dBm  
12.4 GHz to 18. GHz: -28 dBm  
18.0 GHz to 26.5 GHz: -23 dBm

**Maximum Input:** +7 dBm (See OPT 002, 003 for higher levels)

**Impedance:** 50 ohms, nominal

**Connector:** 5342A: Precision Type N female  
5343A: APC 3.5 male with collar

**Damage level:** +25 dBm, peak (See OPT 006 for +39 dBm protection)

**Coupling:** DC to Load, AC to instrument.

**SWR:** < 2:1, 500 MHz-10 GHz  
< 3:1, 10 GHz-18 GHz/26.5 GHz



**FM tolerance:** switch selectable (rear panel)

**Wide:** 50 MHz p-p worst case

**Normal:** 20 MHz p-p worst case

**Narrow:** (5343A only) 6 MHz p-p worst case

For Modulation Rates from DC to 10 MHz.

**AM tolerance:** any modulation index provided the minimum signal level is not less than the sensitivity specification.

**Automatic amplitude discrimination:** automatically measures the largest of all signals present, providing that signal is 6 dB above any signal within 500 MHz; 20 dB above any signal, 500 MHz–18 GHz/26.5.

**Modes of operation:**

**Automatic:** counter automatically acquires and displays highest level signal within sensitivity range.

**Manual:** center frequency entered to within  $\pm 40$  MHz of true value.

**Acquisition Time**

**Automatic mode:**

Narrow FM 200 ms worst case (5343A only)

Normal FM 530 ms worst case

Wide FM 2.4 s worst case

**Manual mode:** 80 ms after frequency entered

**Input 2**

**Frequency range:** 10 Hz to 520 MHz direct count.

**Sensitivity:** 50  $\Omega$ : 10 Hz to 520 MHz: 25 mV rms. 1 M $\Omega$ : 10 Hz to 25 MHz: 50 mV rms.

**Impedance:** selectable 1 M $\Omega$ , <50 pF or 50  $\Omega$  nominal.

**Coupling:** AC.

**Connector:** type BNC female.

**Maximum input** 50  $\Omega$ : 3.5 V rms (+24 dBm) or 5 V DC, fuse protected

1 M $\Omega$ : 200 V DC + 5 V rms

**Time Base**

**Crystal frequency:** 10 MHz.

**Stability**

**Aging rate:**  $< 1 \times 10^{-7}$ /month

**Temperature:**  $< \pm 1 \times 10^{-8}$  over the range 0°C to 50°C

**Short term:**  $< 1 \times 10^{-9}$  for 1 second averaging time.

**Line variation:**  $< \pm 1 \times 10^{-7}$  for 10% change from nominal.

**Output frequency:** 10 MHz,  $\geq 2.4$  V square wave (TTL compatible) 1.5 p-p V into 50  $\Omega$  available from rear panel BNC.

**External time base:** requires 10 MHz, 3.0 V p-p sine wave or square wave into 1 K $\Omega$  via rear panel BNC connector. Switch selects either internal or external time base.

**Optional Time Base (Option 001)**

**Crystal frequency:** 10 MHz.

**Stability**

**Aging rate:**  $< 5 \times 10^{-10}$ /day after 24-hour warmup

**Temperature:**  $< 7 \times 10^{-9}$  over the range 0°C to 50°C

**Short term:**  $< 1 \times 10^{-10}$  for 1 second averaging time

**Line variation:**  $< 1 \times 10^{-10}$  for 10% change from nominal

**Warm-up:**  $< 5 \times 10^{-9}$  of final value 20 minutes after turn-on, at 25°C.

**Amplitude Measurement (OPT 002) (5342A Only)**

**Input 1**

**Frequency range:** 500 MHz–18 GHz.

**Dynamic range (frequency and level):**

–22 dBm to +22 dBm 500 MHz to 12.4 GHz

–15 dBm to +22 dBm 12.4 GHz to 18 GHz

**Maximum operating level:** +22 dBm

**Damage level:** +25 dBm, peak

**Resolution:** 0.1 dBm

**Accuracy:**  $\pm 1.5$  dB (excluding mismatch uncertainty).

**SWR:** <2:1 (amplitude measurement).

<5:1 (frequency measurement).

**Measurement time:** 100 ms + frequency measurement time.

**Display:** simultaneously displays frequency to 1 MHz resolution and level. (Option 011 provides full frequency resolution on HP-1B).

**Input 2 (50  $\Omega$  impedance only)**

**Frequency range:** 10 MHz–520 MHz.

**Dynamic range (frequency and level):** –17 dBm to +20 dBm

**Damage level:** +24 dBm.

**Accuracy:**  $\pm 1.5$  dB (excluding mismatch uncertainty).

**SWR:** <1.8:1.

**Measurement time:** 100 ms + frequency measurement time.

**Display:** simultaneously displays frequency and input level.

**Extended Dynamic Range (OPT 003) (5342A Only)**

**Frequency range:** 500 MHz to 18 GHz.

**Sensitivity:** 500 MHz to 12.4 GHz: –22 dBm

12.4 GHz to 18 GHz: –15 dBm

**Maximum operating level:** +22 dBm

**Dynamic range:** 500 MHz to 12.4 GHz: 44 dB

12.4 GHz to 18 GHz: 37 dB

**Damage level:** +25 dBm, peak

**SWR:** <5:1

**Microwave Limiter (Option 006)**

**Input 1**

**Frequency range:** 5342A: 500 MHz – 18 GHz

5343A: 500 MHz – 26.5 GHz

**Sensitivity:** 5342A: 500 MHz – 12.4 GHz: –21 dBm

12.4 GHz – 18 GHz: –15 dBm

5343A: 500 MHz – 12.4 GHz: –30 dBm

12.4 GHz – 18 GHz: –24 dBm

18 GHz – 26.5 GHz: –18 dBm

**Maximum Operating Level:** +7 dBm

**Damage Level:** 500 MHz – 6 GHz: +39 dBm (8W)

6 GHz – 18 GHz: +36 dBm (4W)

(5343A only) 18 GHz – 26.5 GHz: +34.8 dBm (3W)

**SWR:** 2.5:1, 500 MHz – 10 GHz

3.5:1, 10 GHz – 18 GHz/26.5 GHz

**Note:** Option 006 is incompatible with Option 002, Option 003, and Option 005 for 5342A. Please consult factory special to combine Options 005 and 006.

**General**

**Accuracy:**  $\pm 1$  count  $\pm$  time base error.

**Resolution:** front panel push buttons select 1 Hz to 1 MHz

**Display:** 11 digit LED display, sectionalized to read GHz, MHz, kHz, and Hz.

**Self-check:** selected from front panel pushbuttons displays 75 MHz for resolution chosen.

**Frequency offset:** selected from front panel pushbuttons. Displayed frequency is offset by entered value to 1 Hz resolution.

**Frequency multiply:** (5343A only) (mx  $\pm$  b) measured data is multiplied by any integer up to 99. Offset can then be added or subtracted. Front panel selectable.

**Totalize (5343A only):** input 2 can totalize at rates up to 520 MHz. Readout on the fly is controlled by front panel or HP-1B.

**Sample rate:** variable from less than 20 ms between measurements to HOLD which holds display indefinitely.

**IF out:** rear panel BNC connector provides 25 MHz to 125 MHz output of down-converted microwave signal.

**Power requirements:** 100/120/220/240 V rms, +5%, –10%, 48–66 Hz; 100 VA max.

**Weight:** net 9.1 kg (20 lb.). Shipping 12.7 kg (28 lb.).

**Size:** 133 mm H x 213 W x 498 mm D (5.25" x 8.38" x 19.6").

**Options and Accessories**

**001:** High Stability Time Base

**002:** Amplitude Measurement (5342A Only)

**003:** Extended Dynamic Range (5342A Only)

**004:** Digital-To-Analog Converter

**005:** Frequency Extension to 24 GHz (5342A Only)

**006:** Limiter Input Protection (+39 dBm)

**011:** Digital Input/Output (HP-1B) (Cable Not Incl)

**908:** Rack Mounting Adapter Kit

**K70-59992A:** Rack Mounting Adapter Kit With Slot

For access to front connectors from rear.

**10842A:** Extender Board Kit

**5342A Frequency Counter**

**5343A Frequency Counter**





# ELECTRONIC COUNTERS

Microwave Source Synchronizer  
Model 5344S

- Convenient CW Lock
- High Performance Microwave Counter
- Narrow Band Locked Sweeps
- Wideband Lock and Roll

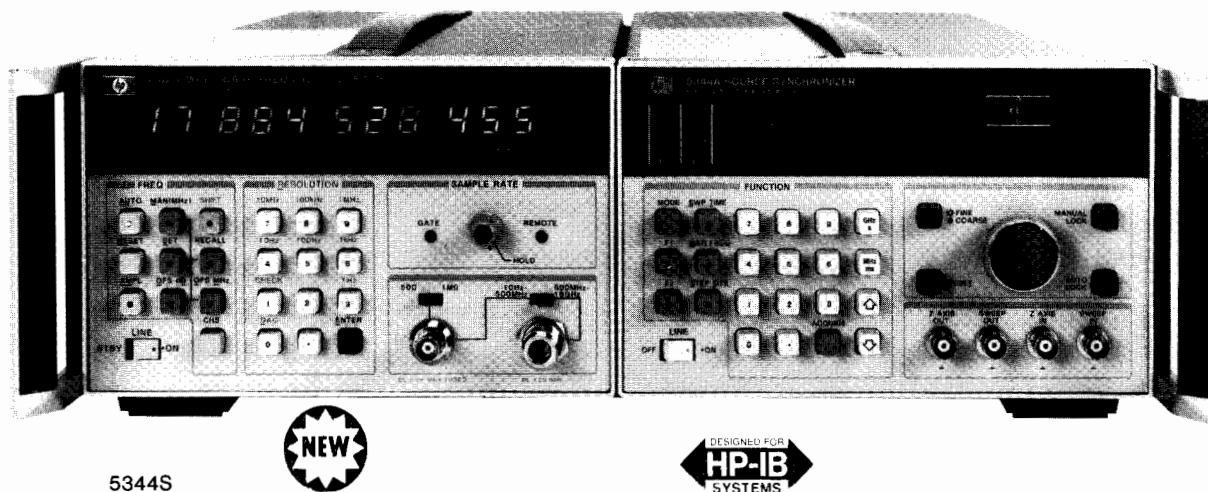

## Description

The 5344S Microwave Source Synchronizer phase locks your microwave signal to a high stability quartz oscillator in the 5344S. This greatly increases the frequency accuracy and repeatability of the microwave source in CW or swept operation. The long-term frequency stability ( $5 \times 10^{-10}$ /day) of your source now becomes comparable to that of a microwave synthesizer but at a much lower cost. The 5344S is a full rack system consisting of the 5344A Source Synchronizer and the 5342A 18 GHz Microwave Counter with an Option 001 High Stability Timebase and Option 011 HP-IB Interface (HP's implementation of IEEE Standard 488). These two half rack instruments are mechanically and electrically integrated at the factory.

For applications requiring direct phase locked frequencies up to 26.5 GHz, the 5344S Option 043 is available which replaces the 5342A with the 5343A 26.5 GHz Microwave Counter.

## 5344S Specifications

### Lock Input

**Frequency coverage:** 500 MHz–18 GHz  
500 MHz–26.5 GHz (5344S Option 043)

**Resolution:** 1 Hz

**Long-term stability:** equal to timebase in counter

	Standard (5342A)	Option (5343A)
<b>Minimum lock level:</b>		
500 MHz–12.4 GHz	–22 dBm	–30 dBm
12.4 GHz–18.0 GHz	–19 dBm	–25 dBm
18.0 GHz–26.5 GHz	—	–20 dBm

**Lock time (TYPICAL):** dependent on source. Typical times with 8350A/83592A source

Manual Lock: 900 ms Apply to CW or LOCK/ROLL modes.  
Auto Lock: 1.5 s For CF/ $\Delta$ F or START/STOP add  
300 ms.

Option 043: all lock times reduced by 400 ms

**Accuracy (CW):** equal to counter accuracy

### Capture range (Manual Mode):

CW or LOCK/ROLL (start frequency):  $\pm 25$  MHz for sources with FM sensitivity greater or equal to 5 MHz/V. Five volts  $\times$  FM sensitivity for sources less than 5 MHz/V sensitivity.

**FM output connector:** rear panel BNC female

**FM output drive:**  $\pm 10$  V in series with 250 ohms

**Polarity:** automatic selection

## Operating Modes

**CW:** Manual Lock—Source is manually tuned to within capture range of desired frequency

Auto Lock—Source is tuned automatically by the 5344S via the HP-IB to bring it into lock.

**CW/ $\Delta$ F sweep (Manual Lock or Auto Lock):** performs a phase continuous locked sweep from  $CF - \frac{1}{2}\Delta F$  to  $CF + \frac{1}{2}\Delta F$  in a sweep time defined by the user. Sweeps up to 40 MHz are available.

**START/STOP sweep (Manual Lock or Auto Lock):** performs a phase continuous locked sweep from START frequency to STOP frequency over a sweep time defined by the user. Sweeps up to 40 MHz are available.

**Accuracy—CF/ $\Delta$ F and START/STOP modes**

Start or Stop Frequencies: 1 kHz TYPICAL

Linearity:  $\pm 0.05\%$  of sweep with respect to Sweep Out voltage (TYPICAL)

**Resolution:** 1 Hz for CF/ $\Delta$ F, START, and STOP frequencies

**Sweep time:** available in CF/ $\Delta$ F and START/STOP modes. Continuously adjustable from 10 ms to 100 s.

**Marker frequencies:** Available in CF/ $\Delta$ F and START/STOP modes. Up to four frequency markers are settable across the sweep band.

**LOCK/ROLL (Manual Lock or Auto Lock):** sweep is phase-locked by the 5344S to a precise start frequency and then control is transferred to the sweeper to complete the sweep. The source determines sweep time, marker frequencies, and stop frequency.

## General

**Microwave counter specifications:** refer to 5342A or 5343A data.  
**Operating temperature:** 0°C to 50°C

**Power requirements:** 100/120/220/240 V rms, +5%, –10%  
48–66 Hz; 125 VA max (5344A) plus 100 VA Max (5342A)

**Size:** 133 mm H x 426 mm W x 498 mm D (5¼" x 16¾" x 19⅝")

**Weight:** net 18.7 kg (41 lbs.) Shipping 25.9 kg (57 lbs.)

**Front handles:** supplied with the instrument.

## Ordering Information

**Option 043** 26.5 GHz operation (5343A microwave counter replaces the 5342A in the system)

**Option 142** Deletes 5342A microwave counter

**Option 908** Rack mounting flange kit for use upon removal of supplied front handles

**Option 913** Rack mounting flange kit for use with supplied front handles

**5344S** Microwave Source Synchronizer (18 GHz)



- Single input 10 Hz to 18 GHz
- Automatic amplitude discrimination
- High sensitivity  $-35$  dBm

- Optional extension to 23 GHz
- High AM and FM tolerance
- Exceptional reliability



5340A



The 5340A Frequency Counter provides an easily used, versatile instrument for the direct measurement of frequencies from 10 Hz through 18 GHz via a single input connector. Utilizing microwave samplers incorporated in advanced phase-lock loops, this counter excels in many important specification parameters. It is therefore suited to a wide range of applications.

The exceptional sensitivity of this instrument enhances measurement in the microwave field, where signals are commonly low level and many times are connected via directional couplers or lossy devices. Wide tolerance of AM, FM, and residual noise insure accurate measurement of microwave carrier frequencies despite the presence of these deviations. Automatic amplitude discrimination allows the 5340A to choose the largest signal in a spectrum (250 MHz to 18 GHz) and measure only that signal's frequency, ignoring all others.

Access to the HP Interface Bus via Option 011 provides a particularly flexible system interface. The ability to program octave range via this input allows reduction of acquisition time to typically less than 40 ms. AN 181-1 describes the use of a calculator-controlled measurement system built around the HP Interface Bus for microwave component testing.

## 5340A Specifications

### Signal Input

#### Input 1

**Range:** 10 Hz to 18 GHz.

**Symmetry:** sinewave or squarewave input (40% duty factor, worst case).

**Sensitivity:**  $-30$  dBm, 10 Hz to 500 MHz;  $-35$  dBm, 500 MHz to 10 GHz;  $-25$  dBm, 10 to 18 GHz.

**Dynamic range:** 37 dB, 10 Hz to 500 MHz; 42 dB, 500 MHz to 10 GHz; 32 dB, 10 GHz to 18 GHz.

**Impedance:** 50  $\Omega$ .

**VSWR:**  $<2:1$ , 10 Hz–12.4 GHz;  $<3:1$ , 12.4–18 GHz.

**Connector:** precision Type N.

**Coupling:** dc to load, ac to instrument.

**Damage level:**  $+30$  dBm. Total power (ac + dc) not to exceed 1 watt. See Option 006 for up to  $+39$  dBm protection.

**Acquisition time:**  $<150$  ms mean typical.

#### Input 2

**Range:** 10 Hz–250 MHz direct count.

**Sensitivity:** 50 mV rms. 150 mV p-p pulses to 0.1% duty factor; minimum pulse width 2 ns.

**Impedance:** 1 M $\Omega$  shunted by  $<25$  pF.

**Connector:** type BNC female.

**Coupling:** ac

**Maximum input:** 200 V rms, 10 Hz to 100 Hz; 20 V rms, 100 Hz to 100 kHz; 2 V rms, 100 kHz to 250 MHz.

**Automatic amplitude discrimination:** automatically selects the strongest of all signals present (within 250 MHz to 18 GHz phase-lock range), providing signal level is: 6 dB above any signal within 200 MHz; 10 dB above any signal within 500 MHz; 20 dB above any signal, 250 MHz–18 GHz.

**Maximum AM modulation:** any modulation index as long as the minimum voltage of the signal is not less than the sensitivity specification.

### Time Base

**Crystal frequency:** 10 MHz.

### Stability

**Aging rate:**  $<3 \times 10^{-7}$  per month.

**Short term:**  $<5 \times 10^{-10}$  rms for 1 second averaging time.

**Temperature:**  $<\pm 2 \times 10^{-6}$  over the range of 0°C to 50°C.

**Line variation:**  $<\pm 1 \times 10^{-7}$  for 10% line variation from nominal.

**Output frequency:** 10 MHz,  $\geq 2.4$  V square wave (TTL compatible) available from rear panel BNC.

**External time base:** requires 10 MHz approximately 1.5 V p-p sine wave or square wave into 1 k $\Omega$  via rear panel BNC. Switch selects either internal or external time base.

**Optional time base (Opt 001) aging rate:**  $<5 \times 10^{-10}$  per day after 24 hour warm-up for less than 24 hour off-time.

### General

**Accuracy:**  $\pm 1$  count  $\pm$  time base error.

**Resolution:** front panel switch selects 1 MHz, 100 kHz, 10 kHz, 1 kHz, 100 Hz, 10 Hz, or 1 Hz.

**Display:** eight digit LED with positioned decimal point and appropriate measurement units of kHz, MHz, or GHz.

**Self check:** counts and displays 10 MHz for resolution chosen.

**Sample rate:** controls time between measurements. Continuously adjustable from 50 ms typical to 5 seconds. HOLD position holds display indefinitely. RESET button resets display to zero and activates a new measurement.

**Operating temperature:** 0°C to 50°C.

**Power:** 115 V or 230 V  $\pm 5\%$ ,  $-10\%$ , 48–66 Hz, 100 VA.

**Weight:** net, 11.3 kg (25 lb). Shipping, 14.1 kg (31 lb).

**Size:** 88.2 H x 425 W x 467 mm D (3.47" x 16.75" x 18.39").

### Options

**001:** High Stability Time Base

**002:** Rear Panel Connectors

**005:** Frequency Extension to 23 GHz

**006:** Limiter Input Protection ( $+39$  dBm)

**011:** Remote Programming-Digital Output (HP-IB).

**908:** Rack Flange Kit

## 5340A Frequency Counter



# ELECTRONIC COUNTERS

## Universal Time Interval Counter

Model 5370A

- 20 ps single shot time interval counter
- Statistics
- Automatic calibration of systematic errors
- Positive or negative time intervals
- Frequency and period to 100 MHz

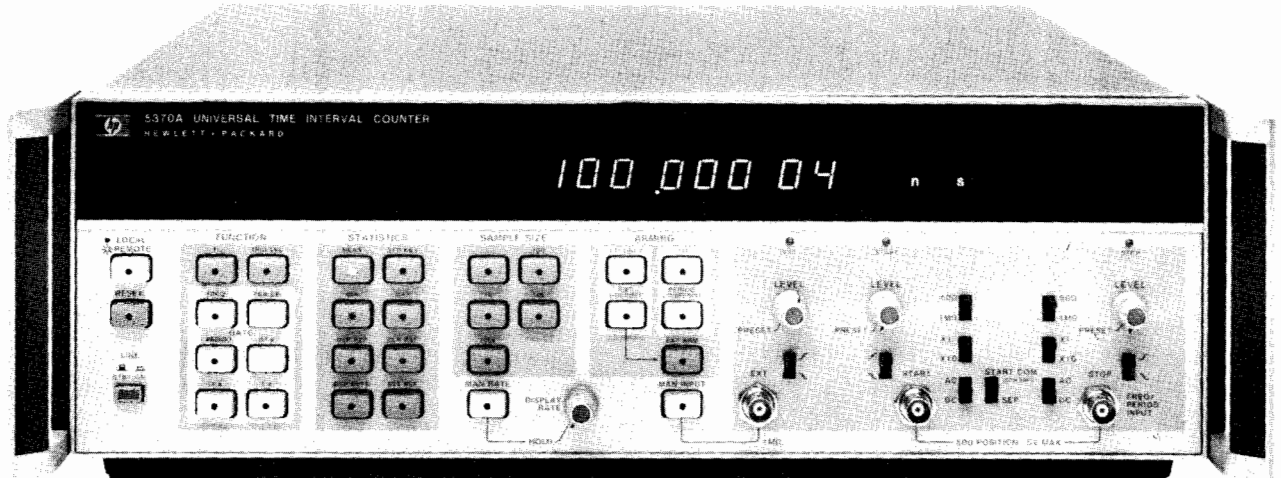

5370A



The 5370A Universal Time Interval Counter represents the highest resolution single-shot time interval counter available today. The counter utilizes a new concept of phase locked vernier interpolation, which allows single-shot time interval measurements with  $\pm 20$  ps resolution. This technique allows positive, zero and negative time intervals to be measured. High resolution period and frequency measurements may also be made.

All major front panel controls including trigger level are programmable by means of the Hewlett-Packard Interface Bus (HP-IB).

User convenience is increased by the inclusion of a microprocessor, which extends the usefulness of the instrument by offering the statistical functions of mean, standard deviation, max, and min for repetitive time intervals. A user-defined time interval reference is included for the cancellations of systematic errors.

The high resolution time interval capability makes the instrument ideal for IC testing, radar and laser ranging, digital communications, ballistics and nuclear measurements.

### Functions

**TI:** time interval function measures time difference from the START to the STOP channel. In the  $\pm$ TI mode, the counter will measure the time from the first event in either channel to the first event in the other channel. The microprocessor affixes a negative sign to the display if the stop channel event occurred first.

The negative time feature allows applications like differential phase measurement between two waveforms to be continuously monitored even though the phase changes from a positive to a negative drift. Statistical functions are available in both TI modes.

**Trig Lvl:** measures the trigger levels of START and STOP channels and displays both levels simultaneously with 10 mV resolution. Additional equipment like an oscilloscope or DVM is not required.

**Freq:** measures the frequency of the STOP channel signal by taking the reciprocal of a period average. Both timed gates and single period gates are available. In the single period mode, resolution may be improved by using a larger sample size. Statistics are available in the single period mode.

The exceptionally high resolution (11-12 digits per second) of the 5370A makes the instrument ideal for directly measuring the drift of oscillators and other applications requiring exceptionally high frequency resolution.

**Period:** measures the period average of STOP channel events. Statistics are available in the single period mode, but not with timed gates.

### Statistics

Statistical functions allow much more complete characterization of time intervals. In addition to the mean, both the max and min within a selected sample size are available and also the standard deviation. In many cases, these parameters are of more interest than the mean. For example, in a digital communications system, the limits of pulse jitter as described by the max and min could be of primary interest. For a normal distribution of jitter, the standard deviation gives the rms jitter directly.

**Sample size:** push-button selectable to 1,100, 1K, 10K, and 100K samples.

**Mean:** displays the mean estimate which is the average for the selected sample size.

**Std dev:** displays a standard deviation estimate for the selected sample size.

**Min:** displays the minimum time interval measured within the selected sample size.

**Max:** displays the maximum time interval measured within the selected sample size.

### Arming

Extremely flexible arming greatly extends the usefulness of the 5370A into new applications. "Hold-off" features allow complex pulse trains to be measured by preventing "stop channel" arming until the removal of an external "gating" signal. An example could be the measurement of time from a radar or laser send pulse to the return pulse, where depending on the range of the object, several return pulses may occur before the return pulse of interest.

Other methods of arming allow the counter to be externally gated by an input waveform which very precisely controls both measurement duration and the time position at which the measurement occurs. Applications are in the frequency profiling of VCO's, pulsed rf bursts, or sweep linearity investigations.

The following modes of arming are available:

#### +TI

Internally armed - no hold-off

Externally armed - no hold-off

Externally armed - external hold-off

#### $\pm$ TI

External arming

Internal arming



## Programming

Major controls are programmable as standard via the HP-IB making the 5370A an economical, versatile unit for systems applications.

### Data Output Rate

- 1) HP-IB: 10-20 readings per second.  
Dead time between measurements within a sample is 330  $\mu$ s.
- 2) Fast Binary: 6 kHz  
Dead time between measurements is 165  $\mu$ s.

## 5370 Specifications

**Sensitivity:** 100 mV p-p, 35 mV rms sine wave  $\times$  attenuator setting.

**Impedance:** selectable 1 M $\Omega$ //30 pF or 50  $\Omega$  nominal.

**Trigger level:** -1.3V to 0.5V, adjustable; 10 mV displayed resolution.

**Trigger slope:** independent selection of + or - slope.

**Attenuators:**  $\times 1$  and  $\times 10$  nominal.

### Dynamic range (preset):

- 50  $\Omega$   $\times 1$ : 100 mV to 1 V p-p pulse;  $\times 10$ : 1 V to 7 V p-p pulse  
 1 M $\Omega$   $\times 1$ : 100 mV to 1 V p-p pulse;  $\times 10$ : 1 V to 10 V p-p pulse  
 Dynamic range for rms sine wave is one-third of the above values.

### Signal operating range:

- 50  $\Omega$   $\times 1$ : -2.5 V to 1 V;  $\times 10$ : -7 V to 7 V  
 1 M $\Omega$   $\times 1$ : -2.5 V to 1 V;  $\times 10$ : -25 V to 10 V

**Coupling:** AC or DC switch selectable.

**Minimum pulse width:** 5 ns

### Maximum input:

- 50  $\Omega$   $\times 1$ :  $\pm 7$  V DC  
 7 V rms below 5 MHz  
 3.5 V rms (+24 dBm) above 5 MHz  
 $\times 10$ :  $\pm 7$  V DC, 7 V rms (+30 dBm)  
 1 M $\Omega$   $\times 1$ :  $\pm 350$  V DC  
 250 V rms to 20 kHz decreasing to 3.5 V rms above 5 MHz  
 $\times 10$ :  $\pm 350$  V  
 250 V rms to 20 kHz decreasing to 35 V rms above 5 MHz

### Common Input

All specifications are the same as for separate operation with the following differences:

**Impedance:** 1 M $\Omega$  becomes 500 k $\Omega$  shunted by <60 pF. 50  $\Omega$  same as in separate.

### Sensitivity (preset):

- 50  $\Omega$   $\times 1$ : 200 mV p-p, 70 mV rms;  $\times 10$ : 2 V p-p, 700 mV rms  
 1 M $\Omega$ : same as in separate

### Dynamic range (preset):

- 50  $\Omega$   $\times 1$ : 200 mV to 2 V p-p pulse;  $\times 10$ : 2 V to 5 V p-p pulse  
 1 M $\Omega$ : same as in separate

### Maximum input:

- 50  $\Omega$   $\pm 5$  V DC or 5 V rms  
 1 M $\Omega$  same as in separate

**Attenuators:** Becomes  $\times 2$  and  $\times 20$  for 50  $\Omega$

## Time Interval Measurements

### Time Interval Range

- $\pm$  **Mode:** -10 seconds to +10 seconds including 0 seconds  
 + **Only mode:** 10 ns to 10 seconds  
**Sample size. (N):** 1, 100, 1000, 10,000, 100,000  
 1 to 16777215 via HP-IB

**Statistics:** Mean, Standard Deviation, Maximum, Minimum. Time between measurements 330  $\mu$ s; minimum rise time 1 ns

**Least significant digit displayed:** 20 ps /  $\sqrt{N}$

### Resolution:

$(\pm 100 \text{ ps rms} \pm \text{Start Trigger Error} \pm \text{Stop Trigger Error}) \div \sqrt{N}$

**Accuracy:**  $\pm$  Resolution  $\pm$  Time Base Error  $\times$  Time Interval  
 $\pm$  Trigger Level Timing Error  $\pm$  1 ns Systematic

### Trigger error =

$$\sqrt{(150 \mu\text{V})^2 + e_n^2}$$

Input voltage slew rate (V/s) at trigger point secs rms

where 150  $\mu$ V is the typical rms input amplifier noise on the 5370A and  $e_n$  is the rms noise of the input signal for a 500 MHz bandwidth.

### Trigger level timing error =

25 mV  $\div$  Input voltage slew rate (V/s) at trigger point

## Frequency Measurements

**Frequency range:** 0.1 Hz to 100 MHz

### Timed gates

**Internal gate time:** 1 period, 0.01, 0.1, 1 seconds

**Least significant digit displayed:**  $\frac{20 \text{ ps}}{\text{Gate Time}} \times \text{FREQ}$

### Resolution:

$$\pm \frac{100 \text{ ps}}{\text{Gate Time}} \times \text{FREQ} \pm 1.4 \frac{\text{Trigger Error}}{\text{Gate Time}} \times \text{FREQ}$$

**Accuracy:**  $\pm$  Resolution  $\pm$  (Time Base Error)  $\times$  FREQ  
 $\pm$  (100 ps Systematic  $\div$  Gate Time)  $\times$  FREQ

**Statistics:** Mean

### Sample Mode (Single Period)

**Sample size:** same as Time Interval

**Least significant digit displayed:** 20 ps /  $\sqrt{N} \times \text{FREQ}$

### Resolution:

$$\pm \frac{100 \text{ ps}}{\text{Gate Time}} \times \text{FREQ} \pm 1.4 \frac{\text{Trigger Error}}{\text{Period} \sqrt{N}} \times \text{FREQ}$$

**Accuracy:**  $\pm$  Resolution  $\pm$  (Time Base Error)  $\times$  FREQ  
 $\pm$  (100 ps Systematic  $\div$  Period)  $\times$  FREQ

**Statistics:** Mean, Standard Deviation, Maximum, Minimum.

### External Gate

**Gate input:** 20 ns to 10 seconds

**Resolution and accuracy** estimates may be made with the same specifications as Timed Gates above.

## Period Measurements

**Period range:** 10 ns to 10 seconds

### Timed gates

**Internal gate time:** 1 period, 0.01, 0.1, 1 seconds

**Least significant digit displayed:**  $\frac{20 \text{ ps}}{\text{Gate Time}} \times \text{PERIOD}$

### Resolution:

$$\pm \frac{100 \text{ ps}}{\text{Gate Time}} \times \text{PERIOD} \pm 1.4 \frac{\text{Trigger Error}}{\text{Gate Time}} \times \text{PERIOD}$$

**Accuracy:**  $\pm$  Resolution  $\pm$  Time Base Error  $\times$  PERIOD  
 $\pm$  (100 ps Systematic  $\div$  Gate Time)  $\times$  PERIOD

### Sample Mode (Single Period)

**Sample size (N):** same as Time Interval.

**Least significant digit displayed:** 20 ps /  $\sqrt{N}$

**Resolution:**  $\pm 100 \text{ ps} / \sqrt{N} \pm 1.4 \text{ Trigger Error} / \sqrt{N}$

**Accuracy:**  $\pm$  Resolution  $\pm$  Time Base Error  $\times$  PERIOD  
 $\pm 100 \text{ ps Systematic}$

**Statistics:** Mean, Standard Deviation, Maximum Minimum

### External Gate

**Gate input:** 20 ns to 10 seconds

**Resolution and accuracy** estimates may be made with the same specifications as timed measurements above.

## Time Base

High Stability Oven Oscillator

**Frequency:** 10 MHz

**Aging:**  $< 5 \times 10^{-10}$  per day

**Temperature:**  $< 2.5 \times 10^{-9}$ , 0 $^\circ$  C to 50 $^\circ$  C

## General

**Display:** 16 digits, suppressed leading zeros.

**Size:** 133 H  $\times$  426 W  $\times$  521 mm D (5.25"  $\times$  16.75"  $\times$  20.5").

**Weight:** 32 lbs.

**Power requirements:** 100, 120, 220, or 240 V ac +5%–10%, 48 to 66 Hz, less than 250 VA.

**Front handles:** supplied with instrument.

## 5370A Universal Time Interval Counter

**Option 908:** Rack Flange Kit for use without handles

**Option 913:** Rack Flange Kit for use with supplied front handles

**10870A:** Service Kit Accessory



# ELECTRONIC COUNTERS

## Time Interval Probes and Preamp

Models 5363B & 10855A

- Precise trigger level setting
- Wide input dynamic range
- Measurements at point under test
- Minimum circuit loading
- HP-IB programmable

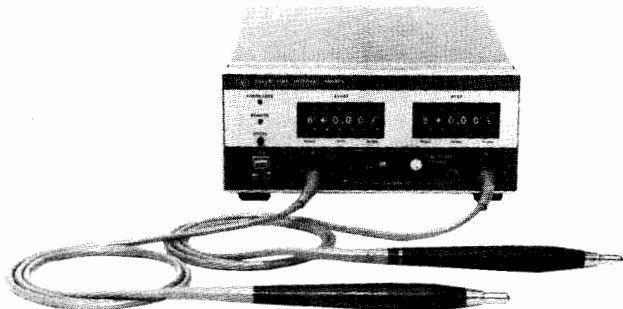

5363B



### 5363B Time Interval Probes Enhanced Counter Measurements

The 5363B provides the necessary input signal conditioning to allow a universal counter to make highly accurate and repeatable time interval measurements. Counters such as the 5345A, 5370A, 5335A, and 5328A when teamed-up with the 5363B can now make more accurate rise time, fall time, slew rate, propagation delay, and other complex measurements—even on signals that may exceed the counter's dynamic range. A unique trigger point calibration scheme insures that the digitally selected values (manually or via HP-IB) is the actual trigger point rather than some unspecified "best estimate" of the trigger point as in hysteresis compensation.

#### Wide Dynamic Range, Fine Trigger Level Settability

Greatly improved dynamic range allows the trigger point to be selected in 10 mV increments from  $-9.99$  V to  $+9.99$  V. The enhanced trigger level accuracy offers capability far superior to built-in counter attenuators.

#### Minimized Circuit Loading

High impedance, low capacitance active probes minimize circuit loading and pulse distortion. Each probe contains two measurement channels (start and stop channels) so timing measurements on one waveform are possible. As an example, the rise time into a device can be measured with one probe, while the rise time out of the device can be measured with the other probe. With the same set-up, propagation delay through the device can be measured between the probes.

#### Eliminate Systematic Timing Errors

Delays through probes, cables and inherent differential delays between a counter's input channels limit the absolute accuracy of time interval measurements to some unknown but fixed amount.

A calibration procedure using the 5363B can equalize such systematic delays to set the counter to read 0.0 ns. This is possible with counters that can measure down to 0 ns like the 5370A and the 5335A. For counters with a minimum time interval specification (5345A and 5328A Option 040 and 041 have 10 ns minimum capability), the 5363B can add a fixed offset of 10 ns to permit measurements of zero time interval.

### 10855A 2-1300 MHz Preamp

The 10855A Preamp provides a minimum of 22 dB gain from 2 MHz to 1300 MHz to enhance measurements of very low-level signals. The  $\pm 1.5$  dB flat response reduces distortion in non-sinusoidal waveforms. The 10855A operates conveniently with a variety of HP measuring instruments having probe power outlets, or will work with the 1122A Probe Power Supply. The 5335A Option 030, 5328A Option 031, and 5305B counters all measure frequency to 1300 MHz and are compatible for use with the 10855A.

#### 5363B Specifications

**Operating range:**  $\pm 10$  V

**Minimum input voltage:**  $\pm 100$  mV above and below the trigger point

- $\geq 22$  dB gain from 2 MHz to 1300 MHz
- $\pm 1.5$  dB flat response to reduce distortion
- Fuse protected input
- Excellent reverse isolation,  $>45$  dB
- 50  $\Omega$  input and output impedances

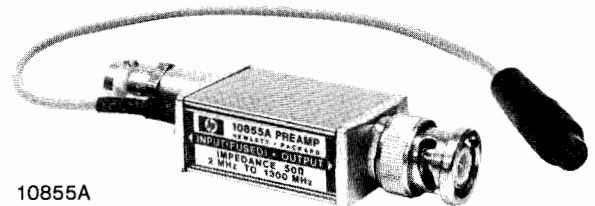

10855A

**Damage level:**  $\pm 30$  V

**Voltage resolution:** 10 mV

**Impedance:** 1 M $\Omega$  shunted by  $<20$  pF

**Effective bandwidth:** 350 MHz (1 ns rise time)

**Minimum pulse width:** input signal must remain 100 mV below and above trigger point for at least 5 ns.

**Output to counter:** separate start and stop outputs;  $-0.5$  V to  $+0.5$  V into 50  $\Omega$ , slew rate through zero volts exceeds 0.25 V/ns

**Delay compensation range:** 2 ns adjustable about 0.0 ns and 10.0 ns

**Power:** 100, 120, 220, or 240 VAC ( $+5\%$ ,  $-10\%$ ), 48-440 Hz; 40 VA max

**Weight:** net 3.0 kg (6.5 lb); shipping 5.5 kg (12 lb)

**Dimensions:** 88.1 H x 212 W x 248 mm D (3.5" x 8.4" x 11.6").

**Absolute accuracy:**<sup>1</sup>

$$\pm 1 \text{ ns}^* \pm \frac{\text{START TLA} + \text{START NTE}}{\text{START slew rate}} \pm \frac{\text{STOP TLE} + \text{STOP NTE}}{\text{STOP slew rate}}$$

where TLA denotes trigger level accuracy and NTE denotes noise trigger error

<sup>1</sup>systematic error that can be eliminated with proper calibration techniques

#### Trigger Level Accuracy:

Trigger Level	-5 to +9 V	-5 V to -10 V	+9 V to +10 V
*Trigger level accuracy	$\pm 8$ mV $\pm 0.4$ mV/ $^{\circ}$ C $\pm 0.15\%$ trigger voltage	$\pm 1\%$ trigger voltage	50 mV
*Differential trigger level accuracy	$\pm 3$ mV $\pm 0.3\%$ trigger voltage	$\pm 1\%$ trigger voltage	100 mV

Differential trigger level accuracy applies when both START and STOP trigger level voltages are set equal and identical waveforms applied.

**Noise trigger error:**  $\sqrt{(125 \mu\text{V})^2 + e_n^2}$  volts where 125  $\mu\text{V}$  is the typical input noise on the 5363B and  $e_n$  is the input signal noise for a 350 MHz bandwidth.

<sup>1</sup>after calibration and within the range of 100 mV or 8% of signal peak (whichever is greater)

#### 10855A Specifications

**Frequency range:** 2 MHz–1300 MHz

**Gain (minimum):** 22 dB; 24 dB typical

**Gain flatness across full frequency range:**  $\pm 1.5$  dB

**Noise figure:**  $<8.5$  dB typical

Output power for 1 dB gain compression: 0 dBm

**Harmonic distortion:**  $-30$  dB for  $-15$  dBm output, typical

Output for  $<-66$  dB harmonic distortion:  $-25$  dBm, typical

**VSWR:** input and output,  $<2.2$

**Impedance:** 50  $\Omega$  nominal

**Reverse isolation:**  $>45$  dB

**Maximum input:** 3.5 V rms ( $+24$  dBm), fuse protected

#### Ordering Information

**5363B Time Interval Probes**

**10821A Probe Accessory Kit** including 2 of each of the following: 10229A Hook Tip; 10218A BNC to Probe Adapter; 10100C 50  $\Omega$  Feedthrough termination; 1250-0655 BNC Tee to Probe Adapter; and 8710-0661 HP Probe tips (extra).

**10855A 2-1200 MHz Preamp**

- A high performance 200 MHz / 2 ns Universal Counter
- Built-in automatic rise time, duty cycle, pulse width, slew rate and phase measurements
- Unique advanced automatic triggering capabilities
- HP-IB plus math and statistics functions standard



5335A



### Remarkable Automatic Measurement Power

The HP-5335A is an advanced universal counter with automatic measurement power built-in. Designed either for bench or systems applications, the counter has 16 front-panel measurement functions, plus four "phantom" functions. All automatically selected by push button or by HP-IB. These twenty functions, plus greatly expanded arming and triggering capability make the 5335A a most powerful universal counter. In addition, math and statistics features, matched Channel A and B input amplifiers, and HP-IB, are all included in the standard unit, making the 5335A easily the most advanced universal counter available at its price.

The 5335A has all the measurement functions normally found in a universal counter. Plus, it has automatic operation. Beyond these features, it possesses new measurements not previously included in this type of instrument.

### Pulse Characterization Measurements

Most HP universal counters provide you with a fairly complete measurement set. The 5335A possesses all these expected universal measurements, and does them better than ever before. But, beyond the expected measurement set, the 5335A has the ability to automatically measure waveform characteristics for various applications. Op Amp Characterization is one area where a number of measurements are needed to define the amplifiers performance. Using the 5335A and a signal source, rise and fall times, output slew rate, and propagation times can be measured with one test set-up. Also, duty cycle can be measured to see the distortion on a square wave through the amplifier due to different rising and falling slew rates. Lastly, phase measurements are also push-button selectable and automatically performed by the counter.

### Complete Triggering Capability

To get good measurement results, a counter must properly trigger on the input signal. The 5335A employs both manual and automatic trigger modes to quickly and easily set the right trigger points.

#### Manual Triggering

The counter has a  $\pm 5$  VDC range to help reduce input attenuator use for most input signals, including TTL.

#### Automatic Triggering

Two auto trigger modes help you trigger automatically. Just press *auto trig* or select auto trig on the HP-IB; and the counter automatically selects 10%-90% Rise/Fall time trigger points, 50% phase trigger points, or the pre-set value of your choice. Then it tracks the signal's DC offset continuously to stay on the right trigger point. Option 040 allows programmability of trigger levels via HP-IB.

### Trigger Level DVM

Built-in to the basic counter. Just press TRG LVL to see both input channel trigger levels displayed.

### A Full Set of Universal Measurement Functions

In addition to waveform characterization features, the 5335A has an extremely wide set of measurement functions covering frequency, time, events and volts. These functions let you characterize signals quicker and more thoroughly than ever before possible.

#### Frequency

Frequency is the most common measurement performed by counters. The 5335A measures to 200 MHz in Channel A, 100 MHz in Channel B, and 1.3 GHz in its optional Channel C. Due to the counter's advanced design and reciprocal measurement technique, resolution is a constant 9 digits per second of gate time across its entire measurement range.

#### Time

In a universal counter, a time interval measurement equates to a stopwatch measurement started and stopped by unique events. Precision is dependent on the counter's circuitry.

To ensure precision, the 5335A has matched custom input amplifiers to greatly reduce trigger errors that might be produced if the start and stop signals were amplified differently. Further, the counter employs an analog interpolation technique that turns its 10 MHz clock into the equivalent of a 1 GHz time base. The 5335A is thus able to resolve single shot time interval measurements to better than 2 nanoseconds (100 ps with averaging). This analog interpolation eliminates the need found in some counters for a phase-modulated (jittered) time base for time interval average measurements.

#### Math and Statistics

Averaging techniques are often used to extend the resolution of a counter. For averaging, the 5335A provides sample sizes of  $N = 100$  or  $N = 1,000$ . Best of all, averaging can be employed for all measurements except phase. In addition to mean, and selection of sample size, the counter takes standard deviations of the current measurement for the sample size selected.

Math functions are another built-in feature that provide operator convenience. These functions let you convert the display into direct indications of parameters like flow, speed, pressure, and temperature. Additionally, the counter remembers the offset, scale, and normalize factors for each measurement function.



## Model 5335A (cont.)

**Specifications****Input Characteristics (Channel A and B)****Range**

DC coupled, 1 to 100 MHz.  
AC 1 M $\Omega$ , 30 Hz to 100 MHz.  
AC 50  $\Omega$ , 200 KHz to 100 MHz.

NOTE: Channel A range 200 MHz when in Frequency A and Ratio modes.

**Sensitivity (X1)**

25 mV rms sinewave.  
75 mV peak-to-peak pulse at minimum pulse width of 5 ns.

**Dynamic Range (X1)**

75 mV to 5 V peak-to-peak, to 100 MHz.  
75 mV to 2.5 V peak-to-peak, >100 MHz.

**Signal Operating Range (X1, DC)**

-5 V dc to +5 V dc.

**Trigger Level Range (X1)****Auto Trigger OFF**

Preset: set to 0 V dc NOMINAL.  
Adjustable: -5 V dc to +5 V dc.

**Auto Trigger ON**

Preset: set to nominal 50% point of input signal.  
Adjustable: nominally between + and - peaks of input signal.

**Auto Trigger (X1)****Range (50% duty cycle):**

DC coupled, 30 Hz to 200 MHz.  
AC 1 M $\Omega$ , 30 Hz to 200 MHz.  
AC 50  $\Omega$ , 200 kHz to 200 MHz.

**Minimum signal:** 100 mV rms.

**Duty cycle range:** 10% to 90%.

**Response time:** 3 seconds, typical.

NOTE: Auto Trigger requires a repetitive signal.

**Coupling:** AC or DC, switchable.

**Impedance:** 1 M $\Omega$ , nominal, shunted by <35 pf or 50  $\Omega$  nominal, switchable. In COMMON A, 1 M $\Omega$  is shunted by <50 pf.

**Attenuator:** X1 or X10 nominal, switchable.

**Slope:** independent selection of + or - slope.

**Channel input:** SEPARATE or COMMON A, switchable.

**Frequency A**

**Range:** 0 to 200 MHz, prescaled by 2.

**LSD Displayed:**

$$\frac{1 \text{ ns}}{\text{Gate Time}} \times \text{FREQ. (e.g. 9 digits in a second)}.$$

**Resolution:**

$$\pm (2 \times \text{LSD}) \pm 1.4 \times \frac{\text{Trigger Error}}{\text{Gate Time}} \times \text{FREQ.}$$

**Accuracy:**  $\pm$  (Resolution)  $\pm$  (Time Base Error)  $\times$  FREQ.

**PERIOD A**

**Range:** 10 ns to 10<sup>7</sup> s.

**LSD displayed:**

$$\frac{1 \text{ ns}}{\text{Gate Time}} \times \text{PER. (e.g. 9 digits in a second)}.$$

**Period average:** user selects MEAN function, and n = 100, or n = 1,000.

**Time Interval A—B**

**Range:** 0 ns to 10<sup>7</sup> s.

**LSD Displayed:** 1 ns (100 ps using MEAN).

**Resolution:**  $\pm$  (2  $\times$  LSD)  $\pm$  (START Trigger Error)  $\pm$  (STOP Trigger Error).

**Accuracy:**  $\pm$  (Resolution)  $\pm$  (Time Base Error)  $\times$  TI  $\pm$  (Trigger Level Error)  $\pm$  (2 ns).

**Gate mode:** MIN only.

**Time interval average:** user selects MEAN function, and n = 100, or n = 1,000.

**Time Interval Delay (Holdoff)**

Front panel Gate Adjust control inserts a variable delay between START and enabling of STOP. Electrical inputs during delay are ignored. Delay ranges are same as gate time ranges (100  $\mu$ s, to 4 s NOMINAL) for gate modes of Fast, Norm, and Manual.

**Inverse Time Interval A—B**

**Range:** 10<sup>-10</sup> to 10<sup>9</sup> units/second

LSD Displayed, Resolution, and Accuracy are inverse of Time Interval A—B specifications.

**Rise and Fall Time A**

**Range:** 20 ns to 10 ms transition with 50 Hz to 25 MHz repetition rates (50% duty cycle).

**Minimum pulse height:** 500 mV peak-to-peak.

**Minimum pulse width:** 20 ns.

**Duty cycle range:** 20% to 80%.

LSD Displayed and Resolution are same as Time Interval A—B Specifications.

**Pulse Width A**

**Range:** 5 ns to 10<sup>7</sup> s.

**Trigger point range:** 40% to 60% of pulse height.

LSD Displayed and Resolution are same as Time Interval A—B specifications.

**Duty Cycle A**

**Range:** 1% to 99%, 0 to 100 MHz.

**Trigger point range:** 40% to 60% of pulse height.

$$\text{LSD Displayed: } \frac{1 \text{ ns}}{\text{PER}} \times 100\%$$

NOTE: Constant duty cycle required during measurement.

**Slew Rate A**

**Range:** 50 V/s to 10<sup>6</sup> V/s slew rate with 50 Hz to 25 MHz repetition rates (50% duty cycle). Minimum Pulse Height, Width, and Duty Cycle Range are same as Rise and Fall Time A.

**Input mode:** automatically set to COMMON A with 10% and 90% trigger levels.

**Ratio A / B**

**Range:** Channel A, 0 to 200 MHz (prescaled by 2).  
Channel B, 0 to 100 MHz.

$$\text{LSD Displayed: } \frac{\text{RATIO}}{\text{FREQ} \times \text{Gate Time}} \text{ where FREQ is higher frequency after prescaling.}$$

**Totalize A**

**Range:** 0 to 100 MHz.

**LSD Displayed:** 1 count of input

**HP-IB Output:** at end of gate.

**Manual**

**Count reset:** via RESET key.

**HP-IB output:** totalize data on-the-fly sent if cycle mode set to Single. Input frequency range in this mode is 0 to 50 Hz nominal.

**Gated**

**Count reset:** automatic after measurement.

**PHASE A REL B**

**Range:** -180° to 360°, Range Hold off, or 0° to 360°, Range Hold on, with signal repetition rates of 30 Hz to 1 MHz.

**Minimum signal:** 100 mV rms.

**LSD Displayed:** 0.1°.

**Gate Time**

**Range:** 100 ns to 10<sup>7</sup> s.

**LSD Displayed:** up to three digits with Ext. Arm Enable OFF, 100 ns when ON. MIN Gate Mode display zero.



### Trigger Level

**Range:** X1, +5 to -5 volts; X10, +50 to -50 volts.

**Resolution:** X1, 10 mV; X10, 100 mV.

**Accuracy (X1):**  $\pm 20$  mV,  $\pm 0.5\%$  of reading.

### Time Base

#### Standard crystal

**Frequency:** 10 MHz.

**Aging rate:**  $< 3 \times 10^{-7}$ /month.

**Temperature:**  $< 4 \times 10^{-6}$ , 0 to 50°C.

**Line voltage:**  $< 1 \times 10^{-7}$  for 10% change.

**High stability crystal:** see Option 010.

**External time base input:** rear panel BNC accepts 5 or 10 MHz, 200 mV rms into 1 k $\Omega$ ; 5 V rms maximum.

**Time base out:** 10 MHz,  $> 1$  V p-p into 50  $\Omega$  via rear panel.

### Statistics

**Sample size:** selectable between either  $n = 100$  or  $n = 1,000$  samples.

**Std. dev.:** displays a standard deviation of selected sample size.

**Mean:** displays mean estimate of selected sample size.

**Smooth:** performs a weighted running average and truncates unstable least significant digits from display.

### Math

All measurement functions, with exception of GATE TIME and TRIG LVL, may be operated upon by Math functions. Offset, Normalize, and Scale may be used independently or together as follows:

$$\text{Display} = \frac{\text{Measurement} + \text{Offset}}{\text{Normalize}} \times \text{Scale.}$$

**Number value range:**  $\pm 1 \times 10^{-9}$  to  $\pm 9 \times 10^9$ .

**Last display:** causes value of previous display to Offset (negative value), Normalize, or Scale all subsequent measurements.

**Measurement t-1:** causes each new measurement to be Offset (negative value), Normalized, or Scaled by each immediately preceding measurement.

### Hewlett-Packard Interface Bus

**Programmable controls:** all measurement functions, Math, Statistics, Reset, Range Hold, Ext. Arm Enable/Slope, Check, Gate Adj. ( $\sim 1$  ms to 1 s), Gate Open/Close (gate times to  $\infty$ ), Gate Mode Cycle, Preset, Slope, Common A, Auto Trigger.

**Special functions:** FREQ B, PULSE B, TIME B  $\rightarrow$  A, TOT A  $\rightarrow$  B, LEARN, MIN, MAX, all internal diagnostic routines.

**HP-IB commands:** Trigger, Clear, Remote, Local, Local Lockout, Require Service.

**Data output:** fixed output format consisting of 19 characters plus CR and LF output is typically 8 ms.

**Option 040:** adds complete systems programmability; see column at right.

### General

**Gate:** minimum, manual, or continuously variable (NORM/FAST) via Gate Adj. control.

**NORM:** 20 ms to 4 s NOMINAL.

**FAST:** 100  $\mu$ s to 20 ms NOMINAL.

**MIN:** minimum gate time. Actual time depends on function.

**MANUAL:** each press opens or closes gate.

**Cycle:** determines delay between measurements.

**NORM:** no more than 4 readings per second, nominal.

**MIN:** updates display as rapidly as possible ( $\sim 15$  readings per second, depending on function).

**SINGLE:** one measurement taken with each press of button.

**Arming:** Ext. Arm Enable key allows rear panel input to determine Start and/or Stop point of a measurement. External gate defined by both Start and Stop armed. All measurements are armable except Manual Totalize, Phase, and Trigger Level.

**Start arm:** + or - slope of arm input signal starts measurement.

**Stop arm:** + or - slope of arm input signal stops measurement. When used, Start Arm must occur before Stop Arm.

**Ext. arm input:** rear panel BNC accepts TTL into 20 k $\Omega$ . Minimum Start To Stop Time: 200 ns.

**Trigger level out:** DC output into 1 M $\Omega$  via rear panel BNC's for Channel A and B; not adjusted for attenuators.

**Accuracy at DC (X1):**  $\pm 15$  mV  $\pm 0.5\%$  of TRIG LVL reading.

**Gate out:** TTL level into 50  $\Omega$ ; goes low when gate open; rear panel BNC.

**Range hold:** freezes decimal point and exponent of display.

**Reset:** starts a new measurement cycle when pressed.

**Check:** performs internal self test and lamp test.

**Display:** 12-digit LED display in engineering format; exponent range of +18 to -18.

**Operating temperature:** 0 to 50°C.

**Power requirements:** 100, 120, 220, 240 VAC (+5%, -10%), 48-66 Hz; 130 VA max.

**Weight:** net, 8.8 kg (19 lbs. 8 oz.); shipping, 13.6 kg (30 lbs.)

**Dimensions:** 425.5 mm W x 132.6 mm H x 345.4 mm D (16 $\frac{3}{4}$ " x 5 $\frac{1}{4}$ " x 13 $\frac{1}{2}$ "), not including removable handles.

### Options

#### Option 010: High Stability Time Base (Oven)

**Frequency:** 10 MHz.

**Aging rate:**  $< 5 \times 10^{-10}$ /day after 24 hour warm up.

**Short term:**  $< 1 \times 10^{-10}$  rms for 1s average.

**Temperature:**  $< 7 \times 10^{-9}$ , 0 to 50°C.

**Line voltage:**  $< 1 \times 10^{-10}$  for 10% change.

**Warm-up:** within  $5 \times 10^{-9}$  of final value in 20 minutes.

#### Option 020: DC Digital Voltmeter

**Range:** 4 digits, autoranging, autopolarity, in  $\pm 10$ ,  $\pm 100$ ,  $\pm 1000$  V ranges.

**Sensitivity:** 100  $\mu$ V, 1 mV, 10 mV, 100 mV for  $\pm 1$  V,  $\pm 10$  V,  $\pm 100$  V,  $\pm 1000$  V readings.

**LSD Displayed:** same as sensitivity.

**Input type:** floating pair.

**Input impedance:** 10 M $\Omega$   $\pm 1\%$ .

#### Option 030: 1.3 GHz C Channel

##### Input Characteristics

**Range:** 150 MHz to 1.3 GHz.

**Sensitivity:** 10 mV rms sinewave (-27 dBm) to 1 GHz. 100 mV rms sinewave (-7 dBm) to 1.3 GHz.

##### Frequency C

**Range:** 150 MHz to 1.3 GHz, prescaled by 20. LSD Displayed, Resolution, and Accuracy are same as Frequency A.

##### Ratio C/A

**Range:** Channel A, 0 to 200 MHz.

Channel C, 150 to 1300 MHz.

#### Option 040: Complete Systems Programmability

Adds remote selection of low pass filter, AC/DC coupling, X1-X10 attenuation, DC trigger level and input impedance for both Channel A and B.

### Definitions

**Duty cycle:** percentage of time a signal is high or low, depending on Slope A setting. Trigger point is high/low dividing point.

$$\text{DUTY CY} = \frac{\text{PULSE}}{\text{PER}} \times 100\%.$$

**Slew rate:** effective slope between 10% and 90% points of rising or falling signal depending on Slope A setting.

$$\text{SLEW} = \frac{V_B - V_A}{T_I}$$

**Phase:** Angle, with respect to B signal, between 50% points of channel A and B signals, trigger slopes selected by Channel A and B slope switches.

$$\text{PHASE} = (T_{I1} + T_{I2}) \div \frac{2}{\text{PER}} \times 360^\circ$$

$T_{I1}$  is time between 50% points of A then B signals using slopes defined during Phase measurement.

$T_{I2}$  is time between 50% points of A then B signals using complement slopes to  $T_{I1}$ .

**Front handles:** supplied with instrument.

### Ordering Information

**Option 010:** Oven Oscillator

**Option 020:** DVM

**Option 030:** C Channel

**Option 040:** Expanded HP-IB Control

**Option 908:** Rack Flange Kit for use without handles

**Option 913:** Rack Flange Kit for use with supplied front handles

**5335A Universal Counter**





# ELECTRONIC COUNTERS

## 100 MHz Universal Counters

### Model 5328A

- 100 MHz, 512 MHz and 1300 MHz
- 100 ns or 10 ns time interval
- T.I. averaging to 10 ps resolution

- "Armed" measurements
- DVM options
- HP-IB interface option

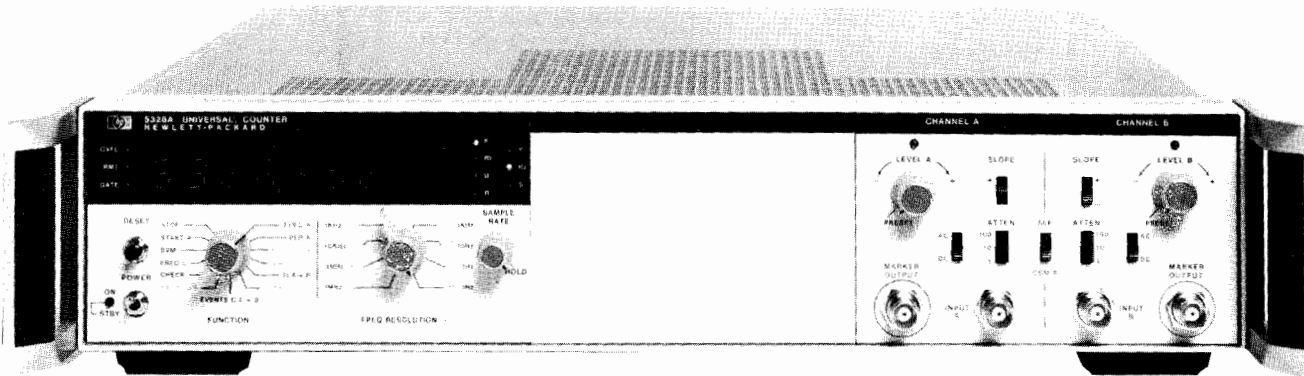

5328A



Opt 020

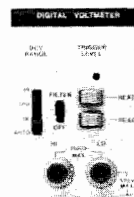

Opt 021



Opt 030

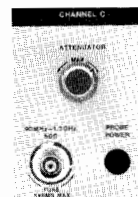

Opt 031

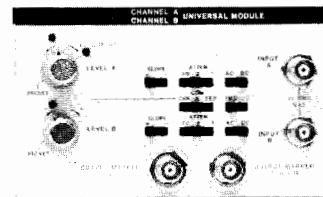

Opt 040

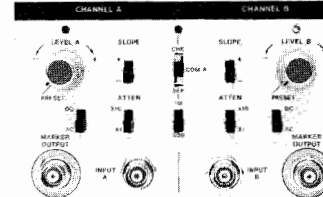

Opt 041

### Description

The 5328A, thru the use of technology such as a ROM controlled measurement cycle and a modular design, provides you with excellent universal counter price/performance. Optional modules allow you to tailor the performance of the 5328A to meet your particular measurement needs. In many instances, however, the standard 5328A offers all the capability you're likely to need.

**Burst and CW measurements to 100 MHz:** special gating circuits start a measurement only when the input signal is present, allowing burst frequencies to be measured as easily as CW signals. The option 030 C Channel extends this capability to 512 MHz; option 031, to 1300 MHz.

**Single shot time interval measurements:** the standard universal module's 100 ns single shot resolution meets or exceeds the requirements for a wide range of applications such as mechanical and electromechanical device timing (relays), time of flight measurements (ballistics), sonar ranging, radio ranging and navigation.

**Time interval averaging:** resolution better than 10 ps ( $10^{-11}$  seconds) for repetitive time intervals as short as 100 ps.

### General

**Display:** 9 digit LED display, ninth digit used only with channel C functions (FREQ. C, Ratio C/A, Events C, A-B).

**Blanking:** suppresses display of unwanted zeros to left of most significant digit.

**Storage:** holds reading between samples; can be overridden by rear panel switch.

**Sample rate:** variable from less than 2 ms between measurements to HOLD which holds display indefinitely.

**Gate output:** rear panel output, TTL levels; high if gate is open.

**Period, period average, ratio, totalize, scale:** extra problem solving power for your special requirements.

**Armed measurements:** versatile arming modes (controlled by a rear panel switch) allow real time control over when a measurement begins. Useful for measurements such as frequency burst profile and frequency sweep linearity.

**Trigger lights:** trigger light blinks when channel is triggering; light is ON when input is above trigger level; OFF when input is below trigger level. Simplifies trigger level adjustments.

**High performance marker outputs:** marker outputs (operational to 100 MHz) indicate where channel is triggering in real time for oscilloscope monitoring applications. Provides measurement feedback to the operator for greatly simplified measurement set-ups.

These features and capabilities make the 5328A an excellent choice for general purpose lab use, electronic service, and production test. For more demanding applications, a variety of options offer extended performance at a modest increase in price.

**Time base output:** rear panel output: TTL levels.

**Check signal:** with function switch in CHECK, counter should display  $10 \text{ MHz} \pm 1$  count. With options 040 and 041, place function switch in FREQ A and universal module in CHECK (CHK). Counter should display  $100 \text{ MHz} \pm 1$  count.

**Operating temperature:**  $0^\circ$  to  $50^\circ \text{ C}$ .

**Power requirements:** 100/120/220/240 V rms, +5%, -10% (switch selectable), 48-66 Hz; 150 VA max.

**Standard Universal Module****Input characteristics****Sensitivity:** 25 mV rms, to 40 MHz

50 mV rms, 40 MHz – 100 MHz

**Impedance** (Nominal): Separate: 1M $\Omega$ //<40 pF;Common: 1M $\Omega$ //<65 pF**Attenuators** (Nominal): X1, X10, X100 switch selectable**Frequency A****Range:** 0 to 100 MHz with resolution to 0.1 Hz**Period A****Range:** 100 ms to 10<sup>8</sup> s with resolution to 100 ns**Period Average A****Range:** 100 ns to 10<sup>8</sup> s with resolution to 100 ps**Time Interval A—B****Range:** 100 ns to 10<sup>8</sup> s with resolution to 100  $\mu$ s**Time Interval Average A—B****Range:** 0.1 ns to 10 s with resolution to 100 ps**Minimum Dead Time:** 150 ns**Ratio B/A****Range:** channel A, 0 to 10 MHz; channel B, 0 to 100 MHz**Time Base Oscillators****Standard Crystal Oscillator****Frequency:** 10 MHz**Aging rate:** <3 x 10<sup>-7</sup>/month**Temperature:**  $\pm 2.5 \times 10^{-8}$ , 0° to 50°C**Line voltage:** <1 x 10<sup>-7</sup> for 10% change**Opt 010 Oven Oscillator****Frequency:** 10 MHz**Aging rate:** <5 x 10<sup>-10</sup>/day after 24-hour warm-up**Short term:** <1 x 10<sup>-10</sup> rms/s**Temperature:** <7 x 10<sup>-9</sup>, 0° to 50°C**Line voltage:**  $\pm 5 \times 10^{-9}$  for 10% variation**Warm-up:** within 5 x 10<sup>-9</sup> of final value in 20 minutes

**Ext. freq. std. input:** 30 kHz to 10 MHz signal of amplitude >1.0 V rms into 1 k $\Omega$ . Maximum input: 5 V p-p. With options 040 and 041 the external frequency standard must be 10 MHz for Period Avg., T.I. Avg., Period (N = 1), and T.I. (N = 1).

**Option 011: HP-IB Interface**

Option 011 provides digital output of measurement data ("talker") as well as input for remote program control ("listener"). HP-IB cable not supplied.

**Programmable features:** function, resolution, sample rate (max or manual control), arming, display modes, measurement cycle modes, output modes, and reset commands. Option 041 adds control of channel A and B trigger level, slope, attenuator, coupling, input impedance, and SEP-COM-CHECK selection.

**HP-IB commands:** responds to the following bus commands (see HP-IB Users Guides for definitions)—Unlisten, Untalk, Local Lockout, Device Clear, Serial Poll Enable, Serial Poll Disable, Go to Local, Selected Device Clear, and Group Execute Trigger

**Service request (SRQ):** if enabled, indicates end of measurement

**Maximum data output rate:** 500 readings/s

**Option 020: Digital Voltmeter****Range:**  $\pm 125$  Vdc**Sensitivity:** 1 mV, 1 mV, 2 mV, 20 mV, 200 mV for measurement times of 10 s, 1 s, 0.1 s, 10 ms, 1 ms respectively**Input type:** single ended**Impedance:** 10 M $\Omega$  Nominal**Maximum input:**  $\pm 500$  V**Trigger level measurements:** 2 mV display resolution**Option 021: High Performance Digital Voltmeter****Range:**  $\pm 10$ ,  $\pm 100$ ,  $\pm 1000$  V dc and Autorange**Sensitivity:** 10  $\mu$ V, 100  $\mu$ V, 1 mV, 10 mV, 100 mV for measurement times of 10 s, 1 s, 0.1 s, 10 ms, 1 ms respectively**Input type:** floating pair**Impedance:** 10 M $\Omega$  Nominal**Maximum input:** Hi to Lo:  $\pm 1100$  V all ranges  
Lo to Chassis ground:  $\pm 500$  V**Trigger level measurements:** 1 mV display resolution**Note:** Trigger level readings are multiplied automatically by attenuator setting of using options 040 or 041.**Option 030: 512 MHz C Channel****Input characteristics****Sensitivity:** 15 mV rms sine wave (-23.5 dBm)**Input protection:** fused input**Maximum input:** 5 V rms**Frequency C****Range:** 5 MHz to 512 MHz, direct count with resolution to 0.1 Hz**Ratio C/A****Range:** channel A, 0 to 10 MHz; channel C, 5 to 512 MHz**Events C, A—B:** totalizes the number of events at C input during the synchronized time interval as defined by inputs to A and B**Option 031: 1300 MHz C Channel****Input characteristics****Sensitivity:** 20 mV rms sine wave (-21 dBm)**Input protection:** fused input**Maximum input:** 5 V rms,  $\pm 5$  V dc**Frequency C****Range:** 90 MHz to 1300 MHz, prescaled by 4 with resolution to 0.1 Hz**Ratio C/A****Range:** channel A, 0 to 10 MHz; channel C, 90 to 1300 MHz**Attenuation:** continuously variable for optimum noise suppression**Extended Capability Universal Modules****(Option 040 and 041)****Input characteristics****Sensitivity:** same as standard unit**Impedance** (Nominal): 10 M $\Omega$  or 50  $\Omega$ , switch selectable**Attenuators** (Nominal):

Option 040—X1, X2, X20 switch selectable

Option 041—X1, X10 switch selectable

**Frequency A:** same as standard unit**Period A****Range:** 100 ns to 10<sup>8</sup> s with resolution to 10  $\mu$ s**Period Average A****Range:** 100  $\mu$ s to 10<sup>8</sup> s with resolution to 0.01 ps**Time Interval A—B****Range:** 10 ns to 10<sup>7</sup> s with resolution to 10 s**Time Interval Average A—B****Range:** 0.1 ns to 1 s with resolution to 10 ps**Minimum dead time:** 40 ns**Ratio A/B:** same as standard unit**Delay** (Option 040 only): 20  $\mu$ s to 20 ns**Programmable control** (Option 041 only): Level, Coupling, Attenuation, Impedance, SEP—COM—CHK**Options and Accessories****010:** High Stability Time Base**011:** HP-IB Interface**020:** DVM**021:** High Performance DVM**030:** 512 MHz Channel C**031:** 1300 MHz Channel C**040:** High Performance Universal Module**041:** Programmable Input Controls Module

(Requires Option 011 for HP-IB use)

**908:** Rack Flange Kit for use w/o front handles**913:** Rack Flange Kit for use with supplied front handles**10855A** Preamp**10856A** Filter Kit**5363B** Time Interval Probes**5328A Universal Counter****Front Handles:** supplied with instrument



# ELECTRONIC COUNTERS

## Universal Counters

Models 5315A/B, 5316A

- Frequency, Period, Ratio, and Totalize to 100 MHz
- Three Versions: Portable, Rackable, or HPIB
- 1 GHz capability available

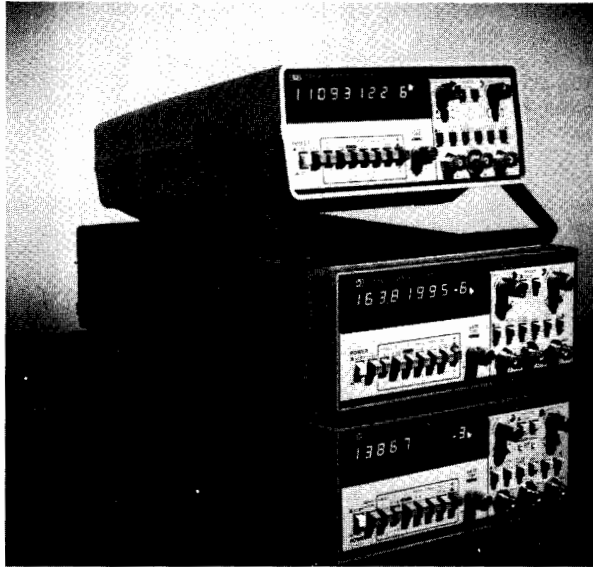

- Uses reciprocal technique for full low-frequency resolution
- 100 ns Time Interval, 10 ps T.I. Averaging
- Oven option for increased accuracy



### A Quiet Revolution in Capability . . .

HP's economical 5315A/B, and 5316A counters provide all the universal counter capability you've come to expect at much higher prices. That's because they use a unique custom circuit called the MRC (Multiple Register Counter) which packs counting and computing power into this popular counter series. To a user, the differences in operation from conventional direct models can be listed quickly: low frequency resolution is an outstanding 7 digits per second of gate time and reliability is extremely good due to the counter's low chip count. Also, the continuously adjustable gate time allows automatic selection of sample size for easy trade-offs between measurement time and resolution.

Much of the counter's performance is based on reciprocal counting techniques first pioneered in HP's high-performance 5360A computing counter, and the current model 5345A Universal Counter. The use of these techniques coupled with HP's MRC and a microprocessor provide a quiet but powerful revolution in counter performance within the 5315A/B and 5316A. For example, this counter gives you its full 7-digits/second resolution over the range from 1 Hz to 100 MHz. This, simply stated, shows the power of the MRC and reciprocal counting.

### High Performance, Low Price

In addition to its economy, the MRC counter offers a full set of universal counter measurements, and there are very few limitations to this capability. Increased accuracy in low-cost portable and system counters is also available with the oven oscillator option through improved temperature stability and lower aging rates.

### Frequency to 100 MHz, C-Channel to 1.0 GHz

The MRC counter measures frequency to 100 MHz. Additionally the optional C-Channel measures to 1.0 GHz for both CW and pulsed RF signals as narrow as 60 ms. The C-Channel option is particularly useful in navigation and communications equipment testing due to this pulsed RF measurement feature.

### Time Interval to 100 ns, T.I. Averaging to 10 ps

The MRC counter provides three time measurement modes. Single-shot time interval allows measurements over a range of 100 ns to 100,000 seconds. This capability can be used to measure pulse width. Time interval averaging provides greater resolution for repetitive events. Finally, time interval delay avoids measurement of spurious signals by holding off the counter's trigger point by a precise, operator-selectable amount of time.

### A Full Set of Measurements

Besides the frequency and time functions mentioned above, the MRC counter has other measurement functions that make it a truly impressive value:

**Period A**—allows single period measurements via Channel A.

**Ratio A/B**—allows frequencies to 100 MHz into both Channel A and B

**A By B**—totalizes the A input between 2 events on B channel

**Totalize**—a manually gated totalize mode of operation

### Input Signal Conditioning Versatility

A full complement of input signal conditioning controls are provided for both channels. These include  $\pm$  slope,  $\pm 2.5$  VDC trigger level, and AC/DC coupling. Other controls are a Separate/Common switch, and a 100 KHz low-pass filter for Channel A.

### A Choice of Three Models

The MRC counter is available in three different versions: **5315A**: A portable, light-weight unit best suited for field applications. This unit has a convenient carrying handle and optional battery power is available for up to 4 hours continuous operation. Despite its high impact plastic case, the 5315A possesses low RF1/EMC characteristics making it equally suitable for bench use.



**5315B:** A rackable, stackable counter that is designed to meet the most demanding RFI/EMC specs, the 5315B is intended primarily for rack mount use. This model has an optional Offset-Normalize (006) module that mathematically modifies the counter's display and so provides readouts directly in engineering units of the user's choice. The 5315B Option 006 is also rackable and stackable.

**5316A:** This model possesses all the characteristics of both the 5315A and 5315B, and it has HP-IB capability built-in as standard equipment. It has low RFI, it is rackable, and it is functionally identical to the 5315A/B. In addition to programmable measurement functions, the user can also select DC trigger level and  $\pm$  slope under HP-IB control. Channel A and B trigger levels are brought out to the front panel on this unit for easy measurement with a DVM.

### 5315A/B 5316A Specifications

#### Input Characteristics (Channel A and Channel B)

**Range:** DC coupled 0 to 100 MHz.

AC coupled 30 Hz to 100 MHz.

**Sensitivity:** 10 mV rms sine wave to 10 MHz.

25 mV rms sine wave to 100 MHz.

75 mV peak-to-peak pulse at minimum pulse width of 5 ns.

Sensitivity can be varied continuously up to 500 mV rms *NOMINAL* by adjusting sensitivity control. In sensitivity mode, trigger level is automatically set to 0 V *NOMINAL*.

#### Dynamic range:

30 mV to 5 V peak-to-peak, 0 to 10 MHz.

75 mV to 5 V peak-to-peak, 10 to 100 MHz.

**Coupling:** AC or DC, switchable.

**Filter:** low pass, switchable in or out of Channel A. 3 dB point of 100 kHz *NOMINALLY*.

**Impedance:** 1 M $\Omega$  *NOMINAL* shunted by less than 40 pF.

500 K $\Omega$  *NOMINAL* shunted by less than 70 pF (COMMON A).

**Signal operating range:** +2.5 Vdc to -2.5 Vdc.

**Attenuator:** X1 or X20 *NOMINAL*.

**Trigger level:** variable between +2.5 Vdc and -2.5 Vdc.

**Slope:** independent selection of + or - slope.

**Common Input:** all specifications are the same for Common A except the following:

**Sensitivity:** 10 mV rms sine wave to 10 MHz; 25 mV rms sine wave to 50 MHz; 50 mV rms to 100 MHz; 150 mV peak-to-peak at a minimum pulse width of 5 ns.

**Dynamic Range:** 30 mV to 5 V peak-to-peak to 10 MHz; 75 mV to 5 V peak-to-peak, 10-50 MHz; 150 mV to 5V peak-to-peak, 50-100 MHz.

**Impedance:** 500 k $\Omega$  *NOMINAL* shunted by less than 70 pF.

#### Damage level:

AC & DC  $\times$  1:

DC to 2.4 kHz	250 V (DC + AC rms)
2.4 kHz to 100 kHz	$6 \times 10^5$ V rms Hz/FREQ
>100 kHz	6 V rms

AC & DC  $\times$  20:

DC to 28 kHz	500 V (DC + AC peak)
28 kHz to 100 kHz	$1 \times 10^7$ V rms Hz/FREQ
>100 kHz	100 V rms

#### Frequency (Channel A)

**Range:** .1 Hz to 100 MHz.

**LSD displayed:** 10 Hz to 1 n Hz depending upon gate time and input signal. At least 7 digits displayed per second of gate time.

#### Period

**Range:** 10 ns to  $10^5$  s.

**LSD displayed:** 100 ns to 1 fs depending upon gate time and input signal. At least 7 digits displayed per second of gate time.

#### Time Interval

**Range:** 100 ns to  $10^5$  s.

**LSD displayed:** 100 ns.

#### Time Interval Average

**Range:** 0 ns to  $10^5$  s.

**LSD displayed:** 100 ns to 10 ps depending upon gate time and input signal.

**Number of intervals averaged (N):** N = Gate Time  $\times$  FREQ.

**Minimum dead time (stop to start):** 200 ns.

#### Time Interval Delay (Holdoff)

Front panel gate time knob inserts a variable delay of *NOMINALLY* 500  $\mu$ s to 30 ms between START (Channel A) and enabling of STOP (Channel B). Electrical inputs during delay time are ignored. Delay time may be digitally measured by simultaneously pressing T.I. Averaging, T.I. Delay and blue key.

#### Ratio

**Range:** 0.1 Hz to 100 MHz, both channels

**LSD:**  $\frac{2.5 \times \text{Period A}}{\text{Gate Time}} \times \text{Ratio}$ . (rounded to nearest decade)

#### Totalize

##### Manual:

Range: 0 to 100 MHz.

##### A gated by B:

Totalizes input A between two events of B. Instrument must be reset to make new measurement. Gate opens on A slope, closes on B slope. Range: 0 to 100 MHz.

#### General

##### Standard Time Base:

**Frequency:** 10 MHz

**Aging Rate:**  $< 3 \times 10^{-7}$ /mo.

**Temperature:**  $\pm 5 \times 10^{-6}$ ,  $0^\circ$  to  $50^\circ\text{C}$

**Line Voltage:**  $< 1 \times 10^{-7}$  for a  $\pm 10\%$  variation.

**Check:** counts internal 10 MHz reference frequency over gate time range *NOMINALLY* 500  $\mu$ s to 30 ms.

**Error light:** LED warning light activated if logic error is found during instrument turn-on self-check.

**Display:** 8 digit amber LED display, with engineering units annunciator.

**Overflow:** only frequency and totalize measurements will overflow. In case of overflow, eight least significant digits will be displayed and amber front panel overflow LED will be actuated.

All other measurements which would theoretically cause a display of more than 8 digits will result in the display of the 8 most significant digits.

**Gate time:** continuously variable, *NOMINALLY* from 60 ms to 10 s or 1 period of the input, whichever is longer.

**Sample rate:** up to 7 readings per second *NOMINAL* except in time interval mode, where it is continuously variable *NOMINALLY* from 250 ms to 10 s via Gate Time Control.

**Operating temperature:**  $0^\circ$  to  $50^\circ\text{C}$ .

**Power requirements:** 100, 120, 220, 240 V (+5%, -10%) 48-66 Hz; 15 VA maximum or 30 VA maximum (5316A).

**Weight:** net, 2.2 Kg (4 lbs. 12 oz.); shipping, 4.1 Kg (9 lbs.).

**Dimensions:** 238 mm W x 98 mm H x 276 mm D (9 $\frac{3}{8}$ " x 3 $\frac{7}{8}$ " x 10 $\frac{7}{8}$ ").

#### Additional 5315B Specifications

Rack and stack metal case with rear panel, switchable AC power line module. Specifications same as 5315A except as follows:

**Rack mount:** 5061-0072 recommended.

**Oscillator output:** 10 MHz, 50 mV pk-pk into 50  $\Omega$  load, on rear panel.

**External frequency standard input:** 10 MHz, 1 V RMS into 500  $\Omega$ , on rear panel.

**Dimensions:** 212 mm W x 88 mm H x 345 mm D (8 $\frac{3}{8}$ " x 3 $\frac{1}{2}$ " x 13 $\frac{3}{4}$ ").

**Weight:** net, 3.2 Kg (7 lbs. 2 oz.); shipping, 4.5 Kg (10 lbs.).



# ELECTRONIC COUNTERS

## Universal Counters

Models 5315A/B, 5316A (Cont.)

### Additional 5316A Specifications

Rack and stack metal case with rear panel, switchable AC power line module, Specifications same as 5315A except as follows:

**Rack mount kit:** 5061-0072 recommended.

**Oscillator output:** 10 MHz, 50 mV p-p into 50  $\Omega$  load on rear panel.  
**External frequency standard input:** 1, 5, 10 MHz, 500 mV rms into 500  $\Omega$ , or rear panel.

**Trigger level output:**  $\pm 5\%$ ,  $\pm 15$  mV, over  $\pm 2.0$  VDC range at front panel connectors.

**Dimensions:** 212 mm W x 88 mm H x 415 mm D (8 3/8 x 3 1/2 x 16 1/2")

**Weight:** net, 3.9kg (8 lbs. 10 oz.); Shipping, 6.3kg (14 lbs.)

### Hewlett-Packard Interface Bus

**Programmable Functions:** Frequency A, Frequency A Armed by B, Totalize, A Gated by B, Ratio A/B, Time Interval Average A $\rightarrow$ B, Time Int. Delay, Read Gate Time, Display Test, 10 MHz Check, Interface Test, Initialize, Reset, Wait State ON/OFF.

**Programmable Controls:** Gate Time Command which sets long (60 ms to 10 s) or short (500  $\mu$ s to 30 ms) range; Trigger Level Commands which set Channel A and/or B slope ( $\pm$ ) and Channel A and/or B trigger from  $-2.50$  Vdc to  $+2.50$  Vdc in steps of .01V.

**Interface Functions:** Group Execute Trigger, Device Clear, Selected Device Clear, Interface Clear, Local, Remote, Local Lockout, Read Status (Serial Poll Enable), Request Service.

### Options

**Opt. 001:** High Stability Time Base (TCXO)

**Frequency:** 10 MHz.

**Aging rate:**  $< 1 \times 10^{-7}$ /mo.

**Temperature:**  $\pm 1 \times 10^{-8}$ ,  $0^\circ$  to  $40^\circ$ C.

**Line voltage:**  $< 1 \times 10^{-8}$  for  $\pm 10\%$  variation.

**Opt. 002:** Battery (5315A only)

**Type:** rechargeable lead-acid (sealed).

**Capacity:** TYPICALLY 4 hours of continuous operation at  $25^\circ$ C.  
**Recharging time:** TYPICALLY 16 hours to 98% of full charge, instrument non-operating. Charging circuitry included with Option. Batteries not charged during instrument operation.

**Low voltage indicator:** instrument turns itself off automatically when low battery condition exists. *Discharge* LED flashes slowly when this happens. *Discharge* LED is on whenever battery is supplying power to instrument.

*Charge* LED indicates state of charge of battery during charging only and is on whenever battery is charged to 95% *NOMINAL* of capacity. *Charge* LED flashes when 90% *NOMINAL* of charge taken out is replaced. *Charge* LED is off if charge is less than 70% *NOMINAL* of capacity.

**Line failure protection:** instrument automatically switches to battery in case of line failure.

**Weight:** Opt. 002 adds 1.4 Kg (3 lbs.) to weight of instrument.

**Option 003:** C Channel

#### Input Characteristics

**Range:** 50 to 1000 MHz, prescaled by 10.

**Sensitivity:** 15 mV rms sinewave ( $-23.5$  dBm) to 650 MHz. 75 mV rms sinewave ( $-9.5$  dBm) to 1000 MHz.

Sensitivity can be decreased continuously by up to 20 dB *NOMINAL*, 50 to 500 MHz and 10 dB *NOMINAL*, 500 to 1000 MHz by adjusting sensitivity control. Trigger level is fixed at 0 V *NOMINAL*.

**Dynamic range:** 15 mV to 1 V rms (36 dB), 50 to 650 MHz. 75 mV to 1 V rms (20 dB), 650 to 1000 MHz.

**Signal operating range:**  $+5$  V dc to  $-5$  V dc.

**Coupling:** AC

**Impedance:** 50  $\Omega$  *NOMINAL* (VSWR,  $< 2.5:1$  TYPICAL).

**Damage level:**  $\pm 8$  V (DC + AC peak), fuse protected. Fuse located in BNC connector.

### Frequency (Channel C)

**Range:** 50 to 1000 MHz.

**LSD displayed:** 100 Hz to 1 Hz depending upon gate time. At least 7 digits per second of gate time.

**Option 004:** High Stability OVEN Time Base (5315A Only)

**Frequency:** 10 MHz

**Aging Rate:**  $< 3 \times 10^{-8}$ /mo\*

**Temperature:**  $\pm 1 \times 10^{-8}$ ,  $0^\circ$  to  $50^\circ$ C.

**Line Voltage:**  $< 1 \times 10^{-8}$ , for a 10% variation.

Oven will operate continuously off of a fully charged battery for  $> 24$  hours, typically, when in standby mode (no power applied, instrument OFF, and Freq. A button depressed).

(5315B and 5316A)

**Frequency:** 10 MHz

**Aging Rate:**  $< 3 \times 10^{-8}$ /mo.\*\*

**Temperature:**  $\pm 2 \times 10^{-8}$ ,  $0^\circ$  to  $50^\circ$ C.

**Line Voltage:**  $< 1 \times 10^{-8}$ , for a 10% variation.

**Option 006:** Offset-Normalize Module

**Measurements (X) operated on:** Frequency, Period, Time Interval, Time Interval Delay, Ratio, and Check. Time Interval place holding zeros are not operated upon.

**Modes:** Normalize (X/A), Offset (X + B), Normalize and Offset ((X/A) + B); switch selectable. Dividing by zero displays zero.

**A and B value selection:** entered by thumbwheel switch with 8-digit mantissa and 1-digit exponent with sign. B may be positive or negative value.

**Display:**  $999.99999 \times 10^9$  to  $< 1 \times 10^{-9}$  range. For negative numbers, the minus sign reduces resolution by one digit.

**Overflow:** frequency measurements will overflow 3 decades after which LSD will be truncated.

**Rack mount kit:** 5061-0074 recommended.

**Weight:** Option 006 adds 1.8 kg (4 lbs. 1 oz.) to instrument weight.

### Dimensions:

**5315B plus Option 006:** 425 mm W x 88 mm H x 345 mm D (16 3/4 x 3 1/2 x 16 1/2")

**5316A plus Option 006:** 425 mm W x 88 mm H x 415 mm D (15 3/4 x 3 1/2 x 16 1/2")

### Ordering Information

		5315A	5315B	5316A
Option 001	TCXO Time Base	X	X	X
Option 002	Battery Pack	X		
Option 003	C-Channel (1.0 GHz)	X	X	X
Option 004	High Stability OVEN Time Base	X	X	X
Option 006	Offset-Normalize Module		X	X

All 5315A orders must include one (1) of these line power options:

**Option 100:** 90-105 VAC

**Option 120:** 108-126 VAC

**Option 220:** 198-231 VAC

**Option 240:** 216-252 VAC

### 5315A Universal Counter

### 5315B Universal Counter

### 5316A Universal Counter

\*After 30 days continuous operation (AC power applied, in OFF or ON position).

\*\*After 30 days continuous operation.

$< 5 \times 10^{-8}$ /mo., after 7 days continuous operation.



- 100 MHz
- 100 ns Time Interval
- Portable

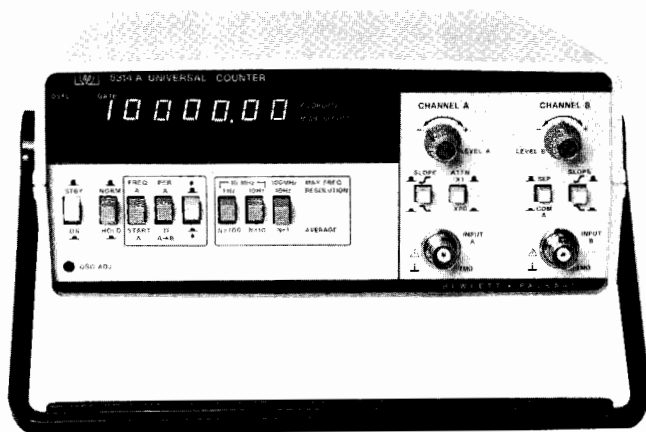

## 5314A

The 5314A Universal Counter is the newest result of HP's continuing low cost counter product development effort. It combines excellent performance and traditional HP quality at a very attractive price. This counter is designed to deliver reliable, high quality operation in such areas as: Production Test, Frequency Monitoring, Education, Training, Service and Calibration. Additionally, the optional battery (option 002) makes the 5314A especially attractive for field and portable applications.

**Input Characteristics (Channels A and B)**

**Range:** CHANNEL A: 10 Hz to 10 MHz Direct.

1 MHz to 100 MHz Prescaled.

CHANNEL B: 10 Hz to 2.5 MHz.

**Sensitivity:** CHANNEL A: 25 mv rms to 100 MHz.

75 mv peak-to-peak at minimum pulse width of 5 ns (100 MHz range).

CHANNEL B: 25 mv rms to 2.5 MHz.

75 mv peak-to-peak at minimum pulse width of 200 ns.

**Coupling:** AC.

**Impedance:** 1 MΩ NOMINAL shunted by less than 30 pf.

**Attenuator:** X1 or X20 NOMINAL (A channel only).

**Trigger level:** continuously variable  $\pm$  350 mV times attenuator setting around average value of signal.

**Slope:** independent selection of + or - slope.

**Channel input:** selectable SEPARATE OR COMMON A.

**Dynamic range:** 75 mV p-p to 4 V p-p.

**Frequency**

**Range:** 10 Hz to 10 MHz direct count.

10 Hz to 100 MHz prescaled by 10.

**Least significant digit (LSD) displayed:** direct count 0.1 Hz, 1 Hz, 10 Hz switch selectable. Prescaled 10 Hz, 100 Hz, 1 KHz switch selectable.

**Resolution:**  $\pm$  LSD.

**Accuracy:**  $\pm$  LSD  $\pm$  (time base error) x Freq.

**Period**

**Range:** 10 Hz to 2.5 MHz.

**LSD displayed:**  $\frac{100 \text{ ns}}{N}$  for N=1 to 1000 in decade steps of N.

**Resolution:**  $\pm$  LSD  $\pm \frac{(1.4 \times \text{TRIGGER ERROR})}{N}$

**Accuracy:**  $\pm$  LSD  $\pm \frac{(1.4 \times \text{TRIGGER ERROR})}{N}$

$\pm$  (time base error) x Per.

**Time interval**

**Range:** 250 ns to 1 sec.

**LSD Displayed:** 100 ns.

**Resolution:**  $\pm$  LSD  $\pm$  START trigger error  $\pm$  STOP trigger error.

**Accuracy:**  $\pm$  LSD  $\pm$  START trigger error

$\pm$  STOP trigger error  $\pm$  (time base error) x TI.

External arming required for START/STOP channels.

**Ratio**

**Range:** 10 Hz to 10 MHz CHANNEL A.

10 Hz to 2.5 MHz CHANNEL B.

**LSD Displayed:** 1/N in decade steps of N for N = 1 to 1000.

**Resolution:**  $\pm$  LSD  $\pm$  (B trigger error x Frequency A)/N.

**Accuracy:**  $\pm$  LSD  $\pm$  (B trigger error x Frequency A)/N.

**Totalize**

**Range:** 10 Hz to 10 MHz.

**Resolution:**  $\pm$  1 count of input.

Totalize controlled by front panel switch.

**General**

**Check:** counts internal 10 MHz oscillator.

**Display:** 7 digit amber LED display with gate and overflow indication.

**Max sample rate:** 5 readings per second.

**Operating temperature:** 0° to 50 °C.

**Power requirement:** 115, +10%, -25%; 230 V, +9%, -17%; 48-66 Hz; 10 VA max.

**Weight:** 2.0 kg (4.4 lb.).

**Dimension:** 238 mm W x 98 mm H x 276 mm D (9 $\frac{3}{8}$ " x 3 $\frac{3}{8}$ " x 10 $\frac{7}{8}$ ").

**Time base:**

**Frequency:** 10 MHz.

**Aging rate:** < 3 part in 10<sup>7</sup> per month.

**Temperature:** <  $\pm$  10 parts in 10<sup>6</sup>, 0 to 50°C.

**Line voltage:** <  $\pm$  1 part in 10<sup>7</sup> for  $\pm$  10% variation.

**Options**

**Option 001:** High stability time base (TCXO).

**Frequency:** 10 MHz.

**Aging rate:** < 1 part in 10<sup>7</sup> per month.

**Temperature:** <  $\pm$  1 part in 10<sup>6</sup>, 0 to 40°C.

**Line voltage:** <  $\pm$  1 part in 10<sup>8</sup> for  $\pm$  10% variation.

**Option 002:** Battery.

**Type:** rechargeable lead-acid (sealed).

**Capacity:** typically 8 hours of continuous operation at 25°C.

**Recharging time:** typically 16 hours to 98% of full charge, instrument non-operating. Charging circuitry included with option. Batteries not charged during instrument operation.

**Battery voltage sensor:** automatically shuts instrument off when low battery condition exists.

**Line failure protection:** instrument automatically switches to batteries in case of line failure.

**Weight:** option 002 adds typically 1.5 kg (3.3 lb.) to weight of instrument.

**Definitions**

**Resolution:** smallest discernible change of measurement result due to a minimum change in the input.

**Accuracy:** deviation from the actual value as fixed by universally accepted standards of frequency and time.

**Trigger error:** 
$$\frac{\sqrt{(80 \mu\text{V})^2 + e_n^2}}{\text{input slew rate at trigger point } (\mu\text{V/s})} \text{ (rms)}$$

Where  $e_n$  is the RMS noise of the input for a 100 MHz bandwidth in CHANNEL A and 10 MHz bandwidth in CHANNEL B.

**Options**

**001** High stability time base

**002** Battery

All orders must include one (1) of these line power options:

**Option 115:** 86-127 V

**Option 230:** 190-250 V

**5314A 100 MHz / 100 ns Universal Counter**

# ELECTRONIC COUNTERS

## Plug-On Modular / Portable Counter System

### Model 5300 A/B system & 5301A-5312A

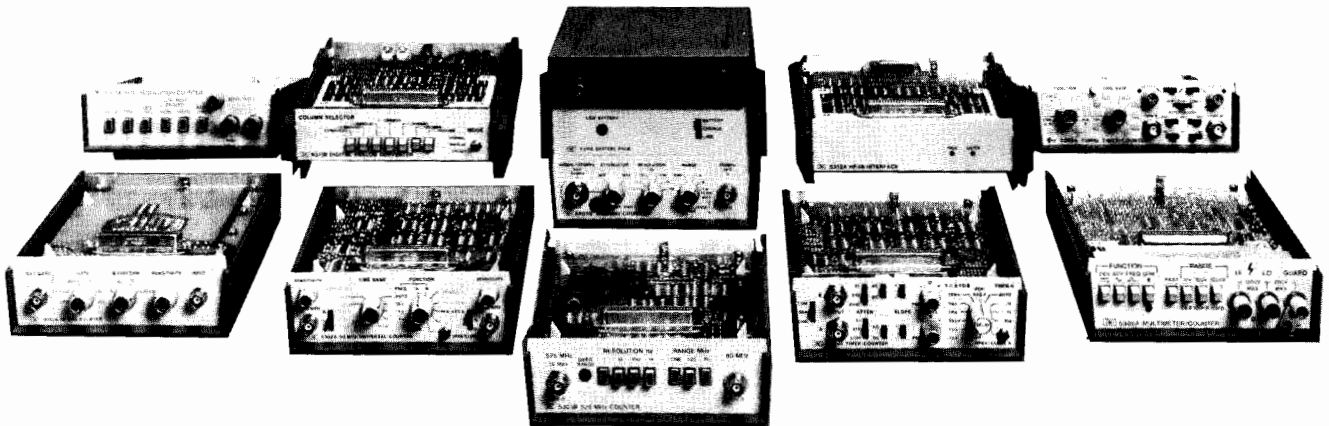

## 5300 Measuring System

### Description

The 5300 measurement system consists of two mainframes, the 5300A and 5300B; 8 snap-on modules for different measurement functions; and snap-between battery pack, digital-to-analog converter and HP-IB interface modules. Easy-to-use and reliable, this versatile system allows the user to select the capability wanted now, expanding later if needed.

The battery pack provides portable, go anywhere operation with all modules. Digital output in BCD format is standard with the 5300A mainframe or in ASCII format via the 5312A HP-IB snap-between module (available with 5300B mainframe only).

Functions of the snap-on module include frequency to 1.3 GHz and 100 ns time interval and time interval averaging. These are summarized in the chart at the bottom of this page.

Compact and rugged, this system is designed for quick and easy owner servicing. On most functional models, immediate checking of the basic counter circuits can be done from the front panel. A user-oriented service support package is also available, providing plug-in cards with automatic diagnostic routines.

## 5300A and 5300B Measurement System Mainframe

The mainframe units provide the system with power, reference frequency, display, counting logic and timing control.

The 5300A has a 6-digit dot matrix display, standard time base, external time base input and BCD output as a standard rear panel output. The 5300B has an 8-digit 7-segment display, standard time base or optional TCXO time base, external time base input and no digital output from the mainframe. See mainframe/plug-on display chart below for number of display digits with a particular mainframe and plug-on combination.

### Time Base

**Standard crystal frequency:** 10 MHz.

### Stability

**Aging rate:** < 3 parts in  $10^7$ /mo.

**Temperature:** <  $\pm 5$  parts in  $10^6$ , 0° to 50°C.

**Typically:** <  $\pm 2$  parts in  $10^6$ , 15° to 40°C.

**Line voltage:** <  $\pm 1$  part in  $10^7$  for 10% line variation.

**Oscillator output:** 10 MHz, approximately 1 V rms at rear panel BNC, 100  $\Omega$  source impedance.

**External input:** 1 MHz to 10 MHz, 1 V rms into 200  $\Omega$ .

### Opt 001 High Stability Time Base (5300B Only)

**Frequency:** 10 MHz.

### Stability

**Aging rate:** < 1.2 parts in  $10^6$ /year.

**Temperature:** <  $\pm 5$  parts in  $10^7$ , 0° to 50°C.

**Line voltage:** <  $\pm 5$  parts in  $10^8$  for 10% line variation.

**Oscillator output:** 10 MHz, approximately 1 V rms at rear panel BNC, 100  $\Omega$  source impedance.

**External input:** 1 to 10 MHz, 1 V rms into 500  $\Omega$ .

### General

**Display:** 6-digit, dot matrix (5300A) or 8-digit, 7-segment matrix (5300B), solid state LED display.

**Operating temperature:** 0° to 50°C.

**Power requirements:** 115 V + 13%, -17% 48-440 Hz; 230 V + 13%, -17% 48-66 Hz; 25 VA maximum (depends on plug-on module). Mainframe power without plug-on nominally 5 watts. Battery operation with 5310A re-chargeable battery pack (see 5310A specifications).

**Dimensions (with snap-on module):** 89 mm H x 160 mm W x 248 mm D (3.5" x 6.25" x 9.75").

**Digital Output:** digital serial, 4-bit BCD parallel standard on 5300A mainframe. HP-IB output available on the 5300B using the plug-in between 5312A.

Model	Frequency MHz	Period	Period Average	Time Interval	Time Interval Average	Totalize	Ratio	Multimeter ACV, DCV, $\Omega$	High Resolution Reciprocal	Display Digits	
										w/5300A	w/5300B
5301A	10					•				6	7
5302A	50	•	•	•		•	•			6	7
5303B	525					•				6	8
5304A	10		•	•		•				6	7
5305B	1300									N/A	8
5306A	10							•		6/5	7/5
5307A	2								•	6	6
5308A	75	•	•	•	•	•	•			N/A	8



### 5301A 10 MHz Frequency Counter Module

#### Input

**Range:** 10 Hz to 10 MHz.

**Sensitivity (min):** 25 mV rms sine wave 50 Hz to 1 MHz, 50 mV rms sine wave 10 Hz to 10 MHz.

#### Frequency Measurement

**Range:** 10 Hz to 10 MHz.

**Gate times:** manually selected 0.1, 1, or 10 seconds AUTO position selects gate time within 1 second for maximum resolution.

**Open/Close (Totalizing):** 10 MHz max

### 5302A 50 MHz Universal Counter Module

#### Input Channels A and B

**Range:** Channel A, 10 Hz to 50 MHz; Channel B, 10 Hz to 10 MHz.

**Sensitivity (min):** 25 mV rms sine wave 50 Hz to 1 MHz. 50 mV rms sine wave 10 Hz to 10 MHz. 100 mV rms sine wave at 50 MHz. 150 mV p-p pulse at minimum pulse width, 50 ns.

**Trigger level:** selectable positive, negative, or zero volts.

**Marker outputs:** rear BNC, TTL low level while gate is open.

#### Frequency

**Range:** Channel A, 10 Hz to 50 MHz, prescaled by 10; Channel B, 10 Hz to 10 MHz.

**Gate times:** manually selected 0.1, 1, or 10 seconds. AUTO position selects for maximum resolution within 1 sec measurement time.

#### Time Interval A to B

**Range:** 500 nsec to 1000 seconds.

**Resolution:** 100 ns to 1 ms in decade steps.

#### Period B/Period Average B

**Range:** 10 Hz to 1 MHz.

**Resolution:** 100 ns to 1 ms in decade steps.

**Periods averaged:** 1 to  $10^3$  automatically selected.

#### Ratio

**Display:**  $F_B/F_A$  times multiplier (N),  $N = 10$  to  $10^7$ .

**Range:** Channel A: 10 Hz to 1 MHz, Channel B: 10 Hz to 10 MHz.

**Open/Close (Totalizing):** 10 MHz max

### 5303B Frequency Counter Module

#### Input Channel A (CW or Burst)

**Range:** DC to 525 MHz, prescaled by 8.

**Sensitivity (fixed):** 100 mV rms sine wave, dc to 500 MHz. 125 mV rms sine wave, 500 MHz to 525 MHz. Signal must pass through zero.

#### Input Channel B (CW or Burst)

**Range:** 50 Hz to 80 MHz, direct.

**Sensitivity (automatic):** 25 mV rms sine wave, 100 Hz to 50 MHz. 50 mV rms sine wave, 50 Hz to 100 Hz and 50 MHz to 80 MHz. Sensitivity is adjusted automatically by Automatic Gain Control.

#### Frequency Measurement

**Resolution (selectable):** 1, 10, 100, 1000 Hz.

**Opt 001: High Stability Time Base** (for use with 5300A)

**Frequency:** 10 MHz.

#### Stability

**Aging rate:**  $< 1.2$  part in  $10^6$ /year.

**Temperature:**  $< \pm 5$  parts in  $10^7$ ,  $0^\circ$  to  $50^\circ\text{C}$ .

**Line voltage:**  $< \pm 5$  parts in  $10^8$  for 10% line variation.

**Oscillator output:** 10 MHz, approx. 1 V rms at rear panel BNC.

**External input:** 1 to 10 MHz, 1 V rms into 500  $\Omega$ .

### 5304A Timer/Counter Module

#### Input Channels A and B

**Range:** DC coupled, 0 to 10 MHz; AC coupled, 100 Hz to 10 MHz.

**Sensitivity (min):** 25 mV rms sine wave to 1 MHz, 50 mV rms sine wave to 10 MHz, 150 mV p-p pulse at minimum pulse width, 40 nsec. Attenuator reduces sensitivity by 10 or 100 times.

**Trigger level:** PRESET position centers triggering about 0 volts, or continuously variable over the range of  $-1$  V to  $+1$  V.

**Gate output:** rear panel BNC. TTL low level while gate is open.

#### Time Interval A to B

**Range:** 500 ns to  $10^4$  sec.

**Resolution:** 100 ns to 10 ms in decade steps.

**Time interval holdoff:** inserts variable delay of approximately 100  $\mu\text{s}$  to 100 ms between START and enabling of STOP; may be disabled. Electrical inputs during delay time are ignored.

#### Period Average A

**Range:** 10 Hz to 1 MHz.

**Periods averaged:** 1 to  $10^3$  automatically selected.

#### Frequency A

**Range:** 0 to 10 MHz.

**Gate times:** manually selected 0.1, 1, or 10 seconds. AUTO position selects gate time to 1 second for maximum resolution.

**Open/Close (Totalizing):** 10 MHz max

### 5305B 1300 MHz Frequency Counter Module

#### Input Channel A (CW or Burst)

**Range:** 90 MHz to 1300 MHz, prescaled by 16.

**Sensitivity:** 20 mV rms.

**Impedance:** 50  $\Omega$ .

**Attenuator:** continuously variable for signals up to 3.5 V rms.

**Operating dynamic range:**  $> 47$  dB

#### Input Channel B (Normal and High Resolution Mode)

**Range:** 50 Hz to 100 MHz in normal mode. 50 Hz to 10 kHz in high resolution mode.

**Sensitivity:** 20 mV rms.

#### Frequency Measurement

**Resolution:** (selectable)

**Normal mode:** (50 Hz to 1300 MHz): 0.1 Hz to 10,000 Hz.

**High resolution mode:** (50 Hz to 10 kHz): 0.0001 to 10 Hz.

### 5306A Digital Multimeter/Counter Module

#### DC Voltage

**Sensitivity:** 100  $\mu\text{V}$  for 10 V range, 1 mV for 100 V range, 10 mV for 1000 V range.

**Sample times:** normal, 0.5 sec; fast, 0.05 sec.

**Effective common mode rejection (1 k $\Omega$  imbalance):** DC,  $> 80$  dB; 50 Hz or 60 Hz  $\pm 0.1\%$ ,  $> 80$  dB.

**Normal mode rejection:** 50 Hz or 60 Hz  $\pm 0.1\%$ :  $> 50$  dB.

#### AC Voltage

**Frequency:** 40 Hz to 100 kHz for 10 V range, 40 Hz to 500 Hz for 100 V range, 40 Hz to 500 Hz for 1000 V range.

**Effective common mode rejection (1 k $\Omega$  imbalance):** DC,  $> 80$  dB; 50 Hz or 60 Hz  $\pm 0.1\%$ ,  $> 50$  dB.

#### Ohms

**Sensitivity:** 0.1  $\Omega$  for 10 k $\Omega$  range, 1  $\Omega$  for 100 k $\Omega$  range, 100  $\Omega$  for 10 M $\Omega$  range.

**Current through unknown:** 1 mA on 10 k $\Omega$  range, 100  $\mu\text{A}$  on 100 k $\Omega$  range, 1  $\mu\text{A}$  on 10 M $\Omega$  range.

#### Frequency

**Range:** 40 Hz to 10 MHz.

**Sensitivity (min):** 50 mV rms to 1 MHz; 125 mV rms to 10 MHz.

**Trigger level:** automatically adjusts to 40% of peak level of input.

**Gate times:** normal, 1 sec; fast, 0.1 sec.

### 5307A High Resolution Counter Module

#### Input

**Range:** Hz mode, 5 Hz to 2 MHz; CPM mode, 50 to 10 M counts/minute (0.8333 Hz to 166 KHz).

**Sensitivity (min.):**

	Hz	CPM
10 mV rms	5 Hz–1.2 MHz	120 CPM–10 MCPM
25 mV rms	1.2 MHz–2.0 MHz	50 CPM–120 CPM

**Pulses:** for low duty-cycle pulses ( $< 15\%$ ); 15 mV peak for 250 nsec pulses, 100 mV peak for 100 nsec pulses.

**Low pass filters:** (3 dB point) 100 Hz 10 kHz

Max. attenuation 60 dB 40 dB

Roll-off 20 dB per decade

#### Frequency Measurement

**Periods averaged:** automatically selected for maximum resolution.

**Measurement time:** varies from 312 ms to 815 ms.





## 5300A/B System (cont.)

## 5308A Universal Timer/Counter Module

## Input (Channels A and B)

**Range:** DC coupled, 0 to 75 MHz; AC coupled, 20 Hz to 75 MHz.

**Sensitivity (min):** 25 mV rms to 10 MHz, 50 mV rms to 75 MHz, 150 mV p-p pulse at pulse width of 10 nsec.

**Trigger level:** variable over the range of  $\pm 2.0$  V and  $\pm 20$  V.

**Rear outputs:** gate, trigger levels and time base/scaling.

## Frequency

**Range:** 0 to 75 MHz, Channel A or Channel B.

**Gate times:** 8 selectable times from 1  $\mu$ s to 10 s.

## Frequency Ratio

**Display:** Fa/Fb, 1 to  $10^4$  periods selectable manual or auto.

**Range:** Channel A, 0 to 75 MHz; Channel B, 0 to 5 MHz.

## Period

**Range:** 0 Hz to 5 MHz, Channel B.

**Resolution:** 100 nsec to 10 sec.

## Period Average

**Range:** 0.1–5 MHz; (200 nsec to 10 sec), Channel B.

**Periods averaged:**  $10$ – $10^6$  selectable manual or automatic.

## Time Interval A — B

**Range:** 200 nsec to  $10^9$  sec. 25 ns minimum pulse width.

**Resolution:** 100 nsec to 10 sec.

## Time Interval Average A — B

**Range:** 1 ns to 10 s, 200 ns dead time between intervals.

**Intervals averaged:** 1 to  $10^6$ , selectable manual or automatic.

## Totalize

Totalizes Channel A while Channel B is low.

Totalizes Channel A between pulses on channel B.

**Range:** 75 MHz in X1 position, 5 MHz in X $10^4$  positions.

## General

**Auto position:** automatically sets time base to give maximum resolution within 1.1 seconds measurement time.

## 5310A Battery Pack Module

**Battery capacity:** 48 watt-hours, nominal. Minimum 3, typically 5, hours of continuous operation at charging and operating temperature.

**Recharging time:** 18 hours from minimum level to full charge.

**Battery voltage:** 12 Vdc.

**Low voltage indicator:** solid state warning light begins to glow at approximately 90% discharge.

**Line failure protection:** allows instrument to be operated in LINE position with automatic switch-over to battery power if line voltage fails.

**Operating temperature:** operating 0° to 50°C. Charging 0° to 40°C, mainframe not operating.

**Power requirements:** charging power via mainframe, nominal 7.5 watts.

## 5311B Digital-to-Analog Converter Module

Manual pushbuttons select any three consecutive digits or the last two digits of the mainframe display.

Three operating modes are selectable by switch on front panel.

Mode	Output		
	0 to 50% of Scale	50% of Scale	50% to 100% of Scale
Normal	0 to 499	500	501 to 999
Plus/Minus	-999 to -001	000	001 to 999
Offset	500 to 999	000	001 to 499

**Potentiometric recorder output:** 0.1 V, 1.0 V, or 10 V full scale into  $>20$  k $\Omega$ . Dual banana plugs.

**Galvanometer recorder output:** 1 mA full scale into  $<1.5$  k $\Omega$  phone jack.

**Accuracy:**  $\pm 0.25\%$  of range  $\pm 50$   $\mu$ V/°C on potentiometric output,  $\pm 20$  nA/°C on galvanometer output after calibration for appropriate range.

**Calibration:** zero and full scale calibration switch and adjustments on rear panel.

**Transfer time:**  $<5$  ms.

**Operating temperature:** 0° to 50°C.

**Power requirements:** nominally 1 watt.

## 5312A HP-IB (ASCII) Interface Module

The data output format consists of fifteen characters with a maximum transfer rate of 40 readings/sec, dependent on plug-on capability. 5300 measuring system front panel controls are not programmable. Note that the 5312A is not compatible with the 5300A mainframe, which has its own BCD output.

## Ordering Information

5300A 6 digit mainframe

5300B 8 digit mainframe

Opt 001: TCXO (5300B only)

5301A 10 MHz Frequency Counter Module

5302A 50 MHz Universal Counter Module

5303B 525 MHz Counter

Opt 001: High Stability Time Base

5304A Timer/Counter Module

5305B 1300 MHz Counter

5306A Digital Multimeter/Counter

5307A High Resolution Counter

5308A 75 MHz Timer/Counter

5310A Battery Pack Module

5311B Digital-To-Analog Converter

5312A HP-IB Interface

## Accessories

**10533A Digital recorder interface:** (for use with 5300A)

**10548A Service support package:** contains an interface card and 4 diagnostic cards for easy trouble shooting of 5300A or 5300B

**10855A:** Preamp: 22 dB gain with  $\pm 1$  dB flatness from 2 MHz to 1300 MHz.

**18019A Leather carrying case:** holds 5300A or 5300B, snap-on module and 5310A battery pack plus accessories

## Rack Mount Kits

10851A Single

10852A Double

10853A Single/with plug-between

10854A Double/with plug-between

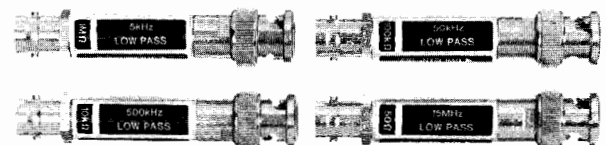

## 10856A Low Pass Filter Kit

The four low pass filters of the 10856A filter kit are recommended for use with any HP frequency counter to reduce high frequency noise or unwanted signals that cause frequency or period measurement errors. For use in calibration of frequency standards or instrument time bases, a 15 MHz, 50  $\Omega$  filter has been included. Further applications for the kit include reducing noise (trace fuzz) in oscilloscope and spectrum analyzer displays.

## Specifications

Cut Off Frequency (NOMINAL)	5 KHz	50 KHz	500 KHz	15 MHz
Input Impedance (NOMINAL)	1 M $\Omega$	100 k $\Omega$	10 k $\Omega$	50 $\Omega$
Signal Rejection, 100 MHz to 500 MHz	$>40$ dB	$>40$ dB	$>40$ dB	$>20$ dB

**Roll-off:** 20 dB per decade.

**Attenuation:**  $\times 2$ , reduces signal voltage by a factor of 2.

**Output impedance:** for use with 1 M $\Omega$  input instruments.

10856A Low Pass Filter Kit

# ELECTRONIC COUNTERS

## Low Cost Counters for Frequency Measurements

Models 5381A, 5382A & 5383A

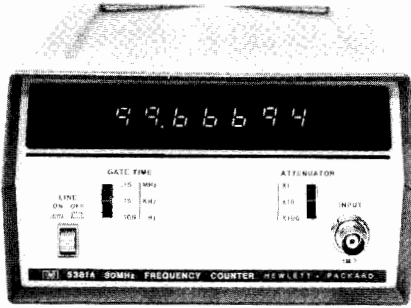

5381A

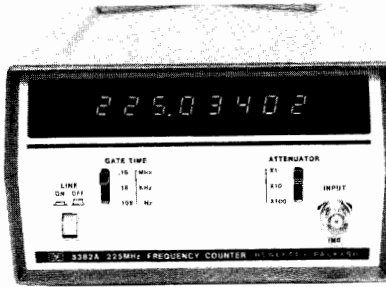

5382A

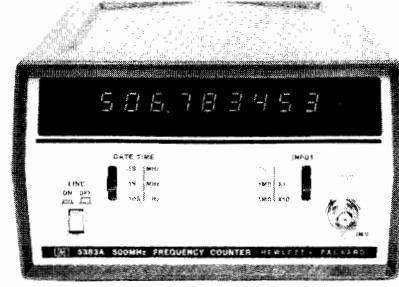

5383A

## Description

### General

The 5381A, 5382A and 5383A are a logical result of HP's long-standing leadership in frequency counter development. Leadership in quality, technology and efficient production procedures allows HP to offer a superb price/performance combination in these three precision instruments. These counters are designed to deliver reliable, high quality operation in such diverse areas as: production line testing, service and calibration (two-way radio and test equipment), frequency monitoring, education and training.

### Resolution

The 5381A, 5382A and 5383A employ the direct counting technique and, with 7, 8 and 9 digits respectively, offer resolution of 10 Hz in 0.1 sec., 1 Hz in 1 sec and 0.1 Hz in 10 seconds.

## Specifications

### 5381A

**Frequency range:** 10 Hz to 80 MHz.

**Sensitivity:** 25 mV rms—30 Hz to 20 MHz.  
50 mV rms—10 Hz to 80 MHz.

**Input impedance:** 1 M $\Omega$ , <50 pF.

**Input attenuation:** X1, X10, X100.

**Accuracy:**  $\pm 1$  count  $\pm$  time base error.

**Resolution:** Direct count; 1 Hz in 1 second.

**Gate times:** 0.1 second, 1 second, 10 seconds.

**Display:** 7 LED digits.

**Rear panel input:** sensitivity, TTL levels or 2.5 V rms.

**Ratio:** Rear Panel Input, 10 kHz to 2 MHz.

**External frequency standard:** Rear Panel Input, 1 MHz.

#### Time Base

**Frequency:** 1 MHz.

**Aging:** <0.3 ppm/month.

**Temperature:**  $\pm 10$  ppm 0°C to 40°C.

**Line voltage:**  $\pm 1$  ppm for 10% line change.

### 5382A

**Frequency range:** 10 Hz to 225 MHz.

**Sensitivity:** 25 mV rms—30 Hz to 10 MHz.  
50 mV rms—10 Hz to 225 MHz.

**Input impedance:** 1 M $\Omega$ , <40 pF.

**Input attenuation:** X1, X10, X100.

**Accuracy:**  $\pm 1$  count  $\pm$  time base error.

**Resolution:** direct count; 1 Hz in 1 second.

**Gate time:** 0.1 second, 1 second, 10 seconds.

**Display:** 8 LED digits, nonsignificant zero blanking.

**Rear panel input:** sensitivity, 250 mV rms.

**Ratio:** Rear Panel Input, 100 kHz to 10 MHz.

**External frequency standard:** Rear Panel Input, 10 MHz.

#### Time Base

**Frequency:** 10 MHz.

**Aging:** <0.3 ppm/month.

**Temperature:**  $\pm 2.5$  ppm 0°C to 40°C.

**Line voltage:**  $\pm 0.5$  ppm for 10% line change

### 5383A

**Frequency range:** 10 Hz to 520 MHz.

**Sensitivity:**

1 M $\Omega$ : 25 mV rms—20 Hz to 10 MHz.

50 mV rms—10 Hz to 50 MHz.

50  $\Omega$ : 25 mV rms—20 Hz to 520 MHz.

**Input impedance:** selectable: 1 M $\Omega$ , <40 pF or 50  $\Omega$ .

**Input attenuation:** 1 M $\Omega$   $\times$  1,  $\times$  10; 50  $\Omega$   $\times$  1—fuse protected.

**Accuracy:**  $\pm 1$  count  $\pm$  time base error.

**Resolution:** direct count; 1 Hz in 1 second.

**Gate time:** 0.1 second, 1 second, 10 seconds.

**Display:** 9 LED digits, nonsignificant zero blanking.

**Display test:** RESET function (activated with GATE TIME switch) illuminates all segments of all digits.

**Rear panel input:** sensitivity: 250 mV rms.

**Ratio:** Rear Panel Input, 100 kHz to 10 MHz.

**External frequency standard:** Rear Panel Input, 10 MHz.

#### Time Base Output

**Frequency:** 10 MHz.

**Voltage:** 200 mV p-p into 50  $\Omega$  load.

**Control:** active with Rear Panel Internal/External switch in internal position.

#### Time base

**Frequency:** 10 MHz.

**Aging:** <0.3 ppm/month.

**Temperature:**  $\pm 2.5$  ppm 0°C to 40°C.

**Line voltage:**  $\pm 0.5$  ppm for  $\pm 10\%$  line change.

#### TCXO Option

**Opt 001:** (available for all models) Temperature Compensated Crystal Oscillator time base

**Frequency:** 10 MHz.

**Aging:** <0.1 ppm/month.

**Temperature:** <1 ppm 0°C to 40°C.

**Line voltage:**  $\pm 0.1$  ppm for  $\pm 10\%$  line change.

**Note:** Time base output available for both 5382A and 5383A with Option 001.

#### 5380 Family General Data

**Overflow:** LED lamp indicator when most significant digit overflows.

**Reset:** manual selection of reset occurs when GATE TIME switch is between three normal positions.

**Package:** rugged, high strength metal case.

**Operating temperature:** 0°C to 40°C.

**Power requirements:** 100, 120, 220, 240, V rms (+5%, -10%) 48-440 Hz; 30 VA maximum.

**Weight:** net, 2.2 kg (4 $\frac{3}{4}$  lb). Shipping, 2.8 kg (6 lb).

**Dimensions:** 98 H x 60 W x 248 mm D (3.5" x 6.25" x 9.75").

#### Ordering Information

5381A Frequency Counter

5382A Frequency Counter

5383A Frequency Counter

Opt 001: TCXO (all models)

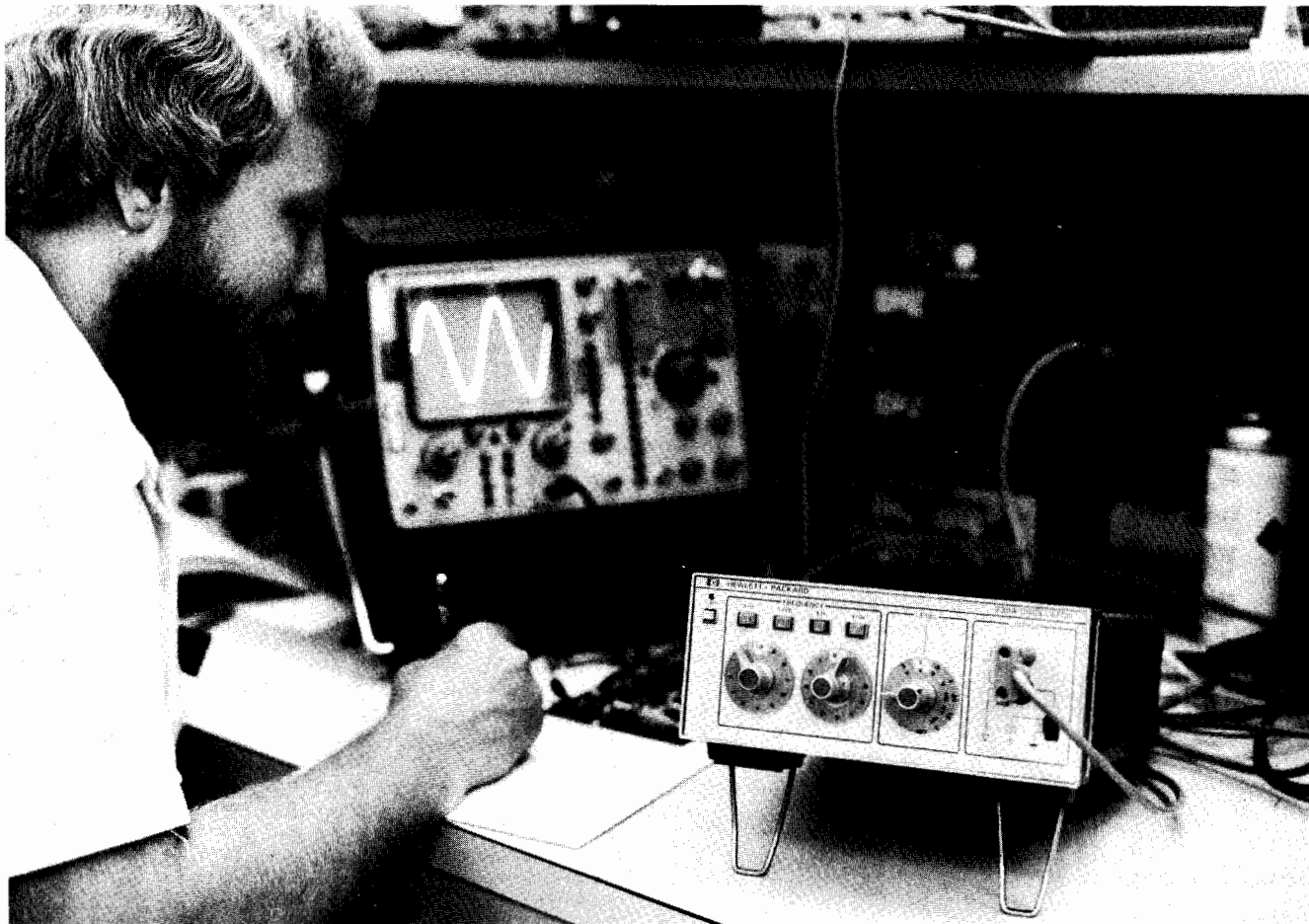

Signal sources are described by various names: oscillators, audio signal generators, function generators, etc. The names are typically associated with the application area. Signal generator describes an oscillator which has modulation capability. The term oscillator refers exclusively to a sinusoidal source while a function generator always provides additional wave shapes, most often square waves, triangle waves, and increasingly, pulses.

In this section, we are considering oscillators covering the audio through video frequency range.

#### Basic Considerations

In choosing a particular oscillator, frequency range, output level and distortion (THD) are the key considerations. Typically, oscillators used for testing of audio equipment, filters, amplifiers, etc., require total harmonic distortion (THD) to be less than 65 dB and often as much as 95 dB below the fundamental. Oscillators used in video testing must provide signals to at least 6 MHz and often to 10 MHz. For many general purpose applications, high level signals are needed, an example being 10 volts in 600 ohms. Hewlett-Packard offers oscillators that meet all of these requirements. Table 1 is a summary chart comparing the main features of all the products.

#### Distortion

Distortion in total harmonic terms is a measure of the oscillator's signal purity. It is presented as a ratio of the total harmonic

content to the fundamental and expressed either as dB's below the fundamental or as a percentage of it. A typical value for audio work might be a THD of  $-60$  dB ( $\approx 0.1\%$ ).  $-95$  dB is becoming more necessary especially in the audio entertainment and Hi-Fi areas. Hewlett-Packard offers this high level of signal purity in the 239A Oscillator.

#### Frequency Stability

Frequency stability of an oscillator determines the ability of the instrument to maintain a selected frequency over a period of time. Component aging, power-supply variations and temperature changes all affect stability. Carefully chosen components, such

as precision resistors and variable capacitors in the frequency-determining networks, contribute to long-term stability. Technology, particularly large scale integration, minimizes the adverse effects of temperature and in such situations all but eliminates the effects of discrete component aging.

#### Amplitude Stability

Amplitude stability with time and over a desired frequency range is an important characteristic in most applications. Hewlett-Packard uses negative feedback techniques to minimize variations in amplitude with time and pays great attention to circuit elements that influence the frequency response of the oscillator.

Oscillator Summary

INSTRU. NO.	FREQUENCY RANGE	POWER OUTPUT	THD	PAGE
200CD	1 Hz to 10 MHz	160 mW	0.2%	311
201C	10 Hz to 10 kHz	3 W	0.5%	311
204C	10 Hz to 10 MHz	10 mW	0.1%	311
204D	10 Hz to 10 MHz	10 mW	0.1%	311
209A	10 Hz to 10 MHz	40 mW	0.1%	311
239A	10 Hz to 10 MHz	17 mW	0.0018%	312
651B	10 Hz to 10 MHz	200 mW	1%	313
652A	10 Hz to 10 MHz	200 mW	1%	313
654A	10 Hz to 10 MHz	13 mW	1%	313

1 Hz 10 100 1 kHz 10 kHz 100 kHz 1 MHz 10 MHz

# OSCILLATORS

311

## 4 Hz to 2 MHz Sine, Square Wave Oscillators

Models 200CD 201C 204C 204D 209A



### Description

This series of dependable oscillators provides stable, high quality signals for a wide variety of applications. All models feature low distortion, excellent flatness and large, well-calibrated dials.

Choose from such features as balanced or single ended outputs, precision attenuators, external synchronization, high output power and self-contained, battery operation.

### Accessories Available

- 11000A Cable Assembly
- 11001A Cable Assembly
- 11004A Line Matching Transformer
- 11005A Line Matching Transformer

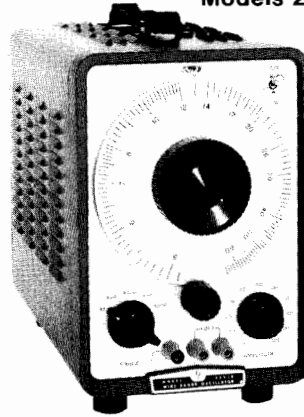

200CD (shown), 201C



209A (shown), 204C, 204D

### Specifications

	200CD	201C	204C,D	209A
frequency range	5 Hz. to 600 KHz.	20 Hz. to 20 KHz.	5 Hz. to 1.2 MHz.	4 Hz. to 2 MHz.
number of ranges	5 overlapping	3 overlapping	6 overlapping	
dial accuracy	± 2%	± 1%	± 3%	
flatness (1 KHz. ref.)	± 1 dB.	± 1 dB.	(Low Distortion mode) ± 1% 5 Hz to 100 Hz ± 5% 100 Hz to 300 KHz ± 1% 300 KHz to 1.2 MHz  (Normal mode) as above, except: +5%, -1% 5 Hz to 100 Hz	± 1% 4 Hz to 100 Hz ± 5% 100 Hz to 300 KHz ± 1% 300 KHz to 1 MHz ± 5% 1 MHz to 2 MHz  as above, except: +5%, -1% 4 Hz to 100 Hz
output voltage (600 ohm load) (open circuit)	10 V rms (> 160 mW.) 20 V rms	42.5 V rms (3 W.) 50 V rms	>2.5 V rms (10 mW.) >5.0 V rms	5 V rms (40 mW.) 10 V rms
output impedance	600 ohms	600 ohms (20,30,40 dB.) <600 ohms (0.10 dB.)	600 ohms	
attenuator	continuously variable	0 to 40 dB in 10 dB steps plus vernier	(204C) continuously variable, >40 dB. range (204D) +10 to -70 dBm in 10 dB steps plus vernier. Accuracy is ± 0.3 dB through -60 dBm range, ± 0.5 dB through -70 dBm range.	continuously variable. >26 dB. range
distortion	<.5% 5 Hz to 20 Hz <.2% 20 Hz to 200 KHz <.5% 200 KHz to 600 KHz	<.5% 50 Hz to 20 KHz (1W.) <1% 20 Hz to 20 KHz (3W.)	<.6% 5 Hz to 30 Hz <.1% 30 Hz to 100 KHz <1% 100 KHz to 1.2 MHz	<.2% 4 Hz to 200 Hz <.1% 200 Hz to 200 KHz 1% 200 KHz to 2 MHz
hum and noise voltage	<.1% of rated output	<.1% of rated output	<.01% of output	
balance	<.1% at lower frequencies approx. 1% at higher frequencies	one terminal at ground potential	>40 dB below 20 KHz	
square wave output				20 V p-p open circuit symmetrical about 0 V.
rise/fall time				<50 nSec into 600 ohms
synchronization input			oscillator can be synchronized to an external signal. Sync range, the difference between sync frequency and set frequency, is a linear function of sync voltage. ± 1%/V rms for sine wave, maximum input ± 7 V pk (± 5 V rms).	
synchronization output			sine wave in phase with output; fixed level: 204C,D: 100mV into 10 Kohms, 100 pF 209A: 1.7 V rms (open circuit)	
input voltage	115 or 230 VAC ± 10% 48-440 Hz.			
power consumption	90 VA	75 VA	7 VA	
net weight	9.9 kg (22 lb)	7.2 kg (16 lb)	2.7 kg (6 lb)	
shipping weight	10.8 kg (24 lb)	8.6 kg (19 lb)	3.6 kg (8 lb)	
dimensions H x W x D	292 mm x 187 mm x 365 mm (11.5 x 7.4 x 14.4")	292 mm x 191 mm x 318 mm (1.5 x 7.5 x 12.5")	155 mm (without removeable feet) x 130 mm x 203 mm (6.1 x 5.1 x 8")	
options			option 002 - operation from AC line or internal rechargeable batteries	
			204C:	204D:
			Option 002:	

# OSCILLATORS

## 10 Hz to 110 kHz Low Distortion Oscillator

### Model 239A

- $< -95$  dB THD to 20 kHz
- Calibrated attenuator
- 10 Hz to 110 kHz

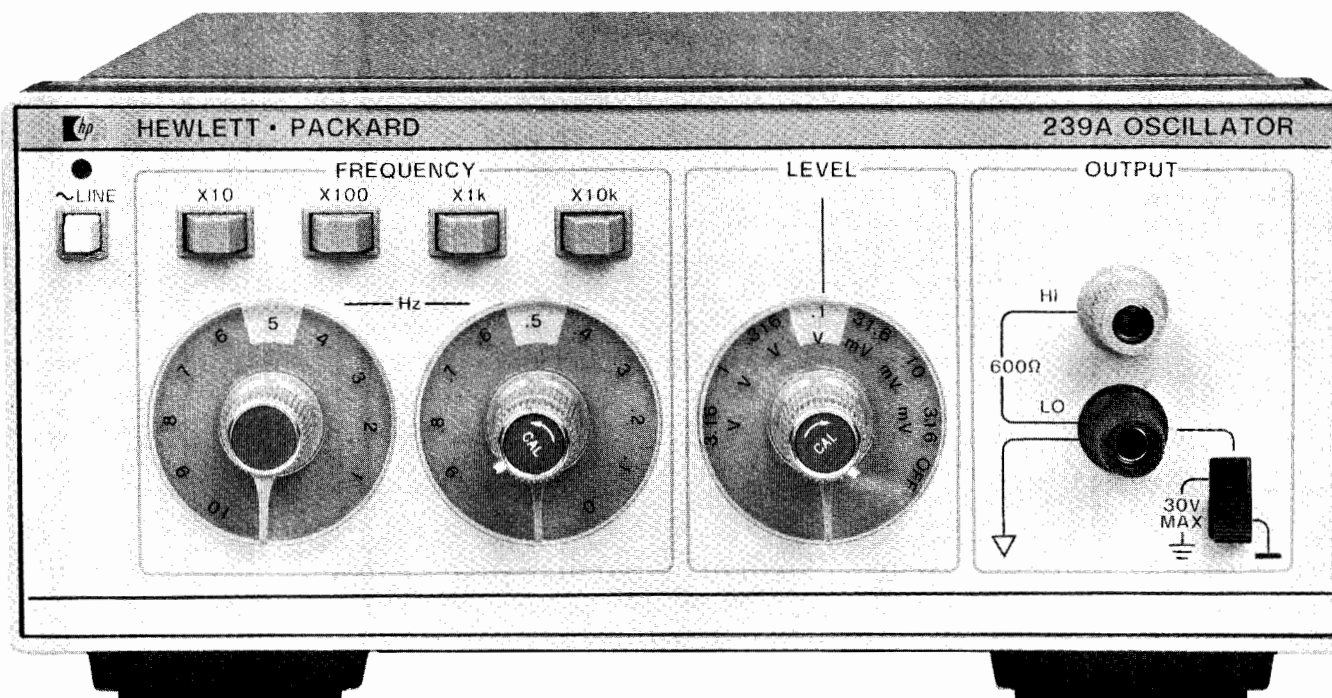

239A

### Description

The HP 239A Oscillator provides a low distortion sine-wave output with  $> 3$  Vrms amplitude from 10 Hz to 110 kHz and less than  $-95$  dB (.0018%) total harmonic distortion (THD) to 20 kHz, increasing to  $-70$  dB (.032%) at 110 kHz. Low THD performance combined with a  $600\ \Omega$  output that can be floated to 30 V peak makes the 239A an excellent general purpose audio test source.

### Companion Oscillator for Distortion Measurements

The 239A Oscillator is electrically similar to the built-in oscillator used in the HP 339A Distortion Measurement Set and can be used in conjunction with the 339A where a remote audio source is needed for low distortion measurements such as broadcast studio through transmitter tests. Use of the 239A can improve the range of distortion measurements with earlier model analyzers. Its small size and weight makes the 239A convenient to use on the bench or easy to carry for remote tests.

### Calibrated Output Attenuator

The accurately calibrated output allows measurements to be made without time consuming external calibration. The output level can be changed in 10 dB steps with  $\pm 0.25$  dB/step accuracy over a 60 dB range from a maximum calibrated output of  $+10$  dBV (3.16 Vrms). The output is continuously variable between steps down to a level of 1 mV with the amplitude vernier control.

Level flatness is  $\pm 0.1$  dB from 20 Hz to 20 kHz and less than  $\pm 0.2$  dB over the full frequency range.

### Accurate Frequency Selection

Frequency selection with  $\pm 2\%$  accuracy is easily made with 2-digit resolution using rotary knob tuning and the multiplier push-buttons. The frequency vernier control provides continuous frequency coverage between the second digit switch settings.

### 239A Specifications

**Frequency:** 10 Hz to 110 kHz in 4 overlapping decade ranges with 2-digit resolution. Frequency vernier provides continuous frequency coverage between second digit switch settings. Frequency accuracy:  $\pm 2\%$  of selected frequency (with Frequency Vernier in CAL position).

**Output level:** Maximum calibrated output (1 kHz,  $600\ \Omega$  load):  $+10$  dBV (3.16 Vrms)  $\pm .2$  dB

Output variable from  $< 1$  mV to 3.16 Vrms into 600 ohms.

**Output attenuator:** Range: 60 dB in 10 dB steps; Accuracy:  $\pm .25$  dB/10 dB step. Maximum Cumulative Error  $\pm 1$  dB; Output Vernier:  $> 10$  dB range, continuously variable

**Level flatness:** 20 Hz to 20 kHz:  $\leq \pm 0.1$  dB; 10 Hz to 110 kHz:  $\leq \pm 0.2$  dB

**Distortion ( $\geq 600\ \Omega$  Load,  $\leq 3$  V Output):** 10 Hz to 20 kHz:  $< -95$  dB (0.0018%) THD; 20 kHz to 30 kHz:  $< -85$  dB (0.0056%) THD; 30 kHz to 50 kHz:  $< -80$  dB (0.01%) THD; 50 kHz to 110 kHz:  $< -70$  dB (0.032%) THD

**Output impedance:**  $600\ \Omega \pm 5\%$

Output terminals may be floated up to 30 V peak.

**Operating environment:** Temperature:  $0^\circ\text{C}$  to  $50^\circ\text{C}$  ( $+32^\circ\text{F}$  to  $+122^\circ\text{F}$ )

**Humidity range:**  $< 95\%$ ,  $0^\circ\text{C}$  to  $40^\circ\text{C}$  ( $+32^\circ\text{F}$  to  $+104^\circ\text{F}$ )

**Storage temperature:**  $-40^\circ\text{C}$  to  $+75^\circ\text{C}$  ( $-40^\circ\text{F}$  to  $+167^\circ\text{F}$ )

**Power:** 100/120/220/240 V,  $+5\%$ ,  $-10\%$ , 48 to 66 Hz, 10 VA max.

**Weight:** Net 2.5 kg (5.5 lbs.); Shipping 3.9 kg (8.5 lbs.).

**Size:** 213 mm W x 88 mm H x 269 mm D (8.4" x 3.5" x 10.6").

239A Oscillator

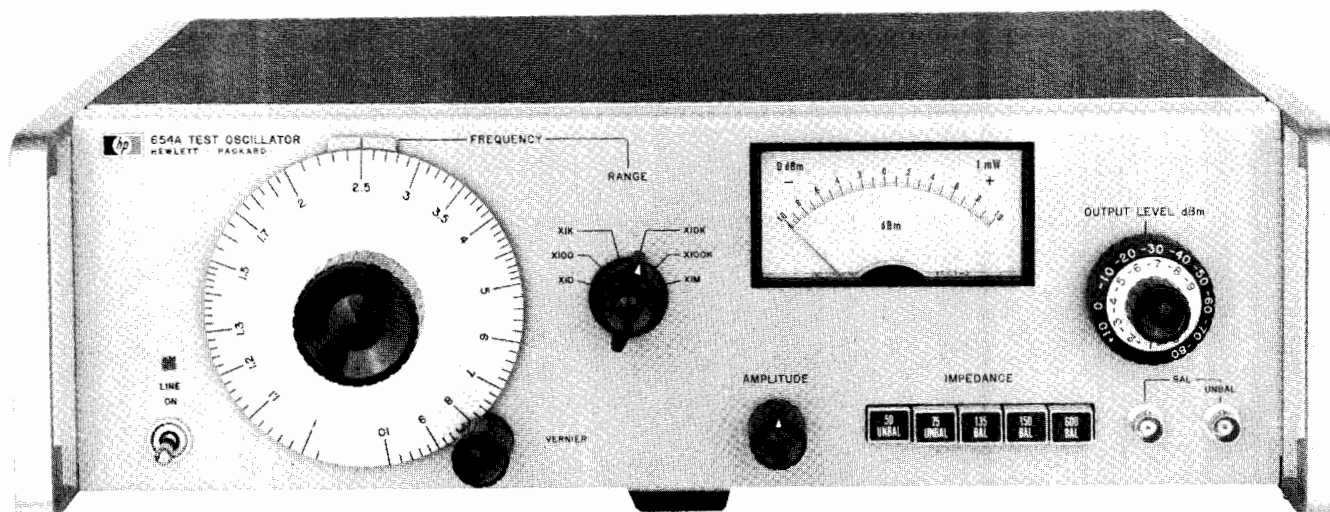

654A

### Specifications & General Information

MODEL NO.	651B	652A	654A
Description	Amplitude and frequency stability of this solid state capacitance-tuned test oscillator provides high quality signals for general purpose lab or production measurements.	Similar to Model 651B, HP's Model 652A offers an expandable output monitor for amplitude control to 0.25% across its entire frequency band for greater output and resettability.	Similar to the 651B Test Oscillator, HP's 654A has balanced outputs of 135 $\Omega$ , 150 $\Omega$ , and 600 $\Omega$ , automatic leveling over entire frequency range, and expanded meter.
Frequency Range	10 Hz to 10 MHz, 6 bands.		
Frequency Accuracy	$\pm 2\%$ , 100 Hz to 1 MHz; $\pm 3\%$ , 10 Hz to 100 Hz and 1 MHz to 10 MHz.		$\pm 2\%$ 100 Hz to 5 MHz; $\pm 3\%$ 10 Hz to 100 Hz; $\pm 4\%$ 5 MHz to 10 MHz.
Frequency Response (Flatness)	$\pm 2\%$ , 100 Hz to 1 MHz; $\pm 3\%$ , 10 Hz to 100 Hz; ( $\pm 4\%$ , 1 MHz to 10 MHz applies only at 50 $\Omega$ or 75 $\Omega$ output and amplitude readjusted to a reference on the output monitor.)	$\pm 0.25\%$ , 3 V and 1 V range; $\pm 0.75\%$ , 0.3 V to 0.3 mV range; $\pm 1.75\%$ , 0.1 mV range. (Amplitude readjusted using expanded scale on output monitor).	( $\pm 10$ dBm and 0 dBm, 1 kHz ref) $\pm 0.5\%$ from 10 Hz to 10 MHz for unbalanced outputs and 10 Hz to 5 MHz for 135 $\Omega$ and 150 $\Omega$ outputs, and 10 Hz to 1 MHz for 600 $\Omega$ output.
Distortion	$<1\%$ , 10 Hz to 2 MHz; $<2\%$ , 2 MHz to 5 MHz; $<4\%$ , 5 MHz to 10 MHz.		10 Hz to 1 MHz, $>40$ dB below fundamental; 1 MHz to 10 MHz, $>34$ dB below fundamental.
Output	3.16 V into 50 $\Omega$ or 600 $\Omega$ ; 6.32 V open circuit. 0.1 mV to 3.16 V full scale, 10 steps in 1, 3, 10 sequence; $-70$ dBm to $+23$ dBm (50 $\Omega$ output) full scale, 10 dBm per step; 20 dB coarse and fine adjustable amplitude control.		$+11$ dBm to $-90$ dBm, 10 dB and 1 dB steps with adjustable $\pm 1$ dB meter range, calibrated for each impedance of 50 $\Omega$ and 75 $\Omega$ unbalanced and 135 $\Omega$ , 150 $\Omega$ and 600 $\Omega$ balanced.
Output Monitor (Monitor's Level at input of attenuator)	Top scale calibrated in volts, bottom scale in dB. Accuracy $\pm 2\%$ of full scale.	Same as 651B plus Expand Scale which expands reference voltage of the normal scale from 0.9 to 1.0 or 2.8 to 3.2	$\pm 1$ dBm of full scale with 0.02 dB resolution. Accuracy $\pm 0.05$ dB.
Output* Connectors	BNC connectors.		
Attenuator	90 dB range in 10 dB steps; $\pm 0.075$ dB, $-60$ dBm to $+20$ dBm; $\pm 0.2$ dB, $-70$ dBm to $-60$ dBm.		99 dB range in 10 dB and 1 dB steps; $\pm 1.5\%$ (0.13 dB) except $\pm 10\%$ (1 dB) at output levels below 60 dBm at frequencies $>300$ kHz.
Temperature Range	0°C to $+50^\circ\text{C}$ (32°F to 122°F).		0°C to $+55^\circ\text{C}$ (32°F to 130°F)
Power	115 V $\pm 10\%$ , 48 Hz to 440 Hz; 230 V $\pm 10\%$ 48 to 66 Hz; 35 VA max.		
Weight	Net, 7.6 kg (17 lb). Shipping, 9.90 kg (22 lb).		Net, 9.4 kg (21 lb). Shipping, 11.8 kg (26 lb).
Dimensions	133 mm H x 425 mm W x 337 mm D (5.21" x 16.75" x 13.25").		

\*Maximum dc voltage that can be applied to output:  $< \pm 3$  V p.

# OSCILLATORS

## 10 Hz to 1 MHz Digital Oscillator

Model 4204A

- 0.2% frequency accuracy
- Accurate 80 dB output attenuator
- 0.01% frequency repeatability
- Excellent stability
- Flat frequency response



### Description

Hewlett-Packard's 4204A Digital Oscillator provides accurate, stable test signals for both laboratory and production work. This one instrument does the job of an audio oscillator, an ac voltmeter, and an electronic counter when an accurate frequency source of known amplitude is required.

Any frequency between 10.0 Hz and 999.9 kHz can be digitally selected with an in-line rotary switch to four significant figures. As many as 36,900 discrete frequencies are available. Infinite resolution is provided by one vernier control, which also extends the upper frequency limit to 1 MHz. Frequency accuracy is better than  $\pm 0.2\%$  and repeatability is typically better than  $\pm 0.01\%$ .

A built-in high impedance voltmeter measures output. The meter is calibrated to read volts or dBm into a matched 600 ohm load. (0 dBm = 1 mW into 600 Ohms.) The output attenuator has an 80 dB range, adjustable in 10 dB steps with a 20 dB vernier. Maximum output power can be increased to 10 volts (22 dBm) into 600 Ohms or 20 volts open circuit.

Frequency response is flat with less than  $\pm 3\%$  variation over the entire frequency range at any attenuator setting. Frequency stability is better than 10 parts in  $10^6$  per minute.

### Specifications

**Frequency range:** 10 Hz to 1 MHz, 4 ranges.

**Frequency accuracy:**  $\pm 0.2\%$  or  $\pm 0.1$  Hz (at 25°C).

**Frequency stability**

$\pm 10\%$  line voltage variation: less than  $\pm 0.01\%$ .

**Change of frequency with temperature:**  $< \pm 100$  ppm/°C.

**Drift:**  $< 10$  ppm/minute.

**Frequency response:** flat within  $\pm 3\%$ , 9.999 kHz ref. (25°C  $\pm 5^\circ$ C).

**Output:** 10 V (22 dBm) into 600 ohms (160 mW). 20 V open circuit.

**Output attenuator:** 80 dB in 10 dB steps:  $< \pm 0.5$  dB error.

**Output monitor:** voltmeter monitors level at input of attenuator in volts or dB.

**Accuracy:**  $\pm 2\%$  of full scale.

**Flatness:**  $\pm 1\%$  at full scale, 10 Hz to 500 kHz;  $\pm 2\%$  at full scale, 500 kHz to 1 MHz.

**Distortion:** less than 0.3%, 30 Hz to 100 kHz. Less than 1%, 10 Hz to 600 kHz. Less than 1.2%, 10 Hz to 1 MHz.

**Hum and noise:** less than 0.05% of output.

**Temperature range:** 0°C to +50°C.

**Power:** 115 V/230 V switch,  $\pm 10\%$ , 10 VA, 50 to 60 Hz.

**Weight:** net, 8.5 kg (19 lb). Shipping, 11 kg (28 lb).

**Size:** 141 mm H x 426 mm W x 336 mm D ( $5\frac{1}{2}$ " x  $16\frac{3}{4}$ " x  $13\frac{1}{4}$ ".)

### Accessories Available

**11000A** Cable: dual banana plugs

**11001A** Cable: banana plug to BNC male connector

**11004A** Line Matching Transformer has a frequency response of 5 kHz to 600 kHz providing fully balanced outputs for 135 or 600 ohms.

**11005A** Line Matching Transformer has a frequency response of 20 Hz to 45 kHz providing full balanced output into 600 ohms.

**16252A** Matching Transformer has a frequency response of 10 kHz to 1 MHz providing unbalanced 75 ohm output, terminated in UG-657/U female BNC connector.

### Options

**001:** 4204A Output Monitor top scale calibrated in dBm/600  $\Omega$ . Bottom scale calibrated in volts

**908:** Rack Flange Kit

**910:** Extra Manual

**4204A Digital Oscillator**

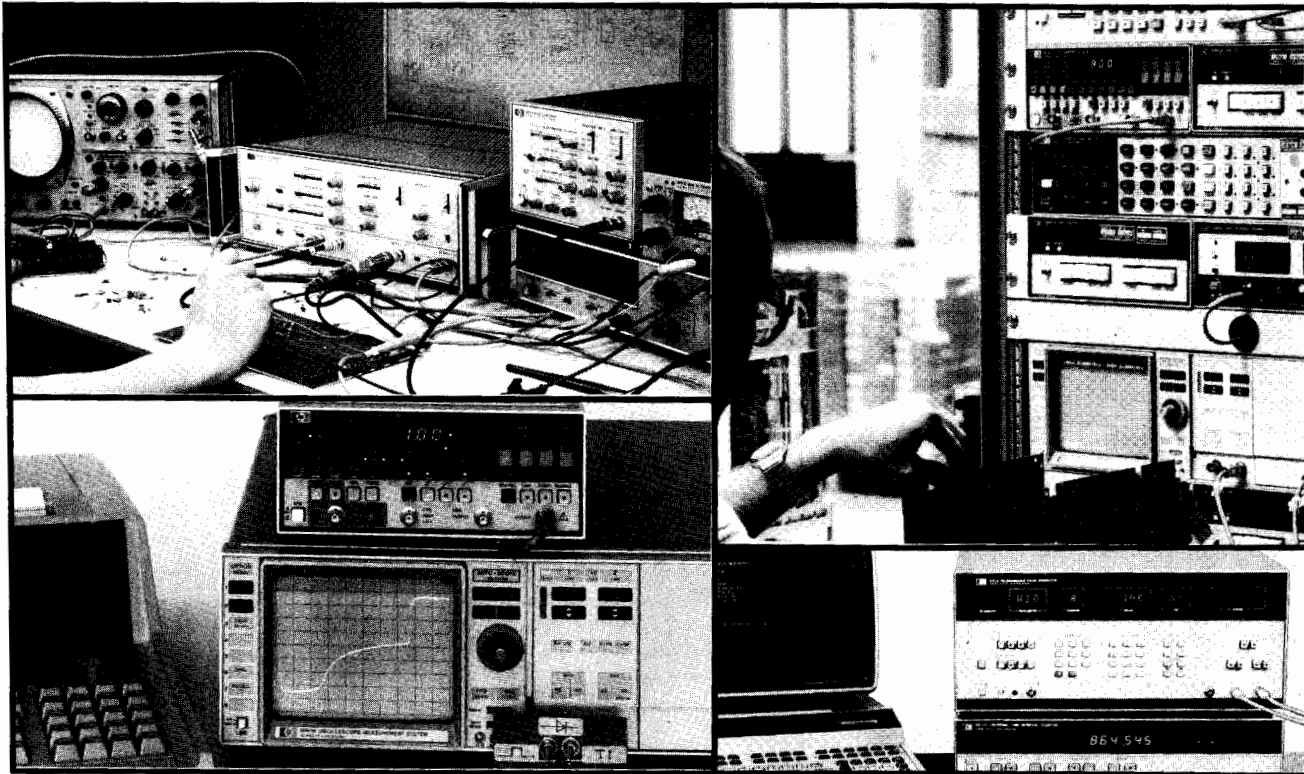

### Analog and Digital Test

HP's pulse generators range from simple, inexpensive units to high performance, microprocessor-based instruments offering precision pulse generation. Depending on model, variable clock speeds to 1 GHz and variable amplitudes up to 100 V are available.

Pulse parameters are independently variable for thorough characterization and worst-case testing. Variable pulse transitions permit parametric analysis like trigger circuit hysteresis, and the fastest settings are ideal for at-speed logic test and amplifier transient investigations.

Pulse/function generators combine pulse capability with all features expected of a function generator. The benefits are high flexibility for analog requirements plus an entry into logic test.

### Operating Comfort

Clear front panel layout, guided parameter selection, and error detection and recovery features, mean quick familiarization and rapid, error-free use. In addition, great emphasis is placed on ruggedness, reliability and serviceability. The generators are developed and produced using high quality standard components and custom-designed ICs. Resultant technical benefits are, for exam-

ple, broad operating temperature range and clean 50-Ohm output impedance.

Selectable polarity, complement and offset help make hook-up simpler and, for further flexibility, *inverters, adders and splitters* are available (page 328).

Complex waveform capability allows glitches, ringing and multi-level signals to be simulated. Constant numbers of pulses, unaffected by other parameters are available in HP's counted burst mode.

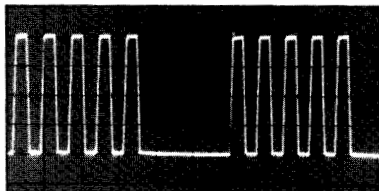

### Bench and Automatic Test

A new generation of very versatile models offer good repeatability and high operating comfort for fast, accurate testing. These instruments also offer HP-IB which makes bench automation a reality for time-consuming tests. Setup time is a minimum because the syntax is simple and uses the same command sequence as the front panel.

Straight-forward syntax helps develop ATS software quickly; good repeatability and error reporting eliminate the need for software measurement loops. Specified performance over the entire 0°C to 55°C operating temperature range guarantees reliability in system racks.

### Time Synthesis (page 321)

Time Synthesizers are mainly used in radar and laser ranging, component and circuit testing, and precise triggering and calibrating applications. They give a precisely timed output pulse with an accurate, adjustable delay which may be incremented in steps as small as 50 pico-seconds. A fixed, virtually jitter-free insertion delay allows phase locking to equipment under test.

### Logic Capability

**CMOS:** 8011A, 8015A, 8111A, 8112A, 8116A, 8160A

**TTL:** 8012B, 8013B, 8015A, 8111A, 8112A, 8116A, 8160A.

**S-TTL:** 8007B, 8082A, 8161A

**ECL:** 8082A (0.7 ns), 8080A (0.5 ns/0.2 ns, depending on configuration), 8161A (0.9 ns). Figures in brackets are the equivalent ECL switching time, 20% to 80% of amplitude.





# PULSE GENERATORS

## General Information

### Pulse Generator Selection Chart

DESIGN 11-9-91 HP-IB SYSTEMS Page	Pulse Generators												Pulse/Function Generators		
	214B 322	8005B 323	8011A 323	9012B 324	8013B 324	8015A 325	8007B 326	8082A 327	8080A 328	8112A 317	8160A 318	8161A 318	8111A 337	8116A 338	8165A 344
Timing															
Max frequency (MHz)	10	20	20	50	50	50	100	250	300/1000	50	50	100	20	50	50
Transition time (ns)	15	10 var	10	5 var	3.5	6 var	2 var	1 var	0.8/0.3	5 var	6 var	1.3 var	10	6	5
Var width (ns) min	25	25	25	10	10	10	5	2	Sp Opt	10	10	4	25	10	10
Square/duty cycle (%)	1-10	Sq	Sq	Sq	Sq	Sq	Sq	Sq	Sq	1-99			10-90	10-90	20/50/80
Variable delay	*	*		*	*	*	*	*	*	*	*	*			
Output (max values are quoted: see specifications for conditions).															
Amplitude (V)	100	10	16	10	10	30	10	5	4/2.4	32	20	5	32	32	20
Offset/Window (V)		±4/±10		±2.5/±7.5	±2.5/±7.5	±28/±16	±8/±18	±2/±5	±2/±4	±16/±16	±20/±20	±5/±5	±16/±16	±16/±16	±10/±10
Format	+/-	*	*	*	*	*	*	*	*	*	*	*	*	*	*
* = positive, negative, symmetrical, normal and complement formats.															
Outputs	1	+ and -	1	1	+ and -	2	1	1	Configurable	1	2-chan option	2-chan option	1	1	1
Additional outputs		TTL				TTL		Compl			Compl				
Operating Modes															
Trigger	*	*	*	*	*	*	*	*	*	*	*	*	*	*	*
Ext width															
Gate	*	*			*	*	*	*	*	*	*	*	*	*	*
Ext burst	Option		Option			Option				*	*	*	Option	Option	*
Int burst													Option	Option	
Double pulse	*	*		*	*	*	*	*	*	*	*	*	*	*	*
Control (Modulation) Modes													*	*	*

### Pulse Generator Definitions

**Time Reference Point:** Median (50% amplitude point on pulse edge).  
**Pulse Period:** The time interval between the leading edge medians of consecutive trigger output pulses.

**Trigger Delay:** Interval between trigger point of input signal and the trigger output pulse's leading edge median. Applies in trigger, external width, gate and burst modes.

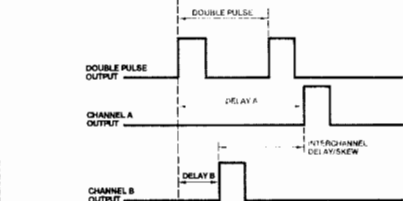
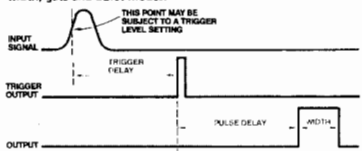

**Pulse Delay:** Interval between leading edge medians of trigger output pulse and output pulse.

**Double Pulse:** Interval between leading edge medians of the double pulse.

**Interchannel Delay/Skew:** Interval between corresponding leading edge medians.

**Pulse Width:** Interval between leading- and trailing-edge medians.

Additional information for Pulse Generators with Variable Transition Times

**Pulse Width:** The specified and displayed value is that obtained with fastest edges; essentially equal to the interval from the start of the leading edge to the start of the trailing edge.

By designing so that the pulse edges turn about their start points, the interval from leading edge start to trailing edge start stays unchanged\* when transition times are varied. This is more convenient for programming and the width display is easy to interpret.

\*In practice, start points may shift with change in transition time.

**Delay:** The specified and displayed value is that obtained with the fastest leading edge. For a slower edge, the actual delay exceeds the displayed delay by the combined shift of start point and median.

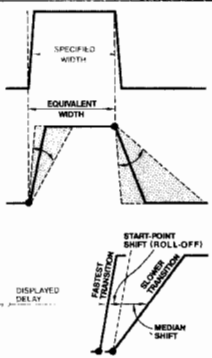

**Transition Time:** Interval between the 10% and 90% amplitude points on the leading/trailing edge.

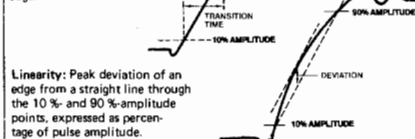

**Linearity:** Peak deviation of an edge from a straight line through the 10% and 90% amplitude points, expressed as percentage of pulse amplitude.

**Jitter:** Short-term instability of one event with respect to another. Unless stated otherwise, value is p-p, expressed as a percentage of the main parameter.

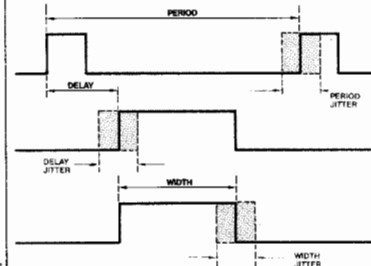

**Stability:** Long-term average instability, expressed as percentage of main parameter over a specific time duration, e.g. hour, year. Excludes jitter.

**Pulse Level:** High level and low level. Any limitation is expressed by an amplitude specification.

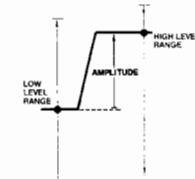

**Pulse Amplitude (alternative to level definition):** Pulse amplitude and offset\* are specified. Any limitation is expressed by a window (max high level, min low level).

\*Pulse generators use baseline offset. Function generator outputs are symmetrical and consequently use median offset.

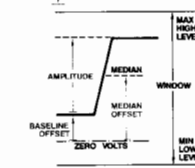

**Preshoot, Overshoot, Ringing:** Preshoot and overshoot are peak distortions preceding/following an edge. Ringing is the positive peak and negative peak distortion excluding overshoot, on pulse top or base. A combined preshoot, overshoot, ringing specification of e.g. ± 5% implies:

- Overshoot/undershoot < 5%;
- Largest pulse top oscillation < ± 5% of pulse amplitude.

**Settling Time:** Time taken for pulse levels to settle within level specification, measured from 90% point on leading edge.

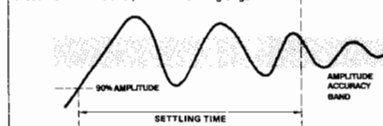

**Duty Cycle:** Percentage ratio of pulse width to period. In pulse/function generators, this term is also used to define sine and triangle symmetry.

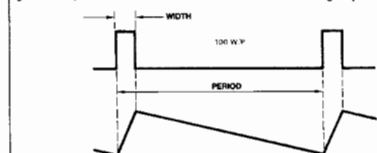

**Output Impedance/Resistance:** Effective pulse source impedance/dc resistance.  
**Reflection Coefficient:** Reflection at pulse generator output expressed in percent of incident pulse amplitude. (Test pulse edges correspond to generator's fastest transitions).

**Repeatability:** When an instrument operates under the same environmental conditions, and with the same settings, the value of a parameter will lie within a band inside the accuracy window. Repeatability defines the width of this band.



#### HP-IB Programming Times

- Listen Time:** The time an instrument occupies the bus to receive and verify a message. The NRFD signal is active during this period.
- Settling Time:** The time taken by the instrument to execute an HP-IB message, and for the output to settle within the accuracy specification. NRFD inactive.
- Execution Time:** The sum of Listen Time and Settling Time.
- Talk Time:** The time an instrument occupies the bus to output a specified string. Output data is typically instrument error status, or current or stored parameters.

# PULSE GENERATORS

## Programmable Low Cost Pulse Generator

8112A



- Full pulse capability
- Modulation
- Ramps and haversines

- Width/duty cycle
- Device protection
- Error recognition and self test

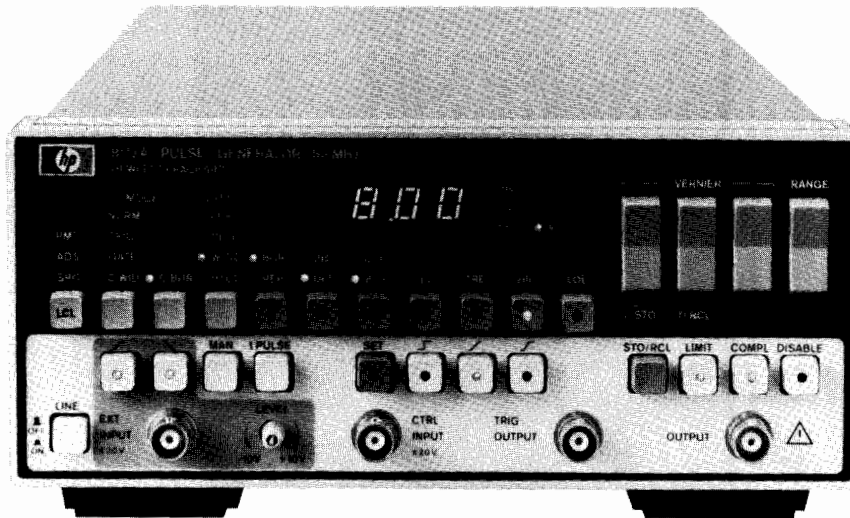

The 8112A is fully programmable 50 MHz pulse generator with 5 ns transitions and 32 V<sub>pp</sub> (into open circuit) max output amplitude. All pulse parameters are variable including delay and double pulse spacing.

Besides the comprehensive trigger modes, external modulation capabilities extend applicability. 3-level signals and upper level, width, period and delay-modulated signals are available. These can be combined with the trigger modes so that complex real-life signals like modulated bursts are simulated easily.

Step response and trigger hysteresis measurements require fast transitions or sawtooth signals as obtained in the 8112A's linear transition mode—either fixed 5 ns or variable from 6.5 ns. The new cosine transitions, also variable from 6.5 ns, mean that band-filtered signals are now just as simple to obtain.

Sensitive devices are protected by programming output limits and the upper level can be controlled by the device supply. Also, constant energy or constant width can be programmed.

Dual channel operation is feasible by operating two 8112A's in parallel. This also permits channel addition using a BNC "Tee".

For really easy operation a green button gives error-free settings. A new softkey operating concept plus detailed error recognition make the 8112A's powerful versatility easy to handle.

### Specifications

Specifications apply with 50-ohm load, and temperatures in the range 0°C to 55°C.

**Timing** (Specifications apply for min transition times)

**Period:** 20.0 ns to 950 ms.

**Delay:** 65.0 ns to 950 ms.

**Double Pulse:** 20.0 ns to 950 ms.

**Width:** 10.0 ns to 950 ms.

**Accuracy:** ± 5% of progr value ± 2 ns (delay: ± 4 ns).

**Duty Cycle:** 1% to 99% (Min: 10 ns. Max: period -10 ns).

Accuracy: ± 10% of progr value.

**Pulse Characteristics** (Voltages double when driving into open circuit)

**Levels**

High level: -7.90 V to 8.00 V.

Low level: -8.00 V to 7.90 V.

Accuracy: ± 1% of progr value ± 3% amplitude ± 40 mV.

Settling time: 100 ns + transition time.

### Transition Times

Fixed: 5 ns

Linear and Cosine: 6.5 ns to 95.0 ms (max edge ratio 1:20 within a 1.5-decade range. Ranges overlap by 0.5 decade).

Accuracy: ± 5% of programmed value ± 2 ns.

**Preshoot, Overshoot, Ringing:** ± 5% ± 10 mV (variable transitions), ± 10% ± 10 mV (fixed transitions).

**Output Resistance:** 50 ohm ± 5%.

**Operating Modes:** Normal, Trigger, Gate, Ext Width (pulse restoration), Ext Burst (1 to 1999 pulses).

### Control (Modulation) Modes

**Period, Delay, Width** covered in 8 non-overlapping decades (max input frequency 20 kHz).

**High Level:** -8 V to +8 V, independent of progr low level (min input transition 200 μs).

### General

**HP-IB:** All keys programmable. Learn, status and error reporting capability.

**Memory:** Retains current operating state. 9 store/recall locations, 1 fixed set of parameters.

**Repeatability:** factor 4 better than accuracy.

### Environmental

Storage temperature: -40°C to +65°C.

Operating temperature: 0°C to 55°C.

Humidity: 95% RH, 0°C to 40°C.

**Power:** 100/120/220/240 V rms; +5%; -10%; 48 to 440 Hz; 120 VA max

**Weight:** net, 5.9 kg (13 lb). Shipping, 8.0 kg (18 lb).

**Size:** 89 H x 212.3 W x 450 mm D (3.5" x 8.36" x 17.7").

### Ordering Information

**8112A Programmable Pulse Generator\***

**Opt 910:** Extra Operating and Service Manual

**5061-2001** Bail Handle Kit

**5061-0072:** Rack Mount Kit (single 8112A)

**5061-0074:** Rack Mount Kit (two instruments)

**5061-0094:** Lock Link Kit (for use with 5061-0074)

\* HP-IB cables not supplied, see page 29

# PULSE GENERATORS

## Programmable Precision Pulse Generators

### Models 8160A, 8161A

- 50 MHz repetition rate
- 6.0 ns variable transition time
- 20 V output amplitude

- 1-3% pulse parameter accuracy
- Full dual channel capability (option 020)
- 1 year recalibration period

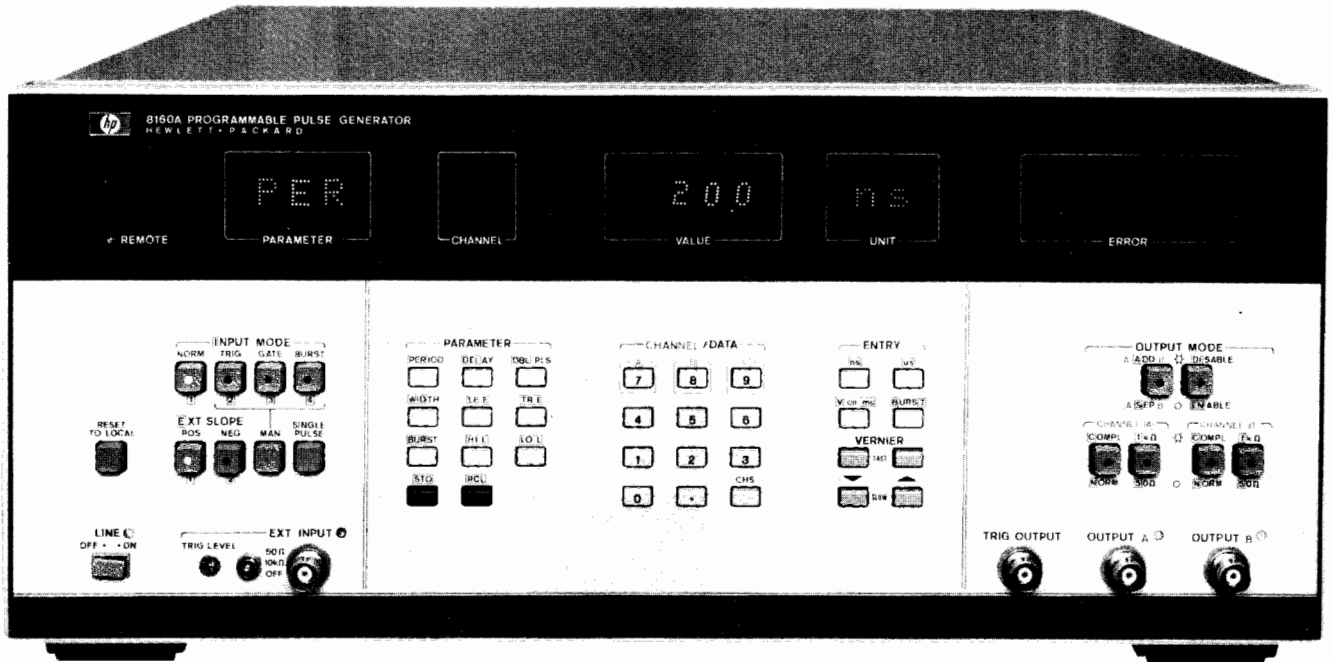

8160A Option 020  
Dual Channel



- 100 MHz repetition rate
- 1.3 ns variable transition time
- 5 V amplitude

- 1-3% basic timing accuracy
- Full dual channel capability (Option 020)
- 1 year recalibration period

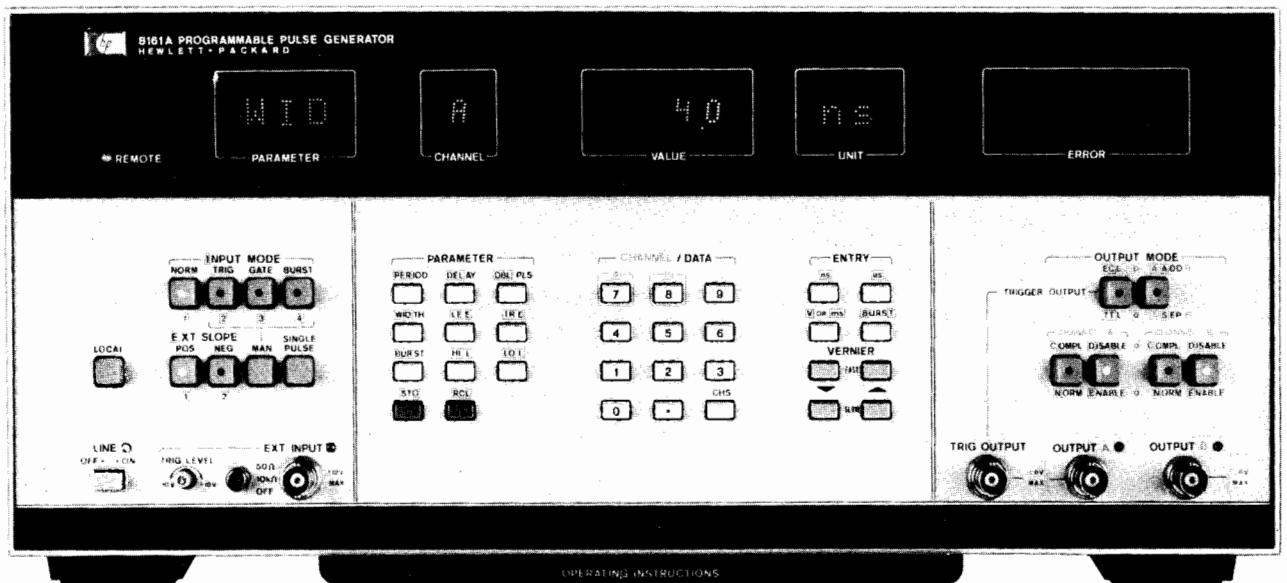

8161A Option 020  
Dual Channel



The 8160A and 8161A are fully programmable pulse generators designed for high performance applications on the bench and in automatic test systems. Operation is made easy because the pulse parameters are controlled independently and do not inter-react. Dual channel options permit synchronous or complex waveforms to be generated. With its 50 MHz repetition rate, 20 V output, and 6 ns variable transition times, the **8160A** is a general purpose pulse generator. The **8161A** covers the high end of technology with its 100 MHz, 5 V and 1.3 ns variable transition times. Measured between the 20% to 80% amplitude points, these transitions are faster than 1 ns and meet ECL requirements.

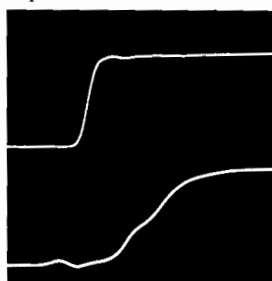

8161A input pulse (upper) and ECL memory output pulse (lower).

Combining high programming accuracy with microprocessor-based control capabilities, pulses can be set up without a measuring instrument. Pulse parameters are entered and displayed numerically, and generated with a basic timing accuracy of 1-3%, depending upon parameter.

An easy-to-use HP-IB interface brings high-accuracy pulses to automatic test. All parameters and operating modes are remotely programmable using straight-forward command sequences. Faster, easier program generation and reduced software costs are direct benefits.

### Precision Pulse Generation

Both models provide precision control over all parameters of their output pulses. The 8160A's leading and trailing edge transition times may be independently programmed down to 6 ns. The 8161A's transitions have a common control from 1.3 ns to 5 ns, and are independent above 5 ns. Variable transition times are indispensable when digital IC's need to be characterized: either the IC's data sheeted input transition time is required, or the IC's functioning range with various transitions needs to be evaluated.

Direct entry of the high and low levels of the output pulse enables easy adjustment to the logic levels concerned. Pulse width is variable from 4 ns (8161A) or 10 ns (8160A) to 1 s, giving a wide range of duty cycle programmability. Delay shifts the output pulse in relation to the trigger output or, in double pulse mode, defines the pulse spacing.

In the dual-channel versions, double pulse can be selected in either or both channels. This means, for example, that simultaneous clock and data signals can be generated.

### Complex Signals

Independent pulse parameters plus individual programmability of the Option 020's dual outputs are augmented by the A ADD B mode. Summation allows complex signals to be precisely and easily set up. Here are some examples:

Applications such as radar coincidence circuits and special codes in communications require 3- and 4-level signals. These are conveniently generated by combining channel A and channel B pulses.

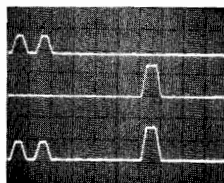
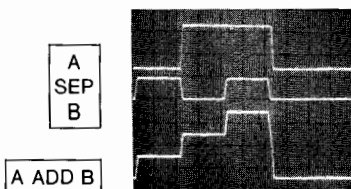

A  
SEP  
B

A ADD B

Transponder circuits need accurate delays, often with respect to a double-pulse interrogation signal. In the 8160A, this is arranged by operating one channel in double pulse mode and setting up the transponder delay in the other.

A critical test for digital circuits and IC's is its glitch and noise sensitivity, which can be easily performed with the A ADD B mode.

A  
SEP  
B

A ADD B

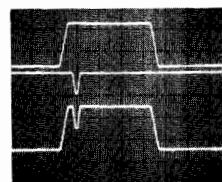

### Counted Burst

Using Burst Mode, a predetermined number of pulses is generated independent of frequency. Bursts from 0 to 9999 pulses in length may be produced, and can be triggered via an external signal manually or with an HP-IB command.

### Wide temperature range for system reliability

The 8160A's and 8161A's 0-50°C operating range ensures calculable performance. Indeed, temperatures will generally be between 20-40°C where there is no derating factor.

### User Features

#### Fast, Reliable Setup

Microprocessor control promotes highly accurate pulses. Parameters are directly entered via the instrument's keyboard, and are then displayed on numeric LED's with 3-digit resolution.

In bench applications, the vernier controls give a fine adjust capability to "tweak-in" any pulse parameter. You can increment or decrement the selected parameter either in single steps or at speed.

Error detection by the microprocessor further simplifies pulse setup by solving the old problem of incompatible settings. Should pulse width exceed pulse period, for example, the microprocessor indicates a TIMING error. All possible mis-settings are detected and the type of error is indicated to aid rapid correction.

#### HP-IB Programming

Microprocessor control over all interface functions makes remote programming as easy and straight-forward as manual control. The instruments employ keystroke programming so that data entry via the HP-IB is an exact simulation of manual entry. Bus commands for each front panel key simply replace manual keystrokes.

#### Parameter Storage

Complete parameter and mode information for 9 independent instrument set-ups can be stored. Waveforms may be stored and recalled either manually or via the HP-IB.

By utilizing a single command to recall an entire instrument set-up, controller time is saved. In simple repetitive testing applications, storage of test waveforms gives a high degree of user convenience without an external controller.

# PULSE GENERATORS

## Programmable Precision Pulse Generators

### Models 8160A, 8161A (Cont.)

#### Learn Mode

When interrogated by the system controller, the instruments output a character string to the interface bus. This string completely describes the pulser's current set-up or any one of its stored parameter sets. Using Learn Mode, you can enter and try out waveforms manually and then automatically transfer them via the HP-IB to the controller for storage in a program.

#### Verification Software for the 8160A

Test system accuracy is guaranteed by accessory software which verifies the 8160A's performance standards. The software is fully documented and comes recorded on a cassette suitable for Model 9825A Desktop Computer.

In the event of a failure, downtime is minimized because the software also delivers diagnostic information to accelerate repair and calibration.

#### Specifications

(50-ohm source into 50-ohm load). Standard instruments are single channel. Option 020 provides independent dual channels with common pulse period.

Timing (with minimum transitions)	8160A	8161A
<b>Period</b> Range: Accuracy: Max Jitter:	20 ns to 999 ms. ±3% of progr value ±0.3 ns (period < 100 ns); ±2% of progr value (period ≥ 100 ns). 0.1% of progr value + 50 ps.	10 ns to 980 ms. ±3% of progr value ±0.5 ns (period < 100 ns); ±2% of progr value (period ≥ 100 ns). 0.1% of progr value + 50 ps.
<b>Delay, Double Pulse, Width</b> Delay Range: Double Pulse Range: Width Range: Accuracy: Max Jitter:	0.0 ns to 999 ms. 20.0 ns to 999 ms. 10.0 ns to 999 ms. ±1% of progr value ±1 ns. 0.1% + 50 ps (≤999 ns); 0.05% (999 ns < -≤9.99 μs); 0.005% (>9.99 μs).	0.0 ns to 990 ms. 8.0 ns to 990 ms. 4.0 ns to 990 ms. ±1% of progr value ±1 ns. 0.1% + 50 ps (≤999 ns); 0.05% (999 ns < -≤9.99 μs); 0.005% (>9.99 μs).
<b>Output Characteristics</b>  <b>Output levels</b> High Level Range: Low Level Range: Amplitude: Level Accuracy:  Settling Time:	<b>50 Ω into 50 Ω</b> -9.89 V to 9.99 V. -9.99 V to 9.89 V. 0.10 V min, 9.99 V max. ±1% of progr value ±1% of ampl ±50 mV. 40 ns.	<b>50 Ω into open or 1 kΩ into 50 Ω</b> -19.7 V to 19.9 V -19.9 V to 19.7 V 0.2 V min, 19.9 V max
<b>Transition Times (10 – 90% amplitude)</b> Leading Edge: Trailing Edge: Accuracy: Linearity:	6.0 ns to 9.99 ms. 6.0 ns to 9.99 ms. ±3% of progr value ±1 ns. ±3% for transitions > 30 ns.	1.3 ns to 900 μs. 1.3 ns to 900 μs. ±10% of progr value ±1 ns. ±5% for transitions > 30 ns.
<b>Preshoot, Overshoot, Ringing:</b>	±5% of ampl ±10 mV.	±5% of ampl ±10 mV (may increase to ±10% of ampl ±10 mV for transitions < 2.5 ns).
<b>A ADD B:</b>	Adds channel A and B outputs (Opt 020 only).	Adds channel A and B outputs (Opt 020 only).
<b>Output Format:</b>	Normal/Complement Selectable. (Independently selectable in each channel in Option 020.)	Simultaneous Normal and Complement Outputs. (Independently selectable in each channel in Option 020.)
<b>Source Impedance:</b>	50 ohm/1 kohm selectable.	50 ohm.

**Operating Modes:** Normal, Trigger, Gate, Ext Burst (0–9999 pulses).

**HP-IB Capability:** All modes and parameters can be programmed. Talk mode for status, error messages, stored parameters.

**Memory:** 9 programmable locations\*,  
1 location for active operating state\*,  
1 location with fixed parameter set.

**Capacity:** 1 complete operating state per location.

\*Battery back-up for power-off storage

#### General

**Recalibration Period:** 1 year.

**Repeatability:** Factor 2 better than specified accuracy.

**Operating Temperature:** 0°C to 50°C (Specifications apply from 20°C to 40°C. Accuracy derating factors for 0°C to 20°C and 40°C to 50°C).

**Power:** 115/230 V ac + 10%, -22%, 48-66 Hz; 675 VA max.

**Weight:** net 20.8 kg (46 lbs). Shipping 25 kg (55 lbs).

**Size:** 178 H x 426 x 530 mm D (7" x 16.8" x 20.9").

#### Ordering Information

**8160A/8161A Programmable Pulse Generator\***

**Opt 001:** Rear panel inputs and outputs

**Opt 020:** Second channel (Rate common)

**Opt 907:** Front handle kit (P/N 5061-0090)

**Opt 908:** Rack flange kit (P/N 5061-0078)

**Opt 909:** Opt 907, 908, combined (P/N 5061-0084)

**Opt 910:** Additional Operating Manual

**08160-39910** Verification Software (8160A only).

\* HP-IB cables not supplied, see page 29.

# PULSE GENERATORS

## High Resolution Time Synthesizer

### Model 5359A

321



- Precise digital delays 0-160 ms
- 50 ps increments
- Jitter < 100 ps

- Programmable
- Fully synchronous to external trigger
- Automatic calibration

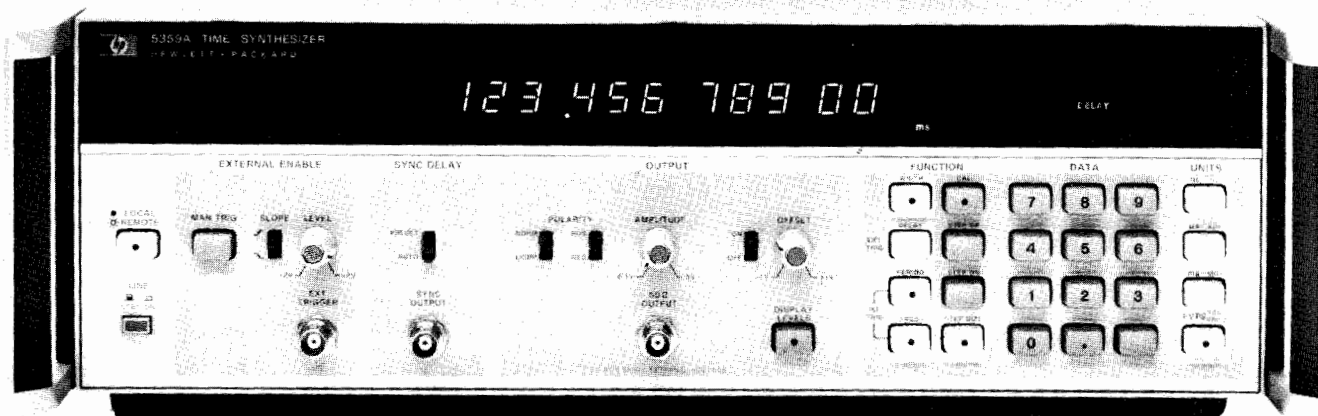

The 5359A Time Synthesizer produces two extremely precise, low jitter time delays. These delays,  $T_d$  and  $T_w$ , are individually selectable by means of the keyboard, in 50 ps or greater steps to generate delays of up to 160 ms.

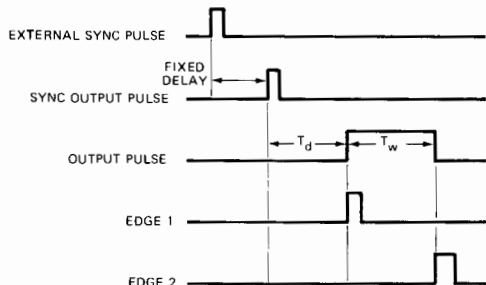

The 5359A has many applications and may be used for the calibration of Radar, Loran, DME and Tacan Systems, or for precision generation of delayed sweeps in oscilloscopes, and for extremely accurate "time positioning" control of external gates on frequency counters. In component and circuit test, the instrument may be used for extremely accurate delay line simulation.

## Specifications

### Modes

**External trigger mode:** the delays from the sync out to the beginning of the output pulse, and the width of the output pulse, are selected.

**Internal trigger mode:** the "period" or "frequency", and the width of the output pulse, are selected.

### Range

**Delay  $T_d$ :** 0 ns to 160 ms.

**Width  $T_w$ :** 5 ns to 160 ms (width & delay  $\leq$  160 ms).

**Period:** 100 ns min. or width + 80 ns, 160 ms max.

**Frequency:** same as corresponding "period".

**Repetition rate:** 10 MHz max.

**Accuracy:**  $\pm 1$  ns  $\pm$  time base error.

**Insertion delay:** fixed at < 150 ns; selectable as < 50 ns for delays > 100 ns.

**Jitter:** typical 100 ps rms; maximum 200 ps rms

**External trigger input:** -2 V to +2 V slope selectable.

**Sync output:** 1 V - 50  $\Omega$ ; 5 V - 1 M $\Omega$ . Width 35 ns nominal.

### Output pulse

**Amplitude:** 0.5 V to 5 V into 50  $\Omega$ .

**Polarity:** positive or negative.

**Offset:** -1 V to 1 V, or OFF.

**Transition time:** < 5 ns.

External voltage must not be applied. Offset and Amplitude voltage into 50  $\Omega$  may be displayed.

**EDGE 1 OUTPUT (rear panel):** occurs in Sync with leading edge of output pulse (same spec. as Sync out).

**EDGE 2 OUTPUT (rear panel):** occurs in Sync with falling edge of output pulse (same spec. as Sync out).

**Events mode:** substitutes external input (to 100 MHz) for the internally counted clock (Delay and width must both be specified in terms of events instead of time).

**Triggered frequency mode:** the same as internal frequency mode except the output is a burst beginning in synchronism with an external trigger signal, and continues for the duration of this signal.

**Calibrate mode:** performs an internal calibration to remove the effects of internal delay differences.

**External probes:** provides outputs to control the 5363B probes and accepts inputs from the probes to include external devices in the calibration loop.

**HP-IB:** All controls except trigger levels are programmable as standard.

### Time base

High Stability Oven Oscillator

**Frequency:** 10 MHz

**Aging:**  $< 5 \times 10^{-10}$ /day

**Temperature:**  $< 2.5 \times 10^{-8}$ , 0°C to 50°C

**Line voltage:**  $< 1 \times 10^{-10}$ ,  $\pm 10\%$  from nominal

**Size:** 146.1 H x 425.5 W x 520.7 mm D (5.25" x 16.75" x 20.50").

**Weight:** 30 lbs.

**Power requirements:** 100, 120, 220, or 240 Vac +5% -10%, 48 to 66 Hz, less than 250 VA

**Front handles:** supplied with instrument.

### Options and Accessories

**908:** Rack Flange Kit for use without handles

**913:** Rack Flange Kit for use with supplied handles

**10870A:** Service Kit

**5359A Time Synthesizer**



# PULSE GENERATORS

## Fast, High Power Pulse Generator

### Model 214B

- High power 100 V, 2 A output
- 10 MHz repetition rate
- Constant duty cycle
- Counted pulse burst option

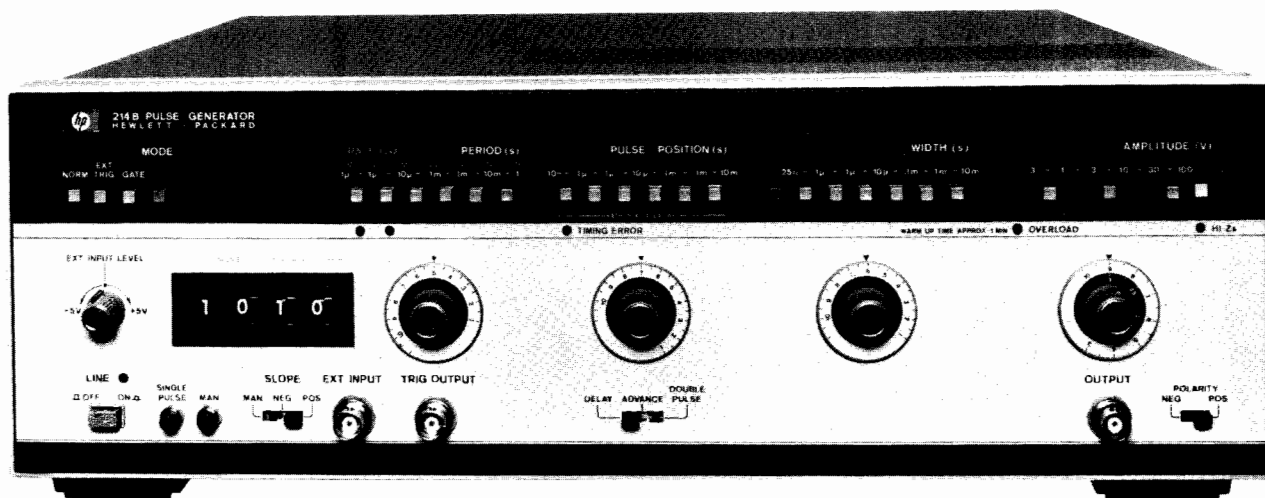

214B Option 001

The HP 214B pulse generator employs semiconductor technology for high power pulse generation at up to 10 MHz repetition rate. Delivering 100 V pulses with 15 ns risetimes, the 214B meets the speed demands of today's applications.

State-of-the-art VMOS FETS used as current sources for the output amplifier tubes enable pulse width to be specified down to 25 ns. The 214B is thus well-equipped for low duty cycle applications such as laser diode pulsing or transient simulation.

Where changing duty cycle threatens destruction to the device under test, the 214B Constant Duty Cycle (CDC) mode provides device protection. In CDC operation the duty cycle, hence power, remains constant as frequency is varied. The 214B is itself protected against excessive duty cycles via an overload protect circuit.

Easy operation is assured by the timing error indication. Calibrated dials enable fast accurate adjustments. Operating into unmatched loads, clean pulse shape is guaranteed by the low reactance 50  $\Omega$  source impedance. Pulse distortions such as preshoot and overshoot are specified as 5% at all amplitudes.

## Specifications

### Timing

**Repetition rate:** 10 Hz to 10 MHz in 6 ranges. In 30 V - 100 V amplitude range, maximum rep. rate is 4 MHz. Calibrated vernier provides continuous adjustment within ranges. **Vernier accuracy:**  $\pm(10\%$  of setting + 1% full scale). **Period Jitter:**  $\leq 0.1\% + 300$  ps. **Pulse delay/advance:** pulse can be delayed/advanced with respect to the trigger output from 10 ns to 10 ms ( $\pm$  fixed delay of 45 ns) in 5 ranges. Calibrated vernier provides continuous adjustment within ranges. **Vernier accuracy:**  $\pm(10\%$  of setting + 1% full scale) + fixed delay. **Position Jitter:**  $\leq 0.1\% + 500$  ps. **Maximum pulse position duty cycle:**  $\geq 50\%$ . **Double pulse:** 5 MHz maximum in all ranges except 30 V - 100 V range which is max. 2 MHz. Minimum separation is 100 ns. **Pulse width:** 25 ns to 10 ms in 6 decade ranges. Calibrated vernier provides continuous adjustment within ranges. **Accuracy:**  $\pm(10\%$  of setting + 1% full scale) + 5 ns. **Width Jitter:**  $\leq 0.1\% + 500$  ps. **Max. duty cycle:**  $\geq 10\%$  for 30 - 100 V range.  $\geq 50\%$  all other ranges.

**Constant duty cycle mode (disabled in ext. trigger mode):** duty cycle of output pulse remains constant as the period is varied. The duty cycle limits in this mode are typically 8% fixed for the 10 M - 1 MHz range (max. 4 MHz); 2.5% to 10% for 1 MHz - .1 MHz range; .25% to 10% for .1 MHz - 10 kHz range; 0.1% for all other ranges. Calibrated vernier provides continuous adjustment within ranges.

**Accuracy:**  $\pm(15\%$  of setting + 1% of full scale).

### Trigger output:

**Amplitude:**  $\geq +5$  V (50 ohm into open circuit).

**Pulse width:** 10 ns typical.

### External Operating Modes

#### External Input (Impedance 10 k ohm, dc Coupled)

**Repetition rate:** dc to 10 MHz. **Sensitivity:** 500 mVpp, dc coupled.

**Slope:** pos. or neg. **Trigger level:** +5 V to -5 V adjustable.

**Maximum input level:**  $\pm 100$  V. **Trigger pulse width:**  $\geq 10$  ns.

**EXT TRIG mode:** An output pulse is generated for each input pulse.

**GATE mode:** gate signal turns on rep. rate generator synchronously. Last pulse always completed.

**BURST mode (optional):** preselected number of pulses generated on receipt of trigger signal. **Number of pulses:** 1 to 9999. Minimum spacing between bursts: 200 ns.

**Manual:** pushbutton can be used for triggering single pulses (EXT TRIG mode), generating gate signals (GATE mode) or triggering pulse bursts (BURST mode).

### Output

**Amplitude:** 0.3 V to 100 V in 5 ranges. Calibrated vernier provides adjustment within ranges. **Vernier accuracy:**  $\pm 10\%$  of setting.

**Source impedance:** fixed 50  $\Omega$  nominal on ranges up to 10 V. Selectable 50  $\Omega$  nominal or HI-Z on 10 - 30 - 100 V ranges (with 50  $\Omega$  / 50  $\Omega$  impedance, amplitude decreases to 5 - 15 - 50 V).

**Polarity:** pos. or neg. selectable.

**Transition times:**  $\leq 15$  ns for leading and trailing edges.

**Pulse top perturbations:**  $\leq \pm 5\%$  of amplitude.

### General

**Operating temperature:** 0°C to 55°C.

**Power:** 100/120/220/240 Vrms; +5%, -10%, 48 to 66 Hz, 360 VA max.

**Size:** 133 mm H x 426 mm W x 422 mm D (5.2" x 16.8" x 16.6").

**Weight:** net 13.6 kg (30 lb), shipping 15.6 kg (34.3 lb).

### Ordering Information

#### 214B Pulse Generator

**Opt 001:** Counted Burst

**Opt 907:** Front Handle Kit (part number 5061-0089).

**Opt 908:** Rack Mount Kit (part number 5061-0077).

**Opt 909:** Opt 907, 908 Combined (part number 5061-0083).

**Opt 910:** extra Operating and Service Manual

# PULSE GENERATORS

20 MHz Pulse Sources

Models 8005B, 8011A

323



- Dual outputs, +10 V and -10 V
- TTL output
- Gating, square wave double pulse modes

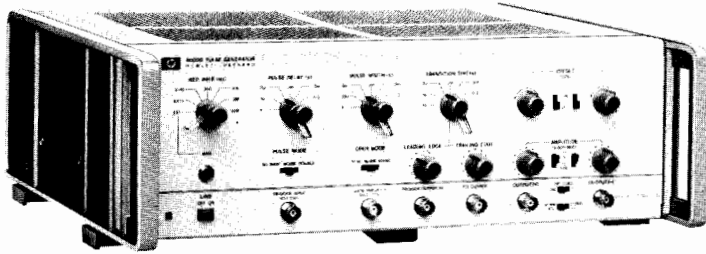

8005B

The 8005B is a general purpose, triple output pulse generator. This instrument has all parameters variable and produces simultaneous pos. and neg. pulses. It also has a TTL output with all parameters variable except amplitude. This feature, together with the normal/complement facility, greatly improves the ease of operation.

## 8005B Specifications

### Pulse Characteristics

**Transition times:**  $\leq 10$  ns to 2 s. Edges independently variable.  
**Non-linearity:** for transition times  $> 30$  ns,  $< 4\%$  of pulse amplitude.  
**Preshoot, overshoot, ringing:**  $< 5\%$  of pulse amplitude.  
**Pulse width:**  $< 25$  ns to 3 s. **Jitter:**  $< 0.1\%$  of setting + 50 ps.  
**Max. duty cycle:**  $> 80\%$  (0.3 Hz - 1 MHz),  $> 50\%$  (1-20 MHz).  
**Square wave:** 0.15 Hz - 10 MHz.  
**Pulse delay:**  $< 100$  ns to 3 s. **Jitter:**  $< 0.1\%$  of setting + 50 ps.  
**Pulse outputs:** simultaneous pos., neg. and TTL outputs.  
**Pulse amplitude:** 300 mV to 10 V.  
**Output protection:** max. external voltage  $\pm 10$  V.  
**Source impedance:** 50 ohms  $\pm 10\%$  or high impedance selectable.  
**TTL compatible output:** +4.6 V norm. or comp. 50  $\Omega$  impedance.

### Repetition Rate and Trigger

**Repetition rate:** 0.3 Hz to 20 MHz in 5 ranges. **Jitter:**  $< 0.1\%$  + 50 ps.  
**Double pulse:** 10 MHz max. Simulates 20 MHz.  
**Trigger output:**  $> +2$  V ampl. across 50 ohms. **Width:**  $> 6$  ns.

### External Operating Modes

#### External triggering (dc to 20 MHz)

**Delay:** approx. 35 ns trig. input to trig. output.  
**Maximum input:**  $\pm 10$  V. **Sensitivity:** sine 2 Vpp.  
**Impedance:** approx. 1k ohms, dc coupled. **Pulses:**  $\pm 1$  Vpeak.  
**Input pulse width:**  $\geq 10$  ns.

#### Gating

**Synchronous:** gate signal turns on repetition rate. Last pulse is always completed.  
**Asynchronous:** gate signal controls output of rate generator.  
**Gate input (impedance 1 k ohms dc coupled).**  
**Amplitude:** 2 V to 20 V (max.). **Polarity:** negative.

#### General

**Operating temperature:** 0°C to 55°C.  
**Power:** 115/230 V rms; +10%, -15%; 48 to 440 Hz, 180 VA max.  
**Weight:** net 7 kg (15.5 lb). Shipping 9 kg (20 lb).  
**Size:** 130 H x 426 W x 290 mm D (5.1" x 16.8" x 11.4").

## Ordering Information 8005B, 8011A

### 8011A Pulse Generator

**Opt 001:** Pulse Burst

**Opt 910:** extra Operating and Service Manual

**15179A (for 8011A):** Adapter frame, Rack mount for 1 or 2 units, includes blank panel for single-unit operation.

### 8005B Pulse Generator.

**Opt 908:** Rack Flange Kit (part number 5060-8740).

**Opt 910:** extra Operating and Service Manual.

- Repetition rate 0.1 Hz to 20 MHz
- Positive/negative/symmetrical output
- Normal/complement switch



8011A Option 001

The 8011A is a versatile, reliable, low cost pulse generator. This compact instrument features an uncomplicated design using high quality components to ensure long, dependable service. Ease of operation results from the logical and simple front panel layout. These qualities and the many pulse formats available emphasize the Model 8011A's cost-effectiveness in a wide application range.

## 8011A Specifications

### Pulse Characteristics (50 ohm Source/Load Impedances)

**Transition times:**  $< 10$  ns fixed.  
**Overshoot, ringing and preshoot:**  $< \pm 5\%$  of pulse amplitude. May increase to 10% at counter-clock wise positions of amplitude vernier.  
**Pulse width:** 25 ns to 100 ms in four ranges. Vernier provides continuous adjustment within each range.  
**Width jitter:**  $< 0.1\%$  + 50 ps on any width setting.  
**Maximum duty cycle:**  $> 50\%$  (100% using pulse complement)  
**Maximum output:** 8 V. With internal 50  $\Omega$  and external Hi-Z or internal Hi-Z/external 50  $\Omega$ , then 16 V max.  
**Attenuator:** 3-step attenuator provides the ranges 0.25 V - 1 V - 4 V - 16 V. Vernier provides continuous adjustment within each range.  
**Source impedance:** 50  $\Omega \pm 10\%$  shunted by 30 pF, except in 4 V - 16 V range which is 50  $\Omega$ /Hi-Z, switch selectable.  
**Polarity/Format:** pos., neg., or sym./norm. or compl., switch select.

### Repetition Rate and Trigger

0.1 Hz to 20 MHz in 5 ranges. Vernier provides continuous adjustment within each range. **Period jitter:**  $< 0.1\%$  + 50 ps of per. setting.  
**Square Wave:** 0.05 Hz to 10 MHz.  
**Trigger output:** dc coupled 50  $\Omega$  (typ.) source delivering  $\geq +1$  V into 50  $\Omega$  (can increase to +5 V). **Trigger pulse width:** 20 ns  $\pm 10$  ns.

### External Operating Modes

**Input impedance:** 50  $\Omega \pm 10\%$ . **Trigger polarity:** positive.

**Maximum input:**  $\pm 5$  V. **Sensitivity:** 1 V.

**Manual:** front panel pushbutton for generating single pulse.

**Repetition rate:** 0 to 20 MHz. In square wave, output frequency is half the input frequency.

**Trigger source:** manual or ext. signal. Min. ext. signal width 20 ns.

**Pulse burst mode (option 001):** preselected number of pulses generated on receipt of trigger.

**Burst trigger source:** man. or ext. signal. Min. signal width 25 ns.

### General

**Operating temperature:** 0°C to 55°C.

**Power:** 100/120/220/240 V rms; +5%, -10%; 48 Hz to 440 Hz, 70 VA max.

**Weight:** net, 4 kg (9 lb). Shipping, 6.5 kg (14.6 lb).

**Dimensions:** 126 H x 200 W x 280 mm D (5" x 7.9" x 11").



# PULSE GENERATORS

## 50 MHz Pulse Sources

Models 8012B & 8013B

- Variable transition times down to 5 ns
- $\pm 10$  V amplitude; selectable source impedance
- Ideal for testing TTL

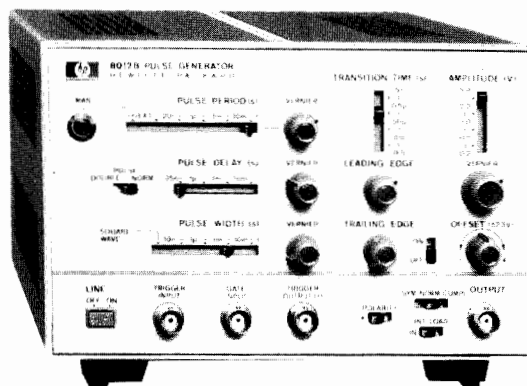

8012B

- Fixed 3.5 ns transition times
- 10 V amplitude; selectable source impedance
- 2 outputs

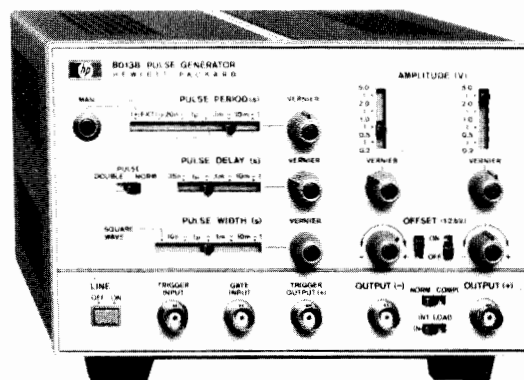

8013B

The 8012B and 8013B are at the top of their class for versatility, ease of operation and wide range of application. They provide the ideal solution to almost all digital logic testing problems with fixed 3.5 ns transition times on the 8013B and variable transition times down to 5 ns on the 8012B. The well-composed layout of the front panel controls (horizontal controls for horizontal parameters, vertical controls for vertical parameters) enables output pulses to be set up quickly and accurately with minimum risk of incompatible settings. Both models feature normal and complement outputs and a switchable internal 50 ohm source.

### Specifications

#### Pulse Characteristics

Parameter	8012B		8013B	
	Int. load IN	Int. load OUT	Int. load IN	Int. load OUT
Transition times	5 ns—0.5s 4 ranges, Verniers provide separate control of both edges within ranges up to max. ratios of 100:1 or 1:100.	6 ns—0.5s	3.5 ns fixed	5 ns fixed
Source impedance	50 ohms $\pm 10\%$ shunted by typically 20 pF	>50 ohms	50 ohms $\pm 3\%$ shunted by typically 20 pF	>50 ohms

Parameter	8012B/8013B	
	Internal load IN	Internal load OUT
Overshoot ringing	$\pm 5\%$ of pulse amplitude	May increase to $\pm 10\%$ when amplitude is between 0.4—4 V
Maximum output	5 V across 50 ohms, 10 V across open circuit. Short cct. protection.	10 V across 50 ohms. Short cct. protection.
Attenuator	4-step, reduces output to 0.2 V.	4-step, reduces output to 0.4 V.
DC offset	$\pm 2.5$ V across 50 ohms. Independent of amplitude settings.	DC offset switched off.

**Linearity (8012B):** for transition times  $> 30$  ns, maximum straight line deviation is 5% of pulse amplitude.

**Preshoot:**  $< \pm 5\%$  of pulse amplitude.

**Pulse width:**  $< 10$  ns to 1 s in four ranges. Vernier provides continuous adjustment within ranges.

**Width jitter:**  $< 0.1\% + 50$  ps on any width setting.

**Maximum duty cycle:**  $> 75\%$  from 1 Hz to 10 MHz, decreasing to  $\geq 40\%$  at 50 MHz. Up to 100% in COMPL mode.

**Polarity:** 8012B; positive or negative selectable, NORM/COMPL/SYM selectable; 8013B, one positive + one negative channel, NORM/COMPL selectable.

**Pulse delay:**  $< 35$  ns to 1 s (with respect to trigger output) in four ranges; vernier provides continuous adjustment within ranges.

**Delay jitter:**  $< 0.1\% + 50$  ps on any setting.

#### Repetition Rate and Trigger

1 Hz to 50 MHz in four ranges, continuous adjustment within ranges.

**Period jitter:**  $< 0.1\% + 50$  ps on any rate setting.

**Square wave:** 0.5 Hz to 25 MHz in four ranges. Duty cycle 50%  $\pm 5\%$  up to 1 MHz, tolerance increases to  $\pm 15\%$  at 25 MHz.

**Trigger output:**  $> +1$  V across 50  $\Omega$ , 16 ns  $\pm 10$  ns wide.

#### External Triggering

0 to 50 MHz; for square wave output, frequency divided by factor 2.

**Trigger input:** sine waves 1.5 V p-p (about zero) or pulses  $> 0.8$  V either polarity,  $> 7$  ns wide. Maximum input  $\pm 7$  V.

**Impedance:** 50  $\Omega \pm 10\%$ , dc coupled.

**Delay:** 25 ns  $\pm 8$  ns leading edge trig. input to trig. output.

**Manual:** pushbutton for single pulse.

#### Gating

**Synchronous gating:** gating signal turns generator "on". Last pulse is completed even if the gate ends during pulse.

**Gate input:** dc-coupled; voltage at open connector approx. +1.8 V. Shorting current  $\leq 12$  mA. Input impedance  $\approx 160 \Omega$

**Gate input signal:** voltage  $> +1.5$  V or resistor  $> 1$  k  $\Omega$  to ground enables rep. rate generator. Voltage  $< +0.8$  V or resistor  $< 160 \Omega$  disables rep. rate generator. Input TTL compatible, max.  $\pm 5$  V.

#### External Width and RZ

**External width:** output pulse width determined by width of drive input signal. Amplitude, transition times selectable. Trigger output independent of external width input signal.

**RZ mode:** external drive input switched to delay generator. Period determined by period of drive input signal. Delay, amplitude and width selectable.

**Input signal:**  $> +1$  V,  $> 7$  ns wide. Max.  $\pm 5$  V. 50  $\Omega$  dc coupled.

#### General

**Operating temperature:** 0°C to 55°C.

**Power:** 100/120/220/240 V rms; +5%, -10%; 48 to 400 Hz, 100 VA max.

**Weight:** net, 4 kg (8.8 lb). Shipping, 6.5 kg (14.6 lb).

**Size:** 126 H x 200 W x 280 mm D (5 x 7.9 x 11 in.)

#### Ordering Information

8012B Pulse Generator

Opt 910: extra operating and service manual

8013B Pulse Generator

Opt 910: extra operating and service manual

15179A Adapter frame. Rack mounting for 1 or 2 units, includes blank panel for single-unit requirements

# PULSE GENERATORS

50 MHz, Dual Output

Model 8015A

325



- Two independent  $\pm 16$  V outputs
- Additional TTL output

- Remote control and counted burst options
- Complex waveforms

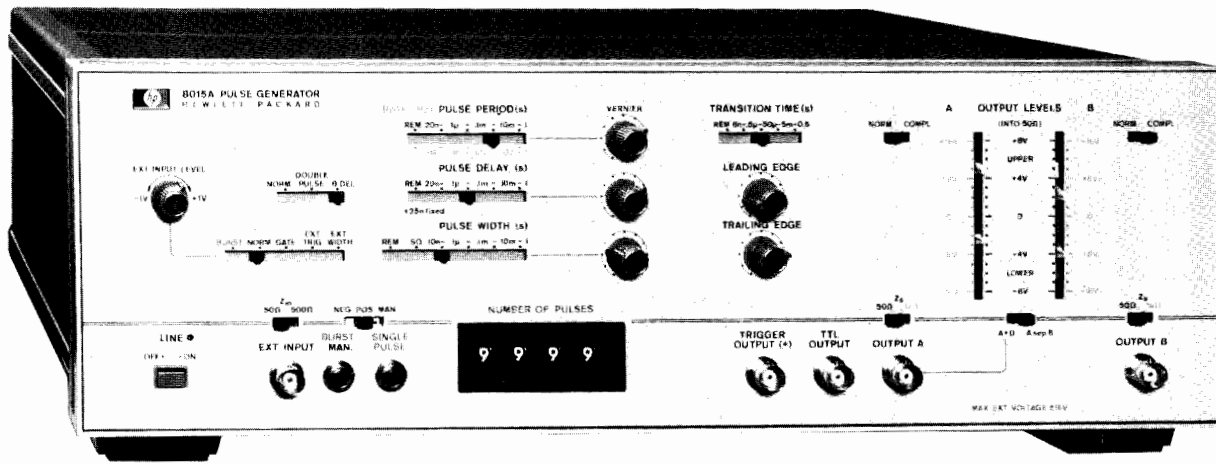

8015A Option 002

Offering B Delay mode in addition to variability of all pulse parameters, the 8015A is ideal for analyzing critical timing conditions, or generating 2-phase clocks.

A + B mode gives a 30 V output within a  $\pm 16$  V window. Combined with B Delay mode, three-level signals, special codes or simulated biomedical signals can be generated.

Option 002 Burst mode generates an exact number of pulses by means of an internal counter.

Direct access to either or both output amplifiers (Option 007) converts to MOS/CMOS levels. Alternatively, high-level tracking capability ensures that clock and data signals follow the supply, and thus safeguards CMOS devices.

For use in automatic test, Option 003 allows all pulse parameters to be controlled remotely.

## Specifications

### Timing

**Repetition rate:** 1 Hz to 50 MHz (square wave and double pulse to 25 MHz, A + B mode to 40 MHz, B delay 20 MHz).

**Width:** 10 ns to 1 s or square wave.

**Delay:** 20 ns to 1 s (both channels, interchannel or double pulse).

**Jitter:** 0.1% + 50 ps.

**Output** (50  $\Omega$  Output Impedance into 50  $\Omega$  termination. Voltages double in 50  $\Omega$  / 1 k $\Omega$  or 1 k $\Omega$  / 50  $\Omega$  operation).

**Magnitude:** 1 V to 8 V amplitude (2 V to 16 V in A + B mode).

**High level:** -7 V to +8 V. **Low level:** -8 V to +7 V.

**Transition times:** 6 ns to 0.5 s in four ranges, independent leading/trailing vernier adjustment.

**Non-linearity:** 5% for transitions > 30 ns.

**Preshoot, overshoot and ringing:** 5%.

**A + B mode:** sum of channel A and channel B outputs.

**Complement:** independently selectable.

**Impedance:** 50  $\Omega$  / 1 k $\Omega$ , independently selectable.

### Trigger Input

**Impedance:** 50  $\Omega$  / 500  $\Omega$  selectable.

**Level:** adjustable +1 V to -1 V (50  $\Omega$ ), +10 V to -10 V (500  $\Omega$ ).

**Slope:** + or - selectable.

### Auxiliary Outputs

**TTL:** 50  $\Omega$  output impedance, timing as channel A.

**Trigger output:** 1 V, 50  $\Omega$  into 50  $\Omega$ .

### Option 002 Burst Mode

**Burst length:** 1-9999 pulses, selectable.

**Pulse Repetition rate:** 1 Hz to 40 MHz.

**Burst trigger:** trigger input.

**Minimum Burst Separation:** 200 ns.

### Option 003 Remote Control

**Timing ranges:** TTL or contact closure.

**Timing verniers:** current, voltage or resistor programming.

**Output levels:** voltage programming.

**Burst:** BCD, TTL/contact closure.

### Option 007 Amplifier and Tracking Modes

#### Dual Amplifier Mode

**Gain:** 0.8 to 6.4.

**Frequency response (-3 dB):** 0 to 80 MHz.

#### Upper Level Tracking Mode

**Upper level:** input voltage  $\pm 5\%$ .

**Lower level:** 0 V  $\pm 250$  mV.

**Settling time:** 400  $\mu$ s to  $\pm 5\%$  of final value.

### General

**Operating temperature:** 0°C to 55°C.

**Power:** 100/120/220/240 V rms; +5%, -10%; 48 to 440 Hz, 180 VA max.

**Weight:** net, 11 kg (24.26 lb); shipping, 14.7 kg (32.4 lb).

**Size:** 133 H x 426 W x 346 mm D (5.2" x 16.75" x 13.6").

### Ordering Information

8015A Pulse Generator

Opt 002: Pulse Burst

Opt 003: Remote Control

Opt 007: Dual Amplifier and Level Tracking modes

Opt 907: Front Handle Kit (Part No. 5061-0089)

Opt 908: Rack Flange Kit (Part No. 5061-0077)

Opt 909: Opt. 907, 908 combined

(Part No. 5061-0083)

Opt 910: Additional Operating and Service Manual

# PULSE GENERATORS

100 MHz Pulse Source  
Model 8007B

- Variable transition times down to 2 ns.

- Extremely linear slopes

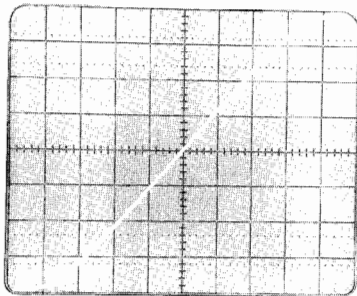
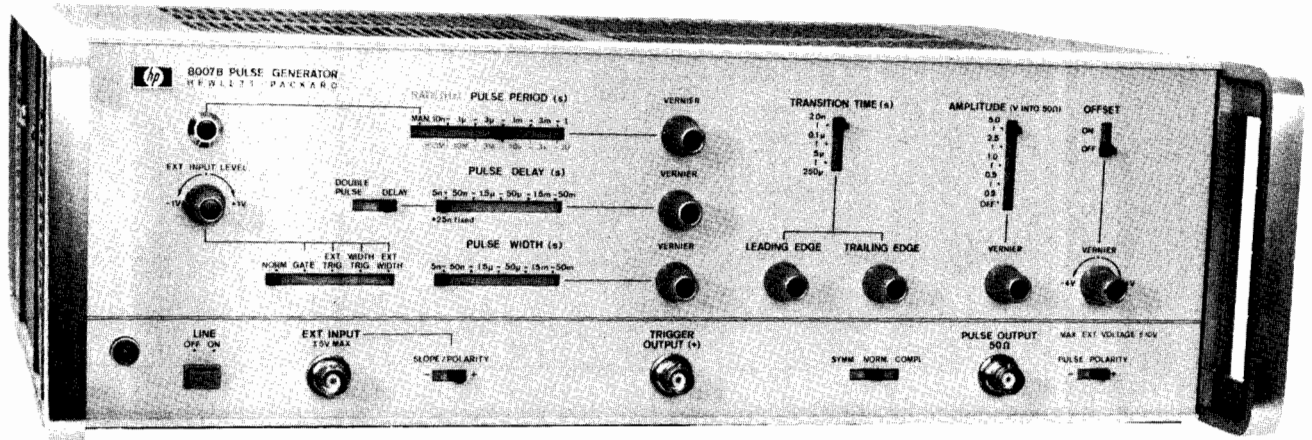

1 ns/cm  
0.5 V/cm  
1 GHz bandwidth

The 8007B is a high speed pulse generator that is well suited for STTL and ECL applications.

The output can be set to positive or negative polarity, complement or symmetrical to ground. A high dc-offset of up to  $\pm 4$  V is also included.

External triggering and synchronous gating are provided. The trigger level is adjustable for all externally controlled modes with the slope polarity selectable. This is very useful for avoiding malfunctions caused by noise and ringing on the external trigger signal.

In "External Width" mode the external input and pulse output have equal width. Transition times and amplitude of the output pulse can be set by the front panel controls. This mode is useful for shaping NRZ signals, as the width information is passed on to the output pulse unchanged.

The "Width Trigger" mode is suitable for RZ signal shaping. Width, transition times and amplitude are determined by the front panel controls.

## Specifications

### Pulse Characteristics (50 $\Omega$ Source and Load Impedance)

**Transition times:**  $< 2$  ns to 250  $\mu$ s, three ranges (common for both transition times). Independent verniers for adjusting leading and trailing edge within each range up to maximum ratios of 1:50 or 50:1.

**Linearity:** maximum deviation from a straight line between 10% and 90% points  $\leq 5\%$  of pulse amplitude.

**Preshoot, overshoot, ringing:**  $< \pm 5\%$  of pulse amplitude.

**Pulse width:**  $< 5$  ns to 50 ms in five ranges. Vernier provides continuous adjustment within ranges.

**Width jitter:**  $< 0.1\%$  on any width setting.

**Maximum duty cycle:** normal  $> 50\%$ ; complement approx. 100%.

**Amplitude:** 5 V max (10 V across open circuit) to 0.2 V in four ranges; vernier adjustment within ranges. Pulse can be switched off.

**Pulse output:** + or - polarity selectable; normal, complement, or symmetrical to ground.

**Source impedance:** 50  $\Omega \pm 4 \Omega$  shunted by typ. 10 pF.

**DC-offset:**  $\pm 4$  V across 50  $\Omega$  load. Independent of amplitude setting, can be switched off.

**Pulse delay:**  $< 30$  ns to 50 ms with respect to trigger output. Five ranges, with continuous adjustment within ranges.

**Delay jitter:**  $< 0.1\%$  on any delay setting.

### Repetition Rate and Trigger

10 Hz to 100 MHz in 5 ranges. Continuous adjustment within ranges.

**Period jitter:**  $< 0.1\%$ .

**Double pulse:** available only up to pulse rate setting of 50 MHz, representing an output pulse rate of 100 MHz.

**Trigger output:**  $> +1$  V across 50  $\Omega$ , 4ns  $\pm 2$  ns wide.

### External Triggering (0 to 100 MHz)

**Delay:** approx. 15 ns between trig. input and trig. output.

**Manual:** front panel pushbutton for single pulse.

### External Width and Width Trigger

**External width:** output pulse width determined by width of drive input.

**Width trigger:** external drive input switched to the width generator. Pulse width determined by front panel width setting.

**Rate generator:** provides trigger pulses independent of drive input.

### Synchronous Gating

Gating signal turns generator "on." Last pulse is completed even if gate ends during pulse.

### External Input

**Impedance:** 50  $\Omega$ , dc-coupled. Max input  $\pm 5$  V.

**Level:** adjustable from +1 V to -1 V, Polarity: + or -.

**Sensitivity:** sine waves 1 V p-p; pulses 1 V.

### General

**Operating temperature:** 0°C to +55°C.

**Power requirements:** 115 or 230 V rms; +10%, -15%; 48 to 440 Hz, 100 VA (maximum).

**Weight:** net, 8 kg (17.6 lb). Shipping, 9 kg (19.8 lb).

**Size:** 128 H x 426 W x 345 mm D (5" x 16.8" x 13.6").

### Ordering Information

#### 8007B Pulse Generator

**Opt 908:** Rack Flange Kit (Part No. 5060-8740)

**Opt 910:** Additional Operating and Service Manual

- < 1 ns variable transition times
- Ultra-clean 50 ohm source

- Switch-selectable ECL levels
- Dual  $\pm 5$  V outputs

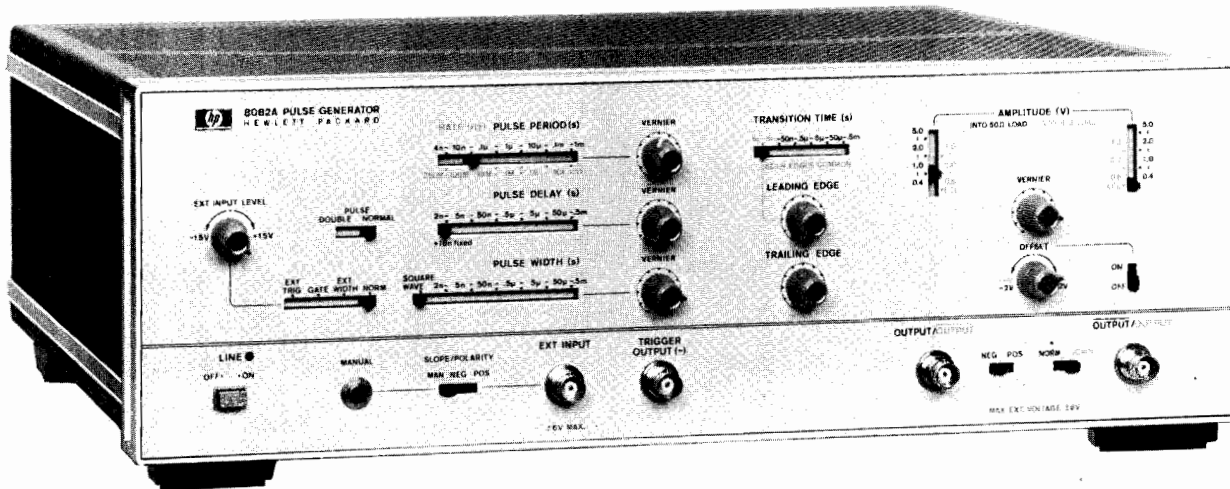

The 8082A is Hewlett-Packard's fastest pulse generator with all pulse parameters variable. With repetition rates to 250 MHz, transition times down to 1 ns and amplitudes to 5 V, the 8082A is ideally suited for state-of-the-art TTL and ECL logic designs. Using the 8082A, you can rapidly test logic circuits under all operating conditions by simply varying pulse parameters. Although a highly sophisticated instrument, the 8082A is still easy to operate because of its logical front panel layout and switch selectable ECL output levels. Another feature that contributes to ease of operation is the square wave mode. You can, for example, carry out toggle rate tests in this mode up to 250 MHz without having to worry about pulse duty cycle.

Hybrid IC's, manufactured by Hewlett-Packard, are used extensively in the design of the 8082A. These ICs eliminate the need for fans, reduce power consumption and enable a low reactance 50 ohm source impedance to be used. This source impedance absorbs 98% of reflections from signals up to 4 V amplitude.

## Specifications

### Pulse Characteristics (50 $\Omega$ Source and Load Impedance)

**Transition times:** < 1 ns - 0.5 ms (10% to 90%) in 6 ranges. < 750 ps (20% to 80%). Leading/trailing edges controlled together on fastest range, independently variable over 1:10 ratio on other ranges.

**Overshoot and ringing:**  $\leq \pm 5\%$  of pulse amplitude may increase to  $\pm 10\%$  with amplitude vernier CCW.

**Preshoot:**  $\leq \pm 5\%$  of pulse amplitude.

**Linearity:** linearity aberration for both slopes  $\leq 5\%$  for transition times > 5 ns.

**Output:** maximum amplitude is 5 V from 50  $\Omega$  into 50  $\Omega$ . Maximum output voltage is  $\pm 5$  V (amplitude + offset).

**Offset:**  $\pm 2$  V, into 50  $\Omega$ .

**DC-source impedance:** 50  $\Omega \pm 5\%$ .

**Reflection coefficient:** reflection is 2% typical for steps with 1 ns rise time applied to output connector on all amplitude ranges except 5 V range. On the 5 V range, the reflection may be 15%.

**Output protection:** cannot be damaged by open or short circuits or application of ext.  $\leq \pm 6$  V or  $\pm 200$  mA independent of control settings.

**Attenuator:** two separate three step-attenuators reduce the outputs to 1 V. Vernier is common for both outputs and reduces the output to 0.4 V minimum. A further position provides ECL-compatible outputs (-0.9 V to -1.7 V typ. open circuit).

### Timing

**Repetition rate:** 250 MHz to 1 kHz in 6 ranges.

**Period jitter:** < 0.1% of setting + 50 ps.

**Delay:** 2 ns - 0.5 ms in 6 ranges plus typ. 17 ns fxd. with respect to trigger output. Duty cycle > 50%.

**Delay jitter:** < 0.1% of setting + 50 ps.

**Double pulse:** up to 125 MHz max. (simulates 250 MHz).

**Pulse width:** < 2 ns - 0.5 ms in 6 ranges.

**Width jitter:** < 0.1% of setting + 50 ps.

**Width duty cycle:** > 50%.

**Square wave:** delay and double pulse are disabled, max. Rep. Rate 250 MHz. Duty cycle is 50%  $\pm 10\%$  up to 100 MHz, 50%  $\pm 15\%$  for > 100 MHz.

**Trigger output:** negative going Square Wave (50% duty cycle typ.) > 500 mV from 50  $\Omega$  into 50  $\Omega$ . Internal 50  $\Omega$  can be switched off by slide-switch on PC-board. Amplitude up to 1 V into 50  $\Omega$  up to 200 MHz.

**Trigger output protection:** cannot be damaged by short circuit or application of external  $\pm 200$  mA.

## External Operating Modes

### External input

**Input impedance:** 50  $\Omega \pm 10\%$ . DC coupled.

**Maximum input:**  $\pm 6$  V.

**Trigger level:** adjustable -1.5 V to +1.5 V.

**Slope control:** positive, negative or manual selectable. In the manual position all ext. functions can be controlled by push button. Button pushed in simulates an "on-signal."

**Sensitivity:** sine-wave > 200 mV p-p pulses > 200 mV.

**Repetition rate:** 0 to 250 MHz.

### External-controlled modes:

**External trigger:** there is approximately 7 ns delay between the external input and the trigger output. Rep. rate is externally controlled (is triggered by external signal). Trigger output provides the pulse-shaped input signal.

**Synchronous gating:** gating signal turns rep. rate generator on. Last pulse normal width even if gate ends during pulse.

**External width:** output pulse width determined by width of drive input. Rep. rate and delay are disabled. Trigger output provides shaped input signal.

## General

**Operating temperature:** 0°C to 55°C.

**Power:** 100/120/220/240 Vrms; +5%, -10%; 48-440 Hz. 85 VA max.

**Weight:** net, 7.9 kg (17.44 lb). Shipping 8.9 kg (19.63 lb).

**Size:** 133 mm H x 426 W x 345 mm D (5.2" x 16.75" x 13.6").

## Ordering Information

8082A Pulse Generator

**Opt 907:** Front Handle Kit (part number 5061-0089).

**Opt 908:** Rack Flange Kit (part number 5061-0077).

**Opt 909:** Opt 907, 908 Combined (part number 5061-0083).

**Opt 910:** Additional Operating and Service Manual



# PULSE GENERATORS

## Configurable Pulse/Data Stimuli

### 8080A Series

Example: 8080A, SO4

- 1 GHz, 300 ps transitions
- Interchannel delay

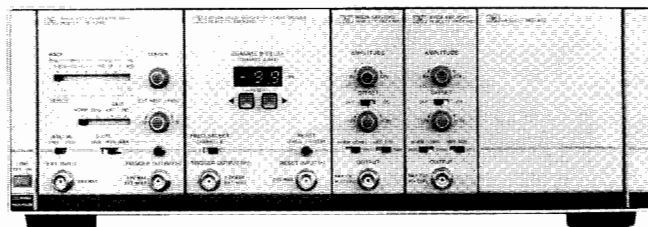

8091A Rate Generator      8092A Delay Generator      CHA CHB Output Amplifiers  
8093A

Example: 8080A DO1

- 300 MHz, 800 ps transitions
- Manually programmable data

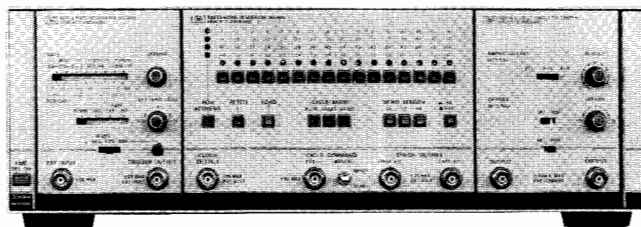

8081A Rate Generator      8084A Word Generator      8083A Output Amplifier

Research and development in advanced technologies such as sub-nanosecond ICs, fiber optics and nucleonics, require fast pulses for thorough characterization. The 8080A can, for example, generate simultaneous 1 GHz clock and simulated NRZ data for testing today's fastest memories, or complementary data with up to 64 bits and fast 300 ps edges for state-of-the-art communication devices. Cost-effectiveness is promoted because the 8080A's modular structure allows performance and capability to be tailored to the requirement.

Two examples are shown here. Full details of these and all other factory-systemized configurations are in the data sheet. Individual modules are also available for special applications or for extending an existing configuration. Ask for the systemizing and adjustment guidelines.

### Leading Characteristics (50-ohm load)

#### 8080A SO4

##### Timing

**Repetition Rate:** 100 Hz – 1 GHz.

**Interchannel delay:**  $\pm 9.9$  ns in 0.1 ns steps.

**Channel B divider:** 0.5 f selectable for simulating NRZ data.

**Width:** Square wave.

**Modes:** Int, Ext Width, Gate, Manual.

##### Independent 50-ohm Outputs

**Amplitude:** 0.6 V to 1.2 V<sub>pp</sub>.

**Offset:**  $\pm 1.2$  V.

**Transitions times (10% to 90%):** <300 ps.

**Polarity:** selectable

**Format:** Normal/Complement selectable

#### 8080A DO1

##### Timing

**Repetition Rate:** 10 Hz–300 MHz.

**Width:** Square wave (RZ) or NRZ.

**Modes:** Int, Ext/Manual Width.

**Data Cycle Modes:** Ext/Man Single and Gated Cycle, Auto Cycle.

**Data:** Serial, 16/32/64 bit selectable.

##### Simultaneous Normal and Complement 50-ohm Outputs

**Amplitude:** 0.2 V to 2 V.

**Offset:**  $\pm 1$  V.

**Transition times (10% to 90%):** <800 ps.

**Polarity:** Selectable.

### General

**Operating temperatures:** 0°C to 55°C.

**Power:** 115/230 V rms; +10%, -22%; 48 to 66 Hz, 200 VA max.

**Weight:** (typical, 8080A Mainframe plus full complement of modules) 9.4 kg (16.6 lbs) net; 19.7 kg (43.3 lbs) shipping.

**Size:** (8080A Mainframe): 133 H x 426 W x 422 mm D (5.24" x 16.77" x 16.61").

### Ordering Information

**8080A Mainframe**

**Opt 907:** Front handle kit

**Opt 908:** Rack flange kit

**Opt 909:** Opt 907, 908 combined

**Opt S01:** (8081/83A, 2 x 15400A)

**Opt S02:** (8081/93A, 2 x 15400A, 15401A)

**Opt S03:** (8091/93A, 2 x 15400A, 15401A)

**Opt S04:** (8091/92A, 2 x 8093A, 15400A)

**Opt D01:** (8081/83/84A)

**Opt D02:** (8081/84/93A, 15401A)

**Opt D03:** (8081/84A, 2 x 8093A)

**8081A** 300 MHz Rate Generator module

**8083A** 300 MHz Output Amplified module

**8084A** 300 MHz Word Generator module

**8091A** 1 GHz Rate Generator module

**8092A** 1 GHz Delay Generator module

**8093A** 1 GHz Output Amplifier module

**Additional Manuals:** Opt 910, per module

### Accessories available

**15400A** Blank Panel, 1/4 mainframe width

**15401A** Blank Panel, 1/8 mainframe width

**15402A** BNC Feedthru panel, 1/8 width

### Pulse Generator Accessories



15104A/15115A



15116A

**15104A** Pulse Adder/Splitter dc to 2 GHz

**15116A** Pulse Inverter 3 MHz to 2 GHz

**15115A** Pulse Splitter/Inverter 3 MHz to 2 GHz

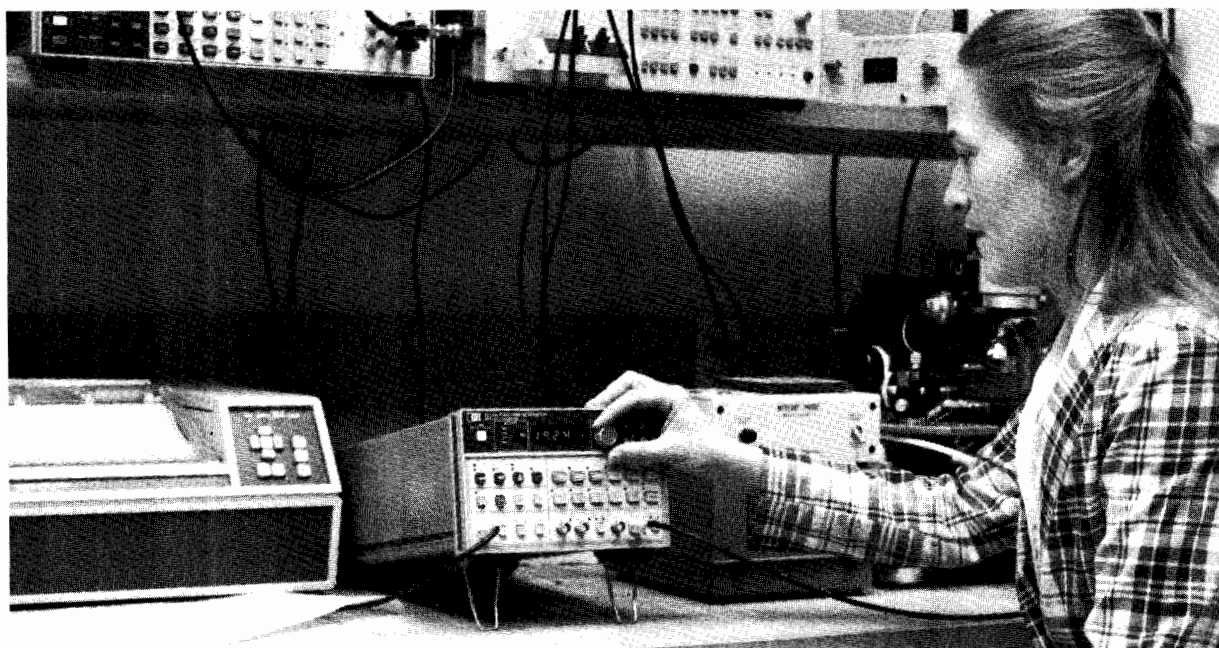

### Function Generators

The function generator is a versatile, multi-waveform signal source capable of very wide frequency coverage.

The HP 3310A/B, 3311A, 3312A, 3314A, and 3325A offer a complete set of functions including sine, square, triangle, ramp, and even Arbitrary Waveforms (3314A). For ex-

tended pulse capabilities, the 8111A and 8116A Pulse/Function Generators include precise timing waveforms.

In addition to this complete set of waveforms, Function Generators include versatile modulation capabilities such as amplitude, frequency, phase, pulse width, and VCO control.

The Function Generator is an indispensable general purpose signal source for production testing, instrument repair, and the electronics laboratory. Diverse fields of applications in which the function generator is being used include medical research, education, chemical, communications, geophysics, industrial control, military and aerospace.

### Function Generator Summary

	Function Generators				Pulse/Function Generators		Synthesizer/Function Generators	
	3310A/B	3311A	3312A	3314A	8111A	8116A	3325A	8165A
Frequency								
Min	0.5 mHz	0.1 Hz	0.1 Hz	1.0 mHz	1.0 Hz	1.0 mHz	1 $\mu$ Hz	1 mHz
Max	5.0 MHz	1.0 MHz	13 MHz	20 MHz	20 MHz	50 MHz	21 MHz-sine 11 MHz-square 11 kHz-triangle	50 MHz 20 MHz-pulse/ramp
Waveforms (symmetry)								
Sine	50%	50%	20-80% ②	5-95%	10-90% ④	10-90% ⑤	50%	50%
Square	15/50/85%	50%	20-80% ②	5-95%	10-90% ④	10-90% ⑤	50%	20, 50, 80%
Transition time	<30 ns	<100 ns	<20 ns	<9 ns	<10 ns	<6 ns	<20 ns	<5 ns
Triangle	15/50/80%	50%	20-80% ②	5-95%	10-90% ④	10-90% ⑤	50% + ramp	20, 50, 80%
Output (into 50 Ohms)								
Amplitude (p-p)	15 V	10 V ①	10 V	10 V	16 V	16 V	10 V ⑥	20 V
DC Offset	$\pm 5$ V	$\pm 5$ V	$\pm 5$ V	$\pm 5$ V	$\pm 8$ V	$\pm 8$ V	$\pm 5$ V	$\pm 5$ V
Output Impedance	50	600	50	50	50	50	50	50/1000
Modes								
Counted Burst	—	—	—	1 to 1999 ③	1 to 1999	1 to 1999	—	1 to 1999
Gate	ext—3310B	—	int/ext	int/ext	ext	ext	—	ext
Phase Lock	—	—	—	$\pm 200$ deg	—	—	$\pm 720$ deg	ext
Trigger	ext—3310B	—	int/ext	int/ext	ext	int/ext	—	ext
Arbitrary	—	—	—	150 vectors	—	—	—	—
Modulation/Sweep								
AM	—	—	int/ext	ext	—	ext	ext	option
FM	—	—	int/ext	ext	—	ext	PM	ext
PWM	—	—	—	—	—	ext	—	—
VCO	ext	ext	int/ext	ext	ext	ext	—	ext
Lin Sweep	—	—	int/ext	int	—	—	int	—
Log Sweep	—	—	—	int	—	option	int	option
Programmability	—	—	—	HP-IB	—	HP-IB	HP-IB	HP-IB
Catalog page	331	332	333	334	337	338	340	344
Notes		① into 600	② 50% above 1 MHz	③ also 1/2 cycle bursts	④ 50% above 1 MHz	⑤ 20-80% above 1 MHz	⑥ 40 Vp-p to 1 MHz option	



# FUNCTION GENERATORS & FREQUENCY SYNTHESIZERS

## General Information (Cont.)

### Frequency Synthesizers

Today's measurement needs are placing increasingly stringent requirements on signal sources for greater frequency resolution and stability. Narrowband component testing, satellite and terrestrial communications, local oscillator and automatic test systems are only a few of the many applications that continually require higher precision sources.

Square waves, triangle waves, and pulses are signals typically associated with non-synthesized sources. This situation is changing. Precision signals of these types are finding important applications in mechanical, civil, and environmental engineering.

Increased amplitude accuracy and resolution are also requirements in many applications. The telecommunications industry's Frequency Division Multiplex (FDM) systems require high amplitude accuracy and resolution (0.01 dB) as well as high frequency resolution and stability. These requirements are becoming commonplace in R & D and production test environments.

### Frequency Synthesis Techniques

Traditional approaches to indirect synthesis techniques require a phase-locked loop for every decade of frequency resolution. This method provides adequate performance, but many component parts leads to an expensive product. However, a new technique has been developed by Hewlett-Packard that allows a single phase-locked loop to offer multidigit resolution. The process is called Fractional Frequency Synthesis or Fractional N--a method of relating the "VCO" frequency to the crystal reference by other than

an integer N. Up to 11 digits of frequency resolution can be achieved from a single phase locked loop with this new technique. Significant cost savings and increased reliability result.

### Signal Quality

The common specifications which describe signal sources include frequency range and resolution, amplitude range and resolution, distortion and stability.

Additional specifications that are pertinent to the synthesizer are phase noise and spurious content. Phase noise describes the short term frequency stability of a signal source. It is typically specified as single sideband spectral density or integrated (total) phase noise. Spurious signals are discrete, nonharmonically related signals appearing in the output.

### Synthesizers

Hewlett-Packard offers a wide range of high quality frequency synthesizers and synthesized signal generators covering the frequency range of dc to 18 GHz. In addition to being high performance synthesized signal sources, they incorporate many additional features which allow them to fulfill the needs of either bench or programmable applications.

The combined frequency ranges of the HP 8656A, 8660A/C, 8662A, 8663A, and 8672A Synthesized Signal Generators span 10 kHz to 18 GHz. These generators couple the frequency accuracy and stability of synthesizers with the modulation capability and precise, calibrated, wide-range level control of high quality signal generators. In addition, each of these generators offer HP-IB remote control of frequency, level, and modulation.

### Synthesized Level Generator

The HP 3335A is a synthesized level generator covering the range of 200 Hz to 80 MHz. This instrument is ideal as a stand-alone generator with synthesizer stability or as a companion generator for the HP 3745A/B SLMS and 3586A/B/C selective level meter. It offers the traditional range of connectors and output impedances, balanced and unbalanced, required by the telecommunications industry. The 3336A/B/C is a 21 MHz synthesized level generator with a similar set of telecommunications features. It too, is ideal as a stand-alone generator or as a companion for HP's 3586A/B/C Selective Level Meter. For more information on these generators, refer to the Telecommunications section.

### Sweep Capability

The 3325A, 3330B, 3335A, 3336A/B/C, 8660C, 8662A, and 8663A are among the most linear sweepers ever built. Keyboard control of microprocessors gives these instruments digital control of sweep start/stop frequencies and sweep times.

### Synthesizer/Function Generator

The HP 3325A is a function generator whose functions are derived from a primary synthesized oscillator. It provides a high purity synthesized sine wave from 0.000001 Hz to 21 MHz, precision square waves to 11 MHz, linear ramps and triangle waveforms to 11 KHz, 11 digit resolution (1  $\mu$ Hz < 100 kHz), wideband phase continuous sweep, and HP-IB programmability. The low price makes the 3325A an excellent choice for automatic test systems or bench applications.

## Synthesizer Summary

HP Model	Frequency Range	Frequency Resolution	Frequency Stability	Level Range dBm - 50 $\Omega$	Level Resolution	Remote Control	Other Features*
3325A*** (Pg. 340)	DC-21 MHz (sine) DC-11MHz (square)	.000001 Hz or .001 Hz (11 digits)	$5 \times 10^{-10}$ /yr	-56.02 to + 23.98 (sine)	.01 dB or .001 mV to .01V (4 digits)	Freq. Ampl. Sweep & Phase	8, 11, 12, 13
3335A (Pg. 342)	200 Hz-80 MHz	.001 Hz	$10^{-9}$ /day	-87 to +13	0.01 dB (4 digits)	Freq. & Ampl.	2, 3, 8
3336A/B/C (Pp. 343 and 564)	10 Hz-21 MHz (Pg. 343)	.001 Hz or 11 digits	$1.5 \times 10^{-9}$ /day	-71 to +8	0.01 dB	Freq. Ampl. Sweep & Phase	8, 11, 12, 13
8656A (Pg. 348)	100 kHz to 990 MHz	100Hz or 250 Hz	$10^{-9}$ /day	-127 to +13	0.1dB	Freq., Ampl. Modulation	8, 14
8660A/C** (Pg. 353)	10kHz to 2600 MHz (3 plug-ins)	1 Hz or 2 Hz (10 digits)	$3 \times 10^{-9}$ /day	-146 to +13	Local: 10 dB steps plus Vernier Remote: 1dB Steps	Freq., Ampl. & Modulation	8660A: 5, 7, 8 8660C: 3, 5, 7, 8
8662A** (Pg. 350)	10 kHz-1280 MHz	0.1 Hz or 0.2 Hz (11 digits)	$5 \times 10^{-9}$ /day	-139.9 to +13	0.1 dB (4 digits)	Freq. Ampl. Modulation & Sweep	3, 8, 14
8663A (Pg. 352)	10 kHz to 2560 MHz	0.1 Hz or 0.2Hz (11 digits)	$5 \times 10^{-9}$ /day	-129.9 to +16	0.1dB	Freq. Ampl Modulation Sweep	3, 8, 14 15
8671A (Pg. 367)	2 to 6.2 GHz	1 kHz	$5 \times 10^{-10}$ /day	>+ 8	—	Freq., FM Modulation	8, 9
8672A** (Pg. 366)	2 to 18 GHz	1, 2, 3 kHz	$5 \times 10^{-9}$ /day	-120 to +3	Local: 10 dB steps plus Vernier Remote: 1dB Steps	Freq., Ampl. & Modulation	8, 10
8165A (Pg. 344)	1 mHz to 50 MHz	4 digits	$1 \times 10^0$ /day	10.0 mV to 20 V P-P	3 digits	Modulation & Trigger	3, 8, 10

\* Other features: (1)  $10^{-10}$ /day freq. stability optional, (2)  $5 \times 10^{-10}$ /day, (3) digital freq. sweep, (4) digital ampl. sweep, (5) internal AM/FM,  $\phi$ M, (6) External AM, (7)  $3 \times 10^{-9}$ /day stability Opt. 001 (8) HP-IB, (9) External FM, (10) External AM & FM, (11)  $5 \times 10^{-8}$ /week stability optional, (12) external AM &  $\phi$ M, (13) phase continuous sweep, (14) Internal & External AM & FM, (15) Independent and simultaneous A, FM, PM and pulse modulation.

\*\* The 8660A/C, 8662A, 8663A and 8672A are synthesized signal generators. They are discussed in detail in the section labeled "Signal Generators."

\*\*\* The 3325A Synthesizer/Function Generator includes squarewaves, positive and negative ramps, and triangle waveforms in addition to sinewaves.

# FUNCTION GENERATORS & FREQUENCY SYNTHESIZERS

0.0005 Hz to 5 MHz Function Generators

Model 3310A/B

331

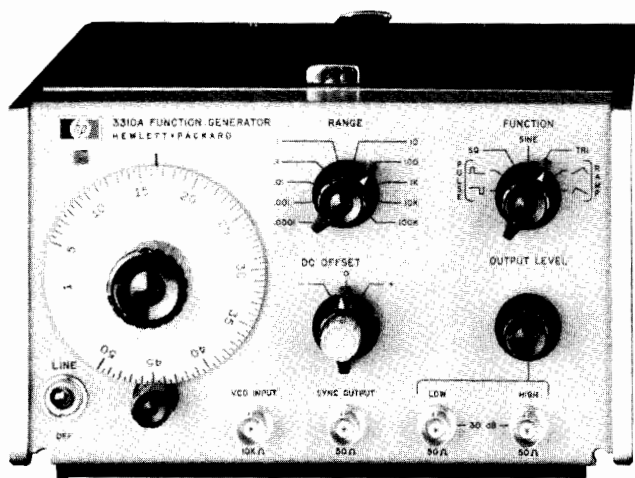

3310A



3310B

## Description

The 3310A Function Generator is a compact voltage-controlled generator with 10 decades of range. Ramp and pulse functions are available in addition to sine, square and triangle. DC offset and external voltage control provide wide versatility. A fast rise time sync output is provided. Aspect ratio of nonsymmetrical function is 15%/85%.

The 3310B has all the features of the standard 3310A plus single and multiple cycle output capability.

## 3310A Specifications

**Output waveforms:** sinusoidal, square, triangle, positive pulse, negative pulse, positive ramp and negative ramp. Pulses and ramps have a fixed 15% or 85% duty cycle.

**Frequency range:** 0.0005 Hz to 5 MHz in 10 decade ranges.

### Sine Wave Frequency Response

**0.0005 Hz to 50 kHz:**  $\pm 1\%$ ; 50 kHz to 5 MHz:  $\pm 4\%$ . Reference, 1 kHz at full amplitude into 50  $\Omega$ .

### Dial Accuracy

**0.0005 Hz to 500 kHz all functions:**  $\pm (1\% \text{ of setting} + 1\% \text{ of full scale})$ .

**500 kHz to 5 MHz sine, square and triangle:**  $\pm (3\% \text{ of setting} + 3\% \text{ of full scale})$ .

**500 kHz to 5 MHz pulse and ramps:**  $\pm (10\% \text{ of setting} + 1\% \text{ of full scale})$ .

**Maximum output on high:**  $> 30 \text{ V p-p}$  open circuit;  $> 15 \text{ V p-p}$  into 50  $\Omega$  (except for pulses at frequency  $> 2 \text{ MHz}$ ).

**Pulse (frequency  $> 2 \text{ MHz}$ ):**  $> 24 \text{ V p-p}$  open circuit;  $> 12 \text{ V p-p}$  into 50  $\Omega$ .

**Minimum output on low:**  $< 30 \text{ mV p-p}$  open circuit;  $< 15 \text{ mV p-p}$  into 50  $\Omega$ .

**Output level control:** range  $> 30 \text{ dB}$ . High and low outputs overlap for a total range of  $> 60 \text{ dB}$ ; low output is 30 dB down from high output.

### Sine Wave Distortion

**0.0005 to 10 Hz:**  $> 40 \text{ dB}$  (1%).

**10 Hz to 50 kHz (on 1 k range):**  $> 46 \text{ dB}$  (0.5%).

**50 kHz to 500 kHz:**  $> 40 \text{ dB}$  (1%).

**500 kHz to 5 MHz:**  $> 30 \text{ dB}$  (3%).

**Square wave and pulse response:**  $< 30 \text{ ns}$  rise and fall times at full output.

**Triangle and ramp linearity:** 0.0005 Hz to 50 kHz,  $< 1\%$ .

**Impedance:** 50  $\Omega$ .

### Sync

**Amplitude:**  $> 4 \text{ V p-p}$  open circuit,  $> 2 \text{ V p-p}$  into 50  $\Omega$ .

## DC Offset

**Amplitude:**  $\pm 10 \text{ V}$  open circuit,  $\pm 5 \text{ V}$  into 50  $\Omega$  (adjustable).

**Note:** max V ac peak + V dc offset is  $\pm 15 \text{ V}$  open circuit,  $\pm 7.5 \text{ V}$  into 50  $\Omega$ .

**External frequency control:** 50:1 on any range.

**Input requirement:** with dial set to low end mark, a positive ramp of 0 to  $+10 \text{ V} \pm 1 \text{ V}$  will linearly increase frequency 50:1. With dial set at 50, a linear negative ramp of 0 to  $-10 \text{ V} \pm 1 \text{ V}$  will linearly decrease frequency 50:1. An ac voltage will FM the frequency about a dial setting within the limits  $(1 < f < 50) \times \text{range setting}$ .

**Linearity:** ratio of output frequency to input voltage ( $\Delta F/\Delta V$ ) will be linear within 0.5%.

**Sensitivity:** approximately 100 mV/minor division.

**Input impedance:** 10 k $\Omega$ .

## General

**Power:** 115 V or 230 V  $\pm 10\%$ , 48 Hz to 440 Hz,  $< 20 \text{ VA}$  max.

**Size:** 114 mm H (without removable feet) x 197 mm W x 203 mm D (4.5" x 7.8" x 8").

**Weight:** net, 2.7 kg (6 lb); shipping, 4.5 kg (10 lb).

## Accessories Available

For rack mounting, order HP 5060-8762 Rack Adapter Frame; 5060-8540, 5060-8760 Filler panels.

## 3310B Specifications

Same as 3310A with the following additions:

**Modes of operation:** free run, single cycle, multiple cycle.

**Triggered frequency range:** 0.0005 Hz to 50 kHz (usable to 5 MHz in normal mode).

**Single cycle\*\*:** ext trigger (ac coupled) requires a positive-going square wave or pulse from 1 V p-p to 10 V p-p. The triggering signal can be dc offset, but  $(V_{ac \text{ peak}} + V_{dc}) \leq \pm 10 \text{ V}$  ext gate (dc coupled) will trigger a single cycle on any positive waveform  $\geq 1 \text{ V}$  but  $\leq 10 \text{ V}$  which has a period greater than the period of the 3310B output, and a duty cycle less than the period of the 3310B output. The gate signal cannot exceed 10 V.

**Multiple cycle\*\*:** manual trigger will cause the 3310B to free run when depressed. When the trigger button is released, the waveform will stop on the same phase as it started. Ext. gate will cause the 3310B to free run when the gate is held at between +1 and +10 V. When the gate signal goes to zero, the 3310B will stop on the same phase as it started.

**Start-stop phase:** the start-stop phase can be adjusted over a range of approximately  $\pm 90^\circ$ .

## Ordering Information

3310A Function Generator

3310B Function Generator

\*\*This specification applies on the X.0001 to X 1k range only.



# FUNCTION GENERATORS & FREQUENCY SYNTHESIZERS

0.1 Hz to 1 MHz

Model 3311A

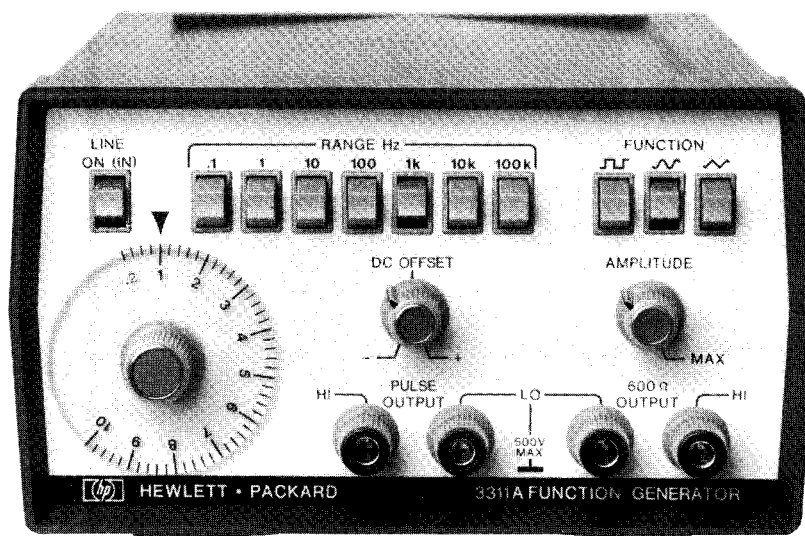

## Description

The 3311A Function Generator offers wide functional capability at a modest price. This compact unit has seven decades of range from 0.1 Hz to 1 MHz. Pushbutton range and function selection add convenience to versatility. Added features normally not found on function generators in this price range are 10:1 voltage control and a separate pulse output suitable for synchronization or driving TTL logic circuits.

### Output

Ten V p-p into 600  $\Omega$  (20 V p-p open circuit). This output may be attenuated by >30 dB by a variable attenuator and offset by  $\pm 5$  V. The DC offset allows the sine, square, and triangle functions to be positioned to the most desired level. This feature adds to the usefulness of all three functions.

### VCO

The DC coupled voltage control allows the use of an external source to sweep the 3311A > 10:1 in frequency.

### Pulse Output

A separate TTL compatible pulse output provides current sinking for up to 20 TTL loads. The pulse has a 15/85 aspect ratio with a <25 ns rise time.

## Specifications

**Waveforms:** sinusoid, square, triangle, and positive pulse.

**Frequency range:** 0.1 Hz to 1 MHz in seven decade ranges.

**Dial accuracy:**  $\pm 5\%$  of full scale.

**Isolation:** using an external supply, outputs may be floated up to  $\pm 500$  V relative to the instrument case (earth ground).

### 600 Ohm Output

**Maximum output amplitude:** 20 V p-p open circuit; 10 V p-p into 600  $\Omega$ .

**Amplitude control:** continuously variable, >30 dB range. DC off-

set: up to  $\pm 10$  V open circuit,  $\pm 5$  V into 600  $\Omega$ , continuously adjustable and independent of amplitude control. Maximum  $V_{ac}$  peak +  $V_{dc}$  offset without clipping is  $\pm 10$  V open circuit,  $\pm 5$  V into 600  $\Omega$ .

**Output impedance:** 600  $\Omega \pm 10\%$ .

**Sine wave amplitude flatness:** within  $\pm 3\%$  of 10 kHz reference (maximum output amplitude) to 100 kHz,  $\pm 6\%$  to 1 MHz.

**Sine wave total harmonic distortion:** <3% (maximum output amplitude).

**Triangle linearity:** deviation <1% from best straight line at 100 Hz (maximum output amplitude).

**Square wave transition time:** rise time: <100 ns; fall time: <100 ns.

**Square wave time axis symmetry error:**  $\pm 2\%$  maximum to 100 kHz.

### Pulse Output

**Output amplitude:** >3 V positive (open circuit) TTL compatible.

**Duty cycle:** 13.5% to 16.5% of the total period.

**Transition times:** <25 ns.

### External Frequency Control

**VCO range:** >10:1 on any frequency range.

**Input requirement:** with frequency dial set to 1.0, a linear ramp of 0.0 V to  $-10$  V  $\pm 2$  V will linearly increase frequency >10:1

**Input impedance:** 10 k $\Omega \pm 10\%$  in parallel with <60 pFd.

### General

**Operating temperature:** 0°C to 55°C; specifications apply from +15°C to +35°C.

**Storage temperature:**  $-40^\circ\text{C}$  to  $+75^\circ\text{C}$ .

**Power:** 100/120/220/240 V  $-10\%$ ,  $+5\%$  switchable: 48 Hz to 66 Hz;  $\leq 12$  VA.

**Size:** 89 mm H x 159 mm W x 248 mm D (3.5" x 6.3" x 9.8").

**Weight:** net, 1.5 kg (3.3 lb); shipping, 2.5 kg (5.5 lb).

**Rack Mount Kits:** 10851A for one 3311A, 10852A for two.

## 3311A Function Generator



- Two function generators in one instrument
- AM-FM, sweep, trigger, gate and burst

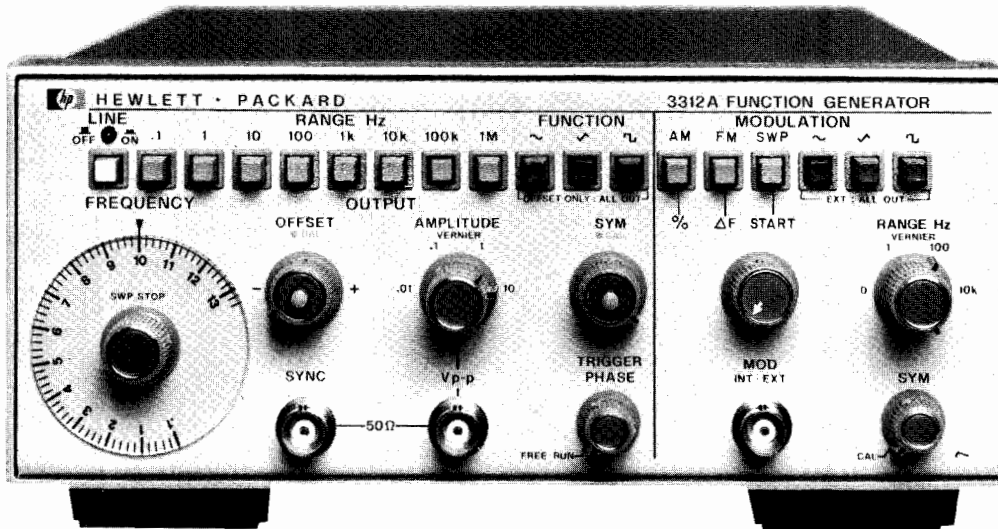

## Description

Hewlett-Packard's 3312 A Function Generator combines two separate, independent function generators with a modulator section in one compact instrument.

The main generator can—via pushbutton control—be triggered by the modulation generator to provide sweep functions, AM, FM or tone burst.

Ten V p-p into 50  $\Omega$  provides adequate power for most applications. The output attenuator has a range of more than 10,000:1 so clean low-level signals from 10 V to 1 mV p-p into 50  $\Omega$  can be obtained. The main generator includes dc offset up to 10 volts p-p into 50  $\Omega$ .

Hewlett-Packard's 3312A is an effective low cost solution for generating a multitude of functions.

## Specifications

**Output waveforms:** sine, square, triangle,  $\pm$  ramp, pulse, AM, FM, sweep, triggered and gated.

### Frequency Characteristics

**Range:** 0.1 Hz to 13 MHz in 8 decades ranges.

**Dial accuracy:**  $\pm 5\%$  of full scale.

**Square wave rise or fall time (10% to 90%):** <20 nsec.

**Aberrations:** <10%.

**Triangle linearity error:** <1% at 100 Hz.

**Variable symmetry:** 80:20:80 to 1 MHz.

**Sine wave distortion:** <0.5% (-46 dB) THD from 10 Hz to 50 kHz. (10 kHz range maximum). >30 dB below fundamental from 50 kHz to 13 MHz.

### Output Characteristics

**Impedance:** 50  $\Omega \pm 10\%$ .

**Level:** 20 V p-p into open circuit, >10 V p-p into 50  $\Omega$  at 1 kHz.

**Level flatness (sine wave):** < $\pm 3\%$  from 10 Hz to 100 kHz at full rated output (1 kHz reference). < $\pm 10\%$  from 100 kHz to 10 MHz.

**Attenuator:** 1:1, 10:1, 100:1, 1000:1 and >10:1 continuous control.

**Attenuator error:** <5%.

**Sync output:** impedance: 50  $\Omega \pm 10\%$ , >1 V p-p square wave into open circuit. Duty cycle varies with symmetry control.

**DC offset:** Variable up to  $\pm 10$  volts. Instantaneous ac voltage + Vdc offset cannot exceed  $\pm 10$  V (open circuit) or  $\pm 5$  V (terminated 50 ohm).

### Modulation Characteristics

**Types:** internal AM, FM, sweep, trigger, gate or burst; external AM, FM, sweep, trigger, gate or burst.

**Waveforms:** sine, square, triangle, ramp or variable symmetry pulse.

**Frequency range:** 0.01 Hz to 10 kHz.

**Output level:** >1.0 V p-p into 10 k $\Omega$ .

### Amplitude Modulation

**Depth:** 0 to 100%.

**Modulation frequency:** 0.01 Hz to 10 kHz (internal). DC to >1 MHz (external).

**Carrier 3 dB bandwidth:** <100 Hz to >5 MHz.

**Carrier envelope distortion:** <2% at 70% sine wave modulation with  $f_c = 1$  MHz,  $f_m = 1$  kHz.

**External sensitivity:** <10 V p-p for 100% modulation.

### Frequency Modulation

**Deviation:** 0 to  $\pm 5\%$  (internal).

**Modulation frequency:** internal: 0.01 Hz to 10 kHz; external: DC to >50 kHz.

**Distortion:** <-35 dB at  $f_c = 10$  MHz,  $f_m = 1$  kHz, 10% modulation.

### Sweep Characteristics

**Sweep width:** >100:1 on any range.

**Sweep rate:** 0.01 Hz to 10 kHz, 90:10 ramp, and 0 Hz Range (provides manual setting of "Sweep Start" without modulation generator oscillating).

**Sweep mode:** repetitive linear sweep between start and stop frequency settings. Retrace time can be increased with symmetry control.

**Ramp output:** 0 to >-4 p-p into 5 k $\Omega$ .

### Gate Characteristics

**Start/stop phase range:** +90 $^\circ$  to -80 $^\circ$ .

**Frequency range:** 0.1 Hz to 1 MHz (useful to 10 MHz).

**Gating signal frequency range (external):** DC to 1 MHz, TTL compatible.

### External Frequency Control

**Range:** 1000:1 on any range.

**Input requirement:** with dial set at 10, 0 to -2 V  $\pm 20\%$  will linearly decrease frequency >1000:1. An ac voltage will FM the frequency about a dial setting within the limits (0.1 <  $f$  < 10) x range setting.

**Linearity:** the frequency versus voltage curve will be linear within 0.5% over a 100:1 frequency range.

**Input impedance:** 2.8 k $\Omega \pm 5\%$ .

### General

**Operating temperature:** 0 $^\circ$ C to +55 $^\circ$ C; specifications apply from 0 $^\circ$ C to 40 $^\circ$ C.

**Storage temperature:** -40 $^\circ$ C to +75 $^\circ$ C.

**Power:** 100 V, 120 V, 220 V, 240 V +5%, -10%, switchable; 48 Hz to 440 Hz;  $\leq 25$  VA.

**Size:** 102 mm H x 213 mm W x 377 mm D (4" x 8.4 x 14.8").

**Weight:** net, 3.8 kg (8.4 lb). Shipping, 5.9 kg (13 lb).

## 3312A Function Generator



# FUNCTION GENERATORS & FREQUENCY SYNTHESIZERS

## 1 MHz to 20 MHz Function Generator with Arbitrary Waveforms

Model 3314A

- Lin/Log sweeps
- AM/FM/VCO
- Phase lock  $\times N$  and  $\div N$
- Gate and Counted Burst
- 1/2 Cycle Mode
- Arbitrary Waveform Generator



### 3314A Multi-Waveform Generator

The 3314A is a Function/Waveform Generator with the precision and versatility to produce numerous waveforms. Its feature set includes accurate sine, square, and triangle waves, with ramps and pulses available using variable symmetry. Additional features include counted bursts, gate, lin/log sweeps, AM, FM VCO, DC offset, and phase lock. For increased versatility, the Arbitrary waveform mode allows a countless number of user defined waveforms. Since complete programmability is provided, all of these capabilities are available for ATE systems, as well as bench applications.

#### Precise Functions

The 3314A provides sine, square, and triangle waveforms from 0.001 Hz to 19.99 MHz with an amplitude range of 0.01 mV to 10 Vp-p into 50 Ohms, with optional 30 Vp-p into > 500 Ohms.

Continuous waveforms are provided with high accuracy and low distortion, with frequency accuracy on the upper ranges of 0.01% and sine distortion < -55 dBc to 50 kHz.

Pulses and ramps are provided to 2 MHz using the variable symmetry control over the full 5% to 95% symmetry range. This provides narrow pulses with 9 nsec rise/fall times for digital circuit testing, and positive or negative ramps for amplifier testing and process control.

Independent DC offset to  $\pm 5$  V (into 50 Ohms) can be added to any AC signal. A post-attenuator summing technique is used providing large ac signals with small offsets and vice versa.

#### Burst and Gate

The 3314A's N Cycle burst mode generates an integer number of complete cycles at each trigger. Bursts of 1 to 1999 cycles are possible for use in applications ranging from sonar testing to digital circuits. Variable symmetry and start/stop phase can be used to produce single ramps and haversines.

Like burst mode, gate mode can be triggered internally or externally. In gate, the 3314A output consists of complete cycles, pulses or Arb's which start when the trigger is true, and stop after the trigger goes false. In gate and burst modes, the full frequency range applies for sine, square, triangle, pulse, and ramp waveforms.

#### New 1/2 Cycle and "Integer" Phase Lock Modes

The new 1/2 Cycle burst mode allows simulation of specialized signals found in electronics. At each trigger, alternating 1/2 cycles of sines or triangles are produced. With the addition of variable start/stop phase and symmetry, pulses with variable rise/fall time and overshoot can be produced. Repetition rate, 1/2 cycle frequency, symmetry, and phase can be set independently to produce a variety of waveforms.

The Fin  $\times N$  Fin  $\div N$  modes provide powerful phase locking capability. With "integer" phase lock, fractions or multiples of the reference signal can be provided, and  $\pm 200$  deg of phase offset is available. Since the 3314A phase locks to the plus or minus edge of the trigger signal, it can lock to a variety of signals such as sines, squares, pulses, ramps, and others—with complete control of output function, symmetry, N, phase, amplitude and offset.

#### Modulation and Sweep

Complete AM, FM/VCO modulation give the 3314A versatile signal modifying capabilities. With 100 kHz bandwidths, AM and FM/VCO can be used separately or simultaneously to produce a multitude of waveforms.

Multi-frequency measurements can be made with the 3314A's sweep capabilities. Linear, logarithmic, and manual sweep make measurements of filters, amplifiers, and other networks convenient and accurate. X drive, marker, and trigger output signals are also provided.

#### Arbitrary Waveforms

For specialized low frequency applications, the 3314A's Arbitrary (ARB) waveform mode lets you create custom waveforms as a series of voltage ramps or vectors. Values are easy to enter from the front panel using the modify knob as a "pencil" and an oscilloscope as a "pad". For remote programming, use a desktop or mainframe computer to calculate the values, then program them using the HP-IB. Arb waveforms are automatically stored in non-volatile memory for quick recall.

#### Two Sources in One

A square wave trigger source is included for generation of complex waveforms with a single 3314A. The 0.5 MHz to 500 kHz internal trigger is useful in gated, burst, and phase locked waveforms. This signal is provided as an output for synchronizing the 3314A to other devices.

#### Source for your System

Because all front panel controls are programmable, the 3314A's precision and versatility can be utilized in automated test systems.

System efficiency can be improved with standard features such as Service Request (SRQ) interrupt capability and buffered transfer mode.

In production test environments, the 3314's Query commands can be used when an operator and computer are sharing control of the instrumentation. Parameters can be read from the 3314A into the computer where its computational capabilities can be utilized.

# FUNCTION GENERATORS & FREQUENCY SYNTHESIZERS

1 MHz to 20 MHz Function Generator with Arbitrary Waveforms

Model 3314A (cont.)

335



## Arbs Made Easy

With complete control of each vector, the modify knob is used as a "pencil" to draw the waveform on an oscilloscope.

1. After ~20 unit vectors have been inserted, use modify to set the marker, VMKR, to #1. Then set the height of #1 to 400.
2. Press V LEN and use modify to set the length to 3.
3. Press V HGT twice, and set the height of #2 to -190.
4. Continue to use V HGT and V LEN to create the desired waveform, and INS (insert) or DEL (delete) vectors as needed. Amplitude and frequency can now be set without affecting the vector values. Waveform parameters are automatically stored in non-volatile memory while they are being created.
5. Later, if a slightly different waveform is needed, just use the marker to select an individual vector, and modify its height and length without affecting the height and length of other vectors!

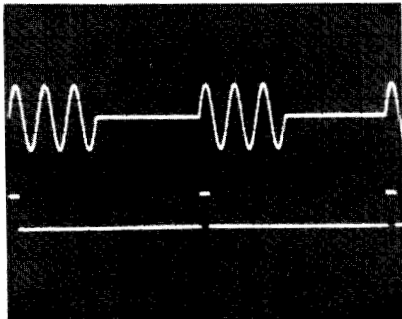
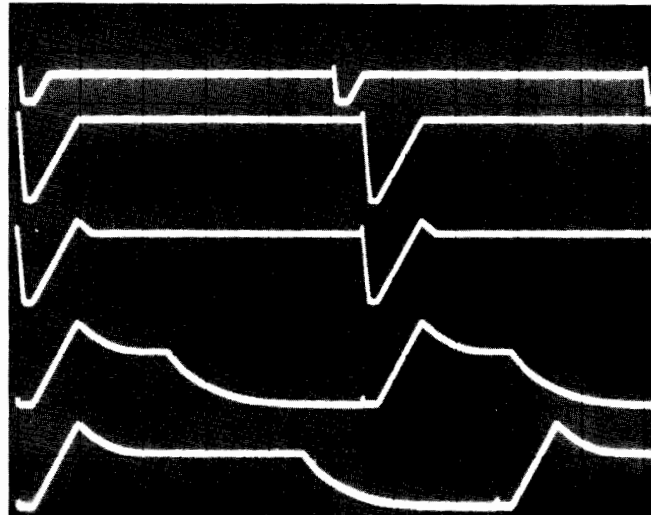

Counted burst with ext. trigger

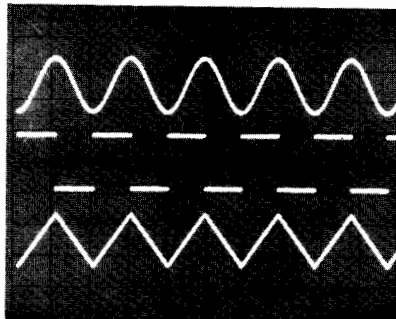

Sine, square, and triangle to 20 MHz

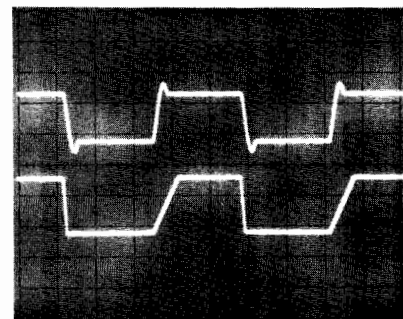

1/2 cycle mode simulating overshoot and variable rise/fall pulses

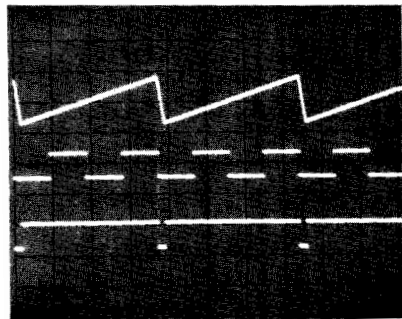

Ramp output phase locked to internal trigger. Shown with sync output.

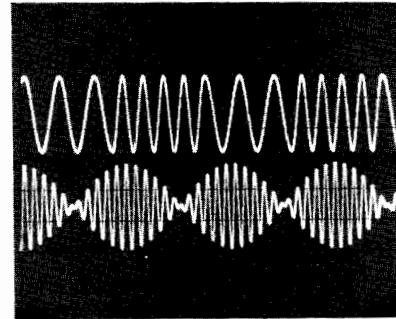

FM and AM (suppressed carrier)

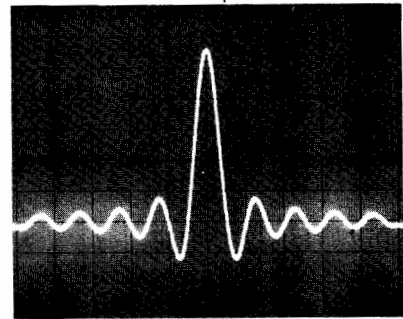

$\frac{\text{sine } x}{x}$  using ARB's

## Specifications

### Frequency

**Frequency Range:** 0.001 Hz to 19.99 MHz-sine, square and triangle waveforms, 0.001 Hz through 2 MHz range when symmetry  $\neq$  50%

**Resolution:** 3 1/2 digits

**Frequency Accuracy:**

HP-IB #	Range	Minimum Frequency		Maximum Frequency	Accuracy
		Range Hold	Autorange		
1	2 Hz	.001 Hz	.001 Hz	1.999 Hz	$\pm$ (0.4% setting + 0.2% range)
2	20 Hz	0.01 Hz	1.50 Hz	19.99 Hz	
3	200 Hz	00.1 Hz	15.0 Hz	199.9 Hz	$\pm$ (0.2% setting + 0.1% range)
4	2 kHz	001. kHz	150. Hz	1999. Hz	
5	20 kHz	0.01 kHz	1.50 kHz	19.99 kHz	
6	200 kHz	00.1 kHz	15.0 kHz	199.9 kHz	
Synthesized					
7	2 MHz	001. kHz	150. kHz	1999. kHz	$\pm$ (0.01% setting +50 ppm/year)
8	20 MHz	0.01 MHz	1.50 MHz	19.99 MHz	

Accuracy applies in the Free Run mode, with VCO Off, and Symmetry = 50% (Fixed)

### Amplitude

**Amplitude Range:** 0.01 mVp-p to 10 Vp-p into 50  $\Omega$

**Resolution:** 3 1/2 digits

HP-IB #	Range	Minimum	Maximum	Step Attenuator
1	10 mV	0.01 mV	10.00 mV	60 dB
2	100 mV	10.0 mV	100.0 mV	40 dB
3	1 V	.100 V	1.000 V	20 dB
4	10 V	1.00 V	10.00 V	0 dB

### Absolute Amplitude Accuracy:

$\pm$  (1% of display + 0.035 Vp-p), sine and square wave

$\pm$  (1% of display + 0.06 Vp-p), triangle

**Amplitudes:** 1.00 Vp-p to 10.00 Vp-p (Range 4)

**Frequency:** 10 kHz, Autorange ON

### Flatness-sine wave: Relative to 10 kHz, 1.00 V to 10.0 V (Range 4)

20 Hz	50 kHz	1 MHz	19.99 MHz
.07 dB	.33 dB	1.5 dB	



# FUNCTION GENERATORS & FREQUENCY SYNTHESIZERS

## 1 MHz to 20 MHz Function Generator with Arbitrary Waveforms

Model 3314A (cont.)

### Frequency Sweep

	Range (decades)	Start Freq	Stop Freq	Sweep Time
linear	0 to 2	≥.001 Hz	≤19.99 MHz	7.2 ms to 1999 s/sweep
log	1 to 7 (integer only)	≥.2 Hz	≤19.99 MHz	40 ms to 1999 s/decade

### Manual Sweep:

Modify knob tunes between start and stop frequencies. X drive follows sweep.

### X Drive Start/Stop Voltage:

-5 V to +5 V into 1 K $\Omega$  load

### Z Axis Output:

Blanking Pulse, > +5 V

Baseline, 0V  $\pm$  1 V

Marker Pulse, < -5 V into 1 K $\Omega$  load

### Modulation Inputs:

	Bandwidth	Sensitivity	Range	Z
AM	dc to 100 kHz	2 Vp-p for 100% -1 Vdc for suppressed carrier	>100%	10 k $\Omega$
FM	100 Hz to 100 kHz	$\pm$ 1 Vp for $\pm$ 1% of range deviation	1%	10 k $\Omega$
VCO	dc to 100 kHz	10%/Volt	+1 to -10V	10 k $\Omega$

### Waveform Characteristics

#### Sine Harmonic Distortion:

Individual harmonics will be below these levels, relative to the fundamental. Offset = 0V. Function Invert = OFF. Range Hold = OFF.

20 Hz	50 kHz	1490 kHz	19.99 MHz
-55 dB*	-40 dB	-25 dB	

\*add 4 dB for ambient temperature 0 to 55°C and 45 to 55°C, 20 Hz to 50 kHz

#### Square Wave Rise/Fall Time:

< 9 ns, 10% to 90% at 10 Vp-p output

#### N Integer:

N = 1 to 1999, Preset to 1

For Phase-lock Fin  $\div$  N, Fin  $\times$  N

or N CYCLE (counted burst)

#### Function Invert:

Inverts ac portion of signal outputs

Sine, square, triangle, ramp, pulse, and ARBs

Does not affect Sync and Trigger outputs or dc offset setting

#### Phase

##### Phase Offset—Phase lock Modes:

Resolution: 0.1°

Range:  $\pm$ 199.9°

Accuracy:  $\pm$ 2° (50 Hz to 15 kHz)

Phase Offset is referenced to:

signal output for Fin  $\div$  N

signal input for Fin  $\times$  N

##### Start/Stop Phase—Burst Modes:

Resolution: 0.1°

Range:  $\pm$ 90.0° for frequencies to 19.99 MHz

Accuracy:  $\pm$ 3° (applies from .001 Hz to 1 kHz)

#### Trigger

##### Internal Trigger:

Range: .002 ms (500 kHz) to 1999 s (.5 MHz) square wave.

Period Accuracy:

$\pm$  (0.01% + 50 ppm/year) of displayed interval (excluding sweep intervals)

Trigger Output: Low < .5 V, high > 2.5 V Output Resistance 1 k $\Omega$

##### External Trigger:

For Gate, N Cycle, 1/2 Cycle, Fin  $\times$  N, Fin  $\div$  N, and external sweep triggers

Frequency Range: 50 Hz to 20 MHz

Trigger Slope: Selectable-positive or negative

Trigger Level: Selectable to 0 V or +1 V

Trigger Level Hysteresis:  $\pm$ 0.15 V

Input Resistance = 1 k $\Omega$

### Symmetry

Symmetry Range: 5% to 95% of period

Frequency Range: 2 Hz to 2 MHz ranges

### Arbitrary Waveforms

Output consists of a series of voltage ramps called Vectors. Arbitrary Waveforms can be comprised of 2 to 150 Vectors. A maximum of 160 Vectors can be stored in six available storage registers with a minimum of 2 vectors per waveform (#1 and return-to-start vectors).

#### Waveform Parameters:

Key	Range	Description
$\Delta t$	.2 ms to 19.99 ms	sets the time value for each unit of V LEN (length)
V HGT	0 to $\pm$ 1999	sets the relative height of an individual vector
V LEN	1 to 127	sets the length in time of an individual vector in integral multiples of $\Delta t$
V MKR	1 to 150	marker is used to select an individual vector
INS		insert is used to add a vector before the marker location
DEL		deletes the vector at marker location
FREQ	.002 Hz to 2.5 kHz	Freq = $\frac{1}{\Delta t(VLEN_1 + VLEN_2 + \dots VLEN_n)}$
AMPTD	.01 mV to 10 Vp-p	sets amplitude window for ARB waveform
OFFSET	0 to $\pm$ 5 Vdc	offsets the ARB waveform independent of AMPTD setting
PHASE	+90° to -90°	sets wave start/stop voltage within the window defined by AMPTD

Marker Output: Located on Z axis rear panel connector

Sync Output: Low during the return-to-start vector

Gate Mode: Allows external gating of ARB output-complete ARB waveforms only

#### Option 001

Simultaneous X3 output (into > 500  $\Omega$ ).

30 Vp-p max.

#### General

##### Specifications apply when:

Main signal output terminated into 50  $\pm$  0.1  $\Omega$

Warm-up > 30 min

Within  $\pm$ 5°C and 24 hours of last internal calibration

Temperature: 0 to 55°C

Relative Humidity: <95% at 40°C

Altitude: <15,000 ft

Storage Temperature: -40 to +75°C

##### Power:

100/120/220/240 V + 5% -10%, 48 to 66 Hz

90 VA maximum

Weight: net, 7.3 kg = (16 lb). Shipping, 10.5 kg = (23 lb).

Dimensions: 132.6 mm (5.22 in) H x 212.3 mm (8.36 in) W x 419.0 mm (16.50 in) D

##### HP-IB:

IEEE Standard 488-1978 abbreviated definition

SH1 AH1 T6 TE0 L3 LE0 SR1 RL1 PP0 DC1 DT1 C0 E2

##### Accessories Included:

11048C 50  $\Omega$  feed-through termination

50  $\pm$  .1  $\Omega$

##### Accessories:

Transit case for one 3314A

HP #9211-2677

#### Ordering Information

3314A Function Generator

Option 001: simultaneous X3 output

# FUNCTION GENERATORS & FREQUENCY SYNTHESIZERS

1 Hz–20 MHz Pulse/Function Generator

Model 8111A



- Sine, triangle, square, haversines
- 20 MHz, 32 Vpp for all waveforms
- Variable duty cycle or pulse width

- Trigger, gate, VCO and optional burst
- Digital display for all parameters
- Error recognition

8111A Option 001



The 8111A combines pulse generator and function generator capabilities in a single, compact unit. Triggered operation for all waveforms, and the ability to define rectangular waveforms in terms of pulse width or duty cycle, are examples of the 8111A's versatility.

## Saves Space and Equipment

Small size and manifold capability make the 8111A an ideal source for service and bench. Digital display, error detector and good repeatability assure high operating confidence. This reduces the need for output monitoring and consequently saves equipment.

## Flexible

Operating modes include VCO which permits frequency-shift keying and dc-to-frequency conversion as well as sweep and FM applications. Option 001's Burst mode simplifies tone burst generation and digital preconditioning by generating a precise number of waveform cycles. An "extra cycle" feature activated after a burst allows critical events to be examined.

Pulse mode's variable width down to 25 ns and clean 10 ns transitions provide useful digital test capability. High analog flexibility is assured because all waveforms can be generated in trigger, gate and burst modes. Adjustable duty cycle up to 999 kHz means that CRT sawtooth waveforms and rectangular signals for dc motor control can be simulated.

## Specifications (50-ohm load resistance)

### Waveforms:

sine, triangle, ramp, square, pulse, haversines.

### Timing

#### Frequency

- Range:** 1.00 Hz to 20.0 MHz (3-digit resolution).
- Accuracy (50% duty cycle):** 5% ( $\pm 10\%$  below 10 Hz).
- Jitter:**  $< 0.1\%$  + 50 ps.
- Stability:**  $\pm 0.2\%$  (1 hour),  $\pm 0.5\%$  (24 hours).

#### Duty Cycle (sine, triangle, square, haversines):

	Calibrated	Variable (below 1 MHz)
Range:	50% nominal	10% to 90%.
Resolution:	2 digits	2 digits.
Accuracy:	$\pm 1$ digit	$\pm 6$ digits ( $\pm 3$ in range 20 to 80%).

### Pulse Width

- Range:** 25.0 ns to 100 ms (3-digit resolution).
- Accuracy:**  $\pm 5\%$   $\pm 2$  ns.

## Output Characteristics

(voltages double into high impedance)

### Amplitude

- Range:** 1.60 mVpp to 16.00 Vpp ( $3\frac{1}{2}$  digit resolution).
- Accuracy:**  $\pm 5\%$  (at 1 kHz for sine and triangle).
- Flatness (sine, triangle):**  $\pm 3\%$  ( $+10\%$ ,  $-15\%$  above 1 MHz).

### Offset

- Range:** 0.00 mV to  $\pm 8.00$  V (3-digit resolution).
- Accuracy:**  $\pm 0.5\%$  setting  $\pm 1\%$  ampl  $\pm 20$  mV (ampl  $\geq 160$  mVpp),  
 $\pm 0.5\%$  setting  $\pm 1\%$  ampl  $\pm 1$  mV (ampl  $< 160$  mVpp).

**Distortion:** THD (1 Hz–1 MHz)  $< 3\%$  ( $-30$  dB); harmonics (1 MHz–20 MHz)  $< -26$  dB. Distortion may increase by 3 dB below  $10^\circ\text{C}$  and above  $45^\circ\text{C}$ .

**Linearity (triangle):**  $< \pm 3\%$  ( $< \pm 1\%$  below 1 MHz)

### Pulse and Squarewave Performance

- Transitions:**  $< 10$  ns.
- Perturbations:**  $< \pm 5\%$  ( $< \pm 10\%$  below 0.16 Vpp).
- Output impedance:**  $\pm 50$  ohm  $\pm 5\%$ .

### Modes:

normal, trigger\*, gate\*, VCO and (Option 001) burst\*.  
\*Adjustable start-phase for haversine, haverstriangle

**VCO range:** 2 decades, ext. signal 0.1 V to 10 V (dc to 1 kHz).

**Burst length:** 1 to 1999 periods for all waveforms.

### General

**Repeatability:** factor 2.5 better than accuracy.

### Environmental

- Storage temperature:**  $-40^\circ\text{C}$  to  $+75^\circ\text{C}$ .
- Operating temperature:**  $0^\circ\text{C}$  to  $55^\circ\text{C}$ .
- Humidity:** 95% RH,  $0^\circ\text{C}$  to  $40^\circ\text{C}$ .
- Power:** 100/120/220/240 V rms;  $+5\%$   $- 10\%$ ; 48 to 440 Hz; 70 VA max.
- Weight:** net, 4.6 kg (10 lb). Shipping, 6.6 kg (15 lb).
- Size:** 89 H x 212.3 W x 345 mm D (3.5" x 8.36" x 13.6").

### Ordering Information

**8111A** Pulse/Function Generator

**Opt 001:** Burst

**Opt 910:** Extra Operating and Service Manual

**5061-2001:** Bail Handle Kit

**5061-0072:** Rack Mount Kit (single 8111A)

**5061-0074:** Rack Mount Kit (two instruments)

**5061-0094:** Lock Link Kit (for use with 5061-0074)



# FUNCTION GENERATORS & FREQUENCY SYNTHESIZERS

## 1 mHz–50 MHz Pulse/Function Generator

Model 8116A

- Sine, triangle, square, haversine functions and dc
- 1 mHz–50 MHz, 32 Vpp for all waveforms
- Variable (10 ns min) pulse width, 6 ns transitions
- Wide range of operating capability
- Self-prompting operating concept
- Error recognition and self test



8116A  
Option 001



The fully programmable 8116A features pulse as well as function generator capabilities in one small unit. A broad 1 mHz–50 MHz band for all waveforms and a wide choice of operating and modulating modes assure high flexibility. These factors, plus good repeatability, make the 8116A a sound, long-term investment.

### Unique Operating Concept Saves Engineering Time

HP's custom IC's have made it feasible to put the many 8116A capabilities into such a small volume. Handling is simplified by a unique, microprocessor-controlled, operating concept which ensures a clear overview of the compact front panel at all times. When the mode and waveform have been selected, illuminated labels show which parameters must be set. There's no clutter, no confusion.

**Auto vernier.** In normal mode, the 8116A's auto-vernier increments any desired parameter continuously until a stop signal is applied. This means that thresholds can be measured automatically, without a controller.

**Level or amplitude programming.** The 8116A's output can be programmed in terms of high and low levels or in terms of amplitude and offset. Consequently a direct, automatic, conversion is always feasible so that the 8116A can be programmed in the same terms as the device is specified.

**Safe limit.** Devices can be protected by the limit feature. This prevents the output from exceeding a given magnitude.

### Rectangular Waveforms

For applications such as laser diodes or dc motors, square waves can be programmed for constant duty cycles from 10% to 90%. For digital test, or for simulating very low duty-cycle events, pulse width can be programmed down to 10 ns. Square wave and Pulse modes provide clean 6 ns edges that are ideal for many technologies. Pulse width modulation and pulse recovery capability are available in Pulse mode.

### Sine and Triangle Functions

10% to 90% duty cycle, programmable in 1% steps, provides ramps and asymmetrical sine waves for testing VCO's, servos, amplifier linearity and industrial process control systems. Haversine functions,

available in External Trigger, Gate and Burst modes, extend the applications to areas such as telephone line and vibration testing.

### Modulation

All waveforms can be amplitude or frequency modulated. VCO operation allows frequency variation over two decades with an external voltage; consequently transducer output can be conditioned for magnetic tape recording, or frequency-shift keying or linear sweep can be carried out.

### Option 001

**10 1/2-decade log sweep.** Sweep mode covers the wide 1 mHz–50 MHz band in a single up sweep. Test setups require no more than an X-Y recorder or scope because all necessary control signals are available. The 8116A sweeps can be internally triggered, if desired.

**Accurate, counted bursts.** A preprogrammed number of cycles of any waveform can be generated in Burst mode. With sine, triangle and square functions, bursts can be triggered internally as well as externally.

**Hold capability.** For material stress testing, low frequency functions can be held at instantaneous levels. Hold is controlled by an external signal.

### Low-Cost Automation for Bench and Systems

Powerful capability, small size and wide specified temperature range make the 8116A a good choice for automatic test systems. Also, the low cost means that it's now realistic to automate those routine bench jobs and leave more time for design. Comfortable software features such as easy syntax and flexible format contribute to rapid system design.

### Operating Confidence

There's reliance in the 8116A's output because proper operation is always ensured by the instrument's error detector. This helps the user to recover from an incorrect front panel or programming operation by indicating the offending parameter. Also, the built-in test and diagnosis feature verifies correct function each time the instrument is switched on.

### Specifications

Specifications apply with 50-ohm load and temperatures in the range 0°C to 55°C.

### Functions

Sine, triangle, ramp, square, pulse, haversine, havertriangle, dc.

### Timing

#### Frequency

**Range:** 1 MHz to 50 MHz (3-digit resolution).

**Accuracy<sup>1</sup>** (pulse mode, 50% d/c):  $\pm 3\% \pm 0.3$  MHz below 100 kHz,  $\pm 5\%$  above 100 kHz.

**Jitter** (pulse mode, 50% d/c):  $< 0.1\% + 100$  ps.

**Stability:**  $\pm 2\%$  (1 hour),  $\pm 5\%$  (24 hours).

**Duty Cycle:** (sine, triangle, square, haversine, havertriangle).

**Range:** 10% to 90% (20% to 80% above 1 MHz), 2-digit resolution.

**Accuracy<sup>1</sup>:**  $\pm 0.5$  digits ( $\pm 3$  digits above 1 MHz).

#### Pulse Width

**Range:** 10.0 ns to 999 ms (3-digit resolution).

**Accuracy<sup>1</sup>:**  $\pm 5\% \pm 2$  ns.

**Jitter:**  $< 0.1\%$  ( $0.2\% + 200$  ps for width  $\leq 10$   $\mu$ s).

### Output Characteristics

(Voltages double into high impedance).

#### Amplitude

**Range:** 10.0 mV<sub>pp</sub> to 16.0 V<sub>pp</sub> (3-digit resolution).

**Accuracy<sup>1</sup>:**  $\pm 5\%$  (at 1 kHz for sine and triangle).

**Flatness (sine):**  $\pm 3\%$  ( $\pm 5\%$  above 1 MHz,  $+5$ – $15\%$  above 10 MHz).

**Flatness (triangle):**  $\pm 3\%$  ( $\pm 5\%$  above 1 MHz,  $+5$ – $25\%$  above 10 MHz).

#### Offset and dc Mode

**Range:** 0.00 to  $\pm 7.95$  V (0 to  $\pm 795$  V mV for amplitude  $< 100$  mV<sub>pp</sub>).

**Resolution:** 3 digits.

**Accuracy<sup>1</sup>:** 0.5% of setting  $\pm 1\%$  of ampl  $\pm 40$  mV ( $+2$  mV if ampl  $< 100$  mV<sub>pp</sub>,  $\pm 20$  mV in dc mode).

**Distortion** (Sine, normal mode, 50% duty cycle).

**Total harmonic distortion (10 Hz–50 kHz):**  $< 1\%$  ( $-40$  dB)\*.

**Harmonic related signals (50 kHz–1 MHz):**  $< -34$  dB,  
(1 MHz–50 MHz):  $< -23$  dB\*.

\*May increase by 3 dB below 10°C and above 45°C.

**Non-linearity** (triangle, ramp, 100 mHz–1 MHz):  $< \pm 3\%$ .

### Pulse and Square Wave Characteristics

**Transitions:**  $< 6$  ns.

**Pulse perturbations:**  $< \pm 5\% \pm 2$  mV.

**Output impedance:** 50 ohm  $\pm 5\%$ .

### Operating Modes

Normal, trigger\*, gate\*, external width.

### Additional Modes in 8116A Option 001

**Logarithmic Up Sweep** (for all waveforms).

**Range:** Start and stop frequencies selectable up to full range (1 MHz–50 MHz).

**Sweep time:** selectable in 1–2–5 sequence from 10 ms to 500 seconds per decade.

**Sweep repetition:** continuous sweeps (internal sweep) or externally triggered.

**Counted Burst\*** (for all waveforms).

**Burst length:** 1 to 1999 cycles.

**Burst repetition:** internally triggered at selectable intervals from 100 ns to 999 ms (except in Pulse mode), or externally triggered, up to 40 MHz.

\*Selectable ( $-90^\circ$ ) start-phase for haversine, havertriangle.

### Control Modes

**Frequency modulation:**  $\pm 5\%$  max deviation.

**Sensitivity:** 1 V for 1% deviation.

**Modulating frequency:** dc to 20 kHz.

### Amplitude Modulation

**Sensitivity:**  $\pm 2.5$  V for 100% mod. ( $+2.5$  V to  $-7.5$  V for DSBSC).

**Modulating frequency:** dc to 1 MHz.

<sup>1</sup>Applies from 15°C to 35°C, %-error increases 0.05 per °C outside this range.

### Pulse Width Modulation

**Range:** 10 ns to 1 s in 8 non-overlapping decade ranges.

Max. width ratio: 10:1.

**Sensitivity:**  $\pm 9$  V for 1:10 ratio.

### Voltage-Controlled Oscillator

**Range:** 2 decades in range 1 MHz–50 MHz.

**Sensitivity:** 0.1 V to 10 V for 2 decades.

**Modulating frequency:** dc to 1 kHz.



### Auxiliary Modes

**Manual:** simulates external input.

**1 Cycle (Option 001):** triggers single output cycle in Trigger, Gate and Ext Burst modes.

**Auto Vernier:** continuous vernier which can be remotely or manually stopped.

**Limit:** programmable maximum output levels to protect DUT.

**Complement:** selectable normal/complement output.

**Disable:** relay disconnects output.

### Auxiliary Inputs and Outputs

#### External Input

**Threshold:**  $\pm 10$  V adjustable.

**Max input voltage:**  $\pm 20$  V.

**Sensitivity:** 500 mV<sub>pp</sub>.

**Min pulse width:** 10 ns.

**Input impedance:** 10 k $\Omega$  typ.

**Trigger slope:** positive, negative and off.

#### Control Input

**Max input voltage:**  $\pm 20$  V.

**Input impedance:** 10 k $\Omega$  typ.

#### Trigger Output

**Output levels:** 0/2.4 V typ.

**Output impedance:** 50 ohm typ.

**X-Output** (Option 001) for sweep X-Y recording (rear panel).

**Output levels:** 0 V (= start frequency) to 10 V max.

**Slope:** 1.5 V per sweep decade.

**Marker Output** (Option 001) for sweep (rear panel).

**Output levels:** TTL.

**Leading edge:** positive at selected marker frequency.

**Hold Input** (Option 001), rear panel.

**Input levels:** TTL.

**Leading edge:** positive transition causes 8116A output ( $f < 10$  Hz) to hold at instantaneous level. Output droop 0.01% per second.

**Max input voltage:**  $\pm 20$  V

### HP-IB Capability:

All manual key operations are programmable. Talk mode provides learn, status byte and error report capabilities.

### Memory:

Battery-backup RAM retains current operating state.

### General

**Repeatability:** factor 4 better than accuracy.

### Environmental

**Storage temperature:**  $-40^\circ\text{C}$  to  $+70^\circ\text{C}$ .

**Operating temperature:**  $0^\circ\text{C}$  to  $55^\circ\text{C}$ .

**Humidity:** 95% RH,  $0^\circ\text{C}$  to  $40^\circ\text{C}$ .

**Power:** 100/120/220/240 V rms;  $+5\%$ ,  $-10\%$ ; 48 to 440 Hz; 120 VA max.

**Weight:** net, 5.9 kg (13 lb). Shipping, 8.0 kg (18 lb).

**Size:** 89 H x 212.3 W x 422 mm D (3.5" x 8.36" x 16.6").

### Ordering Information

**8116A Programmable Pulse/Function Generator\***

**Opt 001:** Burst and Logarithmic Sweep

**Opt 910:** Extra Operating & Service Manual

**5061–2001:** Bail Handle Kit

**5061–0072:** Rack Mount Kit (single 8116A)

**5061–0074:** Rack Mount Kit (two instruments)

**5061–0094:** Lock Link Kit (for use with 5061–0074)

\*HP-IB cables not supplied, see page 29.





# FUNCTION GENERATORS & FREQUENCY SYNTHESIZERS

## 1 $\mu$ Hz to 21 MHz Synthesizer/Function Generator

### Model 3325A

- Synthesizer
- Function generator
- Sweeper
- Programmable

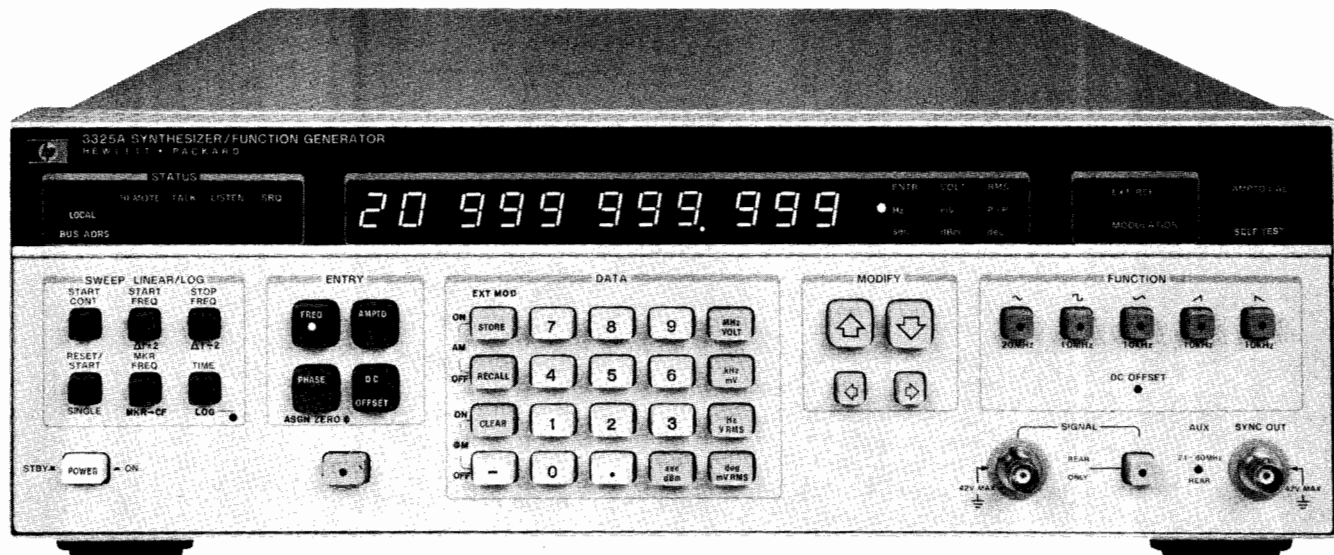

3325A



### Description

The 3325A Synthesizer/Function Generator is an uncompromising, high performance synthesizer with 11 digit resolution, a function generator with precision waveforms, a wideband sweeper, and a fully programmable systems instrument.

### Synthesizer

The 3325A is first with microhertz resolution below 100 kHz along with frequency coverage from .000001 Hz to 20.999 999 999 MHz. Signal purity, accuracy and stability are as good or better than earlier stand-alone HP synthesizers. Harmonics are 65 dB down below 50 kHz and you can externally modulate with AM and PM.

### Function Generator

The 3325A is also a high performance function generator providing precision waveforms with synthesizer accuracy and resolution. Squarewaves to 10.999 999 999 MHz have 20 ns rise and fall times. Triangles and ramps with .05% linearity are available up to 10.999 999 999 kHz. All waveforms can be DC and phase offset.

### A Wideband Sweeper

A major contribution is wideband phase continuous sweep, covering up to the full frequency range of each waveform. Sweep log or linear, single or continuous without the phase discontinuities usually associated with synthesizers. Phase lock loop testing is made easier.

Make convenient swept frequency network measurement on filters, amplifiers or any passive or active network. Use the TTL marker to check the frequency of points of interest on a swept frequency display desired. Use the convenient "zoom" functions  $\Delta F \times 2$  and  $\Delta F \div 2$  to quickly change the frequency span for the display desired.

### Fully Programmable

All necessary functions are programmable on the HP-IB, including frequency, amplitude, all functions, phase and DC offset, modulation, all sweep parameters, amplitude cal and self-test, making the 3325A a very versatile and powerful addition to automatic test systems. The isolated interface combined with floating outputs and inputs and talk mode make the 3325A easy to use in Automatic Test Systems.

### More Features

The phase of the output can be changed  $\pm 719.9^\circ$  with  $1^\circ$  resolution. The phase is advanced (or retarded) with respect to the starting

phase. Two 3325A units can be phase locked together for dual phase output applications.

DC offset is capable of  $\pm 4.5$  VDC on the standard instrument. The high voltage option (Opt 002) allows AC voltages up to 40 Vpp and AC + DC up to  $\pm 18$  V Total (AC peak + DC).

Ten storage registers can be programmed with ten different combinations of function/parameter settings from the front panel, stored and then recalled.

The 3325A can display 11 digits of frequency and 4 digits of volts or millivolts from 1 mV to 10 volts peak to peak. Conversion to RMS or dBm is simple with the touch of a button.

### New Technology

The 3325A provides unprecedented performance per dollar thanks to several major contributions from advances in HP technology. A single loop Fractional-N synthesis technique allows synthesizer accuracy with 11 digits of resolution, and as an added bonus... phase continuous frequency sweep. Fewer parts and integrated circuit technology make the difference. A unique method of triangle and ramp waveform generation provides excellent linearity. Add microprocessor control and Hewlett-Packard Interface Bus (HP-IB) operation and the result is more performance, flexibility and versatility on the bench, or in automatic test systems than previously available, and at a lower cost.

### Specifications

Refer to the 3325A Data Sheet for complete specifications.

#### Waveforms

Sine, Square, Triangle, negative and positive Ramps

#### Frequency

##### Range:

**Sine:** 1  $\mu$ Hz to 20.999 999 999 MHz

**Square:** 1  $\mu$ Hz to 10.999 999 999 MHz

**Triangle/ramps:** 1  $\mu$ Hz to 10.999 999 999 kHz

**Resolution:** 1  $\mu$ Hz,  $< 100$  kHz

1 mHz  $\geq 100$  kHz

**Aging rate:**  $\pm 5 \times 10^{-6}$ /year, 20° to 30°C

**Warm-up time:** 20 minutes to within specified accuracy



## Main Signal Output (All Waveforms)

**Impedance:** 50  $\Omega$

**Connector:** BNC; switchable to front or rear panel, nonswitchable with option 002, except by internal cable change.

### Amplitude

**Range:** 1 mV to 10 V p-p in 8 amplitude ranges, 1-3-10 sequence (10 dB steps), into 50  $\Omega$  load.

Function	Sine		Square		Triangle/Ramps	
	min	max	min	max	min	max
Units Displayed						
peak-peak	1.000 mV	10.00 V	1.000 mV	10.00 V	1.000 mV	10.00 V
rms	0.354 mV	3.536 V	0.500 mV	5.000 V	0.289 mV	2.887 V
dBm (50 $\Omega$ )	-56.02	+23.98	-53.01	+26.99	-57.78	+22.22

**Resolution:** 0.03% of full range or 0.01 dB (4 digits).

**Amplitude Accuracy:** (without dc offset, relative to programmed amplitude and accuracy)

### Sinewave amplitude accuracy:

1 mHz to 100 kHz:  $\pm 1$  dB,  $\geq 3$  Vpp;  $\pm 2$  dB,  $< 3$  Vpp

100 kHz to 20 MHz:  $\pm 4$  dB,  $\geq 3$  Vpp;  $\pm 6$  dB, .1 to 3 Vpp

### Squarewave amplitude accuracy:

1 mHz to 100 kHz: 1%,  $\geq 3$  Vpp; 2.2%,  $< 3$  Vpp

100 kHz to 10 MHz: 11.1%,  $\geq 3$  Vpp; 13.6%,  $< 3$  Vpp

### Triangle amplitude accuracy:

1 mHz to 2 kHz: 1.5%,  $\geq 3$  Vpp; 2.7%,  $< 3$  Vpp

2 kHz to 10 kHz: 5%,  $\geq 3$  Vpp; 6.2%,  $< 3$  Vpp

### Sinewave Spectral Purity

**Phase noise:** -60 dB for a 30 kHz band centered on a 20 MHz carrier (excluding  $\pm 1$  Hz about the carrier) with high-stability option 001 installed.

**Spurious:** All non-harmonically related output signals will be more than 70 dB below the carrier (60 dB with DC offset), or less than -90 dBm, whichever is greater.

**Sinewave harmonic distortion:** Harmonically related signals will be less than the following levels (relative to the fundamental) at full output for each range:

Frequency Range	Harmonic Level
0.1 Hz to 50 kHz	-65 dB
50 kHz to 200 kHz	-60 dB
200 kHz to 2 MHz	-40 dB
2 MHz to 15 MHz	-30 dB
15 MHz to 20 MHz	-25 dB

### Squarewave Characteristics

**Rise/fall time:**  $\leq 20$  ns, 10% to 90% at full output

**Overshoot:**  $\leq 5\%$  of peak to peak amplitude, at full output

**Settling time:**  $< 1$   $\mu$ s to settle to within .05% of final value.

### Phase Offset

**Range:**  $\pm 719.9^\circ$  with respect to arbitrary starting phase or assigned zero phase

**Resolution:** 0.1 $^\circ$

**Accuracy:**  $\pm 0.2^\circ$

### DC Offset

**Range:** DC only (no AC signal): 0 to  $\pm 5.0$  V/50  $\Omega$ .

DC + AC: Maximum DC offset  $\pm 4.5$  V on highest range, decreasing to  $\pm 4.5$  mV on lowest range.

**Resolution:** 4 digits

### Sinewave Amplitude Modulation

**Modulation depth at full output for each range:** 0-100%

**Modulation frequency range:** DC to 400 kHz (0-21 MHz carrier frequency)

**Sensitivity:**  $\pm 5$  V peak for 100% modulation

### Sinewave Phase Modulation

**Range:**  $\pm 850^\circ$ ,  $\pm 5$  V input

**Modulation frequency range:** DC -5 kHz

### Frequency Sweep

#### Sweep Time

**Linear:** 0.01 s to 99.99 s

**Logarithmic:** 2 s to 99.99 s single, 0.1 s to 99.99 s continuous

**Maximum sweep width:** Full frequency range of the main signal output for the waveform in use, except minimum log start frequency is 1 Hz.

**Phase continuity:** Sweep is phase continuous over the full frequency range of the main output.

### Auxiliary Inputs and Outputs

**Reference input:** For phase-locking 3325A to an external frequency reference signal from 0 dBm to +20 dBm into 50  $\Omega$ . Reference signal must be a subharmonic of 10 MHz from 1 MHz to 10 MHz.

**Auxiliary frequency output:** 21 MHz to 60.999 999 999 MHz, under range coverage to 19.000 000 001 MHz, frequency selection from front panel. 0 dBm; output impedance: 50  $\Omega$

**Sync output:** Square wave with V (high)  $\geq 1.2$  V, V (low)  $\leq 0.2$  V into 50  $\Omega$ .

**X-Axis drive:** 0 to  $> +10$  V DC linear ramp proportional to sweep frequency, linearity, 10-90%,  $\pm .1\%$  of final value.

**Sweep marker output:** High to low TTL compatible voltage transition at selected marker frequency.

**Z-Axis blank output:** TTL compatible voltage levels capable of sinking 200 mA from a positive source.

**1 MHz reference output:** 0 dBm output for phase-locking additional instruments to the 3325A.

**10 MHz oven output:** 0 dBm internal high stability frequency reference output for phase-locking 3325A. (Opt. 001 only)

### Option 001 High Stability Frequency Reference

**Aging rate:**  $\pm 5 \times 10^{-8}$ /week (72-hr. warm up);  $\pm 1 \times 10^{-7}$ /month (after 15 days continuous operation).

**Ambient stability:**  $\pm 5 \times 10^{-8}$  ( $0^\circ$  to  $+55^\circ$ C).

**Warm-up time:** Reference will be within  $\pm 1 \times 10^{-7}$  of final value 15 minutes after turn-on for an off time of less than 24 hours.

### Option 002 High Voltage Output

**Frequency range:** 1  $\mu$ Hz to 1 MHz

### Amplitude

**Range:** 4.00 mVpp to 40.00 Vpp (500  $\Omega$ ,  $< 500$  pf load).

### Accuracy and flatness at full output:

**Sine, square, and triangle waves:**  $\pm 2\%$  at 2 kHz

**Ramps:**  $\pm 2\%$  at 500 Hz

**Flatness:**  $\pm 10\%$  relative to programmed amplitude

**Sinewave distortion:** Harmonically related signals will be the same as the standard instrument to 1 MHz

**Maximum output current:** 80 mApp.

**Output impedance:**  $< 2$   $\Omega$  at DC,  $< 10$   $\Omega$  at 1 MHz

**DC offset range:** 4 times the specified range of the standard instrument.

### General

#### Operating environment:

**Temperature:**  $0^\circ$ C to  $55^\circ$ C.

**Relative humidity:** 95%,  $0^\circ$ C to  $40^\circ$ C.

**Altitude:**  $\leq 15,000$  ft.

**Storage temperature:**  $-40^\circ$ C to  $+75^\circ$ C.

**Storage altitude:**  $\leq 50,000$  ft.

**Power:** 100/120/220/240 V, +5%, -10%, 48 to 66 Hz; 90 VA, 120 VA with all options; 10 VA standby.

**Weight:** 9 kg (20 lbs.) net; 14.5 kg (32 lbs.) shipping.

**Size:** 132.6 H x 425.5 W x 497.8 mm D (5.25" x 16.75" x 19.63").

**Accessories:** 11356A Ground Isolator for breaking signal grounds between input/output connectors.

### Ordering Information\*

3325A Frequency Synthesizer

Opt. 001 High Stability Frequency Reference

Opt. 002 High Voltage Output

Opt 907 Front Handle Kit (stand alone orders P/N 5061-0089)

Opt 908 Rack Flange Kit (stand alone orders P/N 5061-0077)

Opt 909 Rack Flange and Handle Combination Kit (stand alone orders P/N 5061-0083)

11356A Ground Isolator

\*HP-IB cables not supplied, see page 29.

# FUNCTION GENERATORS & FREQUENCY SYNTHESIZERS

## Synthesizer/Level Generator 200 Hz to 81 MHz

Model 3335A

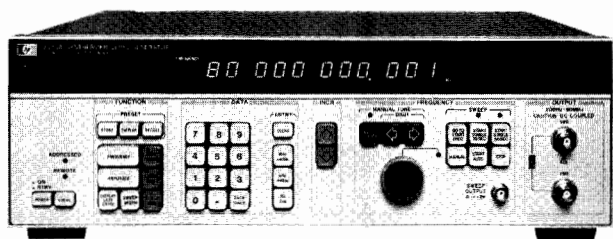

3335A

- 1 MHz resolution
- High spectral purity
- Precision amplitude control
- Program storage
- HP-IB



### Description

Covering a frequency range of 200 Hz–81 MHz, the 3335A Synthesizer/Level Generator has performance characteristics that make it ideally suited for the telecommunications industry, as well as for traditional synthesizer applications, including testing of Frequency Division Multiplex (FDM) equipment and R & D and production testing of communications systems. It features precision level control, millihertz resolution, high spectral purity, internal frequency sweep, HP-IB programmability and numerous user conveniences.

### Internal Storage

Up to 10 different front panel settings (frequency, level, 0 incr, etc.) can be stored in internal memory registers for later recall. The DISPLAY key allows viewing of register contents without altering the synthesizer output.

### Precision Amplitude

Increasing channel capacity of Frequency Division Multiplex (FDM) systems is continually placing more stringent requirements on the testing of transmission parameters. To meet these performance standards, the 3335A incorporates a state-of-the-art attenuator resulting in attenuator accuracies of up to  $\pm .025$  dB over the 81 MHz frequency range.

### Programmability

The 3335A is fully programmable via the Hewlett-Packard Interface Bus (HP-IB), HP's implementation of IEEE Standard 488–1975. Most Hewlett-Packard 9800 Series Programmable Calculators, as well as Models 21 MX and 2100 series minicomputers, are easily interfaced to the HP-IB.

### Frequency Stability

The 3335A synthesizes its output frequency from an internal temperature-controlled crystal oscillator which provides  $\pm 1 \times 10^{-7}$ /day frequency stability ( $\pm 5 \times 10^{-10}$  is optional). The 3335A can also be phase-locked to any external frequency standards.

### Automatic Frequency Sweep

The 3335A combines the precision frequency accuracy and stability of a synthesizer with the time-saving convenience of a digital sweeper.

### SLMS - Tracking Generator

The 3335A operates as a tracking generator with the HP 3745A/B Selective Level Measuring Set (SLMS), or the 3586A/B/C Selective Level Meter for automatic or semi-automatic testing of FDM systems. For closed-loop tracking where the 3335A and 3745A/B are in the same location, the frequency of the generator is controlled by the microprocessor in the SLMS.

### Options

**Standard:** Equipped with switch-selectable 50 $\Omega$  and 75 $\Omega$  outputs (BNC connectors).

**001:** High-stability frequency reference

**002/004:** Equipped with 75 $\Omega$  unbalanced and 124 $\Omega$  and 135 $\Omega$  balanced connectors per table.

	Option	Fits WECO Type	Spacing	Accepts WECO Type
75 $\Omega$	002	477B	N/A	358A
	004	560A		439A/440A
124 $\Omega$	002	477B	16 mm (.625")	372A
	004	560A	12.7 mm (0.5")	443A
135 $\Omega$	002/004	223A	16 mm (.625")	241A

**003:** 75 $\Omega$  unbalanced BNC output and 150 $\Omega$  balanced output using a pair of BNC connectors at 20 mm (0.80 in.) spacings.

### Abbreviated Specifications

(For complete specifications, refer to page 386 and the 3335A data sheet.)

#### Frequency range:

**Standard:** 200 Hz–81 MHz;

**Opt. 002/004:** 75 $\Omega$ , 200 Hz–81 MHz; 124 $\Omega$ , 10 kHz–10 MHz; 135/150 $\Omega$ , 10 kHz - 2 MHz.

**Opt. 003:** 75 $\Omega$ , 200 Hz–81 MHz; 150 $\Omega$ , 10 kHz - 2 MHz

#### Frequency resolution: .001 Hz.

**Stability, long term:**  $\pm 1 \times 10^{-8}$ /day;  $\pm 1 \times 10^{-7}$ /month.

**Opt. 001** (high stability frequency reference):

**Aging rate:**  $\pm 5 \times 10^{-10}$ /day;  $\pm 2 \times 10^{-8}$ /month;  $\pm 1 \times 10^{-7}$ /year

**Warmup:** Within  $5 \times 10^{-9}$  of final value 20 minutes after turn-on at 25°C.

#### Spectral Purity

**Harmonic distortion:** 200 Hz–10 MHz:  $< -45$  dBc; 10 MHz–81 MHz;  $< -40$  dBc

**Phase noise** (30 kHz band, excluding  $\pm 1$  Hz, centered on the carrier): 9.9 MHz:  $< -63$  dBc; 20 MHz;  $< -70$  dBc; 40 MHz:  $< -64$  dBc; 81 MHz:  $< -58$  dBc

**Spurious:** Nonharmonically related signals: the greater of  $-75$  dBc or  $-125$  dBm (50/75  $\Omega$ ),  $-97$  dBm (124  $\Omega$ ),  $-68$  dBm (135/150  $\Omega$ )

#### Amplitude range:

**Standard:** 50 $\Omega$ : +13.01 dBm to  $-86.98$  dBm; 75 $\Omega$ : +11.25 dBm to  $-88.74$  dBm.

**Opt. 002/004:** 75/124/135 $\Omega$ : +11.25 dBm to  $-88.74$  dBm

**Opt. 003:** 75/150 $\Omega$ : +11.25 dBm to  $-88.74$  dBm

**Signal balance (124 $\Omega$ , 135 $\Omega$ , 150 $\Omega$  balanced outputs):**  $> 60$  dB at 100 kHz

**Resolution:** 0.01 dB

**Absolute level accuracy (max. output at 100 kHz, 20°C to 30°C):** 50/75  $\Omega$   $\pm 0.05$  dB; 124/135/150  $\Omega$ :  $\pm 0.1$  dB

**Flatness (relative to 100 kHz, full amplitude):** 50/75 $\Omega$ : 1 kHz–25 MHz:  $\pm 0.07$  dB; 200 Hz - 81 MHz:  $\pm 0.15$  dB. 124 $\Omega$ : 10 kHz - 10 MHz:  $\pm 0.15$  dB, 10 kHz - 10 MHz  $\pm 0.4$  dB; 135/150 $\Omega$ : 10 kHz - 2 MHz:  $\pm 0.18$  dB

**Attenuator accuracy (relative to 100 kHz, full amplitude)**

Impedance	Amplitude (dBm)	Frequency	
		200 Hz	25 MHz 80 MHz
50 $\Omega$	+13.01 to $-6.98$	$\pm 0.03$ dB	
	$-6.99$ to $-46.98$	$\pm 0.07$ dB	
	$-46.99$ to $-86.98$	$\pm 0.20$ dB	

75 $\Omega$	+11.25 to $-8.74$	$\pm 0.04$ dB	$\pm 0.15$ dB
	$-8.75$ to $-48.74$	$\pm 0.09$ dB	$\pm 0.25$ dB
	$-48.75$ to $-88.74$	$\pm 0.20$ dB	$\pm 0.50$ dB

NOTE: For 124 $\Omega$ , 135 $\Omega$ , and 150 $\Omega$ , refer to data sheet.

### Options

**001:** Hi-stability reference  $\pm 5 \times 10^{-10}$ /day

**002:** Connector option (75/124/135 $\Omega$ )

**003:** Connector option (75/150 $\Omega$ )

**004:** Connector option (75 $\Omega$ , miniature WECO on 124/135 $\Omega$ )

**3335A Synthesizer/Level Generator**

# FUNCTION GENERATORS & FREQUENCY SYNTHESIZERS

Synthesizer/Level Generator

Model 3336C

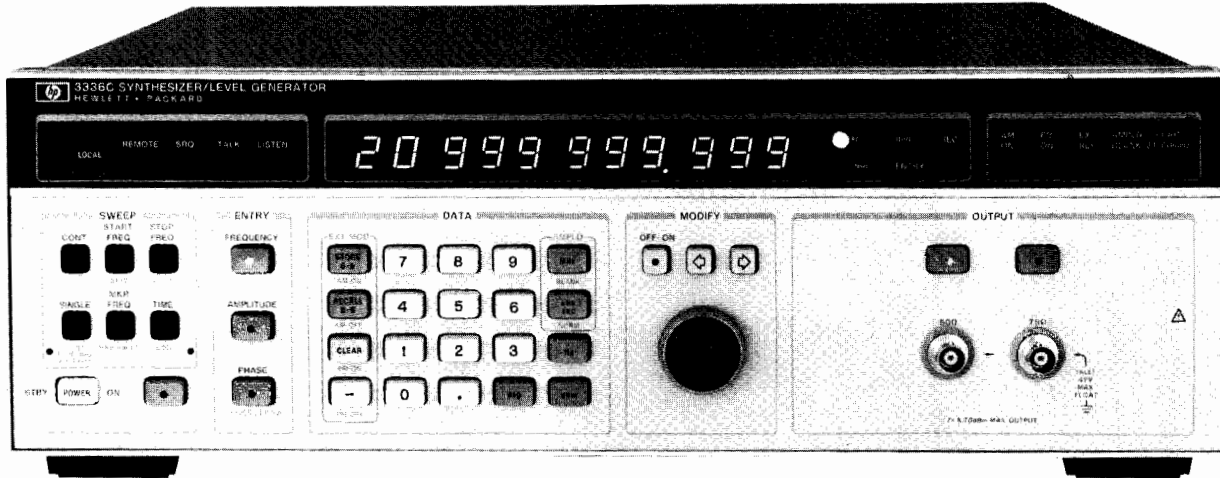

3336C



## Description

Covering a frequency range of 10 Hz to 20.999 MHz, the 3336C is designed for traditional synthesizer applications as well as R&D and production testing of systems or components features precision level control, high spectral purity, optional frequency stability of  $\pm 5 \times 10^{-8}$ /week, internal frequency sweep and numerous user conveniences. All models include HP-IB (IEEE Std. 488-1975) as a standard feature for use in automatic test systems.

## Precision Frequency Measurements

Major advances in HP technology have provided a single loop, fractional-N synthesis technique which allows synthesizer accuracy with 11 digits of resolution, with completely phase continuous frequency sweep over any of the instrument's frequency ranges. Microhertz resolution below 100 kHz allows precise frequency measurements over a range of 10 Hz to 20.999 999 999 MHz. Harmonics are below -60 dBc over the range from 50 Hz to 1 MHz (-50 dBc to 20 MHz), with spurious signals below -70 dBc or -100 dBm in the standard instrument, -115 dBm with an option. Integrated Phase Noise is -64 dBc (30 KHz bw).

## $\pm 0.05$ dB Amplitude Accuracy

New HP attenuator technology coupled with custom designs in leveling loops and thermal converters produce amplitude accuracies seen only in instruments at much greater cost. The fast leveling loop makes extremely flat sweeps possible at fast sweep speeds. External leveling is also available for those custom applications where a control loop is desired.

## Other Features

Models 3336 A & B are also available for the telecommunications industry. See page 564. All three models (the 3336A, B & C) have 10 storage registers; amplitude blanking capability during frequency switching; linear or logarithmic phase continuous sweep capabilities; RPG (rotary pulse generator) to simplify modification of any digit in the display; phase offset capability; output connector and impedance flexibility; AM and PM modulation, and many other features. Refer to the data sheet for complete information.

## Abbreviated Specifications

### Frequency

**Range:** 10 Hz to 20.999 999 999 MHz

**Resolution:** 1  $\mu$ Hz for frequencies <100 kHz, 1 mHz for frequencies  $\geq 100$  kHz

**Accuracy:**  $\pm 5 \times 10^{-6}$  of programmed frequency (20° to 30°C)

**Aging rate:**  $\pm 5 \times 10^{-6}$ /year (20° to 30°C)

**Warm-up time:** 30 minutes to within specified accuracy

### Amplitude

**Range:** 50  $\Omega$ : -71.23 to +8.76 dBm; 75  $\Omega$ : -72.99 to 7.00 dBm

**Absolute accuracy:**  $\pm .05$  dB, 20° to 30°C (for the top 9.99 dB of amplitude range at 10 kHz),  $\pm .08$  dB, 0° to 55°C

**Flatness:** 50/75  $\Omega$ ,  $\pm .1$  dB ( $\pm .07$  dB with option 005) referenced to 10 kHz.

**Attenuator accuracy:** (Instruments without Option 005)

	10 Hz	1 MHz	10 MHz	20.9 MHz
10 to 19.99 dB	$\pm .1$ dB	$\pm .15$	$\pm .2$ dB	$\pm .2$ dB
20 to 39.99 dB	$\pm .15$ dB	$\pm .2$ dB	$\pm .25$ dB	$\pm .25$ dB
40 to 79.99 dB	$\pm .2$ dB	$\pm .25$ dB	$\pm .3$ dB	$\pm .3$ dB

Note: Amplitude Accuracy is the sum of the Absolute Accuracy and, as necessary, Flatness and Attenuator Accuracy.

## Phase Offset

**Range:**  $\pm 719.9^\circ$  with respect to arbitrary reference phase.

## Amplitude Modulation

**Modulation depth:** 0 to 100%

**Modulation frequency range:** 50 Hz to 50 kHz

**Envelope distortion:**  $< -30$  dB to 80% modulation (1 kHz modulating freq.)

## Phase Modulation

**Range:** 0° to  $\pm 850^\circ$

**Linearity:**  $\pm 0.5\%$  from best fit straight line

**Modulation frequency range:** dc to 5 kHz

**Input sensitivity:**  $\pm 5$  V peak for 850° phase shift (170°/volt)

## Frequency Sweep

**Sweep time:** Linear; 0.01 s to 99.99 s. Single Log; 2 s to 99.99 s. Continuous Log; 0.1 s to 99.99 s.

**Maximum sweep width:** specified frequency range of selected output

**Minimum sweep width:** Log; 1 decade. Linear; minimum BW (Hz) = .1 (Hz/s) x Sweep Time (s)

**Phase continuity:** phase is continuous over full frequency range.

**Sweep flatness:** fast leveling;  $\pm .15$  dB, 10 kHz to 20 MHz, .03 s

**Sweep time:** normal leveling;  $\pm .15$  dB, 50 Hz to 1 MHz, .5s sweep time.

## General

### Operating environment:

**Temperature:** 0° to 55°C

**Relative humidity:**  $\leq 85\%$ , 0° to 40°C

**Altitude:**  $\leq 15,000$  ft, (4600 meters)

**Storage temperatures:** -50° to +65°C

**Storage altitude:**  $\leq 50,000$  ft, (15,240 meters)

**Power requirements:** 100/120/220/240 V, +5%, -10%, 48 to 66 Hz, 60 VA, (100 VA with all options), 10 VA standby

**Size:** 132.6 mm H x 425.5 mm W x 497.8 mm D, (5.2" x 16.8" x 19.6")

**Weight:** net, 10 kg. (22 lbs.); shipping, 15.5 kg. (34 lbs.)

### Ordering Information\*

3336C Synthesizer/Level Generator (General Purpose)

**Opt 004** High Stability Frequency Reference

**Opt 005** High Accuracy Attenuator

**Opt 907** Front Handle Kit

**Opt 908** Rack Flange Kit

**Opt 909** Rack Flange and Handle Kit

\*HP-IB cables not supplied, see page 29.

## FUNCTION GENERATORS &amp; FREQUENCY SYNTHESIZERS

## 50 MHz Programmable Signal Source

Model 8165A

- Pulse/function capability
- Sine, triangle, square to 50 MHz
- Pulses and ramps to 20 MHz
- Trigger, gate and counted burst
- Synthesizer stability, precision amplitude
- Storage of operating parameters

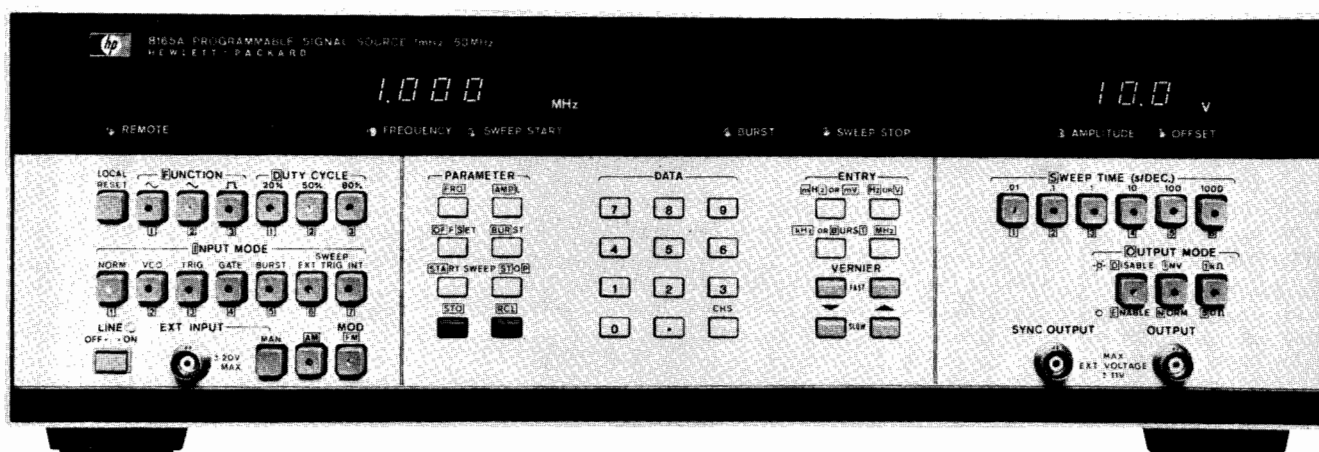

8165A Option 002

**Versatility and Simplicity for Systems and Bench**

The 8165A Programmable Signal Source is a versatile function generator with good accuracy and many trigger features. Micro-processor control assures rapid, accurate setup whether programming locally or via HP-IB.

**Operating Set Storage**

Ten complete sets of operating information can be stored and recalled. In the event of power failure, battery back up retains all data plus the active settings.

**Stability and Resolution**

Very stable frequency is ensured with phase lock loop techniques and internal crystal reference. The four-digit frequency display means a 1  $\mu$ Hz resolution in the 1 to 9.999 mHz range.

**Specifications****Waveforms and Frequency Range**

**Sine, Square, Triangle (50% duty cycle):** 1.000 mHz to 50.00 MHz.

**Pulse/Ramp (20, 80% symmetry):** 1.000 mHz to 19.99 MHz.

**Haversine/havertriangle:** please inquire for special option.

**Output Characteristics**

**Range:** amplitude and offset independently variable within  $\pm 10$  V window.

**Source impedance:** selectable 50  $\Omega \pm 1\%$  or 1 k $\Omega \pm 10\%$

**Amplitude:** 10.0 mVpp to 10.0 Vpp (50  $\Omega$  into 50  $\Omega$ )

2.00 Vpp to 20.0 Vpp (1 k $\Omega$  into 50  $\Omega$ )

**Accuracy:** (sine, square)  $\pm 2\%$ ,  $\pm 5\%$  above 5 MHz

**Offset:** 0  $\pm 10$  mV to  $\pm 5.00$  V (50  $\Omega$  into 50  $\Omega$ )

0  $\pm 20$  mV to  $\pm 10.0$  V (1 k $\Omega$  into 50  $\Omega$ )

**Accuracy:**  $\pm 1\%$  programmed value  $\pm 1\%$  signal Vpp  $\pm 20$  mV.

**Sine characteristics**

**Distortion:** total harmonic distortion (THD) for fundamental up to 1 MHz:  $\pm 1\%$ .

**Harmonic signals:** (fundamental 1-10 MHz):  $\leq -36$  dB

**Harmonic signals:** (fundamental above 10 MHz):  $\leq -30$  dB.

**Non-harmonic:**  $\leq -40$  dB.

**Square/pulse characteristics**

**Transition times:** (10% to 90%):  $\leq 5$  ns (50  $\Omega$  into 50  $\Omega$ ),  $\leq 7$  ns (1 k $\Omega$  into 50  $\Omega$ )

**Preshoot/Overshoot/ringing:**  $\leq \pm 5\%$  (50  $\Omega$  into 50  $\Omega$ ),  $\pm 10\%$  (1 k $\Omega$  into 50  $\Omega$ ).

**Triangle/ramp characteristics**

**Linearity:** (10% to 90%):  $\leq \pm 1\%$  ( $\leq \pm 5\%$  above 5 MHz).

**Operating Modes**

**Norm** (continuous phase locked), **VCO** (external sweep voltage), **Trig** (ext or man. one-shot), **Gate**, **Burst** (1-9999 counted cycles), **Frequency modulation**.

**HP-IB:** control and learn capability for all modes and parameters.

**General**

**Memory:** non volatile. 10 addressable locations plus one for active operating state. Each location can store a complete set of operating parameters and modes.

**Power:** 100/120/220/240 Vrms;  $\pm 5\%$ ,  $-10\%$ ; 48 to 66 Hz, 200 V A max.

**Operating Temperature:** 0° to 50°C

**Weight:** net 12 kg (26.5 lbs). Shipping 16 kg (35.3 lbs).

**Size:** 133 H x 426 W x 422 mm D (5.2" x 16.8" x 16.6").

**Ordering Information**

**8165A Programmable Signal Source\***

**Opt 002:** AM and logarithmic sweep

**Opt 003:** Rear Panel Connectors

**Opt 907:** Front Handle Kit (Part No 5061-0089)

**Opt 908:** Rack Mounting Kit (Part No 5061-0077)

**Opt 909:** Opt 907, 908 combined (Part No 5061-0083)

**Opt 910:** additional Operating and Service Manual

\*HP-IB cables not supplied, see page 29.

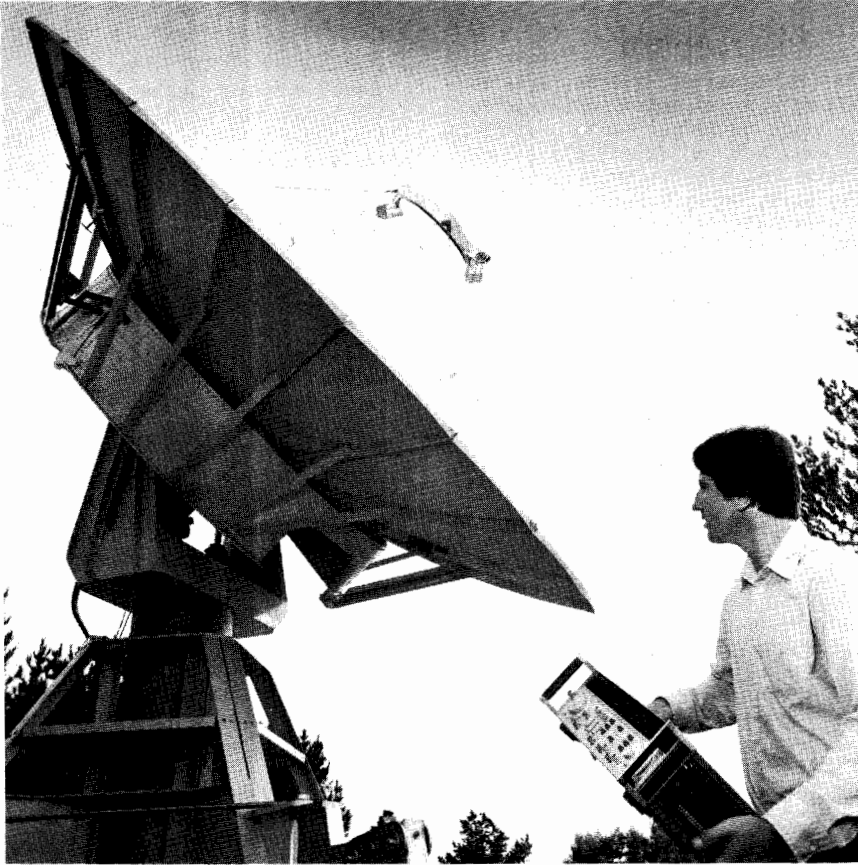

Hewlett-Packard offers a complete line of easy to use HF, VHF, UHF, and SHF signal generators covering a frequency range from 10 kHz to 40 GHz. This line includes synthesized signal generators and solid-state mechanically tuned generators as well as performance-proven vacuum tube signal generators. Each includes the following: 1) accurately calibrated variable frequency, 2) accurately calibrated variable output level, and 3) wide modulation capability.

HP signal generators ensure the utmost convenience and accuracy for a wide variety of measurements, including receiver tests such as sensitivity and selectivity. Signal generators are also used for signal simulation measurements such as signal-to-noise ratio, gain bandwidth, conversion loss, and antenna gain. They also provide power to drive mixers, bridges, slotted lines, etc.

### Synthesized Signal Generators

Collectively covering a frequency range from 10 kHz to 26.5 GHz, these highly versatile programmable signal generators find application in a wide variety of automated systems and high performance applications.

#### 10 kHz to 2560 MHz Low Noise Synthesized Signal Generators

The 8662A covers 10 kHz to 1280 MHz with calibrated output level from +13 to -140 dBm. The 8663A shares the frequency synthesis circuitry of the 8662A, and covers 100 kHz to 2560 MHz with calibrated levels from +16 to -130 dBm. Both generators

feature extremely low phase noise and spurious while maintaining fast frequency switching. The low phase noise close to the carrier (-112 dBc/Hz at a 100 Hz offset) optimizes the 8662A and 8663A for the most critical low noise applications like local oscillator substitution and multiplication of signals up to microwave frequencies. In addition, the low noise at typical channel spacings (-132 dBc/Hz at 10 kHz offset) allows both in-channel and out-of-channel measurements to be made under programmable control. The 8662A is a high performance AM and FM generator. The 8663A offers AM, FM,  $\Phi$ M, and pulse modulation and a 10 Hz to 99.9 kHz modulation oscillator. Both the 8662A and the 8663A utilize a microprocessor to provide ease of operation including incrementing of all functions, precision digital sweep, and full HP-IB programmability.

#### 0.1 to 990 MHz Low Cost Synthesized Signal Generator

The 8656A, an economical programmable RF signal generator, provides synthesized signals from 0.1 to 990 MHz. The 8656A offers a wide range of standard features, including 100 and 250 Hz resolution, full keyboard control, reverse power protection to 50 W, and HP-IB programmability.

Featuring AM, FM and simultaneous modulation with external modulating signals or internal 400 Hz and 1 kHz tones, the 8656A is ideal for in-channel receiver testing. Receiver channels are easily selected with the frequency increment feature. Be-

cause HP-IB is standard, the 8656A is a cost-effective programmable solution for in-channel measurements and an ideal general-purpose RF source for other automatic system applications.

The 8656A also features excellent output level accuracy of  $\pm 1.5$  dB and precise output level resolution of 0.1 dB for increased measurement accuracy and settability. Testing of RFI-susceptible devices is made possible by the low RFI leakage of the 8656A.

#### 10 kHz to 2600 MHz Synthesized Signal Generator

The HP 8660A/C is a particularly versatile synthesized signal generator family, offering two mainframes and a variety of RF and modulation plug-ins. The 8660A mainframe utilizes thumbwheel switches for frequency selection. The 8660C has a more versatile keyboard control featuring synthesized digital sweep and frequency-step capability. Both HP-IB and BCD programming interfaces are available.

Three plug-in RF sections provide separate frequency ranges: 10 kHz to 110 MHz, 1 MHz to 1300 MHz, and 1 MHz to 2600 MHz. Output levels are calibrated over >140 dB range. Five different modulation plug-ins provide versatile combinations of AM, FM,  $\Phi$ M, and pulse modulation.

#### 0.01 to 26.5 GHz Microwave Synthesized Signal Generators

The 8670 series of microwave synthesizers, covering four frequency ranges for measurement flexibility, provides extremely broadband frequency coverage, good spectral purity and stability, versatile modulation, and full programmability for stringent signal simulation applications. The 8672A is an AM/FM generator covering from 2 to 18 GHz, with calibrated output from +3 to -120 dBm (to +8 dBm with Option 008). The 8672A-E24 provides all the capability of the 8672A, plus extended frequency coverage from 0.01 to 18 GHz and an internal pulse modulator allowing high-quality pulse modulation over the entire frequency range.

The 8673A spans the entire 2 to 26.5 GHz range, with +8 to -100 dBm output level. The 8673A has versatile modulation, with an internal pulse modulator as well as external metered AM and FM. Also featuring 1 to 4 kHz frequency resolution and stable digital sweep, the 8673A provides maximum performance and reliability.

The 8671A is a synthesizer only, with a minimum output of +8 dBm from 2 to 6.2 GHz and external FM capability only. Fully programmable, the 8671A is ideal for use in local oscillator applications.

#### Solid State, Mechanically Tuned Generators

Solid-state mechanically tuned generators combine fundamental oscillators with solid-state circuitry to yield excellent spectral purity for modern performance requirements.



# SIGNAL GENERATORS

## Signal Generators to 40 GHz

### 2.3 to 12.5 GHz Solid-State Generators

The 8680 series solid-state high performance signal generators are designed to meet the stringent requirements of modern microwave radar and communications testing. With the 8683 covering from 2.3 to 6.5 GHz, and 8684 spanning 5.4 to 12.5 GHz, these generators feature state-of-the-art cavity-tuned oscillators to provide excellent frequency stability, spectral purity, and reliability.

Both the 8683 and the 8684 are available in the "A" version, optimized for communications testing, and the "B" version for radar applications. The B models feature +10 dBm standard output power, and an internal pulse modulator and pulse generator yielding >80 dB on/off ratio, and rise/fall times <10 ns.

The A models offer the same outstanding performance as the B models, but with only limited external pulse modulation. Both the A and B models have low distortion AM and FM, an internal variable sawtooth for FM swept measurements, and provide outstanding  $\pm 2.5$  dB level accuracy and 1% frequency accuracy.

### 0.5 to 1024 MHz, High Performance

The high performance leaders of the RF solid-state, mechanically tuned family are the 8640A and 8640B signal generators, covering 450 kHz to 550 MHz. Frequency coverage can be extended to 1024 MHz with an

internal doubler (Option 002), and an optional built-in audio oscillator extends the CW range down to 20 Hz (Option 001). The 8640 provides wide output level range and high power output from +19 to -145 dBm. Featuring high performance AM and FM with low phase noise at typical receiver channel spacings, the 8640 is an ideal generator for a wide variety of receiver measurements.

The 8640B with built-in counter has the ability to count external signals at frequencies up to 550 MHz and to phase-lock the generator's RF output to the counter time base for frequency stability of better than  $5 \times 10^{-8}$ /hour. The 8640A utilizes a mechanical slide rule frequency dial.

For avionics navigation and communications applications, the 8640B Option 004 can be combined with suitable external modulation sources for testing ILS, VOR, and VHF communications receivers.

### 10 to 520 MHz, Compact, Field Portable, Economy

Compact, portable signal generators form another part of the solid-state, mechanically tuned family. The 8654A and 8654B cover from 10 to 520 MHz, providing output power from +10 to -130 dBm. Small size and light weight make them well suited for field maintenance and operational readiness checks in addition to general purpose signal generator applications. The 8654B has fully calibrated and metered AM and FM, whereas the 8654A is an AM generator with uncalibrated FM capability.

### Performance-proven Vacuum Tube Signal Generators

Hewlett-Packard's microwave vacuum tube signal generators provide coverage from 800 MHz to 21 GHz. The 618C, 620B, 626A, and 628A incorporate cavity-tuned klystron oscillators with low drift and residual FM. Pulse, square-wave and frequency modulation capabilities make them useful for microwave receiver testing as well as SWR and transmission line measurements.

The 8614A and 8616A Signal Generators, covering 0.8 to 2.4 GHz and 1.8 to 4.5 GHz, feature built-in PIN diode modulators. These modulators allow internal or external output power leveling as well as high performance pulse and amplitude modulation.

HP 938A and 940A Frequency Doubler Sets provide low-cost signal generator capability in the 18 to 40 GHz range by doubling the frequency of signal sources in the 9 to 20 GHz range.

### Signal Generator Accessories

A variety of accessories are available to enhance the operation of HP signal generators. These include frequency doublers, balanced mixers, a series of PIN modulators, a pulse modulator and a down converter. The 11720A Pulse Modulator provides high performance pulse modulation capability over the range of 2 to 18 GHz. The 11710B Down Converter extends the frequency range of the 8640 and 8654 down to 10 kHz.

### Signal Generator Summary

Frequency Range	Model	Characteristics	Page
0.5 to 512 MHz	8640B Opt. 004 Avionics Generator	Same as 8640B with AM phase shift $< \pm 0.01^\circ$ at 30 Hz, demodulated AM output, 1 dB step attenuator. For use with external VOR/ILS audio generators.	359
10 to 520 MHz	8654A, 8654B Signal Generators	Calibrated and leveled output from +10 to -130 dBm. Amplitude and frequency modulation. Compact, portable (17.5 lb).	360
0.5 to 1024 MHz	8640A, 8640B Signal Generators	Calibrated and leveled output from +19 to -145 dBm. AM, FM, and ext. pulse modulation. 8640B has built-in counter and phase lock capability.	356
0.1 to 990 MHz	8656A Synthesized Signal Generator	$\pm 1.5$ dB absolute level accuracy from +13 dBm to -127 dBm in 0.1 dB steps. Calibrated AM and FM. Frequency resolution of 100 Hz or 250 Hz. Time base aging rate of $\pm 2$ ppm/year.	348
0.01 to 1280 MHz	8662A Synthesized Signal Generator	Low noise. 0.1 Hz frequency resolution, $5 \times 10^{-10}$ /day stability. Calibrated and leveled output from +13 to -140 dBm. Digital sweep. Completely HP-IB programmable. AM/FM modulation.	350
0.1 to 2560 MHz	8663A Synthesized Signal Generator	Low noise. 0.1 Hz frequency resolution, $5 \times 10^{-10}$ /day stability. Calibrated and leveled output from +16 to -130 dBm. Digital sweep. Completely HP-IB programmable. AM, FM/PM, pulse modulation.	352
0.01 to 110 MHz 1 to 1300 MHz 1 to 2600 MHz	8660A, 8660C Synthesized Signal Generators	1 Hz frequency resolution, $3 \times 10^{-8}$ /day stability. Calibrated and leveled output from +13 to -146 dBm. HP-IB and BCD programmable. AM, FM, PM, pulse modulation. Plug-ins determine frequency range and modulation capability.	353
0.8 to 2.4 GHz 1.8 to 4.5 GHz	8614A, 8616A Signal Generators	Output +20 (8616: +3 dBm above 3 GHz) to -127 dBm into 50 ohms, leveled below 0 dBm. Internal square-wave; external pulse, AM and FM. Auxiliary RF output.	361
0.01 to 18 GHz	8672A-E24 Synthesized Signal Generator	1 to 3 kHz frequency resolution, $5 \times 10^{-10}$ /day stability. Internal pulse modulator. Calibrated and leveled output from +2 to -120 dBm. Metered external AM and FM. Completely HP-IB programmable.	368
2 to 6.2 GHz	8671A Synthesizer	1 kHz frequency resolution, $5 \times 10^{-10}$ /day stability, +8 dBm minimum output. Completely HP-IB programmable. Ext. FM.	368
3.8 to 7.6 GHz 7 to 11 GHz	618C, 620B Signal Generators	Output +0 to -127 dBm into 50 ohms. Int. pulse, frequency or square-wave modulation; ext. FM or pulse modulation. Auxiliary RF output.	364
2.3 to 6.5 GHz 5.4 to 12.5 GHz	8683B, 8684B Signal Generators	High spectral purity, stability. $\pm 2.5$ dB absolute level accuracy from +10 to -110 dBm. AM, FM, and high performance int. pulse modulator, int. pulse generator. Portable, rugged (19.1 kg).	362
2.3 to 6.5 GHz 5.4 to 12.5 GHz	8683A, 8684A Signal Generators	Same as B models except with only limited ext. pulse modulation, +0 dBm standard output power.	362
2 to 18 GHz	8672A Synthesized Signal Generator	1 to 3 kHz frequency resolution, $5 \times 10^{-10}$ /day stability. Calibrated and leveled output from +3 to -120 dBm. Completely HP-IB programmable. Metered external AM and FM.	367
2 to 26.5 GHz	8673A Synthesized Signal Generator	1 to 4 kHz frequency resolution, $5 \times 10^{-10}$ /day stability, +8 to -100 dBm output. Pulse, amplitude, and frequency modulation. Digital sweep. Completely HP-IB programmable.	366
10 to 15.5 GHz 15 to 21 GHz	626A, 628A Signal Generators	Output +10 to -90 dBm. Int. pulse, frequency or square-wave modulation. Ext. FM or pulse modulation.	364
18 to 26.5 GHz 26.5 to 40 GHz	938A, 940A Frequency Doublers	Driven by 9 to 13.25 GHz. 13.25 to 20 GHz sources (HP 626A, 628A, 8690, 8672A, 8350A, and 8620 series sweepers or klystrons). 100 dB precision attenuator.	365

- Additional capabilities for signal generators

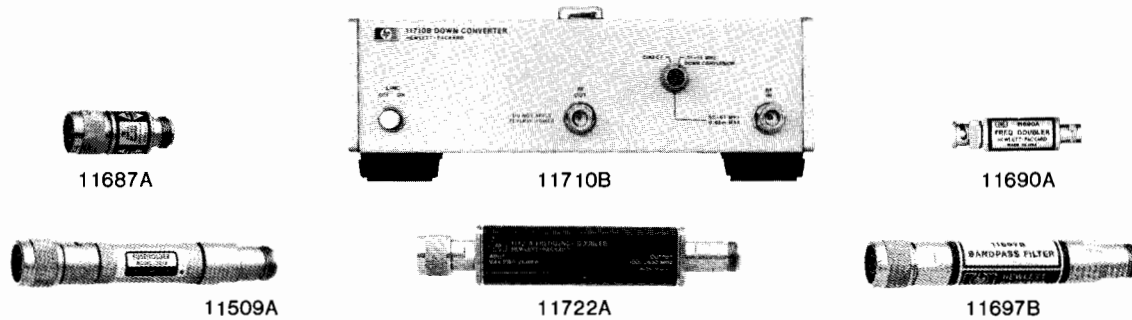

#### 11509A Fuseholder

Accidental burnout of attenuators in HP 8640 and 8654 Signal Generators can be prevented by using this fuse element between the signal generator and a transceiver. The fuseholder has a frequency range of dc to 480 MHz, insertion loss of  $\leq 1$  dB, SWR of  $\leq 1.35$  (50  $\Omega$  load), and Type N connectors. Ten extra fuses are furnished.

#### 11687A 50-75 $\Omega$ Adapter

This 50-75  $\Omega$  Adapter with Type N connectors is recommended for use with HP 8640, 8654, 8660, 8656, and 8662 Signal Generators for measurements in 75  $\Omega$  systems. The voltage calibration on the output level meter is unaffected by use of the adapter, but 1.76 dB must be subtracted from the dB scale on the meter to determine the output in dBm into 75  $\Omega$ . Frequency range is dc to 1300 MHz.

#### 11697A,B,C Bandpass Filters

These filters reduce any harmonic and subharmonic-related spurious signals present in the output of doubled signal sources (such as the HP 8640 Signal Generator with Option 002 Internal Doubler or 11690A external Frequency Doubler). The 11697A and 11697B cover the USA UHF television band and the 11697C covers the range used for navigation aids and mobile radio. Midband attenuation is  $\leq 0.6$  dB, pass band attenuation is  $\leq 1.1$  dB, and pass band SWR is  $\leq 1.4$ . Connectors are Type N.

#### Rejection band attenuation:

Model	Below Passband		Above Passband	
	Frequency (MHz)	Attenuation	Frequency (MHz)	Attenuation
11697A	$\leq 337$	$\geq 20$ dB	768-3000	$\geq 20$ dB
11697B	$\leq 445$	$\geq 20$ dB	1011-3000	$\geq 20$ dB
11697C	$\leq 550$	$\geq 20$ dB	1333-3000	$\geq 20$ dB

#### 11690A Frequency Doubler

The 11690A extends the frequency range of all HP 8640 series Signal Generators by doubling the 256-512 MHz frequency band up to 1024 MHz (to 110 MHz with band overrange). All 8640's indicate the correct doubled output frequency on a dial or counter when the 512-1024 MHz range is selected. The 11690A will also perform well with any source meeting the input requirements of 200-550 MHz at +10 to +19 dBm. Conversion loss is  $< 13$  dB, output flatness has  $< 4$  dB total variation, and the 1st and 3rd input harmonics are suppressed  $> 20$  dB. Connectors are BNC.

#### 11710B Down Converter

The 11710B Down Converter is an accessory for the 8640 and 8654 series signal generators. Frequency inputs from 50.01 to 61 MHz are down converted to the 10 kHz to 11 MHz range respectively. The output level and modulation functions of the 8640 and 8654 remain calibrated. A straight-through selection switch allows the input to pass through unchanged, and thus minimizes the necessity to move cables when testing. Option 001 provides rails and semi-rigid coax for combining the 11710B with an 8654A,B Signal Generator.

#### 11710B Specifications

##### Input

**Down-conversion mode:** 50.01 to 61.00 MHz at  $\leq 0$  dBm.

**Straight-through mode:** 0.01 to 1100 MHz (dc coupled).

#### Down-converted output

**Frequency range:** 10 kHz to 11 MHz.

**Level range:** 0 to  $-107$  dBm

**Level flatness:** RF source flatness  $\pm 0.5$  dB (referred to 4.0 MHz).

**Total level accuracy:**  $\pm 1$  dB plus input level accuracy.

**Harmonics:**  $> 35$  dB below the carrier (dBc).

**Intermixing spurious:**  $> 60$  dBc.

**Local oscillator feed-through (50 MHz):**  $< -100$  dBm.

#### Internal Reference Characteristics

**Time base output:** 1 MHz or 5 MHz selectable, nominally  $> 0.5$  V p-p into 500  $\Omega$ . This will drive an 8640B external time base input.

**Typical overall accuracy: (within 3 months of calibration and from 15°C to 35°C):**  $\pm 2$  ppm.

#### General

**Operating temperature range:** 0 to 55°C.

**Power requirements:** 100, 120, 220, 240V (+5%, -10%), 48 to 440 Hz; 25 VA maximum.

**Weight:** net, 3.2 kg (7 lb); shipping, 4.5 kg (9 lb).

**Size:** 102 H  $\times$  266 W  $\times$  295 mm D (4"  $\times$  10.5"  $\times$  11.6").  $\frac{1}{2}$  MW  $\times$  4 H  $\times$  11 D System 1 Module.

#### 11721A Frequency Doubler

The 11721A Doubler is an ideal accessory for extending the useable frequency range of signal generators, frequency synthesizers, or other signal sources. Operating on input frequencies of 50 MHz to 1300 MHz, it provides a doubled output in the range of 100 MHz to 2600 MHz. The 11721A will work well with any RF source with an output in the range 50 to 1300 MHz.

The 50  $\Omega$  passive circuit of the 11721A offers low conversion loss, low spurious, and excellent flatness over its entire frequency range when operated above +10 dBm.

#### 11721A Specifications

**Input frequency range:** 50 to 1300 MHz.

**Output frequency range:** 100 to 2600 MHz.

**Conversion loss (+13 dBm input, 50 to 1280 MHz):**  $< 15$  dB.

**Spurious referenced to desired output frequency f (+13 dBm input with harmonics  $< -50$  dBc, 50 to 1280 MHz):**  $f/2$ ,  $-15$  dB;  $3f/2$ ,  $-15$  dB.

**Input SWR:** 1.5 typical.

**Input/output impedance:** 50  $\Omega$  nominal.

**Operating temperature range:** 0 to +50°C.

**Connectors:** input, type N male; output, type N female.

**Size:** 161 L  $\times$  30 W  $\times$  20.5 mm H (6  $\frac{3}{8}$ "  $\times$  1  $\frac{3}{16}$ "  $\times$   $\frac{13}{16}$ ").

**Weight:** net, 181 g (6.4 oz); shipping, 335 g (11.8 oz).

#### Ordering Information

11509A Fuseholder

11687A 50  $\Omega$ -75  $\Omega$  Adapter

11690A Frequency Doubler

11697A Bandpass Filter (512-674 MHz)

11697B Bandpass Filter (674-890 MHz)

11697C Bandpass Filter (800-1100 MHz)

11710B Down Converter

Option 001: Combining Kit

Option 910: Extra operating & service manual

11721A Frequency Doubler





# SIGNAL GENERATORS

## Synthesized Signal Generator

Model 8656A

- 100 kHz to 990 MHz
- $\pm 1.5$  dB absolute output level accuracy
- 0.1 dB output level resolution
- Versatile modulation
- Increments and Store/Recall/Sequence
- Fully HP-IB programmable

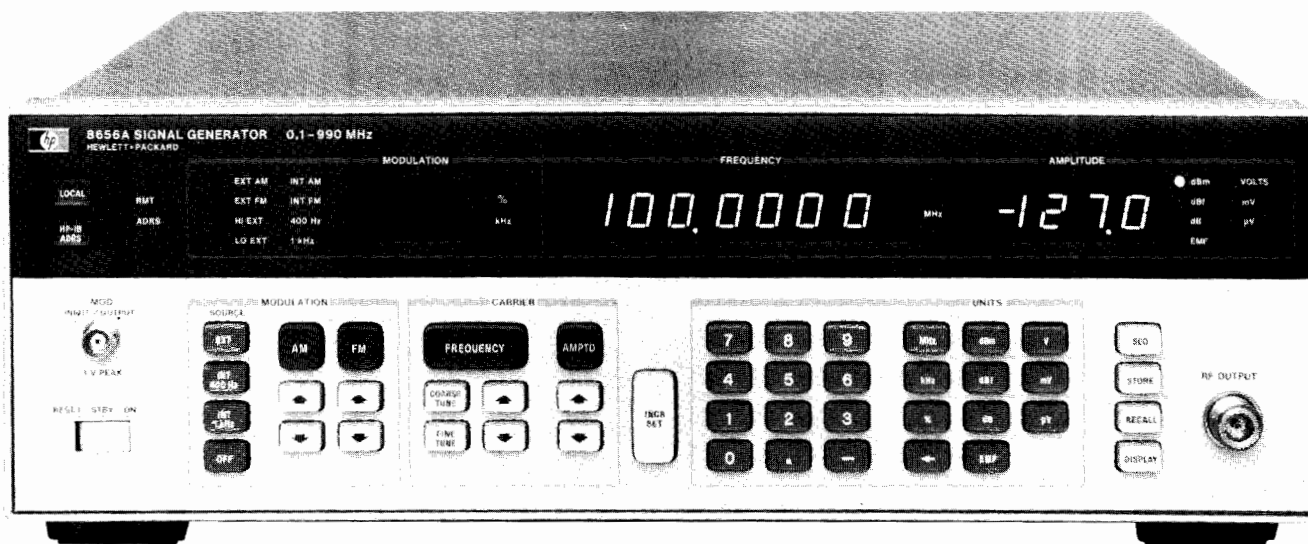

8656A



### Description

The 8656A is a programmable synthesized signal generator that offers exceptional value through versatility, ease of operation, and a broad range of standard features.

### Frequency

The 8656A provides frequency coverage from 0.1 to 990 MHz (with underrange to 10 kHz). This wide range covers the IF and LO frequencies as well as the RF frequencies of most receivers. It also allows testing in a variety of communication systems including the 800 MHz FM mobile band and some telemetry bands. Frequency resolution of 100 Hz or 250 Hz allows convenient setting of increments including 6.25 kHz channel spacings. Frequency accuracy and stability are determined by the reference used. The standard internal reference has an aging rate of 2 ppm/year. Improved stability and accuracy can be achieved by adding the optional  $1 \times 10^{-9}$ /day high stability time base (Option 001) or using an external reference of 1, 5, or 10 MHz.

### Output

The 8656A features  $\pm 1.5$  dB absolute accuracy and 0.1 dB resolution for more accurate receiver sensitivity tests, circuit characterization, and R&D applications. The output levels are calibrated from +13 to -127 dBm and may be set and displayed in convenient units including dBm, volts, dB $\mu$ V, or EMF. Shielding keeps leakage at  $< 1 \mu$ V for testing RFI susceptible devices, and standard resettable reverse power protection for up to 50 watts guards against accidental damage from transmitters.

### Modulation

The 8656A has versatile modulation capabilities: internal 400 Hz and 1 kHz tones, simultaneous and mixed modulation modes (AM-AM, FM-FM, AM-FM) from internal and external sources, and the ability to accept low frequency digital unselecting signals. For calibrated external modulation, a 1V peak signal is required. HI/LO annunciators on the 8656A indicate when the external signal is within 5% of the correct amplitude.

### Ease of Operation

A microprocessor-based controller provides a broad range of operating features for simple but efficient control. Keyboard data entry uses a function/data/units format, and all function entries are made using a left-to-right keystroke sequence. All information entered is visible via LED displays and annunciators. Modulation, frequency, and level functions can be individually incremented by step sizes that are set by convenient keyboard entries. In addition, resolution control keys allow coarse and fine tuning of output frequency in decade steps.

Up to ten front-panel setups can be stored and recalled. A sequence function allows you to cycle through stored setups at the touch of a key or via remote control.

### HP-IB Programmability

Full HP-IB programmability is standard in the 8656A. Each programming command has an easy-to-remember, two-character, alphanumeric HP-IB code, and all functions are quickly programmed using the same format as in the manual mode.



## 8656A Specifications

### Frequency

**Range:** 100 kHz to 990 MHz (8 digit LED display).

**Resolution:** 100 and 250 Hz.

**Accuracy and stability:** same as internal time base.

### Time base characteristics:

Typical Characteristics	Standard Time Base	Option 001 Time Base
Aging Rate	±2 ppm/year	1 x 10 <sup>-9</sup> /day
Frequency	50 MHz	10 MHz
External Reference Input (rear panel)	Accepts any 10, 5 or 1 MHz (±0.002%) frequency standard at a level >0.15 Vrms into 50 ohms.	
Frequency Underrange	10 kHz with uncalibrated output	

**Typical frequency switching speed (to be within 100 Hz of final frequency):** <2 seconds.

### Spectral Purity

**Spurious signals (≤ +7 dBm output levels)**

**Harmonics:** <-25 dBc.

**Non-harmonic spurious (greater than 5 kHz from carrier in CW mode):** <-60 dBc.

**Sub-harmonic spurious:** none.

### Residual FM:

Post Detection Noise Bandwidth	Frequency Range (MHz)			
	0.1 to 123.5	123.5 to 247	247 to 494	494 to 990
0.3 to 3 kHz	<15 Hz rms	<3 Hz rms	<6 Hz rms	<15 Hz rms
0.05 to 15 kHz	<30 Hz rms	<8 Hz rms	<16 Hz rms	<30 Hz rms

**Residual AM (0.05 to 15 kHz post detection noise bandwidth):** <-70 dBc.

### Typical SSB phase noise (CW only):

Offset from Carrier	0.1 to 123.5 MHz (dBc/Hz)	123.5 to 247 MHz (dBc/Hz)	247 to 494 MHz (dBc/Hz)	494 to 990 MHz (dBc/Hz)
20 kHz	<-115	<-127	<-121	<-115
500 kHz	<-125	<-135	<-131	<-125

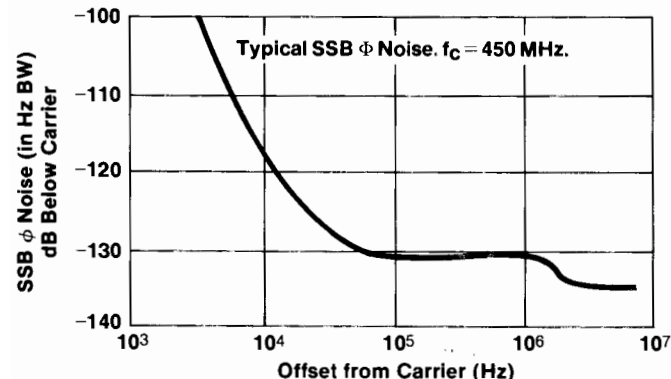

### Output

**Level range (into 50 ohms):** +13 dBm to -127 dBm (3½ digit LED display).

**Resolution:** 0.1 dB.

**Absolute level accuracy:** ≤1.5 dB.

**Level flatness (100 kHz to 990 MHz):** ≤ ±1.0 dB at an output level setting of 0.0 dBm.

**Reverse power protection:** protects signal generator from application of up to 50 watts (typical) of RF power to 990 MHz into generator output; dc voltage cannot exceed 25 V.

### Modulation

#### Amplitude modulation (2 digit LED display)

**AM depth<sup>1</sup>:** 0 to 99% to +7 dBm and 0 to 30% to +10 dBm.

**Resolution:** 1%.

**AM rate:** internal 400 Hz and 1 kHz, ±3%; external (1 dB bandwidth), 25 Hz to 25 kHz.

**AM distortion (at internal rates):** <1.5%, 0-30% AM; <3%, 31-70% AM; <5%, 71-90% AM.

**Indicator accuracy (for depths <90% and internal rates)<sup>1</sup>:** (±4% of reading) ±2%.

**Incidental phase modulation (at 30% AM depth and internal rates):** <0.3 radian peak.

#### Frequency modulation (2 digit LED display)

##### FM peak deviation:

Center Frequency ( $f_c$ )	Maximum Peak Deviation ( $\Delta f_{pk}$ ) <sup>*</sup>	
	Rates ≥ 60 Hz	Rates <60 Hz
0.1-123.5 MHz	99 kHz	1600 x Rate
123.5-247 MHz	25 kHz	400 x Rate
247-494 MHz	50 kHz	800 x Rate
494-990 MHz	99 kHz	1600 x Rate

<sup>\*</sup> FM not specified for  $f_c - \Delta f_{pk} < 100$  kHz.

**Resolution:** 100 Hz for deviations less than 10 kHz; 1 kHz for deviations greater than 10 kHz.

**FM rate:** internal 400 Hz and 1 kHz, ±3%; external (1 dB bandwidth, ac coupled), 25 Hz to 25 kHz.

**FM distortion (for 100 Hz to 99 kHz peak deviations and internal rates):** <0.5% THD.

**Indicator accuracy<sup>1</sup>:** ±5% of reading at internal rates. (Add ±5% if 250 Hz frequency increments are used).

**Incidental AM (for center frequency ≥500 kHz, peak deviation >20 kHz and internal rates):** <0.1%.

**Digital FM:** will accept typical digital unquenching signals. Sag of resultant demodulated signal is typically less than 8% at 1 kHz deviation for a 10 Hz square-wave modulating signal.

### Remote Programming

**Interface:** HP-IB (Hewlett-Packard's implementation of IEEE Standard 488).

**Interface functions implemented:** SH1, AH1, T0, L2, SRO, RL1, PP0, DC1, DT0, and C0.

### General

**Operating temperature range:** 0 to +55°C.

**Leakage:** conducted and radiated interference is within the requirements of methods CE03 and RE02 of MIL STD 461A, VDE 0871, and CISPR Publication 11. Furthermore, RF leakage of less than 1.0 μV is induced in a two-turn loop, 2.5 cm in diameter, held 2.5 cm away from the front surface.

**Power requirements:** 100, 120, 220, or 240 V, (+5, -10%); 48 to 66 Hz; 125 VA maximum.

**Weight:** net, 18.1 kg (40 lb); shipping, 24.5 kg (54 lb).

**Size:** 133 H x 425 W x 520 D mm (5.25" x 16.75" x 20.5"). 5.25" x 1 MW x 17", system II module. For cabinet accessories, see pages 714-719.

**Rack slides and transit case:** HP part numbers are: slide kit, 1494-0018; tilt slide kit, 1494-0025; full module transit case, 9211-2661.

### Ordering Information

**8656A Signal Generator<sup>2</sup>**

**Option 001:** High stability time base

**Option 002:** Rear panel input and output

**Option 907:** Front handle kit

**Option 908:** Rack flange kit

**Option 909:** Rack flange and front handle kit

**Option 910:** Extra operating & service manual

<sup>1</sup>AM depth and FM deviation are further limited by Indicator Accuracy specifications.

<sup>2</sup>HP-IB cables not supplied, see page 29 for description and prices.

# SIGNAL GENERATORS

## Synthesized Signal Generators

Models 8662A, 8663A

- 10 kHz to 1280 MHz Frequency Range
- $< -147$  dBc/Hz SSB Phase Noise at 10 kHz offset
- 0.1 Hz Frequency Resolution
- 100 kHz to 2560 MHz Frequency Range
- AM/FM/PM/Pulse in One Generator
- Internal Variable Modulation Oscillator

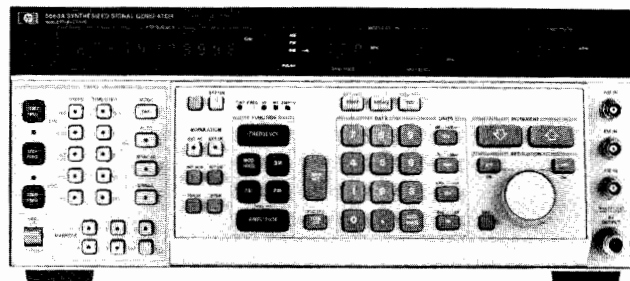
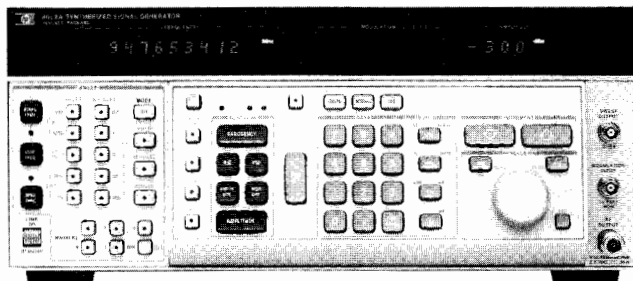

### 8662A Synthesized Signal Generator

The 8662A derives exceptional RF performance from an indirect frequency synthesis technique that results in frequency resolution of 0.1 Hz from 10 kHz to 640 MHz and .2 Hz from 640 MHz to 1280 MHz.

Output level accuracy is held to  $\pm 1$  dB using microprocessor correction. This makes the 8662A an ideal generator for performing precise receiver sensitivity tests either manually or in automated systems.

The 8662A offers versatile phase-locked AM/FM using either internal 400 Hz and 1 kHz rates or externally applied modulating signals, which can be either dc or ac coupled. Several different modes of simultaneous modulation (such as AM + FM or FM + FM) are possible.

#### Exceptional Spectral Purity

The key contribution of the 8662A is spectral purity. Fast-tuning, switched-inductance, voltage-controlled oscillators combined with a low noise reference multiplication chain result in very low SSB phase noise, especially at small offsets from the carrier. The phase noise at 20 kHz to 50 kHz offsets is comparable to that of the best cavity-tuned fundamental oscillators. Such excellent noise performance makes possible complete automation of receiver out-of-channel measurements.

With its excellent long and short-term frequency stability, high output power, fine frequency resolution, and broad frequency range the 8662A also meets the requirements of the most critical low noise local oscillator applications. In addition, its fast frequency switching and sweep capabilities also permit its use in many frequency agile and swept local oscillator applications.

An advanced microprocessor-based controller allows convenient keyboard control of all 8662A functions. For example, all functions can be incremented and decremented in any user-defined step size within the resolution of the synthesizer using the increment keys and the knob. Up to nine full front panel setups can be stored in the 8662A's memory and recalled for later use in any user-defined sequence at the touch of a pushbutton. This permits time-saving semi-automation of generator operation in production setups where the generator must perform many different tests.

#### Precision Digital Sweep

Fast frequency switching combined with microprocessor control gives the 8662A a powerful sweep capability. Automatic, single, and manual modes are available for both linear and logarithmic sweeps with user-selectable step size and number of steps. Five different sweep speeds can be chosen and up to five amplitude or Z-axis markers can be set. All sweep parameters can be controlled with full synthesizer resolution.

### 8663A Synthesized Signal Generator

The 8663A provides all the features and the exceptional spectral purity of the 8662A with increased frequency range and modulation capability.

#### Broad Frequency Range

The 8663A utilizes the complete frequency synthesis portion of the 8662A with the addition of an internal frequency doubler to achieve a broad frequency range of 100 kHz to 2560 MHz in a single instrument. In the 8663A, the exceptional spectral purity of the 8662A is maintained up to 1280 MHz. Above this, phase noise is typically increased 6 dB to a level of  $-125$  dBc/Hz at 10 kHz offset from a 2.5 GHz carrier. High output power of +16 dBm (with overrange to 19.9 dBm) is available for efficiently driving frequency translators when low noise microwave signals are needed. Combined with a microwave synthesizer such as the HP 8673A, full frequency coverage from 100 kHz to 26 GHz is possible.

#### Flexible Modulation

Complete modulation capability across a wide carrier frequency range is the key contribution of the 8663A. AM and FM characteristics are similar to those offered in the 8662A. The 8663A adds high performance pulse and biphasic modulation with wide bandwidth linear phase modulation available with option 002. For complete flexibility, and 8663A option 002 has the capability to simultaneously provide AM+FM+pulse+phase modulation across its entire frequency range. AM, FM, and linear phase are either AC or DC coupled while biphasic and pulse are DC coupled. This modulation flexibility assures exact signal simulation when testing complex systems such as those involving pulsed doppler radar and electronic warfare. An internal 100 kHz sinusoidal modulation synthesizer phase locked to the 10 MHz time base is standard. Microprocessor flexibility allows the sweep functions to be applicable to the internal audio synthesizer as well as the RF synthesizer making applications involving swept modulation possible with a single instrument.

#### Similarity to the 8662A

Because the 8663A has been designed to be upward compatible with the 8662A, the two generators have identical control and performance characteristics for those functions that are common. Either generator can be combined with the HP 11729A Microwave Converter and the HP 3047A Spectrum Analyzer to perform microwave phase noise measurements simply and quickly.

## 8662A Specifications

### Frequency

**Range:** 10 kHz to 1280 MHz (1279.999998 MHz).

**Resolution:** 0.1 Hz (0.2 Hz above 640 MHz).

**Accuracy and stability:** same as reference oscillator.

**Internal reference oscillator:** 10 MHz quartz oscillator. Aging rate  $< 5 \times 10^{-10}$ /day after 10 day warm-up (typically 24 hrs in normal operating environment).

### Spectral Purity

**Residual SSB phase noise in 1 Hz BW ( $320 \leq f_c < 640$  MHz):**

Offset from carrier				
10 Hz	100 Hz	1 kHz	10 kHz	100 kHz
-100 dBc	-112 dBc	-121 dBc	-131 dBc	-132 dBc

**SSB broadband noise floor in 1 Hz BW at 3 MHz offset from carrier:**  $< -146$  dBc for  $f_c$  between 120 and 640 MHz at output levels above +10 dBm.

### Spurious signals:

	Frequency range (MHz)				
	0.01 to 120	120 to 160	160 to 320	320 to 640	640 to 1280
Spurious non-harmonically related <sup>1,2</sup>	-90 dBc	-100 dBc	-96 dBc	-90 dBc	-84 dBc
Sub-harmonically related ( $\frac{f}{2}$ , $\frac{3f}{2}$ , etc.)	none	none	none	none	-75 dBc
Power line (60Hz) related or microphonically generated (within 300 Hz) <sup>3</sup>	-90 dBc	-85 dBc	-80 dBc	-75 dBc	-70 dBc
Harmonics	$< -30$ dBc				

### Output

**Level range:** +13 to -139.9 dBm (1 V to 0.023  $\mu$ V<sub>rms</sub> into 50  $\Omega$ ).

**Resolution:** 0.1 dB.

**Absolute level accuracy (+15° to +45°C):**  $\pm 1$  dB between +13 and -120 dBm,  $\pm 3$  dB between -120 and -130 dBm.

**SWR:** Typically from 1.5 to 1.8 depending on output level and frequency.

**Reverse Power Protection:** Typically up to 30W or  $\pm 8$  Vdc.

### Amplitude Modulation

**Depth:** 0 to 95% at output levels of +8 dBm and below (+10 dBm in uncorrected mode). AM available above these output levels but not specified.

**Resolution:** 1%, 10 to 95% AM; 0.1%, 0 to 9.9% AM.

**Incidental PM (at 30% AM):** 0.15-640 MHz,  $< 0.12$  radian peak; 640-1280 MHz,  $< 0.09$  radian peak.

**Incidental FM (at 30% AM):** 0.15-640 MHz,  $< 0.12 \times f_{mod}$ ; 640-1280 MHz,  $< 0.09 \times f_{mod}$ .

**Indicated accuracy:**  $\pm 5\%$  of reading  $\pm 1\%$  AM. Applies for rates given in table below, internal or external mode, for depths  $\leq 90\%$ .

**Rates and distortion with internal or external modulating signal:**

Frequency range	AM rate	AM Distortion		
		0-30% AM	30-70% AM	70-90% AM
0.15-1 MHz	dc-1.5 kHz	2%	4%	5.75%
1-10 MHz	dc-5 kHz	2%	4%	5.75%
10-1280 MHz	dc-10 kHz	2%	4%	5.75%

### Frequency Modulation

**FM rates (1 dB bandwidth):** external ac, 20 Hz to 100 kHz; external dc, dc to 100 kHz.

**FM deviation:** from 25 to 200 kHz depending on carrier frequency.

**Indicated FM accuracy:**  $\pm 8\%$  of reading plus 10 Hz (50 Hz to 20 kHz).

**FM resolution:** 100 Hz for deviations  $< 10$  kHz, 1 kHz for deviations  $\geq 10$  kHz.

**Incidental AM (AM sidebands at 1 kHz rate and 20 kHz deviation):**  $< -72$  dBc,  $f_c < 640$  MHz;  $< -65$  dBc,  $f_c \geq 640$  MHz.

**FM distortion:**  $< 1.7\%$  for rates  $< 20$  kHz,  $< 1\%$  for rates  $< 1$  kHz.

**Center frequency accuracy and long term stability in AC mode:** same as CW mode.

### Supplemental Characteristics

#### Typical SSB Phase Noise:

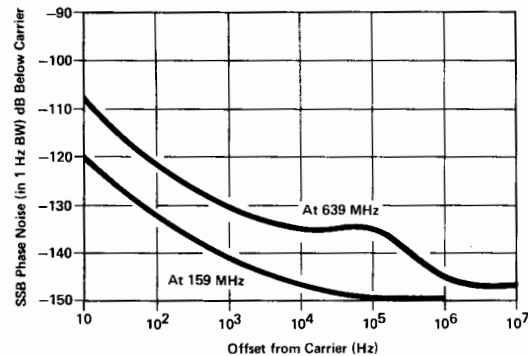

**Frequency switching speed:**<sup>4</sup> From 420  $\mu$ sec to 12.5 msec, depending on the programming mode.

## 8663A Specifications

The 8663A signal generator is related to the 8662A in both concept and structure. The 8662A concept of an extremely low phase noise signal source incorporating signal generator modulation capabilities and output characteristics is carried even further by the 8663A. While maintaining high spectral purity, the 8663A offers increased frequency range to 2560 MHz, increased output level to +16 dBm, and the addition of phase and pulse modulation. The result is a highly flexible and powerful signal generator that utilizes and extends the proven circuitry of the 8662A. Thus, the 8662A and 8663A share many of the same specifications as shown below:

### Frequency

**Range:** 100 kHz to 2560 MHz (2559.999996 MHz)

**Resolution:** .1 Hz ( $f_c < 640$  MHz)

.2 Hz ( $640 \text{ MHz} \leq f_c < 1280$  MHz)

.4 Hz ( $f_c \geq 1280$  MHz)

**Accuracy, stability, and internal reference oscillator:** identical to 8662A.

### Spectral Purity

**Residual SSB phase noise in 1 Hz BW ( $320 \leq f_c < 640$  MHz):** identical to 8662A.

**Typical SSB phase noise:** identical to the 8662A for  $f_c$  between 100 kHz and 1280 MHz (see graph). For  $f_c$  between 1280 and 2560 MHz, the noise will be approximately 12 dB higher than the 639 MHz curve on the "typical SSB phase noise" graph.

**Spurious Signals:** Identical to 8662A except for  $f_c$  between 1280 and 2560 MHz the spurious non-harmonics are -78 dBc, the sub-harmonically related ( $f/2$ ,  $3f/2$ , etc.) are -40 dBc, and the power line (60 Hz) or microphonically generated spurious are -65 dBc.

**Harmonics:**  $< -30$  dBc,  $f_c < 1280$  MHz;  $< -25$  dBc,  $f_c \geq 1280$  MHz

### Output

**Level range:** +16 dBm to -129.9 dBm

**Resolution:** .1 dB

**Absolute level accuracy (+15° to +45°C):**  $\pm 1$  dB, +16 dBm to -119.9 dBm;  $\pm 3$  dB for -120 dBm and below.

**SWR:** Typically from 1.5 to 1.75 depending on output level and frequency.



# SIGNAL GENERATORS

Models 8662A, 8663A (Cont.)

## Amplitude Modulation

**Depth:** 0 to 95% at levels of +10 dBm and below

**Resolution:** .1%

**Incidental FM (at 30% AM):** Identical to 8662A except:  $<.3 \times f_{\text{mod}}$  for  $1280 \leq f_c < 2560$  MHz

**Indicated accuracy:**  $\pm 6\%$  of reading  $\pm 1\%$  AM (400 Hz and 1 kHz, depth 90%)

### AM Bandwidth (1dB):

DC to  $>1.5$  kHz,  $0.15 \text{ MHz} \leq f_c < 1 \text{ MHz}$ ;

DC to  $>5$  kHz,  $1 \text{ MHz} \leq f_c \leq 10 \text{ MHz}$ ;

DC to  $>10$  kHz,  $f_c > 10 \text{ MHz}$ ;

External dc coupling.

External ac coupling or internal; low frequency coupling is 20 Hz.

**Distortion (400 Hz and 1 kHz):**  $<2\%$  (0–30% AM)  
 $<4\%$  (30–70% AM)  
 $<6\%$  (70–90% AM)

## Frequency Modulation

**FM rates (1 dB bandwidth):** External ac, 20 Hz to 100 kHz, external dc, dc to 100 kHz.

**Maximum allowable peak deviation:** Identical to 8662A for  $f_c$  between 100 kHz and 1280 MHz. Up to 400 kHz for  $f_c$  between 1280 and 2560 MHz.

**Indicated FM accuracy (50 Hz to 20 kHz):**  $\pm 9\%$  of setting +10 Hz.

**FM resolution:** 100 Hz to 1 kHz depending on  $f_c$  and deviation setting.

**Incidental AM (AM sidebands at 1 kHz rate and 20 kHz deviation):**

$< -72$  dBc ( $10 \leq f_c < 640$  MHz)

$< -65$  dBc ( $640 \leq f_c < 2560$  MHz)

**FM distortion:**  $<1.25\%$  (400 Hz and 1 kHz rates)  
 $<1.75\%$  (rates less than 20 kHz)

### Phase Modulation (Option 002)

**Maximum peak phase deviation:** from  $\pm 25^\circ$  for  $f_c$  between 120 and 160 MHz up to  $\pm 400^\circ$  for  $f_c$  between 1280 and 2560 MHz.

**Maximum rate:** from 10 kHz for  $f_c$  between .15 and 10 MHz up to 10 MHz for  $f_c$  between 250 and 2560 MHz.

**Phase deviation resolution:**  $1^\circ$  ( $.1 \leq f_c < 640$  MHz)  
 $2^\circ$  ( $640 \leq f_c < 1280$  MHz)  
 $4^\circ$  ( $1280 \leq f_c < 2560$  MHz)

**Phase modulation distortion:** 10% at maximum rate

### Biphase Modulation

Biphase modulation is available on the standard 8663A for  $f_c$  less than 640 MHz and available for all  $f_c$  with option 002.

**Deviation:**  $\pm 90^\circ$

**Carrier null when modulated with 1 MHz, 50% duty cycle square wave:**  $> 25$  dBc.

**Modulation input required:** TTL positive true. The internal modulation oscillator can be used for 50% duty cycle modulation. External input is on rear panel.

### Pulse Modulation<sup>5</sup>

**Pulse on/off ratio:**  $>80$  dB (50–640 MHz);  $>85$  dB ( $f_c \geq 640$  MHz)

**Pulse rise/fall time:**  $<250$  ns (50–640 MHz);  $<50$  ns ( $f_c \geq 640$  MHz)

### Pulse repetition frequency:

Internal: 10 Hz to 99.9 kHz (50% duty cycle)

External: 10 Hz to 2 MHz,  $50 \text{ MHz} < f_c < 640 \text{ MHz}$

10 Hz to 5 MHz,  $f_c > 640 \text{ MHz}$

### Internal Modulation Oscillator

**Rates:** 10 Hz to 99.9 kHz

**Frequency resolution:** 3 digits

**Frequency accuracy:** Same as reference oscillator.

**Output level (available on rear panel):** 1 volt peak into 600  $\Omega$

**Output impedance:** 600  $\Omega$

**Flatness (referenced to 1 kHz):**  $< \pm 1\%$

**Distortion:**  $<1\%$

## Other 8662A and 8663A Information

**Remote programming:** The HP-IB interface is standard on the 8662A and 8663A signal generators. All functions controlled from the front panel with the exception of the line switch are programmable with the same accuracy and resolution as in manual mode.

**Operating temperature range:**  $0^\circ$  to  $+55^\circ\text{C}$ .

**Leakage:** Meets radiated and conducted limits of MIL STD 461A methods RE02 and CE03 as well as VDE 0871. Furthermore, less than  $1 \mu\text{V}$  is induced in a two-turn, 1-inch diameter loop 1 inch away from the front panel and measured into a 50  $\Omega$  receiver.

**Power requirements<sup>7</sup>:** 115 (90-126) V or 230 (198-252) V; 48 to 66 Hz; 450 VA max.

**Weight:** 8662A: net 30 kg (65.5 lb.); shipping 36 kg (80 lb.).

8663A: net 33.8 (74 lb.); shipping 40 kg (88 lb.).

**Size:** 8662A: 178 mm H x 425 mm W x 572 mm D (7" x 16.75" x 22.5")

8663A: 178 mm H x 425 mm W x 642 mm D (7" x 16.75" x 25.3")

Note: depth includes front panel depth of 45 mm (1.75").

## Ordering Information

**8662A 1280 MHz Signal Generator<sup>6</sup>**

**Option 001:** Rear panel RF output and mod input

**Option 907:** Front Handle kit

**Option 908:** Rack flange kit

**Option 909:** Rack flange & front handle kit

**Option 910:** Extra operating & service manual

**11721A** External frequency doubler for operation to 2.56 GHz (8662A only)

**8663A 2560 MHz Signal Generator<sup>6</sup>**

**Option 001:** Rear panel RF output and mod inputs

**Option 002:** Wideband linear phase modulation

**Option 907:** Front handle kit

**Option 908:** Rack flange kit

**Option 909:** Rack flange & front handle kit

**Option 910:** Extra operating & service manual

**11714A** Service Support Kit (required for service for 8662A/8663A)

<sup>1</sup>In the remote mode it is possible to have microprocessor clock related spurious signals spaced 3 MHz apart at an absolute level of typically less than  $-145$  dBm.

<sup>2</sup>Spurious signals can be up to 3 dB higher in the dc FM mode.

<sup>3</sup>At a 50 Hz line frequency, power line or microphonically related spurious signals may be up to 3 dB higher and appear at offsets as high as 1 kHz from the carrier.

<sup>4</sup>Due to automatic leveling loop bandwidth changes, brief (30 msec) level inaccuracies may occur when switching through 150 kHz and 1 MHz RF output frequencies.

<sup>5</sup>Pulse modulation is available for  $f_c < 50$  MHz but is unspecified.

<sup>6</sup>HP-IB cables not supplied, see page 29 for description and prices.

- 10 kHz to 2600 MHz
- Synthesizer stability and accuracy
- 1 Hz resolution (2 Hz above 1300 MHz)

- Ten digit display
- Calibrated output over > 140 dB range
- AM, FM,  $\Phi$ M, or pulse modulation

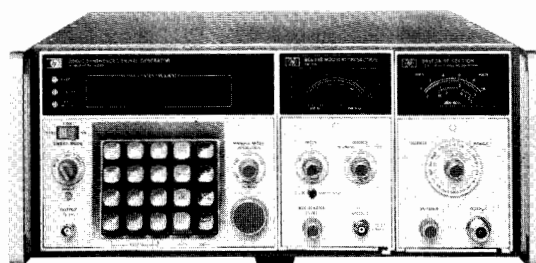

8660C

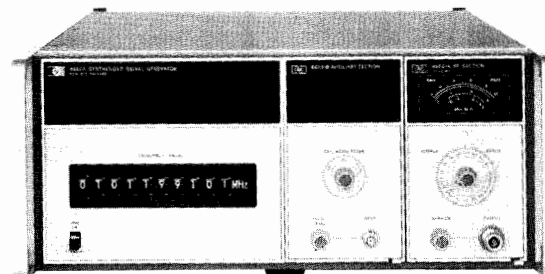

8660A

## 8660A, 8660C Synthesized Signal Generators

### System Concept

The 8660 is a modular solid-state plug-in system. Each system includes: 1) a programmable synthesized signal generator mainframe. 2) an RF section plug-in, and 3) a modulation section. Synthesized accuracy and stability along with complete programmability make the 8660 ideal for most automated receiver and component testing situations.

### Mainframes

There are two mainframes, the 8660A and 8660C which both offer a BCD or optional HP-IB interface and operation from an internal or external frequency reference. The 8660A mainframe uses thumb-wheel switches to select CW output frequencies. The 8660C mainframe provides direct keyboard entry of CW frequencies. Added capabilities of the 8660C include digital sweep, frequency stepping, control of frequency with a tuning knob, and a ten-digit numerical display.

### Plug-in RF Sections

The 86601A (.01 - 110 MHz), 86602B (1 - 1300 MHz), and 86603A (1 - 2600 MHz) are the three RF section choices. The 11661B Frequency Extension Module (mainframe option 100) must be used with the 86602B and 86603A and is installed internal to an 8660 mainframe. When using the 8660A mainframe, the 86603A plug-in must be ordered with option 003.

### Plug-in Modulation

There are five modulation sections to choose from. The 86631B Auxiliary Section provides external AM and pulse modulation. The 86632B offers AM and FM and utilizes a free-running VCO to provide high FM deviations and rates while the 86633B provides AM and phase locked FM. The 86634A offers high performance phase modulation with rates to 10 MHz while the 86635A provides both FM and phase modulation. (The 86634A and 86635A must be used with option 002 RF Section.)

## 8660A, 8660C Mainframe Specifications

**Frequency accuracy and stability:** CW frequency accuracy and long term stability are determined by internal reference oscillator ( $3 \times 10^{-8}$ /day), or by external reference.

### Reference Oscillator

**Internal:** 10 MHz quartz oscillator. Aging rate less than  $\pm 3$  parts in  $10^6$  per 24 hours after 72 hours warm-up ( $\pm 3$  parts in  $10^9$  per 24 hours, Option 001).

**External:** rear panel switch allows operation from 5 MHz or 10 MHz frequency standard at a level between 0.5 and 2.5 Vrms into 170 ohms.

**Reference output:** rear panel BNC connector provides output of reference signal selected at level of at least 0.5 Vrms into 170 ohms.  
**Digital sweep (8660C):** auto, single, or manual. Selectable speeds 0.1, 1, or 50 seconds.

### Remote Programming

#### Functions

**8660A:** all front panel frequency and output level (and most modulation functions) are programmable.

**8660C:** CW frequency, frequency stepping (STEP $\downarrow$ , STEP $\uparrow$ ), output level, and most modulation functions are programmable. Note: digital sweep is NOT programmable.

#### Programming Input

**Connector type:** 36-pin Cinch type 57 (mating connector supplied). 24-pin Cinch type 57 for optional HP-IB interface (mating connector NOT supplied).

**Logic:** TTL compatible (negative true).

**Switching time:** less than 5 ms to be within 100 Hz of any new frequency selected. (Less than 100 ms to be within 10 Hz.)

### General

**Operating temperature range:** 0 to +55°C.

**Power:** 100, 120, 220, or 240 volts +5%, -10%, 48-66 Hz; approximately 350 watts.

**Weight (mainframe only):** net 23.2 kg (51 lb); shipping, 28.6 kg (63 lb).

### Supplemental Characteristics

#### Typical single sideband phase noise

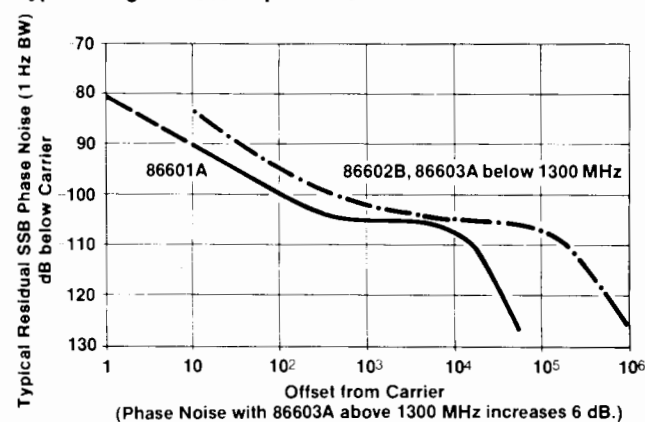



10 kHz to 110 MHz

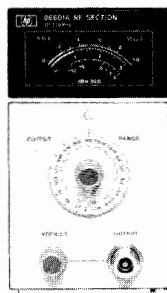

86601A

1 MHz to 1300 MHz

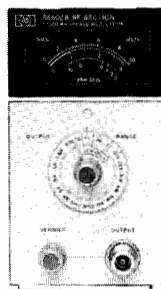

86602B (11661B required)

1 MHz to 2600 MHz

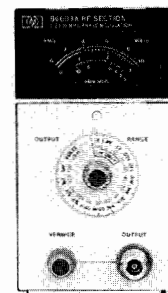

86603A (11661B required)

## RF Section Specifications (Installed in 8660A or 8660C mainframe)

		86601A	86602B (requires 11661B)	86603A (requires 11661B)	
FREQUENCY CHARACTERISTICS	Frequency Range	0.01–110 MHz (109.999999 MHz)	1–1300 MHz (1299.999999 MHz)	1–2600 MHz (2599.999998 MHz)	
	Frequency Resolution	1 Hz	1 Hz	CF < 1300 MHz: 1 Hz CF ≥ 1300 MHz: 2 Hz	
	Harmonics	< -40 dBc	< -30 dBc (< -25 dBc above +3 dBm)	< -20 dBc <sup>1</sup>	
	Spurious Non Harmonically Related	-80 dBc	-80 dBc below 700 MHz -80 dBc above 700 MHz within 45 MHz of carrier -70 dBc above 700 MHz > 45 MHz from carrier -50 dBc on +10 dBm range	-74 dBc within 40 MHz of carrier <sup>1</sup> -64 dBc > 45 MHz from carrier < -64 dBc	
	Power Line Related (CW, AM, φM only) <sup>2</sup>	-70 dBc	< -70 dBc	< -70 dBc	
	Signal To Phase Noise Ratio (CW, AM, φM only) <sup>2</sup>	> 50 dB	> 45 dB	> 39 dB	
OUTPUT CHARACTERISTICS	Output Level (into 50 Ω)	+13 dBm to -146 dBm	+10 to -146 dBm	+10 to -136 dBm +7 to -136 dBm <sup>3</sup>	
	Output Accuracy (local and remote)	± 1 dB, +13 to -66 dBm ± 2 dB, -66 to -146 dBm	± 1.5 to -76 dBm ± 2.0 to -146 dBm	± 2.5 dB to -76 dBm <sup>3</sup> ± 3.5 dB to -136 dBm	
	Flatness (output level variation with frequency)	< ± 0.75 dB	< ± 1.0 dB	< ± 2.0 dB (1–2600 MHz)	
	Impedance	50 Ω			
MODULATION CHARACTERISTICS	AM	AM Modulation Depth	0 to 95%	0 to 90% <sup>4</sup>	
		3 dB Bandwidth:	0–30%	200 Hz, CF < 0.4 MHz 10 kHz, 0.4 ≤ CF < 4 MHz 100 kHz, CF ≥ 4 MHz	10 kHz, CF < 10 MHz 100 kHz, CF ≥ 10 MHz
			0–70%	125 Hz, CF < 0.4 MHz 6 kHz, 0.4 ≤ CF < 4 MHz 60 kHz, CF ≥ 4 MHz	6 kHz, CF < 10 MHz 60 kHz, CF ≥ 10 MHz
			0–90%	100 Hz, CF < 0.4 MHz 5 kHz, 0.4 ≤ CF < 4 MHz 50 kHz, CF ≥ 4 MHz	5 kHz, CF < 10 MHz 50 kHz, CF ≥ 10 MHz
	Distortion, <sup>5</sup> THD at 30% AM at 70% AM at 90% AM		< 1%, 0.4–110 MHz < 3%, 0.4–110 MHz < 5%, 0.4–110 MHz	< 1% < 3% < 5%	< 5% N/A N/A
	FM	FM Rate	dc to 1 MHz with 86632B 20 Hz to 100 kHz with 86633B	dc to 200 kHz with 86632B and 86635A 20 Hz to 100 kHz with 86633B	
		Maximum Deviation (peak)	1 MHz with 86632B 100 kHz with 86633B	200 kHz with 86632B and 86635A 100 kHz with 86633B	400 kHz w/ 86632B, 86635A 200 kHz w/ 86633B
		Distortion, THD (at rates up to 20 kHz)	< 1% up to 200 kHz dev. < 3% up to 1 MHz dev.	< 1% up to 200 kHz dev.	
	PULSE	Pulse Rise/Fall Time	200 ns	50 ns	
		ON/OFF Ratio (with pulse level control at max.)	> 50 dB	> 40 dB	> 60 dB
φM	φM Rate	N/A	dc to 1 MHz with 86635A dc to 1 MHz for CF < 100 MHz dc to 10 MHz for CF ≥ 100 MHz with 86634A		
	Maximum Peak Deviation	N/A	0 to 100 degrees	0 to 200 degrees	
	Distortion, THD	N/A	< 5% up to 1 MHz rates < 7% up to 5 MHz rates < 15% up to 10 MHz rates		
GENERAL	Weight	Net 5 kg (11 lb) Shipping 6.8 kg (15 lb)	Net 4.1 kg (9 lb) Shipping 5.5 kg (12 lb)	Net 5 kg (11 lb) Shipping 6.4 kg (14 lb)	
		11661B: Net 2.3 kg (5 lb); shipping 2.7 kg (6 lb)			

<sup>1</sup>For output levels +3 dBm and below; slightly higher +3 to +7 dBm.

<sup>2</sup>Measured in a 30 kHz band centered on the carrier excluding a 1 Hz band centered on the carrier.

<sup>3</sup>For +3 to +7 dBm output levels, output accuracy and flatness will be slightly degraded (above 1300 MHz only)

<sup>4</sup>For RF output level meter readings from +3 dB to -6 dB and only at +3 dBm and below.

<sup>5</sup>Applies only at 400 Hz and 1 kHz rates with output meter set between 0 and +3 dB. At -6 dB meter setting the distortion approximately doubles.

<sup>6</sup>Phase modulation is only possible with Option 002 RF Sections.

Pulse / AM

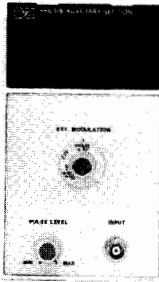

86631B

AM / High Deviation FM

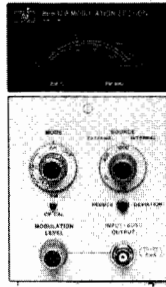

86632B

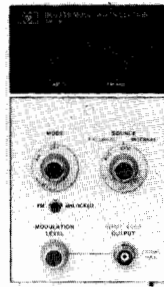
AM /  $\phi$  Locked FM

86633B

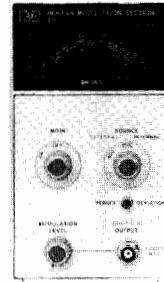
High rate  $\phi$ M

86634A

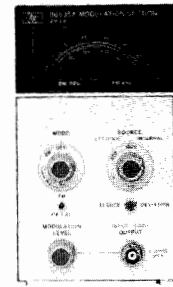
 $\phi$ M / FM

86635A

## Modulation Section Specifications

		86631B	86632B	86633B	86634A	86635A
AM	Functions	Ext. Only	Int. and Ext.	Int. and Ext.	—	—
	Indicated Accuracy (at 400 and 1000 Hz rates)	—	$\pm 5\%$ of full scale With 86601A RF Section: $\pm 7\%$ , center frequency $\geq 100$ MHz. With 86603A RF Section: $\pm 10\%$ , center frequency $\geq 1300$ MHz.		—	—
FM	Functions	—	Int. and Ext., FM CF CAL	Int. and Ext.	—	Int. and Ext., FM CF CAL
	Center Frequency Long Term Stability	—	Typically less than 200 Hz/h	Same as in CW Mode ( $3 \times 10^{-8}$ /day)	—	Typically less than 200 Hz/h
	Indicated Accuracy (up to 20 kHz rates)	—	$\pm 5\%$ of full scale		—	$\pm 5\%$ of full scale
Pulse	Functions	Ext. Only	—	—	—	—
$\phi$ M	Functions	—	—	—	Int. and Ext.	Int. and Ext.
	Indicated Accuracy (15°C to 35°C)	—	—	—	$\pm 5\%$ of full scale up to 100 kHz rates $\pm 8\%$ of full scale up to 2 MHz rates $\pm 15\%$ of full scale up to 10 MHz rates	
Meter		—	0—100% AM 0—10, 100, 1000 kHz FM Pk. Dev. (0—20, 200, 2000 kHz FM for CF $\geq 1300$ MHz)	0—100% AM 0—10, 100 kHz FM Pk. dev. (0—20, 200 kHz FM for CF $\geq 1300$ MHz)	0—100° Peak $\phi$ M (0—200° for CF $\geq$ 1300 MHz)	0—10, 100, 1000 kHz FM, 0—100° Pk $\phi$ M (0—20, 200, 2000 kHz FM, 0—200° Pk. $\phi$ M for CF $\geq 1300$ MHz)
Internal Modulation Source Output		None	400 Hz and 1 kHz $\pm 5\%$ 200 mV minimum into 10k $\Omega$ . Available at front panel BNC connector			
Input Impedance		50 $\Omega$ Pulse 600 $\Omega$ AM	600 $\Omega$	600 $\Omega$	50 $\Omega$	600 $\Omega$
Weight		Net, 1.4 kg (3 lb) Shipping, 2.3 kg (5 lb)	Net, 2.7 kg (6 lb) Shipping, 4.1 kg (9 lb)	Net, 2.7 kg (6 lb) Shipping, 4.1 kg (9 lb)	Net, 1.8 kg (4 lb) Shipping, 3.2 kg (7 lb)	Net, 2.7 kg (6 lb) Shipping, 4.1 kg (9 lb)

### Ordering Information

**8660A** Synthesized Signal Generator Mainframe

**8660C** Synthesized Signal generator Mainframe

#### Options for 8660A, 8660C

**Option 001:**  $\pm 3 \times 10^{-9}$ /day internal reference oscillator

**Option 002:** no internal reference oscillator

**Option 003:** operation from 50 to 400 Hz line

**Option 004:** 100 Hz frequency resolution (200 Hz above 1300 MHz)

**Option 005:** HP-1B programming interface

**Note:** HP-1B cables not supplied, see page 30.

**Option 009:** (8660A only) LED display indicates selected frequency in 1-2-4-8 BCD code

**Option 100:** 11661B factory installed inside mainframe

**Option 908:** Rack Flange Kit

**86601A** 0.01–110MHz RF Section

**86602B** 1–1300 MHz RF Section

**86603A** 1–2600 MHz RF Section

**Note:** 86602B and 86603A RF sections require an 11661B for operation.

**Option 001:** no RF output attenuator (all RF Sections)

**Option 002:** adds phase modulation capability (86602B, 86603A only)

**Option 003:** allows operation of 86603A with 8660A mainframe

**11661B** Frequency Extension Module

**86631B** Auxiliary Section

**86632B** AM/FM Modulation Section

**86633B** AM/FM Modulation Section

**86634A**  $\phi$ M Modulation Section

**86635A**  $\phi$ M/FM Modulation Section

**11672A** Service Accessory Kit

**11707A** Test Plug-in





# SIGNAL GENERATORS

## Mechanically Tuned VHF Generator

### Models 8640A, 8640B

- 0.5 to 512 MHz frequency range with optional coverage to 1024 MHz
- +19 to -145 dBm output power range
- Low SSB phase noise
- Calibrated, metered AM, FM, and pulse modulation
- 8640B also features: internal phase lock/synchronizer, digital frequency readout, external count capability to 550 MHz

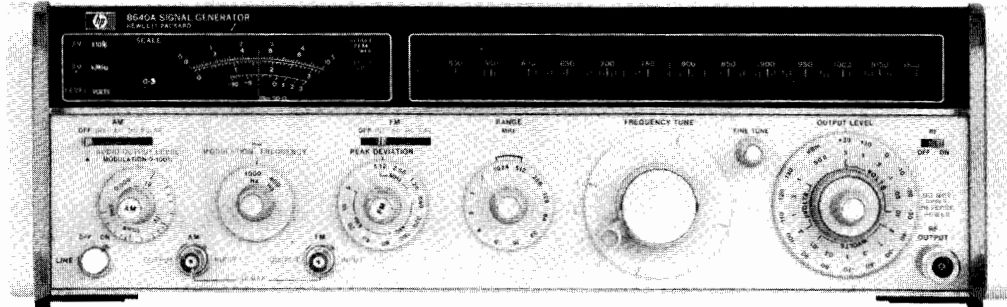

8640A (with Option 002)

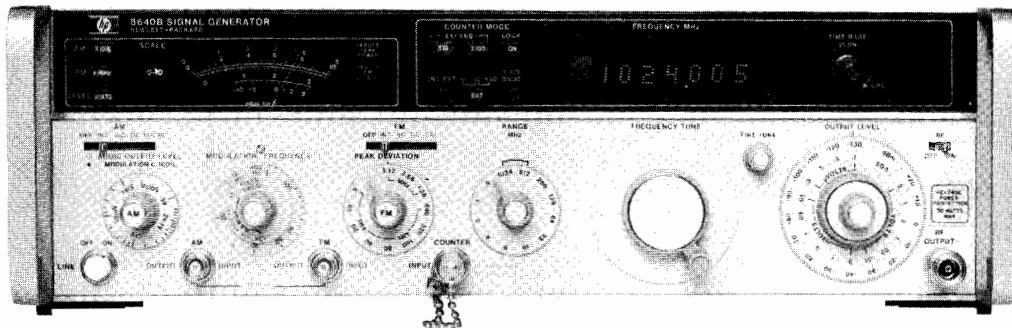

8640B (with Option 001, 002, 003)

### 8640A and 8640B Signal Generators

The 8640 Signal Generator covers the frequency range 500 kHz to 512 MHz (450 kHz to 550 MHz with band overrange) and can be extended to 1024 MHz with an internal doubler (Opt 002). Using the 11710B Down Converter, the 8640 frequency range can be extended down to 10 kHz. An optional audio oscillator (Opt 001) is also available with a frequency range of 20 Hz to 600 kHz. This broad coverage, together with calibrated output and modulation, provides for complete RF and IF performance tests on virtually any type of HF, VHF, or UHF receiver.

Both solid state generators, 8640A and B have an output level range of +19 to -145 dBm (2V to 0.013  $\mu$ V) which is calibrated, metered, and leveled to within  $\pm 0.5$  dB across the full frequency range of the instrument.

The 8640A and 8640B generators provide AM, FM, and pulse modulation for a wide range of receiver test applications. This modulation is calibrated and metered for direct readout under all operating conditions.

A reverse power protection option (Opt 003) is available to eliminate instrument damage due to accidental transmitter keying. This module protects against up to 50 watts of applied power and automatically resets upon removal of the reverse power.

#### Spectrally Pure Output Signals

Noise performance of the 8640 is state-of-the-art for a solid-state generator. The high-Q cavity oscillator has been optimized with use of a low-noise microwave transistor for spectrally pure output signals. At a 20 kHz offset from the carrier, SSB phase noise is  $< -130$  dBc for carrier frequencies from 230 to 450 MHz, and rises to  $-122$  dBc at 550 MHz. The SSB phase noise level decreases by approximately 6 dB for each division of the output frequency down to the broadband noise floor of better than 140 dB/Hz. This exceptional noise performance is also preserved during FM modulation and in the phase-locked mode of the 8640B.

#### Mechanical Dial or Built-in Counter

There are two versions of the 8640 Signal Generator. The 8640A has an easy-to-read slide rule dial with scales for each of the 10 output frequency ranges. There is an additional scale to provide direct readout of the output frequency even in the Option 002 INTERNAL DOUBLER band, 512-1024 MHz.

The 8640B combines the same performance features as the 8640A with a built-in 550 MHz frequency counter and phase lock synchronizer.

The internal 6 digit counter displays the output frequency and can also be used to count external input signals from 20 Hz to 550 MHz. This eliminates the need for a separate frequency counter in many measurement systems.

#### Internal Pushbutton Synchronizer

At the push of a button, the 8640B built-in phase lock synchronizer locks the RF output frequency to the crystal time base used in the counter. In this locked mode, the output stability is better than  $5 \times 10^{-8}$ /h and the spectral purity and FM capability of the unlocked mode are preserved. For higher stability, it is possible to lock to an externally applied 5 MHz standard. Two 8640B's can also be locked together for various 2-tone measurements.

In the phase locked mode, increased resolution is available by using the  $\frac{1}{2}$  digit increment button. For example, 500 Hz resolution is possible for frequencies between 100 and 1000 MHz.

#### FM While Phase Locked

In the phase locked mode, full FM capability is preserved down to modulation rates of 50 Hz. The narrow bandwidth of the phase lock loop ( $< 5$  Hz) provides for FM modulation up to 250 kHz rates and assures no degradation in noise from the unlocked mode. This crystal stability, coupled with the precision modulation and low noise, makes the 8640B ideal for testing narrowband FM or crystal-controlled receivers.



### 8640A and 8640B Specifications

(See technical data sheet for complete specifications.) All specifications apply over the nominal frequency ranges and over the top 10 dB of the output level vernier range unless otherwise specified.

#### Frequency

**Range:** 500 kHz to 512 MHz in 10 octave ranges (to 1024 MHz with option 002 internal frequency doubler).

**Ranges and range overlap:** ranges extend approximately 10% below and 7% above the nominal frequency ranges shown below.

Frequency ranges (MHz)		
0.5-1	8-16	128-256
1-2	16-32	256-512
2-4	32-64	512-1024
4-8	64-128	(opt 002)

#### Fine Tuning

**8640A and 8640B unlocked:** >1000 ppm total range.

**8640B locked mode:** > ±20 ppm by varying internal time base vernier.

#### Internal counter resolution (8640B unlocked):

Frequency Ranges (MHz)	Normal Mode	Expand	
		X10	X100
0.5-1	10 Hz	1 Hz	0.1 Hz
1-16	100 Hz	10 Hz	1 Hz
16-128	1 kHz	100 Hz	10 Hz
128-1024	10 kHz	1 kHz	100 Hz

#### Optimum counter resolution when phase-locked (8640B):

Frequency Ranges (MHz)	With 6 Digits	
	With 6 Digits	+ 1/2 Digit
0.5-0.9999995	1 Hz	0.5 Hz
1.0-9.999995	10 Hz	5 Hz
10.0-99.99995	100 Hz	50 Hz
100.0-999.9995	1 kHz	500 Hz
1000-1024	10 kHz	5 kHz

#### Accuracy:

**8640A:** mechanical dial; accuracy better than ±1.0%, resettability better than 0.1%.

**8640B:** 6½ digit LED display with X10 and X100 expand; accuracy depends on internal or external reference used.

#### Stability (after 2 hour warmup):

**Normal:** <10 ppm/10 min.

**Locked:** (8640B) <0.05 ppm/h.

#### Restabilization time after frequency change:

**Normal:** <15 min.

**Locked (8640B):** <1 min. after relocking to be within 0.1 ppm of steady state frequency.

#### Output

**Range:** 10 dB steps and 18 dB vernier provide the following output power settings into 50Ω.

Frequency Range (MHz)	8640A/B	With Option(s)		
		002	003	002/003
0.5 to 512	+19 to -145 dBm	+18.5 to -145 dBm	+18.5 to -145 dBm	+18 to -145 dBm
512 to 1024 (Option 002)		+13 to -145 dBm		+12 to -145 dBm

**Level flatness (referred to output at 50 MHz and applies to 1 V range and for top 10 dB of vernier range)**

Frequency Range (MHz)	8640A 8640B	With Option(s)		
		002	003	002/003
0.5 to 64	±0.5 dB	±0.75 dB	+0.75 dB -1.25 dB	+1.0 dB -2.0 dB
64 to 512		±1.0 dB		
512 to 1024 (Option 002)		±1.5 dB		±2.0 dB

**Level accuracy:** (worst case as indicated on level meter) ±1.5 dB to ±4.5 dB depending on level, frequency, and options installed.

#### Spectral Purity

**Harmonics (at 1 volt, +10 dBm output range and below):**

>30 dB below fundamental, 0.5 to 512 MHz.

>12 dB below fundamental, 512 to 1024 MHz (option 002).

**Spurious output signals (excluding frequencies within 15 kHz of the signal whose effects are specified in residual AM and FM)**

Frequency Range (MHz)	Subharmonically Related		Non-harmonically Related	
	8640A	8640B	8640A	8640B
0.5 to 512	none detectable	<-100 dBc	none detectable	<-100 dBc
512 to 1024 (Option 002)	<-20 dBc			

dBc = dB below the carrier.

**Residual AM (averaged rms):** 0.3 to 3 kHz post-detection noise bandwidth >85 dBc.

**Residual FM (averaged rms):** 0.3 to 3 kHz post-detection noise bandwidth. (CW and up to 1/4 maximum allowable peak deviation.)

0.5 to 512 MHz: <5 Hz.

512 to 1024 MHz: <10 Hz.

**Measured SSB noise (typical):** in graph below, triangular markers indicate specified limits.

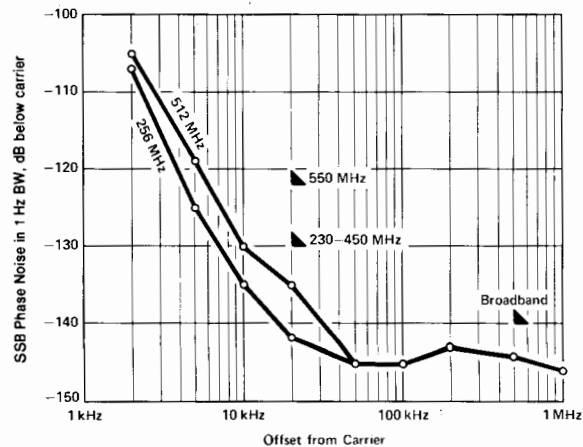



## Modulation

### General

**Types:** Internal AM and FM; External AM, FM, and PULSE; simultaneous AM and FM or PULSE and FM.

**Internal modulation sources** (independently adjustable output level is available at front panel):

**Standard:** 8640A or 8640B.

**Frequency:** fixed 400 Hz and 1 kHz,  $\pm 3\%$ .

**Output level:** 10 mV to 1 V rms into 600 $\Omega$ .

**Optional** (internal variable audio oscillator Option 001, 8640A or 8640B):

**Frequency:** variable 20 Hz to 600 kHz,  $\pm 15\%$  plus fixed 400 Hz and 1 kHz  $\pm 3\%$ .

**Output level:** 1 mV to 3 V rms into 600 $\Omega$ .

### Amplitude Modulation

#### Depth:

**0.5 to 512 MHz:** 0 to 100% for output levels from +13 dBm and below.

**512 to 1024 MHz:** 0 to 100% for output levels of +7 dBm and below, excluding the top 6 dB of output vernier range.

**AM Rates:** INT and EXT ac, 20 Hz to AM 3 dB bandwidth; EXT dc, dc to AM 3 dB bandwidth.

#### AM 3 dB bandwidth:

Frequency Ranges	0 to 50% AM	50 to 90% AM
0.5 to 2 MHz	20 kHz	12.5 kHz
2 to 8 MHz	40 kHz	25 kHz
8 to 512 MHz	60 kHz	50 kHz
512 to 1024 MHz	60 kHz	50 kHz

#### AM distortion (at 400 Hz and 1 kHz rates):

Frequency Ranges	0 to 30% AM	30 to 50% AM	50 to 90% AM
0.5 to 512 MHz	<1%		<3%
512 to 1024 MHz	<10%	<20%	

#### External AM sensitivity (400 Hz and 1 kHz rates):

**0.5 to 512 MHz:** (0.1  $\pm$  0.005)% AM per mV peak into 600 $\Omega$  with AM vernier at full clockwise position.

**512 to 1024 MHz:** nominal 0.1% AM per mV peak into 600 $\Omega$  with AM vernier at full clockwise position.

#### Indicated AM accuracy (400 Hz and 1 kHz rates using internal meter):

**0.5 to 512 MHz:**  $\pm 5.5\%$  of reading  $\pm 1.5\%$  of full scale from 0 to 50 $^{\circ}$ C.

**512 to 1024 MHz:** not specified; each generator can be individually calibrated using operating manual procedure.

#### Peak incidental phase modulation (at 30% AM):

**0.5 to 128 MHz:** <0.15 radian.

**128 to 512 MHz:** <0.3 radian.

**512 to 1024 MHz:** <0.6 radian.

**Peak incidental frequency deviation:** equals peak incidental phase modulation x modulation rate.

### Pulse Modulation<sup>1</sup>

	Frequency Ranges (MHz)					
	0.5-1	1-2	2-8	8-32	32-512	512-1024
Rise and Fall Times	<9 $\mu$ s	<4 $\mu$ s	<2 $\mu$ s	<1 $\mu$ s		<1 $\mu$ s typical
Pulse Repetition Rate	50 Hz to 50 kHz		50 Hz to 100 kHz	50 Hz to 250 kHz	50 Hz to 500 kHz	
Pulse Width Minimum <sup>2</sup>	10 $\mu$ s		5 $\mu$ s	2 $\mu$ s		
Pulse ON/OFF ratio at max. vernier	>40 dB				>60 dB	
Peak Input Required	Nominally +0.5 V (5 V max). Sinewave or pulse return to zero into 50 $\Omega$ .					

<sup>1</sup>Pulse performance degrades below 500 Hz repetition rates.

<sup>2</sup>For level accuracy within 1 dB of CW (>0.1% duty cycle).

### Frequency Modulation

**Deviation:** maximum allowable deviation equals 1% of lowest frequency in each nominal output frequency range.

Frequency Range (MHz)	Maximum Peak Deviation (kHz)
0.5-1	5
1-2	10
2-4	20
4-8	40
8-16	80
16-32	160
32-64	320
64-128	640
128-256	1280
256-512	2560
512-1024	5120

**FM 3 dB Bandwidth:** internal and external ac, 20 Hz to 250 kHz; external dc, dc to 250 kHz. (8640B locked mode: FM above 50 Hz only.)

#### FM distortion (at 400 Hz and 1 kHz rates):

<1% for deviations up to  $\frac{1}{8}$  maximum allowable.

<3% up to maximum allowable deviation.

**External FM sensitivity:** 1 volt peak into 600 $\Omega$  yields maximum deviation indicated on PEAK DEVIATION switch with FM vernier at full clockwise position.

**Indicated FM accuracy (400 Hz and 1 kHz rates from 15 $^{\circ}$  to 35 $^{\circ}$ C, using internal meter):**  $\pm$  (7% of reading + 1.5% of full scale).

#### Incidental AM (at 400 Hz and 1 kHz rates)

**0.5 to 512 MHz:** <0.5% AM for FM up to  $\frac{1}{8}$  maximum allowable deviation; <1% AM for FM at maximum allowable deviation.

**512 to 1024 MHz (Opt 002):** <1% AM for FM up to  $\frac{1}{8}$  maximum allowable deviation; <7% AM for FM deviations up to maximum allowable.

## Counter (8640B)

### External RF Input

**Frequency range:** 1 Hz to 550 MHz.

**Sensitivity:**  $\geq$  100 mV rms into 50 $\Omega$ , ac only.

**Resolution:** 6-digit LED display.

Mode	Normal	Expand X10	Expand X100
0-10 MHz	100 Hz	10 Hz	1 Hz
10-550 MHz	10 kHz	1 kHz	100 Hz

**External reference input:** 5 MHz, nominally >0.5 V p-p (5 V maximum) into 1 k $\Omega$ .

#### Internal Reference (after 2 h warm-up and calibration at 25 $^{\circ}$ C)

**Ageing Rate:** <0.05 ppm/h; <2 ppm/90 days.

#### Temperature Drift:

< $\pm 2$  ppm from 15 $^{\circ}$  to 35 $^{\circ}$ C.

< $\pm 10$  ppm from 0 $^{\circ}$  to 50 $^{\circ}$ C.

**Typical Overall Accuracy (within 3 months of calibration and from 15 $^{\circ}$  to 35 $^{\circ}$ C):**  $\pm 2$  ppm.

## General

**Operating temperature range:** 0 to 55 $^{\circ}$ C.

**Power Requirements:** 100 or 120 volts (+5%, -10%) from 48 to 440 Hz; or 220 or 240 volts (+5%, -10%) from 48 to 66 Hz. 175 VA max (Option 002: 190 VA max).

**Weight (8640A and 8640B):** net, 20.8 kg (46 lb); shipping, 24.1 kg (53 lb).

**Size:** 140 H x 425 W x 476 D (5.5" x 16.75" x 18.75").

### Ordering Information

**8640A** Signal Generator

**8640B** Signal Generator

**Option 001:** internal variable audio oscillator, 20 Hz to 600 kHz (8640A/B)

**Option 002:** internal doubler 512-1024 MHz (8640A/B)

**Option 003:** reverse power protection (8640A/B)

**Option 004:** avionics option (8640B only)

**Option 908:** rack mount kit (8640A/B)

**Option 910:** extra operating and service manual (8640A/B)

- Demodulated output from RF detector, ac and dc

- Phase shift less than  $0.01^\circ$  at 30 Hz

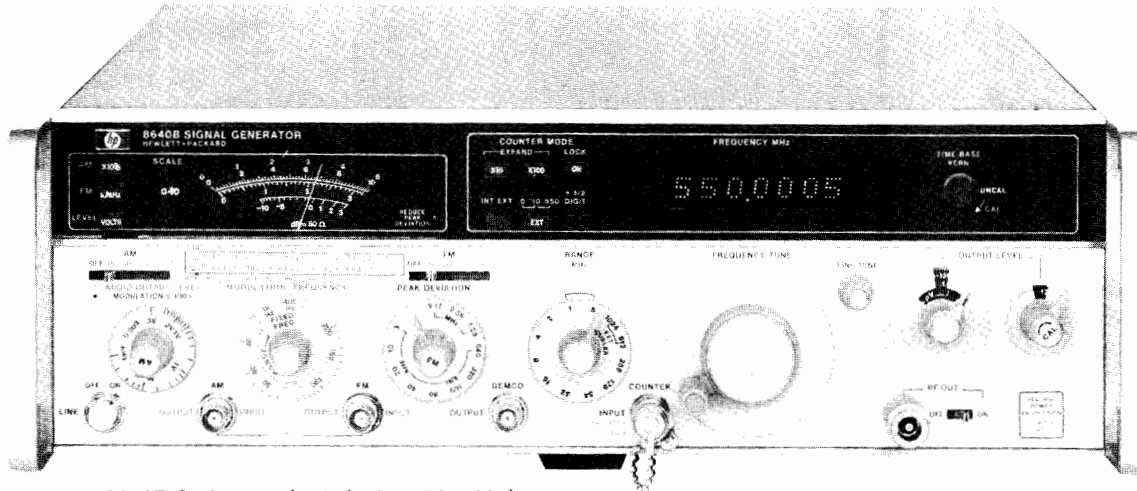

8640B Option 004 (with Options 001, 003)

### 8640B Avionics Option 004 Signal Generator

The Hewlett-Packard Model 8640B Option 004 NAV/COM Signal Generator is an 8640B AM/FM Signal Generator specially adapted for testing ILS (Marker Beacon, Localizer and Glide Slope), VOR and VHF communications receivers used throughout the aviation industry. VOR, LOCALIZER and VHF communications frequencies (108 to 136 MHz) are available on one frequency band for rapid channel selection. GLIDE SLOPE (329 to 335 MHz) and MARKER BEACON (75 MHz) frequencies are also easily set using the 6-digit LED display.

The 8640B Option 004 provides highly stable, spectrally pure RF signals for testing narrow-channel, crystal controlled receivers. For avionics testing, external audio generators are required to provide the composite modulation. Designed with versatile AM and FM modulation, Option 004 features low distortion modulation when used with suitable, external VOR/ILS Audio Generators.

Operation and specifications of the 8640B Option 004 are the same as the Standard 8640B AM/FM Signal Generator with the following additions:

#### Demodulated Output

One front panel BNC connector provides demodulated output from the RF peak detector for precise AM settings. A choice of combined ac/dc at 1 V rms or ac only at 5 V rms is provided.

#### Output Level Setting

To ensure the best possible demodulated output linearity, Option 004 combines a 10 dB step attenuator and a 1 dB step attenuator with a vernier. This provides output levels from +15 dBm to -142 dBm (1.3 V to 0.018  $\mu$ V). The output level can be read directly from the attenuator dial in dBm or from the front panel meter in dBm or volts.

#### External AM Input Impedance

External AM input impedance of 2 k $\Omega$  allows compatible operation with old and new generations of external audio generators.

#### Low Distortion Modulation

The 8640B Option 004 provides flat AM response and minimum phase shift at 30 Hz and 9960 Hz as well as constant group delay between 9 kHz and 11 kHz for accurate VOR and ILS testing.

### 8640B Option 004 Specifications

(These specifications apply to 8640B Option 004 in addition to standard 8640B specifications. See 8640B AM/FM Signal Generator technical data for complete specifications.)

#### Spectral Purity

**Noise:** SSB band noise floor greater than 1 MHz offset from carrier: > 130 dB down.

#### Output Characteristics

**Range:** +15 dBm to -142 dBm (1.3 V to 0.018  $\mu$ V).

**Attenuators:** a 10 dB step attenuator plus a 1 dB step attenuator with vernier allow selection of any output level over the full output level range.

**Vernier:** 2 dB continuously variable from a CAL detent position.

**Level flatness (referred to 190 MHz and for +10 to -10 dBm):** <  $\pm 0.75$  dB from 0.5 to 512 MHz; <  $\pm 0.5$  dB from 108 to 336 MHz.

**Level accuracy:**

Output Level (dBm)	+15 to -10	-10 to -50	-50 to -142	With Option 003
Total Accuracy as Indicated on Level Meter	$\pm 1.5$ dB	$\pm 2.0$ dB	$\pm 2.5$ dB	Add $\pm 0.5$ dB except from 108 to 336 MHz

#### Modulation Characteristics

**Demodulated output (Output vernier in CAL position, 108 to 118 and 329 to 336 MHz):** an internal selector switch allows selection of ac only or ac and dc at the demodulated output.

**AC only output:** directly proportional to AM depth (90 to 150 Hz modulation frequency).

**%AM equals:** (20  $\pm$  0.6)% per V rms, 0 to 55°C; (20  $\pm$  0.4)% per V rms, 20 to 30°C; (20  $\pm$  0.2)% per V rms (using calibration sheet provided).

**AC and DC output:** AC output voltage is directly proportional to AM depth (90 to 150 Hz modulation frequency). DC output equals (1.414  $\pm$  0.010) V dc with vernier in CAL position.

**%AM equals:** (100  $\pm$  3)% per V rms, 0 to 55°C; (100  $\pm$  2)% per V rms, 20 to 30°C; (100  $\pm$  1)% per V rms (using calibration sheet provided).

#### AM Characteristics (+10 dBm Output and Below)

**External input impedance:** nominally 2 k $\Omega$ .

**Frequency response:** < 0.04 dB from 90 Hz through 150 Hz (108 to 118 and 329 to 335 MHz.); < 0.1 dB, 9 kHz through 11 kHz (108 to 118 MHz);  $\pm 3$  dB (0 to 50% AM), dc through 50 kHz (8 to 512 MHz);  $\pm 3$  dB (0 to 70% AM), dc through 35 kHz (8 to 512 MHz).

**Phase shift from audio input to demodulated output (108 to 118 MHz, AM EXT DC mode, meter function on VOLTS):**

30 Hz <  $\pm 0.01^\circ$ ; 30 Hz to 10 kHz <  $\pm 3^\circ$ ; 9 kHz to 11 kHz <  $\pm 2^\circ$ .

#### Ordering Information

8640B Signal Generator with Avionics Option 004

**Option 001:** Internal variable audio oscillator, 20 Hz to 600 kHz

**Option 002:** not available with Option 004

**Option 003:** Reverse power protection

**Option 908:** Rack mount kit

**Option 910:** Extra Operating and Service Manual



# SIGNAL GENERATORS

## AM-FM Solid-State Generator 10 to 520 MHz; Synchronizer/Counter

Models 8654A, 8654B, 8655A

- Calibrated output power
- Calibrated AM, FM; internal, external

- 25 Watt reverse power protection (optional)
- Synchronized stability with 8655A

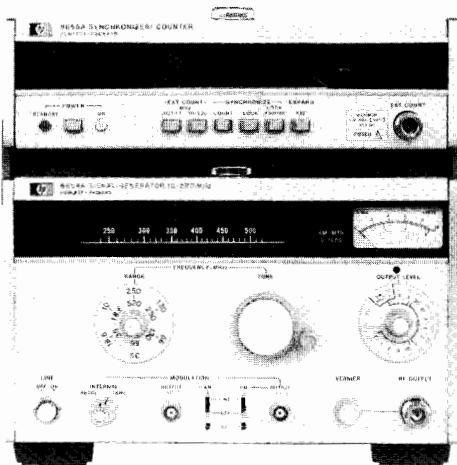

8654A with 8655A

### 8654A/B Signal Generators

The HP 8654A/B Signal Generators are portable, low-cost solid-state generators providing calibrated output and versatile modulation capabilities over the 10 to 520 MHz frequency range. The 8654 provides clean RF signals for testing receivers, amplifiers, antennas, and filter networks.

Its compactness allows the 8654 to fit easily into production, mobile, airborne, and shipboard test locations. Its rugged, lightweight construction is also suitable for field maintenance and service applications.

Effective RF shielding and output range permit receiver sensitivity measurements to be made down to power levels of 0.1  $\mu$ V.

Phase locked stability of 0.1 ppm/hour can be achieved by adding the 8655A synchronizer/counter.

### 8654A/B Specifications

#### Frequency Characteristics

**Range:** 10 to 520 MHz in 6 ranges.

**8654A ranges (MHz):** 10 to 18.6, 18.6 to 35, 35 to 66, 66 to 130, 130 to 250, 250 to 520.

**8654B ranges (MHz):** 10 to 19, 19 to 35, 35 to 66, 66 to 130, 130 to 270, 270 to 520.

**Accuracy:**  $\pm 3\%$  after 2-hour warm-up.

**Settability:** settable to within 5 ppm of the desired frequency with an external indicator after 1-hour warm-up.

**Stability (after 2-hour warm-up and 15 min. after frequency change):**  $< (1 \text{ kHz plus } 20 \text{ ppm})/5 \text{ min}; 0.1 \text{ ppm/hr. with } 8655A.$

#### Spectral Purity

**Harmonic distortion (output power  $\leq +3 \text{ dBm}$ ):**  $< -20 \text{ dBc}; < -15 \text{ dBc}$  with Option 003.

**Subharmonics and non-harmonic spurious (excluding line related):**  $< -100 \text{ dBc}.$

**Residual AM (average rms):**  $-55 \text{ dBc}$  in a 50 Hz to 15 kHz post-detection noise bandwidth.

**Residual FM on CW (averaged rms deviation):**  $< 0.3 \text{ ppm}$  in a 0.3 to 3 kHz post-detection noise bandwidth;  $< 0.5 \text{ ppm}$  in a 50 Hz to 15 kHz post-detection noise bandwidth.

#### Output Characteristics

**Range:** 10 dB steps and a 13 dB vernier provide power settings from +10 dBm to  $-130 \text{ dBm}$  (0.7 V to 0.07  $\mu$ V) into 50  $\Omega$ . With Option 003, maximum output power is +8 dBm (0.56 V).

**Impedance:** 50  $\Omega$  ac coupled, SWR  $< 1.3$  on 0.1 V range or lower. With Option 003, SWR  $< 1.5$  on 0.1 V range or lower.

**Level accuracy (total as indicated on level meter):** +10 to  $-7 \text{ dBm}$ ,  $\pm 1.5 \text{ dB}$ ;  $-7$  to  $-57 \text{ dBm}$ ,  $\pm 2.0 \text{ dB}$ ;  $-57$  to  $-97 \text{ dBm}$ ,  $\pm 2.5 \text{ dB}$ ;  $-97$  to  $-127 \text{ dBm}$ ,  $\pm 3 \text{ dB}.$

**Level flatness:**  $\pm 1 \text{ dB}$  referenced to the output at 250 MHz for output levels  $> -7 \text{ dBm}.$

**Auxiliary RF output:**  $> -7 \text{ dBm}$  (100 mV) into 50  $\Omega$ .

**Reverse power protection (Option 003):** protects signal generator from accidental applications of up to 25 W (+44 dBm) of RF power (between 10 and 520 MHz) into generator output.

#### Modulation Characteristics

**Amplitude modulation:** specifications apply for output power  $< +3 \text{ dBm}$ . AM is possible above +3 dBm as long as the combination of the AM depth plus carrier output level does not exceed +9 dBm.

**Depth:** 0 to 90%

**Modulation rate:** internal, 400 and 1000 Hz  $\pm 10\%$ , external 3 dB bandwidth, dc to  $> 20 \text{ kHz}.$

**External AM sensitivity:**<sup>2</sup>  $(0.1 \pm 0.01)\%$  AM/mV pk into 600  $\Omega$ .

**Indicated AM accuracy:**<sup>2</sup>  $\pm (5\%$  of reading +5% of full scale).

**Peak incidental frequency deviation (30% AM):**<sup>2</sup>  $< 200 \text{ Hz}.$

**Envelope distortion:**<sup>2</sup>  $< 3\%$ , 0 to 70% modulation;  $< 5\%$ , 70 to 90% modulation.

#### Frequency Modulation

**8654A:** uncalibrated.

**8654B:** fully calibrated.

**Peak Deviation:** 0 to 30 kHz from 10 to 520 MHz.  
0 to 100 kHz from 80 to 520 MHz.

**Deviation ranges:** 0 to 3 kHz, 0 to 10 kHz, 0 to 30 kHz, 0 to 100 kHz.

**Modulation rate:** internal, 400 and 1000 Hz  $\pm 10\%$ ; external 3 dB bandwidth, dc to  $> 25 \text{ kHz}.$

**FM distortion:**<sup>2</sup>  $< 2\%$  for deviations up to 30 kHz,  $< 3\%$  for deviations up to 100 kHz.

**External FM sensitivity (with FM vernier fully clockwise):**<sup>2</sup> 1 volt peak yields maximum deviation indicated on peak deviation meter.

**Sensitivity accuracy (15° to 35°C):**<sup>2</sup>  $\pm 12\%$ . For 100 kHz deviation above 130 MHz, add 3%.

**Indicated FM accuracy (15° to 35°C):**<sup>2</sup>  $\pm (12\%$  of reading +3% of full scale). For 100 kHz deviation above 130 MHz, add 3% of reading.

**Incidental AM:**<sup>2</sup>  $< 1\%$  AM at 30 kHz deviation.

**Frequency modulation, 8654A:** uncalibrated.

**Deviation:**  $> 0.1\%$  of carrier frequency, maximum.

**Modulation rate:** internal, 400 & 1000 Hz  $\pm 10\%$ . External 3 dB bandwidth, dc coupled to  $> 25 \text{ kHz}$  driven from 600  $\Omega$  or less.

**External FM sensitivity:** 10 V<sub>pk</sub> into 600  $\Omega$  yields  $> 0.1\%$  deviation ( $\pm 15 \text{ volts max}.$ )

#### General Characteristics

**Power:** 100 or 120 volts (+5%,  $-10\%$ ) from 48 to 440 Hz; or 220 to 240 volts (+5%,  $-10\%$ ) from 48 to 66 Hz. Power consumption is 25 VA max. 2.3 m (7.5 ft.) power cable furnished with mains plug to match destination requirements.

**Weight:** net, 8.0 kg (17.5 lb); shipping, 9.5 kg (21 lb).

**Size:** 178 H x 267 W x 306 mm D (7" x 10.5" x 12").

#### Ordering Information

**8654A** AM/FM Signal Generator

**8654B** AM/FM Signal Generator

**Option 003:** Reverse power protection (for 8654A/B)

**Option 910:** Extra operating and service manual

**8655A** Synchronizer/Counter

**Option 001:** High stability time base (for 8655A)

<sup>1</sup>Specifications apply from 10 to 520 MHz for output power  $-+10 \text{ dBm}$  and over the top 10 dB of output level vernier range unless otherwise specified.

<sup>2</sup>400 and 1000 Hz modulation rates.

- Stable, easy to use, 800-2400MHz, 1800-4500MHz

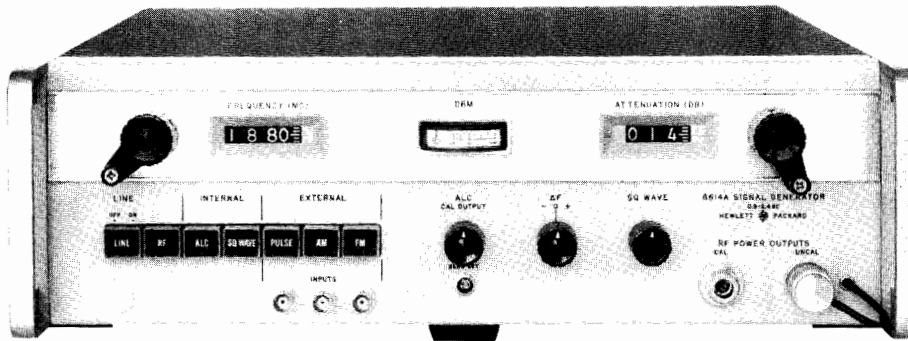

8614A

## 8614A, 8616A Signal Generators

The HP 8614A and 8616A Signal Generators provide stable, accurate signals from 800 to 2400 MHz (8614A) and from 1800 to 4500 MHz (8616A). Both frequency and attenuation are set on direct-reading digital dials. Selectable functions include CW, leveled output, square-wave modulation, and external AM, FM and pulse modulation. Modulation can be accomplished simultaneously with or without leveling.

Two RF power outputs are simultaneously available from separate front-panel connectors. One provides at least 10 mW (2 mW above 3000 MHz) or a leveled output from 0 to -127 dBm. The other is at least 0.5 mW across the band. This signal can be used for phase-locking the signal generators for extreme stability, or it can be monitored with a frequency counter for extreme frequency resolution without adversely affecting the primary output.

A unique PIN diode modulator permits amplitude modulation from dc to 1 MHz or RF pulses with a 2  $\mu$ s rise time. This broad modulation bandwidth permits remote control of output level or precise leveling using external equipment. The internal leveling is also obtained by using a PIN modulator.

The 8614A and 8616A can also be used with companion modulators, HP 8403A modulators and HP 8730-series PIN modulators to provide 80 dB pulse on/off ratio (see page 369). In addition, TWT amplifiers can be used with these generators to provide high power levels.

## Specifications

### 8614A

**Frequency range:** direct reading within 2 MHz, 800 to 2400 MHz.  
**Vernier:**  $\Delta F$  control has a minimum range of 1.0 MHz for fine tuning.

**Frequency calibration accuracy (0 dBm & below):**  $\pm 5$  MHz.

**Frequency stability:** approximately 50 ppm/ $^{\circ}$ C change in ambient temperature, less than 2500 Hz peak residual FM; 30 ppm change for line voltage variation of  $\pm 10\%$ .

**RF output power:** +10 dBm (0.707 V) into 50  $\Omega$  load. Output attenuation dial directly calibrated in dBm from 0 to -127 dBm. A second uncalibrated output (approximately -3 dBm) is provided on front panel.

**RF output power accuracy (with respect to attenuation dial):**  $\pm 0.75$  dB + attenuator accuracy (0 to -127 dBm) including leveled output variations.

**Attenuator accuracy:** +0, -3 dB from 0 to -15 dBm;  $\pm 0.2$  dB  $\pm 0.06$  dB/10 dB from -15 to -127 dBm; direct reading dial, 0.2 dB increments.

**Output impedance:** 50  $\Omega$ ; SWR < 2.0.

**Modulation:** on-off ratio at least 20 dB for square wave, pulse.

**Internal square wave:** 950 to 1050 Hz. Square wave can be synchronized with a +1 to +10 V signal at PULSE input.

**External pulse:** 50 Hz to 50 kHz; 2  $\mu$ s rise time, +20 to +100 V peak input.

**External AM:** dc to 1 MHz.

**External FM:** front-panel connector capacity-coupled to repeller of klystron; four-terminal rear-panel connector (Cinch-Jones type S304AB) is dc-coupled to repeller of klystron.

**Power source:** 115 or 230 V  $\pm 10\%$ , 50 to 60 Hz, approximately 130 W.

**Size:** cabinet, 141 H x 425 W x 467 mm D (5.5" x 16.75" x 18.4"); rack mount, 133 H x 416 W x 483 mm D (5.2" x 16.4" x 19").

**Weight:** net, 19.5 kg (43 lb); shipping, 22.7 kg (50 lb).

**Accessory furnished:** 11500A Cable Assembly.

### 8616A

**Frequency range:** direct reading within 2 MHz, 1800 to 4500 MHz.  
**Vernier:**  $\Delta F$  control has a minimum range of 1.0 MHz for fine tuning.

**Frequency calibration accuracy (0 dBm & below):**  $\pm 10$  MHz.

**Frequency stability:** approximately 50 ppm/ $^{\circ}$ C change in ambient temperature, less than 2500 Hz peak residual FM; 30 ppm change for line voltage variation of  $\pm 10\%$ .

**RF output power:** +10 dBm (0.707 V) to -127 dBm into 50  $\Omega$  load, 1800 to 3000 MHz; +3 dBm to -127 dBm from 3000 to 4500 MHz into a 50  $\Omega$  load. Output attenuation dial directly calibrated in dBm from 0 to -127 dBm. A second uncalibrated output (approximately -3 dBm) is provided on the front panel.

**RF output power accuracy (with respect to attenuation dial):**  $\pm 1.0$  dB + attenuator accuracy (0 to -127 dBm).

**Attenuator accuracy:** +1, -2 dB from 0 to -10 dBm;  $\pm 0.2$  dB  $\pm 0.06$  dB/10 dB from -10 to -127 dBm.

**Output impedance:** 50  $\Omega$ ; SWR < 2.0.

**Modulation:** on-off ratio at least 20 dB for square wave, pulse.

**Internal square wave:** 950 to 1050 Hz. Other frequencies available on special order.

**External pulse:** 50 Hz to 50 kHz; 2  $\mu$ s rise time, +20 to +100 V peak input.

**External AM:** dc to 1 MHz.

**External FM:** front panel connector capacity-coupled to repeller of klystron; four-terminal rear panel connector (Cinch-Jones type S304AB) is dc-coupled to repeller of klystron.

**Power Source:** 115 or 230 V  $\pm 10\%$ , 50 to 60 Hz, approximately 130 W.

**Size:** cabinet, 141 H x 425 W x 467 mm D (5.5" x 16.75" x 18.4"); rack mount, 133 H x 416 W x 483 mm D (5.2" x 16.4" x 19").

**Weight:** net, 19.5 kg (43 lb); shipping, 22.7 kg (50 lb).

**Accessory furnished:** 11500A Cable Assembly

## Ordering Information

8614A Signal Generator (800-2400 MHz)

8616A Signal Generator (1800-4500 MHz)

### 8614A and 8616A Options

**Option 001:** External modulation input connectors on rear panel in parallel with front-panel connectors; RF connectors on rear panel only.

**Option 908:** Rack mounting flange kit

**Option 910:** Extra operating and service manual

# SIGNAL GENERATORS

## Solid-State Microwave Signal Generators

Models 8683A, 8683B, 8684A, 8684B

- Spectrally pure signals, 2.3–6.5 GHz; 5.4–12.5 GHz
- +10 to –130 dBm calibrated output
- Calibrated AM, FM and Pulse Modulation
- Communications and radar versions
- 2 kW reverse power protection (optional)
- Internal service diagnostic

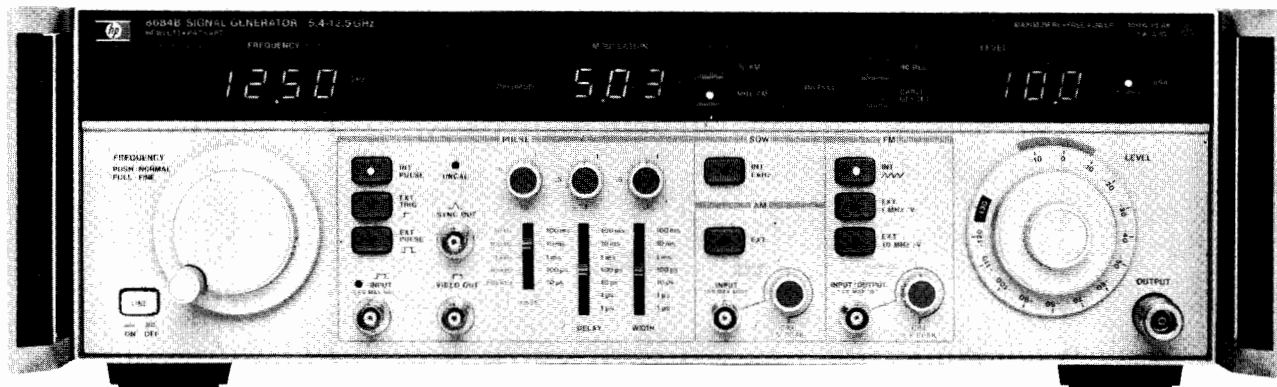

8684B

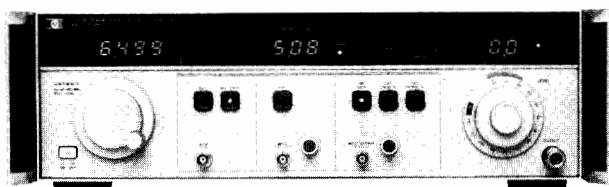

8683A

### 8683/8684 Microwave Signal Generators

The 8683 and 8684 are rugged, portable signal generators which provide similar capabilities in two overlapping frequency ranges. Each is available as a communications version (8683/84A) or a more versatile radar/communications version (8683/84B).

Freq. Band	Communication Appl.	Radar/Commun. Appl.
2.3–6.5 GHz	8683A	8683B
5.4–12.5 GHz	8684A	8684B

The “B” versions differ from the “A” versions by offering higher maximum leveled output power and high performance pulse modulation with an internal pulse generator.

#### Clean, Stable Cavity-Tuned Oscillator

At the heart of the signal generators is their mechanically-tuned cavity oscillators. The oscillators are the result of coupling state-of-the-art electronics with sophisticated mechanical design and precision manufacturing techniques. Mechanical cavity-tuning is chosen for its excellent frequency stability and spectral purity. The oscillators’ active elements (bipolar transistors in the 8683 and GaAs FET’s in the 8684) help attain the very low residual FM and spurious response specifications of the generators.

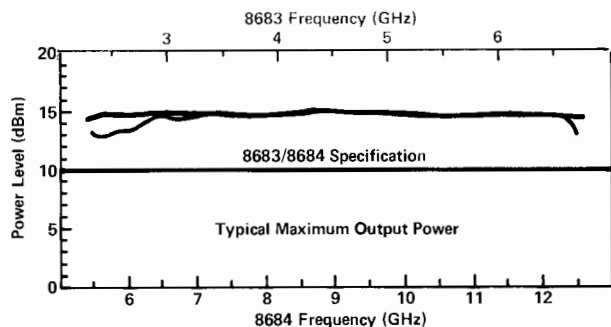

#### Microprocessor Enhances Measurement Accuracy

A microprocessor has been incorporated into the design of these manually-tuned generators. Characteristics of microwave components such as oscillators, amplifiers, and attenuators vary considerably with frequency and power level. The microprocessor provides an effective and economical means for this compensation.

The microprocessor also makes possible convenience features such as displaying output level in absolute dBm, dB relative to a user-selected power level, or with a specified Cable Offset. When Cable Offset is selected, the output level display indicates the power level at the end of a user-selected length of RG-214/U cable rather than the level at the generator’s output connector.

#### Capabilities for Specific Microwave Measurements

The 8683 and 8684 were designed to meet the requirements of major microwave systems applications. In making out-of-channel communications receiver measurements, wide frequency range, low spurious, and a low noise floor are imperative. Receiver sensitivity measurements require excellent signal generator performance at low signal levels. These performance features are built into the 8683 and 8684. In addition, convenience features such as Cable Offset can significantly enhance overall measurement accuracy.

The features included in the “B” models provide the capability to handle advanced radar applications. With the addition of the high performance pulse modulator and internal pulse generator, simulation of a wide variety of radar transmissions is possible. Simultaneous FM and pulse allow chirping, while simultaneous AM and pulse allow simulation of antenna scan patterns. Of course, basic receiver sensitivity and AGC measurements can easily be made.

#### Reliability and Serviceability

The 8683 and 8684 were designed with reliability and serviceability as major considerations. The instruments were type tested to rigorous military specifications (MIL-T-28800 Class IV) for operating and non-operating temperature, humidity, condensation, shock and vibration, and EMI. The instruments’ success in these tests is an indication of their ruggedness. Confidence that a desired output signal has been accurately generated is derived, in part, from a diagnostic test which is automatically executed on turn-on. These tests monitor most critical circuit nodes within the generator locating possible problem areas prior to the generator entering its operating mode. Reliability is further enhanced with optional reverse power protection.

Excellent serviceability results from the combination of accessibility to components, completeness of service manuals, and internal diagnostic capability. In the diagnostic mode, failures can be isolated to at least circuit function level with the aid of the front panel display or a computer terminal.



## 8683A/B, 8684A/B Specifications

### Frequency Characteristics

**Range:** 8683, 2.3–6.5 GHz; 8684, 5.4–12.5 GHz.  
**Resolution:** 8683, 5 MHz using a 4 digit LED display; 8684, 10 MHz using a 3½ digit LED display.

**Calibration accuracy:** 8683,  $\pm 1.25\% \leq 4$  GHz,  
 $\pm 0.75\% > 4$  GHz;

8684,  $\pm 1.25\% < 9$  GHz,  $\pm 0.75\% > 9$  GHz.

### Stability (typical),

**vs. time (20 min. after turn-on):**  $< 30$  kHz/min.

**vs. time (60 min. after turn-on):**  $< 100$  kHz/hr.

**vs. temperature (0 to 55°C):** 8683,  $< 15$  MHz; 8684,  $< 30$  MHz.

**vs. line voltage (transients of +5%/–10%):**  $< 20$  ppm.

### Spectral Purity

**Harmonics ( $< 18$  GHz, at specified max output):**  $< -25$  dBc.

**Spurious (non-harmonically related):**  $< -80$  dBc; typ.,  $< -90$  dBc.

**Residual FM (50 Hz to 15 kHz post detection BW):**  $< 5$  kHz peak.

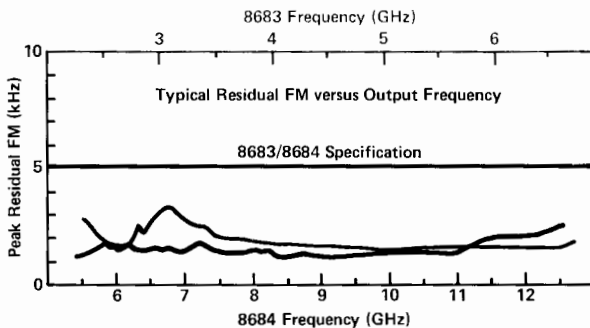

**Single-sideband phase noise (avg. rms, 1 Hz BW, 10 kHz offset from carrier, typical):** 8683,  $< -72$  dBc; 8684,  $< -65$  dBc.

**Residual AM (avg. rms, 300 Hz to 15 kHz post det. BW):**  $< 0.1\%$ .

### Output Characteristics

**Range (leveled into 50  $\Omega$ ):** 8683/84A, 0 to  $-130$  dBm; 8683/84A opt. 001 and 8683/84B,  $+10$  to  $-130$  dBm.

**Resolution:** 0.1 dB using a 3½ digit LED display.

**Accuracy:**  $\pm 2.5$  dB from maximum specified output to  $-110$  dBm;  $\pm 3.5$  dB from  $-110$  to  $-120$  dBm. Typ.  $< \pm 0.9$  dB at  $-110$  dBm option 002 affects level accuracy  $< \pm 0.5$  dB.

**Flatness (power level  $> -10$  dBm):**  $\pm 1.0$  dB.

**Reverse power protection:** The generators typically accept 1 watt avg. or 100 watts peak power with no damage resulting. Option 002 increases this protection to 10 watts avg. or 2 kW peak.

**Typical output impedance:** 50  $\Omega$  nominal. 8683 SWR  $< 2.0$ ; 8684 SWR  $< 2.5$  on  $+10$  and 0 dBm ranges,  $< 2.0$  for  $-10$  dBm and below.

**Auxiliary output:** rear panel, typically  $> -15$  dBm into 50  $\Omega$ , prior to AM or pulse modulation; source impedance approx. 50  $\Omega$ .

### Modulation Characteristics

**Types:** internal and external AM, FM, and Pulse (8683/84B only) Simultaneous AM, FM, Pulse.

**Metering:** 3-digit LED, selectable for % AM or FM deviation.

### Amplitude Modulation

**Depth (1 kHz rate):** 0–70%.

**Rates (3 dB BW at 40% depth):** dc to 10 kHz (dc coupled); 50 Hz to 10 kHz (ac coupled).

**Distortion (THD):**  $< 5\%$  at 40% depth and 1 kHz rate.

**Indicated AM accuracy (depth  $\leq 50\%$ , 15 kHz rate):**  $\pm 5\%$  of f.s.

**Incidental FM (30% AM depth):**  $< 15$  kHz peak to peak.

**Internal AM:** fixed 1 kHz nom. square wave with 50  $\pm 5\%$  duty cycle.

### Frequency Modulation

**Peak deviation:**  $\pm 5$  MHz.

**Rates (3 dB BW):** dc to 10 MHz, 100 Hz to 10 MHz (ac coupled).

**Distortion:**  $< 5\%$  at 100 kHz rate and  $< 1$  MHz peak deviation.

**Indicated accuracy (typ., 10 MHz/V range):**  $\pm 10\%$  of full scale, deviations  $< 5$  MHz, 100 kHz rate.

**Incidental AM (rate  $< 100$  kHz, peak deviation  $< 1$  MHz):**  $< 6\%$ .

**Internal FM:** FM sawtooth with a fixed sweep rate of 1 kHz nom. and variable deviation up to  $\pm 5$  MHz.

**Phase lock input:** typical sensitivity of  $-5$  MHz/V.

### Pulse Modulation

#### 8683/84B Internal pulse generator

**Rate:** 10 Hz to 1 MHz in 5 ranges with continuous adjustment within ranges.

**Width:** 50 ns to 100 ms in 7 ranges with continuous adjustment within ranges.

**Delay (time between sync out and video out):**  $< 50$  ns to 100 ms in 7 ranges with continuous adjustment within ranges.

**Accuracy:** calibration accuracy is 20% of full scale.

#### Synchronizing Signals

**Video out:**  $> 3$  V peak positive replica of the selected RF pulse.

**Sync out:**  $> 1$  V peak positive pulse; nominal width 20 ns; in advance of RF pulse set by pulse delay control.

**External trigger:** 0–1 MHz, dc coupled. Levels must be  $> +1.0$  V and held  $> 20$  ns to affect trigger. Input impedance is approx. 50  $\Omega$ .

#### 8683/84B External Pulse Input Requirements

**Rate:** 0 to 1 MHz.

**Width:**  $> 100$  ns.

**Level:** on  $> +1.0$  V peak; off  $< +0.4$  V peak.

#### 8683/84B RF Pulse Characteristics

**Rise/fall time:**  $< 10$  ns.

**On/off ratio:**  $> 80$  dB.

**Minimum pulse width:**  $< 100$  ns.

**Maximum pulse repetition frequency:**  $> 1$  MHz.

**Pulse width compression:**  $< 50$  ns.

**Minimum duty cycle:** 0.01% (may become unlevelled below 0.01%).

**Peak pulse power:**  $\pm 0.5$  dB of level set in CW mode.

### General

**Operating temperature range:** 0° to 55°C.

**EMI:** MIL-STD-461, VDE0871, CISPR Pub. 11.

**Environmental (operating and non-operating temperature, humidity, shock and vibration):** type tested to MIL-T-28800B Class IV requirements.

**Safety:** meets the requirements of IEC 348.

**Power:** 100, 120, 220, or 240,  $+5\%$ ,  $-10\%$ ; 48 to 66 Hz; (Opt. 003 adds 400 Hz operation at 100 or 120 V);  $< 200$  VA max.

**Dimensions:** 145 H x 457 W x 472 mm D (5.7" x 18" x 18.6").

### Weight:

Model	8683	8684
Net	$< 17.3$ kg (38 lb)	$< 15.9$ kg (35 lb)
Shipping	$< 22.8$ kg (50 lb)	$< 21.4$ kg (47 lb)

### Ordering Information

**8683A** Microwave Signal Generator

**8684A** Microwave Signal Generator

**8683B** Microwave Signal Generator

**8684B** Microwave Signal Generator

**Option 001:**  $+10$  dBm output power, 8683A, 8684A

**Option 002:** Reverse power protection

**Option 003:** 400 Hz line frequency operation

**Option 910:** Extra operating and service manual

**Option 913:** Rack mounting flange kit



# SIGNAL GENERATORS

## SHF Signal Generators

Models 618C, 620B, 626A, 628A

- Signal simulations, 3.8-21 GHz
- FM, Pulse modulation

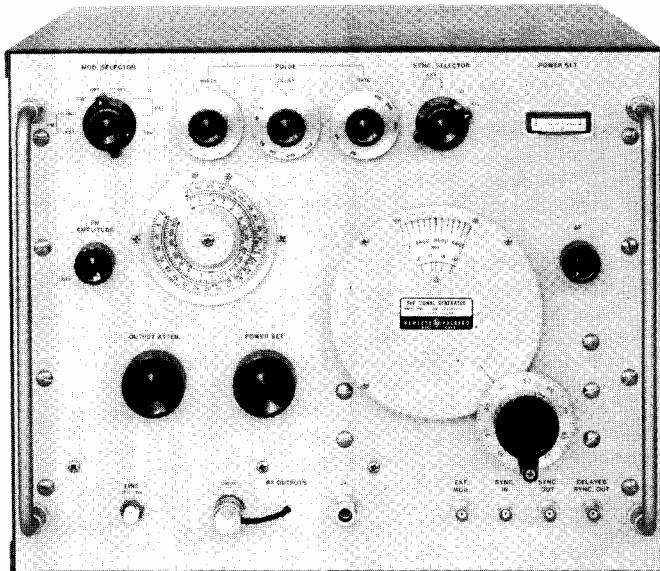

618C

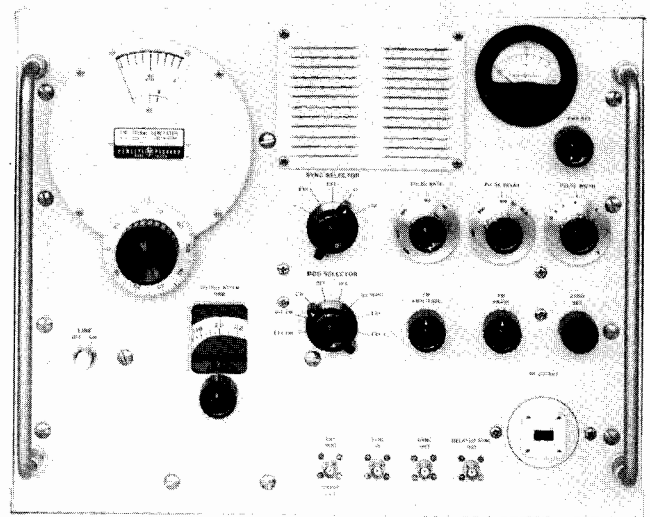

628A

### 618C, 620B, 626A, 628A SHF Signal Generators

These SHF Signal Generators cover 3.8 to 21 GHz in four bands. Carrier frequency is set and read directly on the large tuning dial. No voltage adjustment is necessary during tuning because the klystron repeller voltage is tracked with frequency changes automatically. Oscillator output is also set and read directly, and no frequency correction is necessary throughout operating range. A frequency logging scale permits frequency to be reset within 0.1%.

All offer internal pulse, squarewave and frequency modulation, plus external pulse and frequency modulation. The pulse generators may be synchronized with an external sine wave and positive or negative pulse signals.

#### 618C, 620B Specifications

**Frequency range:** 618C: 3.8 to 7.6 GHz; 620B: 7 to 11 GHz.

**Frequency calibration:** direct reading dial; accuracy  $\pm 1\%$ .

**Modulation:** Int. pulse, squarewave, FM, plus Ext. pulse and FM. Similar to 626/28.

**Output range:** 0 dBm to  $-127$  dBm (0.224 volt to 0.1 microvolt) into 50 ohms; directly calibrated in dBm and volts; type N connector.

**Output accuracy:** within  $\pm 2$  dB from  $-7$  to  $-127$  dBm, within  $\pm 3$  dB from 0 to  $-7$  dBm, terminated in 50-ohm load.

**Source impedance:** 50 ohms nominal; SWR  $< 2.0$ .

**Auxiliary output:**  $> 0.3$  mW useful for phase-locking or counting.

**Power:** 115 or 230 volts  $\pm 10\%$ , 50 to 60 Hz, approximately 230 VA.

**Size:** cabinet, 353 H x 445 W x 518 mm D (13.9" x 17.5" x 20.4"); rack mount, 355 x 483 x 483 mm (14" x 19" x 19").

**Weight:** net, 31.1 kg (69 lb); shipping, 33.5 (74 lb).

#### 626A, 628A Specifications

**Frequency range:** 626A, 10 to 15.5 GHz; 628A, 15 to 21 GHz.

**Frequency calibration:** dial direct-reading in GHz, accuracy better than  $\pm 1\%$ .

**Output range:** (10 mW to 1 pW)  $+10$  dBm to  $-90$  dBm; attenuator dial calibrated in output dBm.

**Source impedance:** 50  $\Omega$  nominal; SWR  $< 2.5$  at  $+10$  dBm;  $< 1.35$  at 0 dBm and below.

**Output monitor accuracy:** better than  $\pm 1$  dB; temperature-compensated thermistor bridge circuit monitors RF oscillator power level.

**Output connector:** 626A: WR75 waveguide, flat cover flange; 628A: WR51 waveguide, flat cover flange.

**Output attenuator accuracy:** better than  $\pm 2\%$  of attenuation in dB introduced by output attenuator.

**Internal pulse modulation:** repetition rate variable from 40 to 4000 pps; pulse width variable 0.5 to 10  $\mu$ s.

**Internal square-wave modulation:** variable 40 to 4000 Hz controlled by "pulse-rate" control.

**Internal frequency modulation:** power line frequency; deviation up to  $\pm 5$  MHz.

**External pulse modulation:** requires pulse amplitude of 15 to 70 volts peak positive or negative; width 1 to 2500  $\mu$ s.

**External frequency modulation:** max. deviation approx.  $\pm 5$  MHz.

**Sync out signals:** positive 20 to 100 V peak into 1000-ohm load; better than 1  $\mu$ s rise time; 1) simultaneous with RF pulse, positive; 2) in advance of RF pulse, positive, variable 5 to 300  $\mu$ s.

**External synchronization:** sine wave, 40 to 4000 Hz, 5 to 50 V rms amplitude, pulse signals, 40 to 4000 pps, 5 to 50 V amplitude, positive or negative, 0.5 to 5  $\mu$ s width, 0.1 to 1  $\mu$ s rise time.

**Power:** 115 or 230 volts  $\pm 10\%$ , 50 to 60 Hz, approx. 200 VA.

**Size:** cabinet, 356 H x 432 W x 381 mm D (14" x 17" x 15"); rack mount, 356 H x 483 W x 313 mm D (14" x 19" x 12.8").

**Weight:** net, 26.8 kg (59 lb); shipping, 29.8 kg (66 lb).

#### Ordering Information

618C or 620B SHF Signal Generator (cabinet mount)

618CR or 620BR SHF Signal Generator (rack mount)

Option 910: Extra operating and service manual

626A or 628A SHF Signal Generator (cabinet)

626AR or 628AR SHF Signal Generator (rack)

Option 910: Extra operating and service manual

- Doubler sets for signal output 18-26.5 GHz, 26.5-40 GHz

- 2 to 18 GHz
- <10 ns rise and fall times
- >80 dB ON/OFF ratio

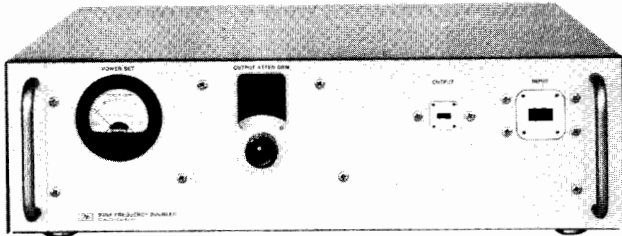

938A

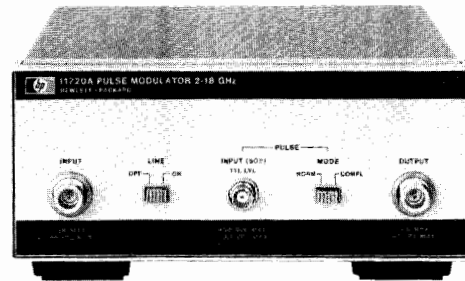

11720A

### 938A, 940A Frequency Doubler Sets

Model 938A supplies power from 18 to 26.5 GHz and Model 940A from 26.5 to 40 GHz when driven by 9 to 13.25 GHz and 13.25 to 20 GHz sources respectively. For manually tuned frequencies, models 626A and 628A Signal Generators are ideal driving sources because of their excellent high power outputs and stable signal performance. For synthesized signal performance, the 8672A generator provides input signals up to 18.6 GHz, under programmed control. For a swept output, use a swept-frequency source such as Model 8350A or Model 8620A/B/C series with appropriate RF units.

These frequency doubler sets consist of broadband harmonic generators suitably mounted in a waveguide section, a power monitor, a broad stopband low-pass filter, and a precision attenuator. The input signal may be CW, pulsed, or swept. Thus, the frequency doubler sets retain all the modulation versatility of the driving source.

The calibrated power monitor and precision, calibrated output attenuators allow the power output of the doubler to be calibrated even though the output of the driving source is not, and the attenuator allows output power to be accurately controlled over a range from 0 to 100 dB.

#### 938A, 940A Specifications

**Frequency range:** 938A, 18 to 26.5 GHz; 940A, 26.5 to 40 GHz.  
**Conversion loss:** less than 18 dB at 10 mW input.  
**Output power:** approximately 0.5–1 mW when used with typical 626A, 628A signal generators; input power 100 mW maximum.  
**Output monitor accuracy:**  $\pm 2$  dB  
**Output attenuator accuracy:**  $\pm 2\%$  of reading of  $\pm 0.2$  dB whichever is greater.  
**Attenuator range:** 100 dB.  
**Output reflection coefficient:** approx. 0.33 at full output; less than 0.2 with attenuator set to 10 dB or greater.  
**Output flange:** 938A, K-band flat cover flange for WR-42 waveguide; 940A, R-band flat cover flange for WR-28 waveguide.  
**Input flange:** 938A, M-Band flat cover flange for WR-75 waveguide; 940A, N-Band flat cover flange for WR-51 waveguide.  
**Accessories available:** 938A, waveguide adapters MP292B, MX292B, X-band flexible waveguide 11504A, P-band flexible waveguide 11503A; 940A, waveguide adapters NP292A, MP292B, P-band flexible waveguide 11503A.  
**Size:** 137 H x 489 W x 457 mm D (5.4" x 19.25" x 18").  
**Weight:** net, 9 kg (20 lb); shipping, 11.8 kg (26 lb).

### 11720A Pulse Modulator

The 11720A Pulse Modulator is a high performance microwave pulse modulator covering the range of 2 to 18 GHz. Because of this wide frequency coverage, it can be used to increase the modulation capabilities of many microwave sources (sweepers or signal generators) and eliminate the need for several individual modulators in broadband applications.

The 11720A features extremely short rise and fall times (<10 ns) and a high on/off ratio (>80 dB), making it suitable for almost any pulsed RF application.

The 11720A contains all the necessary modulator drive circuitry to achieve specified performance so that a standard pulse generator, or any other source that can deliver >3 V peak into 50 ohms, can supply the input. In addition, a normal/complement function is provided to adapt the 11720A to positive-true or negative-true logic inputs.

#### 11720A Specifications

**Frequency range:** 2 to 18 GHz.  
**ON/OFF ratio:** >80 dB.  
**Rise and fall times:** <10 ns.  
**Insertion loss:** <6 dB, 2 to 12.4 GHz; <10 dB, 2 to 18 GHz.  
**Maximum RF input power:** +20 dBm.  
**Maximum repetition rate:** >5 MHz.  
**Minimum RF pulse width:** <50 ns.  
**Video feedthrough:** <60 mV peak-to-peak.  
**Pulse Input**  
**Normal mode:** >3 V (on), <0.5 V (off).  
**Complement mode:** <0.5 V (on), >3 V (off).  
**Impedance:** 50  $\Omega$  nominal.  
**Operating temperature:** 0°C to +55°C.  
**Power:** 100, 120, 220, 240 V +5, -10%; 48–400 Hz; 25 VA max.  
**Weight:** net, 2.6 kg (5 lb 12 oz); shipping, 3.6 kg (8 lb).  
**Size:** 101 mm H x 212 mm W x 290 mm D (4.0" x 8.4" x 11.4").  
 ½ MW x 3½ H x 11 D System II Module. For cabinet accessories, see pages 644–649.

#### Ordering Information

**938A or 940A Frequency Doubler**  
**Option 910:** Extra operating & service manual  
**11503A Flexible Waveguide P-Band**  
**11504A Flexible Waveguide X-Band**  
**11720A Pulse Modulator**  
**Option 910:** Extra manual

# SIGNAL GENERATORS

## Synthesized Signal Generators

Models 8673A, 8672A

- 2 to 26.5 GHz frequency range
- 1 to 4 kHz frequency resolution
- Low spurious and phase noise
- +8 to -100 dBm calibrated output
- Internally leveled pulse modulation
- Metered AM/FM

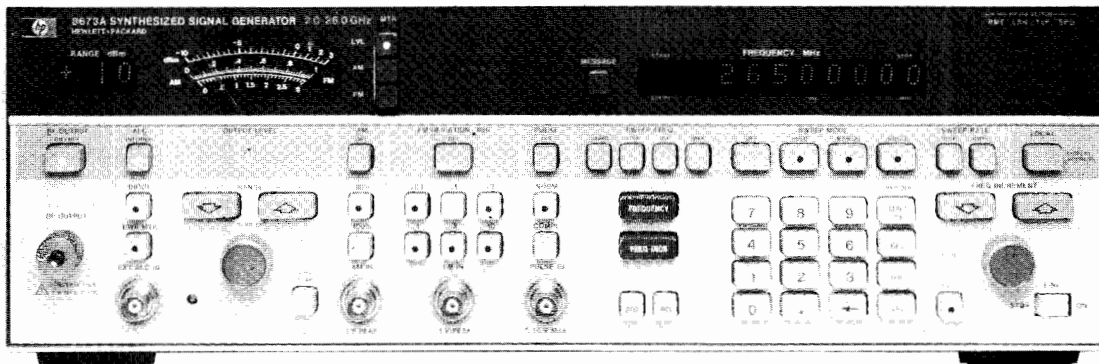

8673A



### 8673A, 8672A Synthesized Signal Generators

The new 8673A and established 8672A Synthesized Signal Generators deliver precise microwave signals over the 2.0 to 26.0 GHz and 2.0 to 18.0 GHz frequency ranges respectively. The generators feature a compact solid-state package (133mm, 5.25 in. high), calibrated and leveled output power, AM/FM modulation capability, and full programmability. The 8673A further features internally leveled pulse modulation and microprocessor-enhanced control facilitating digital sweep.

#### Excellent Spectral Purity

For LO applications and many tests on radar and microwave communication systems, the 8672A and 8673A provide extremely stable frequencies. Output signals are derived by multiplying a fundamental 2.0 to 6.6 GHz - 1 kHz resolution YIG-tuned oscillator  $\times 1$ ,  $\times 2$ ,  $\times 3$ , or  $\times 4$  to yield resolutions of 1 to 4 kHz depending upon band of operation. Indirect synthesis phase-locks the YIG-tuned oscillator to a 10 MHz quartz crystal reference providing both excellent long and short term stability (frequency drift  $< 5 \times 10^{-10}$  per day). Phase-locked loop responses are optimized to allow the 8672A/73A generators to exhibit the lowest possible single-sideband phase noise.

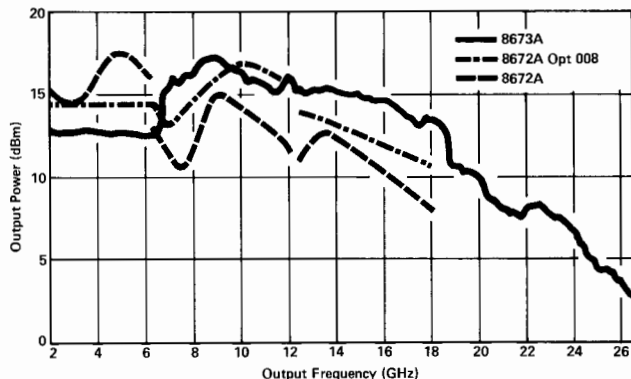

Figure 1. Maximum power typically available from 8673A, standard 8672A, and 8672A Option 008 instruments at 25°C.

#### Wide Dynamic Output Range

For broadband component and receiver testing applications, the 8673A and 8672A exhibit exceptionally flat power outputs across their full frequency ranges. For receiver sensitivity measurements, power is internally (or externally) leveled and calibrated to -120 dBm on the 8672A and to -100 dBm on the 8673A. Maximum available power varies with frequency as shown in Figure 1. The 8672A Option 008 raises the guaranteed 8672A maximum output to +8 dBm from a standard +3 dBm. 8673A output power is guaranteed to be at least +8 dBm up to 18 GHz and 0 dBm up to 26 GHz.

#### Internally Leveled Pulse Modulation

The 8673A features an internal pulse modulator that provides high-quality pulse modulation over the entire 2.0 to 26.0 GHz range. The modulation is done before the frequency multiplication allowing the peak pulsed power to be leveled and calibrated to within  $\pm 1$  dB of the set level referenced to CW. ON/OFF ratios  $> 80$  dB and rise/fall times  $< 35$  ns make the 8673A ideal for use in pulsed radar test systems. Externally supplied TTL level drive signals determine pulse rates up to 1 MHz and leveled pulse widths as narrow as 100 ns.

#### Calibrated AM/FM Modulation

To expand the versatility of the 8672A and 8673A in receiver testing applications, AM/FM capability is included. AM depth at rates up to 100 kHz can be accurately set using the front panel meter. Six ranges of metered FM are available at rates and peak deviations up to 10 MHz. Both AM depth and FM deviation are linearly controlled by varying the externally supplied modulating input voltage up to 1 V peak.

#### Full Programmability and Digital Sweep

The 8673A and 8672A both provide full programmability of all front-panel functions for automatic test system applications. Over HP-IB, output level can be controlled in steps as fine as 1 dB (8672A) and 0.1 dB (8673A). In addition, the 8673A uses an internal microprocessor that facilitates convenient keyboard control, easy HP-IB interfacing following front-panel keystroke sequences, and digital sweep. Sweep spans can be set over the entire frequency range with variable rates, step sizes, and selectable markers available. Sweep outputs needed for compatibility with scalar and network analyzers are provided on the 8673A rear panel.

- 2 to 18 GHz frequency range
- Low spurious and phase noise
- Metered AM/FM

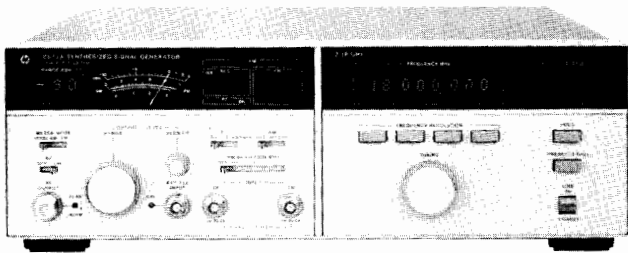

8672A

**8672A, 8673A Specifications**

(8672A and 8673A specifications are identical except for additional 8673A specifications in *italic type*.)

**Frequency Characteristics**

**Frequency range:** 2.0–18.0 GHz (18.599997 GHz overrange).  
*2.0–26.0 GHz (26.5 GHz overrange).*

**Frequency bands:** Band 1, 2.0–6.2 GHz; 2.0–6.6 GHz  
Band 2, 6.2–12.4 GHz; *6.6–12.3 GHz*  
Band 3, 12.4–18.0 GHz; *12.3–18.6 GHz*  
Band 4, *18.6–26.0 GHz*.

**Frequency resolution:** 1 kHz in Band 1, 2 kHz in Band 2, 3 kHz in Band 3, *4 kHz in Band 4*.

**Time base:** internal 10 MHz ( $<5 \times 10^{-10}$ /day aging rate) or external 5 or 10 MHz.

**Frequency switching time:**  $<15$  ms ( $<20$  ms) to be within specified resolution, all bands.

**Spectral Purity**

**Single-sideband phase noise (1 Hz BW, CW mode):**

F <sub>c</sub>	Offset from F <sub>c</sub>				
	10 Hz	100 Hz	1 kHz	10 kHz	100 kHz
Band 1	-58 dBc	-70 dBc	-78 dBc	-86 dBc	-110 dBc
Band 2	-52 dBc	-64 dBc	-72 dBc	-80 dBc	-104 dBc
Band 3	-48 dBc	-60 dBc	-68 dBc	-76 dBc	-100 dBc
Band 4	-46 dBc	-58 dBc	-66 dBc	-74 dBc	-98 dBc

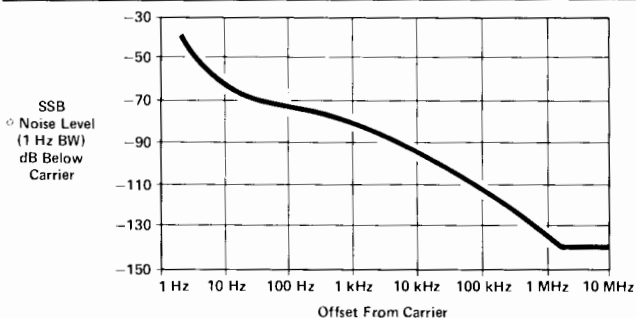

Figure 2. Typical 8672A & 8673A single-sideband phase noise performance using the internal standard, Band 1.

**Harmonics (up to maximum frequency, output level meter readings  $<0$  dB on 0 dBm range and below):**  $<-25$  dBc,  $<-40$  dBc.

**Sub-harmonics and multiples thereof:**  $<-25$  dBc, Bands 1–3;  $<-20$  dBc, Band 4.

**Spurious (CW and AM modes)**

**Non-harmonically related:**  $<-70$  dBc, Band 1;  $<-64$  dBc, Band 2;  $<-60$  dBc, Band 3;  $<-58$  dBc, Band 4.

**Power line related and fan rotation related within 5 Hz below line frequency and multiples thereof:**

F <sub>c</sub>	Offset from F <sub>c</sub>		
	$<300$ Hz	300 Hz to 1 kHz	$>1$ kHz
Band 1	-50 dBc	-60 dBc	-65 dBc
Band 2	-44 dBc	-54 dBc	-59 dBc
Band 3	-40 dBc	-50 dBc	-55 dBc
Band 4	-38 dBc	-48 dBc	-53 dBc

**Output Characteristics**

**Output level (+15°C to +35°C):** +3 to -120 dBm; +8 to -100 dBm up to 18 GHz, +4 to -100 dBm up to 22 GHz, 0 to -100 dBm up to 26 GHz.

**Flatness (0 dBm range, +15°C to +35°C):**  $\pm 0.75$  dB through Band 1,  $\pm 1.0$  dB through Band 2,  $\pm 1.25$  dB through Band 3,  $\pm 1.75$  dB through Band 4.

**Remote programming output level resolution:** 1.0 dB; *0.1 dB*.

**Source impedance:** 50 ohms nominal.

**Pulse Modulation**

**ON/OFF ratio:**  $>80$  dB.

**Rise/fall times:**  $<35$  ns.

**Minimum leveled pulse width:**  $<100$  ns.

**Pulse repetition frequency:** *dc–1 MHz*.

**Maximum peak power:** *same as in CW mode*.

**Peak level accuracy (relative to CW, +15°C to +35°C):**  $\pm 1$  dB.

**Pulse modulation input requirements:** *normal mode, positive-true TTL levels; complement mode, negative-true TTL levels.*

**Video feedthrough:** *typically  $<-50$  dBc.*

**Amplitude Modulation**

**Rates (3 dB BW, 30% depth):** 10 Hz–100 kHz; 10 Hz–50 kHz (Option 008); 20 Hz–100 kHz.

**Sensitivity:** 30% V, 100% V ranges. Max. input 1 V peak into 600  $\Omega$ .

**Frequency Modulation**

**Peak deviation (max.):** the smaller of 10 MHz or  $f_{mod} \times 5$ , Band 1; 10 MHz or  $f_{mod} \times 10$ , Band 2; 10 MHz or  $f_{mod} \times 15$ , Band 3; *10 MHz or  $f_{mod} \times 20$ , Band 4.*

**Sensitivity:** 30, 100, 300 kHz/V and 1, 3, 10 MHz/V ranges. Max. input 1 V peak into 50  $\Omega$ .

**Rates (3 dB BW typical):** 30, 100 kHz/V ranges: 50 Hz to 10 MHz; 300 kHz/V and 1, 3, 10 MHz/V ranges: 1 kHz to 10 MHz.

**Digital Sweep Characteristics.**

**Sweep function:** *start/stop or  $\Delta F$  (span) sweep.*

**Sweep modes:** *manual, auto, or single sweep.*

**Step size:** *maximum of 9999 frequency points per sweep; minimum step size equals frequency resolution.*

**Dwell time:** *set from 1 to 255 ms per frequency.*

**Markers:** *5 independent, fixed frequency markers.*

**Sweep outputs:** *0 to +10 V ramp start to stop; 1 V/GHz ramp (18 V maximum); Z-axis blanking/markers; tone marker; penlift.*

**Remote Programming**

All functions HP-IB programmable with the exception of line switch. The 8673A can output over the interface frequency and output level settings, error/malfunction codes, and operational status codes.

**General**

**Operating temperature range:** 0°C to +55°C.

**Power:** 100, 120, 220, 240 V, +5%, -10%, 48–66 Hz; 400 VA max.,  
**Weight:** net, 27 kg (60 lb), 29 kg (64 lb); shipping, 32.5 kg (72 lb), 34.3 kg (76 lb).

**Size:** 133 mm H x 425 mm W x 603 mm D (5.25" x 16.75" x 23.75").

**Ordering Information**

**8673A Synthesized Signal Generator**

**8672A Synthesized Signal Generator**

**Option 001:** Delete RF output attenuator

**Option 002:** Delete reference oscillator

**Option 003:** Operation at 400 Hz line

**Option 004:** Rear panel RF output

**Option 005:** Rear panel RF output without RF attenuator

**Option 006:** Chassis slide kit

**Option 008:** +8 dBm output level (8672A only)

**Option 907:** Front panel handle kit

**Option 908:** Rack mounting flange kit

**Option 909:** Front panel handle kit plus rack mounting flange kit

**Option 910:** Extra operating and service manual

**11712A Support Kit (for 8672A)**

**11726A Support Kit (for 8673A)**



# SIGNAL GENERATORS

## Synthesized Signal Generator, Synthesized Source

Models 8672A-E24, 8671A

- 10 MHz–18 GHz frequency range
- Internal pulse modulator
- HP-IB programmability

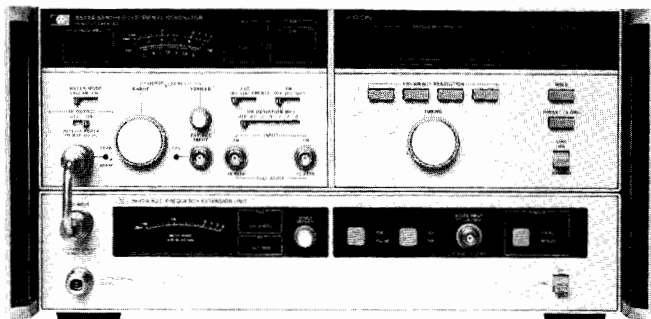

8672A-E24

### 8672A-E24 Synthesized Signal Generator

The 8672A-E24 Synthesized Signal Generator consists of an 8672A Synthesized Signal Generator and an 8672A-K22 Frequency Extension Unit. The 8672A-K22 uses a heterodyne technique to extend the frequency coverage of a standard 8672A to a lower limit of 10 MHz. As a single 9-inch high package, the 8672A-E24 features 10 MHz to 18 GHz single-knob continuous frequency tuning, calibrated CW output power, and an internal pulse modulator allowing high-quality pulse modulation over the entire 10 MHz to 18 GHz frequency range. All front-panel functions, with the exception of the line switches, are HP-IB programmable.

Specifications for the 8672A-E24 are identical to those of a stand-alone 8672A for the 2 to 18 GHz frequency range with the exception of a 1 dB decrease in maximum output power and no AM modulation available below 2 GHz.

Existing 8672A signal generators can be retrofitted to the 8672A-E24 configuration by ordering the 86720K Frequency Extension Retrofit Kit.

### 8672A-E24 Specifications

(Specifications for the 8672A-E24 are identical to those of the standard 8672A with the following exceptions.)

#### Frequency Characteristics

**Frequency range:** 10 MHz–18.0 GHz (18.599997 GHz overrange).

**Frequency range:** 1 kHz to 6.2 GHz, 2 kHz to 12.4 GHz, 3 kHz to 18.0 GHz.

**Non-harmonic spurious:**  $< -60$  dBc, 10 MHz–1.999999 GHz.

**Power line and fan rotation related spurious:** 10 MHz–6.2 GHz, same as 8672A 2.0–6.2 GHz.

**Single-sideband phase noise (1 Hz BW, CW mode):** 10 MHz–6.2 GHz, same as 8672A 2.0–6.2 GHz.

#### Output Characteristics

**Output level:** +13 dBm to –120 dBm, 0.01–2.0 GHz; +2 dBm (+7 dBm, Opt. 008) to –120 dBm, 2.0–18.0 GHz.

**Total indicated meter accuracy:** 0.01–2.0 GHz, same as 8672A 2–6.2 GHz degraded by 0.5 dB; 2.0–18.0 GHz, 8672A degrades by 0.25 dB.

**Level flatness:** same as 8672A degraded by  $\pm 0.25$  dB

#### Modulation Characteristics

**Frequency modulation:** 0.01–2.0 GHz, same as 8672A 2–6.2 GHz.

**Pulse modulation:**  $> 80$  dB ON/OFF ratio;  $< 15$  ns rise/fall times; peak pulsed power within 1.0 dB of level selected in CW mode for 0.01–2 GHz, uncalibrated for 2.0–18.0 GHz.

#### General

**Programming:** all functions HP-IB programmable except line switches and meter mode.

**Operating temperature range:** 0 to +55°C (+15 to +35°C for specified performance).

**Size:** 222 H x 425 W x 620 mm D (8.8" x 16.8" x 24.4").

- 2–6.2 GHz frequency range
- Low spurious and phase noise
- +8 dBm minimum output power

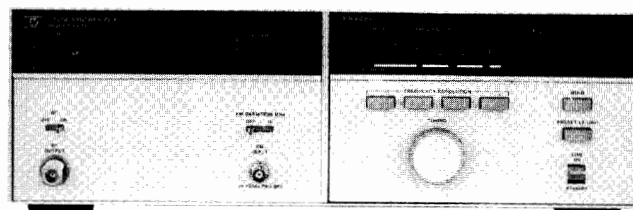

8671A

### 8671A Synthesizer

The 8671A microwave frequency synthesizer covers the frequency range of 2.0 to 6.2 GHz in 1 kHz steps with excellent stability and spectral purity. It is well suited for most LO applications that require state-of-the-art performance as well as broadband capability.

### 8671A Specifications

#### Frequency Characteristics

**Frequency range:** 2.0–6.2 GHz (6.199999 GHz).

**Frequency resolution:** 1 kHz.

**Time base:** internal 10 MHz ( $< 5 \times 10^{-10}$ /day aging rate) or external 5 or 10 MHz.

**Switching time:**  $< 15$  ms to be within 1 kHz.

**Harmonics:**  $< -15$  dBc.

#### Single-sideband phase noise (1 Hz BW, CW mode):

	Offset from $F_c$				
	10 Hz	100 Hz	1 kHz	10 kHz	100 kHz
SSB level	-58 dBc	-70 dBc	-78 dBc	-86 dBc	-110 dBc

**Non-harmonically related spurious:**  $< -70$  dBc.

#### Output Characteristics

**Power (unleveled):** +8 dBm (min.), +15 to +35°C.

**Flatness:**  $< 6$  dB total variation across full frequency band.

**Source impedance:** 50  $\Omega$

#### Frequency Modulation

**Peak deviation (max):** 10 MHz or  $f_{mod} \times 5$ , whichever is smaller.

**Sensitivity:** 50 kHz/V and 5 MHz/V ranges; max input 2 V peak.

**Rates (3 dB BW):** 50 Hz to 10 MHz typical.

#### Remote Programming

**Frequency:** programmable over full range with 1 kHz resolution.

**FM modulation:** OFF, 50 kHz/V, and 5 MHz/V ranges.

#### General

**Operating temperature range:** 0 to +55°C.

**Power:** 100, 120, 220, or 240 V +5, –10%; 48–66 Hz; 300 VA max.

**Weight:** net, 24 kg (53 lb); shipping, 29.5 kg (65 lb).

**Size:** 133 H x 425 W x 603 mm D (5.25" x 16.75" x 23.75").

#### Ordering Information

##### 8671A Microwave Frequency Synthesizer

**Option 002:** No internal reference

**Option 003:** Operation at 400 Hz line

**Option 005:** Rear panel RF output

**Option 006:** Chassis slide kit

**Option 907:** Front panel handle kit

**Option 908:** Rack mounting flange kit

**Option 909:** Front panel handle plus rack mounting flange kit

**Option 910:** Extra operating and service manual

##### 11712A Support Kit

##### 8672A-E24 Synthesized Signal Generator

**Option 008:** +7 dBm leveled output power

**86720K Frequency Extension Retrofit Kit**

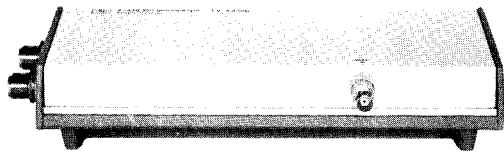

8730B Series

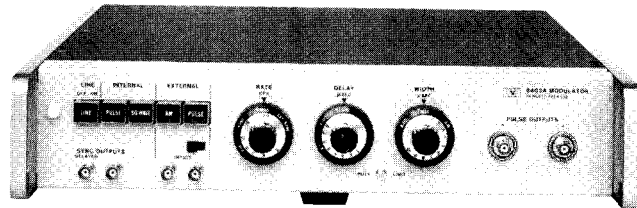

8403A

### 8730 Series PIN Modulators

With HP 8730 series PIN Modulators, signal sources, including klystrons, can be pulse-modulated, leveled or amplitude-modulated with sinusoidal and complex waveforms. Fast-rise times, low incidental FM and a nearly constant impedance match to source and load are typical of these absorption-type modulators.

### 8403A Modulator

The Model 8403A provides complete control of the PIN modulators, supplying the appropriate modulation wave shapes and bias levels for fast rise times, rated on/off ratios and amplitude modulation. An internal square-wave and pulse modulator with PRF of 50 Hz to 50 kHz and adjustable pulse width and delay also provide square wave and pulses for general pulse applications. For applications requiring an absorption-type modulator plus controls in a single unit, a PIN modulator can be installed in the Model 8403A.

### 8403A Specifications

**Output characteristics** (available separately at front panel).  
**For driving 8730 PIN modulators:** AM and pulse output, pulse output specially shaped for optimum RF rise and decay times.  
**For general pulse applications:** positive dc-coupled pulse 25 to 30 volt in amplitude, approximately symmetrical about 0 volt; no AM signal.

#### Modulation

##### Internal square wave

**Frequency:** variable from 50 Hz to 50 kHz.

**Symmetry:** better than 45/55%.

##### Internal pulse

**Repetition rate:** variable from 50 Hz to 50 kHz.

**Delay:** variable from 0.1  $\mu$ s to 100  $\mu$ s, between sync out pulse and RF output pulse.

**Width:** variable from 0.1  $\mu$ s to 100  $\mu$ s.

##### External sync

**Signal:** 5 to 20 volts peak, + or -, pulse or sine wave.

**Input impedance:** approximately 2000 ohms, dc-coupled.

#### Trigger out

**Sync out:** simultaneous with or 0.1 to 100  $\mu$ s in advance of RF pulse, as set by delay control.

**Delayed sync out:** simultaneous with output pulse.

**Amplitude:** approximately -2 volts.

**Source impedance:** approximately 330 ohms.

#### External Pulse

**Amplitude and polarity:** 5 volts to 20 volts peak, + or -.

**Repetition rate:** maximum average PRF, 500 kHz/s.

**Input impedance:** approximately 2000 ohms, dc-coupled.

**Width:** minimum 0.1  $\mu$ s; maximum 1/PRF - 0.4  $\mu$ s.

#### Amplitude Modulation (with 8730 series)

**Frequency response:** dc to approximately 10 MHz (3 dB).

**Sensitivity:** approximately 10 dB/volt with HP 8730A series; approximately 20 dB/volt with HP 8730B series.

**Input impedance:** approximately 1000 ohms.

#### General

**Power:** 115 or 230 volts  $\pm$  10%, 50 to 400 Hz, approximately 10 watts.

**Size:** 96 H x 425 W x 467 mm D (3.75" x 16.73" x 18.4").

**Weight:** net, 7.4 kg (16.5 lb); shipping, 9 kg (20 lb).

#### Ordering Information

##### 8403A Modulator

##### Option

**001:** 8731A PIN Modulator installed in **8403A**

**002:** 8731B PIN Modulator installed in **8403A**

**003:** 8732A PIN Modulator installed in **8403A**

**004:** 8732B PIN Modulator installed in **8403A**

**005:** 8733A PIN Modulator installed in **8403A**

**006:** 8733B PIN Modulator installed in **8403A**

**007:** 8734A PIN Modulator installed in **8403A**

**008:** 8734B PIN Modulator installed in **8403A**

**009:** Input and Output Connectors on rear panel

**908:** Rack flange kit

**910:** Extra Manual

### 8730 Series Specifications

HP Model	8731A	8731B	8732A	8732B	8733A	8733B	8734A	8734B	8735A	8735B	8731B-H10*
Frequency range (GHz)	0.8-2.4	0.8-2.4	1.8-4.5	1.8-4.5	3.7-8.3	3.7-8.3	7.0-12.4	7.0-12.4	8.2-12.4	8.2-12.4	0.4-1.2
Dynamic range (dB)	35	80	35	80	35	80	35	80	35	80	35
Max. residual atten. (dB) <sup>1</sup>	<1.5	<2.0	<2.0	<3.5 <sup>2</sup>	<2.0	<3.0	<4.0	<5.0	<4.0	<5.0	<2.0
Typical rise time (ns) <sup>3</sup>	40	30	40	30	30	30	30	30	30	30	40
Typical decay time (ns) <sup>3</sup>	30	20	30	20	20	20	20	20	20	20	30
SWR, min. attenuation	1.5	1.6	1.5	1.6 <sup>4</sup>	1.8	2.0	1.8	2.0	1.7	2.0	1.5 <sup>7</sup>
SWR, max. attenuation	1.8	2.0	1.8	2.0	2.0	2.2	2.0	2.2	2.0	2.2	2.0 <sup>7</sup>
Forward bias input resistance (ohms)	300	100	300	100	300	100	300	100	300	100	300
RF connector type	N(f)	N(f)	N(f)	N(f)	N(f)	N(f)	N(f)	N(f)	W/G <sup>5</sup>	W/G <sup>5</sup>	N(f)
Weight, net kg (lb)	1.4 (3.0)	2.5 (5.5)	1.4 (3.0)	2.7 (6.0)	1.0 (2.1)	1.4 (3.0)	1.3 (2.8)	1.4 (3.0)	1.4 (3.0)	1.4 (3.0)	2.5 (5.5)
shipping kg (lb)	1.9 (4.2)	3.3 (7.3)	1.9 (4.2)	3.5 (7.8)	1.4 (3.2)	1.9 (4.2)	1.8 (3.9)	1.9 (4.2)	1.9 (4.1)	1.9 (4.2)	3.3 (7.3)
Dimensions											
Height, mm (in)	57 (2.25)	57 (2.25)	57 (2.25)	57 (2.25)	57 (2.25)	57 (2.25)	57 (2.25)	57 (2.25)	57 (2.25)	57 (2.25)	57 (2.25)
Width, mm (in)	83 (3.25)	124 (4.9)	83 (3.25)	124 (4.9)	83 (3.25)	83 (3.25)	83 (3.25)	83 (3.25)	83 (3.25)	83 (3.25)	124 (4.9)
Depth, mm (in)	283 (11.1)	289 (11.4)	283 (11.1)	289 (11.4)	213 (8.4)	311 (12.3)	213 (8.4)	311 (12.3)	171 (6.75)	267 (10.5)	289 (11.4)

Maximum ratings: maximum input power, peak or CW: 1 W; bias limits: +20 V, -10 V.

Bias polarity: negative voltage increases attenuation.

RFI: radiated leakage limits are below those specified in MIL-I-6181D at input levels < 1 mW; at all input levels radiated interference is sufficiently low to obtain rated attenuation.

1. With +5 V bias.

2. 4 dB, 4 to 4.5 GHz.

3. Driven by HP 8403A Modulator.

4. 2.0 SWR, 4 to 4.5 GHz.

5. Fits 1 x 1/2 in. (WR 90) waveguide.

6. External high-pass filters required.

7. Excluding high-pass filters.

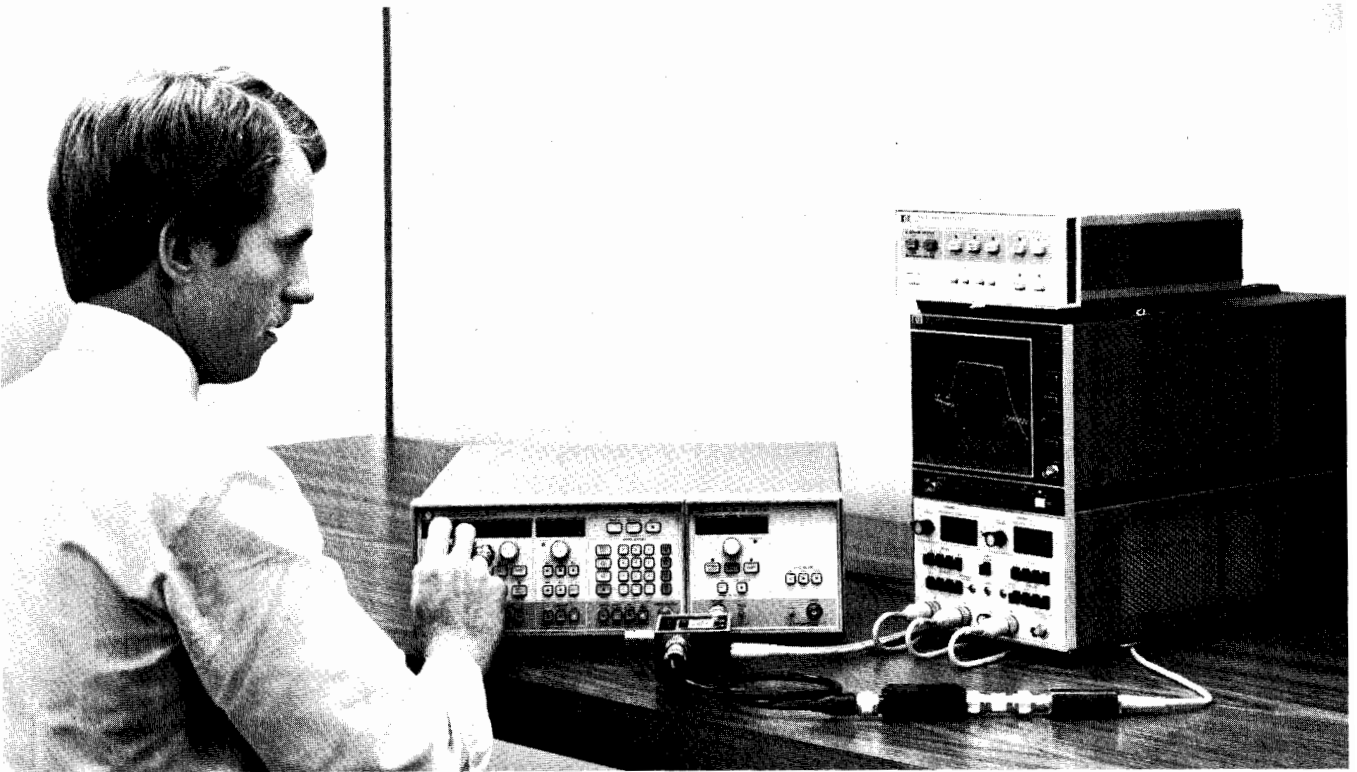

## Sweep Oscillators

Swept frequency oscillators are used in applications where the characteristics of a device must be determined over a wide, continuous range of frequencies. Combined with a broadband detector and display test set, sweep oscillators provide many benefits compared to CW frequency sources. A swept measurement provides a dynamic display of the data. The results of any adjustments to the unknown test device are seen immediately (real time) on the display. By replacing laborious point-by-point techniques swept measurements increase the speed and convenience of broadband testing. The continuous frequency characterization of the unknown device also eliminates the chance of missing important information between frequency points. Swept techniques are applicable in all phases of design, manufacture and maintenance.

### Hewlett-Packard Sweep Oscillators

Hewlett-Packard sweepers cover the entire frequency spectrum from dc to 40 GHz. Self-contained, multi-octave sweepers cover the frequency range to 110 MHz. The 8620 family of solid state oscillators provide a versatile choice of configurations—single band, straddle band, or very wide band plug-ins from 10 MHz to 22 GHz. 10 MHz to 26.5 GHz coverage is available in the 8350 family of plug-in sweep oscillators. The new 8340A provides broadband synthesized frequency coverage (10 MHz to 26.5 GHz) with excellent stability ( $5 \times 10^{-10}$ /day) and phase noise. A chart of the individual frequency bands available appears on page 372.

### Sweep Oscillator Features Sweep Flexibility

Every HP sweeper has several different sweep modes available for setting the fre-

quency limits of the instrument. A full band or independently adjustable start/stop frequency sweep can be selected. Alternatively, a marker sweep or a symmetrical  $\Delta F$  sweep about the desired center frequency can be chosen. Switching from one sweep mode to another is a simple pushbutton operation. In the auto mode the sweep retriggers automatically. Sweep times from 0.01 to more than 100 seconds can be selected. A manual sweep is also available as a front panel control, a real convenience for calibrating displays such as X-Y recorders. An external trigger is provided as well for applications where the sweeper must be synchronized to other instrumentation or remotely controlled.

On all sweeps a linear voltage proportional to frequency is available on an external connector which is useful for driving the horizontal of a display. Blanking and pen lift signals are also provided at rear output connectors during retrace time when the RF is off.

Marker capability, both Z-axis intensity dots and RF pips, are available on HP sweepers to note your important measurement frequencies. Two or more independent markers are offered on all sweepers with up to five markers on the new 8340A and 8350A mainframe. Crystal markers are offered on the 86222B and 83522A 10 MHz to 2.4 GHz RF plug-ins, and the 83525A/B 10MHz to 8.4 GHz plug-in.

Another powerful feature available on the new 8340A and 8350A sweeper mainframe is Save/Recall Mode. With Save/Recall Mode up to nine complete front panel states can be stored in memory and later recalled when the measurement is repeated. This saves considerable time when repetitive tests are required.

### Power output and leveling

Power output is continuously adjustable at the front panel over approximately a 10 dB range of all plug-ins. Built-in attenuators are also available on most plug-ins for greater power control. Internal or external leveling is employed to obtain (1) a constant power output and (2) a good source match (low VSWR). This ensures high accuracy when making swept measurements.

The new 8340A and 83500 series of plug-ins offer calibrated output power and internal leveling as standard features. Power is calibrated over a 15 dB range (30dB for the 8340A) with 0.1 dB resolution (programmable to 0.02 dB); with an internal step attenuator, the calibrated range is extended to 85 dB (110 dB on the 8340A).

Power as well as frequency can be swept with the 8340A or the 8350A and 83500 series plug-ins. This means that both the frequency response and power response of level sensitive devices like transistors and amplifiers can be measured using the same test set-up. Using the Power Sweep function 1 dB gain compression can easily be measured at a CW frequency (Figure 1). Also, the ability to alternate between two discreet power levels on successive sweeps (8340A or 8350A and 83500 series plug-

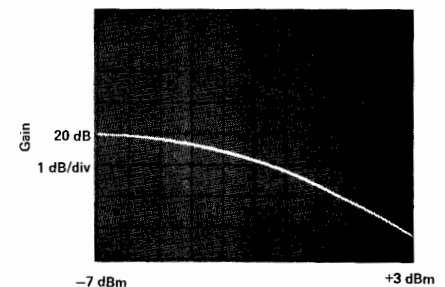



ins) allows a swept measurement of 1 dB compression point. Output power characteristics can be optimized simultaneously (Figure 2).

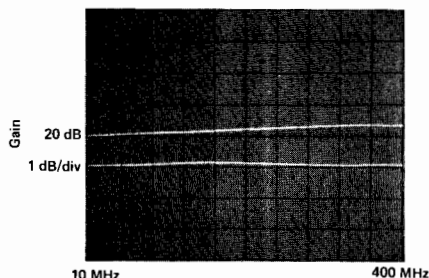

Figure 2.

## Modulation

Modulation capabilities further extend the sweeper's usefulness both as a sweeper and a signal generator for signal simulations. Wide AM and FM bandwidths are useful for a variety of tests on communication receivers. The flexible FM capability allows remote analog frequency programming which is important for many applications.

External pulse modulation is also available on many plug-ins. Most plug-ins also accept the 27.8 kHz square wave modulation required by the HP 8755C Frequency Response Test Set directly, eliminating the need for an external modulator. The 8350A mainframe will even supply the 27.8 kHz square wave modulation directly to the plug-in.

The 8340A Synthesized Sweeper has extensive modulation capability, providing both internal pulse and AM modulation. The pulse modulation capability works for pulse widths as narrow as 100 nsec, having rise and fall times less than 25 nsec and ON/OFF ratio greater than 80 dB. The AM is DC coupled and has a 3 dB bandwidth of 100 kHz. The maximum modulation depth varies with available output power but it is never less than 90%. In addition, the 8340A may simultaneously pulse and amplitude modulate the RF to simulate the effect of antenna scan on a pulse modulated signal.

## MLA Compatibility

In communications applications where up-converter simulation is required in conjunction with the HP Microwave Link Analyzer, the 86200 series of plug-ins provides this capability as an option in frequency ranges from 500 MHz to 18 GHz. Group delay of less than 1 nanosecond and linearity of better than 0.5% across 30 MHz across most of the frequency range permit very accurate RF to RF, RF to IF and RF to BB distortion measurements. See page 577 for more information.

## Programming

The 8340A, 8350A mainframe and 83500 series plug-ins offer total HP-IB control of all front panel functions. Not only CW frequencies, but sweeps, markers, power levels, etc., can be remotely programmed via the HP-IB. This means there are no limitations to designing customized automatic systems for either component or system testing.

The 8620C solid state sweeper mainframe provides optional BCD or HP-IB program-

ming capability. More than ten thousand frequency points per band permit very fine frequency control. In addition, band selection, sweep mode, RF attenuator, and remote-local can be controlled remotely. This allows the sweeper to be used in a wide variety of automatic systems and sophisticated signal simulation applications.

For example, a 1 MHz to 26.5 GHz frequency synthesizer can be configured using a controller, the 8350A/83594A 2-26.5 GHz Sweep Oscillator, and the 8660 (or 8656A or 8662A) UHF Synthesizer. (See Figure 3). Harmonics of the 8660 are used to phase lock the sweeper to the accuracy and stability of the synthesizer. The desktop computer is then used to control the sweeper, the UHF synthesizer, and RF switches to allow keyboard selection of a CW signal or to step the source across a band of interest.

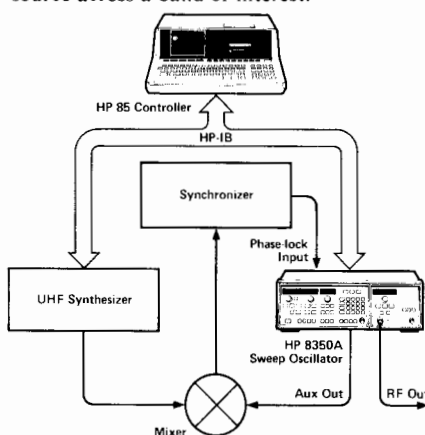

Figure 3.

Another way to improve the accuracy and stability of the 8350A or 8620C Sweep Oscillator is to phase-lock the output with the HP 5344S Source Synchronizer. With the 5344S the frequency may be set to a 1 Hz resolution and the long term stability becomes  $5 \times 10^{-10}$ /day. In addition to phase-locking a CW frequency the 5344S when used with a sweeper is also capable of phase continuous locked sweeps up to 40 MHz wide and broadband sweeps with a phase-locked start frequency.

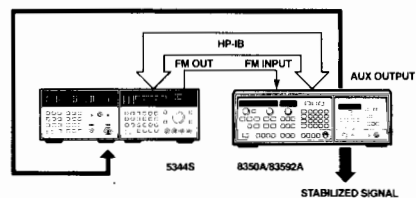

Figure 4.

In many applications, a computer can be used to assimilate data from a frequency response test set (HP 8755C) or network analyzer (HP 8410C). With automatic systems the computer can completely set up the measurement, sweep width, markers, power level, etc., and then document the measurement results in a printed or plotted format. For operations requiring a minimum of user interactions specification comparisons can be made for automatic "go no-go" testing. Using the programmable power capability of

the 83500 series plug-ins, automatic power as well as frequency response testing is possible.

## Digital Sweeping Synthesizers

The 3325A, 3330B, 3335A, 8660C, and 8662A combine the precision frequency accuracy and stability of a synthesizer with the time saving convenience of a sweeper. Parameters such as start/stop/center frequencies, sweep width, frequency step and sweep time are entered and executed through a convenient keyboard or remote programming. Some additional features are phase continuous linear/log sweep in the 3325A and amplitude sweeping in steps as small as 0.01 dB in the 3330B. This in conjunction with frequency sweeping can provide a comprehensive family of curves.

## Sweeper Applications

Sweepers are used extensively with swept frequency test sets to characterize the amplitude response of broadband devices or with network analyzers when the phase characteristics of the device (or S-parameters) are also needed. Two measurements—transmission and reflection—are basic to both types of analyzer. Hewlett-Packard offers a complete line of directional couplers, power splitters, and other transducers which together with the analyzers and sweep oscillators provide a total swept measurement solution.

The HP 8755C Frequency Response Test Set operates over the 10 MHz to 26.5 GHz frequency range (operation at higher frequencies can be achieved using the HP 11664C Detector Adapters). It is a two channel diode detection receiver system with -50 dBm sensitivity and ratio capability. Combined with the 8350A and broadband plug-ins like the 83592A (.01 - 20 GHz) it is ideal for simultaneous magnitude-only transmission and reflection measurements. Convenience is enhanced since the 8350A provides the required 27.8 kHz modulation directly. With the 8755C alternate sweep testing is possible, since Channel 1 is only permitted to respond to the 8350A's current state while Channel 2 responds to the alternate state. This allows "simultaneous" measurements of both filter skirt and passband responses (see Figure 5).

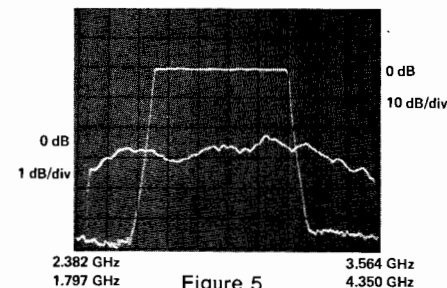

Figure 5.

For measurements requiring immunity from harmonics, more sensitivity and/or phase information, sweepers may be used with network analyzers. These measurements can easily be made across many octaves of frequency. For example, with the 83522A or 86222A/B RF Plug-ins and the 8410C Network Analyzer, phase-magnitude transmission or reflection coefficients can be measured across the full, 0.11-2.4 GHz





range in one continuous sweep. Since the 8410C is a tuned receiver there is a spurious-free sensitivity of -78 dBm.

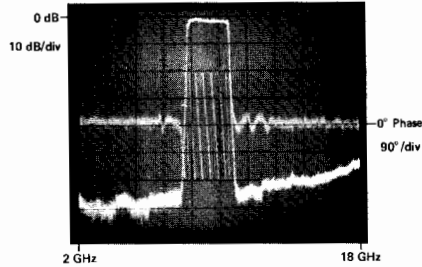

Figure 6

Figure 6 is a CRT photo of simultaneous phase and magnitude transmission characteristics of an 8 to 10 GHz using the 86290B Sweep Oscillator Plug-in.

For high power applications such as RF-susceptibility tests and high attenuation measurements, Hewlett-Packard offers TWT amplifiers which provide better than 1 watt from 1 to 18 GHz.

Synthesizer accuracy and stability can be obtained by phase-locking the Hewlett-Packard sweep oscillators to a harmonic of a very stable source or to the 5344S Source Synchronizer. This high stability is important in

many applications including microwave spectroscopy and high-Q swept frequency measurements.

Noise figure measurements above 1500 MHz can be made using the 8970A Noise Figure Meter with either the 8340A or the 8350A serving as the local oscillator. To perform these measurements the 8970A Noise Figure Meter sends frequency commands over the interface bus (HP-IB) to tune the sweep oscillator to the frequency of interest. With this equipment noise figure and gain measurements can be made on microwave components such as amplifiers, transistors or mixers.

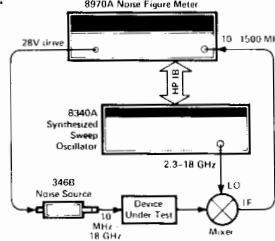

Two-tone sweep testing of devices such as mixers and receiver front ends requires two signals offset from each other by the IF. This is accomplished by phase-locking the difference frequency of two sweep oscillators to a very stable source. The sweepers may then be swept across the band of interest.

The modulation and built-in attenuator features of Hewlett-Packard sweep oscillators make them useful in many traditional CW signal generator applications. The excel-

lent stability, phase noise, frequency range and modulation capability of the new 8340A make it well suited for most of these applications. In addition, accuracy, linearity, and flatness of the broadband plug-ins like the 83590A, 83594A, 83595A, 83592A/B, 86290A/B/C, 83525A/B, 86222A/B, and 83522A make them more than adequate in many applications requiring a general purpose CW generator.

For wideband applications these RF plug-ins feature performance that rivals octave band oscillators in the areas of frequency purity and accuracy, harmonics, flatness, and power.

For a complete discussion of swept frequency measurements the following application notes and others are available from your local Hewlett-Packard sales office:

AN 155-1 "Active Device Measurements with the 8755..."

AN 155-2 "100 dB Dynamic Range Measurements, using the 8755 Frequency Response Test Set"

AN 183 "High Frequency Swept Measurements"

AN 187-2 "Configuration of a 2-18.6 GHz Synthesized Frequency Source using the 8620C Sweep Oscillator"

AN 187-5 "Calculator Control of the 8620C Sweep Oscillator using the HP-IB"

AN 187-6 "Frequency Performance of the 8620C Sweep Oscillator Under Remote Programming"

AN 312-1 "Configuration of a Two-tone Sweeping Generator"

### Sweep Oscillator—Summary Chart

Frequency Range*	Model Number			100 kHz	1 MHz	10 MHz	100 MHz	1 GHz	2 GHz	4 GHz	8 GHz	12 GHz	18 GHz	26 GHz	40 GHz
	8350 Series	8620 Series**	Other Sweepers												
0.1 Hz-13 MHz 10 Hz-21 MHz 1 μHz-21 MHz 1 mHz-50 MHz 200 Hz-80 MHz 10 kHz-1280 MHz 10 kHz-2600 MHz			3312A 3336A/B/C 3325A 8165A 3335A 8662A 8660C	→	→	→	→	→	→	→	→	→	→	→	→
100 kHz-110 MHz 10 MHz-1.3 GHz 10 MHz-2.4 GHz 10 MHz-8.4 GHz 10 MHz-20 GHz 10 MHz-26.5 GHz	83522A 83525A/B 83592A/B 83595A	86220A 86222A/B	8601A    8340A	→	→	→	→	→	→	→	→	→	→	→	→
1.7-4.3 GHz 1.8-4.2 GHz 2-8.4 GHz 3.6-8.6 GHz 2-18.6 GHz 2-20 GHz 2-22 GHz 2-26.5 GHz	83540A/B  83590A 83594A	86235A 86230B 86240A/B 86240C 86290A/B/C 86290A/B Opt H08	8673A	→	→	→	→	→	→	→	→	→	→	→	→
3.2-6.5 GHz		86241A		→	→	→	→	→	→	→	→	→	→	→	→
5.9-9.0 GHz 5.9-12.4 GHz 7-11 GHz 7.5-18.6 GHz 8-12.4 GHz	83545A	86242D 86245A 86250D Opt H08 86251A 86250D		→	→	→	→	→	→	→	→	→	→	→	→
10-15.5 GHz 12.4-18 GHz 17-22 GHz 18-26.5 GHz	83570A	86260B 86260A 86260C		→	→	→	→	→	→	→	→	→	→	→	→

\*Other Special Frequency Ranges Can Be Provided Upon Request.

\*\*86200 Series RF Plug-ins are usable with the 8350A Mainframe via the 11869A Adapter. 83500 Series Plug-ins are not usable in the 8620C Mainframe.

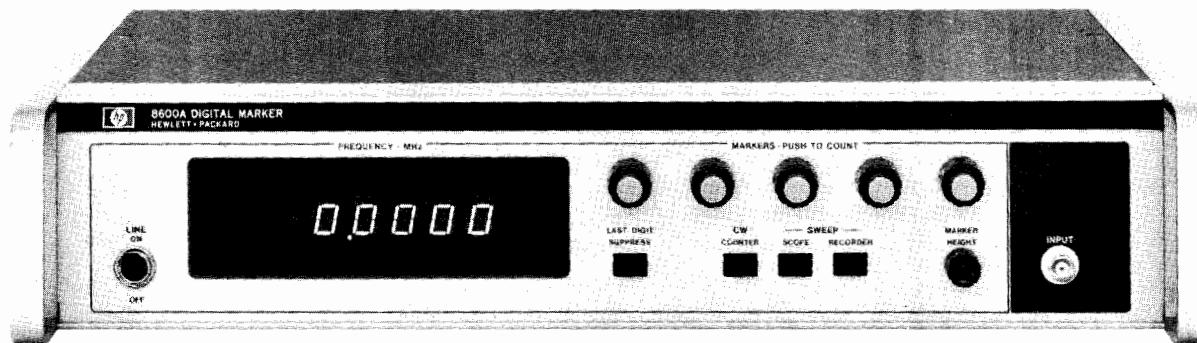

8600A

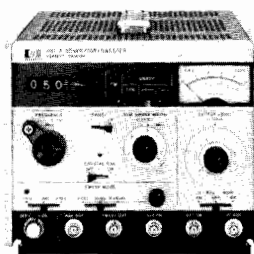

8601A

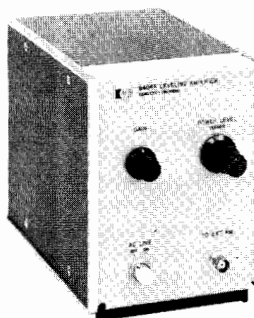

8404A

Covering 100 kHz to 110 MHz, the Model 8601A Generator/Sweeper combines the high linearity and flatness of a precision sweeper with a signal generator's frequency accuracy and wide range of calibrated power levels. Though it's small and lightweight, it does the work of two instruments easily and conveniently.

### 8601A Specifications

**Frequency range:** low range, 0.1-11 MHz; high range, 1-110 MHz.

**Frequency accuracy:** approximately  $\pm 1\%$  of frequency.

**Power output:** +20 to -110 dBm; 10-dB steps and 13-dB vernier provide continuous settings over entire range. Meter monitors output in dBm and rms volts into 50  $\Omega$ .

**Power accuracy:**  $\pm 1$  dB accuracy for any output level from +13 dBm to -110 dBm.

**Flatness:**  $\pm 0.25$  dB over full range,  $\pm 0.1$  dB over any 10 MHz portion (+10 dBm step or below).

**Impedance:** 50 $\Omega$ , SWR <1.2 on 0 dBm step and below.

**Harmonics and spurious signals:** (CW above 250 kHz, output levels below +10 dBm) harmonics at least 35 dB below carrier. Spurious at least 40 dB below carrier.

**Residual FM:** noise in a 20 kHz bandwidth including line related components (dominant component of residual FM is noise).

**CW:** <50 Hz rms, low range; <500 Hz rms high range.

**SYM 0, sweep:** <100 Hz rms, low range; <1 kHz rms, high range.

**Residual AM:** AM noise modulation index (rms, 10 kHz bandwidth) is <-50 dB; (typically -60 dB at 25°C).

**Crystal calibrator:** internal 5 MHz crystal allows frequency calibration to  $\pm 0.01\%$  at any multiple of 5 MHz.

**Sweep modes:** full, video, and symmetrical.

**Internal AM:** fixed 30%  $\pm 5\%$  at 1 kHz.

**External AM:** 0 to 50%, dc to 400 Hz; 0 to 30%, up to 1 kHz.

**Internal FM:** 1 kHz rate, fixed 75 kHz  $\pm 5\%$ , deviation, high range; 7.5 kHz  $\pm 5\%$ , deviation, low range; <3% distortion.

**External FM:** sensitivity, 5 MHz per volt  $\pm 5\%$ , high range, 0.5 MHz per volt  $\pm 5\%$ , low range; negative polarity; FM rates to 10 kHz.

**Weight:** net, 9.5 kg (21 lb). Shipping, 12.3 kg (27 lb).

**Size:** 155 mm H x 190 mm W x 416 mm D (6  $\frac{3}{32}$ " x 7  $\frac{25}{32}$ " x 16  $\frac{3}{4}$ ").

The Model 8600A Digital Marker provides five independent, continuously variable frequency markers over the range 0.1-110 MHz when used with the HP 8601A or HP 8690B/8698B Generator Sweeper.

The high resolution controls and 6-digit readout permit 0.05% frequency settability. The frequency of any marker may be read while sweeping, simply by pushing a button within the marker control. The marker selected is brighter than the others and points in the opposite direction, ensuring positive marker identification.

### 8600A Specifications

**Marker accuracy:** any marker may be placed at a desired frequency  $\pm (0.05\%$  of sweep width + sweeper stability).

**Weight:** net, 5.9 kg (13 lb); shipping 8.2 kg (18 lb).

**Size:** 99 mm H x 413 mm W x 337 mm L (3  $\frac{3}{8}$ " x 16  $\frac{3}{4}$ " x 13  $\frac{1}{4}$ ").

### 8404A Power Meter Leveling Amplifier

The 8404A Leveling Amplifier permits the HP 431B/C or HP 432A/B/C Power Meter to level both the HP 8620 and HP 8690 sweeper plug-ins. RF output is leveled to  $\pm 0.5$  dB or less when connected to the AM input of the sweeper.

#### Ordering Information

**8600A Digital Marker**

**Opt 001:** Modification kit for 8690B/8698B

**8601A Generator/Sweeper**

**Opt 008:** 75  $\Omega$  BNC output

**8404A Power Meter Leveling Amplifier**

**Opt 001:** 4 line BCD level control



# SWEEP OSCILLATORS

## 8350 Family: 10 MHz– 26.5 GHz

### Model 8350A

- Versatile Microprocessor-Controlled Mainframe
- Single-Band, Straddle-Band and Broad Band Plug-ins
- 10 MHz to 26.5 GHz in one Plug-In
- 10 mW Output Power to 26.5 GHz
- Total HP-IB Programmability

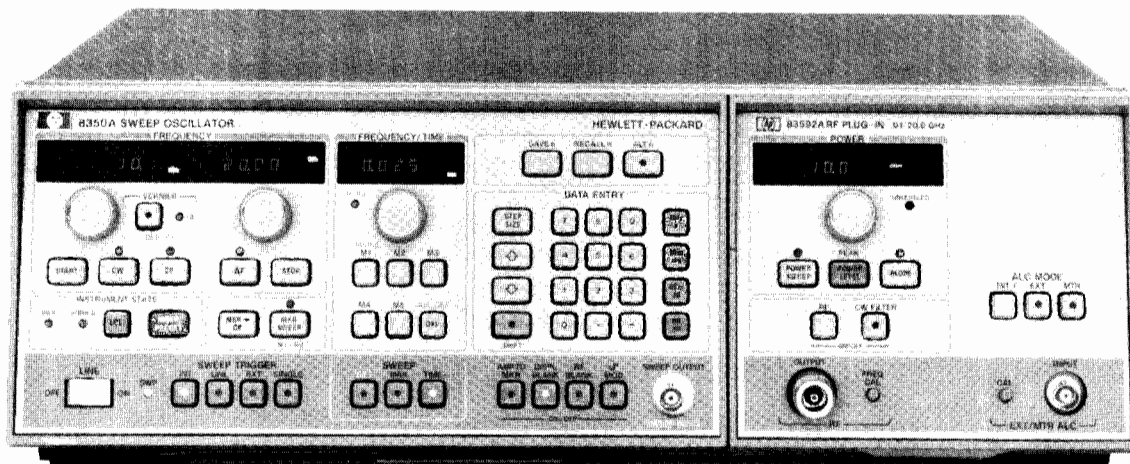

8350A



### 8350 System

The HP 8350 is a powerful RF and microwave source for swept measurements, wideband CW signal generation and automatic testing. It incorporates the efficiency of microprocessor control with state-of-the-art YIG-tuned oscillators and GaAs FET amplifiers to produce a high performance sweep oscillator system ideally suited for either manual or automatic measurements.

You can easily configure a source to meet your application's frequency coverage and power requirements. Just combine the versatile 8350A mainframe with any of the 31 standard RF plug-ins (see table at right) and you are ready to make measurements. Both the advanced 83500 series plug-ins and the existing 86200 series plug-ins (via the 11869A adapter) are accepted by the 8350A mainframe.

### 8350A Mainframe

The 8350A has been designed to include many features that not only speed and simplify measurements but also improve accuracy. In addition, it is the first sweep oscillator to provide total computer control of all front panel function settings.

All function values (sweep limit frequencies, marker frequencies, etc.) are indicated on high resolution digital displays, thus eliminating the time consuming task of reading and interpolating between dial scale graduations. Function values are easily modified using the appropriate knob, step keys, or data entry keyboard. The knob provides a "continuous" analog feel while the step keys allow values to be increased or decreased by specific amounts. Fast entry of precise values is made from the data entry keyboard.

Five independent, continuously variable markers are available to note your measurement frequencies. The active marker frequency or the difference frequency between any two markers is read easily from high resolution digital display. You can also use marker sweep to zoom in on a particular frequency span while retaining your original sweep limits.

Another particularly useful feature in making repetitive measurements is the 8350A's Save/Recall Mode. Once the sweeper has been set for a particular measurement, all front panel settings (8350A and 83500 series plug-in) can be *Saved* and later *Recalled* to repeat the measurement by accessing one of nine internal storage registers.

In the past, HP-IB programming of sweepers was limited to a series of CW frequencies. With the 8350A all front panel functions, e.g. sweeps, markers, sweep time, even output power (83500 series plug-ins) can be programmed. This means there are no limitations in designing your own customized test systems. Utilizing the Learn Mode function, the 8350A becomes a "talker" as well as "listener" on the bus, transferring all manually entered front panel controls to the computer.

Full compatibility with both the HP 8410C Network Analyzer and the HP 8755C Frequency Response Test Set are provided for convenient vector and scalar measurement with the 8350A. The HP 5343A Counter can be combined with the 8350A to measure Start, Stop, or marker frequencies with up to 100 kHz accuracy while sweeping. Improved frequency accuracy and stability may be achieved by using the HP 5344S Source Synchronizer with the 8350A to phase-lock the RF output. Microwave noise figure measurements may be made using the 8350A with the HP 8970A Noise Figure Meter.

### 83500 Series Plug-ins

Broadband frequency coverage from 10 MHz to 26.5 GHz with high output power is provided in the 83500 series RF plug-ins. One plug-in, the 83595A, operates over the entire 10 MHz to 26.5 GHz range without sacrificing frequency accuracy (15 MHz at 26.5 GHz). The 18 GHz to 26.5 GHz band is filled by the 83570A RF plug-in and boasts a 10 mW power level (comparable to most BWO's).

The 83500 series plug-ins offer output power level control previously unavailable on a swept source. First, power level control is calibrated with 0.1 dB resolution and up to 80 dB range (with Opt 002 attenuator). Second, calibrated power sweeps are available for characterizing device performance as a function of power. And third, slope and internal leveling controls are standard on all units.

All 83500 series front panel functions and HP-IB programmable including power level. This means your automatic test systems can now characterize a device both as a function of frequency and input power level.

### 86200 Series Plug-ins

Simply combining the 86200 series plug-in (including the one you may already own) with an 11869A Adapter makes all the convenient digital controls, markers, and HP-IB capability of the 8350A immediately available to you. The 86200 series are a particularly attractive plug-in choice when economical single-band operation is desired with the 8350A mainframe. For measurements with HP Microwave Link Analyzer, specially characterized 86200 series plug-ins can be used with the 8350A to create an upconverter for communications distortion measurements.

The 86290A/B/C plug-ins cover the 2-18 GHz frequency range with 5 mW, 10 mW, and 20 mW of output power respectively. Frequency accuracy at 18 GHz is 20 MHz exceeding that available on most single-band plug-ins. Both 83500 series and 86200 series plug-ins compatible with the 8350A Mainframe are summarized in the table below. Note that the 11869A Adapter is required with all 86200 series plug-ins. See specifications on page 386.

### Product Notes

8350A-2 "Improved Frequency Accuracy by Calibrating HP 83590 Series RF Plug-ins to HP 8350A Sweep Oscillator Mainframe"

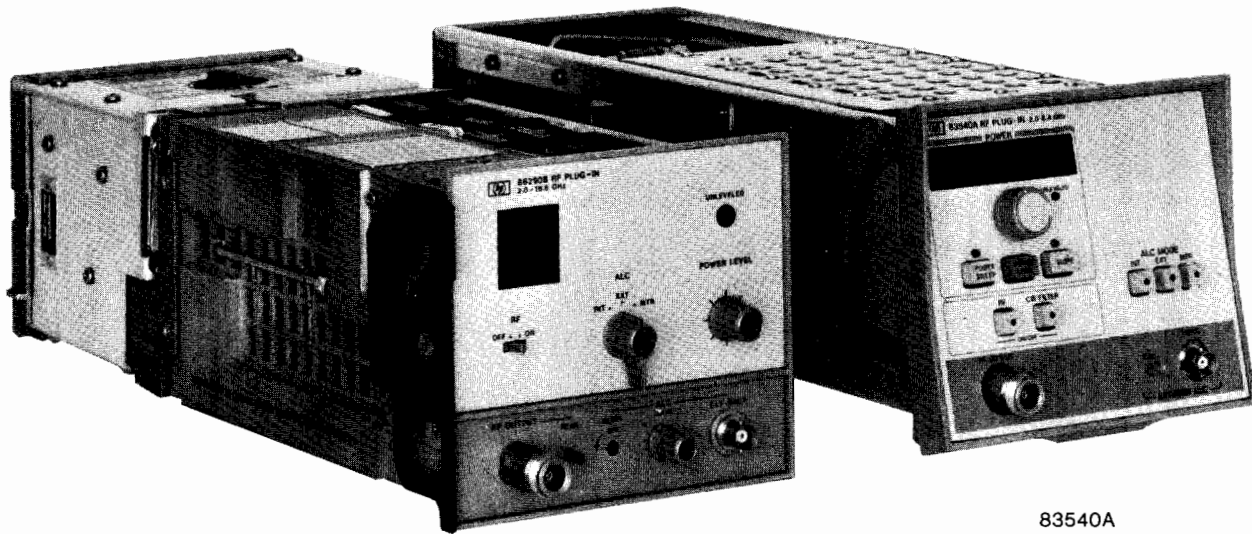

86290B

83540A



	Model number	Frequency range (GHz)	Leveled power output	Frequency accuracy (MHz)	Complete specifications on page
Broad-band Plug-ins	83595A	.01-26.5	2.5 mW	±12	378, 379
	83594A	2-26.5	2.5 mW	±12	378, 379
	83592A/B	.01-20	6.3 mW/20 mW*	±10	378, 379
	83590A	2-20	6.3 mW	±10	378, 379
	83525A/B	.01-8.4	20 mW/10 mW	±7	380, 381
	83522A	.01-2.4	20 mW	±5	380, 381
	86222A/B	.01-2.4	20 mW	±10	389
	86290A	2-18	5 mW	±20	390
	86290B	2-18.6	10 mW	±20	390
Straddle-band Plug-ins	86290C	2-18.6	20 mW	±20	390
	83540A/B	2-8.4	40 mW/20 mW	±7	382, 383
	86240A	2-8.4	40 mW	±20	391
	86240B	2-8.4	20 mW	±20	391
	86240C	3.6-8.6	40 mW	±20	391
Single-band Plug-ins	86251A	7.5-18.6	10 mW	±20	391
	86220A	.01-1.3	10 mW	±10	392, 393
	86230B	1.8-4.2	10 mW	±15	392, 393
	86235A	1.7-4.3	40 mW	±20	392, 393
	86241A	3.2-6.5	3.2 mW	±30	392, 393
	86242D	5.9-9	10 mW	±35	392, 393
	83545A	5.9-12.4	50 mW	±40	382, 383
	86245A	5.9-12.4	50 mW	±40	392, 393
	86250D	8.0-12.4	10 mW	±40	392, 393
	86260B	10-15.5	10 mW	±50	392, 393
	86260A	12.4-18	10 mW	±50	392, 393
86260C	17-22	10 mW	±50	392, 393	
83570A	18-26.5	10 mW	±30	384, 385	

NOTE: The 11869A Adapter is required to interface 86200 series plug-ins with the 8350A mainframe.

\* 83592B: 20 mW to 18.6 GHz.

# SWEEP OSCILLATORS

- Accurate, high resolution, digital displays
- Five markers with Marker  $\Delta$  and Marker Sweep
- Save/Recall 9 complete front panel states
- Accepts new 83500 series plug-ins
- Total HP-IB programmability

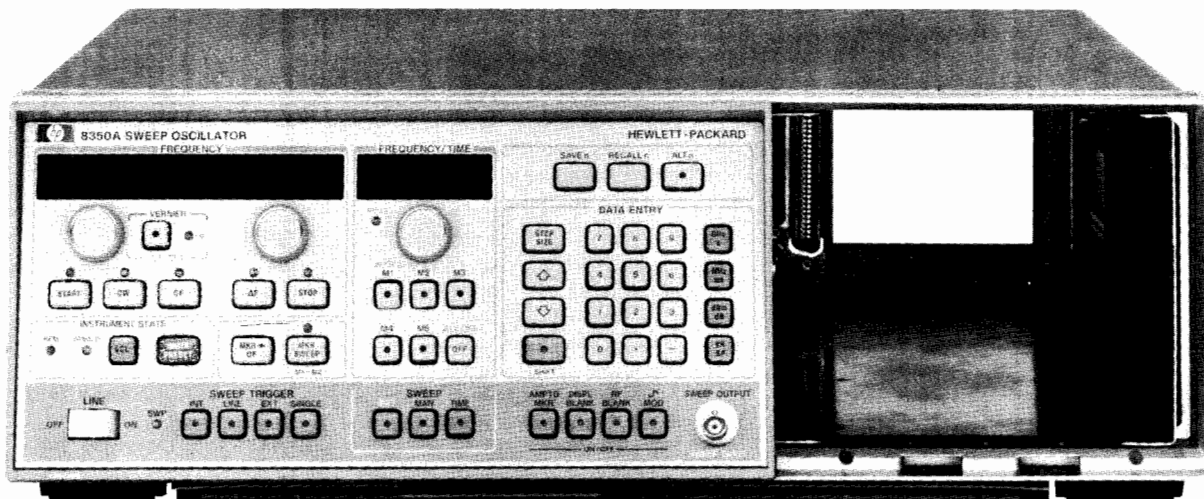

8350A



## 8350A Mainframe:

Sweep Oscillator applications are greatly expanded by the new features of the HP 8350A. Along with the traditional swept and CW frequency functions the 8350A adds five markers with extensive capabilities, versatile data entry and complete HP-IB programmability. The 8350A mainframe accepts the 86200 series plug-ins via the 11869A Adapter as well as the new wideband 83500 series plug-ins. In order to aid system set ups, the 8350A is directly compatible with the HP 8410C and HP 8755C network analyzers. The frequency accuracy is easily enhanced when the HP 5343A Counter is used to count the START, STOP, or ACTIVE MARKER frequency. For even more frequency accuracy and stability the HP 5344S Source Synchronizer may be used to phase-lock the RF output.

The 8350A has three methods of changing function values; control knobs, keyboard entry, or step key entry. The traditional control knob provides an analog "feel" of control which is useful for continuous parameter adjustment. Numerical keyboard entry allows for fast, accurate input. Finally, quantized inputs are possible with step keys.

Five markers are available with the 8350A. These markers combined with the high resolution digital readout make the accurate location of important frequency responses easy. A key marker feature, marker  $\Delta$ , computes the difference between any two markers. While the markers are in this mode the trace is intensified between the two markers, thereby aiding the user's visual comprehension. This feature is particularly useful for measurements such as the determination of the bandwidth between 3 dB points. With the extensive marker capabilities key frequency ranges may be marked and swept. The markers can modify the center frequency (marker — CF) or the START/STOP frequency (Marker Sweep). These expanded marker capabilities simplify sophisticated measurements.

A necessity in making repetitive measurements or automatic tests is the Save/Recall Feature. Once the 8350A controls have been set for a

particular measurement, all of the front panel controls can be "Saved" in a memory location and later "Recalled" when the measurement is repeated. This feature supplies nine memory locations, each storing a complete front panel set up. Memory storage or access may be done randomly or sequentially. Non-volatile memory is included so that all memories are retained even when line power is removed.

The HP 8350A makes "simultaneous" comparison of two separate frequency ranges or power levels easy via the alternate sweep mode. When the alternate sweep mode is activated the 8350A alternates between the current front panel setting and any stored memory setting on successive sweeps. The output from this function may be processed through a network analyzer such as the HP 8755C and viewed on a two channel display.

All front panel controls (except the ac line power switch) may be programmed or controlled via the HP-IB. The 8350A may interact as a listener or as a talker on the HP-IB. As a talker the 8350A is capable of outputting the manually entered front panel information to a controller. The HP-IB capabilities of the 8350A are far more extensive than in other sweepers hence increasing its range of applications.

As a result of the 8350's internal microprocessor design, a self test is performed at turn on or whenever the instrument pre-set function is activated. This function verifies that the 8350A is functioning properly. If there is a problem, error codes are displayed on the front panel to help locate the problem quickly to the board and component level.

In the 8350A the frequency resolution is determined by the digital to analog converters that are used to produce the tuning voltage and marker pulses. The center frequency resolution is 0.00038% of the full band (262,144 points across the band). The  $\Delta F$  resolution is variable, such that higher resolution is provided for narrow sweep widths. The  $\Delta F$  resolution is 0.1% of the full band range for full bands sweeps and improves to 0.0015% of the full band range for very narrow band sweeps.



## 8350A Specifications

### Instrument Control

**Control knobs, Step keys and data entry keyboard:** All instrument parameters whether time, frequency or power may be set three ways: control knobs, keyboard entry, or step keys. The step size either can be entered by the user or the pre-programmed default values may be used. The SHIFT key is used to effect the functions written in blue.

### Frequency Control Functions

**Range:** Determined by RF plug-in unit used

**Linearity:** Refer to RF unit specifications

**START/STOP sweep:** Sweeps up from the START frequency to the STOP frequency.

**CF/ΔF Sweep:** Sweeps symmetrically upward, centered on CF

**ΔF:** Frequency Width of sweep. Continuously adjustable from zero to 100% of frequency range.

**ΔF Accuracy:** Refer to RF unit specifications.

**CF Accuracy:** Refer to RF unit specifications.

**CF Resolution:** 0.00038% (262,144 points across band)

**ΔF Resolution:** 0.1% of full band (1024 points across band)

0.012% of band for 1/8 of band or less

0.0015% of band for 1/64 of band or less

**Display resolution:** 5 digits

**CW Operation:** Single frequency RF output.

**CW Accuracy:** Refer to RF unit specifications.

**CW Resolution:** Same as CF.

**Vernier:** Adjusts CW frequency or swept center frequency up to 0.05% of RF plug-in band being swept.

**Vernier resolution:** 4 ppm (64 points between each CW point; 262,144 points across band)

**Offset:** Allows the CW frequency or center frequency to be offset by any amount up to the full range of the plug-in.

**Resolution:** same as CF

**Accuracy:** Refer to RF unit specifications

**Frequency markers:** Five frequency markers are independently adjustable and fully calibrated over the entire sweep range. Amplitude or intensity markers available.

**Resolution:** 0.4% of selected sweep width (256 points/sweep)

**Accuracy:** Refer to frequency accuracy.

**Marker output:** Rectangular pulse, typically -5 volts peak available from the POS Z BLANK connector on rear panel.

**Marker sweep:** RF output is swept between Marker 1 and Marker 2.

**Marker—CF:** Causes the CW or the swept center frequency to equal the frequency of the active marker.

### Sweep and Trigger Modes

**Internal:** Sweep recurs automatically

**Line:** Sweep triggered by ac power line frequency.

**External trigger:** Sweep is actuated by external trigger signal.

**Single:** Selects mode and triggers a single sweep.

**Sweep time:** Continuously adjustable from 10 msec to 100 seconds.

**Manual sweep:** Front panel controls provide continuous manual adjustment of frequency between end frequencies.

**External sweep:** Sweep is controlled by external signal applied to front or rear panel SWP OUTPUT/SWP INPUT connector.

**Sweep output:** Direct-coupled sawtooth, zero to approximately ±10 volts, at front or rear panel concurrent with swept RF output.

### Instrument State Storage

**Save n/Recall n:** Up to 9 different front panel settings can be stored in the 8350A via the Save n (n = 1 through 9) function. Settings can be recalled randomly or in sequence.

**Alt n:** Causes the RF output to alternate on successive sweeps between the current front panel setting and a setting stored in memory.

### Instrument State

**Instrument preset:** Sets the front panel of the 8350A into a pre-determined state. It also causes an internal analog and digital self-test to occur. If internal errors or failures are detected they are indicated via error codes.

**Local operation:** This key is used to return the 8350A to local control from the remotely controlled state. The REM lamp indicates remote control. The ADRS'D lamp indicates transmitted or received data over the HP-IB.

### Modulation

**External AM:** Refer to RF unit specifications.

**Internal AM:** Square wave modulation available at all sweep speeds. Factory preset to 27.8 kHz although selectable to 1000 Hz or 27.8 kHz. On/off ratio, refer to RF unit specifications.

**External FM:** Refer to RF unit specifications.

**Phase-lock:** Refer to RF unit specifications.

### Remote Programming (HP-IB)

The 8350A has both input and output capability. The HP-IB address can be displayed on the front panel and is selectable (any number from 0 to 31).

**Input mode functions:** All front panel controls except the ac line power switch are programmable. Numerical values typically have greater entry resolution than is displayed.

**Frequency resolution:** Same as CF/ΔF plus vernier.

**Power resolution:** See 83500 Series Plug-ins.

**Output mode functions:** The 8350A can output to a controller an instrument state message that describes the present instrument status.

### General Specifications

**Non volatile memory:** Continuous memory that retains the contents of all instrument state storage registers, the HP-IB address, and current instrument state when ac line power is off.

**Blanking:**

**RF:** When enabled, RF turns off during retrace and remains off until next sweep.

**Display:** POS Z BLANK; direct-coupled rectangular pulse approximately +5.0 volts during retrace and bandswitch points of sweep. NEG Z BLANK; direct-coupled rectangular pulse approximately -5.0 volts coincident in time with RF blanking.

**Pen Lift:** Output to control the pen lift function of XY recorder at end point of sweep.

**Counter trigger (CNTR TRIG):** Output for controlling the external trigger input of the HP 5343A Frequency Counter.

**Stop sweep:** Input for stopping the progress of a forward sweep, used with HP 5343A Frequency Counter.

**Program connector:** Additional control of and information on the 8350A instrument state is provided via a 25 pin rear panel connector.

**8410B/C Interface Cable:** Permits multi-octave operation of HP 8410B/C Network Analyzer with 8350A.

**Operating temperature range:** 0°C to +55°C

**Power:** 100, 120, 220 or 240 volts +5-10%, 50 to 60 Hz (Option 400, 60 to 400 Hz). Approximately 270 volt-amps including RF unit.

**Weight (not including RF unit):** Net 16.5 kg (36.4 lb). Shipping 22.7 kg (50 lb)

**Dimensions:** 425 mm wide, 133.3 mm high, 422 mm deep (16.75" x 5.25" x 16.6")

### Ordering Information

#### 8350A Sweep Oscillator Mainframe

#### Options:

**400:** 400 Hz Power Line Frequency Operation

**907:** Front Handles Kit

**908:** Rack Mounting Kit

**909:** Rack Mounting/Front Handles Kit

**910:** Extra Manual

**803:** HP 5343A Interface Cables

**850:** HP 8410B/C Source Control Cable

# SWEEP OSCILLATORS

## 8350A Family: Broadband Plug-ins

Models 83595A, 83592A/B, 83594A, 83590A

- Calibrated output power with 0.1 dB resolution
- +13 dBm from 0.01-18.6 GHz
- 12 MHz frequency accuracy at 26.5 GHz

- Internal leveling and slope standard
- HP-IB

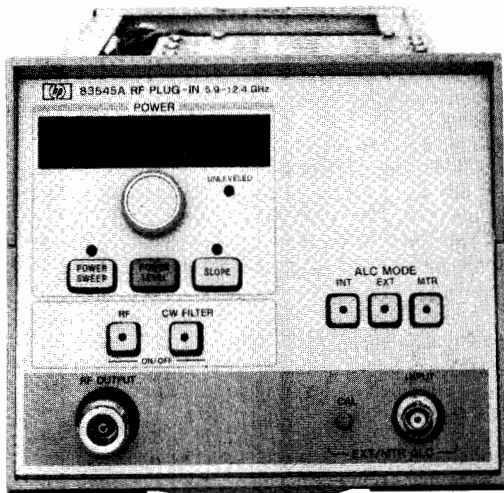

83592B

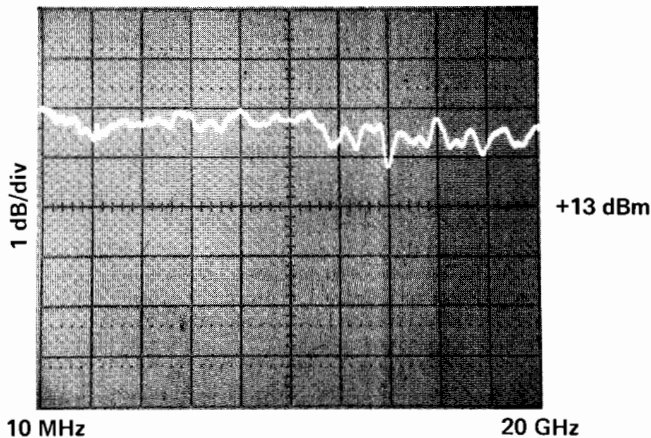

The four 83590 series plug-ins feature ultra-wideband frequency coverage as exemplified by the 83595A which covers 0.01-26.5 GHz in a single sweep. While the 83590 series features broadband sweeps, they still maintain narrowband precision. The frequency output exhibits excellent stability and accuracy. At 26.5 GHz the 83595A maintains an accuracy of  $\pm 12$  MHz. The 83592B does not sacrifice power for broadband high frequency coverage, the output power is internally leveled for a minimum  $\pm 13$  dBm (to 18.6 GHz) output with  $\pm 0.9$  dB flatness. Power output capabilities have been expanded to provide power sweep and slope control. In addition the 83590 series plug-ins are completely HP-IB programmable.

The most outstanding feature of the 83590 series plug-ins is their broad frequency range. Innovative technology is used to create this precision frequency range. The principle behind this technology is the Switched YIG Tuned Multiplier circuit (SYTM). This circuit contains a pin diode switch and a YIG Tuned Multiplier (YTM) in a single package. More specifically, the YTM circuit uses the output of a fundamental oscillator to drive a high-efficiency multiplier that has been integrated together with a tracking YIG filter in order to create and select high order harmonics to be used as output frequencies. On the 83595A, for example, the PIN diode allows the low frequency heterodyne band to be switched to the output for a single 0.01-26.5 GHz sweep. From this method, five frequency bands may be identified; one from the heterodyne, and then four bands resulting from the 1st, 2nd, 3rd or 4th harmonics. For wideband sweeps these bands have very small overlap areas (20 MHz), yet for narrow band sweeps these bands are flexible enough to contain the complete sweep in one band.

Another figure of merit for the 83590 series are their flat output power over the entire frequency range. The output power is internally leveled within 0.9 dB for a minimum output power of 10 dBm, with a displayed resolution of 0.1 dB. The power level may be controlled to a minimum settable power level of -5 dBm. This level may be extended to -75 dBm on the 83592A/B and 83590A with Option 002 (70 dB Step Attenuator) or to -60 dBm on the 83595A and 83594A with Option 002 (55 dB Step Attenuator).

Since power parameters are critical to high frequency measurements the 83590 Series (along with all 83500 series plug-ins) offer many modes of power output. In addition to a single power output, the 83590 Series offers a Power Sweep function. The Power Sweep function sweeps a power range for characterizing level sensitive devices like amplifiers and transistors. The Slope mode is also supplied to provide compensation for cable or test set losses. In all these modes the power output is internally monitored and leveled. If preferred, the

power may be externally leveled.

HP-IB programmability is an essential feature when one of the 83590 series is used in automatic test systems. For example, the automated tests of amplifiers for gain compression are possible. These plug-ins are completely programmable which means the power mode may be set, or the power level may be set with .02 dB resolution.

The 83590 series plug-ins are excellent sources for high frequency, broadband network measurements. These plug-ins accept a 27.8 kHz squarewave modulation from the HP 8350A mainframe and hence become directly compatible with the HP 8755C Frequency Response Test Set. By eliminating the need for an external modulator, full sweeper power is available at the test device. Phase/Amplitude network analysis is possible when these plug-ins are used in conjunction with the HP 8410C Network Analyzer. The 8410C becomes automatically phase-locked over multi-octave sweeps when it is interfaced with a source control cable from the 8350A mainframe and the 1V/GHz from the plug-in. In addition, a low frequency, auxiliary output may be used for counting or phase-locking to improve the frequency accuracy and stability. The HP 5344S Source Synchronizer takes advantage of this auxiliary output with its subharmonic and off-set locking capability.

### General Specifications

**Sweep time (minimum):** 10 msec for a single band (Bands 0, 1, 2, 3, 4). 25 msec for full band.

**Switch Points:** 83595A, 83592A/B: Internal bands are 0.01-2.4 GHz, 2.3-7.0 GHz, 6.9-13.5 GHz, 13.4-20.0 GHz and 19.9-26.5 GHz (83595A only). Broadband switch points are at approximately 2.4 GHz, 7.0 GHz, 13.5 GHz and 20.0 GHz (83595A only). 83594A, 83590A: Internal bands are 2.0-7.0 GHz, 6.9-13.5 GHz, 13.4-20.0 GHz and 19.9-26.5 GHz (83594A only). Broadband switch points are at approximately 7.0 GHz, 13.5 GHz and 20.0 GHz (83594A only).

**Auxiliary Output:** 83595A, 83592A/B: Rear Panel 2.3-7.0 GHz fundamental oscillator output, nominally 0 dBm 83594A, 83590A: Rear Panel 2.0-7.0 GHz fundamental oscillator output, nominally 0 dBm.

**Frequency Reference Output:** 83595A, 83592A/B: nominal 1V/GHz (0.01-19 GHz)  $\pm 20$  mV rear panel BNC output. 83594A, 83590A: nominal 1V/GHz (2-19 GHz)  $\pm 20$  mV rear panel BNC output.

**RF Output Connector:** 83595A, 83594A: Type APC 3.5 male. 83592A/B, 83590A: Type N female (Option 005 APC-7 RF Output Connector).

**Weight:** Net 6.0 kg (13.2 lb.) Shipping 9.2 kg (20 lb.)



**Output Characteristics**

**Impedance:** 50 Ω nominal

**VSWR:** < 1.9:1

**Power Sweep** (with option 002 Power Sweep cannot cross an attenuator step)

**Calibrated range:** 83590A, 83592A/B: > 10 dB (15 dB typical); 83594A, 83595A: 9 dB

**Accuracy** (Including Linearity): < ± 1.5 dB typical

**Resolution:** 0.1 dB

**Slope Compensation** (with option 002 Slope cannot cross an attenuator step)

**Calibrated range:** Up to .5 dB/GHz (10 dB over full range)

**Linearity:** < .3 dB typical

**Resolution:** 0.1 dB/GHz

**Attenuator Accuracy** (±dB referenced from the 0 dB setting, 83590A, 83592A/B only)

Frequency Range (GHz)	Attenuator Setting (dB)						
	10	20	30	40	50	60	70
0.01-12.4	0.6	0.7	0.9	1.8	2.0	2.2	2.3
12.4-18.0	0.7	0.9	1.2	2.0	2.3	2.5	2.8
18.0-20.0	0.9	1.5	2.5	3.0	3.2	3.3	3.5

**Modulation Characteristics**

**External AM**

**Frequency response:** Typically 100 kHz

**Input impedance:** Approximately 10 kΩ

**Range of amplitude control:** Typically 15 dB

**Sensitivity:** 1 dB/V typical

**Maximum input:** 15 V

**Pulse In** (83595A and 83592A/B only)

TTL Compatible: Logic high = RF on, Logic low = RF off.

0.01 to 20.0 GHz: Squarewave modulation up to 30 kHz.

0.01 to 7.0 GHz

Rise/Fall Time: Typically 10 ns.

Minimum Pulse Width

Leveled: Typically 1 μsec.

Unleveled (Power level set to +20 dBm): Typically 100 ns.

**External FM**

**Maximum Deviations for Modulation Frequencies**

**DC to 100 Hz:** ± 75 MHz

**100 Hz to 1 MHz:** ± 10 MHz

**1 MHz to 2 MHz:** ± 5 MHz

**2 MHz to 10 MHz:** ± 1.5 MHz

**Sensitivity**

**FM Mode:** -20 MHz/V typical

**Phase-lock mode:** -6 MHz/V typical

**Input Impedance:** 2 kΩ nominal

**Frequency response:** (DC to 2 MHz): ± 3 dB

**Ordering Information**

**83590A** 2.0 to 20 GHz RF Plug-in

**Option 002:** 70 dB Step Attenuator

**Option 004:** Rear Panel RF Output

**83592A** 0.01 to 20 GHz RF Plug-in

**Option 002:** 70 dB Step Attenuator

**Option 004:** Rear Panel RF Output

**83592B** 0.01 to 20 GHz (13 dBm) RF Plug-in

**Option 002:** 70 dB Step Attenuator

**Option 004:** Rear Panel RF Output

**83594A** 2.0 to 26.5 GHz RF Plug-in

**Option 002:** 55 dB Step Attenuator

**Option 004:** Rear Panel RF Output

**83595A** 0.01 to 26.5 GHz RF Plug-in

**Option 002:** 55 dB Step Attenuator

**Option 004:** Rear Panel RF Output

	83592A/B 83590A (excluding Band 0)					83595A 83594A (excluding Band 0)					
	Band 0	Band* 1	Band 2	Band 3	Full* Band	Band 0	Band* 1	Band 2	Band 3	Band 4	Full* Band
	.01-2.4	2.4-7.0	7.0-13.5	13.5-20	.01-20	.01-2.4	2.4-7.0	7.0-13.5	13.5-20	20-26.5	.01-26.5
Frequency Characteristics											
Accuracy: (25°C ± 5°C)											
CW Mode: (MHz)	±5	±5	±10	±10		±5	±5	±10	±10	±12	
Typically: (MHz)	±2	±2	±3	±4		±2	±2	±3	±4	±5	
All Sweep Modes (100msec Sweep Time): (MHz)	±15	±20	±25	±30	±50	±15	±20	±25	±30	±35	±50
Linearity: Typ. (MHz)	±2	±2	±4	±6	±10	±2	±2	±4	±6	±8	±10
Stability											
With Temperature: Typically (MHz/°C)	±.2	±.2	±.4	±.6	±.6	±.2	±.2	±.4	±.6	±.8	±.8
With 10% Line Voltage Change: (kHz)	±50	±50	±100	±150	±150	±50	±50	±100	±150	±200	±200
With 10 Power Level Change: (kHz)	±200	±200	±400	±600	±600	±200	±200	±400	±600	±800	±800
With 3:1 Load VSWR: (kHz)	±200	±200	±400	±600	±600	±200	±200	±400	±600	±800	±800
With Time (after 1 hour warmup at the same frequency) Typically (kHz)	<200	<200	<400	<600	<600	<200	<200	<400	<600	<800	<800
Residual FM (10 kHz bandwidth, peak): (kHz)	<8	<5	<7	<9	<600	<5	<5	<7	<9	<12	<800
Output Characteristics											
Maximum Leveled Power** (mW) (25°C ± 5°C)	10(20)****	10(20)****	10(20)****	10/6.3****	6.3	10	10	10	10	2.5	2.5
Opt 002	10(16)****	7(14)****	7(14)****	3.2	3.2	7	6.3	5	5	1.25	1.25
Power Level Accuracy											
(Internally Leveled): (dB)	<±1.5	<±1.3	<±1.3	<±1.4	<±1.5	<±1.5	<±1.3	<±1.3	<±1.4	<±1.7	<±1.8
Minimum Settable Power: (dBm)	-5	-5	-5	-5	-5	-5	-5	-5	-5	-5	-5
With Opt 002	-75	-75	-75	-75	-75	-60	-60	-60	-60	-60	-60
Remote Programming Resolution Displayed: (dB)	.1	.1	.1	.1	.1	.1	.1	.1	.1	.1	.1
Settable (dB)	.02	.02	.02	.02	.02	.02	.02	.02	.02	.02	.02
Power Variation (Max. Rated Pwr)											
Internally Leveled: (dB)	<±.9	<±.7	<±.7	<±.8	<±.9	±.9	±.7	±.7	±.8	±.9	±1.0
Externally Leveled (Excludes Coupler/Detector Variation) (For Negative Crystal Detector and HP 432A/B/C Power Meter): (dB)	<±.2	<±.2	<±.2	<±.2	<±.2	<±.2	<±.2	<±.2	<±.2	<±.2	<±.2
With Temperature: (dB/°C)	.1	.1	.1	.1	.1	.1	.1	.1	.1	.1	.1
Residual AM in 100 kHz Bandwidth: (dBc)	>50	>50	>50	>50	>50	>50	>50	>50	>50	>50	>50
Spurious Signals											
Harmonically Related: (dBc)	>25(20)****	>25	>25	>25	>25	>25	>25	>25	>25	>20	>20
Typically: (dBc)	>35	>40	>35	>35	>35	>35	>40	>35	>35	>25	>25
Non-Harmonics: (dBc)	>25	>50	>50	>50	>25	>25	>50	>50	>50	>50	>50

\*Band 1 on the 83590A and the 83594A covers 2.0-7.0 GHz, and Full Band on the 83590A and 83594A covers 2-20 GHz and 2-26.5 GHz.

\*\*0.5 dB lower with Opt 004.

\*\*\*10 mW (13.5-18.6 GHz); 6.3 mW (18.6-20 GHz).

\*\*\*\*83592B only.





# SWEEP OSCILLATORS

## 8350 Family: Broadband Plug-ins (Cont.)

Models 83522A, 83525A and 83525B

- 10 MHz–2.4 GHz and 10 MHz–8.4 GHz in One Continuous Sweep
- Calibrated Output Power
- Power Sweep

- 1, 10, and 50 MHz Crystal Markers
- > 45 dBc Harmonics 83525B from 2–8.4 GHz Output
- Complete HP-IB Programmability

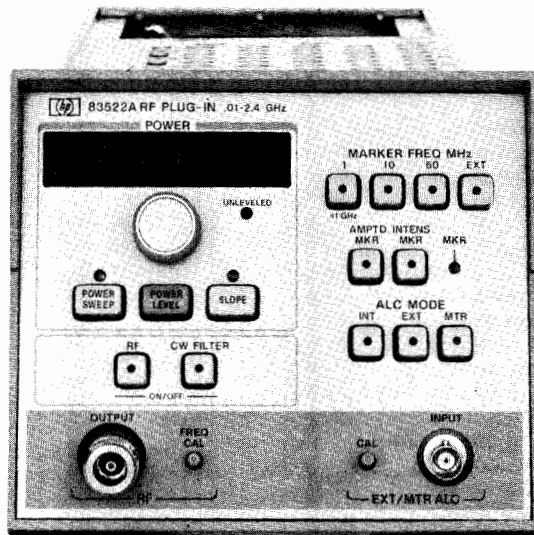

83522A

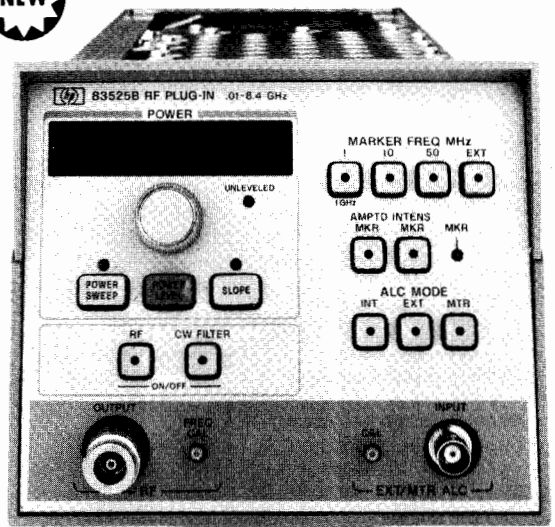

83525B

Broadband frequency measurements may be made with the HP83522A (10 MHz to 2.4 GHz) plug-in and the HP 83525A/B (10 MHz to 8.4 GHz) plug-in. These plug-ins have similar functions as well as individual merits which are all described in the following article.

### 83522A

The 83522A uses a heterodyne circuit to provide high performance 10 MHz to 2.4 GHz frequency coverage. This frequency range is covered in one continuous sweep having excellent frequency characteristics. Frequency accuracy is maintained within 5 MHz and the linearity is within 2 MHz over the full band. The power output is internally leveled to  $\pm 0.25$  dB flatness over the entire 10 MHz to 2.4 GHz range while maintaining a power level  $\geq 13$  dBm.

### 83525A/B

The 83525A/B cover the unmatched frequency range of 10 MHz to 8.4 GHz with excellent frequency stability, accuracy, and output power. This wide frequency range is created by automatically switching two bands together with a PIN diode switch. The lower frequency band covers 0.01–2.1 GHz which results from a heterodyne circuit. The upper frequency band is produced by a 2–8.4 GHz YIG oscillator. This 0.1 GHz frequency overlap is provided to enable smooth, narrowband sweeps around the switch point. On a full band sweep (10 MHz to 8.4 GHz) the band discontinuity at the switchpoint will be typically  $< 8$  MHz. The 83525A/B maintain excellent frequency parameters with a lower band accuracy within  $\pm 5$  MHz and an upper band accuracy within 8 MHz. Full band frequency linearity is  $\pm 3$  MHz while the lower band maintains a linearity of  $\pm 2$  MHz.

The 83525A plug-in, with its extremely broad frequency range, does not sacrifice power. This plug-in provides at least +13 dBm of output power while being internally leveled to a flatness of  $\pm 1$  dBm.

The 83525B plug-in provides the same outstanding specifications as the 83525A plus 45 dBc harmonics for maximum dynamic range in RF component and system measurements.

## 83522/83525 Common Features

### Crystal Marker Capability

A powerful feature offered by the 83522A and the 83525A/B is Crystal Marker capability. This capability provides harmonic markers at 10 or 50 MHz intervals over the full range of the 83522A and below 2 GHz with the 83525A/B. In addition, 1 MHz harmonic markers are available below 1 GHz with all three plug-ins. These

markers may either be seen as intensity spots or amplitude dips. The x-axis intensity markers are compatible with the HP8755 Swept Frequency Response Test Set. These crystal markers simplify and speed up precision frequency measurements.

### Power Output

The 83522A and the 83525A/B plug-ins have a calibrated output power range of typically 15 dB that may be extended to  $> 80$  dB with Option 002 (70 dB attenuator). The output power level accuracy is within 1 dB on the 83522A and within 1.5 dB on the 83525A/B. The front panel digital resolution enables the power to be manually set to a 0.1 dB resolution. The power may be remotely HP-IB programmed to 0.02 dB resolution.

These plug-ins also offer a variety of power functions. An innovative feature offered on these plug-ins is Power Sweep, which sweeps the output power from one level to another. With this function, power response measurements may be made in a single test. Slope compensation is provided for situations that involve lossy cables or test set ups. This function slopes the power to compensate for high frequency losses via a "Slope" control.

### Programmability

The 83522A and the 83525A/B are completely programmable plug-ins. This infers that the power level, power mode (Power Sweep, Slope, etc.), crystal markers and other plug-in functions may be externally controlled via the HP-IB. Programmability is a key feature for automatic test systems or production environments requiring multiple, repetitive tests.

### Network Measurements

Increased dynamic range scalar measurements can be made using either the HP83522A or the 83525A with the HP8755 Swept Frequency Response Test Set. The dynamic range is increased by internally modulating the RF output with the required 27.8 KHz square wave (produced by the 8350A). This causes the output to be modulated before it is passed through the output amplifier, thereby avoiding modulation of the amplifier noise. The advantage of increased dynamic range is complemented by the simple interface between the sweep oscillator and the HP8755. In addition these plug-ins are directly compatible with the HP 8410B Network Analyzer for vector measurements, the HP 8970A Noise Figure Meter for noise level analysis and the HP 5344S Source Synchronizer for phase-lock applications.





## Frequency Characteristics

Range	83522A	83525A/B	
	0.01-2.4 GHz	0.01-8.4 GHz	
		0.01-2 GHz	2-8.4 GHz
<b>Accuracy* (25°C ± 5°C)</b>			
CW Mode:	± 5 MHz	± 5 MHz	± 8 MHz
Typically:	± 1.5 MHz	± 1.5 MHz	± 3.5 MHz
All Sweep Modes	± 15 MHz	± 15 MHz	± 20 MHz
Linearity Typically:	± 2 MHz	± 2 MHz	± 3 MHz
<b>Stability</b>			
With Temperature: Typically	± 200 kHz/°C	± 200 kHz/°C	± 200 kHz/°C
With 10% Line Voltage Change:	± 20 kHz	± 20 kHz	± 20 kHz
With 10 dB Power Level Change:	± 100 kHz	± 100 kHz	± 1 MHz
With 3:1 Load SWR:	± 10 kHz	± 10 kHz	± 250 kHz
With Time (in 10 minute period after one hour warmup at the same frequency setting): Typically	< ± 100 kHz	< ± 100 kHz	< ± 200 kHz
Residual FM (10 Hz-10 kHz Bandwidth), peak	< 5 kHz	< 5 kHz	< 7 kHz

## Output Characteristics

	83522A	83525A/B	
		.01-2 GHz	2-8.4 GHz
<b>Maximum Levelled Output Power</b> (25°C ± 5°C) With Option 002	+20 mW +20 mW	+20 mW +20 mW	+20 mW/10 mW +16 mW/10 mW
<b>Power Level Accuracy</b> (Internally Levelled):	± 1 dB	± 1.5 dB	± 1.5 dB
<b>Calibrated Range:</b>	15 dB	15 dB	15 dB
With Option 002:	85 dB	85 dB	85 dB
<b>Attenuator Accuracy</b> (per 10 dB step, typical):	± 0.5 dB	± 0.5 dB	± 0.5 dB
<b>Resolution (displayed):</b>	0.1 dB	0.1 dB	0.1 dB
<b>Remote Programming (Settable):</b>	± 0.02 dB	± 0.02 dB	± 0.02 dB
<b>Power Variation (Max. Rated Pwr)</b>			
Internally Levelled:	± 0.25 dB	± 1 dB	± 1 dB
Externally Levelled (Excludes Coupler/Detector Variation) For Negative Crystal Detector and HP 432A/B/C Power Meter:	< ± 0.1 dB	< ± 0.1 dB	< ± 0.1 dB
With Temperature:	± 0.02 dB/°C	± 0.02 dB/°C	± 0.02 dB/°C
<b>Residual AM in 100 kHz Bandwidth:</b>	> 50 dBc	> 50 dBc	> 50 dBc
<b>Spurious Signals</b>			
Harmonics (for 10 mW output pwr):	> 25 dBc	> 25 dBc**	> 25 dBc/ 45 dBc
Typical:	> 30 dBc	> 30 dBc	> 30 dBc/50 dBc
Non-Harmonics:	> 25 dBc	> 30 dBc	> 60 dBc
Typical:	> 30 dBc	> 35 dBc	> 60 dBc
<b>Output VSWR (internally levelled)</b>	< 1.5	< 2.0	< 1.6

**Unlevelled Indicator:** Lights when RF power level is set too high to permit leveling over sweep range selected.

**Impedance:** 50 Ω nominal

### Power Sweep

**Calibrated range:** 15 dB

**Accuracy (including linearity):** < ± 1.5 dB Typical

**Resolution:** 0.1 dB

### Slope Compensation

**Calibrated range:** up to 5 dB/GHz (10 dB over full range, typically 15 dB)

**Linearity:** < 0.2 dB Typical

**Resolution:** 0.1 dB/GHz

### Modulation Characteristics

#### External AM

**Frequency response:** 100 kHz Typically

**Input impedance:** Approximately 10 kΩ

**Range of amplitude control:** 15 dB Typically

**Sensitivity:** 1 dB/V Typically

**Maximum input:** 15 V

**Pulse modulation:** (83525A/B, 2-8.4 GHz)

**Rise/fall time:** 20 nsec Typically

**Minimum pulse width:** Levelled: 1 μsec Typically

Unlevelled: 100 nsec Typically

\*When calibrated using internal crystal markers and FREQ CAL adjustment.

\*\*83525A harmonics > 20 dBc for 20 mW output power.

#### Internal AM

Selectable (by Internal Jumper in 8350A) to 1 kHz or 27.8 kHz square wave modulation. 27.8 kHz Modulation guarantees operation with HP 8755 Frequency Response Test Set.

**On/Off Ratio:** ≥ 30 dB (> 40 dB above 2 GHz)

#### External FM

Maximum Deviations for Modulation Frequencies

**DC to 100 Hz:** ± 75 MHz

**100 Hz to 1 MHz:** ± 7 MHz

**1 MHz to 2 MHz:** ± 5 MHz

**2 MHz to 10 MHz:** ± 1 MHz

#### Sensitivity

**FM Mode:** -20 MHz/V Typical

**Phase-lock mode:** -6 MHz/V Typical

**Input impedance:** 2 kΩ nominal

**Frequency response (DC to 2 MHz):** ± 3 dB

#### Crystal Marker Capability

**Internal crystal markers:** Harmonic markers of 10 and 50 MHz are available over the full range of the 83522A and below 2 GHz with 83525A/B. 1 MHz harmonic markers are available below 1 GHz with the 83522A and 83525A/B. Markers are output as intensity spots through the POS Z BLANK connector on the 8350A or as amplitude dips on the RF output.

**Accuracy of center frequencies (25°C):** ± 5 × 10<sup>-6</sup>

Typical Marker Width Around Center Frequency

**1 MHz Markers:** ± 100 kHz

**10 MHz Markers:** ± 200 kHz

**50 MHz Markers:** ± 300 kHz

**Temperature stability:** ± 2 × 10<sup>-6</sup>/°C Typical

**External marker input:** Generates amplitude or Z-axis marker when sweep frequency equals external input frequency.

**Frequency range:** .01 to 2.4 GHz (2.0 GHz for 83525A/B)

**Marker width:** ± 300 kHz

**Marker indicator light:** LED lights when coincident with crystal or external marker for accurate CW calibration.

#### General Specifications

**Sweep Time (minimum over full band)**

**83522A (.01-2.4 GHz):** 10 ms

**83525A/B (.01-8.4 GHz):** 17 ms

**Switch points (83525A/B Only):** Low Band .01-2.1 GHz, High Band 2.0-8.4 GHz. Internal band switch point at 2.0-2.1 GHz

**Frequency reference output:** Nominal 1 V/GHz (over full sweep range) ± 10 mV rear panel BNC output.

**RF Output connector:** Type N female

**Weight:** Net 4.5 kg. (10 lb.). Shipping 7.7 kg. (17 lb.)

#### Improved Network Measurement Capabilities

The 83522A and 83525A/B are compatible with the:

8410 Network Analyzer

8755 Scalar Network Analyzer

8970A Noise Figure Meter (Frequencies > 2 GHz)

8709A Phase-lock Synchronizer

5344S Source Synchronizer

#### Ordering Information

**83522A** +13 dBm .01-2.4 GHz RF Plug-in

**Options:**

**002:** Programmable 70 dB Step Attenuator (10 dB steps)

**004:** Rear Panel RF Output

**83525A** +13 dBm .01-8.4 GHz RF Plug-in

**83525B** +10 dBm .01-8.4 GHz RF Plug-in

**Options:**

**002:** Programmable 70 dB Step Attenuator (10 dB steps)

**004:** Rear Panel RF Output

# SWEEP OSCILLATORS

## 8350 Family: RF Plug-Ins

Models 83540A, 83540B and 83545A

- 83540A offers 40 mW Internally Leveled 2-8.4 GHz Output
- 83545A offers 50 mW Internally Leveled 5.9-12.4 GHz Output
- 83540B offers >45 dBc Harmonics 2-8.4 GHz Output
- Calibrated Output Power with 0.1 dB Resolution
- Power Sweep
- Complete HP-IB Programmability

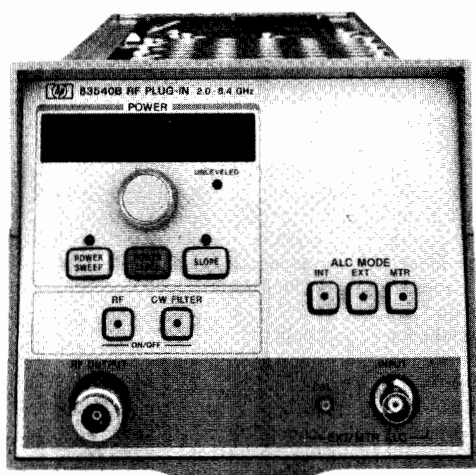

83540B

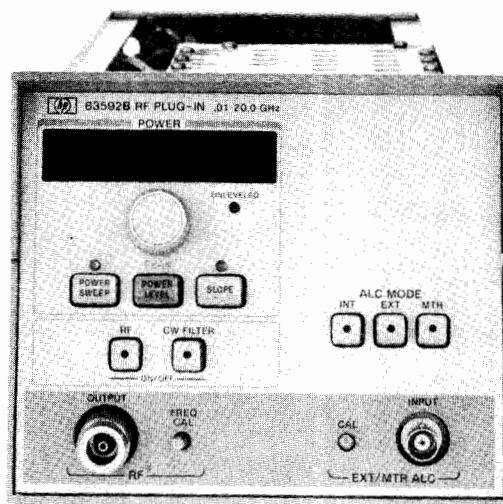

83545A



### 83540A / B

High power, high performance, straddle band frequency coverage from 2-8.4 GHz is provided by the 83540 plug-ins. The output power is leveled at a minimum of 16 dBm from the 83540A and 13 dBm from the 83540B with variations less than 1 dB. The calibrated power output range is 15 dB which may be extended to >80 dB with Option 002 (70 dB Step Attenuator). These plug-ins also feature Power Sweep which allows realtime power response measurements to be made in a single test. Another power function is slope compensation which adjusts for high frequency cable or test set losses. All plug-in features are completely HP-IB programmable. The frequency outputs are accurate within 8 MHz while maintaining a full band linearity typically within 0.1%. In addition to its sweeper functions, the 83540 is also directly compatible with the HP 8755 Swept Frequency Response Test Set and the HP 8410B/C Network Analyzer.

The 83540B gives emphasis to signal purity with 45 dBc harmonics for extended dynamic range in precision RF scalar measurement systems.

The clear, high power test signal of the 83540B is produced by employing a YIG-filtered oscillator (YFO). The YFO consists of a broadband, YIG tuned 2-8.4 GHz oscillator driving a 100 mW power amplifier followed by another YIG element to filter the signal. By incorporating both YIG elements within the same magnetic housing and controlling them simultaneously, a very accurate, pure and powerful RF test signal is achieved.

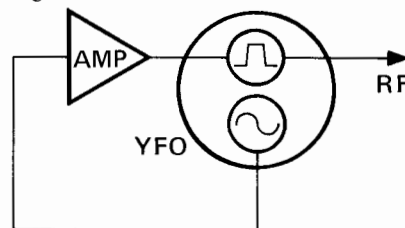



### 83545A

The 83545 plug-in features high performance 5.9-12.4 GHz frequency coverage with exceptionally high output power. The output power is internally leveled to at least 17 dB, with power variations less than 0.6 dB! The calibrated output power has a range of 15 dB which is expandable to >80 dB with Option 002 (70 dB Step Attenuator). A power sweep function is available for power response measurements. In addition, the 83545 provides slope compensation and complete HP-IB programmability. The frequency output is accurate to 20 MHz with excellent stability and linearity (typically 0.1%). Network analysis is simplified since the 83545 provides 27.8 kHz internal modulation for direct compatibility with the HP 8755 Swept Frequency Response Test Set and it is also directly compatible with the HP 8410B/C Network Analyzer.

### Frequency Characteristics

**Linearity:** (83540A/B, 83545A)  $\pm 0.1\%$  typical

**Reference output:** (83540A, 83545A) DC-coupled voltage proportional to RF frequency. Typically 1V/GHz with accuracy of  $\pm 25$  mV.

### Output Characteristics

**Power level accuracy:**  $\pm 1$  dB typical

**Option 002 (70 dB Step Attenuator):** (83540A, 83545A)  $\pm 0.2$  dB/10 dB step typical

### RF power leveling:

**Internal:** Selected by front panel switch; Refer to chart for figures. Standard for 83540 and 83545.

### External:

**Crystal input:** Approximately  $-20$  to  $-250$  mW for specified leveling at rated output; For use with negative polarity detectors such as 780 Series Directional Detectors, 423A/B and 424 Series Crystal detectors.

**Power meter input:** Switch selects proper compensation for HP 432A/B/C Power Meters.

**Indicator:** Front panel indicator lights when RF power becomes unlevelled. Residual AM in 100 kHz Bandwidth:  $> 50$  dBc

**Impedance:** 50  $\Omega$  nominal

### Power Sweep:

**Calibrated range:**  $\geq 15$  dB

**With Option 002:**  $\geq 14$  dB

**Accuracy:**  $\pm 1$  dB typical

**Resolution:** 0.1 dBm

**Slope compensation:** Compensates for high frequency power losses in external test sets by attenuation power at lower frequencies:

**Calibrated range:** up to 5 dB/GHz (10 dB max., typically 15 dB)

**Linearity:**  $< 0.2$  dB typical

**Resolution:** 0.1 dB/GHz

### General Specifications

**RF Output connector:** Type N female

**Sweep Time** (minimum over full band)

**83540A/B** (2.0–8.4 GHz): 10 ms

**83545A** (5.9–12.4 GHz): 10 ms

**Weight:** 83540A, 83545A: Net 3.8 kg (8.4 lbs); Shipping 7 kg (15.4 lbs).

### Improved Network Measurement Capabilities

The 83540A/B and 83545A are compatible with the:

8410 Network Analyzer

8755 Frequency Response Test Set

8970A Noise Figure Meter

8709A Phase-lock Synchronizer

5344S Source Synchronizer

### Frequency Characteristics

	83540A	83540B	83545A
<b>Range:</b>	2-8.4 GHz	2-8.4 GHz	5.9-12.4 GHz
<b>Accuracy</b> (25°C $\pm 5^\circ$ C)			
CW Mode:	$\pm 8$ MHz	$\pm 8$ MHz	$\pm 20$ MHz
Typical:	$\pm 3.5$ MHz	$\pm 3.5$ MHz	$\pm 10$ MHz
All Sweep Modes: (for sweep time $> 100$ msec)	$\pm 20$ MHz	$\pm 20$ MHz	$\pm 35$ MHz
<b>Stability</b>			
With Temperature:	$\pm 200$ kHz/ $^\circ$ C	$\pm 200$ kHz/ $^\circ$ C	$\pm 700$ kHz/ $^\circ$ C
With 10% Line Voltage Change:	$\pm 20$ kHz	$\pm 20$ kHz	$\pm 40$ kHz
With 10 dB Power Level Change:	$\pm 1$ MHz	$\pm 1$ MHz	$\pm 1.5$ MHz
With 3:1 Load SWR Change:	$\pm 250$ kHz	$\pm 250$ kHz	$\pm 250$ kHz
With Time: (in 10 minute time period after one hour warmup at the same frequency setting) Typ/10 min.	$\pm 200$ kHz	$\pm 200$ kHz	$\pm 200$ kHz
Residual FM: (in 10 kHz bandwidth, CW mode):	$< 7$ kHz peak	$< 7$ kHz	$< 15$ kHz peak

### Output Characteristics

	83540A	83540B	83545A
<b>Maximum Leveled Power</b> (25°C $\pm 5^\circ$ C) Opt 002 (70 dB step atten.)	$> 40$ mW $> 32$ mW	$> 20$ mW $> 16$ mW	$> 50$ mW $> 40$ mW
<b>Power Variation</b> (At max. rated power)			
Internally Leveled:	$< \pm 1$ dB	$< \pm 1$ dB	$< \pm 0.6$ dB
Unleveled: Typically	$< \pm 2$ dB	$< \pm 2$ dB	$< \pm 3\alpha$ B
Externally Leveled (Excluding coupler and detector variation):			
Crystal Detector or Power Meter	$< \pm 0.1$ dB	$< \pm 0.1$ dB	$< \pm 0.1$ dB
<b>Spurious Signals:</b> (Below fundamental at specified maximum power)			
Harmonically Related:	$> 20$ dB ( $\text{@ } 20$ mW) $> 16$ dB ( $\text{@ } 40$ mW)	$> 45$ dB $> 50$ dB	$> 17$ dB 5.9-7 GHz $> 30$ dB 7-12.4 GHz
Non-Harmonics:	$> 60$ dB	$> 60$ dB	$> 60$ dB
Source VSWR: 50 nominal impedance			
Internally leveled:	$< 1.6$	$< 1.6$	$< 1.6$
Unleveled: Typically			$< 2.5$
<b>Modulation Characteristics</b>			
External FM			
Maximum Deviations for Modulation Frequencies			
DC to 100 Hz:	$\pm 75$ MHz	$\pm 75$ MHz	$\pm 75$ MHz
100 Hz to 1 MHz:	$\pm 7$ MHz	$\pm 7$ MHz	$\pm 7$ MHz
1 MHz to 2 MHz:	$\pm 5$ MHz	$\pm 5$ MHz	$\pm 5$ MHz
2 MHz to 10 MHz:	$\pm 1$ MHz	$\pm 1$ MHz	$\pm 1.5$ MHz
<b>Sensitivity:</b> Nominal			
FM Mode:	$-20$ MHz/V	$-20$ MHz/V	$-20$ MHz/V
Phase-lock Mode:	$-6$ MHz/V	$-6$ MHz/V	$-6$ MHz/V
<b>External AM</b>			
Input Impedance: nominal	10 k $\Omega$	10 k $\Omega$	10 k $\Omega$
Frequency Response: Typical	100 kHz	100 kHz	100 kHz
Range: Typical	15 dB	15 dB	15 dB
<b>Pulse Modulation</b>			
Rise/Fall Time: Typical	20 nsec	20 nsec	15 nsec
Minimum Pulse Width			
Leveled: Typical	1 $\mu$ sec	1 $\mu$ sec	1 $\mu$ sec
Unleveled: Typical	100 nsec	100 nsec	100 nsec
<b>Square Wave Response</b>			
ON/Off Ratio: Typical	$> 30$ dB	$> 30$ dB	$> 40$ dB
Symmetry: Typical	40/60	40/60	40/60
<b>Internal AM:</b>			
Selectable to 1 kHz or 27.8 kHz square wave (Guarantees HP 8755 Frequency Response Test Set compatibility)			
On/Off Ratio:	$> 30$ dB	$> 30$ dB	$> 40$ dB

### Ordering Information

**83540A** 2-8.4 GHz Plug-in (Internal leveling standard)

**83540B** 2-8.4 GHz Plug-in (Internal leveling standard)

**83545A** 5.9-12.4 GHz Plug-in (Internal leveling standard)

### Options

**002:** 70 dB Step Attenuator

**004:** Rear Panel RF Output Connector



# SWEEP OSCILLATORS

## 8350 Family: RF Plug-Ins (Cont.)

### Model 83570A

- 83570A offers 10 mW Internally Leveled 18-26.5 GHz Output
- Low Frequency Auxiliary Output for Easy Counting and Phase-locking
- Calibrated Output Power with 0.1 dB Resolution
- Power Sweep
- Complete HP-IB Programmability

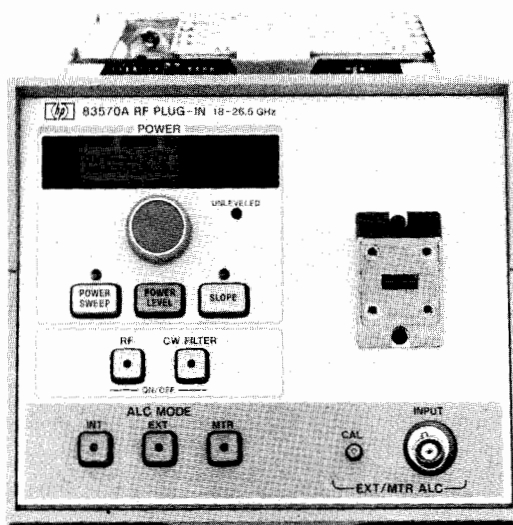

83570A



### 83570A

Now precision measurements to 26.5 GHz are possible with the solid state 83570 plug-in. The 83570 plug-in maintains a minimum leveled output power of 10 dBm which is comparable to the output power of Backward Wave Oscillators. Power is internally leveled to a flatness  $< \pm 1.4$  dB. At the output, power losses are minimized with a waveguide output connector (a coaxial output connector may be made using the HP K281C adapter). Full range coverage of the 83570 extends from 18 GHz to 26.5 GHz. This frequency range maintains a 30 MHz frequency accuracy and 0.1% linearity. With high frequency coverage, complete HP-IB programmability and outstanding leveled output power, the 83570 plug-in, combined with the many features of the 8350A mainframe adds a new dimension to microwave measurements above 18 GHz.

The output power has a calibrated range of 11 dB which can be extended with external attenuators such as the HP 8495K. The power level may be manually set to a 0.1 dB resolution, or the power level may be remotely HP-IB programmed to a 0.02 dB resolution. In addition to a single output power, the 83570 also has a power sweep function. This function sweeps the power from one level to another. Another important feature that the 83570 offers is slope compensation. This compensates for high frequency power losses in external tests by attenuating the power at lower frequencies.

Scalar measurements at high frequencies may be easily made since the 83570 provides internal 27.8 KHz modulation required to interface with the HP 8755 Scalar Network Analyzer. In addition to simplifying the interface circuitry, internal modulation reduces connection losses which are critical at high frequencies.

The high output power and HP-IB programmability also make the 83570A ideal for use with the 8410 Network Analyzer and K8747A Test Set when making vector network measurements from 18 to 26.5 GHz. The +10 dBm output power (unavailable on other solid state sources) is required for proper operation of K8747A mixers.

The 18-26.5 GHz signal is generated by doubling the output of a 9-13.25 GHz YIG oscillator. This half frequency is coupled off to an output which may be used for phase locking or counting. Key to the high power of the HP 83570 is a single doubler package. This package contains the frequency doubler, amplifier, modulator and the leveling coupler with detector. This single package configuration significantly reduces power losses. (See 83570A Block Diagram.)

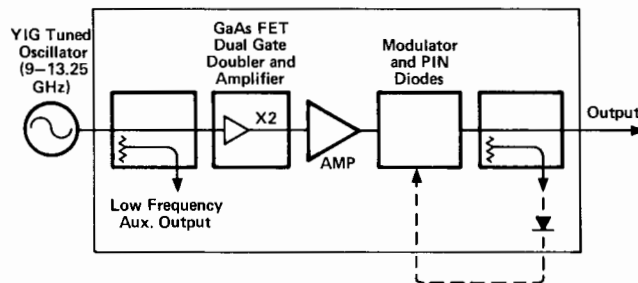

83570A Block Diagram



### Output Characteristics

**Power level accuracy:**  $\pm 1$  dB typical

#### RF power leveling:

**Internal:** Selected by front panel switch; Refer to chart for figures. Standard for 83570.

#### External:

**Crystal input:** Approximately  $-20$  to  $-250$  mW for specified leveling at rated output; For use with negative polarity detectors such as 780 Series Directional Detectors, 423A/B and 424 Series Crystal detectors.

**Power meter input:** Switch selects proper compensation for HP 432A/B/C Power Meters.

**Indicator:** Front panel indicator lights when RF power becomes unlevelled. Residual AM in 100 kHz Bandwidth:  $> 50$  dBc

**Impedance:**  $50 \Omega$  nominal

#### Power Sweep:

**Calibrated range:**  $\geq 11$  dB

**Accuracy:**  $\pm 1$  dB typical

**Resolution:** 0.1 dBm

**Slope compensation:** Compensates for high frequency power losses in external test sets by attenuation power at lower frequencies:

**Calibrated range:** up to 5 dB/GHz (10 dB max., typically 11 dB)

**Linearity:**  $< 0.2$  dB typical

**Resolution:** 0.1 dB/GHz

### General Specifications

**Sweep Time** (minimum over full band)

83570A/B (18–26.5 GHz): 10 ms

**RF Output connector:** Type WS42 waveguide

**Auxiliary output:** (83570A) Real Panel 9-13.25 GHz fundamental oscillator output, nominally 0 dBm

**Weight:** 83570A: Net 5.4 kg (12 lbs); Shipping 8.7 kg (19 lbs).

#### Improved network measurement capabilities

The 83570A is compatible with the:

8755 Frequency Response Test Set

5344S Source Synchronizer

8410 Network Analyzer using the K8747A Test Set

### Ordering Information

**83570A** 18–26.5 GHz Plug-in (Internal leveling standard)

### Frequency Characteristics

	83570A
<b>Range:</b>	18–26.5 GHz
<b>Accuracy</b> (25°C $\pm$ 5°C)	
CW Mode:	$\pm 30$ MHz
Typical:	$\pm 20$ MHz
All Sweep Modes:	$\pm 55$ MHz
Linearity typically:	$\pm 15$ MHz
<b>Stability</b>	
With Temperature:	800 kHz/°C
With 10% Line Voltage Change:	$\pm 80$ kHz
With 10 dB Power Level Change:	+1 MHz
With 3:1 Load SWR:	$\pm 500$ kHz
With Time: (in 10 minute time period after one hour warmup at the same frequency setting)	$\pm 400$ kHz
Residual FM: (in 10 kHz bandwidth, CW mode):	$< 30$ kHz

### Output Characteristics

Maximum Levelled Power (25°C $\pm$ 5°C Opt 002 (70 dB step atten.))	$> 10$ mW
<b>Power Variation</b> (At max. rated power)	$< \pm 1.4$ dB
Internally Levelled:	$< \pm 2$ dB
Unlevelled: Typically	
Externally Levelled (Excluding coupler and detector variation):	
Crystal Detector or Power Meter	$< \pm 0.1$ dB
<b>Spurious Signals:</b> (Below fundamental at specified maximum power)	
Harmonically Related:	$> 25$ dB
Non-Harmonics:	$> 50$ dB
Source VSWR: 50 nominal impedance	
Internally levelled:	$< 2.5$
<b>Modulation Characteristics</b>	
External FM	
Maximum Deviations for Modulation Frequencies	
DC to 100 Hz:	$\pm 75$ MHz
100 Hz to 1 MHz:	$\pm 7$ MHz
1 MHz to 2 MHz:	$\pm 5$ MHz
2 MHz to 10 MHz:	$\pm 1.5$ MHz
Sensitivity: Nominal	
FM Mode:	$-20$ MHz/V
Phase-lock Mode:	$-6$ MHz/V
<b>External AM</b>	
Input Impedance: nominal	10 k $\Omega$
Frequency Response: Typical	100 kHz
Range: Typical	10 dB
<b>Square Wave Response</b>	
ON/Off Ratio: Typical	$> 30$ dB
Symmetry: Typical	40/60
<b>Internal AM:</b>	
Selectable to 1 kHz or 27.8 kHz square wave (Guarantees HP 8755 Frequency Response Test Set compatibility)	
On/Off Ratio:	$> 25$ dB



# SWEEP OSCILLATORS

## 8350 Family: Plug-In Adapter

### Model 11869A

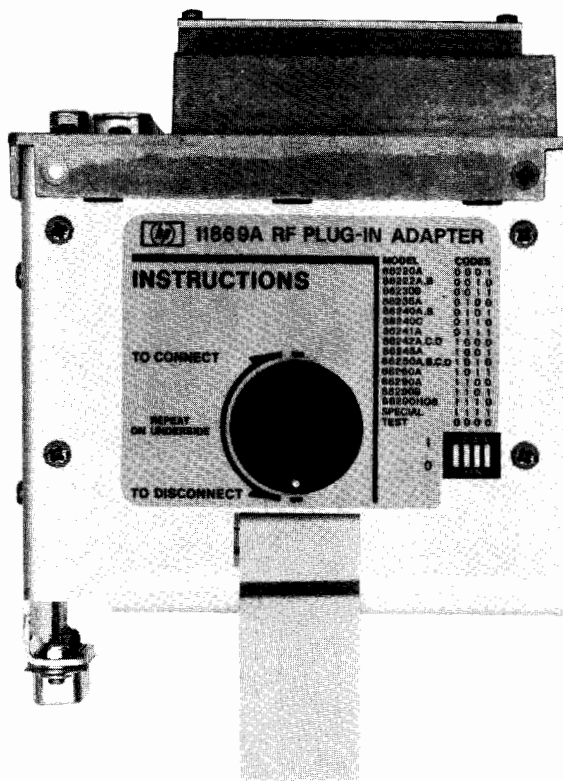

#### 11869A Adapter

The 11869A Adapter provides the electrical and mechanical interface between the 8350A and 86200 series plug-ins. All of the 8350A's standard operating features, including HP-IB remote programming, are available. However, specific plug-in functions (output power level, RF on/off, etc.) cannot be controlled or remotely programmed by the 8350A mainframe.

#### Plug-ins with Rear Panel RF Output

Option 004 allows the adapter to be used with 86200 plug-ins that are equipped with rear panel RF output. Supplied with Option 004 are two pre-shaped, semi-rigid coax cables with the appropriate mating connectors so that the RF output can be extended to the rear panel of the adapter.

#### Rear Panel Description

On the rear panel of the 11869A are five hole plugs that pop out to allow connections to be made to the rear panel. Four of the holes are for low frequency (small diameter) cables while one is for a high frequency (large diameter) RF cable. For user convenience four of the holes are labeled — EXT ALC IN, PULSE IN, FREQ REF AND RF OUT.

Three BNC cables are supplied to extend the plug-in rear panel inputs/outputs to the rear panel of the adapter. A separate cable (BNC/SMD) is installed for connection of the plug-in FM input to the adapter/mainframe.

#### Plug-ins Compatible with the 11869A Adapter

The 11869A Adapter attaches to the back of the plug-in and is equipped with a switch for setting the specific interface code for the plug-in being used.

The following plug-ins will operate in the 8350A by using the 11869A Adapter.

86220A (0.01–1.3 GHz)	86245A (5.9–12.4 GHz)
86222A/B (0.01–2.4 GHz)	86250A/B/C/D (8.0–12.4 GHz)
86230B (1.8–4.2 GHz)	86251A (7.5–18.6 GHz)
86235A (1.7–4.3 GHz)	86260A (12.4–18.0 GHz)
86240A/B (2.0–8.4 GHz)	86260B (10.0–15.5 GHz)
86240C (3.6–8.6 GHz)	86260C (17.0–22.0 GHz)
86241A (3.2–6.5 GHz)	86290A (2.0–18.0 GHz)
86242A/C/D (5.9–9.0 GHz)	86290B/C (2.0–18.6 GHz)
	86290B H08 (2.0–22 GHz)

#### Special Plug-ins

For factory modified 86200 series plug-ins with non-standard frequency coverage a special PROM must be inserted in the 11869A Adapter. Consult your local HP Sales and Service Office for further information.

#### Plug-ins Not Compatible with the 11869A Adapter

The 8621B RF Drawer and 86300 series RF modules are not compatible with the 11869A and will not operate in the 8350A.

**Furnished:** Three BNC cables for extending plug-in rear panel inputs/outputs to adapter rear panel; BNC/SMD (factory installed) for connecting plug-in FM input to adapter/mainframe; plug-in handle assembly for simplified installation in the 8350A mainframe.

#### Ordering Information

##### 11869A Adapter

**Option 004:** Extension Cables for Plug-ins with Rear Panel RF Output (Opt. 004)

**Special PROM module:** For plug-ins with non-standard frequency coverage. (Consult Sales and Service Office)

**Option 006:** Type N Aux Out Interface Connector for 86251A and 86290A/B/C

# SWEEP OSCILLATORS

## Solid State Sweeper Family, 10 MHz to 22 GHz

### Model 8620 System

387



- Single-band, Straddle-band and Broadband Plug-ins
- External Phase-lock Capability
- > 10 mW to 22 GHz



### 8620 System

The Hewlett-Packard 8620 solid state sweeper system offers the flexibility of the 8620C mainframe in addition to a choice of single-band, multiband, straddle-band, and broadband plug-ins. The 8620 system also offers high output with solid state reliability—greater than 10 mW leveled to 22 GHz.

The fundamental oscillators used in the plug-ins and modules are YIG tuned transistor or bulk effect circuits. YIG tuning results in exceptional tuning linearity, low noise, and low spurious content; it also allows frequency modulation at high rates and wide deviations with low distortion.

Typical unlevelled power output

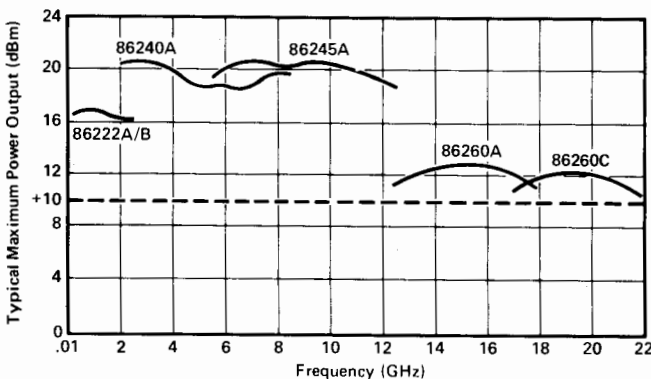

### 8620C Sweeper Mainframe

The 8620C has many features which are highly useful in stringent applications. With convenient functionally grouped controls and lighted pushbutton indicators the mainframe offers extreme ease of operation and flexibility. In addition, it can be a completely programmable source, either HP-IB or BCD, an indispensable feature for automatic systems and signal simulation applications.

### 86222A/B and 86290A/B/C Broadband Plug-ins

Now the 10 MHz to 18.6 GHz frequency range can be covered with just two plug-ins—the 86222A/B and 86290A/B/C. Besides their broad frequency range these plug-ins offer many special features including unique crystal markers in the 86222B and better than  $\pm 30$  MHz frequency accuracy in a 86290A/B/C even at 18 GHz.

### 86240A/B/C and 86251A Straddle-band Plug-ins

Covering more than an octave of frequencies the 86240A and B span 2 to 8.4 GHz and the 86251A spans from 7.5 to 18.6 GHz with major advances in power output and signal purity. The 86240A offers more than 40 mW while the 86251A provides over 10 mW of leveled output across the full band. All three plug-ins deliver a high quality test signal of low harmonic content with the 86240B providing harmonics of >45 dBc. This can be very important when making measurements across more than one octave.

### 86200 Series Single-band Plug-ins

The 86200 series of plug-ins covers both ends of the frequency spectrum from 10 MHz to 22 GHz with a choice of more than eleven plug-ins.

### Plug-In Compatibility with 8350A

The entire line of 86200 series plug-ins can be used in the 8350A Sweep Oscillator mainframe with no degradation in performance by using the 11869A Adapter.





# SWEEP OSCILLATORS

## 8620 Family: Mainframe

Model 8620C

- Optional BCD or HP-IB Programming
- 3 Markers
- 100%  $\Delta F$  Capability, Fully Calibrated

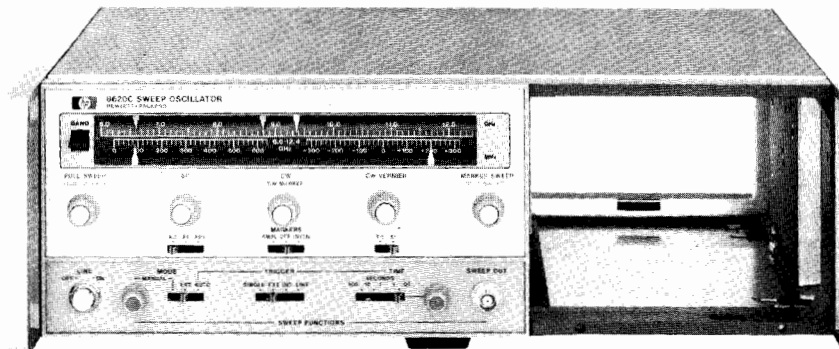

The 8620C offers many features as standard equipment. For example, up to four separate bands and their respective frequency scales can be selected with a band select lever to the left of the dial scale. Pushbuttons, concentrically located in the frequency control knobs, light when actuated to indicate the sweep function in use. The sweep functions available are: FULL SWEEP, MARKER SWEEP, CW/ $\Delta F$  and CW. Three markers are available, controlled by the START MARKER, STOP MARKER, and CW MARKER knobs.

The 8620C is fully and continuously calibrated for any  $\Delta F$  sweep width. The sweep is symmetrical about the CW MARKER setting and three continuously variable  $\Delta F$  ranges are available by using the range switch below the  $\Delta F$  knob. This allows calibrated sweep widths of up to 1%, 10% or 100% of full band.

When in CW/ $\Delta F$  or CW modes, the CW VERNIER knob allows for excellent frequency resolution. In terms of improved frequency resolution the vernier increases the effective length of the dial scale to 7.5 meters (300 inches).

Another feature is the capability to fully program the sweeper. The standard 8620C includes inputs for band selection, sweep function selection, and analog frequency control. In addition to this, more flexible digital frequency programming options are available to control the 8620C via the HP-IB (Option 011) or by BCD programming (Option 001).

### 8620C Specifications

#### Frequency

**Frequency range accuracy and linearity:** determined by band select lever and RF unit specs.

#### Sweep Functions

**FULL SWEEP:** sweeps the full band as determined by the plug-in and the band select lever.

**MARKER SWEEP:** sweeps from START MARKER to STOP MARKER frequency settings; up to the full range of the plug-in can be set to sweep either up or down in frequency.

**$\Delta F$  Sweep:** sweeps symmetrically upward in frequency, centered on CW setting, CW vernier can be activated for fine control of center frequency.

**Width:** continuously adjustable and calibrated from zero to 1%, zero to 10%, or zero to 100% of frequency band.

**CW operations:** single-frequency RF output controlled by CW MARKER knob selected by depressing pushbutton in CW MARKER control.

**CW vernier:** calibrated directly in MHz about CW setting. CW vernier activated by pushbutton in CW vernier control. Zero to  $\pm 0.5\%$  or zero to  $\pm 5\%$  of full bandwidth, selectable with front panel switch.

**Frequency markers:** three constant width frequency markers are fully calibrated and independently adjustable over the entire range in FULL SWEEP function, controlled by START MARKER, STOP MARKER, and CW MARKER controls. In  $\Delta F$  sweep START and STOP MARKERS are available, and in MARKER SWEEP the CW MARKER is available. Front panel switch provides for the selection of either amplitude or intensity markers (amplitude modulating the RF output or Z-axis modulating the CRT display).

**Marker output:** rectangular pulse, typically  $-5$  volts peak available from Z-axis BNC connector on rear panel. Source impedance, approximately 1000 ohms.

#### Sweep Modes (auto, line or externally triggered)

**Sweep time:** continuously adjustable from 0.01 to 100 seconds. Single sweep, manual sweep and external sweep control also available.

**Sweep output:** direct-coupled sawtooth, zero to approximately +10 volts, at front panel BNC connector, concurrent with swept RF output.

#### Modulation

External AM, FM and phase-lock capability; internal 1000 Hz square wave AM modulation available.

#### Remote Control

**Remote band select:** frequency range can be controlled remotely by three binary contact closure lines available at rear panel connector.

#### Remote Frequency Programming, Opt 001 (BCD) and Opt 011 (HP-IB)

##### Functions

**Band:** manual enable or remote control of up to four bands.

**Mode:** seven modes are selectable, including digital control in three modes with a resolution of 10,000 points. For more information on remote control of the 8620C refer to Application Note 187-5.

#### General

##### Blanking

**RF:** with blanking switch enabled, RF automatically turns off during retrace, and remains off until start of next sweep.

**Display (Z-AXIS/MKR/PEN LIFT Output):** direct-coupled rectangular pulse approximately +5.0 volts coincident in time with RF blanking is on rear panel.

**Negative (Negative blanking output):** direct-coupled rectangular pulse approximately  $-5.0$  volts coincident in time with RF blanking.

**Pen lift:** for use with X-Y recorders having positive power supplies. Transistor-switch signal is available on Z-AXIS/MKR/PEN LIFT connector. This signal is also available on the programming connector.

**Furnished:** 2.29 m (7½-foot) power cable with NEMA plug and calibration scale. With Option 011, an HP-IB connector/adaptor are included.

**Power:** 100, 120, 220, or 240 volts  $\pm 5 - 10\%$ , 50 to 400 Hz. Approximately 140 watts.

**Weight:** (not including RF unit): Net, 11.1 kg (24 lb). Shipping 13.4 kg (30 lb).

**Size:** 132.6 mm H x 425 mm W x 337 mm D (5.29" x 16.75" x 13.25").

#### Ordering Information

8620C Sweep Oscillator Mainframe

Opt 001: BCD Frequency Programming

Opt 820: 8410C Interface Cable

Opt 011: HP-IB Frequency Programming

Opt 007: Rear Sweep Out

Opt 908: Rack Flange Kit

# SWEEP OSCILLATORS

8620 Family: 10 MHz to 2.4 GHz Plug-Ins

Models 86222A and 86222B

389



- 10 MHz to 2.4 GHz in ONE, CONTINUOUS Sweep
- Internally Leveled FLATNESS  $\pm 0.25$  dB over Full Range

- 1, 10, and 50 MHz Crystal Marker Combs with 86222B
- Compatible with 8350A Mainframe via 11869A Adapter

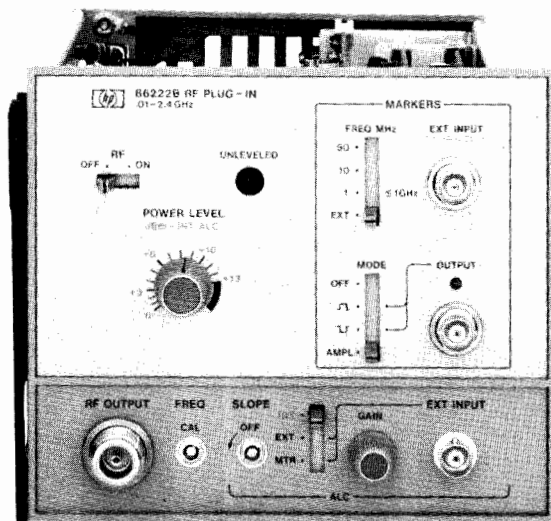

86222B

The 86222A and 86222B RF plug-ins can provide CW or continuous swept 10 MHz to 2.4 GHz frequency coverage. Power output is calibrated from 0 to +13 dBm in 1 dB increments with  $\pm 0.25$  dB flatness and excellent linearity (2 MHz) over the entire 0.01 to 2.4 GHz range. For applications demanding precise frequency identification, the 86222B offers a crystal marker system which provides a comb of markers at 1, 10 or 50 MHz. Markers may be displayed as intensified spots on a CRT or as amplitude dips on the RF output (often useful for XY recordings). In addition, when the output frequency is coincident with a 50, 10 or 1 MHz comb of the internal crystal oscillator, a front panel LED lights for independent CW frequency calibration (75 kHz accuracy at 1 GHz). For scalar measurements, the 27.8 kHz square wave modulation from the HP 8755 Frequency Response Test Set is accepted directly through the external AM input. For phase/magnitude network analysis the interfacing between the sweeper and the 8410B Network Analyzer permits the 8410B to automatically phase-lock over multi-octave sweeps.

## Specifications

### with Plug-in Installed in an 8620C Mainframe

#### Frequency Characteristics

**Range:** 10 MHz to 2.4 GHz.

#### Accuracy (25°C)

**CW mode:**  $\pm 10$  MHz.

**Remote programming:** typically  $\pm 1.5$  MHz.

**All sweep modes:**  $\pm 15$  MHz ( $> 100$  msec sweep time). Accuracy of 86222B may be enhanced to better than  $\pm 200$  kHz through use of crystal markers.

**Linearity:** typically  $\pm 2$  MHz.

#### Stability

**With temperature:**  $\pm 500$  kHz/°C.

**With 10% line voltage change:**  $\pm 20$  kHz.

**With 10 dB power level change:**  $\pm 100$  kHz.

**With 3:1 load SWR, all phases:**  $\pm 10$  kHz.

**With time (after 1-hour warm-up):** typically  $\pm 100$  kHz/10 min.

**Residual FM:** (10 kHz bandwidth; FM switch in NORM; CW Mode):  $< 5$  kHz peak.

#### Output Characteristics

**Maximum leveled power (25°C):**  $> 20$  mW (+13 dBm); typically  $> +15$  dBm.

**Power level accuracy (internal leveling only):**  $\pm 1$  dB.

**Attenuator Opt 002:** add  $\pm 0.2$  dB/10 dB step.

**Power Variation (at max. rated power)**

#### Internally leveled

**0.01 to 2.4 GHz:**  $\pm 0.25$  dB.

**Stability with temperature:** typically  $\pm 0.02$  dB/°C.

#### Externally leveled (excluding coupler and detector variation)

**Crystal detector:** ( $-10$  to  $-100$  mV at rated output):  $\pm 0.1$  dB.

**Power meter (with HP 432A/B/C Series power meters):**  $\pm 0.1$  dB.

**Residual AM in 100 kHz BW:**  $> 50$  dBc.

**Spurious signals:** (below fundamental)

**Harmonics:**  $> 25$  dB at +13 dBm; typically  $> 30$  dB at +10 dBm.

**Non-Harmonics**

**0.01 to 2.3 GHz:**  $> 30$  dB at +13 dBm; typically  $> 40$  dB at +10 dBm.

**2.3 to 2.4 GHz:**  $> 25$  dB at +13 dBm; typically  $> 35$  dB at +10 dBm.

**Broadband noise in 100 kHz bandwidth:** typically  $< -70$  dBm.

**Impedance:** 50  $\Omega$  nominal.

**SWR:**  $< 1.5$  internally leveled.

**Slope control:** allows variable compensation for frequency dependent losses in test set-up.

**RF output connector:** type N female.

## Modulation Characteristics

### External AM

**Input impedance:** approximately 10 k $\Omega$ .

**Frequency response:** typically 150 kHz.

**Square wave response:**

**On/Off ratio:**  $> 30$  dB.

**Symmetry:** 40/60, for  $> 10$  dBm output power.

**Attenuation for +6 V input:**  $> 30$  dB.

### Internal AM

**1 kHz square-wave On/Off ratio:**  $> 30$  dB.

**RF blanking On/Off ratio:**  $> 30$  dB.

### External FM

#### Maximum deviations for modulation frequencies

**DC to 100 Hz:**  $\pm 75$  MHz.

**100 Hz to 1 MHz:**  $\pm 5$  MHz.

**1 MHz to 2 MHz:**  $\pm 2$  MHz.

#### Sensitivity (typically)

**FM mode:**  $-20$  MHz/V.

**Phase-lock mode:**  $-6$  MHz/V.

## Crystal Marker Capabilities (86222B Only)

**Internal crystal markers:** harmonic markers of 10 and 50 MHz usable over full 0.01 to 2.4 GHz range and 1 MHz markers usable 0.01 to 1 GHz. Positive (+) or negative (-) voltage output pulses can be selected to Z-axis intensify a scope trace; or RF amplitude pips can be selected (at maximum sweep speed pulse width optimized for approximately 10 markers/sweep).

**Accuracy of center frequencies (25°C):**  $\pm 5 \times 10^{-6}$ .

#### Typical marker width around center frequency

**1 MHz markers:**  $\pm 75$  kHz.

**10 MHz markers:**  $\pm 200$  kHz.

**50 MHz markers:**  $\pm 300$  kHz.

**Temperature stability:** typically  $\pm 2 \times 10^{-6}$ /°C.

**Marker output mode:** nominally  $> 3$  V.

**mode:** nominally  $-3$  to  $-8$  V, internally adjustable.

**Amplitude mode:** typically 0.5 dB, internally adjustable.

## General

**Weight:** net, 2.5 kg (5.5 lb). Shipping 4 kg (9 lb).

## Ordering Information

**86222A** 0.01-2.4 GHz RF Plug-In (internal leveling standard)

**86222B** 0.01-2.4 GHz RF Plug-In with Crystal and External Markers (internal leveling standard)

**Opt 002:** 70 dB Step Attenuator (10 dB steps)

**Opt 004:** Rear Panel RF Output



# SWEEP OSCILLATORS

## 8620 Family: Broadband Plug-Ins

Models 86290A, 86290B and 86290C

- +13 dBm 2 to 18.6 GHz with 86290C
- $\pm 30$  MHz Frequency Accuracy at 18.6 GHz

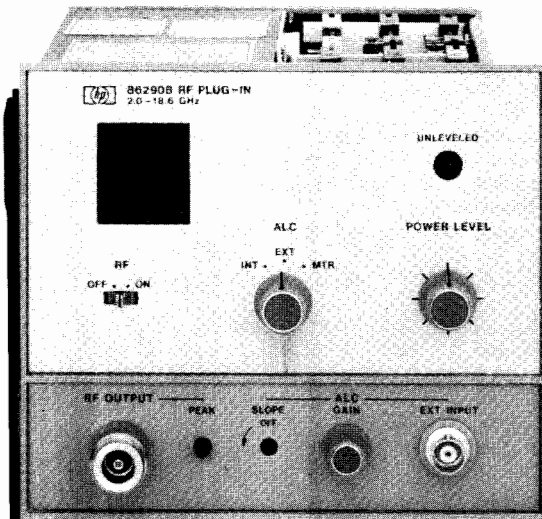

86290B

The 86290A/B/C broadband plug-ins set new standards in sweeper performance and versatility. For broadband testing, a continuous sweep from 2 to 18.6 GHz (18 GHz with the 86290A) is provided. In addition, higher frequency resolution is achieved by covering the 2 to 18.6 GHz range in three individual bands of 2 to 6.2, 6 to 12.4, 12 to 18.6 (or 18 GHz). The 86290C offers outstanding electrical performance producing  $>20$  mW swept output over the 2 to 18.6 GHz range along with excellent linearity and low spurious and harmonic content. For scalar measurements the 27.8 kHz square wave modulation from the HP 8755 Frequency Response Test Set is accepted directly through the EXTERNAL AM input. When performing phase/amplitude network analysis the interfacing between the sweeper and the HP 8410B/C Network Analyzer permits the 8410B/C to automatically phase lock over multi-octave sweeps for continuous swept 2 to 18.6 GHz phase and amplitude measurements.

### Specifications

#### with Plug-in Installed in an 8620C Mainframe

##### Frequency Characteristics

	Band 1	Band 2	Band 3	Band 4
Range: (GHz) 86290A	2-6.2	6-12.4	12-18	2-18
86290B/C	2-6.2	6-12.4	12-18.6	2-18.6
Accuracy (25°C)				
CW mode (or $>100$ ms sweep time): (MHz)	$\pm 20$	$\pm 30$	$\pm 30$	$\pm 100$
Remote programming: (typ.)	$\pm 2.5$	$\pm 2.5$	$\pm 3.5$	—
All sweep modes: (MHz)	$\pm 30$	$\pm 40$	$\pm 40$	$\pm 80$
Marker: (MHz)	$\pm 30$	$\pm 30$	$\pm 30$	$\pm 80$
Linearity (MHz) typ.:	$\pm 8$	$\pm 8$	$\pm 8$	$\pm 30$
Frequency Stability				
With temperature: (MHz/°C)	$\pm 0.5$	$\pm 1.0$	$\pm 1.5$	$\pm 2.0$
With 10% line voltage change: (kHz)	$\pm 100$	$\pm 100$	$\pm 100$	$\pm 100$
With 10 dB power level change: (MHz)	$\pm 0.6$	$\pm 1.2$	$\pm 1.8$	$\pm 1.8$
With 3:1 load VSWR, all phases: (kHz)	$\pm 100$	$\pm 200$	$\pm 300$	$\pm 300$
With time (in 10 minute period after 30 minute warmup): typically (kHz)	$\pm 300$	$\pm 600$	$\pm 900$	$\pm 900$
Residual FM (10 kHz bandwidth CW mode: (kHz peak)	$<10$	$<20$	$<30$	$<30$

- Compatible with 8350A Mainframe via 11869A Adapter

### Output Characteristics

#### Maximum leveled power (25°C):

86290A: +7 dBm, 2 to 18 GHz. (Opt. 004: +6.5 dBm)

86290B: +10 dBm, 2 to 18.6 GHz. (Opt. 004: +9.5 dBm)

86290C: +13 dBm, 2 to 18.6 GHz. (Opt. 004: +12.5 dBm)

Power level control range:  $>10$  dBm

	Band 1	Band 2	Band 3	Band 4
<b>Power Variation (Max Rated Pwr)</b>				
Internally leveled: (dB)	$\pm 0.7$	$\pm 0.7$	$\pm 0.8$	$\pm 0.9$
Externally leveled (excluding coupler and detector variation)				
Crystal detector: $-20$ to $-250$ mV for specified leveling at rated output: (dB)	$\pm 0.15$	$\pm 0.15$	$\pm 0.15$	$\pm 0.15$
Power meter: internal leveling amplifier with compensation for HP models 432A/B/C provided: (dB)	$\pm 0.15$	$\pm 0.15$	$\pm 0.15$	$\pm 0.15$
With temperature, typically (dB/°C)	$\pm 0.1$	$\pm 0.1$	$\pm 0.1$	$\pm 0.1$

Residual AM in 100 kHz BW:  $>55$  dBc.

#### Spurious signals

Harmonically related signals:  $>25$  dBc.

Non-harmonics:  $>50$  dBc.

Impedance: 50 $\Omega$  nominal.

SWR:  $<1.9$  internally leveled.

RF output connector: type N female (standard) and APC-7 (Option 005).

### Modulation Characteristics

#### External AM

Input impedance: approximately 1000 $\Omega$ .

Frequency response: typically 300 kHz leveled.

#### Square wave response

On/Off ratio:  $>30$  dB.

Symmetry: 40/60.

Attenuation for +5V input:  $>30$  dB.

#### Internal AM (1000 Hz):

Square-wave On/Off ratio:  $>25$  dB.

RF blanking On/Off ratio:  $>30$  dB.

#### External FM:

Maximum deviations for modulation frequencies

DC to 100 Hz:  $\pm 75$  MHz.

100 Hz to 2 MHz:  $\pm 5$  MHz.

#### Sensitivity (typically)

FM mode:  $-20$  MHz/V.

Phase-lock mode:  $-6$  MHz/V.

### General

Sweep time (min): 10 ms single bands, 60 ms on 2 to 18.6 GHz band.

Auxiliary output: rear panel 2 to 6.2 GHz fundamental oscillator output, nominally  $-10$  dBm.

Slope control: front panel control allowing compensation for frequency dependent test setup losses.

Peak control: front panel control for peaking power over desired frequency range.

Frequency reference output: nom. 1 V/GHz (2-18.6 volts)  $\pm 35$  mV rear panel BNC output.

Weight: net, 4.4 kg (9.6 lb). Shipping, 5.9 kg (13 lb).

### Ordering Information

86290A 2 to 18 GHz +7 dBm (5mW) plug-in (internal leveling standard)

86290B 2 to 18.6 GHz +10 dBm (10 mW) plug-in (internal leveling standard)

86290C 2 to 18.6 GHz +13 dBm (20 mW) plug-in (internal leveling standard)

Opt 004: rear panel RF output:

Opt 005: APC-7 RF output connector:

# SWEEP OSCILLATORS

## 8620 Family: Straddle Band Plug-Ins

Models 86240A, 86240B, 86240C and 86251A



- 7.5–18.6 Continuous Sweep with 86251A
- 45 dBc Harmonics with 86240B
- Up to 40 mW Output Power with 86240A

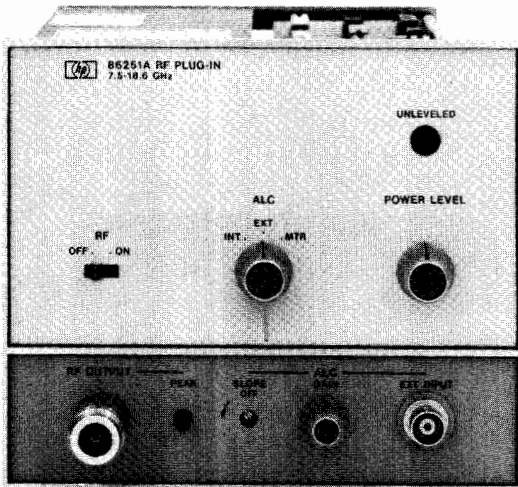

86251A



### 86251A: 7.5–18.6 GHz

The 86251A excels in meeting the most stringent of swept or CW source requirements for precise Radar and ECM component measurements. Covering the essential frequency bands with one continuous sweep, the 86251A is ideal for testing active devices like multioctave TWT's or RF memories as well as passive devices like filters or isolators.

### 86240A/B: 2–8.4 GHz

The 86240A/B are designed for high power and superior performance with the 86240A delivering 40 mW of RF output power and the 86240B offering 45 dBc harmonics (typically > 50 dBc). For precise RF power level control, internal leveling (Option 001) and slope control are also available.

### 86240C RF Distortion analysis of mW links: 3.6-8.6 GHz

The 86240C can be used for MLA Upconverter Simulation as well as a general purpose sweeper. It is optimized for group delay of less

- MLA Compatibility with 86240C
- Usable in 8350A Mainframe with 11869A Plug-in Adapter

than 1 ns peak-to-peak over 30 MHz, linearity better than 0.5% and power output up to 40 mW. It has 10 MHz FM bandwidth, flat to  $\pm 1.5$  dB for noise loading applications, power control and optional leveling. For further information on MLA Upconverter Simulation refer to the Telecommunications Test Equipment section on page 577.

### Specifications

with plug-in installed in an 8620C mainframe (or 8350A mainframe using the 11869A Plug-in Adapter)

#### Frequency Characteristics

**Linearity:** typically  $\pm 0.1\%$ .

**Residual FM** (in 10 kHz bandwidth, FM switch in NORM, CW Mode): <9 kHz peak. <30 kHz peak for 86251A.

**Reference output:** DC-coupled voltage proportional to RF frequency, voltage approximately 1 V/GHz.

#### Output Characteristics

##### RF Power Leveling

**Internal, option 001:** Selected by front panel switch; refer to RF plug-in specifications. (Standard on 86240B and 86251A)

**Source SWR:** 50 $\Omega$  nominal impedance

**Internally leveled:** <1.6 SWR for 86240. <1.9 SWR for 86251A.

**Unleveled:** Typically 3 SWR.

**RF output connector:** Type N female.

##### 86240C Modulation Characteristics

**External FM** (Maximum deviation for modulation frequencies)

**DC to 100 Hz:**  $\pm 100$  MHz

**90 kHz to 10 MHz:**  $\pm 1.5$  MHz

**Frequencies response, DC to 10 MHz:**  $\pm 1.5$  dB

**Nominal sensitivity**

**FM mode:** +20 MHz/volt

**Upconverter mode:** +20 MHz/volt

#### General

**Weight:** Net, 2.3 kg (5 lb). Shipping, 3.2 kg (7 lb) for 86240A/B/C. Net, 4.4 kg (9.6 lb). Shipping, 5.9 kg (13 lb) for 86251A.

#### Options

**002:** 70 dB Step Attenuator (86240A/B/C only)

**004:** Rear Panel RF Output

**005:** APC-7RF Output Connector (86251A only)

	86240A	86240B	86240C	86251A
<b>FREQUENCY</b>				
<b>Frequency Range (GHz):</b>	2.0–8.4	2.0–8.4	3.6–8.6	7.5–18.6
<b>Frequency Accuracy: (25°C)</b>				
CW Mode (MHz)	$\pm 25$	$\pm 25$	$\pm 25$	$\pm 30$
CW Remote Programming typically (MHz):	$\pm 3.5$	$\pm 3.5$	$\pm 3.5$	$\pm 3.5$
All Sweep Modes (for sweep time >100 ms) (MHz):	$\pm 40$	$\pm 50$	$\pm 35$	$\pm 40$
<b>POWER OUTPUT</b>				
Maximum Leveled Power (25°C) (mW):	>40	>20	>40	>10
With Option 002 (mW):	>32	>16	>32	
<b>Power Variation: (At Max Rated Power)</b>				
Unleveled (Typically) (dB):	$< \pm 6$	$< \pm 6$	$< \pm 6$	$< \pm 5$
Internally Leveled (Opt 001):	$< \pm 1$	$< \pm 0.5$	$< \pm 0.8$	$\pm 0.8$
Externally Leveled (Excluding Coupler and Detector Variation) Crystal Detector and Power Meter (dB):	$< \pm 0.1$	$< \pm 0.1$	$< \pm 0.1$	$\pm 0.15$
<b>Spurious Signals: (dB below fundamental at specified maximum power)</b>				
Harmonics:	>20 (@20 mW) >16 (@40 mW)	>45	>20 (@20 mW) >16 (@40 mW)	>40
Nonharmonics:	>60	>60	>60	>30
<b>Plug-in:</b>				
Opt 001 (Internal Leveling):		Included		Included



# SWEEP OSCILLATORS

## 8620 Family: Single Band Plug-ins

### Model 86200 Series and 11869A Adapter

- 10 MHz to 22 GHz Coverage
- > 50 mW from 5.9 to 12.4 GHz
- Compatible with 8350A Mainframe via 11869A Adapter

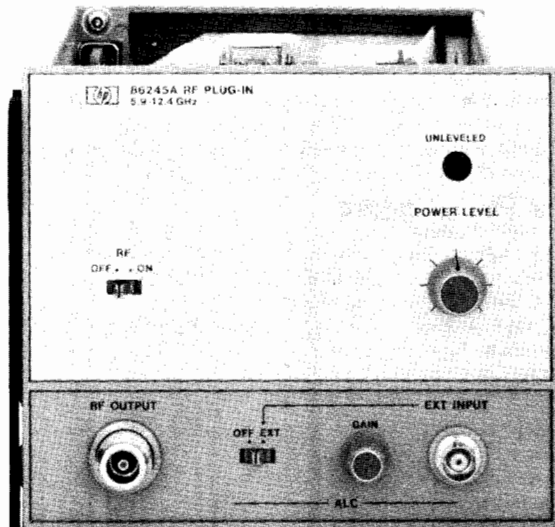

86245A

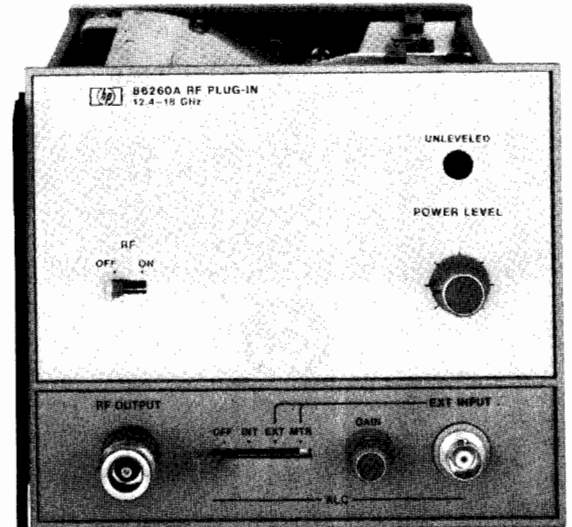

86260A

### 86200 Series

The 86200 series plug-ins feature a wide choice of bandwidths and power specifications for covering the 10 MHz to 22 GHz frequency range. The 86222A/B 10 MHz to 2.4 GHz plug-ins, the 86240A/B/C 2 GHz to 8.6 GHz plug-ins, and the 86290A/B/C 2 GHz to 18.6 GHz plug-ins cover multi-octave frequency ranges with exceptional frequency precision and RF output characteristics. See preceding pages for specifications on these plug-ins. For octave band applications, smaller range plug-ins covering, for instance, 5.9 GHz to 12.4 GHz are available with optional capability to operate as up-converters for MLA measurements.

### 11869A Adapter

The 86200 series can be used in the 8350A Sweep Oscillator mainframe with the addition of the 11869A Adapter. The 11869A provides the electrical and mechanical interface between the 86200 plug-in and the 8350A so that digital control of the plug-in is possible. All of the performance and features of the 8350A Sweep Oscillator Mainframe are available when using the 86200 plug-ins and 11869A Adapter. For more information on the 11869A see page 386.

### Specifications

**With plug-in installed in an 8620C Mainframe**

**Frequency linearity:** typically  $\pm 1\%$ .

**Frequency reference output:** typically 1 V/GHz dc-coupled voltage is available for referencing or phase-locking external equipment to the plug-in or for multi-octave operation with an 8410B/C.

**RF power leveling:** internal dc-coupled leveling amplifier and PIN modulator provided.

**Internal, Opt 001:** selected by front panel switch; refer to RF plug-in specifications (standard on 86220A).

#### External

**Crystal input:** approximately -20 to 250 mV for specified leveling at rated output; for use with negative polarity detectors such as 780

Series Directional Detectors, 423A/B and 8470 Series Crystal Detectors.

**Power meter input:** leveling amplifier with compensation for HP 432A power meter included internally in all plug-ins except the 86230B and 86241A which require the use of an 8404A Leveling Amplifier and the EXT AM input on the 8620 Mainframe.

**Indicator:** front panel indicator lights when RF power level is set too high to permit leveling over entire selected sweep range or when operating in unleveled mode.

**Residual AM in 100 kHz bandwidth:** > 50 dB below fundamental at specified maximum power.

#### External AM

**Frequency response:** typically dc to 100 kHz unleveled, dc to 50 kHz leveled (at maximum leveled power).

**Input impedance:** approximately 5000 ohms.

**RF output connector:** type N Female.

**8350A Compatibility:** The 11869A Adapter provides the electrical and mechanical interface so that the 86200 series plug-ins can be used in the 8350A Sweep Oscillator mainframe. For more information see the section on 11869A Adapter page 386.

**Weight:** net, 2.3 kg (5 lb). Shipping, 3.2 kg (7 lb).

### Options

**001:** Internal leveling. Refer to RF plug-in specifications.

**002:** 70 dB attenuator in 10 dB steps

**004:** rear panel RF output

**005:** APC-7 RF output connector available on 86260A

**Upconverter simulation options:** options are available which guarantee compatibility with the HP Microwave Link Analyzer. For further information on these plug-ins refer to the Telecommunications Test Equipment Section beginning on page 577.

## Single Band Plug-ins

Refer also to broadband models 86222A/B (0.01-2.4 GHz), 86240A/B/C (2-8.6 GHz), 86251A (7.5-18.6 GHz), and 86290A/B/C (2-18.6 GHz)

Specifications with plug-in installed in 8620C	86220A	86230B	86235A	86241A	86242D	86245A	86250D	86260B	86260A	86260C
<b>Frequency range<sup>1</sup></b> (GHz):	0.01-1.3	1.8-4.2	1.7-4.3	3.2-6.5	5.9-9.0	5.9-12.4	8.0-12.4	10.0-15.5	12.4-18.0	17.0-22.0
<b>Frequency accuracy</b> CW mode (MHz):	±10	±15	±20	±30	±35	±40	±40	±50	±50	±50
Remote programming typically (MHz):	±6.0	±2.5	±2.5	±10.5	±5.0	±20	±20	±5.5	±5.5	±6.8
All sweep modes (sweep time >100 ms) (MHz):	±15	±20	±30	±33	±40	±50	±50	±70	±70	±70
<b>Stability:</b> With Temperature:	±600 kHz/°C	±500 kHz/°C	±500 kHz/°C	±650 kHz/°C	±750 kHz/°C	±1.2 MHz/°C	1.2 MHz/°C	±5.4 MHz/°C	±5.4 MHz/°C	±5.4 MHz/°C
With 10% Line Voltage Change:	±20 kHz	±20 kHz	±40 kHz	±30 kHz	±40 kHz	±40 kHz	±40 kHz	±180 kHz	±180 kHz	±180 kHz
With 10 dB Power Level Change:	±20 kHz	±1 MHz	±1 MHz	±1 MHz	±1.5 MHz	±1.5 MHz	±1.5 MHz	±6 MHz	±6 MHz	±6 MHz
With 3:1 Load SWR Change, all Phases:			±250 kHz		±250 kHz	±250 kHz	±250 kHz			
With Time (after warm-up): Typ/10 min.	±200 kHz	±200 kHz	±200 kHz	±200 kHz	±600 kHz	±600 kHz	±600 kHz		±450 kHz	
<b>Residual FM</b> (10 kHz BW, FM switch in NORM) CW mode (kHz peak):	<5	<7	<7	<7	<15	<15	<15	<25	<25	<25
<b>Maximum leveled power<sup>1</sup></b> (mW):	10	>10	>40	>7	>10	>50	>10	>10	>10	>10
<b>Power variation</b> Internally leveled (dB):	<±0.5	<±1.2	<±0.8	<±0.8	<±0.5	<±0.6	<±0.5	<±4	<±0.7	<±4
Externally leveled (dB) (excluding coupler & detector variation):	N/A	<±0.1	<±0.1	<±0.1	<±0.1	<±0.1	<±0.1	<±0.1	<±0.1	<±0.1
<b>Spurious signals:</b> (dB below fundamental, at specified max power) Harmonics:	>25	>20	>20	>16(3.2-3.8 GHz) >20(3.8-6.5 GHz) >60	>40	>17(5.9-7 GHz) >30(7-12.4 GHz) >60	>40	>25	>25	>25
Nonharmonics:	>50	>60	>60	>60	>60	>60	>60	>60	>50	>50
<b>Source SWR:</b> (50 Ω nom, Internally leveled)	<1.3	<1.6	<1.6	<1.6	<1.6	<1.6	<1.6		<1.6	
<b>External FM:</b> Max deviations (MHz) for modulation frequencies: DC-100 Hz:	±15	±25	±75	±25	±100	±100	±100	±75	±75	±75
DC-1 MHz:	±0.5	±2	±5	±2	±7	±7	±7	±5(DC-200 kHz)	±5(DC-200 kHz)	±5(DC-200 kHz)
Sensitivity (nom, MHz/V):	+3.5	-4	-20/-6	-6	-20/-6	-20/-6	-20/-6	-20/-6	-20/-6	-20/-6
<b>AM:</b> Internal 1 kHz Square wave On/Off ratio & EXT AM sensitivity To -10 V (dB):	>35	>25	>30	>25	>40	>40	>40	>25	>25	>25
EXT AM Response compatible with 8755 Mod drive signal:	No	No	Yes	No	Yes	Yes	Yes	No	No	No
<b>Plug-in:</b> Opt 001 (int. lev):	Included									

<sup>1</sup>Special frequency bands and high power outputs available on request.

# SWEEP OSCILLATOR

## Synthesized Sweeper

Model 8340A

- Synthesized frequencies from 10 MHz to 26.5 GHz
- 1 to 4 Hz frequency resolution
- Low spurious and phase noise
- Narrowband and broadband swept capability
- Pulse and AM modulation
- Total HP-IB programmability

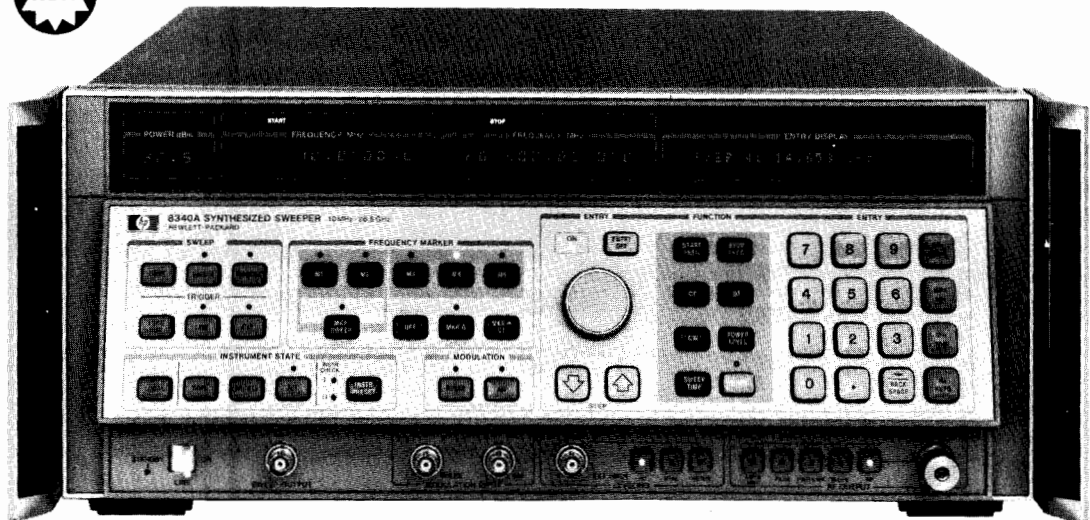

8340A



### 8340A Synthesized Sweeper

The 8340A Synthesized Sweeper combines a high-performance synthesizer and a broadband sweep oscillator into one instrument of convenient (188 mm, 7.4 in. high) size. This combination of performance and versatility, plus total HP-IB programmability, makes the 8340A ideal in many automatic test or bench applications, where it can often replace several separate instruments.

#### Synthesizer Precision

The 8340A uses indirect synthesis techniques to generate synthesized output frequencies from 10 MHz to 26.5 GHz with extremely fine frequency resolution (1 to 4 Hz, depending on frequency band). The 8340A has also been designed for very low single-sideband phase noise (see figure 1), which is important in many microwave systems tests. Long-term stability is  $1 \times 10^{-9}$ /day.

#### Swept Capability

For rapid and thorough device characterization, the 8340A provides an analog sweep with sweep widths as wide as the full instrument range or as narrow as 100 Hz, permitting the testing of virtually any device within the 8340A's frequency range. Five frequency markers are also provided, along with useful marker functions such as Marker Sweep, Marker to Center Frequency (MKR—CF), and Marker Difference, which simplify many swept measurements. Direct compatibility with the HP 8410 and 8755 Network Analyzers also enhances the 8340A's swept capability.

#### Pulse and AM Modulation

The 8340A has a high-performance pulse modulator with an ON/OFF ratio  $> 80$  dB and rise and fall times  $< 25$  ns. Pulse amplitude is leveled and can be as narrow as 100 ns. The 8340A also features DC-coupled AM modulation with a 3 dB bandwidth of 100 kHz and a minimum depth of 90%. Pulse and amplitude modulation can be used simultaneously.

#### Output Power

The 8340A provides high output power which can be varied all the way down to the minimum level ( $-90$  dBm) with 0.05 dB resolution.

High resolution is complemented by outstanding accuracy and flatness, as shown at right. The 8340A also features power sweep capability for complete characterization of level-sensitive devices.

#### Usability and Programmability

The ENTRY DISPLAY makes it easy to use all of the 8340A's powerful capability. It always displays the active function and its current value, which can then be changed via the data entry keyboard, step keys, or the knob. The 8340A is also completely programmable via the Hewlett-Packard Interface Bus (HP-IB), a capability which is enhanced by features such as the learn mode and easy-to-use programming codes (for example, a CW frequency at 5 GHz would be programmed by: CW 5 GZ).

### 8340A Specifications

(See technical data sheet for complete specifications)

#### Frequency

**Range:** 10 MHz to 26.5 GHz.

**Resolution (CW Mode):**

1 Hz, 0.01 to  $< 7.0$  GHz

2 Hz, 7.0 to  $< 13.5$  GHz

3 Hz, 13.5 to  $< 20.0$  GHz

4 Hz, 20.0 to  $< 26.5$  GHz

**Time Base:** Internal 10 MHz time base. Aging rate: less than  $1 \times 10^{-9}$ /day and  $2.5 \times 10^{-7}$ /year after 30 day warm-up.

**Swept Capability:** Analog sweep,  $\Delta F$  from 100 Hz to 26.49 GHz; sweep times from 45 ms full span to 200 sec full span.

**Swept Frequency Accuracy** (sweep time  $> 100$  ms):  
 $\Delta F \leq 5$  MHz:  $\pm 1\%$  of indicated sweep width ( $\Delta F$ )  $\pm$  time base accuracy.

5 MHz  $< \Delta F \leq 100$  MHz:  $\pm 2\%$  of indicated sweep width ( $\Delta F$ ).

$\Delta F > 100$  MHz:  $\pm 1\%$  of indicated sweep width ( $\Delta F$ ).

#### Spectral Purity

Specifications below apply to CW mode and all swept modes unless otherwise stated.

**Spurious Signals** (expressed in dB relative to the carrier level (dBc) at ALC level of 0 dBm)

**Harmonics** (up to 26.5 GHz) of output frequency: <-35 dBc.

**Subharmonics and Multiples thereof** (up to 26.5 GHz) of output frequency:

<-25 dBc, 7.0 to <20.0 GHz

<-20 dBc, 20.0 to 26.5 GHz

**Non-Harmonically Related Spurious** (CW and Manual sweep mode only):

<-55 dBc, .01 to < 2.3 GHz

<-70 dBc, 2.3 to < 7.0 GHz

<-64 dBc, 7.0 to <13.5 GHz

<-60 dBc, 13.5 to <20.0 GHz

<-58 dBc, 20.0 to 26.5 GHz

**Single-Sideband Phase Noise** (dBc/1 Hz Noise BW, CW Mode, all power levels):

Frequency Range (GHz)	Offset from Carrier				
	30 Hz	100 Hz	1 kHz	10 kHz	100 kHz
.01 to < 2.3	-64	-70	-78	-86	-107
2.3 to < 7.0	-64	-70	-78	-86	-107
7.0 to <13.5	-58	-64	-72	-80	-101
13.5 to <20.0	-54	-60	-68	-75	-97
20.0 to 26.5	-52	-58	-66	-74	-95

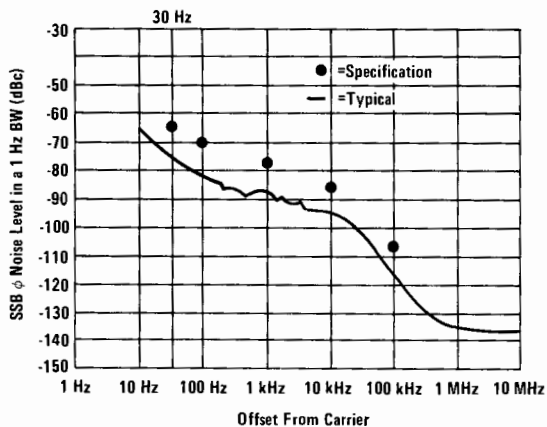

Figure 1. Typical 8340A Phase Noise performance from 2.3 to 7.0 GHz.

**RF Output**

**Range:** -90 dBm to +20 dBm.

**Resolution:** .05 dB in ENTRY DISPLAY.

**Maximum Levelled Power** (0°C to +35°C)

Frequency Range	Specified	Typical
.01 to < 2.3 GHz	+10.0 dBm	+12 dBm
2.3 to < 7.0 GHz	+12.0 dBm	+16 dBm
7.0 to <13.5 GHz	+10.0 dBm	+12 dBm
13.5 to <20.0 GHz	+ 9.0 dBm	+11 dBm
20.0 to <23.0 GHz	+ 3.0 dBm	+ 5 dBm
23.0 to <26.5 GHz	+ 1.0 dBm	+ 3 dBm

**Output Power Accuracy** (0°C to +35°C)

Output Level Range	Frequency Range (GHz)		
	.01 to <2.3	2.3 to <20	20 to 26.5
+20 to -10 dBm	±0.8 dB	±1.2 dB	±1.8 dB
-10 to -20 dBm	±0.8 dB	±1.4 dB	±2.1 dB
-20 to -30 dBm	±0.9 dB	±1.7 dB	±2.5 dB
-30 to -40 dBm	±1.0 dB	±2.1 dB	±2.9 dB
-40 to -80 dBm	±1.2 dB	±2.1 dB	±3.2 dB
-80 to -90 dBm	±1.6 dB	±2.5 dB	±3.6 dB

**Flatness** (internally levelled, relative to 100 MHz, 0°C to +35°C)

Output Level Range	Frequency Range (GHz)		
	.01 to <2.3	2.3 to <20	20 to 26.5
+20 to -10 dBm	±0.5 dB	±0.9 dB	±1.5 dB
-10 to -20 dBm	±0.6 dB	±1.2 dB	±1.9 dB
-20 to -30 dBm	±0.7 dB	±1.5 dB	±2.3 dB
-30 to -40 dBm	±0.8 dB	±1.9 dB	±2.7 dB
-40 to -90 dBm	±1.0 dB	±1.9 dB	±3.0 dB

**Pulse Modulation**

**ON/OFF Ratio:** >80 dB.

**Rise and Fall Times:** <25 ns.

**Minimum Internally Levelled RF Pulse Width:** <100 ns.

**Minimum Unlevelled RF Pulse Width:** typically <25 ns.

**Video Feedthrough:**

<3%, 0.4 to <2.3 GHz

<0.1%, 2.3 to 26.5 GHz

**Amplitude Modulation**

**Rates (3 dB BW):** DC to 100 kHz.

**Depth:** 0 to 90%.

**Sensitivity:** 100%/V.

**Remote Operation**

All front panel functions (except line power) may be programmed via the Hewlett-Packard Interface Bus (HP-IB).

**General**

**Temperature:** operation 0°C to 55°C except as noted in electrical specifications.

**Power Requirements:** 47.5 to 66 Hz; 100, 120, 200, or 240 volts (+5%, -10%); 500 VA maximum (40 VA in STANDBY).

**Weight:** 34 kg (75 lbs).

**Dimensions:** 188 H x 425.5 W x 609.6 mm D (7.4" x 16.75" x 24.0").

**Ordering Information**

**8340A** Synthesized Sweeper

**Opt 001:** Front Panel RF Output Without Attenuator

**Opt 003:** Operation at 400 Hz Line only

**Opt 004:** Rear Panel RF Output With Attenuator

**Opt 005:** Rear Panel RF Output Without Attenuator

**Opt 806:** Rack Mount Slide Kit

**Opt 850:** 8410B/C Interface Cable

**Opt 908:** Rack Flange Kit

**Opt 910:** Extra Operating and Service Manual

**Opt 913:** Rack Flange Kit for Instruments With Front Handles

**08340-60134** Support Kit



### Average Power Measurements

At microwave frequencies, power is the best measure of signal amplitude because, unlike voltage and current, power remains constant along a lossless transmission line. For this reason, power meters are almost indispensable for microwave measurements. Typical applications include monitoring transmitter power levels, calibrating signal generators, leveling signal sources, and measuring transmission characteristics of unknown devices.

To satisfy the requirements of this broad range of applications Hewlett-Packard has developed a family of general purpose microwave power meters. These power meters use a diode, thermocouple, or thermistor as the power sensing element, and it is important to understand the merits of each of these sensors before choosing a particular power meter.

### Power Meters and Sensors

Hewlett-Packard makes five average-reading power meters. The 435B and the 436A are analog and digital meters, which are designed to operate with HP's line of thermocouple and diode power sensors. The 432 power meters are designed to operate with HP's line of thermistor mounts: the 432A is an analog power meter, the 432B is digital with BCD output, and the 432C is like the 432B but is fully programmable and auto-ranging.

Thermocouple power sensors are generally preferred for measuring power because they exhibit lower SWR and wider dynamic range than previously used thermistor elements. Low SWR is directly responsible for superior accuracy since mismatch errors are lower.

HP thermocouple sensors (8481, 8482, 8483, 8485A) are available from 100 kHz to 26.5 GHz and range from -30 dBm to +44 dBm. The model 8484A diode sensor operates with the same meters and extends the input level down to -70 dBm. This sensor uses a Low-Barrier Schottky Diode to achieve exceptional 100 pW (-70 dBm) sensitivity and low noise and drift. Because the diode is always operated in its square law region (voltage out  $\propto$  power in), the 8484A can be used to measure the true power of complex as well as CW waveforms.

Thermistor power sensors (478A, 486A series) operate with the 432A, 432B and 432C power meters. Since these power meters are based on balanced bridge principles, they are used whenever a direct dc-substitution technique is required. In addition, waveguide thermistor mounts are available from 8.20 to 40 GHz.

### Peak Power Measurements

A frequent requirement in microwave work is the measurement of peak power in a periodic pulse. Rather than calculate peak power from an average power measurement, it would be more convenient to measure peak power directly. Hewlett-Packard produces two versatile instruments that accurately and conveniently measure peak power from 50 MHz to 18 GHz, and from 0 dBm to +20 dBm on pulses with widths from 100 nanoseconds to CW.

The 8900C is an economical analog power meter calibrated in watts and dBm. The 8900D has an easy to read 3½ digit display calibrated in watts. Both of these peak power meters work with the 8481A peak power sensor that conveniently detaches from the meters for storage, recalibration, or replacement.

The 8900C/D meters feature two modes of operation, Direct and Compare. In the Direct mode, the meter automatically measures and displays the maximum RF power.

In the compare mode, an oscilloscope and a meter front panel control are used to measure power at arbitrary points on the pulsed waveform. In this mode, the detected pulse train and an accurate reference line, supplied by the 8900C/D, can be simultaneously displayed on the oscilloscope CRT. The front panel control moves the reference line up or down with respect to the detected waveform. The user can then measure power at any desired point on the waveform by simply moving the reference line to that point.

### Automatic Systems to Calibrate Power Sensors and Attenuators

Power sensors and attenuators, in most cases, are the standards against which signal levels are compared. For this reason, it is essential that they be periodically recalibrated to maintain measurement integrity. Power sensors and attenuators are calibrated by either a highly accurate and fast, but expensive automatic network analyzer or by an economical, manual, but slow and tedious system. There is very little calibration capability offered in between. But now, HP offers a series of automatic power sensor and attenuator calibration systems, the 436A-E40's. The heart of these systems is a power meter based reflectometer controlled by the HP 85F computer. Calibration systems similar to the 436A-E40 have been in use for several years at key Hewlett-Packard calibration laboratories throughout the world.

Figure 1 shows the system configuration. In operation, for power meter calibration, test signals are standardized against a specially calibrated power sensor standard. The sensor to be calibrated is compared against the standardized signals and a calibration chart is plotted.

The system is also ideal for attenuation calibration. The accuracy and linearity of power meters plus the low SWR of power sensors offer attenuation accuracy surpassed only by error correcting automatic network analyzers.

The reports for Cal-Factor and attenuation are printed in either tabular or graph form and they include the calibration uncertainty. Coaxial power sensors and attenuators can be calibrated from 100 MHz to 26.5 GHz in 3 bands, 100 MHz to 2 GHz, 2 to 18 GHz, and 18 to 26.5 GHz. Waveguide thermistor sensors can be calibrated in X, P, and K bands.

### Noise Figure Measurement

Modern receiving systems must often process very weak signals, and noise added by the receiving system components often determines whether or not an input signal can be processed properly. Noise figure is the figure of merit used to express how well a system and its components can process weak signals. It expresses the degradation in the S/N ratio as the signal passes through the system. Noise figure is unique and universal; it may be determined for transistors, amplifiers, mixers, and entire systems. Considering the S/N ratio, it is often more economical to reduce the noise figure of the receiving system components than it is to increase the signal by increasing transmitted power or antenna gain.

Noise figure may also be expressed as the ratio of total output noise power (at a source temperature of 290K) compared to the output noise power if there were no noise added by the device under test (DUT) (such as in a perfect amplifier that merely amplifies the

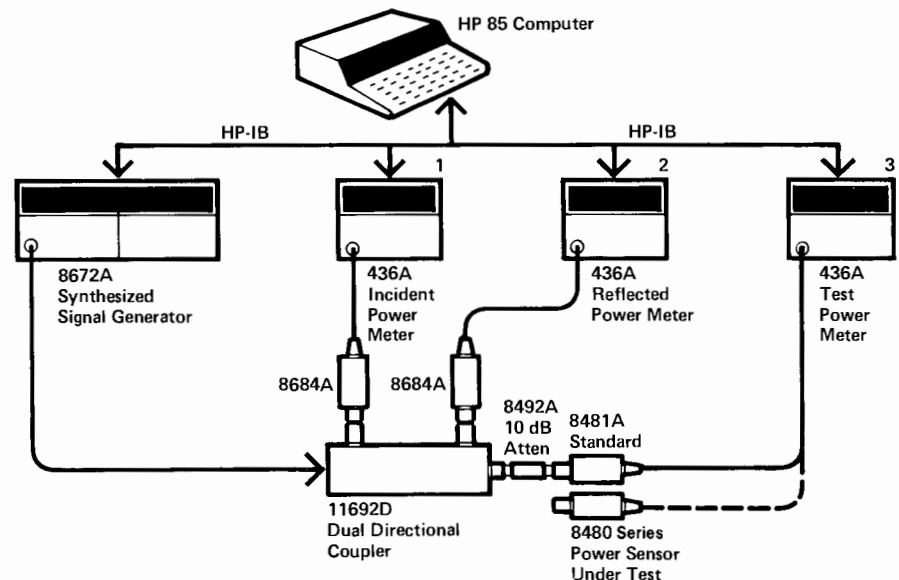

Figure 1. Power sensors and attenuators calibration system.

thermal noise of the input termination). Consider the representation of the noise power at the output of a DUT vs the temperature of the source impedance at the DUT input.

$$N_p = N_a + kGBT_s$$

Figure 2 is a graph of the equation. In the equation,  $N_a$  is the noise added by the DUT,  $k$  is Boltzman's constant,  $G$  is the gain of the DUT,  $B$  is the measurement bandwidth, and  $T_s$  is the temperature of the source termination, in kelvins. Modern noise figure meters drive a noise source on and off to generate two temperature points ( $T_c$  and  $T_h$  on a straight line of slope  $kGB$ ) and measure the two power output levels of the DUT ( $N_1$  and  $N_2$ ) for these two temperatures. Extrapolating the straight line to the  $T_s = 0$  point gives  $N_a$ , the noise added by the DUT. This noise added is transformed, using the ratio mentioned above, into noise figure,  $F$ .

### Modern Automatic Noise Figure Measurement

There are many sources of uncertainty in making noise figure measurement. Before the microprocessor was employed, error correction required much hand calculation and several separate measurements at each frequency. A modern microprocessor controlled noise figure meter, the HP 8970A, eliminates most of this uncertainty by means of self-calibration. Through self-calibration, the 8970A measures the noise contribution of the measurement equipment and sets a gain reference. It can then correct for the noise figure of the measurement system and calculate and display the noise figure and gain of the DUT alone. The 8970A also uses the control and calculation capability of the microprocessor to greatly reduce measurement time for accurate measurements.

### 10 MHz to 18 GHz Noise Figure Measurement

The 8970A can be tuned or swept anywhere between 10 and 1500 MHz. For testing devices and components with output

frequencies above 1500 MHz, down conversion to the 10 to 1500 MHz range is necessary (see Figure 3). For measurements on amplifiers from 2 to 18 GHz, adding a suitable commercially available double-balanced mixer and a suitable LO (such as the HP 8672A or 8673A) to the 8970A and its companion noise source, the 346B, is all that is necessary. (For mixer and receiver measurement, see Product Note 8970A-1 mentioned below). Since most low-noise LO's do not extend below 2 GHz, a different technique is often required from 1.5 to 2 GHz (single sideband, discussed in the next section). The 8970A will correct for ENR variations with frequency and for the noise contribution of the mixer, LO, and the 8970A. In Figure 3, the 8970A sends frequency commands over the interface bus (HP-IB) to tune the LO across the frequency band of interest. Thus, no external controller is necessary for error-corrected, swept, microwave measurements.

### Single Sideband vs Double Sideband

When an ordinary mixer is used in the setup of Figure 3, all measurements are double sideband. (LO/noise source mixing provides two bands, upper and lower sideband, that will convert to the IF). Since the self-calibration and measurement are both double sideband, the 8970A will display the correct noise figure and gain. For double sideband measurement, it is best to have a low IF, since measurement is like an average of upper and lower sideband values.

If double sideband measurement is inappropriate, such as when the DUT varies rapidly with frequency, or impossible, such as for the 1.5 to 2 GHz range where the LO may be too noisy for accurate measurements, a single sideband measurement must be made. For these cases a high IF is best, so that the unwanted sideband may be easily filtered.

For 1.5 to 2 GHz amplifier measurement, one method is to fix the LO to a proper frequency (such as 2.4 GHz), sweep the 8970A input (such as from 900 to 400 MHz), and

the lower sideband will sweep from 1.5 to 2 GHz. The upper sideband (sweeping from 2.8 to 3.3 GHz) may be filtered easily (an HP 360C works well). Another method uses a swept LO and an appropriate high fixed IF, with the 8970A controlling the external LO. In either case, the 8970A displays the measurement frequency during the sweep (1.5 to 2 GHz) and the microprocessor takes care of all of the control chores automatically.

### Noise Figure Measurement Applications

Hewlett-Packard's noise figure measurement equipment is exceptional in a variety of applications. It exhibits the following benefits in these applications.

**Amplifiers:** 1) Simultaneous noise figure and gain measurement, 2) Results automatically corrected for ENR variations, ambient temperature, and mixer, LO, and IF noise contributions, 3) Real-time, swept, corrected output to oscilloscope for easy tuning (display is digitally stored), 4) Automatic control of an external LO for measurements above 1500 MHz.

**Transistors:** The above benefits, plus: 1) Easy real-time tuning for best noise figure and gain, 2) Real-time tuning to actual transistor  $F_{min}$  without second stage effects, 3) Easy single-sideband measurement (high 8970A IF makes filtering easy), 4) Easy to program for automatic systems.

**Receivers and Mixers:** 1) Simultaneous measurement of gain (conversion loss) and noise figure, 2) Tunable and swept IF from 10 to 1500 MHz, 3) No external IF gain needed, 4) Automatic ENR correction, even for broadband sweeps, 5) Effects of LO power, IF power, and IF frequency changes on noise figure are easily observed, 6) Easy to program.

### Literature

Product Note 8970A-1, **Applications and Operation of the 8970A Noise Figure Meter**, describes the 8970A and many of its applications in more detail. It is both an introduction to the 8970A and a summary reference manual.

In addition to this note on the 8970A, information on virtually all aspects of microwave power measurements is contained in the following Hewlett-Packard Application Notes:

**Application Note 64-1, Fundamentals of RF and Microwave Power Measurements**, deals with the general theory of microwave power measurements. It covers the basic principals of measurement, calculation of measurement uncertainty, traceability, etc.

**Application Note 64-2, Extended Applications of Automatic Power Meters**, discusses an automatic power meter system for measuring attenuation gain saturation and the calibration factor of power sensors.

**Application Note 196, Automated Measurements using the 436A Power Meter**, contains several typical uses of the 436A with the HP-IB interface bus. All of these applications notes and a coaxial and waveguide catalog are available without charge. See page 659.

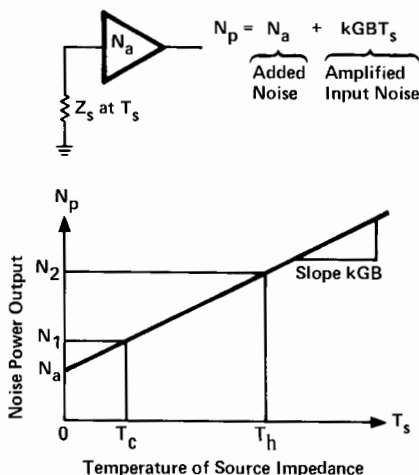

Figure 2. Available noise power.

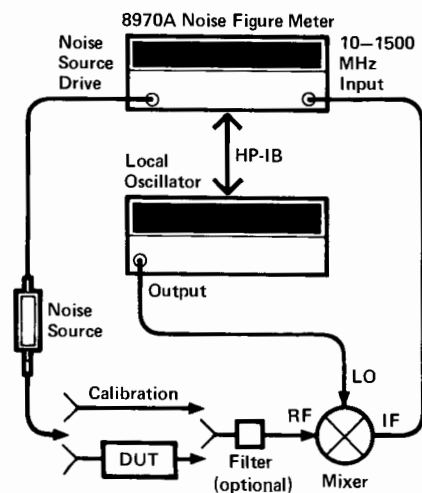
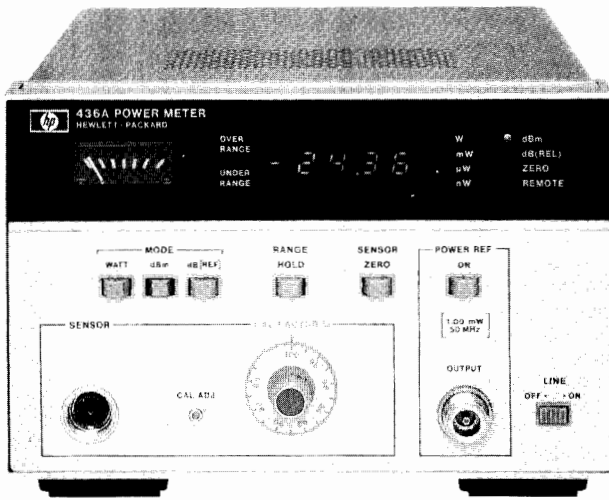

Figure 3. Swept microwave amplifier measurement.



## Thermocouple Power Meter

### Model 436A



436A



## 436A Power Meter

The HP Model 436A Power Meter is a general purpose digital power meter intended for manual and automatic RF and microwave power measurements. It is compatible with the entire series of 8480 power sensors. Depending on which power sensor is used, the 436A can measure power from  $-70$  dBm (100 pW) to  $+44$  dBm (25W) at frequencies up to 26.5 GHz.

The logically organized and uncluttered front panel, and the convenience of push-button operation and digital display make the 436A both easy to interpret and easy to use in any application. The auto-ranging capability allows for "hands-off" operation.

The 436A measures either absolute or relative power. It displays absolute power in either watts or dBm, and relative power in dB.

The 436A Power Meter also features optional programmability; both Hewlett-Packard Interface Bus (HP-IB) and BCD interfaces are available. These interfaces allow full remote control of all power meter functions (CAL function can be programmed to either 100 percent or the CAL factor which has been manually set on the front panel). These options may be added by the user at a later time.

## 436A Specifications

**Frequency range:** 100 kHz to 26.5 GHz (depending on power sensor used).

**Power range** (display calibrated in watts, dBm, and dB relative to reference power level).

**With 8481A, 8482A, 8483A, 8485A sensors:** 50 dB with 5 full-scale ranges of  $-20$ ,  $-10$ ,  $0$ ,  $10$ , and  $20$  dBm (10  $\mu$ W to 100 mW).

**With 8481B or 8482B sensors:** 44 dB with 5 full-scale ranges of  $10$ ,  $20$ ,  $30$ ,  $40$ , and  $44$  dBm (10 mW to 25 W).

**With 8481H or 8482H sensors:** 45 dB with 5 full-scale range of  $0$ ,  $10$ ,  $20$ ,  $30$  and  $35$  dBm (1 mW to 3 W).

**With 8484A sensor:** 50 dB with 5 full-scale ranges of  $-60$ ,  $-50$ ,  $-40$ ,  $-30$ , and  $-20$  dBm (1 nW to 10  $\mu$ W).

## Accuracy

### Instrumentation

**Watt mode:**  $\pm 0.5\%$ .

**dBm mode:**  $\pm 0.02$  dB  $\pm 0.001$  dB/ $^{\circ}$ C.

**dB (REL) mode:**  $\pm 0.02$  dB  $\pm 0.001$  dB/ $^{\circ}$ C.

<sup>1</sup> Specifications are for within range measurements. For range-to-range accuracy add another  $\pm 0.02$  dB.

**Zero:** automatic, operated by a front-panel switch.

**Zero set:**  $\pm 0.5\%$  of full scale on most sensitive range, typical;  $\pm 1$  count on other ranges.

**Zero carry over:**  $\pm 0.2\%$  of full scale when zeroed on the most sensitive range.

**Power reference:** internal 50 MHz oscillator with Type N female connector on front panel (or rear panel, Option 003 only).

**Power output:** 1.0 mW. Factory set to  $\pm 0.7\%$  traceable to the National Bureau of Standards.

**Accuracy:**  $\pm 1.2\%$  worst case ( $\pm 0.9\%$  rss) for one year ( $0^{\circ}$ C to  $55^{\circ}$ C).

## Supplemental Characteristics

**Noise** (typical, at constant temperature, peak change over any one-minute interval): 20 pW (8484A); 40 nW (8481A, 8482A, 8483A, 8485A); 40  $\mu$ W (8481B, 8482B); 4  $\mu$ W (8481H, 8482H).

**Drift** (1 hour, typical, at constant temperature after 24-hour warm-up): 20 pW (8484A); 10 nW (8481A, 8482A, 8483A, 8485A); 10  $\mu$ W (8481B, 8482B); 1  $\mu$ W (8481H, 8482H).

**Response time** typical, measured at recorder output, 0 to 99% of reading:

Range 1 (most sensitive range)  $< 10$  seconds

Range 2  $< 1$  second

Ranges 3 through 5  $< 100$  milliseconds

**Cal factor:** 16-position switch normalizes meter reading to account for calibration factor. Range 85% to 100% in 1% steps.

**Cal adj:** front-panel adjustment provides capability to adjust gain in meter to match power sensor in use.

**Recorder output:** linearity proportional to indicated power with 1 volt corresponding to full scale and 0.316 volts to  $-5$  dB; 1 k $\Omega$  output impedance, BNC connector.

**RF blanking:** open collector TTL; pulls low during meter zeroing. Useful for turning off RF input to sensor during auto-zeroing. BNC connector.

**Display:** four-digit display with 20% over-range capability on all ranges; analog uncalibrated peaking meter to show fast changes.

**Power consumption:** 100, 120, 220, or 240 V ( $+5\%$ ,  $-10\%$ ), 48 to 66 Hz, and 360 to 440 Hz;  $< 20$  V  $\cdot$  A ( $< 23$  V  $\cdot$  A with option 022 or 024).

**Weight:** net, 4.5 kg (10 lb); shipping, 5.5 kg (12 lb).

**Size:** 134 H x 213 W x 279 mm D (5.2" x 8.4" x 11.0").

## Accessories

**Furnished:** 1.5 m (5 ft) cable for power sensor; 2.3 m (7.5 ft) power cable. Mains plug shipped to match destination requirements.

**Available:** to rack mount one 436A by itself, order 5061-0057 Rack Mount Adapter Kit.

## Ordering Information

### 436A Power Meter

**Option 002:** Input connector on rear panel in parallel with front

**Option 003:** Input connector and reference oscillator output on rear panel only

**Option 009:** 3 m (10 ft) cable for power sensor

**Option 010:** 6.1 m (20 ft) cable for power sensor

**Option 011:** 15.2 m (50 ft) cable for power sensor

**Option 012:** 30.5 m (100 ft) cable for power sensor

**Option 013:** 61 m (200 ft) cable for power sensor

**Option 022:** Digital input/output, fully compatible with HP Interface Bus (HP-IB)

**Option 024:** Digital input/output BCD Interfact

**Option 908:** Kit for rack mounting one 436A

**Option 910:** Extra operating and service manual

# POWER & NOISE FIGURE METERS

Thermocouple Power Meter, Range Calibrator

Model 435B, 11683A

399

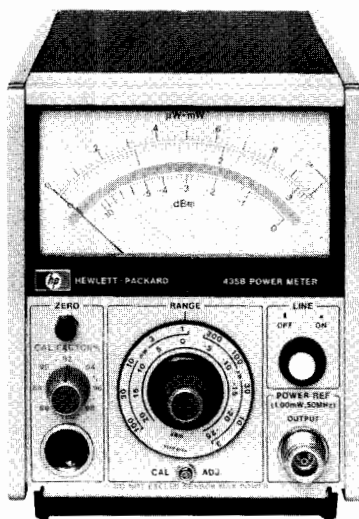

435B



11683A

## 435B Power Meter

The 435B Power Meter is an analog power meter, compatible with the entire series of 8480 power sensors. Depending on which sensor is used, the 435B can measure power from  $-65$  dBm to  $+44$  dBm, full scale, at frequencies from 100 kHz to 26.5 GHz. This versatile instrument also features  $<1\%$  instrumentation uncertainty, low noise and drift, auto-zero, recorder output, optional battery operation, and long cable options up to 61 m (200 ft).

## 11683A Range Calibrator

The 11683A calibrator is specifically designed for use with the 435B and 436A power meters. It allows verification of full-scale meter readings on all ranges, as well as meter tracking. Simply connect the cable between the power meter and calibrator. The CAL ADJ control on the power meter is used to set the meter to full scale on the 1 mW range. The calibrator and meter are then stepped through the other ranges verifying accuracy within  $\pm 1\%$  plus noise and drift. The 11683A also has a polarity switch which tests the Auto-Zero circuit.

## 435B Specifications

**Frequency range:** 100 kHz to 26.5 GHz (depending on power sensor used).

**Power range** (calibrated in watts and dB in 5 dB steps).

With 8481A, 8482A, 8483A or 8485A:  $-25$  dBm ( $3 \mu\text{W}$ ) to  $+20$  dBm (100 mW) full scale.

With 8481B or 8482B:  $+5$  dBm (3 mW) to  $+44$  dBm (25 W) full scale.

With 8481H or 8482H:  $-5$  dBm (0.3 mW) to  $+35$  dBm (3 W) full scale.

With 8484A:  $-65$  dBm (300 pW) to  $-20$  dBm ( $10 \mu\text{W}$ ) full scale.

## Accuracy

**Instrumentation:**  $\pm 1\%$  of full scale on all ranges.

**Zero:** automatic, operated by front-panel switch.

**Zero set:**  $\pm 0.5\%$  of full scale on most sensitive range, typical.

**Zero carryover:**  $\pm 0.5\%$  of full scale when zeroed on the most sensitive range.

**Power reference:** internal 50 MHz oscillator with Type N female connector on front panel (or rear panel, Option 003 only).

**Power output:** 1.00 mW. Factory set to  $\pm 0.7\%$  traceable to the National Bureau of Standards.

**Accuracy:**  $\pm 1.2\%$  worst case ( $\pm 0.9\%$  rss) for one year ( $0^\circ\text{C}$  to  $55^\circ\text{C}$ ).

## Supplemental Characteristics

**Noise** (typical, at constant temperature, peak change over any one-minute interval): 20 pW (8484A); 40 nW (8481A, 8482A, 8483A, 8485A); 40  $\mu\text{W}$  (8481B, 8482B); 4  $\mu\text{W}$  (8481H, 8482H).

**Drift** (1 hour, typical, at constant temperature after 24-hour warm-up): 40 pW (8484A); 15 nW (8481A, 8482A, 8483A, 8485A); 15  $\mu\text{W}$  (8481B, 8482B); 1.5  $\mu\text{W}$  (8481H, 8482H).

**Response Time** (typical, measured at recorder output, 0 to 99% of reading):

Range 1 (most sensitive range)  $<10.0$  seconds

Range 2  $<3.8$  seconds

Range 3  $<1.3$  seconds

Ranges 4 to 10  $<500$  milliseconds

**Cal factor:** 16-position switch normalizes meter reading to account for calibration factor; range 85% to 100% in 1% steps.

**Recorder output:** linearly proportional to indicated power with 1 volt corresponding to full scale; 1 k $\Omega$  output impedance, BNC connector.

**RF blanking output:** provides a contact closure to ground. Used for turning off RF input to sensor during auto-zeroing. BNC connector.

**Cal adj:** front-panel adjustment provides capability to adjust gain of meter to match power sensor in use.

**Power consumption:** 110 or 120 V ( $+5\%$ ,  $-10\%$ ), 48 to 66 Hz and 360 to 440 Hz; also 220 or 240 V ( $+5\%$ ,  $-10\%$ ), 48 to 66 Hz only;  $<20\text{V} \cdot \text{A}$ .

**Weight:** net, 2.7 kg (5.9 lb); shipping, 4.2 kg (9.2 lb).

**Size:** 155 H x 130 W x 279 mm D (6.3" x 5.1" x 11").

## Accessories

**Furnished:** 1.52 m (5 ft) cable for the power sensor; 2.3 m (7.5 ft) power cable, (mains plug shipped to match destination requirements).

**Available** (see page 649)

**11076A:** Carrying case.

**5060-8762:** Rack adapter frame (holds three instruments the size of the 435B).

**Combining cases** (see page 648).

**1051A:** 286 mm (11.25 in.) deep.

**1052A:** 416 mm (16.4 in.) deep.

These combining cases accept  $\frac{1}{2}$ -module Hewlett-Packard instruments for bench use or rack mounting.

## 11683A Range calibrator

**Calibration functions:** outputs corresponding to meter readings of 3, 10, 30, 100 and 300  $\mu\text{W}$ ; 1, 3, 10, 30, and 100 mW.

**Calibration uncertainty:**  $\pm 0.25\%$  in all ranges.

**Power:** 115 or 230 V  $\pm 10\%$ , 50-400 Hz, less than 2 W.

**Weight:** net, 1.13 kg (2.5 lb); shipping, 1.9 kg (4.2 lb).

**Size:** 89 H x 133 W x 216 mm D (3.5" x 5.25" x 8.5").

## Ordering Information

**11683A** Range Calibrator

**435B** Power Meter

**435B Options**

**001:** Rechargeable battery installed provides up to 16 hours of continuous operation

**002:** Input connector placed on rear panel in parallel with front

**003:** Input connector and reference oscillator output on rear panel only

**009:** 3.0 m (10-foot) cable for power sensor

**010:** 6.1 m (20-foot) cable for power sensor

**011:** 15.2 m (50-foot) cable for power sensor

**012:** 30.5 m (100-foot) cable for power sensor

**013:** 61 m (200-foot) cable for power sensor

**910:** Extra operating and service manual

# POWER & NOISE FIGURE METERS

## Power Sensors

Models 8481A/B, 8481H, 8482A/B, 8482H, 8483A, 8484A, 8485A, 11708A

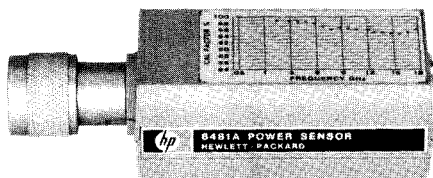

8481A

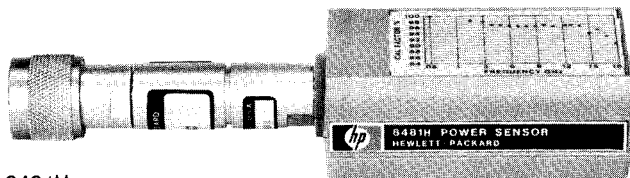

8481H

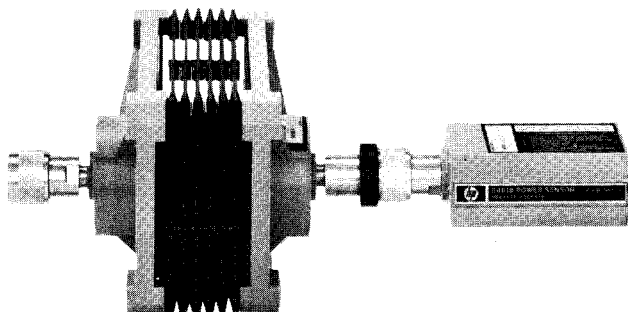

8481B

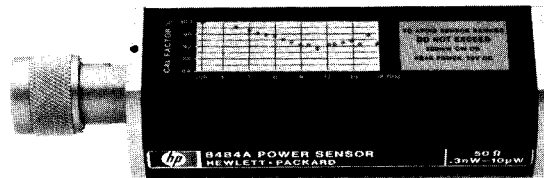

8484A



11708A

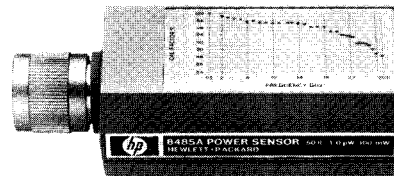

8485A

### 8480 Series Power Sensors

The 8480 series of power sensors have been designed for use with the 435B and 436A Power Meters. They feature wide frequency and amplitude ranges in addition to very low SWR.

The power measurement range of these sensors is from 0.1 nW to 25 Watts. With just three sensors a power measurement range of 114 dB can be achieved.

#### Wide Frequency Range for Many Applications

Power measurements can be made over a frequency range of 100 kHz to 26.5 GHz. The four frequency ranges covered with these units are 10 MHz to 18 GHz, 100 kHz to 4.2 GHz, 50 MHz to 26.5 GHz, and 100 kHz to 2 GHz, with the 75-ohm unit.

#### Low SWR for Low Measurement Uncertainty

The 8481/82/83/85 series of sensors use a silicon monolithic thermocouple as the sensing element. The small physical size of the thermocouple enables the sensors to have a very low SWR even at 26.5 GHz. A low SWR reduces mismatch uncertainty error, one of the largest single sources of error in power measurements. The 8484A sensor uses a crystal detector for higher sensitivity without degrading SWR.

#### Individually Calibrated for More Confidence in Results

Each sensor is individually calibrated, traceable to the National Bureau of Standards. A Cal Factor control on the meter compensates for power sensor efficiency at any frequency. A precise Automatic Network Analyzer printout for Cal Factor and reflection coefficient in magnitude and phase is supplied with the 8481A/B/H, 8484A, and 8485A. This means you can significantly reduce mismatch uncertainty by calculating the mismatch error.

### High Power Sensors to 25 Watts

The new 8481B and 8482B high power sensors both have a power range of 1 mW to 25 watts. The 8481B covers a frequency range of 10 MHz to 18 GHz and the 8482B has a frequency range of 100 kHz to 4.2 GHz.

Previous methods of measuring medium power levels usually required adding a separate attenuator in front of a low power sensor. With the 8481/82B power sensors, the attenuator and sensor are combined into one unit. This reduces mismatch uncertainty error and improves accuracy by including the attenuator in the measured Calibration Factor curves. In addition, the design incorporates lightweight, heat-dissipating fins to prevent burns.

### Medium Power Sensors to 3 Watts

Model 8481H measures power from 100  $\mu$ W to 3 watts over a frequency range of 10 MHz to 18 GHz. The 8482H measures power from 30  $\mu$ W to 3 watts over a frequency range of 100 kHz to 4.2 GHz.

### Standard Sensors to 100 mW

The 8481A, 8482A, 8483A, and 8485A power sensors all measure power over a range of 0.3  $\mu$ W to 100 mW. The 8481A is a 50-ohm sensor with a frequency range of 10 MHz to 18 GHz. The 8482A is a 50-ohm sensor with a frequency range of 100 kHz to 4.2 GHz. The 8485A is a 50-ohm sensor with a frequency range of 50 MHz to 26.5 GHz. The 8483A is a 75-ohm sensor and covers a frequency range of 100 kHz to 2 GHz.

### High Sensitivity Sensors

The 8484A measures power from 0.1 nW to 10  $\mu$ W over a frequency range of 10 MHz to 18 GHz. It is furnished with the 11708A 50 MHz Reference Attenuator for precise calibration with 1 mW Power Meter Reference Oscillator. Noise and drift have been reduced to less than 5% of full scale on the 300 pW range—only 15 pW when it is used with the 435B Power Meter. Noise and drift are even less with the 436A Power Meter.

### Broadband Power Sensor

The 8485A thermocouple power sensor covers a frequency range of 50 MHz to 26.5 GHz and a power range of -30 dBm to +20 dBm (1  $\mu$ W to 100  $\mu$ W). Low SWR (<1.25 at 26.5 GHz) reduces mismatch uncertainty which increases power measurement accuracy. The ruggedized APC-3.5 input connector is SMA compatible and repeatable. The actual Cal Factor is plotted on each 8485A label at 34 frequencies. Each unit is shipped with a print-out which lists Cal Factor plus the actual SWR (reflection coefficient) in magnitude and phase.



### 8480 Series Specifications

Model	Nominal Impedance	Frequency Range	Power Range	Maximum Power	Power Linearity <sup>a</sup>	Maximum SWR (Reflection Coefficient)	Size mm (in.)	Shipping Weight kg (lb)	RF Connector
8481A	50 Ω	10 MHz-18 GHz	1 μW to 100 mW	300 mW avg. 15 W peak 30 W • μs (per pulse)	+10 to +20 dBm +2, -4%	10 MHz - 30 MHz: 1.40 (0.166) 30 MHz - 50 MHz: 1.18 (0.083) 50 MHz - 2 GHz: 1.10 (0.048) 2 - 12.4 GHz: 1.18 (0.083) 12.4 - 18 GHz: 1.28 (0.123)	30 x 38 x 105 (1.2 x 1.5 x 4.1)	0.5 (1)	N(m)
Option 001									APC-7
8481B	50 Ω	10 MHz-18 GHz	0-35°C, 1 mW-25W; 35°C-55°C, 1 mW-20 W	0-35°C: 30 W avg. <sup>1</sup> 35°C-55°C: 25 W avg.  10 MHz-5.8 GHz 500 W peak 5.8-18 GHz 125 W peak  500 W • μs (per pulse)	+35 to +44 dBm ±4%	10 MHz - 2 GHz: 1.10 (0.048) 2-12.4 GHz: 1.18 (0.083) 12.4-18 GHz: 1.28 (0.123)	83 x 114 x 248 (3.25 x 4.5 x 9.75)	1.5 (3.2)	N(m)
8481H	50 Ω	10 MHz-18 GHz	100 μW to 3W	3.5 W avg. 100 W peak 100 W • μs (per pulse)	+25 to +35 dBm ±5%	10 MHz - 8 GHz: 1.20 (0.091) 8-12.4 GHz: 1.25 (0.110) 12.4 - 18 GHz: 1.30 (0.130)	30 x 38 x 149 (1.2 x 1.5 x 5.9)	0.5 (1)	N(m)
8482A	50 Ω	100 kHz-4.2 GHz	1.0 μW to 100 mW	300 mW avg. 15 W peak 30 W • μs (per pulse)	+10 to +20 dBm +2, -4%	100-300 kHz: 1.60 (0.231) 300 kHz - 1 MHz: 1.20 (0.091) 1 MHz - 2 GHz: 1.10 (0.048) 2-4.2 GHz: 1.30 (0.130)	30 x 38 x 105 (1.2 x 1.5 x 4.1)	0.5 (1)	N(m)
8482B	50 Ω	100 kHz-4.2 GHz	0-35°C, 1 mW-25 W; 35°C-55°C, 1 mW-20 W	0-35°C: 30 W avg. <sup>1</sup> 35°C-55°C: 25 W avg.  500 W peak  500 W • μs (per pulse)	+35 to +44 dBm ±4%	100 kHz - 2 GHz: 1.10 (0.048) 2 GHz - 4.2 GHz: 1.18 (0.083)	83 x 114 x 248 (3.2 x 4.5 x 9.7)	1.5 (3.2)	N(m)
8482H	50 Ω	100 kHz-4.2 GHz	100 μW to 3W	3.5 W avg. 100 W peak 100 W • μs (per pulse)	+25 to +35 dBm ±5%	100 kHz-4.2 GHz: 1.20 (0.091)	30 x 38 x 149 (1.2 x 1.5 x 5.9)	0.5 (1)	N(m)
8483A	75 Ω	100 kHz-2 GHz	1.0 μW to 100 mW	300 mW avg. 10 W peak 30 W • μs (per pulse)	+10 to +20 dBm +2, -4%	100-600 kHz: 1.80 (0.286) 600 kHz - 2 GHz: 1.18 (0.083)	30 x 38 x 105 (1.2 x 1.5 x 4.1)	0.5 (1)	N(m) 75 Ω
8484A <sup>4</sup>	50 Ω	10 MHz-18 GHz	0.1 nW to 10 μW	200 mW avg. 200 mW peak	-30 to -20 dBm ±1%	10-30 MHz: 1.40 (0.166) 30 MHz - 4 GHz: 1.15 (0.070) 4-10 GHz: 1.20 (0.091) 10-15 GHz: 1.30 (0.130) 15-18 GHz: 1.35 (0.149)	36 x 44 x 133 (1.4 x 1.7 x 5.2)	0.5 (1)	N(m) <sup>3</sup>
8485A	50 Ω	50 MHz-26.5 GHz	1 μW to 100 mW	300 mW avg. 15 W peak 30 W • μs (per pulse)	+10 to +20 dBm +2, -4%	50 MHz-100 MHz: 1.15 100 MHz-2 GHz: 1.10 2-12.4 GHz: 1.15 12.4-18 GHz: 1.20 18-26.5 GHz: 1.25	30 x 38 x 95 (1.2 x 1.5 x 3.7)	0.5 (1)	APC3.5(m)

<sup>1</sup>For pulses greater than 30 W the maximum average power (Pa) is limited by the energy per pulse (E) in W • μs according to Pa = 30-0.02E.

<sup>2</sup>Negligible deviation except for those power ranges noted.

<sup>3</sup>Includes 1250-0597 adapter from 75 Ω type N to 50 Ω type N for calibration.

<sup>4</sup>The 11708A 30 dB attenuator for calibrating against a 0 dBm, 50 MHz power reference is shipped with the 8484A.

### Uncertainty of calibration factor data for 8482A and 8483A

Frequency (MHz)	Sum of Uncertainties (%) <sup>1</sup>				Probable Uncertainties (%) <sup>2</sup>			
	8482A	8482B	8482H	8483A	8482A	8482B	8482H	8483A
0.1	±2.3	±5.7	±3.3	±2.6	±1.3	±2.8	±1.6	±1.5
0.3	2.2	5.7	3.2	2.5	1.2	2.8	1.6	1.4
1.0	2.2	5.7	3.2	2.5	1.2	2.8	1.6	1.4
3.0	2.2	5.7	3.2	2.5	1.2	2.8	1.6	1.4
10.0	2.5	5.7	3.5	3.0	1.3	2.8	1.6	1.6
30.0	2.6	5.7	3.6	3.1	1.4	2.8	1.7	1.6
50.0	0(ref)	2.7	0(ref)	0(ref)	0(ref)	2.7	0(ref)	0(ref)
100.0	3.1	5.6	4.1	3.9	1.6	3.3	1.9	2.0
300.0	3.1	5.6	4.1	3.9	1.6	3.3	1.9	2.0
1000.0	2.7	5.7	3.7	3.7	1.4	3.3	1.7	2.0
2000.0	2.7	5.5	3.7	3.9	1.4	3.1	1.7	2.1
4000.0	2.8	5.5	3.8	—	1.5	3.1	1.8	—

### Uncertainty of calibration factor data for 8481A/B, 8484A and 8485A

Frequency (GHz)	Sum of Uncertainties (%) <sup>1</sup>					Probable Uncertainties (%) <sup>2</sup>				
	8481A	8481B	8481H	8484A	8485A	8481A	8481B	8481H	8484A	8485A
0.1	±3.1	±6.4	±4.1	±4.4	—	±1.6	±3.0	±1.9	±1.9	—
2	2.7	5.8	3.7	4.0	±3.6	1.4	3.1	1.7	1.8	±2.1
4	2.8	5.8	3.8	4.1	—	1.5	3.1	1.8	1.8	—
6	2.8	5.8	3.8	4.1	4.0	1.5	3.1	1.8	1.8	2.3
8	3.2	6.0	4.2	4.6	—	1.7	3.2	2.0	2.0	—
10	3.6	6.2	4.6	5.1	4.7	1.9	3.3	2.2	2.2	2.7
12	3.9	7.8	4.9	6.5	—	2.1	4.1	2.4	2.8	—
14	4.8	7.9	5.8	7.4	5.6	2.6	4.1	2.8	3.2	3.2
16	5.2	8.0	6.2	7.8	—	2.9	4.2	3.0	3.4	—
18	5.8	8.3	6.8	8.4	5.9	3.2	4.3	3.4	3.7	3.6
22	—	—	—	—	6.8	—	—	—	—	3.7
26.5	—	—	—	—	7.3	—	—	—	—	4.0

<sup>1</sup>Includes uncertainty of reference standard and transfer uncertainty. Directly traceable to NBS.

<sup>2</sup>Square root of sum of the individual uncertainties squared (RSS).



# POWER & NOISE FIGURE METERS

## Thermistor Power Meters & Power Meter Calibrator

Models 432A/B/C, 8477A

- Automatic zero
- High accuracy

- Recorder outputs, analog & digital
- Long cable options

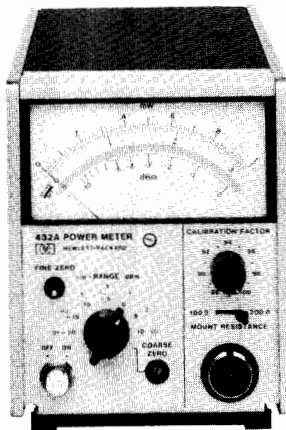

432A

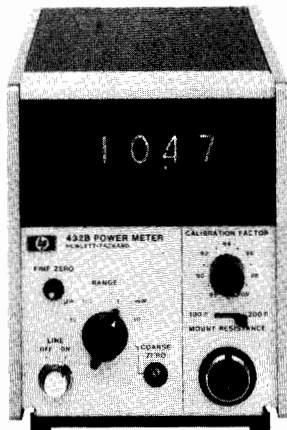

432B



432C

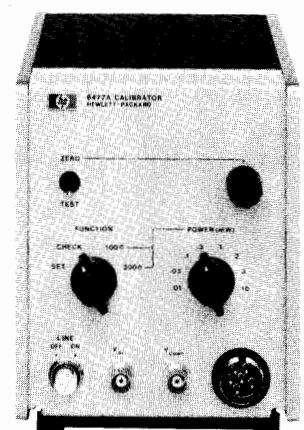

8477A

### 432A/B/C Power Meters

**High accuracy—no thermoelectric error:** High accuracy over a wide temperature range is featured on the 432 Power Meters. By measuring the output voltage of the thermistor bridges, and computing the corresponding power, even higher accuracy of  $\pm 0.2\% \pm 0.5 \mu\text{W}$  can be obtained.

Accuracy can be maintained on even the most sensitive range because the error due to thermoelectric effect is reduced to a negligible level.

**Calibrated mounts:** Each thermistor mount is furnished with data stating the Calibration Factor\* and Effective Efficiency\* at various frequencies across the operating range. For easy and accurate power measurements, the front panel of the 432 contains a calibration factor control, calibrated in 1% steps from 88% to 100%, that compensates for losses in the mount and eliminates the need for calculation.

**Instrument type:** automatic, self-balancing power meter for use with temperature-compensated thermistor sensor.

\*"Calibration Factor" and "Effective Efficiency" are figures of merit expressing the ratio of the substituted signal measured by the power meter to the microwave power incident on and absorbed by the sensor.

### Specifications (Partial)

#### Power Range

**432A:** seven ranges with full-scale readings of 10, 30, 100, and 300  $\mu\text{W}$ , 1, 3, and 10 mW; also calibrated in dBm from  $-20$  dBm to  $+10$  dBm full scale in 5 dB steps.

**432B, 432C:** four ranges with full-scale readings of 10 and 100  $\mu\text{W}$ , and 1 and 10 mW.

**Noise:** Less than 0.25% of full scale peak (typical).

**Response time:** At recorder output, 35 ms time constant (typical).

**Fine zero:** Automatic, operated by front panel switch. Remote fine zero may be accomplished with 432C.

**Zero carryover:** Less than 0.50% of full scale when zeroed on most sensitive range.

#### Meter

**432A:** taut-band suspension, individually calibrated, mirror-backed scales. Milliwatt scale more than 108 mm (4.25 in.) long.

**432B, 432C:** three digits with one digit overrange. 20% overrange capability on all ranges.

**Calibration factor control:** 13-position switch normalizes meter reading to account for thermistor sensor calibration factor. Range 100% to 88% in 1% steps.

**Thermistor sensor:** Thermistor sensors are required for operation of the 432A/B/C. For microwave sensors HP 478B, 8478B and 486 series see page 403.

**Recorder output:** Proportional to indicated power with 1 volt corresponding to full-scale. 1 k $\Omega$  output impedance.

**BCD output:** 8, 4, 2, 1 code: "1" positive. TTL compatible logic. Operates with HP 5055A Digital Recorder. "Print" and "Inhibit" lines available. (432B and 432C only.)

**Model 432C control lines:** Instrument is referenced to +5 V, "Logic 0" is equivalent to 0 V.

#### Power Consumption

**432A:** 115 or 230 V ac  $\pm 10\%$ , 50 to 400 Hz, 2.5 watts.

**432B:** 115 or 230 V ac  $\pm 10\%$ , 50 to 400 Hz, 10 watts.

**432C:** 115 or 230 V ac  $\pm 10\%$ , 50 to 400 Hz, 16 watts.

#### Weight

**432A:** net, 2.3 kg (5.5 lb); shipping, 4.6 kg (10 lb).

**432B:** net, 3 kg (6.5 lb); shipping, 4.8 kg (10.5 lb).

**432C:** net, 3.2 kg (7.2 lb); shipping, 5 kg (11 lb).

**Size:** 130 W x 155 H x 279 mm D (5.2" x 6.1" x 11.0").

### 8477A Power Meter Calibrator

The 8477A Calibrator is specifically designed for use with the 432 Power Meter. It allows you to verify full-scale meter readings on all ranges, and meter tracking. Simply connect three cables between the power meter and calibrator; no charts or additional instruments are required.

### Ordering Information

**432A** Power meter

**432B** Power meter

**432C** Power meter

#### 432A/B/C Options

**001:** rechargeable battery installed, provides up to 24 hours continuous operation (432A only)

**002:** input connector placed on rear panel in parallel with front

**003:** input connector on rear panel only

**009:** 3.1 m (10 ft) cable for 110-ohm or 200-ohm sensor

**010:** 6.1 m (20 ft) cable for 100-ohm or 200-ohm sensor

**011:** 15.2 m (50 ft) cable for 100-ohm or 200-ohm sensor

**012:** 30.5 m (100 ft) cable for 100-ohm or 200-ohm sensor

**013:** 61 m (200 ft) cable for 100-ohm or 200-ohm sensor

**100:** 100 Vac operation

**910:** extra operating and service manual

**8477A** Power Meter Calibrator

# POWER & NOISE FIGURE METERS

Thermistor Mounts, Peak Power Sensor & Peak Power Meters  
Models 478A, 8478B, 486 Series, 8900C/D, 84811A

403

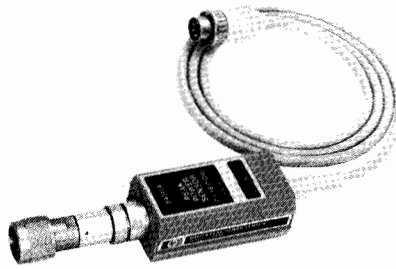

84811A



478A

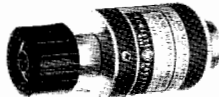

8478B

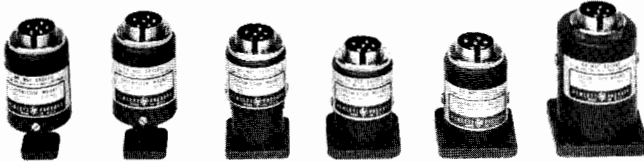

486 Series

## Temperature Compensated Thermistor Mounts

High efficiency and good RF match are characteristic of the HP 478A and 8478B Coaxial and 486A Series Waveguide Thermistor mounts. Used in conjunction with the 432 Power Meter they provide high accuracy even in routine power measurements. These thermistor mounts are temperature-compensated for low drift, even in the presence of thermal shocks, permitting measurement of microwave power as low as one microwatt. Each mount contains data showing Calibration Factor and Effective Efficiency at six frequencies, directly traceable to the National Bureau of Standards at those frequencies where NBS provides calibration service.

### 486, 478, 8478B Specifications

Model	Frequency range, GHz	Maximum SWR	Operating Resistance (Ohms)
478A	10 MHz to 10 GHz	1.75, 10 to 25 MHz 1.3, 25 MHz to 7 GHz 1.5, 7 to 10 GHz	200
8478B <sup>1</sup>	10 MHz to 18 GHz	1.75, 10 to 30 MHz 1.35, 30 to 100 MHz 1.1, 0.1 to 1 GHz 1.35, 1 to 12.4 GHz 1.6, 12.4 to 18 GHz	200
X486A	8.20 to 12.4	1.5	100
M486A	10.0 to 15.0	1.5	100
P486A	12.4 to 18.0	1.5	100
K486A <sup>2</sup>	18.0 to 26.5	2.0	200
R486A <sup>2</sup>	26.5 to 40.0	2.0	200

<sup>1</sup>Option 011: furnished with APC-7 RF connector

<sup>2</sup>Circular flange adapters:

K-band (UG-425/U) HP 11515A  
R-band (UG-381/U) HP 11516A

## 84811A Peak Power Sensor

The 84811A Peak Power Sensor works with the 8900C/D Peak Power Meters to measure the peak power of RF pulses. It is supplied with a 4 foot flexible cable to easily reach the pulses source being measured. Any sensor can be used with any meter. The 84811A also conveniently detaches from the meter for storage, recalibration or replacement.

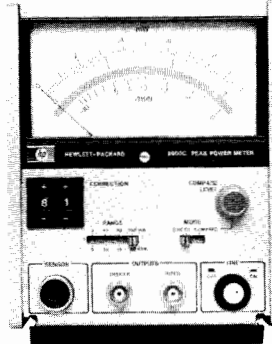

8900C

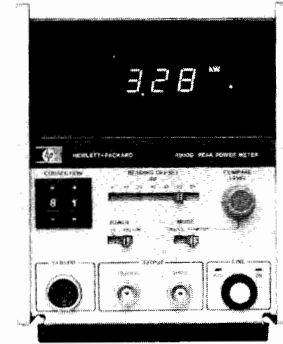

8900D

## 8900C/D Peak Power Meters

The 8900C and 8900D Peak Power Meters directly display the peak power of RF pulses over a 100 MHz to 18 GHz frequency range. Measurements can be made on pulses with widths from 1  $\mu$ s (100 ns in Compare mode) to CW, and repetition rates from 100 Hz (0 Hz in Compare mode) to 100 kHz.

The 8900C is an economical analog meter calibrated in watts and dBm. The analog display with its large, easy to read scale makes it simple to peak or null pulsed power systems. The 8900D has a high resolution 3 1/2 digit digital display calibrated in watts. The direct reading display and range annunciators make the digital version a good choice for production and field applications where unambiguous or frequent readings are required.

### 8900C/D Peak Power Meters Specifications

**Frequency range:** 100 MHz to 18 GHz.

**Dynamic range:** 20 dB (0 to +20 dBm).

**8900C:** 4 ranges of 3, 10, 30 and 100 mW full scale.

**8900D:** 2 ranges of 10 and 100 mW full scale.

#### Pulse response

##### Direct mode

**Pulse width:** 1  $\mu$ s to CW.

**Repetition rate:** 100 Hz to 100 kHz.

##### Compare mode

**Pulse width:** 100 ns (typical) limited by rise time specification.

**Repetition rate:** 0 to 100 kHz

**Rise time:** 75 ns.

**Fall time:** 125 ns (as measured on video output).

Meter Accuracy	CW	Pulse	Transfer Accuracy CW to Pulse
Direct	$\pm 0.2$ dB	$\pm 0.35$ dB	$\pm 0.2$ dB
Compare	$\pm 0.2$ dB	$\pm 0.25$ dB	$\pm 0.1$ dB

## 84811A Peak Power Sensor Specifications

**Power range:** 0 to +20 dBm (1 mW to 100 mW).

**Frequency range:** 100 MHz to 18 GHz.

**SWR:** 100 MHz to 12 GHz < 1.5, 12 GHz to 18 GHz < 2.0.

**Maximum peak power:** +24 dBm (250 mW) for 5 minutes.

**Connector type:** N (male).

**Calibration:** every 2 GHz from 2 to 10 GHz. Every 1 GHz from 11 to 18 GHz.

**Operating temperature:** 0 to +55°C.

**Calibration accuracy:** (+10 to +40°C),  $\pm 0.7$  dB 0.1 to 12 GHz.  $\pm 1.0$  dB to 18 GHz. 0–10°C and 40–55°C: add  $\pm 0.2$  dB.

## Ordering Information

**8900C** Analog peak power meter

**8900D** Digital peak power meter

**84811A** Peak power sensor



# POWER & NOISE FIGURE METERS

## Automatic Noise Figure Meter Noise Source

Models 8970A, 346B

- Accurate and simple, swept or CW measurements.
- Automatic operation, 10 MHz—18 GHz.
- Second stage correction.
- Display of both noise figure and gain.
- Calibrated display on oscilloscope or recorder.
- Powerful special function enhancements.

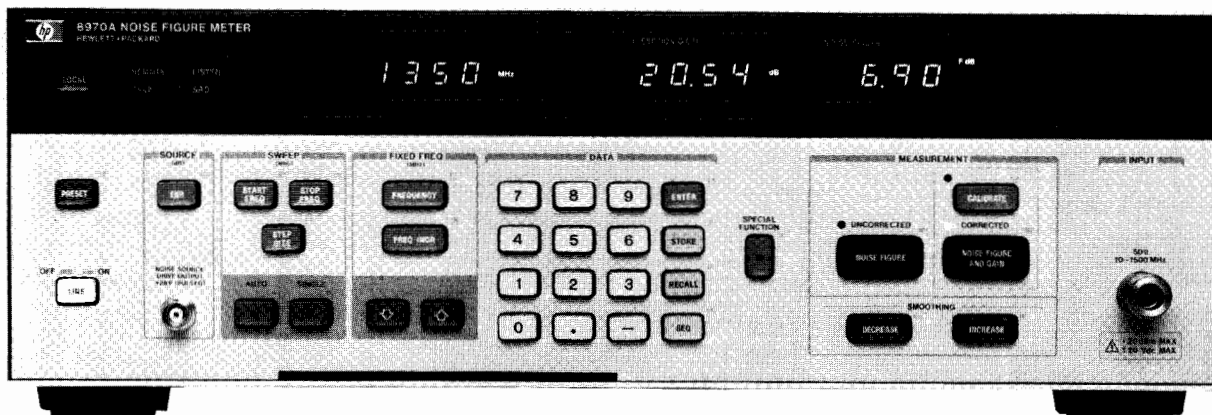

8970A

### 8970A Noise Figure Meter

With the 8970A Automatic Noise Figure Meter, accurate and repeatable noise figure measurements are now easy. RF and microwave (with an external local oscillator) measurements from 10 MHz to at least 18 GHz are equally simple; any IF between 10 and 1500 MHz may be used. The ENR (Excess Noise Ratio) calibration table of the noise source may be stored in the 8970A, and a properly interpolated value is automatically used at each frequency. Automatic second stage correction makes accurate noise figure readings possible even for low gain devices. The 8970A's dynamic range allows it to measure either gain up to at least 40 dB (higher in some cases) or loss to  $-20$  dB, with no external attenuation or amplification required.

#### Microprocessor and Controller Functions

The 8970A takes the mystery out of noise figure measurement. It uses a microprocessor to make the myriad calculations and corrections necessary for truly accurate, convenient and flexible noise figure measurement. The 8970A also acts as a controller to external HP-IB local oscillators (such as the 8672A Synthesized Signal Generator or 8350A Sweep Oscillator) so that swept, broad-band microwave measurements of amplifiers, mixers, and transistors are essentially as simple as RF measurements.

In addition to acting as controller for an HP-IB local oscillator at microwave frequencies, the 8970A is fully programmable. Virtually all front panel buttons and functions are accessible over HP-IB, which is Hewlett-Packard's enhanced implementation of IEEE-488.

#### Simple Calibration and Second Stage Correction

Accuracy is greatly enhanced because the 8970A measures its own noise figure (and that of the rest of the measurement system) at up to 81 points. It stores this information, interpolates if necessary, and corrects for it to remove second stage (measurement system) effects. The 8970A also measures the gain of the device under test (DUT).

#### Display

The 8970A has an LED digital front panel display. For swept display of Noise Figure and gain on an oscilloscope, or x-y recorder, rear panel BNC Connectors are available. Either display mode is easily and accurately scaled from the 8970A from the front panel. The swept oscilloscope display allows the design engineer to optimize his DUT in real time for both corrected noise figure and gain. The noise figure display is easily changed from noise figure to effective noise temperature ( $T_e$ ) if desired, or y factor.

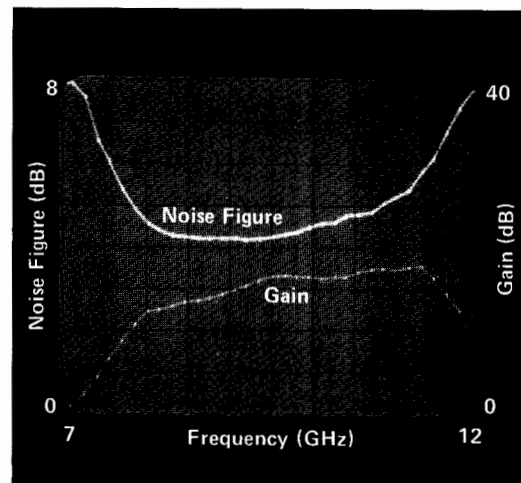

Typical oscilloscope display of amplifier.

#### Front Panel and Special Functions

The 8970A front panel buttons control the number entry, calibration, and measurement functions. STORE, RECALL, and SEQ buttons allow up to 9 front panel settings to be stored and sequenced automatically or manually to save set-up time. Smoothing INCREASE and DECREASE buttons are used to average up to 512 readings before display, to eliminate flicker and increase accuracy.

The simple front panel control of the 8970A satisfies many noise figure measurement needs. In addition, for those who may need even greater measurement power, there are more than 150 special functions that are easily selected via a numerical code and the SP button. Two examples are hot-cold measurements and automatic compensation for losses at the input of the DUT. One special function is a catalog that quickly indicates the current special function status. Three pull-out cards serve as a mini-reference manual to the instrument, including most of the special functions, the HP-IB formats and codes, and typical measurement setups. A complete set of service-oriented special functions can also be accessed.





### Microwave Test Equipment Product Line

Hewlett-Packard offers a complete line of microwave coaxial and waveguide measuring equipment. Measuring systems can be assembled from this equipment to make accurate reflection and transmission measurements on other components such as filters, mixers, cables, etc.

The bulk of microwave measurements made in production test, maintenance, and calibration require amplitude information only. These are sometimes referred to as scalar measurements.

The tables to the right summarize HP capabilities in scalar microwave measurements. More detailed information is available in the following publications:

- AN 64-2 Extended Applications of Automatic Power Meters
- AN 183 High Frequency Swept Measurements

### HP Impedance/SWR Measuring Techniques and Capabilities

Measurement Technique	Coaxial Freq. Range	Waveguide Freq. Range	Typical Range	Remarks/Cost/Accuracy/Speed
Manual Slotted Line	500-4000 MHz 1-18 GHz	3.95-18 GHz (4 Bands)	30-35 dB	Lowest cost, high accuracy, slow, point-by-point
Swept Slotted Line	1.8-18 GHz	—	34 dB	Moderate cost, high accuracy, good speed, comprehensive
Reflectometer Square-Law	100-4000 MHz 2-18 GHz	3.95-40 GHz (6 Bands)	35-40 dB	Moderate cost, moderate accuracy, fast, comprehensive
Reflectometer RF-Substitution	100-4000 MHz 2-18 GHz	3.95-40 GHz (6 Bands)	50 dB	Moderate cost, high accuracy, fast, requires display storage
Bridge	1-110 MHz 40 MHz-18 GHz	—	40 dB	Multi-octave, good for coax, best for low SWR, 9 dB insertion loss

### HP Insertion Loss Measuring Techniques and Capabilities

Measurement Technique	Coaxial Freq. Range	Waveguide Freq. Range	Typical Range	Remarks/Cost/Accuracy/Speed
Square-Law	10 MHz-18 GHz	2.6-40 GHz (7 Bands)	50 dB	Low cost, moderate accuracy, simple, fast
RF Substitution	10 MHz-18 GHz	2.6-18 GHz 18-40 GHz	50-100 dB 50-80 dB	Moderate cost, high accuracy fast, requires display storage
IF Substitution	10 MHz-18 GHz	2.6-18 GHz (5 Bands)	30-120 dB	High cost, very high accuracy, best range, moderate speed
Desktop computer mini-system	100 kHz-4 GHz 10 MHz-18 GHz	—	40-70 dB	Moderate cost, very high accuracy, automated

# MICROWAVE TEST EQUIPMENT

## Variable Attenuators and OEM Step Attenuators

Models 375 Series, 382 Series, 393A, 394A, 33300 Series, 33320 Series

407

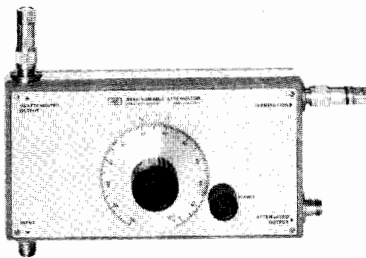

394A

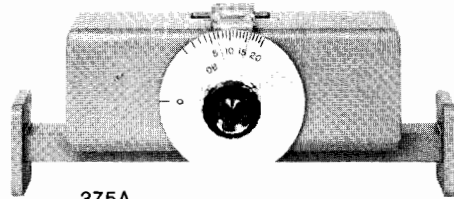

375A

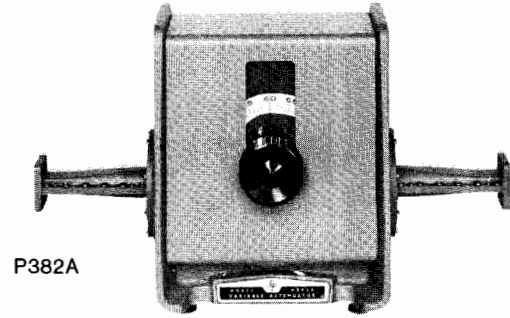

P382A

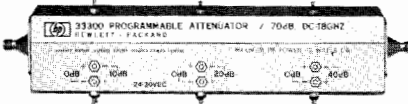

33300A



33321H



33323K



### 393A, 394A Coaxial Variable Attenuator 33300 Series, 33320 Series OEM Step Attenuators

Models 393A and 394A are high power, variable coaxial attenuators for the 0.5 to 2 GHz range. They use the principle of a variable directional coupler to achieve up to 120 dB range with 200 watt power handling capability.

33300 series step attenuators provide wideband programmable signal level control. Magnetic latching solenoids switch individual attenuating elements into and out of contact with a 50-ohm transmission line. C/D models have separate indicator contacts and A/B models have no indicator contacts. Three three-digit connector options (0XY) must be specified. X is the input connector, Y is the output

### 393A, 394A, 33300 Series, 33320 Series Specifications

Model	Freq Range (GHz)	Mode	Range	Remarks
393A	0.5-1	Manual	5-120 dB Variable	200 W average
394A	1-2	Manual	6-120 dB Variable	200 W average
33300 A/B C/D	dc-18	Prog.	0-70 dB 10 dB steps	A&C models 12-15 V
33301 A/B C/D	dc-18	Prog.	0-42 dB 6 dB steps	B&D models 24-30 V
33304 A/B C/D	dc-18	Prog.	0-11 dB 1 dB steps	Connector options available:
33305 A/B C/D	dc-18	Prog.	0-110 dB 10 dB steps	0: N(f), 1: N(m) 2: 7mm(f), 3: 7mm(m) 5: SMA(f), 6: SMA(m)
33320A B	dc-4 dc-18	Manual	1-11 dB 1dB steps	Specifications identical to 8494 series page 411
33320G H	dc-4 dc-18	Prog.		
33321A B D	dc-4 dc-18 dc-26.5	Manual		
33321G H K	dc-4 dc-18 dc-26.5	Prog.		
33322A B	dc-4 dc-18	Manual	0-110 dB 10 db steps	Specifications identical to 8496 series page 411
33322G H	dc-4 dc-18	Prog.		SMA (f) connectors
33323K	dc-26.5	Prog.	0-90 dB 10 dB steps	Specifications identical to 8497K page 411 APC-3.5 only

connector, first digit is always 0. See specifications table for option numbers.

33320 series step attenuators are compact versions of the 8494/5/6/7 bench attenuators on page 411 (same specifications) and are configured for designing into microwave systems and instruments. Manual or electrically-actuated versions are available. The manual models take less than 1.5 square inches of panel space. OEM quantity discounts are available for 33300 and 33320 series.

### 375 Series, 382 Series Waveguide Attenuators

Operation of these 382 series rotary-vane, continuously-variable attenuators depends on a mathematical law, rather than on the resistivity of the attenuator card. They are direct-reading and provide accurate attenuation from 0 to 50 dB (60 dB for S382C) regardless of temperature and humidity.

375A series variable flap attenuators consist of a short slotted section of waveguide in which a matched resistive strip is inserted.

### 375A Series 382 Series Specifications

Model	Frequency Range (GHz)	Accuracy	Attenuation Range (dB)	Waveguide & Equivalent Flange
S382C	2.6-3.95	±1% of reading or 0.1 dB whichever greater ±2% above 50 dB	0-60	WR 284 UG-584/U
G382A	3.95-5.85	±2% of reading or 0.1 dB whichever greater	0-50	WR 187 UG-407/U
J382A	5.3-8.2	±2% of reading or 0.1 dB whichever greater	0-50	WR 137 UG-441/U
H382A	7.05-10.0	±2% of reading or 0.1 dB whichever greater	0-50	WR 112 UG-138/U
X382A	8.2-12.4	±2% of reading or 0.1 dB whichever greater	0-50	WR 90 UG-135/U
P382A	12.4-18.0	±2% of reading or 0.1 dB whichever greater	0-50	WR 62 UG-419/U
K382A	18.0-26.5	±2% of reading or 0.1 dB whichever greater	0-50	WR 42 UG-597/U
R382A	26.5-40.0	±2% of reading or 0.1 dB whichever greater	0-50	WR 28 UG-599/U
X375A	8.2-12.4	±1 dB, ±2 dB	0-20	WR 90 UG-39/U
P375A	12.4-18	±1 dB, ±2 dB	0-20	WR 62 UG-419/U

# MICROWAVE TEST EQUIPMENT

## Coaxial Fixed Attenuators

Models 8491A/B, 8492A, 8493A/B, 8498A, 11581/2/3A, 33340A/B

- Flat frequency response
- Low SWR
- Specifications traceable to NBS



11581A

### 8491A/B, 8492A, 8493A/B Fixed Attenuators

Hewlett-Packard coaxial fixed attenuators provide precision attenuation, flat frequency response, low SWR over broad frequency ranges at low prices. Attenuators are available in nominal attenuations of 3-dB and 6-dB, also 10-dB increments from 10 dB to 60 dB. These attenuators are swept-frequency tested to ensure meeting specifications at all frequencies. Calibration points are provided on a nameplate chart attached to each unit.

### 11581A, 11582A, 11583A Attenuator Sets

A set of four Hewlett-Packard attenuators—3, 6, 10 and 20 dB—are furnished in a handsome walnut accessory case. The 11581A set consists of 8491A attenuators. A set of 8491B attenuators is contained in the 11582A, and the 11583A consists of 8492A attenuators. In addition to the calibration label on each of the attenuators, the set includes a calibration report. The calibration report is certified traceable to the National Bureau of Standards, and includes both the attenuation and the reflection coefficients for each attenuator at four frequencies for the 11581A (dc, 4, 8, 12.4 GHz) and five frequencies for the 11582A and 11583A (dc, 4, 8, 12.4, 18 GHz). By specifying option 890, calibration data is given at 26 frequencies (11581A) or 42 frequencies (11582A and 11583A). See next page for exact frequency lists.

These sets are ideal for calibration labs or where precise knowledge of attenuation and SWR is desired.

### 8498A High Power Attenuator

The 8498A Option 030 is designed to meet the needs of high power attenuation applications in the RF and microwave frequency range. It is specified from dc to 18 GHz at 25 watts average, 500 watts peak, from dc to 5.8 GHz and 125 watts peak from 5.8 to 18 GHz. Available only in a 30 dB model (option 030), the unit offers low SWR (<1.30 at 18 GHz) and good accuracy ( $\pm 1$  dB at 18 GHz). The unit also features 'human engineered' cooling fins that prevent operator burns even under continuous maximum input power conditions.



33340B

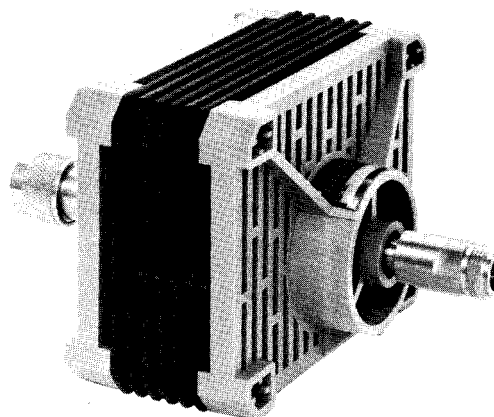

8498A  
Option 030

### Option 890 Calibration Data

Extensive calibration data is now available on HP attenuators at low cost. When option 890 is specified for the fixed attenuators or microwave step attenuators, standardized calibration data from 100 MHz to the upper frequency of the unit is provided, in frequency steps no larger than 500 MHz. This data is generated from measurements made on an HP 8542 Automatic Network Analyzer and features excellent accuracy (traceable to NBS) and low cost (averages less than \$1 per frequency for three measurements). Data is given for attenuation and the SWR of each port and is provided in a protective plastic envelope.

Calibration data has important uses in applications such as RF substitution measurements and test system verification. Using the actual calibration data rather than data sheet specifications allows the attenuation uncertainty to be reduced 60% or more. Also, the calculated mismatch uncertainty for a test system is lower if the actual SWR data for the attenuators is used. Similar calibration data is used in HP production areas to verify the performance of manual and automated test systems. For automated system checkout, the calibrated unit is tested and the results are compared to the previously stored calibration data. If the differences are within the measurement uncertainty, proper operation is ensured. For step attenuators, the calibration data can be used in automated test systems to more accurately characterize a device's characteristics. By storing the calibration data for the individual steps, the measurement results can be adjusted by the actual amount of attenuation (for example, when a nominal 10 dB step is actually 9.6 dB).

The calibration data frequencies, prices, and ordering information for fixed attenuators are on the adjacent page, and the same information for step attenuators is on page 411.

### 33340A/B Fixed Attenuators

The 33340A and 33340B are coaxial fixed attenuators intended for OEM and systems use. Frequency range specifications are dc—12.4 GHz and dc—18 GHz. These OEM attenuators are similar to the 8493 series attenuators.

For more information regarding the 33340A and 33340B refer to the data sheet (5952-8247).

### Ordering Information

- 33340A Coaxial Fixed Attenuator  
Option 890
- 33340B Coaxial Fixed Attenuator  
Option 890



8491A/B series



8492 series



8493A/B series

**Ordering example**

Include appropriate frequency range/connector and attenuation designations from the ordering example below with every attenuator order.

**Calibration Data**  
Include "Option 890" in addition to attenuation option when ordering calibration data.

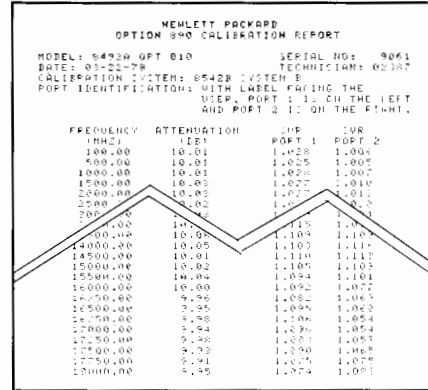
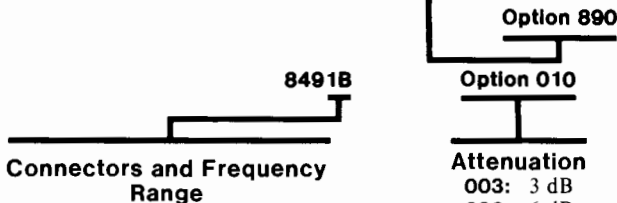

**Ordering Information**

- 11581A 3, 6, 10, 20 dB 8491A set Option 890 Calibration Data
- 11582A 3, 6, 10, 20 dB 8491B set Option 890 Calibration Data
- 11583A 3, 6, 10, 20 dB 8492A set Option 890 Calibration Data

\* Not available for 8493A/B

**8491A/B, 8492A, 8493A/B, 8498A, Option 890 Specifications**

Model	Frequency Range GHz	SWR Maximum	Maximum input Power	Attenuation Accuracy								Connector
				3 dB (Option 003)	6 dB (Option 006)	10 dB (Option 010)	20 dB (Option 020)	30 dB (Option 030)	40 dB (Option 040)	50 dB (Option 050)	60 dB (Option 060)	
8491A 3-30 dB	dc-12.4	dc-8 GHz: 1.2 8-12.4 GHz: 1.3	2 W Avg. 100 W Peak	±0.3 dB	±0.4 dB	±0.6 dB	±0.6 dB	±1 dB	—	—	—	N(m,f)
				—	—	—	—	—	±1.5 dB	±1.5 dB	±2 dB	
8491B 3-30 dB	dc-18	dc-8 GHz: 1.2 8-12.4 GHz: 1.3 12.4-18 GHz: 1.5	2 W Avg. 100 W Peak	±0.3 dB	±0.4 dB	±0.6 dB	±0.6 dB	±1 dB	—	—	—	N(m,f)
				dc-12.4 GHz: ±0.4 dB 12.4-18 GHz: ±0.4 dB	dc-12.4 GHz: ±0.5 dB 12.4-18 GHz: ±0.5 dB	dc-12.4 GHz: ±1.0 dB 12.4-18 GHz: ±1.0 dB	—	±1.5 dB	±1.5 dB	±2 dB		
8492A 3-30 dB	dc-18	dc-8 GHz: 1.15 dc-12.4 GHz: 1.25 12.4-18 GHz: 1.35	2 W Avg. 100 W Peak	±0.3 dB	±0.4 dB	±0.6 dB	±0.6 dB	±1 dB	—	—	—	APC-7
				dc-12.4 GHz: ±0.4 dB 12.4-18 GHz: ±0.4 dB	dc-12.4 GHz: ±0.5 dB 12.4-18 GHz: ±0.5 dB	dc-12.4 GHz: ±1.0 dB 12.4-18 GHz: ±1.0 dB	—	±1.5 dB	±1.5 dB	±2 dB		
8493A 3-20 dB	dc-12.4	dc-8 GHz: 1.2 8-12.4 GHz: 1.3	2 W Avg. 100 W Peak	±0.3 dB	±0.4 dB	±0.6 dB	±0.6 dB	—	—	—	—	SMA (m,f)
				—	—	—	—	±1 dB	—	—	—	
8493B 3-20 dB	dc-18	dc-8 GHz: 1.2 8-12.4 GHz: 1.3 12.4-18 GHz: 1.5	2 W Avg. 100 W Peak	±0.3 dB	±0.4 dB	±0.6 dB	±0.6 dB	—	—	—	—	SMA(m,f)
				dc-12.4 GHz: ±0.4 dB 12.4-18 GHz: ±0.4 dB	dc-12.4 GHz: ±0.5 dB 12.4-18 GHz: ±0.5 dB	dc-12.4 GHz: ±1.0 dB 12.4-18 GHz: ±1.0 dB	±1 dB	—	—	—		
8498A Option 030	dc-18	dc-2 GHz: 1.1 2-12.4 GHz: 1.2 12.4-18 GHz: 1.35	25 W Avg. 500 W Peak (dc-7 GHz) 125 W Peak (7-18 GHz) 500 Watt-μsec max. per pulse	—	—	—	—	±1 dB	—	—	—	N(m,f)
Option 890 Calibration Data Information				Models		Calibration Frequencies (MHz)						
				8491A, 8493A		100, 500, 1000, every 500 MHz to 12000, 12400. (26 frequencies)						
8491B, 8492A, 8493B, 8498A		Same as above plus 12500 to 16000 in 500 MHz steps, 16000 to 18000 in 250 MHz steps. (42 frequencies)										

# MICROWAVE TEST EQUIPMENT

## Coaxial Step Attenuators

Models 355 series, 8494/5/6/7 series, 11713A, 11716A/B, 11717A

- Excellent repeatability
- Manual and programmable
- Calibration data available

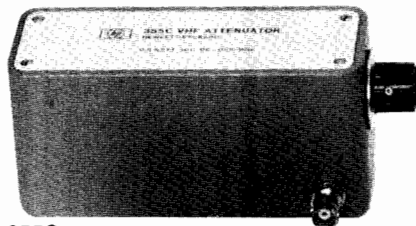

355C

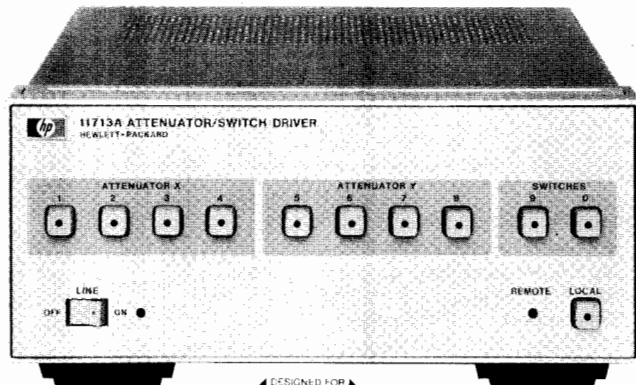

11713A

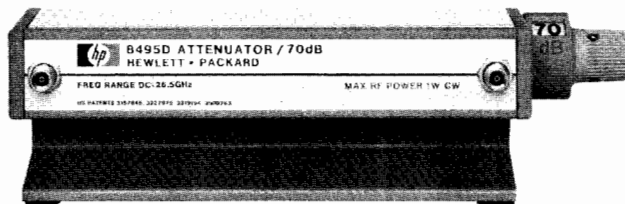

8495D option 004

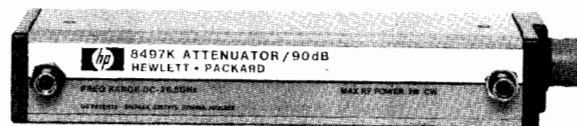

8497K

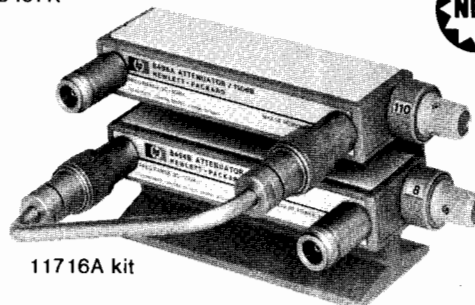

11716A kit

### 355C/D/E/F Manual and Programmable Step Attenuators, dc to 1000 MHz

Precision attenuation from dc to 1000 MHz is available with these Hewlett-Packard attenuators. Models 355C/E provide 0 to 12 dB in 1-dB steps and models 355D/F provide 0 to 120 dB in 10-dB steps. For the 355E and 355F models, attenuation programming is done through a 7-pin connector. All standard models are equipped with BNC connectors.

### 8494A/B/G/H, 8495A/B/D/G/H/K, 8496A/B/G/H, 8497K Manual and Programmable Step Attenuators, dc to 26.5 GHz

Four attenuation ranges are available: 0 to 11 dB in 1-dB steps (Model 8494), 0 to 70 dB in 10-dB steps (Model 8495) and 0 to 110 dB in 10-dB steps (Model 8496) and 0 to 90 dB in 10 dB steps (Model 8497). There is choice of three connectors Type N (f), SMA (f), and APC-7 (APC-3.5 on 8495D/K and 8497K only). Manual and programmable versions are available as well as coverage of three frequency ranges (dc-4 GHz, dc-18 GHz, and dc-26.5 GHz). Calibration data (SWR and attenuation) is available on the 8494/5/6/7 models as option 890. The data is generated by an automatic network analyzer test system and is given for each step of the attenuator at 14 frequencies (dc-4 GHz models), 47 frequencies (dc-18 GHz models), 72 frequencies (dc-26.5 GHz); see frequency lists on next page. This data is very useful for improving measurement accuracy in manual and automated test systems.

Each attenuator consists of three or four attenuation sections connected in cascade. Attenuator sections are inserted and removed by cam-actuated "edge line" contacts. These contacts are gold-plated leaf-springs that ensure long life (over a million steps) and high repeatability (typically 0.03 dB).

The G, H, and K programmable models offer the same high performance as the manual models with the addition of fast switching solenoids. Attenuation programming is done through a 12-pin connector.

For ease of connection to the driving circuit, each attenuator is provided with a five-foot cable assembly that includes the mating connector. With the HP 11713A Attenuator Driver, the attenuators are easily integrated into a Hewlett-Packard Interface Bus (HP-IB) automated system.

#### 11716A/B Interconnection Kit

Convenient interconnection of 1 dB and 10 dB models is provided with the 11716A/B. These kits provide a rigid RF cable, mounting bracket, and screws to connect any pair of 8494/5/6 attenuators in series (see picture above). Attenuators must be ordered separately.

Equivalent versions of these attenuators for incorporation in equipment (i.e., "OEM") are available under HP model numbers 33320, 33321, 33322 and 33323. See following pages.

#### 11713A Attenuator/Switch Driver

This instrument has all of the necessary features to provide HP-IB control of up to two programmable attenuators of the 8494/5/6/7 or 33320/1/2/3 series and concurrently up to two electro-mechanical switches (e.g., 8761B or 33311 series). Alternatively, the 11713A can be used to supply +24 V common and ten pairs of transistor switches (total current less than 1.25A) to control up to ten relays. The 11713A includes an integral power supply with short circuit protection that can simultaneously provide 125 milliamps at 24 volts to all contacts for control of the attenuators and switches, so no external power supply is needed. For convenience in connecting 8490 or 33320-series attenuators, two 5-foot cables with appropriate connectors are supplied.

A local mode and front panel push buttons allow switches and attenuator sections to be operated manually. Switching time for the drivers is less than 10 milliseconds.

#### Ordering Information

11713A Attenuator/Switch Driver

11716A Interconnection Kit for Type N (f) Connectors

11716B Interconnection Kit for APC-7 Connectors

11717A Attenuator/Switch Rack Mount Support Kit



## How to Order the 8494/5/6/7 Series Attenuators

Each order must include basic model number, suffix letter, and connector option.

Optional calibration data.

### 8494 A Option 001 Option 890

4 (1dB step, 11 dB max)	A (Manual, dc—4 GHz)	001 (N-Female)
5 (10 dB step, 70 dB max)	B (Manual, dc—18 GHz)	002 (SMA Female)
6 (10 dB step, 110 dB max)	D (Manual, dc—26.5 GHz)*	003 (APC-7)
7 (10 dB step, 90 dB max)	G (Programmable, dc—4 GHz)	004 (APC-3.5 Female)*
	H (Programmable, dc—18 GHz)	
	K (Programmable, dc—26.5 GHz)*	

\* Option 004 is only available on 'D' and 'K' models.

## 355 Series, 8494/5/6/7 Series Specifications

Model and (Switching Mode)	Frequency Range (GHz)	Incremental Attenuation (dB)	SWR Maximum (50 Ω Nominal)	Insertion Loss (0 dB setting)	Attenuation Accuracy	Power Rating, Minimum Life	Solenoid Voltage Speed Power	Size, Shipping Weight	Connector Options Available	
355C (Manual)	dc—1	0—12 1 dB steps	dc—0.25 GHz: 1.2 dc—0.5 GHz: 1.3 dc—1.0 GHz: 1.5	0.11 dB + 1.39 dB/GHz	±0.1 dB @ 1000 Hz ±0.25 dB: dc—0.5 GHz ±0.35 dB: dc—1.0 GHz	0.5 W avg 350 W peak 0.6 million steps	— 15—18 V <65 ms 3.0 W	67 H x 70 W x 152 mm D (2.6" x 2.75" x 6") 1.4 kg (3 lb)	BNC (f) See Note 1	
355E (Programmable)										
355D (Manual)	dc—1	0—120 10 dB steps	dc—0.25 GHz: 1.2 dc—0.5 GHz: 1.3 dc—1.0 GHz: 1.5	0.11 dB + 1.39 dB/GHz	±0.3 dB @ 1000 Hz ±1.5 dB to 90 dB, and ±3 dB to 120 dB @ 1 GHz	0.5 W avg 350 W peak 0.6 million steps	— 15—18 V <65 ms 3.0 W	67 H x 70 W x 152 mm D (2.6" x 2.75" x 6") 1.4 kg (3 lb)	BNC (f) See Note 1	
355F (Programmable)										
8494A (Manual)	dc—4	0—11 1 dB Steps	1.5	0.6 dB + 0.09 dB/GHz	±0.2 dB: 1—2 dB ±0.3 dB: 3—6 dB ±0.4 dB: 7—10 dB ±0.5 dB: 11 dB	1 W avg 100 W peak 10 μs max. 1 million steps	— 20—30 V <20 ms 2.7 W	43 H x 73 W x 159 mm D (1.7" x 2.9" x 6.2") 0.9 kg (2 lb) 43 H x 73 W x 142 mm D (1.7" x 2.9" x 5.6")	001 002 003 See Note 2	
8494G (Programmable)										
8494B (Manual)	dc—18	0—11 1 dB steps	dc—8 GHz: 1.5 dc—12.4 GHz: 1.6 dc—18 GHz: 1.9	0.6 dB + 0.09 dB/GHz	dc—12.4 GHz ±0.3 dB: 1—2 dB ±0.4 dB: 3—4 dB ±0.5 dB: 5—6 dB ±0.6 dB: 7—10 dB ±0.7 dB: 11 dB dc—18 GHz ±0.7 dB: 1—5 dB ±0.8 dB: 6—9 dB ±0.9 dB: 10—11 dB	1 W avg 100 W peak 10 μs max. 1 million steps	— 20—30 V <20 ms 2.7 W	43 H x 73 W x 159 mm D (1.7" x 2.9" x 6.2") 0.9 kg (2 lb) 43 H x 73 W x 142 mm D (1.7" x 2.9" x 5.6")	001 002 003 See Note 2	
8494H (Programmable)										
8495A (Manual)	dc—4	0—70 10 dB steps	1.35	0.4 dB + 0.07 dB/GHz	±1.7% of setting or ±0.4 dB, whichever is greater	1 W avg 100 W peak 10 μs max. 1 million steps	— 20—30 V <20 ms 2.7 W	43 H x 73 W x 130 mm D (1.7" x 2.9" x 5.1") 0.9 kg (2 lb) 43 H x 73 W x 114 mm D (1.7" x 2.9" x 4.5")	001 002 003 See Note 2	
8495G (Programmable)										
8495B (Manual)	dc—18	0—70 10 dB steps	dc—8 GHz: 1.35 dc—12.4 GHz: 1.5 dc—18 GHz: 1.7	0.4 dB + 0.07 dB/GHz	±3%: dc—12.4 GHz ±4%: dc—18 GHz % in dB from Atten. Setting	1 W avg 100 W peak 10 μs max. 1 million steps	— 20—30 V <20 ms 2.7 W	43 H x 73 W x 130 mm D (1.7" x 2.9" x 5.1") 0.9 kg (2 lb) 43 H x 73 W x 114 mm D (1.7" x 2.9" x 4.5")	001 002 003 See Note 2	
8495H (Programmable)										
8495D (Manual)	dc—26.5	0—70 10 dB steps	dc—12.4 GHz: 1.6 12.4—18 GHz: 1.9 18—26.5 GHz: 2.2	0.5 dB + 0.13 dB/GHz	±3%: dc—12.4 GHz ±4%: dc—18 GHz ±7%: dc—26.5 GHz % in dB from Atten. Setting	1 W avg 100 W peak 10 μs max. 1 million steps	— 20—30 V <20 ms 2.7 W	43 H x 52 W x 159 mm D (1.7" x 2.1" x 6.2") 0.9 kg (2 lb) 43 H x 52 W x 168 mm D (1.7" x 2.1" x 6.6")	004 APC-3.5 See Note 2	
8495K (Programmable)										
8496A (Manual)	dc—4	0—110 10 dB steps	1.5	0.6 dB + 0.09 dB/GHz	±1.7% of setting or ±0.4 dB, whichever is greater	1 W avg 100 W peak 10 μs max. 1 million steps	— 20—30 V <20 ms 2.7 W	43 H x 73 W x 159 mm D (1.7" x 2.9" x 6.2") 0.9 kg (2 lb) 43 H x 73 W x 142 mm D (1.7" x 2.9" x 5.6")	001 002 003 See Note 2	
8496G (Programmable)										
8496B (Manual)	dc—18	0—110 10 dB steps	dc—8 GHz: 1.5 dc—12.4 GHz: 1.6 dc—18 GHz: 1.9	0.6 dB + 0.09 dB/GHz	±3%: dc—12.4 GHz +4%: dc—18 GHz % in dB from Atten. Setting	1 W avg 100 W peak 10 μs max. 1 million steps	— 20—30 V <20 ms 2.7 W	43 H x 73 W x 159 mm D (1.7" x 2.9" x 6.2") 0.9 kg (2 lb) 43 H x 73 W x 142 mm D (1.7" x 2.9" x 5.6")	001 002 003 See Note 2	
8496H (Programmable)										
8497K (Programmable)	dc—26.5	0—90 10 dB steps	dc—8 GHz: 1.5 8—12.4 GHz: 1.6 12.4—26.5 GHz: 1.9	0.6 dB + 0.09 dB/GHz 93 dB @ 26.5 GHz	whichever is greater ±3.0% or ±0.6 dB: dc— 12.4 GHz ±4.0% or ±0.7 dB: 12.4—18 GHz ±5.0% or ±0.8 dB: 18— 26.5 GHz	1 W avg 100W peak 10 μs max. 1 million steps	5 V or 24 V	43 H x 52 W x 168 mm D (1.7" x 2.1" x 6.6") 0.9 kg (2 lb)	004 APC-3.5 See Note 2	
<b>Option 890 Calibration Data Information</b>		<b>Option 890 Frequency List (MHz)</b>				<b>Models</b>				
		DC to 4 GHz Models: 100, 300, 500, 700, 900, 1000, 1250, 1500, 1750, 2000, 2500, 3000, 3500, 4000 DC to 18 GHz Models: Same as above to 4000 MHz, every 500 MHz to 16000 (plus 12400 MHz), every 250 MHz from 16000 to 18000.				8494A/G, 8496A/G, 33320A/G, 33322A/G 8495A/G, 33321A/G 8494B/H, 8496B/H, 33320B/H, 33322B/H 8495B/H, 33321B/H				
Note 1: 355C/D/E/F connector options (BNC (f) standard) Option 001 N(f) Option 005 TNC(f) Option 007 Transistor protection					Note 2: 8494/5/6/7 orders must specify connector option. See ordering example above. Option 001 N(f) Option 002 SMA(f) Option 003 APC-7 Option 004 APC-3.5 (8495D/K, 8497K only)					





# MICROWAVE TEST EQUIPMENT

## Coaxial Single and Dual-Directional Couplers

Models 770 series, 790 series, 11691D, 11692D

- Broadband coverage
- High directivity
- Close tracking

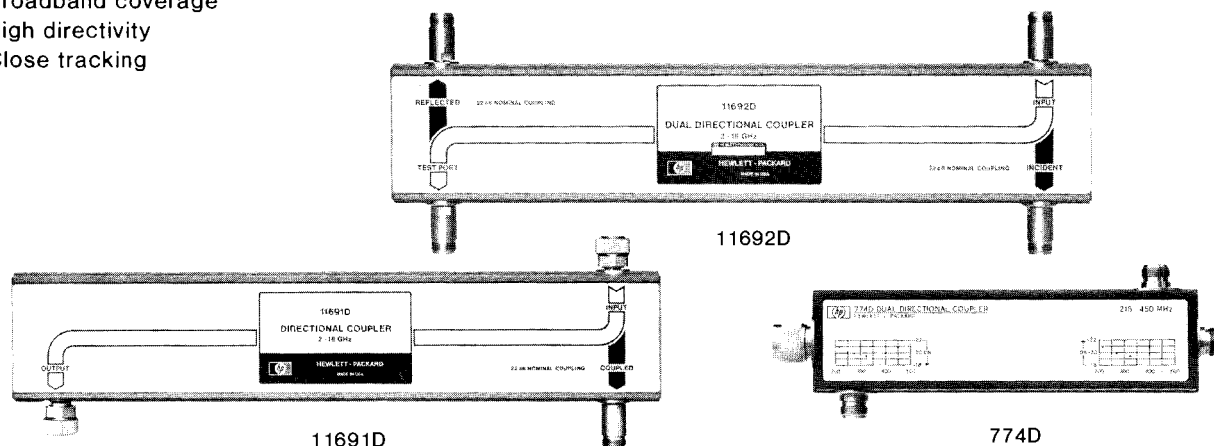

### 779D Directional Coupler

The HP 779D spans more than two octaves from 1.7 to 12.4 GHz with excellent directivity. With increased coupling factor (typically 24 dB), the 779 is useful down to 500 MHz. Upper frequency usefulness extends to 18 GHz with directivity reduced to about 15 dB. Various connector options are available.

### 790 Series Directional Couplers (Octave Bands)

The 790 directional couplers are ultra-flat, high directivity couplers which are ideal for power-monitoring applications in coaxial systems. Output coupling (ratio of output power from main and auxiliary arms) is specified rather than coupling factor. Thus, no correction factor is required to account for insertion loss in the main arm.

### 11691D Directional Coupler

The 11691D is an ultra-wide-band single-directional coupler covering 2 to 18 GHz with high directivity. It is useful as a power monitoring or leveling coupler, or for making reflection measurements. Couplers are preferred over broadband bridges in reflectometer applications in situations where the power level of the source is limited, or where simultaneous measurement of return loss and insertion loss is desired.

### 779D, 790 Series, 11691D Specifications

Model	Frequency Range (GHz)	Mean Output Coupling (dB)	Output Coupling Variation (dB)	Minimum Directivity (dB)	Equivalent* Source Match
779D	1.7-12.4	20 ± 0.5	±0.75	1.7-4 GHz: 30 4-12.4 GHz: 26	1.2
796D	0.96-2.11	20 ± 0.5	±0.2	30	1.13
797D	1.9-4.1	20 ± 0.5	±0.2	26	1.16
798C	3.7-8.3	10 ± 0.3	±0.3	20	1.25
11691D	2-18	22 Nominal	±1.0	2-8 GHz: 30 dB 8-18 GHz: 26 dB	1.2
<b>796D-798C</b> Standard connectors Primary Line: N(f), N(m) Auxiliary Arm: N(f)					
<b>779D</b> Standard connectors Primary Line: N(m) input, N(f) output; auxiliary arm: N(f)  <b>Option 010:</b> Primary Line: N(f) input, N(m) output; auxiliary output: N(f) Other options: APC-7 on any or all ports					
<b>11691D</b> Standard connectors Primary line: APC-7, APC-7; Auxiliary Arm: N(f)  <b>Option 001:</b> All N(f) <b>Option 005:</b> All APC-7					
*Apparent SWR at the output port of a coupler when used in a closed-loop leveling system.					

### 774D-777D Dual-Directional Couplers (Octave Bands)

The economical 774D-777D couplers cover frequency spreads of more than two-to-one, each centered on one of the important VHF/UHF bands. With their high directivity and a mean coupling accuracy of ±0.5 dB, these couplers are ideal for reflectometer applications. Furthermore, the close tracking of the auxiliary arms makes these couplers particularly useful for reflectometers driven by externally leveled sweep oscillators such as the HP 8690B and 8620C. Power ratings are 50 W average, 500 W peak.

### 778D, 11692D Dual-Directional Couplers (Multi-Octave Bands)

These couplers are ideal for swept-frequency reflectometer testing of broadband coaxial components. The 778D covers 100 MHz to 2 GHz and the 11692D covers 2 to 18 GHz. High directivity and close tracking of the auxiliary arms are featured. Various connector options are available. Both couplers handle 50 W average power. Peak power: 778D, 500 W; 11692D, 250 W.

### 774D, 775D, 776D, 777D, 778D, 11692D Specifications

Model	Frequency Range (GHz)	Nominal Coupling (dB)	Maximum Coupling Variation (dB)	Minimum Directivity (dB)	SWR Primary Line Maximum (50% Nom.)
774D	0.215-0.450	20	±1	40	1.15
775D <sup>1</sup>	0.450-0.940	20	±1	40	1.15
776D <sup>1</sup>	0.940-1.90	20	±1	40	1.15
777D	1.90-4.0	20	±0.4	30	1.2
778D	0.10-2.0	20	±1.5	0.1-1 GHz: 36 <sup>2</sup> 1-2 GHz: 32	1.1
11692D	2.0-18.0	22	±1 incident to test port	2-8 GHz: 30 8-18 GHz: 26 <sup>3</sup>	2-12.4 GHz: 1.3 12.4-18 GHz: 1.4
<b>774D-777D</b> Standard connectors Primary Line: N(m), N(f) Auxiliary Arm: N(f), N(f)					
<b>778D</b> Standard connectors Primary Line: N(m), N(f); Auxiliary Arms: N(f), N(f)  <b>Option 011:</b> Primary Line, APC-7, N(f) <b>Option 012:</b> Primary Line, N(m), N(f)					
<b>11692D</b> Standard connectors Primary line: N(f), APC-7; Auxiliary Arms: N(f), N(f)  <b>Option 001:</b> Primary Line, N(f), N(f) <b>Option 002:</b> Primary Line, N(f), N(m)					
<sup>1</sup> Maximum auxiliary arm tracking: 0.3 dB for 776D; 0.5 dB for 777D <sup>2</sup> 30 dB, 0.1 to 2 GHz, input port. <sup>3</sup> 24 dB with Type N connector on the test port.					

- Flat frequency response
- Low equivalent source match
- High directivity to > 40 dB

- Low SWR
- Coverage to 40 GHz

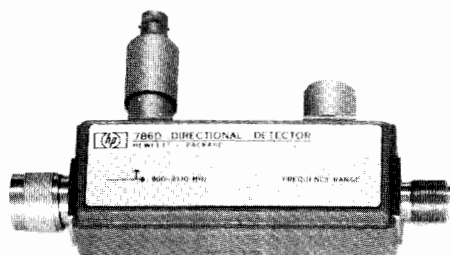

786D

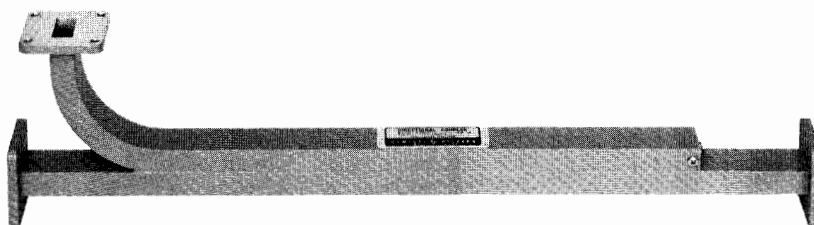

X752A

### 780 Series Directional Detectors

The 780 series detectors are directional couplers with built-in crystal detectors. The couplers have flat frequency response and good directivity, while the detectors have good frequency response plus high sensitivity. The configuration of the directional detector reduces the number of ambiguities over the standard system of separate coupler and detector and makes possible tighter correlation between main-arm power and detected signal. The directional detector is well suited for sweep oscillator leveling and can also be used to monitor power with a voltmeter or oscilloscope.

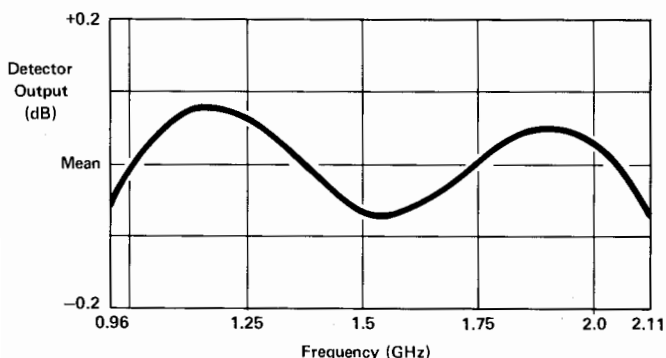

Figure 1. Typical 786D Frequency Response.

### 780 Series Specifications

#### Standard Connectors

**Output:** All models, N(f)

**Input:** 786D-788C, N(m); 789C, N(f)

Model	Frequency Range (GHz)	Frequency <sup>1</sup> Response	Equivalent <sup>2</sup> Source Match
786D	0.96-2.11	±0.2	1.13
787D	1.9-4.1	±0.2	1.16
788C	3.7-8.3	±0.3	1.25
789C	8-12.4	±0.5	1.25

<sup>1</sup>Includes coupler and detector variation with frequency as read on a meter calibrated for square-law detector (e.g., HP 415E).

<sup>2</sup>Apparent SWR at the output port of the directional detector when used in a closed-loop leveling system.

### 752 Series Waveguide Directional Couplers

The HP 752 series couplers are specified to meet a wide variety of microwave applications. Every coupler has a minimum directivity of 40 dB over its entire frequency range. Each coupler is swept-frequency tested to ensure that the main guide SWR and directivity specifications are accurate. Performance characteristics are unaffected by humidity, temperature, and time, making these units especially useful in microwave "standards" measurements.

The 752 couplers are an essential part of many waveguide measurement systems. Attenuation measurements, reflectometer setups, power measurements, source leveling and network analysis are just a few areas in which these couplers are used.

#### 752 Series Specifications

Model	Frequency Range (GHz)	Nominal Coupling (dB)	Mean Coupling Accuracy (dB)	Maximum Coupling Variation (dB)	Minimum Directivity (dB)	Waveguide & Flange
J752A	5.85-8.2	3	±0.4	±0.5	40	WR137 UG-441/U
J752C	5.85-8.2	10	±0.4	±0.5	40	
J752D	5.85-8.2	20	±0.4	±0.5	40	
H752A	7.05-10.0	3	±0.4	±0.5	40	WR112 UF-138/U
H752C	7.05-10.0	10	±0.4	±0.5	40	
H752D	7.05-10.0	20	±0.4	±0.5	40	
X752A	8.2-12.4	3	±0.4	±0.5	40	WR90 UG-135/U
X752C	8.2-12.4	10	±0.4	±0.5	40	
X752D	8.2-12.4	20	±0.4	±0.5	40	
P752A	12.4-18.0	3	±0.4	±0.5	40	WR62 UG-419/U
P752C	12.4-18.0	10	±0.4	±0.5	40	
P752D	12.4-18.0	20	±0.4	±0.5	40	
K752A	18.0-26.5	3	±0.7	±0.5	40	WR42 UG-595/U
K752C	18.0-26.5	10	±0.7	±0.5	40	
K752D	18.0-26.5	20	±0.7	±0.5	40	
R752A	26.5-40.0	3	±0.7	±0.5	40	WR28 UG-599/U
R752C	26.5-40.0	10	±0.7	±0.5	40	
R752D	26.5-40.0	20	±0.7	±0.6	40	

# MICROWAVE TEST EQUIPMENT

## Coaxial Crystal Detectors

Models 420C, 423A/B, 8470A/B, 8471A, 8472A, 8473B/C, 33330B/C

- Flat frequency response
- High burnout protection

- Low SWR
- Field replaceable detector elements



33330B



8470B Opt 012



423A



8470A



423B

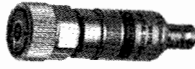

8470B



8472A



8471A

### 423B, 8470B, 8473B/C, 33330B/C Low Barrier Schottky (LBS) Detectors

The low-barrier Schottky (LBS) detectors are a state-of-the-art addition to the HP family of high performance detectors. Various models provide coverage to 12.4, 18, and 26.5 GHz and input connectors are Type N, APC-7, or APC-3.5 depending on frequency range. Output connector is BNC (f) except for the 33330B/C (SMC).

Matched pairs (Opt 001), square law load (Opt 002), and positive polarity output (Opt 003) are available for most models.

### 423A, 8470A, 8471A, 8472A Point-Contact Detectors

These point-contact detectors have been widely used for many years and provide high performance at an economical price. The 8470A, 8470A Opt 012, and 8472A provide APC-7, Type N, and SMA connector versions to 18 GHz. Matched pairs are available for applications requiring close detector tracking, and all but the 8472A can be supplied with video loads for optimum conformance to square law.

### Coaxial Crystal Detector Specifications

Model	Frequency Range (GHz)	Frequency Response (dB)	SWR Maximum (50Ω Nom.)	Low Level Sensitivity	Maximum Input (Peak or Average)	Short-Term Maximum Input (<1 min.)	Option 001 Matched Pair (order 2 units for each pair)	Options Available	Input Connector	Output Connector
420C	0.01-12.4 Point Contact	±2	2.0	>0.15 mV/μW	100 mW	0.1 watt	±1 dB	001 003	N (m)	BNC (f)
423B	0.01-12.4 LBS	±0.2/octave to 8 GHz ±0.3 overall	<1.15 to 4 GHz <1.3 to 12.4 GHz	>0.5 mV/μW	200 mW	1 watt	±0.2 dB to 12.4 GHz	001 002	N (m) 003	BNC (f)
423A	0.01-12.4 Point Contact	±0.2/octave to 8 GHz ±0.5 overall	<1.2 to 4.5 GHz <1.35 to 7 GHz <1.5 to 12.4 GHz	>0.4 mV/μW	100 mW	0.1 watt	±0.2 dB to 8 GHz ±0.3 dB to 12.4 GHz	001 002 003	N (m)	BNC (f)
8470B	0.01-18.0 LBS	±0.2/octave to 8 GHz ±0.3 to 12.4 GHz ±0.6 to 18 GHz	<1.15 to 4 GHz <1.3 to 15 GHz <1.4 to 18 GHz	<0.5 mV/μW	200 mW	1 watt	±0.2 dB to 12.4 GHz ±0.3 dB to 18 GHz	001 002 003	APC-7 N (m)	BNC (f)
8470A	0.01-18.0 Point Contact	±0.2/octave to 8 GHz ±0.5 to 12.4 GHz ±1.0 to 18 GHz	<1.2 to 4.5 GHz <1.35 to 7 GHz <1.5 to 12.4 GHz <1.7 to 18 GHz	>0.4 mV/μW	100 mW	0.1 watt	±0.2 dB to 8 GHz ±0.3 dB to 12.4 GHz ±0.6 dB to 18 GHz	001 002 003	APC-7 N (m)	BNC (f)
8473B	0.01-18.0 LBS	±0.2/octave to 8 GHz ±0.6 to 18 GHz	<1.2 to 12.4 GHz <1.5 to 18 GHz	>0.5 mV/μW	200 mW	1 watt	±0.2 dB to 12.4 GHz ±0.3 dB to 18 GHz	001 003	APC-3.5 (m)	BNC (f)
8473C	0.01-26.5 LBS	±0.6 to 20 GHz ±1.5 with a -3.5 dB slope, 20 to 26.5 GHz	<1.2 to 4 GHz <1.5 to 18 GHz <2.2 to 26.5 GHz	>0.5 mV/μW to 18 GHz >0.18 mV/μW to 26.5 GHz	200 mW	1 watt	±0.2 dB to 12.4 GHz ±0.3 dB to 18 GHz ±0.5 dB to 26.5 GHz	001 003	APC-3.5 (m)	BNC (f)
8472A	0.01-18.0 Point Contact	±0.2/octave to 8 GHz ±0.5 to 12.4 GHz	<1.2 to 4.5 GHz <1.35 to 7 GHz <1.5 to 12.4 GHz <1.7 to 18 GHz	>0.4 mV/μW	100 mW	0.1 watt	±0.2 dB to 8 GHz ±0.3 dB to 12.4 GHz ±0.6 dB to 18 GHz	001 003	SMA (m)	BNC (f)
33330B	0.01-18.0 LBS	±0.6	<1.5	>0.5 mV/μW	200 mW	1 watt	±0.3 dB	001 003	APC-3.5 (m)	SMC (m)
33330C	0.01-26.5 LBS	±0.6 to 20 GHz ±1.5 with a -3.5 dB slope 20 to 26.5 GHz	<1.5 to 18 GHz <2.2 to 26.5 GHz	>0.5 mV/μW to 18 GHz Degrades to 0.18 mV/μW at 26.5 GHz	200 mW	1 watt	±0.3 dB to 18 GHz ±0.5 dB to 26.5 GHz	001 003	APC-3.5 (m)	SMC (m)
8471A	100 kHz-1.2 GHz Point Contact	±0.6 (typical) ±0.1/100 MHz	1.3 (typical) 50Ω	>0.35 mV/μW	3 Vrms	3 Vrms	No	004 005 006	BNC (m)	BNC (f)

#### Options

**Option 001:** Matched response. Must order two (2) option 001's for a pair of detectors with matched frequency response.

**Option 002:** Optimum square law load.

**Option 003:** Positive polarity output.

Model 8471A

**004:** positive output

**005:** 75 ohm negative output

**006:** 75 ohm positive output

Point Contact Detectors				Low Barrier Schottky Diodes			
Model	Opt. 001	Opt. 002	Opt. 003	Model	Opt. 001	Opt. 002	Opt. 003
420C				423B			
423A				8470B			
8470A				8472B			
8472A				8473B			
				8473C			
				33330B			
				33330C			

# MICROWAVE TEST EQUIPMENT

Waveguide Crystal Detectors; Frequency Meters

Models 422A, 424A, 532 Series, 536A, 537A



K422A

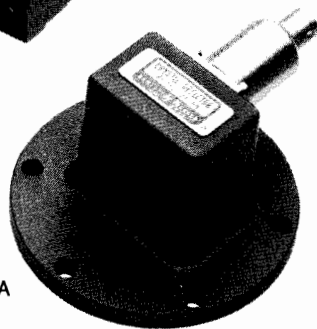

J424A

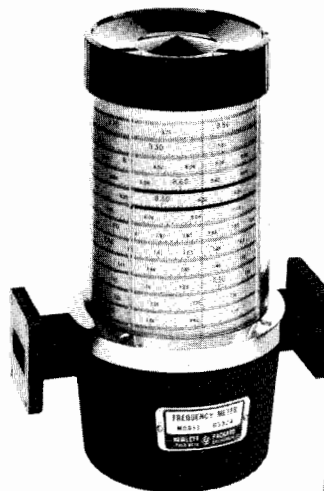

H532A

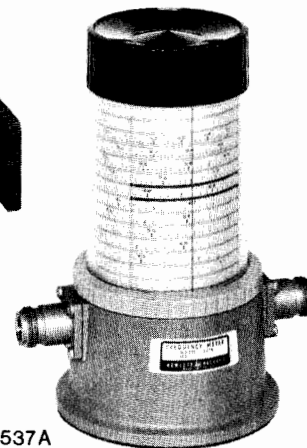

537A

## 422 Series, 424 Series Crystal Detectors

The 422A and 424A families of crystal detectors combine high sensitivity with flat frequency response and low SWR to provide waveguide band coverage from 3.95 to 40 GHz. They deliver between 0.2 and 0.4 mV/ $\mu$ W output at low level and handle 100 mW peak input. SWR ranges from 1.35 at G-band to 3 at R-band.

For reflectometer applications in which both flat frequency response and square-law characteristics are important, these models can be supplied as matched pairs (Option 001) and an optimum square-law load (Option 002).

## 422 Series 424 Series Waveguide Crystal Detector Specifications

Model	Frequency Range (GHz)	Frequency Response (dB)	Option 001 Matched Response (dB)	Option 003 Positive Polarity Output Available	Waveguide & Equivalent Flange
G424A	3.95-5.85	$\pm 0.2$	$\pm 0.2$ dB	Yes	WR187 UG-407/U
J424A	5.2-8.2	$\pm 0.2$	$\pm 0.2$ dB	Yes	WR137 UG-441/U
H424A	7.05-10.0	$\pm 0.2$	$\pm 0.2$ dB	Yes	WR112 UG-138/U
X424A	8.2-12.4	$\pm 0.3$	$\pm 0.3$ dB	Yes	WR90 UG-135/U
M424A	10.0-15.0	$\pm 0.5$	$\pm 0.5$ dB	Yes	WR75 Cover
P424A	12.4-18.0	$\pm 0.5$	$\pm 0.5$ dB	Yes	WR62 UG-419/U
K422A	18.0-26.5	$\pm 2$	$\pm 1$ dB	N/A	WR42 UG-595/U
R422A	26.5-40.0	$\pm 2$	$\pm 1$ dB	N/A	WR28 UG-599/U

Option 001: Matched response. Must order two (2) option 001's for a pair of detectors with matched frequency response.  
Option 002: optimum square-law load.  
Option 003: positive polarity output.

### Option Prices

Model	Opt. 001	Opt. 002	Opt. 003
G424A			N/C
H424A			N/C
J424A			N/C
K422A			N/A
M424A			N/C
P424A			N/C
R422A			N/A
S424A			N/C
X424A			N/C

## 532 Series, 536A, 537A Frequency Meters

These direct-reading frequency meters measure frequencies from 5.30 to 40 GHz in waveguide and from 960 MHz to 12.4 GHz in coax quickly and accurately. Their long scales and numerous calibration marks provide high resolution which is particularly useful when measuring frequency differences or small frequency changes. Frequency is read directly in GHz so neither interpolation nor charts are required.

The instruments comprise a special transmission section with a high-Q resonant cavity which is tuned by a choke plunger. A 1 dB or greater dip in output indicates resonance; virtually full power is transmitted off resonance. Overall accuracy of each frequency meter includes allowance for 0 to 100 percent relative humidity and temperature variation from 13 to 33°C. Except for the J532A, there are no spurious modes or resonances.

## 532 Series, 536A and 537A Specifications

Model	Frequency Range (GHz)	Overall Accuracy (%)	Calibration Increment (MHz)	W/G-Coax Equivalent Flange (Connector)
536A	0.96-4.20	0.96 to 1 GHz: 0.22 1 to 4.2 GHz: 0.17	2	Coax Type N(f)
537A	3.7-12.4	0.170	10	Coax Type N(f)
J532A	5.30-8.20	0.065	2	WR137 UG-441/U
H532A	7.05-10.0	0.075	2	WR112 UG-138/U
X532B	8.20-12.4	0.080	5	WR90 UG-39/U
P532A	12.4-18.0	0.100	5	WR62 UG-419/U
K532A	18.0-26.5	0.110	10	WR42 UG-595/U
R532A	26.5-40.0	0.120	10	WR28 UG-599/U

# MICROWAVE TEST EQUIPMENT

Slotted Lines, Carriage, Probes, SWR Meter

Models 415E, 442B, 444A, 447B, 448B, 805C, 809C, 810B series, 816A, 817B

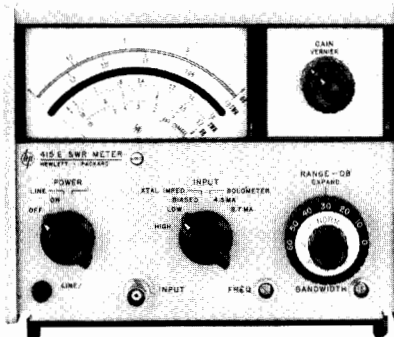

415E

## 415E SWR Meter

Model 415E SWR Meter is a low noise, 1000 Hz tuned amplifier and voltmeter, calibrated in dB and SWR. Designed for use with square law detectors, it measures SWR, attenuation, and gain directly from metered scales, or drives an X-Y recorder for RF substitution measurements. Front panel INPUT switch selects unbiased low (50-200 Ω) or high (2500-10,000 Ω) impedance crystal, biased crystal (1 V into 1 KΩ), or low or high current bolometer (4.5 or 8.7 mA ± 3% into 200 Ω).

An internal precision 60 dB attenuator allows the 415E to operate over a 70 dB range in 10 or 2 dB steps, with ±0.05 dB accuracy for a 10 dB step; maximum cumulative error between any two 10 dB steps is ±0.1 dB. Sensitivity is 0.15 μV rms for full scale deflection at maximum bandwidth (1 μV rms on high impedance crystal input).

Continuously adjustable bandwidth can be adjusted from 15 Hz for maximum sensitivity at CW frequencies to 130 Hz for swept frequency uses. An optional rechargeable battery pack provides up to 36 hours of continuous operation for portable use. Weight: Net 4 kg (9 lbs). Shipping 5.8 kg (13 lbs). Power: 115-230 V +/-10%, 50-400 Hz, 1 VA.

## 805C Coaxial Slotted Line System, 0.5 to 4 GHz

Model 805C slotted line system, employs 5 parallel ground planes and a rigid center conductor. This configuration has negligible slot radiation and is less sensitive to probe depth. The probe is tunable from 500 to 4000 MHz.

## 817B Coaxial Swept Slotted Line System, 1.8 to 18 GHz

817B fully tested system provides comprehensive swept frequency reflection data with the accuracy inherent in slotted lines. 817B consists of the 816A line, 809C carriage, and the 448B sweep adapter which accepts the detectors of the HP8755 Frequency Response Test Set.

### 805C, 817B Specifications

Model	Frequency Range (GHz)	SWR Residual	Connectors	Remarks
805C	0.5-4.0	1.04	AN(m) N(f)	11512A N(m) short, 11511A N(f) short furnished
817B	1.8-18.0	1.06	APC-7 N(f)	11512A N(m) short, 11565A APC-7 short furnished
817B Options	001: APC-7 connectors on 448B probes			
	022: N(m) and N(f) connectors on 816A slotted section			

## 809C Slotted Line Carriage

The 809C carriage operates with the 816A coaxial slotted section and four 810B waveguide slotted sections. It is compatible with the 442B, 444A, 447B, and 448B coaxial probes. The carriage has a centimeter scale with a vernier reading to 0.1 mm, and provision is made also for mounting a dial gauge if more accurate probe position reading is required.

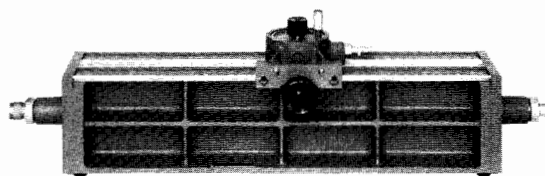

805C

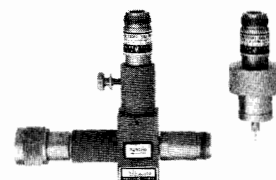

448B

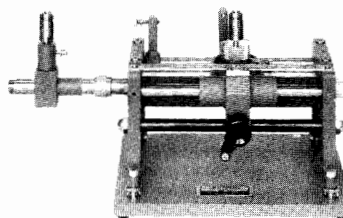

817B

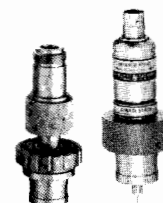

442B

447B

## 810B Series, 816A Slotted Sections

810B waveguide and 816A coaxial slotted sections are used with the 809C carriage. The 810B waveguide sections accept the 444A untuned probe or the 442B probe plus 440A tuned detector. The 816A coaxial line accepts the 447B probe or the 448B adapter sets.

### 810B Series, 816A Specifications

Model	Frequency Range (GHz)	SWR Residual	WG & Flange or Coax Conn.	Remarks
J810B	5.3-8.2	1.01	WR 137 UG-441/U	Use with 809C Carriage, 444A or 442B + 440A Probes
H810B	7.05-10.0	1.01	WR 112 UG-138/U	
X810B	8.2-12.4	1.01	WR 90 UG-135/U	
P810B	12.4-18.0	1.01	WR 62 UG-419/U	Use with 809C carriage 444A Probe
816A	1.8-18.0	1.02-1.04	Coaxial APC-7 N(f)	11512A N(m) Short furnished
Opt 011			Both APC-7	11565A APC-7 Short furnished
Opt 022			N(m), N(f)	Use with 809C Carriage 447B Probe or 448B Sweep Adapter

## 440A, 442B, 444A, 447B, 448B Probes/Adapters

440A is a single stub-tuned detector (1N21 crystal not supplied) for 2.4-12.4 GHz, to be used on the 442 broadband probe. 442B fits the 809C carriage and provides sampled RF at a Type N jack.

444A is an untuned probe for 2.6-18 GHz for use with the 809C carriage or other 3/4 inch (19 mm) mounting hole and the 810B waveguide sections. 447B is similarly used with the 809C and the 816A coaxial section for 1.8 to 18 GHz.

448B sweep adapter has a fixed and moveable probe with Type N connectors for mating with the detectors of the HP8755 Frequency Response Test Set.

### Ordering Information

- 440A Detector mount
- 442B RF probe
- 444A Untuned probe
- 447B Detector probe
- 448B Slotted line sweep adapter probes 1.8-18 GHz
- 809C Slotted line carriage
- 415E SWR Meter
- Opt 001: rechargeable battery installed
- Opt 002: rear panel input connector



- Precision loads and shorts for measurements to 40 GHz

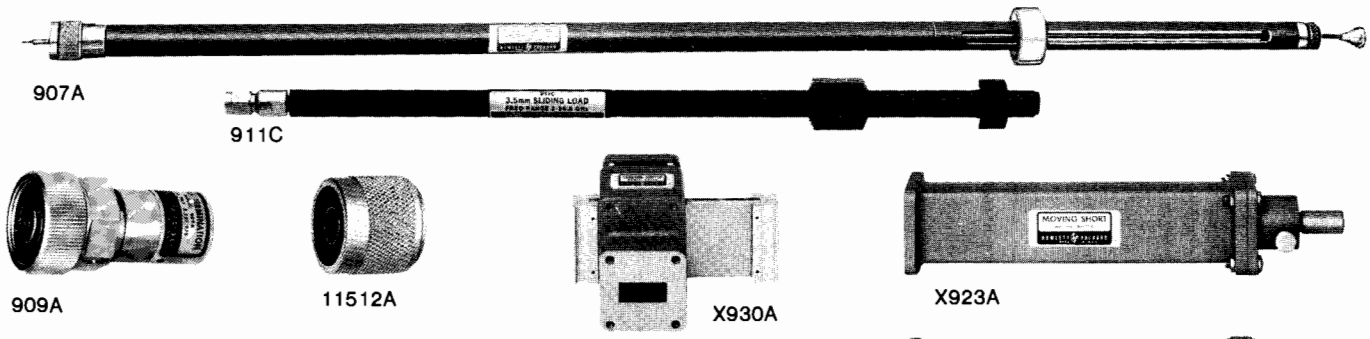

### 905A, 907A, 911A, 911C Coaxial Sliding Loads

The 905A, 907A and 911A are movable, low reflection 50 Ω loads for precision measurements. The 905A and 907A are supplied with three interchangeable connectors, N-male, N-female and APC-7. The 911A is supplied with SMA male and female.

The 911C is a sliding load designed for 3.5 mm coaxial transmission lines and uses the APC-3.5 connector. This permits mode-free operation to 26.5 GHz. The 911C is furnished with interchangeable male and female connectors in a carrying case.

### 905A, 907A, 911A, 911C Specifications

HP Model	Frequency range (GHz)	Load SWR	Power rating	Length (mm) in.	Shipping weight
905A	1.8-18	1.05	1 W avg. 5 kW pk	(440) 17.25	(1.4 kg) 3 lb
907A	1-18	1.1, 1-1.5 GHz; 1.05, 1.5-18 GHz	1 W avg. 5 kW pk	(778) 30.62	(4.1 kg) 9 lb
911A	2-18	1.1, 2-4 GHz; 1.05, 4-18 GHz	1 W avg. 5 kW pk	(380) 14.87	(1.4 kg) 3 lb
911C	2-26.5	1.2, 2-10 GHz; 1.07, 10-26.5 GHz	1 W avg. 5 kW pk	(266) 10.5	(1.7 kg) 3.8 lb

### 908A, 909A Coaxial Fixed Terminations

The 908A and 909A terminations are low-reflection loads for terminating 50 Ω coaxial systems in their characteristic impedance.

### 908A, 909A Specifications

HP Model	Frequency Range (GHz)	Impedance	SWR	Power Rating	Connector
908A	dc-4	50 ohms	1.05	½ W avg. 1 kW pk	N male
909A	dc-18	50 ohms	1.05, 0-4 GHz; 1.1, 4-12.4 GHz; 1.25, 12.4-18 GHz	2 W avg. 300 W pk	APC-7
909A Option 012 and Option 013	dc-18	50 ohms	1.06, 0-4 GHz; 1.11, 4-12.4 GHz; 1.3, 12.4-18 GHz	2 W avg. 300 W pk	Opt. 012 N male Opt. 013 N female

### 920A/B, X923A, X930A Waveguide Shorts

The 920A/B are movable shorts, adjustable through at least half a wavelength at the low end of the band. The X923A is also a movable short, but is adjustable through about two wavelengths at 8.2 GHz.

The X930A is a shorting switch. SWR is less than 1.02 in the "through" position and greater than 125 in the "short" position.

### 920A/B, X923A, X930A Specifications

Model	Frequency Range (GHz)	Waveguide Size EIA
J920A	5.3-8.2	WR137
H920A	7.05-10.0	WR112
X923A	8.2-12.4	WR90
P920B	12.4-18	WR62
K920B	18.0-26.5	WR42
R920B	26.5-40.0	WR28
X930A	8.2-12.4	WR90

### 910A/B, 914A Waveguide Fixed and Movable Terminations

The 910A/B are fixed terminations for waveguide systems. The 914A/B are similar to the 910A/B, except that their absorptive elements are movable and locking plungers control the position of the elements.

### 910A/B, 914A/B Specifications

Model	Frequency Range (GHz)	SWR	Power Rating	Type	Waveguide Size (EIA)
J910A	5.3-8.2	1.02	1 watt	fixed	WR137
H910A	7.05-10.0	1.02	1 watt	fixed	WR112
X910B	8.2-12.4	1.015	1 watt	fixed	WR90
P910A	12.4-18	1.02	1 watt	fixed	WR62
J914A	5.3-8.2	1.01	2 watt	sliding	WR137
H914A	7.05-10.0	1.01	1 watt	sliding	WR112
X914B	8.2-12.4	1.01	1 watt	sliding	WR90
P914A	12.4-18	1.01	½ watt	sliding	WR62
K914B	18-26.5	1.01	½ watt	sliding	WR42
R914B	26.5-40	1.01	½ watt	sliding	WR28

### 11511A, 11512A, 11565A Coaxial Shorts

These shorts are used for establishing measurement planes for known reflection phase and magnitude in 50 Ω and 75 Ω coaxial systems for various connectors.

### Ordering Information

- 11511A N-female short (50 ohm)
- 1250-1531 N-female short (75 ohm)
- 11512A N-male short (50 ohm)
- 1250-1530 N-male short (75 ohm)
- 11565A APC-7 short (50 ohm)
- 0960-0054 SMA-female short (50 ohm)
- 0960-0055 SMA-male short (50 ohm)

# MICROWAVE TEST EQUIPMENT

## Filters, Mixers, and Tuners

Models 360 series, 362 series, 870A, P932A, 934A, 10514A, 10534A

- Effective elimination of undesirable signals
- Low insertion loss through passband

- Correct waveguide discontinuities
- Measure microwave frequencies



X362A

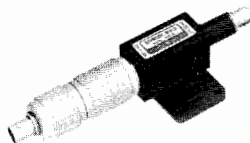

P932A



10514A



360D

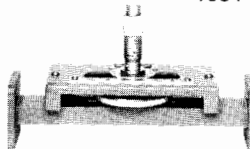

X870A

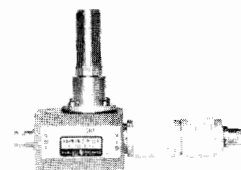

934A

### 360 Series Coaxial Low Pass Filters, 362 Series Waveguide Low Pass Filters

These Hewlett-Packard low-pass filters facilitate microwave measurements by eliminating undesirable signals (such as harmonics) from the measurement system. Suppression of such signals is particularly important in applications such as broadband reflection and transmission measurements or slotted line measurements, where harmonics generated by the signal source could otherwise impair measurement accuracy.

### X870A, P870A Waveguide Slide-Screw Tuners

Waveguide slide-screw tuners are used primarily for correcting discontinuities or for "matching" waveguide systems. X870A covers 8.2-12.4 GHz in WR 90 waveguide and P870A covers 12.4-18.0 GHz in WR 62 waveguide. Both can correct a SWR of 20 to a value of 1.02, with a maximum loss of 2 dB.

### 934A, P932A Harmonic Mixers

These mixers can be used for frequency measurements and phase lock applications from 2 to 18 GHz. Both accept stable VHF signals from 100 to 1000 MHz and provide broadband, high sensitivity mixing with microwave signals. 934A handles coaxial inputs from 2 to 12.4 GHz while P932A mixes signals from 12.4 to 18 GHz in WR 62 waveguide. With 0 dBm input signal 934A provides 1.4 mV p-p output and P932A 0.4 mV p-p.

### 10514A, 10534A Double Balanced Mixers

These mixers are excellent in a variety of mixing applications as well as AM, pulse, and square-wave modulation applications. The careful balancing of the hot carrier diodes in the 10514A and 10534A provides excellent output suppression of the local oscillator and input frequencies. Frequency ranges are 0.2-500 MHz for the 10514A and 0.05-150 MHz for the 10534A. Connectors are BNC.

### Ordering Information

X870A Waveguide tuner

P870A Waveguide tuner

P932A Waveguide harmonic mixer

934A Coaxial harmonic mixer

10514A Double Balanced Mixer (0.2-500 MHz)

10534A Double Balanced Mixer (0.05-150 MHz)

### 360 Series Coaxial Filter Specifications

Model	Cut-off Frequency (MHz)	Insertion Loss	Rejection	Impedance	VSWR Maximum	Connectors	Overall Length mm (in)	Shipping Weight kg (lb)
360A	700	Less than 1 dB below 0.9 times cut-off frequency	Greater than 50 dB at 1.25 times cut-off frequency	50 Ω	<1.6 to within 100 MHz of cut-off	N (m, f)	276 (10.9)	0.9 (2)
360B	1200			50 Ω		N (m, f)	183 (7.2)	0.9 (2)
360C	2200			50 Ω	<1.6 to within 200 MHz of cut-off	N (m, f)	274 (10.8)	0.9 (2)
360D	4100			50 Ω	<1.6 to within 300 MHz of cut-off	N (m, f)	187 (7.4)	0.45 (1)

### 362 Series Waveguide Low Pass Filter Specifications

Model	Passband (GHz)	Stopband (GHz)	Passband Insertion Loss	Stopband Rejection	SWR Maximum	Waveguide Size	Equivalent Flange	Length mm (in)	Shipping Weight kg (lb)
X362A	8.2-12.4	16-37.5	<1 dB	At least 40dB	1.5	WR 90	UG-39/U	136 (5.4)	0.9 (2)
M362A	10.0-15.5	19-47			1.5	WR 75	Cover	114 (4.5)	0.9 (2)
P362A	12.4-18.0	23-54			1.5	WR 62	UG-419/U	94 (3.7)	0.37 (13 oz)
K362A <sup>1</sup>	18.0-26.5	31-80			1.5	WR 42	UG-595/U	64 (2.5)	0.15 (5.3 oz)
R362A <sup>1</sup>	26.5-40.0	47-120	<2 dB	>35 dB	1.8	WR 28	UG-599/U	42 (1.7)	0.11 (4 oz)

<sup>1</sup>Circular Flange Adapters available: For K-Band, specify 11515A (UG-425/U). For R-Band, specify 11516A (UG-381/U).

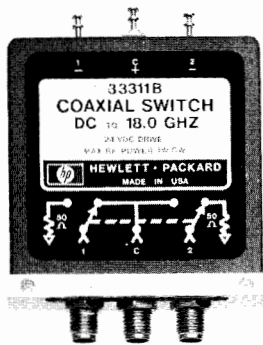

33311B

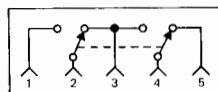

33311B-C05  
Wiring Diagram

### 33311B/C Coaxial Switches

The 33311B and 33311C are high-isolation, single-pole, double-throw coaxial switches with excellent reliability, repeatability, and performance. They are designed for use in 50 Ω systems and have internally-switched 50 Ω terminations which results in all ports being matched. The switches are controlled by magnetic latching solenoids and switching current is automatically cut off when switching is complete.

### 8761A/B Coaxial Switches

The 8761 is a single-pole, double-throw coaxial switch with low standing-wave ratio, low insertion loss, and excellent isolation from dc to 18 GHz. Mechanically, the switch is a break-before-make type controlled by a latching solenoid. Any of seven coaxial connectors, or a 50-ohm termination, may be specified for each port.

### 33311B-C05 Coaxial Switch

Model 33311B-C05 is a 5-port coaxial switch, which can be connected as a "transfer switch" to insert or remove a component from a signal path. In a test system, it can also switch in a device to be tested. In the label schematic above, the signal path connects to ports 2 and 3 while the device to be inserted connects between ports 1 and 4. Insertion loss, SWR, isolation, and solenoid drive power are all similar to the 33311B.

#### HP-IB Compatible

The 33311B/C and the 8761A/B switches can be remotely controlled by HP-IB with either the 11713A or the 59306A. The 11713A Attenuator Switch Driver is referenced on page 410. The 59306A HP-IB Relay Actuator is referenced on page 24.

#### 33311B/C Specifications

##### Frequency Range

**33311B:** dc to 18 GHz.

**33311C:** dc to 26.5 GHz.

##### SWR (50 ohm characteristic impedance)

**33311B:** <1.25, dc to 12.4 GHz; 1.5, 12.4 to 18 GHz.

**33311C:** <1.3, dc to 10 GHz; <1.5, 10 to 16 GHz; <2.3, 16 to 26.5 GHz.

##### Insertion Loss

**33311B:** <0.25 dB, dc to 2 GHz; <0.5 dB, 2 to 18 GHz.

**33311C:** <0.25 dB, dc to 2 GHz, < 0.5 dB, 2 to 10 GHz; <0.8 dB, 10 to 16 GHz; <1.4 dB, 16 to 26.5 GHz.

##### Isolation

**33311B:** >90 dB, dc to 18 GHz.

**33311C:** >90 dB to 12.4 GHz; >85 dB, 12.4 to 18 GHz; >50 dB, 18 to 26.5 GHz.

##### RF Connectors

**33311B:** (3) SMA female.

**33311C:** (3) APC-3.5 female (SMA compatible).

**Power:** 1 W average, 100 W peak (10 μs duration).

**Solenoid voltage (dc or pulsed):** 24 volts. Diode protected to reduce voltage transients.

**Switching speed:** <30 ms (including settling time).

**Life:** >1,000,000 switchings.

PORT 1 PORT 2

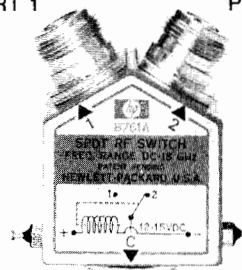

8761A Option 001

PORT C

**Size:** 54 H x 53 W x 14 mm D (2.13" x 2.13" x 0.56") excluding connectors and solenoid terminals.

**Weight:** net, 88 gm (0.2 lb); shipping, 220 gm (0.5 lb).

**Options:** 011, 5-volt solenoid voltage (only on 33311B).

#### 8761A/B Specifications

**Characteristic impedance:** 50 ohms.

**Frequency range:** dc to 18 GHz.

**Standing-wave ratio**

Frequency	SWR		
	7-mm	N	SMA
dc-12.4 GHz	1.15 (1.20)	1.20 (1.25)	1.30 (1.30)
dc-18 GHz	1.20 (1.25)	1.25 (1.30)	1.35 (1.35)

SWR in parentheses applies to switch with built-in termination

**Insertion loss:** <0.5 dB, dc to 12.4 GHz; <0.8 dB, dc to 18 GHz.

**Isolation:** >50 dB, dc to 12.4 GHz; >45 dB, dc to 18 GHz.

**Power:** 10 W average, 5 kW peak; built-in termination rated at 2 W average, 100 W peak.

**Switching energy:** 1.5 W for 20 ms (permanent magnet latching).

**Solenoid voltages (dc or pulsed):** 12 to 15 V, 8761A; 24 to 30 V, 8761B.

**Switching speed:** 35 to 50 ms (including settling time).

**Life:** >1,000,000 switchings.

**Size:** 41 H x 38 W x 38 mm D (1.6" x 1.5" x 1.5") excluding connectors and solenoid terminals.

**Weight:** net, 140 to 220 gm (0.3 to 0.5 lb); shipping, 220 to 300 gm (0.5 to 0.7 lb).

#### How to Order 8761A/B Switches

Specify solenoid voltage and connectors (including built-in 50-ohm termination) by the alphabetic suffix on the switch model number and the appropriate three-digit option number.

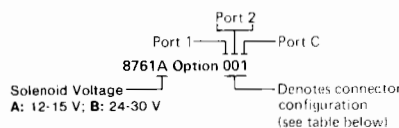

Option Code	Connector Type	Option Code	Connector Type
0	N (f)	4	APC-7 for UT-250 Coax
1	N (m)	5	SMA (f)
2	APC-7 w/Threaded sleeve	6	SMA (m)
3	APC-7 w/Coupling nut	7	50Ω Termination

#### Ordering Information

**8761A/B** order must include option number

**8761A/B** Coaxial Switch (quantity 1-9)

**8761A/B** Coaxial Switch (quantity 10-24)

**8761A/B** Coaxial Switch with 50-ohm termination

**33311B** Coaxial Switch (quantity 1-9)

**33311B** Coaxial Switch (quantity 10-24)

**33311B-C05** Coaxial Switch (quantity 1-9)

**33311C** Coaxial Switch (quantity 1-9)

**33311C** Coaxial Switch (quantity 10-24)



# MICROWAVE TEST EQUIPMENT

Adapters, Waveguide Stands, Air Lines

Models 281A/B/C, 292A/B, 11515/6/A, 11540 series, 11566/7/A, 11588A, 11606A



K281C

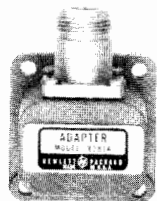

X281A



MX292B



11566A



11515A



11606A

11542A-11548A

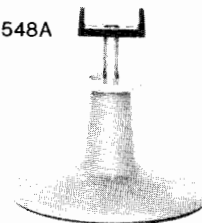

11540A

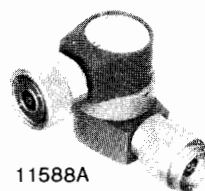

11588A

## 281A/B/C, 292A/B, 11515A/6A Coax and Waveguide Adapters

HP 281A,B adapters transform waveguide transmission line into 50-ohm coaxial line. The newer 281C family has improved SWR.

Models 292A,B waveguide-to-waveguide adapters connect two different waveguide sizes with overlapping frequency ranges. Models 11515A/16A adapt circular to rectangular flanges in K-band and R-band.

### 281A/B/C Specifications

HP Model	SWR	Frequency Range (GHz)	Waveguide Size EIA	Coaxial Connector	W/G Flange UG-( ) U
S281A	1.25	2.60-3.95	WR284	N Female	584
G281A	1.25	3.95-5.85	WR187	N Female	407
J281A	1.25	5.30-8.20	WR137	N Female	441
H281A	1.25	7.05-10.0	WR112	N Female	138
X281A	1.25	8.20-12.4	WR90	N Female	135
X281B	1.25	8.20-12.4	WR90	APC-7	135
Option 013				N Female	
P281B	1.25	12.4-18.0	WR62	APC-7	419
Option 013				N Female	
X281C	1.05	8.20-12.4	WR90	APC-7	135
Option 012				N Male	
Option 013				N Female	
P281C	1.06	12.4-18.0	WR62	APC-7	419
Option 012				N Male	
Option 013				N Female	
K281C	1.07	18.0-26.5	WR42	APC-3.5 (f)	597
Option 012				APC-3.5 (M)	

### 292A/B, 11515A, 11516A Specifications

HP Model	Frequency Range (GHz)	SWR	W/G Size Flange to	W/G Size Flange
HX292B	8.2-10.0	1.05	WR 112 UG-51/U	WR 90 UG-39/U
MX292B	10.0-12.4	1.05	WR 75 Cover	WR 90 UG-39/U
MP292B	12.4-15.0	1.05	WR 75 Cover	WR 62 UG-419/U
NP292A	15.0-18.0	1.05	WR 51 Cover	WR 62 UG-419/U
NK292A	18.0-22.0	1.05	WR 51 Cover	WR 42 UG-595/U
11515A	18.0-26.5	—	WR 42 UG-425/U	WR 42 UG-595/U
11516A	26.5-40.0	—	WR 28 UG-381/U	WR 28 UG-599/U

## 11588A Swivel Adapter, 11606A Rotary Air Line

The 11606A rotary air line and the 11588A swivel adapter are capable of a full 360° of rotation. A combination of the air line and the adapter permits rigid coax movement in three dimensions. Even the most awkwardly shaped devices can be easily connected or disconnected in a coax system with the aid of these components. Insertion loss is <0.5 dB and uncertainty due to rotation is -57 dB.

## 11566A, 11567A Air Line Extension

**Impedance:** 50 ohms.

**Frequency:** dc-18 GHz.

**Reflection coefficient:** 0.018 + 0.001 (frequency in GHz).

**Connector:** APC-7

**Length:** 11566A, 102.5 mm (4 in.); 11567A, 202.5 mm (8 in.).

**Shipping weight:** 0.45 kg (1 lb).

## 11540 Series Waveguide Stand, Waveguide Holders

The 11540A waveguide stand locks HP waveguide holders at any height from 70 to 133 mm (2.75 in. to 5.25 in.). The waveguide holders are offered in seven sizes to hold waveguide covering frequencies from 3.95 to 40 GHz.

### 11588A, 11606A Specifications

HP Model	Frequency Range GHz	SWR	Connectors	Dimensions mm (in)	Shipping Weight kg (lb)
11588A	DC-12.4	1.1	APC-7(m)(f)	42 x 59 x 30 (1 3/4 x 2 3/8 x 1 3/16)	0.28 (10 oz.)
11606A	DC-12.4	1.1	APC-7(f)	100 x 19 (4 x 3/4)	0.45 (1 lb)

### Ordering Information

**11566A** Air line extension

**11567A** Air line extension

**11540A** Waveguide stand

**11542A** G-Band Waveguide holder

**11543A** J-Band, **11544A** H-Band, **11545A** X-Band,

**11546A** P-Band, **11547A** K-Band, **11548A** R-Band

Waveguide holders

# MICROWAVE TEST EQUIPMENT

## Frequency Response Test Sets, 10 MHz to 26.5 GHz

### Model 8755 System

421



- 10 MHz to 26.5 GHz frequency range
- Absolute & ratio measurement capability
- Complete complement of measurement accessories
- 0.1 dB resolution and offset

- 60 dB dynamic measuring range for each detector
- Excellent stability with time and temperature
- Free of interference from stray fields or unwanted signals

8750A Storage-Normalizer

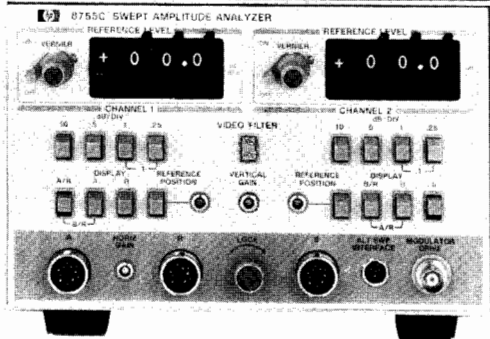
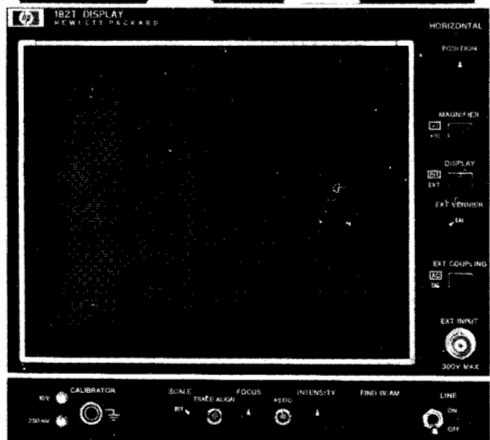
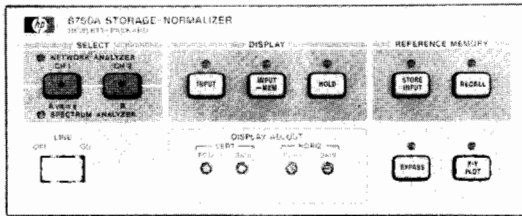

182T Display / 8755C Plug-in  
11664A Detectors

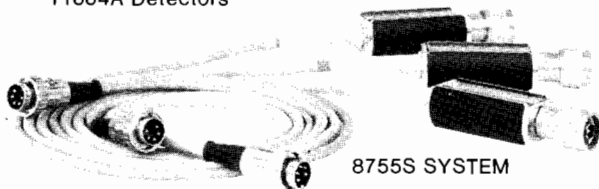

8755S SYSTEM

The 8755C has two independent channels and three detector inputs allowing simultaneous ratio measurement capability. All three detectors have a +10 dBm to -50 dBm dynamic range, are interchangeable, and require no calibration. For each channel a resolution of 10, 5, 1, 0.25 or 0.1 dB per division is available (also combinations of these, e.g., 15 dB/division) as well as a calibrated offset of  $\pm 59.9$  dB in 0.1 dB increments. The 8750A Storage-Normalizer connects directly to the 8755/182T by a single cable to provide digital normalization and storage capability for both channels.

Common measurements made with the 8755 are simultaneous insertion and return loss, amplifier gain and gain compression, and mixer conversion loss and return loss, all on a swept frequency basis. The 8755S system has many features that improve both the accuracy and the versatility compared with other scalar measurement systems.

The 8755S system can interface with sources having alternate sweep capability, such as the 8350A Sweep Oscillator, allowing two independent frequency and power ranges to be displayed on consecutive sweeps. With this powerful capability, measurements of amplifier compression and filter pass/stop band response become simple manual measurements. For added flexibility in this mode, the 8755C allows full channel independence of scale per division and offset.

The 8755C uses an ac detection system which can reject undesired RF signals such as local oscillator feedthrough in mixer measurements, external traffic in antenna measurements, and broadband noise in amplifier measurements. The 8755C provides the 27.8 kHz squarewave drive to AM modulate the RF sweeper output either directly (most HP 8620 and all 8350 RF sweeper plug-ins are directly compatible with the 8755) or by using the 11665B External Modulator.

In addition to making absolute or relative power measurements with a single detector, the 8755 will also measure the logarithmic difference in power between two detectors, i.e., ratio measurements. Ratio measurement techniques improve accuracy by providing better equivalent source match and immunity to source power variations. A ratio technique can also allow dynamic range expansion up to 100 dB.

The 8750A Storage-Normalizer improves both the accuracy and convenience of swept frequency measurements. System frequency response error is eliminated by subtracting a digitally stored calibration trace from the measurement trace using the 8750 input minus memory mode. The input minus memory mode also facilitates comparison measurements by providing a single trace display of the difference between two devices. The 8750A has digital storage for flicker-free displays so that a complete trace is seen independently of the RF sweep rate. This is a real benefit when device constraints require a slow sweep rate as when making narrow band filter measurements. The 8750A also makes x-y plotting much more convenient by automatically outputting the x, y and penlift signals from digital memory at the push of a single button.

A number of accessories are available for use with the 8755S system to meet most signal separation and filtering requirements. These include the HP 11666A Reflectometer Bridge, the HP 11667A Power Splitter, and the HP 11678 Filter Kits. The HP 11679A and B Extension Cables are also available for use with the 11664 Detectors or the 11666A Bridge to make remote measurements without performance degradation.

## 8755S Frequency Response Test System

The 8755S is an economy network measurement system designed to make absolute power and ratio measurements over the 10 MHz to 26.5 GHz frequency range. It is a versatile system capable of fulfilling the majority of scalar (amplitude only) impedance and transmission measurement requirements. The 8755S system consists of the following separate instruments: (1) 8755C Swept Amplitude Analyzer, (1) 182T display unit, (1) 8750A Storage Normalizer, and (3) 11664A Schottky diode detectors.

# MICROWAVE TEST EQUIPMENT

## 8755 System Accessories

Models 11666A, 11667A, 11665B, 11678A, 11668A, 11679A/B

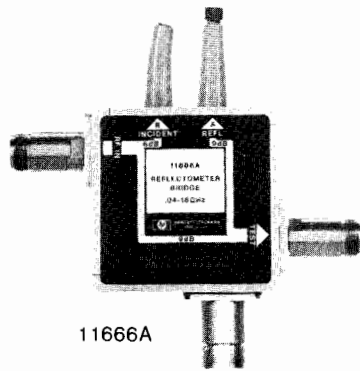

11666A

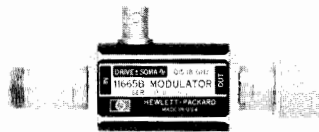

11665B

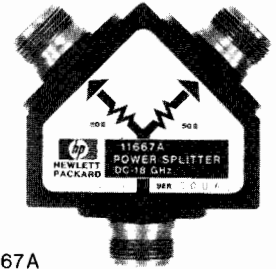

11667A

### 11666A Reflectometer Bridge

Reflection measurements covering from 40 MHz to 18 GHz with one directional device can be made with the Model 11666A Reflectometer Bridge. Operation of this type of directional device is based on principles of the resistive Wheatstone Bridge extended to microwave frequencies. When three bridge arms are 50Ω, the voltage across corners of the bridge is directly proportional to the reflection coefficient of the device connected in the fourth arm. Equivalent directivity is then a measure of how well the bridge circuit is balanced with a 50Ω termination connected. (Ideally this would create a voltage null representing infinite return loss.) The high equivalent directivity achievable over wide bandwidths makes the bridge configuration attractive.

The 11666A is completely dedicated to the 8755; two Schottky diode detectors (which sample the incident and reflected signals for ratioing by the 8755) are incorporated as an integral part of the bridge unit. The effective external leveling achieved by ratioing thus isolates the measurement port from source/bridge input mismatch. With the addition of an external 11664A Detector, two simultaneous ratio measurements of insertion and return loss can be made. Small size combined with its wide frequency range and high directivity make the 11666A ideal for production use.

#### Specifications 11666A (connected to the 8755C Analyzer)

**Frequency Range:** 40 MHz to 18 GHz.

Frequency Range	Equivalent Directivity	Equivalent Output SWR
40 to 100 MHz	30 dB	1.25
0.1 to 1 GHz	38 dB	1.25
1 to 2 GHz	36 dB	1.25
2 to 4 GHz	33 dB	1.25
4 to 8 GHz	29 dB	1.25
8 to 12 GHz	27 dB	1.27
12 to 18 GHz	26 dB	1.52

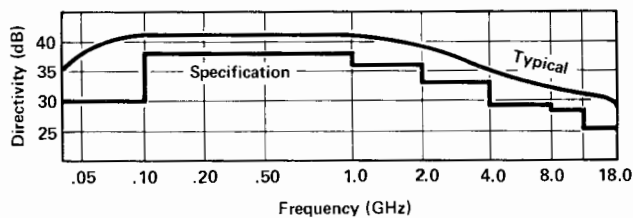

#### Frequency tracking

(between incident and reflected arms): <3.2dB  
(between incident and test port, including 1.1 dB from 11664A Detector): <4.3dB

**Nominal coupling:** 6-dB incident arm. 9-dB reflected arm. 9-dB transmission loss.

**Input SWR:** 1.92.

**Maximum input power:** +15 dBm.

**Connectors:** Type N-Female on input and output. APC-7 Optional. **Size:** 69.9 mm H x 69.9 mm W x 46.4 mm D (2<sup>3</sup>/<sub>4</sub>" x 2<sup>3</sup>/<sub>4</sub>" x 1<sup>7</sup>/<sub>32</sub>"). Cable length, 1219 mm (48").

**Weight:** net, 0.7 kg (1.5 lb). Shipping, 2.26 kg (5.13 lb).

**Accessories furnished:** 11512A Short, Type N-Male (11565A short, APC-7 with Opt 002).

### 11667A Power Splitter

The 11667A Power Splitter is recommended when making wide-band transmission measurements using the 8755 Test Set. This two-resistor type splitter provides excellent output SWR at the auxiliary arm when used for source leveling or ratio measurement applications. The 0.25 dB tracking between output arms over a frequency range from dc to 18 GHz allows wideband measurements to be made with a minimum of uncertainty.

**Frequency range:** dc to 18 GHz.

**Impedance:** 50Ω.

	dc-4 GHz	dc-8 GHz	dc-18 GHz
<b>Input SWR:</b>	≤1.15	≤1.25	≤1.45
<b>Equivalent output SWR:</b>	1.10	1.20	1.33
leveling or ratio			
<b>Output tracking:</b> (between output arms)	<0.15 dB	<0.20 dB	<0.25 dB

**Insertion loss:** 6 dB nominal (input to either output).

**Maximum input power:** +27 dBm (0.5 watt).

**Connectors:** Type N female on all ports.

**Size:** 46 H x 50 W x 19 mm D (1<sup>13</sup>/<sub>16</sub>" x 2" x 3/<sub>4</sub>").

**Weight:** net, 0.06 kg (2 oz). Shipping 0.22 kg (8 oz).

### Other Signal Separation Devices

Many other signal separation devices are available from HP for use with the 8755. Coaxial couplers from 0.1 to 18 GHz are available with the 770 series, the 790 series, and the 11692. Higher directivity 752 series waveguide couplers can also be used with the 8755S with the addition of appropriate 281 series waveguide to coax adaptors.

### 11665B Modulator

**Function:** absorptive on-off modulator designed for and powered by the 8755C plug-in.

Frequency Range	Return Loss On and Off	Insertion Loss On Off
15-40 MHz	≥10 dB	≤7.0 dB ≥35 dB
40 MHz-4 GHz	≥15 dB	≤3.2 dB ≥35 dB
4-8 GHz	≥12 dB	≤3.8 dB ≥40 dB
8-12.4 GHz	≥8 dB	≤4.3 dB ≥45 dB
12.4-18 GHz	≥8 dB	≤5.0 dB ≥45 dB

**Modulator drive feedthrough:** ≤8 mV (peak) at 27.8 kHz at either port when powered by the 8755C. Reduced to ≤1mV (peak) using the 11668A. (See 11668A High Pass Filter).

**Drive current:** nominally +50 mA in ON condition, -50 mA Off condition.

**Weight:** net, 0.17 kg (6 oz). Shipping, 0.9 kg (2 lb).

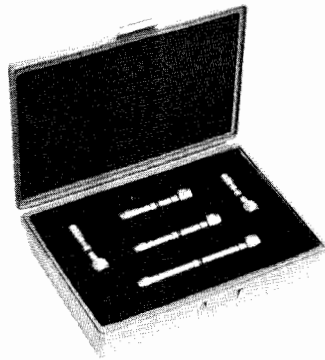

11678A



11668A

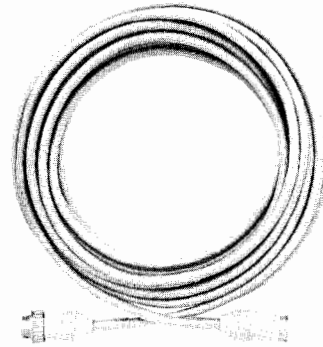

11679A

### 11678A Low Pass Filter Kit

The 11678A Low Pass Filter Kit contains five filters conveniently matched to HP 8620 sweeper bands. These filters have  $<1.1$  dB insertion loss at 0.95 fc with  $>40$  dB rejection at 1.25 fc. Filter use is recommended to reduce undesirable harmonics causing errors in broadband detector measurements.

**Frequency range:** low pass filters, cutoff frequency fc: 11688A, 2.8 GHz; 11689A, 4.4 GHz; 11684A, 6.8 GHz; 11685A, 9.5 GHz; 11686A, 13.0 GHz.

**Connectors:** N-Male, N-Female.

**Weight:** net 0.44 kg (1 lb). Shipping 1.2 kg (2.9 lb).

### 11668A High Pass Filter

The 11668A High Pass Filter accessory is recommended when making measurements on active devices which have gain below 50 MHz. Use of the 11668A, placed after the 11665B, reduces the modulator drive feedthrough from 8 mV to 1 mV and prevents possible amplifier saturation. Use of the 11668A filter is not necessary for passive measurements since the feedthrough from the 11665B is  $-65$  dBm and causes no degradation in system performance.

**Frequency range:** 50 MHz to 18 GHz.

	Insertion Loss	Return Loss
50–100 MHz	$\leq 2.5$ dB	$\geq 12$ dB
100 MHz–8 GHz	$\leq 1.0$ dB	$\geq 16$ dB
8–12 GHz	$\leq 1.0$ dB	$\geq 14$ dB
12–18 GHz	$\leq 1.5$ dB	$\geq 14$ dB

**Maximum input:** +27 dBm.

**Connectors:** N-female, N-male

**Weight:** 0.13 kg (5 oz). Shipping 0.28 kg (10 oz).

### 11679A/B Extension Cables

11679A 25-foot Extension Cable and 11679B 200-foot Extension Cable fit directly between 11664A Detector and display. Remote detector operation is permitted without performance degradation.

## Common System Specifications

### Power Measurement Range:

**Single channel:** +10 dBm to  $-50$  dBm (noise level).

**System accuracy** (Ratio Measurements):

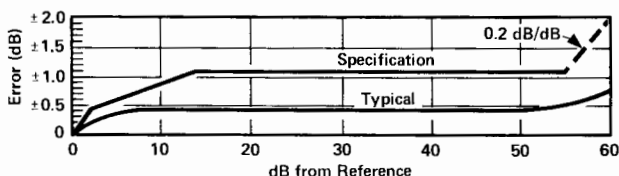

Accuracy curve shows system uncertainty for a relative measurement with +10 dBm incident at the test detector when the 0-dB reference is set. Accuracy when calibration levels below +10 dBm are used remains the same, except the additional 0.2 dB/dB uncertainty should be added for measurements below  $-45$  dBm. This curve includes system noise, offset uncertainty, and crosstalk, and assumes the reference detector power remains fixed between calibration and test. Refer to detector, coupler, or bridge specifications to determine system frequency response.

### Absolute Measurements:

Absolute power incident on a detector is displayed with respect to the 0 dBm POSITION line when the OFFSET CAL switch is turned OFF. Accuracy at any power level is typically  $\pm 0.5$  dB not including detector frequency response or mismatch errors. For applications requiring more precision, increased accuracy can be obtained if the 8755 display is calibrated at a specific power level using a power meter. The stability of the 8755 then permits accurate power measurements repeatable to hundredths of dBs.

### General

**Resolution:** Independent for each channel in steps of 10, 5, 1, 0.25, or 0.1 dB per division. Combinations of steps can be engaged, e.g. 10 dB/div. and 5 dB/div. to achieve 15 dB/div.

**Offset:** Independent for each channel.  $\pm 59.9$  dB in 0.1 dB increments.

**Graticule:** 8755S, 1 Div.  $\approx 1.29$  cm. 8755S Option 001, 1 Div.  $\approx 1$  cm.

**Temperature range:** Operation, 0 to 55°C; storage,  $-40$ °C to 75°C.

**Power:** 48 to 440 Hz, 115/230 V  $\pm 10\%$ , typically 100 watts.

### 8755S Specifications

Consists of:

- 8755C Swept Amplitude Analyzer
- 182T Display
- 11664A Detectors (3 each)
- 8750A Storage-Normalizer

**Frequency range:** 10 MHz to 18 GHz (determined by the 11664A Detectors)

### 8755S Option 001 Specifications

Consists of:

- 8755C Swept Amplitude Analyzer
- 180TR Display
- 11664A Detectors (3 each)
- 8750A Storage-Normalizer

### 8755S Option 002 Specifications

Consists of:

- 8755C Swept Amplitude Analyzer
- 182T Display
- 11664A Detector (1 each)
- 11666A Reflectometer Bridge
- 8750A Storage-Normalizer

**Frequency range:** 40 MHz to 18 GHz (determined by the 11666A Bridge).

### 8755S Option 003 Specifications

Adds 11665B External Modulator.

**Frequency range:** 15 MHz to 18 GHz (determined by the 11665B Modulator).

### 8755S Option 004 Specifications

Deletes the 8750A Storage-Normalizer.

### 8755S Option 005 Specifications

Consists of:

- 8755C Swept Amplitude Analyzer
- 182T Display
- 11664B Detectors (3 each)
- 8750A Storage-Normalizer

**Frequency range:** 10 MHz to 26.5 GHz (determined by the 11664B Detectors).



# MICROWAVE TEST EQUIPMENT

## 8755 System

Models 8755C, 11664A/B/C, 8750A Components

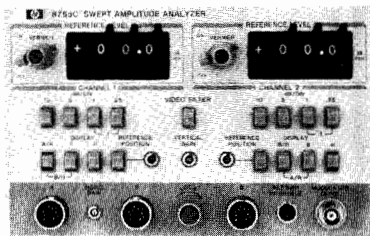

8755C

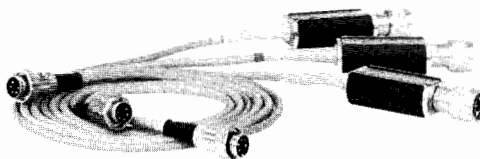

11664A

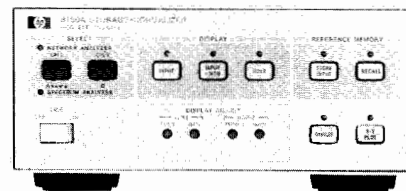

8750A

### Individual Instrument Specifications

#### 8755C Plug-in

**Function:** The 8755C plug-in processes demodulated 27.8 kHz signals from the 11664 Detectors (R,A,B) for logarithmic display on 180 series oscilloscopes.

**Resolution:** Independent for each channel in steps of 10, 5, 1, 0.25, or 0.1 dB per division.

**Offset:** Independent for each channel.  $\pm 59.9$  dB in 0.1 dB increments.

#### Display Units

180 "T" series displays are recommended for use with the 8755C. They provide zero offset recorder outputs, and both positive and negative 5-volt retrace blanking inputs.

**Large screen (Model 182T):** This display unit is contained in the 8755S standard configuration. It has an 8 x 10 division internal graticule with 1 div = 1.29 cm. and medium persistence P39 phosphor.

**Rack mount (Model 180TR).** This display unit is contained in the 8755S Option 001 system configuration. It has an 8 x 10 division internal graticule with 1 div = 1 cm. and medium persistence P39 phosphor.

The 182T and 180TR are directly compatible with the 8750A Storage-Normalizer. As a result of the 8750A compatibility, the 182T and 180TR cannot be used with time domain plug-ins.

**Variable persistence/storage (Model 181T, Cabinet Model 181TR, Rack Mount):** These displays can be ordered individually for use with the 8755C. Because they offer CRT storage, they have not been made compatible with the 8750A Storage-Normalizer. They have an 8 x 10 division internal graticule with 1 div = 0.95 cm. and offer variable persistence phosphor for storing single or multiple traces.

#### 11664A Detectors

**Function:** Designed specifically for use with the 8755C Swept Amplitude Analyzer, the 11664A detects the envelope of the 27.8 kHz modulated microwave signal. It uses a biased Schottky diode to achieve -50 dBm sensitivity.

**Frequency range:** 10 MHz to 26.5 GHz.

**Tracking between two 11664A Detectors:**

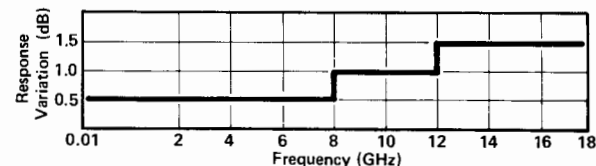

#### Typical frequency response:

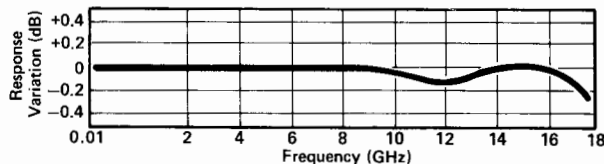

#### Return loss:

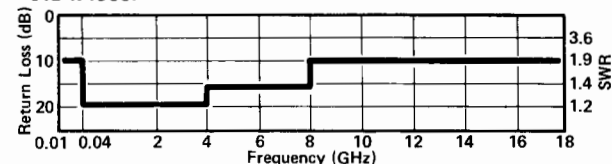

**Impedance:** 50 ohms nominal

**Connector:** N-Male.

#### 11664B Detectors

(All specifications are the same as the 11664A with the following differences):

**Frequency range:** 10 MHz to 26.5 GHz.

**Tracking between two 11664B Detectors:** Tracking between two detectors at the same power level is typically <2 dB from 10 MHz to 26.5 GHz.

**Return Loss:**

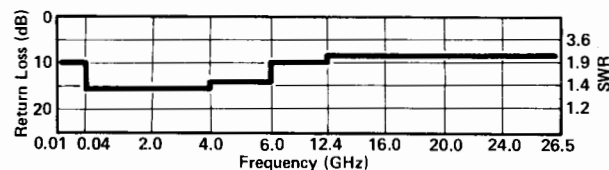

**Connector:** APC 3.5 Male.

#### 11664C Detector Adapter

**Function:** Allows the 8755 to be used with many available diode detectors. Two adjustments allow the detector to be mated with the 8755 to provide absolute power as well as ratio with a frequency range that is determined by the diode detector used.

**Connector:** BNC male

#### 8750A Storage-Normalizer

**Function:** Provides digital storage display and digital normalization for both channels of the 8755. The 8750A connects directly to the 8755/182T via a single cable.

#### Ordering Information

The 8755S system and its options are configured of separate instruments and components solely for ordering convenience. If a different display or optional connectors are desired, each part of the system should be listed separately.

#### 8755S Complete Test Set

**Opt 001:** Rack mount version

**Opt 002:** deletes (2) 11664 Detectors, adds

11666A Reflectometer Bridge

**Opt 003:** adds 11665B Modulator

**Opt 004:** deletes 8750A Storage-Normalizer

**Opt 005:** Replaces (3) 11664A with (3) 11664B

8755C Test Set Plug-in only

**11665B** 15 MHz 18 GHz Modulator

**11664A** 10 MHz 18 GHz Detector

**Opt 001:** APC-7 Connector

**11664B** APC 3.5 10 MHz to 26.5 GHz Detector

**11664C** Detector Adapter

**182T** Large Screen Cabinet Scope Display

**180TR** Standard Screen Rack Display

**181T** Storage, Cabinet Display

**181TR** Storage, Rack Display

**11666A** Reflectometer Bridge

**11679A** 7.6 m (25 ft) Detector Extension Cable

**11679B** 61 m (200 ft) Detector Extension Cable

**11668A** 50 MHz High Pass Filter

**11667A** DC to 18 GHz Power Splitter

**11678A** Low Pass Filter Kit

**Individual filters:** specify model number

# MICROWAVE TEST EQUIPMENT

Automatic Scalar Network Analyzer

Model 8755P System

425



- Measures insertion loss (or gain) and return loss
- 40 MHz to 18 GHz frequency range
- Automatically plot or display up to 500 points of data

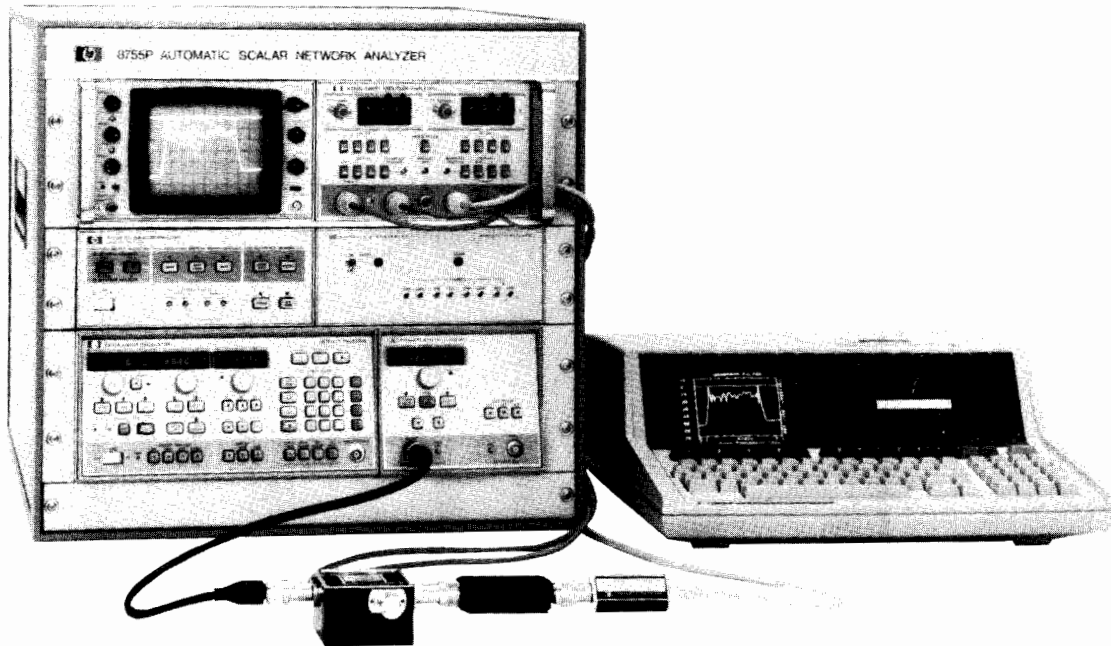

The HP 8755P is an Automatic Scalar Network Analyzer that can measure insertion loss (or gain) and return loss at microwave frequencies. Control for this automatic system is provided through the Hewlett-Packard Interface Bus (HP-IB). Included in the system are an HP 8755S Frequency Response Test Set, an HP 8350A Sweep Oscillator with an HP 83592A Plug-in (0.01 to 20 GHz), an HP 85F Computing Controller, and a Software Pac.

## Easy to Use

The 8755P system is fully assembled and integrated at the factory. Included with the system are an HP 11666A Reflectometer Bridge and one HP 11664A Detector. Calibration accessories (a short circuit and a shielded open circuit) are also provided.

The 8755P system comes with software that demonstrates many of the capabilities of the system. With it, you can automatically calibrate and measure up to 500 points of insertion or return loss, or up to 250 points of both. You also get your choice of output formats: print (or display) the data in a tabular style, or print (or display) a graph of the data.

The measurement program is written in a modular style so that you can easily customize it for your specific measurement needs.

## Versatile

With this system, manual measurements as well as automatic measurements are fast, easy, and convenient. The 8755P comes with an HP 8750A Storage Normalizer to make manual measurements less fatiguing and more accurate. The 8750A uses digital storage to display slow-sweeping signals at a flicker-free rate, and it can store a calibration trace and subtract it from subsequent measurements.

## High Performance

Each component of the 8755P is a high performance instrument in its own right. Together, they form the highest performance Automatic Scalar Network Analyzer available.

The 8755C Frequency Response Test Set has 60 dB of calibrated dynamic range (+10 to -50 dBm) in all three input channels (A, B, and R). It uses an AC modulation/detection system for improved performance when measuring signals that are in the presence of unmodulated noise. Detector adapters (HP 11664C) are available that can be used with waveguide detectors for measurements up to millimeter-wave frequencies.

Test signals are provided by the HP 8350A, the highest performance Sweep Oscillator made. While the 8350A is fully programmable via HP-IB, the sweeper is also extremely easy to use from the front panel. For example, frequencies may be entered by a knob, through the keyboard, or by increment and decrement keys. Up to nine independent front panel settings may be saved or recalled at the touch of a key, or through HP-IB, to help speed your measurements.

With the 8755C, this sweeper offers Alternate Sweep Capability: the ability to define two different frequency ranges (or power settings with 83500 series plug-ins) and alternate between them on successive sweeps. This is invaluable for making adjustments to a test device and observing the effects in two different frequency ranges at once.

## Dimensions:

**Cabinet:** 41 H x 53 W x 56 cm D (16" x 21" x 22").

**Controller:** 16 H x 44 W x 45 cm D (6.3" x 16.5" x 17.8").

**Weight:** Net 68 kg (150 lbs). Shipping 123 kg (270 lbs).

**Power consumption:** 450 W

## Ordering Information

HP 8755P Automatic Scalar Network Analyzer (0.4 to 18 GHz)

**Option 001** Substitute HP 86290B Plug-in (2 to 18.6 GHz) for HP 83592A

**Option 002** Delete Controller

**Option 003** Delete Plug-in



### Why Network Analysis?

Characterizing the behavior of linear networks that will be stimulated by arbitrary signals and interfaced with a variety of other networks is a fundamental problem in both synthesis and test processes. For example, the engineer designing a multi-component network must predict with some certainty the final network performances from knowledge of the individual components. Similarly, a production manager must know allowable tolerances on the products manufactured and whether the final products meet the specified tolerances. Network analysis offers a solution to these problems through complete description of linear network behavior in the frequency domain.

Network analysis accomplishes the description of both active and passive networks by creating a data model of such component parameters as impedances and transfer functions. However, these parameters not only vary as a function of frequency but are also complex variables in that they have both magnitude and phase. Until the advent of the modern network analyzer, phase was difficult to measure at CW frequencies and often involved laborious calculations; these measurements were accomplished by conventional oscilloscopes at lower frequencies and slotted lines at microwave frequencies. However, swept network analyzers now measure magnitude and phase (the total complex quantity) as a function of frequency with less difficulty than conventional CW measurements. Impedance and transfer functions can then be conveniently displayed on a swept CRT, as in Figure 1, X-Y recorder, or com-

puter controlled peripherals such as a printer and/or a plotter. HP computers also combine with network analyzers to give new levels of speed and accuracy in swept measurements that could only be attained previously by long calculations at CW frequencies.

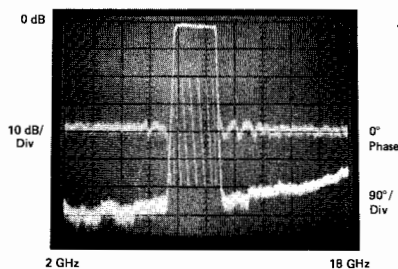

Figure 1. 2 GHz to 18 GHz measurement of magnitude and phase in a single sweep

Thus, network analysis satisfies the engineering need to characterize the behavior of linear networks quickly, accurately, and completely over broad frequency ranges. In design situations, this minimizes the time required to test new designs and components, allowing more time to be spent on the design itself. Likewise, production test times may be minimized while reducing the uncertainties surrounding the test.

### What Is Network Analysis?

Network analysis is the process of creating a data model of transfer and/or impedance characteristics of a linear network through sine wave testing over the frequency range of interest. All network analyzers in the HP

product line operate according to this definition.

Creating a data model is important in that actual circuit performance often varies considerably from the performance predicted by calculations. This occurs because the perfect circuit element doesn't exist and because some of the electrical characteristics of a circuit may vary with frequency.

At frequencies above 1 MHz lumped elements actually become "circuits" consisting of the basic elements plus parasitics like stray capacitance, lead inductance, and unknown absorptive losses. Since parasitics depend on the individual device and its construction they are almost impossible to predict. Above 1 GHz component geometries are comparable to a signal wavelength, intensifying the variance in circuit behavior due to device construction. Further, lumped-element circuit theory is useless at these frequencies and distributed-element (or transmission-line) parameters are required to completely characterize a circuit.

Data models of both transfer and impedance functions must be obtained to completely describe the linear behavior of a circuit under test. At lower frequencies,  $h$ ,  $y$ , and  $z$ -parameters are examples of transfer and/or impedance functions used in network description; at higher frequencies,  $S$ -parameters are used to characterize input-output impedances and transfer functions. Therefore, a network analyzer must measure some form of a circuit's transfer and impedance functions to achieve its objective of complete network characterization. Figure 2 shows an example of a swept impedance measurement.

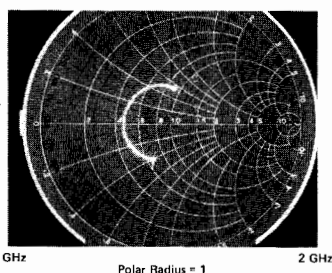

Figure 2. Input impedance of microcircuit amplifier is read directly with Smith Chart Overlay for Polar Display

Network analysis is limited to the definition of linear networks. Since linearity constrains networks stimulated by a sine wave to produce a sine wave output, sine wave testing is an ideal method for characterizing magnitude and phase response as a function of frequency. In non-linear measurements phase is often meaningless and amplitude has to be defined with respect to individual frequency components. For non-linear measurements see sections on spectrum analyzers and wave analyzers.

## Network Analyzers

Hewlett-Packard Network Analyzers are instruments that measure transfer and/or impedance functions of linear networks through sine wave testing. A network analyzer system accomplishes these measurements by configuring its various components around the device under test. The first requirement of the measurement system is a sine wave signal source to stimulate the device under test. Since transfer and impedance functions are ratios of various voltages and currents, a means of separating the appropriate signals from the measurement ports of the device under test is required. Finally, the network analyzer itself must detect the separated signals, form the desired signal ratios, and display the results.

### Signal Sources and Signal Separation

In the general case, any sine wave source meeting the network analyzer's specifications can be used to stimulate the device under test. For CW measurements a simple oscillator may suffice; for greater CW frequency accuracy a signal generator or synthesizer may also be desirable. If the analyzer is capable of swept measurements, great economies in time can be achieved by stimulating the device under test with a sweep oscillator or sweeping synthesizer. This allows quick and easy characterization of devices over broad frequency ranges. Some network analyzers will operate only with a companion source which both stimulates the device under test and acts as the analyzer's local oscillator.

At low frequencies it is not particularly difficult to separate the appropriate voltages and currents required for transfer and impedance function measurements. Signal separation is merely the process of establishing the proper shorts, opens, and connections at

the measurement ports of the device under test. As frequencies increase, the problem of signal separation usually involves traveling waves on transmission lines and becomes correspondingly more difficult. Hewlett-Packard manufactures test sets (often called "transducers") applicable for separating the appropriate traveling waves in a variety of high frequency measurements.

### Broadband and Narrowband Detection

After the desired signals have been obtained from the test set (or transducer) they must be detected by the network analyzer; HP network analyzers can use one of two detection methods. Broadband detection accepts the full frequency spectrum of the input signal while narrowband detection involves tuned receivers which convert CW or swept RF signals to a constant IF signal. There are certain advantages to each detection scheme.

Broadband detection reduces instrument cost by eliminating the IF section required by narrowband analyzers but sacrifices noise and harmonic rejection. However, noise is not a factor in many applications, and careful measurement techniques, using filters, can eliminate harmonic signals that would otherwise preclude accurate measurements. Broadband systems are generally source independent while some narrowband systems require companion tracking sources. Finally, broadband systems can make measurements where the input and output signals are not of the same frequency, as in the measurement of the insertion loss of mixers and frequency doublers. Narrowband systems cannot make these measurements.

Narrowband detection makes a more sensitive low noise detection of the constant IF possible. This allows increased accuracy and dynamic range for frequency selective measurements (as compared to broadband systems) and high resolution through IF substitution using precision IF attenuators. Source dependent narrowband systems utilize a companion tracking source not only to stimulate the device under test, but also to produce a signal offset from the RF by a fixed frequency for tuning the analyzer's constant IF.

### Signal Processing and Display

Once the RF has been detected, the network analyzer must process the detected signals and display the measured quantities. All HP network analyzers are multi-channel receivers utilizing a reference channel and at least one test channel; absolute signal levels in the channels, relative signal levels (ratios) between the channels, or relative phase difference between channels can be measured depending on the analyzer. Using these measured quantities, it is possible to either display directly as shown in Figure 2, or compute the magnitude and phase of transfer or impedance functions.

Magnitude measurements fall into two categories, relative and absolute; absolute measurements involve the exact signal level in each channel while relative measurements involve the ratios of the two signal channels.

Absolute measurements are usually expressed in voltage (dBV) or in power (dBm). The units dBV are derived by taking the log ratio of an unknown signal in volts to a one volt reference. Similarly, dBm is the log ratio of unknown signal power to a one milliwatt reference.

Relative ratio measurements are usually made in dB, which is the log ratio of an unknown signal (Test Channel) with a chosen reference signal (Reference Channel). This allows the full dynamic range of the instrumentation to be used in measuring variations of both high and low level circuit responses. For example, 0 dB implies the two signal levels have a ratio of unity while  $\pm 20$  dB implies a 10:1 voltage ratio between two signals.

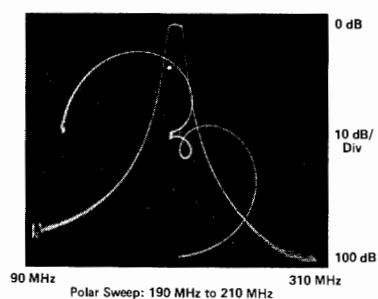

Figure 3. Simultaneous measurement of transmission response and passband reflection coefficient

All network analyzer phase measurements are relative measurements with the reference channel signal considered to have zero phase. The analyzer then measures the phase difference of the test channel with respect to the reference channel.

Measurement results at CW frequencies may be displayed on analog meters, LEDs or computer controlled printers. Swept frequency measurements of amplitude and phase may be displayed versus frequency on CRTs or X-Y plotters. Insertion Loss is displayed in two different ways in Figure 4. The addition of digital storage and normalization to network analyzer CRT's assures flicker-free traces and removal of frequency response errors for fast, real-time displays of test device responses versus frequency.

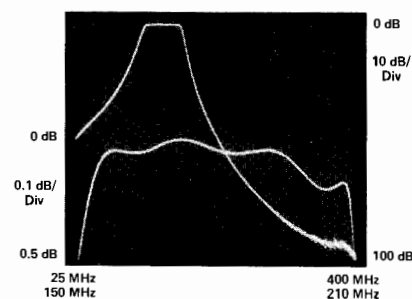

Figure 4. Simultaneous measurement of filter passband and skirts using alternate sweep





### Low Frequency Network Analysis

Networks operating at frequencies below 10 MHz are generally characterized by measuring the gain and phase changes through the network and the associated input and output impedances; h, y, and z-parameters as well as other lumped-component models are typical analytical and computational tools used to represent these measurements. The first derivative of phase with respect to frequency, group delay, is an important measurement of distortion in communication systems. Hewlett-Packard produces a broad line of instrumentation capable of measuring all of these parameters.

Phase information complements amplitude data in the measurement of low frequency parameters. Phase is more sensitive to network behavior and it is a required component of complex impedance and transfer functions. For instance, phase is required to determine the frequency of network resonances (poles) and anti-resonances (zeroes). This is because the phase shift of a network transfer function is exactly zero at the frequency of resonance. Phase information is also vital in circuit design, particularly loop design, where phase margins are critical.

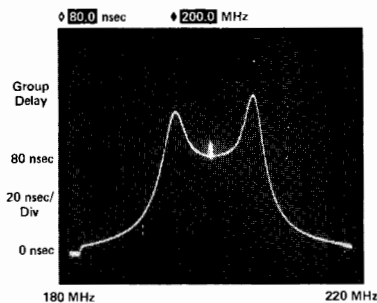

Figure 5. Direct Measurement of Group Delay with digital readout at marker

Phase data is also required to measure delay distortion or group delay of networks. Delay distortion occurs when different frequency components of a complex waveform experience nonlinear phase shifts as they are transmitted through a network. Group delay is a measure of this distortion and is defined as:

$$T_g = -\frac{d\theta}{d\omega}$$

There are several techniques for measuring group delay; the most common techniques are phase slope, amplitude modulation, frequency modulation, and frequency deviation. Most HP network analyzers can make measurements with at least one of these techniques while several analyzers measure and display group delay directly. Choice of a group delay measurement technique is dependent on the particular device under test and the resolution required.

An alternative method for measuring phase distortion is deviation from linear phase or differential phase. Deviations from linear phase can be measured by introducing enough electrical length in the network analyzer's reference channel to linearize a device's phase shift. Once this has been accom-

plished it is possible to observe any variations in phase shift linearity at high resolution. Since group delay is the derivative of phase ( $d\theta/d\omega$ ), nonlinearities in phase shift correspond directly to changes in a device's group delay. Figure 6 shows deviation from linear phase and group delay. Introduction of electrical length in the measurement channel may be accomplished by physically adding cable, or it may be accomplished electronically on some network analyzers.

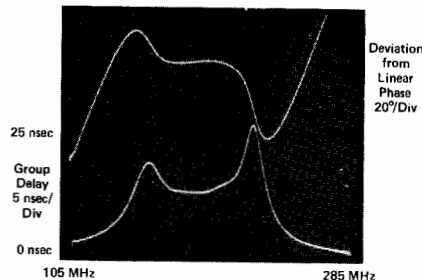

Figure 6. Two independent techniques for measuring filter phase distortion

At lower frequency (typically  $\leq 50$  kHz) digital signal analysis using Fast Fourier Transformations (FFT) can also be used to determine the magnitude and phase of transfer characteristics. This subject is treated in the Analysis section of this catalog.

### High Frequency Network Analysis

Measurements of voltages and currents become more and more difficult as frequency increases. Consequently, H, Y, and Z parameters lose their usefulness at high frequencies. High frequency network behavior can be better described using transmission line theory in terms of forward and reverse traveling waves. Thus, travelling waves make a logical replacement for voltages and currents in high frequency measurements.

Scattering parameters or S-parameters were developed to characterize linear networks at high frequencies. S-parameters define the ratios of reflected and transmitted traveling waves measured at the network ports. A two-port device is modeled with S-parameters in Figure 7.  $S_{11}$  is the complex reflection coefficient at port 1 and is the ratio of  $E_r/E_i$ , if  $E_{i2} = 0$  (port 2 terminated in its characteristic impedance).  $S_{21}$  is the complex transmission coefficient from port 1 to port 2,  $E_{t2}/E_{i1}$ , if  $E_{i2} = 0$ .  $E_i$  and  $E_r$  represent the amplitude and phase of the incident and

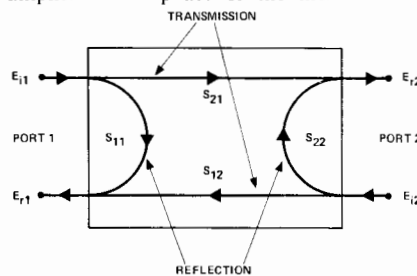

Figure 7. S-parameter model for a two-port linear network

emerging or reflected traveling waves. By reversing the ports and terminating port 1 in its characteristic impedance,  $S_{22}$  and  $S_{12}$  can be similarly defined. From these definitions, the following equations can be derived:

$$E_{r1} = S_{11}E_{i1} + S_{12}E_{i2}$$

$$E_{r2} = S_{21}E_{i1} + S_{22}E_{i2}$$

where incident signals act as independent variables determining the signals leaving the network. The definition of an S-parameter can be easily extended to multiport networks; measurement is also easily accomplished by terminating additional ports in their characteristic impedances. Thus, S-parameters completely describe linear network behavior in the same manner as low frequency parameters.

S-parameters offer numerous advantages to the microwave engineer because they are both easy to use and easy to measure. They are easy to measure because the device is terminated in its characteristic impedance allowing swept broadband frequency measurement without tuning, enhancing the stability of active devices, and permitting a test set up to be used for different devices. The design process is simplified because S-parameters are directly applicable to flow graph analysis. HP network analyzers and the appropriate test sets will measure and directly display  $S_{21}$  or  $S_{12}$  as gain or attenuation and  $S_{11}$  or  $S_{22}$  as reflection coefficient, return loss or impedance. Figure 8 shows measurements of both  $S_{21}$  and  $S_{11}$ . Also, S-parameters may be directly related to h, y, and z-parameters through algebraic transformations.

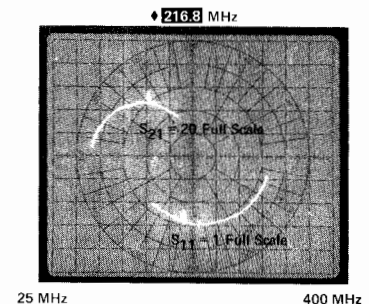

Figure 8. Simultaneous measurement of transistor S-parameters

### Additional Capabilities

The computational capabilities of a digital computer can complement the network analyzer's versatility through simplifying and speeding measurements, data processing, and accuracy enhancement. Hewlett-Packard has combined network analyzers and computers into measurement systems and now offers some analyzers that may be easily interfaced with HP desktop computers through the Hewlett-Packard Interface Bus.

Precision design work and manufacturing tolerances demand highly accurate measurements, but most errors in network measurements are complex quantities that vary as a function of frequency, making manual error correction prohibitive. However, the computer can make great contributions to measurement accuracy by quickly and easily performing the complex mathematics for sophisticated error correction.

Aside from new levels of accuracy, computer controlled network analyzers can be programmed to set up and make many measurements automatically. The measurement process is further accelerated by the computer's ability to store, transform, summarize, and output data in a variety of formats to a number of peripherals. These capabilities make the computer controlled network analyzer ideal for both computer aided design or automatic production testing.

**Network Analyzer Product Line**

Hewlett-Packard offers a complete line of network analyzers capable of measurements through the 1 Hz to 40 GHz frequency range. Further information and detailed specifications on individual network analyzers are available on the following pages (see matrix on following page for specific page numbers).

**3575A**

The 3575A measures Phase and Amplitude or Gain. With the 3575A, the complete response picture is available at a reasonable cost from a single instrument, over an 80 dB range, from 1 Hz to 13 MHz. The 3575A uses a broadband measurement technique, which is attractive because the measurement is not constrained by internal tracking source or dedicated external device. The 3575A is not dependent on the wave shape, thus measurements can be made on a variety of waveforms such as triangle and square waves.

**3040A / 3042A**

The 3040A is a network analysis system capable of measuring amplitude, phase, and group delay to 13 MHz. The system consists of a synthesizer signal source and a two-channel tracking detector. Measurement applications include filter design and production, amplifier testing, delay measurements on communication devices, and measurements on any linear two-port device.

The 3042A is a fully automatic system which uses the HP 9825T Desktop Computer as a computing controller. The memory, computational power and decision-making power of the computing controller extend the measurement solutions to complex networks in the lab or rapid production line testing. Accuracy can be improved by subtracting system errors from the measurements by using the memory and algebraic powers of the computer and supplied software.

**8407A**

The 8407A Network Analyzer tracks the 8601A generator/sweeper (or the 8690B/8698B sweeper) from 100 kHz to 110 MHz. Measurement capabilities include:

- 1) Transmission (gain, loss, phase shift) and reflection (return loss, impedance) measured quickly and easily in either 50 Ω or 75 Ω by sweeping over the frequency range of interest.
- 2) Complex impedance [Z], θ, or  $R \pm jX$  over the wide impedance range 0.1 Ω to >10 kΩ.

- 3) Voltage and current transfer functions.
- 4) High impedance in-circuit probing.

A rectangular and polar display and various CRT overlays permit direct readings of parameters of interest as frequency is swept. Applications are detailed in Application Notes 121-1 and 121-2.

**8405A**

The 8405A Vector Voltmeter is a dual-channel RF millivoltmeter and phasemeter. It reads the absolute voltages on either of two channels and simultaneously determines the phase relationship between them. CW measurements can be made over the frequency range 1 MHz to 1 GHz.

Besides its use as a voltmeter, applications of the 8405A include:

- 1) Transmission measurements (gain, loss, phase shift and return loss) in 50 Ω systems.
- 2) Group delay and amplitude modulation index.
- 3) In-circuit probing.
- 4) S-parameters in 50 Ω systems.

Application Notes 77-1, 77-3, 77-4, and 91 are available for more detail on the above measurements.

**8754A**

The 8754A is a completely integrated stimulus/response system for testing a wide variety of networks (like filters, amplifiers, and attenuators) in the 4 to 2600 MHz frequency range. By combining a swept source, three channel tuned receiver, and polar/rectilinear CRT display into a single compact package, outstanding performance can be achieved at an economical price. Magnitude, phase, polar reflection coefficient and impedance are all measured directly over 80 dB of spurious free dynamic range. Frequency accuracy is provided by a crystal marker system and since three receiver inputs are available, network transmission and reflection parameters can be measured simultaneously. Additionally, a complete line of 50 Ω and 75 Ω power splitters, transmission/reflection test sets, and S-parameter test sets, are available. High impedance probe can also be used if necessary and an external signal generator can be used directly to characterize narrow-band devices like crystal filters.

**8505A / 8507B / 8507C**

The 8505A Network Analyzer provides measurement capability from 500 kHz to 1.3 GHz. Three RF input ports, each with 100 dB of dynamic range, make possible simultaneous network measurements of reflection and transmission parameters. Two independent yet identical display channels are each capable of displaying magnitude, phase, deviation from linear phase and group delay of either the transmission or reflection characteristics of an RF network. These parameters can be displayed in rectangular, in polar coordinates or both formats at the same time. The swept source, which is an integral part of the analyzer, offers extreme frequency

flexibility through seven different modes of operation.

The 8507B and 8507C are Automatic Network Analyzers using the 8505A with HP-IB interface and HP Desktop Computers as controllers. The "Learn" mode of operation extends the traditional automatic operation to a new level of operator convenience. Accuracy enhancement, formatting of data, and the speed and ease with which data can be accumulated and summarized are all network measurement contributions made by the 8507B and 8507C.

**8410C / 8408B / 8409C**

The 8410C network analyzer system measures the transmission and reflection characteristics of linear networks in the form of gain, attenuation phase shift, reflection coefficient, normalized impedance and S-parameters in the frequency range of 110 MHz to 40 GHz.

The 8410C is a ratiometer using both reference and test signal inputs; consequently, the sweeper output must be divided into channels. This is accomplished by a "Test Set" whose other major function can be to provide the switching required for making transmission and reflection measurements with minimum or no changes in the measurement setup. Hewlett-Packard offers test sets covering various frequency ranges and switching functions.

Another major instrument required in the 8410 measurement system is a unit for the detection and display of the IF amplitude and phase. Three plug-in displays (for the 8410C mainframe) are available for this purpose: a phase-gain indicator with meter readouts for CW measurements; a phase-gain display for displaying log amplitude and phase versus frequency; and a polar display for displaying amplitude and phase in polar coordinates.

The 8410C is capable of swept measurements over multi-octave bands through 18 GHz. Between 18 GHz and 40 GHz, 2 GHz windows may be viewed. Measurements of more than 60 dB of attenuation and 40 dB of gain are possible.

The 8409C Automatic Network Analyzer System is a practical solution to the need for automatic error-corrected RF and microwave network measurements using a simple and economical configuration. It is a complete measurement system consisting of the programmable 8350A Sweeper, the 8410C Network Analyzer System, and the 9845B, 9826A or 9836A Desktop Computer. It brings the major advantages in accuracy, speed, data collection, and operating convenience at a modest cost increase over the manual network analyzer system. Further information is available in Application Notes 117-1, 117-2 and 221A.

The 8408B is a low cost, programmable network measurement system based on the 8410C Network Analyzer, the 8350A Sweeper and the 85F Desktop Computer. Using automatic error correction techniques, primarily in reflection, the 8408B offers the capability of making more accurate measurements than with the 8410C manual system.



# NETWORK ANALYZERS

## Complete Characterization of Linear Networks (Cont.)

### Network Analyzer Product Line Summary

Model	Frequency Range	Source	Measurement Capabilities
3582A Spectrum Analyzer Page 560	20 mHz to 25.599 kHz	Built-in source that is selectable as either random or pseudorandom. The noise signal is automatically band-limited and band-translated to match the analysis.	Transfer function amplitude and phase. Coherence function. Transient capture and analysis.
5420A Digital Signal Analyzer Page 568	16 mHz–25.6 kHz	Built-in random noise source.	Transfer function, coherence, power spectral density, Histogram, time record average, impulse response.
5451C Fourier Analyzer Page 570	DC to 50 kHz	Optional random pseudo-random or periodic source.	Same as 5420A
3575A Gain Phase Meter Page 486	1 Hz–13 MHz	None	Gain, Phase and Amplitude Low Frequency Analysis
3040A Manual Network Analyzer Page 483	50 Hz–13 MHz	3320B or 3330B Synthesizer	Amplitude and Phase Group Delay Gain or Loss Linear Frequency Sweep
3042A Automatic Network Analyzer Page 484	50 Hz–13 MHz	3330B Synthesizer	9825T Desktop Computer as Systems Controller Complex Network Analysis Decision Making Ability Computational Capability
8407A Network Analyzer Page 446	100 kHz–110 MHz	8601A Generator / Sweeper 8690B/8698B Sweep Oscillator	Transfer Functions, Impedance in 50 $\Omega$ , 75 $\Omega$ Systems Complex Impedance 0.1 $\Omega$ to >10 k $\Omega$ High Impedance In-Circuit Probing S-parameters in 50 $\Omega$ , 75 $\Omega$ systems
8405A Vector Voltmeter Page 448	1 MHz–1 GHz (CW)	3200B Oscillator, VHF Signal Generators, 8654 (UHF), and 8640 A/B	Voltmeter Transfer Functions, Impedance in 50 $\Omega$ systems Group Delay, Amplitude Modulation Index S-parameters in 50 $\Omega$ systems
8754A Network Analyzer Page 436	4–2600 MHz	Swept source included external source usable.	Magnitude and phase transmission coefficient reflection coefficient and return loss S-parameters, impedance.
8505A RF Network Analyzer Page 438	500 kHz–1.3 GHz	Swept Source Included	Complex Transfer functions—Gain/Loss or S-parameters Complex Impedance— $\Gamma$ , Return Loss, $R \pm jX$ Distortion—Group Delay, Deviation from Linear Phase Digital Readout of Data while sweeping Frequency Counter included HP-IB with Learn Mode
8507B and 8507C Automatic Network Analyzers Page 444	500 kHz to 1300 MHz	Swept Source Included	8507B: 9825T Desktop Computer with 8505A and 8501A 8507C: 9845B Desktop Computer with 8505A and 8501A Automatic Measurements with Data Formatting and Graphics. Error Corrected Measurements
8410C Network Analyzer Page 450	110 MHz–40 GHz	8350, 8620, 8690 Series Sweep Oscillators	Transmission/Reflection Characteristics, S-Parameters 50 $\Omega$ Coax Measurements 110 MHz to 18 GHz Waveguide Measurements 8.2 GHz to 40 GHz Continuous Multioctave Measurements with 8620 and 8350 Series Sweepers DC Bias for Semiconductor Measurements
8409C Automatic Network Analyzer Page 459	110 MHz–18 GHz	8350 or 8620 Series Sweep Oscillators	Automatic Transmission/Reflection Measurements Full Error Correction in Transmission/Reflection Measurements 8410C Network Analyzer System 9826A/9836A or 9845B Desktop Computer
8408B Automatic Network Analyzer Page 458	110 MHz–18 GHz	8350 or 8620 Series Sweep Oscillators	Automatic Transmission/Reflection Measurements Full Error Correction in Reflection Measurements Tracking Error Correction in Transmission Measurements 8410C Network Analyzer System 85F Desktop Computer

# NETWORK ANALYZERS

## Network Analysis From 50 Hz to 13 MHz

Model 3040A



- High resolution digital amplitude, phase and group delay measurements
- 100 dB dynamic range
- Synthesizer frequency accuracy and stability

- Precision digital sweep capability
- Narrow band analysis
- Full digital control via HP-IB

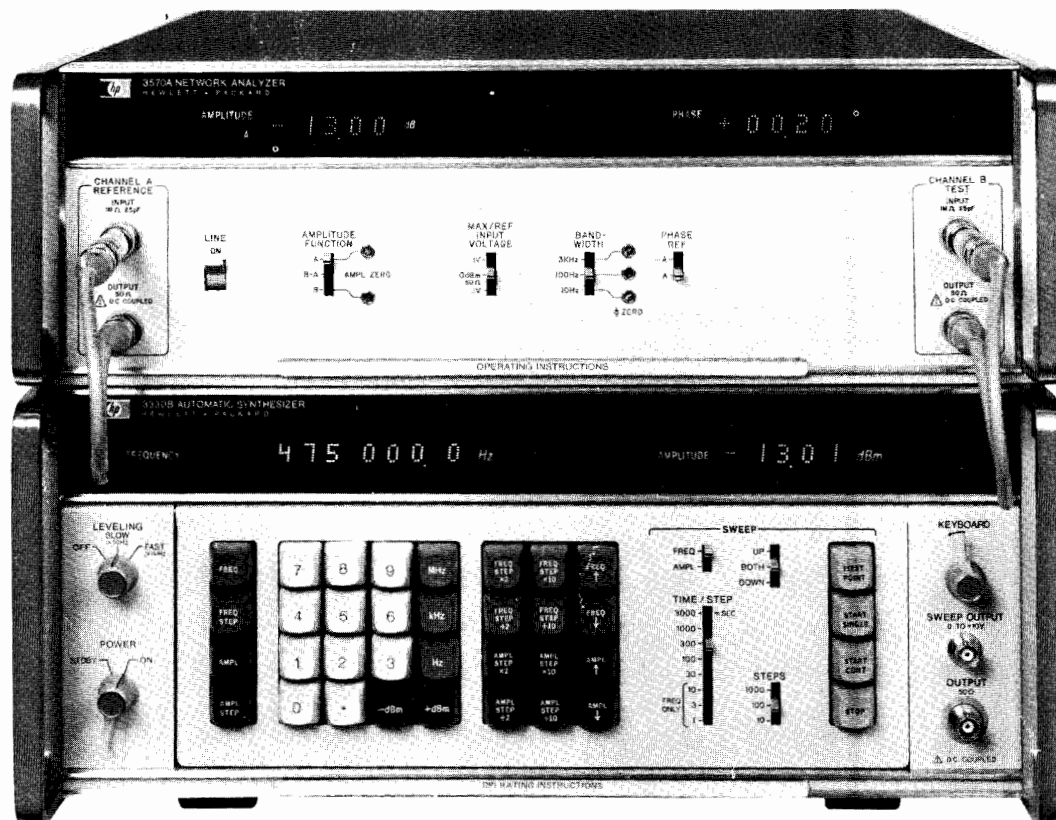

### Description

The 3040A Network Analyzer is designed to meet the demand for precise and fast characterization of both active and passive linear two-port devices. The Network Analyzer is a powerful bench system that makes digital amplitude, phase and group delay response measurements over a 50 Hz to 13 MHz frequency range. It uses the 3330B Automatic Synthesizer with leveled output and digital sweep capability to generate the local oscillator signal for the 3570A Tracking Receiver and to provide the stimulus to the device under test.

This system effectively combines the wide dynamic range and the high accuracy of the 3570A Tracking Receiver with the high resolution and stability of the 3330B Synthesizer, giving design, production and Q.A. engineers working at audio, video and RF frequencies the precision, convenience, and high information content of digital swept-frequency response measurements, but with the point by point accuracy of synthesized incremental frequency sweeps.

Residual FM, often a serious limitation to the frequency resolution of swept frequency measurements, is very low ( $\ll 1$  Hz) in the 3040A System, allowing accurate narrow band sweeps.

The 3570A Analyzer (Tracking Receiver) has two identical channels for fast, high accuracy "B-A" measurements of gain or insertion loss of two-port devices and to measure the phase shift between input and output ports. It can also function as a limit comparator to determine how closely the gain and phase response of a device matches that of a reference.

Both the passband and the stopband of a device can be examined in detail because the 3570A Analyzer has both a wide amplitude range of 120 dB (1  $\mu$ V to 1 V) and a high resolution display (0.01 dB increments). The digital readout also displays phase readings with 0.01° resolution.

Beyond the basic amplitude and phase measurements, the 3040A offers several automatic features not found in more conventional network analyzers.

**One is Digital Offset:** Values of amplitude and/or phase measured on a reference device are stored in the instrument's memory at the push of a button. Future measurements can then be displayed relative to the stored values. This could be used, for example, to quickly find the -3 dB passband limits of a filter or amplifier.

**Another feature is Group Delay:** As the synthesizer is stepped in frequency, the analyzer's internal digital processor calculates group delay from two phase shift measurements as  $T_d = \Delta\theta/360\Delta f$  sec.

**A third one is Limit Test:** High and low limits can be entered as digital words from an external controller. The analyzer can be set to stop or output a marker when a limit is reached. This capability is useful, for example, to precisely find the center frequency of a resonant circuit by stopping at the 0° phase reading.

The 3040A Network Analyzer introduces precision, convenience and built-in "intelligence" to the problem of characterizing the behavior of linear networks on the bench.



# NETWORK ANALYZERS

Automatic Network Analysis From 50 Hz to 13 MHz

Model 3042A

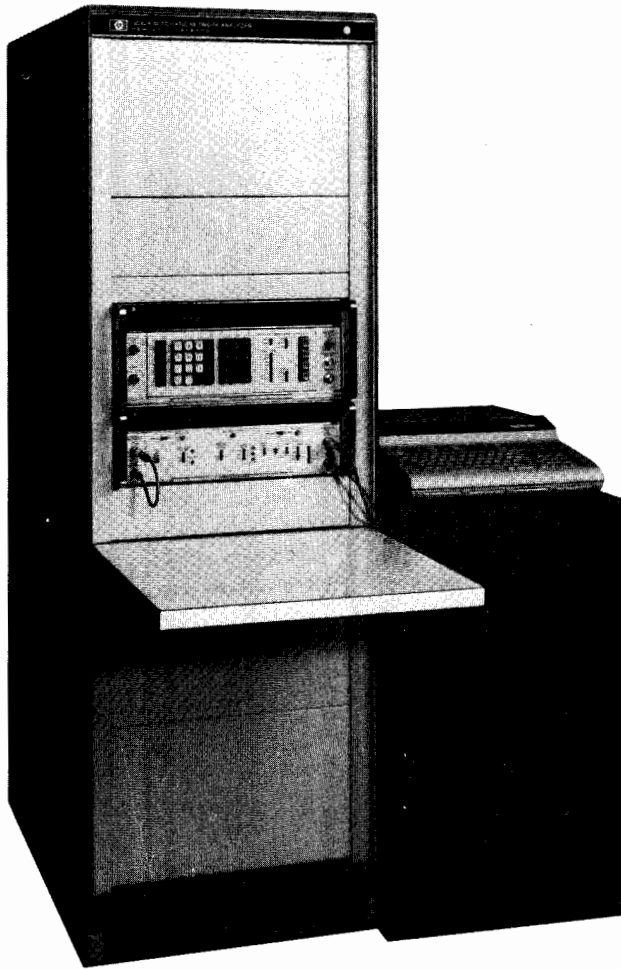

3042A Automatic Network Analyzer



## Description

The 3042A is an automatic network analyzer system that greatly improves the capabilities of the 3040A Manual Network Analyzer by adding the control and computational power of the 9825T Desktop Computer. The 9825T adds speed, automation, enhanced accuracy, and simple operation to the precise amplitude, phase and group delay measurement performance of the 3040A. The versatility of the 9825T allows on-line data analysis, data reduction and decision making capability plus formatted graphic or tabular representation of results or data storage for further processing at a later time.

Environments such as production, quality assurance and the laboratory are now provided with the capability of extending precision network analysis to applications that were previously impractical because of the length of time it took to make the necessary measurements.

### Production Applications

In production applications the 3042A substantially reduces the time and cost of making a range of simple or complicated tests on all types of components (e.g., crystals, amplifiers, filters and other analog devices). The system can run through a long series of tests on a device, checking performance at all specified points and deliver a simple pass/fail answer. Additionally, automatically compiled test data provides excellent statistics for improved production control, more precise scheduling and accurate production cost analysis.

- Full automation and low cost
- Speed and precision in measurements
- Accuracy enhancement of results
- Data analysis and presentation of results
- Simplicity and flexibility in operation
- HP-IB systems interfacing
- 9825T Desktop Computer

Test programs with built-in operator instructions minimize requirements for highly trained technicians, and uniform test procedures may easily be established.

### Quality Assurance Applications

In quality assurance applications, the 3042A significantly reduces the cost of test equipment necessary to assure a comprehensive product testing job. In addition, the system's inherently flexible HP-IB interface structure allows the system configuration to be easily adapted by either simple software modifications or hardware additions. Skilled technicians may be relieved from repetitive yet demanding tasks and placed in positions that maximize the use of their knowledge and skills. The 3042A provides reliable and repeatable results. Various parameters may be tested in greater detail and in less time, resulting in greater product confidence and quality, and lower warranty costs. Also, automatically compiled test data provides excellent statistical data for identifying problem areas.

### Laboratory Applications

In laboratory applications, engineers gain greater insight into their circuit design due to the speed and ease with which data can be accumulated and summarized with the 3042A. The easy-to-use programming format allows easy-to-write, customized programs which solve specialized measurement problems in a fraction of the time required to manually perform and evaluate the same measurements. In addition, the accuracy enhancement software furnished with the 3042A System increases accuracy of the system seven times over that of a single channel measurement (three times over a "B-A" measurement).

### System Control and Interface

The 3042A Automatic Network Analyzer incorporates the 9825T Desktop Computer as system controller, operator interface and data processor. The 9825T offers the power and speed of much larger computers but features a high level programming language and editing capabilities that allow nearly instant use of the system with minimal effort. System-operator interface is greatly simplified through the 9825T's alphanumeric display and typewriter-like keyboard.

### Summary

The 3042A Automatic Network Analyzer provides a complete solution to production, quality assurance and laboratory applications at audio, video and RF frequencies with accurate, reliable, repeatable and fast results plus the high information content that automatic gain-phase-delay measurements can give.

### Specifications 3040A and 3042A Systems

**Sources** (Channel A & B outputs are isolated and electrically identical)

#### Frequency

**Range:** 0.1 to 13,000,999.9 Hz.

**Resolution:** 0.1 Hz (9 digits).

#### Amplitude

**Range:** +13.44 to -86.55 dBm (50 Ω).

+11.68 to -88.31 dBm (75 Ω option).

**Resolution:** 0.01 dB.

#### Accuracy

**Leveled frequency response (10 kHz reference)\***

10 Hz	13 MHz	
±0.45 dB		+13.44 dBm
±0.5 dB		-16.55 dBm
±0.6 dB		-36.55 dBm
±0.6 dB		-66.55 dBm
±0.8 dB		-86.55 dBm

\*Add 0.5 dB for leveling switch in off position.

**Attenuator:** (10 kHz reference, 25°C ± 5°C) ±0.02 dB/10 dB step of attenuation down from maximum output.

**Absolute:** (10 kHz, maximum output, 25°C ± 5°C) ±0.45 dB.

**Stability:** (24 hr., 25°C ± 1°C): ±0.01 dB.

**Impedance:** 50 or 75 Ω (optional) ±2%.

**Receivers** (Channel A & B inputs are electrically identical and both tuned precisely to the signal source's frequency)

#### Frequency

**Range:** 50 Hz to 13 MHz.

**Resolution:** 0.1 Hz.

**Selectivity:** 10 Hz, 100 Hz and 3 kHz bandwidths (60 dB/3 dB bandwidths, 20:1).

**Amplitude:** (Output is in dB relative to 1 V, 0 dBm or 0.1 V, corresponding to the position of the "Max/Ref Input Voltage" switch.)

**Measurement range:** 1 V rms to 1 μV rms.

**Dynamic range:** 0 to -100 dB (using A or B amplitude function), -100 dB to +100 dB (using B-A amplitude function).

**Resolution:** 0.01 dB.

**Accuracy:** (25°C ± 5°C): Accuracy of the 3042A is enhanced with software supplied with the system from 50 Hz to 10 MHz and over the top 20 dB of the dynamic range as shown below.

**Frequency response:** A or B "Amplitude Function" ±0.5 dB; B-A "Amplitude Function" ±0.1 dB; using Accuracy Enhancement Software ±0.03 dB furnished with 3042A system.

### Linearity: (A or B amplitude function)

0 to -20 dB	±0.2 dB
	±0.06 dB with Accuracy Enhancement
-20 to -80 dB*	±0.5 dB
-80 to -100 dB*	±1.5 dB

\*Only specified to -70 dB for 3 kHz bandwidth.

### Stability (8 hr., 25°C ± 1°C after 3 hr. warmup)

	Temp. Coefficient (20°C-30°C)		
100 Hz & 3 kHz BW	±0.05 dB	±0.08 dB	±0.02 dB/°C
10 kHz BW	±0.08 dB	±0.15 dB	±0.05 dB/°C
	0 dB	-20 dB	-80 dB

### Phase (Phase Reference is Channel A)

**Range:** -179.5° to +179.5° (display recycles).

**Resolution:** 0.01°.

**Accuracy:** (25°C ± 5°C).

**Frequency response (Channel at 0 dB)**

	±0.8°	±0.2°	±1°
50 Hz	100 Hz	1 MHz	13 MHz

**Amplitude response Channel B within 6 dB of Channel A**

0 dB	-20 dB	-70 dB	-80 dB
	±0.4°	±0.6°	±1°

For channels at different levels (specification determination by lowest input).

0 dB	-20 dB	-60 dB	-80 dB*
	±1.3°	±1.5°	±3.5°

\*Only specified to -70 dB for frequencies from 50 Hz to 60 kHz.

**Linearity:** ±0.2° (Channel B within 6 dB of Channel A).

**Input impedance:** 1 MΩ ± 2% shunted by <30 pF.

### General

**Programmability:** all controls, except power switches, are programmable using the HP-IB format.

**Ultra-high accuracy:** the 3040A/3042A systems can be coupled with an external device such as a calibrated attenuator to provide relative measurements whose amplitude accuracy is limited to the amplitude stability of the receiver and source and the accuracy of the external device.

### 3040A Options

The basic 3040A system options are listed below. For more information refer to the 3040A/3042A data sheet.

(Order Opt 110 or 111 and Opt 120 or 121)

**110:** standard 50 Ω 3570A

**111:** standard 75 Ω 3570A

(Options 110 and 111 include Delay/Limit Test/Offset and Cable Lead Kit)

**120:** standard 50 Ω 3330B

**121:** standard 75 Ω 3330B

### 3042A Automatic Network Analyzer

Consisting of: 3330B Synthesizer, 3570A Network Analyzer, 9825T with 64 kBytes of memory, ROMs, Interface and documentation, 56" Rack.

### 3042A Options

The basic 3042A system options are listed below. For more information refer to the 3040A/3042A data sheet

**200:** 50 Ω System

**201:** 75 Ω System

The 3042 system is fully integrated, tested, verified and specified as a system. It is supplied with complete software and documentation.

# NETWORK ANALYZERS

**Gain/Phase Meter**  
Model 3575A

- dBV, dB ratio and degrees from 1 Hz to 13 MHz

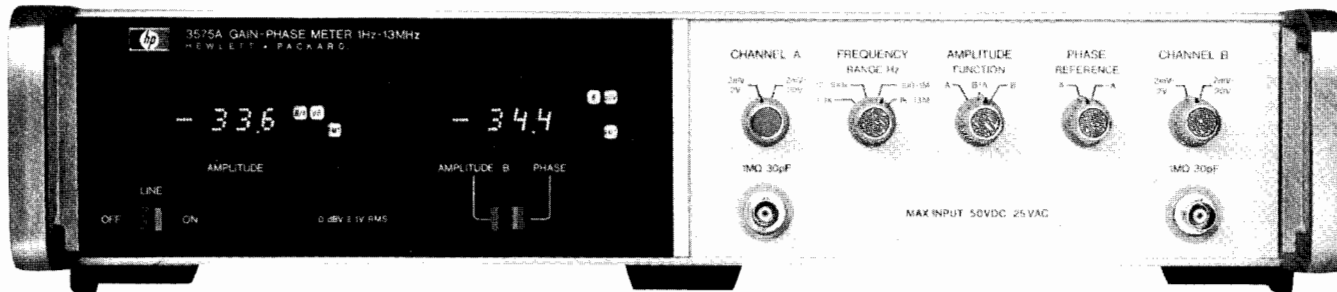

3575A Option 001 dual panel meters

## Description

The HP 3575A Gain-Phase Meter is a versatile two-channel analyzer which can measure and display the absolute amplitude level or amplitude ratio of signals present at the inputs. In addition, the 3575A can measure the phase relationship of the two signals. This analyzer is a broadband detector, which is easy to use because no frequency tuning is required.

Since a dedicated tracking source is not required to operate with the 3575A, a wide selection of stimuli is possible. This flexibility coupled with a variety of possible amplitude, gain and phase outputs (LED display, analog outputs, and optional BCD) give you a wide choice of cost/results tradeoffs. For example, you may wish to manually plot your network response data on a Bode diagram in which case a low cost sine wave oscillator stimulus may be used. For easier, quicker results you may select a sweeping oscillator and an x-y plotter and let the instruments plot your response. You may use a calculator or computer to control a programmable stimulus source and the 3575A to provide automatic measurements. Here you have a wide range of computation and output possibilities.

## Phase

The phase relationship of two signals is indicated over a range of  $\pm 192$  degrees with 0.1 degree resolution. A unique logic circuit (patent) design allows the 3575A to make stable phase measurements in the presence of noise. This feature minimizes the error to less than two degrees for a signal-to-noise ratio of 30 dB. One of three band limiting filters may be selected to get further noise rejection.

The 3575A is also capable of measuring the phase relationship of a variety of waveforms, such as square waves and triangle waves. Even harmonic and in-phase odd harmonic components of these signals cause no phase measurement error. For out-of-phase odd harmonic signal-to-harmonic ratios of 40 dB, measurement errors are less than 0.6 degree as shown in Figure 1.

## Amplitude

The amplitude of either channel or the ratio of the two can be measured over an 80 dB dynamic range and 100 dB measurement range. Resolution is 0.1 dB. Results are displayed in dBV for channel amplitude and dB for ratio measurements. Digit blanking and channel overload annunciators will turn on if the maximum allowable signal level at either channel input is exceeded.

## Readout

The standard three-digit LED display may be selected by the operator to indicate the amplitude of channel A or B, gain or phase. A second three-digit LED display is optionally available for simultaneous display of amplitude and phase readings. Lighted annunciators identify the measurement function, units and remote status.

## Programmable

Two programmable options both offer full control of front panel functions and BCD output of information (amplitude, ratio or phase) contained in both digital displays. The two options give the user a choice of negative true or positive true outputs.

## Applications

The 3575A can solve network analysis problems in the 1 Hz to 13 MHz frequency range where complex measurements (gain or phase or both) are required. A few of the many measurements it can make are: gain and phase response of feedback systems, envelope delay and return loss of transmission lines, complex impedance of components, and insertion loss of mixers and frequency doublers. Bode plots and Nichols charts are useful graphical tools for analyzing many of these response data.

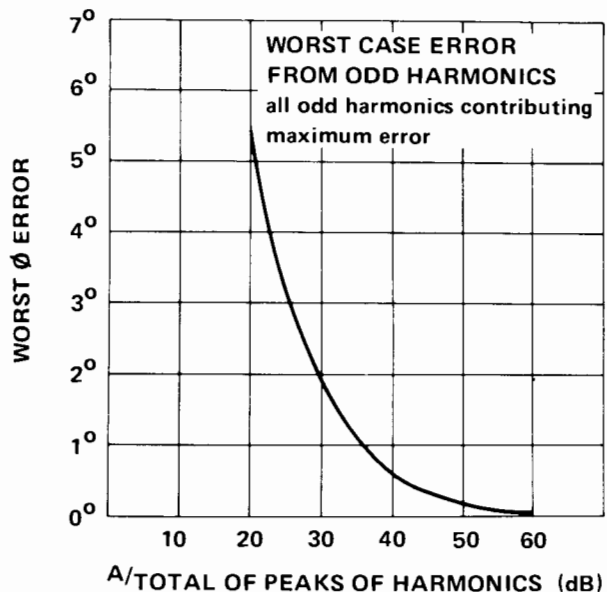
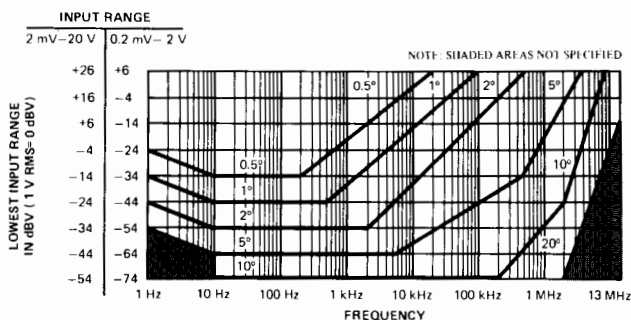

Figure 1. Worst case error from odd harmonics.

## Specifications

### Phase Accuracy\*



\*Conditions: Temperature: 25°C ± 10°C; Frequency range switch on lowest applicable range; Analog Output accuracy (rear panel).

Input signal range: 200 μV rms to 20 V rms.

### Harmonic Rejection

**Even harmonics:** no error.

**Odd harmonics:** (in phase) no error.

**Odd harmonics:** (out of phase) 0.57° worst case error when total odd harmonic distortion is 40 dB below the fundamental.

**Noise tolerance:** 2° error for a 10 kHz, 1 V sine wave on one channel. One volt sine wave added to Gaussian noise (limited to a 1 MHz bandwidth and 30 dB S/N ratio) on the other channel. The 100 Hz to 1 MHz frequency range was used.

### Display

**Range:** ± 180° with 12° of overrange.

**Resolution:** 0.1°.

**Panel meter accuracy:** ± 3 counts (0.3 degrees/dB/dBV). The panel meter error must be added to the phase and amplitude errors to obtain the display error.

### Inputs

**Impedance:** 1 MΩ 30 pF.

**Protection:** ± 50 V dc, 25 V rms.

**Response time to achieve 95% of final reading**

Frequency Range	Time
1 Hz to 1 kHz	20 s
10 Hz to 100 kHz	2 s
100 Hz to 1 MHz	0.2 s
1 kHz to 13 MHz	20 ms

Rear terminal inputs are available as a special (3575A-C09). Digital (Opt. 002). 0, +5 V; ground true. Twelve lines to fully program all functions.

### Outputs

#### Analog

**Phase:** 10 mV/degree.

**Amplitude:** 10 mV/dB or dBV.

**Output impedance:** 1 kΩ

**Digital (Opt 002):** 0, +5 V; ground true. 31 output lines (1-2-4-8 BCD).

**Digital readout:** 3½ digits with sign and annunciators. Four readings per second, fixed.

### Amplitude Accuracy\*

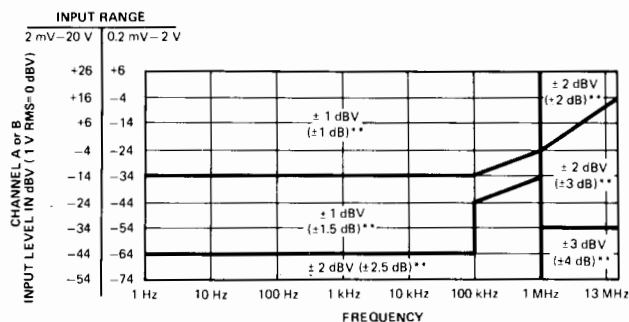

\*Conditions: Temperature: 25°C ± 10°C; accuracy applies to dBV and ratio measurements with the same frequency on both channels; for ratio measurements, the lowest level channel determines accuracy; analog output accuracy (rear panel).

\*\*Ratio (B/A) tolerances

**Amplitude functions:** A dBV, B dBV or B/A dB.

**Amplitude reference:** (A dBV, B dBV) 1 V rms = 0 dBV.

### Display

**Range:** A dBV, B dBV: -74 dBV to +26 dBV (in two ranges). B/A dB: -100 to +100 dB. (Both input signals must be within the range of 0.2 mV rms to 20 V rms)

**Resolution:** 0.1 dBV, 0.1 dB.

### General

**Power:** 115 V/230 V ± 10%, 48 Hz to 440 Hz, 40 VA.

**Weight:** net, 8.3 kg (18.4 lb). Shipping, 11.3 kg (25.8 lb).

**Size:** 88 H x 425 W x 337 mm D (3.47" x 16.75" x 13.25").

**Accessories furnished:** extender boards, line cable and 50-pin connector (Opt 002 and 003 only).

### Options

**001 Dual panel meters:** HP's 3575A Opt 001 is equipped with two digital readouts and two analog outputs for simultaneous amplitude and phase readings. This option has no additional measurement capability over the standard instrument.

Dual analog outputs: rear panel BNC connectors provide dc output voltages that correspond to the respective panel meter readings.

**001:** Dual Readout

**002/003 Programmable:** 3575A Opt 002 and Opt 003 are equipped with dual panel meters and dual analog outputs (same as Opt 001) plus BCD outputs and complete remote control capability. Opt 002 has negative true output levels and Opt 003 has positive true output levels. BCD information from the 3575A (Opt 002) can be read by the 9800 series HP Desktop Computers with appropriate interfacing.

**002:** Programmable (negative true output levels)

**003:** Programmable (positive true output levels)

**908:** Rack Flange Kit

**910:** Extra Product Manual

### 3575A Gain/Phase Meter





# NETWORK ANALYZERS

## RF Network Analyzer, 4 MHz to 1300 MHz (optional to 2600 MHz)

Model 8754A

- H26 option covers 4 to 2600 MHz
- Integrated source, receiver, and display
- Three inputs, two measurement channels
- 80 dB dynamic range

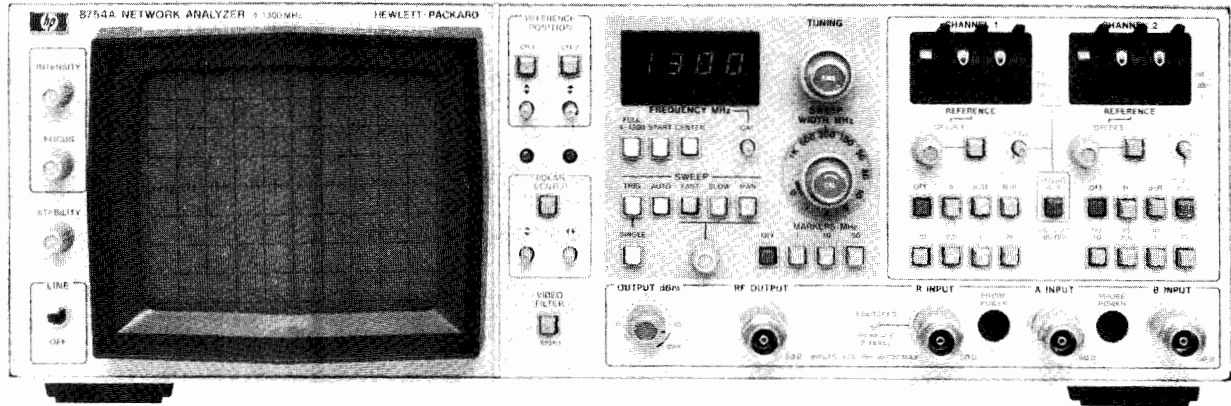

### Description

The 8754A is a complete stimulus/response test system which combines a 4-1300 MHz swept source, three-input narrowband, tuned receiver, and both rectilinear and polar displays in a compact package. The convenient built-in source incorporates digital display of the start or center frequency, the ability to sweep all or any portion of the 4-1300 MHz range, and crystal markers at 1, 10, or 50 MHz intervals to enable accurate frequency calibration and measurement. The receiver provides 80 dB dynamic range in two independent measurement channels to allow simultaneous measurement of any two transmission or reflection parameters using a single test setup. Measurements of absolute power, magnitude ratio, phase angle, and reflection coefficient are displayed on the fully calibrated CRT with resolutions up to 0.25 dB and 2.5 degrees per major division. With these features the 8754A offers a new level of operating convenience and technical performance to swept magnitude and phase measurements in laboratory, production, and field testing applications at an economical price.

A comprehensive line of 50  $\Omega$  and 75  $\Omega$  test sets allow maximum versatility in a wide range of applications. Matched cable sets, precision adapters, and transistor fixtures provide convenient reliable connections to the test device. Adding the 8750A Storage-Normalizer provides flicker-free rectilinear displays regardless of sweep rate and eliminates the need for grease pencils through automatic normalization of frequency response errors. For applications that require exceptional frequency accuracy and stability, the 8754A may be used with external sources such as the HP 8660 or HP 8640 signal generators.

In addition, network measurements are now possible up to 2600 MHz with the 8754A Option H26 Network Analyzer. A full line of test sets and accessories complement the analyzer to provide a complete 2600 MHz stimulus/response test system. The 8754A Option H26 family provides the solution for economical, broadband network analysis. For a complete description of these options, ask your HP Field Engineer for a data sheet.

### 8754A Network Analyzer Specifications

#### Source

**Frequency range:** 4 MHz to 1300 MHz (optional to 2600 MHz).

**Sweep modes:** Linear full sweep (4 MHz to 1300 MHz) and calibrated sweep widths with variable start or center frequency.

**Sweep widths:** Selectable sweep width ranges from 1 to 1000 MHz in a 1, 2, 5 sequence, plus CW. A vernier allows continuous adjustment of sweep width within each range.

**Digital frequency readout:** Indicates start or center frequency with 1 MHz resolution.

**Markers:** Internal, crystal-generated harmonic markers at 50, 10, or 1 MHz intervals ( $\pm 0.01\%$  accuracy).

**Output power range:** 0 to typically +13 dBm;  $\pm 0.5$  dB flatness.

**Spectral purity** (+10 dBm RF output level):

**Residual FM** (swept and CW):  $\leq 7$  kHz RMS (10 kHz bandwidth).

**Harmonics:**  $-28$  dBc.

#### Receiver

**Frequency:** 4 MHz to 1300 MHz.

**Input Channels:** Two test inputs (A and B) and one reference (R) input.

**Impedance:** 50  $\Omega$  ( $\leq 1.22$  SWR).

**Maximum input level:** 0 dBm at R, A, and B inputs.

**Damage level:** +20 dBm (50 Vdc).

**Noise level:**  $< -80$  dBm, A and B Inputs.

**Minimum R input level:**  $-40$  dBm ( $\geq -40$  dBm required to operate R input phase-lock).

**Crosstalk between channels:**  $> 83$  dB.

**Magnitude frequency response** (flatness): Absolute (A, B):  $\leq \pm 1$  dB, Ratio (A/R, B/R):  $\leq \pm 0.3$  dB.

**Magnitude dynamic accuracy** (20 – 30°C):  $\pm 0.3$  dB from 0 to  $-50$  dBm,  $\pm 0.5$  dB from  $-50$  to  $-60$  dBm,  $\pm 1$  dB from  $-60$  to  $-70$  dBm,  $\pm 2.5$  dB from  $-70$  to  $-80$  dBm.

**Magnitude reference offset range:**  $\pm 199$  dB in 1 dB steps ( $\pm 0.1\%$ ). Vernier provides variable offset for calibration.

**Absolute power measurements** (A, B, and R): Typically  $\pm 0.5$  dBm at 0 dBm, 50 MHz input.

**Phase frequency response:**  $\pm 2.5^\circ$ .

**Phase range:**  $\pm 180^\circ$

**Phase dynamic accuracy:**  $\pm 2^\circ$  from 0 to  $-50$  dBm.  $\pm 4^\circ$  from  $-50$  to  $-70$  dBm.

**Phase reference offset range:**  $\pm 199^\circ$  in  $1^\circ$  steps ( $\pm 1\%$ ). Vernier provides variable offset for calibration.

**Electrical length/Reference plane extension:** Typically 0 to 16 cm length for transmission phase; typically 0 to 8 cm reference plane extension adjustment at reflection test port.

#### Display

**Measurement functions:** CRT displays either polar trace or Channel 1 and Channel 2 rectilinear traces.

**Reference position:** Independent reference lines for Channel 1 and Channel 2 and Polar center can be set to any position.

**Video filter:** Typically 100 Hz (10 kHz without filter).

**Graticule size:** Rectilinear, 10 cm by 8 cm; polar 8 cm in diameter.

**Smith chart overlays:** 2, 1, 0.2, and 0.1 full scale.

**CRT photography:** Tektronix C-5B Oscilloscope Camera is recommended. (UV illumination will not provide graticule exposure.)

**Resolution:** 10, 2.5, 1, 0.25 dB/major division. 90, 45, 10, 2.5°/major division.

**Accuracy:**  $\pm 2\%$   $\pm 0.05$  divisions for rectilinear trace; within 2.5 mm for polar trace.

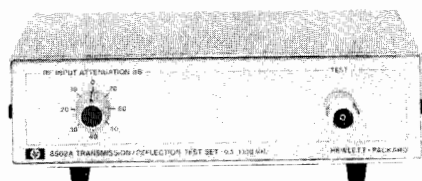

8502A

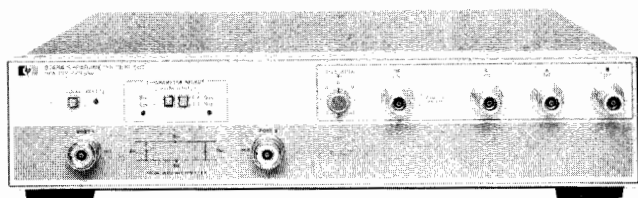

8748A

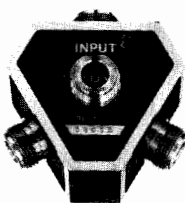

11850A

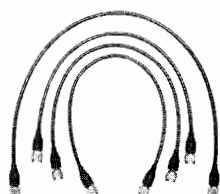

11851A

**8502A 50 Ω Transmission/Reflection Test Set****8502B 75 Ω Transmission/Reflection Test Set**

**General:** Contains a power splitter and directional bridge to allow simultaneous transmission and reflection measurements. Use the 11851A RF Cable Set for interconnections. Detailed specifications on page 442.

**11851A RF Cable Set**

**General:** Three 61 cm (24 in.) 50 Ω cables, phase matched to  $\pm 4^\circ$  and one 86 cm (34 in.) 50 Ω cable. Used with 8502A/B and 11850A/B. Detailed specifications on page 442.

**8748A 50 Ω S-parameter Test Set Specifications**

**Frequency range:** 4 MHz to 1.3 GHz

**Directivity:**  $\geq 40$  dB.

**Frequency Response:**

**Transmission**<sup>1</sup>( $S_{21}$ ,  $S_{12}$ ):  $\pm 1$  dB,  $\pm 12^\circ$

**Reflection**<sup>1</sup>( $S_{11}$ ,  $S_{22}$ ):  $\pm 2$  dB,  $\pm 15^\circ$ .

**Port match**<sup>2</sup>:

**Test Port 1 and 2:**  $\geq 26$  dB Return Loss ( $\leq 1.11$  SWR).

**Test Port 1 and 2 open/short ratio:**  $\leq \pm 0.75$  dB and  $\pm 6^\circ$  from 4 to 1000 MHz;  $\leq 0.9$  dB and  $\pm 7.5^\circ$  from 1000 MHz to 1300 MHz.

**Insertion loss:**

**Input to Test Port 1 or 2:** 13 dB nominal.

**Input to Port A, B, or R:** 19 dB nominal.

**Maximum operating level:** +20 dBm.

**RF attenuator range:** 0 to 70 dB in 10 dB steps.

**Test port connectors:** APC-7.

**DC bias input range:**  $\pm 30$  Vdc,  $\pm 200$  mA.

**Includes:** Cables for connection to 8754A and Reference Plane Extension Cable Kit.

**Recommended accessory:** 11857A Test Port Extension Cables, 11608A Transistor Fixture, or 11600B, 11602B Transistor Fixtures.

**Power:** 20 Vdc, supplied from 8754A via interface cable.

**Size:** 432 mm W x 90 mm H x 495 mm D (17" x 3½" x 19½").

**Weight:** Net, 9.1 kg (20 lb). Shipping, 11.3 kg (25 lb).

**11857A APC-7 Test Port Extension Cables**

**General:** Two precision 50 Ω cables phase matched to  $\pm 2^\circ$  to connect test device between 8748A test ports. Detailed specifications on page 443.

**Transistor Fixtures**

**General:** Three transistor fixtures can be used with the 8748A. The 11600B and 11602B require use of the 11858A Transistor Fixture Adapter. The 11608A transistor fixture connects directly to the 8748A. Detailed specifications on pages 452 and 454.

**Adapter Kits**

**General:** The 11853A, 11854A, 11855A, and 11856A accessory kits are available to provide precision Type N and BNC adapters and calibration standards for use with the 11850A/B, 8502A/B, and 8748A test setups. Detailed specifications on page 443.

<sup>1</sup>  $\pm$  degrees, specified as deviation from linear phase.

<sup>2</sup> Effective port match for ratio measurements.

**Ordering Information:**

**8754A** Network Analyzer

**Opt H26:** 4-2600 MHz

**Opt 907:** Front Handle Kit

**Opt 908:** Rack Flange Kit

**Opt 909:** Rack Mount Flange/Front Handle Kit

**11850A** 50 Ω Three-Way Power Splitter

**Opt H26:** 4-2600 MHz (50 Ω)

**11850B** 75 Ω Three-Way Power Splitter

**8502A** 50 Ω Transmission/Reflection Test Set

**Opt H26:** 4-2600 MHz (50 Ω)

**8502B** 75 Ω Transmission/Reflection Test Set

**11851A** RF Cable Set

**11857A** Test Port Extension Cables

**8748A** 50 Ω S-Parameter Test Set

**Opt 907:** Front Handle Kit

**Opt 908:** Rack Flange Kit

**Opt 909:** Rack Mount Flange/Front Handle Kit

**Opt H26:** 4-2600 MHz (50 Ω)

**General**

**Sweep output:**  $-5$  V to  $+5$  V.

**External sweep inputs:** 0 to 10 V nominal.

**X-Y recorder/External CRT output:**

**Horizontal and vertical:** 0.1 V/div.

**Penlift/blanking:**  $+5$  V Blanking and Penlift.

**External marker input:** Typically  $-13$  dBm RF signal produce a marker at the frequency of the RF signal.

**Magnitude/phase output:**  $-10$  mV/Degree and  $-100$  mV/dB.

**Probe power:** Two  $+15$  Vdc and  $-12.6$  Vdc.

**Storage-normalizer interfaces:** Directly compatible with the HP 8750A Storage-Normalizer. HP 8501A Storage-Normalizer requires a single internal adjustment for compatibility.

**Programming connector:** Outputs include magnitude/phase and sweep outputs and inputs described above as well as measurement mode selection by TTL levels or contact closures.

**External source:** The 8754A sweep-out voltage is provided to frequency modulate (sweep) an external signal generator for narrow-band measurement applications. A sweep input is provided to synchronize the CRT display for use with an externally swept source (8620 and 8350 Series).

**Temperature:**

**Operating:**  $0^\circ$  to  $55^\circ$ C except where noted.

**Storage:**  $-40^\circ$ C to  $+75^\circ$ C.

**EMI:** VDE 0871/0875 and CISPR publication 11.

**Safety:** Conforms to the requirements of IEC 348.

**Power:** Selection of 100, 120, 220 and 240 V  $+5\%$   $-10\%$ . 48 to 66 Hz, 20 VA max.

**Size:** 425.5 mm W x 133 mm H x 505 mm D (16¾" x 5¼" x 19¾").

**Weight:** Net 16.8 kg (37 lb). Shipping 19 kg (42 lb).

**11850A 50 Ω Three-Way Power Splitter****11850B 75 Ω Three-Way Power Splitter**

**General:** One output port provides the reference output and the other two output ports can be used for independent transmission measurements. Use the 11851A RF Cable Set for interconnections. Detailed specifications on page 442.



# NETWORK ANALYZERS

## RF Network Analyzer, 500 kHz to 1.3 GHz

### Model 8505A

- 100 dB of dynamic range
- Digital readout of data with analog display
- Direct group delay and deviation from linear phase
- High performance sweep oscillator
- Complete family of 50  $\Omega$  and 75  $\Omega$  test sets
- Digital storage and normalization

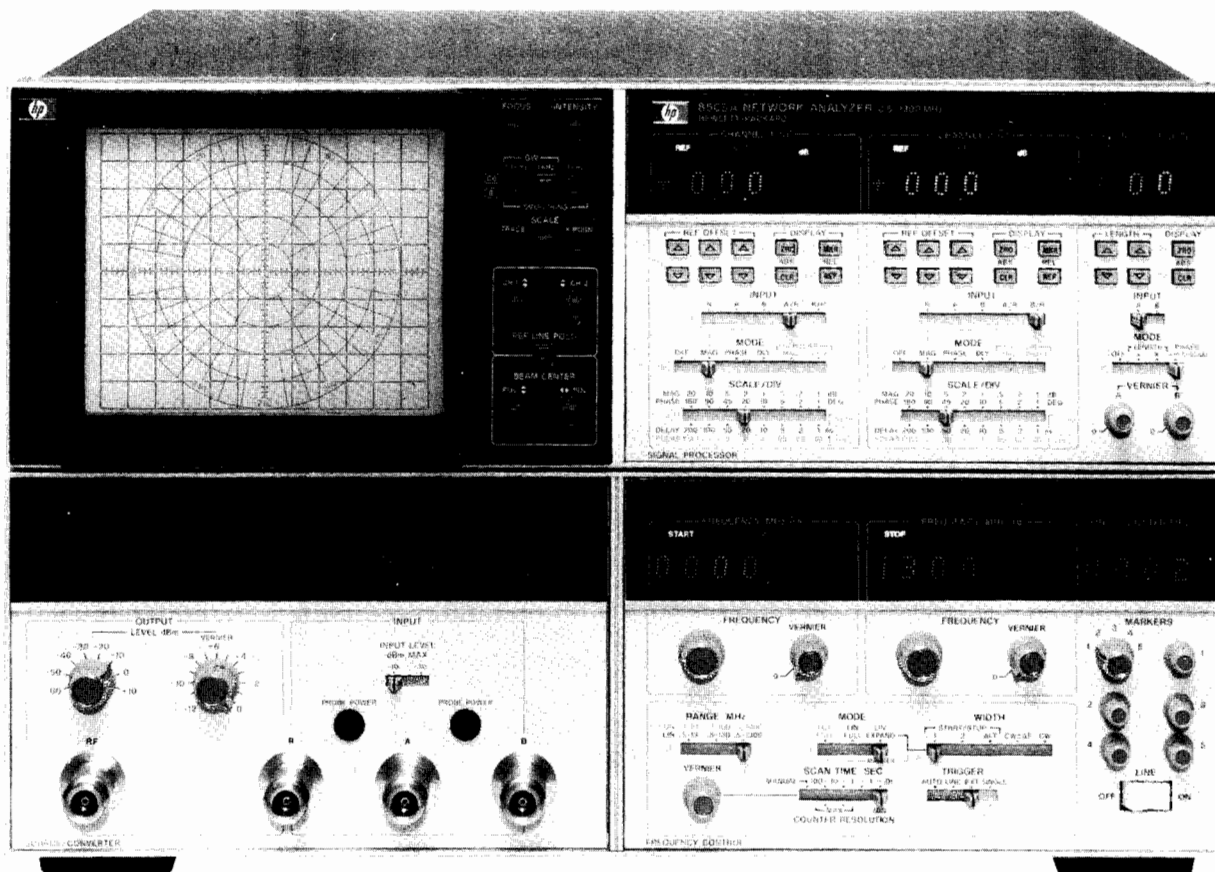

8505A



The HP 8505A is a high performance RF network analyzer operating over the 500 kHz to 1.3 GHz frequency range. It accurately and easily measures complex impedance, transfer functions and group delay of coaxial components and semiconductors. Because both magnitude and phase are measured, it is possible to completely characterize the linear behavior of either active or passive networks.

Since magnitude and phase can be measured and displayed over 100 dB of dynamic range (-10 to -110 dBm), it is a simple process for the 8505A to measure transmission loss of high rejection devices such as filters or gain and return loss of small signal devices like amplifiers. Distortion parameters like group delay, deviation from linear phase, and deviation from constant amplitude are measured in an equally straightforward manner. Group delay is measured and displayed directly to resolutions of 1 ns per major division using a new linear FM measurement technique. A unique new electrical line stretcher compensates for the linear phase shift of the device under test so that phase non-linearities may be examined at high resolution (1° per major division). Amplitude deviations with frequency can be similarly observed to resolutions 0.1 dB per major division with clear, crisp trace stability. In addition, it is possible to read out swept amplitude, phase and delay digitally at any one of five continuously variable markers with resolutions of 0.01 dB, 0.1°, and 0.1 ns respectively.

Many of the 8505A's high performance features and operating conveniences are derived from the fact that it is a completely integrated system including both the sweep oscillator and receiver. The basic instrument also includes a built-in frequency counter, polar and rectangular displays on the same CRT, the new electronic line stretcher, group delay measurement, and frequency selective digital readings of swept amplitude, phase and delay. The frequency counter with resolutions up to 100 Hz adds further precision to the measurements by allowing frequency as well as amplitude, phase and delay to be read out at any of the five markers. The 8505A is fully programmable in a straightforward fashion using the Hewlett-Packard Interface Bus (HP-IB operation is standard). The user can configure a customized automatic system or for convenience HP offers two fully configured systems, the 8507B and 8507C. (See pages 444, 445.)

Companion instruments include the 11850A Three Way Power Splitter for high resolution transmission comparison measurements, the 8502A Transmission/Reflection Bridge for simultaneous transmission and reflection measurements, and the 8503A S-parameter Test Set for complete characterization of two port devices in a single test set-up. The 8501A Storage-Normalizer adds digital storage, normalization, signal averaging, increased resolution, and graphics to 8505A measurements.

## 8505A Specifications

### Source

#### Frequency Characteristics

**Frequency range:** 500 kHz to 1.3 GHz in three ranges; 500 kHz to 13 MHz, 500 kHz to 130 MHz and 500 kHz to 1.3 GHz.

**Swept frequency accuracy:**  $\pm 1\%$  of range for linear sweep.

**CW frequency accuracy:**  $\pm 2$  counts  $\pm$  time-base accuracy.

**Frequency stability:** better than  $\pm 0.01\%$  of reading  $\pm 0.01\%$  of frequency range over 10 minutes after warm-up.

**Frequency counter characteristics:** frequency counter measurements are made at any one of five continuously variable marker positions without interrupting the swept RF signal.

#### Resolution (least significant digit)

Frequency Range (MHz)	0.5 to 13	0.5 to 130	0.5 to 1300
10 ms Sweep time	10 kHz	100 kHz	1 MHz
100 ms Sweep time	1 kHz	10 kHz	100 kHz
>1 second Sweep time	100 Hz	1 kHz	10 kHz

**Counter accuracy:**  $\pm 2$  counts  $\pm$  time-base accuracy.

**Marker frequency accuracy:**  $\pm 0.002\%$  of scan width  $\pm$  counter accuracy. Measured in CW  $\pm \Delta F$

**Time-base accuracy:**  $\pm 5$  ppm  $\pm 1$  ppm/ $^{\circ}\text{C}$   $\pm 3$  ppm/90 days

#### Output Characteristics

**Output power range:** +10 dBm to -72 dBm.

**Attenuator accuracy:**  $\pm 1.5$  dBm over 70 dB range.

**Vernier accuracy:**  $\pm 1$  dB.

**Leveling:**  $\pm 0.5$  dB from 500 kHz to 1.3 GHz.

**Impedance:** 50  $\Omega$ ;  $\geq 16$  dB return loss at -10 dBm output level (<1.38 SWR).

#### Residual FM

Frequency Range (MHz)	0.5 to 13	0.5 to 130	0.5 to 1300
Residual FM	50 Hz rms	200 Hz rms	2 kHz rms
Bandwidth	20 Hz-1 kHz	20 Hz-1 kHz	20 Hz-10 kHz

**Harmonics:** >25 dB below main signal at +10 dBm output level.

**Sub-harmonics and spurious signals:** below -50 dBm at +10 dBm output level.

#### General Characteristics

**Sweep modes:** Linear Full, Log Full, Start/Stop 1, Start/Stop 2, Alternate, CW  $\pm \Delta F$ , and CW.

**Sweep times:** 10 ms to 100 s in decade ranges.

**Trigger modes:** auto, line sync., single scan or external sync.

**RF Output connector:** Type N female

### Receiver

**Frequency range:** 500 kHz to 1.3 GHz

#### Input Characteristics

**Input channels:** three channels (R, A, and B) with 100 dB dynamic range.

**Damage level:** +20 dBm or  $\geq 50$  V dc.

**Noise** (average, 10 kHz BW): -110 dBm from 10 to 1300 MHz; -100 dBm from 2 to 10 MHz; -95 dBm from 0.5 to 2 MHz.

**Impedance:** 50  $\Omega$ ;  $\geq 20$  dB return loss (<1.22 SWR). Typically >26 dB return loss (<1.11 SWR).

#### Magnitude Characteristics

**Absolute frequency response** (A, B, R):  $\pm 1.5$  dB

**Ratio frequency response** (A/R, B/R):  $\pm 0.3$  dB from 0.5 MHz to 1.3 GHz.

**Dynamic accuracy:**  $\pm 0.01$  dB/dB from -20 to -40 dBm;  $\pm 0.2$  dB from -10 to -50 dBm;  $\pm 0.5$  dB from -50 to -70 dBm;  $\pm 1.0$  dB from -70 to -90 dBm;  $\pm 2.0$  dB from -90 to -100 dBm;  $\pm 4.0$  dB from -100 to -110 dBm.

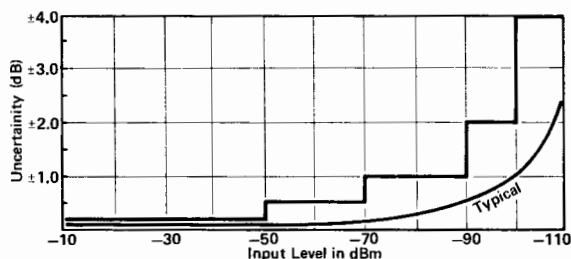

**Crosstalk error limits:** >100 dB isolation between inputs.

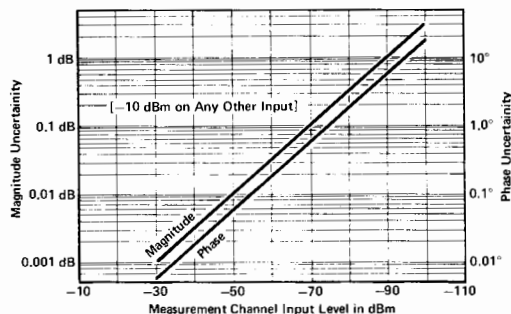

**Reference offset range:**  $\pm 199.9$  dB

**Reference offset accuracy:**  $\pm 0.03$  dB  $\pm 0.003$  dB/dB of offset

**Marker measurement resolution:** 0.01 dB over any <10 dB range; 0.1 dB over any  $\geq 10$  dB range.

**CRT Display resolution:** 0.1 dB to 20 dB/division in 1, 2, 5 sequence.

#### Phase Characteristics

**Frequency response:**  $\pm 3^{\circ}$  from 500 kHz to 750 MHz;  $\pm 5^{\circ}$  from 750 MHz to 1.3 GHz.

**Range:**  $\pm 180^{\circ}$ .

**Accuracy:**  $\pm 0.01^{\circ}/\text{degree}$  for  $\pm 170^{\circ}$ ;  $\pm 0.01^{\circ}/\text{degree}$   $\pm 0.5^{\circ}$  for  $\pm 180^{\circ}$ .

**Dynamic accuracy** (in 10 kHz Bandwidth):  $\pm 0.02^{\circ}/\text{dB}$  from -20 to -40 dBm;  $\pm 0.5^{\circ}$  from -10 to -50 dBm;  $\pm 1^{\circ}$  from -50 to -70 dBm;  $\pm 3^{\circ}$  from -70 to -90 dBm.

**Crosstalk:** see amplitude crosstalk specification.

**Reference offset accuracy:**  $\pm 0.3^{\circ} \pm 0.5\%$  of offset.

**Marker measurement resolution:**  $\pm 0.1^{\circ}$  over <100 $^{\circ}$  range and  $1^{\circ}$  for  $\geq 100^{\circ}$  range.

**CRT display resolution:**  $1^{\circ}$  to  $180^{\circ}$  per division in 8 steps.

**Polar characteristics:** Frequency Response, Dynamic Response, Reference Offset and Marker Measurement specifications are the same as magnitude and phase characteristics.

**CRT display accuracy:** actual value is within less than 3 mm circle of the displayed value.

**Tracking between dB offset controls and polar full switch positions:**  $\leq 0.2$  dB.

**Full scale magnitude range:** 1 to 0.01 in a 1, 0.5, 0.2 sequence.

#### Delay characteristics

**Frequency response:**  $\pm 1$  ns from 500 kHz to 1.3 GHz.

**Delay accuracy:**  $\pm 3\%$  of reading  $\pm 3$  units (Units = 1 ns for 0.5 to 1300 MHz range, 10 ns for 0.5 to 130 MHz range, and 100 ns for 0.5 to 13 MHz range.).

<sup>1</sup>  $\pm 3$  units may be calibrated out with thru connection.



# NETWORK ANALYZERS

RF Network Analyzer, 500 kHz to 1.3 GHz (cont.)

Model 8505A

## Range Resolution and Aperture

Frequency Range (MHz)	0.5 to 13	0.5 to 130	0.5 to 1300
Range	0 to 80 $\mu$ s	0 to 8 $\mu$ s	0 to 800 ns
Resolution			
CRT:	100 ns	10 ns	1 ns
Marker:	100 ns	10 ns	1 ns
Marker with Delay scale/Div Switch set to:			
	10 ns (<1 $\mu$ s)	1 ns ( $\leq$ 100 ns)	0.1 ns ( $\leq$ 10 ns)
Aperture <sup>1</sup>	7 kHz	20 kHz	200 kHz

Reference offset range:  $\pm 1999$  dB

Reference offset accuracy:  $\pm 0.3$  units  $\pm 0.3\%$  of offset.

## Electrical length/ref. plane extension characteristics

Calibrated electrical length range and resolution:<sup>2</sup>

Frequency Range (MHz)	0.5 to 13	0.5 to 130	0.5 to 1300
Range X1	$\pm 19.9$ m	$\pm 1.99$ m	$\pm 19.9$ cm
X10	$\pm 100$ m	$\pm 10$ m	$\pm 1$ m
Resolution X1	10 cm	1 cm	0.1 cm
X10	1 m	10 cm	1 cm

Calibrated electrical length accuracy:  $\pm 3\%$  of reading  $\pm 1\%$  of range.

Linear phase substitution (degrees/scan) Range:  $\pm 1700^\circ$  per scan with  $0^\circ$  offset.

$$\frac{\pm 1.4 \text{ km}}{\text{scan width (MHz)}} \quad \text{or} \quad \frac{\pm 4.7 \mu\text{s}}{\text{scan width (MHz)}}$$

Linear phase substitution resolution:  $10^\circ$

Linear phase substitution accuracy:  $\pm 3\%$  of reading  $\pm 10^\circ$  / scan

Phase compensation linearity:  $<0.2\%$  of phase slope inserted.

## General Characteristics

RF Input connectors: type N Female

Display bandwidth: selectable IF bandwidths of 10 kHz and 1 kHz. A video filter position is also provided.

CRT overlays: Smith Charts (2, 1, 0.5, 0.2, 0.1 full scale), Log Charts (10 MHz, 100 MHz and 1000 MHz).

CRT photography: HP 197A Opt 006 camera or HP 197A with 10375A Bezel Adapter required to fit 8505A display. A CRT illumination control is provided.

## Auxiliary Outputs

Channel 1 and 2 outputs: 0.25 V/display division.

Sweep output: 0.25 V/display division.

Pen lift: DC coupled, 200 mA current sink.

## Programming

The 8505A has a remote programming interface using the Hewlett-Packard Interface Bus with Learn Mode. One 0.5 m (HP 10631D) HP-IB cable included.

Power: selection of 100, 120, 200 or 240 V  $\pm 5\%$   $-10\%$ . 50 to 60 Hz approximately 275 watts.

Size: 279 H x 426 W x 553 mm D (11 x 16.75 x 21.75 in.).

## 8505A Opt 005 Specifications (Phase-Lock Operation)

### Source

#### Frequency Characteristics

Modes (8505A): CW and CW  $\pm \Delta F$  only.

Range and Resolution (8505A and 8660C/86602B/86632B): the total frequency range is 1 to 1300 MHz with a CW resolution of 1 Hz (set on the 8660C). The maximum  $\pm \Delta F$  and  $\pm \Delta F$  resolution is 1.3 kHz and 1 Hz from 0.5 to 13 MHz, 13 kHz and 10 Hz from 0.5 to 130 MHz, and 130 kHz and 100 Hz from 0.5 to 1300 MHz respectively.

Range and resolution (8505A and 8640B Opt 002): (Total Frequency Range: 0.5 to 1024 MHz).

	8640 Frequency Ranges (MHz)	8505A Frequency Range (MHz)		
		0.5-13	0.5-130	0.5-1300
CW Resolution (Set on 8640B)	0.5-1 1-13 16-128 128-1024	0.1 Hz 1 Hz	10 Hz	10 Hz 100 Hz
$\pm \Delta F$ Resolution (Set on 8505A)	All freq. Ranges	1 Hz	10 Hz	100 Hz
Max $\pm \Delta F$	0.5-8 8-16 16-1024	1.3 kHz 1.3 kHz	13 kHz 13 kHz	130 kHz

Typical system residual FM: the Residual FM of a phase-locked 8505A approaches that of the 8660C/86602B/86632B or 8640B.

## Output Characteristics

Power output, harmonics, spurious outputs, RF noise, etc. are determined by the 8660C with 86602B and 86632B or the 8640B.

## Receiver

Magnitude and phase characteristics are unchanged with the exception of the dynamic range specification.

## Delay Characteristics

Accuracy:  $\pm 3\%$  of reading  $\pm 3$  units. Units: 1  $\mu$ s for 0.5-1300 MHz; 10  $\mu$ s for 0.5-130 MHz; 100  $\mu$ s for 0.5-13 MHz.

Range, resolution and aperture: (8660C/86602B/86632B or 86640B)

(8505A indicated units x 1000)

	8505 Frequency Range (MHz)		
	0.5-13	0.5-130	0.5-1300
Range	0-80 ms	0-8 ms	0-800 $\mu$ s
Resolution:			
CRT & Digital Marker	100 $\mu$ s	10 $\mu$ s	1 $\mu$ s
Digital Marker with Delay Switch Setting	10 $\mu$ s <1 ms	1 $\mu$ s <100 $\mu$ s	100 ns <10 $\mu$ s
Aperture <sup>1</sup>	1.5 kHz	2.0 kHz	4.0 kHz

## Electrical Length Characteristics

Accuracy:  $\pm 3\%$  of reading  $\pm 3\%$  of range.

Calibrated electrical length, range, and resolution: (8660C/86602B/86632B or 8640): (8505A digital readouts  $\times 1000$ ) give electrical length 1000 times larger and resolution divided by 1000.

## General Characteristics

### RF Inputs

L.O. drive input level: 10 dBm  $\pm 2$  dB (Rear panel BNC).

RF drive input level: 0 dBm  $\pm 2$  dB (Rear panel BNC).

Tuneable FM output:  $\pm 1.3$  V maximum (rear panel BNC with output level controlled by  $\pm \Delta F$  control on front panel of 8505A).  $\pm 1.3$  V output is obtained independent of the frequency range switch setting.

Capture range of phase-lock loop: 100 kHz (0.5-13 MHz Range); 400 kHz (0.5-130 MHz Range); 4 MHz (0.5-1300 MHz Range).

Standard/phase-lock operation: rear panel switch can disable all phase-lock circuitry when using the instrument in its standard (non phase-lock) operating mode.

<sup>1</sup>Typical measurement Aperture using linear FM modulation technique.

<sup>2</sup>Vernier provides continuous adjustment of electrical length. Calibrated Electrical Length Linearity:  $\Delta \phi = 0.7\% \times 1.2 f$  (MHz)  $\times 1$  (meters).

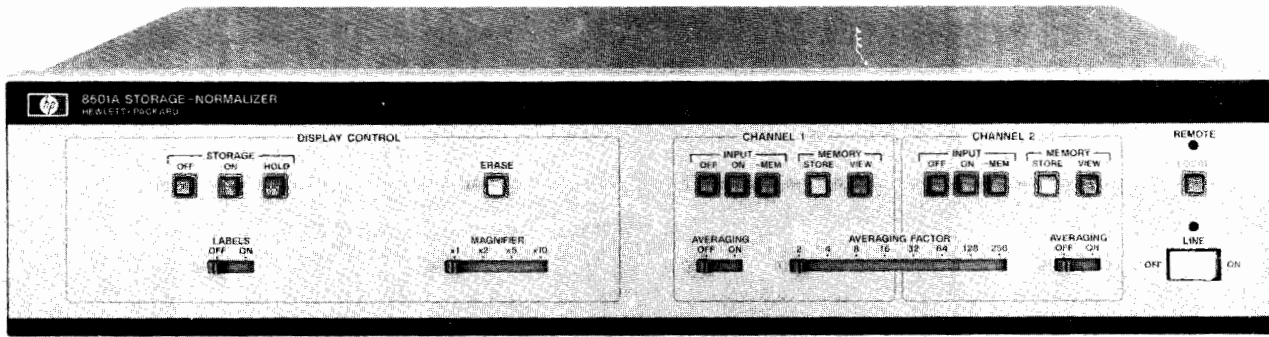

8501A



## Description

The 8501A high performance Storage-Normalizer is a dedicated accessory that extends the measurement capability of your HP 8505A RF Network Analyzer (500 kHz to 1.3 GHz). Flicker free displays with digital storage and CRT annotation of major control settings provide convenient easy documentation. Using normalization, frequency response errors are simply removed. In addition the 8501A can digitally average signals to dramatically improve signal-to-noise ratios and magnify the display for high accuracy measurements. With a desktop computing controller, computer graphics capability is added to the 8505A for displaying corrected data, operator messages, or computer programs.

## 8501A Specifications

### Display

#### Rectangular displays

**Horizontal display resolution:** two display channels, 500 points per channel (0.2% of full scale, 0.24 mm).

**Vertical display resolution:** 500 points displayed full scale (0.2% of full scale) plus a 50% overrange (250 points) both above and below full screen.

#### Polar displays

**Display resolution:** two display channels, 250 points per polar display (0.2% of full scale, 0.2 mm in X and Y).

**Display tracking:** visual offsets between direct 8505A and stored displays are approximately  $\pm 1/2$  CRT minor division ( $\pm 1$  mm).

**Horizontal input sweep times:** 100 sec max/10 ms min.

**Conversion time:** 10 ms max for  $500 \pm 2$  data points (20  $\mu$ s per point).

**Display refresh time:** nominally 20 ms depending upon information displayed.

**Line generator:** a line generation technique is used to connect points on a CRT display, yielding a smooth continuous trace.

**Markers:** all five markers are also available in the digital display mode.

### Output

**Auxiliary outputs XYZ:** (BNC female connectors on rear panel).

X—1 V full screen, 83 mV/div (12 div).

Y—1 V full screen, 100 mV/div (10 div).

Z—1 volt blanks display, +2 volt unblanks display. (Signal compatible for all HP CRT displays such as 1332, 1304, or 1310).

**Offsets:** The X, Y, and polar display offsets can be adjusted over a  $\pm 10\%$  range of screen by means of potentiometers on the rear panel of the 8501A.

**Labeling interface:** all major control settings of the 8505A and 8503A and phase-lock indication are displayed on the CRT.

## HP-IB Interface

### HP-IB Interface capabilities

#### Remote programming

**Learn mode:** this feature provides the ability to output the current instrument state to a computing controller.

**Input data:** data for graphics or other purposes can be sent to the 8501A at a rate of:

**ASCII mode:** 600 points per second.

**Binary mode:** 10000 points per second.

**Output data:** data can be read from the 8501A at a rate of:

**ASCII mode:** 800 points per second.

**Binary mode:** 9000 points per second.

**Graphics:** data for graphics can be read into the 8501A and viewed in two types of displays.

**Text displays:** 22 lines of text with 54 characters per line can be displayed on the CRT.

**Vector display:** lines can be drawn on the display between any two points with a resolution of 432 points in X and 360 points in Y (nominal).

## General

### Display controls

**Storage Off:** the 8501A is bypassed so the display returns to normal analog operation.

**Storage On:** turns on digitally stored display.

**Storage Hold:** the current display is not updated and is frozen for CRT photography or further analysis.

**Erase:** display and memory are erased.

**Labels:** switches all display labeling on or off.

**Magnifier:** expands the display by a factor of 1, 2, 5, or 10.

### Processing functions (Channel 1 and 2)

**Input Off:** display of channel 1 (2) is blanked.

**Input On:** channel 1 (2) measurement is displayed.

**Input Mem:** the difference between the channel 1 (2) measurement and the stored memory content is displayed (normalization).

**Memory Store:** the current measurement is stored in memory.

**Memory View:** the stored memory content is displayed.

**Averaging:** the data averaging function for channel 1 (2) is switched on or off.

**Averaging Factor:** the degree of averaging is selectable from 2, 4, 8 . . . to 256. The current averaged trace is always displayed and updated at the sweep rate.

**Local:** returns the 8501A control to the front panel from remote HP-IB control.

**Includes:** 0.5 m HP-IB cable and the processor interconnect cable.

**Accessories:** the 11864A Accessory Kit provides the labeling interface boards and connectors for retrofitting the 8505A. Labeling interface now standard on the 8505A.

**Power:** selection of 100, 120, 220, or 240 V +5%–10%, 50 to 60 Hz and <140 VA (<140 watts).

**Size:** 90 H x 426 W x 534 mm D (3.5" x 16.75" x 21.0").

**Weight:** net, 12.25 kg (27 lb). Shipping, 14 kg (31 lb).

# NETWORK ANALYZERS

RF Network Analyzer, 500 kHz to 1.3 GHz (cont.)

Model 8505A

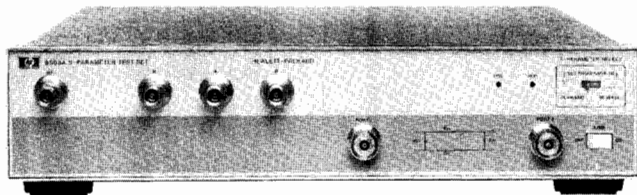

8503A

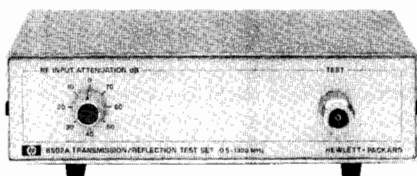

8502A



11850A

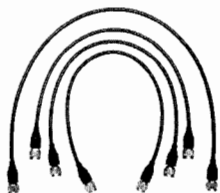

11851A

## 8502A 50 $\Omega$ Transmission/Reflection Test Set

## 8502B 75 $\Omega$ Transmission/Reflection Test Set

**Frequency range:** 500 kHz to 1.3 GHz.

**Impedance:** 8502A, 50  $\Omega$ ; 8502B 75  $\Omega$ .

**Directivity:**  $\geq 40$  dB.

### Frequency Response

**Transmission:**  $\leq \pm 0.8$  dB and  $\leq \pm 8^\circ$ .

**Reflection:**  $\leq \pm 1.5$  dB and  $\leq 15^\circ$  from 0.5–1300 MHz;  $\leq \pm 10^\circ$  from 2–1300 MHz.

### Port Match

**Test port:**  $\geq 26$  dB return loss from 2–1300 MHz ( $\geq 24$  dB for 8502B);  $\geq 20$  dB return loss from 0.5–2 MHz ( $\geq 18$  dB for 8502B).

**Test port open/short ratio:**  $\pm 0.75$  dB and  $\pm 6^\circ$  from 2–1000 MHz ( $\pm 0.9$  dB and  $\pm 7.5^\circ$  for 8502B);  $\pm 0.9$  dB and  $\pm 7.5^\circ$  from 1000–1300 MHz;  $\pm 1.25$  dB and  $\pm 10^\circ$  from 0.5–2 MHz.

**Reference and reflection ports:**  $\geq 25$  dB return loss from 2–1000 MHz;  $\geq 23$  dB return loss from 0.5–1300 MHz.

**Input port:**  $\geq 23$  dB return loss.

### Nominal insertion loss:

**Input to Test Port:** 13 dB (8502A), 19 dB (8502B).

**Input to Reference Port:** 19 dB (8502A), 19 dB (8502B).

**Input to Reflection Port:** 19 dB (8502A), 31 dB (8502B).

**Maximum operating level:** +20 dBm.

**Damage level:** 1 watt CW.

**RF Attenuator range:** 0 to 70 dB in 10-dB steps.

**Connectors test port:** 50  $\Omega$  Type N Female for 8502A and 75  $\Omega$  Type N Female for 8502B; all other RF ports 50  $\Omega$  Type N Female; Bias input, BNC Female.

**DC Bias input:**  $\pm 30$  V dc and  $\pm 200$  mA.

**Includes:** 8502B includes 50  $\Omega$ /75  $\Omega$  minimum loss pad.

**Recommended accessory:** 11851A RF Cable Kit for either 8502A or 8502B.

**Size:** 61.5 H x 101 W x 204 mm D (2.44" x 7.5" x 8.0").

**Weight:** net, 1.7 kg (3.25 lb). Shipping, 3.1 kg (7 lb).

## 8503A 50 $\Omega$ S-Parameter Test Set

## 8503B 75 $\Omega$ S-Parameter Test Set

**Frequency range:** 500 kHz to 1.3 GHz.

**Impedance:** 8503A, 50  $\Omega$ ; 8503B, 75  $\Omega$ .

**Directivity:**  $\geq 40$  dB.

### Frequency Response

**Transmission ( $S_{12}$ ,  $S_{21}$ ):**  $\pm 1$  dB,  $\pm 12^\circ$  from 0.5–1300 MHz.

**Reflection ( $S_{11}$ ,  $S_{22}$ ):**  $\pm 2$  dB,  $\pm 20^\circ$  from 0.5–1300 MHz;  $\pm 15^\circ$  from 2–1300 MHz.

### Port Match

**Test ports 1 and 2:**  $\geq 26$  dB return loss from 2–1300 MHz ( $\geq 24$  dB for 8503B),  $\geq 20$  dB return loss from 0.5–2 MHz ( $\geq 18$  dB for 8503B).

**Test port 1 and 2 Open/Short Ratio:**  $\leq \pm 0.75$  dB and  $\pm 6^\circ$  from 2–1000 MHz ( $\pm 0.9$  dB and  $\pm 7.5^\circ$  for 8503B);  $\leq \pm 0.9$  dB and  $7.5^\circ$  from 1000–1300 MHz;  $\pm 1.25$  dB and  $\pm 10^\circ$  from 0.5–2 MHz.

**Reference and return ports:**  $\geq 23$  dB return loss from 2–1000 MHz;  $\geq 20$  dB return loss from 0.5–2 MHz and 1000–1300 MHz.

**RF input port:** 20 dB return loss from 0.5–1300 MHz.

**Maximum operating level:** +20 dBm.

**Damage level:** 1 watt CW.

**Connectors:** test ports, 50  $\Omega$  APC-7 for 8503A and 75  $\Omega$  Type-N Female for 8503B; all other RF connectors, 50  $\Omega$  Type-N Female; Bias inputs BNC Female.

**DC Bias input:** 30 V dc,  $\pm 200$  mA.

**Includes:** four 19 cm (7.5") cables for connection to 8505A.

**Recommended accessory:** 11857A 50  $\Omega$  Test Port Extension Cables or 11857B/C 75  $\Omega$  Test Port Extension Cables.

**Programming:** Programming via HP-IB. 0.5 m HP-IB cable included.

**Power:** 100, 120, 220, or 240 V +5%–10%, 50 or 60 Hz. Approx. 10 watts (15 watts for 8503B).

**Size:** 90 H x 426 W x 553 mm D (3.5" x 16.75" x 21.0").

**Weight:** net, 9.1 kg (20 lb). Shipping, 11.3 kg (25 lb).

## Accessories

### 11850A 50 $\Omega$ Power Splitter

### 11850B 75 $\Omega$ Power Splitter

**Frequency range:** DC to 1.3 GHz.

**Impedance:** 11850A, 50  $\Omega$ ; 11850B, 75  $\Omega$ .

**Tracking between any two output ports:**  $\leq 0.1$  dB and  $\leq 1.5^\circ$ .

**Equivalent source match (ratio or leveling):**  $\geq 32$  dB return loss ( $\leq 1.05$  SWR).

**Input port match:**  $\geq 20$  dB return loss.

**Nominal insertion loss:** 9.54 dB for 11850A; 7.78 dB for 11850B.

**Frequency response absolute:** Input to Output  $\leq 0.2$  dB.

**Maximum operating level:** +20 dBm.

**Burn-out level:**  $\geq 1$  watt CW.

**Connectors:** 11850A, 50  $\Omega$  Type N female; 11850B, three outputs 75  $\Omega$  Type N female, RF input 50  $\Omega$  Type N female.

**Recommended accessory:** 11851A RF Cable Kit.

**Includes:** 11850B includes three (3) 50  $\Omega$ /75  $\Omega$  Minimum Loss Pads

**Size:** 46 H x 67 W x 67 mm D (1.88" x 2.63" x 2.63").

**Weight:** net, 1.8 kg (4 lb). Shipping, 3.1 kg (7 lb).



#### 11851A RF Cable Kit

**General:** Three 610 mm (24 in.) 50  $\Omega$  cables phase matched to 4° at 1.3 GHz and one cable 860 mm (34 in.). Connectors are Type N Male. Recommended for use with 8502A/B Transmission/Reflection Test Set and 11850A/B Power Splitter.

**Weight:** net, 0.91 kg (2 lb). Shipping, 1.36 kg (3 lb)

#### 11852A 50 $\Omega$ /75 $\Omega$ Minimum Loss Pad

**General:** the 11852A is a low SWR minimum loss pad required for transmission measurements on 75  $\Omega$  devices with 8505A receiver (50  $\Omega$ ).

**Frequency range:** DC to 1.3 GHz.

**Insertion loss:** 5.7 dB.

**Return loss:** 75  $\Omega$  side, 50  $\Omega$  side terminated: Typically  $\geq 34$  dB ( $\leq 1.04$  SWR). 50  $\Omega$  side, 75  $\Omega$  side terminated: Typically  $\geq 30$  dB ( $\leq 1.06$  SWR).

**Typical Flatness:**  $\leq 0.1$  dB from DC to 1.3 GHz.

**Maximum input power:** 250 mW (+24 dBm).

**Connectors:** 50  $\Omega$  Type N female and 75  $\Omega$  Type N male.

**Size:** 14 D x 70 mm L (0.56" x 2.75").

**Weight:** net, 0.11 kg (4 oz). Shipping, 0.26 kg (9 oz).

#### 11853A 50 $\Omega$ Type N Accessory Kit

**General:** the 11853A furnishes the RF components required for measurement of devices with 50 Type N Connectors using the 11850A, 8502A, or 8503A (8503A also requires the 85032A). Kit contains a Type N Female short, a Type N Male short, two Type N Male barrels, two Type N Female barrels and storage case.

**Weight:** net, 0.91 kg (2 lb). Shipping, 1.36 kg (3 lb).

#### 11854A 50 $\Omega$ BNC Accessory Kit

**General:** the 11854A furnishes the RF components required for measurement of devices with 50 BNC Connectors using the 11850A, 8502A, or 8503A (8503A also requires the 85032A). Kit contains two Type N Male to BNC Female adapters, two Type N Male to BNC Male adapters, two Type N Female to BNC Female adapters, two Type N Female to BNC Male adapters, a BNC Male short and storage case.

**Weight:** net, 1.13 kg (2½ lb).

#### 11855A 75 $\Omega$ Type N Accessory Kit

**General:** the 11855A provides the RF connecting hardware generally required for measurement of devices with 75  $\Omega$  Type N connectors using the 8502B, 8503B or 11850B. Kit contains two 75  $\Omega$  Type N Male barrels, two Type N Female barrels, a 75  $\Omega$  Type N Female short, a 75  $\Omega$  Type N Male short, a 75  $\Omega$  Type N Male termination, and storage case.

**Weight:** net, 0.91 kg (2 lb). Shipping, 1.36 kg (3 lb).

#### 11856A 75 $\Omega$ BNC Accessory Kit

**General:** the 11856A provides the RF connecting hardware generally required for measurement of devices with 75  $\Omega$  BNC connectors using the 8502B, 11850B, or 8503B. Kit contains two Type N Male to BNC Female adapters, two Type N Male to BNC Male adapters, two Type N Female to BNC Female adapters, two Type N Female to BNC Male adapters, a BNC Male short, a 75  $\Omega$  BNC Male termination, and storage case.

**Weight:** net, 0.91 kg (2 lb). Shipping, 1.36 kg (3 lb).

#### 11857A 50 $\Omega$ APC-7 Test Port Extension Cables

**General:** two precision 61 cm (24 in.) cables, phase matched to 2° at 1.3 GHz for use with 8503A S-parameter test set. Connectors are 50  $\Omega$  APC-7.

**Weight:** net, 0.91 kg (2 lb). Shipping, 2.3 kg (5 lb).

#### 11857B 75 $\Omega$ Type N Test Port Extension Cables

**General:** two precision 61 cm (24 in.) cables, phase matched to 2° at 1.3 GHz for use with 8503B S-parameter test set. One cable has 75  $\Omega$  Type N Male connectors on both ends; the other has one Type N Male and one Type N Female connector.

**Weight:** net, 0.91 kg (2 lb). Shipping, 2.3 kg (5 lb).

#### 11858A Transistor Fixture Adapter

**General:** the 11858A adapts the 11600B and 11602B transistor Fixtures (vertical test port configuration) to the 8503A S-parameter test set. Connectors are APC-7.

**Weight:** net, 0.91 kg (2 lb). Shipping, 1.36 kg (3 lb).

#### Ordering Information

8505A\* RF Network Analyzer

Opt 005: Phase Lock

Opt 908: Rack Mounting Kit (for use without front handles)

Opt 910: Extra Manual

Opt 913: Rack Mounting Kit

8503A\* 50  $\Omega$  S-Parameter Test Set

Opt 908: Rack Mounting Kit (for use without front handles)

Opt 910: Extra Manuals

Opt 913: Rack Mounting Kit

8503B\* 75  $\Omega$  S-Parameter Test Set

Opt 908: Rack Mounting Kit (for use without front handles)

Opt 910: Extra Manual

Opt 913: Rack Mounting Kit

8501A\* Storage Normalizer

Opt 908: Rack Mounting Kit (for use without front handles)

Opt 910: Extra Manual

Opt 913: Rack Mounting Kit

8502A 50  $\Omega$  Transmission/Reflection Test Set

Opt 910: Extra Manual

8502B 75  $\Omega$  Transmission/Reflection Test Set

Opt 910: Extra Manual

11850A 50  $\Omega$  Power Splitter

11850B 75  $\Omega$  Power Splitter

11851A RF Cable Kit

11852A 50  $\Omega$  to 75  $\Omega$  Minimum Loss Pad

11853A 50  $\Omega$  Type N Accessory Kit

11854A 50  $\Omega$  BNC Accessory Kit

11855A 75  $\Omega$  Type N Accessory Kit

11856A 75  $\Omega$  BNC Accessory Kit

11857A 50  $\Omega$  APC-7 Test Port Extension Cables

11857B 75  $\Omega$  Type N Test Port Extension Cables

11858A Transistor Fixture Adapter

11864A Labeling Interface Kit

\*Front Handles are Standard





# NETWORK ANALYZERS

Automatic Network Analyzers, 500 kHz to 1.3 GHz

Models 8507B/C

- Improve productivity in lab and factory
- Accuracy enhancement
- Ease of operation via HP-IB
- 9825T or 9845T Desktop Computer
- Learn mode
- Graphics Transfer with 8507C

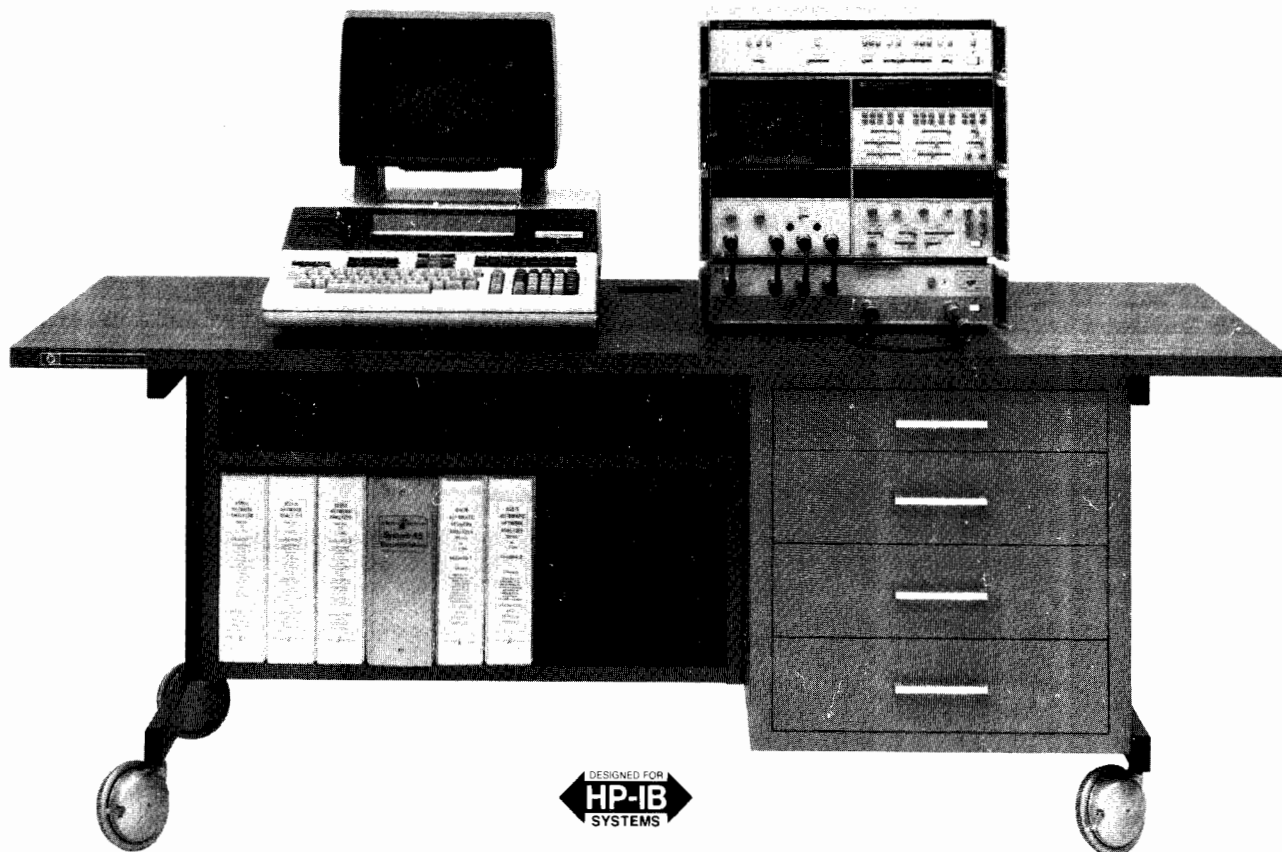

8507C

## Description

Two factory-configured automatic systems based on the 8505A Network Analyzer are available. The 8507B is controlled by the 9825T Desktop Computer; the 8507C is controlled by the 9845T. Mating the versatile, easy-to-use desktop computer with the completely programmable network analyzer produces a powerful RF network measurement tool for both lab and production uses.

## Cost Effective Solutions

In laboratory applications, engineers gain greater circuit insight via the speed and ease with which the 8507B/C accumulate and summarize data. With only a few hours training, engineers with no previous programming experience have been able to write customized programs which solve specialized measurement problems. In production environments, the 8507B/C can dramatically reduce the time and cost of making complicated limit tests on all types of components. Testing programs with built-in operator instructions can minimize training cost, assure uniform test procedures and eliminate subjective decisions.

## Simplicity and Flexibility of HP-IB

Configuration of the standard 8507B/C or your own customized system is a simple matter since it is programmed via the Hewlett-Packard Interface Bus. For example, perhaps your RF measurement application requires a programmable power supply for transistor biasing or a digital voltmeter. Simply choose an instrument from the selection of HP-IB interfaceable instruments and add it to your 8507B/C using universal HP-IB cables.

It is equally easy to get started making measurements since the 8507B/C come with software that complements the Hewlett-Packard hardware. Included are programs for accuracy enhancement and general network analyzer applications. In addition, a system check-out program is provided. This is all made possible because HP-IB is not just IEEE-488, but the hardware, documentation and support that delivers the shortest path to a measurement system.

## Learn Mode Operation

The "Learn" mode of operation has extended traditional automatic operation to a new level of operator convenience. The desktop computer can accept (Learn) a data string from the network analyzer which defines all of the manually set front panel control settings. This is accomplished by a single keystroke. Once stored in the desktop computer (or permanently recorded on a cartridge) this data string can then be used to automatically return the network analyzer to its exact original test conditions. And this can all be done without the operator ever writing a single program line!

## Programmability Features

1) The unique marker mode operation provides a real time display simultaneously with digital data logging. This mode insures that no glitches are missed, even when taking a limited number of data points.

2) The human-engineered HP-IB coding alleviates complex code tables. To program a function, simply type its name (shortened to first letter if you like) and its switch position number (numbered 1 to N left to right).

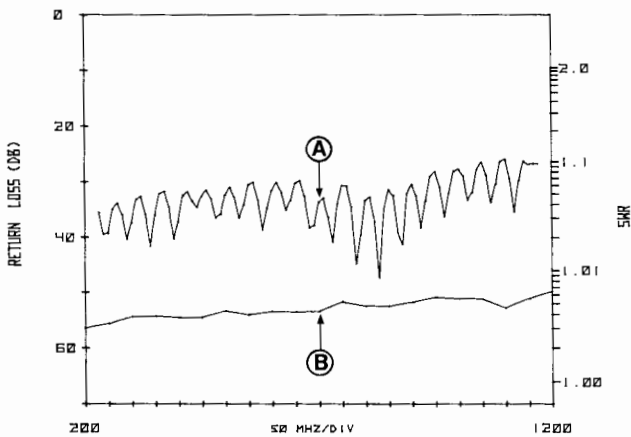

### Accuracy Enhancement

Each 8507B/C system is supplied with a program that permits frequency tracking, mismatch, and directivity errors to be characterized by applying known standards. These stored system errors are then removed from the measurement of the unknown to provide a degree of accuracy exceeding that possible with the standard 8505A.

### An Example

The plots on the left show the result of software accuracy enhancement. Curve A depicts raw measurements on a 50 dB return loss termination at the end of a six-foot RG 214 cable—a typical application problem in testing in temperature chambers. Curve B shows the results after calibrating at the end of the cable—a 25 dB improvement.

### Data in the Form you Need

With the desktop computers, it is a simple matter to obtain customized printed or plotted outputs. Or you may want to store data on tape for later analysis. Data can be analyzed or statistically summarized directly, bypassing the laborious and error-prone task of manually recording and re-entering data. Data reformatting such as converting return loss to SWR or S-parameters to Y-parameters can be accomplished also.

## 8507B/C Automatic Network Analyzers

### Includes:

- 8505A Network Analyzer
- 8501A Storage Normalizer
- 8503A S-Parameter Test Set
- APC-7 Calibration Kit (85031A)
- Systems Table and Cables
- System Assembly and check-out

### And with the 8507B:

- 9825T Desktop Computer (62 Kbytes memory) with String-Advanced Programming, Plotter-General I/O—Extended I/O ROMS, 9876A Printer, and 88076A cradle.
- HP-IB interface card, 98034A

### With the 8507C:

- 9845T Desktop Computer with Option 280, additional memory, IO and Graphics ROMs, second tape cartridge drive, and thermal line printer.
- HP-IB interface card, 98034A

**Power:** 8507B—115 or 230 V, 50–60 Hz, 750 VA.

8507C—115 or 230 V, 50–60 Hz, 735 VA

**Weight:** 8507B—net 227 kg (500 lb). Shipping, 272 kg (600 lb)

8507C—net 255 kg (561 lb). Shipping, 312 kg (686 lb)

### Ordering Information

**8507B** Automatic Network Analyzer

**Opt 002:** Delete Systems Table

**Opt 003:** Delete 9825T Calculator

**Opt 005:** Phase lock

**Opt 910:** Extra Set of Manuals

**Opt 913:** Rack Mounting Kit

**8507C** Automatic Network Analyzer

**Opt 002:** Delete Systems Table

**Opt 003:** Delete 9845T

**Opt 005:** Phase Lock

**Opt 910:** Extra Set of Manuals

**Opt 913:** Rack Mounting Kit

**85010B** Basic Measurements Program Pac for 8505A, 8501A, 8503A, and 9825T

**85030B** Applications Pac Software for 8505A/8503A/9825T

**85030C** Applications Pac Software for 8505A/8501A/8503A/9845T

**85031A** Verification/APC-7 Calibration Kit (Included with 8507B/C)

**85032A** 50  $\Omega$  Type-N Calibration Kit

**85033A** SMA Calibration Kit

**85036A** 75  $\Omega$  Type-N Calibration Kit

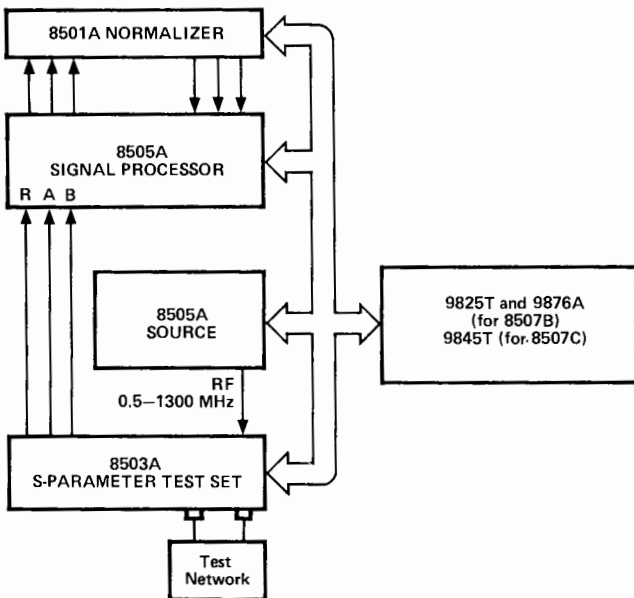

## 8507B/C Calibration Kits

### 85031A Verification and APC-7 Calibration Kits

Included with 8507B/C. Contains Precision APC-7 Load, APC-7 Short, and two verification standards.

### 85032A Type N Calibration Kit

For use with 8507B/C. Contains 2 APC-7 to N-Male Adapters, 2 APC-7 to N-Female Adapters, 1 N-Male Load, 1 N-Female Load, 1 N-Female Short, 1 N-Male Short.

### 85033A SMA Calibration Kit

For use with 8507B/C. Contains 2 APC-7 to SMA-Male Adapters, 2 APC-7 to SMA-Female Adapters, 1 SMA-Male Load, 1 SMA-Female Load, 1 SMA-Female Short, and 1 SMA-Male Short.

### 85036A 75 $\Omega$ Type N Calibration Kit

For use with the 8507B/C Opt E75 75  $\Omega$  Automatic Network Analyzer. Contains 1 Type N Male Termination, 1 Type N Female Termination, 1 Type N Male Short, 1 Type N Female Short, 1 Type N Male Barrel, and 1 Type N Female Barrel.



# NETWORK ANALYZERS

## RF Network Analyzer System, 100 kHz to 110 MHz

### Model 8407 system

- Complete swept characterization of linear networks
- Modular system flexibility
- 50  $\Omega$  and 75  $\Omega$  measurements
- Digital storage

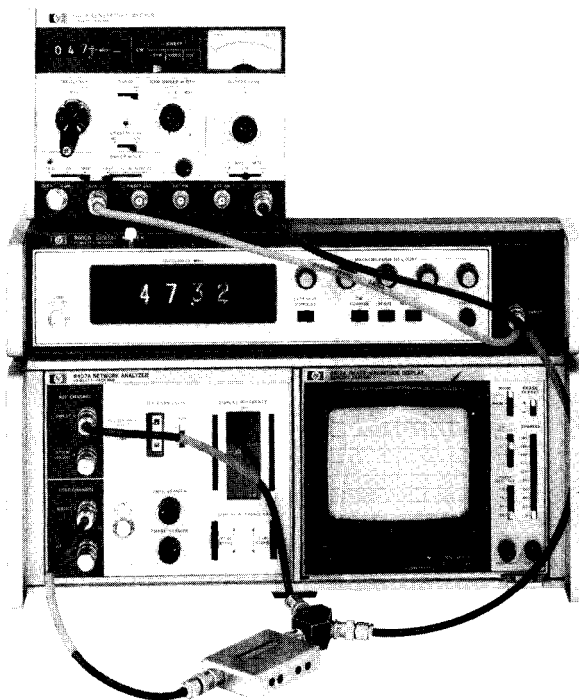

Swept measurements for either designing or testing are made with ease by HP's versatile 8407 Network Analyzer System. Since phase as well as magnitude is measured by this Network Analyzer, the behavior of both active and passive linear networks can be completely characterized from 100 kHz to 110 MHz by swept measurement.

Measurements of gain, loss, phase shift (compute a group delay), return loss, and complex reflection coefficient are all possible in either 50  $\Omega$  or 75  $\Omega$  systems. These measurements allow the linear behavior of the networks under test to be completely characterized by their complex S-Parameters. Swept complex impedance [Z] and  $\theta$  as well as voltage and current transfer functions are also measured quickly and easily by the 8407 system. Typical linear networks designed and tested with the 8407 are filters, amplifiers, attenuators, antennas, detectors, cables, and recording heads.

Much of the 8407's versatility stems from its modular construction which allows the system to perform a variety of measurements or be economically tailored to one application. The basic instruments of the 8407 system are: The HP 8407A Network Analyzer, HP 8601A Sweeper/Generator, choice of two plug-in displays (HP 8412B Phase-Magnitude Display or HP 8414B Polar Display), an optional digital marker (HP 8600A), and one of the transducers (HP 11652A, or 1121A) depending on the measurement. Because the 8407A is a tracking receiver, the HP 8601A is the only source providing the VTO output required to operate the network analyzer. Thus, an operating system must be configured with the required source, the network analyzer, a display and one or more of the transducers depending on the device under test and the network parameters desired.

## Specifications

### 8407A

**General:** 8407A is a two input tracking receiver, using both inputs (reference and test channels) to form their magnitude ratio and phase difference before routing to display.

**Frequency range:** 0.1–110 MHz.

**Impedance:** 50  $\Omega$ , SWR < 1.08; Option 008: 75  $\Omega$ , SWR < 1.08.

**Dynamic range:** 80 dB.

**Test input:** DIRECT –10 to –90 dBm signal range. ATTENUATED, +20 to –50 dBm signal range. Damage level +26 dBm/50 V dc.

**Reference input:** DIRECT level required, –10 to –60 dBm. ATTENUATED level required +20 to –20 dBm. Damage level +26 dBm/50 V dc.

**Amplitude accuracy:** FREQUENCY RESPONSE  $\pm 0.2$  dB for DIRECT input (test input > –60 dBm), 0.1–110 MHz;  $\pm 0.05$  dB over any 10 MHz portion; may be calibrated out. Typically  $\pm 0.05$  dB for DIRECT inputs (REFERENCE level of –10 dBm). DISPLAY REFERENCE, <0.05 dB/1 dB step, total error  $\leq 0.1$  dB; <0.1 dB/10 dB step, total error  $\leq 0.25$  dB. ATTENUATED INPUTS, 40 dB  $\pm 0.5$  dB. REFERENCE CHANNEL GAIN CONTROL, 20 dB and 40 dB steps  $\pm 0.5$  dB/step. CROSSTALK, <0.03 dB when test/ref = –40 dB to <4 dB when test/ref = –80 dB.

**Power:** 65 watts, 50–60 Hz, 115/230  $\pm 10\%$  V ac.

**Weight:** net, 14.6 kg (32 lb). Shipping, 17.8 kg (39 lb).

### 8412B

**General:** plug-in PHASE-MAGNITUDE CRT Display. Displays magnitude and/or phase vs. frequency.

**Amplitude accuracy:** display, 0.08 dB/dB from midscreen. Rear output: 0.03 dB/dB variation from 0 volt output.

**Phase Accuracy:** DISPLAY, 0.065°/degree from midscreen. PHASE OFFSET, 0.3°/20° step,  $\leq 3^\circ$  for 360° change, positive or negative direction. VS. DISPLAYED AMPLITUDE, <1°/10 dB; total <6° over 80 dB range.

**Rear panel inputs:** sweeping,  $\leq 15$  V dc. Blanking, –4 V dc blanks CRT. Z axis (marker), –5 V dc intensifies and +5 V dc blanks trace.

**Power:** 23 watts, supplied by 8407A.

**Weight:** net, 7.8 kg (17 lb). Shipping, 10 kg (22 lb).

Detailed Specifications on page 451.

### 8750A

**General:** the 8750A Storage-Normalizer provides digitally stored and normalized CRT displays when used with the 8412A Phase-Magnitude Display. Measurements are faster, easier, and more accurate when the 8750A is employed because the CRT is flicker-free and frequency response errors are eliminated. The 8750A is not compatible with the 8414A Polar Display.

**Power:** selection of 100, 120, 220, or 240 V +5%–10%, 48 to 440 Hz and  $\leq 20$  VA ( $\leq 20$  watts).

**Weight:** net, 2.72 kg (6 lbs). Shipping, 5.0 kg (11 lbs).

Detailed Specifications on page 449.

### 8414B

**General:** normalized POLAR coordinate display with magnitude calibration in 0.2 of full scale gradations. Full scale is determined by DISPLAY REFERENCE on 8407A; phase calibration is in 10° increments over 360° range. Smith Chart overlays available.

**Accuracy:** all errors in amplitude and phase due to display are contained within a circle of 3mm about measurement point.

**Rear panel inputs:** blanking, –4 to –10 V dc blanks CRT. Marker, intensified trace with –4 to –10 V dc.

**Rear panel outputs:** horizontal and vertical both  $\pm 2.5$  V for full scale deflection.

**Power:** 35 watts, supplied by 8407A.

**Weight:** net, 5.9 kg (13 lb). Shipping, 8.0 kg (18 lb).

Detailed specifications on page 451.

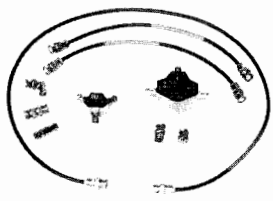

11652A



1121A

**8601A**

**General:** GENERATOR/SWEEPER operating in either CW or SWEPT modes. Sweep modes are full, variable stop frequency, and symmetrical (up to 10 MHz). Features very low residual FM, spurious, harmonics, and drift. 8601A provides the VTO signal required to operate the 8407A.

**Frequency:** 0.1–11 MHz in two sweep ranges, 0.1–11 MHz and 1–110 MHz.

**Impedance:** 50 Ω VSWR < 1.2. Option 008: 75 Ω. VSWR < 1.2.

**Accuracy:** 1% of frequency, 0.5% linearity, and 2% of sweep width.

**Calibrated output:** ±0.25 dB flatness over full range, output accuracy ±1 dBm from +10 to -110 dBm.

**Auxiliary outputs:** sweep out, blanking (for 8412 and 8414), VTO (required by 8407A), and auxiliary output (0.1–11 MHz both ranges) for 8600 counter/digital marker.

Detailed specifications on page 373.

**8600A**

**General:** DIGITAL MARKER used with 8601A generator/sweeper to provide five continuously variable markers on a display while reading out the frequency of any one marker. Six digit display.

**Markers/accuracy:** 5 markers accurate at desired frequency ± (0.05% sweep width + sweep stability).

**Counter frequency range:** 0.1–15 MHz (automatically scales up by ten when 8601A on 0.1–110 MHz range).

Detailed specifications on page 373.

**11652A**

**General:** REFLECTION-TRANSMISSION KIT containing power splitter, 8721A DIRECTIONAL BRIDGE, precision termination, calibrating short, three BNC adapters, and four matched, low-leakage cables for both transmission and reflection measurements. All 50 Ω BNC connectors, Option 008 75 Ω.

**Directional bridge:** 8721A: 6 dB insertion loss and 6 dB coupled to auxiliary arm. Frequency response ±0.5 dB (0.1–110 MHz). Directivity >40 dB (1 to 110 MHz). Load port return loss >30 dB ( $\rho < 0.03$ ). Max input power +20 dBm. 50 Ω, Option 008: 75 Ω.

**Power splitter:** 6 dB through each arm. Max input power +20 dBm. 50 Ω.

**50 Ω termination:** return loss >43 dB.

**Weight:** net, 0.7 kg (1.5 lb). Shipping, 1.2 kg (2.5 lb).

**11658A**

**General:** 50 Ω to 75 Ω matching resistor for matching the 50 Ω of the 8407A to a 75 Ω environment. Two 11658A's are very useful for frequent 50 Ω to 75 Ω changes. The 11658A's mount directly on the front panel, of 8407A, FREQUENCY, 0.1–110 MHz. INSERTION LOSS, 3.5 dB. RETURN LOSS, >40 dB. CONNECTORS, 50 Ω BNC male and 75 Ω BNC female.

**Net Weight:** 28 g (1 oz).

**1121A**

**General:** 1:1 active probe for making measurements without disturbing circuitry and measuring voltage transfer functions in systems different from 50 Ω. 10:1 and 100:1 dividers and BNC adapter also furnished.

**Frequency response:** ±0.5 dB and ±2% from 0.1–110 MHz with a bandwidth (3 dB) of 1 kHz to >500 MHz and gain 0 dB ±1 dB.

**Input impedance:** 100 kΩ, shunt capacitance of 3 PF at 100 MHz. With 10:1 or 100:1 divider, 1 MΩ, shunt capacitance 1 PF at 100 MHz.

**Output impedance:** 50 Ω nominal.

**Maximum input:** 300 mV rms, +80 V dc; with 10:1 divider, 30 V rms, ±350 V dc.

**Power:** supplied by 8407A through PROBE PWR jacks.

**Weight:** net, 0.7 kg (1.5 lb). Shipping, 1.2 kg (2.5 lb).

**Ordering Information**

- 8407A Network Analyzer
- Opt 008: 75 Ω input
- 8412B Phase Magnitude Display
- 8750A Storage-Normalizer
- 8414B Polar Display
- 8601A Sweeper/Generator
- Opt 008: 75 Ω output
- 8600A Digital Marker
- 11652A Reflection/Transmission Kit (50 Ω)
- Opt 008: 75 Ω
- 11658A Matching Resistor
- 1121A AC Probe Kit
- 8721A Directional Bridge (50 Ω)
- Opt 008: 75 Ω



# NETWORK ANALYZERS

## Vector Voltmeter

Model 8405A

- Accurate voltage and phase measurement
- 1 to 1000 MHz

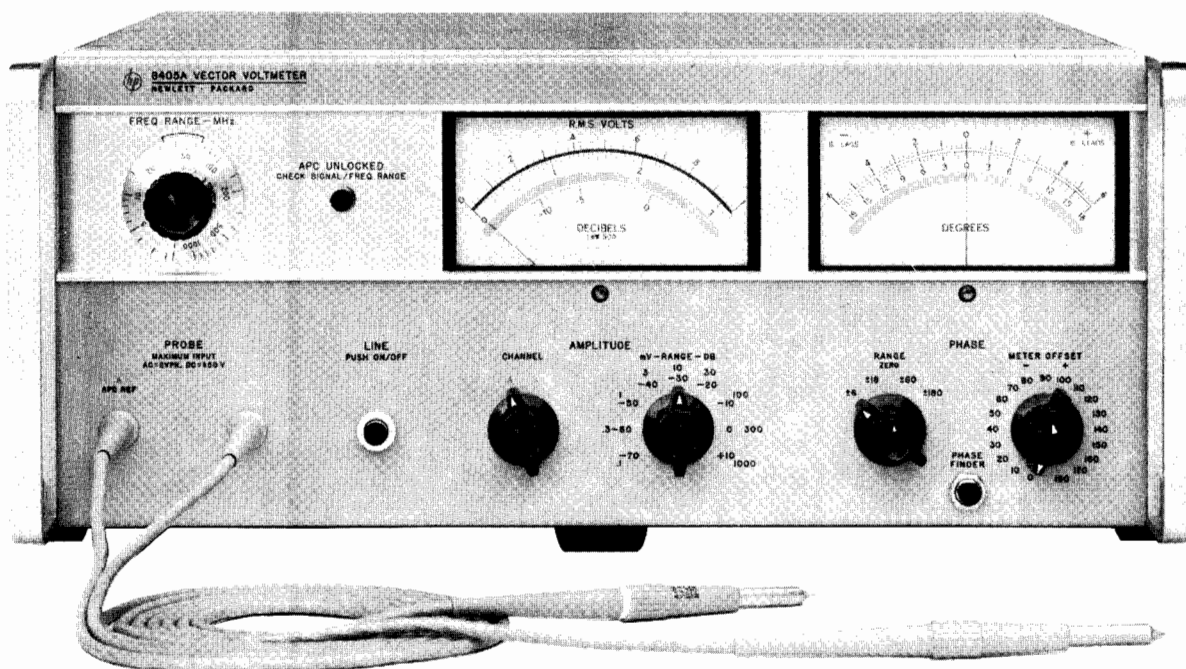

The 8405A Vector Voltmeter measures voltage vectors described by both magnitude and phase. This capability makes the 8405A a unique instrument for about any design and test application in the frequency range 1 to 1000 MHz.

In addition to absolute voltage measurements, capabilities include insertion loss and computed group delay of bandpass filters and other transmission devices, gain and phase margin of amplifiers, complex impedance of mixers, antennas, matching the electrical lengths of cables, s-parameters of transistors, amplitude modulation index, RF distortion measurements and in-circuit probing.

The 8405A achieves this measurement versatility through its two-channel capability enabling voltage magnitude measurements in either channel, thus allowing ratio measurements, and phase difference measurements between the two channels. Gain or loss in excess of 90 dB and phase measurements with 0.1° resolution over a 360° phase range are possible.

Accuracy is achieved through the 1 kHz bandwidth entailing response only to the fundamental frequency of the input signal. Also, phase-locked coherent sampling to translate 1 to 1000 MHz RF signals to 20 kHz IF signals enables accurate detection of voltage magnitude and phase. Automatic phase-locked tuning makes it possible to select the one of 21 overlapping octave ranges which contains the input signal frequency by simply rotating a switch.

### Specifications

**Frequency range:** 1 MHz to 1 GHz in 21 overlapping octave bands; tuning automatic within each band.

**Isolation between channels:** 1 to 300 MHz, >100 dB; 300 to 1,000 MHz >80 dB.

**Maximum input:** ac, 2 V peak; dc,  $\pm 50$  V.

**Input impedance (nominal):** 0.1 M $\Omega$  shunted by 2.5 pF; 1 M $\Omega$  shunted by 2 pF when 11576A 10:1 Divider is used; 0.1 M $\Omega$  shunted by 5 pF when 10216A Isolator is used. AC coupled.

### Voltage Range (rms)

Channel	1 - 10 MHz	10 - 500 MHz	500 - 1000 MHz
A	1.5 mV - 1.0 V	300 $\mu$ V - 1.0 V	500 $\mu$ V - 1.0 V
B	<20 $\mu$ V - 1.0 V	<20 $\mu$ V - 1.0 V	<20 $\mu$ V - 1.0 V

**Voltmeter ranges:** 100  $\mu$ V to 1 V rms full scale in 10 dB steps.

**Voltage ratio accuracy:** 1-200 MHz, 0.2 dB for -60 to 0 dB ranges and 0.5 dB for -70 dB to +10 dB ranges; 200-1000 MHz, 0.2 dB for -60 to -10 dB ranges, 0.5 dB for -70 dB to 0 dB ranges and 1.5 dB for +10 dB range.

**Phase range:** 360° indicated on zero-center meter with end-scale ranges of  $\pm 180^\circ$ ,  $\pm 60^\circ$ ,  $\pm 18^\circ$ , and  $\pm 6^\circ$ .

**Phase resolution:** 0.1° at any phase angle.

**Phase meter offset:**  $\pm 180^\circ$  in 10° steps.

**Phase accuracy:**  $\pm 1.5^\circ$  (equal voltage Channel A and B).

**Accessories furnished:** two 11576A 10:1 Dividers, two 10216A Isolators, two 10218A BNC Adapters, six ground clips for 11576A or 10216A; six replacement probe tips.

**Bandwidth:** 1 kHz.

**Power:** 115 or 230 V  $\pm 10\%$ , 50 to 60 Hz, 35 W.

**Weight:** net, 13.9 kg (31 lb). Shipping, 16.3 kg (36 lb).

**Size:** 177 H x 425 W x 467 mm D (7.0" x 16.75" x 18.38").

### 11570A Accessory Kit

**50  $\Omega$  Tee:** 11536A: for monitoring signals on 50  $\Omega$  transmission lines without terminating line. Kit contains two with type N RF fittings.

**50  $\Omega$  Power Splitter:** 11549A: all connectors Type N female.

**50  $\Omega$  Termination:** 908A: for terminating 50  $\Omega$  coaxial systems in their characteristic impedance.

**Shorting plug:** 11512A: Shorting Plug, Type N male.

### Ordering Information

**8405A Vector Voltmeter**

**Opt 002:** linear dB scale

**11570A Accessory Kit** (measurement in 50  $\Omega$  systems only)

- Digital storage and normalization
- Simple CRT photos and x-y recordings
- Use with HP network and spectrum analyzers

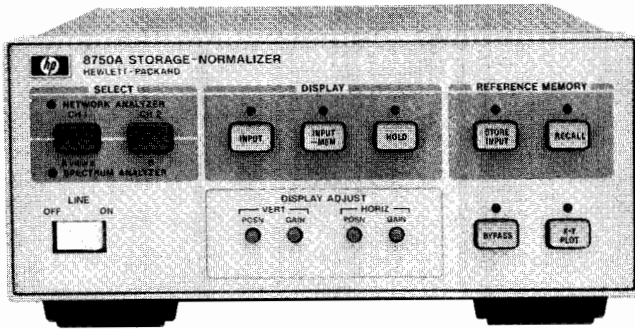

8750A

With HP's versatile 8750A Storage-Normalizer, you can make your network analyzer or spectrum analyzer measurements faster, easier, and more accurately through the simple addition of digital storage and normalization. This useful instrument accessory is directly compatible via a single interface cable with the following recently produced or appropriately modified Hewlett-Packard instruments; the 8755 Frequency Response Test Set, the 8407A/8412A, the 8410/8412A, the 8754A and the 8505A Networks Analyzers and 8557A, 8558B, 8565A and 8559A Spectrum Analyzers. A special I/O Adapter (opt 001 or opt 002) is available for interfacing instruments (like 140 Series Spectrum Analyzers) that are not directly compatible with the 8750A. An external oscilloscope can then be used for digitally stored and normalized displays. (The 8750A is not compatible with the 8414A Polar Display or the polar mode of the 8505A or the 8754A.)

In network analyzer applications, digital storage always yields a flicker-free display of the complete device response, facilitating easy adjustment of test devices under slow sweep conditions. Measurement accuracy is also improved since frequency response errors can be automatically removed through digital normalization. This effectively eliminates the need to manually record calibration traces on a CRT or x-y recorder and allows high resolution measurements of attenuator, amplifier, or filter passband flatness.

In spectrum analyzer applications, the 8750A's digital storage feature simplifies many difficult tests requiring slow scan times such as high resolution modulation measurements. Drift tests are also easy since two traces, a stored reference and the current input, can be displayed simultaneously.

Hard copy documentation can be obtained quickly and easily since data can be frozen on the CRT for straightforward CRT photography or outputted to an x-y recorder at a constant 30 second sweep rate.

## Supplemental Performance Characteristics

### Display

**Horizontal memory resolution:** two display channels, 256 points per channel (0.4% of full scale, 8 bit word)

**Vertical memory resolution:** 512 points displayed full scale (0.2% of full scale, 10 bit word) plus a 50% overrange (256 points) both above and below full screen.

**Horizontal input sweep rates:** 100 sec max./10 ms. min.

**Display refresh rate:** 6 ms.

### Video Detection

**Network analyzer:** Average Detection (20 kHz).

**Spectrum analyzer:** Peak Detection.

### Input/Output

#### A/D Horizontal Input

**Network analyzer:** 0 to 10 V nominal. Offset  $\pm 0.5$  V and Gain Adjust for 6 to 15 V sweep.

**Spectrum analyzers:**  $\pm 5$  V nominal. Offset  $\pm 0.5$  V and Gain Adjust for  $\pm 4.5$  to  $\pm 5.5$  V.

#### A/D Vertical Input

**Network analyzer:**  $\pm 1$  V min. and  $\pm 2$  V max, with continuous gain adjustment. Offset  $\pm 0.3$  V.

**Spectrum analyzer:** 0 to 0.8 V or 0 to  $-0.8$  V. Offset  $\pm 0.1$  V and Gain Adjust  $\pm 10\%$ .

#### D/A Horizontal Output

**Network analyzer:** gain adjustment for 1 to 3 V peak. Offset adjustment  $+5$  to  $-1.5$  V.

**Spectrum analyzer:** gain adjustment for 1 to 3 V peak. Offset  $+5$  to  $-1.5$  V.

#### D/A Vertical Output

**Network analyzer:** same as Vertical Input with  $\pm 10\%$  adjustment range.

**Spectrum analyzer:** same as Vertical Input with  $\pm 10\%$  adjustment range.

#### X-Y Recorder Outputs

**Horizontal range and accuracy:** 0  $\pm 20$  mV to 1 V nominal, settable within  $\pm 3\%$  of full scale. BNC female output (rear panel).

**Vertical range and accuracy:**  $\pm 4$  V  $\pm 3\%$  BNC female output (rear panel).

**Sweep time:** 30 sec per displayed trace.

**Penlift output:** BNC female (rear panel with open collector driver 20 V maximum.)

#### Controls

**Select:** LED display indicates Network or Spectrum Analyzer operation depending on the plug-in interface card.

#### Display

**Input:** initiates digital storage.

**Input-Mem (Input minus Memory):** Stored Reference trace is subtracted from input data (normalization).

**Hold:** freezes display for CRT photos or further analysis.

#### Reference Memory

**Store input:** current input trace is stored as Reference.

**Recall:** displays stored Reference trace.

**Bypass:** bypasses 8750A so display is returned to conventional analog operation.

**X-Y Plot:** initiates X-Y plots.

#### General

**Interface Cards:** The 8750A is supplied with two general plug-in interface cards. One for use with the HP Spectrum Analyzers listed above, one for use with the 8407A/8412A and 8505A Network Analyzers. When the 8750A is to be used primarily with an 8755B/C Frequency Response Test Set and 8350A/8620C Sweeper, 8410B/8412A Network Analyzer and 8350A/8620C Sweeper, or the 8754A Network Analyzer, calibration and adjustment of the 8750A to these instruments can be greatly simplified by ordering one of the plug-in interface cards dedicated to these instruments (Opt. 003 and 004.) All offset and gain adjustments are significantly reduced. When Opt. 003 or 004 are ordered the two general interface cards are also included so you have the flexibility to change your test set up at any time.

**Power:** selection 100, 120, 220, or 240 V  $+5\%$   $-10\%$ . 48 to 440 Hz and  $<20$  VA ( $<20$  watts).

**Size:** 102 H x 212 W x 280 mm D (4" x 8.4" x 11.2").

**Weight:** net. 2.72 kg (6.1 lbs). Shipping, 5.0 kg (11 lbs).

#### Ordering Information

8750A Storage-Normalizer

Opt 001: BNC Interface Adapter (Deletes direct interface cable)

Opt 002: BNC Interface Adapter (Retains direct interface cable)

Opt 003: 8755B/C or 8412A/8620C Plug-in Interface Card

Opt 004: 8754A Plug-in Interface Card

# NETWORK ANALYZERS

Microwave Network Analyzer, 110 MHz to 40 GHz  
8410 Family

- Complete microwave measurement systems
- Measures all network parameters
- Multioctave swept frequency measurements
- Eliminate harmonic and spurious responses

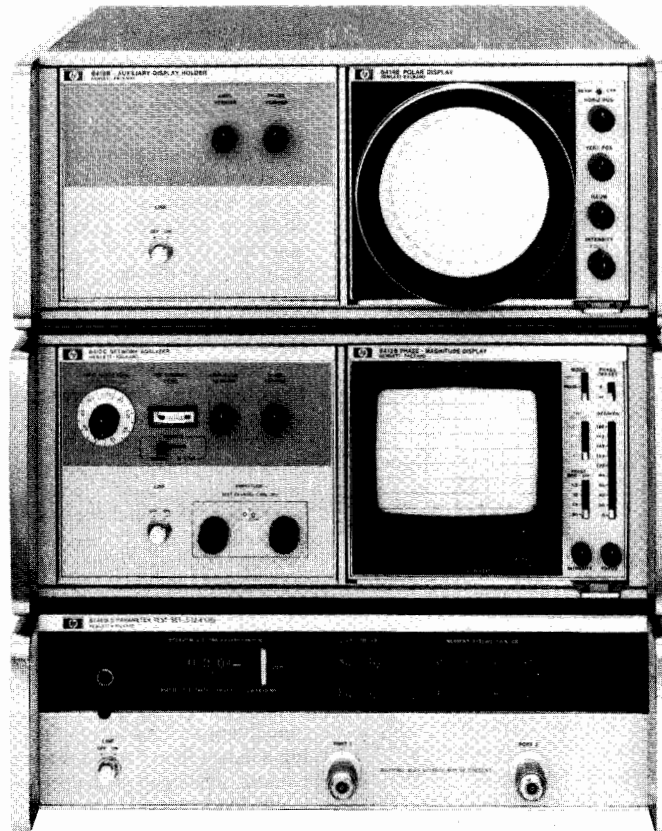

#### Receiver:

- 8410C Network Analyzer
- 8411A Harmonic Frequency Converter
- Opt 018 Operation to 18 GHz

#### Displays:

- 8412B Phase/Magnitude Display
- 8418B Auxiliary Display Holder
- 8414B Polar Display

#### Test Set:

- 8746B S-Parameter Test Set

#### General

This configuration is the basis for the high performance 8409-series automatic network analyzer described on page 459. This building-block approach to system configuration allows HP-IB accessories such as an A/D converter and relay switching instruments to be added to a manual system to allow upgrading to fully automatic applications. Refer to HP application note AN 221A for information on automating the 8410C Microwave Network Analyzer.

#### Receiver

The 8410C Network Analyzer and 8411A Harmonic Frequency Converter comprise the nucleus of the swept-frequency system which provides magnitude and phase measurement capability from 110 MHz to 18 GHz in coax and 12.4 to 40 GHz in waveguide. Automatic frequency locking allows continuous multioctave sweeps. Frequency conversion from RF to IF gives high sensitivity and greater than 60 dB dynamic range, free of spurious and harmonic responses. Calibrated IF substitution makes possible accurate gain or insertion loss measurements.

#### Displays

The 8412B Phase/Magnitude Display displays magnitude and phase versus frequency. The 8414B Polar Display provides a polar plot of magnitude and phase. These displays are interchangeable plug-ins for the 8410C mainframe. The 8418B Auxiliary Display Unit can be added to provide simultaneous rectilinear and polar display capability.

#### Sources

Although the 8410C can produce octave-width sweeps using any swept source, continuous multi-octave sweeps limited only by the frequency range of the test set are possible with the 8620C or 8350A Sweep Oscillators.

#### Test Sets

The 8745A, 8743B, and 8746B test sets contain all necessary splitters and couplers required to provide stimulus to the device under test and route the reference and reflected or transmitted signals to the receiver. Accessories allow the test sets to be configured for active and passive coaxial measurements as well as for semiconductor measurement applications.

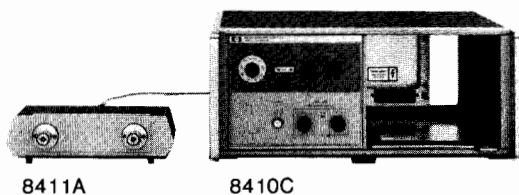

8411A

8410C

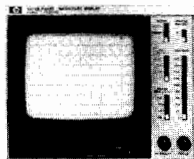

8412B

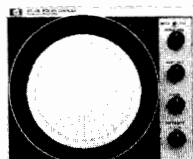

8414B

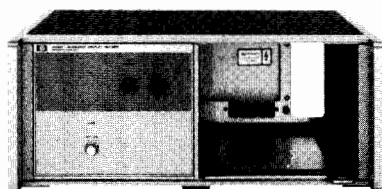

8418B

### Phase

**Phase range:** 0 to 360°

**Control:** vernier control  $\leq 90^\circ$

**Connectors (8411A):** APC-7.

**Power:** 115 or 230 V  $\pm 10\%$ , 50-60 Hz, 70 watts (includes 8411A).

### Weight

**8410C:** net, 14.9 kg (33 lb). Shipping, 18.5 kg (41 lb).

**8411A:** net, 3.2 kg (7 lb). Shipping, 4.5 kg (10 lb).

### Size

**8410C:** 191 H x 425 W x 467 mm D (7.5" x 16.75" x 18.38").

**8411A:** 67 x 228 W x 143 mm D (2.63" x 9" x 5.63") exclusive of connectors and cable.

### 8412B Phase-Magnitude Display

**Function:** plug in CRT display unit for 8410C. Displays relative amplitude in dB and/or relative phase in degrees between reference and test channel inputs versus frequency. Programmable 180° phase offset by ground closure.

### Amplitude

**Range:** 80 dB display range with selectable resolutions of 10, 2.5, 1 and 0.25 dB/division.

**Accuracy:** 0.08 dB/dB from midscreen.

### Phase

**Range:**  $\pm 180^\circ$  display range with selectable resolutions of 90, 45, 10, and 1°/division.

**Accuracy:** 0.065°/degree from midscreen.

**Phase offset:** 0.3°/20° step cumulative  $< 3^\circ$ .

**Power:** 23 watts supplied by mainframe.

**Weight:** net, 7.8 kg (17 lb). Shipping, 10 kg (22 lb).

**Size:** 152 H x 186 W x 395 mm D (6" x 7.28" x 15.56") excluding front panel knobs.

### 8414B Polar Display

**Function:** plug-in CRT display unit for 8410C. Displays amplitude and phase data in polar coordinates on 5-in. cathode ray tube.

**Range:** normalized polar coordinate display; magnitude calibration 20% of full scale per division. Scale factor is a function of IF setting on 8410C. The beam center function is controllable by an external contact closure.

**Accuracy:** error circle on CRT  $\pm 3$  mm.

**Power:** 35 watts supplied by mainframe.

**Weight:** net, 5.8 kg (13 lb). Shipping 8.1 kg (18 lb).

**Size:** 152 H x 186 W x 395 mm D (6" x 7.28" x 15.56") excluding front panel knobs.

### 8418B Auxiliary Display Holder

**Function:** the 8418B Auxiliary Display Holder provides power for operating of the 8412B, 8413A or the 8414B display units. Used in conjunction with the 8410C Network Analyzer, it provides the capability of viewing amplitude and phase readout in both rectangular and polar coordinates simultaneously. Includes a remotely programmable 0-70 dB IF attenuator required for autoranging in automatic applications.

**Weight:** net, 11.2 kg (25 lb). Shipping, 19.7 kg (44 lb).

**Size:** 177 H x 483 W x 450 mm D (6.97" x 19" x 17.13").

### Ordering Information

**8410C** mainframe

**Opt 908:** Rack Flange Kit

**8411A** Frequency Converter

**Opt 018:** 0.11 to 18 GHz

**8412B** Phase-Magnitude Display

**8414B** Polar Display

**8418B** Auxiliary Display Holder

**Opt 908:** Rack Flange Kit

## Specifications

### 8410C / 8411A Network Analyzer

**Function:** 8411A converts RF signals to IF signals for processing in 8410C mainframe. 8410C is the mainframe for display plug-in units. Mainframe includes tuning circuits (octave bands or multioctave bands when used with HP 8620C or 8350A sweep oscillator), IF amplifiers and precision IF attenuator. 8410C allows injection of an external local oscillator used in automatic applications to lock the 8410C receiver to an external source such as the HP 3335A.

**8410C frequency range:** 0.11 to 18 GHz.

**8411A frequency range:** 0.11 to 12.4 GHz.

**Opt 018:** 0.11 to 18 GHz.

**8411A input impedance:** 50 ohms nominal. SWR  $< 1.5$ , 0.11 to 2.0 GHz;  $< 2.0$ , 2.0 to 16.0 GHz; 3, 6.0 to 18.0 GHz.

**Channel isolation:**  $> 65$  dB, 0.1 to 6 GHz;  $> 60$  dB, 6 to 12.4 GHz;  $> 50$  dB, 12.4 to 18 GHz.

### Magnitude Range

**Reference channel:** -18 to -35 dBm, 0.11 to 12.4 GHz; -18 to -25 dBm from 12.4 to 18.0 GHz.

**Test channel:** -10 to -75 dBm from 0.11 to 12.4 GHz; -10 to -68 dBm from 12.4 to 18 GHz.

**Maximum RF input to either channel:** 50 mW.

**IF gain control:** 69 dB range in 10 dB and 1 dB steps with a maximum cumulative error of  $\pm 0.2$  dB.

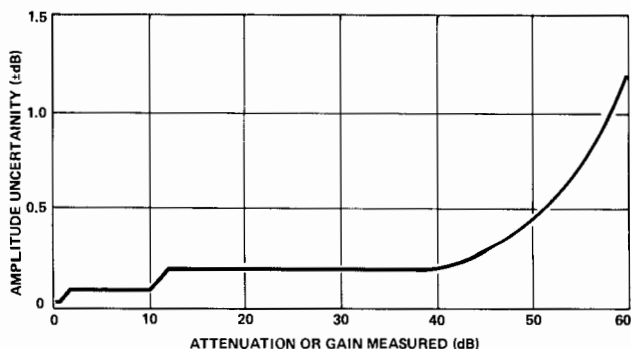



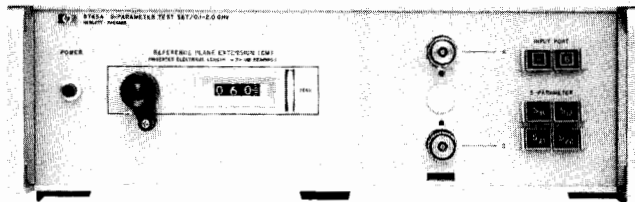

8745A

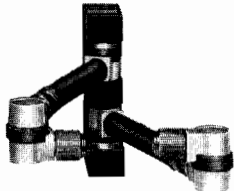

11604A

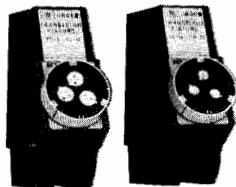

11602B

11600B

### 8745A S-Parameter Test Set

**Function:** wideband RF power splitter and reflectometer with calibrated line stretcher. Pushbutton operated for either forward or reverse transmission or reflection measurements with network analyzer.

**Frequency range:** 100 MHz to 2 GHz.

**Impedance:** 50 ohms nominal.

**Source reflection coefficient:**  $\leq 0.057$ , 0.11 to 2.0 GHz.

**Termination reflection coefficient:**  $< 0.10$ , 100, to 200 MHz;  $< 0.063$ , 200 MHz to 2.0 GHz.

**Directivity:**  $\geq 36$  dB, below 1 GHz;  $\geq 32$  dB, 1 to 2 GHz.

**Reference plane extension:** 0 to 15 cm for reflection; 0 to 30 cm for transmission.

**Maximum RF power:** 2 watts.

**Connectors:** RF input type N female; all other connectors APC-7; Option 001, type N female.

**Remote programming:** ground closure.

**Power:** 115 or 120 V  $\pm 10\%$ , 50 to 400 Hz, 40 watts.

**Weight:** net, 15.4 kg (34.25 lb). Shipping, 18.0 kg (40 lb).

**Size:** 140 H x 425 W x 654 mm D (5.50" x 16.75" x 25.75").

### 11604A Universal Extension

**Function:** mounts on front of 8745A; connects to device under test. Rotary air-lines and rotary joints connect to any two port geometry.

**Frequency range:** dc to 2 GHz.

**Impedance:** 50 ohms nominal.

**Reflection coefficient:** 0.035.

**Acc. included:** semi-rigid coax. cable, HP Part #11604-20021.

**Weight:** net, 1.8 kg (4 lb). Shipping, 2.2 kg (5 lb).

**Size:** 127 H x 32 W x 267 mm D (5" x 1.25" x 10.50").

### 11600B/11602B Transistor Fixtures

**Function:** mounts on front of 8745A S-parameter test set; holds devices for S-parameter measurements in a 50 ohm, coax circuit. Both fixtures provide bias for bipolar transistors and FETs. Other devices also fit the fixture (tunnel diodes, etc.).

#### Transistor Base Patterns

**Model 11600B:** accepts TO-18/TO-72 packages.

**Model 11602B:** accepts TO-5/TO-12 packages.

**Calibration references:** short circuit termination and a 50 ohm through-section.

**Frequency ranges:** dc to 2 GHz.

**Impedance:** 50 ohm nominal.

**Reflection coefficient:**  $< 0.05$ , 100 MHz to 1.0 GHz;  $< 0.09$ , 1.0 to 2 GHz.

**Connectors:** hybrid APC-7; Option 001, type N female.

**Weight:** net 1.1 kg (2.38 lb). Shipping, 1.8 kg (4 lb).

**Size:** 152 H x 44 W x 229 mm D (6" x 1.75" x 9").

### 8410S Opt 110 Specifications

**Function:** the 8410S option 110 measurement system configuration is described on page 457. Following are specifications describing measurement capabilities of the 8410C/8411A when used with the 8745A/11604A over the frequency range of 110 MHz to 2 GHz.

**Frequency range:** 0.11 to 2.0 GHz.

**RF input:** 20 dB range between +5 dBm and -12 dBm.

**Source reflection coefficient:**  $\leq 0.067$ , 0.11-2.0 GHz.

**Termination reflection coefficient:**  $\leq 0.11$ , 100-200 MHz;  $\leq 0.07$ , 200-2000 MHz.

**Directivity:**  $\geq 28$  dB 0.11-1.0 GHz;  $\geq 27$  dB 1.0-2.0 GHz.

**Insertion loss, RF input to test port:** 4 dB nominal.

#### Frequency Response

**Transmission:** typically  $< \pm 0.35$  dB amplitude and  $< \pm 5^\circ$  phase.

**Reflection:** typically  $< \pm 0.06$  magnitude and  $\pm 5^\circ$  phase with a short on the test port.

**Transmission measurement accuracy:** (see common performance specifications).

**Reflection measurement accuracy (using 8414B):** sources of error included in the accuracy equations are directivity, source match, and polar display accuracy.

#### Magnitude accuracy:

$\rho_u = \pm (0.0398 + 0.03 \rho_L + 0.067 \rho_L^2)$  0.11-1.0 GHz.

$\rho_u = \pm (0.0447 + 0.03 \rho_L + 0.067 \rho_L^2)$  1.0-2.0 GHz.

$\rho_u$  = magnitude uncertainty.

$\rho_L$  = measured reflection coefficient magnitude.

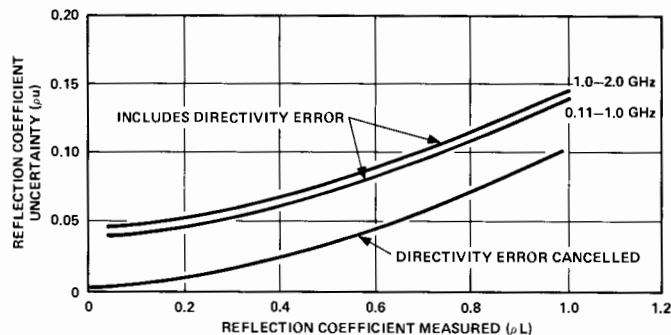

#### Phase accuracy:

$\Phi_u = \sin^{-1} \rho_u / \rho_L$  for  $\Phi_u < 90^\circ$ .

$\Phi_u$  = phase uncertainty.

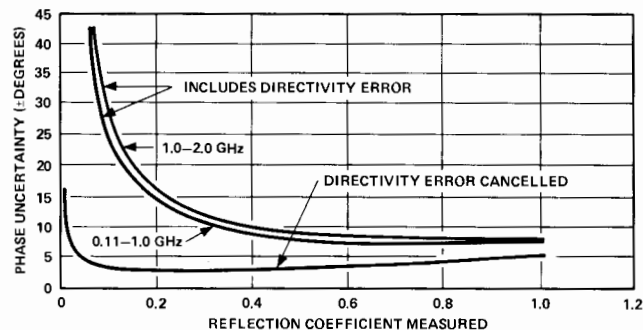

See 8410S Network Analyzer Systems Table for price and instrument breakdown.

### Ordering Information

8745A Test Set

Opt 001: Type N Test Port Connectors

Opt 908: Rack Flange Kit

11604A Universal Arm Extension

11600B/11602B Transistor Fixtures

Opt 001: Type N Female Connectors

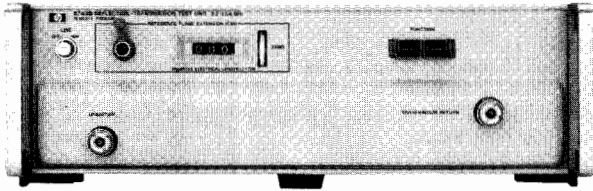

8743B

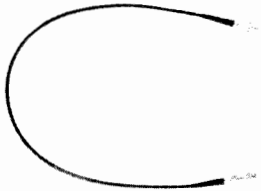

11610B

### 8743B Reflection/Transmission Test Unit

**Function:** wideband RF power splitter and reflectometer with calibrated line stretcher. Pushbutton operated for either transmission or reflection measurement with network analyzer. Designed for use with the 11610B Test Port Extension Cable.

**Frequency range:** 2 to 12.4 GHz, (Opt 018: 2 to 18 GHz).

**Impedance:** 50 ohms nominal.

**Source reflection coefficient:**  $\leq 0.09$ , 2.0 to 8.0 GHz;  $\leq 0.13$ , 8.0 to 12.4 GHz;  $< 0.2$ , 12.4 to 18 GHz.

**Termination reflection coefficient:**  $\leq 0.13$  in reflection mode, 2.0 to 12.4 GHz;  $\leq 0.2$  in transmission mode, 2.0 to 12.4 GHz; typically  $< 0.2$ , 12.4 to 18 GHz.

**Directivity:**  $\geq 30$  dB, 2.0 to 12.4 GHz;  $\geq 18$  dB, 12.4 to 18 GHz.

**Reference plane extension:** 0 to 15 cm for reflection; 0 to 30 cm for transmission.

**Connectors:** RF input, type N female; all other connectors APC-7.

**Remote programming:** ground closure.

**Power:** 115 or 230 V  $\pm 10\%$ , 50-400 Hz, 15 W.

**Weight:** net, 12.1 kg (29 lb). Shipping, 15.3 kg (34 lb).

**Size:** 140 H x 425 W x 467 mm D (5.50" x 16.75" x 18.38").

### 11610B Microwave Cable

**Function:** A high quality semirigid coaxial cable used with the 8409B Automatic Network Analyzer at frequencies up to 18 GHz. It is designed for applications which require excellent magnitude and phase repeatability from connection to connection. The cable exhibits minimum change in transmission characteristics when flexed during normal use. The 11610B is the recommended transmission return cable for use with the 8743B and the 8746B.

**Frequency range:** dc to 18 GHz.

**Impedance:** 50 ohms nominal. Reflection coefficient of ports  $< 0.14$ .

**Insertion loss:**  $< 0.7$  dB + 0.12 dB/GHz.

**Stability with three repeated flexings:**  $< 0.3$  dB,  $< 0.5$  degrees + 0.12 degrees/GHz change.

**Connectors:** APC-7.

**Length:** 1.07 m (42 inches)

### 8410S Opt 210 Specifications

**Function:** The 8410S Option 210 measurement system configuration is described on page 457. Following are specifications describing measurement capabilities of the 8410C/8411A when used with the 8743B/11610B over the frequency range of 2 GHz to 12.4 GHz.

**Frequency range:** 2.0 to 12.4 GHz.

**RF input:** 20 dB range between +12 dBm and -5 dBm.

**Source reflection coefficient:**  $\leq 0.09$ , 2-8 GHz;  $\leq 0.13$ , 8-12.4 GHz.

**Termination reflection coefficient:**  $\leq 0.09$ , 2-8 GHz;  $\leq 0.13$ , 8-12.4 GHz.

**Directivity:**  $\geq 30$  dB, 2-12.4 GHz.

**Insertion loss, RF input to test port:** 20 dB nominal.

#### Frequency Response

**Transmission:** typically  $< \pm 0.5$  dB amplitude and  $< \pm 5^\circ$  phase.

**Reflection:** typically  $< \pm 0.09$  magnitude and  $< \pm 6^\circ$  phase, with a short on the unknown port.

**Transmission measurement accuracy:** (see Common Performance Specifications).

**Reflection measurement accuracy (using 8414B):** sources of error included in the accuracy equations are directivity, source match, and polar display accuracy.

#### Magnitude accuracy:

$$\rho_u = \pm(0.0316 + 0.03 \rho_L + 0.09 \rho_L^2) \quad 2-8 \text{ GHz.}$$

$$\rho_u = \pm(0.0316 + 0.03 \rho_L + 0.13 \rho_L^2) \quad 8-12.4 \text{ GHz.}$$

$\rho_u$  = magnitude uncertainty.

$\rho_u$  = measured reflection coefficient magnitude.

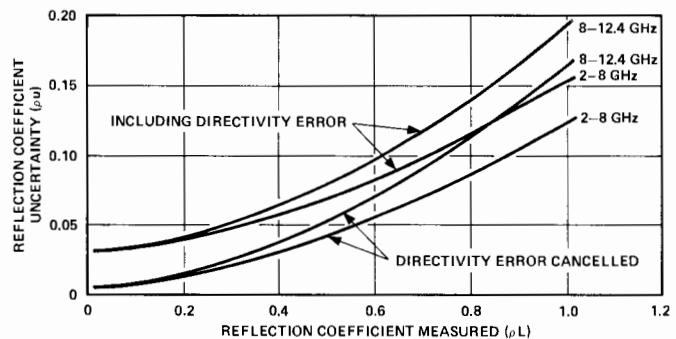

#### Phase accuracy:

$$\Phi_u = \sin^{-1} \rho_u / \rho_L \text{ for } \Phi_u < \pm 90^\circ.$$

$\Phi_u$  = phase uncertainty.

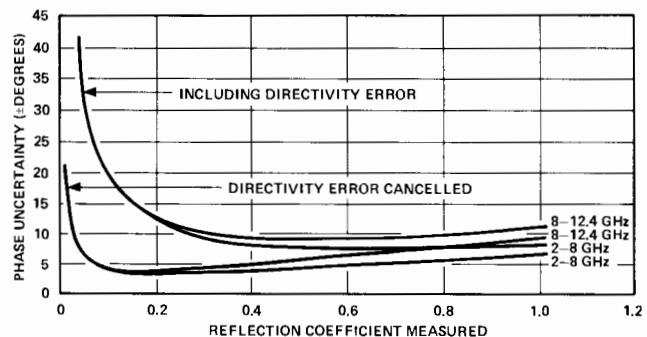

See 8410S Network Analyzer Systems Table for price and instrument breakdown.

#### Ordering Information

8743B Reflection/Transmission Test Unit

Opt 018: 2 to 18 GHz

Opt 908: Rack Flange Kit

11610B Microwave Cable



# NETWORK ANALYZERS

## Test Sets and Accessories (Cont.)

### 8410 Family

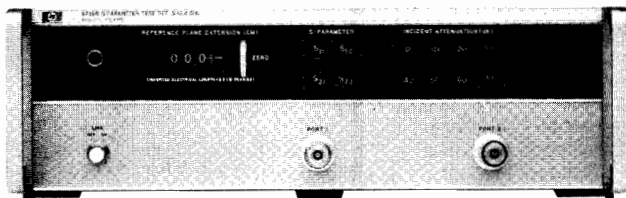

8746B



11608A

#### 8746B S-Parameter Test Set

**Function:** wideband RF power divider and reflectometer with calibrated line stretcher and a selectable 0-70 dB incident signal attenuator. Provides internal bias for completely characterizing two port active devices.

**Frequency range:** 0.5 to 12.4 GHz.

**Source and termination reflection coefficient:**  $\leq 0.13$ .

**Directivity:**  $\geq 30$  dB, 0.5 to 4.0 GHz;  $\geq 26$  dB, 4.0 to 12.4 GHz.

**Incident attenuation:** 0-70 dB in 10 dB steps  $\pm 5\%$ .

**Reference plane extension:** adds 0 to 15 cm for reflection; 0 to 30 cm for transmission.

**Remote programming:** ground closure.

**Transistor biasing:** via 36 Pin connector.

**Connectors:** input type N female, test ports APC-7.

**Opt 001:** provides 10 dB higher power level at the test port.

**Power:** 115 or 230 V  $\pm 10\%$ , 48 to 440 Hz, 110 VA max.

**Weight:** net, 16.1 kg (35 lb). Shipping, 19.1 kg (42 lb).

**Size:** 140 H x 425 W x 467 mm D (5.5" x 16.75" x 18.38").

#### 11608A Transistor Fixture

**Function:** provides the capability of completely characterizing stripline transistors. A through-line microstrip and bolt-in grounding structure machineable by customer is included.

**Frequency range:** dc to 12.4 GHz.

**Reflection coefficient:**  $< 0.05$ , dc to 4 GHz;  $< 0.07$ , 4.0 to 8.0 GHz;  $> 0.15$ , 8 to 12.4 GHz.

#### Package styles

**Opt 003:** 0.205 inch diameter packages.

**Calibration references:** option 003 only, short circuit termination and a 50-ohm through-section.

**Connectors:** APC-7 Hybrid.

**Weight:** net, 0.9 kg (2 lb). Shipping, 1.4 kg (3 lb).

**Size:** 25 H x 143 W x 89 mm D (1" x 5.63" x 3.5").

#### 8410S Opt 500 Specifications

**Function:** The 8410S option 500 measurement system configuration is described on page 457. Following are specifications describing measurement capabilities of the 8410C/8411A when used with the 8746B/11608A over the frequency range of 500 MHz to 12.4 GHz.

**Frequency range:** 0.5 to 12.4 GHz.

**Transistor dc bias selection;** front panel slide switches establish proper dc biasing for both Bi-polar and FET transistors. The voltage and current controls operation independently and are continuously adjustable over a current range of 0 to 500 mA and a range of 0 to 30 Vdc.

**RF input:** 20 dB range between +12 and -5 dBm.

**Incident attenuation range:** 0 to 70 dB in 10 dB steps.

**Source reflection coefficient:** (typically)  $\leq 0.132$ , 0.5 to 4.0 GHz;  $\leq 0.135$ , 4.0 to 8.0 GHz;  $\pm 0.141$ , 8.0 to 12.4 GHz.

**Termination reflection coefficient:** (typically)  $< 0.139$ , 0.5 to 4.0 GHz;  $< 0.148$ , 4.0 to 8.0 GHz;  $\pm 0.170$ , 8.0 to 12.4 GHz.

**Directivity:**  $\geq 28$  dB, 0.5 to 4.0 GHz;  $\geq 24$  dB, 4 to 8.0 GHz;  $\geq 23$  dB, 8.0 to 12.4 GHz.

**Frequency response:** (typically)  $< 0.5$  dB,  $\pm 7$  degrees, 0.05 to 4.0 GHz;  $< 0.75$  dB,  $\pm 7$  degrees, 4.0 to 8.0 GHz;  $< 1.25$  dB,  $\pm 7$  degrees, 8.0 to 12.4 GHz.

**Transmission measurement accuracy:** (see Common Performance Specifications).

**Reflection measurement accuracy:** sources of error included in the accuracy equation are directivity and source match.

#### Magnitude accuracy:

$\rho_u = \pm (0.04 + 0.08 \rho_L + 0.13 \rho_L^2)$  0.5 to 4.0 GHz.

$\rho_u = \pm (0.06 + 0.09 \rho_L + 0.135 \rho_L^2)$  4.0 to 8.0 GHz.

$\rho_u = \pm (0.074 + 0.098 \rho_L + 0.14 \rho_L^2)$  8.0 to 12.4 GHz.

$\rho_u =$  magnitude uncertainty.

$\rho_L =$  measured reflection coefficient magnitude.

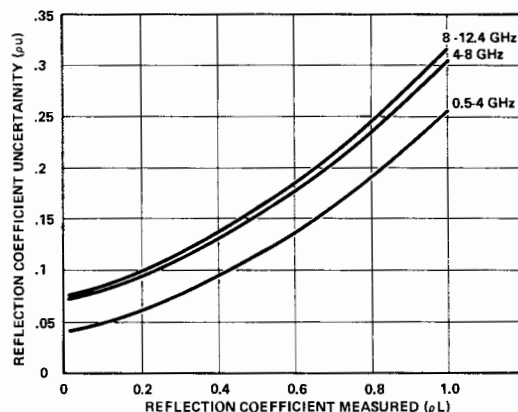

#### Phase accuracy:

$\Phi_u = \sin^{-1} \rho_u / \rho_L$  for  $\Phi_u < 90^\circ$ .

$\Phi_u =$  phase uncertainty.

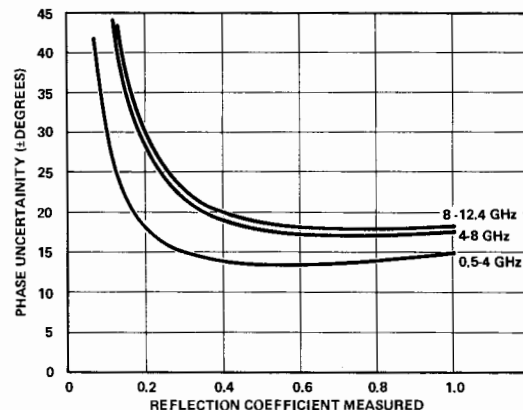

See 8410S Network Analyzer Systems Table for price and instrument breakdown.

#### Ordering Information

8746B Test Unit

Opt 001: Large Signal

Opt 908: Rack Flange Kit

11608A Transistor Fixture Customer Machineable

Opt 003: 0.205 inch diameter package style



8717B

**11589A and 11590A Bias Networks**

**Function:** auxiliary units for use with the 11600B, 11602B and 11608A transistor fixtures. These bias networks provide dc bias to the center conductor of a coaxial line while blocking the dc bias from the input RF circuit.

**Frequency range:** 11589A—0.1 to 3.0 GHz; 11590A—1.0 to 12.4 GHz; 11590A Option 001—1.0 to 18.0 GHz.

**Connectors:** BNC for dc biasing; type N female for RF (Option 001; APC-7).

**Weight:** net, 0.3 kg (0.67 lb). Shipping, 0.5 kg (1 lb).

**Size:** 29 H x 76 W x 114 mm D (1.38" x 3" x 4.5").

**11650A Accessory Kit**

**Function:** accessories normally used for transmission and reflection tests with the 8745A and 8743B.

**Weight:** net, 1.34 kg (3 lb). Shipping, 2.23 kg (5 lb).

**11609A Cable Kit**

**Function:** interconnecting cables normally required for network measurements using the 8410C network analyzer.

**Weight:** net, 0.9 kg (2 lb). Shipping, 1.36 kg (3 lb).

**11866A APC-7 Calibration Kit**

**Function:** a 50 Ω (>52 dB return loss @ 2 GHz) termination, a short circuit and a shielded open circuit are used with the 8409C to quantify directivity, source match, and frequency tracking errors.

**Weight:** net 0.57 kg (1.25 lb). Shipping 0.91 kg. (2.0 lb).

**Size:** 50.8 H x 7 W x 12.7 D (2.0" x 5.0" x 5.0").

**85032A Type N Calibration Kit**

**Function:** provides two Type N male to APC-7 adapters, two Type N female to APC-7 adapters, as well as one each Type N male and female short circuits and 50 Ω (<1.01 SWR at 2 GHz) terminations. Option 001 adds one each male and female Type N shielded open circuits.

**85033A SMA Calibration Kit**

**Function:** provides two SMA male to APC-7 adapters, two SMA female to APC-7 adapters, as well as one each SMA male and female short circuits and 50 Ω (<1.06 SWR at 1 GHz) terminations.

**85033B APC-3.5 Calibration Kit**

**Function:** provides two APC-3.5 male to APC-7 adapters, two APC-3.5 female to APC-7 adapters, as well as one each APC-3.5 male and female short circuits shielded open circuits with center pin extenders, and 50 Ω (<1.03 SWR at 2 GHz) terminations. This kit is specially designed for use with 8409-series Automatic Network Analyzer systems.

**Ordering Information**

- 8717B Transistor Bias Supply
- Opt 001: Programmable D/A Converter
- Opt 90B: Rack Flange Kit
- 11589A Bias Network
- Opt 001: APC-7 Connectors
- 11590A Bias Network
- Opt 001: APC-7 Connectors, 1–18 GHz
- 11650A Accessory Kit
- 11609A Cable Kit
- 11866A APC-7 Calibration Kit
- 85032A N Calibration Kit
- Opt 001: Shielded Open Circuits
- 85033A SMA Calibration Kit
- 85033B APC-3.5 Calibration Kit

**8717B Transistor Bias Supply**

**Function:** for manual or programmable transistor testing. It is particularly useful with the 11600B, 11602B, and 11608A Transistor Fixtures. The 8717B has two meters for independently monitoring current and voltage on any of the three leads of a transistor under test. Bias connections are conveniently selected for all transistor configurations with a front panel switch. Special circuitry protects sensitive devices from excessive current transients which commonly occur in less sophisticated supplies.

**Voltage ranges:** 1, 3, 10, 30, 100 V.

**Current ranges:** 0.1, 0.3, 1, 3, 10, 30, 100, 300, 1000 mA.

**Accuracy:** 4% of full scale for both current and voltage.

**Option 001:** programmable D/A converter.

**Weight:** net, 9.0 kg (20 lb). Shipping, 11.0 kg (25 lb).

**Size:** 86 H x 425 W x 336 mm D (3.38" x 16.75" x 13.5").

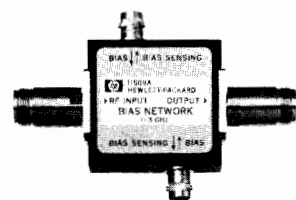

11589A and 11590A

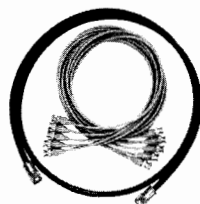

11609A



11650A



11866A



85032A

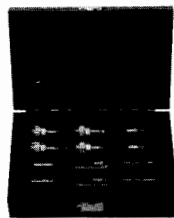

85033B



85033A

# NETWORK ANALYZERS

Accessories, Waveguide Test Sets, 8410S Systems

8410 Family

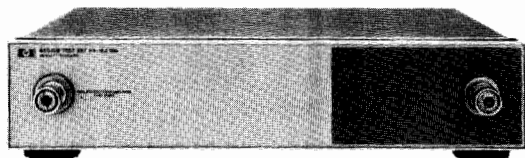

85040B

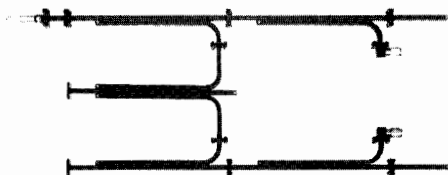

X8747A and P8747A

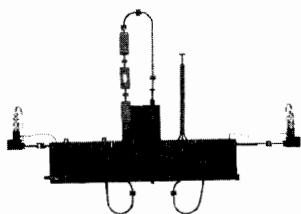

K8747A and R8747B

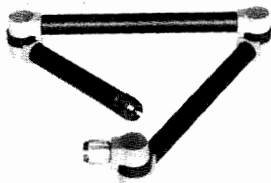

11605A

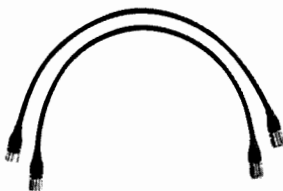

11857A

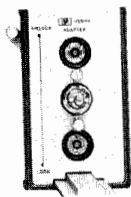

11599A

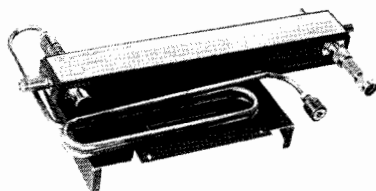

11607A

## 85040B 0.5-18 GHz Reflection/Transmission Test Set

The HP 85040B is a reflection/transmission test set designed for automatic systems, specifically the HP 8408B Automatic Network Analyzer. Switching between transmission and reflection is done with an external 24 Volt signal from the HP 11713A Attenuator/Switch Driver via a cable supplied with the 85040B.

**Frequency Range:** 0.5 to 18 GHz, (0.1 to 18 GHz transmission only)

**Impedance:** 50 ohms nominal.

**Maximum Operating level** (with 8411A installed):

**RF Input:** +8 dBm.

**Test Port:** +10 dBm.

**Transmission Return:** -10 dBm, +17 dBm damage level.

**Connectors:** RF input type N female; all other RF connectors APC-7.

**Source Reflection Coefficient:** <.2.

**Directivity:** >24 dB, .5 to 8 GHz; >20 dB, 8 to 18 GHz.

**Typical Insertion Loss:**

RF In to RF Out: <9 dB.

RF Out to 8411A (Reflection Mode): <38 dB, .5 to 2 GHz; < 31 dB, 2 to 18 GHz.

**Typical performance with accuracy enhancement in 8408B system (in APC-7):**

**Reflection**

**Directivity:** 40 dB.

**Source Match:** 1.05 SWR.

**Frequency Response:** <.05 dB, <.5 degree.

**Transmission**

**Source Match:** 1.3 SWR

**Load Match:** 1.2 SWR.

**Frequency Response:** <.05 dB, <.5 degree.

## X8747A, P8747A Reflection/Transmission Test Units

**Function:** waveguide setup for measuring reflection and transmission parameters of waveguide devices with the network analyzer.

**Frequency range:** X8747A: 8.2-12.4 GHz; P8747A: 12.4-18 GHz.

## K8747A, R8747B Reflection/Transmission Test Units

**Function:** waveguide setup for measuring reflection and transmission parameters of waveguide devices with the network analyzer; down-converts with built-in mixers to the frequency range of the 8411A.

**Frequency range:** K8747A: 18-26.5 GHz; R8747B: 26.5-40 GHz.

## 11605A Flexible Arm

**Function:** Mounts on front of 8743B Test Set; connects to device under test. Rotary air-lines and rotary joints connect to any two-port geometry. Primarily intended for use with existing 8743A's but can be used with 8743B (11610B recommended for use with 8743B).

**Frequency range:** dc to 12.4 GHz. (Opt 018, 2 to 18 GHz).

**Impedance:** 50 ohms nominal. Reflection coefficient of ports:  $\leq 0.11$ , dc to 12.4.

**Opt 018:**  $\leq 0.23$ , 2.0 to 12.4 GHz;  $\leq 0.31$ , 12.4 to 18 GHz.

**Connectors:** APC-7.

**Weight:** net, 1.8 kg (4 lb). Shipping, 2.7 kg (6 lb).

**Length:** 257 mm (10.09") closed; 648 mm (25.50") extended.

## 11857A 50 Ohm APC-7 Test Port Extension Cables

**General:** two precision 61 cm (24 in.) cables, for use with 8745A S-parameter test set. Connectors are 50 Ohm APC-7.

**Weight:** net, 0.91 kg (2 lb). Shipping, 2.3 kg (5 lb).

## 11599A Quick Connect Adapter

**Function:** quickly connects and disconnects the 8745A and the transistor fixtures or 11604A universal extension.

**Weight:** net, 0.4 kg (0.88 lb). Shipping, 0.9 kg (2 lb).

**Size:** 127 H x 76 W x 108 mm D (5" x 3" x 4.5").

## 11607A Small Signal Adapter

**Function:** used with the 8745A S-parameter test set. The incident signal levels to the test device are reduced to the -20 to -40 dBm range.

**Weight:** net 4.1 kg (4.63 lb). Shipping, 4.5 kg (10 lb).

**Size:** 60 H x 413 W x 244 mm D (2.38" x 16.25" x 9.63").

## Ordering Information

85040B 0.5-18 GHz Reflection/Transmission Test Set

11605A Flexible Arm

Opt 018: 0.11 to 18 GHz

11857A 50 Ohm APC-7 Test Port Extension Cables

11599A Quick Connect Adapter

11607A Small Signal Adapter

X8747A Waveguide Test Set

P8747A Waveguide Test Set

K8747A Waveguide Test Set

R8747B Waveguide Test Set



8413A



8750A

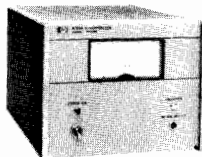

8709B

**8413A Phase-Gain Indicator**

**Function:** plug-in meter display unit for 8410C. Displays relative amplitude in dB or relative phase in degrees between reference and test channel inputs. Pushbutton selection of meter function and range.

**Amplitude**

**Range:** ±30, ±10, and ±3 dB full scale.

**Accuracy:** ±3% of end scale.

**Log output:** 50 millivots per dB up to 60 dB total.

**Phase**

**Range:** ±180, ±60, ±6 degrees full scale.

**Accuracy:** ±2% of end scale.

**Output:** 10 millivots per degree.

**Phase offset:** ±180 degrees in 10-degree steps.

**Accuracy:** ±2° +0.3°/10° step, cumulative <2°.

**Power:** 15 watts supplied by mainframe.

**Weight:** net, 4.9 kg (11 lb). Shipping, 6.7 kg (15 lb).

**Size:** 152 H x 186 W x 395 mm D (6" x 7.28" x 15.56").

**8750A Storage-Normalizer**

**General:** the 8750A Storage-Normalizer provides digitally stored and normalized CRT displays when used with the 8412B Phase Magnitude Display. Measurements are faster, easier and more accurate when the 8750A is employed because the CRT is flicker-free and frequency response errors are eliminated. The 8750A is not compatible with the 8414B Polar Display. Option 003 adds 8412B Compatibility. Detailed specifications on page 449.

**8709B Phase Lock Synchronizer**

The 8709B Synchronizer is designed for use in the source phase-lock subsystem of HP 8409 type automatic network analyzer systems. Using the 8709B, the HP 8620C or 8350A solid state sweeper is phase-locked to the HP 8410 IF frequency (20.278 MHz). This provides a stabilized, synthesizer class RF source with excellent frequency resolution and accuracy. The 8709B is a dedicated version of the 8709A Synchronizer. The 8709A has a locking frequency of 20 MHz.

**Ordering Information**

**8413A** Phase-Gain Display

**8750A** Storage-Normalizer

**Opt 003: 8412B** Plug-In Interface Card

**8709B** Phase Lock Synchronizer

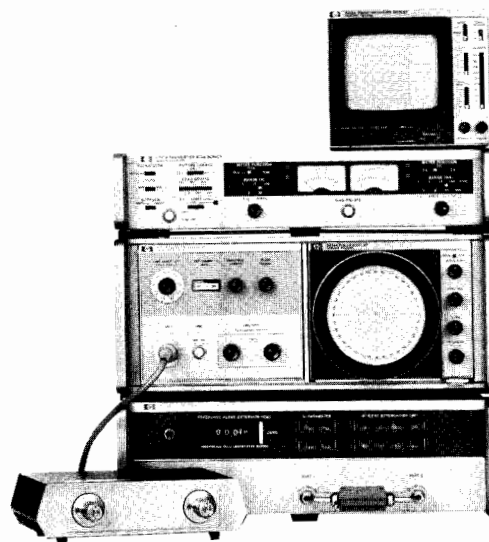

8410S Opt 500

8410S systems enable ordering a complete network analyzer system, except for source, using a single model number. Each option has been configured for making general measurements on coaxial or semiconductor devices. The 8410S Systems enable the operator to view a real time CRT display over octave or multioctave bands with a dynamic range of 60 dB amplitude and 360° phase. Multioctave, continuous network measurements over the frequency range of 2 to 18 GHz are possible when the 8410C is used with the HP 8620C or 8350A Sweep Oscillator.

The 8410S Systems' upper frequency limit for coaxial and semiconductor measurements is 12.4 GHz; however, individual instruments may be ordered that will expand coaxial measurement capability to 18 GHz (option 018 instruments) and waveguide measurements from 8.2 GHz to 40 GHz (8747A series).

**8410S Network Analyzer Systems Table**

GENERAL PURPOSE MEASUREMENTS			All 8410S Systems Include the Following Instrument Model Numbers: 8410C, 8411A, 8412B, 8414B, 11609A, and 8750A opt. 003									
Frequency Range	Option No.	Measurement Port Configuration	8743B	8745A	8746A	8717B	11600B	11602B	11608A	11604A	11610B	11650A
0.11 to 2 GHz	110	Coaxial (APC-7)		X						X		X
0.11 to 12.4 GHz	310	Coaxial (APC-7)	X	X						X	X	X
2 to 12.4 GHz	210	Coaxial (APC-7)	X								X	X
SEMICONDUCTOR CHARACTERIZATION												
0.11 to 2 GHz	400	T018/T072 Packages		X		X	X					
0.11 to 2 GHz	401	T05/T012 Packages		X		X		X				
0.5 to 12.4 GHz	500	Stripline			X	X			X			



# NETWORK ANALYZERS

## Automatic Network Analyzer, 500 MHz to 18 GHz

### Model 8408B

- 40 dB Effective Directivity
- Economical reflection and transmission measurements
- 8-term vector error-correction
- Friendly, easy-to-use

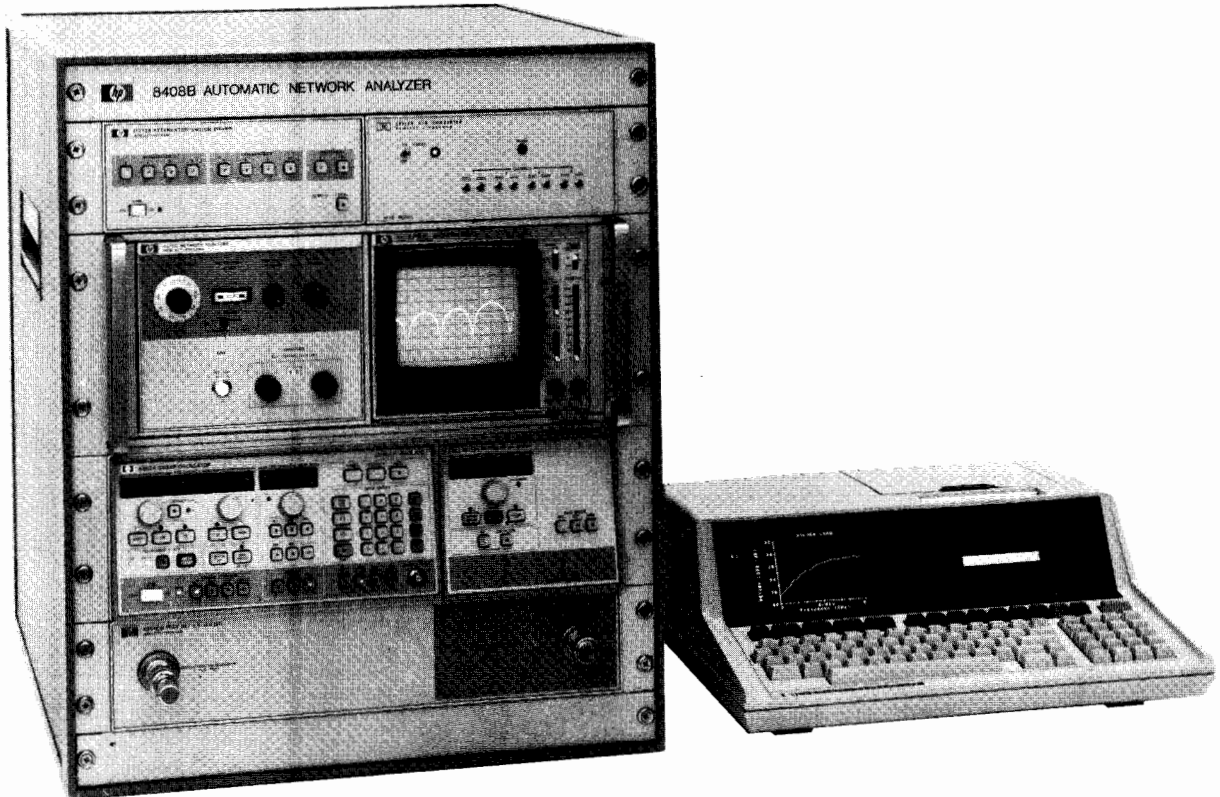

### Description

The HP 8408B Automatic Network Analyzer is a complete microwave network measurement system composed of a network analyzer (receiver), reflection/transmission test set, programmable source, computing controller, and accuracy enhancement pac for making vector error-corrected measurements. The HP 8408B system is fully assembled and integrated at the factory. All accessories and cables necessary for making transmission and reflection measurements are supplied with the system, including calibration standards for measurements in APC-7.

Utilizing a single broadband source and test set, the HP 8408B system measures return loss and transmission (magnitude and phase) over the 500 MHz to 18 GHz frequency range. To verify that the proper connections have been made or to adjust the test device, a real-time CRT display of swept magnitude and phase is provided over the selected frequency range. The test set is a one path reflection transmission test set. The 85040B Test Set is a low cost test set designed for automatic systems. When used with the 11873B Accuracy Enhancement Pac in the 8408B system, measurements can be made from 500 MHz to 18 GHz with an effective system directivity better than 40 dB.

The HP 8408B is a tuned receiver that allows both magnitude and phase information of the test signal to be obtained. In comparison to a magnitude-only (scalar) measurement system, a tuned receiver provides a 60 dB measurement range that is immune to measurement ambiguities caused by source harmonics or spurious signals. Using phase information, system errors like directivity and source match can be measured and effectively removed. Hence magnitude measurements can be made with much greater accuracy than in scalar systems.

The HP 8408B makes vector error-corrected measurements by initially measuring several calibration standards in order to quantify and store the repeatable system errors. Then at each measurement frequency the measured data is enhanced by using an 8-term error correction model that effectively removes these system errors. By using vector error-correction and the appropriate calibration standards, the effective system directivity is better than 40 dB at the measurement test port using the desired test connector type.

The 11873A Accuracy Enhancement Pac provided with the system allows the user to immediately make measurements at up to 100 frequencies. The software guides the user via simple prompts through the initial setup, calibration, measurement, and output sequences in order to simplify system operation. After measuring the test device, the data can be displayed in a tabular listing, plotted versus frequency in a rectangular format, or plotted in a polar format. Direct the output to the CRT or the internal thermal printer for hard copy results. When plotting, you even have the option of selecting the scale values or letting the software automatically scale the data for you.

For measurements in APC-3.5 or Type-N, the proper calibration standards and adapters are available. For APC-3.5, use the 85033B Calibration Kit and 911C Sliding Load. For Type-N, use the 85032A Option 001 Calibration Kit. The sliding load provided with the system can be used for APC-7 and Type-N.

### Ordering Information

**8408B** Automatic Network Analyzer (0.5 to 18 GHz)

**Opt 001:** 2 to 18 GHz Coverage only  
(substitute 83590A for 83592A)

**Opt 002:** Delete HP 85 Controller System

**Opt 003:** Delete Sweep Oscillator Plug-in  
**85040B** Test Set

**Opt 908:** Rack Flange Kit

**11873A** Accuracy Enhancement Pac

# NETWORK ANALYZERS

## Automatic Network Analyzer, 110 MHz to 18 GHz

Model 8409C



- Synthesized network analyzer with phase-locked source
- Full S-Parameter and group delay measurement capability
- High performance calibration/metrology system
- 12-term vector error-correction

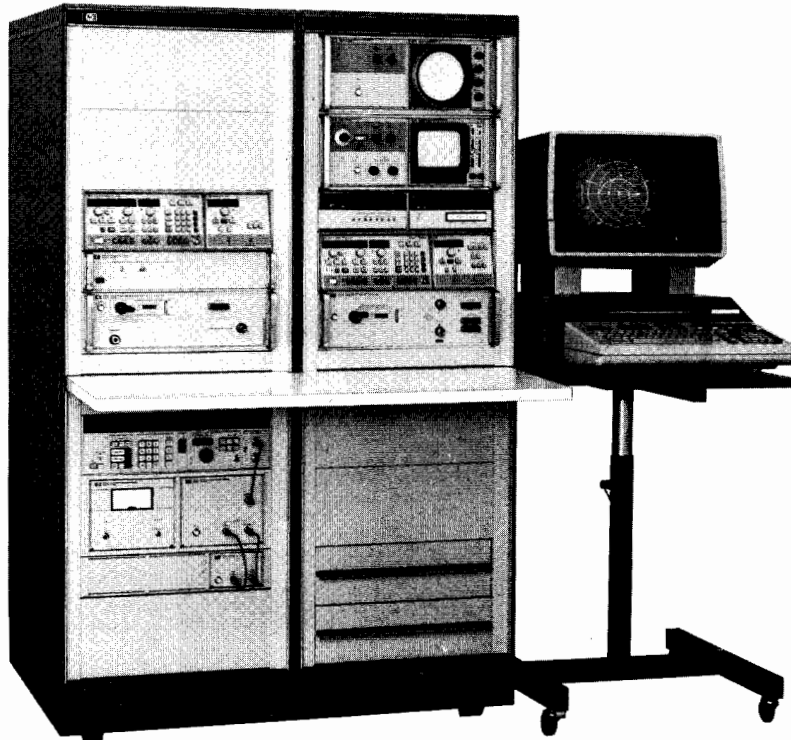

### Description

The HP 8409C Automatic Network Analyzer is a complete, high performance microwave network measurement system for high accuracy, vector error-corrected S-Parameter and Group Delay measurements. The system includes a synthesized network analyzer, phase-locked source, S-Parameter test set, desktop computer, and software using a comprehensive vector error-correction model. The 8409C is ideal for calibration requirements and difficult to measure devices that have either very low or high input reflection coefficients, such as cables and transistors. All accessories are provided for vector error-corrected measurements in APC-7, APC-3.5, and Type N.

The Phase-lock subsystem provides a synthesized receiver for improved measurement accuracy and a synthesizer class phase-locked source for high resolution frequency control. For best measurement accuracy and dynamic range, phase and low level magnitude information is taken from a polar display, with a phase-magnitude display used for all other information. The vector error-correction model used in the 8409C is user selectable between the simple 8-term model and a more comprehensive 12-term model. This allows flexibility in making tradeoffs between measurement accuracy and speed depending on unique measurement requirements.

### System Configurations

The standard 8409C system is a two bay rack that covers the 110 MHz to 18 GHz frequency range in two bands: 110 MHz to 2 GHz, and 2 to 18 GHz, with the appropriate source and test set outputs automatically switched to the network analyzer. The system is controlled by a 9845B Desktop Computer that uses the 11863F Accuracy Enhancement Pac, a BASIC language program. Also available is the 9826A Desktop Computer and its associated 11863E Accuracy Enhancement Pac (an HPL program that provides the same measurement capability as the 11863F software).

For narrower frequency coverage, select either 2 to 18 GHz, or 500 MHz to 12.4 GHz, coverage. These single bay rack versions utilize a single source and test set combination. For active device measurements over the 500 MHz to 12.4 GHz frequency range, two configurations include a programmable bias supply (8717B) with the proper control hardware for use with either the 9845B or the 9826A Desktop

Computer. For less demanding applications, the phase-lock subsystem can be deleted in any 8409C configuration.

### Ordering Information

**8409C Automatic Network Analyzer (110 MHz to 18 GHz)**

**Option 100:** Delete Phase-lock subsystem from standard 8409C (0.11-18 GHz)

**Frequency range / phase-lock options: (select one only)**

2 to 18 GHz Operation Only:

**Option 001:** With phase-lock subsystem

**Option 101:** Without phase-lock subsystem

500 MHz to 12.4 GHz Operation Only (no bias supply):

**Option 010:** With phase-lock subsystem

**Option 110:** Without phase-lock subsystem

500 MHz to 12.4 GHz Operation with programmable bias supply for use with the 9845B:

**Option 011:** With phase-lock subsystem

**Option 111:** Without phase-lock subsystem

500 MHz to 12.4 GHz Operation with programmable bias supply for use with 9826A or 9836A:

**Option 012:** With phase-lock subsystem

**Option 112:** Without phase-lock subsystem

**System controller options: (select one only)**

**Option 002:** Delete 9845B Controller system and 11863F Software

**Option 003:** Substitute 9826A Controller system and 11863E HPL Software for 9845B/11863F BASIC language system

**230 Volt line operation options: (select one only)**

**Option 230:** For standard 8409C (0.11-18 GHz) system (two bay rack version)

**Option 231:** For all optional 8409C frequency ranges (single bay rack versions)

**Accuracy Enhancement Pacs**

**11863E:** HPL for 9826A/9836A

**11863F:** BASIC for 9845B



# SIGNAL ANALYZERS

## Wave, Distortion, Modulation, Spectrum and Fourier Analyzers

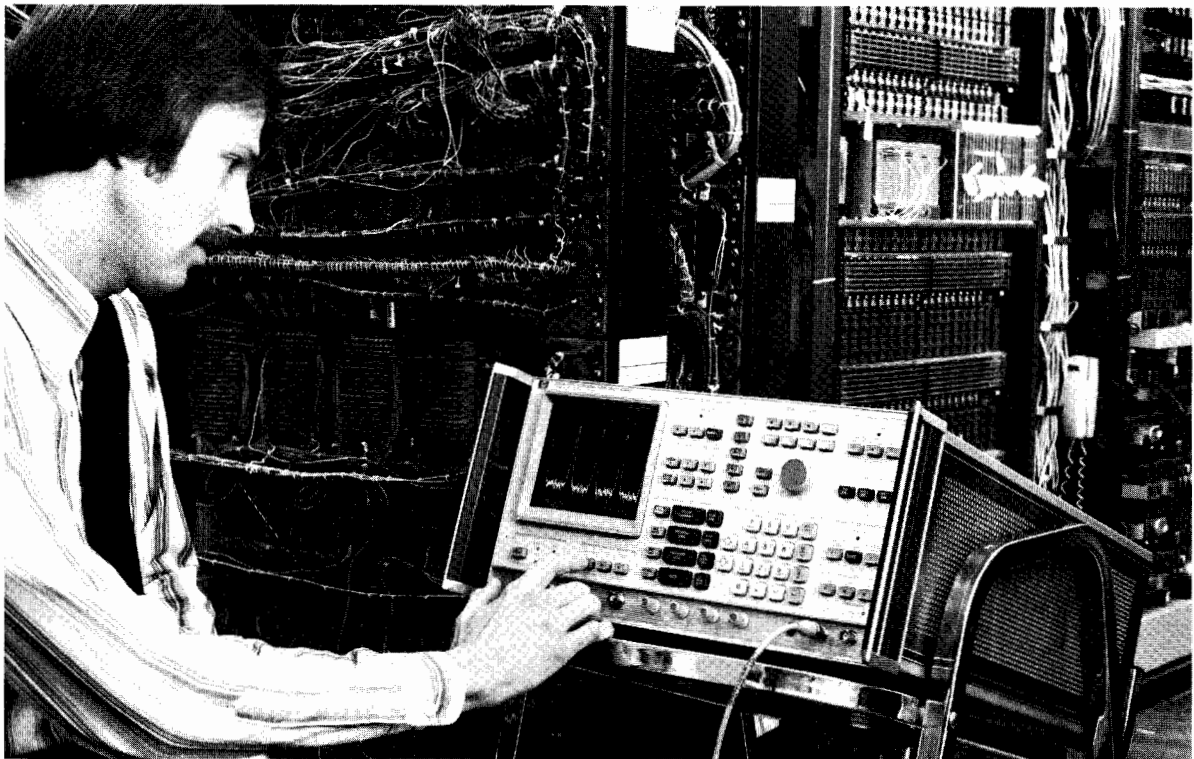

Analysis of signals in the frequency domain is an important measurement concept which is widely used for providing electrical and physical system performance information. Several examples will illustrate some important applications where signal analyzers are useful.

### Mechanical Measurements

Noise and vibration levels are of major concern to manufacturers and users of mechanical structures such as aircraft, automobiles, and bridges. With an appropriate motion-to-electrical signal transducer the spectrum analyzer or the Fourier analyzer can examine vibration signals in the frequency domain. This makes it possible to monitor and analyze vibration components of rotating machines associated with unbalance, worn bearings or worn gears, and to identify a structure's natural modes of vibration.

### Communications

In the fields of telecommunications, the spectrum, modulation, wave and audio analyzers provide vital operational performance verification of transceivers and multiplex systems. Unwanted signals such as carrier leak signals, out-of-band noise, and cross modulated signals must be identified. System gain, loss, distortion and pilot tone measurements must also be made. These measurements are discussed in more detail in the Telecommunications Test Equipment section of this catalog.

### Electronic Testing

Finally, in the general field of electronics, there are four primary uses for the signal analyzer. First, the analyzer is used to identify and measure signals which result from non-linear effects in the process of amplification, filtering, and mixing. Second, the purity of signal sources is commonly observed.

Third, the modulation analyzer serves a special purpose in analyzing modulated communication signals by measuring and displaying RF power, frequency and modulation characteristics. Fourth, the signal analyzer with a companion tracking generator is used as an amplitude only network analyzer for frequency response measurements of filters, amplifiers, and many other types of networks.

### Basic Analyzers

This section discusses the definition and use of several types of instruments for frequency response signal analysis: spectrum analyzers, digital Fourier analyzers, wave analyzers, distortion analyzers, audio analyzers and modulation analyzers.

Each of these instruments measure basic properties of a signal in the frequency domain, but each uses a different technique. The spectrum analyzer is a swept receiver that provides a visual display of amplitude versus frequency. It shows on a single display how energy is distributed as a function of frequency, displaying the absolute value of Fourier components of a given waveform. The Fourier analyzer uses digital sampling and transformation techniques to form a Fourier spectrum display that has phase as well as amplitude information. The wave analyzer is the true tuned voltmeter, showing on a meter the amplitude of the energy in a specific frequency window which is tunable over a specific frequency range. The distortion analyzer performs an almost reciprocal function to that of the wave analyzer. It collectively measures the energy outside a specific bandwidth tuning out the fundamental signal and displaying the energy of the harmonics and other distortion products on a meter. The Audio Analyzer performs the same measurement function as a distortion analyzer but also includes the additional

measurement functions of SINAD, signal to noise ratio, frequency count, true rms dvm and dc dvm. The modulation analyzer tunes to the desired signal and recovers the entire modulation envelope of AM, FM and phase modulation for processing and display.

### Different Views

Figure 1 shows a graphical representation of the way five of the analyzers view a signal and one harmonic. The time domain scan of the signal is presented in Figure 1a.  $A(t)$  is the complex voltage waveform as it would be viewed on an oscilloscope. The dashed lines represent the vector components of the signal:  $A_1(t)$ , the fundamental and  $A_2(t)$  the second harmonic. In 1b, the spectrum analyzer displays the frequency spectrum showing both vector components and their amplitude relationship. Spectrum analysis is useful from 0.02 Hz to 220 GHz.

The Fourier analyzer uses digital signal processing techniques to extract both the amplitude and phase information about each spectral component. Conceptually the Fourier analyzer can be viewed as measuring a large number (up to 2048) of parallel filters as shown in Figure 1c. These filters are actually very specialized digital filters so that precise, repeatable results can be obtained. With this arrangement of parallel filters the complete display is generated in the time that it takes to analyze the lowest frequency component. HP Fourier analyzers presently cover the range of DC to 100 kHz.

The wave analyzer in Figure 1d, measures the amplitude and frequency of the signal in the frequency window to which it is tuned. This window can be moved to measure the amplitude of the second harmonic, thereby making a precise comparison with the fundamental. This technique is practical from 15 Hz to above 32 MHz.

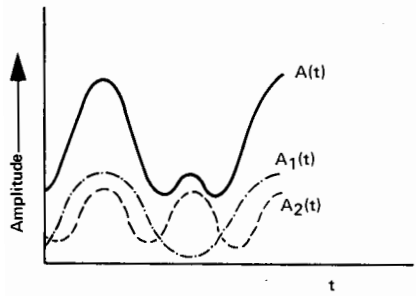

Figure 1a. Waveform

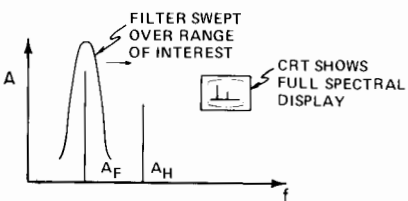

Figure 1b. Spectrum analyzer

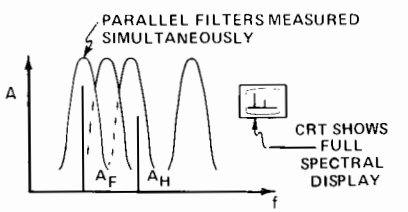

Figure 1c. Fourier analyzer

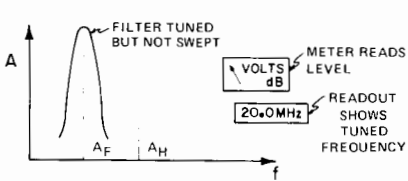

Figure 1d. Wave analyzer

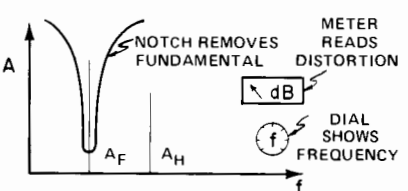

Figure 1e. Distortion analyzer

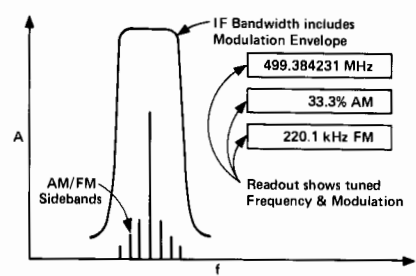

Figure 1f. Modulation analyzer

The distortion analyzer as pictured in Figure 1e. rejects the fundamental to which it has been tuned and measures the energy everywhere else within the instrument's frequency spectrum. Distortion, as a percentage or in dB down from the fundamental, is displayed directly on a meter. Hewlett-Packard distortion analyzers cover 5 Hz to 600 kHz.

The modulation analyzer of Figure 1f tunes to a desired frequency just as the wave analyzer. Its IF bandwidth and detection system are designed to pass the entire modulation envelope so that percent modulation, distortion, residual and peak deviation measurements can be made. All close-in spectral components are combined in the measurement.

The following section considers each instrument technique, showing the particular strength and flexibility of each.

### Spectrum Analyzers

To display useful information about a frequency scan, a spectrum analyzer must be sensitive, frequency stable, free of spurious responses over a wide band, and have calibrated accuracy in the CRT display. The examples which follow best demonstrate the wide variety of information which can be measured on the spectrum analyzer.

#### Measurements with the Spectrum Analyzer

**CW signal:** the most basic spectrum analysis measurement is the single CW signal.

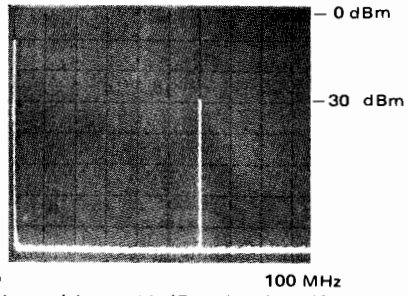

Pictured is a -30 dBm signal at 60 MHz. The zero frequency indicator is at the far left graticule.

**Spectral purity of a CW signal:** one very important oscillator signal measurement is spectral purity. This 70 MHz carrier has power line related sidebands ( $\pm 60$  Hz) which are 65 dB down.

Such sidebands may result from power supply ripple. The 50 Hz/division spectrum analyzer scan and the 10 Hz analyzer bandwidth provide the high degree of resolution required to see these sidebands.

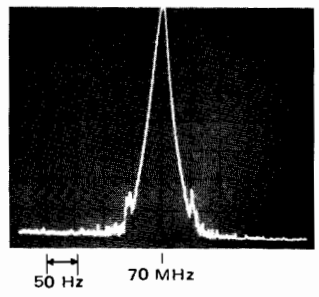

**Frequency conversion products:** the spectrum analyzer is well suited for frequency conversion measurements such as the output of a balanced mixer as shown.

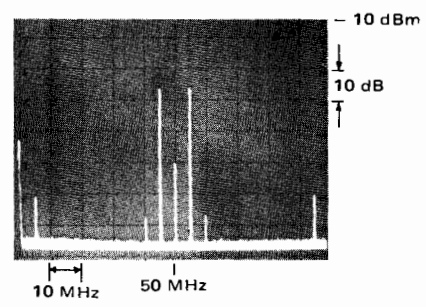

With the 50 MHz local oscillator input at 0 dBm and a 5 MHz, -30 dBm mixer signal, two sidebands at 45 MHz and 55 MHz result. The sidebands are -36 dBm, giving the mixer a 6 dB conversion loss. The local oscillator has 60 dB isolation and the 5 MHz signal has 41 dB isolation. Second order distortion products at 40 and 60 MHz are 40 dB below the desired mixer outputs.

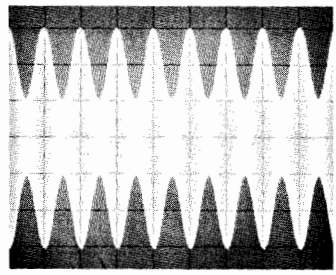

Oscilloscope

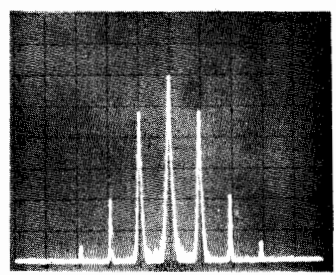

Spectrum Analyzer

**Amplitude modulation:** percent amplitude modulation is often more easily measured with the spectrum analyzer than it is with the oscilloscope. This is especially true for low level modulation.

With the oscilloscope time display, percent modulation,  $M$ , is measured as a ratio of the signal's dimensions:  $M = 100(6-2)/(6+2) = 50\%$ . In the spectrum analyzer display, whose vertical calibration is 10 dB/division, the carrier and sidebands differ by 12 dB, the voltages in the sidebands are  $1/4$  of that of the carrier and again,  $M = 50\%$ . At the same time the second and third harmonic distortion of the sidebands can be measured at 28 and 44 dB respectively.



# SIGNAL ANALYZERS

## Wave, Distortion, Modulation, Spectrum and Fourier Analyzers (Cont'd)

**Frequency modulation:** information transmitted by FM can be characterized by the spectrum analyzer.

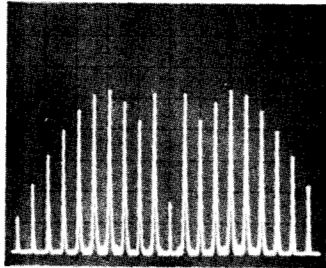

Low Deviation FM

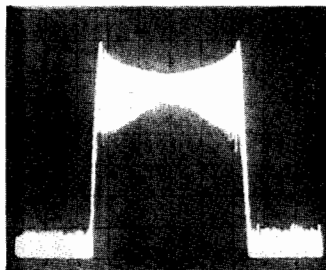

High Deviation FM

Low deviation FM is applied to a 60 MHz carrier in the first photo. The deviation has been adjusted for the second carrier null ( $M = 5.52$ ). The sideband spacing is 10 kHz, the modulation frequency; therefore,  $\Delta f_{\text{peak}} = 5.52 \times 10 \text{ kHz} = 55.2 \text{ kHz}$ .

The second photo is an example of a high deviation FM. The transmission bandwidth is 2.5 MHz.

**Pulsed CW power:** by viewing the spectra of a repetitive RF pulse on the spectrum analyzer, pulse width, average and peak power, occupied bandwidth, and duty cycle can be determined.

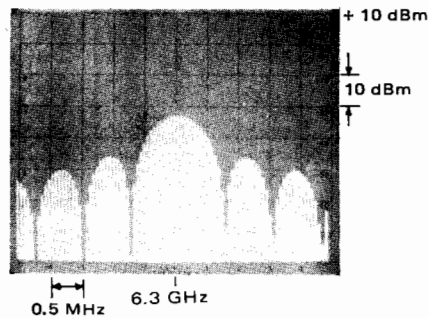

From the spectral output shown the pulse's complete characteristics are determined: 6.3 GHz RF at 0 dBm, pulsed at 50 kHz rate. The pulse width is 1.3  $\mu\text{s}$ .

**Noise:** spectrum analysis is effective in measuring impulse noise, random noise, carrier to noise ratio, and amplifier noise figure.

**Phase noise:** the short term frequency fluctuations of a sine wave source can be measured directly as phase modulation sidebands. Hewlett-Packard spectrum analyzers with narrow resolution and synthesized internal frequency sources can make many phase noise measurements directly. Bandwidth corrections, analyzer corrections, data averaging and setup calibration factors can be accounted for by Hewlett-Packard microprocessor controlled spectrum analyzers. All instrument controls, data transfer and data reduction can be handled by easy-to-write software for Automatic Spectrum Analyzers.

**Frequency response:** using a tracking signal source and a spectrum analyzer the frequency response of filters can be displayed with ease.

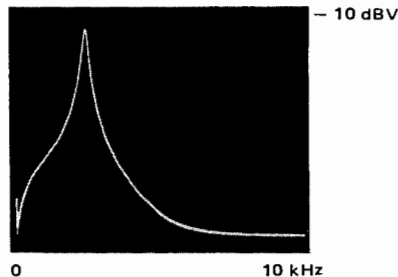

In this case, an audio filter used in a communications system is being measured. Since the input reference level to the filter is -13 dBV, the insertion loss at 2.4 kHz is 4 dB. Extremely high Q devices can be measured with this system.

### Spectrum Analyzer Capabilities

To be useful in making measurements in the frequency domain, the analyzer must be capable of making quantitative measurements. Specifically, an analyzer must:

1. make absolute *frequency* measurements
2. make absolute *amplitude* measurements
3. operate over a *large amplitude dynamic range*
4. have *high resolution* of frequency and amplitude
5. have *high sensitivity*
6. provide means of *observing, preserving, and recording* its output in a convenient and rapid manner by using variable persistence, digital storage and adaptive sweep. Hewlett-Packard spectrum analyzers excel in these six measures of performance. Let us consider each of these performance standards in greater detail.

**Absolute frequency measurements:** Frequency readout accuracy depends upon the tuning and readout techniques employed, as well as the stability of the spectrum analyzer's frequency reference. The absolute frequency accuracy read off the slide-rule type of frequency dial is approximately 1% of full scale. Synthesized local oscillators allow accuracies to  $\pm 4 \text{ Hz}$  at 1500 MHz in narrow

frequency spans. When the spectrum analyzer is used in conjunction with a tracking generator (a source whose frequency is the same as the analyzer tuning frequency) accuracy much better than 1% can be achieved by counting the generator output.

**Absolute amplitude measurements:** all Hewlett-Packard spectrum analyzers are absolutely calibrated for amplitude measurements. This means the spectrum analyzer indicates to the user what the log/reference level or linear sensitivity is regardless of control settings. Either a warning light or CRT message indicates an uncalibrated condition, making operation of the analyzer easy and foolproof.

Microprocessor controlled analyzers feature built-in calibration routines which account for changes in analyzer controls such as the resolution bandwidth and RF attenuator.

**Dynamic range:** the dynamic range of a spectrum analyzer is defined as the difference between the input signal level and the average noise level or distortion products, whichever is greater. Hence, dynamic range can be either distortion limited, noise limited or display limited. Hewlett-Packard microprocessor controlled analyzers can be set to ensure that distortion products of on-screen signals will be below a certain level.

**Frequency and amplitude resolution:** frequency resolution is the ability of the analyzer to separate signals closely spaced in frequency. The frequency resolution of an analyzer is a function of three factors: 1) minimum IF bandwidth, 2) IF filter shape factor, 3) spectrum analyzer stability.

The minimum IF bandwidth ranges down to 1 Hz on Hewlett-Packard spectrum analyzers.

One way to define IF filter shape factor is the ratio of 60 dB bandwidth to 3 dB bandwidth. Filter shape factor specifies the selectivity of the IF filter. Hewlett-Packard spectrum analyzers have IF filter shape factors as low as 5:1.

Analyzer frequency stability also limits resolution. The residual FM (short term stability) should be less than the narrowest IF bandwidth. If not, the signal would drift in and out of the IF pass band. Hewlett-Packard analyzers have excellent stability. Low frequency and microwave frequency models are available with residual FM  $< 1 \text{ Hz}$ , enabling the measurement of noise sidebands. The stabilization circuitry is completely automatic and foolproof. No signal recentering, manual search, or checking is required.

Amplitude resolution is a function of the vertical scale calibration. Hewlett-Packard analyzers offer both log calibration for observing large amplitude variations (10, 5, 2 and 1 dB/div) and linear calibration for observing small amplitude variations.

**Sensitivity:** sensitivity is a measure of an analyzer's ability to detect small signals, and is often defined as the point where the signal level is equal to the noise level or  $(S+N)/N=2$ . Since noise level decreases as the bandwidth is decreased, sensitivity is a function of bandwidth. The maximum attainable sensitivity ranges from  $-150$  dBm to  $-125$  dBm with Hewlett-Packard analyzers.

**Variable persistence, digital storage, and adaptive sweep:** high resolution and sensitivity both require narrow bandwidths and consequently slow sweep rates. Because of these slow sweeps, both digital display and variable persistence are virtually indispensable in providing a bright, steady flicker-free trace.

The digital storage feature on Hewlett-Packard analyzers covering audio to microwave frequency ranges make measurements and CRT photography simple. It gives the CRT display a dot matrix connected by line generators for an unbroken and uniform intensity scan. In addition, the microprocessor controlled analyzers feature CRT annotation to completely describe the data characteristics displayed.

On low frequency analyzers, adaptive sweep effectively speeds the measurement times. On the very slow sweep times (required when using the 1 Hz bandwidth), adaptive sweep allows the scan to sweep rapidly when no signals occur and slow down when a signal is above a preset level. The measurement time savings can be greater than 20:1.

### Tracking Preselector

The only way to simultaneously avoid spurious, multiple, harmonic and image responses is to filter the RF signal through a tracking preselector. This is an electronically tuned bandpass filter that automatically tracks the analyzer's tuning. A preselector improves the spurious-free range of the analyzer from 70 dB to 100 dB.

### Tracking Generator

A tracking generator expands the measurement capability of the spectrum analyzer by providing a signal source which tracks the tuning frequency of the analyzer. The source/receiver combination can be used to measure insertion loss, frequency response, return loss and allow precision frequency counting.

It helps make these additional measurements with increased distortion-free dynamic range, sensitivity and selectivity. The tracking generator is also an excellent stable sweeping generator. The residual FM varies from  $<1$  Hz to  $<200$  Hz for Hewlett-Packard tracking generators.

### Automatic Spectrum Analyzers

The measurement capability of a spectrum analyzer can be greatly enhanced by allowing a desktop computer to control instrument functions and record frequency and ampli-

tude information. Data can be gathered and processed into a variety of formats at a very rapid rate. Through comprehensive self-calibration, automatic spectrum analysis offers amplitude accuracy of up to  $\pm 0.4$  dB with 0.01 dB resolution. User cost savings are realized through faster measurements, lower operator skill requirements, and unattended operation capability.

Further discussion of computer based automatic spectrum analysis can be found on page 482.

### Frequency Stability Analysis

Frequency stability and spectral purity are important parameters when characterizing precision frequency sources. Long term stability or frequency drift due to aging or temperature effects is generally measured with a precision frequency counter such as the HP 5345A; random fluctuations in frequency or phase stability can be measured in the time domain with an electronic counter and the Allan Variance technique.

Another measure of frequency stability is the phase spectral density. The most common method of making this measurement is to mix two signals together and feed the output into a lower frequency wave analyzer or spectrum analyzer. The technique works well for offset frequencies far away enough from the carrier to be compatible with the bandwidths of the analyzer.

For offset frequencies close to the carrier, (e.g. below 100 Hz) the bandwidths of analog analyzers become large in comparison to the frequencies being measured. As 1 Hz is approached, measurements become extremely difficult.

An automatic system for making phase spectral density measurements very close to the carrier is the HP 5390A Frequency Stability Analyzer which is based upon a high performance electronic counter and a programmable calculator. The counter is ideally suited to make measurements in the time domain, and the calculator can transform the data into the frequency domain. This technique allows measurements to be made from 0.01 Hz away from the carrier out to 10 kHz. Sensitivities greater than  $-150$  dBc can typically be obtained at a 1 Hz offset on carriers ranging from 500 kHz to 18 GHz. The standard 5390A requires two sources which can be offset from one another. The 5390A option 010, based on the dual mixer time difference technique, can perform these same measurements on non-offsettable sources. For a more complete description of this automated technique refer to the 5390A Frequency Stability Analyzer on page 519.

### Fourier Analyzers

The Fourier analyzer uses digital signal processing techniques to provide measurement capability over and above that of a swept spectrum analyzer. Some of these include the precise measurement of random signals obscured by noise, measurement of

the joint properties or relationships of two or more signals, measurements of statistical properties of signals, and measurements of very low frequency (e.g. below 5 Hz) or very closely spaced (e.g. less than 1 Hz) signals.

Fourier analyzers are based on the calculation of the Discrete Fourier Transform using a highly efficient algorithm known as the Fast Fourier Transform. As shown in Figure 2, this algorithm calculates the magnitude and phase of each frequency component from a block of time domain samples of the input signal.

The block diagram that is involved is shown in Figure 3. First, the input signal is filtered to remove out-of-band components. Next, the input is sampled and digitized at regular  $\Delta t$  intervals until a full block of samples called a time record has been collected. The processor then executes the desired series of computations on the time data to produce the frequency domain results. These results, which are stored in memory, can be analyzed on a CRT display, plotted, or processed further to provide the user additional useful information.

$$X(k \Delta f) = \sum x(n \Delta t) e^{-j2\pi(n)k/N}$$

EACH FREQUENCY POINT IS COMPOSED OF A MAGNITUDE AND PHASE VALUE

EACH FREQUENCY POINT CONTAINS INFORMATION FROM ALL TIME DOMAIN SAMPLES

COMPLEX FACTOR

Figure 2

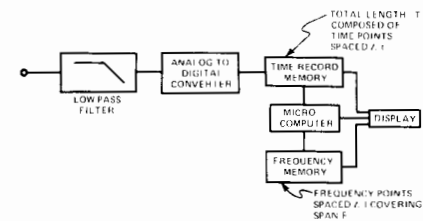

Figure 3

When two or more input channels are provided, signals can be sampled simultaneously. The processor can then additionally compute joint properties of the signals. This is useful for characterizing the transfer function of a linear device and for investigating cause/effect relationships.

The digital nature of Fourier analysis insures *high accuracy, stability and repeatability*. In addition, there are several specific advantages that are achieved.

### Low Frequency Coverage

The Fourier transform calculates equally spaced frequency components from DC to the maximum frequency. By simply varying the sample rate it is possible to make measurements down to a few micro Hertz. For such low frequency measurements, the laws of physics dictate a long observation time. Since the Fourier transform simultaneously calculates all frequency points from one set of observation points, a one to two order of magnitude speed improvement over a swept measurement is possible.

# SIGNAL ANALYZERS

## Wave, Distortion, Modulation, Spectrum and Fourier Analyzers (Cont'd)

### High Frequency Resolution

By digitally translating a band of frequencies down to DC it is possible to provide very high frequency resolution over the entire range. This technique, known as Band Selectable Fourier Analysis, can provide resolution of a few millihertz as shown in Figure 4. Here a 5 Hz band of frequency located at 3 kHz is analyzed showing 0.48 Hz sidebands over 20 dB down.

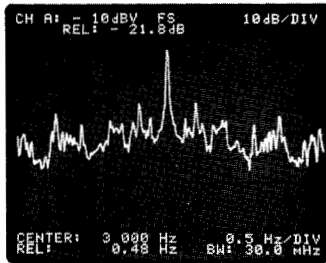

Figure 4

### Direct Transfer Function Measurements

With simultaneous sampling of both the input and output of an electrical, mechanical, or acoustical system, it is possible to directly characterize transfer functions. Since the Fourier analyzer measures the frequency components simultaneously, energy must also be provided at these frequencies. This can be done with a broadband white noise signal, a pseudorandom noise signal or an impulse. Results presented in magnitude/phase or real/imaginary format help quickly illustrate the performance characteristics of a system.

The measurement of the coherence function can additionally provide a measure of the validity of a transfer function. It can distinguish portions of the output power that are not directly caused by the input, but may instead be due to additive noise, distortion products, or unmeasured inputs.

### Systems Compatibility

Since the Fourier analyzer is basically all digital, interfacing to a computing controller or other digital peripherals is relatively simple. Remote programming and data input/output can considerably expand the range of potential applications.

### Fourier Analyzer Applications

The versatility and performance of the Fourier analyzer make it an ideal tool for a variety of applications as a few specific examples will illustrate.

In the general area of electronics, the Fourier analyzer functions as a very high performance spectrum and network analyzer. It can be very useful for measuring phase noise or for characterizing filters.

In the field of communications, the Fourier analyzer can be very useful for characterizing audio signals, such as modems and touch tone signals.

When combined with a microphone the Fourier analyzer can be useful in characterizing acoustic devices, such as loud speakers.

With a motion transducer the Fourier analyzer can be used to analyze the vibration signatures of rotating machines. This can be very useful in helping to establish scientific maintenance policies.

The transfer function of a mechanical structure can illustrate how the structure responds to vibration inputs. This is extremely important in optimizing the design of structures that will be subjected to substantial vibration.

### Wave Analyzers/SLM's

Wave analyzers are known by several different names: frequency selective voltmeter, carrier frequency voltmeter, and selective level meter. These names describe the instrument's function rather well.

As mentioned in the introduction to this section a wave analyzer can be thought of as a finite bandwidth window filter which can be tuned throughout a particular frequency range.

Signals will be selectively measured as they are framed by the frequency window. Thus, for a particular signal, the wave analyzer can indicate its frequency (window position) and amplitude. Amplitude is read on an analog meter; frequency is read on either a mechanical or electronic readout.

The uses of wave analyzers can be categorized into three broad areas: 1) amplitude measurement of a single component of a complex frequency system, 2) amplitude measurement in the presence of noise and interfering signals and, 3) measurement of signal energy appearing in a specified, well defined bandwidth.

### Wave Analyzer/SLM Considerations

#### Frequency characteristics

**Range:** should be selected with the future in mind as well as present requirements.

**Accuracy and resolution:** should be consistent with available bandwidths. Narrow bandwidths require frequency dial accuracy to place the narrow window in the proper position for measurement. Accuracy of instruments with selectable bandwidths is determined by the basic center frequency accuracy of the IF bandwidth filters in addition to the local oscillator frequency accuracy.

**Readout:** usually an LED display.

**Stability:** frequency stability is important when using narrow bandwidths and for long term signal monitoring. Stability is best

achieved with automatic frequency control (AFC) or frequency synthesis. AFC locks the local oscillator to the incoming signal and eliminates any relative drift between the two. A frequency synthesized local oscillator allows frequency accuracy of  $<1 \times 10^{-5}$  with 0.1 Hz resolution.

**Sweep:** some instruments are equipped with sweep to allow use as a spectrum analyzer. Readout is a CRT or X-Y recorder.

### Amplitude Characteristics

**Range:** the amplitude range is determined by the input attenuator and the internal noise of the instrument. Sensitivity is defined as the lowest measurable signal equal to the noise level for a unity signal-to-noise ratio (often called tangential sensitivity). Sensitivity will vary with bandwidth and input impedance.

**Dynamic Range:** defined as the dB ratio of the largest and smallest signals that can be simultaneously accommodated without causing an error in the measurement.

**Attenuators:** the amplitude range switch is an attenuator in the input and IF stages. Intermodulation distortion is lowest when the input amplifier has the minimum signal applied and the IF gain is greatest. Conversely the internal noise, important when making sensitive measurements, is lowest with maximum input signal and lowest IF gain. Newer instruments use auto-ranging techniques.

**Accuracy:** amplitude accuracy is a function of frequency, input attenuator response, IF attenuator performance, calibration oscillator stability and accuracy, and meter tracking. Often specifications are expanded to separately describe each contributor.

**Readout:** amplitude readout is usually a meter calibrated in dB and/or volts or a LED digital display. Linear voltage meters are used to allow the user to see down into the noise at the bottom of the scale. Digital readouts are often used with an analog meter to aid in tuning to signals. Expanded scale meters allowing expansion of any 1 or 2 dB portion of the scale into a full scale presentation allow resolution of input level changes of a few hundredths of a dB while LED displays allow .01 dB resolution. This is useful when the wave analyzer is used as a sensitive indicator in bridge or comparison measurements. The expanded scale meter is included in some instruments and is an optional accessory on others.

### Input Characteristics

**Impedance:** may be high impedance bridging input or terminating impedance to match standard transmission lines. High frequency measurements require matched systems to avoid error-producing standing waves on interconnecting cables. The measure of impedance accuracy is usually return loss or

reflection coefficient ( $RL=20 \log \rho$ ). In low frequency instruments, percent accuracy is used. High input impedance instruments are usually poorer in high frequency and noise performance and are usually low frequency instruments. High impedance at high frequencies is accomplished by using a bridging probe to place the impedance at the point of measurement. The probe may be active with unity gain or passive with 20-30 dB insertion loss.

**Input arrangement:** input may be balanced to ground or unbalanced. Communications system usage typically requires balanced input. Standard 600 and 135/150  $\Omega$  balanced inputs are limited in frequency to less than 1 MHz and 124  $\Omega$  balanced to less than 10 MHz in most instruments. The impedance may be balanced to ground with the center point grounded or may be completely isolated from ground. Unbalanced inputs do not have frequency range limitations.

### Network Analysis Application

**Frequency response testing:** with its tracking generator output, the wave analyzer is particularly useful for measuring filter and amplifier frequency responses. If a notch filter is being measured, for example, a narrow band measurement like that provided by a wave analyzer is essential for obtaining acceptable accuracy. A broadband technique will lead to some misleading results. For example, a notch filter may be driven with a flat oscillator and the response measured with a broadband voltmeter. The notch filter will reject the oscillator's fundamental tone, but pass its harmonics which are in voltmeter's measurement range. Thus, an error results. If the voltmeter were frequency selective, like a wave analyzer, the harmonics would be rejected and the true level of the notch would be measured. Accurate and fast measurements can be made because Hewlett-Packard wave analyzers track and detect on the tracking generator frequency.

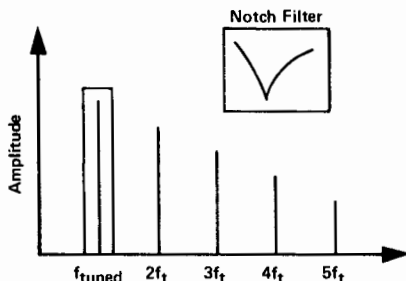

Only signal detected by wave analyzer. For example, the notch of a filter can be accurately measured to its full depth.

### Distortion, Audio Analyzers

Harmonic distortion is one of many types of distortion created in communications equipment, audio and ultrasonic sound sys-

tems. Nonlinear elements in amplifiers cause harmonic related frequencies from a pure tone stimulus to be created at the output. Hence, to a listener, a poor reproduction quality becomes apparent. The total of these frequency components present in a signal, in addition to the fundamental frequency, can be measured quickly and easily with Hewlett-Packard distortion and audio analyzers.

The ratio of these frequency components to the amplitude of the fundamental is the total harmonic distortion (THD) as defined by the following equation (1):

$$THD = \frac{\sqrt{\sum (\text{harmonics})^2}}{\text{fundamental}}$$

The Hewlett-Packard distortion and audio analyzers consist of a narrow band rejection filter and broadband detector. Before the fundamental is rejected, the analyzer first measures the amplitude of the fundamental, all the harmonic components, and noise. Then the rejection filter is employed to remove the fundamental. The ratio of the two measurements is an approximation of equation (1) above and is defined by the following equation (2):

$$THD = \frac{\sqrt{\sum [(\text{harmonics})^2 + (\text{noise})^2]}}{\sqrt{\sum [(\text{fundamental})^2 + (\text{harmonics})^2 + (\text{noise})^2]}}$$

An approximation error of 1/2% can be expected for the THD levels of 10%. However, distortion levels as high as 10% are seldom encountered in most measurement situations. The harmonic content of the stimulus source must not be more than a third of the distortion expected to be caused by the system under test.

### Audio Analyzers

The Audio Analyzer performs several basic low frequency measurements in addition to distortion, making it a general purpose audio test set. The audio analyzer includes the SINAD function for testing mobile radio receiver sensitivity. It contains a low distortion audio oscillator for stimulus response testing in combination with its distortion analyzer. It contains a true rms voltmeter and dc voltmeter for accurate measurement of complex waveform levels. Swept ac level and swept distortion measurements can be made when using the audio analyzer with a suitable X-Y recorder. Signal to noise ratio measurements are performed automatically when using the internal source and rms voltmeter. A reciprocal frequency counter is also included that continuously counts the frequency of the input signal.

These basic capabilities provide a general purpose instrument that represents high value in three major applications areas: 1) General audio component characterization, 2) radio transceiver audio measurements, 3) HP-IB systems. The Audio Analyzer provides sophisticated measurement capabilities with significantly reduced operator interaction.

### True Harmonic Distortion Measurements

The Hewlett-Packard desk-top computer controlled automatic spectrum analyzers provides the user a rapid means of measuring true harmonic distortion levels. The fundamental and its harmonic components are rapidly measured one at a time and the distortion is computed by applying equation (1). In production test situations, distortion calculations can be stored on tape for future reference and/or plotted for hard copy needs. Limit testing can also be applied.

### Modulation Analyzers

A modulation analyzer is a precision receiver, designed to detect the entire modulation envelope of a signal under test. It can measure and display the carrier characteristics of RF frequency and power as well as AM, FM and phase modulation characteristics such as AM depth, peak deviation, residual modulation, and various ratios associated with them. The modulation analyzer also faithfully recovers the actual modulating signal for further analysis such as distortion testing.

Applications for modulation analyzers center mostly in transmitter testing and signal generator calibration. The precision receiver capability allows comprehensive testing of the transmitter. All phases of design, production test, and maintenance of transmitters and their modules and subassemblies are applications. And since signal generators are "precision transmitters", numerous applications will be found in metrology and calibration labs for signal generator calibration.

### Capabilities

The unique measurement capabilities of modulation analyzers are easily shown on system tests with multiple-mode modulations such as simultaneous AM and FM. For example, if both amplitude and frequency modulation are present on a signal, a complex modulation spectrum is produced. To demonstrate this, an HP 8640B Signal Generator was 46.5% amplitude modulated with a 5 kHz triangular wave and 4.5 kHz peak frequency modulated with a 5 kHz sine wave simultaneously. The picture below shows the resulting signal as seen on a spectrum analyzer.

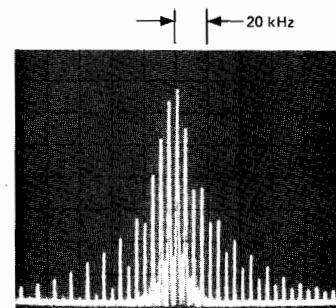

Spectrum Analyzer display of simultaneous AM (46.5%) and FM (4.5 kHz pk deviation) modulation.

# SIGNAL ANALYZERS

## Wave, Distortion, Modulation, Spectrum and Fourier Analyzers (Cont'd)

Unequal, complex sidebands result and little data can be deduced. However, since a modulation analyzer faithfully recovers both modulation signals in independent detection systems insensitive to each other, it is easy to separate and read directly the various modulation components involved.

500.00 184 MHz

46.5 %AM

9.942 -3 Watts

4.49 kHz FM

Modulation Analyzer displays of RF signal parameters.

In addition, since the modulation analyzer handles the full complex modulation envelope, it measures and displays peak RF envelope power and average frequency of the entire signal. The readings are all available at the push of a button.

The independent detection systems demodulate the waveforms and present the resulting signal at the output for viewing on an oscilloscope or for further analysis by a distortion analyzer or audio wave analyzer.

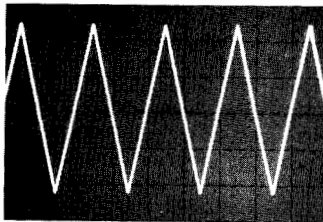

Recovered 5 kHz AM input signal viewed on oscilloscope.

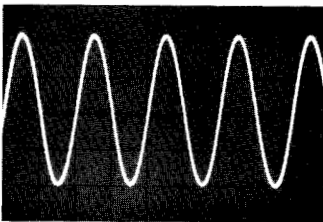

Recovered 5 kHz FM input signal.

Since the AM and FM detection systems are independent and highly insensitive to each other, incidental modulation measurements can be made with high precision. For example, even with 90% amplitude modulation, the FM demodulator will accurately indicate incidental FM. Such capability is

valuable for design of oscillators, modulators, mixers and other components. It is very difficult to separate multiple modulation effects on spectrum analyzer displays because the effects are combined.

The HP 8901A Modulation Analyzer contains selectable filters to provide commonly used system characteristics for low-pass and high-pass filtering and FM de-emphasis. Thus measurement of transmitter modulation frequency response doesn't require additional equipment. Selectable detectors, including peak hold, allow measurements such as transmitter modulation limiting to be made very easily.

Finally the modulation analyzer can serve as a high sensitivity, selective frequency counter. Since the superheterodyne design allows high sensitivity amplification of low level modulated signals, frequency counting of signals as low as -65 dBm is possible with good rejection of other signals, even large interfering ones.

Display and computational conveniences speed typical transmitter measurements and improve confidence in results. For example, ratio keys allow any measurement to be expressed in % or dB relative to any other measured or key-entered value. Such computations are valuable in applications such as mobile FM measurements, where hum and noise is expressed relative to an industry standard of 60% of maximum allowable deviation.

## Signal Analyzers Selection Guide Spectrum Analyzers

Frequency Range	Amplitude Calibration Range	Bandwidths		Model Description	Companion Instruments	Page
		Min	Max			
0.02 Hz-25.6 kHz	-120 to +30 dBV	0.02 Hz	363 Hz	3582A Spectrum Analyzer		508
5 Hz-50 kHz	-150 to +30 dBm	1 Hz	300 Hz	3580A Spectrum Analyzer		506
20 Hz-300 kHz	-142 to +10 dBm	10 Hz	10 kHz	8556A Tuning Section Plug-In <sup>1</sup>		496
10 Hz-13 kHz	-140 to +20 dBm	3 Hz	10 kHz	3044A/45A Spectrum Analyzer		511
20 Hz to 40.1 MHz	-137 dB to +30 dBm	3 Hz	30 kHz	3585A Spectrum Analyzer		468
1 kHz-110 MHz	-140 to +10 dBm	10 Hz	300 kHz	8553B Tuning Section Plug-In <sup>1</sup>	8443A Tracking Generator	498
10 kHz-350 MHz	-117 to +20 dBm	1 kHz	3 MHz	8557A Spectrum Analyzer Plug-In <sup>2</sup>		488
100 kHz-1250 MHz	-122 to +10 dBm	100 Hz	300 kHz	8554B Tuning Section Plug-In <sup>1</sup>	8444A Tracking Generator (500 kHz-1250 MHz)	500
100 kHz-1500 MHz	-117 to +30 dBm	1 kHz	3 MHz	8558B Spectrum Analyzer Plug-In <sup>2</sup>	8444A Opt. 059 Tracking Generator (500 kHz-1500 MHz)	490
100 Hz-1500 MHz	-137 dBm to +30 dBm	10 Hz	3 MHz	8568A Spectrum Analyzer and 8581B Automatic Spectrum Analyzer	8444A Opt. 059 Tracking Generator (500 kHz-1500 MHz) 85650A Quasi-Peak Adapter	476 482
10 MHz-21 GHz	-111 dBm to +30 dBm	1 kHz	3 MHz	8559A Spectrum Analyzer <sup>2</sup>		492
100 Hz-40 GHz <sup>3</sup>	-134 dBm to +30 dBm	10 Hz	3 MHz	8566A Spectrum Analyzer and 8582B Automatic Spectrum Analyzer	85650A Quasi-Peak Adapter	479 482
10 MHz-40 GHz <sup>3</sup>	-122 dBm to +30 dBm	100 Hz	3 MHz	8565A Spectrum Analyzer	8750A Storage-Normalizer 8444A Opt. 059 Tracking Generator (10 MHz-1500 MHz)	486
10 MHz-115 GHz <sup>3</sup>	-123 to +30 dBm	100 Hz	3 MHz	8569B Spectrum Analyzer	8444A Opt. 059 Tracking Generator (10 MHz-1500 MHz)	484
10 MHz-40 GHz	-127 to +10 dBm	100 Hz	300 kHz	8555A Tuning Section Plug-In <sup>1</sup>	8444A Opt. 059 Tracking Generator (10 MHz-1500 MHz) 8445B Automatic Preselector (10 MHz-18 GHz)	502
0.01 Hz-10 kHz offset from carrier 500 kHz-18 GHz carrier range	-150 dBc min.	<100 $\mu$ Hz	10 kHz	5390A Frequency Stability Analyzer	59309A Digital Clock	519

NOTE 1: For use in display mainframes 140T and 141T with IF section plug-ins 8552A or 8552B (page 494).

NOTE 2: For use in display mainframes 853A, 180TR, 181T/TR and 182T.

NOTE 3: Frequency range extendable to 220 GHz with commercially available mixers.

**Modulation Analyzer (8901A)**

Frequency Range	Modulation				RF Level Accuracy	Audio Filters		Page
	Mode	Range	Accuracy	Distortion		Type	Time Constant/Frequency	
150 kHz-1300 MHz	FM	40 kHz pk ( $f_c \leq 10$ MHz) 400 kHz pk ( $f_c > 10$ MHz)	1% of reading $\pm 1$ digit (rates 30 Hz-100 kHz)	<0.1% THD	$\pm 1.3$ dB ( $f_c < 650$ MHz)  $\pm 1.5$ dB ( $f_c > 650$ MHz)	Low-pass	3 kHz 15 kHz >20 kHz	526
	AM	0-99%	1% of reading $\pm 1$ digit (rates 50 Hz-50 kHz)	<0.3% THD		High-pass	50 Hz 300 Hz	
	$\Phi$ M	400 radians ( $f_c > 10$ MHz, rate < 1 kHz)	3% of reading $\pm 1$ digit (rates 200 Hz-20 kHz)	<0.1% THD		De-emphasis	25 $\mu$ s 50 $\mu$ s 75 $\mu$ s 750 $\mu$ s	

**Dynamic Signal Analyzers**

Frequency Range	Amplitude Calibration Range	Resolution Points		Model Description	Functions Available	Page
		Min	Max			
DC-100 kHz (See Note 1)	7 steps from $\pm 0.125$ to $\pm 8$ V	32	2048	5451C Fourier Analyzer (See Note 3)	Power spectrum Transfer function Coherence Convolution	517
DC-25 kHz	7 Steps From $\pm 0.1$ to $\pm 10$ V	256	32,000 (See Note 2)	5420B Digital Signal Analyzer  5423A Structural Dynamic Analyzer (See Note 3)	Time Average Linear Spectrum Auto Spectrum Transfer Function Coherence Function Histogram Correlation Impulse Response	515
0.1-25 kHz	7 steps from $\pm 0.125$ to $\pm 8$ V	256 PS 128 TF	1024 PS 512 TF	5427A Digital Vibration Control System (Analysis Mode)	Power Spectrum (PS) Transfer Function (TF) Transient Capture Shock Response Spectrum	518
0.02 Hz-25.6 kHz	9 steps from 3 mV to 30 V RMS	256	>1.3x10 <sup>6</sup> (See note 2)	3582A Spectrum Analyzer	Voltage Spectrum Phase Spectrum Transfer Function Coherence Function Digital Averaging	508

NOTE 1: Standard range is DC to 50 kHz, expandable with options to 100 kHz.  
NOTE 2: Equivalent number of points using Band Selectable Analysis.  
NOTE 3: Also includes modal analysis capability.

**Distortion / Audio Analyzers**

Fundamental Frequency Range	Minimum Distortion	Auto Set Level	Auto Nulling	True RMS	AM Detector	Filters	Model No.	Internal Source	HP-IB	Page
5 Hz to 600 kHz	0.03% (-70 dB)	.	.	.	.	.	334A	.	.	520
10 Hz-110 kHz	0.0018% (-95 dB)	.	.	.	.	.	334A Opt 002	.	.	520
20 Hz-100 kHz	0.01% (-80 dB)	.	.	.	Note 1	.	8903A*	.	.	526

\*The 8903A also performs Frequency Count, Signal/Noise, SINAD, watts, ac/dc volts measurements.  
NOTE 1: The 8901A Modulation Analyzer (p. 523) provides complete demodulation of AM, FM, and  $\Phi$ M signals.

**Wave Analyzers / Selective Level Meters**

Frequency Range	Selective Bandpass	Dynamic Range		Freq. Readouts	Type of Inputs	Type of Outputs	Modes of Operation	Model Number	Page
		Absolute	Relative						
15 Hz to 50 kHz	3 Hz 10 Hz 30 Hz 100 Hz 300 Hz	0.1 $\mu$ V-300 V full scale	>85 dB	5-place digital	Banana Jacks	rec: 5 V full scale, with pen lift BFO, Local Oscillator, tuning loudspeaker, and headphone jack	AFC, normal, BFO	3581A/ 3581C	522 547
	50 Hz to 32.5 MHz	20 Hz 400 Hz 3100 Hz	-130 to +20 dBm	LED, 0.1 Hz Resolution	50/75 $\Omega$ , BNC 600 $\Omega$ Banana Jacks	Tracking Generator Audio/Loud Speaker 1 MHz Ref.	Wideband Selective USB/LSB	3586C (3336C*)	471 340
50 Hz to 32.5 MHz	20 Hz 400 Hz Optional 3100 Hz WTD	-130 to +20 dBm	>70 dB	LED 0.1 Hz Resolution	75 $\Omega$ BNC/WECO 124 $\Omega$ WECO 135 $\Omega$ WECO 150 $\Omega$ Siemens 600 $\Omega$ WECO/Siemens	Tracking Generator Audio/Loud Speaker 1 MHz Ref.	Wideband Selective SSB	3586A/B (3336A/B*) (3335A)	564 564 342

\*Tracking Synthesizers.



# SIGNAL ANALYZERS

## 20 Hz to 40 MHz Spectrum Analyzer

### Model 3585A

- 80 dB dynamic range
- 3 Hz resolution bandwidth
- $\pm 0.4$  dB amplitude accuracy
- Self-calibrating

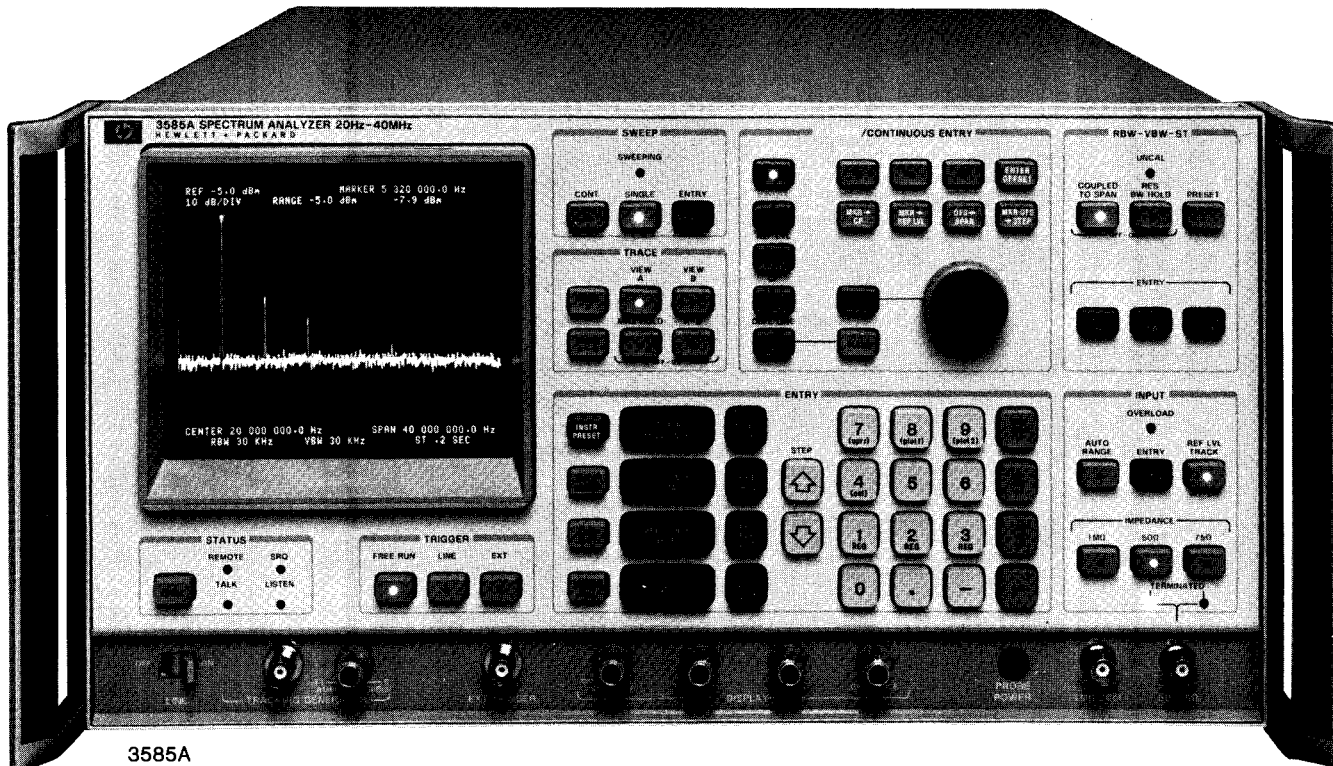

3585A  
(Shown with Opt. 907)



### Description

The HP 3585A Spectrum Analyzer has a fully synthesized local oscillator controlled by a microprocessor. The result of this state-of-the-art contribution offers outstanding performance over its frequency range of 20 Hz to 40.1 MHz. Center frequency and span settings have 0.1 Hz resolution and  $1 \times 10^{-7}$ /mo. stability over its entire operating range. The frequency precision and stability enables the 3 Hz resolution bandwidth filter to be used for close-in analysis even at 40 MHz.

An automatic internal calibration routine, administered by the microprocessor, provides up to  $\pm 0.4$  dB accuracy over most of the measurement range. Improvements in measurement performance of this magnitude cannot be realized by the user unless the basic limitations of the CRT display are bypassed. This has been accomplished by digitizing the detected video signal, which is then stored in memory. Photographic documentation of the display is greatly simplified by displaying all the essential frequency, amplitude and resolution parameters alpha-numerically around the edge of the CRT.

The power of the microprocessor provides a bonus by making this analyzer easier to use. Several of the usually tedious operations, such as centering a signal, raising it to the reference level, etc., are now simplified with dedicated key operated routines working in conjunction with the display marker. Adjustment of resolution and video bandwidth when modifying span is now an automatic function unless individual manual selection is required. In addition, new functions have been added, such as noise power density measurements and off-set capability for both frequency and amplitude.

### Measurement Power & Convenience

The power and convenience of the 3585A's microcomputer-based controls and CRT readout simplify and speed use in so many ways that previously impractical analysis now become routine. Functions such as center frequency and amplitude reference level may be keyboard-set with 0.1 Hz and 0.1 dB precision, varied with an 'analog' knob (actually a rotary pulse-generator), or incrementally key-stepped. The autoranging input attenuator eliminates the error-prone task of adjusting the attenuator to achieve the correct mixer level.

A tunable marker in the 3585A makes basic measurements precise and quick by directly measuring a signal or by speeding the process of magnifying the portion of the spectrum to be analyzed. With the marker set to the signal peak, signal amplitude and frequency (with counter accuracy) are numerically displayed on the CRT. A second marker makes measurements instantly available with numerical display of the difference in amplitude and frequency between the two markers. This is useful for modulation, distortion measurements, and bandwidth measurement. For example, in the case of telecommunications applications, the second marker can be set at harmonic or channel spacing from the first so the operator can simply step frequencies to track higher order harmonics or additional channels.

Amplitude and frequency may be offset to normalize values to some reference signal such as a pilot tone or to reflect the relative value of a signal. Other amplitude units, such as dBV or volts, can be chosen. On any occasion all settings can be stored, then later recalled with a short key sequence. As many as three sets of settings may be stored.

Two different traces each of 1001 horizontal points, may be taken, stored in memory, then shown separately or together as desired while comparisons among them may be calculated and displayed digitally on the CRT. A Max Hold key causes the largest amplitude in successive sweeps to be displayed, making it easy to measure residual FM or drift. A built-in tracking generator, with a maximum output of 0 dBm, enables frequency response measurements to be made.

### Automatic Measurements

Not only are all 3585A functions remotely-programmable via the HP Interface Bus (IEEE Standard 488-1975), the instrument also can be commanded to transfer its measurements out via the bus for interpretation and further interaction by a computing controller. The analyzer can be remotely tuned with the precision of the synthesizer, while retaining analog sweep and exceptional spectral purity. The result is a new and higher level of interaction between the user and the measurement system.

### Frequency Accuracy

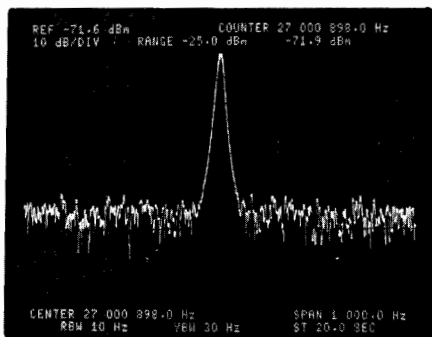

Counter measurements with spectrum analyzer selectivity and sensitivity can be made to  $1 \times 10^{-7}$ /mo. stability while sweeping or manually tuning.

### Dynamic Range

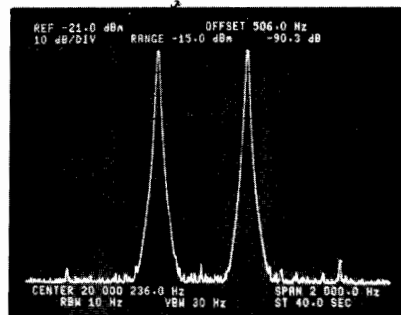

>80 dB spurious free dynamic range with full scale inputs of -25 dBm to +30 dBm in 5 dB steps. Autoranging input provides full dynamic range with no guesswork.

### Internal Calibration

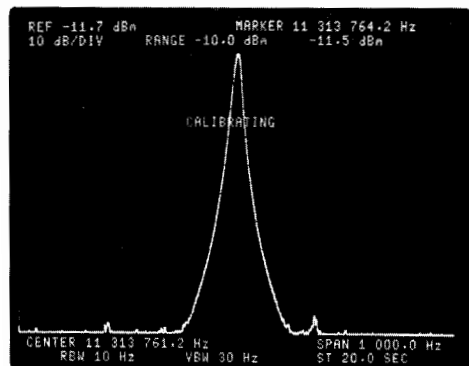

Maximum accuracy is assured at all times by an automatic internal calibration routine which compensates for frequency and amplitude errors in measurements made at the reference level at the center of the screen.

### Swept Response Measurements

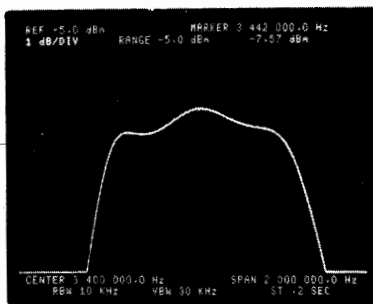

The built-in tracking generator offers superb stability and resolution for crystal filters as well as excellent flatness for wideband devices. The 1 dB/div. amplitude scale is used to expand and resolve small amplitude differences with .01 dB resolution using the marker readout.

### Marker Aided Measurements

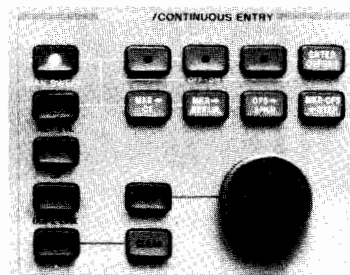

Along with the marker readout capability, there are three additional functions: counter measurements, noise level measurements, and offset (relative) measurements. The four operating aids just above the knob indicate that the marker or offset value can be directly entered into the center frequency, reference level, frequency span, or center frequency step size.

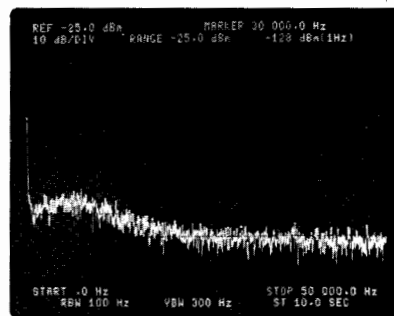

### Noise Measurement

The noise level key displays RMS noise density normalized to a 1 Hz bandwidth at the marker position. All correction factors are accounted for in the internal measurement routine.

### Terminal Interaction

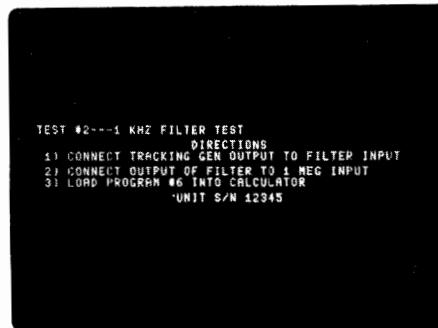

Measurement routines selected from the controller memory via the



# SIGNAL ANALYZERS

## 20 Hz to 40 MHz Spectrum Analyzer (Cont.)

### Model 3585A

analyzer keyboard, such as this filter test, can provide instructions to the operator to minimize errors and reduce training time for complex measurements.

### Specifications

#### Frequency

**Measurement range:** 20 Hz to 40.1 MHz

#### Displayed Range

##### Frequency span:

**Range:** 0 Hz to 40.1 MHz variable with .1 Hz resolution or 10 Hz to 40 MHz in 1, 2, 5 steps

**Accuracy:** -0% + .2% of frequency span setting

##### Center, Start/Stop, and Manual Frequency

**Range:** 0 Hz to 40.1 MHz with .1 Hz resolution

**Accuracy:**  $1 \times 10^{-7}$ /month of frequency

#### Marker

**Readout accuracy:**  $\pm .2\%$  of frequency span  $\pm$  resolution bandwidth

**Counter accuracy:**  $\pm .3$  Hz  $\pm 1 \times 10^{-7}$ /month of counted frequency for a signal 20 dB greater than other signals and noise in the resolution bandwidth setting

#### Resolution

##### Resolution bandwidths

**Range:** 3 dB bandwidths of 3 Hz to 30 kHz in a 1, 3, 10 sequence

**Accuracy:**  $\pm 20\%$  at the 3 dB points

**Selectivity:** 60 dB/3 dB  $< 11:1$

#### Amplitude

**Measurement range:** -137 dBm to +30 dBm (50/75 $\Omega$ ) or equivalent level in dBV or volts, 31 nV to 22 V (1 M $\Omega$ )

#### Displayed Range

**Scale:** 10 division CRT vertical axis with Reference Level at the top graticule line

**Calibration:** 10, 5, 2 and 1 dB/division from the Reference Level

**Input range:** -25 dBm to +30 dBm in 5 dB steps

#### Reference Level (Relative to Input Range)

**Range:** -100 dB to +10 dB

**Accuracy (using 1 or 2 dB/div., at midscreen with sweep rate reduced by 4 or at the manual frequency):**

50/75  $\Omega$  input:

+10 dB	-50 dB	-70 dB	-90 dB
$\pm .4$ dB	$\pm .7$ dB	$\pm 1.5$ dB	

1 M $\Omega$  input - add to above

20 Hz	10 MHz	40.1 MHz
$\pm .7$ dB	$\pm 1.5$ dB	

#### Amplitude linearity (referred to Reference Level)

0 dB	-20 dB	-50 dB	-80 dB	-95 dB
$\pm .3$ dB	$\pm .6$ dB	$\pm 1.0$ dB	$\pm 2.0$ dB	

#### Frequency response (referred to center of span)

50/75  $\Omega$  input:  $\pm .5$  dB

1 M $\Omega$  input:

20 Hz	10 MHz	40.1 MHz
$\pm .7$ dB	$\pm 1.5$ dB	

#### Marker

##### Amplitude accuracy

**Midscreen at the reference level:** Use Reference Level accuracy from +30 dBm to -115 dBm, add Amplitude Linearity below -115 dBm.

**Anywhere on screen:** Add Reference Level Accuracy, Amplitude Linearity and Frequency Response.

#### Dynamic Range

**Spurious responses (image, out of band, and harmonic distortion):**

50/75  $\Omega$  input:  $< -80$  dB referred to a single signal equal to or less than Input Range

1 M $\Omega$  input:  $< -80$  dB except second harmonic distortion  $< -70$  dB

##### Intermodulation distortion:

50/75 $\Omega$  input:  $< -80$  dB referred to the larger of two signals

each  $\geq 6$  dB below Input Range except 2nd order IM from 10 MHz to 40 MHz  $< -70$  dB

1 M $\Omega$  input:  $< -70$  dB

**Residual responses (no signal at input):**  $< -120$  dBm using -25 dBm range

#### Average noise level

50/75  $\Omega$  input:

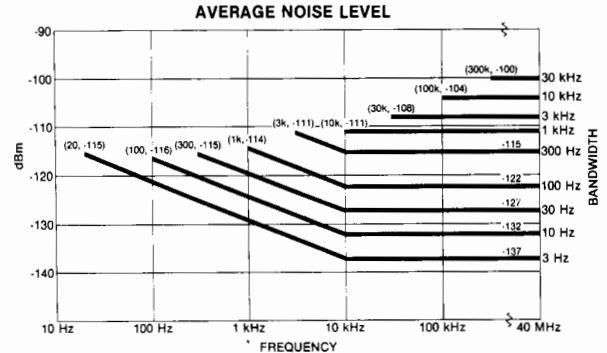

1 M $\Omega$  input: Below 500 kHz add 12 dB to above

#### Sweep

**Modes:** Continuous, single or manual

**Trigger:** Free Run, Line, or External

**Time:** .2 s full sweep to 200 s/Hz of Frequency Span (swept time excluding auto calibration cycles)

#### Input

##### Signal inputs:

50/75  $\Omega$ :  $> 26$  dB return loss, BNC connector

1 M $\Omega$ :  $\pm 3\%$  shunted by  $< 30$  pf, BNC connector

##### Maximum input level:

50/75  $\Omega$ : 13 V peak ac plus dc relay protected against overloads to 42 V peak.

1 M $\Omega$  input: 42 V peak ac plus dc (derate by factor of two for each octave above 5 MHz).

**External trigger input:** Negative going TTL level or contact closure required to initiate sweep.

**External reference input:** 10MHz (or subharmonic to 1 MHz), 0 dBm minimum level

#### Output

##### Tracking generator:

Level: 0 dBm to -11 dBm with a single turn knob

Frequency accuracy:  $\pm 1$  Hz relative to analyzer tuning

Frequency response:  $\pm .7$  dB

Impedance: 50  $\Omega$ ;  $> 14$  dB return loss

**Probe power:** +15 Vdc, -12.6 Vdc; 150 ma max.

Suitable for powering HP 1120A Active Probe

##### External display:

X, Y: 1 volt full deflection; Z:  $< 0$  V to  $> 2.4$  V

Recorder:

X Axis: 10 V full scale

Y Axis: 10 V full scale

Z — penlift output TTL

**IF:** 350 kHz, -11 dBV to -15 dBV at the reference level

**Video:** 10 V at the reference level

**Frequency reference:** 10.000 MHz  $\pm 1 \times 10^{-7}$ /mo., +10 dBm into 50 $\Omega$

#### General

##### Environmental

**Temperature:** Operating 0 $^{\circ}$ C to 55 $^{\circ}$ C

**Humidity:**  $< 95\%$  RH except 300 Hz BW  $< 40\%$  RH

**Warm-up time:** 20 minutes at ambient temperature

**Power requirements:** 115 V (+11% -25%), 48-440 Hz

230V (+11% -18%), 48-66 Hz

180 Watts 3A max

**Weight:** 39.9 kg (88 lb.)

**Size:** 22.9 cm (9") H  $\times$  42.6 cm (16.75") W  $\times$  63.5 cm (25") D

#### Ordering Information

**Opt. 907:** Front Handle Kit

**Opt. 908:** Rack Flange Kit

**Opt. 909:** Combined Opt. 907 and 908

**Opt. 910:** Extra Manual

**Model 3585A Signal Analyzer**

# SIGNAL ANALYZERS

## 50 Hz to 32.5 MHz Selective Level Meter

Model 3586C

471

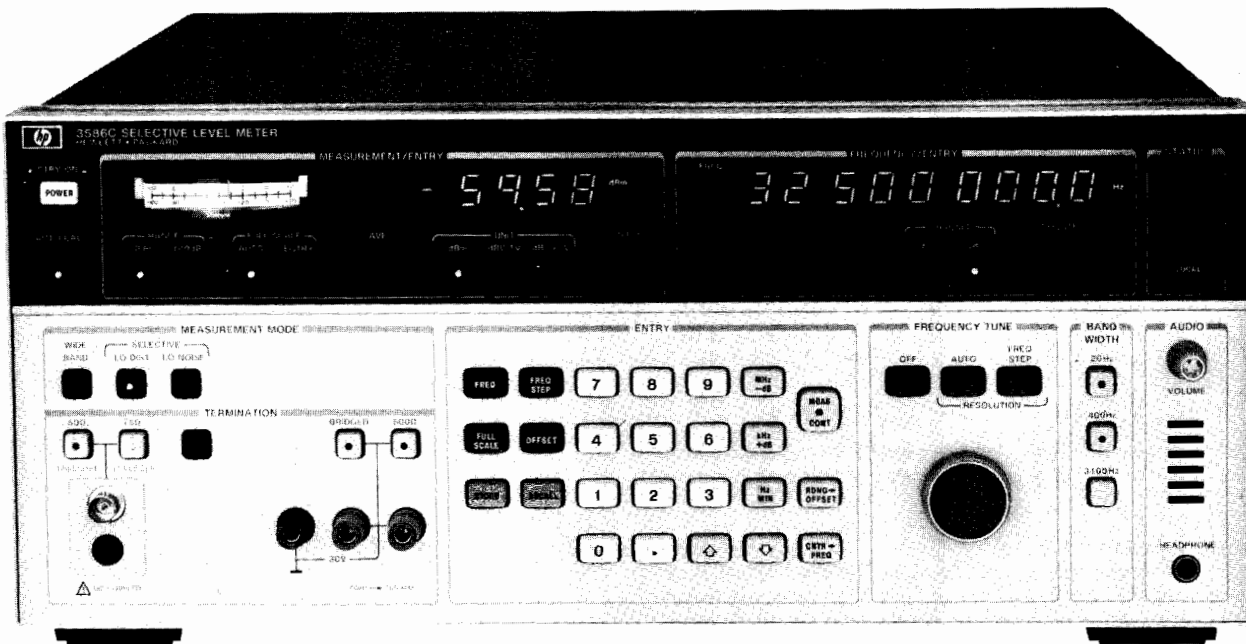

3586C



### Description

The 3586C selective Level Meter is designed for general purpose wave analysis applications in the design, manufacture, and maintenance of electronic systems.

Microprocessor control and HP-developed fractional-N synthesis provides precise frequency setting and time saving ease-of-use features, and the 3586C is fully HP-IB programmable.

The 3586C Selective Level Meter covers the frequency range from 50 Hz to 32.5 MHz allowing measurement of audio, sonar, and other low frequency systems as well as high frequency communications and sub-systems. Input impedances of 50, 75, or 600  $\Omega$  with 10 k $\Omega$  bridging adds measurement flexibility for a wide variety of applications.

Wideband power measurements can be made up to 32.5 MHz and down to -45 dBm. Measure selectively in LO Distortion or LO noise modes or use USB or LSB for single sideband demodulation of a carrier.

### Measurement Precision

Signal levels are measured with up to  $\pm 0.2$  dB accuracy down to -80 dBm with .01 dB resolution and bandwidth choices of 20, 400, or 3100 Hz. Automatic level calibration eliminates the need for manual calibration operations prior to critical level measurements. Frequency can be set precisely with 0.1 Hz resolution and  $\pm 1 \times 10^{-5}$  stability ( $\pm 2 \times 10^{-7}$  optional). The built-in frequency counter allows you to measure the frequency of a signal greater than -100 dBm within the filter bandwidth chosen and then tune the center of the filter pass-band precisely to that signal with one keystroke.

### Selective Measurements

Make measurements on signals as close as 80 Hz spacing with 50 dB rejection using the 20 Hz filter. Use the extremely selective 3100 Hz filter for telecommunications channel level or noise measurements with 60 dB carrier rejection and 75 dB adjacent channel rejection, or demodulate the upper or lower sideband signal for further processing and listen to it with the speaker output.

### Level Offset

Measurements can be made with respect to an entered offset level such as the fundamental signal level. Relative measurements can be made with respect to any keyboard entered or measured level, saving time-consuming operator calculations.

### Digital or Analog Frequency Control

Frequencies may be entered directly on the keyboard with 0.1 Hz resolution and then changed by entering any step size and stepping up or down in frequency, or use the analog frequency tune control. The analog frequency tune control will change frequency in automatically chosen steps proportional to the bandwidth chosen, or in the step size entered.

### Nine Storage Registers

Nine different combinations of front panel settings can be stored in the non-volatile storage registers and then recalled at a keystroke—even if the instrument has been turned off. Significant time is saved when repetitive testing is required in manufacturing, development, or metrology environments.

### Tracking Synthesizer

The 3586C will operate in the frequency tracking mode with either the 3336C Synthesizer (see page 343) for measurements up to 20.9 MHz, or the 3335A Synthesizer (see page 342) for full frequency coverage up to 32.5 MHz. The tracking synthesizer will automatically tune to the frequency programmed on the 3586C in the tracking mode when their HP-IB interfaces are connected together with a bus cable.

Use the tracking mode to save time in amplitude-only network analysis or for loop-around measurements in telecommunications systems.

### Fully Programmable

All necessary functions on the 3586C Selective Level Meter are programmable on the HP-IB using a desktop computer controller such as the HP Model 85F, 9826A, 9836A, or 9845B, or a mainframe computer such as the HP-1000. All measurements and necessary frequency and front panel settings can be interrogated and read out to the bus for print-out or further data processing.

### High Impedance Accessory Probe

Model 1124A 100 MHz Active Divider Probe provides high voltage, high impedance general purpose probing capability for the 50 ohm input impedance on the 3586C Selective Level Meter (see page 208 for specifications).



# SIGNAL ANALYZERS

## 50 Hz to 32.5 MHz Selective Level Meter

Model 3586C (Cont.)

### TOTAL HARMONIC DISTORTION TEST

FUNDAMENTAL FREQ		ABSOLUTE AMP
10,805.1 Hz		1.18 dBm
HARMONIC FREQ		RELATIVE AMP
2	21,610.2 Hz	-50.65 dB
3	32,415.3 Hz	-50.36 dB
4	43,220.4 Hz	-72.35 dB
5	54,025.5 Hz	-50.55 dB
6	64,830.6 Hz	-67.73 dB

THD = -46.89 dB OR 0.45 %

The 3586C and an HP computer were used to characterize a function generator for total harmonic distortion as well as harmonic level.

### Distortion Measurements

The front panel convenience features of the 3586C allow fast, accurate measurement of individual harmonic levels. To measure harmonic levels relative to the fundamental, first measure the fundamental signal level, and enter that level as an offset. Then, enter a frequency step size equal to the fundamental frequency. Now you can quickly step to the harmonic frequencies and measure the harmonic distortion directly without time-consuming calculations. When the exact fundamental frequency is unknown, the built-in counter can be used to measure the fundamental frequency, thereby ensuring precise tuning and accurate measurement.

Intermodulation distortion can also be measured quickly by storing the intermod frequencies and front panel settings in the non-volatile storage registers of the 3586C.

Verifying the total harmonic distortion specifications of sources and amplifiers is a laborious measurement unless a special purpose distortion analyzer is used. With a simple routine in a controller such as the HP 85F Personal Computer, the HP 3586C can be used to quickly measure total harmonic distortion as well as individual harmonic levels.

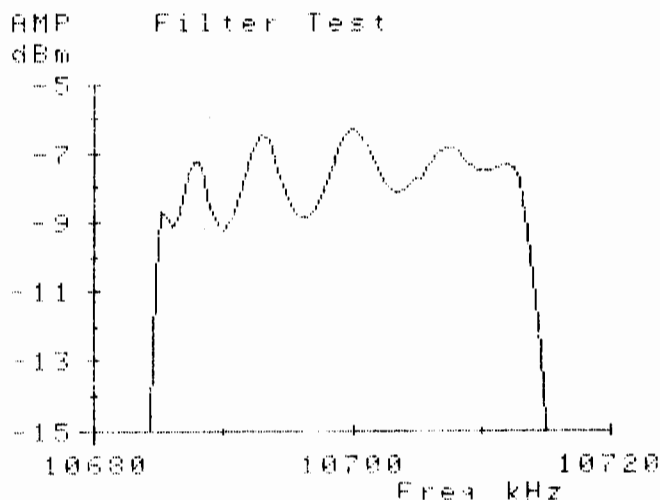

This bandpass filter was characterized using a 3586C and an HP 85F computer. By expanding the y-axis to cover only 10 dB, the passband ripple and 3 dB points are easy to identify.

### Frequency Response Measurements

The 3586C includes a rear panel tracking output of approximately 0 dBm amplitude and  $\pm 0.5$  dB flatness at the same frequency as the passband center frequency. The tracking output has the same accuracy, stability and resolution as the 3586C center frequency specifications. This means the tracking output can be used for frequency response testing of high-Q filters and other selective networks. External attenuators can be used to adjust the input and output levels of the device under test to acceptable ranges.

For applications requiring improved amplitude accuracy and flatness, full amplitude range control without external attenuators, or better signal purity, use the 3336C or 3335A tracking synthesizer in place of the 3586C tracking output. By automatically tracking the frequency of the 3586C, the tracking synthesizers improve the accuracy and flexibility of frequency response measurements without increasing the measurement time.

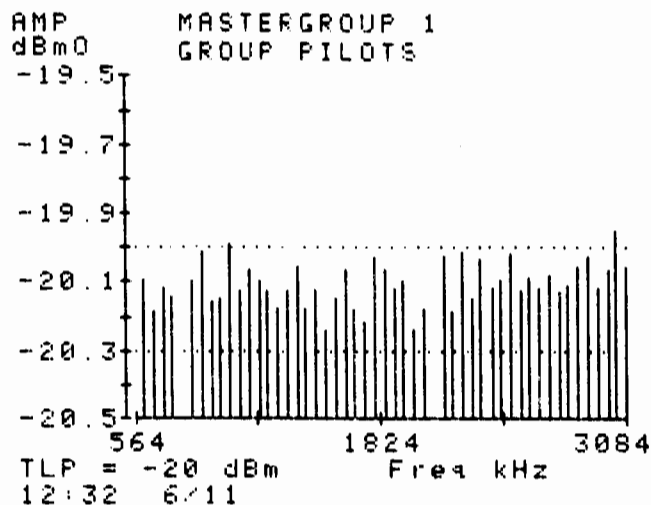

FDM NO	FREQ	AMP
MG SG G CH	kHz	dBm0
> 1 13 1	-800.080	-20.75
> 1 14 1	-1048.080	-19.99
> 1 28 2	-3032.080	-19.95

In this group pilot test, all pilot levels are graphed and the out-of-tolerance pilots are additionally listed in tabular form.

### Telecommunications Measurements

The HP 3586C can also be used for monitoring telecommunication systems. The 3586C can perform single sideband (SSB) voice channel measurements of pilot, carrier and tone levels. Idle channel noise and channel power measurements are made possible with the highly selective 3100 Hz filter. Single sideband AM channels can be demodulated for audio listening or for further measurements using additional equipment. In the wideband mode, the 3586C can be used for measuring the baseband power entering a microwave radio link.

With the addition of an HP computer, the 3586C can provide unattended, automatic surveillance of frequency multiplexed telemetry systems. Besides controlling the selective level meter, the computer can test for measurements that exceed user-defined limits.

The HP Models 3586A/B Selective Level Meters are designed specifically for North American Bell and CCITT Frequency Division Multiplex (FDM) measurements. Refer to page 564 for more information.



### 3586C Specifications

#### Frequency

**Frequency range:** 50/75  $\Omega$  Unbalanced Input; 50 Hz to 32.5 MHz, 600  $\Omega$  Balanced Input; 50 Hz to 100 kHz

**Frequency resolution:** 0.1 Hz

**Center frequency accuracy:**  $\pm 1 \times 10^{-5}$ /year, ( $\pm 2 \times 10^{-7}$ /year with option 004).

**Counter accuracy:**  $\pm 1.0$  Hz in addition to center frequency accuracy for signals within the 60 dB bandwidth of the IF filter chosen or greater than -100 dBm (largest signal is measured).

**Frequency display:** 9 digit LED

#### Selectivity

**3 dB bandwidth,\***  $\pm 10\%$ : 20 Hz, 400 Hz, 3100 Hz

\*Noise bandwidth is the same as the 3 dB bandwidth

**60 dB bandwidth:** 3100 Hz BW,  $\pm 1850$  Hz; 400 Hz BW,  $\pm 1100$  Hz; 20 Hz BW,  $\pm 90$  Hz

**Adjacent channel rejection:** 75 dB minimum at  $\pm 2850$  Hz, 3100 Hz BW

**Passband flatness:**  $\pm 0.3$  dB

#### Passband Flatness:

Bandwidth	Flatness Range	Flatness
3100 Hz	$\pm 1000$ Hz	$\pm 0.3$ dB
400 Hz	$\pm 50$ Hz	
20 Hz	$\pm 3$ Hz	

#### Amplitude

**Measurement range:** +20 to -120 dBm

**Amplitude resolution:** .01 dB

**Level accuracy:** 10 dB auto range, low distortion mode, after calibration, signal at  $\pm 1$  Hz from center frequency.

#### 50/75 $\Omega$ inputs

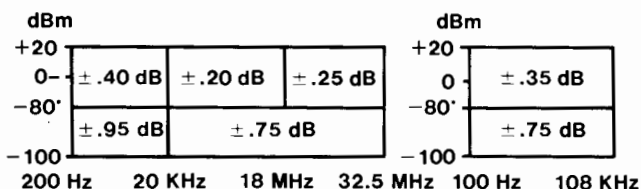

\*20 Hz & 400 Hz BW below -90 dBm

**Level accuracy:** 100 dB Range (after calibration), add correction to 10 dB auto range accuracy for dB below full scale. (Not required when in 10 dB auto-range.)

dB Below Full Scale	Accuracy Correction
0 to -20 dB	$\pm .25$ dB
-20 to -40 dB	$\pm .50$ dB
-40 to -80 dB	$\pm 2.0$ dB

**Wideband power accuracy:** after calibration, 100 dB range, average on, -45 to +20 dBm.

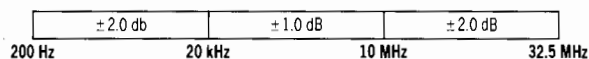

#### Dynamic Range

##### Spurious responses:

-110 dBm maximum or the following, whichever is greater.

**Image rejection (100-132 MHz):** -80 dBc

**IF rejection:** 15625 Hz, -80 dBc; 50 MHz, -60 dBc

**Spurious signals:** > 1600 Hz offset, > -80 dBc; 300 Hz to 1600 Hz, > -75 dBc

**Residual spurious:** -110 dBm maximum; < 350 Hz, -95 dBm

#### Distortion:

**Harmonic distortion:** -75 dB below full scale, low distortion mode, above 4 kHz.

**Intermodulation distortion:** two-tone second and third order, separation 7 kHz to 1 MHz, -78 dB below full scale. Either tone  $\geq 10$  MHz, -70 dB.

#### Noise floor (full scale setting -35 to -120 dBm):

Frequency	Bandwidth	Noise Level
100 kHz to 32.5 MHz	3100	-114 dBm
	20 Hz, 400 Hz	-120 dBm
2 kHz to 100 kHz	All	-105 dBm

The noise floor for full scale settings of -30 to +25 dBm will be 75 dB below full scale for > 100 kHz, or 55 dB below full scale for < 100 kHz.

#### Signal Inputs

Impedance	Frequency	Mating Connector
50/75 ohms unbalanced	50 Hz to 32.5 MHz	BNC
600 ohms balanced	50 Hz to 100 kHz	Dual Banana Plug 0.75 inch Spacing

**Return loss:** 50/75  $\Omega$ , 30 dB; 600  $\Omega$ , 25 dB

**Balance:** 600  $\Omega$ ; 40 dB

#### Demodulated Audio Output

**Output level:** 0 dBm into a 600  $\Omega$  load

**Output connector:** 1/4" jack, mates with WECO 347.

#### Auxiliary Signal Inputs/Outputs

**Tracking output:** 0 dBm rear panel tracking output

**Ext. reference input:** 1 MHz to 10 MHz or sub-harmonic input.

**Reference output:** 10 MHz at 8 dBm output (also 10 MHz oven oscillator on instruments with option 004).

**Probe power:** front panel DC output for HP active high impedance accessory probes, (+15, -12 VDC)

**HP-IB interface:** rear panel interface meeting IEEE 488-1978 for remote operation. Used for tracking synthesizer interface.

**Additional outputs:** audio, phase jitter and meter output.

#### Options

**Option 004: High stability frequency reference:** 10 MHz oven stabilized reference oscillator, improves frequency stability to  $\pm 2 \times 10^{-7}$ /year.

#### General

##### Operating Environment

**Temperature:** 0° to 55°C

**Relative humidity:** 95%, 0° to 40°C

**Altitude:**  $\leq 15,000$  ft.,  $\leq 4600$  metres

**Storage environment temperature:** -40°C to 75°C

**Storage altitude:**  $\leq 50,000$  ft.,  $\leq 15,240$  metres

**Power:** 100/120/220/240 V, +5%, -10%, 48 to 66 Hz, 150 VA

**Weight:** 23 kg. (50 lbs.) net; 30 kg. (65 lbs.) shipping

**Size:** 177 mm H x 425.5 mm W x 475.5 mm D (7" x 16.75" x 16.75")

#### 3586C Selective Level Meter\*

**Opt 004:** High Stability Frequency Reference

**Opt 907:** Front Panel Handles

**Opt 908:** Rack Flange Kit

**Opt 909:** Rack Flange & Handle Combination Kit

#### Accessories

**1124A:** High Impedance Probe

\*HP-IB cables not supplied. See page 29.

# SIGNAL ANALYZERS

Spectrum Analyzers, 100 Hz to 220 GHz

Models 8568A & 8566A

- 100 Hz to 1.5 GHz coverage with counter accuracy
- 10 Hz resolution bandwidth
- Trace markers with amplitude and frequency readout
- 100 Hz to 220 GHz coverage with synthesizer accuracy
- 2 to 22 GHz preselected range
- Comprehensive HP-IB capability

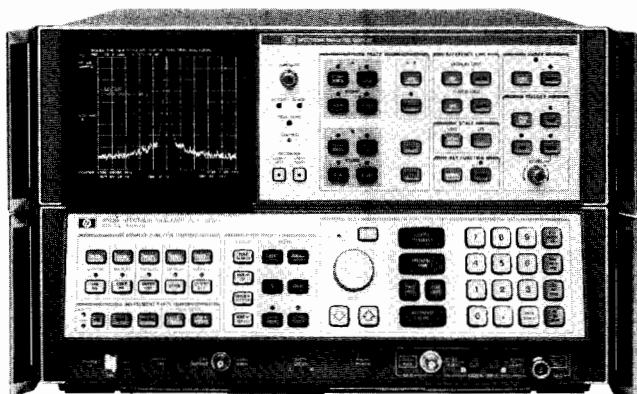

8568A

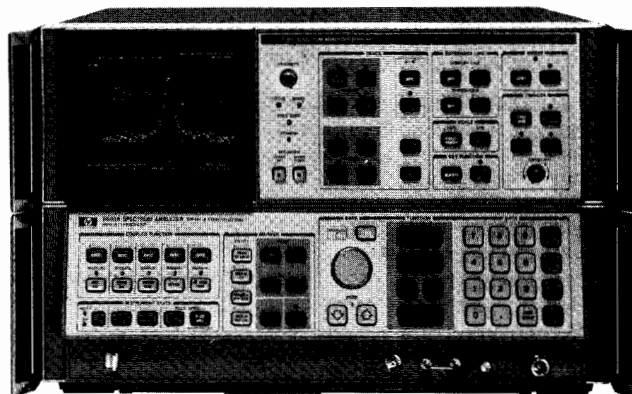

8566A



The 8568A and 8566A are high performance spectrum analyzers for bench and HP-IB system use. The 8568A operates over the 100 Hz to 1500 MHz frequency range, the 8566A operates over a 100 Hz to 22 GHz internal mixing range with preselection from 2 GHz to 22 GHz. The frequency range may be extended to 40 GHz with the Option E50 External Mixer Kit and to 220 GHz with commercially available external mixers. (For more information on external mixing, see Product Note 8566A-1 or contact your local HP field engineer). Each analyzer is designed around its own internal bus and controlled by its own microcomputer to yield significant improvements in RF measurement performance, new operational features, and unparalleled flexibility under program control.

The performance specifications for the 8568A and 8566A are described on pages 476 and 479.

### Performance

Exceptional frequency stability in both the 8568A and 8566A enables the use of a 10 Hz resolution bandwidth over their respective frequency ranges. Superior spectral purity and narrow resolution make it possible to measure clean oscillators directly at RF frequencies. 10 Hz resolution also results in sensitivities to  $-135$  dBm which makes greater than 85 dB spurious-free dynamic range achievable. A frequency reference error of  $1 \times 10^{-9}$ /day together with the analyzers' resolution and sensitivity allow small signals in the presence of large ones to be measured with unequalled accuracy.

### Usability

All the control settings are conveniently read on the CRT display. The operator changes control settings through the data controls. To activate a function the user pushes the appropriate key; he then has the option of setting the function's value using the knob, step keys or numeric/unit keyboard.

Measurements can be made following conventional "zoom" techniques using the center frequency, frequency span and reference level functions, or with the help of certain measurement aids. A preset but-

ton sets all analyzer controls to a convenient starting point; coupled functions, such as resolution bandwidth and sweptime change automatically as frequency span is reduced to maintain a calibrated display.

A tunable marker is available for directly measuring a signal or speeding the process of magnifying the portion of the spectrum to be analyzed. With the marker set to the signal peak, the signal's *amplitude* and *frequency* are displayed on the CRT. A second marker, useful for modulation or distortion measurements, makes relative measurements by displaying the difference in amplitude and frequency between the two markers. Marker information enables the operator to step between evenly spaced portions of the frequency spectrum such as communication channels or signal harmonics; the noise level at the marker can be converted to the RMS noise density normalized to a 1 Hz bandwidth. The marker may also be positioned at the peak of the largest signal on the screen and used to zoom-in on signals *automatically*.

Once the analyzer's controls have been adjusted, all settings can be *saved* in memory and later *recalled* to repeat the measurements. An internal battery maintains the contents of memory in the event of a power failure.

All displayed information resides in a digital memory from which the CRT is refreshed at a flicker-free rate. Display titles may be added. A trace may be viewed real-time or stored; max hold displays the largest amplitude at 1001 points across the CRT over successive sweeps to aid in the measurement of residual FM or drift. Up to three traces may be observed simultaneously and arithmetic between traces or a trace and reference display line is possible for comparison or frequency response normalization.

### Automatic Measurement Capability

The 8568A and 8566A analyzers lend themselves to automatic control via the HP Interface Bus (IEEE Standard 488-1975). The analyzers can be tuned with the precision of a synthesizer while retaining analog sweep and exceptional resolution. The analyzers' control ar-

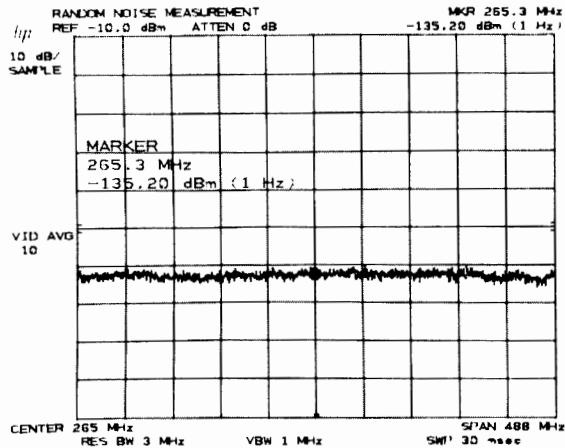
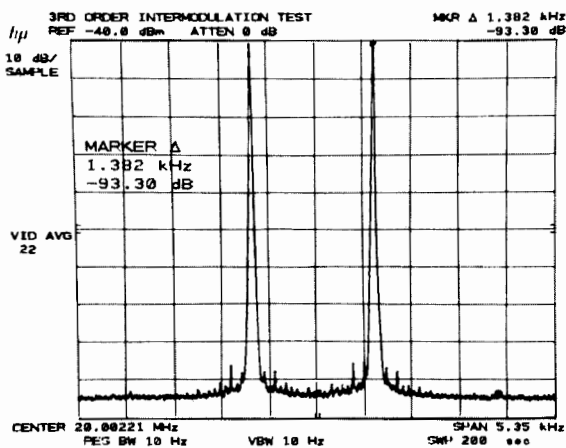
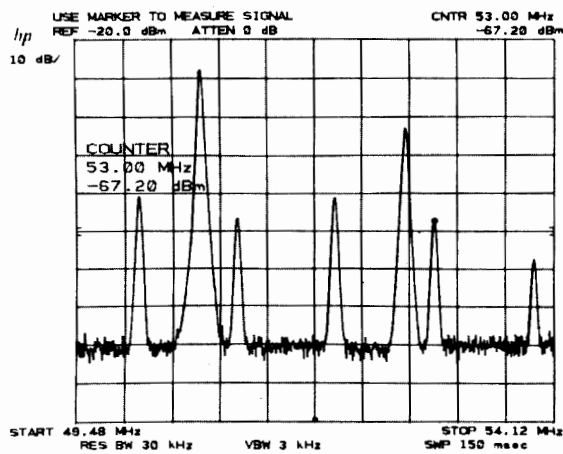
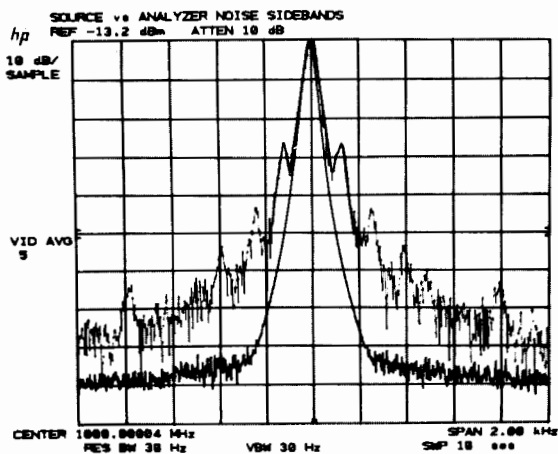
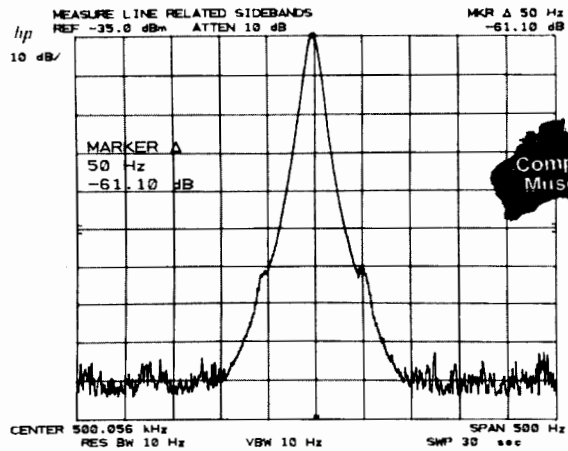
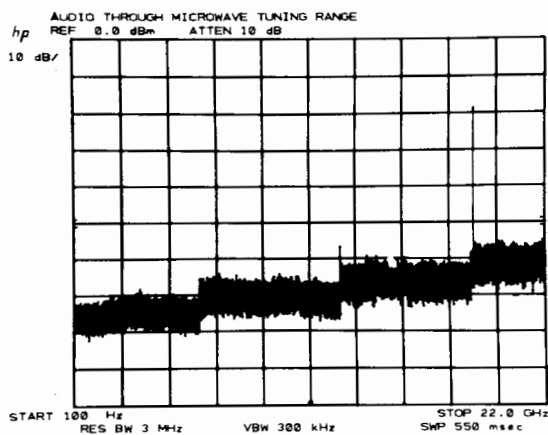

chitecture facilitates the remote operation of all function settings and the output of CRT trace information; the display itself is accessible for annotation and graphing purposes.

Friendly analyzer codes and HP-IB commands are used to program the analyzer; for example, CF 20 MZ instructs the analyzer to set center frequency to 20 MHz. Built-in firmware features such as instrument preset, peak search and automatic zoom further simplify writing software.

The primary advantage of computer control is the execution of complicated or time consuming measurement routines with a minimum of involvement by the operator. This capability is especially useful in production line testing or unattended measurement situations such as spectrum monitoring. An analyzer may be joined by other instruments in a distributed system, or be controlled remotely through a data communications network. External control is desirable for setting the proper analyzer function values, reading data,

performing any numerical manipulation required (including error correction), analyzing the results, and providing output data in a convenient format on a printer, plotter, or the analyzer CRT.

### Operation Training Course HP 5003A

This four day course is designed for engineers and senior technicians who will be integrating the 8566A or 8568A Spectrum Analyzers into their own automatic test systems. The course teaches manual and remote operation techniques using the HP 9826A Computer and HP-IB. The use of interactive lectures, hands-on oriented labs and small class size give students a solid understanding of spectrum analyzer remote measurement capabilities. Contact your local HP sales office for enrollment information.

Automatic capability is available in two configured systems, the 8581B and 8582B Automatic Spectrum Analyzers. These are specified on page 482.



# SIGNAL ANALYZERS

## Spectrum Analyzer, 100 Hz to 1500 MHz

### Model 8568A

- 100 Hz to 1.5 GHz frequency range
- 10 Hz resolution bandwidth
- Frequency counter accuracy
- Digital display
- Tunable marker with amplitude and frequency readout
- Store and recall of control settings

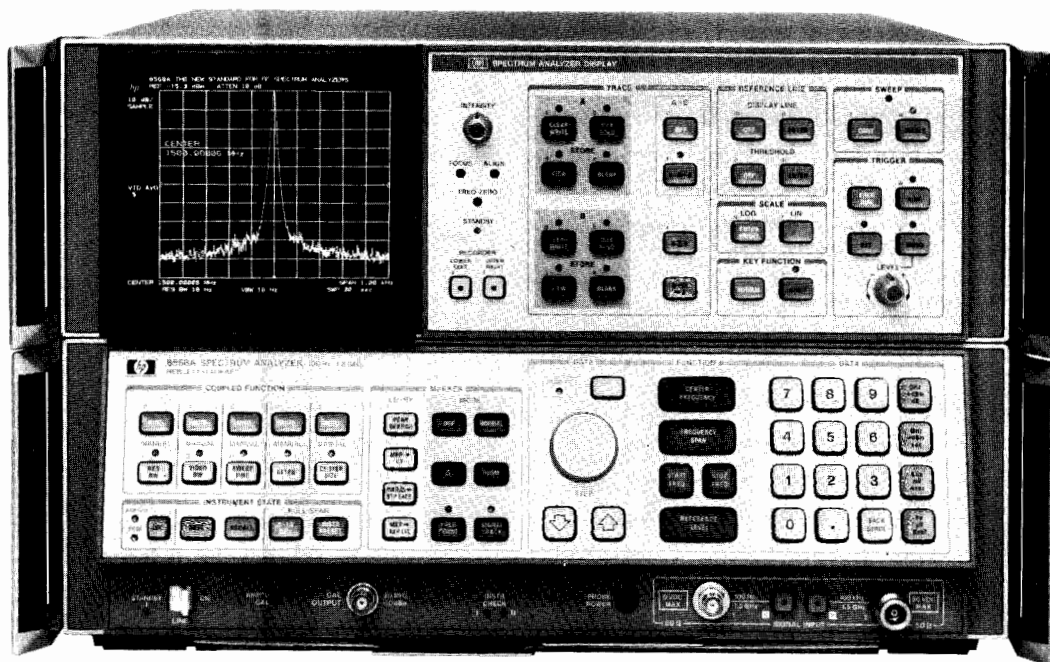

8568A



The 8568A Spectrum Analyzer is a high performance spectrum analyzer for bench and remote operation which covers the 100 Hz to 1.5 GHz frequency range. Frequency stabilized local oscillators and an internal counter bring unequaled measurement precision to RF spectrum analysis. Exceptional frequency stability and local oscillator spectral purity enables the use of a 10 Hz resolution bandwidth to make difficult, close-in sideband measurements on RF signals.

An internal microprocessor opens new horizons of operator convenience features. Digital display, store and recall of control settings, automatic zoom-in and signal track functions are administered by powerful firmware within the 8568A, thus simplifying operation of the analyzer.

All 8568A functions are programmable via HP-IB (IEEE 488-1975). Programming is as straightforward as encoding the steps used in a manual measurement. Friendly programming codes and easily recognizable mnemonics facilitate learning the analyzer language.

## 8568A Specifications

### Frequency

#### Displayed Range

**Frequency span:** 100 Hz to 1500 MHz over 10 division CRT horizontal axis. In zero span, the instrument is fixed tuned at the center frequency.

**Full span (0–1500 MHz):** is immediately executed with a 0–1.5 GHz or INSTR PRESET keys.

**Frequency span accuracy:** for spans  $>1$  MHz,  $\pm(2\%$  of the indicated frequency separation between two points  $+0.5\%$  span); for span  $\leq 1$  MHz,  $\pm(5\%$  of frequency separation  $+0.5\%$  span).

**Center frequency:** 0 Hz to 1500 MHz. Center frequency step size may be set using the numeric keyboard or MKR/ $\Delta$ —STP SIZE key.

**Readout accuracy:** Span  $\geq 100$  Hz:  $\pm(2\%$  of frequency span + frequency reference error  $\times$  tune frequency  $+10$  Hz) in AUTO resolution bandwidth after adjusting freq zero at stabilized temperature, and using the error correction function, SHIFT W and SHIFT X.

**Start-stop frequency:** permissible values must be consistent with those for center frequency and frequency span. SHIFT O sets the analyzer start and stop frequencies equal to the frequencies of the two  $\Delta$  markers.

**Readout accuracy:** center frequency accuracy +  $\frac{1}{2}$  frequency span accuracy.

### Marker

**Normal:** displays the frequency at the horizontal position of the tunable marker.

**Accuracy:** center frequency accuracy + frequency span accuracy between the marker and center frequencies.

**PEAK SEARCH** positions the marker at the center of the largest signal response present on the display to within  $\pm 10\%$  of resolution bandwidth. MKR  $\rightarrow$  CF sets the analyzer center frequency equal to the marker frequency; MKR/ $\Delta$   $\rightarrow$  STP SIZE sets the center frequency step equal to the marker frequency.

**Frequency count:** displays the frequency signal on whose response the marker is positioned. The marker must be positioned at least 20 dB above the noise or the intersection of the signal with an adjacent signal and more than four divisions up from the bottom of the CRT.

**Accuracy:** for span  $\leq 100$  kHz: frequency reference error  $\times$  displayed frequency  $\pm 2$  counts. For span  $> 100$  kHz but  $\leq 1$  MHz: freq. ref. error  $\times$  displayed frequency  $\pm (10$  Hz  $+ 2$  counts). For span  $> 1$  MHz:  $\pm (10$  kHz  $+ 1$  count).

**Frequency reference error:** aging rate  $< 1 \times 10^{-9}$ /day; temp stability  $< 7 \times 10^{-9}$ ,  $0^\circ$  to  $55^\circ\text{C}$ .

**Signal track:** re-tunes the analyzer to place a signal identified by the marker at the center of the CRT and maintain its position. Useful when reducing frequency span to zoom-in on a signal; also keeps a drifting input signal centered.

$\Delta$ : displays the frequency difference between the stationary and tunable markers. Reference frequency need not be displayed.

**Accuracy:** same as frequency span accuracy; in the FREQUENCY COUNT mode, twice the frequency count uncertainty plus drift during the period of the sweep (typically  $< 10$  Hz/minute). MKR/ $\Delta$   $\rightarrow$  STP SIZE sets the center frequency step size equal to the frequency difference between the markers. SHIFT O sets the

analyzer start stop frequencies equal to the frequencies of the two markers.

**Zoom:** makes it possible to reduce the frequency span about the marker (or signal in the signal track and freq count modes) using the step down key.

**Resolution**

**Resolution bandwidth:** 3 dB bandwidths of 10 Hz to 3 MHz in a 1, 3, 10 sequence. Bandwidth may be selected manually or coupled to frequency span.

**Bandwidth accuracy:** calibrated to:  $\pm 10\%$ , 1 MHz to 3 kHz;  $\pm 20\%$ , 1 kHz to 10 Hz, 3 MHz bandwidths.

**Bandwidth selectivity:** 60 dB/3 dB bandwidth ratio:  $<15:1$ , 3 MHz to 100 kHz;  $<13:1$ , 30 kHz to 10 kHz;  $<11:1$ , 3 kHz to 30 Hz. 60 dB points on 10 Hz bandwidth are separated by  $<100$  Hz.

**Stability**

**Residual FM:**  $<3$  Hz peak-to-peak  $\leq 10$  sec; span  $<100$  kHz, resolution bandwidth  $\leq 30$  Hz, video bandwidth  $\leq 30$  Hz.

**Drift:**  $<10$  Hz/minute of SWEPTIME after 1 hr. warmup at stabilized temperature, for frequency span  $\leq 100$  kHz. Spans  $>100$  kHz but  $\leq 1$  MHz,  $<100$  Hz/minute of SWEPTIME;  $>1$  MHz,  $<300$  kHz/minute of SWEPTIME.

**Spectral Purity**

**Noise Sidebands:**  $>80$  dB below the peak of a CW signal at frequency offsets  $\geq 30$  x resolution bandwidth setting, for resolution bandwidths  $\leq 1$  kHz.

**Line related sidebands:**  $>85$  dB below the peak of a CW signal.

**Amplitude**

**Measurement range:**  $-135$  dBm to  $+30$  dBm.

**Displayed Range**

**Scale:** Over a 10 division CRT vertical axis with the Reference Level at the top graticule line.

**Calibration**

**Log:** 10 dB/div for 90 dB display from Reference Level.

5 dB/div for 50 dB display  
2 dB/div for 20 dB display  
1 dB/div for 10 dB display

expanded from reference level

**Linear:**

10% of Reference Level/div when calibrated in voltage.

**Fidelity:**

<b>Log:</b>	<b>Incremental</b>	<b>Cumulative</b>
	$\pm 0.1$ dB/dB over 0 to 80 dB display	$\leq \pm 1.0$ dB max over 0 to 80 dB display, 20–30°C.
		$\leq \pm 1.5$ dB max over 0 to 90 dB display.

**Linear:**  $\pm 3\%$  of Reference Level.

**Reference Level**

**Range**

**Log:**

$+60.0$  to  $-139.9$  dBm or equivalent in dBmV, dB $\mu$ V, volts.

**Linear:**

228.6 $\mu$  volts to 0.22  $\mu$ volts full scale.

**Accuracy:** the sum of the following factors determines the accuracy of the reference level readout. Depending upon the measurement technique followed after calibration, various of these sources of uncertainty may not be applicable.

An internal error correction function calibrates and reduces the uncertainty introduced by analyzer control changes from the error calibration state ( $-7$  dBm reference level, 1 dB/div scale, 10 dB RF attenuation, 1 MHz bandwidth) when SHIFT W is executed just prior to the signal measurement (i.e., at the same temperature) within the 20°–30° range.

**Calibrator uncertainty:**  $\pm 0.2$  dB.

**Frequency response (Flatness) uncertainty:** input #1:  $\pm 1$  dB, 100 Hz to 500 MHz;  $\pm 1.5$  dB 100 Hz to 1500 MHz; input #2:  $\pm 1$  dB, 100 kHz to 1500 MHz.

**Amplitude temperature drift:** at  $-10$  dBm reference level with 10 dB input attenuation and 1 MHz resolution bandwidth,  $\pm 0.05$  dB/°C (eliminated by recalibration).

**Input connector switching uncertainty:**  $\pm 0.5$  dB when calibration and measurement do not use the same RF input.

**Input attenuation switching uncertainty:**  $\pm 1.0$  dB over 10 dB to 70 dB range.

**Resolution bandwidth switching uncertainty:** (referenced to 1 MHz bandwidth)—corrected (uncorrected)

<b>Range</b>	<b>20–30°C</b>	<b>0–55°C</b>
1 MHz to 30 Hz	$\pm 0.1$ dB ( $\pm 0.5$ dB)	( $\pm 2.0$ dB)
10 Hz	$\pm 0.1$ dB ( $\pm 1.0$ dB)	( $\pm 4.0$ dB)
3 MHz	$\pm 0.1$ dB ( $\pm 1.0$ dB)	( $\pm 2.0$ dB)

**Log scale switching uncertainty:**  $\pm 0.1$  dB corrected ( $\pm 0.5$  dB uncorrected).

**IF Gain uncertainty:** corrected (uncorrected). Assuming the internal calibration signal is used to calibrate the reference level at  $-10$  dBm and the input attenuator is fixed at 10 dB, any changes in reference level in the following ranges will contribute 1F gain uncertainty:

<b>Range</b>	<b>20–30°C</b>	<b>0–55°C</b>
0 dBm to $-55.9$ dBm	NA <sup>2</sup> ( $\pm 0.6$ dB)	( $\pm 1.0$ dB)
$-56$ dBm to $-129.9$ dBm	( $\pm 1.0$ dB) <sup>3</sup> ( $\pm 1.0$ dB)	( $\pm 1.5$ dB)

Each 10 dB decrease (or increase) in the amount of input attenuation at the time of calibration and measurement will cause a corresponding 10 dB decrease (or increase) in the absolute reference level settings described above.

**RF Gain uncertainty (due to 2nd LO shift):**  $\pm 0.1$  dB corrected ( $\pm 1.0$  dB uncorrected)

**Error correction accuracy:** (applicable when controls are change from the error calibration state if SHIFT W and SHIFT X are used):  $\pm 0.4$  dB.

**Marker**

**Normal:** displays the amplitude at the vertical position of the tunable marker.

**Accuracy:** equals the sum of calibrator uncertainty, reference level uncertainty, and scale fidelity between the reference level and marker position.

**PEAK SEARCH** positions the marker at the peak of the largest signal present on the display. MKR — REF LVL set the analyzer reference level equal to the marker amplitude. RMS noise density in a 1 Hz bandwidth is read out using SHIFT M, by sampling the displayed trace and arithmetically correcting for the analyzer envelope detector response, log shaping, and measurement bandwidth.

$\Delta$ : displays the amplitude difference between the stationary and tunable markers. Reference frequency need not be displayed.

**Accuracy:** equals the sum of scale fidelity and frequency between the two markers.

**Reference Lines**

**Display line:** movable horizontal line with amplitude readout.

**Threshold:** movable horizontal trace threshold with amplitude readout.

**Accuracy:** equals the sum of calibrator uncertainty, reference level uncertainty, and scale fidelity between the reference level and reference line.

**Dynamic Range**

**Spurious responses:** for a total signal power  $\leq -40$  dBm at the input mixer of the analyzer, all image and out-of-band mixing responses, harmonic and intermodulation distortion products are  $>75$  dB below the total signal power for inputs 10 MHz to 1500 MHz;  $>70$  dB below the total signal power for input signals 100 Hz to 10 MHz.

**Video bandwidth:** post detection low pass filter used to average.

**Displayed noise:** bandwidth variable from 1 Hz to 3 MHz in a 1, 3, 10 sequence. Video bandwidth may be selected manually or coupled to resolution bandwidth.

**Digital video averaging:** displays the sweep-to-sweep average of the trace over a specifiable number of sweeps with SHIFT G, video averaging is turned off with SHIFT H.

**Gain compression:**  $<0.5$  dB for signal levels  $\leq -10$  dBm at the input mixer.

**Sweep**

**Trigger**

**Free run:** sweep triggered by internal source.

**Line:** sweep triggered by power line frequency.

<sup>1</sup>Maximum input must not exceed +30 dBm (damage level).

<sup>2</sup>Accounted for under Error Correction Accuracy.

<sup>3</sup>Correction only applies over the 0 dBm to  $-55.9$  dBm range.



# SIGNAL ANALYZERS

## Spectrum Analyzer, 100 Hz to 1500 MHz

Model 8568A (Cont'd.)

**Video:** sweep triggered by detected waveform of input signal at an adjustable level; signal must be  $\geq 0.5$  div peak-to-peak.

**External:** sweep triggered by rising edge of signal input to rear panel BNC connector; trigger source must be  $> 2.4$  volt (5 volt max).

### Continuous

Sequential sweeps initiated by the trigger: 20 msec full span to 1500 sec full span in 1, 1.5, 3, 5, 7.5, 10 sequence.

**Accuracy:** sweep time  $\leq 100$  sec,  $\pm 10\%$ ;  $> 100$  sec,  $\pm 20\%$ .

**Zero frequency span:** 1  $\mu$ sec full sweep (10 divisions) to 10 msec full sweep in 1, 2, 5 sequence; 20 msec full sweep to 1500 sec full sweep in 1, 1.5, 2, 3, 5, 7.5, 10 sequence.

**Accuracy:** same as continuous.

Sweep time may be set manually or automatically for the frequency span, resolution bandwidth and video bandwidth selected.

**Single:** single sweep armed on activation and initiated by trigger (sweep  $\geq 20$  msec only).

### Display

**Trace:** A and B are two independent signal response memories each having 1001 horizontal data positions and vertical resolution of 0.1%. Memory contents are displayed on the CRT at a rate independent of the analyzer sweep time. Trace A is displayed brighter than trace B.

**Clear/Write:** clears memory contents when first activated, then writes the analyzer signal response into the memory each sweep and displays memory.

**Max hold:** retains in memory and displays the largest signal level occurring at each horizontal data position over the repetitive sweeps beginning at the time the function is activated.

**View:** stops writing into memory and displays memory without changing its contents.

**Blank:** stops writing into memory and blanks the trace while retaining the last response in memory.

### Arithmetic

**A-B-A:** initially subtracts the stored memory contents of B from the current memory contents of A and writes the difference into A; this process continues as the A memory is updated at the sweep rate. To accomplish A+B-A use SHIFT c.

**A  $\bar{=}$  B:** exchanges A and B display memory contents.

**B-DL-B:** subtracts the amplitude of the display line from the memory contents of B and writes the difference into B.

A third signal response memory, C (also with a 1001 data positions), can be used for signal response storage. It is accessed indirectly by transferring memory contents between B and C.

**B-C:** SHIFT l.

**B  $\bar{=}$  C:** SHIFT i.

**View C:** SHIFT j.

**Blank C:** SHIFT k.

### Annotation

**Title:** allows the user to write characters into a specified area on the CRT by pushing SHIFT E and typing the keys next to the blue front panel characters and data numbers desired. Use BACK-SPACE for corrections.

**Blank:** SHIFT o blanks (SHIFT p unblanks) all CRT characters and control setting readouts. SHIFT m blanks (SHIFT n unblanks) the CRT graticule.

### Input

#### RF Inputs

The standard instrument configuration is as follows:

**Input # 1:** 100 Hz to 1500 MHz, 50  $\Omega$ , BNC connector (Fused); dc coupled.

**Reflection coefficient:**  $> 0.20$  (1.5 SWR) to 500 MHz,  $< 0.33$  (2.0 SWR) 500 MHz to 1500 MHz;  $\geq 10$  dB input attenuation.

**Input # 2:** 100 kHz to 1500 MHz, 50  $\Omega$ , Type N connector; ac coupled.

**Reflection coefficient:**  $< 0.20$  (1.5 SWR);  $\geq 10$  dB input attenuation.

**LO emission:** typically  $< -75$  dBm (0 dB RF Atten).

**Isolation:**  $> 90$  dB between inputs.

**Also available:** Input #1, 100 kHz to 1500 MHz, 75  $\Omega$ , BNC connector, ac coupled (Opt 001).

#### Maximum Input Level

**AC:** continuous power, +30 dBm (1 watt); 100 watts, 10  $\mu$ sec pulse into  $\geq 50$  dB attenuation.

**DC:** Input #1, 0 volts; Input #2,  $\pm 50$  volts.

**Input attenuator:** 70 dB range in 10 dB steps. Zero dB attenuation accessible only through numeric/unit keyboard. Attenuation may be selected manually or coupled to reference level to insure a  $-10$  dBm input mixer drive level for full-screen signals; other mixer levels may be specified using SHIFT ' and entering the desired amplitude through the keyboard.

**Accuracy:**  $\pm 0.10$  dB over 10-70 dB range.

### Output

**Calibrator:** 20 MHz  $\pm 20$  MHz x frequency reference error ( $1 \times 10^{-9}$ /Day),  $-10$  dBm  $\pm 0.2$  dB; 50  $\Omega$ .

**Probe power:** +15 V,  $-12.6$  V; 150 mA max.

### Auxiliary (rear panel; nominal values)

**Display:** X, Y and Z outputs for auxiliary CRT displays. X, Y: 1 volt full deflection; Z: 0 to 1 V intensity modulation,  $-1$  V blank. BLANK output (TTL level  $> 2.4$  V for blanking) compatible with most oscilloscopes.

### Recorder

**Horizontal sweep output (x axis):** a voltage proportional to the horizontal sweep; 0 V for left edge to +10 V for right edge.

**Video output (y axis):** detected video output proportional to vertical deflection of CRT trace. Output increases 100 mV/div from 0 to 1 V.

**Penlift output (z axis):** 15 V blanking output during retrace.

**21.4 MHz IF:** a 50  $\Omega$ , 21.4 MHz output related to RF input to the analyzer. Output nominally  $-20$  dBm for a signal at the reference level. Bandwidth controlled by the analyzer's resolution bandwidth setting.

**1st LO:** 2-3.7 GHz,  $> +4$  dBm; 50  $\Omega$  output impedance.

**Frequency reference:** 10.000 MHz, 0 dBm; 50  $\Omega$  output impedance.

### Instrument State Storage

Up to 6 complete sets of user-defined control settings may be stored and recalled by pressing SAVE or RECALL and the desired register number (1 to 6) from the keyboard. Instrument state information is retained in memory approximately 30 days in STANDBY mode or after line power is removed.

### Remote Operation

The standard 8568A operates on the Hewlett-Packard Interface Bus (HP-IB). All analyzer control settings (with the exception of VIDEO TRIGGER LEVEL, FOCUS, ALIGN, INTENSITY, FREQ ZERO and AMPLD CAL) are remotely programmable. Function values, marker frequency/amplitude, and A/B traces may be output; CRT labels and graphics may be input. An HP-IB cable (not supplied) is required for remote operation.

### General

#### Environmental

**Temperature:** operating 0°C to 55°C, storage  $-40$ °C to +75°C.

**Humidity:** operating  $< 95\%$  R.H., 0°C to 40°C except as noted.

**EMI:** 8568A conducted and radiated interference is within the requirements of CE03 and RE02 of MIL STD 461A, VDE 0871, and CISPR pub'n 11.

**Power requirements:** 50 to 60 Hz; 100, 120, 220 or 240 volts (+5%, -10%); approximately 450 VA (40 VA in standby). 400 Hz operation is available as Opt 400.

**Weight:** total net, 45 kg (100 lb); Display/IF Section, 21 kg (46 lb); RF Section, 24 kg (54 lb). Shipping net, 72 kg (158 lb); Display/IF Section, 27 kg (60 lb); RF Section, 32 kg (70 lb); Manuals and Accessories, 13 kg (28 lb).

**Size:** 267 H x 425.5 W x 558.8 mm D (10.5" x 16.75" x 22").

### Ordering Information

**8568A Spectrum Analyzer**

**Opt 001:** 75  $\Omega$  (BNC), 100 kHz to 1500 MHz RF Input #1

**Opt 010:** Rack Slide Kit

**Opt 400:** 400 Hz Power Line Frequency Operation

**Opt 908:** Rack Flange Kit

**Opt 910:** Extra Manual

**Opt 913:** Rack Flange Kit to Mount Instruments With Handles

**Opt 650:** Quasi-Peak Modification

# SIGNAL ANALYZERS

## Spectrum Analyzer, 100 Hz to 220 GHz

### Model 8566A



- 100 Hz to 22 GHz, external mixing to 220 GHz
- Synthesizer frequency accuracy
- 10 Hz frequency resolution

- Tunable marker with amplitude and frequency readout
- Integrated preselector with automatic peaking feature
- Store and recall of instrument settings

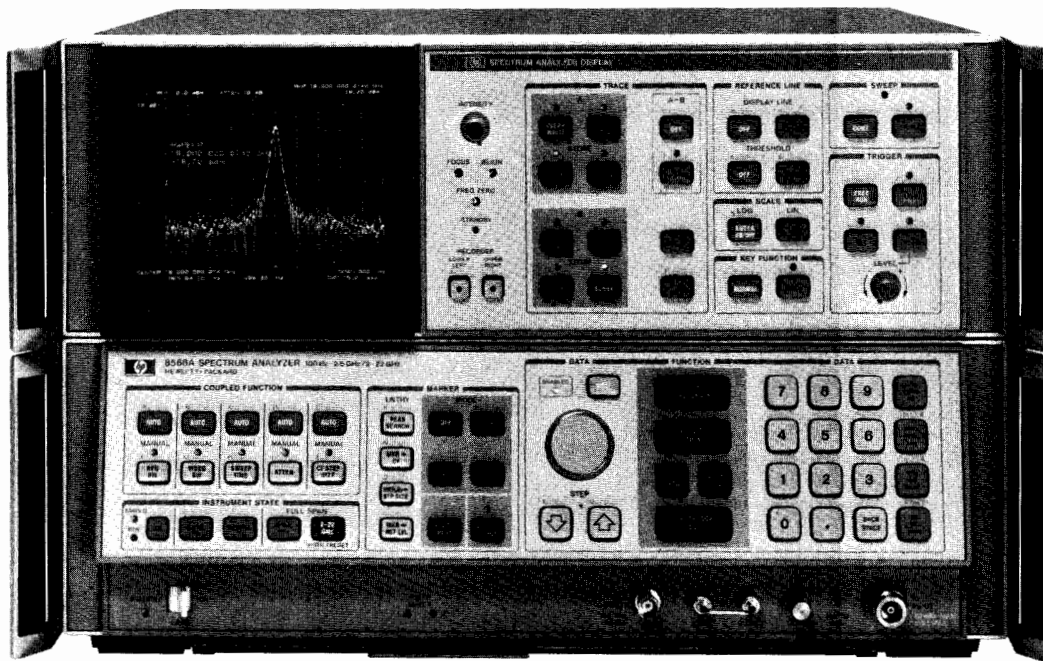

8566A



The 8566A Spectrum Analyzer is a high performance spectrum analyzer for bench and remote operation which operates from 100 Hz to 22 GHz using internal mixing. The frequency range may be extended to 40 GHz with the Option E50 External Mixer Kit and to 220 GHz with commercially available mixers. (For more information on external mixing, see Product Note 8566A-1 or contact your local HP field engineer). A synthesized local oscillator yields counter-like accuracy at microwave and millimeter wave frequencies. 10 Hz resolution bandwidth and superior frequency stability allow difficult measurements such as line-related sideband characterization at 22 GHz.

A unique integrated preselector/mixer provides high sensitivity with preselection from 2 GHz to 22 GHz. For example, in a 10 Hz resolution bandwidth, the sensitivity at 18 GHz is  $<-119$  dBm.

### 8566A Specifications

#### Frequency

**Measurement range:** 100 Hz to 22 GHz with internal mixer, dc coupled input; 18.6 GHz to 40 GHz with the Option E50 External Mixer Kit; 40 GHz to 220 GHz with commercially available external mixers.

#### Displayed Values

**Center Frequency:** 0 Hz to 300 GHz.

**Readout accuracy:** (AUTO resolution bandwidth after adjusting frequency zero at stabilized temperature, and using the error correction function, SHIFT W and SHIFT X) spans  $\leq n \times 5$  MHz:  $\pm(2\%$  of frequency span + frequency reference error  $\times$  center frequency + 10 Hz); spans  $> n \times 5$  MHz:  $\pm(2\%$  of frequency span +  $n \times 100$  kHz + frequency reference error  $\times$  center frequency) where  $n$  is the harmonic number, depending on center frequency:

n	Center Frequency (internal mixing)
1	0 Hz to 5.8 GHz
2	5.8 GHz to 12.5 GHz
3	12.5 GHz to 18.6 GHz
4	18.6 GHz to 22 GHz (external mixing)
6	18.6 GHz to 26.5 GHz
8	26.3 GHz to 40.2 GHz

For center frequencies  $>40.2$  GHz, refer to the Frequency Diagnostic (KSR) display for the value of  $n$ .

**Frequency span:** 0 Hz to 300 GHz over 10 division CRT horizontal axis; variable in approximately 1% increments.

**Full span:** 0 to 2.5 GHz and 2 to 22 GHz. 2 to 22 GHz is selected with INSTR PRESET.

**Readout accuracy:** spans  $\leq n \times 5$  MHz,  $\pm 1\%$  of indicated frequency separation; spans  $> n \times 5$  MHz,  $\pm 3\%$  of indicated frequency separation.

**Start/Stop frequency:** SHIFT O sets the analyzer start and stop frequencies equal to the frequencies of the two  $\Delta$  markers.

**Readout accuracy:** Same as center frequency.

**Frequency reference error:**  $<1 \times 10^{-9}$ /day and  $<2 \times 10^{-7}$ /year.

#### Resolution

**Resolution bandwidth:** 3 dB bandwidths of 10 Hz to 3 MHz in a 1, 3, 10 sequence. Bandwidth may be selected manually or coupled to frequency span.

**Bandwidth accuracy:** calibrated to:  $\pm 20\%$ , 3 MHz to 10 Hz;  $\pm 10\%$ , 1 MHz to 3 kHz.

**Bandwidth selectivity:** 60 dB/3 dB bandwidth ratio:  $<15:1$ , 3 MHz to 100 kHz;  $<13:1$ , 30 kHz to 10 kHz;  $<11:1$ , 3 kHz to 30 Hz. 60 dB points on 10 Hz bandwidth are separated by  $<100$  Hz.

#### Stability

**Residual FM (typical):** for fundamental mixing ( $n = 1$ );  $<50$  kHz peak-to-peak, frequency span  $\geq 5$  MHz;  $<200$  Hz peak-to-peak, frequency span  $\leq 5$  MHz;  $<5$  Hz peak-to-peak, frequency span  $<100$  kHz;  $<0.2$  Hz peak-to-peak, frequency span  $<5$  kHz.

**Drift (typical):** after 1 hour warm-up at stabilized temperature. COUPLED FUNCTION not required.

Frequency Span	Center Frequency Drift
$<100$ kHz	$<10$ Hz/minute of sweep time
100 kHz to 5 MHz	$<500$ Hz/minute of sweep time
$\geq 5$ MHz	$<5$ kHz/minute of sweep time

Because the analyzer is phase locked at the beginning of each sweep, drift occurs only during the time of one sweep.

# SIGNAL ANALYZERS

## Spectrum Analyzer, 100 Hz to 40 GHz

Model 8566A (Cont'd.)

### Spectral Purity

**Noise sidebands:** >85 dB below the peak of a 5.8 GHz CW signal at 1 kHz offset; >79 dB for 12.5 GHz signal; >75 dB for 18.6 GHz signal; >73 dB for 22 GHz signal; all for resolution bandwidth  $\leq$ 100 Hz.

**Power line related sidebands:** >80 dB below the peak of a 5.8 GHz CW signal, <360 Hz offset.

### Amplitude

**Measurement Range:** -134 dBm to +30 dBm.

### Display Range

**Scale:** over a 10 division CRT vertical axis with the Reference Level at the top graticule line.

#### Calibration:

**Log:** 10 dB/div for 90 dB display from Reference Level.

5 dB/div for 50 dB display	expanded from Reference Level
2 dB/div for 20 dB display	
1 dB/div for 10 dB display	

**Linear:** 10% of Reference Level/div when calibrated in voltage.

#### Fidelity

<b>Log:</b>	<b>Incremental</b>	<b>Cumulative</b>
	$\pm 0.1$ dB/dB over 0 to 80 dB display	$< \pm 1.0$ dB max over 0 to 80 dB display, 20-30°C. $< \pm 1.5$ dB max over 0 to 90 dB display.

**Linear:**  $\pm 3\%$  of Reference Level

### Reference Level

#### Range

**Log:** +30.0 to -99.9 dBm or equivalent in dBmV, dB $\mu$ V, Volts Readout expandable to +60.0<sup>1</sup> volts to -119.9 dBm (-139.9 dBm for <1 kHz resolution bandwidth) using SHIFT I.

**Linear:** 7.07 volts to 2.2  $\mu$ volts full scale. Readout expandable to 223.6<sup>1</sup> volts to 2.2  $\mu$ volts (0.22  $\mu$ volts for <1 kHz resolution bandwidth) using SHIFT I.

**Accuracy:** the sum of the following factors determines the accuracy of the reference level readout. Depending upon the measurement technique followed after calibration with the CAL signal, various of these sources of uncertainty may not be applicable. Specifications are with the preselector tracking optimized with MARKER PRESELECTOR PEAK function.

An internal error correction function calibrates and reduces the uncertainty introduced by analyzer control changes from the error calibration state (-7 dBm reference level, and 100 MHz center frequency) when SHIFT W and SHIFT X are executed just prior to the signal measurement (i.e. at the same temperature) within 20-30°C. range.

**Calibration uncertainty:**  $\pm 0.3$  dB.

**Frequency response (flatness) uncertainty:**  $\pm 0.6$  dB, 100 Hz to 2.5 GHz;  $\pm 1.7$  dB, 2.0 GHz to 12.5 GHz;  $\pm 2.2$  dB, 12.5 GHz to 20 GHz;  $\pm 3.0$  dB, 20 GHz to 22 GHz; for 10 dB attenuator setting. Cumulative flatness  $\pm 2.2$  dB, 100 Hz to 20 GHz. COUPLED FUNCTION not required as long as display remains calibrated.

**Absolute amplitude calibration uncertainty:**  $\pm 0.6$  dB. The certainty of setting the frequency response curve absolutely when using the internal CAL signal or any other calibration signal in the 100 Hz to 2.5 GHz band.

**Amplitude temperature drift:** at -10 dBm reference level with 10 dB input attenuation and 1 MHz resolution bandwidth.  $\pm 0.03$  dB/°C (eliminated after recalibration).

#### Scale fidelity

<b>Log:</b>	<b>Incremental</b>	<b>Cumulative</b>
	$\pm 0.1$ dB/dB	$< \pm 1.0$ dB over 0 to 80 dB display $< \pm 1.5$ dB over 0 to 90 dB display

**Linear:**  $\pm 3\%$  of reference level

**Resolution bandwidth switching uncertainty<sup>2</sup>:** referenced to 1 MHz bandwidth, corrected (uncorrected).  $\pm 0.1$  dB ( $\pm 0.5$  dB), 30 Hz to 1 MHz bandwidths.  $\pm 0.1$  dB ( $\pm 1.0$  dB, 10 Hz and 3 MHz bandwidths.

**Log scale switching uncertainty:** Corrected (uncorrected).  $\pm 0.1$  dB ( $\pm 0.5$  dB).

**IF gain uncertainty:** Corrected (uncorrected). Assuming the

<sup>1</sup>Maximum input must not exceed +30 dBm (damage level).

<sup>2</sup>Accounted for under Error Correction Accuracy.

internal calibration signal is used to calibrate the reference level at -10 dBm and the input attenuator is fixed at 10 dB, any changes to the reference level function value from -10 dBm will contribute IF gain uncertainty.

#### Range

0 dBm to -55.9 dBm	<b>Uncertainty</b>
-56.0 dBm to -129.9 dBm <sup>3</sup>	0 dB ( $\pm 0.6$ dB) $\pm 1.0$ dB ( $\pm 1.0$ dB)

The range values change with different input attenuator settings. Each 10 dB decrease (or increase) in the amount of input attenuation at the time of calibration and measurement will cause a corresponding 10 dB decrease (increase) in absolute reference level settings described above.

**RF gain uncertainty:** corrected (uncorrected) 0 dB ( $\pm 0.2$  dB). The gain change between preselected and non-preselected bands.

**Error correction:**  $\pm 0.4$  dB

When the error correction function is used (SHIFT W and SHIFT X), amplitude uncertainty is introduced because additional IF gain is used to offset errors in the switching of resolution BW, amplitude scales and RF gain.

### Dynamic Range

**Spurious responses:** (signals generated by the analyzer due to input signals). For signals  $< -40$  dBm all harmonic and intermodulation distortion  $> 70$  dB below input signal.

**Second order harmonic distortion:** for mixer levels  $\leq -40$  dBm:  $< -70$  dBc, 100 Hz to 50 MHz;  $< -80$  dBc, 50 MHz to 700 MHz;  $< -70$  dBc, 700 MHz to 2.5 GHz. For mixer levels  $\leq -10$  dBm:  $< -100$  dBc, 2 to 22 GHz.

**Third order intermodulation distortion:** third order intercept (TOI):  $> +7$  dBm, 100 Hz to 5.8 GHz;  $> +5$  dBm, 5.8 to 18.6 GHz;  $> +5$  dBm (typical), 18.6 GHz to 22 GHz;  $> +50$  dBm (typical), 2 to 22 GHz for  $> 100$  MHz signal separation.

**Image responses:** (due to input signals 642.8 MHz above or below the tuned frequency)  $< -70$  dBc, 100 Hz to 18.6 GHz;  $< -60$  dBc, 18.6 GHz to 22 GHz.

**Multiple responses:** (due to the input signal mixing with more than one L.O. harmonic)  $< -70$  dBc, 100 Hz to 22 GHz.

**Out-of-band responses:** (due to input signals outside the preselector's frequency span)  $< -60$  dBc, 2 to 22 GHz.

**Synthesis related spurious sidebands:**  $< -90$  dBc.

**Residual responses:** (signals displayed by the analyzer independent of input signals) With 0 dB input attenuation and no input signal:  $< -100$  dBm, 100 Hz to 5.8 GHz;  $< -95$  dBm, 5.8 GHz to 12.5 GHz;  $< -85$  dBm, 12.5 GHz to 18.6 GHz;  $< -80$  dBm, 18.6 GHz to 22 GHz.

**Gain compression:**  $< 1.0$  dB, 100 Hz to 22 GHz with  $\leq -5$  dBm at input mixer.

**Average noise level:** with 0 dB input attenuation and 10 Hz resolution bandwidth.  $< -95$  dBm, 100 Hz to 50 kHz;  $< -112$  dBm, 50 kHz to 1.0 MHz;  $< -134$  dBm, 1.0 MHz to 2.5 GHz;  $< -132$  dBm, 2.0 GHz to 5.8 GHz;  $< -125$  dBm, 5.8 GHz to 12.5 GHz;  $< -119$  dBm, 12.5 GHz to 18.6 GHz;  $< -114$  dBm, 18.6 GHz to 22 GHz.

**Video bandwidth:** post detection low pass filter used to average displayed noise bandwidth variable from 1 Hz to 3 MHz in a 1,3,10 sequence. Video bandwidth may be selected manually or coupled to resolution bandwidth.

**Digital video averaging:** displays the sweep-to-sweep average of the trace over a specifiable number of sweeps with SHIFT G, video averaging is turned off with SHIFT H.

### Reference Lines

**Display line:** movable horizontal line with amplitude readout.

**Threshold:** movable horizontal trace threshold with amplitude read-out.

**Accuracy:** equals the sum of calibrator uncertainty, and scale fidelity between the reference level and reference line.

### Marker

The marker is a bright dot placed upon the display trace which is positioned horizontally by the DATA controls. The marker amplitude and frequency are read out continuously.

### Frequency

**Normal:** displays the frequency at the horizontal position of the tunable marker. PEAK SEARCH positions the marker at the cen-

<sup>3</sup>Correction only applies over the 0 dBm to -55.9 dBm range.



ter of the largest signal response present on the display to within  $\pm 10\%$  of resolution bandwidth. Following peak search, SHIFT K moves marker to next higher trace maximum. Subsequent SHIFT K entries move marker to sequentially lower maxima. MKR—CF sets the analyzer center frequency equal to the marker frequency; MKR/ $\Delta$ —STP SIZE sets the center frequency step size equal to the marker frequency.

**Accuracy:** same as center frequency accuracy.

**Signal track:** re-tunes the analyzer to place a signal identified by the marker at the center of the CRT and maintain its position (provided the signal remains on-screen during the period of one sweep). Useful when reducing frequency span to zoom-in on a signal; also keeps a drifting input signal centered.

$\Delta$ : displays the frequency difference between the stationary and tunable markers. Reference frequency may be outside current frequency span accuracy. MKR/ $\Delta$ —STP SIZE sets the center frequency difference between the markers. SHIFT O sets the analyzer start and stop frequencies equal to the frequencies of the two markers.

**Accuracy:** same as frequency span accuracy.

**Zoom:** makes it possible to reduce the frequency span about the marker (or signal in the track mode) using the step down key.

#### Amplitude

**Normal:** displays the amplitude at the vertical position of the tunable marker. PEAK SEARCH positions the marker at the peak of the largest signal present on the display.

MKR—REF LVL sets the analyzer reference level equal to the marker amplitude. RMS noise density in a 1 Hz bandwidth is read out using SHIFT M, by sampling the displayed trace and arithmetically correcting for the analyzer detector response, log shaping, and measurement bandwidth.

**Accuracy:** same as reference level accuracy plus scale fidelity between the reference level and marker position.

$\Delta$ : displays the amplitude difference between the stationary and tunable marker. Reference frequency may be outside current frequency span.

**Accuracy:** same as frequency response uncertainty and scale fidelity between two markers.

**Preselector peak:** with the marker at the peak of a displayed input signal, preselector peak automatically adjusts preselector tracking for maximum response. SHIFT = resets the preselector tuning to the nominal factory preset condition. If the marker is not activated when preselector peak is used, a peak search will be exercised prior to preselector peaking.

#### Sweep

Trigger, continuous and single is the same as the 8568A, pages 477 and 478.

#### Sweptime

##### Zero frequency span

**With digital storage:** 20 msec full sweep to 1500 sec full sweep  $\sim 1\%$  increments.

**Without digital storage:** 1  $\mu$ sec full sweep to 10 msec in 1, 2, 5 sequence.

##### Marker (sweeps > 20 msec only)

**Normal:** displays time from beginning of sweep to marker position.

$\Delta$ : displays time difference between stationary and tunable marker.

#### Display

The display functions are the same as the 8568A, page 478.

#### Input

**RF Input:** 100 Hz to 22 GHz, precision female type N connector, dc coupled.

**SWR (typical):** 1.2, 100 Hz to 2.5 GHz; 1.5, 2 GHz to 5.8 GHz; 1.9, 5.8 GHz to 22 GHz; with 10 dB input attenuation.

**LO emission (typical):**  $< -80$  dBm when preselected;  $< -90$  dBm when not preselected.

##### Maximum input level

**AC:** +30 dBm (1 watt), continuous power, from 50 ohm source. Mixer protected by diode limiter, 100 Hz to 2.5 GHz.  $< 100$  watts, 10  $\mu$ sec pulse with  $\geq 50$  dB RF attenuation ( $\leq 0$  dBm peak to input mixer).

**DC:**  $< 100$  mA current damage level.

**Input attenuator:** 70 dB steps. Zero dB attenuation accessible only through numeric/unit keyboard. Attenuation may be selected manually or coupled to reference level to insure a  $-10$  dBm input mixer

drive level for full-screen signals; other mixer levels may be specified using SHIFT , and entering the desired amplitude through the keyboard.

**Accuracy:**  $\pm 1.0$  dB over 10–70 dB range.

#### IF Input

##### Maximum input level

**AC:** +10 dBm, continuous power, from 50  $\Omega$  source.

**DC:** 20 volts with rise time of  $< 1$  volt/ $\mu$ sec.

**Sensitivity:**  $-30$  dBm at 321.4 MHz produces full-scale CRT deflection  $\pm 1.0$  dB when KSU has been executed.

#### Output

**Calibrator:** 100 MHz  $\pm$  (frequency reference error).  $-10$  dBm  $\pm 0.3$  dB, 50  $\Omega$  impedance.

##### Auxiliary

Auxiliary outputs are the same as the 8568A, page 478.

**21.4 MHz IF (rear panel):** a 50  $\Omega$ , 21.4 MHz output related to the RF input to the analyzer. In log scales, the IF output is logarithmically related to the RF input signal; in linear, the output is linearly related. The output is nominally  $-20$  dBm for a signal at the reference level. Bandwidth is controlled by the analyzer's resolution bandwidth setting; amplitude controlled by the input attenuator, and IF step gain positions.

##### IF Output (front panel)

##### Maximum input level

**AC:** +10 dBm, continuous power, from 50  $\Omega$  source.

**DC:** 20 volts with rise time of  $< 1$  volt/ $\mu$ sec.

**1st LO output (front panel):** 2.3 to 6.2 GHz,  $> +8$  dBm., 50  $\Omega$  output impedance.

**Maximum input level:** +27 dBm (0.5 watt) total power into 50  $\Omega$  impedance.

**Frequency reference (rear panel):**  $> -5$  dBm, 50  $\Omega$  output impedance

**Sweep plus tune output (rear panel):** 10.000 MHz, 0 dBm; 50  $\Omega$  output impedance.

**10 MHz output (rear panel):**  $> -5$  dBm, 50  $\Omega$  output impedance.

**Sweep plus tune output (rear panel):**  $-1.0$  volt per GHz of tune frequency,  $> 10$  k $\Omega$  load.

**Accuracy:**  $-1$  V/GHz  $\pm 2\% \pm 10$  mV.

#### Instrument State Storage

Up to 6 complete sets of user-defined control settings may be stored and recalled by pressing SAVE or RECALL and the desired register number (1 to 6) from the keyboard. Instrument state information is retained in memory indefinitely in STANDBY and approximately 30 days after line power is terminated.

#### Remote Operation

The standard 8566A operates on the Hewlett-Packard Interface Bus (HP-IB). All analyzer control settings (with the exception of VIDEO TRIGGER LEVEL, FOCUS, ALIGN, INTENSITY, FREQ ZERO and AMPLD CAL) are remotely programmable. Function values, marker frequency/amplitude, and A/B traces may be output; CRT labels and graphics may be input. An HP-IB cable (not supplied) is required for remote operation.

#### General

##### Environmental

**Temperature:** operating 0°C to 55°C, storage  $-40^\circ\text{C}$  to  $+75^\circ\text{C}$ .

**Humidity:** operating  $< 95\%$  R.H., 0°C to 40°C except as noted.

**EMI:** Conducted and radiated interference is within the requirements of CE03 and RE02 of MIL STD 461A, VDE 0871, and CISPR pub'n 11.

**Power requirements:** 50 to 60 Hz; 100, 120, 220, or 240 volts ( $+5\%$ ,  $-10\%$ ); approximately 650 VA (40 VA in standby). 400 Hz operation is available as Opt 400.

**Weight:** total net 50 kg (112 lb); Display/IF Section, 21 kg (47 lb); RF Section, 24 kg (53 lb). Shipping, Display/IF Section 31 kg (69 lb); RF Section 39 kg (87 lb).

**Size:** 267 H x 425.5 W x 598.5 mm D (10.5" x 16.75" x 23.56").

##### Ordering information

8566A Spectrum Analyzer

Opt 010: Rack Slide Kit

Opt 400: 400 Hz Power Line Frequency Operation

Opt 908: Rack Flange Kit

Opt 910: Extra Manual

Opt 913: Rack Flange Kit to Mount Instruments with Handles

Opt 650: Quasi-Peak Modification

Opt E50: 40 GHz External Mixer Kit



# SIGNAL ANALYZERS

Automatic Spectrum Analyzers, 100 Hz to 22 GHz

Models 8581B & 8582B

- Interactive front panel under program control
- Friendly programming codes and powerful firmware
- 9825T Desktop Computer
- Ease of operation via HP-IB
- Software PAC minimizes program development time



8582B

The 8581B and 8582B Automatic Spectrum Analyzers are systems based on the 8568A and 8566A Spectrum Analyzers respectively. Each system has the 9825T Desktop Computer with 62 kbytes of memory, the 9876A Printer with stand, a system software PAC, and a system table. The frequency range of the 8582B can be extended above 22 GHz by using external mixers. Contact your local HP field engineer for further information.

### System Software

The system software provided with each system supplies high level software routines (subprograms) to aid the spectrum analyzer system programmer in developing programs. For the beginning programmers, the software PACs include sample measurement programs which can be run without previous programming experience.

### Sample Measurement Programs

There are four sample programs to illustrate the speed and flexibility of the automatic spectrum analyzers. These programs make carefully controlled measurements of harmonic distortion, spectral content, percent amplitude modulation and noise/impulse bandwidths. The programs use accurate spectrum analyzer measurement techniques, while keeping careful bounds on the complexity of the signal to be measured in order to maintain the program's instructional value. Each measurement program is provided with complete operating instructions, a flow diagram and line-by-line annotation.

### Subprogram Library

The system software includes subprogram modules which can be used by the more experienced programmer to extend the capability of the spectrum analyzer in an automatic environment. The sample programs described above illustrate the use of these subprograms.

One of these modules, called \*PEAKS, is a subprogram that returns a list of the frequencies on the analyzer's trace at which there are peak signals as defined by the user.

Another subprogram, \*OPT-RANGE, sets the spectrum analyzer's RF attenuator for the optimum dynamic range based upon the analyzer's current settings, the input signal power and upon either second or third order distortion criteria.

These subprograms are annotated on an operation and line-by-line basis.

Each software PAC includes two 9825 cartridges containing the sample measurement programs, subprograms, and utilities (including CRT plot and system checkout). Also included is a manual with annotated program listings. Complete compatibility requires 8568A or 8566A, 9825B or T, 9876A Option 025, and 98034B. For plotting CRT information: order 9872C and 10833B HP-IB cable.

### Ordering Information

**8581B** Automatic Spectrum Analyzer (8568A based system)

**8582B** Automatic Spectrum Analyzer (8566A based system)

### System Components

**8568A** Spectrum Analyzer or **8566A** Spectrum Analyzer

**9825T** Desktop Computer with 62 kbytes of memory.

**9876A** Opt 025 Thermal Printer

**98034B** HP-IB Interface Card

**10833A** HP-IB Cable

**88076A** Computer Cradle

System Table

**85860B** Software PAC for 8568A/9825/9876A Opt 025/98034B

**85861B** Software PAC for 8566A/9825/9876A Opt 025/98034B

Factory Assembly and Checkout Prior to Shipment.

Extra HP-IB cables not included.

### System Options and Software

**Opt 002:** Delete System Table

**Opt 910:** Extra Manual Set

**Opt 650:** Quasi-Peak Modification

**85860A** Software PAC for 8568A/9825/9866B

Opt 025/98034A

**85861A** Software PAC for 8566A/9825/9866B

Opt 025/98034A

**85860B** Software PAC for 8568A/9825/

9876A/98034B

**85861B** Software PAC for 8566A/9825/

9876A/98034B

- Quasi-peak detection for the 8566A and 8568A
- CISPR specified bandwidths
- Bypass made for regular spectrum analyzer operation
- Fully programmable via HP-IB
- Built-in speaker with volume control
- Auxiliary switches for accessories control

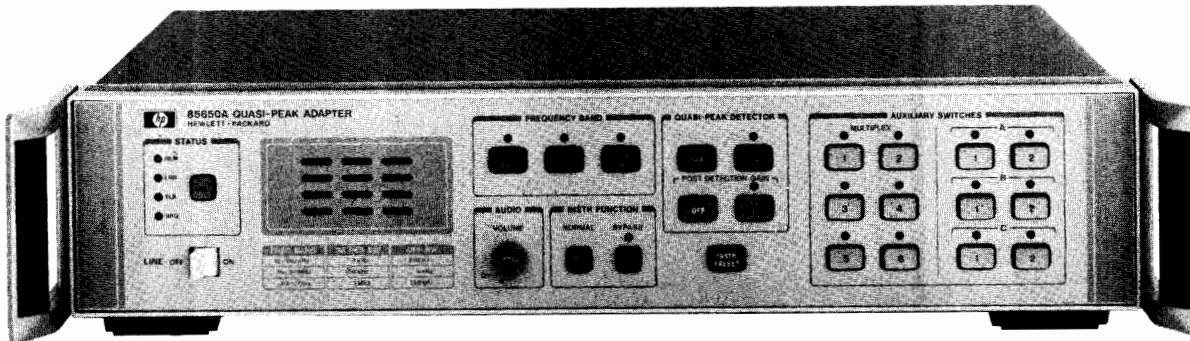

85650A



The 85650A Quasi-Peak Adapter is an accessory to the 8568A and 8566A Spectrum Analyzers. It adds to the spectrum analyzer the resolution bandwidth filters and quasi-peak detection capability specified by Publication 16 of the Comite International Special des Perturbations Radioelectriques (CISPR). Together, the quasi-peak adapter and spectrum analyzer provide many of the elements needed for an EMI receiver system. The 85650A is fully programmable via HP-IB, making automated measurements possible. A bypass switch is provided to enable the spectrum analyzer to bypass the quasi-peak adapter entirely and operate as a stand-alone instrument.

The CISPR pulse is given by:

$$(V\tau)_{\text{CISPR}} = 0.044 \mu\text{Vs for frequency range of 30-1000 MHz}$$

$$= 0.316 \mu\text{Vs for frequency range of 0.15-30 MHz}$$

$$= 13.5 \mu\text{Vs for frequency range of 10-150 kHz}$$

The pulsed RF signal must not cause gain compression and  $\tau$  must be less than  $1/(3 BW_{\text{qp}})$  ( $BW_{\text{qp}}$  = the 6 dB resolution bandwidth specified by CISPR Publication 16.)

## 85650A Specifications

### Fundamental Characteristics

Nominal values for fundamental quasi-peak characteristics are given in the following table:

Frequency Band (MHz)	Bandwidth at 6 dB (kHz)	Charge Time Constant (ms)	Discharge Time Constant (ms)	Display Time Constant (ms)
0.01-0.15	0.2	45	500	160
0.15-30	9	1	160	160
30-1000	120	1	550	100

### Filter Selectivity

Response characteristics of the IF filter that determines the overall resolution of the system conform to the limits of overall selectivity given by CISPR Publication 16.

### Pulse Response Characteristics<sup>1</sup>

The quasi-peak response to a pulsed RF test signal of peak amplitude  $V$  and pulse width  $\tau$ , will be given by:

$$\text{Quasi-peak response to test pulse} = \text{Quasi-peak response to CISPR pulse} + 20 \log \frac{V\tau}{(V\tau)_{\text{CISPR}}}$$

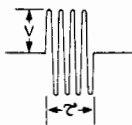

Pulse Repetition Frequency (Hz)	Quasi-Peak Response To CISPR Pulse (dBμV)		
	10 to 150 kHz	0.15 to 30 MHz	30 to 1000 MHz
1000	—	64.5 ± 2.5	68.0 ± 2.5
100	64.0 ± 2.5	60.0 ± 1.5	60.0 ± 1.5
60	63.0 ± 2.5	—	—
25	60.0 ± 1.5	—	—
20	—	53.5 ± 2.5	51.0 ± 2.5
10	56.0 ± 2.5	50.0 ± 3.0	46.0 ± 3.0
5	52.5 ± 3.0	—	—
2	47.0 ± 3.5	39.5 ± 3.5	34.0 ± 3.5
1	43.0 ± 3.5	37.5 ± 3.5	31.5 ± 3.5
Isolated Pulse	41.0 ± 3.5	36.5 ± 3.5	28.5 ± 3.5

### General

#### Accessories Furnished

HP 10833D HP-IB Interconnection Cable 0.5 m (1.6 ft.)

Four HP 11170A Cable Assemblies, 30 cm (12 in.)

Front Panel Handles are included as standard.

#### Compatibility

Requires Option 650 for the HP 8566A or the HP 8568A Spectrum Analyzer.

As an alternative, HP Retrofit Modification Kit Part No. 85650-60050 is available to make the HP 8566A or HP 8568A compatible with the HP 85650A. For HP 8568A Display Sections prefixed 1745A or lower, additional modifications are required as explained in HP Service Note 8568A-40.

#### Environmental

**Temperature:** Operating 0°C to 55°C, storage -40°C to +75°C.

#### EMI

Conducted and radiated interference characteristics are in compliance with methods CE03 and RE02 of MIL-STD 461A, VDE 0871 Level B, and CISPR Publication 11.

#### Warm-up Time

Requires 10 minute warm-up from cold start, 0°C - 55°C.

#### Power Requirements

50 to 60 Hz; 100, 120, 220 or 240 volts (+5%, -10%); approximately 22 VA.

#### Weight

Net 10 kg (22 lb.). Shipping 15.5 kg (34 lb.)

#### Size

102.6 H x 425.5 W x 58.5 mm D (4.11" x 16.75" x 2.2").

### Ordering Information

**85650A** Quasi-Peak Adapter

**Opt 908:** Rack Flange Kit for use with Handles

Removed

**Opt 910:** Extra Manual

**Opt 913:** Rack Flange Kit for use with Handles

Installed

<sup>1</sup>This specification was derived by combining CISPR Publication 16 parts 2.1, "Amplitude relationship," and 2.2, "Variation with repetition frequency."





# SIGNAL ANALYZERS

Microwave Spectrum Analyzer, 10 MHz to 115 GHz

Model 8569B

- 10 MHz to 22 GHz, external mixing to 115 GHz
- Simplified three knob operation
- Internal preselection, 1.7 to 22 GHz
- Wide resolution range, 100 Hz to 3 MHz
- Digital display of traces, control settings
- Unique HP-IB display interface

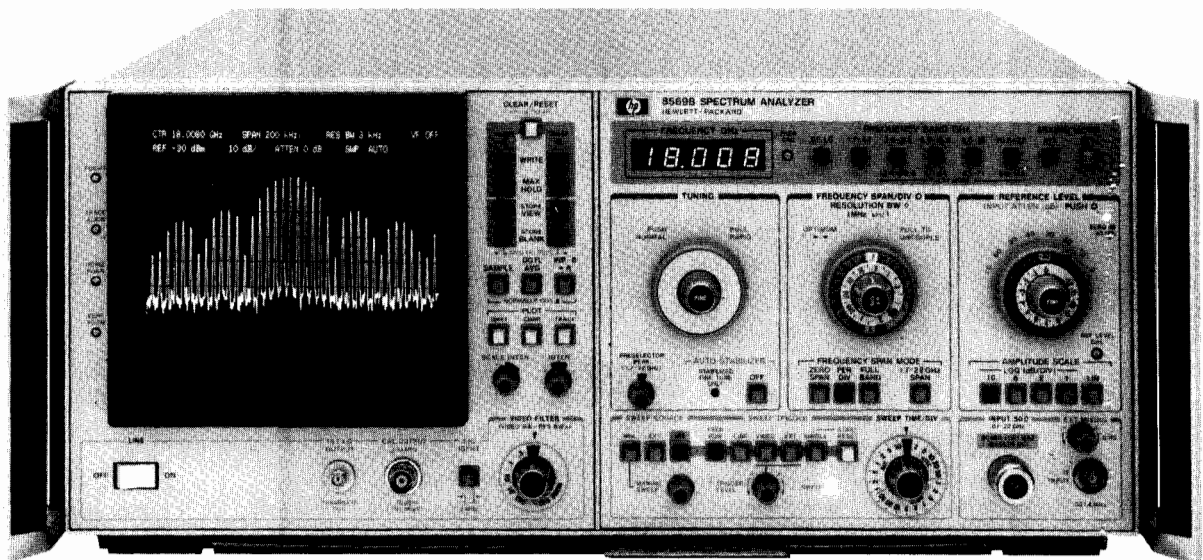

8569B



## 8569B Spectrum Analyzer

High performance and simple operation are combined with unique new microprocessor-controlled capabilities in the 8569B Microwave Spectrum Analyzer. Excellent sensitivity and internal preselection assure the wide, spurious-free measurement range necessary for production applications, while the digital display and coupled controls speed measurement routines. The internal frequency range of 10 MHz to 22 GHz is extended to 40 GHz using external mixers with the 8569B Option E30 and to 115 GHz with other commercially available mixers. For semi-automatic operation, connect a desktop computer to the 8569B via HP-IB to allow access to the displayed trace data and the control settings necessary to analyze or record measurements, or display operator messages and prompts on the CRT. Direct, hard copy output to a digital plotter is possible without the need of a controller or programming.

### Wide Range of Signal Resolution

Optimum resolution is possible for a wide range of signal characteristics with ten IF filters available from 100 Hz to 3 MHz. Fully automatic stabilization in narrow spans reduces residual FM to allow accurate measurements of closely spaced signals using the narrow bandwidths. The wide 1 and 3 MHz resolution bandwidths allow fast sweeps in wide spans and increased dynamic range for pulsed RF applications. All resolution filters are Gaussian-shaped for repeatable measurements, faster non-distortion sweep speeds, and best pulse response.

### High Accuracy and Wide Dynamic Range

Absolute signal levels from  $-123$  to  $+30$  dBm are easily and accurately measured using IF substitution because the 8569B displays the reference level value directly on the CRT above the graticule. Damage to the mixer is prevented for signal levels of  $+30$  dBm with a built-in limiter below 1.8 GHz and a preselector from 1.7 to 22 GHz. The internal preselector also assures maximum use of this wide measurement range by reducing internal distortion products as much as 120 dB. In addition, flat frequency response insures accuracy for relative as well as absolute power measurements.

### Convenient Operation with Digital Display

Preset the 8569B to the color-coded, "basic operation," settings and use the coupled controls to make most measurements in three easy

steps: tune to the signal, select a span and raise it to the reference level. While in the AUTO sweeptime position, a calibrated amplitude display is insured. However, the microprocessor also monitors manually-selected sweeptimes and displays a warning if the sweep speed chosen is too fast for calibrated measurements. Signals are displayed on either of two independent digitally stored traces with all major control settings annotated above the graticule area. Display processing capabilities include Max Hold, digital averaging and trace normalization for extended measurement capability.

### HP-IB Includes Direct Plotter Control

A hard-copy record of the displayed traces, control settings and graticule can be made on a digital plotter via HP-IB quickly and simply using the 8569B's front-panel pushbuttons without need for a controller. For maximum capability, attach a controller to the 8569B to read the trace data and control settings for a measurement analysis or recording on tape. Also, you can illustrate the test parameters for each measurement with display lines and instruct the operator with messages on the CRT. The controller can verify correct control settings before taking the test data or going on to the next step.

## 8444A Option 059 Tracking Generator

Characterize the frequency response of devices up to 1500 MHz by using the 8444A Option 059 Tracking Generator with the 8569B. Dynamic range is greater than 90 dB and system response errors can be removed using trace normalization. In addition, increase the analyzer's frequency accuracy to  $\pm 10$  kHz using a counter with the tracking generator. To configure a stimulus response system above 1500 MHz see Application Note 150-13.

## 8569B Specifications

### Frequency Specifications

**Frequency range:** 0.01 to 22 GHz with internal mixer, 14.5 to 40 GHz with 8569B Opt. E30 external mixers. Extendable to 115 GHz with other commercially available mixers.

**Tuning accuracy** (digital frequency readout in any span mode)

**10 MHz to 115 GHz:**  $\pm(5$  MHz or  $0.2\%$  of center frequency, whichever is greater,  $+20\%$  of Frequency Span/Div).



### Frequency Spans

**1.7 to 22 GHz:** multiband span from 1.7 to 22 GHz in one sweep.

**Full band:** displays spectrum of entire band selected.

**Per division:** 1 kHz to 500 MHz/div in a 1, 2, 5 sequence.

**Span width accuracy:**  $\pm 5\%$ , 500 MHz to 20 kHz/div unstabilized;  $\pm 15\%$ , 100 kHz to 1 kHz/div, stabilized.

**Zero span:** analyzer becomes a manually tuned receiver.

### Spectral Resolution and Stability

**Resolution bandwidths:** resolution (3 dB) bandwidths from 100 Hz to 3 MHz in 1, 3, sequence. Bandwidth and span width are independently variable or may be coupled for optimum display when control markers are aligned ( $\blacktriangleleft$ ).

**Resolution bandwidth accuracy:** 3 dB points are  $\pm 15\%$ .

**Selectivity:** (60 dB/3 dB bandwidth ratio):  $<11:1$ , 100 Hz to 1 kHz;  $<15:1$ , 3 kHz to 3 MHz.

**Total residual FM:** (fundamental mixing 0.01 to 4.1 GHz):  $<100$  Hz p-p in 0.1 sec. First LO automatically stabilized for frequency spans  $\leq 100$  kHz/div.

**Noise sidebands:**  $>75$  dB down,  $\geq 30$  kHz from signal in a 1 kHz Res. Bandwidth and a 10 Hz (0.01) Video Filter.

### Amplitude Specifications

#### Amplitude Range—Internal Mixer

**Total power:** +30 dBm, +137 dB $\mu$ V (1 watt).

**Damage levels:** (50 ohm nominal source impedance):

**dc:** 0 V with 0 dB input attenuation (1 amp),  $\pm 7$  V with  $\geq 10$  dB input attenuation (0.14 amp).

**Peak pulse power:** +50 dBm ( $<10$   $\mu$ sec pulse width, 0.01% duty cycle with  $\geq 20$  dB input attenuation).

**Gain compression:**  $<1$  dB for  $-7$  dBm signal, 0 dB input atten.

**Average noise level:** see table below for max. avg. noise level with 1 kHz Res. bandwidth (0 dB Atten. and 3 Hz video filter).

Frequency Band (GHz)	First IF in MHz	Harmonic Mode	Noise Level (dBm)	Frequency Response* ( $\pm$ dB max)
0.01-1.8	2050	1-	-113	1.2
1.7-4.1	321.4	1-	-110	1.5
3.8-8.5	321.4	2-	-107	2.5
5.8-12.9	321.4	3-	-100	2.5
8.5-18	321.4	4+	-95	3.0
10.5-22	321.4	5+	-90	4.5
12.4-26.5	321.4	6+	Depends on the external mixer that is used with the 8569B.	
21-44	321.4	10+		
33-71	321.4	16+		
53-115	321.4	26+		

\*Frequency response includes input attenuator, preselector and mixer frequency response plus mixing mode gain variation (band to band).

### Reference Level

**Reference level range:** +60 dBm (+30 dBm max. input) to  $-112$  dBm in 10 dB steps and continuous 0 to  $-12$  dB calibrated vernier.

**Reference level accuracy:** Auto Sweep setting of Sweep Time/Div control insures a calibrated display within these limits:

**Calibrator output:** (100 MHz  $\pm 10$  kHz):  $-10$  dBm  $\pm 0.3$  dB.

**Reference level variation:** (input atten. at 0 dB, 20° to 30°C):  $-10$  to  $-70$  dBm:  $\pm 0.5$  dB;  $-80$  to  $-100$  dBm:  $\pm 1.0$  dB.

**Vernier:** (0 to  $-12$  dB continuous); maximum error  $\pm 0.5$  dB.

**Input attenuator:** 0-70 dB in 10 dB steps.

**Step size variation:**  $\pm 1.0$  dB, 0.01 to 18 GHz;  $\pm 1.5$  dB, 0.01 to 22 GHz. Maximum cumulative error:  $\pm 2.5$  dB.

**Frequency response:** see table above.

**Switching between bandwidths:** 3 MHz to 100 Hz,  $\pm 1.0$  dB.

### Calibrated Display Range

**Log:** 1, 2, 5, and 10 dB/div over 8 divisions.

**Linear:** 0.56  $\mu$ V to 224 V in 50 ohm.

### Display accuracy

**Log:**  $\pm 0.1$  dB/dB; maximum cumulative error:  $\pm 1.5$  dB.

**Linear:**  $< \pm 3\%$  over full 8 division deflection.

**Residual responses:** (no signal present at input):  $< -90$  dBm.

**Signal identifier:** available from 10 MHz to 115 GHz.

### Signal Input/Output Characteristics

**Input SWR:** (input impedance 50 ohm nominal)

**Input atten. at 0 dB:**  $<1.5$ , 0.01-1.8 GHz;  $<2.0$ , 1.7-22 GHz.

**Input atten. at  $\geq 10$  dB:**  $<1.3$ , 0.01-1.8 GHz;  $<2.0$ , 1.7-22 GHz.

**LO emission from RF input:** (1.4 to 5.2 GHz):  $< -60$  dBm, 0.01 to 1.8 GHz;  $< -80$  dBm, 1.7 to 22 GHz.

**Input protection:** (for input signals from 0.01 to 22 GHz)

**0.01 to 1.8 GHz:** internal diode limiter.

**1.7 to 22 GHz:** preselector protects mixer to +30 dBm.

**321.4 MHz IF input:** SMA female connector is a port for bias current output ( $\pm 5$  mA) and IF return from an external mixer.

**LO output:** 2 to 4.46 GHz with minimum power of +8 dBm.

### Sweep Specifications

#### Sweep Time

**Auto:** sweep time is automatically controlled by Frequency Span/Div, Resolution Bandwidth and Video Filter controls to maintain an absolute amplitude calibrated display.

**Calibrated sweep times:** 2  $\mu$ sec to 10 sec/div in 1, 2, 5 sequence.

### Digital Display

**Traces:** dual trace, digitally stored display with a resolution of 481 horizontal by 801 vertical points for each trace.

**Control readout:** major control settings annotated on the CRT include Center or Marker frequency, Frequency Span/Div, Resolution BW, Video Filter, Reference Level, Scale Factor, RF Input Attenuator and Sweep Time/Div.

**Signal processing:** Max Hold, trace normalization, sample detection mode, digital avg. and dB $\mu$ V Reference Level readout.

**Internal service routines:** front-panel pushbuttons access test patterns to perform maintenance of digital hardware.

### HP-IB

**Direct plotter control:** all displayed information can be transferred to an HP-IB plotter with front-panel pushbuttons.

### Controller Interface Functions

**Trace data transfer:** all trace data values can be transferred to or from an 8569B with a controller.

**Control readout:** all displayed control settings can be transferred to a controller to check measurement conditions.

**Input messages:** controller-input instructions or annotation can be displayed within two 63 character lines on the CRT.

**Sweep control:** sweeps can be initiated and monitored.

Note: HP-IB cables are not supplied with the 8569B.

### General Specifications

**Temperature range:** operating 0° to +55°C, storage -40° to +75°C.

**Humidity range:** (Operating): 95% R.H., 0°C to 40°C.

**EMI:** Conducted and radiated interference is in compliance with MIL-STD 461A Methods CE03 and RE02, CISPR Publication 11 (1975), and Messempefaenger-Postverfuegung 526/527/79 (Kennzeichnung Mit F-Nummer/Funkschutzzeichen).

**Power requirements:** 48-66 Hz, 100, 120, 220 or 240 volts ( $-10\%$  to  $+5\%$ ), 280 VA max (400 Hz operation available as Opt 400).

**Size:** 188 H x 426 W x 552 mm D (7" x 16.8" x 21.8").

**Weight:** net 29.2 kg (64 lb). Shipping 41 kg (90 lb).

### Standard Options Available

**Opt 001, Internal Comb Generator:** 100 MHz comb signals visible through 22 GHz for increased frequency accuracy (error  $<0.007\%$ , typically  $\pm 1$  MHz at 22 GHz) and preselector peaking verification.

**Opt 002, Delete 100, 300 Hz Bandwidths:** standard specifications apply except minimum resolution bandwidth is 1 kHz with 15:1 shape factor, residual FM  $<200$  Hz when stabilized.

**Opt 400, 50 to 400 Hz Power Supply.**

**Part No. 1450-0654—Transit Case:** Order Part No. 1490-0913 also for castors.

### Ordering Information

8569B Spectrum Analyzer

Opt 001: Internal Comb Generator

Opt 002: Delete 100, 300 Hz Bandwidths

Opt 400: Internal 50 to 400 Hz Power Supply

Opt 908: Rack Flange Kit Without Handles

Opt 910: Extra Operating & Service Manual

Opt 913: Rack Flange Kit with Handles

Opt E30: 18 to 40 GHz External Mixer Set

8444A Opt 059 Tracking Generator



# SIGNAL ANALYZERS

## Spectrum Analyzer, 10 MHz to 40 GHz

### Model 8565A

- 0.01 to 22 GHz, external mixing to 40 GHz
- Internal preselection 1.7 to 22 GHz
- Wide choice of resolution bandwidths
- Simple three knob operation
- Absolute amplitude calibration
- CRT bezel readout displays control settings

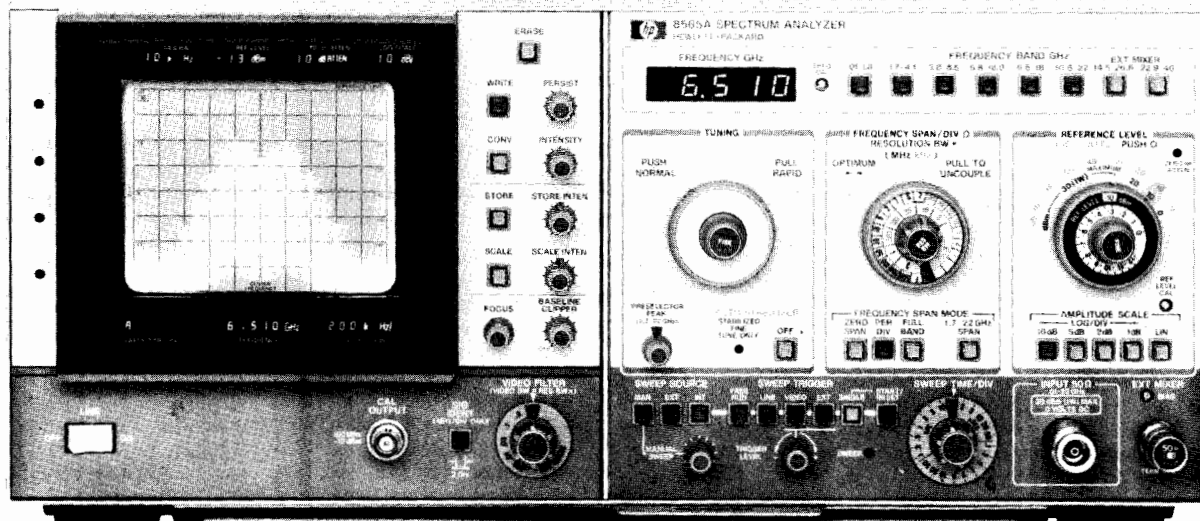

### 8565A Spectrum Analyzer

Covering from 0.01 to 22 GHz with its internal mixer, the 8565A has built-in preselection and brings accuracy plus convenience to microwave spectrum analysis. The wide range, spurious-free display, compact design and ease of use make it well suited for lab, production, or field applications requiring accurate measurement from IF thru microwave frequencies. The 8565A can cover 0.01 to 22 GHz in just two spans for rapid location of signals prior to close-in analysis in one of six bands. Coverage is easily extended up to 40 GHz with the HP 11517A External Mixer.

#### High Resolution

Fully automatic stabilization in narrow spans reduces residual FM and drift. Standard resolution bandwidths range from 1 kHz to 3 MHz. The 1 and 3 MHz bandwidths allow fast sweeps in wide spans and increased dynamic range for pulsed RF; the narrow bandwidths allow measurement of closely spaced signals. Option 100 provides additional 100 Hz and 300 Hz IF bandwidth filters, and residual FM is < 100 Hz when stabilized. This 100 Hz resolution is usable up to 8.5 GHz and the 300 Hz resolution bandwidth to 22 GHz. All resolution filters are gaussian-shaped for repeatable measurements, faster non-distorting sweeps and best pulse response.

#### Absolute Amplitude Calibration

Absolute signal levels from -112 dBm to +30 dBm are easily measured because the HP 8565A always displays the value of the reference line with LED's in the CRT bezel and at the reference level control. Changes in RF, IF gain, and preselector loss are automatically included. In addition, flat frequency response insures accuracy for relative as well as absolute power measurements.

#### Wide Dynamic Range

Internal preselection (1.7 to 22 GHz) enables you to measure distortion products as much as 100 dB down. Even for closely spaced signals or measurements below 1.7 GHz, all distortion products are greater than 70 dB down. In either case, maximum dynamic range is assured even for 1 watt signals with the 70 dB input attenuator. An input limiter (0.01 to 1.8 GHz) and the internal preselector (1.7 to 22 GHz) enable the 8565A to withstand RF signals up to +30 dBm for all input attenuator settings.

#### Designed for Convenience

Coupled controls allow you to make most measurements in 3 simple steps. Green color coded keys preset the 8565A for normal operation so a measurement only requires that you tune to a signal, select a desired span, and raise it to the reference level. Automatically selected sweep times insure a calibrated display for all combinations of fre-

quency span, resolution bandwidth and video filtering.

The CRT bezel LED's display all pertinent control settings to give you all the information needed for signal evaluations in one central location. These data are also captured in CRT photos.

### 8444A Option 059 Tracking Generator

Make swept frequency response measurements to  $\pm 1.7$  dB from 10 to 1300 MHz ( $\pm 2.7$  dB up to 1500 MHz) with greater than 90 dB of dynamic range. The output is absolutely calibrated at 0 dBm and continuously variable to  $< -10$  dBm. The frequency of unknown signals as well as the frequency of any point on the frequency response curve can be measured from the external counter output using the low-cost HP 5300/5305B Counter.

### 8750A Storage-Normalizer

The analyzer is made even easier to use with the digital storage of the 8750A because there is no need to re-adjust intensity or persistence as the sweep time changes. With the push of a button, a signal can be frozen on the CRT and then compared directly to the current input signal. Traces can also be compared arithmetically (i.e., normalized) to automatically remove frequency response variations. This is especially useful when used with the HP 8444A Opt. 059 Tracking Generator.

### 8565A Specifications

#### Frequency Specifications

**Frequency range:** 0.01 to 22 GHz with internal mixer, 14.5 to 40 GHz with HP 11517A External Mixer. Extendable to 220 GHz with other commercially available mixers and using signal ID as in Application Note 150-14.

#### Tuning accuracy (digital frequency readout in any span mode)

**Internal mixing:** 0.01 to 2.5 GHz  $< \pm (5 \text{ MHz} + 20\% \text{ of Frequency Span/Div.})$ ; 2.5 to 22 GHz  $< \pm (0.2\% \text{ of center frequency} + 20\% \text{ of Frequency Span/Div.})$ .

**External mixing:** 14.5 to 40 GHz  $< \pm (0.7\% \text{ of center frequency} + 20\% \text{ of Frequency Span/Div.})$ .

#### Frequency Spans

**1.7 to 22 GHz:** multiband span from 1.7 to 22 GHz in one sweep.

**Full band:** displays spectrum of entire band selected.

**Per division:** eighteen calibrated spans from 1 kHz per div. to 500 MHz per div. in a 1, 2, 5 sequence, plus a full band span, "F".

**Span width accuracy:** the frequency error for any two points on the display for spans from 500 MHz/div to 20 kHz/div (unstable) is less than  $\pm 5\%$  of the indicated separation; for stabilized spans 100 kHz/div and less, the error is less than  $\pm 15\%$ .

**Zero span:** analyzer becomes a manually tuned receiver.



### Spectral Resolution and Stability

**Resolution bandwidths:** resolution (3 dB) bandwidths from 1 kHz to 3 MHz in 1, 3 sequence. Bandwidth and span width are independently variable or may be coupled for optimum display when control markers are aligned (▶◀).

**Resolution bandwidth accuracy:** 3 dB points:  $< \pm 15\%$ .

**Selectivity (60 dB/3 dB bandwidth ratio):**  $< 15:1$ .

**Stability:** Total residual FM (fundamental mixing 0.01 to 4.1 GHz): stabilized,  $< 200$  Hz p-p in 0.1 s; unstabilized  $< 10$  kHz p-p in 0.1 s.

**Stabilization range:** first LO automatically stabilized for frequency spans 100 kHz/div or less. First LO residual FM typically 30 Hz p-p when stabilized.

**Noise sidebands:**  $> 70$  dB down,  $> 30$  kHz from center of CW signal in a 1 kHz Res. Bandwidth and a 10 Hz (0.01) Video Filter.

### Amplitude Specifications

#### Amplitude Range - Internal Mixer

##### Measurement Range

**Total power:** +30 dBm (1 watt).

**Damage levels:** (50  $\Omega$  nominal source impedance.)

**dc:** 0 V with 0 dB input atten,  $\pm 7$  V with  $\geq 10$  dB input atten.

**ac:** 0 V with 0 dB input atten, 10 V peak with  $\geq 10$  dB input atten.

**RF:** (signals above 10 MHz) + 30 dBm for any attenuator setting.

**Gain compression:**  $< 1$  dB for 0 dBm input level with 0 dB attenuation.

**Average noise level:** max. avg. noise level with 1 kHz Res. Bandwidth (0 dB atten and 3 Hz video filter) is in the table below:

Frequency Band (GHz)	First IF in MHz	Harmonic Mode	Noise Level (dBm)	Frequency Response* ( $\pm$ dB MAX)
0.01-1.8	2050	1-	-112	1.2
1.7-4.1	321.4	1-	-109	1.7
3.8-8.5	321.4	2-	-103	2.5
5.8-12.9	321.4	3-	-94	2.5
8.5-18	321.4	4+	-87	3.0
10.5-22	321.4	5+	-75	4.5

\*Frequency response includes input attenuator, preselector and mixer frequency response plus mixing mode gain variation (band to band).

#### Amplitude Range - HP 11517A External Mixer

**Measurement range:** saturation (gain compression  $< 1$  dB), -15 dBm. Damage level  $> +10$  dBm.

**Sensitivity** (Average noise level in a 10 kHz IF bandwidth): 14.5-18 GHz  $< -80$  dBm, 18-26.5 GHz  $< -70$  dBm, 26.5-40 GHz  $< -60$  dBm. Typical sensitivity is 10 dB better for each band.  **$> 40$  GHz:** for signal analysis above 40 GHz with commercially available mixers see Application Note 150-14.

##### Reference Level

**Reference level range** +70 dBm (+30 dBm max. input) to -102 dBm in 10 dB steps and continuous 0 to -12 dB calibrated vernier.

**Reference level accuracy:** the Auto Sweep setting of the sweep time/div control insures a calibrated display within these limits:

**Calibrator output (100 MHz  $\pm 10$  kHz):** -10 dBm  $\pm 0.3$  dB.

**Reference level variation (input attenuator at 0 dB):** 10 dB steps  $< \pm 0.5$  dB (0 to -70 dBm);  $< \pm 1.0$  dB (0 to -90 dBm).

**Vernier (0 to -12 dB)** continuous: maximum error  $< 0.5$  dB.

**Input attenuator:** (at preselector input, 0-70 dB in 10 dB steps).

**Step size variation:**  $< \pm 1.0$  dB, 0.01 to 18 GHz;  $< \pm 1.5$  dB, 0.01 to 22 GHz.

**Maximum cumulative error over the 0 to 70 dB range:**  $< \pm 2.4$  dB, 0.01 to 18 GHz, 0 to 60 dB;  $< \pm 2.5$  dB, 0.01 to 22 GHz, 0 to 40 dB.

**Frequency response:** see table above.

**Switching between bandwidths:** 3 MHz to 1 kHz,  $\pm 1.0$  dB

##### Calibrated Display Range

**Log:** (expanded from reference level down): 70 dB @ 10 dB/div, 40 dB @ 5 dB/div, 16 dB @ 2 dB/div and 8 dB @ 1 dB/div.

**Linear:** full scale from 1.8  $\mu$ V (-102 dBm in 50  $\Omega$  to 707 volts (+70 dBm) in 10 dB steps and continuous 0 to -12 dB vernier.

##### Display Accuracy

**Log:**  $< \pm 0.1$  dB/dB, but  $< \pm 1.5$  dB over full 70 dB display range.

**Linear:**  $< \pm 3\%$  over full 8 division deflection.

**Residual responses (no signal present at input):** with 0 dB input atten, fundamental mixing (0.01 to 4.1 GHz)  $< -90$  dBm.

**Signal identifier:** available from 10 MHz to 40 GHz and in all Freq. Span/Div settings for signal identification.

### Signal Input Characteristics

**Input impedance:** 50 ohm nominal, 0.01 to 22 GHz.

**Input connector:** precision Type N female.

#### Input SWR

**Input attenuator at 0 dB:**  $< 1.5$ , 0.01 to 1.8 GHz;  $< 2.0$ , 1.7 to 22 GHz.

**Input attenuator at  $\geq 10$  dB:**  $< 1.3$ , 0.01 to 1.8 GHz,  $< 2.0$ , 1.7 to 22 GHz.

**LO Emission (2.00 to 4.46 GHz):** -50 dBm, 0.01 to 1.8 GHz; -85 dBm, 1.7 to 22 GHz.

#### Input protection (for input signals from 0.01 to 22 GHz)

**0.01 to 1.8 GHz frequency band:** internal diode limiter.

**1.7 to 22 GHz frequency bands:** saturation of YIG filter (pre-selector) occurs at total input signal power levels below input mixer damage.

**External mixer input:** BNC female connector is a port for LO power transfer, bias current and IF return.

### Sweep Specifications

#### Sweep Time

**Auto:** sweep time is automatically controlled by Frequency Span/Div, Resolution Bandwidth and Video Filter controls to maintain an absolute amplitude calibrated display.

**Calibrated sweep times:** 21 internal sweep times from 2  $\mu$ s/div to 10 s/div in 1, 2, 5 sequence.

### Display Characteristics

**Cathode Ray Tube (aluminized P31 phosphor, 8  $\times$  10 div internal graticule)**

#### Persistence

**Conventional:** natural persistence of P31 phosphor.

**Write:** continuously adjustable from 0.2 s to full storage.

**Storage time:** continuously adjustable from 1 minute (full brightness) to  $> 30$  minutes (minimum brightness).

**Write speed:** continuously adjustable to vary CRT sensitivity to capture large signal deflections in fast sweeps.

**CRT Bezel readout:** bezel LEDs display the following measurement data (included in CRT photographs taken with the HP 197B Opt 001, 006 Oscilloscope Camera): Ampl. Scale Factor, Ref. Level, Input Atten., Res. Bandwidth, Sweeptime/Div., Freq., Freq. Span/Div.

### General Specifications

**Temperature range:** operating 0°C to 55°C, storage -40° to +75°C.

**Humidity range (Operating):**  $< 95\%$  R.H. 0°C to 40°C.

**EMI:** Conducted and radiated interference is in compliance with MIL-STD 461A Methods CE03 and RE02, CISPR publication 11 (1975), and Messemphaenger-Postverfuegung 526/527/79 (Kennzeichnung Mit F-Nummer/Funkschutzzeichen).

**Power requirements:** 48-66 Hz, 100, 120, 200 or 240 volts (-10% to +5%) 220 V A max (400 Hz operation available as Opt 400).

**Size:** 188 H x 426 W x 552 mm D (7" x 16.8" x 21.8").

**Weight:** net 29.5 kg (64 lb). Shipping 39 kg (85 lb).

#### Standard Options Available

**Opt 100, 100 and 300 Hz Resolution bandwidths:** adds 100 Hz and 300 Hz resolution bandwidths with 11:1 shape factor, residual FM  $< 100$  Hz when stabilized and improves sensitivity by 10 dB.

**Opt 200—Calibration in dB $\mu$ V**

**Opt 400—400 Hz Power Supply**

**Part No. 1540-0654 - Transit Case.** Order Part No. 1490-0913 also for castors.

#### Ordering Information

**8565A Spectrum Analyzer**

**Opt 100:** 100 Hz and 300 Hz Resolution Bandwidths

**Opt 200:** Calibration in dB $\mu$ V

**Opt 400:** Internal 50 to 400 Hz Power Supply

**Opt 907:** Front Handle Kit

**Opt 908:** Rack Flange Kit

**Opt 909:** Rack Flange and Front Handle Kit

**Opt 910:** Extra Operating and Service Manual

**11517A External Mixer** (taper section req'd)

**11518A Taper Section**, 12.4 to 18 GHz

**11519A Taper Section**, 18 to 26.5 GHz

**11520A Taper Section**, 26.5 to 40 GHz

**8444A Opt 059 Tracking Generator**, 10 to 1500 MHz

**8750A Storage-Normalizer**



# SIGNAL ANALYZERS

Spectrum Analyzer, 0.01 to 350 MHz

Models 8557A/853A

- Rugged portability
- Simple, three knob operation
- Direct plotter dump of digital trace
- $\pm 2.25$  dB amplitude accuracy
- Resolution bandwidths 1 kHz to 3 MHz
- Optional 75  $\Omega$  input with dBm or dBmV calibration

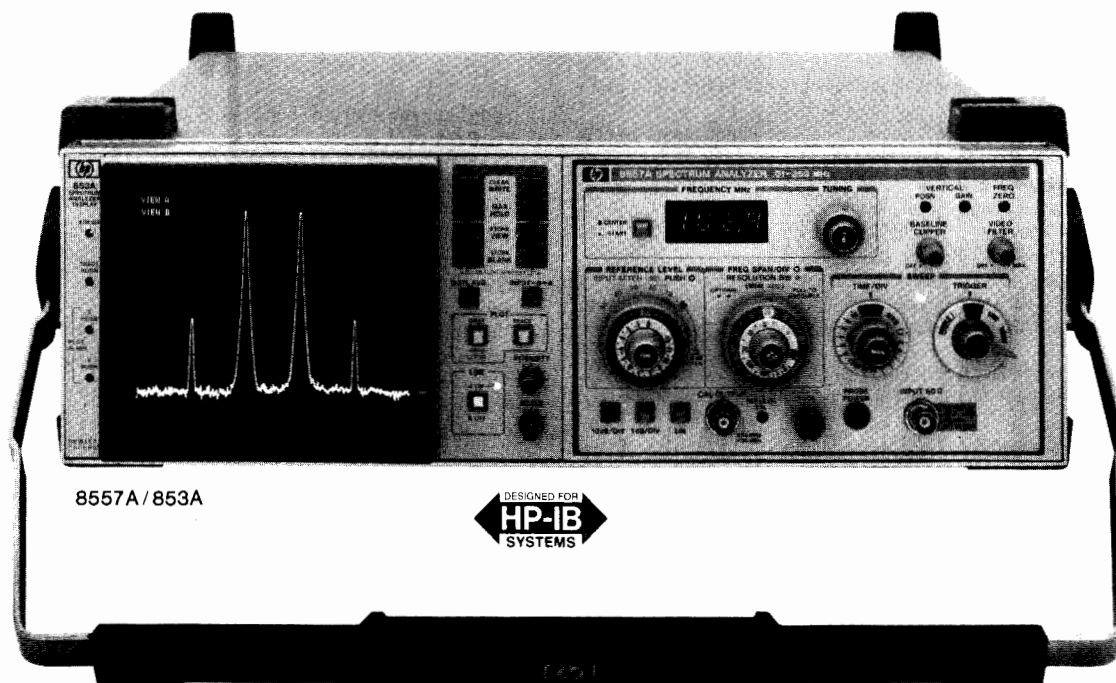

## 8557A Spectrum Analyzer Plug-In

### Performance Plus Economy

The 8557A is a 10 kHz to 350 MHz spectrum analyzer plug-in for use with the 853A or 180-series display. The high performance and convenient operation of this economical unit is ideally suited for a variety of applications in production, R & D or field service measurements.

### Simple 3-knob Operation

Preset the 8557A to the color-coded, "basic-operation" settings and use the coupled controls to make most measurements in three easy steps. Tune to the signal, the LED readout displays its frequency. Zoom-in on the signal by reducing the span width; the resolution bandwidth, video filter, and sweep time automatically change to an optimum value for a calibrated display. Change the reference level to bring the peak of the signal to the top of the screen for the most accurate amplitude measurement.

### Absolute Amplitude Calibration

Signal levels can be read directly from the CRT in dBm (dBmV for Option 002) without the use of external standards or calculations. The signal level represented by the top CRT graticule line is always indicated by the reference level control, and vertical scale factors of 10 dB/Div, 1 dB/Div or linear can be selected.

### Optional 75 $\Omega$ Input

Two options are available which allow measurements in 75  $\Omega$  systems. Option 001 has 75  $\Omega$  impedance, but retains the dBm power calibration. Option 002 is also 75  $\Omega$ , but the amplitude is calibrated in dBmV for measurements on systems such as CATV.

## 853A Spectrum Analyzer Display

### Digital display

The 853A is a digital display mainframe for use with the 8557A spectrum analyzer plug-in. Signals are displayed on either of two independently stored digital traces. Display processing capabilities include Max Hold, digital averaging, and trace normalization for extended measurement capability. A built-in microprocessor manages the display operation, as well as providing access to built-in test routines for display calibration and test (accessible via the front panel).

### Two configurations

The display is offered in two styles. The 853A (pictured) is a ruggedized, portable mainframe complete with tilt-bail handle and drip proof, protective front cover. The 853A is ideally suited for rugged, field service environments and any areas where system mobility is required. The 853A Option 001 offers the digital display in a full module bench or rack mount configuration.

### HP-IB capability includes direct plotter control

A hard-copy record of the displayed traces and graticule can be made on a digital plotter via HP-IB simply using the 853A's front-panel pushbuttons without using a controller. Although the analyzer controls are not programmable some HP-IB capabilities include using a controller for recording trace data, or operator prompts on the 853A CRT. The digital display and processing functions can be remotely programmed and analyzer sweeps can be initiated via HP-IB.

## 8557A Specifications

### Frequency Specifications

Frequency range: 0.01 to 350 MHz.

### Frequency spans

Full band: displays entire spectrum, 0.01 to 350 MHz.

Per division: 5 kHz to 20 MHz/Div in a 1, 2, 5 sequence.

Zero span: analyzer functions as a manually tuned receiver.



### Frequency accuracy

**Tuning accuracy:**  $\pm(3 \text{ MHz} + 10\%$  of frequency span per division).

**Frequency span accuracy:**  $\pm 10\%$  of displayed frequency span.

### Spectral resolution and stability

**Resolution bandwidths:** eight selectable resolution (3 dB) bandwidths from 1 kHz to 3 MHz in a 1, 3 sequence. Bandwidth and frequency span are independently variable or may be coupled for optimum display when control markers are aligned (▶◀).

**Resolution bandwidth accuracy:** 3 dB points are  $\pm 20\%$  ( $10^\circ$  to  $40^\circ\text{C}$ ).

**Selectivity:** (60 dB/3 dB bandwidth ratio):  $<15:1$ .

### Stability

**Residual FM:**  $<1 \text{ kHz p-p}$  in 0.1 second.

**Noise sidebands:**  $\geq 75 \text{ dB}$  down,  $> 50 \text{ kHz}$  from signal in a 1 kHz resolution bandwidth, and full video filtering.

### Amplitude Specifications

#### Maximum input levels

**Total power:** +20 dBm (100 mV, 2.24 Vrms).

**dc or ac ( $<100 \text{ Hz}$ ):**  $\pm 30 \text{ V}$

**Gain compression:** typically  $<1 \text{ dB}$  for  $-10 \text{ dBm}$  signal, 0 dB input attenuation.

**Average noise level:**  $<-107 \text{ dBm}$  with 10 kHz resolution bandwidth, 0 dB input attenuation and maximum (MAX) video filtering.

#### Calibrated display range

**Log:** 70 dB with 10 dB/Div scale; 8 dB with 1 dB/Div scale.

**Linear:** from  $2.2 \mu\text{V}$  ( $-100 \text{ dBm}$ ) full-scale to  $2.24 \text{ V}$  ( $+20 \text{ dBm}$ ) full-scale in 10 dB steps. Reference level variation is typically  $<\pm 1 \text{ dB}$  for any change in Amplitude Scale.

#### Amplitude accuracy

**Calibrator:**  $-30 \text{ dBm} \pm 1 \text{ dB}$ , ( $250 \text{ MHz} \pm 50 \text{ kHz}$ ).

**Reference level:** 10 dB steps and a 12 dB vernier for calibrated adjustment from  $-112 \text{ dBm}$  to  $+40 \text{ dBm}$ .

**Step accuracy:** (with 0 dB input attenuation),  $-10$  to  $-80 \text{ dBm}$ :  $\pm 0.5 \text{ dB}$ ;  $-10$  to  $-100 \text{ dBm}$ :  $\pm 1.0 \text{ dB}$ .

**Vernier accuracy:**  $\pm 0.5 \text{ dB}$ .

**Frequency response:** (includes input attenuator and mixer flatness),  $\leq \pm 0.75 \text{ dB}$  with 10 dB input attenuation.

**Input attenuator:** selectable in 10 dB steps, 0 to 50 dB.

**Step accuracy:**  $<\pm 0.5 \text{ dB}$  per 10 dB step.

**Max cumulative error:** (0 to 50 dB),  $<\pm 1.0 \text{ dB}$ .

**Bandwidth switching:** (amplitude variation)

**3 MHz to 300 kHz:**  $<\pm 0.5 \text{ dB}$

**3 MHz to 1 kHz:**  $<\pm 1.0 \text{ dB}$

#### Display accuracy:

**Log incremental accuracy:**  $\pm 0.1 \text{ dB/dB}$ , but no more than  $\pm 1.5 \text{ dB}$  over full 70 dB range.

**Linear accuracy:**  $\pm 3\%$  of reference level.

#### Spurious responses:

**Second harmonic distortion:**  $>70 \text{ dB}$  below a  $-40 \text{ dBm}$  signal with 0 dB input attenuation.

**Third order intermodulation distortion:**  $>70 \text{ dB}$  below two  $-40 \text{ dBm}$  input signals, separated by  $\geq 50 \text{ kHz}$ , with 0 dB input attenuation;  $>60 \text{ dB}$  below for signals 10 kHz to 1 MHz.

**Residual responses:**  $<-100 \text{ dBm}$  with 0 dB input attenuation and no signal present at input.

### Sweep Characteristics

#### Sweep time

**Auto:** sweep time is automatically adjusted to maintain absolute amplitude calibration for any combination of Frequency Span, Resolution Bandwidth, and Video Filter.

**Calibrated sweep times:** 0.1 msec to 10 sec/Div in 1, 2, 5 sequence.

**Manual sweep:** spectrum analyzer may be swept manually, in either direction with front panel control.

### Signal Input Characteristics

**Input impedance:** 50  $\Omega$  nominal; type BNC female connector.

**Input SWR:**  $<1.5$  with  $\geq 10 \text{ dB}$  input attenuation.

### Output Characteristics

**Probe power:** +15 V, -12.6 V, and GND (150 mA max). Use HP 1120A, 1121A, 1123A, or 1124A high impedance probes.

**Note:** Oscilloscope display outputs refer to 853A, 180T-series displays, and any other 180-series displays with Option 807 installed.

**Vertical output, AUX A:** 0 to 0.8 V for 8 divisions deflection on CRT display; 50  $\Omega$  output impedance.

**Penlift blanking, AUX B:** 0 to 15 V (0 V, pen down); 10 k $\Omega$  output impedance.

**21.4 MHz IF output, AUX C:** output provides a 21.4 MHz signal (linearly related to RF input) from a 50 ohm output impedance. Output bandwidth is controlled by spectrum analyzer Resolution Bandwidth setting; amplitude controlled by Input Attenuator, Reference Level Fine, and first six Reference Level positions ( $-10$  to  $-60 \text{ dBm}$ , 0 dB input attenuation). Output is approximately  $-10 \text{ dBm}$  with signal displayed at reference level.

**Horizontal output, AUX D:**  $-5 \text{ V}$  to  $+5 \text{ V}$  for full 10 division CRT horizontal deflection, 5 k $\Omega$  output impedance.

### 853A Characteristics

#### Digital Display

**Traces:** dual trace, digitally stored display with resolution of 481 horizontal by 801 vertical points for each trace.

**Signal processing:** Max Hold, digital averaging, and trace normalization.

**Internal service routines:** front panel pushbuttons access test routines to perform maintenance of digital hardware.

#### HP-IB

**Direct plotter control:** all displayed information can be transferred to an HP-IB plotter with front panel pushbuttons.

#### Controller Interface Functions

**Trace data transfer:** all trace data values can be transferred to or from 853A with a controller.

**Input messages:** controller input instructions or annotation can be displayed on either of two 60 character lines.

**Display control:** all trace processing functions can be remotely controlled.

**Sweep control:** analyzer sweeps can be initiated and monitored.

#### General Specifications

**180-Series compatibility:** the HP 8557A Spectrum Analyzer is compatible with the 180T-Series displays as well as the 853A'. The 182T is a normal persistence cabinet style display; the 181T offers variable persistence and storage; the 181TR is a rack mount configuration, with normal persistence. All 180T-Series displays provide non-buffered rear panel auxiliary outputs (for unattenuated vertical horizontal, and penlift outputs). However, they do not offer the digital display, HP-IB and direct plotter dump capability, nor the portability features of the 853A.

**Temperature Range:** operating  $0^\circ$  to  $+55^\circ\text{C}$ ; storage  $-40^\circ$  to  $+75^\circ\text{C}$ .

**EMI:** conducted and radiated interference is within requirements of Methods CE03 and RE02 of MIL-STD 461A, CISPR Publication 11 (1975), and Messempfaenger Postverfuegung 526/527/79 (Kennzeichnung Mit F-Nummer/Funkschutzzeichen).

**Power:** (including display) 115 or 230 V ( $\pm 10\%$ ), 48 to 440 Hz, less than 200 VA maximum.

#### Weight

**Model 8557A:** net, 4.5 kg (10 lb). Shipping 5.4 kg (12 lb).

**Model 853A:** net, 15.9 kg (35 lb). Shipping 18.6 kg (41 lb).

**Model 853A Opt 001:** net, 14.5 kg (32 lb). Shipping, 17.3 kg (38 lb.)

#### Size

**Model 853A/8557A:** 158.8 H x 501.7 W x 524.5 mm D (6.25" x 19.75" x 20.65").

**Model 853A Opt 001/8557A:** 133 H x 425.5 W x 473.3 mm D (5.25" x 16.75" x 18.65").

#### Ordering Information

**8557A Spectrum Analyzer**

**Opt 001:** 75 ohm input, dBm calibration

**Opt 002:** 75 ohm input, dBmV calibration

**Opt 910:** Extra Operation and Service Manual

**853A Portable Spectrum Analyzer Display**

**Opt 001:** Full Module Bench/Rack Configuration

**182T Cabinet Style, Normal Persistence Display**

**180TR Rack Mount, Normal Persistence Display**

**181T Cabinet Style, Variable Persistence Display**

**181TR Rack Mount 181T Display**

\*A simple modification is required for 8557A plug-ins with serial prefix 2106A and lower (modification kit, HP part number 00853-60057).



# SIGNAL ANALYZERS

Spectrum Analyzer, 0.1 to 1500 MHz

Models 8558B/853A & 8444A Option 059

- Rugged portability
- Simple three knob operation
- Direct plotter dump of digital trace
- Resolution bandwidths from 1 kHz to 3 MHz
- 0.5 to 1500 MHz tracking generator available
- Optional 75  $\Omega$  input with dBm or dBmV calibration



8558B / 853A

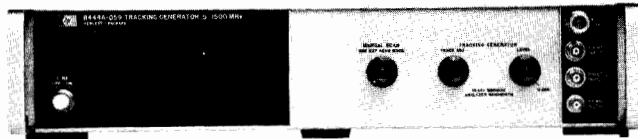

8444A Opt. 059

## 8558B Spectrum Analyzer Plug-in

### Performance Plus Economy

The 8558B is a 100 kHz to 1500 MHz spectrum analyzer plug-in for use with the 853A or 180 series display. The high performance and convenient operation of this economical unit is ideally suited for a variety of applications in production, R&D or field service measurements.

### Simple, 3-knob Operation

Preset the 8558B to the color coded, "basic-operation" settings and use the coupled controls to make most measurements in three easy steps. Tune to the signal, the LED readout displays its frequency. Zoom-in on the signal by reducing the span width; the resolution bandwidth, video filter, and sweep time automatically change to an optimum value for a calibrated display. Change the reference level to bring the peak of the signal to the top of the screen for the most accurate amplitude measurement.

### Absolute Amplitude Calibration

Signal levels can be read directly from the CRT in dBm (dBmV for Option 002) without the use of external standards or calculations. The signal level represented by the top CRT graticule line is always indicated by the reference level control, and vertical scale factors of 10 dB/div, 1 dB/div, or linear can be selected.

### Optional 75 Ohm Input

Two options are available which allow measurements in 75 ohm systems. Option 001 has 75  $\Omega$  impedance, but retains the dBm power calibration. Option 002 is also 75  $\Omega$ , but the amplitude is calibrated in dBmV for measurements on systems such as CATV.

### 8444A Option 059 Tracking Generator (0.5-1500 MHz)

Make swept frequency response measurements from 0.5 to 1500 MHz with greater than 90 dB of dynamic range. The output is abso-

lutely calibrated at 0 dBm and continuously variable to -10 dBm. Frequency of an unknown signal, as well as any point on a frequency response curve, can be measured using the external counter output and a frequency counter such as the Model 5300B/5305B.

### 853A Spectrum Analyzer Display Digital Display

The 853A is a digital display mainframe for use with the 8558B Spectrum Analyzer plug-in. Signals are displayed on either of two independently stored digital traces. Display processing capabilities include Max Hold, digital averaging, and trace normalization for extended measurement capability. A built-in microprocessor manages the display operation, as well as providing access to built-in test routines for display calibration and test (accessible via the front panel).

### HP-IB Capability Includes Direct Plotter Control

A hardcopy record of the displayed traces and graticules can be made on an HP-IB digital plotter by simply using the 853A's front-panel pushbuttons, without need for a controller. Although analyzer controls are not programmable, some HP-IB applications might include using a controller for recording trace data, or placing operator prompts on the 853A CRT. The digital display and processing functions can be remotely programmed and analyzer sweeps can be initiated via HP-IB.

### Two Configurations

The 853A display is offered in two styles. The 853A (pictured) is a ruggedized, portable mainframe complete with tilt-bail handle, and drip-proof protective front cover. The 853A is ideally suited for rugged, field environments and areas where system mobility is required. The 853A Option 001 offers the digital display in a full module bench or rack mount configuration.

## 8558B Specifications

### Frequency Specifications

Frequency range: 0.1 to 1500 MHz.

### Frequency spans:

Per division: 5 kHz to 100 MHz/div in a 1, 2, 5 sequence.

Zero span: analyzer functions as a manually tuned receiver.

### Frequency accuracy

0-195 MHz:  $\pm(1 \text{ MHz} + 20\% \text{ frequency span per division})$ .

195-1500 MHz:  $\pm(5 \text{ MHz} + 20\% \text{ frequency span per division})$ .

Span accuracy:  $\pm 5\%$  of displayed frequency span.



### Spectral resolution and stability

**Resolution bandwidths:** eight selectable resolution (3 dB) bandwidths from 1 kHz to 3 MHz in a 1,3 sequence. Bandwidth and frequency span are independently variable or may be coupled for optimum display when control markers are aligned (▶◀).

**Resolution bandwidth accuracy:** 3 dB points are  $\pm 20\%$  ( $+10^\circ$  to  $+40^\circ\text{C}$ ).

**Selectivity:** (60 dB/3 dB bandwidth ratio):  $<15:1$ .

### Stability

**Residual FM:**  $<1$  kHz p-p in 0.1 second.

**Noise sidebands:**  $\geq 65$  dB down,  $\geq 50$  kHz from signal in a 1 kHz resolution bandwidth, and full video filtering.

### Amplitude Specifications

**Amplitude range:**  $-117$  to  $+30$  dBm.

#### Maximum input levels

**Total power:**  $+30$  dBm (1W, 7.1 Vrms).

**dc or ac ( $<100$  Hz):**  $\pm 30$  V.

**Peak pulse power:**  $+50$  dBm (100W,  $<10$   $\mu\text{sec}$  pulse width, 0.01% duty cycle), with  $\geq 20$  dB input attenuation.

**Gain compression:** typically  $<1$  dB for  $-10$  dBm signal, 0 dB input attenuation.

**Average noise level:**  $<-107$  dBm, with 10 kHz resolution bandwidth, 0 dB input attenuation and maximum (MAX) video filtering.

#### Calibrated display range

**Log:** 70 dB with 10 dB/div scale; 8 dB with 1 dB/div scale

**Linear:** from 2.2  $\mu\text{V}$  ( $-100$  dBm) full scale to 7.1 V ( $+30$  dBm) full scale in 10 dB steps. Reference level variation is typically  $<\pm 1$  dB for any change in Amplitude Scale.

#### Amplitude accuracy

**Calibrator:**  $-30$  dBm  $\pm 1$  dB, (280 MHz  $\pm 300$  kHz)

**Reference level:** 10 dB steps and a 12 dB vernier for calibrated adjustment from  $-112$  dBm to  $+60$  dBm.

**Step accuracy:** (with 0 dB input attenuation),  $-10$  to  $-80$  dBm:  $\pm 0.5$  dB;  $-10$  to  $-100$  dBm:  $\pm 1.0$  dB.

**Vernier accuracy:**  $\pm 0.5$  dB.

**Frequency response:** (includes input attenuator, mixer flatness and internal limiter);  $\leq \pm 1.0$  dB with 10 dB input attenuation.

**Input attenuator:** selectable in 10 dB steps, 0 to 70 dB.

**Step accuracy:**  $<\pm 0.5$  dB per 10 dB step.

**Max cumulative error:** (0 to 70 dB),  $<\pm 1.0$  dB.

**Bandwidth switching:** (amplitude variation)

3 MHz to 300 kHz:  $<\pm 0.5$  dB.

3 MHz to 1 kHz:  $<\pm 1.0$  dB.

#### Display accuracy

**Log incremental accuracy:**  $\pm 0.1$  dB/dB, but no more than  $\pm 1.5$  dB over full 70 dB range.

**Linear accuracy:**  $\pm 3\%$  of reference level.

#### Spurious responses

**Second harmonic distortion:**  $<70$  dB below a  $-40$  dBm input signal, with 0 dB input attenuation; ( $>60$  dB below for signals 100 kHz to 5 MHz).

**Third order intermodulation distortion:**  $>70$  dB below two  $-30$  dBm input signals, separated by  $\geq 50$  kHz, with 0 dB input attenuation; ( $>60$  dB below for signals 100 kHz to 5 MHz).

**Residual responses:**  $<-100$  dBm with 0 dB input attenuation and no signal present at input.

### Sweep Characteristics

#### Sweep time

**Auto:** sweep time is automatically adjusted to maintain absolute amplitude calibration for any combination of Frequency Span, Resolution Bandwidth, and Video Filter.

**Calibrated sweep times:** 0.1 msec to 10 sec/div in 1, 2, 5 sequence.

**Manual sweep:** spectrum analyzer may be swept manually in either direction with front panel control.

### Signal Input Characteristics

**Input impedance:** 50  $\Omega$  nominal; precision Type-N female connector.

**Input SWR:**  $<1.5$  with  $\geq 10$  dB input attenuation.

### Output Characteristics

**Probe power:**  $+15$  V,  $-12.6$  V, and GND (150 mA max). Use HP 1120A, 1121A, 1123A or 1124A High Impedance Probes.

**Note:** Oscilloscope display outputs refer to 853A, 180T-series displays, and any other 180-series displays with Option 807 installed.

**Vertical output, AUX A:** 0 to 0.8 V for 8 division deflection on CRT display; 50  $\Omega$  output impedance.

**Penlift blanking, AUX B:** 0 to  $+15$  V (0 V, pen down); 10 k $\Omega$  output impedance.

**21.4 MHz IF output, AUX C:** output provides a 21.4 MHz signal (linearly related to RF input) from a 50  $\Omega$  output impedance. Output bandwidth is controlled by spectrum analyzer Resolution Bandwidth setting; amplitude controlled by Input Attenuator, Reference Level Fine, and first six Reference Level positions ( $-10$  to  $-60$  dBm, 0 dB input attenuation). Output is approximately  $-10$  dBm with signal displayed at reference level.

**Horizontal output, AUX D:**  $-5$  V to  $+5$  V for full 10 division CRT horizontal deflection, 5 k $\Omega$  output impedance.

## 853A Characteristics

### Digital Display

**Traces:** dual trace, digitally stored display with resolution of 481 horizontal by 801 vertical points for each trace.

**Signal processing:** Max Hold, digital averaging, and trace normalization.

**Internal service routines:** front panel pushbuttons access test routines useful during calibration and maintenance of digital hardware.

### HP-IB

**Direct plotter control:** all displayed information can be transferred to an HP-IB plotter with front panel pushbuttons.

### Controller interface functions

**Trace data transfer:** all trace data values can be transferred to or from 853A with a controller.

**Input messages:** controller-input instructions or annotation can be displayed on either of two 60 character lines.

**Display control:** all trace processing functions can be remotely controlled.

**Sweep control:** analyzer sweeps can be initiated and monitored.

### General Specifications

**180-Series compatibility:** the HP 8558B Spectrum Analyzer Plug-in is compatible with the 180T-Series displays as well as the 853A<sup>1</sup>. The 182T is a normal persistence cabinet style display; the 181T offers variable persistence and storage; the 181TR is a rack mount configuration, with normal persistence. All 180T-Series displays provide non-buffered rear panel auxiliary outputs (for unattenuated vertical horizontal, and penlift outputs). However, they do not offer the digital display, HP-IB and direct plotter dump capability, nor the portability features of the 853A.

**Temperature range:** operating  $0^\circ$  to  $+55^\circ\text{C}$ ; storage  $-40^\circ$  to  $+75^\circ\text{C}$ .

**EMI:** conducted and radiated interference is within requirements of methods CE03 and RE02 of MIL STD 461A, CISPR Publication 11 (1975), and Messenpfaenger Postverfuegung 526/527/79 (Kennzeichnung Mit F-Nummer/Funkschutzzeichen).

**Power:** (including display) 115 or 230 V ( $\pm 10\%$ ), 48 to 440 Hz, less than 200 VA maximum.

### Weight

**Model 8558B:** net, 5.9 kg (13 lb). Shipping 6.8 kg (15 lb).

**Model 853A:** net, 15.9 kg (35 lb). Shipping 18.6 kg (41 lb).

**Model 853A Opt 001:** net, 14.5 kg (32 lb). Shipping, 17.3 kg (38 lb).

### Size

**Model 853A/8558B:** 158.8 H x 501.7 W x 524.5 mm D (6.25" x 19.75" x 20.65").

**Model 853A Opt 001/8558B:** 133 H x 425.5 W x 473.3 mm D (5.25" x 16.75" x 18.65").

### Ordering Information

**8558B Spectrum Analyzer**

**Opt 001:** 75  $\Omega$  input, dBm calibration

**Opt 002:** 75  $\Omega$  input, dBmV calibration

**Opt 910:** Extra Operating and Service Manual

**853A Portable Spectrum Analyzer Display**

**Opt 001:** Full Module Bench/Rack Configuration

**182T Cabinet Style, Normal Persistence Display**

**180TR Rack Mount, Normal Persistence Display**

**181T Cabinet Style, Variable Persistence Display**

**181TR Rack Mount 181T Display**

<sup>1</sup> A simple modification is required for 8558B plug-ins with serial prefix 2145A and lower (modification kit, HP part number 00853-60058).



# SIGNAL ANALYZERS

Spectrum Analyzer, 0.01 to 21 GHz  
Models 8559A/853A

- Rugged portability
- Simple three-knob operation
- Direct plotter dump of digital trace

- Resolution bandwidths of 1 kHz to 3 MHz
- Absolute amplitude calibration in all bands

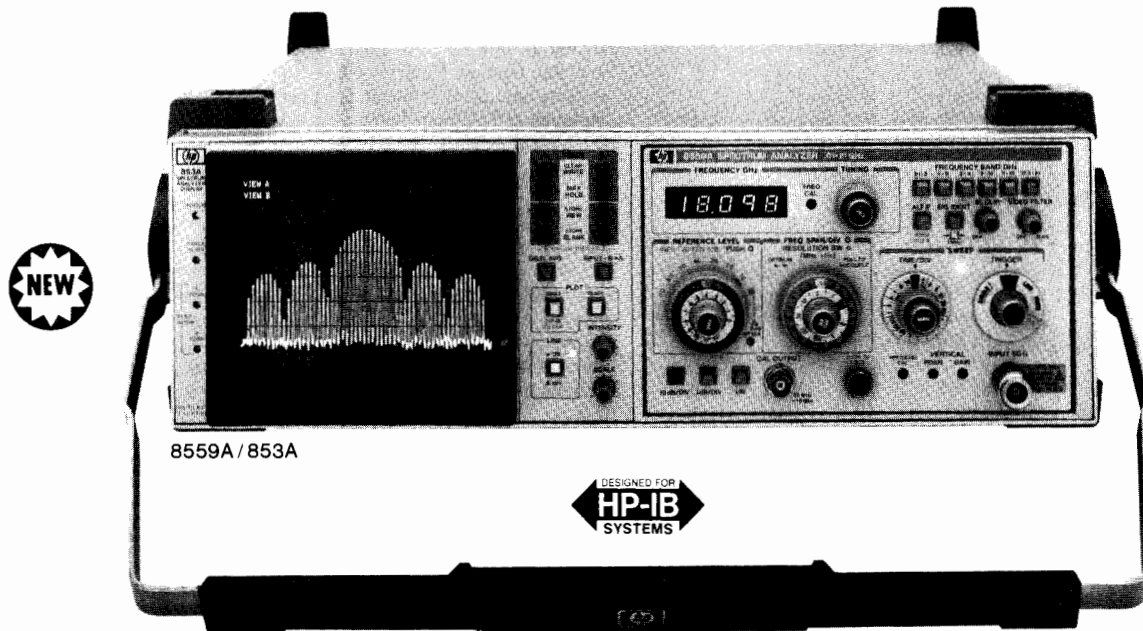

## 8559A Spectrum Analyzer Plug-in

### Performance Plus Economy

The 8559A is a 0.01 to 21 GHz spectrum analyzer plug-in for use with both the 853A and 180-series display. The high performance and convenient operation of this economical unit is ideally suited for a variety of applications in production, R&D or field service environments.

### Simple 3-Knob Operation

Preset the 8559A to the color coded, "basic operation" settings and use the coupled controls to make most measurements in three easy steps. Tune to the signal; the LED readout displays its frequency. Zoom-in on the signal by reducing the span width; the resolution bandwidth, video filter, and sweep time automatically change to an optimum value for a calibrated display. Change the reference level to bring the peak of the signal to the top of the screen for the most accurate amplitude measurement. A signal identifier is available in all bands to provide assurance of correct measurements.

### Absolute Amplitude Calibration

Signal levels can be read directly in dBm from the CRT without the use of external standards or calculations. The signal level represented by the top CRT graticule line is always indicated by the reference level control, and vertical scale factors of 10 dB/Div, 1 dB/Div, or linear can be selected.

### 11870A Low Pass Filter (dc to 2.6 GHz)

For RF measurement applications needing extended coverage to 2.6 GHz, the 11870A low pass filter will reject signals above 3 GHz by more than 60 dB for image-free measurements over the entire 10 MHz to 2.6 GHz range.

### 853A Spectrum Analyzer Display

#### Digital display

The 853A is a digital display mainframe for use with the 8559A spectrum analyzer. Signals are displayed on either of two independently stored digital traces. Display processing capabilities include Max Hold, digital averaging, and trace normalization for extended measurement capability. A built-in microprocessor manages the display operation, as well as providing access to built-in test routines for display calibration and test (accessible via the front panel).

### Two configurations

The display is offered in two styles. The 853A (pictured) is a ruggedized, portable mainframe complete with tilt-bail handle and drip proof, protective front cover. The 853A is ideally suited for rugged, field service environments and any areas where system mobility is required. The 853A Option 001 offers the digital display in a full module bench or rack mount configuration.

### HP-IB capability includes direct plotter control

A hard-copy record of the displayed traces and graticule can be made on an HP-IB digital plotter by simply using the 853A's front-panel pushbuttons without using a controller. Although analyzer controls are not programmable, some HP-IB applications include using a controller for recording trace data, or operator prompts on the 853A CRT. The digital display and processing functions can be remotely programmed, and analyzer sweeps can be initiated via HP-IB.

## 8559A Specifications

### Frequency Specifications

**Frequency range:** 0.01 to 21 GHz.

### Frequency spans

**Fullband:** displays entire spectrum of selected band.

**Per division:** 10 kHz to 200 MHz/Div in a 1, 2, 5 sequence.

**Zero span:** analyzer functions as a manually tuned receiver.

### Frequency accuracy

**Tuning accuracy:** 0.01 to 3 GHz:  $< \pm(1 \text{ MHz} + 0.3\% \text{ of center frequency})$ ; 3 to 21 GHz:  $< \pm(5 \text{ MHz} + 0.2\% \text{ of center frequency})$ .

**Frequency span accuracy:**  $\pm 5\%$  of displayed frequency span.

### Spectral resolution and stability

**Resolution bandwidths:** eight selectable resolution (3 dB) bandwidths from 1 kHz to 3 MHz in a 1, 3 sequence. Bandwidth and frequency span are independently variable or may be coupled for optimum display when control markers are aligned (▶◀).

**Resolution bandwidth accuracy:** 3 dB points are  $< \pm 15\%$  (except for 3 MHz bandwidth:  $< \pm 30\%$ ).

**Selectivity:** (60 dB/3 dB bandwidth ratio):  $< 15:1$

### Stability

**Residual FM:**  $< 1 \text{ kHz p-p}$  in 0.1 second.

**Noise sidebands:**  $\geq 70 \text{ dB}$  down,  $\geq 30 \text{ kHz}$  from center of CW signal with 1 kHz resolution bandwidth, and full video filtering.

### Amplitude Specifications

**Amplitude range:**  $-111$  to  $+30 \text{ dBm}$ .



### Maximum input levels

**Total power:** +20 dBm (100 mW, 2.2 Vrms) with 0 dB input attenuation; +30 dBm (1 watt, 7.1 Vrms) with  $\geq 10$  dB input attenuation.

**dc or ac (< 100 Hz):**  $\pm 7.1$  V.

**Peak pulse power:** +50 dBm (100 watts, 10  $\mu$ sec pulse width, 0.01% duty cycle) with  $\geq 30$  dB input attenuation.

**Gain compression:**  $< 0.5$  dB for a  $-10$  dBm input level, with 0 dB input attenuation.

**Average noise level:** see table below for maximum average noise level with 1 kHz resolution bandwidth, 0 dB input attenuation and maximum (MAX) video filtering.

Frequency Range (GHz)	Avg. Noise Level (dBm/1 kHz)	Frequency Response ( $\pm$ dB max.)	Amplitude Accuracy ( $\pm$ dB max.)
0.01-3	-111	1.0	2.3
6.0-9	-108	1.0	2.3
3.0-9	-103	1.5	2.8
9.0-15	-98	1.8	3.1
6.0-15	-93	2.1	3.4
12.1-18	-92	2.3	3.6
18.0-21	-90	3.0	4.3

**Alternate IF:** regular IF at 3.0075 GHz; alternate IF available at 2.9925 GHz for all frequency bands (minimum frequency is 25 MHz).

### Calibrated display range

**Log:** 70 dB with 10 dB/Div scale; 8 dB with 1 dB/Div scale.

**Linear:** from 0.56  $\mu$ V ( $-112$  dBm) full scale to 7.1 V (+30 dBm) full scale in 10 dB steps. Reference level variation is typically  $< \pm 1$  dB for any change in Amplitude Scale.

### Amplitude accuracy

**Calibrator:**  $-10$  dBm  $\pm 0.3$  dB, (35 MHz  $\pm 400$  kHz).

**Reference level:** 10 dB steps and a 12 dB vernier for calibrated adjustment from  $-112$  dBm to  $+60$  dBm.

**Step accuracy:** (with 0 dB input attenuation),  $-10$  to  $-80$  dBm:  $\pm 0.5$  dB;  $-10$  to  $-100$  dBm:  $\pm 1.0$  dB.

**Vernier accuracy:**  $\pm 0.5$  dB.

**Frequency response:** see table above; includes input attenuator, mixer flatness, and mixing mode gain variation (band to band), with 0 or 10 dB input attenuation.

**Input attenuator:** selectable in 10 dB steps, 0 to 70 dB.

**Log incremental accuracy:**  $\pm 0.1$  dB/dB, but no more than  $\pm 1.5$  dB over full 70 dB range.

**Linear accuracy:**  $\pm 3\%$  of reference level.

### Spurious responses

**Second harmonic distortion:**  $> 70$  dB below a  $-40$  dBm signal, with 0 dB input attenuation.

**Third order intermodulation distortion:**  $> 70$  dB below two  $-30$  dBm input signals, separated by  $\geq 50$  kHz, with 0 dB input attenuation.

**Residual responses:**  $< -90$  dBm, with 0 dB input attenuation and no signal present at input.

**Signal identifier:** available in all frequency bands and spans, useable from 10 MHz to 100 kHz/Div.

### Sweep Characteristics

#### Sweep time

**Auto:** sweep time is automatically adjusted to maintain absolute amplitude calibration for any combination of Frequency Span, Resolution Bandwidth and Video Filter.

**Calibrated sweep times:** 2  $\mu$ sec to 10 sec/Div in a 1, 2, 5 sequence (except 2 sec/Div).

**Manual sweep:** spectrum analyzer may be swept manually in either direction with front panel control.

### Signal Input Characteristics

**Input impedance:** 50  $\Omega$  nominal; precision type-N female connector.

**Input SWR:**  $< 2.0$ , 0 dB input attenuation;  $< 1.3$ , 10 dB input attenuation.

### Output Characteristics

**Note:** Oscilloscope display outputs refer to 853A, 180T-series displays, and any other 180-series displays with Option 807 installed.

**Vertical output, AUX A:** 0 to 0.8 V for 8 division deflection on CRT display; 50  $\Omega$  output impedance.

**Penlift blanking, AUX B:** 0 to 15 V (0 V, pen down). 10 k $\Omega$  output impedance.

**21.4 MHz IF output, AUX C:** output provides a 21.4 MHz signal (linearly related to RF input) from a 50  $\Omega$  output impedance. Output bandwidth is controlled by spectrum analyzer Resolution Bandwidth setting; amplitude controlled by Input Attenuator, Reference Level Fine, and first six Reference Level positions ( $-10$  to  $-60$  dBm, 0 dB input attenuation). Output is approximately  $-10$  dBm with signal display at reference level.

**Horizontal output, AUX D:**  $-5$  to  $+5$  V for full 10 division CRT horizontal deflection, 5 k $\Omega$  output impedance.

## 853A Characteristics

### Digital Display

**Traces:** dual trace, digitally stored display with resolution of 481 horizontal by 801 vertical points for each trace.

**Signal processing:** Max Hold, digital averaging, and trace normalization.

**Internal service routines:** front panel pushbuttons access test routines to perform maintenance of digital hardware.

### HP-IB

**Direct plotter control:** all displayed information can be transferred to an HP-IB plotter with front panel pushbuttons.

### Controller interface functions

**Trace data transfer:** all trace data values can be transferred to or from 853A with a controller.

**Input messages:** controller-input instructions or annotation can be displayed on either of two 60 character lines.

**Display control:** all trace processing functions can be remotely controlled.

**Sweep control:** analyzer sweeps can be initiated and monitored.

### General Specifications

**180-Series compatibility:** the HP 8559A Spectrum Analyzer is compatible with the 180T-Series displays as well as the 853A<sup>1</sup>. The 182T is a normal persistence cabinet style display; the 181T offers variable persistence and storage; the 181TR is a rack mount configuration, with normal persistence. All 180T-Series displays provide non-buffered rear panel auxiliary outputs (for unattenuated vertical, horizontal, and penlift outputs). However, they do not offer the digital display, HP-IB and direct plotter dump capability, nor the portability features of the 853A.

**Temperature Range:** operating 0° to +55°C; storage  $-40^{\circ}$  to +75°C.

**EMI:** conducted and radiated interference is within requirements of methods CE03 and RE02 of MIL-STD 461A, CISPR Publication 11 (1975), and Messempfaenger Postverfuegung 526/527/79 (Kennzeichnung Mit F-Nummer/Funkschutzzeichen).

**Power:** (including display) 115 or 230 V ( $\pm 10\%$ ), 48 to 440 Hz, less than 200 VA maximum.

### Weight

**Model 8559A:** net, 5.5 kg (12.5 lb). Shipping 9.1 kg (20 lb).

**Model 853A:** net, 15.9 kg (35 lb). Shipping 18.6 kg (41 lb).

**Model 853A Opt 001:** net, 14.5 kg (32 lb). Shipping, 17.3 kg (38 lb).

### Size

**Model 853A:** 158.8 H x 501.7 W x 524.3 mm D (6.25" x 19.75" x 20.65").

**Model 853A Opt 001:** 133 H x 425.5 W x 473.7 mm D (5.25" x 16.75" x 18.65").

### Ordering Information

**8559A Spectrum Analyzer**

**Opt 910:** Extra Operating and Service Manual

**853A Portable Spectrum Analyzer Display**

**Opt 001:** Full Module Bench/Rack Configuration

**182T Cabinet Style, Normal Persistence Display**

**180TR Rack Mount Normal Persistence Display**

**181T Cabinet Style, Variable Persistence Display**

**181TR Rack Mount 181T Display**

<sup>1</sup>A simple modification is required for 8559A plug-ins with serial prefix 2208A and lower (modification kit, HP part number 00853-60059).

# SIGNAL ANALYZERS

## Modular Spectrum Analyzer System, 20 Hz to 40 GHz

### Model 141T system

- 20 Hz to 18 GHz, external mixing to 40 GHz
- Absolute amplitude calibration
- Tracking generators for component test
- Tracking preselector simplifies measurements



Hewlett Packard's modular spectrum analyzer permits measurements at frequencies ranging from 20 Hz to 18 GHz with four plug-in tuning sections. For measurements in the 18 to 40 GHz an accessory external mixer may be used with the microwave tuning section. The modularity of the system allows you to keep pace with changing measurement requirements.

The modular spectrum analyzer is comprised of a mainframe/display, one tuning section, and one IF section. Each tuning section covers a different frequency range permitting purchase of those which best meet current requirements. The 8556A covers from 20 Hz to 300 kHz, the 8553B from 1 kHz to 110 MHz, the 8554B from 100 kHz to 1250 MHz, and the 8555A from 10 MHz to 18 GHz. The IF sections, the 8552A or 8552B, provide bandwidth/gain selection and detection. Unless otherwise noted, the specifications shown here apply to a modular spectrum analyzer which contains an 8552B IF section.

For swept frequency testing of components, the 8443A or 8444A Tracking Generator function as a swept signal source which, through locking, accurately tracks the frequency to which the analyzer is tuned. A microwave tracking preselector, the 8445B, simplifies measurements and improves the dynamic range of the 8555A Tuning Section for dense signal environments.

The modular spectrum analyzer displays amplitude and frequency accurately with a large dynamic range.

The following pages contain detailed performance specifications for each configuration of the spectrum analyzer, preselector, and tracking generators.

#### Absolute Amplitude Calibration

Calibrated frequency and amplitude measurements may be made over the entire frequency range. Logarithmic or linear scaling allow display of amplitude in dBm or voltage respectively. A warning light is provided to indicate uncalibrated conditions due to improper control settings.

#### Frequency Calibration

Three scan modes allow simple, accurate measurements. In the FULL SCAN mode the entire tuning section band is displayed. A marker is provided to identify and select signals of interest.

After a signal is selected in the FULL SCAN mode, switching to PER DIVISION mode allows analysis of the signal in narrow scans. Noise sidebands and low deviation FM are examples of measurements that might be made in this mode.

The analyzer can be used as a fixed tuned receiver by selecting the ZERO SCAN mode. In this mode the analyzer provides a time domain display with a calibrated time base, controlled by the scan time setting.

#### High Resolution

In frequency domain analysis it is often necessary to resolve close-in sidebands, such as line related modulation. Bandwidths as narrow as 10 Hz are provided in the 8553B to obtain this resolution. Use of such narrow bandwidths is made possible by frequency stabilization.

#### High Sensitivity, Low Distortion

For best measurement accuracy, a wide dynamic range is essential. Wide dynamic range requires both high sensitivity and low internal distortion.

Signals as low as  $-142$  dBm can be measured using the 8553B tuning section. For most measurements the 141T Modular System offers in excess of 70 dB distortion free dynamic range. For many measurements with the 8555A Tuning section, the 8445B Preselector can increase dynamic range to greater than 100 dB.

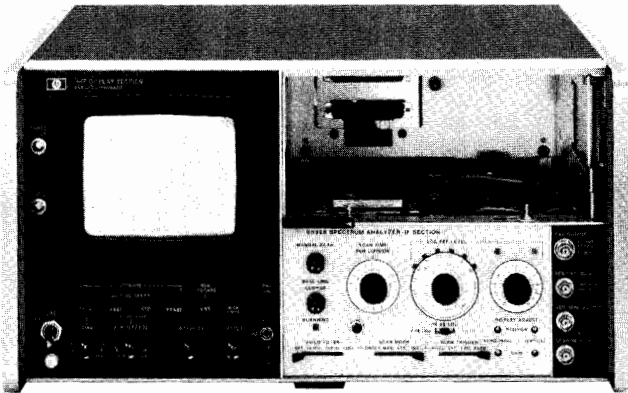

141T, 8552B

### Mainframe/Storage Display

The 141T Mainframe provides variable persistence and storage. When narrow bandwidths are selected, sweep time must be reduced to maintain amplitude calibration. Variable persistence permits displayed traces of constant intensity even for long sweep times. The storage feature allows traces to be held for comparison or photographing. For measurements that do not require trace storage, the 140T Standard Persistence mainframe is available.

### IF Section Features

In addition to providing calibrated bandpass filtering the IF Section offers several user convenience features. Selectable video filters improve signal discernibility when S/N is low and permit display of average noise level. Recorder outputs, compatible with analog XY recorders, are provided. Amplitude and frequency calibration from the front panel are possible using the internal calibration source.

### Tracking Generators for Component Test

Tracking generators—leveled sources which track the tuned frequency of the analyzer—allow precise frequency measurements on two port devices with high dynamic range. Three tracking generators permit characterization of device performance up to 1500 MHz with a nominal dynamic range of 100 dB. The 8556B includes a tracking generator and the 8443A and 8444A may be used with the 8553B and 8554B Tuning Sections respectively.

### 8750A Storage-Normalizer

Digital trace storage and display with the 141T System is possible with the 8750A (Opt. 001) and an external oscilloscope. Digital storage provides a flicker-free display for any sweep speed and allows comparison of two traces. When a tracking generator is used, the normalization feature of the 8750A reduces the effect of system frequency response on the measurement.

### General Specifications

**Input impedance:** 50  $\Omega$  nominal. Reflection coefficient  $<0.30$  (1.85 SWR), input attenuator  $\geq 10$  dB.

**Maximum input level:** peak or average power +13 dBm (1.4 V ac peak),  $\pm 50$  V dc.

**Attenuator:** 0 to 50 dB in 10 dB steps.

**Scan time:** 16 internal scan rates from 0.1 ms/div to 10 sec/div in a 1, 2, 5 sequence, and manual scan (8552B only).

#### Scan Time Accuracy

**0.1 ms/div to 20 ms/div:**  $\pm 10\%$ .

**50 ms/div to 10 s/div:**  $\pm 20\%$ .

### Scan Mode

**Int:** analyzer repetitively scanned by internally generated ramp; synchronization selected by scan trigger

**Single:** single scan with front panel reset.

**Ext:** scan determined by 0 to +8 volt external signal.

**Manual:** scan determined by front panel control.

**Scan trigger:** for internal scan mode, select between

**Auto:** scan free-runs.

**Line:** scan synchronized with power line frequency.

**Ext:** scan synchronized with  $>2$  volt (20 volt max.) signal.

**Video:** scan internally synchronized to envelope of RF input.

### Auxiliary outputs:

**Vertical output:** 0 to  $-0.8$  V for full deflection.

**Scan output:**  $-5$  V to  $+5$  V for 10 div CRT deflection.

**Pen lift output:** 0 to 14 V (0 V, pen down).

### Display Characteristics

#### 141T, 140T

**Plug-ins:** accepts Models 8552A/B, 8553B, 8554B, 8555A and 8556A and Model 140 series Oscilloscope plug-ins.

#### Cathode-Ray Tube Type

**Model 141T:** post-accelerator storage tube, 9000 volt accelerating potential; aluminized P31 phosphor.

**Model 140T:** post-accelerator, 7300 volt potential medium-short persistence (P39) phosphor.

#### Cathode-Ray Tube Graticule

**Model 141T:** 8  $\times$  10 division (approx, 7.1 cm  $\times$  8.9 cm parallax-free internal graticule).

#### Persistence, Model 141T Only

**Normal:** natural persistence of P31 phosphor (0.1 second).

#### Variable

**Normal writing rate mode:** continuously variable from less than 0.2 second to more than one minute.

**Maximum writing rate mode:** from 0.2 second to 15 seconds.

**Erase:** manual; erasure takes approximately 350 ms.

**Storage time model 141T only:** normal writing rate; more than 2 hours at reduced brightness (typically 4 hours).

**Fast writing speed, model 141T only:** more than 15 minutes.

**Functions used with oscilloscope plug-ins only.** Intensity modulation, calibrator; beam finder.

**EMI:** conducted and radiated interference is within requirements of MIL-I-16910C and MIL-I-6181D and methods CEO3, and REO2 of MIL-STD-461 (except 35 to 40 kHz) when appropriate RF tuning section and 8552A or 8552B are combined in a 140T or 141T Display Section.

**Temperature range:** operating,  $0^{\circ}\text{C}$  to  $+55^{\circ}\text{C}$ ; storage,  $-40^{\circ}\text{C}$  to  $+75^{\circ}\text{C}$ .

**Power requirements:** 100, 120, 220, or 240 V  $\pm 5\%$ .  $-10\%$ . 50 to 60 Hz, normally less than 225 watts (includes plug-ins used).

#### Weight

**Model 8552A or 8552B IF section:** net, 4.1 kg (9 lb). Shipping 6.4 kg (14 lb).

**Model 140T display section:** net, 18 kg (40 lb). Shipping, 25 kg (54 lb).

**Model 141T display section:** net, 19.2 kg (43 lb). Shipping, 26 kg (57 lb).

**Tuning section:** see following pages.

**Size:** model 140T or 141T with plug-ins: 221 H  $\times$  425 W  $\times$  416 mm D (8.8"  $\times$  16.8"  $\times$  16.4").

**Special order:** chassis slides and adapter kit.

### Ordering Information

**140T** Normal Persistence Display

**Opt 908:** Rack Flange Kit

**141T** Variable Persistence Display

**Opt 908:** Rack Flange Kit

**8552A** Economy IF Section

**8552B** High Resolution IF Section

# SIGNAL ANALYZERS

## 141T Spectrum Analyzer System: 20 Hz to 300 kHz

Model 8556A

- Accurate signal level measurements ( $\pm 0.95$  dB)
- Accurate frequency measurements ( $\pm 3$  Hz)
- High sensitivity ( $-152$  dBV)
- Built-in tracking generator

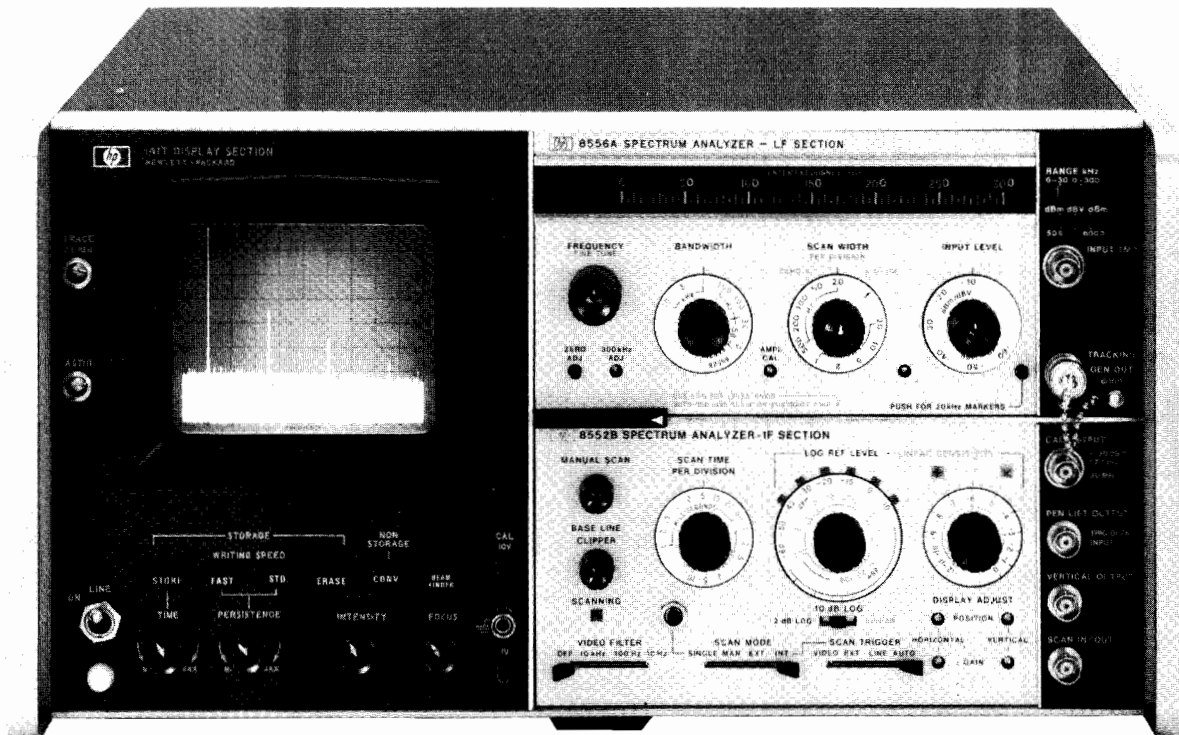

8556A (141T, 8552B)

### Measurement Flexibility

The 8556A offers a frequency range of 20 Hz to 300 kHz. It is compatible with impedances normally encountered at audio frequencies. The input may be either balanced or unbalanced and measurement units may be dBV, dBm or Volts.

### Frequency Range

In addition to the 300 kHz tuning scale, a 30 kHz tuning scale is provided for greater tuning resolution at low frequencies. The 8556A may be swept about the tuned frequency, from 0 Hz to a selectable stop frequency, or fixed tuned to any frequency in its tuning range. Crystal markers with 20 kHz spacing may be selected to ensure accurate frequency measurements.

### Amplitude Calibration

The 8556A is calibrated for dBm in 600 and 50 ohms, as well as dBV and volts. Accurate reference level control ( $\pm 0.2$  dB) and vernier ( $\pm 0.25$  dB) allow accurate amplitude measurements when using the IF substitution method.

### Resolution—Sensitivity

Bandwidths of from 10 Hz to 10 kHz are provided with the 8556A. The 10 Hz bandwidth is useful for measurements close to the carrier such as power line sidebands. The 10 Hz bandwidth together with the low noise figure of the 8556A, allow signals as low as  $-152$  dBV (25 nV) to be measured.

### Isolated Input

The isolated input prevents spurious signal pickup due to ground currents between the analyzer and the signal source. The high input impedance permits the use of an oscilloscope probe. An optional balanced input is transformer coupled to provide isolation and high common mode rejection.

### Tracking Generator

The frequency of low level signals can be measured to  $\pm 3$  Hz accuracy with a frequency counter connected to the output of the built-in tracking generator. Swept insertion loss measurements with 140 dB dynamic range and return loss measurements are also possible using the tracking generator.

### Specifications—with 8552B IF Section

#### Frequency Specifications

**Frequency range:** 20 Hz to 300 kHz. Tuning dial ranges of 0–30 kHz and 0–300 kHz.

**Scan width:** (on a 10-division CRT horizontal axis)

**Per division:** 10 calibrated scan widths from 20 Hz/div to 20 kHz/div in a 1, 2, 5 sequence.

**0–10 f:** 10 calibrated preset scans, from 200 Hz to 200 kHz in a 1, 2, 5 sequence. Analyzer scans from zero frequency to ten times the scan width per division setting.

**Zero:** analyzer is a fixed tuned receiver.

#### Frequency Accuracy

**Center frequency accuracy:** 0–30 kHz Range:  $\pm 500$  Hz; 0–300 kHz Range:  $\pm 3$  kHz.

**Marker accuracy:** RF markers every 20 kHz accurate to within  $\pm 0.01\%$ . Markers controlled by front panel on/off switch.

**Scan width accuracy:** frequency error between any two points on the display is less than  $\pm 3\%$  of the indicated frequency separation.

**Stability**

**Residual FM:** sidebands >60 dB down 50 Hz or more from CW signal, scan time  $\geq 1$  sec/div, 10 Hz bandwidth.

**Noise sidebands:** more than 90 dB below CW signal, 3 kHz away from signal, with a 100 Hz IF bandwidth.

**Frequency drift:** less than 200 Hz/10 min.

**Resolution**

**Bandwidth ranges:** IF bandwidths of 10 Hz to 10 kHz are provided in a 1, 3, 10 sequence.

**Bandwidth accuracy:** individual IF bandwidth 3 dB points calibrated to  $\pm 20\%$  (10 kHz bandwidth  $\pm 5\%$ ).

**Bandwidth selectivity:** 60 dB/3 dB IF bandwidth ratios, with IF section: <11:1 for IF bandwidths from 10 Hz to 3 kHz; <20:1 for 10 kHz bandwidth. For 10 Hz bandwidth, 60 dB points are separated by less than 100 Hz.

**Amplitude Specifications**

**Absolute Amplitude Calibration**

**Log calibration modes**

dBV	0 dBV = 1 V rms
dBm-600 $\Omega$	0 dBm = 1 mW-600 $\Omega$
dBm-50 $\Omega$	0 dBm = 1 mW-50 $\Omega$

Input impedance is 1 M $\Omega$ . dBm ranges are referenced with input properly terminated externally.

**Log calibration range:** from -150 dBm/dBV to +10 dBm/dBV.

**Log display range:** 10 dB/div on a 70 dB display, or 2 dB/div on a 16 dB display.

**Linear sensitivity:** from 0.1  $\mu$ V/div to 1 V/div in a 1, 2, 10 sequence. Linear sensitivity vernier X1 to X0.25 continuously.

**Dynamic Range**

**INPUT LEVEL control:** -10 to -60 dBm/dBV in 10 dB steps. Accuracy  $\pm 0.2$  dB. Marking indicates maximum input levels for 70 dB spurious-free dynamic range.

**Average noise level:** (specified with a 600  $\Omega$  or less source impedance and INPUT LEVEL at -60 dBm/dBV)

Mode	1 kHz IF Bandwidth	10 Hz IF Bandwidth
dBm-50 $\Omega$	<-122 dBm (180 nV)	<-142 dBm (18 nV)
dBm-600 $\Omega$	<-130 dBm (250 nV)	<-150 dBm (25 nV)
dBV	<-132 dBV (250 nV)	<-152 dBV (25 nV)
Linear	<400 nV	<40 nV

**Video filter:** averages displayed noise; bandwidth of 10 kHz, 100 Hz, and 10 Hz. Bandwidth accuracy  $\pm 20\%$ .

**Spurious responses:** input signal level  $\leq$  INPUT LEVEL setting; out of band mixing responses, harmonic and intermodulation distortion products are all more than 70 dB below the input signal level 5 kHz to 300 kHz; 60 dB, 20 Hz to 5 kHz. Third order intermodulation products are more than 70 dB below the input signal level, 5 kHz to 300 kHz with signal separation >300 Hz.

**Residual responses (no signal present at input):** With the INPUT LEVEL at -60 dBm/dBV and the input terminated with 600  $\Omega$  or less, all line related residual responses from 0 to 500 Hz are below -120 dBm/dBV. All other residual responses are below -130 dBm/dBV.

Amplitude accuracy:	Log	Linear
Frequency response	$\pm 0.2$ dB	$\pm 2.3\%$
Amplitude display	$\pm 0.25$ dB/dB but not more than $\pm 1.5$ dB over 70 dB display range	$\pm 2.8\%$ of full 8 div display

**Log reference level control:** provides 90 dB IF gain control in 10 dB steps. Accurate to  $\pm 0.2$  dB ( $\pm 2.3\%$ ).

**Log reference level vernier:** provides continuous 12 dB range. Accurate to  $\pm 0.1$  dB ( $\pm 1.2\%$ ) in 0, -6, -12 dB positions; otherwise  $\pm 0.25$  dB ( $\pm 2.8\%$ ).

**Amplitude measurement accuracy:**  $\pm 0.95$  dB with proper technique.

**General**

**Scan time:** 16 internal scan rates from 0.1 ms/div to 10 sec/div in a 1, 2, 5 sequence.

**Scan Mode**

**Int:** analyzer repetitively scanned internally.

**Ext:** scan determined by 0 to +8 volt external signal.

**Single:** single scan actuated by front panel button.

**Manual:** scan determined by front panel control.

**Input level:** provides 50 dB control of input preamplification and attenuation to prevent input overload. INPUT LEVEL markings of -60 dBm/dBV to -10 dBm/dBV indicate maximum input level for a minimum of 70 dB spurious-free dynamic range. Accuracy  $\pm 0.2$  dB (2.3%).

**Input impedance:** 1 M $\Omega$  shunted by  $\approx 32$  pF.

**Maximum input level:** 10 V rms,  $\pm 200$  V dc. Ground terminals of BNC input connectors are isolated from the analyzer chassis ground to minimize ground loop pickup at low frequencies.

**Maximum voltage, isolated ground to chassis ground:**  $\pm 100$  V dc.

**Isolated ground to chassis ground impedance:** 100 k $\Omega$  shunted by approximately 0.3  $\mu$ F.

**Gain compression:** for input signal level 20 dB above INPUT LEVEL setting, gain compression is less than 1 dB.

**Tracking Generator Specifications**

**Frequency range:** tracks the analyzer tuning, 20 Hz to 300 kHz.

**Amplitude range:** continuously variable from 100 mV rms to greater than 3 V rms into an open circuit.

**Amplitude accuracy:** with TRACKING GEN LEVEL in CAL position and 20 kHz markers off, output level at 100 kHz is 100 mV  $\pm 0.3$  dB into an open circuit.

**Frequency response:**  $\pm 0.25$  dB 50 Hz to 300 kHz.

**Output impedance:** 600  $\Omega$ .

**Residual FM:** <1 Hz peak-to-peak.

**Power requirements:** 100, 120, 200, or 240 V +5%, -10%, 50 to 60 Hz, normally less than 225 watts.

**Weight:** Model 8556A LF section: net, 3.7 kg (8 lb). Shipping, 5.3 kg (12 lb).

**Size:** 102 x H x 226 x W 344 mm D (4" x 8.9" x 13.5").

**Specifications with 8556A Options 001, 002-balanced Input**

**Amplitude**

**Log calibration modes-balanced (bridged) input**

dBm-135 $\Omega$ (Option 001)	0 dBm = 1 mW-135 $\Omega$
dBm-150 $\Omega$ (Option 002)	0 dBm = 1 mW-150 $\Omega$
dBm-600 $\Omega$	0 dBm = 1 mW-600 $\Omega$
dBm-900 $\Omega$	0 dBm = 1 mW-900 $\Omega$

Input impedance is typically 15 k $\Omega$ . dBm ranges are referenced with input properly terminated externally.

**Input**

**Maximum input levels:** Normal Mode,  $\pm 20$  V rms or  $\pm 150$  V dc for normal mode (symmetrical) signals between input signal connectors; Common Mode, 200 V rms at 60 Hz or  $\pm 500$  V dc for common mode (asymmetrical) voltages between input signal connectors and GUARD or instrument chassis; GUARD,  $\pm 100$  V dc from GUARD to instrument chassis. (GUARD to chassis impedance is approximately 100 k $\Omega$  shunted by 0.3  $\mu$ F.)

**Balance (symmetry):** 0 -30kHz Range, greater than 80 dB, 50 Hz to 1 kHz; 1 -300 kHz range, greater than 60 dB, 1 kHz to 20 kHz.

**Ordering Information**

8556A RF Section

Opt 001: Balanced input

Opt 002: Balanced input

# SIGNAL ANALYZERS

## 141T Spectrum Analyzer System: 1 kHz to 110 MHz

### Models 8553B & 8443A

- 10 Hz resolution bandwidth
- High sensitivity ( $-140$  dBm)
- Accurate amplitude measurements ( $\pm 1.25$  dB)
- 10 Hz frequency accuracy with tracking generator



8553B (141T, 8552B) 8443A

The 8553B covers the frequency range 1 kHz to 110 MHz. This frequency range includes audio, video, navigation aids, communications basebands, broadcast AM and FM, and TV. This analyzer features high sensitivity, stability and resolution. The 8443A Tracking Generator improves frequency measurement accuracy and provides a tracking source for swept frequency testing of components.

#### Frequency Range

The frequency range of the 8553B extends from audio through the FM broadcast band. In the PER DIVISION mode, scan widths from 200 Hz to 100 MHz can be selected. ZERO SCAN mode allows operation as a fixed tuned receiver with a time domain display. In addition to the full range dial scale, a 0-11 MHz dial scale provides better tuning resolution at low frequencies.

#### Resolution-Stability

Bandwidths ranging from 10 Hz to 300 kHz may be selected when using an 8553B. Wide bandwidths are useful for measurement of FM or other broadband spectra. The 10 Hz bandwidth allows measurement of 60 Hz sidebands which are greater than 60 dB down from the carrier. Low residual FM due to phase-lock stabilization makes this resolution possible. This low residual FM also permits characterization of oscillator stability.

#### Amplitude Calibration

The 8553B is calibrated for either dBm or Volts over the range  $-142$  dBm (18 nV) to  $+10$  dBm (0.7 V). An accurate amplitude reference is provided by the internal calibrator. This reference together with low frequency response variations ( $\pm 0.5$  dB) make possible accurate measurements of absolute amplitude. Calibrated in-circuit made measurements may be made at frequencies from 100 kHz to 110 MHz when using the 1121A Active Probe with the 8553B.

#### Sensitivity

Low noise figure and 10 Hz bandwidth result in high sensitivity for the 8553B. In a 10 Hz bandwidth signal levels of  $-140$  dBm may be measured. With the addition of a low noise preamp, such as the 8447, sensitivity can be improved by at least 15 dB.

#### 8443A Tracking Generator-Counter

To complement the 8553B, the 8443A Tracking Generator provides a tracking source with a frequency range of 100 kHz to 110 MHz. A built-in counter permits precision frequency measurements and RF attenuators allow precise control of output amplitude.

#### Frequency Accuracy

Frequency measurements with an accuracy of  $\pm 10$  Hz are possible when using an 8443A. In the TRACK ANALYZER mode, the 8443A displays the counted frequency of a tunable marker. The RESTORE mode allows individual signals to be counted in a wide scan without fine tuning.

#### Swept Frequency Measurements

With the 8443A, the 8553B can be used to measure both insertion and return loss over the 100 kHz to 110 MHz frequency range. The excellent stability of the 8443A permits use of the 10 Hz bandwidth, providing a 130 dB dynamic range for swept frequency response measurements. A system (8553B/8443A) frequency response of  $\pm 1.0$  dB insures accurate characterization of DUT frequency response.



## Specifications—with 8552B IF Section

### Frequency Specifications

**Frequency range:** 1 kHz–110 MHz (0–11 MHz and 0–110 MHz tuning ranges).

#### Scan width (on 10-division CRT horizontal axis)

**Per division:** 18 calibrated scan widths from 20 Hz/div to 10 MHz/div in a 1, 2, 5 sequence.

**Preset:** 0–100 MHz, automatically selects 300 kHz bandwidth IF Filter.

**Zero:** analyzer is fixed tuned receiver with selectable bandwidth.

### Frequency Accuracy

**Center frequency accuracy:** the dial indicates the display center frequency within  $\pm 1$  MHz on the 0–110 MHz tuning range;  $\pm 200$  kHz on the 0–11 MHz tuning range with FINE TUNE centered, and temperature range of 20°C to 30°C.

**Scan width accuracy:** scan widths 10 MHz/div to 2 MHz/div and 20 kHz/div to 20 Hz/div: Frequency error between two points on the display is less than  $\pm 3\%$  of the indicated frequency separation between the two points. Scan widths 1 MHz/div to 50 kHz/div: Frequency error between two points on the display is less than  $\pm 10\%$  of the indicated frequency separation.

### Resolution

**Bandwidth:** IF Bandwidths of 10 Hz to 300 kHz are provided in a 1, 3, 10 sequence.

**Bandwidth accuracy:** individual IF bandwidths' 3 dB points calibrated  $\pm 20\%$  (10 kHz bandwidth  $\pm 5\%$ ).

**Bandwidth selectivity:** 60 dB/3 dB IF bandwidth ratios: 10 Hz to 3 kHz bandwidths,  $< 11:1$ , 10 kHz to 300 kHz bandwidths,  $< 20:1$ ; 60 dB points on 10 Hz bandwidth separated by  $< 100$  Hz.

### Stability

**Residual FM stabilized:** sidebands  $> 60$  dB down 50 Hz or more from CW signal, scan time  $\geq 1$  sec/div, 10 Hz bandwidth (typically less than 1 Hz peak-to-peak).

**Residual FM unstabilized:**  $< 1$  kHz peak-to-peak.

**Noise sidebands:** more than 70 dB below CW signal, 50 kHz or more away from signal, with 1 kHz IF bandwidth.

**Long term drift (after 1-hour warm-up),** stabilized: 500 Hz/10 min; unstabilized: 5 kHz/min, 20 kHz/10 min.

### Amplitude Specifications

#### Absolute Amplitude Calibration Range

**Log:** from  $-130$  to  $+10$  dBm, 10 dB/div on a 70 dB display or 2 dB/div on a 16 dB display.

**Linear:** from  $0.1 \mu\text{V/div}$  to  $100 \text{ mV/div}$  in a 1, 2 sequence on an 8-division display.

#### Dynamic Range

**Average noise level:**  $< -110$  dBm with 10 kHz IF bandwidth.

**Video filter:** averages displayed noise; 10 kHz, 100 Hz, and 10 Hz bandwidths.

**Spurious responses:** are below a  $-40$  dBm signal at the input mixer as follows: All image and out-of-band mixing responses, harmonic and intermodulation distortion more than 70 dB down, 2 MHz to 110 MHz; more than 60 dB down, 1 kHz to 2 MHz. Third order intermodulation products more than 70 dB down, 1 kHz to 110 MHz (Signal separation  $> 300$  Hz).

**Residual responses (no signal present at input):** with input attenuation at 0 dB:  $< -110$  dBm (200 kHz to 110 MHz);  $< -95$  dBm (20 kHz to 200 kHz).

#### Amplitude accuracy:

Frequency response  
(Flatness: attenuator  
settings  $> 10$  dB):

1 kHz to 110 MHz

Amplitude Display

Log

Linear

$\pm 0.5$  dB

$\pm 5.8\%$

$\pm 0.25$  dB/dB

$\pm 2.8\%$  of

but not more than  $\pm 1.5$

full 8 div

dB over the full  
70 dB display range

deflection

**Calibrator amplitude:**  $-30$  dBm,  $\pm 0.3$  dB

**Calibrator frequency:** 30 MHz,  $\pm 3$  kHz.

**Log reference level control:** provides 70 dB range (60 dB below 200 kHz), in 10 dB steps. Accurate to  $\pm 0.2$  dB ( $\pm 2.3\%$ , Linear Sensitivity).

**Log reference level vernier:** provides continuous 12 dB range. Accurate to  $\pm 0.1$  dB ( $\pm 1.2\%$ ) in 0,  $-6$ , and  $-12$  dB positions; otherwise  $\pm 0.25$  dB ( $\pm 2.8\%$ ).

**Amplitude measurement accuracy:**  $\pm 1.25$  dB with proper technique.

### General

**Input impedance:** 50  $\Omega$  nominal, BNC connector. Reflection coefficient  $< 0.13$  (1.3 SWR), input attenuator  $\geq 10$  dB. A special 75  $\Omega$  8553B/8552B is available.

**Maximum input level:** peak or average power  $+13$  dBm (1.4 V ac peak),  $\pm 50$  V dc, 1 dB compression point,  $-10$  dBm.

**Scan time:** 16 internal scan rates from 0.1 ms/div to 10 sec/div in a 1, 2, 5 sequence, or manual scan.

#### Scan Mode

**Int:** analyzer repetitively scanned internally.

**Ext:** scan determined by 0 to  $+8$ -volt external signal.

**Manual:** scan determined by front panel control.

**Attenuator:** 0 to 50 dB, in 10 dB increments, coupled to Log Reference Level indicator; automatically maintains absolute calibration. Attenuator accuracy  $\pm 0.2$  dB.

**Power requirements:** 100, 120, 220, or 240 V  $+5\%$ ,  $-10\%$ , 50 to 60 Hz, normally less than 225 watts.

**Weight:** Model 8553B RF Section: net, 5.5 kg (12 lb). Shipping, 7.8 kg (17 lb).

**Size:** 102 H x 226 W x 334 mm D (4" x 8.9" x 13.5").

### Tracking Generator-Counter (8443A)

**Frequency range:** 100 kHz to 110 MHz.

**Amplitude range:**  $< -120$  dBm to  $+10$  dBm in 10 and 1 dB steps with a continuous 1.2 dB vernier.

#### Amplitude Accuracy

**Frequency response (flatness):**  $\pm 0.5$  dB.

**Absolute:** 0 dBm at 30 MHz:  $\pm 0.3$  dB.

**Output impedance:** 50  $\Omega$ , BNC connector, ac coupled, reflection coefficient  $\leq 0.09$  (1.2 SWR) with output  $< 0$  dBm.

#### Counter

**Display:** 7 digits with 1 digit over-range. Reads to  $\pm 10$  Hz increments.

**Resolution (gate time):** 1 kHz (1 ms), 100 Hz (10 ms), 10 Hz (100 ms).

**Accuracy:**  $\pm 1$  count  $\pm$  time base accuracy.

**Time base aging rate:**  $< 3 \times 10^{-9}$ /day (0.3 Hz/day) after warm-up.

**External counter inputs:** 10 kHz to 120 MHz, 50  $\Omega$ ,  $-10$  dBm min.

**Power:** 100, 120, 220, or 240 V  $+5\%$ ,  $-10\%$ , 48 to 440 Hz 75 watts.

**Weight:** Model 8443A: net, 11.04 kg (24.3 lb). Shipping, 14.47 kg (31.9 lb).

**Size:** 88.2 H x 425 W x 467 mm D (3.5" x 16.8" x 18.4").

### Ordering Information

8553B RF Section

8443A Tracking Generator-Counter





# SIGNAL ANALYZERS

## 141T Spectrum Analyzer System: 100 kHz to 1250 MHz

### Models 8554B & 8444A

- High resolution (100 Hz)
- Frequency response  $\pm 1$  dB
- Companion tracking generator
- Optional internal limiter



8554B (141T, 8552B) 8444A

The 8554B RF Section covers the frequency range from 100 kHz to 1250 MHz. This band includes baseband, AM/FM Broadcast, VHF/UHF TV, mobile communications, and VHF/UHF navigation systems. Typical measurements include modulation, intermodulation, harmonics and spurious. Noise power density and carrier to noise ratio can also be measured. The frequency response of filters, amplifiers, mixers or modulators can be measured and displayed when a companion tracking generator is used.

#### Absolute Calibration

Amplitude measurements can be made with an accuracy of  $\pm 2.8$  dB over the range +10 to -122 dBm. This accuracy can be improved to  $\pm 1.75$  dB with IF substitution techniques. The log display mode (dBm) provides a 70 dB calibrated range, while the linear display mode (volts) provides maximum resolution of  $1 \mu\text{V}$  per division. The calibrated reference level (top graticule line) can be set with IF gain to values from +10 to -72 dBm. An UNCAL light warns of control settings which may cause loss of amplitude calibration.

#### Frequency Response

Excellent flatness ( $\pm 1$  dB) insures high accuracies for relative amplitude measurements such as harmonic distortion. Full band sweep allows display of the entire tuning range, 100 kHz to 1250 MHz.

#### Frequency Resolution

Low residual FM allows selection of bandwidths as narrow as 100 Hz. This bandwidth provides the resolution needed to measure close-in sidebands such as those due to power line harmonics or third order

intermodulation distortion. Available bandwidths range from 100 Hz to 300 kHz in a 1, 3, 10 sequence. The filters used are synchronously-tuned which have an excellent response to pulsed signals and permit the lowest sweep time for a given bandwidth.

#### Sensitivity

High sensitivity ( $-122$  dBm/100 Hz) and low spurious ( $-65$  dBc) allow accurate measurements of low level signals such as might be encountered in EMI applications. The sensitivity/spurious performance also provides dynamic range required for signals with large amplitude separation such as intermodulation distortion or incidental AM.

#### Frequency Stabilization

Frequency stabilization reduces residual FM to less than 100 Hz peak-to-peak for scans of 200 kHz or less. The stabilization in narrow scans is implemented by phase-locking the local oscillators to a crystal reference.

#### 8444A Tracking Generator

The 8444A Tracking Generator utilizes the LO's of the 8554B to generate an output signal whose frequency equals the tuned frequency of the 8554B. The tracking generator can provide a swept source for frequency response measurements. The 8444A also provides control of output signal amplitude to prevent overdriving the DUT.

For precise frequency measurements of low level signals, the tracking generator provides a constant amplitude signal which can be used to drive a frequency counter.



## 8554B Specifications—with 8552B IF Section

### Frequency Specifications

**Frequency range:** 100 kHz to 1250 MHz.

**Scan width (on 10-division CRT horizontal axis)**

**Per division:** 15 calibrated scan widths from 100 MHz/div to 2 kHz/div in a 1, 2, 5 sequence.

**Preset:** 0-1250 MHz, automatically selects 300 kHz bandwidth IF filter.

**Zero:** analyzer is fixed-tuned receiver.

### Frequency Accuracy

**Center frequency accuracy:** The dial indicates the display center frequency within 10 MHz.

**Scan width accuracy:** frequency error between two points on the display is less than 10% of the indicated separation.

### Resolution

**Bandwidth:** IF bandwidths of 0.1 to 300 kHz provided in a 1, 3, 10 sequence.

**Bandwidth accuracy:** individual IF bandwidth 3 dB points calibrated to  $\pm 20\%$  (10 kHz bandwidth  $\pm 5\%$ ).

**Bandwidth selectivity:** 60 dB/3 dB IF bandwidth ratio  $< 20:1$  for IF bandwidths from 10 kHz to 200 kHz. 60 dB/3 dB bandwidth ratio  $< 11:1$  for IF bandwidths 100 Hz to 3 kHz.

### Stability (Residual FM)

**Stabilized:**  $< 100$  Hz peak-to-peak.

**Unstabilized:**  $< 10$  kHz peak-to-peak.

**Noise sidebands:** more than 70 dB below CW signal, 30 kHz or more away from signal, with 1 kHz IF bandwidth.

### Amplitude Specifications

#### Absolute Amplitude Calibration Range

**Log:** from  $-122$  to  $+10$  dBm. 10 dB/div on a 70 dB display, or 2 dB/div on a 16 dB display.

**Linear:** from  $0.1 \mu\text{V/div}$  to  $100 \text{ mV/div}$  in a 1, 2 sequence on an 8-division display.

#### Dynamic Range

**Average noise level:**  $< -102$  dBm with 10 kHz IF bandwidth.

**Spurious responses:** All image and out-of-band mixing responses, harmonic and intermodulation distortion products are more than 65 dB below a  $-40$  dBm signal at the input mixer.

**Residual responses (no signal present at input):** with input attenuation at 0 dB:  $< -100$  dBm.

#### Amplitude Accuracy

	Log	Linear
Frequency response (flatness)		
100 kHz to 1250 MHz	$\pm 1$ dB	$\pm 12\%$
Switching between bandwidths (at 25°C)	$\pm 0.5$ dB	$\pm 5.8\%$
Amplitude display	$\pm 0.25$ dB/dB but not more than $\pm 1.5$ dB over the full 70 dB display range.	2.8% of full 8 div deflection

#### Calibrator Output

**Amplitude:**  $-30$  dBm,  $\pm 0.3$  dB.

**Frequency:** 30 MHz,  $\pm 3$  kHz.

**Log reference level control:** provides 70 dB range (60 dB below 200 kHz), in 10 dB steps. Accurate to  $\pm 0.2$  dB ( $\pm 2.3\%$ , Linear Sensitivity).

**Log reference level vernier:** provides continuous 12 dB range. Accurate to  $\pm 0.1$  dB ( $\pm 1.2\%$ ) in 0,  $-6$ , and  $-12$  dB positions; otherwise  $\pm 0.25$  dB ( $\pm 2.8\%$ ).

**Amplitude measurement accuracy:**  $\pm 1.75$  dB with proper technique.

#### RF Input Specifications

**Input impedance:** 50  $\Omega$  nominal. Typical reflection coefficient  $< 0.30$  (1.85 SWR), input attenuator  $\geq 10$  dB.

**Maximum input level:** peak or average power  $+13$  dBm (1.4 V ac peak),  $\pm 50$  V dc.

#### General

**Scan time:** 16 internal scan rates from 0.1 ms/div to 10 sec/div in a 1, 2, 5 sequence, and manual scan.

#### Scan Time Accuracy

**0.1 ms/div to 20 ms/div:**  $\pm 10\%$ .

**50 ms/div to 10 s/div:**  $\pm 20\%$ .

#### Weight

**Model 8554B RF section:** net, 4.7 kg (10.3 lb). Shipping 7.8 kg (17 lb).

**Size:** 102 H x 226 W x 344 mm D (4" x 8.9" x 13.5").

## 8444A Specifications

### Specifications for Swept Frequency Response

#### Measurements

**Dynamic range:**  $> 90$  dB from spectrum analyzer 1 dB gain compression point to average noise level (approximately  $-10$  dBm to  $-100$  dBm). Spurious responses not displayed.

**Gain compression:** for  $-10$  dBm signal level at the input mixer, gain compression  $< 1$  dB.

#### Absolute Amplitude calibration range:

**Tracking generator** (drive level to test device: 0 to  $-10$  dBm continuously variable. 0 dBm absolutely calibrated to  $\pm 0.5$  dB at 30 MHz).

**Frequency range:** 500 kHz to 1250 MHz.

**Frequency resolution:** 1 kHz.

#### Stability

**Residual FM** (peak-to-peak): stabilized,  $< 200$  Hz; unstabilized,  $< 10$  kHz.

#### Amplitude Accuracy

**System Frequency response:**  $\pm 1.50$  dB.

**Tracking generator calibration:** 0 dBm at 30 MHz to  $\pm 0.5$  dB.

### Specifications for Precision Frequency Measurements

**Frequency accuracy:** for unknown signals  $\pm 10$  kHz. (Tracking drift typically 50 kHz/10 min after 2-hour warm-up). For points on frequency response curve, counter accuracy  $\pm$  Residual FM (200 Hz).

#### Counter Mode of Operation

**Manual scan:** scan determined either by front panel control of 8552B IF Section or by external scan signal provided by the 8444A.

**Zero scan:** analyzer is fixed-tuned receiver. Counter reads center frequency to accuracy of tracking drift.

**Counter output level:** typically 0.1 V rms.

### Specifications for Sweep/CW Generator

**Frequency:** controlled by spectrum analyzer. Range 500 kHz to 1250 MHz with 8554B. Scan widths are as enumerated on this page.

**Frequency accuracy:**  $\pm 10$  MHz using spectrum analyzer tuning dial. Can be substantially improved using external counter output.

**Flatness:**  $\pm 0.5$  dB.

#### Spectral Purity

**Residual FM** (peak-to-peak): 200 Hz.

**Harmonic distortion:** 25 dB below output level (typical).

**Nonharmonic (spurious) signals:**  $> 35$  dB below output level.

**Long term stability:** drift typically less than 30 kHz/hour when stabilized after 2-hour warm-up.

**Sweep width:** 20 kHz to 1000 MHz.

**Sweep rates:** selected by Scan Time per Division on spectrum analyzer.

#### General

**Temperature range:** operation,  $0^\circ\text{C}$  to  $55^\circ\text{C}$ , storage  $-40^\circ\text{C}$  to  $75^\circ\text{C}$ .

**EMI:** conducted and radiated interference is in compliance with MIL-STD 461A Methods CE03 and RE02 and CISPR publication 11 (1975).

**Power:** 115 V and 230 V, 48 to 440 Hz, 12 watts max.

**Weight:** net, 7.1 kg (15.6 lb). Shipping, 9.5 kg (21 lb).

**Size:** 88.2 H x 425 W x 467 mm D (3.5" x 16.8" x 18.4").

#### Ordering Information

**8554B RF Section**

**Opt 003:** Internal Limiter

**8444A Tracking Generator**

# SIGNAL ANALYZERS

141T Spectrum Analyzer System: 10 MHz to 40 GHz

Models 8555A, 8444A Option 059 & 8445B

- 10 MHz to 18 GHz, external mixing to 40 GHz
- High sensitivity ( $-125$  dBm)
- 100 Hz resolution
- Companion tracking generator to 1.5 GHz

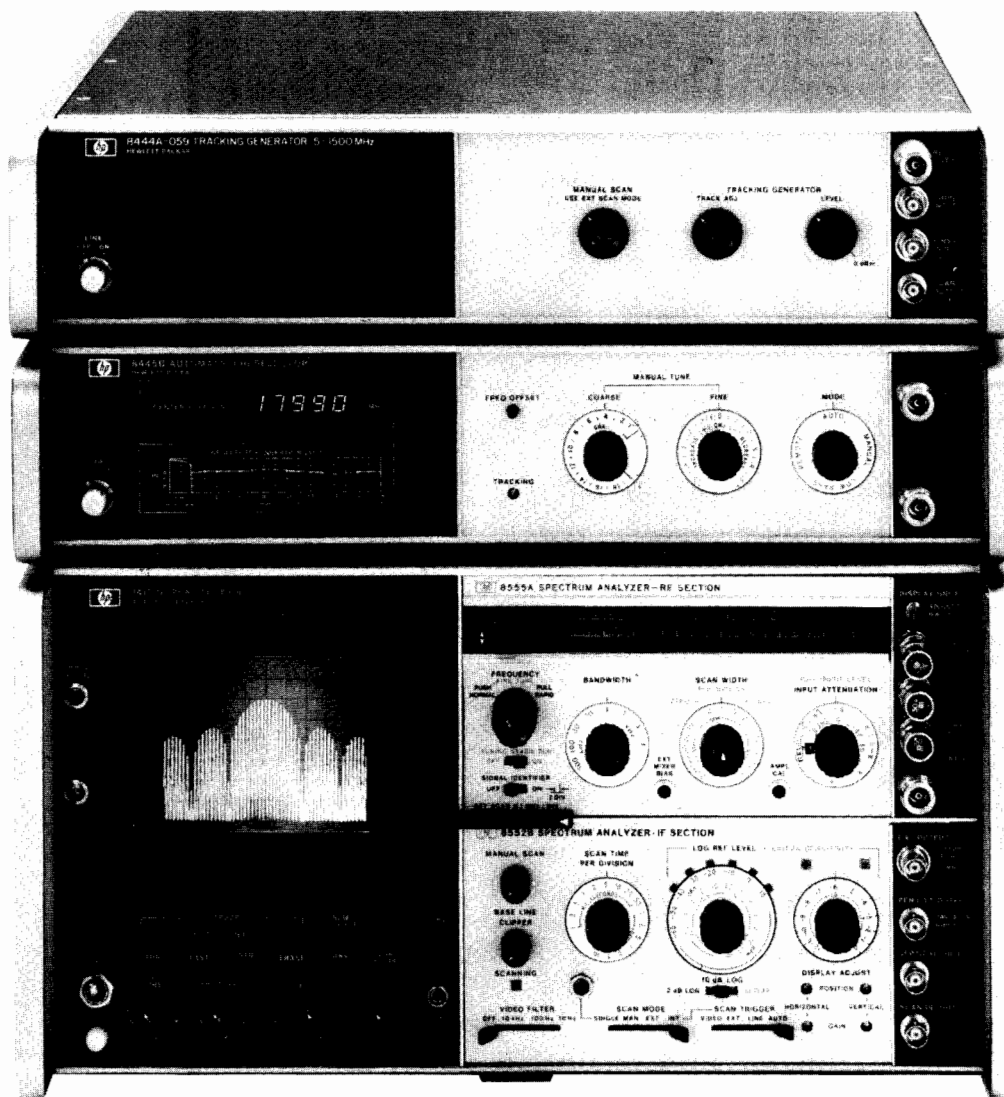

8555A (141T, 8552B) 8444A Opt 059, 8445B

The 8555A Tuning Section offers multiband coverage from 10 MHz to 18 GHz. The range can be extended to 40 GHz with the 11517A external waveguide mixer. The 8555A provides high sensitivity ( $-125$  dBm), high resolution (100 Hz) and frequency scans as wide as 8 GHz. The 8555A is well suited for measurements necessary during both the design and production phases of microwave devices and systems.

### Amplitude Calibration

Absolute amplitude calibration permits accurate amplitude measurements over the range from  $+10$  to  $-125$  dBm. The exceptional flatness of the 8555A, which is  $\pm 2$  dB at 18 GHz, enhances the accuracy of relative power measurements.

### High Sensitivity

With the 100 Hz bandwidth selected, the sensitivity of the 8555A is  $-125$  dBm in the fundamental mixing band and  $-100$  dBm in the 4th harmonic band. This sensitivity permits measurements of low level signals. When these signals are close to the noise floor, a video filter of 10 kHz, 100 Hz or 10 Hz can be selected to improve discernability of the signal.

### High Resolution/ Stability

The low residual FM of the 8555A ( $<100$  Hz p-p) allows a 100 Hz bandwidth to be selected which permits the user to resolve sidebands due to low frequency modulations. The stability of the 8555A also allows measurement of the spectral purity of a DUT.



### 8445B Tracking Preselector

The 8445B Tracking Preselector contains a YIG filter which tracks the tuned frequency of the analyzer over the range 1.8 to 18 GHz. The preselector suppresses the image and multiple responses which result from harmonic mixing. The preselector can also reduce distortion and increase dynamic range when signal separation exceeds the preselector bandwidth. For tuned frequencies below 1.8 GHz, a low pass filter prevents image and multiple responses.

An optional LED display provides a readout of marker frequency with 1 MHz resolution.

### 8444A Option 059 Tracking Generator

The tracking generator provides a leveled, calibrated signal output with a frequency equal to the tuned frequency of the 8555A. This enables swept frequency tests such as insertion loss and return loss at frequencies up to 1500 MHz. With the addition of an external frequency counter, precise measurement of frequency is possible.

## 8555A Specifications—with 8552B IF Section

### Frequency Specifications

**Frequency range:** 0.01–40 GHz.

### Tuning Range

**With internal mixer:** 0.01–18.0 GHz.

**With external mixer:** 12.4–40 GHz.

### Harmonic Mixing Mode

**Signal identification:** not normally required with preselector. Signal identifier provided for positive identification of all responses. Rejection of images and multiple responses with preselector is >70 dB.

### Scan Width

**Full scan:** the width of the scan depends on mixing mode. Scan width =  $n \times 2000$  MHz, where  $n$  is the mixing mode; e.g. for  $n = 2$ , scan width is 4 GHz. Maximum scan width full screen is 8 GHz with coaxial mixer. Preselector necessary to make wide scans usable.

**Per division:** 16 calibrated scan widths from 2 kHz/div to 200 MHz/div in a 2, 5, 10 sequence.

**Zero scan:** analyzer becomes fixed-tuned receiver.

### Frequency Accuracy

**Dial accuracy:**  $n \times (\pm 15 \text{ MHz})$  where  $n$  is the mixing mode.

**Scan accuracy:** frequency error between two points on the display is less than  $\pm 10\%$  of the indicated separation.

**Stability:** residual FM stabilized <100 Hz peak-to-peak (fundamental mixing).

**Noise sidebands:** for fundamental mixing. More than 70 dB below CW signal 30 kHz or more away from signal, with 1 kHz IF bandwidth and 100 Hz video filter.

### Frequency Drift

**Long term drift:** at fixed center frequency after 2-hour warm-up (Typical).

**Stabilized:**  $\pm 3.0 \text{ kHz}/10 \text{ min.}$

**Unstabilized:**  $\pm 25 \text{ kHz}/10 \text{ min.}$

**Stabilization range:** first LO can be automatically stabilized to internal crystal reference for scan widths of 100 kHz/div or less.

### Resolution

**Bandwidth range:** selectable 3 dB bandwidths from 100 Hz to 300 kHz in a 1, 3, 10 sequence.

**Bandwidth shape:** approximately gaussian.

**Bandwidth selectivity:** 11:1 to 20:1 (60 dB/3 dB).

**Bandwidth accuracy:** individual IF bandwidth 3 dB points calibrated to  $\pm 20\%$  (10 kHz bandwidth,  $\pm 5\%$ ).

## Amplitude Specifications

### Measurement Range

**Log reference level:** from  $-60 \text{ dBm}$  to  $+10 \text{ dBm}$ .

**Linear sensitivity:** from  $0.1 \mu\text{V}/\text{div}$  to  $100 \text{ mV}/\text{div}$ .

## Sensitivity and frequency response with internal coaxial mixer noise level: specified for 1 kHz bandwidth.

**Frequency response** with 10 dB input attenuator setting:

Frequency Range (GHz)	Mixing Mode (n)	Average Noise Level (dBm max.)	Frequency Response* (dB max.)
0.01-2.05	1-	-115	$\pm 1.0$
1.50-3.55	1-	-117	$\pm 1.0$
2.07-6.15	2-	-108	$\pm 1.3$
2.60-4.65	1+	-117	$\pm 1.0$
4.11-6.15	1+	-115	$\pm 1.0$
4.13-10.25	3-	-103	$\pm 1.5$
6.17-10.25	2+	-105	$\pm 1.5$
6.19-14.35	4-	-95	$\pm 2.0$
8.23-14.35	3+	-100	$\pm 2.0$
10.29-18.00	4+	-90	$\pm 2.0$

\*Includes mixer frequency response, RF attenuator frequency response, mixing mode gain variation, RF input VSWR.

## Sensitivity and frequency response with 11517A external waveguide mixer and appropriate waveguide tapers

**Average noise level** 10 kHz bandwidth (dBm typical):

Frequency Range (GHz)	Mixing Mode (n)	Average Noise Level (dBm)
12.4-18.0	6-	-90
18.0-26.5	6+	-85
26.5-40.0	10+	-75

**Frequency response:** typically  $\pm 3 \text{ dB}$  over 1 GHz frequency scans.  
**Residual responses:** referred to input on fundamental mixing: <  $-90 \text{ dBm}$ .

### Display Range

**Log:** 70 dB, 10 dB/div and 2 dB/div, expanded on a 16 dB display.

**Linear:** from  $0.1 \mu\text{V}/\text{div}$  to  $100 \text{ mV}/\text{div}$  in a 1, 2, sequence on an 8-division display.

## Spurious responses due to second harmonic distortion with preselector:

Frequency Range	Power Incident on Input Mixer	2nd Harmonic Distortion
0.01-1.85 GHz	-40 dBm	-63 dB
1.85-18.0 GHz	0 dBm	-100 dB

## Spurious responses due to third order intermodulation distortion with preselector

Frequency Range	Signal Separation	Power Incident on Input Mixer	Third Order Intermodulation Distortion
0.01-18.0 GHz	>1 MHz <20 MHz	-30 dBm	-70 dB
0.01-1.85 GHz	>70 MHz	-30 dBm	-70 dB
1.85-18.0 GHz	>70 MHz	0 dBm	-100 dB

**Video filter:** post detection filter used to average displayed noise. Nominal bandwidths: 10 kHz, 100 Hz, and 10 Hz.

**Gain compression:** for internal mixer gain compression <1 dB for  $-10 \text{ dBm}$  peak or average signal level to input mixer. 11517A External Mixer (12.4-40 GHz) gain compression <1 dB for  $-15 \text{ dBm}$  peak or average signal level to input mixer.

## Amplitude Accuracy

**IF gain variation with different bandwidth settings:** (at  $20^\circ\text{C}$ .)

**Log:**  $\pm 0.5 \text{ dB}$ .

**Linear:**  $\pm 5.8\%$

# SIGNAL ANALYZERS

## 141T Spectrum Analyzer System: 10 MHz to 40 GHz

Models 8555A, 8444A & 8445B (Cont'd)

### Amplitude Display

**Log:**  $\pm 0.25$  dB/dB, but not more than  $\pm 1.5$  dB over the full 70 dB display range.

**Linear:**  $\pm 2.8\%$  of full 8-division deflection.

**Log reference level:** accurate to  $\pm 0.2$  dB ( $\pm 2.3\%$  linear sensitivity).

**Log reference level vernier:** accurate to  $\pm 0.1$  dB (1.2%) in 0, -6, and -12 dB positions; otherwise,  $\pm 0.25$  dB ( $\pm 2.8\%$ ).

**Input attenuator range:** 0-50 dB in 10 dB steps, manual safety lock-out for 0 dB position.

**Frequency response:** typically  $\pm 0.6$  dB from 10 MHz to 18 GHz.

**Calibrator output:** amplitude -30 dBm,  $\pm 0.3$  dB. Frequency 30 MHz  $\pm 3$  kHz.

**Absolute calibration accuracy:** overall accuracy is a function of measurement technique. With the appropriate technique, absolute accuracy of  $\pm 1.6$  dB (fundamental mixing) and  $\pm 2.6$  dB (4th harmonic mixing) is achievable.

### Input Characteristics

**Input impedance:** 50 ohms nominal (0.01-18 GHz).

**Reflection coefficient:**  $< 0.130$  (1.30 SWR) for input RF attenuator settings  $\geq 10$  dB.

**Maximum input level:** peak or average power +13 dBm (1.0 V ac rms) incident on mixer (+30 dBm with Opt 002), +33 dBm incident on input attenuator.

**RF input connector:** type N female.

**LO emission:** -10 dBm without preselector, -80 dBm with preselector over recommended operating ranges (10 dB input attenuator setting).

### General

**Scan time:** 16 internal scan rates from 0.1 ms/div to 10 sec/div in a 1, 2, 5 sequence.

**Power requirements:** 100, 120, 220 240 V +5%, -10%, 50-60 Hz, normally less than 225 watts (varies with plug-in units used).

**Weight:** net, 16.8 kg (14.9 lb). Shipping, 8.7 kg (19 lb).

**Size:** 102 H x 226 W x 344 mm D (4" x 8.9" x 13.5").

### Specifications with Option 002;

#### Internal Limiter Installed

All specifications are the same as for the standard unit except the following:

**Frequency range:** 0.1-12.4 GHz, usable over 0.01-18 GHz range.

#### Maximum Input Level

**Continuous:** 1 W (+30 dBm).

**Pulse:** 75 watts peak, pulse width  $\leq 1$   $\mu$ s, 0.001 duty cycle.

**Reflection coefficient:**  $< 0.33$  (2.0 SWR).

**Frequency response (flatness):**  $< \pm 0.5$  dB degradation in response, 0.1-12.4 GHz.

### 8445B Tracking Preselector

#### Frequency Specifications

**Frequency range:** dc-1.8 GHz low-pass filter. 1.8-18 GHz tracking filter.

**Tracking filter 3 dB bandwidth:** typically 20-45 MHz.

**Tracking filter skirt roll-off:** characteristics of a three-pole filter. (Nominal: 18 dB/octave.)

#### Insertion Loss

	Frequency	Insertion Loss (Except Opt. 004)	Insertion Loss (Opt. 004)
Low-Pass Filter	DC-1.8 GHz	$< 2.5$ dB	*
	@2.05 GHz	$> 50$ dB	*
Tracking Filter	1.8-12 GHz	$< 8$ dB	$< 7$ dB
	12-18 GHz	$< 10$ dB	$< 8$ dB

\*Low-Pass Filter deleted with Opt 004.

### Typical preselector minimum insertion loss at 25°C.

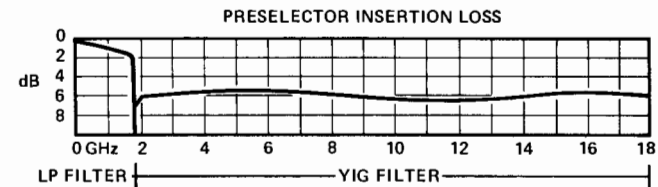

**Out-of-band rejection:** for YIG filter 1 GHz from center of pass-band  $> 70$  dB.

### Digital frequency readout (Option 003):

#### Function:

**Full scan mode:** displays frequency at inverted marker.

**Per division scan.** displays center frequency.

**Manual or remote operation of preselector:** displays tuned frequency of filter.

**Resolution:** 1 MHz.

**Accuracy:** 0.01-1.0 GHz:  $\pm 6$  MHz.

1.0-4.0 GHz:  $\pm 8$  MHz.

4.0-18 GHz:  $\pm 0.2\%$

### Input Specifications

**Input connector:** precision Type N female.

**Input VSWR:** typically  $< 2.0$  (1.8-18 GHz).

**Limiting level:** (maximum input level for  $< 1$  dB signal compression),  $> +5$  dBm.

**Damage level:**  $> +20$  dBm.

### General

**Remote function:** YIG filter frequency can be set by externally supplied voltage.

**Power requirements:** 100, 120, 220, or 240 V +5%, -10%, 48 to 440 Hz, less than 110 watts.

**Weight:** net, 8.8 kg (19.5 lb). Shipping, 11.9 kg (26 lb).

**Size:** 88.2 H x 425 W x 467 mm D (3.5" x 16.8" x 18.4").

### 8444A Opt 059 Tracking Generator

**Frequency range:** 0.5 MHz to 1500 MHz.

**Frequency resolution:** 1 kHz.

**Residual FM (peak-to-peak):** 200 Hz (stabilized).

#### Amplitude Range

**Spectrum analyzer display:** from -130 dBm to +10 dBm, 10 dB/div on a 70 dB display or 2 dB/div on a 16 dB display (8552B only).

**Tracking generator (drive level to test device):** 0 to -10 dBm continuously variable.

#### Amplitude Accuracy

**System frequency response:**  $\pm 2.7$  dB.

**Tracking generator calibration:** 0 dBm at 30 MHz to  $\pm 0.5$  dB.

**Dynamic range:**  $> 90$  dB.

**Counter output:** typically 0.1 V rms.

### General

**Power:** 115 V and 230 V, 48 to 440 Hz, 12 watts max.

**Weight:** net, 7.1 kg (15.6 lb). Shipping, 9.5 kg (21 lb).

**Size:** 85.2 H x 425 W x 467 mm D (3.5" x 16.8" x 18.4").

### Ordering Information

8555A Tuning Section

Opt 001: APC-7 connectors

Opt 002: Internal limiter

Opt 005: Video tape

8445B Tracking Preselector, dc -18GHz

Opt 001: APC-7 connectors

Opt 002: Add manual controls

Opt 003: Add digital frequency readout

Opt 004: Delete low-pass filter

Opt 005: Delete interconnect rigid coax

8444A Opt 059 Tracking Generator

11517A External Mixer (taper section req'd)

11518A Taper Section, 12.4 to 18 GHz

11519A Taper Section, 18 to 26.5 GHz

11520A Taper Section, 26.5 to 40 GHz

# SIGNAL ANALYZERS

## Spectrum Analyzer Accessories

Models 8750A, 8447 Series, 11694A & 1121A



11694A

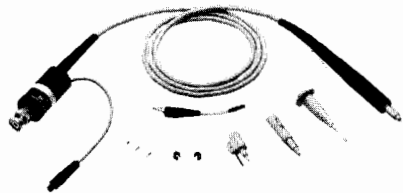

1121A

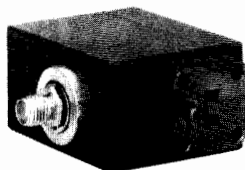

11517A



11693A



11867A

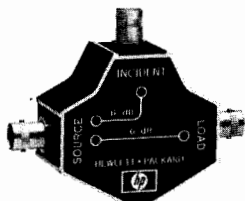

8721A

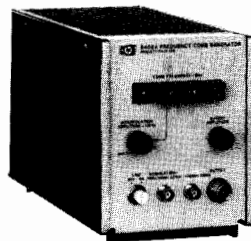

8406A

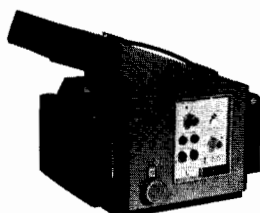

197B

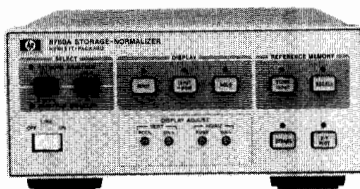

8750A

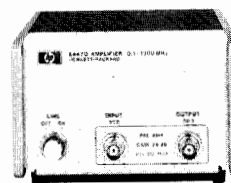

8447 Series

### 8750A Storage-Normalizer

The 8750A is directly compatible with the HP 8557A, 8558B, 8559A, and 8565A Spectrum Analyzers, as well as most HP network analyzers, and requires a conventional low-frequency oscilloscope to be used with the 140 series analyzers. (See page 449).

### 8447 Series Amplifiers (0.1-1300 MHz)

The 8447 Series Amplifiers feature low noise and wide bandwidth. This makes them ideal for improving spectrum analyzer sensitivity and noise figure while providing input isolation. Accurate measurements over a wide frequency range are assured due to the broad frequency coverage, flat frequency response and low distortion of these amplifiers. (See page 54).

### 11694A 75 $\Omega$ Matching Transformer (3-500 MHz)

Allows measurement in 75-ohm systems while retaining amplitude calibration. VSWR is less than 1.2, and insertion loss is less than 0.75 dB. Note: Also see Options 001 and 002 for 75  $\Omega$  versions of 8557A and 8558B.

### 1121A Active Probe (0.1-500 MHz)

Provides high impedance ( $> 100$  k $\Omega$  shunted by  $< 3$  pF) input to spectrum analyzer for measurements on sensitive circuits. Probe power is supplied by most HP Spectrum Analyzers and flat response with unity gain assures accurate, convenient measurements. (See page 447).

### 11517A External Mixer

To extend the frequency range of the 8555A, 8565A and 8566A analyzers to 40 GHz (for use with 8566A, order 11517A, Opt E02). Taper sections for 12.4-18 GHz (11518A), 18-26.5 GHz (11519A) or 26.5-40 GHz (11520A) bands are required.

### 11693A Limiter (0.1-12.4 GHz)

The Model 11693A Limiter provides input protection for a variety of instruments in general applications (usable from 0.01 to 18 GHz). For example, the input circuits of spectrum analyzers, samplers, or amplifiers may be protected for inputs up to 75 watts peak or 1 watt average power. Also, signal generators can be protected from application of reverse power.

### 11867A RF Limiter (DC-1800 MHz)

The 11867A is a general purpose diode limiter designed to provide input protection from inadvertent strong signal overloads. Absolute amplitude calibration is maintained with flatness degraded  $< \pm 0.25$  dB and insertion loss  $< 0.75$  dB. 10 watts average or 100 watts peak power can be tolerated.

### 8721A Directional Bridge

For making return loss measurements from 100 kHz to 110 MHz. (See page 447 under "11652A: Directional Bridge").

### 8406A Frequency Comb Generator

Produces frequency markers at 1, 10, and 100 MHz increments accurate to  $\pm 0.01\%$ . External oscillator can be used to generate precision interpolation sidebands. Comb is usable to beyond 5 GHz.

### 197B Oscilloscope Camera

For a permanent record of your measurements. (See page 213 for necessary adapters).

### Ordering Information

- 11694A 75  $\Omega$  Matching Transformer
- 11517A External Mixer (Mixer only)
- 11518A/11519A/11520A Waveguide Taper Sections
- 11693A Limiter
- 11867A RF Limiter
- 8406A Frequency Comb Generator
- 8750A Storage-Normalizer

# SIGNAL ANALYZERS

## 5 Hz to 50 kHz Spectrum Analyzer

### Model 3580A

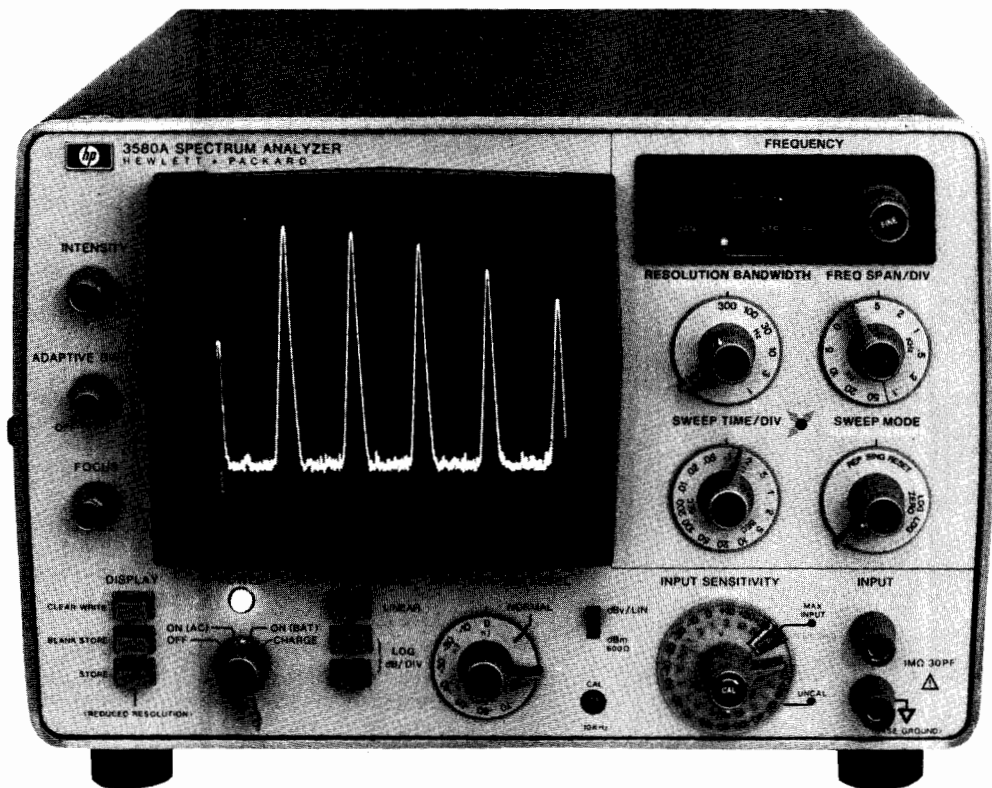

Hewlett Packard's 3580A Spectrum Analyzer is a low frequency high performance analyzer. Its 1 Hz bandwidth allows the user to examine noise and extraneous signal content close in to a signal of interest.

For low frequency applications where sweep speeds can be slow and time-consuming, a special feature, adaptive sweep, allows the user to set a threshold above which only the spectra of interest are observed. In this mode, the CRT is rapidly swept. When a signal is encountered, the sweep slows down to reproduce full response. A factor of ten speed gain is possible.

Digital storage is another important feature which enhances the display for slowly swept low frequency signals. The analyzed signals are digitized and stored in memory. Trace information is then read from memory at a rate appropriate for obtaining an analog-like display.

#### Digital Storage for Spectra Comparison

Digital storage makes it possible to store one or two traces. When two are stored, both may be simultaneously displayed for easy comparison as shown below.

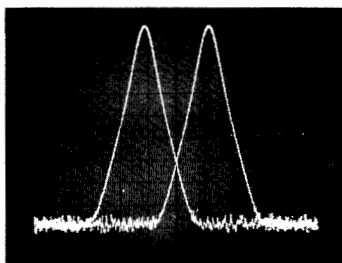

#### Adaptive Sweep

A tremendous savings in sweep time can be achieved by using adaptive sweep. In the left trace below, over 80 dB of dynamic range is used to look at low level signals and noise. Two hundred seconds were required to make the sweep. In the right trace, the baseline is raised to give 50 dB of dynamic range. Noise and other responses are not analyzed so the sweep now takes only 14 seconds.

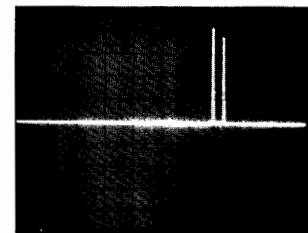
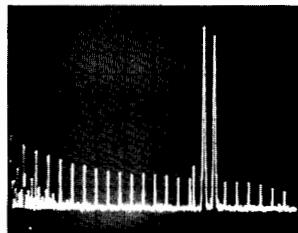

#### 1 Hz Bandwidth

When using a 1 Hz bandwidth 60 Hz line related spectra are clearly exposed as shown in the left trace. An analysis of the same signal with a 10 Hz bandwidth will not resolve the line related spectra as shown on the right.

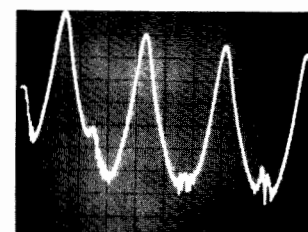
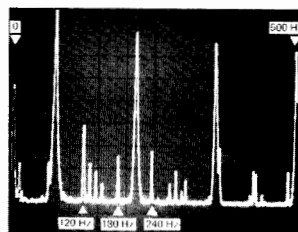

# SIGNAL ANALYZERS

## 5 Hz to 50 kHz Spectrum Analyzer (Cont.)

Model 3580A



### Digital Frequency Display

This display provides 1 Hz resolution for setting analysis range and for determining tuned frequency. In the automatic sweep modes, the sweep start or center frequency is displayed. In the manual sweep mode, actual tuned frequency is indicated. This mode effectively provides a cursor function for easy and accurate determination of the frequency at any point on the screen.

### Internal Calibration Signal

A 10 kHz pulse derived from a crystal can be used to compensate for internal errors. A 10 kHz calibration potentiometer is provided so the 10 kHz fundamental can be adjusted to fall on the top line of the display. With this feature, operation and calibration can be verified for most of the instrument.

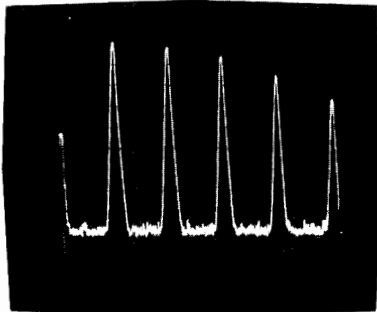

## Specifications

### Frequency Characteristics

**Range:** 5 Hz to 50 kHz.

**Digital Frequency Display:**

**Resolution:** 1 Hz

**Accuracy:**  $\pm 3.5$  Hz, 0 to 55°C.

**Typical stability:**  $\pm 10$  Hz/hr after 1 hour;  $\pm 5$  Hz/°C.

**Bandwidths:**  
(accuracy  $\pm 15\%$ )

1 Hz (25°C $\pm 5^\circ$ C)	3 Hz	10 Hz	30 Hz	100 Hz	300 Hz
Shape factor:					8

**Out of range blank:** if controls are set so portions of displayed signal lie below 0 Hz or above 50 kHz, the baseline is displayed.

### Amplitude Characteristics

#### Overall instrument range:

Linear: 20 V –100 nV full scale  
Log: +30 dBm or dB V;  
–150 dBm or dB V

#### Amplitude accuracy:

	Log	Linear
Frequency response:		
20 Hz–20 kHz	$\pm .3$ dB	$\pm 3\%$
5 Hz–50 kHz	$\pm .5$ dB	$\pm 5\%$
Switching between bandwidths (25°C):		
3 Hz–300 Hz	$\pm .5$ dB	$\pm 5\%$
1 Hz–300 Hz	$\pm 1$ dB	$\pm 10\%$
Amplitude display	$\pm 2$ dB	$\pm 2\%$
Input attenuator	$\pm .3$ dB	$\pm 3\%$
Amplitude reference level: (IF attenuator)		
Most sensitive range	$\pm 1$ dB	$\pm 10\%$
All other ranges	$\pm 1$ dB	$\pm 3\%$

**Dynamic range:** 80 dB

**IF feedthru:** input level  $> 10$  V,  $-60$  dB;  $< 10$  V,  $-70$  dB.

**Spurious responses:**  $> 80$  dB below input reference level.

**Smoothing:** 3 positions, rolloff is a function of bandwidth.

**Overload indicator:** this LED indicator warns of possible input amplifier overloading. Without this indication it would be possible to introduce spurious responses without knowing it.

### Sweep Characteristics

**Scan width:** 50 Hz to 50 kHz.

**Log sweep:** 20 Hz to 43 kHz  $\pm 20\%$  after 3 sweeps.

**Sweep times:** .1 sec to 2000 sec.

**Rep:** Repetitive sweeps over the specified band.

**Reset:** Resets to the beginning of the sweep—used to adjust start or center frequency.

**Manual:** in combination with the concentric knob, manual sweep fully duplicates the span of the electronic sweep.

**Adaptive sweep:** when in adaptive sweep below the threshold level, scan speed is 20 to 25 times faster. Threshold is adjustable to cover 0–60% of screen. Signals greater than about 6 dB above threshold are detected and swept slowly.

**Sweep error light:** this LED indicates a sweep that is too fast to capture full response. When the light is on, response can be  $> 5\%$  lower than it should.

**Zero scan:** to look at the time varying signal at the center or start frequency within the bandwidth selected, the zero scan is used.

### Output Characteristics

**Tracking generator output:** (also known as BFO or tracking oscillator output).

**Range:** 0 to 1 V rms into 600  $\Omega$ .

**Frequency response:**  $\pm 3\%$ , 5 Hz to 50 kHz.

**Impedance:** 600  $\Omega$ .

**Total harmonic and spurious content:** 40 dB below 1 volt signal level.

### X-Y Recorder Analog Outputs

**Vertical:** 0 to +5 V  $\pm 2.5\%$ .

**Horizontal:** 0 to +5 V  $\pm 2.5\%$ .

**Impedance:** 1 k $\Omega$ .

**Pen lift:** contact closure to ground during sweep.

**Size:** 203.2 mm H x 412.8 mm W x 285.8 mm D (8" x 16 1/4" x 11 1/4").

**Weight:** net, 12.25 kg (27 lb); 3580A Opt 001: net, 15.88 kg (35 lb).

**Temperature range:** 0°C to 55°C.

**Power:** 100 V, 120 V, 220 V, or 240 V  $+5\%$   $-10\%$ . 48 to 440 Hz, 35 VA max.

**Opt 001 battery:** 5 hours from full charge. 14 hours to fully recharge. The internal battery is protected from deep discharge by an automatic turn off. Useful life of batteries is over 100 cycles.

### Ordering Information

#### 3580A Spectrum Analyzer

**Opt 001:** internal rechargeable battery

**Opt 002:** balanced input

**Opt 003:** rack mount





# SIGNAL ANALYZERS

Dual-Channel, Dynamic Signal Analyzer 0.02 Hz to 25.5 kHz

Model 3582A

- Transfer function magnitude and phase measurements
- Coherence function measurement
- Phase spectrum measurement
- Transient capture and frequency domain analysis
- Internal periodic and random noise source
- Band selectable analysis for 0.02 Hz resolution
- Alphanumeric CRT annotation and marker readout

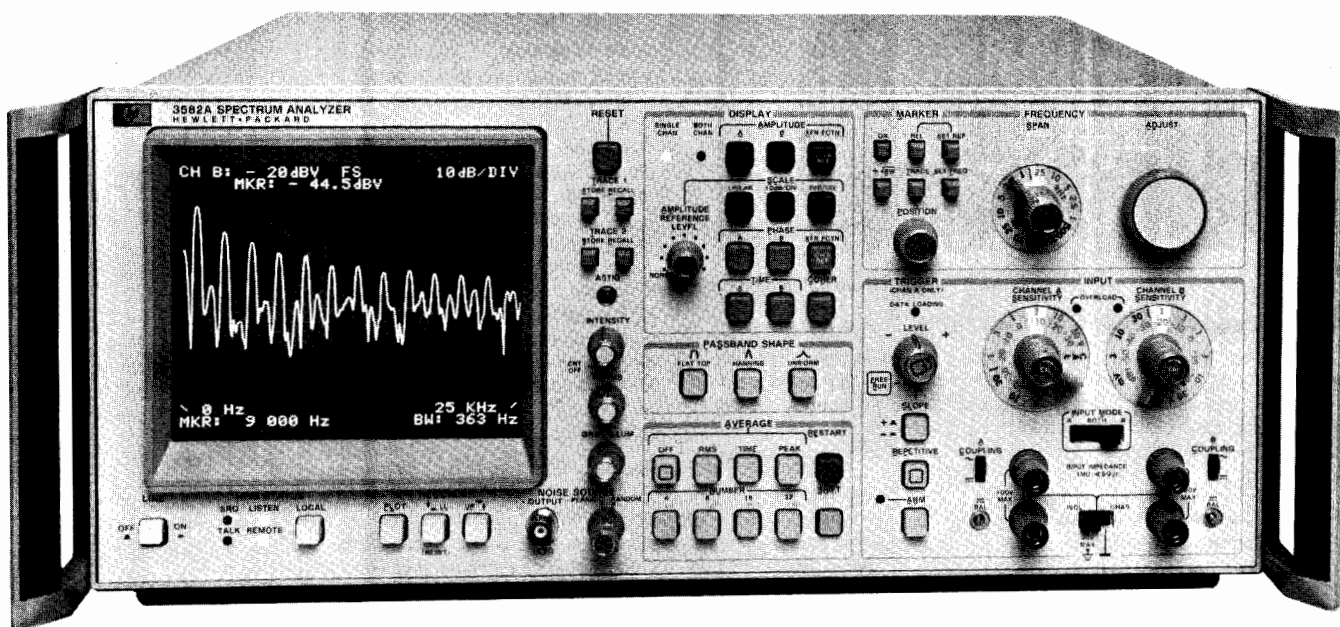

## Description

The 3582A is a powerful dual-channel, real-time spectrum analyzer that solves bench or systems measurement problems in the frequency range of 0.02 Hz to 25.599 kHz. Sophisticated LSI digital filtering combined with microcomputer execution of the Fast Fourier Transform (FFT) provides exceptional measurement capability and performance.

## Exceptional Frequency Resolution

The ability to resolve closely spaced spectral components is often critical in the study of subtle phenomena such as structural transfer functions. Unlike conventional dynamic signal analysis which extends from DC to some maximum frequency, the Model 3582A can "zoom in" to analyze any selected band of frequencies with dramatically improved resolution. The start or center frequency of the 5 Hz to 25 kHz band analysis spans can be adjusted in 1 Hz increments to cover the entire frequency range of the instrument. This provides resolution down to 20 milliHertz across the entire range for spectrum analysis or 40 milliHertz for transfer functions, representing as much as 5000 to 1 improvement over conventional "baseband" analysis.

## Excellent Low Frequency Coverage

Many electrical and physical measurements have significant spectral information in the audio and sub-audio range. With frequency ranges from 25 kHz down to 1 Hz full scale, the Model 3582A is extremely well suited to these types of measurements. The display shown in fig. 1 represents the phase noise of a frequency synthesizer over the range of 0 to 1 Hz with a frequency resolution of 6 milliHertz.

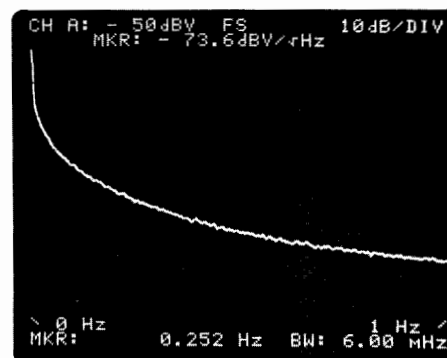

Figure 1: Phase Noise Measurement

## Real Time Measurement Speed

Long measurement times can be a major limitation of swept low frequency spectrum analyzers. In high volume testing or in applications requiring substantial on-line tuning these long measurement times are both expensive and inconvenient. Since the Model 3582A uses an advanced microcomputer to execute the Fast Fourier Transform (FFT), it can perform equivalent measurements as much as one to two orders of magnitude faster than a swept analyzer.

### Wide Amplitude Range

When examining the sensitivity of an analyzer, it is important to consider the full range of potential applications. If the analyzer does not directly cover the range of anticipated signals, external amplifiers or attenuators will be required. These devices can add their own noise and can distort the signal being measured. The Model 3582A offers 150 dB of calibrated measurement range covering +30 dBV (31.6 volts) to -120 dBV (1  $\mu$ volt) and thus minimizes the need for external signal conditioning. Even with input sensitivities down to -120 dBV the input circuit is fully protected against accidental overloads of 100 Volts DC or 120 Volts RMS for short periods.

### Wide Dynamic Range

In many applications the information of interest is contained not in the high amplitude fundamental, but rather in the low amplitude components. For a spectrum analyzer to provide useful information about these low level components in the presence of a large signal, it must offer wide dynamic range. The Model 3582A dynamic range is specified as 70 dB.

### Phase Spectrum Measurement

Most spectrum analyzers can measure only the amplitude spectrum of a signal, yet complete characterization in the frequency domain also requires phase information. Signals with identical amplitude spectra, but different phase spectra can differ significantly. The advanced digital signal processing techniques incorporated in the Model 3582A provide direct measurement of phase spectra.

### Transient Capture and Analysis

Many signals such as mechanical shocks and electrical transients may occur infrequently and spontaneously and may last only for a brief period of time. Swept spectrum analyzers generally cannot handle these transient signals. By using digital processing techniques, the Model 3582A can capture and analyze transients as short as a few milliseconds. This means that spectrum analysis and transfer function analysis are no longer limited to stable, time invariant signals.

### Transfer Function Measurement With the Internal Noise Source

Many electrical circuits and mechanical systems can be treated as linear networks and can be characterized by the magnitude and phase of their transfer functions.

Most spectrum analyzers can measure only the magnitude portion of the transfer function—and even then only by assuming a flat drive signal. The Model 3582A directly measures the complete transfer function, both magnitude and phase. With dual channels the actual drive signal is measured on Channel A and thus does not have to be totally flat; drive signal variations are taken out in the computation process to give valid results. The major constraint on the input signal is that, unlike a swept source, it must stimulate all frequencies of interest simultaneously. Two sources are provided in the Model 3582A which meet this constraint. They are pseudo-random and random noise. For linear networks, the pseudo-random noise source gives you accurate results in the fastest theoretically possible time. When non-

Figure 2: Capture and analyze transients.

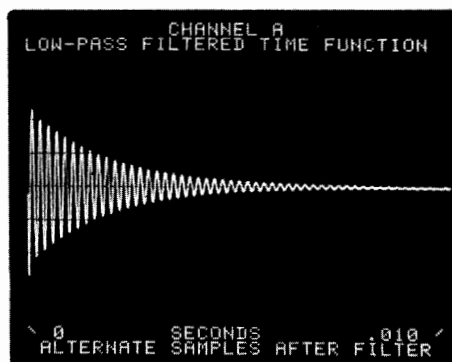

linearities are a problem, random noise gives the best estimate of the transfer function at the operating point. In addition, both noise sources are bandlimited to concentrate all stimulus energy in the band of frequencies analyzed. This minimizes test time because it improves the signal to noise ratio of the measurements. This also minimizes the disturbance to the network under test, which can be very important in control applications.

With this drive signal functioning as a "tracking generator" substitute, the Model 3582A is a low frequency network analyzer with "real-time" measurement speed. As with spectrum measurements, portions of the transfer function as narrow as 5 Hz can be examined anywhere over the 25 kHz frequency range.

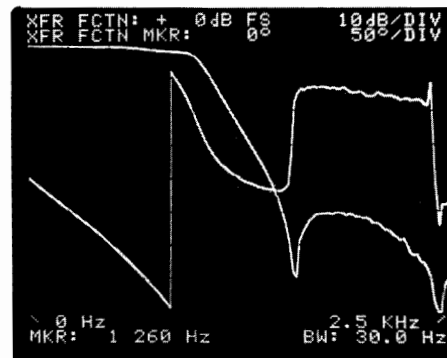

Figure 3: Filter Transfer Function

### Coherence Function Measurement

The measurement of a device transfer function assumes that the device under test is linear and that no portion of the output is caused by noise or extraneous signal sources. In active electronic circuits or mechanical structures these conditions can easily be violated - yet such violations are very difficult to identify. The Model 3582A considerably simplifies this problem by providing the direct measurement of the coherence function. This is a frequency domain measure of the fraction of the power in one signal (e.g., the output) caused by the other measured signal (e.g., the input). If this fraction is 1.0, the output at that frequency is caused by the input and the transfer function is valid. If the fraction is near 0.0, the output is caused by something other than the measured input. This cause could be noise, non-linearities or an unanticipated input, but the result is the same - the transfer function data at that frequency is suspect.

In addition to serving as a valuable check on the validity of transfer functions, the coherence function can be useful when investigating cause/effect relationships particularly in multiple input systems.

### Powerful Marker Operations

The intensified dot marker is a major operational convenience. When active, the frequency and corresponding amplitude, phase or coherence value of the dot, are displayed alphanumerically on the display. Since the results are calibrated, there is no need to go through the time consuming, error-prone process of visually interpreting display points.

For operations such as determining frequency and amplitude separation, the marker can read out in units relative to a previous marker setting which was defined as a reference point.

When making band analysis measurements, the marker can be used in place of the frequency adjust control to define a new start or center analysis frequency.

# SIGNAL ANALYZERS

Dual-Channel, Dynamic Signal Analyzer 0.02 Hz to 25.5 kHz

Model 3582A (cont.)

## Digital Averaging Capability

Many spectral measurements contain both discrete signals and random noise components. Obtaining proper amplitude readings can be difficult if the random components are really the ones of interest or are of nearly the same amplitude as the discrete signals.

The digital averaging techniques incorporated in the Model 3582A help solve these problems. The RMS averaging mode takes the power average of 4 to 256 successive spectra in order to reduce the uncertainty of the estimate of random spectral components. For measurements where the spectral information is not stable but varies slowly with time, a running exponential form of RMS averaging is provided. By continually reducing the importance of older spectra, this mode prevents old data from completely obscuring new data yet still retains the basic advantages of averaging.

When a synchronizing trigger signal is available, the TIME average can enhance the signal-to-noise ratio by as much as 24 dB. Since it involves the averaging of successive time records before transformation it is also significantly faster than other types of averaging.

## Powerful HP-IB Capability

The Hewlett-Packard Interface Bus (HP-IB) is an interface concept that allows two-way communication among as many as fifteen different devices. Generally, at least one of these devices is a "computing controller" which exercises overall system control. This controller directs and coordinates the activities of the other devices in the system.

All major front panel controls with the exception of the verniers are fully programmable via the HP-IB. The programming codes are simple and are logically derived from the front panel control labels. The states of the various controls occupy only ten 8-bit bytes of data that can be read and written by the HP-IB. This allows you to manually set up a test from the front panel and store it in a compact form.

From the HP-IB it is a simple matter to command the Model 3582A to output results in a usable form. Not only can the various control settings be retrieved, but numeric marker data can be extracted. More importantly, the full display can be read in ASCII format along with complete annotation.

The HP-IB structure is entirely flexible, allowing any of the RAM (random access memory) in the instrument to be read or written into. This means that intermediate computational results such as the cross power spectrum can be read by a computing controller. In applications where speed is critical, the controller can transfer the displayed traces in binary, direct from the RAM.

## 3582A Specifications

### Frequency

**Range:** 0.02 Hz to 25.5 kHz with the low frequency limit the result of DC response.

**Spans:** 1 Hz to 25 kHz in a 1-2.5-5-10 sequence. The 1 Hz and 2.5 Hz spans are usable only in the 0-start mode.

**Accuracy:**  $\pm 0.003\%$  of display center frequency.

**Resolution:** 0.4% of the frequency span for single channel or 0.8% of the frequency span for dual channels.

### Filter passband shape:

	Flat Top	Hanning	Uniform
3 dB Bandwidth (single channel)	$(1.4 \pm 0.1\%$ of span)	$(0.58 \pm 0.05\%$ of span)	$(0.35 \pm 0.02\%$ of span)
Shape Factor	$2.6 \pm 0.1$	$9.1 \pm 0.2$	$716 \pm 20$

### Amplitude

#### Display modes:

**Log:** 10 dB/division or 2 dB/division

**Linear:** Constant voltage/division

#### Measurement range:

**Log:** +30 dBV to -120 dBV noise floor

**Linear:** +30 V to 1  $\mu$ V noise floor

**Dynamic range:** 70 dB

**DC response:** Adjustable to >40 dB below maximum input level

#### Accuracy:

**Accuracy at the Passband Center**  $\pm 0.5$  dB

**Flat top filter:** +0, -0.1 dB

**Hanning filter:** +0, -1.5 dB

**Uniform filter:** +0, -4.0 dB

**Note:** Overall accuracy is the sum of the accuracy at the passband center plus the selected filter accuracy.

#### Resolution:

**Log:** 0.1 dB

**Linear:** 3 digits

#### Phase

**Display range:** +200 degrees to -200 degrees

**Accuracy:**  $\pm 10$  degrees

**Resolution:** 1 degree

#### Transfer Function

##### Measurement range:

**Log:** +160 dB full scale to -80 dB full scale

**Linear:**  $4 \times 10^8$  full scale to  $4 \times 10^{-8}$  full scale

**Phase display range:** +200 degrees to -200 degrees

##### Accuracy:

Amplitude	0.4 dB	0.8 dB
$\phi$	$\pm 2^\circ$	$\pm 5^\circ$
	.02 Hz	5 kHz
		25.5 kHz

## Coherence

**Measurement range:** 0.0 bottom display line to 1.0 top display line

**Resolution:** 0.01

## Input

**Impedance:**  $10^6 \Omega \pm 5\%$  shunted by <60 pF from input high to low (for less than 75% relative humidity)

**Isolation:** Input low may be floated up to 30V

**Coupling:** Switch selection of AC or DC coupling. The low frequency 3 dB roll off is <1 Hz.

#### Common mode rejection:

**50 Hz:** >60 dB

**60 Hz:** >58 dB

**Crosstalk:** <-140 dB between channels with 1 k $\Omega$  source impedance driving one channel and the other terminated in 1 k $\Omega$ .

## Output

#### X-Y recorder:

**Level:** 0V to 5.25 V  $\pm 5\%$

**Impedance:** 1 k $\Omega$

**Pen lift:** contact closure during sweep

#### Noise source:

**Type:** Periodic pseudorandom noise or random noise signal with switch selection. Both are band limited and band translated to match the analysis.

**Level:** From <10 mV to >500 mV RMS into >50  $\Omega$

**Impedance:** <2  $\Omega$

## General

#### Environmental:

**Temperature:** 0°C to 55°C operating; -40°C to +75°C storage

**Humidity:** <95% R.H. 0°C to 40°C

**Power requirements:** 100, 120, 220, or 240 volts (+5%, -10%); 48-66 Hz; less than 150 VA

#### Dimensions

**Size:** 425.5 W x 552.5 D x 188 mmH (16.75" x 21.75" x 7.4")

**Weight:** 24.5 kg (54 lbs.); shipping weight: 29 kg (63 lbs.)

## 3582A Spectrum Analyzer

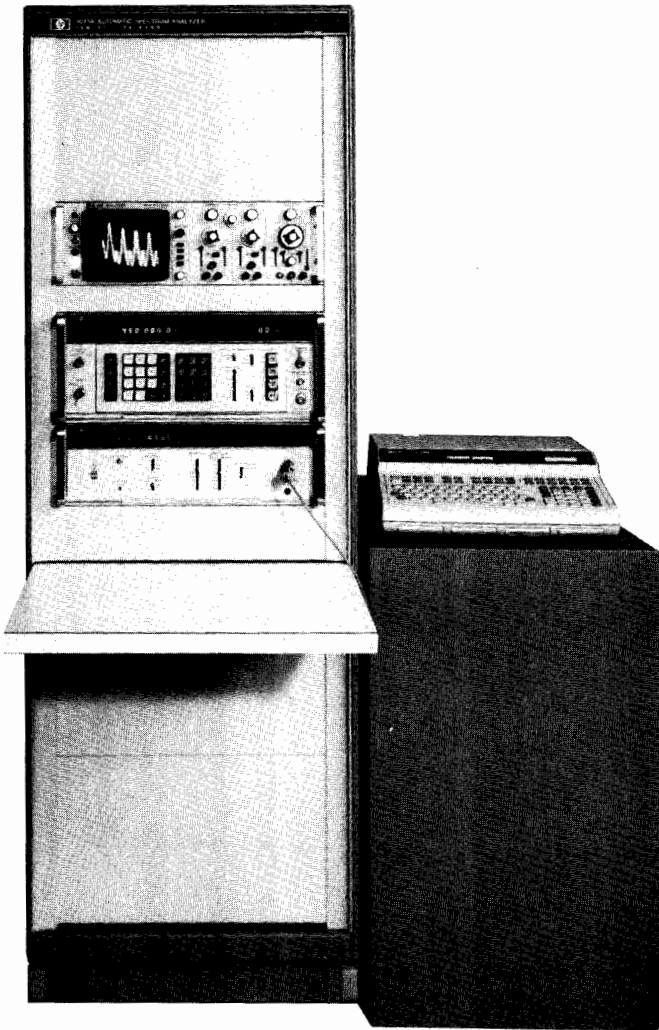

### Description

#### 3044A Spectrum Analyzer

Meeting the demand for precise frequency and amplitude measurements in the 10 Hz to 13 MHz region, the 3044A is a spectrum analyzer with tracking generator. This system uses a synthesizer with leveled output and sweep capability to generate the local oscillator signal for the analyzer and the tracking generator output. This allows fast, extremely accurate "tuning" with the use of frequency up-down keys or keyboard entry of center frequency. The input impedance is front-panel switch selectable to 50 $\Omega$ , 75 $\Omega$ , and 1 M $\Omega$ . The units of the digital display are also front-panel selectable to dBm, dBV and dB relative to a user-entered offset. Digital display of amplitude and frequency gives an unambiguous, high-resolution readout commensurate with the wide dynamic range and high accuracy of this analyzer.

#### 3045A Automatic Spectrum Analyzer

While the 3044A is an excellent stand-alone spectrum analyzer, the capabilities are greatly improved with the addition of the 9825T Desktop Computer, which forms the 3045A system.

The 9825T Desktop Computer allows program and data storage on its fast tape cassette. The tape cassette, short calculation times and

#### 3044A

- High accuracy and resolution digital amplitude measurements
- Synthesizer frequency accuracy and stability
- Wide amplitude range of 150 dB
- Narrow band analysis
- Full digital control via HP-IB

buffered input/output speed allow repeated, automated tests which can greatly reduce production and quality-assurance test times. Also the scope of possible measurements greatly increase with the 3045A System. Logarithmic sweeps and limit tests are only two examples. The calculator also allows data manipulation and presentation in units familiar to the system operator in graphic or tabular form.

The 3045A Automatic Spectrum Analyzer system is fully integrated, tested, verified and specified as a system. It is supplied with complete software and documentation.

#### Accurate and Repeatable Results

Whether the spectrum analysis environment is the R & D lab, production test or Q.A., the prime requirement is almost always for test results that are both accurate and repeatable, and easily and quickly acquired. The 3044A/3045A systems meet all of these testing requirements. The analyzer with its synthesized source offers drift-free performance with high accuracy. Because the system is fully programmable, a controller such as a Desktop Computer can set analyzer RF and IF gains, bandwidths, sweepwidths, etc.—operations that would be time consuming and error-prone with a manual system. Results are thus very repeatable and a highly trained operator is not required.

#### High Resolution and Wide Dynamic Range

The spectrum analyzer systems offer 0.1 Hz tuning resolution and 0.01 dB amplitude resolution. The high resolution display, combined with the analyzer's wide 80 dB dynamic range, allows accurate measurement of signal peaks and spurious responses in one sweep. The analyzer also features a large amplitude range of 150 dB (+10 dBV to -140 dBV), making it suitable for a wide range of applications.

#### Presentation of Results

Using the 9825T Desktop Computer, the 3045A system offers a variety of formats for data presentation—from a simple pass/fail indication on the computer's alphanumeric display to more complete presentations on a wide range of HP-IB printers and plotters.

#### 3044A/3045A Options

The basic 3044A and 3045A system options are listed below. For more information refer to the 3044A/3045A data sheet.

##### 3044A Options

- 110:** Standard 3571A
- 120:** Standard 50  $\Omega$  3330B w/Isol. HP-IB
- 121:** Standard 75  $\Omega$  3330B w/Isol. HP-IB
- 122:** 5 V Output

#### Ordering Information

**3045A** Automatic Spectrum Analyzer consisting of: 3330B Synthesizer; 3571A Spectrum Analyzer; 9825T Desktop Computer, 64 kbytes memory; ROMs, Interface, documentation; 56" Rack.

##### 3045A Options

- 200:** 50  $\Omega$  System
- 201:** 75  $\Omega$  System

# SIGNAL ANALYZERS

## Automated Spectrum Analysis

### Model 3047A Spectrum Analyzer System

Calibrated, Automatic Measurement of

- Phase noise
- Amplitude noise
- Spurious signals
- Close-in sidebands



The HP 3047A Spectrum Analyzer System combines the speed and millihertz resolution of Fast Fourier Transform (FFT) Spectrum Analysis with the frequency range of Swept Spectrum Analysis. This unique measurement combination is joined with the powerful computational and control capabilities of a desktop computer to give a wide variety of calibrated spectrum analyzer measurements, including phase noise.

#### Phase Noise Measurements

When used with the 3047A, the term phase noise includes all forms of frequency and phase instability. Frequency and phase noise as well as undesired modulation like power-line phase modulation and phase jitter are included in the term and can be measured by the 3047A Spectrum Analyzer System.

The complexity of phase noise measurements increases with increasing source performance. For relatively noisy sources, the noise can be measured directly on an existing spectrum analyzer. However, for many sources this measurement is not sensitive enough. If the spectrum analyzer is preceded by a frequency discriminator or phase detector, the system sensitivity can be increased at the cost of additional measurement hardware. The Phase Noise Measurement Mode of the 3047A is designed to reduce the difficulty of making accurate phase noise measurements with either the frequency discriminator or quadrature phase detector techniques.

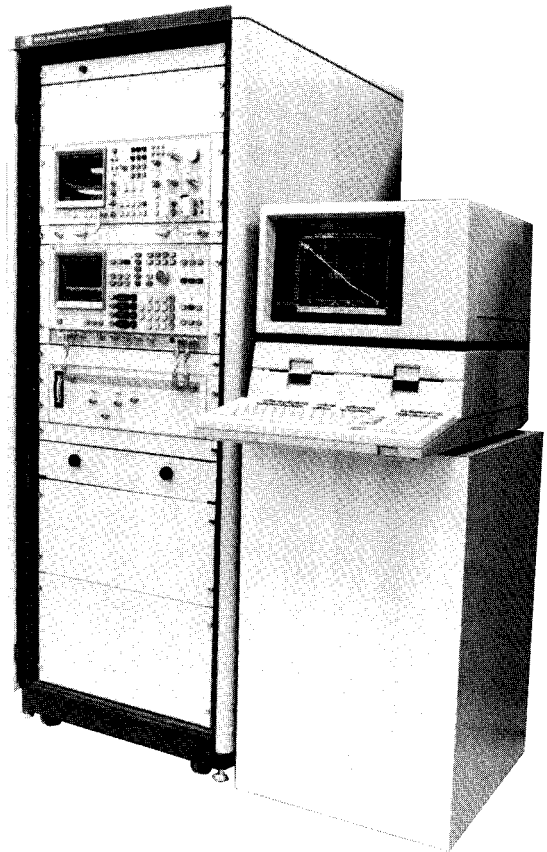

9836A-based 3047A system

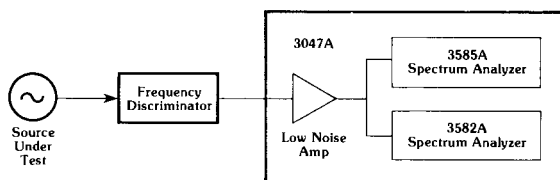

#### Frequency Discriminator Method

##### Frequency Discriminator

With the 3047A, fully calibrated measurements are possible with user-supplied frequency discriminators. The 3047A software gives instructions for setting up an input signal of known characteristics, and then calibrates the system (plus discriminator) as a whole. Overall accuracy is an excellent  $\pm 2$  dB. Although this approach does not optimize sensitivity or bandwidth, it is simple, which makes it quite attractive for a number of applications.

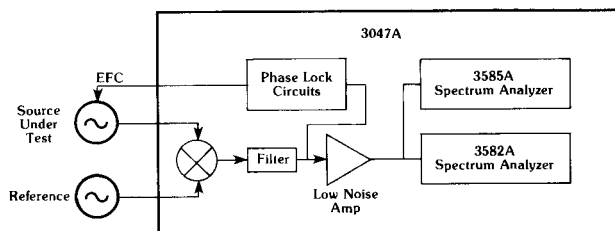

#### Phase Detector Method

#### Quadrature Phase Detector

This phase detection scheme offers the dual benefits of high sensitivity and broad band operation. Until now, these benefits were difficult to realize, due to the need to set up and characterize a phase locked loop. Thanks to the power of the 9836A (or 9845B) desktop computer, these procedures are now fully automated. After the user has connected his unknown and reference sources to the 3047A, system software establishes the phase locked loop, fully characterizes it and performs all the calculations involved in producing a fully calibrated measurement. Accuracy is again  $\pm 2$  db.

#### Phase Noise Measurement Mode—Abbreviated Specifications

##### Phase Detector Inputs

Carrier Frequency Range: 5 MHz to 18 GHz in two ranges

	Frequency Range	Return Loss	Isolation
Low Frequency Inputs:	5 MHz to 1.6 GHz	5 dB (3.5 VSWR)	15 dB
High Frequency Inputs: (may be deleted with Option 110)	1.2 GHz to 18 GHz	5 dB (3.5 VSWR)	15 dB

(The frequency range can be extended with customer supplied mixer or frequency discriminator)

### Single Sideband Phase Noise

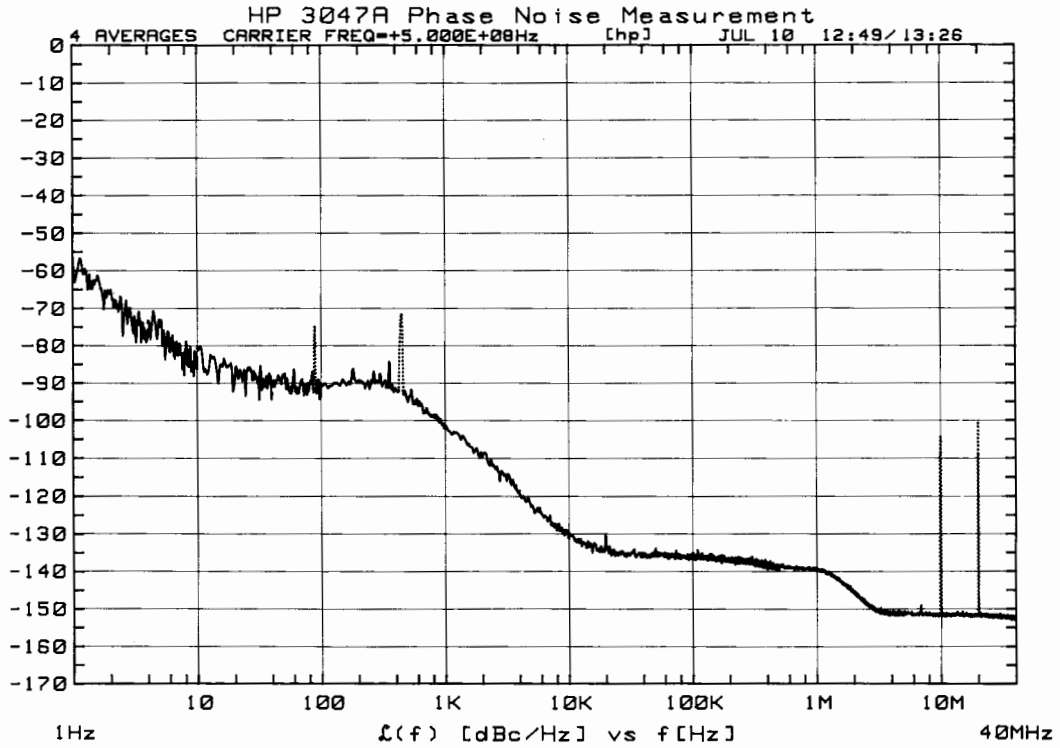

### Amplitude

	5 MHz-1.6 GHz		1.2 GHz-18 GHz	
	L input	R input	L input	R input
Maximum Signal Level (dBm)	+23	+23	+10	+10
Minimum Signal	+15	-5	+7	+0

**Signal Input Port** (for use with external phase detector or frequency discriminator)

Frequency Range: 0.02 Hz to 40.1 MHz  
 Input Impedance: 50  $\Omega$ , Return Loss 9.5 db (2:1 VSWR)  
 Max Amplitude: 1 Volt peak  
 Spurious Signals:  $< -100$  dBm

### Accuracy

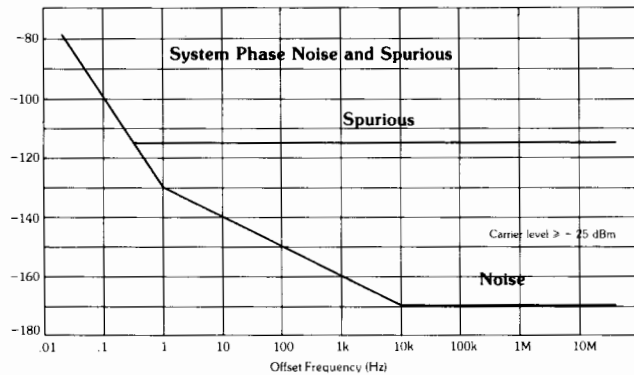
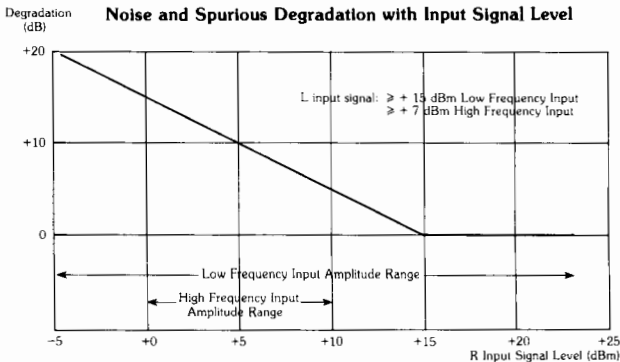
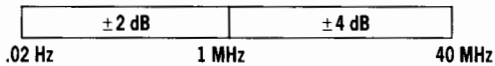

Accuracy: External phase detector measurements or frequency discriminator measurements calibrated with  $\pm 1$  dB accurate signals

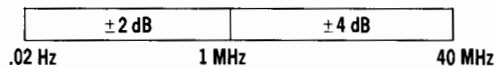



# SIGNAL ANALYZERS

## Automated Spectrum Analysis

### Model 3047A Spectrum Analyzer System

#### Direct Spectrum Mode

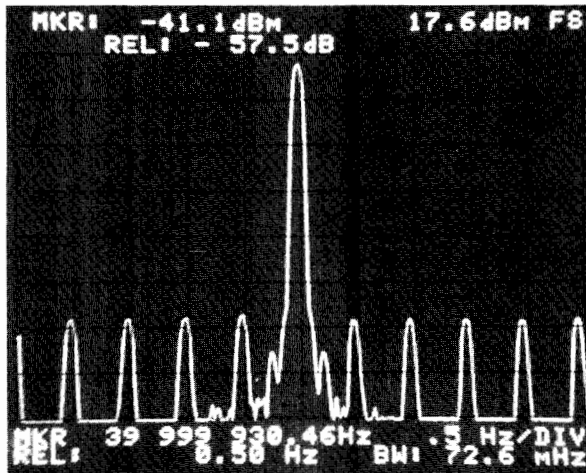

Direct spectrum measurement with 0.072 Hz bandwidth)

In the Direct Spectrum Mode the system hardware is used as a down converter to bring 19 kHz to 40 MHz signals into the frequency range of the 3582A Real Time Spectrum Analyzer. This allows the very high resolution and measurement speed of the Real Time Spectrum Analyzer to be used up to 40 MHz. In this mode the system is capable of resolution bandwidths as narrow as 0.02 Hz and is one to two orders of magnitude faster than a swept spectrum analyzer. The system provides these measurements over the wide dynamic range of 70 dB, calibrated in both frequency and amplitude.

#### Noise Sideband Mode

While the 3047A can measure very high quality sources in the Phase Noise Mode, moderate performance sources can be measured more easily in the Noise Sideband Mode. In this mode the system measures both AM and PM noise without additional hardware. The system software connects the 3047A input to the 3585A and the output of the analyzer is fed into an internal phase detector. The output of the detector is connected to the 3582A Analyzer and the phase noise measured over the .02 Hz to 25 kHz range. In addition, a second detector is provided which outputs the AM noise of the signal to the second channel of the 3582A Analyzer.

Sources with noise greater than the 3585A Spectrum Analyzer's local oscillators are very easy to measure with 3047A in this mode. The source under test is just connected to the 3047A and the measurement is run. There is no need for a high quality reference or for a frequency discriminator.

#### Ordering Information

**HP 3047A** Spectrum Analyzer System

(specify one controller option per system)

**Option 036:** 9836A Based System

**Option 045:** 9845B Based System  
(specify one power line voltage option per system)

**Option 300:** 100 V Line Operation

**Option 320:** 120 V Line Operation

**Option 330:** 220 V Line Operation

**Option 340:** 240 V Line Operation

(miscellaneous options)

**Option 110:** Delete 1-18 GHz input

**Option 207:** Expand 9845B memory to 1 Mbyte

(3047A System Training must be ordered with each system)

**HP3047A + 24A System Training**

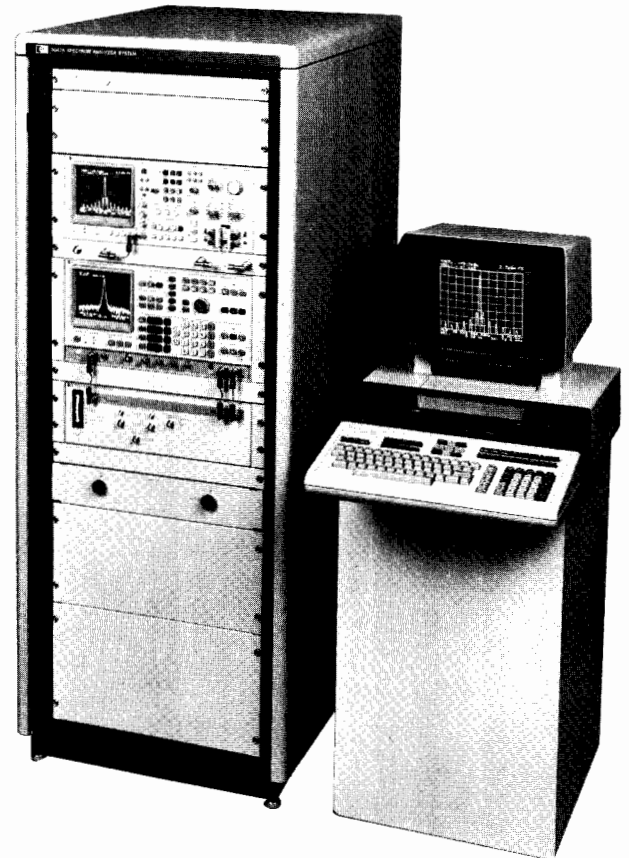

9845B-based 3047A System

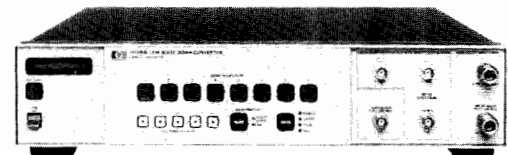

11729A/B Low Noise Downconverter

The most sensitive methods for measuring phase noise require two signal sources; the device under test and a reference source. This reference must be of the same frequency as the unknown, and must be of equal or better noise performance. As the state-of-the-art in low noise microwave sources advances, the problem of finding a suitable reference becomes acute.

The 11729A/B Low Noise Downconverter solves this problem for a great many applications. When driven with a low noise signal source such as the HP 8662A Synthesized Signal Generator, it can provide tuneable reference signals from 5 MHz to 18 GHz. Phase noise is typically as low as  $-123$  dBc/Hz at 1 kHz offset from a 10 GHz carrier.

In addition to providing low noise reference signals for complete systems such as the 3047A, the 11729A/B and 8662A can also form the basis for smaller, custom-built systems. With built-in capabilities for phase locking, output signal conditioning and loop bandwidth selection, the instrument can provide phase noise output spectra suitable for display on low frequency spectrum analyzers such as the 3582A.

Model 11729B provides multiband operation under full HP-IB control, as well as an optional AM noise detector.

# SIGNAL ANALYZERS

Digital Signal Analyzers

Models 5420B and 5423A

515



- Dual-channel transfer function
- Band-selectable analysis
- Fully calibrated annotated display

- Powerful post-measurement processing
- Digital data storage
- Band limited random noise generator with burst mode



5423A



The 5420B Digital Signal Analyzer and 5423A Structural Dynamics Analyzer are high performance dual-channel instruments capable of a number of both time domain and frequency domain measurements over a 25 kHz range. In addition to broad measurement capability, the 5423A Structural Dynamics Analyzer provides complete facilities for analyzing the vibration characteristics of mechanical devices and displaying the results in the form of an animated mode shape. Both instruments are particularly adapted to solving problems associated with structural vibration and noise, rotating machinery, electro-mechanical control systems, acoustics and a host of similar applications which call for advanced low-frequency analysis.

Among the important standard features are a fully annotated and calibrated dual-trace display, permanent digital storage for measurement results, band selectable analysis, extensive data processing, advanced triggering capability, external sampling capability, calibration in engineering units and a built-in band-limited random noise generator with a new burst random mode. Capable of both stimulus-response and response only analysis, their measurement repertoire includes:

- Transfer Function
- Coherence Function
- Impulse Response
- Auto Spectrum
- Cross Spectrum
- Linear Spectrum
- Time Record
- Amplitude Histogram
- Auto Correlation
- Cross Correlation

Important capabilities such as independent pre and post trigger delay on each input channel, overlap processing, and external sampling insure that each instrument's measurement power can be effectively applied to a wide range of problems.

A built-in "waveform calculator" is useful for processing measured or synthesized data and greatly extends the basic capabilities. Examples of useful computed functions include:

- Data Comparisons
- Resonant Frequency
- % Critical Damping
- Open Loop Gain
- Calibration in %
- Mechanical Impedance
- Total Harmonic Distortion
- Coherent Output Power
- Signal-to-Noise Ratio
- Transmissibility
- Function Synthesis
- Power

## Operation

Operation of a digital signal analyzer has never been easier. A novel "menu" concept replaces the rotary and toggle switches commonly used to control an instrument's operation. The entire current set-up state, including measurement type, bandwidth, input ranges, etc., is displayed on the CRT at the push of a key. Changes to the set-up are made by selection from displayed lists (menus) or by direct numerical input from the control keyboard.

Once set-up, measurements are easily executed and may be paused or continued at will. Results are always fully calibrated and annotated. A self-test feature verifies proper operation.

## Data Display

Both the 5420B and the 5423A feature a fully annotated and calibrated, dual trace, three-format display which provides for ease of data interpretation. Each display trace is totally independent of the other in terms of the data which the user selects for display, the horizontal and vertical ranges over which it is displayed, and the coordinate system chosen. The user may select from up to 13 available coordinate systems, including complex plots such as Nyquist, at the push of a key. Display traces may be viewed one at a time in full format or simultaneously in either an upper/lower or overlaid format.

Dual X and Y axis cursors provide numerical data readout, in either absolute or relative terms, on both axes simultaneously in full format. Any area of the display may be graphically expanded for optimum viewing. Cursors may be either swept or set explicitly, via numerical entry, to desired locations. Harmonic cursors are provided. The X axis cursors may also be used to set the frequency range over which the instrument will operate, thereby concentrating its resolution into the bandwidth of interest.

The display section also contains a digital recorder which provides permanent storage of measurement results on small removable tape cartridges and eliminates the need to repeat time consuming and expensive testing. Stored measurements may be easily recalled for display, plotting, or further processing.

### SETUP STATE

MEASUREMENT :	TRANSFER FUNCTION			
AVERAGE :	25	.	STABLE	
SIGNAL :	RANDOM			
TRIGGER :	FREE RUN	.	CHNL 1	
CENT FREQ :	2.0000 KHZ			
BANDWIDTH :	800.000 HZ			
TIME LENGTH :	320.000 $\mu$ S			
AF :	3.12500 HZ		$\Delta$ T :	625.000 $\mu$ S
ADC CHNL	RANGE	AC/DC	DELAY	CAL (C1/C2)
1	5 V	AC	0.0 S	33.3333
* 2	10 V	DC	10.0000 S	20.0000



# SIGNAL ANALYZERS

## Digital Signal Analyzers (cont.)

### Models 5420B and 5423A

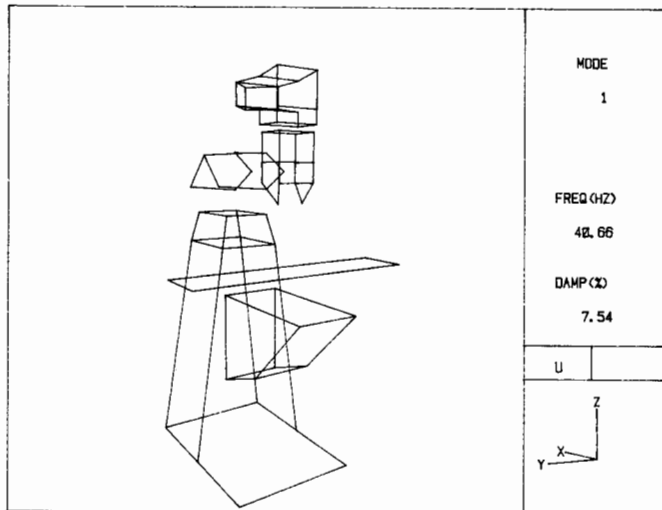
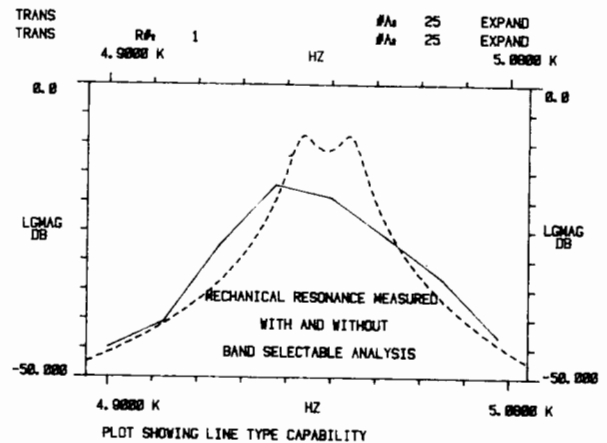
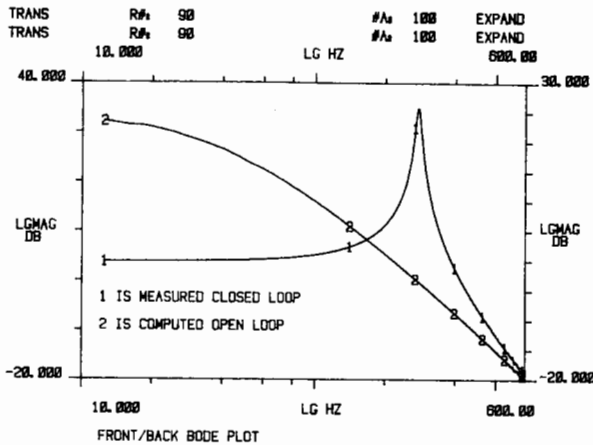
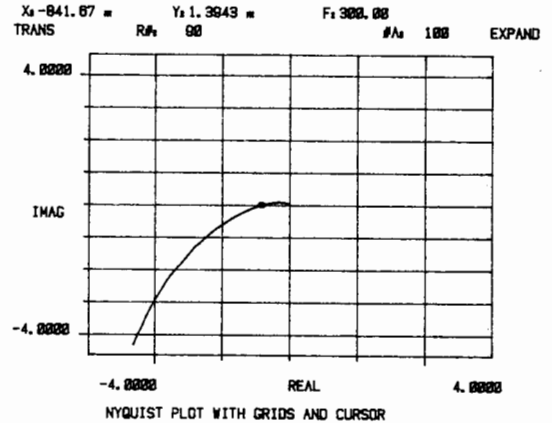
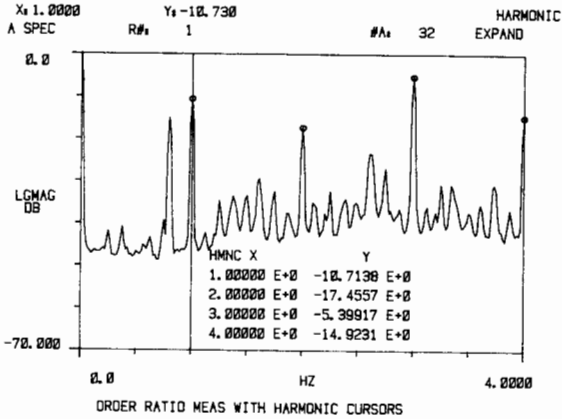

### Dynamic Analysis

The 5423A provides, for the first time in a transportable, easy to use, low cost instrument, complete dynamic analysis capability. Frequency response measurements are made at points of interest on the test structure. The 5423A then analyzes the raw data to determine the frequency and damping associated with the structure's natural modes of vibration. In addition, the deflection pattern or mode shape of the structure is calculated for each mode of vibration. Results are available in tabular form or as an animated display with perspective to ease interpretation.

Mode shape display features include the ability to view the structure from any desired direction and distance. Amplitude and speed of animation are easily controlled and the structure can be made to rotate about any desired axis. A split-screen format facilitates compari-

MODE SHAPE		
MODE NO. :	1	M. MASS: 10.130 μ LB-SEC <sup>2</sup> /IN
FREQ (HZ) :	40.660	M. DAMP: 391.538 μ LB-SEC/IN
DAMP (%) :	7.537	M. STIF: 865.487 μ LB/IN

DOF#	PT	DIR	AMPLITUDE
1	1	X	-15.4060 μ
2	1	Y	30.9480 μ
3	1	Z	-563.770 μ
4	2	X	10.2221 μ
5	2	Y	26.5220 μ
6	2	Z	-640.350 μ
7	3	X	10.2426 μ
8	3	Y	-0.0004 μ
9	3	Z	-470.791 μ
10	4	X	0.1770 μ

TOTAL DEGREES OF FREEDOM: 348

son of different modes of vibration and may also be used to observe the structure in three dimensions with stereo viewers.

### HP-IB\*

Both the 5420B and 5423A include an HP-IB interface to provide for instrument control and data transfer to and from external computing controllers. In addition, both instruments are directly compatible with the HP 9872, 7245, and 7221/17601 Digital Plotters. A separate computing controller, with its attendant cost and programming requirements is not needed. The user merely presses the plot or print key and the instrument will reproduce the desired information in hard copy form on the plotter.

### Ordering Information

5420B Digital Signal Analyzer

5423A Structural Dynamics Analyzer

\*HP-IB cables not supplied, see page 29 for description and prices

# SIGNAL ANALYZERS

## Digital Fourier Analysis System

Model 5451C



- Increased mass storage capability
- Keyboard-controlled data acquisition and analysis
- >75 dB dynamic range

- Multi-channel operation DC to 50 kHz (100 kHz optional)
- Dedicated application packages

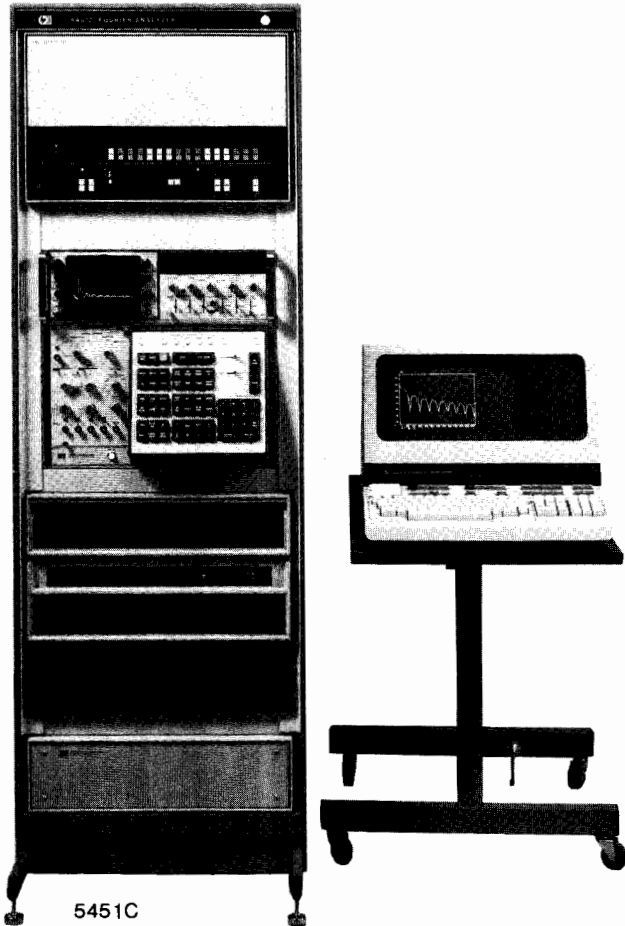

measurement can be increased by a factor of over 400:1 without increasing the amount of computer data space required. Also, frequencies outside the band of interest are attenuated by more than 90 dB, which means that the full dynamic range of the analyzer can be applied to the band of interest without interference from outside frequencies.

Features include: all digital operation, on-line or off-line analysis, keyboard operation, four-channel analysis for cross measurements, and center frequency range from DC to 100 kHz.

### Mass Storage

New to the 5451C Fourier Analysis System, the HP7906 Random Access Disc Drive extends the operational capabilities of the system and provides greater permanent storage for data and programs than ever before. In addition, larger ADC Throughput files permit storage of directly digitized time domain data at a real time rate better than 140 kHz—ensuring that no important data will be missed. This data can then be analyzed in a variety of ways at your convenience.

### 5451C Application Packages

#### Modal Analysis

Hewlett-Packard offers a comprehensive modal analysis system designed to meet the requirements of a wide range of modal testing applications. The Hewlett-Packard Modal System operates on measured transfer function data to determine modal properties. In addition, an animated isometric display of the structure under test is generated to aid in understanding its dynamic characteristics. This system offers significant time savings over traditional swept sine analog techniques and provides random, pseudo-random, transient, or periodic random excitation for transfer function measurements.

#### Signature Analysis

Noise, vibration, and failure problems in rotating machinery are easily analyzed using Hewlett-Packard's powerful Signature Analysis Package. It combines key rotating machinery measurements into a dedicated user-oriented system that's used for preventive maintenance, production quality control, design analysis, and noise and vibration studies.

Six measurements are pushbutton selectable from the operator's control panel: RPM and TIME Spectral Maps, Power Spectrum Analysis, Composite Power Spectrum, Order Ratio, and Order Tracking. This complete range of measurement and analysis features helps you gain insight into the overall dynamic characteristics of the device, eliminating time-consuming trial-and-error procedures.

#### Vibration Test Control

This package provides all the features present in Hewlett-Packard's 5427A Vibration Control System (see next page).

#### Hardware Options

In addition to the above software application packages, the following hardware options are available for increased system versatility:

- Programmable Low Pass Filters to automatically protect your measurements from errors due to aliasing of out-of-band frequencies.
- Pre-Processor for fast, convenient Band Selectable Fourier Analysis on up to 4 channels simultaneously.
- Digital-to-Analog Converter to generate your own test signals directly from digital data created in the 5451C.

#### 5451C Base System Price

### Description

The 5451C Fourier Analysis System provides digital frequency domain analysis of complex time signals in the frequency range of DC to 50 kHz (100 kHz optional). The system is completely integrated and consists of a mini-computer for digital processing, a keyboard for operator control of the system, a dual channel analog-to-digital converter (4 channels optional), a display control unit and CRT, a graphics terminal, and an operating software package. It is a fully calibrated, multi-purpose digital system for data acquisition, data storage, and data analysis. The primary analysis functions which are controlled from the system's keyboard include: forward and inverse Fourier transform, auto and cross power spectrum, transfer and coherence function and time or frequency domain averaging.

The ability to measure these functions quickly and accurately and with large dynamic range makes the Fourier Analysis System a powerful tool for stimulus-response measurements, system identification, vibration control, modal analysis, signature analysis, communications, and more.

### Band Selectable Fourier Analysis

5451C Band Selectable Fourier Analysis (BSFA) allows you to perform digital spectrum analysis over a frequency bandwidth whose center frequency and bandwidth are independently selectable. This frees you from the DC to  $F_{max}$  restriction of conventional baseband digital signal analysis. With BSFA, the frequency resolution of a



# SIGNAL ANALYZERS

## Digital Vibration Test Control System

### Model 5427A and 5451C Option 350

- Random test flexibility for use with MIL, IEC, and other standards
- Automatic out-of-tolerance detection protects device under test

- Economical expansion for sine and transient control
- Ultra-high random control resolution: 512 lines standard (1024 lines optional on 5427A, standard on 5451C option 350)

### Description

Closed-loop control of environmental and/or developmental vibration test stimuli for random, transient, and sine testing is available in either of two product concepts: Option 350 to the 5451C Fourier Analysis System or the 5427A, a dedicated system offering essentially the same control performance but with reduced analysis capability.

The basic 5427A Vibration Test Control system consists of: 2-channel (expandable to 4) analog-to-digital converter for processing feedback information; 21MX-E series, microcoded digital processor; 1335A Persistence CRT display; 2648A Graphics Terminal; push-button control unit; 9885M Flexible Disc storage unit; cabinet and programs for random control.

The 5427A is the ideal vibration control system for production vibration testing where random, transient and sine testing are required and offers a selectable set of analysis routines especially designed for easy operation by laboratory personnel. 5451C Option 350 would be a natural addition for the developmental or research vibration laboratory where a full-capability Fourier Analyzer is required. The following vibration test control capabilities apply to both Option 350 on the 5451C and the 5427A.

### System Operation

Random, sine and transient control follow the same logical operational phases. First, the appropriate disc is loaded and the test program or setup (envelope, alarm and abort limits, test time, calibrations, etc.) is loaded from disc storage in response to search codes or names. If a new program or modifications are desired, a friendly question-and-answer sequence is used. Once a new setup has been generated or changes made, it can be assigned a new name and stored for later use.

After a satisfactory setup is obtained, the operate phase allows control of the actual test via pushbuttons on the central control panel. Removable snap-on overlay panels clearly label buttons for the type of test desired. Choices of on-line displays and a 'save' button allow saving of data for later plotting, including auxiliary PSD measurements during random control.

After the test, results and all saved data are available for review or documentation. The graphics terminal or an optional HP-IB compatible digital plotter provide fully labeled, report-quality plots of test results.

### Specification Summary (5427A and 5451C Option 350)

#### Random Control

**Resolution:** 64, 128, 256, or 512 lines (1024 lines optional on 5427A, standard on 5451C Option 350)

**Bandwidth:**  $\Delta f$  to 5000 Hz

**Loop time:** <0.9 sec for 256 lines, 2500 Hz bandwidth, one control channel and full display

**Dynamic range:** >65 dB

#### Accuracy:

**rms PSD accuracy:**  $\pm 2\%$

**Control PSD accuracy:**  $\pm 1.0$  dB (90% confidence level) Higher accuracies are typically achievable with increased control spectrum averaging.

#### Sine Control

**Frequency range:** 0.1 to 5000 Hz. Upper and Lower sweep frequency limits and starting frequency may be specified anywhere in the frequency range (Resolution: 0.1 Hz).

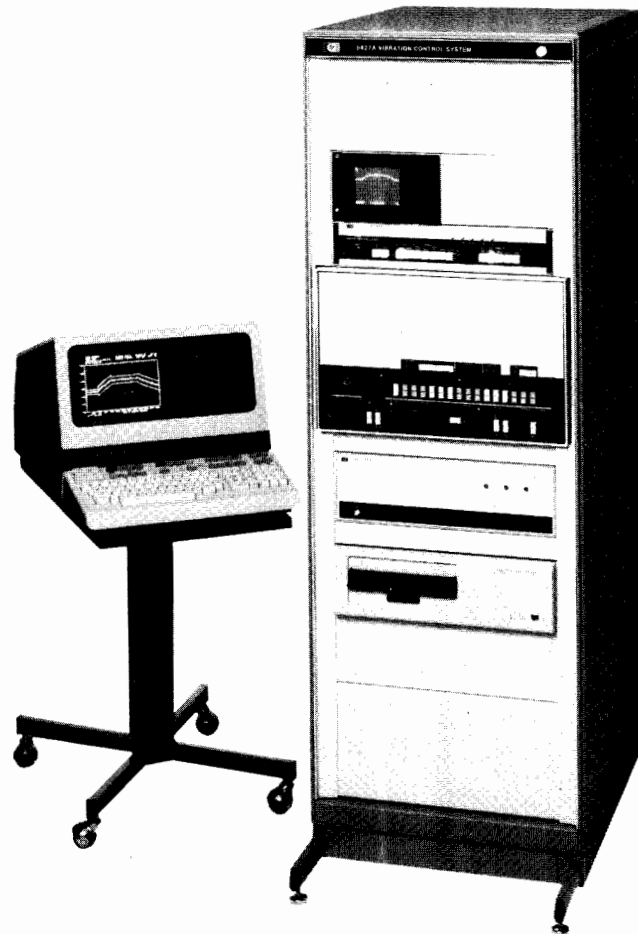

5427A

**Sweep rate:** 0.001 to 100 octaves/minute log, 1 to 100,000 Hz/minute linear, operator selectable.

**Harmonic components:** >60 dB below full level fundamental output

**Sweep time accuracy:**  $\pm 2.5\%$  or  $\pm 52$  msec, whichever is greater

**Amplitude accuracy:** the greater of  $\pm 2.5$  mV or  $\pm 1\%$  of specified reference value.

**Output dynamic range:** 72 dB

#### Transient Control

**Classical reference waveforms:** Half-sine, terminal peak sawtooth, triangle or rectangle

**Polarity:** positive or negative

**Duration range:** 0.5 to 100 msec

**Duration accuracy:**  $\pm 5\%$  for half-sine and terminal peak sawtooth at pulse baseline crossover points

**Shock response spectrum synthesis:** Time domain waveforms are synthesized from a user-specified shock response spectrum (SRS) off-line in the setup mode

**Resolution:** 1/N octave, N is any integer from 1 to 9

**Frequency range:** 2 decades nominal, 2.6 decades maximum

**Maximum frequency:** 1/Nth octave below 10,240 Hz

#### Ordering Information

5427A Vibration Test Control System

5451C Option 350 Vibration Test Software for Fourier Analysis System

# SIGNAL ANALYZERS

## Frequency Stability Analyzer

Model 5390A

519



- Phase noise measurements close to carrier
- Offsets from 0.01 Hz to 10 kHz
- Sensitivity as high as  $-140$  dBc at 1 Hz offset

- Measures sources to 18 GHz
- Automatic operation
- Measurements in both frequency and time domains

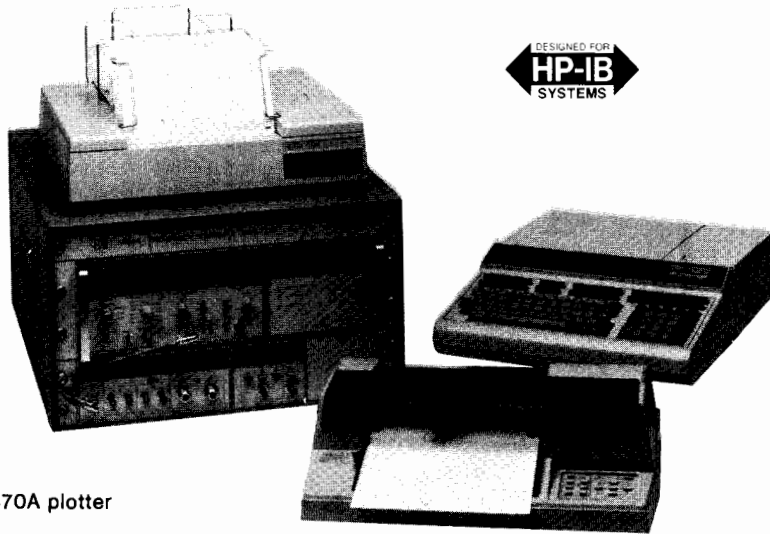

5390A System shown with 7470A plotter

### General

The 5390A Frequency Stability Analyzer will characterize oscillator stability in either the time domain or the frequency domain. For time domain characterization, the 5390A measures fractional frequency deviation which represents the RMS deviation of the signal from the nominal carrier frequency measured over a given time interval. For characterization in the frequency domain, the 5390A presents results in terms of the spectral density of phase fluctuations. The 5390A specializes in high resolution phase noise measurements close to the carrier where other techniques are difficult to use or are unable to make the measurements at all.

The system can accommodate a wide frequency range of input signals from 500 kHz to 18 GHz. Provision is also made for external mixers for broader frequency coverage or direct input in the range of DC-100 kHz. With this amount of flexibility, almost any oscillator can be measured with the 5390A. All the signal processing capabilities needed to make measurements are built into the system, including down-conversion, low-noise amplification, and bandwidth control.

The 5390A is a complete hardware and software measurement system, fully assembled and tested at the factory. Making measurements only requires connecting the test and reference oscillators and specifying a few measurement parameters. Thereafter, the system runs unattended to the completion of the specified group of measurements. Access to the interactive application programs is provided through specially defined keys on the computing controller's keyboard.

### Measurement Technique

The basic system configuration uses a heterodyne down-conversion technique to produce a measurable signal. Two oscillators, the test oscillator at a carrier frequency  $\nu_0$  and a reference oscillator at a frequency  $\nu_0 \pm \nu_b$ , are connected to a double balanced mixer through one of the sets of inputs on the 10830A Mixer/IF Amplifier. (Usually two identical oscillators, one slightly offset, are used. In this case, the noise measured is twice the contribution of either oscillator. The 5390A's software can compensate for this factor of two to produce the correct result). The resultant difference frequency (or "beat" frequency),  $\nu_b$ , is filtered and amplified by a low noise limiting amplifier and applied to the input of the 5345A Electronic Counter. The 5345A makes frequency measurements of the beat frequency under the control of the 5358A Measurement/Storage Plug-in at measurement intervals also determined by the 5358A. The measurement results are stored locally in the 5358A facilitating the taking of a large number of measurements very rapidly and reducing "dead time" between measurements to less than 17  $\mu$ s.

### Option 010 Dual Mixer Time Difference

Measurements can be made with the 5390A using either the standard single heterodyne configuration or the dual mixer time difference configuration (Option 010). The primary application of the single heterodyne method is where an offsettable reference oscillator is available, whose noise over the range of interest is equal to or better than the test oscillator. The primary application of the Option 010 configuration is for measuring non-offsettable sources.

In the Dual Mixer Time Difference configuration of the system (Option 010) a second 10830A Mixer-IF Amplifier is added. A third difference oscillator is used in this set-up to produce two measurable signals. The test oscillator at a frequency  $\nu_0$  and the reference oscillator at essentially the same frequency are each applied to the 10830A's. The difference oscillator's signal ( $\nu_0 + \nu_b$ ) is split and applied to both 10830A's. The resultant two difference signals ( $\nu_b$ ) are applied to the 5345A's inputs and time interval measurements are made between the two at intervals  $\tau$ .

### System Options

**001** Expands 5358A memory in 2K increments. Up to three Opt. 001's may be added.

**004** Adds 59309A Digital Clock and HP-IB cable.

**010** Adds second 10830A, 59308A, power splitter, system cabinet, and expands 5358A memory to 6 Kbytes.

**325** Deletes 9825B and 98034B

**373** Deletes 2673A Printer

### Accessories Available

7470A Plotter

### Ordering Information

5390A Basic System includes:

5345A Option 011 Electronic Counter

5358A Measurement Storage Plug-in

10830A Mixer/IF Amplifier

10831A Test Tone Generator

9825B Computing Controller

98034B HP-IB Interface

2673A Printer

System Cabinet

System Software

5390A Basic System

# SIGNAL ANALYZERS

## Distortion Measurement Set

Model 339A

- Ultra low distortion measurements
- Built-in low distortion oscillator
- Automatic
- True RMS detection

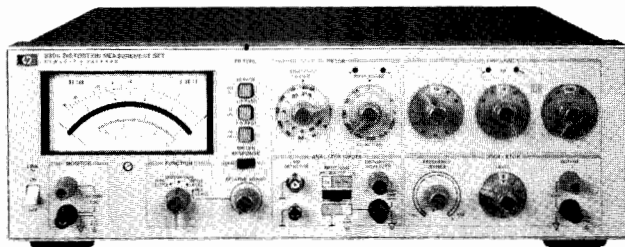

339A

### Description

Hewlett-Packard's new Model 339A Distortion Measurement Set is an ultra low distortion measuring system complete with total harmonic distortion (THD) analyzer, true-rms voltmeter, and sinewave oscillator. This small, lightweight bench measurement set allows you to make THD distortion measurements as low as 0.0018% over a 10 Hz to 110 kHz frequency band including harmonics to 330 kHz.

For fast and easy THD measurements the built-in tracking oscillator in HP's 339A saves test time because you tune one instrument instead of two. Frequency and level measurements are easy to do with HP's 339A's voltmeter, which offers you a 1 mV to 300 V measurement range. The Relative Level mode has been included to further simplify frequency response measurements. Just set a 0 dBm reference at any frequency from 10 Hz to 110 kHz. Gain measurements can be read directly from the easy-to-read meter.

### Operation Simplicity

Automatic frequency tuning and set-level features allow you to make rapid, error free THD measurements. The 339A's built-in tracking oscillator eliminates the need to find the fundamental frequency and tune the analyzer for a null. Just select your oscillator frequency and the rest is automatic. Automatic set-level saves time by automatically setting 0 dB (100%) reference in the distortion measuring mode. Front panel directional indicators light when the input range setting is improper insuring accurate and repeatable measurements. Automatic set-level also greatly simplifies measurements where distortion as a function of level (SINAD<sup>1</sup>, for example) is desired. Without this feature, measurements are very time consuming and tedious.

When an external stimulus is used, analyzer tuning is simplified by directional indicator lights for reaching the fundamental null quickly and easily.

<sup>1</sup>SINAD is a sensitivity measurement computed from the ratio of signal plus noise and distortion to noise and distortion.

### Specifications

#### Distortion

**Fundamental frequency range:** 10 Hz to 110 kHz continuous frequency coverage in 4 decade ranges with 2-digit resolution. Distortion analyzer and oscillator are simultaneously tuned.

**Distortion measurement range:** 0.01% full scale to 100% full scale (-80 dB to 0 dB) in 9 ranges.

**Detection and meter indication:** True rms detection for waveforms with crest factor  $\leq 3$ . Meter reads dB and % THD (Total Harmonic Distortion). Meter response can be changed from NORMAL to VU ballistics with a front panel switch.

#### Distortion measurement accuracy:

20 Hz to 20 kHz	$\pm 1$ dB
10 Hz to 50 kHz	+ 1, -2 dB
50 kHz to 110 kHz	+ 1.5, -4 dB

**Note:** The above specifications apply for harmonics  $\leq 330$  kHz.

#### Fundamental rejection (3 V scale or above):

10 Hz to 20 kHz:	> 100 dB
20 kHz to 50 kHz:	> 90 dB
50 kHz to 110 kHz:	> 86 dB

#### Distortion introduced by instrument (input > 1V rms):

10 Hz to 20 kHz:	< -95 dB (0.0018%) THD
20 kHz to 30 kHz:	< -90 dB (0.0056%) THD
30 kHz to 50 kHz:	< -85 dB (0.01%) THD
50 kHz to 110 kHz:	< -70 dB (0.032%) THD

**Residual noise** (fundamental frequency settings < 20 kHz, 80 kHz filter IN, source resistance  $\leq 1$  K $\Omega$  shielded): < -92 dB referenced to 1V.

**Input level for distortion measurements:** 30 mV to 300 V rms (100 mV range minimum).

**Input impedance:** 100 k $\Omega$   $\pm$  1% shunted by < 100 pF input High to Low.

**Monitor:** Provides scaled presentation of input signal after fundamental is removed for further analysis using oscilloscope or low frequency spectrum analyzer. Output voltage: 1V rms  $\pm$  5% open circuit for full scale meter indication, proportional to meter deflection. Output resistance: 1k $\Omega$   $\pm$  5%.

**Auto set level:** No set level adjustment required. Distortion measurements are made directly over 10 dB range selected by input range switch. Two LED annunciators provide a fast visual indication to change input range for valid distortion measurement. Correct range is indicated when both annunciators are extinguished.

**Automatic fine tuning:** Using internal oscillator: No separate analyzer tuning necessary when using internal oscillator as signal source. Oscillator frequency controls simultaneously tune the analyzer. Using external frequency source: Two LED annunciators provide a quick visual indication for the operator to increase or decrease the frequency. When the analyzer is rough tuned to within one least significant digit of the fundamental frequency, the indicator lights are extinguished and the 339A auto-null circuitry takes over to provide a fast, accurate null without tedious operator tuning.

**Input filters (usable on all functions):** Low Pass: 30 kHz -3 dB point at 30 kHz, + 2.6 kHz, -3 kHz with 60 dB/decade rolloff. Provides band limiting required by FCC for proof-of-performance broadcast testing. 80 kHz -3 dB point at 80 kHz, + 7 kHz, -7.9 kHz with 60 dB/decade rolloff. Normally used with fundamental frequencies < 20 kHz to reduce the effect of higher frequency noise present in the measured signal. High Pass: 400 Hz -3 dB point at 400 Hz, + 35 Hz, -40 Hz with 60 dB/decade rolloff. Normally used with fundamental frequencies > 1 kHz to reduce the effect of hum components in the input signal.

**DC isolation:** Input low may be connected to chassis ground or floated to 30 V to reduce the effects of ground loops on the measurement.

#### Relative Input Level Mode

Provides a ratio measurement relative to an operator selected reference level with readout directly in dBV or dBm (600 $\Omega$ ). Voltage range, frequency range, accuracy specifications, and monitor are the same as in Voltmeter mode. (Accuracy is relative to 0 dB set level input.)

#### Oscillator

**Frequency range:** 10 Hz to 100 kHz in 4 overlapping decade ranges with 2 digit resolution. Frequency vernier provides continuous frequency tuning between 2nd digit switch settings.

**Output level:** Variable from  $< 1$  mV to  $> 3$  V rms into  $600\ \Omega$  with 10 dB/step Level control and  $> 10$  dB Vernier adjustment. OSC Level position on function switch allows a quick check of oscillator level without disconnecting leads to device under test. Off position on Oscillator Level control provides fast signal-to-noise measurement capability. Oscillator output terminals remain terminated in  $600\ \Omega$ .

**Frequency accuracy:**  $\pm 2\%$  of selected frequency (with Frequency Vernier in Cal position).

Level flatness: 20 Hz to 20 kHz:  $\leq \pm 0.1$  dB  
 10 Hz to 110 kHz:  $\leq \pm 0.2$  dB

**Distortion ( $\geq 600\ \Omega$  Load,  $\leq 3$  V Output):**

10 Hz to 20 kHz:  $< -95$  dB (0.0018%) THD  
 20 kHz to 30 kHz:  $< -85$  dB (0.0056%) THD  
 30 kHz to 50 kHz:  $< -80$  dB (0.01%) THD  
 50 kHz to 110 kHz:  $< -70$  dB (0.032%) THD

**Output resistance:**  $600\ \Omega \pm 5\%$

### Voltmeter

**Voltage range:** 1 mV rms full scale to 300 V rms full scale ( $-60$  dB to  $+50$  dB full scale, meter calibrated in dBV and dBm into  $600\ \Omega$ ).

**Detection and meter indication:** True rms detection for waveforms with crest factor  $\leq 3$ . Meter reads true rms volts, dBm into  $600\ \Omega$ , and dBV.

**Accuracy (% of range setting):**

20 Hz to 20 kHz:  $\pm 2\%$   
 10 Hz to 110 kHz:  $\pm 4\%$

**Frequency range:** 10 Hz to 110 kHz.

**Input impedance:**  $100\ \text{k}\Omega \pm 1\%$  shunted by  $< 100$  pF between input High to Low.

**Monitor:** Provides scaled presentation of input signal for further analysis using oscilloscope or low frequency spectrum analyzer. Output voltage: 1 V rms  $\pm 5\%$  open circuit for full scale meter indication, proportional to meter deflection. Output resistance:  $1\ \text{k}\Omega \pm 5\%$ .

### Option 001

**Voltage Range:** 0.1 mV rms full scale to 300 V rms full scale ( $-80$  dBV to  $+50$  dBV full scale); (.1 mV and .3 mV ranges—external source resistance must be  $< 10\ \text{k}\Omega$ ).

**Accuracy: 1 mV to 300 V ranges:**

20 Hz to 20 kHz  $\pm 2\%$   
 10 Hz to 110 kHz

**.1 mV and .3 mV ranges:**

20 Hz to 20 kHz:  $\pm 2\%$   
 10 Hz to 30 kHz:  $\pm 4\%$   
 30 kHz to 80 kHz:  $+10/-30\%$

**Noise Floor ( $600\ \Omega$  source impedance):**

30 kHz filter  $< 6\ \mu\text{V}$   
 80 kHz filter  $< 8\ \mu\text{V}$

### AM Detector

**Frequency range:** Carrier frequencies: 550 kHz to 1.6 MHz. Modulation frequencies: 20 Hz to 20 kHz.

**Distortion introduced by AM Detector (with 30 kHz filter switched IN):** Up to 85% Modulation:  $< -36$  dB (1.6%) THD

85% to 95% Modulation:  $< -30$  dB (3%) THD

**Input level:** Maximum: 60V peak. Modulation signal level: 2V rms minimum; 10V rms maximum.

**Monitor (with Modulated RF Carrier Applied to AM Detector Input).**

**Distortion mode:** Provides scaled presentation of demodulated input signal after fundamental is removed.

**Voltmeter and relative input mode:** Provides scaled presentation of demodulated input signal. Output voltage and output resistance are the same as in Distortion mode.

### General

**Power:** 100/120/220/240 V  $\pm 5\%$ ,  $-10\%$  48 Hz to 66 Hz line operation, 200 mA maximum.

**Size:** 146 mm H x 426 mm W x 375 mm D (5.75" x 16.75" x 14.75").

**Weight:** net 8.2 kg (18 lbs). Shipping 11.3 kg (25 lbs).

### 339A Distortion Measurement Set

Option 001

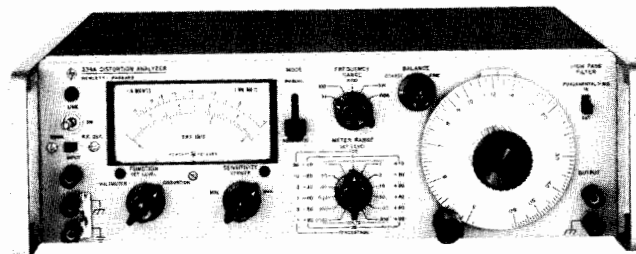

334A

### Description

Hewlett-Packard's model 334A Distortion Analyzer measures total distortion down to 0.1% full scale at any frequency between 5 Hz and 600 kHz; harmonics are indicated up to 3 MHz. Noise levels as low as 25 microvolts can be measured. The HP 334A includes automatic fundamental nulling and amplitude modulation detector. A Meter with VU ballistic characteristics, and a 30 kHz low pass filter are optional.

### 334A Specifications

**Input level for Distortion Measurements:** 0.3 V rms for 100% set level or 0.245 V for 0 dB set level (up to 300 V may be attenuated to set level reference).

**Harmonic Measurement Accuracy (full scale)**

**Fundamental Input Less Than 30 V**

Range	$\pm 3\%$	$\pm 6\%$	$\pm 12\%$
100%–0.3%	10 Hz–1 MHz	10 Hz–3 MHz	
0.1%	30 Hz–300 kHz	20 Hz–500 kHz	10 Hz–1.2 MHz

**Fundamental Rejection:**  $> 80$  dB

**Residual Distortion:**  $> -70$  dB (0.03%) from 5 Hz to 200 kHz.  $> -64$  dB (0.06%) from 200 kHz to 600 kHz. Meter indication is proportional to average value of a sine wave.

**Frequency Calibration Accuracy:** better than  $\pm 5\%$  from 5 Hz to 300 kHz. Better than  $\pm 10\%$  from 300 to 600 kHz.

**Input Impedance:** distortion mode:  $1\ \text{M}\Omega \pm 5\%$  shunted by  $< 70$  pF.

**DC Isolation:** signal ground may be  $\pm 400$  V dc from external chassis

**Voltmeter Range:** 300  $\mu\text{V}$  to 300 V rms full scale (13 ranges) 10 dB per range. Average responding calibrated in rms.

**Noise Measurements:** voltmeter residual noise on the 300  $\mu\text{V}$  range:  $< 25\ \mu\text{V}$  rms, when terminated in 600 (shielded) ohms.

**Output:** 0.1  $\pm 0.01$  V rms open circuit.

**Output Impedance:** 2 k $\Omega$

**Automatic Nulling Mode:** set level: at least 0.2 V rms

**Frequency Ranges:** X1, manual null tuned to less than 3% set level; total frequency hold-in  $\pm 0.5\%$  about true manual null. X10 through X10k, manual null tuned to less than 10% of set level; total frequency hold-in  $\pm 1\%$  about true manual null.

**Automatic Null Accuracy:** 5 Hz to 100 Hz: meter reading within 0 to  $+3$  dB of manual null. 100 Hz to 600 kHz: meter reading within 0 to  $+1.5$  dB of manual null.

**High Pass Filter:** 3 dB point at 400 Hz with 18 dB per octave roll off.

**AM Detector:** 550 kHz to 65 MHz; 40 Vp-p max input.

**Distortion introduced by detector:** carrier frequency: 550 kHz–1.6 MHz:  $< 50$  dB (0.3%) for 3–8 V rms carriers modulated 30%. 1.6 MHz–65 MHz:  $< 40$  dB (1%) for 3–8 V rms carriers modulated 30%.

### General

**Power:** 115 or 230 V  $\pm 10\%$ . 48 to 66 Hz.

**Size:** 426 mm W x 126 mm H x 337 mm D (16.75" x 5" x 13.25").

**Weight:** net 7.89 kg (17.75 lb). Shipping 10.35 kg (23 lb).

334A Distortion Analyzer

Opt 001 VU Characteristics

Opt 002 30 kHz low pass filter

Opt 003 (combined 001 and 002)

# SIGNAL ANALYZERS

## 15 Hz to 50 kHz Wave Analyzer

### Model 3581A

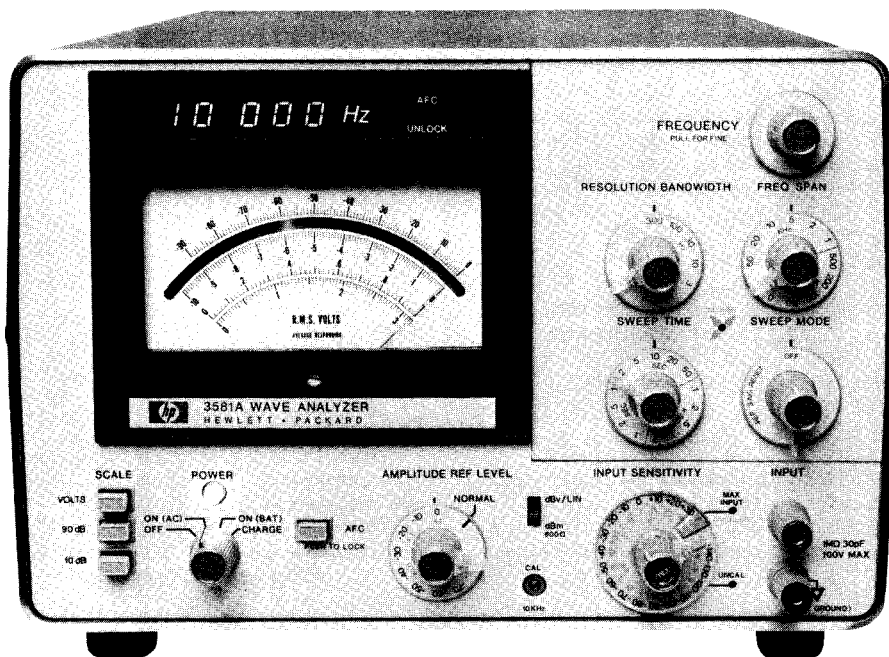

## Description

Hewlett-Packard's 3581A Wave Analyzer resolves and measures the amplitude and frequency of spectral components. This instrument offers accurate amplitude and good frequency resolution in the form of a portable, easy to use measuring tool. Since not all signals originate from a stable frequency source, the 3581A incorporates an AFC circuit which locks to a drifting signal for stable, accurate measurements.

HP's 3581A has other important features that are necessary when making measurements of small voltages from transducers and harmonic signals. Its 30 nV sensitivity becomes important for these measurements. Battery operation can be used to reduce the line related interference common in low level measurements so only the real spectrum is measured.

Digital readout of tuned frequency is located above the analog meter. It has been grouped with the meter for ease of reading. Resolution of the digital readout is 1 Hz for any frequency between 15 Hz and 50 kHz. Readout is updated five times per second so delay between tuning and reading is minimized.

Four meter scales are used to provide a wide range of displays. Two scales are used for linear voltage readings. Two log scales provide either a 90 dB or 10 dB display. In any case, the large meter with its mirror backing can present readings in dBV, dBm or volts. A meter was specifically chosen for amplitude display rather than digital readout because it is easier to peak a meter reading and because it's much easier to get a feel for noise or other amplitude variations by watching the meter. The same voltage used to drive the meter is also available on the rear panel for driving X-Y recorders.

## Specifications

### Frequency Characteristics

**Range:** 15 Hz to 50 kHz.

**Display:** 5 digit LED readout.

**Resolution:** 1 Hz.

**Accuracy:**  $\pm 3.5$  Hz., 0 to 55°C.

**Typical stability:**  $\pm 10$  Hz/hr after 1 hour and  $\pm 5$  Hz/°C.

**Automatic frequency control (AFC) hold-in range:**  $\pm 800$  Hz.

### Amplitude Characteristics

#### Instrument Range

**Linear:** 30 V to 100 nV full scale.

**Log:** +30 dBm or dBV to -150 dBm or dBV.

#### Amplitude accuracy:

Frequency response,  
15 Hz-50 kHz

**Log**

$\pm 0.4$  dB

**Linear**

$\pm 4\%$

**Dynamic range:** > 80 dB.

**Noise sidebands:** greater than 70 dB below CW signal. 10 bandwidths away from signal.

**Spurious responses:** > 80 dB below input reference level.

### Sweep Characteristics

**Scan width:** 50 Hz to 50 kHz, adjustable in a 1-2-5 sequence from 50 Hz to the full frequency range.

**Sweep error light:** this LED indicates a sweep that is too fast to capture full response. When the light is on, response will be lower than it should be.

**External trigger:** a short to ground stops the normal sweep. Opening the short then enables a sweep.

### Input Characteristics

**Impedance:** 1 M $\Omega$ , 30 pF.

**Maximum input level:** 100 V rms,  $\pm 100$  V dc.

### Output Characteristics

**Tracking generator output:** (also known as BFO or tracking oscillator output).

**Range:** 0 to >1 V rms into 600  $\Omega$ .

**Frequency response:**  $\pm 3\%$  15 Hz to 50 kHz.

#### X-Y Recorder Analog Outputs

**Vertical:** 0 to +5 V  $\pm 2.5\%$ .

**Horizontal:** 0 to +5 V  $\pm 2.5\%$ .

**Impedance:** 1 k $\Omega$ .

**Pen lift:** contact closure to ground during sweep.

**Restored output:** acts as a narrow band amplifier.

### General

**Power requirements:** 100 V, 120 V, 220 V, or 240 V  $\pm 5\%$  -10%, 48 Hz to 440 Hz, 10 VA typical.

**Size:** 412.8 mm H x 203.2 mm W x 285.8 mm D (16 $\frac{1}{4}$ " x 8" x 11 $\frac{1}{4}$ ").

**Weight:** 11.5 kg (23 lb). Opt 001: 13.5 kg (30 lb).

### Options

#### 3581A Wave Analyzer

**001:** Internal battery 12 hours from full charge. Internal battery is protected from deep discharge by an automatic turnoff. Useful battery life is over 100 cycles.

**003:** Rack Mount

**910:** Extra set manuals

- Measures AM and FM to 1% accuracy
- Measures RF frequency
- Measures peak envelope power

- Low internal noise
- Completely automatic
- Optional built-in AM & FM calibrators

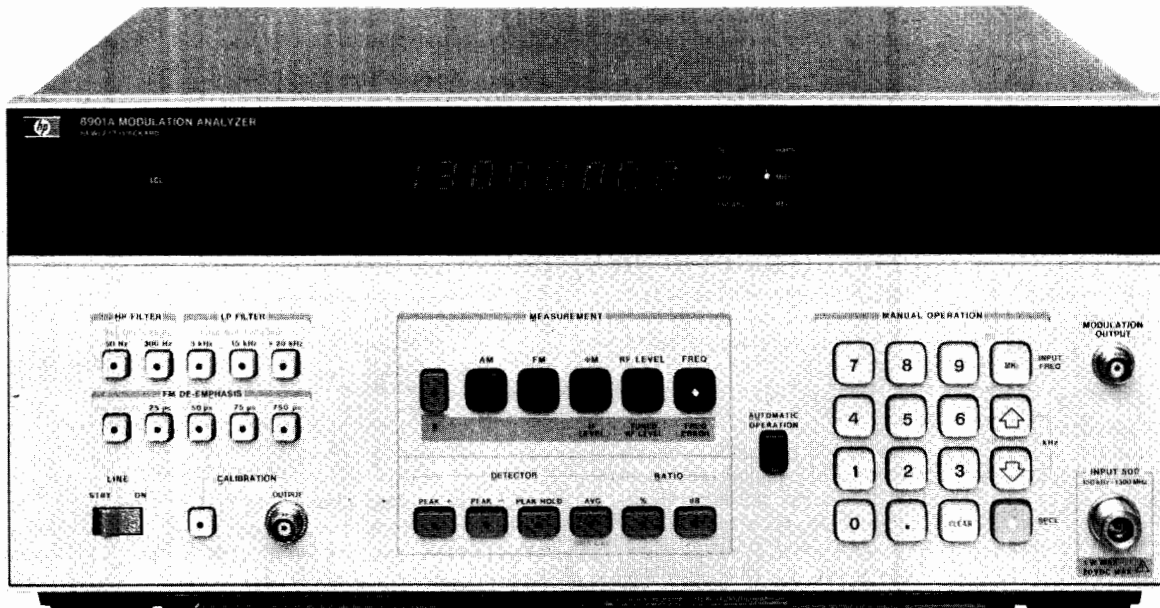

8901A (with Option 010)

### 8901A Modulation Analyzer

The 8901A Modulation Analyzer combines the capabilities of several RF instruments to give a complete, accurate characterization of modulated signals in the 150 kHz to 1300 MHz frequency range. It very accurately measures modulation and recovers the modulation signal. It determines RF frequency with 10 or 100 Hz resolution. It also measures RF peak power and in many instances eliminates the need for a power meter. The analyzer is ideally suited for characterization of transceivers and for metrology applications in calibrating precision signal generators. Some other uses may be less obvious, for example, it can be used to measure mixer compression or to measure VCO FM sensitivity. The fully automatic 8901A makes all major measurements with the push of a single key or under HP-IB control. Hewlett-Packard Interface Bus (HP-IB) control is a standard feature. Further description and example waveforms of the 8901A are on pages 465 and 466 of this catalog.

### Modulation Measurement Accuracy

Very accurate modulation measurements along with very low internal noise enable the 8901A to characterize even high performance signal sources. Its detection system is configured for wideband recovery of the entire modulation spectrum so that highly precise measurements such as signal-to-noise or distortion can be made on the modulation signal. Modulation depth and deviation accuracy is generally  $\pm 1\%$  of reading. Residual AM noise in a 50 Hz to 3 kHz bandwidth is  $<0.01\%$  while FM noise is  $<8$  Hz for 1300 MHz carrier frequencies, decreasing linearly to  $<1$  Hz below 100 MHz. Because the AM and FM demodulators are independent and highly insensitive to each other and because the analyzer has very low residual AM and FM, accurate incidental AM and FM measurements can be made.

Three detectors are available for depth and deviation measurements: positive peak, negative peak, and an average-responding detector with rms (sinewave) calibration. The average detector is ideal for the determination of residual noise on a signal. A PEAK HOLD function captures and displays the maximum peak modulation of a signal and is ideal for making transient measurements such as modulation limiting on mobile radios. It can capture even very short transients and hold their peaks indefinitely.

For measuring convenience, two high-pass (50 Hz and 300 Hz) and

three low-pass (3 kHz, 5 kHz, and  $>20$  kHz) post-detection filters for filtering the recovered modulation are included. The  $>20$  kHz Bessel filter minimizes overshoot on square wave modulation. This allows accurate measurement of signals which are digitally modulated, such as FSK.

Four de-emphasis networks commonly used in FM systems (25, 50, 75, and  $750 \mu\text{s}$ ) are provided. When chosen, the de-emphasis networks always affect the demodulated output but the user can select whether or not the de-emphasis network affects the deviation measured and indicated by the display.

A modulation output provides calibrated signal levels relative to the displayed modulation reading. Further measurements (frequency, distortion, frequency response) can be made on this demodulated signal with the HP 8903A Audio Analyzer described on page 526.

Option 010 provides two precision modulation standards. One is an amplitude modulated signal whose depth is calibrated to better than 0.1% accuracy. The second standard is a frequency modulated signal with peak deviation calibrated to  $>0.1\%$  accuracy. Because the calibrator can be included in the analyzer, metrology laboratories are not required to purchase a separate standard for AM or FM accuracy calibration. The 11715A AM/FM Test Source is necessary to fully test and calibrate other modulation parameters of the 8901A and is described on page 525.

### Complete Signal Characterization

The 8901A Modulation Analyzer is more than just a high quality modulation meter. It also performs as a frequency counter and RF power meter. Resolution for the 150 kHz to 1300 MHz frequency counter is 10 Hz below 1000 MHz and 100 Hz above 1000 MHz. Sensitivity is  $-25$  dBm (12 mV rms) below 650 MHz and  $-20$  dBm (22 mV rms) above 650 MHz, with a dynamic range of  $>50$  dB. The standard instrument's time base stability is  $<1 \times 10^{-6}$ /month or an optional time base is available with  $<1 \times 10^{-9}$ /day stability.

The Modulation Analyzer automatically adjusts the internal level of the signal for optimum measurement. It can also selectively measure signals other than the largest with the approximate frequency entered via the keyboard. This is done with an unprecedented sensitivity of 0.22 mV rms and dynamic range of  $>90$  dB. Input protection from damage is provided for signals up to 25 W with clamping diodes and a relay.





The 8901A uses a diode detection circuit to measure RF input power. This technique measures peak voltage and is calibrated from 1 mW to 1W for sine wave inputs. The RF level measurement accuracy is  $\pm 1.5$  db from 150 MHz to 1300 MHz.

Another function, TUNED RF LEVEL, configures the modulation analyzer as a selective RF power meter, allowing relative measurements of only signal levels in the tuned IF filter passband prior to automatic leveling. The 8901A has two selectable IF filters: one at 1.5 MHz with a 3 MHz nominal 3 dB bandwidth; the other at 455 kHz with a 200 kHz nominal 3 dB bandwidth.

### Ease of Operation

The 8901A Modulation Analyzer provides unexcelled accuracy while remaining extremely easy to use. Under control of an internal microprocessor, the 8901A is fully automatic and autoranging. Most measurements require only a single keystroke. There is no need to tune the analyzer, adjust levels, or select the appropriate range. Data processing routines of the microprocessor permit the user to make measurements relative to a measured value or to one entered from the keyboard by using the ratio keys.

### Special Functions

Special functions entered using the numerical keys and the special function key give the operator manual control of functions, operation, and service aids. For example, one special function configures the instrument to continuously track the input signal as it changes frequency without losing frequency lock. Using this special function, a user can continuously monitor modulation accuracy on a signal generator while tuning across the signal generator's frequency band.

## 8901A Specifications

### RF Input

**Frequency range:** 150 kHz to 1300 MHz

#### Operating level:

150 kHz–650 MHz: 12 mVrms to 7 Vrms

650 MHz–1300 MHz: 22 mVrms to 7 Vrms

**Input impedance:** 50  $\Omega$  nominal

**Tuning:** Manual frequency entry, automatic, or track (frequencies  $> 10$  MHz only).

**Acquisition time (automatic operation):**  $\sim 1.5$  seconds.

**Maximum safe input level (typical):** ac: 35 Vrms (25 W for source SWR  $< 4$ ); dc: 40 V.

### Frequency Modulation

#### Rates:

150 kHz–10 MHz: 20 Hz to 10 kHz

10 MHz–1300 MHz: 20 Hz to 200 kHz

10 MHz–1300 MHz: 20 Hz to 20 kHz with 750  $\mu$ s filter.

#### Deviations:

150 kHz–10 MHz: 40 kHz peak maximum

10 MHz–1300 MHz: 400 kHz peak maximum

10 MHz–1300 MHz: 40 kHz peak maximum with 750  $\mu$ s filter.

#### Accuracy<sup>1</sup>:

250 kHz–10 MHz:  $\pm 2\%$  of reading  $\pm 1$  digit, 20 Hz to 10 kHz rates.

10 MHz–1300 MHz:  $\pm 1\%$  of reading  $\pm 1$  digit, 50 Hz to 100 kHz rates;  $\pm 5\%$  of reading  $\pm 1$  digit, 20 Hz to 200 kHz rates.

#### Demodulated output distortion<sup>2</sup>:

400 kHz–10 MHz:  $< 0.1\%$  THD, deviations  $< 10$  kHz.

10 MHz–1300 MHz:  $< 0.1\%$  THD, rates and deviations  $< 100$  kHz.

**AM rejection (for 50% AM at 400 Hz and 1 kHz rates)<sup>1</sup>:**

$< 20$  Hz peak deviation measured in a 50 Hz to 3 kHz BW.

**Residual FM (50 Hz to 3 kHz BW):**  $< 8$  Hz rms @ 1300 MHz, decreasing linearly with frequency to  $< 1$  Hz rms for 100 MHz and below.

<sup>1</sup>Peak residuals must be accounted for in peak readings.

<sup>2</sup>For peak measurements only, AM accuracy may be affected by distortion generated by the Modulation Analyzer. In the worst case, this can decrease accuracy by 0.1% of reading for each 0.1% of distortion.

<sup>3</sup>After 30 day warm-up.

<sup>4</sup>With 750  $\mu$ s de-emphasis and pre-display "off", distortion is not specified for modulation outputs  $> 4$  V peak. This can occur near maximum deviation for a measurement range at rates  $< 2$  kHz.

### Maximum deviation resolution:

1 Hz,  $< 4$  kHz deviation

10 Hz, 4 kHz to 40 kHz deviation

100 Hz, 40 kHz to 400 kHz deviation

Resolution is increased one digit with 750  $\mu$ s de-emphasis and predisplay "on."

**Stereo separation (50 Hz to 15 kHz):**  $> 47$  dB typical.

### Phase Modulation

**Carrier frequency:** 10 MHz to 1300 MHz.

**Rates:** 200 Hz to 20 kHz; typically useable from 20 Hz to 100 kHz with degraded performance.

### Deviation and maximum resolution:

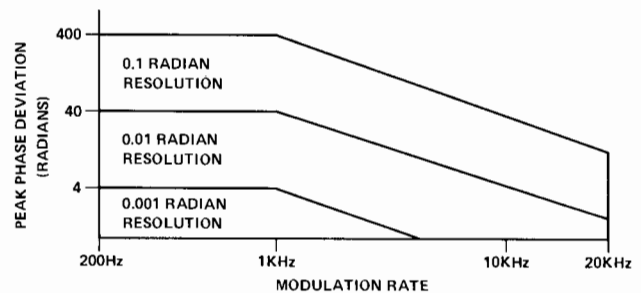

**Accuracy<sup>1</sup>:**  $\pm 3\%$  of reading  $\pm 1$  digit

**Demodulated output distortion:**  $< 0.1\%$  THD

**AM rejection (for 50% AM at 1 kHz rate)<sup>1</sup>:**  $< 0.03$  radian peak deviation (50 Hz to 3 kHz BW)

### Amplitude Modulation

#### Rates:

150 kHz–10 MHz: 20 Hz to 10 kHz

10 MHz–1300 MHz: 20 Hz to 100 kHz.

**Depth:** to 99%

#### Accuracy<sup>1,2</sup>:

**150 kHz–10 MHz:**  $\pm 2\%$  of reading  $\pm 1$  digit,

50 Hz to 10 kHz rates,  $> 5\%$  depth;

$\pm 3\%$  of reading  $\pm 1$  digit, 20 Hz to 10 kHz rates.

**10 MHz–1300 MHz:**  $\pm 1\%$  of reading  $\pm 1$  digit,

50 Hz to 50 kHz rates,  $> 5\%$  depth;

$\pm 3\%$  of reading  $\pm 1$  digit, 20 Hz to 100 kHz rates.

**Flatness (variation in indicated AM depth for constant depth on input signal):** 10 MHz to 1300 MHz:  $\pm 0.3\%$  of reading  $\pm 1$  digit, 90 Hz to 10 kHz rates, 20 to 80% depth.

**Demodulated output distortion:**  $< 0.3\%$  THD for  $\leq 50\%$  depth;  $< 0.6\%$  THD for  $\leq 95\%$  depth.

**FM rejection (at 400 Hz and 1 kHz rates, 50 Hz to 3 kHz BW)<sup>1</sup>:**

250 kHz to 10 MHz:  $< 0.2\%$  AM for  $< 5$  kHz peak deviation.

10 MHz to 1300 MHz:  $< 0.2\%$  AM for  $< 50$  kHz peak deviation.

**Residual AM (50 Hz to 3 kHz BW):**  $< 0.01\%$  rms.

#### Maximum depth resolution:

0.01% for depths  $\leq 39.99\%$ ; 0.1% for depths  $\geq 40\%$ .

### Frequency Counter

**Range:** 150 kHz–1300 MHz.

**Accuracy:** reference accuracy  $\pm 3$  counts of least significant digit.

#### Internal reference:

**Frequency:** 10 MHz.

**Aging rate:**  $< 1 \times 10^{-6}$ /month (optional<sup>3</sup>:  $< 1 \times 10^{-9}$ /day).

#### Maximum resolution:

10 Hz for frequencies  $< 1$  GHz; 100 Hz for frequencies  $\geq 1$  GHz.

### RF Level (Peak Voltage Responding, RMS Sine Wave Power Calibrated)

**Range:** 1 mW to 1W

**Instrumentation accuracy:**  $\pm 1.5$  dB (150 KHz to 1300 MHz); 0.7 dB typical.

**SWR:**  $\leq 650$  MHz:  $< 1.3$  in a 50  $\Omega$  system.

$< 1300$  MHz:  $< 1.5$  in a 50  $\Omega$  system.

#### Resolution:

0.1 mW for levels 0.1 to 1W

0.01 mW for levels 0.01 to 0.1W

0.001 mW for levels  $< 0.01$ W.



## Audio Filters

**High pass (3 dB cutoff frequency):** 50 Hz and 300 Hz

**Low pass (3 dB cutoff frequency except > 20 kHz filter):** 3 kHz, 15 kHz, > 20 kHz

**De-emphasis filters:** 25  $\mu$ s, 50  $\mu$ s, 75  $\mu$ s, and 750  $\mu$ s.

## Flatness:

50 Hz High Pass: <1% at rates  $\geq$  200 Hz

300 Hz High Pass: <1% at rates  $\geq$  1 kHz

3 kHz Low Pass: <1% at rates  $\leq$  1 kHz

15 kHz Low Pass: <1% at rates  $\leq$  10 kHz

> 20 kHz Low Pass: <1% at rates  $\leq$  10 kHz

## Calibrators (Option 010)

**AM calibrator depth and accuracy:** 33.33% depth, nominal; internally calibrated to an accuracy of  $\pm 0.1\%$

**FM calibrator deviation and accuracy:** 34 kHz peak deviation, nominal; internally calibrated to an accuracy of  $\pm 0.1\%$

## General Characteristics

**Operating temperature range:** 0° to 55°C

**Power requirements:** 100, 120, 220, or 240V ac (+5, -10%); 48-66 Hz; 200 VA max.

**Weight:** net, 20 kg (44 lb); shipping, 25 kg (55 lb)

**Size:** 190 mm H x 425 mm W x 468 mm D (7.5 in. x 16.8 in. x 18.4 in.)

## 11715A AM/FM Test Source

The 11715A AM/FM Test Source provides very flat, wide-bandwidth, and low distortion amplitude or frequency modulated RF signals. Designed primarily for performance tests and adjustments of the 8901A Modulation Analyzer, it will also serve as a high quality modulated test oscillator where its frequency ranges apply.

The major components of the 11715A are a low-noise voltage controlled oscillator (VCO), two digital dividers, and a double balanced mixer. The VCO is the primary signal source, with a typical frequency range of 330 to 470 MHz at the FM OUTPUT. FM is produced by directly coupling the external modulation source to the VCO's tune input, providing very wide bandwidth modulation with low phase shift. This design also ensures very little incidental AM. The digital dividers derive the two lower frequency ranges from the FM modulated VCO output. The AM mode routes the external modulation signal directly to the mixer, which modulates the VCO divide-by-32 signal. This amplitude modulated carrier has very low incidental phase modulation. A separate crystal oscillator and frequency doubler provide a low-residual FM output at 560 MHz.

The 11715A can also be used in conjunction with an 8901A as a calibrated signal source for special applications. In particular, the U.S. commercial FM broadcast band of 88 to 108 MHz is covered by the FM  $\div$  4 OUTPUT of the 11715A. Typical stereo separation of 60 dB with very low distortion can be obtained over the full range of broadcast modulation requirements.

## 11715A Specifications

### FM Outputs

#### Frequency Range

**AM FM  $\div$  32 output:** 11 to 13.5 MHz

**FM  $\div$  4 output:** 88 to 108 MHz

**FM output:** 352 to 432 MHz

#### Peak Deviation

**11 to 13.5 MHz carrier:** > 12.5 kHz

**88 to 108 MHz carrier:** > 100 kHz

**352 to 432 MHz carrier:** > 400 kHz

#### Distortion

<0.025% THD (<-72 dB) for

Carrier frequency	Peak deviation	Modulation rate
12.5 MHz	12.5 kHz	<10 kHz
100 MHz	100 kHz	<100 kHz
400 MHz	400 kHz	<100 kHz

#### Flatness

**dc to 100 kHz rates:**  $\pm 0.1\%$

**dc to 200 kHz rates:**  $\pm 0.25\%$

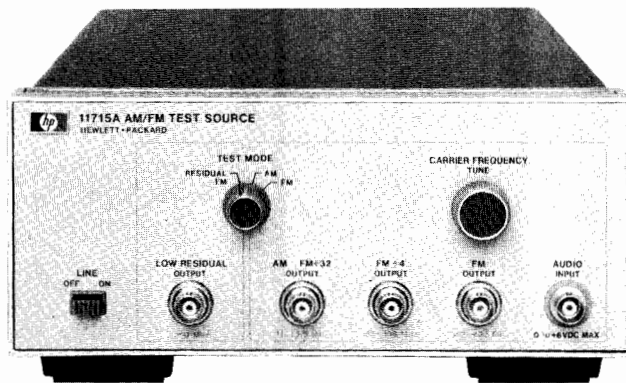

11715A

**Incidental AM (100 MHz carrier, <50 kHz peak deviation, 1 kHz rate, 50 Hz to 3 kHz bandwidth):** <0.08%

**Residual FM (typical, 50 Hz to 15 kHz bandwidth)**

**12.5 MHz:** <1 Hz rms

**100 MHz:** <8 Hz rms

**400 MHz:** <32 Hz rms

**Stereo separation (88 to 108 MHz carrier, 75 kHz peak deviation, 1 kHz rate):** >60 dB typical

### AM Output

**Frequency range (AM FM  $\div$  32 output):** 11 to 13.5 MHz

**Depth:** to 99%

### Distortion

**50% AM, 20 Hz to 100 kHz rates:** <0.05% THD (<-66 dB)

**95% AM, 20 Hz to 100 kHz rates:** <0.1% THD (<-60 dB)

### Flatness

**50 Hz to 50 kHz rates:**  $\pm 0.1\%$

**20 Hz to 100 kHz rates:**  $\pm 0.25\%$

**Incidental  $\emptyset$ M (12.5 MHz carrier, 50% AM, 1 kHz rate, 50 Hz to 3 kHz bandwidth):** <0.008 radian peak

### Linearity

**$\leq 95\%$  AM:**  $\pm 0.1\%$

**$\leq 99\%$  AM:**  $\pm 0.2\%$

**Residual AM (50 Hz to 3 kHz bandwidth):** <0.01% rms

### Low Residual Output

**Residual FM (50 Hz to 3 kHz bandwidth):** <3 Hz rms

**Frequency:** 560 MHz  $\pm$  50 kHz nominal

### General

#### Line Voltage

**48 to 440 Hz:** 100 to 120 Vac (+5%, -10%)

**48 to 66 Hz:** 220 to 240 Vac (+5%, -10%)

**Power dissipation:** 40 VA maximum.

**Weight:** net 4.4 kg (9.5 lb); shipping 6.5 kg (14 lb)

**Size:** 102 mm H x 212 mm W x 444 mm D (4.0 x 8.4 x 17.5 in.)

#### Temperature

**Operating:** 0 to 55°C

**Storage:** -55 to 75°C

### Ordering Information

8901A Modulation Analyzer

(Note: HP-IB cable not supplied. See page 29.)

**Option 001:** Rear panel instead of front panel connectors

**Option 002:**  $1 \times 10^{-9}$ /day internal reference oscillator

**Option 003:** Rear panel connections for external local oscillator

**Option 004:** Operation from 48 to 440 Hz power line (100-120V ac only)

**Option 010:** AM and FM calibrators

**Option 907:** Front panel handle kit

**Option 908:** Rack mounting flange kit

**Option 909:** Front panel handle and rack mounting flange kit

**Option 910:** Extra operating & service manual

11715A AM/FM Test Source

**Option 907:** Front panel handle kit

**Option 910:** Extra operating & service manual

**Rack mounting kit:** (P/N 5061-0072)

# SIGNAL ANALYZERS

## Audio Analyzer, 20 Hz to 100 kHz

### Model 8903A

- Measures distortion, SINAD, signal-to-noise
- Measures true rms volts, dc volts, frequency
- Programmable low distortion source

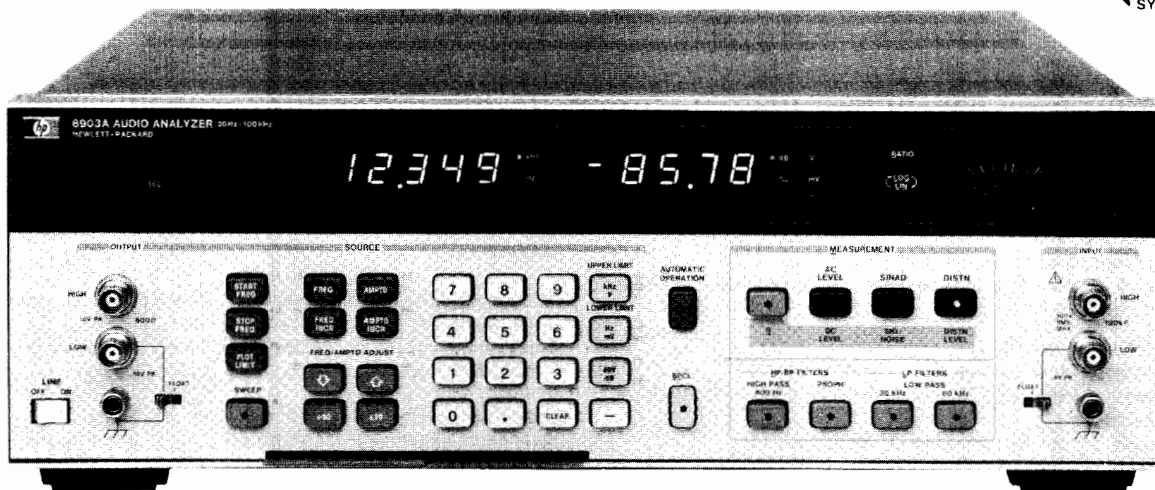

8903A

### 8903A Audio Analyzer

The 8903A Audio Analyzer combines the capabilities of several instruments under microprocessor control to yield accurate and rapid characterizations of audio signals in the range of 20 Hz to 100 kHz. It contains an audio source, measures distortion, SINAD, signal-to-noise ratio, ac and dc level, and counts frequency completely automatically with either a single front panel keystroke or under HP-IB remote control. This combination reduces the number of instruments and complexity of setup needed in many applications.

The analyzer is ideally suited for performing audio measurements on transceivers. Along with a suitable signal generator and modulation analyzer, receiver sensitivity and transmitter distortion measurements can be made accurately and rapidly.

With the internal source and measurement functions enhanced by microprocessor control, the 8903A has more measurement capability and less display ambiguity than separate instruments. The Audio Analyzer makes true rms measurements for ac level and distortion, thus assuring more accurate measurements of complex waveforms and noise. The ability to perform swept measurements makes it an extremely versatile stand-alone bench instrument for general audio stimulus/response work. Its programmability over HP-IB is well suited to system applications.

### Transceiver Testing

The Audio Analyzer performs several measurements and contains various features specifically designed for receiver testing. The most common audio measurements are SINAD for FM receivers and signal-to-noise for AM receivers. In the 8903A, these measurements are optimized for measuring the noisy signals encountered in receiver testing. Measurements of SINAD are indicated both by the analog meter and the digital display. The specially marked meter for EIA and CEPT sensitivity and selectivity results in fast, accurate, repeatable measurements. Also, a psophometric filter allows testing to CEPT standards.

By combining the 8903A with the 8901A Modulation Analyzer, you can make all common transmitter tests. The 8903A provides the tone for microphone inputs, measures transmitter audio distortion, and counts squelch tones. Distortion measurements can be made using the 400 Hz high pass filter to reject squelch tones. In rapid frequency count mode, counter measurements can be made at a rate of 8 ms/reading, allowing burst counting of squelch tone frequencies. In rapid source mode, the 8903A can switch frequencies rapidly enough to generate multiple tone squelch sequences. All functions are remotely programmable.

### Audio Testing

The 8903A simplifies general audio testing by combining several traditional audio instruments into one. It is fully automatic and autoranging, so most measurements take only a single keystroke. Microprocessor control of all functions greatly enhances measurement flexibility. For example, distortion can be displayed in either percent or dB. In ac level you can choose between volts, dBV, or watts by entering the load resistance from the keyboard. You can establish a reference and make measurements in percent or dB relative to a measured or entered value. Using the source increment/decrement keys and relative display mode it is easy to determine parameters such as the 3 dB points of filters and amplifiers. With both low-distortion source and analyzer built in, the 8903A makes stimulus-response measurements. Internal processor control over all functions expands this capability to powerful swept characterization. With only a few keystrokes you can measure frequency response and swept distortion characteristics of filters, high quality amplifiers, audio IC's, and other devices. Hard copy results are easily generated with an X-Y recorder connected to the analyzer's rear panel outputs.

### Systems Applications

The Audio Analyzer is a powerful HP-IB system component. Many low frequency functions frequently required in automatic systems are combined in the 8903A. In many cases it does the work of an audio synthesizer, digital voltmeter, frequency counter, and custom interface with notch filters. All measurements are available at a single input connector. As a result, interfacing requirements, hardware cost, and software development time are reduced. The 8903A makes a major contribution by automatically measuring distortion under HP-IB control. It also provides a low distortion programmable source. Typical combined distortion of both source and analyzer at 1V is <math><0.003\%</math> between 20 Hz and 20 kHz.

Often systems applications involve measuring low level ac signals. The 8903's most sensitive range features a full scale ac level display of .300 mV with an accuracy of 4% of reading (2% of reading > 50 mV, 20 Hz to 20 kHz). The ac converter is true rms for correct noise measurements and the 3 dB bandwidth is greater than 500 kHz.

Large measurement systems often have troublesome noise problems. The 8903A has 30 kHz and 80 kHz low-pass filters to reject high frequency noise. Also, the 400 Hz high-pass filter rejects line related hum and noise more than 68 dB. Floating the input or output can break insidious ground loops, and provide up to 60 dB of common mode rejection.

Two special binary programming modes are available in remote operation. Rapid frequency count mode provides a packed four byte output for fast counting. Also, the rapid source mode allows the internal source to be programmed directly with five bytes.



## 8903A Specifications

### Source

**Frequency range:** 20 Hz to 100 kHz.

**Frequency resolution:** 0.3%

**Frequency accuracy:** 0.3% of setting.

**Output level range:** 0.6 mV to 6V open circuit.

**Output level resolution:** 0.3% or better.

**Output level accuracy (open circuit):** 2% of setting, 60 mV to 6V, 20 Hz to 50 kHz; 3% of setting, 6 mV to 6V, 20 Hz to 100 kHz; 5% of setting, 0.6 mV to 6 mV, 20 Hz to 100 kHz.

**Flatness (1 kHz reference):**  $\pm 0.7\%$ , 20 Hz to 20 kHz;  $\pm 2.5\%$ , 20 Hz to 100 kHz.

**Distortion & noise:** the higher of:  $-80$  dB or  $30 \mu\text{V}$ , 20 Hz to 20 kHz, 80 kHz BW;  $-70$  dB or  $95 \mu\text{V}$ , 20 kHz to 50 kHz, 500 kHz BW;  $-65$  dB or  $169 \mu\text{V}$ , 50 kHz to 100 kHz, 500 kHz BW.

**Impedance:**  $600\Omega \pm 1\%$ .

**Sweep mode:** logarithmic sweep with up to 500 points/decade or 255 points between entered start and stop frequencies, whichever is smaller.

### AC Level

**Full range display:** 300.0V, 30.00V, 3.000V, 0.3000V, 30.00mV, 3.000 mV, 0.3000mV.

**Overrange:** 33% except on 300V range.

**Accuracy:**  $\pm 2\%$  of reading, 30V to 300V, 20 Hz to 1 kHz;  $\pm 2\%$  of reading, 50 mV to 30V, 20 Hz to 20 kHz;  $\pm 4\%$  of reading, 0.3 mV to 30V, 20 Hz to 100 kHz.

**AC Converter:** true-rms responding for signals with crest factor  $\leq 3$  and harmonics up to 80 kHz typical. 3 dB measurement BW:  $> 500$  kHz typical. Average detection selectable by internal jumpers.

### DC Level

**Full range display:** 300.0V, 48.00 V, 16.00V, 4.00V.

**Overrange:** 33% except on 300V range.

**Accuracy:**  $\pm 0.75\%$  of reading, 400 mV to 300V;  $\pm 3$  mV,  $< 400$  mV.

### Distortion

**Fundamental frequency range:** 20 Hz to 100 kHz.

**Display range:** 0.001% to 100%,  $-99.99$  dB to 0 dB.

**Accuracy:**  $\pm 1$  dB, 20 Hz to 20 kHz;  $\pm 2$  dB, 20 kHz to 100 kHz.

**Input voltage range:** 50 mV to 300V.

**Residual noise and distortion:** the higher of: 0.01%,  $-80$  dB, or  $30 \mu\text{V}$ , 20 Hz to 20 kHz, 80 kHz BW; 0.032%,  $-70$  dB, or  $95 \mu\text{V}$ , 20 kHz to 50 kHz, 500 kHz BW; 0.056%,  $-65$  dB, or  $169 \mu\text{V}$ , 50 kHz to 100 kHz, 500 kHz BW.

**Displayed resolution:** 0.0001%,  $< 0.1\%$  distortion; 0.001%, 0.1% to 3% distortion; .01%, 3% to 30% distortion; 0.1%,  $> 30\%$  distortion.

**Detection:** true rms (average detection selectable by internal jumpers).

### SINAD<sup>1,2</sup>

**Fundamental frequency range:** 20 Hz to 100 kHz.

**Display range:** 0 dB to 99.99 dB.

**Accuracy:**  $\pm 1$  dB, 20 Hz to 20 kHz;  $\pm 2$  dB, 20 kHz to 100 kHz.

**Input voltage range:** 50 mV to 300V.

**Detection:** true rms (average detection selectable by internal jumpers).

**Resolution:** 0.01 dB for SINAD ratios  $> 25$ . For ratios  $< 25$  the display is rounded to the nearest half dB to reduce digit flickering of noise signals. (Full resolution is available by defeating this feature using special function 16.1.)

**Analog meter:** active in SINAD only and for SINAD ratios  $< 18$  dB (or 24 dB using special function 7.1.)

**Tuning:** notch filter is tuned to analyzer source frequency.

### Signal to Noise

**Frequency range:** 20 Hz to 100 kHz.

**Display range:** 0 dB to 99.99 dB.

**Accuracy:**  $\pm 1$  dB.

<sup>1</sup>SINAD is a sensitivity measurement computed from the ratio of signal plus noise and distortion to noise and distortion.

<sup>2</sup>Residual noise and distortion same as for distortion mode.

**Input voltage range:** 50 mV to 300V.

**Residual noise:** the higher of  $-80$  dB or  $30 \mu\text{V}$ , 80 kHz BW;  $-70$  dB or  $95 \mu\text{V}$ , 500 kHz BW.

**Resolution:** same as SINAD.

**Operation:** the analyzer displays the ratio of the input voltages as the internal source is automatically switched on and off.

### Frequency Counter

**Range:** 20 Hz to 150 kHz<sup>3</sup>.

**Resolution:** 5 digits<sup>4</sup>.

**Accuracy:**  $0.004\% \pm 1$  digit.

**Input sensitivity:** 50 mV in distortion and SINAD modes, 5.0 mV in ac level and sig/noise modes.

**Counting technique:** reciprocal with 2 MHz timebase.

### Audio Filters

**400 Hz high pass filter:** 3 dB cutoff frequency, 400 Hz  $\pm 40$  Hz; 140 dB/decade rolloff.

**Psophometric filter (CCITT recommendation P53):** deviation from ideal response:  $\pm 0.2$  dB at 800 Hz;  $\pm 1$  dB, 300 Hz to 3 kHz;  $\pm 2$  dB, 50 Hz to 3.5 kHz;  $\pm 3$  dB, 3.5 kHz to 5 kHz.

**30 kHz low pass filter:** 3 dB cutoff frequency, 30 kHz  $\pm 2$  kHz; 60 dB/decade rolloff.

**80 kHz low pass filter:** 3 dB cutoff frequency, 80 kHz  $\pm 4$  kHz; 60 dB/decade rolloff.

### Rear Panel Inputs/Outputs

**Recorder output:** X: 0-10 Vdc (typical) corresponding to log of oscillator frequency.

Y: 0-10 Vdc (typical) corresponding to displayed value and entered plot limits.

**Recorder output resistance:** 1 k $\Omega$  nominal.

**Monitor output:** in ac level mode provides scaled output of measured input signal. In SINAD, distortion, and distortion level modes provides scaled output of input signal with the fundamental removed.

### General

**Input impedance:** 100k $\Omega \pm 1\%$  shunted by  $< 300$  pF with low terminal grounded<sup>5,6</sup>.

**CMRR (@ 60 Hz):** 60 dB for differential input  $< 2\text{V}$ ; 36 dB for differential input  $< 48\text{V}$ ; 30 dB for differential input  $> 48\text{V}$ .

**Remote operation:** HP-IB, all functions except the line switch, low terminal ground switches, and the  $\times 10 \div 10$  increment keys.

**HP-IB compatibility, as defined in IEEE-488-1978, is:** SH1, AH1, T5, TE0, L3, LE0, SR1, RL1, PP0, DC1, DT1, C0.

**Temperature:** operating, 0° to 55°C; storage,  $-55^\circ\text{C}$  to 75°C.

**Power requirements:** 100, 120, 220, or 240 volts (+5, -10%); 48-440 Hz; 100 VA maximum.

**Weight:** net, 12.3 kg (27 lb); shipping, 16.4 kg (36 lb).

**Size:** 146 H x 425 W x 440 mm D (5.75 x 16.8 x 17.3 in.).

**HP System II Module Size:** 5/4 H x 1 MW x 17 D. See pp. 642-645 for compatible accessories.

**EMI:** conducted and radiated interference is within the requirements of methods CE03 and RE02 of MIL STD 461A, VDE 0871, and CISPR publication 11. Conducted and radiated susceptibility meet the requirements of methods CS01, CS02, and RS03 (1 volt/meter) of MIL STD 461A dated 1968.

### Ordering Information

#### 8903A Audio Analyzer

(Note: HP-IB cable not supplied. See page 30.)

**Option 001:** Rear panel connections instead of front panel for source output and analyzer input.

**Option 907:** Front panel handle kit

**Option 908:** Rack mount flange kit

**Option 909:** Front panel handle plus rack mount flange kit

**Option 910:** Extra Operating & Service Manual

<sup>3</sup>20 Hz to 100 kHz in SINAD and distortion.

<sup>4</sup>Resolution is limited to 0.01 Hz for input frequencies  $< 100$  Hz.

<sup>5</sup>In dc level mode input resistance is 101k $\Omega \pm 1\%$ .

<sup>6</sup>Input capacitance is  $< 330$  pF for Option 001.

# TRANSCEIVER TEST EQUIPMENT

## 8955A RF Test System

- High Performance Measurements of AM and FM Transmitters, Receivers, and Their Modules.
- Frequency Range from 150 kHz to 1000 MHz.
- System Calibration, Verification and Diagnostics.

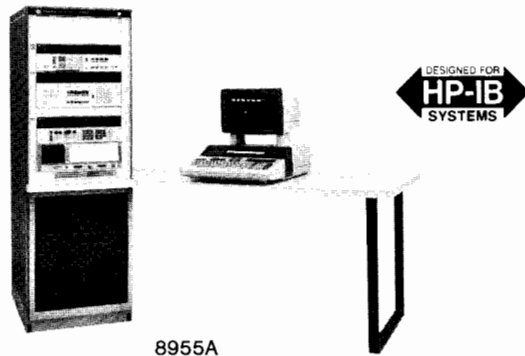

8955A

### 8955A RF Test System

The 8955A RF Test System is a flexible combination of instrumentation and software used in the testing of transmitters, receivers, and subassemblies. The basic system consists of four measurement instruments: 8901A Modulation Analyzer, 8903A Audio Analyzer, 8656A Signal Generator, and 436A Power Meter. To these instruments is added the 8956A System Interface to provide flexibility and easy system integration. The system is automated with a powerful software package that is executed on either the 9845B or 9835A Computer System. All hardware is mounted in a 29402C cabinet and a desk is mounted off one side.

### 11724A/11725A Software Packages

The 11724A Software Package for the 9835A or the 11725A Software Package for the 9845B assure comprehensive transceiver testing on the same day the system is turned on. The software package is a powerful combination of operating system and measurement test routines. The operating system allows you to learn about system operation through its HELP command, verify system operation, reconfigure the system if new instruments are added or generate and execute a program from HP supplied test routines. While the test package is executing, you can interact with the system: halt execution to modify parameters, repeat certain tests, or learn more about system operation. There are over 60 measurement test routines which use the Electronic Industry Association (EIA) and Conference of European Postal and Telecommunications Administration (CEPT) standards for AM and FM receivers, transmitters, and their circuitry.

Additional software includes a powerful verification program, calibration program and configuration program which allows you to change the instrument configuration.

### Options

The system offers a variety of options to meet your needs. These options include instrumentation for SSB testing, out-of-channel testing, spurious response testing, power supplies, computer peripherals and cabinet hardware. All options are fully supported and integrated at the factory. Comprehensive documentation and installation are included with every system.

### Optional Instrumentation

8662A Synthesized Signal Generator  
8568A Spectrum Analyzer  
3325A Synthesizer/Function Generator  
9835A Desktop Computer  
9845B Desktop Computer  
9895A Disc Drive  
9876A Thermal Printer  
Second 29402C Cabinet  
Sidebay  
Second Desk

- A Fully Automatic Operating System With Easy Softkey Interaction.
- Automatic Program Generator.
- Over 60 Tests Using EIA and CEPT Standards.

### 8955A SYSTEM SPECIFICATIONS (INCLUDES SOFTWARE CALIBRATION)

#### RF Signal Measurements (Transmitter Tests)

**Frequency Range:** 150 kHz to 1000 MHz.

**Frequency Measurement Accuracy:** refer to 8901A.

#### Power Measurement Range:

With the 30 dB attenuator: 50 mW to 120 W.

Without the 30 dB attenuator: 100  $\mu$ W to 0.5 W.

#### Power Measurement Accuracy:

**With the 30 dB attenuator:**

Within 2 MHz of calibration frequencies:  $< \pm 0.5$  dB ( $\pm 0.3$  dB typical).

1 MHz to 1000 MHz:  $< \pm 0.45$  dB typical.

#### Input VSWR:

With the 30 dB attenuator:

dc to 1000 MHz:  $\leq 1.2$ .

**Modulation Measurements (AM, FM, PM):** refer to 8901A.

#### RF Signal Source (Receiver Tests)

**Frequency Range:** 100 kHz to 990 MHz.

Option 112 or 122: 10 kHz to 1280 MHz.

#### Output Level Range:

With the 30 dB attenuator:  $-27$  dBm to  $-130$  dBm.

Without the 30 dB attenuator:  $+0$  dBm to  $-130$  dBm.

#### Output Level Accuracy:

**With the 30 dB attenuator:**

Within 2 MHz of calibration frequencies:  $< \pm 1.8$  dB.

100 kHz to 990 MHz:  $< \pm 1.5$  dB typical.

#### Option 112 or 122:

Within 2 MHz of calibration frequencies:  $< \pm 1.3$  dB.

10 kHz to 1000 MHz:  $< \pm 1.1$  dB typical.

#### Output VSWR:

With the 30 dB attenuator:

dc to 1000 MHz:  $\leq 1.2$ .

**Modulation:** Refer to signal generator specifications.

#### Audio Measurements:

**Frequency Range:** Refer to 8903A.

**Voltage Measurement Range:** 50 mV to 30 V.

**Voltage Measurement Accuracy:** Refer to 8903A.

**Distortion Measurement:** Refer to 8903A.

#### Audio Source

**Frequency Range:** 20 Hz to 100 kHz.

**Output Voltage Range:** Refer to 8903A.

**Output Voltage Accuracy:** Refer to 8903A.

**Current Drain Measurement Range:** 0 to 30 A.

**Current Drain Measurement Accuracy:**

$I < 10$  A:  $\pm (2.5\%$  of reading  $+ 12$  mA).

$I > 10$  A:  $\pm (4\%$  of reading  $+ 12$  mA).

#### Timing Measurements:

Closure of relay to half RF power (Carrier Attack Time).

Application of an RF signal to 90% rated audio power (Receiver Attack Time).

Removal of an RF signal to squelch closure (Receiver Squelch Closing Time).

**Timing Accuracy:**  $\pm 5$  msec typical.

**Timing Interval:** 500 msec maximum

**Timing Resoluton:** 0.1 msec.

#### General Specifications

**System Operating Temperature:**  $15^\circ$  to  $35^\circ$  C.

**System Storage Temperature:**  $-40^\circ$  to  $+75^\circ$  C.

**Ambient Humidity:** 5% to 80%.

**Power:** 115 V, 60 Hz; Standard system w/9845B:

Approximately 900 VA worse case.

**Net Weight (less controller):** 150 kg (330 lb).

**Shipping Weight (less controller):** 212 kg (467 lb).

**Cabinet Dimensions:** 163 cm H x 53 cm W x 70 cm D (64.25" x 21.0" x 27.6").

# TRANSCIVER TEST EQUIPMENT

Transceiver Test Set  
Model 8953A

529

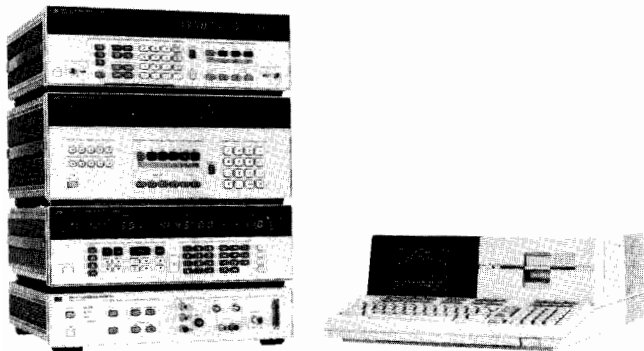

## Description

The 8953A Transceiver Test Set performs automatic and manual in-channel testing of AM and FM communication receivers and transmitters from 150 kHz to 990 MHz. It combines the measurement power of the 8901A Modulation Analyzer, 8903A Audio Analyzer and 8656A Synthesized Signal Generator with the 8954A Transceiver Interface, all necessary cables and accessories and a choice of controllers: the 85F, 9826A or 9836A Computer Systems.

## Flexible and Expandable

Together these instruments and controllers provide a broad range of measurement capability from simple tests such as RF frequency and distortion through complex measurements including receiver usable sensitivity and audio frequency response. Basic in-channel testing of a radio using the test set's 11723B or 11790A Application Pac software typically takes less than a minute. These application pacs, the 11723B for the 85F and the 11790A for the 9826A and 9836A, are comprehensive starter/demonstration software programs written in BASIC language. They are modular in structure and easily customized for specific applications.

For those requiring additional measurement capability such as out-of-channel or SSB testing, the test set's 8954A interface has connections for a second signal generator, a second RF monitor such as a power meter or a spectrum analyzer, and a d.c. power supply.

## Option 100

This option substitutes the more powerful 8956A System Interface for the standard 8954A Transceiver Interface, adding capabilities including current drain and transmitter and receiver attack time measurements. Two controller options, 103 and 104, are available with Option 100. These options include either the 9826A or 9836A Computer System and the 11790B Application Pac software which takes advantage of the added capabilities of the 8956A.

## Easy to Operate

The 8953A test set is easy to use in both automatic and manual operation. Full front panel control, plus indicators for all functions, make test program development easy with the 85F, 9826A or 9836A controller. Procedures can be developed manually and then translated to the controller's BASIC language by simply substituting one- or two-character program codes for keystrokes. For example, the keystroke sequence "Frequency 455 MHz" is equivalent to the program code "FR455MZ".

## Easy to Assemble

Assembling the test set is quick and easy. The 8953A Operating Manuals describe the simple setup procedure, provide a method for verifying setup, and describe how to use the supplied 11723B/11790A/11790B Application Pac software. You need to provide a power supply for the transceiver under test, and cables between the 8954A Transceiver Interface and the transceiver. Everything else is included.

Receiver In-channel	Transmitter	General
Sensitivity* Audio Power* Signal-to-Noise* Distortion* SINAD Quieting Audio Freq. Response* Hum and Noise	Power* Frequency* Frequency Error* AM, FM, $\phi$ M Squelch Frequency* Squelch Deviation* Residual AM, FM or $\phi$ M Incidental AM, FM or $\phi$ M Microphone Sensitivity* Distortion*	AC Volts DC volts Frequency Distortion
<b>Receiver Out-of-Channel</b> Adjacent channel selectivity** Image rejection** IF rejection**	Modulation Limiting* Audio Freq. Response Hum and Noise*	
*Tests performed and displayed by the 11723B/11790A/11790B Application Pac program. Additional subroutines are provided for all the measurements.		**Additional tests performed and displayed using the 11723B/11790A/11790B Application Pac program if an 8662A Signal Generator is added to the test set for out-of-channel testing.

## Ordering Information

### 8953A Transceiver Test Set

#### 8901A Modulation Analyzer

Option 001 Rear Panel Connections

Option 002 High Stability Time Base

#### 8656A Signal Generator

Option 002 Rear Panel Connections

#### 8903A Audio Analyzer

Option 001 Rear Panel Connections

#### 8954A Transceiver Interface

8498A Option 030 Attenuator, 25 watt, 30 dB

10833A Low-RFI HP-IB Cables (3)

11500B 60 cm N Cables (2)

11170A 30 cm BNC Cable

11170B 60 cm BNC Cables (2)

11170C 120 cm BNC Cables (2)

908A 50-Ohm Termination

Option 001: adds HP 85F Computer System, 82903A 16K memory module and 11723B Application Pac

Option 003: adds HP 9826A & HP 98601A option 655 ROM BASIC 2.0 Computer System, 98256A 256 kbyte RAM Memory Board and 11790A Application Pac

Option 004: adds HP 9836A & HP 98601A option 655 ROM BASIC 2.0 Computer System, 98256A 256 kbyte RAM Memory Board and 11790A Application Pac

Option 100: adds 8956A System Interface; deletes 8954A Transceiver Interface, 8498A Attenuator, and 908A Termination

Option 103: adds HP 9826A & HP 98601A option 655 ROM BASIC 2.0 Computer System, 98256A 256 kbyte RAM Memory Board and 11790B Application Pac

Option 104: adds HP 9836A & HP 98601A option 655 ROM BASIC 2.0 Computer System, 98256A 256 kbyte RAM Memory Board and 11790B Application Pac

11723B Application Pac

11790A Application Pac

11790B Application Pac

# TRANSCEIVER TEST EQUIPMENT

## RF Interfaces

Models 8954A, 8956A

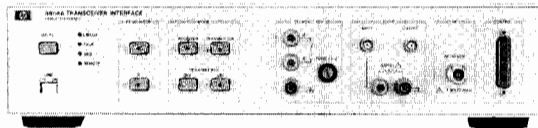

8954A

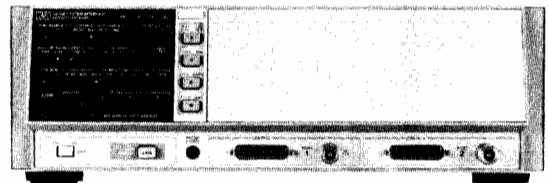

8956A

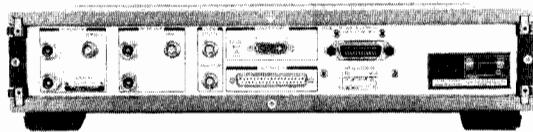

8954A Rear View

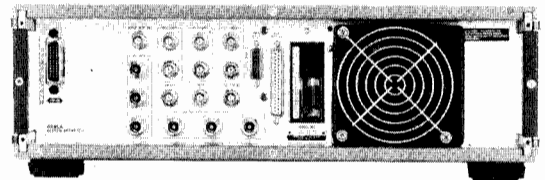

8956A Rear View

### 8954A Transceiver Interface

The 8954A is Hewlett-Packard's lowest priced transceiver test interface. It is fully programmable and designed for dc to 18 GHz measurement applications.

The 8954A interface has connections for the three measurement instruments in the 8953A test set (8901A, 8903A, 8656A). You can add a second signal generator, a second RF monitor such as power meter or a spectrum analyzer, and route a power supply's output through the interface to the front panel transceiver connector. External devices may be controlled with the 8954A's sixteen programmable form-A contact relays.

Using the annunciator front panel keys, you can manually control the Receive/Transmit signal path, select either RF monitor, or key the transmitter. The 8954A Transceiver Interface provides the flexibility needed for most AM, FM and SSB receiver and transmitter testing.

#### 8954A Specifications

**RF Frequency Range:** 100 kHz to 1300 MHz. (Usable dc to 18 GHz.)

**VSWR (RF Port to RF Monitor):**  $\leq 1.15$

**VSWR (RF Source to RF Port):**  $\leq 1.15$

**RF insertion loss: (RF Port to RF Monitor)**  $\leq 0.5$  dB

**RF insertion loss: (RF Source to RF Port)** 6.0 dB +0.45 dB -0.35 dB

**Audio Frequency Range:** 20 Hz to 100 kHz. (dc coupled)

**Audio Insertion Loss:** 0.03 dB, 20 Hz to 20 kHz. 0.3 dB, 20 kHz to 100 kHz.

#### Supplemental characteristics

##### DC power supply circuit

**Current:** 30A (Voltage <28 Vdc)

**Voltage:** 50 Vdc (Current <15A)

##### Transmit Key Relay

**Current:** 1.5A (Voltage <28 Vdc)

**Voltage:** 50 Vdc (Current <0.5 A)

**Auxiliary Relays** (16 Form-A contact)

**Current:** 0.5A (Voltage <20 Vdc)

**Voltage:** 50 Vdc (Current <0.2 A)

#### Ordering Information

8954A Transceiver Interface

### 8956A System Interface

The 8956A System Interface, with its multiple paths and connections, provides flexibility in the designing of systems in the frequency range from dc to 1000 MHz. It can integrate up to 3 signal generators, 3 RF measurement instruments, 2 audio sources, 2 audio measurement instruments and a dc power supply.

A front panel keyboard makes it easy to control all switching operations making it a valuable component in system integration. Store/Recall keys of the front panel settings give extra versatility in manual operation.

The 8956A System Interface has 2 RF test ports for duplex testing, stimulus/response testing or for connect/unconnect of one unit under test while another is being tested. Next to each RF port is a control connector that contains all the audio and power signals.

Other additional functions of the 8956A include current drain and timing measurements.

#### 8956A Specifications

**Frequency Range:** dc to 1000 MHz

##### Maximum Input Power to RF Ports:

With the 30 dB attenuator: 120 W CW

Without the 30 dB attenuator: 0.5 W CW

##### VSWR:

RF Ports: (Instrument connections terminated in 50 ohms):

With the 30 dB attenuator: dc to 1000 MHz:  $\leq 1.2$

##### Audio:

Frequency Range: dc to 100 kHz

#### Supplemental Specifications

##### Insertion Loss:

Maximum variation of insertion loss with frequency: <5 dB.

Insertion loss of major RF source and monitor paths with the attenuator inserted can be characterized by:  $A(\text{dB}) = A_0 + k\sqrt{f}$   
 $A_0$  = Loss at dc,  $k$  = Constant,  $f$  = Frequency (MHz).

#### Ordering Information

8956A System Interface

Option 001 Rear Panel RF and Control Ports



### Introduction

Measurements on digital communications systems are often grouped into those performed on the terminal conversion process of the analog signal to PCM and those on the TDM muldex and transmission link carrying the digitally encoded signal. However, with the merging of switching, terminals and transmission in an Integrated Digital Network (IDN), and the emergence of other digitised services, for example digital data, within the context of an Integrated Services Digital Network (ISDN), this division of "terminal" and "transmission" measurements is not always clear or convenient. For example, a digital switch needs to be tested analog-to-analog (A-A), analog-to-digital (A-D) and digital-to-analog (D-A) on its conventional analog voice ports and digital-to-digital (D-D) on the digital ports. With the development of sophisticated conversion devices like transmultiplexers which directly convert signals in the FDM domain to the TDM domain and vice versa, the need has arisen for D-D tests of voice channel parameters such as channel gain, frequency response, noise and quantizing distortion. The objective and subjective effect of transmission parameters such as error ratio and timing jitter on the decoded analog service carried, for example TV, is also becoming more important. It is convenient perhaps to consider measurements of PCM performance separately from those of TDM performance.

### PCM Measurements and Test Equipment

Traditionally, primary PCM multiplex equipment has been characterised in terms of voice channel performance by either connecting two terminals back-to-back or looping a single terminal at the digital side. The performance parameters and measurement methods have been standardized by the International Telegraph and Telephone Consultative Committee (CCITT). While this approach for local testing has been adequate for local junction or point-to-point systems, the introduction of an IDN requires A-D, D-A and D-D tests to be made in addition to the A-A measurements. The 3779C/D Primary Multiplex Analyzer (PMA) provides this measurement capability in an integrated automatic test set. The instrument can be programmed to execute a complete measurement sequence to stored test limits with pass/fail conditions and print out results on an external printer. Automatic testing of all voice channels in a multiplex can be carried out via the 3777A Channel Selector controlled by the PMA. The PMA also has a general purpose single channel digital interface for testing single channel PCM codecs and digital switching line cards.

### TDM Measurements and Test Equipment

Measurements on digital terminal and transmission equipment are aimed at establishing primarily two performance criteria—binary error and timing jitter performance. Error performance can be expressed in various ways, for example bit error ratio (BER),

error-free seconds (EFS), or percentage time for which mean error rate exceeds a given threshold. The standard out-of-service technique of measuring error performance is to stimulate the system with a test pattern, usually a pseudo-random binary sequence (PRBS) and compare the received signal with a locally generated, error-free reference pattern on a bit-by-bit basis. In-service measurements usually monitor fixed known patterns carried within the traffic signal, for example the frame alignment signal of the terminal multiplex, or, in the case of line systems, monitoring errors in the line code. However, the latter method is only valid where no binary signal processing occurs between system input and output.

Jitter performance of a system or subsystem, regenerator, etc. is normally expressed in three ways—input jitter tolerance (ie jitter which can be applied without causing errors), intrinsic output jitter, and jitter transfer function (or jitter frequency response). Jitter tolerance and jitter transfer function are normally measured with the system out of service and applying a jittered test pattern while measuring errors and output jitter. Basic intrinsic output jitter can be measured out-of-service or in-service provided that the jitter meter has some means of recovering a timing reference from the input signal.

HP has an extensive range of error and jitter performance measuring equipment. The 3780A Pattern Generator/Error Detector provides binary and code error measurements in a single portable instrument for bit rates up to 50 Mb/s. A system comprising

the 3781A Pattern Generator and 3782A Error Detector offers error distribution analysis and jitter tolerance testing with full HP-IB control for 704, 2048, 8448 and 34368 kb/s systems to CEPT European standards. A similar 3781B/3782B system is available for testing DS-1, DS-1C, DS-2 and DS-3 levels in the Bell North American digital hierarchy. This system includes the necessary frame structures of the terminal multiplex equipment (except the DS-1C level where it can only be used on T1-C line systems). The error performance measurement systems are complemented by the 3785A/B Jitter Generator & Receiver which can be used to measure the jitter performance of CEPT and Bell digital transmission equipment. Comprehensive features including full HP-IB control and jitter analysis in the amplitude, frequency and real-time domains are provided in a compact portable instrument. Error performance measurements on higher speed systems up to 150 Mb/s can be made with the 3762A Data Generator and 3763A Error Detector. The system has specific options for interfacing at the 34368 and 139264 kb/s levels of the CEPT digital hierarchy. The 3762A/3763A have also been designed to operate in burst mode for Time Division Multiple Access (TDMA) satellite applications. For in-service measurements on 2048 kb/s systems, the 3783A 30 Ch PCM Alignment Monitor & Error Detector provides error detection on the frame alignment signal of the primary PCM/TDM muldex and HDB3 line code. It also detects and displays any alarm states present in the signal.

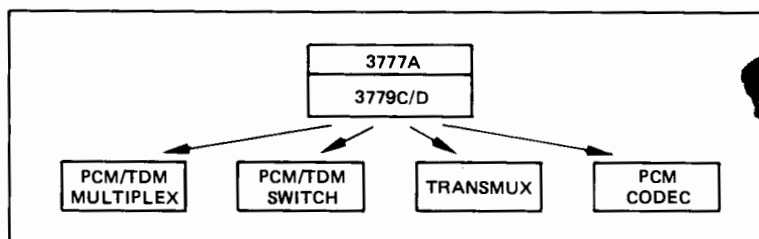

Figure 1. PCM test equipment

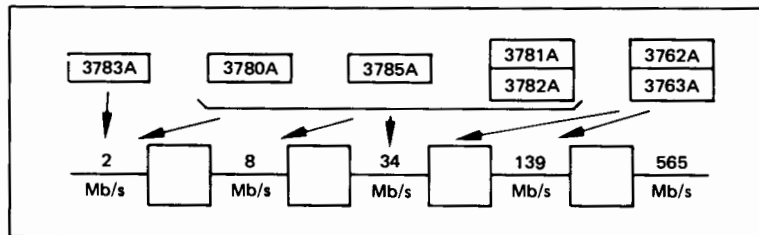

Figure 2. CEPT TDM hierarchy test equipment

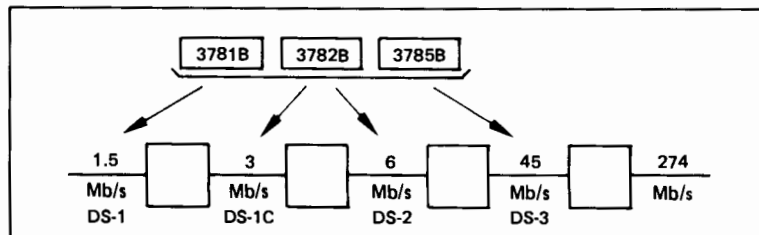

Figure 3. Bell TDM hierarchy test equipment





# TELECOMMUNICATIONS TEST EQUIPMENT

## PCM Multiplex / Channel Bank, Codec, and Digital Switching Line Card Analyzer

Models 3779C, 3779D

- A-A, A-D, D-A and D-D measurements
- Automatic measurement sequencing
- User-level keyboard programming

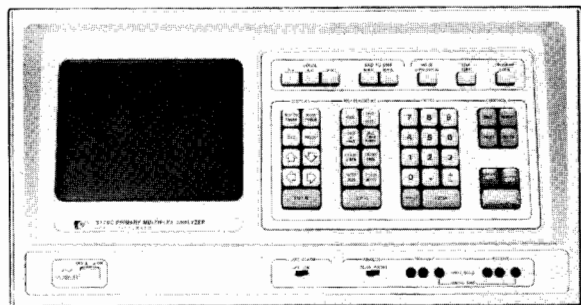

3779C



The 3779C Primary Multiplex Analyzer (PMA) provides voice channel measurements to CEPT recommendations. The digital options are designed to test PCM equipment conforming to CCITT Recommendations G.711 and G.732, i.e., 30 voice channels/32 time slots encoded using the A-law and multiplexed into a 2048 kb/s stream. A single channel TTL compatible interface is available for codec and digital line card testing where clock and sync signals are separate from the PCM data.

Model 3779D provides voice channel measurements to Bell recommendations. Digital options 001 and 003 are designed to test PCM equipment conforming to BSTR Pub 43801 and CCITT Recommendations G.711 and G.733, i.e., 24 voice channels/24 time slots encoded using the  $\mu$ -law and multiplexed into a 1544 kb/s stream. A single channel TTL compatible interface is also available on all options and is used exclusively on option 002 for  $\mu$ -law systems operating at 2048 kb/s.

### Concept

The 3779C/D PMA is an enhanced version of the 3779A/B. Major improvements, including digital signal generation and filtering, allow the 3779C/D to offer a complete range of faster, more accurate analog-analog (A-A), analog-digital (A-D) and digital-analog (D-A) measurements, and, in addition, a flexible D-D measurement capability.

The 3779C/D permits rapid, accurate, automatic testing of voice channel and primary level digital equipment, the main applications being in the areas of PCM terminals, codecs, and other specialised telecommunications IC's or hybrid devices, and digital switching systems, especially line card testing.

The instrument can automatically sequence through a number of measurements to programmed limits, calculate and output results on an alphanumeric CRT display. All measurement execution software is preprogrammed into the instrument, but test levels, frequencies, limits, etc. may be keyboard-modified if required. Measurements may be assembled into a sequence which is stored in non-volatile memory.

The PMA itself can control a number of 3777A Channel Selectors to provide multi-channel access for voice and signalling measurements. It can also format results and print them out via a suitable printer equipped with HP-IB. A built-in modem allows one PMA to control another over the channel under test, facilitating automatic end-end (E-E) testing of a voice circuit. A new feature in the 3779C/D offers considerable improvements in E-E measuring speed when testing on "wet" lines.

### Specifications

The standard 3779C/D provides A-A and E-E measurement capability. A-D, D-A, and D-D capabilities are optional. The A-A, A-D, D-A, and E-E measurements are summarized in Table 1.

- Non-volatile program store
- Automatic end-end testing via built-in data modem
- CCITT, CEPT, and Bell compatible

Table 1. 3779C/D PMA Measurement Capability

Measurements	A-A	A-D	D-A	E-E
Gain	•	•	•	•
High accuracy gain	•			
Digital mW gain			•	
Gain vs frequency	•	•	•	•
Gain vs level using noise (3779C only)	•	•	•	•
Gain vs level using tone	•	•	•	•
Gain vs level using sync 2 kHz			•	
Coder offset		•		
Peak codes		•		
ICN weighted, 3 kHz flat & selective	•	•	•	•
Noise with tone	•	•	•	•
Quantizing distortion using tone	•	•	•	•
Quantizing distortion using noise (3779C only)	•	•	•	•
Intelligible crosstalk	•	•	•	•
Intermodulation using two tones	•	•	•	•
Intermodulation using four tones (3779D only)	•	•	•	•
Discrimination against out-of-band inputs	•			•
Spurious out-of-band outputs	•			•
Spurious in-band outputs	•	•	•	•
Return loss using swept tone (Tx & Rx)	•			•
Impedance balance (Tx & Rx)	•			•
Signal balance	•			•
E & M signalling distortion	•			•
Tx-Rx	•	•	•	

In addition, facilities are available on the 3779C to test automatically the multiplex alignment and alarm strategy.

### D-D Measurement Mode

Crosstalk measurements of both inter-channel and go-return type can be selected. These allow, for example, evaluation of the distant terminal contribution to near-end crosstalk (NEXT) and transhybrid loss/echo return loss.

A Tx-Rx facility allows independent control of digital transmitter and receiver. Thus, the relevant measurements listed in Table 1 can be performed either manually or, using an external controller, automatically in the D-D mode, facilitating transmultiplexer (T-mux) testing in a mixed analog/digital network and allowing digital access and testing in an Integrated Digital Network (IDN).

### Options (3779C)

**001:** provides A-D, D-A, and D-D hardware and software; 2048 kb/s PCM interfaces are ternary rectangular with 75 $\Omega$  unbalanced BNC connectors; single channel digital interfaces are serial or parallel, TTL compatible.

**002:** as Option 001 except PCM and clock connectors are Siemens 1.6/5.6 mm 75 $\Omega$  unbalanced.

**003:** as Option 001 except PCM and co-directional clock connectors are Siemens 3-pin 120 $\Omega$  balanced.

### Options (3779D)

**001:** provides A-D, D-A, and D-D hardware and software; 1544 kb/s PCM interfaces are bipolar rectangular with 100 $\Omega$  balanced WECO connectors; single channel digital interfaces are serial or parallel, TTL compatible.

**002:** provides A-D, D-A, and D-D hardware and software for  $\mu$ -law systems operating at 2048 kb/s; digital connections are via single channel interfaces only, as specified for Option 001.

**003:** as Option 001 except PCM and clock connectors are BNC 75 $\Omega$  unbalanced.

### Ordering Information

**3779C** Primary Multiplex Analyzer (CEPT)

**3779D** Primary Multiplex Analyzer (Bell)

# TELECOMMUNICATIONS TEST EQUIPMENT

HP-IB Controlled Channel Selector; PCM Test Systems

Models 3777A, 3779

533



- DC to 110 kHz
- 2-wire / 4-wire balanced switching
- Modular construction
- Up to 30 4-wire channels

- 3779 multi-measurement capability
- 3779 ease of programming and operation
- Extended operation using the HP-IB
- Wide range of system controllers

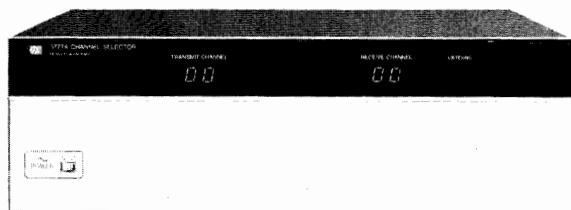

3777A



## 3777A Channel Selector

The 3777A is an HP-IB controlled Channel Selector. It provides test point access for maintenance and production testing of PCM and FDM telecommunications systems.

The instrument contains two identical banks of relays, termed 'Transmit' and 'Receive.' Each bank comprises up to 30 balanced, bi-directional, two-pole changeover switches. The Transmit bank enables switching of a single source to any one of up to 30 outputs. In the Receive bank, any one of up to 30 inputs can be switched to a common output. To provide a quiet termination for telecommunications equipment, all unselected channels are terminated in 600  $\Omega$  in series with 2.2  $\mu$ F. Alternative impedances can be provided on request.

The two switch banks are controlled independently via the HP-IB from the 3779 Primary Multiplex Analyzer, a computer or a programmable calculator. For automatic test systems, the 3777A can scan, under external program control, through a number of channels in any desired sequence.

For applications requiring more than 30 channels, several 3777A's can be connected in a switch array. Other configurations can be realised by the appropriate interconnection of the Transmit and Receive bank inputs and outputs.

Construction of the 3777A is modular, with the 30 channels in both Transmit and Receive banks arranged in 5 blocks, each block having 6 Transmit and 6 Receive channels. 12 and 24 channel versions with only 2 or 4 blocks are available as options.

Principal applications are in testing telecommunications equipment where the 3777A may be used to switch PCM primary multiplex channels, FDM voice channels or groups, and voice frequency telegraph circuits, for measurements during production, installation, or maintenance. The high quality relays employed in the 3777A also make it suitable for many other general purpose applications requiring an HP-IB controlled channel selector.

### 3777A Options

**001:** 24 channels in transmit and receive banks. WECO 310 connectors used for transmit I/P and receive O/P.

**002:** 12 channels in transmit and receive banks. Siemens audio connectors used for transmit I/P and receive O/P.

**003:** 12 channels in transmit and receive banks. WECO 310 connectors used for transmit I/P and receive O/P.

### 3777A Channel Selector

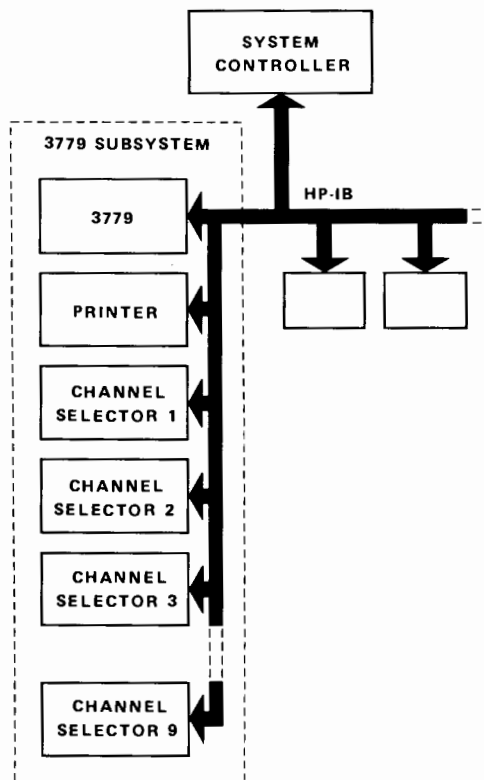

## PCM Test Systems

The 3779 Primary Multiplex Analyzer (PMA) is itself a system controller, containing operating software for a system comprising a printer and up to nine 3777A Channel Selectors. However, versatile as the PMA is, some users may require more. The following examples are just a few of the ways in which the PMA capability can be enhanced by using an external system controller.

- A worst-case channel can be identified, and then analyzed in detail. Statistical analysis of results can also be performed.
- For testing different types of terminal equipment consisting of a wide variety of channel cards, the desired measurement sequences can be constructed in the PMA using the instrument's ease of programmability, then transferred into an external controller and recalled as required.
- In processor-controlled switching applications, the switch controller can instruct the PMA to perform a number of measurements on the matrix path.
- Production test stations using PMA's can be controlled from a centralized computer system. This can be used to give increased test throughput of specialized communications devices, eg codecs, SLIC's.
- A PMA subsystem may form part of a larger automatic test system incorporating, for example, power supplies, DVM's, switches, etc.

### System Components

- 3779 Primary Multiplex Analyzer
- 3777A Channel Selector
- Printer—must have 80-character field width and 128-character upper and lower case ASCII printing set. Data storage preferable to reduce "waiting time". Recommended Printers include 2631A, 9876A, 2608A.



# TELECOMMUNICATIONS TEST EQUIPMENT

## 30 CH PCM Alignment Monitor and Error Detector

Model 3783A

- Provides in-service error monitoring on 2 M b/s systems
- Counts frame or code errors
- Low-cost, portable unit
- Optional rechargeable battery

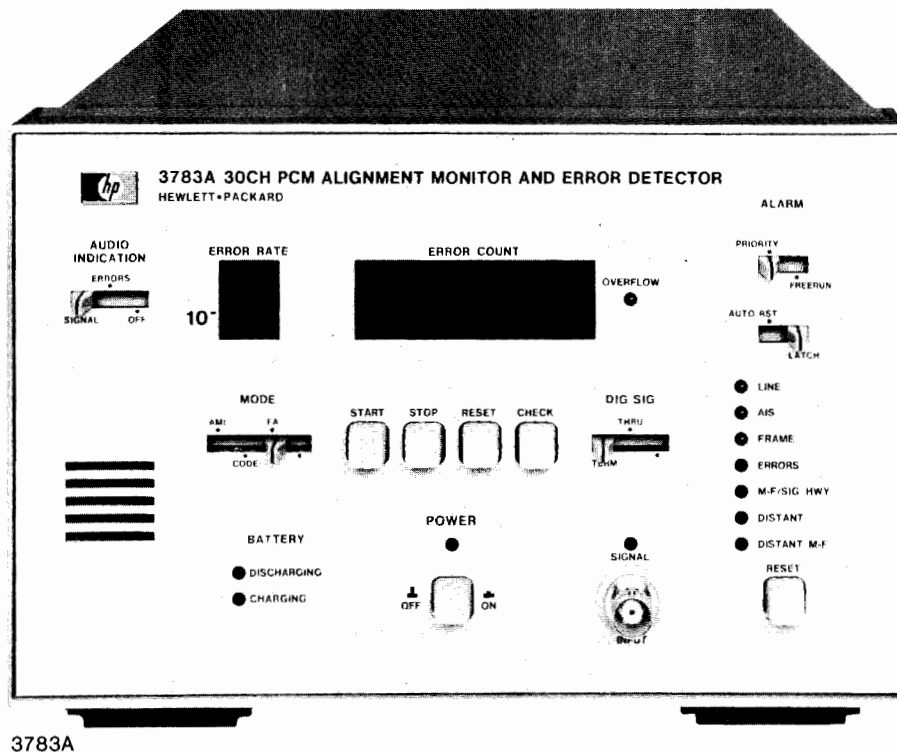

3783A

The 3783A is a low-cost, portable instrument for in-service measurements on 2 Mb/s digital transmission systems conforming to CCITT Recommendation G.732 (European CEPT, 30 channel PCM multiplex standard). The instrument can detect and count:

- Frame alignment signal errors
- Code violation errors
- External input error pulses from a multiplex

Frame alignment signal (FAS) errors are measured by decoding the HDB3 2 Mb/s line signal and recovering the time slot allocated to the framing signal, TS0, from which errors occurring in the FAS can be detected and counted. Display of the measured result can be a binary bit error rate, based on the assumption that the overall signal contains a Poisson distribution of errors, or a FAS error count over a manually selected measurement period. While operating as a FAS error detector, the instrument also detects and displays any system alarm states which are carried in TS0 and TS16, the time slot allocated to signalling. These alarm states can be displayed on a priority or free run basis with a latch/auto-reset facility.

In addition to monitoring FAS errors, the 3783A can check the input line signal for code violation errors according to the AMI or HDB3 encoding rule. The instrument can also count low frequency input pulses such as the error output signal found on some digital transmission equipments.

The 3783A can be attached in terminated mode to the output of an equipment (out-of-service measurement) or in monitor mode to the high impedance monitor point provided on digital transmission equipment (in-service measurement). An optional rechargeable battery pack allows portable field use where normal station ac main supplies are unavailable. An audio indication of signal present or detection of errors can be selected.

### Specifications Summary

**Signal input:** switched digital signal or error count input.

**Clock recovery:** from the digital signal input at 2048 kb/s  $\pm$  100 b/s.

**Signal format:** AMI or HDB3 with frame structure conforming to CCITT Recommendation G.732.

**Impedance:** 75  $\Omega$  unbalanced (120  $\Omega$  balanced, by special request).

**Count input:** maximum 4 kHz binary input.

**Measurements:** code errors, frame alignment errors, and external error count.

**Display:** error rate exponent and 5 digit error count simultaneously.

**Gating:** automatic for error rate, manual for error count with start/stop/reset control.

**Alarm flags:** line, AIS, frame, errors, multi-frame/signalling high-way, distant, distant multi-frame; priority or free run selection with auto-reset or latch plus overall reset facilities.

**Audio indication:** tone burst for signal or errors present, selectable.

**Alarm outputs:** two TTL outputs; each goes high when alarm state detected.

**Recorder output:** current drive proportional to displayed result.

#### General

**Power supply:** 115 V  $\pm$  10% - 22% or 230 V  $\pm$  10% - 18%, ac, 48 to 66 Hz.

#### Options

**001:** operation from rechargeable battery pack.

**002:** 120  $\Omega$  balanced input; 3 pin Siemens connector.

**3783A 30 CH PCM Alignment Monitor and Error Detector**

# TELECOMMUNICATIONS TEST EQUIPMENT

1 kb/s/50 Mb/s PCM/TDM Error Measuring Set for Field Use

Model 3780A

535



- Binary and code error measurements
- Internal crystal clocks and clock recovery
- Clock frequency offset generation and measurement
- Ternary coded and binary interfaces
- PRBS and WORD pattern generation and detection
- Printer and recorder outputs

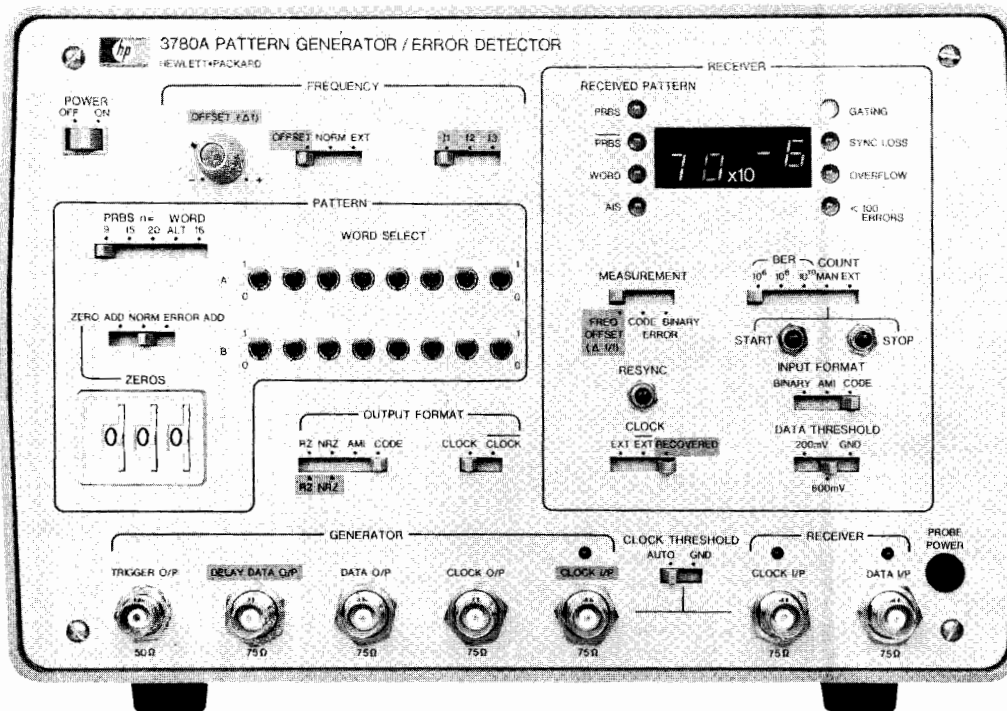

The 3780A Pattern Generator/Error Detector is a comprehensive error measuring set in one portable package. The instrument measures Binary Errors and Code Errors in digital transmission equipment operating at bit rates between 1 kb/s and 50 Mb/s. Frequency offset generation and measurement are also provided at the standard bit rates used in PCM/TDM transmission.

Binary errors are detected by stimulating the system with a test pattern and comparing the output bit-by-bit with a separate internally generated, error-free pattern. Code errors on interface or line coded information are detected during decoding into binary data. The errors can be counted over a chosen gating period and displayed directly as bit error ratio (BER) or total error count (COUNT).

Error measurements can be made with PRBS or WORD patterns and the receiver has automatic pattern recognition and synchronization. Alternatively, the reference pattern can be preset by the pattern switch which allows detection of systematic pattern errors. Zero add facilities allow investigation of regenerator clock recovery performance. This capability can be extended by the optional addition of programmable word and alternating word generation.

The clock frequency in the pattern generator can be offset and measured in the receiver. The offset is displayed as a fraction of the nominal crystal centre frequency. In addition, the offset of external clocks applied to the generator can be measured provided that the frequency is within 25 kHz of one of the installed crystal frequencies.

BER or COUNT results can be displayed directly by LED's on the front panel or monitored via a BCD printer and strip chart recorder. This makes the 3780A ideally suited for unattended long-term measurements. Monitoring, display, and recording of the Alarm Indication Signal (AIS) is now included.

The 3780A has been designed principally for use in field trials, commissioning, and maintenance of digital transmission terminal and link equipment. A new option has been added which provides  $2^{23}-1$  pattern capability and automatic equalization for in-station cabling for 2, 8 and 34 Mb/s systems.

## Specifications

### Measurements

**Binary errors:** closed loop bit-by-bit detection on any pattern produced by generator, excluding added zeros or alternating words.

**Code errors:** violations of coding rule detected on any pattern with AMI, HDB3, or HDB2 coding (optionally AMI, B6ZS, or B3ZS).

**Frequency offset:** measurement of fractional offset of generator clock output from installed crystal rates.

### Options

#### Word/Connector Options

**001:** all words replaced by a 16-bit front panel programmable word

**002:** Siemens 1.6 mm connectors

**003:** combination of 001 and 002

#### Frequency Offset Option

**099:** frequency offset—measurement only; frequency offset generation deleted

#### Frequency/Codec Options

**Std:** internal clock frequencies of 2048, 8448, and 1536 kHz; HDB3/HDB2 codec.

**100:** internal clock frequencies of 2048, 8448, and 34368 kHz; HDB3/HDB2 codec.

**101:** internal clock frequencies of 1544, 6312, and 44736 kHz; B6ZS/B3ZS codec.

**102:** internal clock frequencies of 1544, 6312, and 3152 kHz; B6ZS/B3ZS codec.

**103:** internal clock frequencies of 2048, 8448, and 34368 kHz;  $2^{23}-1$  pattern replaces  $2^9-1$ ; HDB3 codec.

**3780A Pattern Generator/Error Detector**



# TELECOMMUNICATIONS TEST EQUIPMENT

## CEPT and CCITT Compatible PCM/TDM Error Measuring Set

Models 3781A, 3782A

### 3781A

- Bit rates of 704, 2048, 8448 and 34368 kb/s
- Standard CCITT test patterns
- Internal jitter modulator

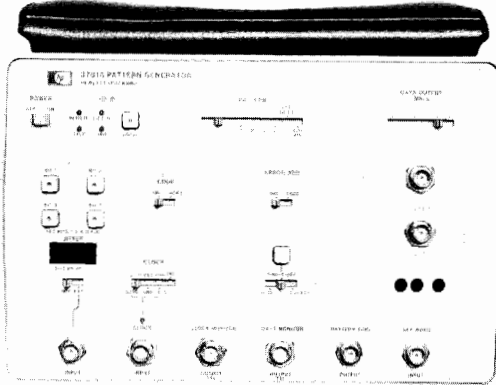

3781A



### 3782A

- Binary and code error measurements
- Error ratio, error count, error seconds and error-free seconds displayed
- Powerful error distribution analysis

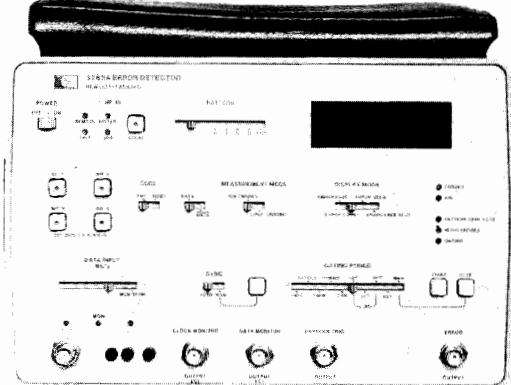

3782A



The 3781A Pattern Generator and 3782A Error Detector form a high performance error measuring system which complements the existing 3780A Pattern Generator/Error Detector. Designed to conform with CEPT and CCITT standards, the 3781A/3782A provide four bit rates (up to 50 Mb/s) of the digital hierarchy in one compact system. Applications of the system are in R&D, field trial and production testing, especially where an automatic and remote measurement capability via the HP-IB is required.

In the 3781A, binary or code errors can be injected as single shot or at  $10^{-3}$  or  $10^{-5}$  rates into a wide range of PRBS and 16-bit WORD test patterns coded in AMI or HDB3. The test patterns provided include standard  $2^9-1$ ,  $2^{15}-1$ , and  $2^{22}-1$  bit PRBS to CCITT Recommendations, fully programmable 16-bit WORD, and two 8-bit WORDS which may be alternated under the control of an external signal. Zero substitution (up to 120 zeros) for PRBS patterns is included to examine, for example, the clock recovery performance of regenerators. 75  $\Omega$  unbalanced and 120  $\Omega$  balanced pseudo-ternary outputs and binary TTL monitor outputs are provided. A jitter modulation input facility is provided for simple oscillator connection, with direct LED display of pk-pk bits of jitter. This can be used to measure the input jitter tolerance of digital transmission equipment. A second data output with 12 bits delay provides adequate simulation of an independent sequence for thorough testing of 4 $\phi$ PSK digital radio systems. As an option, four extra data outputs coded in AMI or HDB3 can be included on the rear panel for driving adjacent radio channels.

The 3782A detects binary or code errors which can be displayed in the form of error ratio, error count, error seconds, and error-free seconds over a wide choice of gating periods. All four results are computed simultaneously over the same gating period. For ease of use there is a built-in automatic check for compatibility of switch position combinations. An error code flashes on the display if incompatibility is detected. When the monitor mode is used, the 3782A can be used for in-service monitoring of digital transmission links.

Measurement results are available on the HP-IB and a rear panel result threshold switch allows pre-selection of an error threshold above which results will be printed. This provides useful data reduction and a first order error distribution analysis. With a built-in real-time clock, results can be output with time, if required.

### Specification Summary

#### 3781A Pattern Generator

**Data outputs:** RZ HDB3 or AMI on internal clocks, NRZ available by internal links.

**Internal clock:** four crystal clocks at 704, 2048, 8448 and 34368 kHz.

**External clock:** 1 kHz to 50 MHz.

#### Patterns

**PRBS:**  $2^9-1$ ,  $2^{15}-1$ , and  $2^{22}-1$  to CCITT Recommendations.

**WORD:** 16-bit WORD (serial combination of 4-bit WORDS A, B, C and D; contents of A, B, C and D can be set by pushbuttons), ALT WORD (8-bit WORD AB may be alternated with 8-bit WORD CD under control of externally applied signal), 1111/AIS (Alarm Indication Signal).

**Jitter modulation:** timing jitter can be added to the clock and data output signals by applying an external modulating source.

#### 3782A Error Detector

**Measurements:** binary errors (closed loop bit-by-bit detection at binary level) and code errors.

**Display modes:** error ratio, error count, error seconds, error-free seconds, error codes, real-time clock.

#### Options

##### 3781A

**001:** adds four 1V pk-pk HDB3/AMI outputs (BNC connectors) to rear panel.

**002:** as standard but with Siemens 75  $\Omega$  connectors in place of BNC connectors on selected ports.

**061:** rack mount

**062:** rack mounted with Opt 001 outputs accessed from front panel.

##### 3782A

**002:** as standard but with Siemens 75  $\Omega$  connectors in place of BNC connectors on selected ports.

**061:** rack mounted.

**062:** rack mounted with front panel access to rear panel controls/connectors.

#### 3781A/3782A

**In-lid operating instructions:** English—std; German—Option 031; French—Option 032; Italian—Option 033; Spanish—Option 034.

#### Ordering Information

3781A Pattern Generator

3782A Error Detector

# TELECOMMUNICATIONS TEST EQUIPMENT

Bell Compatible PCM/TDM Error Measuring Set

Models 3781B, 3782B

537



## 3781B

- DS-1, DS-1C, DS-2, & DS-3 all in one compact system
- Jitter modulation input facility
- Second DS-3 output with 22 bits delay

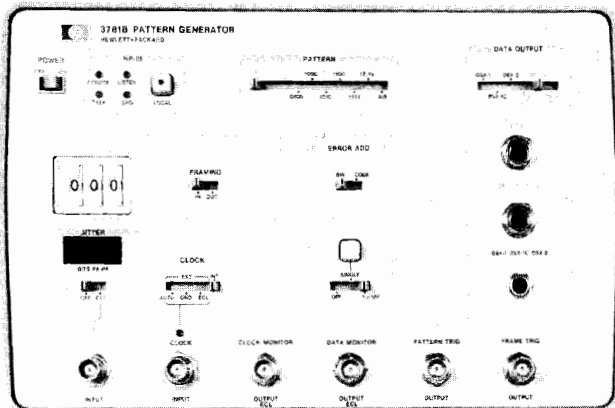

3781B



## 3782B

- Binary, code, and parity error measurements
- Error rate, error count, error secs, and error free secs displayed
- Preselectable error rate threshold for printing of results

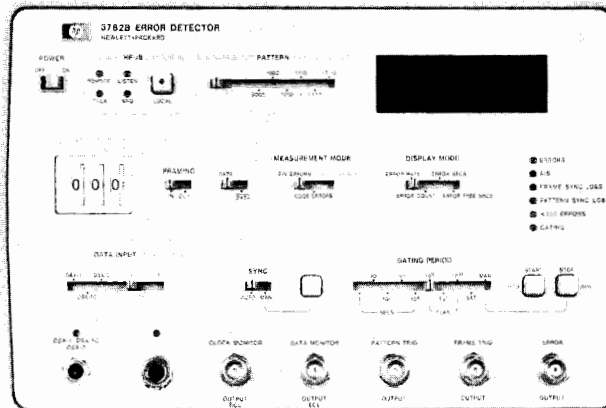

3782B



The 3781B Pattern Generator and 3782B Error Detector form a dedicated error measurement system for testing and evaluating the performance of Bell digital transmission terminal and link equipment, up to and including the DS-3 level in the digital hierarchy. The 3781B/3782B can be used in production testing, field installation, and maintenance of the Bell digital transmission system, including PCM/TDM transmission over cable, radio, satellite, and fibre optic links. The principal application is at the DS-3 level in the Bell digital hierarchy.

The 3781B/3782B are designed to interface at Bell System standard cross connect points with appropriate ternary coding and interface voltage levels at each hierarchical level. Interfacing at the DS-1C and DS-2 levels is limited to T1-C and T2 line systems. At the DS-3 level, a choice of four data formats is available. Alternatively, binary ECL interfaces can be used.

The 3781B Pattern Generator provides a selection of standard  $2^9 - 1$ ,  $2^{15} - 1$ , and  $2^{20} - 1$  bit PRBS and fixed WORD test patterns with a choice of single error or 1 in  $10^5$  error simulation on the digital data stream for normal measurements and troubleshooting. A pattern of 17 ones/15 zeros and zero substitution (up to 999 zeros) for PRBS patterns are included to examine phase sensitive circuitry such as clock recovery of regenerators. A jitter modulation input facility is provided for simple oscillator connection, with direct LED display of pk-pk bits of jitter. This can be used to measure the input jitter tolerance of digital transmission equipment. A second DS-3 output channel with 22 bits delay provides adequate simulation of an independent sequence for thorough testing of  $4\phi$  PSK digital radio systems. As an optional extra, four DSX-3 BNC outputs on the rear panel can be included for driving adjacent radio channels.

The 3782B Error Detector detects any binary or code errors generated by the system under test. At the DS-3 level, it can perform in-service or out-of-service measurements of parity errors within the digital transmission system. The 3782B can measure simultaneously error rate, error count, error seconds, and error free seconds over a single gating period. When the DS-3 MON facility is used, in-service measurements (eg parity errors) of live traffic are possible. For ease of use, there is a built-in automatic check for compatibility of switch position combinations. An error code flashes on the display if incompatibility is detected. Hard copies of results can be obtained on a printer via HP-IB control, either in the "talk-only" or "addressable" modes. In addition, a preselectable error rate threshold and a real time clock allows selection for printing results which exceed a defined threshold (with local time, if required).

## Specifications Summary

### 3781B Pattern Generator

**Data Outputs:** DSX-1, DSX-1C, DSX-2, and DS-3 compatible ternary outputs, and ECL compatible binary outputs.

**Internal Clock:** four crystal controlled clocks at 1.544 MHz (DS-1), 3.152 MHz (DS-1C), 6.312 MHz (DS-2), and 44.736 MHz (DS-3).

**External Clock:** 1 kHz to 50 MHz.

#### Patterns

**PRBS:**  $2^9 - 1$ ,  $2^{15} - 1$ ,  $2^{20} - 1$ .

**WORD:** 0000,1000, 1010, 1100, 1111; 17/15 (17 ones/15 zeros); AIS (alarm indication signal — all ones without framing bits).

**Jitter Modulation:** timing jitter can be added to the clock and data output signals by applying an external modulating source.

### 3782B Error Detector

**Measurements:** binary errors (closed loop bit-by-bit detection at binary level), code errors, and parity errors.

**Display Modes:** error rate, error count, error seconds, error free seconds, error codes, real-time clock.

#### Options

##### 3781B

**001:** adds four additional in-phase DSX-3 BNC outputs to rear panel; front panel DS-3 output connector changed from WECO 440A to BNC.

**061:** rack mounted.

**062:** rack mount allowing Option 001 outputs to be accessed from front panel.

##### 3782B

**001:** DS-3 Data Input connector changed from WECO type 440A to BNC

**061:** rack mounted

**062:** rack mount allowing front panel access to Binary/Ternary Input and Real-Time Clock switches, Binary Data and Clock Inputs, and External Gating

#### Ordering Information

3781B Pattern Generator

3782B Error Detector



# TELECOMMUNICATIONS TEST EQUIPMENT

## Dedicated PCM/TDM Jitter Generator and Receiver

Models 3785A, 3785B

- Jitter generation and measurement on data and clock
- Jitter specifications designed to CCITT Recommendation 0.171
- Transient-free sweeping of internal CCITT defined jitter tolerance masks
- Single portable unit for up to 4 internal bit rates
- Built-in measurement filters to CCITT Recommendations
- Comprehensive jitter analysis against real-time and jitter amplitude

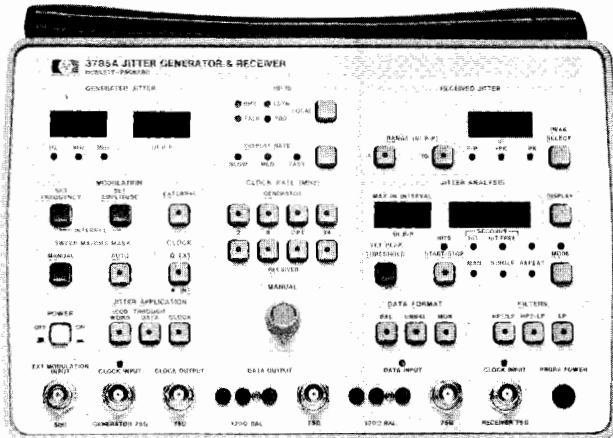

3785A (2048, 8448, 34368 and, optionally, 25776 kHz)  
CEPT

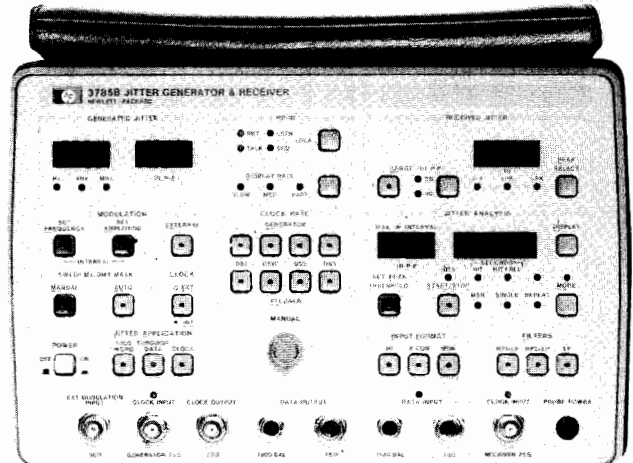

3785B (DS-1, DS-1C, DS-2 and DS-3)  
Bell



The 3785A/B Jitter Generator and Receiver is a dedicated jitter measurement system for testing and evaluating the performance of CEPT or Bell digital transmission terminal and link equipment up to and including the third level (34368 kb/s or DS-3) in the digital hierarchy. The 3785A/B can be used in production testing, field installation and maintenance of the CEPT or Bell digital transmission system including PCM/TDM transmission over cable, radio, satellite, and fiber optic links. The principal application is thorough testing to current CCITT Recommendations at each level in the digital hierarchy.

In addition to providing a comprehensive measurement capability which includes in-service jitter measurements, the microprocessor-controlled Jitter Generator and Receiver is easy to use with ergonomic layout of switches and connectors on the front panel. The instrument is designed to interface fully with the HP-IB, allowing bus-controlled operation and automatic measurement sequencing.

The Jitter Generator may be used to phase modulate an internally provided crystal clock, an externally applied clock (at a nominal digital hierarchy bit rate) or an externally applied data stream. Sinusoidal modulation is provided by an internal synthesizer whose amplitude and frequency can be set manually or swept, transient-free, through a CCITT shaped jitter tolerance mask programmed into the instrument. Alternatively, external modulating signals can be applied. The amplitude of generated jitter in unit intervals (U.I.) pk-pk and the frequency of internal modulation are in accordance with CCITT Recommendation 0.171 and are displayed on the front panel.

The modulated clock output can be applied to an external pattern generator such as the 3780A, 3762A, 3781A or 3782B. For jitter transfer function measurements, the CCITT standard 1000 repetitive pattern is provided within the 3785A/B. In addition, for demultiplexer jitter transfer function, jitter can be applied to an externally applied data stream which has the necessary framing and justification digits.

### Measurements

The Jitter Receiver offers six types of measurement:

- Absolute jitter amplitude in U.I. pk-pk
- Jitter peak, positive or negative
- Jitter hit count of the number of times received jitter exceeds a user-defined hit threshold in U.I. pk

- Jitter hit seconds count of the number of seconds in which one or more jitter hits occur
- Jitter hit-free seconds count of the number of seconds which are free of jitter hits
- Maximum absolute jitter amplitude in U.I. pk-pk is held during the jitter analysis gating period

Simultaneous measurement of all six parameters is possible with result display selection. In addition, the Receiver has a built-in interval timer and real-time clock to allow measurements of jitter distribution against time to be made.

The measurements can be made on clock or data inputs with or without internal filtering. Two high pass filters and one low pass filter as specified by CCITT are provided for each of the four bit rates. In addition, external filters can be connected between the demodulated jitter output and the measuring circuitry input. The demodulated jitter output can also be used to measure rms jitter amplitude on an external voltmeter or to display jitter spectrum on an external analyzer.

The clock reference for the jitter measurements can be internally derived from the applied data or clock via a narrow band phase-locked loop or externally derived from an applied reference.

The data input allows out-of-service or in-service measurements. The MON facility for in-service measurements has built-in additional gain to compensate for the flat loss at the protected monitor points.

### HP-IB Operation

The capabilities of the 3785A/B can be enhanced by using the HP-IB to provide remote operation and automatic sequencing of results. The HP-IB facility offers several principal features:

- Remote control of front panel switches and pushbuttons using programming codes
- Control codes which are set to default values on power-on and can be user-defined with the controller
- The ability to transfer all desired switch positions and masks onto a tape memory and reloaded back onto the instrument at a later time
- Output of the result data to a printer (eg 5150A Thermal Printer) or storage memory

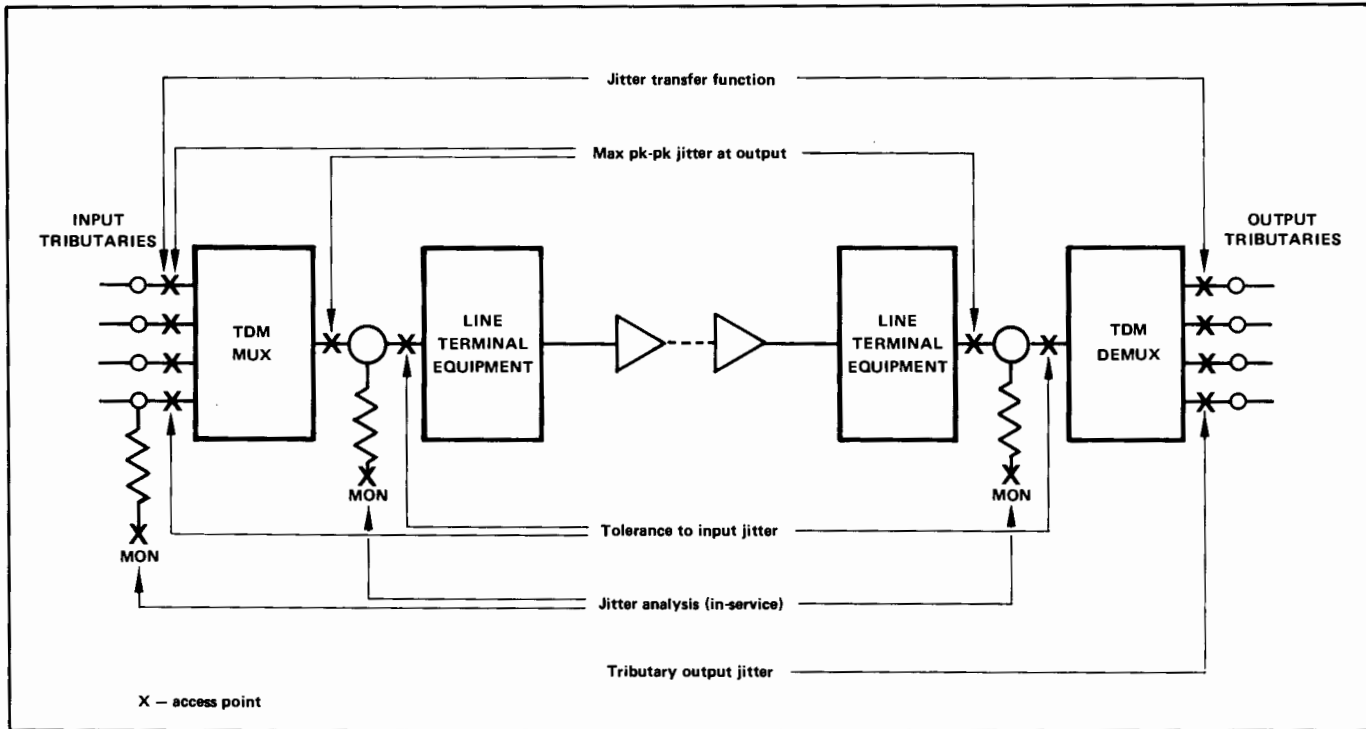

Typical access points for 3785A/B measurements on PCM/TDM digital system hierarchy

## Specifications Summary

### Jitter Generator

#### Data outputs

- 3785A:** CCITT Rec G.703 interfaces for CEPT rates.
- 3785B:** DSX-1, DSX-1C, DSX-2 and DSX-3 ternary outputs.
- Internal clock:** crystal controlled clocks at
  - 3785A:** 2.048, 8.448, and 34.368 MHz.
  - 3785B:** 1.544, 3.152, 6.312, and 44.736 MHz.
- External clock:** at internal rates  $\pm 10\%$ .

- Internal jitter modulation:** conforms to CCITT Rec. 0.171 (lower frequency limit 1 Hz) (DS-3 only up to 1.12 MHz upper frequency).
- External jitter modulation:** conforms to CCITT Rec. 0.171 (lower frequency limit dc) (DS-3 only up to 1.12 MHz upper frequency).
- Internal jitter tolerance masks:** currently conforms to the appropriate CCITT G. series Recommendations.
- Accuracy of jitter display:**

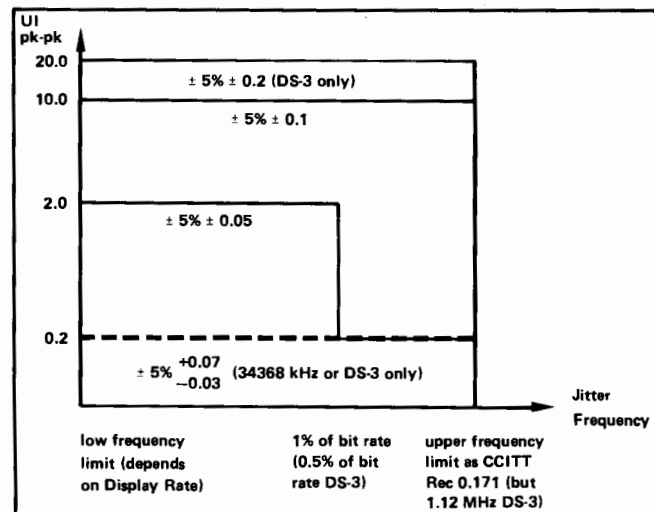

### Jitter Receiver

**Data inputs:** conforms to CCITT Rec. G.703.

- 3785A:** for use at monitor points  $-30$  dB (2.048 and 8.448 MHz) and  $-26$  dB (34.368 MHz).
- 3785B:** compatible with HI and XCON outputs for all internal bit rates, DS-1, DS-1C, DS-2 and DS-3. Additional monitor capability at each internal bit rate.

**Clock input:** at internal rates  $\pm 50$  ppm or 2.0 to 34 MHz (3785A)/1.5 to 45 MHz (3785B) when also using Receiver External Reference Clock Input (rear panel).

#### Jitter amplitude measurement (pk-pk)

- Ranges:** 1, 10 (and 20, 3785B only).
- Max. Jitter amplitude reduced at 6 dB/octave above a nominal corner frequency specified by CCITT Rec. 0.171.
- Bandwidth:** satisfies CCITT Rec. 0.171 (DS-3 upper frequency limit 1.12 MHz).
- Accuracy:**  $\pm 4\%$  + additional intrinsic error.

**Measurements:** intrinsic jitter amplitude pk-pk, jitter amplitude  $+pk$  or  $-pk$ , jitter analysis. When used in conjunction with a pattern generator and error detector, jitter tolerance and jitter transfer function measurements can be made.

### Options

#### 3785A

- 001:** fourth internal clock (25.776 MHz) in addition to the three standard clocks.
- 002:** Siemens connectors on all front panel interfaces.
- 061:** rack mounted.
- 062:** rack mounted with front panel access to rear panel controls/connectors.

#### 3785B

- 001:** provides front panel data output and input connectors to enable direct application in the Canadian digital hierarchy.
- 061:** rack mounted.
- 062:** rack mounted with front panel access to rear panel controls/connectors.

### Ordering Information

- 3785A** Jitter Generator and Receiver (CEPT)
- 3785B** Jitter Generator and Receiver (Bell)



# TELECOMMUNICATIONS TEST EQUIPMENT

Dedicated 150 Mb/s PCM/TDM Error Detection System:

Models 3762A & 3763A

- Crystal clocks and clock recovery
- Frequency offset facilities
- Burst mode operation
- Binary and interface codes
- Input equalization
- Error detection on PRBS + Zeros

3762A

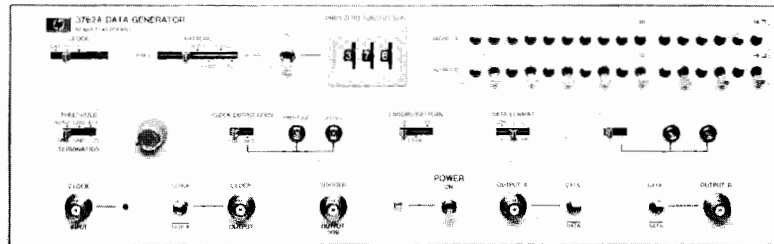

3763A

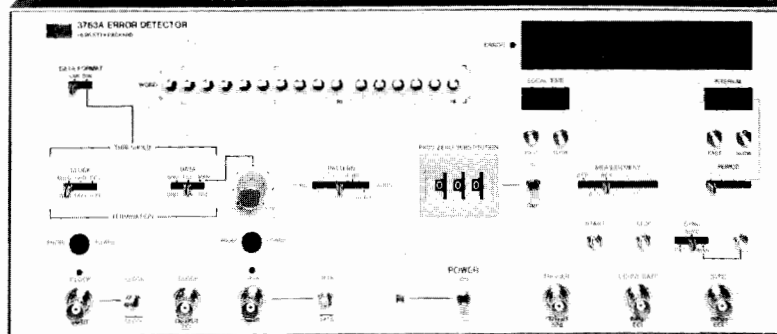

The 3762A Data Generator and 3763A Error Detector comprise a dedicated error performance measurement system for evaluating high-speed digital transmission equipment.

Basically, there are two versions of the system available. One version features CMI and ternary (HDB3 and B3ZS) data formats and is designed for testing digital multiplex and digital cable systems. The other version, with CMI and binary formats, is specifically intended for use in field commissioning and maintenance of microwave digital radio systems both terrestrial and satellite where the burst gating inputs permit the 3762A/3763A to be used in TDMA applications.

The 3762A/3763A can also be used to test the terminal equipment of all presently defined fiber optic systems up to 140 Mb/s. Special options are available which can cater for up to 170 Mb/s at the binary level.

## Specifications Summary

### 3762A Data Generator

**Internal clock:** two crystal clocks in the range 30 to 150 MHz; crystals fitted in standard unit are 139.264 and 141.040 MHz; offset continuously variable up to  $\pm 60$  ppm.

**External clock input:** 1 kHz to 150 MHz; 75  $\Omega$ .

**Patterns:**  $2^{10} - 1$ ,  $2^{15} - 1$ , and  $2^{23} - 1$  PRBS; two 10- or 16-bit programmable words; two 1010... repetitive patterns; two 8-bit words alternated by an external signal; PRBS patterns can be gated off for 1 to 999 clock periods after trigger pulse (zero substitution); error add facilities.

**Data output A:** PRBS or WORD A; DATA or  $\overline{\text{DATA}}$ , in CMI, NRZ or RZ format; 75  $\Omega$ .

**Data output B:** PRBS delayed, or WORD B, in NRZ or RZ format.

### 3763A Error Detector

**Data input:** CMI, NRZ, or RZ formats; 75  $\Omega$  DATA or  $\overline{\text{DATA}}$ ; 12 dB fixed equalization at 70 MHz on CMI inputs with clock recovery.

**External clock:** as 3762A.

**Patterns:** all the patterns of the 3762A, including zero substitution, but excluding alternating words.

**Synchronization:** automatic, manual, or external (ECL).

**Error measurements:** closed loop bit-by-bit comparison at the binary level with an independent, error-free local reference.

**BER:** looks for 10 or 100 errors and takes reciprocal of clock counter; result displayed as  $X.Y \times 10^{-n}$  where  $n = 1$  to 9, with automatic scaling.

**COUNT:** totalizes errors over a selected gating period; internal period can be  $10^6$ ,  $10^8$ ,  $10^{10}$  clock periods or 1 min to 24 h, repetitive or single shot, manual start/stop or external (ECL) control; result displayed as ABCD.

**Measurement gating input:** gates error and clock inputs to error counter, providing a measurement "window"; 50  $\Omega$ ; ECL levels.

**Frequency offset measurement:** measures deviation of received bit rate from nominal rate; result displayed as  $\pm \text{BCD} \times 10^{-6}$ .

**Printer output (rear panel):** 8-4-2-1 BCD, 10-column output of result, plus local time, if required, and flags; TTL print command pulse.

**Recorder output (rear panel):** constant current drive output of BER or COUNT result, with flags.

### Options (3762A; 3763A)

**105:** 75  $\Omega$  interfaces changed to 50  $\Omega$ . Frequencies are 60.032 and 30.016 MHz.

**201:** Data output B not delayed; HDB3/B3ZS/AMI; 75  $\Omega$ ;  $\pm 1$  V. Second data input (B) on 3763A; 75  $\Omega$ ; HDB3/B3ZS/AMI; automatic equalization for up to 12 dB cable loss at  $\frac{1}{2}$  bit rate relative to a  $\pm 1$  V signal; clock recovery at installed crystal frequencies. Channel B cannot be used simultaneously with A. Frequencies are 139.264 and 120.000 MHz.

**202:** as for Option 201 except frequencies are 139.264 and 34.368 MHz.

**330:** as for Option 201 except frequencies are 137.088 and 44.736 MHz. In addition, clock and binary data interfaces changed to 50  $\Omega$ .

**801:** front cover.

### Ordering Information

3762A Data Generator  
3763A Error Detector

# TELECOMMUNICATIONS TEST EQUIPMENT

PCM/TDM Accessories

541



Models 15506A, 15507A, 15508B, 15508C, 15509A, 15509B, 15510A, 15511A, 15512A, 15513A, 15514A, 15515B

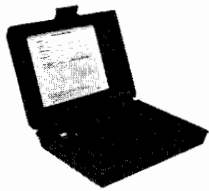

15506A



15509A



15509B

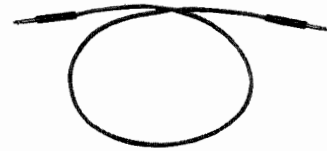

15513A

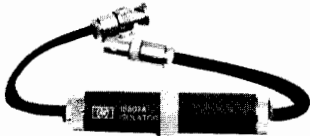

15507A



15510A

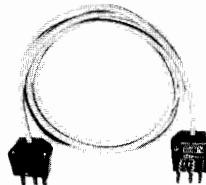

15511A

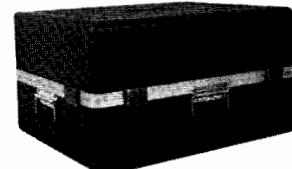

15514A



15508B



15508C

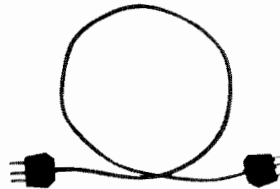

15512A

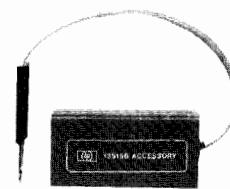

15515B

## 15506A Frame Alignment Generator

The 15506A provides a 2048 kb/s PCM signal, complete with framing structure, coded in AMI or HDB3 via a 75  $\Omega$  unbal or 120  $\Omega$  bal output. It can be used for checking the operation of the 3783A 30 Ch PCM Alignment Monitor and Error Detector.

## 15507A Isolator

This unit provides isolation from longitudinal voltages which may appear on test connections to digital transmission equipment. It can also be used when the ground potential of the test equipment is different from that of the transmission equipment.

## 15508B Converter (75 $\Omega$ unbal—110 $\Omega$ bal)

This unit provides a nominal 110  $\Omega$  balanced interface conversion from 75  $\Omega$  unbalanced interfaces on digital test equipment. This is required at the 1544 kb/s DS-1, 3152 kb/s DS-1C, and 6312 kb/s DS-2 levels of North American digital transmission systems.

## 15508C Converter (75 $\Omega$ unbal—120 $\Omega$ bal)

The 15508C provides a nominal 120  $\Omega$  balanced interface conversion from 75  $\Omega$  unbalanced interfaces on digital test equipment. This may be required at the 2048 kb/s primary multiplex levels of European digital transmission systems.

## 15509A Amplifier

This unit is designed to provide sufficient gain on a digital signal appearing at a standard digital equipment protected monitor point to trigger the Error Detector input. This is required to monitor in-service systems for code violations. Power for the 15509A is supplied from the error detector front panel PROBE POWER socket.

## 15509B Amplifier

The 15509B is similar to the 15509A except that it is intended for operation at the DSX-1, DSX-1C, and DSX-2 monitor points of North American digital transmission systems.

## 15510A 75 $\Omega$ Cable Accessory

The 15510A is designed to provide a protected monitor point to the 15509A input. This allows the Error Detector to monitor in-service

systems (75  $\Omega$ ) for code violations when the system monitor point is unprotected.

## 15511A 120 $\Omega$ Cable Accessory

The 15511A is designed to provide a protected monitor point to the 15508C input and, subsequently, the 15509A input. This allows the Error Detector to monitor in-service systems (120  $\Omega$ ) for code violations when the system monitor point is unprotected.

## 15512A Cable

The 15512A is a 1 m length of 600  $\Omega$  balanced cable with a 3-pin audio connector (Siemens type) at each end.

## 15513A Cable

The 15513A is a 1 m length of 600  $\Omega$  balanced cable with a WECO 310 jack plug at each end.

## 15514A Transit Case

The 15514A is a transit case with moulded foam inserts for transporting the 3779 Primary Multiplex Analyzer.

## 15515B Loop Holding Unit

Model 15515B is a loop holding unit which provides 24 mA loop holding current sinking. It is supplied with WECO connectors.

## Ordering Information

15506A Frame Alignment Generator

15507A Isolator

15508B Converter (75  $\Omega$  unbal-110  $\Omega$  bal)

15508C Converter (75  $\Omega$  unbal-120  $\Omega$  bal)

15509A Amplifier

15509B Amplifier

15510A 75  $\Omega$  Cable Accessory

15511A 120  $\Omega$  Cable Accessory

15512A Cable

15513A Cable

15514A Transit Case

15515B Loop Holding Unit



# TELECOMMUNICATIONS TEST EQUIPMENT

## General Information: Data and Voice Testing

### Data and Voice Testing

As user needs place greater demands on data communications networks, system managers have become increasingly concerned about maximizing network availability. Network availability is defined here as the percentage of time that the network is passing data according to design specifications. This not only implies minimizing downtime for maintenance or installation of new hardware or software, but also verifying that network components are performing to specification when the network is functional. It also includes the concept of network efficiency, determined by utilization profiles and other statistical information.

### Data Network Testing

There are a wide variety of tests which can be made on a data communications system. Depending on the point in the system at which the tests are made, quite different philosophies and techniques apply. These group conveniently into three areas; protocol, digital, and analog testing (Figure 1).

Protocol analysis is usually concerned with overall network performance, determined through monitoring or simulating network software (protocol and/or data). Digital testing involves measuring modem-channel-modem efficiency in terms such as Bit Error Rate (BER), Block Error Rate (BLER), etc. Analog testing measures the tariffed and other key parameters of the transmission line itself.

The interrelationships of these measurement philosophies are complicated and difficult to understand. For example, how is envelope delay distortion of the line related to the BER or the throughput of the system? Generally speaking, the three measurement philosophies are related in a hierarchical fashion. Non-intrusive network monitoring by protocol analyzers gives an indication of overall performance and can often isolate problems to the component or section. When monitoring is insufficient, such as during software debugging or systems integration, protocol analyzers also can be used to simulate network components, such as front end processors or terminals. Once sectionalized,

BER testers are used to verify and quantify the link dysfunction, and analog measurements determine which tariffed parameter is out of specification should the telephone line be the problem.

The three measurement philosophies working together can help speed the isolation of the problem to the specific component. For example, a high number of time-outs from a specific terminal cluster (protocol analysis), combined with a high BER and a low BLER in the data link (digital measurement), would narrow the problem to the suspected terminal's data link (modem and channel). A subsequent analog test which showed an out-of-spec impulse noise measurement would not only isolate the problem to the telephone line, but suggest who is responsible for fault determination and even what circuit component is the problem (e.g., switching equipment).

Thus, combined protocol, digital, and analog tests can be used synergistically to restore the network quickly and efficiently. The next sections describe in more detail how the three measurement areas can be used to increase your network availability.

### Protocol Analysis

The visibility of what happens to information once it enters the datacom network is quite limited. You know what you actually typed or what your program says, but you don't know what the CPU or terminal actually sent. In most cases, the transmitted data stream out will not only be the information you entered, but will also include some synchronization, address, control and error checking information to allow error free, delivery of your data. Similarly, replies from the destination are also encapsulated by this same "overhead".

A protocol analyzer can give you visibility of these entire messages. Attached at the physical network interface connector, a protocol analyzer in its passive mode provides a window to watch the actual character streams as they pass by. If it has simulate capability, the analyzer can also produce data streams that simulate a network component.

Protocol testing is primarily used in the following applications:

- Troubleshooting
- System Integration/Installation
- Software Development
- Network Performance Optimization

Using a protocol analyzer for troubleshooting will allow you to look for errors in the entire message as it relates to your network protocol. This includes verifying the integrity and timing of the overhead characters as well as the data itself. Messages can be displayed in various formats, from the high level code set to be used in the network (such as ASCII or EBCDIC) to a binary presentation. Protocol analyzers will capture some portion of the data stream at the network's operating speed for slower, detailed analysis later. You can also verify hand-shake status and timing with protocol analyzers.

When you have problems connecting new Data Terminal Equipment (DTE) to an existing network, a protocol analyzer can help point out protocol inconsistencies between them. With simulate (interactive) capability you can make your protocol analyzer imitate the DTE to the network (or the network to the DTE) to verify that correct messages are being sent and received by each.

Developing network software can be a problem without a network to test it on. Again, the protocol analyzer's interactive capability can be used to simulate the network to provide an efficient, economical way to debug new software before connecting to the actual operating network with its attendant risks.

Protocol analyzers can make measurements from which network performance statistics can be derived. Line utilization vs. time of day, average poll/response times between devices, and other similar statistical kinds of information can be extremely useful to network designers trying to optimize network throughput or cost effectiveness.

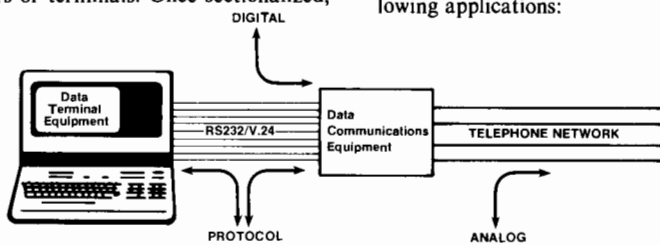

PROTOCOL ANALYZER	1640B
Maximum Bit Rates:	
Asynchronous	9.6 kbps
Synchronous	19.2 kbps
Programmable	(HP-IB)
Mass Storage	(HP-IB)
Monitor Buffer	2k (Bytes)
Simulate Buffer	1k (Bytes)
Triggers	8 Char
Counters	1
Timers	1
Interface Lead Control	yes
HP-IB	optional
Keyboard	hex

Figure 2

### Digital Measurements

Data error analyzers are used to test the quality of both the modem and the transmission facility. They provide information about the modem and transmission line but no information about the DTE which they replace.



	Basic Testing		C & D Conditioning - BELL M1020 & M1040 Conditioning - CCITT	Additional Testing for Complete Troubleshooting	Remote Automatic Testing	
	Up to 2400 bps	Up to 9600 bps and DDS			Master/Slave	Master/Slave
	Continuity Loss Loss vs Freq.	Signal/Noise Ratio Impulse Noise Wideband Impulse Noise P/AR	Envelope or Group Delay Distortion Attenuation	Phase Jitter Dropouts Hits & Crosstalk	Master/Slave	Master/Slave
BELL Recommendations	3551A					
	4935A					
	4944A					
	4943A					
	3771B					
	4940A					
CCITT Recommendations	3552A					
	4936A					
	3770B					
	3771A					

Figure 4

The overall quality of the link is indicated by its BER. A good link will have an error rate better than  $1 \times 10^{-5}$  errors per bit. This measurement will include the effect of both transmission line impairments and the modem's ability to overcome them. Modems vary widely in their sensitivity to line impairments. Low speed (less than 300 bps) and adaptively equalized modems are less sensitive than high speed (more than 4800 bps) and nonadaptively equalized modems.

Since data communications systems transmit data and control information in blocks, these instruments also measure BLER. BER and BLER can be used together to examine the statistics of the error mechanism. If the BER and BLER are both high, the impairment is random and probably due to noise. If the BER is high but the BLER is low, the impairment is more sporadic. This happens when lines are switched, synchronization is temporarily lost or impulse noise is too high.

Error rates are qualitative checks of the data communications system which can be made in a few minutes. If the system is bad, diagnostic measurements are provided to help isolate the problem. Dropouts, clock slips, error skew, jitter, and total peak distortion indicate some of the problems that can occur on a link. These measurements are made simultaneously with the error rate measurements and can be printed out in automatic, unattended mode if desired.

Catastrophic failures can usually be found with self tests and loop back switches built into the modem. Data error analyzers can find failures that are not illuminated by internal self tests.

Degradations of the modem or transmission line are more difficult to find and require more extensive testing equipment. The most common degradation is an excessive error rate due to line impairments or a faulty modem. More on these impairments is found in the next section.

1645A/S MEASUREMENTS:		
Bit Error Rate	1645A	1645S
Block Error Rate		
Jitter		
Carrier Loss		
Skew		
Total Peak Distortion (Jitter & Bias)		
Handshake Timing		
Signal Voltages		
Interface Lead Control		
MAXIMUM BIT RATES:		
Asynchronous Modem Operation	9.6 kbps	9.6 kbps
Synchronous Modem Operation	5 Mbps	5 Mbps

Figure 3

### Data Communications and the Telephone Line

The telephone network, because it exists between virtually every location where data travels, provides the basic mechanism for carrying data long distances. Most common-

ly used is the standard dial-up network which is used for voice communications with the addition of modems. This generally carries low speed data (2400 bps or less), but in some cases can carry 4800 bps or even 9600 bps.

Modems are widely used for medium speed data (up to 9600 bps) on leased telephone lines, which are permanent connections. These lines can be specially selected and conditioned to carry data more effectively.

For high speed data, leased telephone lines are used. In many cases, this data can be carried direct digitally without the need for modems. Bell's DDS service, for example, carries 56 bps data this way.

### Analog Impairments Affect Performance

Analog impairments on the telephone line can significantly affect the efficiency of data communications. What the user notices is a slow down in transmission (because of frequent retransmission of blocks of data), garbled data or no data at all. These effects are a result of the line impairments so distorting the modem signal that the receiving modem cannot make correct decisions. Data bits and blocks are received in error.

The various modem types are susceptible to each impairment in differing degrees. Low speed modems generally use robust modulation schemes and are mostly affected by problems of *Continuity*, *Loss*, *Signal-to-Noise Ratio*, and *Impulse Noise*.

As modem speeds increase, the modulation scheme becomes more complex and so they are more susceptible to other impairments. Two approaches are taken to minimize these effects. One is to select and condition leased telephone lines to eliminate significant impairments. The impairments of concern are *Bandwidth Reduction*, *Envelope (or Group) Delay Distortion*, *Non-Linear (Intermodulation) Distortion*, *Return Loss*, *Phase Jitter*, *Hits*, and *Dropouts*.

The other approach can address a limited number of these with varying degrees of suc-

cess. Automatically adjusting equalization is built into the modem itself. This can take care of significant *Signal/Noise Ratio Reduction*, *Bandwidth Reduction*, and *Envelope (or Group) Delay Distortion*, as well as some *Phase Jitter* and *Return Loss* problems. There is no significant protection against the other impairments and cases of severe or rapidly changing *Envelope (or Group) Delay Distortion* or *Bandwidth Reduction* may not be adequately compensated for either.

Direct digital transmission is significantly more robust and basically affected by problems of *Continuity*, *Signal-to-Noise Ratio*, *Impulse Noise* and to some degree *Jitter*.

### Increasing Network Availability

Whether installing and turning up a data communications network or going through the process of troubleshooting and fault isolation, analog transmission testing will greatly increase network availability.

Installation time and cost can be significantly reduced by prudent use of analog transmission testing in the initial phases. Confidence that the telephone network will pass data saves time-consuming return visits from data line installation personnel to find out why the modems and line will not all work together. A range of test sets is available to permit verification of line parameters for most modem and line type configurations. See (Figure 4) for an aid in selection of the one most appropriate for your application.

Troubleshooting and fault isolation time and cost in a data communications network can be greatly reduced by use of analog transmission testing. Clearly identifying the telephone line impairment, using the recommended Bell and CCITT measurement techniques, leads to immediate identification of how the fix should be approached and who is responsible for the restoration of the network. See (Figure 2) for an aid in selection of the test set most appropriate for your application.

# TELECOMMUNICATIONS TEST EQUIPMENT

## Telephone Line Analyzer

Model 3770B

- Delay and Attenuation Distortion measurements
- Compatible with CCITT Recommendation 0.81
- Rugged, portable, and really easy to use
- Makes all the maintenance measurements listed in CCITT Recommendation M.1060
- Optional slaving facilities

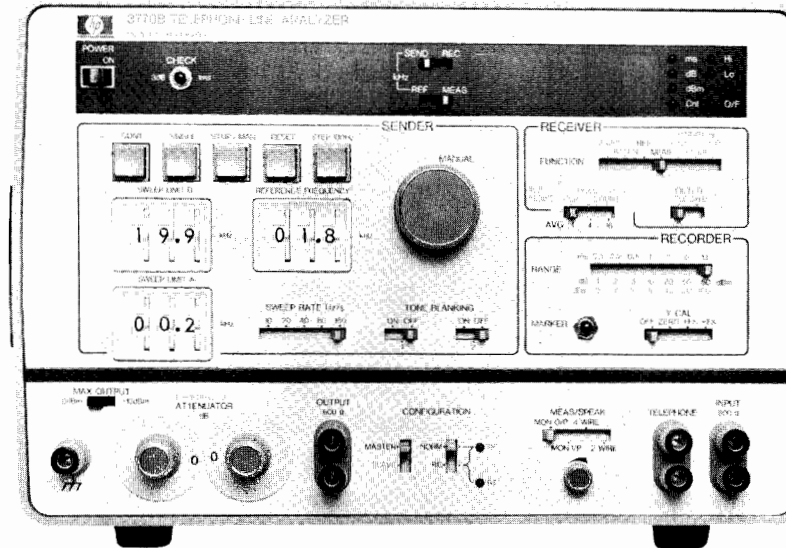

### Description

The 3770B is designed for audio data line characterization to CCITT standards. The 3770B makes, in one combined unit, all of the routine maintenance measurements listed in CCITT Recommendation M.1060 for high speed data lines.

The 3770B measures group delay, attenuation distortion, and absolute level in the frequency range 200 Hz to 20 kHz. It has automatic ranging, zeroing, and synchronization, with simultaneous LED read-out of measurement result and frequency. The sender and receiver are combined in a single, rugged, portable unit.

The 3770B, in addition, measures weighted noise, noise-with-tone and impulse noise. Further, an optional slave facility for group delay and attenuation distortion measurements allows the measurement re-

sults for both directions of transmission on a 4-wire circuit to be displayed at one end of the circuit. Also, the measurements in both directions can be controlled from one end of the circuit, leaving the slave unit unattended.

The 3770B has X-Y recorder outputs to enable a permanent swept record of the measurements to be made. A suitable portable X-Y recorder can be supplied as an option. Pre-printed graph paper showing CCITT limits for group delay and attenuation distortion measurements can also be supplied.

The instrument also has a built-in telephone facility to allow voice communication in a 2- or 4-wire mode over the line or lines under test. An integral loudspeaker allows the operator to monitor either the receiver input or sender output.

### Ordering Information

When ordering a 3770B, select ONE option from the table below (i.e. select the standard instrument OR one option). This completely specifies the measurements selected. Note that group delay, attenuation distortion and absolute level measurement facilities are provided with ALL instruments.

Option	Measurement Facilities			
	Noise	Slaving	+10 dbm Output	Tone Blanking
STD	•			
001	•	•		
002	•	•		
003	•		•	
004	•			•
005	•		•	•
006		•	•	
007		•	•	•
008		•	•	•
009	•	•	•	
010	•	•		•
011	•	•	•	•
020	•*	•		•

\*This Option provides impulse noise measurements to CCITT Recommendation 0.71 in full, and a crosstalk measurement for balanced pair cables.

### Opt 005: tone blanking

**Range:** two bands in the range 0.2 to 9.9 kHz.

**Range limits:** any multiple of 100 Hz.

**Frequency range blanked (kHz):** Opt # specifies range:

Opt	kHz	Opt	kHz	Opt	kHz	Opt	kHz
117:	0.4 to 0.6	103:	1.9 to 2.2	107:	2.3 to 2.7	111:	3.0 to 3.4
101:	0.5 to 0.7	104:	2.0 to 2.4	108:	2.4 to 2.8	112:	3.2 to 3.6
102:	0.6 to 0.9	105:	2.1 to 2.5	109:	2.6 to 3.0	113:	3.4 to 3.8
115:	0.8 to 1.2	106:	2.2 to 2.6	110:	2.8 to 3.2	114:	3.6 to 4.0
116:	1.4 to 1.8	Other ranges available. Order Opt 100 and specify ranges.					

### Opt 012: loop holding for sender output receiver input.

**Maximum dc loop holding current:** 100 mA.

**Voltage drop at maximum current:** ~12 V.

**Dynamic output impedance:** ~50 kΩ.

**In-lid operating instructions:** English: std;

German: Opt 031; French: Opt 032; Italian: Opt 033;

Spanish: Opt 034.

**Opt 061:** rack mount version.

**Opt 910:** additional set of manuals.

**Opt C01:** 0.75 in. banana connectors.

**7010B Option 143:** X-Y Recorder in carrying case suitable for use with Model 3770B. Pre-printed graph paper showing CCITT limits also available; Amplitude Distortion (9280-0403), Delay Distortion (9280-0402).

### 3770B Telephone Line Analyzer

# TELECOMMUNICATIONS TEST EQUIPMENT

Data Line Analyzer

Models 3771A, 3771B

545



- CCITT and Bell versions
- Simultaneous measurement of transients

- HP-IB option
- Optional printer output

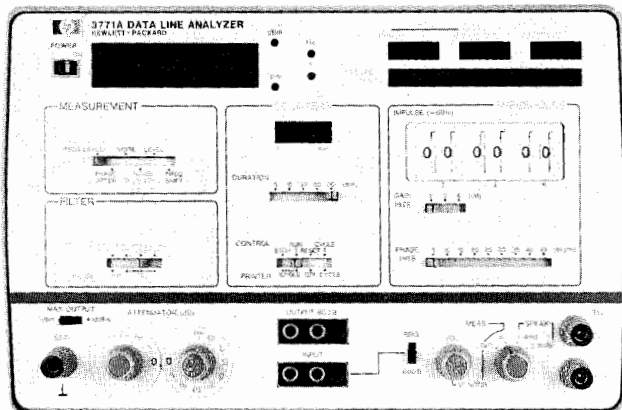

3771A

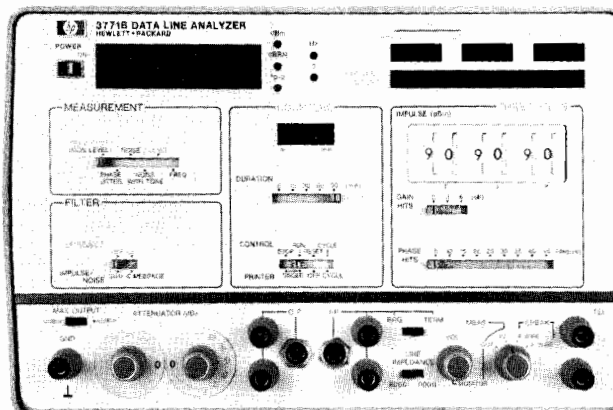

3771B



## Description

The 3771A and 3771B Data Line Analyzers have been designed for making installation and troubleshooting measurements on telephone lines used for carrying high-speed data. Two versions are available—the 3771A is compatible with CCITT standards, the 3771B with Bell Publication 41009 (May 1975).

The 3771A is a companion instrument to the HP 3770B Telephone Line Analyzer. When used with the 3771A, it provides a complete portable easy-to-use CCITT data line testing facility. Routine data line maintenance measurements can be performed using the 3770B, and troubleshooting measurements using the 3771A. The 3771B can be used with the HP 4943A/4A Transmission Impairment Measuring Set for complete data line characterization and testing where Bell measurement standards are required.

The 3771A/B measures two basic types of impairment affecting data lines—steady state and transient.

The steady state parameters measured are:

- Level
- Phase Jitter
- Weighted Noise
- Noise-with-Tone
- Frequency Shift

The transients measured are (all measured simultaneously):

- 3-Level Impulse Noise
- Phase Hits
- Gain Hits
- Dropouts

Transient parameters are normally measured over 15-minute intervals and by measuring all of them simultaneously, the 3771A/B saves considerable operator time. Also, any comparison of results is statistically valid.

The 3771A/B can be used as a stand alone test instrument or as part of an automatic test system. An option allows the 3771A/B to be controlled externally via the Hewlett-Packard Interface Bus (HP-IB). Other optional features available are a printer output for recording the results of unattended long-term transient measurements, and dc loopholding for sender output and receiver input. In-lid

operating instructions are provided for the 3771A/B, in addition to the normal detailed operating booklet. In the 3771A, the in-lid instructions can be supplied in English, French, German, Italian, or Spanish.

## Options (3771A and 3771B)

### Option 001—+10 dBm Output (3771A only)

**Output level:** maximum sender output level 0 or +10 dBm, selected by switch.

### Option 002—Loopholding

### Option 003—Frequency Shift (3771A only)

**Range:** 0 to 10 Hz.

**Tone frequencies:** 1020 and 2040 Hz, in harmonic relationship.

**Technique:** compatible with CCITT Recommendation 0.111.

### Option 004—Printer Output

**Format:** 8421 BCD.

**Compatibility:** HP 5150A, 5055A, 5050B.

**Information:** all transient data at end of each timer interval.

### Option 005—HP-IB Data Output and Remote Control.

### Option 006—LF Phase Jitter (3771B only)

Provides measurement of low frequency jitter components in three ranges: 4 to 20 Hz or 4 to 300 Hz (by internal selection) and 20 to 300 Hz.

### In-lid Operating Instructions: (3771A only)

English—std; German—Option 031; French—Option 032; Italian—Option 033; Spanish—Option 034.

## Ordering Information

3771A Data Line Analyzer—CCITT

3771B Data Line Analyzer—North America

# TELECOMMUNICATIONS TEST EQUIPMENT

## Transmission Test Sets

Models 3551A & 3552A

- Attenuation Distortion
- Loss
- Message Circuit Noise
- Noise-with-Tone
- Noise-to-Ground
- Single Frequency Interference

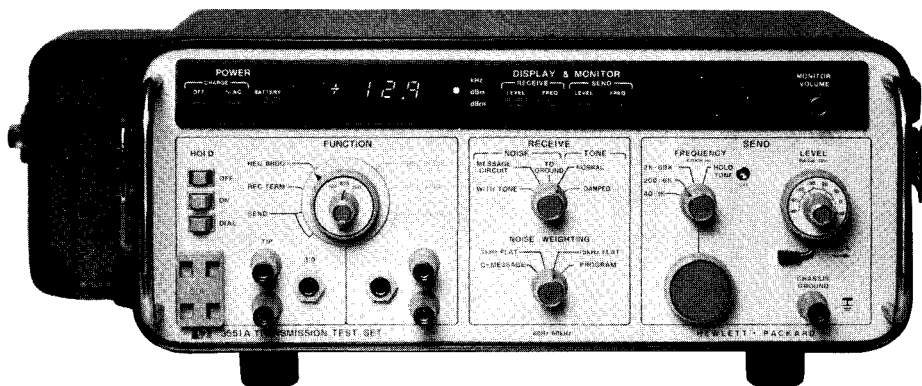

3551A (North American)

### 3551A/3552A Description

The HP 3551A/3552A Transmission Test Sets are rugged, portable test sets ideally suited for measurements on voice, program and data circuits up to 50 kbps. The 3551A is designed for use with North American Bell Standards, while the 3552A is designed for the CCITT standards. Both test instruments contain tests capable of measuring tone level, noise or frequency while simultaneously sending tone. Both level and frequency are fully autoranging.

These test sets can measure both 2 wire and 4 wire balanced circuits. The test sets may be powered by either ac line or internal rechargeable batteries and are suited for both inside and outside plant maintenance.

For frequency measurements, a four digit autoranging frequency counter is provided. The readout features 1 Hz resolution from 40 Hz to 10 kHz and 10 Hz resolution from 10 kHz to 60 kHz.

A convenient set of clip-on dial terminals for connecting a lineman's handset are provided. This allows a line connection to be dialed up and then held in an off-hook condition while making either a receive measurement or transmitting a signal on the line.

Noise measurements are made with a quasi rms detector and displayed in dBm on the 3551A and dBm on the 3552A. Display rate is slowed to 2 per second to provide an analog feel of slowly changing noise levels. Both test sets have the capability of measuring noise-with-tone, message with circuit noise, and noise-to-ground. Four switch selectable weighting networks are provided; 3 kHz, 15 kHz Flat and Program for both models plus a C-message with the 3551A and a Psophometric with the 3552A.

### 3551A & 3552A Specifications

#### Receiver

##### Level Measurements

**Frequency range:** 40 Hz to 60 kHz.

**Dynamic range:** +15 dBm to -70 dBm.

**Resolution:** 0.1 dB.

**Accuracy:** at 25°C ± 10°C, temperature coefficient: ±0.005 dB/°C beyond this range.

INPUT LEVEL (dBm)	FREQUENCY			
	40 Hz	100 Hz	1 kHz	16 kHz 20 kHz 60 kHz
+15	±0.5 dB	±0.1 dB	±0.2 dB	±0.3 dB
-30				
-70	±0.3 dB			

Receiver Accuracy Not Specified Below 500 Hz Or Below -65 dBm When Using 135 Ω Input.

**Transmitter 3551A & 3552A**  
**Frequency range:** 40 Hz to 60 kHz.

**Resolution:** 1 Hz (40 Hz to 10 kHz). 10 Hz (10 kHz to 60 kHz).  
**Level range:** +10 dBm to -60 dBm (40 Hz to 60 kHz). +6 dBm to -60 dBm. (1004 Hz fixed for 3551A; 800 Hz fixed for 3552A).  
**Resolution:** 0.1 dB.  
**Accuracy:** at 25°C ± 10°C, temperature coefficient: ±0.005 dB/°C beyond this range.

OUTPUT LEVEL (dBm)	FREQUENCY		
	40 Hz	100 Hz	1 kHz 4 kHz 60 kHz
+10	±0.5 dB	±0.2 dB	±0.5 dB
-30			
-60	±1 dB		

Transmitter Accuracy Not Specified Below 500 Hz On 135 Ω or 150 Ω Output.

### 3551A Noise Measurements

#### Dynamic Range

**Message circuit noise:** 0 dBm to +85 dBm.

**Noise-with-tone:** 10 dBm to +85 dBm.

**Noise-to-ground:** 40 dBm to +125 dBm.

**Resolution:** 1 dB.

**Detector type:** quasi rms responding.

### 3552A Noise Measurements

#### Dynamic Range

**Message circuit noise:** -90 dBm to -5 dBm.

**Noise-with-tone:** -80 dBm to -5 dBm.

**Noise-to-ground:** -50 dBm to +35 dBm.

**Resolution:** 1 dB.

**Detector type:** quasi rms responding.

### General

**Balanced impedances:** 135 Ω, 600 Ω, 900 Ω (3551A).

**Balanced impedances:** 150 Ω, 600 Ω, 900 Ω (3552A).

**Hold circuit:** 20 milliamps constant current. <0.2 dB holding loss, resistive fuse protection.

**Input/output protection:** blocks 300 V dc.

**Maximum longitudinal voltage:** 200 V rms.

**Battery supply:** >4 hours continuous operation on internal rechargeable batteries at 25°C. Recharge in 12 hours.

**Power requirements:** 100 V, 120 V, 220 V, 240 V ± 10%; 48 Hz to 440 Hz; 15 VA.

**Temperature range:** 0°C to 55°C, operating; -20°C to +65°C, storage.

**Size:** 133 mm H x 343 mm W x 254 mm D (5.25" x 13.5" x 10").

**Weight:** Net, 6.6 kg (14.5 lbs.). Shipping 7.3 kg (16 lbs.).

### Ordering Information

3551A Transmission Test Set

3552A Transmission Test Set (CCITT)

# TELECOMMUNICATIONS TEST EQUIPMENT

15 Hz to 50 kHz Selective Voltmeter

Model 3581C



- Voice grade testing
- Wideband data circuit testing
- Single frequency interference
- Spectrum analysis



## Description

The 3581C Selective Voltmeter has found wide application in testing special service circuits in both inside and outside plant maintenance. The 3581C is used to do spectrum analysis, measure non-linear distortion (harmonic distortion) and to locate and measure unwanted spurious and induced tones. The unit can be operated from ac line or from optional internal batteries.

## Specifications

**Frequency range:** 15 Hz to 50 kHz.

**Display:** 5 digit LED readout. Resolution: 1 Hz. Accuracy:  $\pm 3.5$  Hz.

**Typical stability:**  $\pm 10$  Hz/hr. after 1 hour.  $\pm 5$  Hz/ $^{\circ}$ C.

**Automatic frequency control (AFC), hold-in range:**  $\pm 800$  Hz.

**Pull-in range:**  $> 5 \times$  bandwidth for 3 Hz to 100 Hz bandwidth;  $> 800$  Hz for 300 Hz bandwidth for full-scale signal.

**Lock frequency:** center of passband  $\pm 1$  Hz.

### Amplitude

#### Instrument range

**Linear:** 30 V to 100 nV full scale.

**Log:** +30 dBm or dBV to  $-150$  dBm or dBV.

#### Amplitude accuracy:\*

	Log	Linear
15 Hz–50 kHz, frequency response	$\pm 0.4$ dB	$\pm 4\%$
Switching between bandwidths	$\pm 0.5$ dB	$\pm 5\%$
Amplitude display	$\pm 2$ dB	$\pm 2\%$
Input attenuator	$\pm 0.3$ dB	$\pm 3\%$
Amplitude reference level, Most sensitive range	$\pm 1$ dB	$\pm 10\%$
All other ranges	$\pm 1$ dB	$\pm 3\%$

**Dynamic range:**  $> 80$  dB.

**Noise sidebands:** greater than 70 dB below CW signal. 10 bandwidths away from signal.

**IF feedthrough:** input level  $> 10$  V:  $-60$  dB; input level  $< 10$  V:  $-70$  dB.

**Spurious responses:**  $> 80$  dB below input reference level.

### Sweep

**Scan width:** 50 Hz to 50 kHz. These scans can be adjusted to cover a group of frequencies within the overall instrument range.

**Sweep error light:** this LED indicates a sweep that is too fast to capture full response.

\*Note: these specifications cover the full temperature frequency and amplitude range, and represent worst case. Accuracy is significantly better for measurements not at the extremes.

**External trigger:** a short to ground stops normal sweep. Opening the short then enables a sweep.

### Input

#### Unbalanced (UNBAL)

**Impedance:**  $1 \text{ M}\Omega/40 \text{ pF}$ .

#### Balanced/bridged (BRDG)

**Impedance:**  $10 \text{ k}\Omega$ .

**Frequency response:** 40 Hz–20 kHz,  $\pm 0.5$  dBm for signals  $< 20$  dBm.

#### Balanced/terminated (TERM)

**Impedance:**  $600 \Omega/900 \Omega$  balanced.

**Frequency response:** same as balanced/bridging.

**Input connector:** accepts WECO 310 plug.

### Output Characteristics

**Tracking generator output** (also known as BFO or tracking oscillator output). Switchable on rear panel to restored output (3581C acts as a narrow band amplifier).

**Range:** 0 to 2 V rms.

**Frequency response:**  $\pm 3\%$  15 Hz to 50 kHz.

**LO output:** 100 mV signal from 1 MHz to 1.5 MHz as input is tuned from 0 to 50 kHz.

**Output connector:** WECO 310, for connection to tracking generator output or restored output. In addition to monitoring restored output with headphones, an internal speaker also provides an audio indication of signal content.

**Restored output:** acts as a narrow band amplifier.

**X-Y recorder analog outputs:** 0 to +5V  $\pm 2.5\%$ .

### General

**Operating temperature range:**  $0^{\circ}\text{C}$  to  $55^{\circ}\text{C}$ .

**Humidity:** 95% relative, maximum at  $40^{\circ}\text{C}$ .

**Power requirements:** 100 V, 120 V, 220 V, 240 V  $+5\%$   $-10\%$ , 10 VA typical, 48 Hz to 440 Hz.

**Size:** 412.8 mm H x 203.2 mm W x 285.8 mm D ( $16\frac{1}{4}'' \times 8'' \times 11\frac{1}{4}''$ ).

**Weight:** 11.5 kg (23 lb); Option 001, 13.5 kg (30 lb).

**Accessory available:** 7035B Option 20, X-Y recorder.

**Option 001: Rechargeable battery:** used to make floating measurements; 12 hours to fully charge. Also includes front panel dust cover.

### Ordering Information

3581C Selective Voltmeter

Opt 001: Battery Pack, dust cover

Opt 003: Rack Mount

7035B Opt 020: X-Y Recorder



# TELECOMMUNICATIONS TEST EQUIPMENT

## Transmission Impairment Measuring Sets (TIMS)

Models 4940A

- Complete analog testing of voice/data channels
- Compatible with North American Standard
- Low frequency phase jitter

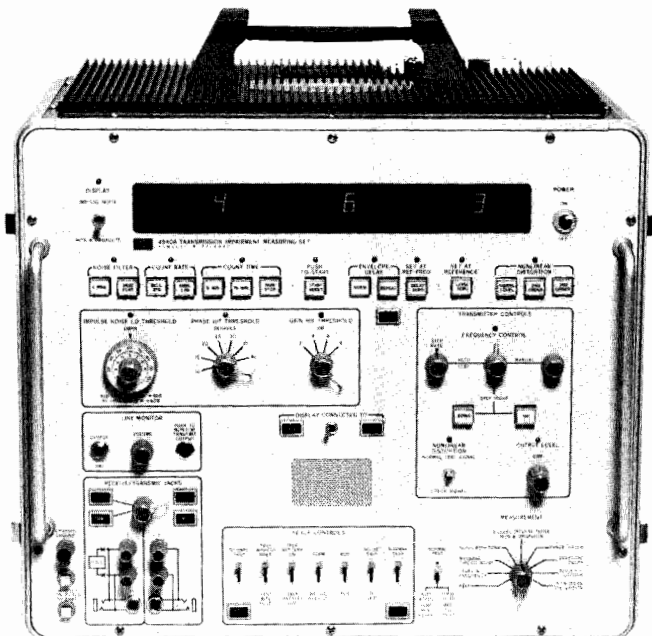

4940A

### TIMS—Transmission Impairment Measuring Set

Most of the important analog parameters can be measured by a combined assortment of analog test sets which measure only a few parameters. However, TIMS are "stand alone" combination test sets that measure 7 to 15 parameters depending on the model and options selected. Thus TIMS can replace a large number of analog test sets. The major advantages of TIMS are that they cost significantly less and are more compact and more portable than a combination of test sets required to do the same measurements.

In addition to cost savings and portability, TIMS are easy to operate. The switches on the front panel are logically arranged in functional groups. Simple straight-forward operating procedures allow the craftsman or engineer to quickly and easily analyze voice band data channel.

#### 4940A TIMS—Complete Analog Testing

The HP 4940A measures all the necessary parameters to completely describe the ability of a voiceband channel to carry medium and high speed data. The 4940A is the ideal tool for analyzing and troubleshooting C and D-1 conditioned lines.

With the HP 4940A it is possible simultaneously to observe all of the transients that cause data errors. By counting phase hits, gain hits, dropouts and three levels of impulse noise at the same time, a more accurate analysis can be made of error causes and channel quality. All of these transients are tallied by TIMS during the selected count time and stored in memory. The pushbutton-selectable count times are 5, 15 minutes and continuous. During the test and at the end of the count time, either the impulse noise totals or the hits and dropout totals may be displayed from memory.

The 4940A TIMS measures the peak-to-peak phase jitter in two separate bands. Bell standard phase jitter is measured in the frequency band of 20 Hz to 300 Hz, and Bell low frequency phase jitter is measured in the frequency band of 4 Hz to 20 Hz. By measuring the peak-to-peak phase jitter in each band, you can identify positively the existence of low frequency phase jitter from standard phase jitter.

### 4940A Specifications

For detailed specifications ask your local HP sales office for a 4940A TIMS data brochure.

#### General

**Power:** 105 to 129 V AC, 60 Hz, 130 watts.

**Dimensions:** 464 H x 470 W x 32.4 mm D (18.3" x 18.5" x 12.8").

**Weight:** net, 18 kg (39 lb). Shipping, 25 kg (54 lb).

#### Options

**001:** adds P/AR measurement

**002:** adds nonlinear distortion measurement

**003:** adds P/AR and nonlinear distortion measurements

**004:** adds P/AR, nonlinear distortion and low frequency phase jitter

**010:** Field carrying case

**019:** 19" Rack Mount Adapter, deletes cover

**023:** 23" Rack Mount Adapter, deletes cover

**910:** extra set of manuals

The nonlinear distortion technique is licensed under Hekimian Laboratories, Inc., USA Patent No. 3862380.

### 4940A Transmission Impairment Measuring Set

Measures level and frequency, message circuit noise (C-message and 3 kHz flat), noise-with-tone, 3-level impulse noise, phase hits, gain hits, dropouts, phase jitter, envelope delay, noise-to-ground.

Low frequency phase jitter can be retrofit at an HP Service Center.

### 4940A, 4943A and 4944A Comparison

Measurement	4940A	4943A	4944A
Message Circuit	•	•	•
Noise-C-Message	•	•	•
3 kHz Flat	•	•	•
Noise with Tone	•	•	•
Attenuation Distortion	•	•	•
Envelope Delay Distortion	•	•	•
Impulse Noise	•	•	•
1 Level	•		
3 Levels	•		
Phase Hits	•		
Gain Hits	•		
Dropouts	•		
Phase Jitter	•	•	
Low Frequency Phase Jitter	†	†	
Non-Linear Distortion	†		•
Peak to Average Ratio	†		
Noise to Ground	•		
Signal to Noise Ratio	•	•	•
† Options			

# TELECOMMUNICATIONS TEST EQUIPMENT

## Transmission Impairment Measuring Set (TIMS)

Models 4943A and 4944A

549



- Portable for field service tests
- Analog testing of voice/data channels

- Master-slave for remote end-to-end testing
- Automatic self check

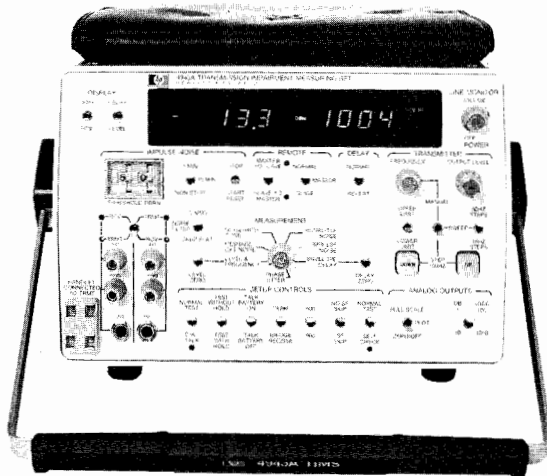

4943A



4944A



### 4943A TIMS

#### Gives You a Permanent Record of Your Measurements

The analog output circuit allows you to display the measured signal on a CRT display or record it on an X-Y recorder or strip chart recorder. Built-in storage and internally generated graticule lines allow you to use non-storage oscilloscopes or uncalibrated CRT display.

MASTER-SLAVE operation allows remote end-to-end testing without adding an external controller. The Slave unit operates unattended, with measurements in both directions controlled and displayed by the Master unit. Adding the HP-IB option provides automatic testing.

#### 4943A Specifications

For detailed specifications ask your local HP Sales Office for a 4943A TIMS Data Brochure.

##### General

**Power:** 100, 120, 220, 240 V AC +5% -10%, 48 to 66 Hz.

**Size:** 196 H x 338 W x 591 mm D (7.7" x 13.3" x 23.3").

**Weight:** 12.2 kg (27 lb).

##### Options

**010:** HP-IB Interface

**012:** Nonlinear distortion replaces phase jitter

**015:** 18055A Transit Case

**019:** 10491B 19" Rack Mount

**910:** Extra set manuals

#### 4943A Transmission Impairment Measuring Set

Measures level and frequency, message circuit noise (C-message and 3 kHz Flat), 1 level impulse noise, signal-to-noise ratio, envelope delay, phase jitter. Analog outputs with internal storage and internally generated graticules, two holding coils, MASTER-SLAVE feature, and portable mainframe. Low frequency phase jitter, either 4-20 Hz or 20-300 Hz, available on special order.

### 4944A TIMS

#### Measures All Parameters for C & D Conditioned Channels

The 4944A TIMS measures all parameters including nonlinear distortion, tariffed for C- and D-conditioned leased data lines. Non-linear distortion is measured using the four tone intermodulation distortion technique. This technique is licensed under Hekimian Laboratories, Inc. USA Patent No. 3862380. The 4944A TIMS computes the 2nd and 3rd order products and automatically corrects the readings for noise.

Applications for the 4944A TIMS include circuit routing, circuit troubleshooting and installation testing. The portable 4944A is designed for both field service use and test center use.

#### 4944A Specifications

For detailed specifications ask your local HP Sales Office for a 4944A TIMS Data Brochure.

##### General

**Power:** 100, 120, 220, 240 V AC, +5% -10%, 48 to 66 Hz.

**Size:** 196 H x 338 W x 591 mm D (7.7" x 13.3" x 23.3").

**Weight:** 12.2 kg (27 lb).

##### Options

**001:** Deletes nonlinear distortion

**010:** HP-IB Interface

**015:** 18055A Transit Case

**019:** 10491B 19" Rack Mount

**910:** Extra set of manuals

#### 4944A Transmission Impairment Measuring Set

Measures level and frequency, message circuit noise (C-message and 3 kHz Flat), signal-to-noise ratio, 1 level impulse noise, envelope delay, non-linear distortion, two holding coils, MASTER-SLAVE feature, and portable mainframe.

# TELECOMMUNICATIONS TEST EQUIPMENT

## Transmission Impairment Measuring Sets (TIMS)

Model 4935A/4936A

- Tests Level vs. Frequency to 110 kHz
- Tests Noise (Including Noise-to-Ground)
- Tests 3 Level Impulse Noise
- Tests P/AR (4935A Option)

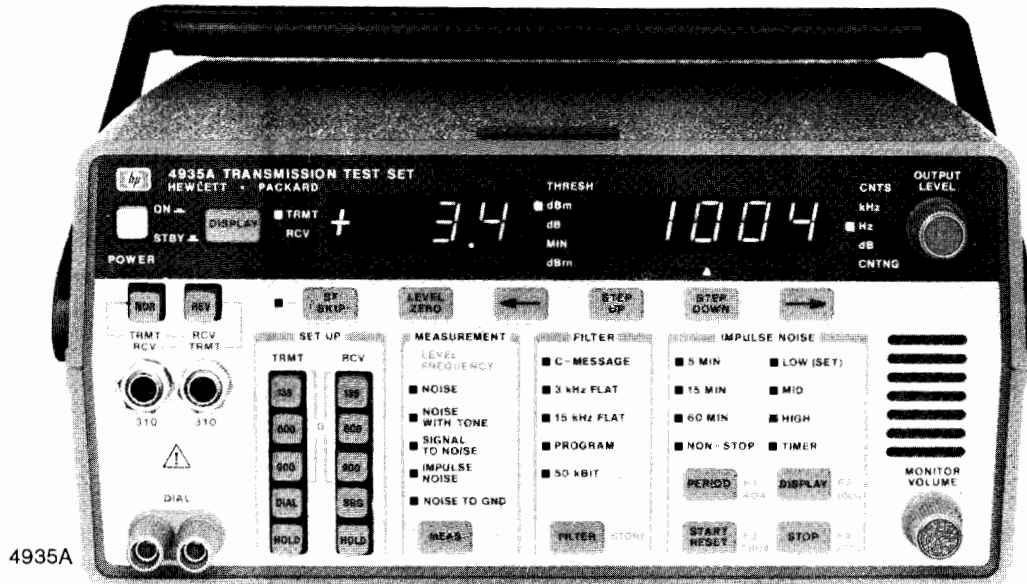

- Filters:
- C Message / 3 kHz
  - Program / 15 kHz
  - 50 kBit (DDS)

### Qualify Circuits for Voice, Data, or Program

The 4935A/4936A Transmission Impairment Measuring Sets provide the basic tests to isolate faults and to qualify circuits for voice, data, or broadcast transmission at frequencies up to 110 kHz. The 4935A is compatible with Bell Standards and the 4936A is CCITT compatible. The 4935A does the required tests to qualify the local loop for Digital Dataphone Service up to 56 kbps. Both test sets provide measurements of level versus frequency, noise with various selectable filters, signal-to-noise ratio, and three-level impulse noise. The users of datacom networks can isolate line faults from equipment faults and call the right vendor first. The Peak-to-Average-Ratio (P/AR) measurement option on the 4935A gives system users a powerful yet simple measure of the combined factors which effect the overall data transmission quality of the line. The P/AR measurement was developed by Bell Laboratories and is useful as a benchmark of a line's data transmission quality.

PABX and other telecommunications equipment service people will find the 4935A/4936A has the analog testing capability they need. Independently selectable transmit and receive impedances make it convenient to test switches at trunk or toll interfaces. For the new generation switches that handle both voice and data, the 4935A/4936A offers all tests in one instrument.

### Easy To Use

The TIMS family from HP is noted for being easy to use. The 4935A/4936A guides you through the measurements by activating only the proper keys for each measurement. The 4935A/4936A is able to store and then recall four independent test tone frequencies which are easily changed by the user from the front panel. This allows one to easily perform slope tests on the line.

Both the North American and CCITT versions offer SF skip (tone blanking) which prevents the transmitter from sending unwanted frequency bands such as the disconnect tone. This 300 Hz band is easily selectable from the front panel.

### Portable for Field Use

The 4935A/4936A in its rugged polycarbonate case weighs only 11 pounds (or 14 pounds with a battery option). A rechargeable battery pack option will provide power in remote areas.

### Ordering Information

4935A Transmission Impairment Measuring Set  
4936A Transmission Impairment Measuring Set  
Accessories Available (Fit Either 4935A or 4936A)

- 18132A-19 in. Rack mount kit.  
Does not require removal of the instrument's handle.  
Uses only 7 in. of rack space.
- 18134A-Vinyl soft pack carrying case.  
The carrying case has a deep pouch for manuals and test cords. The adjustable shoulder strap permits hands-free carrying.

### Options

- 4935A Standard
- 001: adds rechargeable battery pack
  - 002: adds P/AR test, deletes noise-to-ground
  - 003: adds both the battery pack and P/AR
- 4936A Standard (820 Hz Tone and Notch)
- 001: adds rechargeable battery pack to standard
  - 002: 1020 Hz tone and notch
  - 003: 1020 Hz tone plus rechargeable battery pack

## Specifications Level and Frequency

**4935A**

**Transmitter**  
**Frequency range:** 20 Hz to 110 kHz.  
**Resolution:** ± 1 Hz to 100 kHz.  
± 10 Hz, > 100 kHz.  
**Level range:** -40 to +13 dBm  
**Distortion:**

	100 Hz	4 kHz	110 kHz
Output Level (+10 dBm)	-55 dB	-50 dB	-50 dB
Output Level (0 dBm)	-50 dB	-40 dB	-40 dB

**4936A**

**Transmitter**  
**Frequency range:** 20 Hz to 110 kHz.  
**Resolution:** ± 1 Hz to 100 kHz.  
± 10 Hz, > 100 kHz.  
**Level range:** -40 to +13 dBm  
**Distortion:**

	100 Hz	4 kHz	110 kHz
Output Level (+10 dBm)	-55 dB	-50 dB	-50 dB
Output Level (0 dBm)	-50 dB	-40 dB	-40 dB

Distortion in hold tone @ dBm is -65 dB

# TELECOMMUNICATIONS TEST EQUIPMENT

Transmission Impairment Measuring Sets (TIMS) (Cont.)

Model 4935A/4936A

551

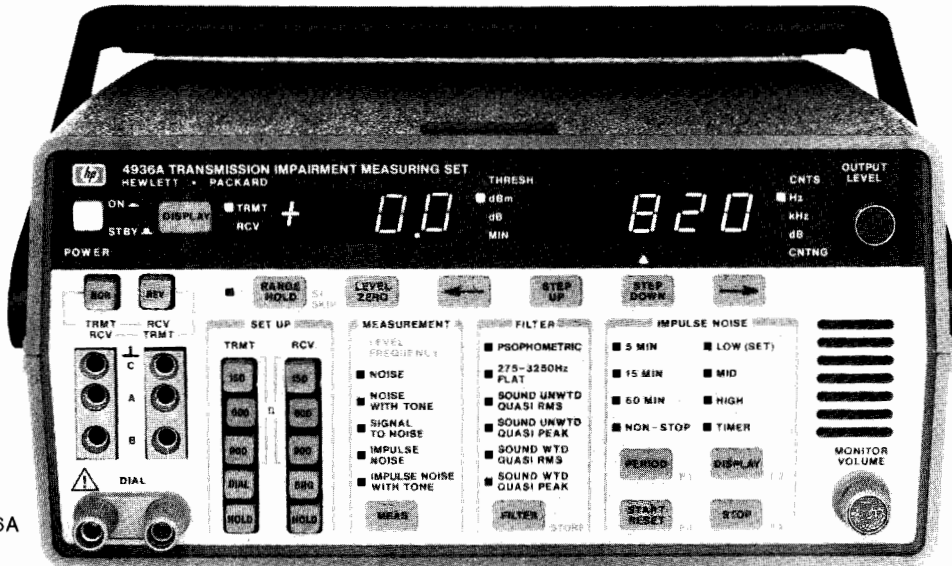

- Psophometric (P. 53)
- Sound, unweighted (J. 16)
- Sound, weighted (J. 16)
- Quasi peak and quasi rms detectors

## 4935A

**Stored frequencies:** 404 Hz, 1004 Hz, 2804 Hz, 2713 Hz.  
**SF skip skips band:** 2600 Hz  $\pm$  150 Hz.  
**Level flatness:** from -40 to +10 dBm.  
 20-200 Hz  $\pm$  1.0 dB  
 200 Hz-15 kHz  $\pm$  0.2 dB  
 15 kHz-85 kHz  $\pm$  0.5 dB

### Receiver

**Frequency range:** 20 Hz to 110 kHz.  
**Resolution:**  $\pm$  1 Hz to 10 kHz.  
 $\pm$  10 Hz, > 10 kHz.  
**Level range:** -60 to +13 dBm.  
**Level accuracy:** from -40 to  $\pm$  13 dBm.  
 20-50 Hz  $\pm$  1.0 dB  
 50-200 Hz  $\pm$  0.5 dB  
 200 Hz-15 kHz  $\pm$  0.2 dB  
 15 kHz-85 kHz  $\pm$  0.5 dB

## 4936A

**Stored frequencies:** 300 Hz, 820 Hz\*, 2000 Hz, 3000 Hz.  
**Tone blanking:** SF skip skips 2280 Hz  $\pm$  150 Hz.  
**Level flatness:** from -40 to +10 dBm.  
 20-100 Hz  $\pm$  1.0 dB  
 200 Hz-15 kHz  $\pm$  0.2 dB  
 15 kHz-85 kHz  $\pm$  0.5 dB

### Receiver

**Frequency range:** 20 Hz to 110 kHz.  
**Resolution:**  $\pm$  1 Hz, to 10 kHz.  
 $\pm$  10 Hz, > 10 kHz.  
**Level range:** -70 to +13 dBm.  
**Level accuracy:** from -40 to  $\pm$  13 dBm.  
 20-50 Hz  $\pm$  1.0 dB  
 50-100 Hz  $\pm$  0.5 dB  
 100 Hz-4 kHz  $\pm$  0.1 dB  
 4 kHz-15 kHz  $\pm$  0.2 dB  
 15 kHz-85 kHz  $\pm$  0.5 dB

\*1020 Hz tone and notch is available as an option.

## Noise Measurements

### 4935A

**Level Range:**  
**Message Circuit Noise:** 0 to 100 dBm.  
**Noise With Tone:** 10 to 100 dBm.  
**Noise to Ground:** 50 to 130 dBm.  
**Detectors:** Quasi rms.  
**Notch filter:** >50 dB rejection from 995 to 1025 Hz.

### 4936A

**Level Range:**  
**Noise:** -90 to +10 dBm.  
**Noise with tone:** -80 to +10 dBm.  
**Detectors:** Quasi rms.  
 Quasi peak—monitored by analog outputs.  
**Notch filter:** >50 dB rejection from 800-855 Hz\*.

## 3 Level Impulse Noise

### 4935A

Threshold ranges @ 600  $\Omega$   
 Low 30 to 109 dBm  
 Mid 4 dB above Low to 109 dBm  
 High 8 dB above Low to 109 dBm  
**Range of tone:** -40 to +13 dBm

### 4936A

Threshold ranges @ 600  $\Omega$   
 Low -60 to 16 dBm  
 Mid 3 dB above Low to 16 dBm  
 High 6 dB above Low to 16 dBm  
**Range of tone:** -40 to +13 dBm

## Peak to Average Ratio

### 4935A

**Transmitted level range:** -40 to 0 dBm.  
**Received level range:** -40 to +3 dBm.  
**P/AR range:** 0 to 120 P/AR units.  
**Resolution:** 1 P/AR unit.  
**General**  
**Impedance:** 135  $\Omega$ , 600  $\Omega$ , 900  $\Omega$ .  
**Filters:** C Message  
 3 kHz Flat  
 15 kHz Flat  
 Program  
 50 kBit

### 4936A

Not offered  
**General**  
**Impedances:** 150  $\Omega$ , 600  $\Omega$ , 900  $\Omega$ .  
**Filters:** Psophometric (P. 53).  
 275-3250 Hz Flat (0.71 Impulse Noise).  
 Sound Unweighted (J. 16).  
 Sound Weighted (J. 16).

\*With option 1020 Hz tone notch is same as 4935A.



# TELECOMMUNICATIONS TEST EQUIPMENT

## Troubleshooting Computer Communications Networks

### Model 1640B

- Identify Network Faults
- Monitor and Simulate
- Capture Relevant Data
- Measure Critical Timing



1640B



### 1640B Description

Selective transparent monitoring and interactive simulation make Hewlett-Packard's 1640B Serial Data Analyzer a valuable tool for quickly locating faulty components in computer networks and most RS-232-C (V.24) interfaces. Regardless of network size, system downtime is minimized when the problem source can be isolated rapidly. Model 1640B combines the convenience of programmed operation in real time with the versatility of a variety of triggering modes: character sequences, time intervals, transmission errors, and external. Whether in design, systems integration, preventative maintenance, or on-line debugging, the 1640B aids you in moving efficiently from the symptom to the cause.

As a passive monitor, the Serial Data Analyzer collects status information and serial data on the RS-232-C (V.24) interface and records up to 2048 characters in memory. You can monitor all data flow, or restrict your data window to specific data types by suppressing the collection of nonpertinent information. Once connected, the 1640B does not interrupt the communication links, permitting you to troubleshoot the system at operating speeds.

In the interactive mode, Model 1640B can simulate the output of a DTE (Data Terminal Equipment) unit or the output of a modem, effectively exercising the entire system for analysis and troubleshooting. Configurations for simulation modes of operation are set quickly on the patch panel matrix which defines the RS-232-C (V.24) interface. A separate 1024-character transmission memory contains messages you construct from the 1640B keyboard, either using a ROM or the HP-IB option with a computer-controller, or "copy" from the 1640B monitor memory. Messages may be transmitted directly or separated for sequential transmission. Branch modes are used to simulate a CPU polling sequence, with one of two simulated replies sent conditional on the stimulus message.

Any character displayed on-screen can be selected with the display cursor for decoding in the code in use, hexadecimal, octal, and binary. The entire contents of memory are accessible by using the up/down cursor keys. This feature was added for the convenience of the operator in entering the code from the 1640B keyboard or checking for skipped bits.

### Easy-to-Use

Operating Model 1640B Serial Data Analyzer is simple and easy to learn because the 1640B uses interactive menus to set up the analysis modes. Each menu presents the appropriate variables, and specific parameters are chosen from a fixed set with the display cursor and Field Select key, or set directly from the keyboard. The four menu keys across the top of the keyboard are FORMAT, MODE (Monitor or Simulate), TX ENTRY, and LIST. Once the menu is selected and the parameters set, the actual operation of the 1640B is automatic, freeing you from learning extensive instruction sets and writing programs for specific tests and simulations.

When the HP-IB interface is added, Option 001, you can further simplify set up and operation of the Serial Data Analyzer with Model 10291B PROMs. Each PROM holds two instrument setups for Format, Mode, and TX Entry menus. Up to five PROMs, ten setups, can be installed in the HP-IB board and loaded into the 1640B by setting rear panel switches and pushing the Load pushbutton. This reduces the opportunity for operator error and is particularly convenient for field applications.

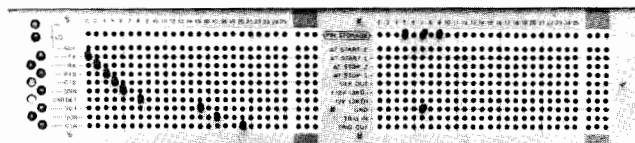

The matrix of the 1640B Serial Data Analyzer provides a versatile interface to configure the analyzer for various applications. The matrix also allows you to control the critical handshake leads, like holding CTS high when the 1640B is simulating a modem in a full duplex system.





## Model 1640B

**Simulation RUN modes:** Five run modes for component simulation by the 1640B allow you to duplicate most common forms of serial communication in computer networks. Single and Count Trigger mode directs the 1640B to send an entire message once. After a total of 2048 TX and RX characters has been captured the run stops automatically. The Repeat and Count Triggers mode causes the message to be sent each time the reply condition occurs. The run must be manually halted. The Repeat and End on Trigger mode causes the message to be sent after each occurrence of the reply condition until the specified trigger condition occurs. This allows repetitive testing with a permanent display of the data at a suspected fault. Branch and End on Trigger mode transmits the first of three message blocks repetitively until a reply is received. Then Block 2 or Block 3 is used, based on the response. The run terminates immediately when trigger conditions are met. Branch and Repeat mode functions in the same manner except that the three block sequence is repeated after transmission of Block 2 or Block 3. At the end of any test, the number of trigger events, number of transmit message repetitions, and results of the last time interval measurement are displayed.

### Programmable Operation

The 1640B solves most network problems in a passive sense, or when necessary, as an interactive simulator. For more complex network interaction the HP-IB option, along with a suitable controller, adds such capabilities as remote control, sophisticated programming, mass storage, data manipulation, and hard copy.

### 1640B Operating Characteristics

Specifications describe Model 1640B's warranted performance. The Operating Characteristics provide extra information for instrument use by describing the nonwarranted operating parameters.

**Patch panel matrix:** permits configuration of 1640B for a variety of configurations. Pin assignments for RS-232-C(V.24) pin assignments are:

TX (transmit data)	Pin 2
RX (receive data)	Pin 3
RTS (request to send)	Pin 4
CTS (clear to send)	Pin 5
DSR (data set ready)	Pin 6
CAR DET (carrier detect)	Pin 8
SCT (synchronous clock transmitter)	Pin 15 or 24
SCR (synchronous clock receiver)	Pin 17
DTR (data terminal ready)	Pin 20

For modem simulation applications, the matrix would be reconfigured. Mylar overlays are provided with repaired pin configurations for common applications to facilitate matrix setup. Any pin, 2 through 25, can be monitored with an auxiliary tristate LED. Other functions configured on the matrix are time interval counter, external trigger input, trigger output, clock output, and buffered power supplies ( $\pm 12$  V, ground).

**Test Results:** after data acquisition any of the run modes (monitor and simulate) is stopped, the following test results are displayed:

1. Last time interval measured, or time interval trigger event, between user-defined start and stop events on the patch panel matrix.
2. Number of trigger events counted during the run.
3. Number of messages transmitted by the 1640B (simulate only).

**Default:** returns the displayed menu to its wakeup condition.

**Display hold:** pressing and holding the FIELD SELECT key while the 1640B is collecting data causes the display to "freeze". Data is still collected, but the display will not be updated until the key is released. Full memory contents are displayed when the run is halted.

**Suppression:** allows capturing only information of interest for efficient use of memory, easier data analysis. Synchronizing characters, idles (all logic one's), nulls (all logic zero's), or everything but trigger and next n characters (with n from 0 to 99) may be suppressed.

### Monitor Mode

#### Run (Execute) Modes

**Continuous:** continuously monitors and records data and counts trigger occurrences; record stopped manually.

**Trigger starts display:** trigger starts a single record of 2048 characters (any combination of transmit and receive data).

**Trigger ends display:** trigger stops a continuous record. Built-in delay of 64 characters captures 64 characters after trigger event.



Model 1640B Serial Data Analyzer monitors or simulates serial data transmissions in computer networks which use the RS-232-C (V.24) interface.

### Simulate Mode

The 1640B can simulate a CPU, terminal, or modem (digital side).

**Output:**  $\geq 3$  V into 3 k $\Omega$  load. Output rows on the patch panel matrix are TX (Transmit Data), RTS (Request To Send), and DTR (Data Terminal Ready).

**Interface control signaling:** automatic with additional control available through the matrix.

**State:** ON is  $> +3$  V; OFF is  $< -3$  V. Nominal values of driven leads are  $\pm 8$  V to  $\pm 12$  V.

**HDX:** Request To Send is on only during transmission. Data Terminal Ready is always on.

**FDX:** Data Terminal Ready is always on; Request To Send is programmable via the matrix, either always on or on only during transmission. Idle condition between transmissions is a steady mark.

**Reply on:** similar to, but separate from, trigger. A Reply On sequence of from 1 to 8 characters, including DON'T CARE and NOT characters, immediately followed by an internally generated time delay from 0 to 6553 ms may be entered which enables a message block to be sent only when these two events occur.

### Run (Execute) Modes

**Single and count triggers:** a message block is transmitted after each occurrence of the REPLY ON condition until all message blocks have been sent once. The run automatically stops when a total of 2048 characters (including the transmitted message) have been recorded in the monitor buffer.

**Report and count triggers:** a message block is transmitted after each occurrence of the REPLY ON condition until all message blocks have been sent. The process repeats until manually stopped with the last 2048 characters retained in memory.

**Repeat and end on trigger:** a message block is transmitted after each occurrence of the REPLY ON condition until all message blocks have been sent. The process repeats and automatically stops when the trigger event occurs with the last 2048 characters prior to the trigger event retained in memory.

**Branch and end on trigger:** a three-block message is loaded in the TX ENTRY memory. Block 1 is transmitted. If no reply is received on the RX lead in the time allotted in the REPLY ON timefield, Block 1 is retransmitted. When a reply is received, Block 2 is transmitted if the response satisfies the REPLY ON character sequences; otherwise Block 3 is transmitted. The 1640B halts automatically when the trigger condition is found.

**Branch and count triggers:** same as Branch and End on Trigger mode, except that the sequence is repeated until the 1640B is halted manually.

**Transmit Modes**

**Transmit first:** the first message block is sent by pressing RUN. Succeeding blocks are sent following each occurrence of the REPLY ON condition.

**Receive first:** a message block is sent after each occurrence of the REPLY ON condition.

**Transmit message entry:** a total of 1024 characters including block delimiter continue symbols (I >) and the end symbol (E), may be entered. The transmit memory may be loaded by transferring contents of monitor memory to the transmit memory with a single key-stroke, or, with Option 001 (HP-IB), through a remote ASCII keyboard or user-definable PROMs (10291B).

**Message Editing Keys**

**CONTINUE:** Places a I > symbol in the message as a block delimiter. Up to 10 continue symbols may be entered. The continue symbol is recognized only by the 1640B and is not sent as part of data.

**END:** Places a E symbol as a message terminator. Additional messages may be added after end symbol as user instructions but will not be transmitted. The end symbol is not sent as part of data.

**INSERT:** inserts a space for an additional character at the point indicated by a moveable cursor by automatically shifting all following characters one cell to the right.

**DELETE:** deletes character immediately above a moveable cursor. All following characters are automatically shifted one space left.

**1640B Specifications**

**Inputs**

**Impedance:** > 30 kΩ on all interface connections except ground.

**Connector:** mates with RS-232-C (V.24) interfaces.

**Format**

**Framing:** 5, 6, 7, or 8 bits with a parity bit.

**Data codes:** ASCII, Hex, or EBCDIC. Other optional code sets in addition to or in lieu of EBCDIC are available.

**Data Modes**

**Asynchronous:** 1 or 2 stop bits in addition to information and parity bits.

**Synchronous:** 1 or 2 user-entered synchronizing characters. Sync search may be initiated on a user-entered character immediately followed by a user-entered number of idle characters from 0 to 99. Idle is defined as a steady mark (logic 1's) in all bit positions.

**Speed**

**Monitor Modes:**

CHARACTER SIZE INCLUDING PARITY (bits)	NORMAL OPERATION		HIGH SPEED MODE*	
	Max Bits Per Second		Max Bits Per Second	
	HDX	FDX	HDX	FDX
9	19200	9600	19200	9600
8	14400	7200	19200	9600
7	14400	7200	19200	9600
6	9600	6400	14400	7200
5	9600	4800	9600	7200

\*Memory data is not displayed while a run is in progress. High speed switch located on rear of Patch Panel Matrix.

**Simulate mode:** Max 9600 bps in branching run modes.

**Internal clock (Asynchronous):** 50, 75, 110, 134.5, 150, 200, 300, 400, 600, 900, 1200, 1800, 2400, 4800, and 9600 bps.

**Note:** asynchronous operation follows the same speed vs character specification as synchronous operation.

**ERROR CHECK:** odd, even, or no parity; optional (003) BCC generation and checking based on LRC-8, CRC-16, or CRC-CCITT from a user-entered beginning to a user-entered ending character. Optional (002) SDLC frame check sum (FCS) generation and error checking for SDLC frames.

**Triggering (Trap) Modes**

**Character sequence:** up to 8 sequential characters including NOT and DON'T CARE may be used as a trigger and may be specified on either the send or receive data lead.

**Note:** DON'T CARE is the set of all possible bit patterns of any given character framing length. The NOT character is the set of all characters except the one specified. For example, NOT C (C) is set of all non-C (A, B, D, etc.).

**Time interval:** time intervals between two RS-232-C events may be used as a trigger. Max or min times to 6553 ms with 1 ms resolution may be specified.

**Error:** data errors, as defined in the FORMAT menu under ERROR CHECK, may be used as a trigger.

**External:** trigger supplied from user hardware or RS-232-C ON conditions (> +3 V).

**General**

**Memory:** 2048 characters of monitor buffer and 1024 characters of transmit message buffer.

**Display:** 10 cm by 13 cm CRT which displays up to 480 characters. All characters in memory can be viewed via the [j] cursor keys.

**Power:** 100, 120, 220, 240 Vac; -10% to +5%; 48 to 440 Hz; 150 VA max.

**Size:** 251 H x 335 W x 546 mm D with handle (9.88" x 13.18" x 21.50"); 445 mm D without handle (17.50").

**Operating environment:** temperature, 0°C to +55°C; humidity, to 95% relative humidity at +40°C; altitude, to 4600 m (15,000 ft); vibration, vibrated in three planes for 15 min. each with 0.3 mm (0.015 in.) excursions, 10 to 55 Hz.

**Weight:** net, 11.4 kg (25 lb); shipping, 15.9 kg (35 lb).

**Accessories supplied:** one 3 m (10 ft) RS-232-C interface cable; Model 10289A Mylar overlay kit, shorting pins and Mylar punch; front panel cover; one 2.3 m (7.5 ft) power cord; one operator's guide; and one service manual.

**Ordering Information**

**Factory Installed Options**

- 001: HP-IB Interface
- 002: SDLC (Synchronous Data Link Control)/HDLC (High Level Data Control) Interface
- 003: LRC, CRC-16, CRC-CCITT Check/Generation
- NOTE: Options 002 and 003 cannot be installed simultaneously
- 005: Menu ROM, messages in ASCII and EBCDIC
- 007: Code Set Board with ASCII, EBCDIC, HEX and space for five other codes
- 008: Dataspeed 40/4, ten tests for teletype
- 105: IPARS Code ROM for Opt 007
- 201: Baudot Code ROM for Opt 007
- 202: EBCD Code ROM for Opt 007
- 203: Selectric Code ROM for Opt 007

**User Installed Kits**

- 10281A HP-IB Field Kits
- 10282A SDLC/HDLC Field Kit
- 10283A LRC/CRC Check Field Kit
- NOTE: Models 10282A and 10283A cannot be installed simultaneously
- 10284A 20/60 Current Loop Interface (Simulate Mode Only)
- 10286A NRZI Interface
- 10288A Code Set Board Field Kit (Option 007)
- 10289A Mylar Overlays, 20 blanks
- 10290B Code ROM (Option 007)\*
- 10291B Menu PROM (Option 001 required)\*
- 10292A Firmware Package for 9825A Desktop Computer

**1640B Serial Data Analyzer**

\*Customer specified code and menu ROM available as specials.





# TELECOMMUNICATIONS TEST EQUIPMENT

## Six Simultaneous, Automatic Data Measurements

Models 1645A & 10235A

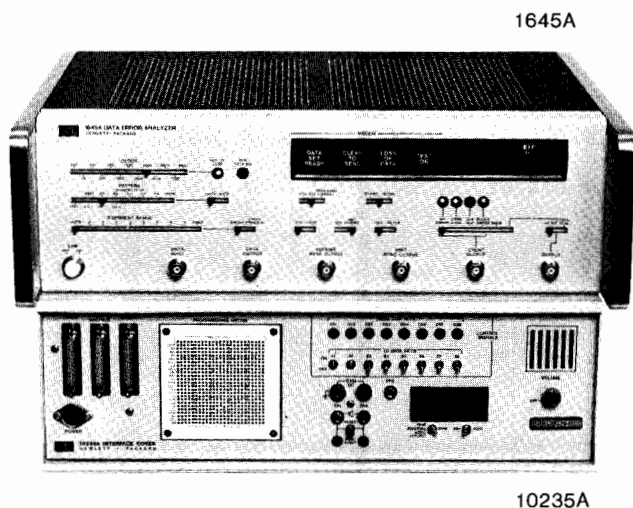

1645A

10235A

### 1645A Description

Hewlett-Packard's Model 1645A Data Error Analyzer quickly isolates data communications link problems through six simultaneous measurements. During tests, the 1645A can be left totally unattended because it automatically maintains synchronization even in the presence of dropouts. For added convenience, the 1645A can be equipped with a printer for hard-copy recordings of long tests.

Bit-error and block-error rate tests are autoranged and displayed directly on an LED readout; there is no need to perform any calculation. Additionally, the 1645A measures jitter or total peak distortion (the sum effect of jitter and bias), counts the number of times carrier loss or dropouts occur, measures data error skew and counts the number of clock slips resulting from phase hits or modem synchronization problems.

With all these measurements made during the same test interval, you'll be able to determine more precisely where your problem is.

### 1645A Specifications

#### Transmitter and Receiver Bit Rate

**Asynchronous Modem Operation:** selectable 75, 150, 200, 300, 600, 1200, 1800, 2400, 3600, 4800, 7200, 9600 bps.

**Synchronous Modem Operation:** to 5 Mbps. (Modem supplies transmit and receive clocks.)

#### Indicators

Out of lock; received data inverted; bit error; carrier loss; clock slip; block error; data set ready (DSR); clear to send (CTS); loss of data; test on.

#### General

**Power:** 115 or 230 V ac, 48 to 440 Hz, 150 VA max.

**Dimensions:** 133 H x 425 W x 286 mm D (5.25" x 16.75" x 11.25").

**Weight:** net, 8.2 kg (18 lb). Shipping, 10.9 kg (24 lb).

**Accessories supplied:** one 3 m (10 ft) RS-232C interconnecting cable to connect the 1645A to the modem (HP P/N 01645-61605), one 2.3 m (7.5 ft) 3 wire power cord (HP P/N 8120-1378); one Operating and Service Manual.

### 10235A Description

The 10235A Interface Cover is designed for troubleshooting problems on the RS-232C interface bus. Common problems such as wrong voltages and excessive turnaround times, which often occur during installation, are easily pinpointed with the measurement capability of the interface cover.

Direct digital readouts of time intervals and transmission signal voltages are easily obtained using the 24 x 25 pin matrix to patch the appropriate lines of the RS-232C interface to the desired measurement. Similarly, logic levels of signals on the RS-232C lines can be monitored using the eight LEDs. Control of individual lines is achieved using any of the eight control switches to apply +5 V or -5 V to the lines. Audio monitoring capability is also provided.

### 10235A Specifications

#### Time interval

**Range:** 999 ms full scale.

**Resolution:** 1 ms.

**Accuracy:**  $\pm 2\%$  of measured interval  $\pm 1$  count.

**Start-Stop:** TP1 & TP2 input, LED indicates event start at TP1 or TP2.

#### DC Digital Voltmeter

**Ranges:** 19.99 V, 199.9 V full scale.

**Accuracy:**  $\pm 1\%$  of reading,  $\pm 1$  count.

#### Indicator and Control Functions

**Indicators:** eight light emitting diodes.

**Audio:** built-in loudspeaker and volume control.

**Control switches:** eight switches supply control signals.

#### General

**Power requirements:** +15 V to 25 V and -15 V to -25 V supplied by the 1645A.

**Dimensions:** 132 H x 399 W x 48 mm D (5.25" x 15.75" x 1.9").

**Weight:** net, 1.8 kg (4 lb). Shipping, 3.2 kg (7 lb).

**Accessories supplied:** one 46 cm (18") RS-232C interconnecting cable—connects 10235A to 1645A (HP P/N 10235-61606); one accessory pouch—attaches to side of 1645A (HP P/N 1540-0385); one power cable (HP P/N 10235-61602); one Operating Note.

#### Ordering Information

**1645A** Data Error Analyzer

**Opt 908:** includes rack mounting kit

**Opt 910:** additional set of manuals

**10235A** Interface Cover

**1645S** Data Transmission Test Set\*

**Opt 910:** additional set of manuals

#### Interfaces

**10387A** for Type 303 modems (with cable)

**10388A** for CCITT V.35 (with cable)

**10389A** Breakout Box (RS-232C) (with cable)

**18062B** MIL-STD-188C Interface

**18063A** RS-449 Interface (with cable)

#### Accessories

**Printer interconnecting cable:** Model 10233A cable connects the 1645A to HP Model 5150A printer; 36 pin male connector on one end and 50 pin male connector on the other.

\*Includes 1645A, 10387A, 10388A, 10389A, 10235A, and interconnecting cables.

# TELECOMMUNICATIONS TEST EQUIPMENT

Cable Maintenance and Construction (CMC)

4960, 4961, 4910G, 4930A, 4904A, 4905A, 4918A



	Buried Plant								Aerial or Underground Plant						
	Path/Depth	Shield or Conductor to Earth	Short	Cross	Ground	Split	Open	Pair I.D.	Short	Cross	Ground	Split	Open	Pair I.D.	Gas Leak
<b>ULTRASONIC DETECTORS</b>															
4905A															
4918A															
<b>DIRECT READING FAULT LOCATORS</b>															
4910G															
4930A			H	H	H				H	H	H				
<b>SHEATH FAULT AND CABLE LOCATORS</b>															
4904A															
<b>PAIR IDENTIFIERS</b>															
4960A/B															
4961A/B															

H = Maximum Sensitivity to high resistance faults



## CMC Test Sets

For cable maintenance and construction (CMC), Hewlett Packard offers test sets that will locate most any fault that is likely to occur in a cable. In addition, advanced pair identifier systems provide simplified and fast identification of wire pairs. Mostly employed by telephone operating companies, this test equipment is also used by power companies, cable TV service, city governments and electrical contractors.

The easy reference matrix above shows the areas in which these test sets are used most effectively. It cross-references the test sets to specific tasks in aerial, buried and underground cables.

### 4960/4961 Automatic Pair Identifier System

The Automatic Pair Identifier system simplifies and makes reliable the identification and testing of working and non-working telephone cable pairs in loaded or non-loaded telephone cables up to 40,000 feet in length. The system has two parts, the 4960 office unit and the 4961 field unit. The office unit operates unattended and is connected to the Main Distribution Frame (MDF) or the access point. A push button starts the operation of testing, identifying and determining the status of each pair. A hundred pairs can be identified in minutes without a control pair.

There are four operating modes: self check, shoe check, scan mode and select mode. Self check tests the operation of the system. Shoe check determines if proper contact is made to the MDF. Scan mode determines the pair number of a randomly chosen pair. Select mode instructs the office unit to send a tone to enable the field unit to trace a pair.

### 4910G Open and Split Fault Locator

The 4910G is designed to provide direct distance readings to opens and splits at the push of a button. It works in the presence of cross battery voltages and leakage resistance. It can be used with or without a good reference pair. The 4910G operates on a capacitance charge sampling principle which relates the change placed on a length of wire to its capacitance and hence its length. The test set averages out the effect of noise on the line by automatically taking several readings on the pair. The distance to a fault or split is displayed on an autoranging display.

### 4930A Conductor Fault Locator

The 4930A is an automatic, digital, direct reading test set operating on the Wheatstone Bridge principle. It is designed to locate extremely high resistance shorts, crosses and grounds. This completely portable, battery operated fault locator is housed in a ruggedized weatherproof case. Faults are easily located in buried, underground or aerial cable and wire. The 4930A is connected to the cable pairs at the access point and the far end of the cable is strapped to form a bridge configuration. Measurements can then be made on either the distance to

the fault, distance strap to fault or distance to the far end. The 4930A contains push button checks of the fault resistance, the condition of the strap as well as of its 12V battery.

### 4904A Cable Fault Locator

The 4904A is a pulsed tone system that accurately locates path and depth of buried cables and pipes. It can also be used for locating shorts, crosses and grounds in aerial, underground (ducted), and direct buried cable. This is a complete, self-contained, troubleshooting system designed for one person operation. Readings are visual, on a meter, and audio on a built-in speaker or headset. It comes complete with transmitter, receiver, search wand, earth contact frame, cables and ground rod.

### 4905A and 4918A Ultrasonic Leak Detectors

The 4905A is a lightweight, portable ultrasonic detector which includes an 18020A directional probe. It is used to detect leaks in aerial cables by detecting the ultrasonic noise created by the leak and converting this to the audible range. By observing the level meter, the craftsperson can "peak-in" on the the leak and determine its exact location.

The 4918A Ultrasonic Leak Detector combines near-laboratory performance with field portability. It is a complete system listed by Underwriters' Laboratories, Inc., for use in Class 1, Group D hazardous environments.

There are many applications for ultrasonic detectors other than detecting pressurized gas leaks. Using air as the conducting medium, corona discharge and arcing from electrical equipment can be detected. In piped systems the operation of steam traps, heat exchangers, and valves can be checked.

### Ordering Information

- 4904A Cable Fault Locator
- 4905A Ultrasonic Leak Detector
- 4910G Open & Split Fault Locator
- 4918A Ultrasonic Leak Detector
- 4930A Conductor Fault Locator
- 4960A Automatic Pair Identifier (Office Unit)
- 4960B Automatic Pair Identifier (Office Unit)
- 4961A Automatic Pair Identifier (Field Unit)
- 4961B Automatic Pair Identifier (Field Unit)

### Accessories

- 18002A Quick Search Wand (for Ultrasonic Detectors)
- 18021A Contact Probe (for Ultrasonic Detectors)
- 18043A Ultrasonic Reflector
- 18100A Underground Leak Location System (Duct Probe)

### FDM/Carrier Systems

FDM/carrier systems are used to transmit large numbers of communications channels simultaneously over a single transmission medium, each channel being allocated a unique part of the frequency spectrum. The transmission media are generally microwave radio networks, which typically carry up to 1800 channels on each RF carrier, and coaxial cable systems, which typically carry up to 3600 channels on each coaxial 'tube'. Higher capacity systems also exist (for example, 60 MHz coaxial cable) which can carry 13,200 channels on each tube.

Each transmission spectrum is complex, containing—in addition to the communications channels—residual carriers, pilot tones, signalling and test tones which may be used to monitor the working of the system while it is actually carrying traffic.

### Measurement Requirements

In the design, manufacture, installation and maintenance of FDM/carrier systems several types of measurement are necessary. Some measurements use general-purpose instruments such as network analyzers, power meters and frequency standards, but the majority of measurements require a dedicated communications selective level meter and a level generator.

HP offers a wide range of instrumentation to satisfy your measurement needs.

### FDM/Carrier System Measurements

Of the many FDM measurements made, the most common are:

- Reference pilots
- Line pilots
- Channel power
- Channel noise
- Group power
- Carrier leak
- Signalling tone
- Test tone
- Supervisory tones
- Inter-supergroup noise
- Spectrum analysis
- Broadband power
- Frequency response
- Gain/loss
- Return loss
- Crosstalk

### Selective Level Meter Requirements

When choosing a selective level meter (SLM), there are several criteria to consider in balancing cost and performance.

1. **Frequency Accuracy:** Ideally, tuning should be accurate and stable, using a synthesized local oscillator. This allows precise tuning to the frequency at which the measurement is to be made and, if required, remote control of the tuning.

Cost savings can be made using a free-running local oscillator, with reduced frequency accuracy and stability. This approach needs manual searching in the region of the signal and peaking the meter on the signal of interest.

2. **Sensitivity:** An SLM as well as being able to measure high level signals accurately needs enough sensitivity to measure, for example, channel noise at a low level test point. In defining measurement range, noise floor is typically the limiting factor and generally -115 dBm in 3.1 kHz is acceptable. Where greater sensitivity is required, external low-noise amplifiers may be used.

3. **Measurement Filters:** It is useful to have a selection of filters for measuring pilots and other single-frequency tones, channel power, channel noise and group power. The pilot filter should have sufficient out-of-band rejection to reject adjacent signals, for example, when measuring a channel virtual carrier leak in the presence of a group pilot. If the SLM is synthesizer-tuned and the need for "peaking" is to be avoided, then a flat top is necessary to allow for drift in the station master oscillator and the SLM between calibrations.

The channel filter should ideally have a flat top and a bandwidth equal to the voice-channel (generally 3.1 kHz). At the same time, it should have sufficient out-of-band rejection to reject adjacent channels, residual carriers and pilots, thereby ensuring an *accurate* measurement of *all* signals within the voice-channel. To make accurate noise measurements on all types of signals, a true psophometric or "C"-message weighting filter should be used with an RMS detector. Account should be taken of inverted channels, since weighting filters are asymmetric.

Cost savings can be made using the conventional 1.74 kHz effective noise bandwidth filters. The sacrifice with these is that they give the correct result only if the signals being measured are single tones or white noise. If the channel contains, for instance, VF signalling tones or data then the measurement may be in error.

The group filter is useful both in measuring the power in a group and in speeding up the search for high level users in the multiplex. In the majority of cases it is found that a high level user in one channel of a group has a sufficiently large effect on the group power to enable reliable detection with the group filter. Thus by measuring blocks of 12 channels the search is greatly speeded up.

4. **RMS versus Average Detector:** A true RMS detector always gives the correct result regardless of the composition of the signal being measured, but it is more expensive than an averaging detector. Usually the averaging detector is calibrated to give correct power measurements with sinusoidal signals and it will be in error when signals with a different spectral composition are measured. In order to overcome this, in the case of the nominal 1.74 kHz bandwidth channel filter, this bandwidth is increased to give the correct results when measuring white-noise signals.

5. **Ease of Use:** When making measurements on an FDM signal with a conventional manually-tuned SLM, the frequency of the desired pilot or channel to be measured must first be determined from the line frequency chart, a table containing several hundred frequencies. The SLM is then tuned to that frequency, its input and IF attenuators adjusted and the meter read, probably after fine tuning to peak the signal. The meter reading must be added to the attenuator settings to complete the measurement. The process is a familiar one, but time consuming and prone to error.

An alternative approach, made possible by developments in microprocessors and semiconductor memories, is to store the tables of FDM frequencies in the SLM so that, with the aid of a synthesized local oscillator, measurements may be made, with speed and confidence, directly in terms of the FDM description.

### Manual Testing

The 3586A & B SLM and its companion Level Generator, the 3336A & B, are specifically designed for FDM system manufacture, installation and maintenance. The units offer state-of-the-art performance in both manual and programmable modes. The SLM local oscillator and the frequency determining circuits of the Generator utilize synthesis techniques that lead to 0.1 Hz

frequency resolution and corresponding frequency stability. The SLM offers absolute amplitude accuracy and flatness of  $\pm 0.2$  dB and Generator leveled output of  $\pm 0.15$  dB. The 3586A/3336A combination is optimized for testing to CCITT standards and the 3586B/3336B to Bell or North American standards.

The accuracy standards of these instruments are enhanced by the resolution of the SLM and the low distortion of the Generator. Filter bandwidths of 20 Hz, 400 Hz, 1.74 kHz, or 3.1 kHz, "C"-message or psophometrically weighted, are available. The 3336A/B Level Generator enjoys a harmonic distortion of  $-60$  dB to 1 MHz and  $-50$  dB to 21 MHz. These characteristics make the 3586A/B and 3336A/B an ideal test set for in-traffic use.

Programmability via HP-IB is standard on both instruments. The 3336A/B Generator can operate either in a stand-alone mode or track the 3586A/B SLM via the HP-IB without the need for an external controller.

The new 3746A and the 3747A/B Selective Level Measuring Sets and the 3335A/3336A/B Synthesizer/Level Generators provide an optimum solution to the problems of measurements on FDM systems for manufacture, installation and field maintenance. These selective level measuring sets each have a synthesized local oscillator, wide sensitivity range of  $+20$  dBm (3746A) or  $+15$  dBm (3747A/B) to  $-120$  dBm (which is adjusted automatically), and absolute measurement accuracy of  $\pm 0.25$  dB including typical flatness of  $< \pm 0.1$  dB. The measurement filters are specifically designed for FDM systems: a 38 Hz flat-topped pilot filter, a 3.1 kHz channel filter with an optional true psophometric or "C"-message

weighted noise filter and a 48 kHz group filter (optional on 3746A). True RMS detection is employed.

The sensitivity is automatically adjusted and the measurement results displayed on a digital LED display. CCITT and Bell frequency plans are stored in memory thus tuning is effected simply by keying in Channel, Group, Supergroup number, etc.

Several automatic routines are also accessible from the simple keyboard. Examples are scans of pilots, channel power, group power, carrier leak and inter-supergroup noise. These sets can also measure broadband power and, optionally, phase jitter, weighted noise and noise-with-tone. Additionally, the 3746A can measure single-level impulse noise (by option). The 3746A standard unit includes an Access Switch Controller (similar in capability to the 3755A Switch Controller), a Frequency Counter and a non-volatile Real-time Clock.

### Automatic Testing

Hewlett-Packard manufactures a wide range of HP-IB automatic system components. These make the implementation of automatic system ideas relatively straight forward from both the hardware and software standpoints. HP-IB systems make automatic testing more economically justifiable.

The 3046A/B is a low cost automatic FDM Surveillance System built around the 3586A/B SLM and 3336A/B Level Generator. The HP 85F Personal Computer is used as system controller, combining powerful control and computational capabilities in a lightweight, easy-to-use package. The system has stored FDM plans and the ability to automate virtually all system measurements, including pilot scans, channel power and slot noise. The system is very flexible, allowing

automatic sequential tests, voice channel impairments vs time, or spot frequency measurements. Results can be listed tabularly or plotted using the 85F's powerful graphics capability and internal printer. Measuring automatically with the 3046A/B is as easy as answering a series of simple questions. This ease-of-use, along with the low cost of the system, make the 3046A/B an ideal way to bring automation to your FDM system.

The majority of the above facilities are provided on the 3746A SLMS, without the need for an external controller, and with faster measurement speed. For even greater capability, the 3746A and 3747A/B SLMS's can be remotely controlled through the HP-IB from a suitable controller such as the 85F Personal Computer, the 9826A Desktop Computer or the HP 1000 Computer System. This facilitates building a range of measurement systems from, for example, a single-instrument automatic, production test system to a fully automatic, multi-station, remote surveillance system. SLMS systems based on the 3747A/B and the 3746A's predecessor (the 3745A/B) are already providing comprehensive automatic measurement capability on FDM networks in many countries throughout the world.

An integral part of both large and small surveillance systems is a means of both connecting test points to the measuring set and connecting test signals to appropriate test inputs. This access switching is provided by the 3754A, 3756A and 3757A Switches which are controlled by a Switch Controller. In the case of 3747A/B and 3046A/B systems, the switch control function is provided by a 3755A Switch Controller. With 3746A systems, the switch control function is included within the SLMS. In either case, manual or remote control is possible.

### Summary of Selective Level Meters

	3586A 3586B	3746A	3747A 3747B
Frequency Range	50 Hz to 32 MHz	50 Hz to 32 MHz	10 kHz to 90 MHz
Level Range	+20 to -120 dBm	+20 to -120dBm	+15 to -120 dBm
Detector	RMS	RMS	RMS
Filters	20 Hz 400 Hz 1.74 kHz/2.0 kHz 3.1 kHz* Psophometric or "C"-Message weighted* Notch filters*	22 Hz 3.1 kHz 48 kHz* Psophometric or "C"-Message weighted* 2.5 kHz* Notch filters*	22 Hz 3.1 kHz 48 kHz Psophometric or "C"-Message weighted* 2.5 kHz* Notch filters*
Broadband Power	Yes	Yes	Yes
Phase Jitter	Yes*	Yes*	Yes*
Impulse Noise	Yes*	Yes*	No
S/N With Tone	Yes*	Yes*	Yes*
Scanning	Manual†	Automatic	Automatic
Companion Level Generator	3335A (32 MHz) 3336A/B (21 MHz)	3335A (32 MHz) 3336A/B (21 MHz)	3335A

\*Optional—refer to specifications †Automatic with external controller

560



# TELECOMMUNICATIONS TEST EQUIPMENT

## Selective Level Measuring Sets, HP-IB CRT Display

Models 3746A, 3747A, 3747B, 37461A

- Fast, accurate measurements on Frequency Division Multiplex (FDM) systems
- Selective filters for pilot, channel and (optionally) group power and weighted noise measurements
- Automatic tuning to stored frequency plans with comparison of measured level to stored limits
- Built-in access switch controller, real-time clock and frequency counter
- HP-IB controller for external printer, frequency synthesizer and companion display unit
- Versatile, efficient remote system device in computer-controlled HP-IB systems

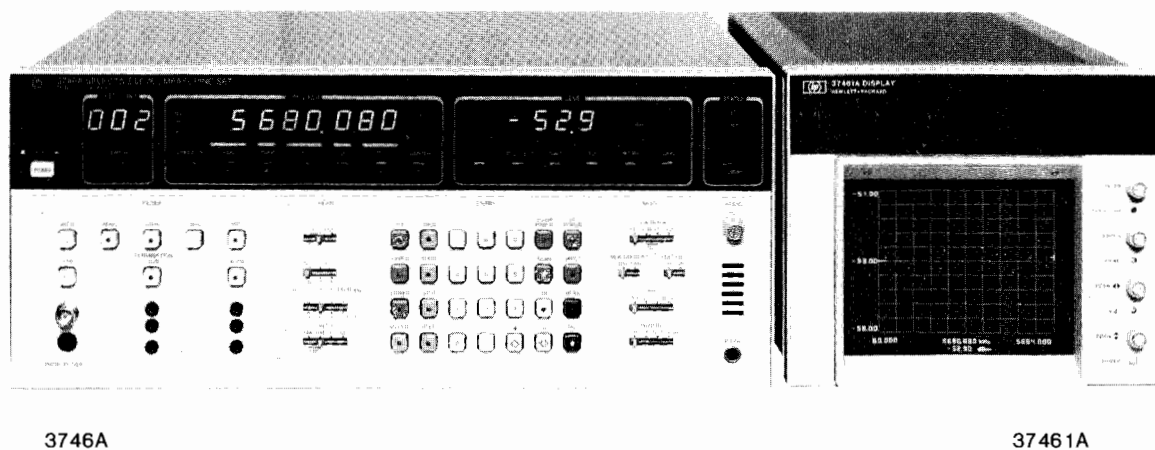

3746A

37461A



### 3746A Selective Level Measuring Set (50 Hz to 32 MHz)

The 3746A Selective Level Measuring Set (SLMS) is designed to make fast, accurate selective level measurements. A built-in frequency synthesizer gives accurate, stable tuning to the precise frequency at which the measurement is to be made. The 3746A can be tuned over its frequency range (50 Hz to 32 MHz) with a resolution of 1 Hz.

The SLMS measures true rms power between +20 dBm and -120 dBm with 1 dB, 0.1 dB, or 0.01 dB resolution. Fully auto-ranging attenuators and amplifiers simplify operation further by eliminating the need to set attenuators and add meter readings. Measurement results are automatically displayed to the selected resolution, in dBm or dB relative terms, on an LED display. The absolute accuracy of the measurement over wide level and temperature ranges is  $< \pm 0.25$  dB.

Many benefits are derived from the purpose designed filters contained in the SLMS. The 38 Hz pilot filter has a flat top over 22 Hz, necessary for automatic tuning, and achieves high out-of-band rejection so that, for example, carrier leak and adjacent pilots can be measured on active systems. The channel filter is a flat-topped 3.1 kHz filter which can be used for measuring all signals in the voice channel. It provides high out-of-band rejection, thus ensuring that pilots, residual carriers, signalling tones, etc. do not interfere with measurements. Optional weighted filters are available to make either true 'C'-message or CCITT psophometrically weighted noise measurements. These options, in addition to providing a weighted filter, give the following voice channel impairment measurements: single level impulse noise, phase jitter on a 1 kHz channel test tone (3 measurement bandwidths) and noise-with-tone measurement. A 48 kHz filter for group power measurements is available by option to facilitate fast location of high level signals on a multiplex. Using the 48 kHz group filter the SLMS can also perform supergroup power measurements by evaluating automatically the logarithmic sum of the 5 group powers in a supergroup. This measurement is useful for assessment of system loading.

The 3746A is internally controlled by a microprocessor which provides many ease-of-use and time-saving features. As well as tuning exactly to an entered frequency, the SLMS can refer to CCITT or

Bell multiplex frequency plans in its memory and automatically tune to the correct frequency at any level in the multiplex. Other frequency plans, as used for example on submarine cable or satellite links, can be installed to special order. Two user-accessible storage areas are available: the random frequency and FDM skip registers. The random frequency registers permit the storage, either from the keyboard or under remote control, of up to 145 unrelated frequencies. The SLMS can then be programmed to scan through these frequencies, at the same speed as if an FDM plan were being scanned. The FDM skip registers give the capability of specifying up to 30 areas of FDM plan where no measurements are to be performed. This facility is useful when, as often happens, the multiplex is not fully loaded—it is then possible to miss out non-significant measurements on, for example, an unloaded supergroup. The storage of FDM skips and random frequencies is non-volatile—if line power is lost the stored data is preserved for several hours by internal battery back-up. The comprehensive FDM plan and frequency storage capability of the SLMS eliminates the need for the operator to refer to FDM plan charts and tables. The SLMS can automatically step through pilots and supervisory tones, channels, group powers, carrier leaks, etc. across the baseband of a multiplex—comparing levels with pre-determined alarm limits and providing a print-out of limit violations on a separate printer. 250 pilot measurements can be made in about 2 minutes and 2700 channel powers can be measured in about 5 minutes. Spectrum analysis measurements of a voice channel, group, supergroup, or even the whole baseband can also be made. Measurements can be made unattended, for example, overnight.

In addition to its extensive selective level measurement capabilities, the 3726A offers several additional functions. Control of test point selection is provided by means of built-in Access Switch Controller. This performs a function similar to the 3755A Switch Controller: control of 3754A, 3756A, or 3757A Switches to select 1 from a possible 10 RF outputs. Up to 11 Switches can be cascaded under control of a single 3746A to allow selection of 1 from up to 1000 RF outputs. A 3-digit display on the SLMS front panel indicates the selected port. Another useful feature is the SLMS's integral Real-time Clock which can display time or date and holds the correct time even when the SLMS is switched off. If a printer is connected to the 3746A via the

# TELECOMMUNICATIONS TEST EQUIPMENT

Selective Level Measuring Sets, HP-IB CRT Display

Models 3746A, 3747A, 3747B, 37461A

561

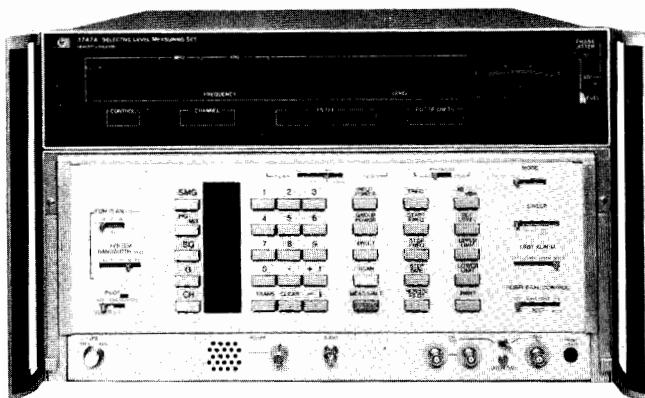

3747A (CCITT)



3747B (Bell)



## 3746A (Cont.)

HP-IB, the SLMS can be configured to output measurement results to the printer together with the date and time at which each measurement is made. The SLMS also incorporates a Frequency Counter which can be used to count the frequency of an incoming signal. The SLMS can then re-tune and capture the signal, provided the signal lies within the 60 dB bandwidth of the selected filter.

The 3746A is fully programmable via the HP-IB, and can itself assume the role of system controller. In this mode, selectable by a rear panel switch, the SLMS can control a tracking Frequency Synthesizer (models 3330B, 3335A, and 3336A/B are compatible), a 20- or 80-column Printer (for example, 5150A or 2631B), and a 37461A CRT Display. It is thus possible to assemble a self-contained test station for network maintenance and surveillance. For more powerful, fully automatic surveillance applications, the SLMS can be switched to its remote mode and controlled via the HP-IB from an external controller (for example, a desktop or mini-computer). In multiple SLMS systems, where the instruments are controlled via HP-IB Extenders and a modem link, the storage of FDM plans and limits within the 3746A minimizes the interaction between controller and SLMS to give optimum system efficiency.

### 3746A Options

- 001: Siemens series 1.6/5.6 mm 75  $\Omega$  connectors
- 005: WECO 477B/223A (equivalent) connectors
- 011: 48 kHz group filter
- 012: tracking generator

- 013: high stability frequency reference
- 015: channel impairments—CCITT
- 016: channel impairments—North America
- 907: front handle kit
- 908: rack flange kit

- 909: rack and handle kit
- 910: extra set of manuals

### 3746A Selective Level Measuring Set

#### 37461A Display

The 37461A Display is a CRT-based display unit with integral processor and HP-IB interface. Under control of the 3746A SLMS, a graticule with labelled frequency and level axes is displayed and up to 256 measurement results can be plotted. This type of visual presentation enables speedy assessment of overall traffic loading, identification of spurious signals and detection of high level users.

#### 37461A Options

- 907: front handle kit
- 908: rack flange kit
- 910: extra set of manuals

#### 37461A Display

## 3747A/B Selective Level Measuring Set 10 kHz to 90 MHz

The 3747A and 3747B Selective Level Measuring Sets (SLMS's) are designed to make selective level measurements over the frequency range 10 kHz to 90 MHz. Many of the original concepts in these instruments are incorporated in the newer 3746A 32 MHz SLMS. The 3747A and 3747B SLMS's include an accurate, stable frequency synthesizer, and fully auto-ranging measurement of true rms power between +15 dBm and -120 dBm with better than  $\pm 0.25$  dB accuracy over wide level and temperature ranges. The SLMS's provide a complete set of purpose-designed filters for pilot, channel, and group power measurements. Optional channel filters are available for psophometric (3747A) or C-message (3747B) weighted noise measurements or for measurements over 2.5 kHz bandwidth on multiplex systems with 16-channel group structure.

Internally stored multiplex frequency plans in the SLMS memory give the capability of automatic scanning through all levels of the multiplex. The 3747A provides all the CCITT plans up to 60 MHz, while the 3747B provides all the North American (Bell) plans up to 65 MHz. Other FDM plans, such as those used on high capacity submarine cables, can be supplied to special order.

The 3747A and 3747B SLMS's provide user-defined limits storage—measurements which fall outside these limits can be output via the HP-IB to an external Thermal Printer. Bus connection of an external tracking Frequency Synthesizer is also possible (models 3330B and 3335A are compatible). For a graphical plot or display of measurement results, analog X, Y and Z outputs are available by option on the SLMS rear panel.

The SLMS's are fully programmable via the HP-IB and so can form the basis of a powerful, fully automatic surveillance system.

### 3747A/B Options

- 001: Siemens series 2.5/6 mm 75  $\Omega$  connectors
- 002: Siemens series 1.6/5.6 mm 75  $\Omega$  connectors
- 004: WECO 560A/562A/223A (equivalent) connectors
- 021: phase jitter + psophometric weighted filter
- 022: phase jitter + C-message weighted filter
- 023: psophometrically weighted noise + tone
- 024: C-message weighted noise + tone
- 025: 2.5 kHz channel filter
- 040: X-Y recorder/display driver
- 908: rack flange kit
- 910: extra set of manuals

### Ordering Information

- 3747A Selective Level Measuring Set (CCITT)
- 3747B Selective Level Measuring Set (Bell)

# TELECOMMUNICATIONS TEST EQUIPMENT

## Access/Distribution Switches and Controller (8.5 MHz, 25 MHz, 90 MHz)

Models 3754A, 3755A, 3756A, 3757A

- Select 1 from a possible 10 RF Inputs/Outputs
- Cascade up to 111 Switches to allow selection from 1000 Inputs/Outputs
- Mix different Switches for the most cost-effective solution
- Switches controllable from 3755A Switch Controller or 3746A SLMS
- Remote input selection using HP-IB (3755A or 3746A)
- 75  $\Omega$  termination of unselected ports



3754A



3756A



3757A

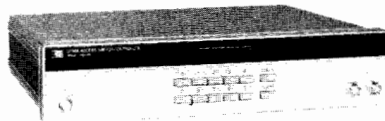

3755A

The 3754A, 3756A and 3757A Switches and the 3755A Controller have been developed to meet the requirements of three main areas.

1. Frequency Division Multiplex (FDM) System surveillance and maintenance—the Switch arrangement is used in conjunction with a Selective Level Measuring Set (SLMS), such as the 3746A (32 MHz) or 3747A/B (90 MHz), to monitor pilot and traffic levels at various points in the multiplex without manually connecting the SLMS to each point. With the 3747A/B SLMS, a 3755A Switch Controller is necessary to control the Switches. The 3746A SLMS, however, contains an integral switch control function with a 2-wire control output on the rear of the 3746A.
2. Production testing—where automatic selection of several RF signals is required.
3. Data logging—where large numbers of RF signals need to be accumulated at one control point.

### 3754A 25 MHz Access Switch

The 3754A 25 MHz Access Switch is an ac-coupled, uni-directional, ten-input switch with a frequency range from 10 kHz to 25 MHz. The 3754A incorporates a virtual-ground amplifier—giving an insertion loss of  $< \pm 0.1$  dB from 50 kHz to 20 MHz and high isolation across the whole frequency range. The isolation between any unselected input and the output is  $> 85$  dB and the isolation between any two inputs is  $> 90$  dB. In addition, pre-set gains of 1, 2 and 3 dB are internally selectable to compensate for losses in cables and equalizers. (The 3754A can be powered from the ac mains or from a dc supply.)

### 3756A 90 MHz Bi-directional Switch

The 3756A 90 MHz Switch is a dc-coupled, bi-directional, ten-way switch with a frequency range from dc to 90 MHz. The 3756A offers isolation of  $> 80$  dB between channels, and  $> 75$  dB between unselected input and output ports. It has an insertion loss of 1 dB with a flatness of  $< \pm 0.2$  dB and  $> 28$  dB return loss. (The 3756A can be powered from the ac mains or from a dc supply.)

### 3757A 8.5 MHz Access Switch

The 3757A 8.5 MHz Access Switch is a low-cost, ac-coupled, uni-directional, ten-input switch with a frequency range of 10 kHz to 8.5 MHz. An option provides expanded frequency range from 200 Hz to 8.5 MHz. The 3757A has an insertion loss  $< 0.1$  dB from 10 kHz to 4 MHz and isolation of  $> 95$  dB between channels. In addition, pre-set gains of 1, 2 and 3 dB are internally selectable to compensate for losses in cables and equalizers. (The 3757A is powered from a  $\pm 15$  V dc supply.)

### 3755A Switch Controller

The 3755A Switch Controller has a small, easy-to-operate keyboard with a 3-digit LED display to denote the input or output selected. Each Switch (3754A, 3756A or 3757A) is given a 1-digit code, to select the required port. In a large Switch network, involving 3 levels of cascaded Switches, selection from up to 1000 inputs or outputs is possible. This requires a 3-digit code (000 to 999) where each digit represents the input or output of the appropriate Switch at each of the 3 levels.

Because the 3755A is a self-contained unit, separate from the Switches, it is possible to locate the Switches remotely from the Controller. In the case of the 3754A and 3757A, the control signal can be transmitted over the same cable as the RF signal. This eliminates the need for separate control cables and makes inter-connection changes easier. Sending control signals over the RF path has no effect on the RF signal source. (The 3755A is powered from the ac mains.)

The control signals can also be sent along a separate two-wire path. This is necessary for the 3756A or when the continuous dc path between the Switches and Controller is interrupted, for example, by an ac-coupled equalizer inserted to compensate the line-frequency response.

A combination of both methods of control signaling can be employed in the same Switch system. Also, if necessary, high and low frequency Switches can be incorporated into the same system.

### HP-IB Control

The 3755A Switch Controller can be remotely controlled over the Hewlett-Packard Interface Bus (HP-IB) by a desk-top computer. Selection of the RF input/output to be accessed is achieved using a 3-digit code that defines the particular input/output required. Since it is the 3755A which is controlled via the HP-IB, only one bus address is used for up to 111 Switches. If the 3746A is used as Switch controller, similar principles apply.

### Ordering Information

3754A 25 MHz Access Switch  
 3755A Switch Controller  
 3756A 90 MHz Bi-directional Switch  
 3757A 8.5 MHz Access Switch

- Operator-oriented user interface.
- Helps reduce network downtime.
- Provides information for management reports.
- Provides information for trend analysis.
- Automatic time scheduled surveillance.
- On-demand measurements

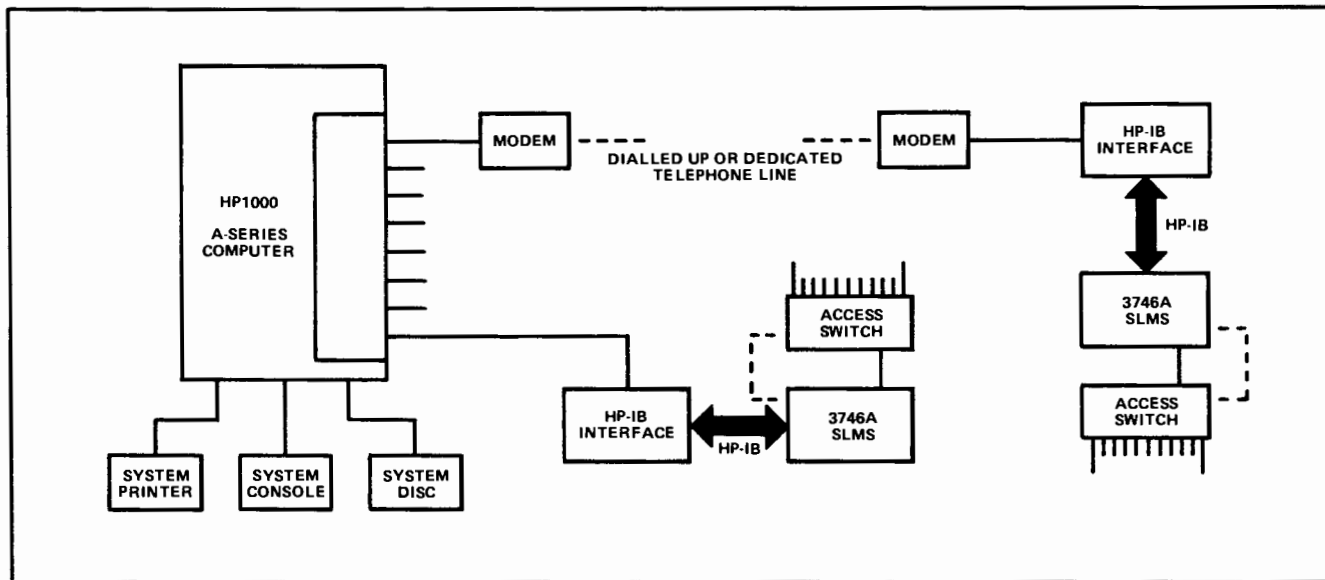

Hewlett-Packard offers software for remote surveillance systems for use with frequency division multiplex (FDM) networks.

The 37016A FDM Network Surveillance Software provides a comprehensive solution to the problems associated with performance monitoring a complex and widely-spaced FDM network. The 37016A software, together with the necessary control and measurement hardware, forms a complete automatic measurement system for use in commissioning, surveillance, fault finding and maintenance of FDM installations.

A system operates under direct control of a central HP 1000 A-series Computer, which gathers measurement information from local and remote measurement subsystems simultaneously. The new 3746A Selective Level Measuring Set (SLMS) forms the basis of each subsystem.

### Capability of the 37016A

The 37016A software provides a full range of automatic surveillance measurement routines, together with the ability to print out measurement results or store them for future analysis. These routines can also be used to make measurements on demand. Access to the computer may be gained from any desired location using a suitable VDU connected via modems and a dialled-up or dedicated telephone line.

Incorporated in the 37016A is a data base management system (DBMS) which allows information about the FDM network to be collected, processed and analyzed cleanly and efficiently, enabling performance trends and management reports to be assembled by a user if required.

### Trend Analysis

The DBMS capability simplifies analysis of long-term trends within a network, allowing performance degradations to be found and the necessary maintenance undertaken before any serious problems develop. This can reduce radically the time during which the network is inoperative, if major faults have to be first diagnosed and then repaired.

When failures do occur, the ability to localize the fault quickly and accurately is of paramount importance. The 37016A software enables specific test points within a network to be monitored continuously, allowing faults to be detected quickly and immediate action to be taken.

### Management Reporting

The extensive results storage capability of the 37016A enables information about the network to be gathered over long periods. This data can be accessed and analyzed using the DBMS to form a concise and convenient basis for management reporting.

### Measurement Hardware

An FDM network surveillance system supported by the 37016A software is based on the 3746A SLMS. Switching to access the measurement test points is achieved with the 3754A, 3756A or 3757A Access Switches, controlled from the 3746A. The 3746A SLMS is controllable from the HP 1000 Computer via the HP-IB either directly using HP-IB cards for on-site processing or via serial interfaces where communication between computer and measurement subsystem is over full-duplex, dedicated telephone lines.

A serial interface enables the parallel HP-IB information (for the instruments) to be converted to an RS 232C compatible serial data form for transmission through voice channel modems. Error detection and correction is provided automatically in the supported configuration by the serial interface. Hewlett-Packard do not supply or support suitable modems.

### System Software

The 37016A FDM Network Surveillance Software consists of functional tests, diagnostics, measurements routines and incorporates a data base management system.

HP's distributed operating system DS/1000-IV can be incorporated if required, enabling several distant computers to be interconnected thereby expanding the monitoring capability.

### Documentation

Details of hardware integration, data base structure, functional tests, diagnostics and measurement routines are provided in the 37016A Library.

### Support Services

A full training course on the operation of the software is available from Hewlett-Packard.





# TELECOMMUNICATIONS TEST EQUIPMENT

## Selective Level Meter and Synthesizer

Models 3586A/B & 3336A/B

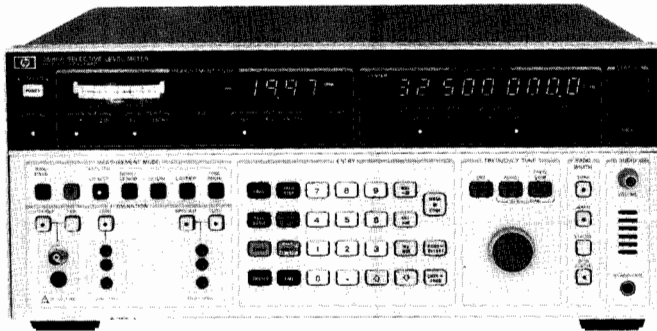

A Selective Level Meter (CCITT) (Shown with Opt 003)



### Description

#### General

Hewlett-Packard's new 3586A/B Selective Level Meters and 3336A/B Tracking Synthesizers offer the high performance necessary to meet the demanding requirements in the design, manufacture, commissioning and maintenance of Frequency Division Multiplex (FDM) systems. The 3586 and 3336 "A" models meet CCITT requirements, and the "B" models meet North American (Bell) standards. Both are fully programmable over the HP Interface Bus. The 3586A & B Selective Level Meter provides a unique combination of features, including wideband power and optional telephone impairment measurement of impulse noise, phase jitter, noise with tone, and signal-to-noise with tone ratio. The 3586A & B's wide frequency coverage to 32.5 MHz allows measurements to be made at both voice channel and carrier frequencies. Microprocessor control adds many ease-of-use features such as amplitude offset measurements of tone and noise level in units of dBmO, dBmCO, or dBpWO. Convenience features include simultaneous analog and digital level displays, precise frequency setting with HP's fractional N synthesized local oscillator, accurate frequency counter and tone measurements with automatic channel alignment for 800 Hz (CCITT) or 1004 Hz (Bell) test tone or carrier frequency reference.

The 3336 A/B Synthesizer/Level Generator is an excellent precision tracking signal source for the 3586A and B Selective Level Meter. When the Selective Level Meter and Synthesizer are in the tracking mode, the frequency of the synthesizer is automatically set to the frequency of the SLM. Frequency coverage is 10 Hz to 20.9 MHz, making the 3336 A and B useful for telephone circuit loop testing on most FDM systems, transfer function and distortion measurements in telecommunications manufacturing.

#### Carrier Frequency and Voice Channel

The 3586A & B can make both carrier frequency measurements to 32.5 MHz and voice channel measurements from 50 Hz to 100 kHz.

You can measure tone levels, idle channel noise or weighted noise at voice channel, then compare at carrier frequency.

#### Transmission Impairments (Optional)

The Transmission Impairments Option 003 permits phase jitter, weighted noise, noise-with-tone, signal-to-noise-with-tone ratio, and single level impulse noise measurements. The 3586A's capability to make these transmission impairment measurements at both FDM voice channel and carrier frequencies is unique.

#### Frequency and Amplitude Precision

The 3336 A/B provides frequency resolution of one microhertz (.000001 Hz) up to 100 kHz and one millihertz (.001 Hz) to 20.9 MHz. Level accuracy is  $\pm .15$  dB at full output over the full frequency range with  $\pm .12$  dB optional. Harmonic levels are more than 60 dB down up to 1 MHz and more than 50 dB down up to 20.9 MHz, performance not previously available in a synthesizer.

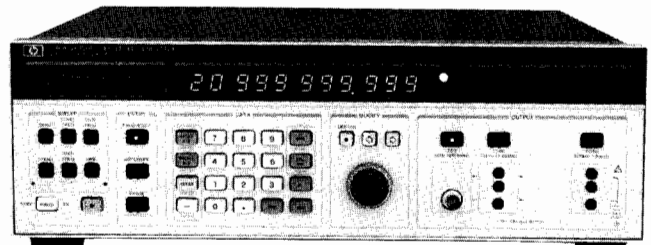

3336A Synthesizer/Level Generator (CCITT)

#### FDM Testing

The flexible output section allows different connectors to be provided either by option or special request. Frequency entry is accomplished by keyboard or analog control for manual tuning or frequency stepping of any digit.

The Amplitude Blanking feature allows testing of operational FDM systems without disturbing adjacent channels while the frequency is changed. The output is blanked to less than  $-85$  dBm until the next desired frequency is reached.

#### General Purpose Features

The 3336 A/B Synthesizer provides wide band sweep capability—sweep the full frequency range (or as little as two microhertz), log or linear, single or continuous. Single phase lock loop design means the sweep is phase continuous and you can modulate with AM to 50 kHz or PM to 5 kHz. Ten storage registers can be used to keep different test settings available for repetitive test. All necessary functions on the 3336 A/B can be remotely programmed by HP-IB control for automatic testing.

#### Designed-in Serviceability

The 3586 A/B Selective Level Meter and the 3336 A/B Synthesizer/Level Generator have been designed for reliable operation and excellent accessibility with many useful service features.

#### North American (Bell) and CCITT Requirements

The 3586A & B Selective Level Meter and 3336 A & B Synthesizer/Level Generator are designed to meet most world-wide connector and impedance requirements for both carrier and voice channel measurements. Special or regional connectors can be provided by option or special request.

#### Input Configuration:

##### CCITT Requirements:

3586A SLM	75 $\Omega$ /10 k $\Omega$ Unbalanced 150 $\Omega$ , 600 $\Omega$ /10 k $\Omega$ Balanced
3336A Synthesizer	75 $\Omega$ Unbalanced 150 $\Omega$ , 600 $\Omega$ Balanced

##### North American (Bell) Requirements:

3586B SLM	75 $\Omega$ /10 k $\Omega$ Unbalanced 124 $\Omega$ , 135 $\Omega$ , 600 $\Omega$ /10 k $\Omega$ Balanced
3336B Synthesizer	75 $\Omega$ Unbalanced 124 $\Omega$ , 135 $\Omega$ , 600 $\Omega$ Balanced

#### Fully Programmable

HP-IB control is standard, allowing automatic operation to be controlled by a desktop calculator such as the HP Model 85A, 9825T, 9826A, 9835A, 9836A or 9845B, or by a main frame computer, such as the HP 1000. FDM tests such as surveillance can be made from a remote location to reduce maintenance costs and increase troubleshooting efficiency. See page 567 for information on 3046 A/B selective level measuring system.

#### High Impedance Accessory Probes

Models 15580A and 15581B unbalanced high impedance probes and model 15576A balanced high impedance probe are available for use with the 3586A/B to facilitate bridging measurements.

# TELECOMMUNICATIONS TEST EQUIPMENT

## Selective Level Meter/Synthesizer

Models 3586A/B and 3336A/B (Cont.)

565



### Frequency

Signal Input	3586A	3586B
75 Ω Unbalanced	200 Hz to 32.5 MHz	
124 Ω Balanced		4 kHz to 10 MHz
135 Ω Balanced		4 kHz to 1 MHz
150 Ω Balanced	4 kHz to 1 MHz	
600 Ω Balanced	100 Hz to 100 kHz	

The 124 Ω, 135 Ω, 150 Ω and 600 Ω inputs are usable over wider frequency ranges, but are not specified in under and overrange operation.

**Frequency resolution:** 0.1 Hz.

**Center frequency accuracy:**  $\pm 1 \times 10^{-5}$ /year, ( $\pm 2 \times 10^{-7}$ /year with option 004).

**Counter accuracy:**  $\pm 1.0$  Hz in addition to center frequency accuracy for signals within the 60 dB bandwidth of the IF filter chosen or greater than -100 dBm (largest signal measured).

**Frequency display:** 9 digit LED.

### Selectivity

**3 dB Bandwidth,  $\pm 10\%$ :**

3586 (CCITT)		3586B (N. American)	
Standard	Option 003	Standard	Option 003
20 Hz	20 Hz	20 Hz	20 Hz
400 Hz	400 Hz	400 Hz	400 Hz
1740 Hz	3100 Hz	2000 Hz <sup>1</sup>	3100 Hz
—	Psophometric Noise Weighting	—	C-Message Noise Weighting

1. Psophometric Equivalent Noise Weighting Filter

2. C-Message Equivalent Noise Weighting Filter

**Adjacent channel rejection:** 75 dB minimum at  $\pm 2850$  Hz., 3100 Hz bw.

**Passband flatness:**  $\pm .3$  dB.

### Amplitude

**Measurement range:** +20 to -130 dBm.

**Amplitude resolution:** .01 dB.

**Level accuracy:** 10 dB autorange, low distortion mode, after calibration.

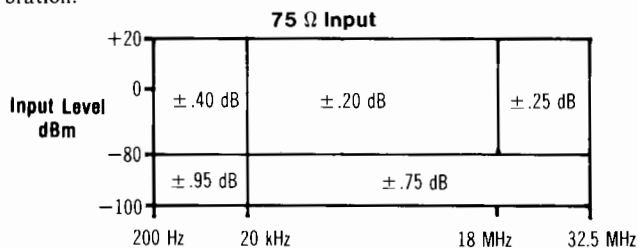

124 Ω Input (3586B):  $\pm 0.6$  dB, 4 kHz to 10 kHz;  $\pm .35$  dB, 50 kHz to 5 MHz;  $\pm .50$  dB, 10 kHz to 50 kHz, and 5 MHz to 10 MHz for +20 to -80 dBm.

135 Ω/150 Ω input (3586A or B):  $\pm 0.6$  dB, 4 kHz to 10 kHz;  $\pm .35$  dB 50 kHz to 1 MHz,  $\pm .50$  dB 10 kHz to 50 kHz for +20 to -80 dBm.

600 Ω input (3586 A/B):  $\pm .35$  dB 200 Hz to 108 kHz for +20 to -80 dBm.

**Level accuracy: 100 dB range (after calibration):** add correction to 10 dB autorange accuracy for dB below full scale. (Not required when in 10 dB autorange).

**Intermodulation distortion:** -70 dB below full scale, 200 Hz to 20 kHz offset; -75 dB below full scale, 20 kHz to 1 MHz offset.

**Wideband power accuracy:** after calibration, 100 dB range, averaging on, -45 to +20 dBm.

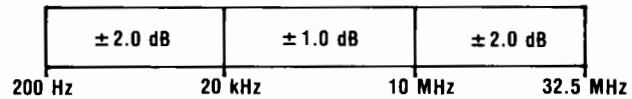

**Noise Floor (Full Scale Setting -35 to -120 dBm):**

Frequency	Bandwidth	Noise Level
100 kHz to 32.5 MHz	3100, 1740, 2000 Hz	-116 dBm
	20 Hz, 400 Hz	-120 dBm
10 kHz to 100 kHz	All	-105 dBm

The noise floor for full scale settings of -30 to +24 dBm will be 80 dB below full scale for > 100 kHz, or 60 dB below full scale for < 100 kHz.

### Signal Inputs

Model	Impedance	Frequency	Mating Connector
3586A	75 ohms unbalanced	200 Hz to 32.5 MHz	BNC
	150 ohms balanced	4 kHz to 1 MHz	Siemens 3-prong 9 Rel 6 AC
	600 ohms balanced	100 Hz to 108 kHz	
3586B	75 ohms unbalanced	200 Hz to 32.5 MHz	WECO 439/440A
	124 ohms balanced	4 kHz to 10 MHz	WECO 443A
	135 ohms balanced	4 kHz to 1 MHz	WECO 241A
	600 ohms balanced	100 Hz to 108 kHz	WECO 310

### Connector options:

**Opt 001 (3586A):** 75 ohms mates with Siemens 1.6/5.6 mm coaxial.

**Opt 001 (3586B):** 75 ohms mates with WECO 358A.

124 ohms mates with WECO 372A.

(Contact local sales office for other special connectors.)

**Return loss:** -30 dB (50/75 Ω); -25 dB (600 Ω).

### Balance:

Input	Frequency	Balance
124 Ω	10 kHz to 10 MHz	-36 dB
135 Ω or 150 Ω	10 kHz to 1 MHz	-36 dB
600 Ω	50 Hz to 108 kHz	-40 dB

### Demodulated Audio Output

Output Level: 0 dBm into a 600 Ω load, adjustable.

Output Connector: mates with WECO 347A.

### Transmission Impairments Option 003

Adds transmission impairment measurement capability to standard instrument. Measures 2 band phase jitter, noise with tone, single level impulse noise and weighted noise at voice channel and carrier frequencies. Compatible with N. American (Bell) or CCITT standards.

### Additional Options

#### 3586A (CCITT)

**Opt 001:** 75 Ω input connector option. Siemens 1.6/5.6 mm coaxial connector replaces BNC.

**Opt 004:** High Stability Frequency reference 10 MHz oven stabilized reference oscillator improves frequency stability to  $\pm 2 \times 10^{-7}$ /year.

#### 3586B (N. American)

**Opt 001:** 75 Ω and 124 Ω input connector option. Changes 75 Ω input connector to mate with WECO 358A and 124 Ω input to mate with WECO 372A.

**Opt 002:** Psophometric equivalent noise filter option. Changes 2000 Hz filter (C-message equivalent) to 1740 Hz (Psophometric equivalent). Not available with opt 003.

**Opt 004:** High Stability Frequency reference. Same as Opt 004-3586A

### Auxiliary Signal Inputs/Outputs

**Tracking generator:** 0 dBm rear panel tracking output.

**External reference input:** 1 MHz, 10 MHz or sub-harmonic input.

**Reference output:** 10 MHz, +8 dBm output.



# TELECOMMUNICATIONS TEST EQUIPMENT

## Selective Level Meter/Synthesizer

Models 3586A/B and 3336A/B (Cont.)

**Probe power:** front panel DC output for HP active high impedance accessory probes.

**HP-IB interface:** rear panel interface meeting IEEE 488-1975 for remote operation. Used for tracking synthesizer interface.

**Additional outputs:** rear panel demodulated audio; phase jitter meter.

### General

#### Operating Environment

**Temperature:** 0° to 55°C.

**Relative humidity:** 95%, 0° to 40°C.

**Altitude:** ≤15,000 ft; ≤4600 metres.

#### Storage Environment

**Temperature:** -40°C to 75°C.

**Altitude:** ≤50,000 ft; ≤15,240 metres.

**Power:** 100/120/220/240 V, +5%, -10% 48 to 66 Hz, 150 VA.

**Weight:** 23 kg (50 lbs) net; 30 kg (65 lbs) shipping.

**Size:** 177 mm H x 425.5 mm W x 466.7 mm D (7" x 16.75" x 18.38")

### 3336 A & B Abbreviated Specifications

(See Data Sheet or manual for complete specifications)

#### Frequency

##### Frequency range of signal outputs

Signal Output	3336A	3336B
75 Ω Unbalanced	10 Hz to 20.999 999 999 MHz	
135 Ω Balanced		10 kHz to .10.999 999 999 MHz
124 Ω Balanced		10 kHz to 2.099 999 999 MHz
150 Ω Balanced	10 kHz to 2.099 999 999 MHz	
600 Ω Balanced	200 Hz to 109.999 999 kHz	

All balanced outputs are usable over wider frequency ranges but are not specified in under and overrange operation.

**Resolution:** 1 μHz for frequencies < 100 kHz, 1 mHz for frequencies ≥ 100 kHz.

**Accuracy (instruments without option 004):** ± 5 x 10<sup>-6</sup> of programmed frequency (20° to 30°C).

**Aging rate (instruments without option 004):** ± 5 x 10<sup>-6</sup>/year (20° to 30°C).

**Warm-up time:** 30 minutes.

#### Amplitude

**Range:** 75 and 600 Ω outputs; -72.99 to +7.00 dBm.

124, 135 and 150 Ω outputs: -78.23 to +1.76 dBm.

**Level accuracy, 20° to 30°C:**

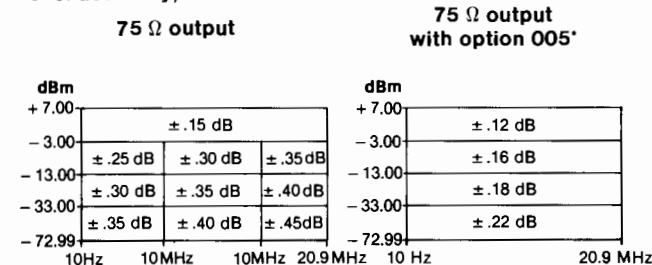

\*high accuracy attenuator

124 Ω output: 50 kHz to 10.9 MHz ± .15 dB -8.23 to 1.76 dBm, ± 0.3 dB -18.23 to -8.24 dBm, ± .35 dB -38.23 to -18.24 dBm ± .4 dB -78.23 to -38.24 dBm.

135 Ω/150 Ω output: 10 kHz to 2.09 MHz, ± .17 dB -8.23 to +1.76 dBm, ± .32 dB -18.23 to -8.24 dBm, ± .37 dB -38.23 to -18.24 dBm, ± .42 dB -78.23 to -38.24 dBm.

600 Ω output: 200 Hz to 109.9 kHz, ± .30 dB -3.00 to +7.00 dBm/ ± .40 dB -13.00 to 2.99 dBm, ± .45 dB -33.00 to -12.99 dBm ± .50 dB -72.99 to -32.99 dBm.

1. Add ± .03 dB for 0° to 55°C operation.

2. Warm-up time is 30 minutes.

**Amplitude blanking:** < -85 dBm output during blanking

#### Spectral Purity

**Phase noise:** < -72 dB, Models 3336A and 3336B, for a 3 kHz band, 2 kHz either side of a 20 MHz carrier.

**Harmonic level:** -35 dB, 10 Hz to 30 Hz; -50 dB, 30 Hz to 50 Hz; -60 dB, 50 Hz to 1 MHz; -55 dB, 1 MHz to 5 MHz; -50 dB, 5 MHz to 20 MHz.

**Spurious:** all non-harmonically related signals will be more than 70 dB below the fundamental or -100 dBm (-115 dBm with option 005 except 150 or 600 Ω), whichever is greater.

#### Phase Offset

**Range:** ± 719.9° with respect to arbitrary starting phase or assigned zero phase.

**Resolution:** 0.1°.

**Increment accuracy:** ± 0.2°

**Ambient stability:** ± 1.0 degree of phase per degree C

#### Frequency Sweep

**Sweep time:** linear sweep, 0.01 s to 99.99 s, single log sweep, 2 s to 99.99 s, continuous log sweep, 0.1 s to 99.99 s

**Maximum sweep width:** specified frequency range of selected output

**Minimum sweep width:** log sweep, 1 decade; linear sweep, minimum sweepwidth (Hz) = 0.1 (Hz/s) x sweep time(s).

**Phase Continuity:** sweep is phase continuous over full frequency range.

**Sweep flatness:** ± 0.15 dB, fast leveling, 10 kHz to 20 MHz, 0.03 s sweep time; ± 0.15 dB, normal leveling, 50 Hz to 1 MHz, 0.5 s sweep time.

**Amplitude modulation:** modulation depth, 0 to 100%. Modulation frequency range, 50 Hz to 50 kHz.

**Phase modulation:** range, 0 to ± 850°. Linearity, ± 0.5% from best fit straight line. Modulation frequency range, dc to 5 kHz.

**External leveling:** input from an external voltage source to regulate the signal amplitude at a remote point.

#### Options

##### Option 001, 3336A/B Synthesizer/Level Generator:

1.6/5.6 mm 75 Ω input, (3336A). 75 Ω mates with WECO 358A, (3336B). 124 Ω connector mates with WECO 372A, (3336B).

##### Option 004, high stability frequency reference:

**Accuracy:** ± 5 x 10<sup>-8</sup>

**Aging rate:** ± 5 x 10<sup>-8</sup>/week after 72 hours continuous operation ± 1 x 10<sup>-7</sup>/month after 15 days continuous operation.

**Ambient stability:** ± 5 x 10<sup>-7</sup> maximum, 0° to 55°C.

**Option 005, high accuracy attenuator:** Improves level accuracy and spurious level. See main specifications.

#### General

##### Operating Environment

**Temperature:** 0° to 55°C.

**Relative humidity:** ≤ 85%, 0° to 40°C.

**Altitude:** ≤ 15,000 ft., ≤ 4600 metres.

##### Storage Environment

**Temperature:** -50° to +65°C.

**Altitude:** ≤ 50,000 ft., ≤ 15,240 metres.

**Power requirements:** 100/120/220/240 V, +5%, -10%, 48 to 66 Hz, 60 VA, (100 VA with all options), 10 VA standby.

**Size:** 132.6 mm high x 425.5 mm wide x 425.5 mm deep; (5¼" x 16¾" x 16¾").

**Weight:** Net wt., 10 kg. (22 lbs). Shipping wt., 15.5 kg. (34 lbs).

#### Ordering Information

##### 3586A Selective Level Meter (CCITT)

**Opt 001:** 1.6/5.6 mm 75 Ω Connector

**Opt 003:** Transmission Impairments Option

**Opt 004:** High Stability Frequency Reference

##### 3586B Selective Level Meter (N. American)

**Opt 001:** 75 Ω Connector mates with WECO 358A

and 124 Ω Connector mates with WECO 372A

**Opt 002:** 1740 Hz Equivalent Noise Bandwidth Filter Replaces 2000 Hz. Not available with opt 003

**Opt 003:** Transmission Impairments Option

**Opt 004:** Same as 3586A

##### 3336A Synthesizer/Level Generator (CCITT)

**Opt 001:** 1.6/5.6 mm 75 Ω Connector

**Opt 004:** High Stability Frequency Reference

**Opt 005:** High Precision Attenuator

##### 3336B Synthesizer/Level Generator (N. American)

**Opt 001:** 75 Ω WECO 358A, 124 Ω WECO 372A

**Opt 004, 005:** Same as 3336A

# TELECOMMUNICATIONS TEST EQUIPMENT

Selective Level Measuring System

Model 3046A/B

567



- Low cost FDM surveillance
- Stored CCITT or Bell FDM plans
- Synthesizer frequency accuracy

- 0.2 dB amplitude accuracy
- Voice channel impairments
- Plotting and storage of data



## Introduction

The 3046A/B systems are designed to automate measurements made on Frequency Division Multiplex (FDM) systems. These include tests such as pilot levels, carrier leaks and slot noise. The system, with all of its measurement power, requires no computer background to operate. Surveillance programs are configured simply by making choices from a series of measurement menus. The 3046A is designed for CCITT applications, while the 3046B meets North American (Bell) requirements.

This system is ideal for automating surveillance and routine maintenance on a local basis for small to medium capacity systems. Hewlett-Packard also provides automatic test equipment for large capacity FDM systems, using a distributed approach. See page 563 for a description of these automatic test systems. With a distributed system, remote selective level meters (SLMs) can be monitored from a central computer. With a local system such as the 3046A/B, each SLM and computer are independent, making installation and operation easier, and the system more mobile.

## System Configuration

- A standard 3046A/B system consists of the following:
  - 3586A/B Selective Level Meter with Transmission Impairments
  - HP 85F Personal Computer with 82903A Memory Module and Matrix ROM
  - System Software (CCITT P/N 03046-90001; Bell 03046-90002)

The computer options listed are required for system operation. System software consists of FDM surveillance programs with stored CCITT (3046A) or Bell (3046B) plans, and system test software. The

system test software can be used to verify proper system operation and to help identify the faulty component in case of failure.

For applications requiring a precision signal source, a 3336A/B Synthesizer/Level Generator can be added to the system. A 0 dBm tracking source is standard with the 3586A/B.

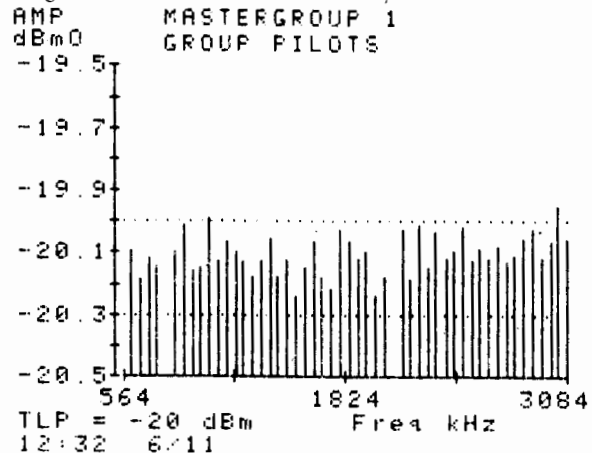

## Tabular and Graphic Outputs

An automatic system will collect large amounts of data in a short time, making effective presentation of the results vital. In addition to a variety of tabular listing formats, the Selective Level



Measuring (SLM) System provides graphics—the ability to plot measured results. A plot of hundreds of data points can be analyzed in seconds, providing real insight into the condition of the system. With only a tabular listing, interpretation of hundreds of data points is difficult if not impossible. An active marker is provided to read the amplitude of any point on the graph to 0.01 dB resolution, and also list FDM number and frequency.

### Storage of Tests and Data

Tests are performed with an automatic system in much the same way they are done manually. First, the measurement parameters (frequency, bandwidth, etc.) are set, and then the measurement is made. The SLM System provides for storage of test parameters on the computer's built-in tape. With this feature, often used test set-ups can simply be recalled from tape, rather than having to be re-entered each time the test is run. In addition, a program can be stored in a file that will load and run when power to the computer is cycled. In this way, a complicated series of tests can be run simply by turning the computer off and then on.

The system can also store measured data for future reference. Short term storage is automatic and has a capacity of 600 readings. This means that measured data can be retrieved any time after a test has been run. If an overnight test were run with only errors printed, this feature would allow printing or plotting of all the data in the morning.

Permanent storage on tape is also provided. This storage allows comparison of today's readings with those taken weeks or months earlier (limit is 600 readings). Data stored includes test limits, TLP, and the time of day and date when the measurement was made.

### Timed Measurements

Every printout of test results includes time from turn on or time of day, and the date. The system also provides for delayed start of test and/or repetition of the test at timed intervals. This makes it easy to run a test at night or over a weekend, and to monitor system performance over time.

### Provision for Custom Plans

An "array sweep" is available for testing of non-standard FDM plans. Each of four arrays has a capacity of 100 custom frequencies. Carrier tests can be performed at each test frequency, tested against limits and plotted or printed. Once an array of custom frequencies and the test at each is entered, it can be stored on tape for easy access.

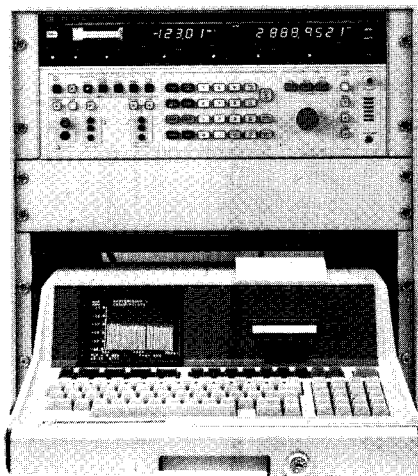

Option 400 cabinet with locking drawer

### Recommended Accessories

**Disk Drive:** A disk drive, such as an HP 82901M, provides much faster access to programs and data. This is highly recommended if the level of system interaction is expected to be high. A mass storage ROM (P/N 00085-15001) for the 85F is required for interfacing.

**Access Switch:** An access switch and switch controller can be added to the system with simple program modifications. The recommended controller is the HP 3755A, with several compatible switches available.

**Printers and Plotters:** For full size plots and printouts, an HP plotter, printer or printer/plotter can be added with a few simple program modifications. Suitable models include the 7225A Plotter and 7245B Plotter/Printer. A Plotter/Printer ROM (P/N 00085-15002) for the 85F is required for interfacing.

## General

### System Specifications

System accuracy specifications are identical to those of the 3586A/B and 3336A/B, see pages 564-566.

**Measurement speed:** 0.5 seconds/reading with no range change; 1.3 seconds/reading with range change; 3.3 seconds/reading with range change and Auto-cal.

## System Performance

### FDM Carrier Tests

#### Pilots:

**3046A (CCITT):** Group, Supergroup, Mastergroup, Super-mastergroup, and Hypergroup

**3046B (North American):** Group, Supergroup and Mastergroup pilots. Non-standard pilots can also be measured.

**Carrier Leaks:** Channel, Group and Supergroup.

**Test Tones:** 1010 Hz or 800 Hz (3046A) or 1004 Hz (3046B), and custom tones

**Signalling Tones:** 2600 Hz (3046B)

#### Channel Noise and Slot Noise:

**3046A:** Flat or Psophometric weighting

**3046B:** Flat or C-Message weighting

### Other Tests

#### Transmission Impairments:

##### Phase jitter

**Weighted Noise** with 3100 Hz channel filter

**Noise with tone** (notched noise)

**Impulse noise** can be measured and graphed over any period of time up to 90 minutes

**Spot Frequency:** In the spot frequency mode, the 3046 can measure and print the level at a single frequency. The point to be measured can be defined by frequency or FDM number. Wide band power can also be measured and printed out in this mode.

**System Verification:** The system verification program verifies operation of the 3586A/B and the 3336A/B, and can be used to locate the source of a hardware failure.

### Physical Parameters

**Temperature:** 5 to 40°C

**Relative Humidity:** 95%, 0 to 40°C

**Altitude:** ≤4600 meters, 15,000 feet

## Ordering Information

### 3046A/B Selective Level Measuring System

#### 3586A/B Options

**001:** Special Connector (3586A/B Option 001)

**004:** High Stability Frequency Reference

#### Synthesizer Options

**100:** 3336A/B Synthesizer/Level Generator

**101:** Special Connector (3336A/B Option 001)

**104:** High Stability Frequency Reference (3336A/B)

**105:** High Accuracy Attenuator

**105:** High Accuracy Attenuator

#### Cabinet Options

**400:** Locking Cabinet for Standard System

**450:** Locking Cabinet for System with Synthesizer

**480:** 220 V Operation

#### Other Options

**600:** Delete 85F, Interface and ROMs

**910:** Extra Software and Documentation

# TELECOMMUNICATIONS TEST EQUIPMENT

SLMS Accessories

15580A, 15581B, 15582A, 15585A, 15589A

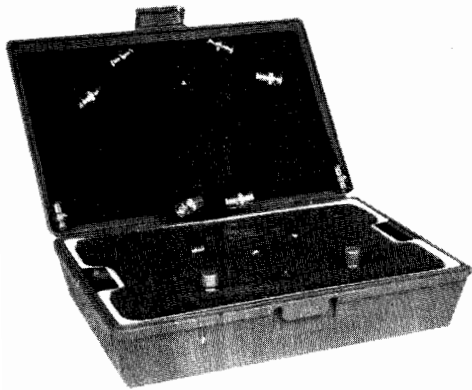

15582A

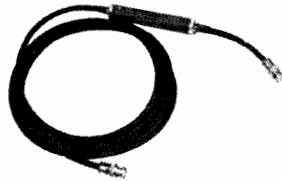

15581B

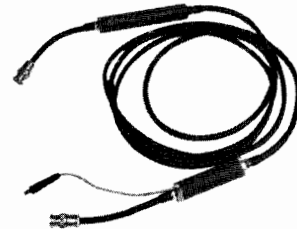

15580A

## Active and Passive Probes

Models 15580A and 15581B High-Impedance Probes are used with the SLMS for bridging measurements. The 15580A is an "active" device having an insertion loss of 0 dB. Model 15581B is a passive probe having an insertion loss of 20 dB. The 15581B can also inject signals from a Level Generator at points where a high impedance source is required.

## Specifications

Parameter	15580A	15581B
Frequency Range	20 kHz to 25 MHz	10 kHz to 25 MHz
Insertion Loss	0 dB $\pm$ 0.2 dB (50 kHz to 20 MHz)	20 dB $\pm$ 0.2 dB (50 kHz to 20 MHz)
Tapping Loss (in 75 $\Omega$ system)	<0.15 dB (50 kHz to 20 MHz)	<0.25 dB (50 kHz to 20 MHz)
Max Input Power	+10 dBm	+25 dBm
Power Supply	+15 V (25 mA)	—

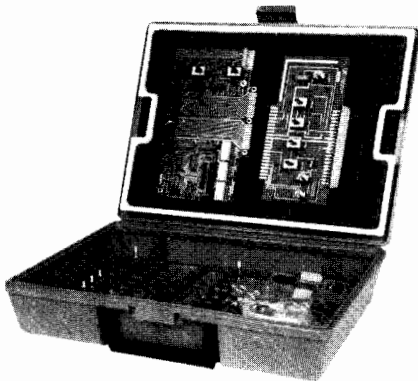

15585A

## Return Loss Kit

Model 15582A Return Loss Kit, with a suitable Level Generator, allows the SLMS to make return loss measurements from 10 kHz to 25 MHz. Extended coverage from 100 kHz to 90 MHz is possible with Model 8721A Opt 008 Directional Bridge.

## Diagnostic Kit

Model 15585A consists of several troubleshooting aids which assist in servicing the 3747A/B SLMS. The 3746A SLMS does not require a separate diagnostic kit.

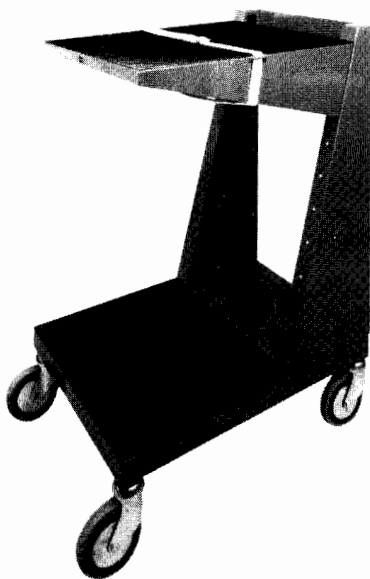

15589A

## Instrument Cart

Model 15589A is suitable for transporting the SLMS and its auxiliary equipment.

In many countries the main communication system consists of a network of FM microwave radio links. Typically, these links can carry up to 1800 FDM telephone channels, using a 70 MHz IF carrier and an RF band in the range 600 MHz to 18 GHz. However, some countries are now installing 140 MHz IF microwave links which can carry up to 2700 FDM telephony channels.

All information signals (speech, television, or data) carried by these links have a common objective—to convey the information with maximum fidelity. Failure to keep distortion in a link within specified limits results in an unacceptably high level of intermodulation noise. This prevents the link from carrying the designated channel capacity and the link operator incurs a severe financial penalty due to loss of revenue-earning channels.

Measurements required on a microwave link are of two distinct types – qualitative and diagnostic. Qualitative measurements, often made using test signals which simulate normal traffic, are intended to assure the operator that the microwave link is performing correctly. Such measurements are normally made from baseband to baseband and

show the overall system performance without giving much diagnostic information if discrepancies are found. Table 1 shows a list of qualitative measurements for both video and FDM traffic together with the capabilities of the 3724A/25A/26A Baseband Analyzer. This instrument provides, in addition to White Noise tests, all the baseband measurements normally required in the design, production, installation, and maintenance of FDM radio systems.

It is often desirable to make qualitative measurements hop-by-hop along a microwave link to ensure that each individual section is set up correctly. In many cases this requires the use of a 70 MHz modem since baseband signals are not available in non-demodulating repeaters. The 3717A 70 MHz Modulator/Demodulator provides this capability and, with its comprehensive range of pre- and de-emphasis options, is a useful companion instrument to the Baseband Analyzer. In addition, since it is fully specified, it may be used as a standby for the link's own modem. If the qualitative tests show that the distortion in a microwave link is too high, then diagnostic measurements are required to discover the source of the problem.

The main contributors to distortion in FM microwave radio links are the modulators, demodulators and carrier circuits at IF such as amplifiers, and carrier circuits at RF such as non-linear amplifiers. The distortion parameters of these circuits can be measured in terms of nonlinearity, amplitude variations and group delay variations. To do this, test equipment must interface with the links at BB, IF and RF. Commissioning microwave link equipment involves minimizing these circuit distortion parameters by adjustment or equalization.

On lower capacity systems, these adjustments are normally enough to reduce intermodulation distortion to an acceptable level. With increased traffic capacity, the tolerances imposed on the circuit parameters become more and more strict and normal commissioning methods often do not produce satisfactory results. Consequently, relating the circuit parameters to the intermodulation noise (measured by a noise-loading test set) becomes increasingly more difficult.

The main source of discrepancy is the result of amplitude modulation to phase modulation (AM/PM) conversion in the transmission carrier path. This AM/PM conversion occurring in non-linear networks introduces additional intermodulation from the signal deviations arising in preceding networks. These 'coupled' responses can be assessed only by differential gain/differential phase (DG/DP) measurements with high-frequency test tones. HP Application Note AN 175-1 'Differential Phase and Gain at Work' covers this subject in considerable detail.

HP microwave link analyzers (MLA's), at 70 MHz IF or dual 70/140 MHz IF, were developed specifically for the purpose of measuring various forms of distortion on terrestrial and satellite microwave radio links. The measurement capabilities of HP link analyzers, as shown in Table 2, were established in close cooperation with the telecommunications industry.

A valuable extension of the MLA measurement capability can be obtained using RF up and down converters. The circuit distortions at RF have identical effects to the IF circuit distortions when the carrier signal is eventually demodulated. Hence, the RF distortions can be analyzed using an MLA, provided a transparent RF-to-IF interface is available. A down converter provides such an interface and allows independent measurements on microwave transmitters. A so-called 'up-converter' in fact provides a transparent BB-to-RF interface, allowing independent measurements on microwave receivers. Both converters used with an MLA provide an RF-to-RF measurement capability.

**Table 1. Qualitative tests to verify radio system performance**

Test	FDM	Video	3724A/25A/26A
1. Insertion Gain	•	•	•
2. Frequency Response	•	•	•
3. Envelope Delay Distortion		•	
4. Spurious Interference Tones	•	•	•
5. Thermal Noise	•	•	•
6. White Noise Loading	•		•
7. Video Waveform Tests		•	
8. Video System Program Channel (Subcarrier) Tests		•	

**Table 2. Diagnostic tests to maintain radio system performance**

Measurement	BB	IF	RF
1. Module Power Levels, Gains and Losses	•	•	•
2. Modem Centre Frequencies		•	•
3. TX and RX Local Oscillator Frequencies			•
4. Transmitter RF Output Frequency			•
5. Spurious Tones	•	•	•
6. FM Mod + Demod Deviation Sensitivity	•	•	•
7. FM Mod + Demod Linearity	•	•	•
8. Return Loss	•	•	•
9. Amplitude Flatness	•	•	•
10. Group Delay		•	•
11. Differential Gain and Phase		•	•

# TELECOMMUNICATIONS TEST EQUIPMENT



Baseband Analyzer  
Models 3724A, 3725A, 3726A

- Automatic noise power ratio scan of up to four slot frequencies
- SLMS scan routines with variable violation limits
- Spectrum analysis for spurious signal identification
- BB frequency response—locally or end to end with storage and normalisation
- Broadband power down to  $-70$  dBm
- Easy conversion between level measurement units

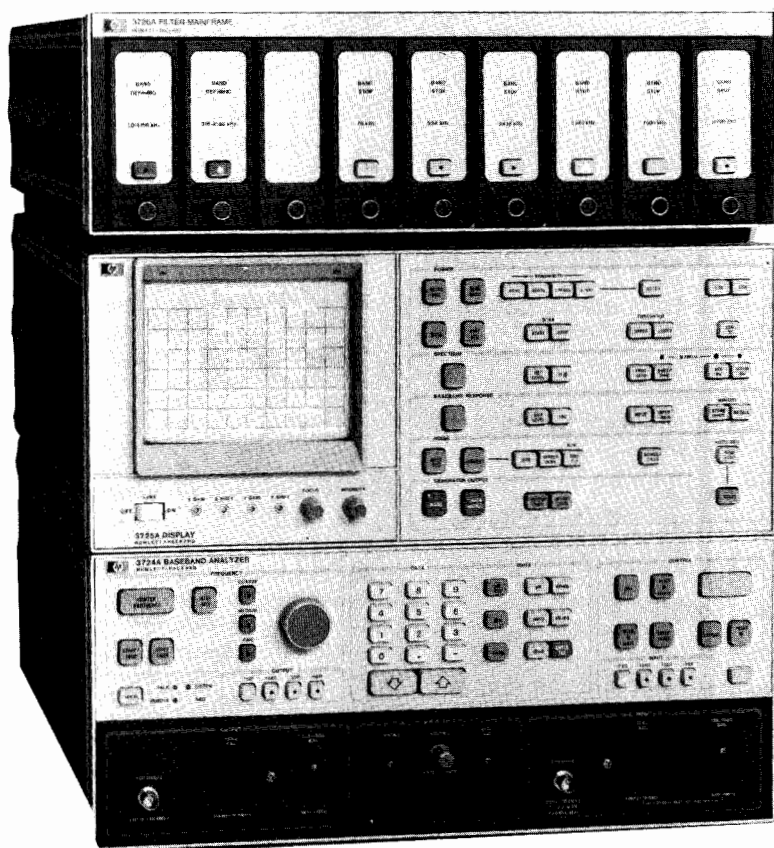

3726A Filter Mainframe with 37264A Band Defining Filter and 37265A Band Stop Filter plug-ins  
3725A Display  
3724A Baseband Analyzer

A new approach to microwave radio maintenance, the 3724A/3725A/3726A Baseband Analyzer provides in a single convenient, transportable package, all the qualitative measurements commonly performed on FDM microwave radio systems.

The full capability of the Baseband Analyzer covers measurements traditionally performed by stand-alone products such as a Selective Level Measuring Set (SLMS), Broadband Power Meter, Spectrum Analyzer, Tracking Generator, and White Noise Measuring Set. For the first time, these instruments have been integrated into a single product offering state-of-the-art features for ease-of-use, high performance, and cost effectiveness.

This measurement capability is enhanced by the ability to make complementary measurements on the same signal. For example, a spurious tone found using the Spectrum Analysis mode may have both its level and frequency accurately measured by changing to the SLMS mode. During the changeover, the tuned frequency is automatically retained.

All measurement results appear on a CRT in both analog and digital form, as appropriate. A hard copy of the information on the screen may be obtained using an X-Y plotter or a printer plotter via the HP-IB. No external controller is required for this function.

For portability, the Baseband Analyzer is manufactured in three separate cabinets. The basic instrument comprises two cabinets—the 3724A Baseband Analyzer and the 3725A Display module. Together they provide all the measurement capability except white noise generation. For white noise loading the third cabinet, the 3726A Filter Mainframe, must be added. The 3726A houses the white noise source, the 37264A Band Defining Filter plug-ins, and the 37265A Band Stop Filter plug-ins. Various bandwidths and frequencies to comply with CCIR, CCITT, Intelsat, and Bell recommendations can be provided as options. For the majority of white noise loading applications band pass filters, as required by conventional white noise receivers, are not required. However, if a noise power ratio performance better than 67 dB is required then 37266A Band Pass Filter plug-ins can be installed, offering a further 10 dB improvement in NPR.





Models 3724A, 3725A, 3726A (Cont.)

## Measurement Summary

### Level Measurements

Make accurate level and frequency measurements of pilots, carrier leaks, channel power, spurious tones, and other measurements associated with Frequency Division Multiplex (Carrier) systems.

### Wideband

**Frequency range:** 20 Hz to 18.6 MHz.

**Power range:**  $\pm 20$  dBm to  $-76$  dBm.

**Accuracy:**  $< \pm 0.5$  dB.

### Selective

**Measurement bandwidths:** 40 Hz; 400 Hz; 1.74 kHz; 3.1 kHz; psophometric; 'C'-message.

**Frequency range:** 50 Hz to 18.6 MHz.

**Power range:**  $+20$  dBm to  $< -130$  dBm.

**Accuracy:**  $\leq \pm 0.2$  dB.

**Frequency measurement:** 0.1 Hz resolution.

### Features

- Synthesizer Based Tuning—for frequency accuracy and stability.
- Scan Routines—enables sequences of measurements on pilots or channels within a supergroup; also tabulates frequency response when used with a tracking generator.
- Fast High Level User Routine—checks in 80 seconds a radio baseband of 1800 channels for signals above a specified level.

## Spectrum Analysis

Make measurements on system traffic to check occupancy, or on unloaded systems to check for spurious signals.

### Spectrum Analysis

**Frequency range:** 100 Hz to 20 MHz.

**Amplitude range** (2 dB or 10 dB/cm):  $+20$  dBm to  $-130$  dBm.

**Dynamic range:** 80 dB.

**Frequency span:** 20 MHz to 5 kHz.

**Sweep time:** 8 ms/div to 32 s/div.

**Resolution bandwidth:** 10 kHz to 100 Hz.

**Video bandwidth:** 5 kHz to 5 Hz.

### Features

- Automatic or manual coupled controls ensure error free measurements along with flexibility.
- Digitally stored and refreshed CRT display—trace can be digitally stored and at a later time recalled for visual comparisons.
- CRT readout of all control settings.
- X-Y plots via the HP-IB—no external controller is required for this function.

## BB Frequency Response Measurements

There are three methods of making frequency response measurements with the Baseband Analyzer, i.e. using the Power, Spectrum, or BB Response modes in conjunction with the tracking generator output.

### Tracking Generator

**Frequency range:** 300 Hz to 18.6 MHz.

**Amplitude range:**  $+6$  dBm to  $-60$  dBm.

**Flatness:**  $< 0.2$  dB.

**Harmonics and spurious:**  $< -40$  dB on output level.

Using the Power and Spectrum modes for BB amplitude response testing offers wide display range coupled with fast response times. However, these modes are limited to local applications. In contrast, the BB Response mode offers:

- No connection needed between sender and receiver (apart from item under test).
- Automatic point-by-point measurements with results presented graphically.
- Trace storage and normalisation.
- Sweep time fast enough to allow adjustments.
- Display scaling of 1 or 0.1 dB per square.

## White Noise Measurements

White noise measurements allow the overall performance of a radio link to be assessed using test signals which simulate normal traffic. The test signal used is white noise, band limited to correspond to the baseband bandwidth of the particular radio under test.

## White Noise Measurements

**Frequency range:** for measurements on systems with 12 to 2700 channels.

**Noise power ratio range:** 0 to 67 dB.

**Signal to noise range:**  $-18.8$  to  $-85$  dBm0p ( $1.3 \times 10^7$  to  $3.16$  pW0p); 72 to 5 dBm0C ( $1.66 \times 10^7$  to 4 pW0c).

**Noise power range:**  $+12$  to  $-60$  dBm.

A full range of band defining and slot filters is available, consult Data Sheet.

### Features

- Simultaneous measurement of broadband and slot power dispenses with repeated reference checking.
- Full range of filters easily changed from front panel.
- Auto mode allows automatic scan of up to four slots even on an end-end measurement.
- V curve and overload plotting made simple by offset key, or fully automate with an external controller.
- Measures all commonly used units, i.e. NPR, dBm0p, and dBm0C.
- Conforms to all relevant CCIR and CCITT Recommendations.

## Options

### 3724A Baseband Analyzer

Input/Output	Standard	Option 003 N/C	Option 004 N/C
75 $\Omega$	BNC	Siemens 1.6 mm	WECO 477B
124 $\Omega$	Blank	Blank	WECO 477B
135 $\Omega$ /150 $\Omega$	Siemens 3-pin Bal	Siemens 3-pin Bal	Large 223A
600 $\Omega$ Audio	Siemens 3-pin Bal	Siemens 3-pin Bal	Large 310
Head Phone	0.75" Banana	0.75" Banana	0.75" Banana

### 3726A Filter Mainframe

**301:** delete noise source (for systems where more than nine filters are required). N.B. Up to three 3726A Filter Mainframes can be controlled by one 3724A Baseband Analyzer.

### 37264A Band Defining Filter

**311:** 60 to 300 kHz.      **315:** 60 to 4100 kHz.      **318:** 316 to 5600 kHz.  
**312:** 60 to 552 kHz.      **316:** 316 to 4100 kHz.      **319:** 316 to 8160 kHz.  
**313:** 60 to 1296 kHz.      **317:** 60 to 5600 kHz.      **320:** 316 to 12360 kHz.  
**314:** 60 to 2600 kHz.

N.B. All nine plug-in compartments of the 3726A Filter Mainframe must be filled for correct operation. The 37268A Dummy Plug-in should be ordered to fill any empty plug-in compartments.

### 37265A Band Stop Filter

**311:** 70 kHz.      **314:** 1248 kHz.      **317:** 5340 kHz.  
**312:** 270 kHz.      **315:** 2438 kHz.      **318:** 7600 kHz.  
**313:** 534 kHz.      **316:** 3886 kHz.      **319:** 11700 kHz.

### 37266A Band Pass Filter

Only required if a noise power ratio performance of better than 67 dB is required. NPR performance of instrument is extended to 77 dB when Band Pass Filter fitted. These filters must be housed in separate 3726A Filter Mainframe.

**311:** 70 kHz.      **314:** 1248 kHz.      **317:** 5340 kHz.  
**312:** 270 kHz.      **315:** 2438 kHz.      **318:** 7600 kHz.  
**313:** 534 kHz.      **316:** 3886 kHz.      **319:** 11700 kHz.

N.B. Consult Baseband Analyzer data sheet for Band Defining, Band Stop, and Band Pass Filters to meet Intelsat and Bell requirements.

### 37267A Adapter Case (for Marconi filters)

**311:** high or low pass.  
**313:** band pass (including 750  $\Omega$ /75  $\Omega$  transformer).  
**314:** band stop.

### 37268A Dummy Plug-in

Must be used to fill any empty plug-in compartments on the 3726A Filter Mainframe.

### 37269A Plug-in With Front Panel Input Connector

To be used in conjunction with 37266A Band Pass Filter.

**003:** Siemens 1.6 mm connector.

**004:** WECO 477B connector.

## Ordering Information

**3724A** Baseband Analyzer

**3725A** Display

**3726A** Filter Mainframe

# TELECOMMUNICATIONS TEST EQUIPMENT

## Baseband Analyzer System Software

Model 37018A, 37018B

573



- Full measurement capability of the Baseband Analyzer plus automatic presentation of white noise loading curves
- Measurement sequences easily and quickly created
- Input data checked for validity (allows sequence creation without measurement hardware)

- Editing capability allows measurement files to be modified to cater for changing requirements
- Store up to 150 unrelated frequencies for multiple selective power measurements
- Measurement results checked against stored tolerances (branching on failures allows diagnostic tests to be performed)

The Baseband Analyzer System Software together with the necessary hardware, makes automatically-controlled baseband measurements associated with the quality evaluation of microwave radio communications systems. The software is modular, allowing the first-time user or programmer to add measurement capability, different output formats, etc, with minimal effort. The software guides the user via simple prompts through the initial set-up, calibration, measurement and output sequences.

Two user-oriented system software packages are available for the Baseband Analyzer (BBA). The 37018A package is intended for applications involving a single BBA such as in manufacturing or in maintenance where a portable test system is required. The 37018B is designed for controlling two BBA's working in remote locations and has the ability to operate with appropriate access switching.

### Measurement Results

The plots in Figure 1 show the results of using the 37018A to test and characterize automatically a wideband modulator and demodulator. Considerable time saving in production test and quality assurance can be achieved by using the BBA in conjunction with the 37018A to produce a complete sequence of performance curves. Each product tested can be fully evaluated and hard copy verification of its performance can easily be provided.

### 37018A Configuration

Operation of the software requires the following:  
HP85 Personal Computer, with  
82937A HP-IB Interface  
82903A 16k Memory Module

82936A ROM Drawer  
00085-15002 Plotter Printer ROM  
00085-15003 Input/Output ROM  
3724A/3725A Baseband Analyzer

To make NPR and signal-to-noise measurements, the BBA must be equipped with the 3726A Filter Mainframe and appropriate filters. An external page printer such as the 2631B or 82905A and an external plotter such as the 7225A can be added easily to allow high quality printed and plotted outputs. These additions only require changes to the address assignments in the 'Autost' program.

### 37018B Configuration

Operation of the software requires the following:  
HP87XM Personal Computer, with  
82937A HP-IB Interface  
82936A ROM Drawer  
00087-15002 Plotter ROM  
00087-15003 Input/Output ROM  
Mass Storage (82902M Single Drive 5¼ Disc Drive or 82901M Double Drive 5¼ Disc Drive)  
3724A/3725A Baseband Analyzer (to make NPR and signal-to-noise measurements, the BBA must be equipped with the 3726A Filter Mainframe and appropriate filters)  
Printers (82905A or B Printer  
2631G Graphics Printer  
2671G Graphics Printer  
2673G Intelligent Graphics Printer)  
Access Switching (3755A Switch Controller  
3756A 90 MHz Bi-directional Switch)

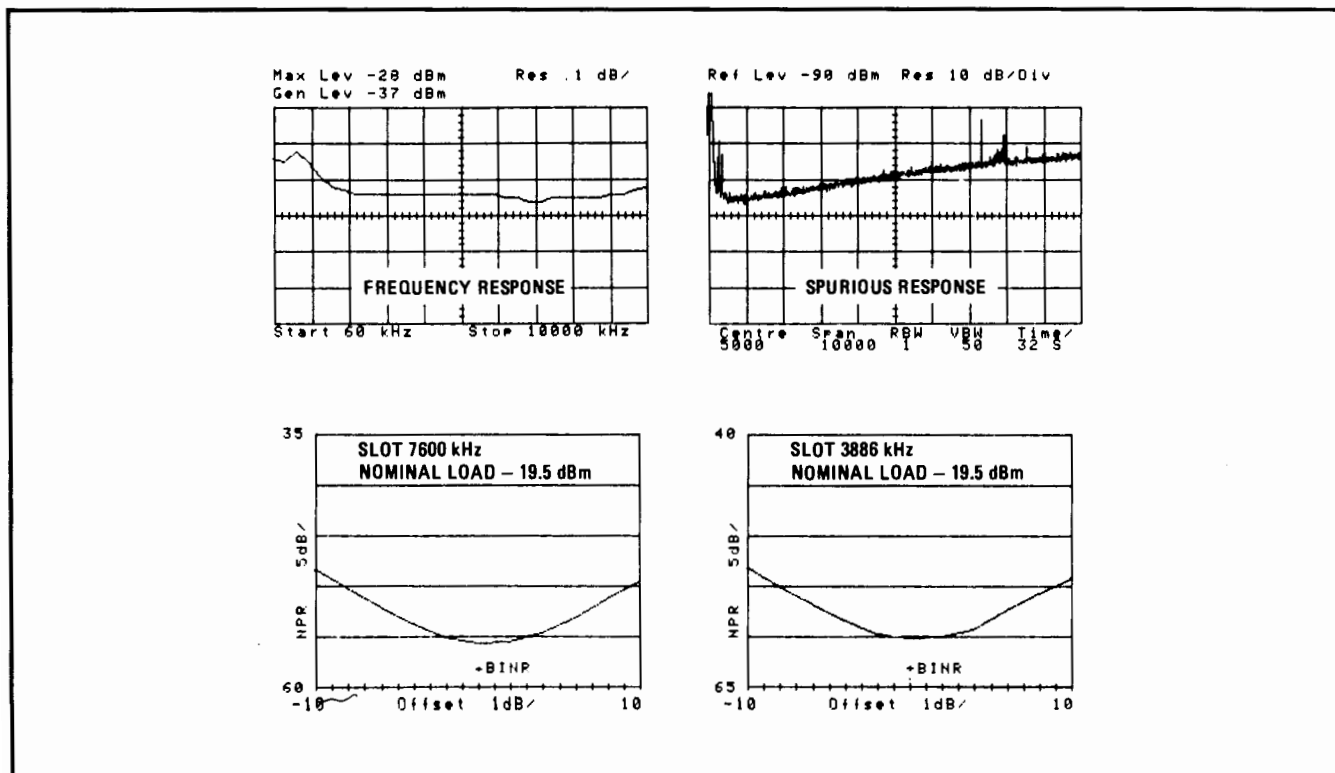

Figure 1. Back-to-back performance characteristics of wideband modulator and demodulator.



# TELECOMMUNICATIONS TEST EQUIPMENT

## Microwave Link Analyzers and Accessories

Models 3711A/3712A, 3710A/3702B, 3743A, 3750A

- Test analog and digital radios
- Isolate and characterize causes of intermodulation distortion in wideband FM microwave radios

- Baseband and IF interfaces
- 70/140 MHz or 70 MHz only IF capability
- Selectable combinations of BB test tones

70/140 MHz IF MLA System

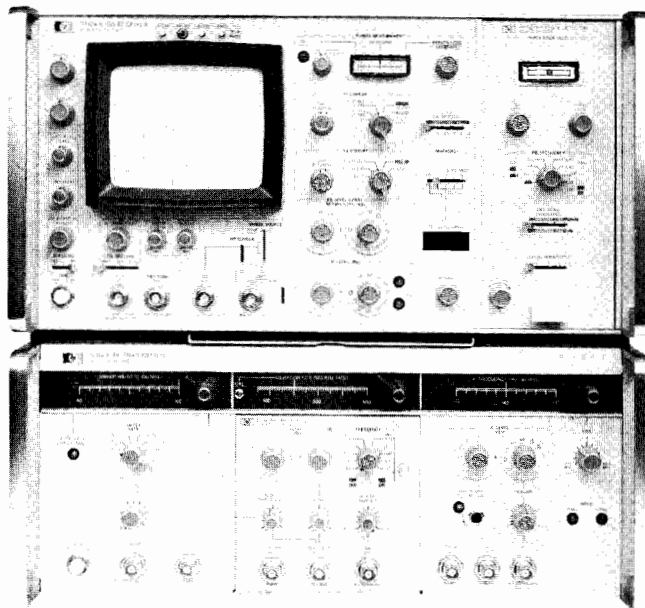

3711A IF/BB Transmitter  
3791B BB Transmitter (Plug-in)  
3712A IF/BB Receiver  
3793B Diff. Phase Detector (Plug-in)

70 MHz IF MLA System



3710A IF/BB Transmitter  
3715A or 3716A BB Transmitter (Plug-in)  
3702B IF/BB Receiver  
3703B or 3705A Group Delay Detector (Plug-in)

Two versions of the Microwave Link Analyzer (MLA) are available: the 70 MHz IF 3710A/3702B System, and the dual 70/140 MHz IF 3711A/3712A System. For microwave radio stations employing both 70 and 140 MHz intermediate frequencies, the dual IF MLA is an economical way of providing a complete range of dedicated measurements at both IF's.

The 3710A/3702B and 3711A/3712A MLA's isolate and characterize causes of intermodulation distortion in wideband microwave radios. They have applications in both analog and digital radio systems. Measurements performed by the MLA's include:

- BB power, gain, and loss
- IF power, gain, and loss
- modulator/demodulator deviation sensitivity
- modulator/demodulator linearity
- modulator/demodulator group delay
- swept IF amplitude response
- swept IF group delay
- swept IF return loss
- BB and IF differential gain (HF linearity)
- BB and IF differential phase (HF group delay)
- BB return loss

When used with the 8620C/86200 Series RF Sweeper system (equipped with the MLA interface option) and the 3730B RF Down Converter, the swept measurements of the basic MLA's can be extended to RF. Pages 576 and 577 give further details about this RF instrumentation (3730B and 8620C).

Apart from the dual 70/140 MHz IF capability, with the full range of measurements available at both frequencies, the 3711A/3712A MLA has many other refinements over earlier systems. These include an improved marker system, an IF input frequency counter, improved input sensitivity at  $-19$  dBm, a slope control, a 16 dB dynamic display range, and X-Y Recorder facilities.

Another major contribution is the provision of an interface for the 8501A Storage-Normalizer. Use of this instrument with the 3711A/3712A MLA provides digital averaging and normalizing facilities. Further, measurement limit masks and adjustment instructions can be displayed on the MLA screen when a desk-top computing controller is used with the Storage-Normalizer.

A series of options are available with the MLA's, including:

- test-tone frequencies
- connectors
- balanced 124  $\Omega$  baseband impedance
- sweep frequencies
- variable phase output of sweep signal



**Options** (3711A/3712A and 3710A/3702B MLA's)

To compile a suitable MLA System for your application, select *one* of the following combinations:

- 70/140 MHz IF** — 3711A/3791B/3712A/3793B.
- 70 MHz IF with low- and high-frequency test-tones** — 3710A/3716A/3702B/3705A.
- 70 MHz IF with low-frequency test-tones only** — 3710A/3715A/3702B/3703B.

**Connector Options**

(3711A/3791B/3712A/3710A/3716A/3715A/3702B only)

Option	BNC	Siemens Large	Siemens Small	WECO 477B	WECO 560A
Std	•				
002		•			
003			•		
004				•	
005*					•

\* Available with 3711A/3791B/3712A only.

**Test-tone (BB) Options**

(3791B/3793B/3716A/3715A/3705A/3703B only)

3791B/ 3793B/ 3716A/ 3705A Options	Test-tone Frequencies										
	83.333 kHz	92.593 250 & 500 kHz	55.556 92.593 & 277.778 kHz	2.4 MHz	3.50 MHz	3.58 MHz	4.43 MHz	4.50 MHz	5.60 MHz	8.20 MHz	12.39 MHz
Std	•										
010		•		•							
011		•		•							
012		•		•							
013	•			•							
014	•			•							
016	•			•							
018	•			•							
019	•			•							
021*		•		•							
022				•							
210*	•			•							
211*				•							
212*				•							
221*				•							
3715A/ 3703B Options											
Std	•										
009		•									

\* Available with 3791B/3793B only.

**Sweep Frequency Options** (3711A/3710A only)

Option	Opt					
	70 Hz	LINE	70 Hz	50 Hz	100 Hz	18 Hz
Std	•	•				
006	•	•		•		
007	•	•			•	
015	•	•				•

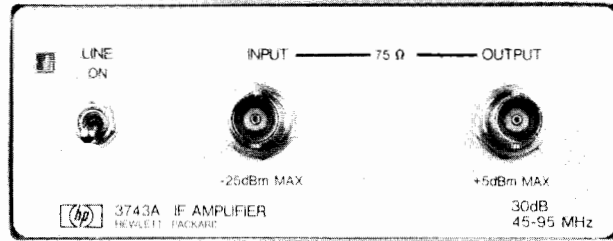

3743A IF Amplifier

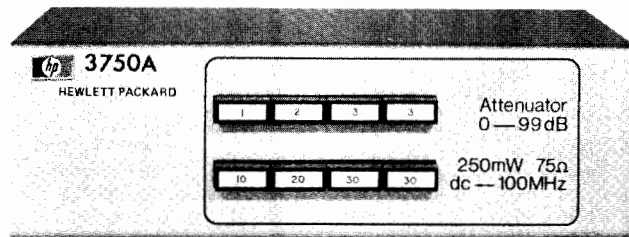

3750A Attenuator

**Miscellaneous Options**

- 008** (3711A/3710A only) Variable phase sweep output.
- 015** (3793B/3705A only) Additional phase detector bandwidths of 90 and 180 Hz—must be used with 18 Hz sweep rate on 3711A or 3710A IF/BB Transmitter.
- 020** (3712A only) CRT graticule illumination.
- 908** (3711A/3712A/3710A/3702B only) Rack mounting kit.
- 910** Extra manuals.

**3743A IF Amplifier**

- Improve MLA IF input sensitivity to -40 dBm.
- Frequency range 45 to 95 MHz.
- Group delay < 0.3 ns.
- Amplitude flatness < 0.2 dB.
- Return loss > 26 dB (75 Ω).
- Noise figure ≤ 8 dB.

**3750A Attenuator**

- Impedance 75 Ω.
- Attenuation range 0 to 99 dB, in 1 dB steps.
- Frequency range dc to 100 MHz.

**Ordering Information**

- 70/140 MHz system** (3711A/3791B/3712A/3793B)
- 70 MHz system with low- and high-frequency test-tones** (3710A/3716A/3702B/3705A)
- 70 MHz system with low-frequency test-tones only** (3710A/3715A/3702B/3703B)
- 3743A IF Amplifier**
- 3750A Attenuator**



# TELECOMMUNICATIONS TEST EQUIPMENT

## RF Down Converter

Model 3730B

- RF to IF frequency conversion
- 1.7 to 14.5 GHz frequency range
- Extends test capability of MLA's to RF
- 70 or 140 MHz IF output

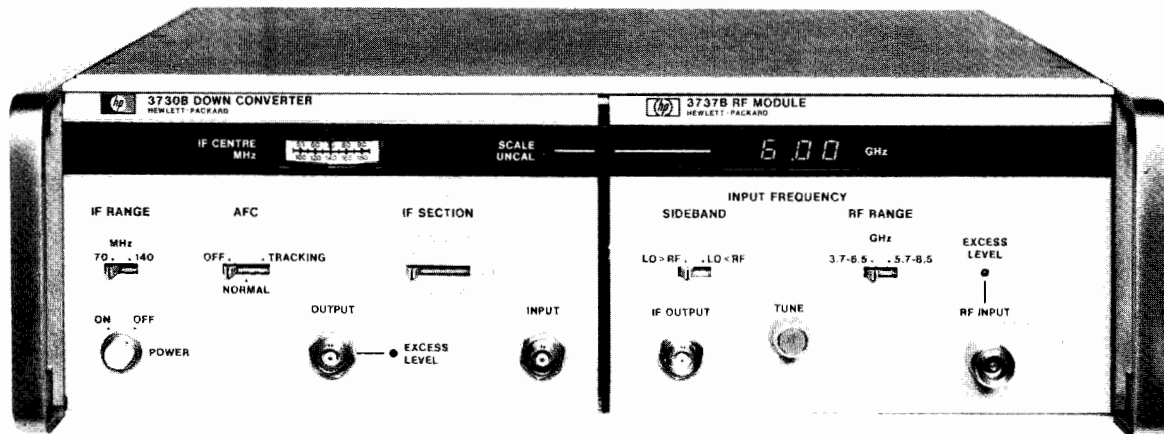

3730B Option 010 Down Converter mainframe with 3737B RF Module plug-in

The 3730B Down Converter and plug-ins provide RF to IF conversion and RF test capabilities for Microwave Link Analyzers (MLA's). The 1.7 to 14.5 GHz RF range is accommodated by a series of local oscillator plug-ins, allowing easy tuning to the desired operating frequency.

The 3730B has dual IF capability which allows the Down Converter to interface with single 70 MHz IF (eg the 3710A/3702B) or dual 70/140 MHz IF (eg the 3711A/3712A) MLA's, or with wideband demodulators (eg the 3717A) when white noise loading.

A tracking AFC and recovered sweep facility causes the local oscillator in the 3730B to track the incoming swept RF signal, thus almost eliminating the swept component of the IF signal. This feature is particularly useful in wideband applications. It allows the Down Converter to be used in conjunction with an Up Converter and a conventional MLA to perform RF to RF measurements over bandwidths of up to 250 MHz.

The tracking AFC facility also has advantages when operating over conventional measurement bandwidths of a Microwave Link Analyzer. Because of the effective sweep compression of the IF signal, the residual distortions of both the Down Converter and Microwave Link Analyzer receiver are reduced considerably.

Provision has been made for incorporating an isolator in the RF input of the Down Converter. The standard RF input circuit of the 3730B is broadband. However, for some measurement applications, introducing a narrow band isolator can provide substantial benefits, eg:

- Improved input return loss
- Reduced L.O. leakage
- Improved noise figure
- Increased input sensitivity

On a microwave radio route containing a number of repeater stations, the local oscillator can be positioned above or below the carrier frequency and this can vary from repeater station to repeater station. This can cause difficulties when comparing MLA responses between stations due to frequency axis inversion of the swept response. Selecting upper or lower sideband operation on the 3730B overcomes this problem.

Lengthy runs of RF cable between the Down Converter and the RF test point can generate ripple responses which can mask the true measurement response. To avoid this problem, it is possible to remove the Down Converter plug-in and mount this directly onto a waveguide test point. The plug-in is then connected to the 3730B mainframe by an umbilical cable (15609A). Only IF signals which are less susceptible than RF signals to lengthy runs of interface cable are transmitted along the umbilical cable.

Option 010 of the 3730B incorporates an additional IF section, comprising a 25 dB fixed gain amplifier and a 30 dB stepped attenuator, to ensure that the IF signal level is sufficient to drive most MLA's when operating at RF input levels below  $-12$  dBm. Note that no deg-

radation of the residual performance specifications occurs when this option is fitted.

### Specifications

#### 3730B + 3736B/7B/8B/9B

#### Residual performance:

	50 MHz Sweep Width at 70 MHz centre frequency	100 MHz Sweep Width at 140 MHz centre frequency
Amplitude Response	0.2 dB	0.3 dB
Group Delay	0.2 ns	0.3 ns
Diff Gain (5.6 MHz test tone)	0.3%	0.5%
Diff Phase (5.6 MHz test tone)	0.3°	0.5°

The residual specifications quoted are measured using the FM Sweep Input to reduce the residual contributions of the RF test source, and using storage normalizer techniques to remove MLA receiver contributions. Further improvements in the residual performance can be obtained by utilising the 3730B's unique tracking AFC facility.

**Min RF input level:**  $-15$  dBm, typically ( $-40$  dBm when Opt 010 is fitted), for correct operation of MLA; however, min input level dependent on input sensitivity of MLA and RF-IF gain conversion of Down Converter (3710A/3702B MLA—min input sensitivity  $-10$  dBm; 3711A/3712A MLA—min input sensitivity  $-19$  dBm).

**Size:** 141 mm H x 425 mm W x 467 mm D (5.5 x 16.75 x 18.38 in.)  
**Power supply:** 100, 120, 220, or 240V ac,  $+5$   $-10\%$ ; 48 to 66 Hz; consumption 100 VA max, including plug-in.

**Weight:** 11.9 kg (26 lb) net, including plug-in.

**Temperature range:** 0 to 55°C, operating.

#### Options

**010:** 25 dB fixed gain amplifier, with 30 dB (10 dB step) attenuator.

#### Accessories

**15600A Isolator:** 3.7 to 4.2 GHz.

**15601A Isolator:** 5.9 to 6.5 GHz.

**15602A Isolator:** 7.1 to 8.5 GHz.

**15603A Isolator:** 10.7 to 11.7 GHz.

**15609A Remote Extender Cable:** 3 metre umbilical cable.

#### Ordering Information

**3730B Down Converter**

**3736B RF Module** 1.7 to 4.2 GHz

**3737B RF Module** 3.7 to 8.5 GHz

**3738B RF Module** 5.9 to 11.7 GHz

**3739B RF Module** 10.7 to 14.5 GHz

# TELECOMMUNICATIONS TEST EQUIPMENT

## RF Sweeper MLA Upconverter Simulation

Models 8350A, 8620C, 86200 Series RF Plug-ins

577



- MLA Upconverter Simulator Options 0.5 to 18.0 GHz
- Use with MLA or as a General Purpose Sweeper
- Swept and CW RF Source
- Test Digital & Analog Microwave Radio Systems & Components

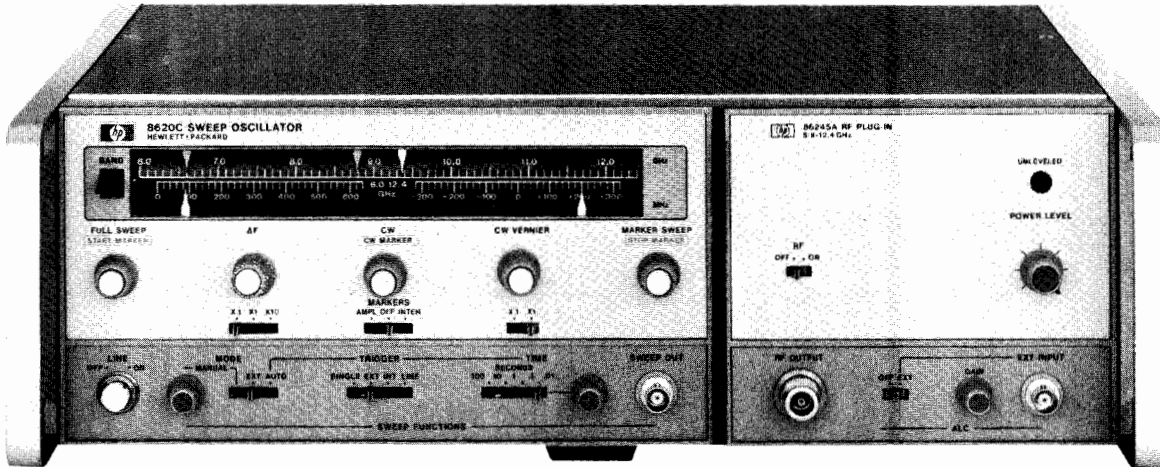

8620C/86245A

### Description

The 8620C Sweep Oscillator and 86200 Series of RF plug-ins provide a high performance, solid state source for Microwave Radio System tests via MLA Upconverter Simulation Options. These permit accurate RF-to-BB, RF-to-IF and RF-to-RF distortion measurements to be made with the 3700 Series MLA Systems. The plug-ins can also be used as standard sweeper plug-ins, with the only basic difference being modified FM circuitry. The RF-to-RF measurements must be made in conjunction with the 3730B RF Down Converter. This allows group delay, linearity, differential gain and phase measurements to be made on RF devices and components within the Microwave Radio System. The 8350A Sweep Oscillator Mainframe is also compatible with the 86200 series MLA option plug-ins through the use of the 11869A Adapter (see page 434).

phase over the specified frequency range. All plug-ins can be used with MLA sweep widths of 100 MHz or less. The following specifications supplement the standard 8620C system specifications (covered on pages 435-441).

### Complementary Equipment

8350A Sweeper Mainframe

11869A Adapter

8620C Sweeper Mainframe (required)

To properly interface the 8620C/86200 Series plug-in to the item under test, the following are recommended for optimal performance:

784C Directional Detector (1.7 - 12.4 GHz)

Flatness over any 30 MHz:  $< \pm 0.1$  dB

Equivalent source match: typically  $\leq 1.5$

11675B Leveling Cable Assembly (1.7 - 12.4 GHz)

Group delay:  $\leq 0.25$  ns p-p (with 1.25 SWR at each end)

### Specifications

The 8620C/86200 Series MLA Upconverter Simulation Plug-ins are optimized for group delay, linearity, and differential gain and

### MLA Upconverter Simulation Plug-in Specifications (25°C)

Model Number	MLA Option Number	MLA Freq. Range (GHz)	Group Delay (ns) p-p		Linearity (%)	Diff. Gain (%)	Diff. Phase (°)	FM Sens. (MHz/V)
			@277.7 kHz	@5.6 MHz <sup>1</sup>				
Across Any 30 MHz BW								
86222A/B	H80	0.5-2.4	<3	<2.5	<2.5	<2.5	<3	N/S
86235A	008	1.7-4.3	<2	<2.0	<2.0	<2.0	<2	+20
86240C	—	3.6-8.6	<1	<0.5	<0.5	<0.5	<1	+20
86242D	008	5.9-9.0	<1	<0.5	<0.5	<0.5	<1	+20
86245A	008	5.9-12.4	<1	<0.5	<0.5	<0.5	<1	+20
86250D	008	8.0-12.4	<1	<0.5	<0.5	<0.5	<1	+20
86260A	H82	12.0-18.0	<3	<2.5	<2.5	<2.5	<3	N/S

<sup>1</sup>Except 86222A/B & 86260A which are tested @ 2.4 MHz.

For applications requiring better distortion specifications, HP also offers plug-in systems which include a leveling cable and directional coupler. These systems are available in the following bands: 5.8-6.5 GHz, 7.0-8.6 GHz, 10.7-11.7 GHz, and 12.2-12.7 GHz. The system specifications are as follows:

Group delay @ 500 kHz:  $< 0.5$  ns p-p

Linearity @ 500 kHz:  $< 0.25\%$

Flatness:  $< \pm 0.1$  dB

For more information consult your local HP Field Engineer.

The options shown after each plug-in provide the special MLA interface capability. Refer to pages 435-441 for details on other RF Sweeper plug-in specifications and options.

# TELECOMMUNICATIONS TEST EQUIPMENT

## 70 MHz Modulator/Demodulator

Model 3717A

- Up to 5 pre-/de-emphasis networks
- Video and telephony inputs and outputs
- Service channel provided
- Built-in 15 dB open-ended attenuator
- Optional HP-IB control
- Optional balanced BB input and output

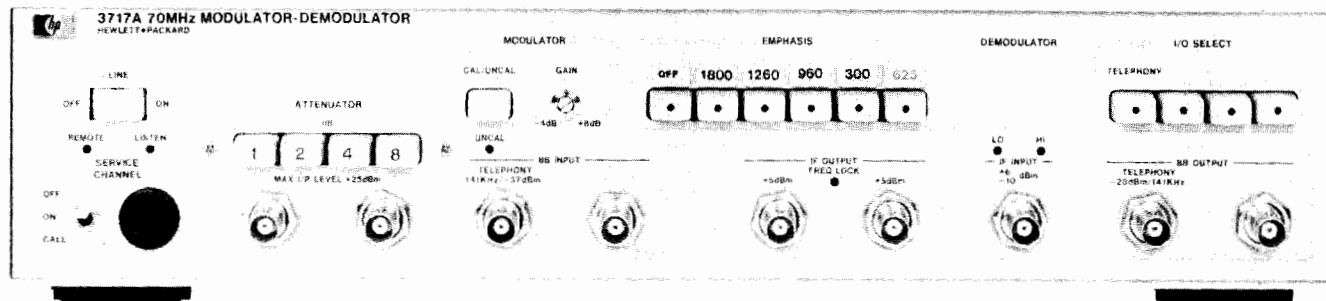

The 3717A 70 MHz Modulator/Demodulator can be used in microwave radio link systems to enable BB qualitative measurements to be made at non-demodulating repeater stations.

Standard measurement practice for the alignment and maintenance of microwave radio links involves two specific categories of tests, i.e. swept response measurements and BB qualitative measurements. Normal practice is to align a microwave radio initially by using swept response techniques such as those provided by an MLA. After these measurements have been completed successfully, qualitative measurements such as white noise loading, TV waveform testing, and BB frequency response are performed at the BB terminals of the microwave radio to verify operational performance.

However, the optimum swept response does not always produce the best possible qualitative figure. When this happens it may be necessary to isolate the faulty section by performing qualitative measurements from BB terminal stations to IF repeater stations, or vice versa. To do this, a high quality wideband test modulator or demodulator is required. The 3717A provides this capability.

### Specifications Summary

#### Back-to-Back Performance (Telephony)

##### BB Frequency Response (with or without Emphasis)

50 Hz to 10 MHz:  $\pm 0.2$  dB.

50 Hz to 20 MHz:  $\pm 3$  dB.

##### Noise Loading Performance

At manual loading for all slots, 70 to 7600 kHz (1800 channels with emphasis):  $\leq 25$  pWOp (57 dB NPR).

**Thermal:** mod/demod is thermally dominated and will typically tolerate a 6 dB overload with no degradation.

##### Spurious Response

300 kHz to 10 MHz:  $\leq -72$  dBm0.

#### Back-to-Back Performance (Video)

##### BB Frequency Response

5 Hz to 10 MHz:  $\pm 0.2$  dB.

Square wave tilt (50 Hz):  $< 1.0\%$ .

Diff. Gain (4.43 MHz)\*:  $\leq 0.7\%$ .

Diff. Phase (4.43 MHz)\*:  $\leq 0.7^\circ$ .

\*Measured on an HP Microwave Link Analyzer with a test tone of 4.43 MHz.

### Options

#### Connector options—select any one.

**Std:** BNC

**003:** Siemens small.

**004:** commercial equivalent of WECO 477B balanced input.

Emphasis networks—up to five may be installed and should be specified with every order.

#### CCIR

**011:** 24 channel emphasis.

**012:** 60 channel emphasis.

**013:** 120 channel emphasis.

**014:** 300 channel emphasis.

**015:** 600 channel emphasis.

**016:** 960 channel emphasis.

**017:** 1260 channel emphasis.

**018:** 1800 channel emphasis.

**021:** 525 line emphasis.

**022:** 625 line emphasis.

**023:** 819 line emphasis.

#### Bell

**031:** Bell 600 channel emphasis.

**032:** Bell 900 channel emphasis.

**033:** Bell 1200 channel emphasis.

**034:** Bell 1500 channel emphasis.

**035:** Bell 1800 channel emphasis.

**036:** Bell 2100 channel emphasis.

**037:** Bell 2400 channel emphasis.

#### Miscellaneous

**006:** deletes Modulator section.

**007:** deletes Demodulator section.

**100:** HP-IB.

**136:** Combination of options 003 and 006.

**137:** Combination of options 003 and 007.

**146:** Combination of options 004 and 006.

**147:** Combination of options 004 and 007.

**3717A 70 MHz Modulator/Demodulator**

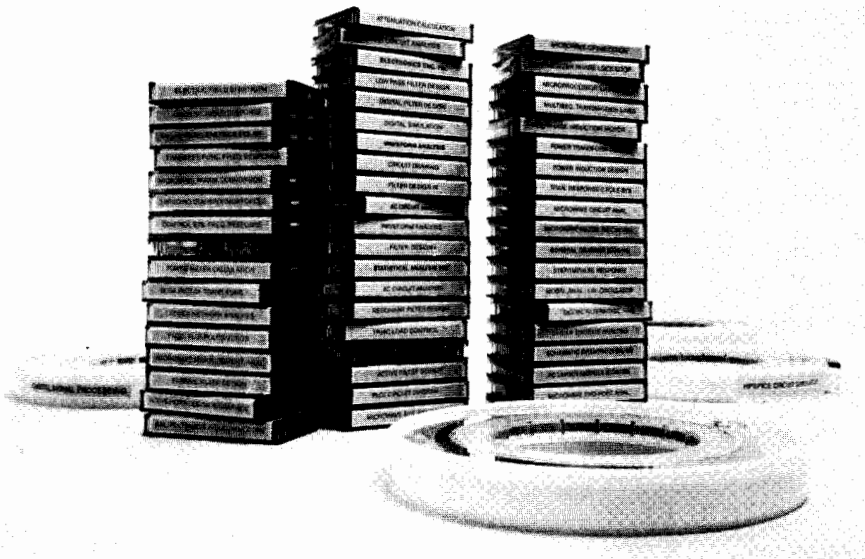

Hewlett-Packard computer products are sold and supported through more than 180 HP offices in 48 countries worldwide. In addition, 23 independent companies have contractual agreements with HP to sell and support our computer products.

As an HP customer, you expect to receive reliable, high-quality products and excellent after-sale support. HP computer hardware products are warranted against defects in material and workmanship for 90 days. During that time, HP will, at its option, repair or

replace any product proven defective. Beyond warranty, HP offers a wide range of hardware and software support.

### Hardware Support Services

HP hardware support starts soon after you place an order for an HP system. Consulting services help you identify and resolve site preparation requirements. Then HP provides Customer Engineering services to ensure proper installation of your HP equipment.

After installation, HP offers a range of maintenance programs designed specifically for HP computer systems. Three types of service agreements—Guaranteed Uptime Service, Standard System Maintenance Service and Basic System Maintenance Service—provide comprehensive system support. All emphasize the concept of maintenance account management.

When you choose an agreement, HP assigns a Customer Engineer to manage your account and work with you to ensure peak system performance and proper staff training. Preventive maintenance visits are regularly scheduled, and during them, factory changes to the system are installed to improve performance and reliability.

In addition to system maintenance, HP offers a range of services which allow you to choose the best combination of service cost and response time for your HP workstations.

Products eligible for this lower-cost support include desktop computers, terminals, plotters, personal computers and associated peripherals.

For details on hardware service agreements, please turn to page 634.

### Software Support Services

With these services, you can maximize the value of your software through increased system and user productivity. HP offers support and customer training, consulting and contractual services.

Contractual software support services are designed to meet most of your technical needs throughout the life of your computer system. Features include account management, software and documentation updates, and personal assistance by phone or at your site.

Customer training classes on software range from introductory courses to highly technical systems programming. HP has more than 25 fully equipped training centers worldwide, and as an option, special on-site courses can be cost-effective if you have a large programming staff. In addition, self-paced courses have been developed to provide low-cost instruction on selected topics.

Software consulting services can provide valuable assistance when your needs are beyond the scope of standard training or contractual support. The goal is to address your specific concerns and improve your ability to solve similar problems in the future.

For more information on software support services, please turn to page 632.

### Software Solutions

To make the best use of your HP computer, you need software that really suits your application. For example, in computer-aided engineering, there are already 200 electronic engineering packages available to run on a range of HP systems, from our personal computers to our desktops to larger HP 1000 systems.

If you need software for manufacturing applications, HP offers Materials Management/3000, Production Management/3000, Semiconductor Information Systems and more.

Software available for these and other application areas falls into three categories: HP proprietary, HP PLUS and some User's Exchange Library. Under our HP PLUS program, we work with independent software suppliers to bring competitively priced, quality solutions to the marketplace.

Currently available HP PLUS software solutions cover a myriad of technical and commercial applications, from structural dynamics and COBOL compilers to accounts receivable and automated payroll.





# COMPUTERS, PERIPHERALS & CALCULATORS

Welcome to the computer section of HP's catalog. This chart briefly summarizes HP's wide range of Computer Group products. We make everything from handheld calculators for science and engineering to mainframe computers for business and manufacturing applications as well as a variety of peripheral

like printers, plotters and data communications devices.

Most of the personal and desktop computers and all of the HP 1000 models are HP-IB compatible. Use this chart to locate the type of computer you are interested in, and then turn to the page with complete information

on that product.

If you have more questions about a computer or its usefulness for your application, please call the local Hewlett-Packard Sales and Service Office listed in the white pages of your phone book.

HP Computer Products	Applications		Operating System	Language	Display	Memory
	Focus	Software				
HP-10C, 11C, 15C	science, engineering	HP-15C Advanced Functions Handbook	proprietary	RPN	12-character LCD	79, 203, 448 program lines (respectively)
HP-12C	financial	HP-12C Solutions Handbook	proprietary	RPN	12-character LCD	99 program lines
HP-16C	digital electronics, computer science	—	proprietary	RPN	12-character LCD	203 program lines
HP-97	science, business engineering		proprietary	RPN	12-character LED	244 program lines
HP-41C/41CV	science, business engineering		proprietary	RPN	12-character LCD alphanumeric	.44 to 6.43 Kb/ 2.23 to 6.43 Kb
HP-85	portable personal/technical/analysis/instrument control	See pp. 592-593	ROM 32 Kb	BASIC, Assembly	5" diagonal built-in	16 - 32 Kb
HP-86	personal/professional/analysis	See pp. 592-593	standard ROM 48 Kb; opt. CP/M,* opt. UCSD p-System*	BASIC, Assembly, Pascal, FORTRAN 77	9" or 12" monitor	64 - 576 Kb
HP-87	personal/professional/analysis/instrument control	See pp. 592-593	standard ROM 48 Kb; CP/M,* opt. UCSD p-System*	BASIC, Assembly, Pascal, FORTRAN 77	10" diagonal built-in	128 - 640 Kb
HP 9845 B/C	engineering design, modeling, business management	utilities, statistics, engineering design/analysis	single-user, ROM-based, proprietary	BASIC, Assembly	CRT	56 - 449 Kb
HP 9826A	computer-aided test, instrument control	statistics, engineering design/analysis, VisiCalc*	ROM- or RAM-based, proprietary single-user	BASIC, HPL, Pascal	CRT	64 Kb - 2 Mb
HP 9836A	computer-aided engineering, graphics	statistics, engineering design/analysis, VisiCalc*	RAM- or ROM-based, proprietary	BASIC, HPL, Pascal	CRT	64 Kb - 2 Mb
HP 9825 B/T	stand-alone computation, instrument controller	statistics, engineering design, terminal emulator	ROM-based, proprietary	HPL	32-character LED	23 - 62 Kb
HP 1000 Model 6 (A600)	computer-aided manufacturing, general purpose OEM	data base management, graphics	multi-user, multi-tasking, real-time	FORTRAN 77, Pascal, BASIC, Assembly	CRT	128 Kb - 3 Mb
HP 1000 Model 16 (A600)	computer-aided manufacturing, general purpose OEM	data base management, graphics	multi-user, multi-tasking, real-time	FORTRAN 77, Pascal, BASIC, Assembly	CRT	128 Kb - 4 Mb
HP 1000 Model 17 (A700)	computer-aided manufacturing, general purpose OEM	data base management, graphics	multi-user, multi-tasking, real-time	FORTRAN 77, Pascal, BASIC, Assembly, Microparaphraser	CRT	256 Kb - 4 Mb
HP 1000 Model 60 (E-Series) Model 65 (F-Series)	computer-aided manufacturing, general purpose OEM	data collection, process control, data base management, graphics	multi-user, multi-tasking, real-time	FORTRAN 77, Pascal, BASIC, Assembly, Microassembler	CRT	256 Kb - 2 Mb
HP 125	business professionals	VisiCalc*, word processing, hard copy graphics, communications, database	CP/M*	BASIC	CRT	64 Kb
HP 250	small business, departments of large companies	text processing, business graphics, financial accounting, bill of materials processing	multi-user, multi-tasking	HP 250 Business BASIC	CRT	256 - 576 Kb
HP 3000 Model 40	business	MM/3000, PM/3000, GA/3000, RAPID, HPWORD, DSG/3000, IFS/3000	MPE	FORTRAN, BASIC, Pascal, COBOL, RPG, SPL	All HP terminals	256 Kb - 2 Mb
HP 3000 Model 44	business	MM/3000, PM/3000, GA/3000, RAPID, HPWORD, DSG/3000, IFS/3000	MPE	FORTRAN, Pascal, BASIC, COBOL, RPG, SPL	All HP terminals	1 - 4 Mb
HP 3000 Model 64	business	MM/3000, PM/3000, GA/3000, RAPID, HPWORD, DSG/3000, IFS/3000	MPE	FORTRAN, Pascal, BASIC, COBOL, RPG, SPL	All HP terminals	2 - 8 Mb

VisiCalc is a registered trademark of VisiCorp.  
CP/M is a registered trademark of Digital Research, Inc.  
UCSD p-System is a trademark of The Regents of the University of California.



HP Computer Products	Storage	Interface Options	I/O Slots	Data Comm	HP Plotters	HP Printers	For more info. see page
HP-10C, 11C, 15C	—	—	—	—	—	—	582
HP-12C	—	—	—	—	—	—	582
HP-16C	—	—	—	—	—	—	582
HP-97	built-in mag card reader	—	—	—	—	built-in thermal printer	582
HP-41C/41CV	memory and extension modules	HP-IL	4	—	—	82143A, 82162A, 82905B Opt. 248	583
HP-85	tape cassette 82901M/02M, 9134A/35A, 9138A, 9895A	HP-IB, HP-IL, RS-232-C serial, GPIO, BCD, 82949A printer	4	82950A modem, data comm software pac	7245B, 7470A, 7580A, 9872C/T 9111A Graphics Tablet	82905B, 2601A, 2631B, 2670 series	589
HP-86	82901M/02M, 9130A, 9134A/35A, 9138A, 9895A	HP-IB, HP-IL, Serial, GPIO, BCD, 82949A printer	4	82950A modem, data comm software pac	7470A, 7580, 9872, 9111A Graphics Tablet	82905B Centronics, 2601A, 2631B, 2670 series	589
HP-87	82901M/02M, 9134A/35A 9138A/9895A	built-in HP-IB, also accepts HP-IL, Serial, GP10, BCD, 82949A printer	4	82950A modem, data comm software pac	7470A, 7580, 9872, 9111A Graphics Tablet	82905B, 2601A, 2631B, 2670 series	589
HP 9845 B/C	tape drives, external flexible or hard discs	HP-IB, BCD, 16-bit parallel, incremental plotter	4	async, RJE	7225B, 7245B, 7580A, 9872C/T	—	594
HP 9826A	flexible or hard discs	HP-IB, Serial, BCD, 16-bit parallel	4	async data link	7225B, 7245B, 7580A, 9872C/T	—	595
HP 9836A	flexible or hard discs	HP-IB, Serial, BCD, 16-bit parallel	4	async, data link	7225B, 7245B, 7580A, 9872C/T, 7470	—	595
HP 9825 B/T	tape cassette	HP-IB, Serial, BCD 16-bit parallel, real-time clock	3	—	7225B, 7245B, 7580A, 9872C/T	—	596
HP 1000 Model 6 (A600)	7908P, 7911P, 7912P, 7970E, 9134A, 9895A	Serial, HP-IB, 8/16-bit duplex	3-5	async, bisync, HDLC, DSN, LAP-B (X.25)	7470A, 7580A, 9872C/T	2608S, 2631B, 82905B, 2671A/G, 2673A	597-599
HP 1000 Model 16 (A600)	7908R, 7911R, 7912R, 7970E, 9895A	Serial, HP-IB, 8/16-bit duplex, analog I/O, digital I/O	16	async, bisync, HDLC, DSN, LAP-B (X.25)	7470A, 7580A, 9872C/T	2608S, 2631B, 82905B, 2671A/G, 2673A	598-599
HP 1000 Model 17 (A7000)	7908R, 7911R, 7912R, 7970E, 9895A	Serial, HP-IB, 8/16-bit duplex, analog I/O, digital I/O	13	async, bisync, HDLC, DSN, LAP-B (X.25)	7470A, 7580A, 9872C/T	2608S, 2631B, 82905B, 2671A/G, 2673A	598-599
HP 1000 Model 60 (E-Series) Model 65 (F-Series)	7906M/S, 7908P, 7911P, 7912P, 7920M/S, 7925S, 7933H, 9895A	Serial, HP-IB 8/16-bit duplex, video output	10-26	async, bisync, HDLC, DSN LAP-B (X.25), RJE	7220C/T, 7221C/T 7470A, 7580A, 9872C/T	2608S, 2611A, 2619A, 2631B	598-599
HP 125	5" and 8" floppies, Winchester drives	—	—	HP-IB, RS-232-C	7225B, 7470A, 9872C	integral thermal printer, 2601A, 2631B, 2671A, 82905B	Call sales office, see pp 667-672
HP 250	disc drives, 7908P, 7911P, 7912P	—	5 standard 10 maximum	RJE* DSN*	7220A, 7221, 7470A	2601A, 2608A, 2631B	601
HP 3000 Model 40	7911P, 7912P 7920M/S, 7925M/S, 7933H, 7970E, 7976A	—	13	RJE, DSN, MTS, MRJE, IMF	7220C/T, 7221C/T 7225B, 7240A, 7580A	2601A, 2608A, 2631B, 2617A, 2619A, 2680A	601
HP 3000 Model 44	7911P, 7912P 7920M/S, 7925M/S, 7933H, 7970E, 7976A	—	26	RJE, DSN, MTS, MRJE, IMF	7220C/T, 7221C/T 7225B, 7240A, 7580A	2601A, 2608A, 2631B, 2617A, 2619A, 2680	601
HP 3000 Model 64	7911P, 7912P 7920M/S, 7925M/S, 7933H, 7970E, 7976A	—	24	RJE, DSN, MTS, MRJE, IMF	7220C/T, 7221C/T 7225B, 7240A, 7580A	2601A, 2608A, 2631B, 2617A, 2619A, 2680A	601

\*RJE Remote Job Entry

\*DSN Distributed Systems Networking

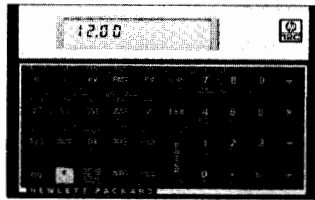

HP-12C

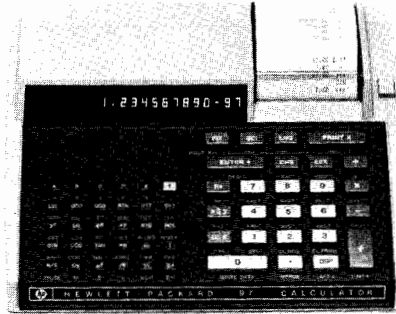

HP-97

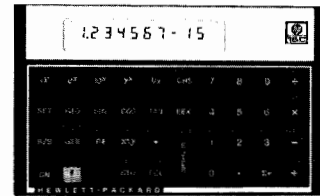

HP-15C

### HP-12C Advanced Financial Programmable with Continuous Memory

The HP-12C is HP's most powerful dedicated financial calculator. With its special functions, programmability, Continuous Memory, and liquid-crystal display, this calculator is ideal for solving most business and financial problems in or out of the office. The HP-12C features basic time and money functions, Net Present Value, Internal Rate of Return, plus a bond function which calculates yield-to-maturity and price. For additional push-button solutions, users can write their own programs, or, take advantage of HP's prewritten software solutions for specific applications.

The HP-12C comes complete with detailed Owner's Handbook and Problem-Solving Guide, long-life disposable batteries, and a soft, carrying case.

**Size:** 12.7 x 8.0 x 1.5 cm (5 x 3 $\frac{1}{8}$  x  $\frac{5}{8}$  in)

### HP-16C Programmable Calculator for Computer Science

The HP-16C is a programmable calculator specifically designed for computer science and digital electronic applications. With the HP-16C's number base modes, users can easily convert between binary, octal, decimal and hexadecimal bases. The advanced programmability of the HP-16C enables the user to call and edit programs easily. The HP-16C has extensive bit manipulation capability: shift, rotate, set, test, checksum and mask. Select word size, 1's and 2's complements and unsigned mode. Through a program, the user can emulate instructions of most available processors. The calculator has four logical Boolean operators: AND, OR, XOR, and NOT.

The HP-16C comes complete with Owner's Handbook, long-life disposable batteries, and a soft, carrying case.

**Size:** 12.7 x 8.0 x 1.5 cm (5 x 3 $\frac{1}{8}$  x  $\frac{5}{8}$  in)

### HP-10C Programmable Scientific

The HP-10C provides basic power and programmability in a lightweight, slim-line design. Programming tools include: 79 program lines, program review, conditional and unconditional branching. You can allocate the HP-10C's memory between program lines and storage registers. Functions include trigonometrics, logarithms, two-variable statistics, summations, linear regression, correlation coefficient, and factorial. The HP-10C will automatically turn itself off after several minutes of discontinued use. The calculator has a self-check routine and provides the user with specific error messages.

The HP-10C comes complete with Owner's Handbook, long-life disposable batteries, and a soft, carrying case.

**Size:** 12.7 x 8 x 1.5 cm (5 x 3 $\frac{1}{8}$  x  $\frac{5}{8}$  in)

### HP-11C Advanced Programmable Scientific

Programming on the HP-11C is easy to learn and easy to use. The HP-11C has subroutine and indirect addressing capability, conditional tests and flags. Insert new instructions by using the "Go To" key to access any part of a program. Delete a program line by pressing the Backarrow key. A convenient User Mode saves time and key-

strokes—at the touch of a single key, branch to any one of five independent programs. Dedicated functions include: trigonometrics, hyperbolics and inverses, permutations and combinations, and a random number generator.

The HP-11C comes complete with Owner's Handbook and Problem-Solving Guide, long-life disposable batteries, and a soft, carrying case.

**Size:** 12.7 x 8 x 1.5 cm (5 x 3 $\frac{1}{8}$  x  $\frac{5}{8}$  in)

### HP-15C Advanced Programmable with Continuous Memory and Matrix Functions

The HP-15C is an advanced programmable calculator with special functions that enable the user to solve problems involving matrices and complex arithmetic. The HP-15C's function set and programming tools are combined in a slim-line design to provide maximum portability. With the HP-15C's built-in matrix functions the user can operate with up to five matrices, (a maximum of 64 elements). Perform transpositions, determine norms, and find determinants with the HP-15C. The calculator has two parallel stacks, one for the real and another for the imaginary part of a complex number. It can also perform calculations with complex matrices. The calculator has solve and integrate functions. Advanced programming features include: 448 program lines, label addressing, insert/delete editing, 7 subroutine levels, program review, 10 flags, and conditional tests.

The HP-15C comes complete with Owner's Handbook, long-life disposable batteries, and a soft, carrying case.

**Size:** 12.7 x 8 x 1.5 cm (5 x 3 $\frac{1}{8}$  x  $\frac{5}{8}$  in)

### HP-97 Desktop Fully Programmable Printing Calculator

The HP-97 is designed for the professional who requires an integrated system with the added convenience of a built-in thermal printer and magnetic card reader. The printer is a valuable aid in editing programs or long calculations. With the magnetic card reader, the user can record from or load information into the calculator by using space-saving magnetic cards. Editing features enable the user to easily correct and modify programs.

The HP-97 comes complete with Owner's Handbook, Standard Pac with 40 magnetic cards, card holder, and manual, rechargeable battery pack, recharger/AC adapter, programming pad, soft carrying case, and two rolls of thermal paper.

**Size:** 64 x 229 x 203 mm (2.5 x 9 x 8 in)

### Ordering Information

HP-10C  
HP-11C  
HP-12C  
HP-15C  
HP-16C  
HP-97

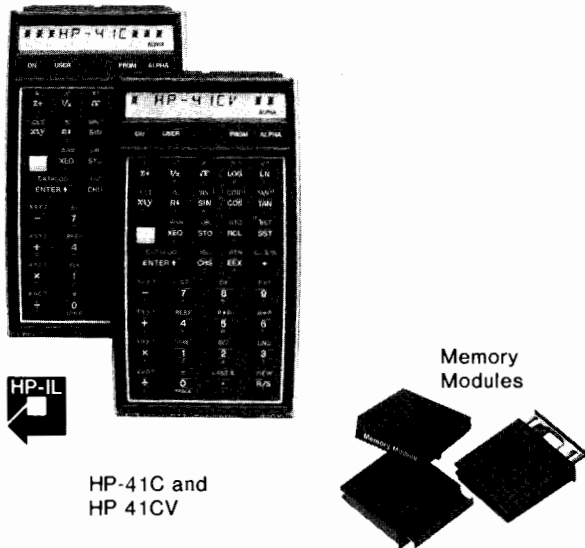

HP-41C and  
HP 41CV

Memory  
Modules

## HP-41 Handheld Computers

The HP-41C and HP-41CV Handheld Computers provide the heart of an expanding computational, data acquisition and instrument control system. Both models are virtually identical, the only difference lies in the amount of built-in memory: 441 bytes for the HP-41C, 2,233 bytes for the HP-41CV. Maximum memory expansion for both machines is 6,433 bytes through the use of Memory Modules and Extension Modules.

The alpha capability of the HP-41 enables the user to label programs with easy-to-remember names. Each program is autonomous and each can have up to 100 different local labels for branching within a program. The HP-41 also features up to 6 levels of subroutines, 10 conditional tests, 56 internal flags, powerful loop control, indirect addressing, and both local and global branching.

Over 128 separate operations comprise the total HP-41 function catalog. Functions and programs can be assigned to almost any key. The HP-41 comes with keyboard overlays and a set of user labels to help facilitate customization of the HP-41.

Key in any combination of letters and numbers up to 24 characters wide and display 12 characters at a time. A complete system of status annunciators indicate mode conditions. Error messages pinpoint calculation errors and ten different tones provide aural feedback. Continuous Memory saves programs and data even when the computer is turned off. (For additional specifications, refer to the Comparison Chart on page 586.)

A variety of dedicated, plug-in peripherals expand the capabilities of the HP-41. In addition, both handheld computers are HP-IL compatible. Simply plug in the HP 82160A HP-IL Module to connect up to 30 HP-IL devices using only one port. Through HP-IL, the HP-41 is capable of transmitting and receiving data, and performing a wide variety of control functions. With the help of the HP 82938A HP-IL/Series 80 Interface, an HP-41 can pass information on to a Series 80 personal computer for further analysis.

Surrounding the HP-41 is a broad range of software solutions. Choose from HP-written Application Pacs and Solutions Books, Users' Library programs or HP PLUS software. Hewlett-Packard offers a Custom Products Program for those who require customized software solutions in large quantities. Customer software can be produced in the following software media: custom modules, magnetic cards, cassettes or bar code. Use custom overlays and keyboards for keyboard personalization.

**Size:** 33 x 79 x 144 mm (1.3 x 3.1 x 5.7 in.)

### HP 82106A Memory Module

Each module contains an additional 64 registers that can be allocated as program memory or storage registers, or any combination. Four Memory Modules can be added to the HP-41C for a total of 319 storage registers or 2,233 bytes. (For the HP-41C only.)

### HP 82170A Quad Memory Module

The Quad Memory Module contains 256 data storage registers or 1,792 program bytes and expands the HP-41C to 319 storage registers or 2,233 program bytes using only one port. (For the HP-41C only.)

### HP 82104A Card Reader

Reads and writes programs and data onto magnetic cards with 32 registers per card. Adds over 30 card reader control functions to the HP-41, including prompts and program security. Also reads HP-67/97 program cards.

### HP 82143A Thermal Printer/Plotter

Portable, quiet, thermal operation and battery operable, the HP 82143A prints upper- and lowercase alpha characters, including user-created special characters. The Printer/Plotter also does high-resolution plotting routines.

### HP 82153A Optical Wand

Easily inputs data or programs by reading HP bar code information. Most HP-41 software is available in bar code, including Users' Library programs and solutions books.

### HP 82180A Extended Functions/Memory Module

This module increases the HP-41 programming function set by adding such functions as programmable SIZE, programmable AS-SIGN and string functions. This module also provides memory management functions for accessing extended memory and 868 bytes of solid-state mass storage.

### HP 82181A Extended Memory Module

This module provides an additional 238 data registers or 1,666 bytes of solid-state mass storage to the HP-41. Up to two HP 82181A's may be used in the HP-41. (HP 82180A Module is required when using the HP 82181A.)

### HP 82182A Time Module

The Time Module expands the HP-41 computing system with time information and time-controlled operations. With this module, the HP-41 can become a time-scheduled system controller, an alarm clock, an appointment reminder, a calendar, a timer, even an advanced stopwatch.

### Ordering Information

HP-41C

HP-41CV

HP 82106A Memory Module

HP 82170A Quad Memory Module

HP 82104A Card Reader

HP 82143A Thermal Printer/Plotter

HP 82153A Optical Wand

HP 82180A Extended Functions/Memory Module

HP 82181A Extended Memory Module

HP 82182A Time Module

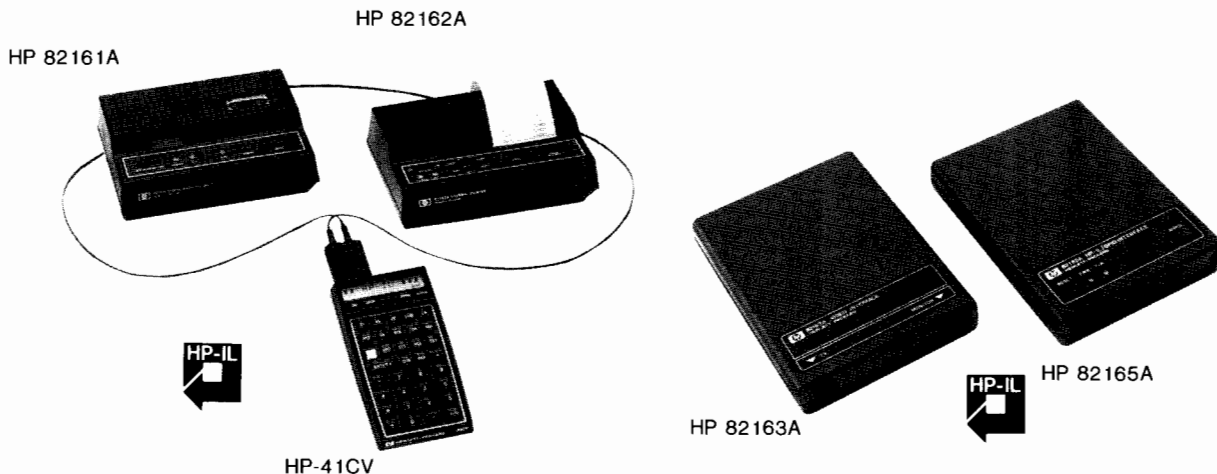

### HP 82160A HP-IL Interface Module

The HP-IL Interface Module plugs into any one of the four ports in the HP-41, connecting the HP-41 Handheld Computer with an ever-growing family of HP-IL peripherals and instruments. The module gives the HP-41 control of up to 30 devices on the loop. There are three function sets supplied by the HP-IL Module: printer, mass storage, and general input/output (I/O).

#### Printer Functions

The printer functions located within the HP-IL Module are consistent with the functions of the HP 82143A Printer/Plotter. This module also provides a FORMAT function, which permits centering, and left and right justification of copy.

A switch on the underside of the HP-IL Module allows selection of either the HP-IL printer functions or the HP 82143A Printer/Plotter functions.

#### Mass Memory Functions

The file-by-name, mass memory functions within the HP-IL Module allow writing and reading programs, data, key assignments, machine status, or the entire HP-41 memory contents to or from an HP-IL mass memory device. Files may be secured to prevent accidental over-writes. Running programs may call in other programs automatically or store data. The entire contents and status of the HP-41 may be replaced under program control.

The mass memory directory capabilities will automatically search out the file by name regardless of the number of mass memory devices attached. Once a file is accessed, the file name and location are saved in a buffer for quick future reference and may be quickly listed.

#### General Purpose I/O Functions

The general purpose input/output (I/O) functions found in the HP-IL Module allow the HP-41 to more directly control devices in the HP-IL loop. Two modes of operation are available—automatic and manual. For most applications, automatic mode is used, and the functions in the module will automatically find the appropriate device and perform an operation. If direct control is needed, the module may be placed in manual mode to override the automatic operation.

Other general purpose instructions allow information to be read into or written from the HP-41's ALPHA register. Peripherals can be turned on or off from the HP-41 or more than one device can be selected to receive information.

#### Physical Specifications

2.8 x 1.2 x 0.4 cm (1.1" x 0.5" x 0.2")  
Cable length: (two attached cables) 80 cm each (31 in. each)

#### Data Transfer Rate

150 bytes per second  
(Typical HP-41 transfer rates)

### HP 82161A Digital Cassette Drive

The Digital Cassette Drive uses a digital-quality mini-cassette, capable of storing up to 128 kbytes of information. Rewind time is under 30 seconds and read/write operations are executed at nine inches per second, with search speed at 30 inches per second. All tape movement is under microprocessor control and buffer space is provided in the Drive for temporary storage of directory information to help minimize access time and tape motion. The Cassette Drive can locate files when under program control. The Digital Cassette Drive also features STANDBY mode, enabling an HP-IL controller to turn the drive on or off remotely. This unique feature helps to extend system battery life and allows for system operation in remote applications. The Drive uses a two-motor system to move the tape past a two-track, magnetic head specially designed to resist data alteration due to externally generated magnetic fields.

#### Physical Specifications

17.8 x 13.2 x 6.1 cm (7" x 5.2" x 2.4").

#### Data Format

Number of tracks: 2 Density: 335 bits per cm (850 bits/inch)  
Format: 256 bytes/record (8 bits/bytes)  
Formatted Capacity: 512 record (131,072 bytes)

### HP 82162A Thermal Printer/Plotter

This HP-IL compatible printer/plotter provides numeric, upper- and lowercase alpha, doublewide characters, and intensity control for optimum contrast and readability.

The chief enhancements of the HP 82162A over the HP 82143A dedicated Printer/Plotter are a 101-character buffer for enhanced graphics capabilities and a FORMAT function which automatically centers or justifies copy to the left and right margins.

The Printer/Plotter also supports STANDBY mode, so that any HP-IL controller on the loop can manage its power consumption.

#### Physical Specifications

17.8 x 13.2 x 6.1 cm (7" x 5.2" x 2.4")  
Cable length: 86 cm (34 in)

#### Character sets

96 standard ASCII  
127 modified-expanded ASCII

#### Ordering Information

HP 82160A HP-IL Interface Module  
HP 82161A Digital Cassette Drive  
HP 82162A Thermal Printer/Plotter

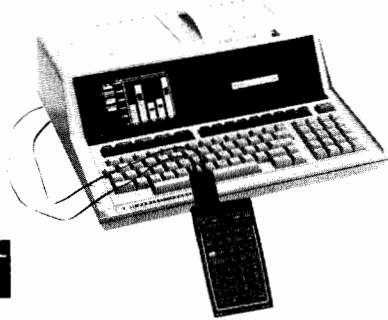

HP-85, HP82160A &amp; HP-41CV

### HP 82905B Impact Printer

The HP 82905B Impact Printer is an 80-column, 9 x 9 dot-matrix printer which is compatible with HP-IL devices. The HP 82905B operates bidirectionally at 80 characters per second. In text mode, a logic-seeking feature finds the shortest route, permitting optimal printing throughput. The 9 x 9 dot-matrix character cells, together with the impact printing technique provide fast, legible character formation, including descenders (e.g. j, y, g, and q). Programmable line spacings, in increments of 1/72 inch, printing of superscripts and subscripts. A Roman character set allows printing in several languages.

The HP 82905B will print single or multipart forms (up to three parts, each with a maximum thickness of 0.3 mm). Its adjustable tractor feed mechanism can be used with all types of computer forms with widths between 10.2 cm (4 in.) and 25.5 cm (10 in.). Programmable page length allows the user to define page size and skip perforations.

#### Interface

Type: HP-IL (Hewlett-Packard Interface Loop)

Default address undefined

Default address after AAU: 5, supports extended addressing 40-bytes interface buffer (additional to printer buffer)

Opt. 248 . . . . . 120 Vac/HP-IL

Opt. 348 . . . . . 220 Vac/HP-IL

Opt. 448 . . . . . 240 Vac/HP-IL

#### Printer Buffer

One line, or up to 132 characters

### HP 82938A HP-IL/Series 80 Interface

The HP 82938A Interface provides a communication link between the portable world of small, battery-operable products and the world of larger computers. Use the HP-41 to gather data in the field and then access an HP Series 80 personal computer to do more complex analyses. With the built-in graphics capabilities of an HP-85, HP-86 or HP-87 Personal Computer, data can be displayed in easy-to-understand graphs and charts, or passed on to an even larger computer using Series 80 data communications products.

### HP 82163 Video Interface

The HP 82163A Video Interface provides video display capabilities for an HP-IL computer system. This HP-IL compatible interface supports a 32-character, 16-line video character display, enabling the user to interface an HP-IL controller with a VHF TV set or TV monitor.

Characters can be displayed in inverse video (black character on white background). The display memory, consisting of 992 bytes, will hold 31 lines of up to 32 characters. Sixteen lines may be viewed at one time. Any remaining lines may be displayed by scrolling them onto the screen. The HP-IL video system is an aid to program development or for making presentations to groups.

#### Display Characteristics

Line length: 32 standard characters.

Number of lines displayed: 16

Display memory: 31 lines (992 one-byte cells).

Character set: 95 ASCII display characters and 4 control characters.

HP82163A—US

HP82163B—European

### HP 82165A GPIO Interface Converter

The GPIO Interface allows HP-IL to control equipment operating with parallel bus structures. This device contains I/O buffering and a built-in power supply that operates from an HP standard ac adapter, (included with the HP 82165A). Potential applications for the HP 82165A include interfacing to computers for data collection, interfacing to specialized devices in production or lab environments, and interfacing to devices such as printers with parallel interfaces.

### HP 82166 HP-IL Converter

The HP 82166 HP-IL Converter is a component which can be designed into a microprocessor-based device. Once integrated into the design, the converter provides HP-IL communication capabilities for the device.

#### HP-IL Interface

The HP-IL interface portion of the converter performs standard operations required by the interface loop, such as maintaining the converter's talker or listener status, and accepting and passing HP-IL messages around the loop. The physical connection to HP-IL consists of standard HP-IL receptacles—one for incoming messages and one for outgoing messages.

#### GPIO Interface

The GPIO interface portion of the converter provides the connection to the host device. The physical connection consists of a 34-pin connector on the printed-circuit assembly. By making the appropriate connections, the host device provides power to the converter and uses signal lines to send and receive information from the converter. The signal lines include two GPIO data buses, GPIO handshake lines, HP-IL interfacing lines, and status lines. This interface may be used in several different configurations, such as 8-bit parallel, 16-bit parallel, and negative or positive true logic. The controller must have the capability of sending device dependent messages to change the default configuration.

#### Packaging

The HP-IL Converter comes in two packaging options:

- HP 82166A—A prototyping kit which includes two converters, an evaluation board, a manual, two HP-IL cables, and two GPIO connectors.
- HP 82166B—A production pack which contains ten converters.

#### Physical Specifications

16.0 x 11.9 x 2.8 cm (6.3" x 4.7" x 1.1")

#### Interface

Type: HP-IL (Hewlett-Packard Interface Loop)

Startup conditions: inactive

Default address: 3

### HP 3468A Digital Multimeter

The HP 3468A is an autoranging, 3½- to 5½-digit, five function digital multimeter with 1  $\mu$ V sensitivity to solve most precise bench applications. The multimeter can be completely calibrated electronically through an easy and simple procedure. The HP-IL compatible multimeter can be controlled with an HP-41 Handheld Computer and comes with a battery option for benchtop convenience or field operation. The HP 82162A Printer/Plotter can be connected to the HP 3468A and, without the aid of a controller, will print or plot information from the multimeter.

#### Ordering Information

HP 82905B Opt. 248, 348, 448

HP 82938A

HP 82163A/B

HP 82165A

HP 82166A

HP 82166B

HP 3468A

# COMPUTERS, PERIPHERALS & CALCULATORS

## Personal Computation Comparison Chart

	Financial		Advanced		Scientific		Computer Science
	HP-12C	HP-97	HP-41C/CV	HP-15C	HP-11C	HP-10C	HP-16C
<b>Operating Features</b>							
RPN logic system (with 4-register stack)	●	●	●	●	●	●	●
Error recovery (last x)	●	●	●	●	●	●	●
Maximum number of storage registers	20	26	919*	67	21	10	101R
Continuous Memory	●		●	●	●	●	●
Maximum number of digits displayed	10	10	10	10	10	10	10F
Number of digits used in computation	10	10	10	10	10	10	10D
Rechargeable batteries/AC recharger		●	●				
Long-life disposable batteries	●		●	●	●	●	●
<b>Software Support</b>							
Application Pacs (with modules)			●				
Application Pacs (with magnetic cards)		●					
Solution Books/Handbooks	●	●	●	●	●		
Users' Library programs		●	●				
<b>Accessory Support</b>							
Memory Modules			●+				
Extended Memory Modules			●				
Time Module			●				
Reserve power pack		●					
Security cradle/cable		●					
Multipurpose rechargeable battery pack			●				
<b>General Features</b>							
One-year limited warranty	●	●	●	●	●	●	●
Display separates thousands	●		●	●	●	●	●F
Diagnostic self-check	●	S	●	●	●	●	●
Error codes/messages	●		●	●	●	●	●
Redefinable keys		●	●	●	●	●	●
Alpha mode/display/keyboard			●	●	●	●	●
Status annunciators	●		●	●	●	●	●
Automatic power off	●		●	●	●	●	●
Audible tones			●				
<b>Programming Features</b>							
Maximum number of program lines	99	244	6,433*	448	203	79	203
Shared program/storage memory	●		●	●	●	●	●
Alpha program labels			●				
Single-character program labels		10	56	5	5		6
Numeric program labels		10	100	20	10		10
Program review (single-and backstep)	●	●	●	●	●	●	●
Insert/delete editing	●	●	●	●	●	●	●
GO TO	●	●	●	●	●	●	●
Levels of subroutines		3	6	7	4		4
Conditional tests	2	8	10	12	8	2	8
Flags		4	56	10	2		6
Pause	●	●	●	●	●	●	●
Indexed looping (DSE, ISG)		●	●	●	●		
Indirect control of: Data storage/recall		●	●	●	●		●
Storage register arithmetic		●	●	●	●		●
Branching		●	●	●	●		●
Looping		●	●	●	●		●
Display format		●	●	●	●		●
Flags		●	●	●	●		●
Integer/fraction truncation		●	●	●	●		●
Alpha string manipulation	●	●	●	●	●		●
<b>Dedicated Input/Output Devices</b>							
Card Reader		●	P				
Printer/Plotter		●	P				
Optical wand			P				
<b>HP-IL Peripherals</b>							
Digital Cassette Drive			P				
Thermal Printer/Plotter			P				
Impact Printer (80-column)			P				

**Symbols**

- Built-in feature or function.
- To be used with the HP-41C only.
- + To be used with the HP-41C only.
- \* The HP-41C has 63 registers or 441 program bytes built in, (expandable to 922 registers or 6,433 bytes with memory modules and extended memory modules).
- The HP-41CV has 319 registers or 2,233 bytes built in, (expandable to 6,433 bytes).
- P Peripheral available
- S Available in software form
- F Using Floating-Point Decimal Mode.
- D Ten digits are used in computation when in Floating-Point Decimal Mode. Word size is user-specifiable in other modes, up to 64 bits.
- R 16-bit registers

	Financial		Advanced		Scientific		Computer Science
	HP-12C	HP-97	HP-41C/CV	HP-15C	HP-11C	HP-10C	HP-16C
HP-IL/GPIO Interface			P				
HP-IL Video Interface			P				
<b>General Arithmetic Features</b>							
+ , - , X , / , √ x , 1/x , CHS	●	●	●	●	●	●	●
Ln x , e <sup>x</sup>	●	●	●	●	●	●	●
y <sup>x</sup> , Log x , 10 <sup>x</sup> , x <sup>2</sup> , π	●	●	●	●	●	●	●
Absolute value	●	●	●	●	●	●	●
Storage register arithmetic	●	●	●	●	●	●	●
<b>Business Features</b>							
Maximum number of dedicated financial registers	5						
Solves for:							
Number of periods (n), compound interest (i), present value (PV), payment, (PMT), future value (FV)	●	S	S	S	S	S	
Simple interest	●	S	S		S	S	
Amortization (accumulated interest/remaining balance)	●	S	S		S		
Net present value (NPV) and internal rate of return (IRR)	●	S	S	S			
Beginning/end of period selection	●	S	S	S	S		
Calendar functions	●	S	S				
Bond:							
Yield-to-maturity	●	S	S				
Price	●	S	S				
Depreciation (SL, DB, SOYD)	●	S	S		S		
<b>Scientific Features</b>							
Solve (root finder)		S	S	●	S		
Integrate (numerical integration)		S	S	●	S		
Matrix operations		S	S	●			
Complex functions		S	S	●	S		
Bit manipulation				●			
Boolean operators (NOT, OR, AND, XOR)							●
Complement modes (1's, 2's, unsigned)							●
Number base arithmetic (binary, octal decimal, hexadecimal)		S	●S				●
Metric conversions		S	S				
Trigonometric functions:							
Modes (degrees, radians, grads)		●	●	●	●	●	●
Sin, Sin <sup>-1</sup> , Cos, Cos <sup>-1</sup> , Tan, Tan <sup>-1</sup>		●	●	●	●	●	●
Hyperbolic and inverses		S	S	●	●	●	●
Rectangular — polar coordinates		●	●	●	●	●	●
Decimal angle — angle in degrees (hrs)/min/sec.		●	●	●	●	●	●
Degrees — radians		●	●	●	●	●	●
Fixed and scientific notation	●	●	●	●	●	●	●
Engineering notation		●	●	●	●	●	●F
Automatic under/over flow into scientific	●	●	●	●	●	●	●F
<b>Statistical Functions</b>							
Percent	●	●	●	●	●	●	●
Percent change	●	●	●	●	●	●	●
Percent total	●	●	●	●	●	●	●
Mean/standard deviation (1- or 2-variable)	●	●	●	●	●	●	●
n, Σx, Σx <sup>2</sup> , Σy, Σy <sup>2</sup> , Σxy	●	●	●	●	●	●	●
Weighted mean	●	S	S				
Linear regression or estimate	●	S	S	●	●	●	●
Correlation coefficient	●	S	S	●	●	●	●
Normal distribution	S	S	S	S	S		
Factorial function	●	●	●	●	●	●	●
Gamma function	●	S	S	●	●	●	●
Permutations and combinations	S	S		●	●	●	●
Random number generator	S	S	S	●	●	●	●



### Calculator and Handheld Computer Accessories

A Hewlett-Packard calculator or computer purchase is a smart decision. Power, convenience, and quality from a company the user can depend on. But HP's computing products also have a versatility unequaled in the industry. There's a complete accessory line engineered to provide the support users need. No matter what type of Hewlett-Packard calculator/computer the user purchases, it is supported by a full line of accessories and supplies to keep it operational.

### HP Users' Library

The Users' Library is a resource of HP reviewed programs, written and submitted by users of HP-41 Handheld Computers and HP-67 and HP-97 calculators. A wide variety of programs have been submitted for specific applications. As a subscriber to the Library, members will receive the "Catalog of Contributed Programs", the "Contributor's Guide", periodic supplements, and coupons for four \$6.00 programs of the subscriber's choice complete with pre-recorded magnetic cards, and a one-year subscription to the HP "Keynotes" newsletter for the HP-41/67/97.

### Ordering Information

One-Year Subscription (U.S. and Canada)

One-Year Subscription (Outside U.S. and Canada)

HP-67, HP-97 Programs (Includes complete documentation and magnetic cards.)

HP-41C, HP-41CV Programs (Includes complete documentation, magnetic cards, and bar code.)

Dealer Catalog 5955-9422 (Includes coupon for one free program)

HP 82176A Cassette Duplication Service (Cassettes included)

### Custom Products

HP Custom Products satisfy the growing need for specialization in portable computing products. Through customization, the powerful HP-41C and HP-41CV Handheld Computers can be tailored to do dedicated complex and repetitious calculations or data acquisition tasks when and where needed. Already many companies have improved their productivity with customized HP-41's. Proven Custom Products applications, in banking, fuel savings, media buying, heavy equipment sales and service, provide the same result: increased performance and improved productivity.

Using customer or third-party written programs, the HP-41 or an HP-41 with blank keys (Option 001), can be customized using one of three options: ROM's, magnetic cards, or bar code. When selecting one of these alternatives, consideration is given to: frequency of code alterations, desired program capacity, updating of variables in the data, required level of privacy and initial investment. For assistance, consult a local HP Field Engineer.

#### HP 82500A or B Custom Modules (ROM's)

4K or 8K bytes of memory with each module. Nearly 21,000 program lines with up to four 8K modules.

#### HP 82502A Custom Magnetic Cards

Used with the HP-41C, HP-41CV, HP-67, and HP-97. Each card can be customized to load up to 225 bytes of instructions.

#### Custom Bar Code

Inexpensive way to load custom programs or data. Available from an independent vendor.

### Custom Overlays and Custom Keyboards

Both re-label the HP-41 keyboard with special functions assigned to each key. Available in a variety of background and printing colors.

A custom HP-41C or HP-41CV Option 001 with a blank keyboard eliminates unnecessary and possibly distracting nomenclature. This special option allows the user to label those keys that precisely fit the application, minimizing potential user error. Custom overlays, (HP 82501A), and custom keyboards, (HP 82504A), label keys to provide the final professional touch.

### Ordering Information

Quantity	Custom Modules		Custom Mag Card	Custom Bar Code	Custom Overlays	Custom Keyboards
	8K	4K	4K (18 cards/set)	4K (6 cards/prog)		
100						
250						
500						
1000						
5000						

\*Contact the local sales office

### HP-41 Application Pacs

Every application pac comes with a comprehensive manual, an application module and, when applicable, a keyboard overlay.

Choose from:

- Aviation (for pre-flight use)
- Clinical Lab & Nuclear Medicine
- Circuit Analysis
- Financial Decisions
- Mathematics
- Games
- Home Management
- Real Estate
- Thermal & Transport Science
- Petroleum Fluids
- Securities
- Statistics
- Stress Analysis—Mechanical Engineers
- Structural Analysis—Civil Engineers
- Surveying
- Machine Design
- Navigation

### HP-41 Solution Books

Business:

- Business Statistics/Marketing/Sales
- Home Construction Estimating
- Lending, Savings, & Leasing
- Real Estate
- Small Business

Engineering:

- Antennas
- Chemical Engineering
- Civil Engineering
- Control Systems
- Electrical Engineering
- Fluid Dynamics & Hydraulics
- Heating, Ventilating & Air Conditioning
- Mechanical Engineering
- Solar Engineering

Computation:

- Geometry
- High-Level Math
- Test Statistics

Other:

- Calendars
- Cardiac/Pulmonary
- Chemistry
- Games
- Optometry I (General)
- Optometry II (Contact Lenses)
- Physics
- Surveying
- Taxes
- Time Module Solutions I



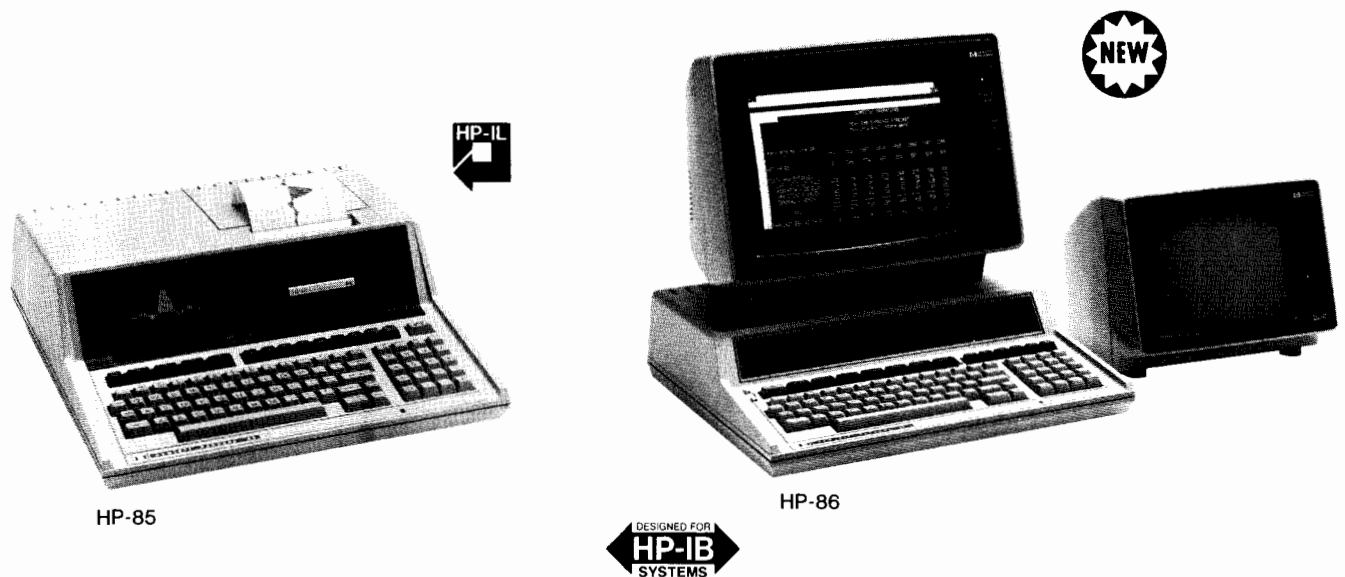

HP-85

HP-86

### Why A Personal Computer?

As a working professional, you need dedicated problem-solving power. HP's personal computers give you that power. The broad line of Series 80 personal computer products includes high-performance mainframes, peripherals, firmware, interfaces, and software, all designed to enhance your on-the-job performance.

#### Series 80 Mainframes

Hewlett-Packard's Series 80 personal computers are designed to be used as analytical computing tools, system controllers, or as office partners, to help you solve your problems in engineering, business, or science. The HP-85, HP-86, and HP-87 Personal Computers all feature enhanced HP BASIC (a superset of ANSI BASIC) with more than 150 commands and statements. Enhancement ROM's (read-only memories) further extend programming capability by adding commands and functions to the mainframe, increasing the capabilities of existing commands, or allowing you to easily and quickly interface the computer with peripherals or instruments.

#### HP-85 Personal Computer

The HP-85 Personal Computer combines an alphanumeric keyboard, CRT screen, thermal printer, tape drive unit, user read/write memory, and a ROM operating system in one portable package. The operating system and read/write memory can be expanded to 120 kbytes. This includes a 32K ROM operating system, 8K of display memory, 16K of internal read/write memory that expands to 32K RAM with a plug-in memory module, and the capacity for six 8K ROM's.

The typewriter-like keyboard includes eight user-definable keys which make it easier to write, execute, and control your programs.

The HP-85's compact design lets you take computing power to your problems. You can use the built-in thermal printer to produce hard copy of your results. And, take along both data and software on tape cartridges that run on the built-in tape drive. In the office or lab, four I/O ports on the back of the HP-85 allow easy interfacing to peripherals and instruments.

#### HP-85A Specifications

**User Memory:** 16 kbytes, expandable to 32 kbytes with the addition of the plug-in HP 82903A 16K Memory Module.

**CRT display area:** 12.7 cm (5 in.) diagonal. 16 lines x 32 characters (alphanumeric), 192 x 256 dots (graphics).

**Thermal printer:** 32-character width, 2 line/sec, bidirectional printer, adjustable intensity.

**Magnetic tape cartridge:** 210 kbytes capacity, 42 separate files, search speed of 60 in./sec, read/write speed of 10 in./sec.

**Power requirements:** 90 to 127 Vac (115 Vac line), 200 to 254 Vac (230 Vac line), switch selectable, Frequency of 50 to 60 Hz.

**Size:** 15 x 41.9 x 45.2 cm (6.3" x 16.5" x 17.8").

#### HP-86 Personal Computer

Hewlett-Packard's newest addition to the Series 80 family features a modular design that gives you convenient system flexibility. With the HP-86 you have the option of using either a 9-inch or 12-inch monitor, via a built-in interface. Additional system configurations are just as simple with built-in interfaces for two HP 9130A disc drives and a Centronics-compatible printer.

The HP-86 also features 64 kbytes of built-in user memory (RAM), expandable to 576 kbytes, a 48K ROM operating system, and 16K CRT memory.

Powerful HP BASIC programming capabilities, an expandable memory, and dedicated disc and printer interfaces add to the features of the HP-86. The keyboard has 14 user-definable keys that aid typing and let you select options within program execution. BASIC functions and statements build on those on the HP-85, with added functions that include string arrays, multi-parameter functions, multiple binary programs, formatted program listings, and graphics, printer, and mass storage commands.

#### HP-86 Specifications

**User memory:** 64 kbytes, expandable to 576 kbytes, with the addition of HP memory modules.

**Memory modules:** HP 82907A 32K, HP 82908A 64K, HP 82909A 128K.

**Power requirements:** 90 to 127 Vac (115 Vac line), 200 to 254 Vac (230 Vac line), switch selectable. Frequency of 50 to 60 Hz.

**Size:** 13 x 42 x 46 cm (5" x 16.5" x 17.8").

**Display capacity:** Alphanumeric—16 or 24 lines (variable) x 80 characters; Graphics—400 or 544 x 240 dots (variable).

#### HP 82912A/HP 82913A Monitors

##### For the HP-86 Personal Computer

##### HP 82912A 9-inch Monitor Specifications

**Display area:** 16.5 x 11 cm (6.4" x 4.3").

**Power requirements:** 108 to 132 Vac (120 Vac line). Frequency of 60 Hz.

**Power requirements (Opt. 001):** 207 to 265 Vac (230 Vac line). Frequency of 50 to 60 Hz.

**Size:** 21.8 x 27 x 26.1 cm (8.5" x 10.5" x 10.2").

##### HP 82913A 12-inch Monitor Specifications

**Display area:** 23 x 15 cm (9" x 5.8").

**Power requirements:** 108 to 132 Vac (120 Vac line). Frequency of 60 Hz.

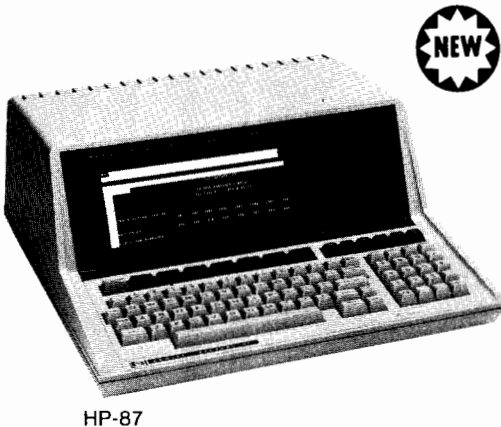

HP-87

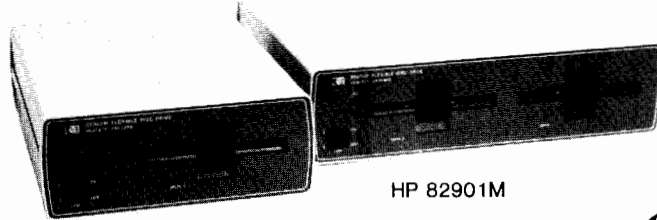

HP 82902M

HP 82901M

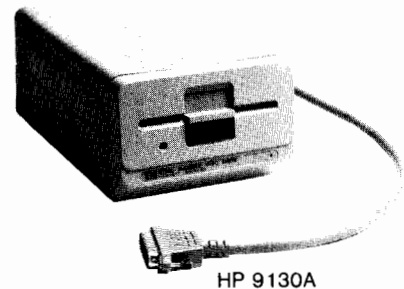

HP 9130A

**Power requirements (Opt. 001):** 207 to 264 Vac (230 Vac line). Frequency of 50 to 60 Hz.  
**Size:** 29.6 x 36 x 33 cm (11.5" x 14" x 12.8").

## HP-87 Personal Computer

If you need an expandable system for demanding applications, the HP-87 Personal Computer is your best choice. It has 128 kbytes of built-in user memory with the capability to expand to 640 kbytes, a 48K ROM operating system, and 16K of display memory.

The HP-87 also features a built-in HP-IB interface that makes it easy to link your computer to up to 14 plotters, printers, disc drives, and instruments without taking up an expansion port.

The typewriter-like keyboard includes 14 user-definable keys that help you speed programming and identify branch routines during program execution. In addition, you can have the advantage of enhanced HP BASIC functions, including string arrays, multi-parameter functions, multiple binary programs, formatted program listings, and graphics, printer, and mass storage commands. Plus, you'll find that most HP-85 programs will run on the HP-86 or HP-87 with little or no modification. HP-86 and HP-87 programs are 100 percent compatible.

The 80-character-wide, high-resolution CRT screen gives you plenty of room to display programs, tables, or graphics. And, with a quick command, you can change the CRT display from 16 to 24 lines of characters.

## HP-87 Personal Computer Specifications

**User memory:** 128 kbytes, expandable to 640 kbytes, with the addition of HP memory modules.

**CRT display area:** 20.3 x 7.6 cm (7.9" x 3") (10 in. diagonal), 16 or 24 lines (variable) x 80 characters, 400 or 544 x 240 dots (variable). Low-glare lens provides high contrast on screen.

**Power requirements:** 90 to 127 Vac (115 Vac line), 200 to 254 Vac (230 Vac line). Frequency of 50 to 60 Hz.

**Size:** 19.6 x 41.9 x 45.2 cm (7.7" x 16.5" x 17.8").

## System Expansion Capability

### Memory Modules

You can increase the internal read/write memory of a Series 80 personal computer with optional memory modules that plug into the

expansion ports on the back of the computer. If you have an HP-85 Personal Computer, use the HP 82903A 16K Memory Module to double user memory.

With the HP-86 and HP-87, you can use the HP 82907A 32K, HP 82908A 64K, and HP 82909A 128K Memory Modules to increase your memory capacity.

## Series 80 Peripherals

### Mass Storage Units

You can choose the mass storage unit that best fits your computing requirements when you need to increase the memory capacity of your Series 80 system, or gain high-speed transfer rates for your data.

**HP 82901M Flexible Disc Drive:** supplies approximately 540 kbytes of on-line storage. This unit consists of two flexible disc drives.

**HP 82902M Flexible Disc Drive:** supplies approximately 270 kbytes of on-line storage. This unit consists of one flexible disc drive.

**HP 9130A Flexible Disc Drive:** supplies approximately 270 kbytes of on-line storage on one disc. This unit is designed specifically for the HP-86, and will operate only with that computer. Two units may be used with the HP-86 at the same time.

**HP 9134A Winchester Disc:** supplies approximately 4.6 Mbytes of storage on one fixed Winchester disc. This unit is designed for the user who needs extra storage capacity and fast data transfer time.

**HP 9135A Combination Disc Drive:** supplies approximately 4.6 Mbytes of storage on one fixed Winchester drive and 270 kbytes on one flexible disc for a combined total of 4.87 Mbytes. With this combination you can take advantage of the large storage capacity and high speed of a fixed Winchester disc, as well as the convenience of a removable flexible disc.

**HP 9138A Combination Disc Drive:** supplies 4.6 Mbytes of storage on one 5 1/4" fixed Winchester disc and 1.15 Mbytes on one 8" flexible disc. With this disc drive you get significant back-up capacity and easy exchange of data and programs.

**HP 9895A Flexible Disc Drive:** supplies 2.3 Mbytes of storage on two 8" flexible discs.

**HP 9895A Flexible Disc Drive Opt. 010:** supplies 1.15 Mbytes of on-line storage on one 8" flexible disc.

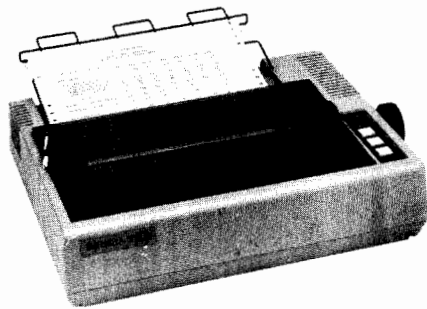

HP 82905B

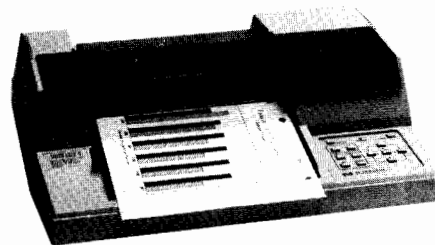

HP 7470A

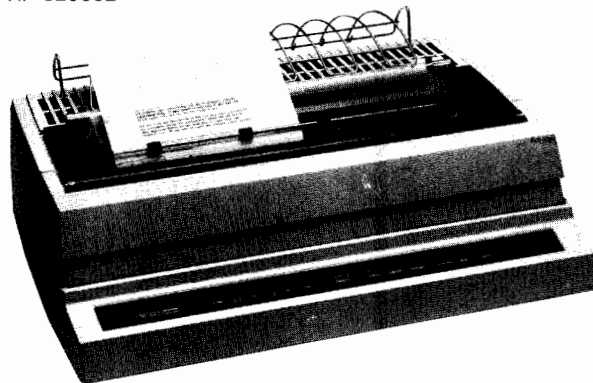

HP 2601A

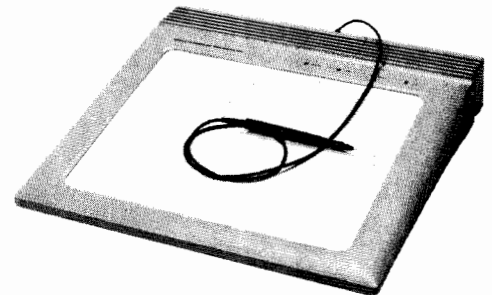

HP 9111A

#### Printer Options

**HP 82905B Graphics Printer:** operates bidirectionally at 80 characters/sec. In text mode, a logic-seeking feature finds the shortest route, permitting optimal printing throughput. A special graphics mode allows dot-by-dot control of the printing to provide either 72 x 60 or 72 x 120 dots per inch. The 9 x 9 dot-matrix provides a character set with true descending characters. Compressed and expanded modes provide print at 5, 8.25, 10, and 16.5 characters/in., allowing up to 132 characters per line on an 8½" page. Programmable line spacing allows the printing of subscripts and superscripts, and specialized forms. HP-IL compatibility is available with the HP 82905B Printer, Opt. 248.

**HP 2601A Daisy Wheel Printer:** gives you letter-quality printouts that equal the caliber of letters and reports you produce on a typewriter. You can use either a metal or plastic wheel and choose from a variety of typefaces. The printer features word processing enhancements and bold and shadow printing.

**HP 2631B Impact Printer:** a full-size, high-speed, bidirectional, dot-matrix impact printer for high-volume applications. The HP 2631B prints 180 characters per second on inexpensive computer paper or multi-part forms. This printer has eight print sizes and a forms tractor.

**HP 2671A Thermal Printer:** features the full 128 USASCII character set, Roman extension characters for international use, and line drawing characters to create forms. The 2671A prints up to 132 characters per line. Additional features include 120 characters-per-second speed, bidirectional thermal printing, 9 x 15 dot-matrix character cells, and true descending characters.

**HP 2671G Graphics Printer:** offers all the features of the HP 2671A plus high-resolution graphics printing of charts, tables, illustrations, and graphs.

**HP 2673A Intelligent Graphics Printer:** includes all the capabilities of the HP 2671A/G plus auto-centering, windowing, and offsets. Margins, tabs, print mode, character sets, page format, and data communications parameters are selected via an expanded control panel. The HP 2673A offers bidirectional thermal printing at 120 characters per second, with 9 x 15 dot-matrix character cells, and true descenders.

#### Graphics Options

**HP 7470A Graphics Plotter:** produces high-quality plots on any size chart up to 19 x 27.3 cm (7.5" x 10.7"). Special paper-moving technology grips 8½" x 11" paper or overhead transparency film and moves it to provide rapid plotting capability.

**HP 9111A Graphics Tablet:** provides an electronic way to create, display, and interact with pictorial information. As you move a pen-like stylus on the tablet's surface, the tablet translates these points into X, Y coordinate points and transmits these points to the HP-85 Personal Computer. Utility software programs for the HP-85 interpret these points in graphic formats specific to each program's application.

Note: For more information about Series 80 peripherals, please consult pages 608 through 624.

#### Ordering Information

**HP-85A Personal Computer**  
**HP-86A Personal Computer**  
**HP 82912A 9-inch monitor**  
**HP 82913A 12-inch monitor**  
**HP-87 Personal Computer**  
**HP 82903A 16K Memory Module**  
**HP 82907A 32K Memory Module**  
**HP 82908A 64K Memory Module**  
**HP 82909A 128K Memory Module**  
**HP 82901M Flexible Disc Drive**  
**HP 82902M Flexible Disc Drive**  
**HP 9130A Flexible Disc Drive**  
**HP 9134A Winchester Disc Drive**  
**HP 9135A Combination Disc Drive**  
**HP 9138A Combination Disc Drive**  
**HP 9895A Flexible Disc Drive**  
**HP 9895A Opt. 010 Flexible Disc Drive**  
**HP 7470 Opt. 001 Graphics Plotter (Serial Interface)**  
**HP 7470A Opt. 002 Graphics Plotter (HP-IB Interface)**  
**HP 9111A Graphics Tablet Opt. 085 (includes utility software for HP-85 only)**  
**HP 82905B Opt. 002 Printer**  
**HP 2601A Daisy Wheel Printer**



Series 80 ROM's  
and ROM Drawer

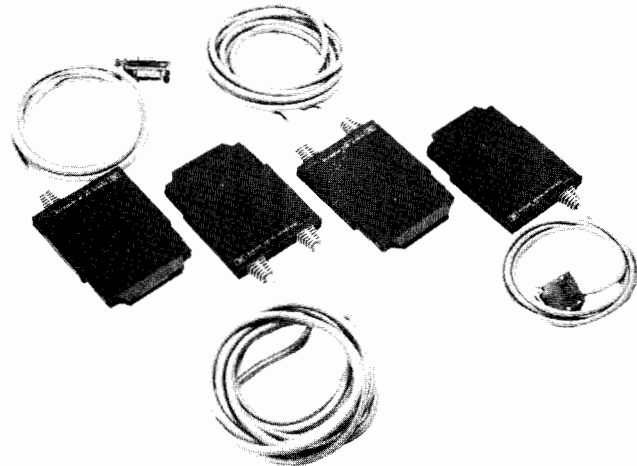

Series 80 Interfaces

- HP 2631B Opt. 885 Printer
- HP 2671A Thermal Printer
- HP 2671G Thermal Graphics Printer
- HP 2673A Thermal Intelligent Graphics Printer

#### Series 80 Enhancements

**HP 82936A ROM Drawer:** plugs into a Series 80 personal computer. The Drawer has slots for six 8K ROM's.

**Mass Storage ROM (00085-15001):** adds 30 operations that enable complete control and utilization of Series 80 mass storage units.

**Plotter/Printer ROM (00085-15002):** enables you to interface your HP-85 Personal Computer with Hewlett-Packard's graphics plotters and printers.

**Plotter ROM (00087-15002):** enables you to interface your HP-86/87 Personal Computer with Hewlett-Packard's graphics plotters. (Printer commands are built into the HP-86 and HP-87.)

**I/O ROM (00085-15003 or 00087-15003):** provides BASIC language extensions to Series 80 personal computers, allowing general I/O capability for a variety of interfaces and devices.

**Matrix ROM (00085-15004):** adds a powerful set of statements and functions to the HP-85 for working with both matrices (two dimensional arrays) and vectors (one-dimensional arrays).

**Advanced Programming ROM (00085-15005):** adds functions, statements, and commands to the HP-85 that give you extended control over data, programs, and system operations.

**Assembler ROM (00085-15007 or 00087-15007):** provides the capability to write customized Assembly language programs on Series 80 personal computers. These programs can be executed from random access memory or from programmable ROM's.

**HP 82928A System Monitor:** provides the necessary hardware to debug Assembly language software for Series 80 computers.

**HP 82929A Programmable ROM Drawer:** enables you to use, in a Series 80 computer, EPROM's that you have created. In conjunction with the Assembler ROM and the System Monitor, this product completes a package designed to supply tools necessary to develop EPROM's for Series 80 computers.

#### Series 80 Interfaces

**HP 82937A HP-IB Interface:** implements the IEEE 488-1978 Standard Digital Interface for programmable instrumentation and is re-

quired for interfacing all HP-IB peripherals. It may communicate to as many as 14 HP-IB peripherals or compatible instruments per interface. (An HP-IB interface is built into the HP-87 Personal Computer.)

**HP 82938A HP-IL Interface:** bit-serial interface that combines low power, small size, and low cost. With HP-IL you can interface as many as 30 devices with up to 10 meters of cable between each device.

**HP 82939A Serial Interface:** provides RS-232 compatible I/O for communications with devices such as printers and terminals.

**Standard HP 82939A:** RS-232C female (DCE) connector.

**Option 001:** serial interface module with male connector for Series 80 computers; typically used with modems.

**Option 002:** serial interface module with current loop cable for Series 80 computers.

**HP 82940A GPIO Interface:** provides 16-bit general purpose input/output operations.

**HP 82941A BCD Interface:** provides the hardware necessary for connection to devices having BCD (binary coded decimal) outputs.

**HP 82949A Printer Interface:** standard 8-bit parallel printer interface module for connecting printers with a Centronics-type interface.

#### HP 82900A CP/M System

The plug-in CP/M module extends the HP-86 or HP-87 system by adding a Z-80 processor and 64 kbytes of dedicated RAM (CP/M user memory). With the CP/M operating system loaded from disc, your HP-86 or HP-87 will accept the vast library of software written under the CP/M system. The CP/M System also gives you ready access to other computer languages, including PASCAL and FORTRAN.

#### HP 82950A Modem

The HP 82950A Series 80 Modem is a serial, asynchronous, full-duplex modem that lets you and your Series 80 personal computer communicate with industrial data bases or commercial time-sharing networks such as the Dow Jones News/Retrieval Service, The Source, and CompuServe. The Modem plugs easily into one of the expansion ports on the back of a Series 80 computer and connects directly to the telephone. The HP 82950A Modem is compatible with the Bell 103/113 modems and lets you communicate with the majority of time-sharing computers in the United States. It operates at speeds of 110 to 300 baud.

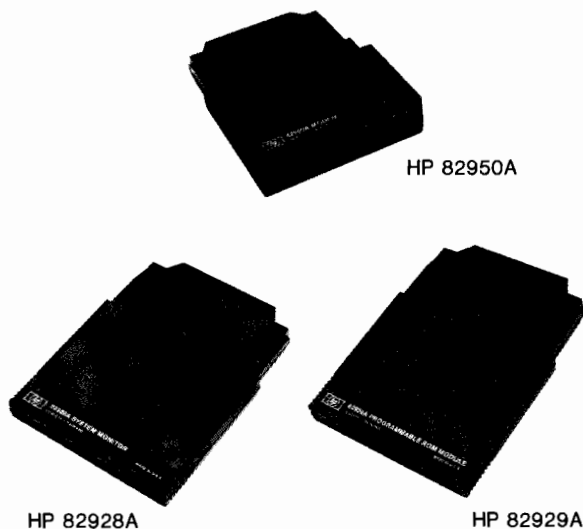

#### Ordering Information

**HP 82936A** ROM Drawer

**00085-15001** HP-85 Mass Storage ROM

**00085-15002** HP-85 Plotter/Printer ROM

**00087-15002** HP-86/87 Plotter ROM

**00085-15003** HP-85 Input/Output ROM

**00087-15003** HP-86/87 Input/Output ROM

**00085-15004** HP-85 Matrix ROM

**00085-15005** Advanced Programming ROM

**00085-15007** HP-85 Assembler ROM

**00087-15007** HP-86/87 Assembler ROM

**HP 82928A** System Monitor

**HP 82929A** Programmable ROM Drawer

**HP 82937A** HP-IB Interface

**HP 82939A** Serial Interface (RS 232C):

Female Connector

**HP 82939A Opt. 001** Serial Interface:

Male Connector

**HP 82939A Opt. 002** Serial Interface: Current Loop

**HP 82938A** HP-IL Interface

**HP 82940A** GPIO Interface

**HP 82941A** BCD Interface

**HP 82949A** Printer Interface

**HP 82900A** HP-86/87 CP/M System

**HP 82950A** Series 80 Modem

#### HP-85F Interfacing Systems

##### HP-85F Interfacng System

Includes: HP-85A, HP 82936A ROM Drawer, I/O ROM (00085-15003), and HP 82937A HP-IB Interface.

##### HP-85F Interfacing System Opt. 001

Includes: HP-85A, HP 82936A ROM Drawer, I/O ROM (00085-15003), and HP 82939A Serial Interface

##### HP-85F Interfacing System Opt. 002

Includes: HP-85A, HP 82936A ROM Drawer, I/O ROM (00085-15003), and HP 82939A Option 001 Serial Interface

##### HP-85F Interfacing System Opt. 003

Includes: HP-85A, HP 82936A ROM Drawer, I/O ROM (00085-15003), and HP 82939A Option 002 Serial Interface

##### HP-85F Interfacing System Opt. 004

Includes: HP-85A, HP 82936A ROM Drawer, I/O ROM (00085-15003), and HP 82940A GPIO Interface

##### HP-85F Interfacing System Opt. 005

Includes: HP-85A, HP 82936A ROM Drawer, I/O ROM (00085-15003), and HP 82941A BCD Interface

## Series 80 Software

If your work includes writing reports, making presentations, performing analyses, and managing information, then you can benefit from using Series 80 software with your personal computer. Series 80 offers a wide range of software packages, including HP-developed software, CP/M software for Series 80 personal computers, and user-proven software that you can purchase from your dealer, HP representative, or suppliers through the HP PLUS program.

### Software Descriptions and Ordering Information Computation and Analysis

**VisiCalc® PLUS:** this powerful analytical tool gives you the capability to prepare a five-year forecast with over 200 line items—on a worksheet with 63 columns and 254 rows. And, you get the Series 80 PLUS: graphics and financial analysis capabilities built into VisiCalc.

**00085-13042** (HP-85 only)

**00087-13001** (HP-86/87 only)

VisiCalc® is a registered trademark of VisiCorp.

**General Statistics:** offers widely-used statistical tools for one-sample analysis, chi-square, one- and two-way analysis of variance, t-test, and multiple linear regression.

**00085-13003**

**Basic Statistics and Data Manipulation:** prepares your data for analysis and computes such summary statistics as mean, standard deviation, number of observations, median, confidence interval, and quartiles.

**00085-13036**

**Regression Analysis:** analyzes relationships between a dependent variable and one or more independent variables.

**00085-13037**

**Statistical Analysis Multi Pac:** gives you a complete, integrated software package for performing statistical analysis. Combines the General Statistics, Basic Statistics and Data Manipulation, and Regression Analysis pacs.

**00085-13058**

#### Report Writing

**WordStar®:** provides aids for editing, reorganizing, and formatting printed documents.

**00087-16001** (HP-86/87 only, requires HP 82900A CP/M System)

**SpellStar®:** uses a dictionary of approximately 20,000 words to check WordStar files for spelling and typographical errors.

**00087-16003** (HP-86/87 only, requires HP 82900A CP/M)

**MailMerge®:** merges files or a mailing list into a form letter file.

**00087-16002** (HP-86/87 only, requires HP 82900A CP/M)

WordStar®, SpellStar®, and MailMerge® are trademarks of Micro-Pro International Corporation.

**Text Editing:** enables you to write memos, outlines, and reports on your display screen, and edit copy by changing words or moving groups of lines.

**00085-13034** (HP-85 only)

#### Data Communications

**Data Communications Pac:** gives Series 80 computers the flexibility to communicate with other computers at speeds of up to 9600 baud.

**00085-13044**

#### Presentations

**Graphics Presentations:** lets you create graphics on paper for reports and analysis, or on transparencies for overhead presentations.

**00085-13038** (HP-85 only)

**00087-13002** (HP-86/87 only)

#### Information Management

**dBase II:** lets you create interrelated files and enter and retrieve information

**00087-16004** (HP-86/87 only, requires HP 82900A CP/M)

**File Manager:** aids record-keeping with nested sort capability, and built-in report and graphics programs.

**HP 88103A** (HP-85 only)

**Information Management Pac (IMPac):** lets your HP-85 handle list management.

**00085-13045** (HP-85 only)

#### Accounting and Finance

**Peach-tree Accounting 8:** use these pacs as a fully integrated set, or buy each module individually, according to your needs.

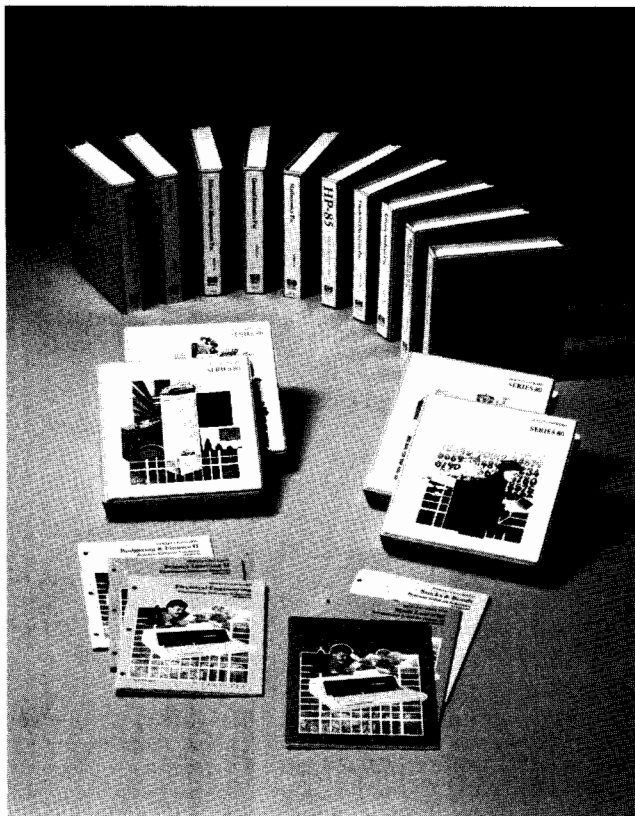

**General Ledger:** helps you track transactions of a company.

00087-16010 (HP-86/87 only)

**Accounts Receivable:** helps you prepare bills and obtain timely collections from your customers.

00087-16011 (HP-86/87 only)

**Accounts Payable:** maintains a complete file for each vendor.

00087-16012 (HP-86/87 only)

**Inventory Control:** helps you exercise control over all facets of your inventory operations.

00087-16014 (HP-86/87 only)

**PeachPay® Payroll System:** maintains a complete employee payroll history and will support weekly, bi-weekly, semi-monthly, and monthly pay periods.

00087-16013 (HP-86/87 only)

**TAJ® The Accounts Journal®:** fully integrates the journals needed in small business accounting.

00085-16001 (HP-85 only)

**Financial Decisions:** provides programs for a variety of financial analyses.

00085-13004

PeachPay® is a trademark of Peachtree Software, Inc. TAJ® and The Accounts Journal® are trademarks of Production Data Systems.

#### Technical Solutions

**Waveform Analysis:** offers a wide range of applications in digital signal processing.

00085-13035

**AC Circuit Analysis:** lets you quickly and easily simulate AC circuits and analyze their performance on a Series 80 personal computer, so you can recognize design problems early in the development process.

00085-13006

**Math:** provides quick access to common mathematical routines.

00085-13005

**Electronics Engineering Multi Pac:** offers a broad solution to your analytical problems by combining the AC Circuit, Waveform Analysis, and Math software packages.

00085-13059

**Surveying:** helps you calculate and reduce field data in field traversing, coordinates, azimuths, sectors and fill areas, and station and elevation for vertical curves and grades.

00085-13046

**Linear Programming:** enables you to optimize linear programming models with up to 200 variables with 80 constraints.

00085-13011

#### Additional Solutions

**BASIC Training:** provides a self-teaching, tutorial course on the operation and programming of Series 80 personal computers.

00085-13003 (HP-85 only)

00087-13004 (HP-86/87 only)

**Games and Games II:** two games pacs include card games, board games, dynamic action games, and games of pattern generation.

00085-13010 (Games)

00085-13057 (HP-85 only) (Games II)

In addition to the software pacs listed above, third-party software solutions exist for such applications as:

- Real Estate Analysis
- Hydrology
- Optical Design
- Tax Planning
- Structural Engineering
- Design & Mapping
- Medical & Dental
- Topography
- Chemical Engineering

**Series 80 Users' Library:** contains over 400 programs written by owners of Series 80 personal computers. These programs cover applications ranging from business and finance to the physical sciences. For more information on purchasing or contributing programs, see the Series 80 Software Catalog, published by Reston Publishers and available from major bookstores and computer retail outlets.

#### Series 80 Solution Books

These books provide you with ready-to-use programs. You need only type them into your computer and they're ready to run. Each of the 16 books contains from nine to twelve programs in one of these application areas—Business, Engineering, Science, Education, and Recreation. Programs are also available on software media (tape or 5¼ in. disc), which you can order directly from the Users' Library.

##### Business

- Stocks & Bonds
- Securities & Investment Analysis
- Budgeting & Finance I
- Budgeting & Finance II
- Management Science
- Real Estate

##### Scientific Series

- Math
- Numerical Analysis
- General Probability
- Decision Analysis

##### Series 80 Solution Books

#### Data Exchange Software

**Data Exchange Utility:** used with the HP 9895A disc drive to turn your Series 80 personal computer into a convenient remote data entry vehicle. Data can be recorded on an 8 in. disc, converted to "IBM" 3740 format, and loaded into larger centralized computer systems for processing.

HP 88095A Data Exchange Utility Software

##### Educational Series

- Math Learning
- Science Learning I
- Science Learning II
- Electrical Engineer Learning

##### Recreational Series

- Games

##### Engineering Series

- Electrical Engineering



# COMPUTERS, PERIPHERALS & CALCULATORS

## Desktop Computers

Models 9845B, 9845C



HP 9845C



HP 9845B



### HP 9845 Desktop Computer

The HP 9845 is HP's proven top-of-the-line, integrated graphics computer. It provides scientists and engineers with minicomputer power in a friendly desktop package, designed to help technical users explore design alternatives and reach an optimal solution in the shortest time. It is ideally suited for engineering design, statistical/numerical analysis, mathematical modeling, data acquisition/control, business management and process monitoring. It offers a totally integrated system with a CRT display, built-in page-width printer, tape cartridge drives, interactive keyboard, and dual processors.

The 9845 offers a choice of several models in two basic configurations: the 9845B and the 9845C. The 9845B provides up to 1.6 megabytes of user-available internal memory, a monochromatic CRT with full graphics capability, language-expanding read-only memories (ROMs), and HP enhanced BASIC programming. A high-performance version (9845B options 2XX) features a bit-slice processor and high-speed CRT enhancements.

The 9845C offers all the 9845B's features, plus a full-color graphics CRT package that provides up to 4,913 different color shades.

### CRT

The 9845 CRT is a flicker-free, raster-scan device with a refresh rate of 60 times/sec. It offers high-speed listing, upper and lower case characters, inverse video, blinking, and underlining. It features an alphanumeric and a graphic mode. The alphanumeric 24-line, 80-character display lets you view data, list programs, and display keyboard input. The graphics mode allows high-speed, interactive plotting within a 560 by 455 dot matrix.

The 9845C's color CRT includes a high-resolution shadow-mask tube with software-assisted color convergence and a high-speed vector generator. For interactive design applications, an optional light pen offers a fast, easy way to pick, move, and construct objects on the CRT screen.

### HP Enhanced BASIC

The 9845's enhanced BASIC is much more powerful than typical BASIC languages, with many of the powerful features of FORTRAN and APL. For example, it provides for unified mass storage operations. You use the same set of statements to address the storage device, whether it is a flexible disc, cartridge disc, or the 9845's built-in 217 Kbyte tape cartridge.

The 9845 can also be programmed in Assembly language by experienced programmers. For certain computation-intensive or I/O routines, Assembly language can increase program execution speeds as much as 100 times.

FORTRAN and Pascal languages are also available through third-party software suppliers.

### Thermal Printer

The 9845's built-in thermal printer prints up to 80 characters per line at up to 480 lines per minute, and plots at about 25.4 mm/s (1 in/s). The printer gives you high-quality copy with standard ASCII upper and lowercase characters. CRT screen graphics can be transferred directly to the printer for fast, precise hardcopy output.

### Interfacing Capability

The 9845 has a wide range of interfacing capabilities for peripheral/instrument control. It features 15 levels of programmable priority interrupt, DMA, buffered I/O, and overlapped processing. Interfaces are listed below under Ordering Information. A complete line of HP peripherals is also available.

### Data Base and Data Communications

HP's IMAGE data base management firmware package is included in the 9845B Option 280 and the 9845C Option 280. This allows you to define, build, maintain, access, restructure, and back up a data base that you can tailor to your own needs. The package also includes QUERY/45 software, which permits you to easily access previously stored data.

A sophisticated data communications capability is included with the 9845B Options 175 and 275, and the 9845C Option 275. This allows you to configure your desktop computer to connect to a host computer using a hardwired or modem link. Asynchronous, RJE Biscync, Distributed Systems, and Data Link connections are available as software/firmware packages.

### Ordering Information

**9845B** Option 175 Monochromatic, standard performance desktop computer with data communications package

**9845B** Option 275 Monochromatic, high-performance desktop computer with data communications package

**9845B** Option 280 Monochromatic, high-performance desktop computer with data base management package

**9845C** Option 275 Color, high-performance desktop computer with data communications package

**9845C** Option 280 Color, high-performance desktop computer with data base management package

**98032A** 16-bit Parallel Interface

**98033A** BCD Input Interface

**98034B** HP-IB (IEEE-488) Interface

**98035A** Real Time Clock

**98036A** RS-232-C Serial Interface

**98040A** Incremental Plotter Interface

**98041A** Disc Interface

**98046B** Data Communications Interface



9826A

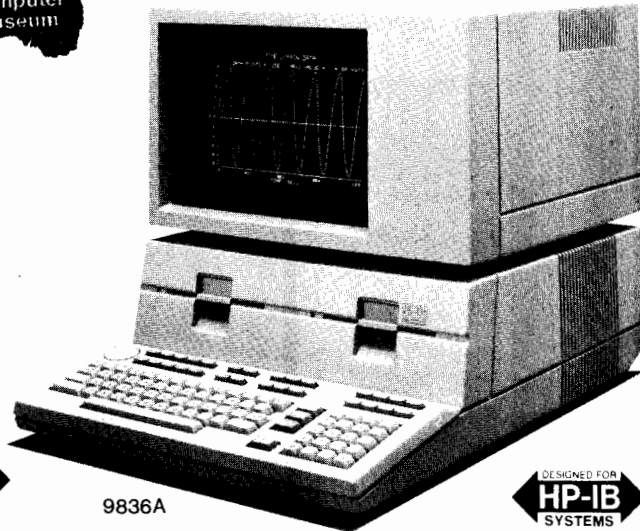

9836A



## HP 9826 and 9836 Desktop Computers

The HP 9826 and 9836 Desktop Computers are fast, versatile tools that can help you in computer-aided engineering and manufacturing. These integrated packages include a 16-bit microprocessor, read/write memory of up to 2 megabytes, alphanumeric and graphics CRT display, multiple language capability, typewriter-like keyboard, built-in flexible disc drive, and real-time clock.

The 9826 and 9836 are advanced power tools ideally suited for computer-aided testing. Their high computational speed make them effective in such areas as computer-aided engineering and manufacturing as well. These computers have proven particularly useful in laboratory instrument automation, production testing, and quality control applications.

The data display graphics lets you view all computational results. The computers can also output results as hard copy via an external printer or plotter. The 9826 has a 7-inch (178 mm) CRT with a 300 by 400 dot raster, while the 9836 has a 12.2 inch (310 mm) CRT with a 390 by 512 dot raster. Both models include ten programmable softkeys (with shift), and 15 levels of priority program interrupt.

## Multiple Languages

The HP 9826 and 9836 feature three languages—BASIC, HPL, and Pascal—allowing you to choose the language that best suits your applications.

HP 9826/9836 BASIC builds on earlier versions of BASIC and includes enhancements from FORTRAN, ALGOL, and APL. It is a high-performance language especially suited to the I/O-oriented user's needs.

HPL is a concise and effective language that meets the requirements of the engineer or scientist. Its features include formula-oriented syntax, explicit I/O control, and high-speed I/O and computing. It is upward-compatible with programs written for the HP 9825 desktop computer.

Pascal is a forward-looking language that provides "top-down" programming structure and ease of writing, debugging, and maintenance. All three languages are available in both RAM and ROM configurations.

## I/O Flexibility

Flexible I/O allows you to tailor the 9826 or 9836 to your particular applications. A wide variety of data formats minimizes system alterations. Insertable I/O cards provide easy interfacing to a wide range of instruments, peripherals, and even other computing systems. Installation is simply a matter of setting address switches and inserting the interface board into one of the slots.

All I/O cards have been designed to be functionally compatible with I/O cards used by the HP9825, 9835, and 9845 at the peripheral or device end. Built-in I/O drivers eliminate the problem of writing drivers or low-level commands by automatically handling I/O formatting and communications with the interface cards.

\*Visi Calc (R) is a registered trade mark of VisiCorp.

## Interfacing Capability

The HP 9826 and 9836 feature a built-in HP-IB (IEEE-488-1978) interface that allows the widest degree of flexibility when connecting with instruments and peripherals. The HP-IB control language is simple, yet powerful, allowing extensive control of external devices.

In addition to the built-in HP-IB interface, there are seven external interface cards: the HP 98622A GPIO interface for bidirectional information transfer; 98623A BCD for bit-parallel, digit-parallel and binary coded decimal devices; 98624A HP-IB to augment the built-in HP-IB; 98626A Serial for bit-serial communication to some asynchronous devices; 98627A Color Video to enable displaying color graphics on an external color CRT monitor; 98628A Data Communications for other asynchronous devices; and a 98620A 2-channel DMA Controller for high-speed I/O.

## Additional Features

Contributing to the speed and versatility of the 9826 and 9836 are a 16-bit Motorola MC68000 CPU with a built-in 8-MHz clock, a 133 mm (5¼ inch) flexible disc with 260 Kbyte capacity, a rotary control knob for cursor control, interrupt generation and analog simulations, a 128-character ASCII keyboard with ten (20 with shift) softkeys, and special function keys for program editing, cursor control and system control.

Keyboards are available in English, French, German, Spanish, Swedish-Finnish, and Japanese. A number of prewritten software packages, such as statistics, electrical engineering design, and Visi-Calc (R)\*, allow the user to quickly apply the 9826 or 9836 to these areas. Graphics and alphanumerics can be easily transferred to hard copy via an external printer.

## Ordering Information

The HP 9826 and 9836 Desktop Computers include 64 Kbytes of R/W memory, graphics, CRT, internal HP-IB and 260 Kbyte disc drive. They are available with the following options:

### 9826A

- Opt. 011 With BASIC 2.0 ROM-based system
- Opt. 014 With HPL 2.0 ROM-based system
- Opt. 711 With BASIC 2.0 language disc and additional 256 Kbytes of R/W memory
- Opt. 714 With HPL 2.0 language disc and additional 256 Kbytes of R/W memory
- Opt. 715 With Pascal language system and additional 512 Kbytes of R/W memory

### 9836A

- Opt. 001 With BASIC 2.0 ROM-based system
- Opt. 014 With HPL 2.0 ROM-based system
- Opt. 711 With BASIC 2.0 language disc and additional 256 Kbytes of R/W memory
- Opt. 714 With HPL 2.0 language disc and additional 256 Kbytes of R/W memory
- Opt. 715 With Pascal language system discs and additional 512 Kbytes of R/W memory



# COMPUTERS, PERIPHERALS & CALCULATORS

## Modular Computer; Desktop Computer

Models HP 9915A, HP 9825B/T

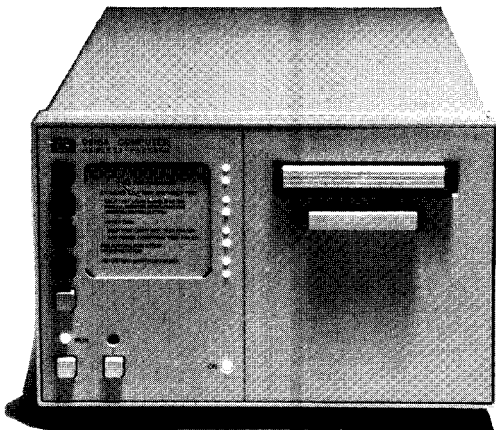

9915A



9825B/T

### HP 9915A Modular Computer

The HP 9915A is a modular computer that contains the heart of the HP-85 desktop system, but excludes keyboard, CRT, and tape drive. It is ideal in automated testing, measurement and control applications where durability is essential. The 9915A is a viable alternative to microprocessors and board computers, which are inexpensive but difficult to engineer, program, and develop.

### Efficient Program Development

Programs for the HP 9915A can be developed and debugged on the HP-85 and transferred to the HP 9915A via either EPROM or magnetic tape. Applications can be running in about half the time it would take for a microprocessor or board computer.

The 9915A can accept up to 32 Kbytes of EPROM-stored programs. HP-85 software is available that allows the designer to program EPROMs with commercially available PROM programmers.

### Flexible Design for Operator Interface

The 9915A is designed for easy operator use, but more extensive controls can be added. For applications requiring minimal attention, the 9915A's program start button and programmable front panel lights will suffice. For moderate operator interface, there are eight software-definable function keys. For extensive operator control, remote pushbuttons, LEDs, CRT displays, and custom keyboards can be added.

Since all of the HP-85's graphics capabilities are built into the 9915A, charts, histograms, block diagrams and other graphics may be easily displayed via an external CRT. CRT and keyboard interfaces are available as an option.

### I/O Capabilities

The HP-85/9915A BASIC language includes a powerful set of statements to simplify I/O, providing the user with interrupt, bit manipulation, high-speed transfer, software control of interface and easy data formatting. I/O drivers are built in, and both machines use the same plug-in interfaces: HP-IB (IEEE 488-1978), serial, 8-bit/16-bit parallel, and binary coded decimal. The interface prices are shown on Page 590.

### Additional Features

Peripherals available for the 9915A include printers, plotters, and flexible disc drives. HP devices such as the HP 6942A Multiprogrammer and the HP 3497A Data Acquisition/Control Unit allow analog input/output. An optional tape unit is available when it is necessary to change programs often or record test data. Its capacity is 200 K bytes, depending on whether the stored information is programs or data.

### HP 9825B/T Desktop Computer

The 9825B or 9825T Desktop Computer offers many features previously found only on minicomputers. It is particularly suited to controller applications, and is a powerful standalone device.

The 9825B/T is a compact computing system with built-in peripherals. The 9825B has 23 Kbytes of read/write (R/W) memory and internally integrated ROMs (read-only memories) for Strings, Advanced Programming, Plotters, General I/O and Extended I/O. The 9825T has 62 Kbytes of R/W memory, all the 9825B's built-in ROMs, and a built-in Systems Programming ROM.

A 32-character LED display and a built-in 16-character thermal printer provide alphanumeric readout. The high-speed bidirectional data cartridge holds 250 Kbytes and has an average access time of 6 seconds. File verification is automatic on recording.

Twelve Special Function keys, combined with the shift key, can handle 24 different operations. They can serve as immediate execute keys, as call keys for subroutines, and as typing aids.

### Powerful Programming

The 9825 is programmed in HPL, a high-level language. HPL allows subroutine nesting and flags, and up to 26 simple variables and 26 multidimensional array variables. Fixed- and floating-point formats can be set from the keyboard. Syntax checking is simple: a flashing cursor in the display identifies error locations.

A live keyboard lets the user examine and change program variables, perform complex calculations, call subroutines, and record or list programs while the 9825 is performing other operations. The tape cassette can be used to record and load the entire memory automatically.

### I/O Performance

Three I/O slots accept any of the following interfaces (prices are shown on Page 594): 98032A 16-bit parallel; 98033A BCD; 98034B HP-IB; 98035A Real Time Clock; and 98036A RS-232-C Serial. This allows the 9825 to communicate with instruments and peripherals. High-speed I/O handles data input speeds up to 400K 16-bit words/sec.

Two-level priority interrupt allows the 9825 to control several instruments or peripherals requiring attention at random rates or times. Auto restart and interface status testing enhance standalone controlling.

### Ordering Information

**9825B** Desktop Computer

**9825T** Desktop Computer

**9915A** Modular Computer with 16K memory, I/O ROM and Program Development ROM

**Opt. 001** Built-in Tape Drive

**Opt. 002** Operator Interface Capability (for commercial video monitors, keyboards and remote front panel control)

# COMPUTERS, PERIPHERALS & CALCULATORS

## Dedicated Real-Time Computer System



- Computer-aided manufacturing
- Computer-aided design
- Computer-aided test



### HP 1000 A-Series Computers: Minicomputer performance at microcomputer prices, for OEMs and end users

The HP 1000 A-Series consists of two new high-performance real-time processors, both with the raw hardware speed (over 1 million instructions per second) to do a big job in computer-aided manufacturing, computer-aided design, and computer-aided engineering.

Of these, the A600 is an ultra-fast microcomputer with very good floating point performance. It is available in fully configured systems, including the Model 6 tabletop Microsystem (photo above) and as a rack mountable computer or as a two-board set with up to 512k bytes of memory.

The A700 is a user-microprogrammable processor with exceptional power and flexibility, including an optional computation acceleration processor that can perform over 220,000 floating point operations per second. The A700 is available in fully configured systems, as a rack mounting computer, and as a four-board set.

Both of these new computers use distributed intelligence architecture with a small, powerful processor on each interface to maximize I/O efficiency.

### HP 1000 Computers—Flexibility and Compatibility for Your Application

With the HP 1000 family of real-time computers, tailoring a computer solution to your application is a simple matter of choice. First, select the computer power you need from the A, L, E, or F-Series of HP 1000 computers. Next choose from three levels of packaging—

component-level board computers, rack-mountable box computers, and totally-integrated systems. Then fine-tune your HP 1000 to the intended task by choosing from an array of hardware and software products designed to help you get results over a wide range of specific applications.

Compatibility of design throughout the HP 1000 family enables you to harness the specific level of power you need to a specific application. It also gives you a clear growth path. Once you've matched the proper combination of HP 1000 products to your initial needs, you remain free to choose an impressive number of options to keep pace with your growth. Or, if your needs change, you can smoothly reconfigure your HP 1000 to handle new applications. This compatibility extends through:

- HP 1000 computers. Because the A, L, E, and F-series computers use the same base instruction set, you can change models with minimal effect on software, peripherals, and operator training.
- HP 1000 systems. You can upgrade from the smallest memory-based system to the largest disc-based system at any time you choose, at once or in gradual increments.
- HP 1000 software. HP's Real-Time Executive (RTE) operating systems are upward-compatible—your programming investment is protected because application programs written for one RTE system will execute on the others with minimal modification.
- HP 1000 applications-oriented software. To wield more computer power, you can superimpose HP 1000 applications software products on your system to move even closer to a computer solution for your specific application.

### HP 1000 Computer Systems

The HP 1000 family consists of disc-based systems for support of computer-aided design and manufacturing.

Available systems include the tabletop Model 6 Microsystem and the Model 16 and 17 Computer Systems, based on the new A600 and A700 Computers and the Model 60 and 65 Systems, based on the E- and F-Series Computers. The System Models 17 and 65 provide the extra processing speed and power of a hardware Floating Point Processor with Vector and Scientific Instruction Sets.

HP 1000 systems feature a Real-Time Executive operating system and are programmable in FORTRAN 77, Pascal, BASIC, and Macro/1000 assembly language.

### Computer-aided design

For computation-intensive computer-aided design applications, the Model 17 and 65 systems combine the fast A700 and F-Series computers with powerful RTE software to provide processing power unique in this price range. Optional Graphics/1000-II software facilitates the development of interactive graphics and a SPICE circuit simulation program is available to support other aspects of computer-aided design.

Data capacity is huge, with data arrays up to 12.6 Megabytes in the Model 17, up to 128 Megabytes in the Model 65, supported in a virtual memory data space.

### Computer-Aided Manufacturing

HP 1000 systems are designed for interaction with process control set point controllers and/or HP-IB instruments for measurement and control. Up to 500 set point controllers and/or up to 14 HP-IB devices can connect to the system via a single interface card for monitoring and control of many points in a process. For small monitoring and control needs, A600 and A700 systems can be equipped with plug-in analog and digital I/O interface cards.

### Factory Data Collection

Optional DATACAP/1000-II software can be used to collect data from multiple terminals for work-in-process or machine usage monitoring, inventory tracking, order control, labor reporting, and Q-A failure analysis. DATACAP sends the data to a data base managed by Image/1000-II Data Base Management software.

### Manufacturer's Productivity Network

DS/1000-IV software/firmware links multiple HP 1000 and/or HP 3000 systems to each other in a large multi-system network. Inter-system communications can be used to exchange vital data throughout the entire plant, maximizing overall efficiency.

### Ordering Information

- HP 1000/6 Microsystem with minifloppy discs
- HP 1000/16 Computer System
- HP 1000/17 Computer System
- HP 1000/60 Computer System
- HP 1000/65 Computer System

### HP 1000 System Summary

\*Price does not include system console or hard disc, which must be ordered separately.

	MODEL 6	MODEL 16	MODEL 17	MODEL 60	MODEL 65
	2186A/B	2196A/B	2197A/B	2178A/B	2179A/B
Base system computer type	A600	A600	A700	E-Series	F-Series
Memory cycle time	454 ns	454 ns	500 ns	665 ns	420 ns
Operating system	RTE-A.1	RTE-A.1	RTE-A.1	RTE-6/VM	RTE-6/VM
Recommended system console terminal series	262X+090	262X	262X	264X+007	264X+007
Memory (bytes)	128k-2 M	128k-4 M	256k-4 M	256k-2 M	256k-2 M
Recommended system disc	9134A (4.6 Mb)	7908R (16.5 Mb)	7911R (28.1 Mb)	7911P (28.1 Mb)	7911P (28.1 Mb)
Alternative disc choices	7908P (16.5 Mb) or 7911P (28.1 Mb) or 7912P (65.6 Mb)	7911R (28.1 Mb) or 7912R (65.6 Mb)	7908R (16.5 Mb) or 7912R (65.6 Mb)	7906M/MR (19.6 Mb) or 7908P (16.5 Mb) or 7912P (65.6 Mb) or 7920M (50 Mb) or 7925M (120 Mb) or 7933H (404 Mb)	
Flexible disc available?	Yes	Yes	Yes	Yes	Yes
Hardware floating point with vector/matrix processing?	No	No	Yes	No	Yes
Graphics/1000-II available?	Yes	Yes	Yes	Yes	Yes
HPSPICE Circuit Simulation available?	No	No	No	No	Yes
Programmable controller interface available?	Yes	Yes	Yes	Yes	Yes
2250 Measurement and Control Processor available?	Yes	Yes	Yes	Yes	Yes
Measurement and Control Interfaces available?	Yes	Yes	Yes	No	No
DATACAP/1000-II available?	No	No	No	Yes	Yes
Image/1000-II available?	Yes	Yes	Yes	Yes	Yes
DS/1000-IV communication with HP 1000 and HP 3000 systems?	Yes	Yes	Yes	Yes	Yes
RJE communication with IBM systems available?	No	No	No	Yes	Yes
I/O Extender available?	No	No	No	Yes	Yes
ATS/1000 Integration Services available?	No	No	No	Yes	Yes

# COMPUTERS, PERIPHERALS & CALCULATORS

## HP1000 A-Series, L-Series, E-Series, and F-Series Computers

599

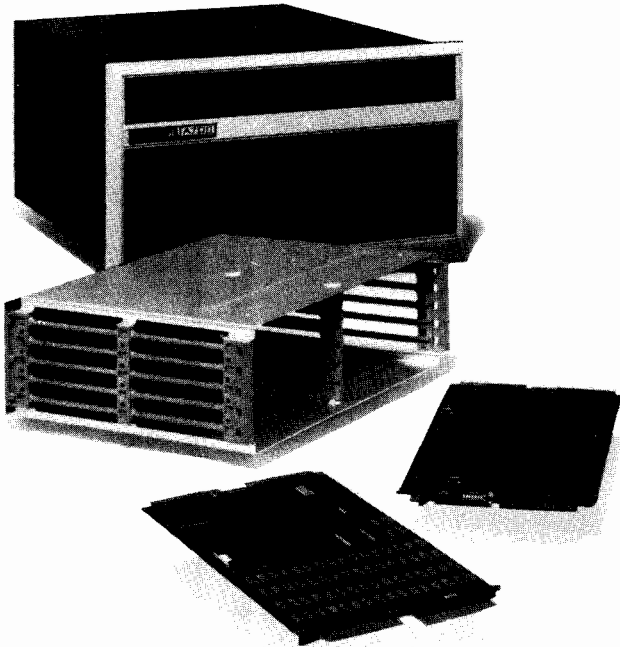

### HP 1000 A-Series

The new A-Series is designed to provide exceptional price/performance value for OEM and end user applications. It consists of an A600 board computer (2106AK), an A600 box computer (2156A), an A700 board computer (2107AK), and an A700 box computer (2137A). Memory capacity up to 4 Mbytes and a 20-slot cage with 18 available card cage slots in the 2156A, 16 available card cage slots in the 2137A, can support all but the very largest applications. The A600 and A700 both provide a base speed over 1 million instructions per second. To this, in the user microprogrammable A700, can be added a hardware Floating Point processor with Vector and Scientific Instruction Sets for ultrafast execution of floating point, trigonometric, logarithmic, and repetitive matrix calculations. Sine computes in 31  $\mu$ s or less. Dynamic mapping system, memory protect, time base generator, self-test, automatic parity generation, firmware floating point, virtual control panel, and high-level language support instructions are standard. I/O bandwidth is a super fast 4 Mbytes/second.

### HP 1000 L-Series

The low-cost L-Series, designed for I/O-intensive applications and ease of integration into a wide range of OEM and end user products or systems, includes the 2103LK board computer and 2103L rack-mountable computer. Memory capacity is 64-512 Kbytes and I/O capacity is 8 channels. Standard features include memory protect, a time base generator, self-test, integer arithmetic, automatic parity generation and checking, and virtual control panel. DMA rate is a very fast 2.7 Mbytes/second.

### HP 1000 E-Series

The E-Series computer provides variable microcycle timing, micro-programmable block I/O, a microprocessor port, asynchronous memory, and large control store address space. E-Series computers are available in two models, HP 2109E and 2113E, with up to 2 Mbytes of mainframe memory and 9 or 14 I/O channels, expandable to 46 channels. (Also available as 2109EK board computer.)

### HP 1000 F-Series

For users who need faster than E-Series processing speed, HP offers the HP 2117F F-Series computer. The 2117F features a hardware floating point processor that speeds calculations (2.5 to 6 times faster than E-Series) and a Scientific Instruction Set for fast execution of trigonometric and logarithmic functions (compute sine in less than 48  $\mu$ s). A Fast FORTRAN Processor, also standard in the 2117F, provides firmware microcode for over a dozen instructions—e.g., array address calculations, parameter passing, and other routines—that run 2 to 20 times faster than conventional software execution speed. An optional vector instruction set can be provided for fast matrix calculations. The 2117F computer features high performance 420-ns memory and is fully user-microprogrammable.

### Alternate Memory Systems.

For configuration flexibility, the standard memory in any HP 1000 computer may be replaced with an alternative memory system of equal or greater size at the time of the order. A 1 Mbyte memory array card means that only three of the available card cage slots are needed to increase total memory size to 4 Mbytes in A-Series computers.

High performance 420-ns memory is optionally available for the E-Series.

Fault-control (error-correcting) memory, optionally available for the A700 and E- and F-Series computers, detects and corrects single-bit errors and detects all double-bit errors, which increases MTBF of memory based on 64 k RAMs by over 60%.

For compatibility and prices of alternative memory packages, consult your HP sales representative.

### Ordering Information

- 2106AK A600 Board Computer w/128 kb memory
- 2107AK A700 Board Computer w/128 kb memory
- 2156A A600 Computer w/128 kb memory
- 2137A A700 Computer w/128 kb memory
- 2103LK L-Series Board Computer w/64 kb memory
- 2103L L-Series Computer w/64 kb memory
- 2109EK E-Series Board Computer w/64 kb memory
- 2109E E-Series Computer w/64 kb memory
- 2113E E-Series Computer w/128 kb memory
- 2117F F-Series Computer w/128 kb high perf memory
- 12103A A-Series 128 kb Memory Array Card
- 12103B A700 256 kb Memory Array Card
- 12103C A-Series 512 kb Memory Array Card
- 12103D A-Series 1 Mb Memory Array Card
- 12104A A700 512 kb Error Correcting Memory Array Card
- 12153A A700 Writable Control Store Card
- 12156A A700 Floating Point Processor
- 12157A A-Series Battery Backup System
- 12158A A-Series 25 kHz Power Module
- 12030A 10-Slot Card Cage for A600/L-Series Board Computer
- 12032A 5-Slot Card Cage for A600/L-Series Board Computer

Quantity discounts are available.

A complete list of HP 1000 computer accessories is available from your HP Sales Office.



# COMPUTERS, PERIPHERALS & CALCULATORS

## Technical Computer Peripherals Interfacing Summary

Interface ports are included in each Hewlett-Packard technical computer to provide interconnection with a wide variety of HP peripherals, as shown in the following table.

### HP Technical Computer Interfacing Summary

Peripherals	Ref Page	Technical Computers							
		85A/F 86A 87A 87XM 9915	9825	H	9826# 9836		9845	1000 Series E,F A,L	
9111A Graphics Tablet	589	●		●	●	●	●	●	●
9874A Digitizer	624	●	●		●	●	●	●	●
9885M/S Flexible Disc Drive	608		●	●	●	●	●	●	●
9895A Flexible Disc Drive	608	●	●	●	●	●	●	●	●
82901M & 82902M Flexible Disc Drive	608	●		●	●	●			
7906M/S Hard Disc Drive	610						●	●	
7908P/R Hard Disc Drive	611				●		●	●	●
7911 & 7912P/R Hard Disc Drive	611				●		●	●	●
7920M/S Hard Disc Drive	610						●	●	
7925M/S Hard Disc Drive	610						●	●	
7933H Hard Disc Drive	611							●	
9121S/D Single/Dual 3-1/2" Flexible Disc Drive	608	●		●	●	●			
9134A Micro Winchester Disc Drive	609	●	●	●	●	●	●		●
9135A Combination Storage Unit	609	●		●	●	●			
9138A Mass Storage System	609	●	●	●	●	●	●	●	●
7970B Tape Drive	**							●	
7970E Tape Drive	**						●	●	
37201A HP-IB Extender	32	●	●	●	●		●	●	●
37203A HP-IB Extender	32	●	●	●	●		●	●	●
9878A I/O Expander	609		●	●	●	●	●		
7220C/T Eight-color Plotter	620	*	*	*	*		*	●	●
7221C/T Eight-color Plotter	620	*	*	*	*		*	●	●
9872C/T Eight-color Plotter	620	●	●	●	●		●	●	●
7470A Graphics Plotter	618	●	●	●	●	●	●	●	●
7580A/7585A Drafting Plotters	622	●	●	●	●		●	●	●
2601A Daisy Wheel Printer	613	●		●	●			●	●
2608S Line Printer	614							●	●
2631B Dot Matrix Impact Printer	613	●	●	●	●	●	●	●	●
2631G Graphics Printer	613	●		●	●		●		
2671A Printer	612	●	●	●	●		●		●
2671G Graphics Printer	612	●		●	●		●		●
2673A Intelligent Graphics Printer	612	●		●	●	●	●		●
9876A Thermal Graphics Printer	609	●	●				●	●	●
82905B Impact Printer	583			●	●			●	●
1351S Graphic Display System	628		●				●	●	
2382A Office Display Terminal	602		●					●	●
2621B CRT Terminal	602		●					●	●
2622A Terminal	603		●					●	●
2623A Graphics Terminal	603		●					●	●
2624B Terminal	604		●					●	●
2626A Terminal	604							*	*
2626W Word Processing Station	604							●	
2635B Hard Copy Terminal	613							●	●
2645A CRT Terminal	605		*					●	●
2647F CRT Graphics Terminal	605		*					●	●
2648A CRT Graphics Terminal	605		*					●	●
3075A & 3076A Data Capture Terminals	607	*	*	*	*	*	*	*	*
3077A Data Capture Terminal	607	*	*	*	*	*	*	*	*
3078A Data Coupler	607							*	*

\* Depends on application; not all functions may be implementable.  
 \*\* Call local Hewlett-Packard sales office for technical data sheet.  
 # 9826, 9836: H = HPL; B = BASIC; P = Pascal

# COMPUTERS, PERIPHERALS & CALCULATORS

## Business Oriented Computer Systems

HP3000, HP250

601

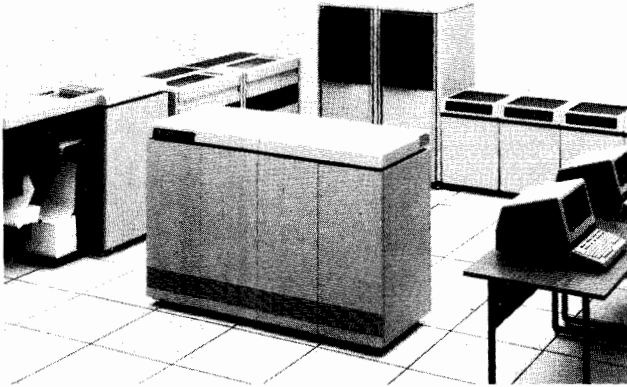

HP 3000, Series 64



HP 250



### HP 3000 Business Computer

The HP 3000s are a compatible family of business computer systems for distributed data processing. All models share the same multiprogramming executive operating system (MPE) featuring virtual memory, the same high-level languages, and are able to run one another's programs interchangeably. Full-function general-purpose capabilities include simultaneous transaction-processing, data communication, on-line program development, and batch operations in COBOL, RPG, BASIC, FORTRAN, PASCAL and SPL (the HP system programming language). Most powerful and capable of greatest expansion is the HP 3000 Series 64, with main memory to 8 megabytes, and ability to support as many as 144 terminals, each running or developing separate programs. The Series 40 and 44 systems offer somewhat less performance at less cost. The entry level Series 40 provides a very cost-effective solution for up to 56 terminals and 2 Mb of memory. When greater expandability is required, the Series 44 can provide a system of up to 96 terminals and 4 Mb of memory. Both models are fully upgradable to the Series 64. The HP 3000s provide a complete data base management and inquiry facility, IMAGE/QUERY, as well as a data entry/forms generation system, VPLUS/3000. In addition, all may be interconnected via an HP Distributed Systems Network that can also integrate HP 3000s with HP 1000 networks and the HP 9800 family of desktop computers, as well as IBM mainframes.

### HP 250 Business Computer

The HP 250 is designed to meet the business management needs of small companies and departments of larger ones. It achieves big-system performance at small-system prices.

A standard system contains 64 Kbytes of user memory, 192 Kbytes of system memory, a high-speed tape cartridge for back-up, and a 16 Mbyte fixed disc. Available on the HP 250 are applications packages for finance, manufacturing, order management, text processing, decision support graphics, and two synchronous data communications packages.

The HP 250 is able to support up to 10 RS232/V.24 ports. For distributed applications, it can communicate with larger computers either asynchronously or synchronously. A software package called LK 3000 links the HP 250 as an interactive terminal to the HP 3000; and another called RJE/250 allows the HP 250 to function in an IBM 2780/3780 terminal emulator mode.

### Office Systems Tools

Several important software packages are available for the HP 3000 which make it especially productive in an interactive office environment. These office systems products, (HPWORD, HPMAIL, INFORM/3000, DSG/3000, HPEASYCHART, and HPDRAW) bring the information processing and communications capabilities of the HP 3000 directly to business professionals and support personnel in the office.

HPWORD sets new standards for ease of use in word processing.

HPMAIL is an electronic mail system for internal communications throughout a company.

INFORM/3000 helps business professionals produce ad hoc reports in minutes.

DSG/3000 is a sophisticated interactive system for creating charts, graphs, statistics, production plans, and other graphic output.

HPEASYCHART is a simple tool for producing pie charts, bar charts, and line graphs.

HPDRAW is used to design and produce high quality presentation aids.

### Application Software Solutions

Hewlett Packard offers applications software for manufacturers which runs on the HP 3000 computer. These application software products include Materials Management/3000, Production Management/3000, General Accounting/3000, and SFD/3000.

Materials Management/3000 is an interactive application system for managing the materials planning and control function of a manufacturing operation.

Production Management/3000 is an interactive application system for managing manufacturing production planning and control.

General Accounting/3000 is an interactive financial accounting application software system which is equally beneficial for manufacturers and other types of businesses. It includes general ledger, accounts payable, and accounts receivable applications.

SFD/3000 is an integrated application system designed to meet an organization's needs for inventory distribution control and order processing.

# COMPUTERS, PERIPHERALS & CALCULATORS

## Interactive Display Terminals

Models 2382A, 2621B



2382A

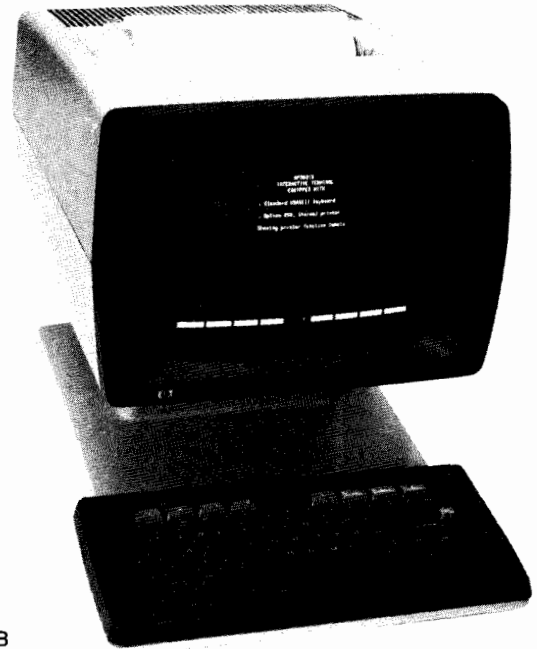

2621B

### Introduction

Hewlett-Packard's family of interactive terminals feature a wide range of capabilities which are optimized to suit a variety of applications on HP computer systems and software packages. These applications include program development, data entry, document preparation and graphics.

The new HP 2382A Office Display Terminal is a block/forms mode display terminal for office use. The 2382A consumes less than a cubic foot of space, which makes it ideal for the office desktop, yet provides many of the high performance features available in larger HP terminals. Non-computer professionals and infrequent computer users, such as managers, will find the 2382A's small size, simple styling and easy to use features the correct solution to their data processing needs.

The HP 2620 family of interactive terminals range from the simplicity of the character mode 2621B, with its two pages of display memory, to the sophistication of the 2626W which provides word processing and multiple user defined workspaces and windowing plus a multipoint data communications capability. The 2622A adds a block/forms mode capability to the 2621B, while the 2623A provides the 2620 family with a low cost graphics capability and supports all the features of the 2622A. The 2620 series features the convenience of built-in hardcopy across the entire line including graphics hardcopy on the 2623A as an option.

The HP 2640 series of interactive terminals support many of the features and applications that are supported with our 2620 family. The important distinction is that local mass storage is available with the 2640 family. In addition, more standalone operations such as word processing, local programmability in BASIC and graphics software for preparing graphics and slides locally are available in the 2647F.

Terminals which are designed for OEM's are available in both the 2620 series (HP 2629 family) and the 2640 series (2649 family).

### 2382A Office Display Terminal

- Small Size  
Requires less than 1 cubic foot of space
- High Resolution Display
- 80 Column X 24 lines
- Two pages of display memory
- Four display enhancements
- Block/Forms Mode
- Screen Labeled Softkeys
- Detached Keyboard

The 2382A Office Display features an 80 column by 24 line high resolution display, two pages of display memory, an optional line drawing character set, and four display enhancements including inverse video, half bright, underline and blinking. Screen labeled softkeys allow an application programmer to customize the keyboard to perform several operations with a single keystroke. The detached typewriter style keyboard is familiar and easy to use. The light weight and small size of the 2382A allows it to be positioned where the operator desires so as to minimize operator fatigue. Also the sculptured keycaps and cursor control keys make the operator's job easier.

### 2621B Interactive Display Terminal

- High resolution display
- Two full pages of memory
- Eight user softkeys
- Optional built-in printer
- Modify Mode

The 2621B can display 1920 characters in 24 lines by 80 column format, and contains two full pages of memory for a review of an interactive dialogue. Local hardcopy is provided by an optional built-in printer, and Modify Mode allows an operator to edit and then transmit any selected line from the terminal's 48 line display memory.

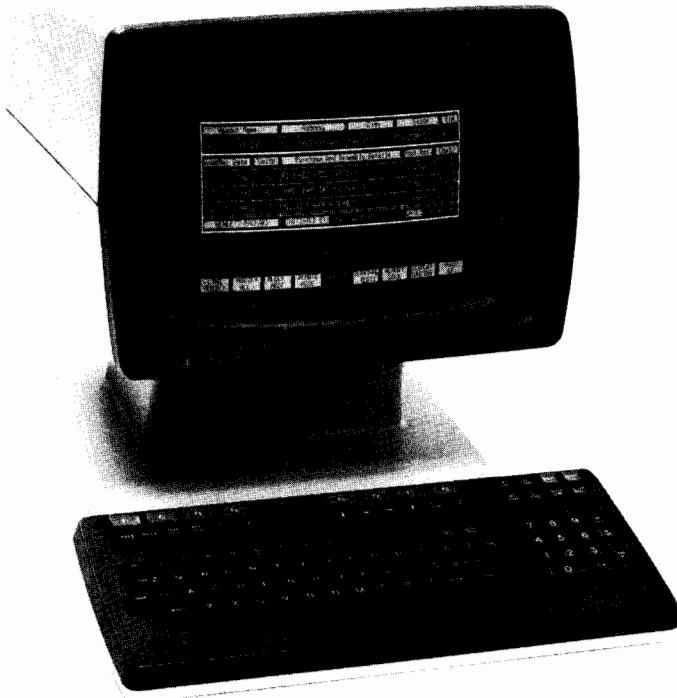

2622A

#### 2622A Display Terminal

- High Resolution Display  
7 × 11 dot matrix, 9 × 15 character cell
- Block/Forms Mode
- User Defined function keys,  
screen labeled
- Six National Character Sets (optional)
- Integral Thermal Printer (optional)

The HP 2622A has been designed to fit data entry needs. Two pages of display memory, the optional line drawing set, and four display enhancements enable the HP 2622A to be tailored to meet data entry form requirements. The display enhancements which include inverse video, half bright, underline and blinking in all combinations, can be used to depict an existing paper form and to facilitate data entry. A familiar and clear form provides ready acceptance by previous users and accelerates training of new operators. For the programmer, the HP 2622A has several advanced features that increase user productivity. The two pages of display memory allow the programmer to scroll or page through 48 lines of code. Information can be logged to an optional internal printer before it rolls out of memory. The printer can copy a line, page, or the entire display memory in either an 80 or 132 column format.

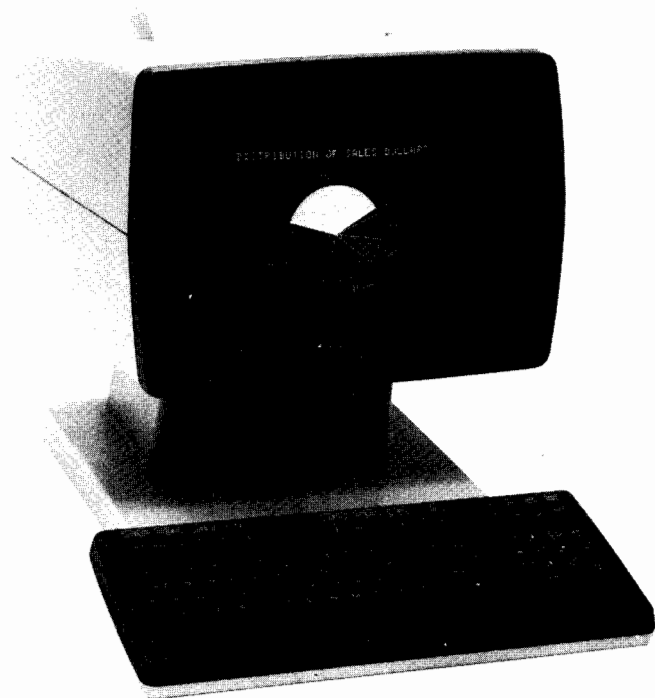

2623A

#### 2623A Graphics Terminal

- High Quality Display  
512 × 390 dot resolution  
TEKTRONIX® 4010 compatible (1024 × 780 dot resolution)
- Built-in Graphics Hardcopy (optional)
- Fast Vector Generation  
9600 baud throughout
- Graphics Text Composition in US ASC II, and Six National Languages
- 2622A Compatible

The low cost 2623A is designed for the graphics user with an extensive on-line capability and system based software. The high quality display features 512 × 390 dot screen resolution and is ideally suited for many display graphics applications as well as some design applications. An optional built-in printer provides low cost graphic hardcopy in only 30 seconds by simply pressing a key.

The 2623A is supported on HP's Graphics 1000/II and Decision Support Graphics Software. The 2623A also works with other third party software such as TEKTRONIX's Plot 10 and is compatible with the TEKTRONIX® 4010 display terminal.

The 2623A can generate vectors at 9600 baud and graphs can be quickly annotated locally in ASCII, or six other optionally available national languages, before obtaining a hardcopy.

All of the alphanumeric capabilities of the low cost block mode 2622A are available in the 2623A.

®TEKTRONIX is a registered trademark of Tektronix Corporation.



# COMPUTERS, PERIPHERALS & CALCULATORS

## Interactive Display Terminals

Models 2624B, 2626A, 2626W



2624B

### 2624B Display Terminal

- High Resolution Display
- Advanced edit checks
- Local Forms Mode
- Block mode format
- Multipoint
- Terminal bypass mode

The 2624B represents the ultimate in a data entry terminal. Multiple forms can be down loaded from the system and stored in display memory for instant retrieval. This reduces the burden on the system and improves system response time while lowering transmission costs. The advanced edit checks which are supported by the HP 2624B improve data integrity and increase data throughput. In addition to protected, unprotected and transmit only fields, the 2624B provides the first level of data verification through field edit checks. The edit checks allow the terminal to detect many data entry errors and notify the user. By correcting errors at the terminal, system overhead is reduced. The checks include all characters, alphabetic, alphanumeric, numeric, integer, signed decimal and implied decimal. The preprocessing capabilities are justify, fills and implied decimal. Required and total fill fields provide entry control. These capabilities are an asset to applications that do not do data checking today and they reduce system overhead in programs where the computer previously performed all of the data verification.

The 2624B provides comprehensive point-to-point communications as well as multipoint communication so that multiple terminals can share an expensive communications line. The 2624B optional integral built-in printer can operate in terminal by-pass mode in multipoint. That is, the printer can be designated as a destination device and information can be sent directly from data comm. to the printer without disturbing the information on the screen or tying up the terminal display.

### 2626W Word Processing Station

- Complete word processing
- Typewriter like keyboard
- Enhanced screen display
- 2626A data processing



2626W

The HP 2626W Word Processing Station is an intelligent terminal designed for use with HPWORD, Hewlett-Packard's word processing software for HP 3000 computer systems. Careful attention has been given to the user interface of this high performance terminal to enhance user productivity and minimize training time. The typewriter-like keyboard is detachable for operator convenience and the screen-labeled function keys provide a friendly user interface. The terminal is ideal for users with both word processing and data processing requirements.

When the user runs HPWORD, micro-code is downloaded from the HP 3000 and stored locally in the HP 2626W's 64K words of Random Access Memory. This capability is primarily responsible for the quick response that HPWORD offers the user. Any functions performed within a paragraph, such as word wrap, insertions and deletions, take place in the terminal. This feature also reduces the burden on the CPU. When in data processing mode, the 2626W is identical to the 2626A.

### 2626A Display Station

- Multiple Workspaces
- Multiple Windows
- Dual Data Communications Ports
- Multipoint Data Communications
- Interactive Forms Design

The 2626A is a high performance terminal which provides unique display capabilities and data communications flexibility. The 2626A display memory can be divided into four independent workspaces, and the display screen into four separate windows to examine and manipulate the contents of the workspaces. This capability amounts to four virtual terminals which may be changed from application to application or system to system.

Dual data communication ports can be linked to workspaces to display data from two different computers, or one port may be linked to a computer and the other used as an external RS232 serial printer port. Data may be communicated to the computer using block, line, line modify, or character modes in a point-to-point or multipoint environment.

The 2626A is ideally suited for program development or data entry particularly when taking advantage of the easy to use function key approach to forms design. The line length may be set from 80 to 160 characters so that 132 column reports as well as double width pages may be handled, with viewing via horizontal scrolling.

# COMPUTERS, PERIPHERALS & CALCULATORS

## Interactive Display Terminals

Models 2645A, 2647F, 2648A



### 2645A Alphanumeric Display Station

- Integrated Mass Storage
- Forms Mode
- Choice of Communications Capability

The 2645A is a high performance alphanumeric display station that can operate at speeds up to 9600 baud in a fully interactive character-by-character mode or in a variable length block mode. Features such as a high resolution display, forms mode, full editing capability, fully integrated mass storage provided by cartridge tapes, user-defined soft keys, flexible choice of data communications, modular architecture, microprocessor control and hard copy interface make the 2645A the perfect solution for many computer applications.

### 2647F Intelligent Graphics Terminal

- High Resolution Graphics
- Independent Graphics and Alphanumeric Display Memories
- Graphics Zoom and Pan
- Programmable in BASIC
- 64K Program Workspace
- Automatic Plotting
- Shared Peripheral Interface
- Mini Disc Drive (5-1/4" discs)
- Word Processing Software
- Application Software
- Host System Software Support

The 2647F is the intelligent solution to a host of applications that require on-line capability, graphics, and local programming. The 2647F supports several host graphics software packages in addition to the number of local programming. The 2647F supports several host graphics software packages in addition to the number of local menu/softkey driven application programs that generate slides and charts. The 2647F features a raster scan display, a full interactive alphanumeric capability, optional word processing, and is designed for easy use by secretaries, professionals, and analysts alike.

The 2647F offers sophisticated graphic capability while requiring no programming knowledge of the user. Menu driven, the Auto-

plot/47 software included with the terminal can plot columnar data in multiple formats chosen by the user. Text charts, pie charts, bar charts, X-Y Cartesian and logarithmic graphs can all be created without host CPU graphics software. Different types of shading patterns are available for highlighting the various charts. Data may be submitted to the 2647F from one of three sources: host computer, mini disc or keyboard. One simply fills in the blanks on a menu form which appears on the terminal screen. Once the data parameters are defined, the data can then be plotted with a single keystroke. This powerful feature makes graphs friendly, easy-to-create, and system software independent.

Option software available includes: Word/47, Graphics Presentation Pac/47, Project Management Pac/47, Statistical Analysis Pac/47, Mathematical Analysis Pac/47, and LINK/47. These software pacs are described in data sheets available from your local HP sales representative.

The local disc drive combined with an easy-to-use English language file system puts any file at your fingertips. All file system instructions are command key driven; a few keystrokes implement any file operation. Each 5-1/4" mini flexible disc holds up to 270 Kbytes of information. A second disc drive is available as an option.

RS 232C Data communications is standard, RS 422 is optional.

### 2648A Graphics Terminal

- Integrated Mass Storage (optional)
- Automatic Plotting

The 2648A is a lower cost alternative to the 2647A. The 2648A provides less standalone capability.

Display Terminal Application Chart				
Display Terminal	Program Development	Data Entry	Document Preparation	Graphics
2382A	○	●	○	
2621B	●	○	○	
2622A	○	●	○	
2623A	○	●	○	●
2624B	○	●	○	
2626A	●	●	○	
2626W	●	●	●	
2645A	○	○	○	
2647F	○	○	○	○
2648A	●	○	○	○

○ = Compatible Terminal with 3000 Software  
 ● = Recommended Terminal with 3000 Software

### Ordering Information

- 2382A Office Display Terminal
- 2621B Interactive Display Terminal
- 2622A Display Terminal
- 2623A Graphics Terminal
- 2624B Display Terminal
- 2626A Display Station Terminal
- 2626W Word Processing Station
- 2645A Display Terminal
- 2647F Intelligent Graphics Terminal
- Opt 072 Second Flexible Mini Disc Drive
- 13257G Graphics Presentation Pac/47
- 13257H Project Management Pac/47
- 13257L Statistical Analysis Pac/47
- 13257M Mathematical Analysis Pac/47
- 13257N LINK/47
- 13257W Word/47
- 2648A Graphic Terminal

Opt 007\* Integrated Dual Cartridge Tape Unit

Opt 050\*\* Integral Printer

Opt 007\* available with the 2645A and 2648A.

Opt 050\*\* available with the 2622A, 2623A, 2624B, 2626A, 2626W.

Opt 072 available with the 2647F

# COMPUTERS, PERIPHERALS & CALCULATORS

## DSN/Data Link and Multipoint Cluster Controller

Model 2333A

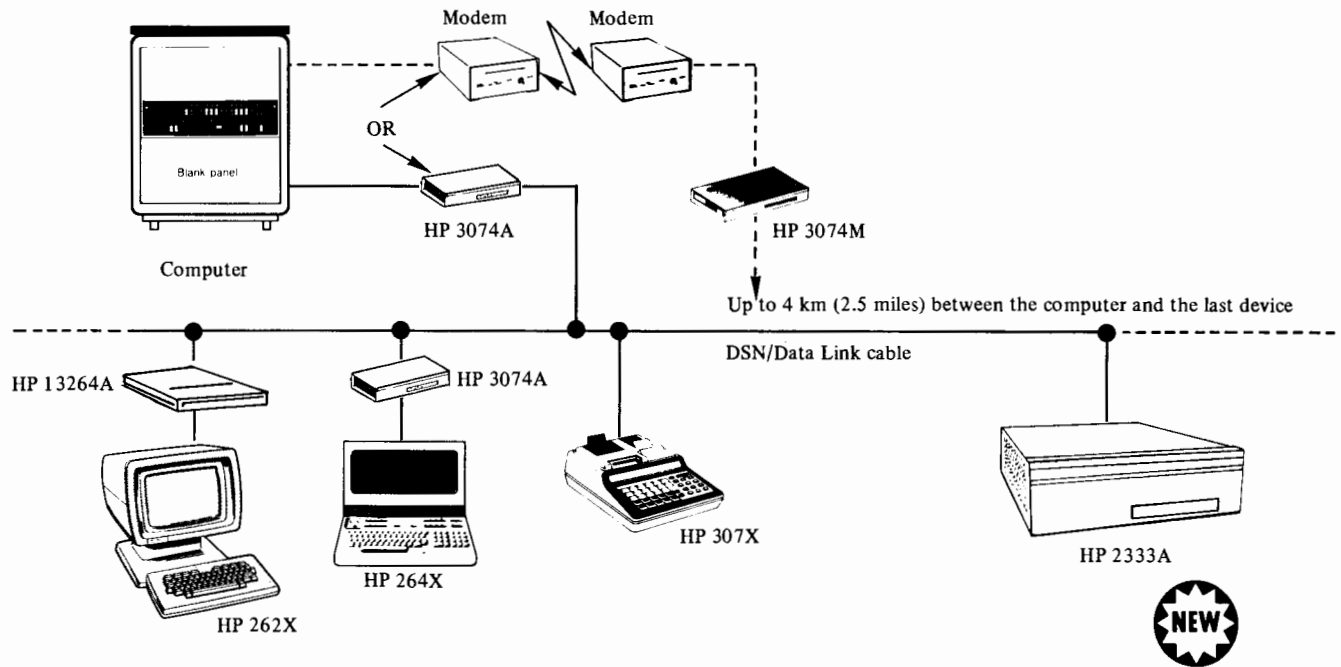

### DSN/Data Link

The "DSN (Distributed Systems Network)/Data Link" provides a data communications interface between a computer and a large number of devices. It is a low cost system ideally suited for applications involving the collection of data from many widely distributed sources in the same building. The Data Link is compatible with any computer that uses RS232C data communications and supports the HP asynchronous multipoint block mode protocol.

The Data Link employs a single cable (up to 4 km/2.5 miles long) to provide the interface between the computer and the devices. The computer/devices are connected to the cable by Data Link Connection Boxes. These simplify connections and allow the installation to be readily changed/upgraded. The "link-dedicated" devices are directly plugged into the connection boxes. The "non link-dedicated" devices are connected to the connection boxes via Data Link Adapters, that convert the device's RS232C electric levels to those of the cable. In addition, the Data Link is resistant to extraneous electric noise, allowing it to be used in an industrial environment. The Data Link Installation Kit (product number HP 92913A) contains all the ancillary components necessary to install a Data Link.

For further details, refer to the DSN/Data Link data sheet and the Data Link Installation Guide (part number 92913-90001).

### DSN/Data Link Compatible Equipment

The following Hewlett-Packard devices may be connected to the Data Link:

- 2333A Multipoint Cluster Controller
- 2624B, 2626A, 2642A, 2645A, 2647A and 2648A CRT terminals
- 3075A, 3076A, 3077A and 3078A Data Capture Terminals
- HP 1000 and HP 3000 computers

### 2333A Multipoint Cluster Controller

The HP2333A is an automatic device-to-host interfacing unit that may be mounted on a desk or in a computer rack. It allows several point-to-point devices to be connected to a multipoint data line, via either a DSN/Data Link or a modem. This provides the convenience of multipoint wiring, coupled with the low cost of point-to-point devices.

Add-on product 40251A enables an additional host to be connected to the 2333A. Therefore a total of two host systems can communicate with a 2333A, each using a discrete multipoint data line. This allows some (or all) the devices to be controlled by host A and some by host B, with switching between hosts as required.

In addition, the operation of the 2333A is transparent to both the system programmer and the device user. Consequently, the point-to-point devices may be programmed and operated in their normal way.

For further details, refer to the 2333A data sheet.

### Ordering Information

2333A Multipoint Cluster Controller

# COMPUTERS, PERIPHERALS & CALCULATORS

607

## Data Capture Terminals

Models 3075A, 3076A, 3077A, 3078A



- Modular choice of displays, keyboards, printer and electric interfaces
- Versatile data acquisition and control

- User definable keys / prompting lights for ease of use
- Simple, low cost installation

HP3077A

HP3075A



HP3076A

HP3078A

### The 307X Terminal Family

The HP3075A/3076A/3077A/3078A family of data capture terminals fulfills a wide range of data collection requirements in both manufacturing and commerce; in applications ranging from stock control to machine monitoring.

The HP3075A (desktop) and HP3076A (wall mounted) terminals are both workstations equipped with user definable special function keys and prompting lights that may be individually labelled and programmed for specific tasks. This allows people with little or no experience of using computers to operate these terminals with no special training. The terminals may also be equipped with a choice of displays, readers, printer and electrical interfaces.

The HP3077A is a wall mounted time reporting station equipped with a time display and a badge/card reader. It may be used, for example, to register personnel arrivals and departures and to control access to restricted areas.

The HP3078A is a desk/wall mounted data coupler that complements the range of 307X Data Capture Terminals by adding a remote, automatic electrical data acquisition capability. The 3078A may be equipped with any three from a wide selection of HP interface cards that allow it to be connected to a variety of instruments commonly used in manufacturing environments.

### 3075A, 3076A Specifications

The 3076A is a wall mounted version of the 3075A, and is supplied with a wall mounting cradle. The other specifications for the 3075A and 3076A are identical.

**Standard terminal.** This includes:

- Standard numeric keyboard
- Standard one line numeric display

**Terminal options.** These include:

- Alphabetic keyboard (option 004)
- Alphabetic one line display (option 005)
- CRT display (option 006)
- Multifunction reader (option 007)
- Type V badge reader (option 008)
- Strip printer (option 009)
- General purpose bar code reader (option 010)

- HP-IB controller (option 011)
- Magnetic stripe reader (option 012)
- Serial (RS232C) interface (option 013)
- Low resolution industrial bar code reader (option 054)
- High resolution industrial bar code reader (option 055)

The terminals are compatible with RS232C communications and may be connected to the computer using any of the following three modes:

- 1) DSN/Data Link
- 2) Multipoint
- 3) Point-to-point

### 3077A Specifications

The 3077A is a wall mounted time reporting terminal and is supplied with a wall mounting cradle.

**Standard features.** These include:

- Clock display
- Type V badge reader

**Terminal options.** These include:

- Multifunction reader (option 001)
- Magnetic stripe reader (option 002)
- One line alphanumeric display (option 005)

The 3077A may be connected to the computer in a similar manner to the 3075A and 3076A. For further details, refer to the 3075A/3076A/3077A data sheets.

### 3078A Specifications

The 3078A Data Coupler is an automatic data capture terminal (i.e. it does not require an operator) that may be mounted on a desk or a wall. It may be equipped with any three of the following interface cards in any combination:

- BCD input card
- 8 bit parallel I/O card
- HP-IB controller card
- 4 channel serial I/O card
- 8 channel logic and event sense card

These cards allow each 3078A to control a variety of user devices. They provide electrical interfacing capabilities in applications such as:

- Machine monitoring
- Automated production testing
- Remote interfacing to various user measuring instruments; e.g. scales

The cards interface the user equipment to the computer. They are designed to comply with existing standards (e.g. IEEE 488-1978 for the HP-IB card). When no standard is available, they may be configured by the program to match the interfacing requirements of the connected device. In addition, the use of simple screw connectors for cabling allows them to be easily connected to various types of instruments. This combination of interfacing capabilities makes the 3078A a highly versatile tool for adapting to a particular requirement.

The 3078A must be connected to the computer via the DSN/Data Link. This allows data to be automatically collected at distances of up to 4 km (2.5 miles) from the computer.

For further details, refer to the 3078A data sheet.

### Ordering Information

3075A Desktop Data Capture Terminal

3076A Wall Mounted Data Capture Terminal

3077A Wall Mounted Time Reporting Terminal

3078A Data Coupler



# COMPUTERS, PERIPHERALS & CALCULATORS

## Mass Storage Peripherals

Models 82901M, 9895A, 9130A, 9121D

The HP family of low-cost 5-1/4" and 8" flexible disc drives, and 5-1/4" micro-Winchester disc drives, provide fast, random access to volumes of information on HP personal, desktop and micro-computers. Your price, capacity and performance needs for entry-level, data exchange and heavy usage mass storage applications have all been considered in the design of these products.

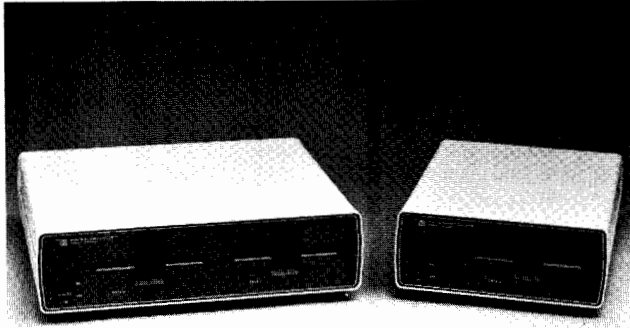

82901M



82902M

### Entry Level—5-1/4" Flexible Disc Drives

#### 82901M Dual-Drive—82902M Single-Drive

For applications requiring low-cost, reliable, on-line access, including small business and professional applications such as Visicalc®, Graphics Presentations, File Manager or word processing, the 82901M offers the speed of random access combined with low-cost, removable media. The single-drive provides 270 Kbytes; the dual-drive has 540 Kbytes storage. These 5-1/4" drives read and write double-sided, double-density format and provide 187 ms average access time.

To bring out the best, most reliable performance in our disc drives, HP provides a convenient source of approved, qualified media.

#### Ordering Information

82901M Dual-Drive Master

82902M Single-Drive Master

92190A HP Qualified Media (Box of 10)

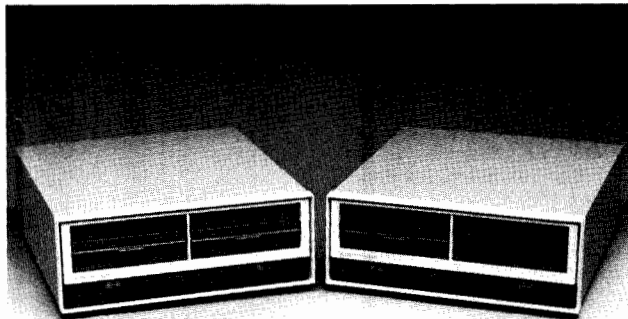

9895A



Opt. 010

### Data Exchange—8" Flexible Disc Drives

#### 9895A Dual-Drive—(Opt. 010 Single-Drive)

The HP 8" flexible disc drives provide 8" flexible disc media for large file back-up or data exchange, CP/M® standard software or other media-format needs.

The 9895A dual-drive provides 2.3 Mbytes of removable mass storage plus back-up capability. The Opt. 010 single-drive provides 1.15 Mbyte capacity.

The 9895A reads and writes double-sided, double-density format on HP qualified media. Access time is 179 ms with transfer speeds up to 23 Kbytes/sec.

Data exchange with HP and non-HP systems is possible through the 9895 as it reads and writes industry standard IBM 3740 single-sided, single-density format. This is also the format used for CP/M standard data storage.

#### Ordering Information

9895A Dual-Drive Master

(order appropriate mainframe option)

9895A Single-Drive Master (Opt. 010)

(order appropriate mainframe option)

92195A HP Qualified media (Box of 10)

#### 9130A Single Flexible Disc Drive

The 9130A provides low-cost random access mass storage for the HP 86 Personal Computer. Up to two drives may be connected to the HP 86. Each 5-1/4" disc can store 270 Kbytes of user data after formatting. It connects to the HP 86 which contains the power supply and controller for the drive.

The 9130A has a transfer rate of 6.8 Kbytes/sec and average access time of 187 msec.

#### Ordering Information

9130A Single Flexible Disc Drive

92190A HP Qualified Media (Box of 10)

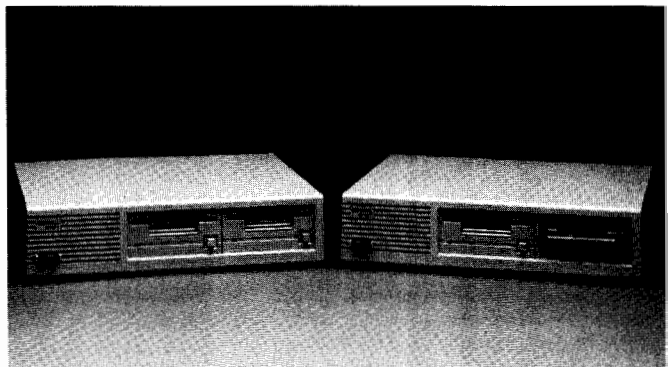

9121D



9121S

### Entry Level—3.5" Flexible Disc Drives

#### 9121D 3.5" Dual-Drive—9121S Single-Drive

In addition to low-cost, reliability, and speed of random access, the HP 9121D/S offers a small, compact flexible disc drive using 3.5-inch media.

The 3.5-inch single-sided drives provide the same amount of storage capacity (270 Kbytes) as the 5-1/4" double-sided drives. This capacity is due to the 3.5-inch drive's increased track density, 135 tracks per inch, compared to 48 tracks per inch of the 5-1/4" drive.

Media used in the 9121 is totally enclosed in a shirt-pocket-sized, hard plastic envelope to protect it from contamination. A built-in hub reduces centering problems of the media.

#### Ordering Information

9121D 3.5" Dual-Drive Flexible Disc

9121S 3.5" Single-Drive Flexible Disc

92191A HP Qualified Media (Box of 10)

\*VisiCalc is a registered trademark of VisiCorp.

\*CP/M is a registered trademark of Digital Research, Inc.

# COMPUTERS, PERIPHERALS & CALCULATORS



## Mass Storage Peripherals

Models 9134A, 9135A, 9138A, 9885M/S, 9876A, 9878A

### Heavy Usage—5-1/4" Micro-Winchester Disc Drives

On-line, heavy-usage applications are covered by the high speed and large-storage capacity of the HP 5-1/4" Winchester disc drives. A sealed, protected drive satisfies the stringent mass storage needs often found in manufacturing, production and lab environments.

The controller of the HP Winchester drive emulates an HP 9895A 8" Flexible Disc Master with three slaves so the many mass storage drives that support the 9895A can also interface with the Winchester. Thus, all software currently used on the HP 9895A 8" Flexible Disc Drive can be used on the Winchester without any change.

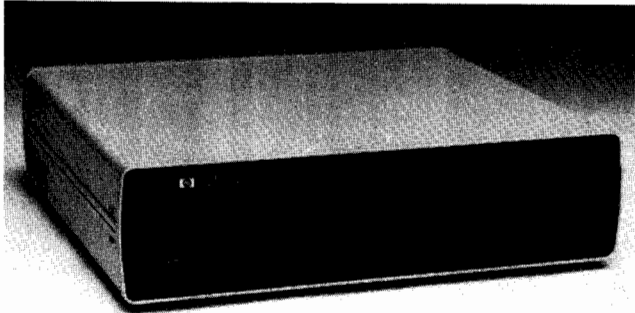

9134A



#### 9134A Micro-Winchester

This drive adds 4.6 Mbyte capacity, fast 60 msec average access time, and high-speed, 50 Kbytes/sec transfer rate to the HP line of high powered desktop and micro-computers.

The built-in tape or flexible disc drive capability of the host computers are used for back-up when teamed with the 9134A micro-Winchester.

#### Ordering Information

9134A Micro-Winchester Disc Drive

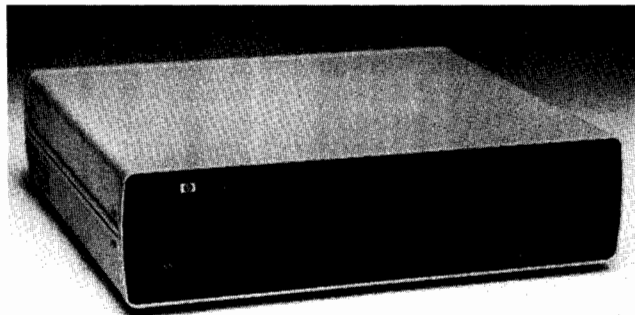

9135A



#### 9135A Combination Storage Unit

The 9135A combination mass storage unit includes the 4.6 Mbyte Winchester for heavy-duty usage, combined with the 5-1/4" (270 Kbyte) flexible disc drive for back-up. This combination unit provides the high speed and large capacity of the micro-Winchester, plus the benefits of removable flexible disc media and back-up capability all in the same unit.

#### Ordering Information

9135A Combination Storage Unit

92190A HP Qualified Media (Box of 10)

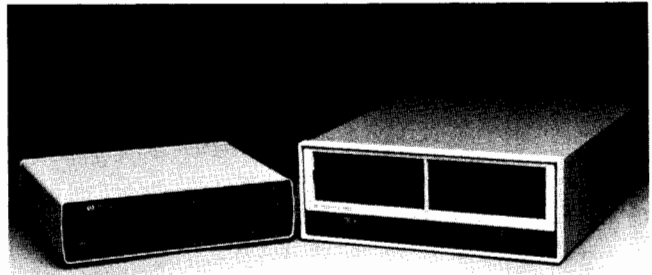

9138A



#### 9138A Mass Storage System

The 9134A 5-1/4" micro-Winchester and 8" single-drive 9895A, Opt. 010 Flexible Disc, can be purchased together as the HP 9138A. Together these two products provide the capacity and speed of the heavy duty Winchester, plus the data exchange and large file back-up capability of the 8" flexible disc drive at a lower price than if individually purchased.

#### Ordering Information

9138A Mass Storage System (inc. one HP-IB cable)

92195A HP Qualified Media (Box of 10)

#### 9885M/S 8" Flexible Disc Drive

The 9885 single-sided double-density mass storage drive provides access time of 267 msec and approximately 500 Kbytes of data per disc. Transfer rate is 46 Kbytes/sec.

This reliable and easy-to-use flexible disc drive comes in two versions: the 9885M (master) and the 9885S (slave).

#### Ordering Information

9885M Flexible Disc Drive Master

9885S Flexible Disc Drive Slave

9164-0105 HP Qualified Media (Box of 10)

#### 9876A Thermal Graphics Printer

The 9876A Thermal Graphics Printer is a fast, quiet line printer. Its speed of up to 480 lines per minute makes it ideal for producing high-speed listings, working reports or quick plots and graphics. Available with HP-IB (IEEE-488), 8 bit parallel or RS232C interfaces, the 9876A is compatible with a wide variety of computers and terminals from HP and other manufacturers.

#### 9878A I/O Expander

Interfaced with the HP 9825, 9835 and 9845 Desktop Computers, it provides six additional I/O ports and will accommodate all the mainframes' interface cards.

#### Ordering Information

9876A Thermal Graphics Printer

11479A Caseless version of 9876A

9878A I/O Expander

HP Mainframe Support Table

	82901/2	9895A	9130A	9121S/D	9134	9135	9138
Personal Computers Series 80, 100	●	●	★	●	★★	●	●
Desktop Computers 9816, 9826, 9836	●	●		●	●	●	●
Desktop Computers 9825T, 9845B/C		●			●		●
Micro-Computers 1000 "L" Series Model 5, 6		●			●		●
Micro-Computers 1000 M.E.F. A600, A700 Series		●					
Business Computers 3000 Series		●					

★ = HP 86 ONLY

★★ = Must include removable storage device, e.g., 82901 when used with HP 125.



# COMPUTERS, PERIPHERALS & CALCULATORS

## MAC Disc Drive Family

Models 7906, 7920, 7925

- Performance
- Reliability
- Serviceability

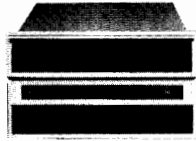

7906MR/SR

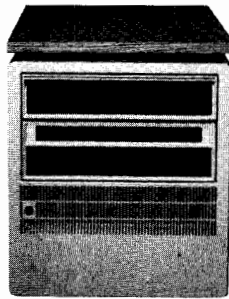

7906M/S

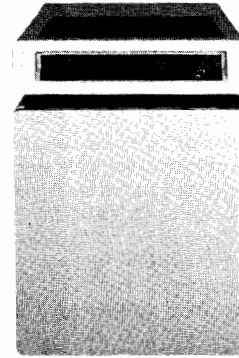

7920M/S, 7925M/S

The Hewlett-Packard Multi-Access Controller (MAC) Disc Drive family offers a wide range of reliable, high-performance mass storage capabilities. Engineering and manufacturing excellence have been emphasized in the HP tradition to insure that the entire disc drive family exhibits the performance, reliability, and serviceability that have established HP products as a marketplace standard.

### Features

- Configuration flexibility from 20 Mbytes to 960 Mbytes of HP-formatted usable storage
- High-performance disc drives, 25 ms average seek times
- Sophisticated microprocessor-based disc controller
- Systems engineered for optimum performance with HP computing systems
- Designed and manufactured for exceptional performance and reliability over a wide range of environments
- World-wide service and support

### Description

Hewlett-Packard offers a complete line of controller-compatible disc drives for the minicomputer industry. The Multi-Access Controller (MAC) Disc Drive family is comprised of three high-performance disc drives: the 120 Mbyte 7925, the 50 Mbyte 7920 and the 20-Mbyte 7906. These mass storage devices have been engineered and manufactured for reliability, performance and low cost of ownership.

The heart of the MAC Disc Drive family is a powerful Multi-Access Controller. Microprocessor-based architecture allows implementation of many sophisticated system features including access to as many as eight disc drives, extensive error correction, multi-CPU access, and automatic alternate track switching to name a few. Plug-to-plug compatibility across the entire family of disc drives permits up to eight 7906, 7920, or 7925 disc drives, in any combination, to be connected to a single controller. These features allow unmatched flexibility in configuring disc-based systems from 20 Mbytes to 960 Mbytes of HP-formatted user storage capacity.

### 7906 Cartridge Type Disc Drive

**19.6 Mbytes formatted capacity:** The 7906 disc drive features 9.8 Mbytes of removable and 9.8 Mbytes of fixed media to provide single-drive users with a convenient backup capability. The cartridge type media is exceptionally easy to store, use, and/or transport. An advanced temperature compensation circuit in each disc drive provides start-up times of less than 60 seconds and allows accurate transfer of data between the fixed and removable surfaces under diverse temperature conditions.

### 7920 Pack Type Disc Drive

**50 Mbytes formatted capacity:** The 7920 Disc Drive is a proven performer in the medium-capacity range of the Hewlett-Packard Multi-Access Controller (MAC) family of disc drives. Dependable, rugged, and attractively styled, the 7920 Disc Drive is an excellent choice for applications where reliability and performance are critical.

### 7925 Pack Type Disc Drive

**120 Mbytes formatted capacity:** Each 7925 removable pack type drive provides 120 Mbytes of formatted storage capacity, which means a total of 960 Mbytes (0.960 gigabytes) would be available using eight 7925 drives on a single Multi-Access Controller.

### Configuration

**MAC**—The maximum configuration for MAC Family disc drives is eight 7906 and/or 7920 and/or 7925 drives per controller. All cabling between Master and Slave drives is included.

### Electromagnetic Emissions/Safety

For EMC/RFI emissions standards such as VDE 0871 and C.I.S.P.R., consult the appropriate HP configuration guide for system certification.

Products have appropriate UL/CSA approvals. VDE certification pending.

### Ordering Information

**79XXM** Master Drive (includes Multi-Access Controller)

**79XXS** Slave Drive (Add-on disc drive with 79XXM)

**7906XR** Rack Mountable unit

Drive	Controller Included?	Max Power@ 120 V, 60 Hz	Media	Available Options
7906M	Yes	740W/8.0A	12940A	015,102
7906MR	Yes	720W/7.8A	12940A	015,020,102
7906S	No	520W/5.7A	12940A	015
7906SR	No	500W/5.5A	12940A	015,020
7920M	Yes	700W/7.4A	13394A	015,102
7920S	No	480W/5.1A	13394A	001,015
7925M	Yes	630W/6.7A	13356A	015,102
7925S	No	410W/4.4A	13356A	001,015,250
7925T	No	410W/4.4A (each drive)	13356A	001,015,250

#### Options:

001 Changes cable lengths. (Substitutes 5.5 m (18 ft.) Multi-Unit and 7.6 m (25 ft.) data cables for standard lengths)

015 230 V/50 Hz operation

020 Substitutes 30 inch rack slide kit

102 Adds HP-IB adapter kit

250 Adds controller upgrade service required to support the first 7925S added to our existing MAC subsystem (may include the use and/or exchange of refurbished printed circuit assemblies)

# COMPUTERS, PERIPHERALS & CALCULATORS



CS/80 Disc Drive Family

Models 7908, 7911, 7912, 7933

- Performance
- Reliability
- Serviceability



- Integral microprocessor controller
- Internal self test and diagnostics

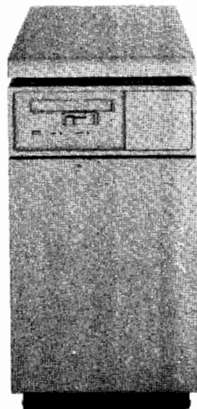

7908P, 7911P, 7912P

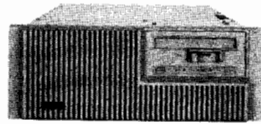

7908R

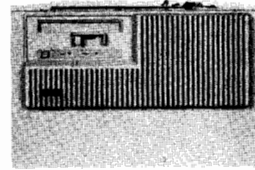

7911R, 7912R

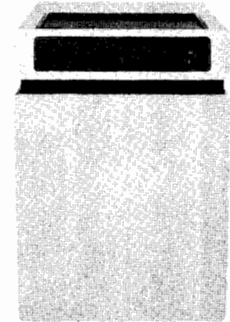

7933H



Creating new standards for efficiency and ease of use, Hewlett-Packard offers the HP7908, 7911, 7912, and 7933 disc products. Whether you require an efficient, entry level product or a larger, more powerful solution, these disc products are designed to satisfy your particular storage requirements.

To ensure flexibility in configuring mass storage needs, each disc product employs the same efficient command structure (CS/80) and the same interface standard (HP-IB), allowing you to mix and match a wide range of compatible storage solutions with little or no need for additional control hardware or software modification.

All of the CS/80 family disc products contain a sophisticated, internal controller which performs advanced, self-diagnostic routines to facilitate maintenance and servicing. These self-diagnostic capabilities, coupled with careful design and engineering, promote a highly reliable and serviceable disc drive which will provide greater system uptime and productivity.

## 7908, 7911, 7912 Disc/Tape Drives

The 7908, 7911 and 7912 Disc/Tape Drives are a family of products designed to satisfy all peripheral storage requirements in a single compact package. Each product utilizes a unique integrated storage concept, featuring a reliable Winchester disc mechanism for mass storage, and a 1/4-inch cartridge tape drive for backup and user I/O.

The product line provides mass storage capacities from 16.5 to 65.6 Mbytes; they include the 7908 (16.5 Mbytes), 7911 (28.1 Mbytes), and 7912 (65.6 Mbytes). Each utilizes a Winchester head and media disc drive for mass storage; the 7908 is based on 8-inch media whereas the 7911 and 7912 are based on 14-inch media.

### Features

- Winchester head/media technology
- Easy to handle, reliable 1/4-inch cartridge tape media
- 16.7/67 Mbyte formatted data storage capacity tape cartridges
- Shared controller for disc and tape
- Internal firmware to execute offline disc-to-tape and tape-to-disc data transfers (backup/restore)
- Automatic track and sector sparing
- Automatic seek and read retry
- Automatic error logging
- Real time error correction—7911 and 7912 only
- Extensive internal diagnostics
- HP-IB compatible

## 7933H Disc Drive

The HP7933H Disc Drive is a fixed media device that provides high levels of performance, reliability, and serviceability. The performance

of the 7933H promotes overall greater system efficiency. The advanced reliability and serviceability features are reflected by the exceptionally low maintenance costs of this product. Major contributions include a powerful microprocessor based controller with sophisticated internal diagnostics, and state-of-the-art packaging.

### Features

- 404 Mbytes of formatted storage
- 1.0 Mbytes/s transfer rate
- Front panel diagnostic access and readout
- Automatic head alignment
- Automatic sector and track sparing
- Automatic error correction
- HP-IB compatible

## Operational Characteristics

### Electromagnetic Emissions

The 7908, 7911, 7912, and 7933 meet the conducted and radiated interference requirements for VDE 0871 level A and FCC Technical Standard for Class A Computing Equipment, September 18, 1978 Docket 20780 Part 15. On some HP systems they meet VDE 0871 level B.

### Safety

The 7908, 7911, 7912, and 7933 meet all applicable safety standards of the following: CSA 22.2 No. 143 and No. 154, IEC 380 and 435  
UL listed (stand-alone cabinet) and recognized (rackmount) to UL 114 and UL 478

### Ordering Information

7908P/R (16.5 Mbytes)

7911P/R (28.1 Mbytes)

7912P/R (65.6 Mbytes)

Opt 001: Dedicated tape controller  
(7911 and 7912 on HP3000 only)

Opt 015: 220-volt operation

Opt 140: Delete cartridge tape drive

7933H (404 Mbytes)

Standard input power: 208 volts

Opt 120: For 120-volt operation in U.S.A., Canada

Opt 220: For 220-volt operation in Canada

Opt 221: For 220-volt operation in continental Europe

Opt 222: For 220-volt operation in Switzerland

Opt 223: For 220-volt operation in Denmark

Opt 241: For 240-volt operation in United Kingdom

Opt 242: For 240-volt operation in Australia,  
New Zealand



# COMPUTERS, PERIPHERALS & CALCULATORS

## Workstation Printers

Models 2671A, 2671G, 2673A



### Introduction to Workstation Printers

Hewlett-Packard's workstation printers provide the convenience of hardcopy output right where it is needed: at the user's work area.

HP's workstation printers offer a broad range of capabilities combining high performance and easy-to-use features to suit a variety of applications. A simple comparison will help you to determine the right workstation printers for your applications. Throughput, print quality, paper handling, printer features, and application examples are summarized in this section.

#### 2670 Series Thermal Printers

The 2670 series Family offers fast, quiet printing and friendly user convenience for workstation operations.

- 120 CPS Bidirectional Printing
- 9 × 15 Dot Matrix Character Cell for Excellent Character Definition with True Descenders
- Quiet Operation for Lab or Office
- Interface Flexibility: HP-IB, RS-232C Serial, HP or Centronics Parallel, Factory Data Link, HP-IL
- Flat Fanfold or Roll Paper
- Three Character Sets: Full 128 USASCII, Roman Extension, and Line Drawing
- FCC Approval for Home Use

#### The 2671A Alphanumeric Printer

The 2671A is an ideal desktop printer for light duty character printing from a terminal, desktop computer, personal computer, or test system. Featuring fast, quiet printing, the 2671A can generate convenient copies of text pages, program output, or test results. Print modes are normal (10 cpi/80-column lines) and compressed (16.2 cpi/132-column lines). Simple escape sequences transmitted from the host device provide text formatting and enhancements. A convenient front panel contains form feed, self test and printer reset buttons.

#### The 2671G Graphics Printer

The 2671G has 90-dots-per-inch raster graphics capability in addition to all the features of the HP 2671A. It is designed to provide graphics and text hard copy from raster graphics terminals, personal computers, and desktop computers.

#### The 2673A Intelligent Graphics Printer

The HP 2673A includes all the features of the HP 2671G, plus more sophisticated graphics capabilities, many alphanumeric printing enhancements, and interactive nonvolatile configuration.

Designed to be used with graphics terminals, personal computers, and desktop computers, the HP 2673A serves hard copy applications requiring graphics formatting and enhancements like expanded characters (5 cpi), high density printing, underlining, and framing. Enhanced graphics capabilities include auto-centering, windowing, and offsets.

In addition to Roman Extension and Line Drawing character sets, the 2673A features JASCII, HPL, Katakana, and eight 7-bit ISO national character sets: Norwegian/Danish, Swedish/Finnish, French, German, United Kingdom, and Spanish.

The 2673A recognizes two ways of defining its features: through escape sequence commands from the host device and through the Configuration Mode. The escape sequence commands turn features on or off without altering the memory. The Configuration Mode controls the settings in the memory; and the control panel provides full access to the Configuration Mode. Margins, tabs, print mode, character sets, page format, and datacomm parameters are selected via the control panel and stored in the printer's nonvolatile memory. Once selected, features come up automatically at printer power-on.

# COMPUTERS, PERIPHERALS & CALCULATORS

Workstation Printers

Models 2601A, 2631B, 2631G, 2631G Option #200, 2635B

613

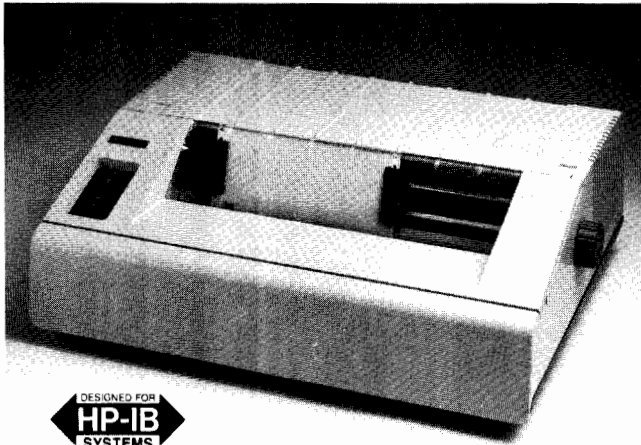

2631B

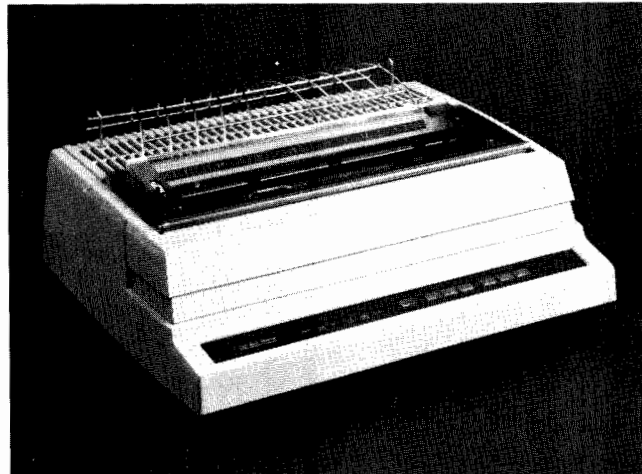

2601A

## The 263X Serial Impact Printers

The 263X Family offers high throughput, forms-handling flexibility, and user convenience to meet the needs of numerous business and technical applications.

- 180 CPS Bidirectional Printing
- 7 × 9 Matrix Allows True Descenders and True Underlining
- Forms-Handling Flexibility
- Adjustable Tractor Feed to Accommodate a Variety of Form Widths
- Full 128 USASCII Standard
- Wide Choice of Optional Character Sets:  
Eight National Character Sets, Math Symbols, Roman Extension, and 90 CPS High Density Characters for Memo-Quality Print

## The 2631B Printer

Printing reports, listing programs, and printing on preprinted multipart forms is made easier by the 2631B's wide range of print features.

The 2631B offers versatile print features such as high-density print, a wide choice of character sets, left and right margins, horizontal and vertical tabs, programmable page length, and twelve vertical line spacings. The 2631B has eight different print modes including: normal (10 cpi), compressed (16.7 cpi), and expanded (5.0 cpi). Multipart forms up to 6 parts can be printed. Form widths can range from 31 mm (1.22") to 400 mm (15.75").

In addition to USASCII, eight national character sets are available in both standard and high density; Swedish/Finnish, Norwegian/Danish, French, German, United Kingdom, or Spanish.

The 2631B has a variety of interfaces: RS-232C, HP-IB, HP compatible 8-bit TTL, and parallel differential.

## The 2631G Graphics Printer

The 2631G combines the capabilities of the 2631B with the ability to do graphics. Its 72 × 72 dots-per-inch graphics is ideally suited for reproduction of business, scientific, and engineering data. Designed to be used as an HP-IB device on graphics terminals, it is ideal for generating crisp, permanent copies of graphics displays or text output.

The HP 2631G, option #200, Factory Data Printer provides automatic bar code printing, mark sense printing, and forms-generation capability. Three of the most commonly used bar code types are resident: CODE 39 alphanumeric bar code\*, Industrial 2 of 5, and Matrix 2 of 5. In addition, user-definable codes may be generated with application programs.

## The 2635B Printing Terminal

The HP 2635B is a printing terminal that provides printing for remote program development, forms completion, and other on-line printing applications via an RS-232C interface.

The typewriter-style keyboard includes a numeric keypad for easy data entry. There are twelve configuration keys for easy access to the same printing features that are available in the 2631B.

## The 2601A Daisywheel Printer

- Letter Quality Printing
- Interchangeable Print Wheels
- RS-232C Interface

The HP 2601A generates letter-quality output for reports, correspondences, and other applications that require high print quality. The word processing capabilities of the HP 2601A include proportional character spacing, auto-underlining, right justification, tabs, and margin controls. Whether used in a word processing system or as a general purpose letter-quality printer, the HP 2601A produces customized output with a minimum of operator interaction.

The 2601A prints at 40 cps with plastic and 32 cps with metalized print wheels. Its interchangeable daisywheels, available through HP Computer Supplies, provide a comprehensive selection of languages and type styles. The cartridge ribbon is also easily installed or removed and requires no hand contact with the ribbon itself.

## Order Information

- HP 2601A
- HP 2631B
- HP 2631G
- HP 2631G, Opt. #200
- HP 2635B
- HP 2671A
- HP 2671G
- HP 2673A

\*CODE 39 is a trademark of Interface Mechanisms, Inc.

# COMPUTERS, PERIPHERALS & CALCULATORS

## Line Printer, Laser Printing System, Tape Subsystems

Model 2608S Model 2680 Model 7971A Model 7976A

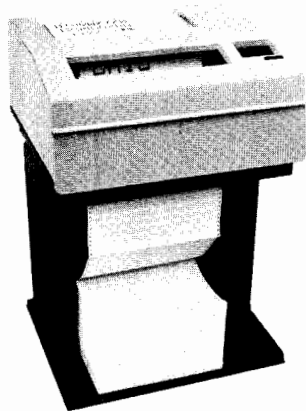

2608S

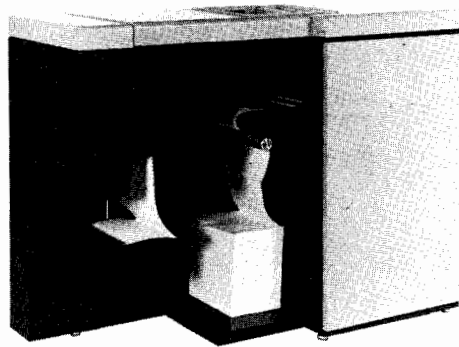

2680

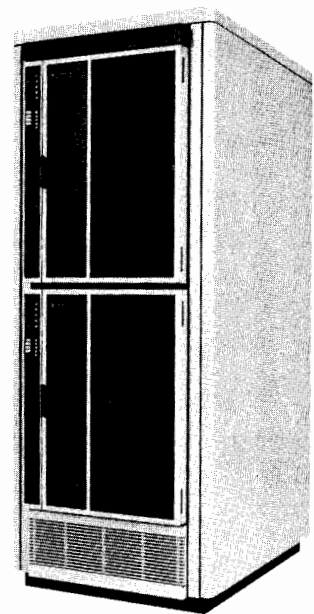

7971A

### HP 2608S Line Printer

The HP 2608S is a highly reliable, medium speed, dot matrix line printer designed for use in most computer applications. The 2608S can print standard or high density characters at 400 and 350 lines per minute, respectively. Features of the 2608S, including a pedestal stand, paper jam detector, easy loading ribbon cartridge and quiet operation, show that the 2608S is successful in EDP applications or office use.

**Versatility:** The flexibility of dot matrix printing makes possible the use of graphics, multiple character sets, double-size characters, over-strike and underlining, and large block characters. Good print quality, especially with multipart forms, and simplified forms usage, makes the 2608S a natural for many EDP applications.

**Reliability:** The printing mechanism has few moving parts, operates virtually without friction and is a leader in the industry for reliability. Microprocessor control provides for many capabilities and also serviceability, which result in low maintenance prices and greater up-time.

**Remote Serial Interface:** An optional interface allows the 2608S to operate remotely using modems, or hardwired when running HP multipoint software on HP 3000 computer systems. The remote spooled 2608S printer(s) can share communications lines with HP terminals.

### 2608S Line Printer

#### HP 2680 Laser Printing System

The 2680 Laser Printing System (LPS) combines the 2680A Laser Printer and several optional application packages. The printer operates at 45 pages per minute on plain 8.5-inch by 11-inch fanfold paper. It features continuous paper feed for paper handling reliability, non-contact fusing which is virtually maintenance free, and a data control system that is capable of handling variable size characters, electronic forms and multiple pages of print on one sheet of paper. In addition to these features, the 2680 LPS is equipped to operate with the following HP 3000 options:

**Interactive Design System:** The IDS/3000 is used for designing characters, symbols and forms using a graphics terminal. This includes digitation of artwork, including signatures.

**Interactive Formatting System:** The IFS/3000 is used to specify page sizing and formatting, and to select forms and character fonts for a print job.

**An optional graphics capability** enables graphical data to be merged with text and printed by utilizing a software option on the HP 3000 and a hardware modification on the 2680. This eliminates manual cut-and-paste for text and graphics manipulation.

### 2680 Laser Printing System

#### HP 7971A Magnetic Tape Subsystem

The Hewlett-Packard 7971A Tape Subsystem provides medium speed, industry standard, one-half inch magnetic tape capabilities for all HP 1000 and HP 3000 computer systems in 1600 bpi (PE) tape format, with 800 bpi (NRZI) available on some HP systems. The 7971A is an upright cabinet consisting of one or two 7970B/E magnetic tape drives; up to four tape units may be supported on most HP controllers.

The features of the 7971A include:

- Field proven reliability
- Data Transfer rates of 36K and 72 Kbytes/second
- 9-track configuration
- 45 ips read/write speed
- 160 ips rewind
- Dynamic braking
- Tension arm tape buffering
- Controllers for various HP Computer Systems
- Single track error correction in 1600 bpi drive

#### 7971A Tape Subsystem

(standard subsystem price for single drive)

#### HP 7976A Magnetic Tape Subsystem

The Hewlett-Packard 7976A magnetic tape subsystem provides high speed, industry standard, one-half inch magnetic tape capability for HP 3000 computer systems. The unit is configured for two tape formats, and is able to read and write either ANSI standard 6250 bpi Group Coded Recording (GCR) data or the 1600 bpi, phase encoded (PE) format. The 7976A comes with an integral formatter/controller and features a high speed HP-IB interface suitable for use with all HP-IB HP 3000 computer systems. This subsystem may also be added to HP 3000 series III systems by using the 30341A interface module. The tape subsystem is mounted in an attractive, upright rack cabinet.

#### 7976A Magnetic Tape Subsystem

# COMPUTERS, PERIPHERALS & CALCULATORS

615

## Modems



37213A, 37214A, 37215A, 37216A, 37230A

- Auto-dial, auto-answer, full-duplex 1200 b/s on dial-up lines
- Compatible with Bell 212A and CCITT V.22 (Alternatives A and B) at 1200 b/s
- Interfaces for external dial-up full-duplex modems
- Card cage accommodates up to 7 independent modems

- For use with the 12792A/B and 12040A/B 8-Port Multiplexers on all HP 1000 Computers
- Provision for local terminal connection at unused modem ports
- Short Haul Modem for data rates up to 19.6 kb/s

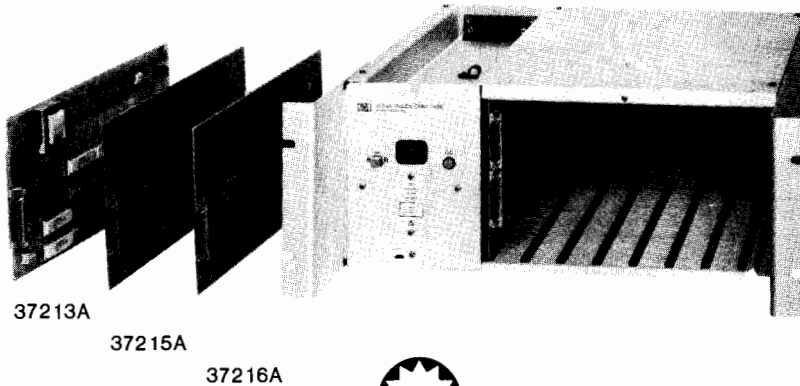

37230A



### Introduction

The HP Systems Modem comprises the 37214A Modem Interface Card Cage and 37213A, 37215A and 37216A family of plug-in cards. The Systems Modem provides 1200 b/s full-duplex modem support on dial-up lines for the 12792A/B and 12040A/B 8-Port Multiplexers on all HP 1000 Computers.

The 37230A Short Haul Modem is designed for half-duplex, full-duplex and multi-drop operation on private or leased local lines at data rates up to 19.2 kb/s.

### 37214A Modem Interface Card Cage

The 37214A is a rack-mount card cage with integral power supply and controller. It can accept up to seven 37213A Modem Cards or other optional interface cards. The 37214A connects to the 8-Port Multiplexer via a single multi-way cable (12828-60002) and distributes one pair of send and receive signal lines to each card slot. Port 7 of the Multiplexer is routed to the integral controller and dialer which communicates with the user program by simulating a terminal. The controller and dialer provide the control signals, the pulse and DTMF dialing control, and loopback control for up to seven Modem Cards.

Local analog loopback or remote digital loopback may be selected under program control to allow a user program to pass data and check the integrity of the looped modem link. Also, a local diagnostic terminal port enables monitoring of all the modem interface lines, and control for diagnostic purposes.

General purpose control protocol permits use with any DTE which does not support auto-dialing modems.

**37214A Modem Interface Card Cage** Price to be announced

### 37213A Modem Card

The 37213A is a single plug-in card full-duplex modem. It will communicate with any Bell 212A compatible modem at 1200 b/s, synchronous or asynchronous, or 300 b/s synchronous, and with any CCITT V.22 (Alternatives A and B) compatible modem at 1200 b/s. The 37213A is also compatible with the Vadic 3450 Series Triple Modem and the HP 35016A Remote Support Modem (212 and 103 modes).

The Modem can perform both pulse and DTMF (tone) dialing under user program control. It incorporates auto-answer operation with auto-speed detection and configuration of port speed.

Interfaces for both the 8-Port Multiplexer and an RS232C DTE connection are incorporated. The RS232C port provides a synchronous or an asynchronous interface for applications other than with the 8-Port Multiplexer.

Local analog or remote digital loopback may be performed under user program control.

**37213A Modem Card** Price to be announced

### 37215A Modem Interface Card

For applications where a PTT supplied modem must be used or where a modem is already available, a 37215A may be used in place of a 37213A Modem Card. The Modem Interface Card provides buffered RS232C and V.24/V.28 compatible lines for controlling all common switched-line, full-duplex modems. The 37215A is compatible with the following modems. Bell 212A, Vadic 3450 Series Triple Modem, Penril 300/1200, Rixon T212A, GDC 212A, British Telecom Modem 27, Racal Milgo MPS 1222.

Loopback of most external modems may be performed under user program control.

The Modem Interface Card also provides auto-configuration of port speed with auto-answer modems. Auto-dialing is not possible when using external modems.

**37215A Modem Interface Card** Price to be announced

### 37216A Terminal Interface Card

The 37216A allows connection of local hardwired terminals to unused Multiplexer ports. With the Terminal Interface Card, one local terminal can be connected to one port of the 8-Port Multiplexer via a standard 25-pin D-type connector.

**37216A Terminal Interface Card** Price to be announced

## Modems

Models 37213A, 37214A, 37215A, 37216A, 37230A

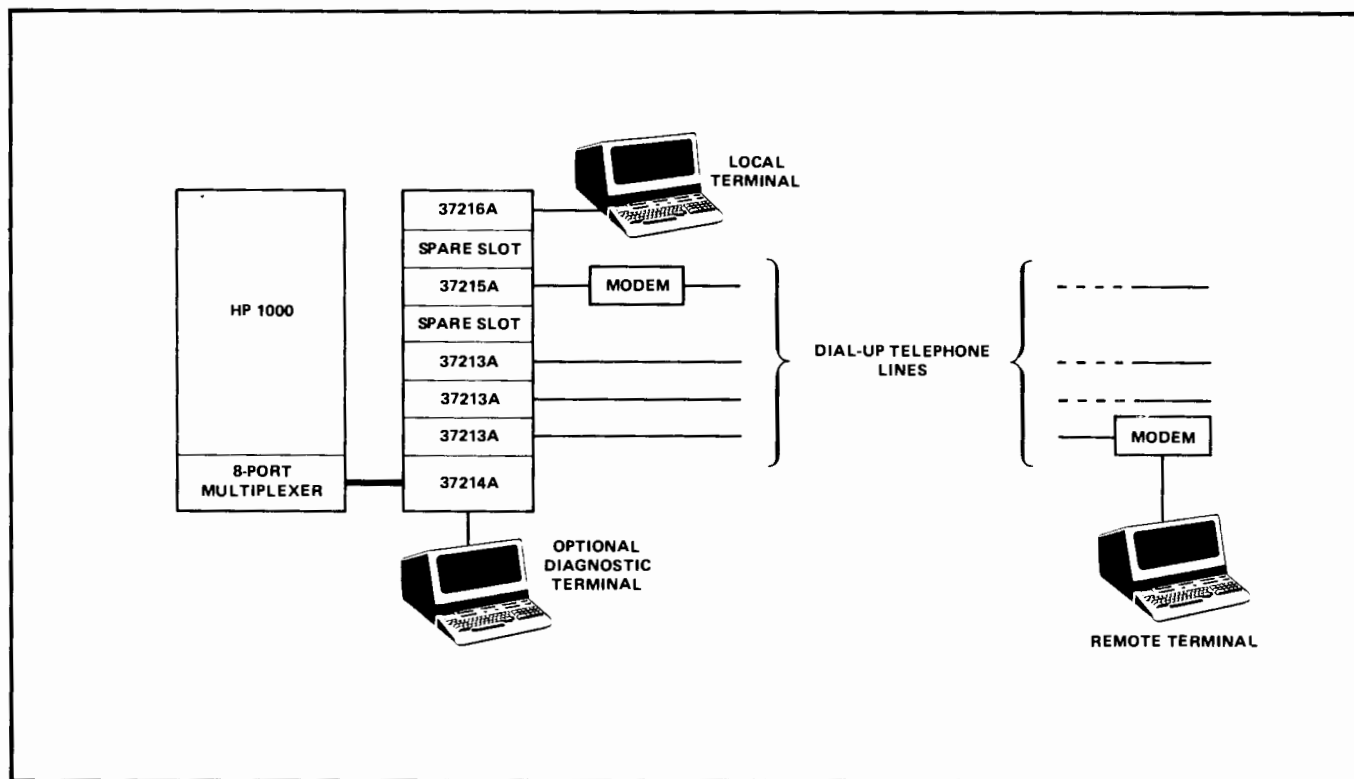

Figure 1. Typical arrangement of the Systems Modem on a dial-up network

### 37230A Short Haul Modem

The 37230A Short Haul Modem provides synchronous transmission of data at rates of 2.4, 4.8, 9.6, and 19.2 kb/s. The unit is designed for half-duplex, full-duplex, and multi-drop operation over local circuits. It offers features similar to those of a conventional modem, but at lower cost. The 37230A is an economic alternative where transmission within a limited area is required.

The modem can be used over unloaded metallic circuits which are either installed privately or leased from the telephone company. The modem operates half-duplex on 2-wire circuits, and half-duplex, full-duplex, and multi-drop on 4-wire circuits. Suitable circuits can normally be obtained from the telephone company but may be restricted to within one end office (exchange) area. The 37230A complies with BSTR Pub 43401 and is also designed to meet the technical requirements of other authorities including many European PTT's.

An automatic equaliser in the modem receiver compensates for variable characteristics of the telephone circuit, optimising the performance throughout the specified range. In multi-drop systems the central modem automatically readjusts its equaliser to compensate for whichever of the remote sites is transmitting.

The 37230A includes diagnostic test features similar to those found on conventional leased line modems. These include local and remote digital loopback, local analog loopback, and a test pattern generator/error detector.

#### Range

The operating range of the 37230A depends on several factors including data rate, transmit signal level, and cable type used for the circuit. Typical operating ranges are shown in Table 1.

To meet the requirements of BSTR Pub 43401, the output level from the modem must be reduced for data rates above 2.4 kb/s. The required reduction in send level causes a corresponding reduction in range.

Table 1 Operating Range (max output level)

Data Rate	19 AWG 0.9mm	22 AWG 0.6mm	24 AWG 0.5mm	26 AWG 0.4mm
2.4 kb/s	22 miles	15 miles	12 miles	10 miles
4.8 kb/s	18 miles	12 miles	10 miles	8 miles
9.6 kb/s	13 miles	9 miles	7 miles	6 miles
19.2 kb/s	9 miles	6.5 miles	5 miles	4 miles

Note: test conditions: maximum send level; 140Ω terminating impedance; polythene insulated twisted pair cable simulator.

#### Remote Control of Loopback

Option 001 of the Short Haul Modem allows the diagnostic loopback facilities to be controlled via the DTE interface connector.

#### Specifications Summary

**Operating mode:** synchronous, 2-wire (half-duplex) and 4-wire (full-duplex, half-duplex, and multi-drop)

**Data rates:** (nominal) 2.4, 4.8, 9.6, 19.2 kb/s.

**Digital interface:** EIA RS232C/CCITT V.24 V.28 compatible.

#### RTS/CTS delay (nominal)

**Constant carrier:** 0 ms.

**Switched carrier:** ≤25 ms at 2.4 kb/s

≤15 ms at 4.8 kb/s

≤10 ms at 9.6 kb/s

≤8 ms at 19.2 kb/s

#### Options

**001:** Remote Control of Loopback

**301:** Rack Mount Kit

**302:** Dual Rack Mount Kit

#### 37230A Short Haul Modem

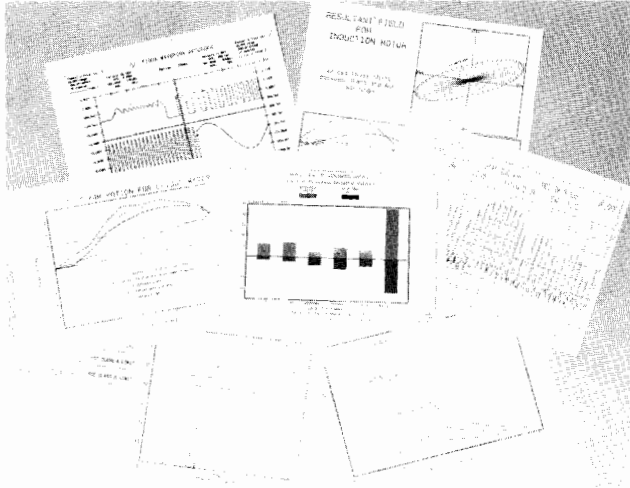

In fields as diverse as engineering, chemistry, medicine, finance, and marketing, the need for hardcopy graphics is growing. The reason is simple: graphics provide a comprehensive, easy-to-understand overview of numerical data. With Hewlett-Packard plotters, you can quickly generate professional, hardcopy graphs and charts from design, measurement, and computational data.

### A Choice of Interfaces

All HP plotters provide either an HP-IB (IEEE 488-1978) or an RS-232-C/CCITT V.24 interface so they can be connected with a range of HP computers and measurement instruments, and with those of most other manufacturers.

### Graphics Instruction Sets

HP plotters understand one of two graphics instruction sets to provide an efficient communication method for your application. Most understand the Hewlett-Packard Graphics Language (HP-GL).

HP-GL is a set of easy-to-remember two-letter mnemonic commands which covers the full range of vector plotting operations. The 7221 series of plotters understands compacted binary instructions for efficient communications at slower data rates such as over telephone lines.

### Software for Most Applications

To make plot generation as effortless as possible, HP supports its plotters with two software packages. Hewlett-Packard's Industry Standard Plotting Package (HP-ISPP) supports plotters that have the HP-GL instruction set. It allows simple adaption of existing application programs for use with HP plotters. HP-PLOT/21 supports the 7221 series of plotters with over 70 high level, user-callable subroutines. Both packages are written in ANSI Standard FORTRAN and operate on many ASCII-based computer systems.

For HP computers and intelligent terminals, a wide range of Hewlett-Packard graphics software application programs and programmer utilities is available for almost any technical or business need.

### Plotting Media and Pen Choices

With HP plotters, you have a choice of plotting media and pen types. Each plotter uses fiber-tip pens to plot on paper. HP's fiber-tip pens come in ten colors and two tip widths. There is a fine tip for grids, tick marks and labels, and a wide tip for bold titles, heavy lines, and filled-in areas.

In addition, each plotter offers at least one other medium and pen combination. Depending on the plotter selected, plots can be made on overhead transparency film with special fiber-tip pens available in seven colors and two tip widths, or engineering drawing media (such as vellum and double-matte polyester film) can be used with refillable drafting pens in six standard widths. Roller-ball pens can be used with HP's drafting plotters for plots on chart paper or tracing bond.

### Intelligent Pen Control

All HP plotters change pens automatically under program control so no operator intervention is necessary. To produce graphics of consistently high quality, HP plotters precisely control pen movements through the use of sophisticated electronic circuitry. As pens descend, their motion is automatically damped to preserve pen tips. When pens are returned to their stalls after use, they are automatically capped so they stay fresh and last longer.

Plotter Description	Media	Media Sizes	Interface	Model No.	Page No.
High-quality plotting for budget-sensitive applications. Programmable 2-pen operation (manual pen changing for more than two colors). Uses fiber-tip pens.	Paper, transparency film	210 x 297 mm or 8.5 x 11 in.	RS-232-C/ CCITT V.24	7470A Option 001	618
			HP-IB (IEEE-488)	7470A Option 002	618
Table-top 8-pen plotter with optional automatic paper advance for unattended operation. Compacted binary language in 7221C/T model. Uses fiber-tip and drafting pens.	Paper, transparency film, vellum, double-matte polyester film	Any size up to 297 x 420 mm or 11 x 17 in.	RS-232-C/ CCITT V.24	7220C/T 7221C/T	620
			HP-IB (IEEE-488)	9872C/T	620
High-speed, high-resolution 8-pen drafting plotter for large-format applications. Excellent price/performance advantage. Uses fiber-tip, roller-ball, and drafting pens.	Paper, tracing bond, vellum, double-matte polyester film	Maximum: 622 x 1190 mm (24.5 x 46.9 in.)  Minimum: 203 x 267 mm (8 x 10.5 in.)	RS-232-C/ CCITT V.24	7580A Option 001	622
			HP-IB (IEEE-488)	7580A Option 002	622
		Maximum: 927 x 1190 mm (36.5 x 46.9 in.)  Minimum: 203 x 267 mm (8 x 10.5 in.)	RS-232-C/ CCITT V.24	7585A Option 001	622
			HP-IB (IEEE-488)	7585A Option 002	622



# COMPUTERS, PERIPHERALS & CALCULATORS

## Two-pen Graphics Plotter

Model 7470A

- Low cost
- High performance

- Plots on paper
- Plots on HP overhead transparency film

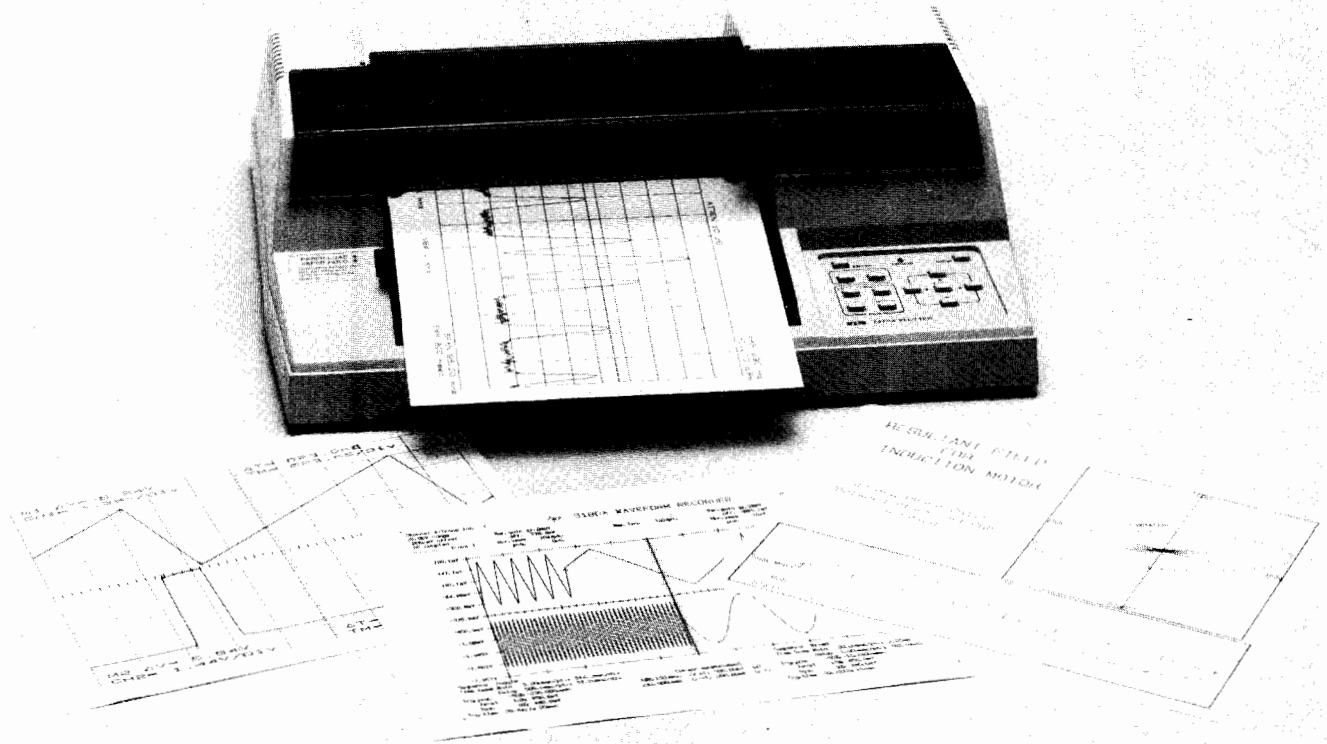

Hewlett-Packard's 7470A graphics plotter is a low-cost, two-pen plotter which accommodates two standard media sizes: 8.5 x 11 in. (ANSI A) and 210 x 297 mm (ISO A4). This new, compact plotter has many features that you would expect to find only in expensive models. It has the same high-quality components and innovative paper-moving technology used in HP's drafting plotters.

Because of its low price and high performance, the 7470A fills numerous measurement and computer applications.

### Measurement Applications

The 7470A can add a hardcopy graphics capability to intelligent instruments and instrument systems with HP-IB (IEEE 488-1978). For most applications that use a display screen and an oscilloscope camera, the 7470A can produce notebook-size, high-quality hardcopy of the screen for a cost that is substantially lower than camera film. Because the 7470A plots directly from measured data, it eliminates problems created by distortion from the screen. And 7470A output provides better visual resolution than photographs. Many systems without screen displays can also have the benefits of 7470A hardcopy graphics at very little additional cost.

### Computer Applications

The 7470A provides hardcopy computer graphics for technical, scientific, and business applications. Colorful charts and graphs from

the 7470A are ideal for summarizing data, identifying trends, comparing results, and focusing on exceptions. The 7470A draws equally well on paper and on HP overhead transparency film, providing users with graphics for reports and handouts, as well as visual aids for meetings and presentations.

### Easy to Use

When the 7470A is turned on, default conditions are automatically established for most plotting parameters. In many cases, it is only necessary to load the pens and plotting medium in order to start plotting.

Interaction with the plotter is easy from the front panel. Pushbuttons permit manual control of paper and pen movement, which includes pen selection, and halting the program to substitute pens or view the plot. The front panel also allows easy access to the plotter's digitizing capability and the scaling points.

### Paper and Pen Movement

Pinch wheels and drive wheels move the paper or overhead transparency film back and forth across the platen, providing plotting capability along the X-axis. Pen movement locates points along the Y-axis. Movement of both paper and pens allows the 7470A to plot lines at speeds of up to 38 cm/s (15 in./s). Labels are drawn at speeds of up to six characters per second.



### Versatile Writing System

The 7470A has two built-in pen stalls which make two-color plotting easy. For plots with more than two colors, the program can be halted through program or front panel control; new pens can then be installed and plotting can be resumed.

Several automatic features are included to protect the tip of the pen, which means longer pen life. When housed in the stall, the pen is capped to prevent premature drying. When a pen down command is given, the pen force is damped and the pen is gently lowered to the plotting surface.

### Intelligence Features

The 7470A has five internal character sets (including three European sets) which eliminate the need to use software-generated characters. Text can be written in any direction, with or without slant, and in many sizes. The plotter's symbol plotting capability and seven dashed-line fonts give users added design flexibility.

There are more than 40 HP-GL (Hewlett-Packard Graphics Language) instructions built in, which allow the 7470A to be programmed with simple commands that perform a variety of complex operations. Software that was written for other HP plotters is easily adapted to the 7470A.

### High-quality Output

The 7470A has an addressable step size of 0.025 mm (0.001 in.). With this resolution, the plotter can plot up to 1000 points in a 1-inch line. When commanded to return to the same point with no pen change, it achieves this repeatability within 0.1 mm (0.004 in.). Because of the 7470A's outstanding resolution and repeatability, it plots straight lines and smooth circles that have an artist-drawn appearance.

### Interface Options

The 7470A offers a choice of two interface options: RS-232-C/CCITT V.24 or HP-IB (IEEE 488-1978). With the RS-232-C option, a dual input/output cable is available which allows connection of the 7470A in series with a terminal and computer.

### Graphics Software

Graphics software packages make it easy for non-programmers to use the 7470A. Software support is available on many HP and non-HP computers. Details are available from any HP sales and support office.

### Specifications

**Plotting sizes:** Accommodates media sizes 8.5 x 11 in. (ANSI A) and 210 x 297 mm (ISO A4)

**Mechanical limits:** (approx.) Y-axis, 191 mm (7.5 in.); X-axis, 273 mm (10.7 in.) for metric setting or 258 mm (10.2 in.) for English setting

**Addressable resolution (step size):** 0.025 mm (0.001 in.)

**Repeatability:** For a given pen, 0.10 mm (0.004 in.); pen-to-pen, 0.20 mm (0.008 in.)

**Pen velocity (each axis):** Pen down, maximum 38.1 cm/s (15 in./s), programmable from 1 to 38 cm/s in increments of 0.38 cm/s; pen up, 50.8 cm/s (20 in./s)

**Power requirements:** Source, 100, 120, 220, 240 V ~ -10%, +5%; frequency, 48-66 Hz; consumption 25 W maximum

**Interfaces:** HP-IB (IEEE 488-1978), implements the following HP-IB functions as defined in IEEE 488-1978: SH1, AH1, T2, TE0, LE0, SR1, RL0, DC1, DT0, L2, PP0 (listen-only or address less than 7, otherwise PP2). RS-232-C/CCITT V.24, asynchronous serial ASCII with switch-selectable baud rates of 75, 110, 150, 200, 300, 600, 1200, 2400, 4800, 9600; external clock input capabilities with intermediate baud rates up to 9600 baud, 255-byte buffer

**Environmental range:** Operating, 0° to 55°C; non-operating, -40° to 75°C

**Size:** 127 H x 432 W x 343 mm D (5" x 17" x 13.5")

**Weight:** Net, 6.1 kg (13.5 lb); shipping, approximately 12.6 kg (28 lb).

**Pens:** Two, fiber-tip

**Media:** Paper and Hewlett-Packard overhead transparency film

**FCC certification:** Certified by the FCC to conform to limits set for radio frequency interference when used with a Class B computing device

### Accessories Supplied

Item	Part No.
Operator's Manual	07470-90002
Interconnection Guide	07470-90003
Reference Card	07470-90004
Interfacing and Programming Manual (not included with option 002, order separately)	07470-90001

Paper and an assortment of pens are also provided with the 7470A plotter. Other supplies and accessories are available from Hewlett-Packard. Please refer to the HP Computer Users Catalog for a complete listing.

### Options

**001** RS-232-C/CCITT V.24 interface

**002** HP-IB interface

**016** Dual I/O cable for use with option 001

### Ordering Information

**7470A Two-pen Graphics Plotter**





# COMPUTERS, PERIPHERALS & CALCULATORS

## Eight-pen Vector Plotters

Models 7220C/T, 7221C/T, 9872C/T

- Drafting pens available
- Choice of interfaces
- Programming language flexibility
- Automatic paper advance

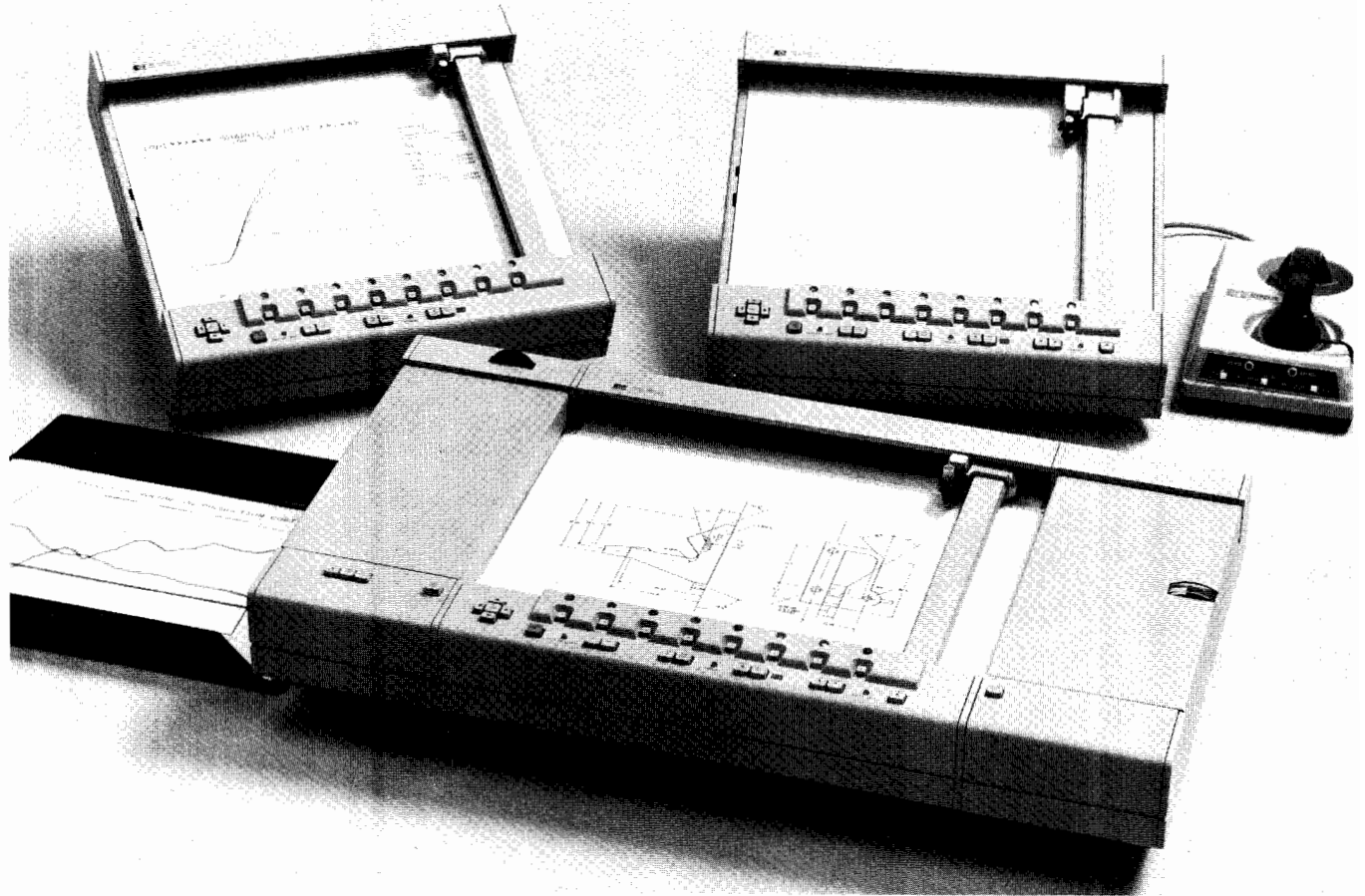

Hewlett-Packard's innovative microprocessor-controlled eight-pen plotters create professional hardcopy graphics for business and industry. They are ideal for plotting applications such as chemical analysis, measurement and test data recordings, manufacturing and engineering drawings, numerical control verification, business and financial planning, education, cartography, and computer-aided design.

### Automatic Pen Control

The plotters' automatic pen changing capability makes it possible to use as many as eight different pens on a single plot without user intervention. The plotters automatically store one pen and select another at the push of a button or upon receipt of a program command.

An air-cushioned pen mechanism gently lowers the pen to the writing surface, increasing the life of the pen tip without sacrificing pen speed. Programmable pen velocity allows users to select speeds which suit a variety of plotting media. Air-tight caps protect the pen tips while they are stored.

### Fiber-tip Pens and Drafting Pens

The wide range of pen types, pen-tip widths, and ink colors make HP's eight-pen plotters almost unlimited in their versatility. Three types of pens are available. In addition to HP's fiber-tip pens for paper and overhead transparency film, liquid-ink drafting pens are

available for engineering drawing media (such as vellum and polyester film).

With the fiber-tip pens, users have a choice of ten ink colors for paper and seven colors for overhead transparencies. And fiber-tip pens come in two widths for drawing both fine and bold lines. For flexibility in engineering applications, HP's drafting pen tips are available in six standard line widths. Automatic pen capping increases the convenience of drafting pens by helping to prevent ink from drying in the pen tip.

### Versatile Format

The plotters' convenient electrostatic holddown secures any size sheet up to 297 x 420 mm (metric ISO A3) or 11" x 17" (English ANSI B). For application flexibility, programmers can define graph limits and scale the plotting area for different media sizes. Alternatively, users can define graph limits using front panel controls.

### Superior Line and Character Quality

Excellent plotter resolution and repeatability contribute to the superior line quality of HP's eight-pen plotters. The smallest addressable move is 0.025 mm (0.001 in.) so lines are straight in all directions, circles are round, and characters are precise. Multiple character sets provide for worldwide use. And for annotation flexibility, the plotters can change the size, slant and direction of the characters.

### Powerful Local Intelligence

Each of these versatile plotters provides error-free off-scale data handling, internal character generation, and line pattern and symbol-mode plotting to provide easy trace identification. With the digitizing sight, users can extract coordinates of points on maps or graphs to provide data for detailed computer analysis.

### Automatic Paper Advance

The "T" model plotters will automatically advance and cut paper a half or full page at a time, according to program command or push-button control. (A switch setting governs whether paper will be cut to metric or English dimensions.) This automatic paper advance feature provides cost and time saving advantages of unattended plotting and peripheral sharing.

### Choice of Interfaces

The eight-pen plotters are available in two interface configurations. Models 7220C/T and 7221C/T have an RS-232-C/CCITT V.24 interface with an I/O buffer, choice of modem or hardware operation, and switch-selectable parity and baud rate settings. The 9872C/T models have an HP-IB (IEEE 488-1978) interface, permitting simple plug-in connection of several devices with individual control of each.

### Efficient Programming Languages

The plotters speak one of two programming languages. The 7221C/T models have a compacted binary instruction set which is advantageous in a data communications environment where transmission efficiency is critical. The 7220C/T and 9872C/T models feature the Hewlett-Packard Graphics Language (HP-GL) which is a set of easy-to-remember mnemonic instructions. Both languages provide graphics commands that cover the full range of plotting needs, from basic vector plotting to enhanced graphics presentations.

### High-level Graphics Software

HP offers a wide range of graphics software for the eight-pen plotters. High-level graphics language software is available on many HP computers, intelligent terminals, and desktop and personal computers. In addition, HP offers user-interactive graph-generation software for non-programmers. Complete details on these software packages are available from any HP sales and support office.

Two utility software packages are available for programmers. HP's Industry Standard Plotting Package (HP-ISPP) supports the 7220C/T plotters, and HP-PLOT/21 provides over 70 user-callable subroutines for the 7221C/T plotters. See page 625 for more details on these utility packages.

Model	Interface	Programming Language
7220C/7220T	RS-232-C/CCITT V.24	HP-GL
7221C/7221T	RS-232-C/CCITT V.24	Compacted Binary
9872C/9872T	HP-IB (IEEE 488-1978)	HP-GL

### Specifications

**Plotting sizes:** Accommodates media up to ISO A3 (297 x 420 mm) and ANSI B (11" x 17")

**Mechanical limits:** Y-axis, 285 mm (11.2 in.); X-axis, 400 mm (15.8 in.)

**Addressable resolution (step size):** 0.025 mm (0.001 in.)

**Repeatability:** For a given pen, 0.10 mm (0.004 in.); pen-to-pen, 0.20 mm (0.008 in.)

**Plotting accuracy:** ±0.2% of deflection ±0.2 mm (0.008 in.), including linearity and repeatability (assumes plotter has been zeroed to exact lower left (0,0) coordinates)

**Pen velocity:** Pen down, maximum, 36 cm/s (14 in./s) in each axis or 50.9 cm (20 in./s) on 45° angle; programmable from 1 to 36 cm/s (0.4 to 14 in./s) in increments of 1 cm/s (0.4 in./s)

**Power requirements:** Source, 100, 120, 220, 240 V -10%, +5% (factory set); frequency, 48 to 66 Hz single phase; consumption, 100 W maximum

**Interfaces:** 9872C/9872T: HP-IB (IEEE 488-1978), implements the following functions as defined in IEEE 488-1978: SH1, AH1, T2, L2, SR1, RL0, PP2, DC1, DT0; 7220C/7220T and 7221C/7221T: RS-232-C/CCITT V.24 asynchronous serial ASCII with switch-selectable baud rate from 75 to 2400 baud

**Buffer size:** 7220C/7220T, 928 bytes (additional 2048 bytes optional); 7221C/7221T, 1110 bytes (additional 1928 bytes optional)

**Environmental range:** 0° to 55°C; 5% to 95% RH (below 40°C)

Size/Weight:	C Model	T Model
Height	189 mm (7.4 in.)	210 mm (8.3 in.)
Width	497 mm (19.5 in.)	858 mm (33.7 in.)
Depth	477 mm (18.7 in.)	477 mm (18.7 in.)
Net weight	18 kg (39 lb)	30 kg (66 lb)
Shipping weight	31 kg (69 lb)	50 kg (110 lb)

**Pens:** Eight; fiber tip and liquid ink drafting pens

**Media:** Paper, overhead transparency film, vellum, and polyester film

### Accessories Supplied

Item	Part No.
Digitizing Sight	09872-60066
Operating and Programming Manual	
7220C/T	07220-90003
7221C/T	07221-90024
9872C/T	09872-90011
Pocket Guide	
7220C/T	07220-90005
9872C/T	09872-90013
Dust Cover	
C model	9222-0742
T model	9222-0741
Male to Male Interface Cable	
7220C/T	8120-3258
7221C/T	8120-3258
Paper Tray Assembly, T models only	17072-60251

A complete assortment of fiber-tip pens and paper are also provided with the plotters. Drafting media, drafting pens, and other plotter supplies are available from Hewlett-Packard. Please refer to the HP Computer Users Catalog for a complete listing.

### Options for 7220C/T

**001** 2048-byte additional buffer memory

### Options for 7221C/T

**001** 1928-byte additional buffer memory

### Options for 9872C/T

- 025** For use with HP 9825
- 026** For use with HP 9826
- 036** For use with HP 9836
- 045** For use with HP 9835 and HP 9845B
- 085** For use with HP Series 80 Personal Computers
- 100** For use with HP 1000
- 125** For use with HP 125
- 145** For use with HP 9845C
- 300** For use with HP 3000

### Ordering Information

**7220C, 7221C, or 9872C** Eight-pen Vector Plotters  
**7220T, 7221T, or 9872T** Eight-pen Vector Plotters



## Eight-pen Drafting Plotters

Models 7580A, 7585A

- 7580A accepts media sizes up to ISO A1 (ANSI D)
- 7585A accepts media sizes up to ISO A0 (ANSI E)
- HP-IB or RS-232-C/CCITT V.24 interfaces
- Choice of pen/media combinations
- Compact
- Moveable

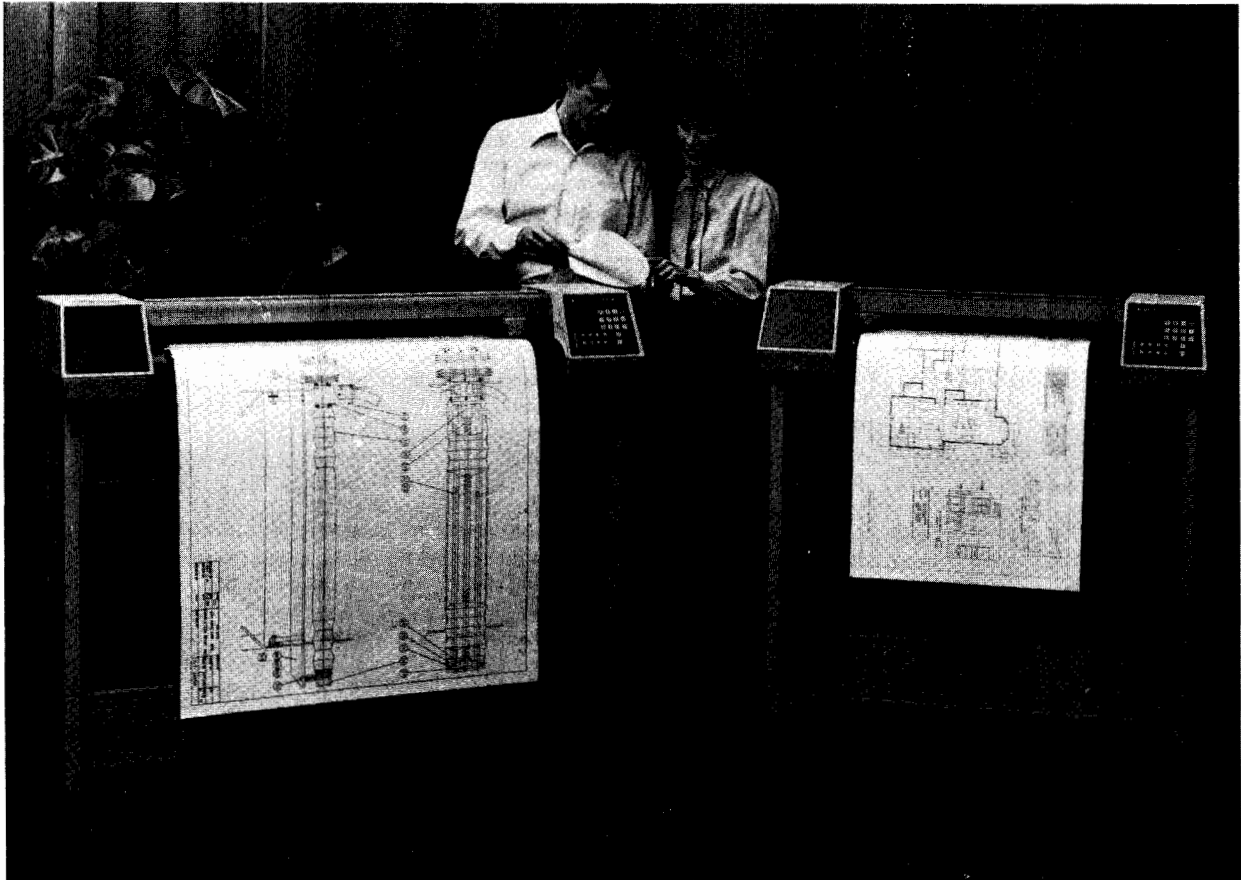

The HP 7580 and the HP 7585 drafting plotters combine high-quality output and high throughput with features that make them exceptionally easy to use. The one important difference between these plotters is media size. The 7580A accepts media sizes ranging from ISO A4 through A1 (ANSI A through D). The 7585A accepts media sizes ranging from ISO A4 through A0 (ANSI A through E).

Both drafting plotters draw on individual sheets of paper, vellum, and double-matte polyester film. Users have a choice of roller-ball, fiber-tip, and liquid ink drafting pens in various colors and line widths. Up to eight pens can be used without operator intervention. Pens are capped when not in use so they last longer and write without repriming.

### Applications

The HP drafting plotters are suited for almost any application that requires large plots that are visually perfect. Common uses in industry include computer-aided drafting; computer-aided design of printed circuit boards, integrated circuits, and mechanical parts; architectural or civil engineering design; and mapping applications. In business and management, these plotters are commonly used to prepare flip-charts or project schedules.

### Media Drive Mechanism

HP drafting plotters are surprisingly compact because of Hewlett-Packard's micro-grip drive technology. The drive system uses a low

mass, low inertia mechanism to grip and move the drawing medium. This permits the use of smaller motors and lightweight components.

### Advanced Writing System

HP's drafting plotters automatically sense sheet size and set the limits of pen motion. Even the pen height is automatically controlled, eliminating the manual adjustments required by many other plotters. Precision control over the settings for velocity, acceleration, and pen force assures high-quality output on various ink and media combinations.

### High Quality Output

Resolution is the most important factor that affects line quality. While the addressable resolution of the HP drafting plotters is excellent at 0.025 mm (0.001 in.), the pen and the drawing medium actually move on an even finer grid to create high-quality lines. These movements are controlled by servos with a mechanical resolution of 0.003 mm (0.00012 in.).

In addition to outstanding resolution, HP drafting plotters offer a feature not found in any other drafting plotter: diagonal lines are the same quality as lines drawn parallel to the axes. A microprocessor keeps pen velocity and acceleration constant regardless of direction so lines are drawn with the same high quality in all directions.



### High Throughput

At 60 cm/s maximum velocity and 4 g acceleration, the 7580A and 7585A are the fastest plotters in their price range. Even when a slower pen speed is required to accommodate a drawing medium, throughput remains high because pen-up movements are always executed at maximum speed. And pen-lift delays are kept to a minimum because the pen is lifted just slightly on small moves (as when labeling) and to maximum height only on long moves.

### Pen Carousels

There are three different pen carousels—one for each type of pen. Each carousel holds up to eight pens and is coded so that the plotter electronically senses the carousel type each time a carousel is loaded. After determining the type, the plotter sets appropriate values for velocity, acceleration, and pen force. Since all of this is automatic, it is remarkably easy for an operator to set up the plotter.

If an application requires it, an operator can select force, acceleration, and velocity using either front panel controls or programmed plotter instructions.

### Intelligent Pen Control System

On descent, pen motion is damped as the pen approaches the surface of the medium so that delicate pen tips are not damaged and pen bounce is minimized. Pens last longer and plotted lines are uniform from start to finish. Pen height above the surface is electronically controlled so the operator never needs to make mechanical adjustment in pen height, even when changing pens or media.

### Quality Labeling

Six different character sets in two fonts provide the user with a large range of annotation capabilities including mapping symbols, special centered symbols, and foreign-language characters.

### Simple, Powerful Command Set

Programming is easy using the Hewlett-Packard Graphics Language (HP-GL). The 60 commands implemented on the plotters are simple, yet powerful. In addition to single commands to draw lines, there are commands to draw circles or arcs, to position labels, change character size, slant, and direction, digitize, and more. These plotters are even smart enough to adjust dashed line patterns to fit between any two points. They can rescale the plotting area in convenient user-defined units, rotate the plot 90 degrees, or "window" and plot only a portion of the original plot.

### Software Support

HP drafting plotters are supported on a number of Hewlett-Packard computer systems, desktop computers, and intelligent terminals. This support, consisting of high-level graphics programming instructions, enhances programmer productivity and ease of use. Several graphics application software packages support the drafting plotters on HP computers.

For users of industry-standard FORTRAN subroutines, a software package, HP-ISPP (Hewlett-Packard Industry Standard Plotting Package), is available. Refer to page 625 for package details and ordering information.

### Specifications

**Media sizes:** 7580A: minimum, 203 x 267 mm (8" x 10.5"); maximum 622 x 1190 mm (24.5" x 46.9"); includes standard sizes A4/A, A3/B, A2/C, and A1/D.

7585A: minimum, 203 x 267 mm (8" x 10.5"); maximum, 927 x 1190 mm (36.5" x 46.9"); includes standard sizes A4/A, A3/B, A2/C, A1/D, and A0/E, excludes some nonstandard sizes between A3/B and A2/C.

**Maximum plotting area:** Drawing medium less margins.

**Margin size:** Expanded mode, three margins of approximately 5 mm, fourth margin is approximately 29 mm; normal mode, three margins of approximately 15 mm, fourth margin is approximately 39 mm.

**Resolution:** Smallest addressable move, 0.025 mm (0.001 in.); mechanical resolution, 0.003 mm (0.00012 in.)

**Repeatability:** For a given pen on paper or vellum: 0.05 mm (0.002 in.)

**Pen velocity:** Pen down, maximum: 60 cm/s (24 in./s) independent of vector direction; programmable: 1 to 60 cm/s in 1-cm increments (0.4 to 24 in./s); front panel selectable: 10 to 60 cm/s in 10-cm increments (4 to 24 in./s); front panel selectable: 10 to 60 cm/s in 10-cm increments (4 to 24 in./s). Pen up, 60 cm/s (24 in./s) independent of vector direction.

**Acceleration:** maximum, 4 g (39 m/sec<sup>2</sup>, 129 ft/sec<sup>2</sup>); programmable, 1 to 4 g in 1-g increments (9.7 to 39 m/sec<sup>2</sup>, 32 to 128 ft/sec<sup>2</sup>).

**Pen force:** Programmable and front panel selectable: 10 to 66 grams in 8-gram increments.

**Power requirements:** Source, 100, 120, 220, 240 V ~ -10%, +5%; frequency, 48-66 Hz single phase; consumption, 170 W max.

**Interfaces:** HP-IB (IEEE 488-1978), implements the following HP-IB functions as defined in IEEE 488-1978: SH1, AH1, T6, L3, SR1, RLO, DC1, DT0, C0, PP0 for listen-only, PP1 for address greater than 7, and PP2 for address of 7 or less.

RS-232-C/CCITT V.24, asynchronous serial ASCII with switch selectable baud rates of 110, 150, 300, 600, 1200, 2400, 4800, and 9600.

**Buffer size:** 1024 bytes.

**Environmental range:** Operating, temperature 0°C to 55°C, relative humidity 5% to 95% (0°C to 40°C); non-operating, temperature -40°C to 75°C, relative humidity 5% to 95% (0°C to 40°C).

Size/weight	7580A	7585A
Height:	1188 mm (46.8 in.)	1188 mm (46.8 in.)
Width:	1087 mm (42.8 in.)	1392 mm (54.8 in.)
Depth:	557 mm (21.9 in.)	557 mm (21.9 in.)
Net weight:	59.1 kg (130 lb)	70.4 kg (155 lb)
Shipping weight:	approx 114 kg (250 lb)	approx 131 kg (290 lb)

**Pens:** 8 per carousel; fiber tip, drafting, roller ball.

**Media:** Most standard paper, vellum, and double-matte polyester film, 3 or 4 mil thick.

### Accessories Supplied

	HP Part No.
Interfacing and Programming Manual	07580-90014
Operator's Manual	07580-90013
Programmer's Reference Card	07580-90012
3 Pen Carousels	
drafting pen carousel	07580-60081
roller ball carousel	07580-60082
fiber tip carousel	07580-60035
Digitizing Sight	07585-60191
Male-to-male RS-232-C/CCITT V.24 cable (supplied with option 001 only)	8120-3258

An assortment of pens and various drawing media and cleaning supplies are also provided with the plotter.

Drafting media and other plotter supplies are available from Hewlett-Packard. Please refer to the HP Computer Users Catalog for a complete listing. Media and liquid ink drafting pen tips may be purchased from your local engineering supply store. Refer to the Operator's Manual for information on suitable pen tips and media.

### Options

001 RS-232-C/CCITT V.24 interface
002 HP-IB interface
025 for use with HP 9825 desktop computer
026 for use with HP 9826 desktop computer
036 for use with HP 9836 desktop computer
045 for use with HP 9835A/B or HP 9845A/B desktop computer
047 for use with HP 2647 graphics terminal
085 for use with HP-85 personal computer
100 for use with HP 1000 computer
145 for use with HP 9845C desktop computer
300 for use with HP 3000 computer

### Ordering Information

7580A Drafting Plotter  
7585A Drafting Plotter  
OEM discounts available



# COMPUTERS, PERIPHERALS & CALCULATORS

## Graphics Tablet

Model 9111A

- Sixteen user-definable softkeys
- Durable ceramic surface

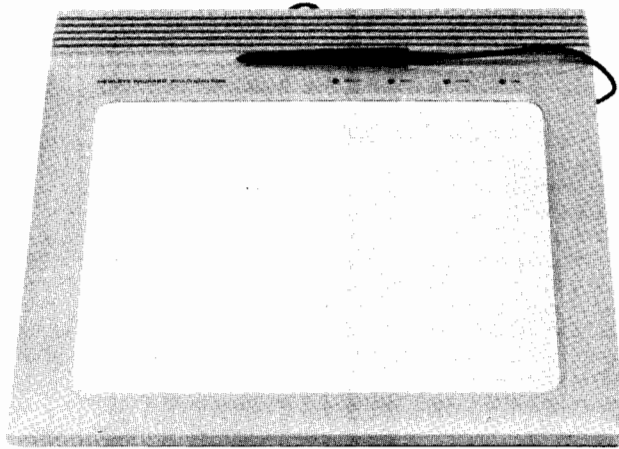

Hewlett-Packard's 9111A Graphics Tablet opens up new opportunities for user interaction in graphics and menu applications. The 9111A can be used as a digitizer or as a cursor mover in interactive graphics systems. Single point or continuous time base digitizing modes may be used to enter raw graphics data into a host computer. The binary data transfer mode combined with single-point digitizing is a perfect combination for fast cursor moving, data entry, and menu selection applications.

### Program Mode

Two features of the 9111A affect the rate of data transfer: the update rate, and the binary data transfer mode. The rate at which the 9111A updates new points is programmable and ranges from a minimum of 1 to a maximum of 60 points per second. The maximum rate matches the refresh rate of most display screens, permitting smooth cursor movement. The binary data transfer mode is provided for maximizing the data transfer rate, allowing the cursor location to be traced without translating from ASCII characters to internal integer representation. In addition, the 9111A has 27 HP-GL commands which provide the user with precise control of all tablet functions.

### Function Keys

Sixteen softkeys provide a hardware menu with interpretation built into the tablet. The user selects a key by positioning the stylus in one of the softkey boxes and pressing down to activate the digitizing switch.

### Additional Features

Quality and durability are apparent from the 9111A's platen and stylus. The platen is made of hard ceramic material which resists scratches and pits; the stylus is slim and lightweight with good tactile feedback on the switch position. Interchangeable inked and non-inked refills are available for the stylus. For audio feedback, the 9111A has a four-octave beeper which is programmable in tone, volume, and duration. Through the standard HP-IB interface (IEEE 488-1978), the 9111A is compatible with a wide variety of computers and terminals.

### Programming Tools

Tools software is available for use with the HP-85, HP 9845B/C, and HP 9826A/36A computers. Software for the HP-85 has sample programs to help users create, edit, store, and plot drawings. In addition,

users can create data files of digitized points, calculate areas inside traced figures, and calculate scaled distances.

With the 9845B/C computers, tools software can be used to create, edit, store, and plot drawings; to pick, place, rotate, and erase elements; and to create and interpret files of menu elements. Tools for the 9845C also allow users to interactively select colors on the graphics display screen.

BASIC language extensions and manual supplements are available for users of HP 9826A/36A computers to make 9111A programming easier.

### 135X/9111 Graphics Display System

The 9111A Graphics Tablet can be used with the HP 1350S and 1351S graphics display systems. This combination provides direct interaction between the display and tablet for cursor movement and rubber banding of lines and rectangles. The configuration offers several benefits: high performance, quick response time, and minimized computer overhead. The 135X/9111 graphics display system is supported on GRAPHICS/1000-II software.

### Specifications

**Resolution:** 0.100 mm (0.00394 in.)

**Accuracy:**  $\pm 0.600$  mm (0.0236 in.) at 20°C for each measured point, change of 0.004 mm for each °C deviation from 20°C

**Repeatability:**  $\pm 1$  resolution unit

**Data rate:** Programmable from 1 to 60 coordinate pairs per second, actual rate  $\pm 2$  Hz from programmed rate

**Active digitizing area:** 218.5 x 300.8 mm (8.6" x 11.8"); can be extended to include the area occupied by the 16 softkeys

**Document material:** Single sheet, electrically nonconductive, homogeneous, less than 0.5 mm thick

**Interface:** HP-IB (IEEE 488-1978). Implements the following HP-IB functions as defined in IEEE 488-1978: SH1, AH1, T5, TE0, L4, LE0, SR1, RL0, PP2, DC1, DT0, C0

**Power requirements:** Source: 100 V, 120 V, 220 V, 240 V,  $\pm 10\%$ ; frequency: 48 to 66 Hz; consumption: 100 V/200 mA max, 120 V/165 mA max, 220 V/90 mA max, 240 V/80 mA max, 25 W max

**Environmental range:** 0° to 55°C, 5% to 90% RH (40°C)

**Dimensions:** 440 L x 440 W x 85 mm H (17.3" x 17.3" x 3.4")

**Weight:** Net 5.8 kg (12.8 lb); shipping 10.8 kg (23.8 lb)

### Options

**026** For use with HP 9826A; includes supplements to BASIC Language Reference manual and BASIC Programming Techniques manual, and BASIC extensions

**036** For use with HP 9836A; includes supplements to BASIC Language Reference manual, BASIC Programming Techniques manual, and BASIC extensions

**045** For use with HP 9845B; includes system tutorial

**085** For use with HP-85; includes system tutorial and system tools software

**086** For use with HP-86 and HP-87

**100** For use with HP 1000

**145** For use with HP 9845C; includes sample program

### Ordering Information

**9111A** Graphics Tablet

**88100A** 9111A-9845B Graphics Tablet System Tools for use with HP 9845B, Option 1XX

**88101A** 9111A-9845C Graphics Tablet System Tools for use with 9845C, Options 1XX and 2XX



- Tools for FORTRAN programmers
- HP-ISPP for small systems
- HP-PLOT/21 for timeshare systems
- HP-ISPP for existing application programs
- HP-PLOT/21 for new software development

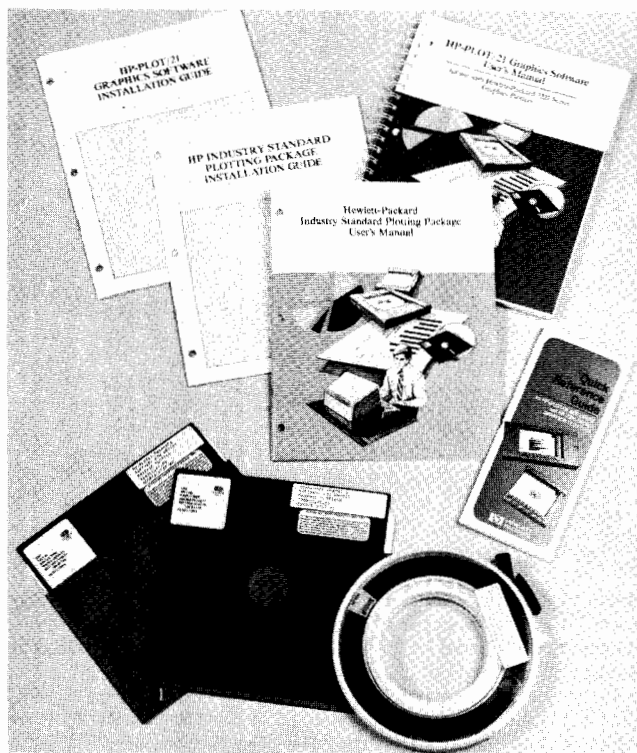

## Graphics Software Packages

HP offers two graphics programming tools for FORTRAN programmers. The HP Industry Standard Plotting Package (HP-ISPP) is for small systems and for adapting existing graphics applications programs for use on HP plotters. HP-PLOT/21 is for timeshare and other larger systems for aid in developing new graphics application programs.

Both packages minimize the effort required to develop data plots on any of HP's plotters with RS-232-C/CCITT V.24 or HP-IB interfaces. Both software packages are written entirely in ANSI Standard FORTRAN (X3.9-1966), and all input and output to the plotter is accomplished through standard FORTRAN formatted read/write statements. Both packages are supplied in source language form, on either magnetic tape or flexible diskette format, depending on the option specified.

Each package can be easily installed on almost any ASCII-based computer system that offers the equivalent of 32,000 sixteen-bit words or more for user application program space. The system must provide a standard asynchronous terminal driver (or equivalent I/O communications software) capable of communicating with the plotter through FORTRAN read/write statements within a user-written application program.

### HP-ISPP

HP-ISPP provides programmers with a versatile tool for plotting data. The package contains a set of 13 user-accessible graphics subroutines which support the following HP-GL plotters: 7220C/T, 7240A, 7245B, 7470A, 7580A, 7585A, and 7225B with 17601A, 17603A, or 17604A personality modules.

HP-ISPP subroutines are very similar to existing industry plotting subroutines and permit users to support HP plotters on existing higher-level software with only minor modifications. Each package includes a user's manual and installation guide. In addition, an annotated sample program is included with the source programs.

### HP-ISPP Features

- Provides absolute coordinate pen positioning from the origin (in centimetres or inches)
- Scales plots larger or smaller
- Changes plot origin
- Draws symbol strings at various angles and sizes
- Provides multiple pen selection
- Plots floating point numbers in FORTRAN 'F' format
- Draws and annotates axes
- Scales data to fit on a graph of a given size
- Connects a set of data points with straight lines
- Generates special characters at data points

### HP-PLOT/21

HP-PLOT/21 is a set of 77 user-accessible graphics subroutines that support the 7221C/T compacted binary language plotters. In addition to providing the features listed below, HP-PLOT/21 uses the powerful intelligence of the 7221 series of plotters to provide single-command arc and circle generation, programmable line types, special symbols and centered markers, and programmable pen selection and velocity control.

### HP-PLOT/21 Features

- Scales data in any of four unit systems
- Positions axes and grids automatically and rotates plots
- Defines rectangular masked areas
- Labels in any of six plotter-resident character sets or in four software-generated sets
- Provides polygon shading capability
- Controls paper advance capability on 'T' models

### Media Options for HP-ISPP

- 001 800 BPI magnetic tape, 9 track, unlabeled, unblocked, 72 byte fixed-length records, ASCII character code
- 002 1600 BPI magnetic tape, 9 track, unlabeled, unblocked, 72 byte fixed-length records, ASCII character code
- 003 Flexible diskette, single-sided, single density, compatible with Digital Equipment Corporation RX01 dual drive used under RT-11 operating system

### Options for HP-PLOT/21

- 001 800 BPI magnetic tape, 9 track, unlabeled, unblocked, 72 byte fixed-length records, ASCII character code
- 002 1600 BPI magnetic tape, 9 track, unlabeled, unblocked, 72 byte fixed-length records, ASCII character code
- 008 800 BPI magnetic tape, 9 track, unlabeled, unblocked, 512 byte fixed-length records, ASCII character code in Digital Equipment Corporation DOS format
- 009 1600 BPI magnetic tape, 9 track, unlabeled, unblocked, 512 byte fixed-length records, ASCII character code in Digital Equipment Corporation DOS format
- 010 Flexible diskette, compatible with Digital Equipment Corporation RX01 and RX02 dual drive; two source discs and one compiled, ready-to-use library disc for RT-11 V03 or V04 operating systems

### Ordering Information (specify media option)

- 17580A HP-ISPP Software
- 72021C HP-PLOT/21 Software



# COMPUTERS, PERIPHERALS & CALCULATORS

## Supplies and Accessories for Graphics Plotters

Models 17055A, 17057A

- Pens, drawing media, accessories
- Optimize plotter performance
- Wide selection
- Convenient ordering

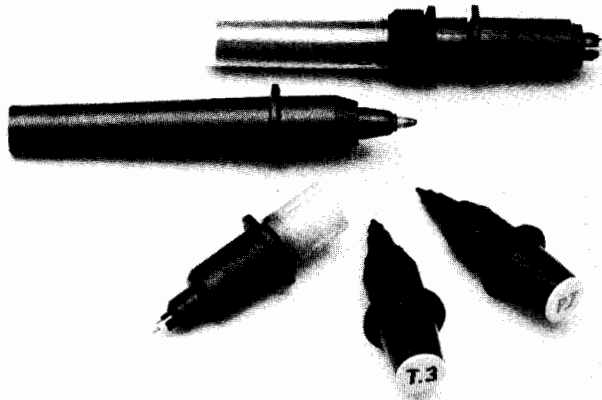

Hewlett-Packard supplies bring out the best in HP's graphics plotters. For your convenience, HP offers a complete line of pens, drawing media, and accessories such as pen holders, digitizing sights, ink solvent, drafting pen tips, and cleaning aids. You can order supplies individually or in convenient kits. Either way, HP can supply everything you need for professional-looking, hardcopy graphics.

### Plotter Pens

HP pens extend the capability of HP plotters because of the variety of pens available. Users can choose from three pen types (fiber-tip, roller-ball, and drafting pens) in a wide range of tip widths and ink colors.

In graphics plotting, the pen is the most critical link between a high-performance machine and high-quality plotted results. For this reason, HP designs and manufactures pens to stringent specifications. Concentricity of the pen body and the distance between indexing flange and tip are monitored carefully during production; this ensures accurate tip placement and line repeatability during plotting. In addition, HP's inks are specially formulated for easy-starting flow. They dry almost instantly when applied to HP quality paper. The colors are vivid, producing publication-quality graphs and charts, and professional-looking overhead transparencies.

### Drawing Media

HP's drawing media complement the performance of HP plotters. Plotter paper, tracing bond, vellum, polyester film, and overhead transparency film are available from Hewlett-Packard in a range of standard sizes.

Users can select blank or printed sheets of plotter paper in metric or English sizes and grids. And roll paper is available for plotters with automatic paper advance capability. For engineering applications, HP provides tracing bond, vellum, and double-matte polyester film of the finest quality. Clear film for overhead transparencies is available by the package or in convenient kits.

### Overhead Transparency Kits

With an HP overhead transparency kit and an HP plotter, users can make professional-looking presentation aids for only a fraction of the

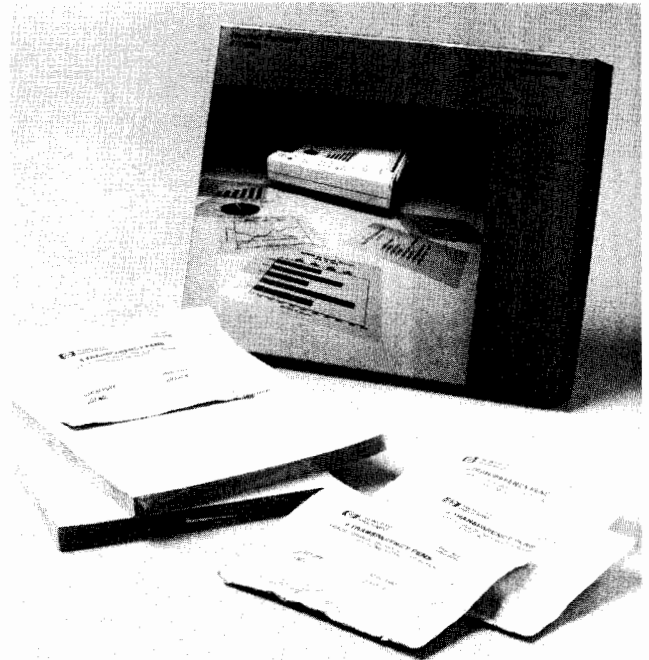

amount charged by commercial graphics services. The same programs used to prepare plots on paper can be used to make overhead transparencies. Finished transparencies are colorful and virtually smearproof, so they can be used again and again.

Two overhead transparency kits are available. One kit (model 17055A) is designed for HP plotters on which the drawing sheet remains stationary during plotting. The other kit (model 17057A) is designed for the 7470A graphics plotter which moves the sheet back and forth during plotting.

Each kit contains transparent sheets of plastic film and 16 pens in 2 tip widths (approximately 0.3 mm and 0.6 mm). Pen colors are black, red, green, blue, violet, orange, and brown. The ink adheres evenly to the film surface, dries in minutes at normal room temperature, and maintains its vivid color when projected.

### More Information on Supplies and Accessories

It's easy to order plotter supplies and accessories from HP sales and support offices or through HP's direct telephone ordering service. The HP Computer Users Catalog, which is available from any HP sales and support office, describes the complete range of supplies and accessories.

### Ordering Information

**17055A** Overhead transparency kit for use with HP 7220A/C/S/T, 7221A/B/C/S/T, 9872A/B/C/S/T plotters and 7225 A/B if equipped with velocity-select capability; contains 200 sheets of transparency film each 216 x 279 mm (8.5" x 11"), 16 pens, and ink solvent

**17057A** Overhead transparency kit for use with HP 7470A graphics plotter; contains 50 sheets of paper-backed transparency film each 216 x 279 mm (8.5" x 11"), and 16 pens



### Introduction to Softcopy Graphics

The need to display and update graphical data in real-time is of primary importance in a number of computer-driven applications. It is also necessary in many applications to display the data quickly, and with high resolution. To meet these needs, Hewlett-Packard offers a number of CRT displays and display systems for engineering and scientific disciplines. Depending on the particular HP display or display system chosen, available features are programmable intensity levels, programmable line types, large screens, character generation, and choice of interface.

#### What is Softcopy Graphics?

Softcopy Graphics uses some volatile device to display the graphical information, in most cases a CRT display. Unless the picture is stored by some means, it is lost when the system is turned off. Because information is not stored by the device, softcopy graphical displays are particularly suited to interactive computer graphics systems.

#### Softcopy or Hardcopy?

Both hard and softcopy graphics have appropriate applications. While plotters and other hardcopy devices provide a permanent record of the picture, they cannot react in real-time. Since it takes a hardcopy device some length of time to plot, making changes to a picture, while using a plotter as a peripheral in an interactive graphics system, would be a time-consuming task. On the other hand, a CRT display can show changes to the picture in real-time, allowing the operator to alter the graphical data and see the results immediately. Because the display is not a permanent storage device, changes can be made while errors are erased from the screen. When all changes are complete, the finished picture can be "dumped" to a hardcopy peripheral for retention.

Softcopy graphics is also essential in areas where decisions are made on the basis of rapid input of information. Radar display is an example. In such an application, high display resolution as well as

high speed data-updating capability are needed to show and update complex pictures quickly.

Electronic instrumentation makes use of softcopy graphics in a number of areas such as oscilloscopes, spectrum analyzers, waveform analyzers, and logic analyzers. Because of the ability of graphics to portray large amounts of data in a form that is easily and quickly assimilated, such instruments use CRT displays.

#### Choice of Interface

Several HP displays and display systems give the user a choice of three interfaces: HP-IB, RS-232C, and 16-bit parallel. The HP 1351A Graphics Generator can take digital information from one of the three interfaces mentioned above and change it to X, Y, and Z analog voltages necessary to drive HP large screen displays. In addition, the 1345A Digital Display Module can accept commands via 16-bit parallel or HP-IB (Opt 002) and is suited for OEM instrumentation graphics.

#### Applications

- Schematic generation
- Engineering design and evaluation (mechanical, electrical, chemical, etc.)
- Radar/Sonar control/Monitoring
- Real-time instrumentation systems (data acquisition/analysis, production testing)
- Architectural design
- Interactive computer graphics systems

#### Advantages

- High resolution
- High drawing and update speed
- Bright, crisp vectors and characters
- Choice of screen sizes
- Digital and analog display interface available





# COMPUTERS, PERIPHERALS & CALCULATORS

## Instrumentation Graphics Systems

### Model 1351S

- Computer / Calculator Compatible Digital Interface
- Fast Display Updating
- High Resolution Graphics

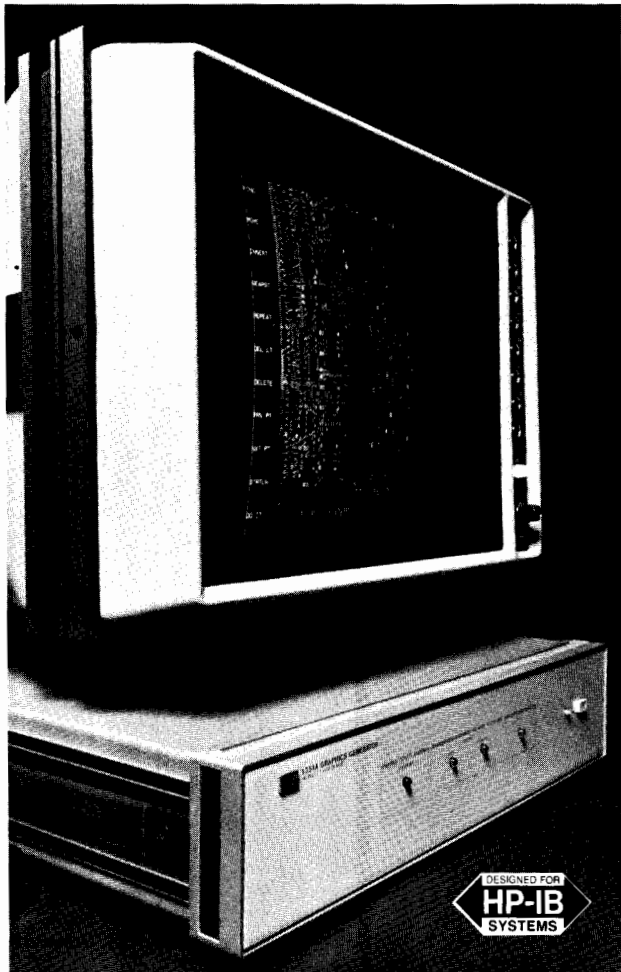

The 1351S Display System includes a 1351A Graphics Generator, a 1311B X-Y Display, a tilt stand which holds the display & provides space below for the generator, an interconnect cable, and a binder for instruction manuals.

The 1351S Graphics System provides a high resolution, real-time method of generating bright line vectors and/or alphanumeric characters. This cost-effective system includes a high quality, large-screen electrostatic CRT display (with programmable binary Z-axis control) and the 1351A Graphics Generator. The system gives bright graphics in minicomputer or desk-top computer systems with a resolution of 1020 x 1020 addressable points on the CRT screen. In addition, it provides the fast information throughput, rapid picture manipulation, and complex vector drawing capability needed in interactive computer graphics for computer-aided design/ computer-aided manufacturing (CAD/CAM) systems, and radar/simulation.

Digital information is received by the Graphics Generator from the standard HP-IB interface or an optional RS-232-C or 16-bit parallel interface bus and stored in internal refresh memory. Analog outputs in the form of vectors and characters are then generated and sent to the display where uniformly bright, sharp lines and alphanumerics are produced at high writing speeds. The display is continuously refreshed by the 1351A, freeing the host computer or controller to collect or process other data.

The 1351A has 64 memory files which are selectable in size, separately addressable and erasable, and can be directed to flash selected information on and off. Variable vector drawing speeds provide three intensity levels for highlighting of selected information. This allows the programmer to highlight on-screen menus, cursors and grids, as well as enhance 3-D drawings, add perspective, or otherwise improve visual clarity and meaning. The 1351A can also produce seven intensity levels for data differentiation via a Binary Z Control on the large screen display. The Binary Z Control feature is standard on HP directed-beam large screen displays.

Each digital word in the 1351A can be a vector coordinate or an upper or lower case ASCII character. A character ROM generates each ASCII character while using only one word of RAM in the 1351A memory, making more RAM available for other display information. Each character can be programmed to be displayed in four different sizes with two orientations (horizontal and 90 degree rotation).

#### RS-232-C or 16-Bit Parallel Optional Interface

The 1351A has a flexible interface structure to allow one of three specific interfaces to be used. Changing from one interface type to another is accomplished by changing the plug-in interface card. An HP-IB interface is standard with optional RS-232-C and 16-bit parallel interfaces available.

Advantages of the 1351A RS-232-C interface are:

- Software compatible with most teletypewriter system handlers.
- Increased transmission distances.

- Special high-speed transmission rate of 57K baud.

Advantages of the 1351A 16-bit parallel interface are:

- High speed data transfer rate of 500K 16-bit words/sec.
- Vector transfer rate of up to 250K vectors/sec.

#### Applications

The 1351S is ideally suited for minicomputer and calculator applications which require high speed and/or high resolution displays.

Typical applications include:

- Radar and Sonar
- Fire Control
- Integrated Circuit Layout
- Production Testing and Calibration
- Process Control
- Flight Instrument Simulation
- Structural Design
- Computer-Aided Design
- Interactive Graphics
- Analytical Chemistry Scans
- Spectrum Analysis

#### Options and Accessories

- 001:** RS-232-C interface in lieu of standard HP-IB
- 002:** 16-bit parallel interface in lieu of standard HP-IB
- 010:** Short tilt stand for 1311B
- 024:** 10-metre cable in lieu of 1-metre cable
- 184:** 10184B Binary Cassette tape for 9825A/B
- 510:** 1310B, 19 in. X-Y display in lieu of 1311B
- 517:** 1317B, 17 in. X-Y display in lieu of 1311B
- 521:** 1321B, 21 in. X-Y display in lieu of 1311B
- 604:** P-4 phosphor display, no graticule
- 639:** P-39 phosphor display, no graticule
- 908:** Rackmount hardware for 1351A and 1311B
- 909:** Rackmount hardware for 1351A and 1310B
- 910:** Extra set of manuals

#### Ordering Information\*

- 1351S** Display System (includes 1311B display)
- 1351A** Graphics Generator (supplied with 1351S)

\*An HP-IB cable is not supplied and must be ordered separately.

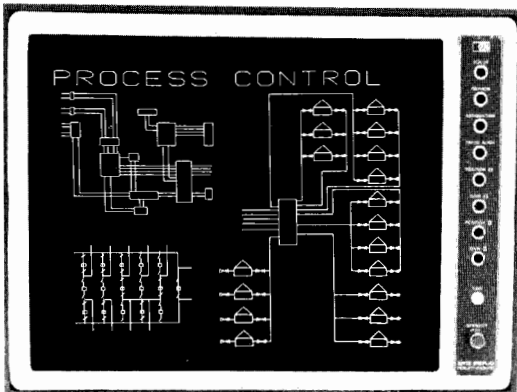

Complex processes such as valve closures and temperature or pressure changes can be shown in real time as in this computer generated 1311B display.

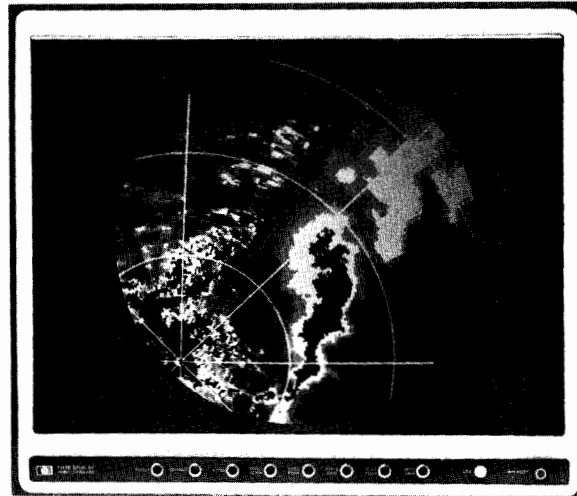

The low power consumption and high reliability of the 1310B are important benefits for remote locations such as shown in this weather radar application.

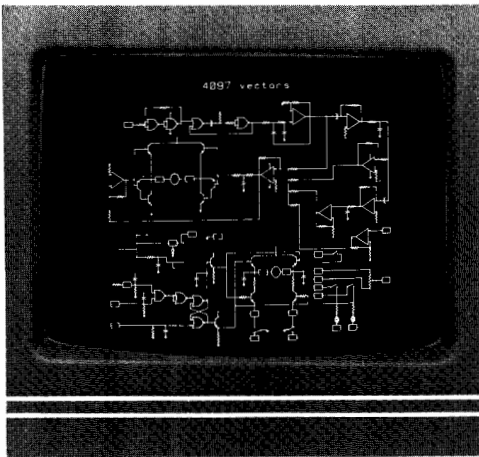

Ideal for standard rack mounting, the 1317B easily displays complex schematics.

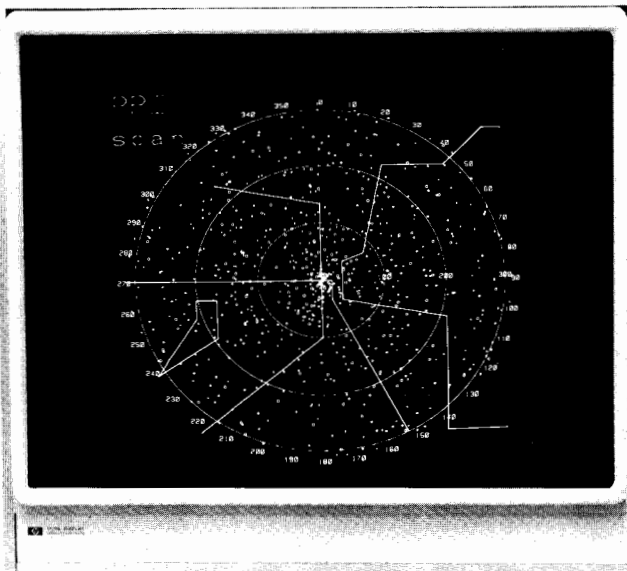

The 1321B can provide densely populated displays such as this PPI scan for simulation, training, or analysis of data. Small image resolution is maintained over the entire screen area.

### Description

Hewlett-Packard's Models 1310B, 1311B, 1317B, and 1321B Large Screen Displays offer the high writing speed, fast settling time, brightness and contrast needed for the display of high density graphics information. These displays are ideal computer peripherals with the high picture quality and dynamic performance required for complex computer generated graphics. Any on-screen movement can be made in less than 500 ns, including settling time. This high speed performance is particularly useful in radar and simulation, where many symbols must be moved about almost simultaneously. It is also useful in computer-aided design (CAD) applications which require complex, high density drawing capability.

These high resolution displays remain exceptionally well focused in all parts of the screen which solves such difficult display problems as writing many characters around the picture edges, while showing great detail in curves, graphs, or diagrams. Excellent image quality is further assured with features such as a contrast control circuit which provides constant contrast with variations in intensity, and a flat, optical quality glass contrast filter which eliminates trace diffusion and minimizes glare.

The 1310B, 1311B, 1317B, and 1321B are electrically almost identical, but offer a wide range of sizes and configurations to fit almost any high-speed, large screen OEM display requirements. The 1321B has the highest overall resolution (screen area divided by spot size) of any HP CRT display, making it the choice for applications where maximum information density is the main consideration. The 1317B is ideal for standard 48.3 cm (19 in.) rack-mount applications requiring the largest possible screen area in the minimum vertical rack space. For table-top applications such as remote monitors, Models 1310B and 1311B offer an attractively styled enclosure with a tilt stand. Both displays may be ordered without the tilt stand (Opt 001) for mounting in standard 48.3 cm (19 in.) racks or custom designed enclosures.

### Ordering Information

For information on options and accessories, refer to the applicable Large Screen CRT data sheet.

**1310B** 48 cm (19 in.) Display

**1311B** 36 cm (14 in.) Display

**1317B** 43 cm (17 in.) Display

**1321B** 53 cm (21 in.) Display

OEM discounts available

# COMPUTERS, PERIPHERALS, & CALCULATORS

## Computer Graphics System

Model 1360

- Low-cost
- High speed
- High resolution

- Graphics data base
- PASCAL programmable
- High-level software library for creating specialized applications

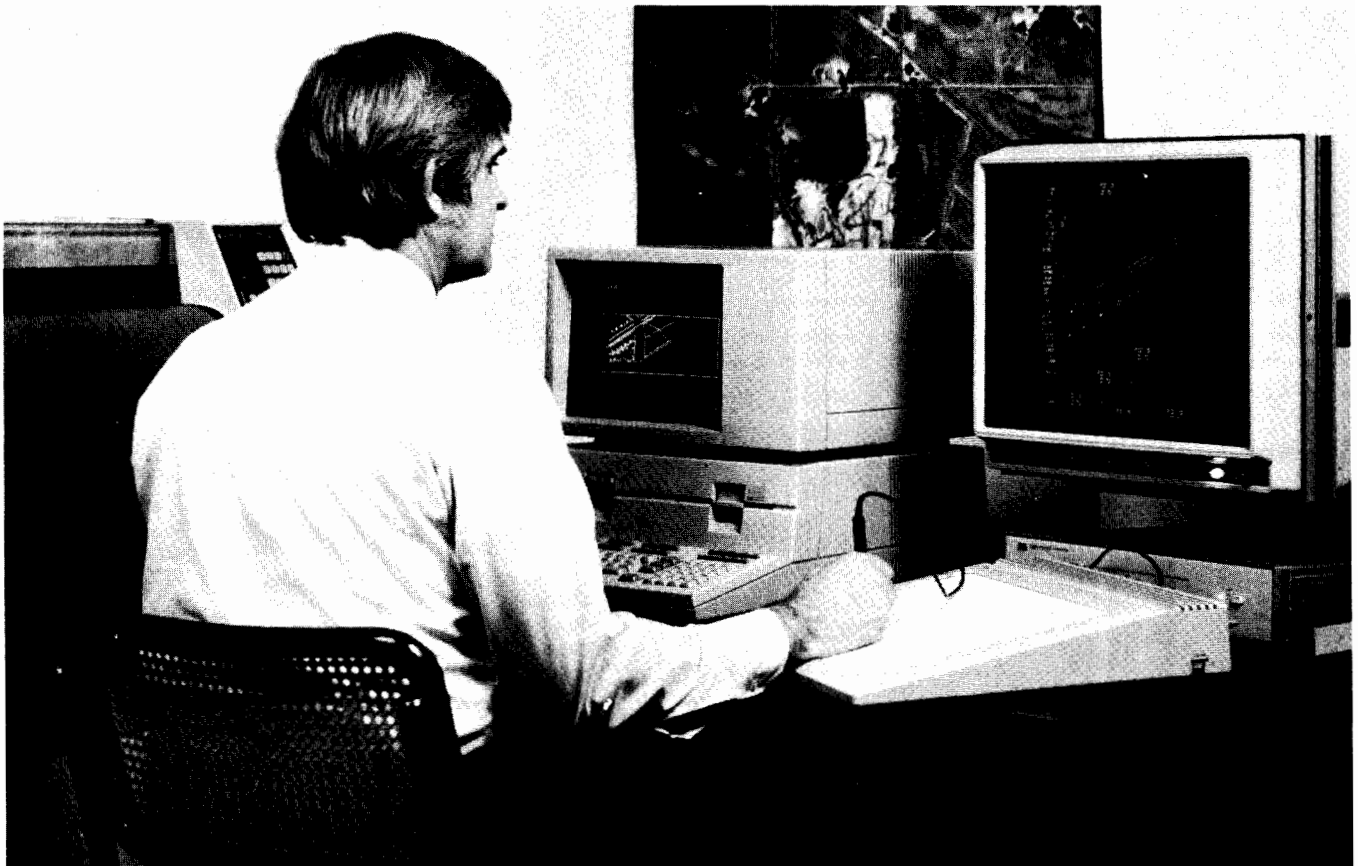

### Introduction

In recent years the engineering and design communities have made large efforts to utilize the power of the computer as a graphical display tool to help solve complex design tasks. This process is commonly referred to as Computer-Aided Design (CAD). CAD has been used to help solve a broad range of problems from the design of simple mechanical parts to the complex task of IC layout.

Historically, a user had two choices in selection of a CAD system: 1) a "turnkey" system with all the resident capabilities to complete the design task, or 2) a "roll-your-own" system, consisting of components purchased by the user. Each of these choices has inherent pitfalls. A turnkey system may cost upwards of \$250,000 and may not be suited to the user's methods of design. Also, the support of peripherals on such a system may be limited.

A "roll-your-own" system can be expensive as well when considering time needed to write I/O level software plus the necessary applications software, in addition to dealing with problems like hardware incompatibilities.

### Description

Hewlett-Packard has made a significant contribution to solving these problems with the introduction of the 1360 Graphics System. The 1360 is a low cost, high performance, single user graphics system for users and OEM's that have, or can acquire the necessary PASCAL programming skills to implement their application using the high-level graphics procedures provided within the 1360 software. A highly interactive graphics system which guarantees hardware compatibility, the 1360 offers a comprehensive package of graphics procedures callable from PASCAL that is designed to shorten the application development cycle. It is particularly well-suited for OEM's involved in graphics systems.

### Software

The Model 52113A, InteGraL/60 is an Interactive Graphics Library comprised of 81 PASCAL procedures. The library can be described in three parts: device handling, graphics functions, and data base. The device handling portion takes care of all of the input/output functions associated with I/O devices like the 9111A Graphics Tablet and 1351A Graphics Generator. This frees the applications programmer from the responsibility of writing code to deal with the input or output intrinsic of each particular device. In addition, InteGraL/60 supports a number of different HP plotters as well as the HP 9874A Digitizer.

InteGraL/60 allows the programmer to define and store objects in a modelling coordinate system, which can then be scaled, rotated, and translated into a global coordinate system by transformation procedures provided.

The graphical functions in InteGraL/60 provide the applications programmer with high-level building blocks for constructing an interactive graphics program. The basic building blocks are lines, text, polygons, and segment references.

Seven different line styles are provided by InteGraL/60. A line can be solid, dotted, dashed, or combinations of dots and dashes with user specified pattern lengths.

Polygons with seven user-specified interior fills are included. The interior of a polygon can be empty or filled with a line pattern. The programmer can also define the spacing between fill lines. The border of a polygon can be made visible or invisible, again with or without a fill pattern.

InteGraL/60 gives the programmer a number of choices in text fonts with any desired spacing. In addition such text parameters as orientation, direction, rotation, justification, and slant can be changed to suit the application.

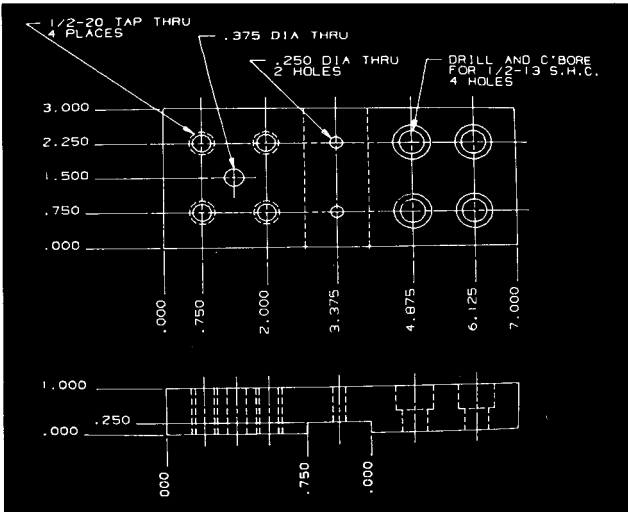

Editing procedures give the user the ability to alter any object that has been previously created. Features like delete, insert, replace, and rename enable the user to change the content of a picture by adding to it or deleting selected parts, replacing the whole picture, or just renaming. Once creating and editing is complete, the picture can be stored by means of record functions which can record part or all of the graphical object onto the specified mass storage device. Not only can the picture be stored, but the working environment as well. This means that the user can cease work on a picture and store it with its working environment, then recall it at some future time and continue at the point where work had previously been stopped.

An object displayed on screen can be interactively manipulated by means of PIVOT, STRETCH, and DRAG procedures within InteGraL/60 and an input device like the 9111A Graphics Tablet or the 9826A/9836A knob. These procedures operate in real-time, so the result of the action performed with the tablet is seen on the CRT immediately. PIVOT rotates an object, STRETCH allows you to change its shape, and DRAG moves the object from one location to another. A PICK operation is available to geometrically locate graphical primitives for editing. In addition, points can be digitized, sequences of line strokes can be drawn, and buttons can be designated for special purpose functions. To allow custom interactive functions to be implemented by application programmers, a SAMPLE INPUT function is provided.

The data base in InteGraL/60 is a collection of objects or sub-objects which are defined in user-convenient coordinate systems. Each primitive (line, polygon, or text block) in the data base has output attributes that are stored with it. These attributes include contrast, linestyle (for lines only), polygonstyle (for polygons only), textstyle, slant, textsize, spacing, rotation and justification (text only).

Since each object in the data base can be defined in a different coordinate system, InteGraL/60 provides transformation functions to convert each of the objects into a global or "world" coordinate system. Thus if one object is defined in inches while another is in centimeters, the transformations allow them to be proportionally scaled into the global coordinate system which would be defined as inches, centimeters, or any other unit of measure desired. By the same transformation, the objects can be rotated and moved into any position to put them in proper perspective with other objects in the global coordinate system.

Another important feature of InteGraL/60 is its device independence. This means that objects are stored in the data base in units that are not oriented toward an input or output device. The same is true of all of the interactive functions. Consequently, InteGraL/60 enables the system to be configured with a 9111A Graphics Tablet, a 9874A Digitizer, or the 9826A/9836A knob as input devices. Output devices include the 1351A and CRT display, and a host of HP plotters.

The 1360 System supports not only a CRT display, and numerous input and output devices, but several HP printers as well. Several mass storage units are supported through the PASCAL Language System, in addition to the internal disc drives of the desktop computer, to allow the user to store more information. For program develop-

ment, the user may wish to configure the 1360 system with a 9836A Desktop Computer in lieu of a 9826A. The 9836A has a 12 in. screen for easier screen editing, and two 264 kbyte flexible disc drives.

### Hardware

The 9826A Desktop Computer serves as the computational element and system controller. Under direction of InteGraL/60, the 9826A controls all of the major system functions like I/O, calculations, information storage, etc.

The 1351A Graphics Generator receives picture data from the desktop computer via a 16-bit parallel interface, stores it in internal memory, and displays it on screen. The display is refreshed from the 1351's memory, keeping the current picture on screen until it is modified or erased.

The 9111A Graphics Tablet is the human/computer interface device for the system. It enables the user to interactively draw lines, pick elements for editing, drag objects, and more on the CRT display.

### System Options

- 13A:** One additional 52113A Disc w/o manual
- 511:** 1311B 14 in. display w/tall tilt stand in lieu of 1310B
- 512:** Short tilt stand for 1310B in lieu of tall tilt stand
- 513:** Short tilt stand for 1311B in lieu of tall tilt stand
- 521:** 1321B 21 in. display in lieu of 1310B
- 910:** Extra 52113A Operating and Programming Manual (does not include hardware components manuals)

### Ordering Information

Complete 1360 Graphics System consists of a 9826A or 9836A Desktop Computer with PASCAL Language System, a 9111A Graphics Tablet, and 1360S Display System.

#### 1360S Display System

- 1351A/Opt 002** Graphics Generator w/16-bit interface
- 1310B** 19 in. CRT display w/tall tilt stand
- 52113A** InteGraL/60 Interactive Graphics Library
- 52121A** 2-metre 16-bit interconnect cable
- 52122A** 1-metre BNC analog interconnect cable
- 10492A** 1-metre Z-axis interconnect cable
- 9826A/Opt 099** Desktop Computer
- 98261A Opt 715** PASCAL Language System
- 98256A** 256 kbyte RAM memory board (2 required)
- 98620A** 2-channel DMA controller card
- 98622A** 16-bit GPIO Interface card
- 9836A/Opt 099** Desktop Computer
- 98261A Opt 715** PASCAL Language System
- 98256A** 256 kbyte RAM memory board (2 required)
- 98620A** 2-channel DMA controller card
- 98622A** 16-bit GPIO Interface card
- 9111A** Graphics Tablet



# COMPUTERS, PERIPHERALS & CALCULATORS

## Computer Support

Overview / Software Training and Consulting

- Assured lasting value for your HP computer products
- Broad range of services worldwide



### Overview

HP's support services ensure the lasting value of your HP computer system. Throughout its lifetime, your HP computer system will be maintained to meet its performance specifications. More important, our training, consulting, and ongoing user support will help you make your HP products an answer to your application needs. In short, HP support services provide the resources you need to use your products successfully.

**Cost effective:** you can tailor the most effective support program for the lowest cost using HP's broad range of support services. Compare the performance features of HP's support programs to your cost as a percentage of the equipment's list price. Or calculate your five year cost-of-ownership, including hardware, software, and support costs. You'll find HP ranks well against the competition in both areas.

**New service programs:** our goal is to introduce innovative support services which better meet your needs. Programs like Guaranteed Uptime Service for the HP 3000 systems and System Information Service for desktop and personal computers are examples of HP's leadership in providing effective support solutions.

**Lasting value:** for services to provide lasting value, they must consistently meet or exceed customer expectations. How do our customers rate HP support? In 1981, a major survey asked over 2,000 customers to rate systems and service from 28 minicomputer vendors. HP maintenance services and mainframe reliability both received the highest ratings in the survey.

**Consistent support worldwide:** Specified services ensure that you receive consistent support throughout the world no matter which HP office provides the services. You receive a detailed set of specifications for every service purchased, so you know what to expect from HP's support programs.

- Expert instruction from the company who designed and built your system
- Specialized solutions for planning and integrating systems

### Software Training and Consulting

Today's capable software systems require training and expert consulting in order to be used most effectively. HP training courses enable you to better understand the system, its utilization, and capabilities. This instruction can improve your productivity and significantly reduce implementation time.

To aid in planning and installing a complete computer system, HP offers the consulting services of an experienced HP Systems Engineer (SE). The SE can offer suggestions for enhancements, new uses for specific applications, and recommendations for improving efficiency of operation. Skilled, advanced planning means good integration of a product with its application and ensures early end-user satisfaction.

### Software Training—Proficiency for Users and Programmers

HP offers training courses to instruct you in the theory and operation of HP software so that you can more fully and effectively utilize your system. This training includes a full complement of standard courses which range from introductory to advanced levels and emphasize both lecture and laboratory.

Regularly scheduled courses are offered at well-equipped training centers in most area sales offices. If you have a large programming staff, you may find optional, on-site courses a cost-effective alternative. In addition, self-paced courses have been developed for the HP 3000 which provide low-cost instructional material on selected topics.

### Ordering Information

Consult a customer training schedule for information on course price and availability. Or call your local HP sales office or sales representative.

### Consulting Services—Specialized Assistance

Consulting is a service delivered by a Systems Engineer, customized to your specific application and needs. It can range from helping you personalize HP training course material to your specific application; to developing techniques for addressing a unique or complex problem; to troubleshooting a system.

Consulting services are not a substitute for training, but rather a technical resource to augment the knowledge you gain from standard training programs. Two types of consulting services are available: unstructured assistance billed on a daily basis and standardized consulting services. Standard programs include commonly requested tasks for a fixed duration and price.

### Ordering Information

You may request consulting from the nearest HP sales office or by conferring with your HP sales representative or an HP Systems Engineer. Charges for consulting is invoiced upon completion of the service or at the close of each calendar month if the service period extends beyond one month.

- Contracts to support desktop and systems owners
- Up-to-date information for managers, operators, programmers
- Flexible options to suit your budget



Benefit	Feature	CSS	SIS	SSS	SNS	MUS
Personal assistance	Account-Assigned SE	•				
	On-Site SE Assistance	•				
	PICS	•	•			
Software updating & Maintenance	Software/Firmware Updates	•		•		
	Software Problem Reporting	•	•	•		
Application notes & tips	Communicator	•	•	•	•	
Status and documentation updates	Software Status Bulletin	•	•	•	•	
	Software Update Notice (HP 1000)	•		•	•	
	Manual Updates	•	•	•		•

Figure 1: Contractual Software Support

## Software Support Programs—Personalized Assistance for Your Staff

Not only does HP help you get started using your equipment, contractual services are available to answer your questions quickly in the months that follow. Other forms of software assistance, such as manual and software updates, are also conveniently packaged into contractual services. The variety of standardized services allows you to choose the level of support you need for continuing efficient operation.

### Customer Support Service—Comprehensive Systems Support

HP systems software support begins even before the computer is ordered. During the selection process, a Systems Engineer (SE) provides technical advice to make sure the system, software products, and support will fit your business needs now and in the future. After you purchase Customer Support Service (CSS), an HP Systems Engineer is assigned to your account to help you with applications software development, resolve any software bugs and discrepancies, and preview new and enhanced HP software for your potential use. SE assistance is available to you via both a Phone-In Consulting Service (PICS) and on-site assistance.

In addition to valuable, personalized assistance from your SE, the CSS program includes one copy of HP software/firmware updates, plus updates and revisions for your HP software reference manuals. Periodic bulletins and newsletter provide information on current programming techniques, and items of general interest. These publications include:

- HP COMMUNICATOR—four times per year
- SOFTWARE STATUS BULLETIN—twice monthly, plus a cumulative quarterly issue
- SOFTWARE UPDATE NOTICE—quarterly, to HP 1000 customers

### Software Information Service—Ongoing Support for Desktop and Personal Computer Users

System Information Service (SIS) is a software and firmware support service especially designed for owners of desktop and personal computers. It provides the technical and applications assistance needed by users and programmers for the effective and productive use of their HP computers. Early proficiency and confidence, during the first months of operation, can mean increased productivity and efficiency. Features of SIS include:

- Phone-In Consulting Service (PICS)
- Software Problem Reporting
- COMMUNICATOR
- Manual Updates

If you select SSS, you can use consulting services for supplemental assistance from a Systems Engineer.

### Software Notification Service and Manual Update Service—Documentation for a Large Staff

Routinely available in both CSS and SSS described above, the Software Notification Service (SNS) is also available separately. If you have a large programming staff or multiple sites, SNS allows you to obtain multiple copies of periodic HP documentation.

Large programming staffs also frequently require multiple copies of manuals. Manual Update Service (MUS) is a valuable supplement to both CSS and SSS, since it relieves you of the administrative burden of monitoring and ordering manual updates.

### Ordering Information

Software support services are normally purchased for a 12-month period, payable in advance, quarterly, or yearly as desired. The minimum purchase is three months. SNS and MUS are each purchased separately for a period of 12 months, renewable annually.

Detailed ordering information can be obtained from an HP Sales Representative or by referring to the appropriate HP Computer System Price/Configuration Guide.



# COMPUTERS, PERIPHERALS & CALCULATORS

## Computer Support

### Hardware Service Agreements

- Cost-effective maintenance agreements
- Flexible options for desktops and systems
- Installation services

- Flexible and comprehensive service plans
- Skilled engineers
- Fixed, monthly maintenance costs

### Hardware Maintenance Agreement Services

All Hewlett-Packard computer products can be covered by one of HP's maintenance agreement services to assure continuous operation and maximum usefulness at a known monthly charge. These services are provided by HP-trained Customer Engineers. Service coverage hours and response times can be selected to fit your business or technical requirements.

#### System Maintenance Services—Customer Engineer Personally Responsible to Your Account

When you purchase an HP System Maintenance Agreement, a Customer Engineer is personally assigned to your accounts. When your system requires service, your CE responds within the length of time designated on your support contract, and stays on the job until your system is restored to normal operation.

Preventative maintenance is performed on a regular basis, scheduled, in advance, to assure that your HP computer system is maintained at its optimum performance specifications. If necessary, your Customer Engineer performs equipment adjustments or replaces worn-out parts.

Levels of system maintenance vary with your application needs. The variables are cost, hours of coverage, and CE response time. The Guaranteed Uptime Service is designed to provide a very high level of system availability. It ensures 99% uptime—money back guarantee—on the critical elements of your system, on-site maintenance services, and round-the-clock continuous coverage. It is currently available for the HP 3000 Series 40, 44, and 64 computers.

The Standard System Maintenance Agreement provides coverage from 8:00 AM to 9:00 PM, Monday through Fridays, excluding HP holidays. This coverage allows all scheduled maintenance services to be performed after normal working hours. For customers located within 100 miles of a Service Responsible Office, same-day service for unscheduled maintenance requests are received during a normal 8:00 AM to 5:00 PM shift.

For minimal interruption to your operations, you can increase the hours of coverage up to a maximum of 24 hours a day, seven days a week. Extended coverage can be tailored to the requirements of critical system uses.

A Basic System Maintenance Agreement plan provides economical coverage from 8:00 AM to 5:00 PM, Monday through Friday, excluding HP holidays. Next-day response is assured at your request for service if you are located within 100 miles of a Service Responsible Office.

The Remote Support Program is an optional feature of HP's System Maintenance Services and is available on selected HP systems. If you meet the specified requirements of this program, HP connects the remote access features of your system to an electronic data link for the purpose of monitoring your systems operations. This hook-up via a modem reduces support costs by providing credit on your monthly maintenance charge while providing a much greater level of service.

#### On-site Product Service—Ideal for Workstation Products

The On-Site Product Service is an economical support program well suited for small workstation products, such as terminals, plotters, and desktop computers. Products placed under this service are maintained for about one-third less than under a Standard System Service.

A highly skilled Customer Engineer responds to your service call by the next working day if you are located within 100 miles of an HP service office. On-site service is provided beyond 100 miles with an increase in response time and cost. Specific hours of coverage are from 8:00 AM to 5:00 PM, Monday through Friday, excluding HP holidays.

#### Field Repair Center Service

The Field Repair Center Service is the lowest price alternative for hardware support covering HP computer products. At about one-half the cost of On-Site Product Service, HP's Field Repair Center Programs performs remedial repairs on workstation products, including terminals, plotters, desktop computers, and printers. Maintenance is carried out by a Customer Engineer at your local field repair center.

HP's Field Repair Service is ideal if you can operate without a unit for one to two weeks or if you have a backup unit available. It is preferable to per-incident charges, because HP covers all hardware problems resulting from normal product use for a low monthly fee, insuring you against expensive maintenance "surprises" after the 90-day warranty period.

Eligible products are shipped to local field repair centers by you. They are repaired within three working days and returned via normal land freight by HP.

Feature	Systems			Workstation Products	
	Guaranteed Uptime	Standard	Basic	On-Site Product	FRC
Response Time	4-hrs.	4 hrs.	Next day	Next day	3-day TA*
Coverage Hours	8 am-8 am	8 am-9 pm	8 am-5 pm	8 am-5 pm	8 am-5 pm
Account-Assigned CE	○	○	○		
Scheduled PMs & ECs	○	○	○		
Work-to-Completion	○	○	○		
Add-on Installation	○	○	○		
Site Environmental Survey	○	○	○		
Extended Coverage Hours	N/A	○			
Guarantee 99% Uptime	○				
Remote Support	○	○	○		

\*Turnaround time

Figure 2 Hardware Maintenance Agreements Summary

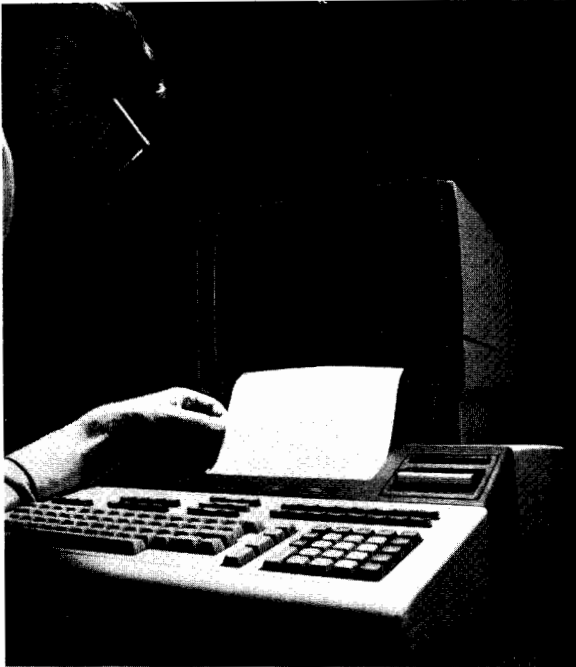

HP 35030A Power Line Conditioner

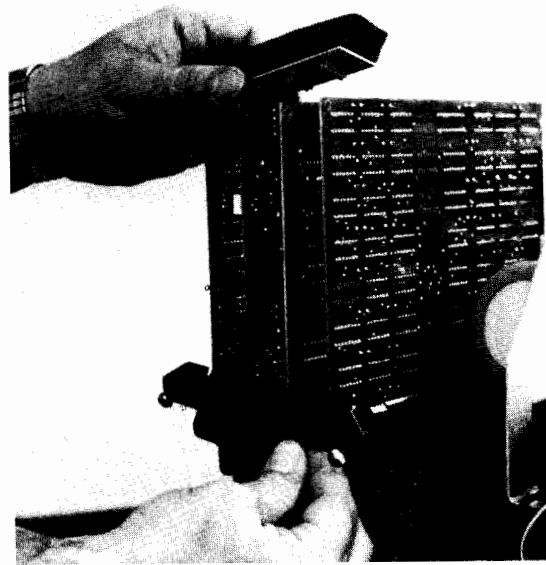

## System Installation Services

When you purchase an HP computer system, support services begin even before your system is installed. A Customer Engineer routinely provides site planning, site environmental survey, and installation services. These services ensure that your HP computer system is installed properly at an acceptable, designated site.

Your site survey may indicate a need for regulation of the power source. HP markets a power line conditioner to handle this need (described below).

## Remote Support Modem

The HP 35016A Remote Support Modem is micro-processor controlled and has these features: high performance, low error, full duplex, and 1200 bps. It combines VA3400, Bell 212, and Bell 103 originates and answers operation. The 35016A comes with an extended power supply, an 8-pin modular telephone plug (requires an RJ455 modular jack installed by TEICO), and a computer modem cable.

## Power Line Conditioner

The HP 35016A Power Line Conditioner provides protection from disturbances normally found on the incoming power line which affect system performance. It alternates noise and compensates for line voltage fluctuations. These combined functions protect your system against 99% of the typical power line disturbances.

Easily installed, the Power Line Conditioner is recommended for protection against down-time in older buildings and areas where electrical storms occur.

## Per-Incident Maintenance

Time and Materials is available for HP computer systems not covered by a maintenance agreement. When you purchase T&M Services, you receive a three-day response during coverage hours of 8:00 AM to 5:00 PM, Monday through Friday, excluding HP holidays. You will be billed for all travel, parts and labor used during the service call.

A Standard Repair Charge (STREP) is defined for selected products and includes all parts and labor. Products with a Standard Repair Charge may be returned to a Field Repair Center for repair or receive the same level of service on-site for an additional charge to cover travel.

## Cooperative Support Services

While self-support is expensive, you may have a very large base of installed HP computer equipment and the technical expertise to make it cost-effective. If this is the case, HP has several Cooperative Support Services to meet your needs.

Customer Maintenance Training is available for the HP 1000, HP 3000, Series 40 and 44, HP desktop computers, and selected peripherals supported with these products. A balance of theory and practical experience is given to provide the skills needed to troubleshoot, repair, and maintain these products down to the major sub-assembly level.

Hardware Subscription Service (HSS) provides timely service information for maintaining products covered by Cooperative Support. This includes the *HP Computer Maintenance Newsletter*, *Service Notes*, and manual updates and revisions. The *HP Computer Maintenance Newsletter* addresses maintenance topics of general interest for service personnel. Service Notes provides technical information regarding specific changes in hardware maintenance. As changes and revisions are made to service manuals, updates are sent to keep these manuals at current levels.

Technical Assistance Service (TAS) provides access to HP technical resources through phone-in consulting. HSS is included with TAS. Account management is provided to assure that you are making the most effective use of all HP hardware services.

## Warranty Services—90-Day Coverage

HP warrants its computer products against defects in material and workmanship for a period of 90 days. (For more information on the HP warranty, see the "Post-Sale Support Service" section of this catalog.)

## HP Service Locations Worldwide

HP maintains computer sales and support offices in 39 countries. For a listing of addresses, see the back of this catalog.



# DIMENSIONAL MEASUREMENT

## Laser Measurement Systems

Models 5501A, 5526A, 5527A, 5528A

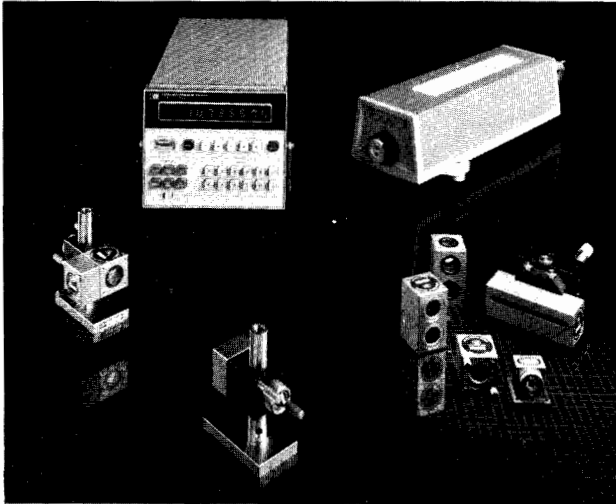

5528A Laser Measurement System



Disc drive research and development using 5528A

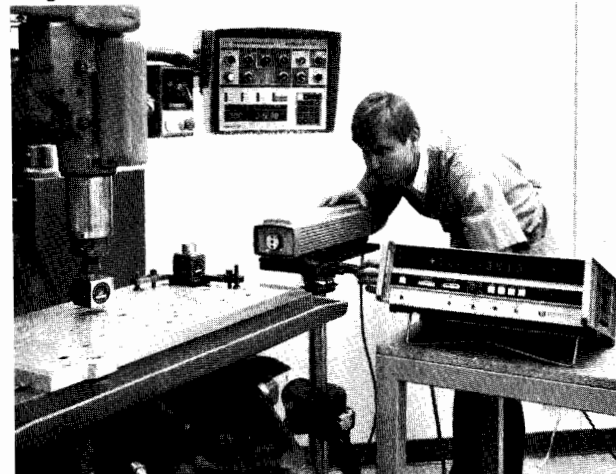

Machine tool calibration using 5526A

### Description

Hewlett-Packard Laser Measurement Systems are accurate and versatile measuring tools for dimensional parameters such as length, angle, straightness, squareness, parallelism and flatness. The wavelength of light from a low power Helium-Neon laser is used to attain resolutions up to 0.01 micrometre (1.0 microinch) and 0.1 arc-second. HP's patented two-frequency design can make measurements over distances up to 61 metres (200 feet)—even in environments with oil mist, air turbulence or thermal gradients. Customer applications range from machine tool calibration and general purpose metrology to built-in position sensors for original equipment manufacturers (OEM's).

### Calibrators

The HP 5526A and HP 5528A Laser Measurement Systems are capable of a wide range of applications. Examples of their use are found in fabrication (calibration of machine tools and coordinate measuring machines), manufacturing (precision alignment and positioning), R&D (non-contact measurements) and metrology (calibration of scales, gages and surface plates). The systems are especially attractive as reference standards for fabrication shops and metrology labs because they are portable and do not degrade from wear or aging. The HP Laser Measurement Systems offer a combination of accuracy, versatility and ease of use unmatched by other systems and methods.

### Modular Design

The basic system consists of a laser head, display and a variety of optics. The head and display are designed to accommodate the full range of dimensional measurements. This includes linear displacement (length), angular displacement (pitch and yaw), translational displacement (vertical and horizontal straightness) and linear velocity. The optics, meanwhile, are designed to make only specific measurements. A basic system configured to meet the requirements of the present can easily be expanded in the future by simply adding the optics for the desired measurements.

### Metrology Systems

Measurement capability can also be enhanced by the addition of a desktop computer, graphics plotter and pre-written metrology programs. The HP 55286A and HP 55288A Dimensional Metrology Analysis Systems allow data to be automatically stored, analyzed and plotted. Machine errors can be quickly identified and downtime can be kept to a minimum. The metrology systems not only reduce the time required to make measurements, but also extend the capabilities of the basic system beyond length, angle and straightness. Dimensional parameters such as squareness and parallelism between two axes can be calculated and displayed. Flatness of a surface plate can be measured and plotted in either numerical or graphical (isometric) form. Multiple runs of data can be analyzed using one of three different error formats. The Statistical Error Analysis even plots the mean and standard deviation. Included in the metrology systems are programs for machine tool calibration, surface plate calibration, velocity of light compensation and large angle correction.

### Manual or Automatic Compensation

The absolute accuracy of the Laser Measurement System depends on the velocity of light in air and the temperature of the object being measured. The velocity of light in air is a function of temperature, pressure and humidity. A compensation factor can be found in a set of tables and manually entered into the display. If the environment is changing, this number may have to be updated continuously. The HP 5510A and HP 5511A Automatic Compensators are designed to automatically input the compensation factor using a multi-purpose air sensor. The temperature of the object being measured can be monitored in a similar fashion. From one to three material temperature sensors are used to automatically compensate for the object's thermal expansion. Both manual and automatic compensation are available for the transducers below.



## 5526A, 5528A Specifications

The following specifications are for a typical measurement where the ambient temperature is 15–25°C and the velocity of light is known.

**Laser type:** Helium-Neon with automatically tuned Zeeman-split two-frequency output.

**Range:** 61 m (200 ft) maximum depending on system configuration.

**Measurement velocity:** 18.3 m/min (720 in/min) maximum.

**Output power:** 1.0 mW maximum.

### Linear Measurement

**Accuracy:**  $\pm 0.1$  part per million.

**Resolution:**  $0.01 \mu\text{m}$  ( $1.0 \mu\text{in}$ ).

**Measurement range:**  $\pm 40$  m ( $\pm 131$  ft) typical.

### Angular Measurement

**Accuracy:**  $\pm 0.2\%$  of displayed value  $\pm 0.05$  arc-second per metre of traveled distance.

**Resolution:** 0.1 arc-second.

**Measurement range:**  $\pm 3600$  arc-seconds.  $\pm 10$  degrees with large angle correction.

### Short Range Straightness Measurement

**Accuracy:** smaller of 2.5% of displayed value or  $0.25 \mu\text{m}$  ( $10 \mu\text{in}$ ) using mirror reversal method.

**Resolution:**  $0.01 \mu\text{m}$  ( $1.0 \mu\text{in}$ ).

**Measurement range:**  $\pm 1.5$  mm ( $\pm 0.06$  in) typical.

**Axial range:** 0.1–3.0 m (0.3–10 ft) typical.

### Long Range Straightness Measurement

**Accuracy:** smaller of 2.5% of displayed value or  $2.5 \mu\text{m}$  ( $100 \mu\text{in}$ ) using mirror reversal method.

**Resolution:**  $0.1 \mu\text{m}$  ( $10.0 \mu\text{in}$ ).

**Measurement range:**  $\pm 1.5$  mm ( $\pm 0.06$  in) typical.

**Axial range:** 1.0–30 m (3.0–100 ft) typical.

## Ordering Information

### 5526A Laser Measurement System

5500C Laser Head

5505A Laser Display

5510A Automatic Compensator

10550B Linear Retroreflector

10558A Angular Beam Bender

10559A Angular Reflector Mount

10563A Material Temperature Sensor

10565B Linear Interferometer

10579A Straightness Adaptor

10580A Laser Tripod

10690A Short Range Straightness Interferometer

10691A Long Range Straightness Interferometer

10692B Optical Square

55286A Dimensional Metrology Analysis System

### 5528A Laser Measurement System

5508A Measurement Display

5518A Laser Head

10751A Air Sensor

10752A Material Temperature Sensor

10753A Laser Tripod

10777A Optical Square

55280A Linear Measurement Kit

55281A Angular Optics Kit

55282A Flatness Accessory Kit

55283A Straightness Measurement Kit

55288A Dimensional Metrology Analysis System

For more complete specifications and ordering information, contact any Hewlett-Packard Sales Office.

## Transducers

The HP 5501A Laser Transducer and HP 5527A Laser Transducer System feature smaller, more modular components than the systems above. Although designed for OEM's who need built-in position sensors with high accuracy and repeatability, simple installation techniques make these systems attractive for end users as well. Typical applications include the servo controls for IC wafer steppers, multi-axis machine tools and coordinate measuring machines. Among the many optical components available are standard interferometers and retroreflectors, single beam interferometers for minimum size and weight, and plane mirror interferometers for precise positioning of X-Y stages. Using several beam splitters and beam benders, a single laser source can monitor up to four axes of motion simultaneously.

### System Interfaces

Output devices and formats can be selected from a variety of electronic interfaces. There are two general purpose interfaces. The calculator interface is based on the Hewlett-Packard Interface Bus (HP-IB) and is designed for use with the HP family of desktop computers. The computer interface outputs binary information in either an 8- or 16-bit format to digital processors and controllers. Two other interfaces are more specialized in nature. The English/metric interface sends microinch or micrometre pulses to the numerical controllers of machine tools, while the closed-loop interface provides high-speed positioning feedback for closed-loop control systems.

## 5501A, 5527A Specifications

The following specifications are for a typical measurement where the ambient temperature is 15–25°C and the velocity of light is known.

**Laser type:** Helium-Neon with automatically tuned Zeeman-split two-frequency output.

**Accuracy:**  $\pm 0.1$  part per million.

**Resolution:**  $0.16 \mu\text{m}$  ( $6.0 \mu\text{in}$ ) using linear and single beam interferometers.  $0.08 \mu\text{m}$  ( $3.0 \mu\text{in}$ ) using plane mirror interferometer. Higher resolutions available with closed loop interface.

**Axes:** 4 maximum depending on system configuration and environmental conditions.

**Range:** 61 m (200 ft) maximum depending on system configuration (sum of axes for multi-axis system).

**Measurement velocity:** 18.3 m/min (720 in/min) maximum.

**Output power:** 1.0 mW maximum.

### Ordering Information

5501A Laser Transducer

### 5527A Laser Transducer System

5511A Automatic Compensator

5517A Laser Transducer

10700A 33% Beam Splitter

10701A 50% Beam Splitter

10702A Linear Interferometer

10703A Linear Retroreflector

10704A Single Beam Retroreflector

10705A Single Beam Interferometer

10706A Plane Mirror Interferometer

10707A Beam Bender

10751A Air Sensor

10752A Material Temperature Sensor

10780A Receiver

For more complete specifications and ordering information, contact any Hewlett-Packard Sales Office.



# PRESSURE & TEMPERATURE

## Quartz Pressure Gauge, Pressure Recording System

Models 2813B, 2816A, 2820A

- 0.01 psi resolution (69 Pa)
- 0.025% full scale accuracy
- Direct surface readout

- Simple operation
- Long term stability
- 200-11000 PSIA range

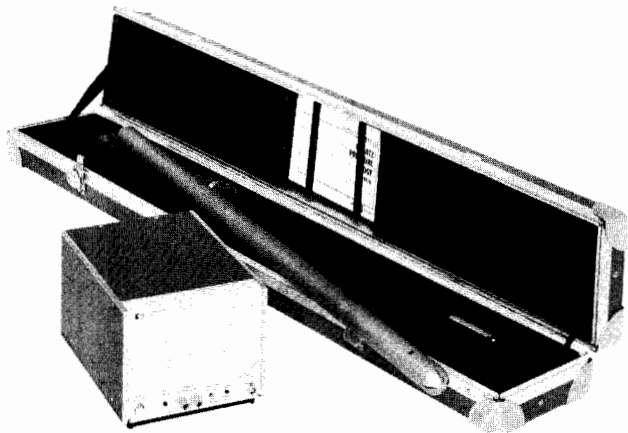

2816A Pressure Signal Processor,  
2813B Quartz Pressure Probe

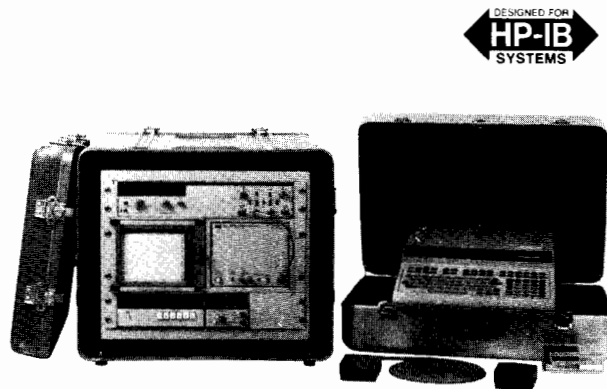

2820A Pressure Recording System



### 2813B, 2816A Description

The gauge consists of a 2813B Quartz Pressure Probe and a 2816A Pressure Signal Processor. A frequency signal proportional to pressure is transmitted from the bottom-hole pressure probe to the signal processor on the surface. It travels through a single-conductor, armored electric line. The processor conditions the pressure-related signal to drive a separate electronic frequency counter for direct readout. An HP Desktop Computer may be used to calculate bottom hole pressure from the probe frequency and temperature.

### 0.01 psi Resolution at 11,000 psi (69 Pa @ 76 MPa)

The HP quartz pressure gauge measures wellbore pressure with a resolution of 0.01 psi over a dynamic range in excess of 11,000 psi. This capability makes it possible to measure pressure changes that cannot be detected with conventional gauges using bourdon tube transducers.

This ability to detect and record small pressure changes allows sophisticated test techniques to be used economically. For example, since the super-sensitive HP quartz pressure gauge can detect small pressure transients at observation wells, pulse tests can be conducted with extremely short pulse cycle times at the stimulus well. Because the shut-in time is reduced, the permeability and formation thickness between wells can be determined at a substantially lower cost.

With the gauge, pressure transients can be observed and recorded on the surface while the test is in progress. When the surface readout indicates the test is completed, the gauge can be retrieved immediately. Pressure data can be read directly without intermediate scaling or other calculations, when used with the 2820A Pressure Recording System.

The quartz pressure gauge was specifically designed for pressure measurement in oil and gas wells and it is used by many oil companies and well service companies. However, its high resolution pressure measuring capability and rugged construction also make it ideally suited for oceanographic research and subterranean hydrodynamic studies.

### 2820A Description

The HP 2820A Pressure Recording System provides surface readout and recording for the 2813B Quartz Pressure Probe. Pressure test data (time, bottom hole pressure, and temperature) is automatically displayed, printed, and recorded on magnetic tape and a strip chart while the test is in progress. The system is simple to set up and operate. Many built-in checks are provided to protect against accidental operator entries and other conditions that would cause an error and halt operation. The user can add other HP-IB compatible instruments and peripherals to the 2820A system to display and plot the pressure test data for extensive analysis after the test.

### System Specifications

**Sensitivity:** (105 Hz/psi) 105 Hz/6.9 kPa nominal output of signal processor.

**Probe operating pressure range:** 0–82.7 MPa (0–12,000 psia.)

**Probe operating temperature range:** 0 to 150°C (32° to 302°F.)

**Signal processor operating temperature range:** 0° to 55°C (32° to 131°F.)

**Calibrated pressure range:** 1.4–75.8 MPa (200–11,000 psia.)

**Resolution:** 69 Pa (0.01 psi) when sampling for a 1-second period.

**Repeatability:** ± 2.76 kPa (± 0.4 psi) over entire range.

**Accuracy (at thermal equilibrium) if operating temperature is known**

**within 1° C (1.8° F):** ± 3.45 kPa or ± 0.025% of reading (± 0.5 psi or ± 0.025% of reading.)

**within 10° C (18° F):** ± 6.89 kPa or ± 0.1% of reading (± 1 psi or ± 0.1% of reading.)

**within 20° C (36° F):** ± 34.5 kPa or ± 0.25% of reading (± 5 psi or ± 0.25% of reading.)

### Dimensions and Weights

**2813B Probe:** 36.5 mm (1.4 in.) OD by 1000 mm (39.4 in.) long. Weight: 5.0 kg (11 lb.).

**2816A Signal Processor:** 154 mm H x 197 mm W x 279 mm D (6.1" x 7.8" x 11").

### 2813B Quartz Pressure Probe

### 2816A Pressure Signal Processor

### 2820A Pressure Recording System

Includes instruments in shock isolated fiberglass transit case and 9825 computer in padded aluminum case.

# PRESSURE & TEMPERATURE

## Quartz Thermometer

Model 2804A

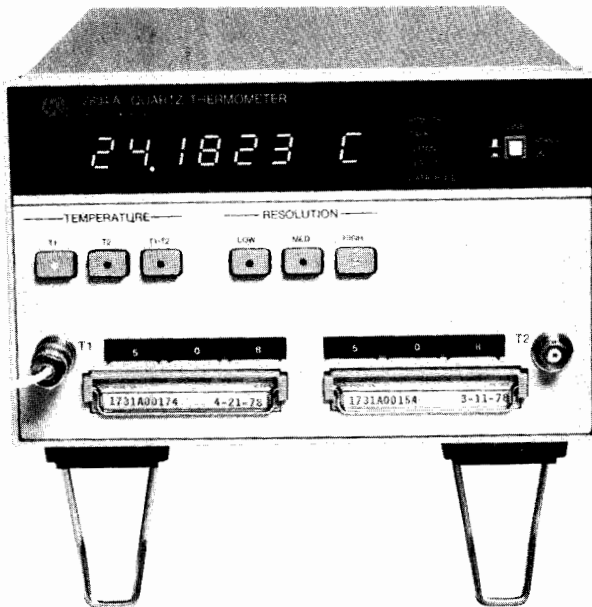

- $\pm 0.04^{\circ}\text{C}$  absolute accuracy
- $0.0001^{\circ}\text{C}$  or  $0.001^{\circ}\text{F}$  resolution
- $-80^{\circ}$  to  $+250^{\circ}\text{C}$  range
- Display of absolute or differential temperature
- Flexible HP-IB system interface
- Variable resolution analog output
- Easy ice point or triple point adjustment



The 2804A Quartz Thermometer allows you to easily measure temperature with exceptionally high accuracy and resolution. Absolute accuracy is  $\pm 40$  millidegrees Celsius over the range of  $-50^{\circ}\text{C}$  to  $150^{\circ}\text{C}$ , NBS traceable to IPTS-68. The useable resolution of  $0.0001^{\circ}\text{C}$  allows you to measure temperature changes that could not be detected by other digital thermometers.

The 2804A can be used with one or two temperature sensing probes. The temperature of either probe, or their difference, can be measured and displayed under pushbutton control. Display resolution is selectable from  $0.01$  to  $0.0001^{\circ}\text{C}$  ( $0.1$  to  $0.001^{\circ}\text{F}$ ) by pushbuttons. An internal switch allows you to easily select measurement in the Celsius or Fahrenheit temperature scale.

Temperature is measured and displayed automatically with the microprocessor and electronics provided in the 2804A package. There is no need to balance a bridge, perform calculations using resistance- or voltage-temperature tables or curves, or to use calibration correction tables. The only adjustment necessary to remove effects of thermal history on the sensor is a simple ice point or triple point calibration adjustment using the front panel thumbwheel switches.

### How It Works

The 2804A temperature sensor is a quartz crystal whose precise angle of cut gives a stable and repeatable relationship between resonant frequency and temperature. Each quartz sensor is individually calibrated at the factory over the full temperature range. The calibration data for each sensor is processed and stored in a calibration module which is supplied with the probe.

In operation, a microprocessor in the thermometer performs the complex control and calculation operations to accurately measure temperature from the quartz sensor frequency and probe calibration information in the calibration module. The microprocessor also performs self-checks to detect fault conditions. If a problem occurs that would give an improper measurement, an error message is displayed to indicate the source of the problem.

### System Oriented Design

The HP-IB option offers you a simple, yet flexible, way to connect the Quartz Thermometer to either an HP computing controller or printer. Temperature data can easily be sent to a calculator or computer for processing and recording. All front panel controls can be operated automatically by commands sent on the bus.

The optional analog output converts any three consecutive digits to a voltage between 0 and  $+10$  volts to drive a chart recorder. Front panel controls allow easy adjustment of pen zero and full scale as well as normal or offset (center-zero) operation. Any three digits can be

selected for conversion allowing you to change the full scale value on the recorder.

## 2804A Specifications

### Performance

**Range:**  $-80$  to  $250^{\circ}\text{C}$ .

**Absolute accuracy:** 2804A with 18110A, 18111A, 18112A or 18117A Quartz Probe —

$\pm 0.040^{\circ}\text{C}$  from  $-50$  to  $150^{\circ}\text{C}$

$\pm 0.075^{\circ}\text{C}$  from  $-80$  to  $250^{\circ}\text{C}$

NBS traceable to IPTS-68

**Resolution:** three levels can be selected —

Level of selection	Resolution		Nominal time between readings in seconds	
	$^{\circ}\text{C}$	$^{\circ}\text{F}$	T1 or T2	T1 - T2
Low	0.01	0.1	0.1	0.2
Medium	0.001	0.01	1	2
High	0.0001	0.001	10	20

### General

**Display:** 7 digit LED with polarity, decimal, and degree C or F annunciator.

**Probes:** a variety of probes are available for use with the 2804A. Refer to the data sheet for specifications and sheath configurations.

### Power Required

100, 120, 220, or 240 VAC,  $+5\%$ – $10\%$ , 48 to 66 Hz,  $<30$  VA.

**006:** Analog Output

**010:** HP-IB Interface

### Accessories and Probes

**18107A** External Oscillator

**18108A** Line Amplifier

**18109A** Diagnostic Kit

**18110A** Laboratory Probe and cal module, 25 mm (1")

**18111A** Laboratory Probe and cal module, 230 mm (9.1")

**18112A** Laboratory Probe and cal module, 460 mm (18.1")

**18115A** Heavy Duty Probe and cal module, 30 mm (1.2")

**18116A** Heavy Duty Probe and cal module, 100 mm (3.9")

**18117A** Heavy Duty Probe and cal module, 180 mm (7.1")

### 2804A Quartz Thermometer

# CABLES & ADAPTERS

## Cables

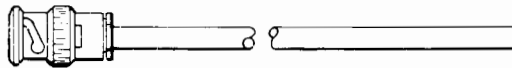

10501A: 112 cm (44 in)

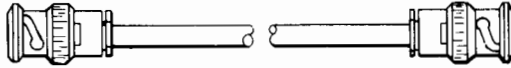

10502A L=23 cm (9 in)  
10503A L=122 cm (48 in)

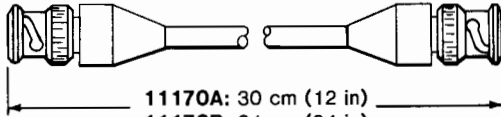

11170A: 30 cm (12 in)  
11170B: 61 cm (24 in)  
11170C: 122 cm (48 in)

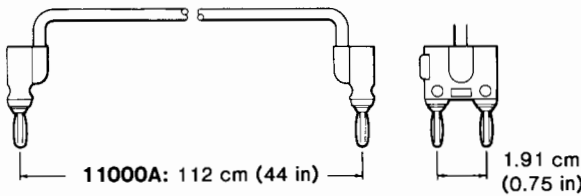

11000A: 112 cm (44 in)

1.91 cm  
(0.75 in)

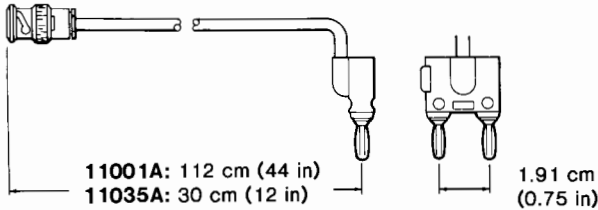

11001A: 112 cm (44 in)  
11035A: 30 cm (12 in)

1.91 cm  
(0.75 in)

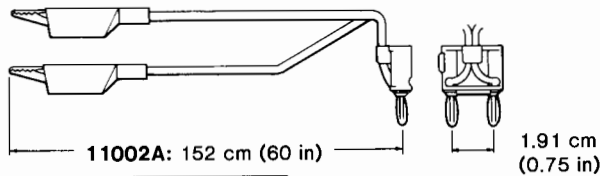

11002A: 152 cm (60 in)

1.91 cm  
(0.75 in)

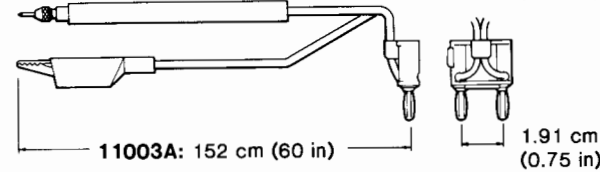

11003A: 152 cm (60 in)

1.91 cm  
(0.75 in)

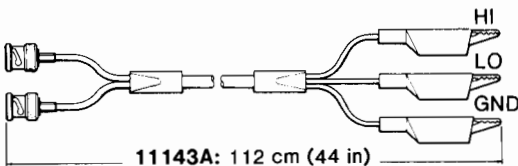

11143A: 112 cm (44 in)

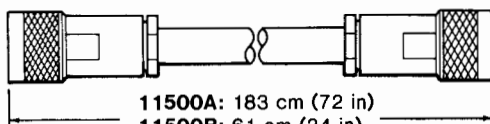

11500A: 183 cm (72 in)  
11500B: 61 cm (24 in)

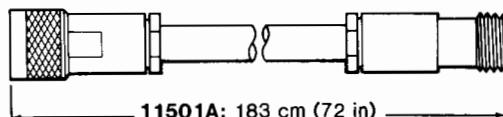

11501A: 183 cm (72 in)

## Cable Assemblies

### 10501A Cable Assembly

112 cm (44 in.) of 50-ohm coaxial cable terminated on one end only with UG-88C/U BNC (m) connector.

### 10502A Cable Assembly

23 cm (9 in.) of 50-ohm coaxial cable terminated on both ends with UG-88C/U BNC (m) connectors.

### 10503A Cable Assembly

122 cm (48 in.) of 50-ohm coaxial cable terminated on both ends with UG-88C/U BNC (m) connectors.

### 11170A Cable Assembly

30 cm (12 in.) of 50-ohm coaxial cable terminated on both ends with BNC (m) connectors.

### 11170B Cable Assembly

61 cm (24 in.) of 50-ohm coaxial cable terminated on both ends with BNC (m) connectors.

### 11170C Cable Assembly

122 cm (48 in.) of 50-ohm coaxial cable terminated on both ends with BNC (m) connectors.

### 11000A Cable Assembly

112 cm (44 in.) of 50-ohm coaxial cable terminated on both ends with a dual banana plug, for (3/4 in.) binding posts.

### 11001A Cable Assembly

112 cm (44 in.) of 50-ohm coaxial cable terminated on one end with a dual banana plug and on the other end with a UG-88C/U BNC (m) connector.

### 11035A Cable Assembly

30 cm (12 in.) of 50-ohm coaxial cable terminated on one end with a dual banana plug and on the other end with a UG-88C/U BNC (m) connector.

### 11002A Test Leads

152 cm (60 in.) test leads alligator clips to dual banana plug.

### 11003A Test Leads

152 cm (60 in.) test leads, probe and alligator clip to dual banana plug.

### 11143A Cable Assembly

112 cm (44 in.) test leads, dual BNC to alligator clips.

### 11500A Cable Assembly

183 cm (72 in.) of 50-ohm coaxial cable terminated on both ends with UG-21D/U Type N (m) connectors.

### 11500B Cable Assembly

Identical with 11500A except 61 cm (24 in.) long.

### 11501A Cable Assembly

183 cm (72 in.) of 50-ohm coaxial cable terminated with UG-21D/U Type N (m) and UG-23D Type N (f) connectors.



**1250-0077**  
**1250-1534**  
**1250-1477**

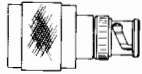

**1250-0082**  
**1250-1533**  
**1250-1473**



**1250-1474**  
**1250-1536**

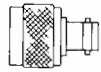

**1250-0780**  
**1250-1535**  
**1250-1476**

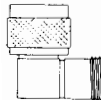

**1250-0176**

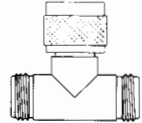

**1250-0559**

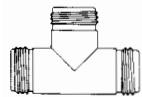

**1250-0846**



**1250-0777**  
**1250-1529**  
**1250-1472**

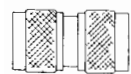

**1250-0778**  
**1250-1528**  
**1250-1475**

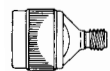

**1250-1250**



**1250-1158**



**1250-1159**

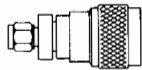

**1250-1743**

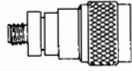

**1250-1744**

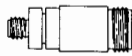

**1250-1745**

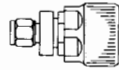

**1250-1746**

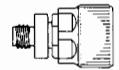

**1250-1747**



**1250-1748**



**1250-1749**



**1250-1750**



**1250-0831**



**1250-1236**



**1250-0832**



**11524A**



**11525A**

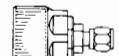

**11533A**



**11534A**



**1250-0076**  
**1250-1286**



**1250-0080**  
**1250-1287**



**1250-0216**  
**1250-1288**

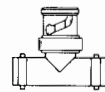

**1250-0781**

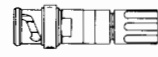

**1250-1263**

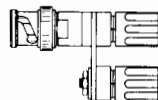

**1250-1264**

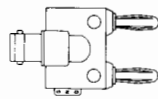

**1251-2277**

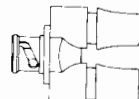

**10110B**

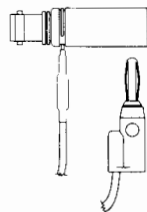

**10111A**

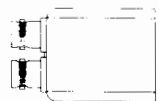

**10113A**

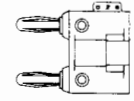

**1251-2816**

### Adapters Type N, Standard 50 Ω Part Number

- 1250-0077 N(f) to BNC(m)
- 1250-0082 N(m) to BNC(m)
- 1250-0176 N(m) to N(f) right angle
- 1250-0559 N tee, (m)(f)(f)
- 1250-0777 N(f) to N(f)
- 1250-0778 N(m) to N(m)
- 1250-0780 N(m) to BNC(f)
- 1250-0846 N tee (f)(f)(f)
- 1250-1250 N(m) to SMA(f)

### Adapters Type N, Precision<sup>1</sup> 50 Ω

- 1250-1472 N(f) to N(f)
- 1250-1473 N(m) to BNC(m)
- 1250-1474 N(f) to BNC(f)
- 1250-1475 N(m) to N(m)
- 1250-1476 N(m) to BNC(f)
- 1250-1477 N(f) to BNC(m)

### Adapters Type N, Standard 75 Ω<sup>2</sup>

- 1250-1528 N(m) to N(m)
- 1250-1529 N(f) to N(f)
- 1250-1533 N(m) to BNC(m)
- 1250-1534 N(f) to BNC(m)
- 1250-1535 N(m) to BNC(f)
- 1250-1536 N(f) to BNC(f)

### Adapters APC-3.5

- 1250-1743 APC-3.5(m) to N(m)
- 1250-1744 APC-3.5(f) to N(m)
- 1250-1745 APC-3.5(f) to N(f)
- 1250-1746 APC-3.5(m) to APC-7
- 1250-1747 APC-3.5(f) to APC-7
- 1250-1748 APC-3.5(m) to APC-3.5(m)
- 1250-1749 APC-3.5(f) to APC-3.5(f)
- 1250-1750 APC-3.5(m) to N(f)

### Adapters SMA

- 1250-1158 SMA(f) to SMA(f)
- 1250-1159 SMA(m) to SMA(m)

### Adapters SMB, SMC

- 1250-0831 SMC(m) to BNC(m)
- 1250-0832 SMC(f) to BNC(f)
- 1250-1236 SMB(f) to BNC(f)

### Adapters APC-7<sup>®</sup>

- 11524A APC-7 to N(f)
- 11525A APC-7 to N(m)
- 11533A APC-7 to SMA (m)
- 11534A APC-7 to SMA (f)

### Adapter Banana Plug

- 1251-2816 Dual Banana plug

### Adapters BNC, Standard 50 Ω

- 1250-0076 Right angle BNC(UG-306/D)
- 1250-0080 BNC(f) to BNC(f) (UG-914/U)
- 1250-0216 BNC(m) to BNC(m)
- 1250-0781 BNC tee(m)(f)(f)
- 1250-1263 BNC(m) to single banana plug
- 1250-1264 BNC(m) to dual banana plug
- 1251-2277 BNC(f) to dual banana plug
- 10110B BNC(m) to dual banana plug
- 10111A BNC(f) to shielded banana plug
- 10113A Dual BNC(f) to triple banana plug

### Adapters BNC, Standard 75 Ω<sup>3</sup>

- 1250-1286 Right Angle BNC
- 1250-1287 BNC(f) to BNC(f)
- 1250-1288 BNC(m) to BNC(m)

<sup>1</sup> "Precision": typically ≥36 dB return Loss to 1.3 GHz.

<sup>2</sup> Type N outer conductor; center pin sized for 75 Ω characteristic.

<sup>3</sup> BNC outer conductor; center pin sized for 75 Ω characteristic.

<sup>®</sup> A registered trademark of the Bunker Ramo Corporation

# CABINETS

## SYSTEM II—General Accessories<sup>1</sup>

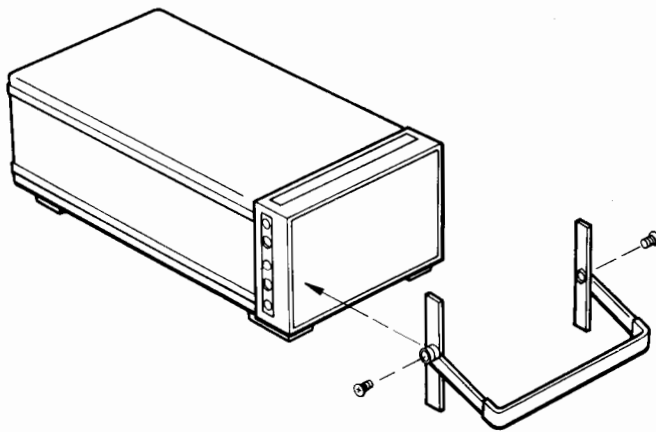

Bail Handle Kit

Bail Handle Kit			
Application	Description	Size	Part No.
½ MW (Half Module) Only	Convenient carrying handle for lightweight cabinets this high:	3½ H	5061-2001
		5¼ H	5061-2002
		7 H	5061-2003

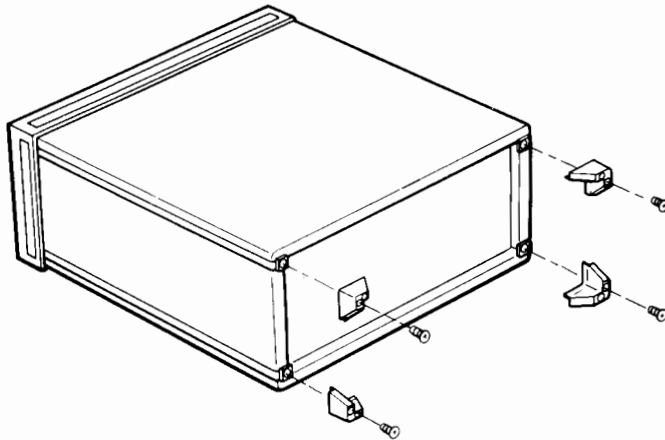

Rear Panel Stand-Off Kit

Rear Panel Stand-Off Kit		
Application	Description	Part No.
For all cabinets—except does not normally fit cabinets which are ¼ MW by 3½ H.	Kit of four special feet which provide 25.4 mm (1 in.) stand-off protection to rear panel. Used when instrument is operated in vertical position, or when it is transported/stored on its rear panel.	5061-2009

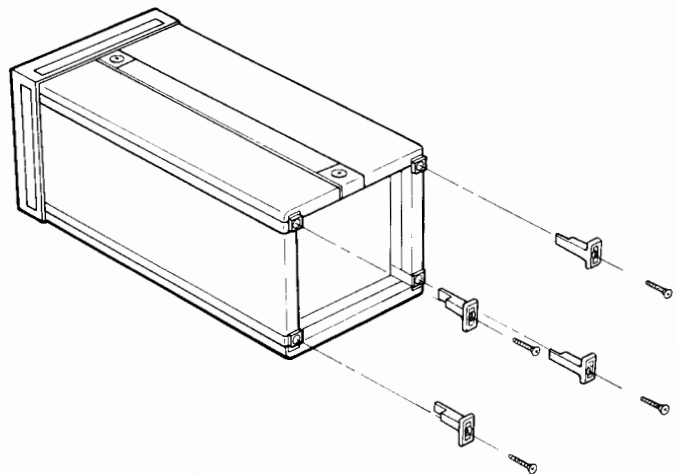

Cord Wrap Feet Kit

Cord Wrap Feet Kit		
Application	Description	Part No.
Recommended for products only ¼ MW and ½ MW weighing less than 11 kg (24 lbs.)	Kit of four flanged posts on which power cords or signal cables may be wrapped for transport/storage. It provides flanged cord wrap posts as a convenient way to keep power cords and signal cables with an instrument (not designed for heavy duty support; use kit 5061-2009 for such applications.)	5061-0095

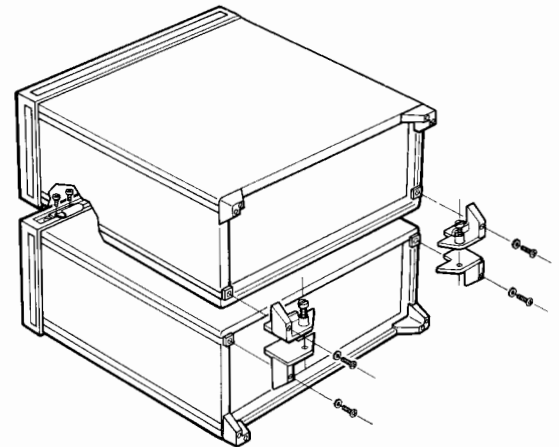

Rear Panel Lock Foot Kit

Full Module Cabinet Lock Foot Kit	
Description	Part No.
Combines Full Modules vertically. Used in combination with Rear Panel Standoff (5061-2009) only. Kit consists of right and left foot pairs, front lock links and fasteners—order 5061-2009 separately.	5061-0099

<sup>1</sup>All kits are supplied with appropriate mounting screws.

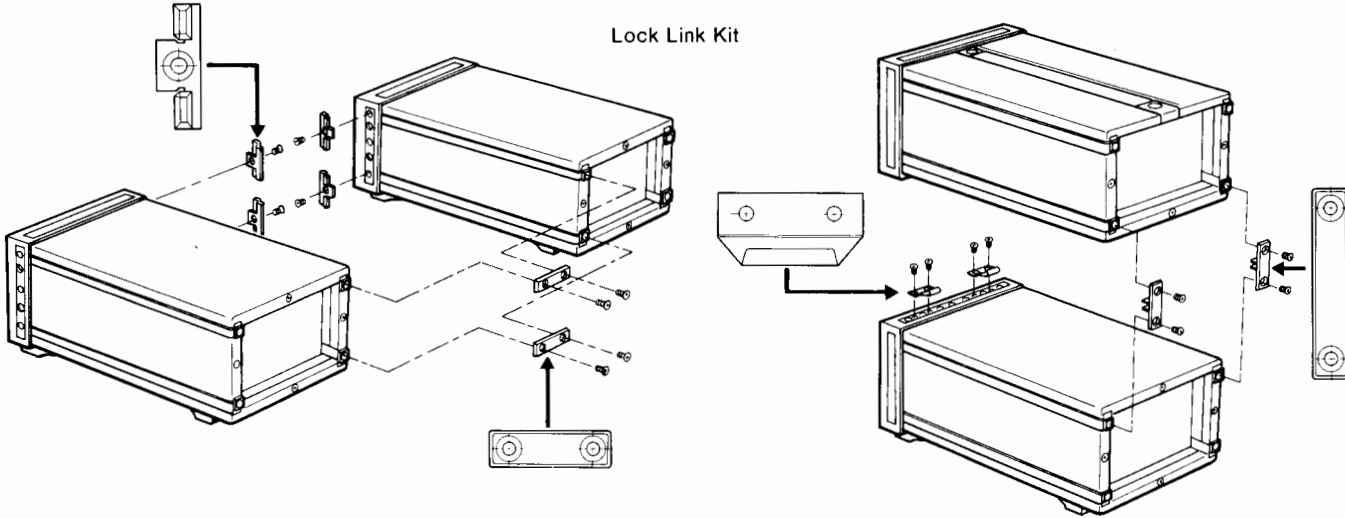

Lock Link Kit

Lock Link Kit			
Application	Description	Part No.	
<p>For use with all subModule cabinets, provided they are of equal depth.<sup>2</sup></p> <p>It is easy to group instruments together horizontally or vertically by using simple lock links. The links can be installed by using threaded holes already provided in the framework, allowing quick assembly and separation of instruments.</p>	<p>Kit consists of lock hardware and screws for joining instrument cabinets in several different configurations. Enough horizontal links (12 front, 6 rear) for three side-by-side joints (up to 4 instruments), and enough vertical links (4 front, 4 rear) to form two over/under joints (up to 3 instruments).<sup>2</sup></p>	5061-0094	

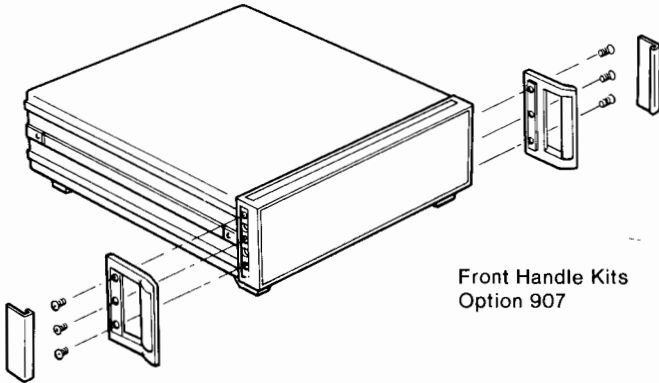

Front Handle Kits  
Option 907

Front Handle Kit			
Application	Description	Size	Part No.
<p>For use with all cabinets—but principle use is on 1 MW (Full Module) cabinets, or on sub-Module cabinets locked together to form width of 1 MW.</p> <p>Will be shipped with instrument, if ordered as Option 907 at same time. Otherwise available separately per Part Numbers listed at right.</p>	<p>Kit includes two front handles to fit on each side of front panel frames, for cabinets this high:</p>	3½ H	5061-0088
		5¼ H	5061-0089
		7 H	5061-0090
		8¾ H	5061-0091
		10½ H	5061-0092
		12¾ H	5061-0093

<sup>1</sup>All kits are supplied with appropriate mounting screws.

<sup>2</sup>Locking cabinets together horizontally in a configuration wider than 1 MW (Full-Module) is not recommended.

Cabinet Feet

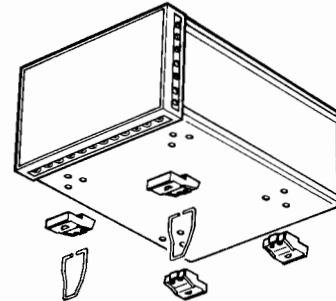

Full and Half Module Cabinet Feet		
Application	Part No.	
Standard foot (1): fits bottom of 1 MW and ½ MW cabinets (requires 2 front, 2 rear).	5040-7201	
Tilt stand (1): fits onto standard foot and is used in pairs (front or rear).	1460-1345	
Non-skid foot (1): used (in pairs) in lieu of standard rear or front foot, to minimize bench-top creeping.	5040-7222	

Cabinet Foot

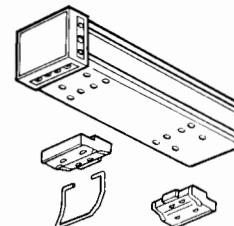

Quarter Module Cabinet Foot		
Application	Part No.	
Standard foot (1): fits bottom of ¼ MW cabinet (requires 1 in front, 1 in rear).	5040-7205	
Tilt stand (1): fits onto ¼ MW standard foot (only 1 used, for front or rear).	1460-1369	





# CABINETS

## SYSTEM II—Rack Mounting Accessories<sup>1</sup>

For full Module Cabinets

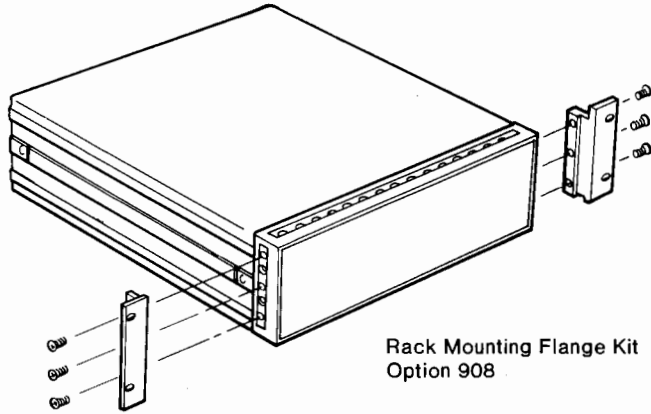

Rack Mounting Flange Kit  
Option 908

Rack Mounting Flange Kit				
Application	Description	Size	Part No.	
Will be shipped with instrument, if ordered as Option 908 at same time. Otherwise available separately per Part Numbers listed at right.	Kit includes two rack flanges to fit on each side of front panel frames, for cabinets this high:	3½ H	5061-0074	
		3½ H	5061-0076*	
		5¼ H	5061-0077	
		7 H	5061-0078	
		8¾ H	5061-0079	
		10½ H	5061-0080	
		12¼ H	5061-0081	
<b>Note:</b> 5061-0074 has 1.75" hole spacing and has the standard flange. 5061-0076 has 3.00" hole spacing and has a special flange.				

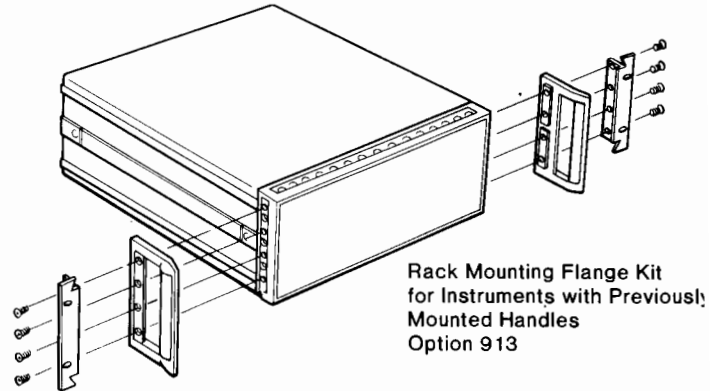

Rack Mounting Flange Kit  
for Instruments with Previous  
Mounted Handles  
Option 913

Rack Mounting Flange Kits with Handles						
Application	Description	Size	Part No.			
Combination kit. Will be shipped with instrument, if ordered as Option 909 at same time. Otherwise available separately as Part Numbers listed at right.	Kit includes two rack flange / front handle combinations to fit on each side of front panel frame, for cabinets this high:	3½ H	5061-0075			
		3½ H	5061-0082*			
		5¼ H	5061-0083			
		7 H	5061-0084			
		8¾ H	5061-0085			
		10½ H	5061-0086			
				12¼ H	5061-0087	
		<b>Note:</b> 5061-0075 has 1.75" hole spacing and has the standard flange. 5061-0082 has 3.00" hole spacing and has a special flange.				

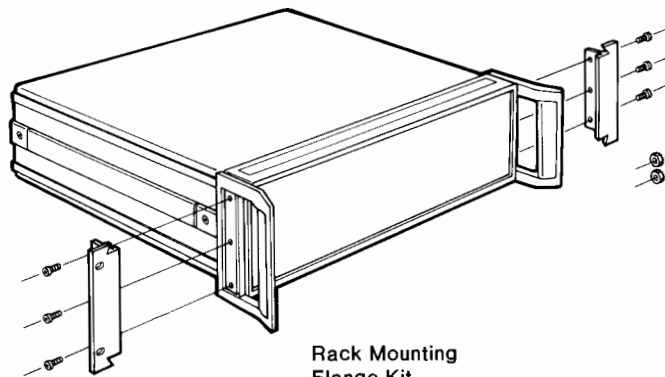

Rack Mounting  
Flange Kit  
with Handles  
Option 909

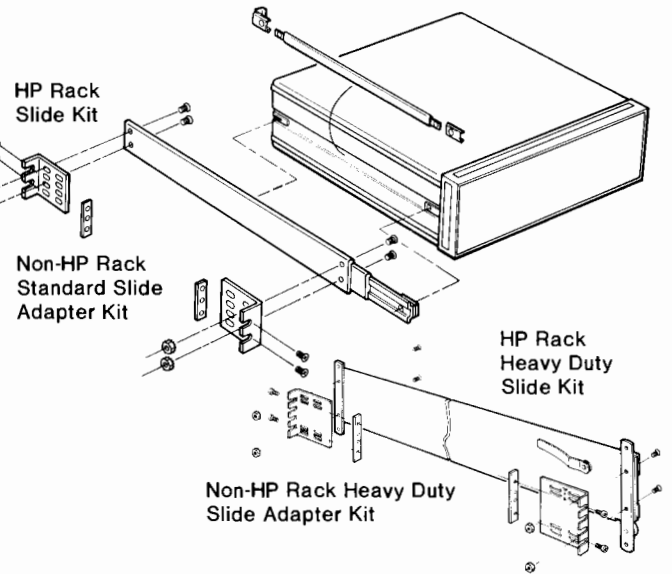

Rack Mounting Flange Kit for Instruments with Handles				
Application	Description	Size	Part No.	
Will be shipped with instrument, if ordered as Option 913 at same time. Otherwise available separately as Part Numbers listed at right.	Kit includes two rack flanges to fit on each side of front panel frames and proper replacement screws for cabinets this high:	3½ H	5061-2069	
		3½ H	5061-2070*	
		5¼ H	5061-2071	
		7 H	5061-2072	
		8¾ H	5061-2073	
		10½ H	5061-2074	
		12¼ H	5061-2075	
<b>Note:</b> 5061-2069 has 1.75" hole spacing and has the standard flange. 5061-2070 has 3.00" spacing and has a special flange.				

Slide Kits and Adapter Brackets				
Application	Description	Size	Part No.	
Kit of 2 slides that fit side handle recess of instruments for mounting in HP Racks	Standard slides. Max loading: 38.6 Kg (85 Lbs.) for cabinets this deep:	14D & 17D	1494-0018**	
		20D & 23D	1494-0017**	
		20D & 23D	1494-0025 #	
	Hvy duty slide. Max 79.6 Kg (175 Lbs.)	20D & 23D only	1494-0016**	
Brackets to adapt above slide kits to most Non-HP Racks		Std. Slide	1494-0023	
		Hvy. Slide	1494-0042	

\*As a special kit, it is not included in Option 913. Order by part number only.

\*\*Non-tilting slide

#Tilting slide

## System II—Rack Mounting Accessories<sup>1</sup> For Sub Module Cabinets

If combined sub-module cabinets equal a full module width, use "Full Module" kits shown on previous page.

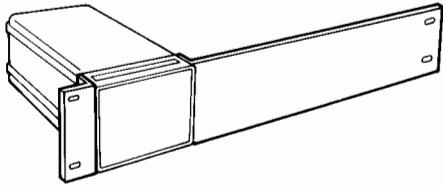

Rack Mounting Adapter Kit <sup>2</sup>			
Description	Size	Part No.	
Kit includes one rack flange and one extension adapter 3/4 MW. For mounting one System II cabinet 1/4 MW, of 3 1/2" height.	3 1/2 H	5061-0073	

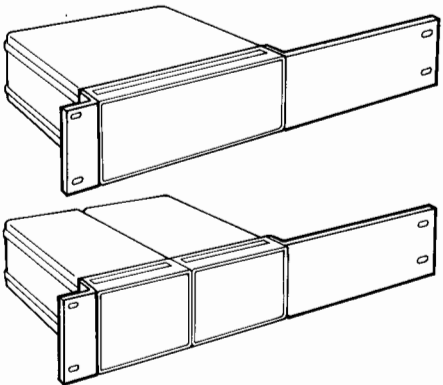

Rack Mounting Adapter Kit <sup>2</sup>			
Description	Size	Part No.	
Kits include one rack flange and one extension adapter 1/2 MW. For mounting one System II cabinet 1/2 MW or two cabinets 1/4 MW, having these heights:	3 1/2 H	5061-0072	
	5 1/4 H	5061-0057	
	7 H	5061-0060	
	10 1/2 H	5061-0066	

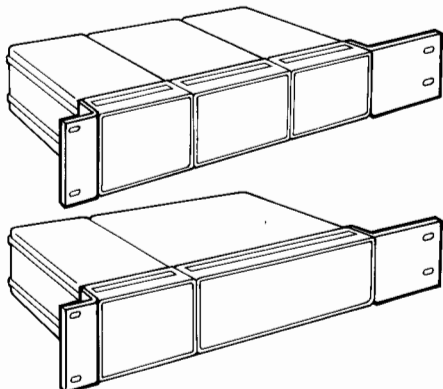

Rack Mounting Adapter Kit <sup>2</sup>			
Description	Size	Part No.	
Kits include one rack flange and one extension adapter 1/4 MW. For mounting one System II cabinet 1/2 MW together with one cabinet 1/4 MW, or for mounting three cabinets 1/4 MW together, having these heights.	3 1/2 H	5061-0071 <sup>3</sup>	
	5 1/4 H	5061-0058 <sup>3</sup>	
	7 H	5061-0061 <sup>3</sup>	
	10 1/2 H	5061-0067 <sup>3</sup>	

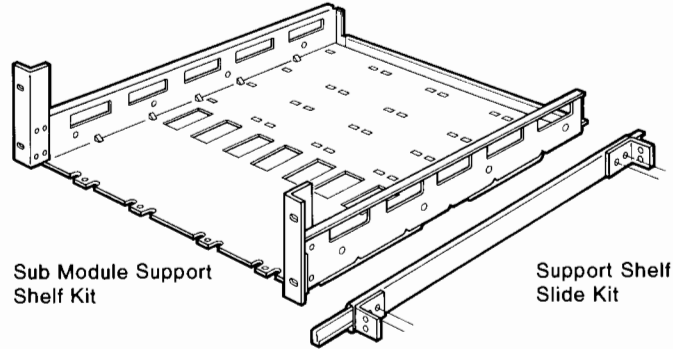

Sub Module Support Shelf Kit

Support Shelf Slide Kit

Support Shelves and Slide Kits			
Description	Size	Part No.	
Support Shelf for mounting one or more cabinets which are 1/2 MW or 1/4 MW, and up to 20 D. Cabinet depths need not be equal, but heights must match support shelf height, except where top filler panels are used. Maximum shelf projection behind front mounting panel is 534 mm (21 in.). Maximum combined instrument weight is 22.7 kg (50 lb.).	3 1/2 H	5061-0096	
	5 1/4 H	5061-0097	
	7 H	5061-0098	
Slide Kit includes two slides for slide-mounting any of the above three support shelves in HP rack enclosures. Shelf can easily be removed from rack.		1494-0041	

Top Filler Panel

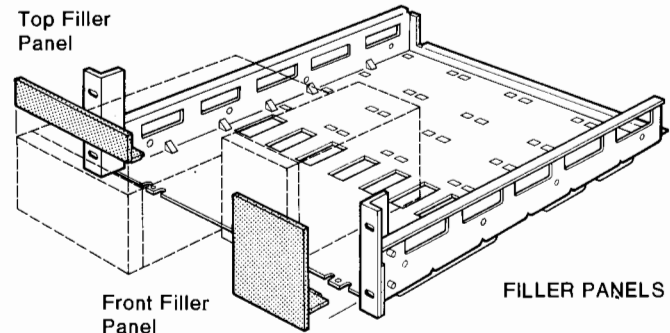

Front Filler Panel

FILLER PANELS

Support Shelf Filler Panels			
Description	Size	Part No.	
For 3 1/2 H support shelf partially filled with instruments, and having the following front panel space to fill:	1/4 MW to fill	5061-2021	
	1/2 MW to fill	5061-2022	
	3/4 MW to fill	5061-2023	
For 5 1/4 H support shelf, and having the following front panel space to fill:	1/4 MW to fill	5061-2024	
	1/2 MW to fill	5061-2025	
	3/4 MW to fill	5061-2026	
For 7 H support shelf, and having the following front panel space to fill:	1/4 MW to fill	5061-2066	
	1/2 MW to fill	5061-2027	
For 1/4 MW and having the following vertical space to fill:	1 3/4 H	5061-2035	
	3 1/2 H	5061-2036	
For 1/2 MW and having the following vertical space to fill:	1 3/4 H	5061-2037	
	3 1/2 H	5061-2038	

**Note:** Mounting hole patterns conform to EIA Standard RS-310-C for Racks, Panels, and Associated Equipment and the equivalent IEC standard

<sup>1</sup>All kits are supplied with proper hardware for attaching kits to instruments but do not include rack front panel mounting screws.

<sup>2</sup>Cabinet lock-together kit (5061-0094) is also required whenever two, three or four sub-modules (1/4 MW and or 1/2 MW) are to be joined in a configuration using rack mounting adapters or rack flanges. Also, sub-modules must be of equal depth.

<sup>3</sup>Requires two kits if one cabinet 1/2 MW is to be center-mounted.

# CABINETS

## SYSTEM I—Rack Hardware and Accessories

1051A

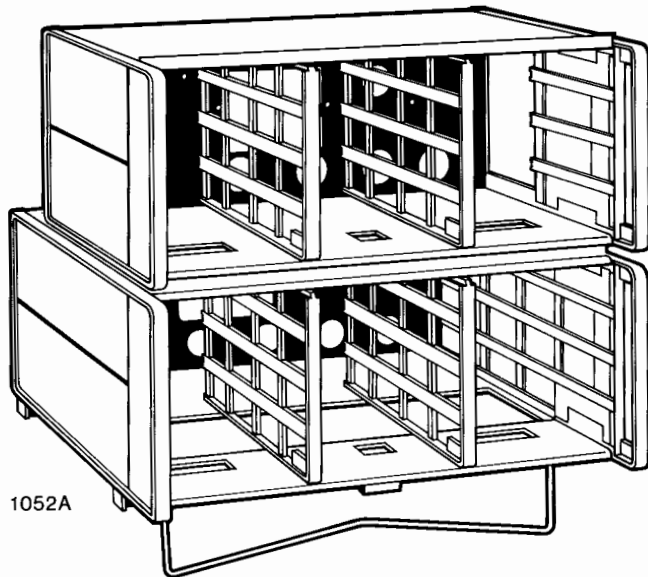

1052A

### Combining Cases, 1051A, 1052A

Models 1051A and 1052A combining cases conveniently rack or bench mount combinations of small modular Hewlett-Packard SYSTEM-I instruments. In addition, these cases can be stacked on each other or on any full module instrument. Both cases accept  $\frac{1}{8}$  or  $\frac{1}{2}$  instrument modules, 130mm or 198 mm wide ( $5\frac{1}{8}$  or  $7\frac{25}{32}$  inches). The basic difference is that the 1052A is 130 mm ( $5\frac{1}{8}$  in.) deeper, and will accept modules up to 416mm deep ( $16\frac{3}{8}$  in.). The extra depth provides more space in the rear for wiring. The 1051A accepts instruments up to 286mm deep ( $11\frac{1}{4}$  in.). Each case is furnished with two dividers.

### 1051A, 1052A Specifications

#### Size

**1051A:** 178 H x 482.6 W x 337 mm D ( $7''$  x  $19''$  x  $13\frac{1}{4}''$ ).

**1052A:** 178 H x 482.6 W x 467 mm D ( $7''$  x  $19''$  x  $18\frac{3}{8}''$ ).

#### Weight

**1051A:** net, 4.5 kg (10 lb); shipping, 6.7 kg (15 lb).

**1052A:** net, 5.4 kg (12 lb); shipping, 8.1 kg (18 lb).

**Opt 908:** Rack Mount Kit

**Opt 910:** Extra Manual

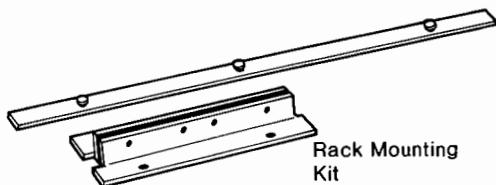

Rack Mounting Kit

### Rack Mounting Kits, 5060-8739 to 5060-8744

With these kits all Hewlett-Packard products in full rack-width cabinets of the integral side frame-handle style (see 1051A, 1052A, Combining Cases above) can be easily prepared for rack mounting. Each kit contains two flanges, a filler strip, and mounting screws.

### Rack Mounting Kit Ordering Information

Part Number	Nominal Cabinet Height	
	Millimetres	Inches
5060-8739	88.1	$3\frac{1}{2}$
5060-8740	132.6	$5\frac{1}{4}$
5060-8741*	177	7
5060-8742	221.5	$8\frac{3}{4}$
5060-8743	265.9	$10\frac{1}{2}$
5060-8744	310.4	$12\frac{1}{4}$

\* Also used to rack mount Combining Kits 1051A & 1052A shown above.

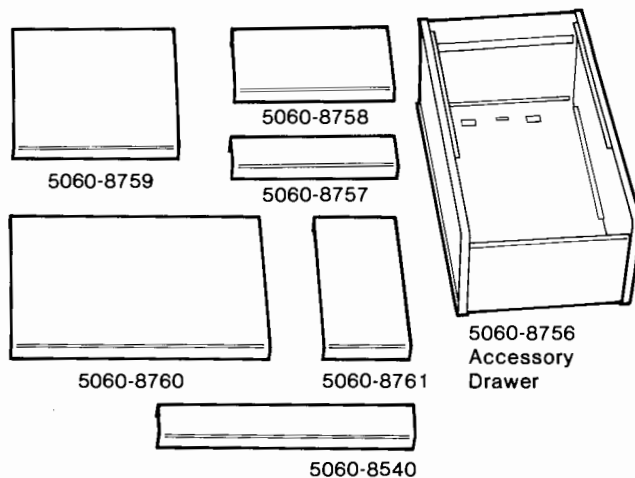

### Filler Panels, 5060-8540, 5060-8757 to 5060-8761

Filler panels can be used to close off any leftover space after instruments are mounted in combining cases or adapter frames. Panels are made in a variety of widths and heights. Available widths are  $\frac{1}{8}$ ,  $\frac{1}{4}$ , and  $\frac{1}{2}$  modules; heights are  $\frac{1}{4}$ ,  $\frac{1}{2}$  and the full 155 mm ( $6\frac{1}{8}$  in.).

### Specifications, Filler Panels

Part No.	Module Case Height x Width	Dimensions	
		Millimetres	Inches
5060-8540	$\frac{1}{4}$ x $\frac{1}{2}$	38 x 198	$1\frac{1}{2}$ x $7\frac{25}{32}$
5060-8757	$\frac{1}{4}$ x $\frac{1}{2}$	38 x 130	$1\frac{1}{2}$ x $5\frac{1}{8}$
5060-8758	$\frac{1}{2}$ x $\frac{1}{2}$	77 x 130	$3\frac{1}{32}$ x $5\frac{1}{8}$
5060-8759	full x $\frac{1}{2}$	155 x 130	$6\frac{3}{32}$ x $5\frac{1}{8}$
5060-8760	full x $\frac{1}{2}$	155 x 198	$6\frac{3}{32}$ x $7\frac{25}{32}$
5060-8761	full x $\frac{1}{8}$	155 x 63	$6\frac{3}{32}$ x $2\frac{31}{64}$

### Accessory Drawer, 5060-8756

The accessory drawer can be used in place of a  $\frac{1}{4}$  width filler panel to finish off unused space in the HP 1051A and 1052A Combining Cases. Size: 77 H x 130.2 W x 279.4 D ( $3\frac{1}{32}''$  x  $5\frac{1}{8}''$  x  $11''$ ).

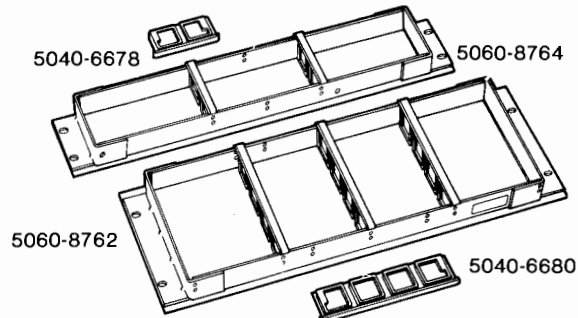

### Rack Adapter Frames, 5060-8762, 5060-8764

These Frames can be used to hold combinations of  $\frac{1}{8}$  and  $\frac{1}{2}$  module-width HP instruments. Each frame is furnished with mounting hardware and dividers. Two models are available for different instrument rack heights. Adapter frames are for permanent or semipermanent rack mounting. Where quick removal and reinstallation of instruments is desirable, the 1051A and 1052A should be used.

Note: Instruments in full rack-width cabinets can be rack mounted with kits described above; they do not require rack adapter frames.

**5060-8762:** Equivalent to EIA 4U (7 in.) rack height. Accepts instrument heights of 38, 77, or 155 mm ( $1\frac{1}{2}$  in.,  $3\frac{1}{32}$  in.,  $6\frac{3}{32}$  in.).

**5060-8764:** Accepts only instrument heights of 38 or 77 mm ( $1\frac{1}{2}$  in.,  $3\frac{1}{32}$  in.). EIA 2U narrow ( $1\frac{3}{4}$  in.) rack height.

### Extra Divider Panels

Part Number	For Frame
5040-6678	5060-8764
5040-6680	5060-8762

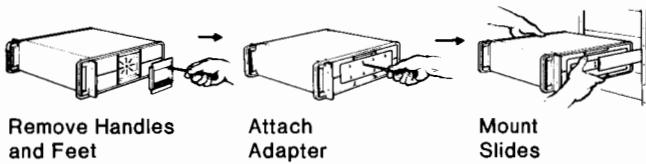

### Rack Mount Slide Kits, 1490-0713 to 1490-0720

Cabinet Depth	Extension Length	Part Number <sup>1</sup>
All Sizes	482.6 (19) <sup>2</sup>	<b>1490-0713*</b>
All Sizes	635.0 (25) <sup>3</sup>	<b>1490-0714*</b>
279.4 (11)	482.6 (19) <sup>2</sup>	<b>1490-0715#</b>
406.4 (16)	482.6 (19) <sup>2</sup>	<b>1490-0716#</b>
279.4 (11)	533.4 (21) <sup>3</sup>	<b>1490-0717#</b>
406.4 (16)	558.8 (22) <sup>3</sup>	<b>1490-0718#</b>
482.6 (19)	635.0 (25) <sup>3</sup>	<b>1490-0719#</b>
558.8 (22)	635.0 (25) <sup>3</sup>	<b>1490-0720#</b>

**Notes:** \*Fixed type slide; #Tilt type slide  
 1. Cabinet Adapters, below, must be added to slides  
 2. Slide's stationary mounting depth: 406.4 (16)  
 3. Slide's stationary mounting depth: 558.8 (22)  
 Maximum instrument weight 31.7 Kg (70 lbs)

### Cabinet Adapters for Above Slides 1490-0721 and 1490-0722

Cabinet Height	Part Number
88.9 (3.5)	<b>1490-0722</b>
All others	<b>1490-0721</b>

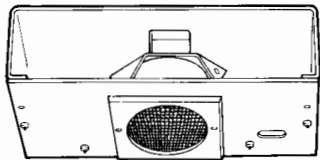

### Cooling Kits, 5060-0789 and 5060-0796

These cooling kits are designed to be easily installed in the 1052A Combining Case. They can be installed in the 1051A, at the factory upon special request, but installation in the shorter case limits the depth of instruments the case can accept, and makes it impossible to use the accessory drawer.

**5060-0789:** 115 V, 50 to 60 Hz  
**5060-0796:** 230 V, 50 to 60 Hz

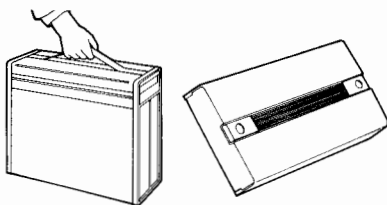

### Control Panel Covers, 5060-8766 to 5060-8771

A series of control panel covers equipped with carrying handles are available for full rack width instruments. These covers protect instrument front panels and make rack mounted instruments tamper-proof.

One of these covers, the 5060-8768, fits both the 1051A and the 1052A Combining Case (page 646). Other covers are available to fit the six modular enclosures with front panel heights ranging from 88.1 to 310.4 mm (3 1/2 to 12 1/4 in.). Cover locks securely to front handles.

<b>5060-8766:</b>	88.1 mm (3 1/2 in.) EIA panel height
<b>5060-8767:</b>	132.6 mm (5 1/4 in.) EIA panel height
<b>5060-8768:</b>	177 mm (7 in.) EIA panel height
<b>5060-8769:</b>	221.5 mm (8 3/4 in.) EIA panel height
<b>5060-8770:</b>	265.9 mm (10 1/2 in.) EIA panel height
<b>5060-8771:</b>	310.4 mm (12 1/4 in.) EIA panel height

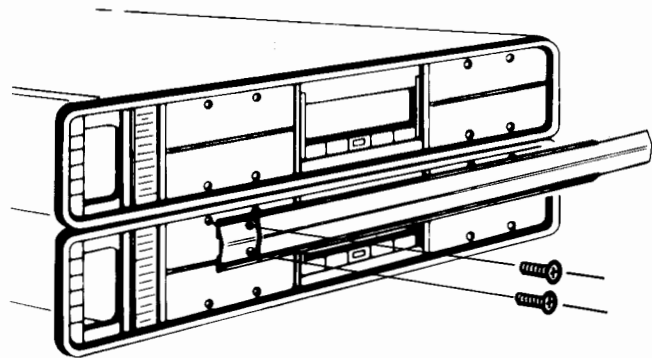

### Joining Bracket Kits, 5060-8541 to 5060-8545

These kits join HP SYSTEM I instruments of the same width and length into easily handled single stacks. Each kit consists of two brackets, mounting hardware and trim. They are available to fit the three most common instrument depths:

**5060-8541:** 279 mm (11 in.) EIA panel depth  
**5060-8543:** 406 mm (16 in.) EIA panel depth  
**5060-8545:** 480 mm (19 in.) EIA panel depth

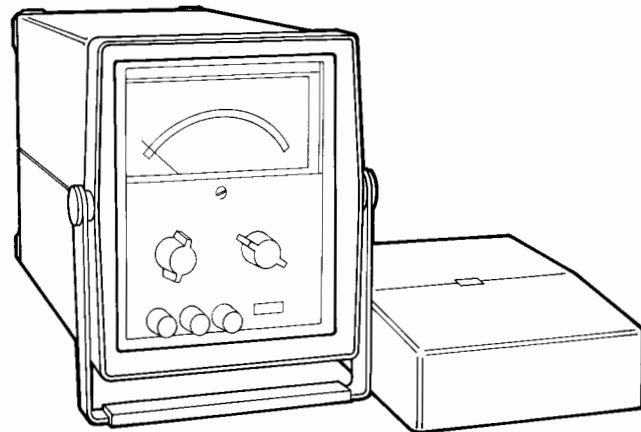

### Module Instrument Cases, 11075A, 11076A

Rugged, high impact plastic instrument cases for HP 1/2 module instruments. Instruments can be operated, stored or carried in this splashproof case. Storage compartment for power cord in rear of case is accessible through a removable hatch. Front lid contains adequate storage space for cables, test leads, etc. The dual purpose tilt stand also serves as a carrying case handle. 11075A is 203 mm D (8 in.); 11076A is 279 mm D (11 in.).

**11075A:** Module Instrument Case  
**11076A:** Module Instrument Case

#### RACK MOUNTING

SYSTEM I and SYSTEM II products can be mounted vertically in the same rack cabinet, or stacked on one another. However, the rack mounting hardware is not interchangeable, nor can SYSTEM I and SYSTEM II sub-modules be combined in the same horizontal rack space.

SYSTEM II module size and rack mounting hole spacing meet the specifications described in EIA Standard RS-310-C for Racks, Panels, and Associated Equipment.

# CABINETS

Rugged Protection for Instruments  
Modular instrument transit cases

Typical system II transit case

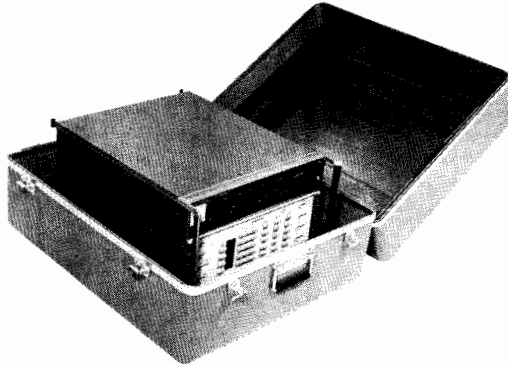

Typical system I transit case

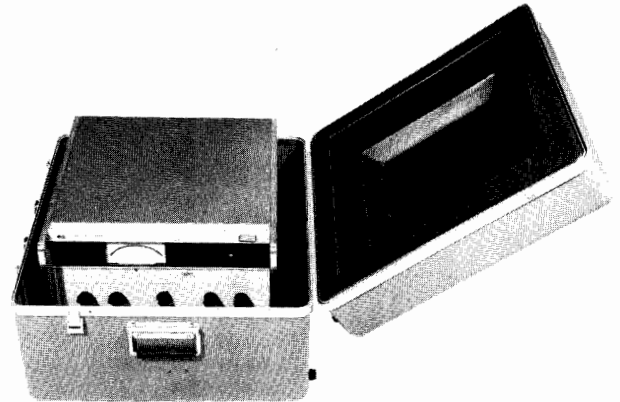

Standard off the shelf transit case

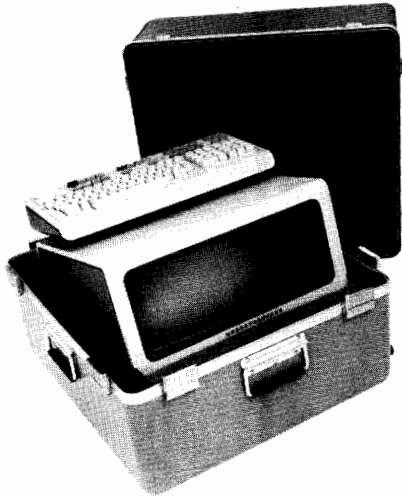

Typical molded cushion

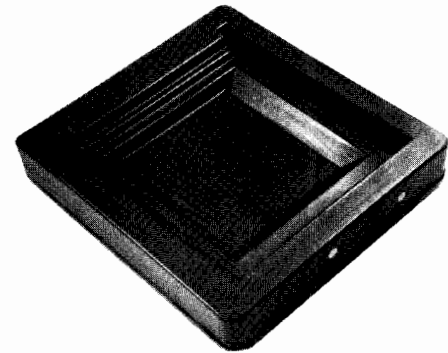

## Transit Case Styles

The HP transit cases are rugged protective outer shells for use when instruments must be frequently transported and used away from laboratory conditions. They are molded of strong fiberglass-reinforced plastic. All are sealed tightly with O-ring gaskets and clamping latches. They are rainproof under the test conditions of MIL-STD-108. Carrying handles are conveniently placed, fold flat when not in use.

Transit cases are typically provided with foam cushions, custom formed to fit the standard HP modular cabinets. This arrangement

provides maximum protection against damage from handling, dropping, or crushing. A selection of case sizes is available to accommodate nearly any instrument and combination of accessories.

Each transit case will be coded with one of three designations in the following table. Valise (V), hinged with the handle opposite the hinge. Transit (T), a completely removable cover with a handle at each end. Valise Transit (VT), a hinged transit case with a handle opposite the hinge and a handle at each end. An † next to the case style designator indicates the addition of removable casters as an option.

## Transit Cases - System I

Instrument Size (inches)			Instrument Size (mm)			Case Size* (inches) Not including hardware			Case size (mm) Not including hardware			Style	Shipping Weight		HP Part Number
H	W	D	H	W	D	L	W	D	L	W	D		Lbs.	kg	
3½	16¾	13¾	88.1	425.5	336.6	20½	17½	9	520.7	444.5	228.6	VT†	15	68	9211-1288
5¼	16¾	13¾	132.6	425.5	336.6	20½	17½	10¾	520.7	444.5	273.1	VT†	16	73	9211-1289
7	16¾	13¾	177.0	425.5	336.6	20½	17½	12½	520.7	444.5	317.5	VT†	17	77	9211-1290
8¾	16¾	13¾	221.5	425.5	336.6	20½	17½	14¼	520.7	444.5	362.0	T	18	82	9211-1291
3½	16¾	18¾	88.1	425.5	466.7	22½	21½	9¾	584.2	533.4	228.6	VT†	18	82	9211-1292
5¼	16¾	18¾	132.6	425.5	466.7	22½	21½	10¾	584.2	533.4	273.1	VT†	19	86	9211-0839
7	16¾	18¾	177.0	425.5	466.7	22½	21½	12½	584.2	533.4	317.5	VT†	20	91	9211-1293
8¾	16¾	18¾	221.5	425.5	466.7	22½	21½	14¼	584.2	533.4	362.0	VT†	21	95	9211-1294
10½	16¾	18¾	265.9	425.5	466.7	22½	21½	16	584.2	533.4	406.4	T	22	100	9211-1295
12¼	16¾	18¾	310.4	425.5	466.7	22½	21½	17¾	584.2	533.4	450.9	T	22	100	9211-1313
5¼	16¾	21¾	132.6	425.5	542.9	25½	23½	10¾	647.7	596.9	273.1	VT†	24	110	9211-1296
7	16¾	21¾	177.0	425.5	542.9	25½	23½	12½	647.7	596.9	317.5	VT†	24	110	9211-1735
12¼	16¾	24¾	310.4	425.5	542.9	24	18¾	29¾	609.6	482.6	755.7	T	32	150	9211-1297
6½	5½	8	165.1	130.2	203.2	14¼	9	11¼	362.0	228.6	285.8	V	8	36	9211-1317
6½	5½	11	165.1	130.2	279.4	16¾	10¾	11¼	428.6	263.5	285.8	V	11	50	9211-1318
6½	7¾	8	165.1	196.9	203.2	16¾	10¾	11¼	428.6	263.5	285.8	V	11	50	9211-1316
6½	7¾	11	165.1	196.9	279.4	16¾	10¾	11¼	428.6	263.5	285.8	V	11	50	9211-1315
6½	7¾	16	165.1	196.9	406.4	21¾	12½	11¼	520.7	317.5	285.8	V	15	68	9211-1734
6½	10½	11	165.1	266.7	279.4	16½	14¼	8½	419.1	368.3	215.9	V	12	55	9211-1895

†Caster kit available.



## Full-Module Width Instruments

### Transit Cases-System II:

Appropriate Front Handle Kit (HP Part Number 5061-0088 to -0093) must be installed on instruments for adequate protection.

#### Dimensions in inches and mm

Instrument size				Case size (not including hardware)								Style	HP Part Number				
in	H	mm	in	W	mm	in	D	mm	in	L	mm			in	W	mm	in
3½	88.1	16¼	425.5	13¾	349.3	22½	584.2	21½	533.4	8¾	222.3	VT	9211-2642				
5¼	132.6	16¼	425.5	13¾	349.3	22½	584.2	21½	533.4	10½	266.7	VT	9211-2643				
7	177.0	16¼	425.5	13¾	349.3	22½	584.2	21½	533.4	12¼	311.2	VT	9211-2644				
8¾	221.5	16¼	425.5	13¾	349.3	22½	584.2	21½	533.4	14	355.6	VT	9211-2645				
10½	265.9	16¼	425.5	13¾	349.3	22½	584.2	21½	533.4	15¾	400.1	T†	9211-2646				
12¼	310.4	16¼	425.5	13¾	349.3	22½	584.2	21½	533.4	17½	444.5	T†	9211-2647				
3½	88.1	16¼	425.5	16¼	425.5	24½	622.3	24½	622.3	8¾	222.3	VT	9211-2648				
5¼	132.6	16¼	425.5	16¼	425.5	24½	622.3	24½	622.3	10½	266.7	VT	9211-2649				
7	177.0	16¼	425.5	16¼	425.5	24½	622.3	24½	622.3	12¼	311.2	VT	9211-2650				
8¾	221.5	16¼	425.5	16¼	425.5	24½	622.3	24½	622.3	14	355.6	T†	9211-2651				
10½	265.9	16¼	425.5	16¼	425.5	24½	622.3	24½	622.3	15¾	400.1	T†	9211-2652				
12¼	310.4	16¼	425.5	16¼	425.5	28	711.2	24	609.6	17½	444.5	T†	9211-2653				
3½	88.1	16¼	425.5	19¾	501.7	28	711.2	24	609.6	8¾	222.3	VT	9211-2654				
5¼	132.6	16¼	425.5	19¾	501.7	28	711.2	24	609.6	10½	266.7	VT	9211-2655				
7	177.0	16¼	425.5	19¾	501.7	28	711.2	24	609.6	12¼	311.2	VT	9211-2656				
8¾	221.5	16¼	425.5	19¾	501.7	28	711.2	24	609.6	14	355.6	T†	9211-2657				
10½	265.9	16¼	425.5	19¾	501.7	28	711.2	24	609.6	15¾	400.1	T†	9211-2658				
12¼	310.4	16¼	425.5	19¾	501.7	28	711.2	24	609.6	17½	444.5	T†	9211-2659				
3½	88.1	16¼	425.5	22½	577.9	30¾	774.7	24¾	622.3	8¾	222.3	VT	9211-2660				
5¼	132.6	16¼	425.5	22½	577.9	30¾	774.7	24¾	622.3	10½	266.7	VT	9211-2661				
7	177.0	16¼	425.5	22½	577.9	30¾	774.7	24¾	622.3	12¼	311.2	T†	9211-2662				
8¾	221.5	16¼	425.5	22½	577.9	30¾	774.7	26¼	666.8	14	355.6	T†	9211-2663				
10½	265.9	16¼	425.5	22½	577.9	30¾	774.7	26¼	666.8	15¾	400.1	T†	9211-2664				
12¼	310.4	16¼	425.5	22½	577.9	30¾	774.7	26¼	666.8	17½	444.5	T†	9211-2665				

†Caster kit available

## Half-and Quarter-module Width Instruments

### Transit Cases-System II:

#### Dimensions in inches and mm

Instrument size				Case size (not including hardware)								Style	HP Part Number				
in	H	mm	in	W	mm	in	D	mm	in	L	mm			in	W	mm	in
3½	88.1	8¾	204.2	10¾	273.1	14¾	377.8	13¾	349.3	7½	190.5	V	9211-2666				
5¼	132.6	8¾	204.2	10¾	273.1	14¾	377.8	13¾	349.3	9¼	235.0	V	9211-2667				
7	177.0	8¾	204.2	10¾	273.1	14¾	377.8	13¾	349.3	11	279.4	V	9211-2668				
8¾	221.5	8¾	204.2	10¾	273.1	14¾	377.8	13¾	349.3	12¾	323.9	V	9211-2669				
10½	265.9	8¾	204.2	10¾	273.1	14¾	377.8	13¾	349.3	14½	368.3	V†	9211-2670				
3½	88.1	8¾	204.2	13¾	349.3	20	508.0	13	342.9	7½	190.5	V	9211-2671				
5¼	132.6	8¾	204.2	13¾	349.3	20	508.0	13	342.9	9¼	235.0	V	9211-2672				
7	177.0	8¾	204.2	13¾	349.3	20	508.0	13	342.9	11	279.4	V	9211-2673				
8¾	221.5	8¾	204.2	13¾	349.3	20	508.0	13	342.9	12¾	323.9	V	9211-2674				
10½	265.9	8¾	204.2	13¾	349.3	20	508.0	13	342.9	14½	368.3	V	9211-2675				
3½	88.1	8¾	204.2	16¼	425.5	20	508.0	13	342.9	7½	190.5	V	9211-2676				
5¼	132.6	8¾	204.2	16¼	425.5	20	508.0	13	342.9	9¼	235.0	V	9211-2677				
7	177.0	8¾	204.2	16¼	425.5	20	508.0	13	342.9	11	279.4	V	9211-2678				
8¾	221.5	8¾	204.2	16¼	425.5	20	508.0	13	342.9	12¾	323.9	V	9211-2679				
10½	265.9	8¾	204.2	16¼	425.5	20	508.0	13	342.9	14½	368.3	V	9211-2680				
3½	88.1	8¾	204.2	19¾	501.7	24¾	616.0	13	330.2	7½	190.5	V	9211-2681				
5¼	132.6	8¾	204.2	19¾	501.7	24¾	616.0	13	330.2	9¼	235.0	V	9211-2682				
7	177.0	8¾	204.2	19¾	501.7	24¾	616.0	13	330.2	11	279.4	V	9211-2683				
8¾	221.5	8¾	204.2	19¾	501.7	24¾	616.0	13	330.2	12¾	323.9	V	9211-2684				
10½	265.9	8¾	204.2	19¾	501.7	24¾	616.0	13	330.2	14½	368.3	V	9211-2685				
3½	88.1	4¾	104.8	10¾	273.1	14	355.6	10	254.0	6¾	165.1	V	9211-2686				
5¼	132.6	4¾	104.8	10¾	273.1	14	355.6	10	254.0	8¼	209.6	V	9211-2687				
7	177.0	4¾	104.8	10¾	273.1	14	355.6	10	254.0	10	254.0	V	9211-2688				
3½	88.1	4¾	104.8	13¾	349.3	16¾	428.6	10¾	266.7	6¾	165.1	V	9211-2689				
5¼	132.6	4¾	104.8	13¾	349.3	16¾	428.6	10¾	266.7	8¼	209.6	V	9211-2690				
7	177.0	4¾	104.8	13¾	349.3	16¾	428.6	10¾	266.7	10	254.0	V	9211-2691				
3½	88.1	4¾	104.8	16¼	425.5	20¼	514.4	11¾	298.5	6¾	165.1	V	9211-2692				
5¼	132.6	4¾	104.8	16¼	425.5	20¼	514.4	11¾	298.5	8¼	209.6	V	9211-2693				
7	177.0	4¾	104.8	16¼	425.5	20¼	514.4	11¾	298.5	10	254.0	V	9211-2694				

†Caster kit available

## Standard Cases

Off the shelf transit cases are available for the following instruments.

83	432A/B/C	2635A	5335A	7225B	9134A	9872T
85	435B	3046B	5342A	7240A	9135A	9874A
86	436A	3312A	6266B	7245B	9138A	9876A
87	1222A	3325A	6274B	7470A	9815A	9895A
141T	1311A	3336A/B/C	7015B	7580A	9825B	82901M
262X series	1340A	3456A	7020T	8350A	9825T	82902M
264X series	1980B	3586A/B	7040A	8640B	9835A	82905A
267X series	2382A	5061A	7220C	8656A	9835B	
307X series	2601 series	5315A	7221C	8660C	9845B/C	
334A	2631B/G	5328A	7221T	9111A	9872C	

# CABINETS

Operating Cases: Rugged Protection for Instruments

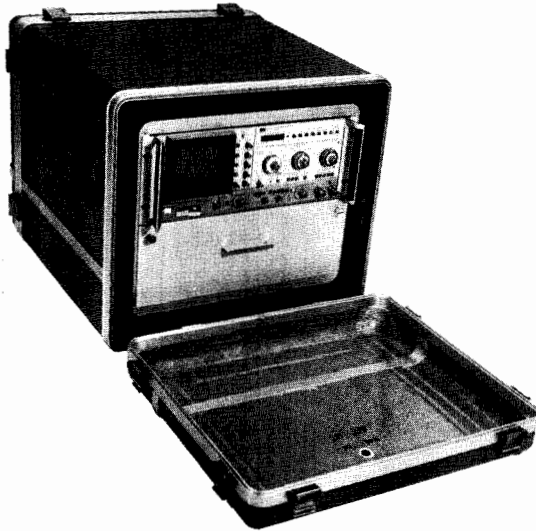

Operating Case with instrument and drawer

HP cases are rugged protective outer shells for use when instruments must be frequently transported and used away from laboratory conditions. They are molded of strong fiberglass and have conveniently placed carrying handles that fold flat when not in use. All are sealed tightly with O-ring gaskets and clamping latches and are rain-proof under the test conditions of MIL-STD-108.

Operating cases are equipped internally with shock-mounted frames that accept any standard 19-inch rack-mounting instruments up to the maximum height of the frames. This arrangement offers the convenience of operation without removing the instrument from its carrying case. At the same time, environmental protection is afforded.

More than one instrument may be combined in a single operating case for convenience in setting up and operating. Patch-cable interconnections may then be left in place within the case, so that when the unit has been transported to its place of use the covers are removed and the instruments inside are ready to put into use with a minimum of delay.

Drawers are available in three different heights so that small accessories, tools, etc., can be kept inside the case with the instruments. Fitted foam cushions can be made up to accommodate nearly any shape articles.

Heavy duty removable swivel caster

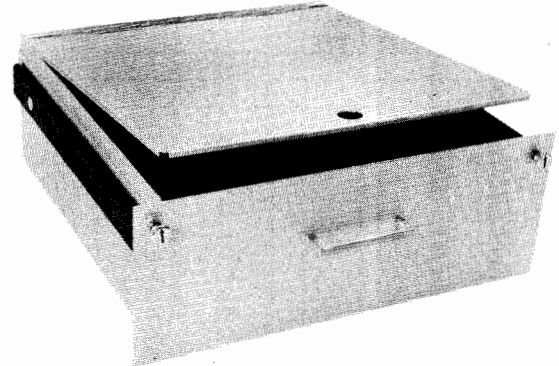
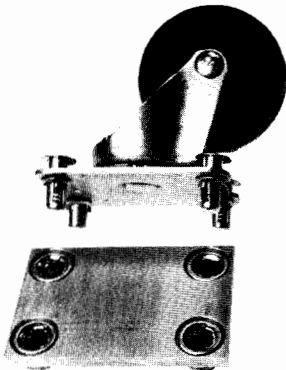

Sturdy drawers that accommodate various HP accessories are available.

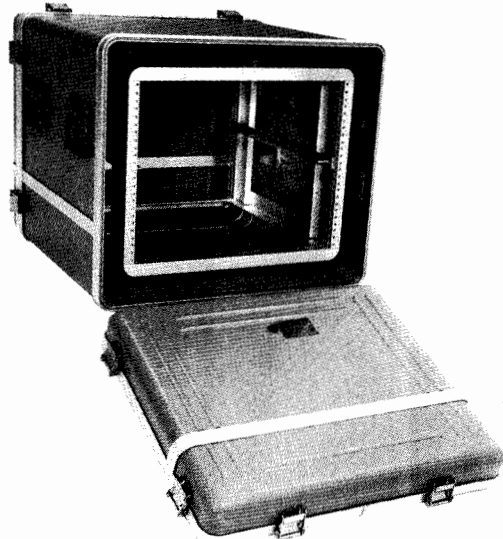

Elastomeric shock mounted frames provide outstanding shock and vibration attenuation. A set of standard shock mounts can be provided for any equipment weight and fragility.



T-bar instrument support brackets and aluminum skids are available as are other hardware items for customers who wish to make additions to stock cases.



Nominal rack ht. in	ISO	Instrument Weight				Case Size (inches) Not including hardware			Case Size (mm) Not including hardware			Weight				HP Part Number
		Maximum		Minimum		W	H	D	W	H	D	Case		Shipping		
		lb	kg	lb	kg							lb	kg	lb	kg	
5¼	3U	75	34.0	20	9.1	24.00	10.75	28.50	609.6	274.3	723.9	40	18.1	50	28.7	9211-1302
8¼	5U	75	34.0	20	9.1	24.00	15.20	28.50	609.6	381.0	685.8	46	20.9	56	25.4	9211-1303
10½	6U	130	59.0	30	13.6	24.00	17.00	28.50	609.6	431.8	723.9	53	24.0	64	29.0	9211-2635
12¼	7U	100	45.4	25	11.3	24.00	18.87	28.50	609.6	480.1	723.9	55	24.9	65	29.5	9211-1163
14	8U	130	59.0	30	13.6	24.00	20.50	28.50	609.6	523.2	723.9	57	25.9	70	37.8	9211-1241
15¼	9U	130	59.0	30	13.6	24.00	22.25	28.50	609.6	569.0	723.9	60	27.2	75	34.0	9211-1242
17½	10U	130	59.0	30	13.6	24.00	24.00	28.50	609.6	612.1	723.9	64	29.0	80	36.3	9211-1243
19¼	11U	130	59.0	30	13.6	24.00	25.75	28.50	609.6	657.9	723.9	69	31.3	85	38.6	9211-1244
21	12U	250	113.4	50	22.7	24.00	28.00	28.50	609.6	711.2	723.9	75	34.0	90	40.8	9211-1245
22¾	13U	250	113.4	50	22.7	24.00	29.75	28.50	609.6	749.3	723.9	77	34.9	95	43.1	9211-2636
24½	14U	250	113.4	50	22.7	24.00	31.50	28.50	609.6	787.4	723.9	80	36.3	100	45.4	9211-1911
26¼	15U	250	113.4	50	22.7	24.00	33.25	28.50	609.6	782.3	723.9	83	37.6	105	47.6	9211-2637
28	16U	250	113.4	50	22.7	24.00	35.00	28.50	609.6	876.3	723.9	87	39.5	110	49.9	9211-2638
29¾	17U	250	113.4	50	22.7	24.00	36.75	28.50	609.6	924.6	723.9	90	40.8	115	52.2	9211-2639
31½	18U	250	113.4	50	22.7	24.00	38.50	28.50	609.6	965.2	723.9	94	42.6	120	54.4	9211-2640
33¼	19U	250	113.4	50	22.7	24.00	40.25	28.50	609.6	995.7	723.9	97	44.0	125	56.7	9211-1713
47¼	27U	320	145.2	70	31.8	24.00	53.88	28.50	609.6	1369.1	723.9	140	63.5	175	79.4	9211-2641

### Standard Features

Inner rack frame with provision for infinitely adjustable T-bar instrument support brackets. Standard 20" depth.

Inner rack frame with RETMA hole pattern drilled in rear rails. Standard color: tan

### Special Features Available

- A. Mating feet for stacking one case on top of another.
- B. Special color other than tan. Please specify.
- C. Modified inner rack frame depth. Standard depth 20" from front panel mounting surface to rear surface of frame. This option includes an appropriate change in the overall depth of the enclosure. Please specify desired inner frame depth. Maximum 23", minimum 12".
- D. Chassis trak C-300 instrument slide pair to mount on either side of inner frame using RETMA hole pattern drilled in front and rear rails.
- E. Special shock mounts for unusual instrument weights. Please specify weights.
- F. Increased front cover depth. Maximum depth 6". Please specify.
- G. Increased rear cover depth. Maximum depth 6". Please specify.
- H. Latches recessed into the surface of the case.
- I. Handles recessed into the surface of the case.
- J. Hermetically sealed case tested by the hot water method.
- K. MIL-C-4150 certification with the exception of design and preproduction testing. Case will have increased wall thickness, hardware anodized to military specification, and will be hermetically tested using the hot water method.

### Special Features Available (Continued)

- L. Addition of an automatic pressure relief valve.  
Manual pressure relief valve.
- M. Addition of four permanently mounted, 3½" diameter swivel casters. Operating Cases only.
- N. Addition of four removable, 3½" diameter swivel casters. Also available in kit form.
- O. Addition of two aluminum hat-section skids to the case bottom.
- P. Addition of lift rings to either side of the case.
- Q. 3½ H (88.1 mm) Drawer with ball bearing slides.
- R. 5¼ H (132.6 mm) Drawer with ball bearing slides.
- S. 7 H (177 mm) Drawer with ball bearing slides.

### Accessories (When Ordered Separately)

- 9211-1164** 3½ H (88.1 mm) Drawer with ball bearing slides.
- 9211-1165** 5¼ H (132.6 mm) Drawer with ball bearing slides.
- 9211-1166** 7 H (177 mm) Drawer with ball bearing slides.
- 0950-0122** AC power receptacle strip with four outlets mounted on bottom rear of inner rack frame. Power cord 1 m (3.3') long, NEMA connectors.
- 9211-1173** Pair T-Bar instrument support brackets.
- 1490-0913** Caster kit, four removable 3½" (88.9 mm) swivel casters.
- 5081-5832** Aluminum hat section skids (2) for case bottom
- 5081-5834** Caster kit, four removable 3½" (88.9 mm) swivel casters. Heavy duty for Operating Cases only.

On special order, complete transportable field instrument groups can be assembled to suit individual requirements. On request, cases can be fabricated that meet the environmental requirements of Military Specifications.



# SOLID STATE COMPONENTS

## Optoelectronics

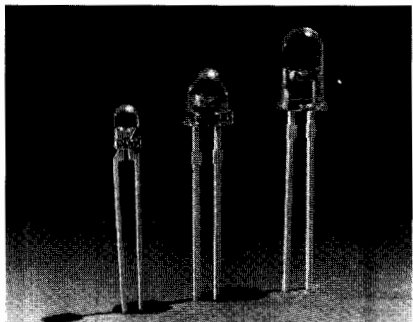

Ultra-Bright LED Lamps

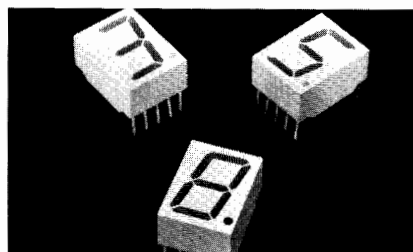

Seven-Segment High Ambient LED Displays

### LED Solid State Lamps, Light Bars & Arrays

Hewlett-Packard is a world leader in the area of LED technology, and offers a broad variety of LED indicator products available in red, yellow and green. Emphasizing high brightness and superior reliability, Hewlett-Packard's most recent product introductions include a revolutionary family of high-performance green indicators, ultrabright LED lamps (125 mcd at 20 mA), and LED bar graph arrays of 10- and 101- elements. Recent advancements in the fundamental semiconductor material have generated new areas of contribution, particularly in sunlight viewability and low power consumption.

### Solid State Displays

Hewlett-Packard offers a complete line of LED alphanumeric and seven-segment display products available in red, yellow, and green. These displays are suited to meet the needs of high light ambient conditions, military systems, instruments, point of sale equipment, appliances, and automobile instrumentation. Their high-reliability and ruggedness qualifies them for use in applications with stringent environmental requirements.

### Optocouplers

Hewlett-Packard's family of logic compatible high-performance optocouplers provides solutions to problems caused by ground loops and induced common mode noise for both analog and digital applications in commercial, industrial and military products.

Types of optocouplers available include high-speed and high-gain devices as well as AC/DC to logic interface optocouplers.



39301A Fiber Optic Multiplexer

Plastic packaged devices are available in single and dual versions. For military users Hewlett-Packard has multichannel hermetic DIP packages with or without hi-rel testing and test data.

### Fiber Optic Components

Hewlett-Packard offers a wide range of high-reliability transmitter/receiver components, cable, connectors and connector assembly tools, as well as two families of low cost components for high-volume OEM design. Link design and guaranteed specifications take device variation into account, as well as effects of temperature and lifetime for trouble free system performance.

Typical applications include data acquisition and control, electronic data processing, and process monitoring and control.

### Fiber Optic Data Communications Equipment

The newest member of HP's growing family of local data communications equipment is the 39301A Fiber Optic Multiplexer. The multiplexer system incorporates Hewlett-Packard's fiber optic device and cable technologies.

A pair of 39301A's enable up to 16 RS-232-C/V.24 channels to be extended up to 1 km over interconnecting fiber optic cables at 19.2 kbytes data rates. The advantages of this configuration are complete immunity to noise producing electromagnetic interference such as RFI, EMI and EMP.

### Optical Shaft Encoders

Hewlett-Packard's high-reliability, yet easy-to-assemble optical encoders are motion sensors that provide a digital link between mechanical shaft rotation and the control



Snap-In Fiber Optic Link

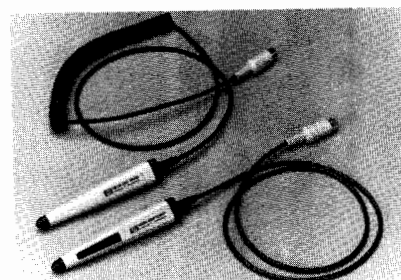

High-Resolution Digital Bar Code Wands

electronics in a closed loop servo system. By combining precision lenses and custom IC's, Hewlett-Packard provides superior performance and high reliability in two compact package sizes.

Encoders are used in a wide variety of applications from computer peripherals to industrial and instrument applications where digital information is needed to monitor rotary motion.

### Bar Code Products

Bar code data entry is an effective alternative to the keyboard when used to collect information in self-contained blocks. Because most codes have check-sums built-in, bar code scanning is faster and more accurate.

All Hewlett-Packard bar code wands provide constant TTL level digital output, eliminating the need for the designer to provide an analog-to-digital interface with their equipment. The more recently introduced HEDS-3200 is a hand-held scanner designed to read high density bar codes such as 3 of 9 alphanumeric code.

For customers not wishing to invest in decoding technology, HP offers a fully integrated Code 3 of 9 bar code decoder board which interfaces directly to HP digital bar code wands. It is ideally suited to serve as a slave MPU board to almost any data entry terminal, or as the heart of a small transmit-only terminal. When combined with HP bar code wands, the user is provided with a complete OEM data entry package.

### Emitter/Detector Components

In addition to the complete bar code system, Hewlett-Packard also offers the designer the choice of both integrated

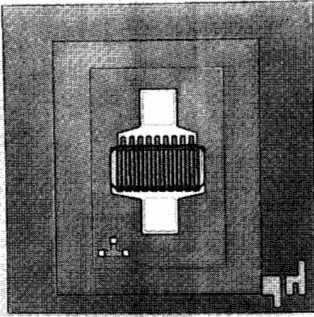

Transistor Chip, HXTR-5001

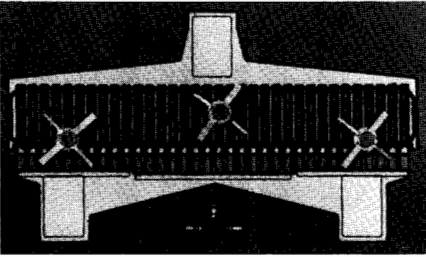

Bipolar Transistor, HXTR-5002

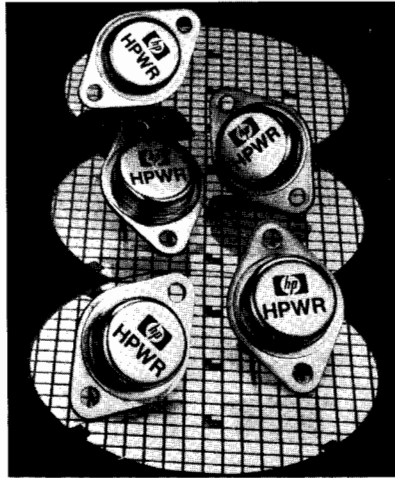

Power MOS FETS, HPWR-6501, -6502, -6503, -6504

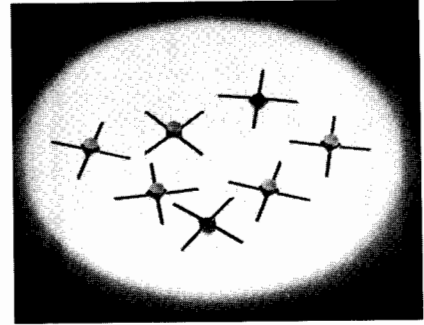

HXTR, 3101, -3102 Bipolar Transistors

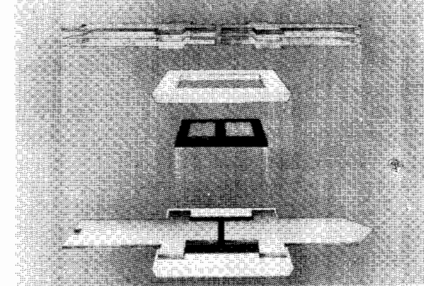

Beam Lead PIN Diode, HPND-4005

and discrete emitter/detector components, such as a high-resolution optical sensor, high radiant intensity emitters in the near infrared range, and PIN photodiodes.

#### Silicon Bipolar Transistors

Device-to-device uniformity and superior performance are combined in the HXTR series of microwave transistors which have been individually designed for low noise (HXTR-6000 series), high gain (HXTR-2000 series), low distortion linear power (HXTR-5000 series), or low cost (HXTR-3000 series). With guaranteed RF performance specifications from 1500 to 4000 MHz, these devices are well suited for high-reliability, space, military, and industrial applications at frequencies up to 6000 MHz.

#### GaAs Field Effect Transistors

HP offers a wide range of GaAs FETs to meet your application needs for low noise, high gain, and linear power from 1 GHz to 20 GHz. This family of GaAs FETs includes both chip and packaged devices for use in communications, satellite, radar and military systems. All devices are available with high reliability testing. Examples of products include the low noise HFET-2201 with 2.4 dB typical noise figure at 10 GHz; the dynamic range HFET-5001 with 100 mW typical output power at 8 GHz; and the general purpose HFET-1001 chip which is suitable for low noise, high gain or medium power application.

#### Power MOS FETs

HP Power MOS Field-Effect Transistors are designed to meet the performance requirements of high voltage, high current, high speed switching circuits. Double-diffused "DMOS" construction, with guarding design and silicon-nitride passivation make HP the designers' choice for reliability

in Power MOS. Silicon n-channel, enhancement mode products are available in industry standard packages for use in wide range of industrial and military applications.

#### Diodes

**Schottky Barrier Diodes:** Schottky diodes combine extremely high rectification efficiency with pico-second switching speeds, low series resistance, and low noise characteristics. This combination makes the Schottky an excellent mixer/detector diode.

At HF, VHF, and UHF frequencies, HP delivers glass-packaged devices. These same diodes have many digital circuit applications such as clipping and clamping where switching speed is important. The most popular of the glass packaged diodes are available in JAN qualified types.

**PIN Diodes:** PIN Diodes function as variable resistors at microwave frequencies. By controlling the DC bias, the RF resistance of a PIN diode can be varied from 1  $\Omega$  to about 10 k $\Omega$ . This property of the PIN diode makes it extremely useful as a switch, attenuator, modulator, phase shifter, limiter or AGC element at all frequencies from 1 MHz to 18 GHz and above. Package configurations include beam lead devices as well as conventional microstrip, ceramic and axial-leaded packages.

**Step Recovery Diodes:** SRD's are intended for use as comb generators and harmonic frequency multipliers. When used as a comb generator, the abrupt termination of the diode's reverse recovery current generates voltage pulses up to tens of volts with pulse widths as narrow as 100 ps giving useful power at frequencies in excess of 20 GHz. By optimizing the circuit around any specific harmonic, high efficiency multiplication can be accomplished.

#### Diodes for Hybrid Integrated Circuits:

Hybrid Integrated Circuits are used to achieve circuits with light weight, small size, operation to high frequencies, repeatable characteristics and lower end product costs. HP offers a wide range of PIN, Schottky and SRD single diodes in beam lead, chip and LID configurations as well as Schottky beam lead quad diodes.

#### Integrated Products

Hewlett-Packard manufactures a broad line of components for the control, conversion, and generation of RF and microwave signals. This line of integrated products (combinations of chip and beam lead diodes with hybrid thin film circuit technology) includes SPST switches, absorptive modulators, attenuators, limiters, comb generators, double-balanced mixers, and mixer/detectors.

#### High Reliability Testing

Many Hewlett-Packard components are space qualified. The reliability of these devices is established by one of the finest high reliability testing facilities in the microwave component industry. Hewlett-Packard's High Reliability Test Group maintains military approved JAN and JANTX parts in stock and can recommend HP standard screening programs, patterned after MIL-S-19500, for any HP component. Those who wish to design their own screening specifications can consult with and obtain quotations from Hewlett-Packard's staff of dedicated field sales engineers.

#### Write For More Information

Specifications of Hewlett-Packard's component products are available in individual data sheets or complete designer catalogs. These are available free of charge from your local HP sales office or authorized distributor, or return the Information Request Card located at the back of this catalog.



## Gas Chromatographs

Whether you require the maximum in chromatographic capability and data handling or simply an instrument for precise routine analysis, Hewlett-Packard has the gas chromatograph to meet your needs.

### HP 5880A

The 5880A, Hewlett-Packard's most sophisticated gas chromatograph, offers expandable levels of advanced GC capability. Configurations range from a single column, single detector instrument with programmable oven, to a four detector GC with dual channel integration and computation. You can augment this system with a tape cartridge unit and BASIC language programming capable of interacting with the GC. Clearly the 5880A design is completely dedicated to helping you solve your analytical problem.

**Reproducibility**—You can count on the 5880A to give the consistent dependable results you require. Extraordinary retention time stability is the result of new oven design coupled with sophisticated electronics and software control.

**Automation**—All 5880A GC's include run time, clock time, keystroke programming, and multi-external event/valve control. Complete automation is achieved with the addition of an automatic sampler and/or valves.

**Data Handling**—Peak integration, preprogrammed chromatographic calculations and BASIC programming are optional. You can store programs, instrument setpoints and other data on the tape cartridge unit and recall the information when you need it.

**Communications**—Options are available that allow the 5880A to accept analog signals from other GC's for processing and reporting. The 5880A can also optionally output analog detector signals to an external data system/integrator, or output digital signals to an HP 3350 series lab automation system. In addition, the 5880A can communicate analysis report information to a central computer system or calculator for archival storage or further processing.

### HP 5790A

The HP 5790A is a small, cost-effective GC. Entering setpoints and displaying actual values is made simple. Built in valve control, stopwatch, keyboard lock and setpoint method storage, with years of memory protection, add to its versatility. Diagnostics continually monitor the 5790A and display valuable information which is accessible from the keyboard.

Simplicity of operation has not compromised performance. The 5790A was designed for chromatographic excellence. Qualitative confidence requires an oven designed for retention time stability, especially for capillary columns. The 5790A's unique oven-within-an-oven design means retention time reproducibility of  $\pm 0.005$  minutes run-to-run and day-to-day. Data correlation from lab-to-lab is also more reliable with the factory calibration of the oven to  $0.05^\circ\text{C}$  of absolute temperature at  $130^\circ\text{C}$ .

To ensure further operational flexibility the 5790A provides a simple and direct approach in interfacing to integrators and data

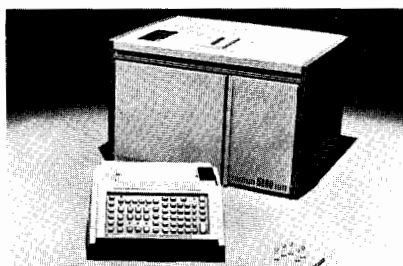

HP 5880A

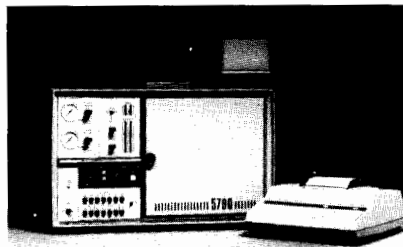

HP 5790A &amp; HP 3390A



HP 3357

systems. With its RS232C communications interface, setpoints can be monitored as well as controlled from an external device. The availability of automatic samplers and custom valving further adds to the HP 5790A's flexibility in the laboratory.

## Laboratory Automation Systems

HP 3350 Series Laboratory Automation Systems can increase your sample throughput, provide easy-to-use, yet sophisticated data reduction, perform record keeping tasks and automate your analytical procedures. Ascending levels of laboratory automation give you the freedom to configure an affordable system to meet your present needs, and grow easily and economically to meet future requirements. Software capability can grow from the turn-key chromatographic package to include automatic sampler control, simulated distillation, and LAB BASIC. Up to 1 mega-word of mainframe memory, 1.2 gigabytes of on-line disc storage, and four 9-track magnetic tapes are available.

The state-of-the-art in automation, lab data handling, and data management, the HP 3357 Lab Automation System is designed for the analytical customer whose computational and data handling needs are extensive. Operationally, the HP 3357 is a combination of LAS software and the RTE-6/VM Real Time Executive Operating System, using the SESSION MONITOR capability. The RTE users can be assigned capability levels restricting access to system commands depending on their own level of



HP 5985B

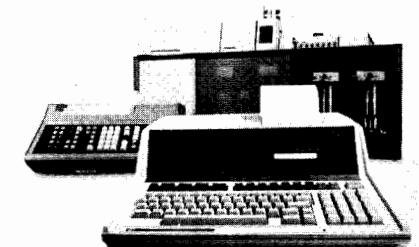

HP 1084B

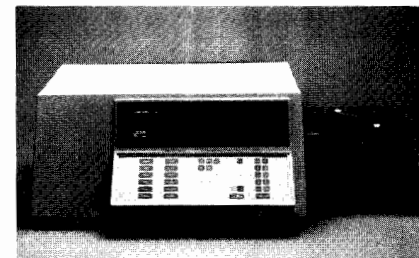

HP 8450A

expertise, and can write programs to access the data produced by the LAS routines.

In addition to FORTRAN and Pascal programming, the HP 3357 can handle up to 60 instrument interfaces.

## Diode Array Spectrophotometers

### HP 8450A

This powerful, computer-controlled UV/VIS instrument measures in seconds and displays: multiple components, a full spectrum, list of analysis conditions and concentrations.

The HP 8450A has an innovative reversed-optics design which disperses the light that has passed through a sample simultaneously across two parallel arrays of light-sensitive diode detectors—one array measuring visible, the other ultraviolet light. Resulting spectra are shown instantly on the instrument's built-in video display.

The HP 8450A offers high precision, high productivity and versatility in single and multicomponent sample analyses with easy keystroke programming of operating parameters and measurement of virtually any sample with only minimum preparation.

Because of its high sensitivity, speed, and ability to monitor several component concentrations simultaneously, the HP 8450A is particularly well suited for kinetics work. From the keyboard, which is sealed to prevent damage from chemical spills, the spectrophotometer can be programmed to alter many operating parameters at specified times during an analysis.



Internal diagnostics shorten down time and lower service costs. Peripherals offered for the HP 8450A include a temperature controller, printer/plotters, and flexible disc drives for external data storage.

## Liquid Chromatographs

The HP1082/84B Liquid Chromatographs are proven instruments for both method development and routine analysis. They are integrated chromatographic systems in which all of the components are optimally combined to offer a better overall performance without sacrificing flexibility.

Closed loop control systems for the two most important chromatographic parameters, flow rate and column temperature, ensure high reproducibility essential to the chromatographer. The variable wavelength detector's scanning capability enables positive identification of separated compounds and selection of the optimum detection wavelength. Time programming allows the detection wavelength to be automatically switched to the absorption maximum of each compound. Also, any chromatographic parameters can be time- or run-programmed. Combination of these features with the 60 vial autosampler provides the automation and accuracy required for precise unattended analysis.

### HP 1081B

The HP 1081B is a compact, isocratic liquid chromatograph which is simple to use and offers the precise control of parameters needed to operate efficiently for repetitive quantitative analysis. Only six keys on the 1081B are needed to access, set and check all functions, including operation of the optional automatic sampling system. Using the same pump and control system as the 1082/84B is also offers the same high standard of chromatographic performance.

### HP 1040A Detector

The HP 1040A high-speed Spectrophotometric Detector provides fast peak identification and confirmation. With it, the analyst can obtain spectra within an extremely short time at any time during the analysis without interrupting the chromatographic run. 205 photodiodes work in parallel to simultaneously monitor all wavelengths over a range of 190-600nm. Spectral data from the photodiode array is processed by the mainframe's two microprocessors and delivered to the HP-85 computer for storage and/or display. Fast scans are obtained at any time during the analysis, either manually or through the keyboard, or automatically via time programming. Peak status routines control spec-

tra acquisition at baseline, peak inflection points and peak apices. The HP 1040A also permits chromatographic analysis at eight independent wavelengths simultaneously. The detector can be connected easily to any existing liquid chromatograph.

Hewlett-Packard also offers a complete range of accessories for liquid chromatography like columns, detectors, backflushing and solvent switching valves and an automatic fraction collector. Real two-way communication between liquid chromatographs and the HP-85 computer further enhance the automation capabilities.

## Reporting Integrators

HP's integrators satisfy almost any analytical requirement from simple area % reporting to sophisticated data handling and automation.

### HP 3388A

The HP 3388A Reporting Integrator provides the chromatographer with extensive analytical capabilities for data handling. The dual channel option allows for simultaneous operation of two instruments, each with its own printer/plotter. Standard calculation procedures include area %, external standard, normalization, and internal standard.

Other features of the 3388A include BASIC programming, alphanumeric and functional keyboards, multiple reference peaks, automatic recalibration, multiple internal standards, time-selectable area slices, and retention time labeling to 1/1000 of a minute.

HP automatic sampler control and cartridge tape unit are available as options.

### HP 3390A

The compact, economical HP 3390A Reporting Integrator detects and integrates peaks with a flexibility adaptable to all forms of chromatography as well as many non-chromatographic techniques. Calculations can be made by peak area or peak height, and signal filtering systems minimize noise for enhanced reproducibility.

The HP 3390A performs all standard chromatographic calculations, calibrations, and stores up to 9 methods.

Use with the 19400A Sampler/Event Control Module provides automated control of HP automatic samplers and external devices. Also available as an option is the HP 85 Personal Computer, for report manipulation, storage, and a host of calculator functions.

## GC/Mass Spectrometer Systems

All HP systems are of advanced design and include innovations such as hyperbolic quadrupole mass filters, the theoretically ideal design which provides improved peak shapes and higher sensitivity, compared to round-rod filters.

### HP 5995B

A versatile, second generation benchtop GC/MS, the HP 5995B, offers excellent per-

formance at an economical price. Features include an HP 9825B Desktop Computer Controller with HP 2671G Printer, easy-to-use software with AUTOTUNE (automatic tuning), and other programs which control the gas chromatograph, scan the mass spectrometer, monitor up to six ions in the selected ion monitoring mode, plot and tabulate normalized spectra, search libraries, and perform self-diagnostics. FID and split/splitless capillary are options. Options include direct insertion probe, turbomolecular pump, plus provision for CO<sub>2</sub> sub-ambient cooling. Mass range to 800; 1 ng scanning sensitivity.

### HP 5993B

This cost-effective GC/MS is ideal for organic mixture analysis in quality control and other applications requiring high productivity. The HP 5993C combines the compact GC/MS of the HP 5995B with a powerful data system very similar to that provided with the 5985B. A full line of computer accessories, including 9-track magnetic tape, is available.

### HP 5986A

The HP 5986A has dual CI/EI source and other GC/MS features of the HP 5985B. It is controlled by the HP 9825B Desktop Computer operating with the expandable, flexible disc system available on the HP 5995B. Its 800 amu mass range can be increased to 1000 and a powerful data system can be added by upgrading to the HP 5985B Hardware/ Software Operating System.

### HP 5985B

This top-of-the-line research system provides the ideal answer for collecting, storing, and processing the vast amount of data produced from GC/MS measurements. It includes CI/EI dual source, mass range to 1000 amu, and direct insertion probe operation. The microprocessor-controlled dual column HP 5840A GC can operate independent from the MS for use as a stand alone GC with integrator, time and run programming and methods analysis. The data system in the 5985B includes 10 million words of disc storage, a program for automatic sampler control, Probability Based Library Search, and simultaneous data acquisition/reduction operation. Options include negative ion detection, LC/MS interface, and turbomolecular pumps.

## Customer Support

Analytical on-site Product Maintenance Service includes comprehensive repairs (all parts except certain expendables and consumables), labor and travel. Routine customer maintenance training can be provided at customer request and, as an option, installation for instruments where it is not normally provided. Normal on-site response to a service request is 1 day.

For further information about HP analytical Instruments and Systems write or call one of the sales offices listed on pp. 667-672.

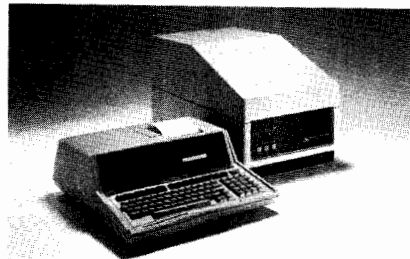

HP 1040A

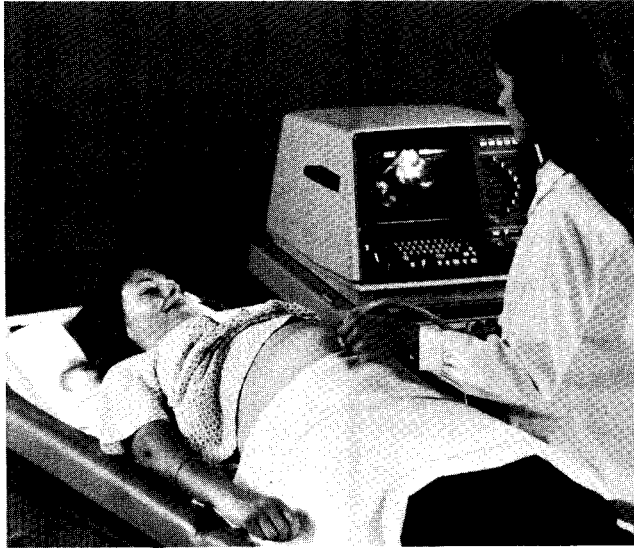

#### Ultrasound Imaging

- Real-time phased array systems
- New 77020AC System configured specifically for the cardiologist—totally mobile—VCR and stripchart
- New 77020AR System configured specifically for economical abdominal, obstetrical and pelvic imaging
- Small lightweight transducers.

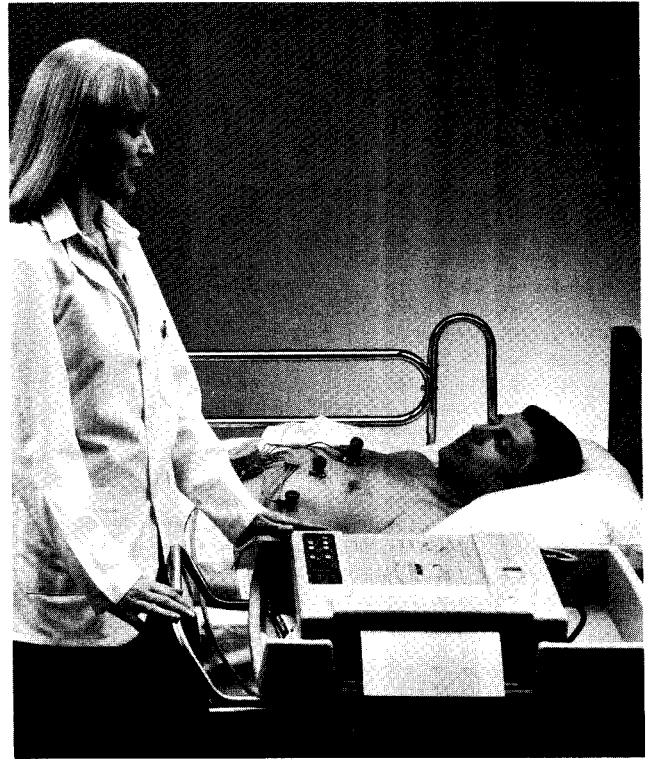

#### Cardiography Instrumentation

- New 4700A PageWriter Cardiograph
- ECG Management Systems for computer-aided interpretation of electrocardiograms
- ECG Stress Testing Systems.

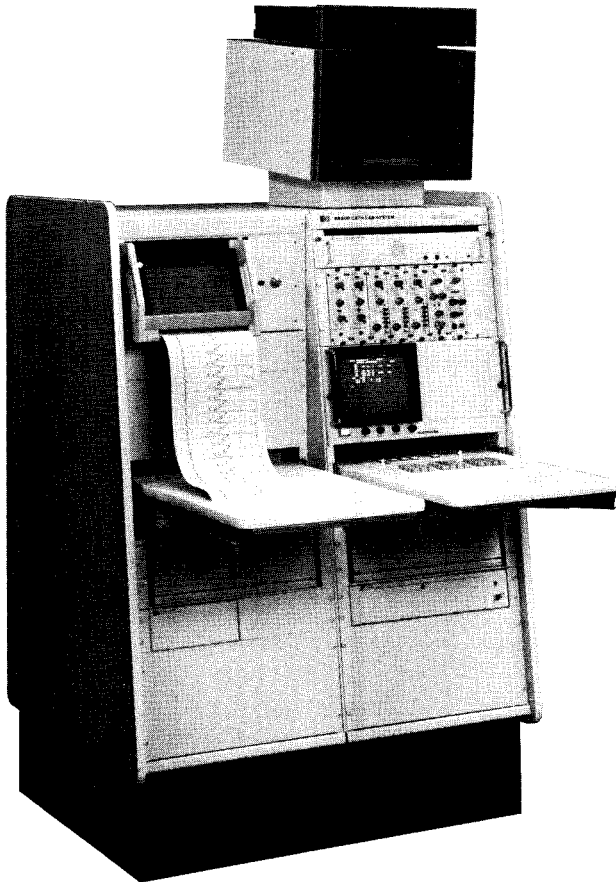

#### Cardiovascular Instrumentation

- Computerized catheterization data analysis system automates on-line data collection analysis
- Complete choice of plug-in signal conditioners, transducers, meter and numerical displays.



#### Perinatal Instrumentation

- Fetal/maternal monitoring equipment includes new 8040A Bed-side Fetal Monitor, and central stations
- Telemetry for birthing centers
- Neonatal monitoring includes heart rate, temperature, respiration, ambient oxygen.



#### OR Monitor

- New 78345A Patient Monitor • For OR, ICU and recovery room
- Continuous, realtime measurement of ECG, pulse, CO<sub>2</sub> and inspired O<sub>2</sub> in the same instrument.



#### Resuscitation

- Portable defibrillator/monitor that provides medical/legal documentation • Battery/AC operating • Digital heart rate display
- Mobile resuscitation systems.



#### Patient Monitoring

- Stand-alone monitors • Modular instruments
- ECG Telemetry • Arrhythmia detection, storage and recall
- Patient Data Management.



- For Additional Information on HP Medical instrumentation, request from following brochures, data sheets, and catalogs:
- Patient Monitoring #5953-1391 • Resuscitation #5952-6835 and #5952-6836
- Perinatal #5953-5303 (Fetal Monitor) and #5953-1125 (Obstetrical Telemetry)
- Cardiography #5953-4949 (PageWriter) and #5953-4915 (ECG Management Systems)
- Ultrasound Imaging #5953-4935 (Radiology) and #5953-4934 (Cardiology) • Critical Care Supplies Catalog #5953-4802.

**An Invitation** for you to become a subscriber to **ADVANCES FOR MEDICINE**, the Hewlett-Packard medical products magazine. To receive **ADVANCES** free of charge, simply fill in and return the request card at the back of this catalog.

# X-RAY SYSTEMS

## Scientific and Industrial X-ray Systems



### Faxitron® Cabinet Systems

Radiography, the art and science of making pictures with X-rays, has an important place in modern technology. It is one of the major nondestructive test methods available to industry, provides an indispensable tool in scientific investigations and is a valuable aid to law enforcement agencies. Hewlett-Packard makes a major contribution to these activities with X-ray equipment that offers a "better way" through advanced technology and design. This equipment makes radiographs easier and safer to take.

### Industrial Inspection

Industrial quality control and inspection procedures, especially in the field of electronics, benefit from nondestructive testing by radiography. The advantages of a testing method which does not harm the test objects are obvious. Radiography, therefore, offers benefits in design engineering, incoming inspection, production quality control, product reliability and failure analysis. X-rays are used to detect misregistration or plate-thru problems in multi-layer P.C. boards; porosity, poor substrate bonding and wiring or lead location in transistors and integrated circuits; voids and other encapsulation problems in potted components; and solder balls or other defects in sealed relays.

Die casting is another industry that benefits from the nondestructive aspects and abil-

ity to "see inside" provided by radiography. Porosity, gas voids, tramp metal inclusion and other common defects can be easily detected and the cause determined. Expensive machining time can be avoided for castings found to be defective through X-ray inspection. The integrity of welds, alignment of connectors, inspection for proper assembly and mechanical defects are further examples of tests which radiography performs for industry. The benefits of X-ray testing are reduced production costs, better quality assurance and product safety. The results are increased profits.

### Law Enforcement Applications

Radiography aids many law enforcement groups. Crime labs use X-rays to visualize certain types of latent fingerprints, for powder and lead splatter patterns in ballistics and for questioned-document examination. Medical examiners use X-rays for cause-of-death investigations and identification of remains. X-rays aid in examining parcels or mail to identify dangerous devices and to verify bomb circuitry.

These are among the many applications served by HP Faxitron® Cabinet X-ray Systems. They offer a unique combination of high quality radiographic capability, simplicity of operation and convenience of use which is expanding the capabilities of scientific and industrial concerns throughout the world.

### Scientific Applications

Oceanography, geology, marine biology, paleontology, pathology, botany, forestry and agricultural research are a few examples of scientific disciplines that use X-rays. Applications range from the study of the interior anatomy of fossils to determining the viability of seeds.

### 43700 Series Flash X-Ray Systems

High-speed (flash) radiography is used to record and study dynamic events where interposed material, smoke, flame, debris, or pressure variations exclude the use of high-speed cameras. Typical events include ballistics, shaped charges, explosives, behind-armor studies, shock waves in solids, aerospace phenomena, and crash-injury studies.

The basic performance requirement of a flash X-ray system used for the study of transient mechanisms is to provide high resolution radiographs with exposure times short enough to eliminate motion blur. HP Series 43700 flash X-ray systems produce X-ray pulses of sub-microsecond duration and are designed specifically for "stop motion" radiographic applications. All Model 43700 Series systems utilize the same basic components, the same electrical theory, and are modular in concept. Standard systems include 150 kV, 300 kV, 450 kV, 1 MV, and 2.3 MV models.

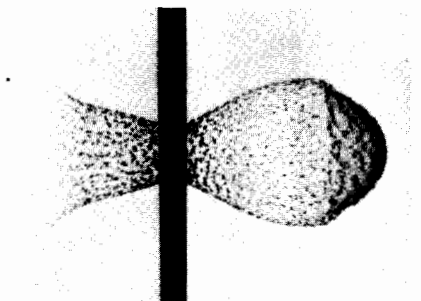

An HP basic single "channel" flash X-ray system, composed of a pulse generator, high-voltage power supply, cold-cathode field emission X-ray tube, and associated controls, provides a single radiograph per event. Additional pulser/X-ray tube sets (add-on channels) may be combined with the initial single-channel system to provide multiple-channel "systems." Multiple channel systems may be of identical output voltage or may use varied output voltage pulser/tube combinations.

For specific information and consultation regarding HP X-ray systems, contact Hewlett-Packard, 1700 S. Baker Street, McMinnville, Oregon 97128, telephone: (503) 472-5101.



## No-charge aids to selecting, using & maintaining HP products



HP offers a variety of no-charge publications to help you choose the HP products that best fill your needs, to help you benefit from applications knowledge acquired by users inside and outside of HP, and to help you maintain your HP products. These publications range from new-product announcements, catalogs, product family brochures, and single-product technical data through application notes, product notes, and programming aids to service notes and general maintenance periodicals. Since the number and types of publications vary with product type, an outline of available publications organized by product type is provided below for your convenience.

### Instruments and Systems Product Information

Measurement/Computation News  
Data sheets and brochures

#### Catalogs

- DC Power Supplies
- Recorder Supplies
- Coaxial & Waveguide Measurement Accessories
- Digital IC Tester Program

#### HP Journal

### Application Information

Application Notes  
Product Notes  
Programming Notes

### Service Information

Service Notes  
Bench Briefs

### Computers, Peripherals & Calculators

#### Product Information

Computer Advances  
Measurement/Computation News  
Basic Exchange  
Data sheets & brochures  
Catalogs

Computer Users Catalog

#### HP Journal

### Application Information

Application Notes  
Application Briefs

### Medical

#### Product Information

Advances for Medicine

### Catalogs

- Medical Instrumentation Supplies
- Critical Care Supplies
- Cardiology Supplies
- Labor and Delivery Supplies
- Multi-Channel Recording Supplies
- Pulmonary Diagnostic Supplies

### Data sheets & brochures

#### HP Journal

### Application Information

Application Notes

### Analytical

#### Product Information

Data sheets & brochures  
HP Journal

### Application Information

Application Notes

### Components

#### Product Information

#### Catalogs

- Diode and Transistor Designer's Catalog
- Optoelectronics Designer's Catalog
- Microwave Integrated Products

#### Data sheets

#### HP Journal

### Application Information

Application Notes  
Application Bulletins

### Measurement/Computation News

Six times a year M/C News brings you announcements of HP's latest electronic measuring instruments and their accessories; personal, desktop, and minicomputers, their software, peripherals, and accessories; optoelectronic and semiconductor components; and new no-charge literature such as catalogs and application notes.

### Computer Advances

Published bimonthly for owners and users of HP computer products, Computer Advances keeps you up-to-date on the latest computer products and services.

### Basic Exchange

A quarterly newsletter for owners of HP personal computers, Basic Exchange provides information about new hardware, software, and policies plus suggestions for operating, programming, and further reading.

### Advances for Medicine

Advances for Medicine is a quarterly magazine that presents timely articles on measuring physiological parameters in unique or improved ways; on saving time, labor, and equipment costs; and on using data processing for efficient hospital management.

### Application Briefs, Bulletins, and Notes

These aids to solving your measurement, computation, and design problems offer the benefit of the applications research and experience of both HP customers and HP engineers. Some are tutorial, others describe how-to procedures.

### Product Notes

Product Notes augment the Operating and Service Manuals supplied with HP electronic instruments by providing information on various topics that include specifications and characteristics, operation and use, applications and performance.

### Programming Notes

Programming Notes provide product-specific information on the use and operation of instruments in HP-IB systems. Some notes address the needs of inexperienced users and cover basic operation of an HP-IB instrument using a specific HP desktop computer. Others address the needs of experienced users.

### Service Notes

Service Notes contain product-specific servicing information for HP's electronic instruments. Subjects include improvement modifications and procedures for troubleshooting, maintenance, and repair. Service Notes are published as appropriate throughout the life of a product, and new Notes are announced in Bench Briefs.

### Bench Briefs

Bench Briefs provides those who maintain HP instruments with timely information that has both specific and general application. Subjects include troubleshooting tips and descriptions of new technologies, components, tools, and equipment. Also, new Service Notes are listed in Bench Briefs as they become available.

### Hewlett-Packard Journal

Published monthly to communicate technical information from the laboratories of HP to all of the fields served by HP, the Journal contains descriptions of current hardware and software products as well as more general information such as advancements in technology.

### How to Obtain No-charge Publications

To obtain any of the publications described on this page, contact your nearest Hewlett-Packard office. Locations of HP offices are listed on the back pages of this catalog.

HP offices are also your best source of correct information on the topics covered by Application Briefs, Application Bulletins, Application Notes, Product Notes, and Programming Notes.





### Training Alternatives

With Hewlett-Packard's extensive product line and worldwide customer mix there are two main avenues for technical customer training. These are live training sessions and video tapes. Live training sessions fall into three subcategories: applications, service and tutorial. Application seminars aimed at increasing your utilization of general purpose test instrumentation are often available at no charge. On the other hand, seminars on the operation of dedicated systems are more specific in nature and generally have a fee for tuition. Service seminars are available on a supply-and-demand basis and also have a tuition fee. For detailed information on all HP seminars, contact your Hewlett-Packard field engineer or call the Hewlett-Packard office nearest you—see pages 667-672.

### HP Video Tapes

#### A Better Way to Learn

Part of the "extra value" which comes with each Hewlett-Packard product is our continuing commitment to provide Hewlett-Packard customers with useful training information in the areas of applications and service. In the past, this information has often been in the form of classroom seminars, either at your nearby Hewlett-Packard sales office or at one of our training facilities in California.

Now our capability is expanding by offering you both service and applications training via video tape. Video tape training is exceptionally convenient and readily available for your own use at any time or any place, including within your own facilities.

**Effective:** Hewlett-Packard has found that video tape is a highly effective training medium. Video tapes can convey more information in less time, and with higher retention, than even the best live instruction. Hewlett-

Packard programs are professionally produced and are based on measurable instructional objectives. They consider what the student already knows, emphasize what he needs to know, and omit what he does not need to know. Many video tapes utilize split-screen techniques, allowing students to watch a procedure on one part of the screen while observing its effect on another part. Most Hewlett-Packard video tapes are 100% visualized, as opposed to conventional, partially visualized video taped "lectures."

**Flexible:** With video tapes, you can tailor your training program to suit the many needs of your organization. You may select training programs for individuals with different backgrounds and specific needs, present effective programs to audiences of just one or hundreds, and offer a library of technical programs your staff members can easily consult on their own . . . for new information or for refresher purposes.

**Faster:** It has been our experience that Hewlett-Packard video programs compress learning time by a factor of up to 6-to-1. A video tape library also reduces the time needed to organize and schedule your training. You can schedule highly professional presentations anytime and anywhere, without arranging for outside instructors or juggling the detailed logistics that are often required for live training sessions. More effective training in one-sixth the time!

**Convenient:** Video tape programs come on small, easy-to-file magnetic tape cassettes. Inexpensive playback equipment is easily operated by unskilled personnel. Programs may be viewed on small portable monitors or on full-screen TV sets. Video tapes can be quickly searched for specific information using "fast forward" or "fast rewind," and many recorders can stop on a single frame for more detailed study.

**Time-tested:** All the video tapes offered in the Hewlett-Packard Videotape Catalog

were developed to serve Hewlett-Packard's needs for a practical, low cost source of up-to-date training in a wide variety of subjects. Now, after having been tested in Hewlett-Packard training activities throughout the world, many of these video programs are available to help meet your training objectives.

### Understanding Microprocessors 90301RD

This videotape training module, developed to train HP technicians, provides a practical introduction to microprocessor systems.

Microprocessors are now found in the most familiar places: automobiles, kitchen appliances, toys, home entertainment devices, as well as in modern electronic instruments. Soon all electronic technicians must be able to troubleshoot and repair this type of equipment.

Understanding Microprocessors consists of 5 videocassette lessons in color, a textbook/experiment book, and a study guide. Each lesson concludes with a self-scoring quiz. The HP 5036A Microprocessor Lab is recommended for performing assigned experiments. The lessons are directed to technicians who already are able to troubleshoot and repair equipment using digital circuitry. After completing this module, technicians should be well prepared for more advanced microprocessor troubleshooting modules. The more advanced modules presently are offered as live tutorial training courses (see photo above). They are being produced in video format for future release.

### What is a Microprocessor? 90302RD Lesson 1 17 Mins.

This first lesson reviews the history of computers and microprocessor systems and provides an overview of the microprocessor video series. Microprocessor systems are graphically demonstrated along with the elements of microprocessor systems. Lesson 1 con-



cludes with a summary and a short self-scoring quiz.

### Analog vs Digital Systems

**90303RD Lesson 2 40 Mins.**

The differences between analog and digital systems are never more apparent than when studying microprocessor systems. This program clearly describes these differences and goes on to explain the three-state bus concept, talkers and listeners, and bus troubleshooting techniques.

### Introduction to Programming

**90304RD Lesson 3 19 Mins.**

This brief review of programming defines a few terms, describes what a program is, why programs are necessary, and how to develop them. The concepts of low and high level programs and a review precede the self-scoring quiz.

### Processor Registers and Instruction Set

**90305RD Lesson 4 51 Mins.**

This lesson describes the many registers contained on the microprocessor chip, including their uses in the operational sequence: fetch, execute and increment. The instruction set is described briefly to enable the viewer to follow the succeeding lessons.

### Simple Assembly Programming

**90306RD Lesson 5 41 Mins.**

Using the knowledge of the instruction set, the viewer is led through simple examples of assembly language programs. Translating the assembly language into machine language is shown, as well as how the program is stored in memory and executed by the processor. A program review precedes the self-scoring quiz.

### Microprocessor Fundamentals

#### Algorithmic State Machines

**90308RD Lesson 1 36 Mins.**

This first lesson of Microprocessor Fundamentals describes algorithmic state machines as they appear around us. As the complexity of each succeeding algorithmic state machine is increased the program relates this complexity to the instruction decoder of a microprocessor. A self scoring quiz completes the lesson.

#### Basic Design & Terminology of

#### Microcomputers

**90309RD Lesson 2 26 Mins.**

This lesson reviews the terms needed to understand microprocessors. Appliances and peripherals are discussed next, giving the student an overview of how microcomputers are used in modern electronics. The short self-scoring quiz gives a thorough review.

### Digital Troubleshooting 90420D

Developed to train HP's own technicians, this course is especially useful in showing how to approach real problems in real equipment.

- Practical demonstrations
- Proven teaching techniques
- Flexibility of use for classroom or individual study
- Latest in digital troubleshooting tools
- Most recent logic symbology
- Useful troubleshooting tips

Digital troubleshooting was made for technicians. It is an appropriate transition from transistors to digital electronics. It also can be used as a refresher course. Equivalent in coverage to a college term of 13 weeks, the course is presented in color on 14 videocassettes having a total running time of 5 hours and 31 minutes. The lab demonstrations shown in video are from the workbook included with the series. Also included is a 180 page text and a study guide.

There is ample use of reinforcement in the presentation and in the self-scoring quizzes at the end of most of the modules.

### Digital Troubleshooting Videotapes

#### Introduction to Digital Electronics/

**90421D Lesson 1 12 Mins.**

Digital products and techniques are becoming more popular and widely used. This lesson looks at some of the areas where digital techniques are used—areas such as computers, communications, telemetry, test equipment, industrial control, and consumer-electronics. It also points out how the integrated circuit (IC) has caused a virtual explosion in the use of digital techniques. Widely used terms and concepts such as binary, digital, analog, gates, and memory are explained. The lesson concludes with a comparison of digital and analog techniques, a summary, and a short, self-scoring quiz.

#### Binary Nature of Digital Circuits

**90422D Lesson 2 18 Mins.**

Digital circuits operate using the binary or two-digit number system. Binary digits (bits) are introduced in this lesson covering the operation of the pure binary and Binary Coded Decimal (BCD) systems. Mechanical or transistor switches can be used to control the two logic levels used to represent binary data. Either positive or negative logic systems can be used to represent binary numbers, and they can be transmitted in either serial or parallel fashion. This lesson concludes with a summary and a short, self-scoring quiz.

### Basics of Transistors and IC's

**90423D Lesson 3 18 Mins.**

Integrated Circuits have revolutionized digital electronics. An IC contains many transistorized circuits deposited on a tiny silicon chip. These transistorized circuits switch between two voltage levels that represent binary 1's and 0's. Because of their importance, this lesson reviews the basics of transistors and diodes. PN junction diodes are covered first, then PNP and NPN junction transistors are reviewed. The lesson then discusses how transistors can be operated as either saturated or non-saturated switches. Metal Oxide Semiconductor (MOS) transistor switches are also covered. Packaging and classification of Integrated Circuits are the final topic in this lesson followed by a summary and a short, self-scoring quiz.

### Logic Gates and Symbols

**9042D Lesson 4 25 Mins.**

Logic gates and flip-flops are the two main digital building blocks. This program covers six basic logic gates and their symbols. The logic circuits covered are the AND, NAND, OR, NOR, Exclusive OR, and Inverter. After the operation of each logic element is explained using logic symbols, the operation of a circuit is demonstrated. Next, troubleshooting of gate circuits is covered, then the use of logic troubleshooting tools is demonstrated. The lesson ends with a summary and a short, self scoring quiz.

Note: The logic symbols included in this series are based on ANSI Y32.14/IEEE 91-193. This industry standard document supersedes MIL-STD-806 B/C and is approved for use by the U.S. Department of Defense.

### Introduction to Digital IC Families

**90425D Lesson 5 29 Mins.**

This is the first of two lessons dealing with digital IC families. In this section DCTL, RTL, and DTL are covered.

This videotape begins with a review of logic gates consisting of the circuit diagram, truth table, logic diagram, and Boolean expression. Several schematics from an actual instrument are explained. Equivalent gates, shown on these schematics, are discussed according to function. This is followed by a discussion of the history of gate design as it applies to the digital troubleshooter, so that bad troubleshooting practices can be avoided. The lesson concludes with a short, self-scoring test.

### Modern Digital IC Families

**90426D Lesson 6 27 Mins.**

This is the second of two lessons dealing with digital IC families. In this section TTL, HTL, ECL and CMOS are covered.

This videotape begins with a review of the principles introduced in Lesson 5, then explains how the five subfamilies of TTL work (Standard TTL, Low Power TTL, High

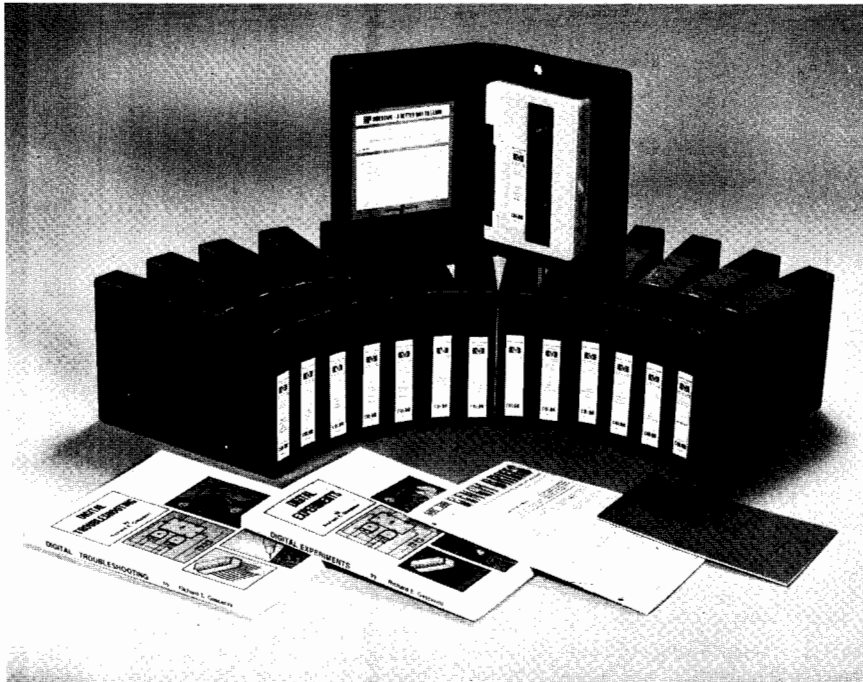

Speed TTL, Schottky TTL, and Lower Power Schottky TTL. Also explained are open-collector TTL and three-state logic. Similar discussion occurs about HTL, ECL, and CMOS families. The lesson concludes with troubleshooting as applied only to families.

**Simple Troubleshooting Techniques**  
**90427D Lesson 7 18 Mins.**

Experienced service technicians use a number of simple troubleshooting tools and techniques to help reduce repair time and eliminate the need for electrical measurement when servicing integrated circuit assemblies.

This program focuses attention on logical approach to troubleshooting, highlighting simple techniques of isolating and replacing defective components on integrated circuit assemblies.

**Troubleshooting Digital IC's**

**90428D Lesson 8 27 Mins.**

Fundamental differences between analog and digital circuits make traditional troubleshooting tools inefficient. Products designed especially for testing digital circuits include: The Logic Clip, Logic Probe, Logic Pulser, Current Tracer, and Logic Comparator. This program takes a close look at these IC Troubleshooters. Also covered are the types of failures found in digital integrated circuits and how to troubleshoot them.

**Flip-flops**  
**90429D Lesson 9 31 Mins.**

Flip-flops are one of the main building blocks of digital circuits. This program covers both the NAND and NOR RS, closed RS, D, T, and JK flip-flops. The theory of operation of each flip-flop is covered using ANSI Y32. 14/IEEE 91-1973 logic symbolology. Then, the flip-flop is demonstrated and its operation summarized. Clocked logic, edge and level triggering, direct set and reset inputs, and troubleshooting flip-flops are also covered.

**Counters and Shift Registers**  
**90430D Lesson 10 30 Mins.**

Counters and Shift Registers are the two most popular uses of flip-flops. This program covers binary and decade counters, both ripple and synchronous types. Also covered are up and down counters, presettable counters, frequency dividers, circular shift registers and strobed displays. The operation of each circuit is first explained using logic symbols, then demonstrated. Troubleshooting is the final topic in this program. The lesson ends with a short, self-scoring quiz.

**Combinational Logic Circuits**  
**90431D Lesson 11 30 Mins.**

The basic building blocks of combinational logic circuits are gates. In this videotape we see how gates are combined to form line drivers, three-state drivers, one-shot multivibrators, multiplexers, adders, and code converters.

After an overview of the operation of these devices, they're shown in actual use in a production line device.

The program concludes with a section on troubleshooting, which deals with typical problems which may arise in combinational logic circuits.

**Display Technologies**  
**90432D Lesson 12 30 Mins.**

A large variety of display technologies is used with digital circuits. This program looks at the types and configurations of displays, then discusses typical troubleshooting problems specific to them. Some of the types covered are neons, gaseous discharge tubes, and light emitting diodes (both segmented and dot matrix forms). Included is a discussion on planar tubes, incandescent displays, and liquid crystals.

In the troubleshooting section typical faults the technicians might encounter are discussed. Each of these faults is demonstrated and solutions are suggested.

**IC Manufacturing**  
**90433D Lesson 13 11 Mins.**

A basic knowledge of IC manufacturing should prove helpful to anyone involved in servicing digital equipment.

Manufacturing IC's involves a photographic process, and a series of masks is used to control the areas where impurities are allowed to diffuse forming semiconductors. This program shows the steps in the manufacture of IC's, starting with an actual wafer and following it through to a completed IC package.

**Memories**  
**90434D Lesson 14 25 Mins.**

Due to the many unique demands of today's users of computers and calculating devices, many different configurations for different types of memory are required. This lesson considers six types of memory-punched paper tape, punched cards, magnetic (reel-to-reel and cartridge), magnetic disc (hard and floppy), ferrite core, and semiconductor.

This lesson defines and describes the use of sequential access and Random Access Memory (RAM), volatile and nonvolatile memory, Read/Write Memory, Read-Only Memory (ROM) and Programmable Read-Only Memory (PROM). Tips on handling the various types of memory conclude the program.

**Practical Transistors 90100D**

The widely used Practical Transistor Series is a definitive, monochrome, 15-tape excursion into the exceedingly important (and mysterious) world of transistors. As outlined below, each highly informative program in the wide-ranging series is primarily concerned with examining the many practical aspects of transistors rather than just dwelling on theory and math. The end result, after viewing this popular series, will be a deeper working understanding of transistors which will make maintenance and troubleshooting problems far easier and more efficient. The series is therefore highly recommended for electronics students, service personnel and engineers.

A supplementary textbook by transistor authority George Stanley Jr. (who also hosts the series), plus a complete set of homework problems and answers, is included with the nearly nine hours of video taped material.\*

**Transistors vs. Tubes**  
**90030D330 Lesson 1 30 Mins.**

The first program in the 15-part series introduces author George C. Stanley Jr., who defines the objectives of the course, describes the text upon which the course is based and explains the use of the homework problems. The rest of the program then reviews and builds upon the student's prior knowledge to make comparisons between vacuum tubes and transistors.

**Temperature Effects**  
**90030D316 Lesson 2 41 Mins.**

Part 2 develops the various common techniques of biasing transistors, and emphasizes the effects of heat on transistor circuits with demonstrations.

**Current/Voltage Drive**  
**90030D317 Lesson 3 41 Mins.**

Part 3 is concerned with the comparison between voltage drive and current drive in



transistor circuits. During this program, several concepts are developed which become important building blocks for the rest of the course.

#### Answers by Inspection

**90030D318 Lesson 4 43 Mins.**

Part 4 develops the first of several valuable timesaving rule-of-thumb formulas: a simplified expression for voltage gain. Demonstrations serve to illustrate the usefulness and effectiveness of this formula.

#### Answers by Inspection

**90030D319 Lesson 5 40 Mins.**

Part 5 develops additional rule-of-thumb formulas for the calculation of voltage gain with feedback, input impedance, output impedance, and distortion in common emitter circuits.

#### Answers by Inspection

**90030D331 Lesson 6 37 Mins.**

Part 6 concentrates on the emitter follower circuit and develops expressions for its voltage gain, and input and output impedance.

#### Multistage Amplifiers

**90030D322 Lesson 7 44 Mins.**

Part 7 is devoted to applying the knowledge gained in Parts 4, 5, and 6 to an analysis of a three-stage transistor amplifier. Demonstrations on an actual circuit illustrate the accuracy of the approximations involved.

#### Troubleshooting

**90030D323 Lesson 8 43 Mins.**

The information obtained in preceding programs is further clarified in Part 8, which covers troubleshooting on both single-stage and multi-stage transistor circuits. Class problems are presented and solved using actual circuits.

#### Feedback Amplifiers

**90030D324 Lesson 9 27 Mins.**

Part 9 first reviews single-stage and multi-stage circuits with feedback. Valuable troubleshooting tips for feedback circuits are then illustrated with demonstrations.

#### Why a Transistor Amplifies

**90030D325 Lesson 10 27 Mins.**

Part 10 illustrates how and why transistors amplify electrical signals. Discussion of the roles of majority and minority carriers leads to an intriguing example of the effect of nuclear radiation on transistor performance.

#### Troubleshooting

**90030D326 Lesson 11 33 Mins.**

Part 11 is devoted to more practical applications of what has been learned so far. Demonstrations of troubleshooting are given on an actual multistage transistor amplifier to illustrate common failure patterns.

#### Fets and Unijunctions

**90030D327 Lesson 12 34 Mins.**

Part 12 provides explanations of the operation of both junction and MOS field-effect transistors. Troubleshooting tips and the effects of nuclear radiation on these devices are given. The program concludes with the operation of the Unijunction transistor.

#### Breakdown Diodes

**90030D328 Lesson 13 37 Mins.**

Part 13 compares Zener and avalanche diodes in terms of their temperature coefficient of voltage. This leads to a discussion of the use of various kinds of diodes for tempera-

ture compensation networks.

#### SCR's and Tunnel Diodes

**90030D329 Lesson 14 28 Mins.**

Part 14 covers the operation and the uses for silicon controlled rectifiers and tunnel diodes. Special video effects help to explain the complexities of tunnel diode operation. Comparisons are then drawn to other semiconductor devices.

#### PIN, SRD, and HC Diodes

**90030D332 Lesson 15 28 Mins.**

Part 15 explains step recovery diodes, hot carrier diodes, and PIN diodes, and outlines their typical applications. The series concludes with a short presentation on how the many special video effects were created for the various tapes in the series.

#### How to Use an Oscilloscope Series

**90741D 1 hr, 16 Mins.**

The oscilloscope is one of the most versatile and widely used electronic test instruments. However, for best results it must be used properly. The purpose of this 3 videotape series, in color, is to train electronic technicians in the basic techniques of waveform measurement, using an oscilloscope. The HP1740A general purpose scope and the HP1741A storage scope are used in this series. However, the information presented will also help you operate other scopes.

#### Front Panel Controls

**90742D Part I 27 Mins.**

This videotape will show you how to:

- measure the peak-to-peak ac voltage, time period, frequency and dc component (if any) of a waveform;
- measure low level signals such as power supply ripple;
- trigger or synchronize the scope to obtain a stable display on the CRT; and
- avoid errors in control settings that could lead to measurement inaccuracies.

#### Front Panel Controls (cont.)

**90743D Part II 24 Mins.**

This program completes the coverage of the front panel controls of a general purpose oscilloscope. In Part I, only single channel operation was covered. This program covers dual channel operation. You will see how to operate a scope in the dual trace, A + B, A - B, and A versus B modes. Also covered are selectable and composite triggering, trigger view mode, bandwidth limit and delayed sweep operation.

#### Oscilloscope Measurements

**90744D Part III 25 Mins.**

This program completes the series. It shows you how to check your scope and probe to make sure they are operating properly. You'll see that one probe cannot be used for all measurements, so the three types of commonly available voltage probes are covered. Then you will see how to make some typical oscilloscope voltage and time measurements. Finally, storage scopes are covered. You will see how they can help you solve the problem of viewing low rep-rate signals and one-shot events. The program ends with a short summary.

#### How to Solder

**90751D 35 Mins.**

This program is especially useful for training new hires who will work in electronic

manufacturing and servicing—including those persons who believe they already know how to solder and unsolder properly.

Part I (16 minutes) covers:

- What is soldering Flux
- Wetting Soldering Irons
- Solder Tinning

Part 2 (19 minutes) shows:

- How to clean parts to be soldered
- The four basic soldering steps
- How to recognize a good solder connection
- How to unsolder, using the vacuum bulb, the solder-sucker, and the desoldering wick.

The program ends with a summary and a self-scoring quiz.

#### Ordering Information

To order video programs, books, the HP 5035T Logic Lab or the 5036A Microprocessor Lab, please contact your local Hewlett-Packard sales office. Addresses are listed on pages 667-672.

#### HP Product Number

**90100A, -B, or -D** Practical Transistors (15 monochrome videocassettes plus a textbook, work-book, and problem sets)  
**90301RA, -B, or -D** Digital Understanding Microprocessors (5 videocassettes, plus a textbook/experiment book, and study guide).

Lab experiments are used to reinforce learning. They require access to a microprocessor lab such as the HP 5036A.

**90420A, -B, or -D** Digital Troubleshooting (14 videocassettes, plus a textbook, lab work-book, and a study guide)

Lab experiments are used to reinforce learning. They require access to a digital experimenter's kit such as the HP 5035T Logic Lab.

**90741A, -B, or -D** How to Use an Oscilloscope Series

**90751A, -B, or -D** How to Solder

**90302RA, -B, or -D** What is a Microprocessor?

**90303RA, -B, or -D** Analog vs Digital Systems

**90304RA, -B, or -D** Introduction to Programming

**90305RA, -B, or -D** Processor Registers and Instruction Set

**90306RA, -B, or -D** Simple Assembly Programming

**90308RA, -B, or -D** Algorithmic State Machines

**90309RA, -B, or -D** Basic Design & Terminology of Microcomputers

Local taxes, shipping and handling will be added to all orders.

Video programs are supplied in NTSC, the U.S. television standard. Some programs can be supplied in the PAL standard.

Videocassette formats are identified by an alpha suffix: A is for VHS(SP), B is for BETA I, and D is for ¾" U-matic.

Domestic U.S. Prices only.

\*Not eligible for quantity discount.



# POST-SALE SUPPORT SERVICE

## Instrument Support

Training, Consulting, and Maintenance Support

- Training conducted by instrumentation system specialists
- Consulting helps you solve your system application problems
- Maintenance and calibration support available world-wide

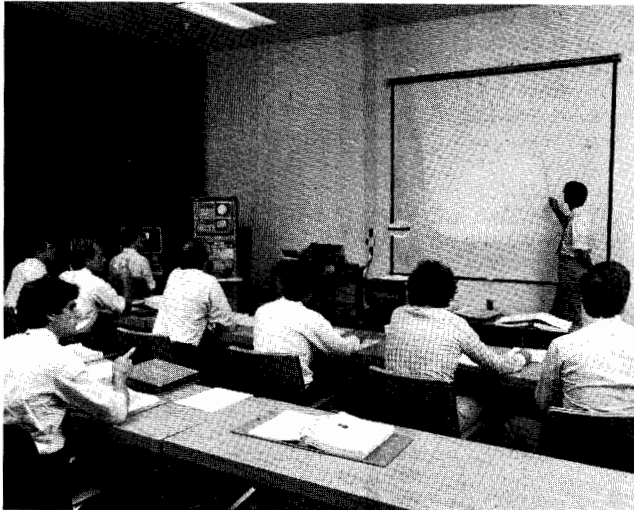

### Overview—Support Plans to Fit Your Needs

Hewlett-Packard is dedicated to insuring that its customers have reliable, high quality instrumentation that provides the measurement capability required for the particular application. We recognize that an important part of the choice of any instrumentation system is the support that the supplier can provide. HP offers a wide variety of support programs to insure that the instrument is properly maintained and calibrated either at HP maintenance facilities or on-site. HP also offers training and consulting programs to help you be successful.

### Training—Helps You be Successful

Essential to the success of any measurement application is knowledge of measurement techniques and instrumentation capabilities. For more efficient utilization of HP products, systems and software, HP offers a wide variety of customer training courses at HP locations around the world. Training gives you a boost up the learning curve by helping you to quickly acquire the knowledge it takes to become productive using the full capabilities of your measurement system. Experienced Systems Engineers teach courses ranging from general introduction to advanced training on specific products or applications. HP also provides service seminars covering theory of operation, service techniques, and component level repair for selected electronic instruments. Training courses can also be scheduled for presentation at your location. Contact your local HP office for a training schedule which includes course descriptions, training locations and dates.

### Consulting—Providing You Specialized Technical Assistance

When you require help beyond the scope of existing HP customer training programs, Hewlett-Packard consulting services provide this assistance in a way which will most efficiently serve your specific needs. As with our customer training programs, the primary goal is to provide you with the knowledge necessary to fulfill your measurement and testing needs through efficient utilization of your HP products. An HP Systems Engineer, trained and experienced in your application area is made available for consultation. Instrumentation consulting services are available by contacting your nearest HP sales office or by conferring with your HP Field Engineer or HP Systems Engineer.

### System Support—Responsive to Your On-Site Maintenance and Calibration Needs

We firmly believe that our obligation to you as a customer goes beyond delivery of your new HP product. This philosophy is implemented in two ways; (1) by designing and building excellent products with good serviceability, and (2) by backing those products with innovative customer support programs which quickly respond to all your needs. These services are available at your site, or at HP Repair Centers located around the world. Additional information is available from your HP Field Engineer or Sales Office.

HP customer support programs provide responsive instrumentation on-site services throughout the world. These programs are one of the major reasons for Hewlett-Packard's reputation of integrity and responsibility.

**Contractual On-Site Support:** HP offers a number of on-site support services under the Customer Support Services Agreement (CSSA) for HP measurement systems products. This ongoing agreement features a known cost billed on a periodic basis and can be added to as required. These support programs provide a choice among optional levels of response, hours of coverage, critical instrument sparing, and calibration.

**Per-Call On-Site Support:** Per-call service can meet your need for repairs, installation, site planning, site surveys, calibrations, preventive maintenance, safety and performance checks, overhauls, and technical assistance.

**Travel for On-Site Service:** Hewlett-Packard routinely provides its on-site services within defined travel areas of each country where the products are sold. In many instances these travel areas encompass the entire country. However, there are instances which prohibit routine travel such as geographical obstacles, underdeveloped roads, or unsuitable public transportation. In such cases these areas will be excluded from routine travel.

### Return-to-HP Repair—Quality Maintenance and Calibration for Your Instruments

**Agreements:** Return-to-HP repair agreements provide you ongoing support through a variety of service programs for instruments and measurement systems. HP instrument repair centers located around the world support HP instrument products under several CSSA programs. A Calibration Agreement assures ongoing instrument performance checks at either HP or customer recommended intervals. A Repair Agreement provides an insurance policy for instrument failures resulting from normal use. Both these services can be obtained under a Full Service Agreement.

**Per-Incident Services:** Maintenance and calibration services provide you support when you need it. For many Hewlett-Packard products, the labor and parts costs for repair of failures resulting from normal use have been combined into a convenient Standard Repair charge which can be quoted prior to the repair. If a Standard Repair charge has not been established, per-incident services are performed on a time and material basis.

### Replacement Parts and Supplies—Compatible and Reliable

Replacement parts play a key role in Hewlett-Packard's customer support services program. Hewlett-Packard strategically located parts centers supply parts to both HP field operations and our customers. HP's field operations maintain extensive part inventories at repair centers and local service offices to assure prompt repair of your product.

The reliability and product life of HP products can be enhanced by the use of quality operating supplies. Hewlett-Packard provides a complete selection of high quality supplies. Separate catalogs describing the supplies for each product line are available from your local HP office.

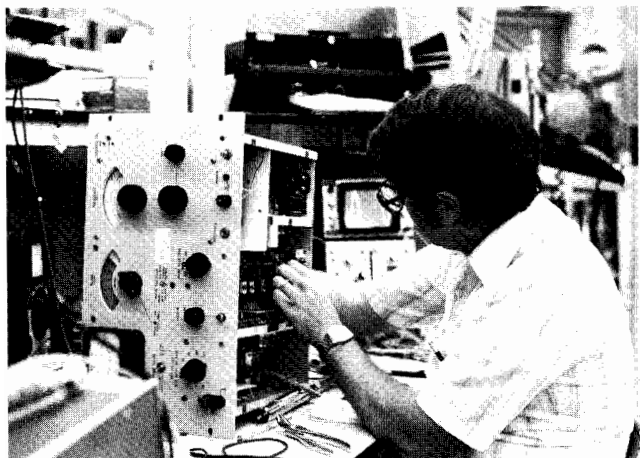

and incorporated herein. The warranty period begins either on the date of shipment or, where the purchase price includes installation by HP, on the date of installation. If Buyer schedules or delays installation more than thirty (30) days after delivery, the warranty period begins on the thirty first (31st) day from the date of shipment.

c. **PLACE OF PERFORMANCE:** Within HP service travel areas, warranty and installation services for products installed by HP and certain other products designated by HP will be performed at Buyer's facility at no charge. Outside HP's service travel areas, warranty and installation services will be performed at Buyer's facility only upon HP's prior agreement and Buyer shall pay HP's round trip travel expenses and applicable additional expenses for such services.

On-site warranty services are provided only at the initial installation point. If products eligible for on-site warranty and installation services are moved from the initial installation point, the warranty will remain in effect only if Buyer purchases additional inspection or installation services at the new site.

Installation and on-site warranty services are available outside the country of initial purchase only if Buyer pays HP international prices. If Buyer transports a product from the country of initial purchase without having paid HP international prices, any remaining warranty covers parts and labor only and applies only if the product is returned to HP. However, Buyer may obtain on-site warranty service if the location is one where HP can normally provide on-site service for the product and the Buyer pays HP established travel charges. Service outside the country of initial purchase is subject to the conditions regarding HP service travel areas and initial installation point described above.

For product warranties requiring return to HP, products must be returned to a service facility designated by HP. Warranties requiring return to HP are not limited to the country of purchase. Buyer shall prepay shipping charges (and shall pay all duties and taxes) for products returned to HP for warranty service. Except for products returned to Buyer from another country, HP shall pay for return of products to Buyer.

d. **LIMITATION OF WARRANTY:** The foregoing warranty does not apply to defects resulting from:

1. Improper or inadequate maintenance by Buyer;
2. Buyer supplied software or interfacing;
3. Unauthorized modification or misuse;
4. Operation outside of the environmental specifications of the product; or
5. Improper site preparation and maintenance.

**THE WARRANTY SET FORTH ABOVE IS EXCLUSIVE AND NO OTHER WARRANTY, WHETHER WRITTEN OR ORAL, IS EXPRESSED OR IMPLIED. HP SPECIFICALLY DISCLAIMS THE IMPLIED WARRANTIES OF MERCHANTABILITY AND FITNESS FOR A PARTICULAR PURPOSE.**

#### EXCLUSIVE REMEDIES

The remedies provided herein are Buyer's sole and exclusive remedies. In no event shall HP be liable for direct, indirect, special, incidental or consequential damages (including loss of profits) whether based on contract, tort, or any other legal theory.

#### Certification—Traceability of Measurements to Known Standards

Products provided by Hewlett-Packard are thoroughly tested and calibrated to meet their published specifications. A Certificate of Conformance (certifying that the product meets its published specifications and that its calibration is traceable to appropriate National Standards) is available upon request at the time of purchase.

Hewlett-Packard's calibration measurements are traceable to National Standards—the National Bureau of Standards in the United States and to Standards authorities of comparable standing in other countries of manufacture.

#### Service Publications—Help You Maintain Your Instruments

The *Operating and Service Manual* supplied with Hewlett-Packard instrumentation contains maintenance, calibration, diagnostic and repair procedures, with troubleshooting charts circuit diagrams, and replacement parts lists. Most operating and service manuals, manual updates, and Service Notes are now available on COSATI standard, positive microfiche.

Bench Briefs, a periodic newsletter, has information to help repair and maintenance personnel get maximum performance from Hewlett-Packard instruments. It describes new Service Notes and other company publications as they become available. To become a regular subscriber, ask your local HP office to place your name on the mailing list.

#### Warranty—Confidence in Quality and Reliability

As an expression of confidence that our products will continue to meet the high standards of reliability and performance that our customers expect, Hewlett-Packard products carry the following warranty:

HP hardware products are warranted against defects in materials and workmanship. If HP receives notice of such defects during the warranty period, HP shall, at its option, either repair or replace hardware products which prove to be defective.

HP software and firmware products which are designated by HP for use with a hardware product, when properly installed on that hardware product, are warranted not to fail to execute their programming instructions due to defects in materials and workmanship. If HP receives notice of such defects during the warranty period, HP shall repair or replace software media and firmware which do not execute their programming instructions due to such defects. HP does not warrant that the operation of the software, firmware or hardware shall be uninterrupted or error free.

If HP is unable, within a reasonable time, to repair or replace any product to a condition as warranted, Buyer shall be entitled to a refund of the purchase price upon return of the product to HP.

a. **SUPPLEMENTAL STATEMENT:** Supplemental statements setting forth the duration and implementation of warranty and installation are available for most product types. These statements, if applicable to purchased products, are attached hereto and incorporated herein.

b. **DURATION AND COMMENCEMENT OF WARRANTY PERIOD:** The warranty period for each product is specified in the supplemental statement of warranty and installation attached hereto

# ORDERING INFORMATION

## Shipping, Prices, and Terms of Sale



### Communicating With HP

Hewlett-Packard is committed to providing convenient local support and the best possible attention to customer needs on a worldwide basis. There are more than 172 sales offices and representatives, many of which provide service, located in 65 countries; a listing of these offices commences on page 667.

Your entry point to the resources of Hewlett-Packard is through the local HP office nearest you. Our sales representatives and order support specialists there are well-equipped to provide you with pre-sale assistance in product selection, as well as related business information such as current product availability and price delivered to your location.

Many HP sales offices are tied into a sophisticated intra-company communications system. This not only means prompt transmission of orders to any HP product responsible division—it also speeds the flow of regular messages among HP sales offices and factories. The objective, of course, is to provide the fastest possible response to your product interests.

### Placing Your Order

Hewlett-Packard people at the sales office nearest you will be pleased to provide assistance in selecting the HP equipment most appropriate to your needs, and to help you prepare your order.

The information in this catalog will, in many cases, be sufficient for you to decide to buy a particular HP product. In those instances, a telephone call to the nearest HP office will provide you with (1) information

on product availability, and (2) the product's price.

HP wants to be sure the product delivered to you is exactly the one you want. Therefore, when placing your order, please specify the product's catalog (model, accessory, or part) number, as well as the product's name. Be as complete as possible in specifying exactly what you'd like, including standard options.

In the event you want special features or capabilities such as different color or a non-standard power line voltage, ask your HP sales representative about availability and cost of these "specials" first—and then, to prevent misunderstandings, include special instructions and specification details with your order.

### Shipping Methods

**Inside the USA:** Shipments to destinations in the USA are made directly from factories or local warehouses. Unless specifically requested otherwise, express or truck transportation is used, whichever is less expensive and most serviceable to you. Small items are sent parcel post or UPS. If fast delivery is needed, we gladly ship by air freight, air express, or air parcel post, when specified on your order, at prevailing rates. In many parts of the USA, a consolidated air freight service provides the speed of air transport at surface rates. Ask your HP sales representative for details.

**Outside the USA:** Shipments to destinations outside the USA are made from the appropriate Hewlett-Packard facility by either surface or air, as requested. Sea shipments usually require commercial export packaging at a nominal extra charge.

### Budgetary Prices

Price information which may be supplied with this catalog provides you with helpful budgetary guidance.

Please call your nearby Hewlett-Packard sales office to determine a product's delivered price.

Prices furnished with this catalog are net prices prevailing at the time of printing. Hewlett-Packard reserves the right to change prices, and those prices prevailing at the time an order is received will apply.

### Quotations and Pro Forma Invoices

Destination prices and other details you may need to know before ordering can be quickly obtained via telephone. Just call your nearest HP office.

If you are an international customer requiring formal paperwork such as pro forma invoices or quotations, please contact the Hewlett-Packard office or representative serving your area. Exportation or importation assistance is also available.

### Terms of Sale

**Inside the USA:** Hewlett-Packard's standard credit terms for established customers in the USA are net 30 days from invoice date. If credit with Hewlett-Packard has not already been established, shipments will be made COD or on receipt of cash in advance.

Leasing and extended financial terms are available. However, the associated costs are not included in any product prices furnished with this catalog. Your nearby HP office will be pleased to discuss your requirements and work with you in setting up an appropriate program.

**Outside the USA:** Terms for orders placed on Hewlett-Packard Company by customers outside the USA are irrevocable letters of credit or cash in advance—unless other terms have been previously arranged. Please contact authorized Hewlett-Packard international subsidiaries or distributors regarding terms for orders placed with them.

### U.S. Government Sales

Some products in this catalog are covered on GSA federal supply schedule multi-award contracts.

### Product Changes

Although product information and illustrations in this catalog were current at the time it was approved for printing, Hewlett-Packard, in a continuing effort to offer excellent products at a fair value, reserves the right to change specifications, designs, and models without notice.

# SALES & SUPPORT OFFICES

## Arranged Alphabetically by Country



### Product Line Sales/Support Key

#### Key Product Line

<b>A</b>	Analytical
<b>CM</b>	Components
<b>C</b>	Computer Systems Sales only
<b>CH</b>	Computer Systems Hardware Sales and Services
<b>CS</b>	Computer Systems Software Sales and Services
<b>E</b>	Electronic Instruments & Measurement Systems
<b>M</b>	Medical Products
<b>MP</b>	Medical Products Primary SRO
<b>MS</b>	Medical Products Secondary SRO
<b>P</b>	Personal Computation Products
<b>.</b>	Sales only for specific product line
<b>..</b>	Support only for specific product line

**IMPORTANT:** These symbols designate general product line capability. They do not insure sales or support availability for all products within a line, at all locations. Contact your local sales office for information regarding locations where HP support is available for specific products.

*HP distributors are printed in italics.*

### ANGOLA

*Telectra*  
*Empresa Técnica de Equipamentos*  
*Eléctricos, S.A.R.L.*  
*R. Barbosa Rodrigues, 41-I DT.*  
*Caixa Postal 6487*  
**LUANDA**  
*Tel: 355 15.355 16*  
*E,M,P*

### ARGENTINA

Hewlett-Packard Argentina S.A.  
 Avenida Sanla Fe 2035  
 Martínez 1640 **BUENOS AIRES**  
 Tel: 798-5735, 792-1293  
 Telex: 17595 BIONAR  
 Cable: HEWPACKARG  
 A,E,CH,CS,P

*Biotron S.A.C.I.M. e I.*  
*Av Paseo Colon 221, Piso 9*  
*1399 BUENOS AIRES,*  
*Tel: 30-4846, 30-1851*  
*Telex: 17595 BIONAR*  
**M**

*Fale S.A. I.C.I. Electronica*  
*Venezuela 1326*  
*1095 BUENOS AIRES*  
*Tel: 37-9020, 37-9026/9*  
*Telex: 9234 FATEN AR*  
**P**

### AUSTRALIA

#### Adelaide, South Australia Office

Hewlett-Packard Australia Ltd.  
 153 Greenhill Road  
**PARKSIDE, S.A. 5063**  
 Tel: 272-5911  
 Telex: 82536  
 Cable: HEWPARAD Adelaide  
 A\*,CH,CM,,E,MS,P

#### Brisbane, Queensland Office

Hewlett-Packard Australia Ltd.  
 49 Park Road  
**MILTON, Queensland 4064**  
 Tel: 229-1544  
 Telex: 42133  
 Cable: HEWPARAD Brisbane  
 A,CH,CM,E,M,P  
 Effective November 1, 1982:  
 10 Payne Road  
**THE GAP, Queensland 4061**  
 Tel: 30-4133  
 Telex: 42133

### Canberra, Australia Capital Territory Office

Hewlett-Packard Australia Ltd.  
 121 Wollongong Street  
**FYSHWICK, A.C.T. 2609**  
 Tel: 80 4244  
 Telex: 62650  
 Cable: HEWPARAD Canberra  
 CH,CM,E,P

### Melbourne, Victoria Office

Hewlett-Packard Australia Ltd.  
 31-41 Joseph Street  
**BLACKBURN, Victoria 3130**  
 Tel: 877 7777  
 Telex: 31-024  
 Cable: HEWPARAD Melbourne  
 A,CH,CM,CS,E,MS,P

### Perth, Western Australia Office

Hewlett-Packard Australia Ltd.  
 261 Stirling Highway  
**CLAREMONT, W.A. 6010**  
 Tel: 383-2188  
 Telex: 93859  
 Cable: HEWPARAD Perth  
 A,CH,CM,,E,MS,P

### Sydney, New South Wales Office

Hewlett-Packard Australia Ltd.  
 17-23 Talavera Road  
 P.O. Box 308  
**NORTH RYDE, N.S.W. 2113**  
 Tel: 887-1611  
 Telex: 21561  
 Cable: HEWPARAD Sydney  
 A,CH,CM,CS,E,MS,P

### AUSTRIA

Hewlett-Packard Ges.m.b.h.  
 Grottenhofstrasse 94  
 Verkaufsburo Graz  
**A-8052 GRAZ**  
 Tel: 291-5-66  
 Telex: 32375  
 CH,E\*

Hewlett-Packard Ges.m.b.h.  
 Stanghofweg 5  
**A-4020 LINZ**  
 Tel: 0732 51585  
 CH

Hewlett-Packard Ges.m.b.h.  
 Liebigasse 1  
 P.O. Box 72  
**A-1222 VIENNA**  
 Tel: (0222) 23-65-11-0  
 Telex: 134425 HEPA A  
 A,CH,CM,CS,E,MS,P

### BAHRAIN

*Green Salon*  
*P.O. Box 557*  
**BAHRAIN**  
*Tel: 255503-255950*  
*Telex: 844 19*  
**P**  
*Wael Pharmacy*  
*P.O. Box 648*  
**BAHRAIN**  
*Tel: 256 123*  
*Telex: 8550 WAEI BN*  
**M, E**

### BELGIUM

Hewlett-Packard Belgium S.A./N.V.  
 Blvd de la Woluwe, 100  
 Woluwedal  
**B-1200 BRUSSELS**  
 Tel: (02) 762-32-00  
 Telex: 23-494 paloben bru  
 A,CH,CM,CS,E,MP,P

### BRAZIL

Hewlett-Packard do Brasil I.e.C.  
 Ltda.  
 Alameda Rio Negro, 750  
 Alphaville 06400 **BARUERI SP**  
 Tel: (11) 421-1311  
 Telex: 01 133872 HPBR-BR  
 Cable: HEWPACK Sao Paulo  
 A,CH,CM,CS,E,M,P  
 Hewlett-Packard do Brasil I.e.C.  
 Ltda.  
 Avenida Epitacio Pessoa, 4664  
 22471 **RIO DE JANEIRO-RJ**  
 Tel: (21) 286-0237  
 Telex: 021-21905 HPBR-BR  
 Cable: HEWPACK Rio de Janeiro  
 A,CH,CM,E,MS,P\*

### CANADA

**Alberta**  
 Hewlett-Packard (Canada) Ltd.  
 210, 7220 Fisher Street S.E.  
**CALGARY, Alberta T2H 2H8**  
 Tel: (403) 253-2713  
 A,CH,CM,E\*,MS,P\*  
 Hewlett-Packard (Canada) Ltd.  
 11620A-168th Street  
**EDMONTON, Alberta T5M 3T9**  
 Tel: (403) 452-3670  
 A,CH,CM,CS,E,MS,P\*

### British Columbia

Hewlett-Packard (Canada) Ltd.  
 10691 Shellbridge Way  
**RICHMOND,**  
 British Columbia V6X 2W7  
 Tel: (604) 270-2277  
 Telex: 610-922-5059  
 A,CH,CM,CS,E\*,MS,P\*

### Manitoba

Hewlett-Packard (Canada) Ltd.  
 380-550 Century Street  
**WINNIPEG, Manitoba R3H 0Y1**  
 Tel: (204) 786-6701  
 A,CH,CM,E,MS,P\*

### New Brunswick

Hewlett-Packard (Canada) Ltd.  
 37 Sheadiac Road  
**MONCTON, New Brunswick E2B 2V0**  
 Tel: (506) 855-2841  
 CH\*\*

### Nova Scotia

Hewlett-Packard (Canada) Ltd.  
 P.O. Box 931  
 900 Windmill Road  
**DARTMOUTH, Nova Scotia B2Y 3Z6**  
 Tel: (902) 469-7820  
 CH,CM,CS,E\*,MS,P\*

### Ontario

Hewlett-Packard (Canada) Ltd.  
 552 Newbold Street  
**LONDON, Ontario N6E 2S5**  
 Tel: (519) 686-9181  
 A,CH,CM,E\*,MS,P\*  
 Hewlett-Packard (Canada) Ltd.  
 6877 Goreway Drive  
**MISSISSAUGA, Ontario L4V 1M8**  
 Tel: (416) 678-9430  
 A,CH,CM,CS,E,MP,P  
 Hewlett-Packard (Canada) Ltd.  
 2670 Queensview Dr.  
**OTTAWA, Ontario K2B 8K1**  
 Tel: (613) 820-6483  
 A,CH,CM,CS,E\*,MS,P\*  
 Hewlett-Packard (Canada) Ltd.  
 220 Yorkland Blvd., Unit #11  
**WILLOWDALE, Ontario M2J 1R5**  
 Tel: (416) 499-9333  
 CH

### Quebec

Hewlett-Packard (Canada) Ltd.  
 17500 South Service Road  
 Trans-Canada Highway  
**KIRKLAND, Quebec H9J 2M5**  
 Tel: (514) 697-4232  
 A,CH,CM,CS,E,MP,P\*  
 Hewlett-Packard (Canada) Ltd.  
 Les Galeries du Vallon  
 2323 Du Versant Nord  
**STE. FOY, Quebec G1N 4C2**  
 Tel: (418) 687-4570  
 CH

### CHILE

*Jorge Calcagni y Cia. Ltda.*  
*Arturo Burihe 065*  
*Casilla 16475*  
**SANTIAGO 9**  
 Tel: 222-0222  
 Telex: Public Booth 440001  
 A,CM,E,M  
*Olympia (Chile) Ltda.*  
*Av. Rodrigo de Araya 1045*  
*Casilla 256-V*  
**SANTIAGO 21**  
 Tel: 2-25-50-44  
 Telex: 340-892 OLYMP CK  
 Cable: Olympiachile Santiagochile  
 CH,CS,P

### CHINA, People's Republic of

*China Hewlett-Packard Rep. Office*  
*P.O. Box 418*  
*1A Lane 2, Luchang St.*  
*Beiwei Rd., Xuanwu District*  
**BEIJING**  
 Tel: 33-1947, 33-7426  
 Telex: 22601 CTSHP CN  
 Cable: 1920  
 A,CH,CM,CS,E,P

### COLOMBIA

*Instrumentación*  
*H. A. Langebaek & Kier S.A.*  
*Carrera 7 No. 48-75*  
*Apartado Aereo 6287*  
**BOGOTA 1, D.E.**  
 Tel: 287-8877  
 Telex: 44400 INST CO  
 Cable: AARIS Bogota  
 A,CM,E,M,PS,P

### COSTA RICA

*Cientifica Costarricense S.A.*  
*Avenida 2, Calle 5*  
*San Pedro de Montes de Oca*  
*Apartado 10159*  
**SAN JOSE**  
 Tel: 24-38-20, 24-08-19  
 Telex: 2367 GALGUR CR  
 CM,E,MS,P

### CYPRUS

*Telerexa Ltd.*  
*P.O. Box 4809*  
*14C Sissinos Avenue*  
**NICOSIA**  
 Tel: 62698  
 Telex: 2894 LEVIDO CY  
 E,M,P

### DENMARK

Hewlett-Packard A/S  
 Datavej 52  
**DK-3460 Birkerød**  
 Tel: (02) 81-66-40  
 Telex: 37409 hpas dk  
 A,CH,CM,CS,E,MS,P  
 Hewlett-Packard A/S  
 Navervej 1  
**DK-8600 SILKEBORG**  
 Tel: (06) 82-71-66  
 Telex: 37409 hpas dk  
 CH,E

### ECUADOR

*CYDE Cia. Ltda.*  
*Avenida Eloy Alfaro 1749*  
*Casilla 6423 CCI*  
**QUITO**  
 Tel: 450-975, 243-052  
 Telex: 2548 CYEDE ED  
 A,CM,E,P  
*Hospitalar S.A.*  
*Robles 625*  
*Casilla 3590*  
**QUITO**  
 Tel: 545-250, 545-122  
 Telex: 2485 HOSPTL ED  
 Cable: HOSPITALAR-Quito  
**M**

### EGYPT

*International Engineering Associates*  
*24 Hussein Hegazi Street*  
*Kast-el-Aini*  
**CAIRO**  
 Tel: 23829, 21641  
 Telex: IEA UN 93830  
 CH,CS,E,M  
*Informatic For Systems*  
*22 Talaal Harb Street*  
**CAIRO**  
 Tel: 759006  
 Telex: 93938 FRANK UN  
 CH,CS,P  
*Egyptian International Office*  
*for Foreign Trade*  
*P.O.Box 2558*  
**CAIRO**  
 Tel: 650021  
 Telex: 93337 EGPOR  
**P**

### EL SALVADOR

*IPESA de El Salvador S.A.*  
*29 Avenida Norte 1216*  
**SAN SALVADOR**  
 Tel: 26-6858, 26-6868  
 Telex: Public Booth 20107  
 A,CH,CM,CS,E,P

### FINLAND

Hewlett-Packard Oy  
 Revontulientie 7  
**SF-02100 ESPOO 10**  
 Tel: (90) 455-0211  
 Telex: 121563 hewpa sf  
 A,CH,CM,CS,E,MS,P  
 Hewlett-Packard Oy  
 Aatoksenkatu 10-C





# SALES & SUPPORT OFFICES

Arranged Alphabetically by Country

SF-40720-72 JYVASKYLA

Tel: (941) 216318  
CH

Hewlett-Packard Oy  
Kainvuntie 1-C  
SF-90140-14 OULU  
Tel: (981) 338785  
CH

## FRANCE

Hewlett-Packard France  
Z.I. Mercure B  
Rue Berthelot  
F-13763 Les Milles Cedex  
**AIX-EN-PROVENCE**  
Tel: (42) 59-41-02  
Telex: 410770F  
A,CH,E,MS,P\*

Hewlett-Packard France  
Boite Postale No. 503  
F-25026 BESANCON  
28 Rue de la Republique  
F-25000 BESANCON  
Tel: (81) 83-16-22  
CH,M

Hewlett-Packard France  
Bureau de Vente de Lyon  
Chemin des Mouilles  
Boite Postale 162  
F-69130 ECULLY Cédex  
Tel: (7) 833-81-25  
Telex: 310617F  
A,CH,CS,E,MP

Hewlett-Packard France  
Immeuble France Evry  
Tour Lorraine  
Boulevard de France  
F-91035 EVRY Cédex  
Tel: (6) 077-96-60  
Telex: 692315F  
E

Hewlett-Packard France  
5th Avenue Raymond Chanas  
F-38320 EYBENS  
Tel: (76) 25-81-41  
Telex: 980124 HP GRENOB EYBE  
CH

Hewlett-Packard France  
Centre d'Affaire Paris-Nord  
Bâtiment Ampère 5 etage  
Rue de la Commune de Paris  
Boite Postale 300  
F-93153 LE BLANC MESNIL  
Tel: (01) 865-44-52  
Telex: 211032F  
CH,CS,E,MS

Hewlett-Packard France  
Parc d'Activites Cadera  
Quartier Jean Mermoz  
Avenue du President JF Kennedy  
F-33700 MERIGNAC  
Tel: (56) 34-00-84  
Telex: 550105F  
CH,E,MS

Hewlett-Packard France  
32 Rue Lothaire  
F-57000 METZ  
Tel: (8) 765-53-50  
CH

Hewlett-Packard France  
Immeuble Les 3 B  
Nouveau Chemin de la Garde  
Z.A.C. de Bois Briand  
F-44085 NANTES Cedex  
Tel: (40) 50-32-22  
CH\*\*

Hewlett-Packard France  
Zone Industrielle de Courtaboeuf  
Avenue des Tropiques  
F-91947 Les Ulis Cédex ORSAY  
Tel: (6) 907-78-25  
Telex: 600048F  
A,CH,CM,CS,E,MP,P

Hewlett-Packard France  
Paris Porte-Maillet  
15, Avenue De L'Amiral Bruix  
F-75782 PARIS 16  
Tel: (1) 502-12-20  
Telex: 613663F  
CH,MS,P

Hewlett-Packard France  
2 Allee de la Bourgonette  
F-35100 RENNES  
Tel: (99) 51-42-44  
Telex: 740912F  
CH,CM,E,MS,P\*

Hewlett-Packard France  
98 Avenue de Bretagne  
F-76100 ROUEN  
Tel: (35) 63-57-66 CH\*\*,CS

Hewlett-Packard France  
4 Rue Thomas Mann  
Boite Postale 56  
F-67200 STRASBOURG  
Tel: (88) 28-56-46  
Telex: 890141F  
CH,E,MS,P\*

Hewlett-Packard France  
Pericentre de la Capière  
F-31081 TOULOUSE Cedex  
Tel: (61) 40-11-12  
Telex: 531639F  
A,CH,CS,E,P\*

Hewlett-Packard France  
Immeuble Péricentre  
F-59658 VILLENEUVE D'ASCQ Cedex  
Tel: (20) 91-41-25  
Telex: 160124F  
CH,E,MS,P\*

## GERMAN FEDERAL REPUBLIC

Hewlett-Packard GmbH  
Technisches Büro Berlin  
Keithstrasse 2-4  
D-1000 BERLIN 30  
Tel: (030) 24-90-86  
Telex: 018 3405 hpbm d  
A,CH,E,M,P

Hewlett-Packard GmbH  
Technisches Büro Böblingen  
Herrenberger Strasse 110  
D-7030 BOBLINGEN  
Tel: (07031) 667-1  
Telex: bbn or  
A,CH,CM,CS,E,MP,P

Hewlett-Packard GmbH  
Technisches Büro Dusseldorf  
Emanuel-Leutze-Strasse 1  
D-4000 DUSSELDORF  
Tel: (0211) 5971-1  
Telex: 085/86 533 hppd d  
A,CH,CS,E,MS,P

Hewlett-Packard GmbH  
Vertriebszentrale Frankfurt  
Berner Strasse 117  
Postfach 560 140  
D-6000 FRANKFURT 56  
Tel: (0611) 50-04-1  
Telex: 04 13249 hpfm d  
A,CH,CM,CS,E,MP,P

Hewlett-Packard GmbH  
Technisches Büro Hamburg  
Kapstadttring 5  
D-2000 HAMBURG 60  
Tel: (040) 63804-1  
Telex: 021 63 032 hphd d  
A,CH,CS,E,MS,P

Hewlett-Packard GmbH  
Technisches Büro Hannover  
Am Grossmarkt 6  
D-3000 HANNOVER 91  
Tel: (0511) 46-60-01  
Telex: 092 3259  
A,CH,CM,E,MS,P

Hewlett-Packard GmbH  
Technisches Büro Mannheim  
Rosslauer Weg 2-4  
D-6800 MANNHEIM  
Tel: (0621) 70050  
Telex: 0462105  
A,C,E

Hewlett-Packard GmbH  
Technisches Büro Neu Ulm  
Messerschmittstrasse 7  
D-7910 NEU ULM  
Tel: 0731-70241  
Telex: 0712816 HP ULM-D  
A,C,E\*

Hewlett-Packard GmbH  
Technisches Büro Nürnberg  
Neumeyerstrasse 90  
D-8500 NÜRNBERG  
Tel: (0911) 52 20 83-87  
Telex: 0623 860  
CH,CM,E,MS,P

Hewlett-Packard GmbH  
Technisches Büro München  
Eschenstrasse 5  
D-8028 TAUFKIRCHEN  
Tel: (089) 6117-1  
Telex: 0524985  
A,CH,CM,E,MS,P

## GREAT BRITAIN

Hewlett-Packard Ltd.  
Trafalgar House  
Navigation Road  
ALTRINCHAM  
Cheshire WA14 1NU  
Tel: (061) 928-6422  
Telex: 668068  
A,CH,CS,E,M

Hewlett-Packard Ltd.  
Oakfield House, Oakfield Grove  
Clifton  
BRISTOL BS8 2BN, Avon  
Tel: (027) 38606  
Telex: 444302  
CH,M,P

Hewlett-Packard Ltd.  
(Pinewood)  
Nine Mile Ride  
EASTHAMPTSTEAD  
Wokingham  
Berkshire, 3RG11 3LL  
Tel: 3446 3100  
Telex: 84-88-05  
CH,CS,E

Hewlett-Packard Ltd.  
Fourier House  
257-263 High Street  
LONDON COLNEY  
Herts., AL2 1HA, St. Albans  
Tel: (0727) 24400  
Telex: 1-8952716  
CH,CS,E

Hewlett-Packard Ltd  
Tradax House, St. Mary's Walk  
MAIDENHEAD  
Berkshire, SL6 1ST  
Tel: (0628) 39151  
CH,CS,E,P

Hewlett-Packard Ltd.  
Quadrangle  
106-118 Station Road  
REDHILL, Surrey  
Tel: (0737) 68655  
Telex: 947234 CH,CS,E  
Hewlett-Packard Ltd.  
Avon House  
435 Stratford Road  
SHIRLEY, Solihull  
West Midlands B90 4BL  
Tel: (021) 745 8800  
Telex: 339105  
CH

Hewlett-Packard Ltd.  
West End House 41  
High Street, West End  
SOUTHAMPTON  
Hampshire SO3 3DO  
Tel: (703) 886767  
Telex: 477138  
CH

Hewlett-Packard Ltd.  
King Street Lane  
WINNERSH, Wokingham  
Berkshire RG11 5AR  
Tel: (0734) 784774  
Telex: 847178  
A,CH,E,M

## GREECE

Kostas Karayannis S.A.  
8 Omirou Street  
ATHENS 133  
Tel: 32 30 303, 32 37 371  
Telex: 215962 RKAR GR  
A,CH,CM,CS,E,M,P  
PLAISIO S.A.  
G. Gerardos  
24 Stournara Street  
ATHENS  
Tel: 36-11-160  
Telex: 221871  
P

## GUATEMALA

IPESA  
Avenida Reforma 3-48, Zona 9  
GUATEMALA CITY  
Tel: 316627, 314786  
Telex: 4192 TEL TRO GU  
A,CH,CM,CS,E,M,P

## HONG KONG

Hewlett-Packard Hong Kong, Ltd.  
G.P.O. Box 795  
5th Floor, Sun Hung Kai Centre  
30 Harbour Road  
HONG KONG  
Tel: 5-8323211  
Telex: 66678 HEWPA HX  
Cable: HEWPACK HONG KONG  
E,CH,CS,P

CET Ltd.  
1402 Tung Way Mansion  
199-203 Hennessy Rd.  
Wanchia, HONG KONG  
Tel: 5-729376  
Telex: 85148 CET HX  
CM  
Schmidt & Co. (Hong Kong) Ltd.  
Wing On Centre, 28th Floor  
Connaught Road, C.  
HONG KONG  
Tel: 5-455644  
Telex: 74766 SCHMX HX  
A,M

## ICELAND

Elding Trading Company Inc.  
Hafnarvöli-Tryggvagötu  
P.O. Box 895  
IS-REYKJAVIK  
Tel: 1-58-20, 1-63-03  
M

## INDIA

Blue Star Ltd.  
Sabri Complex II Floor  
24 Residency Rd.  
BANGALORE 560 025  
Tel: 55660  
Telex: 0845-430  
Cable: BLUESTAR  
A,CH,CM,CS,E

Blue Star Ltd.  
Band Box House  
Prabhadevi  
BOMBAY 400 025  
Tel: 422-3101  
Telex: 011-3751  
Cable: BLUESTAR  
A,M

Blue Star Ltd.  
Sahas  
414/2 Vir Savarkar Marg  
Prabhadevi  
BOMBAY 400 025  
Tel: 422-6155  
Telex: 011-4093  
Cable: FROSTBLUE  
A,CH,CM,CS,E,M  
Blue Star Ltd.

Kalyan, 19 Vishwas Colony  
Alkapuri, BORODA, 390 005  
Tel: 65235  
Cable: BLUE STAR  
A

Blue Star Ltd.  
7 Hare Street  
CALCUTTA 700 001  
Tel: 12-01-31  
Telex: 021-7655  
Cable: BLUESTAR  
A,M

Blue Star Ltd.  
133 Kodambakkam High Road  
MADRAS 600 034  
Tel: 82057  
Telex: 041-379  
Cable: BLUESTAR  
A,M

Blue Star Ltd.  
Bhandari House, 7th/8th Floors  
91 Nehru Place  
NEW DELHI 110 024  
Tel: 682547

Telex: 031-2463  
Cable: BLUESTAR  
A,CH,CM,CS,E,M  
Blue Star Ltd.  
15/16-C Wellesley Rd.  
PUNE 411 011  
Tel: 22775  
Cable: BLUE STAR  
A

Blue Star Ltd.  
2-2-47/1108 Bolarum Rd.  
SECUNDERABAD 500 003  
Tel: 72057  
Telex: 0155-459  
Cable: BLUEFROST  
A,E

Blue Star Ltd.  
T.C. 7/603 Poornima  
Maruthankuzhi  
TRIVANDRUM 695 013  
Tel: 65799  
Telex: 0884-259  
Cable: BLUESTAR  
E

## INDONESIA

BERCA Indonesia P.T.  
P.O.Box 496/JKT.  
Jl. Abdul Muis 62  
JAKARTA  
Tel: 373009  
Telex: 46748 BERSAL IA  
Cable: BERSAL JAKARTA  
P  
BERCA Indonesia P.T.  
Wisma Antara Bldg., 17th floor  
JAKARTA  
A,CS,E,M  
BERCA Indonesia P.T.  
P.O. Box 174/SBY.  
Jl. Kutei No. 11  
SURABAYA  
Tel: 68172  
Telex: 31146 BERSAL SB  
Cable: BERSAL-SURABAYA  
A\*,E,M,P

**IRAQ**

Hewlett-Packard Trading S.A.  
Service Operation  
Al Mansoor City 9B/3/7  
**BAGHDAD**  
Tel: 551-49-73  
Telex: 212-455 HEPAIRAQ IQ  
CH,CS

**IRELAND**

Hewlett-Packard Ireland Ltd.  
82/83 Lower Leeson St.  
**DUBLIN 2**  
Tel: (1) 60 88 00  
Telex: 30439  
A,CH,CM,CS,E,M,P  
*Cardiac Services Ltd.*  
*Kilmore Road*  
*Artane*  
**DUBLIN 5**  
Tel: (01) 35 1820  
Telex: 30439  
M

**ISRAEL**

*Eldan Electronic Instrument Ltd.*  
P.O. Box 1270  
**JERUSALEM 91000**  
16, Ohaliav St.  
**JERUSALEM 94467**  
Tel: 533 221, 553 242  
Telex: 25231 AB/PAKRD IL  
A

*Electronics Engineering Division*  
*Motorola Israel Ltd.*  
16 Kremenetski Street  
P.O. Box 25016  
**TEL-AVIV 67899**  
Tel: 3-338973  
Telex: 33569 Motil IL  
Cable: BASTEL Tel-Aviv  
CH,CM,CS,E,M,P

**ITALY**

Hewlett-Packard Italiana S.p.A.  
Traversa 99C  
Via Giulio Petroni, 19  
I-70 124 **BARI**  
Tel: (080) 41-07-44  
M  
Hewlett-Packard Italiana S.p.A.  
Via Martin Luther King, 38/111  
I-40 132 **BOLOGNA**  
Tel: (051) 402394  
Telex: 511630  
CH,E,MS

Hewlett-Packard Italiana S.p.A.  
Via Principe Nicola 43G/C  
I-95 126 **CATANIA**  
Tel: (095) 37-10-87  
Telex: 970291  
C,P

Hewlett-Packard Italiana S.p.A.  
Via G. Di Vittorio 9  
I-20063 **CERNUSCO SUL NAVIGLIO**  
Tel: (2) 903691  
Telex: 334632  
A,CH,CM,CS,E,MP,P  
Hewlett-Packard Italiana S.p.A.  
Via Nuova San Rocco a  
Capodimonte, 62/A  
I-80 131 **NAPLES**  
Tel: (081) 7413544  
Telex: 710698  
A,CH,E

Hewlett-Packard Italiana S.p.A.  
Viale G. Modugno 33  
I-16 156 **GENOVA PEGLI**  
Tel: (010) 68-37-07  
Telex: 215238  
E,C

Hewlett-Packard Italiana S.p.A.  
Via Turazza 14  
I-35 100 **PADOVA**  
Tel: (049) 664888  
Telex: 430315  
A,CH,E,MS

Hewlett-Packard Italiana S.p.A.  
Viale C. Pavese 340  
I-00 144 **ROMA**  
Tel: (06) 54831  
Telex: 610514  
A,CH,CM,CS,E,MS,P\*

Hewlett-Packard Italiana S.p.A.  
Corso Svizzera, 184  
I-10 149 **TORINO**  
Tel: (011) 74 4044  
Telex: 221079  
CH,E

**JAPAN**

Yokogawa-Hewlett-Packard Ltd.  
Inoue Building  
1-21-8, Asahi-cho  
**ATSUGI**, Kanagawa 243  
Tel: (0462) 28-0451  
CM,C\*,E

Yokogawa-Hewlett-Packard Ltd.  
Towa Building  
2-2-3, Kaigandori, Chuo-ku  
**KOBE**, 650, Hyogo  
Tel: (078) 392-4791  
C,E

Yokogawa-Hewlett-Packard Ltd.  
Kumagaya Asahi Yasoji Bldg 4F  
3-4 Chome Tsukuba  
**KUMAGAYA**, Sailama 360  
Tel: (0485) 24-6563  
CH,CM,E

Yokogawa-Hewlett-Packard Ltd.  
Asahi Shinbun Dai-ichi Seimei Bldg.,  
2F

4-7 Hanabata-cho  
**KUMAMOTO-SHI**, 860  
Tel: (0963) 54-7311  
CH,E

Yokogawa-Hewlett-Packard Ltd.  
Shin Kyoto Center Bldg. 5F  
614 Siokoji-cho  
Nishiruhigashi, Karasuma  
Siokoji-dori, Shimogyo-ku  
**KYOTO 600**  
Tel: 075-343-0921  
CH,E

Yokogawa-Hewlett-Packard Ltd.  
Mito Mitsui Building  
1-4-73, San-no-maru  
**MITO**, Ibaragi 310  
Tel: (0292) 25-7470  
CH,CM,E

Yokogawa-Hewlett-Packard Ltd.  
Sumitomo Seimei Nagoya Bldg.  
2-14-19, Meiki-Minami,  
Nakamura-ku  
**NAGOYA**, 450 Aichi  
Tel: (052) 571-5171  
CH,CM,CS,E,MS

Yokogawa-Hewlett-Packard Ltd.  
Chuo Bldg., 4th Floor  
5-4-20 Nishinakajima,  
Yodogawa-ku  
**OSAKA**, 532  
Tel: (06) 304-6021  
Telex: YHPOSA 523-3624  
A,CH,CM,CS,E,MP,P\*

Yokogawa-Hewlett-Packard Ltd.  
1-27-15, Yabe,  
**SAGAMIHARA** Kanagawa, 229  
Tel: 0427 59-1311  
Yokogawa-Hewlett-Packard Ltd.  
Shinjuku Dai-ichi Seimei 6F  
2-7-1, Nishi Shinjuku  
Shinjuku-ku, **TOKYO 160**  
Tel: 03-348-4611-5  
CH,E

Yokogawa-Hewlett-Packard Ltd.  
3-29-21 Takaida-Higashi  
Suginami-ku **TOKYO 168**  
Tel: (03) 331-6111  
Telex: 232-2024 YHPTOK  
A,CH,CM,CS,E,MP,P\*

Yokogawa-Hewlett-Packard Ltd.  
Daichi Asano Building 4F  
5-2-8, Oodori,  
**UTSUNOMIYA**, 320  
Tochigi  
Tel: (0286) 25-7155  
CH, CS, E

Yokogawa-Hewlett-Packard Ltd.  
Yasudaseimei Yokohama  
Nishiguchi Bldg.  
3-30-4 Tsuruya-cho  
Kanagawa-ku  
**YOKOHAMA**, Kanagawa, 221  
Tel: (045) 312-1252  
CH,CM,E

**JORDAN**

*Mouasher Cousins Company*  
P.O. Box 1387

**AMMAN**  
Tel: 24907, 39907  
Telex: 21456 SABCO JO  
CH,E,M,P

**KENYA**

*ADCOM Ltd., Inc., Kenya*  
P.O. Box 30070  
**NAIROBI**  
Tel: 331955  
Telex: 22639  
E,M

**KOREA**

*Samsung Electronics Computer*  
*Division*  
76-561 Yeoksam-Dong  
Kangnam-Ku  
C.P.O. Box 2775  
**SEOUL**  
Tel: 555-7555, 555-5447  
Telex: K27364 SAMSAN  
A,CH,CM,CS,E,M,P

**KUWAIT**

*Al-Khaldiya Trading & Contracting*  
P.O. Box 830 Safat  
**KUWAIT**  
Tel: 42-4910, 41-1726  
Telex: 22481 Areeg kt  
CH,E,M

*Photo & Cine Equipment*  
P.O. Box 270 Safat

**KUWAIT**  
Tel: 42-2846, 42-3801  
Telex: 22247 Matin-KT  
P

**LEBANON**

*G.M. Dolmadjian*  
*Achrafieh*  
P.O. Box 165.167  
**BEIRUT**  
Tel: 290293  
MP\*\*

**LUXEMBOURG**

Hewlett-Packard Belgium S.A./N.V.  
Blvd de la Woluwe, 100  
Woluwedal  
B-1200 **BRUSSELS**  
Tel: (02) 762-32-00  
Telex: 23-494 paloben bru  
A,CH,CM,CS,E,MP,P

**MALAYSIA**

Hewlett-Packard Sales (Malaysia)  
Sdn. Bhd.  
1st Floor, Bangunan Briith  
American  
Jalan Semantan, Damansara Heights  
**KUALA LUMPUR 23-03**  
Tel: 943022  
Telex: MA31011  
A,CH,E,M,P\*

*Protel Engineering*  
Lot 319, Satok Road  
P.O.Box 1917  
**Kuching, SARAWAK**  
Tel: 53544  
Telex: MA 70904 PROMAL  
Cable: PROTELENG  
A,E,M

**MALTA**

*Philip Toledo Ltd.*  
Notabile Rd.  
**MRIEHEL**  
Tel: 447 47, 455 66  
Telex: 649 Media MW  
P

**MEXICO**

Hewlett-Packard Mexicana, S.A. de  
C.V.  
Av. Periferico Sur No. 6501  
Tepepan, Xochimilco  
**MEXICO D.F. 16020**  
Tel: 676-4600  
Telex: 17-74-507 HEWPACK MEX  
A,CH,CS,E,MS,P  
Effective November 1, 1982:  
Hewlett-Packard Mexicana, S.A. de  
C.V.  
Ejercito Nacional #570  
Colonia Granada  
11560 **MEXICO, D.F.**  
CH\*\*

Hewlett-Packard Mexicana, S.A. de  
C.V.  
Rio Volga 600  
Pte. Colonia del Valle  
**MONTERREY, N.L.**  
Tel: 78-42-93, 78-42-40, 78-42-41  
Telex: 038-2410 HPMTY ME  
CH

Effective Nov. 1, 1982  
Ave. Colonia del Valle #409  
Col. del Valle  
Municipio de garza garcia  
**MONTERREY, N.V.**  
ECISA  
Taihe 229, Piso 10  
Polanco **MEXICO D.F. 11570**  
Tel: 250-5391  
Telex: 17-72755 ECE ME  
M

**MOROCCO**

*Dolbeau*  
81 rue Karatchi  
**CASABLANCA**  
Tel: 3041-82, 3068-38  
Telex: 23051, 22822  
E

*Gerep*  
2 rue d'Agadir  
Boite Postale 156  
**CASABLANCA**  
Tel: 272093, 272095  
Telex: 23 739  
P

**NETHERLANDS**

Hewlett-Packard Nederland B.V.  
Van Heuven Goedhartlaan 121  
NL 1181KK **AMSTELVEEN**  
P.O. Box 667  
**NL 1180 AR AMSTELVEEN**  
Tel: (20) 47-20-21  
Telex: 13 216  
A,CH,CM,CS,E,MP,P

Hewlett-Packard Nederland B.V.  
Bongerd 2  
NL 2906VK **CAPPELLE**, A/D IJssel  
P.O. Box 41  
NL 2900 AA **CAPELLE**, IJssel  
Tel: (10) 51-64-44  
Telex: 21261 HEPAC NL  
A,CH,CS

**NEW ZEALAND**

Hewlett-Packard (N.Z.) Ltd.  
169 Manukau Road  
P.O. Box 26-189  
Epsom, **AUCKLAND**  
Tel: 687-159  
Cable: HEWPACK Auckland  
CH,CM,E,P\*  
Hewlett-Packard (N.Z.) Ltd.  
4-12 Cruickshank Street  
Kibirnie, **WELLINGTON 3**  
P.O. Box 9443  
Courtenay Place, **WELLINGTON 3**  
Tel: 877-199  
Cable: HEWPACK Wellington  
CH,CM,E,P

*Northrop Instruments & Systems*  
*Ltd.*

369 Khyber Pass Road  
P.O. Box 8602  
**AUCKLAND**  
Tel: 794-091  
Telex: 60605  
A,M

*Northrop Instruments & Systems*  
*Ltd.*

110 Mandeville St.  
P.O. Box 8388  
**CHRISTCHURCH**  
Tel: 486-928  
Telex: 4203  
A,M  
*Northrop Instruments & Systems*  
*Ltd.*

*Sturdee House*  
85-87 Ghuznee Street  
P.O. Box 2406  
**WELLINGTON**  
Tel: 850-091  
Telex: NZ 3380  
A,M

**NORTHERN IRELAND**

*Cardiac Services Company*  
95A Finaghy Road South  
**BELFAST BT 10 OBY**  
Tel: (0232) 625-566  
Telex: 747626  
M

**NORWAY**

Hewlett-Packard Norge A/S  
Folke Bernadottes vei 50  
P.O. Box 3558  
N-5033 **FYLLINGSDALEN** (Bergen)  
Tel: (05) 16-55-40  
Telex: 16621 hpnas n  
CH,CS,E,MS  
Hewlett-Packard Norge A/S  
Österndalen 18  
P.O. Box 34  
N-1345 **ÖSTERÅS**  
Tel: (02) 17-11-80  
Telex: 16621 hpnas n  
A,CH,CM,CS,E,M,P

**OMAN**

*Khimjil Ramdas*  
P.O. Box 19  
**MUSCAT**  
Tel: 722225, 745601  
Telex: 3289 BROKER MB MUSCAT  
P



# SALES & SUPPORT OFFICES

## Arranged Alphabetically by Country

**Suhalil & Saud Bahwan**  
P.O. Box 169  
**MUSCAT**  
Tel: 734 201-3  
Telex: 3274 BAHWAN MB

**PAKISTAN**  
**Mushko & Company Ltd.**  
1-B, Street 43  
Sector F-8/1  
**ISLAMABAD**  
Tel: 26875  
Cable: FEMUS Rawalpindi  
A,E,M

**Mushko & Company Ltd.**  
Oosman Chambers  
Abdullah Haroon Road  
**KARACHI 0302**  
Tel: 511027, 512927  
Telex: 2894 MUSKO PK  
Cable: COOPERATOR Karachi  
A,E,M,P\*

**PANAMA**  
**Electrónico Balboa, S.A.**  
Calle Samuel Lewis, Ed. Alfa  
Apartado 4929  
**PANAMA 5**  
Tel: 64-2700  
Telex: 3483 ELECTRON PG  
A,CM,E,M,P  
**Foto Internacional, S.A.**  
Colon Free Zone  
Apartado 2068  
**COLON 3**  
Tel: 45-2333  
Telex: 8626 IMPORT PG  
P

**PERU**  
**Cía Electro Médica S.A.**  
Los Flamencos 145, San Isidro  
Casilla 1030  
**LIMA 1**  
Tel: 41-4325, 41-3703  
Telex: Pub. Booth 25306  
A,CM,E,M,P

**PHILIPPINES**  
**The Online Advanced Systems Corporation**  
Rico House, Amorsolo Cor. Herrera Street  
Legaspi Village, Makati  
P.O. Box 1510  
**Metro MANILA**  
Tel: 85-35-81, 85-34-91, 85-32-21  
Telex: 3274 ONLINE  
A,CH,CS,E,M  
**Electronic Specialists and Proponenis Inc.**  
690-B Epitanio de los Santos Avenue  
**Cubao, QUEZON CITY**  
P.O. Box 2649 Manila  
Tel: 98-96-81, 98-96-82, 98-96-83  
Telex: 40018, 42000 ITT GLOBE  
MACKAY BOOTH  
P

**PORTUGAL**  
**Mundinter**  
Intercambio Mundial de Comércio S.a.r.l.  
P.O. Box 2761  
Av. Antonio Augusto de Aguiar 138  
**P-LISBON**  
Tel: (19) 53-21-31, 53-21-37  
Telex: 16691 munter p  
M

**Soquimica**  
Av. da Liberdade, 220-2  
1298 LISBON Codex  
Tel: 56 21 81/2/3  
Telex: 13316 SABASA P  
**Telectra-Empresa Técnica de Equipamentos Eléctricos S.a.r.l.**  
Rua Rodrigo da Fonseca 103  
P.O. Box 2531  
**P-LISBON 1**  
Tel: (19) 68-60-72  
Telex: 12598  
CH,CS,E,P

**PUERTO RICO**  
**Hewlett-Packard Puerto Rico**  
P.O. Box 4407  
**CAROLINA**, Puerto Rico 00628  
Calle 272 Edificio 203  
Urb. Country Club  
**RIO PIEDRAS**, Puerto Rico 00924  
Tel: (809) 762-7255  
A,CH,CS

**QATAR**  
**Nasser Trading & Contracting**  
P.O. Box 1563  
**DOHA**  
Tel: 22170, 23539  
Telex: 4439 NASSER DH  
M  
**Computeabia**  
P.O. Box 2750  
**DOHA**  
Tel: 883555  
Telex: 4806 CHPARB  
P

**Eastern Technical Services**  
P.O. Box 4747  
**DOHA**  
Tel: 329 993  
Telex: 4156 EASTEC DH

**SAUDI ARABIA**  
**Modern Electronic Establishment Hewlett-Packard Division**  
P.O. Box 281  
**Thuobah AL-KHOBAR**  
Tel: 864-46 78  
Telex: 671 106 HPMEEK SJ  
Cable: ELECTA AL-KHOBAR  
CH,CS,E,M,P  
**Modern Electronic Establishment Hewlett-Packard Division**  
P.O. Box 1228  
**Redec Plaza, 6th Floor JEDDAH**  
Tel: 644 38 48  
Telex: 402712 FARNAS SJ  
Cable: ELECTA JEDDAH  
CH,CS,E,M,P  
**Modern Electronic Establishment Hewlett-Packard Division**  
P.O. Box 2728  
**RIYADH**  
Tel: 491-97 15, 491-63 87  
Telex: 202049 MEERYD SJ  
CH,CS,E,M,P

**SCOTLAND**  
**Hewlett-Packard Ltd.**  
Royal Bank Buildings  
Swan Street  
**BRECHIN**, Angus, Scotland  
Tel: (03562) 3101-2  
CH  
**Hewlett-Packard Ltd.**  
**SOUTH QUEENSFERRY**  
West Lothian, EH30 9GT  
GB-Scotland  
Tel: (031) 3311188  
Telex: 72682  
A,CH,CM,CS,E,M

**SINGAPORE**  
**Hewlett-Packard Singapore (Pty.) Ltd.**  
P.O. Box 58 Alexandra Post Office  
**SINGAPORE**, 9115  
6th Floor, Inchcape House  
450-452 Alexandra Road  
**SINGAPORE 0511**  
Tel: 631788  
Telex: HPSGSO RS 34209  
Cable: HEWPACK, Singapore  
A,CH,CS,E,MS,P  
**Dynamar International Ltd.**  
Unit 05-11 Block 6  
Kolam Ayer Industrial Estate  
**SINGAPORE 1334**  
Tel: 747-6188  
Telex: RS 26283  
CM

**SOUTH AFRICA**  
**Hewlett-Packard So Africa (Pty.) Ltd.**  
P.O. Box 120  
Howard Place  
Pine Park Center, Forest Drive,  
Pinelands  
**CAPE PROVINCE 7405**  
Tel: 53-7954  
Telex: 57-20006  
A,CH,CM,E,MS,P  
**Hewlett-Packard So Africa (Pty.) Ltd.**  
P.O. Box 37099  
92 Overport Drive  
**DURBAN 4067**  
Tel: 28-4178, 28-4179, 28-4110  
Telex: 6-22954  
CH,CM

**Hewlett-Packard So Africa (Pty.) Ltd.**  
6 Linton Arcade  
511 Cape Road  
Linton Grange  
**PORT ELIZABETH 6001**  
Tel: 041-302148  
CH

**Hewlett-Packard So Africa (Pty.) Ltd.**  
P.O. Box 33345  
Glenstantia 0010  
**TRANSVAAL**  
1st Floor East  
Constantia Park Ridge Shopping Centre  
Constantia Park  
**PRETORIA**  
Tel: 982043  
Telex: 32163  
CH,E  
**Hewlett-Packard So Africa (Pty.) Ltd.**  
Private Bag Wendywood  
**SANDTON 2144**  
Tel: 802-5111, 802-5125  
Telex: 4-20877  
Cable: HEWPACK Johannesburg  
A,CH,CM,CS,E,MS,P

**SPAIN**  
**Hewlett-Packard Española S.A.**  
c/Entenza, 321  
**E-BARCELONA 29**  
Tel: (3) 322-24-51, 321-73-54  
Telex: 52603 hpbpe  
A,CH,CS,E,MS,P  
**Hewlett-Packard Española S.A.**  
c/San Vicente S/N  
Edificio Albia II, 7 B  
**E-BILBAO 1**  
Tel: (4) 23-8306, (4) 23-8206  
A,CH,E,MS

**Hewlett-Packard Española S.A.**  
Calle Jerez 3  
**E-MADRID 16**  
Tel: (1) 458-2600  
Telex: 23515 hpe  
A,CM,E

**Hewlett-Packard Española S.A.**  
c/o Costa Brava 13  
Colonia Mirasierra  
**E-MADRID 34**  
Tel: (1) 734-8061, (1) 734-1162  
CH,CS,M

**Hewlett-Packard Española S.A.**  
Av Ramón y Cajal 1-9  
Edificio Sevilla 1,  
**E-SEVILLA 5**  
Tel: 64-44-54, 64-44-58  
Telex: 72933  
A,CS,MS,P  
**Hewlett-Packard Española S.A.**  
C/Ramon Gordillo, 1 (Entlo.3)  
**E-VALENCIA 10**  
Tel: 361-1354, 361-1358  
CH,P

**SWEDEN**  
**Hewlett-Packard Sverige AB**  
Sunnanvagen 14K  
S-22226 LUND  
Tel: (046) 13-69-79  
Telex: (854) 17886 (via SPÅNGA office)  
CH  
**Hewlett-Packard Sverige AB**  
Vastra Vintergatan 9  
S-70344 ÖREBRO  
Tel: (19) 10-48-80  
Telex: (854) 17886 (via SPÅNGA office)  
CH

**Hewlett-Packard Sverige AB**  
Skalholtsgatan 9, Kista  
Box 19  
S-16393 SPÅNGA  
Tel: (08) 750-2000  
Telex: (854) 17886  
A,CH,CM,CS,E,MS,P  
**Hewlett-Packard Sverige AB**  
Frötälisgatan 30  
S-42132 VÄSTRA-FRÖLUNDA  
Tel: (031) 49-09-50  
Telex: (854) 17886 (via SPÅNGA office)  
CH,E,P

**SWITZERLAND**  
**Hewlett-Packard (Schweiz) AG**  
Clarastrasse 12  
CH-4058 BASLE  
Tel: (61) 33-59-20  
A  
**Hewlett-Packard (Schweiz) AG**  
Bahnhofweg 44  
CH-3018 BERN  
Tel: (031) 56-24-22  
CH  
**Hewlett-Packard (Schweiz) AG**  
47 Avenue Blanc  
CH-1202 GENEVA  
Tel: (022) 32-48-00  
CH,CM,CS

**Hewlett-Packard (Schweiz) AG**  
19 Chemin Château Bloc  
CH-1219 LE LIGNON-Geneva  
Tel: (022) 96-03-22  
Telex: 27333 hpag ch  
Cable: HEWPACKAG Geneva  
A,E,MS,P  
**Hewlett-Packard (Schweiz) AG**  
Allmend 2  
CH-8967 WIDEN  
Tel: (57) 31 21 11  
Telex: 53933 hpag ch  
Cable: HPAG CH  
A,CH,CM,CS,E,MS,P

**SYRIA**  
**General Electronic Inc.**  
Nuri Basha  
P.O. Box 5781  
**DAMASCUS**  
Tel: 33-24-87  
Telex: 11216 ITIKAL SY  
Cable: ELECTROBOR DAMASCUS  
E

**Middle East Electronics**  
Place Azmé  
Boite Postale 2308  
**DAMASCUS**  
Tel: 334592  
Telex: 11304 SATACO SY  
M,P

**TAIWAN**  
**Hewlett-Packard Far East Ltd.**  
Kaohsiung Office  
2/F 68-2, Chung Cheng 3rd Road  
**KAOHSIUNG**  
Tel: 241-2318, 261-3253  
CH,CS,E  
**Hewlett-Packard Far East Ltd.**  
Taiwan Branch  
5th Floor  
205 Tun Hwa North Road  
**TAIPEI**  
Tel: (02) 751-0404  
Cable: HEWPACK Taipei  
A,CH,CM,CS,E,M,P  
**Ing Lih Trading Co.**  
3rd Floor, 7 Jen-Ai Road, Sec. 2  
**TAIPEI 100**  
Tel: (02) 3948191  
Cable: INGLIH TAIPEI  
A

**THAILAND**  
**Unimesa**  
30 Patpong Ave., Suriwong  
**BANGKOK 5**  
Tel: 234 091, 234 092  
Telex: 84439 Simonco TH  
Cable: UNIMESA Bangkok  
A,CH,CS,E,M  
**Bangkok Business Equipment Ltd.**  
5/5-6 Dejo Road  
**BANGKOK**  
Tel: 234-8670, 234-8671  
Telex: 87669-BEQUIPT TH  
Cable: BUSIQUIPT Bangkok  
P

**TRINIDAD & TOBAGO**  
**Caribbean Telecoms Ltd.**  
50/A Jerningham Avenue  
P.O. Box 732  
**PORT-OF-SPAIN**  
Tel: 62-44213, 62-44214  
Telex: 235,272 HUGCO WG  
A,CM,E,M,P

**TUNISIA**  
**Tunisie Electronique**  
31 Avenue de la Liberté  
**TUNIS**  
Tel: 280-144  
E,P  
**Corema**  
1 Ter. Av. de Carthage  
**TUNIS**  
Tel: 253-821  
Telex: 12319 CABAM TN  
M

**TURKEY**  
**Teknim Company Ltd.**  
Iran Caddesi No. 7  
Kavaklidere, ANKARA  
Tel: 275800  
Telex: 42155 TKNM TR  
E  
**E.M.A.**  
Medina Eldem Sokak No.41/6  
Yüksel Caddesi  
**ANKARA**  
Tel: 175 622  
M

**UNITED ARAB EMIRATES**  
**Emitac Ltd.**  
P.O. Box 1641  
**SHARJAH**  
Tel: 354121, 354123  
Telex: 68136 Emitac Sh  
CH,CS,E,M,P

**UNITED KINGDOM****see: GREAT BRITAIN****NORTHERN IRELAND****SCOTLAND****UNITED STATES****Alabama**

Hewlett-Packard Co.  
700 Century Park South  
Suite 128

**BIRMINGHAM, AL 35226**  
Tel: (205) 822-6802  
CH,MP

Hewlett-Packard Co.  
P.O. Box 4207  
8290 Whitesburg Drive, S.E.  
**HUNTSVILLE, AL 35802**  
Tel: (205) 881-4591  
CH,CM,CS,E,M\*

**Alaska**

Hewlett-Packard Co.  
1577 "C" Street, Suite 252  
**ANCHORAGE, AK 99501**  
Tel: (907) 276-5709  
CH\*

**Arizona**

Hewlett-Packard Co.  
2336 East Magnolia Street  
**PHOENIX, AZ 85034**  
Tel: (602) 273-8000  
A,CH,CM,CS,E,MS

Hewlett-Packard Co.  
2424 East Aragon Road  
**TUCSON, AZ 85706**  
Tel: (602) 889-4631  
CH,E,MS\*\*

**Arkansas**

Hewlett-Packard Co.  
P.O. Box 5646  
Brady Station  
**LITTLE ROCK, AR 72215**  
111 N. Filmore  
**LITTLE ROCK, AR 72205**  
Tel: (501) 664-8773, 376-1844  
MS

**California**

Hewlett-Packard Co.  
99 South Hill Dr.  
**BRISBANE, CA 94005**  
Tel: (415) 330-2500  
CH,CS

Hewlett-Packard Co.  
7621 Canoga Avenue  
**CANOGA PARK, CA 91304**  
Tel: (213) 702-8300  
A,CH,CS,E,P

Hewlett-Packard Co.  
5060 Clinton Avenue  
**FRESNO, CA 93727**  
Tel: (209) 252-9652  
MS

Hewlett-Packard Co.  
P.O. Box 4230  
1430 East Orangethorpe  
**FULLERTON, CA 92631**  
Tel: (714) 870-1000  
CH,CM,CS,E,MP

Hewlett-Packard Co.  
320 S. Kellogg, Suite B  
**GOLETA, CA 93117**  
Tel: (805) 967-3405  
CH

Hewlett-Packard Co.  
5400 W. Rosecrans Boulevard  
**LAWNSDALE, CA 90260**  
P.O. Box 92105  
**LOS ANGELES, CA 90009**  
Tel: (213) 970-7500  
Telex: 910-325-6608  
CH,CM,CS,MP

Hewlett-Packard Co.  
3200 Hillview Avenue  
**PALO ALTO, CA 94304**  
Tel: (415) 857-8000  
CH,CS,E

Hewlett-Packard Co.  
P.O. Box 15976 (95813)  
4244 So. Market Court, Suite A  
**SACRAMENTO, CA 95834**  
Tel: (916) 929-7222  
A\*,CH,CS,E,MS

Hewlett-Packard Co.  
9606 Aero Drive  
P.O. Box 23333  
**SAN DIEGO, CA 92123**  
Tel: (714) 279-3200  
CH,CM,CS,E,MP

Hewlett-Packard Co.  
2305 Camino Ramon "C"  
**SAN RAMON, CA 94583**  
Tel: (415) 838-5900  
CH,CS

Hewlett-Packard Co.  
P.O. Box 4230  
Fullerton, CA 92631  
363 Brookhollow Drive  
**SANTA ANA, CA 92705**  
Tel: (714) 641-0977  
A,CH,CM,CS,MP

Hewlett-Packard Co.  
Suite A  
5553 Hollister  
**SANTA BARBARA, CA 93111**  
Tel: (805) 964-3390

Hewlett-Packard Co.  
3003 Scott Boulevard  
**SANTA CLARA, CA 95050**  
Tel: (408) 988-7000  
A,CH,CM,CS,E,MP

Hewlett-Packard Co.  
5703 Corsa Avenue  
**WESTLAKE VILLAGE, CA 91362**  
Tel: (213) 706-6800  
E\*,CH\*,CS\*

**Colorado**

Hewlett-Packard Co.  
24 Inverness Place, East  
**ENGLEWOOD, CO 80112**  
Tel: (303) 771-3455  
Telex: 910-935-0785  
A,CH,CM,CS,E,MS

**Connecticut**

Hewlett-Packard Co.  
47 Barnes Industrial Road South  
P.O. Box 5007  
**WALLINGFORD, CT 06492**  
Tel: (203) 265-7801  
A,CH,CM,CS,E,MS

**Florida**

Hewlett-Packard Co.  
P.O. Box 24210 (33307)  
2901 N.W. 62nd Street  
**FORT LAUDERDALE, FL 33307**  
Tel: (305) 973-2600  
CH,CS,E,MP

Hewlett-Packard Co.  
4080 Woodcock Drive, #132  
Brownell Building  
**JACKSONVILLE, FL 32207**  
Tel: (904) 398-0663  
C\*,E\*,MS\*\*

Hewlett-Packard Co.  
1101 W. Hibiscus Ave., Suite E210  
**MELBOURNE, FL 32901**  
Tel: (305) 729-0704  
E\*

Hewlett-Packard Co.  
P.O. Box 13910 (32859)  
6177 Lake Ellenor Drive  
**ORLANDO, FL 32809**  
Tel: (305) 859-2900  
A,CH,CM,CS,E,MS

Hewlett-Packard Co.  
6425 N. Pensacola Blvd.  
Suite 4, Building 1  
P.O. Box 12826  
**PENSACOLA, FL 32575**  
Tel: (904) 476-8422  
A,MS

Hewlett-Packard Co.  
5750B N. Hoover Blvd., Suite 123  
**TAMPA, FL 33614**  
Tel: (813) 884-3282  
A\*,CH,CM,CS,E\*,M\*

**Georgia**

Hewlett-Packard Co.  
P.O. Box 105005  
**ATLANTA, GA 30348**  
2000 South Park Place  
**ATLANTA, GA 30339**  
Tel: (404) 955-1500  
Telex: 810-766-4890  
A,CH,CM,CS,E,MP

Hewlett-Packard Co.  
P.O. Box 816 (80903)  
2531 Center West Parkway  
Suite 110  
**AUGUSTA, GA 30904**  
Tel: (404) 736-0592  
MS

Hewlett-Packard Co.  
200-E Montgomery Cross Rds.  
**SAVANNAH, GA 31401**  
Tel: (912) 925-5358  
CH\*\*

Hewlett-Packard Co.  
P.O. Box 2103  
**WARNER ROBINS, GA 31099**  
1172 N. Davis Drive  
**WARNER ROBINS, GA 31093**  
Tel: (912) 923-8831  
E

**Hawaii**

Hewlett-Packard Co.  
Kawaiahao Plaza, Suite 190  
567 South King Street  
**HONOLULU, HI 96813**  
Tel: (808) 526-1555  
A,CH,E,MS

**Illinois**

Hewlett-Packard Co.  
211 Prospect Road, Suite C  
**BLOOMINGTON, IL 61701**  
Tel: (309) 662-9411  
CH,MS\*\*

Hewlett-Packard Co.  
1100 31st Street, Suite 100  
**DOWNS GROVE, IL 60515**  
Tel: (312) 960-5760  
CH,CS

Hewlett-Packard Co.  
5201 Tollview Drive  
**ROLLING MEADOWS, IL 60008**  
Tel: (312) 255-9800  
A,CH,CM,CS,E,MP

**Indiana**

Hewlett-Packard Co.  
P.O. Box 50807  
7301 No. Shadeland Avenue  
**INDIANAPOLIS, IN 46250**  
Tel: (317) 842-1000  
A,CH,CM,CS,E,MS

**Iowa**

Hewlett-Packard Co.  
1776 22nd Street, Suite 1  
**WEST DES MOINES, IA 50265**  
Tel: (515) 224-1435  
CH,MS\*\*  
Hewlett-Packard Co.  
2415 Heinz Road  
**IOWA CITY, IA 52240**  
Tel: (319) 351-1020  
CH,E\*,MS

**Kansas**

Hewlett-Packard Co.  
1644 S. Rock Road  
**WICHITA, KA 67207**  
Tel: (316) 684-8491  
CH

**Kentucky**

Hewlett-Packard Co.  
10300 Linn Station Road  
Suite 100  
**LOUISVILLE, KY 40223**  
Tel: (502) 426-0100  
A,CH,CS,MS

**Louisiana**

Hewlett-Packard Co.  
8126 Calais Bldg.  
**BATON ROUGE, LA 70806**  
Tel: (504) 467-4100  
A\*\* ,CH\*\*

Hewlett-Packard Co.  
P.O. Box 1449  
**KENNER, LA 70062**  
160 James Drive East  
**DESTAHAN, LA 70047**  
Tel: (504) 467-4100  
A,CH,CS,E,MS

**Maryland**

Hewlett-Packard Co.  
7121 Standard Drive  
**HANOVER, MD 21076**  
Tel: (301) 796-7700  
Telex: 710-862-1943  
Eff. Dec. 1, 1982  
3701 Koppers St.  
**BALTIMORE, MD 21227**  
Tel: (301) 644-5800  
A,CH,CM,CS,E,MS

Hewlett-Packard Co.  
2 Choke Cherry Road  
**ROCKVILLE, MD 20850**  
Tel: (301) 948-6370  
A,CH,CM,CS,E,MP

**Massachusetts**

Hewlett-Packard Co.  
32 Hartwell Avenue  
**LEXINGTON, MA 02173**  
Tel: (617) 861-8960  
A,CH,CM,CS,E,MP

**Michigan**

Hewlett-Packard Co.  
23855 Research Drive  
**FARMINGTON HILLS, MI 48024**  
Tel: (313) 476-6400  
A,CH,CM,CS,E,MP

Hewlett-Packard Co.  
4326 Cascade Road S.E.  
**GRAND RAPIDS, MI 49506**  
Tel: (616) 957-1970  
CH,CS,MS

Hewlett-Packard Co.  
1771 W. Big Beaver Road  
**TROY, MI 48084**  
Tel: (313) 643-6474  
CH,CS

**Minnesota**

Hewlett-Packard Co.  
2025 W. Larpenteur Ave.  
**ST. PAUL, MN 55113**  
Tel: (612) 644-1100  
A,CH,CM,CS,E,MP

**Mississippi**

Hewlett-Packard Co.  
P.O. Box 5028  
1675 Lakeland Drive  
**JACKSON, MS 39216**  
Tel: (601) 982-9363  
MS

**Missouri**

Hewlett-Packard Co.  
11131 Colorado Avenue  
**KANSAS CITY, MO 64137**  
Tel: (816) 763-8000  
A,CH,CM,CS,E,MS

Hewlett-Packard Co.  
P.O. Box 27307  
1024 Executive Parkway  
**ST. LOUIS, MO 63141**  
Tel: (314) 878-0200  
A,CH,CS,E,MP  
Effective September 1982:  
13001 Hollenberg Drive  
**BRIDGETON, MO 63044**

**Nebraska**

Hewlett-Packard  
7101 Mercy Road  
Suite 101, IBX Building  
**OMAHA, NE 68106**  
Tel: (402) 392-0948  
CM,MS

**Nevada**

Hewlett-Packard Co.  
Suite D-130  
5030 Paradise Blvd.  
**LAS VEGAS, NV 89119**  
Tel: (702) 736-6610  
MS\*\*

**New Jersey**

Hewlett-Packard Co.  
W120 Century Road  
**PARAMUS, NJ 07652**  
Tel: (201) 265-5000  
A,CH,CM,CS,E,MP

Hewlett-Packard Co.  
60 New England Av. West  
**PISCATAWAY, NJ 08854**  
Tel: (201) 981-1199  
A,CH,CM,CS,E

**New Mexico**

Hewlett-Packard Co.  
P.O. Box 11634  
**ALBUQUERQUE, NM 87112**  
11300 Lomas Blvd., N.E.  
**ALBUQUERQUE, NM 87123**  
Tel: (505) 292-1330  
Telex: 910-989-1185  
CH,CS,E,MS

**New York**

Hewlett-Packard Co.  
5 Computer Drive South  
**ALBANY, NY 12205**  
Tel: (518) 458-1550  
Telex: 710-444-4691  
A,CH,E,MS

Hewlett-Packard Co.  
P.O. Box 297  
9600 Main Street  
**CLARENCE, NY 14031**  
Tel: (716) 759-8621  
Telex: 710-523-1893  
CH

Hewlett-Packard Co.  
200 Cross Keys Office  
**FAIRPORT, NY 14450**  
Tel: (716) 223-9950  
Telex: 510-253-0092  
CH,CM,CS,E,MS

Hewlett-Packard Co.  
7641 Henry Clay Blvd.  
**LIVERPOOL, NY 13088**  
Tel: (315) 451-1820  
A,CH,CM,E,MS

Hewlett-Packard Co.  
No. 1 Pennsylvania Plaza  
55th Floor  
34th Street & 8th Avenue  
**NEW YORK, NY 10119**  
Tel: (212) 971-0800  
CH,CS,E\*,M\*

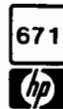



# SALES & SUPPORT OFFICES

Arranged Alphabetically by Country

Hewlett-Packard Co.  
250 Westchester Avenue  
**WHITE PLAINS, NY 10604**  
CM,CH,CS,E

Hewlett-Packard Co.  
3 Crossways Park West  
**WOODBURY, NY 11797**  
Tel: (516) 921-0300  
Telex: 510-221-2183  
A,CH,CM,CS,E,MS

## North Carolina

Hewlett-Packard Co.  
4915 Water's Edge Drive  
Suite 160

**RALEIGH, NC 27606**  
Tel: (919) 851-3021  
C,M

Hewlett-Packard Co.  
P.O. Box 26500  
5605 Roanne Way  
**GREENSBORO, NC 27450**  
Tel: (919) 852-1800  
A,CH,CM,CS,E,MS

## Ohio

Hewlett-Packard Co.  
9920 Carver Road  
**CINCINNATI, OH 45242**  
Tel: (513) 891-9870  
CH,CS,MS

Hewlett-Packard Co.  
16500 Sprague Road  
**CLEVELAND, OH 44130**  
Tel: (216) 243-7300  
Telex: 810-423-9430  
A,CH,CM,CS,E,MS

Hewlett-Packard Co.  
962 Crupper Ave.  
**COLUMBUS, OH 43229**  
Tel: (614) 436-1041  
CH,CM,CS,E\*

Hewlett-Packard Co.  
P.O. Box 280  
330 Progress Rd.  
**DAYTON, OH 45449**  
Tel: (513) 859-8202  
A,CH,CM,E\*,MS

## Oklahoma

Hewlett-Packard Co.  
P.O. Box 32008  
Oklahoma City, OK 73123  
1503 W. Gore Blvd., Suite #2  
**LAWTON, OK 73505**  
Tel: (405) 248-4248  
C

Hewlett-Packard Co.  
P.O. Box 32008  
**OKLAHOMA CITY, OK 73123**  
304 N. Meridian Avenue, Suite A  
**OKLAHOMA CITY, OK 73107**  
Tel: (405) 946-9499  
A\*,CH,E\*,MS

Hewlett-Packard Co.  
Suite 121  
9920 E. 42nd Street  
**TULSA, OK 74145**  
Tel: (918) 665-3300  
A\*,CH,CS,M\*

## Oregon

Hewlett-Packard Co.  
1500 Valley River Drive  
Suite 330  
**EUGENE, OR 97401**  
Tel: (503) 683-8075  
C

Hewlett-Packard Co.  
9255 S. W. Pioneer Court  
**WILSONVILLE, OR 97070**  
Tel: (503) 682-8000  
A,CH,CS,E\*,MS

## Pennsylvania

Hewlett-Packard Co.  
1021 8th Avenue  
King of Prussia Industrial Park  
**KING OF PRUSSIA, PA 19406**  
Tel: (215) 265-7000  
Telex: 510-660-2670  
A,CH,CM,CS,E,MP

Hewlett-Packard Co.  
111 Zeta Drive  
**PITTSBURGH, PA 15238**  
Tel: (412) 782-0400  
A,CH,CS,E,MP

## South Carolina

Hewlett-Packard Co.  
P.O. Box 21708  
Brookside Park, Suite 122  
1 Harbison Way  
**COLUMBIA, SC 29210**  
Tel: (803) 732-0400  
CH,E,MS

Hewlett-Packard Co.  
Koger Executive Center  
Chesterfield Bldg., Suite 124  
**GREENVILLE, SC 29615**  
Tel: (803) 748-5601  
C

## Tennessee

Hewlett-Packard Co.  
P.O. Box 22490  
224 Peters Road  
Suite 102  
**KNOXVILLE, TN 37922**  
Tel: (615) 691-2371  
A\*,CH,MS

Hewlett-Packard Co.  
3070 Directors Row  
**MEMPHIS, TN 38131**  
Tel: (901) 346-8370  
A,CH,MS

Hewlett-Packard Co.  
230 Great Circle Road  
Suite 216  
**NASHVILLE, TN 32228**  
Tel: (615) 255-1271  
MS\*\*

## Texas

Hewlett-Packard Co.  
Suite 310W  
7800 Shoal Creek Blvd.  
**AUSTIN, TX 78757**  
Tel: (512) 459-3143  
E

Hewlett-Packard Co.  
Suite C-110  
4171 North Mesa  
**EL PASO, TX 79902**  
Tel: (915) 533-3555, 533-4489  
CH,E\*,MS\*\*

Hewlett-Packard Co.  
5020 Mark IV Parkway  
**FORT WORTH, TX 76106**  
Tel: (817) 625-6361  
CH,CS\*

Hewlett-Packard Co.  
P.O. Box 42816  
**HOUSTON, TX 77042**  
10535 Harwin Street  
**HOUSTON, TX 77036**  
Tel: (713) 776-6400  
A,CH,CM,CS,E,MP

Hewlett-Packard Co.  
3309 67th Street  
Suite 24  
**LUBBOCK, TX 79413**  
Tel: (806) 799-4472  
M

Hewlett-Packard Co.  
417 Nolana Gardens, Suite C  
P.O. Box 2256  
**MCALLEN, TX 78501**  
Tel: (512) 781-3226  
CH,CS

Hewlett-Packard Co.  
P.O. Box 1270  
**RICHARDSON, TX 75080**  
930 E. Campbell Rd.  
**RICHARDSON, TX 75081**  
Tel: (214) 231-6101  
A,CH,CM,CS,E,MP

Hewlett-Packard Co.  
P.O. Box 32993  
**SAN ANTONIO, TX 78216**  
1020 Central Parkway South  
**SAN ANTONIO, TX 78232**  
Tel: (512) 494-9336  
CH,CS,E,MS

## Utah

Hewlett-Packard Co.  
P.O. Box 26626  
3530 W. 2100 South  
**SALT LAKE CITY, UT 84119**  
Tel: (801) 974-1700  
A,CH,CS,E,MS

## Virginia

Hewlett-Packard Co.  
P.O. Box 9669  
2914 Hungary Spring Road  
**RICHMOND, VA 23228**  
Tel: (804) 285-3431  
A,CH,CS,E,MS

Hewlett-Packard Co.  
3106 Peters Creek Road, N.W.  
**ROANOKE, VA 24019**  
Tel: (703) 563-2205  
CH,E\*\*

Hewlett-Packard Co.  
5700 Thurston Avenue  
Suite 111  
**VIRGINIA BEACH, VA 23455**  
Tel: (804) 460-2471  
CH,MS

## Washington

Hewlett-Packard Co.  
15815 S.E. 37th Street  
**BELLEVUE, WA 98006**  
Tel: (206) 643-4000  
A,CH,CM,CS,E,MP

Hewlett-Packard Co.  
Suite A  
708 North Argonne Road  
**SPOKANE, WA 99206**  
Tel: (509) 922-7000  
CH,CS

## West Virginia

Hewlett-Packard Co.  
4604 MacCorkle Ave., S.E.  
**CHARLESTON, WV 25304-4297**  
Tel: (304) 925-0492  
A,MS

## Wisconsin

Hewlett-Packard Co.  
150 S. Sunny Slope Road  
**BROOKFIELD, WI 53005**  
Tel: (414) 784-8800  
A,CH,CS,E\*,MP

## URUGUAY

*Pablo Ferrando S.A.C. e L.*  
*Avenida Italia 2877*  
*Casilla de Correo 370*  
**MONTEVIDEO**  
Tel: 80-2586  
Telex: Public Booth 901  
A,CM,E,M

*Guillermo Kraft del Uruguay S.A.*  
*Av. Lib. Brig. Gral. Lavalleja 2083*  
**MONTEVIDEO**  
Tel: 234588, 234808, 208830  
Telex: 22030 ACTOUR UY  
P

## VENEZUELA

Hewlett-Packard de Venezuela C.A.  
3A Transversal Los Ruices Norte  
Edificio Segre  
Apartado 50933  
**CARACAS 1071**  
Tel: 239-4133  
Telex: 25146 HEWPACK  
A,CH,CS,E,MS,P  
*Colimodio S.A.*  
*Este 2 - Sur 21 No. 148*  
*Apartado 1053*  
**CARACAS 1010**  
Tel: 571-3511  
Telex: 21529 COLMODIO  
M

## Headquarters offices

If there is no sales office listed for your area,  
contact one of these headquarters offices.

## NORTH CENTRAL

### AFRICA

Hewlett-Packard S.A.  
7 Rue du Bois-du-Lan  
CH-1217 **MEYRIN 2**, Switzerland  
Tel: (022) 98-96-51  
Telex: 27835 hpse  
Cable: HEWPACKSA Geneve

### ASIA

Hewlett-Packard Asia Ltd.  
6th Floor, Sun Hung Kai Center  
30 Harbor Rd.  
G.P.O. Box 795  
**HONG KONG**  
Tel: 5-832 3211  
Telex: 66678 HEWPA HX  
Cable: HEWPACK HONG KONG

### CANADA

Hewlett-Packard (Canada) Ltd.  
6877 Goreway Drive  
**MISSISSAUGA, Ontario L4V 1M8**  
Tel: (416) 678-9430  
Telex: 610-492-4246

### EASTERN EUROPE

Hewlett-Packard Ges.m.b.h.  
Liebigasse 1  
P.O.Box 72  
A-1222 **VIENNA**, Austria  
Tel: (222) 2365110  
Telex: 1 3 4425 HEPA A

### NORTHERN EUROPE

Hewlett-Packard S.A.  
Uilenstede 475  
NL-1183 AG **AMSTELVEEN**  
The Netherlands  
P.O.Box 999  
NL-1180 AZ **AMSTELVEEN**  
The Netherlands  
Tel: 20 437771

### OTHER EUROPE

Hewlett-Packard S.A.  
7 Rue du Bois-du-Lan  
CH-1217 **MEYRIN 2**, Switzerland  
Tel: (022) 98-96-51  
Telex: 27835 hpse  
Cable: HEWPACKSA Geneve  
(Offices in the World Trade Center)

## ZIMBABWE

*Field Technical Sales*  
45 Kelvin Road, North  
P.B. 3458  
**SALISBURY**  
Tel: 705 231  
Telex: 4-122 RH  
C,E,M,P

## MEDITERRANEAN AND

### MIDDLE EAST

Hewlett-Packard S.A.  
Mediterranean and Middle East  
Operations  
Atrina Centre  
32 Kifissias Ave.  
Maroussi, **ATHENS**, Greece  
Tel: 682 88 11  
Telex: 21-6588 HPAT GR  
Cable: HEWPACKSA Athens

### EASTERN USA

Hewlett-Packard Co.  
4 Choke Cherry Road  
**ROCKVILLE, MD 20850**  
Tel: (301) 258-2000

### MIDWESTERN USA

Hewlett-Packard Co.  
5201 Tollview Drive  
**ROLLING MEADOWS, IL 60008**  
Tel: (312) 255-9800

### SOUTHERN USA

Hewlett-Packard Co.  
P.O. Box 105005  
450 Interstate N. Parkway  
**ATLANTA, GA 30339**  
Tel: (404) 955-1500

### WESTERN USA

Hewlett-Packard Co.  
3939 Lankersim Blvd.  
**LOS ANGELES, CA 91604**  
Tel: (213) 877-1282

## OTHER INTERNATIONAL

### AREAS

Hewlett-Packard Co.  
Intercontinental Headquarters  
3495 Deer Creek Road  
**PALO ALTO, CA 94304**  
Tel: (415) 857-1501  
Telex: 034-8300  
Cable: HEWPACK