

Test &  
Measurement  
Catalog  
1989



*Fifty Years of  
Looking to the Future*



### **In This Catalog**

- **New Product Highlights** . . . . . 1
- **New Product Information Request Card** . . . . . Inside Back Cover

### **Finding The HP Product You Need**

- **Table of Contents** . . . . . II
- **Indexes**
  - **General** . . . . . 50
  - **Alphabetical** . . . . . 25
  - **Model Number** . . . . . 37

### **Doing Business With Hewlett-Packard**

- **About Hewlett-Packard** . . . . . 21
- **Ordering Information** . . . . . 769
- **Leasing, Renting, Financing** . . . . . 768
- **Office Addresses and Phone Numbers** . . . . . 771
- **Warranty Information** . . . . . 770



**HP Computer Museum**  
**[www.hpmuseum.net](http://www.hpmuseum.net)**

**For research and education purposes only.**

## PRODUCT GROUPS

### HP Support



- Hardware ..... 757
- Extended Hardware Service ..... 759
- Software ..... 763
- Consulting Services ..... 764
- Customer Education ..... 760

### HP Services

- Customer Information Center . . . Inside Back Cover
- Fast-ship  ..... 766
- Leasing, Renting, Financing ..... 768
- Free Publications ..... 792
- Test & Measurement News ..... 792
- Test & Measurement Accessories Catalog ..... 767
- Application Notes ..... 780

### Hewlett-Packard Interface Bus



- General Information ..... 556

**Analyzers  
& Meters**  
Pages 54-299

**Sources/Analyzers**  
Pages 302-353

**Sources**  
Pages 356-491

**Telecom/Datacom  
Test**  
Pages 494-521

**Semiconductor Test  
& Board Test**  
Pages 524-549

**Controllers  
& CAT**  
Pages 552-613

**Design Automation &  
Technical Computers**  
Pages 616-671

**Computers,  
Peripherals &  
Other Key Products**  
Pages 674-737

**Accessories, Support,  
Ordering & Offices**  
Pages 740-792

#### Prices Subject to Change

Prices in this catalog are subject to change. Prices prevailing at the time an order is received will apply. To determine a product's delivered price, just contact your nearest HP office. A listing of HP office locations starts on page 771. For more on shipping, prices and terms of sale, please refer to page 769.



# CONTENTS

ALPHABETICAL INDEX .....	25
GENERAL INDEX .....	50
MODEL NUMBER INDEX .....	37
About Hewlett-Packard .....	21
Application Notes.....	780
Customer Support .....	756
Free Publications .....	792

Information Request Card .....	Back of catalog
Instrument Financing .....	768
New Product Highlights.....	1
Operating Environments & Warranty.....	770
Ordering Information .....	769
Sales & Support Offices .....	771

## PRODUCT SECTIONS

Amplifiers .....	406
Analytical Instruments for Chemistry .....	676
Automatic Test.....	612
Board Test Systems .....	546
Business Computer Systems.....	696
Cabinets & Cabinet Accessories.....	748
Cables & Adapters .....	740
Calculator Products .....	692
Component Measurement .....	278
Computer Aided Test .....	582
Computer Peripherals.....	706
Controllers .....	552
Data Acquisition Systems .....	564
Data Communications Test Equipment.....	511
Data Generators & Data Analyzers .....	316
Design Automation.....	616
Digital Circuit Testers.....	272
Digital Multimeters.....	92
Dimensional Measurements .....	350
Electronic Counters .....	176
Frequency & Time Standards.....	484
Frequency, Function & Waveform Synthesizers.....	410
Hewlett-Packard Interface Bus.....	556
Lightwave Test Equipment .....	302

Logic Analyzers.....	256
Medical Instrumentation.....	678
Microwave Test Equipment .....	332
Network Analyzers.....	216
Noise Figure Meter .....	328
Operating Cases.....	746
Oscilloscopes & Waveform Analyzers.....	54
Personal Computers & Terminals.....	682
Plotters & Recorders.....	84
Power Meters.....	208
Power Supplies.....	446
Pressure & Temperature.....	352
Pulse Generators.....	432
Signal Analyzers.....	108
Signal Generators .....	356
Solid State Devices .....	674
Semiconductor Test Equipment .....	524
Sweep Oscillators.....	392
Technical Computer Systems.....	638
Telecommunications Test Equipment.....	494
Transceiver Test Equipment .....	324
Transit Cases .....	742
X-Ray Equipment .....	680



Identifies products having the Hewlett-Packard Interface Bus (HP-IB) capability. HP-IB is our implementation of ANSI/IEEE Standard 488, "Digital interface for programmable instrumentation." For the complete story, see pages 556-560.



Identifies products appearing for the first time in this catalog. New products are also indicated by **boldface** listings in the Model Number Index.



Identifies products available by **Fast-Ship Service**. **Fast-Ship Service** is the quick way for you to choose from thousands of HP products, order them by phone and receive expedited delivery. For more information, see pages 766 and 767.

**Specifications** describe the product's performance. Parameters that are described as **typical**, **nominal**, or **approximately** (≈) are supplemental characteristics intended to provide information useful to applying the product.



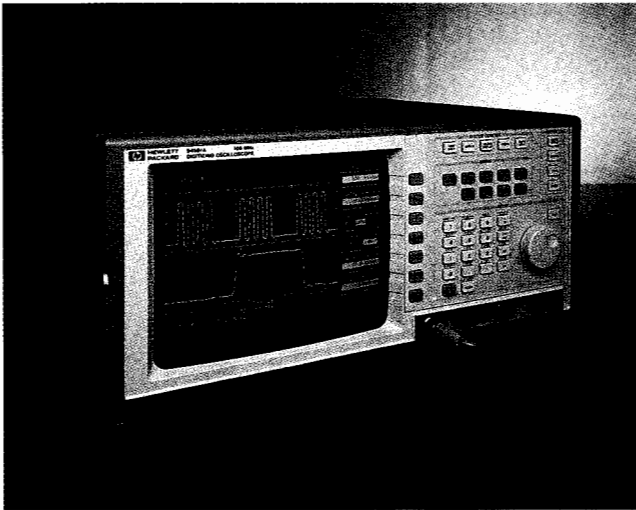

### HP 54501A Digitizing Oscilloscope

The HP 54501A is a low-priced oscilloscope that provides 100-MHz repetitive signal capture. The HP 54501A maintains many of the features of our higher-priced scopes, including full programmability, direct hardcopy output, and the full Advanced Logic Triggering capability formerly available only in the HP 54100D. See page 60 or check 6 on the reply card.



### HP 54118A 500 MHz-18 GHz Trigger

True event triggering is now possible at microwave frequencies. No longer are you restricted to a countdown synchronizer to use your oscilloscope up to 18 GHz. Simply add the HP 54118A 500-MHz-to-18-GHz Trigger to your HP 54120T Digitizing Oscilloscope system and you will be able to make measurements that were never before possible. See page 66 or check 7 on the reply card.

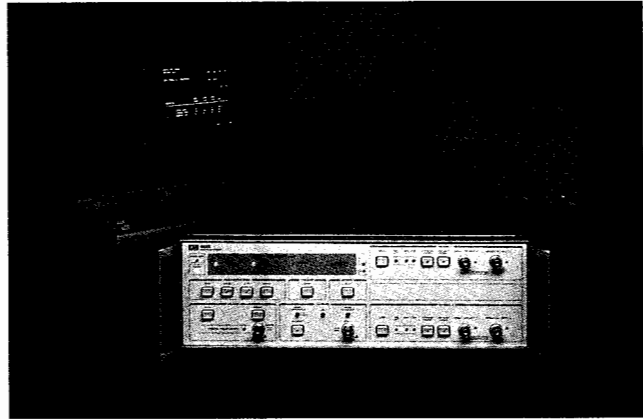

### Software for HP 5183A Waveform Recorder

The HP 5183A Waveform Recorder is a 72-dB dynamic-range transducer that captures transient or repetitive signals. Functioning as a front end to a computer, the recorder features two channels, each with a 12-bit, 4-megasample/s analog-to-digital converter. The HP 5183A includes new high-performance BASIC driver software, which eases recorder setup and operation while increasing measurement throughput to an HP 9000 Series 200/300 engineering workstation or HP Vectra PC. The driver software, which controls up to 32 instruments, provides high-speed data transfer and high system measurement throughput. Using the HP 9000 Model 350 computer, for example, the user can acquire and transfer 1000-point waveforms at greater than 27 measurements/s. See page 73 or check 8 on the reply card.

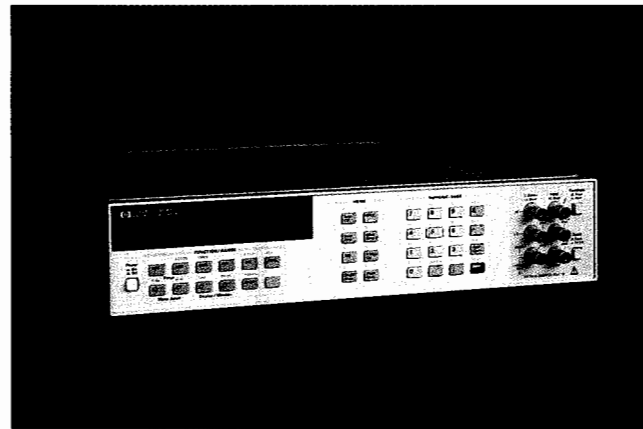

### HP 3458A Multimeter

The HP 3458A Multimeter is the fastest, most flexible, and most accurate multimeter ever offered by Hewlett-Packard. In your system or on the bench, the HP 3458A saves you time and money with unprecedented test system throughput and accuracy, seven function measurement flexibility, and low cost of ownership. Select a reading rate of 100,000 readings per second for maximal test throughput. Or achieve highest levels of precision with up to 8½ digits of measurement resolution and 0.1 part per million transfer accuracy. These features combined with programming compatibility through the HP Multimeter Language (HPML) and simplicity of operation make the HP 3458A the ideal multimeter for your most demanding applications. See page 94 or check 9 on the reply card.

## NEW PRODUCT HIGHLIGHTS

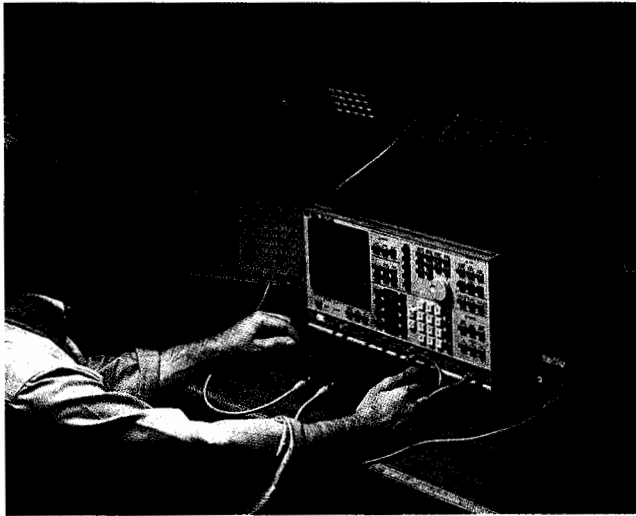

### HP 3585B Spectrum Analyzer

HP's highest-performance audio/video/baseband spectrum analyzer has been enhanced for more power and convenience with no increase in price. The HP 3585B maintains the accuracy, dynamic range, and resolution of the HP 3585A while adding features that improve measurement productivity. New features include automatic limit testing (with pass/fail results on the front panel and over HP-IB), flexible peak searches and signal tracking, and a direct interface to HP-IB printers and plotters for measurement hard copy. The HP 3585B is a compatible replacement for the HP 3585A, with matching specifications and HP-IB programming codes. See page 112 or check 10 on the reply card.

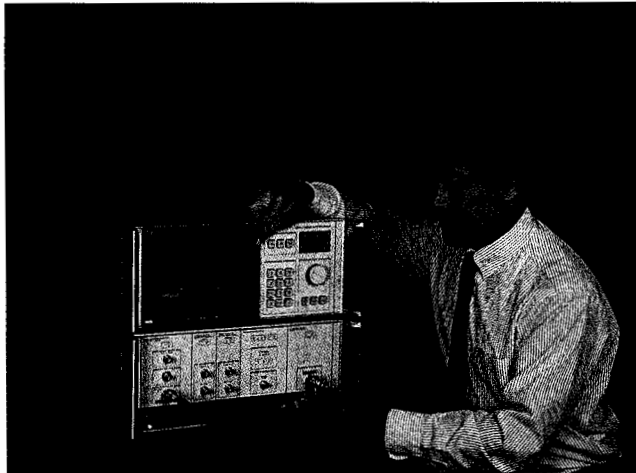

### HP 71100XL Scalar/Spectrum Analyzer

By combining both scalar and signal-analysis capabilities, the HP 71100XL provides a single, cost-effective measurement system for testing RF components. A frequency range of 100 Hz to 2.9 GHz makes this instrument ideal for audio, baseband, HF, VHF, IF, and microwave applications. And in addition to excellent analog performance, the analyzer offers a powerful scalar analysis interface that speeds up stimulus-response testing. See page 116 or check 11 on the reply card.

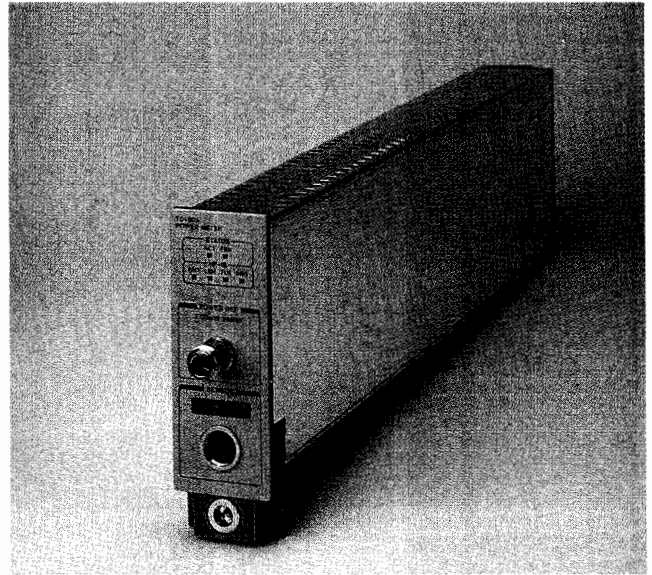

### HP 70100A Power Meter Module

The HP 70000 Modular Measurement System now has very accurate power measurement capability with the addition of the HP 70100A Power Meter Module. The HP 70100A provides all the functional performance of the HP 437B Power Meter and is fully compatible with the entire HP 8480 family of 15 power sensors. Since it is only 1/8-rack wide, up to eight modules can be assembled in a single HP 70001 mainframe, allowing power sampling at a number of system nodes, or computation of power ratios or differences. See page 122 or check 12 on the reply card.



### HP 8449A, 70620A Microwave Preamplifiers

With state-of-the-art technology these high-gain, low-noise preamplifiers offer a cost-effective means of increasing the sensitivity of your spectrum analyzer system from 2 to 22 GHz. Better sensitivity not only allows you to detect and analyze signals at much lower levels but also increases the speed of your measurements. The HP 8449A is a stand-alone, manually operated preamplifier. The HP 70620A is a 1/8-width module that adds a fully integrated, automatic amplification stage to the HP 70000 Modular Measurement System. See pages 407 (HP 8449A) and 116 (HP 70620A) or check 13 on the reply card.

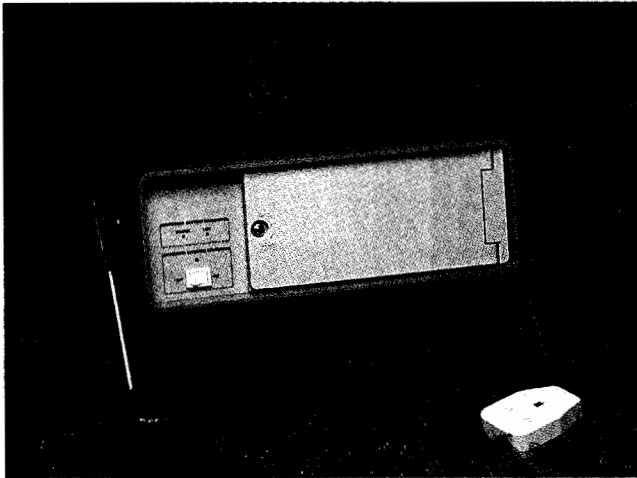

#### HP 85901A AC Power Source

Hewlett-Packard's first portable battery pack for test equipment provides 200 watts of continuous power for field and mobile applications. This self-contained ac power source has outputs of either 115V or 230V and runs on its own internal battery, an external battery, or on another 12 Vdc source. Typical operating time exceeds one hour for 100-watt continuous use at room temperature. The inverter output has overvoltage, short-circuit, and overload protection. The power source comes in a sturdy package with an adjustable handle that can also be used as a tilt stand. See page 136 or check 14 on the reply card.

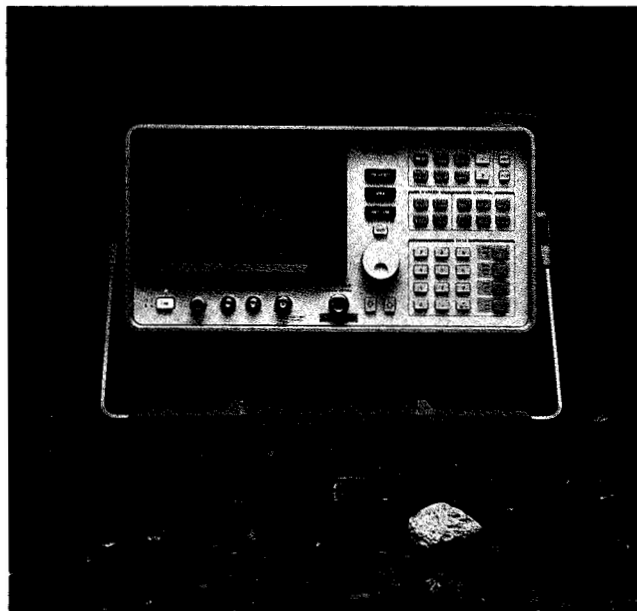

#### HP 8592A Spectrum Analyzer

This low-cost, portable spectrum analyzer has a 50-kHz-to-22-GHz frequency range and full microwave preselection. Its small, sturdy mainframe has a briefcase handle for easy carrying and it fits easily under an airplane seat. Features include a built-in comb generator for frequency accuracy and full programmability with options for HP-IB, HP-IL, or RS-232. For truly portable use in the field, the spectrum analyzer can be operated with the HP 85901A portable AC Power Source. See page 137 or check 15 on the reply card.



#### HP 35660A Dynamic Signal Analyzer

The HP 35660A is a 2-channel FFT-based analyzer offering spectrum and network measurements in electronics, mechanical test, acoustics, and other low-frequency application areas. The instrument features an internal programming language and a built-in disc drive for full automation of analyzer functions. The programming language (HP 35680A Instrument BASIC) is fully syntax-compatible with HP BASIC so that HP workstation owners can easily merge the HP 35660A and Instrument BASIC into existing test systems. The analyzer can also function as a small system controller, thereby decreasing the burden on host computer testing. See page 153 or check 16 on the reply card.

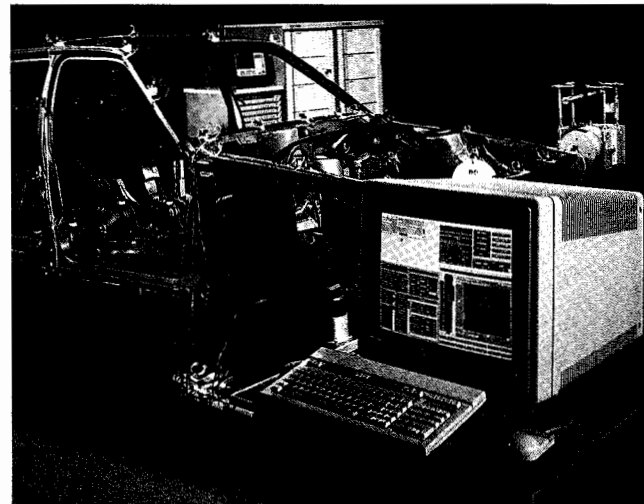

#### Software for HP 3565S Signal Processing System

With the addition of two software packages, the HP 3565S Signal Processing System becomes the leader in the area of multiple-channel stimulus response testing. HP SINE (HP 35631A) gives the HP 3565S system swept-sine capability for normal mode testing and sinusoidal frequency-response testing. It also provides sine-reduction capability for processing environmental test data. The HP 35652A Modal Data Manager organizes and formats HP 3565S data for easy transfer to advanced third-party modal solutions. Modal Data Manager also enhances structural data by adding to it transducer orientation and sign and spatial coordinates indicating where the measurement was made. See page 157 or check 17 on the reply card.



## NEW PRODUCT HIGHLIGHTS

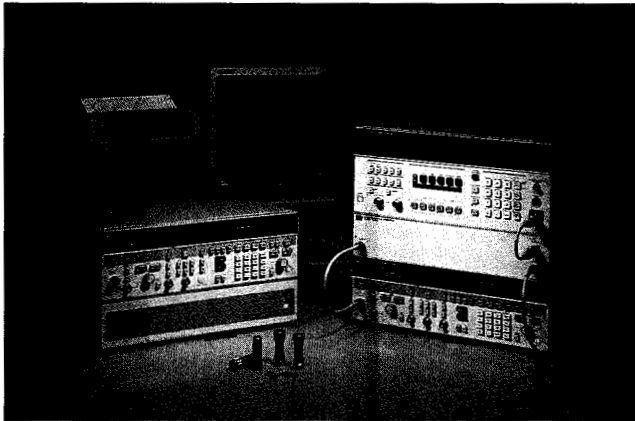

### HP 8902SG Signal Generator, 8902AT Attenuator Calibration Systems

The 8902SG Signal Generator Test System provides a versatile and powerful solution for RF and microwave signal-generator test needs. The system combines the accuracy of the HP 8902A Measuring Receiver and HP 8903B Audio Analyzer with the new HP 11808A Signal Generator Performance Test Software. A key feature of this software is the use of data files. Files with instrument settings and specifications are created and edited through on-screen work sheets, requiring no programming experience. The HP 8902AT Attenuator Calibration System offers high performance in attenuator calibration from 10 MHz to 26.5 GHz. Combining the exceptional accuracy and wide dynamic range of the HP 8902A Opt. 050 Measuring Receiver, the HP 8902AT tests fixed, manual, and programmable attenuators. After data is taken, it can be stored on disc and then statistical analyses such as arithmetic average and standard deviation can be done. See pages 170 and 171 or check 18 on the reply card.

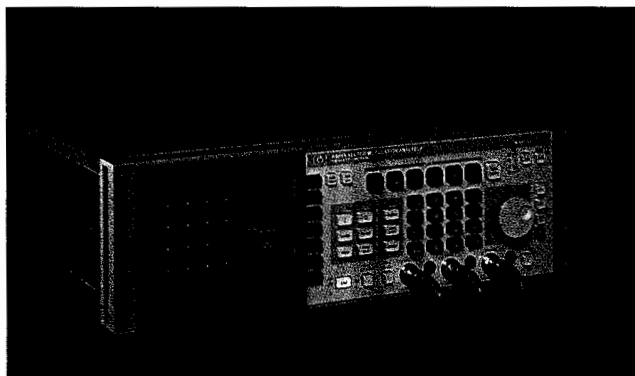

### HP 8981A Vector Modulation Analyzer

The HP 8981A improves on the HP 8980A Vector Analyzer (dual-channel, dc to 350 MHz) by adding a precision coherent demodulator at its input for 50-to-200-MHz frequency coverage. In addition, powerful calibration firmware corrects quadrature error as well as I- and Q-channel imbalances. Display modes match the new applications made possible by the demodulator; vector and constellation are for analyzing in-phase and quadrature signal components, and a time-domain mode displays "eye" diagrams. A unique 3-dimensional format gives new insights on complex microwave modulations such as chirp radar. Five markers help quantify details of displayed signals. See page 162 or check 19 on the reply card.

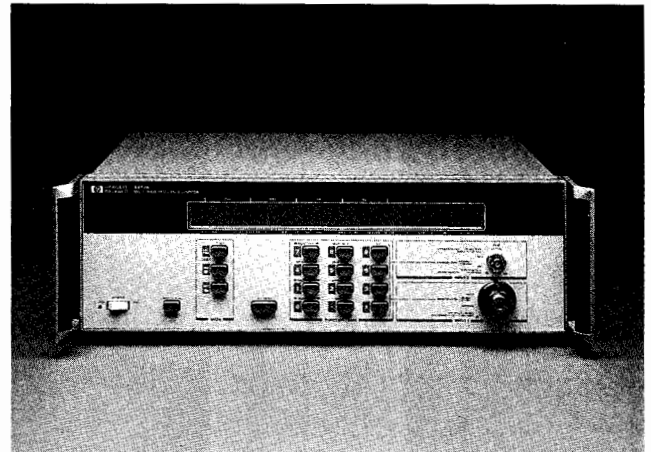

### Frequency-Extension Option for HP 5352B Microwave Counter

A new 46-GHz frequency-extension option significantly enhances the performance of the HP 5352B Microwave Counter. Option 005 features a 2.4-mm input connector and allows broadband, coaxial frequency measurement to 46 GHz without an external mixer. The HP 5352B's sensitivity of -30 dBm at 26.5 GHz, linearly decreasing to -15 dBm at 46 GHz, makes it possible to measure weak EHF satellite communication-system signals without using external amplifiers and filters. In system applications, the counter's 120-measurement/s throughput improves overall system efficiency. The HP 5352B also features 60-ms acquisition time and 1-GHz/s tracking speed. See page 178 or check 20 on the reply card.



### HP 5364A Microwave Mixer/Detector

The HP 5364A offers wide IF, phase linear downconversion, and video detection of microwave signals from 2 to 18 GHz. Designed as a companion instrument to the HP 5371A Frequency and Time Interval Analyzer, the HP 5364A extends modulation-domain measurement and analysis into the microwave frequency range. By combining these instruments with a suitable local oscillator, you can assemble a system to recover phase, frequency, and various digital modulations, such as QPSK, from a microwave carrier. Agile microwave carriers can be measured directly in a single shot over a 500-MHz bandwidth. The modulation-domain makes it possible to measure switching speed, overshoot, and settling time of VCOs. Source stability, jitter and PRF/PRI measurements also benefit from modulation-domain analysis. See page 193 or check 21 on the reply card.



### HP 437B Power Meter

The HP 437B single-channel, programmable power meter offers low cost, 120,000 hours MTBF (mean-time-between-failure), and a flexible feature set. The HP 437B measures power from 100 kHz to 50 GHz and from -70 to +24 dBm, using the complete family of 14 HP power sensors. One new sensor covers power to 50 GHz in 2.4-mm coax, and three high-sensitivity diode sensors cover 26.5 to 50 GHz in waveguide and to 26.5 GHz in 3.5-mm coax. Other features include enough memory to store cal factor tables for 10 sensors, as well as pre-stored tables of average values of the 10 most popular models. Also, the cal factor no longer needs to be entered for each new measuring frequency. By merely entering frequency, you eliminate errors. See page 209 or check 22 on the reply card.

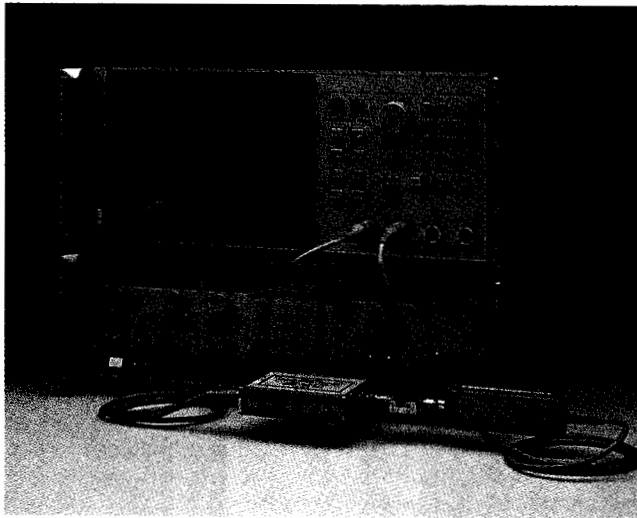

### Accessories Extend Scalar Network Analysis to 40 GHz

Now you can quickly and accurately measure insertion loss/gain, return loss, and absolute power over a broad 10-MHz-to-40-GHz range with new instrumentation and accessories that use the 2.4-mm broadband coaxial connector. A complete 40-GHz coaxial scalar network analyzer system can be configured using the HP 8757A Scalar Network Analyzer and the HP 8350B Sweep Oscillator Mainframe combined with one of two new RF plug-ins, the HP 83597A and the HP 83596A.

Complete the system by combining the appropriate new 2.4-mm scalar accessories for your measurement configuration: the HP 85025D 2.4-mm Detector and the HP 85027D 2.4-mm Directional Bridge. See pages 222 (HP 85025D, 85027D) and 401 (HP 83596A, 83597A) or check 23 on the reply card.



### HP 41952A/B Transmission/Reflection Test Sets

The HP 41952A (50 $\Omega$ ) and 41952B (75 $\Omega$ ) Transmission/Reflection Test Sets speed and simplify transmission and reflection measurements with the HP 4195A Network/Spectrum Analyzer. Each test set contains a power splitter and a directional coupler and connects directly to the HP 4195A. For added convenience Option 009 permits full s-parameter measurements without having to reverse the device under test. See page 233 or check 24 on the reply card.

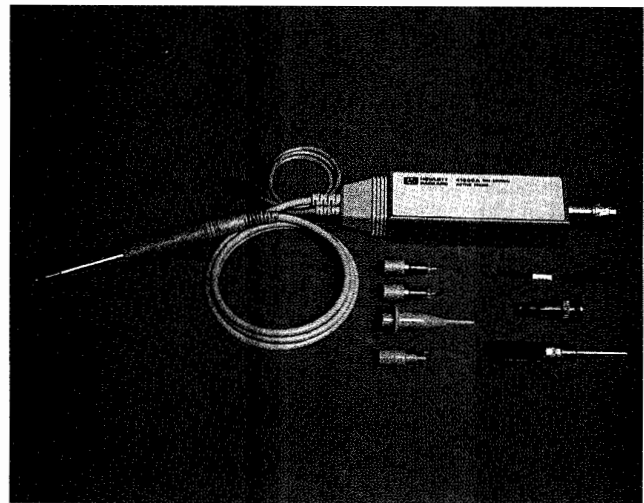

### HP 41800A Active Probe

The HP 41800A Active Probe is a high-input-impedance probe that covers 5 Hz to 500 MHz and makes it easy to perform signal analysis on circuits in the audio, video, HF, and VHF bands. Suitable for both spectrum and network analysis, the HP 41800A features low distortion and low noise. The HP 41800A is directly compatible with HP analyzers such as the HP 4195A, HP 3577A, HP 3585A, and HP 8568B, which supply probe power from the front panel. See page 233 or check 25 on the reply card.

## NEW PRODUCT HIGHLIGHTS



### HP 8508A Vector Voltmeter

The HP 8508A provides economical RF voltage and phase measurements in the 100-kHz-to-2-GHz range. Two different input modules give you considerable flexibility, depending on your desired frequency coverage and application needs. The HP 85081A High-Impedance Probe Input Module covers the 100-kHz-to-1-GHz range, whereas the HP 85082A 50-Ohm Input Module operates between 300 kHz and 2 GHz. Built-in data processing allows for real-time ratio measurements and units conversions to linear or log magnitude in polar or Cartesian coordinates. When making reflection measurements, display your results in terms of reflection coefficient or even absolute or normalized impedance. The HP 8508A offers an easy-to-read digital display as well as trend indicators for peaking and nulling applications. Full HP-IB programmability makes the HP 8508A a good value for automated ATE systems or, when used with a programmable signal generator and a computer, for automatic stimulus-response component measurements. See page 242 or check 26 on the reply card.

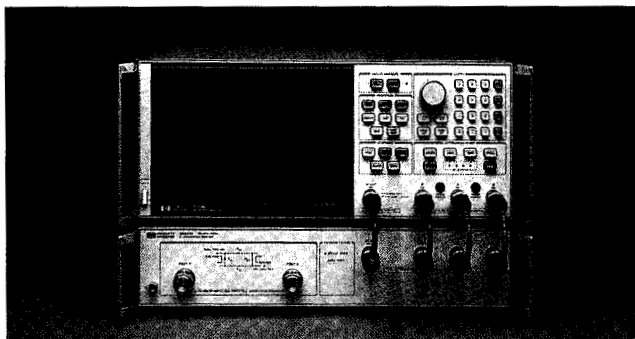

### HP 8753B RF Network Analyzer

The HP 8753B RF Network Analyzer continues the tradition of affordable excellence in RF component measurements set by the HP 8753A. The HP 8753B offers wider frequency coverage (300 kHz to 3 GHz— Option 006 extends to 6 GHz) to characterize RF components in both transmission and reflection and then display the measured magnitude and phase response in your choice of formats. It also adds non-linear measurement capability for the characterization of mixers and amplifier harmonics. You can perform repetitive tests more quickly and easily using the HP 8753B's built-in sequencing. The HP 8753B is a powerful automatic vector network analyzer ideal for use in the lab while maintaining simplicity and speed for production test areas. See page 243 or check 27 on the reply card.



### HP 8720A Microwave Network Analyzer

The HP 8720A provides simple and complete vector network measurements in a compact and fully integrated microwave network analyzer optimized for incoming inspection, production, and final test. Characterize the reflection and transmission properties of your microwave components and networks accurately yet economically over the entire 130-MHz-to-20-GHz synthesized frequency range. Use such features as limit testing, arbitrary frequency list mode, external disc save/recall, and the HP 8720A's direct plotter/printer output to simplify your alignment and test process and to increase the productivity of your manufacturing area. See page 247 or check 28 on the reply card.

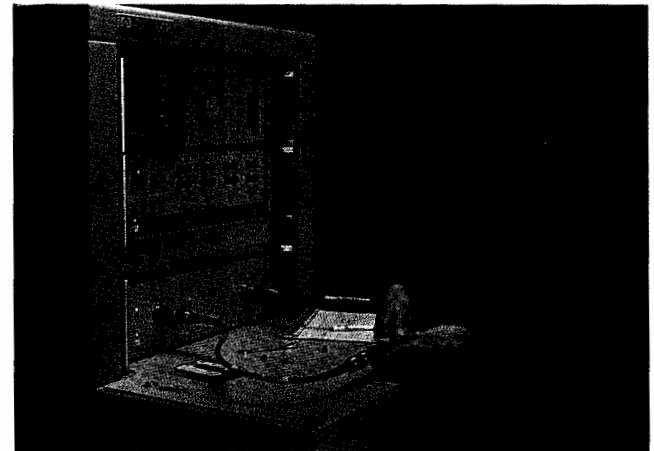

### HP 8510B Network Analyzer

The HP 8510B Network Analyzer can now be configured for coaxial magnitude, phase, and group delay measurements over a broad 45-MHz-to-40-GHz frequency range in a single sweep. Powerful features, such as through-reflect-line (TRL) calibration, fast ramp sweep, and time-domain analysis, provide the highest quality measurement results. These capabilities are made possible by a new test set that features the rugged 2.4-mm coaxial connector. The HP 8516A S-Parameter Test Set allows the system to make fully error-corrected measurements without the need to reverse the test device. It also has built-in bias tees to simplify active device testing. A complete line of 2.4-mm measurement accessories featuring the precision slotless female interface (PSC-2.4) is available.

The HP 8510B can also be configured for millimeter-wave operation in the waveguide bands from 26.5 to 100 GHz. Overall, the HP 8510B incorporates features and performance to keep pace with the demands of high-frequency component testing. See page 249 or check 29 on the reply card.



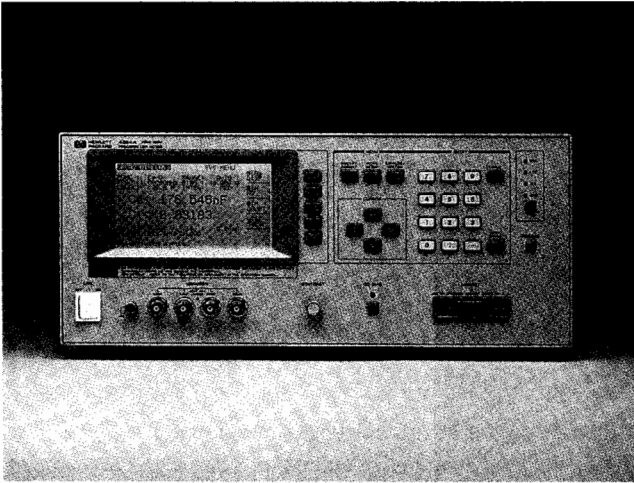

### HP 4284A Precision LCR Meter

The HP 4284A Precision LCR Meter helps you improve component and material quality through accurate, high-volume testing. Its wide 20-Hz-to-1-MHz frequency range and superior test signals allow the HP 4284A to test components to the most commonly used standards under conditions that simulate the intended application. The HP 4284A's wide impedance measurement range covers from 0.01-mohm minimum resolution to 100-Mohm full scale with unmatched basic accuracy of 0.05 through the full range to 1 MHz. Six full digits of resolution for all measurement parameters allow you to determine even the smallest differences in materials or component performance. The test signal (voltage/current) is variable from 5 mVrms to 2 Vrms, and from 50  $\mu$ Arms to 20 mArms. The constant test-signal level feature guarantees that the applied test-signal level will remain constant for demanding tests.

Combining the HP 4284A Precision LCR Meter, HP 42841A Current Source, and the HP 42842A/B Current Fixture gives you a high-performance system for testing power inductors and transformers. This system enables you to test inductors up to 1 MHz at the high dc current levels (up to 20A, 40A with two HP 42841As and the HP 42842B) demanded for components used in advanced switching power supplies. Whether in R&D, production, quality assurance, or incoming inspection, the HP 4284A will meet all of your LCR meter test and measurement requirements. See page 286 or check 30 on the reply card.

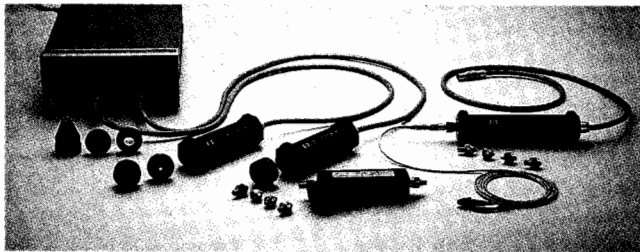

### HP 81522A Optical Head

The HP 81522A Optical Head, together with the HP 8152A Optical Average Power Meter, makes measurements down to 0.1 pW (-100 dBm sensitivity). It is individually calibrated over its full wavelength range of 1000 nm to 1650 nm with an absolute accuracy of  $\pm 5\%$ . See page 306 or check 31 on the reply card.

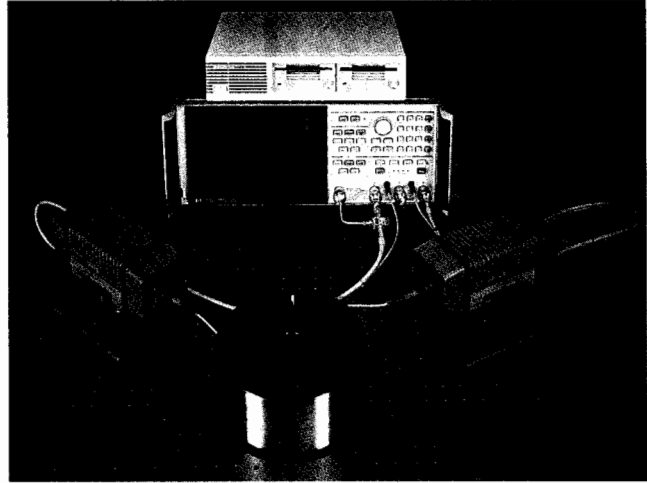

### HP 8702A Lightwave Component Analyzer

The HP 8702A system characterizes the components in a high-speed fiber optic transmission system. It does this by measuring their transmission and reflection response to swept modulation frequencies up to 3 GHz. For example, the HP 8702A can measure the modulation transfer function of lasers, the bandwidth of fiber, and the demodulation transfer function of photodiodes. With a lightwave coupler, the HP 8702A can locate discontinuities and measure optical return loss. In addition, the HP 8702A can be used as a network analyzer to measure system gain and complex impedance. See page 312 or check 32 on the reply card.

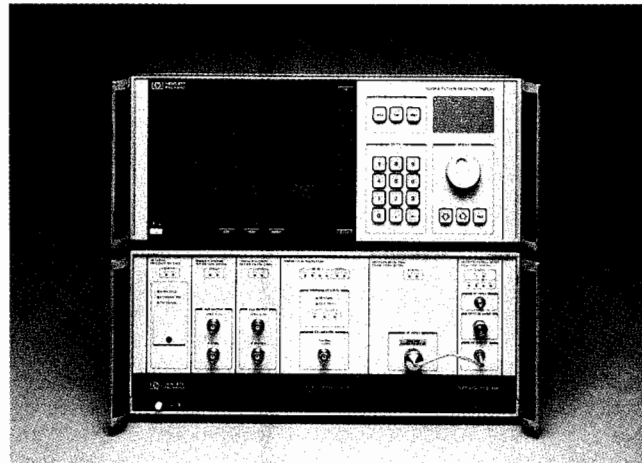

### HP 71400A Lightwave Signal Analyzer

The HP 71400A is the first commercially-available receiver for measuring modulated light transmitted at high speeds. It has a receiver bandwidth of 100 kHz to 22 GHz, sensitivity of -60 dBm (optical), and full calibration at 1300 nm and 1550 nm. As part of the HP 70000 Modular Measurement System, the lightwave signal analyzer has all the benefits of modularity and the high performance of the HP 71210A Microwave Spectrum Analyzer, on which it is based. An RF version, the HP 71401A, is also available. See page 314 or check 33 on the reply card.

## NEW PRODUCT HIGHLIGHTS

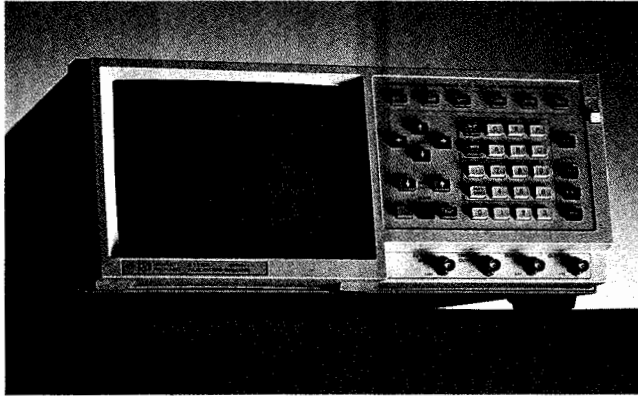

### HP 8118A 100-Mbit/s Pulse Pattern Generator

The HP 8118A introduces a new generation of measurement equipment. It combines pulse and pattern capabilities in one box and offers full control over level, timing, pattern, and transition parameters. Each of the instrument's two channels is capable of 16-kbit-long data streams with individually programmable slopes and timings and 16 V<sub>pp</sub> into 50 ohms for in-depth parametric analysis of digital circuits. The HP 8118A addresses the requirements of digital design engineers who evaluate the worst-case conditions of a circuit under test. In the area of low-speed communication, the HP 8118A helps to analyze and tune digital communication modules. See page 317 or check 34 on the reply card.

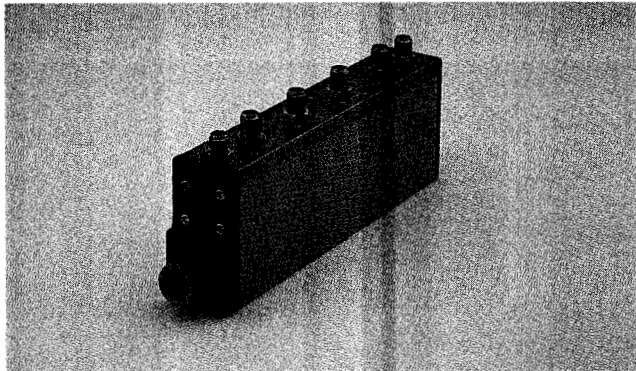

### Step Attenuator/Switch Combinations

Hewlett-Packard's family of combination step attenuators and switches offers the microwave design engineer many alternatives that can reduce coaxial cabling and component count. With the design based on the highly-reliable HP 33320 Series Step Attenuators (5 million steps per pad), Hewlett-Packard can add SPDT switch functions on either end, or one or two transfer switches. Operating range is dc to 26.5 GHz, and even higher performance is possible in the lower ranges. See page 340 or check 35 on the reply card.



### 50-GHz Coaxial Measurement Accessories

Hewlett-Packard continues to complete its line of test accessories that have 2.4-mm coaxial connectors. Now we offer detectors, pads, terminations, power sensors, scalar network analyzer detectors, cross-series adapters, design kits for stripline launch service, and other items needed for your systems to operate up to 50 GHz. See page 333 or check 36 on the reply card.

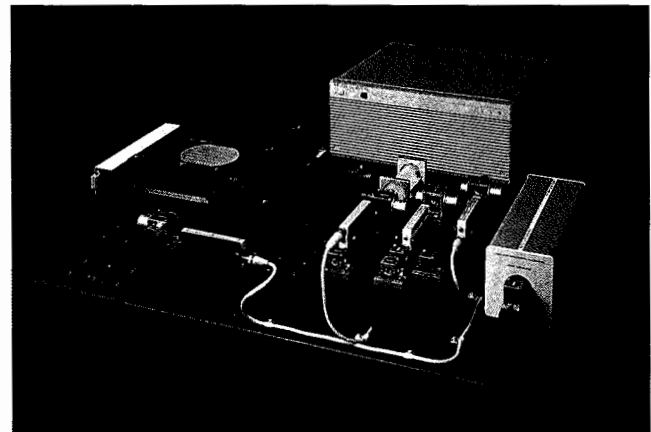

### HP 5527A Laser Position Transducer System Enhancements

Submicron position monitoring and control is now significantly faster, easier, and less costly with a new printed-circuit board for the HP 5527A Laser Position Transducer System. The HP 10936A Servo-Axis Board, a programmable digital servo controller, added to the HP 5527A system along with a commercially available servo motor and motor amplifier, provides the entire closed-loop positioning function in a high-performance, high-accuracy system. The HP 10936A features multiple outputs to drive all available motor amplifiers, motion control algorithms (difference equations) in firmware, a trace function to gather real-time data on system performance, and supports coordinated multiaxis moves.

The HP 10716A High-Resolution Interferometer improves laser system accuracy and repeatability with finer measurement resolution and reduced thermal drift. The HP 10716A has two times better measurement resolution than previously available and  $1/12$  the measurement drift of a conventional plane mirror interferometer. The HP 10716A is compatible with both the HP 5527A system and the HP 5501A Laser Transducer System. The new HP 10724A Plane Mirror Reflector can be used with the HP 10716A and all other HP plane mirror interferometers. See page 350 or check 37 on the reply card.

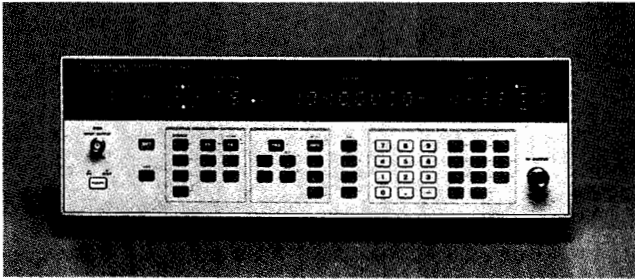

### HP 8657A Synthesized Signal Generator

The HP 8657A Synthesized Signal Generator is a 1040-MHz economy generator with AM and FM modulation and good spectral purity. With -130 dBc phase noise at 500 MHz, the HP 8657A meets many adjacent-channel measurement needs for receiver testing. In addition, the HP 8657A enhances signal generator reliability by offering a new electronic attenuator with an estimated 0.2% failure rate. See page 359 or check 38 on the reply card.

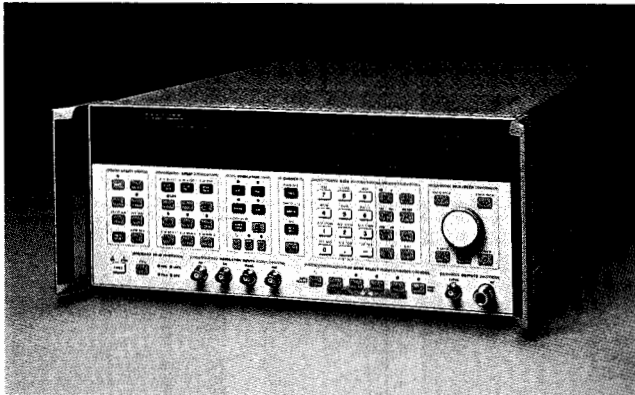

### HP 8644A, 8645A, 8665A Synthesized Signal Generators

Using the same architecture, these three signal generators offer high performance for a wide range of applications. The HP 8644A Synthesized Signal Generator offers exceptional spectral purity to 2060 MHz, and its features are well-suited to R&D testing. The HP 8645A Agile Signal Generator combines 15-microsecond switch speed with -124 dBc phase noise for testing both the stringent RF performance and the dynamic fast-hopping capability of frequency-agile and surveillance receivers. The HP 8665A Synthesized Signal Generator offers high spectral purity to 4.2 GHz for making measurements such as sensitivity on telemetry receivers and spurious emissions on mobile radios.

All three generators use an internally modular configuration; you can add options to improve spectral purity, extend frequency range, reduce leakage, and enhance modulation. Or you can add an electronic attenuator for high-volume production testing and an advanced modulation source for testing all areas of a design. In addition, the modular structure offers greater reliability, lower cost, modular support, and compatible programming commands. See pages 361, 363, and 365 or check 39 on the reply card.

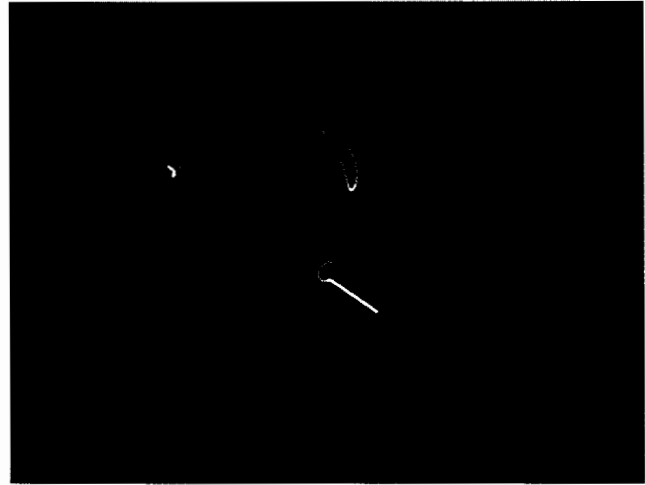

### Exceptionally-Complex Signal Simulation, 10 to 3000 MHz

HP's vector/arbitrary waveform synthesizer (VAWS) is a new combination of the HP 8780A Vector Signal Generator and two HP 8770A Arbitrary Waveform Synthesizers, which furnish in-phase and quadrature modulation signals. The resultant benchtop signal simulator permits comprehensive testing of modern radar, EW, and communications systems and components. It generates not only ideal system signals but also distortion, multipath fades, noise, and other stress signals. See page 382 or check 40 on the reply card.



### HP 8347A RF Amplifier

The HP 8347A is a convenient, compact, instrumentation amplifier that provides greater than 25 dB of gain, a +2 to +20 dBm internally-leveled output power range, and low harmonics over the 100-kHz-to-3-GHz frequency range. Really a cross between a preamplifier and a power amplifier, the versatile HP 8347A can provide gain and power to overcome RF path losses, drive high-power devices, or improve measurement system performance. See page 406 or check 41 on the reply card.



## NEW PRODUCT HIGHLIGHTS

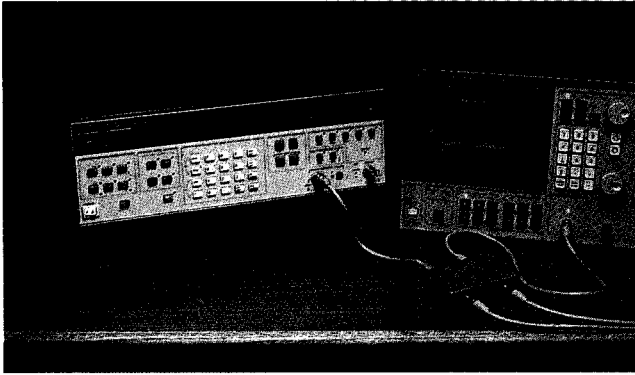

### HP 3325B Synthesizer/Function Generator

HP's most popular low-frequency (dc-21 MHz) synthesized source now offers more functionality at the same price. The new HP 3325B adds features and flexibility to the HP 3325A and is fully compatible in even the most complex automated system. New features include a second fully programmable sine/square source for modulation or stand-alone use, and a dc-60 MHz TTL-compatible output with synthesizer accuracy and resolution. There is also a new discrete sweep feature with up to 100 sweep elements and an RS-232 interface for more flexible remote control. See page 414 or check 42 on the reply card.

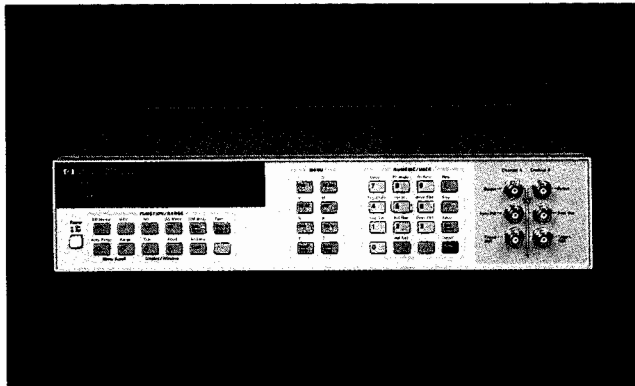

### HP 3245A Universal Source

Precision dc voltage and dc current outputs with  $6\frac{1}{2}$  digits of resolution are possible with the HP 3245A Universal Source. AC waveforms with accurate amplitude and frequency are also available. Standard ac outputs include sinewave, squarewave, and ramp. For increased versatility, arbitrary waveforms can be generated as well, making this a truly universal source. The ac signals are generated by direct digital synthesis, which provides high accuracy and resolution down to .001 Hz. Output amplitude can be  $\pm 10V$ , while maximum frequency, including arbitrary waveforms, is 1 MHz. A second channel option allows the generation of two outputs, either independent of one another or phase related. See page 430 or check 43 on the reply card.

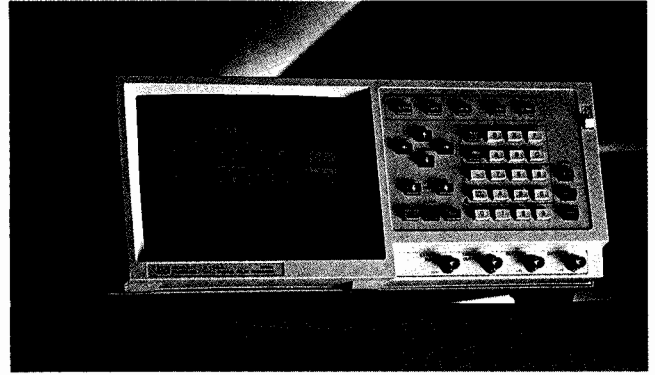

### HP 8115A 50-MHz Dual-Channel Pulse Generator

The HP 8115A is a two-channel, programmable, low-cost pulse generator that addresses standard bench and ATE system applications in all industry segments. It is HP-IB programmable and offers full control over timing, level, and transition parameters. It is an excellent tool for design engineers in analog and digital industry segments who must evaluate worst-case conditions or stimulate a device under test with the appropriate signal. The HP 8115A matches applications where two parameter-independent but synchronous pulse trains are required. See page 435 or check 44 on the reply card.



### HP 8131A 500-MHz Pulse Generator

The HP 8131A 500-MHz Programmable Pulse Generator addresses the requirements of high-speed circuit design, especially work done on digital ECL and GaAs circuits. The HP 8131A, a one-channel instrument, offers a 500-MHz repetition rate with  $<200$ -ps (10%-90% of amplitude) fixed rise/fall times and 10-ps resolution on all programmable timing parameters. It offers an output amplitude of 5 V<sub>pp</sub> into 50 ohms in a  $\pm 5V$  window and is fully HP-IB programmable. An optional second channel is available (Option 020). See page 436 or check 45 on the reply card.

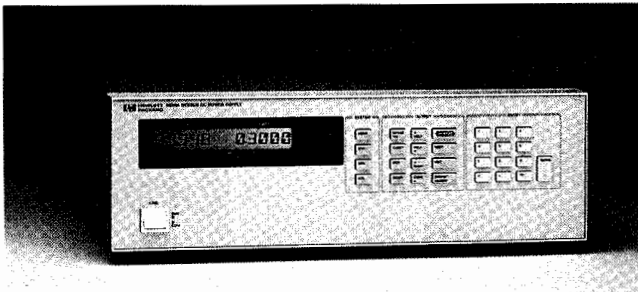

### HP 6625A, 6626A Multiple-Output System DC Power Supplies

HP has expanded its family of HP-IB controlled system dc power supplies with two multiple-output, high-performance models, the HP 6625A and 6626A. The HP 6625A, a two-output power supply, offers 75 watts total output power; the HP 6626A is a four-output power supply offering 150 watts total output power. Both models offer high-resolution programming of output voltage and current. High-resolution measurement of voltage and current output, including instrument status and fault conditions, can be read back over the HP-IB. Overvoltage and overcurrent protection guard the device under test and the power supply. Each isolated output integrates the functions of a power supply, HP-IB interface, DVM, and precision current shunt into one package. This one-box solution yields substantial savings in system-integration time, rack space, HP-IB address space, and design and documentation costs. See page 458 or check 46 on the reply card.

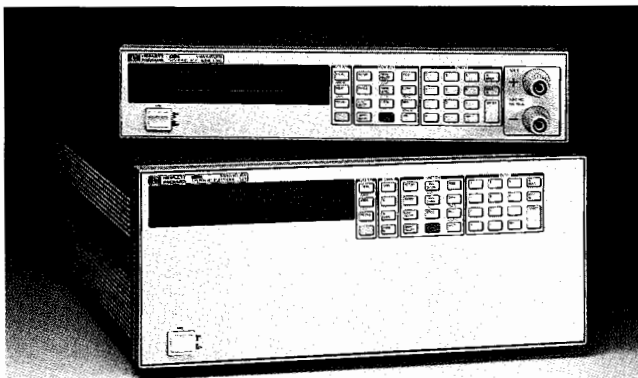

### HP 6050A, 6060A Electronic DC Loads

High performance and reliability are designed into a new full-featured family of electronic load products from Hewlett-Packard. Testing power supplies, batteries, and power components with the HP 6060A 300-Watt Single Input Electronic Load or the HP 6050A 1800-Watt Electronic Load Mainframe can be done in automated or manual environments. System features include a built-in HP-IB interface for full control and readback of all functions. Manually operating the load is easily done using the front-panel keypad and LCD display.

These electronic loads offer significant system-design advantages over presently available alternatives that use individual components. The HP 6050A and 6060A integrate IEEE-488 isolated D/A programmers, a pulse generator, a DVM, and current-monitor shunt into a single package. See pages 448 and 449 or check 47 on the reply card.

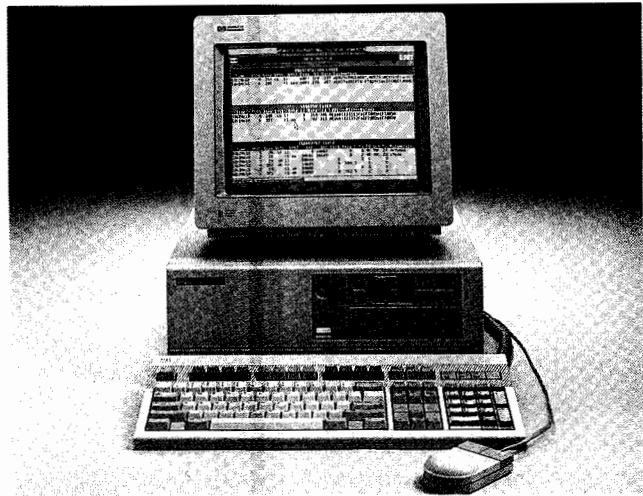

### HP 4974S MAP Protocol Analyzer

The HP 4974S is an HP Vectra PC-based protocol analyzer for testing and debugging MAP communications software. Designed for multivendor networking environments, the analyzer connects to IEEE 802.4 networks and offers testing for the MAP 3.0 protocol stack. Frames can be captured as they occur and decoded in accordance with the MAP protocol specifications. The HP 4974S provides an independent view of protocol events on an IEEE 802.4 network with summary information of protocol-data-unit (PDU) header values. Supported protocols include IEEE 802.4, IEEE 802.2 Link Layer, ISO Network, ISO Transport Class 4, ISO Session, ISO Presentation, ACSE, FTAM, NMS, DS, and NM. See page 514 or check 48 on the reply card.

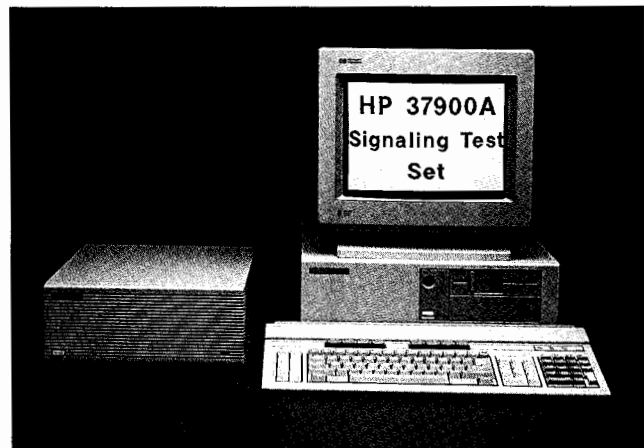

### HP 37900A Signaling Test Set

The HP 37900A Signaling Test Set combines modular interfaces, dedicated software, and a computer controller to give a high-performance test solution for No. 7 common-channel signaling. The HP 37900A can non-intrusively monitor No. 7 signaling links, emulate No. 7 signaling devices, and generate typical signaling link impairments. Network operators can assess performance and troubleshoot No. 7 networks, using the powerful monitoring and data-analysis features. Emulation allows response testing of new equipment useful for automating commissioning, installation, or manufacturing test procedures. The HP 37900A also helps in product development as it can be programmed to mimic the operation of network equipment or new designs. See page 515 or check 49 on the reply card.

## NEW PRODUCT HIGHLIGHTS

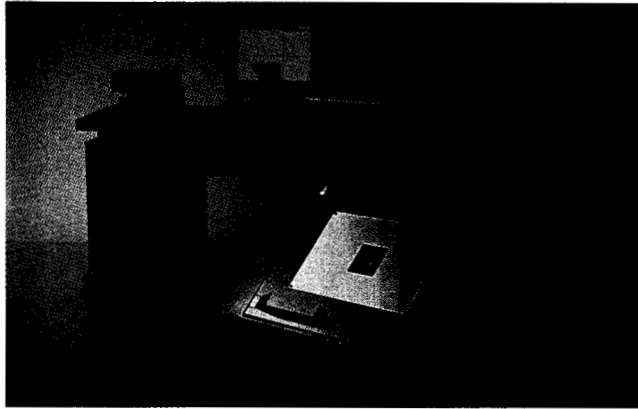

### HP 82000 IC Evaluation System

The HP 82000 is a fully integrated system designed to perform functional verification and in-depth characterization on ASICs and VLSI devices. Applications include low-volume production test, failure analysis, and incoming inspection. The system features "tester-per-pin" architecture, which provides separate timing and level generators on up to 384 true I/O channels. Combining these features with a 200-MHz vector rate, 50 ps resolution, and high accuracy, this system delivers the performance required to test the most demanding digital ICs. The interactive software running under X Windows supports automatic test generation and has built-in ac/dc characterization. See page 526 or check 50 on the reply card.

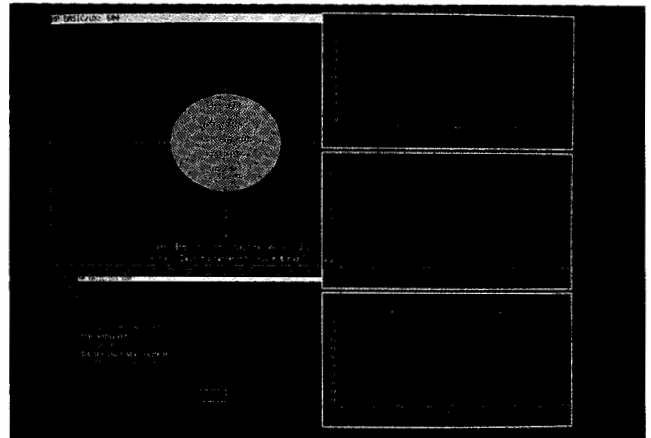

### HP BASIC/UX for Series 300 Instrument Controllers

HP BASIC/UX combines the ease-of-use of HP BASIC, the world's most powerful language for instrument control, with the powerful facilities of the industry-standard HP-UX operating system. HP BASIC/UX is available on HP 9000 Series 300 systems running HP-UX. HP BASIC/UX adds significant capabilities to the already rich feature set of HP BASIC: features include industry-standard networking, multitasking, windowing, and the ability to link to compiled C, FORTRAN, and Pascal subroutines. HP BASIC/UX also gives you easy access to HP-UX tools and applications. See page 553 or check 52 on the reply card.

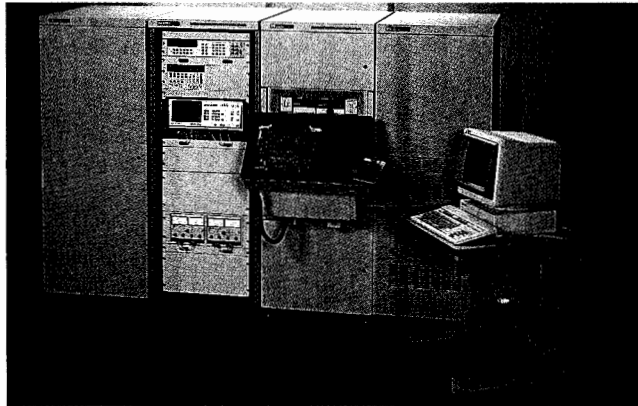

### HP 3065CT Communications Technologies Board Test System

The newest member of the HP 3065 Board Test Family, the HP 3065CT, is a completely integrated one-stage test system for the telecommunications industry. Based on the solid foundation of the HP 3065AT Advanced Technologies Combinational Test System and the HP Telecomtest software, the HP 3065CT adds test instrumentation to perform standard CCITT specification tests on telecom products. Prior to specification testing, production-induced faults can be detected with the HP 3065CT's in-circuit test capability. The HP 3065CT performs tests required to verify the quality of transmission channels as well as the quality of signaling requirements. See page 546 or check 51 on the reply card.

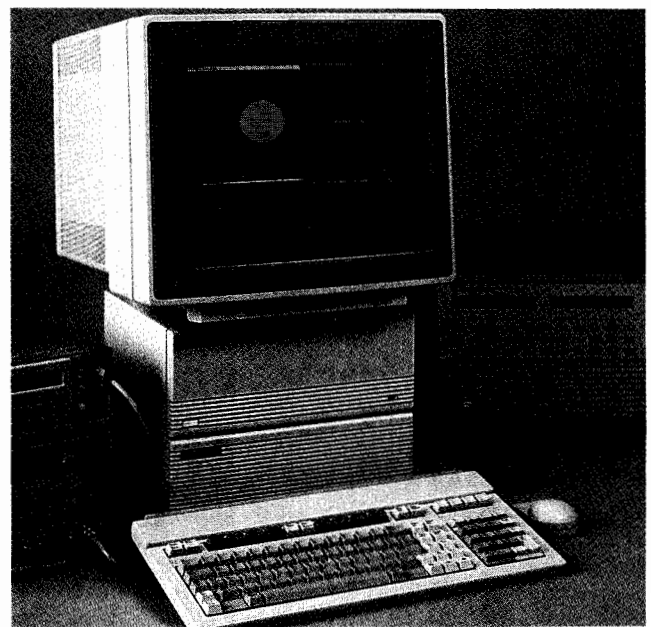

### HP 9000 Model 360 Instrument Controllers

The HP 9000 Models 360MMA/CMA and 360MMAX/CMAX are tailor-made solutions for applications requiring high to exceptional performance in an instrument controller. The Model 360MMA and CMA combine high-performance I/O and computational power with HP BASIC, the premiere language for instrument control. Model 360MMAX and CMAX provide the power required for the most demanding instrument control applications. They are configured with HP BASIC/UX, HP's BASIC measurement language running on the industry-standard HP-UX operating system. See page 555 or check 53 on the reply card.

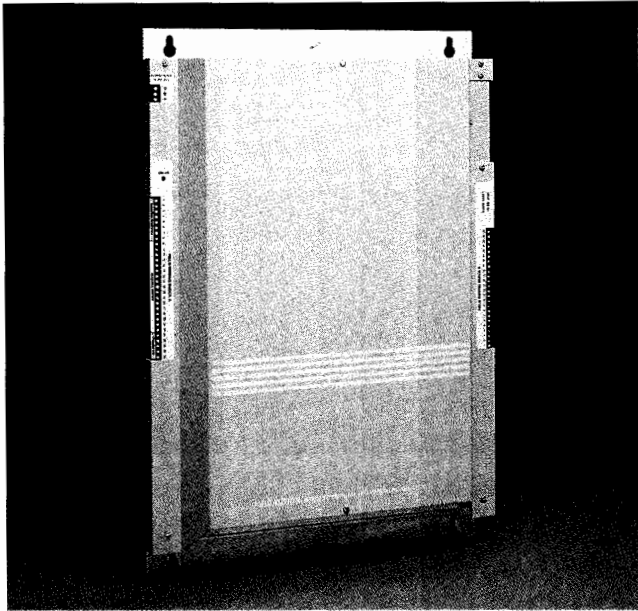

#### HP 48050A Remote Terminal Unit

The HP 48050A Remote Terminal Unit (RTU) is a compact, intelligent measurement and control unit designed to operate in harsh industrial and remote environments. As the newest member of the HP 48000 RTU family, the HP 48050A addresses small-point-count applications (23, expandable to 45). The HP 48050A RTU features built-in intelligence, ease of programming, communications flexibility, and high reliability. Target markets include oil and gas, water and wastewater, electrical utilities, telecommunications, and process industries. Applications range from supervisory control and data acquisition (SCADA) systems to energy management, facilities monitoring, and process monitoring and control. See page 568.

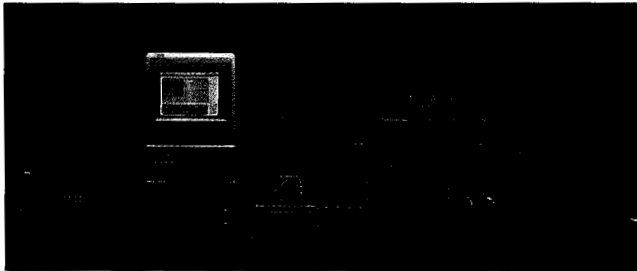

#### HP Interactive Test Generator (HP ITG)

HP ITG accelerates HP BASIC test development through windowed, mouse-driven instrument drivers. Designed specifically for controlling HP-IB instruments, HP ITG's on-screen instrument panels simplify measurement automation. Instead of writing code that requires knowledge of instrument-specific HP-IB mnemonics, you use a mouse to adjust instrument settings and make measurements interactively. HP ITG automatically generates the HP BASIC code needed for your test program. The friendliness of HP ITG, combined with HP BASIC, enables you to focus on your test task, not on software development. Support on computing environments such as the BASIC Workstation, HP-UX, and DOS ensures flexibility as your needs change. See page 606.

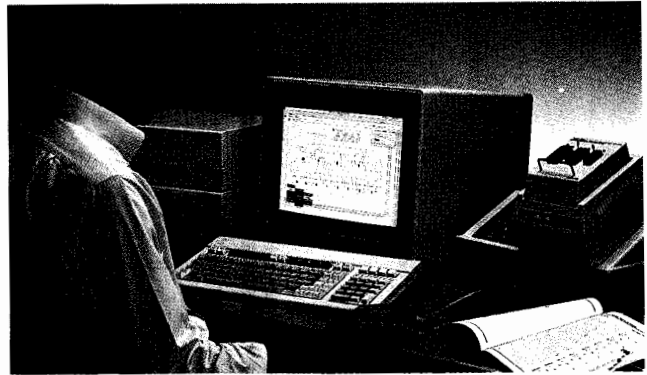

#### HP PLD Design System

HP PLD Design System is a device-independent design tool that supports the entire design process of Programmable Logic Devices (PLDs). You can enter designs through schematic symbols, state transition diagrams, waveforms, or Boolean equations/truth tables. PLD debuggers are tightly integrated with each design editor for quick entry and verification of designs at the same level of abstraction. More importantly, you can describe and verify your logic in a device-independent environment, without the constraints imposed by particular PLD architectures. HP PLD Design System eliminates the issue of device selection by automatically fitting designs into the most efficient PLD, and automatically partitioning large designs into multiple PLDs to shorten design time. Existing PLDs can be upgraded to newer devices through a link to the JEDEC standard for PLD fusemaps. Automatic test-vector generation creates manufacturing test vectors to be used in device programming and verification. See page 630.

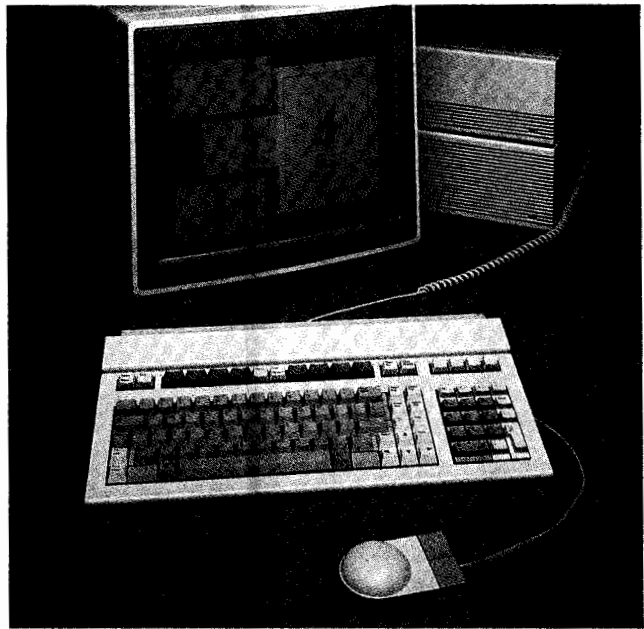

#### HP 85150A Microwave Design System

The HP 85150A Microwave Design System is a graphics-based CAE system for RF and microwave designers. It includes three integrated modules for design capture, circuit simulation and optimization, and artwork generation. Integrated into the program are extensive capabilities for documenting designs and provisions for networking several CAE stations for file sharing. See page 631.

## NEW PRODUCT HIGHLIGHTS

```

hit_total % IA function file
8 / 12 ( 66.67) * keyconvert convert.c
6 / 9 ( 66.67) bitpos convert.c
3 / 5 ( 60.00) *getkeyvalue getkey.c
5 / 7 ( 71.43) twobits multibits.c
22 out of 33 retained branches executed (66.67%)
[ 24 branches were ignored ]

```

**NOTE:**

A '\*' in the 'I' column means this function had one or more branches that were ignored  
 A '\*' in the 'A' column means this function had a BBA\_ALERT which was executed

### Basis Branch Analyzer

HP's Basis Branch Analyzer (BBA) is a test coverage tool that provides an integrated, straightforward way to measure the effectiveness of software tests within the cross development environment. The BBA uses the actual prototype hardware, running the program under test, to produce metrics. Comprehensive reports provide detailed feedback on the thoroughness of test cases for an embedded microprocessor product.

The BBA allows software engineers to analyze the testing, create more complete test suites, and quantify the level of testing. A high confidence in these test suites, and subsequently high confidence in the quality of the code tested, means that the software is more reliable and much less costly to maintain. The test suites can be reused for regression testing to ensure that original functionality is preserved whenever changes are made. Thoroughly tested and maintainable code is also more attractive for reuse in other programs. See page 623.



### HP 64700 Series Emulators

High-performance PC-based emulators offer real-time performance for designers of embedded systems. By combining innovative emulator technology with logic-analyzer-on-a-chip technology, HP offers high-performance microprocessor development tools at entry-level prices. The HP 64700 Series Emulators can operate as stand-alone or in-circuit emulators and have emulation bus analyzers for the industry's most popular 8- and 16-bit processors. An optional 100-MHz state analyzer integrates measurements of target system performance with other HP 64700 measurements. In the simplest configuration, these stand-alone emulators/analyzers can be controlled from a terminal. Or, the HP 64700 Series can be operated from IBM PC-compatibles or HP 9000 Series 300 workstations. See page 625.

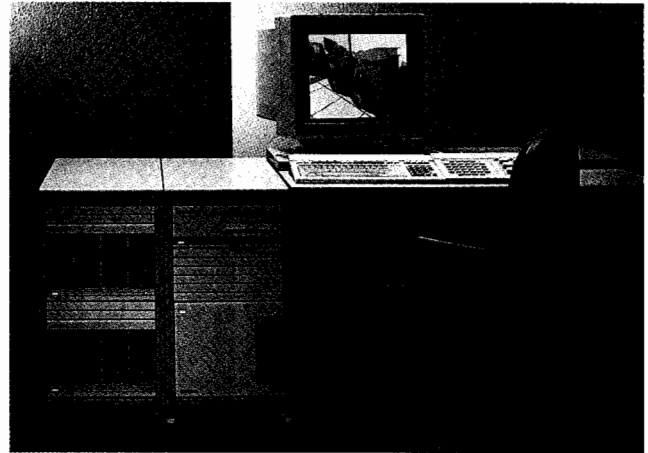

### HP 9000 Model 835 TurboSRX Superworkstation

The HP 9000 Model 835 TurboSRX Superworkstation combines advanced 3D solid-rendering graphics with a high-performance (14 MIPS) computational engine to meet the interactive needs of designers doing solid modeling, imaging, mapping, and other 3D applications. Because of advanced photorealism, designs look like 3D pictures, which in many cases eliminates the need to construct an expensive physical prototype and speeds up design cycles. See page 646.

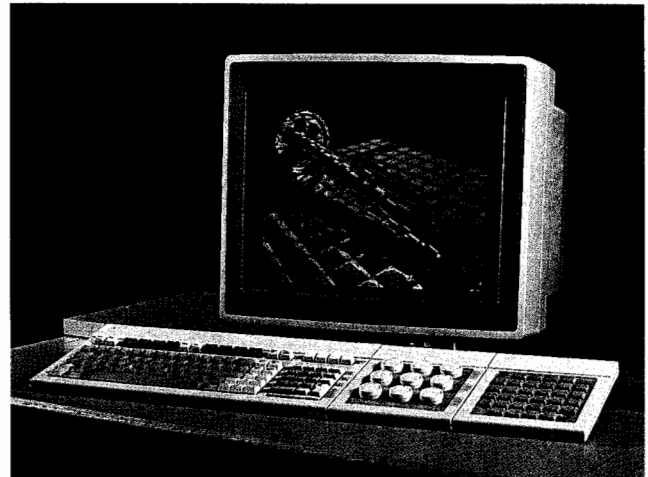

### HP 9000 Models 825/835 CHX 2D Color Superworkstations

The Models 825CHX and 835CHX combine powerful computation power with high-performance 2D graphics for applications such as printed circuit board and VLSI design, 2D mechanical design, 2D mapping, and architectural and engineering construction. The Model 825CHX bundled system features the Model 825 system processing unit with 8 megabytes error checking and correcting RAM, HP-IB, LAN, HP 98752A 19-inch color monitor, eight planes of frame buffer memory, two overlay planes, and an integer-based graphics accelerator. The Model 835CHX bundles the Model 835 SPU with the CHX graphics subsystem. The Model 835 provides 50% faster integer performance and more than three times the floating-point performance of the Model 825. Each superworkstation supports up to four interactive CHX subsystems. See page 646.





### HP 9000 Model 370 Technical Workstation

Based on the 33-MHz MC68030 processor with a 33-MHz MC68882 floating-point coprocessor, the Model 370 delivers up to 7 MIPS and can address up to four gigabytes of virtual memory. The Model 370 SPU contains four system slots. Three slots are used by the system processor board, an 8-megabyte RAM board, and a standard system-interface board. The interface board includes LAN, a two-channel DMA controller, a high-speed disc interface, an HP-IB interface, an RS232 interface, and an HP-HIL interface. The fourth system slot is available for installing a video board, display system interface board, or a 2-slot DIO backplane. The Model 370 features a full 32-bit I/O bus (DIO-II) and a dedicated 32-bit memory bus, which supports 8 to 32 megabytes of parity RAM or 8 to 48 megabytes of error checking and correcting (ECC) RAM. See page 647.

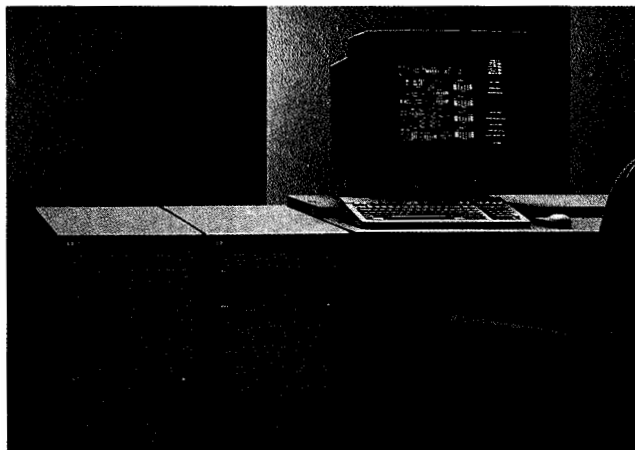

### HP 9000 Model 360 Technical Workstation

The Model 360 is a 5-MIPS computer based on the 25-MHz MC68030 processor with the 25-MHz MC68882 floating-point coprocessor. Maximum system performance is ensured in all RAM configurations by the tight processor/RAM coupling that exists between the on-board as well as the additional RAM. The Model 360 features a 32-bit memory bus, 32-bit DIO-II bus, and the same system interface board as the Model 370. Two system slots are available for adding a video board, floating-point accelerator, or 2-slot DIO-II backplane for accessories. Applications include data manipulation and general computation, microprocessor system development, schematic design capture, 2D mechanical design, personal productivity, computer-aided software engineering, and data acquisition/analysis. See page 647.

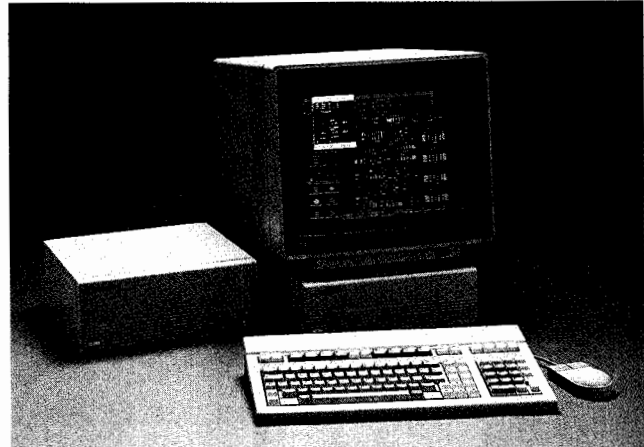

### HP 9000 Model 319C+ Color Workstation

Using the same 16.6-MHz CPU board as the Model 330, the Model 319C+ is a low-cost, restricted-configuration, two-board computer system. It includes an MC68881 floating-point coprocessor, 4-megabyte RAM (expandable to 8, 12, or 16-megabyte), 32-bit memory bus, and 1024 x 768 bit-mapped color display and keyboard. Also featured are an IEEE-488 HP-IB interface, an RS-232C serial interface, and IEEE 802.3/Ethernet LAN interface with ThinMAU and "T" connector, HP-HIL, and a two-channel DMA controller. Available options are a high-speed HP-IB disc or SCSI disc interface and a 19-inch color display. See page 648.



### X Window System

The X Window System Version 11 provides HP's Series 300 and Series 800 Computers with a network-compatible "windowing" system that allows interconnection between HP computers and computers from other vendors. With the X Window system, you can create multiple windows on your computer, another HP computer, or even workstations from other vendors that are connected to your system over a network. Programs that are compiled on another vendor's computer to use X ("clients") can use the X windowing software on HP computers ("servers") for their input and output, and the reverse. See page 665.

## NEW PRODUCT HIGHLIGHTS



### HP 9000 Model 855S Superminicomputer

The HP 9000 Model 855S Superminicomputer is the most powerful engineering, manufacturing, and scientific computer ever offered by Hewlett-Packard. It is the fastest member of the HP 9000 Series 800 family of HP Precision Architecture systems based on RISC principles. It offers 50% more performance than the HP 9000 Model 850S and more than three times the performance of the Model 825S. For Model 850 customers, a simple field-installable board upgrade from the Model 850S is available. The Model 855S is based on HP's proprietary NMOS III technology and runs HP-UX, HP's implementation of the UNIX™ operating system. All Series 800 systems are object-code compatible with one another, preserving your investments in application software. See page 641.

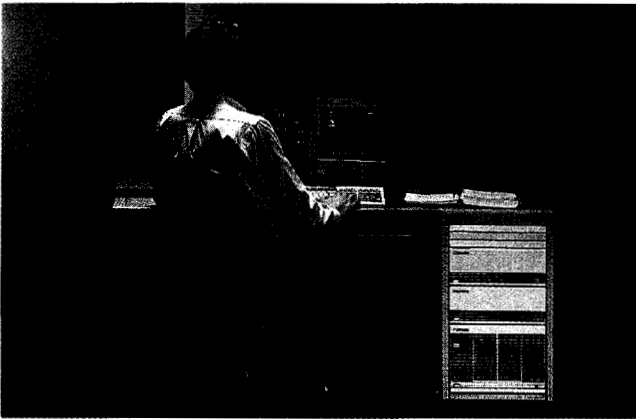

### HP 9000 Model 835S, 835SE Superminicomputers

The HP 9000 Models 835S and 835SE are new midrange processors in Hewlett-Packard's Series 800 line of computers based on HP Precision Architecture. Running under the HP-UX operating system, the Model 835 systems offer an average of 1.5 to 2 times the performance of the Model 825S. As with all Series 800 systems, the Model 835 products are object-code compatible with every other member of the Series 800 family. HP-UX is HP's implementation of the UNIX operating system. It is SVID compatible and contains a variety of unique HP extensions including real-time capabilities. Migration and compatibility with HP 1000 systems is possible through highly compatible compilers and subsystems and the PORT/HP-UX facilities. Compatibility with Series 200, 300, and 500 systems is possible through a high degree of source-code compatibility. See page 642.

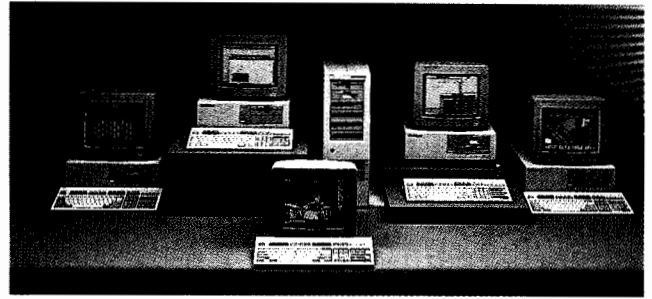

### HP Vectra Personal Computer Family

The HP Vectra PC Family offers a broad range of price/performance choices, from entry-level 8086-based systems to advanced 80386 PC workstations. The HP Vectra CS PC provides power with expandability at a low price. The HP Vectra ES and ES/12 PCs are 80286-based desktop models that easily handle tasks such as complex graphics, large databases, and sophisticated spreadsheet applications. The powerful, expandable HP Vectra RS PCs use the power of an 80386 microprocessor in a floor-mount unit for applications such as CAD/CAM and for multiuser systems. See page 682.

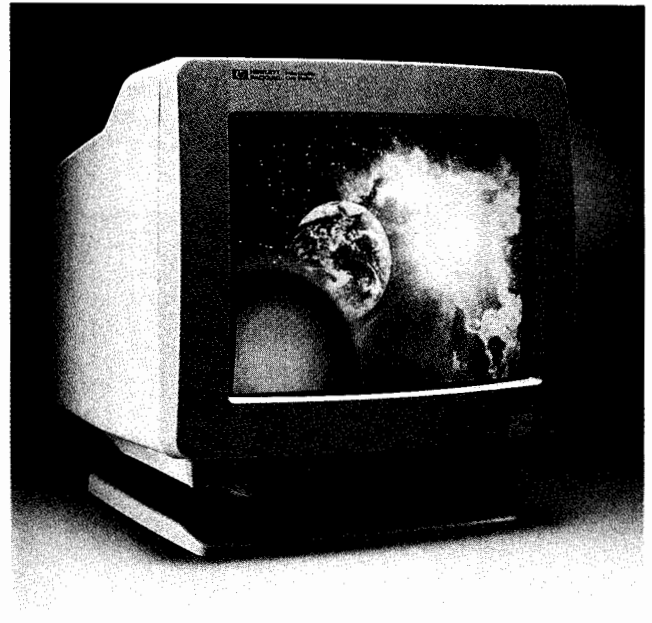

### HP D1182A Color Video Graphics Display

The HP D1182A Color Video Graphics Display is a 14-inch medium-resolution color display designed for business professionals and low-end CAD users. It is compatible with HP's new Video Graphics Adapter. The high quality of the screen and fine resolution of the display tube are exceptionally well suited for high-use environments. The display provides resolution up to 640×480 and high-quality text-character formation. See page 690.



### HP 700/43 Display Terminal

The HP 700/43 Display Terminal combines functionality and ergonomics in a fully-featured ASCII terminal. It offers 12 terminal compatibility modes that allow connection to a wide variety of computer systems and software applications. Extra memory (four pages of display memory), combined with an 80/132 column format, allows easier review of data, improving user productivity and reducing system overhead. The terminal has 58 programmable keys and a 14-inch screen available in soft white, amber, or green. See page 691.

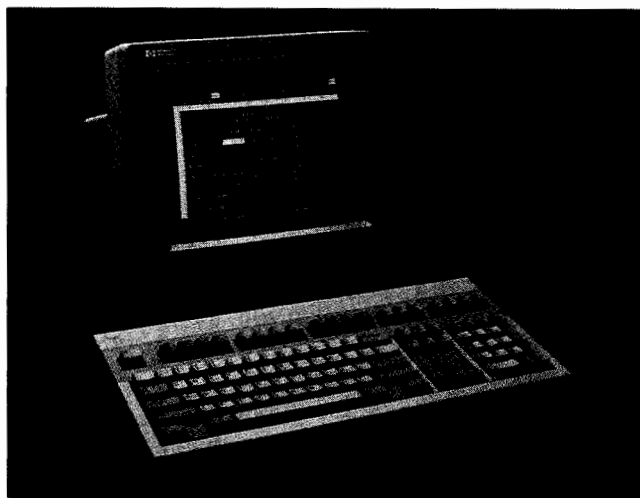

### HP 700/44 PC Terminal

The HP 700/44 PC Terminal is designed for connection to a multiuser personal computer system. It offers a full-featured alphanumeric terminal with DEC VT220 emulation and PC characteristics including AT2 keyboard and IBM PC character set. The 14-inch screen is available in soft white, amber, and green phosphor and provides selectable refresh rate (50, 60, and 72 Hz) for enhanced readability. See page 691.

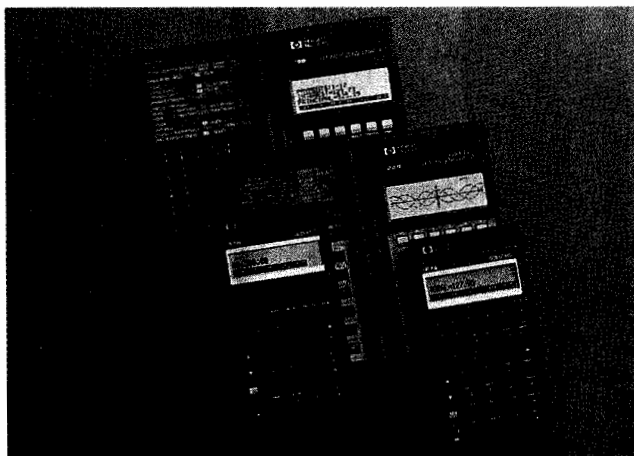

### HP Calculators

A new family of calculators for business and science expands HP's calculator line. The HP Business Consultant II and HP-17B are designed for business use, and the HP-28S, HP-42S, HP-32S, HP-27S, and HP-22S are scientific calculators. Both the business calculators, the HP-27S, and the HP-22S feature algebraic-entry systems, whereas the HP-28S, HP-42S, and HP-32S feature RPN. A variety of features make all the new calculators efficient and easy to use. See pages 692 and 693.

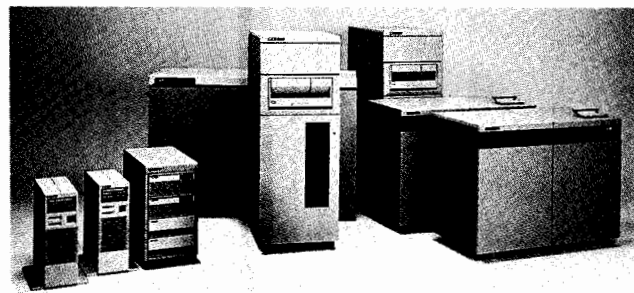

### HP 3000 Computer Systems

The HP computer family has been expanded to offer a full range of systems for a multitude of business solutions. The HP 3000 MICRO LX and GX systems are compact units that use proprietary VLSI technology, delivering mid-range performance at entry-level prices. The addition of the Series 925, 935, and 955 systems broadens and extends Hewlett-Packard's Precision Architecture product line. The Series 925 and 935 systems offer cost-effective, mid-range performance in a compact unit that can fit right into most office environments. The Series 955 system provides powerful uniprocessor performance for high-end data processing applications. See page 698.

## NEW PRODUCT HIGHLIGHTS

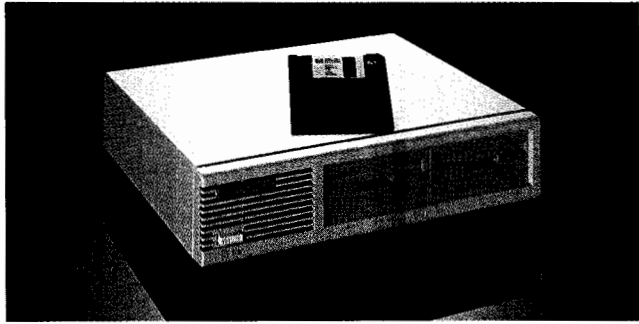

### HP Personal Data Storage Family

The HP 9122C and 9153C Disc Drives are new members of HP's personal data storage family. The HP 9122C is a 2-megabyte (unformatted) floppy disc drive available in a single-drive or dual-drive configuration. The floppy capacity is twice that found on previous HP models, but at no increase in price. The rugged HP 9153C is especially designed for measurement automation and general office environments. The drive is available in three hard-disc capacities: 10, 20, and 40 megabytes. In addition, a 20-megabyte stand-alone disc mechanism is available for expanding the 10- and 20-megabyte versions to 30 and 40 megabytes, respectively. And each drive can be configured with a 2-megabyte microfloppy, which give you more backup storage than with previous microfloppy models. See page 708.

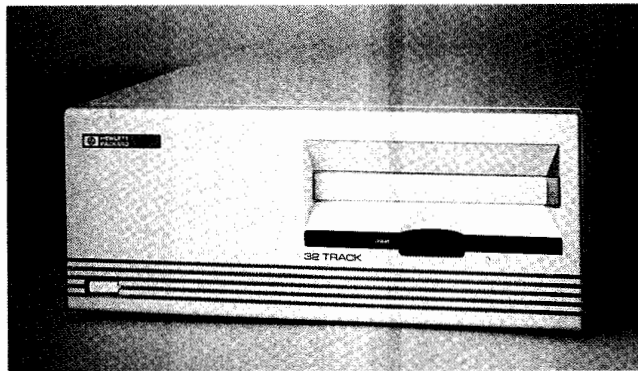

### HP 9145A Cartridge Tape Drive

The HP 9145A is a high performance  $\frac{1}{4}$ -inch cartridge tape drive for technical and small business systems. Features include a transfer rate of 4 Mbytes per minute, cartridge capacity of 133 Mbytes, read compatibility with existing  $\frac{1}{4}$ -inch cartridge tape drives, and an enhanced front panel display for ease of use. See page 712.

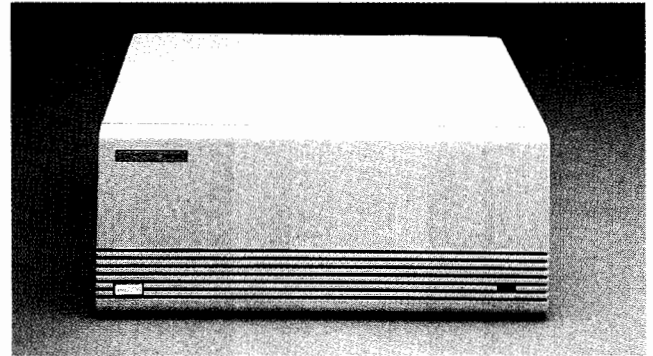

### HP 7957B, 7958B, 7959B Disc Drives

The foundation of the HP 7957B (81 megabytes), 7958B (152 megabytes), and 7959B (304 megabytes) is an HP-designed-and-built  $\frac{5}{8}$ -inch Winchester mechanism. This high-performance mechanism features a special track positioning system using embedded servo code that essentially eliminates seek errors. It also enhances read/write accuracy of the entire operating temperature range. See page 710.

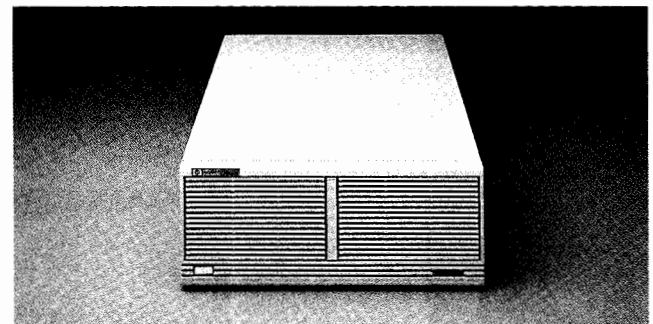

### HP 7962B and 7963B Disc Drives

Because of their compact size and tolerance over a range of operating environments, the HP 7962B (152 megabytes) and 7963B (304 megabytes) Disc Drives are well-suited for office or workstation settings. Users of HP 1000, 9000, and 3000 Computers will be attracted to the compact size of the drives and their storage capacity potential: up to 912 megabytes can be enclosed in one package.

The efficient design of the disc drives allows placement of up to three Winchester mechanisms in their compact packages. Users initially purchasing a drive with one disc mechanism can later install as many as two additional stand-alone mechanisms in the original package. The stand-alone mechanisms are available in 152- or 304-megabyte upgrade kits, complete with controllers. HP's own  $\frac{5}{8}$ -inch Winchester is integrated into each product for optimized performance, exceptional reliability, and low cost of ownership. See page 710.

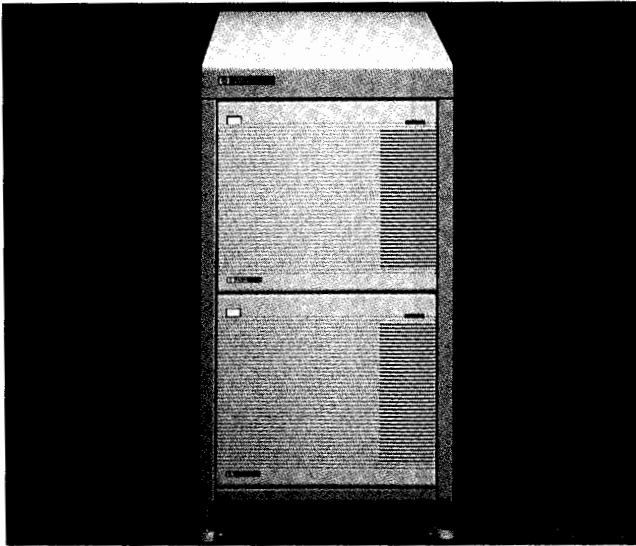

#### HP-FL Fiber-Optic Link

HP-FL is a new high-speed interface designed exclusively for HP Precision Architecture computer systems. Since data is transmitted via light, the fiber-optic cable is immune to electromagnetic interference and does not emit radio-frequency energy. The HP-FL fiber-optic link is made up of four components: the HP-FL interface card and HP 3000 Series 900 and Series 800 Computers, the HP-FL controller found in the HP 7936FL Disc Drives, the fiber-optic cable that connects the CPU to its disc drives, and PBus cables that "daisychain" multiple discs. Together, these components provide HP-PA owners cable lengths of up to 500 metres and support of up to 48 discs on some computer models. See page 711.

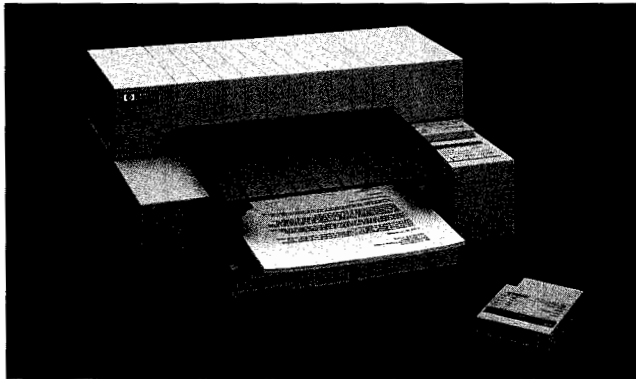

#### HP DeskJet Printer (HP 2276A)

The HP DeskJet printer offers laser-quality (300 dots per inch) printing at a personal printer price. Features include multiple fonts, 120-cps letter quality, and 240-cps draft printing. The HP DeskJet printer is an affordable step up to superior print quality for individual personal-computing applications.

The printer comes standard with 14 built-in fonts and 10 proportional fonts in an S2 font cartridge. Typefaces and sizes for many applications are available in font cartridges or soft (disc-based) fonts. The 512-Kbyte printer memory can be augmented with a 1-, 2-, or 4-megabyte memory board to accommodate more downloaded (soft) fonts or full-page graphics at 300 x 300 dpi resolution. See page 717.

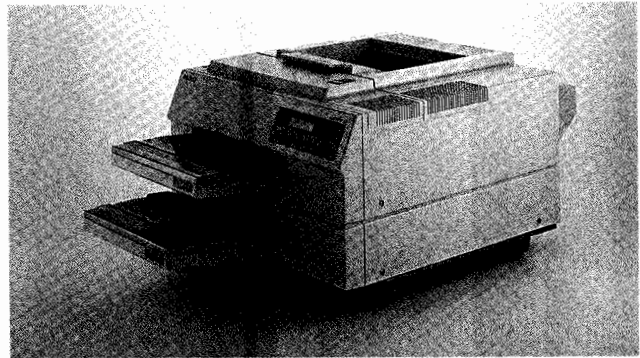

#### HP LaserJet IID Printer (HP 33447A)

The HP LaserJet IID printer replaces the HP LaserJet 500 PLUS printer and adds many new features. It provides the same high-resolution printing and 8-page-per-minute speed as the HP LaserJet Series II printer. New features include two paper-input trays holding 200 sheets of paper each and an envelope-feeder accessory for a third input tray, which holds up to 50 envelopes.

The HP LaserJet IID printer features duplex (two-sided) printing to save paper, filing, storage, and mailing costs. With both paper-input trays full, up to 800 pages of information can be printed without having to reload paper. Sizes include letter, legal, executive, and European A4 paper. Using the manual feed, the printer also handles overhead transparencies, labels, and heavier paper. See page 717.

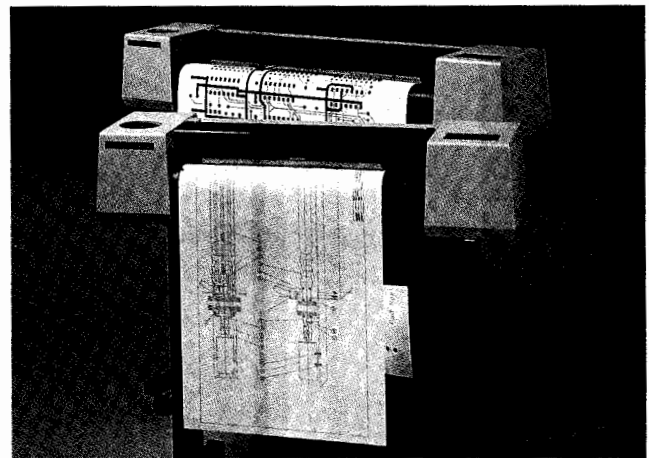

#### HP DraftPro DXL, EXL Plotters

HP DraftPro DXL and EXL large-format drafting plotters complete HP's line of low-cost plotters. These plotters combine the reliability, quality, performance, flexibility, and support required by today's CAD professionals. Features include very good line quality, medium throughput, one- and two-megabyte buffer options, powerful HP-GL command set, media and pen flexibility, and compatibility with a wide variety of hardware and software. The HP DraftPro DXL plotter accepts A4/A through A1/D media; the HP DraftPro EXL plotter accepts A4/A through AO/E media (standard ISO, ANSI, and architectural sizes). See page 726.



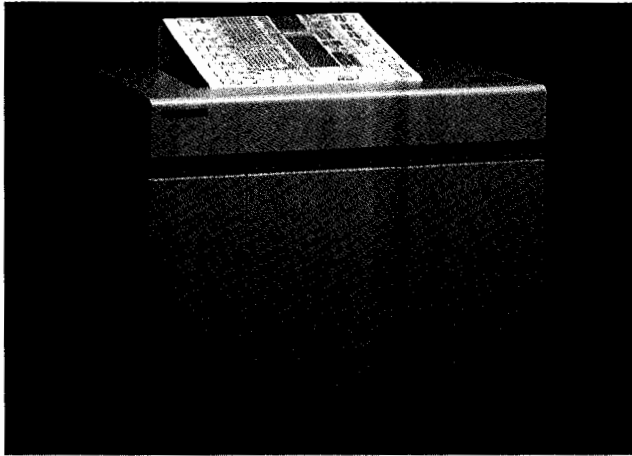

### HP 7600 Series Models 240D, 240E Electrostatic Plotters

The HP 7600 Series Models 240D and 240E Electrostatic Plotters are high-performance plotters designed for the high-volume demands of departments using computer-aided-design (CAD) systems. These monochrome plotters are also well suited to CAD applications involving complex, intricate images or large amounts of area fill. The HP 7600 Series plotters give you pen-plotter quality in a fraction of the time. Features include fast plotting; excellent resolution; long-axis plotting; three standard interfaces and HP-GL compatibility; rugged, compact design; and excellent reliability. Model 240D accepts media 609 mm (24 in.) wide, and the Model 240E uses media 914 mm (36 in.) wide. One low price includes the plotter, the vector-to-raster converter (VRC), and installation. See page 730.

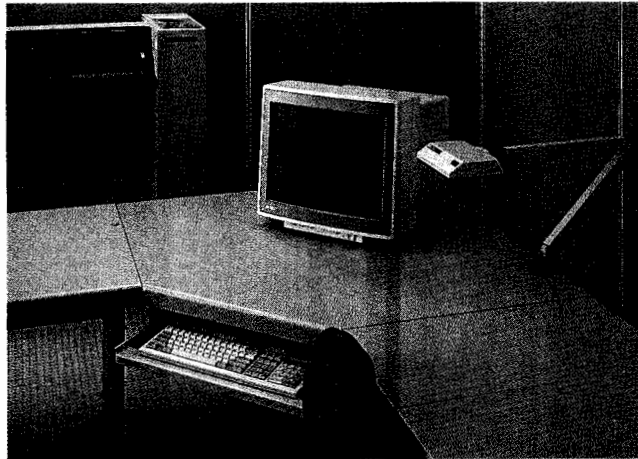

### HP 92214K Design Plus CAD Corner Workstation

A new addition to the Design Plus furniture line is the CAD corner turn, perfectly fitted for use with all HP CAD systems. The corner piece has depth and strength for the largest white phosphor or color CAD monitors weighing up to 200 pounds. The workstation comes with a keyboard drawer and cable management. See page 735.

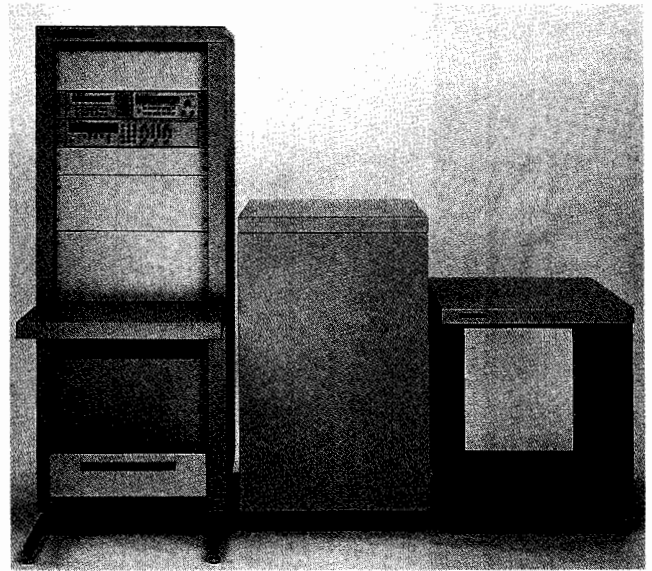

### HP EIA Rack Cabinets

Hewlett-Packard now offers you a total system of test instruments, rack cabinets, computers, and workstations. All these pieces are compatible in both form and function. The 19-inch commercial/industrial EIA rack cabinets easily accommodate HP test instruments and incorporate the same design elements as HP's Design Plus workstation furniture (see page 734). The rack system is modular. Choose from three heights: 1600 mm (63.0 in.), 1000 mm (39.4 in.), or 720 mm (28.4 in.). Then purchase doors, filler panels, or other products as you need them. You can select from blank front doors, ventilated rear doors, front caps, blank filler panels, a sliding drawer, and anti-tip feet. We can even provide mounting hardware. See page 754.



## HEWLETT-PACKARD: Fifty Years of Innovation

Hewlett-Packard Company was founded in 1939 by Bill Hewlett and Dave Packard. HP's first product was an audio oscillator, and Walt Disney Studios, which used eight of these oscillators to develop and test an innovative sound system for the movie "Fantasia", was the company's first major customer.

A significant invention in 1951 was the high-speed frequency counter (HP Model 524A). Its accuracy and ease of use revolutionized the measurement of frequency, reducing the time required to accurately measure high frequencies from about 10 minutes to one or two seconds.

### Divisions Formed

Until 1957, the company was a one-plant operation with one central research and development team. In 1959, when employment reached 1,500, divisions were formed to preserve the personal touch of the small operation. Each division had its own research and development, manufacturing, marketing, and support operations, as well as its own family of products.

In 1965 a central research facility, HP Laboratories, was established. HP Labs' success in developing prototype products resulted in a number of major new product lines. HP Labs was also the starting point for the company's entry into the field of computation.

### First Computer and First Calculator

HP's first computer, the HP 2116A introduced in 1966, was marketed as an instrument controller. At that time HP's focus was on automated test equipment, so the HP 2116A was designed to operate in the same environments as instruments. As a result, when most computers could operate only under tightly controlled conditions, the HP 2116A was in demand because of its reliability.

Another pioneering effort resulted in the first desktop electronic calculator, the HP 9100A (1968). Four years later the HP-35, the world's first handheld scientific calculator, was born and quickly took the place of the engineer's slide rule.

### Later Contributions

In the late 1960s, Hewlett-Packard recognized the importance of digital logic design and formed a special team to develop equipment for logic troubleshooting. The result was the HP 5000A Logic Analyzer, the first in a family of products designed to help develop and troubleshoot digital products.

HP's commitment to scientific and technical contribution is also illustrated by the HP 8542A, an automated network analyzer that created excitement in the early 1970s. At its first public demonstration, major customers asked to use it to speed

development of their experimental microwave transistors.

The growth of Hewlett-Packard over 50 years has been reflected by this catalog. The first catalog, published in 1943, described 12 products on 24 pages. This 1989 edition describes about 1,700 of more than 10,000 products on 790 pages.

### The Next 50 Years

Looking ahead to its next half-century, the company believes that test and measurement is a dynamic market, with new technologies and opportunities driving the development of future products. There will be more emphasis on systems and a tighter coupling of computer and instrument capabilities. Instrumentation will be programmable, have standard interfaces, and be easier to use and customize.

Computer technologies will have an increasing impact. Instruments that use digital architectures have improved performance, lowered prices, and are changing the way analog measurements are made.

Improved performance has resulted in new measurement opportunities. New demands have emerged in digital, lightwave, and secure communications, chirped radar and frequency-agile radios. HP's customers also drive demand for test and measurement systems as they strive to become more competitive in global markets.

Hewlett-Packard looks forward to meeting the challenges and satisfying the needs of the future by continuing to advance the sciences of test and measurement.

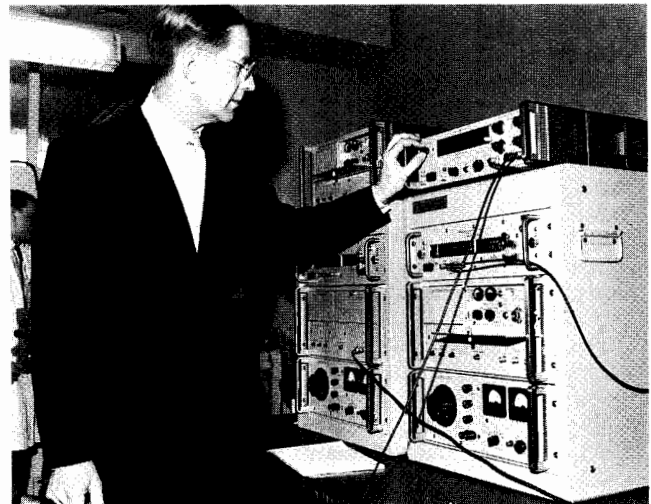

The HP 5060A, a cesium-beam frequency standard, gained worldwide recognition as the "flying clock" in 1964. In a 35-day, 35,000 mile trip HP engineers used two new cesium-beam clocks to coordinate the national time standards of various countries to within a millionth of a second. Carl Åbom, research engineer of the Swedish National Defense Research laboratory, observes comparisons between his instruments and the visiting clocks.

# ABOUT HEWLETT-PACKARD

## Hewlett-Packard in Profile

Hewlett-Packard Company develops, manufactures and markets measurement and computation products and systems used by people in science, engineering, business, industry, education, and medicine. These products are known for their high quality, reliability and advanced technology and include calculators, computers and peripherals, electronic instruments, instruments for chemical analysis, medical instrumentation, and electronic components.

Headquartered in Palo Alto, California, Hewlett-Packard employs approximately 83,000 people worldwide, of whom some 53,000 work in the U.S.A. Product research and manufacturing activity is highly decentralized, with facilities in the U.S.A., Europe, Japan, Southeast Asia, Latin America and Canada. The worldwide sales organization includes nearly 150 sales and support offices in the U.S.A. and some 335 sales and support offices and distributorships in 77 other countries.

With a 1987 revenue of 8.1 billion dollars, HP is ranked in the top 50 U.S. industrial corporations. Approximately 50 percent of this revenue was generated outside the United States.

## HP Test and Measurement Systems

Customers use HP instruments to evaluate the performance of their own electrical equipment, in developing products, in controlling quality and manufacturing processes, and in field service applications.

In addition to the electronics industry, major markets for HP test and measurement equipment include telecommunications, aerospace, aviation, and scientific research. In fact, HP instruments are used in almost every industry where precise testing, measurement and control are required.

The impact of increasingly scarce and costly technical manpower has accelerated the need for measurement systems, with their high speed, accuracy, repeatability and productivity. HP instruments and computers are designed with systems in mind.

In 1965 Hewlett-Packard created its own internal standard for linking HP instruments and computers. The standard became a worldwide standard, IEEE-488, and today it is used by several hundred manufacturers worldwide. We call this standard HP-IB, the Hewlett-Packard Interface Bus. In this catalog, system-ready products are marked with the symbol



The HP 54501A Digitizing Oscilloscope is one example of how Hewlett-Packard's investment in advanced technology also results in product reliability. Four custom integrated circuits were key to the design of the single-board, low-priced system. The single-board design reduces the number of parts, resulting in fewer part failures and greater reliability. The new oscilloscope has four channels, a 100-MHz bandwidth, and is about half the price of Hewlett-Packard's previous low-end model, the HP 54200A.

In all cases, the goal of HP systems is to provide essential information in a useful form and in the most efficient and timely manner. The result is that customers can improve the productivity of their processes and organizations.

## HP Computers

Hewlett-Packard's first computer was introduced in 1966. Its purpose was to gather and analyze the data produced by HP electronic instruments. Today, HP computers, computer systems, and peripheral devices account for a substantial portion of the company's product line. This broad range of computation products and systems offers solutions for many different applications.

Hewlett-Packard's strength in engineering, scientific and manufacturing applications has enabled it to make major contributions in key technical computer markets. Advanced data communications technology allows instrument systems to be linked with computers, giving customers tools for acquiring, analyzing, managing, and transmitting data. Hewlett-Packard also is an important business computer manufacturer. Offerings include portable

computers, personal computers, and minicomputers. The company's mini-computer line is one of the most widely installed general-purpose business computers in the world, with more than 30,000 machines in use. Our strong support of industry networking standards and open systems makes multi-vendor connectivity possible and gives us the flexibility to solve customer problems using a variety of approaches, including software application packages developed by third parties.

In 1986, Hewlett-Packard introduced the first in a series of new high-performance computers based on HP Precision Architecture. The simplicity of the new architecture ensures ease of manufacture while providing both business and technical customers with superior price/performance compared with conventional designs. More important, HP Precision Architecture promises future performance capabilities many times greater than today's computer systems and allows the company to develop a range of compatible computer systems, including personal computers, engineering workstations, and minicomputers. The unified architecture enables customers



to leverage their software investments, since the same application can run on a wide range of machines within the same family.

### Other HP Products

In addition to electronic measurement and computation products, Hewlett-Packard manufactures a number of other product lines, all of them related by basic electronics technology. Among these are electronic components such as microwave semiconductor and optoelectronic devices. Other important fields of interest include medicine and analytical chemistry. Today, hospitals and clinics use HP equipment for patient monitoring, diagnosis and therapy, and data management. Analytical instruments are widely used in the chemical, energy, pharmaceutical, biotechnology, environmental monitoring and food industries, as well as in medical and chemical research programs for government and industry.

### HP Innovation

Hewlett-Packard's continuing growth is based on a strong commitment to research and development. Each year the company invests about ten percent of its net revenue in R&D (\$900 million in 1987). This heavy investment enables Hewlett-Packard to remain at the forefront of technological development and to maintain a steady flow of new and useful products. Well over half of the company's 1987 orders were for products introduced during the previous three years, a clear indication of the importance of HP's product-development efforts.

About 85 percent of the company's yearly R&D budget is allocated to product development within some 50 separate divisions. The remaining 15 percent is invested in more basic, higher risk, longer term research undertaken by HP Laboratories, the company's centralized research facility. HP Labs ranks as one of the leading electronic research centers in the world. Through endeavors in various areas of science and technology, the corporate laboratories also help the company develop new areas of business. Customers benefit through access to computers and instruments that are at the forefront of technology.

### HP Product Standards

All HP products are designed to operate under the environmental conditions expected for the product. All new hardware designs are tested to internal HP standards in typical operating environ-

ments before they are released for customer sales. Internal HP standards are derived from our experience with environmental conditions at customer installations and from industry standards such as IEC, ISO, ANSI, and MIL.

The classification codes used to identify expected environments range from A1 to C2. A1 corresponds to the severe environments found in heavy industrial areas that are unsuitable for operating personnel, and C2 corresponds to the controlled environments of dedicated computer rooms. Most HP hardware products are designed to meet Class B2, general-purpose applications in light industrial and commercial facilities.

### HP Support

Hewlett-Packard's commitment to engineering excellence is equaled by its commitment to providing customers with high-quality support services. Hewlett-Packard's support organization consists of a worldwide sales and service network staffed by highly trained engineers and

technicians. Our support starts before you purchase an HP product and continues long after the product has been delivered.

Before you purchase a product or system, HP sales representatives are available to help you assess your needs and choose the product or system that meets your immediate and longer term requirements. We offer applications and training support to help you obtain full use of your system, hardware support to help maximize system up time, and software support to keep your system software current and productive.

To help you plan your system and its use, we offer the consulting and training expertise of experienced systems engineers. For the installation and maintenance of your system and its components, we offer the services of customer engineers. And for the long-term support of your system, Hewlett-Packard offers an extensive menu of services. The menu includes contract or as-needed calibration and repair with on-site and at-HP options, as appropriate. Update services are available for both software and hardware,

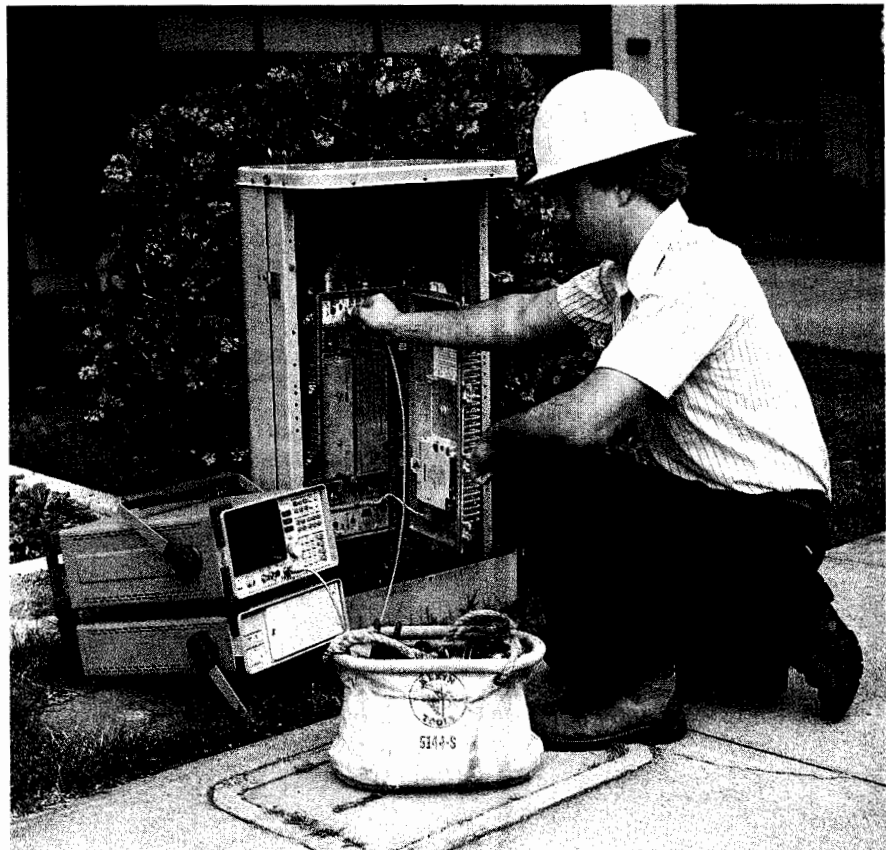

The HP 8590A Portable CATV Analyzer has been a popular, easy-to-use tool for proof-of-performance testing and system maintenance. With the addition of the new HP 85901A Portable AC Power Source, it has increased portability and versatility. Lab-quality measurements can be made anywhere in a cable-TV system even though ac-line power may not be available.

as is training for your own service personnel.

Hewlett-Packard also rents and leases equipment. Because of our low cost of funds, we offer finance plans at very competitive rates. From 12-month rentals to 5-year leases and purchase plans, an HP finance representative can help you tailor a plan to meet your financial requirements.

Rental and operating lease plans provide an answer for short-term project needs, a hedge against obsolescence, and a way to smooth out your cash flow by avoiding large cash outlays. If you want to expense your equipment rather than funding it through a capital budget, Hewlett-Packard can provide "off-balance sheet" financing. See page 768 for more details.

Hewlett-Packard's worldwide support network ensures prompt availability of replacement parts throughout the service life of products and beyond. Replacement parts services also include parts stocking recommendations based on extensive component reliability histories and the numbers and mix of HP products to be supported.

For products requiring consumable supplies, such as recording paper, ribbons and magnetic media, we offer fast, convenient service from well-stocked supply centers. These centers also offer personal computers and software, peripherals and terminals, cables and connectors, workstation furniture, books and learning aids. The support services outlined above are described in more detail beginning on page 756.

HP's comprehensive support extends to information services, including excellent hardware and software manuals and a wide variety of no-charge publications. These publications help you choose the HP products that best fill your needs, allow you to benefit from applications knowledge acquired by users inside and outside of Hewlett-Packard, and help you maintain your HP products. This literature

includes new-product announcements, catalogs, product family brochures and single-product data sheets, application notes, programming aids, service notes, and maintenance periodicals. More details on these publications can be found on page 792.

### The HP Catalog

This catalog is divided into sections that are based on nine broad product groups, including sources and analyzers, design automation and technical computers, semiconductor test and board test, etc. Many of the sections are prefaced by descriptions of basic kinds of measurements and the techniques of measurement that are associated with the featured products.

Products described in this catalog are indexed three ways: alphabetically, numerically by HP model number, and by product type or application. In addition, a set of blue page tabs allows you to readily locate a particular product group. The alphabetical index begins on page 25, the numerical index begins on page 37, and the general index begins on page 50.

A description is provided for each product, but for some products you'll want to refer to a data sheet for a full set of specifications. Data sheets are available on request at local HP sales offices.

### Contacting Hewlett-Packard

Locations of HP sales and service offices are listed on pages 771 through 779. Calls to your local HP office will be routed to the person best qualified to assist you. Just give the operator your specific product interest: test and measurement, computers, medical, analytical, or components.

Our sales force is made up of specialists in each of these five major product areas. Staff engineers are always available during business hours. Our sales representatives

are supported by the HP systems engineering organization, which has specialists in measurement and computation systems.

Information on product availability, prices, and order status is immediately available through our worldwide order processing network.

You can also contact Hewlett-Packard by way of toll-free phone numbers at a growing number of Customer Information Centers (CICs) worldwide. These centers can provide pre-sale assistance with product selection and information on product availability and price. In addition, CICs can arrange for you to receive free publications such as data sheets, catalogs, application notes, and new-product announcements. CIC locations and phone numbers are included in the listing of HP offices that starts on page 771.

### Suggestions Welcomed

The purpose of this catalog is to give you useful information about HP products, along with some company background that may help you reach decisions on products and systems that will fill your needs. The catalog emphasizes test and measurement products and systems and includes representatives of Hewlett-Packard's other product categories. Literature describing the other products in detail is available through your local sales office.

If you have any comments and suggestions about how we can make this catalog more useful to you, please let us know by writing to:

Hewlett-Packard Company  
Max Trescott  
Catalog Manager  
3200 Hillview Avenue  
Palo Alto, CA 94304-1298  
U.S.A.



- A**
- AC**
- Power Source ..... 136
  - Probes ..... 107
  - True RMS Voltmeters ..... 106
  - Voltmeters ..... 92-107
- Accelerometers** ..... 581
- Access and Test System** ..... 510
- Accessories**
- Adapters ..... 254, 309, 349, 740, 741
  - Cabinet ..... 748-755
  - Cables/Connectors ..... 224, 245, 254, 309, 561, 740, 741
  - Component Measurement ..... 278
  - Computer ..... 766
  - Connectors ..... 309, 349, 740, 741
  - Digital Multimeter ..... 107
  - EMI Measurement ..... 133
  - Fiber-Optic Lenses ..... 309
  - Fixtures, Board Test System ..... 549
  - HP Touch ..... 690
  - Logic Analyzer ..... 266
  - Network Analyzer ..... 216, 222-225, 230, 244-246, 248, 273
  - Operating Cases ..... 746, 747
  - Optical ..... 309
  - Oscilloscope ..... 66, 81-83
  - Pulse Generator ..... 444
  - Signal Generator ..... 377
  - SLMS ..... 506
  - Spectrum Analyzer ..... 132, 133, 144, 233
  - Transit Cases ..... 742-745
  - Voltmeter ..... 107
  - Waveguide ..... 253, 343, 347, 348, 349
- Active Probes** ..... 81, 233, 275
- Adapters**
- 2.4mm ..... 333
  - 50-75Ω ..... 246, 377, 741
  - APC-3.5 ..... 740
  - APC-7® ..... 740
  - Optical ..... 309
  - Quasi-Peak ..... 132
  - Waveguide ..... 349
- A/D Converters** ..... 54, 68-78, 84, 599, 603, 605, 608
- AdvanceLink** ..... 689
- Agile Signal Generator** ..... 363, 382
- Agile Upconverter** ..... 382
- Air Line Extensions** ..... 344
- Alphanumeric LED Displays** ..... 674
- AM/FM Signal Generators** ..... 357-376, 384, 387-390
- AM/FM/φM Modulation Analyzers** ..... 166, 191-194
- AM/FM/φM Signal Generators** ..... 361-374, 380
- AM/FM Test Source** ..... 167
- Ammeters** ..... 92-107, 540
- Amplifiers**
- Broadband Power ..... 406
  - Broadband Preamp ..... 407
  - Distribution ..... 490
  - Power Supply ..... 478
  - Microwave ..... 407, 408
  - RF ..... 406, 409
- Analog**
- Circuit Test Systems ..... 546
  - Converters, A-D ..... 54, 68-78, 84, 599, 603, 605, 608
  - Input/Output Cards For HP-1000 A-Series ..... 605
- LSI Test System** ..... 528
- Voltmeter** ..... 106
- Analyzers**
- Amino Acid ..... 677
  - Audio ..... 164, 505
  - Audio Spectrum ..... 112, 145-158, 230
  - Automatic Network ..... 234, 238, 249
  - Automatic Scalar Network ..... 219
  - Automatic Spectrum ..... 112, 116-146, 230
  - Customer Support ..... 756-765
  - Data ..... 316, 320
  - Data Error ..... 519
  - Data Line ..... 495
  - Digital Transmission ..... 162, 497, 509
  - Distortion ..... 164-174
  - Fourier (FFT) ..... 146-158
  - Frequency and Time Domain ..... 68-75, 146-158
  - Frequency and Time Interval ..... 191
  - Frequency Stability ..... 160, 161, 191-194
  - Gain-Phase ..... 234, 239, 280
  - Impedance ..... 233, 278-285
  - Impedance/Gain-Phase ..... 233, 280, 282
  - Jitter ..... 191
  - LAN Protocol ..... 514
  - Lightwave Component Test ..... 312
  - Logic ..... 256-271, 621
  - Microwave Link ..... 507
  - Microwave Modulation ..... 162, 191, 194, 509
  - Modulation ..... 162, 166, 191
  - Natural Gas ..... 676
  - Network ..... 150, 153, 216-229
  - Phase ..... 162, 191
  - Phase Noise ..... 160-161, 191
  - Phase Noise, Side Band ..... 160-161, 191
  - Primary Multiplex ..... 495
  - Protocol ..... 511-514
  - Pulsed Phase ..... 162
  - RF Impedance ..... 284
  - RF Signal Modulation ..... 162, 166
  - Scalar Network ..... 219-229
  - Selective Level ..... 115, 175, 502-505
  - Semiconductor Parameter ..... 536
  - Signature ..... 272-274
  - Spectrum ..... 108-144, 233
  - Time and Frequency Domain ..... 146-158
  - Time Interval ..... 191
  - Training ..... 761, 762
  - Vector Modulation ..... 162
  - Vibration ..... 147-149
  - WAN Protocol ..... 512-513
  - Wave ..... 115, 175, 418, 419, 502, 505
  - Waveform ..... 54-77, 84, 116-122, 147, 150, 157, 162, 191
- APC-3.5 series Adapters** ..... 740
- APC-7® series Adapters** ..... 740
- Application Notes** ..... 780
- Arbitrary Waveform Generators** ..... 76, 318, 378, 380, 412, 420, 427
- Arbitrary Waveform Synthesizer** ..... 378
- Artificial Intelligence** ..... 666
- ASIC Test System** ..... 526
- Atomic Clock/Frequency Standard** ..... 484
- Attenuators**
- Calibration ..... 170
  - Coaxial ..... 334-338
  - Coaxial, Microwave, OEM ..... 338
  - Optical ..... 308

## ALPHABETICAL INDEX

- Test System ..... 170  
 Waveguide ..... 348  
 Attenuator/Switch Combinations ..... 340  
 Audio Synthesizer ..... 412, 414, 416, 418, 419, 502  
 Automatic Test Systems ..... 612
- B**
- Balanced 2/4 Wire Audio Channel Selector ..... 495  
 Bar Code  
   Identification System ..... 677  
   Printers ..... 718  
   Readers ..... 675  
   Terminal ..... 706  
   Wand ..... 675  
 Bar Graph Array, LED ..... 674  
 BASIC Language Processor System ..... 654, 656  
 Battery Operated  
   Calculators/Computer ..... 692-695  
   Counters ..... 187, 204-206  
   Disc Drive ..... 708  
   DMM ..... 94-106  
   Microwave Power Meter ..... 211  
   Portable AC Power Source ..... 136  
   Printers ..... 717  
 Beam Lead Diodes ..... 675  
 Bias Networks ..... 252  
 Bias Supply, Transistor ..... 252  
 Bit Error Rate Test Sets ..... 495, 496, 519  
 Bipolar Transistors ..... 675  
 BNC Series Adapters ..... 741  
 Board Test Fixtures ..... 549  
 Board Testers ..... 546, 547  
 Breadboard Cards, Multiprogrammer ..... 599, 603  
 Bridges, Directional ..... 222, 223, 341  
 Broadband Amplifiers ..... 406-409  
 Business Computer Systems ..... 683, 696-705
- C**
- Cabinet Accessories ..... 748, 750  
 Cabinets, Rack ..... 754, 755  
 Cable Assemblies ..... 224, 241, 245, 254, 309, 740  
 Cable Kit, Scalar Analyzer ..... 224  
 Cables/Connectors ..... 740  
 Cables, HP-IB ..... 561  
 Cables, Network Analyzer ..... 224, 243, 253  
 Cables, Optical ..... 309  
 CAD Software ..... 616-637  
 CAE Software ..... 544, 627  
 Calculators, Handheld Computers & Peripherals  
   Business ..... 692  
   Card Reader ..... 694  
   Cassette Drive ..... 694  
   Financial Programmable ..... 692  
   I/O Module ..... 694  
   Memory Modules ..... 693  
   Optical Wand ..... 694  
   Printer/Plotter ..... 716, 720  
   Scientific ..... 692  
 Calibration Data, Attenuators ..... 334  
 Calibration Kits (Network Analyzer) ..... 224, 245, 253  
 Calibration Service ..... 757  
 Calibration System, Attenuator ..... 170  
 Calibrators  
   AM/FM (HP 8901A/B) ..... 166  
   Power Meter, for HP 432 Series ..... 214  
   Range, for HP 435B Power Meter ..... 211  
   Scalar, for HP 8756A & 8757A ..... 225  
   Time Interval ..... 189
- Cardiography/Cardiovascular Instrumentation ..... 678  
 Capacitance Meters ..... 292-296, 542  
 Capacitor, Blocking 26.5 GHz ..... 344  
 Capacitor Sets ..... 299  
 Carrier Testing ..... 501  
 Carts, Instrumentation ..... 83  
 Cases, Combining ..... 752, 753  
 Cases, Transit ..... 742-745  
 Catalog  
   Coaxial/Waveguide Measurement Accessories ..... 332  
   Computer Users Supplies and Accessories ..... 766  
   DC Power Supply ..... 792  
   Software ..... 620  
   Summary ..... 792  
   Test and Measurement Accessories ..... 766  
 CATV Analyzer ..... 134  
 Cavity Frequency Meters ..... 347  
 Cellular Radio Test System ..... 324  
 Cesium Beam Frequency Standard ..... 485  
 ChemStations ..... 676  
 Chromatographs, Gas ..... 676  
 Chromatographs, Liquid ..... 677  
 Circuit Test Systems ..... 546-549  
 Circuit Testers, Digital ..... 272-277, 546-549  
 Clip, Logic ..... 276  
 Clock, Atomic ..... 485  
 Clock, Digital ..... 562  
 C Meters ..... 292-296, 542  
 C Meter/C-V Plotter ..... 542  
 Coaxial  
   Accessories ..... 332-349, 740  
   Adapters ..... 349, 741  
   Air Lines ..... 344  
   Attenuators ..... 334-337  
   Crystal Detectors ..... 342  
   Directional Couplers ..... 346  
   Dual Directional Coupler ..... 346  
   Fixed Attenuators ..... 334, 348  
   Frequency Meters ..... 347  
   Low-Pass Filters ..... 348  
   Matrix Switches ..... 340  
   Multiport Switches ..... 338  
   Noise Sources ..... 331  
   Pad Attenuators ..... 334  
   Power Sensors ..... 212, 215  
   Shorts ..... 345  
   Sliding Loads ..... 345  
   Step Attenuators ..... 336  
   Switches ..... 338, 339, 583  
   Terminations ..... 344, 345  
   Thermistor Mounts ..... 215  
   Thermocouple Mounts ..... 212  
   Waveguide Adapters ..... 333, 349  
 Comb Generator ..... 144  
 Combining Cases ..... 752, 753  
 Communications, Data ..... 191, 511-521, 689, 696, 701  
 Communications, Signaling ..... 412, 414-419  
 Communications Test Equipment ..... 68, 162, 324,  
   380, 412, 494-521, 546  
 Comparator, Logic ..... 276  
 Comparator, Phase ..... 239, 489  
 Component & Semiconductor Measurement  
   Digital IC Test System ..... 526, 536  
   Digital IC Testers ..... 320, 526, 536  
   Impedance, LCR Meters ..... 278-296  
   Semiconductor Parametric Test ..... 530-545  
 Components, Solid State ..... 674, 675

- Computer-Aided Design (CAD) ..... 544, 616-637,  
714, 721-729
- Computer-Aided Engineering (CAE) ..... 544, 616-637,  
714, 721-729
- Computer-Aided Software Engineering (CASE) ..... 622
- Computer-Aided Test ..... 582
- Computers & Peripherals
- Artificial Intelligence ..... 666
  - Automatic Test Systems ..... 546, 612
  - BASIC Language Processor System ..... 654, 656
  - Board Computers ..... 670
  - Business Computer Systems ..... 683, 696-705
  - Common Lisp Development Environment ..... 658, 666
  - Computer Users Catalog ..... 766
  - Controllers ..... 552-555, 638
  - Digitizing Tablets ..... 714, 715
  - Disc Drives ..... 708-711
  - Display Boards ..... 649
  - DOS Coprocessor ..... 649, 669
  - Engineering Workstations ..... 619, 638
  - Flexible Disc Drives ..... 708
  - Furniture ..... 734
  - Graphics ..... 650, 690, 705, 716-729
  - Graphics Boards ..... 649, 650
  - Interface Summary ..... 668
  - Modems ..... 707
  - Monitors ..... 690
  - Networking and Data Communications ..... 619, 627,  
660-664, 689, 699
  - Personal Computers ..... 682-691
  - Plotters ..... 720-729
  - Portable Computers ..... 657, 688
  - Printers ..... 716-719
  - Real-Time Systems ..... 670
  - Scanner ..... 713
  - Software Catalogs ..... 620
  - Supplies and Accessories ..... 733, 766
  - Support ..... 756
  - Tablets ..... 714
  - Tape Drives ..... 712, 713
  - Technical Computers ..... 552, 638-671
  - Terminals ..... 691
  - X-Window Software ..... 665
- Connector Adapters ..... 740
- Connector Gage, 2.4mm and 3.5mm ..... 344
- Connectors, 50 GHz, 2.4mm ..... 333
- Connectors, Microwave Precision ..... 333, 740
- Connectors, Optical ..... 309
- Constellation Analyzer ..... 508, 509
- Consulting Services
- HP ASSIST ..... 765
  - Installation ..... 764
- Contents, table of ..... II
- Controllers ..... 552-555, 595, 638, 654, 656
- Converters
- A-to-D ..... 54, 68-78, 84, 599, 603, 608
  - D-to-A ..... 562, 570, 599, 603, 608
- Counters, Electronic
- Counter/Analyzer ..... 191
  - Counter/Timers ..... 189, 196-207
  - Digital Multimeter/Counters ..... 273, 566, 570, 599
  - DVM/DMMs ..... 200-203
  - Low Cost ..... 187-207
  - Microwave ..... 178-188, 191
  - Multiprogrammer Card ..... 599
  - Portable, Battery Operated ..... 187, 204-207
  - Pulsed RF ..... 184, 191
  - Reciprocal ..... 178-188, 196-202, 204-206,  
566, 570
  - Time Interval ..... 189-194, 196-207
  - Time Interval Probes ..... 195
  - Universal ..... 189, 196-207
- Counter/Totalizer Cards ..... 599, 603
- Couplers, Directional (Coax and Waveguide) ..... 346, 347
- Crystal Detectors ..... 342, 343
- Crystal Oscillator ..... 487
- Current Tracer, Digital ..... 275
- Customer Support ..... 756-767
- C-V Meter ..... 295
- C-V Plotter ..... 542
- D**
- D/A Converters ..... 562, 570, 599, 603, 608
- D/A Converter Cards, Multiprogrammer ..... 599, 603
- Data
- Acquisition Systems ..... 56, 68, 78, 84, 564-577
  - Acquisition System Training ..... 761
  - Analyzer ..... 316, 320
  - Communications ..... 191, 511-521, 689, 696, 701
  - Error Analyzer ..... 519
  - Generators ..... 316, 320
  - Pulse Pattern Generator ..... 317
  - Time Interval Analyzer ..... 191
  - Transmission Test Set ..... 519
- Data Acquisition
- Measurement and Control Unit ..... 564
  - Systems ..... 68, 78, 84, 564-581
  - System Training ..... 761
  - Voltmeters/Counters ..... 92-107, 191,  
196-204, 564-577
- Datacommunications Test Equipment
- Bit Error Rate Test Sets ..... 519
  - Data Line Analyzers ..... 496
  - General Information ..... 511, 516
  - LAN Protocol Analyzer ..... 514
  - Network Circuit Access Test Set ..... 521
  - Protocol Analyzers ..... 511-514
  - Selective Level Meter ..... 115, 502
  - Spectrum Analyzers ..... 108, 175
  - Time Interval Analyzer ..... 191
  - Transmission Impairment Test Sets ..... 516-521
  - Vector Modulation Generator/Analyzer ..... 509
  - Waveform Analyzer ..... 68
- DC Electronic Loads ..... 448, 449
- DC Source/Monitor ..... 458, 534, 539
- DC Voltmeters ..... 92-107, 200-203,  
566, 570-577
- DC Power Supplies
- Amplifier/Power Supply ..... 478
  - Autoranging ..... 460, 467, 472
  - Condensed Listing ..... 478-482
  - Constant-Current Sources ..... 483
  - Digitally Controlled ..... 468
  - Dual Tracking ..... 456, 470, 479
  - General Information ..... 446
  - General Purpose: 10-30 W Output ..... 479
  - General Purpose: 25-200 W Output ..... 470
  - General Purpose: 100-2000 W Output ..... 472, 474
  - General Purpose: 300-11,000 W Output ..... 476
  - HP-IB Programmable ..... 450, 454-469
  - Precision Voltage Sources ..... 468, 482
  - Programmable ..... 446-469
  - Source/Monitors ..... 458, 534, 539
  - Specifications, Definitions ..... 453
  - Test Loads ..... 448, 449

## ALPHABETICAL INDEX

- Transistor Bias ..... 252  
 Decade Capacitor ..... 299  
 Degaussers ..... 489  
 Delay Generators ..... 432-445  
 Design Automation  
   Electronic Design System ..... 627  
   Engineering Workstations ..... 619, 638  
   Overview ..... 616-619  
   Software Catalog ..... 620  
 Design Interfaces ..... 627  
 DesignCenter Products ..... 616-637  
 Desktop Publishing Computer ..... 686  
 Detectors  
   Adapter ..... 226  
   Coaxial, Microwave, OEM ..... 342  
   Crystal, Coaxial and Waveguide ..... 342, 343  
   Diode Array ..... 677  
   Error ..... 496  
   Scalar ..... 222, 223  
 Development Systems, Logic ..... 621  
 Dial-Up Modem ..... 707  
 Digital  
   AC Voltmeters ..... 92-107  
   Ammeter ..... 540  
   Analyzer, Logic ..... 623  
   Analyzers, Signature ..... 272-274  
   Audio Synthesizer ..... 412  
   Bar Code Wand ..... 675  
   Board Testers ..... 546-549  
   Capacitance Meters ..... 292-296, 542  
   Cassette Drive ..... 694  
   Circuit Test ..... 272-277, 546-549  
   Combinational Board Tester ..... 546  
   Communications Board Tester ..... 546  
   Constellation Analyzer ..... 508, 509  
   Current Tracer ..... 275  
   DC Voltmeters ..... 92-107, 200-203,  
     566, 570-577  
   DC Voltmeter/Counters ..... 200-203  
   IC Testers ..... 272-276, 320, 528, 529, 540, 546-549  
   IC Test Systems ..... 320, 526-529  
   Impedance Analyzers ..... 278-285  
   In-Circuit Board Test Systems ..... 547-549  
   Input Cards, Multiprogrammer ..... 599, 603  
   LCR Meters ..... 286-296  
   Microprocessor Troubleshooting ..... 272-274  
   Modulation Analyzer ..... 162  
   Modulation Signal Generator ..... 380  
   Multimeters ..... 92-107  
   Multimeters, Multiprogrammer ..... 598  
   Multimeters, Signature ..... 272  
   Noise Figure Meter ..... 329  
   Oscilloscopes ..... 54-75, 263  
   PC Board Test Systems ..... 546-549  
   Power Meters ..... 208-210  
   Pressure Gauge ..... 352  
   Programmable Power Supplies ..... 446-469  
   Signal Analyzers ..... 163  
   Signal Generators ..... 265, 380  
   Signature Analyzers ..... 272-274  
   Stimuli ..... 316-323, 432-445  
   Thermometers ..... 566, 570  
   Time Interval Analyzer ..... 191  
   D/A Current Converter Cards ..... 570, 599, 603  
   D/A Voltage Converter Cards ..... 570, 599, 601  
   Transmission Analyzer ..... 497  
   Troubleshooting ..... 272-277  
   Voltmeters ..... 92-107  
 Digital-to-Analog Converters ..... 562, 570,  
     599, 603, 608  
 Digital Data Test Set ..... 500  
 Digitizer Module ..... 122  
 Digitizing Tablets ..... 714, 715  
 Digitizing Oscilloscopes ..... 54-75  
 Dimensional Measurements ..... 332, 351  
 Diodes ..... 675  
 Diode Array Spectrophotometers ..... 677  
 Directional Bridges ..... 222, 223  
 Directional Couplers ..... 346, 347  
 Disc Drives ..... 708-711  
 Disc/Tape Drives ..... 712  
 Distortion Analyzers ..... 164, 165, 173, 174  
 Distribution Amplifier ..... 490  
 DOS Coprocessor ..... 649, 669  
 Double Balanced Mixer ..... 343  
 Doubler, Frequency ..... 377  
 Down Converters ..... 143, 377, 507  
 Drafting, Mechanical Engineering ..... 636-637  
 Drafting Plotters ..... 724-731  
 DS3 Transmission Test Set ..... 499  
 Dual Arbitrary Waveform Generator ..... 318, 420  
 Dual Tracking Power Supplies ..... 456, 470, 479, 480  
 Dual VHF Switch Module ..... 587  
 Dynamic Signal Analyzers ..... 146, 147, 150, 162  
**E**  
 Education Support ..... 760-762  
 Eight-Pen Plotters ..... 720, 722-729  
 Electrical Engineering (EE) DesignCenter ..... 616  
 Electronic Counters ..... 176-207  
 Electronic Loads ..... 448, 449  
 Electronic Mail ..... 704  
 Electrostatic Plotters ..... 730  
 EMI Measurement Software and Accessories ..... 131-133  
 EMI Measurement Systems ..... 130  
 Emulators, Microprocessor ..... 625  
 Engineering Graphics ..... 632, 634  
 Engineering Workstations ..... 619, 638, 643-648  
 Environments, Operating ..... 770  
 Error Rate Measurements ..... 496, 497  
 Extenders, HP-IB ..... 563  
**F**  
 Factory Floor Terminal ..... 706  
 FDM Measurement Systems ..... 502, 510  
 FDM Network Monitoring Systems ..... 501, 502, 510  
 Fiber Optics  
   Adapters ..... 309  
   Attenuators ..... 308  
   Average Power Meter ..... 306  
   Cables ..... 309, 674  
   Connectors ..... 309, 674  
   Heads ..... 304, 306  
   Interferometer ..... 305  
   Laser Diode Source ..... 307  
   LED Source ..... 307  
   Lightwave Component Test Analyzer ..... 312  
   Lightwave Signal Analyzer ..... 314  
   Optical Time Domain Reflectometer ..... 310  
   Pulse Power Meter ..... 304  
   Receiver ..... 305  
   Signal Sources ..... 303, 307  
   Test Equipment ..... 302, 311  
   Transmitters/Receivers ..... 674



**F**

Filters  
 High Pass ..... 225  
 Low Pass ..... 225, 348

Financing ..... 768

Fixtures, Board Test System ..... 549

Fourier Analyzers ..... 146, 147, 150, 157

FM Modulation Analyzers ..... 166, 191

FM Signal Generators ..... 380, 383, 384, 387-389

**F**requency  
 Analyzer ..... 191  
 Counters ..... 97-99, 176-207, 566  
 Doublers ..... 377  
 Meters, Coaxial and Waveguide ..... 347  
 Stability Analyzer ..... 160, 161, 191  
 Synthesizers ..... 357-374, 386-390, 394, 395, 412, 414-419

Frequency and Time Domain Analyzers ..... 146-158

Frequency and Time Standards ..... 484-491  
 Cesium ..... 485  
 Distribution Amplifier ..... 490  
 General Information ..... 484  
 Quartz ..... 487  
 Rubidium ..... 486  
 Standby Power Supplies ..... 491

Frequency Selective Meter and Tracking Oscillator ..... 115, 502

Functional Test Software ..... 610

Function Generators ..... 410-429

Furniture ..... 734

**G**

Gage, Connector, 2.4mm and 3.5mm ..... 344

Gas Chromatographs ..... 676

GC/Mass Spectrometer Systems ..... 677

**G**enerators  
 Arbitrary Waveform ..... 76, 318, 378, 380, 412, 420, 427  
 Data ..... 265, 316-317  
 Delay ..... 432-445  
 Digital Modulation ..... 380  
 Digital Signal ..... 420  
 Function ..... 410-429  
 Interactive Test ..... 606  
 Jitter ..... 498  
 Noise ..... 412  
 Optical, Pulse/Function ..... 303  
 Pattern ..... 316-317, 496-498  
 PRBS ..... 318, 322, 496-498  
 Pulse ..... 427, 432-444  
 Pulse/Function ..... 378, 388, 410-417, 420-429, 433  
 Pulse/Pattern ..... 317  
 Signal ..... 356-391, 394  
 Square Wave ..... 410-429, 412  
 Sweep ..... 392-405, 414-419, 426, 427  
 Synthesized ..... 386-390  
 Timing ..... 445  
 Tracking ..... 122  
 Vector ..... 318, 380  
 Vector Modulation ..... 380  
 Waveform ..... 378, 412, 414-419, 427  
 Word ..... 318, 320, 322, 444, 500, 526

**G**raphics  
 Displays ..... 650, 690  
 Plotters ..... 78, 84, 720-732  
 Printers ..... 716-719  
 Software ..... 85, 620, 634, 651, 689, 690, 705  
 Supplies ..... 733  
 Tablets ..... 714

Technical Computers ..... 616, 619, 638-671

Terminals ..... 691

**H**

Hammer Kits ..... 581, 692-695

Hardware Support ..... 757-759

Harmonic Mixers (Coaxial and Waveguide) ..... 143, 343

Hewlett-Packard Interface Bus (HP-IB) ..... 556-563

**H**P-IB  
 Attenuator/Switch Driver ..... 336  
 Cables ..... 561  
 Channel Selector ..... 495  
 Computers ..... 552-555, 638-639  
 Digital Clock ..... 562  
 Digitizer ..... 122  
 Extenders ..... 563  
 Frequency Counters ..... 176-204  
 General Information ..... 556-560  
 Interface and Command Library ..... 655  
 Logic Analyzers ..... 256  
 Oscilloscopes ..... 54, 263  
 Power Meters ..... 169, 208-210  
 Relay Actuators ..... 562, 570, 583, 645  
 Signal Sources ..... 412-424, 427  
 Spectrum Analyzers ..... 108, 116-158  
 Switches ..... 336, 339  
 Switch Controller ..... 506, 587  
 Switch/Control Unit ..... 506, 587  
 Switch Driver ..... 336  
 Switch Test Unit ..... 583  
 Time Synthesizer ..... 445  
 VHF Switches ..... 562, 587

**H**P Offices ..... 771

**I**

IBM-Compatibles ..... 684, 686, 696

IC Design Analysis Software ..... 525

IC Design Verification System ..... 320, 526-527

IC Prototype Verification System ..... 526-527

IC Testers, Digital ..... 272-276, 320, 528, 529, 540, 546-549

IC Test Systems, Analog ..... 528

IC Test Systems, Digital ..... 320, 526-527

Impedance Analyzers ..... 233, 278-285

Impedance/Gain-Phase Analyzer ..... 233, 280, 282

Impedance Meter ..... 280

Impedance Transformers (50-75  $\Omega$ ) ..... 144

Indicators, LED ..... 674

**I**ndexes  
 Alphabetical ..... 25  
 General ..... 50  
 Model Number ..... 37

Industrial Touch Terminal ..... 706

Infrared Detector ..... 677

Inkjet Printers ..... 716-719

Installation Services ..... 764

Integral Personal Computer, The ..... 657

Integrators ..... 676

Interactive Test Generator ..... 606

Interface Bus (HP-IB) ..... 556-563

Interface Cards for Technical Computers ..... 668

Interface Kits  
 IBM Disc/Tape ..... 685  
 Multiprogrammer ..... 597, 602

Interface Summary for Computers ..... 668

Interference & Noise Test Set ..... 508

Interferometer, Lightwave Accessory ..... 315

Interferometers, Laser ..... 350, 351



## ALPHABETICAL INDEX

- Interrupt Card, Multiprogrammer ..... 599, 603  
 I/Q Tutor Digital Training Program ..... 509  
 I/Q Vector Modulated Generator (VAWS) ..... 382  
 I/Q Vector Modulation Analyzer ..... 162  
 Isolators, Optical ..... 674  
 Isolators, Waveguide ..... 347
- J**  
 Jitter Generation & Measurement ..... 496-500  
 Jitter, Time Interval Analyzer ..... 191
- K**  
 Kits, Accelerometer and Hammer ..... 581  
 Kits, Fiber Optic Link ..... 674  
 Kits, Interface ..... 597, 602, 708  
 Kits, Rack Mounting ..... 748, 749, 752
- L**  
 Laboratory Automation Systems ..... 676  
 Laboratory Information Management ..... 676  
 LAN Protocol Analyzer ..... 514  
 Laser  
   Calibrator System ..... 351  
   Diode Source ..... 307  
   Interferometers ..... 350  
   Position Transducer ..... 350  
   Printers ..... 717-719  
   Transducer System ..... 350  
 LC/MS Systems ..... 677  
 LCR Meters ..... 286-295  
 LCZ Meters ..... 294  
 Leasing ..... 768  
 LED Displays ..... 674  
 LED Indicators ..... 674  
 LED Source ..... 307  
 LF Impedance Analyzer ..... 282  
 Light Bar Modules, LED ..... 674  
 Light Emitting Diodes ..... 674  
 Lightwave  
   Component Analyzer ..... 312  
   Couplers ..... 313  
   Instruments ..... 302-311  
   Receiver ..... 313  
   Signal Analyzer ..... 314  
   Sources ..... 313  
 Limiters ..... 133, 144  
 Liquid Chromatographs ..... 677  
 Loads, DC Electronic ..... 448, 449  
 Local Area Networks ..... 660-664, 701  
 Logic  
   Analyzer, Development Systems ..... 621  
   Analyzer Training Courses ..... 762  
   Analyzers ..... 256-271, 621  
   Clip ..... 276  
   Comparator ..... 276  
   Current Tracer ..... 275  
   Development System ..... 621  
   Pattern Generator ..... 265  
   Probes ..... 264, 265, 268, 275  
   Pulser ..... 275  
   Signal Sources ..... 316, 410, 432  
   Troubleshooting Kits ..... 277  
 LSI Test System ..... 528
- M**  
 Mail, Electronic ..... 704  
 Mass Memory Module ..... 141  
 Mass Selective Detectors ..... 677  
 Mass Spectrometers ..... 677  
 MATE Power ..... 210  
 Matrix Switch (HP-IB) ..... 339, 538, 583-588  
 Matrix Switch, Microwave ..... 340  
 Measurement and Control Cards,  
   HP-1000 A-Series ..... 605  
 Measurement Graphics Software ..... 79, 85  
 Measurement Plotting System ..... 78, 84  
 Measuring Receiver ..... 168  
 Mechanical Engineering  
   Design ..... 636  
   DesignCenter ..... 636  
   Drafting ..... 636  
   Drafting Plotters ..... 724-729  
   Solids Modeling ..... 636, 646, 650  
   Test ..... 146-157, 636  
 Medical Instrumentation ..... 678  
 Memory Card, Multiprogrammer ..... 599  
 Memory Modules, HP-41 ..... 693  
 Meters  
   AC ..... 92-107  
   Capacitance ..... 292-296, 542  
   Carrier Noise ..... 161  
   Distortion ..... 164-174, 505  
   Frequency ..... 97, 176-207, 349, 566  
   High Resistance ..... 298  
   Impedance ..... 232, 233, 278-285  
   LCR ..... 286-291  
   LCZ ..... 294  
   Low Resistance ..... 102, 298  
   Modulation ..... 162, 191  
   Multifunction ..... 92-107  
   Multimeter ..... 92-107  
   Noise Figure ..... 329  
   Ohmmeter ..... 92-107, 298  
   pA Meter ..... 540  
   Peak Power ..... 215  
   Phase ..... 146, 150, 191, 234  
   Picoampere ..... 540  
   Power ..... 169, 208-215, 304, 306  
   Q ..... 297  
   Signature ..... 272-274  
   Standing-Wave-Ratio (SWR) ..... 255  
   Susceptance ..... 284, 286, 290, 291  
   Time Interval ..... 189, 191, 196-207  
   True RMS ..... 92-107  
   Vector Impedance ..... 285  
 Microprocessor  
   Bus Analyzer ..... 621  
   Development Environment ..... 621  
   Development Station ..... 621  
   Emulation ..... 621  
   PROM Programming ..... 621  
   Software Analyzer ..... 621  
   Troubleshooting ..... 272, 274, 621  
 Microwave  
   Amplifiers ..... 407, 408  
   Attenuator Calibration ..... 170  
   Counters ..... 178-188  
   Design System (CAE) ..... 631  
   Diodes ..... 675  
   Down-Converter ..... 172, 193, 194  
   Link Analyzers ..... 507  
   Measurement System ..... 172  
   Modulators ..... 172, 391  
   Network Analyzers ..... 216-226  
   Noise Figure Meter ..... 329

- Noise Figure Test Set ..... 330  
Oscilloscope/TDR ..... 66  
Power Measuring Equipment ..... 168, 208-215  
Preamplifiers ..... 116, 122, 407  
Preselector Module ..... 122  
Radio Testing ..... 501  
Semiconductors ..... 675  
Signal Generators ..... 380-390  
Signal Generator Calibration ..... 171  
Spectrum Analyzers ..... 116-126, 137-142  
Sweep Oscillators ..... 392-405  
Synthesizers ..... 361-374, 386-390, 394-395  
TDR/Oscilloscopes ..... 66  
Test Equipment ..... 332-349  
Transistors ..... 675
- Millimetre Wave Instrumentation**
- Adapters ..... 349  
Attenuators ..... 348  
Bends ..... 349  
Counters ..... 178, 184  
Detectors ..... 343  
Directional Couplers ..... 347  
Frequency Meters ..... 347  
General Information ..... 332  
Harmonic Mixers ..... 143, 343  
Isolators ..... 347  
Network Analyzer ..... 222, 251  
Power Sensors ..... 212  
Shorts ..... 345  
Spectrum Analyzers ..... 117, 119, 123, 125, 139  
Straight Sections ..... 349  
Sweep Oscillator ..... 403  
Synthesized Sweeper ..... 388  
Terminations ..... 345  
Twists ..... 349
- Milliohmmeters ..... 102, 298  
Miniature Fiber Optic Link ..... 674  
Mixers, Double-Balanced ..... 343  
Mixers, Coaxial and Waveguide ..... 143, 343  
Modems ..... 380, 707  
Modular DC Source Monitor ..... 534  
Modular Measurement System ..... 116-122  
Modulation Analyzers ..... 162, 166, 191  
Modulation Analyzers, Vector I/Q ..... 162  
Modulation Domain Analyzers ..... 191-194  
Modulator/Demodulator ..... 380, 507  
Modulators, Absorptive ..... 391  
Modulators, I/Q, Vector ..... 380  
Modulators, PIN ..... 391  
Modulation Test Source ..... 167, 380, 509  
Module, Mass Memory ..... 141  
Module, Test & Adjustment ..... 141  
Module Part Kits ..... 122  
Monitors ..... 649, 690  
Multimeters ..... 92-107, 272  
Multimeter, Signature ..... 272  
Multiplex (Primary) Analyzer ..... 495  
Multiplexers ..... 97, 566-577, 583-588  
Multipoint HP-IB Extender ..... 563  
Multiport Coaxial Switches ..... 338  
Multiprogrammers ..... 593-604
- N**
- Network Analysis, General Information ..... 216-218  
Network Analyzers ..... 150, 153, 216-229  
Automatic ..... 234, 238, 249  
Impedance/Gain-Phase ..... 280  
Millimeter-Wave ..... 252
- Scalar ..... 219-229  
Vector ..... 146, 150, 230-255, 280  
Network Circuit Test Set ..... 510
- Networking**
- Board Test Systems ..... 548  
Business Computers ..... 689, 701  
Computer Integrated Manufacturing ..... 663  
Personal Computers ..... 689  
Technical Computers ..... 660
- New Product Highlights** ..... 1
- Noise**
- Figure Meter ..... 329  
Generator ..... 331, 412  
Measurements ..... 160, 161, 328  
Microwave Noise Figure Test Set ..... 330  
Sources ..... 331  
Noise and Interference Test Set ..... 508
- O**
- Obstetrical and Neonatal Instrumentation ..... 679
- OEM**
- Computers ..... 670, 683  
Displays, CRT ..... 690, 691  
Graphics Plotters ..... 720-732  
Measurement Plotting System ..... 78, 84  
Microwave Attenuators ..... 334-337  
Microwave Components ..... 675  
Microwave Crystal Detectors ..... 342, 343  
Microwave Switches ..... 339  
Optoelectronic Components ..... 674  
Power Supplies ..... 446  
Printers ..... 716-719
- Offices, Sales & Support ..... 771  
Ohmmeters ..... 92-107, 298  
Operating Cases ..... 746  
Operating Environments ..... 770
- Optical**
- Accessories ..... 309  
Adapters ..... 309  
Attenuator ..... 308  
Average Power Meter ..... 306  
Cables ..... 309  
Connectors ..... 309  
Heads ..... 304, 306  
Laser Diode Source ..... 307  
LED Source ..... 307  
Pulse Power Meter ..... 304  
Receiver ..... 305  
Signal Source ..... 303, 307  
Time Domain Reflectometer ..... 310
- Optocouplers ..... 674  
Optoelectronics ..... 674  
Ordering Information ..... 769  
OR Monitors ..... 679
- Oscillators**
- Function ..... 410-429  
General Information ..... 392  
Low Frequency ..... 412-417, 426, 502  
Sinewave ..... 412-419, 502  
Squarewave ..... 412-429  
Sweep ..... 164, 369, 383, 387, 388, 392-405  
412-419, 426, 428, 502  
Synthesized Sweep ..... 387-388, 412-419
- Oscilloscopes** ..... 54
- Accessories ..... 81-83  
Digital Waveform Storage ..... 58-65  
Digitizing ..... 54-67, 70, 72  
Precision ..... 68-77

## ALPHABETICAL INDEX

- Spectrum Analyzer Plug-In ..... 116-122  
 Testmobiles ..... 83
- P**
- pA Meter/DC Voltage Source ..... 540  
 Pad, Coaxial Attenuator ..... 334  
 Parameter Extraction Software ..... 525  
 Parts Libraries, Electronic Design System ..... 627  
 Patient Monitors ..... 679  
 Pattern Generator, Digital ..... 265, 318, 320  
 Pattern Generator/Error Detector ..... 496, 497  
 Pattern Generator/Pulse Capability ..... 317  
 PC BASIC Controllers ..... 654, 656  
 PC Board Design/Test Link ..... 632  
 PC Board Testers ..... 546-549  
 PCM Test Equipment ..... 494-499  
 Peak Power Meters ..... 215  
 Peripherals, Computer ..... 712, 713  
 Personal Calculators & Handheld Computers ..... 692-695  
 Personal Computers ..... 682-691  
 Phase Comparator ..... 239, 489  
 Phase Meters ..... 146, 150, 191, 234, 239  
 Phase Modulation Analyzers ..... 162, 166, 191  
 Phase Noise Measurement ..... 160-161  
 PIN Diodes ..... 675  
 PIN Modulators, Microwave ..... 391  
 Plotter Accessories and Supplies ..... 733  
 Plotters, Drafting ..... 724-729  
 Plotters, Graphics ..... 78, 84, 720-732  
 Portable AC Power Source ..... 136  
 Portable Spectrum Analyzers ..... 134-143  
 Portable Vectra CS ..... 688  
 Position Measurement, Laser ..... 350  
 Power Amplifiers ..... 407-409  
 Power Dividers ..... 225, 341  
 Power Meter Calibrators ..... 211, 214  
 Power Meter/Measuring Receiver ..... 168  
 Power Meter, MMS Module ..... 116, 209  
 Power Meter, Optical ..... 304, 306  
 Power Meters, RF & Microwave ..... 168, 208-214  
 Power Sensors, RF & Microwave ..... 169, 212, 215  
 Power Source, Portable AC ..... 136  
 Power Splitters, Coaxial ..... 225, 227, 245  
 Power Splitters, Optical ..... 309  
 Power Supplies  
   Amplifier/Power Supplies ..... 450  
   Atomic Clock ..... 491  
   Condensed Listing ..... 446, 447, 450-452  
   Constant Current Sources ..... 483  
   Digitally Controlled ..... 446-469  
   Dual Tracking ..... 456, 470, 481  
   Frequency Standards ..... 491  
   HP-IB Programmable ..... 446-469  
   Laboratory ..... 446-483  
   Multiprogrammer Control ..... 450-452  
   Output Isolation Relays ..... 464  
   Polarity Reversal Relays ..... 464  
   Precision Current, Voltage Sources ..... 482-483  
   Programmable ..... 446-469  
   Specifications, Definitions ..... 453  
   Standby ..... 491  
 Power Supply/Amplifier ..... 478  
 PRBS Generators ..... 318  
 Preamplifiers ..... 116, 122, 195, 407  
 Precision Architecture ..... 698  
 Precision Coaxial Connectors ..... 333, 740  
 Precision Digitizing Oscilloscopes ..... 68-77  
 Precision Frequency Reference ..... 122  
 Precision Frequency Sources ..... 484-491  
 Precision LCR Meter ..... 286  
 Precision Oscillator ..... 487  
 Precision Time Interval Counters ..... 189, 191  
 Preprocessor, Logic State Development System ..... 623  
 Preprocessors, Logic Analyzer ..... 266, 267  
 Preselectors ..... 122, 132  
 Pressure Probes, Quartz ..... 352  
 Primary Multiplex Analyzer ..... 495  
 Printed Circuit Design ..... 632-633  
 Printers  
   Bar Code ..... 718  
   Color ..... 716  
   Desktop Publishing ..... 717, 718  
   Dot Matrix ..... 717-719  
   Graphics ..... 717-719  
   Impact ..... 717-718  
   Inkjet ..... 717  
   Laser ..... 717-719  
   Line ..... 718, 719  
   Page ..... 718, 719  
   Personal ..... 717  
   Supplies ..... 766  
   Tempest ..... 718  
 Probes  
   Accessories ..... 107, 275  
   Close-Field ..... 133, 144  
   Digital Multimeter ..... 107  
   High Frequency ..... 107, 240, 313  
   High Voltage ..... 107  
   Impedance ..... 280  
   Logic ..... 265, 268, 275  
   Oscilloscope ..... 67, 81, 82  
   Pressure ..... 352  
   RTD ..... 580  
   Spectrum/Network ..... 230  
   Temperature ..... 353  
   Time Interval ..... 195  
   Voltage Divider ..... 107  
 Programmable Logic Device Design System (PLDDS) ... 630  
 Protocol Analyzers ..... 511-514  
 Publications ..... 780, 792  
 Pulse Adder, Splitter, Inverter ..... 444  
 Pulse Generators ..... 410, 426, 428, 432-445  
   Configurable ..... 444  
   High Power ..... 441  
   Programmable ..... 428, 434-440  
 Pulse/Function Generators ..... 378, 388, 410-417,  
   420-429, 433  
 Pulse/Function Generator, Optical ..... 303  
 Pulse Width/Duty Cycle Analyzer ..... 191  
 Pulsers, Logic ..... 275
- Q**
- Q Meter ..... 297  
 Quartz Frequency Standard ..... 487  
 Quasi-Peak Adapter ..... 132  
 Quartz Pressure Probe ..... 352  
 Quartz Pressure Set ..... 352  
 Quartz Thermometer ..... 353
- R**
- Rack Cabinets ..... 754, 755  
 Rack Mount Kits ..... 748, 749, 752  
 Rack Slides ..... 749, 750, 752, 753  
 Radio System Testing ..... 191, 501  
 Radio Test Systems ..... 324, 510  
 Range Calibrator (for HP 435B Power Meter) ..... 211

- Receiver, Measuring ..... 168  
Receiver, Optical ..... 305  
Recorders  
  Measurement Plotting System ..... 78, 84  
  Waveform ..... 68-78, 84, 122  
  X-Y ..... 78, 84  
Reflection/Transmission Test Sets ..... 233, 237,  
  243, 244  
Reflectometer, Optical Time Domain ..... 310  
Relay Accessories, Power Supply Output ..... 464  
Relay Actuators (HP-IB) ..... 562, 570, 583-588  
Relay Output Card, Multiprogrammer ..... 599, 603  
Remote Access & Test System ..... 510  
Remote Terminal Unit ..... 568  
Rentals ..... 768  
Resistance Meters ..... 92-107, 298  
Resuscitation Instrumentation ..... 679  
RF  
  Amplifiers ..... 406, 409  
  Counters ..... 177  
  Impedance Analyzer ..... 242, 284  
  Network Analyzer ..... 234, 240-246  
  Preselector ..... 132  
  Signal Generators ..... 356  
  Spectrum Analyzers ..... 117-119, 123, 127, 134  
  Switch ..... 339, 583  
  Time and Frequency Analyzers ..... 68-77, 191  
  Tracking Generator Module ..... 122  
  Transceiver Test Systems ..... 324  
RMS Voltmeters ..... 92-107  
Rotary Vane Attenuators, Waveguide ..... 348  
RTD Probes ..... 580  
Rubidium Frequency Standard ..... 486  
**S**  
S-Parameter Test Sets ..... 237, 243, 244, 250  
Sales & Support Offices ..... 771  
Sampler, Automatic ..... 676  
Scalar Network Analyzers ..... 219-229  
Scanners ..... 599, 603, 713  
Scanner Cards, Multiprogrammer ..... 599, 603  
Schottky Diodes ..... 675  
Selective Level Measuring Set ..... 506  
Selective Level Voltmeters ..... 115, 175, 502, 505, 506  
Semiconductor/Component Test Systems ..... 320, 526-533  
Semiconductor Parameter Analyzer ..... 536  
Semiconductor Parameter Extraction Software ..... 525  
Semiconductor Parametric Test System ..... 530-532  
Semiconductor Test Equipment ..... 524-545  
Sensor Module ..... 169, 212  
Sensors, Power ..... 169, 212, 215  
Service ..... 757  
Shorts, Coaxial ..... 345  
Shorts, Waveguide ..... 345  
Signal Analyzers  
  Audio ..... 112, 145-158, 164, 175, 505  
  Distortion ..... 164-174  
  Frequency and Time Interval ..... 191  
  General Information ..... 108  
  Modulation ..... 162, 166, 191  
  Phase Noise ..... 160-161, 191  
  Spectrum ..... 112, 116-146, 160-161, 233  
  Time Interval ..... 191  
  Waveform ..... 54-67, 84, 116-122, 147,  
  150, 157, 162, 191  
Signal Generators  
  Accessories ..... 377  
  Agile (VAWS) ..... 382  
  Avionics ..... 375  
  Calibration ..... 171  
  Digital ..... 420  
  General Information ..... 356  
  Generator/Recorder ..... 76  
  HF, VHF, UHF, SHF ..... 357-376, 378-390, 414-419  
  Microwave ..... 386-390  
  Programmable ..... 357-374, 386-390  
  Pulse Modulator ..... 391  
  Service Kits ..... 368, 371, 389, 390  
  Sweep ..... 387-388, 392-405, 414-419,  
  426, 427  
  Synthesized ..... 357-374, 386-390,  
  394-395, 410-429  
  Vector, I/Q ..... 380  
  VOR Modulator ..... 412  
Signal Monitoring Software ..... 129  
Signal Simulation, Agile Frequency ..... 382  
Signal Simulation System ..... 378  
Signal Sources ..... 303-307, 316-323, 357-374,  
  392-405, 410-429, 432-444  
Signal Sources, Optical ..... 303, 307  
Signal Sources, Programmable ..... 316-317, 357-374,  
  410, 411, 412-424, 434-440  
Signaling, RF Radio ..... 412  
Signaling Test Set ..... 515  
Signature Analysis ..... 272-274  
Signature Analyzer, Digital ..... 274  
Signature Multimeter, Digital ..... 272  
SimPlate Fixture Series ..... 549  
Simulation, Signal ..... 378  
Single Sideband Phase Noise Test System ..... 160  
Single Sideband Phase Noise Test Set ..... 161  
Slides for Rack Mounting ..... 749, 750, 752, 753  
Sliding Loads (Coaxial and Waveguide) ..... 345  
SMA, SMB, SMC Series Adapters ..... 741  
Software  
  Active Device Measurement ..... 252  
  Applications Solutions ..... 616-637, 689,  
  695, 696, 702, 705  
  Attenuator Test ..... 170  
  Basic Network Measurement ..... 238, 248, 253  
  Business ..... 689, 696-705  
  Calculators ..... 695  
  Catalog ..... 620  
  Cellular Radio Test ..... 325  
  CAD ..... 616-637  
  CAE ..... 627  
  CAE Link ..... 320  
  Computer Aided Test (CAT) ..... 601  
  Data Acquisition ..... 608  
  Data Base Management ..... 689, 699  
  Datacom ..... 689, 699, 701, 704-705  
  Electronic Design ..... 616, 627  
  Electronic Test ..... 610  
  EMI Measurement ..... 131  
  Engineering Documentation ..... 634  
  Engineering Graphics Systems (EGS) ..... 634  
  Functional Test ..... 610  
  Graphics ..... 85, 634, 651, 689, 705  
  IC Prototype Verification System ..... 320  
  IGES Translator ..... 634  
  Integral ..... 624  
  Mechanical Design & Drafting ..... 636  
  Mechanical Engineering ..... 636  
  Microprocessor Development ..... 621  
  NC Drill ..... 635



# ALPHABETICAL INDEX

- Network Measurement ..... 248, 253
  - Operating System (for HP 3000) ..... 698-699
  - Parameter Extraction (TECAP) ..... 525
  - Personal Computer ..... 689
  - Photoplotter/NC Drill ..... 635
  - Portable Vectra CS Personal Computer ..... 688
  - Printed Circuit Design ..... 632
  - Production Test ..... 610
  - Scalar Network Analyzer ..... 228
  - Signal Generator Test ..... 171
  - Signal Monitoring ..... 129
  - Software Materials Subscription (SMS) ..... 763
  - Spectrum Analyzer System ..... 124, 129, 131
  - Spreadsheets ..... 689, 700, 705
  - Support ..... 763
  - Terminal Emulation ..... 705
  - Test ..... 610
  - Transceiver Test ..... 325
  - Translator (IGES) ..... 634
  - Transmission Line Test System ..... 229
  - Updates ..... 763
  - Vectra Personal Computer ..... 689
  - Vector Network Analyzer ..... 248, 253
  - Waveform Measurement ..... 75
  - Waveform Generator ..... 77, 378
  - Word Processing ..... 689, 699, 705
  - Solid State
    - Displays, Lamps, Optocouplers, Fiber Optics ..... 674
    - Diodes, Transistors, Integrated Products ..... 675
  - Solids Modeling ..... 646, 647, 650
  - Source, AM/FM Test ..... 166
  - Source, Avionic ..... 412
  - Source, Universal ..... 430
  - Sources, Optical ..... 303, 307
  - Sources, Signal ..... 303-307, 316-323, 357-374  
392-405, 410-429, 432-444
  - Spectrophotometer, Diode Array ..... 677
  - Spectrum Analyzers, General Information ..... 108-111
  - Spectrum Analyzers ..... 112, 116-146
  - Spectrum Analyzer Preselector ..... 122, 132
  - Stability Analyzer, Frequency ..... 160, 161, 191
  - Standard Capacitor Sets ..... 299
  - Standards, Frequency and Time ..... 484-491
  - Standby Power Supply ..... 491
  - Standing Wave Ratio (SWR) Meter ..... 255
  - Step Attenuators, Coaxial ..... 336
  - Stepping Motor Control Card (Multiprogrammer) ..... 603
  - Storage-Normalizer ..... 255
  - Supplies, Plotter & Printer ..... 733
  - Support, Customer ..... 756-765
  - Sweep Oscillators, General Information ..... 392
  - Sweep Oscillators ..... 164, 369, 383, 387, 388,  
392-405, 412-419, 426, 428, 502
  - Sweep Signal Generators ..... 387-388, 392-405,  
414-419, 426, 427
  - Sweeper Synthesizers ..... 383, 394, 414, 416, 418,  
419, 502
  - Switch/Attenuator Combinations ..... 340
  - Switch Controller, HP-IB ..... 336, 506, 587
  - Switches
    - AC Power Controller ..... 572
    - Access, Distribution and Bidirectional ..... 506
    - Actuators ..... 97, 336, 566, 572, 587
    - HP-IB Driver ..... 336
    - Coaxial, Five-Port ..... 339, 566
    - Coaxial, Microwave OEM ..... 339
    - Matrix Microwave ..... 340
  - Matrix (HP-IB) ..... 538, 583, 587
  - Multiport Coaxial ..... 338
  - Switch/Test Unit ..... 583
  - SPDT ..... 339
  - VHF, HP-IB ..... 562, 583, 587
  - Switching Matrix ..... 340
  - Synthesized Function Generators ..... 378, 412, 427
  - Synthesized Signal Generators ..... 357-374, 386-390,  
394-395, 410-429
  - Synthesized Signal Sources ..... 386-390, 394, 395, 412,  
414-419
  - Synthesized Sweep Oscillators ..... 392-405
  - Synthesizer, Audio Complex ..... 412
  - Synthesizer, Arbitrary Waveform ..... 378, 427
  - Synthesizer, Time ..... 445
  - Synthesizers, Frequency ..... 386-390, 394, 395, 414, 416
  - Systems
    - Analog LSI Test ..... 528
    - Attenuator Calibration ..... 172
    - Automatic Test ..... 612
    - Board Test ..... 546-549
    - CAD ..... 632, 636
    - CAT (Computer Aided Test) ..... 582
    - Combinational Test ..... 546
    - Communications Test ..... 546
    - Computer-Aided Engineering (CAE/CAD) ..... 616-637
    - Computer-Aided Software Engineering (CASE) ..... 622
    - Data Acquisition ..... 564-581
    - DC Electronic Load ..... 448, 449
    - Digital IC Test ..... 320, 526-527
    - EMI Measurement ..... 130
    - IC Prototype Verification ..... 320, 526-527
    - In-Circuit Test ..... 546, 547
    - Laser Measurement ..... 351
    - Logic Analysis ..... 260, 323
    - LSI Test ..... 528
    - Microprocessor Development ..... 621
    - Modular Measurement ..... 116-122
    - Network Analysis ..... 238, 392-394
    - Phase Noise Measurement ..... 160-161
    - Real-Time Computer ..... 670
    - Remote Access & Test ..... 510
    - Semiconductor Test ..... 526-533
    - Signal Generator Calibration ..... 171
    - Signal Monitoring ..... 129
    - Transceiver Test ..... 324
    - Transmission Line Test ..... 229
    - Waveform Generation ..... 77, 378
    - Waveform Measurement ..... 74
  - System I, System II Cabinets ..... 748-755
- ## T
- Tablets ..... 714
  - Tape Drives ..... 712
  - TECAP Parameter Extraction Software ..... 525
  - Technical Computers and Peripherals ..... 552, 616, 638
    - Artificial Intelligence ..... 666
    - Computers ..... 552, 638
    - Computing Overview ..... 638-639
    - Controllers ..... 552-555
    - Disc Drives ..... 708-711
    - DOS Coprocessor ..... 649, 669
    - Engineering Workstations ..... 619-638
    - Graphics ..... 650
    - HP-IB Interface ..... 663, 668
    - Integral, The ..... 624
    - I/O Expander ..... 668
    - Interface Summary ..... 668



Multiprogrammer: I/O Expander & Converter .....	602
Networking .....	660-664
Operating Systems .....	658
Parallel Asynchronous FIFO Interface .....	644
Peripherals .....	667
Plotters .....	720-732
Printers .....	716-719
Real-Time Systems .....	670
Selection Guide .....	639
Software Catalog .....	620
Technical Documentation Software .....	634
Telecommunications Test Equipment .....	112, 115, 175, 230, 234, 310
Access Switch .....	506
Audio Channel Selector: HP-IB Controlled .....	495
Balanced 2/4-wire Audio Channel Selector .....	495
Bidirectional Switch .....	506
Bit Error Measurements .....	496-497
Carrier Testing .....	501
Cellular Radio Test Equipment .....	324
Constellation Analyzer .....	162, 508
Controller, Switch .....	336, 506
Customer Support .....	756
Digital Data Test Set .....	500
Digital Modulation Generator/Analyzer .....	162, 380
Digital Transmission Analyzer .....	497
Digitizing Oscilloscopes .....	54-67, 74
Down Converter .....	507
DS3 Transmission Test Set .....	499
Error Rate Measurements .....	496, 497
FDM Measurements .....	501-504, 510
FDM Surveillance Software .....	510
Frequency Analyzer .....	191
HP-IB Controlled Channel Selector .....	495
Jitter Generator & Receiver .....	498
Jitter, Time Interval Analyzer .....	191
Microwave Counters .....	178-188
Microwave Link Analyzers .....	507
Microwave Network Analyzers .....	216-255
Microwave Radio Testing .....	501
Microwave Upconverter .....	405
Modulation Analyzers .....	166, 168, 191
Modulator/Demodulator .....	380, 507
Noise and Interference Test Set .....	508
Optical Time Domain Reflectometer .....	310
Pattern Generator/Error Detector .....	497
PCM Terminal Test Set .....	495
PCM Testing .....	191, 494-500
Power Meters .....	172, 208-215
Primary Multiplex Analyzer .....	495
Remote Access and Test System .....	510
Remote Automatic Surveillance Systems .....	510
RF Radio Testing .....	324
Selective Level Measuring Sets .....	506
Selective Level Meters .....	502, 505, 506
SLMS Accessories .....	506
Spectrum Analyzers .....	112-158, 233
Switch, Access .....	506
Switch Controller .....	506
System DC Electronic Load .....	448
Time Interval Analyzer .....	191
Transmission Impairment Measuring Sets .....	517-521
Transmission Line Test Sets .....	229
Vector Modulation Generator/Analyzer .....	162, 380
Voice & Data Testing .....	516
Waveform Analyzers .....	54-77, 84, 116-122, 147, 150, 157, 162, 191

Temperature Measurement .....	353, 566, 570, 572
Temperature Transducers .....	580
Terminal Emulation .....	705
Terminals, Display .....	691
Terminals, Rugged .....	706
Termination Panel, Multiprogrammer .....	602
Terminations, Coaxial and Waveguide .....	344
Test and Adjustment Module .....	141
Test and Measurement Accessories Catalog .....	766
Test Generator, Interactive .....	606
Test Head .....	320
Testmobiles .....	83
Test Set, Signal Generator .....	171
Test Systems, Automatic .....	595, 612
Test Systems, Board .....	546-549
Test System, Digital IC .....	320, 526, 527
Test System, LSI .....	528
Thermistor Assemblies .....	215
Thermistor Sensors, Coaxial and Waveguide .....	215
Thermocouple Power Meters .....	208-211
Thermocouple Power Sensors .....	212
Thermocouple Scanning Cards .....	566, 570, 572, 599
Thermocouple Wire .....	580
Thermometer, Quartz .....	353
Time Base Card, Multiprogrammer .....	598
Time, Frequency Domain Analyzers .....	68-77
Time Interval Analyzer .....	191
Time Interval Calibrator .....	189
Time Interval Counters .....	189-194, 196-207
Time Module, HP-41 .....	695
Time Standards .....	484-491
Time Synthesizer .....	445
Timer/Pacer Cards, Multiprogrammer .....	599, 603
Timing Analyzer .....	191
Timing Generator, HP-IB .....	445
TNC Adapters .....	740
Touch Accessory, HP .....	690
Tracer, Current .....	275
Tracking Generators .....	122, 418, 502
Tracking Generator Module .....	122
Training Support .....	760-762
Transceiver Modulation Analyzer .....	166
Transceiver Test Systems .....	324-327
Transducer, Laser Position .....	350
Transfer Function Analyzer .....	146
Transient Digitizers .....	77, 146-157
Transient Generators .....	76, 378
Transient Limiter .....	133, 144
Transient Recorders .....	146-157
Transmission Impairment Measuring Sets .....	516-521
Transmission Line Test Software .....	228
Transmission Line Test System .....	229
Transmission Test Sets .....	520, 521
Transistor Bias Supply .....	252
Transistor Test Fixtures .....	252
Transistors, Bipolar .....	675
Transit Cases .....	742
Troubleshooter Kits, IC .....	277
True RMS Voltmeters .....	92-107
Type N Series Adapters .....	740
Type N Short .....	345
<b>U</b>	
UHF Signal Generators .....	357-374, 380
Ultrasound Imaging .....	678
<b>V</b>	
Vector Analyzer .....	162

# ALPHABETICAL INDEX

- Vector/Arbitrary Waveform Synthesizer ..... 382  
 Vector Generator ..... 380  
 Vector Impedance Meter ..... 285  
 Vector Modulation Generator/Analyzer ..... 162, 380  
 Vector Network Analyzers ..... 146, 150, 230-255, 280  
 Vector Voltmeter ..... 242  
 Vectra PC ..... 656, 682  
 Verification Kits (Network Analyzer) ..... 253  
 VHF Signal Generators ..... 357-376  
 VHF Switch Module ..... 562, 583  
 Vibration Analyzers ..... 146-149  
 Voice/Data Testing ..... 516  
 Voltmeters ..... 92-107  
     Analog ..... 106  
     Digital ..... 94-107  
 VXIbus Development Tools ..... 589
- W**
- WAN Protocol Analyzers ..... 512-513  
 Warranty ..... 770  
 Waveform  
     Analyzers ..... 54-77, 84, 116-122,  
         147, 150, 157, 162, 191  
     Digitizers ..... 77, 122, 146-157, 263  
     Generator, Arbitrary ..... 76, 318, 378,  
         380, 412, 420, 427  
     Recorders ..... 68-78, 84, 122  
     Synthesizer, Arbitrary ..... 378, 427  
     Synthesizer, Complex ..... 412
- Waveguide**
- Adapters ..... 349  
 Attenuators ..... 348  
 Calibration Kits ..... 251  
 Coaxial Adapters ..... 349  
 Detectors ..... 343  
 Directional Couplers ..... 347  
 Frequency Meters ..... 347  
 Harmonic Mixers ..... 343  
 Holders ..... 348  
 Low-Pass Filters ..... 348  
 Movable Shorts ..... 345  
 Sliding Loads ..... 345  
 Sliding Shorts ..... 345  
 Stand ..... 348  
 Terminations ..... 345  
 Thermistor Mounts ..... 215  
 Variable Attenuators ..... 348  
 Wideband Amplifiers ..... 407-409  
 Wire, Thermocouple ..... 580  
 Word Generators ..... 318, 320, 322, 444, 500, 526
- X**
- X-Ray Systems, Scientific & Industrial ..... 680  
 X-Y Recorders ..... 78, 84  
 X Window Software ..... 665

# MODEL NUMBER INDEX

New product listings are printed in bold face type

37

A1004A Series 800 Model 825S.....	645
A1005A Series 800 Model 825SRX.....	646
A1008A Series 800 Model 825CHX.....	646
A1010A RAM Memory Card (8MB ECC RAM Board).....	668
A1015A Access Port Kit.....	645
A1017A Display Controller Interface.....	644
A1035A Series 800 Model 835S.....	642
A1037A RAM Memory Card (16MB ECC RAM Board).....	668
A1045A Series 800 Model 835SRX.....	646
A1050A Series 800 Model 835CHX.....	646
A1055A Series 800 Model 835 TurboSRX.....	646
A1101A Additional Channel Adapter.....	643
A1104A Additional 16MB Main Memory.....	643
A1108A Floating Point Upgrade Kit.....	643
A1122A CIO Terminal Expander.....	643
A1123A Expansion Module Kit.....	643
A1124A Add-on Expander.....	643
A1125A Cable Management Rack.....	643
<b>B1151A Series 300 X Window Version 11</b>	
License-to-Use.....	665
<b>B1152A Media and Documentation for B1151A</b> .....	665
<b>B1155A X Window System Version 11 for Model 825, 835</b> .....	665
<b>B1156A Right to Copy B1155A</b> .....	665
<b>B1157A X Window System Version 11 for Model 840</b> .....	665
<b>B1158A Right to copy B1157A</b> .....	665
<b>D1001A HP Portable Vectra CS Personal Computer</b> .....	688
<b>D1009A HP Vectra Portable CS Model 20</b> .....	683, 688
<b>D1030A EGA Cable</b> .....	690
<b>D1110A HP Vectra CS Model 10 PC</b> .....	683
<b>D1115A HP Vectra CS Model 15 PC</b> .....	683
<b>D1116A HP Vectra CS Model 16 PC</b> .....	683
<b>D1120A HP Vectra CS Model 20 PC</b> .....	683
<b>D1126A HP Vectra CS Model 26 PC</b> .....	683
<b>D1127A HP Vectra CS Model 27 PC</b> .....	683
<b>D1180A Video Graphics Adapter</b> .....	690
<b>D1181A/G/W Monochrome Monitor</b> .....	690
<b>D1182A/B VGA Color Monitor</b> .....	690
<b>D1183A HP Touch Accessory</b> .....	690
<b>D1184A VGA Cable</b> .....	690
<b>D1210A HP Vectra ES Model 10 PC</b> .....	683
<b>D1215A HP Vectra ES Model 15 PC</b> .....	683
<b>D1220A HP Vectra ES Model 20 PC</b> .....	683
<b>D1226A HP Vectra ES Model 26 PC</b> .....	683
<b>D1227A HP Vectra ES Model 27 PC</b> .....	683
<b>D1310A HP Vectra ES/12 Model 10 PC</b> .....	683
<b>D1315A HP Vectra ES/12 Model 15 PC</b> .....	683
<b>D1320A HP Vectra ES/12 Model 20 PC</b> .....	683
<b>D1326A HP Vectra ES/12 Model 26 PC</b> .....	683
<b>D1327A HP Vectra ES/12 Model 27 PC</b> .....	683
<b>D1340A HP Vectra ES/12 Model 40 PC</b> .....	683
<b>D1346A HP Vectra ES/12 Model 46 PC</b> .....	683
<b>D1347A HP Vectra ES/12 Model 47 PC</b> .....	683
<b>D1500A HP Vectra RS/16 Model 40 PC</b> .....	683
<b>D1501A HP Vectra RS/16 Model 106 PC</b> .....	683
<b>D1502A HP Vectra RS/16 Model 100 PC</b> .....	683
<b>D1600A HP Vectra RS/20 Model 40 PC</b> .....	653, 683
<b>D1601A HP Vectra RS/20 Model 106 PC</b> .....	683
<b>D1602A HP Vectra RS/20 Model 100 PC</b> .....	653, 683
<b>D1603A HP Vectra RS/20 Model 150 PC</b> .....	653, 683
<b>D1604A HP Vectra RS/20 Model 300 PC</b> .....	653, 683
<b>D1606B HP Vectra RS/20 Power User PC</b> .....	683
<b>D1800A ARPA Services/Vectra</b> .....	661
<b>D1801A ARPA ThinLAN/Vectra</b> .....	661
<b>E1400A C-Size VXIbus Mainframe</b> .....	590
<b>E1404A C-Size VXIbus Slot 0/Translator Module</b> .....	590
<b>E1408A C-Size VXIbus A or B-Size Module Carrier</b> .....	590
<b>E1409A C-Size VXIbus Stainless Steel Chassis Shield</b> .....	590
<b>E1490A C-Size VXIbus Register-Based Breadboard Module</b> .....	590
<b>E1495A VXIbus Development Software</b> .....	590
<b>HP-12C Programmable Financial Calculator</b> .....	692
<b>HP-14B Business Calculator</b> .....	692
<b>HP-17B Business Calculator</b> .....	692
<b>HP-19B HP Business Consultant II</b> .....	692
<b>HP-22S Scientific Calculator</b> .....	694
<b>HP-27S Scientific Calculator</b> .....	693
<b>HP-28S Advanced Scientific Calculator</b> .....	693

<b>HP-41CV/CX Advanced Programmable Calculators</b> .....	693
<b>HP-32S RPN Scientific Calculator</b> .....	693
<b>HP-42S RPN Scientific Calculator</b> .....	693

## 100

105B Quartz Oscillator.....	487
-----------------------------	-----

## 200

214B Pulse Generator.....	441
281 Series Coaxial-Waveguide Adapters.....	349
292 Series Waveguide-Waveguide Adapters.....	349

## 300

334A Distortion Analyzer.....	174
339A Distortion Measuring Set.....	173
346A/B/C Noise Sources.....	331
347B Series Waveguide Noise Sources.....	331
355 Series Coaxial Step Attenuators.....	336
362A Series Waveguide Low-pass Filters.....	348
365 Series mm-Wave Waveguide Isolators.....	347
370 Series mm-Wave Fixed Attenuators.....	348
373 Series mm-Wave Fixed Attenuators.....	348
382 Series Waveguide Precision Variable Attenuators.....	348

## 400

415E SWR Meter.....	255
422A/C Series Waveguide Crystal Detectors.....	343
423B Coaxial Crystal Detectors.....	342
432 Series Power Meters.....	214
435B Power Meter.....	211
436A Power Meter.....	208
437B Power Meter.....	209
438A Dual Power Meter.....	210
438A Option 700 MATE - Programmed Power Meter.....	210
478A Coaxial Thermistor Mount.....	215
486A Series Waveguide Thermistor Mounts.....	215

## 500

532 Series Waveguide Frequency Meters.....	347
537A Coaxial Frequency Meter.....	347
545A Logic Probe.....	275
546A Logic Pulser.....	275
547A Digital Current Tracer.....	275
548A Logic Clip.....	276

## 700

700/22 Display Terminal.....	691
700/41 Display Terminal.....	691
<b>700/43 Display Terminal</b> .....	691
<b>700/44 Display Terminal</b> .....	691
700/71 Display Terminal.....	691
700/92 Display Terminal.....	691
700/94 Display Terminal.....	691
752 Series Waveguide Directional Couplers.....	347
774-777D Coaxial Dual Directional Couplers.....	346
778D Coaxial Dual Directional Coupler.....	346
779D Coaxial Directional Coupler.....	346

## 800

894 Series Waveguide Mismatches.....	349
896 Series Waveguide Precision Straights.....	349
897 Series E-, H-Plane Waveguide Bends.....	349
898 Series Waveguide Twists.....	349
899 Series Waveguide Straight Sections.....	349

## 900

905A Coaxial Sliding Load.....	345
908A Coaxial 50-Ohm Termination.....	344
909A/C/D/E/F Coaxial 50-Ohm Terminations.....	344
910 Series Waveguide Terminations.....	345
911C Coaxial Sliding Loads.....	345
<b>911D/E Sliding Loads</b> .....	345
<b>911F/G Sliding Mismatches</b> .....	345
914 Series Waveguide Sliding Loads.....	345



# MODEL NUMBER INDEX

New product listings are printed in bold face type

920 Series Waveguide Moving Shorts .....	345
921 Waveguide Fixed Shorts .....	345

## 1000

1000 Computers and Systems .....	670
1040A Series HPLC Detectors .....	677
1050 Series HPLC Modules .....	677
1051A & 1052A Combining Cases .....	752
1090 Liquid Chromatograph Systems .....	677
1122A Probe Power Supply .....	82
1124A Active Divider Probe .....	82
1133A TV Video Sync Pod .....	83
1631A/D Logic Analyzers .....	259
<b>1631D + 24D Logic Analysis Measurement Techniques Course</b> .....	761
1645A Data Error Analyzer .....	519
1650A 80-Channel Logic Analyzer .....	257
1651A 32-Channel Logic Analyzer .....	257

## 2000

<b>ATS 2000 Automatic Test System</b> .....	612
2106CK/DK Board Computer .....	670
2134A Computer .....	670
2137B Computer .....	670
2139B Computer .....	670
2156C/D Computer .....	670
2196G/H Model 26 Computer Systems .....	670
2197E Model 27 Computer Systems .....	670
2199E Model 29 Computer Systems .....	670
2225A/B/C/D/P ThinkJet Personal Printer .....	717
2227A/B QuietJet PLUS Printer .....	717
2228A QuietJet Printer .....	717
2235A/B/C/D RuggedWriter 480 Printer .....	717
<b>2276A DeskJet Printer</b> .....	717
<b>2345A Distributed Terminal Controller</b> .....	664
<b>2346A/B/C Distributed Terminal Controller</b> .....	664
2393A Graphics Terminal .....	691
2397A Color Graphics Terminal .....	691
2424A Micro 14 Computer .....	670
2426G/H Micro 16 Computers .....	670
2434A Micro 24 Computer .....	670
2436G/H Micro 26 Computer .....	670
2437B Micro 27 Computer .....	670
2439B Micro 29 Computer .....	670
2484B Micro 24 Computer .....	670
2486B/C Micro 26 Computer System .....	670
2487B Micro 27 Computer System .....	670
2489B Micro 29 Computer System .....	670
2563B Line Printer .....	718
2564B Line Printer .....	718
2566B Line Printer .....	718
2567B Line Printer .....	718
2680A Laser Printing System .....	718
2685C Laser Print Station .....	718
2804A Quartz Thermometer .....	353
2813D Quartz Pressure Set .....	352
2813E Quartz Pressure Probe .....	352
2816A Pressure Signal Processor .....	352
2932A General Purpose Printer .....	718
2934A Business Printer .....	718

## 3000

<b>3000 Micro 3000LX/GX/XE, Series 52, 58, 925LX, 925, 70, 935, 950, 955 Business Computer Systems</b> .....	697-701
3048A Phase Noise Measurement System .....	160
3048A + 24A Phase Noise Measurement Course .....	761
3065 Board Test Family (HP-IB) .....	546
3065C + 24D Board Test System User Training .....	762
<b>3065 CT Communications Technologies Board Test System</b> .....	546
3065ST Standard Technologies Board Test System .....	547
3082A Industrial Touch Terminal .....	706
3235A Switch/Test Unit .....	583
<b>3245A Universal Source</b> .....	430
3312A Function Generator .....	426
3314A Function Generator .....	427
<b>3325B Synthesizer/Function Generator</b> .....	414
3326A Two-Channel Synthesizer .....	416
3335A Synthesizer/Level Generator .....	418

3336A/B/C Synthesizer/Level Generators .....	419, 502
<b>3396A Integrator</b> .....	676
3400A RMS Voltmeter .....	106
3421A Data Acquisition/Control Unit .....	566
3437A System Voltmeter .....	103
3455A Digital Voltmeter .....	103
3456A Systems DVM .....	102
3457A Multimeter .....	97
<b>3458A Multimeter</b> .....	94
3466A Digital Multimeter .....	106
3468A/B Digital Multimeter .....	104
3478A Multimeter .....	100
3488A Switch/Control Unit .....	587
3497A Data Acquisition/Control Unit .....	570
3498A Extender .....	570
3551A Transmission Test Set .....	520
3552A Transmission Test Set .....	520
3561A Dynamic Signal Analyzer .....	147
3562A Dynamic Signal Analyzer .....	150
3565S Signal Processing System .....	157
3575A Gain/Phase Meter .....	239
3577A Network Analyzer .....	234
3577S Network Analyzer System .....	238
3580A Spectrum Analyzer .....	145
3581A Wave Analyzer .....	175
3581C Selective Voltmeter .....	505
3582A Spectrum Analyzer .....	146
<b>3585B Spectrum Analyzer</b> .....	112
3586A/B Selective Level Meter .....	502
3586C Selective Level Meter .....	115
3630A PaintJet Color Graphics Printer .....	716
3708A Noise and Interference Test Set .....	508
3709B Constellation Analyzer .....	508
3711A IF/BB Transmitter (70/140 MHz IF) .....	507
3712A IF/BB Receiver (70/140 MHz IF) .....	507
3717A 70 MHz Modulator/Demodulator .....	507
3730B Down Converter: RF to IF .....	507
3736B RF Module (1.7 to 4.2 GHz) .....	507
3737B RF Module (3.7 to 8.5 GHz) .....	507
3738B RF Module (5.9 to 11.7 GHz) .....	507
3739B RF Module (10.7 to 14.5 GHz) .....	507
3746A Selective Level Measuring Set (32 MHz) .....	506
3754A Access Switch .....	506
3755A Switch Controller .....	506
3756A 90 MHz Bi-directional Switch .....	506
3757A 8.5 MHz Access Switch .....	506
3764A Digital Transmission Analyzer .....	497
3776A PCM Terminal Test Set .....	495
3776B PCM Terminal Test Set .....	495
3777A HP-IB-Controlled Channel Selector .....	495
3779C Primary Multiplex Analyzer (CEPT) .....	495
3779D Primary Multiplex Analyzer (Bell) .....	495
3780A Pattern Generator/Error Detector .....	497
3781A Pattern Generator (CEPT, CCITT) .....	496
3781B Pattern Generator (BELL) .....	496
3782A Error Detector (CEPT, CCITT) .....	496
3782B Error Detector (BELL) .....	496
3785A Jitter Generator & Receiver (CEPT) .....	498
3785B Jitter Generator & Receiver (Bell) .....	498
3787B Digital Data Test Set .....	500
3789A DS3 Transmission Test Set .....	499
3789B DS3 Transmission Test Set .....	499
3852A Data Acquisition/Control Unit .....	572
<b>3852A + 24D Data Acquisition Training</b> .....	761
3852S Data Acquisition/Control System .....	572

## 4000

4061A Semiconductor/Component Test System .....	533
4062B Semiconductor Parametric Test System .....	532
4062C Semiconductor Parametric Test System .....	530
<b>4062C + 24D HP 4062C Operating and Programming Course</b> .....	761
4085M Switching Matrix .....	538
4140B pA Meter/DC Voltage Source .....	540
4141B DC Source/Monitor .....	539
4142B Modular DC Source/Monitor .....	534
4145B Semiconductor Parameter Analyzer .....	536
4191A RF Impedance Analyzer .....	284
4192A LF Impedance Analyzer .....	282
4193A Vector Impedance Meter .....	285

4194A Impedance/Gain - Phase Analyzer.....280  
4195A Network/Spectrum Analyzer.....230  
4261A Digital LCR Meter.....296  
4262A Digital LCR Meter.....296  
4274A Multifrequency LCR Meter.....290  
4275A Multifrequency LCR Meter.....290  
4276A LCZ Meter.....294  
4277A LCZ Meter.....294  
4278A 1 kHz/1 MHz Capacitance Meter.....292  
4279A 1 MHz C-V Meter.....295  
4280A 1 MHz C Meter/C-V Plotter.....542  
**4284A Precision LCR Meter.....286**  
4328A Milliohmeter.....298  
4329A High Resistance Meter.....298  
4342A Q Meter.....297  
4440B Decade Capacitor.....299  
4925B Bit Error Rate Test Set.....519  
4935A Transmission Impairment Measuring Set.....520  
4936A Transmission Impairment Measuring Set.....520  
4937A Transmission Impairment Measuring Set.....521  
4938A Network Circuit Access Test Set.....521  
4945A Transmission Impairment Measuring Set.....517  
4947A Transmission Impairment Measuring Set.....517  
4948A In-Service Transmission Impairment Measuring Set.....518  
4951C Protocol Analyzer.....512  
4952A Protocol Analyzer.....512  
4954A Protocol Analyzer.....513  
4972A LAN Protocol Analyzer.....514  
**4974S MAP Protocol Analyzer.....514**

**5000**  
5005B Signature Multimeter.....272  
5006A Signature Analyzer.....274  
5011T Logic Troubleshooting Kit.....277  
5021A Logic Troubleshooting Kit.....277  
5022A Logic Troubleshooting Kit.....277  
5023A Logic Troubleshooting Kit.....277  
5024A Logic Troubleshooting Kit.....277  
5061B Cesium Beam Frequency Standard.....485  
E21-5061B Flying Clock (Cesium).....485  
5065A Rubidium Frequency Standard.....486  
E21-5065A Portable Rubidium Time Standard.....486  
5087A Distribution Amplifier.....490  
5089A Standby Power Supply.....491  
5180A Waveform Recorder.....74  
5180S Waveform Measurement System.....75  
5180T,U Precision Digitizing Oscilloscopes.....68, 74  
5182A Waveform Recorder/Generator.....76  
5182S Waveform Generation System.....77  
5183A Waveform Recorder.....73  
5183T,U Precision Digitizing Oscilloscopes.....72  
5185A Waveform Recorder.....71  
5185T Precision Digitizing Oscilloscopes.....70  
5314A Universal Counter.....207  
5315A Universal Counter.....204  
5316B Universal Counter.....204  
5328B Universal Counter.....203  
5334B Universal Counter.....198  
5335A Universal Counter.....200  
5340A Microwave Frequency Counter.....183  
5342A Microwave Frequency Counter.....181  
5343A Microwave Frequency Counter.....181  
5345A Electronic Counter.....184, 196  
5350B Microwave Frequency Counter.....178  
5351B Microwave Frequency Counter.....178  
5352B Microwave Frequency Counter.....178  
5355A Automatic Frequency Converter.....184  
5356A, B, C, D Frequency Converter Heads.....184  
5359A Time Synthesizer.....445  
5363B Time Interval Probes.....195  
**5364A Microwave Mixer/Detector.....193**  
5370B Universal Time Interval Counter.....189  
5371A Frequency & Time Interval Analyzer.....191  
5384A Frequency Counter.....187  
5385A Frequency Counter.....187  
5386A Frequency Counter.....187  
5501A Laser Transducer System.....351  
5507A Laser Position Transducer Electronics.....350  
5517A Laser Head.....350

5517B High Slew Rate Laser Head.....350  
5527A Laser Position Transducer System.....350  
5528A Laser Measurement System.....351  
5890A Gas Chromatograph.....676  
5965A Infrared Detector.....677  
5970B Mass Selective Detector.....677  
5988A GC/Mass Spectrometer.....677  
5988A LC/Mass Spectrometer.....677

**6000**  
6002A Autoranging DC Power Supply.....467  
6010A 1000 Watt Autoranging Power Supply.....472  
6011A 1000 Watt Autoranging Power Supply.....472  
6012B 200 Watt Autoranging Power Supply.....472  
6023A 200 Watt Autoranging Power Supply.....472  
6024A 200 Watt Autoranging DC Power Supply.....472  
6030A 1000 Watt Autoranging System Power Supply.....460  
6031A 1000 Watt Autoranging System Power Supply.....460  
6032A 1000 Watt Autoranging System Power Supply.....460  
6033A 200 Watt Autoranging System Power Supply.....460  
6038A 200 Watt Autoranging System Power Supply.....460  
**6050A Load Mainframe.....449**  
**6060A Single Input Load.....448**  
6114A & 6115A Precision DC Power Supplies.....482  
6129C-6131C Digitally Controlled Voltage Sources.....468  
6140A Digital Current Source.....468  
6177C Precision DC Current Source.....483  
6181C Precision DC Current Source.....483  
6186C Precision DC Current Source.....483  
6200B-6209B DC Power Supplies.....479-481  
6212C-6218C DC Power Supplies.....479-481  
6227B Dual Tracking DC Power Supply.....470  
6228B Dual Tracking DC Power Supply.....470  
6234A Dual Output Power Supply.....479, 481  
6235A Triple Output Power Supply.....480  
6236B Triple Output DC Power Supply.....480  
6237B Triple Output DC Power Supply.....480  
6253A Dual Output DC Power Supply.....470  
6255A Dual Output DC Power Supply.....470  
6259B DC Power Supply.....474  
6260B DC Power Supply.....474  
6261B DC Power Supply.....474  
6263B DC Power Supply.....474  
6264B DC Power Supply.....474  
6266B DC Power Supply.....474  
6267B DC Power Supply.....474  
6268B DC Power Supply.....474  
6269B DC Power Supply.....474  
6274B DC Power Supply.....474  
6281A DC Power Supply.....470  
6282A DC Power Supply.....470  
6284A DC Power Supply.....470  
6286A DC Power Supply.....470  
6289A DC Power Supply.....470  
6291A DC Power Supply.....470  
6294A DC Power Supply.....470  
6296A DC Power Supply.....470  
6299A DC Power Supply.....470  
6434B DC Power Supply.....476  
6443B DC Power Supply.....476  
6448B DC Power Supply.....476  
6453A DC Power Supply.....476  
6456B DC Power Supply.....476  
6459A DC Power Supply.....476  
6464C DC Power Supply.....476  
6466C DC Power Supply.....476  
6469C DC Power Supply.....476  
6472C DC Power Supply.....476  
6475C DC Power Supply.....476  
6477C DC Power Supply.....476  
6479C DC Power Supply.....476  
6483C DC Power Supply.....476  
6621A System Power Supply.....456  
6622A System Power Supply.....456  
6623A System Power Supply.....456  
6624A System Power Supply.....456  
**6625A System Power Supply.....458**  
**6626A System Power Supply.....458**  
**6627A System Power Supply.....456**



# MODEL NUMBER INDEX

New product listings are printed in bold face type

6632A System Power Supply	454
6633A System Power Supply	454
6634A System Power Supply	454
6824A DC Power Supply/Amplifier	478
6825A DC Power Supply/Amplifier	478
6826A DC Power Supply/Amplifier	478
6827A DC Power Supply/Amplifier	478
6940B Multiprogrammer	602
6941B Multiprogrammer Extender	602
6942A Multiprogrammer	597
6943A Multiprogrammer Extender	597
6944A Multiprogrammer	596
<b>6944S + 24D HP 6944S Multiprogrammer System</b>	
<b>User Course</b>	761
6954A Multiprogrammer	595

## 7000

7060A HP SketchPro Graphics Tablet	714
7090A Measurement Plotting System	78, 84
7440A ColorPro Plotter	720
7475A 6-Pen Graphics Plotter	721
7550A 8-Pen Graphics Plotter	722
7570A DraftPro Plotter	724
<b>7575 DraftPro DXL Plotter</b>	726
<b>7576 DraftPro EXL Plotter</b>	726
7595A DraftMaster I Plotter	728
7596A DraftMaster II Rollfeed Plotter	728
<b>7600 Series Model 240D Electrostatic Plotter</b>	730
<b>7600 Series Model 240E Electrostatic Plotter</b>	730
<b>7673A Automatic Sampler</b>	676
7907A Fixed/Removable Disc Drive	709
7935H/XP Disc Drives	709
7936H/XP Disc Drive	711
7937H/XP Disc Drive	711
<b>7957B Disc Drive</b>	710
<b>7958B Disc Drive</b>	710
<b>7959B Disc Drive</b>	710
<b>7962B Disc Drive</b>	710
<b>7963B Disc Drive</b>	710
7979A 1/2" Tape Drive	712
7980A 1/2" Tape Drive	712
<b>7980XC 1/2" Tape Drive</b>	712

## 8000

8011A Pulse Generator	442
8012B Pulse Generator	442
8013B Pulse Generator	442
8018A Serial Data Generator	322
8080A Pulse Generator Mainframe	444
8081A Repetition Rate Generator, 300 MHz	444
8082A Pulse Generator	443
8083A Output Amplifier, 300 MHz	444
8084A Word Generator, 300 MHz	444
8091A Rate Generator, 1 GHz	444
8092A Delay Generator	444
8093A Output Amplifier, 1 GHz	444
8111A Pulse/Function Generator	425
8112A Pulse Generator	434
<b>8115A 50-MHz Dual-Channel Pulse Generator</b>	435
8116A Pulse/Function Generator	423
<b>8118A 100 MBit/s Pulse Pattern Generator</b>	317
<b>8131A 500-MHz Pulse Generator</b>	436
8145A Optical Time Domain Reflectometer	310
8150A Optical Signal Source	303
8151A Optical Pulse Power Meter	304
8152A Optical Average Power Meter	306
8154B LED Source 1300 nm	307
8155A LD Source	307
8157A Optical Attenuator	308
8158B Optical Attenuator	308
8160A Programmable Pulse Generator	438
8161A Programmable Pulse Generator	438
8165A Programmable Signal Source	422
8175A Digital Signal Generator	318, 420
8180B Data Generator	320
8181B Data Generator Extender	320
8182B Data Analyzer	320
8328A/S Transmission Line Test Set	229
8340B Synthesized Sweeper	383, 394

8341B Synthesized Sweeper	383, 394
<b>8347A RF Amplifier</b>	406
8349B Microwave Amplifier	408
8350B Sweep Oscillator Family	396-405
8403A Modulator	391
8447 Series Amplifiers	409
<b>8449A Microwave Preamplifier</b>	407
8452A Diode Array Spectrophotometer	677
8470B Coaxial Crystal Detectors	342
8472B Coaxial Crystal Detector	342
8473B/C/D/E Coaxial Crystal Detectors	342
8477A Power Meter Calibrator	214
8478B Coaxial Thermistor Mount	215
8481A/B/H Power Sensors	212
8482A/B/H Power Sensors	212
8483A Power Sensor	212
8484A Power Sensor	212
8485A/D Power Sensors	212
8486A/D Power Sensors	212
8487A Power Sensor	212
8490D 2.4mm Coaxial Fixed Attenuator	334
8491A/B Coaxial Fixed Attenuators	334
8492A Coaxial Fixed Attenuator	334
8493A/B/C Coaxial Fixed Attenuators	334
8494A/B/G/H Coaxial Step Attenuators	336
8495A/B/D/G/H/K Coaxial Step Attenuators	336
8496A/B/G/H Coaxial Step Attenuators	336
8497K Coaxial Step Attenuator	336
8498A Coaxial Fixed Attenuator	334
<b>8508A Vector Voltmeter</b>	242
8510B Network Analyzer	249
<b>8510B + 24D Basic Measurements Using HP 8510</b>	
<b>Network Analyzer System Course</b>	761
8511A Frequency Converter	250
8514B S-Parameter Test Set (45 MHz-20 GHz)	250
8515A S-Parameter Test Set (45 MHz-26.5 GHz)	250
<b>8516A S-Parameter Test Set (45 MHz-40 GHz)</b>	250
8562A Portable Spectrum Analyzer	139
8562B Portable Spectrum Analyzer	139
8566B Spectrum Analyzer	123, 125
8566S Automatic Spectrum Analyzer	124
8567A Spectrum Analyzer	123, 127
8967S Automatic Spectrum Analyzer	124
8568B Spectrum Analyzer	123, 127
8568S Automatic Spectrum Analyzer	124
8573A CISPR EMI Receiver	130
8574A CISPR EMI Receiver	130
8590A Portable RF Spectrum Analyzer	134
<b>8592A Spectrum Analyzer</b>	137
8640B AM/FM Signal Generator	375
8640B Option 004, Avionics Signal Generator	375
8642A/B Synthesized Signal Generators	367
<b>8644A Synthesized Signal Generator</b>	361
<b>8645A Agile Signal Generator</b>	363
8656B Synthesized Signal Generator	357
<b>8657A Synthesized Signal Generator</b>	359
8660D Synthesized Signal Generator	372
8662A Synthesized Signal Generator	369
8663A Synthesized Signal Generator	369
<b>8665A Synthesized Signal Generator</b>	365
8671B Synthesized CW Generator	386
8672A Synthesized Signal Generator	390
8672S Synthesized Signal Generator	390
8673B Synthesized Signal Generator	388
8673C/D Synthesized Signal Generators	388
8673E Synthesized Signal Generator	387
<b>8673G Synthesized CW Generator</b>	388
8683B/D Signal Generators	384
8684B/D Signal Generators	384
<b>8702A Lightwave Component Test Analyzer</b>	312
8717B Transistor Bias Supply	252
<b>8720A Network Analyzer</b>	247
8721A Coaxial Directional Bridge	341
8731-8734 series PIN Modulators	391
8750A Storage-Normalizer	255
8753B Network Analyzer	243
<b>8753A + 24A HP 8753A RF Network Analyzer Course</b>	761
8754A Network Analyzer	240
8757A Scalar Network Analyzer	221
8757S Automatic Scalar Network Analyzer System	219

8761A,B Coaxial Switches.....	339
8770A Arbitrary Waveform Synthesizer.....	378
8770S Signal Simulator System.....	378
8780A Vector Signal Generator.....	380, 509
8900C/D Peak Power Meters.....	215
8901A Modulation Analyzer.....	166
8901B Modulation Analyzer.....	166
8902A Measuring Receiver.....	168
8902AT Attenuator Calibration System.....	170
8902S Microwave Measurement System.....	172
8902SG Signal Generator Test System.....	171
8903B Audio Analyzer.....	164
8903E Distortion Analyzer.....	164
8904A Multifunction Synthesizer.....	412
8953A Transceiver Test Set.....	324
8954A Transceiver Interface.....	327
8955A RF Test System.....	324
8956A System Interface.....	327
8957S Cellular Radio Test System.....	324
8958A Cellular Radio Interface.....	327
8970B Noise Figure Meter.....	329
8970S/T Microwave Noise Figure Measurement Systems.....	330
8971B Noise Figure Test Set.....	330
8980A Vector Analyzer.....	162, 509
8981A Vector Modulation Analyzer.....	162

## 9000

9000 Series 300 Computers.....	652, 638, 647
9000 Model 310 Technical Computer & Controller.....	647
9000 Model 310C Low-Cost Color Workstation.....	648
9000 Model 310M Measurement Automation Workstation.....	648
9000 Model 318M Monochrome Workstation.....	648
9000 Model 319C+.....	648
9000 Model 330 Technical Computer System.....	647
9000 Model 330CH Color Workstation.....	648
9000 Model 330CMA Color Instrument Controller.....	648
9000 Model 330M Monochrome Workstation.....	648
9000 Model 330MMA Monochrome Instrument Controller.....	648
9000 Model 349C+.....	652
9000 Model 349CH.....	652
9000 Model 349M.....	652
9000 Model 349MH.....	652
9000 Model 349SRX.....	652
9000 Model 360.....	647
9000 Model 360CH.....	648
9000 Model 360MH.....	648
9000 Model 360SRX.....	648
9000 Model 360 TurboSRX.....	648
9000 Model 370.....	647
9000 Model 370CH.....	647
9000 Model 370MH.....	647
9000 Model 370 TurboSRX.....	647
9000 Series 800 Superworkstations.....	646
9000 Model 825CHX Superworkstations.....	646
9000 Model 825S Entry Level Superminicomputer.....	638, 645
9000 Model 825SRX Superworkstation.....	646
9000 Model 835CHX Superworkstation.....	646
9000 Model 835S/SE Technical Computer System.....	642
9000 Model 835SRX Superworkstation.....	646
9000 Model 835 TurboSRX.....	646
9000 Model 840S Minicomputer.....	638, 644
9000 Model 850S Superminicomputer.....	643
9000 Model 855S Superminicomputer.....	638, 641
9114B Double-Sided 3½" Disc Drive.....	708
9122C 3½" Microfloppy Disc Drive.....	708
9123D Dual 3½" Drive (for HP Touchscreen II).....	708
9127A Single-Sided 5¼" Flexible Disc Drive.....	708
9144A ¼" High Performance Tape Subsystem.....	712
9145A ¼" Cartridge Tape Drive.....	712
9153C 10, 20, 40 Mbyte Winchester 3½" Microfloppy.....	708
9190A HP ScanJet Desktop Scanner.....	713
9480 Analog LSI Test System.....	528
9666A Rugged Terminal, Operator Interface Unit.....	706
9807A The Integral Personal Computer.....	657
9836A + 24D HP DesignCenter ME 5 User's Course.....	762
9888A 16-Slot DIO Expander.....	649

## 10000

10002A 50:1 Voltage Divider Probe.....	82
10020A Resistive Divider Probe Kit.....	82
10024A IC Test Clip.....	82
10062A Protective Cover.....	319
10100C 50-ohm BNC Feedthrough.....	82
10229A Hook Tip Adapter.....	82
10269C GP Probe Interface.....	266
10275A PDP-11 UNIBUS Interface.....	271
10276A LSI-11 Interface.....	271
10342B/G Bus Preprocessor.....	266
10345A 8 Channel ECL Differential Driver Pod.....	271
10346A 8 Channel TTL Tristate Buffer.....	271
10387A Interface, Type 303 Modems (HP 1645A).....	519
10388A Interface, CCITT V.35 (HP 1645A).....	519
10389A Interface, Breakout Box (RS-232C/V.24) (HP 1645A).....	519
10390A System Performance Analysis.....	271
10391A Inverse Assembler Development Package.....	271
10430A 10:1 Passive Oscilloscope Probe.....	81
10431A 10:1 Passive Oscilloscope Probe.....	81
10432A 10:1 Passive Oscilloscope Probe.....	81
10433A 10:1 Passive Oscilloscope Probe.....	81
10434A 10:1 Passive Oscilloscope Probe.....	81
10435A 10:1 Passive Oscilloscope Probe.....	81
10436A 10:1 Passive Oscilloscope Probe.....	81
10437A 50 Ohm Probe.....	81
10438A 1:1 Passive Oscilloscope Probe.....	81
10439A 1:1 Passive Oscilloscope Probe.....	81
10440A 100:1 Passive Oscilloscope Probe.....	81
10501A Cable Assembly.....	740
10502A Cable Assembly.....	740
10503A Cable Assembly.....	740
10514A Double-Balanced Mixer.....	343
10529A Logic Comparator.....	276
10534A Double-Balanced Mixer.....	343
10541A Reference Boards.....	276
10541B Preprogrammed Reference Boards.....	276
10595A Board Extender Kit (HP 5345A).....	197
10638A Degausser.....	489
10715A Differential Interferometer.....	350
10716A High-Resolution Interferometer.....	350
10717A Wavelength Tracker.....	350
10821A Probe Accessory Kit (HP 5363B).....	195
10833A/B/C/D HP-IB Cables.....	561
10834A HP-IB Cable Adapter.....	561
10842A Extender Board Kit (HP 5342/5343/5344S).....	182
10855A Broadband Preamplifier.....	195
10870A Service Kit (HP 5370B).....	190
10871B Service Kit (HP 5180A).....	75
10873A Rack Mount Kit.....	75
10874A Slide Mount Kit.....	75
10875A/B DMA Cables.....	75
10936A Servo/Axis Board.....	350

## 11000

11002A Test Leads.....	107, 740
11003A Test Leads.....	107, 740
11053A Low Thermal Lug-Lug Jumper Set.....	107
11058A Low Thermal Banana-Banana Jumper Set.....	107
11059A Kelvin Probe Set.....	107
11060A Surface Mount Device Probe Set.....	107
11062A Kelvin Clip Set.....	107
11096B High Frequency Probe.....	107
11174A Low Thermal Lug-Banana Jumper Set.....	107
11340A/B/C HP-IL Cable Assemblies.....	567
11500A/B/C/D/E/F Precision Cables.....	740
11501A Cable Assembly.....	740
11509A Fuseholder.....	377
11511A Coaxial Short.....	345
11512A Coaxial Short.....	345
11515A Waveguide Adapter.....	349
11516A Waveguide Adapter.....	349
11524A APC-7 to N (female) Adapter.....	740
11525A APC-7 to N (male) Adapter.....	740
11533A APC-7 to SMA (male) Adapter.....	740
11534A APC-7 to SMA (female) Adapter.....	740
11536A Probe Tee for HP 8508A.....	242
11540A Waveguide Stand.....	348

# MODEL NUMBER INDEX

New product listings are printed in bold face type

11545A-11548A Waveguide Holders.....	348
11549A Power Splitter for HP 8508A.....	242
11565A Coaxial Short.....	345
11566A Air Line Extension.....	344
11567A Air Line Extension.....	344
11570A Accessory Kit for HP 8508A.....	242
11581A Attenuator Set.....	334
11582A Attenuator Set.....	334
11583A/C Attenuator Sets.....	334
11590B Bias Network.....	252
11608A Transistor Fixture.....	252
11612A/B Bias Network.....	252
11613B Calibrator for HP 8756A, 8757A.....	225
11614A Firmware Enhancement for HP 8757A.....	224
11635A Bias Decoupling Network.....	252
11636A/B Power Dividers.....	225, 341
11643A Series Millimeter-Wave Test Set Kits.....	251
11644A Series Millimeter-Wave Calibration Kits.....	253
11661B Frequency Extension Module.....	372
11664A/D/E Detector for HP 8755, 8756 and 8757.....	222
11664C Detector Adapter for HP 8755, 8756 and 8757.....	222
11665B Modulator for HP 8755, 8756 and 8757.....	225
11667A/B/C Power Splitters.....	226, 341
11668A High Pass Filter for HP 8755, 8756, 8757.....	225
11672A Service Accessory Kit for HP 8660A/C/D.....	374
11678A Low Pass Filter Kit.....	225
11679A/B Extension Cables for HP 8755, 8756 and 8757.....	224
11683A Range Calibrator.....	211
11684/5/6/8/9A Low Pass Filters.....	225
11687A Adapter, 50 to 75 $\Omega$ .....	377
11690A Frequency Doubler.....	377
11691D Coaxial Directional Coupler.....	346
11692D Coaxial Dual Directional Coupler.....	346
11693A Limiter.....	144
11694A Matching Transformer, 50-75 $\Omega$ .....	144
11707A Test Plug-in.....	374
11708A Attenuator (for Calibrating HP 8484A).....	212
11710B Down Converter.....	377
11712A Service Support Kit (for HP 8671A, 8672A/S).....	390
11713A Attenuator/Switch Driver.....	336
11714A Service Support Kit (for HP 8662A, 8663A).....	371
11715A AM/FM Test Source.....	167
11716A/B Interconnection Kits.....	336
11717A Attenuator/Switch Rack Mount Kit.....	336
11720A Pulse Modulator.....	391
11721A Frequency Doubler.....	377
11722A Sensor Module.....	169
11726A Support Kit for HP 8673B/C/D.....	389
11729C Carrier Noise Test Set.....	161
11731A Frequency Extension Retrofit Kit.....	390
11732A Frequency Extension Retrofit Kit.....	390
11736A/B I-Q Tutor Training Kit.....	509
11742A/B Coaxial Blocking Capacitor.....	344
<b>11748A High-Impedance Probe Set (HP 8980/81A).....</b>	<b>163</b>
<b>11752D/E 2.4, 3.5-mm Connector Gages.....</b>	<b>344</b>
11776A Waveform Generation Software.....	378
<b>11776A + 24D Waveform Generation Language Software User's Course.....</b>	<b>761</b>
11792A Sensor Module.....	172
11793A Microwave Converter.....	172
11794A Software Pac for HP 8902S.....	172
11798A Software Application Pac for Cellular Radio Test.....	326
11799A Signaling Unit.....	327
11801A/B/C On-Site Service Kits for HP 8642A/B.....	368
11804A Accessory Kit for HP 8957S.....	324
11805A Software Application Pac for HP 8953A.....	325
<b>11806B Attenuator Test Software for HP 8902AT, HP 8902S.....</b>	<b>170</b>
<b>11808A Signal Generator Performance Test Software for HP 8902SG, HP 8902S.....</b>	<b>171</b>
11816A Retrofit Kit for HP 8904A Opt. 001.....	413
11817A Retrofit Kit for HP 8904A Opt. 002.....	413
11818A Retrofit Kit for HP 8904A Opt. 003.....	413
<b>11823A/B Attenuator Accessory Kits for HP 8902AT.....</b>	<b>170</b>
<b>11823C SWR Accessory Kit for HP 8902AT.....</b>	<b>170</b>
11845A 2-GHz Retrofit Kit for HP 8645A.....	363
11848A Phase Noise Interface.....	160
11850C/D Power Splitters.....	245
11851B RF Cable Kit.....	245
11852B 50-75 $\Omega$ Minimum Loss Pad.....	245
11853A 50 $\Omega$ Type N Accessory Kit.....	245
11854A 50 $\Omega$ BNC Accessory Kit.....	245
11855A 75 $\Omega$ Type N Accessory Kit.....	245
11856A 75 $\Omega$ BNC Accessory Kit.....	245
11857B/D Test Port Extension Cables for HP 85046A & B.....	245
11858A Transistor Fixture Adapter.....	245
11867A RF Limiter.....	144
11869A Adapter for HP 86200 Series Sweeper Plug-ins.....	398
<b>11889A RF Interface Kit.....</b>	<b>313</b>
<b>11890A Lightwave Coupler 1300 nm 9/125<math>\mu</math>m.....</b>	<b>313</b>
<b>11891A Lightwave Coupler 1300 nm 50/125<math>\mu</math>m.....</b>	<b>313</b>
11900 Series 2.4 mm Coaxial Adapters.....	333
11940A Close-Field Probe.....	133, 144
11941A Close-Field Probe.....	133, 144
11945A Close-Field Probe Set.....	133, 144
11970 Series Harmonic Mixers.....	143, 343
11971 Series Harmonic Mixers.....	143, 343
11975A Microwave Power Amplifier.....	407
<b>11980A Lightwave Interferometer.....</b>	<b>315</b>
<b>12000</b>	
<b>12005B HP 1000 A-Series Async Serial.....</b>	<b>664</b>
<b>12007B HDLC Network I/F.....</b>	<b>664</b>
<b>12009A Asynchronous Multiplexer HP-IB I/O.....</b>	<b>664</b>
<b>12040D 8-Channel Asynch. Multiplexer for HP9000/200,300.....</b>	<b>664</b>
<b>12041A/B 8-Channel Multiuse.....</b>	<b>664</b>
<b>12042B Programmable Serial Interface.....</b>	<b>664</b>
<b>12043A HP 1000-A Multiuse Serial.....</b>	<b>664</b>
<b>12044A HDLC Network I/F for DS/1000-IV.....</b>	<b>664</b>
12060B 8-Channel Analog Input Card.....	605
12061A 32-Channel Analog Input Expansion Card.....	605
12062A 4-Channel Analog Output Card.....	605
12063A 32-Channel Digital Multifunction Card.....	605
<b>12072A DS/1000-IV Data Link Slave.....</b>	<b>664</b>
<b>12073A Binary Synchronous Model &amp; Direct Connect Interfaces.....</b>	<b>664</b>
<b>12075A HP 1000-A LAP-B Modem.....</b>	<b>664</b>
<b>12076A LAN/1000 Link and DDA LAN.....</b>	<b>664</b>
<b>12079A Interface Controller.....</b>	<b>664</b>
<b>12082A Binary Synchronous Modem &amp; Direct Connect Interfaces.....</b>	<b>664</b>
<b>12092A Data Link/Multipoint Master.....</b>	<b>664</b>
12100A A400 Single-Board Computer.....	670
<b>14000</b>	
14513A Rack Kit (for one unit, 3 $\frac{1}{2}$ in. H).....	471, 481
14515A Rack Kit (for one unit, 5 $\frac{1}{4}$ in. H).....	471
14521C Rack Kit (for Bench Series).....	481
14523A Rack Kit (for two units, 3 $\frac{1}{2}$ in. H).....	471, 481
14525A Rack Kit (for two units, 5 $\frac{1}{4}$ in. H).....	471
14533B Pocket Programmer.....	468
14534A Pocket Programmer Extension Cable.....	468
14535A Interface Kit, DCPS-to-HP 1000 Computers.....	468
14536A Chaining Cable.....	468
14540A Input Cable Assembly, Multiprogrammer-to HP 1000 Computers.....	602
14541A Chaining Cable, HP 6940B or 6941B to HP 6941B.....	602
14545A Casters for HP 6464C - 6483C.....	477
14550B Interface Kit, Multiprogrammer-to- HP 1000 Computers.....	602
14551A Multiprogrammer Service Kit.....	602
14555A Connector Kit.....	602
14556A Software Library for HP 9825A.....	602
14557A Power Supply Interconnect Cable.....	602
14558A Termination Panel.....	602
14560A Cable Assembly.....	602
14561A Cable Assembly.....	602
14562A Cable Assembly.....	602
14704A/B/C Multiprogrammer Interface Cables.....	596
14753A Computer Aided Test Programming Package.....	596, 601
14753R Right to Reproduce CAT Program Pkg.....	596, 601
<b>15000</b>	
15104A Pulse Adder/Splitter.....	444



15115A Pulse Splitter/Inverter .....	444
15116A Pulse Inverter .....	444
15179A Rack Adapter Frame .....	442
15408A-15411A HP 8175A Accessories .....	319
15415A Plug-on Miniprobe .....	319
15425A Test Head .....	320
15429A Solder-in Receptacles .....	319
15430A Cable for Master-Slave Operation .....	319
15461A ECL Pod .....	319
15462A TTL/CMOS Pod .....	319
15463A Trigger Pod .....	319
15464A TTL Pod .....	319
15466A Test Head .....	320
15475A Optical Cleaning Kit .....	303, 309
15512A Cable .....	495, 521
15513A Cable .....	495, 521
15515B Loop Holding Unit .....	495
15518A/B/C Loop Holding Accessories .....	495
15580A 20 MHz High-Impedance Active Probe .....	506
15581B 25 MHz High-Impedance Passive Probe .....	506
15582A Return Loss Kit .....	506
15589A Instrument Cart .....	506

## 16000

16005A Probe .....	298
16006A Probe .....	298
16007A/B Test Leads .....	298
16008A Resistivity Cell .....	298
16014A Series Loss Test Adapter .....	297
16023B DC Bias Controller .....	291
16034A/E Test Fixture for Chip Components .....	279
16047A Direct Coupled Test Fixture .....	279
16047B Test Fixture with Safety Cover .....	279
16047C Test Fixture for High Frequencies .....	279
16047D Direct Coupled Test Fixture .....	279
16048A Test Leads, BNC .....	279
16048B Test Leads, RF Miniature .....	279
16048C Test Leads, Alligator Clips .....	279
16048D Test Leads, BNC (2m) .....	279
16048E Test Leads .....	279
16053A Test Leads .....	541
16054A Connection Selector .....	541
16055A Test Fixture .....	541
16056A Current Divider .....	541
16058A Test Fixture .....	535, 537
16061A Test Fixture .....	279
16062A Test Leads .....	279
16063A Test Leads .....	279
16064A Retrofit Kit for Comparator .....	294
16065A External DC Bias Test Fixture .....	279
16066A Test Fixture Adapter .....	531
16067A 24-pin DIP Low Leakage Fixture .....	531
16068A 48-pin DIP Low Leakage Fixture .....	531
16069A Universal Low Leakage Fixture .....	531
16070A General Purpose DIP Fixture .....	531
16071A Universal Fixture .....	531
16071B Universal Fixture .....	531
16072A Personality Board .....	531
16072B Personality Board .....	531
16075A Relay Test Adapter .....	531
16076A System Test Module .....	531
16077A Extension Cable Fixture .....	531
16080A Direct Coupled Test Fixture .....	543
16081A Test Leads .....	543
16082A Test Leads .....	543
16083A Pulse Bias Noise Clipper .....	543
16085A Terminal Adapter .....	279
16091A Coaxial Fixture Set .....	279
16092A Spring Clip Fixture .....	279
16093A/B Binding Post Fixture .....	279
16094A Probe Fixture .....	279
16095A Probe Fixture .....	279, 283
16096A 2-Port Component Test Fixture .....	279, 283
16097A Accessory Kit .....	283
16099A Test Fixture Adapter .....	279

16117A Low Noise Test Leads .....	298
16143A Probe Cable .....	298
16320B Pin Board .....	531
16320C Pin Board .....	531
16334A Test Fixture for Chip Components .....	279
16355A Relay Test Adapter .....	531
16356A System Test Module .....	531
16370A Test Fixture Adapter .....	531
16371A 24-pin DIP Low Leakage Fixture .....	531
16372A 48-pin DIP Low Leakage Fixture .....	531
16373A 64-pin DIP Low Leakage Fixture .....	531
16374A Universal Low Leakage Fixture .....	531
16375A General Purpose DIP Fixture .....	531
16376A Universal Fixture .....	531
16376B Universal Fixture .....	531
16377A Personality Board .....	531
16377B Personality Board .....	531
16378A Extension Cable Fixture .....	531
16380A/C Standard Capacitor Sets .....	299
16451A Dielectric Test Adapter .....	297
16462A Auxiliary Capacitor .....	297
16470A/B/C Reference Inductors .....	297
16500A Logic Analysis System .....	260
16510A 80 Channel 25 MHz State/Timing Card .....	262
16515A 1 GHz Timing Card .....	264
16516A 1 GHz Timing Card .....	264
16520A 50 Mb Pattern Generator Master Card .....	265
16521A 50 Mb Pattern Generator Expansion Card .....	265
16530A 400 Msample Digitizing Oscilloscope Card .....	263
16531A 400 Msample Digitizing Oscilloscope Card .....	263

## 17000

17090B Measurement Graphics Software .....	79, 85
--------------------------------------------	--------

## 18000

18063A RS-449 Interface (with cable) .....	519
18064A Noise-to-Ground Adapter for HP 4935A .....	521
18107A External Oscillator (HP 2804A) .....	353
18110A Laboratory Probe and Cal Module (HP 2804A) .....	353
18111A Laboratory Probe and Cal Module (HP 2804A) .....	353
18132A Rack Mount .....	521
18134A Carrying Case .....	521
18160A Interface Pod .....	512
18161A Ladder Bracket for HP 4935A, 4937A .....	521
18174A Interface Pod .....	512
18176A Rack Mount Kit .....	517
18179A RS-232C/V.24 Interface Pod .....	512
18180A RS-232C/V.24, RS-449/422A/423A Interface .....	512
18182A 1.5m Audio Cable .....	521
18183A RS-232C/V.24 Interface .....	519
18184A V.35 Interface .....	519
18185A 115V Power Module .....	519
18190A Soft Vinyl Carrying Case .....	512
18191A Rack Mount .....	519
18192A Carrying Case .....	519
18194A 220V Power Module .....	519
18263A 3270 Installation, Maintenance Software .....	512
18264A X.25, SNA Link Level Analysis .....	512
18265A DDCMP Analysis .....	512
18266A Enhanced X.25 Analysis .....	512
18267A X.25 Test Library and Emulator .....	512
18331D SNA, DDCMP, X.25 Analysis .....	512
18332D 3270 Installation & Maintenance .....	512
18347A HP 4951C Protocol Analyzer User's Course .....	761
18352A X.21 State Simulator .....	513
18353A Password Security .....	513
18355A CCITT #7/CCS7 Analysis .....	513
18360A SNA Emulation Language .....	513
18361A 3270 Device Exerciser .....	513
18362A LU6.2 Node Exerciser .....	513
18369A Asynchronous Terminal Emulator .....	513
18370A X.25 Network Performance Analysis .....	513
18371A SNA/BSC Network Performance Analysis .....	513
18587A Bar Code Identification System .....	676

# MODEL NUMBER INDEX

New product listings are printed in bold face type

## 19000

<b>19500B Rack kit for mounting 7957B/58B/59B</b> .....	710
<b>19511A Cabinet for 2 7936/7937 disc drives</b> .....	711
<b>19512A Cabinet Mounting Kit</b> .....	711
<b>19514A Cabinet for 8 7936/7937 disc drives</b> .....	711
<b>19521H 2 7937H drives with cabinet</b> .....	711
<b>19521FL 2 7937FL drives with cabinet</b> .....	711
<b>19521XP 2 7937XP drives with cabinet</b> .....	711
<b>19522H 4 7937H drives with cabinet</b> .....	711
<b>19522FL 4 7937FL drives with cabinet</b> .....	711
<b>19522XP 4 7937XP drives with cabinet</b> .....	711
<b>19524H 8 7937H drives with cabinet</b> .....	711
<b>19524FL 8 7937FL drives with cabinet</b> .....	711
<b>19524XP 8 7937XP drives with cabinet</b> .....	711
<b>19560B Rack kit for mounting 7962B/63B in EIA Rack</b> .....	710
<b>19500B 19-inch Rack Mount Kit for Battery Backup</b> .....	645
<b>19733A Additional 32 Mbytes of RAM</b> .....	644
<b>19746A Model 840S I/O Expander</b> .....	644
<b>19748A Additional 8 Mbytes of RAM</b> .....	644
<b>19749A Cable Management System</b> .....	643, 644

## 20000

<b>22861A Arpa/Berkeley Services for Series 300</b> .....	762
<b>24602A PSI Firmware Dev. Package</b> .....	664
<b>27110B HP-IB Interface</b> .....	643, 644, 645, 668
<b>27114A Parallel Async FIFO Interface</b> .....	643, 644, 645, 668
<b>27116A HP-CIO Service Extender</b> .....	668
<b>27122A RJE/500 Interface</b> .....	662, 664
<b>27125B LAN/9000 Series 500 Link</b> .....	661, 662, 664
<b>27128 Channel Asynchronous Serial</b> .....	662, 664
<b>27130B Async 8-Channel Multiplexer</b> .....	662, 664
<b>27140A Async 6-Channel Multiplexer</b> .....	643, 644, 645, 662, 664, 668
<b>27212A StarLan Hub</b> .....	664
<b>27505A HP Word/PC</b> .....	689
<b>27515A HP Office Connect to DISOSS</b> .....	664
<b>27534A AdvanceMail</b> .....	689
<b>27535F AdvanceMail</b> .....	689
<b>27536F HP Word/PC</b> .....	689
<b>27546F AdvanceWrite PLUS</b> .....	689
<b>28641A ThinMAU</b> .....	661, 662, 664
<b>28645A ThinLAN Hub</b> .....	664
<b>28647A StarLan Bridge</b> .....	664
<b>28648A LAN Bridge</b> .....	662

## 30000

<b>30144A ATP System Interface Board</b> .....	664
<b>30145A ATP Direct Port Controller</b> .....	664
<b>30155A ATP Modem Port Controller</b> .....	664
<b>30240A ThinLAN 3000/V Link</b> .....	664
<b>30241A MAU</b> .....	661, 662, 664
<b>30242A LAN 3000/V Link</b> .....	664
<b>30245A SNA/NRJE</b> .....	664
<b>30246A SNA Link</b> .....	664
<b>30247A SNA/IMF</b> .....	664
<b>30252A HP LU 6.2 Base</b> .....	664
<b>30254A/55A/56A SNA Server</b> .....	664
<b>30273A ATP Direct Connect Package</b> .....	664
<b>30274A ATP Modem Expansion Package</b> .....	664
<b>30276A/77A ATP for Meridian SL-1 I/O</b> .....	664
<b>30284A/85A NS Point-to-Point Link/3000</b> .....	664
<b>32187A X.25 Link/3000</b> .....	664
<b>32344A NS3000/V Network Services</b> .....	664
<b>31112A Introduction to Pascal</b> .....	761
<b>33300 Series Coaxial Step Attenuators</b> .....	338
<b>33311B/C Coaxial Switches</b> .....	339
<b>33312B/C Coaxial Switches</b> .....	339
<b>33313B/C Coaxial Switches</b> .....	339
<b>33320 Series Coaxial Step Attenuators</b> .....	338
<b>33330B/C/D/E Coaxial Crystal Detectors</b> .....	342
<b>33340A/B/C/D OEM Coaxial Attenuators</b> .....	334
<b>33363K Multipoint Coaxial Switch</b> .....	338
<b>33364K Multipoint Coaxial Switch</b> .....	338
<b>33365K Multipoint Coaxial Switch</b> .....	338
<b>33440A LaserJet Series II Printer</b> .....	717
<b>33447A LaserJet IID Printer</b> .....	717
<b>34110A Carrying Case</b> .....	107
<b>34111A High Voltage Probe</b> .....	107

<b>34118A Test Lead Kit</b> .....	99, 107
<b>34119A High Voltage Probe</b> .....	99, 107
<b>34300A 40 kV AC/DC High Voltage Probe</b> .....	107
<b>34301A RF Detector Probe</b> .....	107
<b>34302A Clamp-on AC/DC Current Probe</b> .....	107
<b>34303A Temperature Probe</b> .....	107
<b>34804/805 Functional Test Manager</b> .....	610
<b>34800A + 24D Developing Test Plans Using FTM/300</b> .....	761
<b>35073 Series 200 System Administration</b> .....	762
<b>35129B Series 500 System Administration</b> .....	762
<b>35130B Programming in C</b> .....	761
<b>35151D The Calendar</b> .....	689
<b>35152D The List Manager</b> .....	689
<b>35153D The Writer</b> .....	689
<b>35154D The Speller</b> .....	689
<b>35155D The Planner</b> .....	689
<b>35156D The Personal Correspondence Pack</b> .....	689
<b>35157D The Personal Organizer Pack</b> .....	689
<b>35177M JetStart (for HP ThinkJet)</b> .....	689
<b>35178M LaserStart (for HP LaserJet)</b> .....	689
<b>35184A Sideways (for Touchscreen PC, ThinkJet printer)</b> .....	689
<b>35188A Laser Plotter</b> .....	689
<b>35188D iPrint</b> .....	689
<b>35190J LaserControl 100 (for Vectra PC, LaserJet)</b> .....	689
<b>35305A HP TODAY Developer Pack</b> .....	642, 645
<b>35306A HP TODAY Runtime Environment</b> .....	642, 645
<b>35307A HPtoday Developer Pack/HP-UX for 850S</b> .....	643
<b>35308A HPtoday Run-time Environment/HP-UX for 850S</b> .....	643
<b>35401A 1/4" Cartridge Tape Drive</b> .....	712
<b>35629A HP 3562A User's Course</b> .....	761
<b>35630A HP VISTA Signal Processing Software</b> .....	158
<b>35630A + 42B HP Signal Processing System Installation</b> .....	764
<b>35631A HP Sine</b> .....	158
<b>35632A Model Data Manager</b> .....	159
<b>35650A Mainframe</b> .....	159
<b>35651A HP-IB Signal Processing Module</b> .....	159
<b>35652A Input Module</b> .....	159
<b>35653A Source Module</b> .....	159
<b>35605A 720-mm Rack</b> .....	159
<b>35606A 1600-mm Rack</b> .....	159
<b>35660A Dynamic Signal Analyzer</b> .....	153
<b>35675A Accuracy Enhancement Software</b> .....	238
<b>35676A/B 50/75 Ohm Reflection/Transmission Test Kit</b> .....	237
<b>35677A/B 50/75 Ohm S-Parameter Test Sets</b> .....	237
<b>35678A/B 50/75 Ohm Type N Calibration Kits</b> .....	238
<b>35679A/B 50/75 Ohm Type N Port Extension Cables</b> .....	238
<b>35680A HP Instrument BASIC</b> .....	155
<b>35681A Analysis Pack</b> .....	156
<b>35723A Touchscreen Bezel</b> .....	649, 690
<b>35731A/B Monochrome Monitor</b> .....	690
<b>35731D 12-Inch Monochrome Plus Video Display</b> .....	653
<b>35732A Monochrome Plus Video Adapter</b> .....	653
<b>35741A 12-inch Color Monitor</b> .....	653, 690
<b>36217A ALLBASE/HP-UX</b> .....	644
<b>36568A HPMMessage</b> .....	689
<b>36569E HPMMessage</b> .....	689
<b>36590A HP-UX SNA 3270</b> .....	662, 664
<b>36591A HP-UX Gateway SNA/3270</b> .....	662, 664
<b>36592A HP-UX SNA Link</b> .....	662, 664
<b>36593A HP-UX Gateway/SNA Link</b> .....	662, 664, 668
<b>36890F Print Central</b> .....	689
<b>36898A HP Access</b> .....	689
<b>36898F HP Access</b> .....	689
<b>36911A/R HP-UX Gateway SNA/3270</b> .....	644, 662, 664
<b>36918A/R HP-UX Gateway SNA/3270</b> .....	642, 645, 662
<b>36919A/R HP-UX Gateway SNA/3270 for Model 850</b> .....	662, 643
<b>36920A NS3000/XL Network Services</b> .....	664
<b>36921A ThinLAN 3000/XL Link</b> .....	664
<b>37050S FDM Network Monitoring System</b> .....	510
<b>37050S + 24A HP 37050S User &amp; System Manager Course</b> .....	761
<b>37051S FDM Measurement System</b> .....	510
<b>37100S Remote Access and Test System</b> .....	510
<b>37201A HP-IB Extender</b> .....	563
<b>37204A Multipoint HP-IB Extender</b> .....	563
<b>37204B Multipoint HP-IB Extender</b> .....	563
<b>37212B Error Correcting Modem</b> .....	707
<b>379000A/B Signaling Test Sets</b> .....	515
<b>38564B Series 300 Model 370 TurboSRX</b> .....	647



40000

40290A ATP 37/M for HP 1000.....664  
40651 Hammer and Accelerometer Kits.....581  
40652 Thermocouple Wires.....580  
40653 Thermistor Assemblies.....580  
40654A RTD Probe.....580  
40654B RTD Probe.....580  
41420A Source/Monitor Unit.....534  
41421B Source/Monitor Unit.....534  
41424A Voltage Source/Voltage Monitor Unit.....534  
41425A Analog Feedback Unit.....534  
41800A Active Probe.....233  
41941A/B Impedance Probe Kits.....280  
41951A Impedance Test Kit.....232  
41952A/B Transmission/Reflection Test Sets.....233  
43730 Flash X-Ray Systems.....681  
43850 Cabinet X-Ray Systems.....680  
44203C/D/L/S SimPlate Fixtures.....549  
44203K Sim Plate Spare Parts Kit.....549  
44210A Sim Plate Assembly Tools.....549  
44458A/B/R Data Acquisition Manager.....609  
44459A/B/R Data Acquisition Manager.....609  
44461A HP-IB Interface.....567  
44462A 8 Channel Multiplexer Assembly.....567  
44463A Extra Connector Block.....567  
44464A Breadboard Assembly.....567  
44465A 8-Bit In, 8-Bit Out Digital I/O Assembly.....567  
44466A Extra Connector Block.....567  
44469A Seven 10:1 Dividers.....567  
44531A HP 3060A/61A/62A User Training.....762  
44582A BTL PLUS Software.....548  
44670C/L/X NS/3065 Software.....548  
44671C/L/X PR PLUS Software.....548  
44672A Q-STATS II Software.....548  
44672A + 60A HP Q-STATS II/HP PR PLUS ASSIST.....765  
44672A + 65Z HP Q-STATS II ASSIST  
Additional Service Units.....765  
44850A HP 3065 Advanced User Training.....762  
44851A HP 3065AT User's Course.....762  
45070A HP 260 Series 30 SPU.....696  
45071A I/O Extender.....696  
45072A HP 260 Series 40 SPU.....696  
45310A BASIC Programmer's Library.....689  
45311A ICON Design System.....689  
45412A VT100 Terminal Emulator.....689  
45418A Executive MemoMaker.....689  
45419C Programmer's Tools.....689  
45421A Executive Card Manager.....689  
45427D WordStar Professional®.....689  
45431A AdvanceLink.....689  
45435A Touchscreen Programmer's Tools.....689  
45437A The Gallery Collection.....689  
45443A Forms Master.....689  
45445D BASIC by Microsoft®.....689  
45446D Compiled BASIC by Microsoft.....689  
45447D Pascal by Microsoft.....689  
45448A COBOL by Microsoft.....689  
45449D FORTRAN by Microsoft.....689  
45450D GW™ BASIC by Microsoft.....689  
45452D Lattice® C Compiler.....689  
45474D MicroSoft WORD.....689  
45498A Symphony® from Lotus.....689  
45504K MemoMaker/Time Management, Opt. 400.....689  
45539K Lotus® 1-2-3®, V2.01, Opt. 400.....689  
45549K Microsoft® WORD, Opt. 400.....689  
45554K MultiMate™, Opt. 400.....689  
45555K Executive Card Manager, Opt. 400.....689  
45566A Lotus® 1-2-3®.....689  
45640A Touchscreen Internal Modem.....689  
45641B Touchscreen 3278 Emulation Accessory.....689  
45811A 360K-Byte Flexible Disc Drive.....685, 686  
45812A 1.2M-Byte Flexible Disc Drive.....685, 686  
45813A 1.44M-byte Flexible Disc Drive.....685, 686  
45911A Graphics Tablet.....649, 715  
45981A Multimode Video Adapter.....653  
45984A Multimode Color Adapter.....653  
46021A Keyboard (U.S. ASCII Version).....649, 661  
46060A Mouse, 2-button.....649, 685  
46060B Mouse, 3-button.....649  
46080A-46089A HP 9000 Series 300 HP-HIL Devices.....649

46094A, 46095A HP 9000 Series 300 HP-HIL Devices.....649  
46298 Series Rack Cabinets.....754  
48000 Remote Terminal Unit.....568  
48050 Remote Terminal Unit.....568

50000

50011C HP-IB Instrument Control Using Series  
200/300 BASIC.....761  
50697A Programming in FORTRAN 77.....761  
50904F StarLAN Server Kit.....664  
50905F StarLAN User Link Kit.....664  
50906A StarLAN Server Kit.....664  
50910A HP Serial Network.....664  
50912A/R StarLAN ThinLan Configurator Diagnostics  
Software.....664  
50920A 3278 Emulator for HP Vectra PC.....662  
50921A SNA/Link/3270.....662  
50950A Network Services for DEC VAX.....643, 645,  
661, 662, 664  
50952B Network Services-ARPA/300.....664  
50952CL Network Services - ARPA/300.....661  
50954A/R Network Services/500.....661, 662, 664  
50955A 3278 Display Station Emulator.....662, 664, 668  
50956A Network Services/200.....661, 664  
50957A Network Services/200.....661, 664  
50959A Using SRM from BASIC and PASCAL.....761  
50960A/61A/62A/63A Shared Resource Management.....656,  
661, 662, 664, 668  
50967A HP-UX RJE Emulator 300.....662, 664  
50968A HP-UX RJE Emulator 500.....662, 664  
50969A/L NFS/300.....661  
50970A/R NFS/825.....645, 661  
50971A/R NFS/840.....644, 661  
50972A/R NFS/850.....643, 661  
50980A/R ARPA Services/800.....644, 661, 662, 664  
50981A/R ARPA Services/800.....645, 661  
50982A/R ARPA Services/850.....643, 661, 662  
51409A HP-IB Theory.....761  
51412A HP-IB with MS-DOS®.....761  
51414A Additional Time and Materials Consulting.....764  
51432A HP-UX Fundamentals for General Users.....761  
51433A Shell Programming for General Users.....761  
51434A HP-UX for Programmers.....761  
51435A Advanced HP-UX Tools.....761  
51436A HP-UX System Administration for Series 300.....762  
51438X SCS and make.....761  
51439A Advanced Editing with VI.....761  
51473A Architecture for Test, Measurement Software.....761  
51482A Series 800 System Administration.....762  
51489A HP-UX Basics for Application Users.....761  
51820A Waveform Generation Software.....77  
52126A Intel Multibus Interface.....271  
54001A 1-GHz Miniature Active Probe Pod.....62  
54002A 50Ω BNC Input Pod.....62  
54003A 1-MΩ 10:1 Probe Pod.....62  
54006A Resistive Divider Probe Kit.....67  
54007A Low Loss Measurements Kit.....67  
54100A 1-GHz Digitizing Oscilloscope.....62  
54100D 1-GHz Logic Triggering Digitizing Oscilloscope.....62  
54110D 1-GHz Color Digitizing Oscilloscope.....62  
54111D 500-MHz Logic Triggering Digitizing  
Oscilloscope.....63  
54112D 100-MHz, 4-Channel Digitizing Oscilloscope.....65  
54118A 18-GHz Trigger.....66  
54120T 20 GHz Digitizing Oscilloscope.....66  
54200A 50-MHz Digitizing Oscilloscope.....58  
54200D 50-MHz Logic Triggering Digitizing Oscilloscope.....58  
54201A 300-MHz Digitizing Oscilloscope.....58  
54201D 300-MHz Logic Triggering Digitizing  
Oscilloscope.....58  
54300A Probe Multiplexer.....80  
54501A 100-MHz Digitizing Oscilloscope.....60  
55280A + 24A Basic Laser Measmnt Sys. Course.....761  
55283A + 24A Advanced Laser Measmnt Sys. Course.....761  
59306A Relay Actuator.....562  
59307A Dual VHF Switch.....562  
59309A HP-IB Digital Clock.....562  
59401A Bus System Analyzer.....561  
59500A Multiprogrammer HP-IB Interface.....602  
59501B HP-IB Power Supply Programmer.....469, 562

# MODEL NUMBER INDEX

New product listings are printed in bold face type

<b>59510A Relay Accessory for Power Supplies</b> .....	464	69436A Process Interrupt Card.....	603
<b>59511A Relay Accessory for Power Supplies</b> .....	464	69480A Breadboard Input Card.....	603
59991A-K34 Broadband Linear Phase Comparator.....	489	69500A Unloaded Resistance Programming Card.....	603
59992A-J06 Time Interval Calibrator.....	189, 194	69501A-69513A Power Supply Control Cards.....	603
59992A-K70 Rack Mount Adapter Kit (HP 5342A, 5343A).....	182	69520A Power Supply Programming Card.....	603
<b>60000</b>		69602A Timer/Pacer Card.....	603
60502A Electronic Load Module.....	449	69700A-69706A Resistance Output Cards.....	599
60504A Electronic Load Module.....	449	69709A Power Supply Control Card.....	599
64000 Logic Development System.....	622	69720A D/A Voltage Converter Card.....	599
<b>64000-PC Personal Integration Environment</b> .....	625	69721A D/A Current Converter Card.....	599
64000-UX Microprocessor Development Environment.....	621	69730A Relay Output Card.....	599
64100A HP 64000-UX Microprocessor Development Environment, Development Station.....	623	69731B Digital Output Card.....	599
64100A+24D Logic Development Concepts and Measurements Course.....	762	69734A Timebase Card.....	600
<b>64120A Instrumentation Cardcage</b> .....	621	69735A Pulse Train Output/Stepping Motor Control Card.....	599
<b>64120T HP DesignCenter 64000-UX User's Course</b> .....	762	69736A Timer/Pacer Card.....	599
<b>64121T HP-UX for HP 64000-UX User's Course</b> .....	762	69750A Scan Control/Pacer Card.....	599
64131S Bundled Emulation Systems.....	624	69751A Analog-to-Digital Converter Card.....	599
64132S Bundled Emulation Systems.....	624	69752A 64 Channel FET Scanner Card.....	599
642XXS HP 64000-UX, Emulation Subsystems.....	623	69753A Temperature Scanner Card.....	600
64302A Emulation Bus Analyzer.....	623	69754A 32 Channel Relay Scanner Card.....	599
64310A Software Performance Analyzer.....	623	69755A 16 Channel FET Scanner Card.....	599
64310A + 24D Software Performance Analysis Training.....	762	69759A 500 kHz A/D Converter Card.....	599
64330 High-Level Software Analyzer.....	623	69761A Integrating Digital Multimeter Card.....	600
64340 Real-Time, High-Level Software Analyzer.....	623	69770A Isolated Digital Input Card.....	599
64600S + 24D Timing/Hardware Analysis Training.....	762	69771A Digital Input/Analog Comparator Card.....	599
64610S Logic Timing/State Analyzer.....	623	69774A Counter Card.....	600
64620S Logic State/Software Analyzer.....	623	69775A Counter/Totalizer Card.....	599
64620S + 24D State/Software Analysis Training.....	762	69776A Interrupt Card.....	599
<b>64700 Series Emulators</b> .....	625	69790B Memory Card.....	599
<b>647XX HP Teamwork SA/SD/RT Access</b> .....	624	69791A/69792A Memory Cards.....	599
<b>64710S + 42A HP Teamwork Products Installation</b> .....	764	69793A Breadboard Card.....	599
<b>64801S + 42A HP 64000-UX Microprocessor Development Environment Installation</b> .....	764	<b>70000</b>	
<b>64810A + 24D Pascal/64000 on 8080/8085 Course</b> .....	762	70000 Modular Measurement System.....	116
<b>64812A + 24D HP 64000/Pascal on Z80 Microprocessors Course</b> .....	762	70001A Modular Measurement System Mainframe.....	122
<b>64814A + 24D Pascal on 8086/8088 Microprocessors Course</b> .....	762	<b>70100A Power Meter Module (MMS System)</b> .....	122, 209
<b>64815A + 24F HP 64000/Pascal on 68000 Microprocessors Course</b> .....	762	70205A Graphics Display Module.....	119, 122
<b>64817A + 24F HP 64000 System HOST Pascal Programming Course</b> .....	762	70206A System Graphics Display.....	119, 122
68324F Office Activities Portfolio.....	689	70300A Tracking Generator Module.....	119, 122
68325F Chemical/Petrochemical Portfolio.....	689	70310A Precision Frequency Reference Module.....	122
68326F Business Management Portfolio.....	689	70591A 1/4-Width Module Part Kit.....	122
68327F HPDraw Figures Portfolio.....	689	70592A 1/4-Width Module Part Kit.....	122
68330F Executive Memo Maker.....	689	70593A 3/8-Width Module Part Kit.....	122
68330F Executive Memo Maker, Opt. 003.....	689	70594A 1/2-Width Module Part Kit.....	122
68331F Executive Card Manager.....	689	70595A Module Design Guides.....	122
68331F Executive Card Manager, Opt. 003.....	689	70596A Module Communication Design Guides.....	122
68333F AdvanceLink 2392.....	662, 664, 689	70600A Preselector Module.....	122
68333F AdvanceLink, Opt. 003.....	689	<b>70601A Preselector Module</b> .....	122
68339F Symphony from Lotus.....	689	<b>70620A Preamplifier Module</b> .....	116, 122
68340F 1-2-3 from Lotus, V2.01.....	689	70700A Digitizer.....	122
68340F 1-2-3 from Lotus, V2.01 Opt. 003.....	689	70900A Local Oscillator Module.....	122
68350F Charting Gallery.....	689	70902A IF Section Module (Res BW 10 Hz - 300 kHz).....	122
68351F Drawing Gallery.....	689	70903A IF Section Module (Res BW 100 kHz - 3 MHz).....	122
68352F Gallery Collection.....	689	70904A RF Section Module (100 Hz - 2.9 GHz).....	122
68352F Gallery Collection, Opt. 003.....	689	70905A/B RF Section Modules (50 kHz - 22 GHz).....	122
69280A Breadboard Card.....	603	70906A/B RF Section Module (50 kHz - 26.5 GHz).....	122
69321B D/A Voltage Converter.....	603	70907A External Mixer Interface Module.....	122
69322A Quad D/A Voltage Converter Card.....	603	70908A RF Section Module.....	122
69331B Digital Output Card.....	603	71000S Spectrum Analyzer System Reference.....	119
69332A Open Collector Output Card.....	603	71100A RF Spectrum Analyzer (100 Hz - 2.9 GHz).....	119
69335A Stepping Motor Control Card.....	603	<b>71110XL Scalar/Spectrum Analyzer (100 Hz - 2.9 GHz)</b> .....	116, 119
69336B High Speed Scanner Card.....	603	71200A Microwave Spectrum Analyzer (50 kHz - 22/26.5 GHz).....	116, 119
69351C Voltage Regulator Card.....	603	71201A Preselected Microwave Spectrum Analyzer.....	116, 119
69370A D/A Current Converter Card.....	603	<b>71201A Opt. 001 Preselected Microwave Spectrum Analyzer (50 kHz - 26.5 GHz)</b> .....	116, 119
69380A Breadboard Output Card.....	603	71210A Fundamentally-Mixed Microwave Spectrum Analyzer.....	119
69422A High Speed A/D Converter Card.....	603	71300A Millimeter Spectrum Analyzer.....	119
69423A Low Level A/D and Scanner Card.....	603	<b>71400A Lightwave Signal Analyzer</b> .....	116, 119, 314
69430A Isolated Digital Input Card.....	603	<b>71401A Lightwave Signal Analyzer</b> .....	116, 119, 314
69431A Digital Input Card.....	603	<b>74150A Programmable Logic Device Design System</b> .....	630
69433A Relay Output With Readback Card.....	603	<b>74153A Advanced Programmable Logic Device Utilities</b> .....	630
69434A Event Sense Card.....	603	74210A Design Capture System.....	629
69435A Pulse Counter Card.....	603	<b>74210A + 42A HP Electronic Design System Installation</b> .....	764
		74230A Design Verification Interface.....	629
		74230B HILO-3 Logic Simulator.....	629
		74230C HILO-3 Simulator Models.....	629

74230D HILO-3 Fault Simulator.....629  
74230S HP Design Verification Sub-System.....629  
74231A HICHP Hardware Modeling System.....629  
74241A HP EDS/3065 Test Program Generator.....629  
74240A HP EDS/16500A CAE Link.....629  
74240B Simulation Data File Comparator.....629  
74241A HP EDS/3065 Test Program Generator.....629  
74298A Electronic Design System Overview.....762  
74298B Electronic Design Capture, Verification.....762  
74298C Electronic Design Modeling Course.....762  
74298D Electronic Design System Administration.....762  
74300A Introduction to HP EGS.....762  
74301A PCB Design with HP EGS.....762  
74302A Customizing HP EGS.....762  
74305A Standard, Modular HP EGS.....635  
74306A HP EGS, Add-on Modules.....635  
74307A Hybrid Circuit Design Module.....635  
74308A High Performance HP EGS.....635  
74309A Vectra HP EGS.....635  
74400A/R HP Printed Circuit Design System.....633  
74400A+42A HP PC Design System Installation.....764  
74400A+65Z HP PCDS-ASSIST Additional Service Unit.....765  
74490A PCB Design with PCDS.....762  
74493A Building Parts with PCDS.....762  
74494A PCDS System Management.....762  
74610A Analog Workbench.....629  
74836A + 60A ME-30 ASSIST Base Unit (1st workstation).....765  
74836A + 60B ME-30 ASSIST Two Additional Workstations.....765  
74836A + 60C SRX-ASSIST.....765  
74836A + 65Z ME-30 ASSIST Additional Service Units.....765  
74836T HP DesignCenter ME 30 Users Course.....762  
79232U HP PROLOG Artificial Intelligence Language.....666

**80000**

81000AS Optical Power Splitter, 600 - 1200 nm.....309  
81000BS Optical Power Splitter, 1200 - 1650 nm.....309  
81317DX Low-Cost HP BASIC Controller.....555  
81511A Optical Head, 550 - 950 nm.....304, 305  
81512A Optical Head, 900 - 1725 nm.....304, 305  
81519A Optical Receiver.....305  
81520A Optical Head, 450 - 1020 nm.....306, 309  
81521B Optical Head, 900 - 1700 nm.....306, 309  
81522A Optical Head, 1000-1650 nm.....306  
81810S Digital IC Test System.....320  
82000 IC Evaluation System.....526  
82104A Card Reader (HP-41CV/CX).....694  
82160A HP-IL Module (HP-41CV/CX).....694  
82161A Digital Cassette Drive.....694  
82162A Thermal Printer/Plotter.....694  
82164A HP-IL/RS-232C Interface.....695  
82165A HP-IL/GPIO Interface.....695  
82169A HP-IL/HP-IB Interface.....695  
82180A Extended Functions/Memory Module.....694  
82181A Extended Memory Module.....694  
82182A Time Module.....694  
82183A Extended I/O Module.....694  
82240A Infrared Printer.....694  
82300B HP BASIC Language Processor.....656  
82301B HP BASIC Software.....656  
82303A 512K RAM Expansion Kit.....656  
82304B HP BASIC ROM 5.1.....656  
82305A RAM Expansion Board.....656  
82306A GP-IO Interface.....656  
82307A GP-IO Cable.....656  
82310A HP Pascal Language Processor System.....656  
82311A HP Pascal (Software Only).....656  
82312A HP BASIC/Pascal Right-to-Execute.....656  
82313A Hierarchical File System.....656  
82314D Vectra ES/12 PC-308 HP ML BASIC Controller.....656  
82314DX Model PC-308ML HP BASIC Controller.....555  
82315D Vectra ES/12 PC-308CL HP BASIC Controller.....656  
82315DX Model PC-308CL HP BASIC Controller.....555  
82316D Vectra CS PC-305M HP BASIC Controller.....656  
82316DX Model PC-305M HP BASIC Controller.....555  
82317D Vectra CS PC-308ML HP BASIC Controller.....656  
82317DX Model PC-305ML HP BASIC Controller.....555  
82319D Vectra ES/12 PC-308CM HP BASIC Controller.....656  
82318DX Model PC-305CM HP BASIC Controller.....555

82328A Intelligent Graphics Controller.....653  
82329A EGA Emulation Module.....653  
82862K BASIC by Microsoft, Opt. 400.....689  
82863K REFLECTION I™, Opt. 400.....689  
82866KD Localization, German—Opt. 400.....689  
82866KF Localization, French—Opt. 400.....689  
82866KZ Localization, Italian—Opt. 400.....689  
82867K YTERM 3278 Emulation, Opt. 630.....689  
82870K AdvanceMail, Opt. 400.....689  
82990A HP-IB Interface and Command Library.....664  
83400A Lightwave Source.....313  
83401A Lightwave Source.....313  
83410A Lightwave Receiver.....313  
83522A 0.01-2.4 GHz RF Plug-in.....398, 402  
83525A/B 0.01-8.4 GHz RF Plug-ins.....398, 402  
83540A/B 2-8.4 GHz RF Plug-ins.....398, 402  
83545A 5.9-12.4 GHz RF Plug-in.....398, 402  
83550A 8-20 GHz RF Plug-in.....398, 402  
83554A 26.5-40 GHz Millimeter-Wave Source Module.....403  
83555A 33-50 GHz Millimeter-Wave Source Module.....403  
83556A 40-60 GHz Millimeter-Wave Source Module.....403  
83570A 18-26.5 GHz RF Plug-in.....398, 402  
83572A/B 26.5-40 GHz RF Plug-in.....398, 402  
83590A 2-20 GHz RF Plug-in.....399  
83592A/B/C 0.01-20 GHz RF Plug-in.....399  
83594A 2-26.5 GHz RF Plug-in.....399  
83595A 0.01-26.5 GHz RF Plug-in.....399  
83596A 2.4-40 GHz RF Plug-In.....398, 401  
83597A 0.01-40 GHz RF Plug-In.....398, 401  
84811A Peak Power Sensor.....215  
85014B Active Device Measurements Application Pac.....252  
85015B System Software for HP 8756S and 8757S.....228  
85016B Transmission Line Test Software.....228  
85020A/B RF Directional Bridges.....222  
85022A System Cable Kit.....224  
85023A/B/C/D/F System Verification Kit.....224  
85024A RF Probe.....313  
85025A/B/D/E AC/DC Detectors.....222  
85025C Detector Adapter.....222  
85026A Waveguide Detectors.....222  
85027A/B/C/D/E Microwave Directional Bridges.....222  
85028A Directivity Verification Kits.....224  
85029B 7mm Verification Kit.....246  
85031B APC-7 Calibration Kit for HP 8753A.....245  
85032B 50 Ω Type-N Calibration Kit.....246  
85033C 3.5mm Calibration Kit.....246, 313  
85036B 75 Ω Type-N Calibration Kit.....246  
85041A Transistor Text Fixture Kit.....252  
85043B Systems Cabinet.....245  
85044A/B Transmission/Reflection Test Sets.....244  
85046A/B S-Parameter Test Sets for HP 8753B.....244  
85047A 6-GHz S-Parameter Test Set for 8753B.....245  
85050B/C/D 7mm Calibration Kits.....253  
85051B 7mm Verification Kit.....253  
85052B/D 3.5mm Calibration Kits.....253  
85053B 3.5mm Verification Kit.....253  
85054B Type N Calibration Kit.....253  
85055A Type N Verification Kit.....253  
85100A LO/IF Kit.....251  
85130B Adapter Set.....254  
85130D Adapter Set.....254  
85131C/D/E/F 3.5mm Cables.....254  
85132C/D/E/F 7mm Cables.....254  
85138A/B 2.4mm 50 Ω Terminations.....333  
85140A/B 2.4mm Short Circuits.....333  
85141A/B 2.4mm Open Circuits.....333  
85150A Microwave Design System (CAE).....631  
85151A Microwave Linear Simulator (CAE).....631  
85152A Microwave Artwork Generator (CAE).....631  
85153A GDS-II Translator.....631  
85150A + 24D Intro to HP Microwave Design System.....761  
85150A + 42A 85150A Microwave Design System Installation Service.....764  
85160A Measurement Automation Software.....246  
85161A Measurement Automation Software.....249  
85162A Measurement Automation Software.....248  
85620A Mass Memory Module.....141



# MODEL NUMBER INDEX

New product listings are printed in bold face type

85650A Quasi-Peak Adapter .....	132	92460A ALLBASE/HP-UX .....	645, 642
<b>85668A Spectrum Analyzer Operation Course</b> .....	761	92461A HP FORTRAN 77/HP-UX .....	643
85685A RF Preselector .....	132	92462A HP Pascal/HP-UX for 850S .....	643
85863B System Software .....	124	92463A Starbase/HP-UX Graphics Library for 850S .....	643
85864C EMI Measurement Software .....	131	92464A HP DGL/AGP/HP-UX Graphics Library for 850S .....	643
85865B Signal Monitoring Software .....	129	92468A ALLBASE/HP-UX and HPtoday .....	643
85867A EMI Receiver Functions .....	132	92469A ALLBASE/HP-UX for 850S .....	643
85870A Open-Site EMI Measurement System Software .....	131	92521A HP GKS .....	651, 642
<b>85901A AC Power Source</b> .....	136	92524A X Window System .....	645, 642
86200 Series RF Plug-ins .....	405	<b>92526A HP Display List</b> .....	644
86222A/B RF Plug-ins .....	405	<b>92528A X Window System</b> .....	644
86235A RF Plug-in .....	405	92529A HP GKS for 850S .....	643
86240A/B/C RF Plug-ins .....	405	92533A HP VISOR HP SQL Interface .....	645, 642
86241A 3.2-6.5 GHz RF Plug-in .....	405	92534A HP Visor Interface to HP SQL .....	644
86242D 5.9-9 GHz RF Plug-in .....	405	92535A HP Visor for 850S .....	643
86245A 5.9-12.4 GHz RF Plug-in .....	405	92916A Bar Code Reader .....	649
86250D 8-12.4 GHz RF Plug-in .....	405	<b>97009A Starbase Driver Development Guide</b> .....	651
86251A 7.5-18.6 GHz RF Plug-in .....	405	<b>97054A Single-user Ada Software for HP-UX</b> .....	659
86260A 12.4-18 GHz RF Plug-in .....	405	<b>97055A Multi-user Ada Software for HP-UX</b> .....	659
86260B 10-15.5 GHz RF Plug-in .....	405	<b>97056A Asynchronous Terminal Emulator</b>	
86260C 17-22 GHz RF Plug-in .....	405	for Series 500 BASIC .....	662
86290B/C RF Plug-ins .....	405	<b>97099A 19-inch Rack Mount Kit for 825S</b> .....	645
86601A 0.01-110 MHz RF Section .....	372	<b>97252FL HP-FL Controller Upgrade</b> .....	711
86602B 1-1300 MHz RF Section .....	372	<b>97962B 152 Megabyte Upgrade Kit with Controller</b> .....	710
86603A 1-2600 MHz RF Section .....	372	<b>97963B 304 Megabytes Upgrade Kit with Controller</b> .....	710
86631B Auxiliary Section .....	372	98053A Versatec Hardcopy Support (Series 300) .....	651
86632B AM/FM Modulation Section .....	372	<b>98184A HP-UX Gateway/SNA 3770 for Series 300</b> .....	662
86633B AM/FM Modulation Section .....	372	<b>98185A/R HP-UX Gateway/SNA 3770 for Model 825</b> .....	662
86634A 0M Modulation Section .....	372	<b>98186A/R HP-UX Gateway/SNA 3770 for Model 840</b> .....	662
86635A 0M/FM Modulation Section .....	372	<b>98187A/R HP-UX Gateway/SNA 3770 for Model 850</b> .....	662
86720A Frequency Extension Unit .....	390	<b>98188A HP-UX SNA 3270 for Series 300</b> .....	662
88190 HP ScanJet Automatic Document Feeder .....	713	98194A LAN/9000 Series	
88290A HP ScanJet PC Interface Kit .....	713	800 Link .....	644, 661, 662, 664, 668
<b>88293A HP ScanJet PS/2 Model 30 Kit</b> .....	713	98195A NS/9000 Series 800 Software .....	644, 661, 662, 664
<b>88390B HP ScanJet Macintosh Interface Kit</b> .....	713	98203C Keyboard with Rotary Knob for BASIC/Pascal .....	649
88400A HP ScanJet ReadRight OCR Software .....	713	98242A 4-Slot DIO Backplane .....	649
<b>88401A HP ScanJet ReadRight International OCR Software</b> .....	713	<b>98242B 2-Slot DIO Backplane</b> .....	649
<b>88490A HP ScanJet PS/2 Interface Kit</b> .....	713	98243B Model 310 to 320 Processor Board Upgrade .....	649
88500A IBM Disc/Tape Interface .....	708	<b>98244A Model 330 to 350 Processor Board Upgrade</b> .....	649
88703A HP 7979A to 7980A Field Upgrade Kit .....	712	98250A Series 300 DGL, AGP .....	651
<b>88705A HP 7980A to 7980XC Field Upgrade Kit</b> .....	712	98253A EPROM Programmer Interface .....	668
		98255A EPROM Card .....	668
		98256A 256-Kbyte RAM Card .....	668
		98257A 1 MB RAM Board for 310 and 320 Only .....	649, 668
		98258A 4 MB RAM Controller for 330, 370 .....	649
		98258B 4 MB RAM Add-on for 370 .....	649
		98258C 12 MB RAM Add-on for 370 .....	649
		98259A Bubble Memory Interface .....	668
		<b>98264A 8 MB Error-Checking, Correcting RAM</b>	
		for 370 Only .....	649
		<b>98264B 16 MB Error-Checking, Correcting RAM</b>	
		for 370 Only .....	649
		<b>98265A SCSI Interface</b> .....	668
		98286A DOS Coprocessor Interface Card .....	668
		<b>98286D DOS Coprocessor Discless Node Kit</b> .....	669
		98286S DOS Coprocessor System .....	669
		98286T HP Series 300 DOS/Memory Enhancement Kit .....	669
		98287A Series 300/98700H Interface .....	668
		98310A HP EGS Photoplotter/NC Drill Utility .....	635
		98311A HP EGS, IGES Translator .....	635
		98358A VME Bus Software Drivers .....	649
		<b>98365A+60A ME-5/10 ASSIST</b>	
		Base Unit (1st workstation) .....	765
		<b>98365A+60B ME-5/10 ASSIST</b>	
		Two Additional Workstations .....	765
		<b>98365A+60C ME-ASSIST Network</b> .....	765
		<b>98365A+60D ME-ASSIST Add to Network</b> .....	765
		<b>98365A+65Z ME-5/10 ASSIST Additional Service Units</b> .....	765
		98366A + 42A HP ME- 5, 10, 30 CAD System Installation .....	764
		<b>98501B Introduction to Workstation BASIC</b> .....	761
		<b>98510D Series 200/300 BASIC Operating and Advanced</b>	
		Programming Course .....	761
		<b>98511C Series 200/300 Pascal Operating and Advanced</b>	
		Programming Course .....	761
		98515L HP-UX Application Execution Environment .....	659
		98542A Monochrome Graphics Board (512 x 400) .....	649
		98543A Color Graphics Board (512 x 400) .....	649
		98544B Monochrome Graphics Board (1024 x 768) .....	649
		98546A Monochrome Alpha/Graphics Board (512 x 390) .....	649
		98547A Color Graphics Board (1024 x 768) .....	649
<b>90000</b>			
91290A 5 1/4" HP Qualified Media .....	708		
91781A RJE/1000-II .....	664		
91782A MRJE/1000 .....	664		
91786A LAN/9000 Series 800 Link .....	645, 661, 662, 642		
91787A NS/9000 Series 800 Software .....	645, 661, 662, 642		
91788A LAN/850 Link .....	643, 662, 661		
91789A/R NS850 .....	643, 662, 661		
<b>91790A Network Services/1000</b> .....	664		
92192A 3 1/2" 1-Mbyte Doublesided Microfloppy Discs .....	708		
92192X 3 1/2" 2-Mbyte Doublesided Microfloppy Discs .....	708		
<b>92208 Series Chairs</b> .....	734		
<b>92210 Series Tables</b> .....	736, 737		
<b>92211 Series Cabinets</b> .....	735		
<b>92213 Series Work Stations</b> .....	735		
<b>92214 Series Tables</b> .....	735		
92223A/C Repeater Kit .....	664		
92248BA Cross-Reference Utility .....	689		
92430A HP FORTRAN 77/HP-UX .....	644		
92431A HP Pascal/HP-UX .....	644		
92433A HP Simplex (Kanji Font) .....	643, 644, 659		
92436A Starbase Graphics Library .....	644		
92437A DGL, AGP, Starbase Graphics Libraries .....	644		
92438A Development System Bundle .....	644		
92439A Native Language I/O (Kanji) .....	643, 644, 659		
92440A HPtoday Developer Pack .....	644		
92441A HPtoday Run Time Environment .....	644		
92442A ALLBASE/HP-UX, HPtoday Developer Pack .....	644		
92443A HP FORTRAN 77/HP-UX .....	645, 642		
92444A HP Pascal/HP-UX .....	645, 642		
92445A/R Starbase Graphics Library .....	645, 651, 642		
92446A DGL/AGP, Starbase Graphics Library .....	645, 651, 642		
92447A Development System Bundle .....	645, 642		
<b>92452A 16-User HP-UX License</b> .....	659		
<b>92453A 32-User HP-UX License</b> .....	644, 645, 659		
<b>92454A 64-User HP-UX License</b> .....	644, 645, 659		
92455A Unlimited HP-UX License .....	644, 659		
92459A ALLBASE/HP-UX, HPtoday Developer Pack .....	645, 642		

98548A Monochrome Graphics Board (1280x1024).....	649, 650	98635A Floating Point Math Board.....	668
98549A Color Graphics Board (1024x768).....	649, 650	98640A ADC.....	668
98550A Color Graphics Board (1280 x 1024).....	649, 650	98641A RJE Interface.....	662, 668
98556A 2D Integer-Based Graphics Accelerator.....	649, 650	98642A RS-232C MUX Interface.....	662, 664, 668
98561A Model 310.....	647	98643A HP LAN/300 Link.....	662, 664, 668
98563A Model 318M Monochrome Workstation.....	648	98646A VMEbus Interface.....	668
98564A Model 319C+.....	648	98647A PC Instruments Interface.....	668
98567A Rackmount Kit for HP 35731A.....	649	98672A GKS Graphics Library (Series 300).....	651
98567B Rackmount Kit for HP 35741A.....	649	98674A/98522A Starbase Display List.....	651
98568A Eight-Slot I/O Expander.....	649	98678A HP Common LISP I Media/Manuals.....	666
98569A Rackmount Kit for S300 SPU.....	649	98678L HP Common LISP I License-to-Use.....	666
98570A DIO-II Expander.....	649	98683X DGL Skeleton Device Handler.....	651
98579A Model 360.....	647	98688A HP Common LISP II Media/Manuals.....	666
98579B Model 370.....	647	98688L HP Common LISP II License-to-Use.....	666
98580A Model 310M Measurement Automation Workstation.....	648	98690A Programmable Datacomm Interface.....	662, 664, 668
98580B Model 310 Controller.....	555	98691A Programmable Datacomm Interface.....	662, 664, 668
98580S Model 330MMA Monochrome Instrument Controller.....	648	98720A 3D Display Controller (1280 x 1024).....	644, 649, 650
98581A Model 310C Low-Cost Color Workstation.....	648	98721A 3D Graphics Accelerator.....	644, 649, 650
98581B Model 310 Color Controller.....	555	98722A 8-Plane Frame Buffer Memory.....	644, 650
98581S Model 330CMA Color Instrument Controller.....	555, 648	98725A Interface to Connect 98720A.....	668
98580W Model 360MMA HP BASIC Controller.....	555	98726A Interface to Connect 98730A.....	668
98580WX Model 360 MMAX HP BASIC/UX Controller.....	555	98730A 3D Display Controller (1280 x 1024).....	649, 650
98581W Model 360 CMA Color HP BASIC Controller.....	555	98732A 3D Graphics Accelerator.....	649, 650
98581WX Model 360 CMAX HP BASIC/UX Controller.....	555	98751A 19-Inch Color Monitor (1024 x 768).....	649, 653
98587T Model 360 TurboSRX.....	648	98752A 19-Inch Color Monitor (1280 x 1024).....	649
98587W Model 360SRX.....	648	98785A 16-Inch Color Monitor (1024 x 768).....	649, 653
98588G Model 370CH.....	647	98786A 17-Inch Monochrome Monitor (1024 x 768).....	649
98588S Model 330CH Color Workstation.....	648	98788A 19-inch Monochrome Monitor (1280 x 1024).....	649
98588W Model 360CH.....	648	98789A 16-Inch Color Monitor (1280 x 1024).....	649
98589G Model 370MH.....	647	98791B HP 2392A/VT100 Terminal Emulator.....	662, 664
98589S Model 330M Monochrome Workstation.....	648	98819A HP TechWriter Software.....	635
98589W Model 360MH HP-UX System.....	648	98855A HP 5080 Emulator.....	662
98595A + 42A HP-UX Application Execution Environment Installation.....	764	05096A SA/SD for Test, Measurement Software.....	761
98597L HP-UX Programming Environment.....	659	0960-0054 SMA-Female Short (50 Ohm).....	345
98597B + 42A HP-UX Programming Environment Installation.....	764	0960-0055 SMA-Male Short (50 Ohm).....	345
98598L HP-UX FORTRAN 77 Compiler.....	659	1250-XXXX Series Adapters and Connectors.....	740
98599L HP-UX Pascal Compiler.....	659	1250-1530 N(m) Short.....	345
98603A/B BASIC 5.1 Language System.....	659	1250-1531 N(f) Short.....	345
98604A HPL 2.0 Language System.....	659	1251-2277 Dual Banana Plug to BNC Female.....	740
98613B RAM-Based BASIC 4.0 Language System.....	659	1251-2816 Dual Banana Plug (for Cable).....	740
98614A RAM-Based HPL 2.1 Language System.....	659	1460-XXXX Series Cabinet Parts.....	751
98615C RAM-Based Pascal 3.1 Language System.....	659	1490-XXXX Series Slide Kits, Casters.....	752
98616A RAM-Based BASIC 5.1 Language System.....	659	1494-XXXX Series Slide Kits.....	750
98617A RAM-Based Pascal 3.2 Language System.....	659	5040-XXXX Series Rack Frames.....	752
98618A BASIC 5.0/5.1 Compiler.....	659	5060-XXXX Control Panel Covers.....	752
98620B DMA Controller.....	668	5060-XXXX Filler Panels.....	752
98622A GPIO Interface.....	668	5060-XXXX Rack Adapter Frames.....	752
98623A BCD Interface.....	668	5060-XXXX Rack Mounting Kits.....	752
98624A HP-IB Interface.....	664, 668	5060-XXXX Series Racking Accessories, Covers.....	753
98625B High-Speed Disc Interface.....	668	5062-XXXX Series System II Cabinet Parts.....	748, 749
98626A/44A Serial Interface, RS-232C.....	662, 668	8120-XXXX Cables and Adapters.....	740
98627A RGB Color Video Interface.....	668	9211-XXXX Series Operating Cases.....	746
98628A Datacomm Interface.....	662, 668	9211-XXXX Series Transit Cases.....	742
98630A Breadboard Interface.....	668	11000-60001 Dual Banana-Dual Banana Cable.....	740
98633A HP 6944A Multiprogrammer Interface.....	668	11001-60001 Dual Banana-BNC Cable.....	740
		11652-60001 BNC (m) 50-ohm Termination.....	345



# GENERAL INDEX

## General-Purpose Electronic Measurement

Amplifiers .....	406
Automatic Test Systems.....	612
Board Test Systems.....	546
Component Measurement .....	278
Computer-Aided Test.....	582
Data Analyzers/Generators.....	316
Digital Circuit Testers.....	272
Digital IC Tester .....	320, 526
Electronic Counters.....	176
Electronic Loads.....	448
Frequency & Time Standards.....	484
Frequency & Time Interval Analyzers.....	191
Frequency Synthesizers.....	356, 410
Function Generators.....	378, 410
HP-IB.....	556
Impedance Analyzers.....	278
LCR Meters.....	278
Lightwave Test .....	302
Logic Analyzers.....	256, 621
Modulation Domain Analyzers.....	191
Multimeters.....	92
Network Analyzers.....	216
Oscilloscopes.....	54
Plotters.....	84, 720
Power Supplies.....	446
Pulse Generators.....	432
Recorders, Printers.....	84, 716
Semiconductor Testers.....	320, 524
Signal Analyzers.....	108
Signal Sources.....	316, 356, 392, 410, 432
Support .....	756
Waveform Analyzers.....	68
Waveform Synthesizers.....	378, 410

## CAT/HP-IB

Automatic Test Systems.....	612
Board Test Systems.....	546
Computer-Aided Test.....	582
Computer Peripherals.....	706
Controllers.....	552
Data Acquisition Systems.....	564
Digital IC & Circuit Testers.....	272, 320, 526
Electronic Counters.....	176
Electronic Loads.....	448
HP-IB Cables.....	561
HP-IB Extenders.....	563
HP-IB Overview.....	556
Lightwave Test .....	302
Multimeters.....	92
Multiprogrammers.....	593
Network Analyzers.....	216
Noise Figure Meter.....	328
Oscilloscopes.....	54
Plotters & Recorders.....	84, 720
Power Meters.....	208
Power Supplies.....	446
Semiconductor Testers.....	320, 524
Signal Analyzers.....	108
Signal Sources.....	316, 356, 392, 410, 432
Support .....	756
Switches, Switch Driver.....	336, 339
Telecommunications Test.....	494
Transceiver Test .....	324
Waveform Analyzers.....	68

## Telecommunications & Data Communications

Amplifiers .....	406
Communications Board Test System.....	546
Data Generators.....	316
Data & Voice Testing.....	516
Data Communications Test.....	511
Digital Communications Measurements.....	494
Digital Radio Testing.....	501, 507
Frequency Synthesizers.....	356, 410
Lightwave Test .....	302
Microwave Counters.....	178, 191
Microwave Radio Testing.....	494
Microwave Test Equipment.....	191, 332
Network Analyzers.....	216
Noise Figure Meter.....	328
Operational Support Systems.....	510
Optical TDR.....	310
PCM Testing.....	494
Plotters.....	84, 720
Power Meters.....	208
Private VF Circuit Testing.....	516
Protocol Analyzers.....	511
Pulse Generators.....	432
Radio & FDM Carrier Testing.....	324, 501, 510
Signal Analyzers.....	108
Signal Sources.....	316, 356, 392, 410, 432
Support .....	756
Telecommunications Test.....	494
Transceiver Test .....	324

## RF & Microwave Measurement

Amplifiers .....	406
Automatic Test Systems.....	612
Coaxial Test Equipment.....	332
Digital Radio Testing.....	501
Electronic Counters.....	176
Frequency Synthesizers.....	356, 392, 410
Microwave Counters.....	178, 191
Microwave Design System (CAE).....	631
Microwave Link Analyzers.....	507
Microwave Semiconductors.....	675
Microwave Test Equipment.....	332
Millimeter-Wave Equipment.....	332, 392-403
Modulation Domain Analyzers.....	191
Network Analyzers.....	216
Noise Figure Meter.....	328
Oscilloscopes.....	54
Plotters.....	84, 720
Power Meters.....	208
RF Impedance Analyzer.....	284
Signal Analyzers.....	108
Signal Generators.....	356
Support .....	756
Sweep Oscillators.....	392
Time Domain Reflectometry.....	66
Transceiver Test Equipment.....	324
Waveform Analyzers.....	68
Waveguide Test Equipment.....	332

**Data Acquisition & Control**

Automatic Test Systems.....	612
Board Test Systems.....	546
Component Testers.....	278
Computers.....	552, 638
Computer-Aided Test.....	582
Data Acquisition Systems.....	564
Digital Circuit Testers.....	272
Digital IC Tester.....	320, 526
Disc Drives.....	708
Electronic Counters.....	176
Fourier Analyzers.....	146
Hammers & Accelerometers.....	581
HP-IB.....	556
HP-IB Extenders.....	563
Multimeters.....	92
Multiprogrammers.....	593
Recorders, Plotters, & Printers.....	78, 84, 716, 720
Signal Analyzers.....	108
Semiconductor Testers.....	320, 524
Support.....	756
Switches.....	583
Temperature Transducers.....	580
Waveform Analyzers.....	68

**Computers, Peripherals & Calculators**

AI Workstations.....	666
BASIC Controllers.....	656
Business Computers.....	682, 696
Calculators.....	692
Computers.....	552, 619, 638, 682, 696
Data Acquisition Systems.....	564
Digitizing Tablet.....	714
Drafting Plotters.....	724
Electrostatic Plotter.....	730
Engineering Workstations.....	619, 638
Furniture.....	734
HP-IB.....	556
HP-IB Extenders.....	563
IBM PC Compatible Computers.....	656, 684, 688, 696, 701
Mass Storage.....	708
Modems.....	707
Multiprogrammers.....	593
Networking.....	660, 663, 701
Network Testing.....	511
Peripherals.....	84, 667, 706
Personal Computers.....	656, 682
Portable Computers.....	657, 682, 688
Precision Architecture Computers.....	640, 698
Printers.....	716
Supplies & Accessories.....	766
Support.....	756
Technical Computers.....	619, 638
Terminals.....	691
Terminals, Rugged.....	706

**CAE/CAD**

Digital IC Prototype Verification.....	526
Digital Oscilloscopes.....	54
Drafting Plotters.....	724
Electronic Design System (CAE).....	627
Electrostatic Plotters.....	730
Engineering Graphics System.....	634
Fourier Analyzers.....	146
Logic Analyzers.....	256, 621
ME/CAD Systems.....	636
Microprocessor Development Systems.....	621
Microwave Design System (CAE).....	631
Overview.....	616
Personal Computers.....	656, 682
Plotters.....	84, 720
Printed Circuit Design System.....	632
Printers.....	716
Programmable Logic Device Design System.....	630
Signal Analyzers.....	108
Support.....	756
Third-Party Software.....	620
Workstations.....	619, 638

**Logic & Processor-Based Circuit Analysis**

Board Test Systems.....	546
Data Generators/Analyzers.....	316
Digital Circuit Testers.....	272
Digital IC Tester.....	320, 526
IC Troubleshooters.....	272
Logic Analyzers.....	256, 621
Microprocessor Development Systems.....	621
Plotters.....	84, 720
Signature Analyzers.....	272
Support.....	756

**Other Products**

Adapters.....	740
Analytical Instruments for Chemistry.....	676
Cabinet Accessories.....	748
Cabinets.....	754
Cables.....	561, 740
Digital Education Products.....	275
Dimensional Measurement.....	350
Frequency & Time Standards.....	484
Laser Interferometers.....	350
Medical Instrumentation.....	678
Microwave Semiconductors.....	675
Operating Cases.....	746
Optoelectronic Devices.....	674
Pressure & Temperature.....	352
Support.....	756
Transit Cases.....	742
X-Ray Systems.....	680

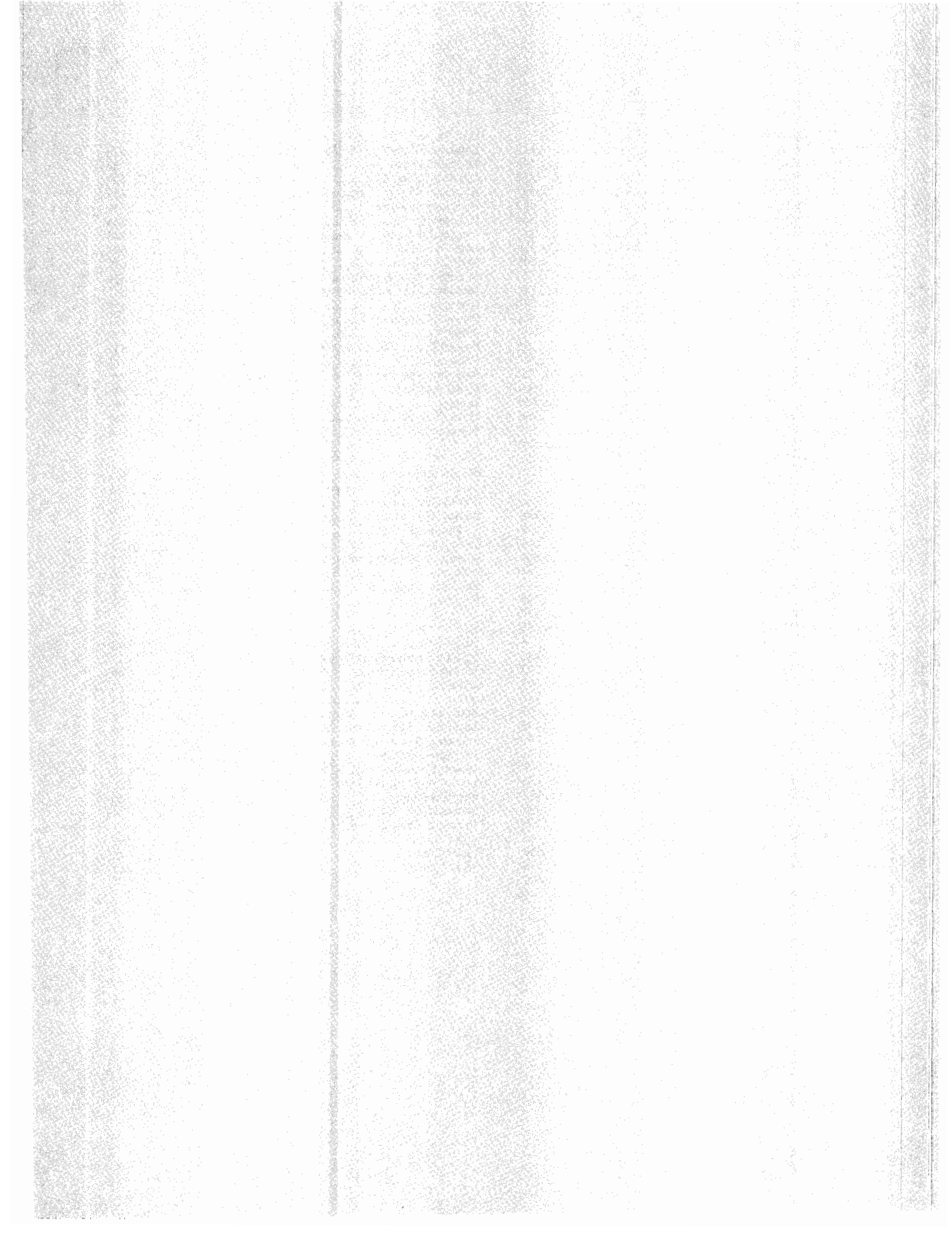

## **ANALYZERS & METERS**

<b>Oscilloscopes &amp; Waveform Analyzers.....</b>	<b>54</b>
<b>Plotters &amp; Recorders.....</b>	<b>84</b>
<b>Digital Multimeters.....</b>	<b>92</b>
<b>Signal Analyzers.....</b>	<b>108</b>
<b>Electronic Counters.....</b>	<b>176</b>
<b>Power Meters.....</b>	<b>208</b>
<b>Network Analyzers.....</b>	<b>216</b>
<b>Logic Analyzers.....</b>	<b>256</b>
<b>Digital Circuit Testers.....</b>	<b>272</b>
<b>Component Measurement.....</b>	<b>278</b>

Hewlett-Packard offers a wide variety of test and measurement products that receive a signal, analyze it and display the results. Included in this category are products ranging from digital multimeters, counters, and digitizing oscilloscopes to network and spectrum analyzers. They are used in both standalone and system applications.



# OSCILLOSCOPES & WAVEFORM ANALYZERS

## HP Digitizing Oscilloscopes

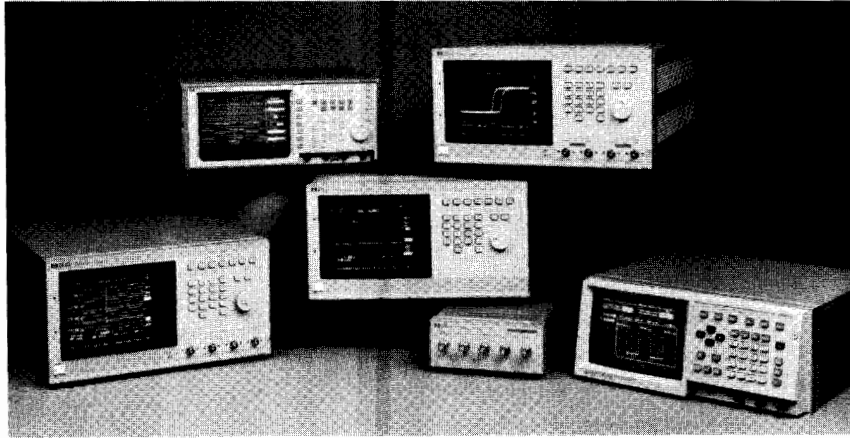

The HP 54100 and HP 54200 Series Digitizing Oscilloscopes . . . combining high bandwidth with high digitizing rates makes these general-purpose oscilloscopes useful for both analog and digital measurements.

### Choose the Right Scope for Your Application

Selecting a digitizing oscilloscope is similar to selecting a conventional one; it involves asking whether the instrument can capture the waveform of interest, and, after storage, whether the data can be recalled and analyzed in the desired way.

### Selection Criteria

**Digitizing rate:** for single-shot transient capture, digitizing rate is the key criteria for determining whether the oscilloscope can capture a one-time event. It is suggested that your scope have a digitizing rate of at least two and a half to four times the bandwidth of the waveform you wish to capture for single-shot measurements. For repetitive waveforms, some scopes use repetitive sampling, for which digitizing rate is a less im-

portant criterion than bandwidth and vertical resolution.

**Bandwidth:** bandwidth is another fundamental selection criterion. It affects the accuracy of amplitude and timing measurements. The bandwidth of an oscilloscope should exceed that of the signal; how much it exceeds it depends on the measurement accuracy needed. In general, the instrument's bandwidth should be three times the highest frequency component of the signal.

For pulse applications, the rise time is related to the maximum frequency content by:

$$\text{frequency} = 0.35/\text{rise time}$$

This guideline suggests that you should choose an oscilloscope with a rise time less than one-third the rise time of your signals.

**Resolution:** voltage resolution and timing resolution are also important criteria when choosing an oscilloscope. Your particular application helps determine how much resolution you need. For single-shot acquisition, there is an inherent trade-off between timing resolution and vertical resolution. Obtaining higher vertical resolution means sacrificing digitizing rate.

The timing resolution of the scope is more important to the digital designer who measures propagation delay and setup and hold times.

If, however, the signal being measured is a complex, modulated-analog signal where frequency-domain analysis is desired in addition to time-domain analysis, then increased voltage resolution results in greater signal-to-noise measurement capability. A guideline is 6 dB signal-to-noise measurement capability per bit of resolution (ten bits gives you 60 dB). Bits of resolution are related to percentage resolution by:

$$\% = 100/2^n$$

where n is the number of bits.

**Memory:** the fourth selection criterion is the memory length of the oscilloscope. Memory length simply describes how long an event (i.e., how many samples can be captured, although there are a variety of techniques to capture long waveforms or non-continuous events using burst timebase or adaptive sample rate.

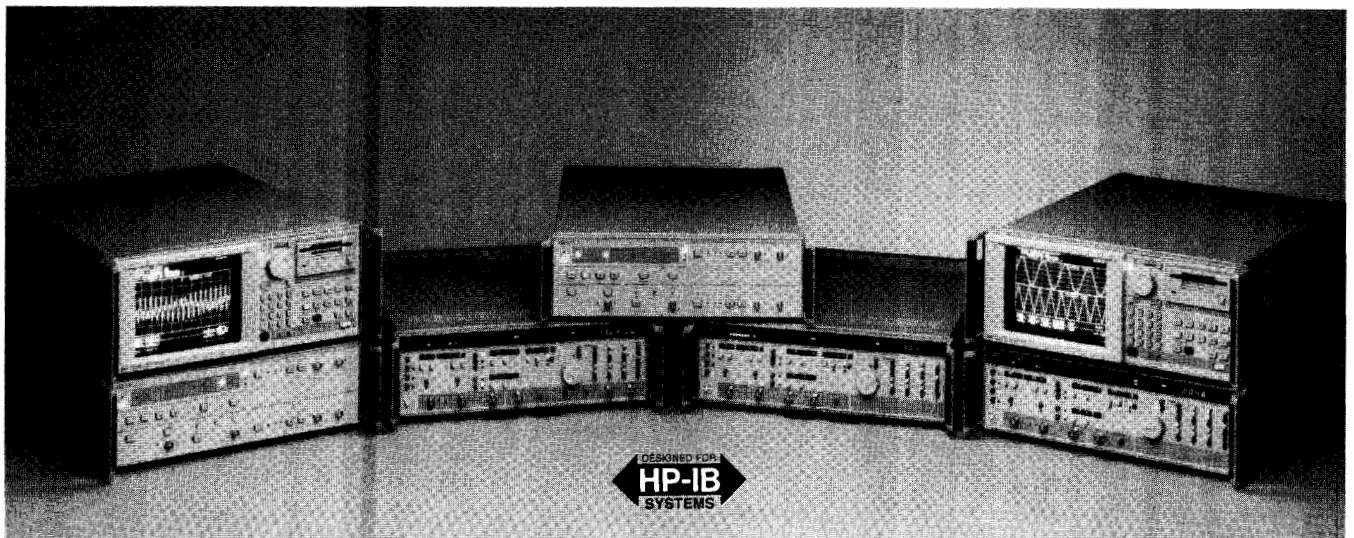

The HP 5180/83 Series Precision Digitizing Oscilloscopes . . . exceptional resolution and dynamic range plus built-in analysis features allow complete characterization of complex modulated signals.

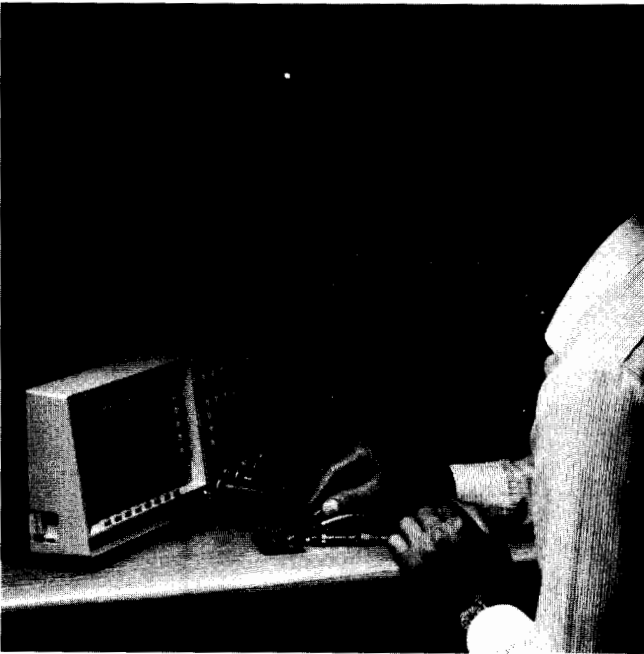

### Triggering on Complex Digital Waveforms

- Logic pattern triggering allows you to trigger on the complex events found in typical digital systems.
- Trigger holdoff can be specified by events or by time for stable triggering on long, complex sequences of events.
- Independent trigger threshold adjustments for each channel. No need to reset the trigger level each time you switch from one trigger source to another.

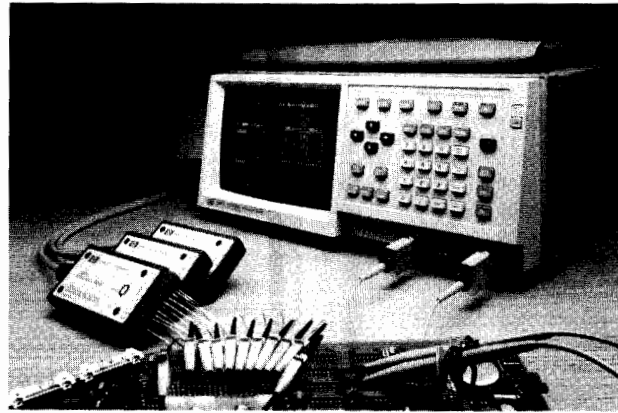

### Digital Storage

- Bright, stable display of low duty-cycle signals.
- Retain waveforms as long as desired for worst-case analysis.
- Fade-free, non-blooming display.
- Store as many waveforms as needed for comparison or reference.
- Make measurements after signal is acquired. This is especially useful on single-shot signals or infrequent error conditions.
- Waveform data available over the HP-IB.
- Signal averaging for noise rejection and increased resolution.

### Automatic Measurements

- Automatic edge finders save time, eliminate uncertainty, and reduce operator error in time-interval measurements.
- Measure pulse parameters automatically, without a controller.
- Markers indicate where the measurement was made, providing confidence in measurement results.

### Pre-trigger Display

- Find causes of events.
- Displayed time can be any time before or after the trigger, and is not limited to one screen width before the trigger. Time intervals can be measured with a resolution of parts per million, before and after the trigger.

### Store Waveforms for Comparison and Reference

- Pixel memories for overlaying multiple waveforms.
- Waveform memories for measurements and comparison of stored signals.

### Easy-to-Use

- Pressing the Autoscale button automatically sets up the time base, sensitivity, offset, and trigger for a stable display over a wide range of input signals.
- Save up to ten front panel setups in non-volatile memory; simplify a sequence of repeated measurements quickly.
- Instant hardcopy with either a pen plotter or a graphics printer eliminates time-consuming, expensive photography.
- ECL and TTL presets scale the vertical gain, offset, and trigger levels for the selected logic family. This saves time in setting up for a measurement.

### Simplified Programming

- Simple, logical, structured programming mnemonics make programs easy to edit, easy to understand, and easy to modify for new applications.
- Measurement-oriented, English-like mnemonics.

### Document Results

Active as well as stored waveforms, setup conditions, and measurement results can be printed or plotted for instant, low-cost documentation. HP printers provide report-quality hardcopy for articles or printed reports at minimal cost, and without the delay of photographic reproduction.

### Color as a Measurement Tool

The addition of color to an oscilloscope can make productivity improvements in applications performed manually as well as those involving automated measurements. Color can be combined with intensity, line types, and modulation to create easier, faster measurements with fewer errors than with a monochrome oscilloscope.

The HP 54110/111D/112D/120T can display a high-resolution, flicker-free color representation of rapidly changing data. With the nine-inch raster display, the user can work with as many as nine colors at one time, selecting these nine from a total of 4096 available. For convenience, a default nine-color palette was designed to provide optimum viewing for users in standard laboratory environments.

Adding color to an instrument such as an oscilloscope aids the user in four ways:

- it helps in differentiating between overlapping, superimposed, or similar waveforms;
- it helps in associating displayed information with corresponding data or waveforms;
- it can be used to emphasize displayed information; and
- the user can choose colors and their use to compensate for color blindness, ambient conditions, or special test requirements.

# OSCILLOSCOPES & WAVEFORM ANALYZERS

## HP Digitizing Oscilloscopes (cont'd)

HP Model #	54200A/D	54201A/D	54501A	54100A/D & 54110D	54111D	54112D
<b>Bandwidth</b> -Repetitive -Single-shot	50 MHz 50 MHz	300 MHz 50 MHz	100 MHz 1 MHz**	1 GHz 4 MHz**	500 MHz 250 MHz	100 MHz 100 MHz
<b>Time Interval Accuracy</b>	N/A 2 ns	200ps 2 ns	1 ns 100 ns	100 ps 300 ps	100 ps 300 ps	300 ps 300 ps
<b>Channels</b>	2	2	4 (2+2)	2	2	4
<b>Digitizing Rate</b>	200Msa/s	200Msa/s	10 Msa/s	40 Msa/s	1 Gsa/s	400Msa/s
<b>Memory/Channel</b>	1k sa	1k sa	500 sa (display) 1 K sa (HP-IB)	1k sa	8k sa	64k sa
<b>Vertical Resolution</b>	6 bits, 8 with avg	6 bits, 8 with avg	8 bits, 10 bits with averaging	7 bits, 10 with avg	8 bits to 25 MHz 7 bits to 100MHz 6 bits to 500 MHz	6 bits
<b>Input Voltage Ranges</b>	Cont. Var. 40mV-40V full scale	Cont. Var. 40mV-16V full scale	Continuously variable 40mV-40V full scale	7 ranges 80mV-8V full scale	Cont. Var 8mV-40V full scale	Cont. Var 40mV-40V full scale
<b>Input Coupling</b>	1 M <sup>Ω</sup> /ac,dc	1M, 50, ac,dc internal	1 M <sup>Ω</sup> , ac, dc internal	50,10K 1M pods	ac,dc, 50 ,1M internal	ac,dc, 50 ,1M internal
<b>Effective Bits</b>	—	—	—	—	5.5-7.2	5.0-5.5
<b>Pulse Parameter Measurements</b>	yes	yes	yes	yes	yes	yes
<b>Waveform Math</b>	—	A+B, A-B,	A+B, A-B, AxB, AvsB, Invert, magnify	A+B, A-B AvsB, Invert	A+B, A-B Invert	A+B, A-B Invert
<b>Other Analysis Functions</b>	Accumulate, Envelope, Averaging	Accumulate, Envelope, Averaging	Infinite Persistence, Averaging, Envelope	Infinite Pers. Avg., Magnify	Infinite Pers. Avg.	Infinite Pers. Avg.
<b>Waveform Storage</b>	4 Waveforms	4 Waveforms	2 Pixel, 4 Waveforms,	2 Pixel, 4 Waveform	2 Pixel 4 Repet. Wft 4 SS Wft	2 Pixel 4 Repet Wft 4 SS Wft
<b>Trigger Enhancements</b>	* 27 bit state Trigger, Missing/ Bit, Digital Delay	* 27Bit state Trigger, Missing/Extra bit, Digital Delay	Edge, Pattern, State, Digital Delay by Event and Time, Time-Qualified Pattern	* Edge, Pattern State, Digital Delay by Event and Time, Time Qualified Pattern	Edge, Pattern State, Digital Delay by Event and Time, Time Qualified Pattern	Edge, Pattern State, Digital Delay by Event and Time Time Qualified
<b>Timebase Enhancements</b>			Dual Timebase Windowing			
<b>Instant Hardcopy &amp; Disc Support</b>	HP Printers HP Plotters		HP Graphic Printers	HP Printers HP Plotters		
<b>Other</b>	—	—	Measurement Statistics, Measurement Limit Test,	Color Display & Color Hardcopy	Color Display & Color Hardcopy	Color Display & Color Hardcopy
<b>Price</b>	\$5900, \$9800	\$7900/9800	\$3465 (List)	\$12,900 \$17,500 \$21,100	\$26,900	\$22,900
<b>Page Reference</b>	58 COL	58	60	62	63	65

\* D Models only

\*\* 10 pts per period without reconstruction

## Compare the Features . . .

Whether you need pinpoint vertical resolution or lightning-fast signal capture, Hewlett-Packard's digitizing oscilloscopes provide a powerful set of features and capabilities in an easy-to-use interface.

Here's a look at how the various models compare in terms of features, capabilities, and price.

HP Model #	54120T	16500A Mainframe with 15530A/16531A	5180T/U	5183T/U	5185T	70700A
<b>Bandwidth</b> -Repetitive -Single-shot	20 GHz N/A	100 MHz 100 MHz	10 MHz 10 MHz	1 MHz 1 MHz	110 MHz 110 MHz	10 MHz 10 MHz
<b>Time (rep)</b> <b>Interval (s-s)</b> <b>Accuracy</b>	10 ps N/A	1 ns 1 ns	50 ns 50 ns	250 ns 250 ns	4 ns 4 ns	50 ns 50 ns
<b>Channels</b>	4	2 - 8	2/4	2/4	2	1-8
<b>Digitizing Rate</b>	N/A	400 Msa/s	20 Msa/s	4 Msa/s	250 Msa/s	20 Msa/s
<b>Memory/Channel</b>	1K sa	4K sa	8k sa	64k sa 256k sa option	64k sa	256 ksa
<b>Vertical Resolution</b>	12 bits, 14 bits with avg	6 bits, 8 bits with averaging	10 bits	12 bits	8 bits	10 bits
<b>Input Voltage Ranges</b>	Cont. Var 8mV-640mV full scale	continuously var. 40 mV-16V full scale	7 ranges 100 mV-10V full scale	9 ranges 100 mV-50V full scale	9 ranges 50mV-20V full scale	4 ranges 600 mV-20V full scale
<b>Input Coupling</b>	50 ohm	ac, dc 50 ohm, 1 Mohm	ac, dc, 1M 50 aux. ch.	ac, dc 1 Mohm	ac, dc 50 ohm 1 Mohm	ac, dc 1 Megohm, dc 50 ohm
<b>Effective Bits</b>	—	—	7.8 eff bits 60 dB	10.0 eff bits 72 dB	6.8 eff bits 48 dB	7.0 eff bits
<b>Pulse Parameter Measurements</b>	yes	yes	yes	yes	yes	yes
<b>Waveform Math</b>	A+B, A-B, AvsB, Invert, Only, Max, Min	A+B, A-B	A+B, A-B, Integration, Differentiation A*B, A+Const., A-Const., A*Const			A+B, A-B, A*B A vs B, Invert
<b>Other Analysis Functions</b>	Infinite Persistence, Averaging, Histograms, TDR, TDT	Infinite persist., averaging	Event crossings, Min/Max hold, FFT, Voltmeter, Freq counter	Event crossing, Min/Max Hold, FFT, Voltmeter, Freq counter, Inverse ASR	Event crossing Min/Max Hold FFT, Voltmeter, Freq counter	Averaging, Magnify, FFT Random Event Capture  4 Waveforms
<b>Waveform Storage</b>	2 Pixel, 4 Waveform	store to built-in disc	250-1k Wfm to optional built-in Floppy Disc			
<b>Trigger Enhancements</b>	Edge, Delay by Time	edge, pattern, delay by event, immediate	Digital Trigger Variable sensitivity, Bi-trigger, Trig Out	Digital Trig, Var sens, Bi-trig, Dropout Trig, High Freq Trig, Delay Trigger Trig Out	Var Sens, Bi-trig, pos/neg, Dropout trig, Delay trig Trig Out	Interpolated digital trigger, Edge, Level, Range
<b>Timebase Enhancements</b>		dual timebase	External Encode	External Encode, External Timebase	External Encode External Timebase Gated Timebase	
<b>Instant Hardcopy &amp; Disc Support</b>	HP Printers HP Plotters	HP printers Paintjet® 2 built-in disc drives	HP 9122 Discs and HP plotters			HP Plotters HP Printers
<b>Other</b>	Color Display	logic analysis, high speed timing, pattern generation	Optional Built-in Floppy Disc			Modular
<b>Price</b>	\$27,850	\$12,700 to \$24,700	\$36,300/ \$59,900	\$21,900/ \$32,900	\$44,000	\$7500/Channel plus Mainframe
<b>Page Reference</b>	66	258	74	73	71	122



# OSCILLOSCOPES & WAVEFORM ANALYZERS

## 200 Megasample/Second Digitizing Oscilloscopes

Models 54200A/D, 54201A/D

- Dual 200 megasample/second digitizers, allowing 50 MHz single-shot capture
- Pre-trigger viewing
- Automatic waveform measurements
- Up to 27 channels of state triggering
- Infinite variable persistence
- Instant hardcopy output
- 300 MHz repetitive bandwidth (HP 54201A/D only)

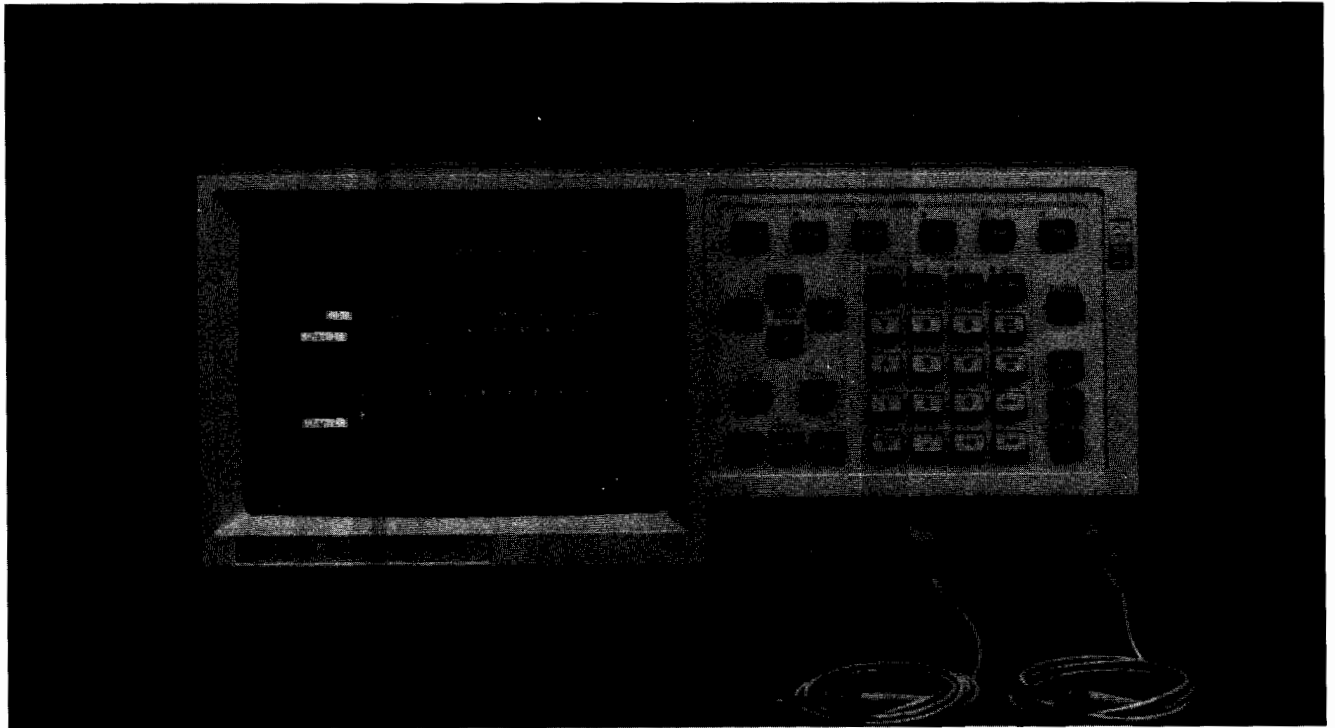

### HP 54200A/D

- Dual 200 megasample/second digitizers
  - 50 MHz bandwidth
  - Pre-trigger display
  - Auto-scaling of input signal
  - Automatic measurements of waveform parameters
  - Infinite persistence display, plus envelope and average display modes
- The HP 54200D model adds:
- Up to 27 channels of state triggering
  - Missing bit triggering mode
  - Extra bit triggering mode

### HP 54201A/D

- 300 MHz repetitive bandwidth
  - Dual 200 megasample/second digitizers
  - 50 MHz single-shot bandwidth
  - Pre-trigger display
  - Auto-scaling of input signal
  - Automatic measurements of waveform parameters
  - Infinite persistence display, plus envelope and average display modes
- The HP 54201D model adds:
- Up to 27 channels of state triggering
  - Missing bit triggering mode
  - Extra bit triggering mode

### Simplify Waveform Capture and Analysis

#### Easy Instrument Setup

- Pressing the Auto-Scale button automatically provides a scaled display of a wide range of input signals.
- Save and recall your front panel setups for quick return to previous measurements.
- ECL and TTL preset keys automatically set up vertical range, offset, and trigger levels for viewing digital signals.
- Input and memory labels aid in signal and setup identification.
- "Configuration" menu gives instrument status in a single display to aid in instrument setup and measurement documentation.
- Built-in 50 ohm switchable inputs eliminate the need for external termination devices (HP 54201A/D only).

#### Digital Storage

- Bright, fade-free, non-blooming displays.
- Waveforms can be stored for comparison or analysis. Stored waveforms can be displayed concurrently with live waveforms and can be output directly to a printer or plotter.
- Time/voltage cursors enable measurements on or between live and stored waveforms.
- Average mode improves signal-to-noise ratio on repetitive signals.
- Envelope mode saves maximum and minimum values of repetitive events for worst-case analysis.
- Accumulate mode displays multi-valued waveforms.
- Connect-the-dots mode aids signal interpretation (HP 54201A/D).

**Specifications**

Channels 1 and 2 (Vertical)	HP 54200A/D		HP 54201A/D			
<b>Acquisition Method</b>	<b>Real-time sampling</b>	<b>Real-time sampling</b>	<b>Repetitive sampling</b>			
<b>Bandwidth (-3 dB)</b> dc-coupled ac-coupled	dc - 50 MHz 10 Hz - 50 MHz	dc - 50 MHz 10 Hz - 50 MHz	dc - 300 MHz 10 Hz - 300 MHz			
<b>Transition Time</b> (10-90%, calculated from: bandwidth X trans. time = 0.35)	7 ns	7 ns	1.2 ns			
<b>Range</b> (fs calibrated with 2-digit resolution)	40 mV to 40 V		40 mV to 16 V			
<b>Gain Accuracy</b>	±2% of full-scale*					
<b>A/D Conversion (ADC) Accuracy</b>	±1.6% of full-scale					
<b>Dc Offset Acc. Chan. Range</b> 40 mV to 390 mV 400 mV to 40 V 40 mV to 790 mV 800 mV to 16 V	±1% (offset) ±5mV ±1% (offset) ±50mV		±1% of offset ±5mV ±1% of offset ±100mV			
<b>Voltage Meas. Accuracy (dc)</b> Single cursor (X or 0) Dual cursor (X to 0 on same waveform)	Gain accuracy + ADC accuracy + offset accuracy Gain accuracy + 2 (ADC accuracy)					
<b>Input Coupling</b>	ac, dc					
<b>Input Resist. (Nominal)</b>	1 MΩ		1 MΩ; 50Ω dc coupling			
<b>Input Cap. (Nominal)</b>	14 pF		10 pF			
<b>Maximum Safe Input Voltage</b>	±40V (dc+pk ac)		1 MΩ: ±40V (dc+peak ac) 50Ω: 5 Vrms or ±40V (dc + peak ac), whichever is less			
<b>Input (dc+pk ac) Operating Range</b> Channel range 40 mV to 390 mV 400 mV to 40 V 40 mV to 16 V	±2 V ±20 V		±1 vertical range from center			
<b>Dc Offset Range/resolution</b>	Channel Range	Offset Range	Offset Res.	Channel Range	Offset Range	Offset Res.
	40 mV/390 mV	±2 V	~1.2 mV	40 mV/790 mV	±1.5 V	1 mV
	400 mV/40 V	±20 V	~12 mV	800 mV/16 V	±30 V	20 mV

\*Specifications apply within ±10° C of auto-calibration temperature.  
 \*\*Dual-cursor specs apply for measurements made on the same or simultaneously-acquired waveforms.  
 \*\*\*Provides 10:1, 1MΩ input at HP 10017A or HP 10018A probe tip.  
 Notes: specifications apply after a 30-minute warmup period. Single-shot reconstruction uncertainty equals ±1 ns (applies for time ranges of 50 ns through 2 μs).

<b>Ordering Information</b>	<b>Price</b>
HP 54200A 50 MHz digitizing oscilloscope	\$3950
Opt W30 Service Extension	\$120
HP 54200D 50 MHz, logic triggering digitizing oscilloscope	\$10,100
Opt W30 Service Extension	\$200
HP 54201A 300 MHz digitizing oscilloscope	\$7950
Opt W30 Service Extension	\$300
HP 54201D 300 MHz, logic triggering digitizing oscilloscope	\$9950
Opt W30 Service Extension	\$380

<b>Time Base (Horizontal)</b>	HP 54200A/D		HP 54201A/D			
<b>Acquisition Method</b>	<b>Real-time sampling</b>		<b>Real-time sampling</b>	<b>Repetitive sampling</b>		
<b>Range</b> (10 div.), 1-2-5 sequence	50 ns - 10 s full-scale			10 ns - 20 μs full-scale		
<b>Time Base Accuracy</b> single/dual cursors	±2 ns or ±0.2% of time range, whichever is greater.**			±200 ps or ±2% of time range, whichever is greater.**		
<b>Delay (Time Offset)</b> Pre/Post-trigger range	Time Range	Pre-trigger Range	Post-trigger Range	Time Range	Pre-trigger Range	Post-trigger Range
	50 ns to 5μs	up to 5μs	up to 1 ms	Real-time Sampling Mode		
	10μs to 10s	up to 1 screen diameter	up to 260 screen diameters	50 ns to 5μs	up to 10μs	at least 200 screen dia.
				10 μs to 10s	up to 2 screen diameters	at least 200 screen diameters
				Repetitive Sampling Mode		
				10ns to 20μs	up to at 2 screen diameters	least 200 screen diameters
<b>Pre/Post-trigger resolution</b>	Adjustable in steps of 0.1 (coarse) and 0.004 (fine) screen diameters, or the LSB digit, whichever is greater.			Adjustable in steps of 0.1 (coarse) and 0.001 (fine) screen diameters, or the LSB digit, whichever is greater.		

<b>Trigger (Analog)</b>	HP 54200A/D		HP 54201A/D		
<b>Acquisition Method</b>	<b>Real-time sampling</b>		<b>Real-time sampling</b>	<b>Repetitive sampling</b>	
<b>Sources</b>	Chan. 1, chan. 2, external trig. input		Chan. 1, chan. 2	External trigger input	
<b>Sensitivity</b>	1/8 of full-scale (dc - 50 MHz)		1/8 of full-scale (dc-250MHz)	500:60 mV - 250 MHz .2MΩ:1V (dc/100 MHz)***	
<b>Trig. Range</b> Chan. range 40 mV - 390 mV 400 mV - 40 V 40 mV - 16 V	±2 V ±20 V			±1.5 X fs ±2 V	
<b>Resolution</b> Chan. range 40 mV - 390 mV 400 mV - 40 V 40 mV - 16 V	~2.4 mV ~24 mV			.02 X fs 20 mV	
<b>Level Acc.</b> Chan. range 40 mV - 390 mV 400 mV - 40 V 40 mV - 790 mV 800 mV - 16 V	±2% ±5 mV ±2% ±50 mV			±*3% ±5 mV ±3% ±100 mV ±3% ±30 mV	
<b>External Trig. Input</b>	HP 54200A/D		HP 54201A/D		
<b>Acquisition Method</b>	<b>Real-time sampling</b>		<b>Real-time sampling</b>	<b>Repetitive sampling</b>	
<b>Input Resist. (Nominal)</b>	1 MΩ		50 Ω	.2M Ω***	
<b>Input Coupling</b>	ac, dc		dc	dc	
<b>Maximum Safe Input Voltage</b>	±40V (dc+peak ac)		5 Vrms or ±40V (dc+pk ac), whichever is less.	±40V (dc + peak ac)	
<b>Input Oper. Range</b>	Same as chan. 1 and chan. 2 inputs.		±5 V (dc + peak ac)		

# OSCILLOSCOPES & WAVEFORM ANALYZERS

## Digitizing Oscilloscopes

### Model 54501A

- 100 MHz Bandwidth
- 4 Channels
- Fully Programmable
- 16 Automatic Pulse Parameter Measurements
- Dual Time Base Windowing
- Automatic Limit Testing
- Three-year Warranty
- \$3,465 List Price

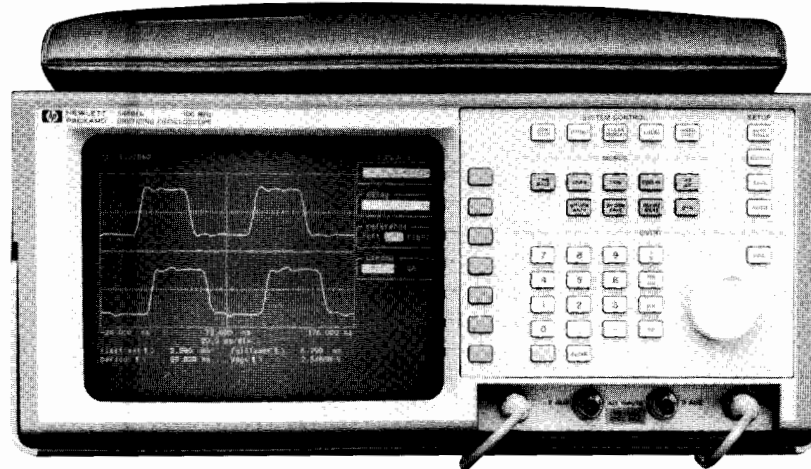

### The HP 54501A Digitizing Oscilloscope Brings You Affordable Digitizing Performance.

#### Get the Digitizing Advantage

The HP 54501A is a full-featured, 100 MHz, four-channel digitizing oscilloscope with features and functions that were previously available only on considerably higher priced instruments. Like the HP 54100 and 54200-series digitizing oscilloscopes, this instrument includes all of HP's digitizing advantages, such as Autoscale, push button hardcopy output to HP graphics printers, 16 automatic measurements, non-volatile setup and waveform memories, and full HP-IB programmability.

#### Affordable Automation

The HP 54501A's fully-programmable setup and data acquisition capabilities can be used with your HP Vectra, IBM, or other compatible personal computer. The oscilloscope's built-in HP-IB interface, its simplified, self-documenting programming language and high data throughput rate provide a modestly-priced, yet powerful automated test system.

#### Easy to Use

The Model 54501A is the easiest-to-use digitizing oscilloscope HP has ever offered. It has a new, simplified user interface that makes front-panel adjustments intuitive and straightforward. Adjustments are made with a single front-panel knob or numeric keypad. Automatic measurements, hardcopy output or instrument setup are performed with a single keystroke.

#### Advanced Logic and TV Triggering

HP's advanced logic triggering is a standard feature on the HP 54501A. Use it to trigger on a wide variety of user-specified conditions. Trigger on Edge, Pattern, State or Trigger-after-delay to capture such elusive events as timing violations or transient bus phenomena. Trigger on glitches as narrow as 7 ns.

Select line and field for a variety of video waveforms. The Model 54501A makes it easy to focus on the video information you need to capture.

#### Measurement Limit Test

The HP 54501A can automatically characterize a circuit or device over temperature or time — without human supervision. Specify upper and lower limits for any three of the instrument's automatic measurements, and leave it running unattended. If a measurement exceeds the pre-defined limits, the current waveform, measurements and other display data can be automatically stored or transferred to an external printer or controller.

The instrument can automatically calculate maximum, minimum, average and most-recent values for all measurements, making device or circuit characterization even more accurate.

#### Dual Time Base Windowing

Dual time base windowing lets you zoom in on fine details of the waveform you are measuring. Similar to the dual-delayed sweep feature found on some analog oscilloscopes, dual time base windowing gives you a time-expanded view of a smaller portion that is defined by you with the instrument's easy-to-use cursors.

#### Lightweight and Portable

The HP 54501A weighs only 22 lbs., and is easily transported. Its small size allows it to fit easily in the trunk of a car, making it ideal for field applications. An optional soft carrying case is also available, as well as a sturdy transit case for safe shipment of the instrument.

## HP 54501A Specifications

### Vertical (Voltage)

#### Bandwidth

dc-coupled:

Repetitive dc to 100 MHz (-3dB)

Single Shot dc to 1 MHz

(Based on 10 points per period of input signal.)

ac-coupled:

Repetitive 10 Hz to 100MHz (-3dB)

Single Shot 10 Hz to 1 MHz (Based on 10 points per period of input signal.)

#### Risetime: 3.5 ns

(calculated from

$$\text{Risetime} = \frac{0.35}{\text{bandwidth}}$$

#### Number Of Channels 4 (2+2)

(Channels 2 and 3 are limited attenuator inputs, optimized for digital signals.)

#### Simultaneous Channels 2+2

Channels 1 and 4 are acquired simultaneously. If four channels are used, data is acquired alternately by channels 1 and 4, then 2 and 3.

**Vertical Sensitivity** Maximum 5 mV/div  
Minimum 5 V/div

#### Vertical Gain

**Accuracy (dc)** ± 1.5%

**Vertical Resolution** ± 0.4% — 8 bit A/D

(Since expansion is used for 5 mV/div range, A/D resolution is 7 bits 0.8% in that range.)  
± 0.1% — 10 bits via HP-IB (with averaging)

**Maximum Sample Rate** 10 Megasamples/second

**Memory Depth** 501 points (display)

1024 points (via HP-IB)

For single-shot via HP-IB, maximum memory depth is 501 points.

For 2ns/div time base range, memory depth is 200 points.

For 5ns/div time base range, maximum memory depth via HP-IB is 501 points.

**Input RC (nominal)** 1 M Ω, 16 pF

**Input Coupling** ac, dc

**Max Input Voltage** ± 250 V DC + peak AC (<10KHz)

Offset Range	Sensitivity range	Available offset
	5 - 50 mV/div	±2V
	0.1 - 1 V/div	±20V
	1 - 5 V/div	±200V

**Offset Accuracy** ± 2% of offset ± 0.2 X (V/div)

± 0.075 division/Δ° C from calibration temperature

**Dynamic Range** ± 16 divisions from center

Operating range for dc + peak AC input.

**Channel-to-channel** 40 dB dc to 20 MHz

**Isolation** 30 dB 20 MHz to 100 MHz

(with channels at equal sensitivity)

#### Voltage Measurement Accuracy

Single Cursor Gain Accuracy + offset accuracy + A/D resolution

Dual Cursor Gain Accuracy + (2 x A/D resolution)

(single channel)

### Horizontal (Time)

**Time Base Range** Minimum 2 ns/div  
Maximum 5 s/div

**Time Base Accuracy** .005%

**Maximum Time Base**

**Resolution** 100 ps

**Delta t Accuracy** 1 ns ± (5E-5) x delta t ± .02 x (t/div)

Delta-t accuracy for dual-cursor, single-channel measurement, or for channel-to-channel measurement after visual time null calibration has been performed.

Delay Range (post-trigger)	Time Base Setting	Available Delay
	50 ms - 5 s	40 x (s/div)
	100 μs - 20 ms	1 s
	2 ns - 50 μs	10,000 x (s/div)

#### Delay Range (pre-trigger)

10 us - 5 s	-40 x (s/div)
20 ns - 5 μs	-200 μs
2 ns - 10 ns	-10,000 x (s/div)

### Triggering

#### Trigger Sensitivity

5mV/div dc-20MHz, 0.1 x full-scale

20MHz-100MHz, 0.25 x full-scale

All Other dc-20MHz, 0.05 x full-scale

20MHz-100MHz, 0.125 x full-scale

**Trigger Pulse Width** 7 ns

(minimum)

**Trigger Level Range** ± 6 div from center

(Specifications valid for temperature range ± 10° C from calibration temperature with 8 averages selected and channel (s) in sensitivity range 1, 2 or 5)

### Ordering Information

The HP 54501A digitizing oscilloscope comes complete with two HP 10432A 10:1 10 MΩ probes, an Operating and Programming Manual, a Service Manual, one miniature-probe-to-BNC male adapter, a power cord and a three-year warranty.

**HP 54501A** Digitizing Oscilloscope \$3,465

**Opt 908** Rackmount Kit (5061-6175) \$250

**Opt 910** One additional Operating/Programming manual (54501-90901) and one additional \$75

Service manual (54501-90902)

**Opt 090** Delete Probes -\$200



# OSCILLOSCOPES & WAVEFORM ANALYZERS

## Digitizing Oscilloscopes

Models 54100A/D, 54110D

- 1 GHz bandwidth
- Auto pulse parameter and time interval measurements
- Digital storage
- Available with color or monochrome display
- Pre-trigger viewing
- Logic triggering capability

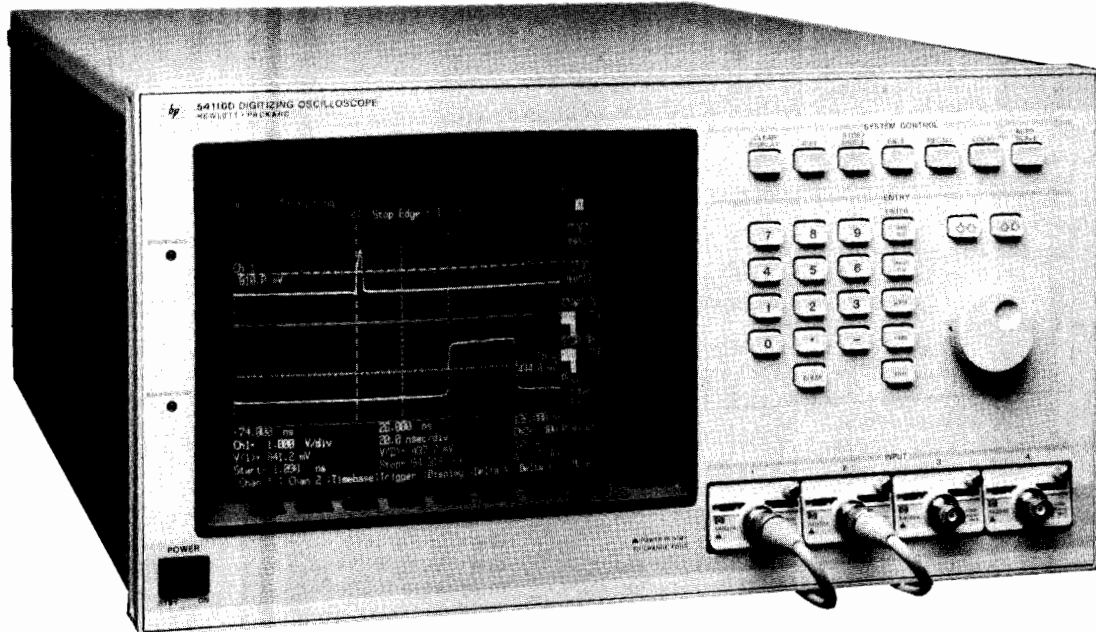

HP 54110D



### HP 54100A/D and HP 54110D

As the speeds of analog and digital logic continue to increase, board and system designers need to pay even closer attention to high-frequency and transmission-line characteristics of their circuits. Design requirements are rigorous. Subnanosecond technology creates narrow and elusive pulses.

#### High Bandwidth

The HP 54100/110 unite a powerful 1 GHz bandwidth with a random repetitive sampling technique for viewing rarely occurring narrow waveforms. These oscilloscopes have 0.002% time base accuracy, 50 ps aperture jitter, and 10 ps resolution for confident measurements of critical timing parameters in high-speed circuitry.

With random repetitive sampling, you can capture waveforms that occur thousands of screen diameters before the trigger event. This gives an effective memory depth of millions of bytes for finding causes of failures that occur long before the trigger.

#### High Resolution

Analyze perturbations within a waveform with high resolution. With vertical magnification and waveform averaging, small signal details can be viewed and measured with 10 bits of effective resolution.

#### Flexible Analysis

Only the HP 54100A/D and HP 54110D allow the display of either vertical channel versus the other. The 1 GHz bandwidth makes this feature valuable in measuring high-speed I-V device characteristics and transfer functions high-speed converters.

#### The HP 54100A/D

When a monochrome display is preferred, for example in a totally automatic test application, choose the HP 54100A or HP 54100D oscilloscope. These units require less rack height (7") than the HP

54110D (8.75") and have all of the same measurement features and specifications. The HP 54100A has one external trigger input, while the HP 54100D and HP 54110D have two.

#### Ordering Information

HP 54100A 1GHz Digitizing Oscilloscope	\$12,900
Opt W30 Service Extension	\$350
HP 54100D 1GHz Digitizing Oscilloscope	\$17,600
Opt W30 Service Extension	\$350
HP 54110D 1GHz Digitizing Oscilloscope with color display	\$21,900
Opt W30 Service Extension	\$426

#### Input Pods and Probes

HP 54001A 1 GHz miniature active probe pod	\$765
HP 54002A 50 ohm BNC input pod	\$130
HP 54003A 1-megohm, 10:1 probe pod	\$165

#### A Choice of Input Pods and Probes

The HP 54100/110 inputs are configured with removable pods that can be chosen according to the application. Pods can be changed quickly and easily, and they occupy a minimum of storage space.

- 50 ohm inputs and probes for a wide variety of environments, without the expense of amplifier plug-ins.
- 1 GHz miniature active probes for densely packed, high-speed logic circuits.
- 1 Mohm probes for circuits sensitive to resistive loading.
- 50 ohm BNC inputs for measurements where terminated lines are important.
- 100:1 probes for extended dynamic range.

For more information on the HP 54100/110's probing system, please refer to page 80.

- 2 Gigasample/second, one channel when used with HP 54114A
- 500 MHz repetitive bandwidth
- 8k memory depth
- PaintJet color hardcopy output

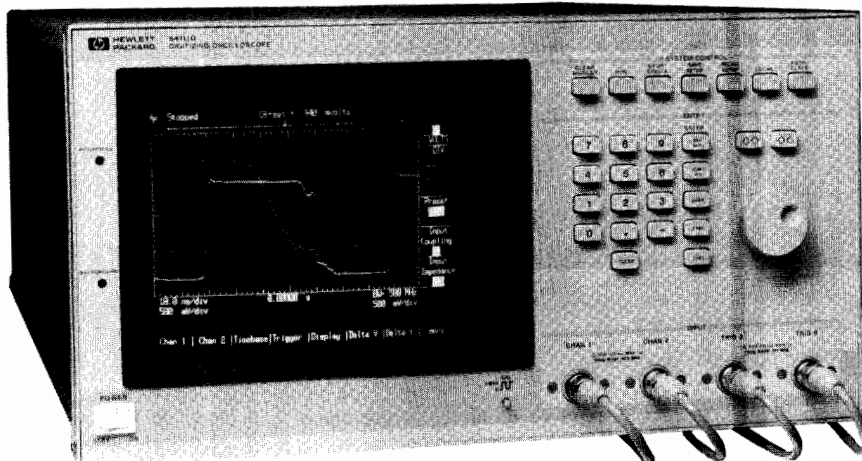

The HP 54111D features a 1 gigasample/second digitizing rate and a 500 MHz bandwidth.

#### HP 54111D: High-speed General-Purpose Scope

The HP 54111D is a 1 gigasample/second, two channel (2 gigasample/second one channel when used with HP 54114A 2 gigasample/second test set) digitizing oscilloscope with a memory depth of 8k samples per channel. The HP 54111D retains all of the key features and user friendliness of the HP 54100/110 oscilloscopes . . . such as automatic measurements, autoscaling, cursors, and a color display. Plus, the HP 54111D adds features necessary for controlling and managing the added memory depth, such as scroll, zoom, and memory bar.

#### Key Contributions

- 2 gigasamples/second digitizing rate (maximum)
- 500 MHz bandwidth
- 8k memory per channel
- Up to eight bits of vertical resolution with bandwidth limits
- Two channels of simultaneous capture at up to 1 GSa/s
- Pre-trigger information
- Automatic measurements
- Fully HP-IB programmable
- Advanced Logic triggering capabilities
- Instant hardcopy output

#### General-purpose to Special Applications

With a 2 gigasample/second digitizing rate, the HP 54111D gives you the fastest sampling rate available in a general-purpose digitizing oscilloscope. However, the HP 54111D is much more than an instrument for capturing fast single-shot transients. With random repetitive sampling, this instrument provides a bandwidth of 500 MHz for high-speed circuit design and test.

In addition to its single-shot and repetitive capabilities, the HP 54111D provides flexible input coupling with a side dynamic range for viewing and analyzing a variety of signals. Use this scope for just about any general-purpose application from very slow to very high-speed repetitive or non-repetitive waveforms.

#### Memory Bar Simplifies Data Viewing

The HP 54111D provides 8k samples of memory per channel. This results in 16 screens of waveform information in each real-time or

single-shot acquisition cycle. To simplify management of all this data, the HP 54111D displays a memory bar. The memory bar is displayed along the top edge of the graticule and shows the portion of memory being viewed relative to the entire memory record. In addition, the trigger point is also shown along the memory bar.

#### Ultra High Digitizing Rate

No longer do you need a manual analog storage oscilloscope to capture high-speed single-shot phenomena found in:

- high-speed pulse analysis
- nuclear test studies
- plasma discharge
- high voltage arcing
- high frequency bursts

All these single-shot events can be captured easily at 2 GSa/s, with 4  $\mu$ s of data stored for review and analysis.

#### High-speed ECL Design

Non-repetitive glitches appearing on the clock signal can be captured easily with the 500 MHz single-shot performance of the HP 54111D with the HP 54114A two gigasample/second test set. Four  $\mu$ s of pre-trigger data is invaluable for determining the cause of the glitch.

#### High-speed Semiconductor Design

Single-shot performance of 500 MHz permits you to measure the outputs from latches (i.e., one-time events for multiple clock periods in ECL circuits).

#### Laser and High Energy Research

Photo detector pulses can be measured via single-shot capture using the 2 GHz sampling rate and built-in automatic measurements. Infinite persistence can also be used to show and measure maximum variations of the waveform to the 500 MHz bandwidth.

The HP 54111D's two simultaneous 1 gigasample/second channels give you the single-shot performance of the most advanced analog storage oscilloscopes, but with all the advantages and ease of use of a digitizing oscilloscope. And with a staggered over-sampling technique, the HP 54111D provides this single-shot performance with up to eight bits of non-blooming vertical resolution.

# OSCILLOSCOPES & WAVEFORM ANALYZERS

## Digitizing Oscilloscopes (cont'd)

Models 54100A/D, 54110D

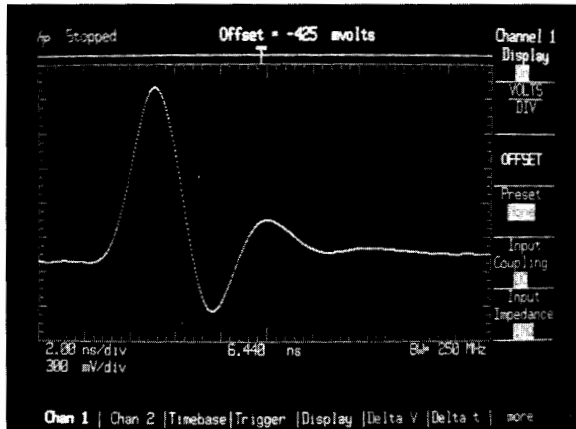

With its 1 gigasample/second digitizing rate, the HP 54111D was able to capture this laser pulse single-shot.

### Data Communications

Combine 1 gigasample/second digitizing rate with eight kbytes of memory depth per channel, and you have an invaluable tool for analyzing high-speed serial waveforms such as data communications or radar testing.

### High Bandwidth Applications

Not only is the HP 54111D digitizing oscilloscope useful for single-shot phenomena, but it also samples repetitively, giving you 500 MHz bandwidth with high signal fidelity. Use this scope for just about any general-purpose application from very slow to very high-speed repetitive or non-repetitive waveforms.

### Computer-aided Test

The HP 54111D has many features that make it an excellent tool in computer-aided test. Its repetitive bandwidth and digitizing rate allow it to cover a wide range of automatic measurement applications. In addition, this instrument has many features that enhance test throughput time, such as built-in automatic measurements, fast acquisition cycles, and deep memory.

### Input Range and Conditioning

The HP 54111D has the widest input dynamic range and coupling capabilities of any of our digitizing oscilloscopes. The input sensitivity can be set from 1 mV/div to 5 V/div. In addition, all input coupling is internal and programmable. The selections include: ac, dc, 1 megohm, 50 ohms, and GND. These input signal conditioning features make the HP 54111D more general-purpose for the circuit designer and test engineer.

### HP 54111D Specifications

#### Vertical (Voltage)

Channels: 2

	Single-shot		Repetitive
	two channel	one channel with HP 54114A	
Bandwidth	250 MHz	500 MHz	500 MHz
Transition Time	1.4 ns	700 ps	700 ps
Resolution/BW	8 bits/25 MHz, 7 bits/100 MHz 6 bits/250 MHz	8 bits/50 MHz 7 bits/200 MHz 6 bits/500 MHz#	6 bits, 8 bits with averaging

**Gain Accuracy:**  $\pm 2\%$  of full-scale\*\*

**Dc Offset Accuracy:**  $\pm 1.5\%$  of setting

#### Measurement Accuracy

Single data point:  $\pm$ gain acc  $\pm$  offset acc  $\pm$  resolution

Between data points on the same waveform:  $\pm$ gain acc  $\pm 2 \times$  resolution

**Dc Offset Range:**  $\pm 200$  mV (1 mV/div to 4.9 mV/div)  
 $\pm 1$  V (5 mV/div to 49 mV/div)  
 $\pm 10$  V (50 mV/div to .49 V/div)  
 $\pm 100$  V (.5 V/div to 5 V/div)

**Input Coupling:** ac/dc/dc-50 ohms/Gnd

**Input Impedance:** 1 Mohm at 6.5 pF or 50 ohm (dc)

**Maximum Safe Input Voltage:**  $\pm 40$  V at 1 Mohm (dc + peak ac), 5 V rms at 50 ohms

### Horizontal (Time)

**Digitizing Rate:** 1 gigasamples/second to 50 samples/second

**Deflection Factor:** 500 ps/div to 1 s/div

**Memory Depth Per Channel:** 8k (8  $\mu$ s at 1 gigasample/second), single-shot only.

**Pre-trigger Delay Range:**  $-8 \mu$ s at timebase settings 50  $\mu$ s/div and less, increasing to  $-160$  seconds at 1 s/div.

**Post-trigger Delay Range:** .16 seconds at timebase settings .5  $\mu$ s/div and less, increasing to 10k seconds at 1 s/div.

	Single-shot	Repetitive
Time Measurement Accuracy		
single channel	$\pm 300$ ps $\pm .03\%$ of reading	$\pm 100$ ps $\pm .03\%$ of reading
dual channel	$\pm 600$ ps $\pm .03\%$ of reading	$\pm 200$ ps $\pm .03\%$ of reading
<b>Triggering</b>		
Sources	Internal Chan 1,2	Ext. Inputs 3,4
Sensitivity		
single-shot	0.1 of full scale, dc to 200 MHz***	15 mV (1:1), dc to 200 MHz
repetitive	0.2 of full scale, 200 MHz to 500 MHz ***	45 mV (1:1), 200 MHz to 500 MHz
Trigger Level Range	$\pm 3 \times$ full scale	$\pm 1$ V (1:1)
Input Resistance	NA	1 Mohm
Maximum Input Safe Voltage	NA	$\pm 10$ V, dc + peak ac
Input Operating Range	NA	$\pm 1$ V(1:1), dc + peak ac

\*Bandwidth for settings 1 mV/div to 4.9 mV/div is reduced to 150 MHz.

\*\*When calibrated to probe tip using front panel calibration source. Applies to major ranges (5 mV/div, 10 mV/div, 20 mV/div, 50 mV/div, 100 mV/div, 200 mV/div, 500 mV/div, 1 V/div, and 2 V/div). All continuous settings between these ranges are  $\pm 3\%$  of full-scale.

\*\*\*Applies to settings 5 mV/div and above.

#Raw Data

### Ordering Information

	Price
<b>HP 54111D</b> 1 gigasample/second digitizing oscilloscope	\$26,900
Option 114	\$1625
Adds HP 54114A 2 gigasample/second test set	
Opt W30 Service Extension	\$480

- 64k memory depth per channel
- Quad 400 megasamples per second digitizing
- Four channels

- 100 MHz bandwidth (single-shot and repetitive)
- PaintJet color hardcopy output

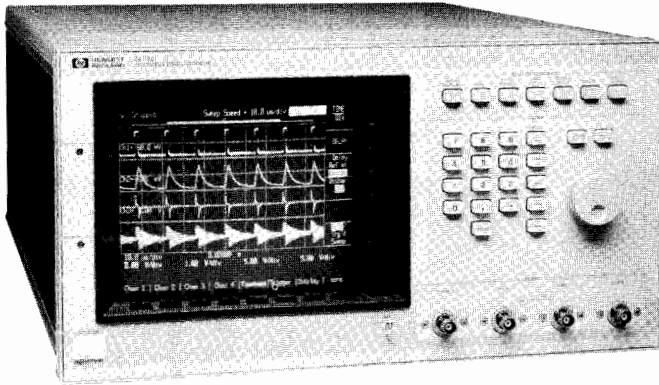

HP 54112D



### HP 54112D: Four Channel Deep Memory Scope

The HP 54112D is a 400 megasample per second, four channel digitizing oscilloscope with 64k samples of memory depth per channel. The HP 54112D retains all the key features and the user friendliness of the HP 54100 series scopes. These features include automatic measurements, autoscaling, cursors, functional color display, scroll, zoom, and memory bar.

#### Key Contributions

- 400 megasamples per second digitizing rate
- 100 MHz repetitive and single-shot bandwidth
- 64k memory per channel
- Four channels of simultaneous capture at the full digitizing rate
- 160  $\mu$ s of pre- or post-trigger information minimum
- Automatic measurements
- Fully programmable
- Advanced Logic triggering capabilities
- Instant hardcopy output

#### Automatic Test Environment

The English-like commands and logical structure of HPOL (Hewlett-Packard Oscilloscope Language) make programming the 54100 series scopes in computer aided test a much easier task. The learning curve is greatly reduced.

The four channels, built-in automatic measurements and very deep memory of the 54112D improve the throughput of ATE systems. Data that used to take many acquisitions passes can now be captured in one.

#### General Purpose Inputs

The fully programmable input impedance and coupling of the four channels allow the user to choose 1 megohm impedance AC or DC coupled or 50 ohm DC coupled on each channel.

### HP 54112D Specification - Vertical (Voltage)

Channels:	4	
Bandwidth	Single-shot	Repetitive
dc-coupled	dc to 100 MHz	dc to 100 MHz
ac-coupled	10 Hz to 100 MHz	10 Hz to 100 MHz
Transition Time (10% to 90%)	3.5 ns (nominal)	3.5 ns (nominal)
Deflection Factor (full scale=8 div)	5 mV/div to 5 V/div continuous	
Resolution	6 bits	6 bits, 8 bits with averaging

**Gain Accuracy:**  $\pm 2\%$  of full-scale\*

**Dc Offset Accuracy:**  $\pm 1.5\%$  of setting

#### Measurement Accuracy

single data point:  $\pm$ gain acc $\pm$ offset acc $\pm$ resolution.  
between data points on same waveform:  $\pm$ gain acc  $\pm 2 \times$  resolution.

**Dc Offset Range:**  $\pm 1$  V (5 mV/div to 49 mV/div)  
 $\pm 10$  V (50 mV/div to .49 V/div)  
 $\pm 40$  V (.5 V/div to 5 V/div)

**Input Coupling:** ac/dc/dc-50 ohms

**Input Impedance:** 1 Mohms at 6.5 pf or 50 ohms

**Maximum Safe Input Voltage:**  $\pm 40$  V at 1 Mohm (dc + peak ac)  
5 V rms at 50 ohms

\* When calibrated to probe tip using front panel calibration source. Applies to major ranges (5 mV, 10 mV, 20 mV, 50 mV, 100 mV, 200 mV, 500 mV, 1 V and 2 V). All continuous settings between these ranges are  $\pm 3\%$  of full scale.

### Horizontal (Time)

**Digitizing Rate:** 400 Megasamples/second to 50 samples/second.

**Memory Depth Per Channel:** selectable either 64k or 8k in single-shot only.

**Pre-trigger Delay Range:**  $-160 \mu$ sec at timebase settings of 125 ns/div and less, increasing to  $-1200$  seconds at 1 second/div.

**Post-trigger Delay Range:** .16 sec at timebase settings .5  $\mu$ sec/div and less, increasing to 10,000 seconds at 1 s/div.

Time Measurement Accuracy	
single channel	$\pm 500$ ps $\pm .002\%$ of reading
dual channel	$\pm 1$ ns $\pm .002\%$ of reading

### Triggering

**Sources:** internal chan. 1,2,3,4 and external input.

#### Sensitivity

**Internal:** 0.1 of full-scale

**External:** 10 mV (1:1)

#### Trigger level range:

**Internal:**  $\pm 3 \times$  full scale

**External:**  $\pm 5$  V (1:1)

#### External trigger input

**Input resistance:** 200k ohms

**Maximum input safe voltage:**  $\pm 40$  V dc + peak ac.

**Input operating range:**  $\pm 5$  V (1:1) dc + peak ac.

### Ordering Information

**HP 54112D** 4 channel 64k memory/channel digitizing oscilloscope.

Opt W30 Service Extension

### Price

\$22,900

5440



# OSCILLOSCOPES & WAVEFORM ANALYZERS

## Digitizing Oscilloscopes (cont'd)

### Models 54120T, 54118A

- 20 GHz bandwidth
- 10 ps time interval accuracy
- Histograms
- True triggering to 18 GHz (only on 54118A)
- TDR
- Paint job hardcopy output

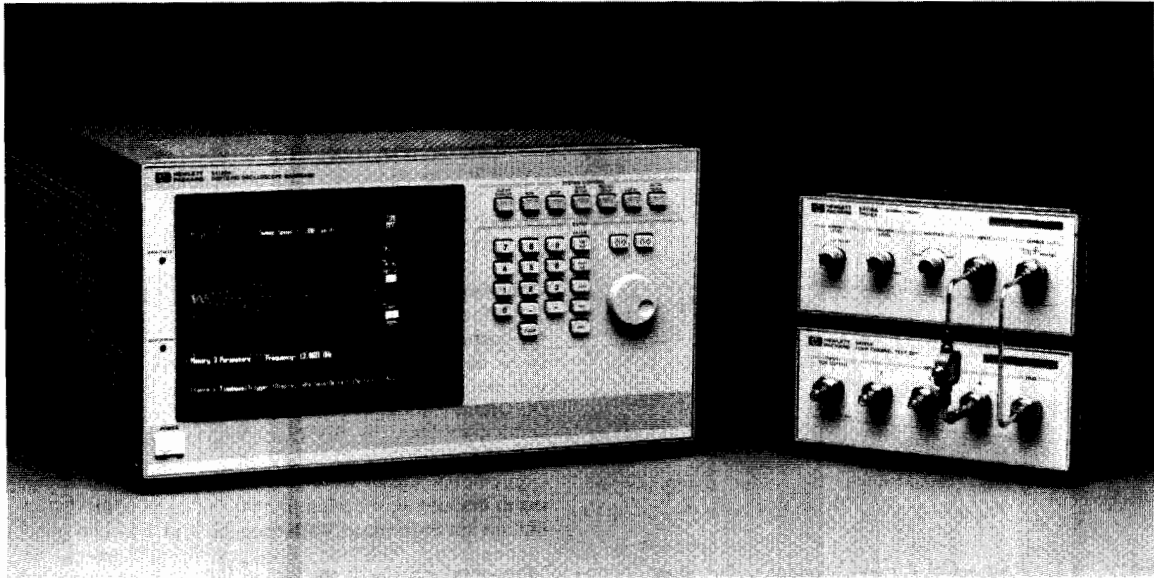

HP 54120T, HP 54118A



### HP 54120T-20 GHz Bandwidth, 10 ps Time Interval Accuracy

The HP 54120T Digitizing Oscilloscope combines a 20 GHz bandwidth, a time domain reflectometer, four input channels and superb stability in an easy-to-use, fully-programmable instrument. Whether your application involves high-speed device and circuit characterization, microwave and RF measurements, or high-speed datacom analysis, this new instrument will give you a new confidence in state-of-the-art measurements.

#### Key Specifications

- dc-20 GHz bandwidth
- 17.5 ps risetime
- 10 ps time interval accuracy
- 0.25 ps time interval resolution
- 10 ps/div-1 s/div timebase
- 0.4% vertical accuracy
- 32  $\mu$ V resolution
- 1 mV/div-80 mV/div vertical sensitivity
- Automatic pulse-parameter measurements
- Fully programmable
- Pushbutton hardcopy documentation
- Four input channels
- Step generator with 35 ps risetime and 1% flatness
- Reflection (TDR)/Transmission (TDT) normalization<sup>1</sup>
- Time and voltage histograms

#### Pluses over the competition

The HP 54120T's 0.25 ps time interval resolution and 10 ps time interval accuracy reduce the scope's contribution to errors in digital timing measurements in semi-conductors and computers.

### True Event Triggering to 18 GHz - the HP 54118A Trigger

The HP 54118A 500 MHz to 18 GHz trigger makes event triggering at microwave frequencies a reality. No longer are you restricted to the use of countdown synchronizers to use your oscilloscope up to 18 GHz. Trigger on the carrier of a pulsed RF signal, CW signals with a large noise component or the output of a microwave component and make measurements that till now were not possible.

### Probe The Inaccessible-The HP 54006A Resistive Divider Probe Kit

The HP 54006A, 10:1 500 ohm and 20:1 1 kohm, 6 GHz resistive divider probe kit gives access to signal points that previously avoided inspection. Now designers can see what the waveform looks like at the input to a GaAs gate, instead of having to settle for what it looks like at the end of a 50 ohm cable.

### Precision Low-loss Measurements-The HP 54007A Accessory Kit

The HP 54007A Accessory Kit provides an assortment of parts with APC-3.5 connectors for low loss measurements. This kit is highly recommended for low loss reflection/transmission measurements. The kit includes low loss 50 ohm coaxial cables, coaxial shorts, coaxial 50 ohm terminations, 7.5 cm airline, 6 dB and 40 dB attenuators, and a power splitter.

1. Normalization utilizes the Bracewell transform which is under license from Stanford University.

### Quantify Noise and Jitter

Time and Voltage histograms, which quantify jitter and noise measurements, characterize the eye pattern in data communications applications. Eye height and width, location of the one or zero, are all easily found with histograms.

### Eliminate Reflections With TDR

Ring and waveform distortion can be eliminated by using time domain reflectometry to locate and remove discontinuities in transmission line systems.

### HP 54120T Specifications

#### Channels (Vertical)

	20 GHz Bandwidth Mode (average mode only)	12.4 GHz Bandwidth Mode (average or persistence modes)
Bandwidth (-3 dB)	dc to 20 GHz, Chs 2, 3, & 4 (Ch 1 is -3.5 dB @ 20 GHz) dc to 18 GHz, Ch 1	dc to 12.4 GHz
Transition Time (10% to 90%) (calculated from $T_r = .35/BW$ )	≤ 17.5 ps, Chs 2, 3, 4 ≤ 19.4 ps, Ch 1	≤ 28.2 ps
dc Accuracy, Single Voltage Marker	Average mode: ± 0.4% of full-scale ± 2 mV Persistence mode: ± 0.4% of full-scale ± 2 mV ± 3.0% of (reading ch offset)	
dc Difference Voltage Accuracy Using Two Voltage Markers On The Same Channel	Average mode: ± 0.8% of full-scale Persistence mode: ± 0.8% of full-scale ± 3.0% of reading	
Programmable dc Offset	Channel offset: ± 500 mV	
Inputs:		
Number	Four	
Dynamic Range	± 320 mV relative to channel offset	
Maximum Safe Input voltage	± 2 V dc + ac peak, (16 dBm)	
Nominal Impedance	50 ohms	
Percent Reflection	≤ 5% for 30 ps risetime	
Connectors	3.5 mm (m)	

#### TDR System

	Combined Oscilloscope and TDR Performance	Normalized Characteristics
Risetime	≤ 45 ps*	Adjustable: allowable values based on timebase setting Minimum: 10 ps or 0.8 x Time/div, whichever is greater Maximum: 5 x Time/div
Flatness	≤ 1% after 1 ns from edge: ≤ +5%, -2% to 1 ns from edge	≤ 0.1%
Step generator levels		
Low	0 V ± 2 mV	0 V +/- 2 mV
High	+200 mV ± 2 mV	+200 mV ± 2 mV

\*The risetime of the generator is less than 35 ps, as calculated by  $(T_r \text{ system})^2 = (T_r \text{ generator})^2 + (T_r \text{ scope})^2$

### Timebase (Horizontal)

Scale Factor (Full-scale is 10 divisions)	
Minimum	10 ps/div
Maximum	1 s/div
Delay (Time offset relative to trigger)	
Minimum	16 ns
Maximum	1000 screen diameters or 10 seconds, whichever is smaller.
Time Interval Accuracy (Dual marker measurement)	10 ps ± 0.1% of reading
Time Interval Resolution	0.25 ps or 0.02 division, whichever is larger

### HP 54118A Trigger Input

Sensitivity	
500 MHz to 2 GHz	<50 mV p-p (-22 dBm)
2 GHz to 12.4 GHz	<500 mV p-p (-2 dBm)
12.4 GHz to 18 GHz	<1 V p-p (+4 dBm)
Nominal Impedance	50 ohms
Maximum Safe Input	25 Vdc, 4 V p-p ac (+4 dBm)
Trigger Level	0 V to 2 V p-p (+10 dBm)
Arming Level	0 V to 2 V p-p (+10 dBm)
Hold Off	50 us to 200 us

### Ordering Information

#### HP 54120T 20 GHz Digitizing Oscilloscope

The HP 54120T 20 GHz Digitizing Oscilloscope consists of an HP 54120A Digitizing Oscilloscope Mainframe and an HP 54121A Four Channel Test Set. The HP 54120T may be ordered or the HP 54120A and HP 54121A may be ordered separately. Only one HP 54121A may be connected to an HP 54120A mainframe at a time.

#### HP 54120T Digitizing Oscilloscope

Opt W30 Service Extension

Opt 090 Delete RF Accessories

Opt 908 Rackmount Kit

#### HP 54120A includes:

Color mainframe, interface cable, operating and programming manual for the HP 54120A and HP 54121A, and a U.S. power cord.

#### HP 54120A Digitizing Oscilloscope

Opt W30 Service Extension

Opt 908 Rackmount Kit

#### HP 54121A includes:

Four vertical channels; switchable step generator; and a trigger input; five adapters, APC-3.5 (f-f); five coaxial shorts, SMA (m); one anti-static mat with wrist strap; and RF accessories. RF accessories include: Five 20 dB attenuators, APC-3.5 (f-m); three 50 ohm cables, SMA (m-m); two SMA (m) to BNC (f) adapters; one 50 ohm termination, SMA (m); One 50 ohm termination, SMA (f); One coaxial short, SMA (f).

#### HP 54121A Four Channel Test Set

Opt W30 Service Extension

Opt 090 Delete RF Accessories

Opt 908 Rackmount Kit

#### HP 54118A 500 MHz to 18 GHz Trigger includes:

External input cable for connecting HP 54118A to the trigger input of HP 54121A 4-channel test set, RF accessories to view the trigger signal, two APC 3.5 adapters (f-f) and two SMA shorts (M).

#### HP 54118A 500 MHz to 18 GHz Trigger

Opt 090 Deletes RF accessories

Opt 908 Rackmount Kit (5061-9672)

Opt 910 One additional manual

Opt W30 Two additional years of return-to-HP service

### Accessories

HP 54006A 6 GHz resistive divider probe kit

HP 54007A Accessory kit

# OSCILLOSCOPES & WAVEFORM ANALYZERS

## Precision Digitizing Oscilloscopes

Models 5180T/U 5183T/U, & 5185T

- HP 5185T: 2 channels, 250 Msamples/s, 64-ksample/trace resolution
- HP 5183T/U: 4 channels, 4 Msamples/s, up to 512-ksample/trace
- HP 5180T/U: 2 channels, 20 Msamples/s, 16-ksample/trace
- 2 channel operation (4 channels for HP 5183U and HP 5180U)
- Dual channel analysis
- High quality 2048 x 2048 pixel video for display
- Complete HP-IB programmability
- 48 dB, 60 dB or 72 dB of dynamic range

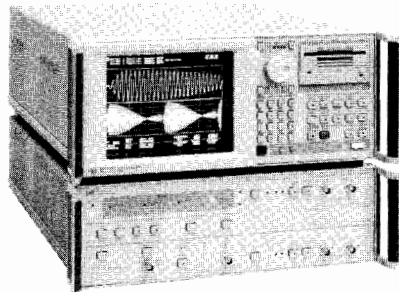

HP 5183T (5183U, 4 channels—not shown), see page 72 for more information.

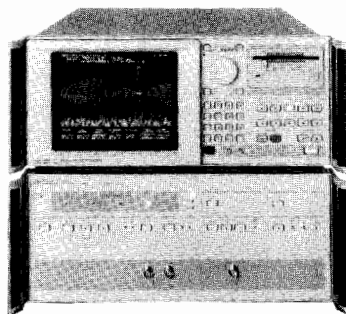

HP 5185T, see page 70 for more information.



HP 5180U (5180T, 2 channels—not shown), see page 74 for more information.



### Precision Digitizing Oscilloscope

The oscilloscope has been one of the fundamental engineering tools for many decades. It is a general purpose instrument, which provides the same measurement answers as racks of instrumentation. Voltage, frequency, phase and many more parameters can be measured using an oscilloscope, but it usually involves laborious human intervention to count graticules and interpret data. Also, until the storage scope, most transient measurements could not be performed.

With the advent of digitizing oscilloscopes, the tedium involved in taking data from a waveform has been vanquished. The production line no longer needs the single, dedicated instruments, customized to take a voltage or time measurement. The digitizing scope can "capture" the waveform, and preprocess the signal to provide single number answers so that the technician or computer can make simple "go" or "no go" decisions. Waveforms can be stored enabling characterization and correlation between runs.

Accuracy unrealized by oscilloscopes is obtained by this new series of precision digitizing oscilloscopes. Measurements with standard analog oscilloscopes produce approximately 30 dB of dynamic range; the HP 5183T/U, 5180T/U, and 5185T precision digitizing oscilloscopes have 72 dB, 60 dB, and 48dB of dynamic range respectively.

### Built-in Analysis Package

HP precision digitizing oscilloscopes provide many analysis features. These features give the designer or technician the information he needs in real time without resorting to the use of sophisticated external software to manipulate the data.

### Precision Pulse Characterization

These oscilloscopes provide pulse measurements according to the IEEE-194 standard. The designers can also define their own pulse characterization environment. Risetime or falltime are provided with the touch of a finger in the analysis menu. Positive and negative

pulse widths along with duty cycle and amplitude are other statistics available. Also included at a single touch are overshoot and undershoot.

### Real Time Conversion to Frequency Domain

With the introduction of the precision digitizing oscilloscope, the designer can now do some frequency domain analysis with the same instrument that does the time domain analysis. Both domains can be observed and characterized simultaneously. An FFT is performed on the time record using either a Hann, Uniform, Flat Top or user defined window. The magnitude and the phase spectrums can then be computed and displayed independently using the flexibility of the instruments.

### Waveform Math and Calculus

Two waveforms can be manipulated mathematically by adding, subtracting or multiplying them together. This gives the designer the ability to experiment quickly with modulation, performing experiments on raw data before breadboarding is done. Afterwards, the data can be gathered from the actual circuit and compared against the theoretical data. All this is accomplished without the aid of external computational equipment.

Incoming signals, or waveforms in memory can be integrated or differentiated, resulting in a waveform that lets the designer bypass special purpose hardware or computer programming. The DC drift of a circuit is easily quantifiable using integration in the analysis feature set. High frequency components of a signal are easily identifiable by integrating an incoming signal and placing it either underneath the signal, or combining the two traces into one display.

### Waveform Reconstruction means Readable Displays

A common complaint when using digitizing oscilloscopes, is that the representation of the data is not always optimum. The following two figures show the same waveform; the top waveform has used the waveform reconstruction algorithm, built into the HP 5183T/U, 5180T/U, and 5185T, and the bottom waveform shows the data with the recon-

struction feature turned off. The top graph is also the representation that would be viewed on a storage oscilloscope.

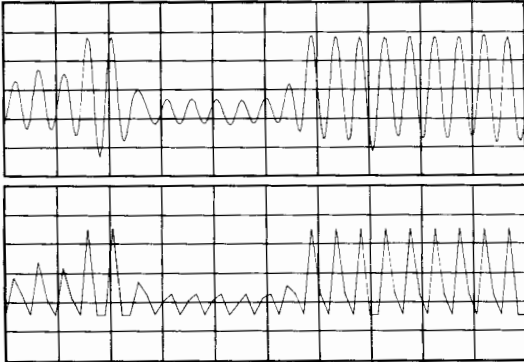

Reconstruction gives designers a truer representation of the data, allowing them to continue thinking in the analog time domain.

### Flexibility in Data Presentation

These digitizing oscilloscopes are extremely friendly as bench top instruments. One to four traces can be displayed, with the designer determining what the traces consist of and how they are displayed. As with analog oscilloscopes, continuous or single-shot waveforms can be displayed. Here the similarity with analog scopes ends; the precision digitizing oscilloscope can also display waveforms stored in memory, or signals that have been processed using the analysis functions inside the scope. These oscilloscopes can display analyzed data and the original measurement continuously as the signals are digitized. Once the waveform has been digitized, the display can be manipulated by zooming in on an interesting section, or changing the gain and offset to show more fine details.

### Permanent Copies of Waveforms

The HP 5183T/U, 5180T/U, and 5185T provide two ways to create permanent copies of waveforms or processed signals. With the

optional internal floppy disc, up to 250 1K records can be stored. In addition to storing captured and processed waveforms, the entire state of the instrument can be stored so that complex series of instrument setups can be recalled at a touch, leaving the designer or technician to concentrate on the device under test, and not setting up instruments. The waveforms are formatted in Hewlett-Packard's LIF directory, permitting the recorded disc to be used with any of the HP 9000 series 200 and 300 computers. In addition to storing the binary waveform, each file is time stamped.

Hardcopies of the display can also be created without the aid of a controller. This series of precision digitizing oscilloscopes operates most HP plotters (see the data sheet for a complete list of the supported plotters).

### Precision Measurements with Cursors

Two cursors are provided for making accurate measurements. A reference level, settable by the operator, is used to make voltage measurements; timing measurements are taken with respect to the trigger point. The difference between two cursors is also available for voltage, timing, frequency and decibels. Measurements using the delta cursors feature can be made on a single trace, or between two different traces being displayed.

Quick timing, frequency, voltage and power analysis can be accomplished using a single cursor. Once the cursor is placed on the desired waveform, the minimum and maximum can be determined with a single touch. A single keystroke places the cursor on the next minimum, maximum, or zero crossing which reveals waveform details without the user having to perform a tedious search.

### Battery Backed up Instrument Settings

Four instrument settings may be stored, but five can be recalled. The fifth memory location contains the instrument environment that was present before the last recall, which means that a complex instrument setting won't be overwritten by accident. This gives the designer or technician the ability to determine the exact instrument settings, and then auto-sequence through five different test setups. The ram that stores the front panel settings along with the internal clock is backed up by a lithium battery.

## Common Analysis Features

#### Pulse characterization

Rise time, fall time, baseline, topline  
+ width, - width, overshoot, period  
frequency and duty cycle

#### Voltmeter

Peak to peak, rms and period rms

#### Frequency Domain

Power spectrum, phase spectrum and magnitude spectrum

#### Available windows

Uniform, Hann and Flat Top

#### Waveform math

Add, subtract and multiply

#### Calculus

Integrate and differentiate

#### Frequency Counter

Average frequency and event crossing

#### Miscellaneous functions

Minimum hold, maximum hold and extract

#### Cursor functions

Waveform maximum, waveform minimum, next maximum, next minimum, next crossing, next positive crossing and next negative crossing

#### Display functions

X zoom, X position, Y gain, Y offset,  
reconstruction and dot or line mode

#### Plotting

Plot waveforms with most HP plotters

#### Mass storage

Using 3.5 inch floppy discs, when option 035 is installed

See next two pages for more information on the HP 5185A/T.  
See pages 72 and 73 for more information on the 5183A/T/U.  
See page 74 and 75 for more information on the HP 5180T/U.



# OSCILLOSCOPES & WAVEFORM ANALYZERS

## Precision Digitizing Oscilloscope (cont'd)

### Model 5185T

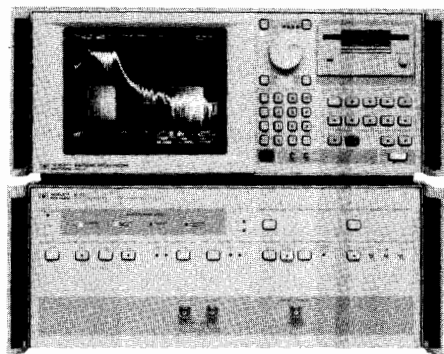

HP 5185T

### High-speed Precision Digitizing Oscilloscope

The HP 5185T provides uncompromised voltage resolution along with its high digitizing speed. In-depth dual domain analysis is now possible at 110 MHz bandwidth. The HP 5185T is one of HP's most powerful single-shot measurement tools because the power of a high-speed waveform recorder (the HP 5185A) is coupled with the multi-talented display section. The display section consists of a high-quality 2048 × 2048-point vector display, a precision analysis package, and a flexible user and computer interface.

#### Capture Your Most Elusive Signals

Triggering on the correct signal is one of the more important features that must be considered when purchasing an oscilloscope. With the correct trigger, less memory is needed because you can trigger on exactly the event of interest. Otherwise, you must record much more than you need and hope the event is buried in your recording. The HP 5185T provides flexible triggering via variable sensitivity (hysteresis), delay trigger, bi-trigger, posneg trigger, drop-out trigger, and pre- and post-triggering.

#### Record the Details That Most Oscilloscopes Ignore

HP builds the HP 5185T with a separate high performance ADC (analog-to-digital-converters) for each of the two channels, allowing simultaneous two channel recording at the maximum speed. The two ADCs are bipolar flash converters, which provide a lower noise-floor than CCDs (charge-coupled-devices), a commonly used technology for high-speed ADCs. The 8-bit ADCs ensures 48 dB<sup>1</sup> of dynamic range, and HP specifications guarantee its usefulness.

Recording high-fidelity information at a 250 Msample/sec rate is a key performance specification for the HP 5185T, but this would be useless if signal conditioning was ignored. The HP 5185T provides nine ranges that can optimize your signal whether it's 50 mV or 20 V peak-to-peak. Standard scope features are supplied, such as 1M $\Omega$ /50 $\Omega$  termination and ac/dc coupling, along with uncommon features such as the wideband input and switchable 6-pole anti-alias filter.

#### Turn Those Details into Answers with Characterized Analysis

The HP 5185T emulates a rack of instrumentation because of the built-in analysis package (see the previous page for a list of the analysis functions). The HP 5185T can emulate a spectrum analyzer, a voltmeter, and a frequency counter for the analysis of single-shot or repetitive signals. Real-time analysis is possible as with dedicated instruments, but one of the real strengths of the precision digitizing oscilloscope, is that it can do post-processing and delimited analysis.

The three graphs show a sample of the measurement characteristics that are in the datasheet. Since the HP 5185T supports delimited analysis, the characteristics for the voltmeter and the frequency counter are graphed as a function of the number of periods.

- 4 ns minimum sample interval
- 8-bits of resolution
- 64 ksample per channel
- Characterized Analysis Results
- Optional high-stability timebase
- Enhanced triggering and timebase

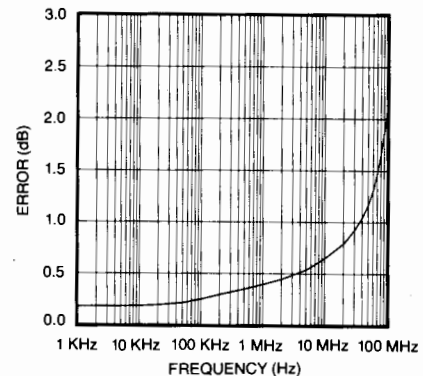

The spectrum plot shows that the error as the frequency goes up is due to the roll-off in the signal conditioning.

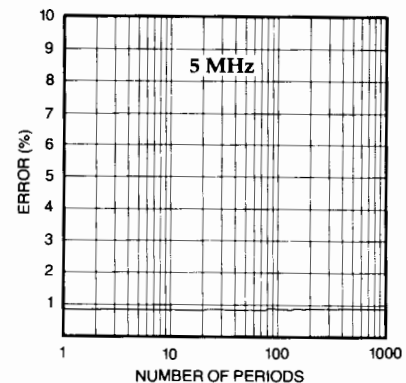

The periodic-rms voltage function ensures that you take the rms voltage of full periods only.

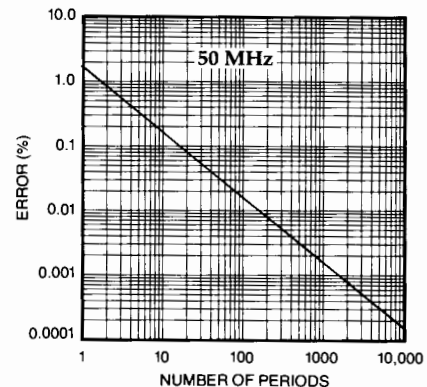

Increasing the number of periods for the frequency counter function improves the resolution. Option 010 ensures that today's measurements match tomorrow's because of the best aging rate available in a digitizing oscilloscope.

<sup>1</sup>Resolution can be determined as approximately 6 dB/bit.

- 150 Msamples per second
- 8 bits of resolution
- 64 Msamples per channel
- Includes powerful HP BASIC drivers
- 12 input ranges
- Enhanced triggering and timebase

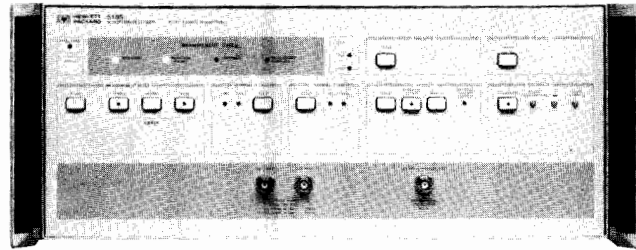

HP 5185A

### HP 5185A Waveform Recorder

For those applications that require high timing resolution coupled with the 48 db of dynamic range of the HP 5185T, but not the characterized analysis, real time control or custom display, the HP 5185A is the optimum solution. The HP 5185A is not a stand-alone instrument, but functions as a digitizing front end to a computer.

### Powerful Data Acquisition with HP BASIC

The interface language of choice with instrumentation is HP BASIC because of rapid program development and easy control of complex instruments. The HP 5185A comes standard with BASIC software drivers for the HP 9000 series 200/300 computers to create an unparalleled data acquisition system. Raw data is transferred across the HP-IB bus at rates of 300 kbytes/ second when the DMA card is installed in the computer.

### Lower Cost Solutions with PCs

When system throughput is not the critical factor, and an installed software base must be used for analysis, an IBM-PC compatible, such as the HP Vectra, can control the HP 5185A. This is accomplished with the standard software drivers when the PC has the HP 82300A BASIC language processor card installed.

### HP 5185A/T Condensed Specifications<sup>1</sup>

#### Channel 1 and 2 inputs

- Input attenuator ranges:**  $\pm 50$  mV to  $\pm 20$  V (full scale).
- Input offset voltage:**  $\pm 1.35$ V below 1 V range,  $\pm 20$  V on the 1 V range and above.
- Input Bandwidth (-3 dB):**  $>110$  MHz (nominal 125 MHz), with anti-alias filter (6-pole)  $<70$  MHz (nominal 60 MHz).
- Input impedance (nominal):** 1 M $\Omega$  switchable 15 pf or 50  $\Omega$ .
- Input coupling:** ac, dc.
- Damage level (50  $\Omega$  input):** 5 Vdc or rms all ranges.
- (1 M $\Omega$  input):**  $\pm 30$  Vdc all ranges, 6.6 Vrms for input ranges below 1 volt, 30 Vrms for input ranges 1 volt and above.

#### Dynamic Performance after Calibration

- Harmonic and spurious distortion:** -46 dBc @ 5 MHz, -36 dBc @ 50 MHz.

- Effective bits:** 6.8 bits @ 5 MHz, 6.5 bits @ 50 MHz.

#### Triggering

- Internal trigger:** level and sensitivity selectable over input voltage range.
- External trigger:** level selectable over  $\pm 2.5$  V.
- External source:** + and -.
- Internal source:** channel 1, channel 2, delay.
- Settable:** level, hysteresis, position, drop-out delay, delay from external trigger.
- Internal slope:**  $\pm$ , bi-trigger, posneg, and dropout.
- Trigger position:** -99% to  $> 1600\%$  of record length.

#### Timebase

- Internal timebase:** 250 MHz internal timebase allows sample intervals of 4 ns, and 8 ns to 490 us in 8 ns multiples.

#### Internal reference:

- Timebase reference=** 10 MHz.
- Aging rate=**  $\pm 3 \times 10^{-6}$ /year after 10 days power.
- Temperature=**  $\pm 5 \times 10^{-6}$ , 0 to 50°C.

#### External reference input: 1, 2, 5, or 10 MHz.

**External encode:** variable from dc to 250 MHz. External encode signal can be divided down using internal timebase divide chain.

**Gated timebase:** Either the internal timebase or the external encode can be gated on and off with the external trigger.

### HP 5185T Condensed Specifications<sup>1</sup>

#### Measurement Control

- Triggering:** Auto, normal, single, and manual.
- Enhancements:** Capture, auto-advance, and loop-advance.
- Averaging:** Average from 1 to 100 records.

#### Memory

- Standard:** 65,536 samples per channel.
- Record size:** 1k samples to 64k samples in powers of two.

#### Timebase

##### High stability frequency reference (Option 010)

- Timebase reference:** 10 MHz
- Aging rate:**  $2 \times 10^{-7}$ /year after 10 days of power.
- Temperature:**  $7 \times 10^{-9}$ , 0 to 50°C.

### HP 5185A<sup>1</sup>

#### Operating System Environment

BASIC software drivers operate under BASIC 4.0 on the HP 9000 series 200/300, and HP Vectra with HP 82300A.

#### Measurement Control

- Triggering:** Single and auto.
- Sweep delay:**  $10^{-2}$  seconds to  $10^5$  seconds (time until a trigger is forced for auto-trigger).

#### Memory

- Standard:** 65,536 samples per channel.
- Record size:** 64 samples to 64k samples per channel.

#### Ordering Information

**HP 5185A** Waveform Recorder 2-channel (includes an interconnect cable, software for control and data transfer on the HP series 200 and 300 computers, and one day of consulting). Requires host computer for operation.

**Price**  
\$31,000

#### Option for the HP 5185A

- Option W30** Two additional years of "return to HP" service and support add \$740

**HP 5185T** Digitizing Oscilloscope 2-channel (includes waveform analyzer, 2-channel recorder section, characterized analysis package, interconnect cables, and one day of consulting).

\$44,000

#### Options for the HP 5185T

- Opt 010** Oven Oscillator add \$1,200
- Opt 035** Floppy Disc Drive add \$1,000
- Opt W30** Two additional years of "return to HP" service and support add \$1,050

<sup>1</sup>See the HP 5185A/T Datasheet (Pub 02-5952-7883) for more information.

# OSCILLOSCOPES & WAVEFORM ANALYZERS

## Precision Digitizing Oscilloscope

Model 5183T/U

- Differential inputs
- Adaptive Sample Rate
- Dropout trigger

- 256K word per channel optional memory
- Complete calibration to probe tip
- Configurable as two or four channels



HP 5183T

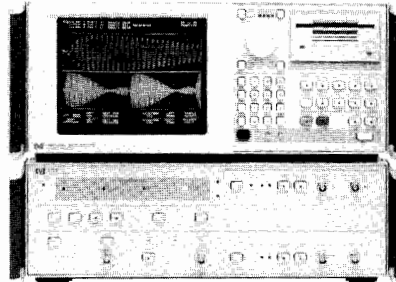

### Unbeatable measurement resolution & accuracy

The HP 5183T/U provides many features unavailable from any other digitizing oscilloscope. Trigger features allow data acquisition that was previously either impossible, or required complex external trigger circuitry. The optional 512K word memory allows long continuous records to be acquired. In one channel operation, channel one can be configured to have 512K samples with option 512 installed. Adaptive Sample Rate gives the benefit of catching glitches that would ordinarily escape detection. The burst timebase feature allows samples to be gathered in packets of samples as small as 1 sample per trigger point. Calibration is now possible out to the probe tip providing greater absolute accuracy.

### Enhanced trigger capability

As with the other Hewlett-Packard waveform recorders, post- and pre-triggering are available. This permits viewing of the trigger point, the events leading up to the trigger point, or events that occur long after the trigger has occurred. Dropout trigger provides the capability to trigger on the absence of a signal. This means that the HP 5183T/U can be used to monitor a signal source such as a power main. The recorder can be configured with auto advance to capture up to 256 1K records showing dropouts, when Option 512 is installed.

Delay trigger is used in the following manner. A trigger event occurs at the external trigger input. Then, when a user defined delay elapses, the recorder will wait for the proper internal trigger and record in the operator defined environment. This can be used for recording signals such as a specific sector on a magnetic disc, using the index pulse as the external trigger, and the approximate delay to the proper sector.

Trigger-on-all allows the trigger circuitry to be or'ed together internally. This trigger scheme is also available in four channel operation, with two recorder sections being used together. This allows the designer to set up triggering conditions for the channels, and whichever event occurs first, will cause synchronous triggering and sampling in all channels.

High frequency trigger will cause the recorder to trigger on a glitch of sufficient amplitude or other large high frequency components in the waveform. This is only available with the optional Adaptive Sample Rate.

### ASR (Adaptive Sample Rate - Option 301)

ASR provides rapid sampling only when it is needed, conserving memory where possible. With this option, the recorder samples at a slow speed until high-frequency energy is detected. When this occurs, the timebase switches to a higher speed to capture the high-frequency signal, returning to the slower speed when the high-frequency component ceases. For some signals, particularly those with low duty cycles, the maximum effective memory length can be increased (by a factor approaching 64) to approximately 30 million words.

### HP 5183T/U Specifications\*

#### Channel 1 and 2 inputs

**Maximum sensitivity (nominal):** 50  $\mu$ V.

**Input attenuator ranges:**  $\pm 100$  mV to  $\pm 50$  V (full scale).

**Input offset voltage:**  $\pm 200\%$  of input attenuator range.

**Input bandwidth (nominal):** ( $-1$  dB) 1 MHz, ( $-2$  dB) 3 MHz with filter (10 pole), ( $-4$  dB) 1 MHz, ( $-65$  dB) 3 MHz.

**Input impedance (nominal):** 1 M $\Omega$  in parallel with 45 pF.

**CMRR at 10 kHz:** 60 dB on 100 mV to 1 V ranges.

**Damage level:**  $\pm 5$  V (dc plus peak ac) on 100 mV to 1 V ranges. 400% of range (dc plus peak ac) on 2 V to 50 V ranges.

#### Dynamic performance after calibration

**Harmonic and spurious distortion:**  $\leq -65$  dBc.

**Effective bits:** 10.0 at 95% of full scale range.

#### Triggering

**Internal trigger:** level and sensitivity selectable over input voltage range.

**External trigger:** level selectable over  $\pm 5$  V range, in mV increments.

**Internal source:** channel 1, channel 2, drop-out, delay, trigger-on-all, or high frequency trigger (with Option 301).

**Measurement control:** auto, normal, single, manual trigger.

**Settable:** level, hysteresis, position, drop out delay, delay from external trigger (sequential trigger).

**Slope:** +, -, or bi-trigger (internal only).

**Trigger position:** - 100% to + 6400% of record length

#### Timebase

**Internal timebase:** 4 MHz reference, sample intervals are between 250 ns and 4 s, in 250 ns increments.

**Aging rate:**  $\pm 3 \times 10^{-6}$ /year after 10 days of power.

**Temperature:**  $\pm 2 \times 10^{-5}$ , 0 to 50 C.

**External timebase:** 1, 4 or 10 MHz.

**External encode:** 1  $\mu$ Hz to 2.1 MHz or 1.9 MHz to 4 MHz.

#### Option 010

**Timebase:** 4 MHz is locked to high-stability 10 MHz reference.

**Aging rate:**  $2 \times 10^{-7}$ /year after 10 days of power.

**Temperature:**  $7 \times 10^{-9}$ , 0 to 50°C.

#### Memory

**Size:** 64k words per channel standard. With Option 512 installed, 256k words per channel, also configurable as a single 512k word record for channel 1.

**Segmentation:** memory can be configured as a single 131,072 word record for channel A, or between 1 to 64 equal length records for channel A and B.

When Option 512 is installed, memory can be configured as a single 524,288 word record for channel A, or between 1 and 256 equal length records for channel A and B.

**ASR (Adaptive Sample Rate):** Slows timebase by a 1:64 rate when high frequency energy is not present; Option 301.

\*See HP 5183T/U Data Sheet for more information. See page 73 for ordering information.

# OSCILLOSCOPES & WAVEFORM ANALYZERS

Waveform Recorder and Ordering Information

Models 5183A/T/U

73

- 72 dB of dynamic range for analysis
- New high measurement throughput BASIC driver software
- Systems of up to 64 channels
- Adaptive sample rate



HP 5183A

## HP 5183A Waveform Recorder

### High Throughput for Automated Measurements

For those applications that require the superb fidelity of the HP 5183T, but not the analysis, display or real time control, the HP 5183A is an excellent solution. The HP 5183A is not a stand-alone instrument, but functions as a digitizing front end to a computer. New HP BASIC driver software, optimized for speed, helps to set up, take measurements, and transfer data at high speeds to an HP 9000 Series 200/300 workstation or HP Vectra PC. The HP 5183A's auto-advance feature can yield up to 70 measurements (1K words) per second with re-arm time as short as 13 ms.

### HP 5183A Condensed Specifications\*

#### Channel 1 and 2 inputs

**Maximum sensitivity (nominal):** 50  $\mu$ V.

**Input attenuator ranges:**  $\pm$  100 mV to  $\pm$  50 V (full scale).

**Input offset voltage:**  $\pm$  200% of input attenuator range.

**Input bandwidth (nominal):** (-1 dB) 1 MHz, (-2 dB) 3 MHz with filter (10 pole), (-4 dB) 1 MHz, (-65 dB) 3 MHz.

**Input impedance (nominal):** 1M $\Omega$  in parallel with 45 pF.

**CMRR at 10 kHz:** 60 dB on 100 mV to 1 V ranges.

**Damage level:**  $\pm$  5 V (dc plus peak ac) on 100 mV to 1 V ranges. 400% of range (dc plus peak ac) on 2 V to 50 V ranges.

#### Dynamic Performance at 1 MHz Signal Input after Calibration

**Harmonic and spurious distortion:**  $\leq$  65 dBc.

**Effective bits:** 10.0 at 95% of full scale range.

#### Triggering Characteristics

**Internal trigger:** level and sensitivity selectable over input voltage range.

**External trigger:** level selectable over  $\pm$  5V range, in mV increments.

**Internal source:** Channel 1, Channel 2.

**Measurement control:** auto, normal, single, manual trigger.

\*See HP 5183A Recorder Data Sheet (Pub 5952-7933D) for more information.

**Settable:** level, hysteresis, position.

**Slope:** +, -, or bi-trigger (internal only).

**Trigger position:** -100% to +6400% of record length.

#### Time Base

**Internal time base:** 4 MHz internal time base allows sample rates between 250 ns and 4 s, in 250 ns increments.

**External time base:** 1, 4 or 10 MHz.

**External encode:** 1  $\mu$ Hz to 2.1 MHz or 1.9 MHz to 4 MHz.

#### Memory

**Size:** 64k words per channel standard. With Option 512 installed, 256k words per channel, also configurable as a single 512k word record for channel 1.

### Ordering Information

**HP 5183A** Waveform Recorder 2-Channel (includes an interconnect cable and software for control and data transfer on the HP 200 and 300 series computers). Requires host computer for operation. **Price** \$12,500

**HP 5183T** Digitizing Oscilloscope 2-Channel (includes waveform analyzer, 2-channel recorder section, and interconnect cables) \$21,900

**HP 5183U** Digitizing Oscilloscope 4-Channel includes waveform analyzer, 2 two-channel recorder sections, and interconnect cables. \$32,900

#### Options for HP 5183A/5183T

**Opt 301** Adaptive Sample Rate +\$3,100

**Opt 512** 512K Word Memory +\$5,200

#### Options for HP 5183T

**Opt 010** Oven Oscillator +\$1,200

**Opt 035** Floppy Disc Drive +\$1,000

#### Options for HP 5183U

**Opt 010** Oven Oscillator +\$1,200

**Opt 035** Floppy Disc Drive +\$1,000

**Opt 301** Adaptive Sample Rate +\$6,200

**Opt 512** 512K Word Memory \$10,400



# OSCILLOSCOPES & WAVEFORM ANALYZERS

## Digitizing Oscilloscope and Waveform Recorder/Measurement System

Models 5180T/U, 5180A, 5180S, 51800A

- High quality display
- Built-in analysis provides answer and raw data
- Utilizes the HP 5180A for quality digitization
- 16K memory records up to 32 waveforms
- High-speed signal acquisition
- Accurately digitizes transient signals
- Up to 1 million words/s data transfer

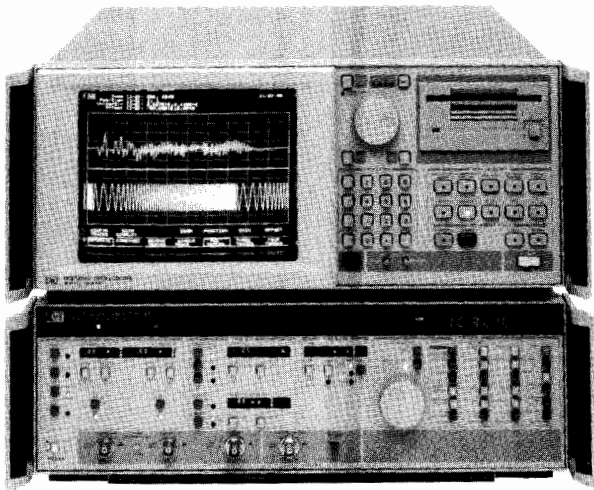

HP 5180T (HP 5180U not shown)

### HP 5180T/U

#### Automatic Analysis

The HP 5180T/U delivers answers normally associated with other instruments such as time interval counters, voltmeters, spectrum analyzers, and storage oscilloscopes. Unlike other instruments, these digitizing oscilloscopes require only one waveform capture to get results. After you capture your signal, you can view it as you would with a storage oscilloscope; you can zoom in to view details, analyze pulses, view its frequency spectrum, and measure its rms or peak-to-peak amplitude - all using the same signal.

#### Dynamic Performance

Dynamic (ac) performance can mean the difference between just looking at a waveform or completely analyzing it. To help you analyze your signals thoroughly, the HP 5180T/U provides 10-bit resolution for waveform data while delivering fully specified, high-fidelity dynamic performance.

#### Automatic Setup

The display provides many convenient features that enhance the system's waveform capture. For example, the AUTOSCOPE function acquires repetitive waveforms and automatically sets the input amplifier, trigger level, and time base to the appropriate values for optimum signal viewing. Existing front-panel settings are automatically saved in non-volatile RAM when AUTOSCOPE is pressed. You can also save up to four additional front-panel setups for recall at your convenience. An optional built-in floppy disc, which is compatible with those for the HP 9000 Series 200 and 300 Computers, lets you store both front-panel settings and captured waveforms. See page 75 for condensed specifications and ordering information.

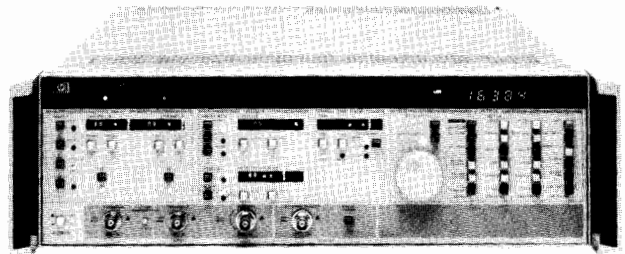

HP 5180A

### HP 5180A

#### High Quality Samples Every 50 Nanoseconds

Signal processing requires high quality input data. Hewlett-Packard's 5180A Waveform Recorder digitizes and stores single-shot or repetitive signals. Voltage waveforms are digitized at sampling rates up to 20 M sa/s (50 ns/sample). Each voltage sample is encoded into a 10-bit word and stored into the memory. These precise voltages (and times) can be read from the front panel with cursors.

Excellent dynamic performance (please read HP Product Note 5180-2) means the ADC does not break up for higher input frequencies. Therefore, your signal is accurately represented for analysis (and replay; see the next pages for description of the HP 5182A Waveform Recorder/Generator).

**Accurately Digitize Transients** - The shape of fast attack and decay single-shot waveforms is preserved because the higher frequency components are accurately digitized. The digital trigger is precisely settable ensuring reliable triggering with no drift. Selectable hysteresis eliminates false triggering due to noise.

#### View Single-shot or Repetitive Signals Quickly

The HP 5180A controls external XYZ displays and hardcopy devices to show the contents of memory records without the need for a computer. Zoom and Gain features expand displayed waveforms horizontally or vertically to look in detail at a selected portion of a waveform. Dual trace capability puts two waveforms on an external display for visual comparison. Digital plotters and printers are controlled by HP-IB. There are two methods of transferring data from the HP 5180A to a computer for analysis: HP-IB and DMA. Direct Memory Access (DMA) can transfer data at a rate up to 1 million words/second, depending on the computer.

The HP 5180A can begin recording a signal at one sampling rate and then switch to another. The switch point is selectable. Set one timebase at a faster sample rate to record more detail, and set the other at a slower rate to conserve memory space. Two transients may be recorded simultaneously using the HP 5180A's input CHOP mode.

The HP 5180A is fully programmable over HP-IB for automated operations. See page 75 for condensed specifications and ordering information.

- Automatic measurements
- Universal measurement solutions
- Modular software

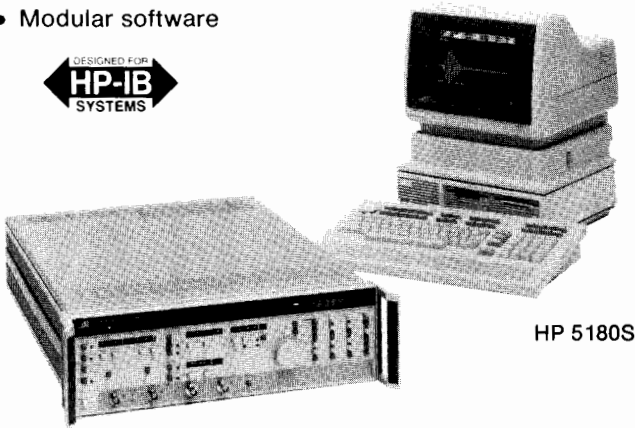

HP 5180S

## HP 5180S and HP 51800A

### Automatic Time Domain Measurements

Make time domain measurements on single-shot or repetitive waveforms with the HP Model 51800A Waveform Measurement Library. The library is a collection of programs designed to make measurements on signals captured by the HP 5180A Waveform Recorder and HP 5182A Waveform Recorder/Generator. Instruments are controlled by sub-programs. All you do is chain them together to make the measurements you need.

### Realize the Power of a Waveform Recorder by Interfacing it to an HP Series 200 or 300 Technical Computer

The HP 5180S Waveform Measurement System allows you to configure a computer-controlled system based on the HP 5180A Waveform Controller. Because the signal has been digitized and stored, it can now be sent to a computer for analysis and then to a disc for permanent storage. Frequency, Period, Pulse Width, Rise/Fall Time, Volts rms and Volts p-p are some of the many standard measurement programs.

### HP 5180A/T/U Specifications

See HP 5180A Waveform Recorder or HP 5180 T/U Digitizing Oscilloscope Data Sheet (Pub 5952-7722D & 5952-7835D) for more information.

#### Channel A and B Inputs

**Maximum sensitivity:** 200  $\mu$ V.

**Input attenuator range:**  $\pm 100$  mV to  $\pm 10$  V (full scale).

**Input offset voltage:**  $\pm$  selected Voltage Range.

**Amplifier bandwidth ( $-3$  dB):** dc to 40 MHz (dc coupling).  
10 Hz to 40 MHz (ac coupling).

**Input impedance (NOMINAL):** 1 M $\Omega$  || 40 pF (10 V range).  
1 M $\Omega$  || 35 pF (other ranges).

**Damage level:**  $\pm 12$  V above 1 kHz.

#### Dynamic Performance (at 1 MHz)

**Harmonic and spurious distortion:**  $-50$  dBc

**Effective bits:** 7.8

#### Triggering

**Internal trigger:** level and sensitivity selectable over input voltage range.

**External trigger:** level selectable over  $\pm 2.5$  V range.

**Trigger position:**  $-100\%$  to  $+9999\%$  of memory.

#### Timebase

**Internal timebase:** 20 MHz internal timebase allows sample rates between 50 ns and 50 ms in a 1-2-5 sequence.

**External timebase:** external timebase signals between 1 MHz and 20 MHz may be used. Internal divide ratio between 1 and  $10^6$  in a 1, 2, 5 sequence.

- Increase test design productivity
- Choose standard measurements
- Add custom tests

#### Memory

**Size:** 16,384 10-bit words.

**Segmentation:** memory may be divided into 1, 2, 4, 8, 16, or 32 equal-length records.

#### Outputs

**XYZ CRT monitor outputs:** X, Y deflection voltages (NOMINAL)  $-1$  to 0V into 50  $\Omega$ . X requires 1 MHz bandwidth input; Y requires 5 MHz bandwidth input. Z voltage (NOMINAL) is 0 to 2 V into 1 k $\Omega$  (0 to 1V into 50  $\Omega$ ), selectable positive or negative going blanking pulse. Z requires 1.25 MHz bandwidth input.

**HP-IB:** all front panel function values selectable via HP-IB. Data I/O in ASCII or binary; maximum 3 Kbyte/second rate, depending on controller. "Talk only" to HP-GL plotters available even if no controller is used.

**DMA:** direct memory access allows fast parallel data transfer; maximum 1M word/second, depending on controller.

#### General

**Operating temperature:** 0°C to 55°C.

**Power requirements:** 100/120/220/240 volts  $+5\%$ ,  $-10\%$ ; 48 to 66 Hz. Max power dissipation 500 VA.

**Weight:** 22 kg (48 lb) net; 25 kg (53 lb) shipping.

**Size:** 142 mm H x 426 mm W x 574 mm D ( $5\frac{5}{8}$ " x  $16\frac{3}{4}$ " x 23").

### Ordering Information

HP 5180A Waveform Recorder

**Price**

\$23,650

HP 5180S Waveform Measurement System

N/C

To ensure coordination of shipments and compatibility of instruments, computers and software, use the system model number when ordering the individual components, including peripherals such as printers and plotters. Obtain an HP 51800A Data Sheet and HP 5180S Ordering Guide from your local sales office. See page 771.

HP 51800A Waveform Measurement Library \$1,320

HP 5180T Digitizing Oscilloscope (2 Channel) includes waveform analyzer, two-channel recorder section, and interconnect cables \$36,300

HP 5180U Digitizing Oscilloscope (4 Channel) includes waveform analyzer, 2 two-channel recorder sections, and interconnect cables \$59,900

HP 5180U Digitizing Oscilloscope (4 Channel) includes waveform analyzer, 2 two-channel recorder sections, and interconnect cables \$59,900

HP 5180U Digitizing Oscilloscope (4 Channel) includes waveform analyzer, 2 two-channel recorder sections, and interconnect cables \$59,900

HP 5180U Digitizing Oscilloscope (4 Channel) includes waveform analyzer, 2 two-channel recorder sections, and interconnect cables \$59,900

HP 5180U Digitizing Oscilloscope (4 Channel) includes waveform analyzer, 2 two-channel recorder sections, and interconnect cables \$59,900

HP 5180U Digitizing Oscilloscope (4 Channel) includes waveform analyzer, 2 two-channel recorder sections, and interconnect cables \$59,900

HP 5180U Digitizing Oscilloscope (4 Channel) includes waveform analyzer, 2 two-channel recorder sections, and interconnect cables \$59,900

HP 5180U Digitizing Oscilloscope (4 Channel) includes waveform analyzer, 2 two-channel recorder sections, and interconnect cables \$59,900

HP 5180U Digitizing Oscilloscope (4 Channel) includes waveform analyzer, 2 two-channel recorder sections, and interconnect cables \$59,900

HP 5180U Digitizing Oscilloscope (4 Channel) includes waveform analyzer, 2 two-channel recorder sections, and interconnect cables \$59,900

HP 5180U Digitizing Oscilloscope (4 Channel) includes waveform analyzer, 2 two-channel recorder sections, and interconnect cables \$59,900

HP 5180U Digitizing Oscilloscope (4 Channel) includes waveform analyzer, 2 two-channel recorder sections, and interconnect cables \$59,900

HP 5180U Digitizing Oscilloscope (4 Channel) includes waveform analyzer, 2 two-channel recorder sections, and interconnect cables \$59,900

HP 5180U Digitizing Oscilloscope (4 Channel) includes waveform analyzer, 2 two-channel recorder sections, and interconnect cables \$59,900

HP 5180U Digitizing Oscilloscope (4 Channel) includes waveform analyzer, 2 two-channel recorder sections, and interconnect cables \$59,900

HP 5180U Digitizing Oscilloscope (4 Channel) includes waveform analyzer, 2 two-channel recorder sections, and interconnect cables \$59,900

HP 5180U Digitizing Oscilloscope (4 Channel) includes waveform analyzer, 2 two-channel recorder sections, and interconnect cables \$59,900

HP 5180U Digitizing Oscilloscope (4 Channel) includes waveform analyzer, 2 two-channel recorder sections, and interconnect cables \$59,900

HP 5180U Digitizing Oscilloscope (4 Channel) includes waveform analyzer, 2 two-channel recorder sections, and interconnect cables \$59,900

HP 5180U Digitizing Oscilloscope (4 Channel) includes waveform analyzer, 2 two-channel recorder sections, and interconnect cables \$59,900

HP 5180U Digitizing Oscilloscope (4 Channel) includes waveform analyzer, 2 two-channel recorder sections, and interconnect cables \$59,900

HP 5180U Digitizing Oscilloscope (4 Channel) includes waveform analyzer, 2 two-channel recorder sections, and interconnect cables \$59,900

HP 5180U Digitizing Oscilloscope (4 Channel) includes waveform analyzer, 2 two-channel recorder sections, and interconnect cables \$59,900

HP 5180U Digitizing Oscilloscope (4 Channel) includes waveform analyzer, 2 two-channel recorder sections, and interconnect cables \$59,900

HP 5180U Digitizing Oscilloscope (4 Channel) includes waveform analyzer, 2 two-channel recorder sections, and interconnect cables \$59,900

HP 5180U Digitizing Oscilloscope (4 Channel) includes waveform analyzer, 2 two-channel recorder sections, and interconnect cables \$59,900

# OSCILLOSCOPES & WAVEFORM ANALYZERS

## Waveform Recorder/Generator, 20 MHz, 10 Bits, 16K Word Memory

### Model 5182A

- 16K nonvolatile waveform memory
- Fully programmable via HP-IB
- Quickly transfer waveforms to/from computer
- Easily simulate complex, real signals
- Record single-shot, replay repetitively

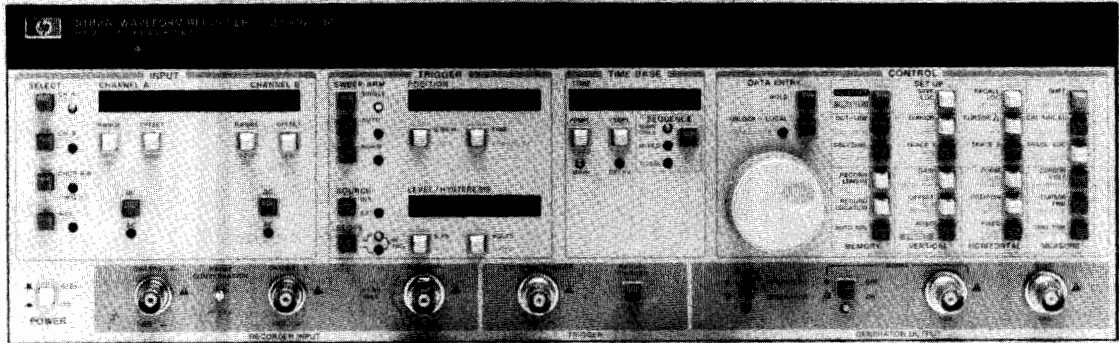

### Duplicate Infrequent Waveforms Whenever You Need Them

Get an "instant replay" of your single shot signal when you buy a HP 5182A Waveform Recorder/Generator. Also create repetitive signals by playing back a single recording over and over again with no time gap between replays.

Now you can test your circuits with the actual signal you record rather than a theoretical one. "What if" testing can be done by adding a computer to modify and store the waveforms. An HP Series 200/300 Technical Computer, HP 9111A Graphics Tablet and an HP 5182A comprise the HP 5182S Waveform Generation System.

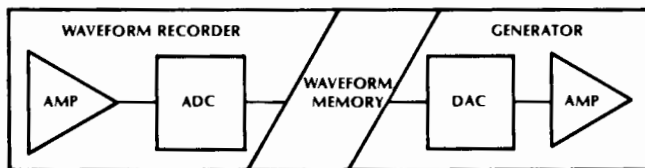

### A Waveform Recorder/Generator is a High Speed Digital "Tape" Recorder

The "tape" is silicon memory. At 20 M samples per second, it can store 819  $\mu$ s, 819 seconds at 20 samples per second. This digitized waveform can be played back once, or over and over again with no time gap. For example, you can accurately store 16 separate lines of video, or a single sector of data from a floppy disc drive. The video signal can generate color bar patterns to test video circuits. The disc signal can be used to test read-recovery circuits.

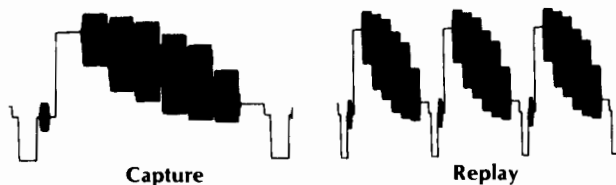

### Capture and Save in the Field, Replay on the Bench

Continuous (battery backed up) waveform memory allows you to record up to 32 waveforms on site. Remove the power and carry the HP 5182A back to the lab. Now you can play them back to test your circuits or for further analysis. Attach the HP 5182A to an HP Series 200/300 Technical Computer and you can store the waveforms on disc, process them further and modify them for "what if" testing.

### Simulate Expensive, Single-Shot Experiments

Some experiments can be very time consuming and expensive to repeat, for example: biomedical experiments, measurements of explosions, and propagation experiments such as radar and sonar. With the HP 5182A you can capture the signal accurately, when it occurs. Then, switch to generator mode, and you're ready to replay it, any time you need it.

A sync pulse is generated once per playback cycle for synchronizing other equipment.

### Generator Section Specifications

For accessories and specifications of the recorder section, please see page 75.

#### Peak output voltage (for full-scale waveform) into 50 ohms

Range	Vernier Range Min	Max	Vernier Step Size
5.12 V	520 mV	5.12 V	40 mV
512 mV	52 mV	512 mV	4 mV
51.2 mV	5.2 mV	51.2 mV	0.4 mV

**Max. output voltage into open circuit:** 10 V (NOMINAL).

**Output offset:** -5.12 V to +5.11 V in 10 mV steps into 50 ohms.

**AC Performance:** Noise: -65 dBc.

**Harmonic distortion (dc to 1 MHz):** -48 dBc.

**Spurious (sample rate related):** -40 dBc TYPICAL.

**Output risetime:** 100 ns max. (10% to 90%).

**Amplifier bandwidth (-3dB):** 10 MHz (NOMINAL)

**DC performance** (10 bits resolution per sample)

**Differential nonlinearity:** <1 LSB (Monotonic).

**Integral nonlinearity:** <3 LSB.

**Offset accuracy:** 100 mV (20-30°C).

**Absolute accuracy:** 1% of p-p full scale range (20-30°C).

**Internal trigger:** Output automatically triggered when armed.

**External trigger:** Slope, level, hysteresis, width, impedance, coupling and maximum input same as for Recorder. (See page 75).

**Insertion delay:** 250 ns max.

#### Time base modes

**Main only:** Available in Single, Auto, and Normal Sweep Arm modes.

**Mixed (main, delay):** Available in Single and Normal Sweep Arm modes.

**Memory size:** 16384 10-bit words; Segmentation: 1,2,4,8,16 or 32 equal length blocks. Generation: Data may be generated from any memory block. Within any one block, a portion of the waveform may be generated by setting the starting point and stopping point. An even number of points is always output.

**Sync output:** Voltage: 0 to -0.75 V NOMINAL into 50 ohms, Pulse Width: One sample interval with the falling (first) edge active (or approximately 100  $\mu$ s when the sync pulse is past the stop position, and Sweep Arm is Single or Normal). Position: Settable from first point in the record to the last point. If the sync position is set outside the limits of the Start and Stop Position markers, the output record is extended to include the Sync Position by assigning a dc voltage (equal to the nearest Start/Stop Position marker) to the waveform between the Start/Stop Position marker and the sync position.

#### Ordering Information

**HP 5182A** Waveform Recorder/Generator

\$27,500

# OSCILLOSCOPES & WAVEFORM ANALYZERS

## Waveform Generation System

Models 5182S, 51820A

77

- Save time storing and recalling waveforms
- Quickly modify and utilize waveforms
- Save time when generating arbitrary waveforms
- No programming necessary

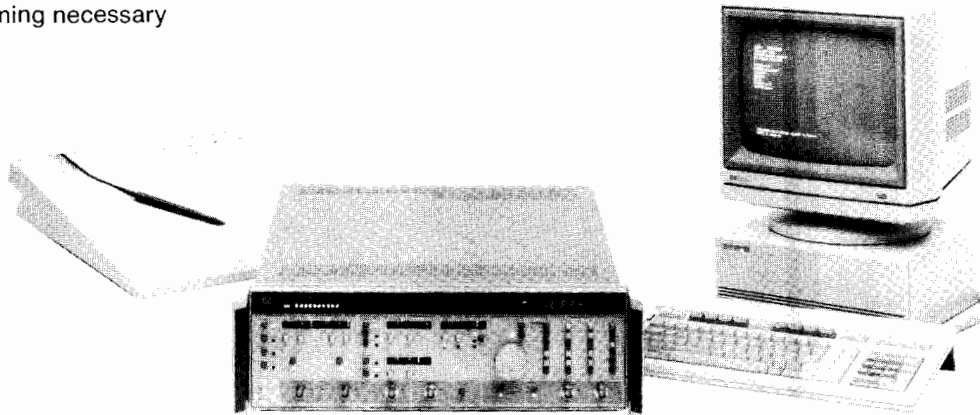

The 5182S waveform capture and playback system.



This signal was recorded from a floppy disc read head.

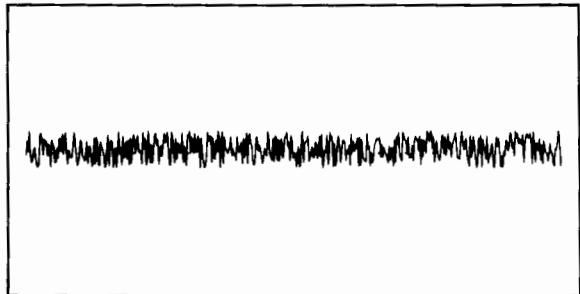

Combined with noise generated from built-in function . . .

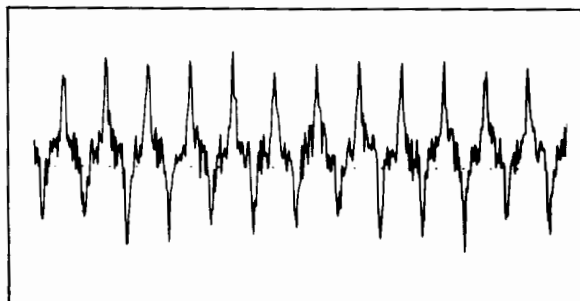

It is used to test the sensitivity of read recovery circuits.

### Save Time Generating Specialized Waveforms

The HP 51820A Software is a powerful set of tools for creating specialized waveforms. Modify captured waveforms or define new ones with the HP 46087A graphics tablet (part of the HP 5182S system). Simply press a SOFTKEY to send waveforms to the HP 5182A for replay or disc for storage. Since the HP 51820A is a complete package (no programming is required), you are productive immediately.

The software is driven by a main menu and three submenus: draw, process and I/O. Because it's only two levels deep, you won't get lost in multiple levels of menus.

### Waveform Capture, Modification and Playback

Modify waveforms you've captured and play them back into the device you are testing. Rather than waiting for a glitch to occur randomly, you can draw one and see the circuit response immediately.

Waveforms can also be modified by processing. Simple functions like offset and gain are built into the SOFTKEY MENU. There are also SOFTKEYS for adding or multiplying two waveforms together.

More complicated processing like calculus and convolution can be accomplished by modifying the user-equation subroutines. Four SOFTKEYS are reserved for your own equations. The Software comes with the equations programmed to generate sine waves, triangle waves, square waves and random noise.

### Arbitrary Waveform Generation

There are three ways to create the waveforms you need. You can recall waveforms from the library, including sine waves, square waves,  $\text{SIN}(X)/X$ , Gaussian pulses, exponentials and more. You can calculate waveform samples with equations. Third, you can draw or trace waveforms with the graphics tablet. Choose the method that will get you the signal you need in the shortest time.

### Ordering Information

HP 5182S Waveform Generation System

Price  
N/C

To ensure coordination of shipments and compatibility of instruments, computers and software, use the system model number when ordering individual components including peripherals such as printers and plotters. Obtain HP 51820A and HP 51800A Data Sheets and a HP 5182S Ordering Guide from your local sales office. See page 771.

HP 51820A Waveform Generation Software

\$1,200



# OSCILLOSCOPES & WAVEFORM ANALYZERS

Three-Channel Recorder to 3 kHz, 12 Bits, 33.3 kHz Sample Rate  
Model 7090A

- DC to 3 kHz bandwidth, 33.3 KHz sampling rate
- 3 Channels with simultaneous sampling
- 12-bit resolution, 1 k buffer/channel
- 6 trigger modes with up to 100% pre-trigger capture
- Full HP-IB programmability
- Annotation of set-up and trigger conditions and data points

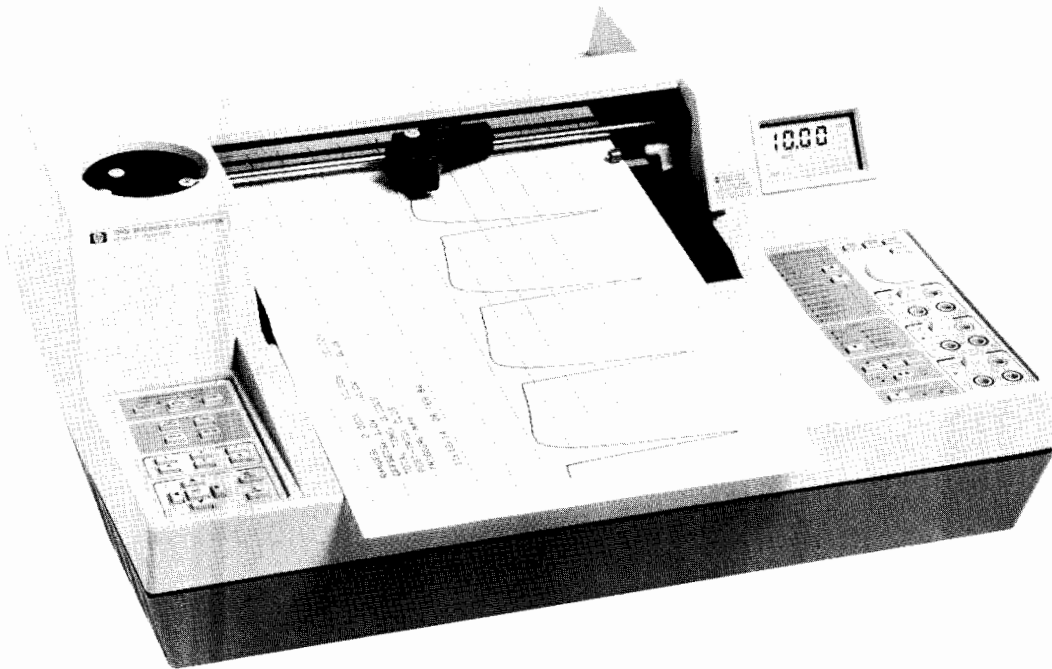

The HP 7090A is designed for low-frequency (<3 kHz) measurement, analysis, and documentation. The HP 7090A merges several technologies - waveform recording, digital plotting, analog recording, and automated measurement - to provide a powerful solution to a broad range of measurement applications. It significantly increases the ability to measure and display low-frequency phenomena and substantially improves real-time recording and digital plotting . . . all in one low-cost system.

### Signal Capture

Simultaneous sampling on each of three channels, 12-bit resolution, bandwidth of dc to 3 kHz (33.3 k samples/s maximum), and 1000 word memory per channel allow high resolution measurement, storage, and display.

### Flexible Triggering

The HP 7090A has six trigger modes which allow virtually any signal change to initiate signal capture, even decaying repetitive signals such as faults in a power line voltage, or in a transducer's carrier. Combined with pre-trigger capability, these trigger modes make the HP 7090A ideal for turn-on/off characterization, fault monitoring and mechanical motion analysis.

### A System Component

All panel functions are programmable via the HP-IB interface. Data can be transferred from the internal 1 k-buffers or streamed in real time from the analog-to-digital converters at up to 500 points/s. In addition, the menu-driven HP 17090B Measurement Graphics Software package is available for HP 9000 Series 200 computers (BASIC 3.0 only). The software allows easy data manipulation, storage and retrieval, and system integration.

### Versatile Capabilities

Uniquely, the HP 7090A is also a high performance analog/digital plotter. It is ideal for a graphics dump from a smart instrument or as part of an HP-IB system; you can also use the HP 7090A to take an X-Y dump from an analog instrument. With the HP 7090A, hand annotation is unnecessary. The 7090A annotates setup conditions, date and time, selected data points from memory, and trigger information. It draws user-defined axes and grids, eliminating the need for

pre-printed graph paper. The HP 7090A even lets you plot overhead transparencies for technical presentations using your current spreadsheet/graphics software.

### Applications

**Capturing Low Frequency Electrical Transients:** General diagnostic monitoring (such as looking for relative timing sequences) and fault monitoring (capturing pre-trigger data for intermittent failure analysis) are natural applications for the HP 7090A.

**Measuring Phase Relationships:** The simultaneous sampling on all channels is ideal for measuring current/voltage phase relationships in power systems.

**Analog Instrument/Digital System Link:** The HP 7090A can integrate an analog instrument into an HP-IB system; the HP 7090A, with a controller can digitize output voltages from analog instruments for HP-IB system data entry.

**Mechanical and Electromechanical Testing:** Applications in which transducers convert velocity, acceleration, force, temperature or torque to voltage are a good fit for the HP 7090A. These applications have a maximum output frequency below 3 kHz. The HP 7090A's flexible trigger capabilities make it useful for one-shot electromechanical events such as clutch and mechanism engagements

**Electromechanical Control Systems:** The HP 7090A can measure the response of a system to a stimulus; a typical use would be exciting the system with a step function and using the measured response to determine damping ratio and the natural frequency of the control system.

**Material Testing:** The HP 7090A can record classic stress-strain curves, particularly those obtained from destructive testing. The data is stored in a buffer, so even though the sample has been destroyed, the data can be viewed and rescaled in several different ways.

**Automatic Test:** When linked to an HP 9000 Series 200 computer, the HP 7090A is a good, inexpensive learning tool for small companies considering automatic test systems. Applications include environmental and production line testing and proof of performance records.

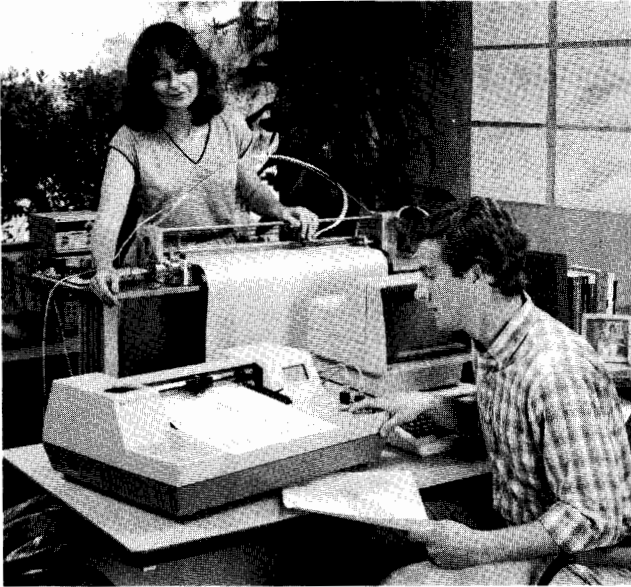

### Measurement Graphics Software

HP 17090 Measurement Graphics Software is designed to access the full capabilities of the HP 7090A Measurement Plotting System and integrate it into computer system applications. This software is compatible with properly configured Series 200 and Series 300 computers. The computer system must have ten softkeys, a knob, and separate displays for alpha characters and graphics. The main user interface with this software is through 10 softkeys on the computer's keyboard and a knob.

**Program Capabilities:** There are six main functional areas of Measurement Graphics Software: measurement setup, measurement, display, annotation, storage and retrieval, and data manipulation.

Measurement Graphics Software helps you use the HP 7090A's features easily and efficiently, and it provides storage, annotation and data transformation capabilities not available on the HP 7090A Unit alone.

**Friendly, Menu-driven Interface:** Each menu allows the user to view several parameters simultaneously. Series 200 and 300 softkeys and cursor-control knob minimize keyboard input, and the "help" softkey displays the available choices and ranges for each parameter setting.

### System Requirements

The following table lists the operating system, memory, and equipment that are needed to use the software with the HP 7090.

HP 17090 Version	Operating System	Available Memory <sup>1</sup>		Applicable HP 9000 Models
		Minimum	Optimum	
A	BASIC 2.0	235K	470K	HP 216 HP 226 HP 236 HP 220 <sup>2</sup>
B	BASIC 3.0	216K	433K	HP 216 HP 226 HP 236 HP 220 <sup>2</sup>
C	BASIC 4.0/4.03	245K	470K	HP 216 HP 217 <sup>3</sup> HP 226 HP 236 HP 220 <sup>3</sup> HP 237 <sup>3</sup> Series 300 <sup>4,5,6</sup>

<sup>1</sup>Memory required after loading BASIC and all necessary binary files. With minimum RAM, short delays will be encountered when software subsystems are swapped in memory.

<sup>2</sup>Applicable when equipped with an HP 98203A/B Keyboard.

<sup>3</sup>Applicable when equipped with BASIC 4.03 and an HP 98203C Keyboard. The HP 220 may also be used with BASIC 4.0 and an HP 98203A/B Keyboard.

<sup>4</sup>BASIC 4.03 is required when the computer is equipped with an HP 98203C Keyboard.

<sup>5</sup>The HP 46083A Knob is required when the computer is equipped with either an HP 46020A or 46021A Keyboard.

<sup>6</sup>The HP 98546A Display Compatibility Interface is required when the computer is equipped with a single-plane monochrome bit-mapped display.

### Summary of HP 7090A Specifications\*

#### Inputs

Number of channels: 3

Input alternator range:  $\pm 5$  mV to  $\pm 100$  V (full scale)

Input offset voltage:  $\pm 2$  full scale or  $\pm 100$  V maximum

Amplifier bandwidth ( $\geq 3$  dB): dc to 3 kHz for all full scale ranges  $\geq 20$  mV, 2.6 kHz for all full scale ranges  $\leq 20$  mV

Input impedance: 1 Mohm, shunted by 45 pf (Nominal)

CMRR: 140 dBdc; 100 dBac @ 60 Hz with 1 kohm unbalance in LOW terminal and most sensitive range (at 25°C)

#### Dynamic Performance

Slewing speed (Nominal)

Direct mode: 127 cm/s (50 in/s)

Plotting mode: 75 cm/s (30 in/s)

Acceleration (Nominal): 2 g constant

Peak capture: 250  $\mu$ s at fastest timebase range

#### Triggering

Internal trigger:

Inside or outside window

Above or below level, selectable over the full-scale range in 1.0% increments (Nominal)

Source: channel 1

External trigger:

BNC connector, TTL level or contact closure to ground

Manual trigger:

Available from front panel controls

Display: Up to 100% pre-trigger; up to 24 hour post-trigger delay after trigger before measurement start

#### Timebase

Range:

Buffer mode: 30 milliseconds to 24 hours

Direct record mode: 1 second to 24 hours

Accuracy:  $\pm 0.1\%$

#### Memory

Size: 1 K per channel

Resolution: 12 bits

### Supplemental Characteristics

#### Analog to Digital

Maximum sampling rate: 33.3 k samples/s

Maximum streaming rate over HP-IB:

1 channel	ASCII	Binary
1 channel plus trigger	167/s	500/s
3 channels	143/s	333/s
3 channels plus trigger	59/s	167/s
	59/s	167/s

#### Writing System

6-pen carousel with automatic pen capping

Fiber-tip pens for paper or transparencies

### Ordering Information

HP 10833A HP-IB (IEEE-488) 1-meter cable

#### Price

\$80

HP 10833B HP-IB (IEEE-488) 2-meter cable

\$90

HP 17090 Measurement Graphics Software A/B/C

Option 630 (3.5 in. disc size)

\$700

Option 655 (5.25 in. disc size)

\$700

HP 7090A Measurement Plotting System

\$5,200

\*Refer to page 87 for complete specifications.

☎ Fast-Ship product—see page 766

# OSCILLOSCOPES & WAVEFORM ANALYZERS

## Probe Multiplexer

HP 54300A, HP 54001A, HP 54002A, and HP 54003A

- Expand Input Capability Of 50 $\Omega$  Instrumentation
- Your choice 50 $\Omega$ , 10k $\Omega$  & 1 M $\Omega$  Input Pods

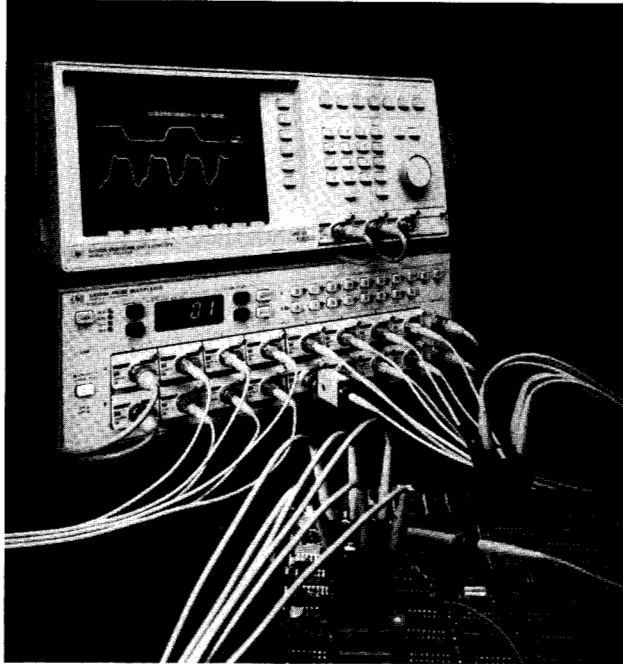

The HP 54300A probe multiplexer expands the input capability of the HP 54100A/D digitizing oscilloscope, or any 50 $\Omega$  input instrument, simplifying delicate high-frequency connections.

### The Multi-input Tool For 50 $\Omega$ Instrumentation

The HP 54300A is a programmable, dual eight-to-one probe multiplexer designed to expand the input capability of instrumentation with 50 $\Omega$  inputs. The unique strength of this multiplexer is its configurability. The user may select from three different input pods: two high-frequency, high-impedance probes, or a 50 $\Omega$  BNC input for terminated line applications.

The HP 54300A features full HP-IB programmability as well as simple front-panel control. It has internal non-volatile memory for storing lists of switching steps. Switch lists can be advanced step-by-step from a front-panel button, over the HP-IB (i.e., IEEE-488) or for data logging applications, through a TTL pulse entered at the rear panel.

### Automate Complex Measurements

The HP 54300A is ideal for delicate situations where high frequency connections must be maintained and probes cannot be conveniently moved from one connection to another. Complex measurements can be automated by using the multiplexer's 16 inputs, switching one or two of them at a time into the test instrument, under computer control. In situations requiring more than 16 inputs, HP 54300A multiplexers may be cascaded in series to give a total of 128 inputs.

### Your Choice Of Inputs

Configurable input is one of the HP 54300A's strongest contributions. It accepts all of the input pods designed for the HP 54100/110 1 GHz digitizing oscilloscope.

- Fully HP-IB Programmable, Plus Convenient Front-panel Control
- Internal Non-volatile Memory

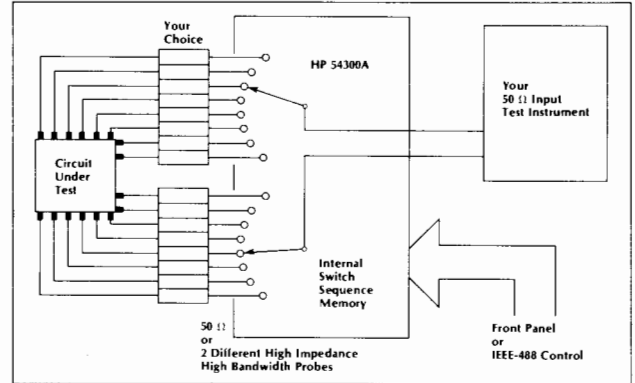

The HP 54300A's configurable inputs and HP-IB programmability make it a powerful addition to your bench or ATE system.

### HP 54001A 1 GHz Active Mini-probe Pod

This pod, with its built-in probe, offers 1 GHz bandwidth with 10k $\Omega$ /2 pF input loading. It uses HP's mini-tip probe for easy access in compact circuits, and features both high-bandwidth and high-impedance at the probe tip. This probe is ideal for making high-speed logic measurements, where high bandwidth is needed and probe capacitance is a significant factor in loading the test circuit.

### HP 54002A 50 $\Omega$ BNC Pod

This pod should be used with terminated 50 $\Omega$  systems. Output from the multiplexer using this pod is <2 dB down at >1 GHz. The 54002A is also useful with divider probes such as the HP 10020A.

### HP 54003A 300 MHz 1 M $\Omega$ Probe Pod

This pod, with a 10:1 detachable mini-tip probe, has 1 M $\Omega$  resistive and 8 pF capacitive loading. It is valuable when resistance is a more significant loading factor than capacitance, such as in operational amplifier measurements. If desired, the probe may be removed from its pod to provide a 1 M $\Omega$  approximately 10 pF BNC input.

### Fully Programmable For Automated Testing

All functions that can be controlled from the HP 54300A front panel can also be controlled over the HP-IB. Simple, English-like commands are used with an optional format that is compatible with the command language of the HP 3488A switch/control unit.

The HP 54300A command set is simple, but complete. Even information such as the type of input pod that is being used or the total number of switch closures that have occurred on a given switch pole may be obtained over the bus. This information is useful in determining whether the correct pods have been inserted for a particular automatic program, or to indicate when switch replacement is due. The HP 54300A is a powerful complement to other HP programmable instruments and HP computers for automated testing of high-frequency circuits.

### Ordering Information

	<b>Price</b>
<b>HP 54300A</b> dual 8:1 probe multiplexer	\$7900
Includes one operating and programming manual. Each HP 54300 accepts up to 16 input pods in any combination. Pods must be ordered separately.	
<b>Opt. 908</b> Rackmount flange kit	\$35
<b>HP 54001A</b> 1 GHz miniature active probe pod	\$765
<b>HP 54002A</b> 50 $\Omega$ BNC input pod	\$130
<b>HP 54003A</b> 1M $\Omega$ 10:1 probe pod	\$665

For information on other probes and probing accessories, please refer to the section on the HP 54100/110 digitizing oscilloscope, page 62.

# OSCILLOSCOPES & WAVEFORM ANALYZERS

## Probes and Other Oscilloscope Accessories

### A New Family of Miniature Oscilloscope Probes

81

- Modular construction
- Improved electrical performance
- New accessories

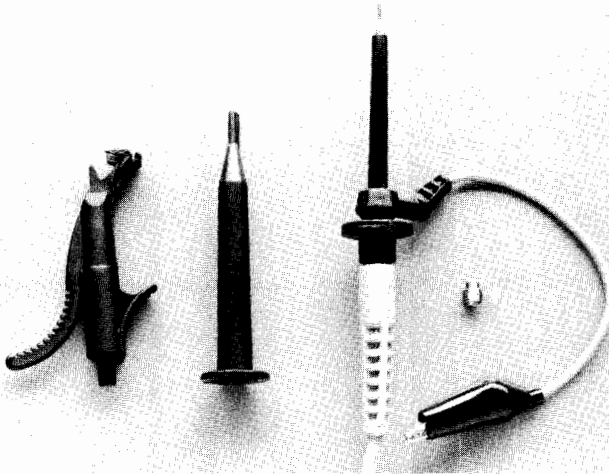

#### The HP 10400A Miniature Probe Family

The HP 10400A miniature probe family offers modular construction, improved reliability, and superior electrical performance over our previous mini-probes. Modular construction allows individual replacement of probe tips, cables, and chassis assemblies cutting down on probe replacement and repair costs. Improved cable and strain relief design increase reliability. Electrical performance is also improved by reducing the probe shunt capacitance and increasing the input resistance that load the circuit under test.

The HP 10400A mini-probe family also features new accessories (see below) including a new ground lead utilizing a ferrite bead for reduced ringing on pulse tops, and a new IC grabber that allows easy connection of a single probe to many IC packages without fear of shorting adjacent pins.

#### OSCILLOSCOPE/MINIATURE PROBE COMPATIBILITY AND PROBE CHARACTERISTICS

HP Oscilloscope/ Logic Analyzer	HP Probe Model No.	Approx Overall Length in Metres (ft)	Division Ratio	Input R	Approx Shunt Capacitance	Compensates Oscilloscope Input	Max dc Volts	Price	
Same as 10431A but without probe indent	10430A	1m (3.3)	10:1	10MΩ	6.5 pF	1MΩ 6-9 pF	450	\$115	☎
54111D, 54112D	10431A*	1m (3.3)	10:1	10MΩ	6.5 pF	1MΩ 6-9 pF	450	\$120	☎
1631A/D, 1715/22/25/26/27 1805/09, 54200/201, 54501, 5185	10432A**	1m (3.3)	10:1	10MΩ	7.5 pF	1MΩ 10-16 pF	450	\$105	☎
1631A/D, 16530/31, 5185 54003A, 54200/201, 54501	10433A	2m (6.6)	10:1	10MΩ	10 pF	1MΩ 10-16 pF	450	\$105	☎
1740/41/42/43/44/45/46	10434A	1m (3.3)	10:1	10M Ω	8 pF	1MΩ 18-22 pF	450	\$105	☎
1631A/D, 1715/22/25/26/27 1805/09, 54200/201, 5185	10435A	1m (3.3)	10:1	1MΩ	7.5 pF	1MΩ 10-16 pF	450	\$115	☎
1740/41/42/43/44/45/46	10436A	2m (6.6)	10:1	10MΩ	11 pF	1MΩ 18-22 pF	450	\$110	☎
For oscilloscopes with 50 Ω inputs	10437A	2m (6.6)	1:1	50Ω				\$80	☎
All scopes with high Z inputs (may reduce bandwidth)	10438A	1m (3.3)	1:1		40 pF		450	\$85	☎
	10439A	2m (6.6)	1:1		64 pF		450	\$90	☎
1631A/D, 1715/22/25/26/27 1805/09, 1950A, 54112D† 54003A, 54111D†, 54200/201†	10440A	2m (6.6)	100:1	10MΩ	2.5 pF	1MΩ 6-14 pF	450	\$115	☎

Note 1: Maximum input voltage may be limited by scope input maximum voltage.

\*Has probe identification pin.

\*\*The 54201A/D can use the HP 10432A or HP 10435A probes for the vertical inputs but the HP 10435A probe must be used for trigger inputs.

†For vertical inputs only

☎ Fast ship product see page 766

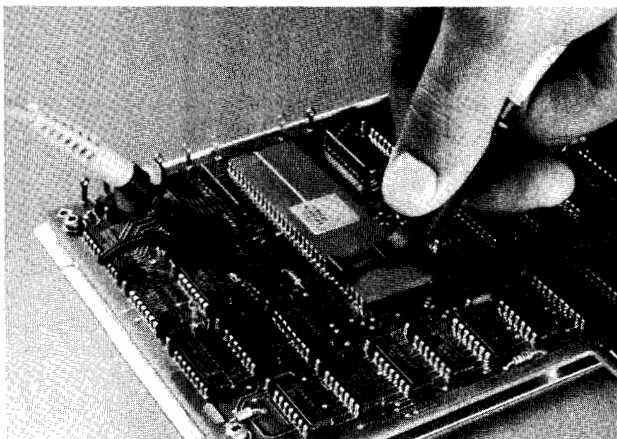

#### HP 10400A Family Accessories

Each 10400A family probe is shipped with one general purpose grabber, one IC grabber, and one ground lead. An accessory package is also included which contains 4 grounding spanners (for close grounds at the probe tip), 1 probe barrel insulator, 1 adjustment screwdriver, and 8 colored cable markers.

The photo at left illustrates use of the IC grabber. This device fits DIPs with 0.1 inch pin spacing (standard) and up to 0.9 inch package width. It is handy for connecting the mini-probe tip to a single DIP pin. Construction prevents shorting adjacent pins during hook-up. For applications where several adjacent DIP pins must be probed, the 10024A accessory can be used (see next page).



# OSCILLOSCOPES & WAVEFORM ANALYZERS

## Probes and Other Oscilloscope Accessories (cont'd)

### HP 10002A 1000V 50:1 Voltage Divider Probe

The HP 10002A voltage divider probe is a general purpose probe for use with instruments that have a bandwidth of less than 40 MHz with an input impedance of 1 megohm shunted by approximately 15 to 55 pF. The probe is rated at 1000V peak.

### HP 10020A Resistive Divider Probe Kit

The HP 10020A Resistive Divider Kit is a signal probing system for measuring fast transition signals in high impedance systems. It is designed for use with 50 ohm input oscilloscopes, but may be used with other than 50 ohm systems if a 50 ohm feedthrough termination (HP 10100C) is used. The extremely low input RC of the 10020A provides high fidelity measurements of fast transition signals.

### HP 10020A Resistive Dividers

Division Ratio	Input R* (ohms)	Division Accuracy	Max V** (rms)	Input C (pF)
1:1	50	—	6	—
5:1	250	±3%	9	<0.7
10:1	500	±3%	12	<0.7
20:1	1000	±3%	15	<0.7
50:1	2500	±3%	25	<0.7
100:1	5000	±3%	35	<0.7

\*When terminated in 50 ohms.

\*\*Limited by power dissipation of resistive element.

**Probe length (overall):** 1.2 m (4 ft).

**Weight:** net, 0.45 kg (1 lb); shipping, 1.4 kg (3 lb).

**Accessories supplied:** blocking capacitor, BNC adapter tip, 6-32 adapter tip, alligator tip, probe handle, cable assy's 5.1 cm (2 in) & 15.2 cm (6 in) ground, spanner tip, insulating caps, colored sleeves.

### HP 1124A 100 MHz Active Divider Probe

The HP 1124A active divider probe provides high voltage, general-purpose probing capabilities for instruments having 50 ohm inputs without selectable high impedance inputs. This 10 Mohm 10 pF probe allows direct measurements of 100 V, in the 100:1 division ratio mode, from dc to 100 MHz. In the 10:1 division ratio mode, input voltage range is ±10 V. Power is supplied by instruments with probe power jacks or the HP 1122A probe power supply.

### HP 1124A Specifications

(Measured when connected to a 50 ohm load)

Bandwidth: (measured from a terminated 50 ohm source) dc-coupled, dc to 100 MHz; ac-coupled, 2 Hz to 100 MHz.

Pulse response: (measured from a terminated 50 ohm source) transition time, <3.5 ns; perturbations, 5% p-p. Measured with pulse transition time of >2.5 ns.

Attenuation ratio: 10:1 ±5%; 100:1 ±5%.

Dynamic range: x10, ±10 V; x100, ±100 V.

Input RC: 10 Mohm shunted by ≈ 10 pF.

Maximum safe input

dc-coupled: x10, ±300 V (dc + peak ac) ≤100 MHz; x100, ±500 V (dc + peak ac) ≤100 MHz.

ac-coupled: x10, ±300 V (dc + peak ac) ≤100 MHz; dc component must not exceed ±200 V; x100, ±500 V (dc + peak ac) ≤100 MHz; dc component must not exceed ±200 V.

Accessories supplied: one 20.3 cm (8 in) ground lead, one retractable hook tip, and two probe tip insulating caps.

Power: supplied by instruments with probe power jacks or the HP 1122A probe power supply.

Weight: net, 0.2 kg (5 oz); shipping, 0.91 kg (2 lb).

Length: 1.5 m (5 ft) overall.

### Ordering Information

HP 10002A 1000V 50:1 Voltage Divider Probe	\$230
HP 10020A resistive divider probe kit	\$495
HP 1124A 100 MHz active probe	\$350

### HP 1122A Probe Power Supply

The HP 1122A is a regulated power supply that provides all power requirements for simultaneous operation of up to four active probes.

### HP 1122A Specifications

Probe driving capability: up to four HP active probes.

Power output: -12.6 V and +15 V, ±3%.

Power input: 115 V or 230 V ±10%, 48 to 440 Hz, 40 W (with four probes).

Weight: net, 2.7 kg (6 lb); shipping 3.6 kg (8 lb).

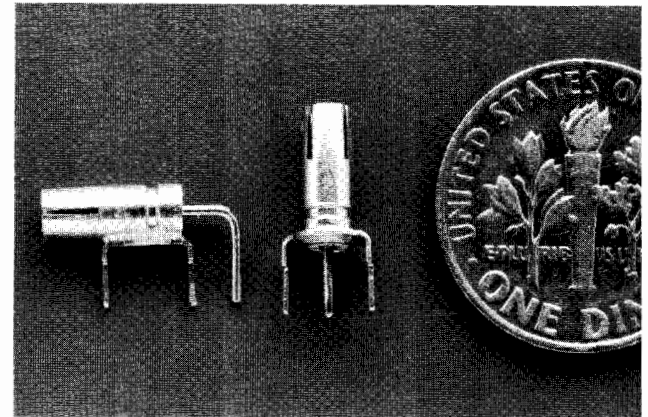

### HP 1250-1737 PC Board Mini Probe Socket

The HP 1250-1737 PC board mini probe socket is ideal for breadboard circuit applications where it is desirable to make a reliable circuit connection between the mini probe tip and a test circuit (Soldering the tip itself into place is not recommended.) The HP 1250-1737 is also useful in production PC board applications as an oscilloscope test point. The probe plugs into the socket parallel to the PC board.

### HP 1250-1918 PC Board Vertical Mini Probe Socket

The HP 1250-1918 is similar to the 1250-1737 (above) except that it is designed for attaching the probe vertically to the board rather than horizontally.

### HP 10024A IC Test Clip

The HP 10024A IC test clip provides easy probing of dual in-line packages and includes four insulated circuit interface pins. Additional circuit interface pins are available (see Ordering Information) in packages of twelve pins. Each pin has a tip on each end so that probes such as those on HP logic analyzers can be connected for fast, functional checks of circuit operation.

### Probe Accessories

#### Terminations

HP 10100C: 50 ohm ±1% BNC male to BNC female feedthrough termination.

#### Standard Probe Tip Adapters

HP 10229A hook tip adapter: retractable pincer tip provides firm connection to circuit nodes. Recommended accessory for HP 10020A resistive divider kit.

### Ordering Information

	Price
HP 1122A probe power supply	\$1235.00
HP 1250-1737 PC board mini probe socket	\$6.75
HP 1250-1918 PC board mini probe socket (vertical)	\$8.75
HP 10024A IC test clip (with 4 circuit interface pins)	\$20.00
HP 10024-69501 interface pin kit for HP 10024A; includes 12 interface pins.	\$39.00
HP 1250-1454 BNC-to-mini probe adapter	\$13.50
HP 10229A retractable hook tip adapter	\$20.00
HP 10100C 50 ohm feedthrough termination	\$40.00

### Testmobiles

The new low-priced HP 1180A Scope cart is now available for HP 54501A, HP 542XX Digitizing Oscilloscopes and HP 163X, HP 165X Logic Analyzers. A quick-connect strap enables users to easily remove or replace the scope on the cart. The large casters give excellent stability and smooth maneuverability. The top shelf tilt angle is adjustable to optimize the oscilloscope's viewing angle. The back of the cart has power cord storage and mounting provisions for a five outlet U.S. power strip (not included, order part number HP 92199B).

### Testmobile Specifications

	HP 1008A	HP 1180A
Height	930 mm (36.6 in)	890 mm (35.0 in)
Overall width	759 mm (29.8 in)	475 mm (18.7 in)
Width of tray	473 mm (18.6 in)	456 mm (18.0 in)
Tilt tray angle	±30°	+30°
Weight	net	13 kg (28 lb)
	shipping	22 kg (48 lb)
Max load on tilt tray		45 kg (100 lb)
	see option 006 description	20.5 kg (45 lb)
Max load below tilt tray	see option 006 description	25 kg (55 lb)

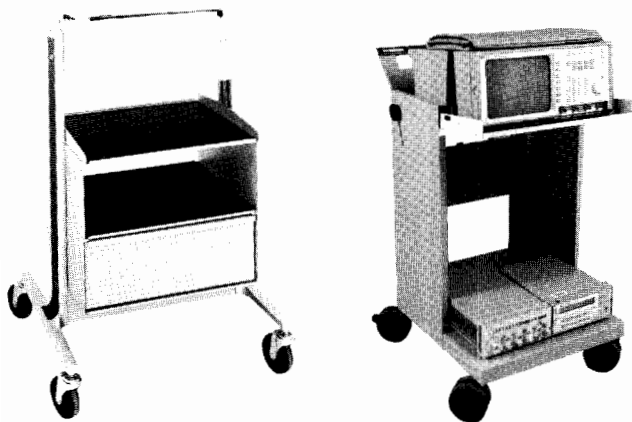

**Opt 006:** storage cabinet with shelf on top and drawer in lower position; load limit 18 (40 lb) each on shelf and in cabinet, 11 kg (25 lb) in drawer.

**HP 1180A:** New low-priced testmobile for the HP 54501A, HP 542XX, HP 163X, and HP 165X.

### Ordering Information

HP 1180A Testmobile \$290.00 ☎  
 HP 1008A Testmobile \$970.00  
 HP 1008A Opt 006 Added shelf and cabinet for 1008A \$270.00  
 HP 92199B U.S. Power Strip for HP 1180A \$36.00 ☎  
 ☎ Fast-ship product - see page 766.

### HP 1133A TV/Video Sync Pod

- Clamped or unclamped video output.
- Trigger output for line and frame.
- For most standard broadcast composite video systems
- Compatible with most analog & digitizing scopes

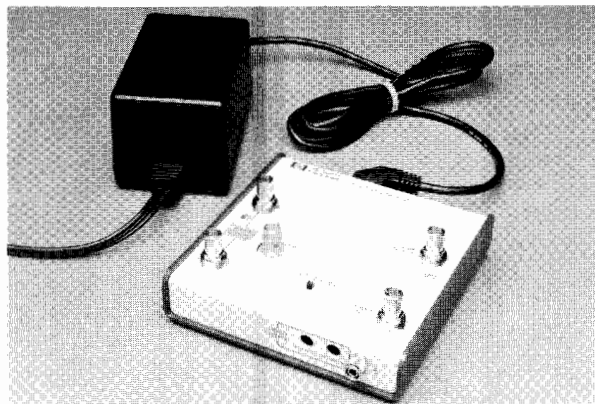

The HP 1133A TV/Video Sync Pod is an accessory that provides users with TV sync triggering for most analog or digitizing oscilloscopes. It features clamped or unclamped video outputs that can be viewed on the oscilloscope's vertical channels and trigger outputs that can synchronize the oscilloscope to video frame and individual lines.

The pod itself is packaged in a case approximately 14x14x4.5 cm (5.5x5.5x1.75") and is powered by a separate ac power module. The pod features a loop-thru input (two female BNC) which can be driven from a 75 ohm source, or for probing high impedance circuits, from a 1-10 megohm probe. The loop-thru feature allows 75 ohm signal to be looped through the TV/Video pod then connected to a video monitor or other 75 ohm device. Clamped or unclamped video outputs are designed to drive a high impedance probe (1-10 megohm) connected to the oscilloscope input.

The HP 1133A is compatible with broadcast standards M, N, C, B, G, H, I, D, K, K1, and L systems.

### Characteristics

Video input: AC coupled with an RC of 1 megohm shunted by approximately 10 pF.

Bandwidth: Approximately 10 MHz

Maximum input voltage: 40 Volts (DC plus peak AC)

Frame output is phase locked to the leading edge of the third field synchronizing pulse on field one, to the leading edge of the second pulse on field two. Frame output goes high on field one, and low on field two.

A switch is provided for positive or negative sync pulse polarity.

A gain control is provided to adjust for signal amplitude at BNC input.

Gain from input BNC to unclamped output is approximately 2.5 to 50.

### Ordering Information

Note: The 1133A must be ordered with a power supply option.  
**HP 1133A TV/Video Sync Pod** \$275.00  
**Opt ABA** Power supply for U.S.A., 120V, nema 515P plug N/C  
**Opt ABB** Power supply for Europe, 220V CEE7-VII plug N/C  
**Opt ABJ** Power supply for Japan, 100V nema 515P plug N/C  
**Opt ABU** Power supply for United Kingdom, 240V BS1363 plug N/C

# PLOTTERS & RECORDERS

## Measurement Plotting System

### Model 7090A

- Floating and guarded inputs
- DC to 3 kHz bandwidth, 33.3 kHz sampling rate
- 3 channels with simultaneous sampling
- 12-bit resolution, 1 k buffer/channel
- 6 trigger modes with up to 100% pre-trigger capture
- Full programmability and data transfer over HP-IB

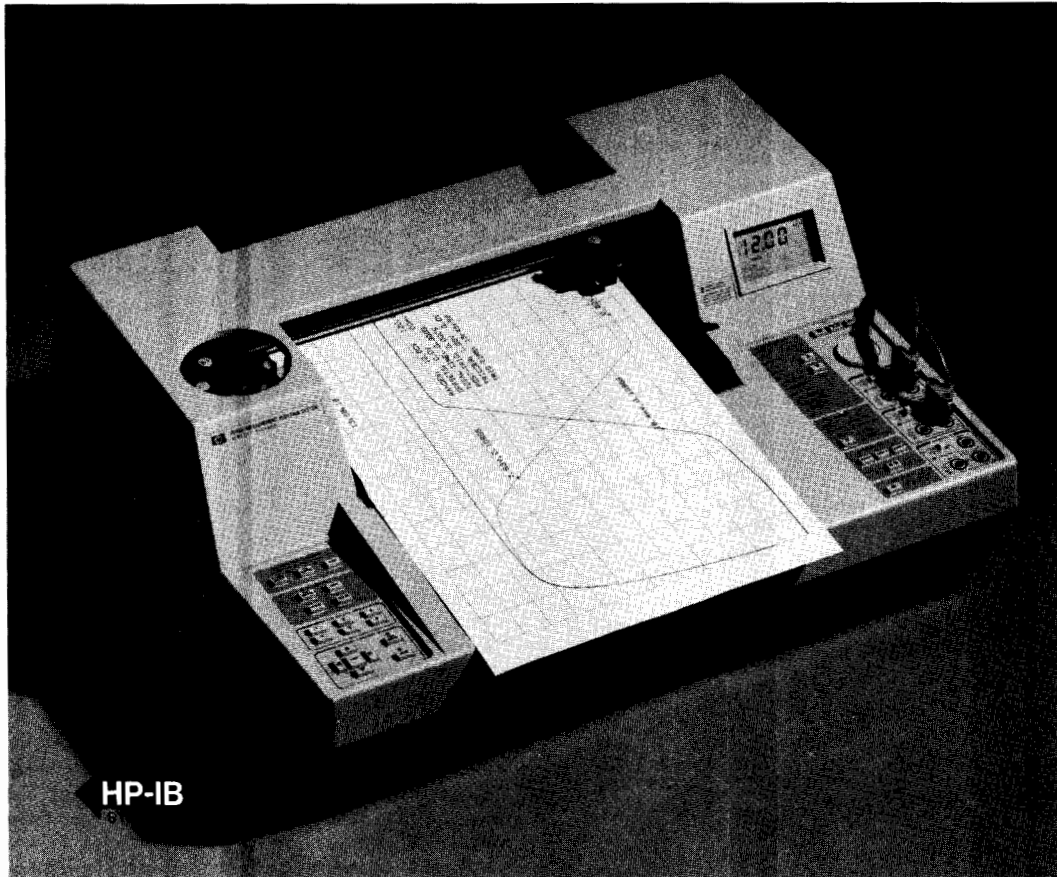

HP 7090A

The HP 7090A is designed for low-frequency (< 3 kHz) measurement, analysis, and documentation. The 7090A merges several technologies - waveform recording, digital plotting, analog recording, and automated measurement - to provide a powerful solution to a broad range of measurement applications. It significantly increases the ability to measure and display low-frequency phenomena and substantially improves real-time recording and digital plotting . . . all in one low-cost system.

#### Signal Capture

Simultaneous sampling on each of three channels, 12-bit resolution, bandwidth of dc to 3 kHz (33.3 k samples/s maximum), and 1000 word memory per channel allow high resolution measurement, storage, and display.

#### Flexible Triggering

The HP 7090A has six trigger modes which allow virtually any signal change to initiate signal capture, even decaying repetitive signals such as faults in a power line voltage, or in a transducer's carrier. Combined with pre-trigger capability, these trigger modes make the HP 7090A Measurement Plotting System ideal for turn-on/off characterization, fault monitoring and mechanical motion analysis.

#### A System Component

All panel functions are programmable via the HP-IB interface. Data can be transferred from the internal 1 k-buffers or streamed in real time from the analog-to-digital converters at up to 500 points/s. In addition, the menu-driven HP 17090B Measurement Graphics Software package is available for HP 9000 Series 200 computers

(BASIC 3.0 only). The software allows easy data manipulation, storage and retrieval, and system integration.

#### Versatile Capabilities

As the name implies, the HP 7090A Measurement Plotting System is also a high performance digital plotter. It is ideal for a graphics dump from a smart instrument (e.g. from an HP 8569B Spectrum Analyzer) or as part of an HP-IB system; you can also use the HP 7090A to take an X-Y dump from an analog instrument (e.g. from an HP 141T Spectrum Analyzer System). With the HP 7090A, hand annotation is unnecessary. The 7090A annotates setup conditions, date and time, selected data points from memory, and trigger information. It draws user-defined axes and grids, eliminating the need for pre-printed graph paper. The HP 7090A even lets you plot overhead transparencies for technical presentations.

#### Applications

**Analog Recording:** Electrical, chemical, mechanical and medical fields all benefit from recording real-time X-Y and Y-T relationships. As an analog recorder, the HP 7090A has sensitivity to 5 mV full scale and 41,000 calibrated ranges for easy and quick calibration to measurement units. The HP 7090A's superior dynamic performance and high sensitivity provide users the versatility and accuracy required in laboratory environments.

**Capturing Low Frequency Electrical Transients:** General diagnostic monitoring (such as looking for relative timing sequences) and fault monitoring (capturing pre-trigger data for intermittent

failure analysis) are natural applications for the HP 7090A. **Measuring Phase Relationships:** The simultaneous sampling on all channels is ideal for measuring current/voltage phase relationships in power systems.

**Analog Instrument/Digital System Link:** The HP 7090A can integrate an analog instrument into an HP-IB system; the HP 7090A, with a controller can digitize output voltages from analog instruments for HP-IB system data entry.

**Mechanical and Electromechanical Testing:** Applications in which transducers convert velocity, acceleration, force, temperature or torque to voltage are a good fit for the HP 7090A. These applications have a maximum output frequency below 3 kHz. The HP 7090A's flexible trigger capabilities make it useful for one-shot electromechanical events such as clutch and mechanism engagements.

**Electromechanical Control Systems:** The HP 7090A can measure the response of a system to a stimulus; a typical use would be exciting the system with a step function and using the measured response to determine damping ratio and the natural frequency of the control system.

**Material Testing:** The HP 7090A can record classic stress-strain curves, particularly those obtained from destructive testing. The data is stored in a buffer, so even though the sample has been destroyed, the data can be viewed and rescaled in several different ways.

**Automatic Test:** When linked to an HP 9000 Series 200 computer, the HP 7090A is a good, inexpensive learning tool for small companies considering automatic test systems. Applications include environmental and production line testing and proof of performance records.

**Measurement Graphics Software**

HP 17090 Measurement Graphics Software is designed to access the full capabilities of the HP 7090A Measurement Plotting System and integrate it into computer system applications. This software is compatible with properly configured Series 200 and Series 300 computers. The computer system must have ten softkeys, a knob, and separate displays for alpha characters and graphics. The main user interface with this software is through 10 softkeys on the computer's keyboard and a knob.

**Program Capabilities:** There are six main functional areas of Measurement Graphics Software:

- measurement setup
- measurement
- display
- annotation
- storage and retrieval
- data manipulation

Measurement Graphics Software helps you use the HP 7090A's features easily and efficiently, and it provides storage, annotation and data transformation capabilities not available on the HP 7090A unit alone.

**Friendly, Menu-driven Interface:** Each menu allows the user to view several parameters simultaneously. Series 200 and 300 softkeys and cursor-control knob minimize keyboard input, and the "help" softkey displays the available choices and ranges for each parameter setting.

**System Requirements**

The following table lists the operating system, memory, and equipment that are needed to use the software with the HP 7090.

HP 17090 Version	Operating System	Available Memory <sup>1</sup>		Applicable HP 9000 Models
		Minimum	Optimum	
A	BASIC 2.0	235K	470K	HP 216 HP 226 HP 236 HP 220 <sup>2</sup>
B	BASIC 3.0	216K	433K	HP 216 HP 226 HP 236 HP 220 <sup>2</sup>
C	BASIC 4.0/4.03	245K	470K	HP 216 HP 217 <sup>3</sup> HP 226 HP 236 HP 220 <sup>2</sup> HP 237 <sup>3</sup> Series 300 <sup>4,5,6</sup>

<sup>1</sup> Memory required after loading BASIC and all necessary binary files. With minimum RAM, short delays will be encountered when software subsystems are swapped in memory.  
<sup>2</sup> Applicable when equipped with an HP 98203A/B Keyboard.  
<sup>3</sup> Applicable when equipped with BASIC 4.03 and an HP 98203C Keyboard. The HP 220 may also be used with BASIC 4.0 and an HP 98203A/B Keyboard.  
<sup>4</sup> BASIC 4.03 is required when the computer is equipped with an HP 98203C Keyboard.  
<sup>5</sup> The HP 46083A Knob is required when the computer is equipped with either an HP 46020A or 46021A Keyboard.  
<sup>6</sup> The HP 98546A Display Compatibility Interface is required when the computer is equipped with a single-plane monochrome bit-mapped display.

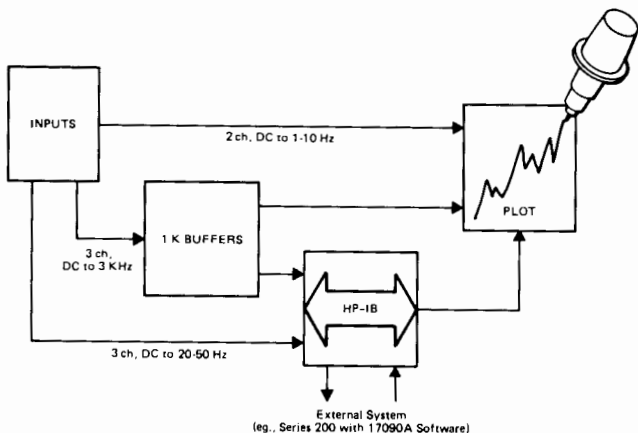
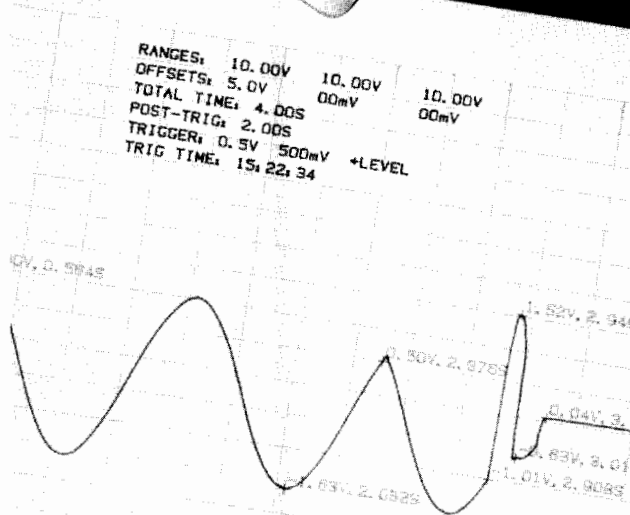
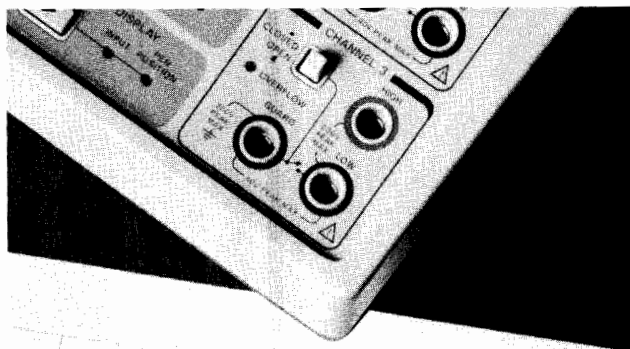

Possible data flow paths for the HP 7090A Measurement Plotting System.



# PLOTTERS & RECORDERS

## Measurement Plotting System (cont'd)

Model 7090A

### HP 7090A Panel Controls



Easy-to-read controls provide accurate feedback of recording conditions.

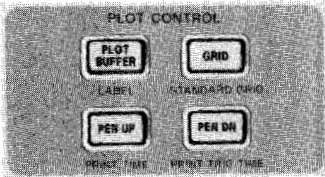

Annotation capability eliminates errors from hand annotation, and creates accurate hardcopy records.

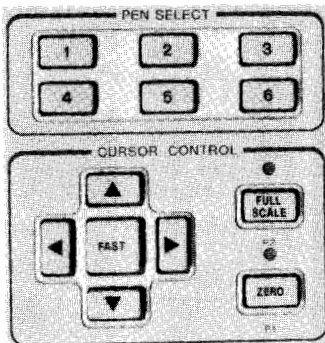

Controls allow the easy selection and movement of pens. Scaling capability allows you to design graphs to fit custom formats.

Ten thousand possible ranges eliminate guessing about exact set-up parameters. Ability to store set-up conditions decreases set-up time for repeated experiments.

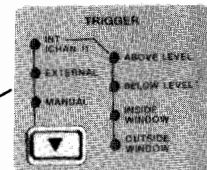
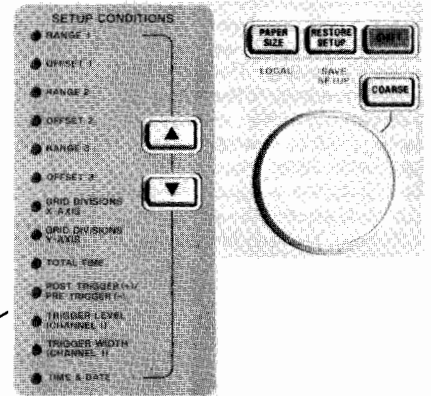

Multiple trigger modes make viewing transient and pre-trigger data easy; eliminates the search through strip chart/oscillographic output for an event.

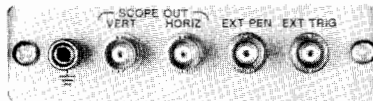

External connectors provide flexibility for configuring experiments to meet your varied measurement needs.

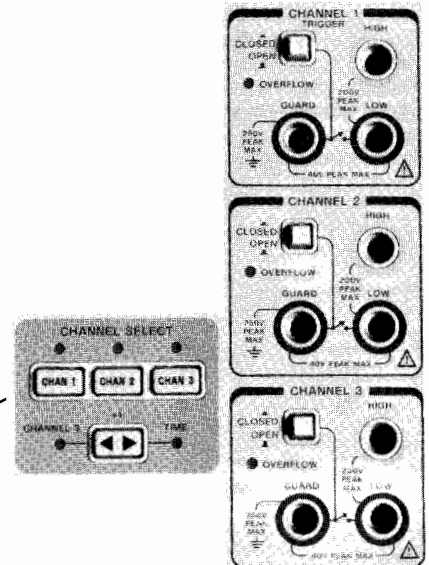

Three output channels allow you to measure and view low-frequency phenomena at a much lower cost than a traditional waveform recorder.



Data display capability allows you to scan the buffer, displaying current values on LCD or labeling datapoints on graph.

## Specifications

### Inputs

Number of channels	3
Type of input	floating, guarded
Sensitivity	5 mV to 100 V full scale
Sensitivity ranges	41,000
Zero offset	$\pm 2$ full scale or $\pm 100$ V maximum
Zero offset ranges	approximately 5% or range steps
Input impedance	1 Mohm, shunted by 45 pf (Nominal)
Maximum input voltage	200 V, dc or peak
Maximum source resistance	10 kohm
Common mode rejection ratio	140 dB dc; 100 dB ac @ 60 Hz with 1 kohm unbalance in LOW terminal and most sensitive range (at 25 C)

### Electrical accuracy (@ 25 C, $\pm 1$ scale offset maximum):

Constant inaccuracy	
1 V to 100 V range	$\pm 0.15\%$ of range
5 mV to 500 mV range	increases from $\pm 0.15\%$ of range @ 500 mV to $\pm 0.26\%$ of range @ 5 mV
Reading inaccuracy	$\pm 0.055\%$ of reading
Temperature coefficient	
Constant inaccuracy	
1 V to 100 V range	$\pm 0.012\%$ of range/degree C
5 mV to 500 V range	increases from $\pm 0.012\%$ or range/degree C @ 500 mV to $\pm 0.044\%$ of range/degree C @ 5 mV
Reading inaccuracy	$\pm 0.01\%$ of reading/degree C

### Timebase

Buffer mode	
Range	30 milliseconds to 24 hours
Number of ranges	4,700
Direct mode	
Range	1 second to 24 hours
Number of ranges	3,700
Accuracy	$\pm 0.1\%$

### Dynamic Performance

Slewing Speed (Nominal)	
Direct mode	127 cm/s (50 in./s)
Plotting mode	75 cm/s (30 in./s)
Acceleration (Nominal)	2 g constant
Bandwidth ( $\geq 3$ dB)	3 kHz for all full scale ranges $\geq 20$ mV 2.6 kHz for all full-scale ranges $< 20$ mV 250 $\mu$ s at fastest timebase range

### Memory per Channel

Size	1000 words
Resolution	12-bits

### Trigger Characteristics

Internal Trigger	Inside or outside window to capture decaying repetitive signals, inside resets with each reverse transition; Above or below level, selectable over the full-scale range in 1.0% of range increments (NOMINAL); Source, channel 1
External Trigger	BNC connector, TTL level or contact closure to ground
Manual Trigger	Available from front-panel controls
Display	Up to 100% pre-trigger capture, up to 24 hour post-trigger delay before measurement start

### Supplemental Characteristics

Writing System	6-pen carousel with automatic pen capping Fiber-tip pens for paper or transparencies
Digital Plotting	Intelligence: over 40 HP-GL instructions; five built in character sets including ANSI ASCII, HP 9825, French/German, Scandinavian,

### Spanish/Latin America

Front-panel controls: P1, P2; pen position cursors; pen selection  
Interface modes (user selectable): listen only; listen/talk

Types: paper, overhead transparency film

Sizes (switch-selectable): A4/A (210 x 297 mm, 8.5 x 11 in.); A3/B (297 x 420 mm, 11 x 17 in.)

HP-IB control of all recorder and plotter functions

Software lockable front panel  
Allows use of X-Y oscilloscope to preview buffer contents

Connectors: 2 BNC, vertical and horizontal

Output:  $-10$  V to  $10$  V (0 V corresponds to origin on chart); refreshed every 15 ms

Resolution: 10-bit

Allows panel display of dc voltage levels on selected channel input

Sampling rate: 1/sec (NOMINAL)

Allows cursor to move pen along plotted buffer data on selected channel, value shown on display, and coordinate pair can be printed at selected points.

### External Pen Lift Control

BNC connector, TTL level or contact closure to ground

### Analog-to-digital

Max. sampling rate: 33.3 k samples/s  
Max. streaming rate over HP-IB:

	ASCII	Binary
1 channel	167/s	500/s
1 channel plus trigger	143/s	333/s
3 channels	59/s	167/s
3 channels plus trigger	59/s	167/s

### Real-time Clock

Functions: second, minute, hour, day, year

Controls: front-panel set, battery (lithium) backup

Accuracy:  $\pm 4$  sec/day @ 25 C

Operating temperature: 0-55 C

Source: 100, 120, 220, 240 V ac  
 $-10\%$ ,  $+5\%$

Frequency: 48-66 Hz

Consumption: 140 W

Height: 205.5 mm (8.1 in.)

Weight: 575.0 (22.6 in.)

Depth: 465.0 (18.3 in.)

Net: 15.7 kg (34.5 lbs)

Shipping: 23.6 kg (18.3 lbs)

### Environmental

### Power Requirement

### Size

### Weight

### Accessories Supplied

Interfacing and Programming Manual

Operator's Manual

Pocket Guide

An assortment of pens and media are also shipped with each HP 7090A unit sold. Paper size and power cord are determined by destination.

### Part Number

07090-90001

07090-90002

07090-90004

### Ordering Information

HP 10833A or 45529A HP-IB (IEEE-488) 1-meter cable

HP 10833B or 45529B HP-IB (IEEE-488) 2-meter cable

HP 7090A Measurement Plotting System

Option 910 (duplicate set of manuals)

HP 17090A/B/C Measurement Graphics Software

Option 630 (3.5 in. disc size)

Option 655 (5.25 in. disc size)

### Price

\$80.00

\$90.00

\$5200.00

\$100.00

\$700.00

\$700.00

# PLOTTERS & RECORDERS

## Recorder/Plotter Selection Guide

The following pages list recommended graphics output devices for over 100 HP instruments. HP instruments designed with microprocessors can control plotting from front-panel buttons or menu-driven softkeys. If your instrument has this capability, it will be listed with a "direct to plotter" output capability.

Other HP instruments require the appropriate controller and software in order to send graphics output to the plotter. These devices are indicated by "indirect to plotter" output capability. If the system includes or requires a particular controller, that controller is indicated. Voltage and penlift for instruments with analog output are also listed.

(To order the ColorPro plotter ask for the HP 7440A.)

HP Instrument	Output Capability*	Plotter Software Support	X-Y Recorder Outputs		Recommended HP Models
			Voltage	Penlift	
PC Instruments	Indirect to plotter	Data Acquisition Software: HP 150, HP 14855A; IBM PC, HP 14856A			7475A ColorPro
141T Spectrum Analyzer System	Direct to recorder		X -5 to 5 V Y 0 to -8 V	YES (14 V pen up, 0 V pen down)	7090A
415E SWR Meter	Direct to recorder		Y 0 to 1 V	NO	7090A
432A/B/C 436A/438A Power Meters	Direct to recorder		Y 0 to 1 V	NO	7090A
853A Spectrum Analyzer Display	Direct to recorder  Direct to plotter (LO)	Front-panel controls graticule and/or trace (no annotation)	X -5 to 5 V Y 0 to .8 V	YES (15 V pen up, 0 V pen down)	7090A 7475A 7550A ColorPro
1040A UV/VIS LC Detector	Indirect to plotter	HP 1040A opt. 631 software available			7475A 7550A ColorPro
1090A Liquid Chromatograph	Indirect to plotter. System includes HP 85B	HP software included			7475A 7550A ColorPro
3046A/B/S Selective Level Measuring Systems	Indirect to plotter	Customer software required			7090A 7475A ColorPro
3047A/S Spectrum Analyzer Systems	Indirect to plotter	HP software included with 3047S			7475A 7550A
3054A/C/DL/S Data Acquisition Systems	Indirect to plotter	Customer software required for 3054C/DL			7475 7550 ColorPro
3314A Function Generator	Direct to recorder		X -5 to 5 V	YES	7090A
3325A Synthesizer/Function Generator	Direct to recorder		X 0 to 10 V	YES TTL	7090A
3326A Two Channel Synthesizer	Direct to recorder		X 0 to 10 V	YES-TTL	7090A
3335A Synthesizer/Level Generator	Direct to recorder		X 0 to 10 V	NO	7090A
3336A/B/C Synthesizer/Level Generator	Direct to recorder		X 0 to 10 V	YES-TTL	7090A
3350A/3357A/B Lab Automation System	Indirect to plotter. System includes HP 1000	HP 19135C CPLOT/3350 software available			7475A 7550A
3421A Data Acquisition/ Control Unit	Indirect to plotter	Customer software required			7475A ColorPro
3497A/S Data Acquisition/ Control System	Indirect to plotter	Customer software required			7475A ColorPro
3561A/62A/65S Dynamic Signal Analyzer	Direct to plotter (05) or indirect to plotter	Front-panel control duplicates screen image to plotter. Software similar to 3577, also adds annotation			7090A 7475A 7550A ColorPro
3575A Gain/Phase Meter	Direct to recorder		Y1 10 mV/degree Y2 10 mV/dB	NO	7090A
3577A Network Analyzer	Direct to plotter (LO) or indirect to plotter	Front-panel control duplicates screen image to plotter. Menu-driven software provides selectable graticule, trace, annotation, pen number, line type.			7090A 7475A 7550A ColorPro
3580A Spectrum Analyzer	Direct to recorder		X 0 to 5 V Y 0 to 5 V	YES Contact closure to ground during sweep	7090A
3581A Wave Analyzer 3581C Selective Voltmeter	Direct to recorder		X 0 to 5 V Y 0 to 5 V	YES Contact closure to ground during sweep	7090A
3582A/S Spectrum Analyzer	Direct to recorder  Indirect to plotter	Customer software required	X 0 to 5.25 V Y 0 to 5.25 V	YES Contact closure during sweep	7090A 7475A ColorPro

\*"Indirect to plotter" requires an appropriate controller and software. "Direct to plotter" may require an address of 05 or L0 (listen only).

HP Instrument	Output Capability*	Plotter Software Support	X-Y Recorder Outputs		Recommended HP Models
			Voltage	Penlift	
3585A Spectrum Analyzer	Direct to recorder Indirect to plotter	HP software available	X 0 to 10 V Y 0 to 10 V	YES TTL	7090A 7475A ColorPro
3586A/B/C Selective Level Meter	Indirect to plotter	Customer software required			7475A ColorPro
3708S Noise and Interference Test System	Indirect to plotter	HP software available (HP 37080 A/B/C/R)			7475A 7090A ColorPro
3712A MLA Receiver	Direct to recorder		X -5 to 5 V Y -5 to 5 V	YES	7090A
3770B Telephone Analyzer	Direct to recorder (Special graph paper available)		X 0 to 5 V Y -5 to 5 V	NO	7090A
3776A/B PCM Terminal Test Set	Direct to recorder or Direct to plotter (LO)				7090A 7475A 7550A ColorPro
3780A Error Measuring Set	Direct to recorder		Y 0 to 1 mA into 10Kohm max	NO	7090A
3852A Data Acquisition/Control Unit	Indirect to plotter	HP 44458A software available			7475A
4061A/S Semiconductor Component Test System	Indirect to plotter	HP software included with 4061S			7475A ColorPro
4062B/S Semiconductor Parametric Test System	Indirect to plotter	Customer software required			7475A ColorPro
4063A/S Semiconductor Parametric Analysis System	Indirect to plotter	HP software included			7475A 7550A ColorPro
4064A/S DLTS Analysis System	Indirect to plotter	HP software included			7475A 7550A ColorPro
4140B pA Meter/DC Voltage Source	Direct to recorder Indirect to plotter	Customer software required	X -10 to 10 V Y -5 to 5 V	YES	7090A 7475A ColorPro
4145A Semiconductor Parameter Analyzer	Direct to plotter (LO)	Front-panel controls select trace and/or graticule, fixed characters			7475A 7550A ColorPro
4191A RF Impedance Analyzer (with Option 004) (Option 004 not required)	Direct to recorder Indirect to plotter	Customer software required	X 0 to 1 V Y1 0 to 1 V Y2 0 to 1 V	NO	7090A 7475A ColorPro
4192A LF Impedance Analyzer	Direct to recorder Indirect to plotter	Customer software required	X -1 to 1 V Y -1 to 1 V	YES TTL (low level at pen down)	7090A 7475A ColorPro
4193A Vector Impedance Meter	Direct to recorder Indirect to plotter	Customer software required	X 0 to 1 V Y1 0 to 1 V Y2 -1 to 1 V	YES	7090A 7475A ColorPro
4194A Impedance Gain-Phase Analyzer	Direct to plotter	Front-panel control duplicates screen image to plotter. Graticule, traces are selectable			7475A 7550A ColorPro
4280A 1 MHz C Meter/C-V Plotter	Direct to recorder Indirect to plotter	HP software available	X -10 to 10 V Y -10 to 10 V	YES	7090A 7475A ColorPro
5180A Waveform Recorder 5182A Waveform Recorder Generator	Direct to recorder Direct to plotter (LO) or Indirect to plotter	Front panel controls provide fixed graticule, trace, annotation; 51800A Waveform Measurement Library also available.	X -1 to 0 V Y -1 to 0 V	YES (0 V and 5 V)	7090A 7475A 7550A
5180T/U 5183T/U Waveform Recorders	Direct to plotter Indirect to plotter	Front panel controls provide user selectable graticule, trace, and annotation. Waveform measurement library also available.			7090A 7475A 7550A ColorPro
5390A Frequency Stability Analyzer	Indirect to plotter	HP software provides graticule, trace, and characters			7475A
54100A/D, 54110D 6 Hz Digitizing Oscilloscope 54200A/D, 54201A/D Digitizing Oscilloscope	Direct to plotter				7090A 7475A 7550A ColorPro
5427A Digital Vibration Test Control System	Direct to plotter (05)	Front-panel controls select fixed-format graticule, trace, and/or characters			7090A 7475A 7550A
55286S/88S Dimensional Metrology Analysis Systems	Indirect to plotter System includes HP 85	Menu-driven software provides fixed-format plots with graticule and characters, selectable trace, title block, and vertical scale			7475A ColorPro
5965A Infrared Detector	Indirect to plotter	HP 59965A software available for series 300.			7475A 7550A ColorPro

\*"Indirect to plotter" requires an appropriate controller and software. "Direct to plotter" may require an address of 05 or LO (listen only).



# PLOTTERS & RECORDERS

## Recorder/Plotter Selection Guide (cont'd)

HP Instrument	Output Capability*	Plotter Software Support	X-Y Recorder Outputs		Recommended HP Models
			Voltage	Penlift	
5987A/5970B/95C/87A/88A GCMS Systems	Indirect to plotter. System includes HP 1000, Series 200 or Series 300.	59872A software available			7475A 7550A ColorPro
6901S Measurement and Analysis System	Direct to plotter (05)	Menu-driven software provides fixed-format plots with graticule and characters, selectable trace			7475A
6940B/42A Multiprogrammers	Indirect to plotter	Customer software required			7475A ColorPro
6942S Computer Aided Test System	Indirect to plotter	Customer software required			7475A ColorPro
6944A/S Multiprogrammer	Indirect to plotter	Customer software required			7475A ColorPro
71000 Series Modular Spectrum Analyzers	Direct to plotter				7475A 7550A ColorPro
8116A Pulse/Function Generator (with Option 001)	Direct to recorder		X 0 to 10 V (1.5 V/decade)	YES TTL	7090A
8165A Programmable Signal Source (with Option 002)	Direct to recorder		X 0 to 2.99 V (1 V/decade)	NO	7090A
8340A Synthesized Sweeper	Direct to recorder		X 0 to 10 V	YES	7090A
8350B Sweep Oscillator	Direct to recorder		X 0 to 10 V	YES	7090A
8405A Vector Voltmeter	Direct to recorder		Y1 0 to 1 V Y2 -5 to 5 V	NO	7090A
8410B Network Analyzer System — The following plug-ins are part of the 8410B system:					
8412A Phase-Magnitude Display	Direct to recorder		Y1 50 mV/dB Y2 10 mV/degree	NO	7090A
8414A Polar Display	Direct to recorder		X -2.5 to 2.5 V Y -2.5 to 2.5 V	NO	7090A
8408B/S Automatic Network Analyzer	Indirect to plotter	HP software duplicates screen image onto plotter			7475A 7550A ColorPro
8450/51A/52A Diode Array Spectrophotometers	Direct to plotter	Selectable graticule, trace, and characters			7475A 7550A
8452A Diode Array Spectrophotometer	Direct to plotter	Selectable graticule, trace, and characters.			7475A 7550A ColorPro
8505A Network Analyzer	Direct to recorder Indirect to plotter	HP software provides graticule, trace, and characters	X 0 to 7.5 V Y -1.25 to 1.25V	YES 200 mA current sink	7090A 7475A 7550A ColorPro
8507D/S Automatic RF Network Analyzer System	Indirect to plotter	HP software provides graticule, trace, and characters			7475A 7550A ColorPro
8510A Network Analyzer	Direct to plotter	Front-panel controls select graticule, trace characters, pen and quadrant			7475A 7550A ColorPro
8557A/58B/59A Spectrum Analyzers With 853A Display	Direct to recorder Direct to plotter		X -5 to 5 V Y 0 to .8 V (with 853A and 180 mainframes)	YES (15 V pen up, 0 V pen down)	7090A 7475A
8565A Spectrum Analyzer	Direct to recorder		X -5 to 5 V Y 0 to .8 V	YES (15 V pen up, 0 V pen down)	7090A ColorPro
8566B/S/68B/S Spectrum Analyzers	Direct to recorder Direct to plotter	HP 85862/63 software packages available	X 0 to 10 V Y 0 to 10 V	YES (15 V pen up, 0 V pen down)	7090A 7475A ColorPro
8569B/8570A Spectrum Analyzers	Direct to recorder Direct to plotter	Front-panel controls select graticule, trace, and/or characters	X -5 to 5 V Y 0 to .8 V	YES (15 V pen up, 0 V pen down)	7090A 7475A 7550A ColorPro
8620C Sweep Oscillator	Direct to recorder		X 0 to 10 V	YES (5 V pen up)	7090A
8642A/B Synthesized Signal Generator	Direct to recorder		X 0 to 10 V	YES-TTL	7090A
8660C Synthesized Signal Generator	Direct to recorder		X 0 to 8 V	YES (with Option H24)	7090A
8662A/63A/73B/C/D Synthesized Signal Generators	Direct to recorder		X 0 to 10 V	YES-TTL	7090A
8683A/B/D/84A/B/D Signal Generators	Direct to recorder		X 0 to 10 V	NO	7090A

\*"Indirect to plotter" requires an appropriate controller and software. "Direct to plotter" may require an address of 05 or LO (listen only).

HP Instrument	Output Capability*	Plotter Software Support	X-Y Recorder Outputs		Recommended HP Models
			Voltage	Penlift	
8750A Storage-Normalizer	Direct to recorder		X 0 to 1 V Y -4 to 4 V	YES (open collector driver, 20 V max)	7090A
8753A Network Analyzer	Direct to plotter				7475A 7550A 7090A ColorPro
8754A Network Analyzer	Direct to recorder		X 0 to 1 V Y -4 to .4 V	YES (5 V pen up, 0 V pen down)	7090A
8755S Scalar Network Analyzer System	Direct to recorder		Y -4 to 4 V X 0 to 10 V	YES (open collector driver, 20 V max)	7090A
8757A/S Automatic Scalar Network Analyzer	Direct to plotter	HP 8757A has softkeys with custom plot capability. HP 8757S has menu-driven software.			7090A 7475A 7550A ColorPro
8756A/S Automatic Scalar Network Analyzer	Direct to plotter	8756A provides menu-driven softkeys, 8756S has menu-driven software to select graticule, trace, and/or characters (rev. 1 does not include 7550A in ID table)			7475A 7550A ColorPro
8900C/D Peak Power Meter	Direct to recorder		Y 0 to 1 V	NO	7090A
8903B Audio Analyzer	Direct to recorder Indirect to plotter	Customer software required*	X 0 to 10 V Y 0 to 10 V	YES	7090A 7475A ColorPro
8953A/S Transceiver Test System	Indirect to plotter	Customer software required*			7475A ColorPro
8955A/S RF Test System	Indirect to plotter	Customer software required*			7475A
8970B Noise Figure Meter	Direct to recorder Direct to plotter	Special functions control plotter	X 0 to 6 V Y 0 to 6 V	YES TTL	7090A 7475A ColorPro

\*"Indirect to plotter" requires an appropriate controller and software. "Direct to plotter" may require an address of 05 or LO (listen only).

## DIGITAL MULTIMETERS

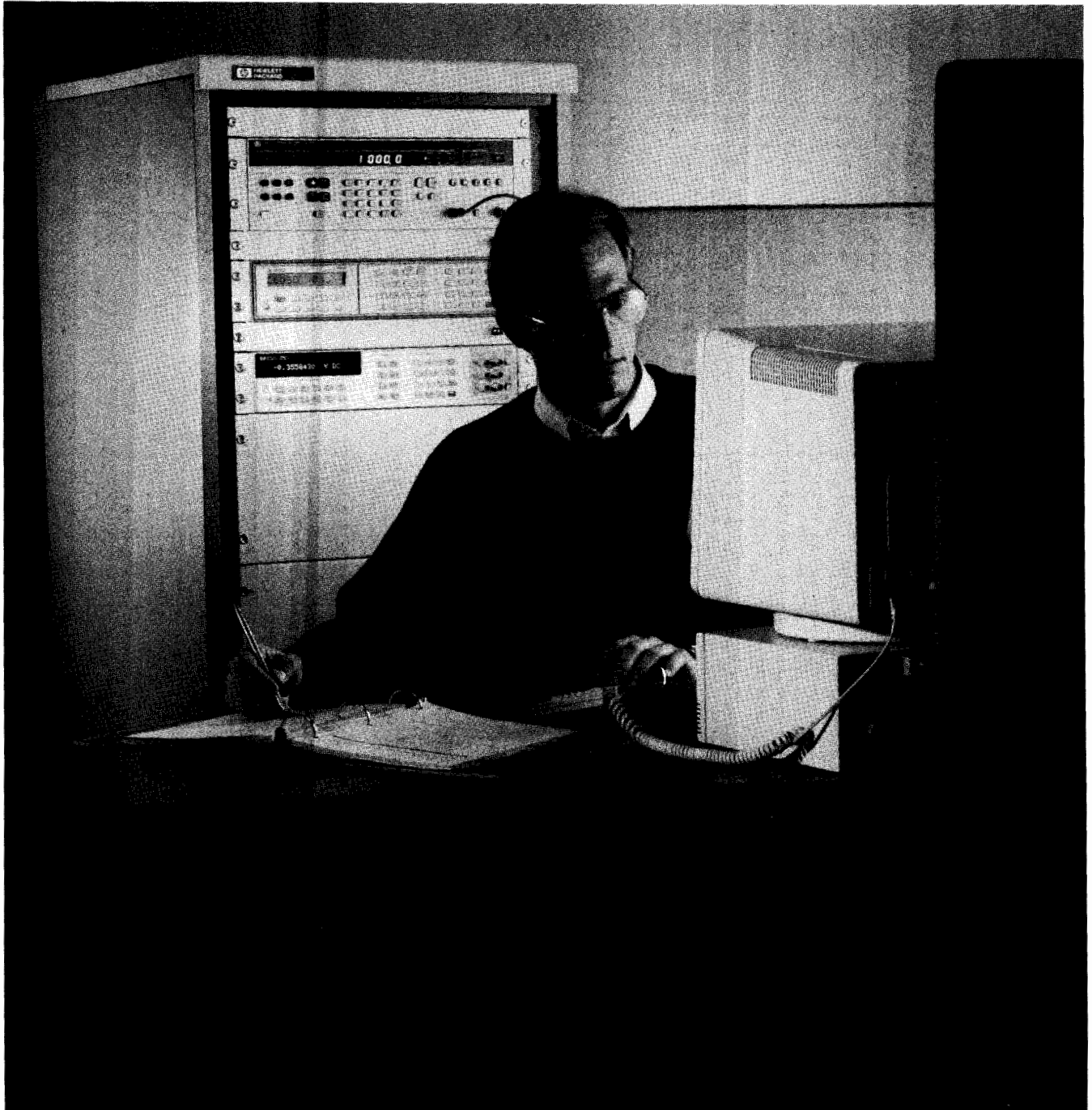

### Optimize Measurements for Your Application Needs

Hewlett-Packard offers multimeters for HP-IB, rack-and-stack test systems to satisfy a wide range of measurement requirements. Your selection depends primarily on the accuracy you need. In many cases, these multimeters are significantly faster than other solutions at the accuracy needed.

All these system multimeter solutions provide measurements of DC and AC voltage, resistance, and DC and AC current. Low cost frequency and period measurements are also available.

In addition to computer-aided test, the HP 3458A multimeter has the accuracy to address metrology/standards lab applications, and the digitizing speed to address

high-resolution digitizing. The HP 3457A multimeter handles most application needs in computer-aided test systems. For low-cost HP-IB systems, the 3 $\frac{1}{2}$  to 5 $\frac{1}{2}$ -digit HP 3478A satisfies many measurement requirements without putting a big dent in your instrumentation budget.

### Increase Test Throughput

Increase your test capacity by reducing the time for each test.

In most system applications, interactions with the computer and other HP-IB instruments have just as much impact on test throughput as reading rates of the multimeter. Most functional tests are a series of tests that require function changes, and voltage or

resistance range changes. Also, transfer rates of data must be fast to reduce traffic on HP-IB. With all these factors taken into consideration, you will find that the HP 3458A multimeter increases your test capacity without having to increase the number of test systems.

HP multimeters also provide math, storage of entire test sequences, reading memory, interrupts, and limit testing to increase test throughput. Finally, HP's system multimeters have a "Voltmeter Complete" pulse output to increment channels on external scanners or switches, without the delay of a computer command. Flexible triggering gives you the ability to ensure that measurements are properly synchronized with the device under test.

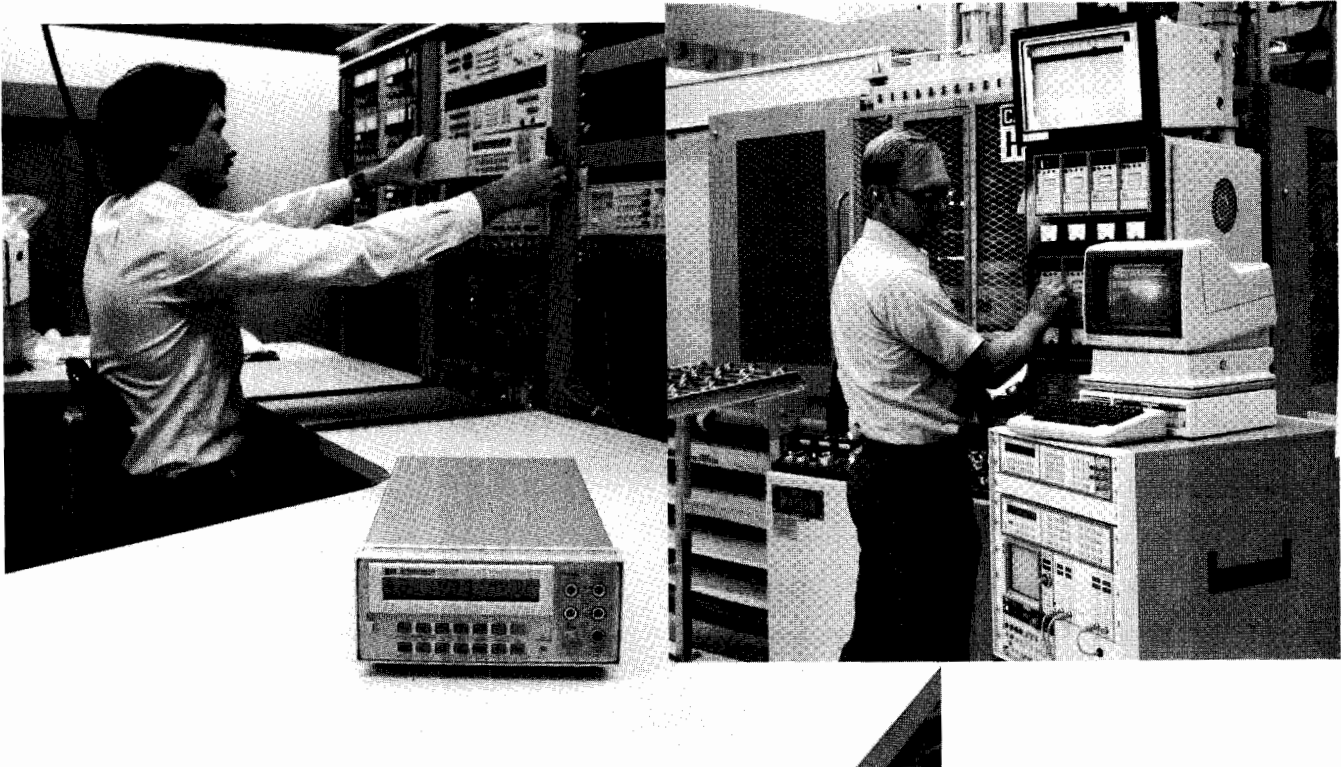

### Increase Up-time

Hewlett-Packard's quality philosophy focuses on continuous process improvement. Although we continue to improve, perfection is the goal. To achieve this goal, we apply scientific methods and data to all processes, where everything is considered a process.

This philosophy requires participation by everyone working together toward a common goal. Improvements in quality result from better designs and careful attention to improvements in production. The anticipated result is that we continue to satisfy our customers by exceeding their needs and expectations.

HP's field-proven multimeters are already living up to such ideals. In keeping with precedents set by the HP 3468A/B and HP 3478A, the HP 3457A and 3458A multimeters include quality and reliability with the performance you need. As one way of demonstrating this reliability, HP offers three years of hardware support as an option, at a surprisingly low incremental price. Whether you take advantage of this option or not, you can expect HP reliability that keeps your test system up and running for a long time.

### SYSTEM DMMs

### BENCH DMMs

HP Model	3458A page 94	3457A 97	3478A 100	3468A/B 104
<b>DC VOLTAGE</b>				
Accuracy				
1 Yr Best Full Scale (parts per million)	5.1 (Opt 002)	27	197	200
Resolution (nanovolts)	10	10	100	1000
Maximum Reading Rate at 5 1/2 digits (readings per second)	50,000	360	4.4	
Maximum Range (volts)	1000	1000 (HP 44497A)	300	300
<b>RESISTANCE</b>				
Accuracy				
1 Yr Best Full Scale (parts per million)	10.5	52	167	180
Resolution (microhms)	10	10	100	1000
<b>AC VOLTAGE</b>				
Bandwidth	1 Hz to 10 MHz	20 Hz to 1 MHz	20 Hz to 300 kHz	20 Hz to 300 kHz
<b>FUNCTIONS</b>	DC & AC V, 2- and 4-w $\Omega$ , Offset-compensated $\Omega$ , DC & AC I, Frequency, Period, Math, Test sequence storage, Ratio, 20 kbytes reading memory, Digitizing, & HP-IB	DC & AC V, 2- and 4-w $\Omega$ , Offset-compensated $\Omega$ , DC & AC I, Frequency, Period, Math, Test sequence storage, 1 kbyte reading memory, & HP- HP-IB	DC & AC V, 2- and 4- w $\Omega$ , DC & AC I, & HP-IB	DC & AC V, 2- and 4- w $\Omega$ , DC & AC I and HP- IB
<b>OPTIONS</b>	Opt 001 Expanded reading memory to 148 kbytes, Opt 002 High stability (4 ppm/yr), Opt 005 Waveform analysis library Opt W30 3 yr hardware support	Opt 700 C11L Opt W30 3 yr hardware support 44497A 1000 V attenuator 44491A Armature relay mux 44492A Reed relay mux	Opt W30 3 yr hardware support	Opt 001 Rechargeable battery Opt W30 3 yr hardware support
<b>BASE PRICE</b>	\$5900	\$2950	\$995	\$750

# DIGITAL MULTIMETERS

## A System Multimeter with Both High Speed and High Accuracy

### Model 3458A

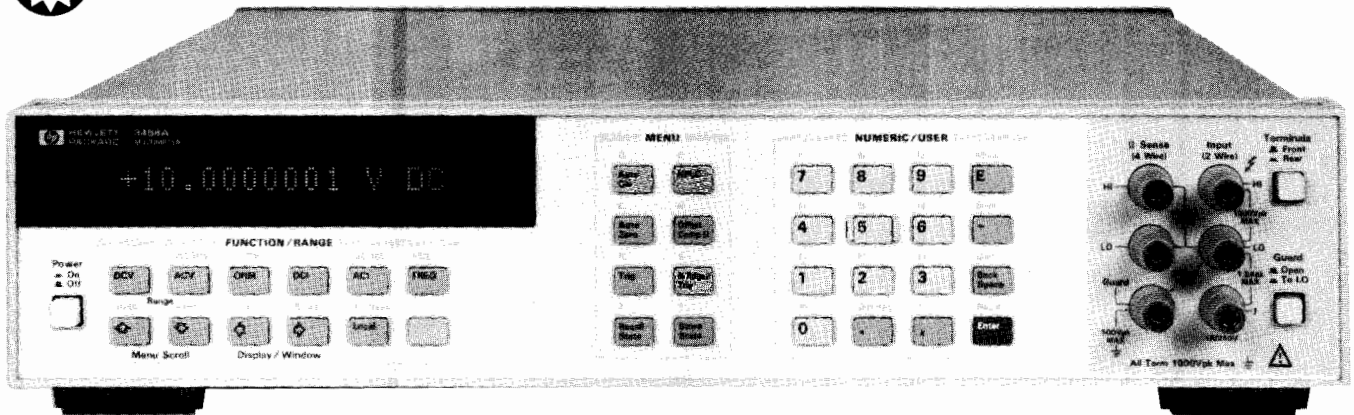

Model 3458A

The HP 3458A multimeter shatters long-standing performance barriers of speed and accuracy on the production test floor, in R&D, and in the calibration lab. The HP 3458A is simply the fastest, most flexible, and most accurate multimeter ever offered by Hewlett-Packard. In your system or on the bench, the HP 3458A saves you time and money with unprecedented test system throughput and accuracy, seven function measurement flexibility, and low cost of ownership.

Select a reading rate of 100,000 readings per second for maximal test throughput. Or achieve highest levels of precision with up to 8½ digits of measurement resolution and 0.1 part per million transfer accuracy. Add to this, programming compatibility through the Hewlett-Packard Multimeter Language (HPML) and the HP 3458A's simplicity of operation and you have the ideal multimeter for your most demanding applications.

### High Test System Throughput

#### Faster Testing

- Up to 100,000 readings/sec
- Internal test setups >200/sec
- Programmable integration times from 500 ns to 1 sec

#### Greater Test Yield

- More accuracy for tighter test margins
- Up to 8½ digits resolution

#### Longer Up-Time

- Two-source (10V, 100kΩ) calibration, including ac
- Self-adjusting, self-verifying auto-calibration for all functions and ranges, including ac

### High Resolution Digitizing

#### Greater Waveform Resolution and Accuracy

- 16 bits at 100,000 samples/sec
- 18 bits at 50,000 samples/sec
- 12 MHz bandwidth
- Timing resolution to 10 ns
- Less than 100 ps time jitter
- Over 75,000 reading internal memory

#### Flexible Digitizing Software

- Powerful, easy-to-use analysis software for HP 9000 Series 200/300 Computers
- Subprograms for waveform acquisition, data transfer, FFT, IFT, and data presentation

### Calibration Lab Precision

#### Superb Transfer Measurements

- 8½ digits resolution
- 0.1 ppm dc Volts linearity
- 0.1 ppm dc Volts transfer capability
- 0.01 ppm rms internal noise

#### Extraordinary Accuracy

- 0.6 ppm for 24 hours in dc Volts
- 2.2 ppm for 24 hours in Ohms
- 100 ppm mid-band ac Volts
- 8 ppm (4 ppm optional) per year voltage reference stability

### HP 3458A Multimeter Performance Features

#### dc Volts

- 5 ranges: 0.1 V to 1000 V
- 8½ to 4½ digit resolution
- Up to 100,000 readings/sec (4½ digits)
- Maximum sensitivity: 10 nV
- 0.6 ppm 24 hour accuracy
- 8 ppm (4 ppm optional)/year voltage reference stability

#### Ohms

- 9 ranges: 10Ω to 1GΩ
- Two-wire and four-wire Ohms with off-set compensation
- Up to 50,000 readings/sec (5½ digits)
- Maximum Sensitivity: 10μΩ
- 2.2 ppm 24 hour accuracy

#### ac Volts

- 6 ranges: 10 mV to 1000 V
- 1 Hz to 10 MHz bandwidth
- Up to 50 readings/sec with all readings to specified accuracy
- Choice of sampling or analog true rms techniques
- 100 ppm best accuracy

#### dc Current

- 8 ranges: 100 nA to 1 A
- Up to 3,500 readings/sec (5½ digits)
- Maximum sensitivity: 1 pA
- 13 ppm 24 hour accuracy

#### ac Current

- 5 ranges: 100 μA to 1 A
- 10 Hz to 100 kHz bandwidth
- Up to 50 readings/sec
- 500 ppm 24 hour accuracy

#### Frequency and Period

- Voltage or current ranges
- Frequency: 1 Hz to 10 MHz
- Period: 100 ns to 1 sec
- 0.01% accuracy
- ac or dc coupled



DC Voltage				Accuracy		Transfer Accuracy	
Range	Full Scale	Maximum Resolution	Input Impedance	1 Year (ppm of Reading + ppm of Range)	Conditions	10 Min Tref ±0.5°C (ppm of Reading + ppm of Range)	Conditions
100 mV	120.00000	10 nV	10 GΩ	9 + 10	<ul style="list-style-type: none"> <li>Specifications for NPLC 100 within 24 hours and ±1°C of last ACAL; TCAL +5°C.</li> <li>For High stability (Option 002) subtract 1.5 ppm of Reading from 90 day, and 4 ppm of Reading from 1 or 2 year accuracy.</li> <li>Add 2 ppm of reading additional error for HP factory traceability of 10 V dc to US NBS. Traceability error is the absolute error relative to National Standards associated with the source of last external calibration.</li> </ul>	0.5 + 0.5	<ul style="list-style-type: none"> <li>NPLC = 100</li> <li>Following 4 hour warm-up. Full scale to 10% of full scale.</li> <li>Measurements on the 1000 V range are within 5% of the initial measurement value and following measurement setting.</li> <li>Tref is the starting ambient temperature.</li> <li>Measurements are made on a fixed range using accepted metrology practices.</li> </ul>
1 V	1.20000000	10 nV	10 GΩ	8 + 1		0.3 + 0.1	
10 V	12.0000000	100 nV	10 GΩ	8 + 0.2		0.05 + 0.05	
100 V	120.000000	1 μV	10 MΩ ±1%	10 + 0.3		0.5 + 0.1	
1000 V	1050.00000	10 μV	10 MΩ ±1%	10 + 0.1		1.5 + 0.05	

#### Noise Rejection (dB)<sup>1</sup>

	AC NMR <sup>2</sup>	AC ECMR	DC ECMR
NPLC <1	0	90	140
NPLC ≥1	60	150	140
NPLC ≥10	60	150	140
NPLC ≥100	70	160	140
NPLC = 1000	80	170	140

<sup>1</sup>Applies for 1 kΩ unbalance in the LO lead and ±0.1% of the line frequency currently set for LFREQ.

<sup>2</sup>For line frequency ±1%, ACNMR is 40 dB for NPLC ≥1, or 80 dB for NPLC ≥ 100. For line frequency ±5%, ACNMR is 65 dB for NPLC ≥100.

#### Maximum Input

	Rated Input	Non-Destructive
HI to LO	±1000 V pk	±1200 V pk
LO to Guard	±100 V pk	±350 V pk
Guard to Earth	±500 V pk	±1000 V pk

#### Resistance

Range	Accuracy Four-Wire Ohms <sup>1</sup>		Conditions
	One Year (ppm of Reading + ppm of Range)		
10 Ω	15 + 5		<ul style="list-style-type: none"> <li>NPLC 200; OCOMP ON</li> <li>Within 24 hours and ±1°C of last ACAL; Tcal ±5°C.</li> <li>Add 3 ppm of reading additional error for HP factory traceability of 10 kΩ to US NBS. Traceability is the absolute error relative to National Standards associated with the source of last external calibration.</li> </ul>
100 Ω	12 + 5		
1 kΩ	10 + 0.5		
10 kΩ	10 + 0.5		
100 kΩ	10 + 0.5		
1 MΩ	15 + 2		
10 MΩ	50 + 10		
100 MΩ	500 + 10		
1 GΩ	0.5% + 10		

<sup>1</sup>Two-Wire Ohms Accuracy  
Add 250 MΩ to the four-wire ohms accuracy.

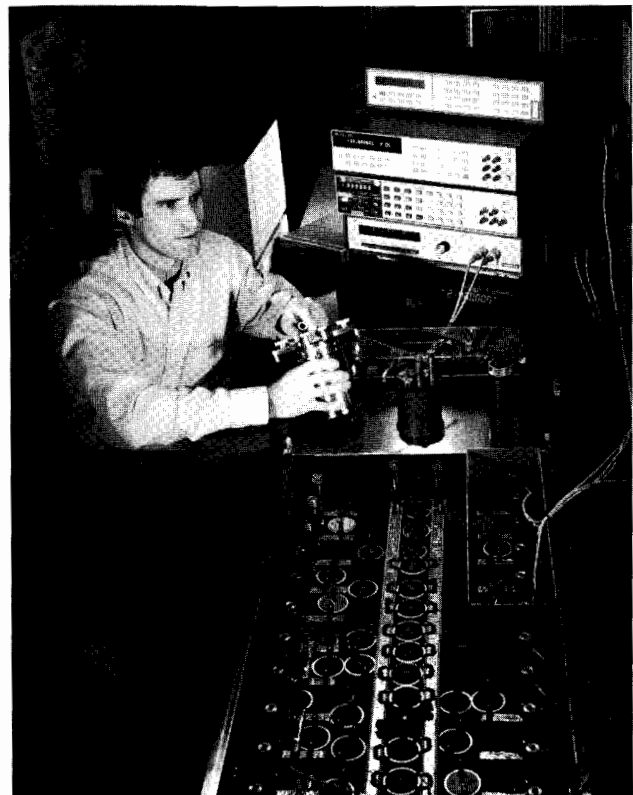

# DIGITAL MULTIMETERS

## A System Multimeter with Both High Speed and Accuracy (Cont'd)

Model 3458A

### AC Voltage (Synchronously Sub-sampled Mode)

Range	Full Scale	Maximum Resolution	Input Impedance	Accuracy 24 hr to 2 Year 40 Hz to 1 kHz (% of Reading + % of Range)	Conditions
10 mV	12.00000	10 nV	1 MΩ ±15% with <140 pF	0.02 + 0.011	<ul style="list-style-type: none"> <li>Specifications apply full scale to 10% of full scale, DC &lt;10% of AC, sine wave input, crest factor = 1.4. Within 24 hours and ±1°C of last ACAL.</li> <li>Peak (AC + DC) input limited to 5 x full scale for all ranges in ACV function.</li> <li>Add 2 ppm of reading additional error for HP factory traceability of 10 V DC to US NBS.</li> </ul>
100 mV	120.0000	100 nV	1 MΩ ±15% with <140 pF	0.007 + 0.002	
1 V	1.200000	1 μV	1 MΩ ±15% with <140 pF	0.007 + 0.002	
10 V	12.00000	10 μV	1 MΩ ±2% with <140 pF	0.007 + 0.002	
100 V	120.0000	100 μV	1 MΩ ±2% with <140 pF	0.02 + 0.002	
1000 V	1050.000	1 mV	1 MΩ ±2% with <140 pF	0.04 + 0.002	

### Maximum Input

	Rated Input	Non-Destructive
HI to LO	±1000 V pk	±1200 V pk
LO to Guard	±200 V pk	±350 V pk
Guard to Earth	±500 V pk	±1000 V pk
Volt-Hz Product	1 x 10 <sup>8</sup>	

### Front/Rear Panel Description

#### Display

- Bright, easy-to-read, vacuum fluorescent display
- 16 character alpha-numeric display to easily read data, messages, and commands

#### Standard Function/Range Keys

- Simple to use, for bench measurements of dcV, acV, Ohms, current frequency and period
- Select autorange or manual ranging

#### Menu Command Keys

- Immediate access to eight common commands
- Shifted keys allow simple access to complete command menu

#### Numeric/User Keys

- Numeric entry for constants and measurement parameters
- Shifted keys (f0 through f9) access up to ten user-defined setups.

#### Volts/Ohms/Ratio Terminals

- Gold-plated tellurium copper for minimum thermal emf
- 2-wire or 4-wire Ohms measurements
- dc/dc or ac/dc ratio inputs

#### Current Measurement Terminals

- Easy fuse replacement with fuseholder built into terminal

#### Guard Terminal and Switch

- For maximum common mode noise rejection

#### Front-Rear Terminal Switch

- Position selects front or rear measurement terminals

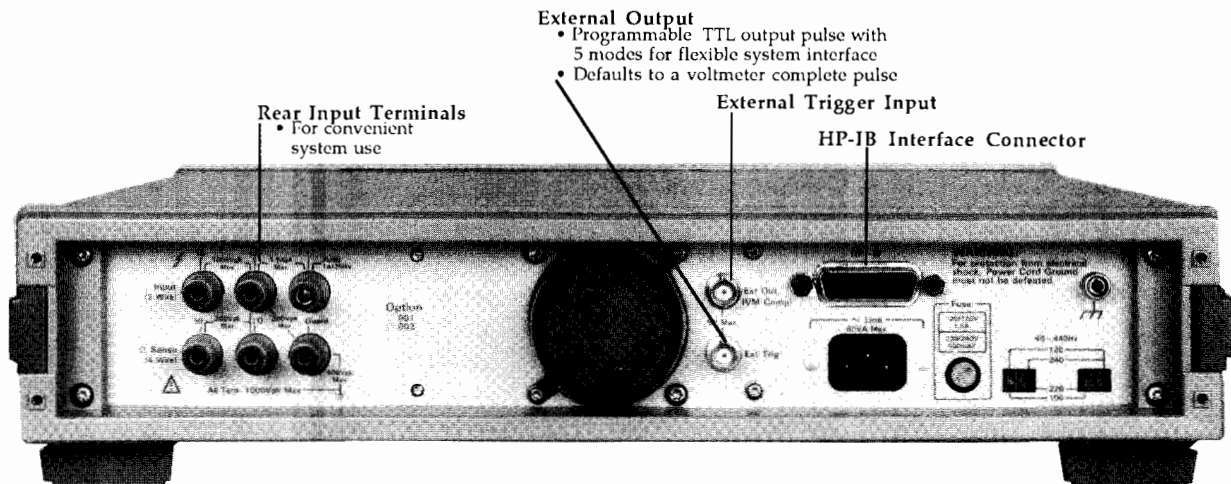

### Throughput

#### Maximum Reading Rates

- 100,000 readings/sec at 4½ digits (16 bits)
- 50,000 readings/sec at 5½ digits
- 6,000 readings/sec at 6½ digits
- 60 readings/sec at 7½ digits
- 6 readings/sec at 8½ digits

#### Measurement System Speed

- 100,000 readings/sec over HP-IB or with internal memory
- 110 autoranges/sec
- 200 function or range changes/sec
- Post-processed math from internal memory

### Ordering Information

**HP 3458A Multimeter** (with HP-IB, 20k bytes reading memory, and 8 ppm stability) \$5900

**Option 001** Extended Reading Memory (Expands total to 148k bytes) \$500

**Option 002** High Stability (4 ppm/year) Reference \$800

**Option 005** Waveform Analysis Library for HP Series 300 Computers with BASIC 4.0 or greater \$400

**Option W30** Two additional years Return-to-HP hardware support \$160

**Option 907** Front Handle Kit \$51

**Option 908** Rack Flange Kit \$31

**Option 909** Rack Flange Kit (with handles) \$73

# DIGITAL MULTIMETERS

## 3 $\frac{1}{2}$ to 6 $\frac{1}{2}$ Digit DMM with Extended Resolution to 7 $\frac{1}{2}$ Digits

HP Model 3457A

97

- Over 1350 Readings/sec at 3 $\frac{1}{2}$  Digits
- Seven Functions—DCV, ACV, DCI, ACI, Ohms, Frequency and Period
- Three Plug-in Multiplexer Options
- DC Sensitivity to 10 Nanovolts
- Outstanding Combination of Performance and Price

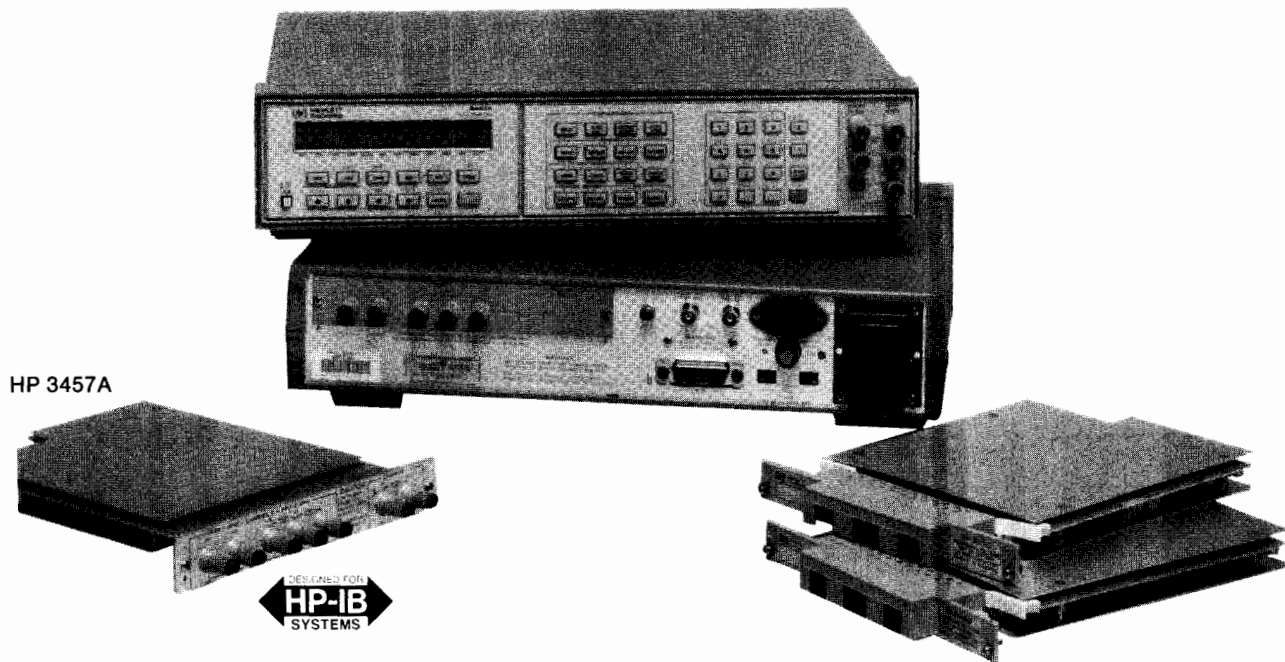

### Description

The HP 3457A has seven functions with 3 $\frac{1}{2}$  to 6 $\frac{1}{2}$  digits of resolution extendable to 7 $\frac{1}{2}$  digits at reading rates from 1 reading every 2 seconds to 1350 rds/s and basic DC volts accuracy as good as 5 ppm. In addition, the input of the HP 3457A can be expanded up to ten channels with either of the optional plug-in multiplexer assemblies. On the bench, the front panel operation is extremely flexible and comprehensive. In systems, the Hewlett-Packard Interface Bus (HP-IB) is standard.

### Powerful Measurement Management

The HP 3457A combines superb analog measuring capability with equally powerful measurement management. More than 1000 readings or whole measurement sequences can be stored in the HP 3457A for convenient and fast measurement throughput. The present dmm setup can be stored in the non-volatile state memory for convenient reconfiguration of the dmm.

Additional power from math functions can be obtained by using PASS/FAIL limit testing, NULL, SCALE, THERMISTOR linearization, and others. The power of total electronic calibration, including AC volts, makes it easy to maintain instrument performance.

### System Features

Keeping with HP's long tradition of systems oriented digital multimeters, the HP 3457A has all the systems features you've come to expect plus more to make interfacing to your computer even easier—features like flexible formatting of ASCII, 16 bit binary, or 32 bit binary data and buffer memory so that you can take measurements with the HP 3457A at its highest speed. In addition, you'll find the VOLTMETER COMPLETE output and EXTERNAL TRIGGER input signals ideal for synchronizing other instrumentation with the HP 3457A. Finally, programmable front-rear terminal switching lets you measure two separate inputs without a scanner.

### Hewlett-Packard Multimeter Language (HPML)

Another first for the HP 3457A DMM is an easy-to-use dmm language—HPML. Designed so that software written for today's multimeter will fit tomorrow's, HPML only asks you to define the parameters necessary to accomplish your measurement. For example, if you want to make a measurement on a 9 volt DC signal with 0.01% resolution, the command sequence is "DCV,9,.01".

### Control Interface Intermediate Language (CIIL)

With Option 700, the HP 3457A responds to standardized DMM CIIL commands via HP-IB. Physically and functionally identical to the standard HP 3457A, Option 700 adds the CIIL command set with a built-in Test Module Adapter (TMA) to the DMM's standard HPML. The HP 3457A is further enhanced by adding the functions of AC and DC current measurement through CIIL through HP-IB.

### Three Rear Panel Plug-In Options

Either one of three different optional assemblies may be used with the HP 3457A for different measurement capabilities. Using the multiplexer assemblies will enable up to ten signal channels to be scanned either sequentially or randomly. All of the functional capability offered through the normal front and rear input terminals is available for multiple inputs. Using the high voltage assembly allows single channel measurement of either AC or DC voltages at the rear panel.

For measurement flexibility, the HP 44491A Armature Relay Multiplexer Assembly offers eight two-wire channels and two current/actuator channels. Under software control, the eight two-wire channels can be reconfigured to four 4-wire ohm channels. The two current channels offer automatic make-before-break switching so that the path for current as high as 1.5 A is never broken. In addition, these two channels can be used as external device actuator channels. Each channel can switch up to 150 V. The general purpose multiplexer can close a channel and make a measurement at a maximum rate of 33 channels per second.

For higher speed scanning, the HP 44492A Reed Relay Multiplexer Assembly offers ten two-wire channels. The HP 44492A is useful for switching dcV, acV, ac+dcV, two wire ohms, frequency and period measurement signals with a maximum amplitude of 125 V. The Reed Relay Multiplexer can close a relay and make a measurement at a maximum rate of 300 channels per second.

For measurement of voltages up to 1414 V peak, the HP 44497A High Voltage Assembly offers a 1000:1 attenuator input (channel 1) for the high voltage measurements. In addition, the other rear terminal input (channel 0) can be utilized to perform conventional VDC, VAC, Two-wire and Four-wire Ohms, Period, Frequency, DCI, and ACI measurements. Using the HP 44497A with HP 3457A in the 6 $\frac{1}{2}$  digit mode will yield a resolution of 1 mV for a 1000 V input. Implementing the MATH Scale function will have the HP 3457A LCD display the measurement results in the correct units of kilovolts.

# DIGITAL MULTIMETERS

## 3 1/2 to 6 1/2 Digit DMM with Extended Resolution to 7 1/2 Digits (cont'd)

### HP Model 3457A

#### Abbreviated Technical Specifications

90 day, Tcal ± 5 deg. C

#### DC Voltage

Range	Maximum Reading	Best 6 1/2 Digit Accuracy <sup>1</sup> ± (% Rdg + Cnts)			Input Resistance
		% of Reading	Count Error		
30 mv	30.03000 mV	0.0040	365		10 GΩ
300 mv	303.0000 mV	0.0025	39		10 GΩ
3.0 V	3.030000 V	0.0017	6		10 GΩ
30.0 V	30.30000 V	0.0035	19		10 MΩ
300.0 V	303.0000 V	0.0050	6		10 MΩ

- After 1 hr warm-up, integration time 100 PLC. Tcal is the temperature of the calibration environment between 18 and 28 deg C.

#### DC Current

Range	Maximum Reading	Best 6 1/2 Digit Accuracy <sup>1</sup> ± (% Rdg + Cnts)			Input Resistance
		% of Reading	Count Error		
300 μA	303.0000 μA	0.02	104		1000Ω
3 mA	3.030000 mA	0.02	104		100Ω
30 mA	30.30000 mA	0.02	104		10Ω
300 mA	303.0000 mA	0.07	204		1Ω
1.0A	1.000000 A	0.07	604		0.1Ω

- After 1 hr warm-up, integration time 100 PLC. Tcal is the temperature of the calibration environment between 18 and 28 deg C.

#### Resistance (2 and 4 wire ohms)<sup>2</sup>

Range	Maximum Reading	Best 6 1/2 Digit Accuracy <sup>1</sup> ± (% Rdg + Cnts)			Current Output
		% of Reading	Count Error		
30 Ohm	30.30000 Ohm	0.0065	315		1 mA
300 Ohm	303.0000 Ohm	0.0045	34		1 mA
3 kOhm	3.030000 kOhm	0.0035	6		1 mA
30 kOhm	30.30000 kOhm	0.0035	6		100 μA
300 kOhm	303.0000 kOhm	0.0040	7		10 μA
3 MOhm	3.030000 MOhm	0.0055	12		1 μA
30 MOhm	30.30000 MOhm	0.0250	80		100nA
300 MOhm <sup>3</sup>	303.0000 MOhm	1.6	1000		100nA
3.0 GOhm <sup>3</sup>	3.030000 GOhm	16.0	1000		100nA

- After 1 hr warm up, integration time 100 PLC. Tcal is the temperature of the calibration environment between 18 and 28 deg C.
- For two-wire ohms, add 200m Ohms to count error specifications.
- For two-wire ohms only, Accuracy is specified following autocal (ACAL), under stable conditions (±1 deg C).

**Maximum Reading Rates** (DCV, DCI, and Resistance up to 30 kOhm)<sup>2</sup>

Power Line Cycles <sup>3</sup>	Maximum # of Digits	Readings per Second-60Hz (50Hz)		
		Auto Zero On	Auto Zero Off	NMR
.0005	3 1/2	300	1350	0
.005	4 1/2	280	1250	0
.1	5 1/2	140 (128)	360 (312)	0
1.0	6 1/2	26 (22)	53 (45)	60dB
10	7 1/2 <sup>4</sup>	2.5 (2.0)	4.8 (4.0)	80dB
100	7 1/2 <sup>4</sup>	25 (0.2)	0.5 (0.4)	90dB

- Using Math HIRES mode.
- Reading rates are specified with zero delay, fixed range, display off, and front panel off. The output is to internal reading memory using single integer format and internal timer.
- Integration Time in Power Line Cycles (PLC).

**Common Mode Rejection** (dB): (1 kOhm unbalance in low lead) DC ECMR 140 dB; AC ECMR: <1 PLC, 76 dB; AC ECMR >1 PLC 156 dB, for 50, 60 Hz ±0.8%.

#### True RMS ACV and (AC+DC)V

**Bandwidth:** 20 Hz to 1 MHz

**Crest Factor:** 3.5 to 1 at full scale

**Common Mode Rejection:** (1 kOhm unbalance in LO): >76 dB, DC to 60 Hz

**Accuracy:** (90 day)

Accuracy specified for sine wave inputs, >10% of range. DC component <10% of AC component after 1 hr warm-up and within one week of autocal. Integration time = 10 PLC. AC Band set to <400 Hz. DC coupled mode requires 2 hour warm-up.

Range	Maximum Reading	(100 Hz to 20 kHz) Best 5 1/2 Digit Accuracy ± (% Rdg + Cnts)				Input Impedance
		AC Coupled		DC Coupled		
		% of Reading	Count Error	% of Reading	Count Error	
30mV	32.50000mV	0.13	116	0.17	364	1MΩ ±1% shunted by <90pf
300mV	325.0000mV	0.13	116	0.17	364	
3.0V	3.250000 V	0.13	116	0.17	364	
30.V	32.50000 V	0.13	116	0.17	364	
300V	303.0000 V	0.19	116	0.23	364	

#### True RMS ACI and (AC+DC)I

**Bandwidth:** 20 Hz to 100 kHz Crest Factor: 3.5 to full scale

**Accuracy:** (90 day)

Accuracy specified for sine wave inputs, >10% of range. DC component <10% of AC component after 1 hr warm-up and within one week of autocal. Integration time = 10 PLC. AC Band set to <400 Hz. DC coupled mode requires 2 hour warm-up.

Range	Maximum Reading	(100 Hz to 20 kHz) Best 5 1/2 Digit Accuracy ± (% Rdg + Cnts)			
		AC Coupled		DC Coupled	
		% of Reading	Count Error	% of Reading	Count Error
30mA	32.50000mA	0.25	290	0.3	1600
300mA	325.0000mA	0.25	290	0.3	1600
1.0A	1.000000 A	0.35	290	0.4	1600

#### Reading Rates (ACV and ACI)<sup>1</sup>

Power Line Cycles	Maximum # of Digits	Readings per Second .60 Hz (50 Hz)	
		Input <400 Hz (Slow Response)	Input >400 Hz (Fast Response)
.0005	3 1/2	1	9.5
.005	4 1/2	1	9.5
.1	5 1/2	1 (1)	9.25 (9.2)
1	6 1/2	1 (1)	7.25 (6.9)
10	6 1/2	0.7 (0.65)	2.0 (1.7)
100	6 1/2	0.2 (0.17)	0.25 (0.2)

- Reading rates are specified with preprogrammed delays, fixed range, and Auto Zero on.

**Frequency and Period:** Measures the frequency or period of the ac component of the ac or dc coupled voltage or current input. The counter uses a reciprocal counting technique to give constant resolution independent of input frequency.

**Input Impedance:** Refer to AC voltage and current specifications.

**Frequency Range:** 10 Hz to 1.5 MHz (voltage input)

10 Hz to 100 KHz (current input)

**Period Range:** .1 s to 667 ns (voltage input)

.1 s to 3.33 us (current input)

**Sensitivity:** 10 mV or 100 μA (sinewave)

**Triggering:** Triggers and counts on zero crossings

**Accuracy:** (1 year)

Frequency	Period	±% of Reading
10 Hz to 400 Hz	.1 s to .025 s	0.05
400 Hz to 1.5 MHz	.025 s to 667 ns	0.01

**Maximum Reading Rate:** 2.0 rdgs/s for integration time of 1 PLC, AC Band >400 Hz, delay zero and math off, and fixed range.

**Memory:** 2139 available bytes that can be partitioned into 3 segments, one devoted to storing measurements, one devoted to storing measurement subprograms, and one devoted to storing instrument states.

**Math Functions:** The HP 3457A performs the following math functions on the measurements—NULL, SCALE, OFFSET, RMS FILTER, SINGLE POLE FILTER, THERMISTOR LINEARIZATION, DB, DBM, % ERROR, PASS/FAIL LIMIT TESTING, and STATISTICS. Two math functions may be used at one time.

**General Specifications**

**Operating Temperature:** 0 to 55° C  
**Warmup Time:** one hour to all specifications except where noted  
**Humidity Range:** 95% R.H., 0 to 40° C  
**Storage Temperature:** -40 to +75° C  
**Power:** 100/120/220/240 V ±10%, 48 Hz - 66 Hz, 220 V, ±10%, 48 Hz to 66 Hz. Fused at .2A (115 V) or 0.08 A (230 V). <30 VA.  
**Size:** 89 mm H (without removable feet) x.425mm W x 292mm D (3.5" x 16.75" x 11.5"). Height (with removable feet): 100 mm (4"). Allow 76mm (3") additional depth for wiring.  
**Net Weight:** 5.05 kgm (11.1 lbs)  
**Shipping Weight:** 9.3 kgm (20.5 lbs)

**Plug-in Options**

**HP 44491A Armature Relay Multiplexer Assembly Input Characteristics:** Eight two-wire armature relay channels and two current/actuator channels. Maximum voltage (terminal-to-terminal or terminal to chassis) 250 Vrms. Maximum current (per channel) -1.0 A DC or AC. Thermal Offset - 3μ V. Closed channel resistance (end of relay life) - <2 Ohms. Maximum switching and measurement speed - 33 channels/second.

**HP 44492A Reed Relay Multiplexer Assembly Input Characteristics:** Ten two-wire reed relay channels. Maximum voltage (terminal-to-terminal or terminal-to-chassis) - 125 V peak. Thermal offset - 3 μV. Closed channel resistance (end of relay life) - <4 Ohms. Specified for <100 kHz ac volts and frequency operation. Maximum switching and measurement speed - 300 channels/second.

DC 0.030% of reading  
 20 Hz - 1 KHz 2.8% of reading  
 1 KHz - 10 KHz 10.0% of reading

Note: One year accuracy applies to Tcal ±5%, NPLC=1 or greater. Specifications are for low-to-earth voltage less than 0.1 times the High-to-Earth voltage.

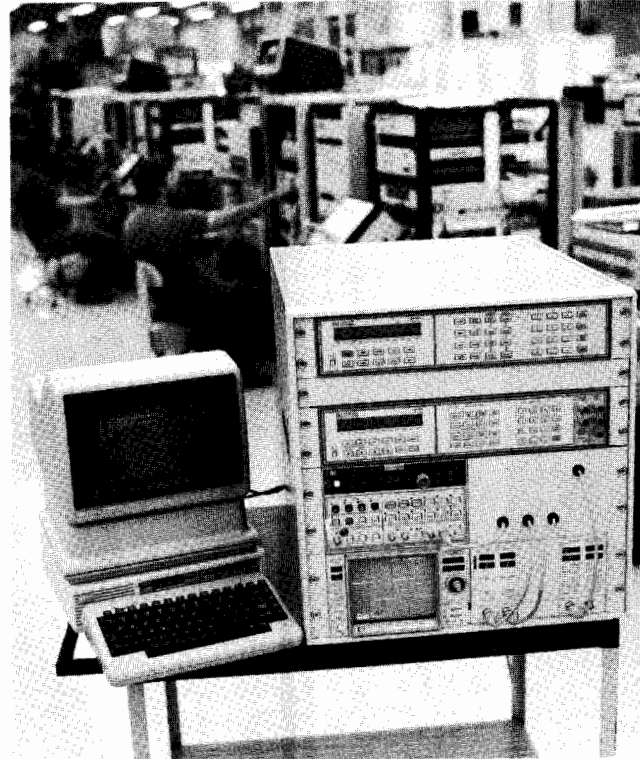

Armature Relay (44491A)

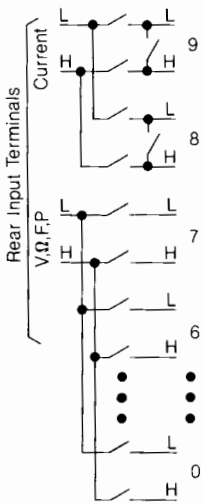

Reed Relay (44492A)

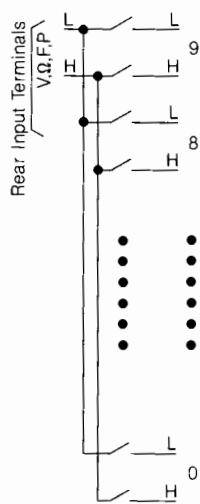

**HP 44497A High Voltage Attenuator Assembly Input Characteristics:** Two relay channels, channel 1 devoted to high voltage measurements. Maximum High-to-Low voltage of 1000 Volts DC or AC rms. Maximum Low-to-Earth voltage of 350 V Peak Non-destructive Overload voltage of 1700 V Peak, 1200 Volts DC. Attenuator accuracy to be added to HP 3457A range and function accuracy for total accuracy.

**Model 3457A Multimeter**

- \*HP 44491A Armature Relay Multiplexer Assembly** \$470
- \*HP 44492A Reed Relay Multiplexer Assembly** \$470
- \*HP 44497A High Voltage Attenuator Assembly** \$390
- Option 401: Side Handle Kit (P/N 5061-1171)** \$40
- Option 700: CIIL Language** \$990
- Option 907: Front Handle Kit (P/N 5061-1170)** \$51
- Option 908: Rack Flange Kit (P/N 5061-1168)** \$32
- Option 909: Rack Flange and Front Handle Kit (P/N 5061-1169)** \$75
- Option 910: Extra Operating and Service Manual** \$110
- Option W30: Two years of additional hardware support** \$80
- Accessories:**
- HP 44490A Rack Slide Kit for 30 inch depth racks** \$230
- HP 44493A Screw Terminal Connector for HP 44491A includes strain relief and housing** \$63
- HP 44494A Screw Terminal Connector for HP 44492A includes strain relief and housing** \$63
- HP 34118A Test Lead Kit** \$27
- HP 34301A RF Detector Probe, 100 KHz to 700 MHz** \$80
- HP 34300A 40 Kv ac/dc Probe, dc to 300 Hz** \$90
- HP 34119A High Voltage Probe, 1000:1, AC & DC Voltage Divider for up to 5000V** \$130
- HP 44414A: Four Thermistor Pack** \$63

\*Plug-in options may be ordered and shipped separately without a HP 3457A mainframe. Unless otherwise specified, the optional plug-in accessories will be shipped with the HP 3457A mainframe.

☎ Fast Ship Product—see page 767.



# DIGITAL MULTIMETERS

## Low Cost 3½ to 5½ Digit HP-IB Multimeter Model 3478A

- 5 measurement functions
- Up to 90 readings/s
- Electronic calibration
- 100 nanovolt resolution



HP 3478A

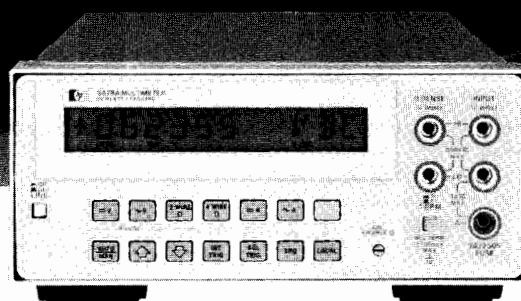

### Description

The HP 3478A is a low cost, full function, reliable DMM for system measurements. Selectable 3½ to 5½ digit resolution and 5 autoranging functions offer flexibility in automated testing. The HP 3478A measures dcV, true rms acV, 2- and 4-wire resistance, and dc and ac current. Simple, fast electronic calibration eliminates all adjustments to provide a lower cost of ownership.

### Low Cost of Ownership

The combination of an extremely reliable DMM with complete electronic calibration and self-test gives you low cost of ownership. The proven reliability of the HP 3478A is so good that Hewlett-Packard offers you two additional years of hardware service (Option W30) for less than four percent of the purchase price of the DMM.

### Performance

Selectable speed and resolution provide the right capability for your measurement. The HP 3478A can perform production tests or acquire experimental data at 90 readings/s with 3½ digit resolution, or take 35 readings/s with 130 dB of noise rejection using 4½ digits. The 5½ digit mode offers 100 nVdc and 100 μΩ resolution for precise measurements. True rms with 300 kHz bandwidth and 4:1 crest factor provides reliable measurements of ac signals. Fast autoranging makes the first reading useful and accurate.

### Designed for Systems

Switchable front/rear inputs permit flexible system connections. The Voltmeter Complete output and External Trigger input allow synchronization of the HP 3478A with a scanner for fast multiplexed measurements without the delay of software commands. The test program can write prompt messages or results on the alphanumeric display. The operator can respond by pressing the HP 3478A's SRQ key to interrupt the controller and start the next test. Built-in self-test capability assures proper operation.

### Electronic Calibration

Complete calibration of the HP 3478A is accomplished without any internal adjustment or removing the instrument's covers. Either manually, from the front panel, or automatically over HP-IB, calibration is fast and easy. Connect your standards to the HP 3478A and, during calibration, the calibration constants are stored in the HP

3478A's non-volatile memory. The result is less calibration error and lower calibration costs.

### Specifications

#### DC Voltage

##### Input Characteristics

Range	Maximum Reading (5½ digit)	Resolution		
		5½ digit	4½ digit	3½ digit
30 mV	±30.3099 mV	100 nV	1 μV	10 μV
300 mV	±303.099 mV	1 μV	10 μV	100 μV
3 V	±3.03099 V	10 μV	100 μV	1 mV
30 V	±30.3099 V	100 μV	1 mV	10 mV
300 V	±303.099 V	1 mV	10 mV	100 mV

**Input resistance:** 30 mV, 300 mV, 3 V ranges:  $>10^{10} \Omega$   
30 V, 300 V ranges:  $10 \text{ M}\Omega \pm 1\%$

**Maximum input voltage** (non-destructive): Hi to Lo: 303 Vrms or 450 V peak; Hi or Lo to Earth Ground:  $\pm 500 \text{ V}$  peak

**Measurement accuracy:**  $\pm(\%$  of reading + number of counts). Auto zero ON.

#### 5½ Digit Mode

Range	TCal* $\pm 1^\circ \text{C}$		TCal* $\pm 5^\circ \text{C}$	
	24 Hour	90 Day	90 Day	1 Year
30 mV	0.025 + 40	0.0275 + 40	0.0275 + 40	0.035 + 40
300 mV	0.004 + 4	0.005 + 5	0.005 + 5	0.007 + 5
3 V	0.003 + 2	0.004 + 2	0.004 + 2	0.006 + 2
30 V	0.004 + 3	0.005 + 4	0.005 + 4	0.007 + 4
300 V	0.004 + 2	0.005 + 2	0.005 + 2	0.007 + 2

\*TCal is the temperature of the environment where the HP 3478A was calibrated. Calibration should be performed with the temperature of the environment between 20°C and 30°C. 24 hour accuracy relative to calibration standards.

**4½ and 3½ digit mode:** accuracy is the same as 5½ digit mode for % of reading; use 1 count for number of counts on all ranges except 30 mV, use 4 counts.

**Temperature coefficient:** 0° to 55°C, 5½ digits, auto zero ON. ±(% of reading + number of counts)/°C

Range	Temperature Coefficient
30 mV	0.0028 + 5.0
300 mV	0.0005 + 0.5
3 V	0.0004 + 0.05
30 V	0.0006 + 0.5
300 V	0.0004 + 0.05

**Noise rejection:** in dB with 1 kΩ imbalance in Lo lead. AC rejection for 50, 60 Hz ± 0.1%. Auto zero ON.

Display	AC NMR	AC ECMR	DC CMR
5½ digits	80	150	140
4½ digits	59	130	140
3½ digits	0	70	140

**Maximum Reading Rates** (readings/s.)

Line Frequency	Auto Zero and Display	Resolution		
		3½ digits	4½ digits	5½ digits
60 Hz	Off	90	35	4.4
	On	60	20	2.3
	Off	85	30	3.7
50 Hz	On	50	17	1.9

**AC Voltage** (true rms)  
**Input Characteristics**

Range	Maximum Reading (5½ Digit)	Resolution		
		5½ Digit	4½ Digit	3½ Digit
300 mV	303.099 mV	1 µV	10 µV	100 µV
3 V	3.03099 V	10 µV	100 µV	1 mV
30 V	30.3099 V	100 µV	1 mV	10 mV
300 V	303.009 V	1 mV	10 mV	100 mV

**Input impedance:** 1 MΩ ± 1% shunted by <60 pF

**Maximum Input Voltage** (non-destructive):

Hi to Low: 303 Vrms or 450 V peak

Hi or Lo to Earth Ground: ±500 V peak

**Measurement accuracy:** ±(% of reading + number of counts). Auto zero ON. 5½ digit display. Accuracy is specified for sinewave inputs only, >10% full scale.

**1 Year, T<sub>Cal</sub>\* ±5°C**

Frequency	Ranges		
	300 mV	3 V, 30 V	300 V
20-50 Hz	1.14 + 163	1.14 + 102	1.18 + 102
50-100 Hz	0.46 + 163	0.46 + 103	0.50 + 102
100 Hz-20 kHz	0.20 + 120	0.20 + 70	0.24 + 70
20-50 kHz	0.38 + 205	0.26 + 140	0.42 + 140
50-100 kHz	1.20 + 840	0.87 + 780	0.98 + 780
100-300 kHz	10.1 + 3720 (30 V range only)		

**Crest factor:** >4:1 at full scale

**Common mode rejection:** with 1 kΩ imbalance in Lo lead, >70 dB, at 60 Hz

**Maximum reading rates:** 3½ or 4½ digits, 1.4 readings/s; 5½ digits, 1.0 readings/s. First reading is correct within 70 counts of final value when triggered coincident with step input. Add 0.6 seconds for each range change.

**Resistance** (2-wire Ω, 4-wire Ω)

**Input Characteristics**

Range	Maximum Reading (5½ Digit)	Resolution		
		5½ Digit	4½ Digit	3½ Digit
30 Ω	30.3099 Ω	100 µΩ	1 mΩ	10 mΩ
300 Ω	303.099 Ω	1 mΩ	10 mΩ	100 mΩ
3 kΩ	3.03099 kΩ	10 mΩ	100 mΩ	1 Ω
30 kΩ	30.3099 kΩ	100 mΩ	1 Ω	10 Ω
300 kΩ	303.099 kΩ	1 Ω	10 Ω	100 Ω
3 MΩ	3.03099 MΩ	10 Ω	100 Ω	1 kΩ
30 MΩ	30.3099 MΩ	100 Ω	1 kΩ	10 kΩ

**Input protection** (non destructive): Hi to Lo: ±350 V peak; Hi or Lo to Earth Ground: ±500 V peak.

**Measurement accuracy:** ±(% of reading + number of counts). Auto zero ON. 5½ digit display. 4-wire ohms.

Range	T <sub>Cal</sub> * ±1°C		T <sub>Cal</sub> * ±5°C	
	24 Hour	90 Day	90 Day	1 Year
30 Ω	0.023 + 35	0.027 + 41	0.034 + 41	0.034 + 41
300 Ω	0.0045 + 4	0.012 + 5	0.017 + 5	0.017 + 5
3 k-300 kΩ	0.0035 + 2	0.011 + 2	0.016 + 2	0.016 + 2
3 MΩ	0.0052 + 2	0.011 + 2	0.016 + 2	0.016 + 2
30 MΩ	0.036 + 2	0.066 + 2	0.078 + 2	0.078 + 2

**Current Through Unknown**

Range	30 Ω	300 Ω	3 kΩ	30 kΩ	300 kΩ	3 MΩ	30 MΩ
Current	1 mA	1 mA	1 mA	100 µA	10 µA	1 µA	100 nA

**DC Current**

**Input Characteristics**

Range	Maximum Reading (5½ Digit)	Resolution		
		5½ Digit	4½ Digit	3½ Digit
300 mA	± 303.099 mA	1 µA	10 µA	100 µA
3 A	± 3.03099 A	10 µA	100 µA	1 mA

**Maximum input** (non-destructive): 3 A from <250 V source; fuse protected.

**Measurement accuracy:** ±(% of reading + number of counts). Auto zero ON. 5½ digit display.

Range	T <sub>Cal</sub> * ±5°C	
	90 Days	1 Year
300 mA	0.11 + 40	0.15 + 40
3 A (<1 A)	0.14 + 6	0.17 + 6
3 A (>1 A)	1.0 + 30	1.0 + 30

**Maximum burden at full scale:** 1 V (3 A range), 0.1 V (0.3 A range)

**AC Current** (true rms responding)

**Input Characteristics**

Range	Maximum Reading (5½ Digit)	Resolution		
		5½ Digit	4½ Digit	3½ Digit
300 mA	303.099 mA	1 µA	10 µA	100 µA
3 A	3.03099 A	10 µA	100 µA	1 mA

**Maximum input:** (non-destructive): 3 A from <250 V source; fuse protected.

**Measurement accuracy:** ±(% of reading + number of counts). Auto zero ON. 5½ digit display. Accuracy is specified for sinewave inputs only, >10% of full scale.

**1 Year, T<sub>Cal</sub>\* ±5°C**

Frequency	Ranges	
	300 mA	3 A
20-50 Hz	1.54 + 163	2.24 + 163
50-1 kHz	0.81 + 163	1.50 + 163
1 k-10 kHz	0.72 + 163	1.42 + 163
10 k-20 kHz	0.86 + 163	1.56 + 163

**Maximum burden at full scale:** 1 V RMS (3A range)

**General**

**Operating temperature:** 0 to 55°C

**Humidity range:** 95% R.H., 0 to 40°C

**Power:** ac line 48 to 440 Hz; 86 to 250 V, 25 VA max.

**Size:** 102 mm H x 215 mm W x 356 mm D (4" x 8" x 14");

3½ in. H without feet.

**Weight:** 3 kg (6.5 lb)

**HP-IB Interface Functions:** SH1, AH1, T5, TE0, L4, LE0, SR1, RL1, PP0, DC1, DT1, C0

**Ordering Information**

**Price**

Choose one N/C power option:

**Opt 315:** 100 V, 50 Hz; **Opt 335:** 220 V, 50 Hz

**Opt 316:** 100 V, 60 Hz; **Opt 336:** 220 V, 60 Hz

**Opt 325:** 120 V, 50 Hz; **Opt 345:** 240 V, 50 Hz

**Opt 326:** 120 V, 60 Hz; **Opt 346:** 240 V, 60 Hz

**Opt W30:** Three year extended hardware support \$35

**Opt 907:** Front Handle Kit (HP P/N 5061-0088) \$51

**Opt 908:** Rack Mount Kit (HP P/N 5061-0072) \$54

**Opt 910:** Extra Manuals (HP P/N 03478-90005 and (HP P/N 03478-90006) \$22

**HP 3478A Multimeter**

**\$995**

Fast Ship Product—see page 767.

# DIGITAL MULTIMETERS

## 6½ to 3½ Digit HP-IB DMM with High Stability

### Model 3456A

- Up to 330 readings per second
- 100 nanovolt resolution

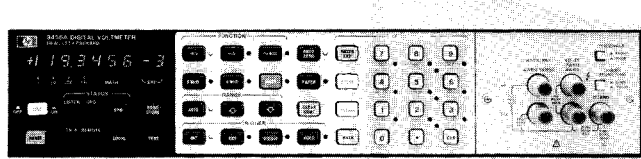

### Description

This fully guarded, integrating Digital Multimeter is designed for bench or systems. The HP Model 3456A measures DC, true RMS AC voltage and resistance.

Measurement speed and accuracy can be enhanced for a specific application, using the HP 3456A's selectable integration time (up to 100 power line cycles). An operator can select up to 330 readings/second for high speed bursts or one reading every fifteen minutes for periodic measurements. Resolution of 100 nanovolts at 48 readings/second (6½ digits) to 10 microvolt resolution at 330 readings per second (3½ or 4½ digits) can be selected.

With good repeatability and 100 nanovolt sensitivity, accuracy on the ten volt range is  $\pm 0.0008\%$  +2 counts over a 24-hour period at  $23^\circ\text{C} \pm 1^\circ\text{C}$ .

Four full-scale, true RMS AC voltage ranges are provided, with reading speeds up to 12 readings per second over a 10 Hz to 250 kHz frequency range. Best accuracy is 0.05%. Crest factor is greater than seven at full scale.

With the HP 3456A's program memory and reading storage capability, the HP 3456A can take measurements and store them while a computer performs some other task.

Another system feature of the HP 3456A is its hardware scanner advance capability for scanned or multiplexed system applications. As soon as the HP 3456A's measurement cycle is complete, a TTL signal is available to trigger a variety of switching instruments.

### Specifications

#### DC Voltage

RANGE	MAXIMUM READING (5½ digit)	6½ digit	RESOLUTION 5½ digit	4½ digit	INPUT RESISTANCE	MAXIMUM INPUT VOLTAGE
0.1 V	1.19999 V	100 nV	1 $\mu\text{V}$	10 $\mu\text{V}$	$>10^{10} \Omega$	$\pm 1000$ V
1.0 V	1.19999 V	1 $\mu\text{V}$	10 $\mu\text{V}$	100 $\mu\text{V}$	$>10^{10} \Omega$	peak
10.0 V	11.9999 V	10 $\mu\text{V}$	100 $\mu\text{V}$	1 mV	$>10^{10} \Omega$	
100.0 V	119.999 V	100 $\mu\text{V}$	1 mV	10 mV	10 M $\Omega \pm 5\%$	
1000.0 V	1000.00 V	1 mV	10 mV	100 mV	10 M $\Omega \pm 5\%$	

Measurement accuracy:  $\pm$  (% of reading + number of counts).

RANGE	24 hour: $23^\circ\text{C} \pm 1^\circ\text{C}$		90 days: $23^\circ\text{C} \pm 5^\circ\text{C}$		1 year: $23^\circ\text{C} \pm 5^\circ\text{C}$	
	6½ digit ( $\geq 10$ PLC)	6½ digit (1 PLC)	6½ digit ( $\geq 10$ PLC)	6½ digit (1 PLC)	6½ digit ( $>= 10$ PLC)	6½ digit (1 PLC)
0.1 V	0.022 + 24	0.0024 + 32	0.0026 + 24	0.0027 + 32	0.0034 + 24	0.0035 + 32
1.0 V	0.0009 + 4	0.0012 + 5	0.0016 + 4	0.0017 + 5	0.0024 + 4	0.0025 + 5
10.0 V	0.0008 + 2	0.0011 + 3	0.0015 + 2	0.0016 + 3	0.0023 + 2	0.0024 + 3
100.0 V	0.0011 + 3	0.0014 + 4	0.0018 + 3	0.0019 + 4	0.0026 + 3	0.0027 + 4
1000.0 V <sup>1</sup>	0.0011 + 2	0.0013 + 3	0.0016 + 2	0.0017 + 3	0.0024 + 2	0.0025 + 3

<sup>1</sup>Add .02  $\left( \frac{\text{Input Voltage}}{1000} \right)^2$  % to % of reading.

#### AC RMS Voltage (AC, AC + DC)

RANGE	MAXIMUM READING (5½ digit)	6½ digit	RESOLUTION 5½ digit	4½ digit	INPUT IMPEDANCE	MAXIMUM INPUT VOLTAGE
1.0 V	1.19999 V	1 $\mu\text{V}$	10 $\mu\text{V}$	100 $\mu\text{V}$	1 M $\Omega \pm 5\%$ shunted by $<90$ pF	$\pm 1000$ V peak (700 V rms)
10.0 V	11.9999 V	10 $\mu\text{V}$	100 $\mu\text{V}$	1 mV		10 <sup>8</sup> VHZ
100.0 V	119.999 V	100 $\mu\text{V}$	1 mV	10 mV		
1000.0 V	700.00 V	1 mV	10 mV	100 mV		

Measurement accuracy:  $\pm$  (% of reading + number of counts).

- 100 micro-ohm to 1.0 gigaohm

90 days:  $23^\circ\text{C} \pm 5^\circ\text{C}$

Integration Time	Frequency In Hz					
	10 to 20	Filter Off → 20 to 30	400-20k 30-20k	20k to 50k 20k to 50k	50k to 100k 50k to 100k	<sup>1</sup> 100k to 250k <sup>1</sup> 100k to 250k
>1~ (6 Digit) <sup>2</sup>	.47 + 450	.35 + 500	.07 + 730	.17 + 1700	.55 ± 2900	5.0 + 6500
.1~ (5 Digit)	.48 + 90	.36 + 53	.08 + 73	.18 + 173	.56 ± 293	5.0 + 653
.01~ (4 Digit)	.56 + 10	.41 + 7	.13 + 9	.23 + 19	.61 + 31	5.1 + 67

<sup>1</sup>Frequencies > 100 kHz are specified for 1.0 V and 10 V ranges only.

<sup>2</sup>Integration Time in Power Line Cycles (PLC). For 5½ digits, multiply counts by 0.1. For 4½ digits, multiply counts by 0.01.

#### Resistance (2 W $\Omega$ , 4 W $\Omega$ , 2 WOC $\Omega$ , 4 WOC $\Omega$ )

RANGE	MAXIMUM READING (5½ digit)	6½ digit	RESOLUTION 5½ digit	4½ digit	CURRENT THROUGH UNKNOWN
	100 $\Omega$	119.999 $\Omega$	100 $\mu\Omega$	1 m $\Omega$	10 m $\Omega$
1 k $\Omega$	1199.99 $\Omega$	1 m $\Omega$	10 m $\Omega$	100 m $\Omega$	1 mA
10 k $\Omega$	11.9999 k $\Omega$	10 m $\Omega$	100 m $\Omega$	1 $\Omega$	100 $\mu\text{A}$
100 k $\Omega$	119.999 k $\Omega$	100 m $\Omega$	1 $\Omega$	10 $\Omega$	50 $\mu\text{A}$
1 M $\Omega$	1199.99 M $\Omega$	1 $\Omega$	10 $\Omega$	100 $\Omega$	5 $\mu\text{A}$
10 M $\Omega$	11.9999 M $\Omega$	10 $\Omega$	100 $\Omega$	1 k $\Omega$	500 nA
100 M $\Omega$	119.999 M $\Omega$	100 $\Omega$	1 k $\Omega$	10 k $\Omega$	$\leq 500$ nA <sup>1</sup>
1 G $\Omega$	1000.00 M $\Omega$	1 k $\Omega$	10 k $\Omega$	100 k $\Omega$	$\leq 500$ nA <sup>1</sup>

<sup>1</sup>Ohms source is a 500 nA current source in parallel with a 10 M $\Omega$  resistance.

Measurement accuracy:  $\pm$  (% of reading + number of counts).

RANGE	24 hour: $23^\circ\text{C} \pm 1^\circ\text{C}$		90 days: $23^\circ\text{C} \pm 5^\circ\text{C}$	
	6½ digit ( $\geq 10$ PLC)	6½ digit (1 PLC)	6½ digit ( $\geq 10$ PLC)	6½ digit (1 PLC)
100 $\Omega$	0.003 + 24	0.003 + 32	0.004 + 24	0.004 + 32
1 k $\Omega$	0.002 + 4	0.003 + 5	0.003 + 4	0.004 + 5
10 k $\Omega$	0.002 + 4	0.003 + 5	0.003 + 4	0.004 + 5
100 k $\Omega$	0.002 + 2	0.003 + 3	0.003 + 2	0.004 + 3
1 M $\Omega$	0.006 + 2	0.006 + 3	0.007 + 2	0.007 + 3
10 M $\Omega$	0.041 + 2	0.041 + 3	0.042 + 2	0.042 + 3
100 M $\Omega$	1.3 + 1	1.3 + 1	1.8 + 1	1.8 + 1
1 G $\Omega$	11 + 1	11 + 1	16 + 1	16 + 1

#### Ratio

Type: DC/DC, AC/DC, or (AC + DC)/DC

Method: 4-wire with Volts Lo input common

$$\text{Ratio} = \frac{\text{Signal Voltage}}{\text{Ref. Hi Voltage} - \text{Ref. Lo Voltage}}$$

#### Reading Rate

INTEGRATION TIME IN POWER LINE CYCLES (PLC)	RATES (rdgs/second)			
	Auto Zero OFF		Auto Zero ON	
	60 Hz	50 Hz	60 Hz	50 Hz
0.01 (4½ digit)	330	290	210	180
0.10 (5½ digit)	210	180	120	100
1.00 (6½ digit)	48	40	25	20
10.00 (6½ digit)	5.8	4.8	2.9	2.4
100.00 (6½ digit)	.57	.47	.29	.24

#### Memory

Reading store: Store up to 350 readings.

Program memory: can execute an internal program which controls instrument configuration and measurement sequence.

#### General

Operating temperature: 0 to  $50^\circ\text{C}$

Humidity Range: 95% R.H., 0 to  $40^\circ\text{C}$

Power: 100/120/220/240 V  $\pm 5\%$ ,  $-10\%$ , 48 Hz to 400 Hz line operation, 45 VA max.

Size: 8.8 mm H x 425.5 mm W x 527.1 mm D (3½" x 16¾" x 20¾")

Weight: net, 10.49 kg (23.13 lb.); shipping, 13.35 kg (29.38 lb.)

#### Ordering Information

Opt 050: Noise rejection for 50 Hz

Opt 060: Noise rejection for 60 Hz

Opt W30: 3 year hardware support

HP 3456A Digital Voltmeter

Price

N/C

N/C

+\$120

\$4600



- 5½/6½-Digit DVM with Auto Cal
- High Speed 3½ Digit System Voltmeter

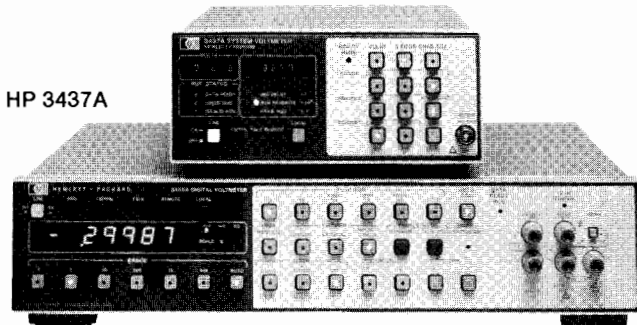

HP 3437A

HP 3455A

### HP 3437A Description

The Hewlett-Packard 3437A System Voltmeter is designed for systems. It is a 3½-digit, high-speed dc voltmeter with sample and hold. The standard unit measures dc volts, provides trigger delay, burst reading capability and Hewlett-Packard Interface Bus (HP-IB).

There are three dc floating input ranges: 0.1V, 1.0V and 10.0V full scale with a maximum display of "1998." Sample and Hold allow the HP 3437A to be an instantaneous reading voltmeter. The trigger delay can be set from 0.1µs to 1.0 second and the number of readings can be set from 0 to 9999 readings.

#### Performance

**Static Accuracy (90 days, 23°C ± 5°C)**

**10 V range:** ±(0.05% of reading + 1.6 counts).

**Static accuracy temperature coefficient (0°C–50°C):** ±(0.002% reading + 0.05 counts) / °C.

#### Input Characteristics

**10 V range:** R = 1 MΩ ± 20%; C < 75 pF.

**Maximum input voltage high to low on all ranges:** < ± 30 V peak.

**Maximum voltage low to chassis:** ± 42 V peak.

**Maximum reading rate (remote, N Rdgs. > 1, and a zero delay listener)**

**ASCII:** 3600 readings/s.

**Packed:** 5700 readings/s.

**Input Bandwidth (3 dB)**

**1 V and 10 V range:** 1.0 MHz.

#### General

**Operating temperature:** 0 to 55°C.

**Storage temperature:** –40°C to 75°C.

**Humidity range:** < 95% R.H., 0°C to 40°C.

**Power:** 100 V, 120 V, 220 V, 240 V +5%, –10%, 48 Hz to 440 Hz line operation, < 42 VA.

**Size:** 88.9 mm H x 212.7 mm W x 527.1 mm D (3½" x 8¾" x 20¾").

**Weight:** net, 5.6 kg (12 lb 4 oz). Shipping, 7.6 kg (16 lb 12 oz).

**HP 3437A System Voltmeter**

**\$3600**

**Option W30:** extended warranty

**\$95**

### HP 3455A Description

Hewlett-Packard's 3455A Digital Voltmeter is a 5½- or 6½-digit integrating voltmeter for bench or systems applications. The standard instrument measures dc volts, ac volts, and resistance. HP-IB and auto or manual ranging are also standard.

#### Measuring Speed

The HP 3455A is fully guarded and has greater than 60 dB normal mode noise rejection at reading rates of up to 24 readings per second on all dc ranges. Ohms reading rates are up to 12 readings/second and an ac fast mode gives reading rates of up to 13 readings/second at

frequencies above 300 Hz. (Readings/second given for 60 Hz operation and high resolution off.)

#### Performance

DC measurements can be made with up to 1µV sensitivity. Ohms measurements are made with either a 2-wire and 4-wire mode. The High Resolution (6½-digit) mode gives dc and ohms measurements with greater than 1 part per million resolution. The standard true rms ac to dc converter measures sinusoid and complex signals with crest factors up to 7:1 at full scale from 30 Hz to 1 MHz.

#### Specifications

##### DC Voltage

**Accuracy ± (% of reading + counts)**

24 hrs: 23°C ± 1°C		
Range	24 Hrs.	90 Days
1 V	0.003 + 4	0.006 + 4
10 V	0.002 + 3	0.005 + 3
100 & 1000 V	0.004 + 3	0.007 + 3

**Input resistance:** 0.1 V through 10 V range: > 10<sup>10</sup> ohms. 100 V and 1000 V range: 10 megohm ± 0.1% with Auto Cal. "off."

**Maximum Input Voltage: High to low input terminals:** ± 1000 V peak; **Guard to chassis:** ± 500 V peak; **Guard to low terminal:** ± 200 V peak.

**NMR at 50 or 60 Hz ± 0.1%:** > 60 dB.

**ECMR with 1 kΩ Unbalance in Lo at DC:** > 160dB;

##### AC Voltage (rms converter)

###### Input Impedance

**Front terminals:** 2 MΩ ± 1% shunted by less than 105 pf.

**Rear terminals:** 2 MΩ ± 1% shunted by less than 90 pf.

###### Maximum Input Voltage

**High to low terminals:** ± 1400 volts peak; 10<sup>7</sup> VHz max.

**Guard to chassis:** ± 500 V peak; **Guard to low terminal:** ± 200 V peak.

**Crest factor:** 7:1 at full scale.

**Accuracy:** [± % of reading + counts] (ac coupled)

Fast ACV	300 Hz to 20 kHz	20 kHz to 100 kHz	100 kHz to 250 kHz	250 kHz to 500 kHz	500 kHz to 1 MHz
	ACV				
90 days					
23°C ± 5°C	0.05 + 50	0.50 + 100	2.00 + 250	5.00 + 500	6.00 + 3100

##### Resistance

**Accuracy ± (% of reading + counts) 4-wire kΩ**

24 hours: 23°C ± 1°C		
Range	24 Hours	90 Days
1 kΩ	0.0025 + 4	0.0035 + 5
10 kΩ	0.0045 + 4	0.0060 + 5
100 kΩ	0.0020 + 5	0.0035 + 6
1000 kΩ	0.0120 + 4	0.0135 + 5
10,000 kΩ	0.1000 + 4	0.1000 + 5

##### Maximum Reading Rates for Remote Operations. (Rdgs/s)

Function	50 Hz	60 Hz
DCV	22	24
Ohms	11	12
ACV (rms)	1.1	1.3
Fast ACV (rms)	12	13

#### General

**Power:** 100 V, 120 V, 240 V +5% – 10%, 48-400 Hz; < 60 VA.

**Size:** 88.9 H x 425.5 W x 527.1 mm D (3.5" x 16.75" x 20.75").

**Weight:** net, 9.38 kg (20.7 lb); shipping, 11.8 kg (26 lb).

#### Options

**001:** average converter

**Price**

less \$100

**HP 3455A Digital Voltmeter**

**\$5950**

# DIGITAL MULTIMETERS

## High Performance 5½ to 3½ Digit Bench DMM

HP Models 3468A/B

- Five functions
- Electronic calibration
- 5½ to 3½ digits

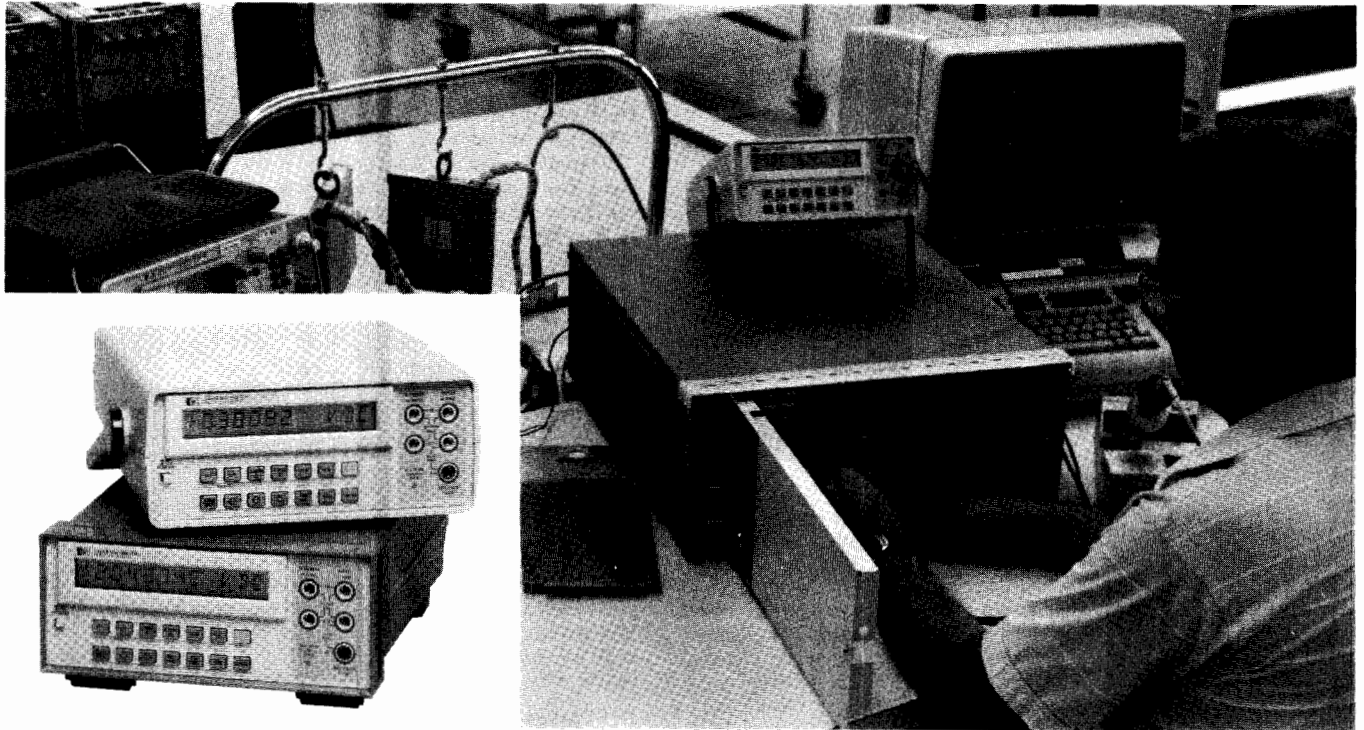

HP 3468A/B

### Description

The HP Models 3468A/B are autoranging 5½ to 3½ digit DMMs, with the five functions of dc volts, true RMS ac volts, 2- and 4-wire ohms, dc current and true RMS ac current. They are low-cost, highly reliable DMMs which can be completely calibrated electronically, either manually from the front panel or remotely in an automatic calibration system. Remote calibration is made possible by the built-in HP-IL (Hewlett-Packard Interface Loop) interface which provides complete programmability of functions, ranges and modifiers.

The HP 3468A comes in a streamlined portable package with a handle for convenient carrying, whereas the HP 3468B comes in a plastic system case for easy rack mounting. Both are available with a rechargeable battery and battery charging circuitry for portable measurements.

### High Performance

The HP 3468A/B have 5 functions with selectable 5½, 4½ or 3½ digit resolution. DC and true RMS ac voltage measurements are provided from 0.3 volt full scale range with 1 µV sensitivity up to 300 volts. The bandwidth of the true RMS ac converter is from 20 Hz to 100 kHz on all ranges and up to 300 kHz on the 30 V range. Either 2 or 4-wire ohms measurements can be selected with a maximum range of 30 MΩ. Both dc and true RMS ac current capability is provided up to 3 A. All functions on the HP 3468A/B incorporate fast autoranging. The HP 3468A/B use an integrating analog to digital conversion technique for high noise rejection. The selectable 3½, 4½ or 5½ digits of resolution allows flexibility for choosing speed or noise rejection.

### Electronic Calibration

Complete calibration of the HP 3468A/B is done electronically, either manually from the front panel or remotely in an automatic calibration system. There are no internal adjustments necessary. Complete calibration of all functions is done without removal of the instrument's covers, thus saving valuable time and reducing cost. The calibration procedure for the HP 3468A/B involves connecting a calibration standard to the input, then pressing three keystrokes to store one calibration constant in CMOS RAM for each range and function. When the HP 3468A/B make a measurement, each reading is corrected according to the calibration constants that have been stored.

The internal CMOS RAM used in the HP 3468A/B is powered by a lithium battery to create a non-volatile memory capable of holding the calibration constants for more than ten years.

### HP-IL

The HP Models 3468A/B are fully programmable with HP-IL, a two-wire serial interface, and the HP-41C/CV handheld calculators. HP-IL provides automatic measurements and adds computational power to these bench DMMs.

### Battery

The optional battery pack includes a rechargeable battery and the battery charger circuitry for up to five hours of continuous measurements.

### DC Voltage

#### Input Characteristics

Range	Maximum Reading (5½ digit)	Resolution		
		5½ digit	4½ digit	3½ digit
0.3 V	±0.301000 V	1 µV	10 µV	100 µV
3 V	± 3.01000 V	10 µV	100 µV	1 mV
30 V	± 30.1000 V	100 µV	1 mV	10 mV
300 V	± 301.000 V	1 mV	10 mV	100 mV

**Input resistance:** 0.3 V, 3 V ranges: > 10<sup>10</sup> Ω  
30 V, 300 V ranges: 10 MΩ ± 1%

#### Maximum Input Voltage (non-destructive)

Hi to Lo: 301 Vrms or 450 V peak

Hi or Lo to Earth Ground: ±500 V peak

**Measurement accuracy:** ±(% of reading + number of counts).  
Auto zero ON. 5½ digits.

Range	TCal*±1°C 24 Hour	TCal*±5°C	
		90 Day	1 Year
0.3 V	0.005 + 4	0.009 + 5	0.02 + 5
3 V	0.0035 + 2	0.0072 + 2	0.0181 + 2
30 V	0.005 + 3	0.009 + 3	0.02 + 3
300 V	0.0055 + 2	0.009 + 2	0.02 + 2

\*TCal is the temperature of the environment where the 3468A/B was calibrated. Calibration should be performed with the temperature of the environment between 20°C and 30°C.



**Temperature coefficient:** 0°C to 55°C, 5½ digits, auto zero ON.  
± (% of reading + number of counts)/°C.

Range	Temperature Coefficient
0.3 V, 30 V	0.0008 + 0.5
3 V, 300 V	0.0007 + .05

**Noise rejection:** in dB, with 1 kΩ imbalance in Lo lead. AC rejection for 50, 60 Hz ±0.1%. Auto zero ON.

Display	AC NMR	AC ECMR	DC CMR
5½ digits	80	150	140
4½ digits	59	130	140
3½ digits	0	70	140

**Maximum reading rate with HP-41CV:** 2 readings/second.

**Resistance** (2-wire Ω, 4-wire Ω)

**Input Characteristics**

Range	Maximum Reading (5½ digit)	Resolution		
		5½ digit	4½ digit	3½ digit
300 Ω	301.000 Ω	1 mΩ	10 mΩ	100 mΩ
3 kΩ	3.01000 kΩ	10 mΩ	100 mΩ	1 Ω
30 kΩ	30.1000 kΩ	100 mΩ	1 Ω	10 Ω
300 kΩ	301.000 kΩ	1 Ω	10 Ω	100 Ω
3 MΩ	3.01000 MΩ	10 Ω	100 Ω	1 kΩ
30 MΩ	30.1000 MΩ	100 Ω	1 kΩ	10 kΩ

**Input protection** (non-destructive): ± 350 V peak.

**Measurement accuracy:** ±(% of reading + number of counts). Auto zero ON. 5½ digit display. 4-wire ohms.

Range	TCal*±1°C 24 Hour	TCal*±5°C	
		90 Day	1 Year
300 Ω	.0045 + 4	.012 + 4	.017 + 5
3 kΩ-300 kΩ	.0035 + 2	.011 + 2	.016 + 2
3 MΩ	.0052 + 2	.011 + 2	.016 + 2
30 MΩ	.036 + 2	.066 + 2	.078 + 2

**Current Through Unknown**

Range	300 Ω	3 kΩ	30 kΩ	300 kΩ	3 MΩ	30 MΩ
Current	1 mA	1 mA	100 μA	10 μA	1 μA	100 nA

**Maximum open circuit voltage:** 6.5 V

**AC Voltage** (true RMS responding)

**Input Characteristics**

Range	Maximum Reading (5½ digit)	Resolution		
		5½ digit	4½ digit	3½ digit
0.3 V	0.301000 V	1 μV	10 μV	100 μV
3 V	3.01000 V	10 μV	100 μV	1 mV
30 V	30.1000 V	100 μV	1 mV	10 mV
300 V	301.000 V	1 mV	10 mV	100 mV

**Input impedance:** 1 MΩ ±1% shunted by <60 pF.

**Maximum input voltage** (non-destructive): 301 Vrms or 450 V peak.

**Measurement accuracy:** ±(% of reading + number of counts) Auto zero ON. 5½ digit display. Accuracy is specified for sinewave inputs only, >10% of full scale.

**1 Year, TCal ±5°C**

Frequency	Ranges		
	0.3V	3 V, 30 V	300 V
20-50 Hz	1.14 + 163	1.14 + 102	1.18 + 102
50-100 Hz	0.46 + 163	0.46 + 103	0.5 + 102
100 Hz-20 kHz	0.29 + 163	0.26 + 102	0.33 + 102
20-50 kHz	0.56 + 247	0.41 + 180	0.55 + 180
50-100 kHz	1.74 + 882	1.05 + 825	1.26 + 825
100 k-300 kHz	10.1 + 3720 (30 V range only)		

**Crest factor:** >4:1 at full scale.

**DC Current**

**Input Characteristics**

Range	Maximum Reading (5½ digit)	Resolution		
		5½ digit	4½ digit	3½ digit
3 A	± 3.01000 A	10 μA	100 μA	1 mA

**Maximum input** (non-destructive): 3 A from <250 V source; fuse protected.

**Measurement accuracy:** ±(% of reading + number of counts). Auto zero ON. 5½ digit display.

Range	TCal ±5°C	
	90 Days	1 Year
3 A, <1 A input	0.14 + 6	0.17 + 6
3 A, >1 A input	1.0 + 30	1.0 + 30

**AC Current** (true RMS responding)

**Input Characteristics**

Range	Maximum Reading (5½ digit)	Resolution		
		5½ digit	4½ digit	3½ digit
.3 A	0.301000 A	1 μA	10 μA	100 μA
3 A	3.01000 A	10 μA	100 μA	1 mA

**Maximum input** (non-destructive): 3 A from <250 V source; fuse protected.

**Measurement accuracy:** ±(% of reading + number of counts). Auto zero ON. 5½ digit display. Accuracy specified for sinewave inputs only, >10% of full scale.

**1 Year, TCal ±5°C**

Frequency	Ranges	
	0.3 A	3 A
20-50 Hz	1.77 + 163	2.5 + 163
50-1 kHz	1.1 + 163	1.8 + 163
1 k-10 kHz	1.0 + 163	1.7 + 163
10 k-20 kHz	1.14 + 163	1.84 + 163

**General Information**

**Operating temperature:** 0 to 55°C

**Humidity range:** 95% R.H., 0 to 40°C

**Power:** AC line 48 to 440 Hz, 86 to 250 V, (see configuration)

**Battery:** (Opt 001) Rechargeable lead-acid; minimum continuous operation for 5 hours at 25°C; recharge time is 16 hours with HP 3468A/B off and 36 hours with HP 3468A/B on.

**Size:** HP 3468A: 98.4 mm H x 238.1 mm W x 276.2 mm D (3.88 in. H x 9.38 in. W x 10.88 in. D). 3468B: 89 mm H x 213 mm W x 275 mm D (without feet), 3.5 in. H x 8.38 in. W x 10.83 in. D.

**Weight:** HP 3468A/B—2.1 kg (4.63 lb); HP 3468A/B with Opt 001—3.1 kg (6.83 lb).

**Configuration:** order one power and frequency option at no charge from below.

**Opt 315:** 100 V, 50 Hz; **Opt 335:** 220 V, 50 Hz

**Opt 316:** 100 V, 60 Hz; **Opt 336:** 220 V, 60 Hz

**Opt 325:** 120 V, 50 Hz; **Opt 345:** 240 V, 50 Hz

**Opt 326:** 120 V, 60 Hz; **Opt 346:** 240 V, 60 Hz

**Ordering Information**

HP 3468A DMM in Streamlined Portable Case with HP-IL and test probes. **Price** \$765

HP 3468B DMM in Rack and Stack Case with HP-IL and test probes. **Price** \$765

**Options and Accessories**

HP 3468A/B Option W30, add 3 year Extended Hardware Support \$25

HP 3468A/B Option 001, add Rechargeable Battery Pack \$155

HP 3468B Option 401, add Side Handle Kit (HP P/N 5061-1171) \$40

HP 3468B Option 907, add Front Handle Kit (HP P/N 5061-1170) \$52

HP 3468B Option 908, add Rack Mount Kit for a Single Instrument (HP P/N 5060-0173) \$55

HP P/N 5060-0174 Rack Mount Kit for rack mounting two instruments side-by-side \$87.50

Fast-Ship product - See page 767

# DIGITAL MULTIMETERS

## Bench, General Purpose and Wide Bandwidth

### HP Models 3466A/3400A

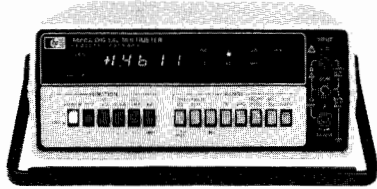

HP 3466A

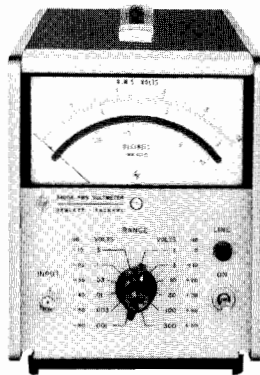

HP 3400A

#### HP Model 3466A

The HP 3466A is a 4 1/2 digit autoranging multimeter offering six functions ACV, DCV, ACI, DCI, Ohms, and Diode Test. ACV and ACI measurements are true rms with selectable ac or dc coupling. Available with rechargeable batteries or ac power only, it offers 1  $\mu$ volt and 1 mOhm sensitivity with zero adjustment on the lowest ranges to compensate for external offsets.

#### Specifications

##### Voltage

###### DC V

Range	Maximum Display	Accuracy: 1 year. 15 to 30 deg. C $\pm$ (% of reading + # of counts)
20 mV	$\pm 19,999$	0.05 + 3
200 mV	$\pm 199.99$	0.04 + 2
2 V	$\pm 1.9999$	0.03 + 1
20 V	$\pm 19.999$	0.03 + 1
200 V	$\pm 199.99$	0.035 + 1
1200 V	$\pm 1199.9$	0.035 + 1, <700 V input
1200 V	$\pm 1199.9$	0.055 + 1 >700 V input

###### AC V (true-rms responding, true-rms calibrated)

Frequency Range	Accuracy: 1 year. 15 to 30 deg. C $\pm$ (% of reading + # counts)
20 to 30 Hz	2 + 50
30 to 50 Hz	1 + 30
50 Hz to 10 kHz	0.3 + 20
10 to 20 kHz	1 + 40
20 to 100 kHz	2 + 150

**Maximum input:** (ac+dc)V: $\pm$  1200 Vdc, 1700 V (dc + peak ac); acV:  $\pm$ 600 V dc, 1700V(peak ac + dc);  $10^7$  volt-Hz max.  
**Crest Factor:** 4:1 at full scale.

##### Resistance

**Ranges:** 20 Ohm to 20 MOhm in 7 ranges

**Input Protection:** 250V or 350V (dc + peak ac).

Range	Accuracy: 1 year. 15 to 30 deg. C $\pm$ (% of reading + # counts)
20 to 200 Ohm	0.08 + 2
2 kOhm to 200 kOhm	0.03 + 1
2000 kOhm	0.04 + 1
20 MOhm	0.15 + 1

##### Current

**Maximum Input:** current: 2 A (fused protected). Voltage: 250 V

###### DC I

Range	Accuracy: 1 year. 15 to 30 deg. C $\pm$ (% reading + # counts)
200 $\mu$ A, 2mA, 20mA	0.07 + 2
200 mA	0.15 + 2
2000 mA	0.5 + 2

###### AC I

Range	Frequency	Accuracy: 1 year. 15 to 30 deg.C $\pm$ (% reading + # counts)
200 $\mu$ A to 200 mA	20 to 30 Hz	2.0 + 50
	30 Hz to 10 kHz	0.9 + 35
2000 mA	20 to 30 Hz	2.0 + 50
	30 Hz to 10 kHz	1.2 + 20

#### Ordering Information

**HP 3466A Opt. 001,** streamlined portable case, ac line power only

**Price**

-\$75

**HP 3466A Opt. 002,** Rack and Stack case, ac line power only. (Rack mount kit not included.)

-\$10

**HP 3466A Digital Multimeter.** Standard configuration in a streamlined portable case with handle, ac line power, batteries and charger, and test leads.

\$1290

☎ Fast-Ship product. See page 767.

#### HP Model 3400A

The HP 3400A is a true rms analog voltmeter. Six-decade frequency coverage makes the HP 3400A extremely flexible for audio and RF measurements up to 10 MHz and permits the measurement of broadband noise and fast risetime pulses.

Pulses or other non-sinusoids with crest factors up to 10:1 can be measured full scale. Plots of measured data and higher resolution measurements can be produced by connecting a dmm to the convenient rear-panel dc output which produces a linear 0 to 1 volt output proportional to the meter deflection.

#### Specifications

**Voltage Range:** 1 mV to 300 V full scale, 12 ranges.

**dB Range:** -72 to + 52 dBm (0 dBm = 1 mW into 600 Ohm).

**Frequency range:** 10 Hz to 10 MHz.

**Response:** responds the rms value (heating value) of the input signal for all waveforms.

**Meter accuracy:** % of full scale (20 to 30 deg. C)\*

10 Hz	50 Hz	1 MHz	2 MHz	3 MHz	10 MHz
5%	1%	2%	3%	5%	

**AC to DC converter accuracy:** % of full scale (20 to 30 deg. C)

10 Hz	50 Hz	1 MHz	2 MHz	3 MHz	10 MHz
5%	0.75%	2%	3%	5%	

\* TC: 0.1% from 0 to 20 and 30 to 55 deg.C

**Crest Factor:** (ratio of peak to rms amplitude of input signal): 10:1 at full scale.

**Input impedance:** from 0.001 to 0.3V range: 10 MOhm shunted by <50 pF. 1.0 to 300 V range: 10 MOhm shunted by < 20 pF, ac coupled input.

**Output:** negative 1 V dc into open circuit at full scale deflection, proportional to meter deflection from 10 to 100% of full scale. 1 mA maximum; nominal source impedance is 1 kOhm. Output noise is <1mV rms.

**Accessories furnished:** 10110A adapter, BNC to dual banana jack.

#### Ordering Information

**HP 3400A Opt. 001** expands the dB scale by placing it on the top of the meter.

**Price**

\$42

Rear terminals in parallel with front terminals and linear log scale uppermost on the meter face are available on special order.

**HP 3400A RMS Voltmeter**

\$1850

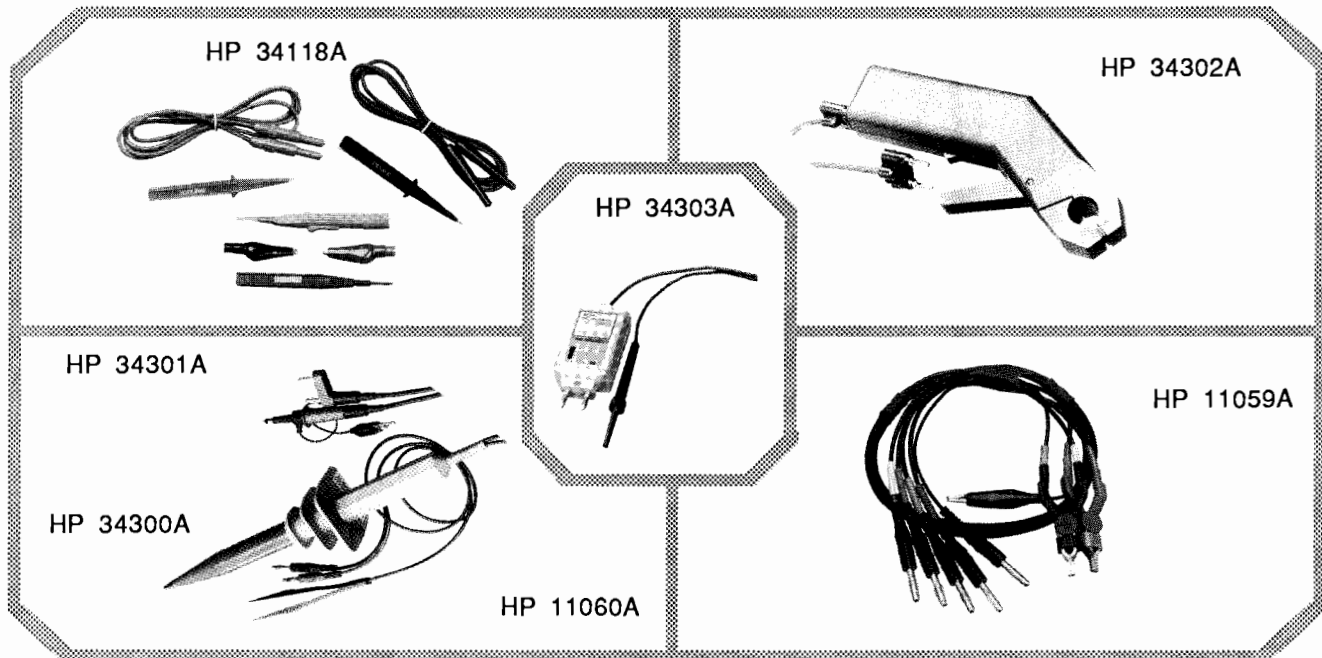

#### HP 34301A RF Detector Probe

This probe detects high frequency signals for voltage measurements. The probe can be used with any dmm having a 10 m  $\Omega$  input.

**Bandwidth:** 100 kHz - 700 MHz

**Accuracy:** 100 kHz - 500 MHz,  $\pm 1$  dB  
100 kHz - 700 MHz,  $\pm 3$  dB

**Input Capacitance:** approx. 5 pF

**Maximum ac Input:** 50 Vrms

**Transfer Ratio:** 1 Vdc output for 1 Vrms input

#### HP 34302A Clamp-on AC/DC Current Probe

A clamp-on probe used for measuring ground currents, power supply ripple, or current distribution in systems. This probe allows you to measure ac, dc and ac+dc currents without breaking the circuit.

**Ranges:**  $\pm 10$  A dc or 10 A ac  
 $\pm 100$  A dc or 100 A ac

**Frequency Response:** dc to 1 kHz

**Recommended Load:**  $> 3.0$  k  $\Omega$

**Rated Output:**  $\pm 1.0$  V dc at 10 A  
 $\pm 1.0$  V dc at 100 A

**Aperture Size:** 19 mm

**Accuracy:**  $\pm 2\%$  or rated output

#### HP 34300A 40 kV AC/DC High Voltage Probe

A probe for use with any dmm having an input resistance of 10 M  $\Omega$ . Maximum input (at sea level): 40 kV (dc + peak ac), derated 1% of voltage rating per 100 meters in rise from sea level.

**Voltage Division Ratio:** 1000:1

**Bandwidth:** dc to 300 Hz

**Input Resistance:** 1 G  $\Omega$

**Division Ratio Accuracy:**  $\pm 2\%$

#### HP 11060A Surface Mount Device Test Probe

Designed for SMD testing, this probe provides an easy method to access and measure SMD resistive networks. Not to be used over 42 volts peak.

#### HP 34303A Temperature Probe

Temperature measurements are read directly in degrees C or F on dmm's having a minimum input impedance of 10 k  $\Omega$ . The probe is a temperature-to-voltage transducer with a forward-biased diode providing calibrated linear output. A standard dual banana plug output connector provides universal connection to dmm's. A 9 volt battery is required for operation and is not included.

**Temperature Range:**  $-58^\circ$  to  $302^\circ$  F;  
 $-50^\circ$  to  $150^\circ$  C

**Output:** 10 mV/ $^\circ$  C or  $^\circ$  F

**Resolution:** 0.01  $^\circ$  C or  $^\circ$  F

**Accuracy:**  $\pm 3.0^\circ$  F;  $\pm 1.7^\circ$  C

#### HP 11059A Kelvin Probe Set

Works with any dmm with 4-wire ohms. Circuit connection is performed with two gold-plated flat tweezers with special gripping surfaces to ensure precise contact to the components being measured. An alligator clip and lead are provided for either grounding or guarding. Instrument connection is through banana plugs. Not to be used over 42 volts peak.

#### Ordering Information

	Price
HP 11002A Test Lead	\$20 ☎
HP 11003A Test Lead	\$20 ☎
HP 11053A Low Thermal Lug-Lug Jumper Set	\$29 ☎
HP 11058A Low Thermal Banana-Banana Jumper Set	\$29 ☎
HP 11059A Kelvin Probe Set	\$135 ☎
HP 11060A Surface Mount Device Test Probe	\$24 ☎
HP 11062A Kelvin Clip Set	\$26 ☎
HP 11096B High Frequency Probe	\$225
HP 11174A Low Thermal Lug-Banana Jumper Set	\$29 ☎
HP 34110A Carrying Case for 1/2 Rack Size Instruments	\$75
HP 34111A DC High Voltage Probe	\$225
HP 34118A Test Lead Kit	\$27 ☎
HP 34119A High Voltage Probe	\$130 ☎
HP 34300A 40 kV AC/DC High Voltage Probe	\$90 ☎
HP 34301A RF Detector Probe	\$80 ☎
HP 34302A Clamp-on AC/DC Current Probe	\$250 ☎
HP 34303A Temperature Probe	\$120 ☎

☎ Fast ship product. See page 767.

# SIGNAL ANALYZERS

## Wave, Distortion, Modulation, Spectrum, and Fourier Analyzers

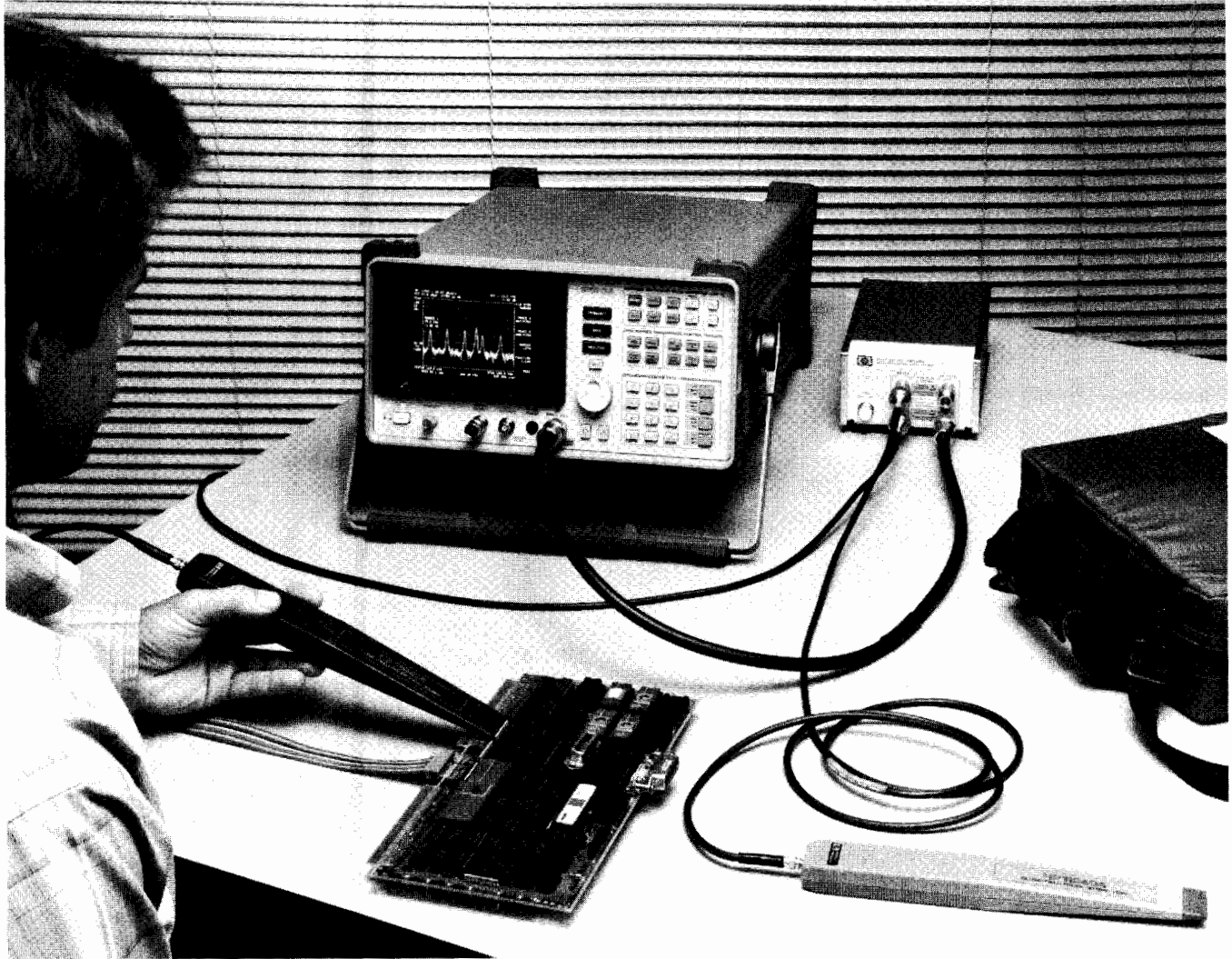

### Signal Analyzers

Several different types of signal analyzers provide frequency domain measurement capability. Spectrum analyzers, distortion analyzers, audio analyzers, modulation analyzers, and measuring receivers are all offered by HP. Each of these instruments has capabilities that make it the preferred instrument for particular measurement applications.

The spectrum analyzer is a swept-tuned, superheterodyne receiver that provides a CRT display of amplitude versus frequency. It is essentially a frequency-selective, peak-responding voltmeter calibrated to display the RMS value of a sine wave. The spectrum analyzer can show the individual frequency components that make up a complex signal. (It does not provide phase information about a signal, however). The swept receiver technique used in Hewlett-Packard spectrum analyzers enables frequency domain measurements to be made over a large dynamic range and a wide frequency range of 5 Hz to 325 GHz.

The Fourier analyzer uses digital sampling and mathematical transformation techniques to form a Fourier spectrum of a signal. This

method is presently useful for measuring signals from a few  $\mu\text{Hz}$  to 100 kHz and provides frequency, amplitude, and phase information. Like the spectrum analyzer, all information is presented on a CRT display. With its real-time signal analysis capability, the Fourier analyzer is able to capture periodic as well as random and transient events.

The wave analyzer uses a tunable filter, which can be visualized as a movable frequency window, to measure both the amplitude and frequency of individual spectral components. This measurement technique essentially makes the instrument a frequency-selective voltmeter. The wave analyzer employs meters and digital displays to show both the amplitude and frequency of the signal within the window. HP wave analyzers provide accurate results from 15 Hz to 32.5 MHz.

Distortion analyzers and audio analyzers employ broadband detectors and notch filters to measure signal properties such as total harmonic distortion. These tunable filters enable the analyzer to selectively display the level and frequency of harmonic and distortion products. Measurement results are shown on a meter or digital display. Audio analyzers include a signal source, making

possible measurements such as SINAD that include signal and distortion levels. The frequency range covered by HP distortion and audio analyzers extends from 5 Hz to 600 kHz.

Modulation analyzers are designed to capture and analyze a fundamental signal and its entire modulation envelope. These analyzers use independent AM and FM detection circuits for simultaneous analysis of complex modulated signals. When a modulation analyzer is combined with a measuring receiver, accurate measurements of frequency, power, and modulation characteristics can be made on signals from 150 kHz to 26.5 GHz. All measurement results are presented on a digital display.

### Spectrum Analyzers

Spectrum analyzers take advantage of the frequency-conversion properties of the swept-tuned heterodyne receiver to make significant contributions to frequency-domain signal analysis. The following are some of the measurements that can be made with spectrum analyzers:

- 1) Absolute and relative frequency.
- 2) Absolute and relative amplitude.

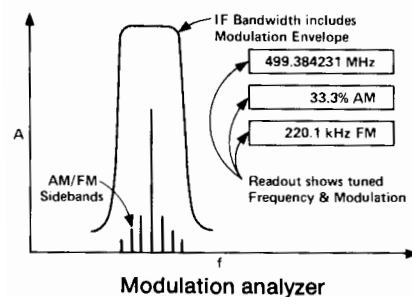
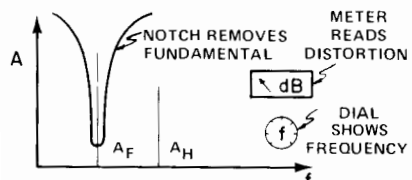
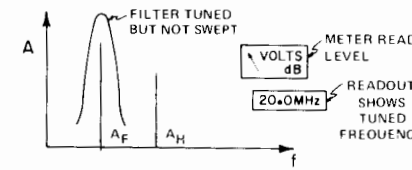
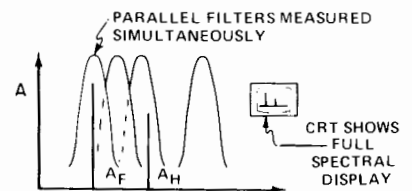
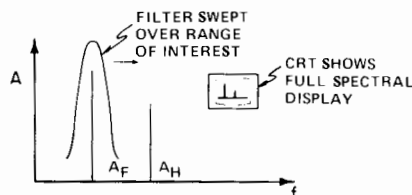
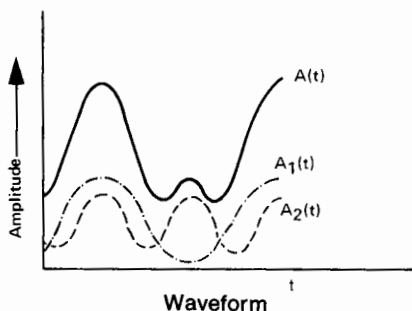

These measurements are possible because spectrum analyzers have the following characteristics:

- 1) Broad frequency coverage from 5 Hz to 325 GHz.
- 2) Wide amplitude range from -138 dBm to +30 dBm.
- 3) Excellent sensitivity for low-signal detection.
- 4) Excellent frequency stability.
- 5) High resolution of frequency and amplitude.

These capabilities allow spectrum analyzers to provide frequency-domain signal analysis for numerous applications, including the manufacture and maintenance of microwave communication links, radar, telecom equipment, CATV systems, and broadcast equipment; EMI diagnostic testing; and signal surveillance.

In addition to the swept-tuned frequency mode, spectrum analyzers can also be used in the fixed-tuned mode (zero span) to provide time-domain measurement capability much like that of an oscilloscope.

With the addition of desktop technical computers, the capability of spectrum analyzers can be greatly enhanced. Computers can be used to directly control the operation of spectrum analyzers over HP-IB. Computers can also be used to develop downloadable programs (DLPs) for those spectrum analyzers with the capability to store such programs in non-volatile memory. These custom measurement routines are then as easy to use as any of the standard instrument features.

In addition, spectrum analyzers with HP-IB capability can directly control a plotter or printer, enabling a hard copy of the CRT display to be made without the use of a computer. Application areas that require accurate, high speed, repetitive routines; physical separation of the operator and the analyzer; unattended operation or operation by personnel with limited technical skills—all are candidates for automation.

Areas that benefit significantly from automated spectrum analysis include

- 1) EMC testing,
- 2) frequency spectrum monitoring,
- 3) production testing of RF or microwave components, subsystems, or systems, and
- 4) remote site testing.

The basic measurement capabilities of the spectrum analyzer, combined with its ability to automate and to interface with other HP-IB instruments and peripherals, make this instrument ideal for many general-purpose and specialized applications.

### Fourier Analyzers

Fourier analyzers offer fast, high-resolution spectrum and network analysis. Unlike conventional swept analyzers, Fourier-based analyzers can measure dynamic signals because they measure all frequencies simultaneously, not one at a time.

Fourier analyzers characterize signals using digital signal processing techniques based on the Discrete Fourier Transform. For a complete description of these techniques, see Application Note 243, "The Fundamentals of Signal Analysis."

Fourier analyzers are especially useful on low frequency signals (<100 kHz) or where very fast measurements are desired. They can improve measurement speed by a factor of 10 to 100 and allow accurate measurements on frequencies as low as a few microHertz. Signal components as closely spaced as 20 microHertz can be clearly resolved and accurately measured.

Since both magnitude and phase of each frequency component are measured, the Fourier analyzer can measure the statistical properties of signals or the joint properties or relationships of two or more signals. Applications include acoustic, modal, vibration or rotating machine analysis. In addition, various types of modulation can be detected and measured.

Simultaneous measurement of magnitude and phase on two or more channels provides high quality network measurements. Transfer functions or frequency response can be easily measured and the use of band-limited or band-translated random noise as the stimulus allows the entire frequency span of interest to be measured at once. Measurement of the coherence function can provide an indication of the validity of many network measurements.

### Wave Analyzers/SLMs

Wave analyzers are known by several different names: frequency selective voltmeters, carrier frequency voltmeters, and selective level meters. A wave analyzer can be thought of as a finite bandwidth filter which can be tuned throughout a particular frequency range. Signals will be selectively measured as they are isolated within the bandwidth of the filter. For a particular signal, the wave analyzer will indicate both its frequency and amplitude.

The uses of wave analyzers can be categorized into three broad areas: (1) amplitude measurement of a single component of a complex frequency system, (2) amplitude measurement in the presence of noise and interfering signals, and (3) measurement of signal energy appearing in a specified, well-defined bandwidth.

Wave analyzers are most commonly used in communication systems and have input configurations and measurement bandwidths optimized for these applications. Both balanced and unbalanced inputs are available and impedances range from 50 Ohms to 600 Ohms.

### Distortion, Audio Analyzers

The Hewlett-Packard distortion and audio analyzers consist of a narrow band rejection filter and broadband detector. Before the fundamental is rejected, the analyzer first measures the amplitude of the fundamental, all the harmonic components, and noise. Then the rejection filter is employed to remove the fundamental. The ratio of the two measurements is total harmonic distortion plus noise.

- 3) Noise.
- 4) Distortion products.
- 5) AM, FM & pulsed RF modulation.
- 6) Stimulus response.
- 7) Electromagnetic compatibility (EMC).



# SIGNAL ANALYZERS

## Wave, Distortion, Modulation, Spectrum and Fourier Analyzers (cont'd)

### Audio Analyzers

The audio analyzer performs several basic low frequency measurements in addition to distortion, making it a general purpose audio test set. The audio analyzer includes the SINAD function for testing mobile radio receiver sensitivity. It contains a low distortion audio oscillator for stimulus response testing in combination with its distortion analyzer. It contains a true rms voltmeter and dc voltmeter for accurate measurement of complex waveform levels. Swept ac level and swept distortion measurements can be made using the internal source and rms voltmeter. A reciprocal frequency counter is also included that continuously counts the frequency of the input signal.

### True Harmonic Distortion Measurements

Computer-controlled spectrum analyzers provide a rapid means of measuring true harmonic distortion levels. The fundamental and its harmonic components are rapidly measured one at a time and the distortion is computed and either stored or printed.

### Modulation Analyzers/ Measuring Receivers

A modulation analyzer is a precision receiver designed to detect the entire modulation envelope of a signal under test. It can

measure and display the carrier characteristics of RF frequency and power as well as AM, FM and phase modulation characteristics such as AM depth, peak deviation, residual modulation, and various ratios associated with them. The modulation analyzer faithfully recovers the actual modulation signal for further analysis such as distortion testing.

In addition to all the capabilities of the modulation analyzer, the measuring receiver can measure power down to  $-127$  dBm. With very high accuracy, the measuring receiver can look at signals up to millimeter-wave frequencies. This makes it ideal for calibration of signal generators and attenuators.

### Microwave Modulation Analyzers

Most modern microwave communication and radar/EW system designs are now turning to the use of complex modulations to improve performance and make them less susceptible to dense signal environments. This typically involves the use of quadrature or "vector" modulation formats, such as QPSK, 16QAM, etc., in the case of communication systems and complex, coded formats in the case of radar/EW systems.

In all of these receivers, the signal processing is not handled in the traditional one-

channel, amplitude-only mode, but instead is demodulated into in-phase and quadrature signals that provide dynamic phase and amplitude information about the carrier's modulation, and thus enhance system performance.

The high bandwidth requirements of those modulations combined with the need to measure and characterize both the amplitude and phase of the signals has led to the introduction of the HP 8980A Vector Analyzer. Both instruments contain a matched dual channel, sampling oscilloscope with dc to 350 MHz baseband capability. Powerful measurement routines and tailored screens make modulation measurements simple and fast. Routines will measure such parameters as quadrature error, lock angle, constellation closure, gain matching, and dc offsets.

The HP 8981A contains an internal I/Q demodulator which takes an IF signal from 50 MHz to 200 MHz and demodulates it into I and Q signals for display and analysis. A user-configured down-converter can be used for analyzing microwave signals. Extensive application information is available. Ask for Application Notes 343-2, 343-3, and 343-4, as well as related data sheets and product notes.

## Signal Analyzers Selection Guide Spectrum Analyzers

Frequency Range	Amplitude Calibration Range	Bandwidths		HP Model Description	HP Companion Instruments	Page
		Min	Max			
0.02 Hz-40 MHz (Offset from Carrier) 5 MHz to 18 GHz (Carrier Range)	0 to $-170$ dBc	0.01 Hz	30 kHz	3048A Phase Noise Measurement System	8662A/8663A Synthesized Signal Generator 8642A/B Synthesized Signal Generator 11729C Carrier Noise Test Set	160
5 Hz-50 kHz	$-150$ to $+30$ dBm	1 Hz	300 Hz	3580A Spectrum Analyzer		145
20 Hz to 40.1 MHz	$-137$ dB to $+30$ dBm	3 Hz	30 kHz	3585B Spectrum Analyzer		112
10 kHz-1.5 GHz	$-113$ to $+30$ dBm	1 kHz	3 MHz	8590A Spectrum Analyzer	8444 Opt. 059 Tracking Generator	134
50 kHz-22 GHz	$-109$ dBm to $+30$ dBm	1 kHz	3 MHz	8592A Spectrum Analyzer		137
100 Hz-1.5 GHz	$-135$ dBm to $+30$ dBm	10 Hz	3 MHz	8568B Spectrum Analyzer and 8568S Spectrum Analyzer	8444A Opt. 059 Tracking Generator 85650A Quasi-Peak Adapter, 85865A RF Preselector	123 124
10 kHz-1.5 GHz	$-115$ dBm to $+30$ dBm	1 kHz	3 MHz	8567A Spectrum Analyzer	85650A Quasi-Peak Adapter, 85865A RF Preselector	123
100 Hz-2.9 GHz	$-134$ dBm to $+30$ dBm	10 Hz	3 MHz	71100A Modular Spectrum Analyzer	70300A Tracking Generator, 70310A Precision Frequency Reference, 70700A Digitizer	117
1 kHz-26.5 GHz <sup>1</sup> (Extendable to 325 GHz)	$-121$ to $+30$ dBm	100 Hz	2 MHz	8562A/B Spectrum Analyzer	85629A Test and Adjustment Module 85620A Mass Memory Module	139
100 Hz-22 GHz <sup>1</sup> (Extendable to 325 GHz)	$-134$ dBm to $+30$ dBm	10 Hz	3 MHz	8566B Spectrum Analyzer and 8566S Spectrum Analyzer	85650A Quasi-Peak Adapter, 85865A RF Preselector 11970K/A/Q/U/V/W Harmonic Mixers	123 124
50 Hz-26.5 GHz	$-132$ dBm to $+30$ dBm	10 Hz	3 MHz	71200A Modular Spectrum Analyzer	70300A Tracking Generator	117
50 kHz-26.5 GHz	$-130$ to $+30$ dBm	10 Hz	300 MHz	71201A Modular Spectrum Analyzer	70300A Tracking Generator, 70310A Precision Frequency Reference, 70700A Digitizer	117
100 Hz-22 GHz	$-138$ to $+30$ dBm	10 Hz	3 MHz	71210A Modular Spectrum Analyzer	70300A Tracking Generator, 70700A Digitizer	117
18 GHz-110 GHz (Extendable from 2.7 to 325 GHz)	$-130$ dBm to $-1$ dBm	10 Hz	3 MHz	71300A Modular Spectrum Analyzer	11970K/A/Q/U/V/W Harmonic Mixers, 70310A Precision Frequency Reference, 70700A Digitizer	117
100 kHz-22 GHz	$-60$ to $+15$ dBm Optical	10 Hz	3 MHz	71400A Lightwave Spectrum Analyzer	70300 Tracking Generator 11980A Interferometer	314
100 kHz-2.9 GHz	$-60$ to $+15$ dBm Optical	10 Hz	3 MHz	71401A Lightwave Spectrum Analyzer	70300 Tracking Generator 11980A Interferometer	314

NOTE 1: Frequency range extendable to 110 GHz through the use of the HP 11970 series Harmonic Mixers. For higher frequency coverage, other external mixers are commercially available.

**Modulation Analyzers/Measuring Receivers**

Frequency Range	Modulation Measurements	Amplitude Measurement Range	Audio Frequency Count + Distortion Measurement	HP Model Number	Page
dc to 350 MHz	Baseband AM, φM	5mV to 5V	No	8980A	163
dc to 350 MHz 50 to 200 MHz	Baseband IF	5mV to 5V -5 to -20 dBm	No	8981A	162
150 kHz-1300 MHz	AM, FM, φM	+30 to 0 dBm	No	8901A	166
150 kHz-1300 MHz	AM, FM, φM	+30 to -20 dBm	Yes	8901B	166
150 kHz-1300 MHz	AM, FM, φM	+30 to -127 dBm	Yes	8902A	168
150 kHz - 18 GHz or 26.5 GHz	AM, FM, φM	+30 to -100 dBm	Yes	8902S	172

**Dynamic Signal Analyzers**

Frequency Range	Number Of Input Channels	Resolution Points Max	HP Model No.	Special Features	Page
.02 Hz to 25.6 kHz	2	256	3582A Spectrum Analyzer	Digital Averaging Coherence function Internal noise source	146
125 μHz to 100 kHz	1	401	3561A Dynamic Signal Analyzer	1/3 and 1/1 octave analysis Internal mass storage Spectral map display Waveform recording Internal noise source	147
64 μHz to 100 kHz	2	801	3562A Dynamic Signal Analyzer	Data throughput to disc Internal sine, noise sources Waveform recording Curve fitter Demodulation Autosequence programming	150
488 μHz to 102.4 kHz	2	401	35660A Dynamic Signal Analyzer	Internal disc drive Waveform recording Internal sine, noise sources Pass/fail limit testing	153
61 μHz to 51.2 kHz	1-63	3200	3565S Signal Processing System	HP VISTA Signal Processing Software runs on HP-UX Flexible system configuration Multiple Input, Multiple Output, (MIMO) response measurements Data throughput to disc	157

**Distortion/Audio Analyzers**

Fundamental Frequency Range	Minimum Distortion	Auto Set Level	Auto Nulling	True RMS	AM Detector	Filters	HP Model No.	Internal Source	HP-IB	Page
5 Hz to 600 kHz	0.03% (-70 dB)		•		•	•	334A			174
			•		•	•	334A Opt 002			174
10 Hz-110 kHz	0.0018% (-95 dB)	•	•	•	•	•	339A	•		174
20 Hz-100 kHz	0.01% (-80 dB)	•	•	•	Note 1	•	8903B*	•	•	164
20 Hz-100 kHz	0.01% (-80dB)	•	•	•	Note 1	•	8903E**		•	164

\*The HP 8903B also performs Frequency Count, Signal/Noise, SINAD, watts, ac/dc voltage measurements.  
NOTE 1: The HP 8901A Modulation Analyzer (page 166) provides complete demodulation of AM, FM, and φM signals. \*\*The HP 8903E also performs Frequency Count, SINAD, and ac/dc voltage measurements.

**Wave Analyzers/Selective Level Meters**

Frequency Range	Selective Bandpass	Dynamic Range		Freq. Readouts	Type of Inputs	Type of Outputs	Modes of Operation	HP Model Number	Page
		Absolute	Relative						
15 Hz to 50 kHz	3 Hz 10 Hz 30 Hz 100 Hz 300 Hz	0.1 μV-300 V full scale	>85 dB	5-place digital	Banana Jacks	rec: 5 V full scale, with pen lift BFO, Local Oscillator, tuning loudspeaker, and headphone jack	AFC, normal, BFO	3581A/ 3581C	175 505
50 Hz to 32.5 MHz	20 Hz 400 Hz 3100 Hz	-130 to +20 dBm	>80 dB	LED, 0.1 Hz Resolution	50/75 Ω, BNC 600 Ω Banana Jacks	Tracking Generator Audio/Loud Speaker 1 MHz Ref.	Wideband Selective USB/LSB	3586C (3336C*)	115 419
50 Hz to 32.5 MHz	20 Hz 400 Hz 1740/2000 Hz Optional 3100 Hz WTD	-130 to +20 dBm	>70 dB	LED 0.1 Hz Resolution	75 Ω BNC/WECO 124 Ω WECO 135 Ω WECO 150 Ω Siemens 600 Ω WECO/ Siemens	Tracking Generator Audio/Loud Speaker 1 MHz Ref.	Wideband Selective SSB	3586A/B (3336A/B*) (3335A)	502 502 418

\*Tracking Synthesizers.

**Carrier Phase Noise Analysis**

Frequency Range	HP Model Number	Maximum Sensitivity dBc/Hz (depends on offset & method)	Functions Available	Page
5 MHz-18 GHz	3048A Phase Noise Measurement System	-170 dBc/Hz (Requires external reference source of equivalent performance)	Fully documented Software with specified Phase Detector, Frequency Discriminator, AM and Two Port Measurements	160
5 MHz-18 GHz	11729C Carrier Noise Test Set	-126 dBc/Hz (Including HP 8662A Reference Source)	Phase Detector Mode Frequency Discriminator Mode AM Noise Option, Pulsed Carrier	161

# SIGNAL ANALYZERS

## 20 Hz to 40 MHz Spectrum Analyzer

### Model 3585B

- 80-100 dB dynamic range
- $\pm 0.25$  dB typical level accuracy
- NEW - Automatic limit testing
- 50, 75, 1M  $\Omega$  inputs
- 3 Hz resolution bandwidth
- NEW - Direct plotter/printer interface

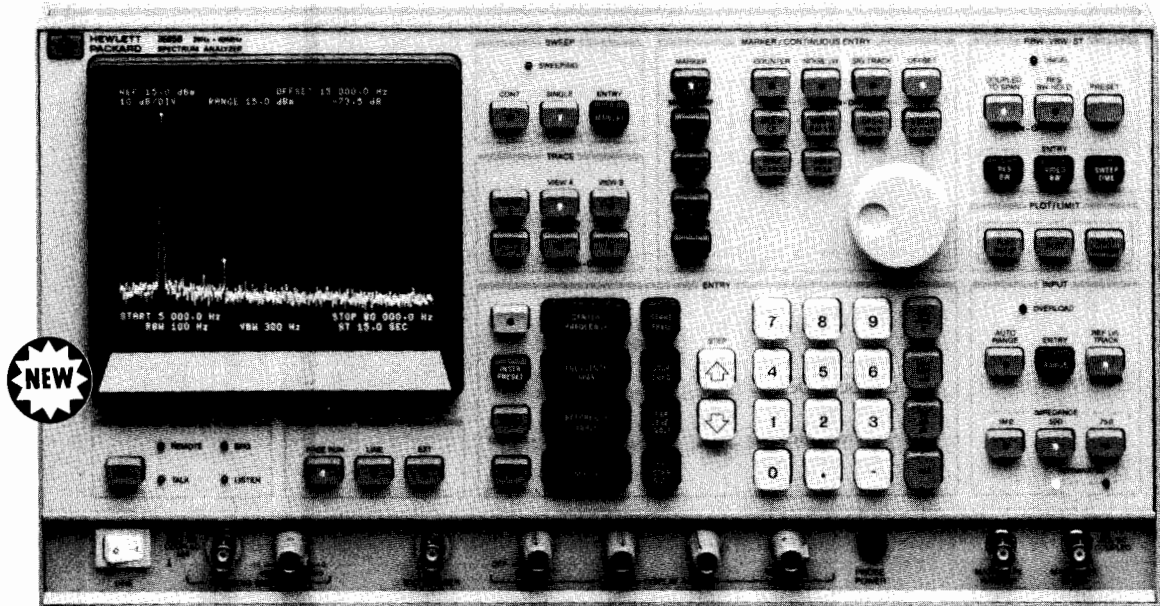

#### Uncompromising Baseband Signal Analysis

The HP 3585B Spectrum Analyzer delivers high performance where it counts—at baseband frequencies. With unmatched accuracy, resolution, and dynamic range, the HP 3585B is HP's best solution for signal analysis at the critical frequencies comprising voice, picture, or digital information.

In today's high speed, high density information processing systems, maintaining the integrity of data signals requires more measurement performance than ever before. The HP 3585B provides 80-100 dB of spurious-free dynamic range, a sharp 3 Hz resolution bandwidth, and a 20 Hz-40.1 MHz frequency range to easily cover most information bandwidths. Fully synthesized tuning (including sweeps) and typical amplitude accuracy to  $\pm 0.25$  dB are unique in this frequency range and ensure complete measurement confidence.

Measurement performance is critically important at baseband frequencies, because signal degradation occurring here is typically not recoverable elsewhere in the system. As a result, test requirements for baseband signals and circuits often demand a level of performance that only a high-performance, low-frequency signal analyzer such as the HP 3585B can provide.

#### Carefully Chosen Features for Better Measurements

Measurements are faster and easier with the HP 3585B's optimized feature set. The automatic limit test function checks all 1000 measurement points against user-defined upper and lower limits in a fraction of a second. Pass/fail results are shown in the display and are available over HP-IB for improved productivity in automated applications.

The automatic peak search and signal track functions speed signal identification and analysis and make examination of drifting signals more convenient. In addition to locating the strongest signal in a display, the peak search function can also find successively smaller signals, or search to the right or left for peaks above a user-defined threshold.

#### Fast, Flexible Frequency Sweeps

Well-designed filters and a phase-continuous, synthesized local oscillator team up with exceptional dynamic range to give the

HP 3585B very fast measurement speeds. A 40 MHz sweep using the 30 kHz resolution bandwidth takes only 200 milliseconds, fast enough for high resolution spectrum surveillance. A 1 MHz sweep using a 1 kHz bandwidth takes only 2 seconds, yet yields an average noise floor of -85 dBc.

#### Powerful Marker Functions

The tunable marker readout of frequency and amplitude can be expressed as an absolute or relative (offset) value. For offset measurements, a reference point is selected and all measurements are displayed relative to this value. Offset measurements are especially useful when comparing various spectral component levels to a carrier in modulation analysis or when determining signal-to-noise ratio.

With a single keystroke the marker value can be entered as the center frequency, reference level, frequency span, or center frequency step size. This improves accuracy and efficiency in manual testing and reduces setup errors.

The built-in frequency counter provides additional accuracy when measuring the frequency of a signal in the display. Results are provided in 0.3 seconds to 0.1 Hz resolution. Since the counter function is combined with the selectivity of the analyzer, it is possible to accurately measure small signals in the vicinity of much larger ones.

For noise measurements, the noise level marker function displays averaged RMS noise density at the marker position, normalized to a standard 1 Hz bandwidth and corrected for the analyzer's characteristics. This function can be combined with the relative measurement mode for fast, easy signal-to-noise ratio measurements.

#### Measurement Hard Copy

Transferring a complete display to a printer or plotter is as easy as pressing a button. The HP 3585B directly controls HP-GL-compatible HP-IB plotters and graphics printers such as the HP Thinkjet.

#### Tracking Generator

The standard 50  $\Omega$  tracking generator covers the full 40 MHz frequency range of the HP 3585B to provide easy scalar (amplitude-only) network analysis. The signal is fully synthesized in CW measurements and sweeps and level is adjustable from 0 dBm to -11 dBm on the front panel.

### Flexible Inputs with Autoranging

50, 75 and 1M  $\Omega$  input impedances are all standard and are electronically selectable to match your system. For sensitive circuits, the 50  $\Omega$  and 1M  $\Omega$  inputs and provided probe power offer maximum compatibility with a variety of passive and active probes.

With input autoranging, the HP 3585B automatically chooses the optimum input range for maximum dynamic range and lowest distortion. This eliminates the need to manually adjust attenuation and IF gain.

### Compatibility

HP protects your investment in measurement solutions with the HP 3585B as a direct replacement for the HP 3585A in virtually every application. The HP 3585B meets all HP 3585A specifications and uses an expanded version of the HP 3585A programming codes. Physical dimensions are identical and inputs and outputs are in the same location, serving the same functions.

### Distortion Measurements

The HP 3585B's dynamic range, resolution and level accuracy make harmonic and intermodulation distortion measurements a straightforward task. The peak search function quickly locates the fundamental and each distortion product, and the automatic limit test function can be used for immediate pass/fail results. Resolve and measure closely-spaced intermodulation products with resolution bandwidths as narrow as 3 Hz. The fully synthesized local oscillator provides the frequency accuracy and stability necessary to make dependable measurements on closely-spaced signals, and to measure distortion products directly with the narrowest bandwidths.

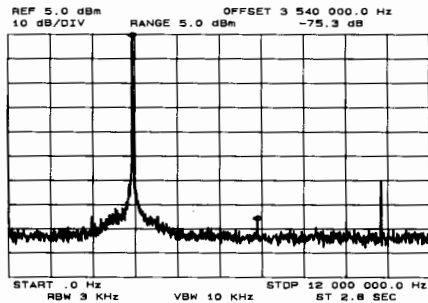

### Network Analysis

Using the HP 3585B's built-in synthesized tracking generator, gain, loss and frequency response measurements are dependable and automatic. Superb amplitude accuracy, resolution and flatness contribute to high quality measurements. The HP 3585B has multiple input impedances to match the network under test and a broad selection of receiver bandwidths to provide the best balance of measurement speed and dynamic range. Use the limit test function to save analysis time and effort with its immediate, automatic pass/fail results. For narrowband devices such as crystal filters the synthesized local oscillator yields stable, repeatable measurements. For devices such as mixers that perform frequency conversion, swept measurements can be synchronized with separate sources for complete characterization in one pass.

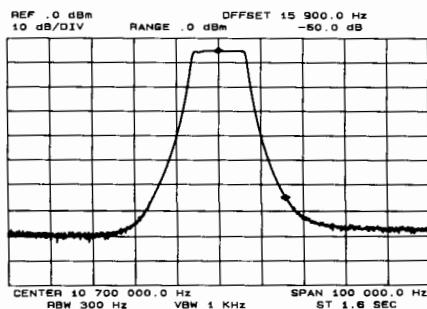

### Noise Level Measurements

The HP 3585B makes fully calibrated noise level measurements automatically. Just select the frequency and press the Noise Level key. The HP 3585B calculates averaged RMS noise density and displays the results normalized to a 1 Hz bandwidth. Its extremely low internal noise level makes repeatable, accurate measurements possible below  $-137$  dBm. For convenience the marker can provide both absolute and relative (signal-to-noise) measurements directly.

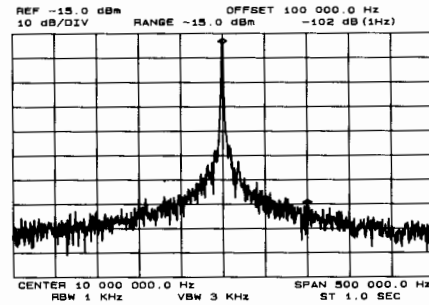

### Specifications

Specifications describe the HP 3585B's warranted performance over the temperature range  $0^{\circ}\text{C}$  to  $55^{\circ}\text{C}$  except where noted. Supplemental characteristics are intended to provide information useful in applying the instrument by describing typical, but non-warranted performance. They are described as "typical" or "approximate" and apply over the temperature range  $25 \pm 5^{\circ}\text{C}$ .

#### Frequency

**Measurement range:** Specifications apply 20 Hz-40.1 MHz

**Start/stop, center, manual frequency range:** 0 Hz-40.1 MHz

**Accuracy:** (same as frequency ref. accuracy)

**Frequency span:** 0 Hz-40.1 MHz

**Frequency reference accuracy:**  $\pm 1 \times 10^{-7}$ /mo. of frequency

**Marker frequency:**

**Readout accuracy:**  $\pm 0.2\%$  of frequency span  $\pm$  resolution bandwidth

**Counter accuracy:**  $\pm 0.3$  Hz  $\pm 1 \times 10^{-7}$ /mo. of counted frequency for a signal 20 dB greater than other signals and noise in the selected resolution bandwidth.

**Resolution:** 0.1 Hz

**Resolution bandwidth:**

**Bandwidth:** 3 Hz-30 kHz (3 dB bandwidth) in 1, 3, 10 sequence.

**Selectivity:** 60 dB/3 dB  $< 11:1$

**Video bandwidth:** 1 Hz-30 kHz in 1, 3, 10 sequence

#### Amplitude:

**Display scale:** 10 vertical division graticule with reference level (0 dB) at top graticule line

**Calibration:** 1, 2, 5, 10 dB/division

**Measurement range:**

**50/75  $\Omega$  inputs:**  $-137$  dBm to  $+30$  dBm or equivalent level in dBV or volts

**1M  $\Omega$  input:** 31 nVrms to 7.08 Vrms

**Input range settings:** Autoranging,  $-25$  dBm to  $+30$  dBm in 5 dB steps

# SIGNAL ANALYZERS

## 20 Hz to 40 MHz Spectrum Analyzer (cont'd)

Model 3585B

### Amplitude Accuracy:

**Accuracy note:** Measurement accuracy is determined by the sum of *reference level accuracy*, *amplitude linearity* (if the signal is not at the reference level) and *frequency response* across the measurement span (if the signal is not at the center or manual frequency). In measurements where the signal is at the reference level and/or at the center or manual frequency, the amplitude linearity and/or flatness uncertainties will not apply.

### Reference level:

**Range:** -100 dB to +10 dB (relative to input range)

**Accuracy:** 50/75  $\Omega$  input (using 1 or 2 dB/div., measured at manual frequency or with sweep rate reduced by a factor of 4):

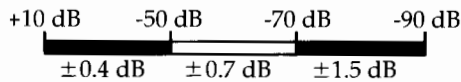

**Typical accuracy, +10 dB to -50 dB:**  $\pm 0.25$  dB For 5 or 10 dB/div. add 0.1 dB to the figures above

**For 1M  $\Omega$  input:** Add to above specification  $\pm 0.7$  dB for 20 Hz-10 MHz;  $\pm 1.5$  dB for 10 MHz-40.1 MHz

### Amplitude linearity, 50/75 $\Omega$ input (relative to reference level):

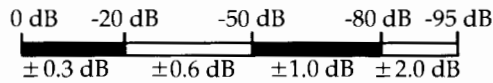

**Typical linearity, 0 dB to -20 dB:**  $\pm 0.2$  dB

### Frequency response, 50/75 $\Omega$ input (relative to center frequency): $\pm 0.5$ dB

**Typical frequency response:**  $\pm 0.3$  dB

**For 1M  $\Omega$  input:** Add to above specification  $\pm 0.7$  dB for 20 Hz-10 MHz;  $\pm 1.5$  dB for 10 MHz-40.1 MHz

### Marker amplitude:

#### Accuracy:

Center or manual frequency at the reference level: Use reference level accuracy from +30 dBm to -115 dBm; add amplitude linearity below -115 dBm.

Anywhere on screen: Add amplitude linearity and frequency response. (Same as display accuracy)

### Dynamic Range:

**Spurious responses:** (image, out-of-band, and harmonic distortion)  
**50/75  $\Omega$  input:**  $< -80$  dB relative to a single signal at or below the input range setting.

**Typical performance:** -84 dB - (1 dB/dB below input range setting)

Example: For a -8 dBm signal on the 0 dBm input range, the spurious responses would be -92 dB.

**1M  $\Omega$  input:**  $< -80$  dB, except 2nd harmonic distortion  $< -70$  dB

### Intermodulation distortion:

**50/75  $\Omega$  input:**  $\geq < -80$  dB relative to the larger of two signals, each  $\geq 6$  dB below input range setting except 2nd order IM from 10 MHz to 40 MHz  $< -70$  dB

**1M  $\Omega$  input:**  $< -70$  dB for 2nd order,  $< -80$  dB for 3rd order

**Residual responses (no signal at input):**  $< -120$  dBm using -25 dBm range, or 95 dB below input range setting

### Residual phase noise (Typical at 40 MHz, -10 dBm input):

5 kHz offset: -112 dBc/Hz

100 kHz offset: -120 dBc/Hz

### Average noise level:

#### 50/75 $\Omega$ input:

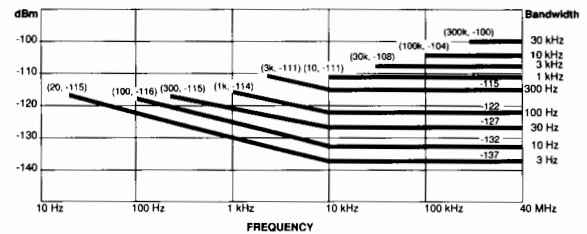

**1M  $\Omega$  input:** Below 500 kHz add 12 dB to above

### Sweep:

**Modes:** Continuous, single, manual (CW, direct or knob entry)

**Trigger:** Free run, external, line

**Time:** 0.2s to 200s/Hz of frequency span, excluding calibration cycles (autocalibration may be disabled)

### Tracking Generator:

**Level:** 0 dBm to -11 dBm, manual control from front panel

**Frequency accuracy:**  $\pm 1$  Hz relative to analyzer tuning

**Frequency response:**  $\pm 0.7$  dB; Typically:  $\pm 0.5$  dB

**Impedance:** 50  $\Omega$ ,  $> 14$  dB return loss

### Signal Inputs:

**50/75  $\Omega$ :**  $> 26$  dB return loss, BNC connectors

**1M  $\Omega$ :**  $\pm 3\%$  shunted by  $< 30$  pF, BNC connector

### Max. input level:

**50/75  $\Omega$ :** 13V peak AC plus DC, relay protected for overloads to 42V peak.

**1M  $\Omega$ :** 42V peak AC plus DC (derated by factor of two for each octave above 5 MHz)

**External trigger:** Negative-going TTL level or contact closure initiates sweep

**External frequency reference:** 10 MHz or subharmonic to 1 MHz, 0 dBm minimum level

### Signal Outputs:

**Frequency reference:** 10.00 MHz  $\pm 1 \times 10^{-7}$ /mo., +10 dBm into 50  $\Omega$

**IF:** 350 kHz, -11 dBV to -15 dBV at the reference level

**Video:** 10V at the reference level

**Probe power:** +15 VDC, -13 VDC; 150 mA max., suitable for HP active probes

**HP-IB Interface Functions:** SH1 AH1 T5 L4 SR1 RL1 PP0 DC1 DT1 C0 E1

### General Information:

#### Environmental:

**Temperature, operating:** 0°C to 55°C

**Humidity:**  $< 95\%$  RH

**Warm up time:** 20 min. at ambient room temperature

#### Power:

115V (+11% -25%), 48-440 Hz

230V (+11% -18%), 48-66 Hz

180 W, 3A max.

#### Weight:

36.7 kG (81 lb.)

**Dimensions:** 22.9 cm (9")H x 42.6 cm (16.75")W x 63.5 cm (25")D

### Ordering information:

#### HP 3585B spectrum analyzer

Option W30 2 years extended warranty

Option 907 Front handle kit

Option 908 Rack flange kit

Option 909 Combined rack flange/handle kit

Option 910 Additional set of manuals

#### Price

\$24,200

\$550

\$77

\$41

\$107

\$204



# SIGNAL ANALYZERS

## 50 Hz to 32.5 MHz Selective Level Meter

### Model 3586C

115

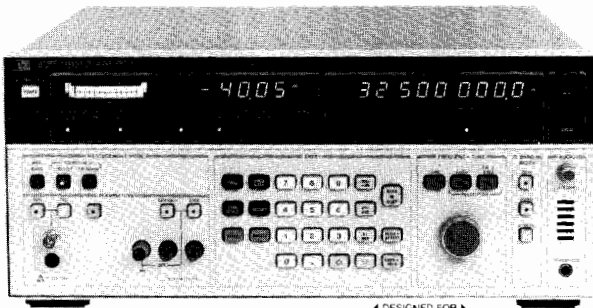

HP 3586C

### DESCRIPTION

The HP 3586C Selective Level Meter is designed for general purpose wave analysis applications in the design, manufacture, and maintenance of electronic systems. It's companion products, the HP 3586A and HP 3586B are optimized for measurements in Frequency Division Multiplex (FDM) systems. The HP 3586C is fully HP-IB programmable and covers the frequency range of 50Hz to 32.5 MHz, allowing measurement of audio, sonar and other low frequency systems, as well as high frequency communications and subsystems. Input impedances of 50, 75, and 600 Ohms are provided with 10kOhm bridging for maximum measurement flexibility in a wide variety of applications. Signal levels are measured with up to  $\pm 0.2$  dB accuracy down to  $-80$  dBm with 0.01 dB resolution and bandwidth choices of 20, 400, or 3100 Hz. The built-in counter and narrow resolution bandwidths allow harmonic and intermodulation measurements to be made with ease. Frequency can be set or measured with 0.1 Hz resolution and  $\pm \times 10^{-5}$  stability ( $\pm 2 \times 10^{-7}$  optional).

Also included is a tracking output for frequency response measurements of high-Q filters and other selective networks

### HP 3586C Specifications (abbreviated)

#### Frequency

**Frequency range:** 50/75  $\Omega$  unbalanced input, 50 Hz to 32.5 MHz; 600  $\Omega$  Balanced Input, 50 Hz to 108 kHz.

**Frequency resolution:** 0.1 Hz.

**Center frequency accuracy:**  $\pm 1 \times 10^{-5}$ /year, ( $\pm 2 \times 10^{-7}$ /year with option 004).

**Counter accuracy:**  $\pm 1.0$  Hz in addition to center frequency accuracy for signals within the 60 dB bandwidth of the IF filter chosen or greater than  $-100$  dBm (largest signal is measured).

#### Selectivity

**3 dB bandwidth,\***  $\pm 10\%$ : 20 Hz, 400 Hz, 3100 Hz.

\*Noise bandwidth is the same as the 3 dB bandwidth

**60 dB bandwidth:** 3100 Hz BW,  $\pm 1850$  Hz; 400 Hz BW,  $\pm 1100$  Hz; 20 Hz BW,  $\pm 90$  Hz.

**Passband flatness**  $\pm 0.3$  dB.

#### Amplitude

**Measurement range:**  $+20$  to  $-120$  dBm.

**Amplitude resolution:** .01 dB.

**Level accuracy:** 10 dB auto range, low distortion mode, after calibration, signal at  $\pm 1$  Hz from center frequency.

**Wideband power accuracy:** After calibration, 100 dB range, average on,  $-45$  to  $+20$  dBm.

$\pm 2.0$ dB	$\pm 1.0$ dB	$\pm 2.0$ dB
200 Hz	20 kHz	32 MHz

#### Dynamic Range

##### Spurious Responses

$-110$  dBm maximum or the following, whichever is greater:

**Image rejection (100-132 MHz):**  $-80$  dBc.

**IF rejection:** 15625 Hz,  $-80$  dBc; 50 MHz,  $-60$  dBc.

**Spurious signals:**  $>1600$  Hz offset,  $>-80$  dBc; 300 Hz to 1600 Hz,  $>-75$  dBc.

**Residual spurious:**  $-110$  dBm maximum;  $<350$  Hz,  $-95$  dBm.

##### Distortion

**Harmonic distortion:**  $-75$  dB below full scale, low distortion mode, above 4 kHz.

**Intermodulation distortion:** Two-tone second and third order, separation 7 kHz to 1 MHz, 78 dB below full scale. Either tone  $\geq 10$  MHz,  $-70$  dB.

##### Noise Floor (full scale setting $-35$ to $-120$ dBm)

Frequency	Bandwidth	Noise Level
100 kHz to 32.5 MHz	3100	$-114$ dBm
	20 Hz, 400 Hz	$-120$ dBm
2 kHz to 100 kHz	All	$-105$ dBm

The noise floor for full scale settings of  $-30$  to  $+25$  dBm will be 75 dB below full scale for  $>100$  kHz, or 55 dB below full scale for  $<100$  kHz.

##### Signal Inputs

Impedance	Frequency	Mating Connector	Return Loss
50/75 ohms unbalanced	50 Hz to 32.5 MHz	BNC	30dB
600 ohms balanced	50 Hz to 108 kHz	Dual Banana Plug 0.75 inch Spacing	25dB

**Balance:** 600  $\Omega$ ; 40 dB.

##### Demodulated Audio Output

**Output level:** 0 dBm into a 600  $\Omega$  load.

##### Auxiliary Signal Inputs/Outputs

**Tracking output:** 0 dBm rear panel tracking output.

**Ext. reference input:** 10 MHz  $\div N$ , where  $N = 1, 2, 3 \dots 10$ .

**Reference output:** 10 MHz at 8 dBm output (also 10 MHz oven oscillator on instruments with option 004).

**Probe power:** Front panel dc output for HP active high impedance accessory probes, (+15,  $-12$  Vdc).

**Additional outputs:** Audio, phase jitter and meter output.

##### Options

**Option 004: High stability frequency reference:** 10 MHz oven stabilized reference oscillator improves frequency stability to  $\pm 2 \times 10^{-7}$ /year.

### General

#### Operating Environment

**Temperature:**  $0^\circ$  to  $55^\circ$ C.

**Relative humidity:** 95%,  $0^\circ$  to  $40^\circ$ C.

**Altitude:**  $\leq 15,000$  ft.,  $\leq 4600$  metres.

**Storage environment temperature:**  $-40^\circ$ C to  $75^\circ$ C.

**Storage altitude:**  $\leq 50,000$  ft.,  $\leq 15,240$  metres.

**Power:** 100/120/220/240 V,  $+5\%$ ,  $-10\%$ , 48 to 66 Hz, 150 VA.

**Weight:** 23 kg. (50 lb) net; 30 kg. (65 lb) shipping.

**Size:** 177 mm H x 425.5 mm W x 475.5 mm D (7" x 16.75" x 16.75").

#### Ordering Information

HP 3586C Selective Level Meter*	Price
HP 3586C Selective Level Meter*	\$10,900
Opt 004: High Stability Frequency Reference	\$750
Opt 907: Front Panel Handles	\$66
Opt 908: Rack Flange Kit	\$36
Opt 909: Rack Flange & Handle Combination Kit	\$92
Opt W30: Extended Warranty	\$310

#### Accessories

HP 1124A: High Impedance Probe	\$350
--------------------------------	-------

\*HP-IB cables not supplied. See page 561.

50/75 $\Omega$ Inputs			600 $\Omega$ Input	
dBm			dBm	
$+20$	$\pm .40$ dB	$\pm .20$ dB	$\pm .35$ dB	$\pm .75$ dB
$-80^*$	$\pm .95$ dB	$\pm .25$ dB		
$-100$		$\pm .75$ dB		
	200 Hz	20 KHz	18 MHz	32.5 MHz
			100 Hz	108 KHz

\*20 Hz & 400 Hz BW below  $-90$  dBm

# SIGNAL ANALYZERS

## HP 70000 Modular Measurement System

New products for

- lightwave signal analysis
- dramatic increases in sensitivity

- swept scalar analysis to 18 GHz
- scalar/spectrum analysis
- tracking preselection to 26.5 GHz

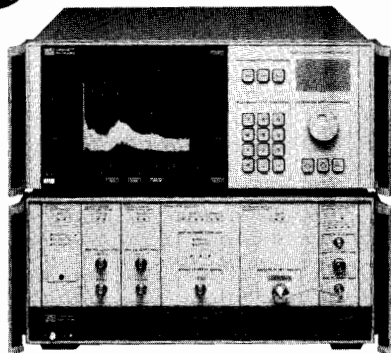

HP 71400A



HP 70620A

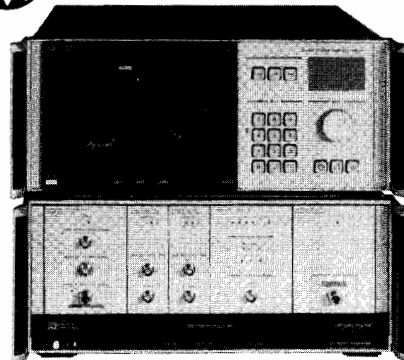

HP 71100XL



### Measure Lightwave Signals Modulated on 1200 to 1600 nm Wavelength Carriers

The first commercially-available receiver for measuring wide-bandwidth modulated light is also part of the HP 70000 modular measurement system. The HP 71400A lightwave signal analyzer has a receiver bandwidth of 100 kHz to 22 GHz; sensitivity of  $-60$  dBm (optical); and full calibration at 1300 nm and 1550 nm. See page 314 for more detailed information.

### Improve Modular Spectrum Analyzer Sensitivity 20 to 25 dB

The HP 70620 preamplifier provides a 2 to 22 GHz low noise, high gain amplification stage for the front-end of any HP 70000 microwave spectrum analyzer. Receiver-quality noise figure of 10 dB (typical) is obtained by combining the preamplifier with the HP 71210A microwave spectrum analyzer. This corresponds to a sensitivity of approximately  $-154$  dBm from 2 to 22 GHz—a 21 dB improvement. Such outstanding sensitivity enables you to detect and analyze extremely low level signals. Use this module with any of the other modular microwave spectrum analyzers for sensitivity improvements ranging from 20 to 25 dB.

Also, if you currently use narrow bandwidths to measure low level signals, the preamplifier can dramatically speed up these measurements. By improving sensitivity more than 20 dB, it allows you to use a bandwidth 100 times wider and sweeptimes up to 10,000 times faster. And, the spectrum analyzer reference level is automatically adjusted to compensate for preamplifier gain. See page 123.

### Make Swept Scalar Analysis Measurements to 18 GHz

The HP 70301A microwave tracking generator covers 2.7 to 18 GHz for swept scalar analysis with greater than 120 dB dynamic range. The  $\frac{3}{8}$ -width module has many applications in microwave and lightwave stimulus-response measurements.

The HP 70301A extends stimulus-response measurement capability to 18 GHz with any HP 70000 microwave preselected spectrum analyzer. An output signal (with maximum leveled power output of greater than  $-2$  dBm) tracks the analyzer's tuning to well within 10 Hz to give the best resolution and dynamic range for measuring narrowband or high rejection devices. Teamed with the HP 70300A RF tracking generator, the microwave generator's output becomes a

tracking source for complete coverage from 10 MHz to 18 GHz. It can also be used in conjunction with the HP 71400A lightwave signal analyzer to measure frequency response of laser systems.

### Combine High Performance Scalar and Spectrum Analyzer

The HP 71100XL scalar/spectrum analyzer provides high performance scalar and spectrum analysis from 100 Hz to 2.9 GHz. It combines the HP 71100A option 002 RF spectrum analyzer, the companion HP 70300A tracking generator, and a new set of downloadable programs (DLPs) that simplify your component testing. The DLPs add a scalar measurement personality to the softkey menus to simplify many transmission and reflection measurements. This makes it easy to take advantage of the full performance of the system; for example, to make measurements with  $>125$  dB dynamic range on a 150 dB display. The softkey menus also guide you through other scalar measurement routines such as open/short/thru calibration, pass-fail testing, and shape factor measurement.

A dual display mode makes it easy to check oscillators for close-in parasitics oscillations while you monitor harmonics. Spectrum analysis routines such as harmonic measurement and spurious signal search are also available. Since the system is modular, the frequency range for spectrum analysis can easily be extended to 26.5 GHz by selecting options that substitute any of the microwave spectrum analyzer input modules for the standard 2.9 GHz input module. See page 119.

### Extend Microwave Preselection to 26.5 GHz

Tracking preselection is now available in the modular spectrum analyzers for applications to 26.5 GHz. Preselection eliminates confusing multiple responses that are products of any multi-band spectrum analyzer. With preselection, there is a one-to-one correspondence between displayed signals and input signals, making it much easier to interpret the display. Also, because the signal identification process is eliminated, faster measurements are often possible.

The HP 70601A preselector module adds 26.5 GHz preselection to the new HP 71201A option 001 microwave spectrum analyzer. You can also add this preselector to an HP 71200A or 71200A option 001 microwave spectrum analyzer, or to an HP 70905B RF module for extended performance up to 26.5 GHz. See page 123.

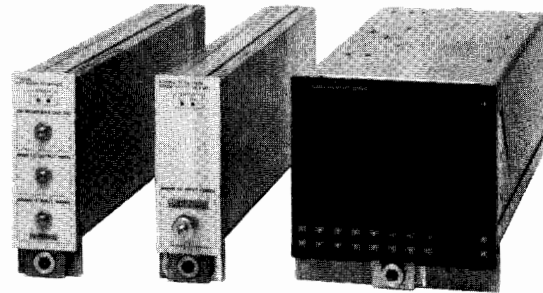
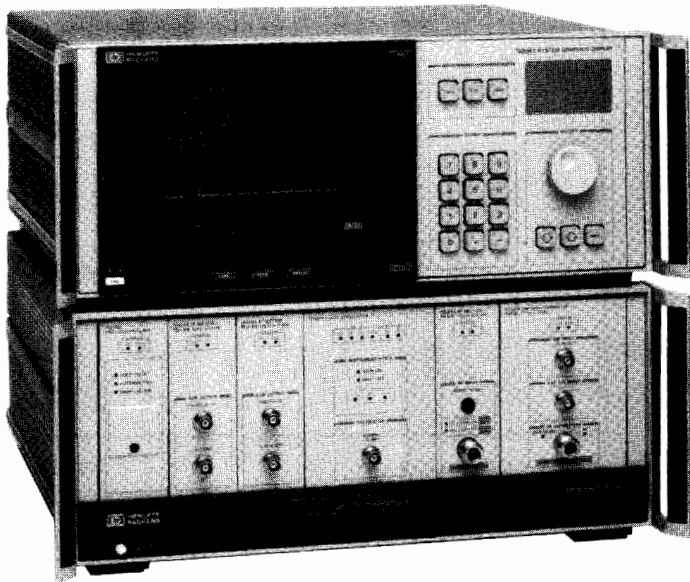

## Modular Spectrum Analyzers

The HP 70000 Modular Measurement System offers state-of-the-art spectrum analysis capability with all the benefits of modularity.

### HP 70000 Modular Measurement System

The modular architecture of the HP 70000 system has been optimized for test instrumentation. A rugged, reliable mainframe and two high-performance display/control units form the core of the HP 70000 Modular Measurement System. These system components combine with an expanding variety of modules to create the measurement system that's right for your application. The HP 70000 Modular Measurement System is an open system into which you can design and develop modular instrumentation that is not currently available. To aid in the development of custom modules, HP 70000 module development design guides and part kits are available. As your needs change or as new modules are developed, you can expand or upgrade your system economically by simply adding new or different modules.

You can choose from six standard, factory configured spectrum analyzer systems or fashion your own custom system from available system components. Either way, a factory assembled and tested system will be delivered ready for use. You can also order individual system components, including mainframes and displays.

The six standard HP 70000 Modular Spectrum Analyzers cover frequency ranges from RF to millimeter. In addition, two versions of a lightwave signal analyzer are now available. (See pages 121 and 314-315 for configurations and specifications.) Options can be added to modify your system or extend warranty.

Custom systems give you the flexibility to configure just the capability you need. The basic elements required to construct a spectrum analyzer are a display, an HP 70900A Local Oscillator, an RF or external mixer interface module, and an IF section. For certain automated systems a display may not be required.

### Expand Your Measurement Capabilities

A growing variety of new modules makes it easy to increase or modify your measurement capability. Improve sensitivity by adding

the HP 70620A preamplifier module to any of the four microwave spectrum analyzers. Stimulus-response measurements can be made with the addition of the HP 70301A Microwave Tracking Generator. Automatic signal monitoring/surveillance capability can be obtained by using a controller and the HP 85865B Signal Monitoring Software. (See page 129 for details.) You can increase frequency accuracy with the addition of the HP 70310A Precision Frequency Reference or add the HP 70700A Digitizer to enhance spectrum analyzer time domain measurements or provide a stand-alone, programmable waveform recorder. Additional mainframes can be added as your system expands, with system control residing in a single display.

### Create Custom Softkeys

Specific measurement routines can be created as downloadable programs (DLPs) and stored in the HP 70000 Modular Spectrum Analyzers. These custom routines (DLPs) become as easy to retrieve and use as any other function of the analyzer. Using custom DLPs that are executable with a single softkey, you can make the analyzer more efficient for a specific measurement requirement.

### Product Support

In addition to the standard one-year, return-to-HP warranty, an optional two-year warranty is offered on every standard or custom system, for total coverage of three years. A one-year standard and two-year optional warranty is also offered on all system components purchased individually.

The HP 11990A software package provides complete electrical test capability to data sheet specifications and is available for any standard system.

A one-day, lab-intensive HP 70000 user's course is offered to help you use the HP 70000 more effectively and more efficiently. You will learn how to connect and configure modules, become familiar with the menus that control system operation, and learn how to use some of the unique features of the HP 70000 system. (See page 119.)

# SIGNAL ANALYZERS

## HP 70000 Modular Measurement System (cont'd)

### Just the Capability You Need - Expand at Any Time!

The HP modular spectrum analyzer family lets you choose the right capability for any application without paying for features you don't need. Choose from any of five RF sections or an external mixing module and mixers for frequency coverage, from two IF sections for frequency resolution, and from two display/control units. As your needs change, expand measurement capability by adding modules instead of replacing your entire system. To meet your long-term measurement needs, powerful new modules are added every year. With its easy system-upgrade path the HP 70000 eliminates many of the hidden costs of replacing an instrument, such as operator and service technician retraining, reprogramming, documentation, and installation time.

### Easy to Use

An improved user interface makes the spectrum analyzer much easier to use. Casual users can now get started making measurements in seconds. Experienced users also prefer the new menus because they can access their favorite functions more quickly.

The secret is in how the menus are organized. Measurement functions are grouped together, each with its own firmkey on the left side of the display. The firmkeys never change so you can access them at any time. Pressing a firmkey activates the most commonly used softkey function. For example, placing a marker on the highest peak now takes only one keystroke compared to four keystrokes previously. And you'll always know which function is active because it is highlighted in inverse video. Finally, special panning modes make it easier than ever to change center frequency or span using the rotary knob.

The new user interface can be retrofitted to older units as a firmware upgrade.

### Downloadable Programming

One-button measurement routines make the system easy for anyone to operate. To use the downloadable programming capability of the HP 70000, a measurement routine is created on a computer and downloaded into the non-volatile memory of the spectrum analyzer, where it can then be executed either manually or remotely.

Any function of the spectrum analyzer can be used in a downloadable program (DLP). And you can place the DLP under the control of a specific softkey, which can be labelled for identification.

A DLP for spur searching appears in the plot at right. This program directs the analyzer to make the calculations, take measurements, and display the results in a usable form. Store these in the USER menu and you create your own softkey-driven test system for the bench.

### Multi-System Control and Management

Many instruments (up to 255 modules) can be configured in the same modular measurement system. System architecture manages communication between modules. Instrument control is handled over HP-IB when no display is present; adding a display allows you to control the instruments in the system manually. Up to four instruments can be displayed simultaneously while all instruments are making measurements. For example, four multi-channel digitizers or spectrum analyzers can be viewed at the same time using the "windowing" functions found in the DISPLAY hardkey menu.

This flexibility is unsurpassed in the microwave instrument industry.

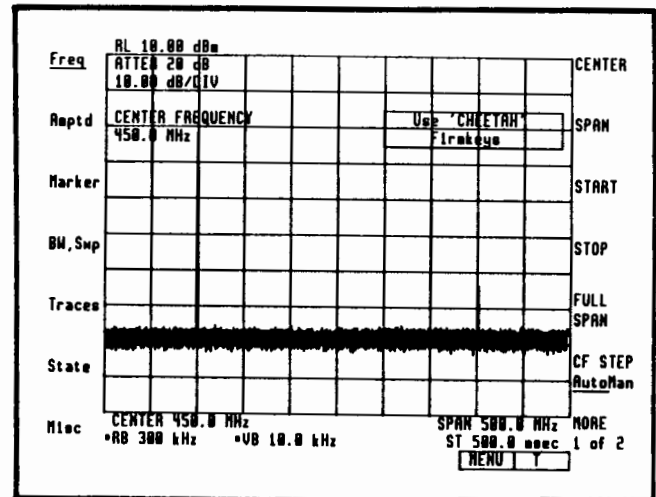

The seven "firmkeys" on the left allow quick access to all the functions in the MENU.

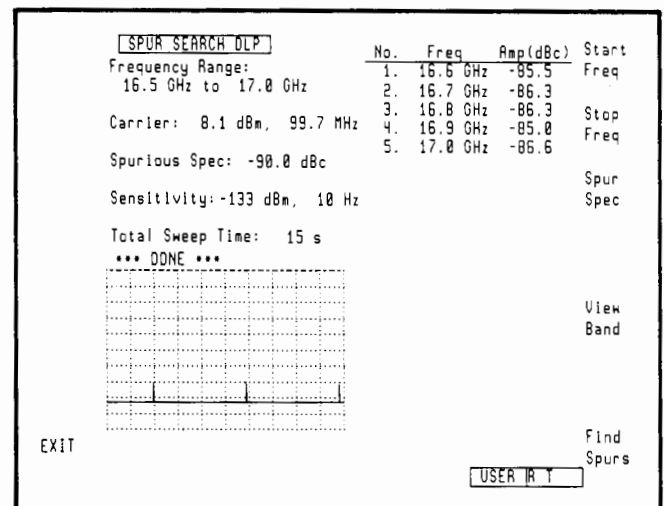

A one-button solution can be created to execute a complex measurement routine such as spur searching.

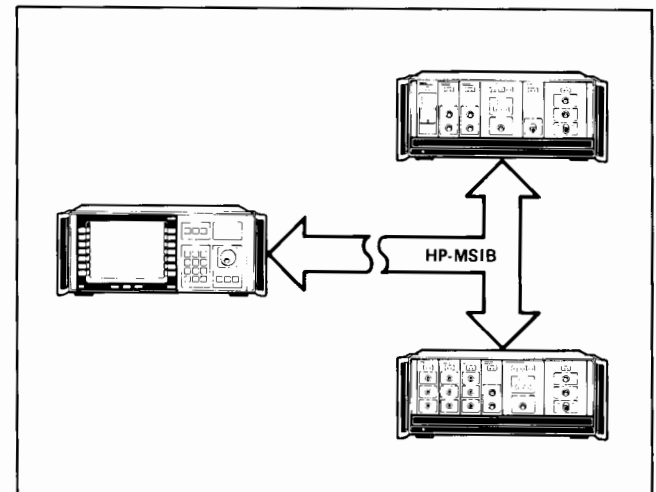

A single display can control multiple instruments separated by more than 500 meters.

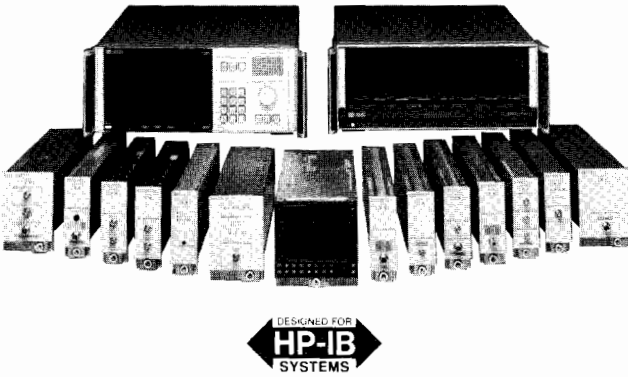

### HP 70000 Standard Spectrum Analyzer Systems

Five standard, factory-configured systems are offered in RF, microwave, and millimeter frequency ranges. Each system is completely assembled and tested at the factory, and is shipped ready to use. A one-year, return-to-HP warranty is included with any standard or custom system. See page 121 for specification summaries.

	Price
<b>HP 71100A RF Spectrum Analyzer</b>	\$35,740
System Components (7/8 mainframe occupied)	
HP 70001A Mainframe	
HP 70205A Graphics Display	
HP 70900A Local Oscillator	
HP 70902A IF Section	
HP 70904A RF Section	
<b>HP 71100XL RF Scalar/Spectrum Analyzer System</b>	\$47,890
Components (% mainframe occupied)	
HP 70001A Mainframe	
HP 70206A System Graphics Display	
HP 70300A Tracking Generator	
HP 70900A Local Oscillator	
HP 70902A IF Section	
HP 70904A RF Section	
HP 70900-60121 System Software	
<b>HP 71200A Microwave Spectrum Analyzer</b>	\$38,550
System Components (7/8 mainframe occupied)	
HP 70001A Mainframe	
HP 70205A Graphics Display	
HP 70900A Local Oscillator	
HP 70902A IF Section	
HP 70905A RF Section	
<b>HP 71201A Microwave Spectrum Analyzer</b>	\$47,940
System Components (8/8 mainframe occupied)	
HP 70001A Mainframe	
HP 70205A Graphics Display	
HP 70900A Local Oscillator	
HP 70902A IF Section	
HP 70905B RF Section	
HP 70600A Preselector	
<b>HP 71210A Microwave Spectrum Analyzer</b>	\$72,890
System Components (7/8 mainframe occupied)	
HP 70001A Mainframe	
HP 70206A System Graphics Display	
HP 70900A Local Oscillator	
HP 70902A IF Section	
HP 70903A IF Section	
HP 70908A RF Section	
HP 70310A Precision Frequency Reference	
<b>HP 71300A Millimeter Spectrum Analyzer</b>	\$36,530
System Components (7/8 mainframe occupied)	
HP 70001A Mainframe	
HP 70205A Graphics Display	
HP 70900A Local Oscillator	
HP 70902A IF Section	
HP 70907A External Mixer Interface	

### System Options

Except as noted, the options below apply to all standard systems.

<b>Option 001</b> Delete HP 70905A RF Section, add HP 70906A RF Section (HP 71200A only)	+\$1,800
<b>Option 001</b> Delete HP 70905B/70600A, add HP 70906B RF Section (50 KHz - 26.5 GHz) and HP 70601A Preselector (to 26.5 GHz) (HP 71201A only)	+\$4,000
<b>Option 002</b> Delete HP 70205A Graphics Display, add HP 70206A System Graphics Display (all models except HP 71210A)	+\$1,800
<b>Option 003</b> Add HP Precision Frequency Reference Module (HP 71100XL only)	+\$4,390
<b>Option 004</b> Add HP 70903A IF Section (all models except HP 71210A)	+\$2,950
<b>Option 005</b> Delete HP 70902A IF Section, add HP 70903A IF Section (all models except HP 71210A)	-\$800
<b>Option 400</b> Add 400 Hz Power Line Frequency Operation to the mainframe	+\$750
<b>Option 401</b> Add 400 Hz Power Line Frequency Operation to the mainframe and HP 70206A System Graphics Display	+\$1850
<b>Option 655</b> Delete 3 1/2" Operation Verification software disks, add 5 1/4" disks	\$0
<b>Option 908</b> Rack Flange Kit for mainframe or HP 70206A Display without handles	+\$35
<b>Option 913</b> Rack Flange Kit for mainframe or HP 70206A Display with handles	+\$40
<b>Option 010</b> Rack Mount Slide Kit for mainframe	+\$450
<b>Option 011</b> Rack Mount Slide Kit for display	+\$200
<b>Option 910</b> Extra Manual Set	+\$250

### System Support Options

Option W30 provides an additional, two year return-to-HP warranty:

<b>HP 71100A Option W30</b>	\$690
<b>HP 71100XL Option W30</b>	\$950
<b>HP 71200A Option W30</b>	\$780
<b>HP 71201A Option W30</b>	\$950
<b>HP 71210A Option W30</b>	\$950
<b>HP 71300A Option W30</b>	\$730

The HP 11990A System Performance Test Software Package provides complete test capability of system specifications (Use of external test equipment required):

<b>HP 11990A</b>	\$0
<b>Option 001</b> (Required for any HP 70000 System both 3 1/2" disks and 5 1/4" disks supplied)	\$1,000
<b>Option 100</b> For HP 71100A	\$300
<b>Option 200</b> For HP 71200A	\$300
<b>Option 201</b> For HP 71201A	\$300
<b>Option 210</b> For HP 71210A	\$300
<b>Option 300</b> For HP 71300A	\$300

The HP 70000 Modular Spectrum Analyzer User's Course is a one-day, hands-on, lab-intensive training class. It is taught by HP system engineers on a consulting basis. Contact your local sales office for more information.

### HP 70000 Custom Spectrum Analyzer Systems

Custom systems can be made up in several ways. You can choose to start with a standard system and then add modules, accessories, and options as desired. You can also build a system by selecting system components individually.

Factory-configured, custom systems can be ordered using the HP 71000S product number. This product number ensures factory assembly and test, and delivery of a system ready to use. System automation can be added under the HP 71000S product number with the selection of series 200 or 300 computers and peripherals. When individual modules are ordered, all necessary cables are included to allow connection into any system configuration. An ordering guide is available from your local HP sales office.



# SIGNAL ANALYZERS

## HP 70000 Modular Measurement System (cont'd)

### HP 70000 Specification Summary

	HP 71100A <sup>1</sup>	HP 71200A
Frequency Range tunable in <1 Hz increments	100 Hz - 2.9 GHz	50 kHz - 22 GHz 50 kHz - 26.5 GHz (Opt. 001)
Total Amplitude Range	-134 to +30 dBm	-132 to +30 dBm
Displayed Avg. Noise Level (dBm) (10 Hz Res. BW, 0 dB attn at three frequencies)	10 kHz <-85 1 MHz <-118 1 GHz <-134	1 MHz <-118 1 GHz <-129 10 GHz <-125
Frequency Response (10 dB input attn)	100 Hz - 2.5 GHz $\pm 1$ dB 100 Hz - 2.9 GHz $\pm 1.5$ dB	50 kHz - 2.9 GHz $\pm 2.3$ dB 2.7 GHz - 12.7 GHz $\pm 1.5$ dB
Scale Fidelity (Log, 10 Hz Res BW, 0-90 dB)	$\pm 0.5$ dB	$\pm 0.5$ dB
Frequency Accuracy After cal One year after cal (At 1 GHz, 0 Hz Span, 0-55°C)	$\pm 10$ kHz ( $\pm 17$ Hz) <sup>2</sup> $\pm 13$ kHz ( $\pm 117$ Hz) <sup>2</sup>	$\pm 10$ kHz ( $\pm 17$ Hz) <sup>2</sup> $\pm 13$ kHz ( $\pm 117$ Hz) <sup>2</sup>
Resolution Bandwidths (-3 dB) adjustable in 1,3,10 sequence & 10% increments (except 3 kHz - 10 kHz)	10 Hz - 300 kHz 10 Hz - 3 MHz (opt. 004)	10 Hz - 300 kHz 10 Hz - 3 MHz (Opt. 004)
Phase Noise 1 GHz, 30 kHz offset	-97 dBc/Hz	-97 dBc/Hz
Dynamic Range (@ 1 GHz) 2nd Harmonic Distortion Third Order Intermod Distortion	<-70 dBc <-70 dBc	<-70 dBc <-74 dBc
Frequency Span - Range (adj - 0.5% of displayed span)	1 Hz to 2.9 GHz and zero span	1 Hz to 22/26.5 GHz and zero span
Sweep Time	50 msec to 1,000 sec; or 15 msec to 335 sec in swept freq. mode & 80 $\mu$ sec to 335 sec in fixed freq. mode (0 span) with HP 70700A	
Weight kg (lb)	30.9 (68.1)	30.6 (67.5)

<sup>1</sup>HP 71100XL Specifications are the same as those for the HP 71100A and 70300A.

<sup>2</sup>with HP 70310A Precision Frequency Reference

### General Specifications

#### Environmental

**Temperature:** Operation 0 to +55° C; Storage -40 to +75° C

**Humidity:** Operation 0 to 95% Relative Humidity at 40° C

**EMI:** Conducted & radiated interference is within the requirements of MIL-STD-461B, RE02/part7, CISPR pub. 11, and FTZ 526/1979

#### Power Requirements

**HP 70001A Mainframe:** 100, 120, 220, or 240 VAC ( $\pm 10\%$ ) 47-66 Hz or 400 Hz with option 400; 570 VA, 310 W

**Modules:** All power supplied by mainframe

**HP 70206A Display:** 100, 120, 220, or 240 VAC ( $\pm 10\%$ ) 47-66 Hz or 400 Hz with option 401

#### Warm-up Time

One hour from cold start (0-55° C)

#### Size in mm (inches)

**HP 70001A Mainframe:** 177.0 (6.97) H, 425.4 (16.75) W, 526.0 (20.7) L

**HP 70206A Display:** 177.0 (6.97) H, 425.4 (16.75) W, 502.0 (19.75) L

### Available System Inputs/Outputs (F=front panel, R=rear panel)

**HP 70205A & 70206A Displays:** Composite video out (BNC R)

**HP 70900A LO Section:** 300 MHz Cal out (BNC F), 100 MHz Ext Freq Ref in (SMB R), Sweep out (SMB R), Tune+Span out (SMB R), HSWP out/in (SMB R)

**HP 70902A IF Section:** Aux video out (BNC F), 3 MHz IF out (BNC F), 21.4 MHz Aux IF out (SMB R), 3 MHz limited IF out (SMB R)

**HP 70903A IF Section:** Aux video out (BNC F), 21.4 MHz IF out (BNC F), 21.4 MHz Log IF out (SMB R)

**HP 70904A RF Section:** RF in (Type N F), 1st LO aux out (SMA R), Probe power out (F)

**HP 70905A RF Section:** RF in (Type N F), 321.4 MHz IF in/out (SMB R), 1st LO aux out (SMA R)

**HP 70905B RF Section:** 321.4 MHz IF in/out (SMB R), 1st LO aux out (SMA R)

### HP 70000 Specification Summary (cont)

HP 71201A	HP 71210A	HP 71300A
50 kHz - 22GHz 50 kHz - 26.5GHz (Opt. 001)	100 Hz - 22 GHz	18-110 GHz w/HP 11970 mixers 2.7-325 GHz w/other mixers
-130 to +30 dBm	-138 to +30 dBm	-130 to -1 dBm
1 MHz bypass/filtered <-117/<-111 1 GHz <-127/<-119 10 GHz <-121/<-109	1 MHz - 10 MHz <-118 10 MHz - 2 GHz <-138 2 GHz - 22 GHz <-133	with HP 11970 mixers 18-40 GHz <-128 33-60 GHz <-124 50-75 GHz <-112
50 kHz - 2.9 GHz bypass/filtered 2.7 GHz - 12.7 GHz +2.6/±2.8 dB ±2.0/±2.3 dB	100 Hz - 2.9 GHz ±1.5 dB 2.7 GHz - 22 GHz ±2.0 dB	with HP 11970 mixers 18 GHz - 60 GHz ±2.3 dB 50 GHz - 75 GHz ±2.5 dB
±0.5 dB	±0.5 dB	±0.5 dB
±10 kHz (±17 Hz)* ±13 kHz (±117 Hz)*	±17 Hz ±117 Hz	At 100 GHz ±1 MHz (±710 Hz)* ±1.3 MHz (±10.7 kHz)*
10 Hz - 300 kHz 10 Hz - 3 MHz (opt. 004)	10 Hz - 3 MHz	10 Hz - 300 kHz 10 Hz - 3 MHz (Opt. 004)
-97 dBc/Hz	-97 dBc/Hz	18 - 26.5 GHz -81 dBc/Hz
bypass/filtered <-70/<-76 dBc <-74/<-66 dBc	<-70 dBc <-70 dBc	depends on external mixer used
1 Hz to 22 GHz Plus 0 Hz	1 Hz to 22 GHz Plus 0 Hz	1 Hz to 110/325 GHz Plus 0 Hz
50 msec to 1,000 sec; or 15 msec to 335 sec in swept freq. mode & 80 µsec to 335 sec in fixed freq. mode (0 span) with HP 70700A		
30.2 (66.6)	50.1 (110)	30.5 (67.2)

### Available System Inputs/Outputs (con't)

**HP 70906A RF Section:** RF in (APC-3.5 F), 321.4 MHz IF in/out (SMB R), 1st LO aux out (SMA R)

**HP 70908A RF Section:** RF in (Type N F), 321.4 MHz IF out (SMB R), 1st LO aux out (SMA R), 21.4 MHz out (SMB R)

**HP 70907A EMIM:** IF in (SMA F), LO out (SMA F), Mixer bias out (SMA F), 1st LO aux out (SMA R), 300 MHz 2nd LO in/out (SMB R)

**HP 70600A Preselector:** RF in (Type N F), Tune+Span in (SMB R)

**HP 70300A Tracking Generator:** RF out (Type N F), Ext ALC in (BNC F), AM in (BNC F), 300 MHz out (SMB R), 21.4 MHz in/out (SMB R), 1st LO aux out (SMA R)

**HP 70310A PFR:** Ext Ref in (SMB R), 10 MHz & 100 MHz Ref out (SMB R); Distrb. Amps in/out (SMB R) - optional

**HP 70700A Digitizer:** Video in (BNC F), Video in (SMB R), Sync out (SMB R)

**HP 70301A Tracking Generator:** Ext ALC in (BNC F), 300 MHz out (SMB R) 0-2.9 GHz in (SMA F).

### Accessory Module Specification Summaries

#### HP 70300A Tracking Generator

**Frequency Range:** 20 Hz - 2.9 GHz swept and CW

**Resolution:** <1 Hz

**Output Amplitude:** -10 dBm to -91 dBm

**Level Flatness:** ±0.5 dB from 10 MHz - 2.9 GHz (relative to 300 MHz); -0.7dB, +1.2 dB from 20 Hz - 10 MHz (relative to 1 MHz)

**AM Rates:** Internal, 400 Hz & 1 kHz; External, 20 Hz - 20 kHz

#### HP 70301A Tracking Generator:

**Frequency Range:** 2.7 GHz to 18 GHz swept and CW.

**Resolution:** 1 Hz

**Output Amplitude:** -2 dBm to -66 dBm

**Level Flatness:** ±1.0 dB

#### HP 70310A Precision Frequency Reference

**Aging:** <5×10<sup>-10</sup>/day (7-day average); <1×10<sup>-7</sup>/year

**Temperature Stability:** <7×10<sup>-9</sup> over 0 to 55° C

**Frequency Range:** 5 MHz to 300 MHz

**Input Range:** -4 to +4 dBm

**Output:** Leveled to 0 dBm (typical)

**Output Power 10 MHz & 100 MHz:** 0 dBm (typical)

**Input Reference Power at 1, 2, 5, or 10 MHz:** -5 to +21 dBm

#### HP 70310A Option 001 Precision Distribution Amplifiers

Two Amplifiers each with 3 outputs

#### HP 70700A Digitizer

**Maximum Sampling Rate:** 20 MSa/sec

**Amplitude Resolution:** 10 bits

**Waveform memory:** 256K 10-bit words

**Gain Accuracy:** ±1%

**Offset Accuracy:** ±1%

**Input Voltage Ranges:** ±0.3V, ±1V, ±3V, ±10V

# SIGNAL ANALYZERS

## HP 70000 Modular Measurement System (cont'd)

### Components

(See page 119 for standard HP 70000 modular spectrum analyzer systems.)

#### HP 70001A System Mainframe

Provides all necessary power, cooling, digital interface, and EMI shielding for any width module. Fits any standard EIA rack and holds a maximum of eight 1/8-width modules. Modules are automatically connected to power, digital interface, and forced-air cooling.

**Price**  
\$5,500

#### HP 70206A System Graphics Display

A full-width, stand-alone, menu-driven interface for the HP 70000 system. Presents measurement results and configuration information with high-resolution-graphic, trace, text, and marker capability. Includes a 9-inch CRT, data and control keys, and an analog control knob. Can be stacked or racked with the HP 70001A mainframe or located up to 30m or more away from the analyzer.

\$7,000

#### HP 70205A Graphics Display

All the capability of the HP 70206A system graphics display in a 3/8-width module.

\$5,000

#### HP 70900A Local Oscillator

This 3/8-width module provides a swept LO signal of 3.0 to 6.6 GHz, processes video signals, and acts as master controller for the spectrum analyzer. Contains the system firmware to control and coordinate measurements and to output data. Has a minimum 32K bytes of memory for DLPs.

\$14,700

#### HP 70902A IF Section (Res BW 10 Hz - 300 kHz)

\$4,100

#### HP 70903A IF Section (Res BW 100 kHz - 3 MHz)

\$2,950

These 1/8-width modules process a 21.4 MHz IF signal received from an RF or external mixer interface module. Contain resolution bandwidth filters, log amplifiers, detection circuitry, and video filters. Used together, provide res BWs of 10 Hz to 3 MHz.

#### HP 70904A RF Section (100 Hz - 2.9 GHz)

\$7,890

#### HP 70905A RF Section (50 kHz - 22 GHz)

\$10,700

#### HP 70905B RF Section (50 kHz - 22 GHz, no attenuator)

\$9,750

#### HP 70906A RF Section (50 kHz - 26.5 GHz)

\$12,500

#### HP 70906B RF Section (50 kHz - 26.5 GHz, no attenuator)

\$11,500

These are 1/8-width front-end modules for RF and microwave spectrum analyzer systems. Convert incoming RF signal to a 21.4 MHz IF. The HP 70905B and 70906B do not have input attenuators and are intended for use with HP 70600A/70601A preselectors.

#### HP 70907A External Mixer Interface

\$8,680

This 1/8-width module provides the interface between external mixers and spectrum analyzer systems. Contains an LO amplifier, mixer bias supply, and down-conversion circuitry to convert the 321.4 MHz input IF to a 21.4 MHz IF signal. Frequency range is 18 GHz to 110 GHz using HP 11970 mixers, and 2.7 GHz to 325 GHz using mixers from other manufacturers.

#### HP 70908A RF Section (100 Hz - 22 GHz)

\$35,900

This 3/8-width front-end module provides state-of-the-art tracking preselection from 2.7 to 22 GHz. Uses fundamental mixing from 100 Hz to 22 GHz for sensitivity <-133 dBm from 2-22 GHz.

#### HP 70600A Preselector (2.7 GHz - 22 GHz)

\$10,350

#### HP 70601A Preselector (2.7 GHz - 26.5 GHz)

\$12,600

These 1/8-width modules can be used with the HP 70905A/B and 70906A/B RF sections. Provide tracking preselection from 2.7 GHz to either 22 or 26.5 GHz. Low pass filtering is used below 2.9 GHz, and preselectors can be bypassed if desired.

#### HP 70620A Preamplifier

\$10,500

This 1/8-width module covers 2 to 22 GHz. Minimum small-signal gain is >22 dB; typically >29 dB. Noise figure is <11 dB; typically <9 dB. Flatness is ±1.8 dB. Sends calibration data to a microwave spectrum analyzer to compensate for preamp gain and flatness.

#### HP 70300A Tracking Generator

\$10,350

A 3/8-width module whose output signal tracks the tuned frequency of the spectrum analyzer. Makes stimulus-response measurements with a dynamic range of 125 dB in conjunction with an HP 70000 spectrum analyzer. Frequency range is 20 Hz to 2.9 GHz.

#### HP 70301A Microwave Tracking Generator

TBA

A 3/8-width module whose output signal tracks the tuned frequency of the spectrum analyzer over a 2.7 to 18 GHz frequency range. When used with the HP 71210A spectrum analyzer, stimulus-response measurements can be made over a 120 dB dynamic range. Use with the HP 70300A RF tracking generator to provide a tracking signal from the output over a 10 MHz to 18 GHz range.

#### HP 70310A Precision Frequency Reference

\$4,930

##### Option 001 Add Distribution Amplifier

+\$1,530

##### Option 002 Delete Ovenized Oscillator and External Power Pak

-\$2,450

This 1/8-width module supplies precise reference signals at 10 and 100 MHz. Signals are phase-locked to an internal ovenized oscillator, improving system frequency reference accuracy after one year from 3 to 0.1 ppm. External reference input allows the use of house standards or other external references at 1, 2, 5, or 10 MHz.

Option 001 adds two distribution amplifiers, each with three outputs and one input. Option 002 deletes the ovenized oscillator and external power pak but retains the external reference input capability.

#### HP 70700A Digitizer

\$7,650

This 1/8-width module adds precision digitizing capability to HP 70000 instruments. Improves analyzer ability to characterize signals in the time domain. Has a sampling rate of 20M-sample/sec, 10 bits/sample, and 256K words of memory.

Digitizing rate improved by a factor of 1000 allows faster start-to-stop frequency sweeps and better resolution of signals such as pulsed RF. Sweep times as fast as 80 usec can be made in zero span (time domain).

Can also be used as a stand-alone, programmable waveform recorder, transient analyzer, or digitizing oscilloscope. For multi-channel applications, up to eight digitizer modules will operate synchronously in a single HP 70001A mainframe.

#### HP 70100A Power Meter

\$2,500

##### Option 003 Move Ref. Oscillator to Rear Panel

\$0

A full-feature, single-channel power meter in a 1/8-width module. Fully compatible with HP 8480 series power sensors. See page 210.

#### HP 70591A 1/8-width Module Part Kit

\$750

#### HP 70592A 3/8-width Module Part Kit

\$800

#### HP 70593A 3/8-width Module Part Kit

\$1400

#### HP 70594A 3/8-width Module Part Kit

\$2,500

#### HP 70595A Module Development Design Guides

\$600

#### HP 70596A Module Communication Design Guides

\$600

Module Part Kits and Module Design Guides provide information and hardware to aid you in the design and fabrication of modules to meet your specific needs.

#### HP 70900-60121 Scalar/Spectrum Analyzer Personality

\$250

Adds scalar measurement personality to an HP 71100A system that also includes an HP 70300A tracking generator. Useful measurement routines include pass-fail and open/short/ thru calibration testing; dual displays, shape factor, and 150 dB display. On 3 1/2" or 5 1/2" discs for HP series 200/300 controllers with BASIC 3.0, 4.0, or 5.0 (included in HP 71100XL system).

HP 11970 Harmonic Mixers (See page 143.)

# SIGNAL ANALYZERS

## Spectrum Analyzers, 100 Hz to 325 GHz

Models 8566B, 8567A & 8568B

123

- 100 Hz to 325 GHz coverage with synthesizer accuracy
- 10 kHz to 1.5 GHz coverage at a lower price
- 100 Hz to 1.5 GHz coverage with counter accuracy

- 2 to 22 GHz preselected range
- Trace markers with amplitude and frequency readout
- 16K bytes of user RAM for trace data or custom routines



HP 8566B



HP 8568B

The HP 8566B, HP 8567A, and HP 8568B are high-performance spectrum analyzers for bench and ATE system use. The HP 8566B is the highest performance analyzer of the three, with extendable frequency range from 100 Hz to 325 GHz. The HP 8567A is identical to the HP 8568B in many respects, but has reduced performance in some areas and a lower price. See pages 124, 126, and 128 for specification summaries on all three analyzers.

Each analyzer is designed around its own internal bus and controlled by its own microcomputer to yield significant improvements in operational and data processing features, as well as flexibility under computer control. Each analyzer has 16K bytes of user RAM for storing trace data, instrument states, or custom downloadable programs (DLPs).

### Performance

The exceptional frequency stability of both the HP 8566B and the HP 8568B makes measurements with 10 Hz resolution bandwidths possible. This narrow resolution bandwidth yields sensitivities to  $-135$  dBm in both instruments. Excellent frequency stability, sensitivity, and frequency-reference accuracy combine to allow very accurate measurement of small signals in the presence of large ones.

For applications that don't require the high performance of the HP 8568B, the HP 8567A offers the same speed, versatility, and automatic operation capability at a lower price. Resolution bandwidths as narrow as 1 kHz yield sensitivities as low as  $-115$  dBm.

### Usability

The instrument control settings are conveniently notated on the CRT for easy reference. Functions are activated by pressing a front-panel key, then selecting the function value using the knob, step keys, or numeric keyboard. To maintain a calibrated display, certain functions are automatically coupled in the analyzer. For example, resolution bandwidth, video bandwidth, and sweep time are automatically adjusted by the instrument when the frequency span is reduced.

Up to four tunable display markers are available to aid in measuring and analyzing signals. Two markers can be used to make relative measurements by displaying their amplitude and frequency difference. Marker information allows you to step between evenly spaced portions of a spectral display (such as signal harmonics) or "zoom-in" on a selected portion of the spectrum.

Analyzer control settings can also be saved in the non-volatile memory of the analyzer. Different operators can recall these settings to make consistent, repeatable measurements.

### Versatile CRT Display and Plotting Capabilities

All displayed information resides in the analyzer's digital memory, which refreshes the CRT at a flicker-free rate. Multiple traces can be displayed to measure residual FM or drift, or to conduct real-time surveillance over a wide frequency range.

By adding an HP-IB plotter, a hardcopy of all information on the display of the analyzer can be made for analysis, documentation, or presentation. Plots can be produced directly or with the aid of a controller.

### Custom Programming of Softkeys

Custom measurement routines can be created to meet your specific requirements. These programs can be created on an external controller or from the front-panel controls of the instrument and then stored in the non-volatile memory of the analyzer. Custom programming allows you to create complex measurement routines that can be stored and executed using a single softkey. This capability makes the analyzer a custom instrument that is more efficient for your specific tasks.

# SIGNAL ANALYZERS

## Spectrum Analyzers, 100 Hz to 325 GHz (cont'd)

Models 8566B, 8567A & 8568B

### Specification Summary

	8566B	8567A	8568B
Frequency Range	100Hz-22GHz 18.6-110GHz w/HP11970 Mixers 110-325GHz w/other mixers	10kHz-1500MHz	100Hz-1500MHz
Total Amplitude Range	-134 to +30dBm	-115 to +30dBm	-135 to +30dBm
Displayed Ave Noise Level (dBm) (10Hz Res BW, 0dB attn)	1MHz-2.5GHz <-134 2.5-8GHz <-132 5.8-12.5GHz <-125 12.5-18.6GHz <-119 18.6-22GHz <-114	50kHz-1MHz <-92' 1MHz-1500MHz <-115'	500Hz-1MHz <-112 1MHz-1500MHz <-135
Frequency Accuracy One year after cal (At 1GHz, 0Hz Span 5-55°C)	±267Hz	±15kHz	±267Hz
Resolution Bandwidths (-3dB) adj in 1,3,10 sequence	10Hz to 3MHz	1kHz to 3MHz	10Hz to 3MHz
Frequency Response (10dB input attn)	2-12.5GHz ±1.7dB 12.5-20GHz ±2.2dB	10kHz-500MHz ±1dB	100Hz-500MHz ±1dB 100Hz-1500MHz ±1.5dB
Weight	50kg (112 lb)	45kg (100 lb)	45kg (100 lb)
Price	\$57,650	\$27,550	\$35,300

<sup>1</sup>1kHz Res BW

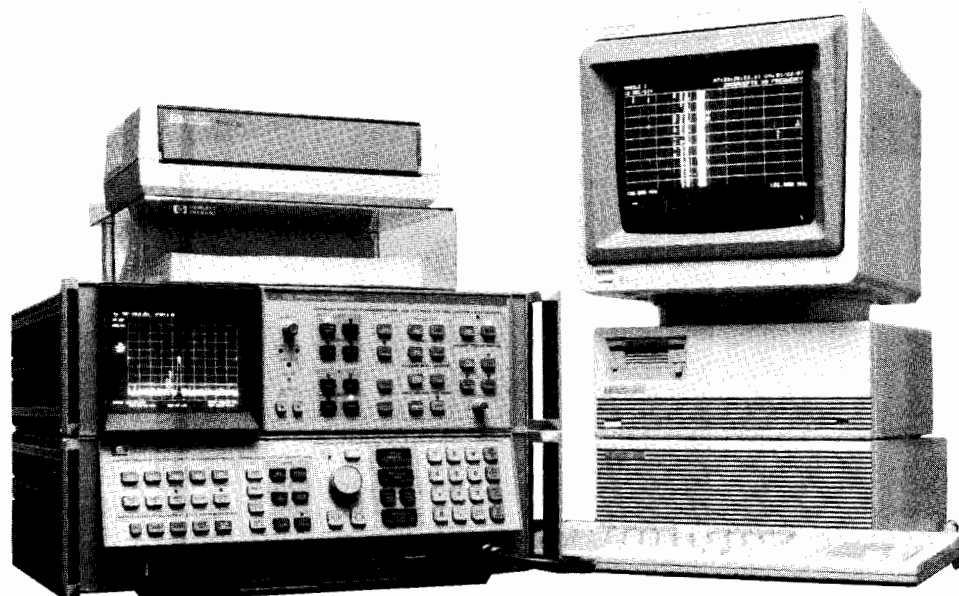

HP 8566S



### HP 8566S, 8567S & 8568S

The HP 8566S, 8567S, and 8568S Automatic Spectrum Analyzers are systems based upon the HP 8566B, 8567A and 8568B Spectrum Analyzers. Each system has an HP 9000 Series 200 or 300 Desktop Computer with system software available in BASIC language. A wide variety of compatible HP-IB printers and plotters can be used to tailor the system to your specific needs. Operator training is also available for the HP 8566S and 8568S systems. This intensive hands-on course will teach you the basic programming techniques needed for remote operation of these two spectrum analyzer systems.

### System Software

System software is available for the HP 8566B, 8567A, and 8568B in BASIC. This software package provides the system programmer with high-level routines to aid in the development of custom programs for specific measurement applications. Capabilities include automatic computation and setting of analyzer functions to insure optimum measurement performance.

The system software comes on a 5¼-inch disk (3½-inch also available) for use with HP Series 200 or 300 computers. Also included is a manual which provides extensive documentation and line-by-line annotation of each program.

### Ordering Information

HP 8566S (HP 8566B based system)  
 HP 8567S (HP 8567A based system)  
 HP 8568S (HP 8568B based system)  
 HP 85668A Operation Training Course  
 HP 85863B System Software for HP 8566B, 8567A and 8568B

For complete details on prices, options, and ordering information contact your local HP sales office.



# SIGNAL ANALYZERS

## Spectrum Analyzer, 100 Hz to 325 GHz

Model 8566B

125

- 100 Hz to 22 GHz, external mixing to 325 GHz
- Synthesizer frequency accuracy
- Direct plot capability

- Expanded firmware feature set
- Enhanced signal-processing power
- 16K bytes of user RAM

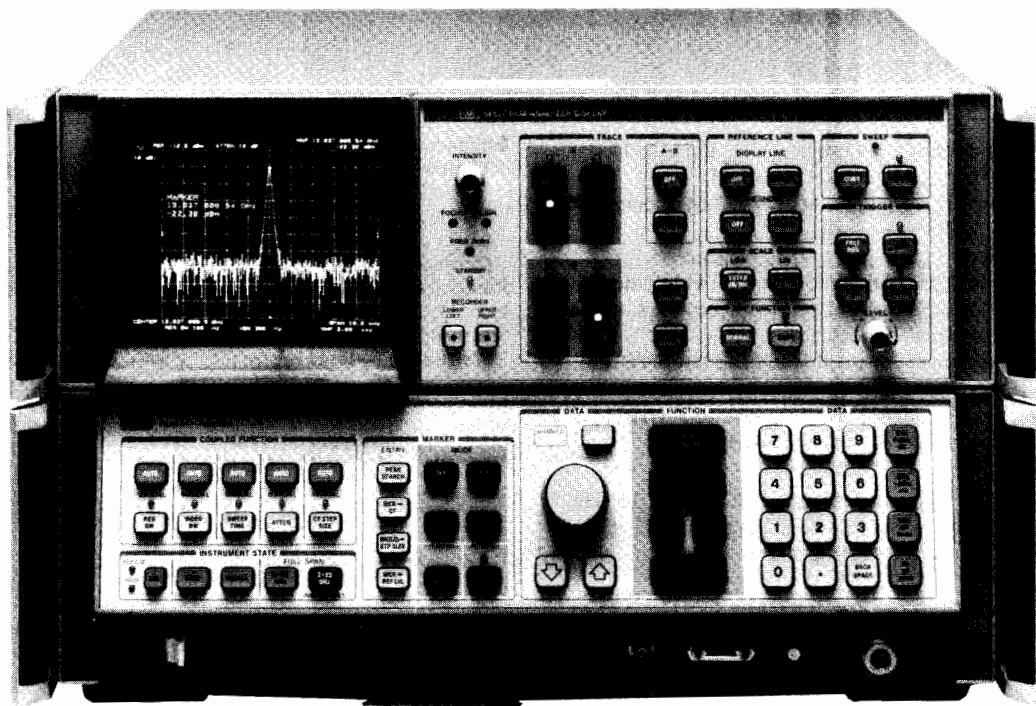

HP 8566B



The HP 8566B Microwave Spectrum Analyzer is a high-performance instrument, ideal for bench or ATE applications. The frequency range of 100 Hz to 22 GHz, using internal mixing, can be extended to 110 GHz with HP 11970 external mixers (see page 143), or to 325 GHz with mixers from other suppliers. A synthesized local oscillator produces counter-like accuracy at microwave and millimeter-wave frequencies. A 10-Hz resolution bandwidth and excellent frequency stability allow difficult measurements such as line-related sideband characterization at 22 GHz.

The HP 8566B offers 16K bytes of RAM for user-defined routines, which can be developed for complex measurements that are made routinely. Using the downloadable programming capability of the HP 8566B, measurement routines can be created on a computer and then downloaded into the non-volatile memory of the analyzer. Custom routines can also be defined and saved using the front-panel controls of the analyzer.

The ability to create and store downloadable programs (DLPs) makes the instrument more efficient for your specific measurement tasks. Custom DLPs can be executed via the HP-IB or user-defined front panel softkeys. Instrument settings can also be saved for future recall to insure that repeatable measurements can be made by different operators. You can control other HP-IB devices such as plotters, printers, signal generators, and power meters with user-defined softkeys on the HP 8566B. And CRT information can be plotted directly without the use of a controller.

All HP 8566B functions are remotely programmable via HP-IB. Many high-level functions are available that produce results instead of just more data. This enables the controller to move on to other tasks, thereby reducing the total execution time. Friendly programming codes and easily recognizable mnemonics facilitate learning the analyzer's language.

A unique, integrated preselector/mixer provides high sensitivity with preselection from 2 GHz to 22 GHz. Coupled functions insure that a calibrated display and a specific input-mixer-drive level are maintained. Functions can be uncoupled and set manually if you wish.

Automatic spectrum analyzer systems can be purchased via the HP 8566S model number. Systems are designed around the HP 8566B analyzer, HP 9000 Series 200 or 300 Desktop Computers, and a variety of peripherals and software packages. System software is available for the HP 8566B in BASIC language for maximum flexibility. Automated signal monitoring and surveillance capabilities can be added with the HP 85865B Signal Monitoring Software. (See page 129 for details.) Operator training is available through the HP 85668A Spectrum Analyzer Operator Course. This four-day, hands-on course teaches programming techniques for remote operation of the spectrum analyzer. (See Customer Education for course details.)

# SIGNAL ANALYZERS

## Spectrum Analyzer, 100 Hz to 325 GHz (cont'd)

Model 8566B

### HP 8566B Specification Summary

#### Frequency

**Frequency Range:** 100 Hz to 22 GHz with internal mixer; extendable to 110 GHz with HP 11970 external mixers and to 325 GHz with mixers from other suppliers

**Frequency Span:** 0 to 2.5 GHz, 2 to 22 GHz, plus 0 Hz (zero span)

**Frequency Reference Accuracy:** Aging rate;  $< 1 \times 10^{-9}$ /day,  $< 2.5 \times 10^{-7}$ /year

**Temperature Stability:**  $< 7 \times 10^{-9}$ , 0 to 55° C

**Resolution Bandwidth:** 3 dB bandwidths of 10 Hz to 3 MHz in a 1, 3, 10 sequence

**Bandwidth Selectivity, 60 dB/ 3 dB ratio:**  $< 11:1$ , 30 Hz to 3 kHz;  $< 13:1$ , 10 kHz & 30 kHz;  $< 15:1$ , 100 kHz to 3 MHz

**Bandwidth Shape:** synchronously tuned, 4- or 5-pole filters, approximately Gaussian shape

**Video Bandwidth:** 1 Hz to 3 MHz in a 1, 3, 10 sequence

**Residual FM (typical peak to peak, fundamental mixing mode):**  $< 0.2$  Hz, frequency span  $< 5$  kHz;  $< 5$  Hz, frequency span  $< 100$  kHz;  $< 200$  Hz, frequency span  $< 5$  MHz

**Drift (typical, after one hour warm-up at stabilized temperature):**  $< 10$  Hz/minute of sweep time, frequency span  $\leq 100$  kHz;  $< 500$  Hz/minute of sweep time, frequency span 100 kHz to 5 MHz,  $< 5$  kHz/minute of sweep time, frequency span  $\geq 5$  MHz

#### Spectral Purity

**Noise sidebands (center frequency 100 Hz to 5.8 GHz):** 320 Hz offset,  $< -80$  dBc/Hz; 1 kHz offset,  $< -85$  dBc/Hz; 10 kHz offset,  $< -90$  dBc/Hz; 100 kHz offset,  $< -105$  dBc/Hz

#### Amplitude

**Amplitude Range (dBm):**  $-134$  to  $+30$ , 1 MHz-2.5 GHz;  $-132$  to  $+30$ , 2.5-5.8 GHz;  $-125$  to  $+30$ , 5.8-12.5 GHz;  $-119$  to  $+30$ , 12.5-18.6 GHz;  $-114$  to  $+30$ , 18.6-22 GHz

**Log Display Range:** 1, 2, 5, or 10 dB/division for 10, 20, 50, & 90 dB displays, respectively

**Scale Fidelity:**  $\pm 0.1$  dB/dB over 0 to 80 dB display;  $< \pm 1.0$  dB max over 0 to 80 dB display;  $< \pm 1.5$  dB max over 0 to 90 dB display

**Calibrator Uncertainty:**  $\pm 0.3$  dB

**Frequency Response (10 dB input atten):** 100 Hz to 2.5 GHz,  $\pm 0.6$  dB; 2 to 12.5 GHz,  $\pm 1.7$  dB; 12.5 to 20 GHz,  $\pm 2.2$  dB; 20 to 22 GHz,  $\pm 3.0$  dB

#### Dynamic Range

**Spurious Responses:**  $< -70$  dBc for mixer levels  $\leq -40$  dBm

#### Second Harmonic Distortion

**Unpreselected, mixer levels  $\leq -40$  dBm:**  $< -70$  dBc, 100 Hz to 2.5 GHz;  $< -80$  dBc, 50 to 700 MHz.

**Preselected, mixer levels  $\leq -10$  dBm:**  $< -100$  dBc, 2 to 22 GHz

**Third Order Intercept (TOI):**  $> +5$  dBm, 100 Hz to 5 MHz;  $> +7$  dBm, 5 MHz to 5.8 GHz;  $> +5$  dBm, 5.8 to 18.6 GHz

**Image Responses:**  $< -70$  dBc, 100 Hz to 18.6 GHz;  $< -60$  dBc, 18.6 to 22 GHz

**Multiple Responses:**  $< -70$  dBc, 100 Hz to 22 GHz

**Out-Of-Band Responses:**  $< -60$  dBc, 2 to 22 GHz

**Residual Responses (0 dB input atten, no input signal):**  $< -100$  dBm, 100 Hz to 5.8 GHz;  $< -95$  dBm, 5.8 to 12.5 GHz;  $< -85$  dBm, 12.5 to 18.6 GHz;  $< -80$  dBm, 18.6 to 22 GHz

**Gain Compression ( $\leq -5$  dBm at mixer):**  $< 1.0$  dB, 100 Hz to 22 GHz

**Displayed Average Noise Level (0 dB input atten, 10 Hz Res BW)**

**Unpreselected:**  $< -95$  dBm, 100 Hz to 50 kHz;  $< -112$  dBm, 50 kHz to 1 MHz;  $< -134$  dBm, 1 MHz to 2.5 GHz

**Preselected:**  $< -132$  dBm, 2 to 5.8 GHz;  $< -125$ , 5.8 to 12.5 GHz;  $< -119$  dBm, 12.5 to 18.6 GHz;  $< -114$  dBm, 18.6 to 22 GHz

#### Sweeptime

**Zero Span:** 1  $\mu$ sec to 1500 seconds

**Swept:** 20 msec to 1500 seconds

**Accuracy:**  $\pm 10\% \leq 200$  second sweeptimes;  $\pm 30\% > 200$  second sweeptimes

**Trigger:** Free run, line, video, external, continuous, and single

### General Specifications

#### Environmental

**Temperature:** Operation; 0 to 55° C Storage;  $-40$  to  $+75$ ° C

**Humidity:** Operating  $< 95\%$  RH, 0 to 40° C

**EMI:** Conducted and radiated interference is within the requirements of MIL-STD-461B, CEO3/part 2, and REO2/part 7, and the requirements of CISPR pub. 11, and FTZ 526/1979

**Power Requirements:** 100, 120, 220, or 240 VAC ( $+5\%$ ,  $-10\%$ ), 50 to 60 Hz or 400 Hz with Option 400

**Warm-up Time Operation:** 30 minutes from cold start (0 to 55° C)

**Frequency Reference:** frequency within  $1 \times 10^{-8}$  of final stability within 30 minutes

**Size (w/out handles), mm (inches):** 279.2 (11) H, 425.5 (16.75) W, 598.5 (23.56) L

**Weight:** 50 kg (112 lb)

#### Inputs

RF in (Type N), Ext Freq Ref in, Ext Sweep Trig in

**Quasi-Peak:** Video in, IF in

#### Outputs

Cal out, 1st LO out, IF out, Sweep + Tune out, Display X, Y, Z out, Horiz Sweep out, Video out, Penlift out, 21.4 MHz IF out, Freq Ref, 10 MHz

**Quasi-Peak:** Video out, IF out

### Ordering Information

HP 8566B Spectrum Analyzer	Price
Option 016: Installed EMI receiver functions	\$57,650
Option 400: 400 Hz power-line frequency operation	+\$250
Option W30: Two additional years return-to-HP warranty	+\$400
Option 462: Impulse bandwidths for EMI measurements	+\$950
Option 655: 5.25" operation verification disks instead of 3.5" disks	+\$2,000
Option 010: Rack mount slide kit	\$0
Option 908: Rack flange kit (instrument w/out handles)	+\$450
Option 913: Rack flange kit (instrument w/handles)	+\$65
Option 910: Extra operating and test and adjustment manuals	+\$70
Option 915: Troubleshooting and repair manual	+\$350
Option 031: German operating manual	\$0
Option 080: Information card in Japanese	+\$200
Option 081: Information card in French	\$0
Option E69: Internal MATE test module adapter	\$0
	\$4,500

# SIGNAL ANALYZERS

## Spectrum Analyzers, 100 Hz to 1500 MHz

Models 8568B & 8567A

127

- 100 Hz or 10 kHz to 1500 MHz frequency range
- Powerful firmware feature set
- Direct plot capability
- 16K bytes of user RAM for custom routines

- Powerful signal- and trace-processing functions
- EMI measurement capability
- Stimulus-response test capability
- Frequency counter accuracy

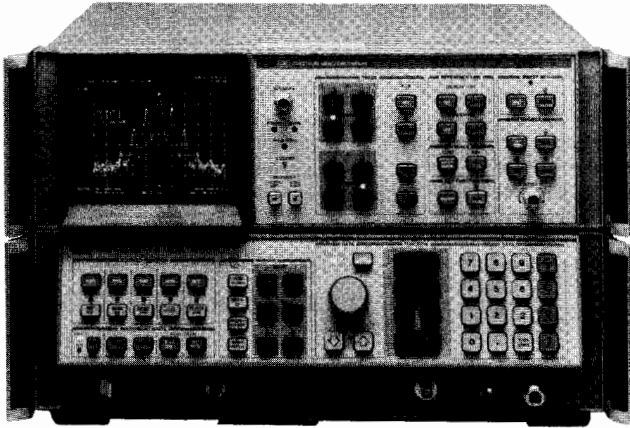

HP 8568B

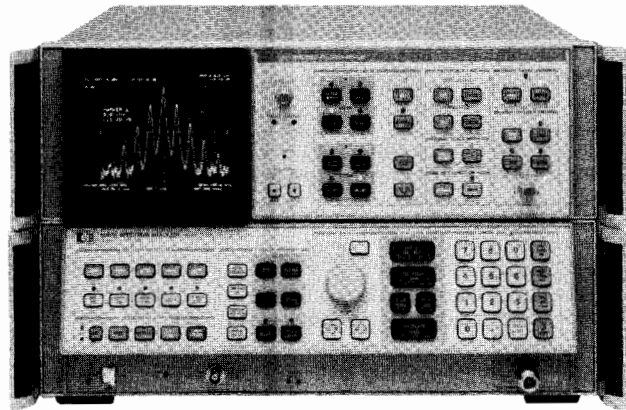

HP 8567A



The HP 8568B and HP 8567A RF Spectrum Analyzers offer a choice in high performance instruments for bench and ATE use. The HP 8568B covers the 100 Hz to 1500 MHz frequency range while the HP 8567A goes from 10 kHz to 1500 MHz. The HP 8568B has superior performance in several areas, including better frequency accuracy, narrower resolution bandwidths, and greater sensitivity (see following page for specification summary). If the higher performance of the HP 8568B is not required, the HP 8567A offers the same powerful feature set and capabilities at a very cost-effective price.

Both instruments offer 16K bytes of RAM for custom user-defined measurement routines. Custom measurement programs can be created, either on an external controller or using the front-panel controls of the spectrum analyzer, and then stored in the non-volatile memory of the instrument. These stored programs can be executed with a single softkey, making them as easy to use as any other function of the analyzer. This capability facilitates customization of either the HP 8568B or the HP 8567A to better suit your particular measurement requirements. In addition, instrument control settings can also be saved for future recall, to insure repeatable measurements even by different operators.

The HP 8568B and 8567A fit into many RF application areas including EMI testing, component stimulus-response testing, and broadband signal surveillance. Add the HP 85650A Quasi-Peak Adapter, HP 85685A RF Preselector, and HP EMI Measurement Software for complete CISPR and MIL-STD EMI measurement capability. (See page 130 for EMI system details.) Stimulus-response measurement capability can be obtained at a minimal cost with the addition of the HP 8444A Option 059 Tracking Generator. If you need automatic broadband surveillance capability, use the HP 85865B Signal Monitoring Software with either analyzer. (See page 129 for Signal Monitoring System details.)

Automatic spectrum analyzer systems can be purchased via the HP 8568S or 8567S model numbers. Systems are designed around the HP 8568B or the HP 8567A RF Spectrum Analyzers, HP 9000 Series 200 or 300 Desktop Computers, and a variety of peripherals and software packages. System software is available in BASIC language for maximum flexibility. (See page 124 for details and ordering information on automatic systems.) Operator training is also available for HP 8568B-based systems. The four-day HP 85668A Spectrum Analyzer Operator Course is designed to teach you programming techniques for remote operation of the HP 8568B. (See Customer Education for course details.)

# SIGNAL ANALYZERS

## Spectrum Analyzers, 100 Hz to 1500 MHz (cont'd)

Models 8568B & 8567A

### Specification Summary

FREQUENCY	8568B	8567A
Frequency Range	100Hz - 1500MHz - DC coupled 100kHz - 1500MHz - AC coupled	10kHz - 1500MHz
Frequency Span	100Hz to 1500MHz + zero span	100Hz to 1500MHz + zero span
Frequency Reference Accuracy		
Aging Rate	$<2.5 \times 10^{-7}$ /year	$<5 \times 10^{-6}$ /year
Temperature Stability	$<7 \times 10^{-9}$ (0-55°C)	$<1 \times 10^{-9}$ (5-55°C)
Resolution Bandwidth (-3dB) 10Hz - 3MHz in 1,3,10 sequence	1kHz - 3MHz in 1,3,10 sequence	1Hz-3MHz in 1,3,10 sequence
Video Bandwidth	1Hz - 3MHz in 1,3,10 sequence	1Hz - 3MHz in 1,3,10 sequence
Residual FM (pk to pk, <100kHz span)	<3Hz (Res BW $\leq$ 30Hz)	<100Hz (Res BW 1kHz)
Drift (per minute of sweep time) (after one hour warm-up)	<10Hz (freq span $\leq$ 100kHz)	<100Hz (freq span $\leq$ 100kHz)
Phase Noise (30kHz offset, 1Hz Res BW)	-107dBc	-105dBc
<b>AMPLITUDE</b>		
Amplitude Range	-135 to +30dBm	-115 to +30dBm
Log Display Range	1,2,5, or 10dB/div for 10,20,50 or 90dB display	1,2,5, or 10dB/div for 10,20,50 or 90dB display
Scale Fidelity - incremental cumulative (20-30°C)	$\pm 0.1$ dB/dB; 0-90dB $\leq \pm 1.0$ dB; 0-80dB $\leq \pm 1.5$ dB; 0-90dB	$\pm 0.1$ dB/dB; 0-80dB $\leq \pm 1.0$ dB; 0-80dB $\leq \pm 1.5$ dB; 0-90dB
Calibrator Uncertainty	$\pm 0.3$ dB	$\pm 0.3$ dB
Frequency Response (input atten $\geq$ 10dB)	$\pm 1.5$ dB, 100Hz - 1500MHz	$\pm 1$ dB, 10kHz - 1500MHz
Spurious Responses (<-40dBm at mixer)	<-70dBc (<10MHz input sig) <-75dBc (>10MHz input sig)	<-70dBc
Second Harmonic Distortion (-30dBm at mixer)	<-70dBc (sig $\geq$ 10MHz) <-60dBc (sig <10MHz)	<-70dBc (sig $\geq$ 10MHz) <-60dBc (sig < 10MHz)
Third Order Intercept (TOI)	+10dBm (sig $>$ 10MHz)	+10dBm (sig $>$ 10MHz)
Residual Responses (at 1MHz) (0dB attn, no input signal)	<-105dBm	<-100dBm
Gain Compression ( $\leq$ 10dBm at mixer)	<0.5dB	<1.0dB
Displayed Average Noise Level (0dB attn, 1Hz Video BW)	<-112dBm, 500Hz-1MHz (10Hz Res BW) <-135dBm, >1MHz (10Hz Res BW)	<-92dBm, 50kHz-1MHz (1kHz Res BW) <-115dBm, >1MHz (1kHz Res BW)
Sweep time - Zero Span	1 $\mu$ sec to 1500 sec	1 $\mu$ sec to 1500 sec
Swept	20 msec to 1500 sec	20 msec to 1500 sec

### General Specifications (Pertain to both 8568B and 8567A unless noted)

#### Environmental

**Temperature:** Operation, 8568B, 0 to 55° C; 8567A, 5° to 55° C  
Storage, -40° to +75° C

**EMI:** Conducted and radiated interference is within the requirements of MIL-STD-461B, CE03/part 2 and RE02/part 7, and the requirements of CISPR pub. 11 and FTZ 526/1979

**Power Requirements:** 100, 120, 220, or 240 VAC (+ 5%, - 10%),  
50-60 Hz or 400 Hz with Option 400

#### Warm-up Time

**Operation:** 30 minutes from cold start

#### Frequency Reference

**8568B:** frequency within  $1 \times 10^{-8}$  of final stab freq within 30 minutes

**8567A:** frequency within  $5 \times 10^{-5}$  of final stab freq within 30 minutes

**Size (w/out handles), mm (inches):** 279.2 (11) H, 425.5 (16.75) W, 558.8 (22) L

**Weight:** 45 kg (100 lb)

#### Inputs

RF in (Type N), RF in (BNC, 8568B only), Ext Freq Ref in, Ext Sweep Trig in

**Quasi-Peak:** Video in, IF in

#### Outputs

Cal out, Display X, Y, & Z out, Horiz Sweep out, Video out, Penlift out, 21.4 MHz IF, 1st LO, Freq Ref, Probe Power out (8568B only)

**Quasi-Peak:** Video out, IF out

### Ordering Information

**HP 8568B** Spectrum Analyzer

**Price**

\$35,300

**HP 8567A** Spectrum Analyzer

\$27,550

**Option 001:** 75 ohm (BNC) RF input

+ \$200

**Option 016:** Installed EMI receiver functions

+ \$250

**Option 044:** Add HP 8444A Opt 059 Tracking Generator (8567A only)

+ \$4,760

**Option W30:** Two additional years return-to-HP warranty

8568B

+ \$690

8567A

+ \$540

**Option 400:** 400 Hz power line frequency operation

8568B

+ \$400

8567A

+ \$700

**Option 655:** 5.25" operation verification disks instead of 3.5" disks

\$0

**Option 010:** Rack mount slide kit

+ \$450

**Option 908:** Rack flange kit (instrument w/out handles)

8568B

+ \$65

8567A

+ \$150

**Option 913:** Rack flange kit (instrument w/handles)

8568B

+ \$70

8567A

+ \$150

**Option 910:** Extra operating and test and adjustment manuals

+ \$350

**Option 915:** Troubleshooting and repair manual

8568B

+ \$200

8567A

+ \$200

**Option 462:** Impulse bandwidths for EMI measurements (8568B only)

+ \$2,000

**Option 080:** 8568B information card in Japanese

\$0

**Option 081:** 8568B information card in French

\$0

Automates the HP 8566B, 8567A, 8568B, 71000 Modular Series, and 8562A Portable Spectrum Analyzers for

- Operator-controlled or unattended long-term signal monitoring
- Broadband surveillance and signal intelligence
- Communication system testing and maintenance



Typical system configuration using HP 85865B Signal Monitoring Software

Increase the power and flexibility of your HP 8566B, 8567A, 8568B, 71000 Modular Series, or 8562A Portable Spectrum Analyzer for signal monitoring and broadband surveillance. The HP 85865B Signal Monitoring Software automates your system for site surveillance applications and long-term attended or unattended monitoring operations. Menu options allow you to store command sequences and set the time of program execution. Monitor up to 128 frequency bands of interest and measure percent occupancy using the software's frequency histogram display. A multiband display option lets you view up to 16 selected bands at one time and you can easily obtain hard copy of statistical information on band usage and transmission length using your system's printer or plotter. Signal data, collected continuously or at intervals over long periods of time, are stored with date and time included to provide comprehensive reports on ambient signal activity.

#### Diverse Applications

The HP 85865B Signal Monitoring Software offers advantages in areas requiring long-term monitoring of signal environments. For example, to maintain quality over the lifetime of a communication system, the program provides information on current band usage for management of the frequency spectrum, and on signal parameters to assure that transmissions meet specified tolerances. A "task scheduler" directs the spectrum analyzer to execute a file of commands at a given time, enabling completely automatic, unattended testing. Large blocks of data are stored and retrieved easily with a Hewlett-Packard Winchester disc drive.

For surveillance operations, the software's run-mode options permit the spectrum analyzer to automatically "search" a defined band, tune to a signal, measure frequency and amplitude, and determine modulation format. Data can be reported selectively: set an "alarm" to notify you when signals meet pre-determined characteristics, or construct a "signal mask" to prevent unwanted signals from being reported. Adding an HP 70700A Digitizer or an HP 54100 or 54200 Digitizing Oscilloscope lets you measure pulse parameters including pulse width, pulse repetition interval, peak power, and average power for use in radar detection and system testing.

#### Powerful Graphics

Powerful display formats transform your system's console into an effective tool to analyze and manipulate data. View multiple bands—up to four at one time—in the frequency as well as the time domain. A "parameter summary" displays such measured signal parameters as pulse width, modulation format, pulse repetition interval, amplitude, and frequency. For a time profile of a particular band, use the three dimensional "raster" display of frequency, amplitude, and time. The "histogram" options provide information on band usage, and the "timegram" reports signal data as a function of time. The "timegram summary" displays statistics on percent occupancy, maximum frequency and amplitude, and average message length of two-way communication signals at specific frequencies. Transfer all display formats directly to an HP-IB plotter or printer for customized hard-copy output. Or, use remote capability to transfer graphic and alpha information from multiple systems to a single hub via RS-232.

The HP 85865B Signal Monitoring Software, written in Pascal 3.2, requires an HP high performance spectrum analyzer and a compatible computer. For pulse analysis, a waveform recorder must be added to the system, and it is recommended that your computer contain at least 3 Mbytes of memory. Contact your nearest HP field representative for a complete list of accessories, including mass-storage devices, printers, and plotters. Hardware can be ordered as a single shipment using the "S" system. See page 124.

#### Ordering Information

	Price
<b>HP 85865B</b> Signal Monitoring Software	
Option 630 (3 1/2 inch discs)	\$5500
Option 700 (1/4 inch tape cartridge)	\$5500
Remote Options:	
Option 001 (3 1/2 inch discs)	+\$2200
Option 701 (1/4 inch tape cartridge)	+\$2200



# SIGNAL ANALYZERS

## CISPR EMI Receivers, 9kHz to 1.5GHz

Models 8573A, 8574A

- Meets CISPR Publication 16\* requirements
- Performs VDE, FCC, VCCI Compliance Tests
- Makes diagnostic EMI measurements
- Automates VDE, FCC, VCCI and MIL-STD EMI tests

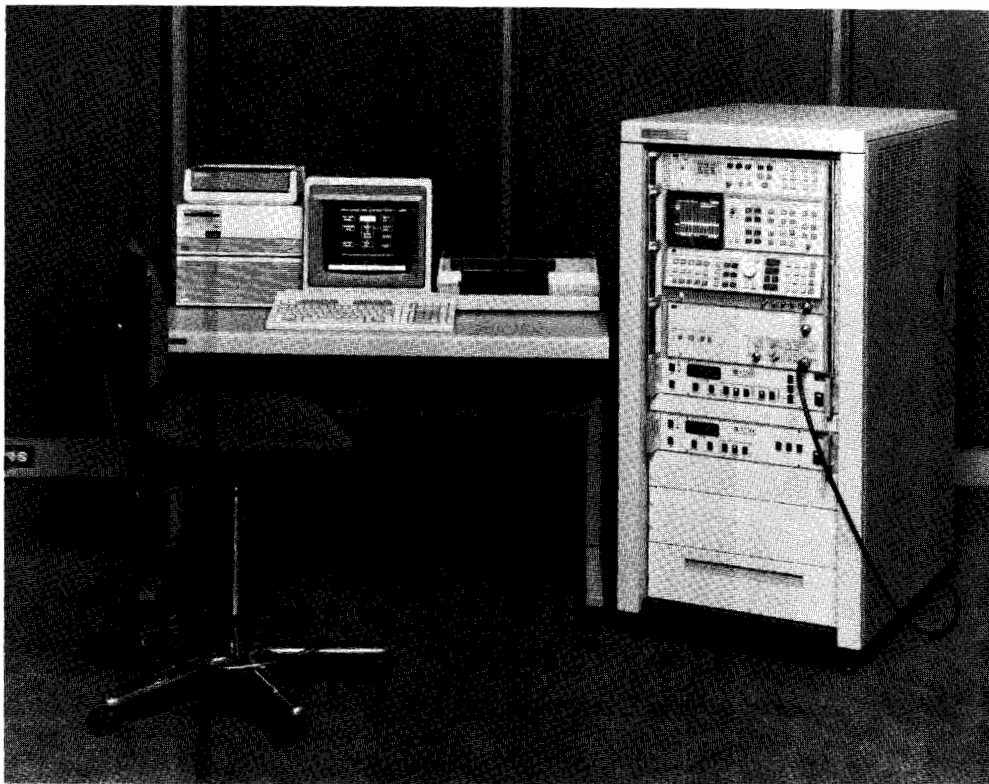

Typical HP 8573A Configuration with additional Controller and optional accessories.



The HP 8573A and 8574A EMI Receivers are designed for making fast, accurate EMI measurements. With improved sensitivity and overload protection, these powerful receivers meet CISPR Publication 16\* recommendations as well as requirements of the FCC, VDE, and VCCI. And, because a versatile HP 8567A or 8568B Spectrum Analyzer forms the heart of each system, full EMI diagnostic capabilities aid you throughout a product's evolution, from design stages to completion of final commercial and MIL-STD qualification tests.

### CISPR/EMI Receiver Features and More

To meet CISPR Publication 16 specifications, the HP 85650A Quasi-Peak Adapter provides the CISPR EMI Receivers with required bandwidths and quasi-peak detection. Each system comes with the HP 85867A EMI Receiver Functions, a set of downloaded programs that make possible speedy "one-button" manual quasi-peak measurements. The HP 85685A RF Preselector adds input overload protection and increased measurement sensitivity, and its built-in absolute amplitude calibration ensures  $\pm 2$ dB amplitude accuracy. The preselector automatically tracks the spectrum analyzer during manual and remote operation. A low-frequency RF input withstands large impulses and Line Impedance Stabilization Network (LISN) transients. Both the low-frequency and high-frequency inputs allow the use of CISPR calibration pulses.

### Automatic Control for Remote Operations

The HP 8573A and 8574A CISPR EMI Receivers let you automate emission measurements via the HP-IB for conducted or radiated tests using a variety of compatible system controllers, EMI

accessories, and peripherals. You can write your own programs or elect HP software: the HP 85864C EMI Measurement software or HP 85870A Open-Site EMI Measurement System Software. Both feature easy-to-use menu structures that lead you through EMI measurements from initial setup to final results. Choose from libraries of FCC, and VDE emission tests, or design your own. Results can be annotated and notes generated as part of your test documentation, and subroutines can be added to the software for automatic control of your EMI accessories.

EMI accessories available for FCC, VDE, VCCI and MIL-STD tests feature a LISN for commercial conducted measurements and current probes for MIL-STD conducted emission requirements. Transducer kits contain magnetic and electric field antennas for radiated emission testing from 9 kHz to 18 GHz. Other EMI accessories include preamplifiers, printers, plotters, and a system cabinet. See page 133.

### Ordering Information

	<b>Price</b>
<b>HP 8573A</b> CISPR EMI Receiver	\$53,700
<b>HP 8574A</b> CISPR EMI Receiver	\$61,465
<b>Option 001</b> HP 85900 System Cabinet (includes Option 913)	+ \$2,850
<b>Option 908</b> Rack mounting kit without handles	+ \$122.50
<b>Option 910</b> Extra set of operating manuals	+ \$410
<b>Option 913</b> Rack mounting kit with handles	+ \$135

\*CISPR Publication 16 is the Comite International Special des Perturbations Radioelectrique specification for radio interference measuring apparatus and measurement methods.

- Locate EMI "hot spots" quickly
- Increase EMI measurement repeatability
- Utilize powerful analysis aids

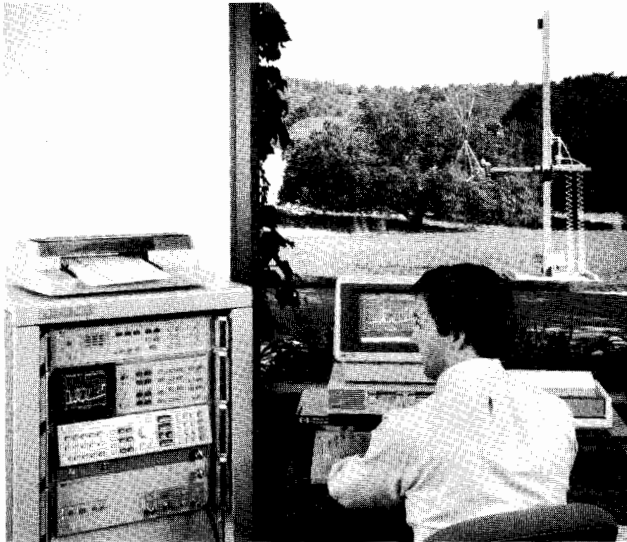

### HP 85870A Open-Site EMI Measurement System Software

The HP 85870A Open-site EMI Measurement System (OEMS) Software is specially designed to automate and simplify commercial EMI, radiated-emission compliance measurements. EMI measurements made at open sites, due to ambient signals present in the measurement environment, are inherently more complex than measurements made in shielded enclosures. The HP 85870A helps EMI engineers and technicians quickly obtain repeatable, accurate, and completely documented measurement results using the HP 8573A and 8574A EMI Receivers.

#### Identify and record ambients

The OEMS Software allows you to identify and categorize ambients by automatically (or manually) generating a list of the frequencies and amplitudes of ambient signals that are present when the equipment under test (EUT) is off. The ambient list is incorporated into a user-defined frequency-band table, which allows you to segment the entire range of interest and categorize the ambients in each band. For example, you can specify and label the 6-meter ham, FM radio, and land mobile bands in the frequency-band table. Methods are provided to generate and maintain complex ambient signal lists for repeated use. The spectrum analyzer screen is marked where the ambient signals occur for simplified identification of suspect EUT emissions.

#### Identify and maximize EUT emissions

With a complete ambient list and a remote AC power switch, the software can automatically turn on the EUT and find suspect emissions, even in the presence of impulsive or noisy environments. The EMC engineer or technician can then select from a number of features such as Tune & Listen, EUT On/Off, and Zoom Local to determine which signals are coming from the EUT. Confirmed emissions are assigned to a final list of signals. Each emission's amplitude is then determined by automatically controlling a turntable and antenna mast using a signal characterization routine of your choice. EUT emissions can be manually maximized using the SIG PEAK function, which controls an HP-IB antenna mast and turntable or allows manual positioning. The OEMS software records information on each signal such as frequency and amplitude deviation from the limit, as well as the antenna height, turntable position, and user comments.

#### Generate complete reports in desired formats

Complete measurement results are documented in the format of your choice using the OEMS Software Report Generator. You can design your own test report using combinations of fixed text and

- Begin testing at system turn-on
- Test to standard or internal limits
- Automatically correct data for transducer and system gain/loss

updateable variable fields for the date and time of test, equipment name and serial number, or any other information. Ambient, suspect, or final signal lists and log frequency plots of the final data can be integrated with your text for concise, professional-looking reports. A library is provided to store these report formats. CRT data and signal lists can also be sent to a printer or plotter from virtually any point in the software.

### HP 85864C EMI Measurement Software

The HP 85864C EMI Measurement Software is a general-purpose program for making automatic commercial and military emission measurements using an HP 8566B, 8567A, or 8568B Spectrum Analyzer. The friendly menu structure of the program leads you through an EMI measurement from initial setup to the final plotting of the test results. The HP 85864C has an easy start-up procedure, so you are "ready to run" even if you have never programmed before.

#### Automate MIL-STD and commercial EMI measurements

The HP 85864C EMI Measurement Software automates military and commercial EMI emission measurements. It is designed to automate EMI measurements made in a shielded enclosure. The HP 85864C takes advantage of the spectrum analyzer's ability to quickly measure wide frequency spans and locate EMI "hot spots" using peak detection. For commercial measurements, quasi-peak data need be taken only at these "hot spots." Save time and effort in your MIL-STD measurements by letting the software take narrowband and broadband data in the same test.

#### Design your own tests

Design your own tests or choose from the examples given in the software. These examples reside in the test library and include MIL-STD, FCC, and VDE/FTZ emission tests. Transducer factors, test limits, and receiver parameters are easily changed and stored in libraries. Once your test is designed, it is stored away and can be executed repeatedly at the push of a key.

#### Compatibility

The HP 85864C and 85870A are compatible with the following equipment:

<b>Spectrum Analyzer*</b>	HP 8566B, 8567A, 8568B
<b>RF Preselector</b>	HP 85685A
<b>Quasi-Peak Adapter</b>	HP 85650A
<b>EMI Receiver</b>	HP 8573A, 8574A
<b>Computer*</b>	HP 9000 Series 300 Model 310, 319, 320, 330, 350 HP 9000 Series 200 Model 216, 236
<b>Memory Requirements*</b>	2 Mbytes
<b>Mass Storage*</b>	HP 9122C, 9153C
<b>Plotters</b>	HP 7440A, 7475A, 7550A
<b>Printers</b>	HP 2225A, 2227B, LaserJet Series II, Deskjet
<b>DMA Controller</b>	HP 98620B
<b>Floating Point Card</b>	HP 98635A
<b>SRM Interface</b>	HP 50962A

\*Minimum equipment required

#### Ordering Information

	<b>Price</b>
<b>HP 85864C EMI Measurement Software</b>	\$0
Opt. 630 3½-inch media	\$3150
Opt. 655 5¼-inch media	\$3150
<b>HP 85870A OEMS Software</b>	\$0
Opt. 630 3½-inch media	\$5100
Opt. 655 5¼-inch media	\$5100
<b>HP 85874A Bundled EMI Software</b>	\$0
Includes HP 85864C and 85870A	\$7140
Opt. 630 3½-inch media	\$7140
Opt. 655 5¼-inch media	\$7140

# SIGNAL ANALYZERS

## RF Preselector, 20 Hz to 2 GHz/Quasi-Peak Adapter

Models 85685A, 85650A

- Automatic filter tracking
- Input overload protection
- Low system noise

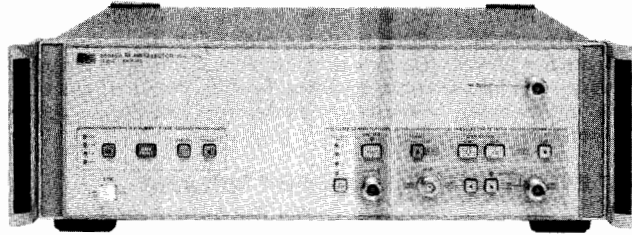

HP 85685A

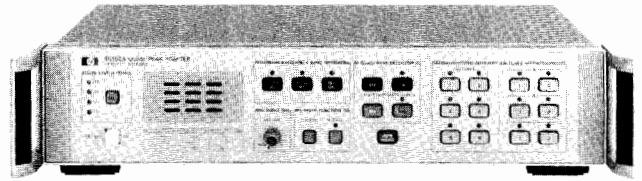

HP 85650A



### HP 85685A RF Preselector

The HP 85685A RF Preselector makes a multi-purpose test receiver of an HP 8566B, 8567A, or 8568B Spectrum Analyzer. In addition to an instrument for general-purpose spectrum analysis, you now have a test receiver for specialized applications. The RF preselector, with tracking filters and preamplifiers covering the 20 Hz to 2 GHz range, improves spectrum analyzer measurement sensitivity while providing overload protection from out-of-band signals. The resulting test receiver system operating in the presence of high-level interference, has a measurement range 30 dB greater than that of a spectrum analyzer alone.

The test receiver/spectrum analyzer measures signals within the preselector filter passband and rejects out-of-band interference by 40 dB. This enables low-level signals to be monitored in the presence of high-level ambients. The preselector decreases input overload from out-of-band signals, thereby increasing the range for measuring low-level signals. Fast, wideband measurements mean a reduction in measurement time.

Combining the HP 85685A RF Preselector with an HP 8566B, 8567A, or 8568B Spectrum Analyzer and the HP 85650A Quasi-Peak Adapter gives you an EMI receiver that meets the recommendations of CISPR Publication 16\*.

The RF preselector adds the measurement sensitivity and overload protection needed for FCC and VDE radiated emission testing at open sites. For commercial and MIL-STD conducted EMI tests, the low-frequency input withstands large impulses and Line Impedance Stabilization Network (LISN) transients. A built-in calibrator ensures  $\pm 2.0$  dB absolute-amplitude accuracy as required by the FCC and VDE, and a convenient linearity check tests for system overload.

Operating the test receiver is easy. Use only the spectrum analyzer controls—the RF preselector automatically adjusts input-filter tracking, and the spectrum analyzer reports preselector operating conditions on the CRT. The receiver system is fully HP-IB programmable, and the HP 85685A comes equipped with the hardware needed to connect it to any compatible spectrum analyzer.

### HP 85650A Quasi-peak Adapter

The HP 85650A Quasi-peak Adapter works with the HP 8566B, 8567A, and 8568B Spectrum Analyzers and with the 85685A RF Preselector to complete an EMI test receiver system. The quasi-peak adapter adds the special bandwidth filters and quasi-peak detection capability specified in CISPR Publication 16\*. These bandwidth filters (200 Hz, 9 kHz, and 120 kHz) have 6 dB resolution and may be selected using either peak or quasi-peak detection.

- Quasi-peak detection
- CISPR-specified bandwidths
- Bypass for regular spectrum analyzer operation

A bypass switch enables the spectrum analyzer to bypass the quasi-peak adapter, and a Normal mode allows use of the three CISPR bandwidths whether or not the quasi-peak detector is being used. The HP 85650A is fully programmable over the HP-IB for automated measurements, and it has both an internal speaker and an audio output jack (for external headphones) for monitoring signals.

### HP 85867A EMI Receiver Functions

This set of softkey programs simplifies commercial EMI measurements performed manually using HP EMI receiver/spectrum analyzers (see page 130). An external computer is not needed after the softkeys are downloaded into spectrum analyzer non-volatile RAM. You can select a CISPR\* band, make automatic quasi-peak measurements at up to six discrete frequencies, and directly print or plot measurement data using front-panel softkeys.

Features of the EMI Receiver Functions include a quasi-peak softkey that automatically chooses resolution bandwidths, video bandwidths, CISPR bandwidths, and sweep times for fast, accurate quasi-peak measurements. Up to six quasi-peak markers and numeric values can be displayed at the same time. This lets you simultaneously view a wide frequency span and the quasi-peak values of up to six signals. A numeric keypad overlay for the spectrum analyzer is included to help you select the right softkey, and a help function gives the purpose of each softkey. Spectrum analyzer options are available for factory installation of this product.

### Ordering Information

	Price
HP 85685A RF Preselector	\$21,000.00
Option 010, Rack mount slide kit	add \$385.00
Option 908, Rack flange kit without handles	add \$32.50
Option 910, Extra manual	add \$50.00
Option 913, Rack flange kit with handles	add \$35.00
HP 85650A Quasi-peak Adapter	\$5,200.00
Option 908, Rack flange kit without handles	add \$25.00
Option 910, Extra manual	add \$10.00
Option 913, Rack flange kit with handles	add \$30.00
HP 85867A EMI Receiver Functions	
Option 630 3 1/2-inch media	\$250.00
Option 655 5 1/2-inch media	\$250.00

\*CISPR Publication 16 is the Comite International Special des Perturbations Radioelectrique specification for radio interference measuring apparatus and measurement methods.

## Impulse Bandwidth/Close-field EMC Analyzer and Probes/EMI Accessories

### HP 8566B/68B Option 462

Option 462 for HP 8566B and 8568B spectrum analyzers provides impulse bandwidths for making MIL-STD and DEF STAN EMI measurements. Standard HP 8566B and 8568B models have 12 resolution bandwidth filters (10 Hz to 3 MHz in a 1, 3, 10 sequence) specified in terms of their 3 dB bandwidth. Option 462 modifies the 1 kHz to 3 MHz resolution bandwidth filters to correspond to their impulse bandwidth instead.

In addition to enhancing instrument capability for MIL-STD 461A/B/C and 462 EMI measurements, spectrum analyzers with Option 462 can still make all commercial EMI and general-purpose measurements. Option 462 spectrum analyzers are compatible with the HP 85650A Quasi-peak Adapter, HP 85685A RF Preselector, HP 85864C EMI Measurement Software, HP 85870A Open-site Measurement Software and the HP 85867A EMI Receiver Functions program. Existing HP 8566B and 8568B spectrum analyzers can be modified to include Option 462. For more information, contact your local sales office.

### HP 8590A Option H51 Close-Field EMC Analyzer

This portable spectrum analyzer, with built-in EMI personality, provides a powerful and cost-efficient tool for EMI troubleshooting. The HP 8590A Option H51 Close-Field EMC Analyzer is calibrated for use with the HP 11945A Close-Field Probe Set while retaining the functionality of a 9 KHz to 1.5 GHz spectrum analyzer. In addition, the HP 8590A Option H51 has special EMI bandwidths and automatic analysis routines available to help designers locate, characterize, and fix EMI troubled areas.

### HP 11940A and 11941A Close-field Probes

These small, hand-held electromagnetic-field sensors are used with a spectrum analyzer for EMI diagnostic and troubleshooting applications. A dual-loop configuration and balun structure enable them to make repeatable, absolute magnetic-field measurements. The HP 11941A operates from 9 kHz to 30 MHz; the HP 11940A, from 30 MHz to 1 GHz.

Designed to measure radiation from surface currents, slots, and cables, these probes are ideal for diagnostic testing of printed circuit boards, cabling, and shielded enclosures. Five antenna factor points appear on the back of each probe for calculating absolute magnetic-field strength (dBuA/m) from the spectrum analyzer's dBuV reading.

Double-shielded cables and adapters are included with the HP 11945A Close-field Probe Set, which includes both probes. Option E51 adds the HP 8447F Option H64 Pre-amplifier and a convenient carrying bag.

### HP 11947A Transient Limiter

The model HP 11947A Transient Limiter protects a spectrum analyzer input from the damage caused by high level transients from line impedance stabilization networks (LISNs) during EMI testing for conducted emissions.

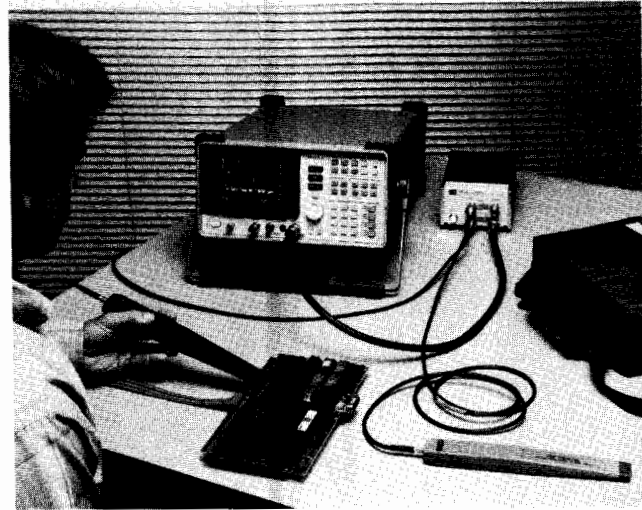

A high-pass filter and a 10 dB attenuator are incorporated into the HP 11947A Transient Limiter, which is capable of withstanding inputs as high as 10 kW for 10  $\mu$ sec, or 2.5 W of average power. The built-in high pass filter helps reduce 60 Hz line feedthrough that might impede conducted emission measurements.

### Ordering Information

Item	Price
HP 8566B/68B Option 462	\$2,000
HP 11945A Close-field Probe Set	\$1,110
Option E51 adds preamplifier, accessory-carrying bag, and 36-inch, Type N cable	\$2,460
HP 11941A Close-field Probe (9 kHz-30 MHz)	\$620
HP 11940A Close-field Probe (30 MHz-1 GHz)	\$620
Option 001 Rotary Joint	\$375
HP 8590A Spectrum Analyzer	\$7,995
Option O21 HP-IB Interface	\$600
Option H51 adds EMC personality, EMC bandwidths, and N-Type input connector	\$560
HP 11947A Transient Limiter	\$450

### EMI Accessories

Item	Price
Turntable for Radiated Emission Testing	
Equipment Testing Turntable with HP-IB control.	
HP 85685A Option K40: 50-60 Hz, 100-120 volts	\$11,165
HP 85685A Option K41: 50-60 Hz, 220-240 volts	\$11,165
Tower for Radiated Emission Testing.	
Antenna Positioning Tower with HP-IB and polarization control.	
HP 85685A Option K42: 50-60 Hz, 100-120 volts	\$17,175
HP 85685A Option K43: 50-60 Hz, 220-240 volts	\$17,175

### Recommended EMI Transducer Kits

Commercial				
Test	Freq. Range	Transducer Kit	Price	
VDE 0871 FCC Part 15J	Radiated	9 kHz-30 MHz	HP 11965A (100-120 volt) Opt. 001 (220-240 volt) Opt. 002 Tripod Opt. 003 BNC cable, 25 ft.	\$2,150 N/C 695 140
		9 kHz-1 GHz	HP 11965B (100-120 volt) Opt. 001 (220-240 volt) Opt. 002 Tripod Opt. 003 BNC cable, 25 ft. Opt. 004 Type N cable, 25 ft.	\$5,085 N/C 695 140 170
	Conducted	10 kHz-30 MHz	HP 11965C (LISN)	\$1,525
	FCC Part 15J (only)	Radiated	30 MHz-1 GHz	HP 11965D Opt. 001 Tripod Opt. 002 BNC cable, 25 ft. Opt. 003 Type N cable, 25 ft.
			HP 85685A Opt. K09 Dipole antennas	\$2,360
Conducted		10 kHz-30 MHz	HP 11965C (LISN)	\$1,525

MIL-STD				
Test	Freq. Range	Transducer Kit	Price	
MIL-STD 461A/B/C 462	Radiated RE-02	14 kHz-1 GHz	HP 11965M (Circularly polarized) or HP 11965N (Linearly polarized)	\$4,645 4,835
			Opt. 001 (220-240 volt) Opt. 002 Tripod Opt. 003 BNC cable, 10m Opt. 004 Type N cable, 10m	N/C 695 140 170
	Conducted CE-03	1-10 GHz	HP 85685A Opt. K22 (Circularly polarized antenna) or HP 85685A Opt. K23 (Linearly polarized antenna)	\$10,100 11,480
		10 kHz-50 MHz	HP 11965R (Current Probe)	\$1,585

# SIGNAL ANALYZERS

## Spectrum Analyzer, 10 kHz to 1.8 GHz

Model 8590A

- Lightweight and portable
- Programmable via HP-IB, HP-IL, or RS232C
- Direct printer and plotter output
- Accessory for battery operation
- Optional CATV functions and 75- $\Omega$  input
- Optional EMC functions

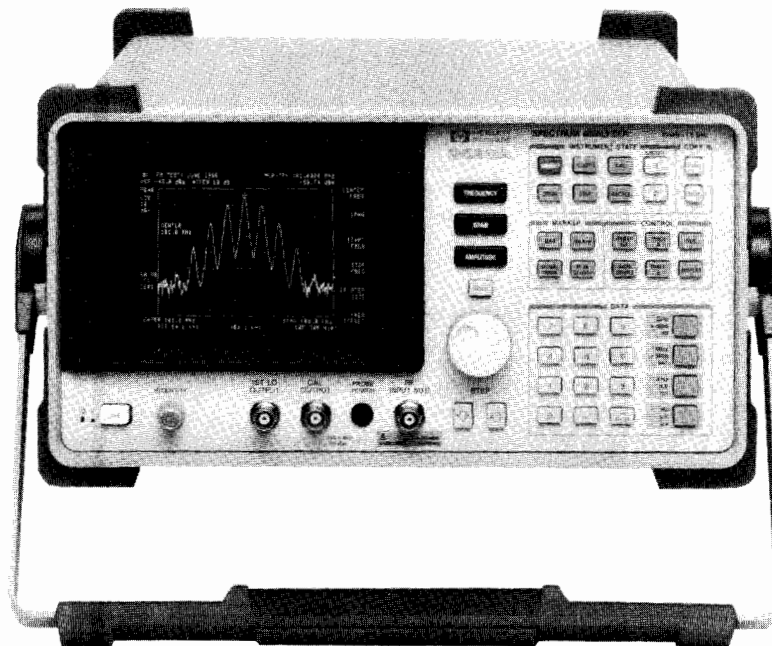

HP 8590A



### HP 8590A Portable RF Spectrum Analyzer

This compact, portable RF spectrum analyzer offers many features of a high-performance model for a low, affordable price. With a wide frequency range (10 kHz to 1.5 GHz or optional 1.8 GHz), large amplitude range ( $-115$  dBm to  $+30$  dBm), and 50- or optional 75  $\Omega$  input, the HP 8590A has the versatility to make most RF signal measurements. Over 100 functions can be programmed from an optional computer interface, and many accessories are available to expand basic spectrum analyzer capabilities.

#### Automatic Control

Three computer-interface options are available to automate the spectrum analyzer's many functions: HP-IB<sup>1</sup>, HP-IL<sup>2</sup>, and RS232C. Even without a computer, the interface will send display data to a printer or plotter.

#### Portability and Performance

With this analyzer you can get the same quality test results in the field that you get in the factory. The analyzer weighs only 30 pounds and has a "briefcase" handle to make carrying easy. When no AC power is available, the analyzer can be run for about two hours from the HP 85901A Portable AC Power Source (see page 136).

#### Add-on Features

The portable spectrum analyzer is compatible with accessories such as computers, multi-pen plotters, a video monitor, and more. The HP 8444A Tracking Generator turns the HP 8590A into a stimulus-response system that makes frequency-response and insertion-loss measurements on RF components. The HP 10855A Preamp

ifier improves the analyzer's noise performance when low-level signals are measured, and a family of close-field probes is available for EMI testing. The HP ThinkJet Printer makes permanent records of test results displayed by the analyzer.

#### HP 8590A Option H18 1790 MHz Operation

Option H18 extends the upper limit of the HP 8590A's frequency range to 1790 MHz.

#### HP 8590A Option H50 CATV Functions

This option adds a set of nine functions to simplify cable TV testing: channel selection, carrier level, carrier-to-noise, power line hum, crossmodulation, composite triple beat, modulation depth, system frequency response, and save/recall traces. A 75- $\Omega$  input (no-cost Option 001) minimizes mismatch loss in cable testing. All of the spectrum analysis capability of the standard HP 8590A is retained.

#### HP 8590A Option H51 EMC Functions

Find EMI "hot spots" in your new-product designs quickly and easily by using the HP 8590A Option H51 Close-Field EMC Analyzer and HP 11945A Close-Field Probe Set. The field strength is measured directly at the probe tip in  $\text{dB}\mu\text{A}/\text{m}$ , and antenna factors for the probe are automatically applied. A special function accessed with a key helps you to discriminate between narrowband and broadband signals. For more information, see page 133.

<sup>1</sup>HP-IB is Hewlett-Packard's hardware, software, documentation, and support for IEEE-488 and IEC-625 worldwide standards for interfacing instruments.

<sup>2</sup>HP-IL is the Hewlett-Packard Interface Loop for serial-interfacing instrument systems.



## HP 8590A Specifications

### Frequency

**Frequency range:** 10 kHz to 1.5 GHz with 4-digit resolution  
10kHz to 1.79 GHz with Opt. H18  
1 MHz to 1.5 GHz with Opt. 001

**Readout accuracy:**  $< \pm(5 \text{ MHz} + 1\% \text{ of span})$  (50- $\Omega$  termination on 1<sup>st</sup> LO Out)

### Frequency stability

**Drift:**  $< 50 \text{ kHz/5 min.}$  after 2-hour warmup and 5 min. after setting center frequency

**Signal track:** signal held at display center compensates for drift

**Noise sidebands:**  $< -65 \text{ dBc}$  at 30 kHz offset (1 kHz RBW, 30 Hz VBW)

**Frequency span range:** zero and 50 kHz to 1.5 GHz with 4-digit resolution

**Readout accuracy:**  $< \pm 3\%$  of indicated frequency span

### Bandwidth Characteristics<sup>3</sup> (-3 dB)

**Resolution BW (RBW):** 1 kHz to 3 MHz in 1,3 sequence (Gaussian shape)

**Video BW (VBW):** 30 Hz to 3 MHz in 1,3 sequence

**Sweptime range:** 20 ms to 100 s

**Readout accuracy:**  $\pm 10\%$  of indicated setting

### Amplitude

#### Amplitude range (1 MHz to 1.3 GHz)<sup>3</sup>

**50- $\Omega$  calibration:**  $-115 \text{ dBm}$  to  $+30 \text{ dBm}$

**75- $\Omega$  calibration (Opt. 001):**  $-60 \text{ dBmV}$  to  $+72 \text{ dBmV}$

**Readout resolution (with markers):**  $< 0.05 \text{ dB}$  for log scale;  $< 0.05\%$  of Ref. Level for linear scale

**Amplitude units:** dBm, dBmV, dBuV, volt, watt

**Amplitude scale:** 1-20 dB/div. in 1 dB steps and linear

**Maximum input power:**  $+30 \text{ dBm}$  (1 W) continuous; 0 V dc

**Maximum dynamic range:** 70 dB for on-screen viewing; 70 dB for signal-to-distortion; 105 dB for IF compression-to-noise

**Displayed average noise:** 1 MHz to 1.3 GHz (0 dB input attenuation, 1 kHz RBW, 30 Hz VBW)<sup>3</sup>

**50- $\Omega$  calibration:**  $< -115 \text{ dBm}$

**75- $\Omega$  calibration (Opt. 001):**  $< -60 \text{ dBmV}$

**Gain compression:**  $< 1 \text{ dB}$  for  $-10 \text{ dBm}$  total power at input mixer

#### Spurious responses

**Second Harmonic:**  $< -70 \text{ dBc}$  for  $-45 \text{ dBm}$  at input mixer, input  $> 5 \text{ MHz}$ <sup>3</sup>

**Third-order intermod.:**  $< -70 \text{ dBc}$  for two  $-30 \text{ dBm}$  signals at input mixer,  $> 50 \text{ kHz}$  signal separation

**Residual responses:**  $< -95 \text{ dBm}$  for no input signal (0 dB input atten. and 50- $\Omega$  termination on RF Input and 1<sup>st</sup> LO Out)

### Amplitude Accuracy

#### Frequency response

**Absolute variation:**  $< \pm 1.5 \text{ dB}$  referenced to Cal Out signal (10 dB atten.)

**Peak variation (flatness):**  $< \pm 1 \text{ dB}$  referenced to mid-point between highest and lowest peak excursions

#### Calibrator accuracy (for 299.9 MHz $\pm$ 300 kHz Cal Out signal)

**50- $\Omega$  calibration:**  $< \pm 1 \text{ dB}$  for  $-20 \text{ dBm}$  level

**75- $\Omega$  calibration (Opt. 001):**  $< \pm 1 \text{ dB}$  for  $+28.75 \text{ dBmV}$  level

#### Reference level setting (log scale)

**0-60 dB atten.:**  $< \pm 1.75 \text{ dB}$  for  $+30$  to  $-120 \text{ dBm}$  range

**10 dB atten.:**  $< \pm 1.25 \text{ dB}$  for 0 to  $-120 \text{ dBm}$  range;  $< \pm 0.5 \text{ dB}$  for 0 to  $-59 \text{ dBm}$  range

**Resolution BW switching:**  $< \pm 0.25 \text{ dB}$  for 3 kHz to 3 MHz RBW range

**Log scale switching:** no significant error for 1-20 dB/div. scale range

**Log scale fidelity:**  $< \pm 0.1 \text{ dB/dB}$  change over 70 dB range with  $\pm 0.75 \text{ dB}$  max. over  $-60 \text{ dB}$  range from Ref. Level;  $\pm 1.0 \text{ dB}$  max. over  $-70 \text{ dB}$  range from Ref. Level

**Linear scale fidelity:**  $< \pm 3\%$  of Reference Level setting

## Input/Output Characteristics

### Front-panel connectors

**RF input:** 50- $\Omega$  BNC (standard); 75- $\Omega$  BNC (Opt. 001)

**Probe power output:**  $+15 \text{ V}$ ,  $-12.6 \text{ V}$ , GND, 150 mA max.

### Cal output

**50- $\Omega$  BNC (standard):**  $-20 \text{ dBm}$ , 299.9 MHz

**75- $\Omega$  BNC (Opt. 001):**  $+28.75 \text{ dBmV}$ , 299.9 MHz

**1<sup>st</sup> LO output:** 50- $\Omega$  BNC,  $+10 \text{ dBm}$ , 2.05 to 3.55 GHz

### Rear-panel connectors

**Aux video output:** 50- $\Omega$  BNC, 0 to 1 V

**Monitor output:** 50- $\Omega$  BNC, NTSC format, 19.2 kHz horiz. sync.

**High sweep In/Out:** BNC, high TTL = sweep, low TTL = retrace

**Sweep output:** BNC, 5 k- $\Omega$ , 0 to  $+10 \text{ V}$  ramp

**Aux IF output:** 50- $\Omega$  BNC,  $-10$  to  $-60 \text{ dBm}$ , 21.4 MHz

**Ext. trigger input:** BNC, TTL levels, positive edge trigger

**Interface connector:** HP-IB (Opt. 021), HP-IL (Opt. 022), or RS232C (Opt. 023)

**HP-IB codes:** SH1, AH1, T6, L4, SR1, RL1, PP0, DC1, DT1, C1, C2, C3, C28

## General

**Temperature:**  $0^\circ$  to  $55^\circ \text{C}$  operating;  $-40^\circ$  to  $+75^\circ \text{C}$  storage

**Temperature stability:** 2 hours after storage at a constant temp. between  $0^\circ$  and  $+55^\circ \text{C}$  and 30 minutes after analyzer turn-on at the same constant temperature

**EMI compatibility<sup>3</sup>:** CISPR pub. 11 (1985) and FTZ 526/527/79

**Audible noise:**  $< 37.5 \text{ dBA}$  pressure and  $< 5.0$  Bels power (ISO DP7779)

**Power requirements:** 86-127 or 195-253 V RMS; 47-66 Hz; 120 VA max.

**Weight (characteristic):** 13.5 kg (29.8 lb)

**Size (characteristic):** 213 mm (8.4") H  $\times$  366 mm (14.4") W  $\times$  460 mm (18.1") D

**Warranty<sup>2</sup>:** One year limited warranty for materials and workmanship

## Recommended Accessories

**HP 2225A/B/D** ThinkJet Printer

**HP 7440A** ColorPro Plotter

**HP 8444A Opt. 059** Tracking Generator

**HP 82913A** Monitor

**HP 85901A** AC Power Source

**HP 10855A** Broadband Preamp

**HP 11945A** Close-Field Probe Set

**HP 11867A** RF Limiter

**HP 11694A** 50-75 $\Omega$  Matching Transformer

**Rack Slide:** P/N 1494-0060 (for HP 8590A Options 908/909)

## Ordering Information

Ordering Information	Price
<b>HP 8590A Portable RF Spectrum Analyzer</b>	\$7995
<b>Option 001:</b> 75- $\Omega$ Input Impedance	\$0
<b>Option 021:</b> HP-IB Interface	\$600
<b>Option 022:</b> HP-IL Interface	\$600
<b>Option 023:</b> RS232C Interface	\$600
<b>Option 040:</b> Front Panel Cover	\$200
<b>Option 908:</b> Rack Mount Without Handles	\$250
<b>Option 909:</b> Rack Mount With Handles	\$300
<b>Option 910:</b> Extra Operating and Installation Manuals	\$24
<b>Option 915:</b> Support Manual and Extra Operating and Installation Manuals	\$110
<b>Option H18:</b> 1790 MHz Operation	\$350
<b>Option H50:</b> CATV Functions and Front Panel Cover	\$500
<b>Option H51:</b> Close-Field EMC Analyzer	\$560
<b>Option W30:</b> Additional Two Years of HP Service	\$190

<sup>2</sup>Refer to Installation Manual (08590-90003) and Operation Manual (08590-90005) for more information.

# SIGNAL ANALYZERS

## Portable AC Power Source

### Model 85901A

- 200 Watts Continuous
- 115 Vrms or 230 Vrms
- Internal 17AH Battery

- Built-In Charger
- Lightweight and Portable
- Small With Briefcase-style Handle

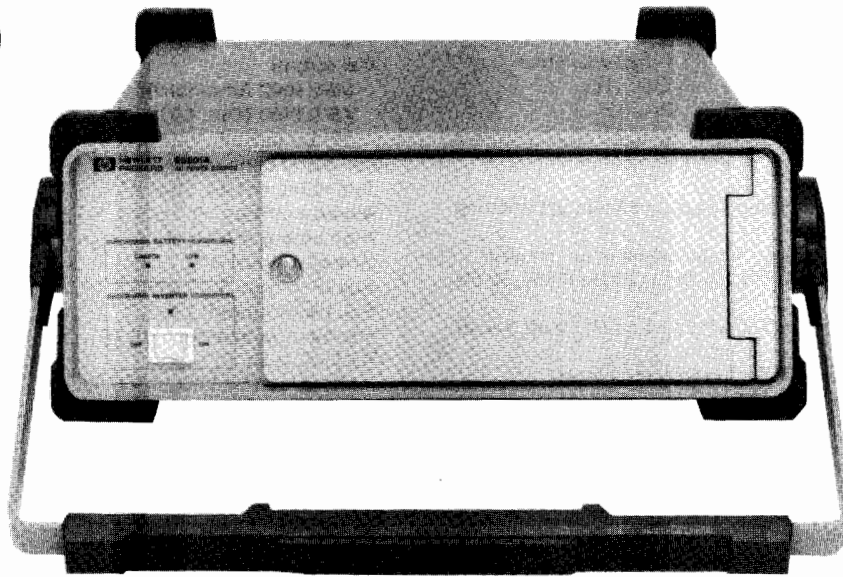

HP 85901A

#### Remote Power Where You Need It

Take the guesswork out of field measurements! Use your test equipment with the HP 85901A Portable AC Power Source to provide the power you need. The power source is small and has briefcase handle that makes it easy to carry. It fits into tight spots, even under an airline seat. You can use it as a stand-alone battery or connect it to an external 12 Vdc source for even longer operating times.

#### Easy to Use

Just plug your piece of test equipment into the HP 85901A AC Power Source and turn them both on. You'll get more than an hour of operation at 100 Watts continuous load. When the battery charge gets low, the power source automatically shuts off. This prevents any deep discharge battery degradation. You can charge the battery in six hours or less.

#### Designed for Reliability

No compromises were made in designing the HP 85901A Portable AC Power Source. Portable and reliable, its gel-cell battery, control circuitry, and charger all fit into a briefcase-sized package similar to our HP 8590A Portable Spectrum Analyzer. The internal battery, in its own rugged box, is accessible through a front panel door and can be replaced by removing just two screws.

#### Built-in Protection

The HP 85901A AC Power Source protects itself and your test equipment. It has over-voltage, short-circuit, and over-load protection on the inverter output. The power source also has over-voltage protection on the inverter input and over-charge and over-discharge protection for the internal battery.

#### Specifications

##### Input

**Inverter Voltage:** 10.8 to 14.5 Vdc

##### Charger

**Voltage:** 90 to 250 Vac Auto Selected

**Frequency:** 47 to 66 Hz

**Power Consumption:** 122 VA Maximum

##### Output

**Voltage:** 135 or 270 Vpeak +5% Rectangular Waveform with 25% Dead Zone (115 or 230 Vrms  $\pm$ 5%)

**Frequency:** 60 Hz  $\pm$ 0.1%, Crystal Ref

**Max. Power:** 200 Watts Continuous

**Connectors:** Two CEE22-V type; female

#### General Specifications

##### Environmental

##### Temperature<sup>1</sup>

**Operating:** 0° to 55°C

**Storage:** With Battery -20° to 40°C, without Battery -40° to 70°C

##### EMI

Conducted VDE 0871 Level B

Radiated VDE 0871 Level B

##### Battery<sup>2</sup>

**Type:** Sealed Lead Acid

**Voltage:** 12 Vdc (Nominal)

**Capacity:** 17 AMP-HR (Nominal)

##### Mechanical (Nominal)

**Dimensions:** 337(W) x 125(H) x 461(D) mm

**Weight:** (With Battery) 14.2 Kg (31.3 lbs.); (Without Battery) 8.0 Kg (17.7 lbs.)

**Shipping Weight:** 16.3 Kg (36.0 lbs.)

#### Ordering Information

**HP 8590A AC Power Source**

**Extra HP Power Cord Adapter**

8120-5220 (For Powering HP Instruments)

**General Purpose Power Cord Adapters**

(For connecting country specific line cords)

European 8120-5210

USA 8120-5211

UK 8120-5212

#### Price

\$980

\$15

\$50

\$50

\$50

<sup>1</sup>Shell life of battery decreases with either extended operation or storage at higher than 40°C.  
<sup>2</sup>Battery cyclic life (charging-discharging) is nominally more than 200 cycles.

# SIGNAL ANALYZERS

## Spectrum Analyzer, 50 kHz to 22 GHz

Model 8592A

137

- Built-in 100 MHz comb generator
- Programmable via HP-IB, RS232C, or HP-IL
- Direct printer and plotter output

- Internal preselection, 2.75 to 22 GHz
- Personalities—Digital Radio and CATV
- Optional 25 GHz operation



HP 8592A

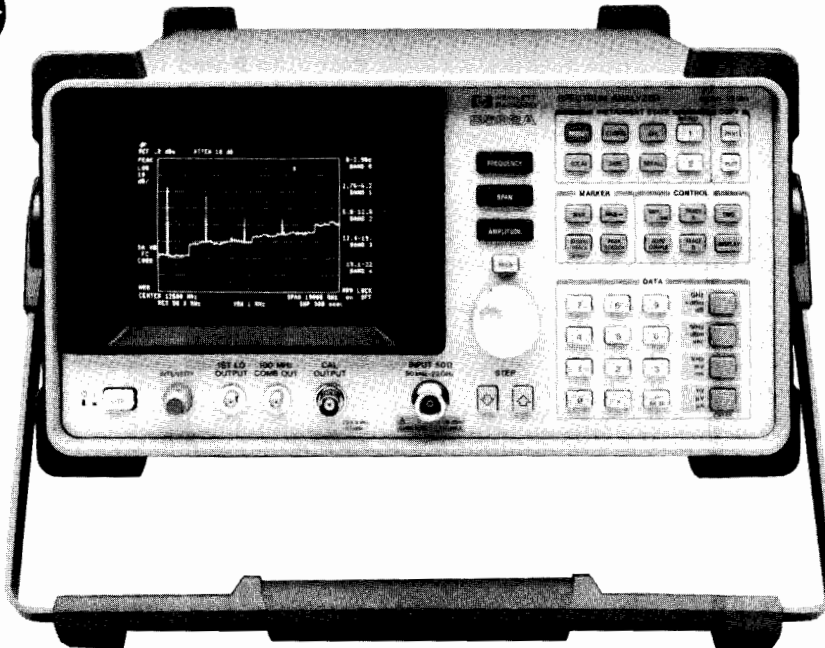

### HP 8592A Portable Microwave Spectrum Analyzer

Never before could you get so much from a portable microwave spectrum analyzer for so small an investment. The HP 8592A is loaded with features and benefits that don't just help you make measurements, but help you make them more easily and more conveniently. The analyzer's wide frequency range (50 kHz to 22 GHz) and amplitude range ( $-109$  dBm to  $+30$  dBm) enable you to make almost any RF and microwave measurement.

An internal preselector eliminates the worry about identifying signals that exist with unpreselected microwave analyzers. A built-in comb generator significantly improves frequency accuracy, especially in the upper frequency range. And if you want programmability, this analyzer's got it. Over 100 different functions are programmable over three different interfaces, allowing you to use a wide variety of computers. Whether your needs are in the field or in the factory, the HP 8592A has so much to offer that you can't afford to be without it.

### It's Easy—Just Push a Button and Turn the Knob

Unquestionably the HP 8592A is one of the easiest spectrum analyzers you'll ever operate whether you are an experienced or a first-time user. Simply use the spectrum analyzer's three main control keys and its data-entry knob or key pad to measure any signal. The analyzer automatically adjusts internal parameters such as resolution bandwidth, video bandwidth, sweep time, IF gain, and input attenuation. You won't waste any time figuring out its operation.

Frequently-used functions are built into dedicated keys, and for additional measurement capability, display-menu softkeys give you nearly 100 more analysis and measurement functions. Easy-to-read control settings surround the graticule, and you can add a 50-character label at the top of the screen to identify traces and to get hardcopy data using HP printers and plotters.

### Powerful New Functions

Many functions previously available only in our high-performance spectrum analyzers are available in our portable analyzers, including

the HP 8592A. With markers, the analyzer will automatically indicate the signal amplitude and frequency, sparing you from visually interpolating between graticule lines. Trace functions offer a multitude of display manipulations. You can store and recall up to nine different analyzer settings and five trace displays in non-volatile memory. The CORRECT TO COMB function can be used to get  $\pm 2.7$  MHz frequency accuracy at 22 GHz, and even better accuracy at lower frequencies and smaller spans. Just temporarily connect the built-in, 100 MHz comb generator, press the CORRECT TO COMB softkey, and use the markers to read the corrected frequency. Special functions perform complex measurements such as percent AM, 99% power bandwidth, and 3- or 6-dB points. The FFT (Fast Fourier Transform) function measures AM sidebands such as power-line hum, even though the sidebands may be less than the minimum resolution bandwidth of 1 kHz.

### Lightweight and Portable

Weighing only 15 kg (33 lb), the HP 8592A does what you need at any location. Its small, compact size and light weight make it ideal for moving between lab benches or transporting to remote sites. Like other portable HP analyzers, it fits under an airplane seat.

### HP 8592A Option H25 25 GHz Operation

Option H25 extends the upper limit of the HP 8592A's frequency range to 25 GHz.

### HP 8592A Option H50 CATV Functions

Similar to HP 8590A Option H50 (see page 134).

### HP 8592A Option H52 Digital Radio

This option adds functions and capability for making easy measurements on digital radio signals. A compare-to-mask function makes a mean power measurement and then compares the result to the mask. The mask can be any of 4 agency masks or of 12 user created masks. Mean power level, recording transient occurrences, and frequency response are also single-button measurements. All tests can be recorded with a hardcopy output.

# SIGNAL ANALYZERS

## Spectrum Analyzer, 50 kHz to 22 GHz (cont'd)

Model 8592A

### Specifications

#### Frequency

**Frequency Range:** 50 kHz - 22 GHz

Band	N	
0	1-	50 kHz - 2.9 GHz
1	1-	2.75 GHz - 6.2 GHz
2	2-	6.0 GHz - 12.8 GHz
3	3-	12.4 GHz - 19.4 GHz
4	4-	19.1 GHz - 22 GHz

**Frequency Readout Accuracy:**  $\pm(2\%$  of span + 5 MHz) for center frequency  $\leq 2.75$  GHz;  $\pm(2\%$  of span + 0.2% of center frequency) for center frequency  $> 2.75$  GHz

**Frequency Readout Accuracy with CORRECT TO COMB function:**

$\pm(2\%$  of separation between signal and nearest reference frequency + 0.5% of span + 0.007% of reference frequency) for spans  $> 17$  MHz and  $\leq 400$  MHz and no change in center frequency or span

#### Frequency Stability

**Drift (nominal):**  $< 60 \cdot N$  kHz / 5 minutes, after 2-hour warm-up and 5 minutes after setting center frequency

**Noise Sidebands:**  $< -65$  dBc/kHz for (50 kHz-6.2 GHz),  $> 30$  kHz offset, 1 kHz RBW, 30 Hz VBW

**Frequency Span Range:** zero span, 0 - 2.9 GHz, 2.75 - 22 GHz

**Readout Accuracy:**  $< \pm 2\%$  of indicated setting for spans  $> 17$  MHz;  $< \pm 5\%$  of indicated setting for spans  $\leq 17$  MHz

**Bandwidth:** -3 dB nominal

**Resolution:** 1 kHz - 3 MHz in 1,3 sequence

**Video:** 30 Hz - 3 MHz in 1.3 sequence

**Sweep Time Range:** 20 ms - 100 s

**Readout Accuracy:**  $< \pm 10\%$  of indicated setting

**Comb Generator:** 100 MHz Fundamental Frequency

**Frequency Accuracy:**  $\pm 0.007\%$

#### Amplitude Accuracy

##### Frequency Response

Absolute Variation:		
$< \pm 2.0$ dB		50 kHz-2.9 GHz
$< \pm 2.0$ dB		2.75-6.2 GHz
$< \pm 3.5$ dB		6.0-12.8 GHz
$< \pm 4.0$ dB		12.4-19.4 GHz
$< \pm 5.0$ dB		19.1-22 GHz

for 10 dB atten., presel peak, Ref. to Cal Out signal, including bandswitching uncertainty

Peak Variation: (Flatness)		
$< \pm 1.0$ dB		50 kHz-2.9 GHz
$< \pm 1.5$ dB		2.75-6.2 GHz
$< \pm 2.0$ dB		6.0-12.8 GHz
$< \pm 2.0$ dB		12.4-19.4 GHz
$< \pm 2.0$ dB		19.1-22 GHz

Ref. to midpoint between highest and lowest peak excursions

**Calibrator Accuracy:** 299.9 MHz  $\pm 300$  kHz; -20 dBm  $\pm 1$  dB

**Reference Level Setting:**  $< \pm 1.5$  dB for +30 to -120 dBm (0-60 dB atten.);  $< \pm 1.0$  dB for 0 to -120 dBm (10 dB atten.);  $< \pm 0.5$  dB for 0 to -59 dBm (10 dB atten.)

**Resolution BW Switching:**  $< \pm 0.25$  dB for 3 kHz to 3 MHz

**Log Scale Switching:** No significant error for 1-20 dB/div. scale range

**Log Scale Fidelity:**  $< \pm 0.1$  dB/dB change over 70 dB range;  $\pm 0.75$  dB max. over -60 dB range from Ref. Level

**Linear Accuracy:**  $< \pm 3\%$  of Reference Level setting

**Input Atten Step Accuracy:**  $< \pm 0.5$  dB;  $\leq 60$  dB atten. (@ 300 MHz)<sup>2</sup>  $< \pm 0.75$  dB;  $\leq 70$  dB atten.

#### General Characteristics

**Temperature:** 0 to +55 C operating; -40 to +75 C storage

**Temperature Stability:** 2 hours after storage at a constant temperature after turn-on at the same constant temperature.

**EMI Compatibility:** CISPR pub. 11(1985) and FTZ 526/527/79

**Audible Noise:**  $< 37.5$  dBA pressure and  $< 5.0$  Bels power (ISO DP7779)

**Power Requirements:** 86-127 or 195-253 V RMS; 47-66 Hz;  $< 160$  VA

**Weight/Size:** 15 kg (33 lbs) 213mm(8.4")H X 366mm(14.4")W X 460mm(18.1")D

**Warranty:** One year limited warranty for materials and workmanship

#### Amplitude

**Amplitude Range:** -109 dBm to +30 dBm

**Readout Resolution (with Markers):**  $< 0.05$  dB for log scale; 0.05% of ref. level for linear scale

**Amplitude Units:** dBm, dBmV, dBuV, volts, and watts

**Amplitude Scale:**  $\log(1-20$  dB/div. in 1 dB steps) and linear

#### Maximum Safe Input Level

**Average Continuous Power:** +30 dBm (1 watt, 7.1Vrms)

**DC:** 0 volts

**Peak Pulse Power:** +50 dBm (100W) for  $< 10$  usec pulse width,  $< 1\%$  duty cycle

**Maximum Dynamic Range:** 70 dB on-screen viewing; 70 dB signal-to-distortion

#### Displayed Average Noise:

-90 dBm - 0.00038% of center frequency	(50 kHz - 5 MHz)
-109 dBm	(5 MHz-2.9 GHz)
-105 dBm	(2.75-6.2 GHz)
-99 dBm	(6.0-12.8 GHz)
-92 dBm	(12.4-19.4 GHz)
-87 dBm	(19.1-22 GHz)

for 0 dB atten., 1 kHz RBW, 30 Hz VBW

**Gain Compression:**  $< 0.5$  dB for -4 dBm total power at input mixer

#### Spurious Responses

**Second Harmonic:**  $< -70$  dBc (10 MHz-2.9 GHz);  $< -100$  dBc<sup>1</sup> ( $> 2.75$  GHz for -40 dBm total power at input mixer)

**Third Order Intermod.:**  $< -70$  dBc (10 MHz-22 GHz) for two -30 dBm signals at the input mixer with  $> 50$  kHz spacing

**Residual Responses:**  $< -95$  dBm (5 MHz-2.9 GHz);  $< -90$  dBm (2.75-6.2 GHz) for 0 dB atten. and 50  $\Omega$  termination on input

**Image, Multiple, and Out-of-Band Responses:**  $< -70$  dBc (50 kHz-2.9 GHz) applied freq.  $\leq 10$  GHz;  $< -70$  dBc (2.75 GHz-22 GHz) applied freq.  $\leq 18$  GHz;  $< -60$  dBc (2.75 GHz-22 GHz) applied freq.  $\leq 22$  GHz

#### Input/Output Characteristics

##### Front Panel Connectors

**Input:** 50  $\Omega$  Type N

**Cal Output:** 50  $\Omega$  BNC, -20 dBm, 299.9 MHz

**1st LO Output:** 50  $\Omega$  SMA, 3.0 - 6.66 GHz

**100 MHz Comb Out:** 50  $\Omega$  SMA, 100 MHz  $\pm 0.007\%$

##### Rear Panel Connectors

**Aux Video Out:** 50  $\Omega$  BNC, 0-1 V

**Monitor Out:** 50  $\Omega$  BNC, NTSC Format, 19.2 kHz horizontal synch.

**High Sweep In/Out:** BNC, high TTL = sweep, low TTL = retract

**Sweep Output:** BNC, 5K  $\Omega$ , 0 to +10 V ramp

**Aux IF Output:** 50  $\Omega$  BNC, -10 to -60 dBm, 21.4 MHz

**Ext. Trigger Input:** BNC, TTL levels, positive edge trigger

**Interface Connector:** HP-IB(Opt. 021), HP-IL(Opt. 022), RS-232(Opt. 023)

**HP-IB Codes:** SH1, AH1, T6, L4, SR1, RL1, PP0, DC1, C1, C2, C3, & C28

#### Recommended Accessories

**HP 2225A/B/D** Thinkjet Printer

**HP 11694A** 50-75  $\Omega$  Matching Transformer

**HP 85901A** Portable Battery Pack

#### Ordering Information

**HP 8592A** Portable Microwave Spectrum Analyzer \$17,000

**Option 021:** HP-IB Interface \$600

**Option 022:** HP-IL Interface \$600

**Option 023:** RS232C Interface \$600

**Option 040:** Front Panel Cover \$200

**Option 908:** Rack Mount without Handles \$250

**Option 909:** Rack Mount with Handles \$300

**Option 910:** Extra Operating and Installation Manuals \$69

**Option 915:** Support Manual and Extra Operating and Installation Manuals \$64

**Option H25:** 25 GHz upper frequency extension \$2,500

**Option H50:** CATV personality \$590

**Option H52:** Digital radio personality \$750

**Option K08:** Soft Carrying Case \$250

**Option W30:** Additional Two Years of HP Service \$399

<sup>1</sup>May be below the displayed average noise.

<sup>2</sup>Refer to Installation Manual (08592-90003) and Operation Manual (08592-90005) for more information.

# SIGNAL ANALYZERS

## Spectrum Analyzers, 1 kHz to 325 GHz

Models 8561A, 8562A/B

139

- Synthesized tuning
- Frequency counter
- Factory adjusted preselector
- AM/FM demodulators
- Portable AC Power Source

- Mass Memory Module
- Test and Adjustment Module
- One Year Calibration Cycle
- MIL-T-28800C Rugged
- Lightweight and Portable

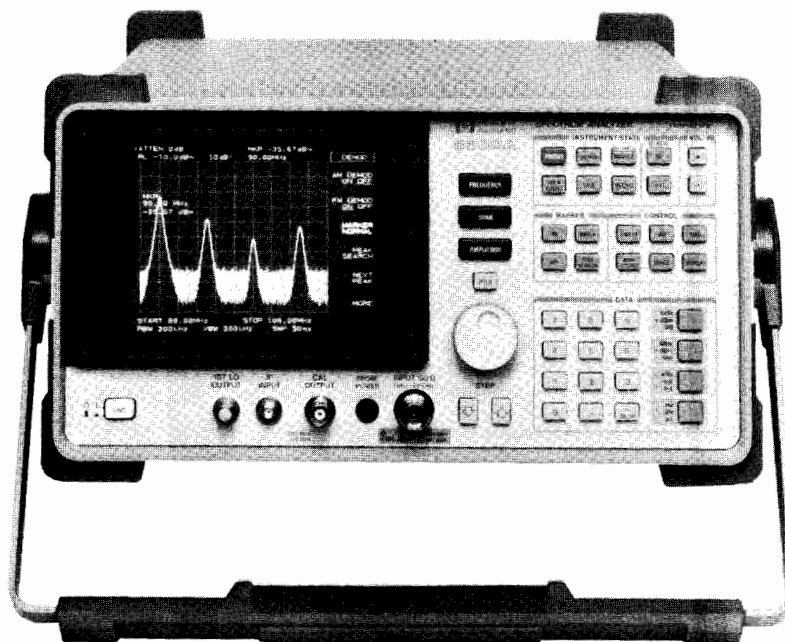

HP 8562A

The HP 8561A and 8562A/B spectrum analyzers put high-performance, synthesized technology into a lightweight, portable package. Ruggedized to military specifications, these analyzers are engineered to survive harsh field conditions. They perform a wide variety of jobs from communication-system and component testing to radar and millimeter measurements. These models are packed with advanced HP technology and HP-IB is standard.

### The Choice is Yours

The HP 8562A has a frequency range of 1 kHz to 22 GHz with microwave preselection that can be extended up to 26.5 GHz with option 026. External mixers extend the range to 325 GHz. The HP 8562B covers the same frequency range as the HP 8562A but without preselection. Satisfy your RF measurement needs by using the economical HP 8561A which has a frequency range of 1 kHz to 6.5 GHz with preselection from 2.75 GHz to 6.5 GHz.

### Use Them Anywhere

The compact size and shape of the HP 8561A and 8562A/B makes them easy to transport to remote sites. They even slide under an airplane seat. Of course, these portable analyzers also make good sense in the laboratory and on the production line. They fit easily onto crowded work benches or instrument racks. And if there's no room on your bench, they will operate upright on the floor.

### Rugged and Dependable

The HP 8561A and 8562A/B are built to perform in adverse conditions. They have been ruggedized to meet MIL-T-28800C requirements for temperature, pulse shock, and transit drop. These analyzers withstand 30 g's of shock, so there is no need to worry if they are knocked around. Climate isn't a problem either—these models warm up in five minutes in ambient temperatures from -10°C to +55°C.

A removable impact cover fits over the front panel for maximum protection during transit. Inside the cover there are several convenient compartments for small accessories like adapters, BNC cables, and external mixers. You'll find a handy, pocket-size operating guide there too.

### Ease of Use

For over 20 years, Hewlett-Packard has been designing spectrum analyzers that are easy for both new and experienced operators to use. The HP 8561A and 8562A/B represent the fifth generation of spectrum analyzers. Their front panels are clean, uncluttered, and inviting to use. Dedicated keys with large, easy-to-read lettering provide the basic tune, zoom, and measure steps. They allow fast access to frequently used functions such as markers, save/recall, and direct printer/plotter output. You may never require more, but if you need it, additional capacity is available using softkeys.

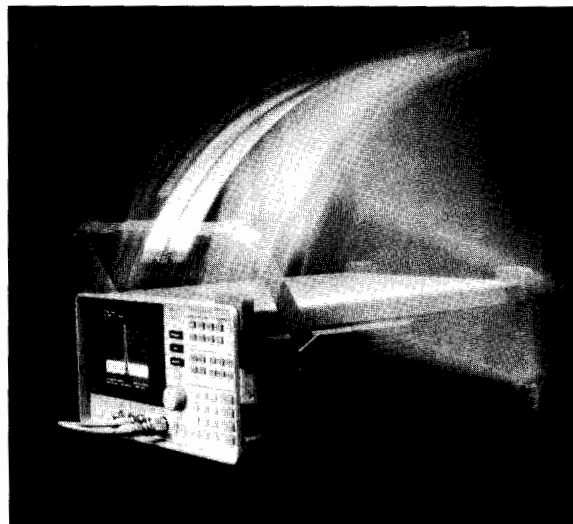

The Portable Spectrum Analyzers meet MIL-T-28800C standards for ruggedness.



# SIGNAL ANALYZERS

## Spectrum Analyzers, 1 kHz to 325 GHz (cont'd)

### Models 8561A, 8562A/B



#### Communication Measurements

The portable spectrum analyzers are ideal tools for bench measurements and field maintenance of digital radios, CATV/Broadcast measurements, terrestrial point-to-point microwave link maintenance, troubleshooting the interference problems of devices and systems, and measuring low level signals in the presence of high level ambients. Eliminate external mixers to analyze K-band signals by using the HP 8562A/Option 026, preselected to 26.5 GHz. Use the HP 8561A to measure the higher harmonics of mobile/cellular radios and other RF devices without the added expense of buying a microwave spectrum analyzer. The built-in AM/FM demodulator/speaker indicates over-modulation, clipping, synch buzz, and troublesome "birdies." The built-in frequency counter accurately measures the frequency of the carrier. Direct carrier-to-noise measurement can be made with delta markers and noise normalization. Use the MAX HOLD function to capture elusive transient signals.

#### Component Testing

Fast, accurate, synthesized tuning allows high-speed measurement of mixing-product suppression. Excellent intermodulation distortion and sensitivity improve dynamic range for distortion measurements.

The 8562A/B are ideal choices for stimulus response measurements. They provide up to 118 dB dynamic range and offset tracking capability when synthesized sources are used for stepped distortion and stepped conversion-loss measurements.

The HP 8561A and 8562A/B spectrum analyzers are valuable tools for electromagnetic compatibility (EMC) design and troubleshooting. In conjunction with the HP 11945A Close-Field Probe Set, these analyzers can be used to localize sources of high emissions and to evaluate shielding effectiveness.

#### Radar Measurements

Some analyzers with digital displays have difficulty capturing short-duration radar pulses. With such analyzers it is not certain whether variations from sweep to sweep are due to equipment under test or to the analyzer itself. The HP 8561A and 8562A/B have a digitization uncertainty specification of  $\pm 1.25$  dB and typical repeatability of 0.2 dB. Users can be sure that observed amplitude variations—those caused by magnetron moding, misfiring, or rotary joint problems—are due to the equipment under test, not the analyzer.

#### Millimeter Measurements

The HP 8562A/B, used with the HP 11970 series of external mixers (18 to 110 GHz), offer excellent specified performance for sensitivity, flatness, and absolute amplitude accuracy. Each mixer is individually calibrated and provided with conversion loss data, which can be entered into the analyzer directly. No costly LO amplifier is

required. These analyzers also supply the bias required for other external mixers operating up to 325 GHz.

#### Automatic Measurements

The HP 8561A and 8562A/B reflect HP's commitment to automated testing. Synthesized performance, low temperature rise, and an 8.75-inch rackmount option make the HP portable spectrum analyzers ideal for automatic measurements. Use them in the field and factory as your standard spectrum analyzers to save development time, documentation effort, and internal training. Their one-year calibration interval reduces downtime, and the continuously self-aligning IF ensures measurements you can rely on.

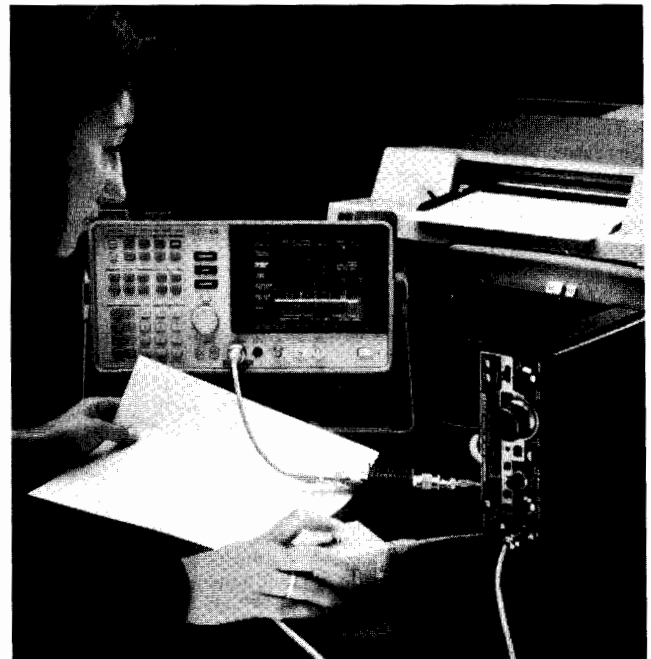

The compact size and direct printer/plotter output of the portable spectrum analyzers are convenient for bench and production applications.



### Mass Memory Module

A companion Mass Memory Module, the HP 85620A, plugs onto the rear panel. Use 128K bytes of built-in, battery-backed RAM of the HP 85620A to store at least 10 downloadable programs (DLPs) or more than 100 traces. This module has the capability to generate "smart" limit lines to track the analyzers' settings and automatically adjust to the changes. With the built-in clock, auto-save, and auto-execute capabilities of the Mass Memory Module, the HP 8561A and 8562A/B can automatically make measurements at specified times or when specific frequency/amplitude criteria are met.



The HP 85620A Mass Memory Module provides the analyzers with built-in computer capability.

### Test and Adjustment Module

The HP 85629B Test and Adjustment Module or "TAM" is a new approach to servicing spectrum analyzers. It plugs onto the rear panel of the HP 8561A and 8562A/B and performs high level diagnostics, self tests, and much more. The TAM is a must for anyone doing his own repair. And one module can service multiple spectrum analyzers.

#### Detect Fault

Automatic Fault Isolation makes functionality checks of the CPU, ADC, IF, LO, and RF sections. Just connect the CAL OUTPUT, press a few keys, and many failures can be isolated to a single board within minutes. No external test equipment is required.

#### Find Fault

Manual probe troubleshooting using the TAM's 8-input voltmeter and the twenty-six 16-pin test connectors spread throughout the analyzer lets you make more than 1000 measurements, isolating the faulty board or component quickly, without racks of equipment.

#### Readjustment

Once you've repaired the analyzer, readjustment is fast and accurate because the TAM controls both internal analyzer settings and external test equipment. For example, the TAM performs the frequency-response adjustment in 10 minutes. The same adjustment performed manually takes an hour. After readjustment, use the TAM's functional tests for immediate confidence that the repair was completed successfully.

### Specifications

#### Frequency

**Frequency Range:** 1 kHz to 6.5 GHz (HP 8561A)  
1 kHz to 22 GHz (HP 8562A/B)  
1 kHz to 26.5 GHz (Opt. 026)  
(325 GHz with external mixers)

Harmonic mode (n)	Center frequency
1	1 kHz - 2.9 GHz
1	2.75 GHz - 6.46 GHz
2	5.86 GHz - 13.0 GHz
3	12.4 GHz - 19.7 GHz
4	19.1 GHz - 22.0 GHz
4	19 GHz - 26.5 GHz (Opt. 026)

**Frequency Readout Accuracy:** Start, Center, Stop, or Marker:  $\pm(\text{freq readout} \times \text{freq reference accuracy} + 5\% \text{ of span} + 15\% \text{ of res BW} + 250 \text{ Hz})$

**Counter Resolution:** 10 Hz - 1 MHz (selectable)

**Counter Accuracy:**  $\pm(\text{marker freq} \times \text{freq reference accuracy} + 50 \text{ Hz} \times n + 2 \text{ LSD})$  for  $S/N \geq 25 \text{ dB}$

**Delta Counter Accuracy:**  $\pm(\text{delta freq} \times \text{freq reference accuracy} + 100 \text{ Hz} \times n + 2 \text{ LSD})$  for  $S/N \geq 25 \text{ dB}$

**Frequency Reference Accuracy:**  $<4 \times 10^{-6}/\text{year}$  (includes aging, temperature drift, settability)

#### Frequency Stability

**Residual FM:**  $<50 \text{ Hz} \times n \text{ p-p}$  in 0.1 sec (zero span)

#### Spectral Purity

**Noise Sidebands:**  $<(-100 + 20 \text{ Log } n) \text{ dBc/Hz}$  at 30 kHz offset

#### Frequency Span

**Range:** 0 Hz, 2.5 kHz  $\times n$  to 19.25 GHz  
2.5 kHz  $\times n$  to 23.75 GHz (Opt. 026)

**Accuracy:**  $<5\%$

#### Resolution Bandwidth (-3 dB)

**Range:** 100 Hz - 1 MHz in a 1,3,10 sequence and 2 MHz

**Accuracy:**  $\pm 30\%$  100 Hz,  $\pm 10\%$  300 Hz to 300 kHz,  $\pm 25\%$  1 MHz and 2 MHz

**Selectivity:**  $<15:1$  ( $-60 \text{ dB}/-3 \text{ dB}$ )

**Shape:** Synchronously-tuned, 4-pole filter

#### Video Bandwidth

**Range:** 1 Hz - 3 MHz in a 1,3,10 sequence

#### Amplitude Range

**Amplitude Range:** +30 dBm to displayed average noise level

#### Maximum Safe Input

**Average Continuous Power:** +30 dBm (1 Watt) with input atten  $\geq 10 \text{ dB}$

**Peak Pulse Power:** +50 dBm (100 Watt) with input atten  $\geq 30 \text{ dB}$  for  $<10 \text{ usec}$  pulse width and  $<1\%$  duty cycle

**DC:** 0 Volts

#### Display Range

**Display:**  $10 \times 10$  Division Graticule

**Calibration:** Log 10,5,2 and 1 dB per division, Linear 10% of Reference Level/division

**Reference Level Range:** Log, -120 to +30 dBm in 0.1 dB steps; linear 2.2 uVolts to 7.07 Volts in 1% steps

**Input Attenuation Range:** 0 to 70 dB in 10 dB steps

#### Dynamic Range

##### Maximum Dynamic Range

**Compression to Noise:** 118 dB

##### Signal to Distortion:

**Harmonic:**  $\geq 2.9 \text{ GHz}$ : 100 dB (77.5 dB unpreselected),  $<2.9 \text{ GHz}$ : 77.5 dB

**Intermodulation:** 86 dB

**Displayed Average Noise Level:** With 100 Hz res BW, 0 dB Input Attenuator, 1 Hz video filter: -90 dBm, 10 kHz; -100 dBm, 100 kHz; -120 dBm, 1 MHz to 2.9 GHz; -121 dBm, 2.75 GHz to 6.46 GHz; -110 dBm, 5.86 GHz to 13.0 GHz; -105 dBm, 12.4 GHz to 19.7 GHz; -100 dBm, 19.1 GHz to 22.0 GHz; -100 dBm, 19.1 GHz to 26.5 GHz (Option 026)

**1 dB Gain Compression:** -3 dBm at input mixer above 10 MHz

**Spurious Responses:** Signals generated by the analyzer due to input signals. For mixer level  $<-40 \text{ dBm}$ : all harmonic and intermodulation distortion  $>60 \text{ dB}^1$  below input signal.

**Second Harmonic Distortion:** for mixer level  $=-40 \text{ dBm}$ :  $<-72 \text{ dBc}$ , 10 MHz to 2.9 GHz;  $<-60 \text{ dBc}$  (8562B only) above 2.75 GHz. For mixer level  $=-10 \text{ dBm}$ :  $<-100 \text{ dBc}$  (8562B unspecified) above 2.75 GHz.

<sup>1</sup>to 6.46 GHz 8561A/8562A, to 2.9 GHz 8562B

# SIGNAL ANALYZERS

## Spectrum Analyzers, 1 kHz to 325 GHz (cont'd)

Models 8561A, 8562A/B

**Third Order Intermodulation Distortion:** for mixer level  $< -30$  dBm:  $< -70$  dBc, 10 MHz to 2.9 GHz;  $< -75$  dBc above 2.75 GHz.

**Image, Multiple, and Out-of-Band Responses:**  $< -70$  dBc, 10 MHz - 22 GHz (8562B unspecified);  $< -60$  dBc, 10 MHz - 22 GHz (8562B unspecified)

**Residual Responses:** No signal at input, 0 dB input atten.  $< -90$  dBm, 200 kHz to 6.46 GHz.

### Amplitude Accuracy

**Frequency Response (flatness):** 10 dB attenuation.

Frequency Range	8561A/8562A	8562B
1 kHz - 2.9 GHz	$\pm 1.0$ dB	$\pm 1.0$ dB
2.75 - 6.46 GHz	$\pm 1.5$ dB	$\pm 1.0$ dB
5.86 - 13.0 GHz	$\pm 2.0$ dB	$\pm 1.5$ dB
12.4 - 19.7 GHz	$\pm 3.0$ dB	$\pm 1.5$ dB
19.1 - 22.0 GHz	$\pm 3.0$ dB	$\pm 2.0$ dB
19.1 - 26.5 GHz (Opt. 026)	$\pm 3.0$ dB	

**Calibrator Accuracy:**  $\pm 0.3$  dB

**IF Gain Uncertainty:**  $\pm 1$  dB for 0 dBm to  $-80$  dBm reference level  
**Scale Fidelity:** 0.4 dB/4 dB to a maximum of  $\pm 1.5$  dB over 0 to 90 dB range. Linear:  $\pm 3\%$  of Reference Level

**Input Attenuator Switching Accuracy:** With 20 to 70 dB settings referenced to 10 dB. 1kHz - 2.9 GHz  $\pm 0.6$  dB/10 dB step, 1.8 dB max  
**Resolution Bandwidth Switching Uncertainty:**  $\pm 0.5$  dB reference to 300 kHz BW

**Pulse Digitization Uncertainty:** Pulse response mode, PRF  $> 720$ /sweep time. Log (peak to peak): 1.25 (RBW  $\leq 1$  MHz), 3 dB (RBW = 2 MHz) dB; Linear (peak to peak): 4% of ref level, (RBW  $\leq 1$  MHz), 12% of ref level, nominal standard deviation: 0.2 dB

### Sweep

#### Sweep Time

**Range:** 50 usec to 60 sec for zero span, 50 msec to 100 sec for span  $\geq 2.5$  kHz

**Sweep Trigger:** Free Run, Line, Single, Video, External

### Demodulation

**Modulation Type:** AM and FM

**Audio Output:** Speaker and phone jack with volume control

### Inputs & Outputs

#### Front Panel Connectors

**RF Input:** Precision type N female, nominal impedance 50  $\Omega$

**VSWR:**  $< 1.5:1$  for  $< 2.9$  GHz and  $\geq 10$  dB Input Attenuation (nominal);  $< 2.3:1$  for  $> 2.9$  GHz and  $\geq 10$  dB Input Attenuation (nominal);  $< 3.0:1$  for 0 dB Input Attenuation (nominal)

**LO Emission Level (average):** With 10 dB input atten.  $< -80$  dBm (8561A/8562A nominal),  $< -10$  dBm (8562B nominal)

**Second IF Input:** SMA female, nominal frequency: 310.7 MHz; NF: 7 dB (nominal); Gain Compression:  $-20$  dBm (nominal)

**First LO Output:** SMA female, nominal impedance: 50 ohm; nominal frequency range: 3.0000 - 6.8107 GHz; amplitude  $+16.5$  dBm  $\pm 2$  dB ( $20^\circ$  -  $30^\circ$  C)

**Calibrator Output:** BNC female, nominal impedance: 50 ohm

#### Rear Panel Connectors

**10 MHz Reference (Input/Output):** BNC female, nominal impedance: 50 ohm; nominal input range:  $-2$  to  $+10$  dBm

**Video Output:** BNC female, nominal impedance: 50 ohms (DC coupled)

**LO Sweep/0.5 V per GHz Output:** Shared BNC female, nominal impedance: 2K ohm (DC coupled); nominal LO sweep output: 0 to  $+10$  V (no load)

**External Trigger Input:** BNC female, nominal impedance:  $> 10$  K ohm; trigger level: rising edge of TTL level

**HP-IB:** Interface Functions: SH1, AH1, T6, L4, SR1, RL1, PPO, DC1, DT1, CO, E1. Direct plotter outputs: HP 7225A, 7440A, 7470A, 7475A, 7550A, 9872A/B/C/T. Printer: HP 3630A Paintjet; HP 2225A Thinkjet; other printers with IEEE 488 interface may work.

### General Specifications

#### Environmental

**Military Specification:** Meets MIL-T-28800C, Type III, Class 3, Style C.

**Calibration Interval:** 1 year

**Warmup:** 5 minutes from ambient conditions

**Temperature:** Operating:  $-10^\circ$  to  $+55^\circ$  C. Non-operating:  $-62^\circ$  to  $+85^\circ$  C

**Humidity:** 95% @  $40^\circ$  C for 5 days

**Altitude:** Operating: 15,000 ft. Non-operating: 50,000 ft.

**Rain Resistance:** Drip-proof at 16 liters/hour/square foot

**Vibration:** 5-15 Hz: 0.059 inch p-p excursion; 15-25 Hz: 0.039 inch p-p excursion; 25-55 Hz: 0.020 inch p-p excursion

**Pulse Shock:** half sine: 30 g's for 11 ms duration

**Transit Drop:** 8-inch drop on 6 faces and 8 corners

**Electromagnetic Compatibility:** Conducted and radiated interference is in compliance with CISPR publication 11 (1985) and FTZ 526/527/79. Meets MIL-STD-461B, Part 4, with the exceptions shown below.

**Conducted Emissions.** CE01 (Narrowband): 1 kHz to 15 kHz only. CE03 (Narrowband): Full limits. CE03 (Broadband): 20 dB relaxation from 15 kHz to 100 kHz.

**Conducted Susceptibility.** CS01: Full limits (limited to 36 Hz for HP 8562B). CS02: Full limits. CS06: Full limits.

**Radiated Emissions.** RE01: 15 dB relaxation to 28 kHz, and exceptioned from 28 kHz to 50 kHz. RE02: Full limits  $< 1$  GHz.

**Radiated Susceptibility.** RS01: Full limits. RS02: Exceptioned. RS03: Limited to 1 V/meter from 14 kHz to 1 GHz, with 20 dB relaxation at IF frequencies.

#### Power Requirements

**115 VAC operation:** Voltage: 90 - 140 V RMS; Current: 3.2 A RMS MAX; Frequency: 47 - 440 Hz

**230 VAC operation:** Voltage: 180 - 250 V RMS; Current: 1.8 A RMS Max; Frequency: 47 - 66 Hz

**Maximum Power Dissipation:** 180 Watts

**Nominal Audible Noise:** 5.0 Bels power at room temperature (ISO DP7779)

**Nominal Weight:** 8561A/8562A: 20 kg (44 lbs.); 8562B: 19 kg (41.8 lbs.)

**Dimensions:** 163 mm high  $\times$  325 mm wide  $\times$  427 mm deep (nominal, without handle, feet, or cover).

#### Ordering Information

	Price
HP 8561A Spectrum Analyzer	\$28,000
HP 8562A Spectrum Analyzer	\$35,000
HP 8562B Spectrum Analyzer	\$31,000
Option 001: Second IF Output	\$800
Option 026: Extended Frequency Coverage (HP 8562A only)	\$3,000
Option 908: Rackmount Kit with flanges	\$250
Option 909: Rackmount Kit with handles and flanges	\$300
Option 910: Extra Manual Set	\$165
Option 915: Technical Reference Manual	\$275
Option 916: Extra Pocket Operating Guide (English)	\$15
Option K08: Soft Carrying Case	\$245
HP 8561A Option W30:	
Additional Two Years of HP Service	\$560
HP 8562A Option W30:	\$700
2 additional years Return-to-HP Service	
HP 8562B Option W30:	\$620
2 additional years Return-to-HP Service	
HP 85620A Mass Memory Module	\$2,000
HP 85629B Test and Adjustment Module	\$2,000
HP 85700A 32 K Byte RAM Memory Card	\$95
HP 85710A Digital Radio Personality	
HP 85901A Portable AC Power Source	\$980
Product Support Kit P/N 08562-60021	
HP 8561A and 8562A/B +22C 1 year Return-to-HP CAL	
HP 8561A and 8562A/B +22X 1 year Return-to-HP MIL-STD CAL	

# SIGNAL ANALYZERS

## Harmonic Mixers, 18 to 110 GHz

### Models 11970 Series and 11971 Series

- Low conversion loss
- Individually amplitude calibrated

- No bias or tuning adjustments
- High 100 mW safe input level

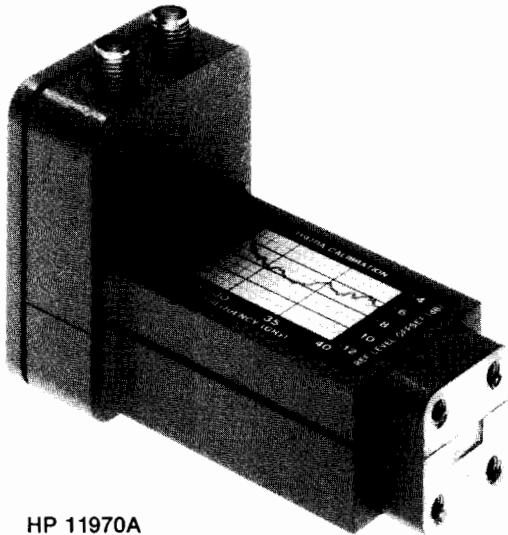

HP 11970A

#### HP 11970 and 11971: Exceptional Performance

The HP 11970 and 11971 series of waveguide Mixers are general purpose harmonic mixers employing state-of-the-art, dual diode design to achieve flat frequency response and low conversion loss. These mixers are available in six bands from 18 GHz through 110 GHz.

#### Easy to Use

The excellent frequency response and low conversion loss of the HP 11970 and 11971 series Harmonic Mixers are achieved without external dc bias or tuning stubs. Manual operation as well as computer controlled operation of hardware is simplified because no mixer bias or tuning adjustments are required.

#### Harmonic Mixer Selection Guide

HP Spectrum Analyzer	HP Compatible Mixer Series	HP LO Drive Amplifier
8562A/B	11970	Not required
8566B	11970	11975A <sup>2</sup>
70000	11970	70907A

#### Extends Spectrum Analysis Frequency

The HP 11970 and 11971 series Harmonic Mixers extend the frequency range of the HP 8562A/B, 8566B, and 70000 series microwave Spectrum Analyzer. The HP 11975A Amplifier provides the optimum LO power to the mixers when the HP 8566B Spectrum Analyzer is used.

#### HP 11970 and 11971 Series Specifications

- IF range:** DC to 1300 MHz
- LO amplitude range:** +14 to +18 dBm, +16 dBm optimum
- Calibration accuracy:** ±2.0dB with optimum LO amplitude
- Typical RF input SWR:** <2.2:1
- Bias requirements:** None
- Typical odd order harmonic suppression:** >20dB
- Maximum CW RF input level:** +20 dBm (100 mW)
- Maximum peak pulse power:** 24 dBm (250 mW) with <1 usec pulse (avg. Power: +20 dBm)
- Environmental:** Meets MIL-T-28800C, Type III, Class 3, Style C.
- IF/LO connectors:** SMA female
- LO Range:** HP 11970 Series, 3.0 to 6.1 GHz  
HP 11971 Series, 2.0 to 4.5 GHz

HP Model	Frequency Range	LO Harm. Number	Conversion Loss (dB)	Noise Level (dB) 1kHz (RBW)	Freq. <sup>1</sup> Response (dB)	Gain Compression (dBm)
11970K	18-26.5	6+	24	-110	±1.9	-3
11970A	26.5-40	8+	26	-108	±1.9	-5
11970Q	33-50	10+	28	-104	±1.9	-7
11970U	40-60	10+	28	-104	±1.9	-7
11970V	50-75	14+	40	-92	±2.1	-3
11970W	75-110	18+	46	-85	±3.0	-1
11971K	18-26.5	6+	24	-110	±2.1	-3
11971A	26.5-40	10+	28	-106	±2.1	-7
11971Q	33-50	16+	40	-92	±2.3	-3
11971U	40-60	16+	40	-92	±2.3	-3
11971V	50-75 <sup>2</sup>	16+	42	-89	±2.5	-3

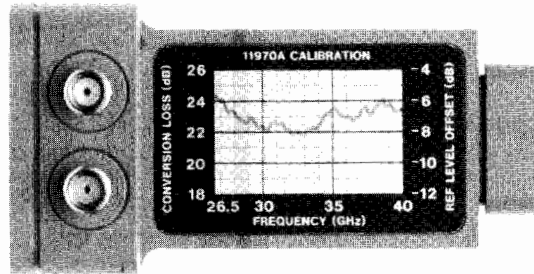

HP 11970A

#### Ordering Information

HP 11970K 18 to 26.5 GHz Mixer	Price	\$1650
HP 11970A 26.5 to 40 GHz Mixer		\$1700
HP 11970Q 33 to 50 GHz Mixer		\$1850
HP 11970T 18 to 40 GHz Mixers and Case		\$3405
Opt 001: Adds 40 to 60 GHz Mixer to 11970T	add	\$2050
Opt 002: Adds 33 to 50 GHz Mixer to 11970T	add	\$1850
HP 11970U 40 to 60 GHz Mixer		\$2050
HP 11970V 50 to 75 GHz Mixer		\$2500
HP 11970W 75 to 110 GHz Mixer		\$2850
HP 11971K 18 to 26.5 GHz		\$1650
HP 11971A 26.5 to 40 GHz		\$1700
HP 11971Q 33 to 50 GHz		\$1850
HP 11971T 18 to 40 GHz Mixer Set and Case		\$3405
HP 11971U 40 to 60 GHz		\$2050
HP 11971V 50 to 75 GHz		\$2500
Opt 009: Mixer Connection Set contains three 1 meter low-loss SMA cables, a wrench, and an allen driver for use with any of the mixers listed above. Space is provided in carrying case for cables and tools.		\$450
HP 11969A Carrying Case for one to five mixers, SMA cables and tools		\$580
HP 11975A 2 to 8 GHz Amplifier		\$4285

<sup>1</sup>Frequency response of the mixers is reduced by 1 dB for LO range of 14 to 18 dBm.  
<sup>2</sup>The HP 11975A Amplifier can be used to provide sufficient LO power to the mixers.

# SIGNAL ANALYZERS

## Spectrum Analyzer Accessories

Models 8406A, 8447 Series, 8449, 8721A, 11693A, 11694A, 11867A, 11940A, 11947A, 11975A, 85901A

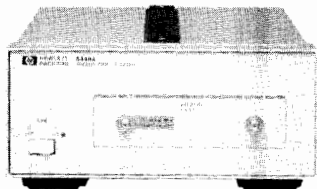

HP 8449A

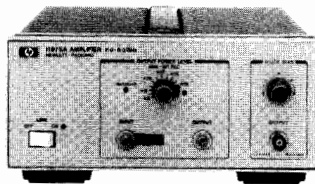

HP 11975A

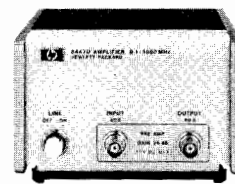

HP 8447 Series



HP 11947A



HP 11693A



HP 11867A



HP 11694A

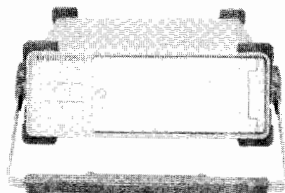

HP 85901A



HP 11940A



HP 11940A

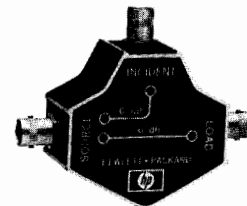

HP 8721A

### HP 85901A AC Power Source

Hewlett-Packard's first portable battery pack for test instruments provides 200 watts of continuous power using an internal battery, external battery, or other 12 Vdc source. See page 136.

### HP 8447 Series Amplifier (9 kHz to 1300 MHz)

These amplifiers feature low noise and wide bandwidths. They are ideal for improving spectrum analyzer sensitivity and noise figure while providing input isolation. Broad frequency coverage, flat frequency response, and low distortion assure accurate measurements. See page 409.

### HP 11975A Amplifier (2 to 8 GHz)

Used in stimulus-response systems, this amplifier allows a wide variety of sources to be leveled to  $\pm 1$  dB and amplitude calibrated up to +16 dBm. As a preamplifier, its small signal gain varies between 9 and 15 dB depending upon frequency. For measurements above 18 GHz, it amplifies the local oscillator signal from a spectrum or network analyzer. See page 407.

### HP 8449A Preamplifier (2 to 22 GHz)

This high gain, low noise preamplifier increases the sensitivity of any microwave spectrum analyzer for detection and analysis of very low level signals. The improved sensitivity can also dramatically reduce measurement time. See page 407.

### HP 11867A and 11693A Limiters

Protect the input circuits of spectrum analyzers, counters, amplifiers, and other instruments from high power levels with minimal effect on measurement performance. The HP 11867A RF limiter (dc to 1800 MHz) reflects signals up to 10 watts average power and 100 watts peak power. Insertion loss is less than 0.75 dB. The HP 11693A microwave limiter (0.1 to 12.4 GHz, useable to 18 GHz) guards against input signals over 1 milliwatt up to 1 watt average power and 10 watts peak power.

### HP 11947A Transient Limiter

Protects a spectrum analyzer or receiver from the damage caused by high level transients from line-impedance-stabilization networks (LISNs) during EMI testing for conducted emissions. See page 133.

### HP 11694A 75 $\Omega$ Matching Transformer (3 to 500 MHz)

Allow measurements in 75  $\Omega$  systems while retaining amplitude calibration with a 50  $\Omega$  spectrum analyzer input. VSWRs less than 1.2; insertion loss is less than 0.75 dB. See options 001 and 002 for 75  $\Omega$  versions of the HP 8590A spectrum analyzer.

### HP 8721A Directional Bridge (100 kHz to 100 MHz)

Used in return-loss measurements made with a swept source such as a tracking generator and spectrum analyzer. 6 dB insertion loss and 6 dB coupled to auxiliary arm. Frequency response is  $\pm 0.5$  dB (0.1 to 110 MHz); directivity >40 dB (1 to 110 MHz); load-part return loss <0.03; maximum input power +20 dBm. 50  $\Omega$  with 75  $\Omega$  option.

### HP 11940A and 11941A Close-field Probes

These small, hand-held, electromagnetic-field sensors are used with a spectrum analyzer for EMI diagnostic and troubleshooting applications. Make repeatable, absolute magnetic-field measurements from 9 KHz to 1 GHz. See page 133.

### HP 85024A High Frequency Probe

Makes in-circuit measurements easy. Input capacitance of only 0.7pF shunted by 1 M  $\Omega$  resistance permits high frequency probing without adverse loading of the circuit under test. Excellent frequency response and unity gain guarantee highly accurate swept measurements. High sensitivity and low distortion levels allow measurements taking advantage of full analyzer dynamic range. Directly compatible with many HP RF spectrum and network analyzers. See page 246.

### Order Information

	Price
HP 85901A Portable AC Power Source	\$980
HP 8447A 0.1 to 400 MHz Preamplifier	\$1,300
HP 8447D 0.1 to 1300 MHz Preamplifier	\$1,400
HP 8447E 0.1 to 1300 MHz Power Amplifier	\$1,600
HP 8447F 0.1 to 1300 MHz Preamplifier and Power Amplifier	\$2,400
Option H64 9 kHz to 1.3 GHz Preamplifier	\$0
HP 11975A 2 to 8 GHz Amplifier	\$4,500
HP 8449A 2 to 22 GHz Preamplifier	\$7,500
HP 11867A RF Limiter	\$450
HP 11693A Microwave Limiter	\$500
HP 11694A 75 $\Omega$ Matching Transformer	\$205
HP 8721A Directional Bridge	\$325
HP 11940A Close-field Probe	\$620
HP 11941A Close-field Probe	\$620
HP 11945A Close-field Probe Set	\$1,110
HP 11947A Transient Limiter	\$450
HP 85024A High Frequency Probe	\$1,900



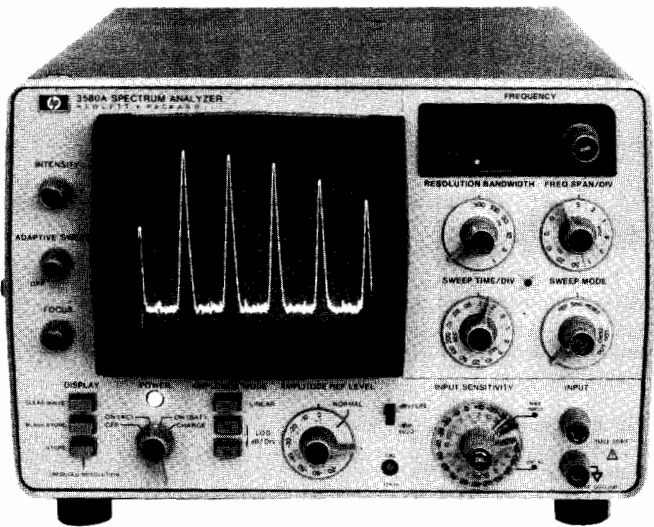

HP 3580A

### Description

Hewlett-Packard's 3580A Spectrum Analyzer is a low frequency high performance analyzer. Its 1 Hz bandwidth allows the user to examine noise and extraneous signal content close in to a signal of interest.

For low frequency applications where sweep speeds can be slow and time-consuming, a special feature, adaptive sweep, allows the user to set a threshold above which only the spectra of interest are observed. In this mode, the CRT is rapidly swept. When a signal is encountered, the sweep slows down to reproduce full response. A factor of ten speed gain is possible.

Digital storage is another important feature which enhances the display for slowly swept low frequency signals. The analyzed signals are digitized and stored in memory. Trace information is then read from memory at a rate appropriate for obtaining an analog-like display.

### Digital Storage for Spectra Comparison

Digital storage makes it possible to store one or two traces. When two are stored, both may be simultaneously displayed for easy comparison.

### Digital Frequency Display

The display provides 1 Hz resolution for setting analysis range and for determining tuned frequency. In the automatic sweep modes, the sweep start or center frequency is displayed. In the manual sweep mode, actual tuned frequency is indicated. This mode effectively provides a cursor function for easy and accurate determination of the frequency at any point on the screen.

### 1 Hz Bandwidth

Resolution bandwidths as narrow as 1 Hz are available to expose and measure closely-spaced spectral components like 50–60 Hz power line sidebands or low-rate modulation. This resolution is available at all frequencies.

### Specifications

#### Frequency Characteristics

**Range:** 5 Hz to 50 kHz.

#### Digital Frequency Display

**Resolution:** 1 Hz.

**Accuracy:**  $\pm 3.5$  Hz, 0 to 55°C.

**Typical stability:**  $\pm 10$  Hz/hr after 1 hour;  $\pm 5$  Hz/°C.

**Bandwidths:**  
(accuracy  $\pm 15\%$ )

1 Hz (25°C $\pm 5$ C)	3 Hz	10 Hz	30 Hz	100 Hz	300 Hz
Shape factor:					8

**Out of range blank:** If controls are set so portions of displayed signal lie below 0 Hz or above 50 kHz, the baseline is displayed.

### Amplitude Characteristics

#### Overall Instrument Range

Linear: 20 V – 100 nV full scale

Log: +30 dBm or dB V;  
–150 dBm or dB V

#### Amplitude Accuracy

Frequency response:

20 Hz–20 kHz

5 Hz–50 kHz

Switching between bandwidths (25°C):

3 Hz–300 Hz

1 Hz–300 Hz

Amplitude display

Input attenuator

Amplitude reference level:

(IF attenuator)

Most sensitive range

All other ranges

**Dynamic range:** 80 dB

**IF feedthru:** Input level > 10 V, –60 dB; < 10 V, –70 dB.

**Spurious responses:** > 80 dB below input reference level.

**Smoothing:** 3 positions, rolloff is a function of bandwidth.

**Overload indicator:** This LED indicator warns of possible input amplifier overloading. Without this indication it would be possible to introduce spurious responses without knowing it.

#### Sweep Characteristics

**Scan width:** 50 Hz to 50 kHz.

**Log sweep:** 20 Hz to 43 kHz  $\pm 20\%$  after 3 sweeps.

**Sweep times:** 0.1 s to 2000 s.

**Rep:** Repetitive sweeps over the specified band.

**Reset:** Resets to the beginning of the sweep—used to adjust start or center frequency.

**Manual:** In combination with the concentric knob, manual sweep fully duplicates the span of the electronic sweep.

**Adaptive sweep:** When in adaptive sweep below the threshold level, scan speed is 20 to 25 times faster. Threshold is adjustable to cover 0–60% of screen. Signals greater than about 6 dB above threshold are detected and swept slowly.

**Sweep error light:** This LED indicates a sweep that is too fast to capture full response. When the light is on, response can be > 5% lower than it should.

**Zero scan:** To look at the time varying signal at the center or start frequency within the bandwidth selected, the zero scan is used.

#### Output Characteristics

**Tracking generator output:** (Also known as BFO or tracking oscillator output).

**Range:** 0 to 1 V rms into 600  $\Omega$ .

**Frequency response:**  $\pm 3\%$ , 5 Hz to 50 kHz.

**Impedance:** 600  $\Omega$ .

**Total harmonic and spurious content:** 40 dB below 1 volt signal level.

#### X-Y Recorder Analog Outputs

**Vertical:** 0 to +5 V  $\pm 2.5\%$ .

**Horizontal:** 0 to +5 V  $\pm 2.5\%$ .

**Impedance:** 1 k $\Omega$ .

**Pen lift:** Contact closure to ground during sweep.

**Recommended Accessory:** HP 7090A Measurement Plotting System.

**Size:** 203.2mm H x 285.8mm W x 412.8mm D (8" x 11 1/4" x 16 1/4").

**Weight:** Net, 12.25 kg (27 lb); HP 3580A Opt 001: net, 15.88 kg (35 lb).

**Temperature range:** 0°C to 55°C.

**Power:** 100 V, 120 V, 220 V, or 240 V +5% – 10%; 48 to 440 Hz; 35 VA max.

**Opt 001 battery:** 5 hours from full charge. 14 hours to fully recharge. The internal battery is protected from deep discharge by an automatic turn off. Useful life of batteries is over 100 cycles.

#### Ordering Information

**HP 3580A Spectrum Analyzer**

**Opt 001:** Internal Rechargeable Battery

**Opt 002:** Balanced Input

**Opt 003:** Rack Mount

**Opt W30:** Extended Warranty

#### Price

**\$8,400**

\$700

\$260

\$335

\$350

# SIGNAL ANALYZERS

## Dual-Channel, Dynamic Signal Analyzer 0.02 Hz to 25.5 kHz

### Model 3582A

- Transfer function magnitude and phase measurements
- Coherence function measurement
- Phase spectrum measurement
- Transient capture and frequency domain analysis
- Internal periodic and random noise source
- Band selectable analysis for 0.02 Hz resolution

### Description

The HP 3582A offers outstanding value in a dual-channel, real-time spectrum analyzer that solves bench and systems measurement problems in the frequency range of 0.02 Hz to 25.599 kHz. Sophisticated LSI digital filtering combined with microcomputer execution of the Fast Fourier Transform (FFT) provides exceptional measurement capability and performance.

### Exceptional Frequency Resolution And Coverage

Unlike conventional dynamic signal analysis which extends from dc to some maximum frequency, the HP 3582A can "zoom in" to analyze any selected band of frequencies with dramatically improved resolution. The start or center frequency of the 5 Hz to 25 kHz band analysis spans can be adjusted in 1 Hz increments to cover the entire frequency range of the instrument. This provides resolution, representing as much as a 5000 to 1 improvement over conventional "base-band" analysis. With frequency ranges from 25 kHz down to 1 Hz full scale, the HP 3582A is extremely well suited to audio and sub-audio measurements.

### Real Time Measurement Speed and Wide Dynamic Range

In high volume testing or in applications requiring substantial on-line tuning, long measurement times are both expensive and inconvenient. Since the HP 3582A uses an advanced microcomputer to execute the FFT, it can perform equivalent measurements as much as one to two orders of magnitude faster than a swept analyzer. For a spectrum analyzer to provide useful information about low level components in the presence of a large signal, it must offer wide dynamic range. The HP 3582A dynamic range is specified as 70 dB—more than adequate for most applications.

### Phase Spectrum Measurement

Most spectrum analyzers can measure only the amplitude spectrum of a signal, yet complete characterization in the frequency domain also requires phase information. The advanced digital signal processing techniques incorporated in the HP 3582A provides direct measurement of phase spectra.

### Transient Capture and Analysis

By using digital processing techniques, the HP 3582A can capture and analyze transients as short as a few milliseconds. This means that spectrum analysis and transfer function analysis are no longer limited to stable, time invariant signals.

### Transfer Function Measurements

The HP 3582A directly measures the complete transfer function, both magnitude and phase. With dual channels analysis of linear and non-linear networks, respectively. In addition, the sources are band-limited to concentrate all stimulus energy in the analysis range.

The HP 3582A coherence function indicates the probability for causality between the two input signals at each frequency. If the coherence between input and measured output is low, the output signal contains a large amount of energy that is not related to the input. Thus, the transfer function measured at that frequency is not reliable.

### Digital Averaging Capability

The RMS averaging mode takes the power average of 4 to 256 successive spectra in order to reduce the uncertainty of the estimate of random spectral components.

When a synchronizing trigger signal is available, the TIME average can enhance the signal-to-noise ratio by as much as 24 dB. Since it involves the averaging of successive time records before transformation, it is also significantly faster than other types of averaging.

### Powerful HP-IB Capability

All major front panel controls are fully programmable via the HP-IB.

HP 3582A

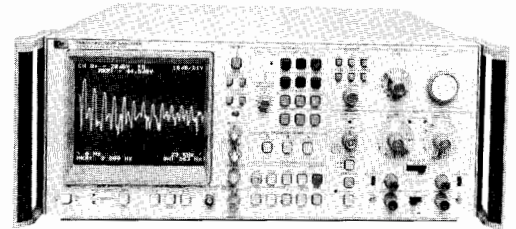

From the HP-IB it is a simple matter to command the HP 3582A to output results, as well. Not only can the various control settings be retrieved, but numeric marker data can be extracted. More importantly, the full display can be read in ASCII format along with complete annotation.

### HP 3582A Specifications

#### Frequency

**Range:** 0.02 Hz to 25.5 kHz

**Spans:** 1 Hz to 25 kHz in a 1-2.5-5-10 sequence.

**Accuracy:**  $\pm 0.003\%$  of display center frequency.

**Resolution:** 0.4% of the frequency span for single channel or 0.8% of the frequency span for dual channels.

#### Amplitude

##### Display Modes

**Log:** 10 dB/division or 2 dB/division.

**Linear:** constant voltage/division.

##### Measurement Range

**Log:** +30 dBV to -120 dBV noise floor.

**Linear:** +30 V to 1 $\mu$ V noise floor.

**Dynamic range:** 70 dB.

**DC response:** Adjustable to >40 dB below maximum input level.

##### Accuracy

**Accuracy at the**  $\pm 0.5$  dB

**Passband Center**

**Flat top filter:** +0, -0.1 dB

**Hanning filter:** +0, -1.5 dB

**Uniform filter:** +0, -4.0 dB

**Note:** Overall accuracy is the sum of the accuracy at the passband center plus the selected filter accuracy.

##### Resolution

**Log:** 0.1 dB.

**Linear:** 3 digits.

##### Phase

**Display range:** +200° to -200°.

**Accuracy:**  $\pm 10^\circ$ .

**Resolution:** 1°.

##### Transfer Function

##### Measurement Range

**Log:** +160 dB full scale to -80 dB full scale.

**Linear:**  $4 \times 10^8$  full scale to  $4 \times 10^{-8}$  full scale.

**Phase display range:** +200 degrees to -200 degrees.

##### Input

**Impedance:**  $10^6 \Omega \pm 5\%$  shunted by <60 pF from input high to low (for less than 75% relative humidity).

**Isolation:** Input low may be floated up to 30V.

**Coupling:** Switch selection of ac or dc coupling. The low frequency 3 dB roll off is <1 Hz.

**Common Mode Rejection:** >58 dB.

##### General

**Power Requirements:** 100, 120, 220 or 240 volts (+5%, -10%); 48-66 Hz; less than 150 VA.

##### Dimensions

**Size:** 425.5 W x 552.5 D x 188 mmH (16.75" x 21.75" x 7.4").

**Weight:** Net, 24.5 kg (54 lb); shipping, 29 kg (63 lb).

##### Ordering Information

HP 3582A Spectrum Analyzer

Opt W30: Extended Warranty

##### Price

\$12,800

\$560

# SIGNAL ANALYZERS

Single Channel, Dynamic Signal Analyzer 0.000125 Hz to 100 kHz

Model 3561A

147

- Spectrum and network analysis, waveform recording,  $\frac{1}{3}$  and  $\frac{1}{1}$  octave analysis
- High accuracy,  $\pm 0.15$  dB
- 80 dB dynamic range and full alias protection
- High speed (7.5 kHz Real Time Rate)
- Band selectable zoom analysis for 640  $\mu$ Hz resolution
- Full CRT annotation and softkey ease-of-use
- Auto-ranging, auto-calibration, auto-scaling
- Internal non-volatile memory stores 2 traces and 6 states. Optional non-volatile memory stores 127 traces and states.

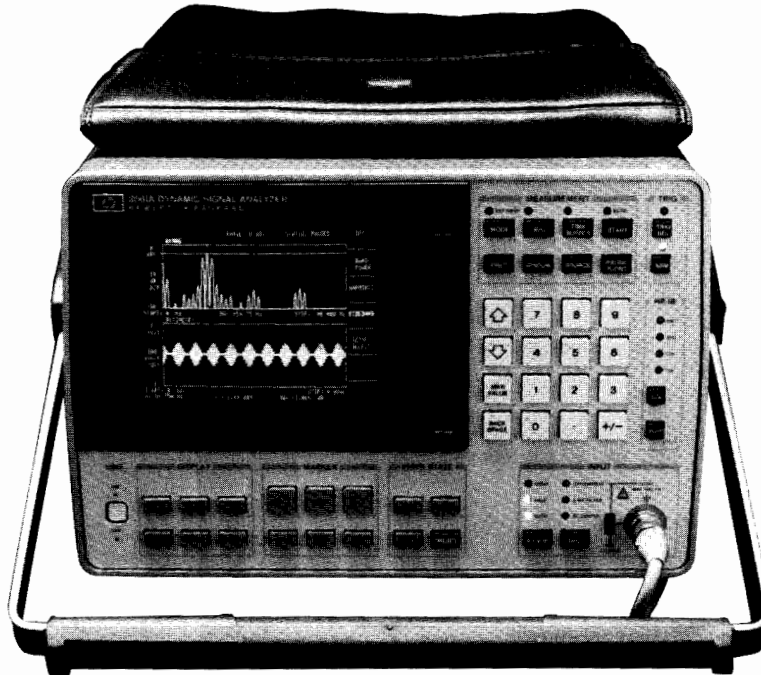

HP 3561A



## Description

The HP 3561A is a versatile, single channel, real time spectrum analyzer with applications in electronics, vibration analysis, and acoustics. It is actually several instruments in one, operating in both the frequency domain and the time domain. In the frequency domain it serves as a spectrum analyzer with  $\pm 0.15$  dB amplitude accuracy and 2 degrees triggered phase accuracy. Utilizing the built-in tracking noise source, it also can serve as a network analyzer. (Trace math can be used when phase response or high accuracy is desired.) Digital signal processing allows the HP 3561A to digitally synthesize  $\frac{1}{3}$  or  $\frac{1}{1}$  octave filters, providing a high accuracy, drift free octave analyzer. Operating in the time domain the HP 3561A can be used as a low frequency digital storage oscilloscope. The HP 3561A contains a 40k-sample time buffer and complete triggering flexibility, so waveform recording is easy. Time or frequency measurements can be stored in an optional non-volatile memory for later analysis. Annotated hardcopy is easily obtained by pressing "plot" . . . the HP 3561A will control HP-GL plotters and raster dump printers directly. All of these capabilities in one portable instrument make the HP 3561A a powerful addition to any bench, and with a standard HP-IB interface, the HP 3561A makes an excellent systems instrument as well.

## Spectrum Analysis

The HP 3561A offers swept analyzer performance with FFT speed. Up to two orders of magnitude speed improvement can be realized, especially in measurements requiring 1 Hz or better frequency resolution. The HP 3561A delivers 158 dB of automatically calibrated measurement range, from +27 dBV (22.4 volts RMS) to -131 dBV (0.28 microvolts RMS). Dynamic range is 80 dB, and amplitude accuracy is  $\pm 0.15$  dB on the +27 dBV to -40 dBV ranges ( $\pm 0.25$  dB on the -41 dBV to -51 dBV ranges). Signals can be read in RMS volts, volts squared, milliwatts, dBV, dBm (with user-selected impedance), and user-defined engineering units. Band, harmonic and sideband power can be computed directly using the built-in special marker

functions. Frequencies spaced as narrow as 640  $\mu$ Hz can be resolved throughout the 100 kHz range, with frequency accuracy  $\pm 0.003\%$  of display center frequency. Phase spectra relative to a trigger signal can be measured with up to 2 degrees phase accuracy, useful for machinery balancing.

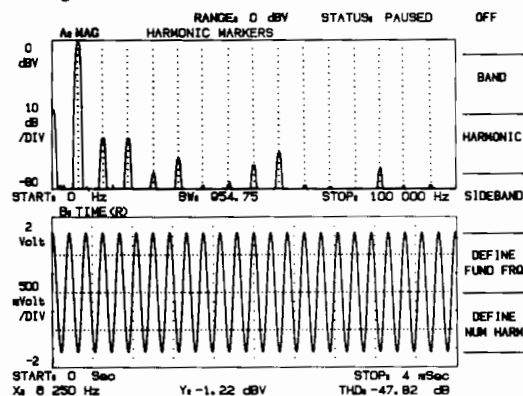

Harmonic marker function computes total harmonic distortion (THD) directly in dB or percent.

## Network Analysis

A band-limited, band-translated noise source allows the HP 3561A to make amplitude and phase frequency response measurements. To make a network measurement, connect the internal noise source to the device under test, adjust the source amplitude, and measure the input spectrum. Store the input spectrum in memory and measure the response spectrum. A simple trace math operation produces the desired frequency response. Amplitude resolution is 0.01 dB and phase resolution is 0.1 degree.

# SIGNAL ANALYZERS

Single Channel, Dynamic Signal Analyzer 0.000125 Hz to 100 kHz (cont'd)

Model 3561A

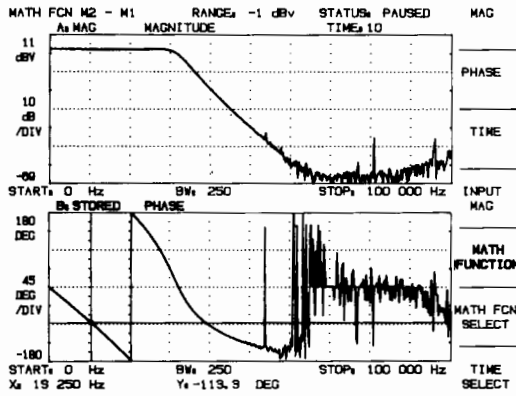

Figure 2: Network amplitude and phase response are measured using the unique internal noise source and trace math.

### Waveform Recording

A high linearity 13 bit analog-to-digital converter makes the HP 3561A a natural for waveform recording. Forty-three sample rates ranging from 256 kHz to 0.026 Hz can be selected. If other sample rates are required, the analyzer can be made to sample on an external TTL clock signal. Up to 40k samples of time data can be stored internally in buffer memory, with complete trigger control. Trigger on an analog level with positive or negative slope and variable level. In either mode you can specify pre- or post-trigger values from 40k samples pre-trigger to 1023k samples of post-trigger delay. Data collected in the time domain is easily analyzed in the frequency domain, making the HP 3561A extremely useful in analyzing transients and other non-steady-state signals.

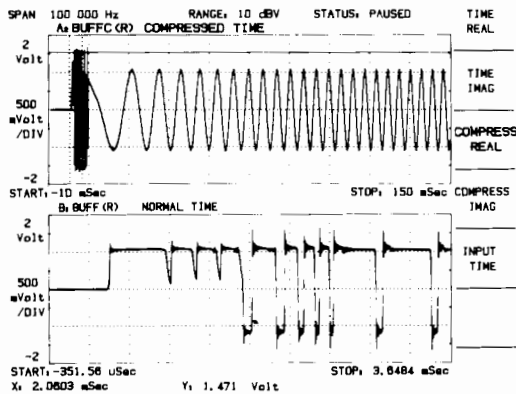

Figure 3: Up to 40,000 samples of a transient waveform can be captured, with analysis in either the time domain or the frequency domain.

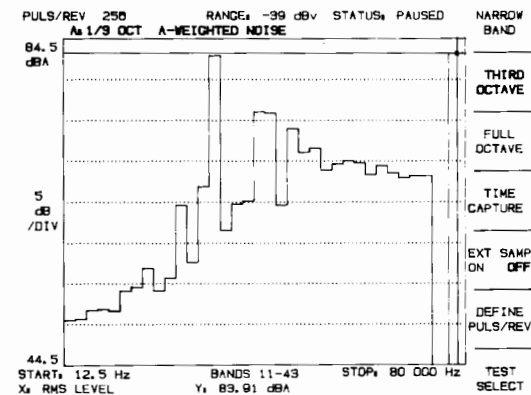

Figure 4: The combination of octave and narrowband analysis makes the HP 3561A a powerful instrument for noise and vibration analysis.

### 1/3 and 1/1 Octave Analysis

Octave analysis is often used in acoustic and vibration work for analyzing signals that are "proportional bandwidth". That is, they exhibit bandwidths that are proportional to their center frequencies. The HP 3561A digitally synthesizes a series of parallel bandpass filters, each with

bandwidth proportional to center frequency. The advantage of the digital technique is better stability and accuracy — there are no analog components to drift, age, or respond to temperature. A built-in hardware A-weight filter can be switched in for acoustic signals where the effects of the human ear must be taken into account.

### Digital Averaging

Digital averaging is provided for improving a measurement in the presence of noise. RMS, RMS exponential, time and peak averaging are provided. Automatic overload signal rejection can be invoked to prevent an otherwise valid reading from being contaminated by one overloaded spectrum. A fast average display mode can be selected which speeds up the averaging process by turning off the display refresh during intermediate averages. This can result in a factor of 3 speed improvement over normal averaging mode. Coupled with its high real time rate, the HP 3561A can make averaged measurements in the same amount of time it formerly took to make an unaveraged measurement!

### Flexible Display Formats and Complete Annotation

Display a single trace, two traces in upper/lower format, or two traces overlaid in front/back format. When several traces must be viewed at once, use the "spectral map" format which can display up to 60 separate traces stacked onto one display. Choose log or linear frequency spacing and log or linear amplitude units. Define your own units, give them a name, and the analyzer will read out in your units! Each trace is completely annotated and can be labeled with your own alphanumeric trace label. A view state display function is provided to quickly give you a summary of the analyzer's current setup state.

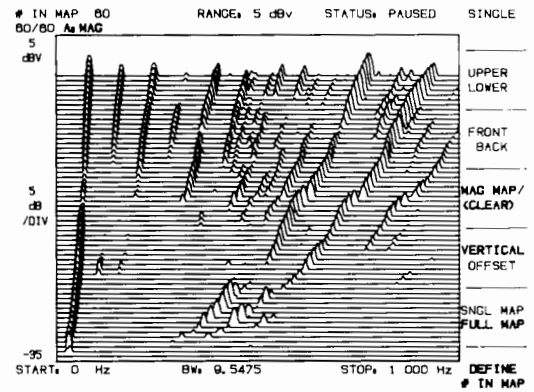

Figure 5: Spectral maps greatly reduce the time required to analyze changes in up to 60 successive measurements.

### Internal Mass Storage

The standard HP 3561A contains 2 traces and 6 setup states of nonvolatile memory. When more storage is required, such as when you wish to store a 40,000-sample waveform captured in waveform recording mode, the "non-volatile memory" option can be installed. This memory allows you to store any combination of 127 traces and states internally. Data stored in internal memory can be transferred via HP-IB to a computer for further analysis or archiving.

FILENAME	INDEX	TYPE	SIZE	USE CAT
SWEEP		BUFFERED	7	FILENAME
AMP-ACC		SETUP	1	
SWEEPTEST		SETUP	1	STORE
TEST-01		SETUP	1	BUFFER
XFER		SETUP	1	
JIM 0		TRACE	1	RECALL
JIM 2		TRACE	1	BUFFER
JIM 4		TRACE	1	
JIM 6		TRACE	1	DELETE

Figure 6: Traces and setups are stored in non-volatile memory by file name. The memory catalog makes recall of stored files easy.

### Annotated Hardcopy

You can obtain fast hardcopy of any display just by pressing the plot button. The HP 3561A controls HP-GL plotters and HP raster dump printers directly. A "marker plot" key allows you to annotate several locations on a plot with amplitude and frequency, or amplitude and time. Simply tune the cursor to the point of interest, press marker plot and the

analyzer annotates the location of interest. Do this as many times as you wish for complete, accurate documentation of measurements.

```

+-DELAY 10 Sec          RANGE: 2 dBV          STATUS: PAUSED          SLOPE
                                                                POS NEG
NARROW BAND MODE          EXT SAMPLE OFF
FREQUENCY:
BASEBAND          CENTER: 250 Hz          DEFINE
                  SPAN: 500 Hz          % OF RNC
                  TIME: 800 mSec
TRIGGER:
INTERNAL          DELAY: 10 Sec          DELAY
AUTO ARM
AVERAGE:
OFF
WINDOW:
FLAT TOP          BW: 4.77375 Hz          DEFINE
SOURCE:
OFF
INPUT:
DC COUPLING      ICP CURRENT OFF      A WEIGHT FLTR OFF
UNITS:
% HZ
dBV
    
```

Figure 7: Plots of the view state display provide quick hard copy of instrument setup for complete measurement documentation.

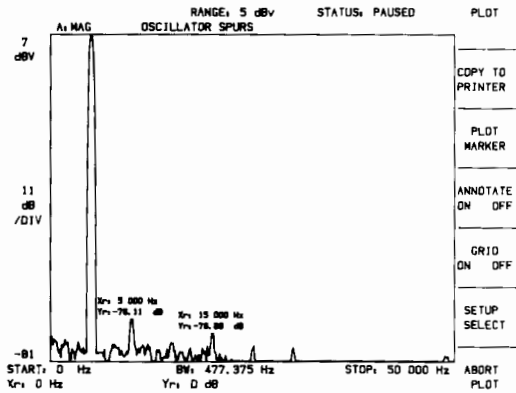

Figure 8: The marker plot function prints x and y marker values for any number of points on the plot.

**Other Features**

In most noise and vibration measurements, a transducer is used to convert the physical phenomena to voltage. These transducers generally require some type of signal conditioning. The HP 3561A contains an internal power supply for ICP type (integrated circuit piezoelectric) transducers. This eliminates an extra piece of equipment, which enhances portability and saves money. Trace math operations are provided that allow you to manipulate traces like numbers on a calculator. This is useful for converting units, compensating for systematic errors, and displaying spectra as a percentage of some reference value.

**HP 3561A Specifications**

**Frequency**

**Range:** 0.000125 Hz to 100 kHz.  
**Spans:** 0.01024 Hz to 100 kHz in a 1, 2, 2.5, 5, 10 sequence. Other spans are available but are too numerous to list here.  
**Accuracy:** ± 0.003% of display center frequency.  
**Resolution:** 0.25% of frequency span.  
**Window:** Flat Top, Hann, Uniform, and Exponential.  
**Bandwidth**

	Flat Top	Hann	Uniform
3 dB Bandwidth (% of frequency span)	0.90%	0.36%	0.22%

**Real Time Bandwidth:** (Typical) Single display, 3.0 kHz. Fast average display, 7.5 kHz.

**Amplitude**

**Measurement Range:** +27 to -120 dBV noise floor (22.4 VRMS to 1µV noise floor.) Input range is selected in 1-dB steps from +27 to -51 dBV. Optimum range is determined automatically in the autorange mode.

**Dynamic range:** 80 dB.

**Accuracy at the Passband**

**Center:** ± 0.15 dB +27 to -40 dBV input ranges  
 ± 0.25 dB -41 to -51 dBV input ranges

**Flat Top window:** +0, -0.01 dB

**Hann window:** +0, -1.5 dB

**Uniform window:** +0, -4.0 dB

**Note:** Overall accuracy is the sum of the accuracy at the passband center plus the selected window accuracy.

**Resolution**

**Log:** 0.01 dB.

**Linear:** 4 digits.

**Phase**

**Accuracy:** ±2 degrees, dc-10 kHz; ± 10 degrees, 10-100 kHz (signals no more than 40 dB below full range).

**Resolution:** 0.1 degree.

**Input**

**Impedance:** 1X10<sup>6</sup> ohms ± 5% shunted by 95 pF maximum.

**Isolation:** Input low may be connected to chassis ground or floated up to 30 volts RMS (42 volts peak) above ground.

**Coupling:** Signal by be ac or dc coupled. Low frequency 3-dB point < 1 Hz in ac mode.

**A-weighting:** Hardware A-weighting filter conforms to ANSI standard S1.4-1971 (R1976).

**ICP current:** Nominal 4 mA current source provided, compatible with integrated circuit piezoelectric accelerometers.

**Output**

**Source:** Band-limited, band-translated, psuedo-random, random, or impulse, or TTL "synch" signals are available on rear panel. Level is selectable between 0.7 and 0.007 volts RMS, nominal. Impedance 50Ω ± 5Ω.

**Print/Plot:** Controls HP-GL plotters and HP raster dump printers directly.

**Display**

**General:** Magnitude, phase, time and math traces may be selected. Units available are; Horizontal: Hz, seconds, RPM, orders; linear or log spacing. Vertical: dBV, dBm (selectable Z), volts, volts squared, and user-defined units.

**Scale:** Linear or log magnitude scales may be selected. Full scale, dB/division, and degrees/division are user definable. Center scale user definable in phase or time traces.

**Math:** Arithmetic operations can be performed on new or recalled frequency spectra. Add, subtract, multiply, divide, integrate, differentiate and user-defined constants are provided. 1/BW is provided for Power Spectral Density (PSD) computations.

**Internal Memory**

	Non-volatile	Volatile
<b>Standard:</b>	2 traces, 6 states	40 time records
<b>Optional:</b>	Traces + states + (1+ 2* time capture records)= 127	40 time records

**Marker**

Single, relative, harmonic, sideband, and power cursors are provided. THD can be calculated from up to 20 harmonics. Sideband power relative to specified carrier can be calculated from up to 10 sidebands. MKR to peak, MKR to center, MKR to full scale and marker peak track are provided.

**General**

**Power:** 100/120 Vac +5%, -10%, 48-440 Hz; 220/240 Vac +5%, -10%, 48-66 Hz.

**Weight:** 15 kg (33 lb) net, 21.6 kg (47.5 lb) shipping.

**Dimensions:** 335 mm W x 595 mm D x 197 mm H (13.2" x 23.4" x 7.8")

**\*HP-IB Interface Functions:** Implementation of IEEE Std. 488-1978 SH1, AH1, T5, TE0, L4, LE0, SR1, RL1, PP0, DC1, DT1, C0.

**Ordering Information**

	Price
<b>HP 3561A Dynamic Signal Analyzer</b>	<b>\$11,200</b>
Opt 001 Extended Non-volatile Memory	\$1,550
Opt W30 Extended Warranty	\$170



# SIGNAL ANALYZERS

## Dual-Channel, Dynamic Signal Analyzer 64 $\mu$ Hz to 100 kHz

### Model 3562A

- Network, spectrum, waveform and transient analysis
- Linear, logarithmic and swept sine measurement modes
- 10 kHz real time rate
- 80 dB dynamic range with full alias protection
- High accuracy ( $\pm 0.15$  dB)
- High resolution (801 Lines)
- Band selectable zoom analysis
- Direct control of disc drives and HP-GL plotters
- Fully Programmable

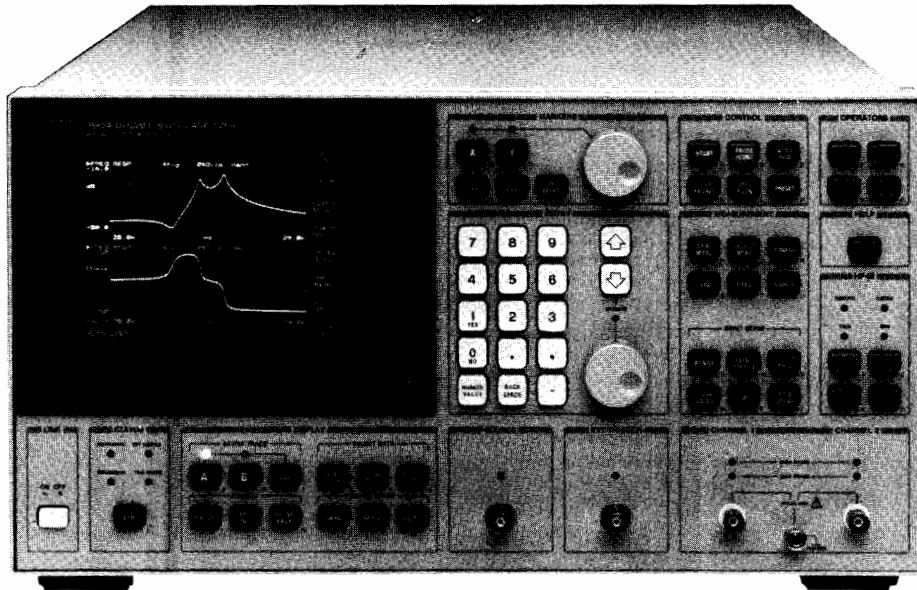

HP 3562A



The HP 3562A Dynamic Signal Analyzer is well suited for the design test and analysis of electronics, mechanical systems, and electromechanical control systems. With two input channels, a dc-to-100 kHz frequency range, 150 dB measurement range and 80 dB dynamic range, this FFT-based analyzer offers the versatility and performance needed to make even the most difficult network, spectrum, and waveform measurements — in both the time and frequency domains.

The two high performance input channels and a built-in signal source (noise and sine signals) address network analysis needs on the bench or in a test system. Zoom analysis with frequency resolution up to 25.6 Hz plus a powerful AM, FM and PM demodulation function makes the Hp 3562A a versatile spectrum analyzer. For transient or waveform analysis, signals can be sampled, digitized then stored in internal memory, or sent via HP-IB to an external disc drive (without a computer). Then stored waveforms can be recalled and analyzed in the time, frequency and amplitude domains (baseband and zoom analysis).

In addition, features such as vector averaging, Waveform Math, a 40-pole/40-zero Curve Fitter, and Frequency Response Synthesis offer a full range of analysis and design capabilities. The HP 3562A is fully programmable both through its own built in Auto Sequence programming capability, or with computers over the HP-IB bus. If hardcopy results or storage of data is required, the HP 3562A can control digital plotters and external disc drives directly via HP-IB.

### Network Analysis

Accurate, high resolution frequency response measurements of electronic and mechanical systems can be performed with Linear Resolution FFT, Logarithmic Resolution and Swept Sine analysis. A built-in signal source provides a variety of random noise and sinewave signals to meet the requirements of the system under test.

Linear Resolution is the measurement technique common to all Dynamic Signal Analyzers. In the HP 3562A, 2048-point time records are Fourier-transformed into 801-line frequency spectra. For

network analysis, frequency response magnitude and phase, as well as input and output power spectra, can be measured with 801 lines of resolution. Accuracy for the frequency response magnitude and phase is  $\pm 0.1$  dB and  $\pm 0.5^\circ$ .

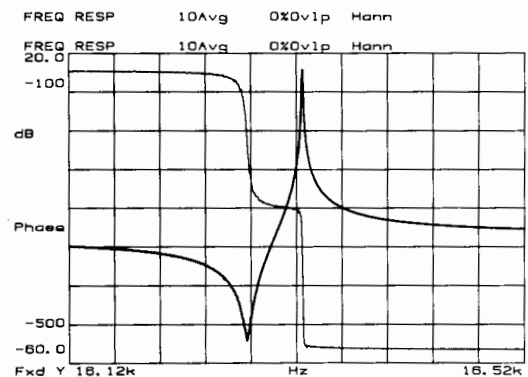

Logarithmic Resolution uses the speed of Linear Resolution FFT measurements to create frequency responses similar to a log-sweep swept sine test. Linear Resolution points are combined internally (rather than just reformatted), on the fly, to create 80-point-per-decade measurements over 1 to 5 decades. Start and stop frequencies can be selected in a 1-2-5 sequence from 0.1 Hz to 100 kHz (for a 0.1 Hz start frequency the maximum stop frequency is 10 kHz — 5 decades).

The Swept Sine mode reconfigures the HP 3562A as a powerful swept sine frequency response analyzer. The source can generate linear or logarithmic sweeps with increasing or decreasing frequency; user-selectable sweep rate and resolution are also standard source

functions. Input channel functions include user-selectable averaging and integration time; automatic input ranging can be activated to provide over 130 dB of dynamic range for measurements of high performance systems.

### Spectrum Analysis

On-line analysis of distortion, drift, modulation and phase noise can benefit from the speed and accuracy of the HP 3562A. High resolution measurements are typically 100 times faster than tuned spectrum analyzers — and, since the HP 3562A is an FFT-based analyzer, you can see transient events that a tuned analyzer would probably miss.

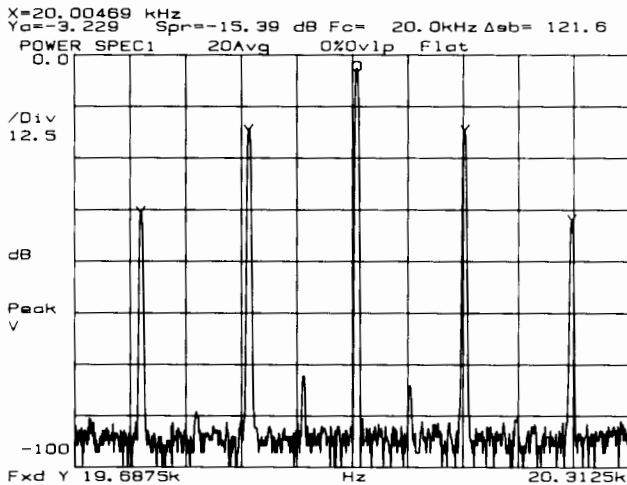

The HP 3562A is essentially a dual-channel spectrum analyzer which provides resolution to 25.6  $\mu$ Hz anywhere within the dc-to-100 kHz measurement range. Single channel accuracy is  $\pm 0.15$  dB with 80 dB of dynamic range. Modulation analysis can be performed on either or both channels with harmonic and sideband markers as well as with the built-in demodulation capability: zoom measurements can be AM, FM or PM demodulated with carrier frequencies up to 99.9 kHz.

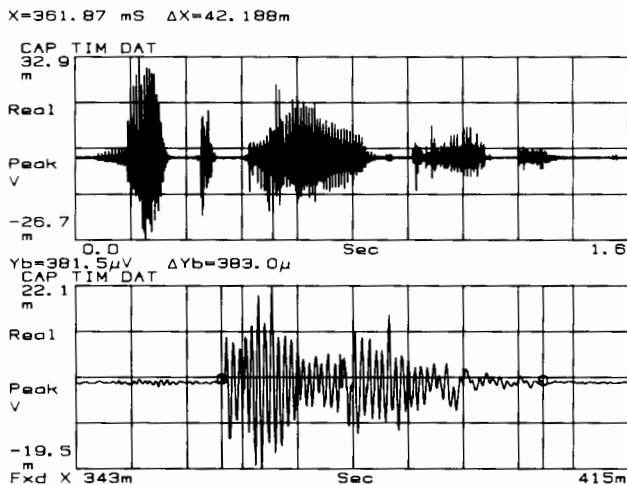

### Waveform and Transient Analysis

Perform complete analysis of waveforms and transients in the time and frequency domains. Sampled and digitized waveforms can be

stored in internal memory (single-channel Time Capture) or on disc in an external disc drive (single- or dual-channel Time Throughput). Data can be recalled for time domain analysis as single time records or as a compressed display of up to 10 time records (Time Capture mode). Data can also be recalled for baseband and zoom analysis in the frequency domain, with vector averaging if needed.

A complete array of triggering capabilities are included to enhance both waveform recording modes. Pre- and post-trigger delays can be specified to capture the rising edge of a transient or to compensate for delays in the system under test.

### Data Throughput to a Disc Drive

When access to prototypes is limited, make your test time more efficient with the Time Throughput capability: through direct control of external disc drives, the HP 3562A can store time data directly to disc without a computer. Set up a measurement and specify the quantity of single- or dual-channel data to be collected. Time data will be sampled, digitized and stored on disc for later analysis as individual time records or as baseband and zoom frequency spectra.

### Hardcopy and Mass Storage with Plotters and Disc Drives

To speed and simplify documentation of results, direct control of plotters and disc drives via HP-IB is a standard feature in the HP 3562A. Literally anything displayed on the analyzer screen can be plotted or saved on disc: measurement results, setup state tables, synthesis tables, curve fit tables and Auto Sequence or Auto Math program listings. Plotting is enhanced with user-selectable line types, pens and paging controls. For mass storage operations, files can be given 8-letter user-defined names; and disc catalog can be recalled and displayed to show file name, type (data, setup, etc.) and date and time of storage.

### Automation for Improved Productivity

Versatile automation capabilities and a wide range of response-only or stimulus/response measurement functions in the HP 3562A help you create productive solutions for your automated testing needs. As a stand-alone solution, the analyzer can "learn" a series of keystrokes and then perform them on command (Auto Sequence programming). Up to five Auto Sequence programs can be stored internally, with additional programs stored in an external disc drive.

For networked HP-IB systems, the HP 3562A provides complete HP-IB programmability. Custom display graphics and messages can be created through direct programming of the high resolution vector display — user-defined softkey menus can also be created to simplify interactive testing. Rear-panel outputs for large screen displays are also standard.

### HP 3562A Specifications

#### Frequency

**Measurement Range:** 64  $\mu$ Hz to 100 kHz, both channels, single- or dual-channel operation.

**Accuracy:**  $\pm 0.004\%$  of frequency reading.

**Resolution:** Span/800, both channels, single- or dual-channel operation.

Spans:	Baseband	Zoom
Number of spans	66	64
Min span	10.24 mHz	20.48 mHz
Max span	100 kHz	100 kHz
Time record (seconds)	800/span	800/span

**Window Functions:** Hann, Flat Top, Uniform, Force, Exponential, and User Defined.

Window Parameters:	Flat Top	Hann	Uniform
3 dB BW (% of span)	0.45%	0.18%	0.12%

**Typical Real Time Bandwidth:** 10 kHz single-channel, 5 kHz dual-channel, with fast averaging on.

# SIGNAL ANALYZERS

## Dual-Channel, Dynamic Signal Analyzer 64 $\mu$ Hz to 100 kHz (cont'd)

Model 3562A

### Amplitude

#### Accuracy (Linear Resolution)

Defined as Full Scale Accuracy at any of the 800 calculated frequency points. Overall accuracy is the sum of absolute accuracy, window flatness and noise level.

#### Absolute Accuracy

Single Channel (Channel 1 or Channel 2)  $\pm 0.15$  dB  $\pm 0.015\%$  of input range (+27 dBV to -40 dBV).

$\pm 0.25$  dB  $\pm 0.025\%$  of input range (-41 dBV to -51 dBV).

#### Frequency Response Channel Match:

$\pm 0.1$  dB,  $\pm 0.5$  degree.

#### Window Flatness

**Flat Top:** +0, -0.01 dB.

**Hann:** +0, -1.5 dB.

**Uniform:** +0, -4.0.

**Noise Floor:** (Flat top window, 50  $\Omega$  source, 50  $\Omega$  input termination).

20 Hz to 1 kHz (1 kHz span)  $< -126$  dBV ( $-134$  dBV/ $\sqrt{\text{Hz}}$ ).

1 kHz to 100 kHz (100 kHz span)  $< -116$  dBV ( $-144$  dBV/ $\sqrt{\text{Hz}}$ ).

**Dynamic Range:** All distortion (intermodulation and harmonic), spurious and alias products  $\geq 80$  dB below full scale input range.

### Phase

**Accuracy:** Single channel, referenced to the trigger point.

$< 10$  kHz  $\pm 2.5^\circ$

10 kHz to 100 kHz  $\pm 12.0^\circ$

### Inputs

**Input Impedance:** 1 M  $\Omega$   $\pm 5\%$  shunted by 100 pF maximum.

**Input Coupling:** The inputs may be ac or dc coupled; ac rolloff is  $< 3$  dB at 1 Hz.

**Crosstalk:** -140 dB (50  $\Omega$  source, 50  $\Omega$  input termination, input connectors shielded).

0 Hz to 66 Hz 80 dB

66 Hz to 500 Hz 65 dB

**Common Mode Voltage:** DC to 500 Hz.

Input Range (dBV rms) Maximum (ac + dc)

+27 to -12  $\pm 42.0$  Vpeak

-13 to -51  $\pm 18.0$  Vpeak\*

\*For the -43 to -51 dBV input ranges, common mode signal levels cannot exceed  $\pm 18$  Vpeak or (Input Range) + (Common Mode Rejection), whichever is the lesser level.

**Common Mode Voltage:** 500 Hz to 100kHz. The ac part of the signal is limited to 42 Vpeak or (Input Range) + (10dB), whichever is the lesser level.

**Common Mode Distortion:** For the levels specified, distortion of common mode signals will be less than the level of the rejected common mode signal.

**External Trigger Input Impedance:** Typically 50 k $\Omega$   $\pm 5\%$ .

**External Sampling Input:** TTL compatible input for signals  $\leq 256$  kHz (nominal maximum sample rate).

#### External Reference Input

**Input Frequencies:** 1, 2, 5 or 10 MHz  $\pm 0.01\%$ .

**Amplitude Range:** 0 dBm to +20 dBm (50  $\Omega$ ).

### Trigger

**Trigger Modes:** Free Run, Input Channel 1, Input Channel 2, Source and External Trigger. Free Run applies to all Measurement Modes; Input Channel 1, Input Channel 2, Source and External Trigger apply to the Linear Resolution, Time Capture and Time Throughput measurement modes.

#### Trigger Conditions

**Free Run:** A new measurement is initiated by the completion of the previous measurement.

**Input:** A new measurement is initiated when the input signal to either Channel 1 or Channel 2 meets the specified trigger conditions. Trigger Level range is  $\pm 100\%$  of Full Scale Input Range; Trigger Level is user-selected in steps proportional to the input range.

**Source:** Measurements are synchronized with the periodic signal types (burst random, sine chirp and burst chirp).

**External:** A new measurement is initiated by a signal applied to the front panel External Trigger input. Trigger Level range is  $\pm 10$  V peak; Trigger Level is user selected in 80 mV steps.

### Trigger Delay

**Pre-Trigger:** The measurement can be based on data from 1 to 4096 samples (1/2048 to 2 time records) prior to trigger conditions being met. Resolution is 1 sample (1/2048 of a time record).

**Post-Trigger:** The measurement is initiated from 1 to 65 536 samples (1/2048 to 32 time records) after the trigger conditions are met. Resolution is 1 sample (1/2048 of a time record).

### Source

**Source Types:** Band limited, band translated random noise, burst random, sine chirp, and burst chirp, as well as fixed sine and swept sine signals are available from the front panel Source output. DC Offset is also user-selectable.

**Output Impedance:** 50  $\Omega$   $\pm 5$   $\Omega$ .

**Output Level:** between -10 and +10 V peak (ac + dc) into a  $\geq 10$  k $\Omega$ ,  $< 1000$  pF load. Maximum current = 20 mA.

**AC Level:**  $\pm 5$  V peak ( $\geq 10$  k $\Omega$ ,  $< 1000$  pF load).

**DC Offset:**  $\pm 10$  V peak in 100 mV steps. Residual offset at 0 V offset  $\leq 10$  mV.

**% In-Band Energy** (1 kHz span, 5 kHz center frequency).

**Random Noise:** 70%.

**Sine Chirp:** 85%.

**Accuracy and Purity:** Fixed or Swept Sine.

**Flatness:**  $\pm 1$  dB.

**Distortion** (Including subharmonics):

dc to 10 kHz. -60 dB

10 kHz to 100 kHz. -40 dB

### General

Specifications apply within 5°C and 2 hours of last internal calibration.

**Ambient temperature:** 0° to 55° C.

**Relative Humidity:**  $\leq 95\%$  at 40° C.

**Altitude:**  $\leq 4,572$  m (15,000 ft.).

#### Storage

**Temperature:** -40° to +75° C.

**Altitude:**  $\leq 15,240$  m (50,000 ft).

#### Power:

115 VAC +10%, -25%, 48 to 66 Hz.

230 VAC +10%, -15%, 48 to 66 Hz.

450 VA maximum.

#### Weight:

26 kg (56 lb) net.

35 kg (77 lb) shipping.

#### Dimensions:

222 mm (8.75 in) high.

426 mm (16.75 in) wide.

578 mm (22.75 in) deep.

### HP-IB

Implementation of IEEE Std 488-1978.

**HP-IB Interface Functions:** SH1 AH1 T5 TE0 L4 LE0 SR1 RL1. PP0 DC1 DT1 C0. Supports the 91XX and 794X families of HP disc drives, as well as Hewlett-Packard Graphic Language (HP-GL) digital plotters.

### Accessories Supplied

Operating, Programming and Service Manuals.

### Accessories Available

Transit Case for one HP 3562A: HP P/N 9211-2663.

### Ordering Information

#### HP 3562A Dynamic Signal Analyzer

**Opt 907:** Front Handle Kit

**Opt 908:** Rack Mount Kit

**Opt 909:** Rack Mount and Front Handle Kit

**Opt 910:** Extra Operating Manuals

**Opt 914:** Delete Service Manuals

**Opt W30:** Extended Warranty

#### Price

**\$25,500**

\$77

\$41

\$102

\$179

less \$100

\$530

\*For more on these codes refer to the HP-IB section of this catalog.

# SIGNAL ANALYZERS

## Dual-Channel, Dynamic Signal Analyzer 244 $\mu$ Hz to 102.4 kHz

Model 35660A

153

- Network and spectrum analysis
- 102.4 kHz single channel measurements
- 51.2 kHz dual channel measurements
- 401 line resolution
- 70 dB dynamic range
- $\pm 0.5$  dB amplitude accuracy
- $\pm 0.4$  dB and  $\pm 1.0$  degree channel match
- Frequency accuracy of  $\pm 30$  ppm

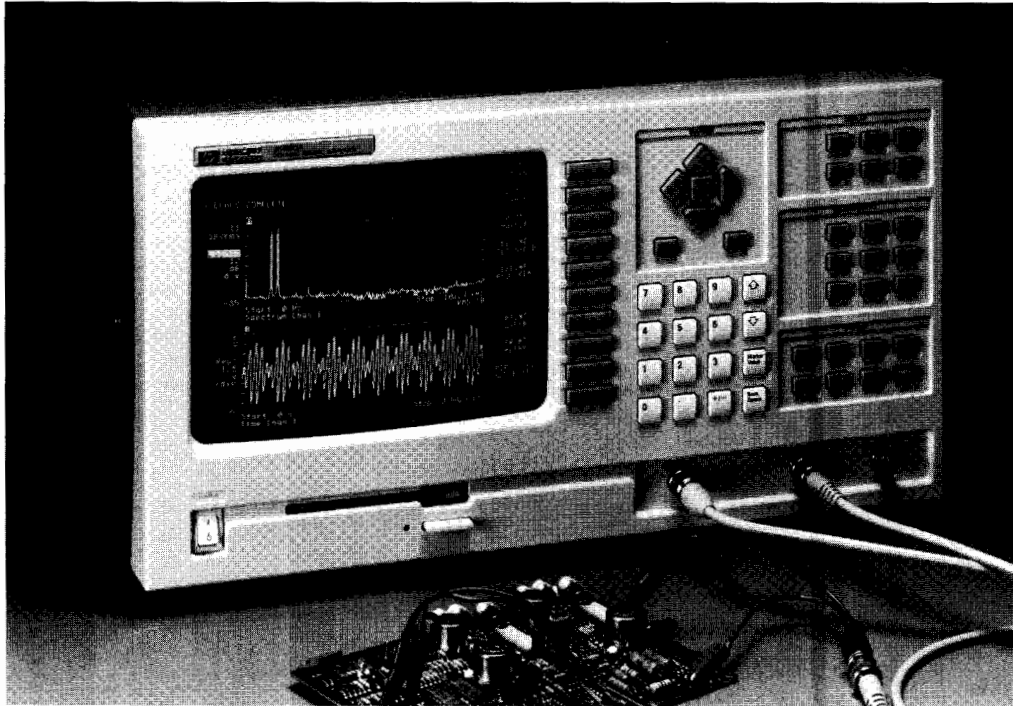

HP 35660A



The HP 35660A Dynamic Signal Analyzer is an FFT-based instrument that provides spectrum and network measurements in electronics, mechanical test, acoustics, and other low frequency application areas. The analyzer also offers built-in test and automation features, traditionally available only with a computer. These features include an internal programming language (HP 35680A Instrument BASIC), a built in disc drive, limit testing and data tables. With automation built in, the HP 35660A can save you both time and money.

The HP 35660A performs spectrum analysis from 488  $\mu$ Hz to 102.4 kHz and network analysis from 244  $\mu$ Hz to 51.2 kHz. The FFT provides 401 lines of resolution in both one- and two-channel modes. Complete alias protection and digital zoom ensure high resolution measurements with warranted accuracy. Measurements include linear

spectrum, power spectrum, frequency response, gain/phase, group delay, time history, and power spectral density. A built-in 3.5 inch disc drive, compatible with HP Series 200/300 workstations, stores traces, tables, states, and application programs.

### Electrical Spectrum Analysis

The HP 35660A is typically 10 to 100 times faster than swept spectrum analyzers for equivalent measurements, and provides higher resolution (244  $\mu$ Hz throughout the 102.4 kHz frequency range). This speed and resolution contribute to the quality of HP 35660A tests for distortion, spur level, frequency drift, intermodulation, and other signal parameters. Amplitude accuracy of  $\pm 0.5$  dB and frequency accuracy of  $\pm 30$  ppm guarantee precision in tests of such devices as headsets, modems, telephone components, speakers, transducers, and electrical motors.

### Electrical Network Analysis

With two input channels and a built-in source, the HP 35660A can quickly measure the response of low-frequency filters and networks. Source signals provided are random noise, periodic chirp, and fixed sine. Periodic chirp is useful for testing non-linear responses such as output clipping of amplifiers. Random noise is ideal to get a linear approximation of a non-linear network. Fixed sine lets you test response at a specific frequency.

The HP 35660A is also a good choice for low-frequency transmission measurements in telecommunications and other areas. To ensure highly accurate magnitude and phase measurements, the HP 35660A offers  $\pm 0.4$  dB gain and  $\pm 1.0$  degree input channel phase match. For custom analysis of these measurements, the HP 35660A provides waveform math, including conjugation, FFT, inverse FFT, square root, and frequency domain integration and differentiation.

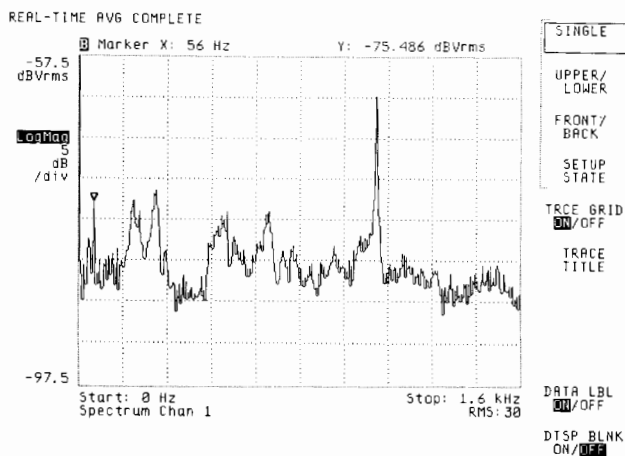

# SIGNAL ANALYZERS

## Dual-Channel, Dynamic Signal Analyzer 244 $\mu$ Hz to 102.4 kHz (cont'd)

Model 35660A

### Machinery Vibration

The HP 35660A is an excellent fit for applications that require vibration monitoring at full load. With the analyzer's built-in limit tables, users can implement vibration and health monitoring of engines, machine tools, and other equipment, without an external computer and without programming. The analyzer's internal disc drive makes it easy to record, store, and recall limits for production or maintenance testing.

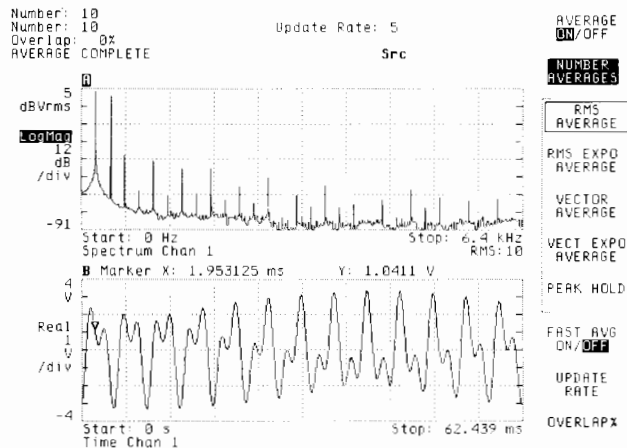

### Structural Analysis

The HP 35660A uses force and exponential windows to perform frequency response testing of mechanical devices and structures. Using HP Instrument BASIC, the analyzer can simplify data collection for your modal surveys. For complete modal analysis, you can choose from several third party modal packages.

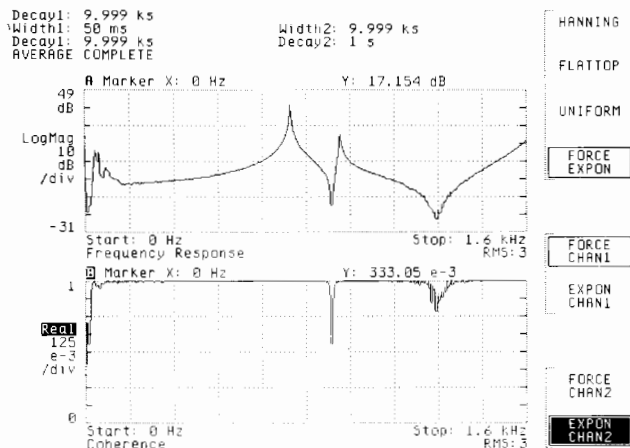

### Acoustics

Another major application area for the HP 35660A is acoustics and noise measurements. This includes testing for room and device responses, noise identification and level, and underwater acoustic tests such as sono-buoy and sonar transducer testing. Acoustic intensity measurements are available with third party software.

### Limit and Data tables for fast, consistent results

Spectrum and network analyzers are frequently used to test signals and device response against certain specifications. The HP 35660A improves this process by providing built-in limit testing. A limit line defines acceptable minimum and maximum values at specific X-axis points (in both time and frequency domains). Users can specify an upper and lower limit for every point in the trace, as well as specifying acceptable bands and slopes. During a test, the HP 35660A checks the trace level against the limit lines, then displays PASS or FAIL on the screen. Limit testing is especially powerful when used with HP Instrument BASIC. For example, a program can quickly pull limit lines off disc and use them as a reference against a series of traces.

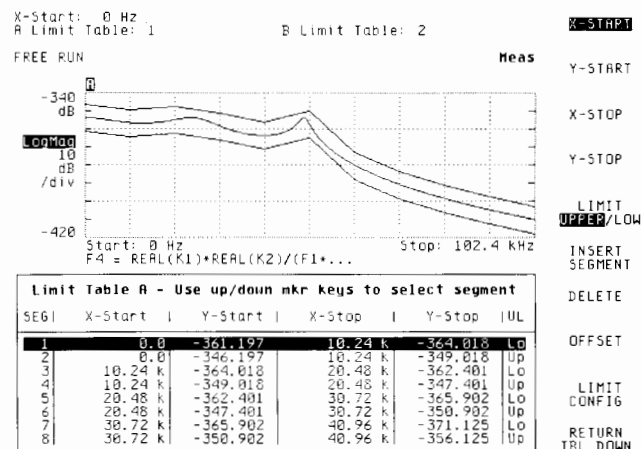

Data tables are another key feature of the HP 35660A. A data table eliminates the need to move markers along a trace to read multiple values. This is particularly useful for such applications as noise level monitoring at multiple frequencies. Enter up to 400 X-axis locations in a data table, and the HP 35660A fills in the table with a Y-axis value for each X entry. You can display, print, or store a completed table. For repeated measurements, you can create a unique table for each test and quickly recall each table from disc.

In addition to data tables and limit testing, the analyzer includes extensive markers to highlight harmonics and sidebands and to search for minimum, maximum, and target values.

### HP-IB System Control

When used with HP Instrument BASIC, the HP 35660A can serve as a test system controller. A system might include peripherals such as hard discs, printers and plotters, as well as other instruments such as switch matrices, voltmeters and signal generators. You can automate smaller systems without the cost of an external computer, while conserving rack or bench space.



### HP 35680A Instrument BASIC

To simplify automation and test analysis, the HP 35660A includes a powerful new feature: a subset of HP Series 200/300 BASIC running inside the analyzer. HP 35680A Instrument BASIC adds decision-making, branching, I/O including control of other instruments, and custom user interfaces. HP Instrument BASIC is fully syntax-compatible with HP BASIC, so current HP workstation owners can easily merge the HP 35660A and HP Instrument BASIC into their test systems.



### A Language for Programmers and Non-Programmers

With over 150 BASIC commands, HP Instrument BASIC is a powerful tool for programmers. But it also includes a feature that makes it easy for non-programmers to automate analyzer functions. Keystroke recording automatically creates a program as the user makes measurements from the front panel. An entire test sequence can be recorded and saved with no programming required.

Users can write or modify HP Instrument BASIC programs from the front panel using a built-in text editor. The editor includes a series of softkeys labeled with keywords, punctuation, and math symbols frequently used in HP BASIC.

### Workstation Compatibility

HP Instrument BASIC programs can be developed on an HP Series 200/300 BASIC workstation and then transferred to the analyzer via a 3.5 inch floppy disc (files must be saved in HP's LIF format). Programs developed on the HP 35660A will also run on a workstation. If desired, the analyzer portion of a computer-aided test (CAT) can be created with keystroke recording, then merged with the main program written on an external computer. The HP 35660A is also fully HP-IB programmable from an external computer, using any language you choose.

### Custom solutions with the HP 35660A

Applications that involve long and repetitive testing can benefit significantly from custom solutions available with the HP 35660A. For example, in a production environment, HP Instrument BASIC programs can automatically recall test setups and prompt a technician for date, time, and other important information. Limit testing can quickly indicate the presence of spurs or undesired harmonics. Operator interaction is further reduced with routines that automatically catalog results to a printer/plotter or to disc.

The HP 35681A Analysis Pack provides examples of how to customize the HP 35660A for specific applications. The Analysis Pack is a set of network and spectrum application programs that enhance the power of the HP 35660A analyzer.

Written in HP Instrument BASIC, the Analysis Pack provides several ready-to-use application tests, including distortion testing, filter parameter testing, and modulation and peak analysis. The Analysis Pack shows how easy it is to customize tests and provides a set of tested, documented routines you can re-use in your own custom applications.

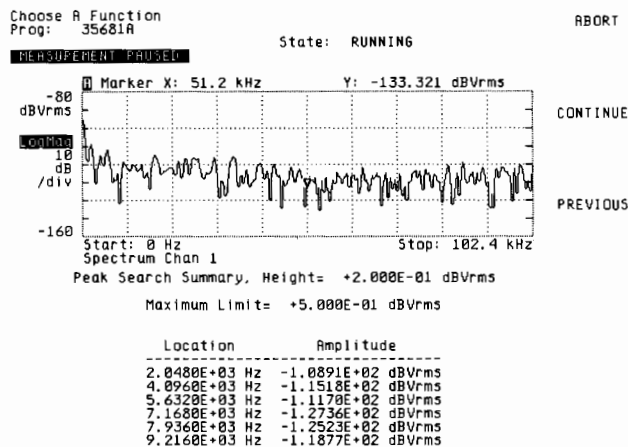

### HP 35660A Specifications

#### Frequency

**Measurement Range:** Channel 1: 488  $\mu$ Hz to 102.4 kHz, single channel mode. Channel 1 and 2: 244  $\mu$ Hz to 51.2 kHz, dual channel mode.

**Accuracy:**  $\pm$  0.003% of frequency reading

**Resolution:** Span/400, both channels, single or dual channel operation.

Spans:	Single Channel	Dual Channel
# of spans available	20 (x2 sequence)	20 (x2 sequence)
min span	195.3 mHz	97.6 mHz
max span	102.4 kHz	51.2 kHz
time record length	400/span	400/span

**Window Functions:** Flat Top, Hann, Uniform, Force, Exponential

#### Window Shape Parameters:

	Noise Equiv. BW (% of span)	-3dB BW (% of span)	Shape Factor (-60dB BW/-3dB BW)	Window Flatness (dB)*
Uniform	0.25	0.25	716	+0, -4.0
Hann	0.375	0.37	9.1	+0, -1.5
Flat Top	0.955	0.9	2.6	$\pm$ 0.005

\*relative to analyzer's 401 calculated frequency points

#### Typical Realtime Bandwidth: (random noise source off)

	Single Channel	Dual Channel
Averaging Off	800 Hz	400 Hz
Fast Averaging	3.2 kHz	1.6 kHz

# SIGNAL ANALYZERS

## Dual-Channel, Dynamic Signal Analyzer 244 $\mu$ Hz to 102.4 kHz (cont'd)

Model 35660A

### Amplitude

**Input Range:** The calibrated input range is +27 dBV (31.7 Vpk) to -51 dBV (3.99 mVpk). Range is adjustable in 2 dB increments.

**Dynamic Range:** All distortion (intermodulation and harmonic) spurious and alias products < -70 dB relative to full scale input range.

**Noise:** (-51 dBV range,  $R_s = 50$  ohms, 16 RMS Averages)  
 160 Hz to 1.28 kHz < -130 dBV/sqrt Hz (.316  $\mu$ V/sqrt Hz)  
 1.28 kHz to 102.4 kHz < -140 dBV/sqrt Hz (.100  $\mu$ V/sqrt Hz)

**Common Mode Rejection:** (Frequency  $\leq 1$  kHz)  
 -51 to -11 dBV Ranges >80 dB (typical)  
 (3.99 mVpk to 399 mVpk)  
 -9 to +9 dBV Ranges >60 dB (typical)  
 (502 mVpk to 3.99 Vpk)  
 +11 to +27 dBV Ranges >40 dB (typical)  
 (5.02 Vpk to 31.7 Vpk)

**Crosstalk:** < -130 dB relative to the transmitting signal, or < -70 dB relative to the receiving channel range, whichever is greater. (Receiving channel input termination = 50  $\Omega$ )

**Absolute Amplitude Accuracy:**  $\pm 0.5$  dB  $\pm 0.03$  % of input range (488  $\mu$ Hz to 102.4 kHz, DC coupled)

### Phase

**Single Channel Phase Accuracy:**  
 488  $\mu$ Hz to 10.24 kHz  $\pm 4.0$  degrees  
 (relative to external trigger, 16 vector averages, DC coupled, amplitude  $\geq -50$  dB relative to full scale)

### Frequency Response

**Gain Accuracy:**  $\pm 0.4$  dB

**Phase Accuracy:** 488  $\mu$ Hz to 10.24 kHz  $\pm 1$  degree  
 10.24 kHz to 51.2 kHz  $\pm 1.8$  degree  
 (DC coupled, 16 RMS averages, 488  $\mu$ Hz to 51.2 kHz, Ch1 range = Ch2 Range, full scale periodic chirp input, Uniform window)

### Inputs

**Connection:** Grounded or Floating

**Input Impedance:** 1 M $\Omega$   $\pm 10\%$  shunted by < 100 pF.  
 Low to chassis in floating mode:  
 1 M $\Omega$  shunted by < 0.01  $\mu$ F (Typical)  
 Low to chassis in grounded mode: 50  $\Omega$  (Typical)

**Input Coupling:** AC or DC coupling;  
 AC roll-off is < 3 dB at 1 Hz

**Common Mode Range:** (floating mode)  
 $\pm 4$  V peak

### Trigger

**Internal:** Positive or negative slope  
 Level:  $\pm 100\%$  of input range

**External:** TTL, positive or negative slope

### Source

**Source types:** Random, periodic chirp, fixed sine

**Output Impedance:** < 5  $\Omega$

**Max. Output Level:**  $\pm 5$  Vpk

**Maximum current:**  $\pm 20$  mA

**Maximum capacitive load:** 1000 pF

### Sine:

**Frequency range:** 15.63 mHz to 102.4 kHz  
**Amplitude Accuracy:**  $\pm 4\%$  Vpk (at 1 kHz, Vpk = .1V to 5V)  
**Flatness:**  $\pm 1.0$  dB (relative to 1 kHz, Vpk = .1V to 5V)  
**Harmonic, subharmonic, and other spurious responses:**  
 488  $\mu$ Hz to 10 kHz: < -60 dB relative to source level  
 10 kHz to 102.4 kHz: < -40 dB relative to source level (Vpk = 0.1V to 5V)  
 Residual DC offset:  $\pm 8.0$  mV,  $\pm 6.0\%$  Vpk

### Random:

**Flatness:** < 5.0 dB (typical)  
 (passband, relative to minimum amplitude in the frequency domain, Vpk = .1V to 5V, full span)

### General

**Power:** 90 - 132 VAC, 48 to 440 Hz  
 198 - 264 VAC, 48 to 66 Hz  
 280 VA maximum

**Weight:** 22 kg (47 lbs) net  
 24 kg (52 lbs) shipping

**Dimensions:** 222mm (8.75") high  
 425.5mm (16.75") wide  
 538mm (21.19") deep

### HP-IB

Implementation of IEEE Std 488.1 and 488.2  
 SH1 AH1 T6 TE0 L4 LE0 SR1 RL1 PP0 DC1 DT1 C1,C2,C3,C12 E2

### Compatible Peripherals

**Disc Drives:** HP SS/80 Protocol Disc Drives (These include the 9122C,D,S; 9133D,H,L; and HP 9153A,C)

**Plotters:** Hewlett-Packard Graphics Language (HP-GL) digital plotters

**Printers:** HP-IB printers, alpha and raster dumps.

### Ordering Information

	Price
HP 35660A Dynamic Signal Analyzer	\$12,500
Option 001 Add 2 Mbyte RAM	\$1500
Option 002 Delete disc drive	-\$100
Option 908 Rack mount kit	\$85
Option 910 Extra Operating Manual Set and HP-IB Programming Reference	\$75
Option 915 Service Manual and Kit	\$150
Option W30 2 Years Additional Hardware Service	\$200
HP 35680A Instrument BASIC	\$500
HP 35681A Analysis Pack	\$250

### Accessories Supplied

Operating and Programming Manuals, HP 35660A performance tests

### Accessories Available

**Transit case** for the HP 35660A HP P/N 9211-2663

**Soft Sided Carrying Case** for the HP 35660A HP P/N 35660-60001

# SIGNAL ANALYZERS

## Multi-channel Signal Processing System, 64 $\mu$ Hz to 51.2 kHz

Model 3565S

157

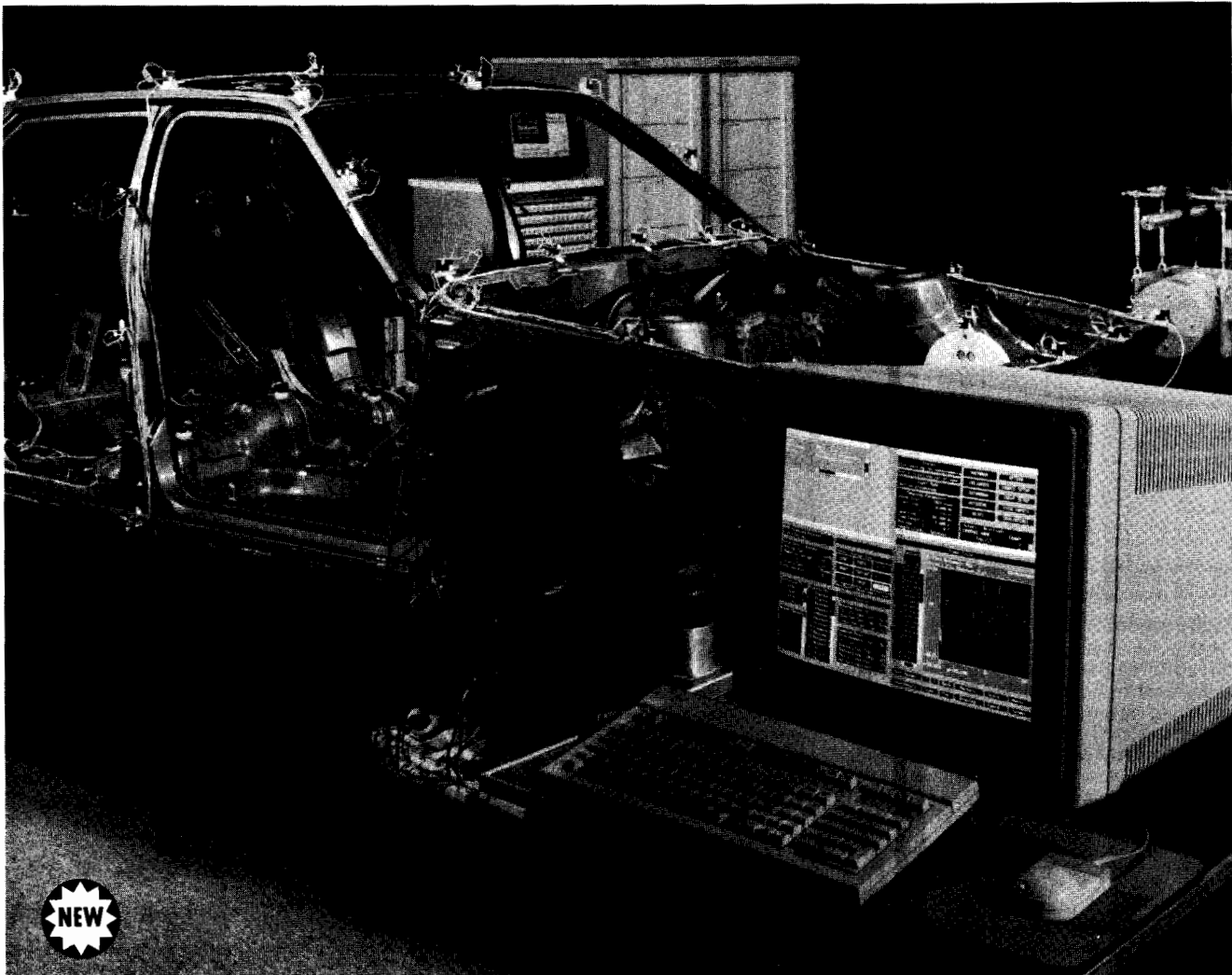

- Time and Frequency Domain Analysis
- Advanced Multiple Input, Multiple Output (MIMO) Measurements
- Built-in Charge or ICP Signal Conditioning
- Expandable from 2 to 62 Input Channels
- Direct ADC Throughput to Disc
- Applications in Acoustics, Vibration Analysis and Structural Testing
- Linear and Log Swept Sine up to 51.2 kHz
- Links to Modal Analysis Software

The HP 3565S Signal Processing System consists of measurement hardware, HP VISTA Signal Processing software (HP 35630A), and a Series 300 computer equipped with the HP-UX operating system. The system provides signal acquisition and analysis from 64  $\mu$ Hz to 51.2 kHz for structural, vibration, and acoustic applications. The modular architecture of the HP 3565S makes system configuration and expansion easy. Beginning with a basic two channel system, add either Input or Source modules to provide up to 62 channels of data collection. HP VISTA signal processing software performs the advanced algorithms and data management required to quickly set up measurements and analyze signals. HP VISTA also provides a complete user interface to the 3565S measurement hardware based on windows and pop-up menus. Program interaction through an HP-HIL mouse gives quick access to measurement results.

Two optional software products, HP SINE (35631A) and HP Modal Data Manager (35632A) further enhance the HP 3565S system. HP SINE adds a swept sine stimulus, normal mode testing, and sine reduction capability. Modal Data Manager provides a method of linking measured data to third party modal analysis solutions. Both software packages require HP VISTA.

### Structural testing

With 3200 lines of resolution and zoom measurements on all channels, the HP 3565S system has no parallel in the area of high quality structural test. The system offers 62 module slots which house any combination of excitation and response channels. For tests that are sensitive to non-linear distortion, the 3565S provides a random noise source. To quantify non-linearities in a system, you can use the swept sine stimulus available with HP SINE software.

The 3565S's ability to provide a number of multiple input, multiple output (MIMO) combinations means you obtain a consistent set of frequency response functions. Since energy is input into the structure at more than one location, closely spaced modes or actual repeated roots can be isolated from frequency response functions. 3565S MIMO measurements also benefit from system speed. For example, a 50 response, 4 excitation measurement with 800 lines of resolution achieves 500 avg/hour with a HP 9000 Series 350 workstation.

# SIGNAL ANALYZERS

## Multi-channel Signal Processing System, 64 $\mu$ Hz to 51.2 kHz (Cont'd)

Model 3565S

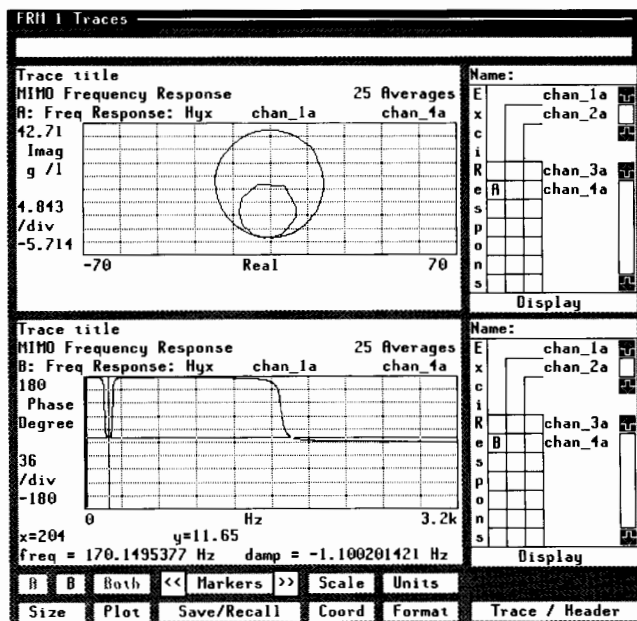

### Environmental Testing

For environmental test labs, HP VISTA can accurately measure PSD and overall Grms for up to 62 accelerometers. Signals can either be digitized in real time and stored on a throughput disc for later processing, or results can be computed on-line for confirmation of excitation levels during the test. HP SINE has the unique ability to lock onto a swept sine excitation signal and compute sinusoidal amplitude, transmissibility and relative phase, and total harmonic distortion for all measurement channels.

### Vibration testing

High speed multi-channel throughput to disc is an important asset in vibration testing. With the 3565S, 40 channels of data can be throughput to disc when measurement span is set to 3200 Hz. With 5 channels of throughput, realtime bandwidth can be up to 25.6 kHz. Throughput rates are as high as 675 Kbytes per second for 7936 (308 Mbyte) and 7937 (571 Mbyte) disc drives.

Because vibration spectra often include closely spaced frequency components, the 3565S system's high resolution and 80 dB of dynamic range are a tremendous asset in vibration testing. Frequency domain resolution choices range from 400 to 3200 lines on every channel—regardless of channel count. Each 3565S input channel has its own anti-alias filter, digital filter, ranging amplifier and transducer amplifier. This guarantees 80 dB of dynamic range on each channel with no need to keep track of various gain/stage settings. Each input module also includes transducer signal conditioning (charge or ICP) to reduce signal conditioning costs. Use HP VISTA's autozero capability to null stray accelerometer DC offset without turning a knob.

### Acoustic testing

Acoustic applications include calibration of transducers and frequency response testing of such devices as loudspeakers, microphones and telephone headsets. In addition to flatness and phase response, HP VISTA together with HP SINE automatically computes total harmonic distortion (THD) versus frequency with a specifiable number of harmonics. Or, for noise control applications, use HP VISTA's multi-channel cross spectrum capability. By attaching high quality microphones to the input channels, you can get cross power spectrum results that indicate sound intensity and direction at each test point.

### HP VISTA Signal Processing Software - HP 35630A

HP VISTA provides both complete control of the 3565S measurement hardware and advanced analysis of measured signals in the time and frequency domains. Detailed frequency domain signal characterization is available by processing time data directly from the input modules, or from time data stored on an ADC throughput disc. Correction algorithms based on measurement hardware calibrations enhance the accuracy of amplitude, gain, and phase measurements to provide high quality signal analysis and network characterization. HP VISTA's open file structure also provides users with data files in a format suitable for custom analysis.

Combined with the measurement hardware, HP VISTA offers the most advanced multiple-input multiple-output (MIMO) measurements available today. Measurements range from 61 force channels—one response channel, to one force channel-61 response channels. MIMO configurations can be set up with simultaneous zoom on each input channel and up to 3200 lines of resolution.

- Measurements: Time record, linear spectrum, auto power spectrum, cross power spectrum, frequency response function, power spectral density and coherence (ordinary, multiple, and partial)
- Frequency Spans: 19 baseband spans from 195 mHz to 51.2 kHz in x2 steps.
- Windows: Hanning, flat top, force and response, exponential, P301, P310, and user-specified
- Absolute amplitude accuracy (calibrated system):  $\pm 0.15$  dB  $\pm 0.015\%$  of full scale (+32 to -48 dBVp ranges)
- Cross-channel accuracy (calibrated system):  $\pm 0.1$  dB,  $\pm .5$  degrees
- Realtime bandwidth: 1 channel active: 12.8 kHz  
7 channels active: 1.6 kHz

(Above rates apply with 1024 complex block size, stable mean average, input monitor inactive, frequency response measurement inactive, fast averaging.)

- Throughput rates to selected HP Drives:  
 HP 7936A (308 Mbytes) or 7937A (571 Mbytes) disc drive:  $\leq 675$  Kbytes/sec  
 HP 7957A (81 Mbytes) or 7958A (130 Mbytes) disc drive:  $\leq 625$  Kbytes/sec

### HP SINE - HP 35631A

With HP SINE it is now possible to make swept sine measurements with the HP3565S system. Frequency response functions (FRF) can be computed for acoustic devices as well as structures. A powerful autogain routine also permits non-linear behavior to be characterized in structures by maintaining a constant excitation level during the sweep. Several FRFs can be compared at incremental force levels to provide a clear indication of nonlinearities. With HP SINE up to 60 channels of data can be acquired with a minimum resolution of 15.625 mHz. An autoresolution feature saves test time by providing fine resolution where it is needed, such as at resonant peaks, and coarser resolution where it is not.

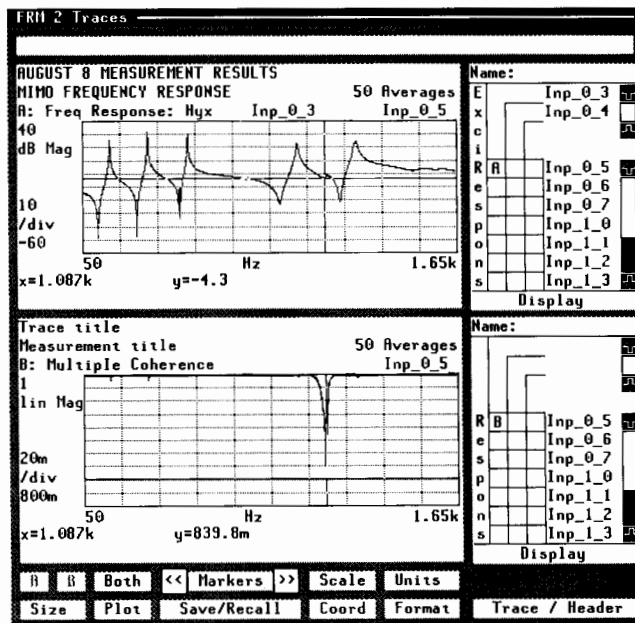

**Modal Data Manager - HP 35632A**

Modal Data Manager is a software product that couples HP 3565S files to third party modal solutions. It enhances the measured data by adding to it a measurement name, transducer orientation, and sign and spatial geometry coordinates. Combined with third party modal analysis software, the HP 3565S offers users a total solution in the area of structural test.

**Hardware flexibility**

Based around the 35650A Mainframe, the HP 3565S measurement hardware allows you to purchase the hardware you need today without limiting future expansion. Providing power, cooling, and access to system buses, each mainframe will accommodate up to eight system modules. If more than eight modules are required, up to eight mainframes can be interconnected to provide up to 64 system slots. After making large channel count measurements, mainframes and modules can be distributed into smaller systems for optimum use of the measurement hardware.

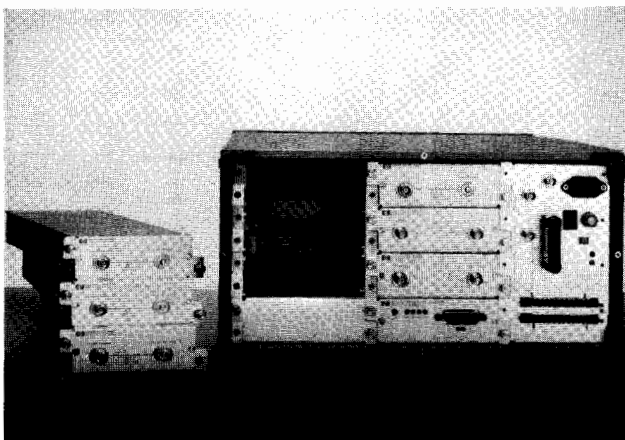

**Mainframe - HP 35650A**

The 35650A mainframe houses the system modules and provides power and cooling in addition to triggering and sampling synchronization. A mainframe can support up to eight modules and up to eight mainframes can be connected together to provide 64 system slots. Each system requires at least one 35650A Mainframe, one 35651A HP-IB/Signal Processor module, two 35652A 51.2 kHz Input modules and one 35653A Source module. Any remaining slots can be filled with either Source or Input modules.

**HP-IB/Signal Processing Module - HP 35651A**

The 35651A HP-IB/Signal Processor Module is the heart of the measurement hardware. This single module controls and manages all modules on the system bus and is also the link between the measurement hardware and the Series 300 computer. Dedicated processors within 35651A can be programmed from the system computer to perform basic signal processing functions such as windowing and fast Fourier transforms. This provides high speed signal processing and allows the system computer to focus on management, advanced processing and display of the data provided by the hardware. The 35651A can also control disc drives directly, allowing ADC throughput of sampled data from Input modules at rates in excess of 675 Kbytes per second (Note: this module supports complete HP-IB programming of all system modules and limited programming of its internal signal processors. An optional HP-IB programming manual provides example programs demonstrating how this measurement hardware can be used in an HP BASIC environment for integration into existing measurement systems or for custom development of focused measurement/analysis solutions.)

- Block Size: Power of 2 block sizes of 512 to 4096 complex or 1024 to 8192 real are selectable in HP VISTA.
- Internal FFT computation time: 1024-point complex transform (800 lines) in approximately 67 ms with 80 dB dynamic range (nominal, includes windowing).
- Maximum Throughput Rate to Disc: 675 Kbytes/second

**51.2 kHz Input Module - HP 35652A**

The 35652A Input module digitizes signals at a 262 kHz sample rate. A 51.2 kHz anti-alias filter, digital filtering, and hardware zoom provide the necessary components for fast, flexible and accurate frequency domain analysis. A built-in 4 mA current source and charge amplifier provide complete signal conditioning for voltage, charge, and ICP-type transducers. This module also supports features such as auto-ranging, overload detection, and DC offset subtraction to ensure high quality results.

- Full Scale Voltage Range: 1.26 mVp (-58 dBVp) to 39.8 Vp (+ 32 dBVp) in increasing steps of 25% (2 dB)
- Full Scale Charge Range: -18 dBpCp to +72 dBpCp in 2 dB steps
- Effective Sample Rates (using internal sample clock): from 0.5 Hz to 262 kHz in x2 steps (all sampling frequencies between 0.5 and 131 kHz inclusive are fully alias protected and are supported by HP VISTA to provide frequency spans from 195 mHz to 51.2 kHz).
- Dynamic Range: <-80 dB relative to full scale (Rs=50 ohms, Cs=1000pF, 16 averages, internal sampling)

**Source Module - HP 35653A**

The 35653A Source module provides the excitation signals necessary to stimulate devices under test. Random noise and fixed sine wave signals are available in both continuous and burst formats. When more than one Source module is installed in a system, the random noise outputs are uncorrelated to support advanced measurements such as multiple input, multiple output (MIMO) testing. The system calibration signal is also provided by this module.

- Signal Types: Random, Burst Random, Fixed Sine, Gated Sine, Variable Pulse
- AC Output Level: 1.26 mVp (-58 dBVp) to 10.00 Vp (+20 dBVp) in 0.375 dB steps

**Ordering/Configuration Information**

Ordering/Configuration Information	Price
<b>Bundled Systems</b>	
74791S 4-Channel 3565S System (includes: 1 Mainframe, 1 HP-IB/Signal Processing Module, 4 Input Modules, 1 Source Module and HP VISTA)	\$28,100
74792S 8-Channel 3565S System (includes: 2 Mainframes, 1 HP-IB/Signal Processing Module, 8 Input Modules, 1 Source Module and HP VISTA)	\$43,950
74791S 16-Channel 3565S System (includes: 3 Mainframes, 1 HP-IB Signal Processing Module, 14 Input Modules, 1 Source Module and HP VISTA)	\$72,650
35633A Software Bundle (includes: HP SINE, HP MDM, and HP VISTA)	\$12,000
<b>Measurement Hardware</b>	
HP 35650A Mainframe	\$3010
HP 35651A HP-IB Signal Processing Module	\$3315
HP 35652A Input Module	\$3210
HP 35653A Source Module	\$1785
HP 35605A 720 mm Rack	\$1530
HP 35606A 1600 mm Rack	\$2040
<b>Software</b>	
HP 35630A HP VISTA Signal Processing Software	\$7140
HP 35631A HP Sine	\$5000
HP 35632A Modal Data Manager (MDM)	\$2500



# SIGNAL ANALYZERS

## Automated Spectrum Analysis

### Model 3048A

Calibrated, Automated Phase Noise Measurements with

- Specified amplitude accuracy of  $\pm 2$  dB
- Offset frequency range of 0.01 Hz to 40 MHz

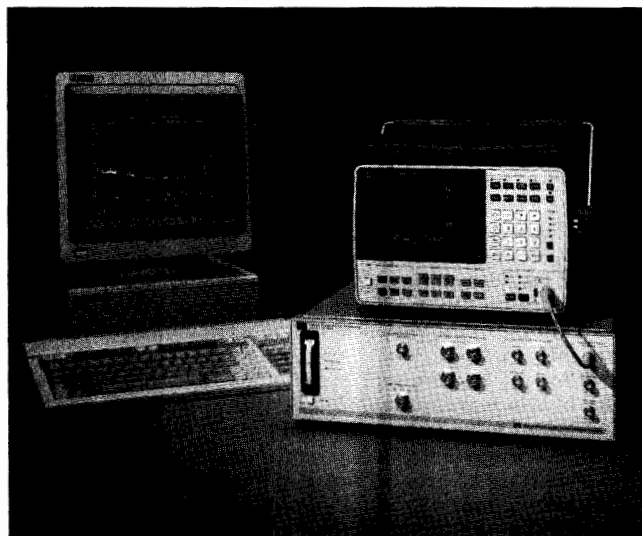

HP 3048A Phase Noise Measurement System controlled by an HP 98580B Desktop Computer.

The HP 3048A Phase Noise Measurement System uses the power of a flexible software program to automate the measurement of the phase noise of a carrier signal. The basic HP 3048A system includes the HP 11848A Phase Noise Interface containing the phase detectors and phase lock loop circuitry, the HP 3561A Dynamic Signal Analyzer, measurement software, and a comprehensive operator training course that teaches measurement procedures. Using an HP 98580B Desktop Computer, this basic system will measure carrier frequencies from 5 MHz to 1.6 GHz (to 18 GHz with option 201) and characterize the demodulated phase noise over an offset range of 0.01 Hz to 100 kHz. Adding other HP spectrum analyzers such as the HP 8566A/B, 8567A/B, 8568A/B, 8562A/B, 3585A/B, or 71000S, provide automated measurements to offsets of 40 MHz. A variety of signal generators such as the HP 8662A, 8663A, or 8642A/B can also be added to the system to provide a low-noise reference signal up to a frequency of 2.56 GHz. Adding an HP 11729C Carrier Noise Test Set in combination with an HP 8662A or HP 8663A provides a low-noise reference signal for measuring carrier signals up to 18 GHz.

The HP 3048A system software uses the HP 11848A interface to demodulate the phase noise of a carrier in the frequency range of 5 MHz to 18 GHz (and beyond with external, user-supplied mixers) and measures the resulting baseband signal with the analyzers. Measurement menus allow the operator to specify the measurement to be made and the system software controls the measurement process, including the calibration of the system. Several output formats are available to the user, including plots of the single sideband phase noise power of a signal, integrated noise power, or the calculated Allen variance. A real-time measurement mode is available to monitor the level of phase noise and discrete spurs as changes are made to the device under test.

As measured by the HP 3048A, the term "phase noise" includes all forms of a signal's frequency and phase instabilities. Randomly occurring frequency and phase noise modulation, as well as discrete sidebands resulting from power-line phase modulation and phase jitter, are detected and accurately measured. Coherent signals are displayed at the power level that was detected while random phase signals are normalized for a 1 Hz bandwidth. The HP 3048A system is optimized for several measurement techniques that are chosen based on the stability and tuning capability of the signal to be measured and the availability of comparable reference oscillators. The two primary techniques for demodulating the phase noise of a signal use either a phase detector or a frequency discriminator.

- Carrier frequency range from 5 MHz to beyond 18 GHz
- Spurs separated from noise spectra
- Optimization for several measurement techniques

### Specifications Summary

#### Sensitivity:

The system's sensitivity is a function of the measurement technique that is used. The following graph indicates the sensitivity of the system as limited by its own internally-generated noise for a signal under test of +15 dBm. Also plotted is the phase noise that would limit the measurement sensitivity for a 1 GHz signal using HP signal generators as reference sources.

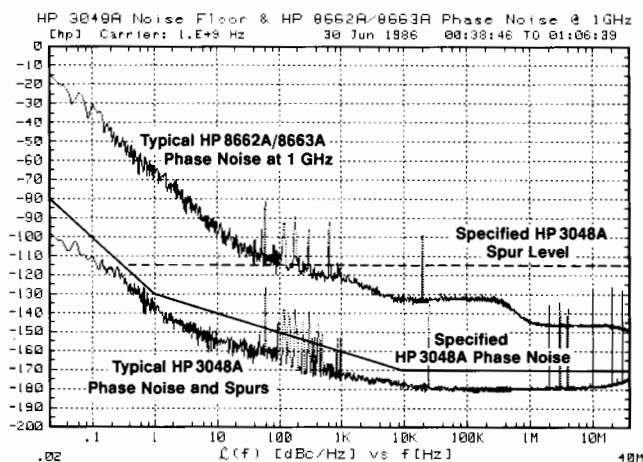

#### Carrier Frequency Range

**Internal Mixer:** 5 MHz to 1.6 GHz, optional to 18 GHz.

**External (user-supplied) Mixer:** The frequency range of the carrier is limited only by the frequency range of the external mixer or the frequency discriminator that is used.

**Offset Frequency Range:** 0.01 Hz to 100 kHz, extended to 40 MHz with an optional spectrum analyzer such as the HP 3585A.

**Amplitude Accuracy:**  $\pm 2$  dB to 1 MHz offset;  $\pm 4$  dB for offsets greater than 1 MHz. This accuracy is verified by the system at the time of the measurement. The system advises the user of any potential accuracy degradations detected during measurement set-up.

#### Ordering Information

**HP 3048A Phase Noise Measurement System** **Price**  
\$32,700

Includes the **HP 11848A** Phase Noise Interface, **HP 3561A** Dynamic Signal Analyzer, measurement software and operator training

Reference oscillator options:

**Opt 001** Adds HP 8662A Opt. 003 Synthesized Signal Generator (0.01 to 1280 MHz) + \$35,635

**Opt 002** Adds HP 8663A Opt. 003 Synthesized Signal Generator (0.01 to 2560 MHz) + \$49,225

**Opt 003** Adds HP 11729C Carrier Noise Test Set (5 MHz to 18 GHz) + \$22,980

**Opt 005** Adds HP 8642A Opt. 001 Synthesized Signal Generator (0.1 to 1057 MHz) + \$26,160

**Opt 006** Adds HP 8642B Opt. 001 Synthesized Signal Generator (0.1 to 2114 MHz) + \$35,265

**System Computer:** HP 98580B Opt. ABA and Opt. 008 Desktop Computer with 3 megabytes of memory and HP-HIL knob. \$9,500

For full details on available system options and ordering information, see the HP 3048A Phase Noise Measurement System Technical Data (5953-8462).

- 10 MHz to 18 GHz
- Phase noise and AM noise measurements
- Low system noise floor

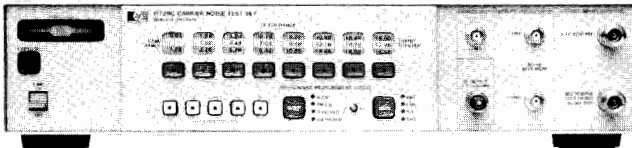

HP 11729C

### HP 11729C Carrier Noise Test Set Versatile Phase and AM Noise Measurements

The HP 11729C, combined with an HP 8662A Synthesized Signal Generator and a baseband spectrum analyzer, provides a broadband measurement system for phase noise and AM noise measurements on microwave oscillators, 10 MHz to 18 GHz. The HP 11729C may be ordered with either full frequency coverage, or in a number of bands to specifically match the application. The HP 11729C supports both the phase detector and frequency discriminator phase noise measurement techniques, as well as AM noise measurements, at offsets from the carrier <math>< 1\text{ Hz}</math> to 10 MHz. The HP 11729C also supports pulsed AM and phase noise measurements.

The HP 11729C Carrier Noise Test Set is a fully programmable instrument. All functions can be automatically controlled via the HP Interface Bus. With an appropriate programmable baseband spectrum analyzer, the HP 11729C can be integrated into your own automatic system. By adding the HP 11729C and an HP 8662A or HP 8663A to the HP 3048A Phase Noise Measurement System, specified phase noise measurements can be made to 18 GHz with a state-of-the-art noise floor.

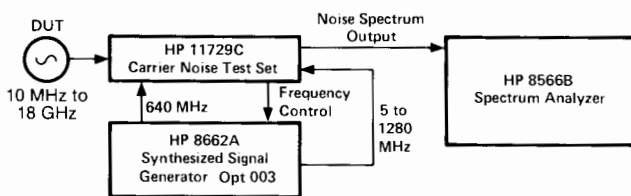

Complete carrier noise characterization system can be assembled from standard instruments.

### Typical System Noise

The HP 11729C/8662A combination includes the critical low noise microwave reference signal (which determines the system noise floor). The HP 11729C also features a new Surface-Acoustic-Wave (SAW) filter which can be configured into an internal SAW oscillator. This built-in oscillator allows the HP 11729C to be used as a low-cost frequency discriminator system for measurements on free-running oscillators. This discriminator mode uses the HP 11729C in a "stand-alone" configuration, combined with a simple length of external delay line (such as RG 223 cable) and an available baseband analyzer.

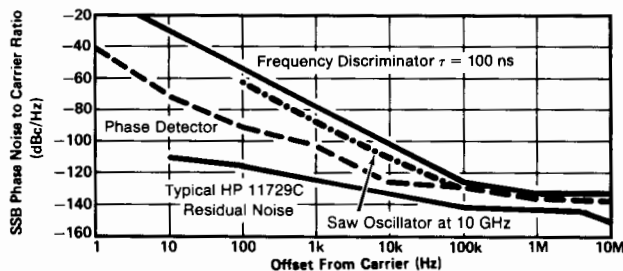

Figure 1. Typical HP 11729C/8662A and HP 11729C self-oscillator mode system sensitivity using the phase detector and frequency discriminator methods at X-Band. Typical HP 11729C residual noise.

### Abbreviated HP 11729C/8662A Specifications

**Frequency range:** 10 MHz to 18 GHz in 8 bands.

**Absolute system noise floor, phase detector method:**

System noise is specified only when the HP 11729C is used with an HP 8662A or HP 8663A Option 003. See the HP 11729C data sheet for more information.

### Test Signal Requirements

**Amplitude:** +7 dBm minimum to +18 dBm maximum (typically useable to -15 dBm with noise floor degradation).

### HP 11729C Outputs

#### IF output

**Bandwidth:** 5 to 1280 MHz.

**Level:** +7 dBm minimum.

#### Noise spectrum outputs

1) Noise spectrum output <math>< 1\text{ MHz}</math>: dc coupled, 600 $\Omega$  nominal.

2) Noise spectrum output <math>< 10\text{ MHz}</math>: 10 Hz to 10 MHz, 50 $\Omega$  nominal, nominal 40 dB of gain over <math>< 1\text{ MHz}</math> output.

3) Auxiliary noise spectrum output: dc coupled, 600 $\Omega$  nominal.

### Phase Lock Loop Function

#### Frequency control outputs

**To crystal oscillator:**  $\pm 10\text{V}$ .

**To dc FM:**  $\pm 1\text{V}$ .

**Lock bandwidth factor:** nominal 1, 10, 100, 1k, 10k selectable.

### Remote Programming

All front panel functions are HP-IB programmable. In addition, the HP 11729C can output current settings and out-of-lock indication.

### AM Noise Detection (Option 130)

**Frequency:** 10 MHz to 18 GHz.

**Input level:** 0 dBm minimum to +18 dBm maximum.

**AM noise floor (at +10 dBm input level, dBc/Hz):**

Offset from Carrier (Hz)	Typical	Specified
1k	-147	-138
10k	-152	-145
100k	-161	-155
1M	-165	-160

### General

**Operating temperature range:** 0 $^{\circ}$  to +55 $^{\circ}$ C.

**Power:** 100, 120, 220, 240 V, +5%, -10%; 48 to 66 Hz; <math>< 75\text{ VA}</math> max.

**Weight:** net, 10.4 kg (23 lb); shipping, 13.6 kg (30 lb).

**Size:** 425 W x 99 H x 551 mm D (21.7" x 16.8" x 3.9"). 1 MW x 3 1/2 H x 20 D System II module.

### Ordering Information

**HP 11729C Carrier Noise Test Set (10 MHz to 18 GHz)**

### Price

\$23,980

Note: Each of options 003 to 027 (only one may be ordered) also includes 0.005 to 1.28 GHz coverage

**Opt 003 (1.28 to 3.2 GHz)** - \$8,500

**Opt 007 (3.2 to 5.76 GHz)** - \$8,500

**Opt 011 (5.76 to 8.32 GHz)** - \$8,500

**Opt 015 (8.32 to 10.88 GHz)** - \$8,500

**Opt 019 (10.88 to 13.44 GHz)** - \$8,500

**Opt 023 (13.44 to 16.0 GHz)** - \$8,500

**Opt 027 (16.0 to 18.0 GHz)** - \$8,500

**Opt 130 AM noise detection** + \$1,750

**Opt 140 Rear panel connectors** + \$500

**Opt 907 Front panel handle kit (5061-9688)** + \$55

**Opt 908 Rack mounting flange kit (5061-9674)** + \$35

**Opt 909 Front panel handle plus rack mounting flange kit (5061-9675)** + \$80

**Opt 910 2 sets operation and service manuals (11729-90017)** + \$35

# SIGNAL ANALYZERS

## Vector Modulation Analysis, dc-350MHz, 50-200MHz

### Models 8980A and 8981A

#### HP 8980A & HP 8981A

- Analyzes coherent phase and amplitude modulation.
- 350 MHz Q vs. I bandwidth.
- Markers for measuring phase, amplitude, and time.
- 12 bit digitizing for HP-IB measurements.

#### HP 8981A adds built-in I/Q demodulator with:

- 50 - 200 MHz modulated IF input frequency range.
- 100 MHz baseband bandwidth with external I/Q filters and 35 MHz with internal filters.
- Automatic internal/external demodulator calibration.

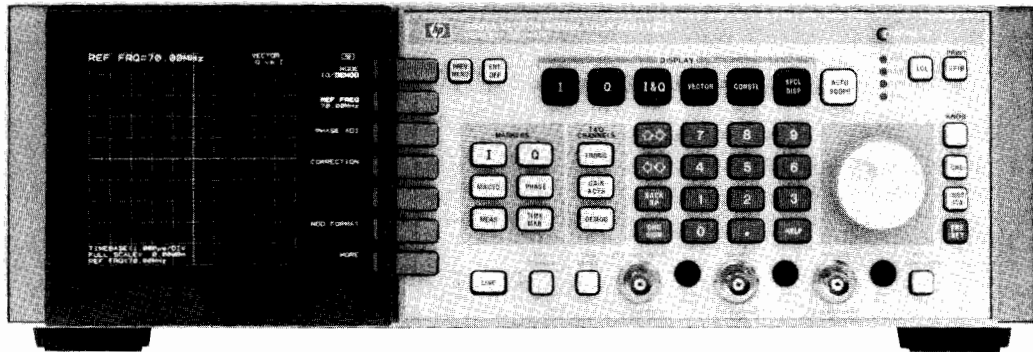

HP 8981A

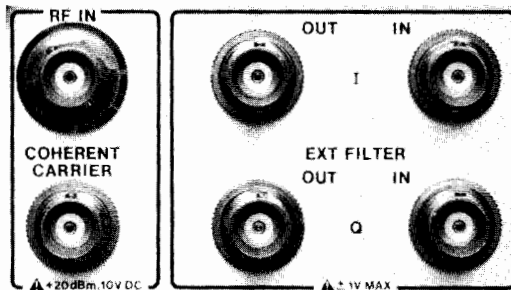

**HP 8981A rear panel** contains the IF and coherent carrier inputs and ports for adding external I/Q filters.

I/Q RECEIVER

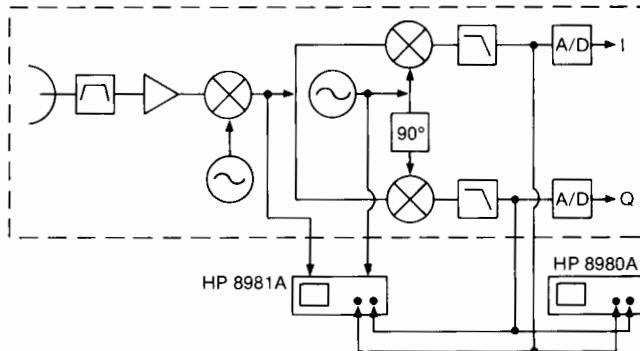

The HP 8980A and HP 8981A analyze a signal's modulation in receivers using I/Q channels. The HP 8980A displays the I and Q analog baseband signals either on a vector diagram (Q versus I) or versus time. The HP 8981A, being a superset of the HP 8980A, also analyzes the analog I and Q signals, but because it contains a built-in demodulator it can also take the IF signal and the coherent reference inputs. This gives the user flexibility to examine the changes in modulation down through the receiver chain and isolate fault areas quickly.

The HP 8981A contains internal 35MHz baseband I and Q filters. If the user desires to use their own filters, ports are provided on the back panel for them. The user can then switch between using the internal or external filters.



#### What is a Vector Analyzer or Vector Modulation Analyzer?

The HP 8980A Vector Analyzer is a calibrated baseband analyzer which connects to the I and Q outputs of your receiver's demodulator. The HP 8981A Vector Modulation Analyzer includes the same baseband analyzer, but adds a vector demodulator for IF measurements as well. It connects to the IF output of your transmitter and to the coherent reference. Both the instruments measure signal magnitude and phase of standard digital communication and radar signals. The instruments perform constellation analysis of quadrature error, lock angle error and closure. The design provides for quick, visual, intuitive measurements as well as giving quantitative data about a signal's modulation. These features allow a user to quickly identify problem sources and measure their magnitude.

#### For Advanced Receiver Design

The HP 8980A/81A contains powerful aids which allow a user to make precise measurements on today's advanced digital communication and radar receivers. Communications advances, such as spectrally efficient, digital microwave radios, dictate new standards for performance testing and new methods for looking at signals. Traditionally tests have been made using an oscilloscope with eye diagrams. The HP 8980A/81A takes this testing one step further and provides, in addition to eye diagrams, wide-band Q vs. I diagrams. Many measurement features have been tailored for automatic radio testing, such as constellation analysis of common modulation formats and built-in phase/magnitude markers.

Testing advanced radars largely consists of digitizing the I and Q channels and having a computer analyze the signals. The HP 8980A/8981A, with its real-time visual display of phase and magnitude, allows a user to make and view the measurements on the screen. Phase slopes and transients can be easily seen and quantified. The effects of adjustments on the receiver will be immediately seen, thus greatly reducing test and alignment time. The many standard features provide versatile and convenient measurements, allowing a user to isolate the source of errors instead of just making go/no go tests.

#### Demodulator Correction (HP 8981A only)

A powerful routine in the HP 8981A measures and corrects demodulator errors. This routine measures the internal demodulator's or an external demodulator's quadrature error, I/Q gain imbalance, and DC offsets. The display and digitized outputs can then be automatically adjusted to correct for these errors.

### Digital Communication Signals

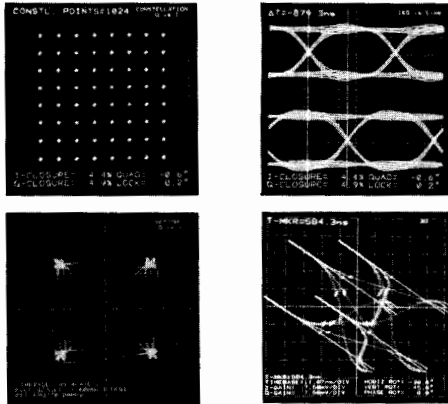

1. Constellation display of a 64 QAM signal. The signal is displayed Q versus I only at the time defined by the time marker, so you can mimic the effects of a digital microwave radio's "slicer" circuits. This display readily shows different types of distortion. The constellation analysis routine digitizes the signal and calculates I & Q closure, lock angle error, and quadrature error. The error values are displayed at the bottom of the screen. This analysis can be performed for QPSK, 9PRS, 16QAM, 25QAM, 256QAM, 49QAM, 49QPR, & 81QPR signals.

2. The I and Q channels displayed versus time here show the eye diagrams of the I and Q channels. By using the time and delta time markers the differential delay can be adjusted and measured. Also the point of maximum eye opening can be determined.

3. A vector display of a QPSK signal shows the transactions between the states whereas the constellation display shows only the states. The vector display is excellent for seeing how the phase and amplitude changes during transitions.

4. 3D display of a QPSK signal. Useful for visual, intuitive analysis of Q vs. I vs. time waveforms. The waveform can be rotated about any of the three axes.

### Radar Signals

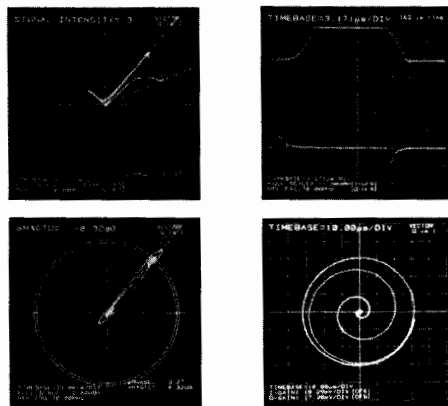

1. A simple coherent radar pulse displayed on a vector diagram. The phase transients at turn on and off, which can cause unwanted doppler shifts, are readily seen. The delta phase and magnitude markers easily qualify these shifts. A phase-coded pulse, such as a Barker code, can be displayed and the phase slopes can be measured.

2. If the pulse "on state" is aligned with the I axis, then I versus time will approximate the magnitude versus time of the pulse and the Q channel will approximate the incidental phase modulation of the pulse.

3. By using the vector display, signal phase and magnitude can be seen and measured. Here a pulse was passed through an amplifier and the phase and magnitude were marked. Then another amplifier of the same model was tested. The delta markers now indicate a phase difference of 3.2 degrees and a magnitude difference of .32 dB between the amplifiers. Thus different components can be matched to an original reference.

4. A demodulated SAW chirp signal on a vector display. The spiral effect is created by a phase change caused by the frequency ramp and the magnitude of the pulse sloping slowly up and down with cosine weighting.

### HP 8980A and HP 8981A Specifications

#### I and Q Channels

**Bandwidth (-3dB):** 350 MHz dc coupled; approximately 1 kHz to 350 MHz, ac coupled.

**Deflection Factor Range:** 5 mV/div to 1 V/div, continuously adjustable; full scale in 10 divisions.

**DC Vector Accuracy Using Internal ADC:**  $\pm 1\%$  of full scale (or 2mV if greater)  $\pm 1\%$  of offset.

**Maximum DC Coupled Input Voltage:**  $\pm 5V$  peak.

**Maximum AC Coupled Input Voltage:**  $\pm 25 V$  dc;  $\pm 5 V$  peak ac.

**Transition Time (10% to 90%):** 1ns.

**I-Q Crosstalk:** -60 dB or 1% of full-scale peak, whichever is greater, dc to 350 MHz.

**Input Termination:** 50 ohms or 75 ohms.

**Input Coupling:** each channel independently: ac, dc, or ground (input disconnected).

#### Timing

**Acquisition Method:** repetitive sampling.

**Time per Division Range:** 500 ps/div to 2 ms/div, continuously adjustable.

**Delay I & Q Range:** 0 to 100 divisions for specified performance, 20 ms maximum.

**Time/Division Accuracy:**  $\pm 3\%$ .

#### Triggering

**Trigger Sources:** selectable from external, internal I, internal Q, or LINE.

**External Trigger Terminations:** selectable 50 or 75 ohms.

**ECL:** 50 ohms or 75 ohms to -2V.

**GND:** 50 ohms or 75 ohms to gnd.

**Internal I or Q Trigger Levels:** selectable ac or dc internal coupling. Adjustable internal trigger levels.

**Gate Operation:** a rear panel input. Gate blanks the display and disables measurements asynchronously with the trigger rate.

**Minimum Gate Pulse Width:** 100 ns (on or off).

**Digitizing Resolution:** 12 bits.

#### Environment

**Operating Temp.:** 0° C to + 55° C (+32 to +131° F).

**Non-operating Temp.:** -40° C to +75° C (-4 to +167° F).

**Operating Humidity:** up to 95% relative humidity at +40° C.

#### Power Requirements

**Voltage:** 100, 120, 220, 240 Vac, -10% to +10%; 48-66 Hz.

**Power:** 245 watts, 320 VA maximum.

**Dimensions:** Package is 5 1/4 inch rack height, one module width 23D HP System II cabinet.

**Weight:** net approximately 20kg (45 lbs), shipping approximately 24 kg (53 lbs).

### HP 8981A Demod Mode Specifications

**Modulated IF Input Frequency Range:** 50 MHz to 200 MHz.

**Modulated IF Input Level Range:** -5 dBm to -20 dBm.

**Coherent Reference Input Frequency Range:** 50 MHz to 200 MHz.

**Coherent Reference Input Level Range:** +10 dBm to -20 dBm.

**Baseband Bandwidth (3 dB):** 100 MHz with external filters. Supplemental characteristic of 35 MHz with internal filters.

**Corrected Vector dc accuracy at 70 MHz:** (typical from 50 to 200 MHz) <2% of full scale IF input.

#### Supplemental Characteristics

**Quadrature Error:** Corrected:  $\leq \pm 5$  deg. Uncorrected:  $\leq \pm 1^\circ$ .

**I/Q Gain Imbalance (dc to 10 kHz):** Corrected:  $\leq \pm 0.1$  dB. Uncorrected:  $\leq \pm 0.25$  dB.

### Ordering Information

	Price
HP 8980A Vector Analyzer	\$19,700
HP 8981A Vector Modulation Analyzer	\$29,000
Option 907: Front handle kit	\$65
Option 908: Rack flange kit	\$35
Option 909: Rack flange and front handle kit	\$90
Option 915: Add service manual	\$45
Option 916: Add extra operating manual	\$30
Option W03: 90 day on-site warranty conversion (where available)	\$0
Option W30: 2 additional years of return to HP service	
HP 8980A \$400, HP 8981A \$600	
HP 11748A Active probe system	\$2,995

# SIGNAL ANALYZERS

Audio Analyzer, 20 Hz to 100 kHz; Distortion Analyzer, 20 Hz to 100 kHz

Models 8903B, 8903E

- Measures distortion, SINAD, signal-to-noise
- Measures true-RMS ac volts, dc volts, frequency
- Low-distortion programmable source
- RMS, average and quasi-peak detection

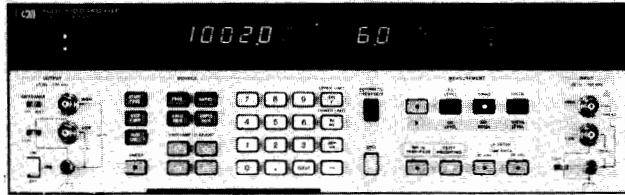

HP 8903B

## HP 8903B Audio Analyzer and HP 8903E Distortion Analyzer

The HP 8903B Audio Analyzer and HP 8903E Distortion Analyzer provide unparalleled versatility and performance for audio measurements from 20 Hz to 100 kHz. The HP 8903B combines the functionality of a low-distortion audio source, high-performance distortion analyzer, frequency counter, ac voltmeter, dc voltmeter and SINAD meter into one compact package. With microprocessor control of source and analyzer, the HP 8903B can perform stimulus-response measurements, such as signal-to-noise ratio and swept distortion, automatically with no additional equipment. The HP 8903E Distortion Analyzer is the analyzer portion of the HP 8903B Audio Analyzer. (The HP 8903E has no source.)

For ease of use, most measurements on the HP 8903B and HP 8903E are made with only one or two keystrokes. Both instruments automatically tune and autorange for maximum accuracy and resolution. For quick identification of input signals, the analyzer counts and displays the input frequency in all ac measurement modes.

### Low Frequency Applications

The HP 8903B/E have many features which make difficult audio measurements easy. These include flexible data display formats, a selectable balanced or unbalanced input, plug-in filters, and automatic notch filter tuning. With the ratio key, you can establish a reference in % or dB and directly make frequency response and 3 dB bandwidth measurements without computation. A fully balanced analyzer input allows testing of bridged power amplifiers found in many radios and car stereos as well as professional balanced audio equipment.

With two internal plug-in filter slots and six optional filters to choose from, we simplify your audio measurements by providing the filter networks required by international standards. (See the next page for a complete list of filters.) The HP 8903B and HP 8903E both use true-RMS detection (for all signals with crest factor 3) for accurate measurement of complex waveforms and noise. Average and quasi-peak detectors are also available. (Quasi-peak is selectable only via HP-IB on the HP 8903E.) Accurate distortion measurements typically can be made down to less than  $-90$  dB (0.003%) from 20 Hz to 20 kHz.

For receiver testing, both instruments have a tunable SINAD notch filter. On the HP 8903B, the filter is automatically tuned to the source frequency. With the HP 8903E, a front-panel key allows the operator to lock the notch filter at any given input frequency.

- Measures distortion, SINAD
- Measures true-RMS ac volts, dc volts, frequency
- RMS, average and quasi-peak detection

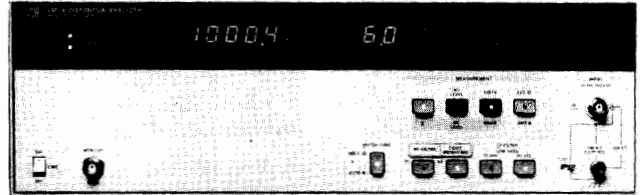

HP 8903E

## HP 8903B and HP 8903E Specifications

### System Specifications

(HP 8903B only, source and analyzer combined)

### Distortion

**Residual Distortion and Noise** (the higher of):

**80 kHz BW:**  $-80$  dB (0.01%) or  $17 \mu\text{V}$ , 20 Hz to 20 kHz.

**500 kHz BW:**  $-70$  dB (0.032%) or  $50 \mu\text{V}$ , 20 Hz to 50 kHz.  
 $-65$  dB (0.056%) or  $50 \mu\text{V}$ , 50 kHz to 100 kHz.

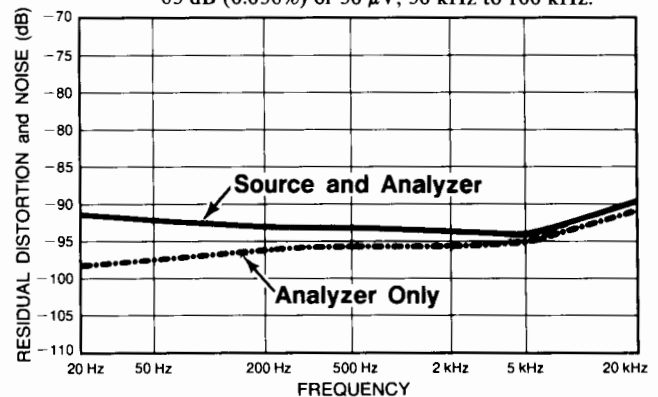

Typical residual THD + noise of source and analyzer combined (source voltage set to 1.5V, 80 kHz BW). Dashed line represents typical residual THD + noise for the analyzer only.

### Signal-to-Noise

**Frequency range:** 50 Hz to 100 kHz.

**Display range:** 0 to 99.99 dB.

**Accuracy:**  $\pm 1$  dB.

**Input voltage range:** 50 mV to 300V.

**Residual noise (the higher of):**  $-85$  dB or  $17 \mu\text{V}$ , 80 kHz BW;  $-70$  dB or  $50 \mu\text{V}$ , 500 kHz BW.

### Source Specifications (HP 8903B only)

#### Frequency

**Range:** 20 Hz to 100 kHz.

**Resolution:** 0.3%.

**Accuracy:** 0.3% of setting.

#### Output Level

**Range:** 0.6 mV to 6V open circuit.

**Resolution:** 0.3% or better.

**Accuracy (open circuit):** 2% of setting 60 mV to 6V, 20 Hz to 50 kHz; 3% of setting 6 mV to 6V, 20 Hz to 100 kHz; 5% of setting 0.6 mV to 6 mV, 20 Hz to 100 kHz.



**Flatness (1 kHz reference):**  $\pm 0.7\%$  ( $\pm 0.06$  dB), 20 Hz to 20 kHz;  $\pm 2.5\%$  ( $\pm 0.22$  dB), 20 Hz to 100 kHz.

**Distortion and noise (the higher of):**

**80 kHz BW:**  $-80$  dB (0.01%) or  $15 \mu\text{V}$ , 20 Hz to 20 kHz.

**500 kHz BW:**  $-70$  dB (0.032%) or  $38 \mu\text{V}$ , 20 Hz to 50 kHz.  
 $-65$  dB (0.056%) or  $38 \mu\text{V}$ , 50 kHz to 100 kHz.

**Impedance:**  $600\Omega \pm 1\%$  or  $50\Omega \pm 2\%$ , Front panel selectable. (HP-IB programmable.)

**Sweep mode:** log sweep with up to 500 points per decade or 255 points total between entered start and stop frequencies.

## HP 8903B and HP 8903E

### Analyzer Specifications

#### Distortion

**Fundamental frequency range:** 20 Hz to 100 kHz.

**Display range:** 0.001% to 100% ( $-99.99$  to 0 dB).

**Accuracy:**  $\pm 1$  dB, 20 Hz to 20 kHz;  $\pm 2$  dB, 20 kHz to 100 kHz.

**Input voltage range:** 50 mV to 300V.

**Residual distortion and noise (the higher of):**

**80 kHz BW:**  $-80$  dB (0.01%) or  $15 \mu\text{V}$ , 20 Hz to 20 kHz.

**500 kHz BW:**  $-70$  dB (0.032%) or  $45 \mu\text{V}$ , 20 Hz to 50 kHz.  
 $-65$  dB (0.056%) or  $45 \mu\text{V}$ , 50 kHz to 100 kHz.

#### Supplemental Characteristics

**3 dB measurement bandwidth:** 10 Hz to 500 kHz.

**Detection:** true rms or rms calibrated average.

#### SINAD

**Fundamental frequency range:** 20 Hz to 100 kHz.

**Display range:** 0 to 99.99 dB.

**Residual distortion and noise:** same as listed under Distortion.

**Accuracy:**  $\pm 1$  dB, 20 Hz to 20 kHz;  $\pm 2$  dB, 20 kHz to 100 kHz.

**Input voltage range:** 50 mV to 300V.

#### Supplemental Characteristics

**Detection:** true rms or rms-calibrated average.

**Tuning:** HP 8903B: notch filter is tuned to the internal source frequency. HP 8903E: notch filter is tuned to the counted input frequency. Notch filter hold function available on front panel.

#### AC Level

**Full range display:** 300.0V, 30.00V, 3.000V, .3000V, 30.00 mV, 3.000 mV, 0.3000 mV.

**Overrange:** 33%, except on 300V range.

**Accuracy:**  $\pm 2\%$ , 50 mV to 300V, 20 Hz to 20 kHz;  $\pm 4\%$ , 0.3 mV to 50 mV, 20 Hz to 100 kHz;  $\pm 4\%$ , 50 mV to 300V, 20 kHz to 100 kHz.

#### Supplemental Characteristics

**AC converter:** true-rms responding for signals with crest factor up to 3, rms-calibrated average detection and quasi-peak.

**3 dB measurement bandwidth:**  $> 500$  kHz.

#### DC Level

**Full range display:** 300.0V, 48.00V, 16.00V, 4.000V.

**Overrange:** 33%, except on 300V range.

**Accuracy:**  $\pm 1.0\%$  of reading, 600 mV to 300V.  
 $\pm 6$  mV,  $V_{in} < 600$  mV.

#### Frequency Measurement

**Measurement range:** 20 Hz to 150 kHz. (20 Hz to 100 kHz in distortion and SINAD modes.)

**Resolution:** 5 digits (0.01 Hz for input frequencies  $< 100$  Hz).

**Accuracy:**  $\pm (0.004\% + 1 \text{ digit})$ .

**Sensitivity:** 50 mV in distortion and SINAD modes, 5.0 mV in ac level and signal-to-noise (HP 8903B only) modes.

#### Standard Audio Filters

##### 30 kHz Low-Pass Filter

**3 dB cutoff frequency:** 30 kHz  $\pm 2$  kHz.

**Rolloff:** third-order Butterworth; 18 dB/octave or 60 dB/decade.

##### 80 kHz Low-Pass Filter

**3 dB cutoff frequency:** 80 kHz  $\pm 4$  kHz.

**Rolloff:** third-order Butterworth; 18 dB/octave or 60 dB/decade.

### Internal Plug-in Filter Options

Both the HP 8903B and HP 8903E have TWO internal plug-in filter slots, each of which will accept one of six optional filters. The standard HP 8903B and HP 8903E come with 30 kHz and 80 kHz low-pass filters, but with NO PLUG-IN FILTERS. The appropriate filter options must be ORDERED for the analyzers to have any of the filters listed below. Each filter option has TWO option numbers: the 010 series for the left filter slot and the 050 series for the right filter slot. Each filter option ordered (maximum of two) adds additional cost to the instrument.

Filters	Option Numbers	
	Left Slot	Right slot
400 Hz High-Pass	010	050
CCITT Weighting Filter	011	051
CCIR Weighting Filter	012	052
C-MESSAGE Weighting Filter	013	053
CCIR/ARM Weighting Filter	014	054
"A" Weighting Filter	015	055

### Analyzer Input

**Input type:** Balanced (full differential).

**Input impedance:**  $100 \text{ k}\Omega \pm 1\%$  shunted by  $< 300$  pF, each side to ground. (In dc-level mode the input resistance is  $101 \text{ k}\Omega \pm 1\%$ ).

**Max input (maximum peak input voltage, any combination of ac/dc):**

**HP 8903B:** 425 volts peak, applied differentially or between either input to ground.

**HP 8903E:** 42 volts peak, Low side to ground.

425 volts peak, differentially or High side to ground.

**CMRR:**  $> 60$  dB, 20 Hz to 1 kHz,  $V_{in} < 2\text{V}$ ;  $> 45$  dB, 20 Hz to 1 kHz;  $> 30$  dB, 20 Hz to 20 kHz.

### General

**Temperature:** operating,  $0^\circ\text{C}$  to  $55^\circ\text{C}$ ; storage,  $-55^\circ\text{C}$  to  $75^\circ\text{C}$ .

**Power:** 100, 120, 220, or 240V ( $+5, -10\%$ ); 48-66 Hz. 100 or 120V  $+5, -10\%$ ; 48-440 Hz. 100 VA maximum.

**Weight:** HP 8903B: net 12.3 kg (27 lb.); shipping 16.4 kg (36 lb.) HP 8903E: net 11.8 kg (26 lb.); shipping 15.9 kg (35 lb.)

**Dimensions:** 146 mm H x 425 mm W x 462 mm D. (5.75 x 16.8 x 18.2 in.)

### Ordering Information

Ordering Information	Price
<b>Analyzer Mainframes</b>	
HP 8903B Audio Analyzer	\$5950
Opt 001 RF connectors on rear panel only	+ \$100
Opt 910 2 sets of operation/calibration (08903-90079) and service manuals (08903-90062)	+ \$285
Opt 915 Service manual (08903-90062) supplied with instrument	+ \$120
Opt W30 2 years additional hardware service	+ \$130
HP 8903E Distortion Analyzer	\$4200
Opt 001 RF connectors on rear panel only	+ \$210
Opt 910 2 sets of operation/calibration (08903-90053) and service manuals (08903-90065)	+ \$298
Opt 915 Service manual (08903-90065) supplied with instrument	+ \$131.50
Opt W30 2 years additional hardware service	+ \$80

### Options for both HP 8903B and HP 8903E

Opt 010 or 050 400 Hz High-Pass filter	+ \$210
Opt 011 or 051 CCITT Weighting filter	+ \$210
Opt 012 or 052 CCIR Weighting filter	+ \$210
Opt 013 or 053 C-Message Weighting filter	+ \$210
Opt 014 or 054 CCIR/ARM Weighting filter	+ \$210
Opt 015 or 055 "A" Weighting filter	+ \$210
Opt 907 Front handle kit (5061-9689)	+ \$55
Opt 908 Rack mounting flange kit (5061-9677)	+ \$33.50
Opt 909 Front panel handle plus rack flange kit (5061-9683)	+ \$82.50

# SIGNAL ANALYZERS

## Modulation Analyzer, 150 kHz to 1300 MHz

Models 8901A, 8901B

- Measures AM and FM to 1% accuracy
- Measures RF frequency
- Measures RF power

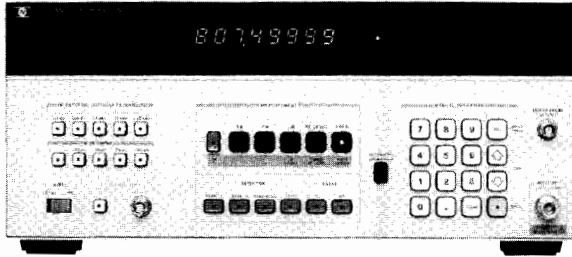

HP 8901A

### HP 8901A and HP 8901B Modulation Analyzers

The HP 8901A and HP 8901B modulation analyzers combine the capabilities of several RF instruments to give complete, accurate characterization of modulated signals in the 150 kHz to 1300 MHz frequency range. Both instruments very accurately measure modulation and recover the modulation signal. They determine RF frequency and measure RF power. The major additional capabilities of the HP 8901B are its improved power meter accuracy, its ability to use external power sensors, to make adjacent channel power measurements or carrier noise measurements (with options 030-037) and its ability to count audio frequencies and measure distortion on 400 Hz and 1 kHz signals. Both instruments are fully automatic and make all major measurements with the push of a key or under HP-IB control.

### Transmitter Testing

The HP 8901A/B has the features required to perform standard transmitter measurements. It measures transmitter power, counts frequency, and measures the signal modulation very accurately. The HP 8901B also characterizes the demodulated audio signal's frequency, level, and distortion. With Option 030 the HP 8901B can quickly and accurately make adjacent channel power measurements to CEPT standards.

### RF Signal Characterization

The HP 8901A/B is an excellent lab & production tool for accurately characterizing RF signals.

Use the HP 8901A/B to make accurate AM/ØM and FM/AM conversion measurements of phase and amplitude sensitive devices such as bandpass filters and multiple channel receivers. Excellent isolation between AM and FM make it simple to separate the AM and ØM of AM stereo, incidental AM of FM transmitters and the AM, FM, and ØM components of complex signals.

### Automatic Test Systems

The HP 8901A/B is an important component of automatic RF test systems. All functions are fully automatic and easily programmed. With these measurements combined into one instrument, interfacing requirements, hardware costs, and software development time are reduced.

### HP 8901A and HP 8901B Specifications

#### RF Input

**Frequency range:** 150 kHz to 1300 MHz

**Operating level:** 12 mVrms to 7 Vrms.

**Input impedance:** 50Ω nominal.

**Tuning:** manual frequency entry, automatic, or track.

**Acquisition time (automatic operation):** ~1.5 seconds.

**Maximum safe input level (typical):** 35 Vrms (25W for source SWR <4), ac; 40V, dc.

#### Frequency Modulation

**Rates:** 20 Hz to 200 kHz.

**Deviations:** 400 kHz.

- Low internal noise
- Completely automatic

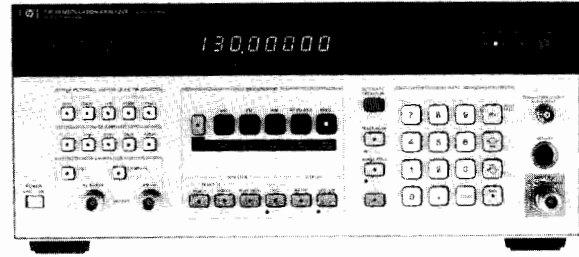

HP 8901B

#### Accuracy:

±2% of reading ±1 digit, 20 Hz to 10 kHz rates, 250 kHz to 10 MHz.  
±1% of reading ±1 digit, 50 Hz to 100 kHz rates, 10 MHz to 1300 MHz.

**Demodulated output distortion:** <0.1% THD.

**AM rejection (for 50% AM at 400 Hz and 1 kHz rates):** <20 Hz peak deviation measured in a 50 Hz to 3 kHz BW.

**Residual FM (50 Hz to 3 kHz BW):** <8 Hz rms @ 1300 MHz, decreasing linearly with frequency to <1 Hz rms for 100 MHz and below.

**Maximum deviation resolution:** 1 Hz.

**Stereo separation (50 Hz to 15 kHz):** >47 dB typical.

#### Phase Modulation

**Carrier frequency:** 10 MHz to 1300 MHz.

**Rates:** 200 Hz to 20 kHz; typically usable from 20 Hz to 100 kHz with degraded performance.

**Deviation:** to 400 radians.

**Maximum deviation resolution:** 0.001 radian.

**Accuracy:** ±3% of reading ±1 digit.

**Demodulated output distortion:** <0.1% THD.

**AM rejection (for 50% AM at 1 kHz rate):** <0.03 radian peak deviation (50 Hz to 3 kHz BW).

#### Amplitude Modulation

**Rates:** 20 Hz to 100 kHz.

**Depth:** to 99%.

**Accuracy:**

±2% of reading ±1 digit, 50 Hz to 10 kHz rates, 150 kHz to 10 MHz.  
±1% of reading ±1 digit, 50 Hz to 50 kHz rates, 10 MHz to 1300 MHz.

**Flatness (variation in indicated AM depth for constant depth on input signal):** ±0.3% of reading ±1 digit.

**Demodulated output distortion:** <0.3% THD.

**FM rejection (at 400 Hz and 1 kHz rates, 50 Hz to 3 kHz BW):** <0.2% AM.

**Residual AM (50 Hz to 3 kHz BW):** <0.01% rms.

**Maximum depth resolution:** 0.01%.

#### Frequency Counter

**Range:** 150 kHz to 1300 MHz.

**Accuracy:** ±3 counts of least significant digit ± reference accuracy.

**Internal reference:**

**Frequency:** 10 MHz.

**Ageing rate:** <1x10<sup>-6</sup>/month (optional: 1x10<sup>-9</sup>/day).

**Maximum resolution:**

**HP 8901A:** 10 Hz for frequencies <1 GHz; 100 Hz for frequencies ≥1 GHz.

**HP 8901B:** 1 Hz.

#### HP 8901A RF Level (Peak Voltage Responding, RMS Sine Wave Power Calibrated)

**Range:** 1 mW to 1W.

**Instrumentation accuracy:** ±1.5 dB; 0.7 dB typical.

**SWR:** ≤1.3, 150 kHz to 650 MHz; ≤1.5, 650 MHz to 1300 MHz.

**Maximum resolution:** 0.001 mW for levels <0.01W.

**HP 8901B RF Level (True RMS)****Frequency range with HP 11722A:** 100 kHz to 2.6 GHz.**Power range:** -20 dBm to +30 dBm.**RF range-to-range change error:**

±0.02 dB/RF range change from reference range.

**Input SWR:** <1.15, using HP 11722A Sensor Module.**Zero set (digital settability of zero):**

±0.5% ±1 digit of full scale on lowest range.

Decrease by a factor of 10 for each high range.

**RF power resolution:**

0.1% of full scale in watts or volts mode.

0.001 in dBm or dB relative mode.

**HP 8901B Selective Power Measurements (Options 030-037)****Frequency range:** 10 MHz to 1.3 GHz.**Carrier power range:** +30 dBm to -20 dBm, 12.5, 25 and 30 kHz filters; +30 dBm to -10 dBm, Carrier Noise Filter.**Dynamic range:** 115 dB.**Carrier rejection (temp. ≤35° C):** >90 dB, for offsets ≥1 channel spacing or 5 kHz, whichever is larger.**Relative accuracy:** ±0.5 dB, levels ≥-95 dBc or levels ≥-129 dBc/Hz.**Power Reference****Power output:** 1.00 mW. Factory set to ±0.7%, traceable to the U.S. National Bureau of Standards.**Accuracy:** ±1.2% worst case (±0.9% rss) for one year (0°C to 55°C).**Audio Filters****High pass (3 dB cutoff frequency):** 50 Hz and 300 Hz.**Low pass (3 dB cutoff frequency except >20 kHz filter):** 3 kHz, 15 kHz, >20 kHz.**De-emphasis filters:** 25 μs, 50 μs, 75 μs, and 750 μs.**Calibrators (Standard HP 8901B, Option 010 HP 8901A)****AM calibrator depth and accuracy:** 33.33% depth, nominal; internally calibrated to an accuracy of ±0.1%.**FM calibrator deviation and accuracy:** 34 kHz peak deviation, nominal; internally calibrated to an accuracy of ±0.1%.**General Characteristics****Operating temperature range:** 0° to 55°C.**Power requirements:** 100, 120, 220, or 240V (+5%, -10%); 48-66 Hz; 200 VA max.**Weight:** HP 8901A—net 20 kg (44 lb), shipping 25 kg (55 lb);

HP 8901B—net 23 kg (52 lb), shipping 31 kg (69 lb).

**Size:** HP 8901A, 190 mm H x 425 mm W x 468 mm D (7.5 in. x 16.8 in. x 18.4 in.); HP 8901B, 190 mm H x 425 mm W x 551 mm D (7.5 in. x 16.8 in. x 21.7 in.)**Ordering Information**

	<b>Price</b>
<b>HP 8901A Modulation Analyzer</b>	\$9,900
<b>Opt 001</b> RF connectors on rear panel only	+\$110
<b>Opt 002</b> 1x10 <sup>-9</sup> /day internal reference	+\$800
<b>Opt 003</b> Connections for external local oscillator	+\$425
<b>Opt 004</b> Operation from 48 to 440 Hz power (Temp. <40°C)	+\$280
<b>Opt 010</b> AM and FM calibrators	+\$650
<b>Opt 910</b> 2 sets of operating (08901-90031) and service manuals (08901-90032)	+\$80
<b>Opt W30</b> 2 years additional hardware service	+\$200
<b>HP 8901B Modulation Analyzer</b>	\$14,000
<b>Opt 001</b> RF connectors on rear panel only	+\$225
<b>Opt 002</b> 1x10 <sup>-9</sup> /day internal reference	+\$775
<b>Opt 003</b> Connections for external local oscillator	+\$400
<b>Opt 004</b> Operation from 48 to 440 Hz power (Temp. <40°C)	+\$300
<b>Opt 021</b> Add HP 11722A Sensor Module	+\$2,147
<b>Opt 030</b> High selectivity (select only 2 filter options) (Options 032-037 require Option 030; Option 030 includes Option 003 connections for external local oscillators.)	+\$2,550
<b>Opt 032</b> 12.5 kHz filter	\$0
<b>Opt 033</b> 20.0/25.0 kHz filter	\$0
<b>Opt 035</b> Cellular Radio Filter	\$0
<b>Opt 037</b> Carrier Noise Filter	\$0

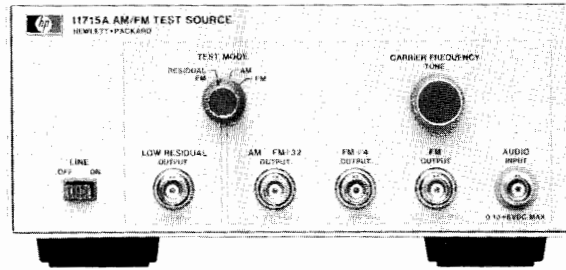
**HP 11715A****Opt 910** 2 sets of operation/calibration (08901-90113) and service manuals (08901-90114) +\$360**Opt 915** Service manual (08901-90114) supplied with instrument +\$150**Opt W30** 2 years additional hardware service +\$260**HP 11715A AM/FM Test Source**

The HP 11715A AM/FM Test Source provides very flat, wide-bandwidth, and low distortion amplitude or frequency modulated RF signals. Designed primarily for performance tests and adjustments of the HP 8901A/B Modulation Analyzer and HP 8902A Measuring Receiver, it will also serve as a high quality modulated test oscillator where its frequency ranges apply.

The major components of the HP 11715A are a low-noise voltage controlled oscillator (VCO), two digital dividers, and a double-balanced mixer. The VCO is the primary signal source, with a typical frequency range of 330 to 470 MHz at the FM OUTPUT. FM is produced by directly coupling the external modulation source to the VCO's tune input, providing very wide bandwidth modulation with low phase shift. This design also ensures very little incidental AM.

The HP 11715A can also be used in conjunction with an HP 8901A/B and an HP 8902A as a calibrated signal source for special applications. In particular, the U.S. commercial FM broadcast band of 88 to 108 MHz is covered by the FM ÷ 4 OUTPUT of the HP 11715A.

**HP 11715A Specifications****FM Outputs****Frequency range:**

11 to 13.5 MHz, AM FM ÷ 32 output.

88 to 108 MHz, FM ÷ 4 output.

352 to 432 MHz, FM output.

**Peak deviation:**

&gt;12.5 kHz, 11 to 13.15 MHz carrier.

&gt;100 kHz, 88 to 108 MHz carrier.

&gt;400 kHz, 352 to 432 MHz carrier.

**Distortion:**

&lt;0.025% THD (&lt;-72 dB) for

Carrier frequency	Peak deviation	Modulation rate
12.5 MHz	12.5 kHz	<10 kHz
100 MHz	100 kHz	<100 kHz
400 MHz	400 kHz	<100 kHz

**Flatness:**

±0.1%, dc to 100 kHz rates.

±0.25%, dc to 200 kHz rates.

**Stereo separation (88 to 108 MHz carrier, 75 kHz peak deviation, 1 kHz rate):** >60 dB typical.**AM Output****Frequency range (AM FM ÷ 32 output):** 11 to 13.5 MHz.**Depth:** to 99%.**Distortion:**

&lt;0.05% THD (&lt;-66 dB), 50% AM, 20 Hz to 100 kHz rates.

&lt;0.1% THD (&lt;-60 dB), 95% AM, 20 Hz to 100 kHz rates.

**Flatness:** ±0.1%, 50 Hz to 50 kHz rates;

±0.25%, 20 Hz to 100 kHz rates.

**Linearity:** ±0.1%, <95% AM; ±0.2%, <99%.**Ordering Information**

<b>HP 11715A AM/FM Test Source</b>	<b>Price</b>
<b>Opt 910</b> 2 sets of operating and service manuals (11715-90004)	\$2,650 +\$24

# SIGNAL ANALYZERS

## Measuring Receiver, 150 kHz to 1300 MHz

### Model 8902A

- RF power: digital power meter accuracy
- Tuned RF level: 0 dBm to -127 dBm dynamic range
- Carrier Noise: AM and phase noise measurements to -140 dBc/Hz

- AM and FM, 1% accuracy;  $\emptyset$ M, 3% accuracy
- RF frequency: 1 Hz resolution
- Audio: frequency, level and distortion

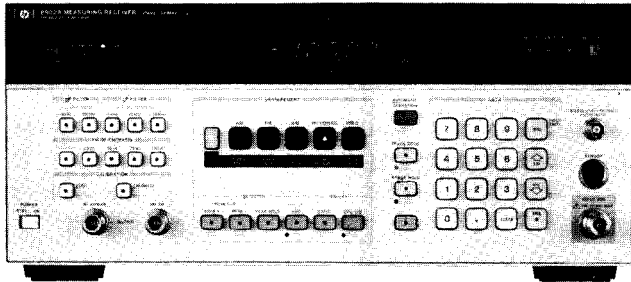

HP 8902A

### HP 8902A Measuring Receiver

The HP 8902A Measuring Receiver combines six precise measurement functions into one fully automatic, HP-IB programmable instrument. It accurately measures RF power, tuned RF level, carrier noise/adjacent channel power, modulation and RF frequency, and characterizes audio signals. For precise signal analysis, the HP 8902A Measuring Receiver provides the performance you need.

### Metrology and Calibration

The HP 8902A Measuring Receiver makes signal generator and attenuator calibration easier than ever before. As the main component in the HP 8902AT Attenuator Calibration System and the HP 8902SG Signal Generator Test System, the HP 8902A provides exceptional accuracy, wide dynamic range and a broad range of measurements.

The HP 8902A quickly and accurately measures your signal generator's RF frequency, RF level flatness, output level accuracy to -127 dBm, AM and FM with 1% accuracy, incidental and residual AM, FM and phase modulation, carrier noise down to -140 dBc/Hz and characterizes the demodulated audio signals.

For attenuator calibration and other relative measurements, the HP 8902A gives you the accuracy and dynamic range you need. Option 050 gives  $\pm(0.015 \text{ dB} + 0.005 \text{ dB}/10 \text{ dB})$  relative power accuracy to test attenuators to the most stringent specifications.

### RF Signal Characterization

The HP 8902A Measuring Receiver is an excellent lab and production tool for accurately characterizing RF signals from 150 kHz to 1300 MHz.

Level measurements down to -127 dBm with superb accuracy make the HP 8902A ideal for testing devices such as antennas, multiplexers, log/linear amplifiers, filters and mixers. Unlike diode detectors, the HP 8902A's power meter accurately measures signals with harmonics and spurious.

The HP 8902A makes accurate AM to  $\emptyset$ M and FM to AM conversion measurements of phase and amplitude sensitive devices such as bandpass filters and multiple channel receivers. Excellent isolation between AM and FM makes it simple to separate the AM and  $\emptyset$ M of AM stereo, incidental AM of FM transmitters and the AM, FM and  $\emptyset$ M components of complex signals.

### Automatic Test Systems

The HP 8902A is an important component of automatic RF test systems. All functions — power, level, frequency count, carrier noise, modulation, audio analysis — are fully automatic and easily programmed. With these measurements combined into one instrument, interfacing requirements, hardware costs, and software development time are reduced.

### HP 8902A Specifications

#### RF Power (with HP 11722A Sensor Module)

**Range:** +30 dBm (1W) to -20 dBm (10  $\mu$ W).

**Frequency range:** 0.1 MHz to 2.6 GHz.

**Linearity:**  $\pm 0.02 \text{ dB}$  (within range)  $\pm 0.02 \text{ dB}$  per range change from reference range  $\pm 1$  count LSD.

**Input SWR:** <1.15.

#### Tuned RF Level

**Range:** 0 dBm to -127 dBm.

**Frequency range:** 2.5 MHz to 1300 MHz.

**Relative accuracy:**  $\pm 0.02 \text{ dB} \pm 0.02 \text{ dB}$  per IF range change  $\pm 0.04 \text{ dB}$  per RF range change  $\pm 1$  digit.

**Worst case cumulative relative power accuracy (with Opt 050)<sup>1,2</sup>:**

$\pm 0.005 \text{ dB}/10 \text{ dB}$  step (0 to -100 dBm).

$\pm 0.050 \text{ dB}/10 \text{ dB}$  step (-100 to -120 dBm).

$\pm 0.015 \text{ dB} \pm 1$  digit.

#### Selective Power Measurements (Carrier Noise, Options 030-037)

**Frequency range:** 10 MHz to 1300 MHz.

#### Carrier power range:

+30 dBm to -20 dBm; 12.5 kHz, 25 kHz and 30 kHz filters.

+30 dBm to -10 dBm; Carrier Noise filter.

#### Relative measurement accuracy:

$\pm 0.5 \text{ dB}$ ; levels > -95 dBc; 12.5 kHz, 25 kHz and 30 kHz filters.

$\pm 0.5 \text{ dB}$ ; levels > -129 dBc/Hz; Carrier Noise filter.

**Filter bandwidths:** 2.5 kHz, Carrier Noise filter; 8.0 kHz, 12.5 kHz filter; 16.0 kHz, 25 kHz filter; 30.0 kHz, Cellular Radio filter.

#### RF Frequency

**Range:** 150 kHz to 1300 MHz.

**Maximum resolution:** 1 Hz.

#### Amplitude Modulation

**Rates:** 20 Hz to 100 kHz.

**Depths:** to 99%.

**Accuracy:**  $\pm 1\%$  of reading  $\pm 1$  digit, for rates 50 Hz to 50 kHz and depths  $\geq 5\%$ .

#### Frequency Modulation

**Rates:** 20 Hz to 200 kHz.

**Deviations:** to 400 kHz.

**Accuracy:**  $\pm 1\%$  of reading  $\pm 1$  digit, for rates 50 Hz to 100 kHz.

#### Phase Modulation

**Rates:** 200 Hz to 20 kHz.

**Deviations:** to 400 radians.

**Accuracy:**  $\pm 3\%$  of reading  $\pm 1$  digit.

#### Audio Level, Frequency and Distortion Capability

##### Audio Level

**Accuracy:**  $\pm 4\%$  of reading, 100 mV to 3V.

##### Audio Frequency

**Display resolution:** 6 digits, to 250 kHz.

##### Audio Distortion

**Accuracy:**  $\pm 1 \text{ dB}$ , 400 Hz and 1 kHz.

<sup>1</sup>Specifications are warranted when using a Hewlett-Packard synthesized source with less than 100 Hz peak residual FM measured in a 3 kHz post detection bandwidth over a 30-second period.

<sup>2</sup>Accuracy specifications do not include mismatch uncertainty.

# SIGNAL ANALYZERS

## Measuring Receiver, Sensor Module, Verification Kit

Models 8902A, 11722A, 11812A

169

### Ordering Information

<b>HP 8902A Measuring Receiver</b>	<b>Price</b>
	\$23,900
<b>Opt 001</b> Rear panel instead of front panel connections for input, modulation output, and calibrators	+ \$225
<b>Opt 002</b> $1 \times 10^{-9}$ /day internal reference oscillator	+ \$775
<b>Opt 003</b> RF connectors on rear panel only	+ \$400
<b>Opt 004</b> Operation from 48 Hz to 400 Hz power line (temp. $< 40^\circ\text{C}$ )	+ \$300
<b>Opt 021</b> Add HP 11722A Sensor Module	+ \$2,147
<b>Opt 030</b> High selectivity (select only two filter options) (Options 032-037 require Option 030. Option 030 includes Option 003 connections for external local oscillator.)	+ \$2,550
<b>Opt 032</b> 12.5 kHz Filter	\$0
<b>Opt 033</b> 25.0 kHz Filter	\$0
<b>Opt 035</b> Cellular Radio Filter	\$0
<b>Opt 037</b> Carrier Noise Filter	\$0
<b>Opt 050</b> Increased power measurement accuracy	+ \$3,600
<b>Opt 907</b> Front panel handle kit (5061-9690)	+ \$65
<b>Opt 908</b> Rack mounting flange kit (5061-9678)	+ \$35
<b>Opt 909</b> Front panel handle plus rack mounting flange kit (5061-9684)	+ \$90
<b>Opt 910</b> 2 sets operation/calibration (08902-90029) and service manuals (08902-90031)	+ \$360
<b>Opt 915</b> Service manual supplied with instrument (08902-90031)	+ \$150

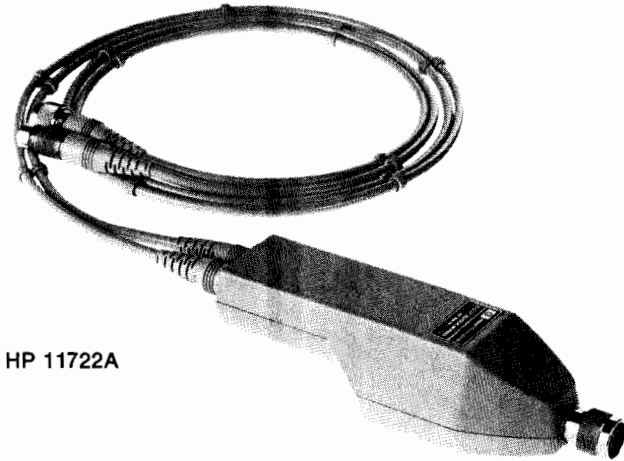

HP 11722A

### HP 11722A Sensor Module

The HP 11722A Sensor Module was designed for use with the HP 8901B Modulation Analyzer and HP 8902A Measuring Receiver. The HP 11722A contains a silicon monolithic thermocouple as a power sensing element.

With the HP 11722A Sensor Module, you get all the performance of the HP 8901B or HP 8902A, plus superb power measurement accuracy, at a single connector. You can characterize a signal without switching back and forth between the power sensor and the analyzer's RF input.

Each HP 11722A Sensor Module is individually calibrated, traceable to the U.S. National Bureau of Standards. The calibration factors are printed on the sensor module for easy reference. Enter these factors into the HP 8901B or HP 8902A's non-volatile memory and the instrument automatically compensates for the power sensor's efficiency and mismatch loss at each frequency.

### HP 11722A Specifications

**Frequency range:** 100 kHz to 2.6 GHz.

**Power range:** +30 dBm (1 watt) to -20 dBm (10  $\mu\text{W}$ ).

**Input SWR (connected to an HP 8901B or 8902A):**  $< 1.15$ , for RF power measurements.

**Power sensor linearity:** +2%, -4%; +30 dBm to +20 dBm. Negligible deviation, levels  $< +20$  dBm.

**Calibration factors:** Each HP 11722A Sensor Module is individually calibrated. The calibration factors are printed on the HP 11722A Sensor Module for easy reference.

### Cal Factor Uncertainty

Frequency	RSS Uncertainty	Worst Case Uncertainty
0.1 MHz	0.7%	1.6%
0.3 MHz	0.7%	1.6%
1.0 MHz	0.8%	1.7%
3.0 MHz	0.8%	1.7%
10.0 MHz	0.9%	2.0%
30.0 MHz	0.9%	2.0%
50.0 MHz	0.0% (ref.)	0.0% (ref.)
100.0 MHz	1.1%	2.2%
300.0 MHz	1.1%	2.2%
1000.0 MHz	1.1%	2.2%
2600.0 MHz	1.2%	2.3%

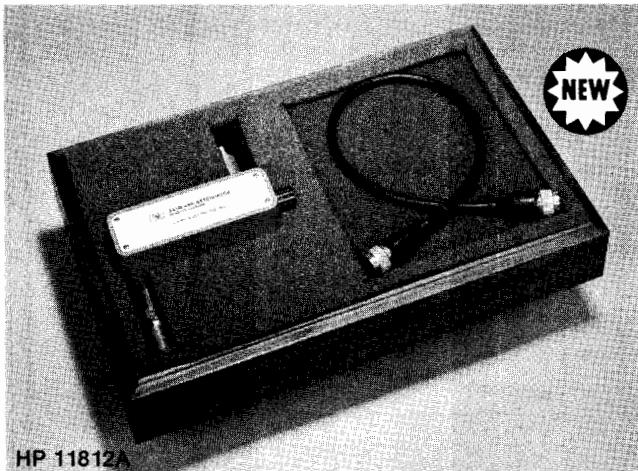

HP 11812A

### HP 11812A Verification Kit

The HP 11812A Verification Kit is available to verify the performance of the HP 8902A Option 050 tuned RF level function to  $\pm(0.015 \text{ dB} + 0.010 \text{ dB}/10 \text{ dB step})$ . The kit consists of a step attenuator, two 10 dB pads semi-permanently attached, a cable, and a case.

### HP 11812A Specifications

**Frequency:** 30 MHz.

**HP 11812A accuracy:**  $\pm(0.003 \text{ dB} + 0.003 \text{ dB}/10 \text{ dB step})$ .

**Option 050 worst case cumulative tuned RF level accuracy verified with the HP 11812A:**

$\pm 0.010 \text{ dB}/10 \text{ dB step}$  (0 to -100 dBm)

$\pm 0.050 \text{ dB}/10 \text{ dB step}$  (-100 to -120 dBm)

$\pm 0.015 \text{ dB} \pm 1$  digit.

**Ordering Information**  
HP 11812A Verification Kit

**Price**  
\$2,050

### Ordering Information

HP 11722A Sensor Module  
Opt 910 Additional operating and service manual

**Price**  
\$2,150  
+ \$10



# SIGNAL ANALYZERS

## Attenuator Calibration System

Models 8902AT, 11806B, 11823A/B/C

- Exceptional accuracy:  $\pm 0.015$  dB  $\pm 0.005$  dB/10 dB
- 100 dB dynamic range
- Tests fixed, manual, and programmable attenuators
- 10 MHz to 26.5 GHz

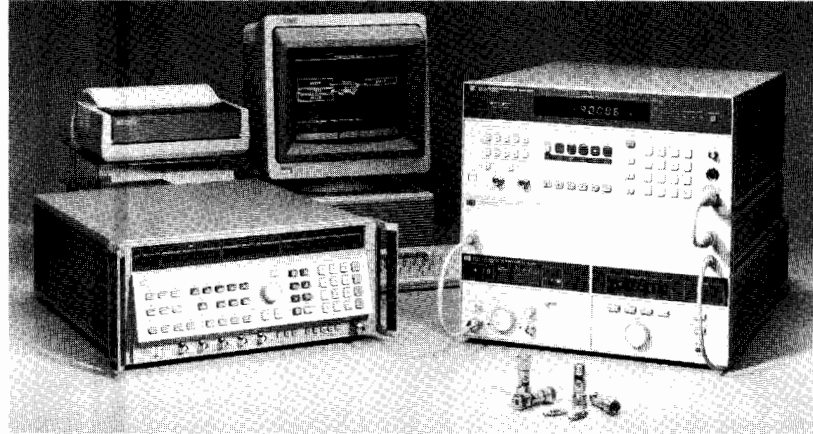

HP 8902AT

### HP 8902AT Attenuator Calibration System

The HP 8902AT offers the total solution for attenuator calibration. It is configured for optimal performance from 10 MHz to 18 GHz. Option 026 extends the superb performance to 26.5 GHz. The HP 8902AT combines the exceptional accuracy of the HP 8902A Option 050 with the HP 11806B Attenuator Test Software to give you precise results with the speed of automation.

The HP 8902AT minimizes measurement uncertainty by specifying 0.005 dB/10 dB attenuation accuracy, monitoring the output power of the attenuator source, and automatically adjusting for any amplitude instabilities. This provides you with state-of-the-art accuracy, simply and repeatably.

The HP 8902AT includes the HP 11806B Attenuator Test Software, HP 8902A Option 050 Measuring Receiver, HP 11793A Microwave Converter, local oscillator, attenuator source, power splitter, power sensor, attenuator accessory kit, and SWR accessory kit. For a detailed list of equipment see the HP 8902S Ordering Guide.

### Accessory Kits

The HP 8902AT Attenuator Calibration System includes an attenuator accessory kit and an SWR accessory kit. The HP 11823A/B Attenuator Accessory Kit includes 10 dB matching attenuators and adapters to test attenuators with Type-N, APC-3.5, and APC-7 connectors. The HP 11823C SWR Accessory Kit includes precision SWR bridges, opens, shorts, and terminations.

### HP 11806B Attenuator Test Software

The HP 11806B provides the efficiency and repeatability of automation for attenuator calibration. By entering a table of frequencies, levels and specification limits, you can test any RF or microwave attenuator - fixed, manual or programmable - quickly and accurately.

The HP 11806B offers flexibility and ease of use with user-selectable averaging, various output formats, and flexible hardware configurations. With additional features such as statistical analysis, multiple test frequencies, and supporting multiple attenuator sources the HP 11806B is the ideal software pac for all your attenuator calibration needs.

### Software Support

Two levels of software support services are available for the HP 11806B Signal Generator Performance Test Software; Software Material Subscription (SMS) and Software Notification Service (SNS).

SMS guarantees that software upgrades are provided on a timely basis as improvements to the software are made. Software Status Bulletins and Software Release Bulletins are also provided with SMS.

SNS provides information about software improvements with Software Status Bulletins and Software Release Bulletins.

### HP 8902AT Specifications

#### Frequency Range:

10 MHz to 18 GHz,  
10 MHz to 26.5 GHz, Option 026.

#### Dynamic Range:

+10 dBm to -117 dBm, 10 MHz to 1300 MHz,  
0 dBm to -100 dBm, 1300 MHz to 18 GHz,  
0 dBm to -95 dBm, 18 GHz to 26.5 GHz.

#### Attenuation Accuracy:<sup>1</sup>

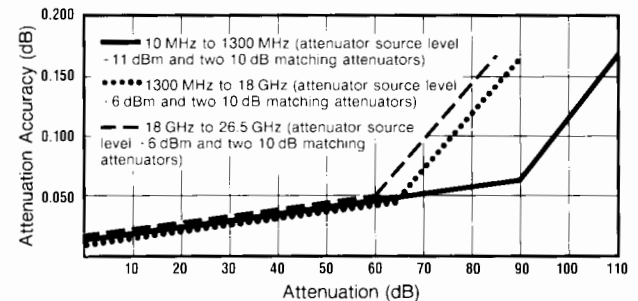

For optimal dynamic range the attenuator source level can be increased to -11 dBm and smaller matching attenuators can be used. This results in an additional 0.1 dB uncertainty for frequencies 1300 MHz to 26.5 GHz.

### Ordering Information

	Price
HP 8902AT Attenuator Calibration System	\$117,000
Option 026 26.5 GHz coverage	+\$44,000
HP 11806B Attenuator Test Software	\$3,000
HP 11806B + S45 Software material subscription	\$15/month
HP 11806B + N00 Software notification service	\$5/month
HP 11823A Attenuator Accessory Kit	\$5,500
HP 11823B Attenuator Accessory Kit	\$6,500
HP 11823C SWR Accessory Kit	\$19,500

<sup>1</sup>Accuracy specifications do not include mismatch uncertainty.

- Frequency coverage to 26.5 GHz
- Powerful software offers simple test modifications

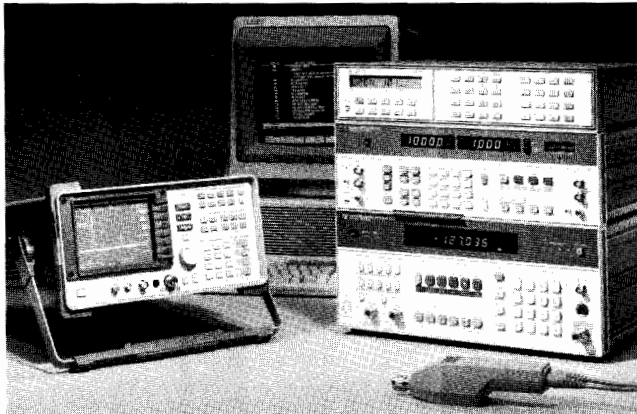

HP 8902SG

### HP 8902SG Signal Generator Test System

The HP 8902SG Signal Generator Test System provides a versatile and powerful solution for testing RF and microwave signal generators. System hardware provides accurate measurements and complete automation; the dedicated software adds flexibility, speed, and ease-of-use.

The standard system includes the HP 8902A Measuring Receiver, the HP 8903B Audio Analyzer, an HP 8562B Spectrum Analyzer, and the HP 3488A Switch Control Unit to provide complete automation. The HP 11808A Signal Generator Performance Test Software is included, as are all cables and adapters required to complete the system. Options 018 and 026 add the HP 11793A Microwave Converter and a synthesized local oscillator to extend measurement capabilities to microwave frequencies.

Many common signal generator performance tests can be run with the 8902SG. Tests such as Output Level Accuracy, Output Flatness, AM and FM Accuracy are but a few of those available. The system can be expanded to offer additional tests such as Pulse Rise/Fall time and third order intermodulation distortion. The system software is easily updated to reflect changes in the test equipment used.

### HP 8902SG Specifications

#### RF Frequency

**Range:** 150 kHz to 1300 MHz, standard system.  
150 kHz to 18 GHz, Opt 018.  
150 kHz to 26.5 GHz, Opt 026.

#### RF Power

**Range:** +30 dBm to -20 dBm, standard system.  
+30 dBm to -20 dBm, options 018 and 026.

**Frequency range:** 100 kHz to 2600 MHz, standard system,  
50 MHz to 18 GHz, Option 018,  
50 MHz to 26.5 GHz, Option 026.

#### Tuned RF Level

**Frequency range:** 2.5 MHz to 1300 MHz, standard system,  
2.5 MHz to 18 GHz, Option 018,  
2.5 MHz to 26.5 GHz, Option 026.

**Range:** +10 dBm to -117 dBm, 2.5 MHz to 1300 MHz,  
0 dBm to -100 dBm, 1300 MHz to 18 GHz (Options 018 & 026),  
0 dBm to -95 dBm, 18 GHz to 26.5 GHz, (Option 026).

**Relative accuracy:** ±0.02 dB ±0.02 dB per IF range change ±0.04 dB per RF range change ±1 digit.

- Fully automated system: more thorough testing in less time
- Fast, accurate, and repeatable measurements

#### Amplitude Modulation

**Rates:** 20 Hz to 100 kHz.

**Depths:** to 99%.

**Accuracy:** ±1% of reading ±1 digit, for rates 50 Hz to 50 kHz and depths ≥5%.

#### Frequency Modulation

**Rates:** 20 Hz to 200 kHz.

**Deviations:** to 400 kHz.

**Accuracy:** ±1% of reading ±1 digit, rates 50 Hz to 100 kHz.

#### Phase Modulation

**Rates:** 200 Hz to 20 kHz.

**Deviations:** to 400 radians.

**Accuracy:** ±3% of reading ±1 digit.

#### Audio Source

**Frequency range:** 20 Hz to 100 kHz.

**Frequency accuracy:** 0.3% of setting.

#### Audio Analyzer

**Distortion frequency range:** 20 Hz to 100 kHz fundamentals.

**Distortion accuracy:** ±1 dB, 20 Hz to 20 kHz.

#### General

**Temperature:** Operating, 0°C to 55°C; Storage, -25°C to 75°C.

**Power:** 100, 120, 220, or 240V (+5%, -10%); 48-66 Hz.

### HP 11808A Signal Generator Performance Test Software

The HP 11808A software provides 29 common performance tests for RF and microwave signal generators. The software is structured so that tests are defined by data files; data files for HP signal generators are included with the software - others can be created easily through simple screen entries.

The software supports the equipment in the HP 8902SG configurations, as well as other types such as digital scopes, digital voltmeters, and function generators. Instruments in the system can be indicated quickly in the program through the use of soft-keys and the configuration can be stored for later use.

#### Software Support

Two levels of software support services are available for the HP 11808A Signal Generator Performance Test Software; Software Material Subscription (SMS) and Software Notification Service (SNS).

SMS guarantees that software upgrades are provided on a timely basis as improvements to the software are made. Software Status Bulletins and Software Release Bulletins are also provided with SMS.

SNS provides information about software improvements with Software Status Bulletins and Software Release Bulletins.

#### Ordering Information

	Price
HP 8902SG Signal Generator Test System	\$76,000
Opt 018 extension to 18 GHz operation	+\$36,000
Opt 026 extension to 26.5 GHz operation	+\$60,000
HP 11808A Signal Generator Performance Test Software	\$5,500
Opt 910 2 sets of operating manual (11808-90001)	+\$95
11808A+S45 Software Material Subscription	\$15/mo
11808A+N00 Software Notification Service	\$5/mo

# SIGNAL ANALYZERS

## 150 kHz to 26.5 GHz

### Models 8902S, 11792A, 11793A, 11794A

- RF power: digital power meter accuracy
- Tuned RF level: 0 dBm to -100 dBm dynamic range
- AM and FM: 1% accuracy,  $\Phi$ M: 3% accuracy

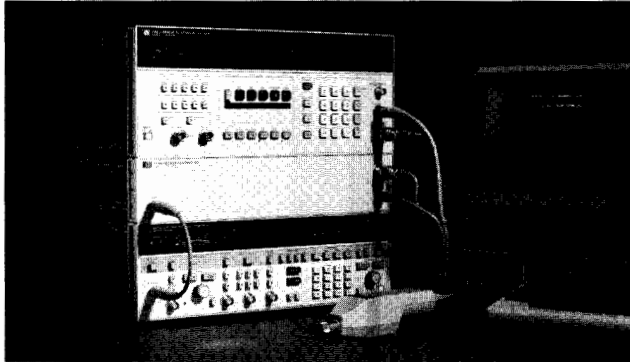

HP 8902S

### HP 8902S Measurement System

The HP 8902S Measurement System extends the superb measurement performance of the HP 8902A Measuring Receiver to microwave frequencies. The frequency is extended by adding an HP 11793A Microwave Converter and a local oscillator. With the HP 11792A Sensor Module the system delivers the accuracy and resolution of a high performance power meter to 26.5 GHz from +30 dBm to -100 dBm. It accurately measures AM, FM, and  $\Phi$ M (including residuals and incidentals) with a single keystroke. Adding options 030-037 to the HP 8902A extends the system's capability to include carrier noise measurements. The HP 8902S counts signals to 26.5 GHz with 10 Hz resolution and excellent long-term frequency stability.

The HP 8902S provides flexibility in specifying a solution that meets your exact needs. It can be configured for attenuator calibration, signal generator performance testing, and general signal characterization. For dedicated, preconfigured systems the HP 8902AT Attenuator Calibration System and the HP 8902SG Signal Generator Test System are available.

#### System Software

Under the control of the HP 11794A Software Pac, the HP 8902S Measurement System functions as a single instrument. You select the frequency and measurement from the front panel of the HP 8902A. The software then calculates and sets the local oscillator frequency, then releases the HP 8902A to make the measurement and display the results.

For a fully automated system the HP 8902S is supported by the HP 11806B Attenuator Test Software and HP 11808A Signal Generator Performance Test Software.

#### HP 11793A Microwave Converter

The HP 11793A Microwave Converter down converts microwave signals to the frequency range of the HP 8902A Measuring Receiver. For signals above 1.3 GHz, the HP 11793A routes the signal through its internal mixer. Below 1.3 GHz, signals are routed directly to the input of the HP 8902A.

The HP 11793A requires +8 dBm leveled output from the local oscillator. For LOs with insufficient power above 18 GHz, the HP 11793A offers an optional 18 to 26.5 GHz amplifier.

#### HP 11792A Sensor Module (50 MHz to 26.5 GHz)

The HP 11792A Sensor Module gives you all the performance of the HP 8902S system, plus superb power measurement accuracy, at a single connector. You can characterize a signal without manually switching between the power sensor and the receiver input.

Each HP 11792A Sensor Module is individually calibrated, traceable to the U.S. National Bureau of Standards. The calibration factors are printed on the sensor module for easy reference. Enter these factors into the HP 8902A's non-volatile memory and the instrument automatically compensates for the power sensor's efficiency and mismatch loss at each frequency.

- Carrier Noise (AM and phase noise measurements):  $\pm 0.5$  dB accuracy
- RF frequency: 10 Hz resolution
- Audio: frequency, level and distortion

### HP 8902S Specifications

#### RF Power (with HP 11792A Sensor Module)

**Range:** +30 dBm (1 W) to -20 dBm (10  $\mu$ W).

**Frequency range:** 50 MHz to 26.5 GHz.

**Linearity:**  $\pm 0.02$  dB (within range)  $\pm 0.02$  dB per range change from reference range  $\pm 1$  digit.

**Input SWR:** <1.10,  $f_c \leq 2.0$  GHz.

<1.28, 2.0 GHz <  $f_c \leq 18$  GHz.

<1.40, 18.0 GHz <  $f_c \leq 26.5$  GHz.

#### Tuned RF Level<sup>1</sup>

**Frequency range<sup>2</sup>:** 2.5 MHz to 26.5 GHz.

**Dynamic range:**

+10 dBm to -117 dBm, 2.5 MHz  $\leq f_c \leq 1300$  MHz.

0 dBm to -100 dBm, 1300 MHz <  $f_c \leq 18.0$  GHz.

0 dBm to -95 dBm, 18.0 GHz <  $f_c \leq 26.5$  GHz.

**Relative accuracy:**  $\pm 0.02$  dB  $\pm 0.02$  dB per IF range change  $\pm 0.04$  dB per RF range change  $\pm 1$  digit.

#### RF Frequency

**Range<sup>2</sup>:** 150 kHz to 26.5 GHz.

**Maximum resolution:** 10 Hz.

**Time base aging rate:**  $< 5 \times 10^{-10}$ /day, for HP 8672A, HP 8673B/D/E;  $< 1 \times 10^{-9}$ /day, for HP 8340A/B, HP 8341A/B.

#### Amplitude Modulation

**Frequency range<sup>2</sup>:** 150 kHz to 26.5 GHz.

**Rates:** 20 Hz to 100 kHz.

**Depths:** to 99%.

**Accuracy:**  $\pm 1\%$  of reading  $\pm 1$  digit, for rates 50 Hz to 50 kHz and depths  $\geq 5\%$ .

#### Frequency Modulation

**Frequency range<sup>2</sup>:** 150 kHz to 26.5 GHz.

**Rates:** 20 Hz to 200 kHz.

**Deviations:** to 400 kHz.

**Accuracy:**  $\pm 1\%$  of reading  $\pm 1$  digit, for rates 50 Hz to 100 kHz.

#### Phase Modulation

**Frequency range<sup>2</sup>:** 150 kHz to 26.5 GHz.

**Rates:** 200 Hz to 20 kHz.

**Deviations:** to 400 radians.

**Accuracy:**  $\pm 3\%$  of reading  $\pm 1$  digit.

#### General

**Temperature:** Operating, 15° C to 35° C; storage, -25° C to 60° C.

**Power:** 100, 120, 220, or 240V (+5%, -10%); 48-66 Hz; 1300 VA maximum (worst case).

**Weight:** Net 122.3 kg (270 lb); shipping, 153.3 kg (338.3 lb) worst case.

#### Ordering Information

##### HP 8902S Measurement System

For complete ordering information, see the "HP 8902S Measurement System Ordering Information" guide, or call your HP sales office.

HP 11794A Software Pac

\$250

<sup>1</sup>An HP 11722A Sensor Module may be used with the HP 8902S to make tuned RF level measurements from 2.5 MHz to 1300 MHz at levels from 0 dBm to -127 dBm.

<sup>2</sup>Frequency range may be limited by the frequency range of the LO.

- Ultra low distortion measurements
- Built-in low distortion oscillator
- Automatic
- True RMS detection

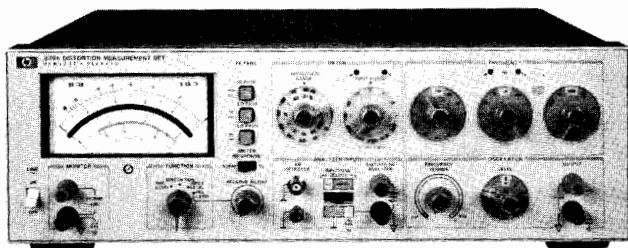

HP 339A

### Description

Hewlett-Packard's Model 339A Distortion Measurement Set is an ultra low distortion measuring system complete with total harmonic distortion (THD) analyzer, true-rms voltmeter, and sinewave oscillator. This small, lightweight bench measurement set allows you to make THD distortion measurements as low as 0.0018% over a 10 Hz to 110 kHz frequency band including harmonics to 330 kHz.

For fast and easy THD measurements the built-in tracking oscillator in HP's 339A saves test time because you tune one instrument instead of two. Frequency and level measurements are easy to do with HP's 339A's voltmeter, which offers you a 1 mV to 300 V measurement range. The Relative Level mode has been included to further simplify frequency response measurements. Just set a 0 dBm reference at any frequency from 10 Hz to 110 kHz. Gain measurements can be read directly from the easy-to-read meter.

### Operation Simplicity

Automatic frequency tuning and set-level features allow you to make rapid, error free THD measurements. The HP 339A's built-in tracking oscillator eliminates the need to find the fundamental frequency and tune the analyzer for a null. Just select your oscillator frequency and the rest is automatic. Automatic set-level saves time by automatically setting 0 dB (100%) reference in the distortion measuring mode. Front panel directional indicators light when the input range setting is improper insuring accurate and repeatable measurements. Automatic set-level also greatly simplifies measurements where distortion as a function of level (SINAD<sup>1</sup>, for example) is desired. Without this feature, measurements are very time consuming and tedious.

When an external stimulus is used, analyzer tuning is simplified by directional indicator lights for reaching the fundamental null quickly and easily.

### Specifications

#### Distortion

**Fundamental frequency range:** 10 Hz to 110 kHz continuous frequency coverage in 4 decade ranges with 2-digit resolution. Distortion analyzer and oscillator are simultaneously tuned.

**Distortion measurement range:** 0.01% full scale to 100% full scale (-80 dB to 0 dB) in 9 ranges.

**Detection and meter indication:** True rms detection for waveforms with crest factor  $\leq 3$ . Meter reads dB and % THD (Total Harmonic Distortion). Meter response can be changed from NORMAL to VU ballistics with a front panel switch.

#### Distortion Measurement Accuracy

20 Hz to 20 kHz:  $\pm 1$  dB

10 Hz to 50 kHz: +1, -2 dB

50 kHz to 110 kHz: +1.5, -4 dB

**Note:** The above specifications apply for harmonics  $\leq 330$  kHz.

#### Fundamental Rejection (3 V scale or above)

10 Hz to 20 kHz: > 100 dB

20 kHz to 50 kHz: > 90 dB

50 kHz to 110 kHz: > 83 dB

#### Distortion Introduced by Instrument (input > 1V rms)

10 Hz to 10 kHz: < -95 dB (0.0018%) THD

10 kHz to 20 kHz: < -92 dB (0.0035%) THD

20 kHz to 30 kHz: < -90 dB (0.0056%) THD

30 kHz to 50 kHz: < -85 dB (0.01%) THD

50 kHz to 110 kHz: < -70 dB (0.032%) THD

**Residual noise** (Fundamental frequency settings < 20 kHz, 80 kHz filter IN, source resistance  $\leq 1$  k $\Omega$  shielded): < -92 dB referenced to 1V.

**Input level for distortion measurements:** 30 mV to 300 V rms (100 mV range minimum).

**Input impedance:** 100 k $\Omega$   $\pm$  1% shunted by < 100 pF input High to Low.

**Monitor:** Provides scaled presentation of input signal after fundamental is removed for further analysis using oscilloscope or low frequency spectrum analyzer. Output voltage: 1V rms  $\pm$  5% open circuit for full scale meter indication, proportional to meter deflection. Output resistance: 1k $\Omega$   $\pm$  5%.

**Auto set level:** No set level adjustment required. Distortion measurements are made directly over 10 dB range selected by input range switch. Two LED annunciators provide a fast visual indication to change input range for valid distortion measurement. Correct range is indicated when both annunciators are extinguished.

**Automatic fine tuning:** Using internal oscillator: No separate analyzer tuning necessary when using internal oscillator as signal source. Oscillator frequency controls simultaneously tune the analyzer. Using external frequency source: two LED annunciators provide a quick visual indication for the operator to increase or decrease the frequency. When the analyzer is rough tuned to within one least significant digit of the fundamental frequency, the indicator lights are extinguished and the HP 339A auto-null circuitry takes over to provide a fast, accurate null without tedious operator tuning.

**Input filters (usable on all functions):** Low pass: 30 kHz -3 dB point at 30 kHz, + 2.6 kHz, -3 kHz with 60 dB/decade rolloff. Provides band limiting required by FCC for proof-of-performance broadcast testing. 80 kHz -3 dB point at 80 kHz, + 7 kHz, -7.9 kHz with 60 dB/decade rolloff. Normally used with fundamental frequencies < 20 kHz to reduce the effect of higher frequency noise present in the measured signal. High Pass: 400 Hz - 3 dB point at 400 Hz, + 35 Hz, -40 Hz with 60 dB/decade rolloff. Normally used with fundamental frequencies > 1 kHz to reduce the effect of hum components in the input signal.

**DC isolation:** Input low may be connected to chassis ground or floated to 30 V to reduce the effects of ground loops on the measurement.

#### Relative Input Level Mode

Provides a ratio measurement relative to an operator selected reference level with readout directly in dBV or dBm (600 $\Omega$ ). Voltage range, frequency range, accuracy specifications, and monitor are the same as in Voltmeter mode. (Accuracy is relative to 0 dB set level input).

#### Oscillator

**Frequency range:** 10 Hz to 100 kHz in 4 overlapping decade ranges with 2 digit resolution. Frequency vernier provides continuous frequency tuning between 2nd digit switch settings.

<sup>1</sup>SINAD is a sensitivity measurement computed from the ratio of signal plus noise and distortion to noise and distortion.

# SIGNAL ANALYZERS

## Distortion Analyzers Set (cont'd)

### Model 339A, 334A

**Output level:** Variable from < 1 mV to > 3 V rms into 600 Ω with 10 dB/step Level control and > 10 dB Vernier adjustment. OSC Level position on function switch allows a quick check of oscillator level without disconnecting leads to device under test. Off position on Oscillator Level control provides fast signal-to-noise measurement capability. Oscillator output terminals remain terminated in 600Ω.

**Frequency accuracy:** ± 2% of selected frequency (with Frequency Vernier in Cal position).

Level flatness: 20 Hz to 20 kHz: ≤ ± 0.1 dB  
10 Hz to 110 kHz: ≤ ± 0.2 dB

**Distortion (≥ 600Ω load, ≤ 3V output)**

10 Hz to 20 kHz: < -93 dB (0.0022%) THD  
20 kHz to 30 kHz: < -85 dB (0.0056%) THD  
30 kHz to 50 kHz: < -80 dB (0.01%) THD  
50 kHz to 80 kHz: < -70 dB (0.032%) THD  
80 kHz to 110 kHz: < -65 dB (0.056%) THD

**Output resistance:** 600Ω ± 5%.

**Voltmeter**

**Voltage range:** 1 mV rms full scale to 300 V rms full scale (-60 dB to + 50 dB full scale, meter calibrated in dBV and dBm into 600Ω).

**Detection and meter indication:** True rms detection for waveforms with crest factor ≤ 3. Meter reads true rms volts, dBm into 600Ω, and dBV.

**Accuracy (% of range setting)**

20 Hz to 20 kHz: ± 2%.

10 Hz to 110 kHz: ± 4%.

**Frequency range:** 10 Hz to 110 kHz.

**Input impedance:** 100 kΩ ± 1% shunted by < 100 pF between input High to Low.

**Monitor:** Provides scaled presentation of input signal for further analysis using oscilloscope or low frequency spectrum analyzer. Output voltage: 1V rms ± 5% open circuit for full scale meter indication, proportional to meter deflection. Output resistance: 1 kΩ ± 5%.

**Option 001**

**Voltage range:** 0.1 mV rms full scale to 300 V rms full scale (-80 dBV to +50 dBV full scale); (.1 mV and .3 mV ranges—external source resistance must be < 10 kΩ).

**Accuracy: 1 mV to 300 V Ranges**

20 Hz to 20 kHz ±2%

10 Hz to 110 kHz

**.1 mV and .3 mV Ranges**

20 Hz to 20 kHz: ±2%

10 Hz to 30 kHz: ±4%

30 kHz to 80 kHz: +10/-30%

**Noise Floor (600Ω source impedance)**

30 kHz filter < 6 μV

80 kHz filter < 8 μV

**AM Detector**

**Frequency range:** Carrier frequencies: 550 kHz to 1.6 MHz. Modulation frequencies: 20 Hz to 20 kHz.

**Distortion introduced by AM detector (with 30 kHz filter switched IN):** up to 85% Modulation: < -36 dB (1.6%) THD  
85% to 95% Modulation: < -30 dB (3%) THD

**Input level:** Maximum: 60V peak. Modulation signal level: 2V rms minimum; 10V rms maximum.

**Monitor (with modulated RF carrier applied to AM detector input).**

**Distortion mode:** Provides scaled presentation of demodulated input signal after fundamental is removed.

**Voltmeter and relative input mode:** Provides scaled presentation of demodulated input signal. Output voltage and output resistance are the same as in Distortion mode.

**General**

**Power:** 100/120/220/240 V + 5%, - 10% 48 Hz to 66 Hz line operation, 200 mA maximum.

**Size:** 146 mm H x 426 mm W x 375 mm D (5.75" x 16.75" x 14.75").

**Weight:** net 8.2 kg (18 lb). Shipping 11.3 kg (25 lb).

**HP 339A Distortion Measurement Set \$3,800**

**Option 001: \$280**

**Option W30: Extended Warranty \$140**

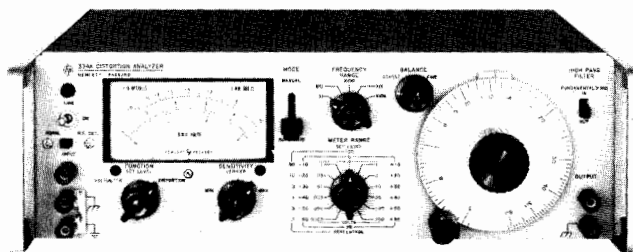

HP 334A

### Description

Hewlett-Packard's model HP 334A Distortion Analyzer measures total distortion down to 0.1% full scale at any fundamental frequency between 5 Hz and 600 kHz; harmonics are indicated up to 3 MHz. Noise levels as low as 25 microvolts can be measured. The HP 334A includes automatic fundamental nulling and amplitude modulation detector. A Meter with VU ballistic characteristics and a 30 kHz low pass filter are optional.

### HP 334A Specifications

**Input level for distortion measurements:** 0.3 V rms for 100% set level or 0.245 V for 0 dB set level (up to 300 V may be attenuated to set level reference).

#### Harmonic Measurement Accuracy (full scale)

#### Fundamental Input Less Than 30 V

Range	±3%	±6%	±12%
100%-0.3%	10 Hz-1 MHz	10 Hz-3 MHz	
0.1%	30 Hz-300 kHz	20 Hz-500 kHz	10 Hz-600 kHz

**Fundamental rejection:** > 80 dB

**Residual distortion:** > -70 dB (0.03%) from 5 Hz to 200 kHz; > -64 dB (0.06%) from 200 kHz to 600 kHz. Meter indication is proportional to average value of a sine wave.

**Frequency calibration accuracy:** Better than ±5% from 5 Hz to 300 kHz. Better than ±10% from 300 to 600 kHz.

**Input impedance:** Distortion mode: 1 MΩ ±5% shunted by < 70 pF.

**DC isolation:** Signal ground may be ±400 V dc from external chassis.

**Voltmeter range:** 300 μV to 300 V rms full scale (13 ranges) 10 dB per range. Average responding calibrated in rms.

**Noise measurements:** Voltmeter residual noise on the 300 μV range: < 25 μV rms, when terminated in 600 (shielded) ohms.

**Output:** 0.1 ± 0.01 V rms open circuit.

**Output impedance:** 2 kΩ.

**Automatic nulling mode:** Set level: at least 0.2 V rms.

**Frequency ranges:** X1, manual null tuned to less than 3% set level; total frequency hold-in ±0.5% about true manual null. X10 through X10k, manual null tuned to less than 10% of set level; total frequency hold-in ±1% about true manual null.

**Automatic null accuracy:** 5 Hz to 100 Hz: meter reading within 0 to +3 dB of manual null. 100 Hz to 600 kHz: meter reading within 0 to +1.5 dB of manual null.

**High pass filter:** 3 dB point at 400 Hz with 18 dB per octave roll off.

**AM detector:** 550 kHz to 65 MHz; 40 Vp-p max input.

**Distortion introduced by detector:** 550 kHz-1.6 MHz: < 50 dB (0.3%) for 3-8 V rms carriers modulated 30%. 1.6 MHz-65 MHz: < 40 dB (1%) for 3-8 V rms carriers modulated 30%.

### General

**Power:** 100V/120V/220V/240V -10% +5%, 48-66 Hz.

**Size:** 426 mm W x 126 mm H x 337 mm D (16.75" x 5" x 13.25").

**Weight:** net 7.89 kg (17.75 lb). Shipping 10.35 kg (23 lb).

### Ordering Information

**HP 334A Distortion Analyzer \$3,300**

**Opt 001:** VU Characteristics \$25

**Opt 002:** 30 kHz Low Pass Filter \$130

**Opt 003:** (combined 001 and 002) \$150

**Opt W30:** Extended Warranty \$120



# SIGNAL ANALYZERS

## 15 Hz to 50 kHz Wave Analyzer

### Model 3581A

175

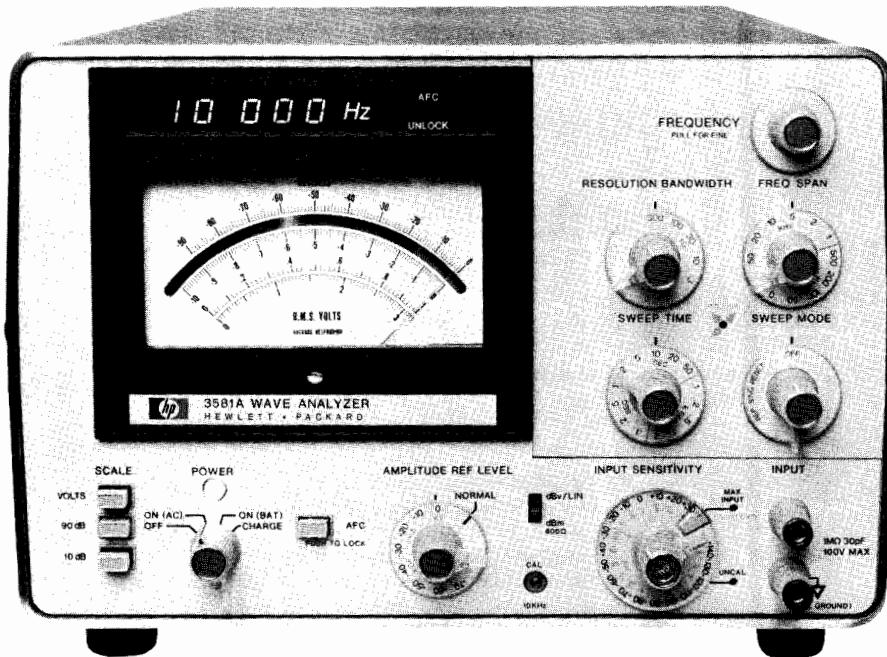

HP 3581A

### Description

Hewlett-Packard's 3581A Wave Analyzer resolves and measures the amplitude and frequency of spectral components. This instrument offers accurate amplitude and good frequency resolution in the form of a portable, easy-to-use measuring tool. Since not all signals originate from a stable frequency source, the HP 3581A incorporates an AFC circuit which locks to a drifting signal for stable, accurate measurements.

The HP 3581A has other important features that are necessary when making measurements of small voltages from transducers and harmonic signals. Its 30 nV sensitivity becomes important for these measurements. Battery operation can be used to reduce the line related interference common in low level measurements so only the real spectrum is measured.

Digital readout of tuned frequency is located above the analog meter. It has been grouped with the meter for ease of reading. Resolution of the digital readout is 1 Hz for any frequency between 15 Hz and 50 kHz. Readout is updated five times per second so delay between tuning and reading is minimized.

Four meter scales are used to provide a wide range of displays. Two scales are used for linear voltage readings. Two log scales provide either a 90 dB or 10 dB display. In any case, the large meter with its mirror backing can present readings in dBV, dBm or volts. A meter was specifically chosen for amplitude display rather than digital readout because it is easier to peak a meter reading and because it's much easier to get a feel for noise or other amplitude variations by watching the meter. The same voltage used to drive the meter is also available on the rear panel for driving X-Y recorders.

### Specifications

#### Frequency Characteristics

**Range:** 15 Hz to 50 kHz.

**Display:** 5 digit LED readout.

**Resolution:** 1 Hz.

**Accuracy:**  $\pm 3$  Hz., 0 to 55°C.

**Typical stability:**  $\pm 10$  Hz/hour after 1 hour and  $\pm 5$  Hz/°C.

**Automatic frequency control (AFC) hold-in range:**  $\pm 800$  Hz.

#### Amplitude Characteristics

##### Instrument Range

**Linear:** 30 V to 100 nV full scale.

**Log:** +30 dBm or dBV to -70 dBm or dBV, full scale.

##### Amplitude Accuracy

Frequency response,  
15 Hz-50 kHz

##### Log

$\pm 0.4$  dB

##### Linear

$\pm 4\%$

**Dynamic range:** >80 dB.

**Noise sidebands:** Greater than 70 dB below CW signal. 10 bandwidths away from signal.

**Spurious responses:** >80 dB below input reference level.

#### Sweep Characteristics

**Scan width:** 50 Hz to 50 kHz, adjustable in a 1-2-5 sequence from 50 Hz to the full frequency range.

**Sweep error light:** This LED indicates a sweep that is too fast to capture full response. When the light is on, response will be lower than it should be.

**External trigger:** A short to ground stops the normal sweep. Opening the short then enables a sweep.

#### Input Characteristics

**Impedance:** 1 M $\Omega$ , 30 pF.

**Maximum input level:** 100 V rms,  $\pm 100$  V dc.

#### Output Characteristics

**Tracking generator output:** (Also known as BFO or tracking oscillator output).

**Range:** 0 to >1 V rms into 600  $\Omega$ .

**Frequency response:**  $\pm 3\%$  15 Hz to 50 kHz.

#### X-Y Recorder Analog Outputs

**Vertical:** 0 to +5 V  $\pm 2.5\%$ .

**Horizontal:** 0 to +5 V  $\pm 2.5\%$ .

**Impedance:** 1 k $\Omega$ .

**Recommended Accessory:** HP 7090A Measurement Plotting System.

**Pen lift:** Contact closure to ground during sweep.

**Restored output:** Acts as a narrow band amplifier.

#### General

**Power requirements:** 100 V, 120 V, 220 V, or 240 V  $\pm 5\%$  -10%, 48 Hz to 440 Hz, 10 VA typical.

**Size:** 203.2 mm H x 285.8 mm W x 412.8 mm D (8" x 11 1/4" x 16 1/4").

**Weight:** 11.5 kg (23 lb). Opt 001: 13.5 kg (30 lb).

#### Ordering Information

##### HP 3581A Wave Analyzer

**Opt 001:** Internal battery 12 hours from full charge.

Internal battery is protected from deep discharge by an automatic turnoff. Useful battery life is over 100 cycles.

**Opt 003:** Rack Mount

**Opt 910:** Extra Manual

**Opt W30:** Extended Warranty

**Price**  
**\$6,100**

\$700

\$335

\$36

\$300

# ELECTRONIC COUNTERS

## General Information

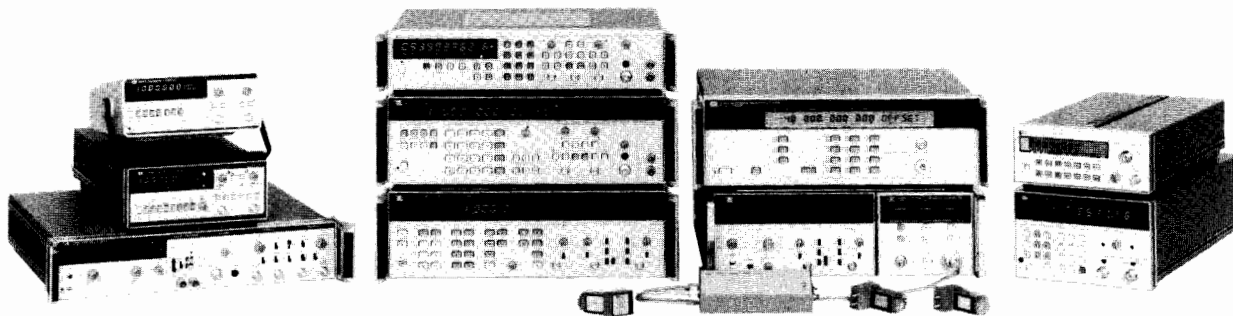

HP offers a wide selection of counters to fit your particular frequency and time measurement needs.

### Counters Provide Fast, Inexpensive and Accurate Time and Frequency Measurements

When you buy a counter from HP, you can be sure you'll get the quality you need. HP counters deliver:

- High measurement accuracy
- Fast system throughput/HP-IB capability
- Low cost of ownership
- Ease of use
- Data reduction on many models
- Triggering simplicity

### A Wide Selection of Counters to Meet your Needs

#### Basic Frequency Counters

- Frequency measurement up to 3 GHz
- Easy to use

#### Microwave and Millimeter CW Counters

- Measurements to 110 GHz
- MTBF's of over 20 years on the HP 5350 series (based on actual use)

#### Microwave and Millimeter Pulse Counters

- Modular expandability via interchangeable heads

#### Basic Universal Counters

- HP value at a low price
- Time measurements down to 100 ns single shot, 1 ns repetitive
- Frequency measurements up to 1 GHz

#### Performance Universal Counters

- Designed for systems
- Time interval measurements down to 2 ns single shot, 100 ps repetitive
- Frequency measurements up to 1.3 GHz

#### Precision Time Interval Products\*

- NBS traceable time interval measurements
- Optimized for systems throughput

\* For companion time synthesizer see page 445

### Why Buy from HP?

- More people rely on HP counters than any other brand.
- Specifications with wide guardbands give you confidence in your measurements.
- Worldwide applications and service support is available when you need it.
- High reliability translates to low cost of ownership for you. Most HP counters have an MTBF of 40,000 hours, over 20 years!
- Choose from the widest range of counters available to get the performance you need.
- The HP 5371A Frequency and Time Interval Analyzer is another example of HP's commitment to better solutions for your measurement problems.

### For More Information

HP offers the most complete set of application and product notes available. This literature will give you detailed information to help you make your measurements with confidence every time. For more information, fill out the card at the back of this catalog, or call your local HP Sales Office listed in your telephone directory. Ask for the electronic instrument department.

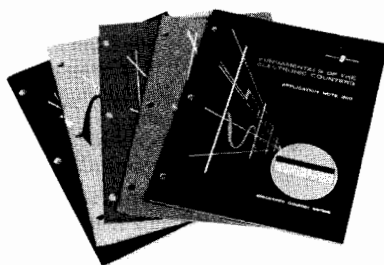

### Introducing Modulation Domain Measurement and Analysis

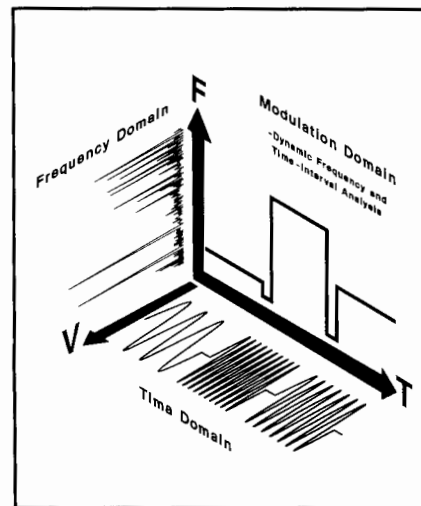

A new domain of measurement and analysis is now available with the HP 5371A Frequency and Time Interval Analyzer. Where oscilloscopes look at signal data in the Time Domain and spectrum analyzers in the Frequency Domain, the HP 5371A adds the missing dimension of Modulation to signal analysis.

Now you can directly characterize variations in frequency, phase and time interval as a function of time up to 500 MHz with the HP 5371A. The HP 5364A Microwave Mixer/Detector allows you to downconvert the same data in the 2 to 18 GHz frequency range.

The HP 5371A also features built-in analysis and display functions. You can directly characterize FM on carriers or see the frequency or phase-coding profile of radar pulses using the Time Variation display. For timing analysis, use the histogram and statistics features.

Are you working on frequency-agile communications, jitter and wander in digital communications, radar/EW systems, electrical/mechanical systems, serial data storage-retrieval, modulation analysis or basic research? Modulation Domain analysis can give you new insight into your complex signals. See page 191-194 for more information.

## Counter Selection Guide

Model	Frequency A	Frequency B	Frequency C	Single Shot Time Interval	Display Digits	Resolution vs. Time	Sensitivity	HP-IB Readings/s	Enhanced Capabilities Available	Standard Price	Page
<b>Basic Frequency Counters</b>											
5384A	10 Hz-100 MHz	50 MHz-225 MHz			11	9 digits/s	10 mV	4	Oven time base, battery	\$1500	187
5385A	10 Hz-100 MHz	90 MHz-1 GHz			11	9 digits/s	10 mV	4	Oven time base, battery	\$1800	187
5386A	10 Hz-100 MHz	100 MHz-3 GHz			11	9 digits/s	15 mV	4	Oven time base	\$3400	187
<b>Microwave And Millimeter CW Counters</b>											
5386A	10 Hz-100 MHz	100 MHz-3 GHz			11	9 digits/s	-23.5 dBm	4	Oven time base	\$3400	187
5340A	10 Hz-18 GHz	10 Hz-250 MHz			8	varies	-35 dBm	10	Oven time base, limiter	\$16500	183
5342A	500 MHz-18 GHz	10 Hz-520 MHz			11	1 Hz/s	-25 dBm	10	Oven time base, limiter, amplitude	\$7600	181
5343A	500 MHz-26.5 GHz	10 Hz-520 MHz			11	1 Hz/s	-33 dBm	10	Limiter, offset, totalize	\$9000	181
5350B	500 MHz-20 GHz	10 Hz-525 MHz			11	1 Hz/s	-40 dBm	to 120	Oven time base, limiter, math, fast acquisition	\$5200	178
5351B	500 MHz-26.5 GHz	10 Hz-525 MHz			11	1 Hz/s	-40 dBm	to 120	Oven time base, limiter, math, fast acquisition	\$6300	178
5352B	500 MHz-46 GHz	10 Hz-525 MHz			11	1 Hz/s	-30 dBm	to 120	Oven time base, math, fast acquisition	\$10000*	178
5356D		36 GHz-110 GHz			11	<2 Hz/s	-20/-3 dBm	to 9000	Frequency averaging	\$6000*	184
<b>Microwave And Millimeter Pulse Counters</b>											
5355A	400 MHz-1.5 GHz		0-500 MHz	2 ns	11	>8 digits/s	-15 dBm	to 9000	Frequency profile, pulse width	\$6000*	184
5356A	1.5 GHz-18 GHz	400 MHz-1.5 GHz	0-500 MHz	2 ns	11	1 Hz/s	-20/-15 dBm	to 9000	Frequency profile, pulse width	\$2000	184
5356B	1.5 GHz-26.5 GHz	400 MHz-1.5 GHz	0-500 MHz	2 ns	11	1 Hz/s	-20/-15 dBm	to 9000	Frequency profile, pulse width	\$2200*	184
5356C	1.5 GHz-40 GHz	400 MHz-1.5 GHz	0-500 MHz	2 ns	11	<2 Hz/s	-25/-10 dBm	to 9000	Frequency profile, pulse width	\$2800*	184
5356D	36 GHz-110 GHz	400 MHz-1.5 GHz	0-500 MHz	2 ns	11	<10 Hz/s	-20/-5 dBm	to 9000	Frequency profile, pulse width	\$6600*	184
<b>Basic Universal Counters</b>											
5314A	10 Hz-100 MHz			100 ns	7	10 or 1 Hz/s	25 mV		Period, ratio, totalize, battery	\$600	207
5315A	.1 Hz-100 MHz		50 MHz-1 GHz	100 ns	8	7 digits/s	10 mV		Period, ratio, totalize, battery, oven TB	\$1250	204
5316B	.1 Hz-100 MHz		50 MHz-1 GHz	100 ns	8	7 digits/s	10 mV	10	Oven time base	\$1475	204
<b>Performance Universal Counters</b>											
5328B	0-100 MHz		90 MHz-1.3 GHz	10 ns	8	1 Hz/s	25 mV	to 500	DVM, oven time base	\$5400	203
5334B	.001 Hz-100 MHz	.001 Hz-100 MHz	90 MHz-1.3 GHz	2 ns	9	9 digits/s	35 mV	to 140	Auto pulse characterization	\$1950	198
5335A	.002 Hz-200 MHz		150 MHz-1.3 GHz	2 ns	12	9 digits/s	25 mV	15	Auto pulse characterization, statistics, DVM	\$4400	200
5345A	0-500 MHz		(see 5355A, 5356 A/B/C/D)	2 ns	11	>9 digits/s	25 mV	to 9000	External gate, frequency average	\$10000	196
<b>Precision Time Interval Products</b>											
5370B	0-100 MHz			20 ps	16	>11 digits/s	35 mV	to 8000	Statistics, external gate	\$11000	189
HP 5363B Time Interval High Impedance Probes										\$4900	195

\*needs 5345A, 5355A and mixers

†needs Opt 005 for coverage to 46 GHz

## Frequency and Time Interval Analyzer Selection Guide

Model	Frequency A and B	Single Shot Time Interval Res.	Analysis and Display	Max. Continuous Measurement Rate	Memory Size	HP-IB Results/s	Standard Price	Page
5371A	.125 Hz-500 MHz	150 ps rms	Histogram Time Variation Event Timing Numeric	10x10 <sup>6</sup> samples/s	1000	to 20,000	\$21,500	191
Frequency extension for the HP 5371A 5364A 2 - 18 GHz							\$13000	191

# ELECTRONIC COUNTERS

## Our Newest, High-Performance CW Microwave Frequency Counters

Models 5350B, 5351B, 5352B

- Frequency coverage from 10 Hz to 46 GHz, without an external mixer
- 2.4 mm connector available with Option 005
- Exceptional sensitivity to  $-40$  dBm
- 1 GHz/second tracking speed
- 60-millisecond acquisition time
- 100 measurements/second over HP-IB in automatic mode
- Two years of extended hardware support with Option W30



The HP 5352B, shown above, is a member of the new HP 5350 CW microwave counter family



DESIGNED FOR  
MATE  
SYSTEMS



### HP 5350B/5351B/5352B Microwave Frequency Counters

The HP 5350B/5351B/5352B are automatic CW Microwave Frequency Counters that measure to 20, 26.5, and 46 GHz respectively. With resolution as fine as 1 Hz, these counters provide you with fast and precise frequency measurements.

By integrating all microwave components onto a single hybrid GaAs circuit, these counters offer you high performance at low prices. Wide frequency coverage, exceptional sensitivity, fast tracking speed, high measurement throughput, and wide FM tolerance are but a few of the high-performance features that you get with these low-cost counters.

With a built-in microprocessor, the HP 5350B/5351B/5352B also have math capabilities such as measurement scaling and offset. These functions are useful when you need indirect measurement results. Also, automatic amplitude discrimination automatically measures frequency of the highest-amplitude signal in a multi-signal environment. Other convenience features include diagnostic routines that let you perform tests on the counter for general information and troubleshooting.

The HP 5350B/5351B/5352B are ideal components for test systems. They are easy to program and their English-like commands simplify systems integration by reducing your programming effort. Their high measurement throughput also saves you money by reducing test time. In automatic test systems, the programmable alphanumeric liquid-crystal display (LCD) can serve as a message center; and if operational security is a concern, keyboard and display lockout can be activated. In noise-sensitive environments, you can put these counters in the SLEEP mode to reduce kickback noise to as low as  $-70$  dBm.

### Direct Inputs to 46 GHz, Providing Low-cost Solutions for your Expanding Needs

The HP 5350B/5351B/5352B provide a full range of high-performance, low-cost products to meet your expanding measurement needs. The HP 5350B and HP 5351B measure frequency from 10 Hz to 20 GHz and 26.5 GHz respectively. The HP 5352B, which extends input capability to 40 GHz (46 GHz with Option 005), now lets you make measurements in the millimeter-wave range directly – without having to purchase expensive mixers.

### Exceptional Sensitivity, Making Direct Measurement of Low-Level Signals Possible

As these counters have input sensitivity to  $-40$  dBm ( $-30$  dBm for HP 5352B), accurately measuring your low-energy signals becomes a simple task. For example, you no longer need expensive microwave amplifiers to make low-level measurements. Also, you no longer have to worry about signal attenuation by the probe when you make frequency measurements at different nodes within your circuit. These conveniences simplify measurements in applications such as receiver front-end testing.

### Reduced Acquisition Time, Significantly Improving Your Measurement Throughput

With acquisition time reduced to 60 milliseconds in automatic, fast-acquisition tracking mode (20 milliseconds in manual mode), these high-speed microwave counters can significantly improve your measurement throughput.

In bench-top applications, this high-speed throughput gives you fast measurement response. The liquid-crystal display (LCD) will update measurements rapidly to shorten your evaluation time. For applications that require fast measurement response to source tuning, these counters are ideal solutions.

In systems environments, the counters' fast measurement throughput also contributes to your overall system efficiency. Delivering more than 100 measurements/second over HP-IB in automatic mode, the counters' systems performance saves you money by reducing test time.

### 1 GHz/second Tracking Speed, Accurately Measuring Your Fast-Moving Signals

Fast acquisition also offers you fast tracking speed. With acquisition time below 60 milliseconds, these counters can track source drift to 1 GHz/second effortlessly. For example, in measuring the response of a voltage-controlled oscillator (VCO) to voltage-source tuning, these counters will track the changing frequency rapidly to measure the transfer characteristics.

### Option W30 Provides you with Convenient Service and Support For the Second and Third Year of Ownership

In addition to the one-year service that HP normally provides for all of its instruments, Option W30 gives you two additional years of support at the time of purchase. This optional support reflects HP's commitment to product reliability and customer satisfaction.

## HP 5350B/5351B/5352B Specifications

### Input 1

**Frequency range:** HP 5350B: 500 MHz to 20 GHz  
 HP 5351B: 500 MHz to 26.5 GHz  
 HP 5352B: 500 MHz to 40 GHz  
 Option 005: 500 MHz to 46 GHz

**Sensitivity**, in dBm (specification/typical performance @ 25°C)

**HP 5350B/5351B: 500 MHz to 12.4 GHz:** -32/-40; Option 002: -31/-39; Option 006: -29/-37.

**HP 5350B/5351B: 12.4 GHz to 20 GHz:** -27/-35; Option 002: -25/-33; Option 006: -23/-31.

**HP 5351B: 20 GHz to 26.5 GHz:** -16/-28; Option 002: -13/-25; Option 006: -11/-23.

**HP 5352B: 500 MHz to 26.5 GHz:** -25/-30; 26.5 GHz to 46 GHz, linear decrease to -10/-15.

**Maximum input:** +7 dBm.

**Damage level:** +25 dBm; HP 5350B/5351B Option 006: 500 MHz to 6 GHz + 39 dBm; 6 GHz to 18 GHz + 36 dBm; 18 GHz to 26.5 GHz + 34.8 dBm.

**SWR (typical):** 500 MHz to 10 GHz 2:1; Option 002/006 2.5:1.  
 10 GHz to 26.5 GHz 3:1; Option 002/006 3.5:1.  
 26.5 GHz to 46 GHz 3.5:1.

**Coupling:** dc to 50Ω termination, ac to instrument.

### Connector:

Precision Type N female (HP 5350B)

APC-3.5 male with collar (HP 5351B/HP 5352A)

APC-2.4 male with collar (Option 005)

**Accuracy:** ± 1 LSD ± time-base error × frequency. (See Graphs 3 & 5).

**Residual stability:** when counter and source use common 10 MHz time base or counter uses external higher stability time base, .3 LSD rms typical for resolution 1 Hz - 1 kHz at 25°C; HP 5352B .7 LSD typical 26.5 - 40 GHz; LSD = least significant digit.

**Resolution:** selectable 1 Hz to 1 MHz.

**FM Tolerance** (see Graph 2: FM Rate Tolerance)

**Maximum deviation:** Auto 20 MHz p-p (HP 5350B/HP 5351A)  
 12 MHz p-p (HP 5352B)  
 9 MHz p-p (Option 005)  
 Manual: 60 MHz p-p (HP 5350B/HP 5351B)  
 55 MHz p-p (HP 5352B)  
 55 MHz p-p (Option 005)

**Maximum FM rate:** 10 MHz.

### Tracking Speed

**Fast-acquisition track:** 1 GHz/s.

**Normal FM rate:** 1 MHz/s.

**Low FM rate:** 80 kHz/s.

**AM tolerance:** any modulation index provided the minimum signal level is not less than the sensitivity specification.

### Modes of Operation

**Automatic:** counter automatically acquires and displays highest level signal within sensitivity range.

**Manual:** center frequency must be entered to within ± 20 MHz or input frequency; ± 3 MHz worst case below 1 GHz; increases measurement and data output rate.

**Automatic amplitude discrimination:** automatically measures the largest of all signals present, providing that signal is >6 dB (typical) above any signal within 500 MHz; >20 dB (typical) above any signal within 500 MHz to 20 (46) GHz.

### Acquisition time

**Automatic mode:** fast-acquisition track: <60 ms.  
 normal FM rate: <125 ms.  
 low RM rate: <1.25 s

**Manual mode:** <20 ms.

	TCX0	Option 001	Option 010
Aging Rate	1 X 10 <sup>-7</sup> per month	5 X 10 <sup>-10</sup> per day	2 X 10 <sup>-9</sup> per year
Short Term	1 X 10 <sup>-9</sup> per s	1 X 10 <sup>-10</sup> per s	1 X 10 <sup>-10</sup> per s
Temperature 0 - 50	1 X 10 <sup>-6</sup>	1 X 10 <sup>-9</sup>	1 X 10 <sup>-9</sup>
Line 10% change	1 X 10 <sup>-7</sup>	1 X 10 <sup>-10</sup>	1 X 10 <sup>-10</sup>
Warm up to <5 X 10 <sup>-9</sup> @ 25°C		10 minutes	10 minutes

Figure 1. Time Base (10 MHz).

### Input 2:

**Frequency range:** 10 Hz to 525 MHz.

### Mode of Operation

**50 Ω:** 10 MHz to 525 MHz.

**1M Ω:** 10 Hz to 80 MHz.

**Sensitivity:** full operating environment:

**50 Ω:** 10 MHz to 525 MHz, 25 mV rms; 15 mV typical @ 25°C;

**1M Ω:** 10 Hz to 80 MHz, 25 mV rms; 15 mV typical @ 25°C;

Gate Time = 1/resolution: 1 ms minimum.

**Resolution:** selectable 1 Hz to 1 MHz.

**High resolution:** 1M Ω mode: 0.001 Hz for <100 kHz input; 0.01 Hz for <1 MHz input; 0.1 Hz for <10 MHz input; 1 Hz for >10MHz input; 1 second gate.

**Accuracy:** (See Graphs 4 & 5). ± 1 LSD

$$\left( \frac{\pm 1.4 \times \text{Trigger Error}^{(1)} \pm \text{Time Base}}{\text{Gate Time}} \right) \times \text{Frequency}$$

**Impedance:** selectable 1M Ω nominal shunted by <70 pF or 50 Ω nominal.

**Coupling:** ac.

**Connector:** replaceable fuse, type BNC female.

**Maximum input:** 50 Ω: +10 dBm; 1M Ω: 1V rms.

**Damage level:** 50 Ω or 1M Ω dc - 5 kHz: 250 V (dc + ac peak); >5 kHz: 5.5 V rms (+ 28 dBm) + 1.25 X 10<sup>6</sup> V rms/FREQ.

**Panel label:** 5.5 V rms (+ 28 dBm).

**Time base output:** 10 MHz and 1 MHz, 2.4 V square wave AC coupled into 1k Ω; 1.5V p-p into 50 Ω; available from rear panel BNC connectors whenever the instrument has AC power connected.

**External time base:** 1, 2, 5 or 10 MHz, 0.7 V min to 8 V max. p-p sine wave or square wave into > 1K Ω shunted by < 30 pF, via rear-panel BNC connector. External reference automatically selected when signal is present.

### General

**Display:** segmented 24-character alphanumeric LCD (backlighted).

**Keyboard:** set-up stored in STBY mode.

**Self-check:** tests for correct circuit operation.

**Diagnostics:** front-panel or HP-IB selectable, Display and Keyboard Lockout, Service Diagnostics and User Information.

**Data output:** over HP-IB bus; varies with Frequency and Resolution.

**Auto mode:** >100 readings/s, 10 kHz resolution, no math functions, "DUMP" mode.

**Manual mode:** >120 readings per second formatted at 10 kHz resolution, no math functions "DUMP MODE".

**Math functions:** result = measurement x scale + offset.

**Offset:** measurement is offset by entered value.

**Scale:** measurement is multiplied by entered value.

**Smooth:** displayed resolution is determined using exponential averaging; displays only stable digits.

**Sample rate:** variable from less than 50 ms between measurements to HOLD, which holds the display indefinitely or until trigger occurs.

**Display rate:** S/s, variable over HP-IB.

**Overload indication:** "OVRLOAD" A user message.

**Sleep mode:** input 1 emissions reduced to <-70 dBm typical when sleep mode or input 2 is selected.

**IF output:** rear panel BNC provides 30 - 110 MHz down-converted microwave signal at >-20 dBm into 50 Ω, ac coupled.

**HP-IB interface functions:** functions and diagnostics are programmable; address-set at front panel, default switches on rear panel; teach/learn programming; IEEE 728 compatible command structure; function subset SH1, AH1, T5, RF1, RL1, PP0, DC1, DT1, C0, E1 (see page 556).

**Reset/local:** returns to local control.

**Operation temperature:** 0° C to 50° C.

**Power requirements:** 100 VA max.

**Line select:** 100 V (90-105 VAC rms; 47.5 - 440 Hz).

115/120 V (104/126 VAC rms; 47.5 - 440 Hz).

220 V (198-231 VAC rms; 47.5 - 66 Hz).

230/240 V (207-252 VAC rms; 47.5 - 66 Hz).

**Accessories furnished:** power cord, manual.

**Size:** 33mmH × 407 mmW × 358 mmD (5¼ in. H × 16 in. W × 14 in. D)

**Weight:** 11 kg (24 lb).

(1) Trigger Error  $\sqrt{e_1^2 + e_n^2}$  s rms

Input Slew Rate in V/s at Trigger Point

Where  $e_1$  = effective rms noise of counter's input channel (100 μV typical)

$e_n$  = rms noise of the input signal for a 500 MHz bandwidth



# ELECTRONIC COUNTERS

Low-Cost, High-Performance CW Microwave Frequency Counters (cont'd)

Models 5350B, 5351B, 5352B

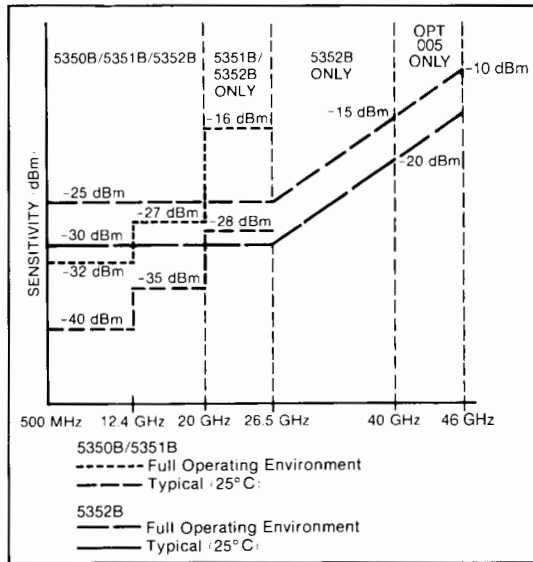

Graph 1. Sensitivity

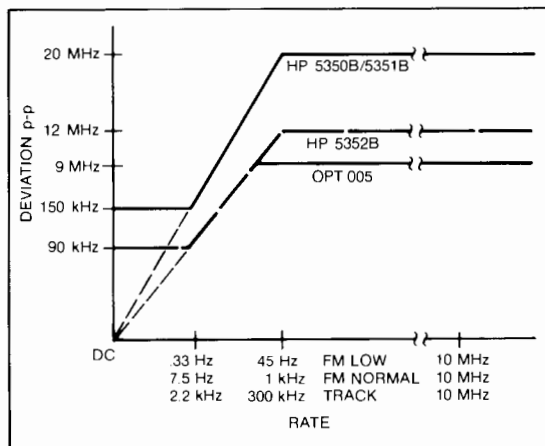

Graph 2. FM Rate Tolerance

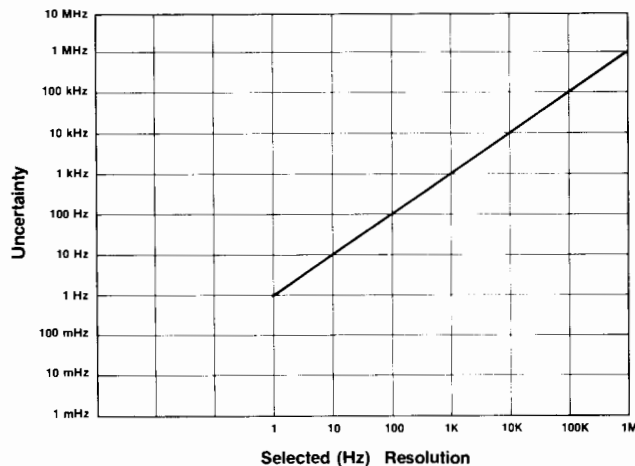

Graph 3. Input 1 uncertainty due to selected resolution

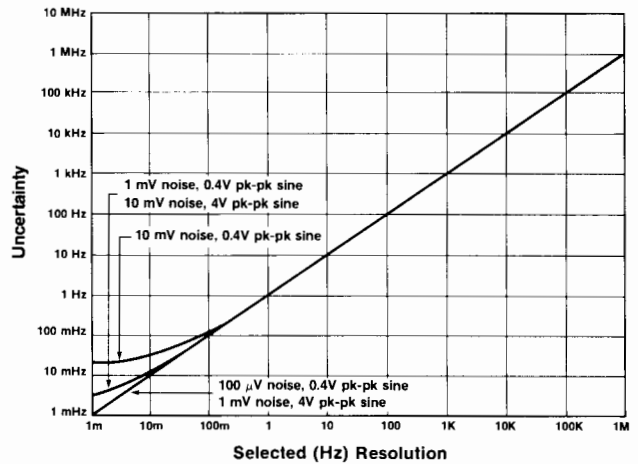

Graph 4. Input 2 uncertainty due to selected resolution and trigger error.

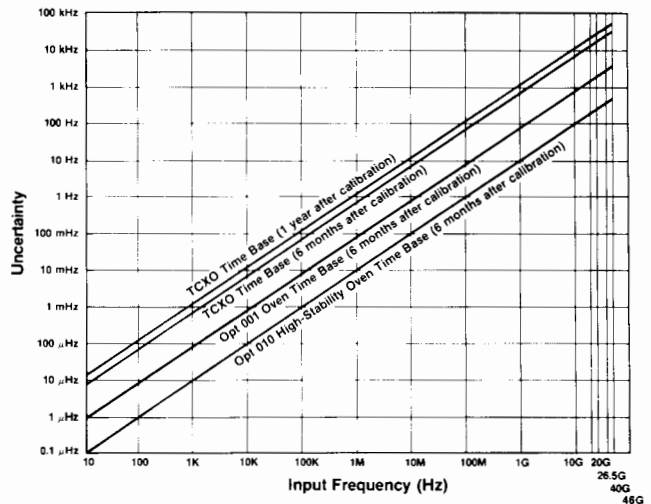

Graph 5. Uncertainty due to time-base error. Time-base error can be reduced by calibrating the time base more frequently, or by using a time base with a slower aging rate.

### Ordering Information

	Price
<b>HP 5350B</b> 20 GHz Microwave Frequency Counter	\$5,200
<b>HP 5351B</b> 26.5 GHz Microwave Frequency Counter	\$6,300
<b>HP 5352B</b> 40 GHz Microwave Frequency Counter	\$10,000
<b>Opt 001</b> Oven Time Base	+\$750
<b>Opt 002</b> Rear Panel Inputs (HP 5350B/51B only)	+\$300
<b>Opt 005</b> Frequency Extension to 46 GHz (HP 5352B only)	\$3900
<b>Opt 006</b> Microwave Level Limiter (HP 5350B/51B only)	+\$550
<b>Opt 010</b> High Stability Oven Time Base	+\$1,500
<b>Opt 700</b> MATE Programming	\$500
<b>Opt 910</b> Additional Operating & Service Manual	+\$75
<b>Opt 908</b> Rack Mount Kit for use with front handles removed	+\$33
<b>Opt 913</b> Rack Mount Kit for use with supplied front handles	+\$35
<b>Opt W30</b> 2-year extended hardware support	+\$160

### Additional Equipment Available:

Transit Case	9211-2643
Waveguide (3" straight) adapter WR28-APC3.5	05356-20217
Waveguide (3" straight) to coaxial adapter WR42-APC3.5	05356-20216
Adapter - In series APC 3.5 Male to Male	1250-1748
Adapter - In series APC 3.5 Female to Female	1250-1749

# ELECTRONIC COUNTERS

## CW Microwave Frequency Counters

### Models 5342A & 5343A

181

- Automatic measurements to 18 GHz/26.5 GHz
- Portability
- Wide FM tolerance

- Amplitude measurement in dBm (HP 5342A Option 002)
- High input sensitivity
- Digital-to-analog converter (Option 004)

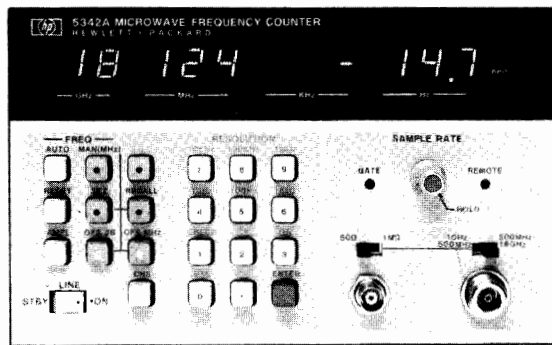

HP 5342A

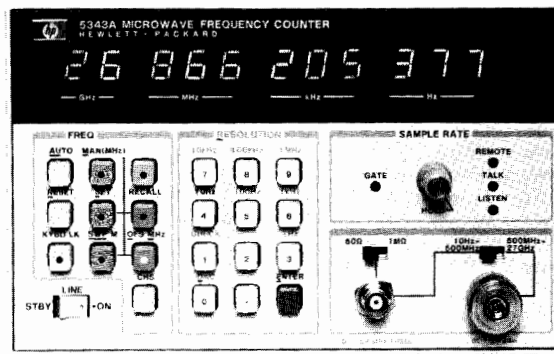

HP 5343A



## HP 5342A & 5343A Microwave Counters

### Portability

The HP 5342A and HP 5343A Microwave Counters provide automatic frequency measurement to 18 or 26.5 GHz in highly portable packages. The operating range of the HP 5342A can be extended to 24 GHz with Option 005.

### Amplitude Measurements (Option 002, HP 5342A only)

Option 002 adds the ability to measure and display the power level of the input in dBm. The 11-digit LED display presents amplitude measurement to 0.1 dBm resolution. Also, the same option extends the instrument's dynamic range to enable frequency measurements to +22 dBm.

### FM Tolerance

Measuring a carrier frequency while it is being frequency modulated has broad appeal in the communication industry and elsewhere. Both the HP 5342A and HP 5343A can tolerate peak-to-peak FM deviation to 50 MHz.

### Digital-To-Analog Converter (Option 004)

Option 004 lets you convert any three consecutive displayed digits (frequency or amplitude) into an analog voltage output on the rear panel. This makes the monitoring of microwave-oscillator-frequency drift easy to make with only a stripchart recorder.

### Scaling and Offset Functions

The versatility of the microprocessor-controlled keyboard allows you to perform math functions by means of a few key strokes. Frequency values to 1 Hz resolution can be added to or subtracted from the measured frequency for IF offset application. The HP 5343A also offers an  $mx \pm b$  mode for both scaling and offset functions.

## HP 5342A Specifications

### Signal Input

#### Input 1

**Frequency range:** HP 5342A: 500 MHz to 18 GHz.

HP 5343A: 500 MHz to 26.5 GHz.

**Sensitivity:** HP 5342A: 500 MHz to 12.4 GHz: -25 dBm.  
12.4 GHz to 18 GHz: -20 dBm.

HP 5343A: 500 MHz to 12.4 GHz: -33 dBm.  
12.4 GHz to 18 GHz: -28 dBm.  
18.0 GHz to 26.5 GHz: -23 dBm.

**Maximum input:** +7 dBm (See Option 002, 003 for higher levels).

**Impedance:** 50, nominal.

**Connector:** HP 5342A: Precision Type N female.

HP 5343A: APC 3.5 male with collar.

**Damage level:** +25 dBm, peak (See Option 006 for +39 dBm protection).

**Coupling:** dc to load, ac to instrument.

**SWR:** < 2:1, 500 MHz-10 GHz.

< 3:1, 10 GHz-18 GHz/26.5 GHz.

**FM tolerance:** switch selectable (rear panel)

**Wide:** 50 MHz p-p worst case.

**Normal:** 20 MHz p-p worst case.

**Narrow:** (HP 5343A only) 6 MHz p-p worst case.

For Modulation Rates from dc to 10 MHz.

**AM tolerance:** any modulation index provided the minimum signal level is not less than the sensitivity specification.

**Automatic amplitude discrimination:** automatically measures the largest of all signals present, providing that signal is 6 dB above any signal within 500 MHz; 20 dB above any signal, 500 MHz-18 / 26.5 GHz.

### Modes of Operation

**Automatic:** counter automatically acquires and displays highest level signal within sensitivity range.

**Manual:** center frequency entered to within  $\pm 40$  MHz of true value.

### Acquisition Time

#### Automatic Mode

Narrow FM 200 ms worst case (HP 5343A only)

Normal FM 530 ms worst case

Wide FM 2.4 s worst case

**Manual mode:** 80 ms after frequency entered.

### Input 2

**Frequency range:** 10 Hz to 520 MHz direct count.

**Sensitivity:** 50  $\Omega$ : 10 Hz to 520 MHz: 25 mV rms. 1 M  $\Omega$ : 10 Hz to 25 MHz: 50 mV rms.

**Impedance:** selectable 1 M  $\Omega$ , <50 pF or 50  $\Omega$  nominal.

**Coupling:** ac.

**Connector:** type BNC female.

**Maximum input 50  $\Omega$ :** 3.5 V rms (+24 dBm) or 5 V dc, fuse protected

1 M  $\Omega$ : 200 V dc + 5 V rms.

### Time Base

**Crystal frequency:** 10 MHz.

### Stability

**Aging rate:**  $< 1 \times 10^{-7}$ /month.

**Temperature:**  $< \pm 1 \times 10^{-6}$  over the range 0°C to 50°C.

**Short term:**  $< 1 \times 10^{-9}$  for 1 second averaging time.

**Line variation:**  $< \pm 1 \times 10^{-7}$  for 10% change from nominal.

**Output frequency:** 10 MHz,  $\geq 2.4$  V square wave (TTL compatible) 1.5 p-p V into 50  $\Omega$  available from rear panel BNC.

**External time base:** requires 10 MHz, 3.0 V p-p sine wave or square wave into 1 k  $\Omega$  via rear panel BNC connector. Switch selects either internal or external time base.

# ELECTRONIC COUNTERS

## Automatic Microwave Counters

Models 5342A & 5343A

### Optional Time Base (option 001)

**Crystal frequency:** 10 MHz.

#### Stability

- Aging rate:**  $<5 \times 10^{-10}$ /day after 24-hour warmup.
- Temperature:**  $<7 \times 10^{-9}$  over the range 0°C to 50°C.
- Short term:**  $<1 \times 10^{-10}$  for 1 second averaging time.
- Line variation:**  $<1 \times 10^{-10}$  for 10% change from nominal.
- Warm-up:**  $<5 \times 10^{-9}$  of final value 20 minutes after turn-on, at 25°C.

### Amplitude Measurement (opt 002) (HP 5342A only)

#### Input 1

**Frequency range:** 500 MHz–18 GHz.

#### Dynamic range (frequency and level)

- 22 dBm to +22 dBm 500 MHz to 12.4 GHz
- 15 dBm to +22 dBm 12.4 GHz to 18 GHz

**Maximum operating level:** +22 dBm.

**Damage level:** +25 dBm, peak.

**Resolution:** 0.1 dBm.

**Accuracy:**  $\pm 1.5$  dB (excluding mismatch uncertainty).

**SWR:**  $<2:1$  (amplitude measurement).

$<5:1$  (frequency measurement).

**Measurement time:** 100 ms + frequency measurement time.

**Display:** simultaneously displays frequency to 1 MHz resolution and level. (Option 011 provides full frequency resolution on HP-1B).

#### Input 2 (50 $\Omega$ impedance only)

**Frequency range:** 10 MHz–520 MHz.

**Dynamic range (frequency and level):** –17 dBm to +20 dBm.

**Damage level:** +24 dBm.

**Accuracy:**  $\pm 1.5$  dB (excluding mismatch uncertainty).

**SWR:**  $<1.8:1$ .

**Measurement time:** 100 ms + frequency measurement time.

**Display:** simultaneously displays frequency and input level.

### Extended Dynamic Range (opt 003) (HP 5342A only)

**Frequency range:** 500 MHz to 18 GHz.

**Sensitivity:** 500 MHz to 12.4 GHz: –22 dBm.  
12.4 GHz to 18 GHz: –15 dBm.

**Maximum operating level:** +22 dBm.

**Dynamic range:** 500 MHz to 12.4 GHz: 44 dB.  
12.4 GHz to 18 GHz: 37 dB.

**Damage level:** +25 dBm, peak.

**SWR:**  $<5:1$ .

### Microwave Limiter (option 006)

#### Input 1

**Frequency range:** HP 5342A: 500 MHz – 18 GHz.

HP 5343A: 500 MHz – 26.5 GHz.

**Sensitivity:** HP 5342A: 500 MHz – 12.4 GHz: –21 dBm.  
12.4 GHz – 18 GHz: –15 dBm.

HP 5343A: 500 MHz – 12.4 GHz: –30 dBm.

12.4 GHz – 18 GHz: –24 dBm.

18 GHz – 26.5 GHz: –18 dBm.

**Maximum operating level:** +7 dBm.

**Damage level:** 500 MHz – 6 GHz: +39 dBm (8W).

6 GHz – 18 GHz: +36 dBm (4W).

(HP 5343A only) 18 GHz – 26.5 GHz: +34.8 dBm (3W).

**SWR:** 2.5:1, 500 MHz – 10 GHz.

3.5:1, 10 GHz – 18 GHz/26.5 GHz.

**Note:** Option 006 is incompatible with Option 002, Option 003, and Option 005 for HP 5342A. Please consult factory special to combine Options 005 and 006.

#### General

**Accuracy:**  $\pm 1$  LSD  $\pm$  time-base error.

**Resolution:** front panel push buttons select 1 Hz to 1 MHz.

**Display:** 11 digit LED display, sectionalized to read GHz, MHz, kHz, and Hz.

**Self-check:** selected from front panel pushbuttons displays 75 MHz for resolution chosen.

**Frequency offset:** selected from front panel pushbuttons. Displayed frequency is offset by entered value to 1 Hz resolution.

**Frequency multiply:** (HP 5343A only) (mx  $\pm$ b) measured data is multiplied by any integer up to 99. Offset can then be added or subtracted. Front-panel selectable.

**Totalize (HP 5343A only):** input 2 can totalize at rates up to 520 MHz. Readout on the fly is controlled by front panel or HP-1B.

**Sample rate:** variable from less than 20 ms between measurements to HOLD which holds display indefinitely.

**IF out:** rear panel BNC connector provides 25 MHz to 125 MHz output of down-converted microwave signal.

**Power requirements:** 100/120/220/240 V rms, +5%, –10%, 48–66 Hz; 100 VA max.

**Weight:** net 9.1 kg (20 lb). Shipping 12.7 kg (28 lb).

**Size:** 133 mm H x 213 W x 498 mm D (5.25 in. H x 8.38 in. W x 19.6 in. D).

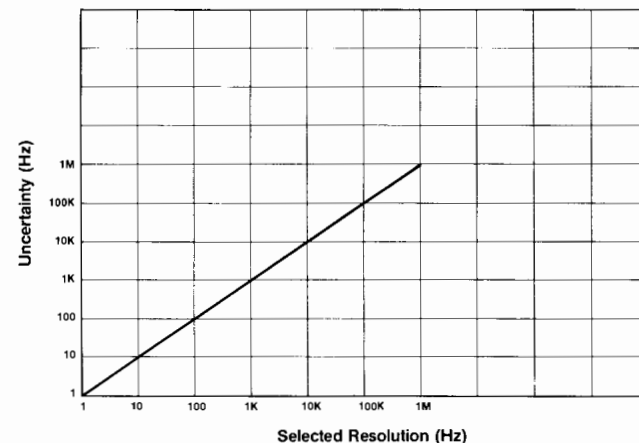

Graph 1. Uncertainty due to selected resolution.

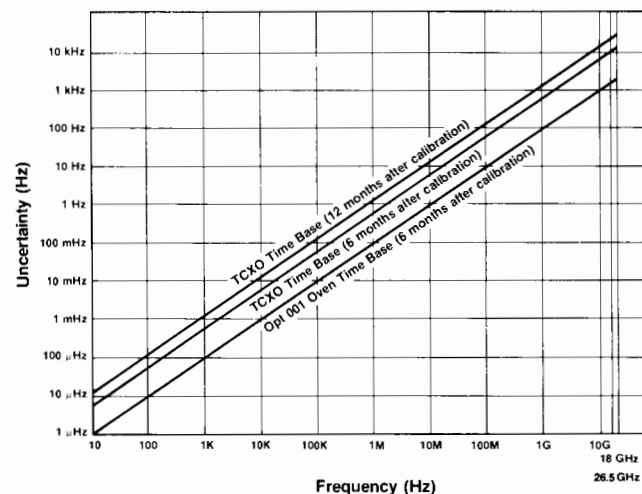

Graph 2. Uncertainty due to timebase error can be reduced by calibrating the timebase more frequently, or by using a timebase with a lower aging rate.

### Ordering Information

**HP 5342A** Frequency Counter

**HP 5343A** Frequency Counter

#### Options and Accessories (both models)

<b>Opt 001</b> High Stability Time Base	+ \$750
<b>Opt 002</b> Amplitude Measurement (HP 5342A Only)	+ \$1700
<b>Opt 003</b> Extended Dynamic Range (HP 5342A Only)	+ \$650
<b>Opt 004</b> Digital-To-Analog Converter	+ \$400
<b>Opt 005</b> Frequency Extension to 24 GHz (HP 5342A Only)	+ \$500
<b>Opt 006</b> Limiter Input Protection (+39 dBm)	+ \$600
<b>Opt 011</b> Digital Input/Output (HP-1B) (Cable Not Incl)	+ \$550
<b>Opt 908</b> Rack Mounting Adapter Kit	+ \$85
<b>HP K70-59992A</b> Rack Mounting Adapter Kit With Slot for access to front connectors from rear.	
<b>HP 10842A</b> Extender Board Kit	\$800

### Price

\$6900

\$8200

# ELECTRONIC COUNTERS

## Automatic Microwave Counters (cont'd)

183

Model 5340A

- Single input 10 Hz to 18 GHz
- Automatic amplitude discrimination
- High sensitivity  $-35$  dBm

- Optional extension to 23 GHz
- High AM and FM tolerance
- Exceptional reliability

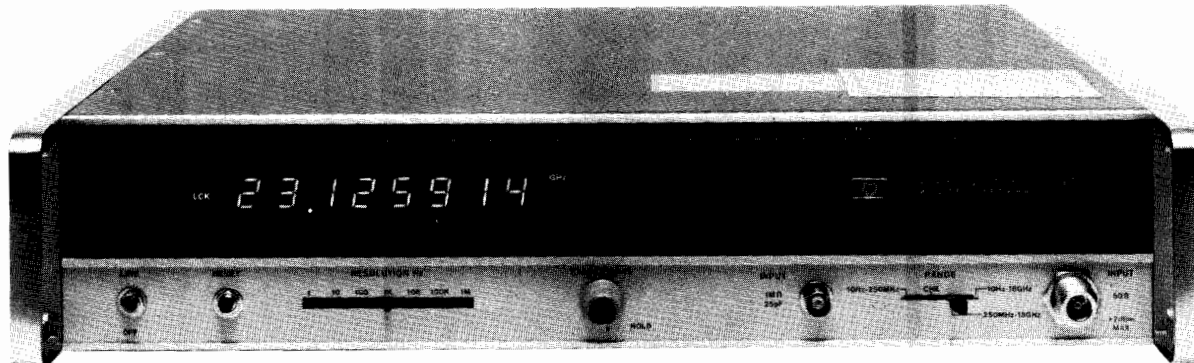

HP 5340A



### HP 5340A Frequency Counter

The HP 5340A Frequency Counter is an easily used, versatile instrument for direct measurement of frequencies from 10 Hz through 18 GHz via a single input connector.

The exceptional sensitivity of this instrument enhances measurement in the microwave field, where signals are commonly low-level and connected via directional coupler or lossy devices.

Access to the HP Interface Bus via Option 011 provides a flexible systems interface. The ability to program octave range through this input reduces acquisition time to less than 40 ms (typical).

### HP 5340A Specifications

#### Signal Input

##### Input 1

**Range:** 10 Hz to 18 GHz.

**Symmetry:** sinewave or squarewave input (40% duty factor, worst case).

**Sensitivity:**  $-30$  dBm, 10 Hz to 500 MHz;  $-35$  dBm, 500 MHz to 10 GHz;  $-25$  dBm, 10 to 18 GHz.

**Dynamic range:** 37 dB, 10 Hz to 500 MHz; 42 dB, 500 MHz to 10 GHz; 32 dB, 10 GHz to 18 GHz.

**Impedance:** 50  $\Omega$ .

**VSWR:**  $<2:1$ , 10 Hz–12.4 GHz;  $<3:1$ , 12.4–18 GHz.

**Connector:** precision Type N.

**Coupling:** dc to load, ac to instrument.

**Damage level:** +30 dBm.

Total power (ac + dc) not to exceed 1 watt. See Option 006 for up to +39 dBm protection.

**Acquisition time:**  $<150$  ms mean typical.

##### Input 2

**Range:** 10 Hz–250 MHz direct count.

**Sensitivity:** 50 mV rms. 150 mV p-p pulses to 0.1% duty factor; minimum pulse width 2 ns.

**Impedance:** 1 M $\Omega$  shunted by  $<25$  pF.

**Connector:** type BNC female.

**Coupling:** ac.

**Maximum input:** 200 V rms, 10 Hz to 100 Hz; 20 V rms, 100 Hz to 100 kHz; 2 V rms, 100 kHz to 250 MHz.

**Automatic amplitude discrimination:** automatically selects the strongest of all signals present (within 250 MHz to 18 GHz phase-lock range), providing signal level is: 6 dB above any signal within 200 MHz; 10 dB above any signal within 500 MHz; 20 dB above any signal, 250 MHz–18 GHz (typical performance).

**Maximum AM modulation:** any modulation index as long as the minimum voltage of the signal is not less than the sensitivity specification.

#### Time Base

**Crystal frequency:** 10 MHz.

#### Stability

**Aging rate:**  $<3 \times 10^{-7}$  per month.

**Short term:**  $<5 \times 10^{-10}$  rms for 1 second averaging time.

**Temperature:**  $<\pm 2 \times 10^{-6}$  over the range of 0°C to 50°C.

**Line variation:**  $<\pm 1 \times 10^{-7}$  for 10% line variation from nominal.

**Output frequency:** 10 MHz,  $\geq 2.4$  V square wave (TTL compatible) available from rear panel BNC.

**External time base:** requires 10 MHz approximately 1.5 V p-p sine wave or square wave into 1 k $\Omega$  via rear panel BNC. Switch selects either internal or external time base.

**Optional time base (opt 001) aging rate:**  $<5 \times 10^{-10}$  per day after 24-hour warm-up for less than 24 hour off-time.

#### General

**Accuracy:**  $\pm 1$  LSD  $\pm$  time-base error.

**Resolution:** front-panel switch selects 1 Hz to 1 MHz.

**Display:** eight digit LED with positioned decimal point and appropriate measurement units of kHz, MHz, or GHz.

**Self check:** counts and displays 10 MHz for resolution chosen.

**Sample rate:** controls time between measurements. Continuously adjustable from 50 ms typical to 5 seconds. HOLD position holds display indefinitely. RESET button resets display to zero and activates a new measurement.

**HP-IB interface functions:** SH1, AH1, T1, L2, SL1, RL2, PP0, DC1, DT1, C0, E1 (see page 556).

**Operating temperature:** 0°C to 50°C.

**Power:** 115 V or 230 V  $\pm 5\%$ ,  $-10\%$ , 48–66 Hz, 100 VA.

**Weight:** net, 11.3 kg (25 lb). Shipping, 14.1 kg (31 lb).

**Size:** 88.2 mm H x 425 mm W x 467 mm D (3.47 in. x 16.75 in. x 18.39 in.).

### Ordering Information

<b>HP 5340A</b> Frequency Counter	<b>Price</b> <b>\$15,000</b>
<b>Opt 001</b> High Stability Time Base	+ \$750
<b>Opt 002</b> Rear Panel Connectors	+ \$200
<b>Opt 005</b> Frequency Extension to 23 GHz	+ \$600
<b>Opt 006</b> Limiter Input Protection (+39 dBm)	+ \$600
<b>Opt 011</b> Remote Programming-Digital Output (HP-IB)	+ \$550
<b>Opt 908</b> Rack Flange Kit	+ \$65

# ELECTRONIC COUNTERS

## Pulse and CW Microwave Frequency Counters

### Models 5345A/5355A/5356A,B,C,D

- -25 dBm sensitivity
- 100 Hz measurement resolution
- 75 nanoseconds minimum pulse width
- 20 nanoseconds minimum external gate
- CHIRP profile or VCO post-tuning drift

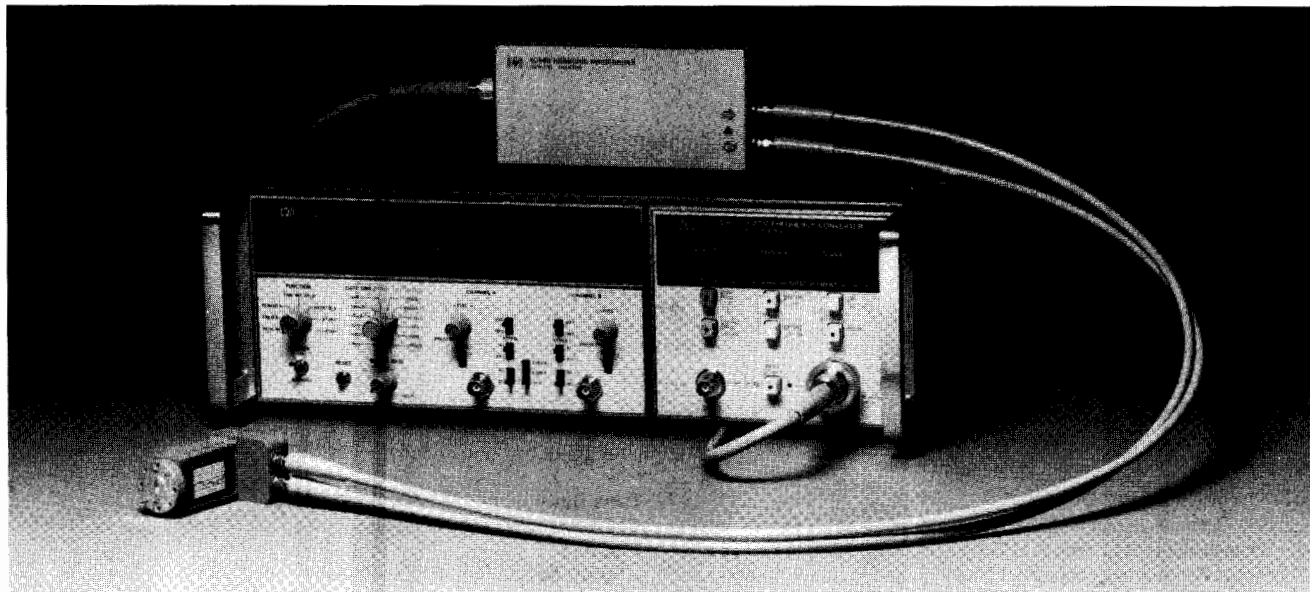

Extending the frequency range of CW and pulse measurements to 100 GHz.



DESIGNED FOR  
MATE  
SYSTEMS

### Pulse and CW Measurements to 110 GHz

HP 5355A Automatic Frequency Converter/5345A Counter, together with the HP 5356A, 5356B, 5356C, 5356D Frequency Converter Heads, provide pulse and CW frequency measurement capability to 18, 26.5, 40, and 110 GHz respectively. The HP 5355A's internal microprocessor controls the measurement algorithm, computes the input microwave frequency, and displays the result on the HP 5345A with 11 digits of resolution.

### Automatic Pulse Detection

This 110 GHz counter is a versatile tool for characterizing pulsed signals. Internal pulse-detection circuitry (Figure 1) can detect incoming RF bursts as short as 75 nanoseconds and generate a measurement gate for the counter. With this internally-generated detection gate, the counter can then measure the average frequency of the RF burst.

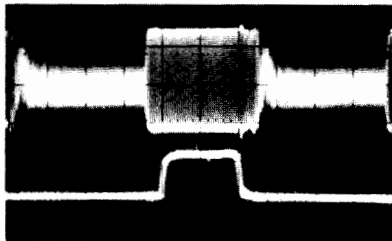

Figure 1. Automatic Pulse Detection

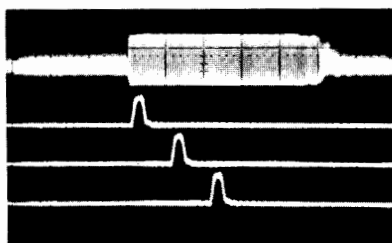

Figure 2. External gates as short as 20 ns

### Pulse Frequency Profiling

If there is FM on the burst carrier, the counter can also accept external measurement gates as short as 20 nanoseconds (Figure 2) to perform dynamic frequency profilings. This external gating capability is useful in applications such as radar CHIRP characterization. (Figure 3) It can also help VCO manufacturers measure oscillator's post-tuning drift (Figure 4).

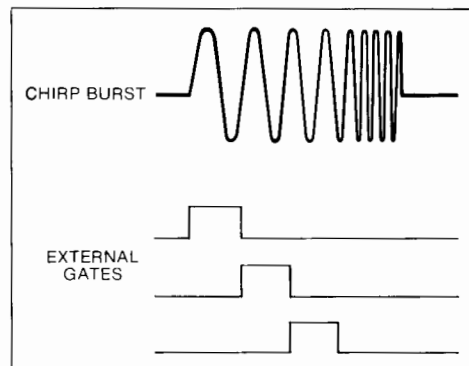

Figure 3. CHIRP radar characterization

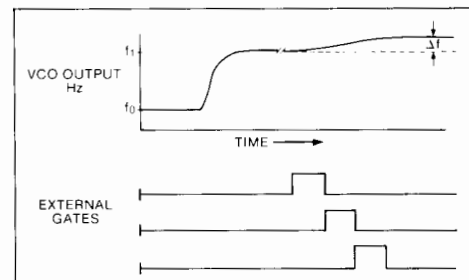

Figure 4. VCO post-tuning drift characterization



**Exceptional Resolution, High Accuracy**

You can select the measurement gate time of this counter from 50 nanoseconds to 1000 seconds. Increasing the measurement gate time increases the resolution of measurement results. In fact, this counter can measure a 110 GHz signal with 100 Hz resolution and 3 kHz accuracy in pulse mode. This performance improves to 1 Hz in CW mode.

Even if your application requires narrow external gates, the counter can still achieve fine resolution through an automatic frequency averaging scheme (Figure 5). When the measurement gate is longer than the external gate, the counter will automatically take several measurements of the repetitive signal. It will then average the results to yield better resolution. The measurement process is completely automatic—making the counter easy to work with.

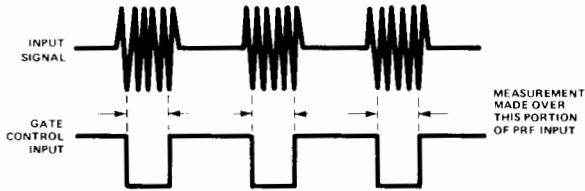

Figure 5. Frequency averaging to increase resolution

**Sensitivity, FM Tolerance, Automatic Amplitude Discrimination**

HP's pulse counters have sensitivity performance to -25 dBm, making measurement of low-level microwave and millimeter-wave signals reliable and accurate. For signals with frequency modulation, these counters also offer high peak-to-peak amplitude discrimination automatically measures the signal with the highest amplitude.

**Systems Performance, 9000 Measurements/Second**

These counters are fully programmable over HP-IB. Measurement throughput of 9000 measurements/second saves you money by reducing test time.

**Input Specifications (pulse and CW mode)**

	HP 5356A	HP 5356B	HP 5356C	HP 5356D
Frequency Range	1.5-18 GHz	1.5-26.5 GHz	1.5-40 GHz	36-110 GHz
Sensitivity				
1.5-12.4 GHz	-20 dBm	-20 dBm	-25 dBm	---
12.4-18 GHz	-15 dBm	-15 dBm	-20 dBm	---
18-26.5 GHz	---	-15 dBm	-20 dBm	---
26.5-34 GHz	---	---	-15 dBm	---
34-40 GHz	---	---	-10 dBm	---
36-50 GHz	---	---	---	-20 dBm
40-60 GHz	---	---	---	-15 dBm
50-75 GHz	---	---	---	-10 dBm
75-95 GHz	---	---	---	-7 dBm
95-105 GHz	---	---	---	-5 dBm
105-110 GHz	---	---	---	-3 dBm
ⓐ Maximum Input				
1.5-12.4 GHz	+5 dBm	+5 dBm	+5 dBm	---
12.4-18 GHz	+5 dBm	+5 dBm	+15 dBm	---
18-26.5 GHz	---	+5 dBm	+15 dBm	---
26.5-40 GHz	---	---	+15 dBm	---
36-110 GHz	---	---	---	+5 dBm
ⓑ Damage Level	+25 dBm peak	+25 dBm peak	+25 dBm peak	+24 dBm peak +20 dBm CW
Impedance	50 Ω NOMINAL	50 Ω NOMINAL	50 Ω NOMINAL	Waveguide
SWR (TYPICAL)				
1.5-10 GHz	<2.1	<2.1	<2.1	---
10-18 GHz	<3.1	<3.1	<3.1	---
18-26.5 GHz	---	<3.1	<3.1	---
26.5-34 GHz	---	---	<3.1	---
34-40 GHz	---	---	<5.1	---
36-110 GHz	---	---	---	<3.1
Connector	N Male	SMA Male	APC 3.5 Male	Waveguide

ⓐ HP 5356A/B. See Option 006 for higher damage protection to +39 dBm  
 ⓑ 1.5-6 GHz, +0 dBm (+5 dBm, TYPICAL)  
 6-12.4 GHz, +5 dBm

**CW Mode**

	HP 5356A/B/C Auto Mode	HP 5356A/B/C/D Man Mode	HP 5356D Auto Mode
FM Tolerance	5356A/B: 15 MHz p-p (60 MHz p-p in special FM mode), rate: dc - 10 MHz 5356C: 60 MHz p-p, rate: dc - 10 MHz	80 MHz p-p rate: dc - 10 MHz	Fig 6
AM Tolerance	Any modulation index provided the minimum signal level is greater than the counter sensitivity		50%
Multiple Signal Discrimination	Automatic Amplitude Discrimination (AAD) Automatically measures largest signal provided signal is 8 dB (TYPICAL) greater than any signal within 500 MHz and 20 dB (TYPICAL) greater than any signal over the full frequency range of the head		15 dB TYP
Acquisition Time (TYPICAL)	HP 5356A/B = 400 ms HP 5356C = 1.4 s	15 ms	ⓐ100 ms
Measurement Time (TYPICAL)	Gate Time ≤ 100 ms: Acquisition time + 4 × HP 5345A GATE TIME + 5345A Sample Rate + 125 ms Gate Time > 100 ms: Acquisition time + HP 5345A GATE TIME + HP 5345A Sample Rate + 35 ms		
Tracking Rate	---		100 MHz/s (TYPICAL)
LSD Displayed	1 Hz ÷ HP 5345A Gate Time		
Resolution	±2 × LSD ±10 <sup>-10</sup> rms × FREQ		
Accuracy	+2 × LSD ±1 × 10 <sup>-10</sup> rms × FREQ + time base error × FREQ		

ⓐ 100 ms (input level -5 to +5 dBm),  
 300 ms (input level -15 to -5 dBm),  
 400 ms (input level -20 to -15 dBm)

**Pulse Mode**

	HP 5356A/B/C/D Input Auto Mode	HP 5356A/B/C/D Input Man Mode
FM Tolerance (TYPICAL)	50 MHz p-p Chirp	80 MHz p-p Chirp
Acquisition Time (TYPICAL)	<ul style="list-style-type: none"> <li>HP 5356A/B/C Input Man Mode: 0</li> <li>HP 5356A/B Input Auto Mode: 100 μs ÷ (EXT GATE WIDTH × PRF) + 650 ms for EXT GATE ≤ 100 μs (2 ÷ PRF) + 650 ms for EXT GATE &gt; 100 μs</li> <li>HP 5356C Input Auto Mode: (8 ÷ PRF) + 1.55s + 100 μs ÷ (EXT GATE WIDTH × PRF) for EXT GATE ≤ 100s (10 ÷ PRF) + 1.55s for EXT GATE &gt; 100 μs</li> <li>HP 5356D -5 to +5 dBm (X) = 2.5</li> <li>HP 5356D -15 to -5 dBm (X) = 3.5</li> <li>HP 5356D -20 to -15 dBm (X) = 4.5</li> </ul> $(X)s + 2 \left( \frac{100 \mu s}{EXT GATE WIDTH \times PRF} \right)$ For EXT GATE ≤ 100 μs $(X)s + \frac{2}{PRF}$ For EXT GATE > 100 μs <ul style="list-style-type: none"> <li>HP 5356D Limited Search: (X) = 1: Range 1 to 6 GHz or ±3 GHz from center frequency</li> </ul>	
Calibration Time	$\left( \frac{HP 5345A GATE TIME}{EXT GATE WIDTH \times PRF} \right) + 75 ms$ Performed during 10 consecutive measurements when PULSE Mode is selected, after any front panel change, or when the EXTERNAL GATE width changes by more than 12%. Only calibrates if External Gate is <100 μs	
Measurement Time (TYPICAL)	Acquisition Time + Calibration Time + HP 5345A SAMPLE RATE + HP 5345A GATE TIME or 100 μs (whichever is greater)	Acquisition Time + Calibration Time + HP 5345A SAMPLE RATE + 60 ms + (1 μs + HP 5345A GATE TIME) ÷ EXT GATE WIDTH × PRF
Pulse Width Min:	100 ns (150 ns, HP 5356D with Opt. 110)	75 ns
Max:	20 ms	20 ms
Pulse Repetition Frequency Min:	50 Hz	50 Hz
Min: (HP 5356D only)	500 Hz	500 Hz
Max:	2 MHz	2 MHz
Minimum On/OFF RATIO	25 dB TYPICAL	
Maximum Video Feed-Through	15 mV p-p TYPICAL for r1 burst rise and fall times > 10 ns for HP 5356A/B/C. No limitation for HP 5356D (Waveguide beyond cutoff)	
Minimum EXT GATE WIDTH	20 ns	
LSD Displayed	1 Hz ÷ HP 5345A GATE TIME	
Resolution	±2 × LSD ±100 Hz rms ±	
Accuracy	$(1 \times \sqrt{HP 5345 GATE TIME \times EXT GATE TIME WIDTH}) \times$ ⓐ $\pm 2 \times LSD \pm 100 Hz rms +$ $(1 \times \sqrt{HP 5345 GATE TIME \times EXT GATE TIME WIDTH}) \times$ ⓑ $\pm 0.04 \pm 3 KHz$ EXT GATE WIDTH ± time base error × FREQ	

ⓐ For (HP 5345 GATE TIME) > 10 ms and PULSE WIDTH > 10 μs, use  
 ⓑ  $(1 \times \sqrt{HP 5345 GATE TIME \times EXT GATE TIME WIDTH})$

For EXT GATE signals generated by the HP 5355A, the EXT GATE WIDTH equals the input PULSE WIDTH minus 30 ns (TYPICAL) for the HP 5356A/B/C/D input and equals input PULSE width minus 65 ns (TYPICAL) for the HP 5355A 0.4-1.5 GHz input.

# ELECTRONIC COUNTERS

## Pulse and CW Microwave Frequency Counters (cont'd)

### Models 5345A/5355A/5356A,B,C,D

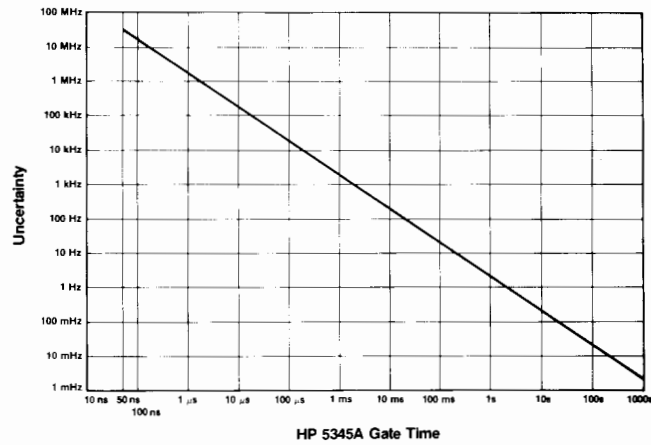

Graph 1. Uncertainty (2 × LSD) due to selected 5345A gate time.

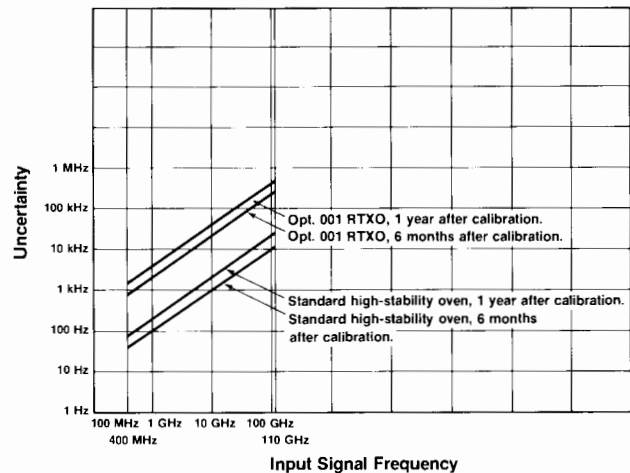

Graph 2. Uncertainty, due to time-base error. Time-base error can be reduced by calibrating the time base more frequently

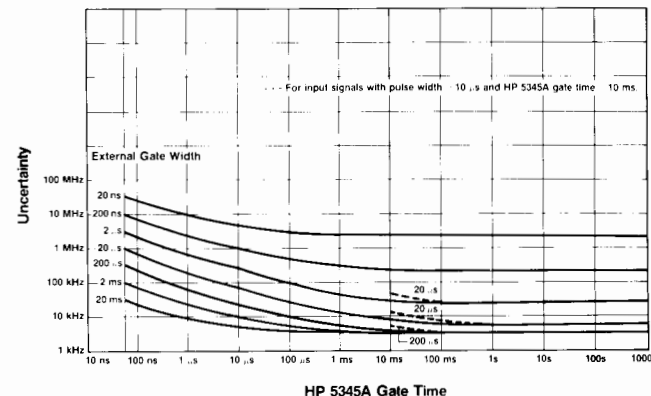

Graph 3. Uncertainty due to jitter (rms jitter) and gate error  

$$\left( \frac{.04}{\text{EXT GATE WIDTH}} \pm 3 \text{ kHz} \right)$$

### Input Specifications

- 5355A 0.4 - 1.6 GHz (condensed)
- Sensitivity:** -15 dBm.
- Maximum input:** +5 dBm.
- Impedance:** 50 Ω nominal.
- Damage level:** +24 dBm peak (fuse in BNC connector).
- Pulse width:** 150 ns to 1 s
- Pulse repetition rate:** 100 Hz to 2 MHz.

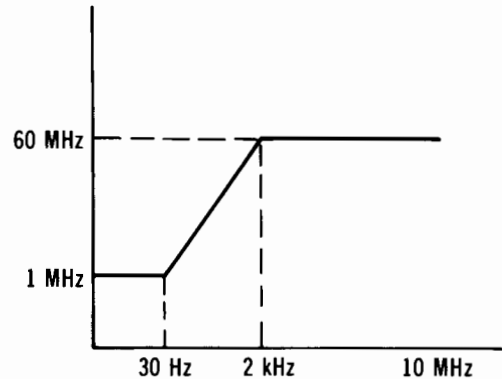

Figure 6 HP 5356D FM Tolerance

### Ordering Information

	<b>Price</b>
<b>HP 5345A</b> Electronic Frequency Counter	\$10,000
<b>HP 5355A</b> Automatic Frequency Converter	\$6,000
<b>HP 5356A</b> 18 GHz Frequency Converter	\$2,000
<b>HP 5356B</b> 26.5 GHz Frequency Converter	\$2,200
<b>HP 5356C</b> 40 GHz Frequency Converter	\$2,800
<b>HP 5356D</b> 36-110 GHz Harmonic Mixer Driver	\$6,600

### Options for HP 5345A

<b>Opt 001</b> Room Temperature Time Base	-\$320
<b>Opt 010</b> HP-IB Talk Only	+\$350
<b>Opt 011</b> HP-IB includes remote programming	+\$950
<b>Opt 012</b> HP-IB similar to Opt 011, but also includes slope and trigger level controls	+\$1,600
<b>Opt 700*</b> Test Module Adapter (TMA) for MATE System	+\$5,000
<b>Opt 908</b> Rack Flange Kit, HP 5060-8740	+\$65 ☎

### Options for HP 5356A

<b>Opt 001</b> High Pass Filter	+\$220
<b>Opt 006</b> Limiter	+\$450

### Options for HP 5356B

<b>Opt 001</b> 18-26.5 GHz Waveguide (WR-42)	+\$950
<b>Opt 006</b> Limiter	+\$450

### Option for HP 5356C

<b>Opt 001</b> 26.5-40 GHz Waveguide (WR-28)	+\$850
----------------------------------------------	--------

**Options for HP 5356D** (requires an HP 5355A with S/N prefix greater than 2620 - xxxxx and one of the following mixer options)

<b>Opt 005</b> (two HP 5061-5458 parts) 2 cables to connect HP 5356D to HP 1197Q/U/V or W	+\$230
<b>Opt 050</b> (HP 11970Q) 36-50 GHz Harmonic Mixer	+\$1,700
<b>Opt 060</b> (HP 11970U) 40-60 GHz Harmonic Mixer	+\$1,850
<b>Opt 075</b> (HP 11970V) 50-75 GHz Harmonic Mixer	+\$2,250
<b>Opt 110</b> (HP 11970W) 75-110 GHz Harmonic Mixer	+\$2,500

☎ Fast-Ship Product — see page 766.

\* Must be ordered with Opt 12 and an HP 5355A

# ELECTRONIC COUNTERS

## Low Cost Counters for Frequency Measurements

Models 5384A, 5385A, 5386A

187

- Frequency measurements to 3 GHz (HP 5386A)
- Up to 11 digits of resolution, 9 digits per second
- -23.5 dBm sensitivity

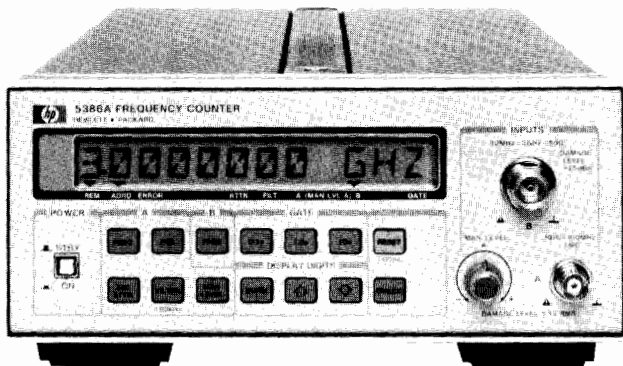

HP 5386A: 10 Hz to 3 GHz (pictured above).  
 HP 5385A: 10 Hz to 1 GHz (not shown).  
 HP 5384A: 10 Hz to 225 MHz (not shown).

### HP 5384A/5385A/5386A Frequency Counters

The HP 5384A/85A/86A are HP's lowest priced system counters. They provide outstanding measurement performance for bench, field, and systems applications. Combining wide frequency range, high resolution, high sensitivity, and HP-IB compatibility, these counters compare with instruments which cost much more.

**Portable:** The half-rack-width package makes the HP 5384A/85A/86A portable and saves rack or bench space.

**Versatile Display:** The twelve-digit, liquid-crystal display has larger characters than other LED displays and is easier to read in sunlight. The added feature of remote display extends the usefulness of these counters beyond that of simply making and displaying frequency measurements. User-friendly messages, prompts and measurement units can now be displayed.

**Low Cost Of Ownership:** Integrated design and extensive self-tests result in greater reliability, easier serviceability, and ultimately lower cost of ownership.

### Performance

If your frequency measurement needs are below 3 GHz, the HP 5386A will provide you with the basic performance of traditional microwave counters, at about half the price. The HP 5386A measures frequencies from 10 Hz to 3 GHz with only two input ports, instead of the three ports found with other counters. The high-frequency input measures frequencies from 100 MHz to 3 GHz with -23.5 dBm sensitivity (10 mV rms). In addition, prescaling techniques offer peak-to-peak FM tolerance of at least 100 MHz for your communications applications. You can select the number of digits displayed from 3-to-11 to blank meaningless digits from an unstable signal source. The HP 5386A also solves your systems problems with full remote programmability (via HP-IB standard feature) and remote display capabilities. The high-stability timebase option will lengthen the required calibration period (for kHz accuracy at 3 GHz) from six months to a full year.

### Applications

The HP 5386A fits well in the following application areas for local oscillator, IF, and radio transmitter frequency measurements:

- Military and private communications
- TACAN, DME, and Identify Friend or Foe
- Global Positioning System
- MDS Television

- HP-IB standard
- Systems performance and portability

### Condensed Specifications

**Input Channel A (HP 5384A/85A/86A):** 1 M ohm // 25 pF.

**Range:** 10 Hz to 100 MHz.

**Sensitivity:** 15 mV rms sine wave 50 Hz (10 Hz for HP 5386A) to 100 MHz; HP 5384A/85A Only: 25 mV rms sine wave 10 Hz to 50 Hz; 45 mV peak-to-peak 5 ns minimum pulse width.

**Dynamic Range:** 45 mV to 4 V peak-to-peak X attenuator setting.

**Attenuator:**  $\times 1$  or  $\times 20$  nominal above 50 Hz input.

**Low Pass Filter:** 100 kHz nominal 3 dB point.

**Manual Trigger Level:** variable, -0.1 V to +0.1 V  $\times$  attenuator.

**Damage Level  $\times 1$ :** 10 - 200 Hz 350 V (dc + ac peak).

0.2 - 420 kHz 170 V (dc + ac peak).

0.42 - 10 MHz ( $5 \times 10^7$  V rms Hz)/FREQ.

> 10 MHz 5 V rms.

$\times 20$ : < 1 MHz, Same as  $\times 1$ ; > 1 MHz, 50 V rms.

**Input Channel B (HP 5384A):** 50 ohm.

**Range:** 50 to 225 MHz.

**Sensitivity:** 10 mV rms 50 to 200 MHz; 15 mV rms 200 to 225 MHz.

**Dynamic Range:** 10 mV to 1 V rms.

**Manual Attenuator:** variable,  $\times 1$  to  $\times 5$  (0 to 14 dB) nominal.

**Damage Level:** 350 V dc + 5 V rms ac.

**Input Channel B (HP 5385A):** 50 ohm, fused.

**Range:** 90 to 1000 MHz.

**Sensitivity:** 10 mV rms (-27 dBm) 100-1000 MHz; 15 mV rms (-33 dBm) 90 - 100 MHz.

**Dynamic Range:** 10 mV to 7 V rms (-27 to +30 dBm).

**Manual Attenuator:** variable,  $\times 1$  to  $\times 18$  (0 to 25 dB) nominal.

**Damage Level:** ac > 1 MHz + 30 dBm (7 V rms).

ac < 1 MHz 2 V rms, dc  $\pm$  5 V.

**Input Channel B (HP 5386A):** 50 ohm nominal, VSWR 2.5, typical.

**Range:** 100 MHz to 3 GHz, prescaled.

**Coupling:** ac.

**Sensitivity:** 15 mV rms (-23.5 dBm).

**Dynamic Range:** 10 mV rms to .5 V rms (-23.5 dBm to +7 dBm).

**Damage Level:** ac: +27 dBm, dc:  $\pm$  5 V.

NOTE: Manual attenuator not active for channel B.

### Frequency A and B

**Range Channel A:** 10 Hz - 100 MHz.

**Range Channel B:** (HP 5384A) 50 MHz - 225 MHz; (HP 5385A) 90 MHz - 1.0 GHz; (HP 5386A) 100 MHz - 3 GHz.

**LSD Displayed:** 10 Hz to 1 nHz.

**Accuracy:**  $\pm$  Resolution  $\pm$  Timebase Error  $\times$  Frequency (see Graphs 1 and 3).

### Period A

**Range:** 10 ns to 0.1 s.

**LSD Displayed:** .001 fs to 10 ns.

**Accuracy:**  $\pm$  Resolution  $\pm$  Timebase Error  $\times$  Period (see Graphs 2 and 3).

### Timebase

**Standard HP 5384A:** 10 MHz.

**Aging Rate:**  $< 3 \times 10^{-7}$ /mo.

**Temperature:**  $< 5 \times 10^{-6}$ , 0° to 50°C, ref. 25°C.

**Line Voltage:**  $< 1 \times 10^{-7}$  for  $\pm$  10% variation.

**Standard HP 5385A/86A, Option 001 (HP 5384A):** TCXO, 10 MHz.

**Aging Rate:**  $< 1 \times 10^{-7}$ /mo.

**Temperature:**  $< 2 \times 10^{-6}$ , 0° to 40°C, ref. 25°C.

**Line Voltage:**  $< 5 \times 10^{-8}$  for  $\pm$  10% variation.

### Oven Timebase (Option 004)

**Frequency:** 10 MHz.

**Aging Rate:**  $< 3 \times 10^{-8}$ /mo. after 30 days continuous operation.

**Temperature:**  $< 1 \times 10^{-7}$ , 0° to 50°C, ref. 25°C.

**Line Voltage:**  $< 2 \times 10^{-9}$  for  $\pm$  10% variation.

**Battery Operation (HP 5384A/85A Only):** the instrument operates for 3 hours (typ.) with Option 004. In STBY, the oven will operate continuously for 24 hours (typ.).

# ELECTRONIC COUNTERS

## Low Cost Counters for Frequency Measurements (cont'd)

Models 5384A, 5385A, 5386A

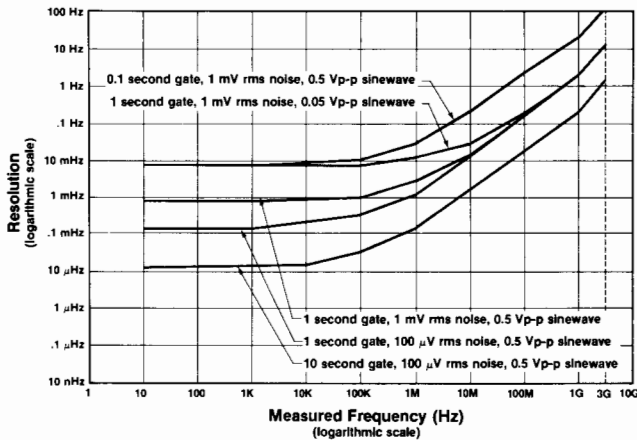

Graph 1. Frequency Resolution. Uncertainties which limit resolution can be reduced by increasing the gate time, reducing the noise on the input signal, or increasing the input signal amplitude.

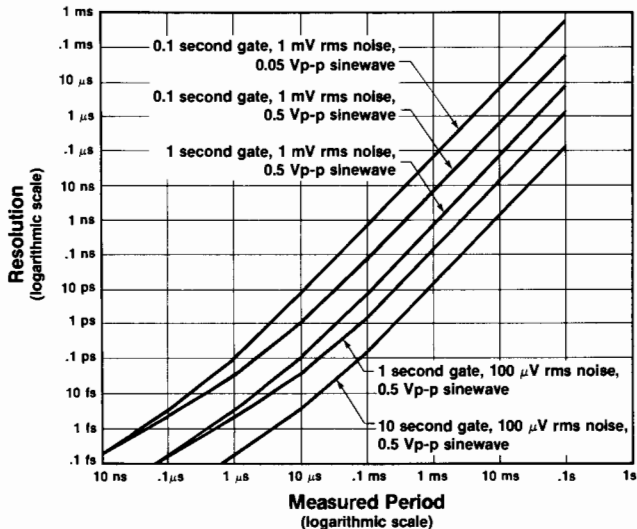

Graph 2. Period Resolution. Uncertainties which limit resolution can be reduced by increasing the gate time, reducing the noise on the input signal, or increasing the input signal amplitude.

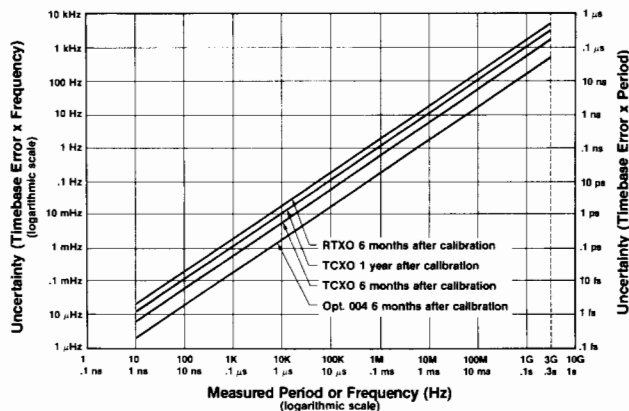

Graph 3. Frequency and Period Uncertainty due to Timebase Error. Timebase error can be reduced by calibrating the timebase more frequently, or by using a timebase with a better aging rate.

### I/O Interface

#### HP-IB Standard

**Programmable Functions:** Frequency A, Frequency B, Period A.  
**Programmable Controls:** ATTN A, FILTER A, MAN LEVEL A, MAN LEVEL A/B (HP 5384A/85A Only), Gate Time.  
**Display:** Normal, Increment, Decrement (digits displayed); Remote, Local; any 12-character message can be displayed on the LCD via a system controller.  
**Data Output:** output will be maximum resolution/gate time.  
**Format:** 17 characters plus CR and LF.  
**Rate:** 4 readings/s maximum at 0.1 s gate.  
**HP-IB Interface Functions:** SH1, AH1, T5, TE0, L4, LE0, SR1, RL1, PP0, DC1, DT1, C0, E1 (see page 556).  
**Talk Only:** Set with address switch = 31.

### Battery Pack (Option 005 - HP 5384A/85A Only)

**Battery Type:** sealed lead-acid.

**Capacity:** 4 hours (typ.) at 25°C without Option 004.

**Recharge Time:** 16 hours (typ.) in the standby mode.

**Battery Low Annunciator:** enabled 20 minutes prior to instrument shutdown nominally.

**Battery Save Switch (rear panel):** prevents discharge of interval battery by the oven timebase, Option 004, during instrument standby (STBY).

**Line Failure Protection:** instrument automatically switches to battery in case of line failure.

**Weight:** Option 005 adds 1.4 kg (3 lb) to instrument weight.

### General

**Check:** 10 MHz self-test.

**Gate Times:** 0.1, 1, or 10 seconds (nominal).

**Display:** 12-digit alphanumeric liquid crystal.

**Display Digits** (variable): frequency 3 to 11; period 3 to 8.

**Timebase Output:** 10 MHz, 25 mV p-p (nominal) into 50 ohm.

**External Timebase Input:** 10 MHz, 0.5 V rms into 500 ohm; 15 V (dc + ac peak) maximum.

**Operating Temperature:** 0° to 50°C.

### Power Requirements

**AC:** selectable, 18 VA max. (30 VA max., HP 5386A) 115 V + 10%, -25%; 230 V + 10%, -15%; 48 - 66 Hz; 115 V ± 10%: 380 - 420 Hz.

**DC:** (HP 5384A/85A Only): 9 - 15 V dc, 1.0 A maximum.

### Weight

**HP 5384A/85A:** net, 2.5 kg (4.5 lb). Shipping, 4.5 kg (9 lb).

**HP 5386A:** net, 3.5 kg (7.5 lb). Shipping 5.5 kg (11 lb).

### Size:

**HP 5384A/85A:** 212 mmW x 98 mmH x 276 mmD (8½ in. x 3¾ in. x 10¾ in.); **HP 5386A:** 212.3 mmW x 88.1 mmH x 421.6 mmD (8½ in. x 3½ in. x 16½ in.).

### Ordering Information

**HP 5384A Frequency Counter 225 MHz**

**HP 5385A Frequency Counter 1.0 GHz**

**HP 5386A Frequency Counter 3.0 GHz**

**Opt 004 High Stability Ovenized Timebase**

**Opt 910 Additional Operating/Service Manual**

**HP 5384A/85A Only:**

**Opt 001 High Stability TCXO (HP 5384A)\***

**Opt 005 Battery Pack**

**HP 5061-1171 Slide Handle Kit**

**HP 5060-0173 Rack Mount Kit (single)**

**HP 5060-0174 Rack Mount Kit (dual)**

**HP 34110A Vinyl Carrying/Operating Case**

\*TCXO timebase is standard with HP 5385A/86A

**HP 5386A only:**

**Side Handle Kit:** HP P/N 5061-9688

**Rack Mount Kit** (single), HP P/N 5061-9672

**Rack Mount Kit** (dual), HP P/N's 5061-9674 and

5061-9694

☎ Fast-Ship product — see page 766.

### Price

\$1500 ☎

\$1800 ☎

\$3400

+ \$550

+ \$20

+ \$150

+ \$300

\$19

\$64

\$62.50

\$40 ☎

\$50 ☎

\$50 ☎

\$55 ☎

# ELECTRONIC COUNTERS

## Universal Time Interval Counter

Model 5370B

189

- 20 ps single shot LSD
- $\pm 100$  ps accuracy achievable
- 8000 measurements/s possible

- Built-in statistics functions
- Positive, zero and negative time
- Frequency and period to 100 MHz

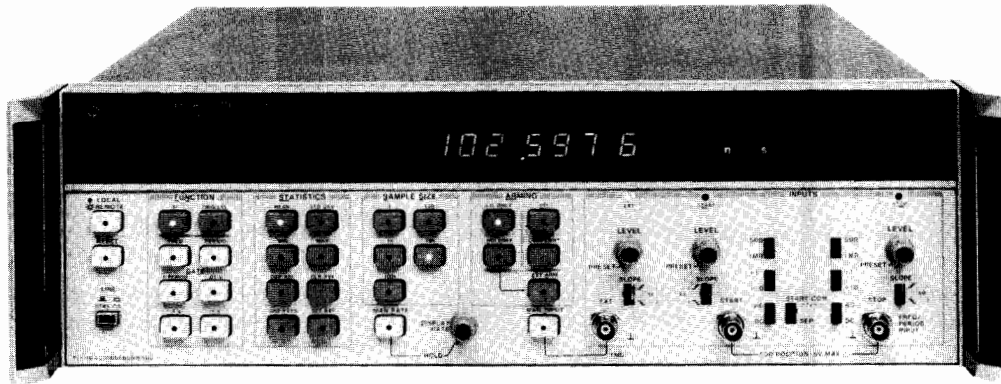

With the HP 5370B, you can make high-precision, time-interval measurements at up to 8000 measurements/second, making it ideal for your production applications.

### Increase Productivity with the HP 5370B's Precision and Measurement Speed

- IC Tester performance verification
- Fast IC characterization
- Disc drive manufacture
- Digital communications - jitter analysis
- Radar/laser ranging calibration
- Nuclear systems
- Calibration Labs

### Use the full range of functions

**Time Interval:** you can get 20 ps single shot LSD on time intervals from zero to 10 s, including negative time (where the STOP channel event occurs before the START channel event).

**Frequency:** measure up to 100 MHz with 11 digits of resolution in one second. Choose gate times down to one period: use one period with average mode and access the powerful STATISTICS capabilities.

**Period:** measure period average from one to 100k samples and use STATISTICS.

**Statistics:** will reduce your external computations, reduce random errors and improve measurement throughput.

**Sample size:** you can select 1, 10, 1k, 10k or 100k samples from the front panel, or 1 to 16,777,215 samples over HP-IB. For the selected sample size you can compute:

Mean  
Standard Deviation  
Minimum  
Maximum

### Select the time interval you want from complex waveforms:

use the extremely flexible arming and gating to select:  
+TI or  $\pm$ TI with internal arming, external arming - no hold-off, or with external arming - external hold-off.

### Program all major capabilities of the HP 5370B over HP-IB:

Data output rates:

- up to 8000 readings/second in fast binary mode - 125  $\mu$ s dead time.
- 10 to 20 readings/second fully formatted - 330  $\mu$ s dead time.

### Time Interval Measurement Characteristics

#### Range:

$\pm$ TI: -10 to +10 seconds, including zero.  
+TI: 10 ns to 10 seconds.

**Resolution:** measurement resolution will depend on input signal noise and slew rate. Refer to Graph 3 for characteristic curves.

#### Accuracy:

Time interval measurement accuracy is influenced by internal systematic uncertainties, trigger level timing error for each trigger edge, and timebase aging in addition to resolution or random uncertainties. Graphs 1 and 2 show characteristic systematic uncertainties for the HP 5370B. These uncertainties may be reduced to less than 10 ps by calibration with the HP J06-59992A Time Interval Calibrator. Careful calibration and averaging will result in accuracies to  $\pm 100$  ps.

#### Frequency and Period Measurement Characteristics

##### Range:

Frequency: 0.1 Hz to 100 MHz  
Period: 10 ns to 10 seconds

**Resolution:** measurement resolution will depend on input signal noise as well as measurement gate time. Refer to Graph 6 for characteristic curves.

#### Accuracy:

Accuracy is influenced by internal uncertainties, timebase aging, and noise on the input signal. Graphs 4 and 5 show the contributions of timebase aging and internal uncertainties to measurement accuracy. Periodic timebase calibration will minimize uncertainty due to timebase aging. Internal uncertainties and noise effects may be reduced by selecting longer gate times, or averaging results.

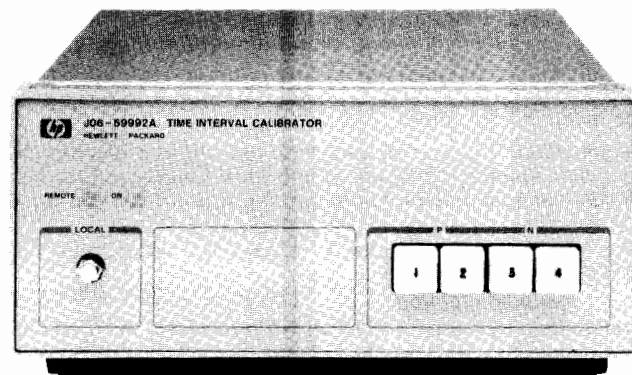

The J06-59992A Time Interval Calibrator gives you the ability to remove systematic errors from your measurement system, so that the 5370B can measure with uncertainties of  $< \pm 100$  ps.



# ELECTRONIC COUNTERS

## Universal Time Interval Counter (cont'd)

### Model 5370B

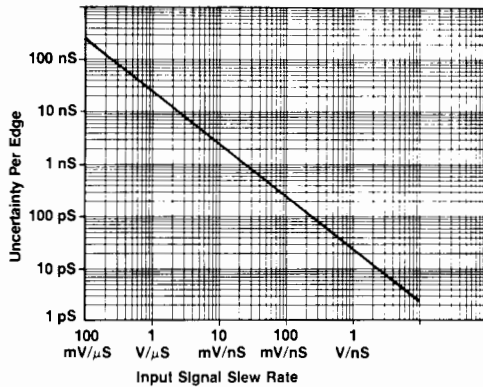

Graph 1. Trigger level timing error varies with input signal slew rate. Uncertainty is associated with both start and stop edges.

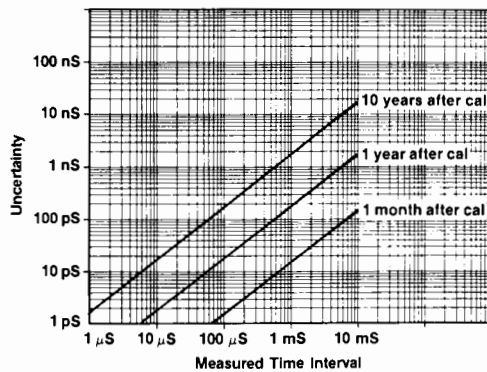

Graph 2. Time base crystal aging affects a time interval or pulse width measurement.

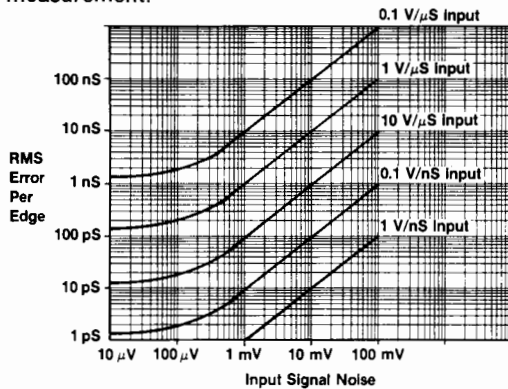

Graph 3. Noise on the input signal will add uncertainty to a time interval measurement. Averaging will reduce the effects of random noise.

**For more information . . .**

Ask your local HP sales representative for the following literature for more details on the HP 5370B Time Interval Counter and the HP J06-59992A Time Interval Calibrator. See page 771 for your local HP sales office.

HP 5370B Technical Data Sheet Literature Number 5952-7915  
 HP J06-59992A Technical Data Sheet Literature Number 5952-7837

**Product Note 5370B-2** "Better than 100 ps Accuracy in HP 5370B Time Interval Measurements Through Bias Error Reduction" Literature Number 5952-7834.

**Product Note 5370B-3** "High Throughput Picosecond Characterization of Pulse Parameters" Literature Number 5952-7769

**Application Note 191-7** "High-Speed Timing Acquisition and Statistical Jitter Analysis" Literature Number 5952-7908.

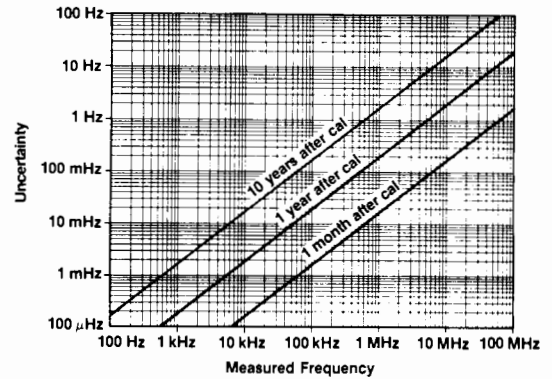

Graph 4. Time base crystal aging affects Frequency and Period measurements. You can further reduce the uncertainty by using an atomic frequency standard.

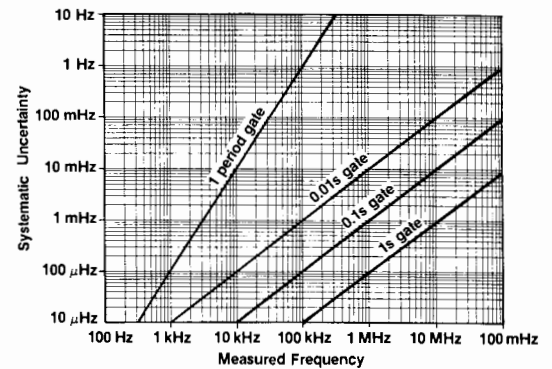

Graph 5. Internal uncertainties affect Frequency and Period measurements.

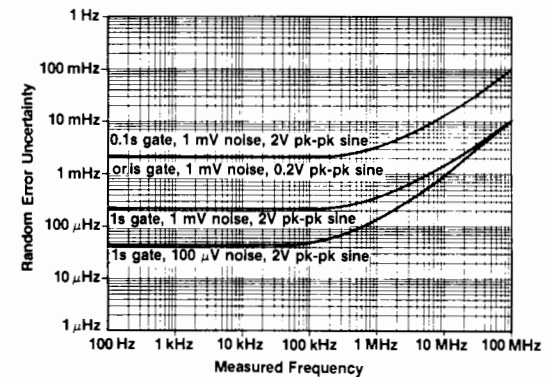

Graph 6. Noise on the input signal will add uncertainty to a Frequency or Period measurement. Longer gate times and averaging will reduce the effects of random noise.

**Ordering Information**

<b>HP 5370B</b> Time Interval Counter	<b>Price</b> <b>\$12,100</b>
<b>Opt 913</b> (5370B Rack Flange Kit - use with supplied front handles)	+ \$30
<b>Opt 908</b> (5370B Rack Flange Kit - without supplied front handles)	+ \$33
<b>HP 10870A</b> HP 5370B Service Kit Accessory	+ \$930
<b>HP J06-59992A</b> Time Interval Calibrator	+ \$3,000

# ELECTRONIC COUNTERS

## A New Concept in Frequency and Timing Analysis

### Model 5371A

191

- New solutions for jitter and timing measurements
- Characterizes frequency and phase changes vs time
- Built-in statistical and graphical analysis
- Extremely flexible triggering and arming for measuring complex signals
- DC to 500 MHz frequency range with continuous measurement technology

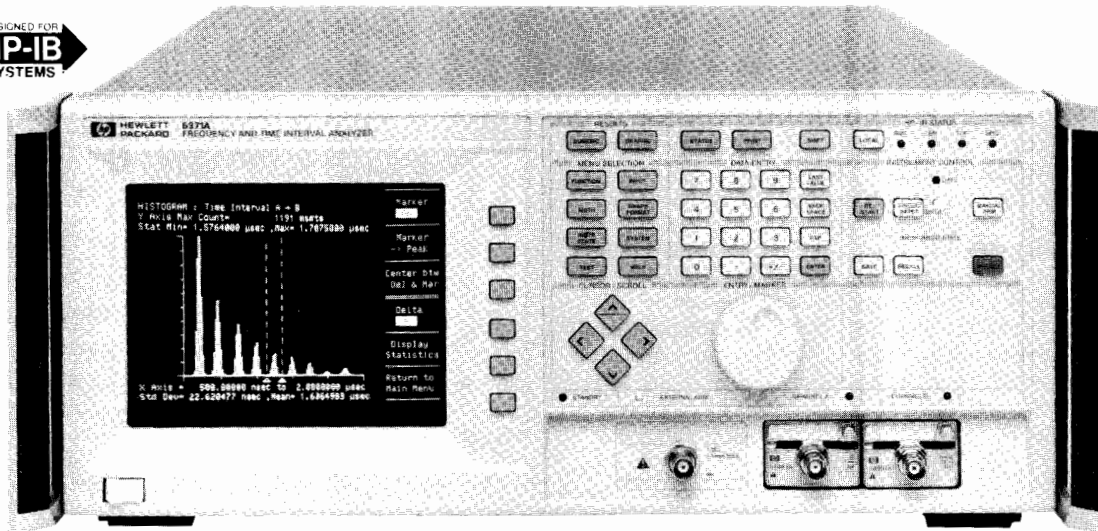
DESIGNED FOR  
**HP-IB**  
SYSTEMS

The HP 5371A offers an entirely new approach to measuring complex signals: the Modulation Domain.

### A New Way to Analyze Complex Signals . . . The Modulation Domain

The HP 5371A Frequency and Time Interval Analyzer brings a new way to view and analyze complex signals: the Modulation Domain. The Modulation Domain is a view of frequency, phase, or time-interval of a signal as a function of time. This powerful technique complements and extends the familiar Time and Frequency Domain methods for analysis of complex signals. The figure below shows the relationship between the three domains.

Today's complex analog and digital modulations require the insight offered by the Modulation Domain. Spread spectrum signals such as agile carriers or chirped radar signals are easily studied as you can now view and analyze a picture of the modulation. Unintended modulations such as frequency overshoot and timing jitter can also be analyzed with the HP 5371A's powerful measurement capabilities.

The HP 5371A measures signals in the Modulation Domain directly to 500 MHz with 10 digits of frequency resolution per second. Using the HP 5364A Microwave Mixer/Detector, you can realize the benefits of Modulation Domain analysis at frequencies from 2 GHz to 18 GHz.

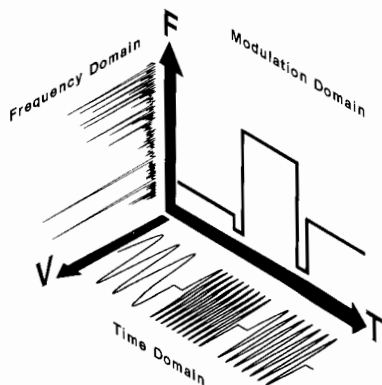

### Continuous Measurement Technique

The HP 5371A implements the Modulation Domain using a continuous measurement technique. The HP 5371A count registers run continuously, filling measurement memory directly for later processing. As a result, no data is lost between measurement samples and continuous frequency profiles of signals may be generated with sampling intervals as short as 100 ns.

In a similar fashion, time interval measurements may be acquired without missing data up to a 10 MHz rate. This data can be sorted into a histogram for convenient jitter analysis. For statistical analysis such as a histogram, the continuous measurement technique insures that you don't miss critical data that can be crucial to accurate results.

### Analysis and Display

With its built-in analysis and display, the HP 5371A brings the Modulation Domain to your bench or test rack just as the oscilloscope and spectrum analyzer offer the Time and Frequency Domains. You can view a Time Variation plot, such as frequency versus time, or time interval versus time and use the cursor and zoom features to analyze characteristics directly on the display. Histogram displays give statistical distribution information with mean and standard deviation values for data between cursors.

Numeric displays let you examine a list of the continuous measurements acquired by the HP 5371A, or view a statistical summary including mean, standard deviation, minimum, maximum, variance, rms, and also Allan Variance for frequency stability applications. All results can be output directly to an HP-IB graphics printer or plotter for hardcopy documentation.

### Applying the Modulation Domain

Many signals used today have modulation characteristics which must be analyzed in a single-shot fashion to completely understand performance characteristics. These signals include agile carriers for secure communications, timing jitter for data storage applications, VCO step response, and chirp linearity for radar systems. The following pages show the benefits of analyzing these signals in the Modulation Domain.

# ELECTRONIC COUNTERS

## A New Concept in Frequency and Timing Analysis (cont'd)

### Model 5371A

#### Agile Radio Characterization

Characterization of agile transmitters is difficult in the time domain or the frequency domain. The pseudorandom selection of the carrier means repetitive techniques are inadequate to properly characterize an agile radio's performance. "Golden receiver" or back-to-back testing where transmitters and receivers are tested in pairs gives little quantitative information about the radio's performance.

The Modulation Domain provides a clear view of these agile signals. Parameters such as dwell time, hop rate, and carrier settling time can be obtained from the HP 5371A display. You can even examine the modulation on top of the agile carrier by zooming in on any hop. A histogram of frequencies is a clear measure of the random usage of the frequency spectrum. "Flat" histogram characteristics indicate that channels are used with equal probability, providing the highest resistance to jamming and communication security.

Combining the HP 5371A with the HP 8645A Agile Signal Generator (page 363), gives you the capability to test both the transmitter and receiver portions of the agile transceiver. Ask for Application Note 358-1, "Characterization of Frequency-Agile Signal Sources" for more information on the use of the HP 5371A to test these radios.

#### Jitter Analysis

Timing jitter is a critical parameter for high speed digital communication systems, data storage devices, and precision mechanical systems such as laser printers. For communication systems and computer disk or tape drives, jitter can degrade error rate performance. For laser printers, jitter in mirror positioning systems degrades print resolution. The time interval measurement performance and statistical analysis features of the HP 5371A provide an excellent means of characterizing these effects.

For magnetic disk drives, the continuous measurement capability of the HP 5371A can be used to separate read and write noise, timing asymmetry, and peak shift. Application Note 358-3 "Time Domain Characterization of Magnetic Disk Drives", describes techniques for this analysis. Combining the HP 5371A with the HP 8770A Arbitrary Waveform Synthesizer (page 378) provides an excellent system to characterize read channel electronics.

For jitter measurements in communications networks, ask for Application Note 358-2, "Jitter and Wander Analysis in Digital Communications". Jitter spectrum and data-clock jitter measurement techniques are described as well as considerations for computer algorithms to derive these characteristics.

#### Direct VCO Measurements

Voltage controlled oscillators are a key component in many electronic systems. VCO switching and settling characteristics directly effect total system performance. Switching and settling measurements have traditionally been made using discriminators and an oscilloscope. The HP 5371A simplifies VCO characterization by directly measuring the VCO output and displaying the step response. Characteristics such as ringing and overshoot, settling time, and post-tuning drift can be directly quantified using the cursor and zoom features. Microwave VCO's operating between 2 and 18 GHz can be measured using the HP 5364A Microwave Mixer/Detector with the HP 5371A.

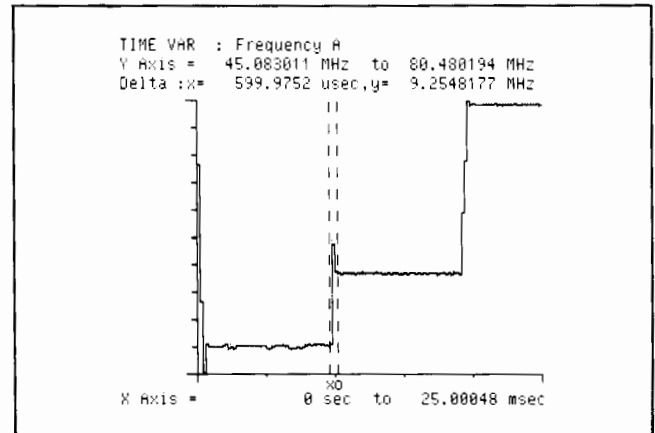

Settling time and overshoot can be examined as well as the modulation on the hopping carrier with the HP 5371A's Time Variation display.

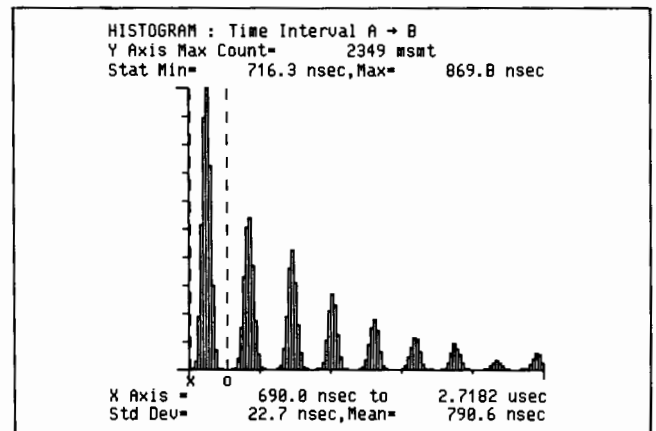

A Histogram of compact disc pulse width measurements with "Eight-to-Fourteen Modulation" coding can be used to statistically analyze each distribution separately.

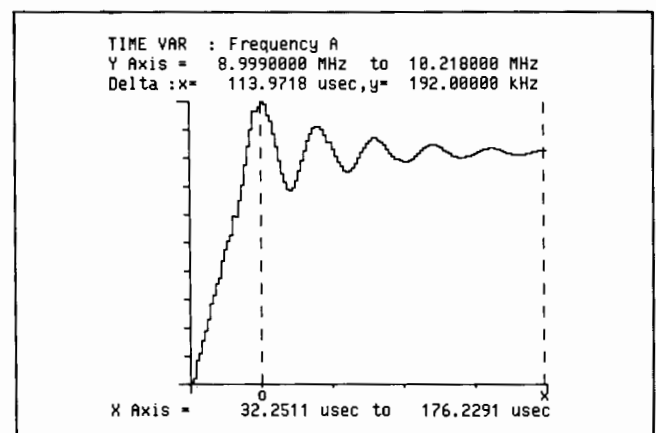

Analyze the settling time characteristics of a stepped VCO in a single shot with the HP 5371A Time Variation plot.

### Radar Chirp Linearity Analysis

Combining the HP 5364A Microwave Mixer/Detector with the HP 5371A Frequency and Time Interval Analyzer and a suitable local oscillator gives you the capability to extend the Modulation Domain to microwave frequencies.

The HP 5364A is designed to insure downconversion with minimal distortion and group delay over its 500 MHz IF bandwidth. You may choose to provide your own local oscillator, or use an HP source such as the HP 8671A Synthesized CW Generator, HP 8673C Synthesized Signal Generator, or the HP 8673E Synthesized Signal Generator. In addition to the IF channel, the HP 5364A provides a video detector output to trigger the HP 5371A. The video output can also be used directly to measure pulsewidth, rise and fall time, and PRF/PRI.

Radar chirp linearity is easily characterized in the Modulation Domain. The HP 5364A is used to downconvert the chirp to baseband, maximizing measurement resolution. The frequency versus time display of the HP 5371A quickly shows any deviation from linearity. For more detailed analysis, the frequency data can be sent directly to a computer for specific linearity calculations.

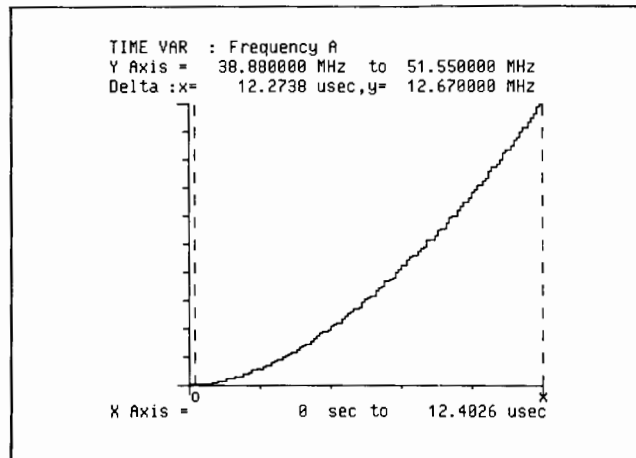

Chirp linearity characterization with the HP 5371A eliminates cumbersome delay line discriminators, dramatically reducing the measurement cost while enhancing precision.



The HP 5364A Microwave Mixer/Detector brings the Modulation Domain to microwave signals.

# ELECTRONIC COUNTERS

## A New Concept in Frequency and Timing Analysis (cont.'d)

Model 5371A

### HP 5371A Performance Summary

#### Basic Performance

- Continuous measurements to a 10 MHz rate - DC to 500 MHz frequency range
- -4.0 to +4.0 second time interval range, including 0 seconds
- 150 ps rms single-shot time interval resolution, 10 digits per second frequency resolution
- 1 ns minimum input pulse width
- 2 mV trigger level resolution
- Auto-trigger capabilities
- Selection of input pods: 50 ohm, 1 Mohm, or 10 Kohm active

#### Arming and Triggering Capabilities

- Measurement holdoff by time, events, or signal edge
- Measurement sample by time, events, signal edge, cycle, or parity
- Arm on any of three input channels: External Arm, Input A, or Input B

#### Measurement Modes

Function	Range
<b>Frequency A*, B*</b>	125 mHz to 500 MHz
<b>Frequency A&amp;B, A+B, A-B, B-A, A/B, B/A</b>	250 mHz to 500 MHz
<b>Period A*, B*</b>	2 ns to 8.0 seconds
<b>Period A&amp;B, A+B A-B, B-A, A/B, B/A</b>	2 ns to 4.0 seconds
<b>Totalize A, B, A&amp;B, A+B, A-B, B-A, A/B, B/A</b>	0 to $2^{32}$ - 1 events, each channel
<b>Time Interval A,B, A → B, B → A</b>	10 ns to 8.0 seconds
<b>Continuous Time Interval A*, B*</b>	100 ns to 8.0 seconds
<b>± Time Interval A→B, B→A, A, B</b>	-4.0 seconds to +4.0 seconds including 0 seconds
<b>Rise and Fall Time A†</b>	1 ns to 100 μs (auto-trigger)
<b>Positive and Negative Pulse Width A†</b>	1 ns to 1 ms (auto-trigger)
<b>Duty Cycle A†</b>	0% to 100% for pulse widths > 1 ns and periods < 1 ms (auto-trigger)
<b>Phase A rel B, B rel A</b>	> ± 360 degrees
<b>Peak Amplitudes A, B</b>	1 kHz to 200 MHz, 200 mV <sub>pk-pk</sub> to 2V <sub>pk-pk</sub>

\* Maximum sample rate for these measurements is 10 MHz (100 ns). For all others, maximum sample rate is 5 MHz (200 ns).

† Requires 8ns setup time between each measurement.

#### Analysis Features

- Time variation of measurements: frequency vs. time, time interval vs. time, and phase vs. time
- Histogram
- Event timing
- Limit test
- Statistics: Mean, minimum, maximum, standard deviation, variance rms
- Allan variance, root Allan variance

#### HP-IB Performance

- Up to 20,000 measurements per second throughput
- Three output formats: ASCII, floating point, or binary
- English-like HP-IB commands
- Full programmability
- Direct graphics output to printer or plotter.

### HP 5364A Microwave Mixer/Downconverter Performance Summary

- 2 GHz to 18 GHz input frequency range
- 10 MHz to 500 MHz IF output range
- 2.2 GHz to 18 GHz local oscillator input range
- Built-in manual attenuator
- 73 dB RF input dynamic range for pulse signals, 53 dB for CW signals
- APC 3.5(m) connectors for RF and LO inputs
- <7.5 ns video output risetime
- Less than 1 ns group delay over 500 MHz IF output range

#### For detailed information, ask for the following literature:

HP 5371A Data Sheet/Brochure Literature Number 5952-7940  
 HP 5364A Data Sheet/Brochure Literature Number 5952-7946  
 HP 5371A Product Note/Specifications Guide (includes detailed specifications for the HP 5371A) Literature Number 5952-7927  
 Application Note 358-1, "Characterization of Frequency-Agile Signal Sources" Literature Number 5952-7924  
 Application Note 358-2, "Jitter and Wander Analysis in Digital Communications" Literature Number 5952-7925  
 Application Note 358-3, "Time Domain Characterization of Magnetic Disk Drives" Literature Number 5952-7928

#### Ordering Information

Ordering Information	Price
<b>HP 5371A Frequency and Time Interval Analyzer</b> (Includes 2 HP 54002A 50 ohm input pods)	\$21,500
<b>Opt 060</b> Rear Panel Inputs (50 ohm, BNC) for channels A and B. 1M ohm BNC for External Arm. Pods not useable with Opt 060. No pods supplied.	No Charge
<b>Opt W30</b> Two Additional Years of "Return-to-HP" service and support	\$400
<b>HP 5364A Microwave Mixer/Detector</b>	\$13,000

#### Accessories

<b>HP 54001A</b> 1 GHz Miniature Active Probe/Pod (10:1, 10 kohm)	\$765
<b>HP 54003A</b> 1M ohm Pod (with 10:1 scope probe)	\$665
<b>HP 54300A</b> Pod Multiplexer	\$7,900
<b>HP J06-59992A</b> Time Interval Calibrator	\$3,000



Use the HP 5364A Microwave Mixer/Detector with the HP 5371A to measure the dynamic frequency characteristics of radar and communication signals as well as VCO's operating between 2 and 18 GHz.





- Precise trigger level setting
- Wide input dynamic range

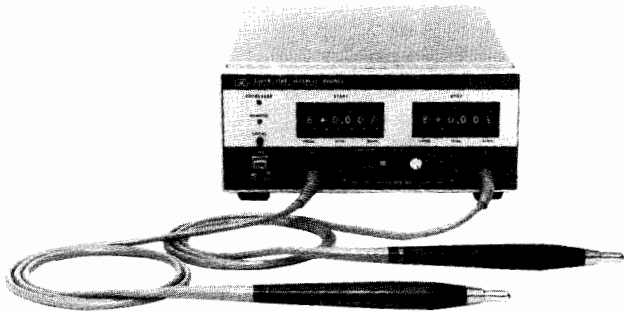

HP 5363B

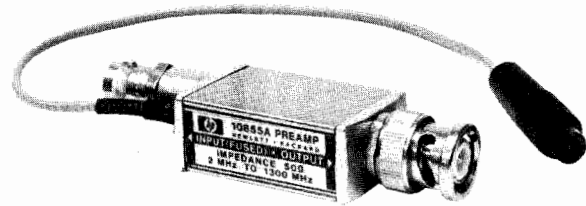

HP 10855A

### HP 5363B Time Interval Probes

#### Enhanced Counter Measurements

The HP 5363B provides the necessary input signal conditioning to allow a universal counter to make highly accurate and repeatable time interval measurements. Counters such as the HP 5345A, 5370B, 5335A, 5334A, 5334B, and 5328B when teamed up with the HP 5363B can now make more accurate rise time, fall time, slew rate, propagation delay, and other complex measurements.

#### Wide Dynamic Range, Fine Trigger Level Settability

Greatly improved dynamic range allows the trigger point to be selected in 10 mV increments from -9.99 V to +9.99 V.

#### Minimized Circuit Loading

High impedance, low capacitance active probes minimize circuit loading and pulse distortion. Each probe contains two measurement channels, start and stop, so timing measurements on one waveform are possible. As example, the input/output rise (propagation delay) of a device can be measured between the probes.

#### Eliminate Systematic Timing Errors

Delays through probes, cables and inherent differential delays between a counter's input channels limit the absolute accuracy of time interval measurements.

A calibration procedure using the HP 5363B can equalize such systematic delays to set the counter to read 0.0 ns. This is possible with counters that can measure down to 0 ns like the HP 5370B, 5334A, 5334B, and 5335A. For counters with a minimum time interval specification (HP 5345A and 5328B have 10 ns minimum capability), the HP 5363B can add a fixed offset of 10 ns to permit measurements of zero time interval.

#### Condensed Specifications

**Operating range:**  $\pm 10$  V.  
**Minimum input voltage:**  $\pm 100$  mV about trigger point.  
**Damage level:**  $\pm 30$  V.  
**Voltage resolution:** 10 mV.  
**Impedance:** 1 M  $\Omega$  shunted by  $< 20$  pF.  
**Effective bandwidth:** 350 MHz (1 ns rise time).  
**Minimum pulse width:** 5 ns at  $\pm 100$  mV about trigger point.  
**Output to counter:** separate start/stop outputs; -0.5 V to +0.5 V into 50  $\Omega$ , slew rate through zero volts exceeds 0.25 V/ns.  
**Delay compensation range:** 2 ns adjustable about 0 ns or 10 ns.  
**Power:** 100, 120, 220, 240 Vac (+5-10%), 48-440 Hz; 40 VA max.  
**Weight:** net 3.0 kg (6.5 lb). Shipping 5.5 kg (12 lb).

**Dimensions:** 88.1 H x 212 W x 295 mm D (3.5 in. x 8.4 in. x 11.6 in.).

#### Absolute Accuracy

$\pm 1 \text{ ns} \pm \frac{\text{START TLA} + \text{START NTE}}{\text{START slew rate}} \pm \frac{\text{STOP TLA} + \text{STOP NTE}}{\text{STOP slew rate}}$   
 where TLA denotes trigger accuracy and NTE denotes noise trigger error.

**Noise trigger error:**  $\sqrt{(125 \mu\text{V})^2 + e_n^2}$  volts where 125  $\mu\text{V}$  is the typical input noise on the HP 5363B and  $e_n$  is the input signal noise for a 350 MHz bandwidth.

#### Accessories Available

**HP 10821A** Probe Accessory Kit including 2 of each of the following: HP 10229A Hook Tip; HP 10218A BNC to Probe Adapter; HP 10100C 50 ohm Feedthrough termination; HP 1250-0655 BNC Tee to Probe Adapter; and HP 8710-0661 HP Probe tips (extra).

#### HP 10855A 2-1300 MHz Preamp

The HP 10855A Preamp provides a minimum of 22 dB gain from 2 MHz to 1300 MHz to enhance measurements of very low-level signals. The  $\pm 1.5$  dB flat response reduces distortion in non-sinusoidal waveforms. The HP 10855A operates conveniently with a variety of HP measuring instruments having probe power outlets, or will work with the HP 1122A Probe Power Supply. The HP 5334A/5335A Option 030 and HP 5328B Option 031 counters all measure frequency to 1300 MHz and are compatible for use with the HP 10855A.

#### HP 10855A Specifications

**Frequency range:** 2 MHz-1300 MHz.  
**Gain (minimum):** 22 dB; 24 dB typical.  
**Gain flatness across full frequency range:**  $\pm 1.5$  dB.  
**Noise figure:**  $< 8.5$  dB typical.  
**Output power for 1 dB gain compression:** 0 dBm.  
**Harmonic distortion:** -30 dB for -15 dBm output, typical.  
**Output for  $< -66$  dB harmonic distortion:** -25 dBm, typical.  
**VSWR:**  $< 2.9$ , typical.  
**Impedance:** 50  $\Omega$  nominal.  
**Reverse isolation:**  $> 45$  dB.  
**Maximum input:** 3.5 V rms (+24 dBm), fuse protected.

#### Ordering Information

**HP 5363B** Time Interval Probes  
**HP 10855A** 2-1300 MHz Preamp  
**HP 10821A** Probe Accessory Kit  
 ☎ Fast-Ship product — see page 766.

#### Price

**\$5400**  
**\$700** ☎  
**\$360**

# ELECTRONIC COUNTERS

Our Fastest Universal Systems Counter

Model 5345A

- 500 MHz Direct Count, Conversion Plug-Ins to 110 GHz
- 2 ns Single Shot Resolution, 2 ps Averaged

- 25 mV Sensitivity to 500 MHz
- Up to 9000 readings/second over HP-IB

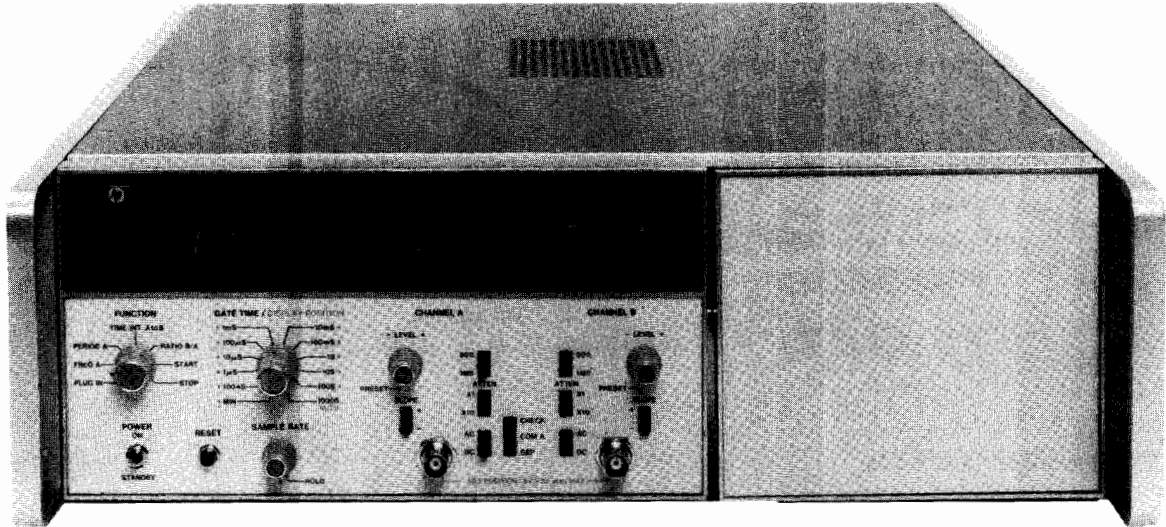

HP 5345A



## Versatile, High-Speed Measurement Power

- High resolution pulsed Frequency measurements and pulse profiling to 110 GHz with the HP 5355A and HP 5356A/B/C/D.
- Rapid 2 ns resolution Time Interval measurements for jitter characterization.
- High throughput Frequency, Period, Ratio, Totalize, and Scale measurements to 500 MHz.

## HP 5345A Condensed Specifications

### Input Channels A and B

**Range:** 0 to 500 MHz dc coupled 50  $\Omega$  and 1 M $\Omega$ ; 4 MHz to 500 MHz ac coupled, 50  $\Omega$ ; 200 Hz to 500 MHz ac coupled, 1 M $\Omega$ .

**Impedance:** selectable, 1 M $\Omega$  shunted by less than 45 pF or 50  $\Omega$  (nominal).

**Sensitivity (X1):** 50 $\Omega$ , 25 mV rms sine wave and 75 mV p-p pulse. 1M $\Omega$ , 25 mV rms sine wave and 75mV p-p pulse to 300 MHz; 50 mV rms sine wave and 150 mV p-p pulse to 500 MHz.

**Trigger level:** adjustable over  $\pm 2.0$  V dc.

**Output:** rear-panel BNC connectors bring out CHAN A TRIG LEVEL and CHAN B TRIG LEVEL for convenient DVM monitoring.

### Common Input

**Range:** ac coupled 50  $\Omega$ , 4 MHz to 400 MHz; ac coupled 1 M $\Omega$ , 300 Hz to 400 MHz; dc coupled, 0 to 400 MHz.

**Impedance:** 50  $\Omega$  remains 50  $\Omega$ ; 1 M $\Omega$  becomes 500 k $\Omega$  shunted by <80 pF.

**Sensitivity (X1):** 50  $\Omega$ , 50 mV rms sine wave and 150 mV p-p pulse. 1M $\Omega$ , 25 mV rms sine wave and 75 mV p-p pulse to 50 MHz; 75 mV rms sine wave and 150 mV p-p pulse to 200 MHz; 120 mV rms sine wave and 360 mV p-p pulse to 400 MHz.

### Frequency A

**Range:** 0.00005 Hz to 500 MHz.

**Resolution:** See Graph 1.

**Accuracy:**  $\pm$  Resolution  $\pm$  Time-Base Error (Graph 2).

### Period A

**Range:** 2 ns to 20,000 s.

**Resolution and Accuracy:**  $\Delta$ Freq [Per]/Freq (Graphs 1 and 2).

**Time Interval/Time Interval Average**

**Range:** 10 ns to 20,000 s.

**Minimum Dead Time:** 10 ns.

**Trigger Pulse Width:** 1 ns (typical) minimum width input at minimum voltage input.

### Resolution

**Time Interval:** 2 ns  $\pm$  Noise Trigger Error (Graph 3).

**Time Interval Average:**  $\pm$  T.I. Resolution  $\pm$  2 picoseconds.  
 $\sqrt{\text{intervals averaged}}$

**Accuracy:**  $\pm$  Resolution  $\pm$  Time Base Error (Graph 2)  $\pm$  Trigger Level Timing Error (Graph 4)  $\pm$  700 ps.

### Ratio B/A

**Range:** both channels accept dc to 500 MHz.

**LSD:** Ratio/[Freq B x Gate Time].

**Resolution and Accuracy:**  $\pm$  LSD  $\pm$  [A Trigger Error (Graph 3)/Gate time] x Ratio.

### Start/Stop

**Range:** both inputs dc to 500 MHz.

**Modes:** A, A  $\pm$  B determined by rear-panel switch.

### Scaling

**Range:** dc to 500 MHz.

**Scaling Factor:** selectable by GATE TIME setting. Scaling factor equals GATE TIME setting/ $10^{-9}$  seconds.

**Input:** input signal through channel A.

**Output:** output frequency equals input frequency divided by scaling factor.

### Time Base

#### Standard High Stability Oven

**Frequency:** 10 MHz.

**Aging rate:**  $< 5 \times 10^{-10}$  per day.

**Short term:**  $< 1 \times 10^{-11}$  for 1 s average.

**Temperature:**  $< 7 \times 10^{-9}$ , 0°C to 55°C.

#### Opt 001

**Frequency:** 10 MHz.

**Aging rate:**  $< 3 \times 10^{-7}$  per month.

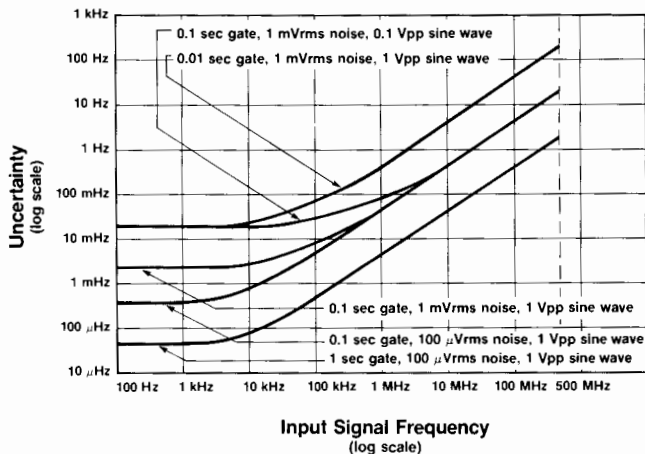

Graph 1, Frequency Resolution Error: Noise on the input signal and internal uncertainties affect Frequency and Period measurements. Longer gate times will reduce this error. (For Period, invert and find the  $\Delta F/F$ , then multiply by the Period. This yields Period Uncertainty ( $\Delta P$ .)

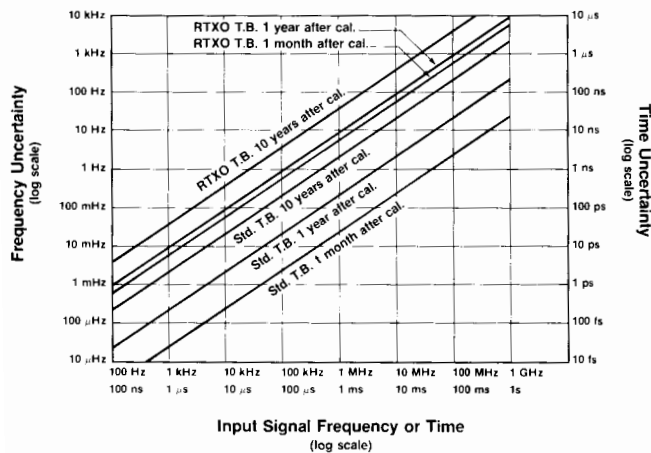

Graph 2, Time-Base Error: Environment and aging of the crystal affects all measurements. Frequent calibration and a better time base will reduce this error.

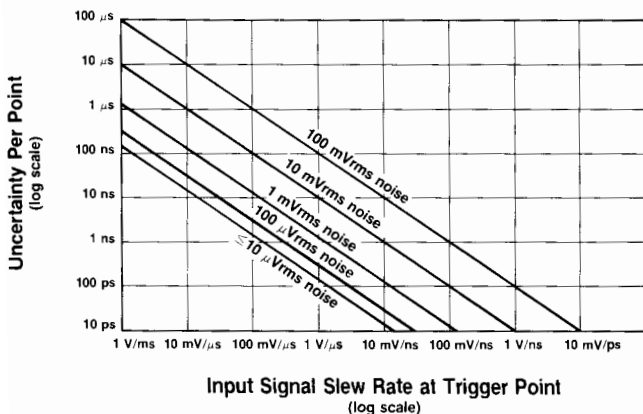

Graph 3, Input Noise Trigger Error: Noise on the input signal affects both the Start and Stop points of all time interval measurements. Averaging will reduce this error.

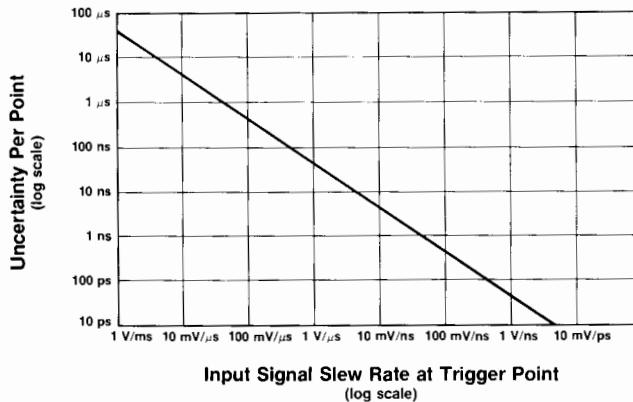

Graph 4, Trigger Level Timing Error: Affects the Start and Stop points, total error is the larger of the two. Input calibration will reduce this error.

**Opt 001 (cont.)**

- Short term:**  $< 2 \times 10^{-9}$  rms for 1 s.
- Temperature:**  $< 2 \times 10^{-6}$ , 25°C to 35°C.
- $< 5 \times 10^{-6}$ , 0°C to 55°C.

**Line voltage:**  $< 1 \times 10^{-8}$ ,  $\pm 10\%$  from nominal.

**External frequency standard input:** input voltage  $> 1.0$  V rms into 1 k $\Omega$  required from source of 1, 2, 2.5, 5 or 10 MHz  $\pm 5 \times 10^{-8}$  ( $\pm 5 \times 10^{-6}$  for option 001).

**Frequency standard output:**  $> 1$  V rms into 50  $\Omega$  at 10.0 MHz sine wave.

**General**

**Display:** 11-digit LED display and sign.

**Gate time:** 1000 s to 100 ns in decade steps;  $< 50$  ns in MIN position.

**Measurement speed**

Mode of Operation	Readings per Second
Normal Operation (Max sample rate)	10
Externally armed	500
Externally gated	500
Computer dump	9,000

**Overflow:** asterisk is illuminated when display is overflowed.

**Sample rate:** continuously variable from  $< 0.1$  s to  $> 5$  s with front-panel control. In HOLD position the last reading is maintained until the counter is reset.

**External arm input:** counter can be armed by a  $-1.0$  V signal applied to the rear panel 50  $\Omega$  input.

**External gate input:** same conditions as for EXT ARM.

**Gate output:**  $> 1$  V into 50  $\Omega$ .

**Operating temperature:** 0°C to 55°C.

**Power requirements:** 100/120/220/240 V rms  $+5\%$   $-10\%$  48 to 66 Hz, maximum power 250 VA.

**Weight:** 17 kg (37 lb).

**Size:** 132.6 mmH x 425 mmW x 495 mmD (5.22 in x 16.75 in x 19.5 in).

**Ordering Information**

- HP 5345A\*** Plug-In Counter \$10,000
- Opt 001** Room Temperature Time Base - \$320
- Opt 010** HP-IB Talk Only + \$350
- Opt 011** HP-IB includes remote programming + \$950
- Opt 012** HP-IB similar to Opt 011, but also includes slope and trigger level controls + \$1,600
- Opt 908** Rack Flange Kit, HP 5060-8740 + \$65
- HP 10595A** Board Extender Kit: For troubleshooting \$1,100

\*Fast-Ship product — see page 766.  
\*See page 184 for Microwave extensions.

# ELECTRONIC COUNTERS

## 100 MHz Universal Counters

### Model 5334B

- Two matched 100 MHz input channels; optional C Channel to 1.3 GHz
- 9 digits per second resolution from .001 Hz to 1.3 GHz
- 2 ns time interval resolution, 200 ps with averaging
- Automatic rise/fall time, pulse width and ac/dc voltage measurements
- Complete HP-IB programmability standard
- MATE interface optional

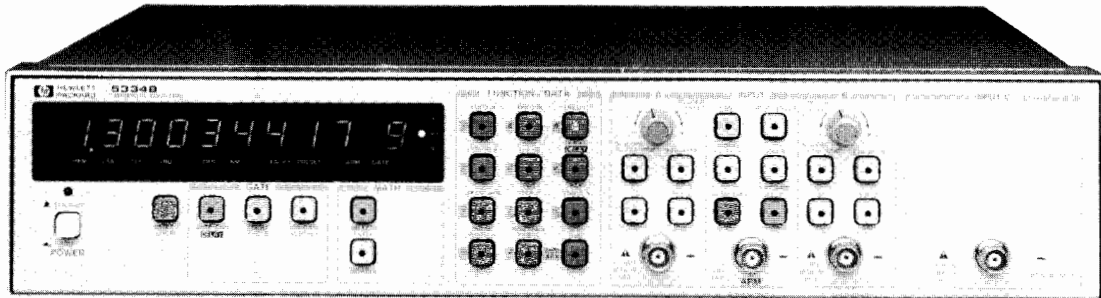

HP 5334B



DESIGNED FOR  
MATE  
SYSTEMS

### Expanded Universal Counter Capability for Bench or System

- Rise/Fall Time and Pulse Width measurements at the push of a button.
- Measure the AC/DC voltage of the input signal.
- Offset, Normalize, and Average measurements for greater use ability of results.
- Auto Triggering and Auto Attenuation for user convenience.

#### As well as

- 100 MHz Frequency and Period measurements with resolution of 9 digits per second of gate time.
- Time Interval and Time Interval Delay to 2 ns resolution, 200 ps with averaging.
- Full HP-IB programmability standard with optional rear inputs for system applications. Make up to 140 readings per second.
- 1.3 GHz C Channel, MATE Interface, and High Stability Oven Time Base options.
- External Arming/Gating for synchronizing measurements to external events.

### Condensed Specifications

#### Input Characteristics (channels A and B)

##### Range

**DC coupled:** 0 to 100 MHz.

**AC coupled:** 1 M $\Omega$ , 30 Hz to 100 MHz; 50 $\Omega$ , 1 MHz to 100 MHz.

##### Sensitivity

15 mV rms sine wave to 20 MHz, 35 mV rms sine wave to 100 MHz.  
100 mV peak-to-peak at a minimum pulse width of 5 ns.

##### Dynamic Range (X1)

45 mV to 5 V peak-to-peak, to 20 MHz.  
100 mV to 2.5 V peak-to-peak, to 100 MHz.

##### Trigger Level Range

**Manual (auto trigger off):** continuously adjustable over  $\pm 5.1$  V ( $\times$  ATTN), displayed in 20 mV steps ( $\times$  ATTN).

**Preset:** 0V NOMINAL in Sensitivity Mode.

##### Auto Trigger

**DC coupled:** 100 Hz to 100 MHz.

**AC coupled:** 1 M $\Omega$ , 100 Hz to 100 MHz; 50  $\Omega$ , 1 MHz to 100 MHz.

**Trigger Slope:** independent selection of + or - slope.

**Impedance:** 1 M $\Omega$  or 50  $\Omega$ , NOMINAL, switch selectable.

##### Attenuator

**Manual:**  $\times 1$  or  $\times 10$  NOMINAL, switch selectable.

**Auto:** attenuator automatically switched when in Auto Trigger.

**Low Pass Filter:** 100 kHz NOMINAL, Channel A, switchable.

##### External Arm

**Sensitivity:** 500 mV peak-to-peak at Min. pulse width of 50 ns.

**Signal Operating Range:** -5 V dc to +5 V dc.

**Slope:** independent selection of START and STOP ARM slopes: +, -, or OFF.

##### Frequency A and Frequency B

**Range:** .001 Hz to 100 MHz.

**Resolution:** See Graph 1.

**Accuracy:**  $\pm$  Resolution  $\pm$  Time Base Error (Graph 2).

##### Period A

**Range:** 10 ns to 10<sup>3</sup> s (single gate), 10 s (100 GATE AVERAGE)

**Resolution and Accuracy:**  $\Delta$ FREQ [PER]/FREQ (Graph 1 and 2)

##### Time Interval A to B

**Range:** -1 ns to 10<sup>3</sup> (single shot), 10 s (100 GATE AVERAGE).

**LSD:** 1 ns (100 ps using 100 GATE AVERAGE).

**Resolution:**  $\pm$  LSD  $\pm$  Noise Trigger Error (Graph 3)  $\pm$  1 ns rms.

**Accuracy:**  $\pm$  Resolution  $\pm$  Time Base Error (Graph 2)  $\pm$  Trig Level

Timing Error (Graph 4)  $\pm$  Trig Level Setting Error (Graph 5)  $\pm$  2 ns.

##### Time Interval Delay

Selectable delay can be inserted between START and STOP of Time Interval A to B. Inputs during delay are ignored. Delay Range is 1 ms to 99,999 s.

##### Ratio A/B

**Range:** .001 Hz to 100 MHz both channels.

**LSD:**  $4 \times$  RATIO/[FREQ A  $\times$  GATE TIME].

**Resolution and Accuracy:**  $\pm$  LSD  $\pm$  [B Trig Error (Graph 3)/GATE TIME].

##### Totalize

**Range:** 0 to 10<sup>12</sup> -1.

**Resolution and Accuracy:** 1 count of input signal.

##### Pulse Width A

**Range:** 5 ns to 10 ms.

**LSD, Resolution, Accuracy:** same as Time Interval A to B except  $\pm 2$  ns in Accuracy deleted.

##### Rise/Fall Time A

**Range:** 30 ns to 10 ms.

**Minimum Amplitude:** 500 mV peak-to-peak.

**Dynamic Range:** 500 mV to 40 V peak-to-peak.

**LSD, Resolution, Accuracy:** same as Time Interval A to B.

##### AC/DC Voltage

Max. and Min. peaks or dc level of Channel A or Channel B input are displayed.

**Frequency Range:** dc, 100 Hz to 20 MHz.

**Dynamic Range:** 0-40 V peak-to-peak;  $\pm 51$  Vdc.

**Resolution:**  $\times 1$ : 20 mV  $\times 10$ : 200 mV

##### Time Base

**Frequency:** 10 MHz.

**Aging Rate:**  $< 3 \times 10^{-7}$  per month.

##### Math

**Display =** (Measurement/Normalize) + Offset.

**Entry Range:**  $\pm 1 \times 10^{-10}$  to  $\pm 9.999999999999 \times 10^9$ .

**Single Cycle:** one measurement per push of RESET.

**100 Gate Average:** 100 measurements accumulated and average value displayed. Adds one digit of resolution to measurements and reduces resolution error by 10.

##### Hewlett-Packard Interface Bus

**Programmable Controls:** all front-panel controls and functions, except power on/stby switch.

**Trigger Level:** set Channel A or B in 20 mV steps ( $\times$  ATTN).

**Data Output**

**Normal Operation:** ten readings/second, formatted.

**High Speed Mode:** up to 140 readings/second (55 readings/second with Option 700), unformatted.

**HP-IB Interface Functions:** SH1, AH1, T5, TE0, L4, LE0, SR1, RL1, PP0, DC1, C0, E2 (see page 556).

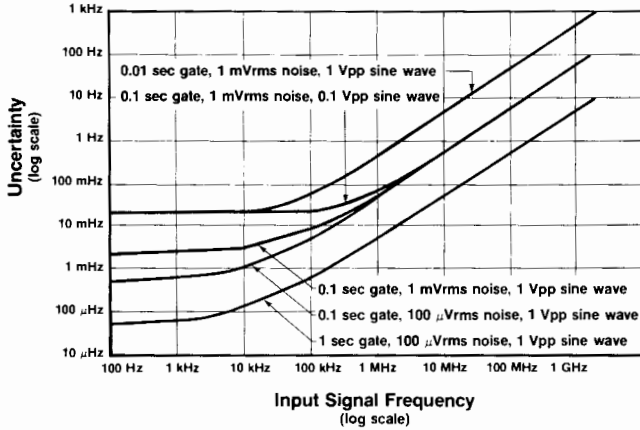

Graph 1, Frequency Resolution Error: Noise on the input signal and internal uncertainties affect Frequency and Period measurements.

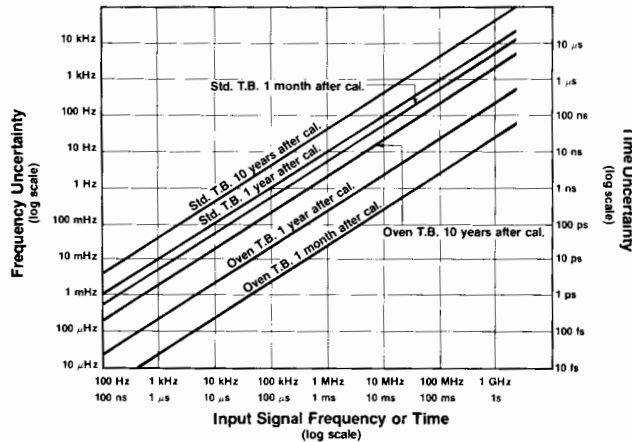

Graph 2, Time Base Error: Crystal environment and aging affects all measurements.

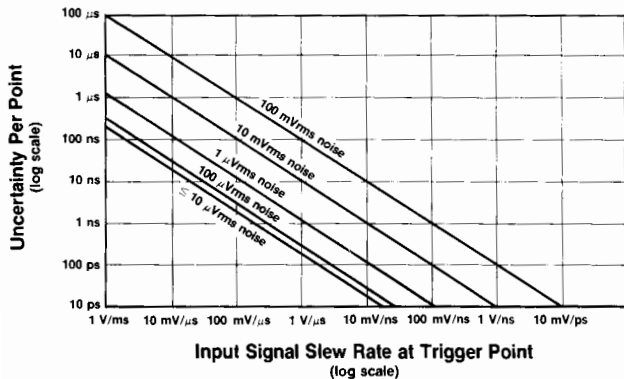

Graph 3, Input Noise Trigger Error: Noise on the input signal affects both the Start and Stop points of all time interval measurements.

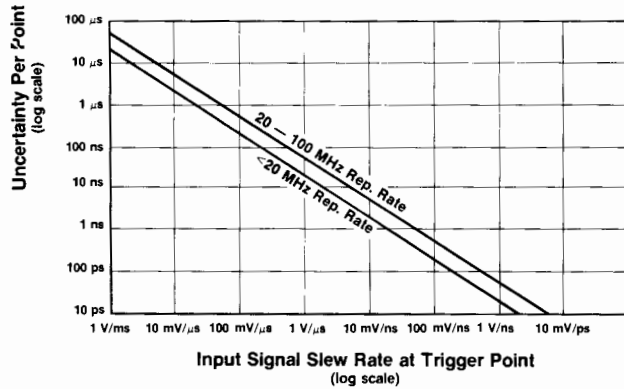

Graph 4, Trigger Level Timing Error: Affects the Start and Stop points of all time-interval measurements. Total error is the larger of the two trigger point errors.

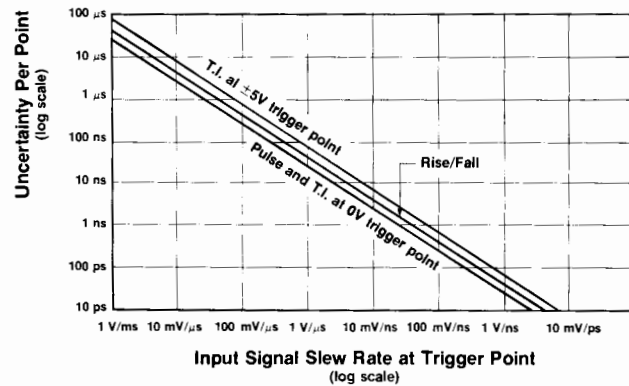

Graph 5, Trigger Level Setting Error: Affects both the Start and Stop points of all time interval measurements.

**Options**

**Option 010 High Stability Time Base (Oven)**

**Frequency:** 10 MHz.

**Aging Rate:**  $5 \times 10^{-10}$ /day after 24-hour warm up.

**Option 030 1300 MHz C Channel**

**Range:** 90 MHz to 1300 MHz.

**Sensitivity:** 15 mV rms (-23.5 dBm) sine wave, 90 MHz to 1000 MHz. 75 mV rms (-9.5 dBm) sine wave, 1000 MHz to 1300 MHz.

**Resolution and Accuracy:** same as Frequency A and B.

**Option 700 Internal CIIL Interface (MATE)**

**Measurement Functions Provided:**

Frequency A, B, and C; Period A, Time Interval A to B, Ratio A/B, Totalize A, Rise/Fall Time A, Pulse Width A, Read Levels A and B (AC/DC Voltage and Trigger).

**Programmable Controls:**

Channel A and B: Trigger Level, Auto Trigger, Coupling, Trigger, Slope, Impedance, Attenuator, Common.

External Arm: External Arm Select, Slope.

General: Gate Time

**Measurement Data Output Rate:** 2.5 readings/second.

**Ordering Information**

**HP 5334B Universal Counter**

**Opt 010** Oven Oscillator

**Opt 030** Channel C

**Opt 060** Rear Terminals

Channel A,B and ARM in parallel with front inputs.

Option 030 at rear panel only.

**Opt 700** Internal MATE programming

☎ Fast-Ship product — see page 766.

**Price**

\$1950 ☎

+\$800

+\$550

+\$125

+\$375



# ELECTRONIC COUNTERS

## Our Highest Performance Universal Systems Counter

### Model 5335A

- A high performance 200 MHz/2 ns Universal Counter
- Built-in automatic rise time, duty cycle, pulse width, slew rate and phase measurements
- Advanced automatic triggering capabilities
- HP-IB plus math and statistics functions standard



HP 5335A



### Remarkable Automatic Measurement Power

The HP 5335A is an advanced universal counter with automatic measurement power built in. Designed either for bench or systems applications, the counter has 16 front-panel measurement functions, plus four "phantom" functions, all automatically selected by push button or by HP-IB. These twenty functions, plus greatly expanded arming and triggering capability, make the HP 5335A a most powerful universal counter. In addition, math and statistics features, matched Channel A and B input amplifiers, and HP-IB are all included in the standard unit, making the HP 5335A easily the most advanced universal counter available at its price.

### Pulse Characterization Measurements

The HP 5335A possesses the expected universal measurements, and does them better than ever before. Beyond the expected measurement set, the HP 5335A has the ability to automatically measure waveform characteristics for various applications. Op amp characterization is one area where a number of measurements are needed to define the amplifier's performance. Using the HP 5335A and a signal source, rise and fall times, output slew rate, and propagation times can be measured with one test set-up. Also, duty cycle can be measured to see the distortion on a square wave through the amplifier due to different rising and falling slew rates. Phase measurements are also push-button selectable and automatically performed by the counter.

### Complete Triggering Capability

To get good measurement results, a counter must properly trigger on the input signal. The HP 5335A employs both manual and automatic triggering modes to quickly and easily set the right trigger points.

### Manual Triggering

The counter has a  $\pm 5$  Vdc range to help reduce input attenuator use for most input signals, including TTL.

### Automatic Triggering

Two auto trigger modes help you trigger automatically. Just press *auto trig* or select auto trig on the HP-IB and the counter automatically selects 10%-90% rise/fall time trigger points, 50% phase trigger points, or the preset value of your choice. Then it tracks the signal's dc offset continuously to stay on the right trigger point. Option 040 allows programmability of trigger levels via HP-IB.

### Trigger Level DVM

Built into the basic counter. Just press TRG LVL to see both input channel trigger levels displayed.

### A Full Set of Universal Measurement Functions

In addition to waveform characterization features, the HP 5335A has an extremely wide set of measurement functions covering frequency, time, events and volts. These functions let you characterize signals quicker and more thoroughly than ever before possible.

### Frequency

Frequency is the most common measurement performed by counters. The HP 5335A measures to 200 MHz in Channel A, 100 MHz in Channel B, and 1.3 GHz in its optional Channel C. Due to the counter's advanced design and reciprocal measurement technique, resolution is a constant 9 digits per second of gate time across its entire measurement range.

### Time

In a universal counter, a time interval measurement equates to a stopwatch measurement started and stopped by unique events. Precision is dependent on the counter's circuitry.

To ensure precision, the HP 5335A has matched custom input amplifiers to greatly reduce trigger errors that might be produced if the start and stop signals were amplified differently. Further, the counter employs an analog interpolation technique that turns its 10 MHz clock into the equivalent of a 1 GHz time base. The HP 5335A is thus able to resolve single shot time interval measurements to better than 2 nanoseconds (100 ps with averaging). This analog interpolation eliminates the need found in some counters for a phase-modulated (jittered) time base for time interval average measurements.

### Math and Statistics

Averaging techniques are often used to extend the resolution of a counter. For averaging, the HP 5335A provides sample sizes of  $N = 100$  or  $N = 1,000$ . Best of all, averaging can be employed for all measurements except phase. In addition to mean, and selection of sample size, the counter takes standard deviations of the current measurement for the sample size selected.

Math functions are another built-in feature that provide operator convenience. These functions let you convert the display into direct indications of parameters like flow, speed, pressure, and temperature. Additionally, the counter remembers the offset, scale, and normalize factors for each measurement function.

## Condensed Specifications

### Input Characteristics (channel A and B)

#### Range

DC coupled, 0 to 100 MHz.  
AC 1 M $\Omega$ , 30 Hz to 100 MHz.  
AC 50  $\Omega$ , 200 kHz to 100 MHz.

NOTE: Channel A range 200 MHz when in Frequency A and Ratio modes.

#### Sensitivity (X1)

25 mV rms sinewave.  
75 mV peak-to-peak pulse at minimum pulse width of 5 ns.

#### Dynamic Range (X1)

75 mV to 5 V peak-to-peak, to 100 MHz.  
75 mV to 2.5 V peak-to-peak, >100 MHz.

#### Signal Operating Range (X1, DC)

-5 V dc to +5 V dc.

#### Trigger Level Range (X1)

##### Auto Trigger OFF

Preset: set to 0 V dc NOMINAL.  
Adjustable: -5 V dc to +5 V dc.

##### Auto Trigger ON

Preset: set to nominal 50% point of input signal.  
Adjustable: nominally between + and - peaks of input signal.

#### Auto Trigger (X1)

##### Range (50% duty cycle)

DC coupled, 30 Hz to 200 MHz.  
AC 1 M $\Omega$ , 30 Hz to 200 MHz.  
AC 50  $\Omega$ , 200 kHz to 200 MHz.

**Minimum signal:** 100 mV rms.

**Duty cycle range:** 10% to 90%.

**Response time:** 3 seconds, typical.

NOTE: Auto Trigger requires a repetitive signal.

Coupling: ac or dc, switchable.

**Impedance:** 1 M $\Omega$ , nominal, shunted by <35 pF or 50  $\Omega$  nominal, switchable. In COMMON A, 1 M $\Omega$  is shunted by <50 pF.

**Attenuator:** X1 or X10 nominal, switchable.

**Slope:** independent selection of + or - slope.

**Channel input:** SEPARATE or COMMON A, switchable.

#### Frequency A

**Range:** 0 to 200 MHz, prescaled by 2.

#### LSD Displayed

$\frac{1 \text{ ns}}{\text{Gate Time}} \times \text{FREQ.}$  (e.g. 9 digits in a second).

#### Resolution

$\pm (2 \times \text{LSD}) \pm 1.4 \times \frac{\text{Trigger Error}}{\text{Gate Time}} \times \text{FREQ.}$

**Accuracy:**  $\pm (\text{Resolution}) \pm (\text{Time Base Error}) \times \text{FREQ.}$

#### Period A

**Range:** 10 ns to 10<sup>7</sup> s.

#### LSD Displayed

$\frac{1 \text{ ns}}{\text{Gate Time}} \times \text{PER.}$  (e.g. 9 digits in a second).

**Period average:** user selects MEAN function, and n = 100, or n = 1,000.

#### Time Interval A $\rightarrow$ B

**Range:** 0 ns to 10<sup>7</sup> s.

**LSD displayed:** 1 ns (100 ps using MEAN).

**Resolution:**  $\pm (2 \times \text{LSD}) \pm (\text{START Trigger Error}) \pm (\text{STOP Trigger Error})$ .

**Accuracy:**  $\pm (\text{Resolution}) \pm (\text{Time Base Error}) \times \text{TI} \pm (\text{Trigger Level Timing Error}) \pm (2 \text{ ns})$ .

**Gate mode:** MIN only.

**Time interval average:** user selects MEAN function, and n = 100, or n = 1,000.

#### Time Interval Delay (holdoff)

Front panel Gate Adjust control inserts a variable delay between START and enabling of STOP. Electrical inputs during delay are ignored. Delay ranges are same as gate time ranges (100  $\mu$ s, to 4 s NOMINAL) for gate modes of Fast, Norm, and Manual.

#### Inverse Time Interval A $\rightarrow$ B

**Range:** 10<sup>-7</sup> to 10<sup>9</sup> units/second.

LSD Displayed, Resolution, and Accuracy are inverse of Time Interval A  $\rightarrow$  B specifications.

#### Rise and Fall Time A

**Range:** 20 ns to 10 ms transition with 50 Hz to 25 MHz repetition rates (50% duty cycle).

**Minimum pulse height:** 500 mV peak-to-peak.

**Minimum pulse width:** 20 ns.

**Duty cycle range:** 20% to 80%.

LSD Displayed and Resolution are same as Time Interval A  $\rightarrow$  B Specifications.

#### Pulse Width A

**Range:** 5 ns to 10<sup>7</sup> s.

**Trigger point range:** 40% to 60% of pulse height.

LSD Displayed and Resolution are same as Time Interval A  $\rightarrow$  B specifications.

#### Duty Cycle A

**Range:** 1% to 99%, 0 to 100 MHz.

**Trigger point range:** 40% to 60% of pulse height.

**LSD displayed:**  $\frac{1 \text{ ns}}{\text{PER}} \times 100\%$

NOTE: Constant duty cycle required during measurement.

#### Slew Rate A

**Range:** 50 V/s to 10<sup>8</sup> V/s slew rate with 50 Hz to 25 MHz repetition rates (50% duty cycle). Minimum Pulse Height, Width, and Duty Cycle Range are same as Rise and Fall Time A.

**Input mode:** automatically set to COMMON A with 10% and 90% trigger levels.

#### Ratio A/B

**Range:** Channel A, 0 to 200 MHz (prescaled by 2).  
Channel B, 0 to 100 MHz.

**LSD displayed:**  $\frac{\text{RATIO}}{\text{FREQ} \times \text{Gate Time}}$  where FREQ is higher frequency after prescaling.

#### Totalize A

**Range:** 0 to 100 MHz.

**LSD displayed:** 1 count of input.

**HP-IB output:** at end of gate.

#### Manual

**Count reset:** via RESET key.

**HP-IB output:** totalize data on-the-fly sent if Cycle mode set to Single. Input frequency range in this mode is 0 to 50 Hz nominal.

#### Gated

**Count reset:** automatic after measurement.

#### Phase A Rel B

**Range:** -180° to 360°, Range Hold off, or 0° to 360°, Range Hold on, with signal repetition rates of 30 Hz to 1 MHz.

**Minimum signal:** 100 mV rms.

**LSD displayed:** 0.1°.

#### Gate Time

**Range:** 100 ns to 10<sup>7</sup> s.

**LSD displayed:** up to three digits with Ext. Arm Enable OFF, 100 ns when ON. MIN Gate Mode display zero.

# ELECTRONIC COUNTERS

## Our Highest Performance Universal Systems Counter (cont'd)

### Model 5335A

#### Trigger Level

**Range:**  $\times 1$ , +5 to -5 V;  $\times 10$ , +50 to -50 V.

**Resolution:**  $\times 1$ , 10 mV;  $\times 10$ , 100 mV.

**Accuracy ( $\times 1$ ):**  $\pm 20$  mV,  $\pm 0.5\%$  of reading.

#### Time Base

##### Standard Crystal

**Frequency:** 10 MHz.

**Aging rate:**  $< 3 \times 10^{-7}$ /month.

**Temperature:**  $< 4 \times 10^{-6}$ , 0 to 50°C.

**Line voltage:**  $< 1 \times 10^{-7}$  for 10% change.

**High stability crystal:** see Option 010.

**External time base input:** rear panel BNC accepts 5 or 10 MHz, 200 mV rms into 1 k $\Omega$ ; 5 V rms maximum.

**Time base out:** 10 MHz,  $> 1$  V p-p into 50  $\Omega$  via rear panel.

#### Statistics

**Sample size:** selectable between either  $n = 100$  or  $n = 1,000$  samples.

**Std. dev.:** displays a standard deviation of selected sample size.

**Mean:** displays mean estimate of selected sample size.

**Smooth:** performs a weighted running average and truncates unstable least significant digits from display.

#### Math

All measurement functions, with exception of GATE TIME, Totalize in Scale Mode, and TRIG LVL, may be operated upon by Math functions. Offset, Normalize, and Scale may be used independently or together as follows:

$$\text{Display} = \frac{\text{Measurement} + \text{Offset}}{\text{Normalize}} \times \text{Scale}.$$

**Number value range:**  $\pm 1 \times 10^{-9}$  to  $\pm 9 \times 10^9$ .

**Last display:** causes value of previous display to Offset (negative value), Normalize, or Scale all subsequent measurements.

**Measurement t-1:** causes each new measurement to be Offset (negative value), Normalized, or Scaled by each immediately preceding measurement.

#### Hewlett-Packard Interface Bus

**Programmable controls:** all measurement functions, Math, Statistics, Reset, Range Hold, Ext. Arm Enable/Slope, Check, Gate Adj. ( $\sim 1$  ms to 1 s), Gate Open/Close (gate times to  $\infty$ ), Gate Mode, Cycle, Preset, Slope, Common A, Auto Trigger.

**Special functions:** FREQ B, PULSE B, TIME B  $\rightarrow$  A, TOT A-B, LEARN, MIN, MAX, all internal diagnostic routines.

**Interface functions:** SH1, AH1, TS, TEQ, L4, SL1, RL1, PP0, DC1, DT1, C0, E1 (see page 40.5).

**Data output:** fixed output format consisting of 19 characters plus CR and LF output is typically 8 ms.

**Option 040:** adds complete systems programmability; see column at right.

#### General

**Gate:** minimum, manual, or continuously variable (NORM/FAST) via Gate Adj. control.

**NORM:** 20 ms to 4 s NOMINAL.

**FAST:** 100  $\mu$ s to 20 ms NOMINAL.

**MIN:** minimum gate time. Actual time depends on function.

**MANUAL:** each press opens or closes gate.

**Cycle:** determines delay between measurements.

**NORM:** no more than 4 readings per second, nominal.

**MIN:** updates display as rapidly as possible ( $\sim 15$  readings per second, depending on function).

**SINGLE:** one measurement taken with each press of button.

**Arming:** Ext. Arm Enable key allows rear panel input to determine Start and/or Stop point of a measurement. External gate defined by both Start and Stop armed. All measurements are armable except Manual Totalize, Phase, and Trigger Level.

**Start arm:** + or - slope of arm input signal starts measurement.

**Stop arm:** + or - slope of arm input signal stops measurement. When used, Start Arm must occur before Stop Arm.

**Ext. arm input:** rear panel BNC accepts TTL into 20 k $\Omega$ . Minimum Start To Stop Time: 200 ns.

**Trigger level out:** dc output into 1 M $\Omega$  via rear panel BNCs for Channel A and B; not adjusted for attenuators.

**Accuracy at dc ( $\times 1$ ):**  $\pm 15$  mV  $\pm 0.5\%$  of TRIG LVL reading.

**Gate out:** TTL level into 50  $\Omega$ ; goes low when gate open; rear panel BNC.

**Range hold:** freezes decimal point and exponent of display.

**Reset:** starts a new measurement cycle when pressed.

**Check:** performs internal self test and lamp test.

**Display:** 12-digit LED display in engineering format; exponent range of +18 to -18.

**Operating temperature:** 0 to 50°C.

**Power requirements:** 100, 120, 220, 240 VAC (+5%, -10%), 48-66 Hz; 130 VA max.

**Weight:** net, 8.8 kg (19 lb 8 oz). Shipping, 13.6 kg (30 lb).

**Dimensions:** 425.5 mm W x 132.6 mm H x 345.4 mm D (16 $\frac{3}{4}$  in. x 5 $\frac{1}{4}$  in. x 13 $\frac{1}{2}$  in.), not including removable handles.

#### Options

##### Option 010: High Stability Time Base (oven)

**Frequency:** 10 MHz.

**Aging rate:**  $< 5 \times 10^{-10}$ /day after 24-hour warm up.

**Short term:**  $< 1 \times 10^{-9}$  rms for 1s average.

**Temperature:**  $< 7 \times 10^{-9}$ , 0 to 50°C.

**Line voltage:**  $< 1 \times 10^{-10}$  for 10% change.

**Warm-up:** within  $5 \times 10^{-9}$  of final value in 20 minutes.

##### Option 020: DC Digital Voltmeter

**Range:** 4 digits, autoranging, autopolarity, in  $\pm 10$ ,  $\pm 100$ ,  $\pm 1000$  V ranges.

**Sensitivity:** 100  $\mu$ V, 1 mV, 10 mV, 100 mV for  $\pm 1$  V,  $\pm 10$  V,  $\pm 100$  V,  $\pm 1000$  V readings.

**LSD displayed:** same as sensitivity.

**Input type:** floating pair.

**Input impedance:** 10 M $\Omega$   $\pm 1\%$ .

##### Option 030: 1.3 GHz C Channel

###### Input Characteristics

**Range:** 150 MHz to 1.3 GHz.

**Sensitivity:** 10 mV rms sinewave (-27 dBm) to 1 GHz. 100 mV rms sinewave (-7 dBm) to 1.3 GHz.

###### Frequency C

**Range:** 150 MHz to 1.3 GHz, prescaled by 20. LSD Displayed, Resolution, and Accuracy are same as Frequency A.

###### Ratio C/A

**Range:** channel A, 0 to 200 MHz.  
channel C, 150 to 1300 MHz.

##### Option 040: Complete Systems Programmability

Adds remote selection of low pass filter, ac/dc coupling,  $\times 1$ - $\times 10$  attenuation, dc trigger level and input impedance for both Channel A and B.

#### Definitions

**Duty cycle:** percentage of time a signal is high or low, depending on Slope A setting. Trigger point is high/low dividing point.

$$\text{DUTY CY} = \frac{\text{PULSE}}{\text{PER}} \times 100\%.$$

**Slew rate:** effective slope between 10% and 90% points of rising or falling signal depending on Slope A setting.

$$\text{SLEW} = \frac{V_B - V_A}{T_I}$$

**Phase:** angle, with respect to B signal, between 50% points of channel A and B signals, trigger slopes selected by Channel A and B slope switches.

$$\text{PHASE} = \frac{(T_{I1} + T_{I2}) 360^\circ}{2 \text{ PER}}$$

$T_{I1}$  is time between 50% points of A then B signals using slopes defined during Phase measurement.

$T_{I2}$  is time between 50% points of A then B signals using complement slopes to  $T_{I1}$ .

**Front handles:** supplied with instrument.

#### Ordering Information

**HP 5335A** Universal Counter

**Opt 010** Oven Oscillator

**Opt 020** DVM

**Opt 030** C Channel

**Opt 040** Expanded HP-IB Control

**Opt 908** Rack Flange Kit for use without handles.

**Opt 913** Rack Flange Kit for use with supplied front handles.

#### Price

**\$4400**

+ \$800

+ \$550

+ \$800

+ \$800

+ \$32

+ \$65

# ELECTRONIC COUNTERS

## 100 MHz Universal Counters

### Model 5328B

203

- 100 MHz and 1300 MHz
- 10 ns Time Interval
- T.I. Averaging to 10 ps resolution

- "Armed" measurements
- DVM option
- HP-IB Interface standard

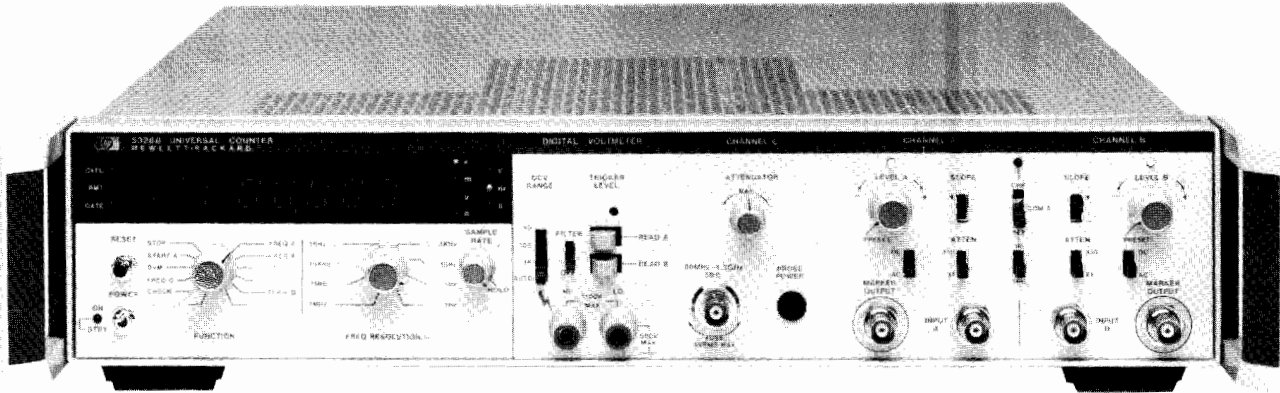

HP 5328B



### Solid Universal Counter Performance for Bench or System

- Frequency measurements to 100 MHz, 1.3 GHz optional.
- 10 ns Time Interval resolution, 10 ps with averaging.
- 10 ns Period resolution, 1 fs with averaging.
- $\pm 1000$  V dc DVM and High Stability Oven Time Base options.
- HP-IB programming and External Arming standard.

### Condensed Specifications

#### Input Characteristics

**Sensitivity:** 25 mV rms, to 40 MHz; 50 mV rms, 40 MHz-100 MHz.  
Attenuators (nominal):  $\times 1$ ,  $\times 10$  switch selectable.

#### Frequency A

**Range:** 0 to 100 MHz.

#### Period A

**Range:** 100 ns to  $10^7$ s with resolution to 10 ns.

#### Period Average A

**Range:** 100 ns to  $10^7$ s with resolution to 1 fs.

#### Time Interval A $\rightarrow$ B

**Range:** 10 ns to  $10^7$ s with resolution to 10 ns.

#### Time Interval Average A $\rightarrow$ B

**Range:** 0.1 ns to 1 s with resolution to 10 ps.

**Minimum Dead Time:** 40 ns.

#### Ratio B/A

**Range:** Channel A, 0 to 10 MHz; Channel B, 0 to 100 MHz.

### HP-IB Interface Bus

**Programmable functions:** Functions, resolution, sample rate, (maximum or manual control), arming, display modes, measurement modes, output mode, and reset commands. Trigger level, trigger slope, input impedance, coupling, separate/common/check, invert A and B. Trigger level is programmable in 10 mV steps in  $\times 1$ ; 100 mV in  $\times 10$ . Trigger level accuracy under remote control in  $\times 1$ :  $\pm 35$  mV.

**Interface functions:** SH1, AH1, T1, L2, SR1, RL1, PP0, DC1, DT1, C0, E1. (See page 556).

**Service request (SRQ):** if enabled, indicates end of measurement.

**Maximum data output rate:** 500 readings/s.

### General

**Display:** 9-digit LED display.

**Sample Rate:** Variable from less than 2 ms between measurements to HOLD, which holds display indefinitely.

**Gate Output:** rear panel output: TTL levels.

**Time Base Output:** rear panel output; TTL levels.

**Operating Temperature:**  $0^\circ$  to  $50^\circ\text{C}$ .

**Power Requirements:** 100/120/240 V rms, +5%, -10% (switch selectable), 48-66 Hz; 150 VA max.

### Time Base Oscillators

#### Standard Crystal Oscillator

**Frequency:** 10 MHz.

**Aging Rate:**  $< 3 \times 10^{-7}$ /month.

**Temperature:**  $< 2.5 \times 10^{-6}$ ,  $0^\circ$  to  $50^\circ\text{C}$ .

**Line Voltage:**  $< 1 \times 10^{-7}$  for 10% change.

#### Option 010: Oven Oscillator

**Frequency:** 10 MHz.

**Aging Rate:**  $< 5 \times 10^{-10}$ /day after 24-hour warm-up.

**Short Term:**  $< 1 \times 10^{-10}$  rms/s.

**Temperature:**  $< 7 \times 10^{-9}$ ,  $0^\circ$  to  $50^\circ\text{C}$ .

**Line Voltage:**  $< 5 \times 10^{-9}$  for 10% variation.

**Warm-Up:** within  $5 \times 10^{-9}$  of final value in 20 minutes.

#### Option 021: High Performance Digital Voltmeter

**Range:**  $\pm 10$ ,  $\pm 100$ ,  $\pm 1000$  V dc and Autorange.

**Sensitivity:** 10  $\mu\text{V}$ , 100  $\mu\text{V}$ , 1 mV, 10 mV, 100 mV for measurement times of 10 s, 1 s 0.1 s, 10 ms, 1 ms respectively.

**Input:** floating pair, 10 M $\Omega$  nominal.

**Maximum Input:** hi to low:  $\pm 1100$  V all ranges; low to chassis ground:  $\pm 500$  V.

**Trigger Level Measurements:** 1 mV display resolution.

#### Option 031: 1300 MHz C-Channel

##### Input Characteristics

**Sensitivity:** 20 mV rms sine wave (-21 dBm).

**Maximum Input:** 5 V rms,  $\pm 5$  Vdc, fuse protected.

##### Frequency C

**Range:** 90 MHz to 1300 MHz, prescaled by 4 with resolution to 0.1 Hz.

##### Ratio C/A

**Range:** channel A, 0 to 10 MHz; channel C, 90 to 1300 MHz

**Attenuation:** continuously variable for optimum noise suppression.

### Ordering Information

**HP 5328B** Universal Counter

**Opt 010** High Stability Time Base

**Opt 021** High Performance DVM

**Opt 031** 1300 MHz Channel C

**Opt 050** DVM and Channel C

**Opt 908** No Handles Rack Flange Kit

**Opt 913** With Handles Rack Flange Kit

### Price

**\$5400**

**+\$800**

**+\$800**

**+\$1100**

**+\$1900**

**+\$30**

**+\$30**

# ELECTRONIC COUNTERS

## Universal Counters

Models 5315A, 5316B

- Frequency, period, ratio, and totalize to 100 MHz
- Portable, and HP-IB models
- 1 GHz capability available

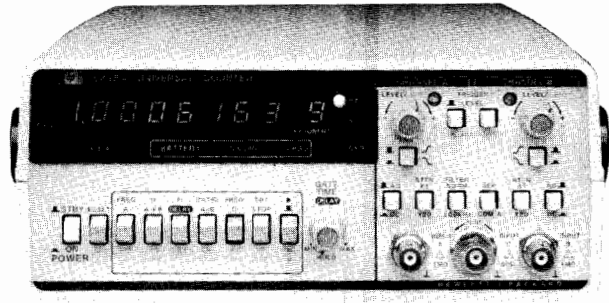

HP 5315A

- Uses reciprocal technique for full low-frequency resolution
- 100 ns time interval, 10 ps T.I. averaging
- Oven option for increased accuracy

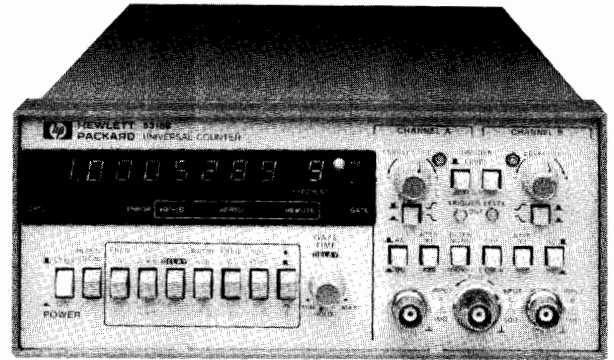

HP 5316B



## HP 5315A and HP 5316B Universal Counters

### A Quiet Revolution in Capability . . .

HP's economical HP 5315A and HP 5316B counters provide all the universal counter capability you've come to expect at much higher prices. That's because they use a unique custom circuit called the MRC (Multiple Register Counter) which packs counting and computing power into this popular counter series. To a user, the differences in operation from conventional direct models can be listed quickly: low frequency resolution is an outstanding 7 digits per second of gate time and reliability is extremely good due to the counter's low chip count. Also, the continuously adjustable gate time allows automatic selection of sample size for easy trade-offs between measurement time and resolution.

Much of the counter's performance is based on reciprocal counting techniques first pioneered in HP's high-performance HP 5360A computing counter, and the current HP 5345A Universal Counter. The use of these techniques coupled with HP's MRC and a microprocessor provides a quiet but powerful revolution in counter performance within the HP 5315A and HP 5316B. For example, this counter gives you its full 7-digits/second resolution over the range from 1 Hz to 100 MHz. This, simply stated, shows the power of the MRC and reciprocal counting.

### High Performance, Low Price

In addition to its economy, the MRC counter offers a full set of universal counter measurements, and there are very few limitations to this capability. Increased accuracy in low-cost portable and system counters is also available with the oven oscillator option through improved temperature stability and lower aging rates.

### Frequency to 100 MHz, C-Channel to 1.0 GHz

The MRC counter measures frequency to 100 MHz. Additionally the optional C-Channel measures to 1.0 GHz for both CW and pulsed RF signals as narrow as 60 ms. The C-Channel option is particularly useful in navigation and communications equipment testing due to this pulsed RF measurement feature.

### Time Interval to 100 ns, T.I. Averaging to 10 ps

The MRC counter provides three time measurement modes. Single-shot time interval allows measurements over a range of 100 ns to 100,000 seconds. This capability can be used to measure pulse width. Time interval averaging provides greater resolution for repetitive events. Finally, time interval delay avoids measurement of spurious signals by holding off the counter's trigger point by a precise, operator-selectable amount of time.

### A Full Set of Measurements

Besides the frequency and time functions mentioned above, the MRC counter has other measurement functions that make it a truly impressive value:

**Period A**—allows single period measurements via Channel A.

**Ratio A/B**—allows frequencies to 100 MHz into both Channel A and B.

**A By B**—totalizes the A input between 2 events on B channel.

**Totalize**—a manually gated totalize mode of operation.

### Input Signal Conditioning Versatility

A full complement of input signal conditioning controls are provided for both channels. These include  $\pm$  slope,  $\pm 2.5$  Vdc trigger level, and ac/dc coupling. Other controls are a Separate/Common switch, and a 100 kHz low-pass filter for Channel A.

### A Choice of Portable or System Models

**HP 5315A:** a portable, light-weight unit best suited for field applications. This unit has a convenient carrying handle and optional battery power is available for up to 4 hours continuous operation.

**HP 5316B:** this model possesses all the characteristics of the HP 5315A, and it has HP-IB capability built-in as standard equipment. It has low RFI, it is rackable, and it is functionally identical to the HP 5315A. In addition to programmable measurement functions, the user can also select dc trigger level and  $\pm$  slope under HP-IB control. Channel A and B trigger levels are brought out to the front panel on this unit for easy measurement with a DVM.



## HP 5315A, 5316B Condensed Specifications

### Input Characteristics (channel A and channel B)

**Range:** dc coupled, 0 to 100 MHz.

ac coupled, 30 Hz to 100 MHz.

**Sensitivity:** 10 mV rms sine wave to 10 MHz. 25 mV rms sine wave to 100 MHz. 75 mV peak-to-peak pulse at minimum pulse width of 5 ns.

Sensitivity can be varied continuously up to 500 mV rms *NOMINAL* by adjusting sensitivity control. In sensitivity mode, trigger level is automatically set to 0 V *NOMINAL*.

### Dynamic Range

30 mV to 5 V peak-to-peak, 0 to 10 MHz.

75 mV to 5 V peak-to-peak, 10 to 100 MHz.

**Coupling:** ac or dc, switchable.

**Filter:** low pass, switchable in or out of Channel A. 3 dB point of 100 kHz *NOMINALLY*.

**Impedance:** 1 MΩ *NOMINAL* shunted by less than 40 pF.

**Signal operating range:** +2.5 Vdc to -2.5 Vdc.

**Attenuator:** ×1 or ×20 *NOMINAL*.

**Trigger level:** variable between +2.5 Vdc and -2.5 Vdc.

**Slope:** independent selection of + or - slope.

**Common input:** all specifications are the same for Common A except the following:

**Sensitivity:** 20 mV rms sine wave to 10 MHz; 50 mV rms to 100 MHz; 150 mV peak-to-peak at a minimum pulse width of 5 ns.

**Dynamic range:** 60 mV to 5 V peak-to-peak to 10 MHz; 150 mV to 5 V peak-to-peak, 10-100 MHz.

**Impedance:** 500 kΩ *NOMINAL* shunted by less than 70 pF.

### Frequency (channel A)

**Range:** 0.1 Hz to 100 MHz.

**Resolution:** See Graph 1

**Accuracy:** ± Resolution ± Time Base Error (Graph 2)

### Period

**Range:** 10 ns to 10<sup>5</sup> s.

**Resolution:** See Graph 1

**Accuracy:** ± Resolution ± Time Base Error (Graph 2)

### Time Interval

**Range:** 100 ns to 10<sup>5</sup> s.

**LSD displayed:** 100 ns.

**Resolution:** ± LSD ± Noise Trigger Error (Graph 3)

**Accuracy:** ± Resolution ± Time Base Error (Graph 2)

### Time Interval Average

**Range:** 0 ns to 10<sup>5</sup> s.

**LSD displayed:** 100 ns/√N, 10 ps maximum.

**Number of intervals averaged (N):** N = Gate Time x FREQ.

**Minimum dead time (stop to start):** 200 ns.

**Resolution:** ±LSD ± [Noise Trigger Error (Graph 3)]/√N

**Accuracy:** ± Resolution ± Time Base Error (Graph 2) ± 4 ns

### Time Interval Delay (holdoff)

Front panel gate time knob inserts a variable delay of *NOMINALLY* 500 μs to 20 ms between START (Channel A) and enabling of STOP (Channel B). Electrical inputs during delay time are ignored. Delay time may be digitally measured by simultaneously pressing T.I. Averaging, T.I. Delay and blue key. Other specifications are identical to Time Interval

### Ratio

**Range:** 0.1 Hz to 100 MHz, both channels.

**LSD:** [(2.5 x Period A)/Gate Time] x Ratio.

### Totalize

#### Manual

Range: 0 to 100 MHz.

#### A gated by B

Totalizes input A between two events of B. Instrument must be reset to make new measurement. Gate opens on A slope, closes on B slope.

Range: 0 to 100 MHz.

### General

#### Standard Time Base

**Frequency:** 10 MHz.

**Aging rate:** < 3 × 10<sup>-7</sup>/mo.

**Temperature:** ± 5 × 10<sup>-6</sup>, 0° to 50°C.

**Line voltage:** < 1 × 10<sup>-7</sup> for a ± 10% variation.

**Check:** counts internal 10 MHz reference frequency.

**Error light:** LED warning light activated if logic error is found during instrument turn-on self-check.

**Display:** 8-digit LED display, with engineering units annunciator.

**Overflow:** only frequency and totalize measurements will overflow. In case of overflow, eight least significant digits will be displayed and front panel overflow LED will be actuated. All other measurements which would theoretically cause a display of more than 8 digits will result in the display of the 8 most significant digits.

**Gate time:** continuously variable, *NOMINALLY* from 60 ms to 10 s or 1 period of the input, whichever is longer.

**Sample rate:** up to 7 readings per second *NOMINALLY* except in time interval mode, where it is continuously variable *NOMINALLY* from 250 ms to 10 s via Gate Time Control.

**Operating temperature:** 0° to 50°C.

**Power requirements:** 100, 120, 220, 240 V (+5%, -10%) 48-66 Hz; 15 VA maximum or 30 VA maximum (HP 5316B).

**Weight:** net, 2.2 kg (4 lb 12 oz). Shipping, 4.1 kg (9 lb).

**Dimensions:** 238 mm W x 98 mm H x 276 mm D (9 3/8 in. x 3 10/16 in.).

### Additional HP 5316B Specifications

Rack and stack metal case with rear panel, switchable ac power line module, Specifications same as HP 5315A except as follows:

**Rack mount kit:** HP 5061-9672 recommended.

**Oscillator output:** 10 MHz, 50 mV p-p into 50 Ω load on rear panel.

**External frequency standard input:** 1, 5, 10 MHz, 1 V rms into 500 Ω, or rear panel.

**Trigger level output:** ±5%, ±15 mV, over ±2.0 Vdc range at front panel connectors.

**Dimensions:** 212 mm W x 88 mm H x 415 mm D (8 3/8 in. x 3 1/2 in. x 16 1/2 in.).

**Weight:** net, 3.7 kg (8 lb 2 oz). Shipping, 6.3 kg (14 lb).

### Hewlett-Packard Interface Bus

**Programmable functions:** Frequency A and C, Frequency A Armed by B, Period A, Totalize A Gated by B, Ratio A/B, Time Interval A→B, Time Interval Average A→B, Time Int. Delay, Read Gate Time.

**Programmable controls:** Gate Time Command which sets long (60 ms to 10 s) or short (500 μs to 30 ms) range; Trigger Level Commands which set Channel A and/or B slope (±) and Channel A and/or B trigger from - 2.50 Vdc to + 2.50 Vdc in steps of .01V.

**HP-IB Interface Functions:** SH1, AH1, T1, L2, SR1, RL1, PP0, DC1, DT1, C0, E1 (see page 556).

### Options

**Opt. 001:** High Stability Time Base (TCXO).

**Frequency:** 10 MHz.

**Aging rate:** < 1 × 10<sup>-7</sup>/mo.

**Temperature:** ± 1 × 10<sup>-6</sup>, 0° to 40°C.

**Line voltage:** < 1 × 10<sup>-8</sup> for ± 10% variation.

# ELECTRONIC COUNTERS

## Universal Counters (cont'd)

Models 5315A, 5316B

### Opt. 002: Battery (HP 5315A only).

**Type:** rechargeable lead-acid (sealed).

**Capacity:** TYPICALLY 4 hours of continuous operation at 25 °C.

**Recharging time:** TYPICALLY 16 hours to 98% of full charge, instrument non-operating. Charging circuitry included with Option. Batteries not charged during instrument operation.

**Low voltage indicator:** instrument turns itself off automatically when low battery condition exists. *Discharge* LED flashes slowly when this happens. *Discharge* LED is on whenever battery is supplying power to instrument. *Charge* LED indicates state of charge of battery during charging only and is on whenever battery is charged to 95% *NOMINAL* of capacity. *Charge* LED flashes when 90% *NOMINAL* of charge taken out is replaced. *Charge* LED is off if charge is less than 70% *NOMINAL* of capacity.

**Line failure protection:** instrument automatically switches to battery in case of line failure.

**Weight:** Opt 002 adds 1.4 kg (3 lb) to weight of instrument.

### Option 003: C Channel.

#### Input Characteristics

**Range:** 50 to 1000 MHz, prescaled by 10.

**Sensitivity:** 15 mV rms sinewave (-23.5 dBm) to 650 MHz. 75 mV rms sinewave (-9.5 dBm) to 1000 MHz. Sensitivity can be decreased continuously by up to 20 dB *NOMINAL*, 50 to 500 MHz and 10 dB *NOMINAL*, 500 to 1000 MHz by adjusting sensitivity control. Trigger level is fixed at 0 V *NOMINAL*.

**Dynamic range:** 15 mV to 1 V rms (36 dB), 50 to 650 MHz. 75 mV to 1 V rms (20 dB), 650 to 1000 MHz.

**Signal operating range:** +5 Vdc to -5 Vdc.

**Coupling:** ac.

**Impedance:** 50 Ω *NOMINAL* (VSWR, < 2.5:1 TYPICAL).

**Damage level:** ±8 V (dc + ac peak), fuse protected. Fuse located in BNC connector.

**Resolution and Accuracy:** same as Frequency A.

### Option 004: High Stability OVEN Time Base

(HP 5315A only).

**Frequency:** 10 MHz.

**Aging rate:**  $< 3 \times 10^{-8} / \text{mo}^*$ .

**Temperature:**  $\pm 1 \times 10^{-7}$ , 0° to 50°C.

**Line voltage:**  $< 1 \times 10^{-8}$ , for a 10% variation.

Oven will operate continuously off of a fully charged battery for > 24 hours, typically, when in standby mode (no power applied, instrument OFF, and Freq. A button depressed).

(HP 5316B)

**Frequency:** 10 MHz.

**Aging rate:**  $< 3 \times 10^{-8} / \text{mo}^{**}$ .

**Temperature:**  $\pm 2 \times 10^{-8}$ , 0° to 50°C.

**Line Voltage:**  $< 1 \times 10^{-9}$ , for a 10% variation.

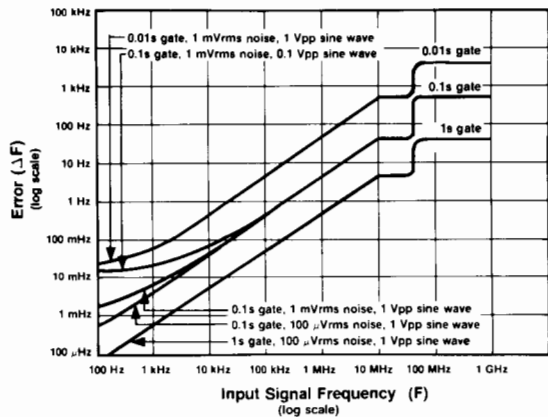

**Graph 1. Frequency Resolution Error:** Noise on the input signal and internal uncertainties affect Frequency and Period measurements. For Period, invert the period (P) of the input signal, and find frequency uncertainty ( $\Delta F$ ). Period uncertainty ( $\Delta P$ ) =  $(\Delta F / F) \times P$ .

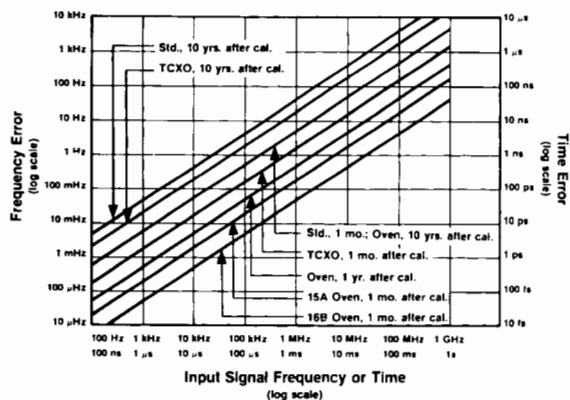

**Graph 2. Timebase Error:** Environment and aging of the crystal affects all measurements.

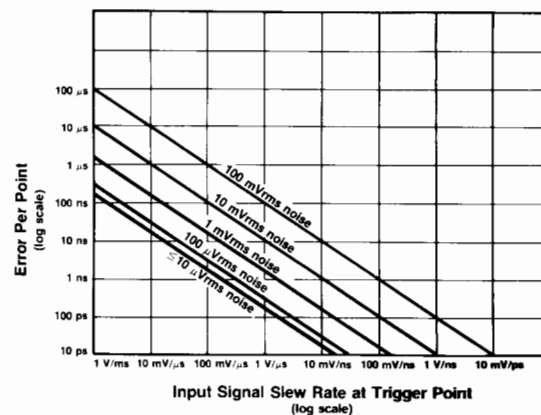

**Graph 3. Input Noise Trigger Error:** Noise on the input signal affects both the Start and Stop points of all Time Interval measurements.

\*After 30 days continuous operation (ac power applied, in OFF or ON position).

\*\*After 30 days continuous operation.  $< 5 \times 10^{-9} / \text{mo.}$ , after 7 days continuous operation.

### Ordering Information

HP 5315A Universal Counter

\$1250 ☎

HP 5316B Universal Counter

\$1475 ☎

		HP 5315A	HP 5316A	Price
Opt 001	TCXO Time Base	X	X	+ \$180
Opt 002	Battery Pack	X		+ \$300
Opt 003	C-Channel (1.0 GHz)	X	X	+ \$400
Opt 004	High Stability Time Base	X	X	+ \$600

All HP 5315A orders must include one (1) of these line power options:

Opt 100 90-105 VAC

N/C

Opt 120 108-126 VAC

N/C

Opt 220 198-231 VAC

N/C

Opt 240 216-252 VAC

N/C

# ELECTRONIC COUNTERS

Low Cost Universal

Model 5314A

207

- 100 MHz
- 100 ns time interval
- Portable

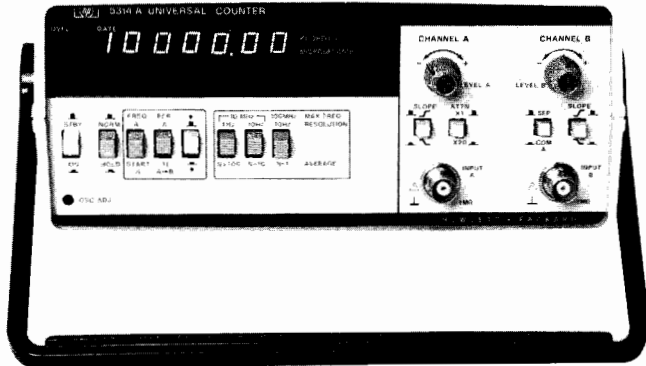

HP 5314A

## HP 5314A Universal Counter

The HP 5314A Universal Counter combines excellent performance and traditional HP quality at a very attractive price. This counter is designed to deliver reliable, high quality operation in such areas as: Production Test, Frequency Monitoring, Education, Training, Service and Calibration. Additionally, the optional battery (option 002) makes the HP 5314A especially attractive for field and portable applications.

### Input Characteristics (channels A and B)

**Range:** CHANNEL A: 10 Hz to 10 MHz Direct.  
1 MHz to 100 MHz Prescaled.  
CHANNEL B: 10 Hz to 2.5 MHz.

**Sensitivity:** CHANNEL A: 25 mV rms to 100 MHz.  
75 mV peak-to-peak at minimum pulse width of 5 ns (100 MHz range).  
CHANNEL B: 25 mV rms to 2.5 MHz.  
75 mV peak-to-peak at minimum pulse width of 200 ns.

**Coupling:** ac.

**Impedance:** 1 MΩ NOMINAL shunted by less than 30 pF.

**Attenuator:** ×1 or ×20 NOMINAL (A channel only).

**Trigger level:** continuously variable ± 350 mV times attenuator setting around average value of signal.

**Slope:** independent selection of + or - slope.

**Channel input:** selectable SEPARATE OR COMMON A.

**Dynamic range:** 75 mV p-p to 4 V p-p.

### Frequency

**Range:** 10 Hz to 10 MHz direct count.  
1 MHz to 100 MHz prescaled by 10.

**Least significant digit (LSD) displayed:** direct count 0.1 Hz, 1 Hz, 10 Hz switch selectable. Prescaled 10 Hz, 100 Hz, 1 kHz switch selectable.

**Resolution:** ± LSD.

**Accuracy:** ± LSD ± (time base error) x Freq.

### Period

**Range:** 10 Hz to 2.5 MHz.

**LSD displayed:**  $\frac{100 \text{ ns}}{N}$  for N=1 to 1000 in decade steps of N.

**Resolution:** ± LSD ±  $\frac{(1.4 \times \text{TRIGGER ERROR})}{N}$

**Accuracy:** ± LSD ±  $\frac{(1.4 \times \text{TRIGGER ERROR})}{N}$

± (time base error) x Period.

### Time Interval

**Range:** 250 ns to 1 s.

**LSD displayed:** 100 ns.

**Resolution:** ± LSD ± START trigger error ± STOP trigger error.

**Accuracy:** ± LSD ± START trigger error

± STOP trigger error ± (time base error) x TI.

External arming required for START/STOP channels.

### Ratio (A to B)

**Range:** 10 Hz to 10 MHz CHANNEL A.

10 Hz to 2.5 MHz CHANNEL B.

**LSD displayed:** 1/N in decade steps of N for N = 1 to 1000.

**Resolution:** ± LSD ± (B trigger error x Frequency A)/N.

**Accuracy:** ± LSD ± (B trigger error x Frequency A)/N.

### Totalize

**Range:** 10 Hz to 10 MHz.

**Resolution:** ± 1 count of input.

Totalize controlled by front panel switch.

### General

**Check:** counts internal 10 MHz oscillator.

**Display:** 7 digit amber LED display with gate and overflow indication.

**Max sample rate:** 5 readings per second.

**Operating temperature:** 0° to 50°C.

**Power requirement:** 115, +10%, -25%; 230 V, +9%, -17%; 48-66 Hz; 10 VA max.

**Weight:** 2.0 kg (4.4 lb).

**Dimension:** 238 mm W x 98 mm H x 276 mm D (9 $\frac{3}{8}$  in. x 3 $\frac{7}{8}$  in. x 10 $\frac{7}{8}$  in.).

### Time Base

**Frequency:** 10 MHz.

**Aging rate:** < 3 parts in 10<sup>7</sup> per month.

**Temperature:** < ± 1 part in 10<sup>5</sup>, 0 to 50°C.

**Line voltage:** < ± 1 part in 10<sup>7</sup> for ± 10% variation.

### Options

#### Option 001 TCXO

**Frequency:** 10 MHz.

**Aging rate:** < 1 part in 10<sup>7</sup> per month.

**Temperature:** < ± 1 part in 10<sup>6</sup>, 0 to 40°C.

**Line voltage:** < ± 1 part in 10<sup>8</sup> for ± 10% variation.

#### Option 002 Battery

**Type:** rechargeable lead-acid (sealed).

**Capacity:** typically 8 hours of continuous operation at 25 °C.

**Recharging time:** typically 16 hours to 98% of full charge, instrument non-operating. Charging circuitry included with option. Batteries not charged during instrument operation.

**Battery voltage sensor:** automatically shuts instrument off when low battery condition exists.

**Line failure protection:** instrument automatically switches to batteries in case of line failure.

**Weight:** Option 002 adds typically 1.5 kg (3.3 lb) to weight of instrument.

### Definitions

**Resolution:** smallest discernible change of measurement result due to a minimum change in the input.

**Accuracy:** deviation from the actual value as fixed by universally accepted standards of frequency and time.

**Trigger error:**

$$\frac{\sqrt{(80 \mu\text{V})^2 + e_n^2}}{\text{input slew rate at trigger point } (\mu\text{V/s})} \quad (\text{rms})$$

Where  $e_n$  is the RMS noise of the input for a 100 MHz bandwidth in CHANNEL A and 10 MHz bandwidth in CHANNEL B.

### Ordering Information

**HP 5314A** 100 MHz/100 ns Universal Counter

**Opt 001** High Stability Time Base

**Opt 002** Battery

All orders must include one (1) of these line power options:

**Opt 115** 86-127 V

**Opt 230** 190-250 V

☎ Fast-Ship product — see page 766.

### Price

**\$600** ☎

+ \$180

+ \$180

N/C

N/C

# POWER METERS

## Power Meter

### Model 436A

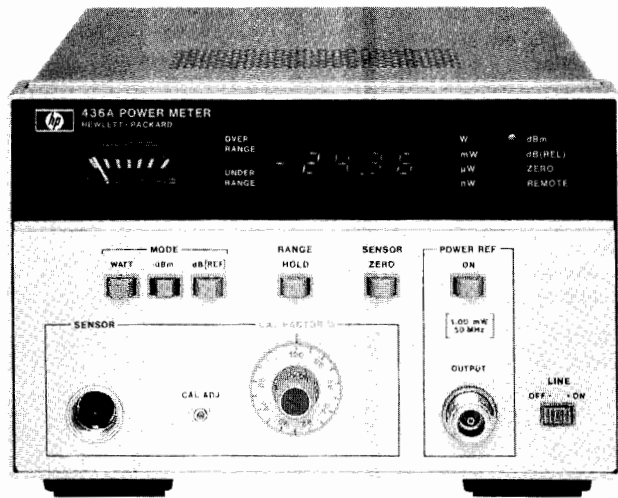

HP 436A



### HP 436A Power Meter

The HP 436A Power Meter is a general purpose digital power meter intended for manual and automatic RF and microwave power measurements. It is compatible with the entire series of HP 8480 Power Sensors. Depending on which power sensor is used, the HP 436A can measure power from  $-70$  dBm (100 pW) to  $+44$  dBm (25W) at frequencies up to 50 GHz.

The logically organized and uncluttered front panel, and the convenience of push-button operation and digital display make the HP 436A both easy to interpret and easy to use in any application. The auto ranging capability allows for "hands-off" operation.

The HP 436A measures either absolute or relative power. It displays absolute power in either watts or dBm, and relative power in dB.

The HP 436A Power Meter also features optional programmability; the Hewlett-Packard Interface Bus (HP-IB) interface is available. This interface allows full remote control of all power meter functions (CAL function can be programmed to either 100 percent or the CAL factor which has been manually set on the front panel). This option may be added by the user at a later time.

### HP 436A Specifications

**Frequency range:** 100 kHz to 50 GHz, sensor dependent.

**Power Range** (display calibrated in watts, dBm, and dB relative to reference power level).  $-70$  to  $+44$  dBm (100 pW to 25W), sensor dependent.

#### Average Power Measurements

At microwave frequencies, power is the best measure of signal amplitude because, unlike voltage and current, power remains constant along a lossless transmission line. For this reason, power meters are almost indispensable for microwave measurements. Typical applications include monitoring transmitter power levels, calibrating signal generators, leveling signal sources, and measuring transmission characteristics of unknown devices.

To satisfy the requirements of this broad range of applications Hewlett-Packard has developed a family of general purpose microwave power meters and power sensors. The power sensors use a diode, thermocouple, or thermistor as the power sensing element, and it is important to understand the merits of each of these sensors before choosing a particular power meter.

#### Power Meters and Sensors

Hewlett-Packard makes six average-reading power meters. The HP 438A is a dual channel power meter designed for ATE systems applications. The 435B, 436A and 437B are analog and digital meters, which are designed to operate with HP's line of

#### Accuracy

##### Instrumentation

**Watt mode:**  $\pm 0.5\%$ .

**dBm mode:**  $\pm 0.02$  dB  $\pm 0.001$  dB/°C.

**dB (REL) mode<sup>1</sup>:**  $\pm 0.02$  dB  $\pm 0.001$  dB/°C.

**Zero:** automatic, operated by a front-panel switch.

**Zero set:**  $\pm 0.5\%$  of full scale on most sensitive range, typical;  $\pm 1$  count on other ranges.

**Zero carry over:**  $\pm 0.2\%$  of full scale when zeroed on the most sensitive range.

**Power reference:** internal 50 MHz oscillator with Type N female connector on front panel (or rear panel, Option 003 only).

**Power output:** 1.0 mW. Factory set to  $\pm 0.7\%$  traceable to the National Bureau of Standards.

**Accuracy:**  $\pm 1.2\%$  worst case ( $\pm 0.9\%$  rss) for one year.

#### Supplemental Characteristics

**Recorder output:** linearly proportional to indicated power with 1 volt corresponding to full scale and 0.316 volts to  $-5$  dB; 1 k $\Omega$  output impedance, BNC connector.

**Power consumption:** 100, 120, 220, or 240 V ( $+5\%$ ,  $-10\%$ ), 48 to 66 Hz, and 360 to 440 Hz;  $<20$  V  $\cdot$  A ( $<23$  V  $\cdot$  A with option 022).

**HP-IB Function codes:** AH1, C0, DC2, DT0, LE0, PP0, RL2, SH1, SR0, T3, TE0. (For more on these codes refer to the HP-IB section in this catalog.)

**Weight:** net, 4.5 kg (10 lb). Shipping, 5.5 kg (12 lb).

**Size:** 134 H x 213 W x 279 mm D (5.2" x 8.4" x 11.0").

#### Accessories

**Furnished:** HP 11730A, 1.5 m (5 ft) cable for power sensor; 2.3 m (7.5 ft) power cable. Mains plug shipped to match destination requirements.

**Available:** To select non-standard lengths for power sensor cables, select option 004 (delete sensor cables) and order as required from HP 11730A-F, power sensor cables. Lengths are available from 1.5 metres (5 ft) to 61 metres (200 ft). To rack mount one HP 436A by itself, order **HP 5061-9657** Rack Mount Adapter Kit.

#### Ordering Information

	Price
HP 436A Power Meter	\$2900
Option 003: Reference oscillator output on rear panel only.	no charge
Option 004: Delete power sensor cable	Less \$75
Option 022: Digital input/output, fully compatible with HP Interface Bus (HP-IB)	Add \$500
Option 908: Kit for rack mounting one HP 436A	\$35
Option 910: Extra operating and service manual	Add \$25
Option W30: Two additional years of return-to-HP warranty	Add \$60

Fast-ship product - see page 766 of 88 catalog.

<sup>1</sup> Specifications are for within range measurements. For range-to-range accuracy add another  $\pm 0.02$  dB.

thermocouple and diode power sensors. The HP 432 power meters are designed to operate with HP's line of thermistor mounts: the HP 432A is an analog power meter, and the HP 432B is digital with BCD output.

Thermocouple power sensors are generally preferred for measuring power because they exhibit lower SWR and wider dynamic range than previously used thermistor elements. Low SWR is directly responsible for superior accuracy since mismatch errors are lower.

#### Literature

**Application Note 64-1, Fundamentals of RF and Microwave Power Measurements**, deals with the general theory of microwave power measurements. It covers the basic principals of measurement, calculation of measurement uncertainty, traceability, etc.

**Application Note 64-2, Extended Applications of Automatic Power Meters**, discusses an automatic power meter system for measuring attenuation, gain saturation and the calibration factor of power sensors.

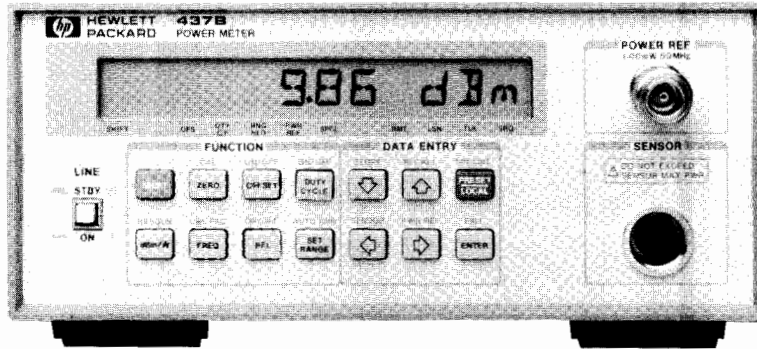

HP 437B



### HP 437B Power Meter

The HP 437B is a low-cost, high performance, single-channel, programmable, average Power Meter compatible with the HP 8480 family of thermocouple and diode power sensors. Depending on which Power Sensor is used, the HP 437B can measure from  $-70$  dBm (100pW) to  $+44$  dBm (25W) at frequencies ranging from 100 KHz to 50 GHz.

Designed for ATE systems and demanding benchtop measurements, the HP 437B Power Meter makes fast, accurate and reliable average power measurements. Only  $3\frac{1}{2}$  inches high and half rack wide, the HP 437B minimizes the use of critical rack space in ATE systems. The advanced plastics technology used in the HP 437B cabinet combines the light weight of plastic with the shielding effectiveness of metal, making the HP 437B the only power meter to meet MIL-STD-461C EMI specifications.

A modern and flexible feature set makes this meter easy to use in any application:

- Automatic calibration and zeroing.
- Frequency entry instead of Cal Factor.
- Ten pre-loaded sensor Cal Factor versus frequency tables.
- Selectable resolution to 0.001 dB.
- Offset entry in dB.
- Duty cycle entry for a convenient peak power representation of the measured average power.
- Ten store/recall registers.
- HP-IB is standard.

With a measurement speed twice as fast as that of the industry-standard HP 436A, powerful programming capability, state-of-the-art accuracy and exceptional reliability, the HP 437B lets you measure your test signal with speed, precision and confidence.

### HP 437B Specifications:

**Frequency Range:** 100 kHz to 50 GHz, sensor dependent.  
**Power Range:**  $-70$  to  $+44$  dBm (100pW to 25W), sensor dependent.  
**Power Sensors:** Compatible with all HP 8480 series Power Sensors.  
**Dynamic Range:** 50 dB in 10 dB steps.  
**Display Units:** Absolute: Watts, dBm.  
 Relative: percent, dB.  
**Resolution:** Selectable resolution of 0.1, 0.01 and 0.001 dB in logarithmic mode; or 1%, 0.1% and 0.01% of full scale in linear mode.

### Accuracy

**Instrumentation:**  $\pm 0.02$  dB or  $\pm 0.5\%$ .  
**In REL mode:**  $\pm 0.02$  dB or  $\pm 0.5\%$  within measurement range;  $\pm 0.04$  dB or 1% outside measurement range.  
**Zero Set:**  $\pm 0.5\%$  of full scale on most sensitive range.  
**EMI:** Radiated and Conducted Emissions and Radiated and Conducted Susceptibility are within the requirements of RE02, CE03, RS01/03 and CS01/03 called out in MIL-STD-461C, and within the requirements of VDE 0871 and CISPR Publication 11.

### Power Reference

**Power Output:** 1.00mW, Factory set to  $\pm 0.7\%$  traceable to US National Bureau of Standards.

**Accuracy:**  $\pm 1.2\%$  worst case ( $\pm 0.9\%$  RSS) for one year.

### General

**Rear Panel Output:** Analog 0-1 volt without digital filtering or Cal Factor correction, 1 kohm output impedance, BNC connector.

**Line Voltage:** 100 and 120 Vac,  $+5\%$ - $10\%$ , 48-66 Hz, 360-440 Hz; 220 and 240 Vac,  $+5\%$ - $10\%$ , 48-66 Hz.

**Power Requirement:** 8 Watts maximum (10 VA max).

**Weight:** Net 2.6 kg (5.9 lbs); shipping 4.5 kg (10 lbs).

**HP-IB Codes:** SH1, AH1, T5, TE0, L4, LE0, SR1, RL1, PP1, DC1, DT1, C0.

**Dimensions:** 88m H x 212mm W x 273mm D (3.46" H x 8.35" W x 10.75" D).

### Accessories

**Furnished:** HP 11730A, 1.5m (5 ft.) cable for power sensors; 2.4m (7.5 ft.) power cable. Main plug shipped to match destination requirements.

**Available:** To select non-standard lengths for power sensor cable, select Option 004 (delete power sensor cable provided) and order as required from HP 11730A-F power sensor cables (see page 210). Lengths are available from 1.5 meters (5 ft.) to 61 meters (200 ft.). To rack mount one HP 437B order part number 5060-0174.

### HP 70100A Power Meter Module (Modular Measurement System)

The HP 70100A is a full-feature single channel power meter module for the Modular Measurement System (see page 122). It has all the capability of the HP 437B Power Meter in an 1/8th rack-width module. The HP 70100A features the same modern and flexible feature set as the HP 437B, the same state-of-the-art accuracy and is also fully compatible with the HP 8480 series of power sensors.

### Ordering Information

	<b>Price</b>
HP 437B Power Meter	\$2500
Option 002: Supplies a parallel rear panel sensor input	+\$75
Option 003: Supplies a parallel rear panel sensor input and moves reference oscillator to rear panel	+\$75
Option 004: Delete the HP 11730A sensor cable provided	-\$75
Option 401: Provides side-carrying handle and standoff feet	+\$25
Option 915: Service Manual	+\$25
Option 916: Extra Operating Manual	+\$25
Option W30: Two additional years of return-to-HP warranty	+\$50
HP 70100A Power Meter Module	\$2500
Option 001: Moves reference oscillator from front to rear panel	\$0
☎ Fast-ship product - see page 766	



# POWER METERS

## Power Meter

### Model HP 438A

- Ideal for ATE applications
- Dual power sensors
- Innovative ratio & difference measurements



HP 438A

DESIGNED FOR  
MATE  
SYSTEMS



The HP 438A Power Meter is a dual channel power meter designed specifically for ATE systems. The compact front panel is designed to save space in rack mounted systems, while the dual channel design allows simple measurements of the ratio and difference of power levels from two separate sensors. Compatible with the HP 8480 series of thermocouple and diode sensors, the power and frequency range of the meter extends from  $-70$  dBm to 44 dBm and from 100 kHz to 50 GHz.

Important measurement contributions are a programmable digital filter for optimizing resolution and measurement speed, independent offset (in dB) values for each channel, 0.001 dB resolution available, and a power difference mode for displaying absorbed power in transmission lines. Up to 19 different operating states of the meter can be stored into non-volatile memory for later recall.

The programmable digital averaging filter gives the user control over the inherent tradeoff between speed and accuracy. The AUTO filter mode is usually adequate for fully settled readings with 0.01 dB resolution. Less digital averaging leads to faster but noisier readings, if speed is the critical issue.

The Hewlett-Packard Interface Bus (HP-IB) capability is standard on the HP 438A with programming codes printed on the front panel for easy reference. For U.S. Air Force MATE (Modular Automatic Test Equipment) system applications, Option 700 provides the HP 438A with the internal capability to be controlled by the MATE language CIIL (Control Interface Intermediate Language). All measurement modes are programmable including zeroing, calibration, and Cal Factor. Complete interrupt capability with flexible SRQ operation optimizes the efficiency of program execution in automatic systems.

#### HP 438A Specifications

**Frequency range:** 100 kHz to 50 GHz (depending on power sensor used).

**Power range:**  $-70$  dBm to  $+44$  dBm (100 pW to 25 W), sensor dependent. Uses HP 8480 series power sensors; see sensor specs for details.

**Operating temperature range:** 0  $-55^{\circ}$ C.

#### Instrumentation Accuracy

**Single channel, linear mode:**  $\pm 0.5\%$ .

**Log mode:**  $\pm 0.02$  dB.

**Dual channel, linear mode:**  $\pm 1\%$ .

**Log mode:**  $\pm 0.04$  dB.

**Zeroing:** automatic,  $\pm 0.5\%$  full scale on most sensitive range.

#### Power Reference

**Power output:** 1.00 mW. Factory set to  $\pm 0.7\%$ , traceable to the U.S. National Bureau of Standards.

**Accuracy:**  $\pm 1.2\%$  worst case ( $\pm 0.9\%$  rss) for 1 year.

**Connector:** front panel type N female (also on rear panel, Opt 002).

#### Meter Adjustments

**Cal factor:** values from 1% to 150% in 0.1% steps can be entered to account for sensor frequency response. Sensor calibration: automatic self calibration to 1.00 mW.

#### General

**Display:** four digit display (five digits in high resolution mode) with 20% over-range capability on all ranges. Annunciators to indicate measurement mode, Cal Factor, offset value, fixed or automatic range and filter values, and error conditions.

**Recorder output:** linearly proportional to power in watts. One volt corresponds to full scale;  $1k\Omega$  output impedance, BNC rear panel female connector.

**Line voltage:** 100, 120, 220 or 240 Vac  $+5\%$   $-10\%$ . 100 and 120 volts, 48 to 66 Hz and 300 to 440 Hz. 220 and 240 volts, 48 to 66 Hz only.

**Power requirements:** 65 VA, 35 watts, maximum.

**Weight:** net, 5.9 kg (13 lb). Shipping, 9.1 kg (20 lb).

**Dimensions:** 89 mmH x 213 mmW x 418 mmD (3.5 x 8.4 x 16.8 in).

**HP-IB interface codes:** SH1, AH1, T5, TE0, L4, LE0, SR1, RL1, PP1, DC1, DT1, C0.

#### Accessories

**Furnished:** HP 11730A, 2 each, 1.5 metre (5 ft) power sensor cables. Power cable, 1 each, 2.4 metres (7.5 ft). Mains plug matches destination requirements.

**Available:** To select non-standard lengths for power sensor cables, select option 004 (delete sensor cables) and order as required from HP 11730A-F, power sensor cables. Lengths are available from 1.5 metres (5 ft) to 61 metres (200 ft).

#### HP 11730A-F Power Sensor Cables

The HP 11730 series power sensor cables are for use with the HP 435B, 436A, 437B and 438A power meters and the HP 8480 series thermocouple and diode power sensors. These cables are designed to reduce RFI effects on low power readings with an improved shielding design in the cable itself. Cables may be ordered individually or in pairs in any combination desired for single and dual channel measurements.

The HP 11730A cable is the standard cable for the HP 435B, 436A, 437B and 438A (2 cables shipped) meters. To order a non-standard cable, select Option 004 for the meter in question, and order the desired cable from below.

#### Ordering Information

	Price
HP 438A Dual Channel Power Meter	\$5,100 ☎
Option 002: Rear panel sensor connectors (in parallel with front panel) and additional reference oscillator with rear panel output.	+\$325
Option 700: Internal MATE programming	+1000
Option 004: Delete power sensor cables	-\$150
Option 910: Additional manual	\$25
Option W30: Two additional years of return-to-HP warranty	+\$100
HP 11730A 1.5 metre (5 ft) sensor cable	\$85 ☎
HP 11730B 3.0 metre (10 ft) sensor cable	\$95 ☎
HP 11730C 6.1 metre (20 ft) sensor cable	\$130 ☎
HP 11730D 15.2 metre (50 ft) sensor cable	\$190 ☎
HP 11730E 30.5 metre (100 ft) sensor cable	\$250 ☎
HP 11730F 61.0 metre (200 ft) sensor cable	\$400 ☎

☎ Fast-ship product—see page 766.

# POWER METERS

## Power Meter, Range Calibrator

Models 435B, 11683A

211

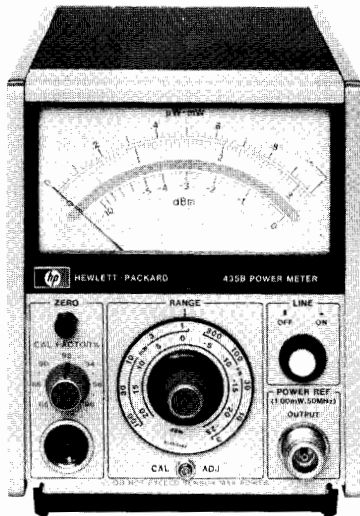

HP 435B

### HP 435B Power Meter

The HP 435B Power Meter is an analog power meter, compatible with the entire series of HP 8480 Power Sensors. Depending on which sensor is used, the HP 435B can measure power from  $-65$  dBm to  $+44$  dBm, full scale, at frequencies from 100 kHz to 50 GHz. This versatile instrument also features  $<1\%$  instrumentation uncertainty, low noise and drift, auto-zero, recorder output, optional battery operation, and long cable options up to 61 m (200 ft).

### HP 11683A Range Calibrator

The HP 11683A Calibrator is specifically designed for use with the HP 435B, 436A, 437B and 438A Power Meters. It allows verification of full-scale meter readings on all ranges, as well as meter tracking. Simply connect the cable between the power meter and calibrator. The CAL ADJ control on the power meter is used to set the meter to full scale on the 1 mW range. The calibrator and meter are then stepped through the other ranges verifying accuracy within  $\pm 1\%$  plus noise and drift. The HP 11683A also has a polarity switch which tests the Auto-Zero circuit.

### HP 435B Specifications

**Frequency range:** 100 kHz to 50 GHz (depending on power sensor used).

**Temperature range:** 0  $-55^{\circ}\text{C}$ .

**Power Range** (calibrated in watts and dB in 5 dB steps).

With HP 8481A, 8482A, 8483A, 8485A, R8486A, Q8486A:  $-25$  dBm ( $3 \mu\text{W}$ ) to  $+20$  dBm (100 mW) full scale.

With HP 8481B or 8482B:  $+5$  dBm ( $3 \text{ mW}$ ) to  $+44$  dBm (25 W) full scale.

With HP 8481H or 8482H:  $-5$  dBm ( $0.3 \text{ mW}$ ) to  $+35$  dBm (3 W) full scale.

With HP 8484A:  $-65$  dBm ( $300 \mu\text{W}$ ) to  $-20$  dBm ( $10 \mu\text{W}$ ) full scale.

### Accuracy

**Instrumentation:**  $\pm 1\%$  of full scale on all ranges.

**Zero:** automatic, operated by front-panel switch.

**Zero set:**  $\pm 0.5\%$  of full scale on most sensitive range, typical.

**Zero carryover:**  $\pm 0.5\%$  of full scale when zeroed on the most sensitive range.

**Power reference:** internal 50 MHz oscillator with Type N female connector on front panel (or rear panel, Option 003 only).

**Power output:** 1.00 mW. Factory set to  $\pm 0.7\%$  traceable to the National Bureau of Standards.

**Accuracy:**  $\pm 1.2\%$  worst case ( $\pm 0.9\%$  rss) for one year.

### Supplemental Characteristics

**Noise** (typical, at constant temperature, peak change over any one-minute interval): 20 pW (HP 8484A, R8486D, Q8486D); 40 nW (HP 8481A, 8482A, 8483A, 8485A, R8486A, Q8486A, 8487A); 40  $\mu\text{W}$  (HP 8481B, 8482B); 4  $\mu\text{W}$  (HP 8481H, 8482H).

**Drift** (1 hour, typical, at constant temperature after 24-hour warm-up): 40 pW (HP 8484A, R8486D, Q8486D); 15 nW (HP 8481A, 8482A, 8483A, 8485A, R8486A, Q8486A, 8487A); 15  $\mu\text{W}$  (HP 8481B, 8482B); 1.5  $\mu\text{W}$  (HP 8481H, 8482H).



HP 11683A

### Response Time (typical, measured at recorder output, 0 to 99% of reading):

Range 1 (most sensitive range)	$<10.0$ seconds
Range 2	$<3.8$ seconds
Range 3	$<1.3$ seconds
Ranges 4 to 5	$<500$ milliseconds.

**Cal factor:** 16-position switch normalizes meter reading to account for calibration factor; range 85% to 100% in 1% steps.

**Recorder output:** linearly proportional to indicated power with 1 volt corresponding to full scale; 1 k $\Omega$  output impedance, BNC connector.

**RF blanking output:** provides a contact closure to ground. Used for turning off RF input to sensor during auto-zeroing. BNC connector.

**Cal adj:** front-panel adjustment provides capability to adjust gain of meter to match power sensor in use.

**Power consumption:** 110 or 120 V ( $+5\%$ ,  $-10\%$ ), 48 to 66 Hz and 360 to 440 Hz; also 220 or 240 V ( $+5\%$ ,  $-10\%$ ), 48 to 66 Hz only:  $<20\text{V} \cdot \text{A}$ .

**Weight:** net, 2.7 kg (5.9 lb). Shipping, 4.2 kg (9.2 lb).

**Size:** 155 H x 130 W x 279 mm D (6.3" x 5.1" x 11").

### Accessories

**Furnished:** HP 11730A, 1.52 m (5 ft) cable for the power sensor; 2.3 m (7.5 ft) power cable (mains plug shipped to match destination requirements).

**Available** (See page 210).

To select non-standard lengths for power sensor cables, select option 004 (delete sensor cables) and order as required from HP 11730A-F, power sensor cables. Lengths are available from 1.5 metres (5 ft) to 61 metres (200 ft).

**HP 11076A:** Carrying case.

**HP 5060-8762:** Rack adapter frame (holds three instruments the size of the HP 435B).

**Combining Cases** (See page 752).

**HP 1051A:** 286 mm (11.25 in.) deep.

**HP 1052A:** 416 mm (16.4 in.) deep.

These combining cases accept  $1/3$ -module Hewlett-Packard instruments for bench use or rack mounting.

### HP 11683A Range Calibrator

**Calibration functions:** outputs corresponding to meter readings of 3, 10, 30, 100 and 300  $\mu\text{W}$ ; 1, 3, 10, 30, and 100 mW.

**Calibration uncertainty:**  $\pm 0.25\%$  in all ranges.

**Power:** 100, 120, 220, or 240 Vac  $+5\%$ ,  $-10\%$ , 48–440 Hz, less than 10 V  $\cdot$  A.

**Weight:** net, 1.13 kg (2.5 lb). Shipping, 1.9 kg (4.2 lb).

**Size:** 89 H x 133 W x 216 mm D (3.5" x 5.25" x 8.5").

### Ordering Information

HP 11683A Range Calibrator

**Price**

\$900

HP 435B Power Meter

\$1500

### HP 435B Options

**001:** Rechargeable battery installed provides up to 16 hours of continuous operation +\$100

**002:** Input connector placed on rear panel in parallel with front +\$25

**003:** Parallel sensor inputs front and rear panels, reference oscillator output on rear panel. +\$25

**004:** Delete power sensor cable -\$75

**910:** Extra operating and service manual +\$7.50

**W30:** Two additional years of return-to-HP warranty +\$50

**☎** Fast-Ship product—see page 766.

# POWER METERS

## Power Sensors

Models 8481A/B, 8481H, 8482A/B, 8482H, 8483A, 8484A, 8485A/D, R/Q 8486A/D, 8487A, 11708A

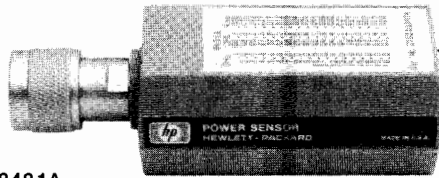

HP 8481A

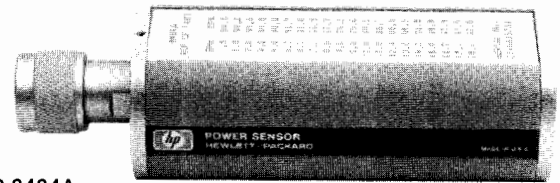

HP 8484A

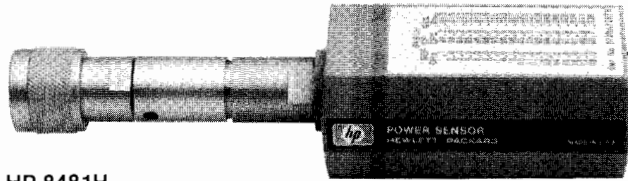

HP 8481H

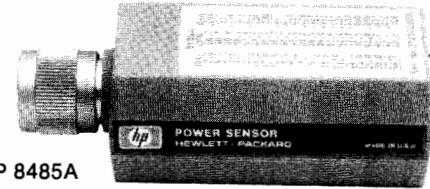

HP 8485A

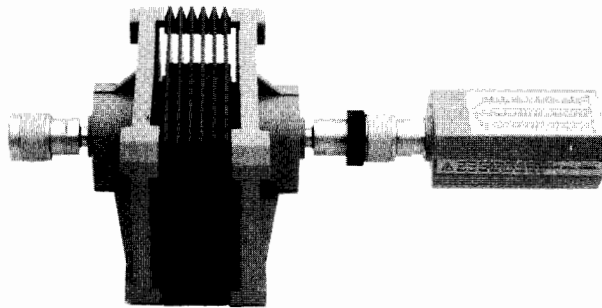

HP 8481B

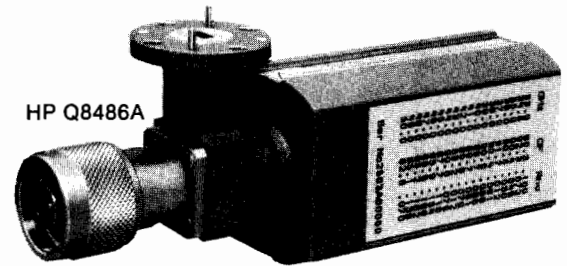

HP Q8486A

### HP 8480 Series Power Sensors

The HP 8480 series of Power Sensors have been designed for use with the HP 435B, 436A, 437B and 438A Power Meters. They feature wide frequency and power ranges in addition to very low SWR.

The power measurement range of these sensors is from 0.1 nW to 25 watts. With just three sensors a power measurement range of 114 dB can be achieved.

#### Wide Frequency Range for Many Applications

Power measurements can be made over a frequency range of 100 kHz to 50 GHz. The seven frequency ranges covered with these units are 10 MHz to 18 GHz, 100 kHz to 4.2 GHz, and 50 MHz to 26.5 GHz, in 50  $\Omega$  sensors and 100 kHz to 2 GHz, with the 75-ohm sensor, and 26.5 to 40 GHz and 33 to 50 GHz in Waveguide. The HP 8487A covers the entire 50 MHz to 50 GHz frequency range.

#### Low SWR for Low Measurement Uncertainty

The HP 8481/82/83/85A/86A/87 series of sensors use a silicon monolithic thermocouple as the sensing element. The small physical size of the thermocouple enables the sensors to have a very low SWR even at 50 GHz. A low SWR reduces mismatch uncertainty error, typically the largest single source of error in power measurements. The HP 8484A, 8485D and R/Q8486D sensors use a diode detector for higher sensitivity and low SWR.

#### Individually Calibrated for More Confidence in Results

Each sensor is individually calibrated, traceable to the National Bureau of Standards. A control on the meter compensates for power sensor Cal Factor at any frequency. A precise automatic network analyzer printout for Cal Factor and reflection coefficient is supplied with all the sensors. This means you can significantly reduce mismatch uncertainty by calculating the mismatch error.

### High Power Sensors to 25 Watts

The HP 8481B and 8482B High Power Sensors both have a power range of 1 mW to 25 watts. The HP 8481B covers a frequency range of 10 MHz to 18 GHz and the HP 8482B has a frequency range of 100 kHz to 4.2 GHz.

Previous methods of measuring high power levels usually required adding a separate attenuator in front of a low power sensor. With the HP 8481/82B power sensors, the attenuator and sensor are combined into one unit. This reduces mismatch uncertainty error and improves accuracy by including the attenuator in the measured Calibration Factor curves. In addition, light-weight, heat-dissipating fins on the attenuator prevent burns.

### Medium Power Sensors to 3 Watts

The HP 8481H measures power from 100  $\mu$ W to 3 watts over a frequency range of 10 MHz to 18 GHz. The HP 8482H measures power from 10  $\mu$ W to 3 watts over a frequency range of 100 kHz to 4.2 GHz.

### Standard Sensors to 100 mW

The HP 8481A, 8482A, 8483A, 8485A and 8487A Power Sensors all measure power over a range of 1  $\mu$ W to 100 mW. The HP 8481A is a 50-ohm sensor with a frequency range of 10 MHz to 18 GHz. The HP 8482A is a 50-ohm sensor with a frequency range of 100 kHz to 4.2 GHz. The HP 8485A is a 50-ohm sensor with a frequency range of 50 MHz to 26.5 GHz. The HP 8483A is a 75-ohm sensor and covers a frequency range of 100 kHz to 2 GHz. The HP 8487A covers the entire 50 MHz to 50 GHz frequency range using a single 2.4-mm input connector.

### High Sensitivity Sensors

The HP 8484A and HP 8485D measure power from 0.1 nW to 10  $\mu$ W over a frequency range of 10 MHz to 18 GHz and 50 MHz to 26.5 GHz respectively. They are furnished with the HP 11708A 50 MHz reference attenuator for precise calibration with 1 mW power meter reference oscillator. Noise and drift have been reduced to less than 5% of full scale on the 300 pW range (only 15 pW) when it is used with the HP 435B power meter. Noise and drift are even less with the HP 436A, 437B and 438A power meters.

### Millimeter-Wave Power Sensors

The HP R8486A and Q8486A Thermocouple Waveguide Power Sensors measure true, average power from 1  $\mu$ W to 100 mW over the frequency ranges of 26.5 to 40 GHz (R-band) and 33 to 50 GHz (Q-band). The HP R8486D and Q8486D diode Waveguide Power Sensors measure true average power from 100pW to 10  $\mu$ W over the same frequency bands.

**HP 8480 Series Specifications**

HP Model (Nominal Impedance)	Frequency Range	Power Range	Maximum Power	Power Linearity <sup>2</sup>	Maximum SWR (Reflection Coefficient)	Size mm (in.)	RF Connector	Price
						Shipping Weight kg (lb)		
8481A (50 Ω)	10 MHz-18 GHz	1 μW to 100 mW	300 mW avg. 15 W peak 30 W • μs (per pulse)	+10 to +20 dBm +2, -4%	10 MHz - 30 MHz: 1.40 (0.166) 30 MHz - 50 MHz: 1.18 (0.083) 50 MHz - 2 GHz: 1.10 (0.048) 2 - 12.4 GHz: 1.18 (0.083) 12.4 - 18 GHz: 1.28 (0.123)	30 x 38 x 105 (1.2 x 1.5 x 4.1)	N(m)	\$650
Option 001						0.5 (1)		
8481B (50 Ω)	10 MHz-18 GHz	1 mW to 25W	0-35°C: 1 30 W avg. 35°C-55°C: 25 W avg.	+35 to +44 dBm ±4%	10 MHz - 2 GHz: 1.10 (0.048) 2-12.4 GHz: 1.18 (0.083) 12.4-18 GHz: 1.28 (0.123)	83 x 114 x 248 (3.25 x 4.5 x 9.75)	N(m)	\$1500
			10 MHz-5.8 GHz 500 W peak 5.8-18 GHz 125 W peak			1.5 (3.2)		
			500 W • μs (per pulse)					
8481H (50 Ω)	10 MHz-18 GHz	100 μW to 3W	3.5 W avg. 100 W peak 100W • μs (per pulse)	+25 to +35 dBm ±5%	10 MHz - 8 GHz: 1.20 (0.091) 8-12.4 GHz: 1.25 (0.110) 12.4 - 18 GHz: 1.30 (0.130)	30 x 38 x 149 (1.2 x 1.5 x 5.9)	N(m)	\$825
						0.5 (1)		
8482A (50 Ω)	100 kHz-4.2 GHz	1.0 μW to 100 mW	300 mW avg. 15 W peak 30 W • μs (per pulse)	+10 to +20 dBm +2, -4%	100-300 kHz: 1.60 (0.231) 300 kHz - 1 MHz: 1.20 (0.091) 1 MHz - 2 GHz: 1.10 (0.048) 2-4.2 GHz: 1.30 (0.130)	30 x 38 x 105 (1.2 x 1.5 x 4.1)	N(m)	\$650
						0.5 (1)		
8482B (50 Ω)	100 kHz-4.2 GHz	1 mW to 25W	0-35°C: 1 30 W avg. 35°C-55°C: 25 W avg.	+35 to +44 dBm ±4%	100 kHz - 2 GHz: 1.10 (0.048) 2 GHz - 4.2 GHz: 1.18 (0.083)	83 x 114 x 248 (3.2 x 4.5 x 9.7)	N(m)	\$1440
			500 W peak			1.5 (3.2)		
			500 W • μs (per pulse)					
8482H (50 Ω)	100 kHz-4.2 GHz	100 μW to 3W	3.5 W avg. 100 W peak 100 W • μs (per pulse)	+25 to +35 dBm ±5%	100 kHz-4.2 GHz: 1.20 (0.091)	30 x 38 x 149 (1.2 x 1.5 x 5.9)	N(m)	\$800
						0.5 (1)		
8483A <sup>3</sup> (75 Ω)	100 kHz-2 GHz	1.0 μW to 100 mW	300 mW avg. 10 W peak 30 W • μs (per pulse)	+10 to +20 dBm +2, -4%	100-600 kHz: 1.80 (0.286) 600 kHz - 2 GHz: 1.18 (0.083)	30 x 38 x 105 (1.2 x 1.5 x 4.1)	N(m) 75 Ω	\$650
						0.5 (1)		
8484A <sup>4</sup> (50 Ω)	10 MHz-18 GHz	0.1 nW to 10 μW	200 mW avg. 200 mW peak	-30 to -20 dBm ±1%	10-30 MHz: 1.40 (0.166) 30 MHz - 4 GHz: 1.15 (0.070) 4-10 GHz: 1.20 (0.091) 10-15 GHz: 1.30 (0.130) 15-18 GHz: 1.35 (0.149)	36 x 44 x 133 (1.4 x 1.7 x 5.2)	N(m)	\$900
						0.5 (1)		
8485A (50 Ω)	50 MHz-26.5 GHz	1 μW to 100 mW	300 mW avg. 15 W peak 30 W • μs (per pulse)	+10 to +20 dBm +2, -4%	50 MHz-100 MHz: 1.15 (0.070) 100 MHz-2 GHz: 1.10 (0.048) 2-12.4 GHz: 1.15 (0.070) 12.4-18 GHz: 1.20 (0.091) 18-26.5 GHz: 1.25 (0.111)	30 x 38 x 95 (1.2 x 1.5 x 3.7)	APC-3.5(m)	\$950
						0.5 (1)		
8485D <sup>4</sup> (50 Ω)	50MHz-26.5 GHz	100 pW to 10 μW	100 mW avg. 100 mW peak	-30 to -20 dBm ±2% (0°C to 55°C) ±1% (15° to 40°C)	50 MHz - 4 GHz: 1.15 (0.069) 4-18 GHz: 1.22 (0.099) 18-26.5 GHz: 1.29 (0.127)	30 x 38 x 102 (1.2 x 1.5 x 4.03)	APC-3.5(m)	\$1,350
						0.5 (1.0)		
R8486A (Waveguide)	26.5-40 GHz	1 μW to 100 mW	300 mW avg. 15 W peak 30W • μs pulse	+10 to +20 dBm +2, -4%	1.4 (0.167)	30 x 38 x 126 (1.2 x 1.5 x 5.0)	Waveguide Flange UG-599/U	\$1900
						0.4 (0.9)		
Q8486A (Waveguide)	33-50 GHz	1μW to 100 mW	300 mW avg. 15 W peak 30W • μs pulse	+10 to +20 dBm +2, -4%	1.5 (0.200)	30 x 38 x 126 (1.2 x 1.5 x 5.0)	Waveguide Flange UG-383/U	\$2250
						0.4 (0.9)		
R8486D <sup>4</sup> (Waveguide)	26.5-40 GHz	100 pW to 10 μW	100 mW avg. 100 mW peak	-30 to -25 dBm ±3%	1.4 (0.167)	30 x 65 x 126 (1.19 x 2.56 x 4.96)	Waveguide Flange UG-599/U	\$2,500
				-25 to -20 dBm ±5%				
Q8486D <sup>4</sup> (Waveguide)	33-50 GHz	100 pW to 10 μW	100 mW avg. 100 mW peak	-30 to -25 dBm ±3%	1.4 (0.167)	30 x 65 x 126 (1.19 x 2.56 x 4.96)	Waveguide Flange UG-383/U	\$3,000
				-25 to -20 dBm ±5%				
8487A (50 Ω)	50 MHz-50 GHz	1 μW to 100 mW	300 mW avg. 15 W peak 30 W • μs (per pulse)	+10 to +20 dBm +2, -4%	50-100 MHz: 1.15 (0.070) 100 MHz - 2 GHz: 1.10 (0.048) 2-12.4 GHz: 1.15 (0.07) 12.4-18 GHz: 1.20 (0.091) 18-26.5 GHz: 1.25 (0.111) 26.5-40 GHz: 1.30 (0.130) 40-50 GHz: 1.50 (0.200)	30 x 38 x 94 (1.19 x 1.5 x 3.70)	2.4 mm(m)	\$1,800
						0.48 (1.07)		

<sup>1</sup>For pulses greater than 30 W the maximum average power (Pa) is limited by the energy per pulse (E) in W • μs according to Pa = 30-0.02E.

<sup>2</sup>Negligible deviation except for those power ranges noted.

<sup>3</sup>Includes HP 1250-0597 adapter from 75 Ω type N to 50 Ω type N for calibration.

<sup>4</sup>Includes HP 11708A 30 dB attenuator for calibrating against a 0 dBm, 50 MHz power reference.

# POWER METERS

## Thermistor Power Meters & Power Meter Calibrator

Models 432A/B, 8477A

- Automatic zero
- High accuracy

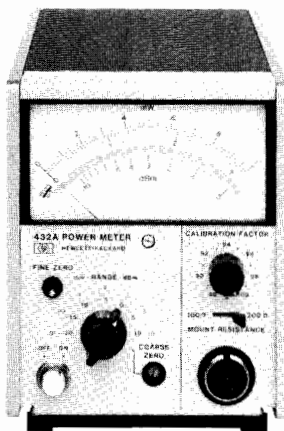

HP 432A

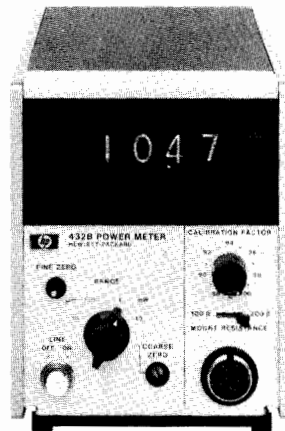

HP 432B

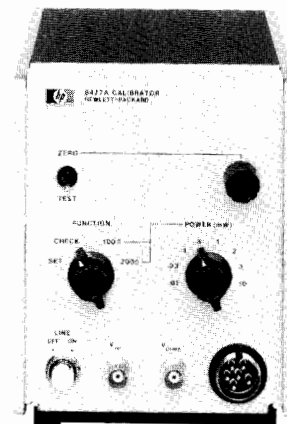

HP 8477A

- Recorder outputs, analog & digital
- Long cable options

### HP 432A/B Power Meters

**High accuracy—no thermoelectric error:** high accuracy over a wide temperature range is featured on the HP 432 Power Meters. By measuring the output voltage of the thermistor bridges, and computing the corresponding power, even higher accuracy of  $\pm 0.2\% \pm 0.5 \mu\text{W}$  can be obtained.

Accuracy can be maintained on even the most sensitive range because the error due to thermoelectric effect is reduced to a negligible level.

**Calibrated mounts:** each thermistor mount is furnished with data stating the Calibration Factor\* and Effective Efficiency\* at various frequencies across the operating range. For easy and accurate power measurements, the front panel of the HP 432 contains a calibration factor control, calibrated in 1% steps from 88% to 100%, that compensates for losses in the mount and eliminates the need for calculation.

**Instrument type:** automatic, self-balancing power meter for use with temperature-compensated thermistor sensor.

\*"Calibration Factor" and "Effective Efficiency" are figures of merit expressing the ratio of the substituted signal measured by the power meter to the microwave power incident on and absorbed by the sensor.

### Specifications (partial)

#### Power Range

**HP 432A:** seven ranges with full-scale readings of 10, 30, 100, and 300  $\mu\text{W}$ , 1, 3, and 10 mW; also calibrated in dBm from  $-20$  dBm to  $+10$  dBm full scale in 5 dB steps.

**HP 432B:** four ranges with full-scale readings of 10 and 100  $\mu\text{W}$ , and 1 and 10 mW.

**Noise:** less than 0.25% of full scale peak (typical).

**Response time:** at recorder output, 35 ms time constant (typical).

**Fine zero:** automatic, operated by front panel switch.

**Zero carryover:** less than 0.50% of full scale when zeroed on most sensitive range.

#### Meter

**HP 432A:** taut-band suspension, individually calibrated, mirror-backed scales. Milliwatt scale more than 108 mm (4.25 in.) long.

**HP 432B:** three digits with one digit overrange. 20% overrange capability on all ranges.

**Calibration factor control:** 13-position switch normalizes meter reading to account for thermistor sensor calibration factor. Range 100% to 88% in 1% steps.

**Thermistor sensor:** thermistor sensors are required for operation of the HP 432A/B. For microwave sensors HP 478B, 8478B and 486 series see page 215.

**Recorder output:** proportional to indicated power with 1 volt corresponding to full scale. 1 k $\Omega$  output impedance.

**BCD output:** 8, 4, 2, 1 code: "1" positive. TTL compatible logic. Operates with HP 5150A, Opt 002 (BCD) Digital Recorder. "Print" and "Inhibit" lines available. (HP 432B only.)

#### Power Consumption

**HP 432A:** 115 or 230 Vac  $\pm 10\%$ , 50 to 400 Hz, 1.5 watts.

**HP 432B:** 115 or 230 Vac  $\pm 10\%$ , 50 to 400 Hz, 10 watts.

#### Weight

**HP 432A:** net, 2.3 kg (5.5 lb). Shipping, 4.6 kg (10 lb).

**HP 432B:** net, 3 kg (6.5 lb). Shipping, 4.8 kg (10.5 lb).

**Size:** 130 W x 155 H x 279 mm D (5.2" x 6.1" x 11.0").

### HP 8477A Power Meter Calibrator

The HP 8477A Calibrator is specifically designed for use with the HP 432 Power Meter. It allows you to verify full-scale meter readings on all ranges, and meter tracking. Simply connect three cables between the power meter and calibrator; no charts or additional instruments are required.

**Power:** 115 or 230 Vac  $\pm 10\%$ , 50 to 400 Hz, 3 watts.

#### Ordering Information

**HP 432A Power meter**

**HP 432B Power meter**

#### Price

\$1450

\$2200

#### HP 432A/B Options

**001:** rechargeable battery installed, provides up to 20 hours continuous operation (HP 432A only) + \$105

**002:** input connector placed on rear panel in parallel with front + \$25

**003:** input connector on rear panel only + \$10

**009:** 3.1 m (10 ft) cable for 110- $\Omega$  or 200- $\Omega$  sensor + \$30

**010:** 6.1 m (20 ft) cable for 100- $\Omega$  or 200- $\Omega$  sensor + \$55

**011:** 15.2 m (50 ft) cable for 100- $\Omega$  or 200- $\Omega$  sensor + \$105

**012:** 30.5 m (100 ft) cable for 100- $\Omega$  or 200- $\Omega$  sensor + \$155

**013:** 61 m (200 ft) cable for 100- $\Omega$  or 200- $\Omega$  sensor + \$260

**100:** 100 Vac operation, 48–66 Hz no charge

**910:** extra operating and service manual + \$5

**W30:** Two additional years of return-to-HP warranty + \$50

**HP 8477A Power Meter Calibrator** \$1100



## Thermistor Mounts, Peak Power Sensor & Peak Power Meters Models 478A, 8478B, 486 Series, 8900C/D, 84811A

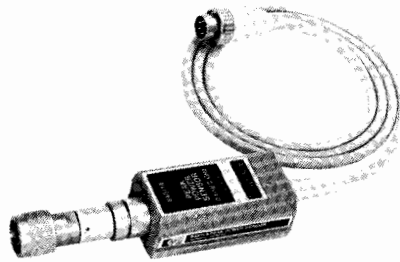

HP 478A



HP 8478B

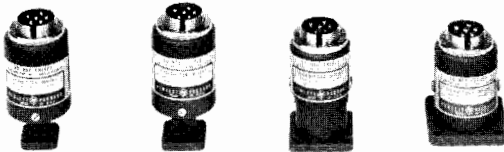

HP 486 Series

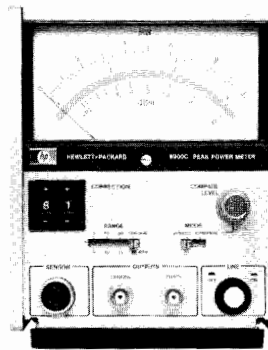

HP 8900C

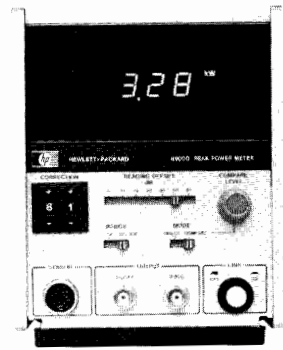

HP 8900D

### HP 8900C/D Peak Power Meters

The HP 8900C and 8900D Peak Power Meters directly display the peak power of RF pulses over a 100 MHz to 18 GHz frequency range. Measurements can be made on pulses with widths from 1  $\mu$ s (100 ns in Compare mode) to CW, and repetition rates from 100 Hz (0 Hz in Compare mode) to 100 kHz.

The HP 8900C is an economical analog meter calibrated in watts and dBm. The analog display with its large, easy-to-read scale makes it simple to peak or null pulsed power systems. The HP 8900D has a high resolution 3½ digit digital display calibrated in watts. The direct reading display and range annunciators make the digital version a good choice for production and field applications where unambiguous or frequent readings are required.

### HP 8900C/D Peak Power Meters Specifications

**Frequency range:** 100 MHz to 18 GHz.

**Dynamic range:** 20 dB (0 to +20 dBm).

**HP 8900C:** 4 ranges of 3, 10, 30 and 100 mW full scale.

**HP 8900D:** 2 ranges of 10 and 100 mW full scale.

#### Pulse Response/Direct Mode

**Pulse width:** 1  $\mu$ s to CW.

**Repetition rate:** 100 Hz to 100 kHz.

#### Compare Mode

**Pulse width:** 100 ns (typical) limited by rise time specification.

**Repetition rate:** 0 to 100 kHz.

**Rise time:** 75 ns.

**Fall time:** 125 ns (as measured on video output).

**Power consumption:** 100 and 120 Vac +5, -10%, 48-66 Hz and 360-440 Hz; 220 and 240 Vac +5, -10%, 48-66 Hz.

Meter Accuracy	Transfer Accuracy		
	CW	Pulse	CW to Pulse
Direct	$\pm 0.2$ dB	$\pm 0.35$ dB	$\pm 0.2$ dB
Compare	$\pm 0.2$ dB	$\pm 0.25$ dB	$\pm 0.1$ dB

### HP 84811A Peak Power Sensor Specifications

**Power range:** 0 to +20 dBm (1 mW to 100 mW).

**Frequency range:** 100 MHz to 18 GHz.

**SWR:** 100 MHz to 12 GHz < 1.5. 12 GHz to 18 GHz < 2.0.

**Maximum peak power:** +24 dBm (250 mW) for 5 minutes.

**Connector type:** N (male).

**Calibration:** every 2 GHz from 2 to 10 GHz. Every 1 GHz from 11 to 18 GHz.

**Operating temperature:** 0 to +55°C.

**Calibration accuracy:** (+10 to +40°C),  $\pm 0.7$  dB 0.1 to 12 GHz.  $\pm 1.0$  dB to 18 GHz. 0-10°C and 40-55°C: add  $\pm 0.2$  dB.

### Ordering Information

HP 8900C Analog peak power meter

HP 8900D Digital peak power meter

Option W30: Two additional years of return-to-HP warranty (for HP 8900C/D)

HP 84811A Peak power sensor

Fast-Ship product—see page 766.

### Price

\$2300

\$2700

+ \$50

\$850

### Temperature Compensated Thermistor Mounts

High efficiency and good RF match are characteristic of the HP 478A and 8478B coaxial and 486A series waveguide Thermistor Mounts. Used in conjunction with the HP 432 Power Meter they provide high accuracy even in routine power measurements. These thermistor mounts are temperature-compensated for low drift, even in the presence of thermal shocks, permitting measurement of microwave power as low as one microwatt. Each mount contains data showing Calibration Factor and Effective Efficiency at six frequencies, directly traceable to the National Bureau of Standards at those frequencies where NBS provides calibration service.

### HP 486, 478, 8478B Specifications

HP Model	Frequency range, GHz	Maximum SWR	Operating Resistance (Ohms)	Price
478A	10 MHz to 10 GHz	1.75, 10 to 25 MHz 1.3, 25 MHz to 7 GHz 1.5, 7 to 10 GHz	200	\$435
8478B <sup>1</sup>	10 MHz to 18 GHz	1.75, 10 to 30 MHz 1.35, 30 to 100 MHz 1.1, 0.1 to 1 GHz 1.35, 1 to 12.4 GHz 1.6, 12.4 to 18 GHz	200	\$600
X486A	8.20 to 12.4	1.5	100	\$570
P486A	12.4 to 18.0	1.5	100	\$830
K486A <sup>2</sup>	18.0 to 26.5	2.0	200	\$750
R486A <sup>2</sup>	26.5 to 40.0	2.0	200	\$830

<sup>1</sup>Option 011: furnished with APC-7 RF connector +\$25  
<sup>2</sup>Circular flange adapters:  
 K-band (UG-425/U) HP 11515A \$210  
 R-band (UG-381/U) HP 11516A \$210

### HP 84811A Peak Power Sensor

The HP 84811A Peak Power Sensor works with the HP 8900C/D Peak Power Meters to measure the peak power of RF pulses. It is supplied with a 4 foot flexible cable to easily reach the pulse source being measured. The HP 84811A also conveniently detaches from the meter for storage, recalibration or replacement.

# NETWORK ANALYZERS

## Complete Characterization of Linear Networks

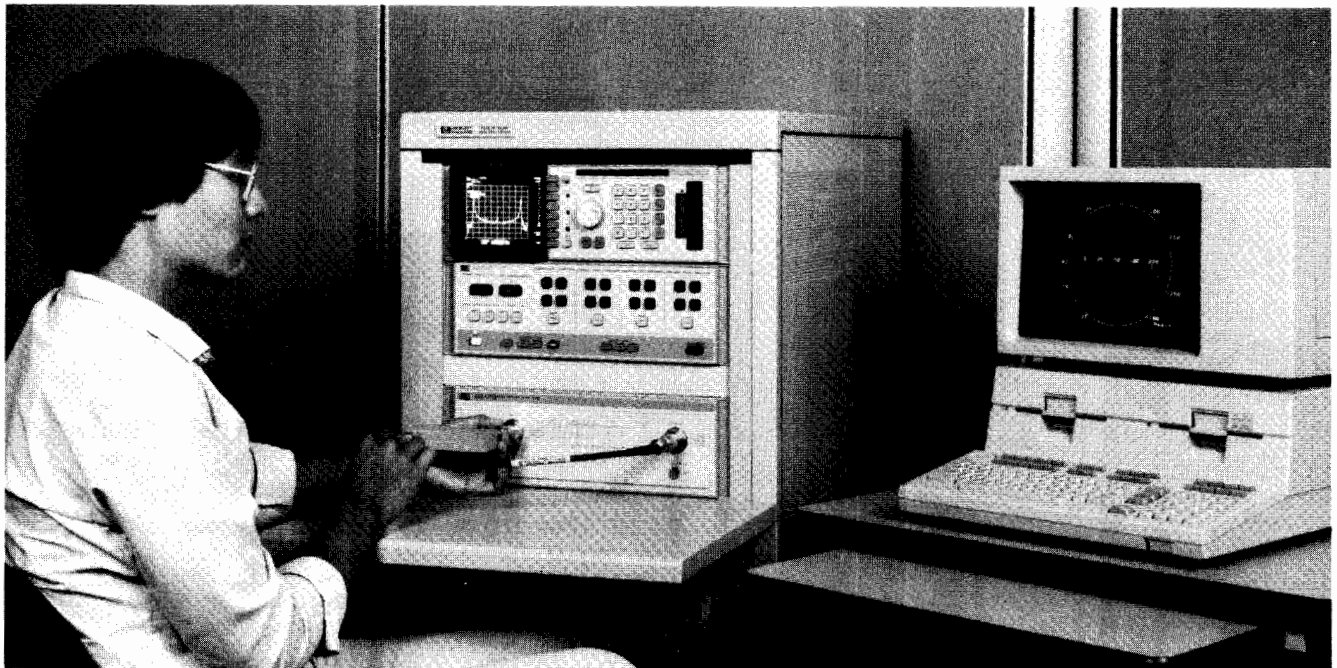

### Why Network Analysis?

Characterizing the behavior of linear networks that will be stimulated by arbitrary signals and interfaced with a variety of other networks is a fundamental problem in both synthesis and test processes. For example, the engineer designing a multi-component network must predict with some certainty the final network performances from knowledge of the individual components. Similarly, a production manager must know allowable tolerances on the products manufactured and whether the final products meet the specified tolerances. Network analysis offers a solution to these problems through complete description of linear network behavior in the frequency domain. Additionally, some network analyzers offer the capability to transform measurement data, taken in the frequency domain, to the time domain providing further insight into the behavior of linear networks.

Network analysis accomplishes the description of both active and passive networks by creating a data model of such component parameters as impedances and transfer functions. However, these parameters not only vary as a function of frequency but are also complex variables in that they have both magnitude and phase. Swept network analyzers now measure magnitude and phase (the total complex quantity) as a function of frequency with less difficulty than conventional CW measurements. Impedance and transfer functions can then be conveniently displayed on a swept CRT, as in Figure 1, X-Y recorder, or peripherals such as a printer and/or a plotter.

Thus, network analysis satisfies the engineering need to characterize the behavior of linear networks quickly, accurately, and completely over broad frequency ranges. Hewlett-Packard manufactures a full line of scalar network analyzers (magnitude only) and vector network analyzers (both magnitude and phase).

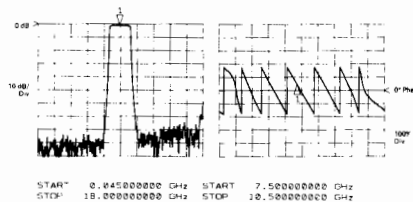

Figure 1. 45 MHz to 18 GHz measurement of magnitude and phase in a single sweep.

### What Is Network Analysis?

Network analysis is the process of creating a data model of the transfer and/or impedance characteristics of a linear network through stimulus-response testing over the frequency range of interest. All network analyzers in the HP product line operate according to this definition.

At frequencies above 1 MHz lumped elements actually become "circuits" consisting of the basic elements plus parasitics like stray capacitance, lead inductance, and unknown absorptive losses. Since parasitics depend on the individual device and its construction they are almost impossible to predict. Above 1 GHz component geometries are comparable to a signal wavelength, intensifying the variance in circuit behavior due to device construction.

Network analysis is generally limited to the definition of linear networks. Since linearity constrains networks stimulated by a sine wave to produce a sine wave output, sine wave testing is an ideal method for characterizing magnitude and phase response as a function of frequency. For non-linear measurements, refer to the sections on spectrum analyzers, wave analyzers (signal analyzers) and vector modulation products in this catalog.

### Network Analyzers

Hewlett-Packard network analyzers are instruments that measure transfer and/or impedance functions of linear networks through sine wave testing. A network analyzer system accomplishes these measurements by configuring its various components around the device under test. The first requirement of the measurement system is a sine wave signal source to stimulate the device under test. Since transfer and impedance functions are ratios of various voltages and currents, a means of separating the appropriate signals from the measurement ports of the device under test is required. Finally, the network analyzer itself must detect the separated signals, form the desired signal ratios, and display the results.

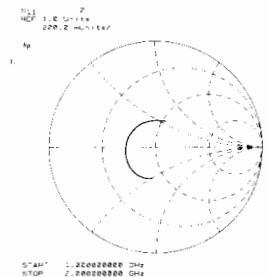

Figure 2. Input impedance of microcircuit amplifier is read directly with Smith Chart overlay for Polar Display.

### Signal Sources and Signal Separation

In the general case, any sine wave source meeting the network analyzer's specifications can be used to stimulate the device under test. If the analyzer is capable of swept measure-

ments, great economies in time can be achieved by stimulating the device under test with a sweep oscillator or synthesized sweeper. This allows quick and easy characterization of devices over broad frequency ranges.

At high frequencies the problem of signal separation usually involves traveling waves on transmission lines and becomes correspondingly more difficult. Hewlett-Packard manufactures test sets applicable for separating the appropriate traveling waves in a variety of high frequency measurements.

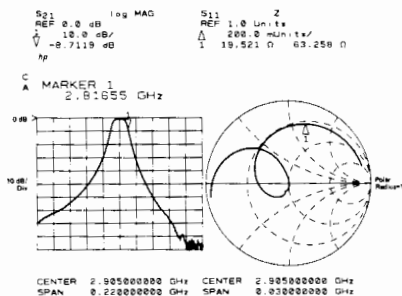

Figure 3. Simultaneous measurement of transmission response and passband reflection coefficient.

**Broadband and Narrowband Detection**

After the desired signals have been obtained from the test set they must be detected by the network analyzer; HP network analyzers can use one of two detection methods. Broadband detection accepts the full frequency spectrum of the input signal while narrowband detection involves tuned receivers that convert CW or swept RF signals to a constant IF signal. There are certain advantages to each detection scheme.

Scalar analyzers usually employ broadband detection techniques. Broadband detection reduces instrument cost by eliminating the IF section required by narrowband analyzers but sacrifices noise and harmonic rejection. However, noise is not a factor in many applications. Finally, broadband systems can make measurements where the input and output signals are not of the same frequency, as in the measurement of the insertion loss of mixers and frequency doublers. Narrowband systems cannot make these measurements.

Vector network analyzers normally employ narrowband detection techniques. Narrowband detection makes a more sensitive low noise detection of the constant IF possible. This allows increased accuracy and dynamic range for frequency selective measurements (as compared to broadband systems).

All network analyzer phase measurements are relative measurements with the reference channel signal considered to have zero phase. The analyzer then measures the phase difference of the test channel with respect to the reference channel.

Phase information complements amplitude data in the measurement of low frequency parameters. Phase is more sensitive to network behavior and it is a required component of complex impedance and transfer functions.

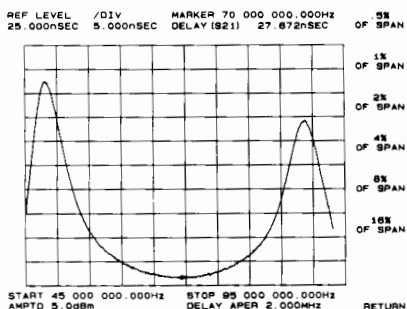

Figure 4. Direct measurement of group delay with digital readout at marker.

Phase data is also required to measure delay distortion or group delay of networks. Delay distortion occurs when different frequency components of a complex waveform experience nonlinear phase shifts as they are transmitted through a network. Group delay is a measure of this distortion and is defined as:

$$T_g = - \frac{d\theta}{d\omega}$$

An alternative method for measuring phase distortion is deviation from linear phase or differential phase. Deviations from linear phase can be measured by introducing enough electrical length in the network analyzer's reference channel to linearize a device's phase shift.

Scattering parameters or S-parameters were developed to characterize linear networks at high frequencies. S-parameters de-

fine the ratios of reflected and transmitted traveling waves measured at the network ports. A two-port device is modeled with S-parameters in Figure 5.  $S_{11}$  is the complex re-

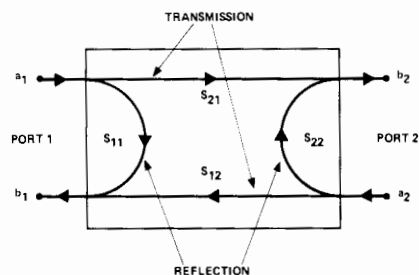

Figure 5. S-parameter model for a two-port linear network.

flexion coefficient at port 1 and is the ratio of  $b_1/a_1$ , if  $a_2 = 0$  (port 2 terminated in its characteristic impedance).  $S_{21}$  is the complex transmission coefficient from port 1 to port 2,  $b_2/a_1$ , if  $a_2 = 0$ . The "a" and "b" signals represent the amplitude and phase of the incident and emerging or reflected traveling waves. By reversing the ports and terminating port 1 in its characteristic impedance,  $S_{22}$  and  $S_{12}$  can be similarly defined.

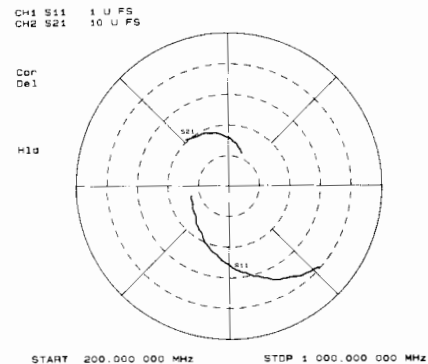

Figure 6. Simultaneous measurement of transistor S-parameters.

**Additional Capabilities**

Precision design work and manufacturing tolerances demand highly accurate measurements, but most errors in network measurements are complex quantities that vary as a function of frequency. By characterizing and virtually removing these systematic errors, measurement accuracies are improved by several orders of magnitude. Hewlett-Packard now offers network analyzers with built-in, high-speed computational hardware that can perform the complex mathematics required for sophisticated error correction.

Computer controlled network analyzers can be programmed to set up and make many measurements automatically. The measurement process is further accelerated by the computer's ability to store, transform, summarize, and output data in a variety of formats to a number of peripherals. These capabilities make the computer controlled network analyzer ideal for both computer aided design or automatic production testing.

**Signal Processing and Display**

Once the RF has been detected, the network analyzer must process the detected signals and display the measured quantities. All HP network analyzers are multi-channel receivers utilizing a reference channel and at least one test channel; absolute signal levels in the channels, relative signal levels (ratios) between the channels, or relative phase difference between channels can be measured depending on the analyzer.

Relative ratio measurements are usually made in dB, which is the log ratio of an unknown signal (Test Channel) with a chosen reference signal (Reference Channel). This allows the full dynamic range of the instrumentation to be used in measuring variations of both high and low level circuit responses. For example, 0 dB implies the two signal levels have a ratio of unity while  $\pm 20$  dB implies a 10:1 voltage ratio between two signals.

# NETWORK ANALYZERS

## Complete Characterization of Linear Networks (cont'd)

### Network Analyzer Product Line Summary

<b>Network Analyzer</b>			
<b>HP Model</b>	<b>Frequency Range</b>	<b>Source</b>	<b>Measurement Capabilities</b>
3562A Dual Channel Dynamic Signal Analyzer Page 150	64 uHz-100 kHz	Swept and fixed sine, chirp, burst, random noise and burst random noise	Transfer functions, magnitude/phase, 40-pole curve fitter, frequency response synthesis, time domain functions, and spectrum analysis HP-IB programmable
3577A Network Analyzer Page 234	5 Hz to 200 MHz	Integrated Synthesized Source	Transfer functions, magnitude/phase, insertion loss/gain, attenuation, electrical length, gain compression. Group Delay, Deviation from Linear Phase HP-IB Programmable
4195A network/spectrum/impedance analyzer Page 230	10 Hz-500 MHz	Integrated Synthesized source	Transfer functions, magnitude/phase, insertion loss, gain, attenuation, group delay, s-parameters, return loss, SWR, complex impedance, accuracy enhancement, HP-IB programmable
8754A Network Analyzer Page 240	4-1300 MHz	Integrated Swept source. external source usable.	Magnitude and phase transmission coefficient reflection coefficient and return loss
8753B Network Analyzer Page 243	300 kHz-3 GHz/6 GHz	Integrated Synthesized Source	Transfer functions - magnitude/phase insertion loss/gain, attenuation, gain compression, s-parameters, electrical length, group delay, deviation from linear phase. Impedance - magnitude/phase - Return Loss, r+jx Full Accuracy Enhancement Time Domain Capability Harmonic Measurement Capability HP-IB programmable
8720A Network Analyzer Page 247	130 MHz-20 GHz	Integrated Synthesized Source (1 Hz Resolution Optional)	Transfer functions - magnitude/phase insertion loss/gain, attenuation, s-parameters, electrical length, group delay, deviation from linear phase. Impedance - magnitude/phase - Return Loss, r+jx Full Accuracy Enhancement Time Domain Capability HP-IB programmable
8510 Series Network Analyzer Page 249	45 MHz to 100 GHz	HP 8350 Series Sweep Oscillators HP 8340B, 8341B Synthesized Sweepers	Transmission/Reflection Characteristics S-parameters Active device characterization Full Accuracy Enhancement Time domain capability HP-IB programmable

### Vector Voltmeter

<b>Hp Model</b>	<b>Frequency Range</b>	<b>Source</b>	<b>Measurement Capabilities</b>
3575A Gain Phase Meter Page 239	1 Hz-13 MHz	None	Gain, Phase and Amplitude
8508A Vector Voltmeter Page 242	.1 MHz-1 GHz .3 MHz-2 GHz	None	Voltage, Impedance Transfer Functions, phase and amplitude HP-IB programmable

### Scalar Analyzer

<b>HP Model</b>	<b>Frequency Range</b>	<b>Source</b>	<b>Measurement Capabilities</b>
8757A Scalar Network Analyzer page 221	10 MHz-60 GHz	HP 8350 or 8620 Series Sweep Oscillators, HP 8340B or 8341B Synthesized Sweepers	Scalar Transmission/Reflection Measurements 50Ω Coax Measurements 10 MHz-26.5 GHz 75Ω Coax Measurements 10 MHz-2.4 GHz Waveguide Measurements 26.5 GHz-60 GHz Open/Short Averaging, Normalization, Averaging, Limit Testing Storage Registers, HP-IB Programmable

# NETWORK ANALYZERS

## Automatic Scalar Network Analyzer System (10 MHz to 100 GHz)

### Model 8757S

219

- Measure insertion loss or gain, VSWR, and power
- Plot and display data
- Customize automatic tests without programming
- Troubleshoot waveguide and coax

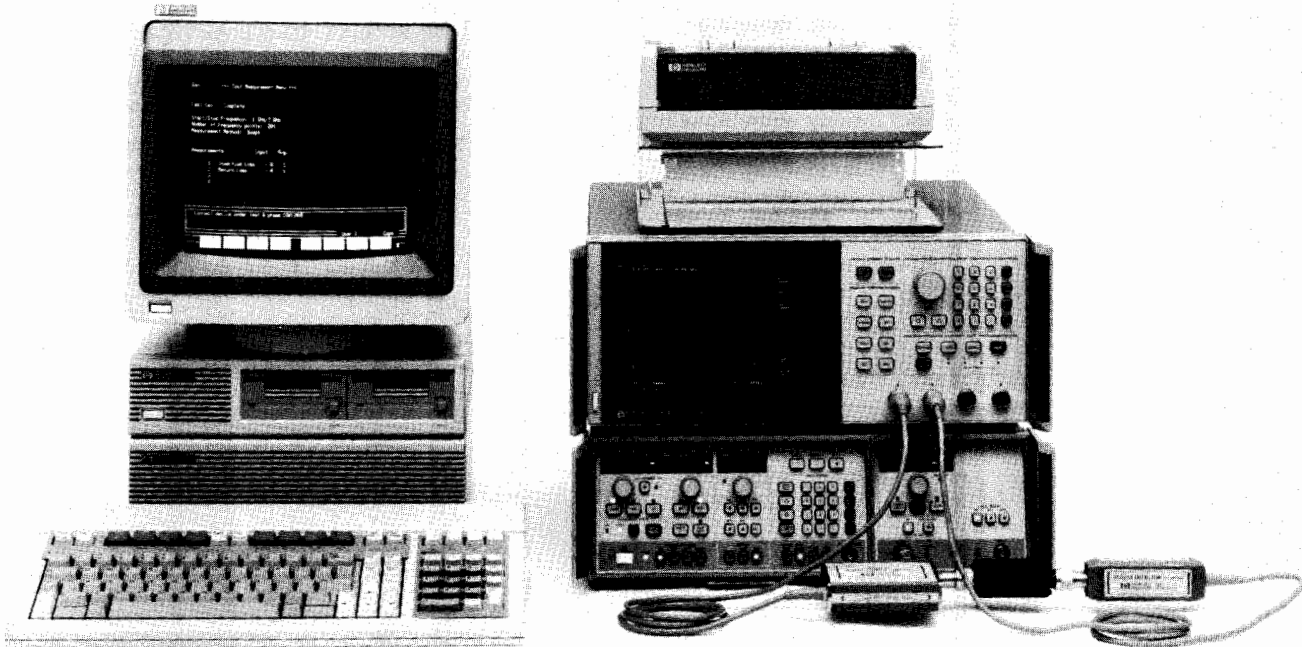

HP 8757S

The HP 8757S is a complete automatic scalar network analyzer for measurements of insertion loss or gain, return loss, and power from 10 MHz to 100 GHz. The system is based on the HP 8757A scalar network analyzer and is controlled by an HP 9000 series 200 or 300 computer over the Hewlett-Packard Interface Bus (HP-IB). Also included in the system are a swept source (HP 8350B sweep oscillator with RF plug-in or HP 8340B/8341B synthesized sweeper), a high directivity (40 dB) directional bridge, detectors, accessories, and the HP 85015B or 85016B system software. All analyzer and source controls are completely programmable.

#### Flexible Plot and Print Formats

Plot or print data and CRT graphics in your choice of formats without any programming. Select automatic scaling of either the vertical or horizontal axes (or both). Customize your own plot configuration with or without labels, grid lines, limit lines, and out-of-spec indicators. Plot up to four plots on a single page or print the data in the format you find most useful.

#### Easy to Use

In either manual or automatic operation, the HP 8757S is easy to operate. The fully annotated HP 8757A CRT is the system's control center with convenient display of frequency, power, and scaling parameters. Manual measurements can be easily controlled with the front panel function keys. With the system software and the entire HP 8757S system, even complex scalar measurements can be performed with ease.

#### High Performance

Each component of the HP 8757S is a high performance instrument in its own right. Together they form a very high performance automatic scalar network analyzer.

The HP 8757A scalar network analyzer offers 76 dB of dynamic range (+16 to -60 dBm) in three (or optionally four) independent inputs (A, B, (C), and R) when used with the HP 11664A/E detectors. Single inputs or ratio combinations of the inputs can be displayed on any of four independent display channels. Using AC modulation and detection, the HP 8757A provides excellent performance in the presence of unmodulated noise and spurious signals. The HP 11664 detectors cover the range from 10 MHz to 40 GHz and the HP 11664C detector adapter can be used with waveguide detectors for higher frequency operation. The HP 85025 and 85026 series detectors cover the range from 10 MHz to 60 GHz and offer the choice between AC and DC detection. In DC mode, the HP 85025 detectors can be used to provide excellent swept power measurements (dBm).

Test signals are provided by the HP 8350B sweep oscillator with an RF plug-in or by the HP 8340B/8341B synthesized sweepers. All source front panel functions are fully programmable via HP-IB and are also easy to use in manual applications. Frequency and power entries can be made with a knob, a numeric keypad, or with increment and decrement keys. Up to nine independent front panel settings may be saved or recalled at the touch of a key or through HP-IB.



# NETWORK ANALYZERS

## System Specifications

### Model 8757S

### System Specifications

#### ACCURACY

**Transmission Loss or Gain Measurement Accuracy:** Transmission loss or gain measurements are made relative to a 0 dB reference point established at calibration. The measurement accuracy is equal to the uncertainty due to the change in power level, called dynamic accuracy, plus mismatch uncertainty. The frequency response errors of the source, detectors, bridge and power splitter may be removed via calibration.

**Dynamic Power Accuracy** (25 ±5°C, 0 dBm reference):

#### Coax Detectors\* (50 MHz)

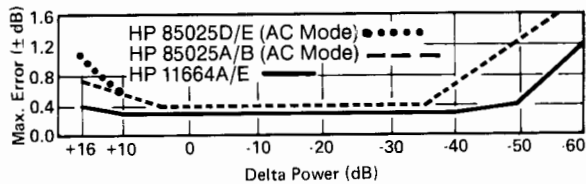

\*For ≤20 dB change of power within +10 to -40 dBm, the specification for the HP 8757A with the HP 11664A/E is ±(0.1 dB + 0.01 dB/dB).

#### Waveguide Detectors

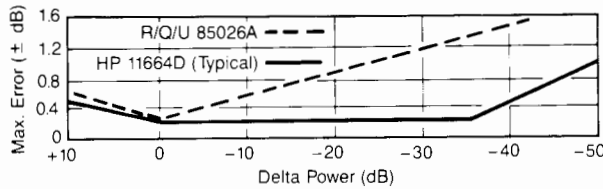

**Absolute Power Measurement Accuracy:** This specification is useful for determining the accuracy of power measurements in dBm when using the HP 85025A/B detectors in the DC mode. The total uncertainty is the sum of the detector frequency response, power accuracy, and mismatch uncertainties.

**Absolute Power Accuracy** (HP 85025A/B/D/E detectors in DC mode, detector offsets removed via power meter cal, 25 ±5°C):

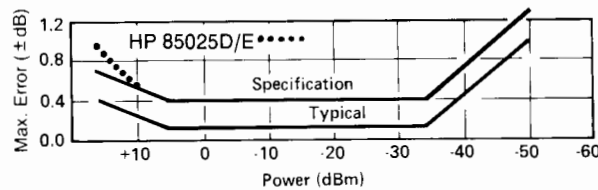

**Detector Frequency Response** (HP 85025A/B detectors, -10 dBm, 25 ±5°C):

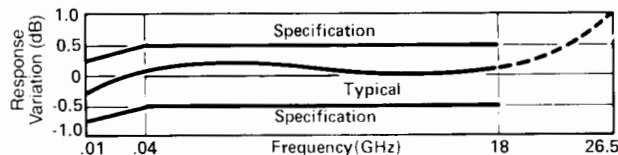

#### DYNAMIC RANGE (on all HP 8757A detector inputs):

Detector	AC Mode	DC Mode
HP 11664A/E	+16 to -60 dBm	
HP 11664D	+10 to -50 dBm	
HP 85025A/B	+16 to -55 dBm	+16 to -50 dBm
HP R/Q/U85026A	+10 to -50 dBm	+10 to -45 dBm

**Reflection Measurement Accuracy:** Uncertainties due to calibration error and the frequency response of the source, detectors and bridge are removed via open/short averaging. The remaining uncertainties are primarily the sum of directivity uncertainty, effective source match uncertainty, and dynamic power accuracy. As shown in the graphs below, directivity is the dominant error term when measuring small reflected signals (high return loss) and source match is dominant when measuring large reflected signals (low return loss).

#### The Effect of Effective Source Match on Reflection Uncertainty:

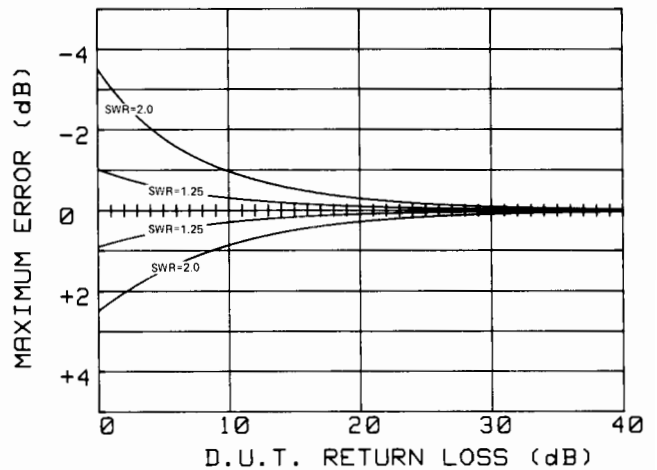

#### The Effect of Directivity on Reflection Uncertainty:

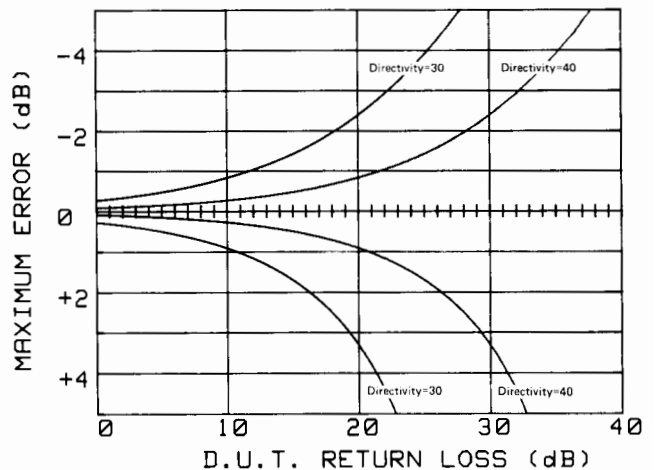

**Dynamic Power Accuracy** (HP 85027/20 bridges, 50 MHz, 25 ±5°C, +7 dBm input):

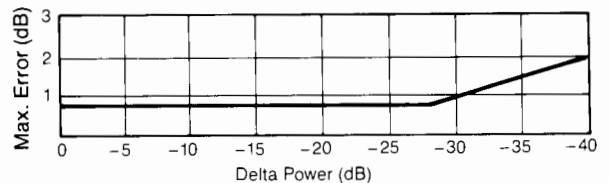

# NETWORK ANALYZERS

## Scalar Network Analyzer, 10 MHz to 100 GHz

### Model 8757A

221

- 76 dB dynamic range
- Accurate swept power measurements (dBm)
- 40 dB directivity bridges

- Four independent display channels
- Limit testing built in
- Save/recall setup and cal data
- Direct plotter or printer output

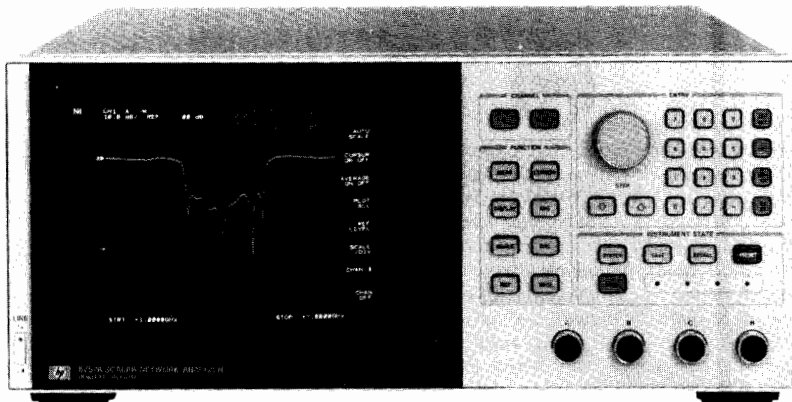

HP 8757A Option 001

### Description

Measure insertion loss or gain, return loss, SWR, and power quickly and accurately with the HP 8757A scalar network analyzer. With high performance detectors and directional bridges and a companion HP source and digital plotter, the HP 8757A becomes the basis of a complete measurement system with superb performance.

### Performance

The HP 8757A features 76 dB of dynamic range ( $-60$  dBm to  $+16$  dBm) when used with the HP 11664A/E detectors. With square wave modulation and detection (AC), the HP 11664 detectors enable reliable, drift-free measurements from 10 MHz to 40 GHz. With the HP 85025 and 85026 AC/DC detectors, make scalar measurements with or without modulation to 100 GHz. In DC mode (no modulation), use the HP 85025A/B to make accurate swept-frequency measurements of power (dBm).

High directivity bridges ( $>40$  dB) covering RF and microwave frequencies help produce excellent measurement results. Using the HP 85020 series and 85027 series directional bridges, make accurate measurements of reflection and transmission parameters simultaneously.

Calibrate your test system, and make normalized measurements with 0.01 dB vertical resolution. Select the optimum horizontal resolution for your application, by choosing 101, 201, 401, 801, or 1601 data points. Lower resolution allows faster sweep times. Calibrate with full 1601 point resolution over your frequency range. Then zoom in on a narrower frequency span and retain calibration. The HP 8757A interpolates the calibration data automatically.

### Easy to Use

With a combination of simple front panel keys and powerful menu-driven soft keys, the HP 8757A allows you to set up the system and make accurate measurements fast. Menus appear on the display, and you control them with the front panel soft keys. The soft keys give you powerful capabilities without adding front panel complexity. Press CAL and let the menu guide you through calibration procedures. Press AUTOSCALE to bring your measurement into view quickly. Activate the "Cursor" and dial it to any point on your data trace for an accurate high resolution reading of magnitude (and frequency with the HP 8350B/8340B/8341B). Measurements are fast and easy.

### Productivity Without a Controller

The HP 8757A increases productivity in scalar measurements even without a controller. Decrease the time it takes you to set up and make measurements, while improving the quality of the results.

Enter your own limit lines for easy comparison of measurement results to upper and lower specification limits. Or use these lines as

your own reference calibration and remove the frequency responses of devices that are inserted after calibration.

Four independent display channels add new capabilities to the system. Each channel can display the data taken from any of the three (or optionally four) detector inputs. Each channel can display a single input (A, B, C, R) or a ratio combination of two inputs (A/R, B/R, A/B, etc.). With four inputs, measure multi-port devices or characterize several devices simultaneously. Or compare the response of the test device to the stored response of your "reference" device.

When used with the HP 8350B sweep oscillator or the HP 8340B/8341B synthesized sweepers, the HP 8757A acts as a system controller by managing the source via the "8757 System Interface." Using this interface the HP 8757A can extract frequency information and annotate the display. When used alone, the HP 8757A can save and recall up to nine front panel states in non-volatile memory, complete with calibration or measurement data, limit lines, and plot labels. With the system interface and a companion HP source, the HP 8757A can save and recall not only its own front panel state, but the source's as well. Configure often repeated measurements only once. Then just recall that set-up and connect your device.

Combining the HP 8757A with an HP 8350B/8340B/8341B also enables the useful "alternate sweep" function, which allows you to sweep different frequency ranges or power levels and display them both in real time.

The HP 8757A can adapt to any sweep ramp input in the 0-10 V range, such as a 2-5 V ramp. Test voltage-controlled oscillators and attenuators, using your test voltage ramp to drive the HP 8757A display. Plot output power or attenuation versus tuning voltage.

### Document Your Results

The HP 8757A also uses the "8757 System Interface" to drive an HP-IB digital plotter or "ThinkJet" printer. Plot what appears on the CRT or define your own plot and plot size. Get crisp, permanent, annotated plots without a controller. Print graphics or tabular data listings on the HP "ThinkJet" printer.

### Millimeter Wave Measurements

Extend scalar measurements to millimeter-wave frequencies with the HP 8757A and the waveguide detector for your frequency range. The HP R, Q, and U85026A detectors offer fully calibrated scalar measurements in the frequency bands 26.5-40 GHz (Ka) 33-50 GHz (Q) and 40-60 GHz (U). Add an HP millimeter-wave source and waveguide coupler for a complete scalar measurement system to 60 GHz. Broadband measurements in coax from 10 MHz to 40/50 GHz can be made with the HP 85025D detector. Measurements from 55 to 65 GHz and 90 to 100 GHz are possible using the HP 85025C detector adapter and external detectors. For other applications above 60 GHz, use your own waveguide detector with either the HP 85025C (AC/DC) or 11664C (AC only) detector adapters.

# NETWORK ANALYZERS

## 8757/8756 System Accessories

Models 85027A/B/C/D/E, 85020A/B, 85025A/B/C/D/E, 11664A/C/D/E, R/Q/U 85026A

### Directional Bridges

The HP 85020 series and HP 85027 series are directional bridges designed especially for the HP 8757, 8756 and 8755 scalar network analyzers. Each bridge features outstanding directivity and test port match in a compact, rugged package.

Within each bridge, one zero-bias Schottky diode detector measures the return loss of the test device. Ratio measurements can be made by adding a power splitter (HP 11667A/B/C) and detector (HP 11664 series or HP 85025 series).



### HP 85027A/B/C/D/E Directional Bridges

The HP 85027 series directional bridges are designed to operate with the HP 8757, 8756 and 8755 scalar network analyzers for reflection measurements from 10 MHz to 47 GHz. A switch on the HP 85027 series bridges allows the user to configure them for operation with the HP 8757 or the HP 8756 and 8755 scalar network analyzers.

When used with the HP 8757 scalar network analyzer, the HP 85027 series bridges allow the user to choose the measurement mode that best suits the application. Use the bridge's AC mode (modulated RF) for measurements in the presence of undesired signals such as broadband noise or electromagnetic interference. Or choose the bridge's DC mode (unmodulated RF) to measure the return loss of modulation sensitive devices such as amplifiers with gain control circuits. Use the companion HP 85025 series detectors for AC and DC measurement versatility or the HP 11664 series detectors for AC only measurements.

High (40 dB) directivity and excellent test port match ensure accurate reflection measurements over a broad swept frequency range. The HP 85027B bridge operates from 10 MHz to 26.5 GHz and has an SMA compatible, precision female 3.5mm (typical) test port connector. The HP 85027A/C bridges operate from 10 MHz to 18 GHz. The HP 85027A has a rugged 7mm (typical) test port connector and the HP 85027C has a precision Type-N connector. The HP 85027E operates from 10 MHz to 26.5 GHz and has an SMA compatible, precision male 3.5mm (typical) test port connector. Reflection measurements from 10 MHz to 47 GHz are possible using the HP 85027D directional bridge.

### Measuring SMA devices

Hewlett-Packard recommends using the HP 85027A bridge and an 7mm (typical) to 3.5mm (typical) adapter for measuring SMA devices from 10 MHz to 18 GHz. For SMA measurements to 26.5 GHz, HP recommends using 3.5mm (typical) to 3.5mm (typical) adapters (included with the HP 85027B/E bridge) to preserve the HP 85027B/E output connector.

### HP 85020A/B Directional Bridges

The economical HP 85020A/B directional bridges also offer high (40 dB) directivity and excellent port match at RF (to 4.3 GHz) frequencies. For 50 ohm measurements choose the HP 85020A. The HP 85020B is designed for 75 ohm environments. Both RF bridges have Type-N connectors.

### Detectors

Two types of detectors are available for use with HP scalar network analyzers for measurements up to 60 GHz. All detectors provide excellent impedance match, and therefore minimize mismatch uncertainty in scalar measurements.



### HP 85025 and 85026 Series Detectors (AC/DC)

The HP 85025 and 85026 series detectors are designed specifically for operation with the HP 8757 Scalar Network Analyzer and are not compatible with either the HP 8756A or the 8755. The HP 85025/26 detectors detect either a modulated (AC) or an unmodulated (DC) microwave signal. In AC mode, the HP 85025/26 series detect the envelope of the 27.8 kHz modulated microwave signal, provided internally by the HP 8350B Sweep Oscillator with RF plug-in or externally with the HP 8340/41 synthesized sweepers. In DC mode, the HP 85025/26 series detectors measure the microwave power directly without modulation. The user can change detection modes from the HP 8757 front panel.

### HP 11664 Series Detectors (AC Only)

The HP 11664 series detectors are designed to operate with the HP 8757, 8756 and 8755 scalar analyzers in AC mode only. The HP 11664A/E cover the 10 MHz to 26.5 GHz range, and the HP 11664D covers from 26.5 to 40 GHz.

### Detector Adapters

The HP 85025C and the HP 11664C Detector Adapters match the scalar analyzer display to most standard crystal, silicon, and gallium arsenide detectors. This enables the user to operate in any frequency band, such as above 60 GHz with the HP 8757A, and above 40 GHz with the HP 8756A.

The HP 85025C Detector Adapter is designed for use with the HP 8757 only, and can operate in either AC or DC detection modes. A softkey calibration sequence calibrates the HP 8757 display to your particular detector for an accurate display of power level. The analyzer can then account for the voltage versus input power characteristics of the detector in use. This calibration requires two known calibration inputs, one at a high level (linear operating region, above 0 dBm) and one at a low level (square law region, below -20 dBm).

The HP 11664C Detector Adapter is designed for use with the HP 8757, 8756, and 8755 scalar analyzers. The HP 11664C is matched to the particular diode used via two screwdriver adjustments. One adjustment sets the adapter's amplifier gain to the correct power level indication on the scalar network analyzer. The second adjustment matches the input impedance of the adapter to the load impedance of the detector. Together, the voltage versus power characteristics of the detector are calibrated for the scalar analyzer display.

### Detector Summary

For use with the HP 8757, 8756, or 8755 in AC detection mode only:

Detector	Freq. Range (GHz)	Connector Type	Return Loss (dB)	Dynamic Range		Weight	
				8757	8756	Net	Shipping
11664A <sup>1</sup>	.01-18	Type-N (m)	.01-.04 GHz: 10 dB .04-4 GHz: 20 dB 4-12 GHz: 18 dB 12-18 GHz: 16 dB	+16 to -60 dBm	+10 to -50 dBm	0.17 kg (0.4 lb)	0.9 kg (2 lb)
11664E	.01-26.5	3.5 mm (m)	.01-.04 GHz: 10 dB .04-6 GHz: 20 dB 6-20 GHz: 16 dB 20-26.5 GHz: 12 dB	+16 to -60 dBm	+10 to -50 dBm	"	"
11664D	26.5-40	WR-28	12 dB	+10 to -50 dBm	+10 to -50 dBm	0.24 kg (0.5 lb)	1.0 kg (2.2 lb)
11664C	<sup>3</sup>	SMA (m)	<sup>3</sup>	<sup>3</sup>	<sup>3</sup>	0.17 kg (0.4 lb)	0.9 kg (2 lb)

# NETWORK ANALYZERS

## 8757/8756 System Accessories (cont'd)

Models 85027 A/B/C/D/E, 85020 A/B, 85025 A/B/C/D/E, R/Q/U 85026A, 11664 A/C/D/E

223

### Detector Summary (cont'd)

For use with HP 8757 only in either AC or DC detection modes:

					AC mode		DC mode	
85025A <sup>1, 2</sup>	.01-18	Type-N (m)	.01-.04 GHz: 10 dB .04-4 GHz: 20 dB 4-18 GHz: 17 dB		+16 to -55 dBm	+16 to -50 dBm	0.24 kg (0.5 lb)	1.0 kg (2.2 kg)
85025B <sup>2</sup>	.01-26.5	3.5mm (m)	.01-18 GHz: Same as 85025A 18-26.5 GHz: 12 dB		+16 to -55 dBm	+16 to -50 dBm	"	"
85025D	.01-50 GHz	2.4mm (m)	10-40 MHz: 10 dB 40-100 MHz: 20 dB .1-14 GHz: 23 dB 14-34 GHz: 20 dB 34-40 GHz: 15 dB 40-50 GHz: 9 dB		+16 to -55 dBm	+16 to -50 dBm	"	"
85025E	.01-26.5 GHz	3.5mm (m)	10-40 MHz: 10 dB 40-100 MHz: 20 dB .1-25 GHz: 25 dB 25-26.5 GHz: 23 dB		+16 to -55 dBm	+16 to -50 dBm	"	"
R85026A <sup>2</sup>	26.5-40	WR-28	12 dB		+10 to -50 dBm	+10 to -45 dBm	"	"
Q85026A <sup>2</sup>	33-50	WR-22	12 dB		+10 to -50 dBm	+10 to -45 dBm	"	"
U85026A <sup>2</sup>	40-60	WR-19	12 dB		+10 to -50 dBm	+10 to -45 dBm	"	"
85025C K57 <sup>4</sup>	55-65 GHz	WR-15			-10 to -50 dBm (typical)	-10 to -45 dBm (typical)	"	"
85025C K71 <sup>4</sup>	90-100 GHz	WR-18			-10 to -50 dBm (typical)	-10 to -45 dBm (typical)	"	"
85025C <sup>2</sup>	<sup>3</sup>	SMA (m)	<sup>3</sup>	<sup>3</sup>	<sup>3</sup>	<sup>3</sup>	"	"

### Directional Bridge Summary

For use with the HP 8757, 8756, or 8755 in AC detection mode only:

Bridge	Freq. Range (GHz)	Nominal Impedance	Connector		Directivity (dB)	Test Port Match (SWR)	Weight	
			Input	Test port			Net	Shipping
85020A	.01-4.3 GHz	50 ohms	Type-N (f)	Type-N (f)	.01-3 GHz: 40 dB 3-4.3 GHz: 34 dB	.01-3 GHz: <1.22 3-4.3 GHz: <1.25	0.5 kg (1.2 lb)	2.3 kg (5 lb)
85020B	.01-2.4 GHz	75 ohms	Type-N (f)	Type-N (f)	40 dB	.01-1.3 GHz: <1.25 1.3-2.4 GHz: <1.43	"	"

For use with the HP 8756, or 8755 in AC detection mode or with the HP 8757 in either AC or DC detection modes

85027A	.01-18 GHz	50 ohms	Type-N (f)	7mm	40 dB	.01-8.4 GHz: <1.15 8.4-12.4 GHz: <1.25 12.4-18 GHz: <1.43	0.5 kg (1.2 lb)	2.3 kg (5 lb)
85027B	.01-26.5 GHz	50 ohms	3.5mm (f)	3.5mm (f)	.01-20 GHz: 40 dB 20-26.5 GHz: 36 dB	.01-8.4 GHz: <1.15 8.4-20 GHz: <1.43 20-26.5 GHz: <1.75	"	"
85027C	.01-18 GHz	50 ohms	Type-N (f)	Type-N (f)	.01-12.4 GHz: 36 dB 12.4-18 GHz: 34 dB	.01-8.4 GHz: <1.15 8.4-12.4 GHz: <1.25 12.4-18 GHz: <1.43	"	"
85027D	.01-47 GHz	50 ohms	2.4mm (f)	2.4mm (m)	.01-26.5 GHz: 35 dB 26.5-40 GHz: 30 dB 40-47 GHz: 25 dB	.01-16 GHz: <1.15 16-30 GHz: <1.25 30-40 GHz: <1.40 40-47 GHz: <1.85 (typical)	"	"
85027E	.01-26.5 GHz	50 ohms	3.5mm (f)	3.5mm (m)	.01-20 GHz: 40 dB 20-26.5 GHz: 36 dB	.01-8.4 GHz: <1.15 8.4-20 GHz: <1.43 20-26.5 GHz: <1.75	"	"

1. Option 001 changes to 7mm connector.

2. The HP 85025 and 85026 series detectors and the HP 85025C require HP 8757A firmware revision 2.0 or higher.

To upgrade previous revisions order the HP 11614A Firmware Enhancement.

3. Depends on the particular external detector used.

4. The HP 85025C K57 requires the HP 85100V millimeter-wave source module and a HP 85025C K56 bandpass filter.

The HP 85025C K71 requires the HP 85100W millimeter-wave source module and a HP 85025C K91 bandpass filter. For further information, contact your local HP sales office.

# NETWORK ANALYZERS

## 8757/8756 System Accessories (con't)

Models 11679A/B, 85023A/B/C/D, 85022A, 85028A, 11614A

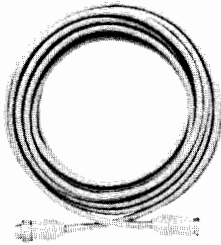

HP 11679A

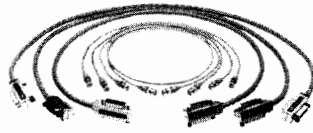

HP 85022A

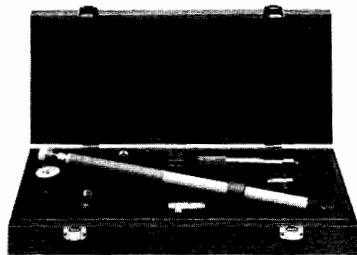

HP 85028A



HP 85023C

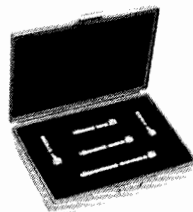

HP 11678A



HP 11668A

### HP 11679A/B Extension Cables

**Function:** These cables extend the distance between the scalar network analyzer and the detector or bridge to a maximum of 200 feet without degradation of performance.

HP 11679A: 7.6 m (25 ft) extension cable

HP 11679B: 61 m (200 ft) extension cable

### HP 85023A/B/C/D/F Verification Kits

The HP 85023 Series system verification kits each contain a set of precision components used to perform a system verification procedure for the HP 8757S/56S scalar network analyzer system. This procedure, which is in the HP 8757/56 Operating and Service Manuals, checks system installation and can be used as a daily functional test.

Choose a system verification kit to match your device under test. For 7mm applications, select the HP 85023A. If you are measuring SMA or 3.5mm devices, choose the HP 85023B. For 50 ohm, Type-N applications, select the HP 85023C. These kits (HP 85023A/B/C) all include an open, short, 10 dB fixed attenuator, 50 ohm termination, and a source to directional bridge adapter of the corresponding connector type. The HP 85023D verification kit, for 75 ohm Type-N measurements, consists of a short, a 75 ohm termination, a 50 ohm 10 dB fixed attenuator and two HP 11852B 50 to 75 ohm minimum loss pads (for 50/75 ohm impedance conversion).

The HP 85023F verification kit includes 2.4mm standards for verifying performance of the HP 8757S system to 50 GHz. Included are a 2.4mm female open, short and 50 ohm load, a 10 dB attenuator, and female to female adapter.

**Frequency range:** HP 85023A/C, dc to 18 GHz.

HP 85023D, dc to 1.3 GHz.

HP 85023B, dc to 26.5 GHz.

HP 85023F, dc to 50 GHz.

**Connector type:** HP 85023A, 7mm.

HP 85023B, 3.5mm.

HP 85023C, Type-N, 50 ohm.

HP 85023D, Type-N, 75 ohm.

HP 85023F, 2.4mm, 50 ohm.

**Characteristic impedance:** HP 85023A/B/C/F, 50 ohm.

HP 85023D, 75 ohm.

**Weight:** net, 0.5 kg (1.2 lb); shipping, 1.2 kg (2.9 lb).

### HP 85022A System Cable Kit

The HP 85022A contains all the BNC and HP-IB cables to connect an HP 8350B sweep oscillator (or HP 8340B synthesized sweeper), an HP Series 200 or 300 computer, and a printer to the HP 8757 or 8756. This kit contains 3 one-meter HP-IB cables (HP 10833A), 3 two-foot BNC cables (HP 11170B), and 1 four-foot BNC cable (HP 11170C).

**BNC connectors:** N-Male, N-Male.

**BNC impedance:** 50 ohm.

**Weight:** net, 0.5 kg (1.2 lb); shipping, 1.2 kg (2.9 lb).

### HP 85028A 7mm Directivity Verification Standards for HP 85021A/85027A

The HP 85028A allows on-site verification of the 40 dB directivity of the HP 85021A and 85027A directional bridges. For frequencies below 2 GHz, a precision 52 dB return loss load is used. For frequencies from 2 to 18 GHz, a sliding mismatch is used to establish a ripple pattern from which the directivity can be calculated. The HP 85028A includes a precision 50 ohm termination, a high-performance sliding mismatch, an 7mm open/short, an 7mm connector gage kit, and a torque wrench.

**Weight:** net, 2.0 kg (4.5 lb); shipping, 3.5 kg (8.0 lb).

### HP 11614A Firmware Enhancement

The HP 11614A firmware enhancement updates the HP 8757A scalar network analyzer to firmware revision 2.1. (HP 8757As with serial number prefix 2802A or higher already have revision 2.1 firmware). Firmware revision 2.1 includes all the features of firmware revision 2.0, which added several new features to previous versions of the HP 8757A. These include the ability to display and plot reflection traces in units of standing wave ratio (SWR), tabular listings of numerical data on an HP ThinkJet printer, full calibration and operation with the HP 85025C detector adapter and R/Q/U85026A waveguide detectors, and the ability to display and plot an external voltage applied to a rear panel input. All revision 2.1 features are HP-IB programmable.



# NETWORK ANALYZERS

8757/8756 System Accessories (cont'd)

Models 11613B, 11636A/B, 11665B, 11668A, 11852B

225

## HP 11668A High Pass Filter

The HP 11668A high pass filter accessory is recommended when making measurements on active devices that have gain below 50 MHz. Use of the HP 11668A, placed after the HP 11665B, reduces the modulator drive feedthrough from 8 mV to 1 mV and prevents possible amplifier saturation. Use of the HP 11668A filter is not necessary for passive measurements since the feedthrough from the HP 11665B is -65 dBm and causes no degradation in system performance.

**Frequency range:** 50 MHz to 18 GHz.

	Insertion Loss	Return Loss
50-100 MHz	≤2.5 dB	≥12 dB
100 MHz-8 GHz	≤1.0 dB	≥16 dB
8-12 GHz	≤1.0 dB	≥14 dB
12-18 GHz	≤1.5 dB	≥14 dB

**Maximum input:** +27 dBm.

**Connectors:** N-female, N-male.

**Weight:** net, 0.13 kg (5 oz); shipping, 0.28 kg (10 oz.).

## HP 11678A Low Pass Filter Kit

**Description:** the HP 11678A low pass filter kit contains five filters. Low pass filters reduce harmonics generated by the RF source when making precision measurements.

**Frequency Range** (low pass filters, cutoff frequency fc)

HP 11688A:	2.8 GHz.
HP 11689A:	4.4 GHz.
HP 11684A:	6.8 GHz.
HP 11685A:	9.5 GHz.
HP 11686A:	13.0 GHz.

**Insertion loss:** <1.1 dB at 0.95 fc.

**Rejection** (at 1.25 fc): greater than 40 dB.

**Impedance:** 50 ohm normal.

**Connectors:** N-Female, N-Male.

**Weight:** net, 0.44 kg (1 lb); shipping, 1.2 kg (2.9 lb).

## HP 11613B Calibrator

HP 8757 and 8756 verification/calibration is recommended every 12 months. This can be accomplished at an HP service center or on-site using the HP 11613B calibrator and an HP 9000 series 200 or series 300 computer.

The HP 11613B is a dedicated transfer standard for calibration of the HP 8757 and 8756. The HP 11613B provides the standard a 27.778 kHz source and a series of precision attenuators. The calibrator includes software (both 3.5 and 5.25 inch formats) that operates on an HP 9000 series 200 or series 300 computer, the BASIC operating system (BASIC 2.0, and above) and a GP-IO cable for use when calibrating the HP 8756. The software verifies (and adjusts if necessary) the internal calibration parameters stored in the non-volatile memory of the HP 8757 and 8756. All HP 8757 and 8756 detector inputs can be calibrated in a matter of minutes. Re-calibration of the HP 11613B is recommended every two years.

**Memory Requirement:** 1/2M byte, including BASIC.

**Hardware Requirement:** HP 98622A 16-bit GP-IO interface card for use with HP 8756.

**Dimensions:** 40 H x 185 W x 203 mm D (1.5 x 7.3 x 8.0 in).

**Cable length:** 1.22 m (48 in).

**Weight:** Net 0.91 kg (2 lbs). Shipping 1.4 kg (3 lbs).

HP 11665B

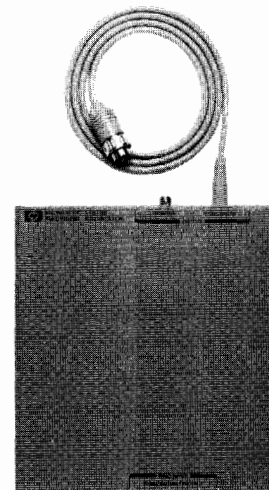

HP 11613B

## HP 11636A/B Power Dividers

The HP 11636A/B power dividers/combiners are recommended when making wideband comparison measurements without ratioing, and in fault location measurements with the HP 8757S/85016. Detailed specifications are on page 341.

## Other Signal Separation Devices

Many other signal separation devices are available from HP for use with the HP 8757, 8756 and 8755. Coaxial couplers from 0.1 to 18 GHz are available with the HP 770 series, the 790 series, and the HP 11692. Higher directivity HP 752 series waveguide couplers can also be used with the HP 8757, 8756 or 8755 with the addition of appropriate HP 281 series waveguide-to-coax adapters.

## 11665B Modulator

**Function:** absorptive on-off modulator designed for and powered by the HP 8757, 8756 or 8755 scalar network analyzers.

Frequency Range	Return Loss On and Off	Insertion Loss On Off
15-40 MHz	≥10 dB	≤7.0 dB ≥35 dB
40 MHz-4 GHz	≥15 dB	≤3.2 dB ≥35 dB
4-8 GHz	≥12 dB	≤3.8 dB ≥40 dB
8-12.4 GHz	≥8 dB	≤4.3 dB ≥45 dB
12.4-18 GHz	≥8 dB	≤5.0 dB ≥45 dB

**Modulator drive feedthrough:** ≤8 mV (peak) at 27.8 kHz at either port when powered by the HP 8757, 8756 or 8755. Reduced to ≤1 mV (peak) using the HP 11668A. (See HP 11668A High Pass Filter).

**Drive current:** nominally +50 mA in On condition, -50 mA Off condition.

**Weight:** net, 0.17 kg (6 oz); shipping, 0.9 kg (2 lb).

## HP 11852B 50 ohm/75 ohm Minimum Loss Pad

The HP 11852B is a low SWR minimum loss pad required between 75 ohm devices and 50 ohm sources and detectors. For more information, see page 245.

# NETWORK ANALYZERS

## 8757/8756 System Accessories (con't)

### Models 11667A/B/C

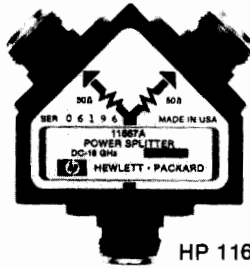

HP 11667A

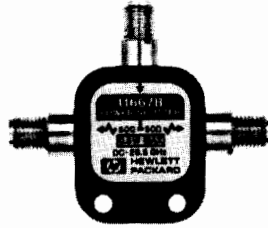

HP 11667B

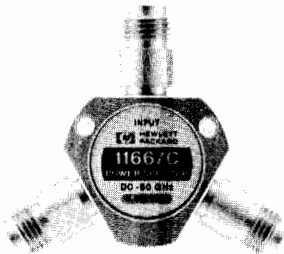

HP 11667C

#### HP 11667A/B/C Power Splitter

The HP 11667A/B/C power splitters are recommended when making wideband ratio measurements using the HP 8757, 8756, or 8755 scalar network analyzer. These two-resistor type splitters provide excellent output SWR at the auxiliary arm when used for source leveling or ratio measurement applications. The tracking between output arms over a frequency range from dc to 50 GHz allows wideband measurements to be made with a minimum of uncertainty.

#### Frequency Range:

HP 11667A: DC to 18 GHz.

HP 11667B: DC to 26.5 GHz.

HP 11667C: DC to 50 GHz.

**Impedance:** 50 ohms nominal.

#### Insertion Loss:

HP 11667A/B: 6 dB nominal.

HP 11667A	DC to 4 GHz	DC to 8 GHz	DC to 18 GHz
<b>Input SWR:</b>	≤1.15	≤1.25	≤1.45
<b>Equivalent Output SWR:</b> (leveling or ratio measurements)	≤1.10	≤1.20	≤1.33
<b>Output Tracking (dB):</b> (between output arms)	≤0.15	≤0.20	≤0.25
<b>Typical Phase Tracking (deg):</b> (between output arms)	0.5	1.5	3.0

HP 11667B/C	DC to 18 GHz	DC to 26.5 GHz	DC to 40 GHz	DC to 50 GHz
<b>Input SWR:</b> HP 11667B HP 11667C	≤1.22 ≤1.22	≤1.29 ≤1.38	≤1.50	≤1.65
<b>Equivalent Output SWR:</b> (leveling or ratio measurements) HP 11667B HP 11667C	≤1.22 ≤1.29	≤1.22 ≤1.29	≤1.50	≤1.65
<b>Output Tracking (dB):</b> (between output arms) HP 11667B HP 11667C	≤0.25 ≤0.30	≤0.40 ≤0.35	≤0.40	≤0.40
<b>Typical Phase Tracking (deg):</b> (between output arms) HP 11667B HP 11667C	1.5 2.0	2.5 2.5	3.0	3.0
<b>Typical Insertion Loss (dB):</b> HP 11667C	6.0	7.0	8.0	8.5

**Maximum Input Power:** +27 dBm

#### Connectors:

HP 11667A: N-female on all ports.

HP 11667B: APC-3.5 female on all ports.

HP 11667C: 2.4 mm female on all ports.

#### Dimensions:

HP 11667A: 46 H x 52 W x 19 mm D (1.8 x 2.0 x 0.7 in.).

HP 11667B: 40 H x 47 W x 10 mm D (1.6 x 1.9 x 0.4 in.).

HP 11667C: 36 H x 36 W x 10 mm D (1.4 x 1.4 x 0.4 in.).

#### Weight:

HP 11667A: net, 0.14 kg (0.31 lb); shipping 0.22 kg (0.5 lb).

HP 11667B: net, 0.06 kg (0.13 lb); shipping 0.14 kg (0.3 lb).

HP 11667C: net, 0.06 kg (0.13 lb); shipping 0.14 kg (0.3 lb).

#### Ordering Information

The HP 8757S Automatic Scalar Network Analyzer is ordered with multiple line items to give you maximum flexibility in specifying a system that meets your needs. This ordering guide lists the HP 8757S line items required for software compatibility. It is not necessary to order any line item you already own. Consult your local HP Sales Office if you would like assistance.

#### HP 8757S Scalar Network Analyzer System

This system model number ensures coordination of shipments and compatibility of instruments and software.

#### Analyzer

HP 8757A Scalar Network Analyzer	\$9,000
Opt. 001 Fourth detector input	\$1,500
Opt. W30 Two years extended service	\$220

**Sweep Oscillators** (choose either HP 8350B with an RF Plug-in, 8340B, or 8341B)

#### Directional Bridges

(choose at least one)	
HP 85027A 0.01–18 GHz, 7mm, 50 ohm	\$2,500
HP 85027B 0.01–26.5 GHz, 3.5mm female, 50 ohm	\$2,950
HP 85027C 0.01–18 GHz, Type-N female, 50 ohm	\$2,500
HP 85027D 0.01–47 GHz, 2.4mm male, 50 ohm	\$3,500
HP 85027E 0.01–26.5 GHz, 3.5mm male, 50 ohm	\$2,950
HP 85020A 0.01–4.3 GHz, Type-N female, 50 ohm	\$1,150
HP 85020B 0.01–2.4 GHz, Type-N female, 75 ohm	\$1,300

#### Detectors

(choose at least one)	
HP11664A 0.01–18 GHz, Type-N male	\$525
Opt. 001 7mm connector	add \$50
HP 11664E 0.01–26.5 GHz, 3.5mm male	\$700
HP 11664D 26.5–40 GHz, WR-28 waveguide	\$1,100
HP 11664C Detector Adapter	\$300
HP 85025A 0.01–18 GHz, Type-N male	\$900
Opt. 001 7mm connector	add \$50
HP 85025B 0.01–26.5 GHz, 3.5mm male	\$950
HP 85025D 0.01–50 GHz, 2.4mm male	\$1,500
HP 85025E 0.01–26.5 GHz, 3.5mm male	\$1,200
HP R85026A 26.5–40 GHz, WR-28 waveguide	\$1,500
HP Q85026A 33–50 GHz, WR-22 waveguide	\$1,700
HP U85026A 40–60 GHz, WR-19 waveguide	\$1,700
HP 85025C Detector Adapter	\$600

#### System Verification Kits

(choose at least one)	
HP 85028A 7mm directivity verification standards	\$5,000
HP 85023A 7mm, 50 ohm	\$625
HP 85023B 3.5mm, 50 ohm	\$850
HP 85023C Type-N, 50 ohm	\$550
HP 85023D Type-N, 75 ohm	\$900
HP 85023F 2.4mm, 50 ohm	\$2,100

**Price  
\$0**

#### Filter Kits

HP 11668 High Pass Filter Kit	\$555
HP 11678 Low Pass Filter Kit	\$1,380

#### System Cable Kit

HP 85022A System Cable Kit	\$355
----------------------------	-------

#### Computer

(choose one)	
HP 98257A 1M byte Memory Board	\$1,480
HP 98580A Series 300, Model 310	\$5,860

#### Disc Drives

(one required for HP 9816S)	
HP 9122D 3.5 inch Dual Flexible Disc Drive	\$1,425

#### Software

(choose one option)	
HP 85015B System Software for HP 8757	\$2,000
Opt. 630 for Computer with HP 9121D/22D Disc Drive	N/C
Opt. 655 for either HP 9826S or 9836S Computer	N/C
HP 85016B Transmission Line Test Software for HP 8757	\$4,500
Opt. 630: for Computer with HP 9121D/22D Disc Drive	N/C
Opt. 655: for either HP 9826S or 9836S Computer	N/C

#### Recommended Accessories

(choose at least one)	
<b>Printer</b>	
HP 2225A ThinkJet Printer	\$495
HP 2227B QuietJet Printer	\$799
HP 2932A Opt 046 Impact Graphics Printer	\$2,745
<b>Plotter</b> (choose at least one)	
HP 7440A Opt. 002 Eight-pen Graphics Plotter (8.5" x 11")	\$1,295
HP 7550 Eight-pen Vector Plotter (11" x 17")	\$3,900

#### Optional Accessories

(for ratio and/or modulation measurements)	
HP 11636A Power Divider DC to 18 GHz	\$450
HP 11636B Power Divider DC to 26.5 GHz	\$950
HP 11665B Modulator	\$900
HP 11667A Power Splitter DC to 18 GHz	\$930
Opt. 001 N-male on input port; N-female on output ports:	N/C
Opt. 002 N-female on input port; 7mm on output ports:	add \$75
HP 11667B Power Splitter DC to 26.5 GHz	\$950
HP 11667C Power Splitter DC to 50 GHz	\$1,500
HP 11852B 50 to 75 ohm Minimum Loss Pad	\$350

#### Service and Support Products

HP 11613B Calibrator	\$900
HP 8757S+23N Onsite Installation (where available)	
HP 8757S+02B Onsite Service (where available)	

# NETWORK ANALYZERS

## Scalar Network Analyzer Software for the HP 8757/8756

Models 85015B, 85016B, 86399-10001

- Custom tests without programming
- Friendly menu operation
- Measure insertion and return loss
- Plot or store data
- Test coax and waveguide
- Locate faults in transmission lines

### HP 85015B System Software

Using the HP 85015B system software for the HP 8757/8756, you can create and run complete scalar measurements without programming. The software guides you all the way from setup to output. Just make your selections using the computer's knob and softkeys. The software makes all the necessary settings on the scalar analyzer and source to provide fast, accurate measurements that can be stored for later reference.

### Easy To Learn

Use the BASIC mode to get up to speed quickly on the software's operation. It prompts you with a few simple questions, then sets up your source and analyzer automatically. The software prompts you to make all the connections necessary for calibration and measurement sequences, then automatically plots the data on the CRT display. For a permanent record, send the plot to a graphics plotter with a single keystroke.

### Use The Analyzer CRT

With the HP 8757, use the scalar analyzer as the control center for your measurements. The analyzer knob and softkeys control the software menus which appear on the CRT of the HP 8757, instead of the computer's.

### Customized Measurement Setups

Use the GENERAL and ADVANCED modes to access more of the software's powerful features. Define up to 4 measurements in one sequence. Specify particular power levels for your test device and enter your specification limits as point, line, or sloped limits. These limit lines allow simple pass/fail testing, or real time adjustment to within the spec limits.

Then output the data using your own customized format with labels, limit lines and "out-of spec" indicators. Make up to 4 plots on a single page. Store the data on computer disc for archival purposes, then recall it later for further analysis.

The software makes it easy to save your configuration, complete with all the parameters you've specified and the calibration data. When you want to run this test later, just recall the configuration and connect the device. The software recalls cal data, plot formats, labels, limit lines . . . everything you need to run complete automated tests.

### Test Transmission Lines

The HP 85016B transmission line test software provides all the capability of the HP 85015B plus fault location for complete testing of coax and waveguide transmission lines. Test frequency response (insertion and return loss), then find faults (mismatches) that affect the signals in your frequency range. Troubleshoot your ECM, radar or communication system quickly and without guesswork.

Fault location is accomplished using frequency domain reflectometry, a technique that uses frequency domain reflection data and the inverse Fast Fourier Transform to characterize reflection as a function of distance. This enables you to locate impedance mismatches resulting from bad connections or faulty cables.

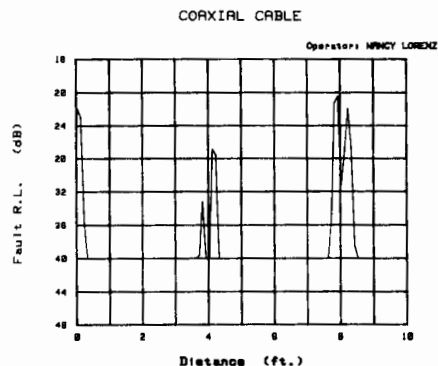

### MISMATCH SUMMARY

Cable or Waveguide Type: Coax  
Relative Velocity: .695  
Loss/100 ft: 50  
Length (Range): 10 ft  
Center Frequency: 5 GHz  
Distance Resolution: .1 ft  
Current Window is: Normal

### Measurement 1:

Operator: NANCY LORENZ

Distance (ft.)	FLT. R.L. A (dB)	% OF TOTAL MISMATCH
.020	21.91	36.347
4.120	26.84	20.607
7.920	20.44	43.046

### Ordering Information

Each software package comes with 5 discs, including a data disc. Order the option that corresponds to your computer configuration. The HP 85015B/16B can run on BASIC 2.0 or greater and requires 1½ Mbytes of RAM memory.

#### HP 85015B system software

Opt. 630: 3.5 inch discs

Opt. 655: 5.25 inch discs

#### HP 85016B transmission line test software

Opt. 630: 3.5 inch discs

Opt. 655: 5.25 inch discs

#### Price

\$2000

N/C

N/C

\$4500

N/C

N/C

### Amplifier Test Software

#### Tailored for Amplifier Testing

The Amplifier Test Software (HP Part No. 86399-10001) allows rapid and systematic characterization of amplifier gain compression. Specifically, the software automates measurements of amplifier output power at the 1-dB compression point at frequencies of interest. The software runs with the HP 8757A and 8756A, and the HP 8350B sweep oscillator or HP 8340B/41B synthesized sweepers. Besides compression testing, the software also allows measurements of gain and return loss/SWR.

#### Easy to Operate and Modify

The Amplifier Test Software's menu-driven, friendly user interface is designed so that measurements can be configured and run soon after the system is set up. Its limited feature set allows for a short program, which can be easily modified by the user to suit his needs. The documentation provided with the software includes a complete program listing, flow diagram, and variable dictionary.

#### Ordering Information

Each software package comes with the software on both 3-½" and 5-¼" formats, and Product Note 8757-6, which documents operation of the software. The Amplifier Test Software can run on BASIC 2.0 or higher on HP 9000 series 200 or 300 computers with at least 1 Mbyte of RAM memory.

#### HP 86399-10001 Amplifier Test Software

\$250

# NETWORK ANALYZERS

## Transmission Line Test System

Model HP 8328A

229

- High resolution - 0.25%
- Fast computation
- Three user levels

- Automatic data correction
- Completely self-contained
- Pass/fail and limit testing

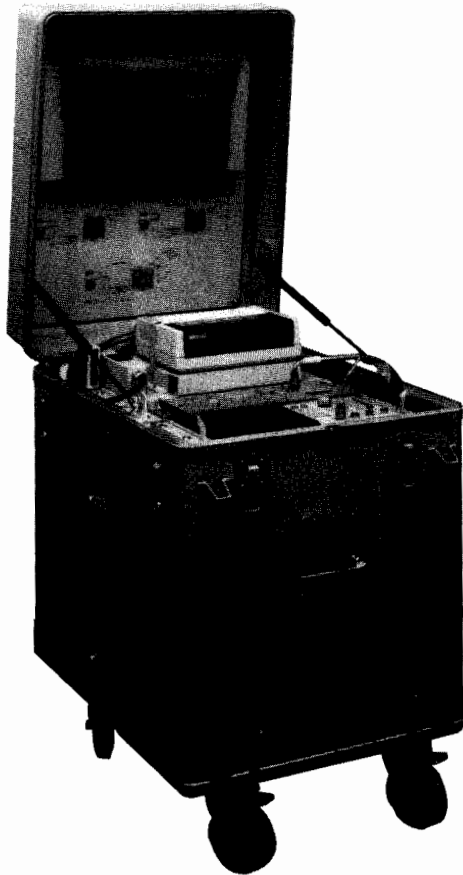

HP 8328A

The HP 8328A Transmission Line Test System tests the performance of waveguide runs and coaxial cables with swept frequency measurements of insertion loss and return loss. Additionally, the HP 8328A system can make fault location tests to find impedance mismatches as a function of distance, quickly and without guesswork.

The HP 8328A is a dedicated transmission line test system for tests from 10 MHz to 18 GHz. It is configured in a rugged, transportable container. The system is self-contained for ease of use and is ideal for accessing transmission lines in difficult-to-reach installations such as aircraft. Although all testing can be done automatically, full manual capability is retained.

The HP 8328A contains the HP 8757A Scalar Network Analyzer, the HP 8350B Sweep Oscillator with the HP 83592A RF Plug-In for coverage from 10 MHz to 18 GHz, the powerful HP 9000 Model 310 computer, the HP 85016B Transmission Line Test Software, and scalar analyzer accessories. The software is accessed from the front panel softkeys and knob of the HP 8757A. Complete measurements including pass/fail and limit testing can be configured and run easily like the HP 85016B software.

It is recommended that the HP 8328A Option 100, an HP 35731A monitor, an HP 46021A keyboard, and an HP 9122D dual disc drive be included for system diagnostics and disc backup for long-term data storage and retrieval.

### Swept Distance Capability

**Measurements vs. distance:** Return loss (dB), SWR, or reflection coefficient.

**Resolution** (distance between data points as a percentage of the transmission line length):

1% (101 pts), 0.5% (201 pts), 0.25% (401 pts).

**Data correction:** Data is normalized to the response with a 50 ohm load at the test port. Data is also completely corrected for line losses and preceding mismatches. If waveguide is tested, the effects of phase dispersion are automatically removed from the response. The correction data for the coaxial cable or waveguide run is contained in a lookup table with over 100 entries stored in the program. This table can be modified to improve entries or updated with new cables.

**Range and resolution (vs. frequency):** The standard RF plug-in for the system is an HP 83592A, with a span from 10 MHz to 18 GHz. This span allows a minimum test range of 2 ft. and a resolution of 0.01 ft. (for 201 distance points and 0.5% resolution). Maximum test range is 500 ft. with a resolution of 2.5 ft.

### Swept Frequency Capability

**Measurements vs. frequency:** Insertion loss, gain, return loss, VSWR, reflection coefficient, and power in dBm, dBW, or mW.

**Frequency range:** 10 MHz to 18 GHz with HP 83592A plug-in; Option 001, 10 MHz to 8.4 GHz with HP 83525B plug-in

**Resolution:** User selectable up to 1024 pts. for swept measurements, or stepped CW measurements.

**Dynamic range (HP 11664A detectors and HP 8757A):** 76 dB (+16 to -60 dBm)

### General

**User modes:** BASIC, GENERAL, and ADVANCED. These user levels vary the level of sophistication to match the experience level of the user and the requirements of the measurement.

### Measurement and data storage:

**Configurations per data volume (typical):** 99

**Measurements per configuration:** 4

**Measurement data sets per data volume:** 99

Additional storage can be obtained with the HP 8328A option 100 and the recommended optional equipment.

### Ordering Information

**HP 8328A** Transmission Line Test System

**Opt 001:** 10 MHz to 8.4 GHz only

**Opt 100:** Adds support software

### Price

\$64,000

less \$7,000

add \$250



# NETWORK ANALYZERS

## Combined Network/Spectrum Analysis, 10Hz to 500MHz

### Model 4195A

- Linear and non-linear device measurement and analysis
- High accuracy and resolution
- User functions
- Color graphics, graphics analysis and direct copy capability
- Direct save/recall with internal disc drive

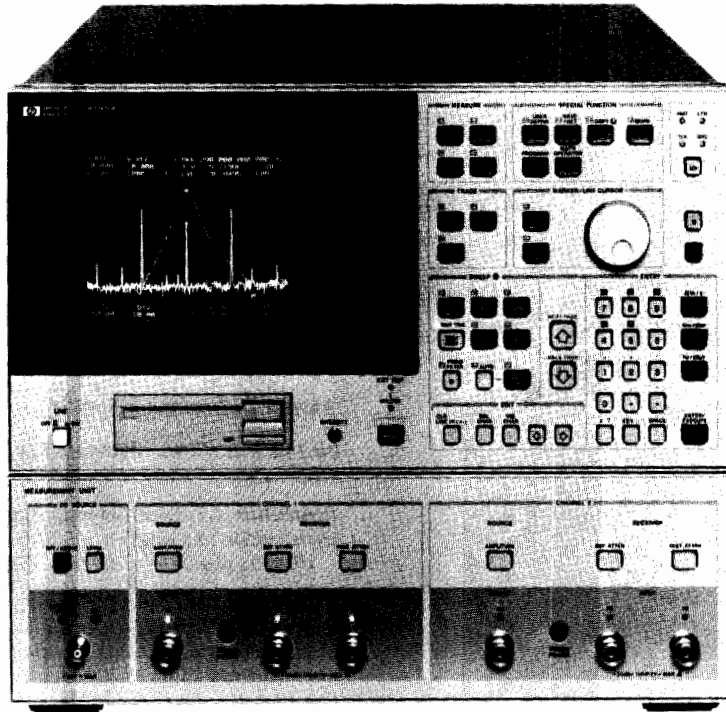

HP 4195A



### Description

The HP 4195A is a high performance, cost effective and intelligent analyzer with combined vector network and spectrum analysis capabilities. The frequency is covered from 10Hz through 500MHz with an excellent 0.001Hz resolution for audio, baseband, HF, VHF and IF applications. It directly measures amplitude ratio, phase, group delay and spectrum level needed for characterizing linear/non-linear analog circuits or components used in communications, telecommunications, consumer electronics and other equipment.

The HP 4195A's excellent accuracy and resolution meets the severe measurement requirements for developing advanced equipment. A color display allows you to readily differentiate between multiple traces. Convenient softkey operation and marker functions make deriving device parameters quick and easy. Measurement results can be directly copied to printer or plotter without an external computer. Furthermore, the HP 4195A has internal user functions for computing and self controlling capability. User Program, User Defined Function and User Math allows you to quickly customize the setups most suited to your application without using an external computer. A built-in 3.5 inch disc drive can save the instrument state, data and user functions.

### Combined Vector Network and Spectrum Analysis

Network analyzers and spectrum analyzers have become essential tools for evaluating subsystems or components used in electronic equipment. Especially, the importance of phase and group delay measurements is rapidly increasing. The HP 4195A offers full network and spectrum analysis from 10Hz to 500MHz at half the price. It has very wide applications. Network analysis functions include characterizing the gain/group delay ripple of filters and amplifiers. Spectrum

analysis functions include the harmonic, intermodulation distortion of amplifiers or IF subsystems in communications and telecommunications. S-parameters can also be measured by using 2 transmission/reflection test sets, without changing direction of the device.

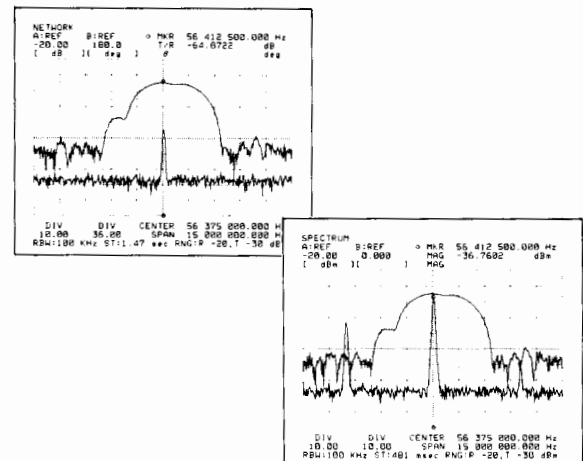

### High Accuracy and Resolution Measurement

The HP 4195A measures amplitude ratio and phase with an accuracy of  $\pm 0.05\text{dB}/\pm 0.3\text{ deg}$  and a resolution of  $0.001\text{dB}/0.01\text{ deg}$ . The amplitude and phase distortion of transmission devices, such as filters, amplifiers, delay lines and cables, affect the quality of information and create bit errors in PSK or QAM systems. The HP 4195A can evaluate distortion with high accuracy and resolution. For accuracy enhancement, 1 Port Full Cal, 1 Port Partial Cal, Normalization and Port Extension capabilities are available. For spectrum analysis, high level accuracy of  $\pm 0.1\text{dB}$  and fully synthesized local OSC allow you to obtain stable and reliable C/N, harmonic distortion or intermodulation distortion measurements. In addition the high shaped digital IF filter technique makes discrimination of closely spaced signals easy, so 50/60 Hz power-line sidebands can be measured using the 10Hz RBW.

### User Functions for Easy Customized Operation

The HP 4195A has three user functions for customizing operations for your applications without using an external computer. The User Program gives you a one key solution for performing your application. You can program a sequence from measurement and marker control, computing, through printing a hard copying. This function is very useful and improves efficiency for C/N (Carrier Noise ratio), THD (Total Harmonic Distortion) measurements or automatic device parameter extraction, such as an amplifier's gain, group delay, gain compression or harmonic distortion. The User Math function helps you put the result in the form you need by using the built-in math operators and arithmetic functions. For example, you can display level in volt peak-to-peak instead of volts rms or perform differentiation of gain or max hold. The User Defined Function gives you the power to define functions which can be called with softkeys as you like, such as input of step size, signal tracking, transmission/reflection alternate sweep or gain/level spectrum alternate sweep. In addition, the HP 4195A has the Program Sweep function which can arbitrarily sweep the points programmed in the table. This increases measurement efficiency by reducing excessive points in the Lin or Log sweep. Also, the resolution bandwidth can be independently set for each programmed point. The above user functions and program sweep table can be saved into the built-in 3.5 inch disc, so you can start your application at any time.

```

SPECTRUM          C/N-MEASUREMENT
PROGRAM EDITOR
FILE NAME: CNI

1  C/N-MEASUREMENT
10 MCF2
50 DELT1
30 MKACT1
40 MKM
50 DMKR=1 MHZ:R1=0
60 FOR R0=1 TO 10
70 SWTRG
80 R1=DMKRA+R1

90 R2=R1/80
100 DISP "C/N(DB)=-",R2
110 NEXT R0
120 CNT "C/N-MEASUREMENT"
130 END
    
```

User Program for C/N Measurement

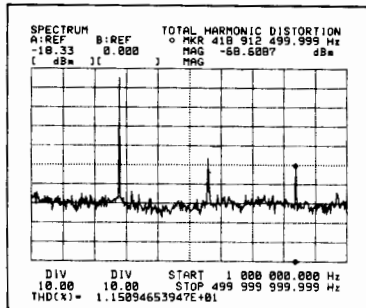

THD Measurement by Using User Define Function

### Advanced Marker Action on Color Graphics

The application oriented marker functions are very useful for both network and spectrum measurements. You can quickly obtain the desired results from the easy to see color graphics CRT. The Next Peak is convenient for searching harmonic or spurious signals. The marker target is used for extraction of SAW filter's 3dB bandwidth or an amplifier's  $-1\text{ dB}$  gain compression point. The delta marker is used for C/N measurement, and the noise marker is used for noise measurements. A maximum of four traces can be simultaneously displayed on the CRT, so it is easy to compare the data. The smith/polar chart is convenient for impedance matching in circuit design. In addition, the results can be directly copied to a compatible plotter or printer without an external computer.

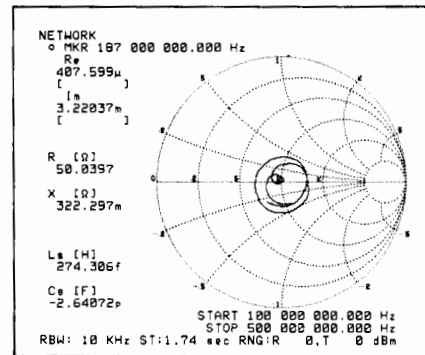

### Specifications

#### Network Measurement Source

- Frequency:** 10Hz to 500MHz, 1mHz resolution
- Power:**  $-50\text{ dBm}$  to  $+15\text{ dBm}$ ,  $0.1\text{dB}$  resolution
- Sweep Parameters:** Frequency, power and dc bias level
- Sweep Types:** Linear, log, cw, program and partial
- Output:** 2 outputs
- DC bias level:**  $\pm 40\text{V}$ ,  $10\text{mV}$  resolution

#### Receiver

- Frequency:** 10Hz to 500MHz
- Input:** 4 inputs,  $50\ \Omega$  nominal
- Resolution Bandwidth:** 3Hz to 300kHz, 1 or 3 step
- Input Crosstalk:**  $\leq -100\text{dB}$

#### Magnitude Ratio

- Dynamic Range:**  $> 100\text{dB}$
- Resolution:**  $0.001\text{dB}$
- Dynamic Accuracy ( $23 \pm 5^\circ\text{C}$ ),  $-30\text{dBm}$  R input:**  $\pm 0.05\text{dB}$  @  $-70\text{dBm}$  to  $-30\text{dBm}$  T input.

#### Phase

- Range:**  $\pm 180^\circ$
- Resolution:**  $0.01^\circ$
- Dynamic Accuracy ( $23 \pm 5^\circ\text{C}$ ,  $-30\text{dBm}$  input):**  $\pm 0.3^\circ$  @  $-70$  to  $-30\text{dBm}$  T input.

#### Delay

- Range:** 10ps to 500s
- Resolution:** 10ps @ 3.6 MHz aperture
- Accuracy:** depends on phase accuracy

#### Error Compensation

- Mode:** Normalization, 1 port partial cal, 1 port full cal and port extension.

#### Spectrum Measurement

##### Frequency

- Measurement Range:** 10Hz to 500MHz
- Resolution:**

- RBW:** 3Hz to 300kHz, 1 or 3 step
- Selectivity (60/3dB):** 4 for 3Hz to 30Hz  
8.5 for 100Hz

# NETWORK ANALYZERS

## Combined Network/Spectrum Analysis, 10Hz to 500MHz (cont'd)

### Model 4195A

#### Amplitude

**Measurement Range:** -135 dBm to +20 dBm

**Accuracy:**  $\pm 1.0$  dB 50MHz

**Linearity** ( $23 \pm 5^\circ\text{C}$ ):  $\pm 0.1$  dB @ -40 to 0dB;  $\pm 0.2$  dB @ -60 to -40dB

**Frequency Response:**  $\pm 1.5$  dB

**Dynamic Range** ( $23 \pm 5^\circ\text{C}$ )

**Second Harmonic Distortion:**  $\leq -70$  dBc @  $\geq 2$  MHz

**T.O.I Distortion:**  $\leq -80$  dBc @  $\geq 2$  MHz

**Residual Response:** -110dB @  $\geq 100$  kHz.

**Average Noise Level:** typically -140dBm @ 10Hz RBW,  $\geq 2$  MHz

#### Sweep

**Sweep Type:** Linear, log, cw, program and partial

**Sweep Mode:** Continuous, single and manual

**Sweep Time:** approximately 500 ms/span to 1800 s/span

#### Input

**Number of inputs:** 4 inputs

**Impedance:** 50  $\Omega$  nominal

**Damage level:** +30 dBm

**Attenuator:** 0 to 50dB, 10dB step

#### Display and Analysis

**Display:** 7.5 inch color CRT

**Display Format:** Rectangulars, Table, Smith and Polar

**Traces:** 4 traces max

**Scale Type:** Linear, log

#### Autoscale

**Phase Display Expansion:** Display phase continuously more than  $\pm 180$  deg.

**Video Filter:** Digital video filtering reduces random noise

**Comment Entry:** Display a comment used alphabet, numeral and special characters ( , , % , etc).

**Marker:** MKR  $\rightarrow$  Max (Min, Ref, Center, Start and Stop), Next Peak, Width and Delta reading mode.

#### User Functions

##### User Math:

Puts the result in the form needed for your application by using built-in math operators, arithmetic functions and editing capability.

##### User Defined Function:

Provides one-key solution for a specific application without an external computer. 6 user functions can be created and soft-keys can be labeled as you like.

##### User Program (Auto Sequence Program):

Allows to program the control or measurement, analysis, copy and other sequence without an external computer.

#### Hardcopy

Hardcopy of traces, measurement data, results of analysis and annotations are produced by the 4195A and HP plotters or printers with LISTEN only capability.

**Dump Mode:** Copy the CRT display to a graphics printer

**Plot Mode:** Copy the traces, graticule and annotations to an HP-GL compatible digital plotter

**Print Mode:** Copy measurement data in tabular form to a printer

#### Storage

Instrument state, trace data, table of Program Sweep and User Program can be independently saved or recalled from the built-in 3.5 inch floppy disk memory via SAVE/GET function.

Instrument state includes active control setting of measurement, active calibration data, active display format, active scale setting, User Math and User Define Function.

#### Remote programming

HP-IB interface operates according to IEEE 488-1987 and IEC 625 standards and IEEE 628-1982 recommended practices

**Interface Function:** SH1, AH1, T5, TE0, L4, LE0, SR1, RL1, PP0, DC1, DT1, C0, E1

**Transfer Formats:** ASCII

32/64 bit IEEE 754 floating point format

#### General Characteristics:

##### Operating Conditions:

**Temperature:**  $0^\circ\text{C}$  to  $+45^\circ\text{C}$

**Humidity:** 95% RH at  $40^\circ\text{C}$

##### Non-Operating Conditions:

**Temperature:**  $-40^\circ\text{C}$  to  $+70$

**Safety:** Based on IEC-348, UL-1244

**Power:** 100, 120, 220V  $\pm 10\%$ , 240V  $-10\%$   $+5\%$ , 48Hz to 60Hz, 500VA (max)

**Dimensions:** 425 (W) x 375 (H) x 620 (D) mm

**Weight:** Approximately 41kg

#### 41951A Impedance Test Kit

The HP 4195A and HP 41951A Impedance Test Kit, which is designed to use with the 4195A, can be used to perform impedance analysis from 100kHz to 500MHz. The direct reading of impedance parameters, error compensation, variable test signal/dc bias level, and dedicated analysis functions are all convenient for evaluation of components, such as crystal/SAW resonators, coils, and varicap diodes. The equivalent circuit function is very useful for modeling and evaluating components under actual operating conditions to improve the quality and reliability of circuit design.

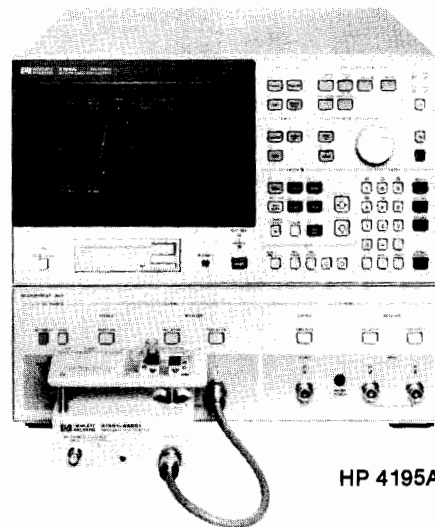

HP 4195A with HP 41951A



HP 41951A

**HP 41951A Impedance Test Kit**

The HP 41951A can be used for impedance measurements from 100kHz to 500MHz when used with the HP 4195A.

**Measured Parameters:** |Z|, |Y|,  $\theta$ , L, C, R, X, G, B, D, and Q

**Error Compensation:** 1 port cal, open/short offset and port extension

**Equivalent Circuit Analysis:** Circuit constants approximation and simulation of frequency characteristics

**Available Accessories:** Refer to page 279.

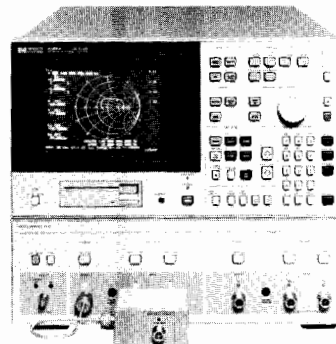
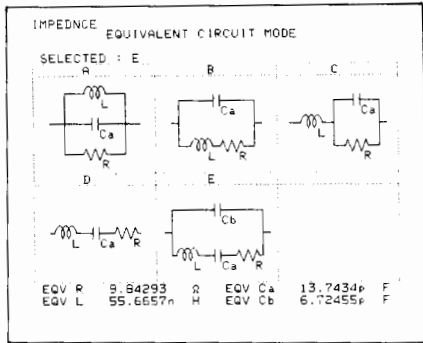

HP 4195A With HP 41952A



**41952A/B Transmission/Reflection Test Sets**

The HP 41952A/B Transmission/Reflection Test Sets provide a neat solution to the HP 4195A Network/Spectrum Analyzer to measure both transmission and reflection characteristics. The HP 41952A/B are directly connected to the HP 4195A and include a power splitter and a directional coupler in each compact box. Furthermore, two test sets of the HP 41952A or 41952B (opt. 009) allow the HP 4195A to perform full s parameters measurement without having to remove and reverse the device. The HP 41952A is used for 50 ohm application, and the HP 41952B is used for 75 ohm application.



**SPECIFICATIONS**

	HP 41952A	HP 41952B
Impedance:	50 ohm	75 ohm
Frequency Range:	100kHz - 500MHz	100kHz - 500MHz
Directivity:	40dB @300kHz-200MHz	35dB @300kHz-200MHz
Frequency Response: *1		
Transmission Magnitude, Phase (@ $\geq 300$ kHz)	$\pm 1$ dB, $\pm 5$ deg	$\pm 1$ dB, $\pm 5$ deg
Reflection Magnitude, Phase (@ $\geq 1$ MHz)	$\pm 1$ dB, $\pm 5$ deg	$\pm 1$ dB, $\pm 5$ deg
Effective Source Match:	$> 20$ dB @ $\geq 300$ kHz	$> 20$ dB @ $\geq 300$ kHz
Test Port:		
Connector:	50 ohm type N-(F)	75 ohm type N-(F)
Accessories Furnished:	50 ohm N cable Operating Note Carrying Case	50 ohm N cable HP 11852B M. L. Pad Operating Note Carrying Case

Note: HP 41952B opt. 009 deletes 50 ohm N cable and HP 11852B.  
\*1: Typical

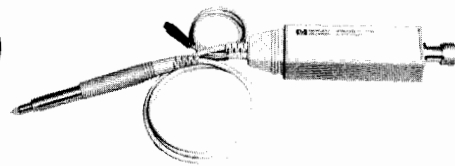

HP 41800A

**Accessories Available**

**HP 85044A/B** Transmission/Reflection Test Set

Refer to page 244.

**HP 85024A** High Frequency Probe

Refer to page 313.

**Ordering Information**

	<b>Price</b>
<b>4195A</b> Network/Spectrum Analyzer	\$23,000
<b>Opt W30:</b> 3-year hardware support	\$490
<b>Opt 001:</b> High Stability Frequency Reference Improve the stability of frequency for evaluation high Q devices such as crystal filter, oscillator or resonator. Frequency Accuracy: $\pm 1$ ppm (23°C $\pm 5$ °C) Frequency Stability: $\pm 1 \times 10^{-8}$ (23°C $\pm 5$ °C)	\$850
<b>Opt 907:</b> Front Handle Kit	\$130
<b>Opt 908:</b> Rack Flange Kit	\$72.50
<b>Opt 909:</b> Rack and Handle Kit	\$185
<b>Opt 910:</b> Extra OP manual	\$50
<b>41951A</b> Impedance Test Kit	<b>\$1500</b>

# NETWORK ANALYZERS

## Audio/Video/Baseband/IF Network Analyzer, 5 Hz to 200 MHz

### Model 3577A

- High speed/high accuracy measurements
- .001 dB, .005 degree, 1 ps, .001 Hz resolution
- Built-in three-term error correction plus normalization
- Magnitude, phase, polar, real, imaginary, and group delay display modes
- Convenience features including direct plotter control and vector math functions

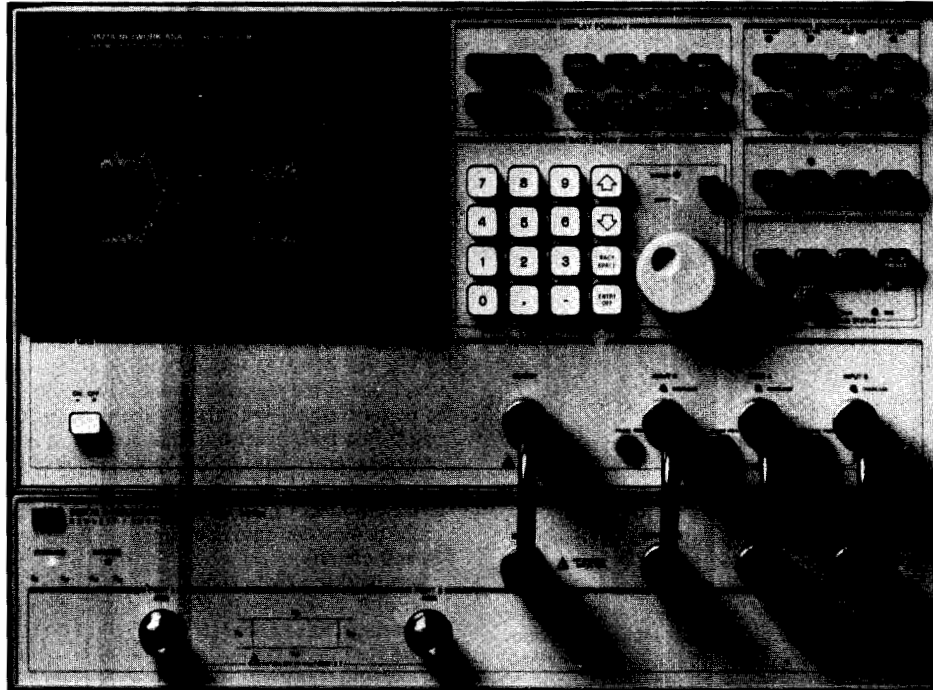

HP 3577A

### HP 3577A Network Analyzer

HP Model 3577A is a high performance network analyzer for audio, video, baseband and IF applications from 5Hz to 200MHz. The 3577A makes precision measurements to characterize filters, amplifiers, crystal devices, cables, and subsystems used in communications, telecommunications, consumer electronics, components and general purpose testing.

Convenient soft-key selection of measurement functions allows you to quickly measure transfer functions, magnitude/phase, insertion loss/gain, attenuation, electrical length and gain compression. In addition, measurement of phase distortion parameters such as group delay and deviation from linear phase can be made with high resolution. With the HP 3577A's flexible receiver input impedances, you can measure in either 50- $\Omega$  or high impedance (1 M $\Omega$ ) environments. Use the HP 35677A/B S-Parameter Test Sets or the HP 35676A/B Reflection/Transmission Test Kits with the HP 3577A to make reflection measurements such as return loss, reflection coefficient and impedance in 50- $\Omega$  or 75- $\Omega$  systems, while simultaneously displaying transmission parameters.

With the addition of an HP 9000 Series 200 or 300 Computer and appropriate system software, the HP 3577A becomes the hub of a powerful network measurement solution, the HP 3577S Network Analyzer System. A full description of the HP 3577S is on page 238.

### Unprecedented Measurement Precision

Precision measurements can be made to characterize both wideband and narrowband devices with high accuracy and resolution. Dynamic magnitude and phase accuracy is 0.02 dB and 0.2 deg, respectively. Device responses can be examined in fine detail with 0.001 dB, 0.005 deg, and 1 ps resolution. A built-in synthesized LO and tracking generator assure superb frequency accuracy with 0.001 Hz resolution. Dynamic range is 100 dB and the noise floor is -130 dBm for the most demanding measurements.

### Versatility and Convenience

User-defined Vector Math functions operate on measured data, constants and functions to present measurement results in the form you need. Multiple Display Formats with electronic graticules provide accurate display in rectangular, polar or Smith chart coordinates. Frequency Sweep (Logarithmic, Linear or Alternate) and Amplitude Sweep capabilities meet measurement needs in a wide range of applications. Accessories such as S-Parameter Test Sets, Power Splitters, Minimum Loss Pad, Cables, Calibration Kits, Transistor Fixtures, Adapters, and the HP85024A High Frequency Probe ensure a complete solution to your measurement needs.

The built-in autoscale functions put the measurement on the screen quickly with a full scale display. Digital Display Markers with Marker  $\rightarrow$  Min or Max and Marker Offset capabilities provide accurate, high resolution readout of data points on a fully annotated dual trace display. Direct Digital Plot (using an HP graphics plotter without a computer) of displayed traces, graticule, annotation and marker data provides quick, cost-effective hard copy of measurement results. Non-volatile Save/Recall Memory of five front panel instrument states is convenient for making rapid and repeatable measurements.

Similarly, trace data can be stored in magnitude and phase format in any one of four data registers. Since data is stored with full accuracy and resolution, it can be rescaled as needed.

### Measurement Display Modes

Magnitude, phase, polar, real, imaginary, and delay modes are directly accessible from the soft key display menu. Input data, stored data and user-defined constants can then be combined using built-in vector math functions (+, -, \*, /) to create arbitrary measurement display modes. As an example, a feedback amplifier can be mathematically analyzed by measuring its open loop gain, storing the data, and then adjusting a complex variable which represents the amount of feedback in the closed-loop gain equation.



### High-Performance Group Delay Measurements

The HP 3577A measures group delay directly by dividing the measured phase changes across a selected frequency aperture by the aperture value. The frequency aperture can be set from 0.5% to 16% of span with annotation directly in Hertz, thus allowing the user to change span and still retain the same effective smoothing.

Sophisticated measurements of both magnitude and phase distortion in communication systems can be made.

Cables and transmission lines can be tested for maximally flat delay with a resolution of up to 1 psec.

### Vector Noise Averaging

Noise reduction in the HP 3577A is accomplished by Vector Noise Averaging and/or selectable Resolution Bandwidth filters. With the proper use of these two noise reduction methods, greater than 130 dB dynamic range can typically be achieved.

### Built-in Error Correction

Three-term Vector Error Correction in the HP 3577A is used to remove the effects of directivity, frequency response, and source mismatch from one-port measurements. Similarly, vector normalization enhances the accuracy of two-port measurements at the push of a button. These powerful accuracy enhancement routines can be used to cancel the repeatable error introduced by cable and test fixtures. Moreover, the HP 3577A can be easily upgraded to an HP 3577S Network Analyzer System with full twelve-term Vector Error Correction, as the need for uncompromising measurement accuracy arises.

### HP-IB Programmability

The HP 3577A is fully programmable over the Hewlett-Packard Interface Bus. Simple programming codes minimize the time it takes to develop control software for automatic measurements. Quickly access a single point or an entire 401-point trace in either fast binary or ASCII modes. Customize the built-in vector display via the HP-IB to draw test limit lines, operator instructions or connection diagrams.

### HP 3577A Network Analyzer Abbreviated Specifications

#### Source

##### Frequency

**Range:** 5 Hz to 200 MHz.

**Resolution:** 0.001 Hz.

**Stability:**  $\pm 5 \times 10^{-8}$ /day, 0 to 55°C.

##### Amplitude

**Range:** +15 dBm to -49 dBm (1.26Vrms to 793 $\mu$ Vrms; 2dBV to -62 dBV) into a 50 $\Omega$  load.

**Resolution:** 0.1 dB.

**Accuracy:**  $\pm 1$  dB at +15 dBm and 100 kHz. Below +15 dBm, add the greater of  $\pm 0.02$  dB/dB or 0.2 dB.

**Flatness:** 1.5 dBp-p from 5 Hz to 200 MHz.

**Impedance:** 50 $\Omega$ ; >20 dB return loss at all levels.

**RF Output Connector:** 50 $\Omega$  Type N female.

**Sweep Types:** Linear, alternate, cw and log frequency; log amplitude.

**Sweep Time:** 100 ms/span to 6553 sec/span for frequency sweep; 1 ms/step to 16 s/step for amplitude sweep.

**Sweep Modes:** Continuous, single, manual.

**Trigger Modes:** Free run, immediate, line, external.

### Input Characteristics

**Frequency Range:** 5 Hz to 200 MHz.

**Inputs:** Three receiver inputs (A, B and R).

**Input Impedance:** Selectable 50 $\Omega$  with >25 dB return loss, or 1 M $\Omega$  in parallel with approximately 30 pF.

**Input Connectors:** 50 $\Omega$  Type N female.

**Full Scale Input Level:** -13 dBV from 10 kHz to 200 MHz with internal 20 dB attenuators ON (0dBm at 50 $\Omega$ ).

**Resolution Bandwidth:** Selectable 1 kHz, 100 Hz, 10 Hz, or 1 Hz.

**Sensitivity (Due to noise and internal crosstalk between source and receiver inputs):**

Resolution Bandwidth	30 kHz - 200 MHz (50 $\Omega$ ) 30 kHz - 20 MHz (1 M $\Omega$ )	
	Internal 20 dB Attenuator ON	Internal 20 dB Attenuator OFF
1 Hz	-110 dBm	-130 dBm
10 Hz	-110 dBm	-130 dBm
100 Hz	-105 dBm	-125 dBm
1 kHz	-95 dBm	-115 dBm

**Crosstalk:** >100 dB isolation between inputs.

**Electrical Length/Reference Plane Extension:** Provides equivalent electrical line length, or delay at inputs A, B and R. Range: -3 x 10<sup>8</sup>m to +3 x 10<sup>8</sup>m or +1 s to -1 s.

**Resolution:** 5 digits or 0.1 cm (3.3 ps) whichever is greater.

**Accuracy:**  $\pm 0.1$  cm or  $\pm 0.02\%$  whichever is greater.

### Magnitude Characteristics

**Range:** Full Scale Input to Sensitivity.

#### Resolution

**Marker:** 0.001 dB (log); 5 digits (linear).

**Display:** 0.01 dB/div to 20 dB/div (log absolute); 0.01 dB/div to 200 dB/div (log ratio); 0.1 nV/div to 10 V/div (linear absolute); 10<sup>-10</sup>/div to 10<sup>20</sup>/div (linear ratio).

**Display Units:** dB, dBm, dBV, V, and linear ratio.

**Accuracy (at 100 kHz, 25°C, and Full Scale Input)**

**Absolute (A, B, R):**  $\pm 0.2$  dB.

**Ratio (A/R, B/R, A/B):**  $\pm 0.15$  dB (50 $\Omega$ );  $\pm 0.2$  dB (1 M $\Omega$ ).

#### Dynamic Accuracy:

Error		Input Level Relative to Full Scale Input
Resolution Bandwidth		
1 kHz, 100 Hz, 10 Hz	1 Hz	
$\pm 0.04$ dB	$\pm 0.04$ dB	0 dB to -10 dB
$\pm 0.02$ dB	$\pm 0.02$ dB	-10 dB to -50 dB
$\pm 0.05$ dB	$\pm 0.05$ dB	-50 dB to -60 dB
$\pm 0.15$ dB	$\pm 0.25$ dB	-60 dB to -80 dB
$\pm 0.75$ dB	$\pm 0.75$ dB	-80 dB to -90 dB
$\pm 0.75$ dB	$\pm 3.00$ dB	-90 dB to -100 dB

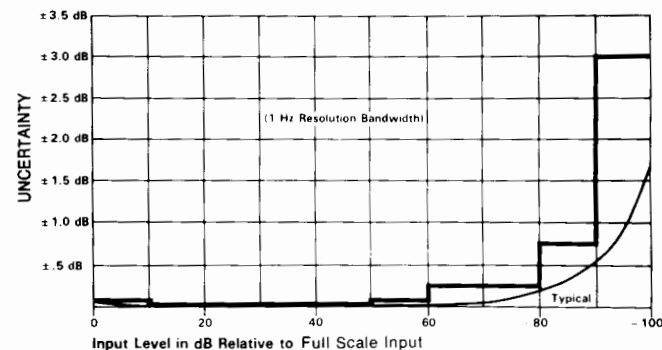
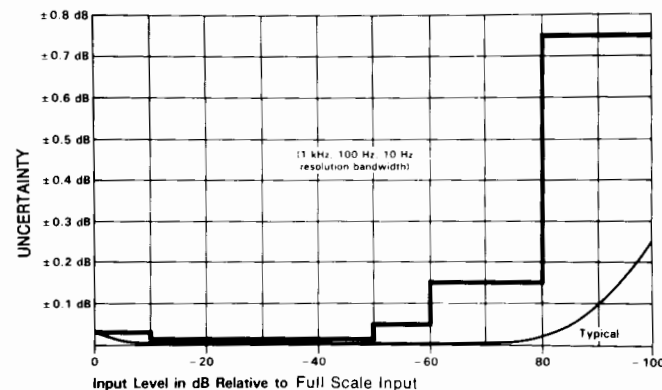

# NETWORK ANALYZERS

## Audio/Video/Baseband/IF Network Analyzer, 5 Hz to 200 MHz (cont'd)

### Models 3577A, 35677A/B, 35676A/B

#### Frequency Response (when driven from a 50 $\Omega$ source and with 50 $\Omega$ receiver input impedance)

**Absolute (A,B,R):** 0.3 dBpp from 20 Hz to 20 MHz; 0.6 dBpp from 5 Hz to 200 MHz.

**Ratio (A/R, B/R, A/B):** 0.3 dBpp from 20 Hz to 20 MHz; 0.4 dB from 5 Hz to 200 MHz.

#### Reference Level

**Range:** -207 dBm to +33 dBm (-220 dBV to +20 dBV) (Log absolute); -400 dB to +400 dB (log ratio); 0 V to 10 V (linear absolute); 0 to 10<sup>20</sup> (linear ratio).

**Resolution:** 0.001 dB (log); 5 digits (linear).

#### Stability

**Temperature:** Typically  $<\pm 0.02$  dB/ $^{\circ}$ C.

**Time:** Typically  $<\pm 0.05$  dB/hour at 25 $^{\circ}$ C.

#### Phase Characteristics (A/R, B/R, A/B)

**Range**  $\pm 180$  deg.

#### Resolution

**Marker:** 0.005 deg (0.0001 rad).

**Display:** 0.01 deg/div to 200 deg/div (0.00018 rad/div to 3.49 rad/div)

**Accuracy:** At 100 kHz, 25 $^{\circ}$ C, and Full Scale Input:  $\pm 2.0^{\circ}$ .

#### Dynamic Accuracy:

Error	Input Level Relative to Full Scale Input
$\pm 4$ deg	0 dB to -10 dB
$\pm 2$ deg	-10 dB to -50 dB
$\pm 5$ deg	-50 dB to -60 dB
$\pm 1.5$ deg	-60 dB to -80 dB
$\pm 7.5$ deg	-80 dB to -100 dB

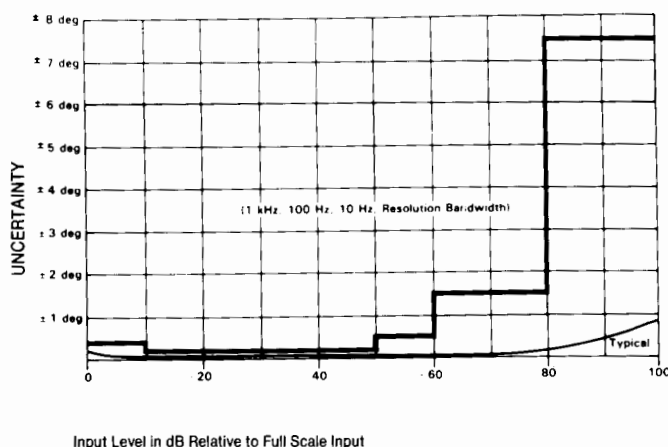

**Reference Level Resolution:** 0.01 deg.

**Temperature Stability:** Typically  $<\pm 0.05$  deg/ $^{\circ}$ C.

**Time Stability:** Typically  $<\pm 0.05$  deg/hr at 25 $^{\circ}$ C.

#### Delay Characteristics

**Range:** 1 ps to 20,000s.

**Resolution:** .01ns/div to 1000s/div.

**Normalized Accuracy:** Dynamic Phase Accuracy  $+2\text{ns}$

**Aperture Range:** 0.5% to 16% of frequency span.

**Reference Level:**  $\pm 10^3$ s.

#### General Display Characteristics

##### Traces

**No. Traces:** Two simultaneous traces may be present with a rectangular graticule. One trace with polar or Smith graticules.

**Markers:** Each trace has one main marker and an offset marker. Markers indicate data at corresponding trace coordinates in the same units as used to set the Reference Level. Markers can be used to modify certain display parameters. Marker resolution is the same as horizontal display resolution.

##### Graticules

**Rectangular Graticule:** 0% to 100% full scale deflection in 0.05% increments. Logarithmic and Linear.

**Polar/Smith Chart Graticule:**  $\pm 500$  deg in 0.001 deg increments.

##### Noise Averaging

**Type:** Exponentially weighted vector averaging on successive sweep data.

**Averaging Factor:** Selectable 1 (off), 4, 8, 16, 32, 64, 128, 256.

**Linear Phase Slope Compensation:** Provides linear phase slope offset of -72,000 deg/span to +72,000 deg/span.

##### Calibration

**Transmission:** Both traces can be normalized to measured data with full accuracy and resolution.

**Reflection:** Corrects for directivity, frequency response and source match errors.

#### Programming Characteristics

**Capability:** Remote programming via the Hewlett-Packard Interface Bus (HP-IB). The HP 35677A/B S-Parameter Test Sets are programmable through the HP 3577A interface only.

**Interface Functions:** SH1, AH1, T5, TE0, L4, LE0, SR1, RL1, PP1, DC1, DT1, C0, E1. For more on these codes refer to the HP-IB section of this catalog.

**Output Data Transfer Time:** 401 data points (single parameter) can be transferred directly to an HP 200 series computer in Basic language as follows:

**ASCII mode:** Typically 1500 ms.

**Binary-floating point mode:** Typically 160 ms.

**Graphics Capabilities:** 12 lines of text with 40 alphanumeric characters per line, and high resolution line vectors can be displayed through HP-IB commands.

#### General Characteristics

##### External Reference Frequency Input

**Frequency:** 10 MHz/N. N is an integer from 1 to 100.

**Level:** 0 dBm  $\pm 10$  dB, nominal.

**Impedance:** 50 $\Omega$ , nominal.

**Connector:** BNC female, rear panel.

##### Reference Frequency Output

**Frequency:** 10 MHz.

**Level:** Typically 0 dBm.

**Impedance:** 50 $\Omega$ , nominal.

**Connector:** BNC female, rear panel.

**External Trigger:** Triggers on negative TTL transition or contact closure to ground.

**Connector:** BNC female, rear panel.

**Plotter Control:** Directly compatible with HP-IB graphics plotters that use Hewlett-Packard Graphics Language (HP-GL) with listen only capability.

**Save/Recall:** Front-panel setups can be stored in non-volatile memory locations 1 through 5. Last state is saved when power is removed.

#### Operating Conditions

**Temperature:** 0 $^{\circ}$ C to +55 $^{\circ}$ C.

**Relative Humidity:**  $<95\%$  at 40 $^{\circ}$ C.

**Altitude:**  $<4,572\text{m}$  (15,000 ft).

#### Non-Operating Conditions

**Temperature:** -40 $^{\circ}$ C to +75 $^{\circ}$ C.

**Altitude:**  $<15,240\text{m}$  (50,000 ft).

**Power:** 115V  $\pm 10\%$ , -25% (47 Hz to 440 Hz), or 230 V  $\pm 10\%$ , -15% (47 Hz to 66Hz), 450 VA maximum.

**Weight:** 31 kg (67 lb) net; 41 kg (90 lb) shipping.

**Dimensions:** 222 mm H x 426 mm W x 578 mm D (8.75 in. x 16.75 in. x 22.75 in.).

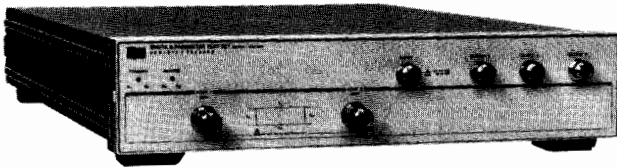

HP 35677A

### HP 35677A/B S-Parameter Test Sets

While test setups can be constructed from discrete RF components such as power dividers, directional bridges, cables, pads, etc., it is much easier to use a fully integrated test set such as the HP Model 35677A/B.

The test set contains the hardware required to make transmission and reflection measurements in both the forward and reverse directions. The only setup required is to connect the device under test to the two measurement ports; the HP 3577A Network Analyzer controls the switching functions, so that even reverse measurements can be made without changing device connections. The HP 35677A is used for 50 $\Omega$  systems and the HP 35677B is used for 75 $\Omega$  systems.

### HP 35677A/B S-Parameter Test Set Specifications

**Frequency Range:** 100 kHz to 200 MHz.

**Test Port Impedance**

**HP 35677A:** 50 $\Omega$ .

**HP 35677B:** 75 $\Omega$ .

**Directivity:** >40 dB.

**Frequency Response**

**Transmission (S<sub>21</sub>, S<sub>12</sub>):**  $\pm 1$  dB,  $\pm 5$  degrees.

**Reflection (S<sub>11</sub>, S<sub>22</sub>):**  $\pm 1$  dB,  $\pm 5$  degrees.

**Port Match**

**Test Ports 1, 2:** HP 35677A, >26 dB; HP 35677B, >24 dB.

**Test Ports 1, 2 Open/Short Ratio:** HP 35677A,  $< \pm 0.75$  dB magnitude and  $< \pm 5$  degrees phase; HP 35677B,  $< \pm 1$  dB magnitude and  $< \pm 7.5$  degrees phase.

**Input Port:** >20 dB return loss.

**Output Ports A, B, and R:** >26 dB return loss.

**Test Port Isolation:** >100 dB.

**Insertion Loss**

**RF Input to Test port 1 or 2:** HP 35677A, typically 13 dB; HP 35677B, typically 19 dB.

**RF Input to Output Ports A, B, or R:** HP 35677A, typically 19 dB; HP 35677B, typically 31 dB.

**Test Port Reciprocity**

**Transmission (S<sub>21</sub>, S<sub>22</sub>):** Typically  $< \pm 0.5$  dB magnitude and  $< \pm 5$  degrees phase.

**Reflection (S<sub>11</sub>, S<sub>22</sub>):** Typically  $< \pm 0.5$  dB magnitude and  $< \pm 5$  degrees phase.

**Incident Power Ratio (Test Port 1 to Test Port 2):** Typically  $< \pm 1.5$  dB.

**RF Input Maximum Operating Level:** +25 dBm or  $\pm 30$  Vdc.

**RF Input Damage Level:**  $\pm 27$  dBm or  $\pm 30$  Vdc.

**Port 1 or 2 Damage Level:** +27 dBm or  $\pm 30$  Vdc.

**Connectors**

**Input Port and Output Ports A, B, and R:** 50 $\Omega$  Type N female.

**Test Ports 1 and 2:** HP 35677A, 50 $\Omega$  Type N female; HP 35677B, 75 $\Omega$  Type N female.

**DC Bias Inputs:** BNC female, rear panel.

**DC Bias Range:** Typically  $\pm 30$  Vdc and  $\pm 20$  mA with some degradation of RF specifications; 200 mA damage level.

**Accessories Supplied**

4 ea. 190 mm (7.5 in.) 50 $\Omega$  cables with Type N male connectors for connection to HP 3577A (HP Part No. 8120-4387).

1 ea. Test Set interconnect cable to HP 3577A (HP Part No. 35677-61620).

1 ea. Rear Panel Lock Foot Kit (HP Part No. 5061-0099).

1 ea. Service Manual (HP Part No. 35677-90010).

**General Characteristics**

**Power:** All power is obtained through the HP 35677A interconnect cable.

**Weight:** 6 kg (13 lb) net; 122 kg (25 lb) shipping.

**Dimensions:** 90mm H x 425mm W x 584mm D (3.5 in. x 16.75 in. x 22.75 in.). Add 1 $\frac{1}{8}$  inch to depth to include front panel connectors.

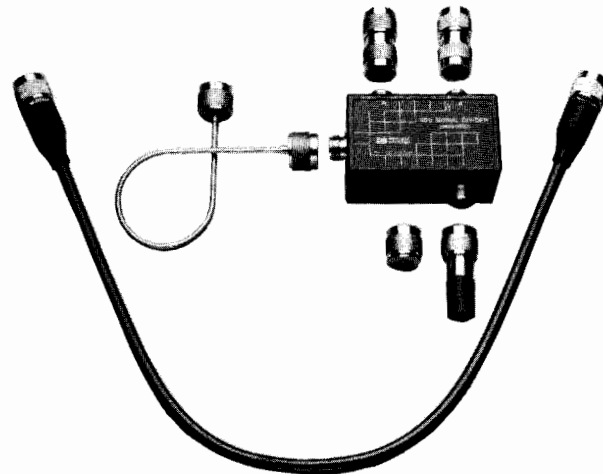

HP 35676A

### HP 35676A/B Reflection/Transmission Test Kits

Low frequency and broadband measurements with the HP 3577A are greatly simplified with the HP 35676A/B Reflection/Transmission Test Kits. Operating in conjunction with internal calibration routines in the HP 3577A, the test kits provide all the measurement capabilities required for reflection, transmission, and impedance measurements throughout the entire 5 Hz to 200 MHz frequency range. Separate versions are available for 50 $\Omega$  (HP 35676A) or 75 $\Omega$  (HP 35676B) environments. Each HP 35676A/B Reflection/Transmission Test Kit contains a precision resistive divider, 50 $\Omega$  (HP 35676A) or 75 $\Omega$  (HP 35676B) reference load, coaxial short, carrying case, and all cables and hardware necessary for basic measurements with the HP 3577A Network Analyzer.

### HP 35676A/B Operating Characteristics\*

**Frequency Range:** 5 Hz to 200 MHz.

**Test Port Impedance:** 50  $\pm$  2% typical (HP 35676A)

75  $\pm$  2% typical (HP 35676B).

**Insertion Loss (Source Input to Test Output):** 10  $\pm$  1 dB typical.

**Equivalent Directivity:** 40 dB typical.

**Equivalent Source Match:** 30 dB typical (HP 35676A)

25 dB typical (HP 35676B).

\*Typical, assuming proper calibration with accessories supplied.

# NETWORK ANALYZERS

## Audio/Video/Baseband/IF Network Analyzer, 5 Hz to 200 MHz (cont'd)

### Model 3577S, 35675A

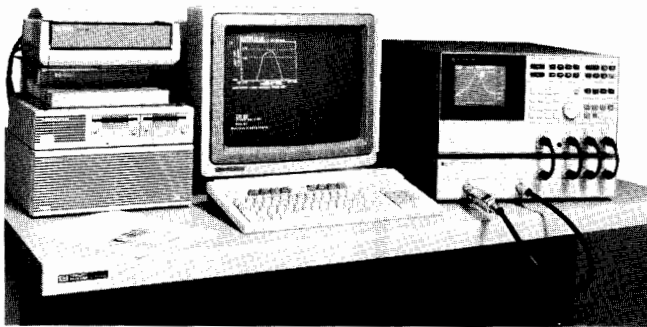

#### HP 3577S Network Analyzer System

The HP 3577S Network Analyzer System combines the HP 3577A Network Analyzer, HP 9000 Series 200 or 300 Computer, HP 35677A/B S-Parameter Test Set, HP 35678A/B Calibration Kit, and HP 35675A Accuracy Enhancement Software to form a powerful automated network measurement solution. Using HP-IB programming, HP 3577S can be integrated with other Hewlett-Packard instruments to solve difficult measurement problems.

#### HP 35675A Accuracy Enhancement Software

At the heart of the system, HP 35675A Accuracy Enhancement Software expands the measurement capabilities of the HP 3577A Network Analyzer. First, it adds full two-port, twelve-term error correction capability. Second, it adds conversion from s-parameters to h, y, or z parameters. Finally, it adds convenient transfer of instrument, calibration, and measurement data between the HP 3577A and HP 9000 Series 200 or 300 computers.

#### Two-port, Twelve-term Error Correction

Repeatable errors due to the effects of cables and connectors are removed from reflection and transmission measurements by a 2-port, 12-term error correction algorithm. Fast, 8-term partial error correction is also available for measuring transmission parameters of well-matched devices. Accurate measurements can be made inside environmental chambers and at remote or custom test fixtures. The entire test setup is characterized by measuring its response to open-circuit, short-circuit, thru, and reference terminations furnished with the HP 35678A/B Calibration Kit, from which the error coefficients are calculated.

#### Parameter Conversion

Error-corrected s-parameters can be converted to hybrid (h), admittance (y), or impedance (z) parameters, allowing device or network behavior to be expressed in the most appropriate form. For example, semiconductor h-parameters can be derived from s-parameter measurements and outputted directly to an HP printer, plotter, computer monitor, or HP 3577A display; all with only a few key strokes.

#### Computer Disc Storage of Entire Test Setups

Entire test setups can be labelled and stored in computer disc memory for later use, allowing complicated measurements to be repeated simply by recalling previously stored instrument setup and calibration data. Actual measured data can be transferred to disc memory for storage, processing, or further mathematical analysis.

#### Friendly Operator Interface

The software guides the operator through easy-to-understand menus, automatically "remembering" every keystroke in an autosequence buffer. When a complicated measurement sequence has been completed, simply give it a name and store it in computer disk memory for later use. Because the most recent instrument state is also remembered, the operator needs only to redefine those variables of interest for each measurement, and on the entire setup. This feature is especially helpful when linking a series of frequency sweeps together to increase resolution.

The entire HP 3577S Network Analyzer System can be controlled from the computer keyboard, eliminating the need for an in-depth understanding of the HP 3577A. A mastery of computer programming is not necessary either.

#### Program Modifications

Although program modification is not required, Hewlett-Packard encourages the experienced operator to tailor the HP 35675A Accuracy Enhancement Software to their specific application. An entire section of the operating manual is devoted to a detailed description of every subroutine and function used by the program; including format, purpose, pass parameter, common variables, error messages, and other required subroutines. Another section describes all program variables and labels. A custom subroutine written in HP Basic can be "installed" in system software and accessed from the menu with a single keystroke.

#### HP 3577S Network Analyzer System Characteristics

**Frequency Range:** 100 kHz to 200 MHz.

**System Impedance:** 50Ω (with HP 35677A)  
75Ω (with HP 35677B).

**Error Correction:** One and two port 8- or 12-term.

**Typical Performance** (401 point, 12 term mode):

**Calibration:** 2 minutes including time to connect devices.

**Measurement plus corrections:** 30 seconds.

#### HP 9000 Series 200 Computers

HP 35675A Accuracy Enhancement Software and HP 3577S will run on any properly configured Series 200 Computer, including HP 9816A, 9826A, 9836A, 9836C, and 9920A. One Mbyte RAM is recommended, and up to 1.3 Mbytes may be required when an SRM and additional Basic extensions are used. The HP 35675A software will run on Series 200 Basic versions 2.0, 3.0, 4.0 and 5.0. Please consult the HP 3577A/S Configuration Guide (# 5953-5184) for more information.

#### HP 9000 Series 300 Computers

HP 35675A Accuracy Enhancement Software and HP 3577S will run on any properly configured Series 300 Modular Computer System. A properly configured system includes one each: System Processor Unit (SPU), video board, video monitor, keyboard, mass storage device, and Basic 5.0 operating system. Either specify option 008 (Display Compatibility Interface), or create a system from individual components. Please consult the HP 9000 Series 300 Hardware Technical Data Guide (# 5953-9572) and Pricing Information Guide (# 5953-9573) to ensure proper coordination of systems and components.

#### HP Printers and Plotters

Permanent documentation of test results can be obtained from a number of different HP graphics printers and plotters including HP ThinkJet 2225A, 7475A, and 7550A.

#### Ordering Information

**HP 3577S Network Analyzer System**

**Price**

\$0

Specify this system reference number to ensure coordination of shipments and guarantee compatibility of instruments and software.

A complete HP 3577S Network Analyzer System includes HP 3577A, HP 35675A, HP 35677A/B, HP 35678A/B, and a properly configured HP 9000 Series 200 or 300 Computer. It is not necessary to order components already owned.

#### HP 3577A Network Analyzer

**\$24,500**

**Option 907:** Front Handle Kit + \$77

**Option 908:** Rack Mount Kit + \$41

**Option 909:** Rack Mount and Front Handle Kit + \$102

**Option 910:** Extra Operating and Service Manuals + \$245

**Option W30:** Extended Warranty \$530

**03577-84401:** Service Accessory Kit for HP 3577A \$470

**HP 35675A Accuracy Enhancement Software** \$1,550

**Option 042:** software on 5.25" disks \$0

**Option 044:** software on 3.5" disks \$0

**HP 35676A 50Ω Reflection/Transmission Test Kit** \$1,300

**Option W30:** Extended Warranty \$120

**HP 35676B 75Ω Reflection/Transmission Test Kit** \$1,550

**HP 35677A 50Ω S-Parameter Test Set** \$3,900

**HP 35677B 75Ω S-Parameter Test Set** \$3,900

**Option 907:** Front Handle Kit + \$50

**Option 908:** Rack Mount Kit + \$26

**Option 909:** Rack Mount and Front Handle Kit + \$61

**Option 910:** Extra Operating and Service Manuals + \$46

**HP 35678A 50Ω Type N Calibration Kit** \$750

**HP 35678B 75Ω Type N Calibration Kit** \$1,450

**HP 35679A 50Ω Type N Port Extension Cables** \$500

**HP 35679B 75Ω Type N Port Extension Cables** \$1,700

**HP 85024 High Frequency Probe** \$1,900

# NETWORK ANALYZERS

Gain/Phase Meter 1 Hz to 13 MHz

Model 3575A

239

- Magnitude, Phase
- Broadband Measurements
- Gain/Loss, Transfer Functions

HP 3575A

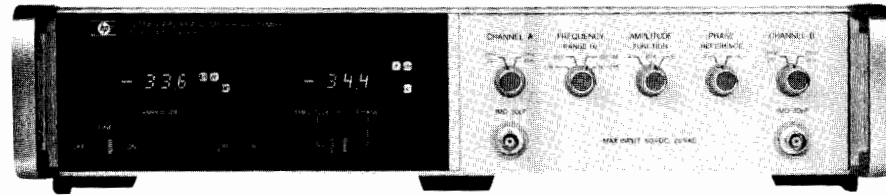

## Description

The HP 3575A Gain-Phase Meter is a versatile two-channel analyzer which can measure the absolute amplitude level, amplitude ratio or phase of its input signals. The HP 3575A is easy to use because it is a broadband device and no tuning is required. A wide range of signal waveforms can be measured, including sine, square and triangular, thus adding versatility to its measuring capability.

## Applications

The HP 3575A can be used to make both magnitude and phase measurements of gain/loss, transfer functions, impedance, and other signal ratios. It is useful, for example, to measure the response of feedback amplifiers and control systems for determining stability margins or creating Bode plots. It's broadband capability allows easy measurement of mixers and doublers where the input and output frequencies are different. The HP 3575A also can be used to measure absolute signal levels at either of its two inputs.

## Specifications

### Inputs

**Frequency:** 1 Hz to 13 MHz.  
**Level:** 200  $\mu$ V rms to 20 V rms.  
**No. Channels:** 2.  
**Impedance:** 1 M $\Omega$  30 pF.  
**Protection:**  $\pm$ 40 V dc, 20 V rms.

### Outputs

**Analog**  
**Phase:** 10 mV/degree.  
**Amplitude:** 10 mV/dB or dBV.  
**Output impedance:** 1 k $\Omega$ .

### Amplitude Accuracy\*

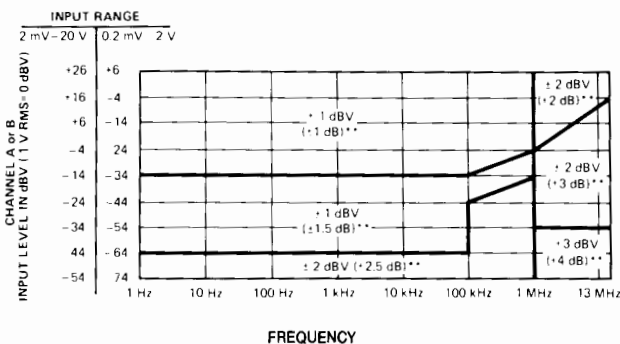

\*Conditions: Temperature: 25°C  $\pm$  10°C; accuracy applies to dB V and ratio measurements with the same frequency on both channels; for ratio measurements, the lowest level channel determines accuracy; analog output accuracy (rear panel).

\*\*Ratio (B/A) tolerances

**Amplitude functions:** A dBV, B dBV or B/A dB.

**Range:** A dBV, B dBV: -74 dBV to +26 dBV (in two ranges). B/A dB: -100 to +100 dB.

**Resolution:** 0.1 dB.

### Amplitude and Phase

Amplitude measurements can be made with an 80dB dynamic range over a 100dB measurement range and 0.1dB resolution. Stable phase measurements can be made in the presence of noise with excellent accuracy. Errors of less than two degrees are possible with a signal-to-noise ratio of 30dB. Additional noise rejection can be obtained by selection of three internal filters. Even harmonic and in-phase odd harmonic signal components do not cause phase errors.

### Readout

A three-digit display may be selected to read amplitude level/ratio or phase of the input signals. An analog output signal is available to drive a recorder such as the HP 7090A. An optional dual three-digit readout and analog output is available for simultaneous amplitude and phase measurements.

### Phase Accuracy\*

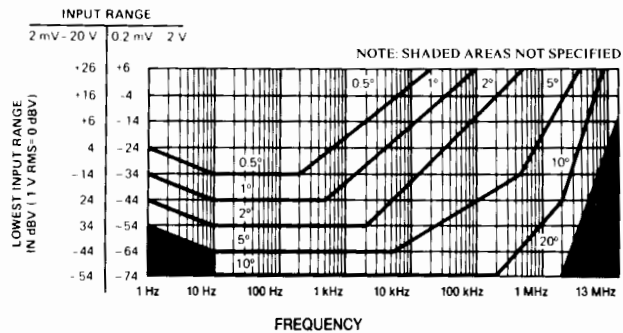

\*Conditions: Temperature: 25°C  $\pm$  10°C; Frequency range switch on lowest applicable range; Analog Output accuracy (rear panel).

**Range:**  $\pm$ 180° with 12° of overrange.

**Resolution:** 0.1°.

### General

**Power:** 115 V/230 V  $\pm$  10%, 48 Hz to 440 Hz, 40 VA.

**Weight:** net, 8.3 kg (18.4 lb). Shipping, 11.3 kg (25.8 lb).

**Size:** 88 H x 425 W x 337 mm D (3.47" x 16.75" x 13.25").

### Ordering Information

#### HP 3575A Gain/Phase Meter

	Price
<b>HP 3575A Gain/Phase Meter</b>	<b>\$5,700</b>
<b>Opt 001:</b> Dual Readouts/Dual Outputs	\$650
<b>Opt *002:</b> BCD Programming (Negative true)	\$1100
<b>Opt *003:</b> BCD Programming (Positive true)	\$1100
<b>Opt 908:</b> Rack Flange Kit	\$36
<b>Opt 910:</b> Extra Manual	\$51
<b>Opt W30:</b> Extended Warranty	\$220

\*Note: Includes option 001



# NETWORK ANALYZERS

## RF Network Analyzer, 4 MHz to 1300 MHz

### Model 8754A

- Integrated source, receiver, and display
- Lock to external source
- Three inputs, two measurement channels
- 80 dB dynamic range

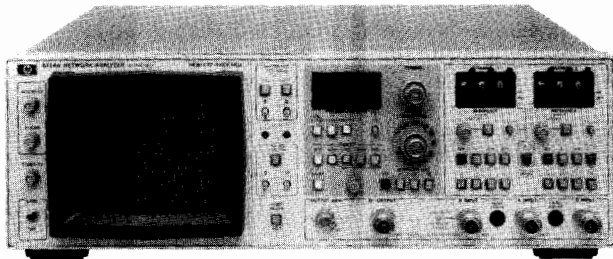

HP 8754A

### Description

The HP 8754A is a complete stimulus/response test system which combines a 4-1300 MHz swept source, three-input narrowband, tuned receiver, and both rectilinear and polar displays in a compact package. The convenient built-in source incorporates digital display of the start or center frequency, the ability to sweep all or any portion of the 4-1300 MHz range, and crystal markers at 1, 10, or 50 MHz intervals to enable accurate frequency calibration and measurement. The receiver provides 80 dB dynamic range in two independent measurement channels to allow simultaneous measurement of any two transmission or reflection parameters using a single test setup. Measurements of absolute power, magnitude ratio, phase angle, and reflection coefficient (or return loss) are displayed on the fully calibrated CRT with resolutions up to 0.25 dB and 2.5 degrees per major division. With these features the HP 8754A offers a high level of operating convenience and technical performance to swept magnitude and phase measurements in laboratory, production, and field testing applications at an economical price.

A comprehensive line of 50-ohm and 75-ohm test sets allow you to tailor your test setup for a specific measurement using the minimum of equipment, or to provide the maximum in versatility for a wide range of applications. Signal separation devices include the HP 11850 Power Splitter for precision transmission measurements, and the HP 85044 Transmission/Reflection Test Set for simultaneous transmission and reflection measurements. Matched cable sets, precision adapters, and transistor fixtures provide convenient, reliable connections to the test device. Adding the HP 8750A Storage Normalizer provides flicker-free rectilinear displays regardless of sweep rate. The HP 8750A will automatically store and subtract out the frequency response of a test set or cable if necessary, eliminating the need to use a grease pencil when making normalized measurements. For applications that require exceptional frequency accuracy and stability, the HP 8754A may be used with external sources such as the HP 8660, 8662A, 8663A, 8556B, or 8642A/B Signal Generators.

### HP 8754A Network Analyzer Specifications

**Frequency range:** 4 to 1300 MHz.

**Spectral Purity** (+10 dBm RF output level)

**Residual FM** (swept and CW):  $\leq 7$  kHz rms (10 kHz bandwidth).

**Harmonics:**  $-28$  dBc.

**Output power range:** 0 to +13 dBm typical,  $\pm 0.5$  dB flatness.

**Input channel:** two test inputs (A and B) and one reference (R) input.

**Input connectors:** type-N Female, 50 ohms nominal impedance.

**Input port match:**  $\geq 20$  dB Return Loss (1.22 SWR).

**Maximum input level:** 0 dBm at R, A, B inputs.

**Damage level:** +20 dBm (50 Vdc).

**Noise level:**  $< -80$  dBm at A and B inputs.

**Minimum R input level:**  $-40$  dBm ( $\geq -40$  dBm required to operate R input phase-lock).

**Crosstalk between channels:**  $> 83$  dB.

**Magnitude frequency response** (flatness)

Absolute (A,B):  $\leq \pm 1$  dB.

Ratio (A/R, B/R):  $\leq +0.3$  dB.

**Magnitude dynamic accuracy:**  $\pm 0.3$  dB from 0 to  $-50$  dBm,  $\pm 0.5$  dB from  $-50$  to  $-60$  dBm,  $\pm 1$  dBm from  $-60$  to  $-70$  dBm,  $\pm 2.5$  dB from  $-70$  to  $-80$  dBm.

**Absolute power measurements** (A, B, and R): typically  $\pm 0.5$  dBm at 0 dBm, 50 MHz input.

**Phase frequency response:**  $\pm 2.5^\circ$  (typically  $\pm 1^\circ$ );

**Phase range:**  $\pm 180^\circ$ .

**Phase dynamic accuracy:**  $\pm 2^\circ$  from 0 to  $-50$  dBm,  $\pm 4^\circ$  from  $-50$  to  $-70$  dBm.

**Electrical length adjustment range:** typically 0 to 16 cm length for transmission phase; typically 0 to 8 cm reference plane extension for reflection measurements.

### Display

**Measurement functions:** CRT displays either polar trace or Channel 1 and Channel 2 rectilinear traces.

**Video filter:** typically 100 Hz (10 kHz without filter).

**Graticule size:** rectilinear 10 cm by 8 cm; polar 8 cm in diameter.

**Smith chart overlays:** 2, 1, 0.2 and 0.1 full scale (furnished).

**CRT photography:** Tektronix C-5B Oscilloscope Camera is recommended (UV illumination will not excite P39 CRT phosphor for graticule exposure).

**Resolution:** 10, 2.5, 1, 0.25 dB magnitude per major division. 90, 45, 10, 2.5 degrees phase per major division.

**Accuracy:**  $\pm 2\% \pm 0.05$  division for rectilinear trace. Within 2.5 mm for polar trace.

### General

**Sweep output:**  $-5$  V to  $+5$  V.

**External sweep inputs:** 0 to 10 V nominal.

### X-Y Recorder/External CRT Output

**Horizontal and vertical:** 0.1 V/div.

**Penlift/blanking:** +5 V Blanking and Penlift.

**External marker input:** typically  $-13$  dBm RF signal produce a marker at the frequency of the RF signal.

**Magnitude/phase output:**  $-10$  mV/degree and  $-100$  mV/dB.

**Probe power:** Two +15 Vdc and  $-12.6$  Vdc.

**Storage-Normalizer interfaces:** directly compatible with the HP 8750A Storage-Normalizer. HP 8501A Storage-Normalizer requires a single internal adjustment for compatibility.

**Programming connector:** outputs include magnitude/phase and sweep outputs and inputs described above as well as measurement mode selection by TTL levels or contact closures.

**External source:** the HP 8754A sweep-out voltage is provided to frequency modulate (sweep) an external signal generator for narrowband measurement applications. A sweep input is provided to synchronize the CRT display for use with an externally swept source (HP 8620 and 8350 series).

### Temperature

**Operating:**  $0^\circ$  to  $55^\circ\text{C}$  except where noted.

**Storage:**  $-40^\circ\text{C}$  to  $+75^\circ\text{C}$ .



HP 85044A

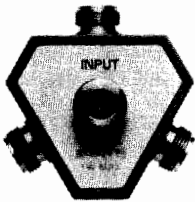

HP 11850C

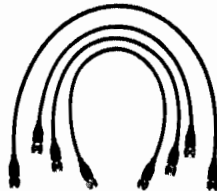

HP 11851B

	HP 85044A	HP 85044B
<b>Impedance:</b>	50 ohm	75 ohm
<b>Frequency Range:</b>	300 kHz - 3 GHz	300 kHz - 2 GHz
<b>Directivity:</b>	35 dB to 1.3 GHz 30 dB to 3.0 GHz	35 dB to 1.3 GHz 30 dB to 2.0 GHz
<b>Typical Tracking:</b>		
<b>Transmission Magnitude, Phase:</b>		
.3 MHz to 2.0 MHz	±1.0 dB, +10°	±1.0 dB, ±10°
2.0 MHz to $F_{max}$	±1.0 dB, ±5°	±1.0 dB, ±5°
<b>Reflection Magnitude, Phase:</b>		
.3 MHz to 2.0 MHz	±1.0 dB, ±25°	±1.0 dB, ±25°
2.0 MHz to $F_{max}$	±1.0 dB, ±5°	±1.0 dB, ±5°
<b>Effective Source Match:</b>		
<b>Test Port:</b>		
.3 MHz to 2.0 MHz	15 dB	15 dB
2.0 MHz to 1.3 GHz	20 dB	17 dB
1.3 GHz to $F_{max}$	16 dB	16 dB

**HP 11850C 50 Ω Three-Way Power Splitter****HP 11850D 75 Ω Three-Way Power Splitter**

**General:** one output port provides the reference output and the other two output ports can be used for independent transmission measurements. Use the HP 11851B RF Cable Set for interconnections. Detailed specifications on page 245.

**HP 11851B RF Cable Set**

**General:** three 61 cm (24 in.) 50 Ω cables, phase matched to ±2° and one 86 cm (34 in.) 50 Ω cable. Used with HP 85044A/B and 11850C/D. Detailed specifications on page 245.

**EMI:** VDE 0871/0875 and CISPR publication 11.

**Safety:** conforms to the requirements of IEC 348.

**Power:** selection of 100, 120, 220 and 240 V +5% -10%. 48 to 66 Hz, 20 VA max.

**Size:** 425.5 mm W x 133 mm H x 505 mm D (16<sup>3</sup>/<sub>4</sub>" x 5<sup>1</sup>/<sub>4</sub>" x 19<sup>7</sup>/<sub>8</sub>").

**Weight:** net, 16.8 kg (37 lb); shipping, 19 kg (42 lb).

**Adapter Kits**

**General:** the HP 11853A, 11854A, 11855A, and 11856A accessory kits are available to provide precision Type N and BNC adapters and calibration standards for use with the HP 11850C/D, and 85044A/B test setups. Detailed specifications on page 245.

**HP 85044A 50 Ohm Transmission/Reflection Test Set****HP 85044B 75 Ohm Transmission/Reflection Test Set**

**General:** the HP 85044 contains a power splitter and directional bridge that permits simultaneous transmission and reflection measurements. Detailed specifications on the HP 85044A and 85044B appear on page 244. For interconnections from the HP 85044A to the HP 8754A use the HP 11851B RF Cable Set. The major specifications of the HP 85044A and 85044B are:

**Ordering Information**

	Price
HP 8754A Network Analyzer	\$15,540
Opt 908: Rack Flange Kit	add \$32.50
Opt 910: Extra Manual	\$80
Opt 913: Rack Mount Kit	add \$35
HP 11850C 50 Ω Three-Way Power Splitter	\$900
HP 11850D 75 Ω Three-Way Power Splitter	\$1,400
HP 85044A 50 Ω Transmission/Reflection Test Set	\$3,000
HP 85044B 75 Ω Transmission/Reflection Test Set	\$3,500
HP 11851B RF Cable Set	\$800
HP 11857D Test Port Extension Cables	\$1,050

# NETWORK ANALYZERS

## Vector Voltmeter and Input Modules

Models 8508A, 85081A, 85082A

- Economical RF Voltage and Phase Measurements
- 100kHz to 1GHz High Impedance Probe Inputs
- 300kHz to 2GHz 50 ohm Inputs

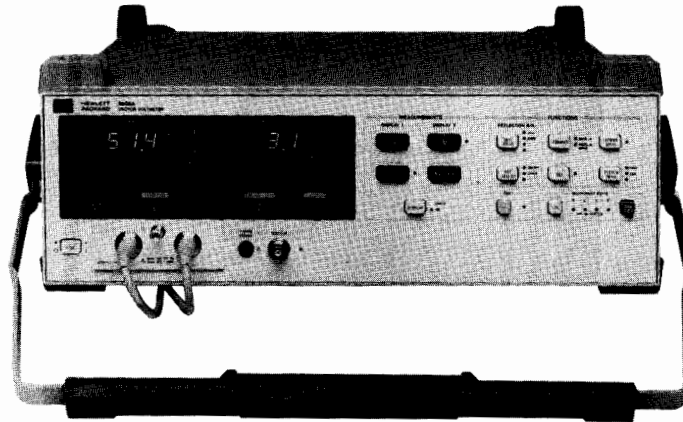

HP 8508A Option 001

The HP 8508A Vector Voltmeter is a fully automatic tuned receiver that makes RF voltage and phase measurements easy. Its narrow-band measuring technique gives it a dynamic range of over 90dB and a sensitivity of 10uV to trace even the smallest signal. The HP 8508A also measures the phase difference between its two input channels with at least 0.1 degree resolution over a full +180 to -180 degree range, so it can be used for another complete set of measurements - like electrical length, phase distortion or impedance. The standard HP 8508A is supplied with the HP 85081A Input Module, and has two high impedance probe inputs that operate from 100kHz to 1GHz. Its ability to store a reference and use it in later measurements means individual circuit sections can be characterized and adjusted independently. Any CW source can be used as a stimulus - even a source that is part of the device being tested, so measurements can be made under normal operating conditions. To adapt the probe inputs for measurements in a 50 ohm environment, the HP 11570A Accessory Kit provides two HP 11536A Probe Tees, an HP 11549A Power Splitter and two HP 908A 50 ohm Terminations. The HP 8508A Option 050 is supplied with the HP 85082A Input Module. Its 50 ohm inputs operate from 300kHz to 2GHz, and provide the accuracy and dynamic range to make measurements on active and passive components. Coaxial transmission and reflection measurements can be made using the HP 85044A (50 ohm) or HP 85044B (75 ohm) Transmission/Reflection Test Sets, and transmission comparison measurements can be made using the HP 11667A power splitter. The HP 11852B 50 to 75 ohm minimum-loss pad can be used to adapt the HP 85082A inputs to a 75 ohm environment.

### Specifications Summary

#### HP 8508A with HP 85081A High Impedance Input Module

(\* specifications apply to HP 85082A 50 Ohm Input Module only)

Frequency Range	100 kHz-1 GHz (300 kHz-2 GHz*)
Maximum Input	2V peak ac (+16 dBm*), ±50V dc
A (ref) Channel minimum	1mV (-47 dBm*), 100 kHz-10 MHz
B Channel noise level	300uV, 10 MHz-1 GHz
Input Crosstalk	(-57 dBm, 10 MHz-2 GHz*) >100 dB, 1 MHz-500 MHz >80 dB, 500 MHz-1 GHz (>70 dB, 1 GHz-2 GHz*)
Magnitude Accuracy	
Absolute Accuracy	+1/-3 dB, 100 kHz-300 kHz
(A, B 100 mV, 15-30 deg C)	±0.5 dB, 300 kHz-1 MHz ±0.2 dB, 1 MHz-100 MHz ±0.5 dB, 100 MHz-300 MHz ±1 dB, 300 MHz-1 GHz (±1 dB, 300 MHz-1.5 GHz*) (+1/-2 dB, 1.5 GHz-2 GHz*)

Ratio Accuracy	±0.3 dB, 300 kHz-500 MHz
(A, B 100mV, 15-30 deg C)	±0.5 dB, 500 MHz-1 GHz (±0.5 dB, 500 MHz-1.5 GHz*) (±1 dB, 1.5 GHz-2 GHz*)
Phase Accuracy	±4 deg, 300 kHz-1 MHz
(A, B 100mV, 15-30 deg C)	±1 deg, 1 MHz-100 MHz ±4 deg, 100 MHz-300 MHz ±6 deg, 300 MHz-1 GHz (+/-6 deg, 300 MHz-1 GHz*) (±12 deg, 1.5 GHz-2 GHz*)

**Search and Lock Time:** Lockup (within one range): 40mS, frequencies up to 3 MHz, 20 mS, frequencies greater than 3MHz.

**Power:** 100, 120, 220 or 240V +5/-10%, 48 to 440Hz, 40VA.

**Size:** 133mm H x 425.5mm W x 473.3mm D (5.25" x 16.75" x 18.65") Opt 001 158.8mm H x 524.5 W x 524.5mm D (6.25" x 19.75" x 20.65").

**Weight:** 8.1Kg net, 11Kg shipping; Opt 001 9.4Kg net, 12.5Kg shipping.

#### HP 11570A Accessory Kit

**50 ohm Tee:** For monitoring signals on 50 ohm transmission line. Kit contains two each with type N female connectors.

**50 ohm Power Splitter:** All connectors type N female.

**HP 908A 50 ohm Termination:** For terminating 50 ohm coaxial systems in their characteristic impedance. Kit contains two each with type N male connectors.

**HP 11512A Short:** Type N male.

#### Ordering Information

<b>HP 8508A Vector Voltmeter</b> (includes HP 85081A Input Module).	\$5,500
<b>Opt 001:</b> Add bail handle and front protective cover.	250
<b>Opt 050:</b> Replace HP 85081A Input Module with HP 85082A Input Module.	-0-
<b>Opt 100:</b> Delete Input Module.	-1,500
<b>Opt 801:</b> Adds 2 each HP 11576A 10:1 Divider and HP 10216A Isolators	630
<b>HP 85081A Input Module</b> (100 kHz to 1 GHz, high impedance probe inputs).	1,500
<b>HP 85082A Input Module</b> (300 kHz to 2 GHz, 50 ohm Type N inputs)	1,500
<b>HP 11570A Accessory Kit</b> (measurement in 50 ohm systems with standard HP 8508A).	950

# NETWORK ANALYZERS

## RF Network Analyzer, 300 kHz to 6 GHz

### Model 8753B

243

- 300 kHz to 6 GHz
- Integrated 1 Hz resolution synthesized source
- Direct save/recall to an external disc drive
- Time domain analysis
- Execute complex test procedures with the test sequence function
- 100 dB of dynamic range
- Group delay and deviation from linear phase
- 0.001 dB, 0.01 deg, 0.01 nanosec marker resolution
- Built-in accuracy enhancement
- Swept harmonic measurements

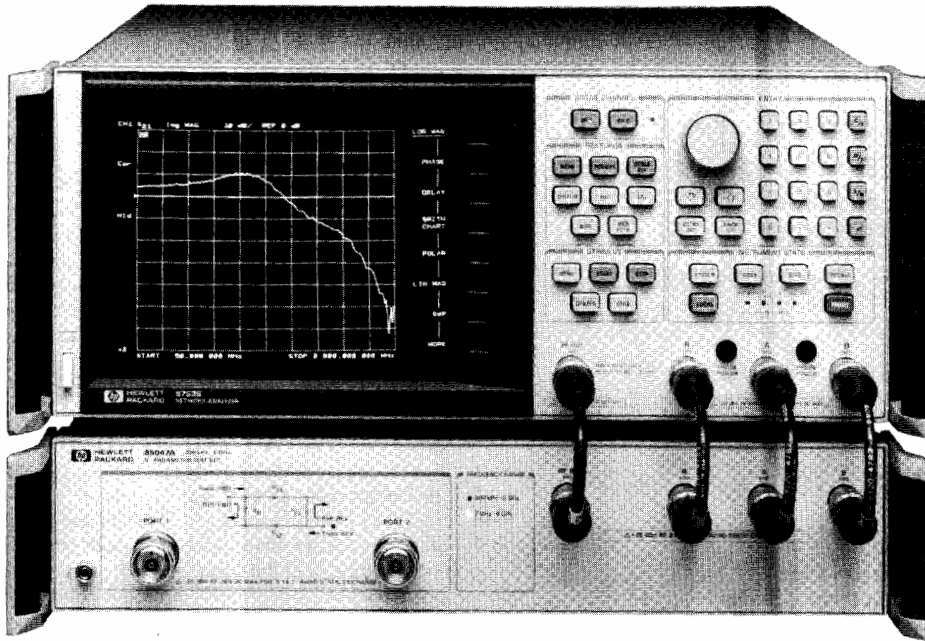

HP 8753B with HP 85047A



### Description

The HP 8753B provides excellent RF network measurements for the lab and production test areas. When combined with a test set, it yields a complete solution for characterizing the linear behavior of either active or passive networks, devices, or components from 300 kHz to 6 GHz. With two independent display channels available, you can simultaneously measure and display the reflection and transmission characteristics of the device under test in overlay or split screen format. The easy-to-use softkey selection of measurement functions allows you to measure the magnitude, phase, or group delay characteristics of your device under test.

The test sequence function allows rapid and consistent execution of complex repetitive tests with a single keystroke. In sequencing mode, you make the measurement once from the front panel and the instrument "learns" the keystrokes so no additional programming expertise is required. You can even set other HP-IB instruments via a test sequence. Other productivity enhancements include a plot/print buffer, limit testing, arbitrary frequency testing, and marker tracking functions. Finally, segmented calibration and interpolative error correction allow you to apply vector accuracy enhancement over a subset of the frequency range that you initially calibrated the HP 8753B.

The HP 8753B's integrated synthesized source provides > 100 mW of output power, 1 Hz frequency resolution, and linear, log, list, power, and CW sweep types. Three tuned, 300 kHz to 3 GHz (Option 006 - extends to 6 GHz) receivers allow versatile independent power measurements or simultaneous ratio measurements over a 100 dB dynamic range. By employing the HP 85047A Test Set with the HP 8753B, the reflection and transmission characteristics of the device under test can be investigated from 300 kHz to 3 GHz or from 3 MHz to 6 GHz with the test set's frequency doubler enabled.

### Non-linear Device Testing

Non-linear device characterization is possible with the HP 8753B. Swept 2nd and 3rd harmonic levels of an amplifier can be displayed directly or relative to the fundamental carrier (dBc) when employing the optional harmonic measurement capability (Option 002). Amplifier harmonics up to 40 dBc can be measured quickly and conveniently on a swept-frequency basis for fundamental signals as low as 16 MHz, using the same test configuration used to measure gain. Power meter calibration provides a leveled absolute power to devices that are sensitive to absolute input or output levels. The HP 8753B automatically controls an HP 436A, 437B, or 438A Power Meter to set the power anywhere in the test configuration with power meter accuracy.

The HP 8753B has the capability to perform mixer tracking and conversion loss measurements. These are possible because the HP 8753B's tuned receiver can be offset from its synthesized source by the LO frequency of the mixer.

### Time Domain Analysis

Time domain responses can be displayed by the HP 8753B with Option 010. The instrument computes the Inverse Fourier Transform of the frequency domain data to display the reflection or transmission coefficient versus time. The HP 8753B offers two time domain modes. The Low Pass mode provides the traditional Time Domain Reflectometer (TDR) measurement capability and gives the response of the network to a mathematically simulated step or impulse response. This mode gives information of the type of impedance (R, L, C) at the discontinuity. The Band Pass time domain mode, which has only the impulse stimulus, has no frequency restrictions and provides the time domain response of frequency selective devices such as SAW filters or antennas. Gating may be used to selectively isolate a single response to view the frequency domain response of individual portions of a component without disturbing the circuit itself.

# NETWORK ANALYZERS

## RF Network Analyzer, 300 kHz to 6 GHz (cont'd)

### Model 8753B

#### HP 8753B Specifications Summary

##### Source

##### Frequency Characteristics

**Frequency Range:** 300 kHz to 3 GHz

**Frequency Resolution:** 1 Hz

**Frequency Accuracy (25 C):**  $\pm 10$  ppm

##### Output Characteristics

**Power Range:** -5 to +20 dBm

**Power Accuracy** (50 MHz, +10 dBm):  $\pm 0.5$  dB

**Power Linearity** (relative to +10 dBm, 25  $\pm 5$  C):

-5 to +15 dBm:  $\pm 0.2$  dB

+15 to +20 dBm:  $\pm 0.5$  dB

**Impedance:** 50

**Harmonics:**  $\leq -25$  dBc (20 dBm output level)

typically  $\leq -50$  dBc (0 dBm output level)

##### Nonharmonics:

**Mixer Related:**  $\leq -32$  dBc (20 dBm output level)

typically  $\leq -55$  dBc (0 dBm output level)

##### Other Spurious:

$f < 135$  MHz: -60 dBc

$f \geq 135$  MHz: -60 dBc +  $20 \cdot \log(f/135 \text{ MHz})$

**Phase Noise** (0 kHz offset in 1 Hz BW):

$f < 135$  MHz: -90 dBc

$f \geq 135$  MHz: -90 dBc +  $20 \cdot \log(f/135 \text{ MHz})$

#### Receiver

**Frequency Range:** 300 kHz to 6 GHz

**Inputs:** A, B 100 dB dynamic range < 3 GHz

95 dB dynamic range 3 to 6 GHz

**Sensitivity** (noise level):

3 kHz BW: -90 dBm < 3 GHz, -85 dBm 3 to 6 GHz

10 Hz BW: -100 dBm < 3 GHz, -95 dBm 3 to 6 GHz

**Maximum Input Level:** 0 dBm

**Impedance:** 50

##### Input Crosstalk:

300 kHz to 1 GHz: -100 dB

1 GHz to 3 GHz: -90 dB

3 GHz to 6 GHz: -80 dB

**Dynamic Accuracy:**  $\pm 0.05$  dB,  $\pm 0.5$  deg over a 50 dB input range

##### Delay Characteristics:

**Range:**  $1/2^*$  (1/minimum aperture)

**Aperture:** selectable (frequency span)/(# points - 1) to 20% of the frequency span

**Resolution:**  $27.8/(\text{aperture in Hz})$

typically 0.01 nanoseconds

**Accuracy:** (phase accuracy)/(360\*aperture in Hz)

##### Dimensions:

178mm H x 425mm W x 498mm D

(7.0 x 16.75 x 20.0 in)

##### Weight:

Net 22 kg (48 lb); Shipping 25 kg (55 lb)

#### HP 8753B Accessories

##### HP 85044A 50 Ohm Transmission/Reflection Test Set

##### HP 85044B 75 Ohm Transmission/Reflection Test Set

The HP 85044 A/B Transmission/Reflection test sets provide the capability to simultaneously measure the impedance and transmission characteristics of 50 and 75 ohm devices. Two-port devices must be physically turned around to measure their reverse direction characteristics. Test port connectors are precision 7 mm and 75 ohm type N (f), respectively.

Specifications	HP 85044A	HP 85044B
<b>Impedance:</b>	50 ohms	75 ohms
<b>Frequency Range:</b>	300 kHz to 3 GHz	300 kHz to 2 GHz
<b>Directivity<sup>2</sup>:</b>	35 dB to 1.3 GHz	35 dB to 1.3 GHz
	30 dB to 3.0 GHz	30 dB to 2.0 GHz

Typical Tracking:	HP 85044A	HP 85044B
<b>Transmission Magnitude, Phase<sup>1,3</sup>:</b>		
.3 MHz to 2.0 MHz	$\pm 1.5$ dB, $\pm 10^\circ$	$\pm 1.5$ dB, $\pm 10^\circ$
2.0 MHz to $F_{\max}^2$	$\pm 1.5$ dB, $\pm 10^\circ$	$\pm 1.5$ dB, $\pm 10^\circ$
<b>Reflection Magnitude, Phase<sup>1,3</sup>:</b>		
.3 MHz to 2.0 MHz	$\pm 1.5$ dB, $\pm 25^\circ$	$\pm 1.0$ dB, $\pm 25^\circ$
2.0 MHz to $F_{\max}$	$\pm 1.5$ dB, $\pm 10^\circ$	$\pm 1.0$ dB, $\pm 10^\circ$
<b>Effective Source Match<sup>3</sup>:</b>		
(Test Ports):		
.3 MHz to 2.0 MHz	14 dB	14 dB
2.0 MHz to 1.3 GHz	20 dB	17 dB
1.3 GHz to $F_{\max}$	16 dB	16 dB
<b>RF Connectors:</b>		
<b>Test Port:</b>	precision 7 mm	75 ohm type N (f)
<b>All others:</b>	50 ohm type N (f)	50 ohm type N (f)
<b>Includes:</b>	HP 85044A—one precision 7 mm to 50 ohm type N (f) adapter; HP 85044B—one HP 11852B minimum loss pad.	
<b>Recommended Accessories:</b>	HP 11851B RF cable kit	
<b>Dimensions:</b>	615H x 101 W x 204 mm D (2.44 x 7.5 x 8.0 in)	
<b>Weight:</b>	net 1.7 kg (3.8 lb)	

#### S-Parameter Test Sets

The S-parameter test sets provide the capability to measure impedance and transmission characteristics (including s-parameters) of 2 port devices in either direction with a single connection. The test sets are controlled from the HP 8753B and include a programmable step attenuator.

#### HP 85046A/B S-Parameter Test Set

Test port connectors are precision 7 mm and 75 ohm type N (f) respectively. Both connectors can be adapted to other interfaces with the appropriate precision adapters.

Specifications	HP 85046A	HP 85046B
<b>Impedance:</b>	50 ohms	75 ohms
<b>Frequency Range:</b>	300 kHz to 3 GHz	300 kHz to 2 GHz
<b>Directivity:</b>	35 dB to 1.3 GHz	35 dB to 1.3 GHz
	30 dB to 3.0 GHz	30 dB to 2.0 GHz
<b>Typical Tracking:</b>		
<b>Transmission Magnitude, Phase<sup>1,3</sup>:</b>		
.3 MHz to 2.0 MHz	$\pm 1.5$ dB, $\pm 20^\circ$	$\pm 1.5$ dB, $\pm 20^\circ$
2.0 MHz to $F_{\max}^2$	$\pm 1.5$ dB, $\pm 10^\circ$	$\pm 1.5$ dB, $\pm 10^\circ$
<b>Reflection Magnitude, Phase<sup>1,3</sup>:</b>		
.3 MHz to 2.0 MHz	$\pm 1.5$ dB, $\pm 25^\circ$	$\pm 1.5$ dB, $\pm 25^\circ$
2.0 MHz to $F_{\max}$	$\pm 1.5$ dB, $\pm 10^\circ$	$\pm 1.5$ dB, $\pm 10^\circ$
<b>Effective Source Match<sup>3</sup>:</b>		
(Test Ports):		
.3 MHz to 2.0 MHz	14 dB	14 dB
2.0 MHz to 1.3 GHz	20 dB	17 dB
1.3 GHz to $F_{\max}$	16 dB	16 dB
<b>RF Connectors:</b>		
<b>Port 1, 2:</b>	precision 7 mm	75 ohm type N (f)
<b>All others:</b>	50 ohm type N (f)	50 ohm type N (f)
<b>Includes:</b>	Four 190 mm (7.5") cables with type N (m) connectors for connection to the HP 8753B. One HP 8753B test set interconnect cable.	
<b>Recommended Accessories:</b>	HP 11857D cables HP 11857B cables	
<b>Dimensions:</b>	90 H x 426 W x 553 mm D (3.5 x 16.75 x 21.5 in.)	
<b>Weight:</b>	9.1 kg (20 lb)	

<sup>1</sup>Degrees, specified as deviation from linear phase.

<sup>2</sup> $F_{\max}$  is the upper frequency limit of the associated test set.

<sup>3</sup>Can be improved through Accuracy Enhancement.



#### HP 85047A S-parameter Test Set

This test set includes a frequency doubler that can be switched in to measure 3 MHz to 6 GHz in a single sweep or switched out to measure 300 kHz to 3 GHz in a single sweep. The HP 8753B controls the frequency doubler. HP 8753B Option 006 (6 GHz receiver) is required to activate the HP 85047A. There are two rear panel BNC outputs. One provides a TTL signal which indicates the result of HP 8753B Test Sequence function.

#### Specifications

**Impedance:** 50 ohms

**Frequency ranges:** 300 kHz to 3 GHz  
3 MHz to 6 GHz

**Directivity:** 300 kHz to 1.3 GHz 35 dB  
1.3 GHz to 3 GHz 30 dB  
3 GHz to 6 GHz 25 dB

#### Typical tracking:

**Transmission magnitude, phase:**

300 kHz to 3 GHz  $\pm 1.5$  dB,  $\pm 10$  deg.

3 GHz to 6 GHz  $+0.5$ ,  $-2.5$  dB,  $\pm 20$  deg.

**Reflection magnitude, phase:**

300 kHz to 3 GHz  $\pm 1.5$  dB,  $\pm 10$  deg.

3 GHz to 6 GHz  $\pm 1.5$  dB,  $\pm 20$  deg.

**Effective source match:** 300 kHz to 1.3 GHz 20 dB  
1.3 GHz to 3 GHz 16 dB  
3 GHz to 6 GHz 14 dB

#### RF connectors:

Port 1, 2: 7 mm precision

All others: 50 ohm type N(f)

Includes: Four 190 mm (7.5") cables with Type N(m) connectors for connection to the HP 8753B. One HP 8753B test set interconnect cable.

Recommended accessories: HP 11857D cables

**Dimensions:** 90 H x 426 W x 533 mm D

**Weight:** 10 kg (22 lb.)

#### HP 11850C/D Three-Way Power Splitters

#### Specifications

	HP 11850C	HP 11850D
<b>Impedance:</b>	50 ohms	75 ohms
<b>Frequency Range:</b>	DC to 3 GHz	DC to 2 GHz
<b>Tracking:</b>	$\pm .25$ dB, $+3^\circ$	$\pm .2$ dB, $\pm 2.5^\circ$
<b>Equivalent Source Match</b> (ratio or leveling)	30 dB @ 1.3 GHz 20 dB @ 3 GHz	30 dB @ 1.3 GHz 20 dB @ 3 GHz
<b>Nominal Insertion Loss:</b>	9.5 dB +1 dB/GHz	7.8 dB
<b>Input Port Match:</b>		
DC to 1.3 GHz	20 dB	20 dB
1.3 GHz to $F_{max}^1$	10 dB	10 dB

#### RF Connectors:

**RF Input:** 50 ohm type N (f) 50 ohm type N (f)

**All Others:** 50 ohm type N (f) 75 ohm type N (f)

**Includes:** 3 ea HP 11852B  
50 to 75 ohm  
min. loss pads

#### Recommended

HP 11851B RF Cable Kit

#### Accessories:

<sup>1</sup> $F_{max}$  is the upper frequency limit of the associated power splitter.

#### HP 11851B RF Cable Kit

**General:** three 610 mm (24 in.) 50  $\Omega$  cables phase matched to  $4^\circ$  at 1.3 GHz and one cable 860 mm (34 in.). Connectors are Type N Male. Recommended for use with HP 85044A/B Transmission/Reflection Test Set and HP 11850C/D Power Splitter.

**Weight:** net, 0.91 kg (2 lb); shipping, 1.36 kg (3 lb).

#### HP 11852B 50 $\Omega$ /75 $\Omega$ Minimum Loss Pad

**General:** the HP 11852B is a low SWR minimum loss pad required for transmission measurements on 75  $\Omega$  devices with HP 8753B receiver (50  $\Omega$ ).

**Frequency range:** dc to 2.0 GHz.

**Insertion loss:** 5.7 dB.

**Return loss:** 75  $\Omega$  typically  $\geq 30$  dB, 50  $\Omega$  typically  $\geq 26$  dB.

**Maximum input power:** 250 mW (+24 dBm).

**Connectors:** 50  $\Omega$  Type N female and 75  $\Omega$  Type N male.

#### Type N Accessory Kits

Kit contains a Type N Female short, a Type N Male short, two Type N Male barrels, two Type N Female barrels and storage case.

#### HP 11853A 50 $\Omega$ Type N Accessory Kit

**General:** the HP 11853A furnishes the RF components required for measurement of devices with 50  $\Omega$  Type N Connectors using the HP 11850C, 85044A, 85046A or 85047A.

#### HP 11855A 75 $\Omega$ Type N Accessory Kit

**General:** the HP 11855A provides the RF connecting hardware generally required for measurement of devices with 75  $\Omega$  Type N connectors using the HP 85044B, 85046B or 11850D. This kit also contains a 75  $\Omega$  Type N Male termination.

#### BNC Accessory Kits

Kit contains two Type N Male to BNC Female adapters, two Type N Male to BNC Male adapters, two Type N Female to BNC Female adapters, two Type N Female to BNC Male adapters, a BNC Male short and storage case.

#### HP 11854A 50 $\Omega$ BNC Accessory Kit

**General:** the HP 11854A furnishes the RF components required for measurement of devices with 50  $\Omega$  BNC Connectors using the HP 11850C, 85044A, 85046A or 85047A.

#### HP 11856A 75 $\Omega$ BNC Accessory Kit

**General:** the HP 11856A provides the RF connecting hardware generally required for measurement of devices with 75  $\Omega$  BNC connectors using the HP 85044B, 11850D, or 85046B. This kit also contains a 75  $\Omega$  BNC Male termination, and storage case.

#### HP 11857D 50 $\Omega$ APC-7 Test Port Extension Cables

**General:** two precision 61 cm (24 in.) cables, phase matched to  $2^\circ$  at 1.3 GHz for use with HP 85046 A S-parameter test set. Connectors are 50  $\Omega$  APC-7.

#### HP 11857B 75 $\Omega$ Type N Test Port Extension Cables

**General:** two precision 61 cm (24 in.) cables, phase matched to  $2^\circ$  at 1.3 GHz for use with HP 85046B S-parameter test set. One cable has 75  $\Omega$  Type N Male connectors on both ends; the other has one Type N Male and one Type N Female connector.

#### HP 11600B/11602B Transistor Fixtures

**Function:** mounts on front of HP 8745A S-Parameter Test Sets, holds devices for s-parameter measurements in a 50 ohm, coax circuit.

#### Transistor Base Patterns

**Model 11600B:** accepts TO-18/TO-72 packages.

**Model 11602B:** accepts TO-5/TO-12 packages.

**Calibration references:** short circuit termination an a 50 ohm through-section.

**Frequency range:** dc to 2 GHz.

**Impedance:** 50 ohms nominal.

**Reflection coefficient:**  $<0.05$ , 100 MHz to 1.0 GHz:  $<0.09$ , 1.0 to 2 GHz.

**Connectors:** hybrid APC-7; Option 001, type N female.

#### HP 11858A Transistor Fixture Adapter

**General:** the HP 11858A adapts the HP 11600B and 11602B transistor fixtures (vertical test port configuration) to the HP 85046A or 85047A S-parameter test set. Connectors are APC-7.

#### HP 85043B Systems Cabinet

The HP 85043B systems cabinet has been ergonomically designed specifically for the HP 8753B and the HP 85046A/B or 85047A S-parameter test sets. The 122 cm (48-inch) system cabinet includes a bookcase, a drawer, and a convenient work surface.

#### Calibration Kits

Accuracy enhancement procedures characterize the systematic errors of the measurement system by measuring known devices (standards) on the system over the frequency range of interest. The calibration kits in the HP 8753B family contain precision standards with which to characterize the systematic errors of a HP 8753B measurement system.

#### HP 85031B 7 mm Calibration Kit

The HP 85031B 7 mm calibration kit contains a set of precision 7 mm fixed terminations, an open circuit, and a short circuit used to calibrate the HP 8753B and its 50 ohm test sets for measurement of devices with precision 7 mm connectors.

# NETWORK ANALYZERS

## Accessories (cont'd)

### 8753B Series

#### HP 85032B 50 $\Omega$ Type N Calibration Kit

The HP 85032B Calibration Kit contains precision 50  $\Omega$  type N standards used to calibrate the HP 8753B and its 50  $\Omega$  test sets for measurement of devices with 50  $\Omega$  type N connectors. Precision phase-matched 7 mm to 50  $\Omega$  type N adapters are included for accurate measurements of non-insertable devices. Standards include fixed terminations, open circuits, and short circuits.

#### HP 85033C 3.5 mm Calibration Kit

The HP 85033C Calibration Kit contains precision 3.5 mm standards used to calibrate the HP 8753B and its 50  $\Omega$  test sets for measurement of devices with 3.5 mm and SMA connectors. Standards include fixed terminations, open circuits, and short circuits. Precision 7 mm to 3.5 mm adapters are included for accurate measurements of non-insertable devices.

#### HP 85036B 75 $\Omega$ type N Calibration Kit

The HP 85036B Calibration Kit contains precision 75  $\Omega$  type N standards used to calibrate the HP 8753B and its 75  $\Omega$  test sets for measurement of devices with 75  $\Omega$  type N connectors. Standards include fixed terminations, open circuits, and short circuits. Precision phase-matched adapters are included for accurate measurements of non-insertable devices.

#### Verification Kits

Measuring known devices, other than the calibration standards, is a convenient way of verifying that the HP 8753B measurement system is operating properly.

#### HP 85029B 7 mm Verification Kit

The HP 85029B Verification Kit contains a set of precision 7 mm devices, with data traceable to NBS, used to verify the calibrated performance of an HP 8753B measurement system. The devices have precision 7 mm connectors and include a 20 dB pad, a 50 dB pad and a mismatch attenuator. Verification process requires only an HP 85031B calibration kit, an HP 85029B verification kits and an external 3.5" disc drive connected to the HP 8753B.

#### Software

Software operates with a BASIC operating system using an HP Series 300 computer (2 megabytes of memory required).

#### HP 85160A Measurement Automation Software

Measurement Automation Software simplifies device measurements by providing guided measurements, limit testing, sequencing to test all four S-parameters, data formatting flexibility (data files can be formatted to be compatible with Touchstone® linear circuit simulation programs) and complete save/recall capability to a floppy disc. Once configured, simply recall a test file and calibration data, connect the device-under-test, and output the results.

#### HP 85165A Resonator Measurement Software

Resonator Measurement Software performs complete characterization of crystals, SAWs, and other resonant devices using the HP 8753B. The software guides the user through the measurement process and calculates key parameters of the device under test according to the EIA-512 resonator measurement standard.

#### HP 85024A High Frequency Probe

The HP 85024A High Frequency Probe makes it easy to perform in-circuit measurements. An input capacitance of only 0.7 pF shunted by 1 Megohm of resistance permits high frequency probing without adversely loading the circuit under test. Excellent frequency response and unity gain guarantees high accuracy in swept measurements with this probe. High probe sensitivity and low distortion levels allows measurements to be made while taking advantage of the full dynamic range of HP RF analyzers. Spectrum analyzers which supply probe power from the front panel include the HP 8568B, 8590A, 8562A/B, and 71100A. RF network analyzers like the HP 8753B, 3577A, and 4195A are also directly compatible. You can use the HP 85024A with other instruments by using the HP 1122A Probe Power Supply or any dual  $\pm 15V$ , 130 mA supply.

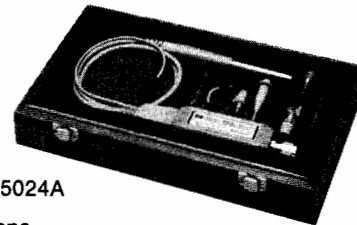

HP 85024A



#### Specifications

**Input Capacitance (@ 500 MHz):** <0.7 pF (nominal)

**Input Resistance:** 1 Megohm (nominal)

**Bandwidth:** 300 kHz to 3 GHz

**Gain (@ 500 MHz):** 0 dB  $\pm$  1 dB

**Average Noise Level (10 Hz to 10 MHz):** <1 mV

**Frequency Response:**  $\pm$  1.25 dB (300 kHz to 1 GHz)  
+ 2, -3 dB (1 GHz to 3 GHz)

**Input Voltage for 1 dB Compression:** 0.3 V

#### Supplemental Characteristics

**Noise Figure:** <50 dB (<100 MHz)

<25 dB (100 MHz to 3 GHz)

**Distortion (@ 0.3 V):** <-30 dBc

#### Includes

Type N Male Adapter, 10:1 Divider, Spare probe tips, 2.5-inch Ground Lead, Hook Tip, Spanner Tip, and Probe Tip Nut Driver.

#### Service and Support Products

Service and support products are available for HP 8753B measurement systems. On-site support products require a specific 50 ohm two-port measurement configuration.<sup>1</sup> Contact your local HP sales office for availability and price.

#### Ordering Information

	Price
HP 8753B Network Analyzer	\$25,500
Option 002 Harmonic Measurement Capability	3,000
Option 006 6 GHz Receiver Option	3,000
Option 010 Time Domain Capability	4,800
Option 802 add Dual Disc Drive and HP 10883A cable	1,495
Option 908 Rack Mount Kit (without handles)	35
Option 910 Extra Operating and Service Manual	75
Option 913 Rack Mount Kit	40
HP 85047A 6 GHz S-Parameter Test Set	9,800
Option 913 Rack Mount Kit	40
HP 85046A 50 Ohm S-Parameter Test Set	7,800
Option 913 Rack Mount Kit	40
HP 85046B 75 Ohm S-Parameter Test Set	7,800
Option 913 Rack Mount Kit	40
HP 85044A 50 Ohm Transmission/Reflection Test Set	3,500
HP 85044B 75 Ohm Transmission/Reflection Test Set	3,500
HP 85029B Precision 7 mm Verification Kit	1,600
HP 85031B Precision 7 mm Calibration Kit	1,000
HP 85032B 50 Ohm type N Calibration Kit	1,500
HP 85033C Precision 3.5 mm Calibration Kit	2,500
HP 85036B 75 Ohm type Calibration Kit	2,000
HP 85043B Systems Rack	2,900
HP 85033A SMA Kit	1,000
HP 85160A Measurement Automation Software	1,500
HP 85165A Resonator Measurement Software	5,000
HP 11850C 50 Ohm Power Splitter	900
HP 11850D 75 Ohm Power Splitter	1,400
HP 11851B type N RF Cable Kit	800
HP 11852B 50 to 75 Ohm Minimum Loss Pad	350
HP 11853A 50 Ohm type N Accessory Kit	350
HP 11854A 50 Ohm BNC Accessory Kit	350
HP 11855A 75 Ohm type N Accessory Kit	450
HP 11856A 75 Ohm BNC Accessory Kit	450
HP 11857B 75 Ohm type N Test Port Extension Cables	1,455
HP 11857D 50 Ohm APC-7 Test Port Extension Cables	1,050
HP 11600B/11602B Transistor Fixtures	1,800
HP 11858A Transistor Fixture Adapter	980
HP 85024A High Frequency Probe	1,900

☛ Fast-Ship Product — See Page 766.

<sup>1</sup>The specific 50 ohm two-port measurement system includes the HP 8753A, the HP 85046A S-parameter test set, the HP 85031B 7 mm calibration kit, and the HP 11857D 7 mm test port extension cable set. This is a minimum configuration required for on-site verification.

# NETWORK ANALYZERS

## Microwave Network Analyzer, 130 MHz to 20 GHz

Models 8720A, 85162A

247

- 130 MHz to 20 GHz frequency range
- Integrated swept synthesized source
- Integrated switching s-parameter test set
- Direct save/recall to an external disc drive
- >85 dB dynamic range
- Built-in vector accuracy enhancement

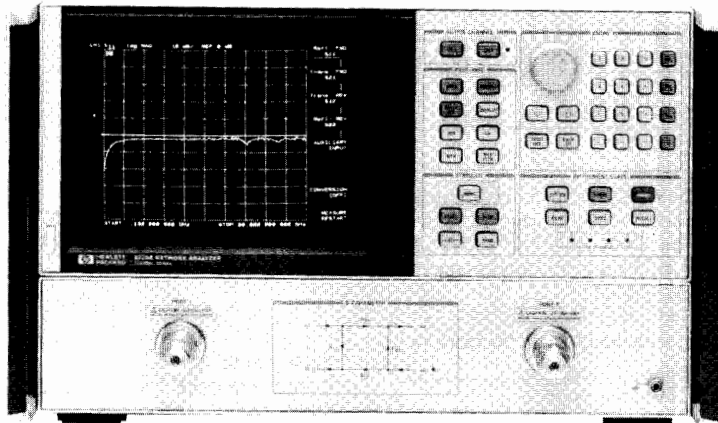

HP 8720A



### Description

The HP 8720A provides simple and complete vector network measurements in a compact and fully integrated microwave network analyzer. Characterize your microwave components and networks accurately, yet economically with the HP 8720A microwave network analyzer. Integration of the 130 MHz to 20 GHz swept synthesized source, test set, and receiver results in a compact, low cost network analyzer which is ideal for incoming inspection, production, and final test measurements.

With two independent display channels available, you can simultaneously measure the reflection and transmissions characteristics of the device under test. The easy-to-use softkey selection of measurement functions allows you to quickly measure the magnitude, phase, or group delay characteristics of your device under test. Directly measure the electrical length of a single device or phase match multiple devices. Data can be displayed in log magnitude, linear magnitude, SWR, phase, group delay, polar, real, or Smith Chart formats.

The HP 8720A's integrated synthesized source provides 100 kHz frequency resolution standard or, with the addition of option 001, it will provide 1 Hz frequency resolution for testing narrowband, frequency selective or electrically long devices. The integrated synthesized source also provides a measurement port power level of  $-10$  to  $-65$  dBm which is settable in 5 dB steps.

### Time Domain Analysis

The HP 8720A with option 010 has the capability of displaying the time domain response of a network, obtained by computing the Inverse Fourier Transform of the frequency domain response. The time domain response displays the reflection coefficient versus time, yielding the magnitude and location of each individual discontinuity of the network. It can also display the transmission coefficient versus time, yielding simulated transient response analysis of the network.

### Features Designed for Manufacturing

The HP 8720A's productivity features allow increased throughput on your production floor. The arbitrary frequency list mode allows selection of only those frequencies you wish to test, resulting in reduced test time. In this mode, you can define up to 30 CW frequencies or swept frequency segments, calibrate once, and then measure all of the segments or "zoom-in" on just one segment and still remain calibrated. The HP 8720A's limit test capability allows your technicians to make pass/fail decisions easily and systematically. Based on the specifications for the device under test, define up to 22 test limits on each channel so your technicians can align and objectively verify the device's response. Utilize the HP 8720A's save/recall capability to reduce set up time and enable all your technicians to repeatedly use the same test configuration. This feature allows your engineer or skilled specialist to define the test configuration once, store it to an external CS80 compatible disc drive, and then have it recalled by each member of your production test line without the use of an external computer. This feature provides confidence that each technician is aligning and evaluating your devices under the same conditions. For a permanent record of your measurement results, the HP 8720A's copy feature allows the entire CRT display to be directly output to a compatible HP-GL plotter or printer.

All of the functions of the HP 8720A are completely programmable from an external computer through the Hewlett-Packard Interface Bus. For fully automated, guided measurements, use the HP 85162A Measurement Automation Software. To completely and efficiently characterize crystals, SAWs, and other resonant devices, use the HP 85165A Resonator Measurement Software.

# NETWORK ANALYZERS

## Microwave Network Analyzer, 130 MHz to 20 GHz

Models 8720A, 85162A (cont'd)

### HP 8720A System Performance

#### Dynamic Range (for transmission measurements)<sup>1</sup>

	Frequency Range			
	0.13 to 0.5 GHz	0.5 to 2 GHz	2 to 8 GHz	8 to 20 GHz
Dynamic Range	70 dB	80 dB	85 dB	85 dB

#### Measurement Port Characteristics<sup>2</sup>

The following specifications show the residual system uncertainties (including switch repeatability) after accuracy enhancement using a full 2-port measurement calibration (including isolation) with an IF bandwidth of 10 Hz, and the specified calibration kit. Environmental temperature is 23±3°C.

#### Calibration Kit: HP 85052B (3.5 mm, male and female lowband and sliding loads)

	Frequency Range			
	0.13 to 0.5 GHz	0.5 to 2 GHz	2 to 8 GHz	8 to 20 GHz
Directivity	40 dB	40 dB	40 dB	40 dB
Source Match	30 dB	30 dB	30 dB	30 dB
Load Match	35 dB	35 dB	30 dB	30 dB
Reflection Tracking	±0.10 dB	±0.10 dB	±0.10 dB	±0.20 dB
Transmission Tracking	±0.10 dB	±0.10 dB	±0.12 dB	±0.15 dB

#### Calibration Kit: HP 85052D (3.5 mm, male and female broadband precision fixed load)

	Frequency Range			
	0.13 to 0.5 GHz	0.5 to 2 GHz	2 to 8 GHz	8 to 20 GHz
Directivity	40 dB	40 dB	38 dB	36 dB
Source Match	30 dB	30 dB	30 dB	30 dB
Load Match	35 dB	35 dB	30 dB	30 dB
Reflection Tracking	±0.10 dB	±0.10 dB	±0.10 dB	±0.20 dB
Transmission Tracking	±0.10 dB	±0.10 dB	±0.12 dB	±0.15 dB

### System Accessories

	3.5 mm	7 mm <sup>3</sup>	Type N <sup>4</sup>
Test port cables			
Semi-flexible	HP 85131C/D	HP 85132C/D	HP 85132C/D <sup>4</sup>
Super-flexible <sup>5</sup>	HP 85131E/F	HP 85132E/F	HP 85132E/F <sup>4</sup>
Adapter sets	HP 85130D	HP 85130B	HP 85130C
Calibration kits			
Standard (sliding loads)	HP 85052B	HP 85050B	HP 85054B
Economy (fixed loads)	HP 85052D	HP 85050D	
Verification kits	HP 85051B	HP 85053B	HP 85055A

<sup>1</sup>Limited by maximum output power and system noise floor. Specified for an IF bandwidth of 10 Hz, using a full 2-port measurement calibration (including an isolation calibration performed with an averaging factor of 16).

<sup>2</sup>Crosstalk, after an isolation calibration, is below the system noise floor and can be ignored.

<sup>3</sup>HP 85130B/C Special Adapter Sets required if devices with 7 mm or Type N connectors are to be connected directly to the HP 8720A's test ports.

<sup>4</sup>Use the cables recommended for 7 mm devices. Precision 7 mm to Type N adapters are included in the HP 85054B Type N calibration kit.

<sup>5</sup>Semi-flexible cables are warranted for 90 days. Super-flexible cables carry a standard one-year warranty.

### General Characteristics

#### Source Frequency Characteristics

**Range:** 130 MHz to 20.0 GHz

**Resolution:** 100 kHz (1 Hz with Option 001)

**Stability:** typically ±7.5 ppm @ 0° to 55°C

typically ±3 ppm/year

**Accuracy:** 10 ppm @ 25°±3°C

#### Output characteristics (at test ports, 25°±3°C)

**Power range:** -10 to -65 dBm in 5 dB steps

**Power level:** -10 dBm ± 3 dB

**Harmonics:** <-15 dBc @ -10 dBm (typical)

#### Test ports

**Connector type:** 3.5 mm (male)

**Impedance:** 50 ohms nominal

**Switch type:** Mechanical

**Switch lifetime:** >3 million cycles (typical)

**Maximum input level:** +20 dBm

**DC bias:** 500 mA, 40 VDC maximum

#### Rear Panel Connectors

##### External reference frequency input:

**Frequency:** 1, 2, 5, and 10 MHz; ≤±200 Hz at 10 MHz

**Level:** -10 dBm to +20 dBm, typical

**Impedance:** 50 ohms

**External trigger:** Triggers start of sweep on a negative TTL transition or contact closure to ground.

**External AM auxiliary input:** 0 to 10 volts (1 dB/volt) into a 10 kohm resistor, 5 kHz max.

**Auxiliary voltage input:** -10 to +10 V

##### IO interconnect:

**Type:** DB-25

**Output:** Standard LS TTL output (active high logic) on pin 17 indicative of PASS/FAIL status during limit testing. Output voltage remains at +5 Vdc (nominal) until a FAIL condition occurs. Remains at 0 Vdc until a PASS condition occurs.

### HP 85162A Measurement Automation Software

The HP 85162A Measurement Automation Software is designed specifically to operate on an HP 9000 series 200 or 300 computer with BASIC 3.0 or higher. The software complements the HP 8720A microwave network analyzer, providing calibration, measurement, and data output capabilities with a minimum of operator interaction.

#### Ordering Information

	Price
HP 8720A Microwave Network Analyzer	\$55,000
Option 001 1 Hz frequency resolution	9,500
Option 010 Time Domain Capability	9,000
Option 802 add HP 9122C Dual Disc Drive, HP 10833A cable	1,495
Option 830 add HP 85052D Cal Kit, HP 85131E cable	5,800
Option 913 Rack Mount Kit	40
HP 85162A Measurement Automation Software	
Requires BASIC 3.0 or above and 2 Mbytes of RAM	1,500
Must select media option (no charge):	
Option 630 for 3.5 in. disc media	N/C
Option 655 for 5.25 in. disc media	N/C

# NETWORK ANALYZERS

## Microwave Network Analyzers, 45 MHz to 100 GHz

### 8510 Series

249

- 45 MHz to 100 GHz frequency range
- "Real Time" error-corrected measurements
- 60 dB effective directivity and source match

- 80 dB to 100 dB dynamic range
- 0.001 dB, 0.01 degree, 0.01 nanosecond measurement resolution
- Time domain analysis

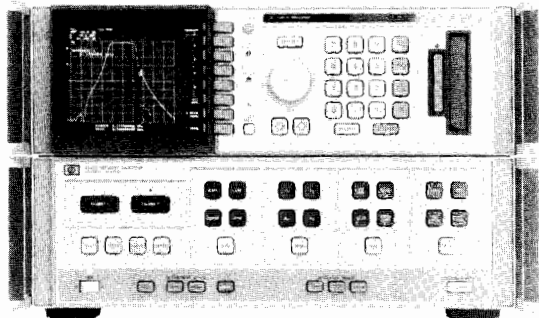

HP 8510B



40 GHz  
in coax

### Description

The HP 8510 series microwave vector network analyzers provide a complete solution for characterizing the linear behavior of either active or passive networks over the 45 MHz to 40 GHz frequency range. A complete system comprises the HP 8510B network analyzer, an S-parameter test set, and a compatible RF source. For millimeter-wave measurement needs, complete systems operating to 100 GHz can be configured.

### RF Sources

The recommended system source for the HP 8510B is the HP 8340B (26.5 GHz) or the HP 8341B (20 GHz) synthesized sweeper. With either source, the system has better than 6 Hz frequency resolution, phase-locked narrowband sweeps, and fully synthesized start frequencies for broadband ramp sweeps. When used with the HP 8516A test set, the HP 8340 or 8341 allow 40 GHz frequency coverage in a single sweep. The HP 8350B sweep oscillator with RF plug-in may also be used in the HP 8510B system.

Measurement results can be displayed on one of two independent, yet identical, channels. The channels may be displayed individually, or simultaneously, with results presented in either log/linear magnitude, phase, or group delay format on rectangular or polar coordinates. Direct measurement of impedance is possible with the Smith chart format. The value and frequency of the data can be read with one of five independent markers. The entire measurement trace can be copied directly to a plotter, such as the HP 7440A, 7475A, or 7550A without the need of an external computer. Also, a list of the trace values can be sent to a printer such as the HP 2225A.

Powerful measurement enhancement functions are also available. Data averaging can be employed to narrow the effective receiver IF bandwidth, extending dynamic range and increasing signal-to-noise ratio. Trace smoothing aids in the interpretation of measurement results and is used to control the aperture of group delay measurements. The equivalent of an electronic line stretcher is available with the electrical delay function.

Built-in storage provides the capability to save and recall up to eight different front panel states, eight separate calibrations, and eight separate measurements in nonvolatile memory. Extension of the internal storage capacity is possible via the built-in tape cassette unit or an external disc drive such as the HP 9122D.

### High Performance

Along with the capability to completely characterize a microwave network with a single connection over the extremely broad 45 MHz to 40 GHz frequency range, the HP 8510 system offers wide dynamic range. Depending on the test set used, 80 dB to 100 dB of dynamic range is available. The precision IF processing and detection system contributes as little as  $\pm 0.05$  dB and  $\pm 0.5$  degree measurement uncertainty at a level of 50 dB below the reference. Meaningful resolutions of 0.001 dB, 0.01 degree, and 0.01 nanosecond are easily available.

### "Real Time" Error Correction

The HP 8510's built-in, high speed computer provides the capability to characterize and effectively remove the impact of systematic errors through accuracy enhancement techniques. Effective directivity and source match can be improved to as much as 60 dB. The data processing speed of the system is such that a fully error-corrected, 401 point trace of data is updated in under one second. This virtual "real time" display of error-corrected data means that you can easily adjust your test device while it's being measured, with the assurance that you are viewing the data at the highest possible accuracy.

### Time Domain Analysis

The HP 8510 (with option 010) has the capability of displaying the time domain response of a network, obtained by computing the Inverse Fourier Transform of the frequency domain response. The time domain response displays the reflection coefficient of the network versus time, which displays the magnitude and location of each individual discontinuity, or else the transmission coefficient versus time, which displays each individual transmission path.

### System Rack

#### HP 85043A System Rack Kit

The HP 85043A system rack stands 123.7 cm (48.7") high, 60 cm (23.6") wide, and 80 cm (31.5") deep. Complete with support rails and AC power distribution (suitable for 50 to 60 Hz, and 110-240 Vac), it includes rack mounting hardware for all instruments. Therman design is such that no rack fan is needed.

### System Software

#### HP 85161A Measurement Automation Software

The HP 85161A Measurement Automation Software provides a more simplified and flexible user interface to the HP 8510B system. The program leads the operator through the measurement sequence one step at a time, from system setup and calibration, to device measurement and hardcopy output. Complete measurement configurations can be saved to disc for later recall. Also, data printout formats can be customized by the operator.

The HP 85161A software is designed for use with HP 9000 Series 200 or 300 computers and the BASIC operating system (3.0 or higher).

### Ordering Information

	<b>Price</b>
<b>HP 8510B</b> Network Analyzer	\$33,800
<b>Option 010</b> Time Domain Capability	9,800
<b>Option W30</b> 2 Years Additional Hardware Service	add \$670
<b>HP 85043A</b> System Rack Kit	2,900
<b>HP 85161A</b> Measurement Automation Software	1,500
<b>Option 630</b> 3 1/2" disc media	N/C
<b>Option 655</b> 5 1/4" disc media	N/C



# NETWORK ANALYZERS

## Test Sets

### 8510 Series

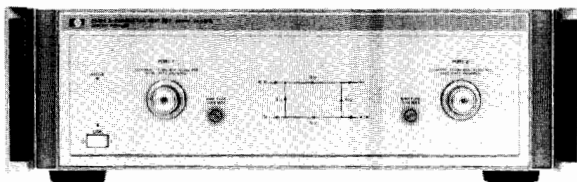

HP 8515A

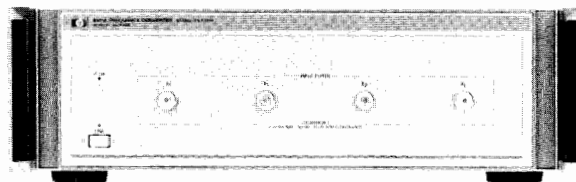

HP 8511A

#### S-Parameter Test Sets

Several S-parameter test sets are available for the HP 8510B network analyzer for broadband coaxial measurements from 45 MHz to 40 GHz. The HP 8514B, 8515A, and 8516A test sets have a dual port architecture which develops a separate reference channel for each incident port. RF switching is done with a single built-in electronic switch. For active device measurements, the test sets include the ability to apply DC bias (external) to the test port center conductors. Also available are two 90 dB step attenuators (10 dB steps) which allow control of the port 1 and port 2 signal levels.

#### High Dynamic Range Configurations

The HP 8514B and 8516A test sets are coupler-based. Two alternate coupler configurations are available. The standard configuration is symmetrical and has identical dynamic range performance in both forward (S21) and reverse (S12) transmission measurements. The port 1 step attenuator allows reduction of the port 1 output power for forward measurements, and the port 2 attenuator allows reduction of the port 2 output power for reverse measurements.

With the Option 003 configuration, the port 2 coupler is reversed. For forward measurements, the port 2 signal is sampled directly through the main arm of the port 2 coupler. Since coupling loss is removed, dynamic range is increased in the forward direction. Since the port 2 step attenuator is in-line with the port 2 sampler, the power incident on port 2 may be reduced. With Option 003, up to 1 Watt may be input into port 2.

#### HP 8511A Frequency Converter

With the HP 8511A Frequency Converter, the HP 8510 becomes a general purpose four-channel magnitude/phase receiver. Add your own power splitters for transmission measurements, and bridges or directional couplers for reflection measurements. Since one input is used for system phase-lock, the other three inputs are available for measurements of multi-port devices, subsystems, and antennas. All four inputs have precision 3.5 mm (f) connectors.

#### Multiple Test Set Operation

A single HP 8510B system may be configured with two test sets. In this configuration, the test sets have different addresses, and the user may select between them from the front panel of the HP 8510 without reconnections. This capability is useful, for example, when combining a microwave coaxial test set with a millimeter-wave test set in the same HP 8510 system.

IF switching (option 001). In the multiple test set configuration, the 20 MHz IF signal is daisy-chained from the test sets to the HP 8510. This capability requires test set option 001 in one of the two test sets.

RF switching. The RF signal must be routed to the desired test set using an HP 33311C coaxial RF switch and an HP 11713A switch driver. The switch driver is controlled automatically by the HP 8510B over the HP 8510 system interface.

#### Test Set General Information

	HP 8514B	HP 8515A	HP 8516A
Frequency range (GHz)	0.045 to 20	0.045 to 26.5	0.045 to 40
Test ports (port 1 or 2): Nominal operating power level (dBm)	0 to -5	-5 to -25	-10 to -20
Connector type	3.5 mm (M)		2.4 mm (M)
Impedance DC bias	50 ohm nominal 500 mA, 40 Vdc maximum		
Attenuation range (incident signal)	0 to 90 dB, in 10 dB steps (0 to 60 dB for HP 8516A)		

#### Ordering Information

	Price
<b>HP 8511A Frequency Converter</b>	\$19,000
Option 001: Add IF switching	add \$2,500
Option W30: 2 years additional hardware service	add \$350
<b>HP 8514B S-Parameter Test Set</b>	\$27,000
Option 001: Add IF switching	add \$2,500
Option 002: Delete step attenuators and bias tees	less \$6,500
Option 003: High forward dynamic range	n/c
Option W30: 2 years additional hardware service	add \$540
<b>HP 8515A S-Parameter Test Set</b>	\$37,900
Option 001: Add IF switching	add \$2,500
Option 002: Delete step attenuators and bias tees	less \$7,000
Option W30: 2 years additional hardware service	add \$750
<b>HP 8516A S-Parameter Test Set</b>	\$41,000
Option 001: Add IF switching	add \$2,500
Option 002: Delete step attenuators and bias tees	less \$7,000
Option 003: High forward dynamic range	n/c
Option W30: 2 years additional hardware service	add \$740

# NETWORK ANALYZERS

## Millimeter-wave Measurement System

### 8510 Series

251

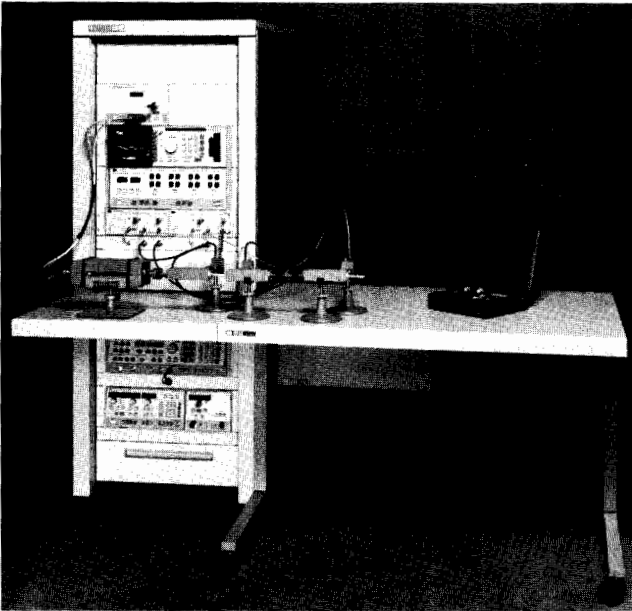

HP 8510 Millimeter-wave Network Analyzer System

The HP 8510B is easily configured for making measurements at millimeter-wave frequencies. Hewlett-Packard offers hardware for configuring systems in the 26.5 to 40 GHz, 33 to 50 GHz, 40 to 60 GHz, 50 to 75 GHz, and 75 to 100 GHz waveguide bands.

#### HP 85106A Millimeter-wave Network Analyzer Subsystem

The HP 85106A millimeter-wave network analyzer subsystem includes an HP 8510B network analyzer, an 8340B RF source, an 8350B/83540A LO source, an 8349B RF source amplifier and an 85100A LO/IF kit rack - mounted in a single bay rack with extendable worksurface and table. Add an HP 11643A series test set kit, 11644A series calibration kit, and millimeter-wave source module for a complete measurement system.

Option 001 adds an HP 8515A test set (with Option 001) and associated RF switching and control hardware to offer combined microwave and millimeter-wave measurement capability.

For systems that require a synthesizer as the LO source (V- and W-bands), Option 002 replaces the HP 8350B/83540A source with an HP 8341B synthesizer.

#### HP 85100A LO/IF Kit

For user-configured benchtop applications, the HP 85100A combines the LO and IF amplifiers, a power divider, waveguide stands, and the interconnect cables that are part of the HP 8510 millimeter-wave system under one model number for ordering convenience.

Kit Includes:<sup>1</sup>

Quantity	Model Part Number	Description
2	11975A	2-8 GHz LO Amplifier
1	8447A	IF Amplifier
1	8447A	IF Amplifier
1	Option 001	Dual IF Amplifier
1	0955-0264	2-8 GHz Power Divider
1	08510-60105	IF Interconnect Cable
4	11540A	Waveguide Stand
	Option E85	Waveguide Stand

<sup>1</sup> Also includes miscellaneous interconnect hardware.

#### HP V11643A V-Band Test Set Kit

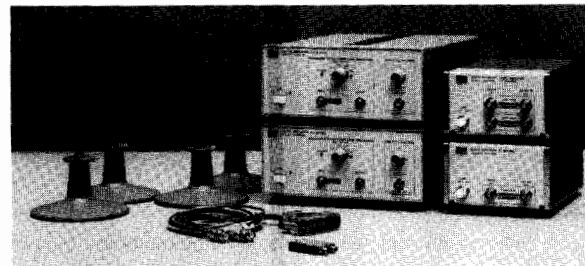
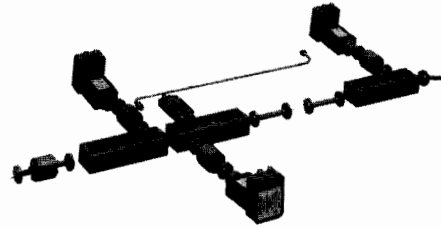

HP 85100A LO/IF Kit

#### HP 11643A-Series Test Set Kits

The millimeter-wave test set kits contain the band-dependent hardware necessary to assemble a reflection/transmission test set for use with the HP 8510 millimeter-wave system. The kit includes directional couplers, harmonic mixers, isolators, a fixed termination, a power divider, and miscellaneous connecting hardware.

Kit includes:<sup>1</sup>

Quantity	Model Part Number	Description
3	752D-series	20 dB <sup>2</sup> Directional Coupler
3	11970A-series	Harmonic Mixer
4	365A-series	Isolator
1	910A-series	Fixed Termination
1	0955-0264	2-8 GHz Power Divider
2	898A-series	Waveguide Twist

<sup>1</sup> Also includes miscellaneous interconnect hardware.

<sup>2</sup> The V-band and W-band test set kits consist of two 20 dB couplers and one 10 dB coupler.

#### Ordering Information

	Price
<b>HP 85106A</b> mm-Wave Network Analyzer Subsystem	\$151,000
<b>Option 001</b> add Microwave Test Set (HP 8515A)	add 44,000
<b>Option 002</b> Synthesized LO (HP 8341B)	add 24,800
<b>HP R11643A</b> WR-28 Test Set Kit	15,000
<b>HP Q11643A</b> WR-22 Test Set Kit	16,000
<b>HP U11643A</b> WR-19 Test Set Kit	17,500
<b>HP V11643A</b> WR-15 Test Set Kit	20,000
<b>HP W11643A</b> WR-10 Test Set Kit	23,500
<b>HP 85100A</b> LO/IF Kit	14,500

# NETWORK ANALYZERS

## Microwave Network Analyzer Accessories

### 8510 Series

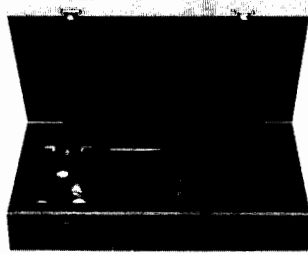

HP 85041A



HP 8717B

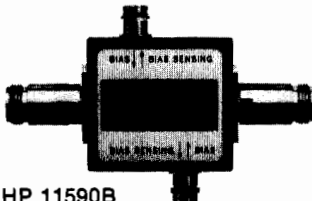

HP 11590B



HP 11612A

#### Active Device Test

Hewlett-Packard offers an extensive array of accessories designed for the needs of active device test and measurement, including fixtures, bias supplies, bias networks, and application software.

#### HP 85041A Transistor Test Fixture Kit

The HP 85041A transistor test fixture (TTF) kit is a comprehensive measurement system for testing and characterizing stripline packaged microwave transistors. Only useful when used with the HP 85014B active device measurement software.

**Frequency Range:** dc to 18 GHz

**Transistor Package Inserts:** 70 mil and 100 mil

**Verification Devices:** Short and through circuits

**Connectors:** precision 7 mm

**Accessories Supplied:** fixture stand, torque tool, tweezers, and lid opening tool

#### HP 8717B Transistor Bias Supply

The HP 8717B transistor bias supply provides manual or automatic biasing for transistor testing. This supply 8717B has two meters for independently monitoring current and voltage. Bias connections are conveniently selected for all transistor configurations with a front panel switch.

**Voltage Ranges:** 1,3,10,30,100 V

**Current Ranges:** 0.1,0.3,1,3,10,30,100,300,1000 mA

**Accuracy:** 4% of full scale for both current and voltage

**Option 001:** programmable D/A converter

**Option 011:** programming cable for HP Series 200/300 computers

#### HP 11608A Transistor Fixture

**Function:** provides the capability of completely characterizing stripline transistors. A through-line microstrip and bolt-in grounding structure machineable by customer is included.

**Frequency range:** db to 12.4 GHz.

**Reflection coefficient:** <0.05, dc to 4 GHz; <0.07, 4.0 to 8.0 GHz; >0.15, 8 to 12.4 GHz.

**Package Styles**

**Opt 003:** 0.205 inch diameter packages.

**Calibration references:** option 003 only, short circuit termination and a 50-ohm through-section.

**Connectors:** APC-7 hybrid.

**Weight:** net, 0.9 kg (2 lb); shipping, 1.4 kg (3 lb.).

**Size:** 25 H x 143 W x 89 mm D (1" x 5.63" x 3.5").

#### Bias Networks

Bias networks are available for applying DC bias to the center conductor of a coaxial line which can be connected to a device under test. The bias network also provides a DC block to the RF input port.

Bias Network	11590B	11590B Opt 001	11612A	11612B
Frequency Range (GHz)	.1-12.4	.1-18	.045-26.5	.045-50
Connectors	Type N (f)	7 mm	3.5 mm (f)	2.4 mm (f)
RF Input	Type N (f)	7 mm	3.5 mm (m)	2.4 mm (m)
RF Output	BNC (f)	BNC (f)	SMB snap-on (m)*	SMB snap-on (m)*
DC Bias				
Insertion Loss (max)	0.8 dB	0.8 dB, .1-12.4 GHz 1.2 dB, 12.4-18 GHz	0.8 dB, .045-12.4 GHz 1.3 dB, 12.4-26.5 GHz	0.8 dB, .045-12.4 GHz 1.3 dB, 12.4-26.5 GHz 26.5-50 GHz
Return Loss (min)	19 dB	19 dB, .1-12.4 GHz 14 dB, 12.4-18 GHz	20 dB, .045-8 GHz 18 dB, 8-18 GHz 14 dB, 18-26.5 GHz	20 dB, .045-8 GHz 18 dB, 8-18 GHz 14 dB, 18-26.5 GHz 10 dB, 26.5-50 GHz
Bias current (max)	500 mA	500 mA	500 mA	500 mA
Bias voltage (max)	100V	100V	40V	40V

\*Cable included, SMB(f) to BNC(m).

#### HP 11635A Bias Decoupling Network

The HP 11635A bias decoupling network is a recommended accessory for prevention of bias oscillations when biasing microwave bipolar transistors with any HP bias network or s-parameter test set. Installing the HP 11635A between the bias supply and the base bias network prevents low frequency oscillations.

#### Application Software

Hewlett-Packard offers application software packages that complement the HP 8510 system providing automated calibration and measurement capability. Software is available for HP Series 200/300 desktop computers using BASIC 2.0, 3.0, 4.0 or 5.0 operating systems on both 3 1/2" and 5 1/4" disc media.

#### HP 85014B Active Device Measurement Application Pac

The HP 85014B software pac provides the capability to the HP 8510 system for measurement of RF and microwave transistors. Features include automated device biasing with the HP 8717B bias supply, system calibration, and de-embedding of s-parameters when using the HP 85041A transistor test fixture. It is also usable with other HP transistor fixtures as well as user-designed fixtures. Plotted and listed output of device S, H, Y, and Z parameters, as well as the device amplifier summary and termination summary are provided. Also available is the capability to store and retrieve s-parameter data in formats suitable for computer-aided-design applications.

#### Ordering Information

	Price
HP 85041A Transistor Test Fixture	\$5,500
HP 8717B Transistor Bias Supply	4,635
Option 001 Programmable Operation (GP-IO)	670
Option 011 Programming Cable	250
Option W30 2 Years Additional Hardware Service	100
HP 11590B Bias Network	675
HP 11612A Bias Network	700
HP 11612B Bias Network	990
HP 11635A Bias Decoupling Network	275
HP 85014B Active Device Measurement Software	3,000
HP 11608A Transistor Fixture Customer Machineable	1,700
Option 003 0.205 inch diameter Package Style	add 450

# NETWORK ANALYZERS

## Microwave Network Analyzer Accessories

### 8510, 8720 Series

253

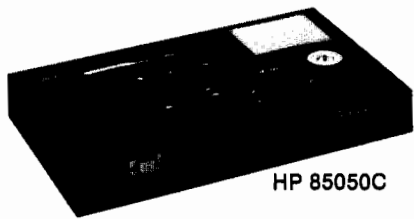

HP 85050C

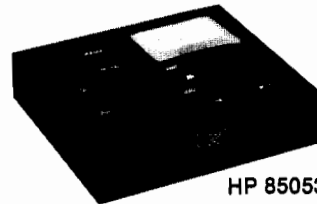

HP 85053B

### Microwave Network Analyzer Accessories

A wide range of accessories is available for both the HP 8720A and the HP 8510B series network analyzers, including calibration kits, verification kits, cables, and adapters for 7 mm, 3.5 mm, Type N and 2.4 mm connector interfaces. The standards used in the 3.5 mm, Type N and 2.4 mm connectors use the precision slotless connector (PSC-3.5, PSC-N and PSC-2.4).

### Calibration Kits

Error-correction procedures require that the systematic errors in the measurement system be characterized by measuring known devices (standards) on the system over the frequency range of interest. All network analyzer calibration kits contain precision standard devices to characterize the systematic errors of the HP 8720A or 8510B network analyzer system.

The calibration kits also contain adapters to change the sex of the test port, connector gages for verifying and maintaining the connector interface, and a torque wrench for proper connection. Each kit contains standards definitions contained on tape for the HP 8510B. (These definitions are already included in the HP 8720A.)

### Verification Kits

Measuring known devices, other than the calibration standards, is a straightforward way of verifying that the network analyzer system is operating properly. Hewlett-Packard offers verification kits that include precision airlines, mismatch airlines and precision fixed attenuators. Traceable measurement data for all devices is shipped with each kit on disc (for HP 8720A) and on tape (for HP 8510B).

Verification kits may be recertified by Hewlett-Packard. This recertification includes a new measurement of all standards, as well as new data and uncertainties. Certification in compliance with MIL-STD 45662 is also available.

### Verification Kit Summary

Verification Kit	Connector Type	Frequency Range (GHz)	Price
85051B	7 mm	.045-18	\$2,750
85053B	3.5 mm	.045-26.5	2,750
85055A	Type N	.045-18	2,750
85057A	2.4 mm	.045-40	4,500

### Calibration Kit Summary<sup>1</sup>

Calibration Kit	Connector Type	Frequency Range (GHz)	Performance Summary		Description	Price
			Directivity/Source Match w/8720A	Match at Fmax w/8510B		
85050B	7 mm	.045-18	45/30	52/41	Contains open and short circuits and fixed and sliding terminations.	\$4,500
85050C	7 mm	.045-18	n/a	60/60	Contains standards for TRL calibration on HP 8510B, including precision airline. Also contains open and short circuit and fixed termination.	\$5,400
85050D	7 mm	.045-18	36/30	40/35	Economy kit. Contains open and short circuits and precision-fixed termination. No gages included.	\$1,500
85052B	3.5 mm	.045-26.5	40/30	44/31	Contains open and short circuits (m and f) and fixed and sliding terminations (m and f), and in-series adapters.	\$7,500
85052D	3.5 mm	.045-26.5	36/30	36/30	Economy kit. Contains open and short circuits (m and f) and precision fixed termination (m and f), and in-series adapters. No gages included.	\$4,000
85054B	Type N	.045-18	40/30	42/32	Contains open and short circuits (m and f) and fixed and sliding terminations (m and f), in-series adapters, and 7mm to type N (m and f) adapters.	\$7,500
85056A	2.4 mm	.045-40	n/a	38/33	Contains open and short circuits (m and f) and fixed and sliding terminations (m and f), in-series adapters, and 7mm to type N (m and f) adapters.	\$9,000
R11644A	WR-28	26.5-40	n/a	50/45	Contain flush short circuit, a precision shim used to make the offset short, and a sliding (R,Q,U) or fixed (V,W) termination. Also contain two straight sections with precision flanges.	\$3,600
Q11644A	WR-22	33-50	n/a	50/45		\$3,850
U11644A	WR-19	40-60	n/a	50/40		\$4,200
V11644A	WR-12	50-75	n/a	50/37		\$4,200
W11644A	WR-10	75-100	n/a	46/36		\$4,400

<sup>1</sup>For measurements in the K-connector, order the HP 85056A 2.4mm calibration kit and the HP 11904S adapter kit.

# NETWORK ANALYZERS

## Microwave Network Analyzer Accessories (cont'd)

### 8510, 8720 Series

#### Test Port Return Cables and Adapters

Test port cables and adapter sets are available for various connector types. The cable/adapter configurations are described below. All cables are designed with one end that connects directly to the special ruggedized ports of the network analyzer test set, and one end that connects to the device under test.

Special test port adapter sets are also available to convert the ruggedized ports of the network analyzer test set to the desired connector interface. Each kit contains two adapters, one male and one female.

Both the cables and the special adapters have one special female connector which is designed to connect directly to the 3.5 mm test port (2.4 mm for HP 8516A). This side of the cable or adapter can only be connected to the test set port, and cannot be mated to a standard 3.5 mm (or 2.4 mm) male connector. The male test set ports, however, can be mated to a standard 3.5 mm (or 2.4 mm) female connector.

Choose one of the configurations shown.

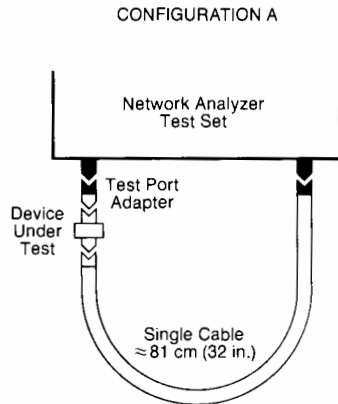

**Configuration A**  
For HP 8720A Network Analyzer or HP 8514B/8515A Test Sets (3.5 mm test port)

	Cables/Adapters	Connector Type (on device side of cable/adapter)	Price
For 3.5 mm devices	85131C Semi-rigid Cable or 85131E Flexible Cable	3.5 mm (f)	\$700
	85130D Adapter Set <sup>a</sup>	3.5 mm (m or f)	\$990
	85132C Semi-rigid Cable or 85132E Flexible Cable	7 mm	\$600 \$1,600
For 7 mm devices	85130B Adapter Set	7 mm	\$700
	For Type N devices: Use 7 mm cables and the 7 mm to N adapters included in the HP 85054B calibration kit.		
	85130C Adapter Set	Type N (m or f)	\$990

a. Recommended but not required.

**Configuration A**  
For HP 8516A Test Set (2.4 mm test port)

	Cables/Adapters	Connector Type (on device side of cable/adapter)	Price
For 2.4 mm devices	85133C Semi-rigid Cable	2.4 mm (f)	\$900
	85130G Adapter Set <sup>a</sup>	2.4 mm (m or f)	\$990
For 3.5 mm devices	85134C Semi-rigid Cable or 85134E Flexible Cable	3.5 mm (f)	\$700 \$1,800
	85130F Adapter Set	3.5 mm (m or f)	\$990
For 7 mm devices	85135C Semi-rigid Cable or 85135E Flexible Cable	7 mm	\$600 \$1,600
	85130E Adapter Set	7 mm	\$990

a. Recommended but not required.

**Configuration A.** This cable arrangement is for applications where the device under test is connected directly to the test set port. This setup offers the best mechanical rigidity for device connection. To adapt the test set port (port 1) to the device under test, choose the appropriate special adapter set. Besides converting the test port to the desired interface, these adapters also function as "test port savers" which protect the test set from damage and wear due to heavy use.

**Configuration B.** This cable arrangement is for applications where the device under test is connected between cable ends. This setup offers more flexibility when connecting to the device under test. Choose semi-rigid or flexible cables.

The cables for 3.5 mm and 7 mm devices are available as semi-rigid cables, offering excellent performance and suitable for applications where the connectors of the device under test are in-line, or as super-flexible cables which are more rugged and have a tighter bending radius, ideal for manufacturing environments. The semi-rigid cables carry a 90-day warranty, whereas the flexible cables are warranted for one full year.

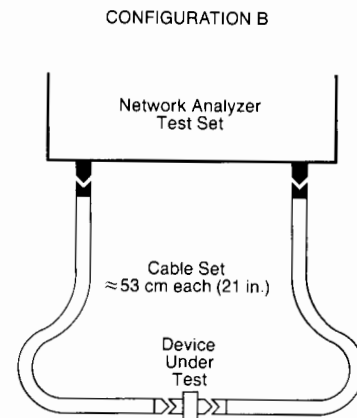

**Configuration B**  
For HP 8720A Network Analyzer or HP 8514B/8515A Test Sets (3.5 mm test port)

	Cable Set	Connector Type (on device side of cables)	Price
For 3.5 mm devices	85131D Semi-rigid Cable Set or 85131F Flexible Cable Set	3.5 mm (one male, one female)	\$1,200 \$2,800
	85132D Semi-rigid Cable Set or 85132F Flexible Cable Set	7 mm	\$1,000 \$2,600
For Type N devices	Use 7 mm cables and the 7 mm to N adapters in the 85054B calibration kit.		—

**Configuration B**  
For HP 8516A Test Set (2.4 mm test port)

	Cable Set	Connector Type (on device side of cables)	Price
For 2.4 mm devices	85133D Semi-rigid Cable Set	2.4 mm (one male, one female)	\$1,600
For 3.5 mm devices	85134D Semi-rigid Cable Set or 85134F Flexible Cable Set	3.5 mm (one male, one female)	\$1,200 \$2,800
	85135D Semi-rigid Cable Set or 85135F Flexible Cable Set	7 mm	\$1,000 \$2,600



# NETWORK ANALYZERS

## SWR Meter, Storage-Normalizer

### Models 415E, 8750A

255

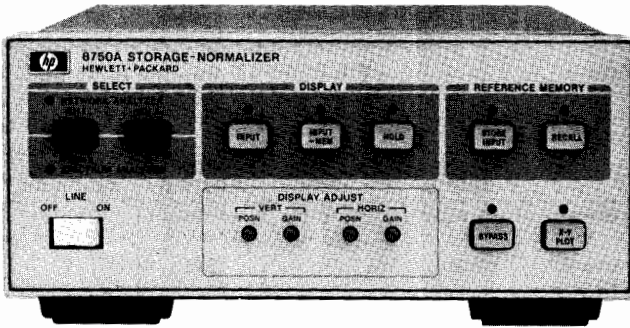

HP 8750A

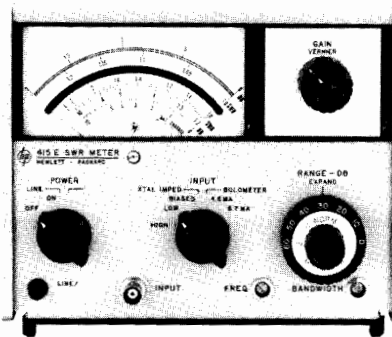

HP 415E

### HP 8750A Storage Normalizer

With HP's versatile 8750A Storage-Normalizer, you can make your network analyzer or spectrum analyzer measurements faster, easier, and more accurately through the simple addition of digital storage and normalization. This useful instrument accessory is directly compatible via a single interface cable with the following Hewlett-Packard instruments; the HP 8755 Scalar Network Analyzer, the HP 8410/8412B, the HP 8754A and the HP 8505A Networks Analyzers and HP 8557A, 8558B, 8565A and 8559A Spectrum Analyzers. A special I/O adapter (opt 001 or opt 002) is available for interfacing instruments (like HP 140 Series Spectrum Analyzers) that are not directly compatible with the HP 8750A. An external oscilloscope can then be used for digitally stored and normalized displays. (The HP 8750A is not compatible with the HP 8414B Polar Display or the polar mode of the HP 8505A or the HP 8754A.)

In network analyzer applications, digital storage always yields a flicker-free display of the complete device response, facilitating easy adjustment of test devices under slow sweep conditions. Measurement accuracy is also improved since frequency response errors can be automatically removed through digital normalization. This effectively eliminates the need to manually record calibration traces on a CRT or x-y recorder and allows high resolution measurements of attenuator, amplifier, or filter passband flatness.

In spectrum analyzer applications, the HP 8750A's digital storage feature simplifies many difficult tests requiring slow scan times such as high resolution modulation measurements. Drift tests are also easy since two traces, a stored reference and the current input, can be displayed simultaneously.

Hard copy documentation can be obtained quickly and easily since data can be frozen on the CRT for straightforward CRT photography or output to an -x-y recorder at a constant 30 second sweep rate.

### Supplemental Performance Characteristics

#### Display

**Horizontal memory resolution:** two display channels, 256 points per channel (0.4% of full scale, 8 bit word)

**Vertical memory resolution:** 512 points displayed full scale (0.2% of full scale, 10 bit word) plus a 50% overrange (256 points) both above and below full screen.

**Horizontal input sweep rates:** 100 s max./10 ms min.

**Display refresh rate:** 6 ms.

#### Video Detection

**Network analyzer:** average detection (20 kHz).

**Spectrum analyzer:** peak detection.

#### General

**Interface cards:** the HP 8750A is supplied with two general plug-in interface cards, one for use with the HP Spectrum Analyzers listed above and one for use with the HP 8407A/8412B and 8505A Network Analyzer. When the HP 8750A is to be used primarily with an 8755C Scalar Network Analyzer, HP 8350B/8620C sweep oscillator, HP 8410C/8412B Network Analyzer, or the HP 8754A Network Analyzer, calibration and adjustment of the HP 8750A to these instruments can be greatly simplified by ordering one of the plug-in interface cards dedicated to these instruments (Opt. 003 and 004). All offset and gain adjustments are significantly reduced. When Opt. 003 or 004 are ordered, the two general interface cards are also included, so you have the flexibility to change your test set-up at any time.

**Power:** selection 100, 120, 220, or 240 V +5% -10%. 48 to 440 Hz and <20 VA (<20 watts).

**Size:** 102 H x 212 W x 280 mm D (4" x 8.4" x 11.2").

**Weight:** net, 2.72 kg (6.1 lbs); shipping, 5.0 kg (11 lbs).

### HP 415E SWR Meter

HP 415E SWR Meter is a low noise, 1000 Hz tuned amplifier and voltmeter, calibrated in dB and SWR. Designed for use with square law detectors, it measures SWR, attenuation, and gain directly from metered scales, or drives an X-Y recorder for RF substitution measurements. Front panel INPUT switch selects unbiased low (50-200 Ω) or high (2500-10,000 Ω) impedance crystal, biased crystal (1 V into 1 kΩ), or low or high current bolometer (4.5 or 8.7 mA ± 3% into 200 Ω).

An internal precision 60 dB attenuator allows the HP 415E to operate over a 70 dB range in 10 or 2 dB steps, with ±0.05 dB accuracy for a 10 dB step; maximum cumulative error between any two 10 dB steps is ±0.1 dB. Sensitivity is 0.15 μV rms for full scale deflection at maximum bandwidth (1 μV rms on high impedance crystal input).

Continuously adjustable bandwidth can be adjusted from 15 Hz for maximum sensitivity at CW frequencies to 130 Hz for swept frequency uses. An optional rechargeable battery pack provides up to 36 hours of continuous operation for portable use.

**Weight:** Net 4 kg (9 lb); shipping 5.8 kg (13 lb).

**Power:** 115-230 V ±10%, 50-400 Hz, 1 VA.

**Dimensions:** 155Hx190Wx279mm D(6<sup>7</sup>/<sub>32</sub>x7<sup>25</sup>/<sub>32</sub>x11in.)

#### Ordering Information

	Price
HP 8750A Storage-Normalizer	\$2,600
Opt 001: BNC Interface Adapter (Deletes direct interface cable)	N/C
Opt 002: BNC Interface Adapter (Retains direct interface cable)	add \$180
Opt 003: HP 8755C or 8412B/8620C Plug-in Interface Card	add \$200
Opt 004: HP 8754A Plug-in Interface Card	add \$200
HP 415E SWR Meter	\$2300
Opt 001: rechargeable battery installed	add \$105
Opt 002: rear panel input connector	add \$25

# LOGIC ANALYZERS

## State, Timing, Analog, and Stimulus/Response Analysis

### Model 1631A/D, 1650A, 1651A, 16500A, 16510A, 16515A/16A, 16520A/21A, 16530A/31A

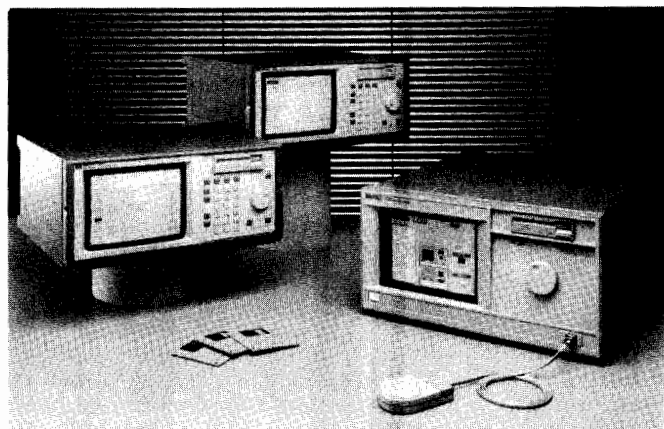

## Introducing HP's New Family of Logic Analyzers and Logic Analysis Systems . . .

### Performance

- Up to 400 channels of general-purpose logic analysis.
- Up to 80 channels of 1 GHz timing analysis.
- Up to 204 channels of 50 Mbit/s pattern generation.
- Up to 8 channels of 400 Msample/s digitizing oscilloscope capability.

### Ease-of-use

- Save time and avoid errors using the HP 16500A's color touch screen or mouse.
- Make measurements quickly with the HP 1650A/1651A's simplified user-interface.
- Give the knob a spin to change values quickly or move measurement markers.

### Value

- Rely on HP's traditional reliability and quality for low cost-of-ownership.
- With Option W30, get 3 year protection for your HP 1650A/1651A/16500A.
- These products come with a one year standard warranty. Option W30 adds two additional years of return-to-HP service.
- Get assistance when and where you need it with HP's worldwide sales and support organization.

### Setup Convenience

- Set up your digitizing oscilloscope or your timing analyzer with push button ease using HP's Auto-Scale.
- Connect to your circuit with new lightweight passive probes and flexible cables.
- Hook up quickly to today's most popular 8-, 16-, and 32-bit microprocessors with HP's preprocessors.
- Store and recall configurations from built-in disc drives for fast set-up.

	HP 1650A	HP 1651A
Timing	100 MHz on ALL 80 channels	100 MHz on ALL 32 channels
State	25 MHz on ALL 80 channels	25 MHz on ALL 32 channels

Memory	1 Kbit/channel	1 Kbit/channels
Microprocessor support	Today's most popular 8-, 16-, and 32-bit microprocessors	Today's most popular 8-bit microprocessors
Price	\$7800	\$3900

	LOGIC ANALYSIS	1 GHz TIMING	PATTERN GENERATION	DIGITIZING OSCILLOSCOPE
Module	HP 16510A**	HP 16515A/ HP 16516A	HP 16520A/ HP 16521A	HP 16530A/ HP 16531A
Channels Per Card	80	16	12/48	2
Maximum Channels Per Frame	400	80	204	8
Memory Depth	1K	8K	4K	4K
Maximum Rate	25 MHz State 100 MHz Timing	1 GHz Timing	50 Mbits/s	400 Msamples/s 100 MHz Bandwidth
PRICE	\$5200	\$7800/ \$6500	\$3700/ \$4000	\$1500/ \$4000

\*\*The HP 16510A has the same capabilities as the HP 1650A and contains 5 of HP's Logic-Analyzer-on-a-Chip.

### Simple, Yet Does the job . . . and More

- Lengthen your timing window with transitional timing on ALL channels.
- Capture elusive glitches with glitch detection on ALL channels.
- Configure the HP 1650A/1651A in four ways: one state analyzer, one timing analyzer, or one state and one timing analyzer.
- Store setups and measurement results with the built-in disc drive for fast recall or permanent records.
- Generate report-quality documentation with push button ease.
- Program the HP 1650A/1651A with easily understood commands through the built-in RS-232C interface.

### Fits Where You Need It . . . Goes Where You Want It

- Compact: With its small footprint, the HP 1650A/1651A fits easily on your bench, within the same field of vision as what you're working on.
- Portable: At only 22 lbs., the HP 1650A/1651A can be easily carried with its built-in handle or the HP 1540-1066 soft carrying case.
- One Piece: Keep everything together, in one place; the probes and cables fit conveniently into the pouch attached to the top of the instrument.

### Solutions for Individual Requirements and Group Needs

- Customize your own system by adding cards to the HP 16500A's five card slots.
- Make time-correlated measurements between cards using the HP 16500A's Intermodule Bus.
- Compare measurement data from hardware with design simulation data using the HP Electronic Design System and the HP 16500A Logic Analysis System.
- Program the HP 16500A with easily understood commands through HP-IB or RS-232C built-in interfaces.
- Store setups and measurement results in either of two built-in disc drives for fast recall or permanent record.
- Generate report-quality documentation with push button ease.

- HP 1650A - 80 channels, HP 1651A - 32 channels of 25 MHz state or 100 MHz timing
- Transitional timing for deep effective memory
- Supports most popular 8-, 16-, and 32-bit micro-processors
- Lightweight passive probing
- Simultaneous state/state, simultaneous state/timing

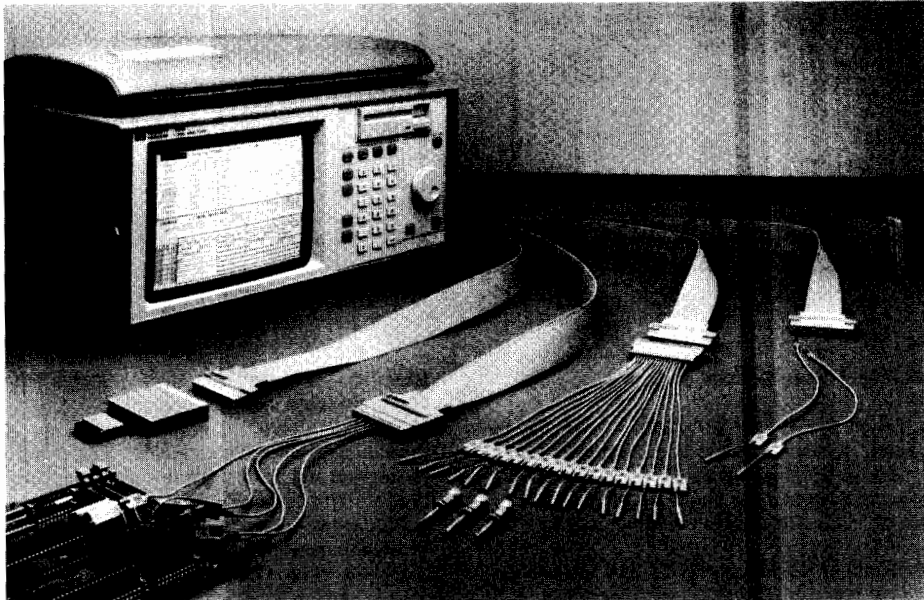

HP 1650A

### Hook Up Quickly and Reliably to Your Circuit

HP's new passive probes are small and lightweight. With an input impedance at the probe tip of 100k ohms in parallel with 8 pF, these probes won't load down your circuit. Individual probes and cables can be removed when they get in the way. Additionally, the HP 01650-63201 Terminating Adaptor enables you to connect your logic analyzer directly to PC boards with 2x10, 0.1" center connectors.

### Debug Quickly with up to 80 Channels

The HP 1650A/1651A/16510A's 5 ns minimum glitch capture on all channels looks for activity between samples. Pattern search helps you to find a specific event quickly. Overlay mode places several timing signals on one display line, so that you can see where timing violations occur. Infinite persistence shows the changes in waveforms during repetitive acquisitions. When more channels means spending less time to find the problem, use up to 80 channels.

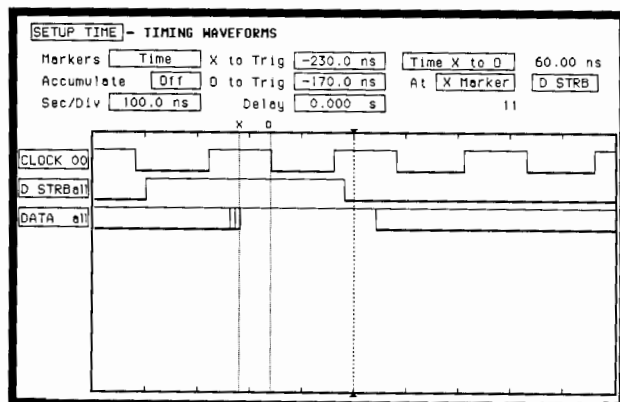

### Capture the Data You Want to See

Trigger on a pattern across the full 80 channels. Or you can qualify a pattern by specifying a duration, glitch, or edge. Specify a pattern duration to capture error conditions indicated by a pattern that exceeds a specified limit. When you need to see what is happening around a troublesome glitch or hardware interrupt signal, use glitch or edge triggering.

### Focus on the Information You Need

The HP 1650A/1651A/16510A's complex state triggering filters out unnecessary data and provides a listing of the crucial data:

- 5 clock inputs/clock qualifiers allow your system to determine when the analyzer takes a sample.
- Storage qualification allows you to specify which states are stored in memory.
- 8 sequence levels determine the sequence of states required for trigger and help you to focus on a specific area of code execution.
- 8 pattern recognizers, 1 range recognizer or logical combinations of these are used to identify states that are stored.
- Tagging keeps track of the amount of time or the number of states between stored states.
- Enable/Disable can be used to restrict storage to the activity of a specific routine.
- Prestore stores two qualified states that precede the states that are normally stored.

Overlap all data channels on the display to measure when all lines are stable.

### Extend the Memory of Your Timing Analyzer with Transitional Timing

Traditionally, a timing analyzer samples the input channels based on its own internal clock and then stores every sample in memory. The HP 1650A/1651A/16510A store data only when there is a transition, thus avoiding redundant data. This effectively extends the memory by lengthening the time covered by an acquisition. The timing analyzer samples at full speed so that events that are seconds or even minutes apart are captured with 10 ns resolution.

# LOGIC ANALYZERS

Today's Best Value in General-purpose Logic Analyzers (cont'd)

Model 1650A, 1651A

6809 STATE - STATE LISTING

Markers Pattern Find x-pattern 1 from Trigger

Pattern > 0039 DATA

Label	ADDR	6809/809E Mnemonic	STAT
Base	Hex	hex	Symbol
+0120	F80A	LDY #1000	OPCODE
+0121	F80B	BE program read	PROGRAM
+0122	F80C	10 program read	PROGRAM
+0123	F80D	00 program read	PROGRAM
+0124	F80E	LDU #1000	OPCODE
+0125	F80F	10 program read	PROGRAM
+0126	F810	00 program read	PROGRAM
+0127	F811	TFR B,DP	OPCODE
+0128	F812	9B program read	PROGRAM
+0129	F813	ABX	OPCODE
+0130	F814	ADCA #55	OPCODE
+0131	F815	55 program read	PROGRAM
+0132	F816	ADCA <0039	OPCODE
+0133	F817	39 program read	PROGRAM
x+0134	0039	FF data read	DATA
+0135	F818	ADCA 1000	OPCODE

NACH A - STATE LISTING

Markers Pattern Find x-pattern 1 from Trigger

Pattern > 000FFF24 CODE RD

Label	ADDR	80386 Mnemonic	STAT
Base	Hex	hex	Sum
0+0004	FFFFFFF8	JMP FFF0H:0024H	CODE RD
+0005	FFFFFFFA	xxxxF000H code read	CODE RD
+0006	FFFFFFFC	ADD [BX]:SI,AL	CODE RD
+0007	FFFFFFFE	ADD no operand	CODE RD
x+0008	000FFF24	CLI	CODE RD
		MOV SI,#0000H	
+0009	000FFF26	xxxx0000H code read	CODE RD
+0010	000FFF28	MOV DI,#0100H	CODE RD
+0011	000FFF2A	MOV CX,#0018H	CODE RD
+0012	000FFF2C	xxxx0018H code read	CODE RD
+0013	000FFF2E	CLD	CODE RD
		MOV AX,# no operand	
+0014	000FFF24	CLI	CODE RD
		MOV SI,#0000H	
+0015	000FFF26	xxxx0000H code read	CODE RD
+0016	000FFF28	MOV DI,#0100H	CODE RD

Motorola 6809 state listing and Intel 80386 state listing, both with inverse assembly.

### Debug Designs that Use Today's Most Popular Microprocessors

HP's preprocessors tailor the HP 1650A/1651A/16510A to microprocessors from Intel, Motorola, Zilog, and National. These preprocessors simplify hookup by plugging directly into the CPU's socket. Companion software converts the acquired state data into microprocessor mnemonics, making it easy to monitor program execution.

For designs that use custom or proprietary CPUs, you can use the HP 10320C User-definable Interface to connect the HP 1650A/1651A/16510A to your system. The HP 10391A Inverse Assembler Development Package can be used to develop custom software that converts the acquired state data into your CPU's mnemonics.

### View Time-correlated Activity of Two Parts of Your System

The HP 1650A/1651A/16510A can be configured into two independent state analyzers, or one state and one timing analyzer. Measurements that might have required two instruments before can now be made with one instrument.

For example, by using the state analyzer to focus on a specific I/O routine, you can watch both the program execution and the activity on the I/O lines with a time correlated display. Or, when you need to examine the interaction of two microprocessors, the HP 1650A/1651A/16510A can display time-correlated state listings.

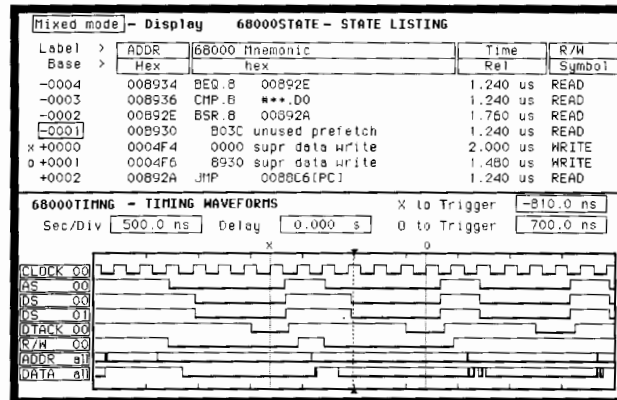

Make simultaneous measurements in both the state and timing domains.

### Identify Performance Bottlenecks with System Performance Analysis

The HP 10390A System Performance Analysis software adds three measurements to the HP 1650A/1651A/16510A. The State Histogram and State Overview measurements can display the intensity of activity in specific areas of memory or identify modules that are prime targets for optimization. The Time Interval measurement can be used to measure execution time of a module, time between calls to a module, or time between two different modules.

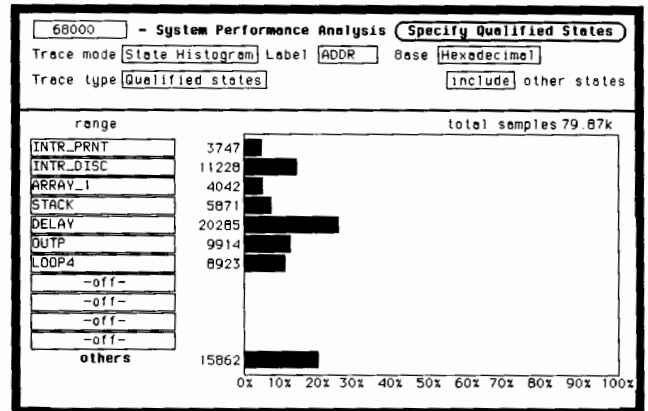

State Histogram... for characterizing the usage of software modules.

### Use Cross-Domain Triggering For Complex Measurements.

Use state to arm timing, or use timing to arm state when the symptom of a problem is best isolated with one analyzer and the cause is best isolated with the other. For example, track a microprocessor's program flow around a hardware interrupt by using the timing analyzer to find the edge of the interrupt signal. Then the timing analyzer can arm the state analyzer to acquire data.

- Built-in two-channel digitizing oscilloscope—50 MHz bandwidth and 200 M sample/second rate
- Up to 43 state channels and 16 timing channels



The HP 1631A/D logic analyzer has a built-in digitizing oscilloscope, enabling digital hardware designers to make the cross-domain measurements needed to troubleshoot and characterize systems.

### Three Instruments in One Box: HP 1631D

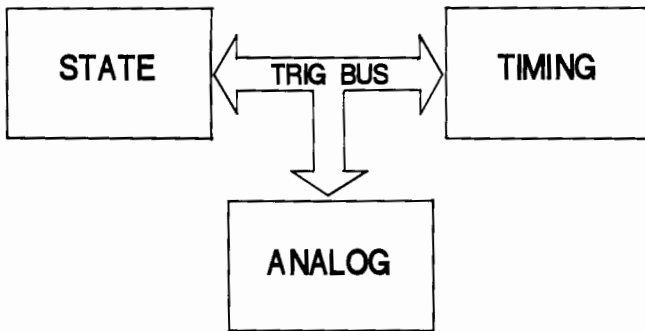

The HP 1631A/D provides three instruments in one, linked by an internal trigger bus. Interactive measurements allow you to trigger on the symptom with one instrument, and analyze the cause with another.

### HP 1631A/D Logic Analyzer . . .

The HP 1631A/D provides a digitizing oscilloscope and a logic analyzer in one low-cost instrument. Its analog, timing, state, and system performance analysis capabilities function separately or interactively to serve the needs of digital design and test engineers.

The A and D models differ only in state/timing channel width. The HP 1631A provides up to 35 state channels, eight timing channels, and two analog channels. The HP 1631D provides up to 43 state channels, 16 timing channels, and two analog channels.

### The One Tool For Every Phase Of Digital Design And Test

#### A 50 MHz digitizing oscilloscope

- 200 megasample/second digitizing rate for capturing single-shot waveforms
- Two simultaneous channels
- Single-shot time intervals to  $\pm 1.5$  ns

#### A complete logic analyzer

- 100 MHz timing analyzer
- Time-interval accuracy to  $\pm 1.5$  ns
- 25 MHz state analyzer

- Interactive measurements
- Automatic time-interval measurements

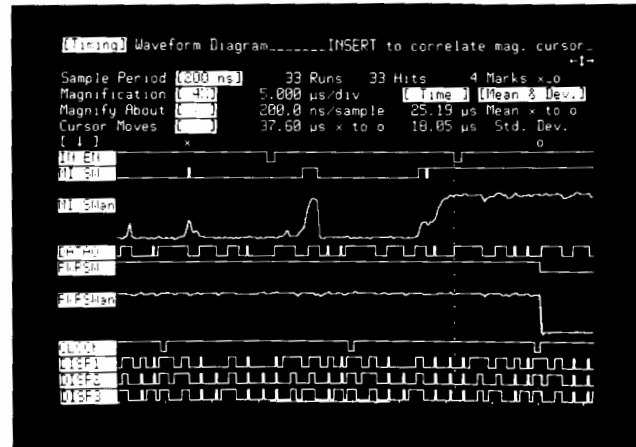

Interactive measurements allow you to use the timing analyzer to locate and trigger on a glitch, and then use the analog analyzer (with higher vertical resolution) to analyze the cause.

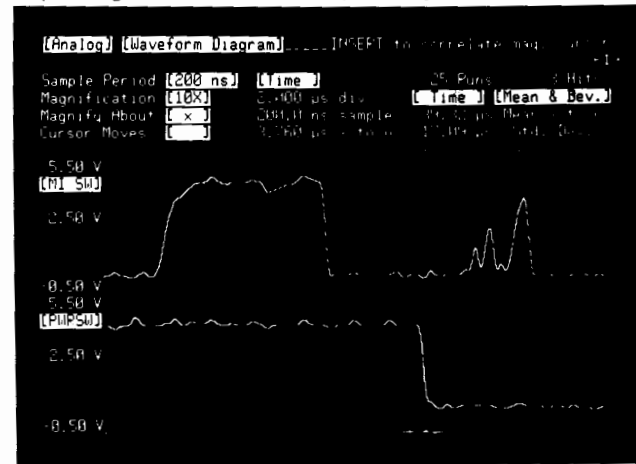

With a built-in oscilloscope, the HP 1631A/D provides two channels of analog analysis plus automatic time-interval measurements and statistics.

### Interactive Analysis

You can use one of the HP 1631A/D's analyzers to capture the symptom and then use one of the other analyzers to analyze the cause. Depending on your measurement needs, you can select state, timing, or analog as master. The other two then become slave. When the master's trigger specification is met, it simultaneously triggers the slave—while maintaining time correlation between the analyzers.

### Analog Waveform Analysis

Analog waveform analysis provides simultaneous display of up to two channels. User-definable labels, wide magnification range, and direct readout of time and voltage between cursors are available.

### State Analysis

State listings and waveforms provide displays and windowing of address, data, status, and control line activity. Selectable display modes include binary, octal, decimal, hexadecimal, ASCII, relocation, user-defined mnemonics, and microprocessor-specific mnemonics. You can assign labels, and display and/or trigger on code in terms of relocatable or absolute addresses, or user-defined mnemonics.

### Timing Analysis

Timing waveform diagrams provide simultaneous display of up to 16 channels, with user-definable labels. Wide magnification range, glitch display, and direct readout of time between cursors are available.



# LOGIC ANALYZERS

## Logic Analysis Systems

Model 16500A, 16510A, 16515A, 16516A, 16520A, 16521A, 16530A, 16531A

- Up to 400 channels of general-purpose logic analysis
- Up to 80 channels of 1 GHz timing analysis
- Up to 204 channels of 50 Mbit/s pattern generation
- Up to 8 channels of 400 Msample/s digitizing oscilloscope capability
- CAE System Link Software ..... HP 74240A/B

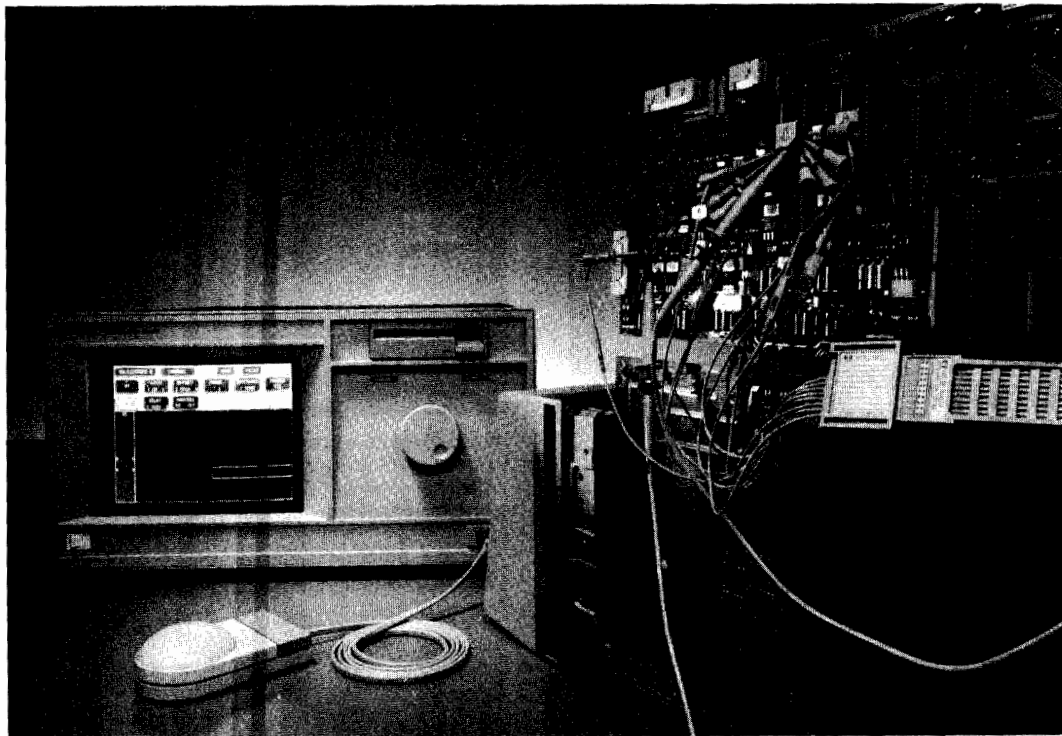

HP 16500A



**HP 16500A Logic Analysis System . . . working interactively to serve the breadth of your system design and test needs.**

### Configurable

The HP 16500A Logic Analysis System can be configured for your debug, characterization, or pass/fail testing applications. Start with a focused system, then expand it as your group's needs grow and evolve. For example, start with an 80 channel logic analyzer and a two channel oscilloscope then add more capability as needed.

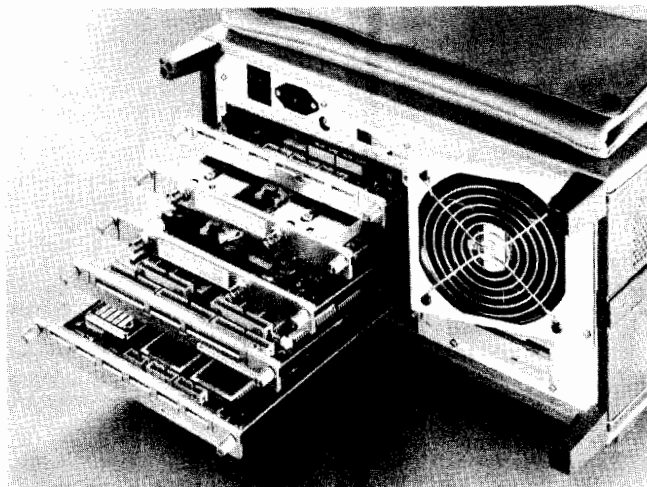

HP 16500A's five card slots provide flexible solutions.

### High performance system

Verify or analyze the performance of your circuits through combined analog, state, and timing measurements. The HP 16500A's five card slots hold state/timing cards, timing cards, pattern generator cards, and digitizing oscilloscope cards. Use these cards in combination to make measurements that could not be made with separate instruments. For example, state can arm both oscilloscope and timing waveform capture, so you can display a mixture of timing and scope waveforms on screen to measure time relationships between events.

### Ease-of-use . . . saves time

You'll enjoy making measurements with the HP 16500A's 9" color touch-screen, knob, pop up windows and optional mouse. The HP 16500A's pop up windows show all choices for a given task, for easy and fast selection without having to hunt. You'll be more productive when you automate measurements through easily understood programming. Color discriminates overlapped traces, emphasizes important points, and can be customized for personal preference and environmental considerations. Even infrequent users will spend less time making measurements and more time analyzing the results.

### Instant documentation

With the push of a button, you can document your results professionally through the standard hardcopy feature. Documentation will help you trace your steps and communicate your findings to others. The HP 16500A supports ThinkJet, LaserJet, PaintJet, QuietJet, and Epson printers.

### Store setups and data quickly

It's easy to store and retrieve measurement results and setups with the HP 16500A's two built-in 3 1/2" floppy disc drives.

### Correlate 1 GHz Timing with Oscilloscope Waveforms

Connect several 1 GHz timing lines while probing simultaneously with oscilloscope channels. For example, configure 32 channels of 1 GHz timing and 4 oscilloscope channels to provide time correlation from a single trace point. Capture the number of channels you need while simultaneously capturing parametric information.

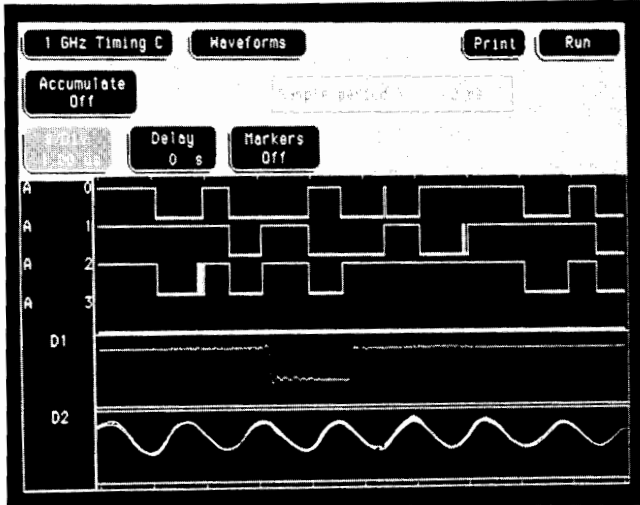

Make time interval measurements between oscilloscope and timing waveforms.

### Interactive Measurements with a Complete Logic Analyzer and a 400 Megasamples/s Digitizing Oscilloscope

For those who need both logic analysis and an oscilloscope to debug and test, the HP 16500A offers unparalleled interactive measurements. The HP 16500A provides enough channels for multiple 8, 16, or 32-bit microprocessor environments while allowing 100 MHz simultaneous single-shot oscilloscope waveform capture. These channels allow you to perform cause and effect analysis between the state, timing, and analog domains.

#### Application Driven Trigger Selection

Select the trigger mode that best suits your application. Use glitch, state, analog, or timing triggers to capture state, analog, and/or timing data. For example, to analyze interrupt handling in a microprocessor system, use the oscilloscope to arm timing, state, and analog capture on the asynchronous interrupt. Then capture microprocessor program flow with state, capture control lines with timing, and capture the interrupt line with the scope. The HP 16500A Logic Analysis System connects state, timing, analog, and pattern generation trigger qualification serially in any order to meet your needs.

#### Generate Patterns Interactively

Generate patterns triggered by the Intermodule Bus or by the pattern generator's external qualification. The Intermodule Bus provides state, analog, timing, and/or pattern generator program flow qualification. Test your circuit's response to patterns that arrive at the right time, for rigorous functional analysis of prototypes. Also, quickly program simple patterns for applications where you need to toggle just a few lines.

#### Mix 1 GHz Timing with 100 MHz Timing

100 MHz timing channels give you the width you need to look at complex systems. The 1 GHz timing channels give you the timing speed and memory depth you need to make 1 ns resolution measurements up to 8  $\mu$ s before or after the trigger event for precise edge placement measurements.

#### Perform Time Correlated State Analysis

In today's multiple microprocessor environments, systems are driven by multiple clocks. The HP 16500A/16510A provides simultaneous capture of separately clocked systems, while time tagging all

states. You can capture the states from several microprocessors, then analyze their flow with interleaved, time-correlated state displays.

### HP 74240A/74240B . . . Bring Real World Measurements Into Your Simulated Environment

The HP 74240A Electronic Design System-To-HP 16500A Logic Analysis System CAE Link translates Electronic Design System (EDS) simulations via HP-IB or disc media into HP 16520A/21A patterns; translates HP 16510A and HP 16515A/16A timing data into simulation vectors.

The HP 74240A also controls tests from the simulated environment by setting up the HP 16500A instrument (assign channels and labels, arm analyzer, and set clock rates), downloading patterns, and making measurements automatically (runs patterns and captures response).

The HP 74240B Simulation Data File Comparator compares data files between any two simulated or measured data files; stimulus-to-stimulus, response-to-response, or stimulus-to-response.

### Prototype verification with CAE simulations

Compare prototype behavior with simulated behavior. By sending simulation test vectors through the HP 74240A link to create prototype tests, you avoid manual test generation and typing in test vectors. The time to create the tests is reduced and the test accuracy is increased. Analysis is easier because you do not need to leave your familiar workstation environment when verifying a prototype. Use the comparison's results to find circuit problems such as setup and hold time violations. Begin developing test patterns in the prototype stage instead of waiting until the product is in the production stage.



HP 74240A Electronic Design System-To-HP 16500A Logic Analysis System CAE link.

### Enhance your simulations

Capture complex circuit activity that is difficult to model, and use this activity in the simulation environment. For example, complex bus activity can be added to the simulation without having to model all the systems feeding the bus. Just capture a representative group of activity from the bus with the HP 16500A (with HP 16510A or HP 16515A/16516A) and feed it into the simulation through the HP 74240A. Then use it as stimulus and response in your model.

# LOGIC ANALYZERS

## Logic Analyzer-on-a-Card

### Model 16510A

- 80 channels of 25 MHz state or 100 MHz timing
- Transitional timing for deep effective memory
- Configure up to 400 channels per frame
- Debug multiple 32-bit microprocessor systems
- Supports 8-, 16-, and 32-bit microprocessors
- Lightweight passive probing

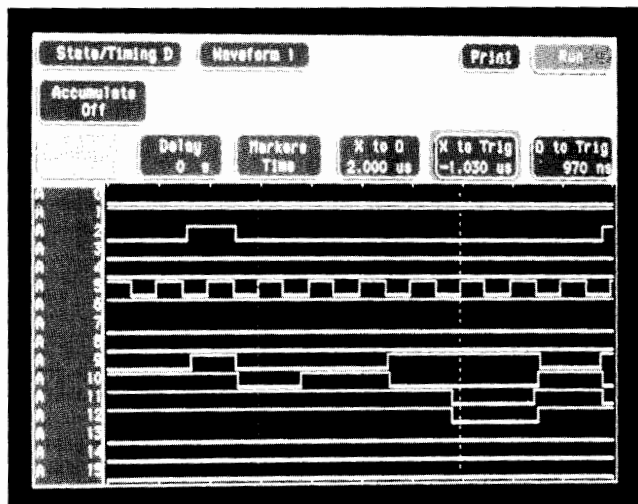

Triggering and Pattern Qualification	Duration, glitch, or edge specify error conditions, 8 sequence levels, 8 pattern recognizers, 1 range recognizer, state armed timing or timing armed state.
Small Lightweight Probing	100 kohm; 8 pF; individually grounded; 2 x 10, 0.1" center connectors.
Microprocessor Support	Most popular 8-, 16-, and 32-bit microprocessors.
Data Qualification	5 clock inputs, 4 clock qualifiers, storage qualification, time and number of state tagging, pre-store.
Interactive Measurements	Configure each HP 16510A module as two independent state analyzers, or one state and one timing analyzer.

\*Refer to the HP 1650A section for more information on the HP 16510A's capabilities.

### HP 16510A Logic Analyzer . . . an HP 1650A on a card\*

Number of Channels	80 channels per card, up to 400 channels in one HP 16500A.
Types of Analysis	25 MHz state, 100 MHz timing, simultaneous state/state, simultaneous state/timing.
Glitch Detection	5 ns minimum pulse width between samples; trigger on and/or capture on all channels.
Marker Measurements	Time interval; number of states; pattern search; minimum, maximum, and average time interval statistics.
Timing Violation Measurements	Acquire data until time interval between two specified patterns violates a specified condition.
System Performance Analysis	State label, time interval, state overview; requires HP 10390A.
Data Display/Entry	Binary, octal, decimal, hexadecimal, ASCII (display only), user-defined symbols.
Deep Effective Memory	Uses transitional timing to store data only when there is a transition.
Debug Modes	Overlap mode allows viewing of timing violations. Infinite persistence shows waveform changes during repetitive acquisitions.



- 400 Megasamples/s single-shot analysis
- Better than 1 ns time interval accuracy (single-shot)
- Up to 8 simultaneous oscilloscope channels

- 4 ksamples memory depth/channel for pre-trigger debugging
- Oscilloscope triggered by logic analyzer
- Automatic measurement and setup aids

### HP 16530A/16531A Digitizing Oscilloscope . . . Capture and Time Correlate Single-shot Events

#### Precision Time Interval Measurements

Make time interval measurements with markers at better than 1 ns accuracy single-shot (after deskewing). Accuracy at the probe tip is assured by a calibration routine that reduces channel-to-channel skew.

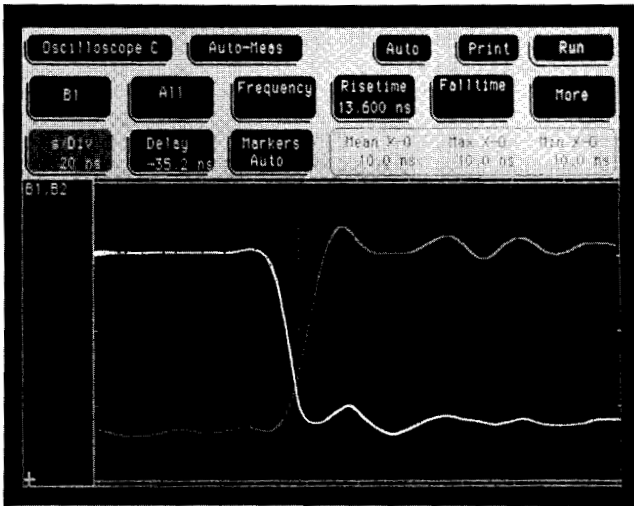

#### Single-shot Analysis

The HP 16531A 2 channel, 400 megasamples/s digitizing oscilloscope captures 100 MHz bandwidth signals single-shot. Multiple channels can be captured simultaneously so that you can determine relationships between infrequent events. A high-resolution color display and post-capture scroll and zoom allow you to examine waveforms in detail.

### Measure Slow and Fast Events Simultaneously

Use the 4K memory depth to measure periods and time intervals; then zoom in for risetime measurements. Add a second oscilloscope module to create a dual timebase digitizing oscilloscope.

#### Find the Causes of Errors

Each channel has 4K memory depth for capturing events before or after the trigger event. View events up to 10 us before the trigger event with greater than 1 ns accuracy.

#### View Analog and Digital Waveshapes . . . and More

Capture random signal variations with Accumulate mode. Filter out noise with Average mode. Show true single-shot events with Single mode. Scan many periods of the waveform easily with Connect-the-dots. View analog-like waveshapes with 6 bit vertical resolution. Analyze differential waveshapes with the A-B mode.

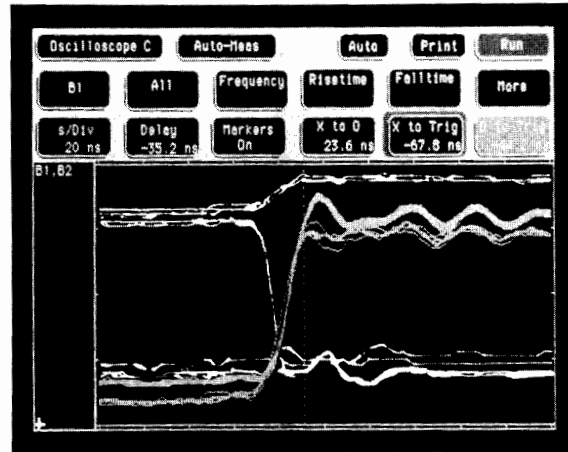

#### Automatic Measurements

Automatic pulse parameters allow fast analysis without having to count gratitudes. Parameters such as frequency, period, pulse width, peak-to-peak voltage, maximum voltage, minimum voltage, risetime, falltime, preshoot, and overshoot are just one keystroke away. Also measure voltage and timing relationships by placing the markers and reading the answer on the display. Display the time between markers, acquire until capturing specified time between markers, perform statistical analysis on the time between markers. Setup is easy with automatic waveform scaling, TTL & ECL presets aid scaling, and automatic marker placement on specified edges.

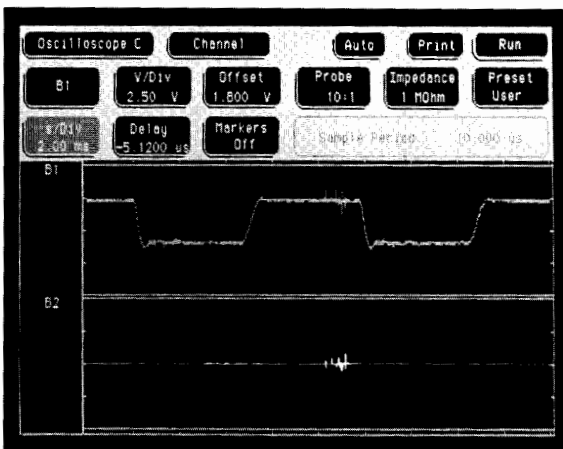

#### Capture Many Waveforms Simultaneously

Run up to four HP 16531A oscilloscope cards with a single HP 16530A timebase card for simultaneous acquisition. Your HP 16530A/16531A oscilloscope module can be configured to acquire from two to eight signals simultaneously. Save time when debugging and characterizing systems by observing multiple test points during each test.

# LOGIC ANALYZERS

## 1 GHz Timing Analyzer-on-a-Card

### Model 16515A, 16516A

- 1 GHz timing for 1 nanosecond resolution
- 16 channels/card for up to 32 channels per analyzer
- Up to 80 channels per frame

- 8 kbits per channel memory depth
- Lightweight passive probing
- Easy-to-use scope-like controls

### HP 16515A/16516A ... Capture High-speed Events with 1 Gigahertz Timing

#### Measure Time Intervals Precisely with 1 ns Resolution

Measure precise time relationships on high speed TTL, CMOS, and ECL circuits with 1 ns single-shot resolution.

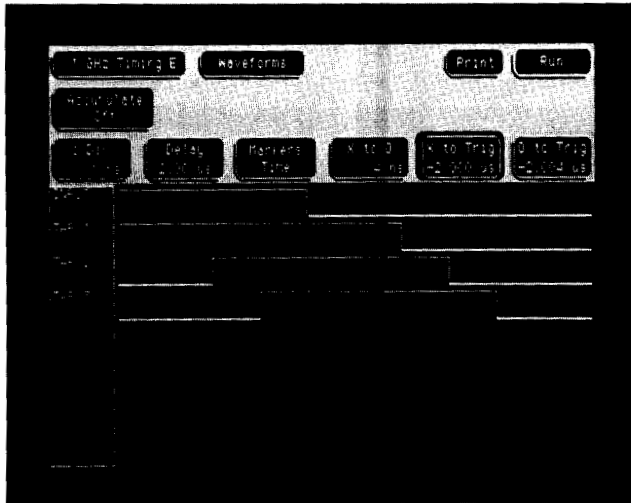

#### Debug Quickly with up to 80 Channels

Avoid having to move probes. Find problems faster by capturing more channels at the same time, and solve applications that require several simultaneous channels. Each HP 16515A/16516A timing card offers 16 simultaneous channels. Add up to five cards for a total of 80 channels for applications where having more channels means taking less time to find the problem.

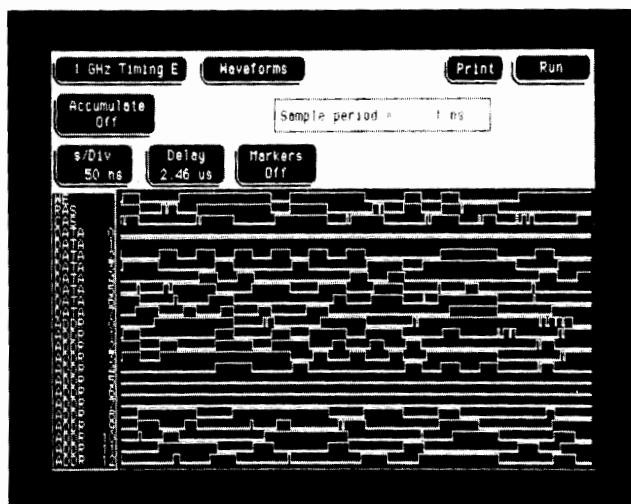

#### Find the Cause of Problems with 8 Kbit/channel Memory Depth

Find and analyze events that occur before or after the trigger event. Each channel stores 8K samples to allow 8  $\mu$ s of negative time capture with 1 ns resolution, for pre-trigger applications. Deep memory stores data over several clock cycles while retaining precise edge placement information. Deep memory also helps you find elusive problems more quickly when you're not sure exactly where to trigger.

#### Hook Up Easily to Your Circuit with HP's New Lightweight Probes

HP's new 10 kohm, 3 pF passive probes are lightweight and easy to connect. These probes can be connected with probe tips or plugged directly into any .1" grid with .026" to .033" diameter round pins or .025" square pins. Individual grounds are provided for each channel to shorten ground loops.

#### Easy-to-use

Enjoy the HP 16515A/16516A timing module's scope-like controls by selecting seconds/division and delay. Automatic pattern search quickly finds patterns. Statistical time interval analysis measures the dynamics of your circuits.



- 12 non-return-to-zero (NRZ) channels 16520A
- 48 NRZ channels 16521A
- 204 NRZ channels maximum/system

- 50 Mbit/s maximum data rate
- 4095 bits memory depth/channel
- Lightweight passive probing

### HP 16520A/16521A 50 Mbit/s Pattern Generation ... When Analysis Requires Both Stimulus and Response

#### Synergistic Solution

Configure the HP 16500A to provide both stimulus and response in one instrument. Use the HP 16520A 50 Mbit/s Pattern Generator Master card and the HP 16521A 50 Mbit/s Pattern Generator Expansion card to provide the functional stimulus. Use the digitizing oscilloscope, 25 MHz state/100 MHz timing cards, or 1 GHz timing cards to capture functional and parametric circuit response. Also use the HP 16500A stimulus/response capability in HP's CAE environment to provide prototype functional testing.

#### Debug Digital Circuits Easily

Quickly generate the patterns necessary to put your circuit in a given state, or single-step your circuit through a series of states.

Generate patterns to isolate and analyze glitches in a repetitive environment.

Two menus (format and listing menus) allow complete data entry. The format menu allows you to group data channels together for easy data entry. Enter data in hex, octal, binary, decimal, or symbols. Editing is enhanced with delete, insert, and copy functions. Merge stored programs to create more complex data files quickly. Macros allow you to repeat portions of code quickly. Apply these complex patterns to duplicate your system's loops, jumps, and subroutines. Run control for the pattern generator can be derived from the screen, external sources, or Intermodule Bus, allowing you to generate patterns when complex trigger conditions occur.

#### Friendly Circuit Connection

Easily attach to boards through probe tips or 2 x 10, 0.1" center connectors on your circuit board. Standard connectors eliminate the need to purchase special connectors or to build custom fixtures to hook into your DUT. The lightweight and passive probing system provides ECL or TTL patterns through 50 ohm connections. Series termination eliminates the need for external 50 ohm terminations. HP also offers the HP 10345A ECL differential Driver, HP 10348A CMOS Tristate Pod and the HP 10346A TTL Tristate Pod.

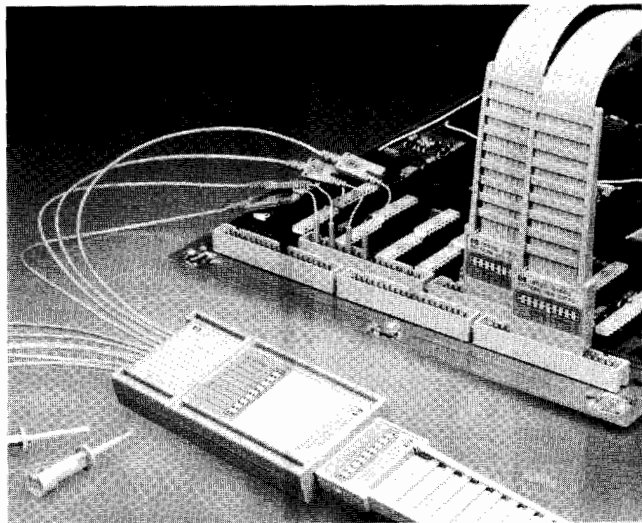

Light passive probing provides easy connections to your DUT.

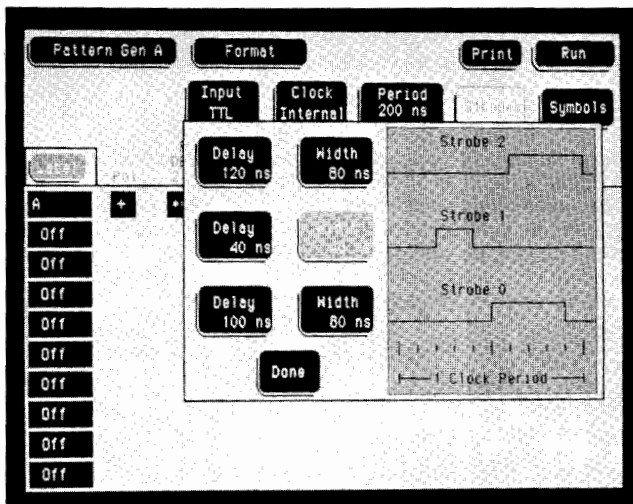

Define strobos with easy pop-up menu.

#### Perform Functional Verification

Avoid designing custom hardware or using other time consuming methods to provide stimulus to your circuit. The HP 16520A/16521A offers functional tests at a low cost-per-channel.

#### Shorten Your Design Cycle

Test partial systems, even though they are missing components. The HP 16520A/16521A can be used to substitute for boards, ICs, and buses. Instead of waiting for the missing pieces, you can continue to test and verify your design.

# LOGIC ANALYZERS

## Preprocessors And Interface Modules

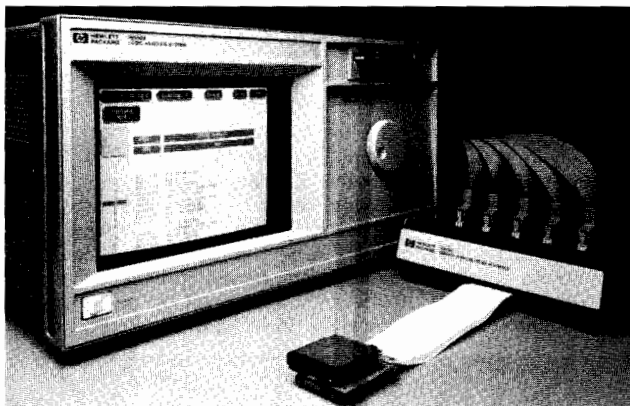

HP 10314B with HP 10269C for Intel 80386 support.

### Simplified Data Interpretation and Interconnections

#### Microprocessor Support

Analyze the code in your microprocessor-based system while the system is running at full speed. HP's microprocessor support accessories allow you to follow the path of your software—from power-up, through interrupts, to fatal system crashes.

HP now offers support for 32-bit microprocessors, including the Motorola 68020 and the Intel 80386. Or, trace the flow of common 16-bit CPU's—the Intel 8086 and 80286 families or the Motorola 68000 devices. In addition, you can completely monitor your Zilog, Intel, National or Motorola 8-bit system.

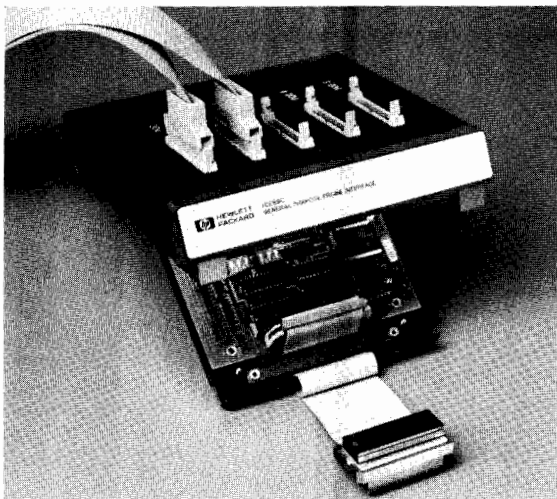

Preprocessors for your microprocessor connect to the logic analyzer probes through the HP 10269C General Purpose Probe Interface.

#### Hook Up Quickly and Reliably to Your Microprocessor System

HP's microprocessor preprocessors are the mechanical and electrical link between your target system and the logic analyzer. They provide: reliable, correct, fast and convenient connections to your microprocessor system; all clocking and demultiplexing circuits needed to correctly capture your system's operation; additional status lines to further decode the operation of your CPU; dequeuing circuits to weed out the unexecuted instructions that were pre-fetched by your microprocessor.

#### Display Captured Data In Your Microprocessor's Mnemonics

Inverse Assembly software translates the ones and zeros captured by the logic analyzer into a display that you're familiar with—microprocessor mnemonics. The resulting display can easily be compared to original assembly language listings to track down software defects.

Each preprocessor includes an inverse assembler on a 3.5 inch disc. When loaded into the logic analyzer from the internal disc drive, it configures the instrument for use with your preprocessor and transforms the data and status of each state into the microprocessor's mnemonics.

#### Microprocessor Preprocessors

Microprocessor	HP Preprocessor Model No.
8085	HP 10304B
8086/88	HP 10305B
80186/88	HP 10306B
80286	HP 10312D
80386	HP 10314B
6800/02	HP 10307B
6809/09E	HP 10308B
68008	HP 10310B
68000/10	HP 10311B (DIP)
68000/10	HP 10311G (PGA)
68020	HP 10313G
NSC800	HP 10303B
Z80	HP 10300B
68HC11	HP 10315G
6301/03	HP 10335G (PGA)
6301/03	HP 10335H (PLCC)
64180	HP 10336G (PGA)
64180	HP 10336H (PLCC)

#### Monitor Your I/O and Bus Interfaces

The HP bus preprocessors provide analysis capabilities for many popular I/O and bus interfaces. These packages give you:

- convenient and reliable access to the signals on your interface;
- software that sets up the HP 1650A, HP1651A and HP16510A Logic Analyzers for the measurement at hand;
- a complete view of the control lines;
- capture of all traffic occurring on the bus;
- conversion of the captured information into easy to understand mnemonics.

Many also provide timing analysis on all data, handshake and management lines for isolating noise, faulty hardware or defective cables.

Each package includes the preprocessor board, termination adapter (if required), and software on a 3.5" disc to set up the logic analyzer and provide inverse assembly of the captured data.

#### Bus Preprocessor

Interface/Bus Type	HP Preprocessor Model No.
MIL-STD-1553	10341B
HP-IB (HP's implementation of IEEE488-1978)	10342B, 10342G
RS232C/CCITT V.24	10342B
RS449	10342B
SCSI	10343B
VME	10344A - Single wide 10344B - Double wide

#### Minicomputer Interfaces for Three Popular Minicomputer Buses

When you need to monitor the flow of information from card to card in your minicomputer, turn to HP's minicomputer interfaces. These modules plug into your minicomputer backplane to give your logic analyzer access to the important address, data and control lines that transfer information between slots in the cardcage.

You can choose from the UNIBUS interface for the DEC PDP-11,

the Q-BUS interface for the DEC LSI-11 or an interface for the Intel MULTIBUS\*. Each card buffers the signals from the backplane and generates the proper clocking signals for the logic analyzer. In addition, switches on each card will filter out unwanted bus cycles, so only the information of interest is sent to the logic analyzer. The interface cards output the buffered backplane signals over two 40-pin ribbon cables. To connect these cables to the logic analyzer, use the HP 10320C User-Definable Interface and the HP 10269C G.P. Probe Interface to mechanically route the cable signals to the logic analyzer probes. Detailed instructions are included with the HP 10320C for constructing the interface, as well as set-up information for your logic analyzer to allow complete analysis of your minicomputer backplane.

### See an Overall Picture of Your System to Find the Routines that Are Slowing You Down

The HP 10390A System Performance Analysis Software (SPA) converts your HP 1650A, HP 1651A or HP 16510A Logic Analyzer into a powerful tool for finding bottlenecks in your system. SPA can help you: find the routines that are called most often in your system; identify inefficient use of discs and peripherals that slow your system down; and find processes that use too much CPU time.

The logic state analyzer is configured to repetitively sample your target system as it operates. The analyzer takes a sample of your system, sorts the captured data into ranges, then delays a random amount of time before starting to sample again. (The random delay ensures that the measurement won't sync on only a small portion of your system.)

After each acquisition, the captured information is translated into histograms and bar charts to present the big picture of your system's operation.

SPA performs three kinds of measurements: State Overview, State Histogram and Time Interval measurements.

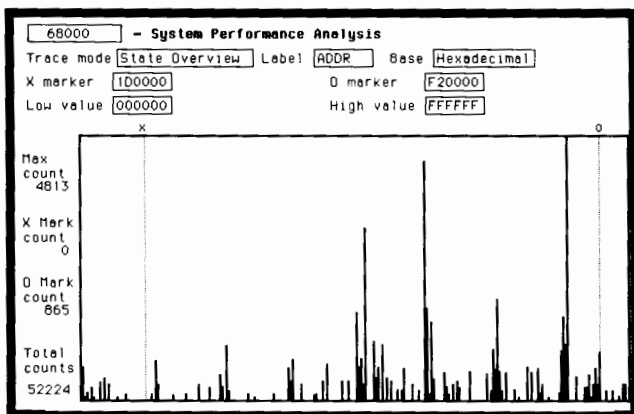

State Overview measurements quickly show which addresses have activity.

### Designing Your Own Preprocessor . . . the HP 10320C

The HP 10320C User-Definable Interface allows you to build a custom preprocessor—a preprocessor that meets your own strict specifications. Use the HP 10320C when you need:

- an interface for analyzing custom or proprietary devices with your HP 1650A, HP 1651A or HP 16510A logic analyzer,
- a semi-custom test fixture for using your logic analyzer in a manufacturing test environment, or
- a link for ribbon cables or connections to your logic analyzer.

The HP 10320C provides a breadboard that fits inside the HP 10269C General Purpose Probe Interface. In addition, the kit includes mechanical hardware to mount the breadboard in place and connectors for sending your signals to the HP 10269C. The accompanying manual discusses the interface design process, including what to look for in your target system, how to design so that set up and hold requirements are met, and tips on power supply distribution.

### Building and Connecting the Interface . . . Extra Convenience with HP's Parts Kit and Special Cables

Companion accessories enhance the utility of the HP 10320C. The HP 10321A Microprocessor Interface Kit provides many of the parts needed when designing an interface that used IC's and other active devices. It includes sockets, bypass capacitors and a fuse for power distribution, and wire-wrap headers to simplify the wiring of your interface. With the HP 10321A, the user only needs to provide the specific components and active parts used in the interface design.

The HP 10322A, HP 10323A and HP 10324A Cables provide a reliable mechanical and electrical connection between a socket on your target system and the HP 10320C User-Definable Interface. The cable has a special socket assembly for easy connection without damaging the pins of your device. Simply remove your IC from your system, plug the cable in its place, then plug your chip into the Zero-Insertion-Force socket on the cable. This technique minimizes the capacitive loading to your system, as well as giving you a low-profile, reliable hook-up.

For 40-pin DIP packages, order the HP 10322A; 48-pin devices require the HP 10323A. 64-pin DIP IC's are supported by the HP 10324A.

### A Display With Your Mnemonics . . . to Match Your Custom Interface

Just as the HP 10320C allows you to design custom hardware, the HP 10391A Inverse Assembler Development Package allows you to design a custom inverse assembler for the HP 1650A, HP 1651A or HP 16510A Logic Analyzers. This software package allows you to write an inverse assembler that will display your system's operation in mnemonics you're familiar with.

The HP 10391A is a macro assembler that runs on the HP Vectra, the IBM-PC or PC compatibles. The HP 10391A includes: Pascal-like instructions, such as CASE and IF-THEN statements; Strong bit-manipulation capabilities allowing the extraction of single bits, or conditional branching on a few bits within a word; Assembly-language constructs, including AND, ROTATE and INCREMENT/DECREMENT instructions.

To write your own inverse assembler, the HP 10391A requires the following equipment: 1) HP Vectra, IBM-PC\* or PC compatible with a minimum of 256K of memory and MS-DOS\* 2.1 or above. 2) 1 floppy disc drive with an internal hard disc (recommended configuration) for the PC, or two floppy disc drives. 3) RS-232C port and cable. Recommended card: HP 24540A Serial/Parallel Card or HP 24541A Dual Serial card. For 25-pin ports, use cable HP 13242G or equivalent. For 9-pin ports, use cable HP 24542G or equivalent. 4) HP 1650A or HP 1651A Logic Analyzer, or HP 16500A Logic Analysis System with an HP 16510A State/Timing card installed.

\*IBM-PC is a trademark of International Business Machines Corporation. MS-DOS is a trademark of MicroSoft Corporation. DEC, UNI-BUS, PDP-11, Q-BUS and LSI-11 are registered trademarks of Digital Equipment Corporation

# LOGIC ANALYZERS

## Specifications And Characteristics

Models 1650A, 1651A, 16500A, 16510A, 16515/16A, 16520A/21A, 16530A/31A

### HP 1650A, 1651A, 16510A Specifications

#### Probes

**Minimum Swing:** 600 mV peak-to-peak.

**Threshold Accuracy:**  $\pm 150$  mV accuracy over the range  $-2.0$  to  $2.0$  volts;  $\pm 300$  mV accuracy over the ranges  $-9.9$  to  $-2.1$  volts and  $2.1$  to  $9.9$  volts.

**Dynamic Range:**  $\pm 10$  volts about the threshold.

#### State Mode

**Clock Repetition Rate:** Single phase is 25 MHz maximum. With time or state counting, minimum time between states is 60 ns. Both mixed and demultiplexed clocking use master-slave clock timing; master clock must follow slave clock by at least 10 ns and precede the next slave clock by  $> 50$  ns.

**Clock Pulse Width:**  $\geq 10$  ns at the threshold.

**Setup Time:** Data must be present prior to clock transition,  $\geq 10$  ns.

**Hold Time:** Data must be present after rising clock transition, 0 ns.

#### Timing Mode

**Minimum Detectable Glitch:** 5 ns wide at the threshold.

### Characteristics

#### Probes

**Input RC:** 100 K $\Omega$   $\pm 2\%$  shunted by approximately 8 pF at the probe tip.

**Minimum Input Overdrive:** 250 mV or 30% of the input amplitude, whichever is greater.

**Maximum Voltage:**  $\pm 40$  volts peak.

**Threshold Setting:** Threshold levels may be defined for pods 1 and 2 individually (HP 1651A). Threshold levels may be defined for pods 1, 2, and 3 on an individual basis and one threshold may be defined for pods 4 and 5 (HP 1650A/16510A).

**Threshold Range:**  $-9.9$  to  $+9.9$  volts in 0.1 volt increments.

#### State Analysis

##### Memory

**Data Acquisition:** 1024 samples/channel

##### Format Specification

**Clock:** Five clocks (HP 1650A/16510A) or two clocks (HP 1651A) are available and can be used by either one or two state analyzers at any time. Clock edges can be ORed together and operate in single phase, two phase demultiplexing, or two phase mixed mode. Clock edge is selectable as positive, negative, or both edges for each clock.

**Clock Qualifier:** The high or low level of four clocks (HP 1650A/16510A) or one clock (HP 1651A) can be ANDed with the clock specification. Setup time: 20 ns; hold time: 5 ns.

##### Trace Specification

**Pattern Recognizers:** Each recognizer is the AND combination of bit (0, 1, or X) patterns in each label. 8 pattern recognizers are available when one state analyzer is on. 4 are available to each analyzer when two state analyzers are on.

**Range Recognizer:** Recognizes data which is numerically between or on two specified patterns (ANDed combination of zeros and/or ones). One range term is available and is assigned to the first state analyzer turned on. The maximum size is 32 bits.

**Qualifier:** A user-specified term that can be anystate, nostate, a single pattern recognizer, range recognizer, or logical combination of pattern and range recognizers.

**Sequence Levels:** There are 8 levels available to determine the sequence of events required for trigger. The trigger term can occur anywhere in the first 7 sequence levels.

**Branching:** Each sequence level has a branching qualifier. When satisfied, the analyzer will restart the sequence or branch to another sequence level.

**Occurrence Counter:** Sequence qualifier may be specified to occur up to 65535 times before advancing to the next level.

**Storage Qualification:** Each sequence level has a storage qualifier that specifies the states that are to be stored.

**Enable/disable:** Defines a window of post-trigger storage. States stored in this window can be qualified.

**Prestore:** Stores two qualified states that precede states that are stored.

#### Tagging

**State Tagging:** Counts the number of qualified states between each stored state. Measurement can be shown relative to the previous state or relative to trigger. Maximum count is  $4.4 \times 10^{12}$ .

**Time Tagging:** Measures the time between stored states, relative to either the previous state or to the trigger. Maximum time between states is 48 hours. With tagging on, the acquisition memory is halved; minimum time between states is 60ns.

#### Symbols

**Pattern Symbols:** User can define a mnemonic for the specific bit pattern of a label. When data display is SYMBOL, mnemonic is displayed where the bit pattern occurs. Bit patterns can include zeros, ones, and don't cares.

**Range Symbols:** User can define a mnemonic covering a range of values. Bit pattern for lower and upper limits must be defined as a pattern of zeros and ones. When data display is SYMBOL, values within the specified range are displayed as mnemonic + offset from base of range.

**Number of Pattern and Range Symbols:** 100 per analyzer. Symbols can be down-loaded from a controller.

#### Timing Analysis

**Transitional Timing Mode:** Sample is stored in acquisition memory only when the data changes. A time tag stored with each sample allows reconstruction of waveform display. Time covered by a full memory acquisition varies with the number of pattern changes in the data.

**Sample Period:** 10 ns

**Maximum Time Covered by Data:** 5000 seconds

**Minimum Time Covered by Data:** 10.24  $\mu$ s

**Glitch Capture Mode:** Data sample and glitch information is stored every sample period.

**Sample Period:** 20 ns to 50 ms in a 1-2-5 sequence dependent on sec/div and delay settings.

**Time Covered by Data:** Sample period  $\times$  512

#### Waveform Display

**Accumulate:** Waveform display is not erased between successive acquisitions.

**Overlay Mode:** Multiple channels can be displayed on one waveform display line. Primary use is to view summary of bus activity.

**Maximum Number of Displayed Waveforms:** 24

#### Time Interval Accuracy

**Sample Period Accuracy:** 0.01% of sample period.

**Channel-to-channel Skew:** 4 ns typical

**Time Interval Accuracy:**  $\pm$ (sample period + channel-to-channel skew + 0.01% of time interval reading)

#### Trigger Specification

**Asynchronous Pattern:** Trigger on an asynchronous pattern less than or greater than specified duration. Pattern is the logical AND of specified low, high or don't care for each assigned channel. If pattern is valid but duration is invalid, there is a 20 ns reset time before looking for patterns again.

**Greater than Duration:** Minimum duration is 30 ns to 10 ms with 10 ns or 0.01% resolution, whichever is greater. Accuracy is  $+0$  ns to  $-20$  ns. Trigger occurs at pattern + duration.

**Less than Duration:** Maximum duration is 40 ns to 10 ms with 10 ns or 0.01% resolution, whichever is greater. Pattern must be valid for at least 20 ns. Accuracy is  $+20$  ns to  $-0$  ns. Trigger occurs at the end of the pattern.

**Glitch/Edge Triggering:** Trigger on glitch or edge following valid duration of asynchronous pattern and while the pattern is still present. Edge can be specified as rising, falling or either. Less than duration forces glitch and edge triggering off.

#### Measurement And Display Functions

**Autoscale (Timing Analyzer Only):** Autoscale searches for and displays channels with activity on the pods assigned to the timing analyzer.

### Acquisition Specifications

**Arming:** Each Analyzer can be armed by the Run key, the other Analyzer, the external trigger in port (HP 1650A/1651A) or the Inter-module Bus (HP 16500A).

**Trace Mode:** Single mode acquires data once per trace specification; repetitive mode repeats single mode acquisitions until stop is pressed or until time interval between two specified patterns is less than or greater than a specified value, or within or not within a specified range. There is only one trace mode when two analyzers are on.

**Labels:** Channels may be grouped together and given a 6-character name. Up to 20 labels in each analyzer may be assigned with up to 32 channels per label. Primary use is for naming groups of channels such as address, data, and control busses.

### Indicators

**Activity Indicators:** Provided in the Configuration, State Format, and Timing Format menus for identifying high, low, or changing states on the inputs.

**Markers:** Two markers (X and O) are shown as dashed lines in the display.

**Trigger:** Displayed as a vertical dashed line in the timing waveform display and as line 0 in the state listing display.

### Marker Functions

**Time Interval:** The X and O markers measure the time interval between one point on a timing waveform and trigger, two points on the same timing waveform, two points on different waveforms, or two states (time tagging on).

**Delta States (State Analyzer Only):** The X and O markers measure the number of tagged states between one state and trigger, or between two states.

**Patterns:** The X or O marker can be used to locate the nth occurrence of a specified pattern before or after trigger, or after the beginning of data. The O marker can also find the nth occurrence of a pattern before or after the X marker.

**Statistics:** X to O marker statistics are calculated for repetitive acquisitions. Patterns must be specified for both markers, and statistics are kept only when both patterns can be found in an acquisition. Statistics are minimum X to O time, maximum X to O time, average X to O time, and ratio of valid runs to total runs.

## HP 16530A/16531A 400 Megasample/s Digitizing Oscilloscope

### Specifications

#### Vertical (at BNC)

**Bandwidth (−3 dB):** dc to 100 MHz (dc-coupled)

**Range:** 40 mV to 16 V full scale (adjustable with 2-digit resolution).

**DC Gain Accuracy:** ±3% of full scale (valid within ±10°C of auto-calibration temperature)

**Analog-to-digital Conversion (ADC) Resolution:** ±1.6% of full scale (6 bits)

**DC Offset Accuracy:** ±1% of offset ±3.2% of full scale (valid within ±10°C of auto-calibration temperature).

#### DC Offset Range/Resolution:

Vertical Range	Offset Range	Offset Resolution
<800 mV	±800 mV	1 mV
≥800 mV	±16 V	20 mV

#### Voltage Measurement Accuracy (DC):

Single Cursor (X or O): = Gain accuracy + ADC resolution + offset accuracy.

Dual Cursor (X to O measurements on the same waveform): = Gain accuracy + 2 (ADC resolution)

#### Horizontal

**Range:** 50 ns to 100 s full scale, adjustable with 3-digit resolution.

**Time Interval Measurement Accuracy (dual channel for deskewed channels with equal rise and fall times):**

±0.75 ns ±0.2% of timebase range ±0.02% of reading (2.5 ns sample period)

± sample period ±0.2% of timebase range ±0.02% of reading (≥ 5 ns sample period)

#### Delay (Time Offset)

**Pre-trigger Range:** 4096 × sample period

**Post-trigger Range:** 500 screen diameters

**Resolution:** Fine adjustment to 0.2% of screen diameter

### Characteristics

#### Vertical

**Transition Time (10% to 90%):** ≤ 3.5 ns

**Input Coupling:** dc

**Input RC:** 1 MΩ ±2% or 50 ohm ±3%, shunted by approximately 13 pF.

**Maximum Safe Input Voltage:** 1 MΩ input, ±40 V (dc + peak ac), 50 Ω input, ± 5 V (dc + peak ac)

**Probe Factors:** Any integer ratio from 1:1 to 1:1000, to scale the oscilloscope to represent voltages seen at the probe tip.

#### Time Base

**Deskewing:** Skew between channels can be nulled out to compensate for probe cable lengths.

#### Digitizer

**Resolution:** 6 bits (1 part in 64)

**Digitizing Rate:** up to 400 megasamples/second

**Digitizing Technique:** Real-time digitizing; each 4K record is acquired on a single acquisition.

**Acquisition Memory Size:** 4096 samples per channel

#### Waveform Display

**Display Formats:** Waveforms can be displayed in an overlapping and/or non-overlapping format.

**Display Resolution:** 500 points horizontally.

#### Display Modes

**Single:** New acquisitions replace old acquisitions on screen.

**Accumulate:** New acquisitions are added to the screen and displayed with older acquisitions until screen is erased.

**Average:** New acquisitions are averaged with older acquisitions with updated waveform displayed until erased.

**Overlay:** Up to 8 acquired waveforms can be overlaid in the same display area.

**Connect-the-dots:** Provides a display of the sample points connected by straight lines.

**Waveform Reconstruction:** When there is insufficient data to fill every horizontal location, a post-acquisition reconstruction filter fills in the missing locations.

**Waveform Math:** Display capability of A−B and A+B functions is provided.

#### Measurement Aids

**Markers:** Two vertical markers are provided for measurements of time and voltage. Capabilities are: measure voltage of X and O on each analog waveform; measure time from X to trigger, O to trigger, and X to O; automatic marker placement by specifying voltage level, edge number, and rising or falling edge type; run until X to O greater than, less than, in-range, and not-in-range provides selective event search; X to O statistics (mean, max, and min) provide analysis of time interval deviation.

**Automatic Measurements:** The following pulse parameter measurements can be performed automatically:

Frequency	Rise time	+ pulse width
Period	Fall time	− pulse width
Vpp	Preshoot	Vtop-base
	Overshoot	

#### Setup Aids

**Autoscale:** Autoscale sets the vertical and horizontal ranges, offset, and trigger level to display the input signals. Requires an amplitude above 10 mV peak, and a frequency between 50 Hz and 100 MHz.

**Presets:** Scale the vertical range, offset, and trigger level to predetermined values for displaying ECL or TTL waveforms.



# LOGIC ANALYZERS

## Specifications And Characteristics (cont'd)

Models 1650A, 1651A, 16500A, 16510A, 16515/16A, 16520A/21A 16530A/31A

### HP 16515A/16516A 1 GHz Timing Analyzers

#### Specifications

##### Probes

**Minimum Swing:** 500 mV peak-to-peak  
**Threshold Accuracy:**  $\pm 150$  mV  $\pm 3.0\%$  over the range 0 to +5 volts.  
 $\pm 150$  mV  $\pm 2.0\%$  over the range -3.5 to 0 volts.  
**Dynamic Range:** +7.0 volts

#### Characteristics

##### Probes

**Input RC:** 10 K +2% shunted by approximately 3 pF at the probe tip.  
**Maximum Input Voltage:** +40 volts  
**Threshold Range:** -3.5 to +5.0 volts in 0.1 volt increments.

##### Acquisition Memory

**Memory Depth:** 8192 samples/channel  
**Data Channels:** 2 eight channel pods (16515A)  
 4 eight channel plds (16515A/16516A)

##### Time Interval Accuracy\*

**Timebase Accuracy:**  $\pm 0.1\%$  of the time interval reading added to:  
 $\pm 500$  ps at 250 MHz to 1 GHz sample rate.  
 $\pm 2$  ns at  $\leq 125$  MHz sample rate.

##### Trigger\*

**Asynchronous Pattern:** Trigger on an asynchronous pattern less than or greater than specified duration, or trigger on not-equal to pattern greater than the specified duration. Pattern is the logical AND of specified low, high or don't care for each assigned channel.

**Greater Than Duration:** Range is 2 ns to 507 sample periods

**Less Than Duration:** Range is 16 ns to 507 sample periods.

**Edge Trigger:** Trigger on edge following valid duration of asynchronous pattern.

**Minimum Pulse Width:** 1.5 nsec

#### Display Functions

##### Data Display/Entry

**Labels:** Channels may be grouped together and given a 6 character name. Up to 20 labels may be assigned with labels may be assigned with up to 32 channels per label.

**Timing Waveform:** Interleaved, time-correlated listing of timing waveforms and waveforms from other measurement modules other measurement modules (i.e. another timing analyzer or oscilloscope). Pattern readout of timing waveforms at X or O marker in the selected base.

##### Waveform Display

**Sec/div:** 1 ns to 1s adjustable, with 3-digit resolution.

**Delay:** -12.5 s to 53.5 ks.

**Accumulate:** Waveform display is not erased between successive acquisitions.

**Overlay Mode:** Multiple channels can be displayed on one waveform display line. Primary use is to view summary of bus activity.

##### Marker Functions

**Time Interval:** The X and O markers, measure the time interval between one point on a timing waveform and trigger, two points on the same timing waveform, or two points on different waveforms.

**Patterns:** The X or O markers can be used to locate the 0 to 8192 occurrence of a specified pattern.

**Statistics:** X to O marker statistics are calculated for repetitive acquisitions. Statistics are minimum X to O time, maximum X to O time, average X to O time, and count of valid runs.

### HP 16520A/16521A 50 Mbit/s Pattern Generator

#### Specifications

##### Clock Sources (16520A Only)

##### Internal Clock

**Clock Period:** programmable from 20 ns to 200  $\mu$ s in a one-two-five sequence.

**Data Period Accuracy:**  $\pm 2\%$  (of period)  $\pm 1$  ns

##### External Clock (provided by user)

**Input Clock Period:** 1 Hz to 50 MHz (20 ns min period) ECL or TTL, internal frequency divide (/1, /5, or /10) provided.

**Duty Cycle:** 10 ns minimum high time, 10 ns minimum low time

##### Strobes (16520A Only)

**Number of Strobes:** 3 (ECL or TTL)

**Bits/Channel:** 4095

**Maximum Bit Rate:** 20 MBit/s (50 ns Period)

**Edge Placement:**  $\leq 10$  MBit/s: tenths of period

$> 10$  MBit/s to 20 MBit/s: fifths of Period

(Delay + Width  $\leq$  Period)

**Minimum Delay:** 0/10 (0/5), maximum delay is 9/10 (4/5) data period.

**Minimum Width:** 1/10 (1/5) of data period, maximum width is the data period (values in parentheses apply to 20 MBit/s timebase setting). If strobes are desired while operating with external clock, the data rate will be divided to 1/5 or 1/10 the external clock rate.

#### Characteristics

**Output:** Eight channel pods can be assigned as either standard ECL or TTL levels. All characteristics are valid at the probe tip.

	ECL	TTL
$V_{OH}$ (steady state)	-0.98V	2.7V
$V_{OL}$ (steady state)	-1.55V (into 10K $\Omega$ , 10 pF)	0.6V (into 10K $\Omega$ , 10 pF)
Risetime/ Falltime (typ)	2.3 ns (-0.98 V to -1.55 V)	2.5 ns (0.6 V to 2.7 V)
Channel-to- channel Skew* (same card)	$\leq 5$ ns	$\leq 5$ ns
Channel-to- channel Skew* (card-to-card)	$< 10$ ns	$< 10$ ns
Number of Std Loads	3 (10 KH ECL, @ $V_{nh}=150$ mV)	3 (LS, @ $V_{nl}=250$ mV)

(Output measurements made into a load consisting of 10 K $\Omega$  in series shunted with 10 pF to ground.)

(\*) Skew measured at (+1.6 V) TTL and (-1.3 V) ECL levels.

	16520A	16521A
DATA CAPACITY		
Number of Channels	12	48
Bits Per Channel	4095	4095
Maximum Bit Rate	50 MBit/s NRZ (20ns Period)	50 MBit/s NRZ (20ns Period)
INPUT	ECL	TTL
$V_{ih}$ (min)	-1.00V	2.08V
$V_{ij}$ (max)	-1.52V	1.12V

**Maximum Input Voltage:**  $\pm 40$ V

**Input Impedance:** 100 K $\Omega$ , 8 pF

**External Clock-in to Clock-out Delay:** 50 ns

##### Data Instruction Set

**Break:** Stops program execution, last data vector is held at output.

**Repeat:** Repeats vector up to 256 times.

**Wait IMB:** Wait for intermodule trigger.

**Wait External:** Wait for user-defines 3-bit pattern on external input pod to become true. No data cycle latency when pattern is true between 30 ns and 0 ns before next clock edge.

**Signal IMB:** Arms other measurement cards.

**Macro:** Four different macros may be defined and inserted as needed. Six character labels may be defined for each macro. Macros contain REPEAT, WAIT EXTERNAL, WAIT IMB, BREAK, and SIGNAL IMB instructions.

### General Characteristics

**Programmability:** Instrument settings and operating modes, including automatic measurements, may be remotely programmed via RS-232C or HP-IB (IEEE-488). HP-IB is available only on HP 16500A.

### Hardcopy Output

**Printers Supported:** HP ThinkJet, HP PaintJet, HP QuietJet, HP LaserJet, Epson and Epson-compatible printers (e.g., Epson FX80) via RS-232C or HP-IB (HP 16500A only).

RS-232C Configurations: Protocol: XON/XOFF, Hardware; Data bits: 7,8; Stop bits: 1, 1½, 2; Parity: none, odd, even; Baud rate: 110, 300, 600, 1200, 2400, 4800, 9600, 19200.

### Ordering Information

	Price
<b>Logic Analyzers</b>	
HP 1631A (35 channels, plus two analog)	\$11,300
HP 1631D (43 channels, plus two analog)	\$13,300
HP 1650A (80 channels)	\$7800
HP 1651A (32 channels)	\$3900
HP 16500A Logic Analysis System	\$7200
HP 16510A (80 channels)	\$5200
HP 16515A (16 channels, 1 GHz timing)	\$7800
HP 16516A (16 channels, 1 GHz timing)	\$6500
HP 16520A (12 channels, pattern generation)	\$3700
HP 16521A (48 channels, pattern generation)	\$4000
HP 16530A (400 MSa/s oscilloscope timebase)	\$1500
HP 16531A (400 MSa/s oscilloscope acquisition)	\$4000

### Probe Interface

HP 10269C G.P. Probe Interface  
Microprocessor Preprocessors-note, inverse assembly is provided on 3.5-inch disc

HP 10304B Intel 8085	\$880
HP 10305B Intel 8086/88	\$1235
HP 10306B Intel 80186/88	\$2000
HP 10312D Intel 80286	\$2040
HP 10314B Intel 80386	\$2200
HP 10307B Motorola 6800/02	\$1110
HP 10308B Motorola 6809/09E	\$1110
HP 10310B Motorola 68008	\$1110
HP 10311B Motorola 68000/10, 64-pin DIP	\$1320
HP 10311G Motorola 68000/10, 68-pin PGA	\$600
HP 10313G Motorola 68020	\$850
HP 10303B National NSC800	\$1010
HP 10300B Zilog Z80	\$880
HP 10315G Motorola 68HC11	\$750
HP 10335G Hitachi 6303/01 (DIP)	\$590
HP 10336G Hitachi 64180 (DIP)	\$580
HP 10336H Hitachi 64180 (PLCC)	\$1160

### Bus Preprocessors

HP 10342B HP-IB, RS-232C and RS-449	\$1220
HP 10342G HP-IB	\$350
HP 10343B SCSI bus	\$1500

### Minicomputer Interfaces

HP 10275A PDP-11 UNIBUS**	\$470
HP 10276A LSI-11 Q-Bus**	\$520
HP 52126A Intel Multibus***	\$370

### Accessory Software

HP 10390A System Performance Analysis	\$500
---------------------------------------	-------

### User-Definable Interface

HP 10320C User-definable Interface	\$270
HP 10321A Microprocessor Interface Parts Kit	\$235
HP 10322A 40-pin DIP Interface Cable	\$410
HP 10323A 48-pin DIP interface Cable	\$470
HP 10324A 64-pin DIP Interface Cable	\$570

HP 10391A Inverse Assembler Development Package	\$1000
-------------------------------------------------	--------

### Printers and Accessories

<b>HP 3630A</b>	
Opt 001 PaintJet with RS232C/V.24	\$1395
Opt 002 PaintJet with HP-IB	\$1395
HP 92269A Desktop Printer/Plotter Stand	\$79
HP 51630P 2-fold PaintJet Paper	\$17.95
HP 2225A ThinkJet Printer with HP-IB Interface	\$495
HP 2225D ThinkJet Printer with RS-232C Interface	\$495
HP 10833A HP-IB Cable, 1m	\$80
13242-60010 RS-232 Cable	\$69

### Oscilloscope Accessories

HP 10503A BNC-to-BNC cable, 1.2m	\$35
HP 10435A 10:1, 1 Mohm, 7.5 pF miniprobe, 1m	\$115
HP 10433A 10:1, 10 Mohm, 10 pF miniprobe, 2m	\$105
HP 10020A 10:1, 100:1, 10 Mohm, 10 pF resistive divider probe set, 1.5m	\$495
HP 10438A 1:1, 40 pF, mini-probe, 1m	\$85
HP 10439A 1:1, 64 pF, mini-probe, 2m	\$90
HP 10437A 1:1, 50 ohm, mini-probe, 2m	\$80
HP 10440A 100:1, 10 Mohm, 2.5 pF mini-probe, 2m	\$115
HP 10240B BNC-to-BNC AC coupling capacitor	\$45
HP 10211A 24-pin IC test clip	\$77

### Logic Analyzer Accessories

01650-61607 16-Channel Probe Cable for HP 1650A and HP 1651A	\$125
16510-61601 16-Channel Probe Cable for HP 16510A (pods 1,3 and 5)	\$160
16510-61602 16-Channel Probe Cable for HP 16510A (pods 2 and 4)	\$140
16515-61604 Probe Cable for HP 16515A and HP 16516A	\$75
16515-69502 Lead Set Kit - 8 signal and 8 ground leads	\$100
01650-61608 16-Channel Lead Set for HP 1650A, HP 1651A and HP 16510A (grey tip)	\$190
01650-63201 Termination Adaptor for HP 1650A, HP 1651A and HP 16510A	\$100
5959-0288 Grabbers (package of 20)	\$20

### Pattern Generator Accessories

16520-61601 Input qualifier Probe Cable	\$110
16520-61602 8-Channel Data Probe Cable	\$140
16520-61603 Clock Probe Cable	\$160
HP 10347A Pattern Generator Probe Lead Set	\$200
HP 10348A 8-Channel CMOS Tristate Buffer Pod	\$120
16520-69501 Input Qualifier Probe Kit	\$115
HP 10345A 8-Channel ECL Differential Driver Pod	\$120
HP 10346A 8-Channel TTL Tristate Buffer Pod	\$120
5959-0288 Grabber (package of 20)	\$20

### Other Accessories

HP 1008A Option 006 Testmobile	\$1240
1540-1066 Soft Carrying Case (for HP 1650A and HP 1651A)	\$135
HP 46060A HP Mouse (for 16500A only)	\$148
HP 92192A Black double-sided 3.5" microfloppy discs (box of 10)	\$39
5061-6175 HP 1650A & HP 1651A Rackmount Kit	\$320
5061-9679 HP 16500A Rackmount Kit	\$40
9211-2658 HP 16500A Transit Case	\$520
9211-2645 HP 1650A & 1651A Transit Case	\$430

\*\*PDP-11, LSI-11, Unibus and Q-bus are trademarks of Digital Equipment Corporation.

\*\*\*Multibus is a trademark of Intel Corporation

# DIGITAL CIRCUIT TESTERS

## Signature Multimeter, Combines Counter and Multimeter Functions with Signature Analysis Model 5005B

- Digital and analog measurement capability optimized for digital troubleshooting
- Easy to use single probe measurement of logic signals, voltage, and frequency

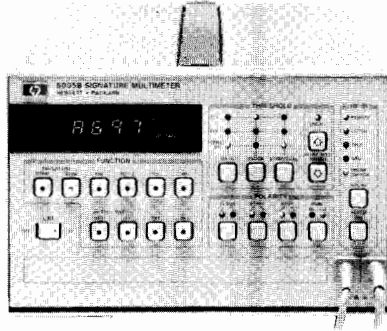

HP 5005B Programmable Signature Multimeter



### HP 5005B

Total checkout of a digital system often requires characterizing both digital data activity and analog signal parameters. A typical troubleshooting procedure may specify a digital multimeter for checking power supplies and circuit board integrity (shorts and opens), a universal counter to measure clock frequencies and time intervals between signals, and a means to verify the analog integrity of active digital signals. The HP 5005B Signature Multimeter offers, in a single instrument, a measurement set optimized for these types of digital troubleshooting applications.

- Field proven Signature Analysis (for multiple logic families).
- Digital multimeter (DC volts, resistance and differential voltage).
- Frequency counter (frequency, totalize, time interval).
- Voltage threshold (upper voltage peak, lower voltage peak).
- Multifunction probe.

### Signature Analysis

HP's patented Signature Analysis technique enables the HP 5005B to generate a compressed, four digit "fingerprint" or signature of the digital data stream at a logic node. Any fault associated with a device connected through the node will force a change in the data stream and, consequently, produce an erroneous signature.

Specific features of the HP 5005B Signature Analyzer include:

- Multiple logic family compatibility—preset threshold levels for TTL, CMOS, and ECL or adjustable thresholds (+12.5 V to -12.5 V) assure coverage of a wide variety of logic device types.
- 25 MHz clock frequency—extends Signature Analysis to high speed circuits such as CRT controllers.
- Qualified signature mode—speeds fault isolation in complex products by windowing signature collection to specific modules or devices without requiring major test setup changes. This simplifies the engineering involvement in hardware and software testability and accelerates test procedure preparation.

### Digital Multimeter

Certain digital problems result from analog circuit failures: a low power supply voltage, an open or shorted circuit path, a faulty A/D or D/A converter. Each may contribute to a system failure. The HP 5005B contains a 4½ digit dc voltmeter, ohmmeter, and differential voltmeter, each with performance geared toward analog measurements necessary in digital troubleshooting.

The implementation of each multimeter function emphasizes simplicity and convenience. Automatic internal self calibration and auto-ranging maximize troubleshooting efficiency by eliminating unnecessary interaction with the instrument. Improvements in display interpretation also aid troubleshooting. The ohmmeter, for example, when measuring an open circuit, produces an "OPEN" indication on the display rather than the typical overload display.

- 25 MHz, multiple logic family signature analysis with qualified clocking mode
- Complete HB-IB programmability of every function

### Frequency Counter

The counter within the HP 5005B provides totalize and frequency measurements to 50 MHz, and time interval measurements to 100 nanosecond resolution. Intended to extend the digital troubleshooting capabilities of the Signature Analysis (synchronous measurements), the counter functions provide the ability to characterize one-shots and timers through time interval measurement; test interrupt lines, reset lines, and asynchronous communication interfaces (RS-232) through totalize; and verify clock and clock driver circuitry through frequency measurement.

### Voltage Threshold

Logic level degradation is a common and troublesome malfunction in digital products. Isolating this failure typically requires displaying and interpreting the waveform. The HP 5005B's peak voltage measurement mode provides a simple, direct method of measuring logic high and logic low voltage of active digital signals.

The peak voltage measurement mode allows the HP 5005B to characterize and display either the greatest (positive peak) or lowest (negative peak) voltage measured at the probe. Selection of either positive peak or negative peak mode displays the appropriate measured threshold for comparison against the specifications of the logic family.

### Multifunction Probe

Several measurement functions incorporated into a single instrument can provide optimal troubleshooting efficiency only when each function is easy to use. The operator, when troubleshooting, must be able to measure the analog signal parameters and digital functional characteristics of a node without requiring time consuming and error-prone probe or instrument setup changes. The HP 5005B multifunction probe solves this problem by providing automatic access to the Signature Analyzer, multimeter, and counter functions through a single probe. All signal multiplexing to the appropriate measurement function is accomplished inside the HP 5005B.

This efficient probing scheme becomes particularly important in automatic applications. The HP 5005B takes advantage of the several functions available in the multifunction probe. A switch, located on the side of the probe, allows the operator to trigger automatic measurement. The instrument controller can then characterize both the analog parameters and functional digital operation of a circuit node while the operator probes the same point. This greater automatic measurement efficiency translates into increased troubleshooting productivity.

### HP-IB Programmability

Complete programmability makes the HP 5005B an ideal choice for automatic digital testing and troubleshooting. Every HP 5005B measurement and control function can be programmed through the HP-IB interface. This flexibility allows the automatic test system designer full access to the many measurement functions in the instrument.

Simplified programming enhances the automatic testing and troubleshooting productivity improvements inherent in the HP 5005B. Straightforward commands and data output formats aid in accelerating test program development. A measurement trigger switch located in the probe allows direct operator communication to the controller. Audible feedback, supplied by the beeper in the HP 5005B, can then indicate the completion of the measurement cycle. This closed-loop communication (controller-to-operator) aids in improving troubleshooting efficiency.

## HP 5005B Specifications

### Signature

**Display:** 4 digits. Characters 0-9, ACFHPU.

**Fault detection accuracy:** 100% probability of detecting single-bit errors; 99.998% probability of detecting multiple-bit errors.

**Minimum gate length:** 1 clock cycle (1 data bit) between START and STOP.

**Maximum gate length:** no limit.

**Minimum timing between gates:** 1 clock cycle between STOP and START.

### Data Probe Timing

**Setup time:** 10 ns (data to be valid at least 10 ns before selected clock edge.)

**Hold time:** 0 ns (data to be held until occurrence of selected clock edge.)

### START, STOP, QUAL Timing

**Setup time:** 20 ns (signals to be valid at least 20 ns before selected clock edge.)

**Hold time:** 0 ns (signals to be held until occurrence of selected clock edge.)

### CLOCK Timing

**Maximum clock frequency:** 25 MHz.

**Minimum pulse width:** 15 ns in high or low state.

**Quality mode:** allows data clock qualification by an external signal. DATA probe input impedance  $\approx 50$  k $\Omega$  to the average value of "0" and "1" threshold settings ( $\pm 6$  V max); 15 pF.

START, STOP, CLOCK, QUAL input impedance  $\approx 100$  k $\Omega$ ; 15 pF.

**Front panel indicators:** flashing GATE light indicates detection of valid START, STOP, CLOCK conditions. Flashing UNSTABLE light indicates a difference between 2 successive signatures, and possible intermittent faults.

### Frequency

**Display:** 5 digits.

**Ranges:** 100 kHz, 1 MHz, 10 MHz, 50 MHz, autoranged.

**Resolution:** 1 LSD (1 Hz on 100 kHz range).

**Accuracy:**  $\pm 0.01\%$  of reading  $\pm 1$  count.

Minimum pulse width  $\approx 10$  ns in high or low state.

Gate time  $\approx 1$  s, fixed.

Input impedance  $\approx 50$  k $\Omega$  to the average value of "0" and "1" threshold settings ( $\pm 6$  V max); 15 pF.

### Totalizing

**Display:** 5 digits.

**Range:** 0-99,999 counts.

**Resolution:** 1 count.

Maximum input frequency  $\approx 50$  MHz, with a minimum pulse width of 10 ns, and minimum pulse separation of 10 ns.

Minimum START/STOP pulse width  $\approx 20$  ns.

DATA input impedance  $\approx 50$  k $\Omega$  to the average value of "0" and "1" threshold settings ( $\pm 6$  V max); 15 pF.

START, STOP input impedance  $\approx 100$  k $\Omega$ ; 15 pF.

### Time Interval

**Display:** 5 digits.

**Ranges:** 10 ms, 100 ms, 1 s, 10 s, 100 s, autoranged.

**Resolution:** 1 count (100 ns on 10 ms range).

**Accuracy:**  $\pm 0.01\%$  of reading  $\pm 2$  counts.

Minimum START/STOP pulse width  $\approx 20$  ns.

START, STOP input impedance  $\approx 100$  k $\Omega$ ; 15 pF.

### Resistance

**Display:** 4 or 5 digits, depending on range.

**Ranges:** 30 k $\Omega$ , 300 k $\Omega$ , 1 M $\Omega$ , 3 M $\Omega$ , 10 M $\Omega$ , autoranged.

**Accuracy:** (at 15°C–30°C).

RANGE	FULL SCALE	ACCURACY	DISPLAY RESOLUTION
30 k $\Omega$	29.999 k $\Omega$	$\pm 1\%$ of reading $\pm 2$ $\Omega$	1 $\Omega$
300 k $\Omega$	299.99 k $\Omega$	$\pm 1\%$ of reading	10 $\Omega$
1 M $\Omega$	999.9 k $\Omega$	$\pm 1\%$ of reading	100 $\Omega$
3 M $\Omega$	2999. k $\Omega$	$\pm 10\%$ of reading	1 k $\Omega$
10 M $\Omega$	10000. k $\Omega$	$\pm 10\%$ of reading	10 k $\Omega$

Input impedance  $\approx 20$  k $\Omega$  to  $\pm 2$  V

### DC Voltage

**Display:** 4½ digits.

**Ranges:**  $\pm 25$  V,  $\pm 250$  V, autoranged; referenced to earth ground.

**Accuracy:** (at 15°C–30°C).

RANGE	ACCURACY	RESOLUTION
25 V	$\pm 0.1\%$ of reading $\pm 2$ mV	1 mV
250 V (<100 V)	$\pm 0.25\%$ of reading $\pm 20$ mV	10 mV
250 V ( $\geq 100$ V)	$\pm 0.25\%$ of reading $\pm 20$ mV	100 mV

Input impedance  $\approx 10$  M $\Omega$ .

### Differential Voltage

**Reading:** reads input voltage present at the probe and displays difference between it and voltage at the time  $\Delta V$  key was depressed.

**Specifications:** same as for DCV, above. Voltage range is determined by larger of 2 compared voltages.

### Peak Voltage

**Display:** 3½ digits.

**Range:** 0– $\pm 12$  Vp.

**Resolution:** 50 mV.

**Accuracy:**  $\pm 2\%$  of reading  $\pm 5\%$  of p-p signal  $\pm 100$  mV.

Minimum peak duration  $\approx 10$  ns.

Maximum time between peaks  $\approx 50$  ms.

Input impedance  $\approx 100$  k $\Omega$ ; 15 pF.

### Signature Analyzer Logic Thresholds

Preset thresholds: TTL, ECL, CMOS.

**Adjustable thresholds:** each preset threshold can be adjusted.

**Range:**  $\pm 12.5$  V, in 50 mV steps.

**Accuracy:**  $\pm 2\%$  of setting,  $\pm 2$  V

Logic threshold circuitry is operative during NORM, QUAL, kHz, TOTLZ and ms measurements.

### General

**Data probe tip:** acts as high-speed logic probe in the NORM, QUAL, kHz and TOTLZ modes. Lamp indicates high, low, bad-level and pulsing states.

Minimum detected pulse width is 10 ns.

### Data Probe Protection

#### Continuous Overload

**DCV,  $\Delta V$ , k $\Omega$  modes only:**  $\pm 250$  V ac/dc.

**All other modes:**  $\pm 150$  V ac/dc, 20 V rms at input frequencies  $> 2$  MHz.

**Intermittent overload:**  $\pm 250$  V ac/dc, up to 1 min, for all modes.

#### Timing Pod Protection

**Continuous overload:**  $\pm 100$  V ac/dc, 20 V rms at input frequencies  $> 2$  MHz.

**Intermittent overload:**  $\pm 140$  V ac/dc, up to 1 min.

**Auxiliary power supply:** three rear-panel connectors supply 5 V at 0.7A total for accessories (HP 5005A only)

**Operating temperature:** 0°C to +55°C.

**Power:** selectable 100 V, 120 V, 220 V or 240 V ac line (+5%–10%), 48–66 Hz, 35 VA maximum.

**Weight:** Net: 5.5 kg (12.0 lb.) Shipping: 8.7 kg (19 lb.).

**Size:** 133 mm H x 212 mm W x 432 mm D (5¼" x 8⅜" x 17"), excluding handle.

### Ordering Information

HP 5005B Signature Multimeter

Opt 910: Additional Manual

### Price

\$5,600

+ \$70

# DIGITAL CIRCUIT TESTERS

## Signature Analyzer, A Digital Troubleshooting Tool

Model 5006A

- Reduce warranty and service support costs
- Full at-speed testing of digital products

- Reduce comparisons to documentation with composite signature
- Compare signatures in groups with signature memory

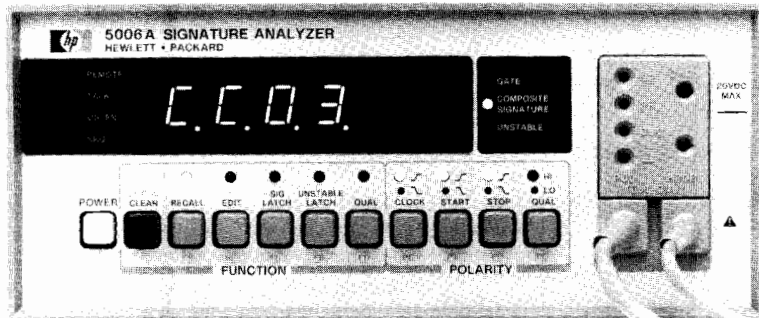

HP 5006A



### HP 5006A Signature Analyzer

#### The Technique

Signature Analysis is a fast and accurate troubleshooting method for digital circuits. Fault finding is reduced to tracing signal flow and comparing measured signatures to those recorded on paper or in a computer. Troubleshoot with Signature Analysis by probing the circuit, reading the display and comparing to the known good signature. A signature is a cyclic redundancy code (CRC) used as an error detection check on blocks of data. Test patterns may be generated within a circuit or stimulated externally.

#### Programmability Means Efficiency

The HP 5006A is completely programmable using the optional HP-IB interface. Upgrade production test and troubleshooting systems to include digital troubleshooting by adding the HP-IB option.

Signatures compress the necessary troubleshooting information of a bit stream into 16 bits. Instead of entire bit streams, only signatures need be compared to detect bit errors in the unit under test.

#### Time Savers

Composite signature and signature memory save time for the troubleshooter who does not have a computer-aided system. Composite signature is the binary sum of individual signatures. The HP 5006A computes it for any grouping of digital signals (i.e., bus or IC). Only one "composite" signature need be compared to documentation if all signals for that group are good.

Signatures are stored in the HP 5006A memory after the probe switch is pushed. The memory stores the last 32 signatures probed. Individual signatures can now be compared in groups instead of after each probe by reviewing the memory in the RECALL mode.

### HP 5006A Specifications

#### General

**Display:** 4 digits. Characters 0-9, ACFHPU.

**Fault detection accuracy:** 100% probability of detecting single-bit errors; 99.998% probability of detecting multiple-bit errors.

**Composite signature:** maximum number of signatures: No limit.

Sums all signatures, triggered by probe switch, following depression of CLEAR key, or power-up.

**Signature memory:** signatures recallable by probe switch: The last 32 signatures triggered by probe switch.

#### Timing

**Clock:** maximum frequency: 25 MHz. Minimum clock time: 15 ns in high or low state.

**Probe:** setup time: 10 ns with 0.2 V overdrive. (Data to be valid at least 10 ns before selected clock edge.) Hold time: 0 ns. (Data to be held after occurrence of selected clock edge.)

**Start, stop, qualifier:** setup time: 20 ns with 0.2 V overdrive. (Data to be valid at least 20 ns before selected clock edge.) Hold time: 0 ns. (Data to be held until occurrence of selected clock edge.)

**Minimum gate length:** 1 clock cycle (1 data bit) between START and STOP.

**Maximum gate length:** no limit.

**Minimum timing between gates:** 1 clock cycle between STOP and START.

#### Input Impedance

**Probe:** 50 k $\Omega$  to ground nominal.

**Pod:** 100 k $\Omega$  to ground nominal.

#### Overload Protection

**Probe:**  $\pm 150$  V continuous.

$\pm 250$  V intermittent.

250 Vac for 1 minute.

**Pod:**  $\pm 20$  V continuous.

$\pm 140$  V intermittent.

$\pm 140$  Vac for 1 minute.

**CMOS sense:** 20 Vdc maximum.

#### TTL Thresholds

**Probe:** Logic one: 2 V + .2-.3. Logic zero: 0.8 V +.3-.2

**Pod:** 1.4 V  $\pm$  .6

#### CMOS Thresholds

**Logic one:** 70% of sensed voltage.

**Logic zero:** 30% of sensed voltage.

#### Display and Indicators

**Signature:** four seven-segment digits with decimal point.

**Lamps:** Key Status: Recall, edit, signature latch, unstable latch, qualify mode, timing polarities. Programmable: Remote, talk, listen, SRQ. (Option 040). Status: Composite signature, gate, unstable.

**Probe:** logic levels indicated: High, low, open and pulsing. Minimum pulse width: 10 ns.

#### Other

**Selectable power:** 115 V +10%–25% ac line, 48-440 Hz.

230 V +10–15% ac line, 48-66 Hz. 25 VA maximum.

**Operating environment:** temperature: 0-55°C. Humidity: 95% RH at +40°C. Altitude: 4600 m (15,000 ft).

**Size:** 89 mm H x 216 mm W 279 mm D (3-1/2 in. x 8-1/2 in. x 11 in.).

**Net weight:** 2.4 kg (5.3 lb). Shipping weight: 4.1 kg (9 lb).

#### Ordering Information

**HP 5006A** Signature Analyzer

**Opt 40** HP-IB Interface

**Opt 910** Additional Manual

**HP 5060-0173** Half Rack Mount Kit

#### Price

\$1920

+ \$300

+ \$16.50

\$68



# DIGITAL CIRCUIT TESTERS

## Logic Probe, Logic Pulser, Digital Current Tracer

Models 545A, 546A, 547A

275

### HP 545A TTL/CMOS Logic Probe

The HP 545A Logic Probe contains all the features built into other HP probes, plus switch-selectable, multi-family operation and built-in pulse memory. Employing straightforward one-lamp display the HP 545A operates from 3 to 18 volts in CMOS applications or from 4.5 to 15 Vdc supplies in the TTL mode while maintaining standard TTL thresholds.

The probe's independent, built-in pulse memory and LED display help you capture hard to see, intermittent pulses. Just connect the probe tip to a circuit point, reset the memory, and wait for the probe to catch those hard to find glitches.

The hand-held HP 545A is light, rugged, overload protected, and very fast: 80 MHz in TTL, 40 MHz in CMOS. It also employs handy power supply connectors that enable you to easily hook up to supply voltage almost anywhere in the unit under test.

### HP 545A Probe Specifications

**Input current:**  $\leq 15 \mu\text{A}$  (source or sink).

**Input capacitance:**  $\leq 15 \text{ pF}$ .

#### Logic thresholds

**\*TTL:** Logic one  $2.0 + 0.4$ ,  $-0.2 \text{ V}$ . Logic zero  $0.8 + 0.2$ ,  $-0.4 \text{ V}$ .

**CMOS:** 3–10 Vdc supply

Logic one:  $0.7 \times V_{\text{supply}} \pm 0.5 \text{ Vdc}$ .

Logic zero:  $0.3 \times V_{\text{supply}} \pm 0.5 \text{ Vdc}$ .

**CMOS:**  $\geq 10$ –18 Vdc supply.

Logic one:  $0.7 \times V_{\text{supply}} \pm 1.0 \text{ Vdc}$ .

Logic zero:  $0.3 \times V_{\text{supply}} \pm 1.0 \text{ Vdc}$ .

**Input minimum pulse width:** 10 ns using ground lead (typically 20 ns without ground lead).

**Input maximum pulse repetition frequency:**

TTL, 80 MHz. CMOS, 40 MHz.

**Input overload protection:**  $\pm 120 \text{ V}$  continuous (dc to 1 kHz);  $\pm 250$  for 15 seconds (dc to 1 kHz).

**Pulse memory:** indicates first entry into valid logic level; also indicates return to initial valid level from bad level for pulse  $\geq 1 \mu\text{s}$  wide.

#### Power Requirements

**TTL:** 4.5 to 15 Vdc\*.

**CMOS:** 3 to 18 Vdc.

**Maximum current:** 70 mA.

**Overload protection:**  $\pm 25 \text{ Vdc}$  for one minute.

**Accessory included:** ground clip.

\* $\pm 5$ – $\pm 10\%$  power supply; usable to  $\pm 15 \text{ Vdc}$  with slightly increased logic low threshold.

### HP 546A Logic Pulser

The Logic Pulser solves the problem of how to pulse IC's in digital circuits. Merely touch the Pulser to the circuit under test, press the pulse button and all circuits connected to the node (outputs as well as inputs) are briefly driven to their opposite state. No unsoldering of IC outputs is required. Pulse injection is automatic, high nodes are pulsed low and low nodes, high, each time the button is pressed.

Automatic polarity pulse output, pulse width, and amplitude make for easy multi-family operation when you use the HP 546A Logic Pulser. But, the real surprise comes when you code in one of its six ROM-programmable output patterns (single pulses; pulse streams of either 1, 10, or 100 Hz; or bursts of 10 or 100 Hz; or bursts of 10 or 100 pulses). This feature allows you to continually pulse a circuit when necessary, or it also provides an easy means to put an exact number of pulses into counters and shift registers. Used with our multi-family IC Troubleshooters, the HP 546A acts as both a voltage and current source in digital troubleshooting applications.

### HP 546A Pulser Specifications

#### Output

Family	Output Current	Pulse Width	Typical Output Voltage	
			HIGH	LOW
TTL/DTL	$\leq 650 \text{ mA}$	$\geq 0.5 \mu\text{s}$	$\geq 3 \text{ Vdc}$	$\leq 0.8 \text{ Vdc}$
CMOS	$\leq 100 \text{ mA}$	$\geq 5.0 \mu\text{s}$	$\geq (V_{\text{supply}} - 1 \text{ Vdc})$	$\leq 0.5 \text{ Vdc}$

**Power supply requirements:** TTL; 4.5 to 5.5 Vdc at 35 mA, CMOS; 3 to 18 Vdc at 35 mA, protected to  $\pm 25 \text{ Vdc}$  for 1 min.

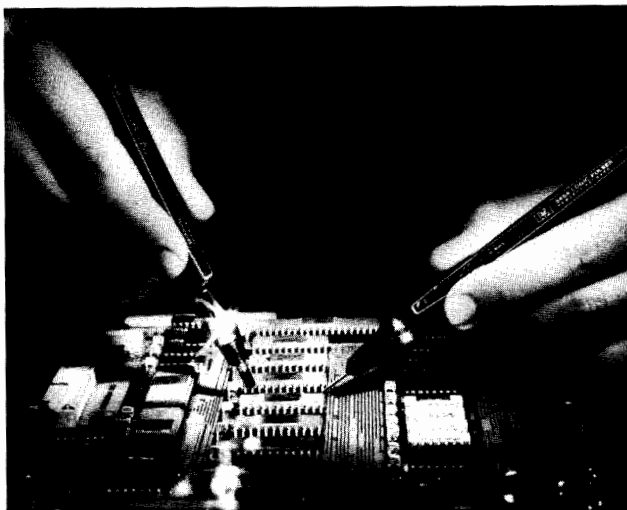

HP 547A/546A

### HP 547A Digital Current Tracer

The HP 547A Current Tracer precisely locates low-impedance faults in digital circuits by locating current sources or sinks. For example, on a bad node the Tracer can verify that the driver is functioning and also show where the problem is by tracing current flow to the source or sink causing the node to be stuck. The Tracer is designed to troubleshoot circuits carrying fast rise-time current pulses. The Tracer senses the magnetic field generated by these signals in the circuit and displays transitions, single pulses, and pulse trains using a simple one-light indicator. Because it is not voltage sensitive, the Tracer operates on all logic families having current pulses exceeding 1 mA, including CMOS, where even lightly loaded outputs can have up to 2 to 3 mA of instantaneous charging current.

To use the Tracer, align the dot on its tip at a reference point, usually the output of a node driver. Set the sensitivity control to indicate the presence of ac current activity. As you probe from point to point or follow traces, the lamp will change intensity; when you find the fault the Tracer will indicate the same brightness found at the reference point.

### HP 547A Current Tracer Specifications

#### Input

**Sensitivity:** 1 mA to 1 A.

**Frequency response:** light indicates single-step current transitions; single pulses  $\geq 50 \text{ ns}$  in width; pulse trains to 10 MHz (typically 20 MHz for current pulses  $\geq 10 \text{ mA}$ ).

**Risetime:** light indicates current transitions with risetime  $\leq 200 \text{ ns}$  at 1 mA.

#### Power Supply Requirements

**Voltage:** 4.5 to 18 Vdc.

**Input current:**  $\leq 75 \text{ mA}$ .

**Maximum ripple:**  $\pm 500 \text{ mV}$  above 5 Vdc.

**Overvoltage protection:**  $\pm 25 \text{ Vdc}$  for one minute.

#### Accessories Available

HP 00545-60104: Tip Kit for HP 546A Pulser, 545A Probe

Price

\$55 ☎

HP 10526-60002: Multi-Pin Stimulus Kit

\$77 ☎

HP 1250-1948 Adapter, Coax Str.

\$25

#### Ordering Information

HP 545A Logic Probe

\$240 ☎

HP 546A Logic Pulser

\$320 ☎

HP 547A Digital Current Tracer

\$570 ☎

☎ Fast-ship product—see page 766.

# DIGITAL CIRCUIT TESTERS

## Logic Clip, Logic Comparator

### Models 548A & 10529A



HP 548A

#### HP 548A Logic Clip

The Logic Clip is an extremely handy service and design tool which clips onto dual-in-line package (DIP) ICs, instantly displaying the states of up to 16 pins. Each of the clip's 16 LEDs independently follows level changes at its associated pin. Lit diodes are logic High, extinguished diodes are Low.

The Logic Clips' real value is in its ease of use. It has no controls to set, needs no power connections, and requires practically no explanation as to how it is used. The clip has its own gating logic for locating ground and  $V_{CC}$  pins and its buffered inputs reduce circuit loading.

The Logic Clip is much easier to use than either an oscilloscope or a voltmeter when you are interested in whether a circuit is in the high or low state, rather than its actual voltage. The Clip, in effect, is 16 binary voltmeters, and the user does not have to shift his eyes away from his circuit to make the readings.

The intuitive relationship of the input to the output—lighted diode corresponding a high logic state—greatly simplifies the troubleshooting procedure. The user is free to concentrate his attention on his circuits, rather than on measurement techniques. Also, timing relationships become especially apparent when clock rates can be slowed to about 1 pulse per second.

When used in conjunction with the Logic Pulser, the Logic Clip offers unparalleled analysis capability for troubleshooting sequential Logic Devices used to inject pulses between gates allowing it to supply signals to the IC under test absolutely independent of gates connected to the IC. All outputs may then be observed simultaneously on the Logic Clip. Deviations from expected results are immediately apparent as the Pulser steps the IC through its truth table.

#### HP 548A Multi-Family Logic Clip

Fully automatic and protected to 30 Vdc, and employing bright individual LEDs in its display, the HP 548A brings multi-family operation to the HP line of IC Troubleshooters. The Clip can be externally powered, if desired, using a simple power connector.

#### HP 548A Specifications

**Input threshold:**  $(\geq 0.4 \pm 0.06 \times \text{Supply Voltage}) = \text{Logic High}$ .

**Input impedance:** 1 CMOS load per input.

**Input protection:** 30 Vdc for 1 minute.

**Supply voltage:** 4-18 Vdc across any two pins.

**Auxiliary supply input:** 4.5 to 20 Vdc applied via connector. Supply must be  $\geq 1.5$  Vdc more positive than any pin of IC under test.

**Supply current:**  $< 55$  mA.

#### HP 548A Logic Clip

☎ Fast-ship product—see page 766.

**\$290** ☎

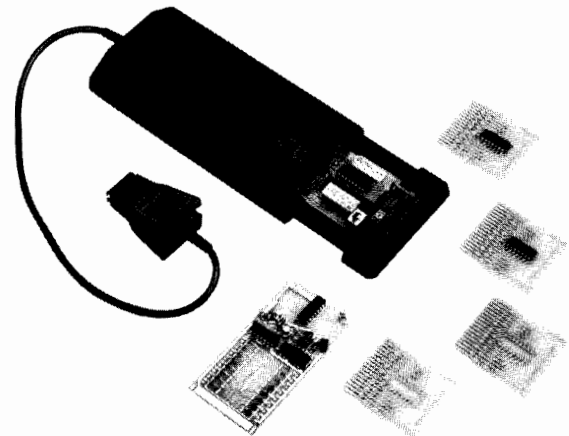

HP 10529A

#### HP 10529A Logic Comparator

The HP 10529A Logic Comparator clips onto powered TTL or DTL ICs and detects functional failures by comparing the in-circuit test IC with a known good reference IC inserted in the Comparator. Outputs of the particular IC to be tested are selected via 16 miniature switches which tell the Comparator which pins of the reference IC are inputs and which are outputs. Any logic state difference between the test IC and reference IC is identified to the specific pin(s) on 14- or 16-pin dual in-line packages on the Comparator's display. A lighted LED corresponds to a logic difference. Intermittent errors as short as 300 nanoseconds (using the socket board) are detected, and the error indication on the Comparator's display is stretched for a visual indication. A failure on an input pin, such as an internal short, will appear as a failure on the IC driving the failed IC; thus a failure indication actually pinpoints a malfunctioning node. A test board is supplied to exercise all of the circuitry, test leads, and display elements to verify proper operation.

**HP 10541A:** twenty additional blank reference boards; identical to the 10 boards provided with the Logic Comparator.

**HP 10541B:** twenty preprogrammed reference boards. The 10541B includes the following ICs: 7400, 7402, 7404, 7408, 7410, 7420, 7430, 7440, 7451, 7454, 7473, 7474, 7475, 7476, 7483, 7486, 7490, 7493, 74121, 9601.

#### HP 10529A Specifications

**Input threshold:** 1.4 V nominal (1.8 V nominal with socket board), TTL or DTL compatible.

**Test IC loading:** outputs driving Test IC inputs are loaded by 5 low-power TTL loads plus input of Reference IC. Test IC outputs are loaded by 2 low-power TTL loads.

**Input protection:** voltages  $< -1$  V or  $> 7$  V must be current limited to 10 mA.

**Supply voltage:** 5 V  $\pm 5\%$ , at 300 mA.

**Supply protection:** supply voltage must be limited to 7 V.

**Maximum current consumption:** 300 mA.

#### Sensitivity

**Error sensitivity:** 200 ns with reference board or 300 ns with socket board. Errors greater than this are detected and stretched to at least 0.1 second.

**Delayed variation immunity:** 50 ns. Errors shorter than this value are considered spurious and ignored.

**Frequency range:** maximum operational frequency varies with duty cycle. An error existing for a full clock cycle will be detected if the cycle rate is less than 3 MHz.

**Accessories included:** 1 test board; 10 blank reference boards; 1 programmable socket board; 1 carrying case.

#### Accessories Available

**HP 10541A:** Twenty Blank Reference Boards

**HP 10541B:** Twenty Pre-programmed Boards

**Price**

\$130 ☎

\$400 ☎

#### HP 10529A Logic Comparator

☎ Fast-ship product—see page 766.

**\$990** ☎

# DIGITAL CIRCUIT TESTERS

## Logic Troubleshooting Kits

Models 5011T, 5021A, 5022A, 5023A & 5024A

277

- Complete multi-family kits
- Stimulus-response capability
- In-circuit fault finding

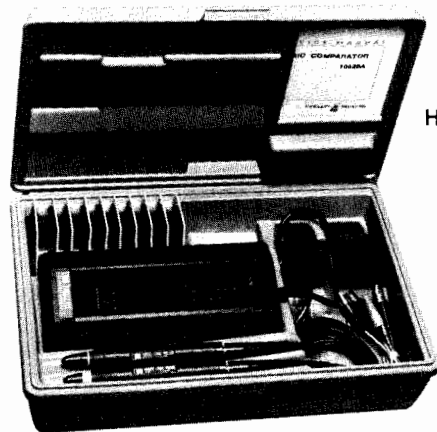

HP 5011T

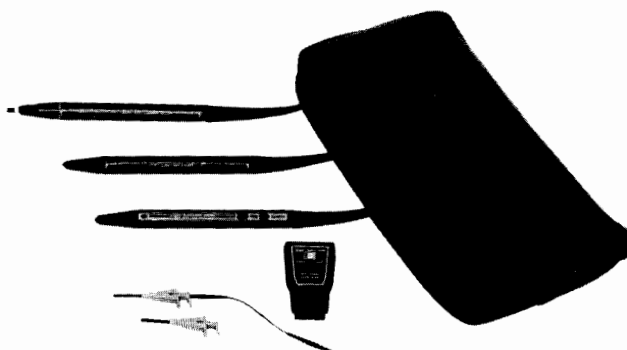

HP 5022A

FAULT	STIMULUS	RESPONSE	TEST METHOD
Shorted Node <sup>1</sup>	Pulser <sup>2</sup>	Current Tracer	<ul style="list-style-type: none"> <li>• Pulse shorted node</li> <li>• Follow current pulses to short</li> </ul>
Stuck Data Bus	Pulser <sup>2</sup>	Current Tracer	<ul style="list-style-type: none"> <li>• Pulse bus line(s)</li> <li>• Trace current to device holding the bus in a stuck condition</li> </ul>
Signal Line Short to Vcc or Ground	Pulser	Probe, Current Tracer	<ul style="list-style-type: none"> <li>• Pulse and probe test point simultaneously</li> <li>• Short to Vcc or Ground cannot be overridden by pulsing</li> <li>• Pulse test point, and follow current pulses to the short</li> </ul>
Supply to Ground Short	Pulser	Current Tracer	<ul style="list-style-type: none"> <li>• Remove power from circuit under test</li> <li>• Disconnect electrolytic bypass capacitors</li> <li>• Pulse across Vcc and ground using accessory connectors provided</li> <li>• Trace current to fault</li> </ul>
Internally Open IC	Pulser <sup>2</sup>	Probe	<ul style="list-style-type: none"> <li>• Pulse device input(s)</li> <li>• Probe output for response</li> </ul>
Solder Bridge	Pulser <sup>2</sup>	Current Tracer	<ul style="list-style-type: none"> <li>• Pulse suspect line(s)</li> <li>• Trace current pulses to the fault</li> <li>• Light goes out when solder bridge passed</li> </ul>
Sequential Logic Fault in Counter or Shift Register	Pulser	Clip	<ul style="list-style-type: none"> <li>• Circuit clock de-activated</li> <li>• Use Pulser to enter desired number of pulses</li> <li>• Place Clip on counter or shift register and verify device truth table</li> </ul>

1. A node is an interconnection between two or more IC's.
2. Use the Pulser to provide stimulus or use normal circuit signals, whichever is most convenient.

### Accessories Available

- HP 00545-60104:** Tip Kit for HP 545A Probe, and 546A Pulser \$55 ☎
- HP 10526-60002:** Multi-pin Stimulus Kit for Logic Pulser \$77
- HP 10529-60006:** External Reference Kit for HP 10529A Comparator \$440
- HP 10541A:** Twenty blank reference boards for HP 10529A Comparator \$130 ☎
- HP 10541B:** Twenty pre-programmed reference boards for HP 10529A Comparator \$400 ☎
- ☎ Fast-ship product—see page 766.

- In-circuit analysis
- Dynamic and static testing
- Multi-pin testing

Used individually, each of HP's IC Troubleshooters provide their own unique and important troubleshooting function. Together they become invaluable stimulus-response testing partners that help pinpoint faults and ensure fast non-destructive repair of digital circuits.

To help you take advantage of the usefulness of the IC Troubleshooters, HP has packaged them into kits which offer both ordering convenience, and cost savings. Also, applications information is available, such as AN 163-2, "New Techniques of Digital Troubleshooting", to help users derive maximum benefit from these instruments.

The table shows a series of typical node and gate faults and the combination of tools used to troubleshoot the circuit. As with all sophisticated measuring instruments, operator skill and circuit knowledge are key factors once the various clues or "bits" of information are obtained using the IC Troubleshooters.

To accomplish troubleshooting at the node and gate level, both stimulus (Pulser) and response (Probe, Tracer, Clip and Comparator) instruments are needed. Moreover, instruments with both voltage and current troubleshooting capability help isolate electrical faults where the precise physical location is hard to identify.

The HP 547A Current Tracer, the latest and most sophisticated of these troubleshooters, lets you "see" current flow on nodes and buses that otherwise appear stuck at one voltage level. Used with the HP 546A Pulser, stimulus-response testing is now also possible in the current domain.

### IC Troubleshooter Kits Ordering Information

Kit	H mm (in)	W mm (in)	D mm (in)	Net Wt kg (lbs, oz)	Ship Wt kg (lbs, oz)
HP 5011T	82.6 (3.25)	203 (8)	311 (12.25)	1.49 (3.5)	2.11 (4.11)
HP 5021A	64 (2.5)	146 (5.75)	298 (11.75)	0.51 (1.2)	0.62 (1.6)
HP 5022A	64 (2.5)	146 (5.75)	298 (11.75)	0.65 (1.7)	0.76 (1.11)
HP 5023A	225 (8.88)	200 (7.88)	337 (13.25)	1.63 (3.10)	2.19 (4.14)
HP 5024A	64 (2.5)	146 (5.75)	298 (11.75)	0.60 (1.5)	0.71 (1.9)

### IC Troubleshooter Kits Selection Guide

HP MODEL	545A TTL/CMOS Probe	546A TTL/CMOS Pulser	547A TTL/CMOS Current Tracer	548A TTL/CMOS Clip	10529A TTL Comparator	PRICE \$
5011T Kit	X	X		X	X	1800 ☎
5021A Kit	X	X		X		830 ☎
5022A Kit	X	X	X	X		1390 ☎
5023A Kit	X	X	X	X	X	2360 ☎
5024A Kit	X	X	X			1110 ☎

☎ Fast-ship product—see page 766

# COMPONENT MEASUREMENT

## General Information Impedance Measurement

Application Area	Component/Material Manufacturer		Component User	
	R&D and QA	Production	Incoming Inspection	R&D
Major Requirements	Verify that device has sufficient performance	Perform GO/NO-GO testing based on MIL, IEC, etc.	Evaluate devices/circuits under actual working conditions	
Required Measurement Functions	Multi-function/General Purpose Wide freq. range Auto freq. sweep Variable signal level & DC Bias Multi-parameter High accuracy and resolution	High Speed/Single Function High Speed Fixed frequency level & DC Bias Single parameter	Multi-function/General Purpose High frequency resolution Auto freq. sweep Variable signal level & DC Bias Multi-parameter High accuracy and resolution	
HP 4195A				
HP 4194A				
HP 4192A				
HP 4191A				
HP 4193A				
HP 4284A				
HP 4274A/ 4275A				
HP 4278A				
HP 4276A/ 4277A				
HP 4279A				
HP 4261A/ 4262A				
HP 4342A				
HP 4328A				
HP 4329A				

**Table 1 Component measurement applications and HP products**

Note: Refer to page 230 for complete information of the HP 4195A.

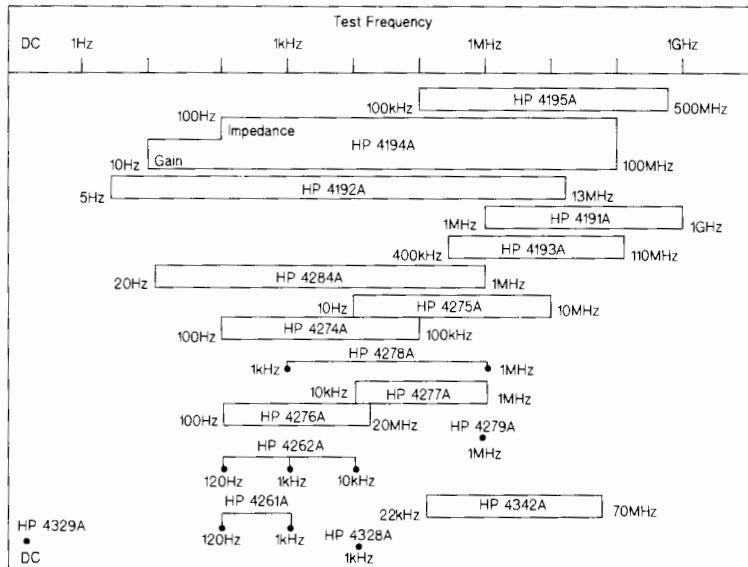

**Table 2 HP component measurement products vs. test frequency**

Note: Refer to page 230 for complete information of the HP 4195A.

### Component Measurement

An impedance-measuring instrument measures impedance characteristics of electronic components, materials and circuits. HP impedance instruments provide:

1. A broad product line, to fit each application;
2. Full evaluation of impedance characteristics under conditions of varying frequency, test-signal level and DC bias.
3. High-precision, high-resolution impedance measurement, with error correction for test-lead or test-fixture effects.

Impedance-measuring instruments can be divided into two general categories: LCR meters and impedance analyzers. The LCR meter primarily measures the inductance, capacitance and resistance of a test device. The impedance analyzer, in addition to all of the functions of the LCR meter, measures the impedance and phase of the test device, and makes detailed analysis of the impedance measurement.

The major applications of impedance-measurement instruments are in electronic-component materials manufacture and electronic equipment manufacture (electronic component users). **Table 1** shows the type of evaluation and the functions required according to instrument application.

Impedance measurements can be divided into two general categories:

1. Tests of whether the test device functions properly under application conditions and
2. Tests under conditions stipulated by MIL or IEC standards.

When type 1 measurements are conducted in an R&D department, the purpose is to shorten development time through careful evaluation. Therefore, a multi-function, general-purpose instrument for the measurement of many characteristics is required, such as an impedance analyzer or high-resolution LCR meter.

Type 2 measurements are conducted for go/no-go tests in manufacturing or incoming inspection. The measurement data are fed back to vendors or manufacturing processes for correction and improvement. Because of volume, test costs must be minimized. Therefore, a high-speed, single-function instrument may be used. Sorting and interpreting test results may be required, so an LCR meter with a comparator option can be used.

**Table 2** shows HP's line of instruments arranged according to measurement frequency and performance. Test frequencies of these instruments range from 5 Hz to 1 GHz, and some have fixed MIL/IEC standard frequencies between 1 kHz and 1 MHz.

Since the time that HP introduced the first digital LCR meter, the company has continued to create high-performance impedance-measurement instruments. Because of this effort, it is now possible for virtually anyone to make the most difficult impedance measurements with ease and great accuracy.

**Variety of available test fixtures and cables**

A variety of test fixtures and cables are available for the HP LCR meters for many applications. Table 3 and Figure 1 are compatibility charts for the test fixtures and cables and HP's LCR meters. Refer to the individual LCR meter data sheet for details.

	4261A	4262A
16061A	○	○
16062A	○	○
16063A	○	○

**Table 3 HP instruments with banana plugs vs. accessories**

- 1: information given with cable length; connector type; recommended frequency for use; max. applicable dc voltage.
- 2: information given with recommended frequency for use; max. applicable dc voltage.
- 3: information given with cable length; recommended frequency for use; max. applicable dc voltage; (shape of UNKNOWN terminals).
- 4: a cable with 7 mm connectors required.

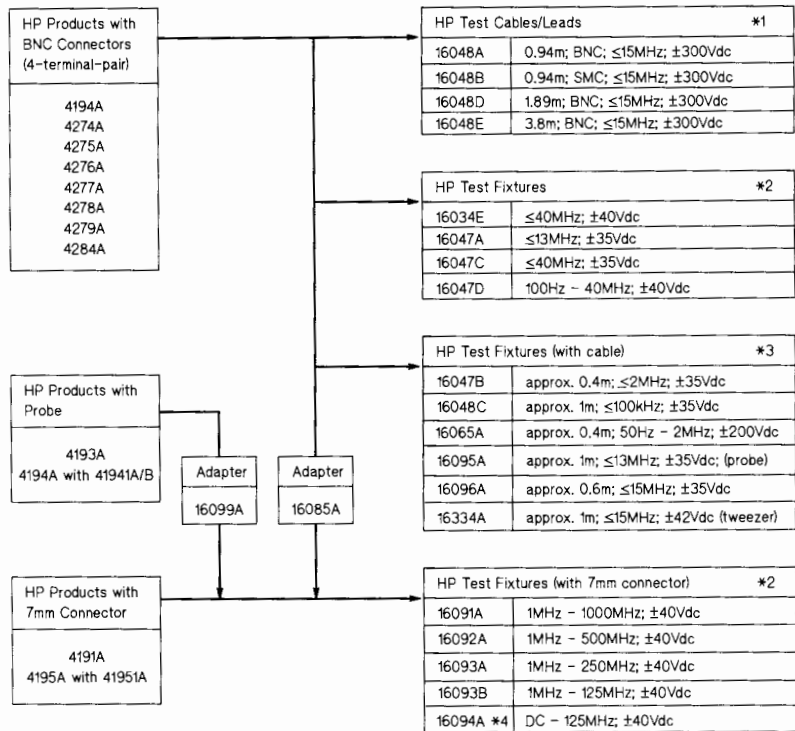

**Figure 1. HP instruments vs. accessories**

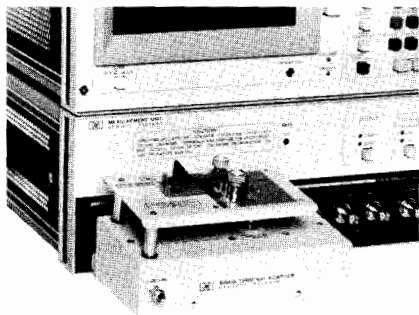

HP 16092A with HP 16085A

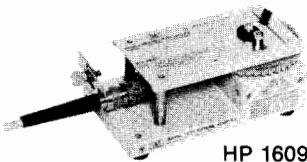

HP 16093A with HP 16099A

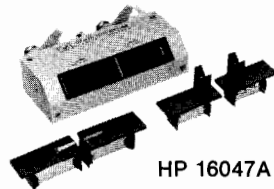

HP 16047A



HP 16047C

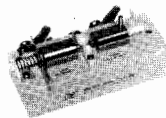

HP 16034E

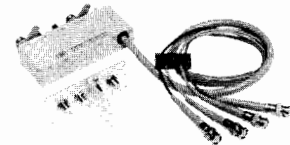

HP 16048A

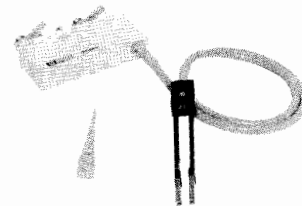

HP 16334A

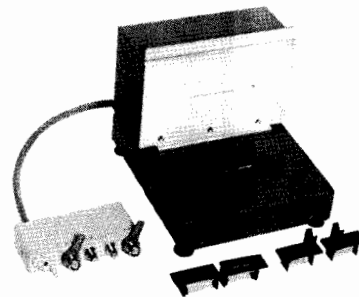

HP 16065A

Note: Refer to the sections of the HP 41941A/B and 41951A for more information.



# COMPONENT MEASUREMENT

## Impedance/Gain-Phase Analyzer

Model 4194A

- High Accuracy and Wide Range

Impedance Measurement:

100Hz to 40MHz, 0.1m $\Omega$  to 1.6M $\Omega$ , 0.17%  
10 kHz to 100 MHz, 0.1 $\Omega$  To 1M $\Omega$ , 1.5% when  
used with the HP 41941A/B

Gain-Phase Measurement:

10Hz to 100MHz, -107dBm to +15dBm, 0.1dB  
resolution

- Flexible Measurement, Computation and Analysis Capabilities on a Color Graphic Display
- Fully Programmable

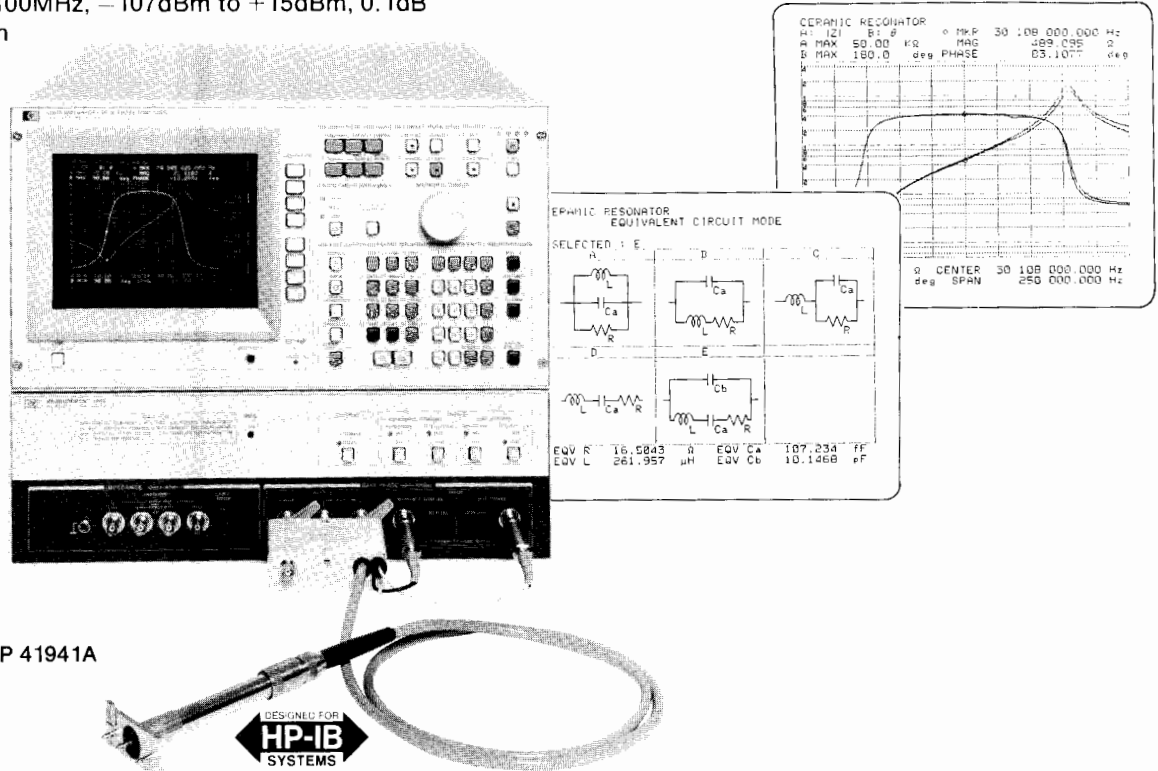

HP 4194A with HP 41941A

### Description

The HP 4194A Impedance/Gain-Phase Analyzer is an integrated solution for efficient measurement and analysis or go/no-go testing of components and circuits. Detailed impedance and transmission characteristics including secondary parameter derivations can be simply and quickly evaluated or tested. The HP 4194A can contribute to improving engineering productivity and reducing test cost. The analyzer is flexible and has wide measurement capabilities in both impedance and transmission measurements, plus it is fully programmable using Auto Sequence Programming (ASP). Desired measurements and computations, including graphics analysis, can be programmed simply by storing front panel keystroke operations, allowing you to customize measurement, computation and analysis functions. The HP 4194A also features high accuracy and error elimination functions to ensure reliable measurements.

### Wide Range Accurate Measurement

Featuring a wide test frequency range — 100Hz to 40MHz for impedance measurements (10kHz to 100MHz when using the HP 41941A/B Impedance Probe Kit) and 10Hz to 100MHz for gain-phase measurements — the HP 4194A satisfies a wide spectrum of needs. Realistic device characteristics can be analyzed under actual operating conditions by varying the test frequency, test signal level, and dc bias. The HP 4194's high degree of measurement accuracy — 0.17% for impedance measurements (1.5% when using the HP 41941A/B) with an amplitude ratio of 0.1 dB — ensures that you'll improve the quality of your test devices.

### Quick Analysis

The HP 4194A makes high speed measurements, (approximately 3.7ms per point), displays results on a color CRT, and performs parameter analysis of components and circuits quickly and efficiently;

substantially reducing development and evaluation time. The analysis function not only provides you with impedance and transmission characteristics, but also allows you to determine secondary parameters. Using the marker and line cursor functions, you can obtain the resonating frequency of resonators and the pass band width of band pass filters quickly.

### Equivalent Circuit Analysis Function

Using the HP 4194A's Equivalent Circuit Analysis Function, you can easily and quickly obtain those equivalent circuit constants that, until now, required a number of time-consuming, complicated calculations. By using measured values, this unique function can approximate the circuit constant values of five circuit models. For example, a resonator's equivalent circuit elements or a coil's self inductance, lead resistance, and stray capacitance can be easily obtained.

The equivalent Circuit Analysis function also simulates the frequency characteristics of components by using derived circuit values or values you specify. By using approximation and simulation, you can compare design values to measurement values, and thereby, improve component design efficiency.

### Auto Sequence Program (ASP)

The HP 4194A's ASP function, an internal programming feature, allows you to control all HP 4194A operations (measurement, display, and analysis) without the need for an external computer. By using ASP and actual measurement values, you can readily calculate many secondary parameters that you may need to evaluate. You can

then use the HP 4194A's powerful analysis functions to analyze these calculated parameters.

You can also use ASP to enhance such HP 4194A functions as alternate sweep, sweep timing control, and marker tracking. Because ASP eliminates the need for external controller, thereby eliminating data transfer time, the HP 4194A can quickly and efficiently perform production line go/no-go testing of components such as resonators and filters. All these features combine to increase your engineering and manufacturing productivity.

### Increased Capabilities With The HP 41941A/B Impedance Probe Kit

When using the HP 4194A with the HP 41941A/B Impedance Probe Kit, you can perform reliable impedance evaluations up to 100MHz. Measurement errors due to residual impedance and stray admittance are eliminated by using the calibration standards furnished with the HP 41941A/B and the HP 4194A's automatic calibration function. This makes it possible to make highly accurate measurements (basic measurement accuracy 1.5 to 3%) over a wide measurement range of 100mΩ to 1MΩ. Calibration accuracy is guaranteed to the tips of the HP 41941A (1.5m) and HP 41941B (3m) impedance probes.

The HP 41941A/B can be used as a grounded probe to evaluate the impedance of in-circuit components such as printed circuit patterns, and the input/output impedance of circuits. In addition, you can connect an external dc bias source directly to the HP 41941A/B to perform dc biased measurements up to  $\pm 150V/0.5A$ , to measure the dc characteristics of inductors, capacitors, materials, and semiconductors. To perform swept dc bias measurements, use the HP 4194A's  $\pm 40V$  internal dc bias source.

### Specifications

#### Impedance Measurements

**Measurement Parameters:**  $|Z|$ ,  $|Y|$ ,  $\theta$ , R, X, G, B, L, C, D, Q. 20 parameter combinations are available.

**Test Frequency:** 100 Hz - 40 MHz (CABLE LENGTH: 0m), 100Hz - 15 MHz (CABLE LENGTH: 1m), 1mHz resolution.

**OSC Level:** 10mV -1Vrms ( $\leq 10MHz$ ), 10mV -0.5Vrms ( $> 10MHz$ ) (UNKNOWN terminal open), 3 digit resolution

**DC Bias:** 0 -  $\pm 40V$ , 10mV resolution

**Measurement terminal:** 4 - terminal pair configuration

**Measurement Range and Maximum Resolution:**

Measurement Parameter	Range	Max Resolution
$ Z , R, X$	10mΩ to 100MΩ	100μΩ
$ Y , G, B$	10nS to 100S	1nS
$\theta$	$\pm 180^\circ$	0.01°
L	1nH to 100kH	10pH
C	10fF to 0.1F	0.1fF
D	0.001 to 10	0.0001
Q	0.1 to 1000	0.1

**Basic Measurement Accuracy:** 0.17%

**Level Monitor:**

#### Gain-Phase Measurements

**Measurement Parameters:** Tch/Rch (dB, Linear Ratio), Tch, Rch (V, dBm, dBV),  $\theta$  (degree, rad),  $\tau$

Tch= Test Channel, Rch= Reference Channel,  $\tau$  = Group Delay

**Measurement Frequency:** 10Hz - 100MHz, 1mHz resolution

**Aperture Frequency Range (Group Delay Measurements):** 0.5% - 100% of frequency span

**OSC Level:** -65dBm - +15dBm, 0.1dB resolution

**Measurement Range:**

**Tch/Rch:** 0 -  $\pm 120dB$ , 0.001dB resolution

**Tch, Rch:** -107dBm - -5dBm (0dB Attenuator)  
-87dBm - +15dBm (20 dB Attenuator)  
0.001dB resolution

$\theta$ :  $\pm 180^\circ$  (can display phase continuously with the phase scale expansion function), 0.01° resolution

$\tau$ : 0.1ns - 1s, 0.1ns resolution

**Basic Measurement Accuracy:**

**Tch/Rch:** 0.1dB, 0.5°

**Tch, Rch:** 0.35dBm

$\theta$ : 0.5°

**Level Monitor**

#### Impedance Measurements using the HP 41941A/B

The specifications listed below are for the HP 4194A when used with the HP 41941A/B.

**Frequency Range:** 10 kHz - 100 MHz, 1 mHz resolution

**OSC Level:** Opt. 350: 10 mV - 1.28 Vrms

Opt. 375: 10 mV - 1.54 Vrms

**DC Bias:** Internal:  $\pm 40V$ ,  $\pm 20 mA$

External:  $\pm 150V$ ,  $\pm 500 mA$ , max 25 W

**Measurement Range:** 100 mΩ - 1 MΩ

**Basic Measurement Accuracy:**

$\pm 1.5%$  to 3% ( $\geq 100 kHz$ ),  $\pm 3%$  to 6% ( $< 100 kHz$ )

**Cable Length:** HP 41941A: 1.5 m, HP 41941B: 3 m

### Common Specifications

**Trigger Mode:** Internal, External and Manual

**Sweep Capability:**

**Sweep Parameter:** Frequency, OSC Level, DC Bias (impedance measurements only)

**Entry:** START/STOP or CENTER/SPAN

**Sweep Type:** LIN, LOG, ZERO SPAN (DC Bias: LIN or ZERO SPAN only)

**Number of Measurement Points:** 2 to 401 points

**Sweep Functions:** Partial Sweep, Expand Markers Sweep, Program Points Measurement

### Display

**CRT:** 7.5 inch color CRT

**Display Mode:** Rectangular (X- A & B), Rectangular (A - B), Table

**Display Control:** Autoscale, Superimpose and Storage

### Analysis

**Maker:** Single, Delta, Double Makers

**Line-Cursor:** Line-Cursor, Delta-Line Cursor

**Equivalent Circuit Function:** Approximation, Simulation

**Arithmetic Operation**

**Data Resister Manipulation:** Use arithmetic operations and functions to manipulate data registers.

**GO/No-Go Limits**

### Programming

**Auto Sequence Program (ASP):** Control the HP 4194A's operation with an internal program language. ASP Programs can be entered using the front panel keys or downloaded from HP-IB.

**Program Memory Size:** 20kBytes of non-volatile memory

**Copy:** Dump, Plot, Print Mode

### General Specifications

**Operating Temperature and Humidity:** 0°C - 40°C (HP 41941A/B: -20 - +65°C),  $\leq 95\%RH$  at 40°C

**Storage Temperature:** -30°C - +60°C (HP 41941A/B: -40 - +65°C)

**Safety:** Based on IEC - 348, UL - 1244

**Power:** 100, 120, 220V  $\pm 10\%$ , 240V - 10% + 5%, 48 - 66Hz, 400VA (max)

**Dimensions:** 425 (W) x 375 (H) x 620(D) mm

**Weight:** Approximately 37kg (net)

### Reference Data

**Typical Measurement Speed:**

**Impedance:** Approximately 3.7ms/point

**Gain-Phase:** Approximately 3.5ms/point

**Impedance when used with the HP 41941A/B:** Approximately 6 ms/point

### Accessories Furnished

**HP 16047D:** Direct Coupled Test Fixture

**HP 8120-1838:** 30cm BNC Cable (2ea) (OPT.350)

**HP 04194-61640:** 30cm BNC Cable (2ea) (OPT.375)

**HP 8120-1839:** 60cm NNC Cable (OPT.350)

**HP 04194-61641:** 60cm NNC Cable (OPT.375)

**HP 1250-0080:** BNC Adapter

### Accessories Available

Refer to page 279

### Ordering Information

**4194A Impedance/Gain-Phase Analyzer**

Price

**Opt 350\*:** 50 Ohm System

\$22,100

**Opt 375\*:** 75 Ohm System

\$0

**Opt W30:** 3-year hardware support

\$440

**Opt 001:** High Stability Frequency Reference

\$850

**HP 41941A\* Impedance Probe Kit (1.5m)**

\$1730

**HP 41941B\* Impedance Probe Kit (3 m)**

\$1730

\*Must select either OPT.350 or 375

# COMPONENT MEASUREMENT

## LF Impedance Analyzer (5 Hz to 13 MHz)

Model 4192A

- 5 Hz to 13 MHz variable measuring frequency
- Gain-phase measurement: amplitude, phase, group delay
- Floating or grounded devices
- Impedance measurement:  $|Z|$  •  $|Y|$  •  $\theta$  • R • X • G • B • L • C • D • Q •  $\Delta$  •  $\Delta\%$
- Standard HP-IB

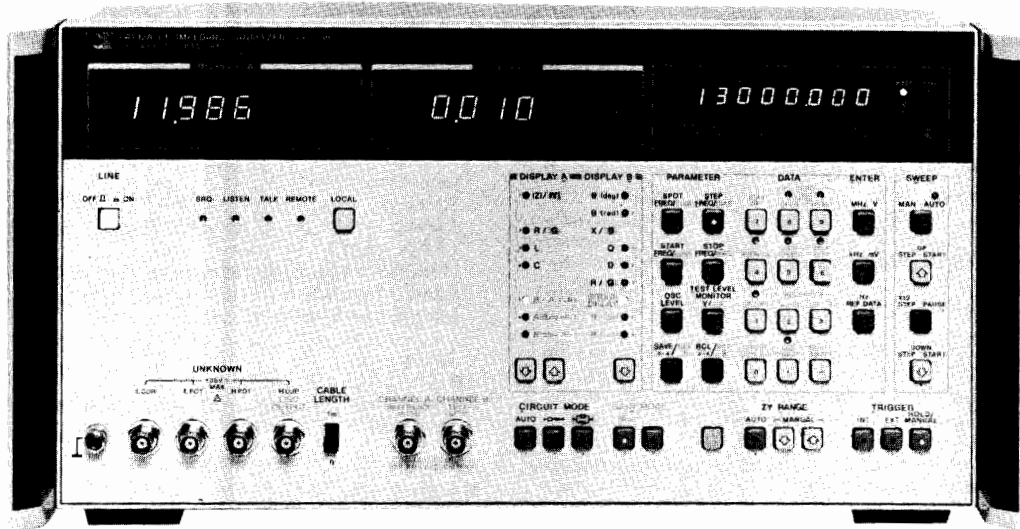

HP 4192A (shown with Opt. 907 handles)



### Description

The HP 4192A LF Impedance Analyzer performs both network analysis and impedance analysis on devices such as telecommunication filters, audio/video electronic circuits, and basic electronic components. Both floating and grounded devices can be tested.

### Automatic Swept Frequency Measurement of All Impedance Parameters

The HP 4192A can measure 11 impedance parameters ( $|Z|$ ,  $|Y|$ ,  $\theta$ , R, X, G, B, L, C, D, Q) over a wide range  $|Z|$ : 0.1 m $\Omega$  to 1 M $\Omega$ ;  $|Y|$ : 1 nS to 10 S).

The built-in frequency synthesizer can be set from 5 Hz to 13 MHz with a maximum resolution of 1 mHz. This feature allows accurate characterization of high Q devices such as crystals. Test signal level is variable from 5 mV to 1.1 V with 1 mV resolution. Also, an internal dc bias voltage source provides  $\pm 35$  V at 10 mV increments. Thus, the HP 4192A can evaluate components and entire circuits near actual operating conditions.

### Specifications (complete specifications on data sheet)

#### Measuring signal (23 $\pm 5^\circ$ C)

**Frequency range:** 5 Hz to 13 MHz

**Frequency step:** 0.001 Hz (5 Hz to 10 kHz), 0.01 Hz (10 kHz to 100 kHz), 0.1 Hz (100 kHz to 1 MHz), 1 Hz (1 MHz to 13 MHz).

**Frequency accuracy:**  $\pm 50$  ppm

**OSC level:** 5 mV to 1.1 Vrms variable into 50  $\Omega$  (amplitude-phase measurement) or open circuit (impedance measurement).

**OSC level step:** 1 mV (5 mV to 100 mV), 5 mV (100 mV to 1.1 V).

**OSC level accuracy:** 5 Hz to 1 MHz:  $\pm((5 + 10/f)\%$  of setting + 2 mV) where f is in Hz. 1 MHz to 13 MHz:  $\pm((4 + 1.5 \times F)\%$  of setting + 2 mV) where F is in MHz.

**Level monitor (impedance measurement):** current through or voltage across sample can be monitored

**Control:** spot and sweep via front panel or HP-IB

#### Measuring Mode

**Spot measurement:** at specific frequency (or dc bias)

**Swept measurement:** manual or automatic sweep from START to STOP frequency (or dc bias) at selected STEP frequency (or dc bias) rate

**Sweep mode:** linear or logarithmic (frequency only)

**Recorder outputs:** output dc voltage proportional to each measured value, and frequency or dc bias.

**Maximum output voltage:**  $\pm 1$  V

**Output voltage accuracy:**  $\pm(0.5\%$  of voltage + 20 mV)

**Key status memory:** 5 sets of measuring conditions can be stored and recalled at any time.

**HP-IB data output and remote control:** standard

**Self-test:** automatic introspective testing

**Trigger:** internal, external, manual or HP-IB

### Amplitude—Phase Measurement

**Parameter measured:** relative amplitude B-A (dB) and phase  $\theta$  (degrees or radians), B-A and group delay, absolute amplitude A (dBm or dBV) or B (dBm or dBV), and deviation ( $\Delta$ ,  $\Delta\%$ ) of all parameters

**Reference amplitude:** 0 dBV = 1 Vrms, 0 dBm = 1 mW (with 50  $\Omega$  termination)

**OSC output resistance:** 50  $\Omega$

**Channels A and B:** input impedance: 1 M $\Omega$   $\pm 2\%$ , shunt capacitance: 25 pF  $\pm 5$  pF

### Display Range and Resolution

**B-A:** 0 to  $\pm 100$  dB, 0.001 dB (0 to  $\pm 20$  dB), 0.01 dB ( $\pm 20$  to  $\pm 100$  dB)

$\theta$ : 0 to  $\pm 180^\circ$ , 0.01 $^\circ$

**Group delay:** 0.1 ns to 19 s, max. resolution 4 $\frac{1}{2}$  digits

**A or B:** +0.8 to  $-100$  dBV, 0.001 dB ( $> -20$  dB), 0.01 dB ( $\leq -20$  dB), +13.8 to  $-87$  dBm, 0.001 dB ( $> -20$  dBm), 0.01 dB ( $\leq -20$  dBm)

**Measuring accuracy (23  $\pm 5^\circ$ C):** specified at BNC unknown terminals after 30 minute warmup (test speed: normal or average)

### B-A (relative amplitude) and $\theta$ (phase) Measurement

Determined by sum of channel A and B accuracies given below (accuracy of each channel changes according to absolute input level)

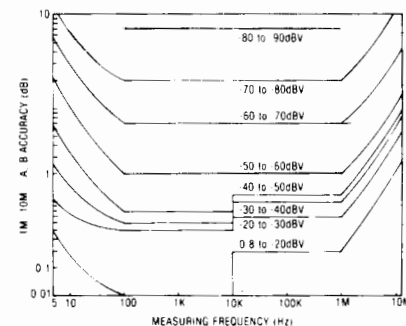

FIGURE 1. GAIN MEASUREMENT ACCURACY

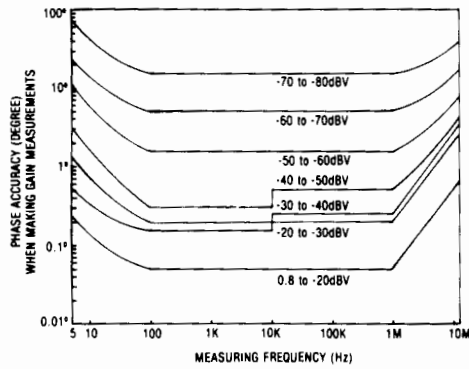

FIGURE 2: PHASE ACCURACY WHEN MAKING GAIN MEASUREMENTS

**Impedance Measurement**

**Parameter measured:**  $|Z| - \theta, |Y| - \theta, R - X, G - B, L - D \cdot Q \cdot R \cdot G, C - D \cdot Q \cdot R \cdot G$  and deviation ( $\Delta, \Delta\%$ ) of all parameters

**Display:** 4½ digits, max. display 12999 counts, 19999 for L & C.

**Circuit mode:** series equivalent circuit (—□—) and parallel equivalent circuit (—□—). Automatic selection available.

**Auto ZERO adjustment:** automatic normalization of the readout offset due to residuals of the test fixture by pushbutton operation (at spot frequency)

**Measuring range and accuracy (23 ± 5°C):** specified at BNC unknown terminals after 30 minute warmup when OSC level is more than 0.1 V and when auto ZERO adjust is performed (test speed: normal or average). Accuracy given below is only valid when the measured value is equal to full scale of each range.

**|Z| - θ, R - X measurement:** range:  $|Z|, R, X: 0.1 \text{ m}\Omega$  to 1.2999 M $\Omega$ ;  $\theta: -180.00^\circ$  to +180.00°. Accuracy: R accuracy ( $D \geq 10$ ); X accuracy ( $D < 1$ )

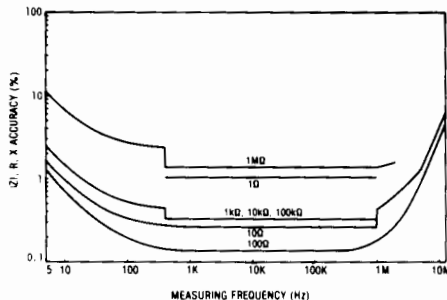

FIGURE 3: |Z|, R, X ACCURACY

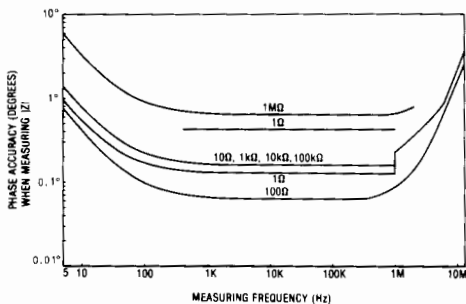

FIGURE 4: PHASE ACCURACY WHEN MEASURING |Z|

**|Y| - θ, G - B measurement:** range:  $|Y|, G, B: 1 \text{ nS}$  to 12.999 S;  $\theta: -180.00^\circ$  to +180.00°. Accuracy: G accuracy ( $D > 1$ ); B accuracy ( $D \leq 0.1$ ).

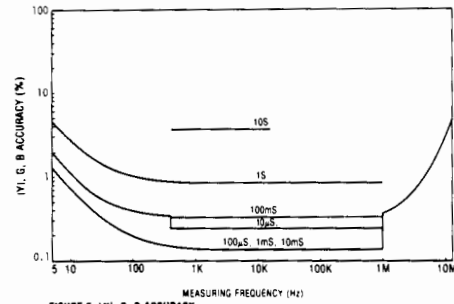

FIGURE 5: |Y|, G, B ACCURACY

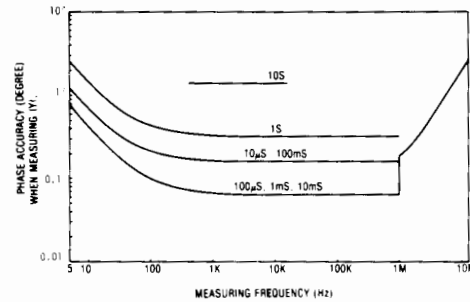

FIGURE 6: PHASE ACCURACY WHEN MEASURING |Y|

**L - D · Q, C - D · Q measurement:** (automatically calculated from measured Z/Y values)

Parameter	Measuring Range*	Basic Accuracy
L	0.01 nH to 1000 H	0.27%
C	0.1fF to 199** mF	0.15%
D(1/Q)	0.0001 to 19.999	0.001 (C-measurement) 0.003 (L-measurement)

\*Varies with measuring frequency except for D(1/Q)

\*\*Accuracy of C ranges over 100 mF is not specified.

**Internal dc bias:** standard (impedance measurement only)

**Voltage range:** -35 V to +35 V, 10 mV step

**Setting accuracy (23 ± 5°C):** 0.5% of setting +5 mV

**Bias control:** spot and swept, using front panel controls or HP-IB

**General**

**Measuring Time (high speed mode)**

**B-A and θ, A or B:** 88 to 127 ms ( $\geq 400 \text{ Hz}$ )

**Impedance parameters:** 58 to 91 ms ( $\geq 1 \text{ kHz}$ )

**Test Level Monitor Range (impedance measurement)**

**Voltage:** 5 mV to 1.1 V

**Current:** 1 μA to 11 mA

**Operating temperature:** 0 to 55°C,  $\leq 95\% \text{ RH}$  at 40°C

**Power:** 100, 120, 220 V ±10%, 240 V + 5% to -10%, 48 to 66 Hz, 150 VA max.

**Size:** 425.5 mm W x 235 mm H x 615 mm D (16.75" x 9" x 22.6")

**Weight:** approx. 19 kg (41.9 lb)

**Furnished accessories and parts:** HP 16047A test fixture, HP 11048C 50 Ω feed thru terminations (2 ea.), power splitter, HP 11170A BNC cables (2 ea.), BNC adapter

**Accessories available**

HP 16095A Probe Fixture	\$850
HP 16096A 2-port Component Test Fixture	\$1,400
HP 16097A Accessory Kit	\$2,200
HP 16047C Test Fixture	\$305
HP 16048A Test Leads (BNC connector)	\$325
HP 16048C Test Leads with alligator clip	\$420

Refer To Page 279

**HP 4192A LF Impedance Analyzer**

**\$15,000**

☎ Fast-Ship product -- see page 766.

# COMPONENT MEASUREMENT

## RF Impedance Analyzer

Model 4191A

- 1-1000 MHz variable test frequency with sweep capability
- Direct reading of  $|Z| - \theta$ ,  $|Y| - \theta$ ,  $|\Gamma| - \theta$ ;  
 $L \bullet C - R \bullet G \bullet D \bullet Q$   
 $R - X, G - B, \Gamma_x - \Gamma_y$

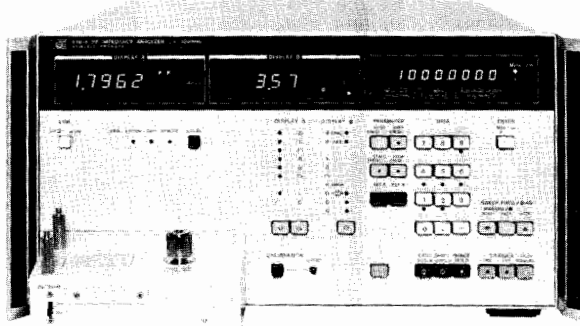

HP 4191A (Shown with Opt 907 Handles)



### Description

The HP 4191A RF Impedance Analyzer measures 14 parameters with a maximum resolution of 4½ digits. The internal synthesizer provides variable frequencies from 1 MHz through 1000 MHz covering the UHF, VHF and video bands with automatic sweep capability. An internal dc bias supply with auto sweep function covers the voltage range of  $\pm 40$  V in 10 mV steps.

The HP 4191A permits reliable measurements over a wide measuring range. Its outstanding repeatability, frequency response and accuracy are made possible by unique error correction capability and specially designed test fixtures. These features allow the HP 4191A to be used in evaluation of electronic materials, components and circuitry.

The internal synthesizer provides a maximum resolution of 100 Hz (Opt 002) with an accuracy of 3 ppm, allowing small changes in the resonant frequency of the device under test to be easily detected. The swept frequency capability aids in the analysis of frequency characteristics of the device.

Two complete front panel settings (parameter selection and the sweep control) can be stored in a non-volatile memory and recalled at any time with a single key operation. This, together with the standard HP-IB interface, makes the HP 4191A extremely efficient either as a stand-alone or systems instrument.

These unique features permit very wide applications in: (1) semiconductor testing such as surface state evaluation at high frequencies (C-V/G-V and conductance (G/ $\omega$ - $\omega$ ) characteristics), and the input/output impedance evaluation of diodes and transistors, (2) resonator, filter, and magnetic and dielectric materials testing, (3) evaluation of LCR components such as high frequency chip and leaded components, and (4) testing of communications related components such as cables, connectors, etc.

### Specifications (Refer to data sheet for complete specifications)

**Parameter measured:**  $|Z| - \theta$ ,  $|Y| - \theta$ ,  $|\Gamma| - \theta$ , R-X, G-B,  $\Gamma_x - \Gamma_y$   
 $L - R \bullet G \bullet D \bullet Q$ , C-R  $\bullet G \bullet D \bullet Q$

**Display:** 4½ digit, max display 19999 counts

**Deviation Measurement** (deviation from stored reference)

$\Delta$ : -19999 to +19999 counts  $\Delta\%$ : -1999.9 to +19999.9%

**Measuring Signal** ( $23 \pm 5^\circ\text{C}$ )

**Frequency range:** 1 MHz to 1000 MHz

**Frequency step:**

Standard: 100 kHz, 1-500 MHz 200 kHz, 500-1000 MHz

Opt 002: 100 Hz, 1-500 MHz 200 Hz, 500-1000 MHz

**Frequency accuracy:**  $\pm 3$  ppm

**Signal level (into 50 $\Omega$ ):**  $-20 \pm 3$  dBm

**Frequency control:** spot and swept

- High resolution—4½ digit max
- Wide measuring range—1 m – 100 k ( $|Z|$ )
- Versatile, easy-to-use test fixtures

### Measuring Mode

**Spot measurement:** at specific frequency (or dc bias)

**Swept measurement:** manual or automatic sweep from start to stop frequency (or dc bias) at step frequency (or dc bias) rate in linear or logarithmic form.

### Auto Calibration

Automatic error compensation referenced to connected terminations (0  $\Omega$ , 50  $\Omega$ , 0 S), 51 frequencies including start and stop frequencies.

**Electrical length compensation:** automatic compensation for electrical length of test fixtures. (Range: 0 to 99.99 cm).

**Internal dc Bias:** Voltage range:  $-40$  to  $+40$  V, 10 mV step

Setting accuracy: 0.1% of setting  $+10$  mV

Bias control: spot and swept

**External dc Bias:** Voltage range:  $-40$  to  $+40$  V

Max allowable current: 100 mA

**Key status memory:** 2 sets of measuring conditions can be stored and recalled at any time. These conditions are kept in storage even when LINE is turned off.

**Ranging:** Auto/Range hold **Trigger:** Internal, External or Manual

**Self-test:** automatic internal program test

**HP-IB data output and remote control:** standard

**$|\Gamma| - \theta / \Gamma_x - \Gamma_y$  Measurement**

**Measuring Range:**  $|\Gamma|$ ,  $\Gamma_x$ ,  $\Gamma_y$ : 0.0001 to 1.0000

$\theta$ :  $0^\circ$  to  $\pm 180.00^\circ$  (0 to  $\pm \pi$  rad.)

$|\Gamma|$ ,  $\Gamma_x$ ,  $\Gamma_y$  resolution: 0.0001

### Reference Data (Not Specified)

**Temperature coefficient for  $|\Gamma|$ :** 0.0001/ $^\circ\text{C}$  ( $23 \pm 5^\circ\text{C}$ )

**Measuring time:**  $< 800$  ms or  $< 250$  ms (high speed mode)

**Frequency switching time:**  $\leq 200$  ms

$|\Gamma|$ ,  $\Gamma_x$ ,  $\Gamma_y$ , ACCURACY

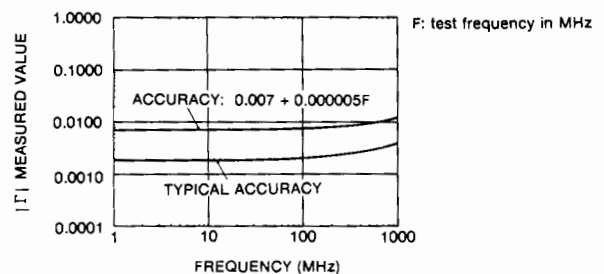

### General

**Temperature:** 0 - 55 $^\circ\text{C}$ ,  $< 95\%$  RH

**Power:** 100, 120, 220 V  $\pm 10\%$ , 240 V  $+ 5\% - 10\%$ , 48 - 66 Hz, 150 VA max.

**Size:** 425.5 mm W x 230 H x 574 mm D (16.75" x 9" x 22.6").

**Weight:** approx. 24 kg (52.8 lb)

**Accessories furnished:** accessory case (with reference terminations included).

### Accessories Available

Accessories Available	Prices
HP 16091A Coaxial Test Fixture	\$560
HP 16092A Spring Clip Test Fixture	\$540
HP 16093A Binding Post Test Fixture	\$220
HP 16093B Binding Post Test Fixture	\$234
HP 16094A Probe Fixture	\$204

Refer to page 279.

### Options

Opt W30: 3-year hardware support	\$480
002: 100 Hz/200 Hz resolution synthesizer	\$2,100
004: Recorder Outputs	\$540



# COMPONENT MEASUREMENT

## Vector Impedance Meter (400 kHz to 110 MHz)

Model 4193A

285

- 400 kHz to 110 MHz spot or swept frequency
- Measure impedance magnitude (10 mΩ to 120 kΩ) and phase (−180.0° to +180.0°)
- Test components in-circuit and out-of-circuit

- Fixtures include low-grounded probe, spring clip fixture and binding post fixture
- Standard HP-IB and analog outputs

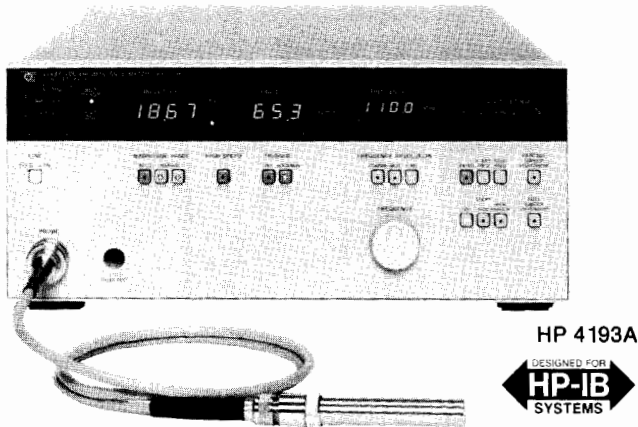

### Description

The HP 4193A Vector Impedance Meter measures impedance magnitude and phase. An internal oscillator provides test signals from 400 kHz to 110.0 MHz. The test signal is constant current between 10 μA and 100 μA, depending on |Z| range.

### Reliable and Accurate Impedance Measurement

The HP 4193A can measure and display impedance magnitudes from 10 mΩ to 120 kΩ. Impedance phase is displayed from +180.0° to −180.0°. Accuracy is as good as 3.0% of reading (magnitude) and 3.2° (phase).

Also, the HP 4193A's 3½ digit resolution makes it easy to see small changes in measurement results during adjustment procedures, for example.

### Frequency Sweep for Complex Component Testing

When testing complex components like ceramic resonators, it is useful (1) to sweep frequency to get the big picture and (2) identify critical impedance points such as the series resonant point. This requires both swept measurement and measurements at individual "spot" frequencies. The HP 4193A can do both.

The HP 4193A can be tuned to any individual frequency from 400 kHz to 110.0 MHz with maximum resolution of 1 kHz. If greater frequency resolution is required, it can be provided by connecting an external synthesized source such as the HP 3335A or HP 8656B to the HP 4193A EXT OSC input.

Flexible internal frequency sweep is an exciting HP 4193A feature. Frequency can be swept linearly over any portion of the HP 4193A frequency range—or swept logarithmically over the entire 400 kHz to 110.0 MHz range.

### Test In-Circuit and Out-of-Circuit Components

Several test fixtures help adapt the HP 4193A to your device under test. For example, the handy L-ground probe is useful for in-circuit testing. The HP 16099A Test Fixture Adapter and three associated fixtures help connect to out-of-circuit devices of various sizes and shapes.

### Specifications (Refer to data sheet for complete specifications)

#### Test Signal Output Specifications

Test signal is output from the furnished low-ground probe.

**Frequency range:** 400 kHz to 110.0 MHz

#### Frequency Resolution

**400 kHz to 9.999 MHz:** 1 kHz resolution

**10.00 MHz to 99.99 MHz:** 10 kHz resolution

**100.0 MHz to 110.0 MHz:** 100 kHz resolution

**Frequency accuracy:** ±0.01% of setting after calibration.

**Frequency stability:** ±100 ppm per month (0 to 55 °C)

#### Frequency Control

**Spot:** spot frequency is set using coarse, medium and fine controls

**Full sweep:** logarithmic sweep at 43 points over full range of 400 kHz to 110 MHz

**Partial sweep:** linear sweep from selected START to STOP frequency. Number of steps is selected as 100, 1000 or "HIGH RESOLN". When "HIGH RESOLN" steps are selected, the operator must also select "coarse", "medium" or "fine" resolution.

**EXT OSC:** increase frequency resolution by connecting an external frequency synthesizer.

### Impedance Measurement Specifications

**Input configuration:** low-grounded probe (furnished)

**Digital display of impedance:** 3½ digits

**|Z|:** 0 to 1999 counts (0 to 120 counts on 100 kΩ range)

**∅:** −1800 to +1800 counts (−180 to +180 counts on 100 kΩ range)

**Measurement trigger:** internal, external, and manual

**Measurement range control:** auto, hold, and manual

#### Measurement Range

**|Z|:** Five decade ranges: 10 Ω, 100 Ω, 1 kΩ, 10 kΩ, 100 kΩ

**minimum |Z| (sensitivity):** 10 mΩ

**maximum |Z|:** 120 kΩ

**∅:** One range: −180.0° to +180.0°

### Reference Data

#### Test Signal Output

**Frequency settling time:** 5 ms to 400 ms. Best case is when (Δf/f)% is less than 10% (below 10 MHz) and less than 1% (above 10 MHz).

#### Signal Purity

**Spurious:** −60 dBc (dBc is dB below carrier)

**Harmonics:** −30 dBc

**Residual FM:** measured in a 100 Hz band centered on the carrier

**1 MHz to 110 MHz:** 100 Hz p-pFM

**Test level:** constant current source

Z	10Ω	100Ω	1KΩ	10KΩ	100KΩ
Current (μA ±20%)	100	100	100	50	10

### Impedance Measurement

**Residual Impedance of Probe (at probe tip)**

**Resistance:** ≤0.55 Ω

**Inductance:** ≤(4.9 + 10/f) nH where f is measuring frequency in MHz

**Parallel Capacitance:** ≤0.11 pF

**Measuring speed:** assumes range is fixed; recorder output is OFF

**HI SPEED:** approximately 150 ms per measurement

**NORMAL:** approximately 1 s per measurement

**Ranging time:** approximately 1.2s

**Temperature coefficient** at 23°C ± 5°C

**|Z|:** 2 mΩ/°C, **∅:** 0.02°/°C

### General

**Operating temperature/humidity:** 0 to 55°C, ≤95% RH @ 40°C.

Note that measurement error in 0°C to 55°C temperature range is typically double the error in the 23°C ± 5°C range.

**Power:** 100/120/220 V ±10%, 240 V −10% to +5%, 48 to 66 Hz, 150 VA max

**Size:** 426 mm W x 178 mm H x 498 mm D, (16.75" x 7" x 19.6")

**Weight:** 18 kg (40 lb)

**Accessories furnished:** low-ground probe kit includes probe, spare pins, spare clips, BNC adapter, component mounting adapter, probe socket and accessory case.

### Accessories Available

HP 16099A Test Fixture Adapter (used with HP 16092A and HP 16093A/B) \$490 ☎

HP 16092A Spring Clip Fixture (used with HP 16099A) \$540 ☎

HP 16093A Binding Post Fixture (used with HP 16099A) \$220 ☎

HP 16093B Binding Post Fixture (used with HP 16099A) \$234 ☎

Refer to page 279.

**HP 4193A Vector Impedance Meter**

**\$9,900**



# COMPONENT MEASUREMENT

## Precision LCR Meter (20 Hz to 1 MHz)

Model HP 4284A

- 20 Hz to 1 MHz, with over 8600 test frequencies
- 0.05% basic accuracy
- 0.01m $\Omega$  to 100M $\Omega$  impedance range
- Test signal level (OPT 001): 5 mV to 20 Vrms, 50  $\mu$ A to 200 mArms
- High resolution 6-digits: D= 0.000001
- High speed measurements (1 MHz): 30 ms/meas
- Measures |Z|, |Y|,  $\theta$ , R, X, G, B, L, C, Q, D, and ESR
- 10-bin component sorting - comparator

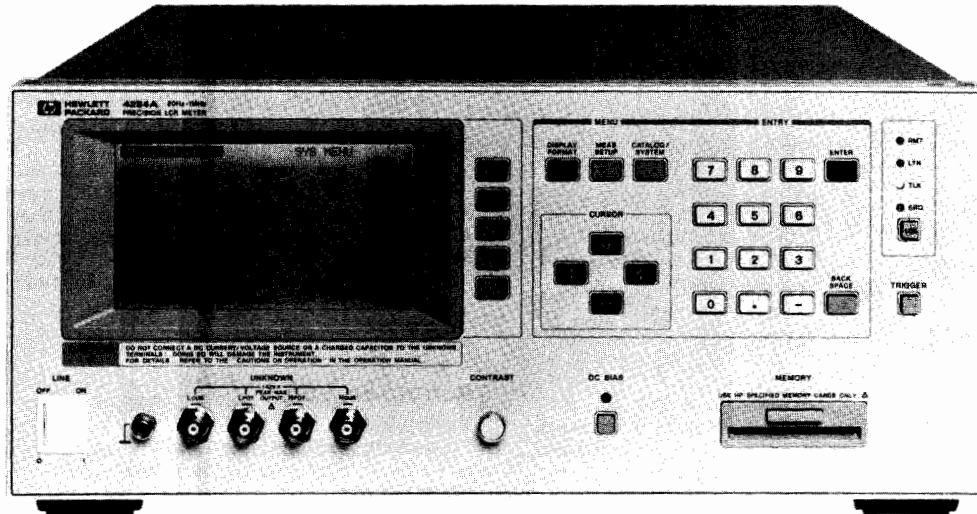

HP 4284A



### Description

The HP 4284A Precision LCR Meter is a cost effective solution for component and material measurement, which can be used to improve component quality by providing an accurate, high throughput test solution. The wide 20 Hz to 1 MHz test frequency range and superior test signal performance allows the HP 4284A to test components to the most commonly used test standards, such as IEC/MIL standards, and under conditions which simulate the intended application. Whether in R/D, production, quality assurance, or incoming inspection the HP 4284A will meet all of your LCR meter test and measurement requirements.

### A Wide Range of Test Signal and DC Bias

The test signal (voltage/current) is variable from 5 mVrms to 2 Vrms, and from 50  $\mu$ Arms to 20 mArms. The constant test signal level feature guarantees that the applied test signal level will remain constant for demanding tests. Option 001 will allow you to vary the test signal level from 5 mVrms to 20 Vrms and from 50  $\mu$ Arms to 200 mArms, offering a convenient method of testing components over a wide range of working conditions. The dc bias is selectable from  $\pm$ 1 mV to  $\pm$ 40 V with an accuracy of 0.1% for applications which require accurate bias control, such as measuring the C-V characteristics of semiconductors.

### High Accuracy, Resolution, and Test Throughput

The HP 4284A's wide impedance measurement range covers from 1 $\Omega$  to 100M $\Omega$  full scale with 0.01m $\Omega$  minimum resolution and with an unmatched basic accuracy of 0.05% to 1MHz. Six full digits of resolution for all measurement parameters allow you to determine even

the smallest differences in materials or component performance. A dissipation factor measurement resolution of 0.000001 is very useful when developing low loss capacitors and inductors used in high performance electronic equipment. The measurement time needed to obtain the optimum accuracy is only 190 ms/meas (1 kHz). A selectable integration time permits a high throughput testing with a measurement time of only 40 ms/meas (1 kHz) for a slight trade off in accuracy.

### High Current Biasing for Power Inductor Evaluation

Combining the HP 4284A Precision LCR Meter, HP 42841A Current Source, and HP 42842A/B Current Fixture gives you a high performance power inductor and transformer test system, which enables the testing of inductors up to 1 MHz and at high dc current levels, up to 20 A (40 A with two HP 42841As and the HP 42842B) demanded for components used in advanced switching power supplies.

### Flexibility and Ease of System Integration

The HP 4284A's built-in comparator, advanced compensation, and optional handler and scanner interfaces permit easy integration with automatic component handling equipment. The 10-bin comparator allows for error free Go/No-Go testing by comparing a component's measured value with user selected test limits. The scanner interface provides control and compensation for up to 128 multiplexed measurement channels. The list sweep feature permits up to ten frequencies, test signal levels, or bias level points to be automatically measured. The high speed HP-IB interface and HP-SL programming language are excellent for data logging and system applications.

**Simple Operation for Error Free Measurement Setup**

The large easy-to-read LCD screen displays the instrument settings and the measurement results. The new softkey and cursor operation provides user-friendly front panel operation. The memory card allows storing and retrieving up to ten entire instrument setups, including bin limit information. It improves operator efficiency and minimizes setup errors.

**Specifications** (Refer to datasheet for complete specifications)

**Parameters measured:**  $|Z|$ - $\theta$ ,  $|Y|$ - $\theta$ , R-X, G-B  
 C-D, Q, ESR, G, Rp  
 L-D, Q, ESR, G, Rp  
 Deviation and % deviation

**Measurement Circuit Modes:** Series and Parallel

**Ranging:** Auto and Manual

**Trigger:** Internal, External and Manual

**Delay time:** 0 to 60.000 sec in 1 ms steps

**Measurement terminals:** Four-Terminal Pair

**Test cable length:** Standard: 0 and 1 meters  
 With Option 006: 0, 1, 2 and 4 meters

**Integration time:** Short, Medium and Long

**Averaging:** 1 to 256, programmable

**Test Signal**

**Test frequency:** 20 Hz to 1 MHz, 8610 selectable frequencies

**Test signal modes:** **Normal:** Programs selected voltage or current at the measurement terminals open or shorted, respectively, and not at the device under test.

**Constant:** Maintains selected voltage or current at the device under test independent of changes in the device's impedance.

Test signal level:

**Standard**

		Range	Accuracy
Normal	V	5 mVrms to 2 Vrms	$\pm(10\% + 1 \text{ mVrms})$
	I	50 $\mu$ Arms to 20 mArms	$\pm(10\% + 10 \mu\text{Arms})$
Constant	V	10 mVrms to 1 Vrms	$\pm(6\% + 1 \text{ mVrms})$
	I	100 $\mu$ Arms to 10 mArms	$\pm(6\% + 10 \mu\text{Arms})$

With Option 001:

		Range	Accuracy
Normal	V	5 mVrms to 20 Vrms	$\pm(10\% + 1 \text{ mVrms})$
	I	50 $\mu$ Arms to 200 mArms	$\pm(10\% + 10 \mu\text{Arms})$
Constant	V	10 mVrms to 10 Vrms	$\pm(10\% + 1 \text{ mVrms})$
	I	100 $\mu$ Arms to 100 mArms	$\pm(10\% + 10 \mu\text{Arms})$

**DC Bias:**

Standard: 0 V, 1.5 V and 2 V

With Option 001: 0 V to  $\pm 40$  V.

Range	Resolution	Accuracy
$\pm(0.000 \text{ to } 4.000)$ V	1 mV	$\pm(0.1\% + 1 \text{ mV})$
$\pm(4.002 \text{ to } 8.000)$ V	2 mV	$\pm(0.1\% + 2 \text{ mV})$
$\pm(8.005 \text{ to } 20.000)$ V	5 mV	$\pm(0.1\% + 5 \text{ mV})$
$\pm(20.01 \text{ to } 40.00)$ V	10 mV	$\pm(0.1\% + 10 \text{ mV})$

**Measurement Range**

Parameter	Range
$ Z $ , R, X	0.01 m $\Omega$ to 99.9999 M $\Omega$
$ Y $ , G, B	0.01 nS to 99.9999 S
C	0.01 fF to 9.99999 F
L	0.01 nH to 99.9999 kH
D	0.000001 to 9.99999
Q	0.01 to 99999.9
$\theta$	-180.000 $^\circ$ to 180.000 $^\circ$
$\Delta\%$	-999.999% to 999.999%

**Display**

**LCD Dot-matrix display:** displays measured values, control settings, comparator limits and decisions, list sweep tables, self test messages and annunciations.

**Correction Function**

**Zero OPEN/SHORT:** Eliminates measurement errors due to the test fixture's stray parasitic impedance.

**Load:** Improves measurement accuracy by using a calibrated device as a reference.

**List Sweep Function**

A maximum of ten frequencies or test signal levels can be programmed. Single or sequential testing can be performed. When Option 001 is installed, DC voltage bias testing can also be performed.

**LIST SWEEP DISPLAY (example)**

```

<LIST SWEEP DISPLAY>   SYS MENU
MODE = SEQ
FREQ[Hz] Cp[E F ] DC J CMP
1.00000k 3.26040n .000905
2.00000k 3.25844n .000897
5.00000k 3.25803n .000630
10.0000k 3.26243n .000305
20.0000k 3.25947n .000767
50.0000k 3.25849n .000340
100.000k 3.26038n .000098
200.000k 3.25946n .000318
500.000k 3.25901n .000169
1.00000M 3.26019n .000296
    
```

# COMPONENT MEASUREMENT

## Precision LCR Meter (20 Hz to 1 MHz) (Cont'd)

### Model HP 4284A

#### Comparator

Ten bin sorting for the primary measurement parameter, IN/OUT for the secondary measurement parameter.

**Bin count:** 0 to 999999

**List sweep comparator:** HIGH/IN/LOW decision output for each measurement point in the list sweep table.

#### BIN COUNT DISPLAY (example)

<BIN COUNT DISPLAY>				SYS MENU
FUNC = Cp-D		NOM = 3.2600nF		
BIN	LOW [ % ]	HIGH [ % ]	>COUNT	
1	- 1.000	+ 1.000	565	
2	- 2.000	+ 2.000	45	
3	- 3.000	+ 3.000	18	
4	- 4.000	+ 4.000	29	
5	- 5.000	+ 5.000	11	
6	- 6.000	+ 6.000	6	
7	- 7.000	+ 7.000	4	
8	- 8.000	+ 8.000	4	
9	- 9.000	+ 9.000	3	
2nd [ ]				
REJ CNT		AUX: OFF	OUT: 9	

#### Measurement Accuracy

Measured accuracy is specified when all of the following conditions are satisfied.

1. Warm up time:  $\geq 15$  minutes
2. Ambient temperature:  $23 \pm 5^\circ\text{C}$
3. Test signal voltage: 0.3 Vrms to 1 Vrms
4. Test cable length: 0 m
5. OPEN and SHORT corrections have been performed
6.  $D \leq 0.1$  for C, L, X and B measurements  
 $Q \leq 0.1$  for R and G measurements

Accuracies are relative to calibrated standards. Absolute accuracies are given as: (HP 4284A's relative accuracy + calibration uncertainty of standards).

|Z|, C, L and D accuracies are shown in Figure 1.

The accuracies are represented as

|Z|, C and L:  $\pm$  (% of reading)

D:  $\pm$  (D value)

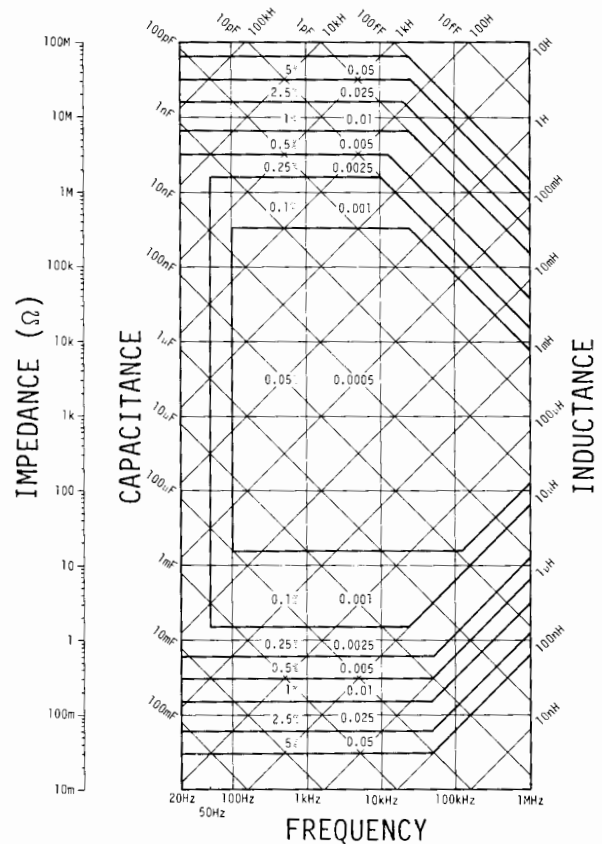

Figure 1

#### Other Functions

**STORE/LOAD:** Ten instrument setups can be stored/loaded from the internal non-volatile memory. Ten additional setups can also be stored/loaded from a memory card.

**HP-IB:** All instrument control settings, measured values, comparator limits, list sweep tables, and self test results.

The memory buffer can store a maximum of 128 measurement results and output the data over HP-IB. ASCII and 64-bit binary data formats.

#### General

**Power requirements:** 100/120/220 V  $\pm 10\%$ , 240 V  $+5\%$  /  $-10\%$ , 47 to 66 Hz

**Power consumption:** 150 VA max

**Operating temperature and humidity:**  $5^\circ\text{C}$  to  $45^\circ\text{C}$ ,  $\leq 95\%$  RH at  $40^\circ\text{C}$

**Size:** 426 (W) x 177 (H) x 498 (D) mm

**Weight:** Approximately 15 kg

### Supplemental Characteristics

**Measurement time:** Typical measurement time from the trigger command to the EOM (End of Measurement) output at the handler interface connector.

	20 Hz	100 Hz	1 kHz	10 kHz to 1 MHz
SHORT	1,100 ms	270 ms	40 ms	30 ms
MEDIUM	1,320 ms	400 ms	190 ms	180 ms
LONG	1,320 ms	1,040 ms	830 ms	820 ms

### Option 001

**DC Bias current output:** 100 mA max

### Options

**Opt 001:** Increases the AC test signal to 20 Vrms/200 mArms. Variable  $\pm 40$  Vdc bias.

**Opt 002:** Allows the HP 4284A Precision LCR Meter to control the HP 42841A Bias Current Source.

**Opt 006:** Increases test cable length capability. Adds 2 and 4 meter operation

**Opt 109:** Delete HP-IB Interface

**Opt 201:** Handler Interface

**Opt 202:** Handler Interface

**Opt 301:** Scanner Interface. Provides control interface for operation with a scanner. OPEN/SHORT/LOAD correction data for up to 128 measurement channels at three frequencies is stored in non-volatile memory.

### Accessories

#### HP 42841A Bias Current Source

**Bias Current Output:** 0 Adc and 0.01 Adc to 20 Adc

**Output Voltage:** 38 Vdc max

**Frequency Range:** Up to 1 MHz

**Basic Impedance Accuracy:** 1% when used with the HP 4284A

**Interface:** Custom, directly controllable by the HP 4284A with Option 002.

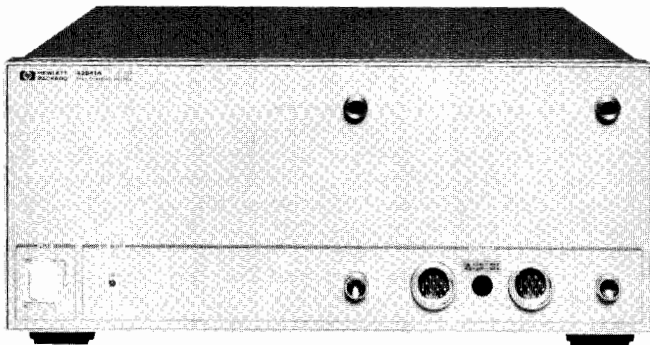

HP 42841A

#### HP 42842A/B Bias Current Test Fixture

Used with the HP 4284A and HP 42841A for high DC bias current measurements,

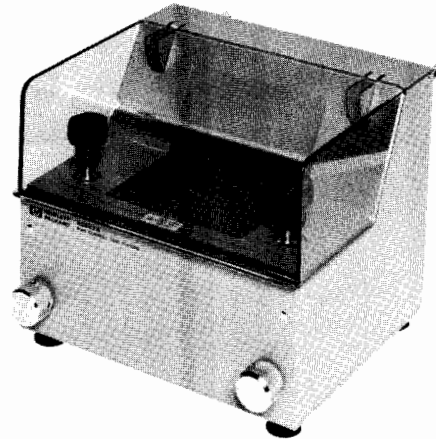

HP 42842A

### Ordering Information

<b>HP 4284A</b> Precision LCR Meter	\$9,400
<b>Opt W30:</b> 3-year hardware support	\$160
<b>Opt 001:</b> Power Amplifier/DC Bias	\$1,200
<b>Opt 002:</b> Bias Current Interface	\$280
<b>Opt 006:</b> 2m/4m Cable Length Operation	\$180
<b>Opt 008:</b> Add Japanese Operation Manual	\$80
<b>Opt 009:</b> Delete Operation Manual	-\$80
<b>Opt 109:</b> Delete HP-IB Interface	-\$240
<b>Opt 201:</b> Handler Interface	\$280
<b>Opt 202:</b> Handler Interface	\$310
<b>Opt 301:</b> Scanner Interface	\$600
<b>Opt 907:</b> Front Handle Kit	\$70
<b>Opt 908:</b> Rack Mount Kit	\$40
<b>Opt 909:</b> Rack Flange and Handle Kit	\$100
<b>Opt 910:</b> Extra Operation Manual	\$80

Refer to page 279 for accessories.



# COMPONENT MEASUREMENT

## Multi-Frequency LCR Meters

Models 4274A & 4275A

- Test frequencies – HP 4274A: 100 Hz to 100 kHz  
HP 4275A: 10 kHz to 10 MHz
- Test signal level – HP 4274A: 1 mV to 5 Vrms  
HP 4275A: 1 mV to 1 Vrms
- 0.1% basic accuracy
- High resolution – 5½ digit; D=0.00001
- Measure L/C – D/Q/ESR/G; |Z| –  $\theta$ ,  
R-X/B/L/C;  $\Delta$ LCRZ,  $\Delta$ %

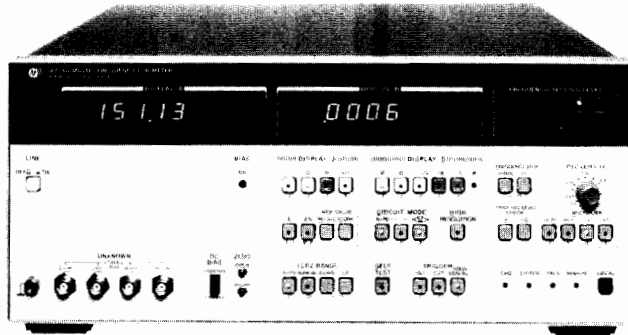

HP 4274A

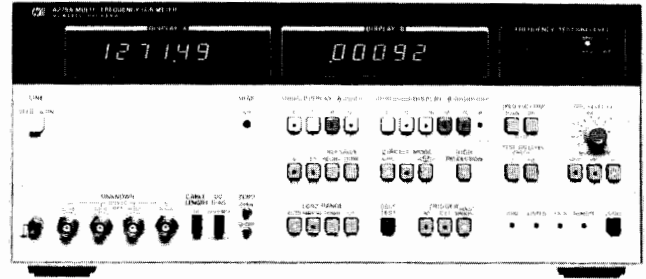

HP 4275A



### Description

The HP 4274A and HP 4275A Multi-frequency LCR Meters, microprocessor-based impedance measuring instrumentation. Both instruments offer LCR components, complex components, electronic circuits "tested under actual working conditions", and semiconductor materials. A measurement under conditions similar to the intended use contributes to the improvements in quality and reliability of electronic components, devices and circuits.

### Reliable Measurements with 5½ Digit Resolution

The HP 4274A and HP 4275A measure only the value of the component and/or device under test, with 5½ resolution and 0.1% basic accuracy by reducing the possibility of errors due to self or mutual inductance, stray capacitance and/or residual inductance in the test leads or test fixture used. This measurement is obtained by a state-of-the-art four terminal pair configuration and a built-in automatic ZERO-offset capability to compensate for these errors.

The fast measurement speed, high resolution, and high accuracy can make major contributions for the component manufacturer and user who is concerned about reducing his costs, improving quality, and throughput efficiency. In these areas, the HP 4274A and the HP 4275A are ideal for D-measurements of film capacitors or insulation material (with the high resolution of 0.00001), the C-G measurements of semiconductors (with maximum resolutions of 0.01 fF, 0.01 nS, respectively), and for the low impedance measurement of aluminum electrolytic capacitors (with a maximum resolution of 0.001 m $\Omega$ ).

### Multi-Frequency Capability

To insure the high reliability in circuits and devices, it is most important that they be tested and evaluated at test signals similar to those of actual operating conditions.

The HP 4274A covers the wide frequency range of 100 Hz to 100 kHz in 11 spot frequencies and the HP 4275A has 10 spot frequencies from 10 kHz to 10 MHz, in 1-2-4 step sequence with 1-3-5 as an option. This feature produces the frequency characteristics of components or devices. In addition, two optional special frequencies (for example, 455 kHz and 10.7 MHz) are available within the frequency

range of each instrument. This wide frequency range selection offers evaluation of circuit design with a continuously variable test signal over the range of 1 mV to 5 Vrms (to 1 Vrms for the HP 4275A), and with internal dc bias optionally available with 1 mV maximum resolution. The test voltage or current values can be monitored on the 3-digit display for accurately setting the actual conditions under which the device-under-test will operate.

### Multi-Parameter Measurements

The HP 4274A and HP 4275A measure equivalent series resistance (ESR), impedance (|Z|), phase angle ( $\theta$ ), reactance (X), susceptance (B), and conductance (G), in addition to the conventional L,C,R,D and Q parameters in certain combinations with a dual 5½ digit display, and an HP-IB standard for systems integration.

This wide selection of 11 parameters provides for more accurate evaluation of electronic materials or components with high measurement speed for most needed combined parameters; for example, the C-G measurement of semiconductors, an R-X measurement in circuit design, or the C-ESR or |Z| -  $\theta$  measurement of tantalum capacitors.

In addition, a deviation measurement capability ( $\Delta$ ,  $\Delta$ %) for the L,C,R, and |Z| functions displays the difference between the actual value and a stored reference, either as a difference value or in percent. Deviation applications include, for example, a temperature dependence measurement of devices in environmental tests.

### Automatic Semiconductor and Component Measurements with HP-IB

Integrating the HP 4274A and the HP 4275A into an HP-IB controlled system is an excellent method for improving efficiency and cost savings both in the laboratory and on the production line. These automatic measurement systems are assembled by connecting the HP-IB cables between the instruments to be utilized for a specific task.

For example, the evaluation of semiconductors based on the frequency dependence of its C-V characteristics that requires a wide range and fast measurement speeds is easily accomplished with these instruments.

**Specifications**

Refer to the HP 4274A & HP 4275A data sheet for details.

**Parameters Measured**

L: inductance C: capacitance	Q: =1/D ESR: equivalent series resistance	θ: phase angle Δ: deviation for L, C, R, Z, Δ%: % of deviation
R: resistance Z: impedance	G: conductance X: reactance	
D: dissipation factor	B: susceptance	

**Measurement Range**

MODEL	HP 4274A	HP 4275A
L	100.00 nH - 1000.0 H	100.00 nH - 10.00 H
C	1.0000 pF - 1.00 F	1.0000 pF - 100.00 μF
R,  Z , ESR, & X	100.00 mΩ - 10.000 MΩ	1.0000 Ω - 10.000 MΩ
D	0.00001 - 9.9999	0.00001 - 9.9999
Q (1/D)	0.01 - 9900	0.01 - 9900
G & B	1.0000 μS - 100.00 S	1.0000 μS - 10.00 S
θ	0 - ±180°	0 - ±180°

**Measurement Accuracy**

FREQUENCY RANGE	C-D/Q	L-D/Q
	D-range: 0.00001-9.9999 Q-range: 0.01-9900 (=1/D) (C & D accuracies apply only when C: full scale and D: ≤ 0.1)	D-range: 0.00001-9.9999 Q-range: 0.01-9900 (=1/D) (L & D accuracies apply only when L: full scale and D: ≤ 0.1)

**HP 4274A**

100 Hz	C: 1000 pF-1000 mF, 0.1% + 3 D: 0.33% + 0.0008 + 1	L: 100 μH-10 kH, 0.1% + 3 D: 0.33% + 0.0013 + 1
120 Hz	C: 1000 pF-1000 mF, 0.1% + 2 D: 0.32% + 0.0007 + 1	L: 100 μH-10 kH, 0.1% + 3 D: 0.32% + 0.0012 + 1
200 Hz	C: 100 pF-100 mF, 0.14% + 1 D: 0.34% + 0.0013 + 1	L: 100 μH-10 kH, 0.1% + 3 D: 0.31% + 0.0011 + 1
400 Hz	C: 100 pF-100 mF, 0.1% + 3 D: 0.33% + 0.0008 + 1	L: 10 μH-1000 H, 0.1% + 3 D: 0.33% + 0.0013 + 1
1 kHz	C: 100 pF-100 mF, 0.1% + 2 D: 0.32% + 0.0007 + 1	L: 10 μH-1000 H, 0.1% + 3 D: 0.32% + 0.0012 + 1
2 kHz	C: 10 pF-10 mF, 0.14% + 1 D: 0.34% + 0.0013 + 1	L: 10 μH-1000 H, 0.1% + 3 D: 0.31% + 0.0011 + 1
4 kHz	C: 10 pF-10 mF, 0.1% + 3 D: 0.33% + 0.0008 + 1	L: 1 μH-100 H, 0.1% + 3 D: 0.33% + 0.0013 + 1
10 kHz	C: 10 pF-100 μF, 0.1% + 2 D: 0.32% + 0.0007 + 1	L: 1 μH-100 H, 0.1% + 3 D: 0.32% + 0.0012 + 1
20 kHz	C: 1 pF-1000 μF, 0.14% + 1 D: 0.34% + 0.0013 + 1	L: 1 μH-100 H, 0.1% + 3 D: 0.31% + 0.0011 + 1
40 kHz	C: 1 pF-1000 μF, 0.1% + 3 D: 0.33% + 0.0008 + 1	L: 100 nH-10 H, 0.1% + 3 D: 0.33% + 0.0013 + 1

**HP 4275A**

10 kHz	C: 10 pF-100 μF, 0.1% + 3 D: 0.33% + 0.008 + 1	L: 10 μH-100H, 0.1% + 3 D: 0.33% + 0.0013 + 1
20 kHz	C: 10 pF-100 μF, 0.1% + 2 D: 0.32% + 0.0007 + 1	L: 10 μH-100 H, 0.1% + 3 D: 0.32% + 0.0012 + 1
40 kHz	C: 1 pF-10 μF, 0.14% + 1 D: 0.34% + 0.0009 + 1	L: 10 μH - 100 H, 0.1% + 3 D: 0.31% + 0.0011 + 1
100 kHz	C: 1 pF-10 μF, 0.1% + 3 D: 0.33% + 0.0008 + 1	L: 1 μH - 10 H, 0.1% + 3 D: 0.33% + 0.0013 + 1
200 kHz	C: 10 pF-10 μF, 0.1% + 2 D: 0.32% + 0.0007 + 1	L: 1 μH - 1000 mH, 0.2% + 3 D: 0.53% + 0.0023 + 1
400 kHz	C: 1 pF-1000 nF, 0.14% + 1 D: 0.34% + 0.0009 + 1	L: 1 μH - 1000 mH, 0.2% + 3 D: 0.51% + 0.0021 + 1
1 MHz	C: 1 pF-1000 nF, 0.1% + 3 D: 0.33% + 0.0008 + 1	L: 100 nH - 100 mH, 0.2% + 3 D: 0.55% + 0.0025 + 1
2 MHz	C: 10 pF-100 nF, 0.3% + 3 D: 0.55% + 0.0025 + 1	L: 1 μH - 10 mH, 0.5% + 5 D: 1.0% + 0.0033 + 1
4 MHz	C: 1 pF-10 nF, 1% + 20 + 0.002 pF D: 3.3% + 0.01 + 1	L: 1 μH - 10 mH, 1% + 5 D: 2.0% + 0.0063 + 1
10 MHz	C: 1 pF-10 nF, 2% + 20 + 0.002 pF D: 4% + 0.011 + 1	L: 100 nH - 1 mH, 2% + 7 D: 3.1% + 0.002 + 1

**Range:** full scale range, accuracy: % of reading + counts (D accuracy: % of reading + absolute D value + count).

(Conditions: Warm-up time ≥ 30 minutes, environment temperature: 23°C ± 5°C). Refer to technical data sheet for accuracy details.

**Measurement Frequencies**

HP 4274A: 100 Hz-100 kHz, 11 spots (100 Hz, 120 Hz, 200 Hz, 400 Hz, 1 kHz, 2 kHz, 4 kHz, 10 kHz, 20 kHz, 40 kHz, 100 kHz; ±0.01%)

HP 4275A: 10 kHz-10 MHz, 10 spots (10 kHz, 20 kHz, 40 kHz, 100 kHz, 200 kHz, 400 kHz, 1 MHz, 2 MHz, 4 MHz, 10 MHz; ±0.01%)

**Test Signal Level:**

HP 4274A: 4-ranges (1 mVrms-5 Vrms) continuously variable  
HP 4275A: 3-ranges (1 mVrms-1 Vrms) continuously variable

**Test Signal Level Monitor:** standard.

**Displays:** dual 5½-digit and single 3-digit; maximum display 199999 (full scale and overrange in high resolution mode), and 4½-digit: maximum display 19999 in normal mode. (Number of digits depends on measurement frequency, test level, and range).

**Circuit modes:**  $\text{---}\square\text{---}\omega$  series equivalent circuit and  $\text{---}\omega\text{---}\square\text{---}$  parallel equivalent circuit. Automatic selection available in AUTO mode.

**Deviation measurement:** difference between recallable stored reference and displayed is deviation value (count or percent).

**Ranging:** AUTO or MANUAL (UP/DOWN).

**Trigger:** internal, external or manual.

**Measurement terminals:** four-terminal pair with guard.

**Auto zero adjustment:** automatic normalization of the readout offset due to residuals of the test fixture by pushbutton operation.

**Normalization range:** C < 20 pF, L < 2000 nH, R < 0.5Ω, G < 5μS.

**Self test:** automatic operational verification check indicates pass or fail condition.

**Reference Data**

**Measurement time:** (typical) 140-180 ms (>1 kHz); 140-210 ms ≤ 1 kHz (measurement time depends on range, sample value and offset adjustment value).

**Z - θ measurement time:** 170-210 ms >1 kHz; 170-240 ms ≤ 1 kHz.

**High resolution mode:** approximately 8 times the normal measurement time.

**Auto ranging time:** 100 ms - 300 ms per range change.

**General Information**

**Operating Temperature and Humidity:** 0°C - 55°C, ≤95% RH at 40°C

**Power:** 100, 120, 220V ±10%, 240V + 5% - 10%, 48 - 66Hz, 135VA max. (HP 4274A); 165VA max. (HP 4275A)

**Size:** 177H x 425W x 574Dmm (7" x 16.75" x 22.6")

**Weight:** 18kg (39.6lbs)

**Accessory Furnished**

HP 16047A: Direct coupled test fixture.

**Accessory Available**

HP 16023B: dc Bias Controller, for control of dc bias \$345 ☎  
Opt 001 or 002 Internal Bias Supply.

**Special Options**

One or two arbitrary test frequencies for each instrument are available. For more details, please contact nearest HP sales office.

**Selectable Frequency Range**

HP 4274A: 100 Hz to 100 kHz to ±0.1%. If two frequencies are added, at least one frequency must satisfy the following equation: f = 1200/N kHz where N is an integer from 12 to 12000.

HP 4275A: 10 kHz to 10.7 MHz ±0.1%.

**Ordering Information**

HP 4274A Multi-Frequency LCR Meter \$10,400

Opt W30: 3-year hardware support \$220

HP 4275A Multi Frequency LCR Meter \$12,600

Opt W30: 3-year hardware support \$160

Opt 001: 0 to ±35 internal dc bias, max resolution; 1 mV steps \$950

Opt 002: 0 to ±99.9 V internal dc bias, resolution: 100 mV steps.

Opt 004: Frequency steps in 1-3-5 sequence \$900

☎ Fast-Ship product—see page 766. N/C

# COMPONENT MEASUREMENT

## 1 kHz / 1 MHz Capacitance Meter

Model 4278A

- Measurement Speed: 6.5ms/10ms/21ms
- Measurement Parameters: C-D•Q•ESR•G
- C-D Measurement Accuracy:  
0.07%, 0.0005(1kHz, 21ms)  
0.05%, 0.0002(1MHz, 21ms)

- High Resolution: 6 digit, D:0.00001
- Intelligent Built-in Comparator: 10-bin Sorting

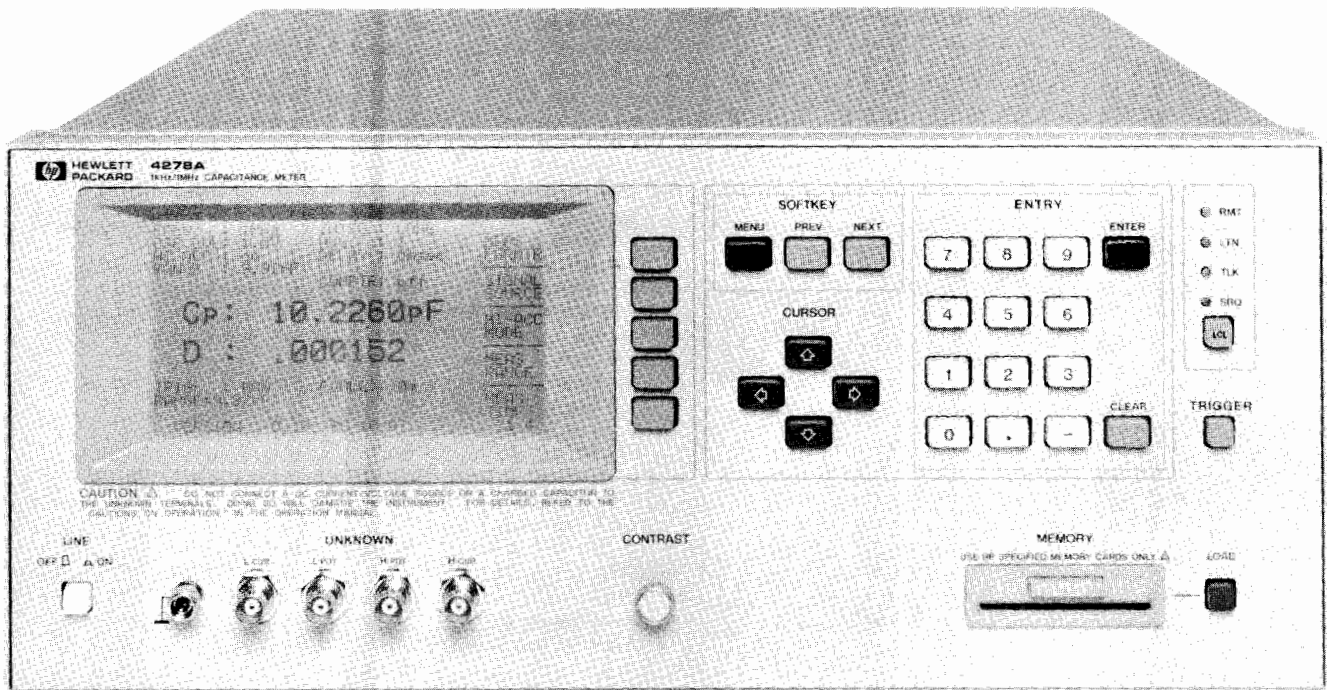

HP 4278A

### Description

The HP 4278A 1kHz/1MHz Capacitance Meter is a high speed, highly reliable, precision test instrument aimed at incoming/outgoing capacitor inspection applications on the production line and in quality control. The HP 4278A will improve test efficiency by performing comparative measurements of low to medium value capacitors (up to 200  $\mu$ F—a range that covers most ceramic and film capacitors) several times faster than previously available capacitance meters.

The HP 4278A's standard measurement frequencies and oscillator output levels are 1kHz/1MHz and from 0.1V to 1V in 0.1V steps, respectively. The HP 4278A's ability to make precision capacitance measurements and to measure low dissipation values will give you an edge in improving the quality of your devices.

The built-in comparator function of the HP 4278A gives you the ability to sort parts into ten bins. A high speed HP-IB interface and an optional handler interface are available for combining the HP 4278A with an automatic handler and an external computer to build a total solution for automatic testing and data acquisition and analysis.

### High Speed Measurements

One of the HP 4278A's main features is its selection of high measurement speeds: 6.5ms (153 measurements/sec), 10ms (100 measurements/sec), or 21ms (47 measurements/sec), with a fast settling time. Additionally, the HP 4278A's built-in comparator and high speed HP-IB interface make it possible to construct a measurement system using an automatic handler and an external computer to minimize production test time, and, therefore, cost.

### High Accuracy and Resolution

Dissipation factor (D), the parameter measured to determine the quality of capacitors, can be measured with an accuracy of 0.0002 (1MHz) and 0.0005 (1kHz) with a resolution of 0.00001 without degrading measurement speed. The HP 4278A has high capacitance measurement accuracy, 0.05% (1MHz) and 0.07% (1kHz) with 6 full digits of resolution in all measurement ranges, 1pF to 2048 pF (1MHz), and 100pF to 100  $\mu$ F (1kHz).

The pushbutton zero adjustment function is used to compensate for stray impedance and admittance of the handler and test fixture. The auto calibration function, when used with a capacitance standard, can be used to calibrate the system up to the point of device connection.

### Intelligent Built-in Comparator

The intelligent built-in comparator gives the HP 4278A the capability to use nine sets of high and low capacitance values and one set of dissipation limits to sort capacitors into nine bins, according to their capacitance values and whether or not they meet the dissipation limits. Capacitors which are not within the capacitance limits or do not meet the dissipation limits go into the tenth or no-go bin.

All comparator settings can be controlled and monitored using an external computer, and the results of the comparisons can be transferred to a handler interface (optional). All control settings and comparator parameters can be saved on the removable EEPROM memory module (memory card) to facilitate instrument setup and to minimize the chance of an instrument setup error.

**Specifications**

(refer to data sheet for complete specifications)

**Measurement Parameters:** C-D-Q-ESR-G

**Display:** Dot-matrix LCD. Displays measurement values with 4, 5, or 6 digit resolution, control settings, comparator limits, the comparator's decision, self test messages and annunciations.

**Measurement Circuit Modes:** Parallel and Series

**Test Signals:**

**Frequency:** 1kHz and 1 MHz, ±0.02%

**Signal Level:** 0.1 to 1 Vrms, ±10% (C ≤ 20μF), in 0.1Vrms steps

**Measurement Time Modes:** SHORT, MEDIUM, and LONG

**Measurement Times:**

Mode	SHORT	MEDIUM	LONG
Time*	6.5ms	10ms	21ms

\* Measurement time includes Setting, Integration (analog measurements), Calculation, and Comparison times.

No additional measurement time is required for measurements performed in an overload (shorted capacitor) condition.

**Measurement Range**

Measurement Parameter	1 KHz	1 MHz Normal Mode	
		1 MHz High Accuracy	
C	0.001 pF to 200.000 μF	0.00001 pF to 1280.00 pF	0.00001 pF to 2663.00 pF
DF	0.00001 to 9.99999	0.00001 to 9.99999	.000001 to .999999
Q	0.1 to 99999.9	0.1 to 99999.9	20 to 99999.9
G	0.00001 μS to 9.99999S	0.00001 μS to 9.99999 mS	0.00001 μS to 9.99999 mS
ESR	0.00001Ω to 9.99999 MΩ	0.001Ω to 999.999 KΩ	0.001Ω to 999.999 KΩ

- 1 kHz Normal Mode: 7 decade ranges 100pF to 100μF full scale. 100% overranging on all ranges, (max. 200000 counts) when D ≤ 0.5.
- 1 MHz Normal Mode: 11 binary ranges, 1pF to 1024pF full scale. 25% overranging on all ranges, when D ≤ 1.
- 1 MHz High Accuracy Mode: Measurement range is ±30% of the user defined nominal value, maximum 2048pF. When D ≤ 0.05.

**Measurement Accuracy**

It is specified at the UNKNOWN terminals and at the end of standard 1 or 2 meter test leads under the following conditions. Refer to data sheet for details.

1. Warm Up Time: ≥ 10 minutes.
2. Ambient Temperature is 23 ± 5°C and variance is less than 0.2°C/minute.
3. Test signal level is set to 1 Vrms.
4. Test cable length is 0, 1, or 2 meters (HP 16048A/B/D).
5. Zero OPEN/SHORT compensation has been performed.
6. D ≤ 0.05 for 1MHz High Accuracy Mode. D ≤ 0.1 for 1kHz and 1MHz Normal Modes.
7. Accuracies are only valid when the measured value is equal to full scale of each range.
8. Accuracy stated in the tables is given for MEDIUM (upper) and LONG (lower) integration times.
9. Accuracy equations are read as follows:  
 C: ± (% of reading + % of full scale)  
 D: ± (% of reading + absolute D value)  
 (C: ± (% of reading + absolute C value) for Table 3)

**Table 1 1kHz Measurement Accuracy**

C range	C	D
100μF	0.13% + 0.3% 0.07% + 0.025%	0.13% + 0.003 0.065% + 0.0025
100pF - 10μF	0.1% + 0.05% 0.05% + 0.025%	0.1% + 0.001 0.05% + 0.0005

**Table 2 1MHz Normal Mode Measurement Accuracy**

C range	C	D
256 - 1024pF	0.2% + 0.02% 0.1% + 0.02%	0.2% + 0.002 0.1% + 0.0005
4 - 128pF	0.2% + 0.02% 0.05% + 0.02%	
2pF	0.2% + 0.03% 0.05% + 0.03%	0.2% + 0.004 0.1% + 0.001
1pF	0.2% + 0.06% 0.05% + 0.06%	

**Table 3 1MHz High Accuracy Mode Measurement Accuracy**

Nominal C + Open Circuit C	C	D
1024 - 2048pF	0.11% 0.11%	0.0007 0.0004
256 - 1024pF	0.11% 0.07%	0.0007 0.0003
4 - 256pF	0.11% 0.05%	0.0007 0.0002
2 - 4pF	0.1% + 0.0004pF 0.06% + 0.0004pF	0.0008 0.0003
0 - 2pF	0.1% + 0.0004pF 0.08% + 0.0004pF	0.0016 0.0006

**Trigger Modes:** Internal, External, or Manual

**Measurement Terminals:** Four-terminal pair, guarded

**Cable Length Compensation:** 0, 1, or 2m

**Compensation Function**

**Zero OPEN/SHORT:** Compensation range: R ≤ 20Ω, G ≤ 20μS, and unlimited C and L.

**Standard:** Improves measurement accuracy by using a standard capacitor as a reference.

**Offset:** Arithmetic correction of measurement data.

**Comparator:** Ten-bin sorting for capacitance, and go/no-go testing for D, Q, ESR, and G.

**Sorting Modes:** Sequential sorting into un-nested bands with absolute limits, and tolerance sorting into nested bands with absolute or percent limits.

**Self Test:** Checks the HP 4278A's basic operation.

**Memory Card:** External memory for storing and recalling control settings and comparator limits.

**General Specifications**

**Operating Temperature and Humidity:** 0-55°C, 95% RH @ 40°C  
**Power:** 100, 120, 220VAC ± 10%, 240VAC +5 -10%, 48-66Hz, 200VA max.

**Dimensions (in mm):** Approximately 426(W) by 177(H) by 498(D)  
**Weight:** Approximately 10kg (22lb., standard)

**Reference Data**

**Stability:** LONG integration and constant operating temperature.

C ≤ 0.01%/day  
 D ≤ 0.0001/day

**Temperature Coefficient:** LONG integration and 12±5°C.

C ≤ 0.01%/°C; 1kHz and 1MHz.  
 D ≤ 0.0001/°C; 1kHz and 1MHz Normal Mode.  
 D ≤ 0.00004/°C; 1MHz High Accuracy Mode.

**HP-IB Data Output Speed:** Maximum 100 bytes/ms, typically 3ms for handshake, depending on the system controller.

**Accessories Available**

HP 16270A: Memory Card Set	\$275
HP 16334A: Tweezer-type Test Fixture for Chip Components	\$430
HP 16047A: Direct-coupled Test Fixture	\$265
HP 16047C: Test Fixture	\$305
HP 16048A: Test Leads, BNC (1m)	\$325
HP 16048B: Test Leads, SMC (1m)	\$325
HP 16048D: Test Leads, BNC (2m)	\$420
HP 16380A: Standard Capacitor Set	\$2955
HP 16380C: Standard Capacitor Set	\$4500

Refer to page 279.

**Ordering Information**

HP 4278A 1kHz/1MHz Capacitance Meter	\$7130
Opt W30: 3-year hardware support	\$180
Opt 001: 1kHz test frequency only	-\$750
Opt 002: 1MHz test frequency only	-\$330
Opt 003: 1% frequency shift: prevents possible test signal interference when component test contacts are located close to those of other test units	\$0
Opt 008: Delete Manual	-\$30
Opt 101: HP-IB compatibility	\$224
Opt 201: Handler Interface	\$255
Opt 202: Handler Interface	\$270
Opt 301: Scanner Interface	\$540

☞ Fast-ship product, see page 766.

# COMPONENT MEASUREMENT

## LCZ Meters

### Models 4276A & 4277A

- 3-digit frequency setting:
  - 100 Hz to 20 kHz (801 spots)
  - 10 kHz to 1 MHz (701 spots)
- High speed measurements
- Measure L/C-D/Q/ESR/G,  $|Z| - \theta$ , high speed L/C
- 10-bin component sorting-comparator (OPT. 002)
- 0.1% basic accuracy over impedance range of 100 m $\Omega$  to 10 M $\Omega$  (HP 4276A), 10 $\Omega$  to 1 M $\Omega$  (HP 4277A)

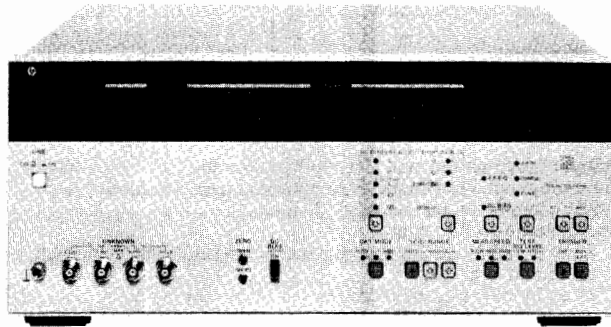

HP 4276A

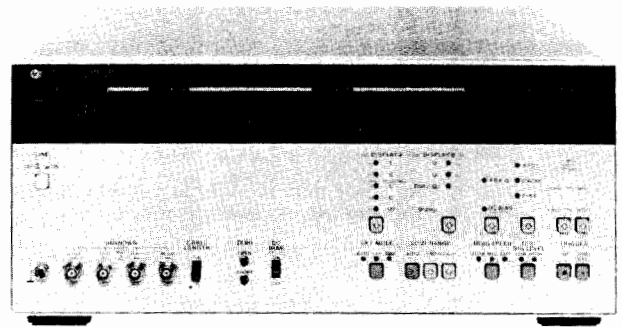

HP 4277A



### Description

HP's 4276A and 4277A LCZ Meters are general purpose impedance measuring instruments designed to measure circuit components such as capacitors and inductors using frequency and dc bias conditions identical to those of the intended application. Both HP 4276A and HP 4277A feature variable test frequency (100 Hz – 20 kHz and 10 kHz – 1 MHz respectively), optional dc bias variable from 0 to  $\pm 40$  V, multiple parameters (L • C •  $|Z|$  • D • Q • ESR • G •  $\theta$ ) with fully automatic high speed measurements, and  $4\frac{1}{2}$  digit resolution. The HP 4276A has an impedance range of 100 m $\Omega$  to 10 M $\Omega$  and the HP 4277A 10  $\Omega$  to 1 M $\Omega$ .

Both instruments are ideal for production line, quality control, and circuit design applications, and are versatile enough for stand-alone use or systems use under HP-IB control (standard). An optional comparator for 10-bin sorting with measurement time of less than 100 ms make the HP 4276A/4277A a good choice for production line testing of discrete components.

**Specifications** (Refer to data sheet for complete specifications)  
Common to HP 4276A and HP 4277A

**Parameters measured:** C-D • Q • ESR • G • L-D • Q • ESR • G  
high speed L, high speed C  
 $|z| - \theta$  and  $\Delta$  (deviation for any parameter)

**Display:**  $4\frac{1}{2}$  digits (max), maximum display 19999

**Measurement circuit modes:** Auto, Parallel, and Series

**Frequency control modes:** SPOT, COARSE (10 freq./decade), and FINE (max. freq. resolution).

**Test Signal Level** (unknown terminal open)

	HIGH	LOW
HP 4276A	1 Vrms $\pm 10\%$ @ 1kHz	50 mV $\pm 20\%$ (CP only) @ 1kHz
HP 4277A	1 Vrms $\pm 10\%$	20 mV $\pm 15\%$

### Test frequencies:

**HP 4276A** - 100 Hz to 20 kHz  $\pm 0.01\%$  (801 points)

**HP 4277A** - 10 kHz to 1 MHz  $\pm 0.01\%$  (701 points)

**Measurement accuracy and range:** specified at the front panel unknown connectors when all of the following conditions are satisfied:

- (1) warmup time  $\geq 30$  min.
- (2) test signal level is set to HIGH (1 Vrms)
- (3) measurement speed mode: MED or SLOW
- (4) ambient temperature is 23°C  $\pm 5$ °C
- (5) cable length switch is set to 0 m (HP 4277A)
- (6) OPEN and SHORT adjustments have been made
- (7) D  $\leq 0.1$

### C Measurement Basic Accuracy:

**HP 4276A:** 0.1% + 17 counts to 3% + 2 counts

**HP 4277A:** 0.1% + 17 counts to 3% + 4 counts

### DC Bias

**Internal dc bias (opt.):** 0 to  $\pm 40$  V

### Reference Data

**Measurement Speed (Typical):** (Circuit mode: AUTO, test signal level: HIGH, display digit: 3 digits, FAST mode)

Measurements	HP 4276A @ 1kHz	HP 4277A @ 1MHz
C-D • ESR • G	65 ms	75 ms
L-D • ESR • G	75 ms	65 ms
Z- $\theta$	80 ms	75 ms
High Speed C	35 ms	40 ms

### General Specifications

**Operating temperature and humidity:** 0° to 55°C,  $\leq 95\%$  RH at 40°C.

**Power requirements:** 100/120/220 Vac  $\pm 10\%$ , 240 V + 5% – 10%; 48 to 66 Hz.

**Power consumption:** 65 VA max (HP 4276A); 75 VA max (HP 4277A).

**Size:** 188 mm H x 426 mm W x 422 mm D ( $7\frac{1}{2}$ " x  $16\frac{1}{4}$ " x  $16\frac{1}{2}$ ").

**Weight:** approx. 8.5 kg (18.7 lb).

### Special Options

**HP 4276A Opt H05:** 1 kHz C-D measurement only (1V/100mV)

**HP 4276A Opt H06:** 1 kHz C-D measurement only (1V/300mV)

**HP 4276A Opt H07:** 1 kHz C-D measurement only (1V/500mV)

**HP 4277A Opt H03:** Programmable DC bias for high speed C-V measurement (1V/20mV, 1 MHz only)

**HP 4277A Opt H04:** Programmable DC bias for high speed C-V measurement (500mV/20mV, 1 MHz only)

**HP 4277A Opt H07:** High accuracy DC bias

Contact your nearest HP sales office for more information.

### Accessories

**Furnished accessories:** HP 16047A Direct Coupled Test Fixture

### Accessories Available

**HP 18064A:** Retrofit Kit for Comparator (HP 4276A/HP 4277A, Opt 002)

### Ordering Information

**HP 4276A** LCZ Meter

**HP 4277A** LCZ Meter

**Opt 001:** Internal dc bias, 0 to  $\pm 40$  V, max resolution 10 mV/100 mV.

**Opt 002:** 10-bin sorting for L/C/ $|Z|$  and go/no-go testing for D/Q, interfaceable with component handler.

**Opt W30:** 3-year hardware support (HP 4276A)

**Opt W30:** 3-year hardware support (HP 4277A)

### Prices

\$5,200

\$7,300

\$230

\$800

\$140

\$200



# COMPONENT MEASUREMENT

1MHz C-V Meter  
Model 4279A

295

- Built-in programmable dc bias sweep source with a voltage accuracy of 0.1%
- High speed C-V measurements: 10ms, 20ms, and 30ms/meas point
- 0.1% basic accuracy and 6 digit resolution for C measurement
- Automatic dc bias polarity control
- High reliability for production testing

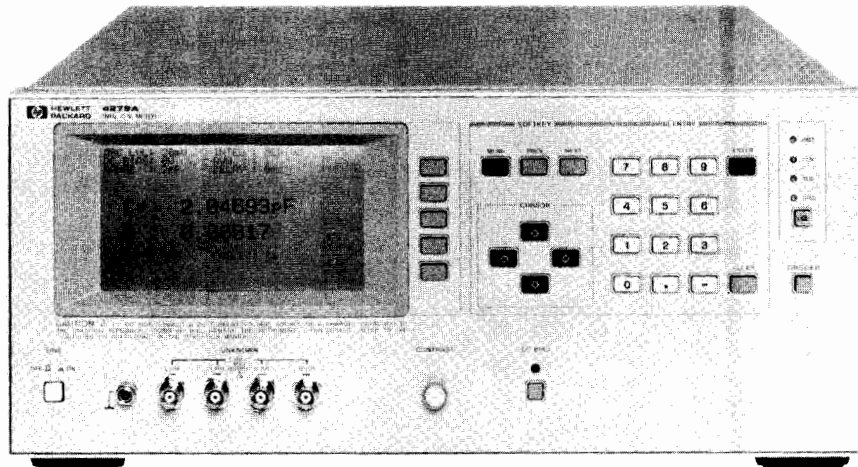

HP 4279A



## Description

The HP 4279A 1MHz C-V Meter offers the optimum solution for increasing quality and throughput when measuring the capacitance vs bias voltage characteristics of semiconductors. The HP 4279A measures capacitance over a range of 0.00001 pF to 1280.00pF with a basic accuracy of 0.1% and a 6 digit display resolution, while sweeping the dc bias voltage. An internal, programmable dc bias sweep source with a 0.1% voltage accuracy throughout the  $\pm 38V$  range assures very low measurement error due to bias voltage uncertainty. It makes the HP 4279A ideal for the precise characterization and testing of varactor diodes, MOS diodes, etc.. Measurement time can be selected from three modes of 10ms, 20ms and 30ms/meas to maximize productivity. The HP 4279A's very fast ranging and high speed HP-IB data transfer capabilities reduce test time. The automatic bias polarity control feature allows quick selection of the correct polarity bias voltage for the device under test. This new function eases manual testing of samples in incoming/outgoing inspection and provides a simple method of polarity control for automatic test systems.

## Specifications

**Parameters measured:** C-D•Q•ESR•G

**Display:** 4, 5, 6 digits, selectable, maximum display 999999

**Measurement circuit modes:** Series and parallel.

**Ranging modes:** Auto, Manual and Program

**Measurement frequency:** 1MHz  $\pm 0.02\%$

**Test signal level (unknown terminal open):** 20mV, 50mV, 100mV, 200mV, 500mV and 1Vrms, selectable

**Measurement terminals:** 4-terminal pair

**Test cable length compensation:** 0m, 1m and 2m

**Error-correction:** OPEN and SHORT adjustments and STD and temperature compensation functions

<b>Measurement time:</b>	Mode	SHORT	MEDIUM	LONG
	Time	10ms	20ms	30ms

**Ranging time:** Less than 3ms in program mode (unspecified)

**Trigger:** Internal, External and Manual

**Delay time:** 0 to 1000ms, programmable in 1ms steps

**Measuring range and accuracy**

**C-D measurement range:** 0.00001pF to 1280.00pF;  
0.00001 to 9.99999D

**C measurement accuracy:** Specified at the front panel unknown terminals and the ends of standard 1m or 2m test leads (HP 16048A/B/D) when all of the following conditions are satisfied:

- (1) Ambient temperature is  $23^{\circ}C \pm 5^{\circ}C$  and temperature variance  $\leq 0.2^{\circ}C/min$
- (2) Warmup time  $\geq 10min$ .

- (3) OPEN, SHORT and temperature compensations have been made
- (4)  $D \leq 0.1$

Accuracies for C measurements in MEDIUM mode are given in Table 1 and are read as  $\pm(\% \text{ of reading} + \% \text{ of full scale value})$ . (Refer to the HP 4279A data sheet for complete accuracy specifications, including D/Q/ESR/G accuracies.)

C range	Test signal level			
	20mV	50mV	100mV	200mV-1V
1024pF 512pF 128pF	0.07%+0.03%	0.07%+0.03%	0.07%+0.03%	0.07%+0.03%
32pF				
8pF	0.06%+0.04%	0.06%+0.04%		
2pF	0%+0.3%	0%+0.15%	0%+0.1%	0.06%+0.04%

## DC bias

**Internal dc bias:** 0V to  $\pm 38V$

Bias voltage	Voltage step	Accuracy (at $23^{\circ}C \pm 5^{\circ}C$ )
$\pm(0.000-4.000)V$	1mV	$\pm(0.1\% \text{ of setting} + 1mV)$
$\pm(4.002-8.000)V$	2mV	$\pm(0.1\% \text{ of setting} + 2mV)$
$\pm(8.005-20.000)V$	5mV	$\pm(0.1\% \text{ of setting} + 3mV)$
$\pm(20.01-38.00)V$	10mV	$\pm(0.1\% \text{ of setting} + 10mV)$

**Bias voltage sweep:** Max. 51 sweep points can be programmed via HP-IB

**Auto bias polarity control:** Completed within 4ms after triggered (unspecified)

**External dc bias:** 0V to  $\pm 100V$  via rear panel connector

**HP-IB:** Standard. Remote control and ASCII or binary data output (packed data output when swept bias measurements are made.)

## General

**Operating temperature and humidity:**  $5^{\circ}C$  to  $45^{\circ}C$ ,  $\leq 95\%RH$  at  $40^{\circ}C$

**Power:** 100/120/220V  $\pm 10\%$ , 240V  $+5\% - 10\%$ : 48 to 66Hz; 200VA maximum

**Size:** 177mmH x 426mmW x 498mmD (7" x 16.8" x 19.6")

**Weight:** Approximately 15kg

## Accessories Available

Refer to page 279.

## Ordering information

HP 4279A 1MHz C-V Meter

**Opt. W30:** 3-year hardware support

**Opt. 003:** 1% frequency shift

**Opt. 009:** Delete manual

**Opt. 910:** Extra manual

## Price

\$9700

\$270

\$0

-\$36

\$36

# COMPONENT MEASUREMENT

## Digital LCR Meters Models 4261A and 4262A

- Automatic balancing, ranging & circuit mode selection
- Test frequencies: HP 4261A, 120 (100) Hz and 1 kHz  
HP 4262A, 120 (100) Hz, 1 kHz and 10 kHz

- Versatile accessories and options
- High reliability

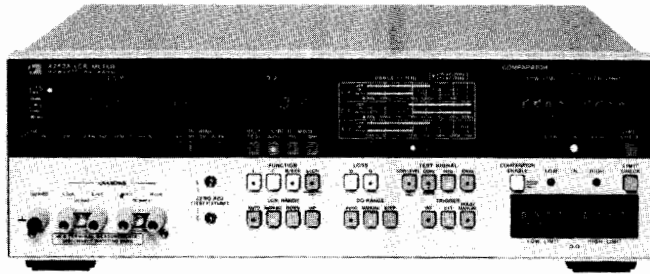

HP 4262A with Opt 004



HP 4261A

### Description

The HP 4261A and HP 4262A are 3½ digit LCR meters that meet today's requirements for component measurements. Both instruments feature fully automatic operation over wide measuring ranges. Simply select the measuring functions and one of the test frequencies, then insert the device to be measured. The instrument does the rest—automatically selecting the proper measuring range and equivalent circuit mode.

In addition to automatic measurements, the HP 4261A and HP 4262A provide high accuracy (0.2% reading), internal dc bias, and series and parallel equivalent circuit modes.

These relatively low cost and easy-to-use LCR meters are capable of a wide range of applications — measuring electrolytic/ceramic capacitors, filter coils, pulse transformers, internal resistance of dry cells and semiconductor junction capacitance, as well as ordinary LCR components. Extended features of these reliable instruments include optionally available HP-IB (HP 4262A) and BCD (HP 4261A) data output capabilities and a comparator option which is convenient for production line applications.

**Specifications** (refer to data sheet for complete specifications) Measurement ranges and accuracies: see table on this page. Accuracy applies over a temperature range of 23°C ±5°C (at 0° to 55°C, error doubles). 10 kHz and Q specifications are given only for the HP 4262A.

	HP 4261A	HP 4262A
Parameters measured	L-D, C-D R	L-D • Q, C-D • Q R (ESR), ΔLCR
Display	3-1/2 digits max. display 1900	3-1/2 digits max. display 1999
Basic Accuracy	0.2%	
Test frequency	120(100) Hz, 1 kHz ±3%	120(100) Hz, 1 kHz 10 kHz ±3%
Test signal level (typical)	1 V, 50 mV (Cp mode only)	
DC bias	Int	1.5 V, 2.2 V, 6 V ±5%, selectable
	Ext	0 to +30 V
Equivalent circuit modes	auto, parallel, series	
Ranging modes	LCR	auto, manual
	DQ	D only - fixed
Trigger	internal, external, manual	
Measuring terminal	5-terminal configuration	

**Deviation measurement (HP 4262A):** displays the difference between a stored value (that is, measured value when LCR switch is depressed) and subsequent measured data.

**Offset adjustments (HP 4262A):** front panel adjustments to compensate for stray capacitance (C: 0 to 10 pF) and residual inductance (L: 0 to 1 μH) of the test fixture.

**Self-test (HP 4262A):** automatically checks basic functions.

### General

**Measuring time (typical):** for a 1000 count measurement on a low loss component on a fixed range:

**1 kHz, 10 kHz:** C/L 220-260 ms, R 120-160 ms

**120 (100) Hz:** C/L 900 ms, R 700 ms

### Ranging Time

**1 kHz, 10 kHz:** 180 ms/range step

**120 (100) Hz:** 670 ms/range step

**Reading rate:** INT (internal trigger) approximately 30 ms between end of measurement cycle and start of the next cycle. EXT (external trigger) measuring cycle is initiated by a remote trigger input.

**Accessories available:** **HP 16061A:** test fixture, direct couple, 5-terminal; **HP 16062A:** test leads with alligator clips, 4-terminal (for low impedance measurements); **HP 16063A:** test leads with alligator clips, 3-terminal (for high impedance measurements).

### Ordering Information (HP 4261A \*1)

<b>Opt 001:</b> BCD Output (L/C/R and D simultaneously)	\$240
<b>Opt 002:</b> BCD Output (L/D, C/D, R alternately)	\$210
<b>Opt 003:</b> BCD Remote Control	\$110
<b>Opt 010:</b> 100 Hz Test Frequency	\$0
<b>Opt 910:</b> Extra Manual	\$23
<b>HP 16061A</b> Test Fixture, Radial/Axial Lead devices	\$224
<b>HP 16062A</b> Test Leads, 4-wire	\$120
<b>HP 16063A</b> Test Leads, 3-wire	\$130

\*1: Options 001 and 002 are mutually exclusive.

### Ordering Information (HP 4262A \*2)

<b>Opt 001:</b> BCD Output	\$420
<b>Opt 004:</b> Digital Comparator	\$1,050
<b>Opt 010:</b> 100 Hz Test Frequency	\$0
<b>Opt 101:</b> HP-IB Interface	\$700
<b>Opt 907:</b> Front Handle Kit	\$56
<b>Opt 908:</b> Rack Flange Kit	\$33
<b>Opt 909:</b> Rack/Handle Kit	\$82
<b>Opt 910:</b> Extra Manual	\$30
<b>HP 16061A</b> Test Fixture for Radial/Axial Lead Devices	\$224
<b>HP 16062A</b> Test Leads, 4-wire	\$120
<b>HP 16063A</b> Test Leads, 3-wire	\$130

\*2: Option combinations 101/001 and 101/004 cannot be ordered.

- Frequency range: 22 kHz to 70 MHz
- Q range: 5 to 1000

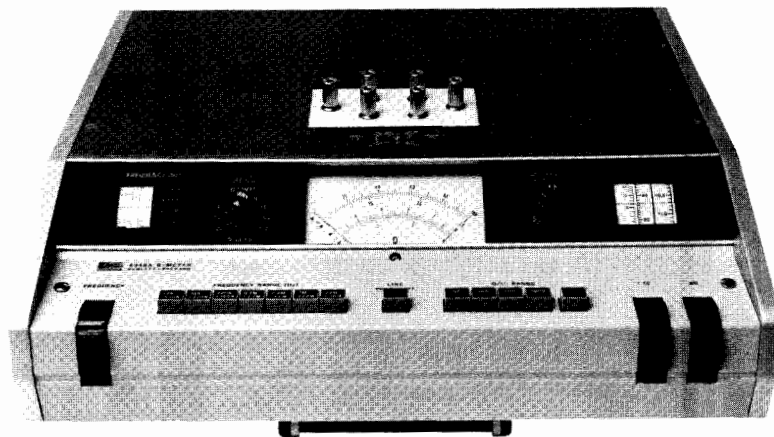

HP 4342A

### Description

The direct-reading expanded scale of the HP 4342A permits measurement of Q from 5 to 1000 and readings of very small changes in Q resulting from variation in test parameters. The HP 4342A is solid state with the elimination of specially matched, fragile thermocouple components.

The HP 4342A will measure dissipation factor and dielectric constant of insulating materials. The Q meter can measure coefficient of coupling, mutual inductance, and frequency response of transformers. RF resistance, reactance, and Q of resistors and capacitors can also be determined.

Pushbutton operation of frequency range and Q/ $\Delta$ Q range selection provides straightforward measurement. Automatic indication of meter scales, frequency dials and frequency multipliers are featured, adding to simplicity and reading speed.

### Specifications

#### RF Characteristics

**RF range:** 22 kHz to 70 MHz in 7 bands: 22 to 70 kHz, 70 to 220 kHz, 220 to 700 kHz, 700 to 2200 kHz, 2.2 to 7 MHz, 7 to 22 MHz, 22 to 70 MHz.

**HP 4342A Opt 001:** 10 kHz to 32 MHz in 7 bands: 10 to 32 kHz, 32 to 100 kHz, 100 to 320 kHz, 320 to 1000 kHz, 1 to 3.2 MHz, 3.2 to 10 MHz, 10 to 32 MHz.

**RF accuracy:**  $\pm 1.5\%$  from 22 kHz to 22 MHz;  $\pm 2\%$  from 22 MHz to 70 MHz;  $\pm 1\%$  at "L" point on frequency dial.

**HP 4342A Opt 001:**  $\pm 1.5\%$  from 10 kHz to 10 MHz;  $\pm 2\%$  from 10 MHz to 32 MHz;  $\pm 1\%$  at "L" point on frequency dial.

**RF increments:** approximately 1% resolution.

#### Q Measurement Characteristics

**Q range:** 5 to 1000 in 4 ranges: 5 to 30, 20 to 100, 50 to 300, 200 to 1000.

**Q accuracy:** % of indicated value: (at 25°C)

Q Freq.	HP 4342A & HP 4342A Opt. 001	HP 4342A
	22 kHz-30MHz	30 MHz-70 MHz
5-300	$\pm 7$	$\pm 10$
300-600	$\pm 10$	$\pm 15$
600-1000	$\pm 15$	$\pm 20$

**Q increments:** upper scale, 1 from 20 to 100; lower scale, 0.5 from 5 to 30.

**$\Delta$ Q range:** 0 to 100 in 4 ranges: 0 to 3, 0 to 10, 0 to 30, 0 to 100.

**$\Delta$ Q accuracy:**  $\pm 10\%$  of full scale.

**$\Delta$ Q increments:** upper scale, 0.1 from 0 to 10; lower scale, 0.05 from 0 to 3.

#### Inductance Measurement Characteristics

**L range:** 0.09  $\mu$ H to 1.2 H, direct reading at 7 specific frequencies.

**L accuracy:**  $\pm 3\%$  after substitution of residuals (approx. 10 nH).

#### Resonating Capacitor Characteristics

**Capacitor range:** main dial, 25 to 470 pF, vernier dial,  $-5$  to  $+5$  pF.

**Capacitor accuracy:** main dial,  $\pm 1\%$  or 1 pF, whichever is greater; vernier dial,  $\pm 0.1$  pF.

**Capacitor increments:** main dial, 1 pF from 25 to 30 pF, 2 pF from 30 to 200 pF, 5 pF from 200 to 470 pF; vernier dial, 0.1 pF.

#### General

##### Rear Panel Outputs

**Frequency monitor:** 170 mV rms min. into 50  $\Omega$ .

**Q analog output:** 0 to 1 V  $\pm 50$  mV dc after 15 minutes warmup, proportional to meter deflection. Output impedance approximately 1 k $\Omega$ .

**Over limit signal output:** contact closure at the rear panel. Relay contact capacity 0.5 A/15 VA.

**Over limit display time:** selectable, 1 s or continuously on, after limit exceeded.

**Temperature range:** 0°C to 50°C.

**Power:** 115 or 230 V  $\pm 10\%$ , 50-400 Hz, approximately 40 VA.

**Size:** 138 mm H x 425 mm W x 414 mm D (5 $\frac{7}{16}$ " x 16 $\frac{3}{4}$ " x 16 $\frac{5}{16}$ ").

**Weight:** net, 14 kg (31 lb); shipping, 18.45 kg (41 lb).

##### Accessories Available

**HP 16014A series loss test adaptor:** designed for measuring low-value inductors and resistors and high-value capacitors.

**HP 16451A Dielectric Test Adapter:** designed for measuring the dielectric constant, capacitance and dissipation factor of insulating materials.

**HP 16462A Auxiliary Capacitor:** designed to extend the Q and L measurement capability of the HP 4342A Q Meter. It is especially useful for measuring small inductors at low frequencies.

**HP 16470A Reference Inductors:** A range of 20 inductors (any of which can be supplied separately) which can be used with the HP 4342A Q Meter when measuring the RF characteristics of capacitors, resistors, or insulating materials.

**HP 16470B Stable Inductors:** A set of 4 inductors (any of which are separately available) which can be used to compensate indicated Q values and/or instrumental variation in the maintenance of the HP 4342A Q Meter. They are usable over a range of 800 kHz to 50 MHz with excellent long-term temperature stability.

#### Options and Accessories

	Price
<b>Opt 001:</b> Frequency Range (10 kHz - 32 MHz)	\$330
<b>Opt 910:</b> Extra Manual	\$21
<b>HP 16014A</b> Series Loss Test Adaptor	\$170
<b>HP 16451A</b> Dielectric Test Adapter	\$700
<b>HP 16462A</b> Auxiliary Capacitor	\$650
<b>HP 16470A</b> Reference Inductors, set of 20	\$3100
<b>HP 16470B</b> Stable Inductors, set of 4	\$1700
<b>HP 16470C</b> Complete set of 24 Inductors (HP 16470A + HP 16470B)	\$4800

**HP 4342A Q Meter**

**\$6,700**

# COMPONENT MEASUREMENT

## Milliohmmeter/High Resistance Meter

Model 4328A/4329A

- 20  $\mu\Omega$  resolution on 1 m $\Omega$  range
- Four terminal measurement
- Low test voltage

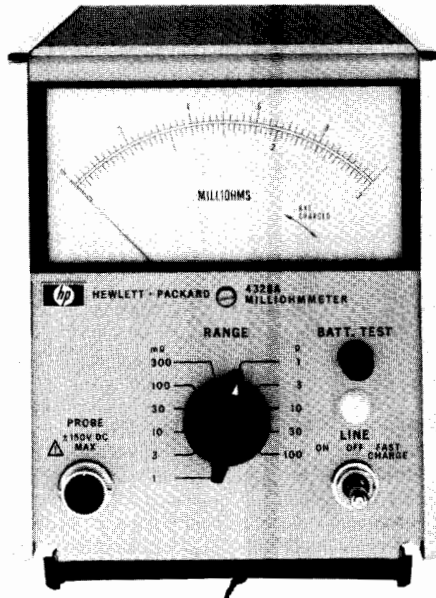

HP 4328A

### Description

HP's 4328A Milliohmmeter is a high sensitivity portable instrument for measurement of low resistances. The 1 m $\Omega$  to 100  $\Omega$  measuring range and 20  $\mu\Omega$  resolution make the HP 4328A ideal for measuring the contact resistance of switches, relays, and connectors and the resistivity of conductors and semiconductors. Series reactances of up to twice the full scale resistance will not affect the accuracy. The maximum voltage across a sample, with the instrument at the proper range, is less than 200  $\mu\text{V}$  peak. Even at incorrect range settings, the voltage across the sample will not exceed 20 mV peak.

The special probes that allow four-terminal measurement in two probes are furnished with the HP 4328A.

The basic HP 4328A is line operated but Opt 001 permits operation from rechargeable batteries for 15 continuous hours.

### Specifications

**Range:** 0.001 to 100 ohms full scale in a 1, 3 sequence.

**Accuracy:**  $\pm 2\%$  of full scale. No additional error is caused by series reactance of samples up to two times full scale.

**Measuring frequency:** 1000 Hz  $\pm 100$  Hz.

**Voltage across sample:** 200  $\mu\text{V}$  peak at full scale.

**Maximum voltage across sample:** 20 mV peak.

**Superimposed dc:** 150 V dc maximum (external source).

**Recorder output:** 0.1 V dc output at full scale, output resistance approx. 1 k $\Omega$ .

**Applied current (mA):** constant by range, 150/(full scale value in milliohms).

### General

**Power requirements:** 115/230 V  $\pm 10\%$ , 50 to 60 Hz, 1.5 VA.

**Weight:** 3.2 kg (7 lb).

**Size:** 155 mm H x 130 mm W x 280 mm D (6 $\frac{1}{32}$ " x 5 $\frac{1}{8}$ " x 11").

**Accessories furnished:** HP 16005A Probe, HP 16006A Probe, HP 16007A/B Test Leads and HP 16143A Probe Cable.

### Ordering Information

HP 4328A Milliohmmeter

Opt 001: Rechargeable battery operation

Opt 910: extra manual

### Price

\$2,300

\$130

\$15

- Wide range: 500 k $\Omega$  to  $2 \times 10^{16} \Omega$
- Selectable test voltages: 10 V to 1000 V

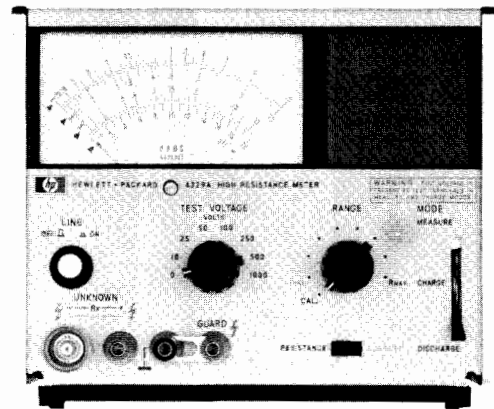

HP 4329A

### Description

The HP 4329A is a solid-state insulation resistance meter designed for easy, accurate and direct readings of the very high resistance values typically found in synthetic resins, porcelain, insulating oils and similar materials. It is also useful for measurements in electrical components such as capacitors, transformers, switches and cables. Seven fully regulated dc test voltages (between 10 and 1000 Vdc) are provided as test sources.

The HP 4329A is instantly convertible from ungrounded-to-grounded-sample operation via a simple relocation of the front panel ground strap from "guard" to "+" position.

The HP 4329A also has a current measurement capability. Minute currents as low as 0.05 pA can be readily measured.

The HP 16008A Resistivity Cell, designed for use with the HP 4329A, can safely, rapidly and conveniently measure the volume and surface resistivity of sheet insulation materials (maximum sample size: 125 mm W x 125 mm D x 7 mm H).

### Specifications

#### Resistance Measurement

**Range:** 500 k $\Omega$  to  $2 \times 10^{16} \Omega$ . (Depends on the test voltage).

**Accuracy:** total accuracy is determined by test voltage and range used. At low resistance end of each scale, accuracy is  $\pm 3\%$ , near center scale  $\pm 5\%$ , and near the specified upper limit on the meter scale (a quarter of full scale), accuracy is  $\pm 10\%$ . Accuracy is not specified above these limits. On all voltage ranges, if multiplier is set to Rmax., an additional  $\pm 3\%$  is included.

**Test voltages:** 10 V, 25 V, 50 V, 100 V, 250 V, 500 V and 1000 V  $\pm 3\%$ .

#### Current Measurement

**Range:**  $5 \times 10^{-14}$  to  $2 \times 10^{-5}$  A in 8 ranges.

**Accuracy:**  $\pm 5\%$  of full scale deflection (there can be an additional  $\pm 3\%$  error at the top decade).

#### General

**Recorder output:** 0 to 100 mV dc, proportional to meter deflection; 1 k $\Omega$  output resistance.

**Power:** 115/230 V  $\pm 10\%$ , 50-60 Hz, approximately 3 VA.

**Size:** 155 mm H x 198 mm W x 204 mm D (6 $\frac{1}{2}$ " x 7 $\frac{25}{32}$ " x 8 $\frac{25}{32}$ ").

**Weight:** 3.5 kg (7.7 lb).

**Accessory furnished:** HP 16117A Low Noise Test Leads.

**Accessory available:** HP 16008A Resistivity Cell.

### Ordering Information

HP 16008A Resistivity cell

HP 4329A High resistance meter

Opt 910: extra manual

### Price

\$1,100

\$2,800

\$15

# COMPONENT MEASUREMENT

## Standard Capacitor Set and Decade Capacitor

Models 16380A, 16380C, 4440B

299

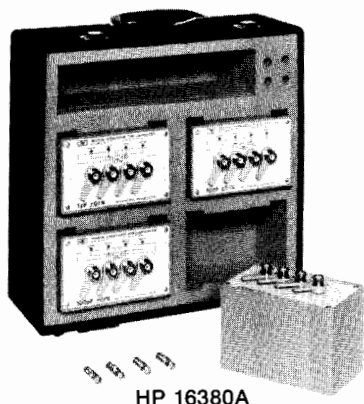

HP 16380A

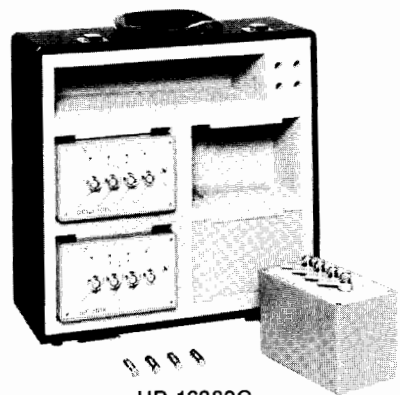

HP 16380C

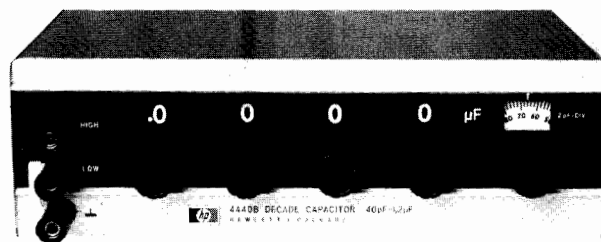

HP 4440B

### HP 16380A, HP 16380C Description

The HP 16380A and HP 16380C are precision standard capacitor sets that cover the range of 1 pF to 1 μF in decade steps. The HP 16380A consists of four discrete air-dielectric capacitors with nominal values of 1 pF, 10 pF, 100 pF, and 1000 pF. Similarly, the HP 16380C consists of four discrete capacitors, but with solid dielectrics and with nominal values of 0.01 μF, 0.1 μF, and 1 μF.

Both the HP 16380A and HP 16380C are furnished with test certification of 0.01% calibration accuracy. Capacitance stability with respect to time varies from capacitor to capacitor but is specified in the range of +/−50 or +/−300 ppm/year.

The HP 16380A and HP 16380C both have the four-terminal pair configuration to allow direct connection to any of Hewlett-Packard's many four-terminal pair impedance measuring instruments. The HP 16380A/C can be easily adapted to two-, three-, and five-terminal configurations.

### HP 16380A, 16380C Specifications (valid at 1 kHz, 23 ± 5 °C)

#### HP 16380A

Capacitance	1 pF	10 pF	100 pF	1000 pF
Nominal Accuracy		±0.1%		
Calibration Accuracy		±0.01%		
Stability		<300 ppm/yr		
Dissipation Factor		<0.0001		
Dimensions	112 mm (H) x 142 mm (W) x 88 mm (D)			
Weight	8.0 kg (includes case)			

#### HP 16380C

Capacitance	0.01 μF	0.1 μF	1 μF
Nominal Accuracy		±0.1%	
Calibration Accuracy		±0.01%	
Stability		<50 ppm/yr	
Dissipation Factor	<0.0004	<0.0005	<0.0007
Dimensions	117 mm (H) x 142 mm (W) x 88 mm (D)		
Weight	6.3 kg (includes case)		

### HP 4440B Description

The Hewlett-Packard 4440B Decade Capacitor is a high accuracy instrument providing usable capacitances from 40 pF to 1.2 μF. Its 0.25% accuracy makes it an ideal aid for circuit design or as a working standard.

The use of silvered-mica capacitors in all four decades provides higher accuracy, lower dissipation factor and good temperature coefficient. An air capacitor vernier provides 100 pF (from 40 pF to 140 pF) with resolution of 1 pF. Capacitors are housed in a double shield in such a way that increased capacitance from two terminals to three terminals is held to 1 pF.

### 4440B Specifications

**Capacitance:** 40 pF to 1.2 μF in steps of 100 pF with a 40 pF to 140 pF variable air capacitor providing continuous adjustment to better than 2 pF between steps.

**Direct reading accuracy:** ±(0.25% + 3 pF) at 1 kHz for three-terminal connection.

**Resonant frequency:** typical values of the resonant frequency are 450 kHz at 1 μF, 4 MHz at 0.01 μF and 40 MHz at 100 pF

**Dissipation factor:** for C ≥ 1040 pF, 0.001 max. at 1 kHz.  
for C < 1040 pF, 0.005 max. at 1 kHz.

**Temperature coefficient:** < +70 ppm/°C.

**Insulation resistance:** 5 GΩ minimum, after 5 minutes at 500 V dc.

**Maximum voltage:** 42 Vdc or 30 Vrms.

**Weight:** net, 2.5 kg (5½ lb); shipping, 3.6 kg (8 lb).

**Size:** 76 mm H x 264 mm W x 152 mm D (3" x 11" x 6").

### Ordering Information

HP 16380A Standard Capacitor Set (1 pF, 10 pF, 100 pF, 1000 pF)

### Price

\$2,955

HP 16380C Standard Capacitor Set (0.01 μF, 0.1 μF, 1 μF)

\$4,500

HP 4440B Decade Capacitor

\$1,650



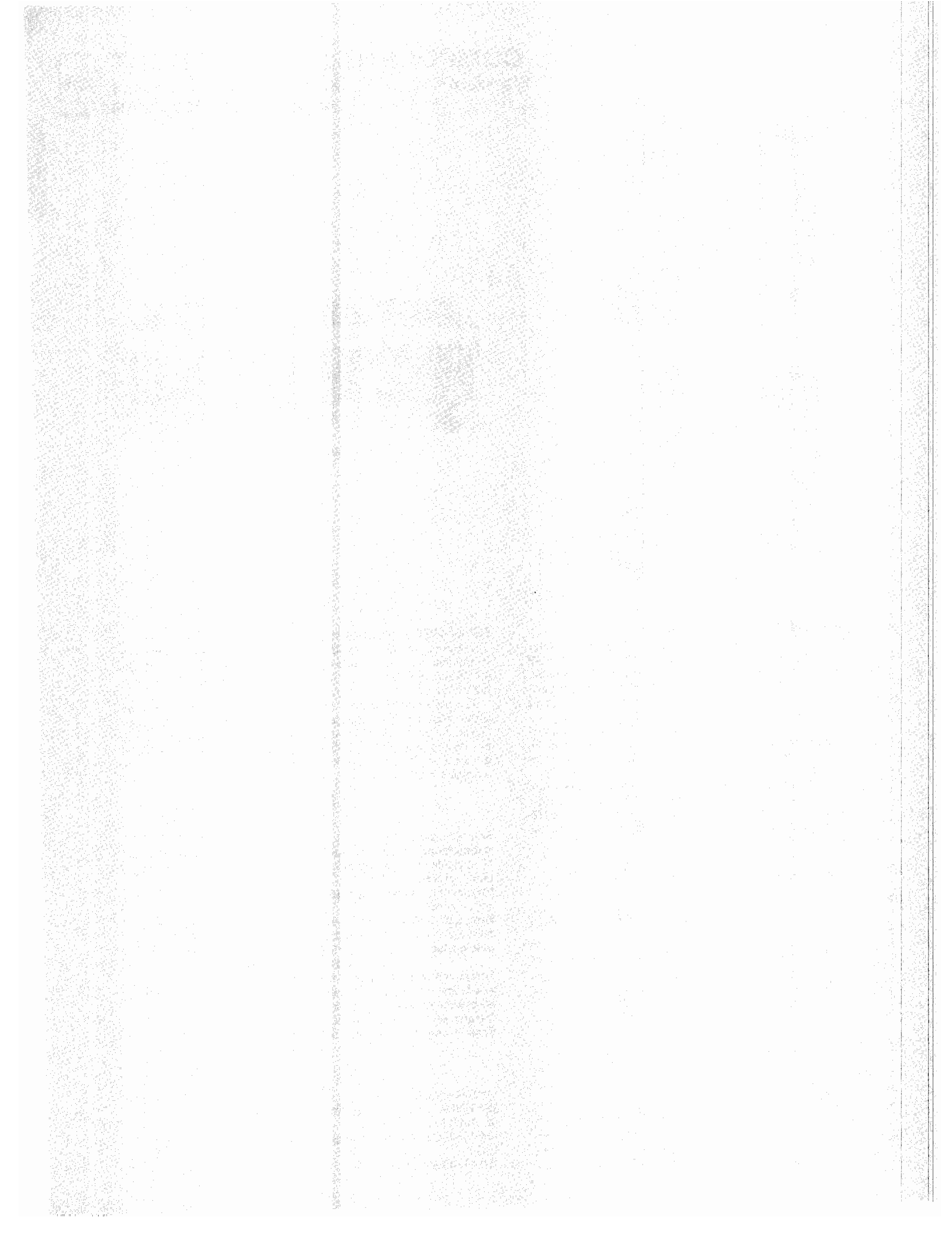

## **SOURCES/ANALYZERS**

## **Sources/Analyzers**

<b>Lightwave Test Equipment.....</b>	<b>302</b>
<b>Data Generators &amp; Data Analyzers.....</b>	<b>316</b>
<b>Transceiver Test Equipment.....</b>	<b>324</b>
<b>Noise Figure Meter.....</b>	<b>328</b>
<b>Microwave Test Equipment.....</b>	<b>332</b>
<b>Dimensional Measurements.....</b>	<b>350</b>
<b>Pressure &amp; Temperature.....</b>	<b>352</b>

Some HP products combine the functions of source and analyzer. These products usually take the form of matched stimulus and response test equipment that together can characterize a wide range of components and systems. These products include lightwave test equipment, data generators and analyzers, transceiver test equipment, and noise figure meters. Also included in this group are microwave test equipment accessories such as microwave couplers and detectors.

# LIGHTWAVE TEST EQUIPMENT

## General Information

Probably the most remarkable fact about the evolution of fiber optics has been their rapid market growth. Design work began some twenty years ago, with trial projects carrying live telephone traffic being installed ten years later. Today, optical fibers are mass-produced for many applications worldwide.

### Technical Background

In general, all fiber optic systems incorporate the following elements: transmitters, fibers, repeaters, and receivers, all of which are linked by connectors and/or splices.

Today, size, lifetime, reliability and ruggedness are major factors in the choice of sources and receivers for optical communication links.

Sources employ LEDs or LDs (laser diodes) to generate the optical output, while APDs or PIN diodes are used to detect the incident optical power on the receiving side.

### Optical Sources

LEDs are primarily used in short distance systems (<10km) with data rates below 100MHz. A limiting factor is their broad spectral width and the low coupling efficiency compared with an LD. Advantages are their simpler drive electronics, a higher reliability, and the lower price.

LDs, on the other hand, feature a small spectral width, an excellent coupling efficiency, and reach data rates up to 2 GHz. Thus LDs enable repeaterless data transmission over great distances (40km).

### Optical Fibers

Inside the fiber, light is guided by total reflection at the core/cladding boundary due to corresponding differences in the refractive indices. Single-mode fibers are dominating today.

### Optical Receivers

To convert light back into an electrical signal for further processing PIN diodes serve as receiving detectors when high data rates are required. This property is combined with favorable linearity and high stability. When increased sensitivity is of major concern, APDs are preferred. Due to their non-linearity, APDs are used only for purely digital applications, while PIN diodes can be used in both analog and digital systems.

### Lightwave Test Equipment

HP's line of lightwave test equipment offers new measurement capabilities for design and production engineers in a wide range of different application areas, from computer networks to high-speed, long-distance telecommunication links.

### Basic Test Instrumentation

Designers, manufacturers and end-users of fiber optic components, modules or systems face a large variety of measurement tasks. These tasks range from physical measurements, such as fiber geometry or numerical aperture, to system performance tests in the time or frequency domain.

HP offers three powerful lines of basic lightwave test instruments. The first line consists of the HP 8150A Optical Signal Source, the HP 8151A Pulse Power Meter, and the HP 81511/81512A Optical Heads. This test equipment offers new ways to perform parametric tests with reliable and repeatable results in the 850 and 1300nm wavelength range.

Testing the sensitivity or defining the pulse response of a receiver demands a stimulus such as the HP 8150A. With the help of this instrument, it is an easy task to perform parametric tests at calibrated levels, under fully-specified and precisely-controlled conditions.

Its counterpart the HP 8151A, together with the HP 81511/81512A, provides technicians and engineers with an ideal tool for verifying analog and digital power level parameters in terms of peak and average power.

The second line consists of the HP 8152A Optical Average Power Meter with two different optical heads for the 450-1700nm range, the HP 8154B LED Sources for 850nm, 1300nm and 1550nm (option 001, 002, and 003), the HP 8155A LD Sources for 1300nm and 1550nm (option 002 and 003), the HP 8157A Optical Attenuator for 1200-1650nm, single-mode, the HP 8158B Optical Attenuators for 600-1200nm and 1200-1650nm (option 001 and 002), for multimode and single-mode.

The HP 8152A features excellent accuracy (directly traceable to NBS and PTB) and linearity (typically better than 1%) for absolute and relative power measurements.

The 8157A Optical Attenuator offers very high optical return loss and polarization insensitivity for tests on your fastest transmitters and automated bit error rate measurements. The HP 8158B Optical Attenuator is very flexible as it handles all fibers with an NA <0.3.

And the HP 8154B LED Sources and HP 8155A LD Sources serve as very stable stimuli for insertion loss measurements.

The third line consists so far of one instrument, the HP 8145A Optical Time Domain Reflectometer. It is a portable, high performance unit for field maintenance and applications in a factory environment. Large dynamic range and superb measurement speed are its main contributions.

### High Speed Instrumentation

In addition to the basic tools for making lightwave measurements, HP offers two high speed lightwave instruments designed to measure lightwave modulation.

In most lightwave systems today, information is transmitted via an intensity modulated light carrier. HP's high speed instrumentation consists of a lightwave signal analyzer, which measures the intensity modulation itself, and a lightwave component analyzer, which measures the modulation transfer function of lightwave components.

In addition to supporting the traditional modulation schemes, the high speed instrumentation also has applications in state-of-the-art coherent communication systems.

### The Lightwave Signal Analyzer

Until now the only way to measure modulation on optical signals has been to use a custom photodetector as the optical front end of a microwave spectrum analyzer. But these custom systems are difficult to calibrate and often have poor sensitivity. The HP 71400A Lightwave Signal Analyzer combines HP's highest performance microwave spectrum analyzer with a sensitive, wide bandwidth optical receiver module to produce the first off-the-shelf instrument for analyzing the modulation on lightwave communication systems and components. With it you can measure modulated light on single-mode optical fibers simply and accurately for modulation rates from 100 kHz to 22 GHz. Optical signals, noise, and average power are presented on a fully-calibrated display. You can accurately characterize semiconductor lasers, laser transmitters, optical modulators, detectors, or any other device involved in modulated light. An RF version, the HP 71401A, is also available.

### The Lightwave Component Analyzer

A fiber optic transmission system is made up of lightwave components ranging from lasers, photodiodes, and fiber to electrical amplifiers and transmission lines. As the information bandwidth of lightwave systems increase, it becomes important to characterize the modulation transfer function of each of these lightwave components. For example, the relaxation oscillation frequency of a laser limits the highest frequency it will pass, and the bias of a pin photodiode directly affects its speed.

The HP 8702A Lightwave Component Analyzer provides the ability to measure all of these lightwave components. Measurements are made at a fixed wavelength (1300 nm), while the modulation frequency is swept from 300 kHz to 3 GHz. In this way, the modulation transfer function of a laser, the modulation bandwidth of fiber, and the demodulation transfer function of a photodiode can be measured.

The lightwave coupler allows the system to make reflection measurements such as optical return loss of a photodiode or connector. With the time domain option of the HP 8702A, the frequency domain information is used to calculate the time domain impulse response, allowing the location of discontinuities as close as 6 cm apart.

# LIGHTWAVE TEST EQUIPMENT

Optical Signal Source

Model 8150A

303

- E/O transducer capability with 250 MHz bandwidth
- Calibrated output power levels from 1 nW to 2 mW

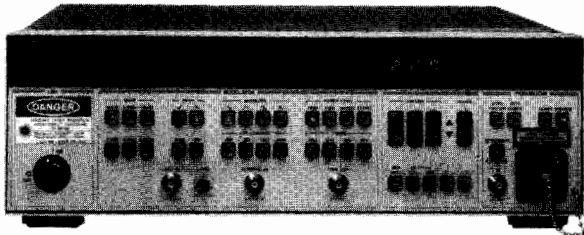

HP 8150A



The HP 8150A is a universal light stimulus for the parametric testing of lightwave components and systems employing an LD with an 850 nm center-wavelength. The instrument's transducer permits the conversion of both digital and analog electrical signals up to 250 MHz ( $-3$  dBm) into their optical equivalents. The internal modulator features additional capabilities which allow the HP 8150A to function as pulse/function generator with an optical output. All specifications refer directly to the open end of the 2m pigtail fiber and provides the user with well-defined signal conditions at his device under test.

## Transducer

In the transducer operating mode, the HP 8150A can be adapted to the user's absolute power level requirements with an adjustable gain from 1.80 nW/V to 1.80 mW/V. Transition times of less than 2 ns ensure the generation of clean, high-speed digital signals up to 250 MHz. Its large bandwidth and optical power range make the HP 8150A a suitable tool for testing large optical systems.

## Modulator

The modulator operating mode offers a straightforward method for generating accurate, calibrated, repeatable power levels, by simply programming high or low power values at the frontpanel, or via the HP-IB. In addition, the mesial power level (50% amplitude level) and extinction ratio values (high/low power) of signals are selectable, allowing the user to simulate attenuation effects of fiber optic systems. A rearpanel monitor output allows the permanent control of the electrical signal responsible for modulating the transducer. The internal modulator also offers the choice of various waveforms with adjustable duty cycles or true pulses with variable width. A host of other features, such as FM, AM, PWM and VCO, can be externally and internally activated and contribute to the versatility of the HP 8150A as a stimulus for fiber optic system and automated bench applications.

## Traceability and safety

The specifications of the HP 8150A are traceable to the NBS in the USA and other national standard bureaus, such as the PTB in Germany.

A set of safety features are provided in order to meet international safety regulations. The ON/OFF safety key, remote interlock facility and appropriate safety labeling are other standard HP 8150A features which help eliminate hazards to the operator.

- Built-in modulator (50 MHz)
- Wavelength 850 nm  $\pm$  15 nm

## HP 8150A Specifications

### Optical Characteristics

**Wavelength:** 850nm  $\pm$  15nm

**Output:** 50/125 $\mu$ m graded index, multimode; NA=0.2

### Transducer Mode

**Conversion range:** 1.80nW/V to 1.80mW/V

**Absolute accuracy:**  $\pm$  2dB of setting

**Relative accuracy:**  $\pm$  0.5dB of setting

**Stability:**  $\pm$ 0.05dB (12 hours, T  $\pm$  2°C)

**Electrical input swing:** 0.1 Vpp to 1.0Vpp

**Electrical input window:**  $\pm$  0.5V

**Input impedance:** 50 Ohm

**Offset compensation range:**  $\pm$  1.2V

**Bandwidth:** DC to 170MHz @  $-1.5$ dB,  
to 250MHz @  $-3.0$ dB)

**Flatness:**  $\pm$  0.25dB (1Hz to 99.9kHz),  
 $\pm$  0.5dB (100kHz to 9.99MHz),  
 $\pm$  1.5dB (10MHz to 170MHz)

**Pulse response:**  $<$  2.0ns; perturbations:  $<$  15% of amplitude

### Modulator Mode (using internal pulse/function generator)

#### Output power

**High level:** 1.18nW to 2.00mW; **Low level:** 1.00nW to 1.01mW

**Mesial level:** 1.09nW to 1.10mW;

**Extinction ratio:** 1.18 to 10.0

**Accuracy High/Low/Mesial level (at 30Hz):**  $\pm$  2dB

**Accuracy Extinction ratio (at 30Hz):**  $\pm$  20%

### Timing Parameters of Internal Modulator

**Frequency Range:** 1mHz to 50MHz (3 digit resolution)

**Operating modes:** Normal, Ext. Trigger\*/Gate\*/Width,  
Int. Trigger\*/Gate\*  
\*Selectable ( $-90^\circ$ ) start phase for haversine/havertriangle

**Control Modes:** FM, AM, PWM and VCO

## General

### HP-IB capability

**Interface functions:** SH1, AH1, T6, L4, SR1, RL1, PP0, DC1, DT1,  
C0

**Recalibration period:** 1 year

### Environmental

**Storage temperature:**  $-40^\circ$ C to  $+65^\circ$ C

**Operating temperature:**  $0^\circ$ C to  $+55^\circ$ C

**Humidity:** 95% R.H. from  $0^\circ$ C to  $+40^\circ$ C

**Power:** 100/120/220/240 Vrms;  $+5\%$ ,  $-10\%$ , 48 - 66 Hz,  
140 VA max

**Weight:** net 12.5kg (27lbs), shipping 16.5kg (36.3lbs)

**Size:** 133mm(H) x 426mm(W) x 422mm(D) (5.2" x 16.8" x 16.6")

## Ordering Information

**HP 8150A** Optical Signal Source

**Opt. 907:** Front handle kit (HP P/N 5061-9689)

**Opt. 908:** Rack mount kit (HP P/N 5061-9677)

**Opt. 909:** Rack flange and handle combination kit  
HP P/N 5061-9683

**Opt. 910:** Extra operating and service manual

**HP 15475A:** Cleaning kit (supplied with instrument)

\*For fiber optic cables, see 'Lightwave Test Accessories' on page 305.

## Prices

\$19,500

\$65

\$33

\$82

\$60

\$102

☎ Fast-Ship product—see page 766.

# LIGHTWAVE TEST EQUIPMENT

## Optical Pulse Power Meter

Model 8151A with 81511A/81512A

- Peak and average power measurements
- Accuracy  $\pm 2.5\%$
- O/E transducer capability

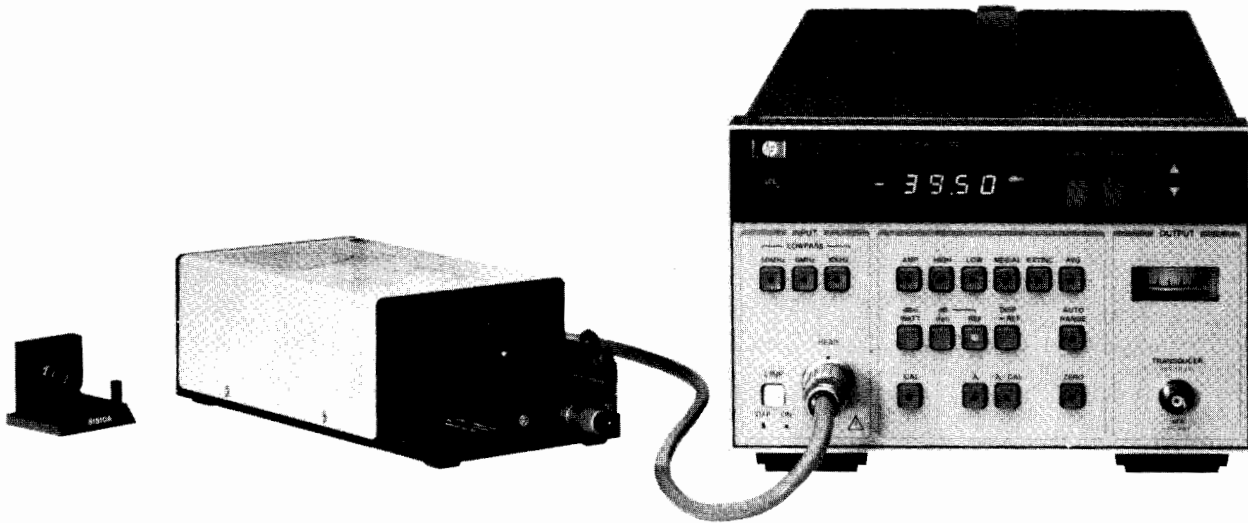

HP 81510A

HP 81511A

HP 8151A



The HP 8151A, in combination with the HP 81511A/81512A Optical Heads, is a response measuring instrument for the level characterization of lightwave components, modules and systems. In addition to performing average power measurements, the HP 8151A enables the user to accurately determine upper and lower peak power levels - important in digital applications. This feature is also useful for applications where non-repetitive signals need to be evaluated, or where threshold levels are to be determined. The instrument's versatility is further enhanced by capabilities which allow the user to measure the amplitude, mesial power and extinction ratio of a signal.

The instrument's transducer has a frequency range of 250MHz, and outputs an electrical signal which corresponds directly to the optical input waveform. The transducer output can be applied to other instruments for further processing, or displayed on an oscilloscope. By using the transducer, timing related measurements as functions of optical power (e.g. propagation delay versus power) are possible.

HP-IB programmability is a standard feature of this instrument, thereby giving the user total remote control of all power meter functions.

### HP 81511A and HP 81512A Optical Heads

These products complement the operation of the HP 8151A Optical Pulse Power Meter. The HP 81511A Optical Head is for use at operating wavelengths between 550 and 950nm (calibrated for 850nm), and the HP 81512A for use between 900 and 1725nm (calibrated for 1300nm). The HP 8151A cannot be operated without an optical head. All heads carry interface adapters for fiber connectors and bare fibers. The manual z-microdrive facilitates the optimum coupling of the fiber end to the PIN diode in the head. The HP 8151A's frontpanel trend meter assists in determining the coupling efficiency.

A calibration grid on top of each optical head indicates typ. correction factors to be entered into the HP 8151A for operating wavelengths other than that for which the head is calibrated. Thus, the HP 8151A can be adapted to operate at any wavelength in the 550 to 1725nm range.

### HP 8151A Specifications

#### Optical Characteristics of HP 81511A/81512A Optical Heads

**Wavelength range** HP 81511A: 550 to 950nm, cal for 850nm  
 HP 81512A: 900 to 1725nm, cal for 1300nm  
**Maximum core diameter:** HP 81511A: 200 $\mu$ m  
 HP 81512A: 100 $\mu$ m

#### Optical Power Measurements

**Parameters measured:** high, low, and mesial power levels, amplitude, extinction ratio, average power

**Measurement range:** HP 81511A: +10dBm to -60dBm  
 HP 81512A: 0dBm to -50dBm

**Resolution:** 3 digits (Watts), 1pW min.  
 4 digits (dB), 0.01dB min.

**Accuracy:** (applies to linear display in Watt, rel. to calibration):

Range [dBm]	$\pm$ (of read + counts)	Hi/Low Peak Power	
		Flatness	Average Power $\pm$ (of read + counts)
+10 <sup>1</sup>	0.3 dB + 5	200 Hz - 9.99MHz: $\pm 0.4$ dB of ampl. <sup>2</sup> 10 MHz - 99.9 MHz: $\pm 0.6$ dB of ampl. <sup>2</sup>	0.1 dB + 5
0	0.3 dB + 30 <sup>2</sup>		0.1 dB + 5
-10	0.35 dB + 50		0.1 dB + 5
<b>Bandwidth</b>			
-20	0.2 dB + 10	10kHz	0.1 dB + 5
-30	0.2 dB + 10	6kHz	0.1 dB + 5
-40	0.2 dB + 20 <sup>2</sup>	1kHz <sup>2</sup>	0.15 dB + 10 <sup>2</sup>
-50	0.2 dB + 50 <sup>2</sup>	1kHz <sup>2</sup>	0.2 dB + 50 <sup>2</sup>
-60 <sup>1</sup>	0.3 dB + 80 <sup>1</sup>	4kHz <sup>1</sup>	0.2 dB + 50 <sup>1</sup>

1) not valid for HP 81512A 2) better specifications for HP 81511A



# LIGHTWAVE TEST EQUIPMENT

## Optical Pulse Power Meter (cont'd), Optical Receiver

### Models 8151A with 81511A/81512A and 81519A

305

- Calibrated O/E conversion
- DC to 400 MHz bandwidth
- $\pm 0.3$ dB conversion accuracy

#### Transducer (opto-electric conversion)

Actual waveform depends on measurement range. Calibrated for 850nm (HP 81511A)/1300nm (HP 81512A).

#### Conversion Accuracy (for 30Hz squarewave):

Range [dBm]	Conversion Factor DC	Accuracy of Conversion	Bandwidth w/o Lowpass	rms Noise [dBm]
+10 <sup>1</sup>	1V/10mW <sup>2</sup>	$\pm 0.3$ dB $\pm 10$ mV <sup>2</sup>	DC-250MHz <sup>2</sup>	-20 <sup>1</sup>
0	1V/ 1mW	$\pm 0.3$ dB $\pm 10$ mV	DC-250MHz <sup>2</sup>	-20 <sup>3</sup>
-10	1V/ .1mW	$\pm 0.35$ dB $\pm 20$ mV	DC-250MHz <sup>2</sup>	-30
-20	1V/10 $\mu$ W	$\pm 0.3$ dB $\pm 20$ mV	DC-10 kHz	-40 <sup>3</sup>
-30	1V/ 1 $\mu$ W	$\pm 0.3$ dB $\pm 20$ mV	DC-6 kHz	-50 <sup>3</sup>
-40	1V/ .1 $\mu$ W	$\pm 0.3$ dB $\pm 20$ mV	DC-1 kHz <sup>3</sup>	-60 <sup>3</sup>
-50	1V/10nW	$\pm 0.3$ dB $\pm 50$ mV <sup>3</sup>	DC-1 kHz <sup>3</sup>	-60 <sup>3</sup>
-60 <sup>1</sup>	1V/ 1nW <sup>1</sup>	$\pm 0.3$ dB $\pm 20$ mV <sup>1</sup>	DC-4 kHz <sup>2</sup>	-70 <sup>1</sup>

1) for HP 81511A only 2)150MHz for HP 81512A 3)better specifications for HP 81511A

#### Pulse Response

**Transition time:**  $\leq 2$ ns full bandwidth ( $\leq 3$ ns for HP 81512A)

**Perturbations:**  $\leq 10\%$  of amplitude

#### General

##### HP-IB capability

**Interface function:** SH1, AH1, T6, L4, SR1, RL1, PP0, DC1, DT1, C0

**Recalibration period:** 1 year

##### Environmental

**Storage temperature:**  $-40^{\circ}\text{C}$  to  $+70^{\circ}\text{C}$

**Operating temperature:**  $0^{\circ}\text{C}$  to  $+55^{\circ}\text{C}$ .

**Humidity:** 95% R.H. from  $0^{\circ}\text{C}$  to  $+40^{\circ}\text{C}$

**Power:** 100/120/220/240 Vrms;  $+5\%$ ,  $-10\%$ , 48 to 66Hz, 100VA max.

**Weight:** **HP 8151A:** net 8kg (17.5lbs), shipping 10kg (22lbs)

**HP 81511A:** net 1.3kg (2.9lbs), shipping 2kg (4.4lbs)

**HP 81512A:** same as for HP 81511A

**Size:** **HP 8151A:** 140mm(H) x 220mm(W) x 530mm(D) (5.7" x 9" x 21.6")

**HP 81511A:** 60mm(H) x 96mm(W) x 200mm(D) (2.5" x 3.9" x 8.2")

**HP 81512A:** same as for HP 81511A

#### Ordering Information

**HP 8151A Optical Pulse Power Meter** \$8150

**Opt. 907:** Front handle kit (HP P/N 5061-9689) \$65

**Opt. 908:** Rack mount kit (HP P/N 5061-9657) \$33

**Opt. 910:** Extra operating and service manual \$60  
HP P/N 08151-90001

**HP 81511A Optical Head 550 to 950nm** \$4050

**HP 81512A Optical Head 900 to 1725 nm** \$5950

Note: The HP 8151A cannot be used without an optical head and connector adapter. For connector adapters, see 'Lightwave Test Accessories' below.

Fast-Ship product—see page 766.

#### Accessories

##### Lightwave test accessories for HP 8150A, HP 8151A, HP 81511A/81512A and HP 81519A

One end of the 2m optical cable is terminated with the standard Diamond® HFS1/KV connector. The other end can be selected from the following table.

Customer Connector	Adapter for Optical Head	Price	Cable 50/125 $\mu$ m 3.5mm Ferrule	Price
Diamond® HFS1/KV	HP 81510A	\$300	HP 81500A	\$800
NEC D4	HP 81510B	\$230	HP 81500B	\$800
Bare Fiber, 50/125 $\mu$ m	HP 81510C	\$230	HP 81500C	\$410
Bare Fiber, 200/250 $\mu$ m	HP 81510D	\$230	—	—
Amphenol 906 SMA	HP 81510E	\$230	HP 81500E	\$800
FC	HP 81510G	\$230	HP 81500G	\$800
Biconic	HP 81510H	\$230	—	—
F&G 3702	HP 81510J	\$230	HP 81500J	\$800
Stratos 430	HP 81510K	\$230	HP 81500K	\$800
AMP-SMA	HP 81510N	\$230	HP 81500N	\$800
Optical Base Plate	HP 81510Q	\$150	—	—
Parallel Beam Adapter	HP 81510R	\$510	—	—
Blank Adapter	HP 81510Z	\$130	—	—

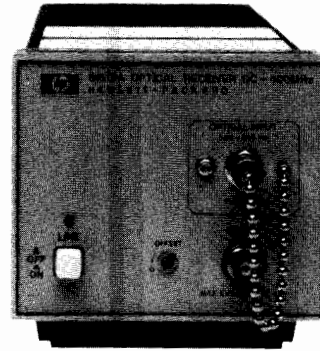

HP 81519A

The HP 81519A is a linear transducer which converts optical signals into their electrical equivalents. The instrument is designed as a front-end interface to conventional electronic test equipment and as a general purpose receiving device for testing lightwave modules and systems.

A PIN diode, calibrated at 850nm, serves as opto/electric converter in the range between 550 and 950nm. The characteristic curve on top of the instrument indicates the transducer gain in this range.

With the wide demodulation frequency band of DC to 400 MHz and an intrinsic transition time of less than 1.1 ns, the HP 81519A is a valuable tool for testing fiber optic devices in computer, local area network and aerospace applications. When operating in conjunction with other equipment, measurements such as pulse response and bandwidth in the time and frequency domains can be performed accurately.

With the adjustable offset, the conversion window can be conveniently shifted between 0 and 1 mW in accordance with the optical input power.

#### HP 81519A Specifications

##### Optical Characteristics

**Wavelength range:** 550 to 950 nm, cal for 850 nm

**Input:** Adapts to core diameters up to 80  $\mu$ m; N.A.  $\leq 0.2$

**Input swing:** 1 mW (min. low level 0mW, max. high 1.5 mW)

**Input connector:** Diamond® HFS1

**Connector uncertainty:**  $\pm 0.1$  dB

##### Transducer Characteristics

###### Conversion, opto/electric

**Conversion gain:**  $-1$  V/mW; **Accuracy:**  $\pm 0.3$ dB  $\pm 10\mu$ W

**Small signal bandwidth:** DC to 400 MHz (@  $-3.0$ dB)

**Flatness of conversion:**  $\pm 0.3$ dB (DC to 150 MHz)

**NEP:**  $< 700$ nW (rms); **Distortion:** typ. 20dB (40dBel.)

###### Output (into 50 Ohm)

**Range:**  $\pm 0.5$ V; Output impedance: 50 Ohm  $\pm 2\%$

###### Response

**Transition time:**  $\leq 1.1$  ns; Perturbations:  $< 10\%$  of ampl.

#### General

##### Environmental

**Storage temperature:**  $-40^{\circ}\text{C}$  to  $+70^{\circ}\text{C}$

**Operating temperature:**  $0^{\circ}\text{C}$  to  $+55^{\circ}\text{C}$

**Humidity:** 95% R.H. from  $0^{\circ}\text{C}$  to  $+40^{\circ}\text{C}$

**Power:** 115/230 Vrms,  $+10\%$ ,  $-22\%$ , 48 to 66 Hz, 16VA max.

**Weight:** net 1.7 kg (3.6 lbs), shipping 2.4 kg (5 lbs)

**Size:** 95mm(H) x 105mm(W) x 345mm(D) (3.8" x 4.3" x 13.6")

#### Ordering Information

**HP 81519A Optical Receiver**

**Opt. 910:** Extra operating and service manual

#### Price

\$3300

\$ 20

# LIGHTWAVE TEST EQUIPMENT

## Optical Average Power Meter

Model 8152A/81520A/81521B/81522A

- Two optical inputs
- Optical heads individually calibrated from 450 to 1700nm
- Multi- and single-mode
- 1% typical linearity

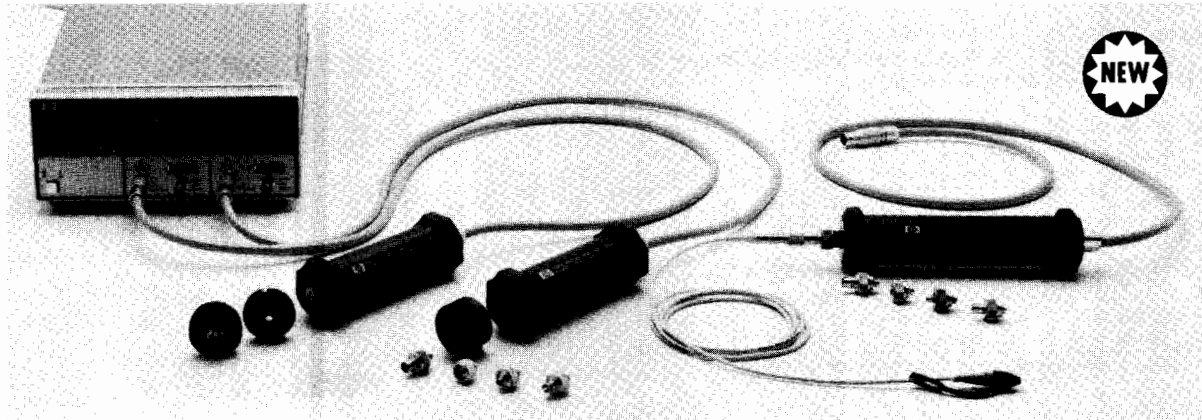

HP 8152A



The HP 8152A Optical Average Power Meter and its optical heads provide the accuracy and versatility for absolute and relative power measurements in a lightwave test environment. Applications range from output power measurement of active optical components, or loss/attenuation measurement of passive optical components, to ratio measurement of power splitters.

Individually calibrated optical heads ensure highly precise measurement results over the entire wavelength range from 450 to 1700nm. After entering the operating wavelength, the appropriate sensitivity correction factor will automatically be taken into account to ensure the correct measurement value is displayed.

The combination of 2 independent optical inputs, the capability to perform ratio measurements, plus an HP 81000AS/BS Optical Power Splitter provides a fast, easy solution to determine the power ratio of an optical splitter or eliminating the instabilities of an optical source.

All functions can be set manually via front panel controls, or programmed via HP-IB for complete remote control. The HP 8152A is therefore an ideal tool for departments such as R&D, production and incoming evaluation.

### HP 8152A/81520A/81521B/81522A Specifications

	81520A	81521B	81522A
Wavelength Range	450-1020nm	900-1700nm	1000-1650nm
Measurement Range	+10 to -100dBm	+3 to -80dBm	+3dBm to -100dBm
Resolution	0.01dB, 0.1pW	0.01dB, 10pW	0.01dB, 0.1pW
Absolute Accuracy	±4%	±3.5%	±5%
Linearity (typ.)	±0.05dB (1%)	±0.05dB (1%)	±0.05dB (1%)
Sensor Element	cooled Si PIN diode	cooled Ge PIN diode	cooled InGaAs PIN diode
Sensor Diameter	5mm	5mm	500µm
Bandwidth (typ.)	700Hz	700Hz	700Hz

#### General

##### HP-IB capability

**Interface function:** SH1,AH1,T6,L4,SR1,RL1,PP0,DC1,DT1,C0

**Recalibration period:** 1 year

**Warm-up time:** 15 minutes

##### Environmental

**Storage temperature:** -40°C to +75°C

**Operating temperature:** 0°C to +55°C

**Humidity:** <95% R.H. from 0°C to +40°C

**Power:** 100/120/220/240Vrms, +5%, -10%, 90VA max., 48-400Hz

**Weight: HP 8152A:** net 4.3kg (9.5lbs), shipping 8.6kg (19lbs)

**HP 81520A/21B/22A:** net 0.45kg (1lbs), shipping 1kg (2.2lbs)

**Size: HP 8152A:** 89mm(H) x 212.3mm(W) x 345mm(D)  
(3.5" x 8.36" x 13.6")

**HP 81520A/21B/22A:** 37.7 diameter, 140mm length  
(1.5" x 5.5")

#### Ordering Information

**HP 8152A** Optical Average Power Meter \$3450

**HP 81520A** Optical Head 450 to 1020nm \$1550

**HP 81521B** Optical Head 900 to 1700nm \$2300

**HP 81522A** Optical Head 1000 to 1650nm<sup>1</sup> \$2600

**Opt. 907:** Front handle kit (HP P/N 5061-9688) \$50 ☎

**Opt. 908:** Rack flange kit (HP P/N 5061-9672) \$51 ☎

**Opt. 916:** Additional operating manual \$40

**P/N 5061-9701:** Bail handle kit \$38 ☎

Note: The HP 8152A cannot be used without an optical head, appropriate connector adapter and optical lens. For additional information, see "Lightwave Test Accessories" on page 309.

<sup>1</sup> The exchangeable connector interfaces for Diamond® HMS-10/HP, FC/PC, DIN 47256 and ST connectors are available as additional accessories, see page 309.

☎ Fast-Ship product—see page 766.

# LIGHTWAVE TEST EQUIPMENT

## LED Source / Laser Diode Source

Models 8154B, 8155A

307

- Stability  $\pm 0.003\text{dB}/12\text{h}$
- External modulation up to 1MHz
- Customer-exchangeable connector adapters

- Stability  $\pm 0.005\text{dB}/12\text{h}$
- External modulation up to 850MHz
- Customer-exchangeable connector adapters

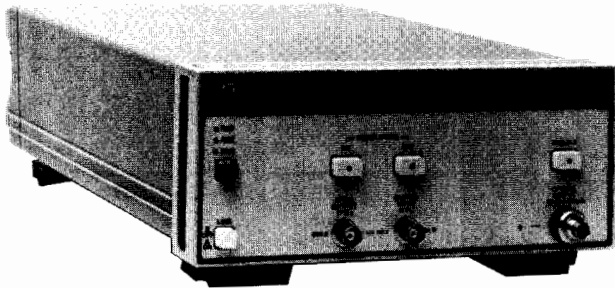

HP 8154B, option 002, option 011



HP 8155A, option 002, option 011



The HP 8154B is a high performance LED source, optional for 850nm, 1300nm and 1550nm. Whether the insertion loss of connectors, attenuation of cables or the splice loss of optical links needs to be evaluated, the HP 8154B provides the required power level stability of typically 0.003dB at constant ambient temperature over 12h.

The HP 8155A is a narrow linewidth laser diode source, optional for 1300nm and 1550nm with excellent short- and longterm stability. It outputs CW or 270Hz chopped light. External modulation up to 850MHz is also possible, and allows signal performance tests on fast telecommunication links.

Both, the HP 8154B and the HP 8155A, offer customer-exchangeable connector adapters.

### HP 8154B, 8155A Specifications

Optical Characteristics	LED 8154B			LD 8155A	
	option 001	option 002	option 003	option 002	option 003
Wavelength	850 $\pm$ 30nm	1300 $\pm$ 40nm	1550 $\pm$ 40nm	1310 $\pm$ 30nm	1550 $\pm$ 40nm
Spectral Bandwidth	30–90nm	40–90nm	70–150nm	<2.5nm (RMS)	<4nm (RMS)
Optical Power	$\geq -17\text{dBm}$	$\geq -20\text{dBm}$	$\geq -23\text{dBm}$	$\geq -4\text{dBm}$	$\geq -4\text{dBm}$
Stability/15min./const. temp	—	—	—	$\pm 0.003\text{dB}$	$\pm 0.003\text{dB}$
Stability/12h/const. temp.(typ.)	$\pm 0.005\text{dB}$	$\pm 0.003\text{dB}$	$\pm 0.003\text{dB}$	$\pm 0.005\text{dB}$	$\pm 0.005\text{dB}$
Stability/12h/ $\pm 2\text{C}$	$\pm 0.03\text{dB}$	$\pm 0.02\text{dB}$	$\pm 0.02\text{dB}$	$\pm 0.03\text{dB}$	$\pm 0.03\text{dB}$
Fiber Type	50/125 $\mu\text{m}$	50/125 $\mu\text{m}$	50/125 $\mu\text{m}$	9/125 $\mu\text{m}$	9/125 $\mu\text{m}$

Connector: Diamond® HMS-10/HP, FC/PC, DIN 47256, ST

#### Supplementary Performance Characteristics

##### Digital Input

Input levels: TTL (8154B),  $\pm 0.2\text{V}$  (8155A)

Max. input voltage:  $\pm 10\text{V}$  (8154B),  $\pm 2.5\text{V}$  (8155A)

Input impedance: 10 kOhm (8154B), 50 Ohm (8155A)

Input frequency: 0 to 1MHz (HP 8154B), DC, 1kHz to 850 MHz (HP 8155A)

##### Operating Modes

Output disable: LED, LD switched off

External modulation enable: Activates the digital input

Internal modulation enable: Activates internal 270Hz generator

##### General

Recalibration period: 1 year

Warm-up time: 45 minutes

##### Environmental

Storage Temperature:  $-40^\circ\text{C}$  to  $+75^\circ\text{C}$

Operating Temperature:  $0^\circ\text{C}$  to  $+55^\circ\text{C}$

Humidity: <95% R.H. from  $0^\circ\text{C}$  to  $+40^\circ\text{C}$

Power: 100/120/220/240Vrms,  $\pm 10\%$ , 48–400Hz, 35VA max. (8154B), 45VA max. (8155A)

After being switched off the instruments will come up with the output and digital input disabled.

Dimensions: 89mm(H) x 212.3mm(W) x 345mm(D) (3.5" x 8.36" x 13.6")

Weight: net 3.75kg (8.3lbs), shipping 7.8kg (17.2lbs) (HP 8154B)  
net 4.5kg (9.9lbs), shipping 8.55kg (18.85lbs) (HP 8155A)

#### Ordering Information

##### HP 8154B LED Source

Opt. 001: 850nm

Opt. 002: 1300nm

Opt. 003: 1550nm

##### HP 8155A LD Source

Opt. 002: 1300nm

Opt. 003: 1550nm

Opt. 011<sup>1</sup>: Diamond® HMS-10/HP connector interface

Opt. 012<sup>1</sup>: FC/PC connector interface

Opt. 013<sup>1</sup>: DIN 47256 connector interface

Opt. 014<sup>1</sup>: ST connector interface

Opt. 907: Front handle kit (HP P/N 5061-9688)

Opt. 908: Rack flange kit (HP P/N 5061-9672)

Opt. 916: Additional operating manual

P/N 5061-9701 Bail handle kit

<sup>1</sup> for both the HP 8154B and the HP 8155A, customer-exchangeable

For adapters, cables and other accessories see "Lightwave Test Accessories" on page 309

☎Fast-Ship product—see page 766.

#### Price

HP 8154B LED Source

\$1700

Opt. 001: \$1170

Opt. 002: \$3055

Opt. 003: \$4175

HP 8155A LD Source

\$2500

Opt. 002: \$8900

Opt. 003: \$10600

Opt. 011<sup>1</sup>: \$305

Opt. 012<sup>1</sup>: \$305

Opt. 013<sup>1</sup>: \$305

Opt. 014<sup>1</sup>: \$305

Opt. 907: \$50 ☎

Opt. 908: \$51 ☎

Opt. 916: \$40

P/N 5061-9701: \$38 ☎

# LIGHTWAVE TEST EQUIPMENT

## Optical Attenuator

Models 8157A, 8158B

- High resolution of 0.01dB
- Short settling time (typ. 20ms)
- Suited for multimode and single-mode fibers (8158B)



HP 8158B option 002 option 011



The HP 8158B Optical Attenuator is a fully programmable and highly flexible test instrument. Due to its state-of-the-art fiberless design, all applications employing fibers with a numerical aperture up to 0.3 are covered with one instrument. Multimode and single-mode measurements can thus be easily performed.

### HP 8158B Specifications

All specs. are measured with Diamond® HMS-10/HP connectors

#### Optical Characteristics

**Wavelength Range:** 600-1200nm (opt. 001),  
1200-1650nm (opt. 002)

**Applicable Fiber Type:** all fiber types with an  $NA \leq 0.3$

**Attenuation Range** (excluding insertion loss): 60.00dB

**Insertion loss** (incl. both connectors)

	single-mode $9\mu\text{m}^1$	multimode $50\mu\text{m}$
worst case	<4.0dB	<2.0dB
typical	2.0dB	1.0dB

<sup>1</sup>option 002 only

**Linearity:**  $\pm 0.4\text{dB}$  for single-mode,  $\pm 0.2\text{dB}$  for multimode

**Return loss** (incl. connectors): 14dB

### HP 8157A Specifications

#### Optical Characteristics

All specifications are measured with Diamond® HMS-10/HP connectors. The connectors must have Manufacturing Date Code Week 31-87 or higher.

**Wavelength Range:** 1200-1650nm

**Applicable Fiber Type:** single-mode fiber

**Attenuation Range** (excluding insertion loss): 60.00dB

**Insertion loss** (incl. two Diamond® HMS-10/HP connectors):  
 $\leq 4.0\text{dB}$

**Linearity:**  $\pm 0.2\text{dB}$  (typical  $\pm 0.05\text{dB}$ )

**Return loss** (incl. Diamond® HMS-10/HP connectors and terminated fiber-end):  $> 33\text{dB}$

### HP 8157A/HP 8158B Specifications

#### Display

**Display range:** 0.00 to 64.00dB

**Display resolution:** 0.01dB (min. step size)

#### Supplementary Performance Characteristics

**Repeatability** (of attenuation after a max. of 6 matings with same connector):

**single-mode** ( $9\mu\text{m}$ ):  $< 0.2\text{dB}$

**multimode** ( $50\mu\text{m}$ ):  $< 0.1\text{dB}$  (HP 8158B only)

#### Operating Modes

**Output disable:** Optical signal path interrupted

**$\lambda$ :** Entering of wavelength for automatic correction of attenuation using typical correction values

**Att:** Attenuation is displayed and can be varied

**Cal:** Entry of calibration factor to adjust display so that displayed value indicates actual power level at output connector of attenuator. Range:  $\pm 99.99\text{dB}$

- Customer-exchangeable connector adapters (8157A)
- $> 36\text{dB}$  typical return loss (8157A)

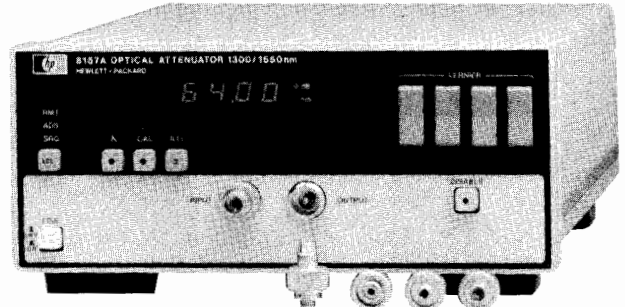

HP 8157A shown with all four available connector options (in the foreground)



The 8157A is a high performance single-mode attenuator for the 1200-1650nm wavelength range. Its excellent linearity, very high return loss and polarization insensitivity make it the ideal attenuator for bit error rate tests on fast optical systems.

### General

#### HP-IB Capability

All modes and parameters can be programmed

**Listen** (time to receive, verify and set up parameter)

**Output disable/enable, attenuation,  $\lambda$ :**  $< 20$  to 550ms (HP 8157A),  
 $< 20$  to 400ms (HP 8158B)

(depending on actual setting/programmed parameter)

**Cal:**  $< 5\text{ms}$

**HP-IB Interface Function Code:** SH1, AH1, T6, L4, SR1, RL1, PP0, DC1, DT0, C0

**Recalibration period:** 1 year

No warm-up time required if previously stored within operating temperature range.

#### Environmental

**Storage Temperature:**  $-40^\circ\text{C}$  to  $+75^\circ\text{C}$

**Operating Temperature:**  $0^\circ\text{C}$  to  $+55^\circ\text{C}$

**Humidity:**  $< 95\%$  R.H. from  $0^\circ\text{C}$  to  $+40^\circ\text{C}$

**Power:** 100/120/220/240Vrms,  $\pm 10\%$ , 48-400Hz, 90VA max.

**Battery back up** (for non-volatile memory): with instrument switched off all current modes and data will be maintained for at least 10 years after instrument delivery

**Dimensions:** 89mm(H) x 212.3mm(W) x 345mm(D) (3.5" x 8.36" x 13.6")

**Weight:** net 5.3kg (11.7lbs), shipping 9.6kg (21.2lbs)

### Ordering Information

**HP 8158B Optical Attenuator** Price \$2350

**Opt. 001:** 600-1200nm \$4700

**Opt. 002:** 1200-1650nm \$4700

**Opt. 011:** Diamond® HMS-10/HP connector \$710

**Opt. 012:** FC/PC connector<sup>1</sup> \$1020

**Opt. 013:** DIN 47256 connector \$1020

**Opt. 014:** ST connector<sup>1</sup> \$1020

**HP 8157A Optical Attenuator 1200-1650nm** \$8600

**Opt. 011:** Diamond® HMS-10/HP connector interfaces \$610

**Opt. 012:** FC/PC connector interfaces \$610

**Opt. 013:** DIN 47256 connector interfaces \$610

**Opt. 014:** ST connector interfaces \$610

**Opt. 907:** Front handle kit (HP P/N 5061-9688) \$50 ☎

**Opt. 908:** Rack flange kit (HP P/N 5061-9672) \$51 ☎

**Opt. 916:** Additional operating manual \$31

**P/N 5061-9701** Bail handle kit \$38 ☎

<sup>1</sup>multimode only

For interface adapters, cables and accessories see "Lightwave Test Accessories" on page 309.

☎ Fast-Ship product—see page 766.

### Lightwave test accessories for HP 8145A, HP 81520A, HP 81521B, HP 8154B, HP 8155A, HP 8157A, HP 8158B

One end of the 2m optical cable is terminated with the standard Diamond® HMS-10/HP connector. The other end can be selected from the following table.

Customer Connector	Cable 10/125um 2.5mm Ferrule	Price	Cable 50/125um 2.5mm Ferrule	Price	Cable 62.5/125um 2.5mm Ferrule	Price	Cable 100/140um 2.5mm Ferrule	Price
Diamond® HMS-10/HP	HP 81101AC	\$630	HP 81501AC	\$580	HP 81621AC	\$580	HP 81991AC	\$580
Bare Fiber	HP 81101BC	\$380	HP 81501BC	\$345	HP 81621BC	\$345	HP 81031BC	\$345
FC	HP 81101FC	\$630	HP 81501FC	\$580	—	—	—	—
NEC D4	HP 81101GC	\$630	HP 81501GC	\$580	—	—	—	—
Amphenol 906 SMA	—	—	HP 81501HC	\$580	HP 81621HC	\$580	HP 81991HC	\$580
AMP-SMA	—	—	HP 81501JC	\$580	—	—	HP 81991JC	\$580
F&G 3702	—	—	HP 81501LC	\$580	—	—	—	—
Stratos 430	—	—	HP 81501NC	\$580	—	—	—	—
PC	HP 81101PC	\$870	—	—	—	—	—	—
DIN 47256	HP 81101SC	\$630	HP 81501SC	\$580	—	—	—	—
ST	HP 81101VC	\$630	HP 81501VC	\$580	HP 81621VC	\$580	—	—
Biconic	HP 81101WC	\$730	HP 81501WC	\$580	—	—	—	—
Diamond® HFS-1	—	—	HP 81501YC	\$630	—	—	—	—

### Lenses

If accurate power measurements from a fiber are required, one of the following lenses must be used in front of the optical head.

**HP 81050AL:** Lens for 450-1020nm and NA=0.2 fibers<sup>1</sup> \$160

**HP 81050BL:** Lens for 900-1700nm and NA=0.2 fibers<sup>1</sup> \$160

**HP 81010BL:** Lens for 900-1700nm and NA=0.1 fibers \$160

<sup>1</sup>Can be used for NA<0.3 fibers

### HP 81220FL Attenuating Lens Adapter \$510

This Adapter, screwed onto an HP 81521B Optical Head, allows to measure the power emerging from an LED or LD chip. The beam's NA may be up to 0.5, the wavelength range is 1200nm to 1650nm.

### HP 81000FF Fixed Filter \$160

This 10dB fixed filter is used to attenuate signals from sources which are too high powered for the HP optical heads. The 81520A can measure linearly up to +10dBm, and the 81521B up to +3dBm. The wavelength range for the 81000FF is from 450nm to 1700nm.

### Optical Power Splitter

The optical power splitter is mode- and polarization insensitive. The split ratio is appr. 1:10. It has to be used with an optical head such as the HP 81521B. One connector option must be ordered. The HP 81000AS/BS Optical Power Splitters are for multimode and single-mode fibers with NA<0.3.

**HP 81000AS:** Optical Power Splitter for 600-1200nm \$1450

**HP 81000BS:** Optical Power Splitter for 1200-1600nm \$1450

**Opt. 011:** HMS-10/HP Connector Interfaces \$460

**Opt. 012:** FC/PC Connector Interfaces \$460

**Opt. 013:** DIN 47256 Connector Interfaces \$460

**Opt. 014:** ST Connector Interfaces \$460

For single-mode fibers with NA<0.1, a dedicated Power Splitter, the HP 81010BS, is available. The connector interfaces are customer exchangeable. The typical return loss depends on the connectors used.

**HP 81010BS:** Optical Power Splitter for 1200-1600nm \$2400

**Opt. 011:** HMS-10/HP Connector Interfaces typ.36dB \$610

**Opt. 012:** FC/PC Connector Interfaces typ.14/30dB \$610

**Opt. 013:** DIN 47256 Connector Interfaces typ.33dB \$610

**Opt. 014:** ST Connector Interfaces typ.20dB \$610

### HP 81000AF Filterholder \$80

This filterholder picks up all presently available standard filters with a diameter up to 1".

### HP 81000AM Through Adapter Diamond® \$360

To connect two HMS-10/HP connectors.

### HP 15475A Cleaning Kit \$102

The kit consists of cleaning brush, tissue and tape etc. to clean the optical surfaces of fibers and lenses. It is supplied in a plastic carrying case. This kit is supplied with the HP 8150A Optical Signal Source.

### Fiber Optics Handbook Pub.No. 5952-9654 \$20

An introduction and reference guide to fiber optic technology and measurement techniques.

☎ Fast-Ship Product—see page 766

### Connector adapters for HP 8152A, HP 81520A, HP 81521B

To interface the optical head to the optical fiber use one of the following connector adapters.

Customer Connector	Adapter for Optical Head	Price
Diamond® HMS-10/HP	HP 81000AA	\$150
Bare Fiber, 50/125um	HP 81000BA	\$480
Bare Fiber, 100/140um	HP 81000CA	\$480
Radiall	HP 81000DA	\$130
FC	HP 81000FA	\$130
NEC D4	HP 81000GA	\$150
Amphenol 906 SMA	HP 81000JA	\$130
AMP-SMA	HP 81000KA	\$130
F&G 3702	HP 81000LA	\$130
Stratos 430	HP 81000NA	\$130
PC	HP 81000OA	\$130
DIN 47256	HP 81000PA	\$130
ST	HP 81000QA	\$130
Biconic	HP 81000WA	\$130
Diamond® HFS-1	HP 81000YA	\$150
Blank Adapter	HP 81000ZA	\$50

### HP 81000RA Non-Reflective Adapter \$510

Low insertion loss (typ. 0.06dB) and high return loss. Together with the HP 81000RA Non-reflective Adapter one of the customer-exchangeable connector interfaces must be used. The connector interfaces listed below can be ordered also separately.

#### Customer-Exchangeable Connector Interfaces

Available Connector Interfaces	Typ. Return Loss	Price
HP 81000 AI Diamond® HMS-10/HP	38 dB	\$305
HP 81000 FI PC	33 dB	\$305
HP 81000 SI DIN 47256	36 dB	\$305
HP 81000 VI ST	25 dB	\$305

### Optical Power Splitter HP 81010BS

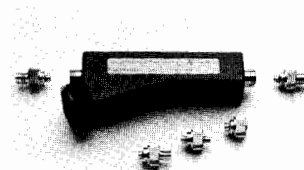

### Non-Reflective Adapter HP 81000RA

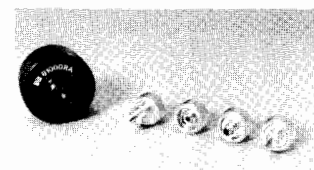

OPTICAL HEAD

FILTER

LENS

CONNECTOR ADAPTER

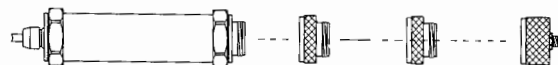



# LIGHTWAVE TEST EQUIPMENT

## Optical Time Domain Reflectometer

Model 8145A option 002 (1300nm), option 003 (1550nm), option 023 (1300nm/1550nm)

- Dynamic range of 28dB (1300nm)/26dB (1550nm) with single-mode fiber
- Up to 150 times faster than conventional units
- Customer-installable laser modules (1300nm or 1550nm)
- Easy-to-learn softkey-guided menu concept
- Non-volatile memory for more than 100 waveforms
- Rugged and light-weight

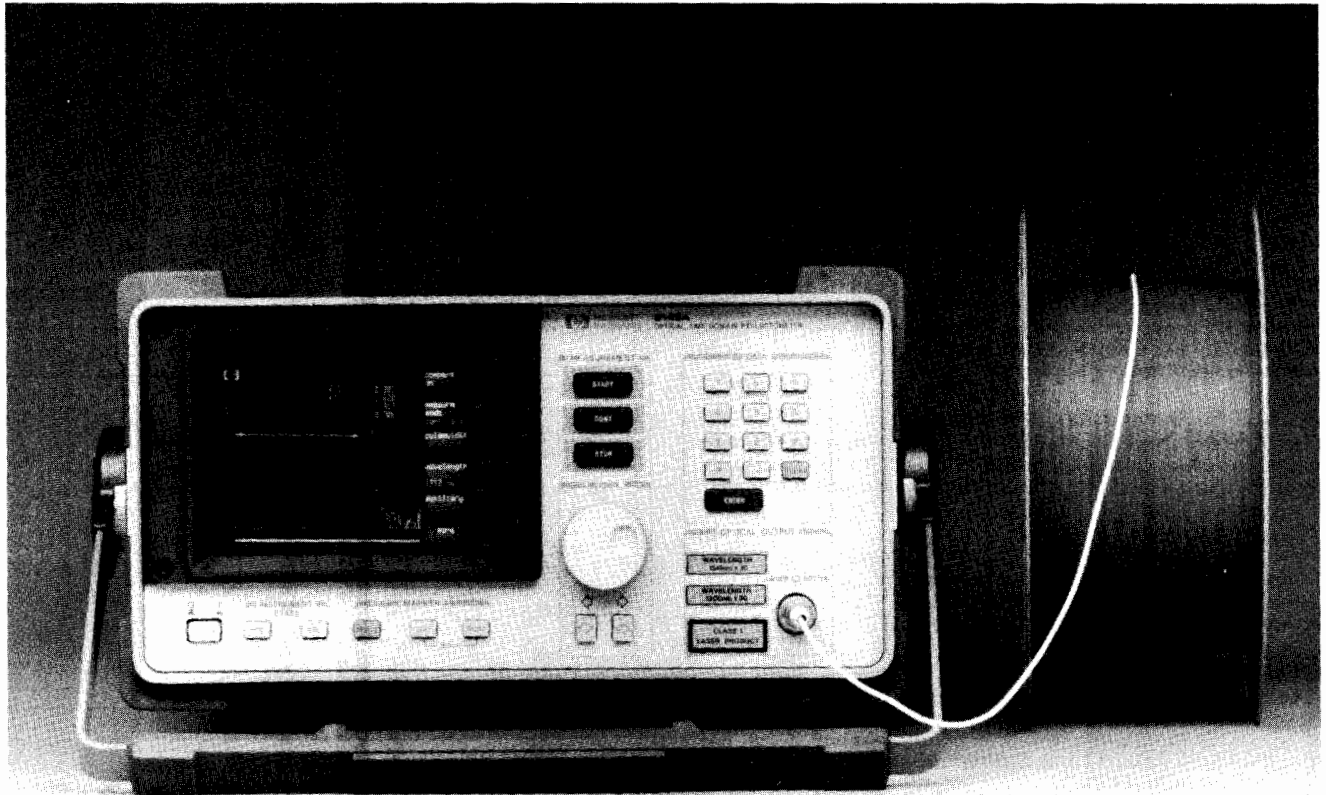

HP 8145A



The HP model 8145A is a high performance optical time domain reflectometer for field maintenance and bench applications. A unique data correlation technique increases the dynamic range to more than 28dB at 1300nm (26dB at 1550nm, regardless, whether the 1300nm module is installed) single-mode and drastically reduces the measurement time. The HP 8145A OTDR can, therefore, perform precise measurements much deeper in the fiber and up to 150 times faster than conventional units.

For field maintenance the HP 8145A features light weight and rugged design. It may be operated on batteries (12 to 30V DC), due to its low power consumption, or mains (90 to 260V AC). Resolution is 0.01dB and 1m over the entire range of 200km.

Unhandy dataloggers and external disk drives which are sensitive to temperature changes, humidity and dust are not needed any more, as a plug-in non-volatile memory module (HP 81450A) stores more than 100 traces, each with all related measurement information. If immediate documentation is required, any data set can be directly printed or plotted out using a Thinkjet, Quietjet or any HP-IB plotter without a controller.

For bench applications including performance tests on optical fibers and cables in design and production the HP 8145A OTDR offers an excellent set of features.

Any previously taken trace may be recalled as reference and compared against the presently sampled one. This ensures fast and easy detection of inhomogeneities and attenuation changes.

The HP 8145A has an easy-to-learn softkey guided operating concept. The user can customize the softkeys individually. The OTDR is also fully HP-IB programmable.

By means of two optional laser modules the HP 8145A operates at either of the wavelengths 1300nm, 1550nm or both. The laser modules are user-installable.

Four exchangeable connector options (Diamond® HMS-10, FC/PC, DIN47256, and ST) are available.

## HP 8145A Specifications

### Optical Characteristics

	option 002	option 003	option 023
Wavelength	1300±30nm	1540±30nm	both wavelength
Dynamic range one way backscatter (SNR=1)*	28dB	26dB	28/26dB
Fresnel reflection (4%)*	42dB	40dB	42/40dB

\* typically 6dB lower for 50/125µm multimode fibers, 2.5dB lower for peak noise

Both wavelength options are user-installable. If both are installed in the HP 8145A, they are switch-selectable. Dynamic range figures are independent of number of options installed.

**Measurement time:** 22dB dynamic range after 10 seconds (16dB after 1 second) at 1300nm on fiber without end reflection (worst case condition for break detection)

**Pulsewidth:** 125/250/500ns/1/2/4/8µs

**Output connector:** optional Diamond® HMS-10, FC/PC, DIN 47256, ST. All options are user-exchangeable.

### Horizontal Parameters

**Start-km:** 0.000 - 199.500km (see "Resolution")

**Span:** 0.000km - 200.000km (see "Resolution")

**Center-km:** 0.250km - 199.750km (see "Resolution")

**Resolution:** 1m in all three cases for parameter setting and distance read-out

**Accuracy:** ±6m ±10<sup>-5</sup> x measured value, uncertainty of fiber refractive index not included, for 125 ns pulsewidth

**Refractive index:** 1.4000 - 1.5999, in steps of 0.0001 settable

**Length correction:** 1.000 - 4.000, in steps of 0.001 settable. Serves to enter actual ratio of fiber/cable length into the OTDR

**Length unit:** switch-selectable between km, miles and feet

### Vertical Parameters

**Vertical scale:** 0.20 - 5.00dB/div

**Resolution:** 0.01dB for parameter setting, 0.001dB for attenuation/loss read-out

**Linearity:** 0.05dB/dB

**Zoom:** All combinations of horizontal and vertical parameters can be entered while the instrument is running. Serves to zoom in on any point of the waveform and allowing close examinations without interrupting the averaging process.

### Documentation

**Waveform memory:** >10 waveforms and related instrument settings can be stored in the HP 8145A in non-volatile memory and recalled. More than 100 waveforms and related instrument settings can be stored in each HP 81450A Memory Module and recalled. The modules contain non-volatile memory and plug into the rearpanel of the HP 8145A.

**ID Codes:** An identification code of up to 38 alpha-numerical characters can be entered for each memory location. All ID codes are displayed when the directory is called up.

**Compare mode:** Presently displayed waveform can be compared against any previously stored one, if the horizontal parameters are identical. Zooming capability is provided.

**Hardcopy:** Any displayed or previously stored waveform can be directly dumped to a Thinkjet, Quietjet or any HPGL plotter.

**Instrument settings:** storage and recall of 9 user selectable instrument settings, recall of 1 standard setting.

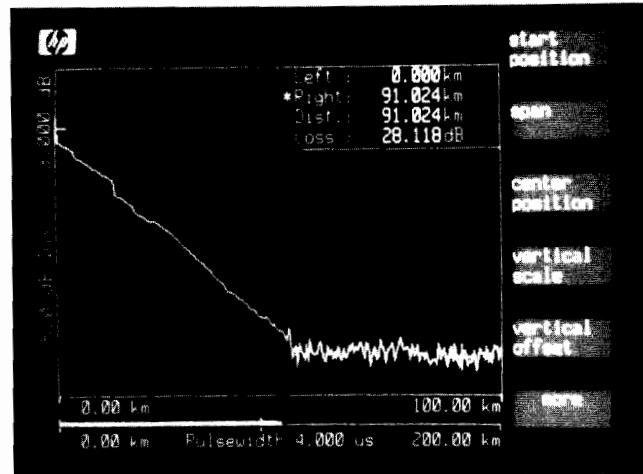

### General

**CRT:** 15cm (6"), green

**Laser safety class:** Class 1

**Recalibration period:** 1 year

### HP-IB Capability

All modes and parameters can be programmed

**HP-IB Interface Function Codes:** SH1, AH1, T5, L3, SR1, RL1, PP0, DC1, DT1, C0

### Environmental

Storage temperature: -40°C to +75°C

Operating temperature: -20°C to +65°C (-10°C to +55°C to meet specs)

Humidity: ±95% R.H. from 0°C to +40°C

### Power

DC: 12 - 30V DC, 80W max

AC: 100/120/220/240Vrms ±10%, 90VA max, 48-400Hz

**Battery back up** (for non-volatile memory): with instrument switched off all current modes and data will be maintained for at least 10 years at 25°C temp.

**Dimensions:** 190mm H, 340mm W, 465mm D (7.5" x 13.5" x 18.3")

**Weight:** net 16 kg (35.3 lbs), shipping 22 kg (48.5 lbs)

### Ordering Information

<b>8145A Optical Time Domain Reflectometer</b>	<b>\$12900</b>
<b>Opt. 002:</b> 1300nm	\$10800
<b>Opt. 003:</b> 1550nm	\$14800
<b>Opt. 023:</b> 1300nm/1550nm	\$21800
<b>Opt. 011:</b> Diamond® HMS-10/HP connector interface	\$305
<b>Opt. 012:</b> FC/PC connector interface	\$305
<b>Opt. 013:</b> DIN 47256 connector interface	\$305
<b>Opt. 014:</b> ST connector interface	\$305
<b>Opt. 050:</b> DC power cable	\$770
<b>81450A:</b> Memory module	\$1100

The connector-interfaces for Diamond® HMS-10/HP FC/PC, DIN47256 and ST connectors are available as additional accessories.

For adapter cables and other accessories see "Lightwave Test Accessories" on page 309.

# LIGHTWAVE TEST EQUIPMENT

## Lightwave Component Analyzer Model 8702A

- 300 kHz to 3 GHz Modulation Frequency
- Single and Multimode

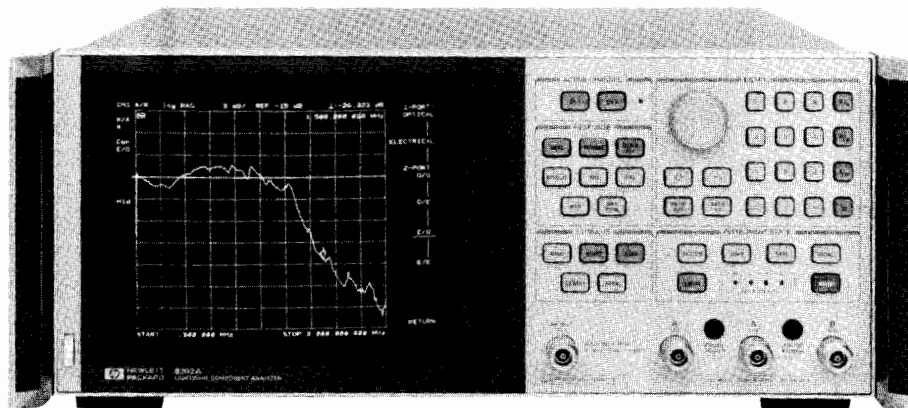

HP 8702A

### Description

The HP 8702A can make calibrated measurements of lasers, photodiodes, optical fiber, and electrical components that operate with high bandwidth. The swept modulation frequency measurements show precisely how a component operates on the "information bearing" signal. Knowing how a single component responds independently of the rest of the transmission system gives insight into how system operates, and how to improve it.

The HP 8702A operates at a fixed wavelength (1300 nm), and sweeps the frequency of the intensity modulation signal. The lightwave source and receiver are independently calibrated. This allows calibrated measurements of the modulation characteristics of lasers and photodiodes.

### Measure Lightwave Components

In-fiber components such as connectors, splitters, couplers, and lenses, as well as fiber itself, can be measured as a function of modulation frequency. This yields modulation bandwidth, insertion loss, length, and optical return loss measurements. With the time domain option, high resolution reflection measurements (6 cm) and modal dispersion measurements can be made.

### Measure Electro-Optical Components

The HP 8702A can make calibrated measurements of the modulation frequency response of lasers, LED's, and modulators. Similarly, it can measure the demodulation frequency response of PIN photodiodes, APD's, and complete receivers. For E/O devices, the measurement shows the actual modulation power generated at a given frequency. For O/E devices, the measurement shows RF current generated as a function of modulation power, at a given frequency. This exact knowledge of the behavior of the electro-optical component gives a designer the ability to optimize the component independently of the measurement system.

### Measure Electrical Components

Typical network analyzer measurements such as bandwidth, insertion loss, gain, phase, and impedance of RF components can be made with the HP 8702A. For example, linear components such as amplifiers, filters, and transmission lines can be characterized.

### Time Domain Measurements

The HP 8702A option 010, Time Domain, takes the data measured in the frequency domain, and applies the inverse Fourier transform to calculate the impulse response of devices. In reflection measurements, the time axis can be related to distance, and the HP 8702A used to locate discontinuities as close as 6 cm apart in fiber. In transmission, the impulse response can be used to calculate dispersion. The time domain calculations apply to all the measurements that the HP 8702A performs.



HP 83401A

### Lightwave Source

HP 83400A Single-mode  
HP 83401A Multimode

A 1300 nm Fabret-Perot laser directly modulated through the RF Input. The HP 83400A has 9/125  $\mu$  fiber, and the HP 83401A has 50/125  $\mu$  fiber.

**Wavelength:** 1308  $\pm$  10 nm

**Spectral Width:**  $\leq$  3 nm

**Average Power:** 1.25  $\pm$  0.75 mW

**Responsivity @ 50 Mhz:** -34 dB<sup>1</sup>

**Modulation Bandwidth:** 300 kHz to 3 GHz

**Modulation Frequency Response:**  $\pm$  3.5 dB

**Optical Connector:** Selected by option<sup>3</sup>



HP 83410A

### Lightwave Receiver

HP 83410A

A 1300 nm PIN photodiode receiver that accepts fiber core sizes up to 62.5 micrometers.

**Wavelength:** 1300 nm (nominal)

**Maximum Power:** 3 mW

**Responsivity @ 50 Mhz:** 20 dB<sup>2</sup>

**Modulation Bandwidth:** 300 kHz to 3 GHz

**Modulation Frequency Response:**  $\pm$  4 dB  $<$  2 GHz  
+4, -14 dB

**Optical Connector:** Selected by option<sup>3</sup>

### Lightwave Coupler

HP 11890A Single-mode

HP 11891A Multimode

**Optical Connector:** Selected by option<sup>3</sup>

A 3 port, directional lightwave coupler for making lightwave reflection measurements, and monitoring lightwave transmission. The coupler has a nominal 3 dB coupling factor.

### RF Interface Kit

HP 11889A

This kit contains the RF accessories required to operate the HP 8702A. The HP 85044 or 85046 test sets replace the function of the HP 11889A. Contains a power splitter, a 20 dB pad, male and female SMA barrels, 3 SMA right angle bends, and a custom cable.

### High Frequency Probe

HP 85024A

The HP 85024A makes it easy to perform in-circuit measurements. Its high impedance (0.7 pF in shunt with 1 megaohm) permits high frequency probing without adversely loading the circuit under test, and allows measurements of non-50 ohm devices. Page 246 has a more complete description of the HP 85024A.

### S Parameter Test Set

HP 85046A

The HP 85046A test set provides the capability to measure impedance and transmission characteristics of 2 port electrical devices in either forward or reverse direction with a single connection. See page 244 for more detailed information.

### 3.5 mm Calibration Kit

HP 85033C

Contains precision 3.5 mm standards used to calibrate the HP 8702A for measurements of 3.5 mm and SMA electrical devices. Page 246 has a more complete description of calibration kits.

### Ordering Information

HP 8702A Lightwave Component Analyzer	\$28,000
Option 010 Time Domain	\$4,800
Option 802 HP 9122 Dual Disc Drive	\$1,495
Option 910 Extra Operating and Service Manual	\$125
Option 913 Rack Mount Kit	\$40
Option W30 Extended return-to-HP service	\$540
HP 83400A Lightwave Source, Single-mode	\$12,700
Option 01X <sup>3</sup> Select Optical Connector	\$0
Option W30 Extended return-to-HP service	\$260
HP 83401A Lightwave Source, Multimode	\$12,700
Option 01X <sup>3</sup> Select Optical Connector	\$0
Option W30 Extended return-to-HP service	\$260
HP 83410A Lightwave Receiver	\$5,000
Option 01X <sup>3</sup> Select Optical Connector	\$0
Option W30 Extended return-to-HP service	\$100
HP 11890A Lightwave Coupler, Single-mode	\$3,900
Option 01X <sup>3</sup> Select Optical Connector	\$0
HP 11891A Lightwave Coupler, Multimode	\$3,900
Option 01X <sup>3</sup> Select Optical Connector	\$0
HP 11889A RF Interface Kit	\$1,500
HP 85024A High Frequency Probe	\$1,900
HP 85046A S-Parameter Test Set	\$7,800
HP 85033C 3.5 mm Calibration Kit	\$2,500

<sup>1</sup> Nominal responsivity, expressed in log format, referenced to 1 Amp/Watt.

<sup>2</sup> Nominal responsivity, expressed in log format, referenced to 1 Watt/Amp.

<sup>3</sup> The optical connector used with these products are determined by an exchangeable adapter.

One adapter option must be specified:

011 Diamond HMS 10/HP

012 FC/PC

013 DIN 47256

014 ST

# LIGHTWAVE TEST EQUIPMENT

## Lightwave Signal Analyzer 100 kHz to 22 GHz

### Models 71400A, 71401A, and Accessory 11980A

- Calibrated measurement of intensity modulation
- 1200 nm to 1600 nm single-mode fiber optic input
- Reference receiver capability
- Customer-exchangeable connector adapters
- High performance electrical spectrum analyzer

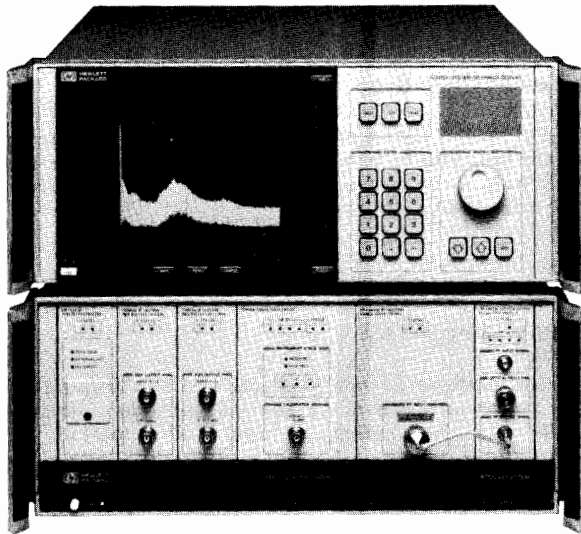

HP 71400A

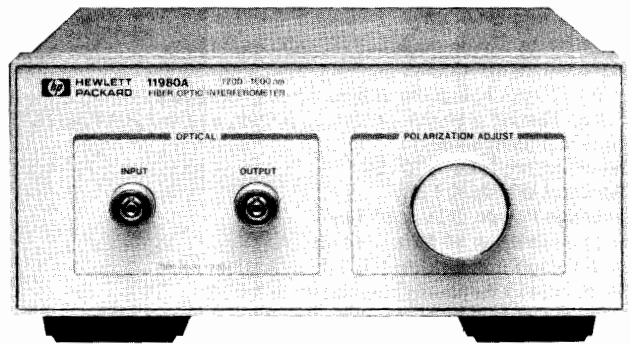

HP 11980A



### For the First Time - Calibrated Measurement of Intensity Modulation

The HP 71400A combines a high performance microwave spectrum analyzer with a new wideband, highly sensitive optical receiver. This system measures modulated light on single-mode optical fibers simply and accurately from 100 kHz to 22 GHz. Optical modulation, noise, and average power are presented on a fully-calibrated display. The system characterizes semiconductor lasers, laser transmitters, optical modulators, and detectors. With the addition of the HP 11980A fiber optic interferometer, the system measures linewidth and FM characteristics of distributed-feedback lasers.

For measurements to 2.9 GHz, a lower cost system is the HP 71401A. Both models, in addition to being lightwave signal analyzers, also function as microwave or RF spectrum analyzers with all the capability of the HP 71210A and 71100A spectrum analyzers on which they are based. And because the lightwave signal analyzers are part of the HP 70000 modular measurement system, their measurement capabilities can be expanded easily. One possibility, for example, is the addition of a tracking generator module for modulation response measurements. (See pages 116 – 122 for more information.)

Both the HP 71400A and 71401A systems measure intensity modulation up to 22 GHz or 2.9 GHz and operate over the wavelengths from 1200 nm to 1600 nm. Their optical sensitivity is better than  $-60$  dBm, which is equivalent to approximately  $-140$  dBm electrical when detector responsivity is taken into account. The analyzers also offer average power measurement, displayed as both a real-time vertical power bar and as a digital readout. Full calibration of both average power and modulation power makes these systems reference receivers for measuring and characterizing optical detectors and receivers.

### New Lightwave Module and Accessories

The HP 70810A Lightwave Section is a  $1/8$ -width lightwave-receiver module in the HP 70000 Modular Measurement System. The HP 70810A offers a wavelength range of 1200 nm to 1600 nm, a detected modulation bandwidth of 100 kHz to 22 GHz, and an optical sensitivity of  $-60$  dBm in a 10 Hz bandwidth. Module features include HP-IB and HP-MSIB communication capability, both optical and electrical input connectors, and a system-control processor that provides master-module capability. The HP 70810A may also be used in stand-alone applications as a lightwave receiver housed in an HP 70000 mainframe. In this configuration, the electrical output is the detected intensity modulation in its amplified and uncorrected state.

### Fiber Optic Interferometer for Laser Chirp Measurements

The HP 11980A is a Mach Zehnder Interferometer of fixed delay for measuring and characterizing single-linewidth lasers. Using a new technique developed by Hewlett-Packard, the HP 11980A accessory and the HP 71400A lightwave signal analyzer measure FM and chirp components on DFB lasers, as well as making traditional measurements of laser linewidth.

Thus by adding the HP 11980A to the HP 71400A lightwave signal analyzer, the true power spectrum of single-frequency lasers (including intensity modulation and chirp components caused by the intensity modulation) can be displayed.

### Input Connectors

An important feature of these lightwave systems and accessories is their versatile input connector system. A variety of optical screw-on connector-interface adapters are available as well as various patch cords for other connector systems. See ordering information on page 315.



## Specifications

### HP 71400A

For general analyzer and electrical-mode specifications, refer to data sheets for the HP 71210A.

#### Optical

**Wavelength Range:** 1200 nm to 1600 nm

**Input Return Loss (characteristic):** > 27 dB (optical) with input atten  $\geq$  5 dB

#### Frequency

**Frequency Range:** 100 kHz to 22 GHz

**Span:** 1 Hz to 22 GHz plus 0 Hz

#### Amplitude (At 25°C)

**Maximum Input Average Power:** +30 dBm (optical);

**Modulated Power:** +15 dBm (opt)

**Average Power Accuracy:** (at 1300 or 1550 nm)  $\pm$ 0.65 dB (optical),  $\pm$ 0.5 nW,  $\pm$  connector losses

**Modulated Power Accuracy (relative to average power) at 100 MHz:**  $\pm$ 1.0 dB (opt)

**Frequency Response (relative to 100 MHz):** 100 kHz to 22 GHz,  $\pm$ 1.0 dB (opt)

**Displayed Average Optical Noise Level, Optical dB (10 Hz Res BW, 0dB Input atten):** -52 dBm, 100 kHz to 1 MHz; -58 dBm, 1 MHz to 10 MHz; -64 dBm, 10 MHz to 16 GHz; -58 dBm, 16 GHz to 22 GHz

#### Inputs

**Optical:** Choice of Diamond, PC/FC, ST, or DIN single-mode Fiber Connectors (see Ordering Guide)

**Electrical:** SMA for optical bypass, 100 Hz to 22 GHz (See HP 71210A for other system inputs)

### HP 71401A

For general analyzer and electrical mode specifications refer to the data sheets of the HP 71100A Opt 02, 04.

#### Optical

**Wavelength Range:** 1200 nm to 1600 nm

**Input Return Loss (characteristic):** > 27 dB (opt) with input atten  $\geq$  5 dB

#### Frequency

**Frequency Range:** 100 kHz to 2.9 GHz

**Span:** 1 Hz to 2.9 GHz plus 0 Hz

#### Amplitude (At 25°C)

**Maximum Input Average Power:** +30 dBm (opt)

**Maximum Modulated Power:** +15 dBm (opt)

**Average Power Accuracy:** (at 1300 or 1550 nm)  $\pm$ 0.65 dB (optical),  $\pm$ 1.0 nW,  $\pm$  connector losses

**Modulated Power Accuracy (relative to average power) at 100 MHz:**  $\pm$ 1.0 dB (opt)

**Frequency Response (relative to 100 MHz):** 100 kHz to 2.9 GHz,  $\pm$ 0.5 dB (opt)

**Displayed Average Optical Noise Level, optical dB (10 Hz Res BW, 0dB input atten):** -52 dBm, 100 kHz to 1 MHz; -58 dBm, 1 MHz to 10 MHz; -64 dBm, 10 MHz to 2.9 GHz

#### Inputs

**Optical:** Choice of Diamond, PC/FC, ST, or DIN single-mode Fiber Connectors (see Ordering guide)

**Electrical:** SMA for optical bypass, 100 Hz to 22 GHz (See HP 71100A for other system inputs)

### HP 70810A Module

#### Optical

**Wavelength Range:** 1200 nm to 1600 nm

**Responsivity:** The responsivity is determined for each instrument to  $\pm$ 20%; typical average value at 100 MHz, 1200 V/W

**Input Return Loss (characteristic):** > 27 dB (opt) with input atten  $\geq$  5 dB

#### Frequency

**Frequency Range:** 100 kHz to 22 GHz

#### Amplitude

**Maximum Input Average Power:** +30 dBm (opt);

**Modulated Power:** +15 dBm (opt)

**Frequency Response (corrected):** (relative to 100 MHz): 100 kHz to 2.9 GHz,  $\pm$  2.0 dB; 2.9 GHz to 22 GHz,  $\pm$ 5.0 dB;

**Uncorrected:** typically < 25 dB roll-off 100 kHz to 22 GHz

**Noise Equivalent Power, (optical dB):** -56 dBm/Hz, 100 kHz to 1 MHz; -62 dBm/Hz, 1 MHz to 10 MHz; -68 dBm/Hz, 10MHz to 16 GHz; -62 dBm/Hz, 16 GHz to 22 GHz

#### Inputs

**Optical:** Choice of diamond, PC/FC, ST, or DIN single-mode fiber connectors (see Ordering Guide)

**Electrical:** SMA for optical bypass.

### HP 11980A Specification Summary

This accessory is a Mach Zehnder Interferometer for use with the HP 71400A.

**Wavelength Range:** 1250 nm to 1600 nm

**Optical Insertion Loss:** 8 dB (optical), at 1300 and 1550 nm

**Delay Time:** typically 3.5  $\mu$ sec

#### Inputs

**Optical:** Choice of Diamond, PC/FC, ST, or DIN single-mode fiber connectors (see Ordering Guide)

### Ordering Information

	<b>Price</b>
HP 71400A Lightwave Signal Analyzer, 100 KHz-22 GHz	\$92,840

The system includes the HP 71210A modular spectrum analyzer and HP 70810A module. Order must also include one of the connector options 11-14 or 16 listed below.

Option 001 Add the HP 11980A Fiber Optic Interferometer	\$6,200
---------------------------------------------------------	---------

Option W30 Additional two years of HP service	\$1,310
-----------------------------------------------	---------

Option 908 Rack Mount without handles	\$35
---------------------------------------	------

Option 913 Rack Mount with handles	\$40
------------------------------------	------

HP 71401A Lightwave Signal Analyzer, 100 KHz-2.9 GHz	\$60,440
------------------------------------------------------	----------

The system includes the HP 71100A opt 02, 04 and HP 70810A module. Must order one of the connector options 11-14 or 16 listed below.

Option W30 Additional two years of HP service	\$1,050
-----------------------------------------------	---------

HP 70810A Lightwave Section 100 KHz-22 GHz	\$18,000
--------------------------------------------	----------

Order must also include one of the connector options 11-14 or 16 listed below.

Option 20 System adjustment and calibration (Use the HP 71400A specifications for this option)	\$1,950
------------------------------------------------------------------------------------------------	---------

Option W30 Additional two years of HP service	\$360
-----------------------------------------------	-------

Option 98 or 99 System LO Firmware Upgrade	\$0
--------------------------------------------	-----

HP 11980A Fiber Optic Interferometer	\$6,200
--------------------------------------	---------

Must order one of the connector options 11-14 listed below.

Option W30 Additional two years of HP service	\$125
-----------------------------------------------	-------

Connector options for the HP 71400A, HP 71401A, HP 70810A, and HP 11980A

Option 011 Diamond® HMS-10/HP Connector Interface	\$0
---------------------------------------------------	-----

Option 012 FC/PC Connector Interface	\$0
--------------------------------------	-----

Option 013 DIN 47256 Connector Interface	\$0
------------------------------------------	-----

Option 014 ST Connector Interface	\$0
-----------------------------------	-----

Option 016 Biconic Patch Cord and HMS-10/HP Connector Interface	\$610
-----------------------------------------------------------------	-------

#### Additional interface connectors:

HP 81000 AI Diamond® HMS-10/HP	\$290
--------------------------------	-------

HP 81000 FI FC/PC	\$290
-------------------	-------

HP 81000 SI DIN 47256	\$290
-----------------------	-------

HP 81000 VI ST	\$290
----------------	-------

#### Various Single-Mode Patch Cords Available

Fiber optic cable from the Diamond® HMS-10/HP connector to the specified connector.

HP 81101 AC Diamond® HMS-10/HP	\$610
--------------------------------	-------

HP 81101 BC Bare fiber	\$305
------------------------	-------

HP 81101 FC FC	\$610
----------------	-------

HP 81101 GC NEC D4	\$610
--------------------	-------

HP 81101 PC PC	\$865
----------------	-------

HP 81101 SC DIN 47256	\$610
-----------------------	-------

HP 81101 WC Biconic	\$610
---------------------	-------

HP 15475A Cleaning Kit for optical surfaces	\$102
---------------------------------------------	-------

# DATA GENERATORS & DATA ANALYZERS

## General Information

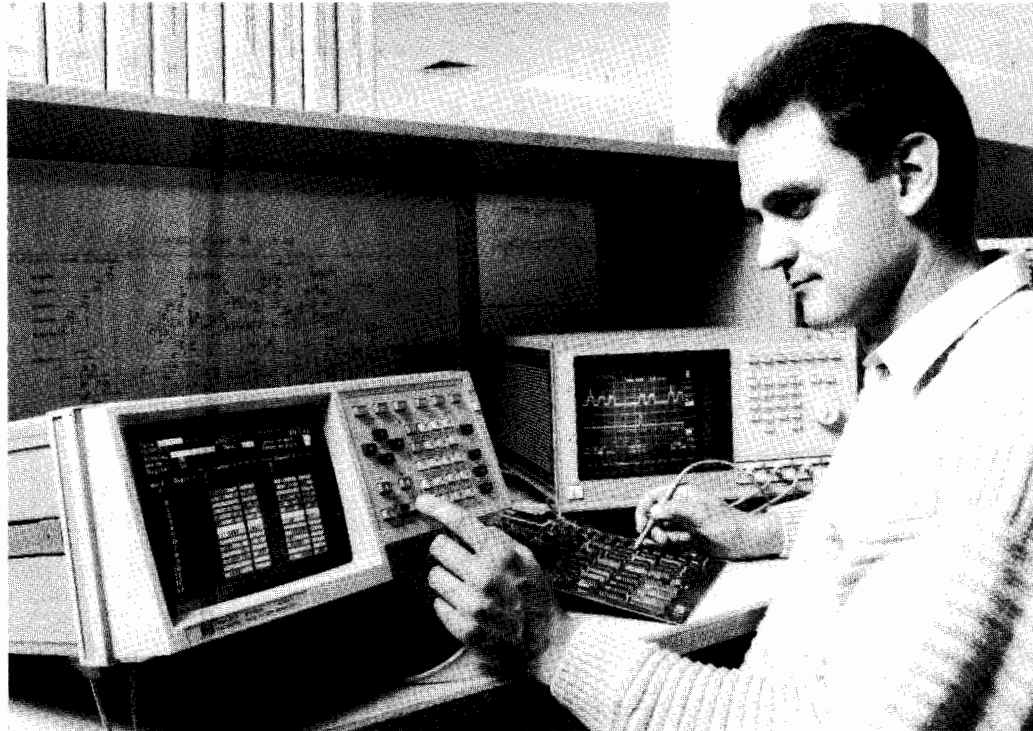

HP 8118A

### Data Generator Selection Chart

Model	8180B* (8181B)	8175A	8118A	8018A	8080A DO1 DO2, DO3
page	320	318	317	322	444
Parameter					
Datarate (Mbit/s)	50	50 paral. 100 ser.	100	50	300
Number of channels	8 paral. (16 opt.) (128 ext.)	24 paral. 2 ser.	2 ser.	2 ser.	1 ser. (2 ser.)
Memory depth (Pattern)	16384	1024 par. 8096 ser.	16384 each ch.	1024/2ch 2048/1ch	64
var. del, width	0 ... 999ms 0 ... 999ms on 8 ch.	20 ... 40ns delay only on 4 ch.	75ns.950ms 10ns.950ms	no	special option
resolution	100ps	100ps	100ps		
RZ/NRZ	RZ/NRZ	NRZ	RZ/NRZ	RZ/NRZ	RZ/NRZ
individual pattern duration	no	20ns.9.99s	no	no	no
resolution		10ns			
output levels	TTL,ECL,VAR -1V ... 17V(HIL) -2V ... 16V(LOL) (high imp.)	TTL,ECL, Tri state var high: 2.4 ... 9.9V (high imp.)	-15.8V ... 16.0V(HIL) -16.0V ... 15.8V(LOL) (high imp.)	ECL, var high: 1.25 ... 15V (high imp.)	DO1: 0.2V ... 2V DO2,DO3: 0.6V ... 1.2V Offs. DO1: ±1.0V DO2,DO3: ±1.2V
resolution	10mV	100mV	10mV	Poti	Poti
channel addition	no	no	yes	no	no
50Ω source impedance	yes	no	yes	yes	yes
HP-IB	yes	yes	yes	optional	no

\*For information about pattern generator modules of the HP 82000 IC evaluation system, please refer to page 526

# DATA GENERATORS & DATA ANALYZERS

## 100 Mbit/s Pulse Pattern Generator

Model 8118A

317

- 2 channels / 16 kbit ea / 100 Mbit/s ea
- Strobe channel (bit, word, or frame trigger)
- Variable word and frame length

- Variable width and delay
- Rise/fall time separately programmable
- Var. high and low level; channel addition

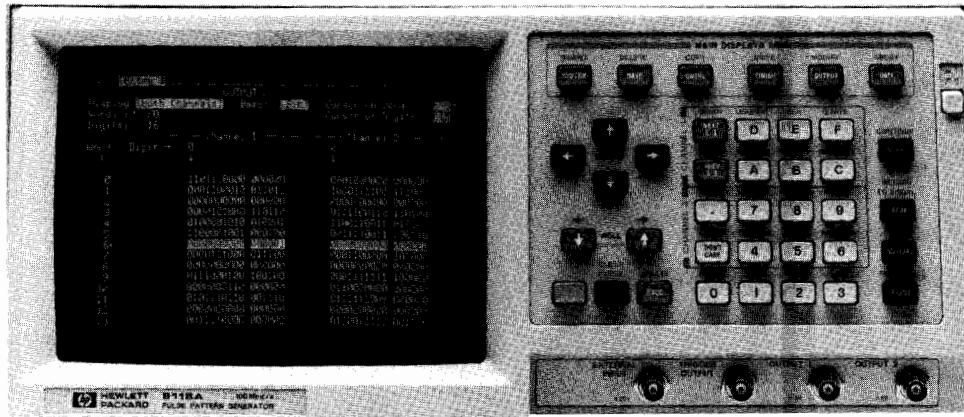

HP 8118A

### HP 8118A Pulse Pattern Generator

The HP 8118A is a two channel serial data generator for pattern lengths up to 16 kbit for each channel with programmable word and frame length, and data rates up to 100 Mbit/s. Furthermore, it provides full control over levels, timing, and transition times.

The HP 8118A is an excellent combination of a fully programmable serial data generator and a pulse generator in one product. It offers functional test capabilities for testing ICs, modules, and boards. With the built-in parametric capabilities, it is possible to combine the digital information with the signal degradation that occurs in practice, and so, testing the DUT with the real-life signal is feasible; thus, the worst case conditions can be evaluated.

For data entry, the HP 8118A offers a convenient and comprehensive set of editing capabilities; thus, the required serial data can be achieved to match the test signal demands of a wide variety of applications. The digital patterns can be combined with PRBS (pseudo-random-binary-sequence), either to just create scrambled data or to generate a true PRBS. Setting the instrument in "Word Mode", it is possible to create word and frame oriented data pattern. Wordlengths from 3 bit up to 256 bit and the number of words up to 3640 are allowed. Protocols with preamble-data-postamble structure and a certain word and frame length, as it is used for data transmission in serial data networks, can be rapidly created.

### Specifications

Specifications describe the instrument's warranted performance (30 minutes warm-up, 50-ohm load) at 0°C to 55°C [20°C to 30°C] ambient temperature.

#### Timing Parameters

(measured at 50% of amplitude with fastest edges).

Common Specifications:

- Resolution** 3 digits (best case, 100 ps)
- Repeatability** factor 4 better than accuracy
- RMS-jitter\*** 0.05% of programmed value + 30 ps
- Period (PER)** 20(10)\*\*ns to 950 ms
- Accuracy** ±5% of progr. value ±2 ns [±2% ±1 ns]
- Delay** 75 ns to 950 ms (max: PER +55 ns)
- Accuracy** ±5% of progr. value ±4 ns [±2% ±4 ns]
- Double Pulse** 20 ns to 950 ms (max: PER - WID)
- Accuracy** ±5% of progr. value ±2 ns [±2% ±2 ns]
- DEL and DOUB are mutually exclusive
- Width (WID)** 10 ns to 950 ms (max: PER - 10 ns)
- Accuracy** ±5% of progr. value ±2 ns [±2% ±2 ns]
- Linear Transitions** (between 10% and 90% of amplitude)
- Range** 6.5 ns to 95 ms
- Accuracy** ±5% of progr. value ±2 ns [±5% ±2 ns]

**Output** (voltages double when driving into open)

**High Level** -7.90 V to +8.00 V

\*see page 433

\*\*10 ns with NRZ data format

**Low Level** -8.00 V to +7.90 V

**Resolution** 3 digits, (10 mV)

**Level-Accuracy** ±1% of progr. value ±3% of ampl. ±40 mV  
[±1% ±1% ±20 mV]

**Repeatability** factor 4 better than accuracy

#### Pattern

**Data Capacity** 16384 bits per channel. (In bit mode: max No of bits)

**Data Formats** RZ with programmable Delay and Width up to 50 Mbit/s DNRZ with programmable Delay up to 50 Mbit/s NRZ up to 100 Mbit/s

**Word length** 3 to 256 bits, common for both channels (word mode only)

**No of words** Number of words \* Word length < 16384 bits, common for both channels (word mode only)

**Random Pattern** up to 16384 bits long, PRBS sequence if blocklength is 2(exp n)-1.

#### Supplemental Specifications

**Trigger Mode** Manual, Auto, Trigger, Gate

**Addition** Adds up channel 2 to channel 1.

**Operating Modes** Bit Mode, Word Mode, Break, Start/Stop, Continue, Autocycle, Single Cycle

**Strobe Output** Fixed TTL levels; Delay, Width independently programmable; bit, word, or frame trigger

**Control Modes** High level, Period, Delay, Width

#### General

**Storage Temperature** -40°C to +65°C

**Operating Temperature** 0°C to 55°C

**Power** 100-120/220-240 Vrms, ±10%, 450 VA max., 48-66 Hz

**Weight** 17 kg (38.8 lb)

**Dimensions (H\*W\*D)** 190 mm \* 426 mm \* 584 mm,  
[7.5 in \* 16.75 in \* 23 in]

**Recalibration Period** 1 year recommended

#### Ordering Information

**HP 8118A 100 Mbit/s Pulse Pattern Generator** \$12,000

#### Options

**908 Rack Flange Kit (P/N 5061-9678)** \$36 ☎

**910 Set of Operating/Programming and Service Manual** \$138

**915 Service Manual (P/N 08118-90001)** \$106

**916 Additional Operating and Programming Manual (P/N 08118-90011)** \$32

**H01 Prepared for Rack Slide Kit (P/N 1494-0059 required)** N/C

**W30 Two additional years of HP service** \$125

#### Accessories

**P/N 1494-0059 Rack Slide Kit (requires HP 8118A #H01)** \$100 ☎

☎ Fast-Ship product—see page 756.

# DATA GENERATORS & DATA ANALYZERS

## 50 MHz Digital/Analog Signal Generator Model 8175A

- 24 channels / 1 kbits ea / 50 Mb/s ea  
2 channels / 8 kbits ea / 100 Mb/s ea
- Individual pattern duration 20 ns to 9.99 s

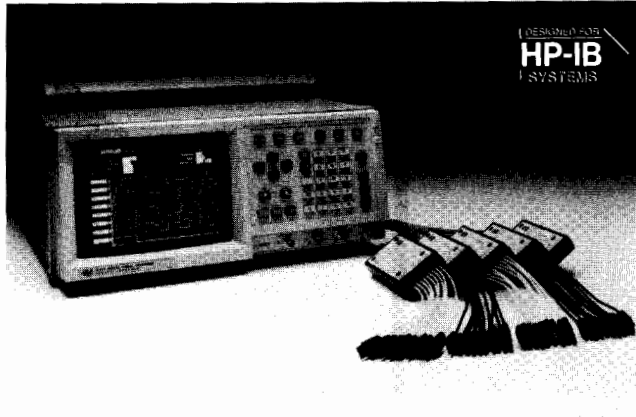

HP 8175A with output pods (15461A/15462A/15464A) and trigger pod (15463A)

### HP 8175A Digital/Analog Signal Generator

The HP 8175A delivers high-speed parallel and serial data with programmable patterns, adequate for at-speed testing of most of present and future logic circuits. Individually Programmable Pattern Durations permit complex timing set-ups for simulation of extreme, asynchronous timings without wasting memory. Virtual Memory Expansion allows very long data sequences by branching to up to 255 user-definable memory segments. Interaction with a device under test provides for simulation of a wide range of data paths in digital systems. Output pods provide the appropriate levels for most logic families and flexible interface adapters ensure the specified signal quality at the probe tip, a precondition for reliable results.

A Fine Timing option (opt. 001) enhances the timing resolution provided with Programmable Pattern Durations in order to delay four channels with 100 ps.

Operational convenience is stressed through a large, menu driven CRT, a comprehensive data editor including waveform graphics and the capability to directly access (via HP-IB) a printer for documentation and a flexible disc drive for use as a test data library.

In Engineering Test, this versatile feature set provides early simulation of elements not yet available, speeding design cycles through reduced integration time at circuit, module and system level.

In Production Test and Incoming Inspection, automated at-speed testing at the module and system level results in early failure detection, thus reducing production cost and improving quality.

Combining the HP 8175A Digital Signal Generator with a HP 1630/31 family logic analyzer results in a complete Stimulus-Response measurement system. For more information on the HP 1630/31 family logic analyzers refer to the respective pages in this catalog.

### Option 002 (Dual Arbitrary Waveform Generator)

With Option 002, the HP 8175A provides two arbitrary channels in addition to the full capabilities of the standard digital signal generator. Thus, some of the stimulation challenges -whether digital, analog or both together- can be met with a single unit (for further information about the analog capabilities, see page 420).

- Virtual Memory Expansion
- Interaction with DUT
- Dual Arbitrary Waveform Generator (opt)

Data Page (PAP) -----

Data [Pattern] Setup

Address	Location Name	POD 2	Used Format	Allocation	Duration
1022		000	00000000	00	0.02 μs
1023		000	00000000	00	0.02 μs
0000	START	007	00000011	00	0.05 μs
0001		200	00000000	00	0.10 μs
0002		000	00000011	00	0.10 μs
0003		200	00000011	10	0.25 μs
0004		007	00000011	11	0.25 μs
0005	DOWN	207	00000011	21	0.15 μs
0006		007	00000011	01	0.10 μs
0007		207	00000011	00	0.05 μs
0008		000	00000000	00	0.10 μs
0009		000	00000010	00	0.10 μs
0010		000	00000010	10	0.25 μs
0011	UP	002	00000010	11	0.25 μs
0012		002	00000010	01	0.15 μs
0013		002	00000010	01	0.10 μs

### Data Page: Pattern Set-Up

Data can be entered and displayed in various codings. Channels to be displayed can be selected. Comprehensive data editing support is provided. For instance, segments can be moved or copied to other memory addresses or data segments can be 'block modified'. Easy exchange of data between channels avoids having to rearrange probes at the test fixture. Also, fixed patterns such as up and down counters with selectable start and stop address are loaded with a few key-strokes. All codings from the pattern Set-Up page will be automatically converted into a timing diagram when switched to this page. Or, the data can be set-up from scratch or easily edited in terms of waveforms.

Program Page (PAP) -----

[Module] Assignment

Available Segments: 235 (max. 255 Segments)

Step	Segment Name	Label or Address	Label or Address	Repetition Times
000	INIT	from 0	to 120	014
001	CLEAR	from 21	to 120	002
015	TEST1	from 200	to UP	002
017		from 250	to 270	001
		end		
018	TEST2	from 981	to 120	001
019		from 300	to 300	001
		end		

### Program Page: Segment Assignment

This page gives an example of how pattern sequencing can be defined. Up to 255 segments of data memory can be defined by first and last addresses or labels in the 0000 to 1023 address range. During data execution the segments are real-time sequenced in the given order thus virtually expanding the memory depth far beyond the physical depth of 1024 data patterns.

## Specifications

Specifications apply for operating temperatures from 0°C to 55°C.

### Parallel / Serial Data Generator

**Number of channels:** 24 parallel, 2 serial  
**Bits per channel:** 1024 parallel, 8192 serial  
**Max. NRZ Bit rate per ch.:** 50 Mbit/s parallel, 100 Mbit/s serial  
**Pattern Duration (with internal clock):**

In *Parallel* mode the duration of each individual pattern is programmable. In *Serial* mode the duration of the data bits is programmable with successive bits always having the same duration. The duration is equal for all channels.

**Range/Resolution:** (10)\*, 20 ns - 9.99  $\mu$ s / 10 ns  
 10  $\mu$ s - 999  $\mu$ s / 1  $\mu$ s  
 1 ms - 99.9 ms / 100  $\mu$ s  
 0.1 s - 9.99 s / 10 ms

\*10 ns in serial mode with fixed timing

**Accuracy:**  $\pm 0.05\%$  of progr. duration  $\pm 2.5$ ns (asynchronous start)  
 $\pm 0.5\%$  of progr. duration  $\pm 2.5$ ns (synchr. start, clock calibration)  
 $\pm 3.0\%$  of progr. duration  $\pm 2.5$ ns (synchr. start, no clock cal.)

**Jitter (max.):** 0.1% of progr. value +150ps

**Pattern Duration (with external clock):** Period of ext. clock x m  
 m (Range) / Resolution:  
 (1)2\*\* to 999 / 1 period  
 1 000 to 99 900 / 100 periods  
 100 000 to 9 990 000 / 10 000 periods  
 10 000 000 to 999 000 000 / 1 000 000 periods  
 \*\*Min. Pattern duration in parallel mode 20ns, in serial mode 10ns.

### Clock

The clock has a programmable period. It is available on line 7 of the pod for the output flags. In serial mode an additional Clock is available providing a pulse at every bit.

#### Period (with internal clock):

**Range / Resolution:** 20ns - 9.99 $\mu$ s / 10ns; 2 $\mu$ s - 999 $\mu$ s / 1 $\mu$ s

**Accuracy:**  $\pm 0.05\%$  of progr. value  $\pm 2.5\mu$ s (asynchronous start)  
 $\pm 0.5\%$  of progr. value  $\pm 2.5\mu$ s (synchr. start, clock cal.)  
 $\pm 3\%$  of progr. value  $\pm 2.5\mu$ s (synchr. start, no clock cal.)

**Period (with external clock):** Period of external clock x m

**Range:** m = 2,3,4 . . . 999, 1000, 1100, 1200, . . . 99 900

**Skew** (maximum time difference between the leading or trailing data bit edges of the same memory address with Fine Timing off)

**across ECL pods:**  $\leq 6$  ns; typical  $\leq 3$  ns

**across TTL/CMOS pods:**  $\leq 7$  ns; typical  $\leq 3$  ns

### Option 001 Fine Timing

(can be retrofitted in HP service office)

#### Parallel Data Generator

**Channels:** 0,1,2 and 3 of pod 0

**Delay (Range/Resolution):** 20 ns to 40 ns / 100 ps

**Accuracy:**  $\pm 5\%$  of progr. value  $\pm 1$  ns

#### Serial Data Generator

**Channels:** 0 and 2 of pod 0

**Delay (Range/Resolution):** 0 ns to 20 ns / 100 ps

**Accuracy:**  $\pm 5\%$  of progr. value  $\pm 2$  ns

### External Input (BNC)

This connector can be used to start / stop datacycling with selectable transitions.

**Impedance:** 10 k $\Omega$  / 50 pF

**Threshold (Range/Resolution):** -9.9V to +9.9 V/100 mV

**Accuracy:**  $\pm 5\%$  of progr. value  $\pm 250$  mV

**Min. swing:** 600 mV pp

**Min. overdrive:** 250 mV or 30% of input amplitude

**Max. input voltage:**  $\pm 20$  V

### External Clock (BNC)

**Clock rate (Range):** 8Hz to 100 MHz

All other specifications see External Input (BNC).

### External Reference (BNC)

**Input characteristics:** LS TTL compatible

### Ordering Information

**HP 8175A Digital/Analog Signal Generator** \$11200

Note: HP 8175A must be ordered with at least one of the options #002, #003, #004, #005 or individual pods, as required.

#### Options:

**Opt. 001** Fine Timing; 4 channels, 100 ps resolution add \$1325

**Opt. 002** Dual Arbitrary Waveform Generator add \$3465

**Opt. 003** Set of 4 ECL Pods Model HP 15461A and 1 Trigger Pod Model HP 15463A add \$4430

**Opt. 004** Set of 4 TTL Pods Model HP 15464A and 1 Trigger Pod Model HP 15463A add \$3005

**Opt. 005** Set of 4 TTL/CMOS Pods Model HP 15462A and 1 Trigger Pod Model HP 15463A add \$6670

**Opt. 908** Rack Flange Kit (PN 5061-9678) add \$36

**Opt. 910** Additional Operating/Programming/Service Manual add \$204

**Opt. 916** Additional Operating/Programming Manual add \$36

**Opt. W30** Two additional years of HP Service \$250

**Pods:**

**HP 15461A** ECL Pod (fixed ECL levels, includes 1 ea HP 15429A) \$970

**HP 15462A** TTL/CMOS Pod (programmable High Level, incl. 1 ea HP 15429A) \$1530

**HP 15463A** Trigger Pod (includes lead set and 10 ea probe tip) \$560

**HP 15464A** TTL Pod (fixed TTL levels, includes 1 ea HP 15429A) \$610

**Adaptors for HP 15461A, HP 15462A and HP 15464A:**

**HP 15408A** plug-on grabbers with ground leads 5 ea \$100

**HP 15409A** plug-on BNC adaptors, 5 ea \$100

**HP 15410A** plug-on SMB adaptors, 5 ea \$100

**HP 15411A** plug-on coax open-end adaptors, 5 ea \$65

**HP 15415A** plug-on miniprobe, usable with HP 10024A IC clip, 5 ea \$100

**HP 15429A** solder-in receptacles (standard accessory, 5x2 ea) \$51

**Adaptors for HP 15463A:**

**HP PN 15463-63201** lead set \$65

**HP PN 10230-62101** probe tip, 1 ea (10 ea necessary per pod) \$3

**Others:**

**HP 15430A** cable for synchronized master-slave operation of two ea HP 8175A \$76

**HP 10062A** Protective Cover (for front panel) \$75

Fast-Ship product—see page 766



# DATA GENERATORS & DATA ANALYZERS

## Data Generator/Analyzer System

Models 8180B, 8181B, 8182B

- Digital ac parametric and functional evaluation
- 50MHz, 16kbit vector memory depth
- 100ps timing/10mV level resolution
- Real-time data comparison
- Ease-of-use
- System Software



HP 8180B Data Generator

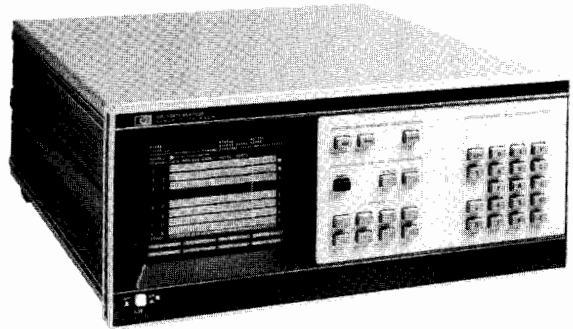

HP 8182B Data Analyzer

### The Tool for At-Speed Evaluation of Digital IC's, Boards & Modules

The HP 8180B is a modular, high speed Data Generator for the stimulation of digital IC's and boards. For the analysis of a digital circuit's response, the HP 8182B provides capabilities for data capture and comparison, and for level and timing characteristics measurements. The Data Generators and Data Analyzers are matched in performance with regard to vector rates, vector memory depth and measurement accuracy and functionality.

### Modular Configurations - From Stand-Alone to Complete Systems

On the bench, the Data Generators and Analyzers are fully operational without an external controller due to a softkey-driven, interactive operating concept.

In remote operation, all set-ups can be programmed with an external controller via the standard HP-IB interface. This enables interactive operation as well as full automation of Stimulus/Response setups.

For IC Test applications, HP is offering complete Systems including Testhead and System Software. This provides the turn-key solution required to test digital devices from MSI to VLSI integration, including ASIC's (Application Specific IC's).

### The HP 81810S IC Design Verification System

Owing to the modular architecture which allows you to combine instrument modules as required, the system is extremely flexible in terms of functionality, performance and price. This enables you to tailor the system and achieve the optimum fit for applications like IC Design Verification, Prototype Evaluation, Failure Analysis, Low-Volume Production Test and Incoming Inspection.

#### Test System Modules

The HP 81810S is composed of the HP 8180B and HP 8181B Data Generator and Extender, the HP 8182B Data Analyzer, the HP 15466A Test Head (for up to 256 tester channels), a systemizing rack, the HP 4141B DC Source/Monitor, the HP 6624A Device Power Supply and a range of accessories. Also included is a HP 9000 series 300 workstation plus the System Software. All system modules except the controller can be installed in one or two racks, depending on the configuration.

#### System Software

The System Software provides a shell around the hardware resources and enables you to focus on the device under test rather than on the machine. Because it is easy to use, users need little training to work with this tool.

Softkey driven menus guide the user through parameter set-up, pattern editing, pin labeling etc. to enter device and test specific data. After a few key-strokes the user can then perform various tests e.g.

functional truth-table verification or automatic level and edge search as required for measuring propagation delays or set-up and hold times.

The CAE link part of the software allows you to link directly to CAE design workstation or host computers running simulation programs. The software provides turn-key programs for downloading data vectors which are compatible with HILO3, FACTOR (SENTRY) and Mentor design station data formats. After downloading, the testvectors are readily available in the Test System for execution.

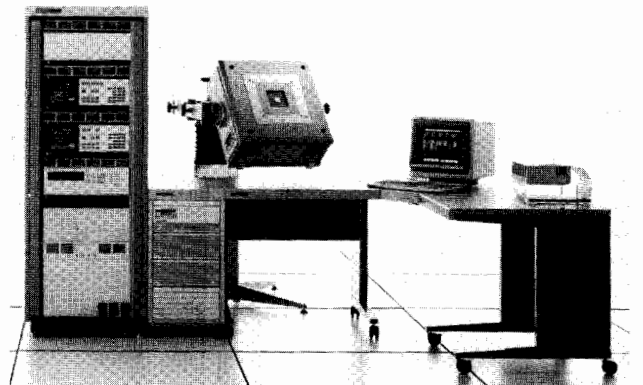

### Applications that Reflect in Features

For at-speed functional verification of prototype circuits, the Generators and Analyzers offer programmable digital patterns at data rates up to 50 MHz. The linear vector memory depth of 16 Kbit/channel allows you to generate and capture the immense number of testvectors required for testing complex devices. Real-time comparison between "expected" data and captured data generates an "Error Map" which gives immediate feedback and increases throughput.

For thorough characterization of a circuits' performance limits, timing edges can be positioned with a best resolution of 100 ps and level pairs can be programmed with a 10 mV resolution. "Window Comparison" simultaneously checks proper upper and lower logic level and timing conditions. This makes the equipment the ideal tool for Critical Path Analysis of prototype circuits and for in-depth analysis of circuits failing a test.

Please refer to the semiconductor test section (page 526) to find information about the HP 82000, a fully integrated IC evaluation system. It features highest performance, like 200 MHz speed and  $\pm 250$  ps accuracy on up to 384 true I/O pins.

## Specifications

Specifications apply for operating temperatures from 0°C to 50°C.

### HP 8180B, 8181B Data Generator/Extender

#### Memory and Channels

**Memory depth:** 16384 bit/channel

**Number of channels:** up to 64 using HP 8180B with two HP 8181B Extenders. Up to 192 channels with 3 sets of equipment in parallel operation.

#### HP 8180B Channels

**RZ (return-to-zero) channels:** independent variable delay and width in each of up to 8 channels.

**NRZ (non-return-zero) channels:** Up to 16 channels minus the number of RZ channels. Fixed timing.

**Strobe channel:** NRZ data or clock. Fixed timing

**Clock channels:** independent delay and width in each of 2 channels. Clock 1 can be selected to run continuously in Break state (see 'Cycle modes').

#### HP 8181B Channels

**NRZ:** up to 24 channels. Fixed timing within an Extender, group delay with respect to HP 8180B.

#### Memory Loading

**Codes:** bin, oct, hex, dec (address codes: oct, hex, dec).

**Entry:** Keyboard or HP-IB.

**Displayed channel order:** user-defined.

**Line edit:** insert, delete, macro.

**Channel edit:** clear, set, copy, prbs, counts, entry mask.

#### Cycle Modes

Single, Auto, Initialization + Auto, Gated, Initialization + Gated. (Initialization data is output at the beginning of the first cycle only).

**Break state:** implemented by manual or external BREAK command or by strobe channel bit. Data is held at current address. Manual or external RUN command cause same cycle to continue.

**Stop state:** implemented by manual or external STOP command. Data is held at current address and the cycle is terminated. Manual or external RUN command trigger a new cycle.

#### Timing

**Clock period:** 20 ns to 950 ms (1.05 Hz to 50 MHz). Ext clock 0 to 50 MHz.

#### Delay

(relative to strobe channel): 0.0 ns to 950 ms, max 90% period -18ns.

**Width:** 10.0 ns to 950 ms, max 90% period -8ns.

**Skew:**  $\leq 2$ ns for NRZ channels and RZ channels programmed for zero delay.

**Resolution:** 3 digits (best case 100 ps).

**Accuracy:**  $\pm 5\%$  of programmed value  $\pm 1$ ns.

**Jitter:**  $\leq 0.2\% + 100$  ps (+ additional 50 ps for delay and width).

#### Outputs

**Output impedance:** 50 Ohm

**Data and clock:** 4 different high level / low level pairs can be defined and assigned to any number of individual outputs. Each channel has independent normal / complement switching. Common 'off'.

**Read-out:** can be selected for 50 Ohm or high impedance load (common selection for all channels).

	50 Ohm load	High-impedance load
<b>High level:</b>	-1.50 to +5.50 V	-1.00 to +17.0 V
<b>Low level:</b>	-2.00 to +5.00 V	-2.00 to +16.0 V
<b>Resolution:</b>	3 digits (10 mV)	3 digits (best case 20 mV)
<b>Amplitude:</b>	0.5 to 5.5 V	1.0 to 17 V

#### Transitions:

10% to 90% (3 + |0.2 ampl|) ns (3 + |0.5 ampl|) ns

20% to 80% at ECL levels: 1.5 ns

**Strobe:** ECL/TTL selectable

### HP 8182B Data Analyzer

#### Memory and Channels

**Memory depth:** 16384 bit/channel

**Number of channels:** up to 32. Up to 128 by parallel operation of four HP 8182B's.

**Expected data memory:** 16384 bit/channel, segmentable.

**Codes:** bin, oct, hex (address code: dec).

**Entry:** Keyboard, HP-IB or read-in from DUT.

**Displayed channel order:** user-defined.

**Line edit:** word mask (don't care), insert, delete.

**Channel edit:** clear, set, copy, mask (don't care), exchange.

#### Modes

**Analysis / store-and-compare:** synchronous sampling with variable analog sampling point delay or asynchronous sampling. Comparison with expected data, if required.

**Displays:** state list, timing diagram, or error map.

**Glitch detection:** down to 5 ns. Memory depth is halved when glitch detection is selected.

**Trigger condition:** can be selected to start or stop analysis.

**Real-time compare:** comparison of actual with expected data throughout a time window. Window has variable analog delay and width. Real-time and latched error output signals are provided.

**Display:** error map.

**Trigger conditions:** starts comparison.

#### Timing

**External clock:** 0 to 50 MHz.

#### Delay

(relative to external clock): 0.0 ns to 1 s, max 95% period - 1 ns

**Compare window width:** 10.0 ns to 1 s, max 95% period - 9 ns

**Channel skew:**  $\leq 2$  ns

**Resolution:** 3 digits (best case 100 ps).

**Accuracy:**  $\pm 5\%$  of programmed value  $\pm 1$  ns.

**Internal clock:** 1 Hz to 50 MHz (1-2-5) steps).

#### Inputs

**Data:** 6 different thresholds or dual threshold pairs can be defined and assigned to any number of individual inputs.

**Clock:** programmable threshold and selectable slope (positive, negative, both).

**Input impedance:** 1 MOhm,  $< 7$ pF.

**Control signals:** (100 kOhm / 50 Ohm selectable input impedance)

**Trigger arm and ext stop signals:** independent programmable thresholds and selectable slope (positive, negative, don't care).

**Trigger qualifier and clock qualifier signals:** independent programmable threshold and selectable levels (high, low, don't care).

**Threshold range:** -10.0 to +10.0 V.

**Dynamic range:** threshold  $\pm 10$  V.

**Resolution:** 3 digits (best case 10 mV).

#### Trigger

Trigger arm, word and qualifier, digital filter (1 to 16), clock and qualifier, delay (0 to 65535.)

#### Ordering and Literature

For Ordering Information (also on accessories) and detailed Technical Data Sheets and Application Notes on the products covered in this chapter, please contact your HP sales office.

# DATA GENERATORS & DATA ANALYZERS

## 50 MHz Serial Data/PRBS Generator

### Model 8018A

- 2048 bit, dual channel memory
- Variable word and pattern length
- TTL, ECL, CMOS compatible
- Programmable, prbs and mixed data

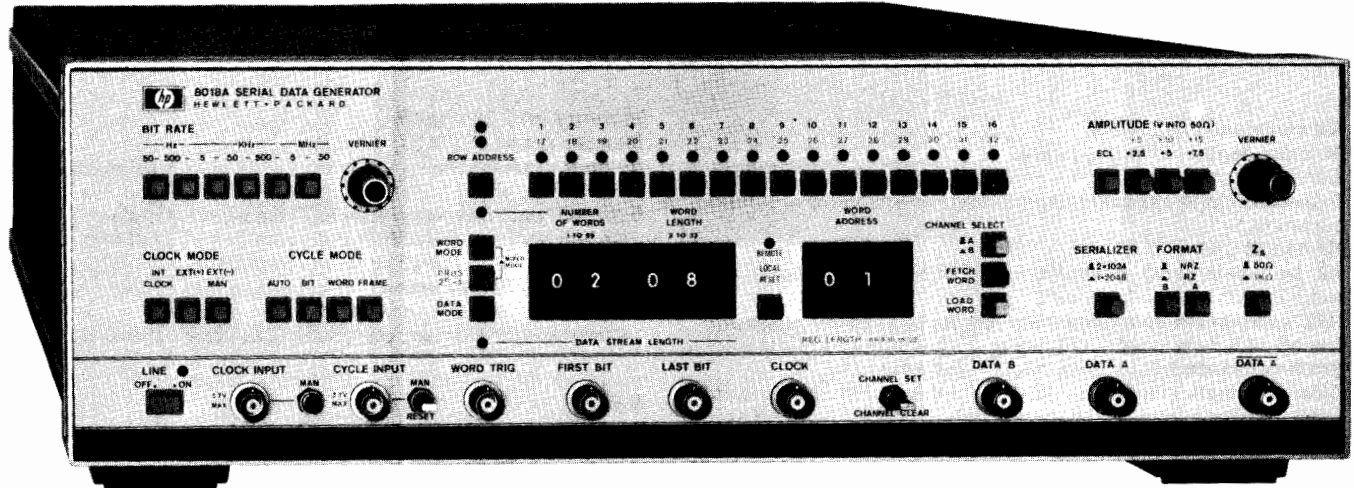

HP 8018A



with Option 001

With 2048 programmable bits, and a choice of pseudo-random binary sequences (prbs) ranging to over 1 Mbits, the HP 8018A is a powerful stimulator for serial digital systems and devices requiring high bit rate and fast pulses. Even preamble-data-post-amble data link patterns are feasible by combining prbs and programmed data. Useful synch outputs simplify testing by locking scope or analyzer to unique points in the data stream.

For data link patterns, mixed mode inserts a prbs after each odd word.

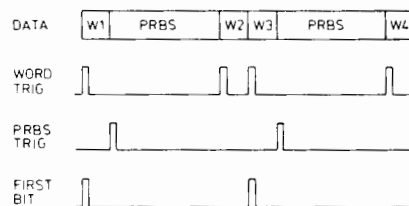

For dual-channel applications, the memory splits so that the outputs have independent 1 Kbits of data.

A high performance output amplifier adds to the HP 8018A's wide applicability. It delivers clean, 6 ns pulses with repetition rates from dc to 50 Mbits/s. Output amplitude is variable up to 15 volts into 50  $\Omega$ . This enables you to directly drive logic circuits ranging from TTL to CMOS. Output levels for emitter-coupled-logic (ECL) are also provided.

To handle patterns for repetitive tests more conveniently, data can be loaded via HP-IB (Option 001).

## Specifications

### Data Capacity and Modes

**Programmable memory:** 2 channels, each 1 kbit, serializable. Thumbwheel switches define data stream length or frame length (N words of Mbits), and set up synch signals accordingly.

**Prbs:** pseudo-random binary sequences of 511, 1023, 32767 and 1048575 bits. Synch pulse at beginning of sequence.

**Mixed:** prbs is inserted after every odd-numbered programmable word.

## Data Outputs

**Channel A:** simultaneous normal and complement outputs. ECL levels or variable +15 V amplitude. Selectable 50  $\Omega$ /1 k $\Omega$  output impedance, RZ/NRZ format.

**Data length:** up to 1024 bit or (serialized with B data) 1025 to 2048 bit.

**Transitions (50  $\Omega$  into 50  $\Omega$ ):**  $\leq 6$  ns (ECL  $\leq 5$  ns)

**Preshoot, overshoot, ringing:**  $\leq 10\%$  (ECL  $\leq 15\%$ )

**Channel B:** normal output, 2.4 V (50  $\Omega$  into 50  $\Omega$ ), up to 1024 bits, RZ/NRZ selectable.

## Bit Rate

**Internal:** 50 Hz to 50 MHz (40 MHz in Mixed mode), jitter 0.2%

**External:** dc to 50 MHz (40 MHz in Mixed mode) or manual.

## Data Cycling

**Auto:** sequence recycles continuously.

**Bit:** bits are triggered/gated by external pulses/level.

**Word:** words are triggered/gated by external pulses/level.

**Frame:** sequence is triggered/gated by external pulses/level.

**Manual:** switch triggers single bits/words/frame.

## General

**Power:** 100/120/220/240 V rms; +5%, -10%; 48 to 440 Hz. 230 V A max.

**Temperature range:** 0°C to 50°C.

**Weight:** net 12 kg (26.5 lbs). Shipping 16 kg (35.3 lbs).

**Size:** 133 H x 426 W x 422 mm D (5.2" x 16.8" x 16.6").

## Ordering Information

HP 8018A Serial Data Generator

**Opt. 001:** HP-IB for data loading\*

**Opt. 907:** Front Handle Kit (Part No. HP 5061-9689)

**Opt. 908:** Rack Flange Kit (Part No. HP 5061-9677)

**Opt. 909:** Opt. 907, 908 combined (Part No. HP 5061-9683)

**Opt. 910:** Extra Operating and Service Manual

\* HP-IB cables: refer to page 561.

☎ Fast-Ship product—see page 766

## Price

\$5900

add \$815

add \$56 ☎

add \$33 ☎

add \$82 ☎

add \$39

# DATA GENERATORS & DATA ANALYZERS

## 50 Mbit/s Pattern Generator

Model 16500A with 16520A and 16521A Modules

323

- From 12 to 204 data channels
- 50 Mbit/s (NRZ) maximum data rate
- 4095 bits memory per channel

- 3 strobes (RZ)
- ECL or TTL output levels
- Data entry in hex, octal, binary, decimal or symbols



### HP 16500A Logic Analysis System

... working interactively to serve the breadth of your system design and test needs.

#### Modular, User-configurable

The HP 16500A logic analysis system is a modular, user-configurable instrument that can provide up to 204 channels of 50 Mbit/s NRZ pattern generation. Its modularity gives it a capability to provide a complete stimulus-response system when used with other system modules, including 100 MHz timing analysis, 25 MHz state analysis, 1 GHz timing analysis, and 100 MHz digitizing oscilloscope capability.

#### A Synergistic Solution

Configure the HP 16500A to provide both stimulus and response in one instrument. Use the HP 16520A 50 MBit/s pattern Generator master card to provide the functional stimulus. Use the digitizing oscilloscope, 25 MHz state/100 MHz timing cards or 1 GHz timing cards to capture functional and parametric response.

Software links to CAE simulation systems are also available, which allows the HP 16500A's stimulus-response capabilities to be used for prototype functional testing.

#### Configuration

The HP 16520A pattern generator master card provides 12 channels of NRZ pattern generation. Channel count can be increased in increments of 48 by adding up to four HP 16521A expansion cards — or you can configure the system in mix-and-match combinations of other measurement modules. An intermodule bus keeps track of which modules are installed and allows cross-module triggering, providing measurement capabilities that would not be possible using individual instruments.

#### Perform Functional Verification

Avoid designing custom hardware or using other time-consuming methods to provide stimulus to your circuit. The HP 16500A offers you functional tests at a low cost per channel.

#### Shorten your Design Cycle

Test partial systems, even if they are missing components. The HP 16500A's pattern generator capabilities can be used to substitute for boards, ICs, and busses. Instead of waiting for missing pieces, you can continue to test and verify your design.

#### Friendly Circuit Connection

The HP 16500A's pattern generator has lightweight, passive probes that let you attach to your board through probe tips or 2 x 10, 0.1" center connectors on your circuit board. Standard connectors eliminate the need to purchase special connectors or to build custom fixtures to hook up to your device under test. The probing system provides ECL or TTL patterns through 50 ohm connections. Series termination eliminates the need for external 50 ohm terminations. HP also offers an ECL differential driver and a TTL tristate pod.

For complete specifications and more information about the HP 16500A logic analysis system and its measurement modules, please refer to page 260 in the logic analyzer section of this catalog.

#### Ordering Information

HP 16500A logic analysis mainframe	\$7,200
HP 16520A 12-channel, 50 MBit/s master card	\$3,700
HP 16521A 48-channel, 50 MBit/s expansion card	\$4,000

#### Price

# TRANSCEIVER TEST EQUIPMENT

## Automated Test Systems

Models 8953A, 8955A, 8957S

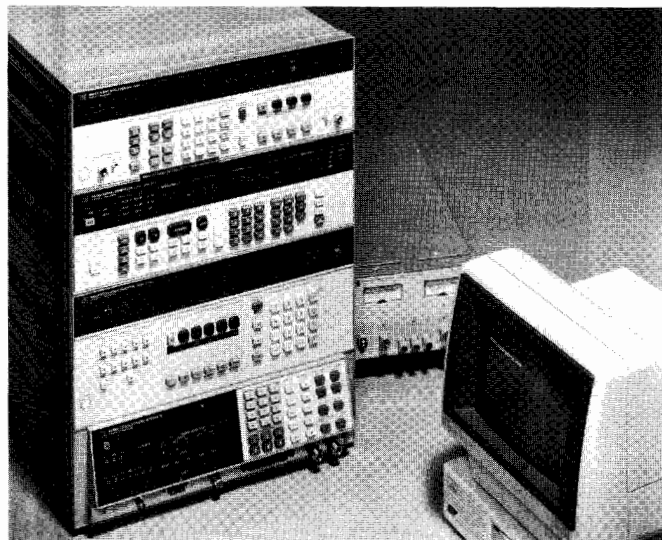

### Transceiver Test Systems

Hewlett-Packard's transceiver test product line was designed to offer maximum flexibility, modularity and expandability to the mobile communications market. All systems are based on three "designed for systems" instruments: the HP 8656B Synthesized Signal Generator, the HP 8903B Audio Analyzer, and the HP 8901A/B Modulation Analyzer. These products together perform the majority of in-channel tests on any AM or FM transceiver. Combining these three basic building blocks, together with a programmable interface for system integration, creates a modular solution that is flexible enough to meet your needs today and tomorrow. These systems then can be automated using one of the many software packages available for the Series 300 and Vectra computers.

Based on the three basic measurement instruments and our system interface product line, Hewlett-Packard has created three separate test systems: the HP 8953A Transceiver Test Set, the HP 8955A RF Test System and the HP 8957S Cellular Radio Test System. From these beginnings, you can add or change instruments depending on your requirements.

#### HP 8953A

The HP 8953A Transceiver Test Set is Hewlett-Packard's lowest-priced system. It combines the measurement power of the three basic measurement instruments with the HP 8954A Transceiver Interface to create a solution capable of performing the majority of in-channel tests and expandable enough to meet all but the most demanding of testing requirements.

#### Ordering Information

**HP 8953A** Transceiver Test System (consisting of:)

- HP 8901A** Modulation Analyzer
    - Opt 001 RF output connectors on rear panel only
  - HP 8656B** Synthesized Signal Generator
    - Opt 001 high stability time base
    - Opt 002 RF output connectors on rear panel only
  - HP 8903B** Audio Analyzer
    - Opt 001 RF output connectors on rear panel only
    - Opt 010 400 Hz high pass filter
    - Opt 051 CCITT weighting filter
  - HP 8954A** Transceiver Interface
  - HP 8498A** Attenuator
    - Opt 030 25 watt, 30 dB
- Cables and connectors

**Price**  
\$30,000

#### HP 8955A

The HP 8955A RF Test System is a powerful and versatile system developed for designers, manufacturers and users of RF communication equipment. It provides a flexible combination of instruments for testing transmitters, receivers, subassemblies and modules in the frequency range from 150 kHz to 1000 MHz. The basic system consists

of the three basic measurement instruments and the HP 436A Power Meter for increased measurement accuracy. The instruments are then integrated using the HP 8956A System Interface. The system also includes a cabinet, side table and comprehensive documentation.

Before a system is shipped, it is assembled and tested at the factory. This includes installing the instruments into the rack and thoroughly testing them as a system, ensuring that the HP 8955A meets its specifications.

#### Ordering Information

**HP 8955A** RF Test System (consisting of:)

- HP 8901A** Modulation Analyzer
    - Opt 001 RF connectors on rear panel only
  - HP 8656B** Synthesized Signal Generator
    - Opt 001 high stability time base
    - Opt 002 RF connectors on rear panel only
  - HP 8903B** Audio Analyzer
    - Opt 001 RF connectors on rear panel only
    - Opt 010 400 Hz high pass filter
    - Opt 051 CCITT weighting filter
  - HP 8956A** System Interface
  - HP 436A** Power Meter
  - HP 8482A** Power Sensor
- Cabinet  
Cables and connectors

**Price**  
\$55,000

#### HP 8957S

The HP 8957S Cellular Radio Test System combines the three basic measurement instrument with the HP 8958A Cellular Radio Interface. This system will perform all signaling necessary to test AMPS and TACS compatible cellular radios. By adding the HP 11799A Signaling Box, the systems capabilities can be increased to include NMT cellular radios.

#### Ordering Information

**HP 8957S** Cellular Radio Test System (consisting of:)

- HP 8901B** Modulation Analyzer
  - Opt 001 RF connectors on rear panel only
  - Opt 002 high stability time base
- HP 8656B** Synthesized Signal Generator
  - Opt 002 RF connectors on rear panel only
- HP 8903B** Audio Analyzer
  - Opt 001 RF connectors on rear panel only
  - Opt 010 400 Hz high pass filter
  - Opt 051 CCITT weighting filter (for TACS only)
  - Opt 053 C-Message weighting filter (for AMPS only)
- HP 8958A** Cellular Radio Interface
- HP 6024A** Power Supply
- HP 11804A** Accessory Kit

**Price**  
\$0  
\$13,800  
+\$225  
+\$775  
\$6,250  
+\$180  
\$5,950  
+\$100  
+\$210  
+\$210  
+\$210  
\$11,500  
\$1,550  
\$2,650





### Automated Transceiver Test

Hewlett-Packard's transceiver test solutions are flexible combinations of instrumentation and software for automatically testing radio transmitters and receivers. This approach to transceiver test gives you comprehensive, expandable solutions for a wide range of applications, allowing you to choose the right combination of hardware and software to fit your needs today and in the future.

### Simplifies Workflow

The diagram below illustrates a typical workflow using manual test equipment. In this case, a technician must manually test each radio and repair it if there is a problem. Then, he checks the radio again to verify that the fault was corrected. Because these tests are tedious and time-consuming, often only a cursory check is performed. The second diagram illustrates the effect of an automatic test system. This system quickly and completely tests the radio. If a fault is found, the technician makes the necessary repairs and the system verifies proper operation. Often, the system finds that an incoming radio is operating properly, saving the technician valuable time.

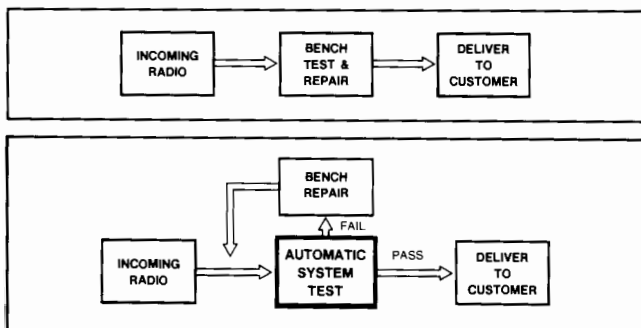

### Ensures Quality

An automatic test system can make a thorough test of every radio, helping to find latent problems. An HP transceiver test system lets you make more measurements at more data points in less time than with manual testing. And it follows the same procedure every time, eliminating operator errors while maintaining consistent testing.

### Improves Productivity

You can save time with an automatic test system. It frees highly skilled technicians for more productive work and allows for expansion to meet the growing demand for mobile radio products and services. Because they perform the tedious and repetitive tasks, automatic test systems help to increase job satisfaction as well.

### System Software

An integral part of Hewlett-Packard's transceiver test product line is the wide variety of software application test packages available. Designed to meet your testing needs, these packages offer a broad spectrum of solutions ranging from basic in-channel measurements to full radio characterization. With test times typically measured in seconds, these packages will quickly and accurately measure your transceiver's performance.

### HP 11805A Transceiver Test Software

#### Exceptional Flexibility and Expandability

The Hewlett-Packard 11805A Transceiver Test Software Package is an easy-to-use, comprehensive solution for automatically testing radio receivers and transmitters. The HP 11805A software package provides quick and easy testing with full softkey operation, concise graphics, and easy-to-read test results.

The software consists of a main executive program coupled with a separate series of measurement test packages. With this format, you purchase only the measurement capability you need, with the ability to expand with full compatibility at a later date. This new approach to software development allows the HP 11805A to fit into any testing environment, dependent only on the measurement capability purchased. If you have a specialized application, the software is written in BASIC language and can be easily modified.

The HP 11805A will test multiple channel radios and, for standard FM and AM radios, can encode and decode Continuous Tone Controlled Squelch (CTCSS) and Digital Coded Squelch (DCS) tones automatically. In addition, all test packages allow you to perform all tests on all channels, selected prime channels, or to select any test/channel combination you desire.

# TRANSCEIVER TEST EQUIPMENT

## System Software (cont'd)

For cellular radio applications the HP 11805A offers test packages that are fully compatible with the AMPS, TACS and EIA-800 cellular radio test standards. In addition, there are application packages capable of fully testing AM and SSB-SC radios.

Pass/Fail limit testing allows you to quickly verify your radio's performance. Optimized for speed and repeatability, the HP 11805A increases productivity and efficiency. With the optional bar code reader, radio parameters can be entered in seconds and stored on disc for future use. In addition, a Manual Mode allows you to manually control test instrument settings through the computer without leaving the program. Clear instructions, easy-to-read graphics, and helpful program prompts guide you through every step of the program.

Utility programs are also among the powerful capabilities of the HP 11805A software package. The System Interconnection Verification program is designed to ensure that all instruments are responding to the computer controller. The System Calibration program measures all the path losses from the radio through the interface. These path losses are then accounted for in the measurement test routines, increasing the accuracy and repeatability of the test results.

### HP 11798A Cellular Radio Software

#### NMT Cellular Radio Software

The HP 11798A Cellular Radio Test Software provides the comprehensive RF and signaling tests required for testing cellular mobile radios conforming to the 450 and 900 MHz standards of the Nordic Mobile Telephone (NMT) system. With user-written software, the system is also capable of simulating a mobile station for base station signaling tests.

Tests can be selected and run in any order, giving you complete control of your test routines. These routines include call processing functions such as origination, origination reorder and paging. The results are then displayed in a concise format with Pass/Fail limits, allowing you to quickly verify your radios performance. The HP 11798A is an excellent solution to your NMT cellular radio testing needs.

Additional features of the HP 11798A include a calibration utility capable of measuring and correcting for the insertion and path losses in the system and a special Manual mode which allows you to manually control the test instruments from the computer controller.

#### Ordering Information

	Price
HP 11805A Software Application Pac	\$0
Opt 001 Operating System Executive	\$1,575
Opt 100 North American FM Tests	\$500
Opt 101 Extended North American FM Tests	\$775
Opt 200 European $\phi$ M Tests	\$500
Opt 201 Extended European $\phi$ M Tests	\$775
Opt 300 AM Radio Tests	\$500
Opt 400 SSB-SC Radio Tests	\$775
Opt 500 AMPS Cellular Radio Tests	\$775
Opt 510 TACS Cellular Radio Tests	\$775
Opt 520 EIA-800 Cellular Radio Tests	\$775
Opt 530 TACS with AMPS Bus Cellular Radio Tests	\$775
HP 11798A Software Application Pac	\$1,100

HP Model No.s	11805A Options										11798A
	100	101	200	201	300	400	500	510	520	530	
Type of radios Tested	FM	Extended FM	PM	Extended PM	AM	SSB-SC	AMPS	TACS	EIA-800	TACS w/ AMPS Bus	NMT
Controllers Supported <sup>1</sup>	200 300 Vectra	200 300 Vectra	200 300 Vectra	200 300 Vectra	200 300 Vectra	200 300 Vectra	200 300 Vectra	200 300 Vectra	200 300 Vectra	200 300 Vectra	200 300
Language Supported	BASIC 5.0	BASIC 5.0	BASIC 5.0	BASIC 5.0	BASIC 5.0	BASIC 5.0	BASIC 5.0	BASIC 5.0	BASIC 5.0	BASIC 5.0	BASIC 5.0
Systems Supported	8953A 8955A 8957S	8953A <sup>2</sup> 8955A	8953A 8955A 8957S	8953A <sup>2</sup> 8955A	8953A 8955A	8953A 8955A	8953A 8955A	8957S	8957S	8957S	8957S <sup>3</sup>
Measure Squelch	CTCSS DCS	CTCSS DCS	CTCSS DCS	CTCSS DCS							
Generate Squelch	CTCSS DCS	CTCSS DCS	CTCSS DCS	CTCSS DCS							
Number of tests Performed	20	9	17	8	17	16	35	20	19	29	21

<sup>1</sup> Only selected configurations are supported

<sup>2</sup> HP 8953A system must include Option 100

<sup>3</sup> HP 11799A is also required

# TRANSCEIVER TEST EQUIPMENT

RF Interfaces

Models 8954A, 8956A, 8958A, 11799A

327

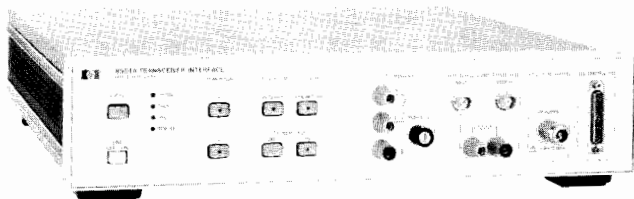

HP 8954A



HP 8958A

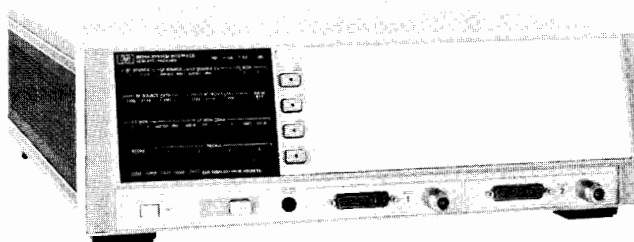

HP 8956A

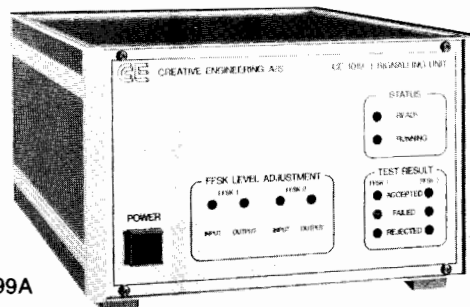

HP 11799A

## HP 8954A Transceiver Interface

The HP 8954A is Hewlett-Packard's lowest priced transceiver test interface. It is fully programmable and uses microwave switches and hardware in all RF paths. Designed for dc to 18 GHz measurements, the HP 8954A Transceiver Interface provides the flexibility needed for most AM, FM and SSB receiver and transmitter testing.

## HP 8954A-H03 Transceiver Interface

The HP 8954A Option H03 Transceiver Interface is a full-duplex version of the standard HP 8954A. The standard RF switching hardware is replaced with a power divider network that is designed for 10 MHz to 1500 MHz use. The HP 8954A Option-H03, when used with the HP 11799A Signaling Unit, is part of the recommended configuration for testing NMT (Nordic Mobile Telephone) cellular radios.

## HP 8956A System Interface

The HP 8956A System Interface, with its multiple paths and connections, provides added flexibility in the designing of systems in the frequency range from dc to 1000 MHz. It has two RF test ports for duplex testing, stimulus/response testing and reduced connect/disconnect times. A built-in, switchable 120 watt 30 dB attenuator can be inserted for transmitter testing and removed for receiver testing, increasing receiver measurement range.

Additional functions of the HP 8956A include current drain and timing measurements.

## HP 8958A Cellular Radio Interface

The HP 8958A Cellular Radio Interface gives your system the capability to fully test a cellular radio. With the flexible Channel Simulator, you can simulate cell-site operation, verify signaling protocol, or perform highly complex and sophisticated tests using an external controller to generate and analyze data content.

## HP 11799A Signaling Unit

For testing cellular radios compatible with the 450 and 900 MHz protocols of the Nordic Mobile Telephone (NMT) system, Hewlett-Packard recommends and supplies the Creative Engineering CE1019-1 Signaling Unit. The CE1019-1 can be ordered from Hewlett-Packard as HP Model 11799A.

When used with the three basic transceiver test instruments and a duplex interface, the HP 11799A simulates a base station and mobile exchange for over-the-air RF and signaling tests of cellular mobile radios.

## Ordering Information

	Price
HP 8954A Transceiver Interface	\$4,200
HP 8954A-H03 Transceiver Interface	\$5,715
HP 8956A System Interface	\$13,600
HP 8958A Cellular Radio Interface	\$11,500
HP 11799A Signaling Unit	\$14,000

## System Interface Comparison

	HP 8954A	HP 8954A-H03	HP 8956A	HP 8958A
Frequency Range	DC to 18 GHz	10 to 1500 MHz	DC to 1000 MHz	10 to 1500 MHz
Number of RF Ports	4	4	6	6
Number of Audio Ports	2	2	4	2
Number of UUT Ports	1	1	2	1
Duplex Capabilities	NO	YES	YES	YES
Typical Applications	AM, FM, $\emptyset$ M, SSB	AM, FM, $\emptyset$ M, SSB, NMT <sup>1</sup>	AM, FM, $\emptyset$ M, SSB	AMPS, TACS, NMT <sup>1</sup>

<sup>1</sup>Requires the HP 11799A Signaling Unit

# NOISE FIGURE METER

## Noise Measurements



### What is Noise Figure?

Modern receiving systems must often process very weak signals. Noise added by the receiving system components often determines whether or not an input signal can be processed properly. Unlike other ways to measure receiver noise (minimum discernable sensitivity, tangential sensitivity, etc.) noise figure is an objective measure, it does not depend on the judgement of the person measuring. In addition, noise figure is universal; it may be determined for transistors, amplifiers, and mixers as well as entire systems.

Noise figure can be expressed as the ratio of total output noise power (at a source temperature of 290K) compared to the output noise power if there were no noise added by the device under test (DUT).

Noise figure is typically measured by applying two known noise powers to the test device input and measuring the corresponding output powers. Assuming the device is linear, it can then be characterized with respect to total output noise power for all values of input noise power. Noise figure is calculated (ratio of total output noise power versus output noise power assuming no device noise) assuming an input noise power generated from a 290K thermal noise source.

To learn more about noise figure basics and measurement, read HP Application Note 57-1 (see **Literature** on this page).

### Single- and Double-sideband Noise Figure Measurements

There are both advantages and disadvantages to single- and double-sideband measurements.

Double sideband microwave measurements are easy. The most basic set-up requires only a mixer and local oscillator. However, the resulting noise figure is the average of the test device performance at the two down-converted frequencies. If the device characteristics vary rapidly with fre-

quency, such as transistors or amplifiers with narrow passbands, double-sideband measurement can introduce significant error. In addition, spurious and harmonically-related signals can also render double-sideband measurement data invalid.

Single-sideband measurements eliminate double-sideband problems. Double-sideband problems like image, spurious, and harmonic signals are removed by pre-selecting the desired noise sideband before mixing. Single-sideband measurements, however, require accurately designed filtering systems (like temperature-compensated YIG filters) which are difficult to design and maintain. In spite of its difficulties, single-sideband is the only way to make a standard, down-converted noise figure measurement - its measured value does not depend on the device characteristics.

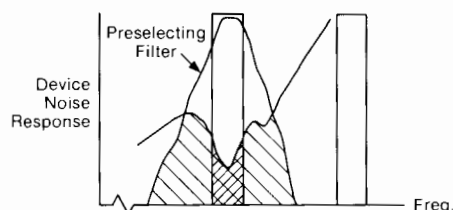
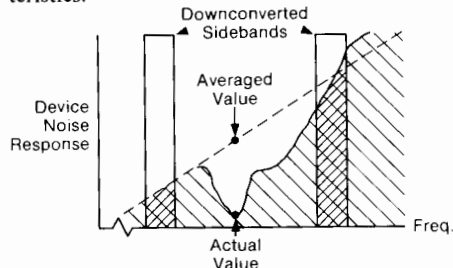

▨ Noise input to mixer  
▩ Down-converted noise

### Noise Figure Measurement Applications

Hewlett-Packard's noise figure measurement equipment is exceptional in applications like these:

**Amplifiers:** 1) Simultaneous noise figure and gain measurement, 2) Results automatically corrected for ENR variations, ambient temperature, and mixer, LO, and IF noise contributions, 3) Real-time, swept, corrected output to oscilloscope for easy tuning (display is digitally stored), 4) Single-test-port calibration and measurement from 10 MHz to 18 GHz (with the 8970S/T systems).

**Transistors:** All the benefits of measuring amplifiers plus: 1) Easy real-time tuning for best noise figure and gain, 2) real-time tuning to actual transistor  $F_{min}$  without second stage effects, 3) Broadband (10 MHz to 18 GHz) single-sideband measurement (with the HP 8970S/T system), 4) Low mismatch effects (the HP 346A features virtually identical impedance for  $T_h$  and  $T_c$ ), 5) Easy to program for automatic systems.

**Receivers and mixers:** 1) Simultaneous measurement of gain (conversion loss) and noise figure, 2) Tunable and swept IF from 10 to 1600 MHz (with the HP 8970B) and 10 MHz to 18 GHz (with the HP 8970S/T), 3) No external IF gain needed, 4) Automatic ENR correction, even for broadband sweeps, 5) Effects of LO power, IF power, and IF frequency changes on noise figure are easily observed, 6) Easy to program.

### Literature

**Product Note 8970B/S-2, Applications and Operation of the HP 8970B Noise Figure Meter**, describes the HP 8970B and many of its applications in more detail. It is both an introduction to the HP 8970B and a summary reference manual.

**Product Note 8970B/S-3, Noise Parameter Measurement using the HP 8970B Noise Figure Meter and the ATN NP4 Noise Parameter Test Set**, describes noise parameter measurement on transistors.

**Application Note 57-1, Fundamentals of RF and Microwave Noise Figure Measurements**, explains the theory behind noise figure and its measurement. This note includes an extensive glossary of noise related terms.

**Application Note 57-2, Noise Figure Measurement Accuracy**, discusses considerations for making accurate noise figure measurements and for determining the accuracy of noise figure measurements.

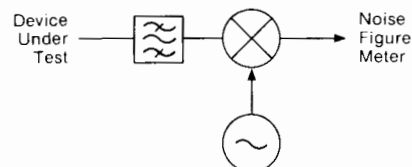

Single sideband noise measurement system.

# NOISE FIGURE METER

## Automatic Noise Figure Meter

### Model 8970B

329

- 10 MHz to 1600 MHz.
- Accurate and simple, swept or CW measurements.
- Second stage correction.
- Displays both noise figure and gain.
- Calibrated display on oscilloscope, recorder, or plotter.
- Powerful special function enhancements.

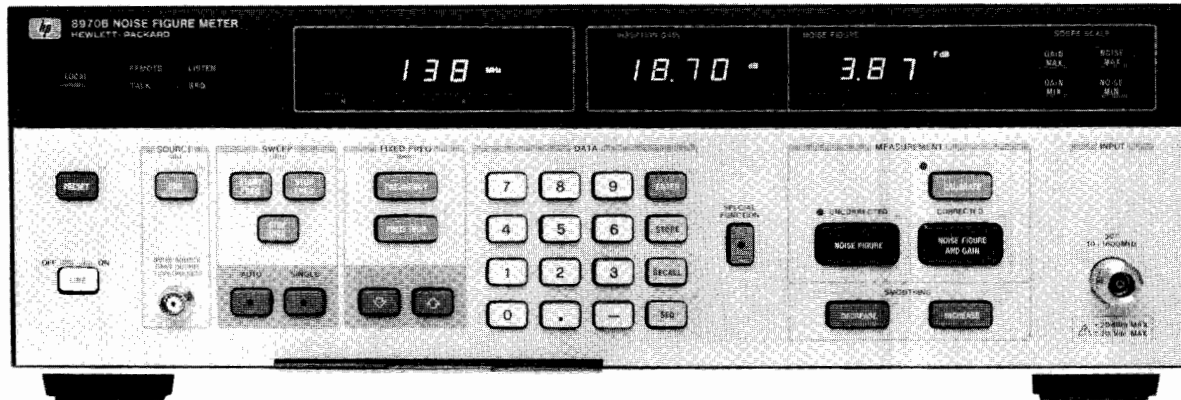

HP 8970B



### HP 8970B Noise Figure Meter

With the HP 8970B Noise Figure Meter, noise figure measurements are easy, accurate, and repeatable. Automatic second stage correction makes accurate noise figure readings possible even for low gain devices. The HP 8970B's dynamic range allows gain measurements of at least 40 dB (higher in some cases) or loss measurements to -20 dB, with no external attenuation or amplification. The HP 8970B can store up to 4 ENR (Excess Noise Ratio) noise source calibration tables. It also properly interpolates ENR values at each measurement frequency.

### Microprocessor and Controller Functions

The HP 8970B takes the mystery out of noise figure measurements. It uses a microprocessor to make the calculations and corrections necessary for truly accurate, convenient, and flexible noise figure measurements. The meter also controls external local oscillators (such as the HP 8670 series synthesizers, HP 8340 series synthesized sweepers, or the HP 8350 sweep oscillator) and the HP 8971B Noise Figure Test Set. This makes accurate, broad-band microwave measurements of amplifiers, mixers, and transistors as simple as RF measurements.

Virtually all of the HP 8970B's front panel keys and functions are accessible over HP-IB, Hewlett Packard's enhanced version of IEEE-488. The meter has an independent System Interface Bus (SIB) to control the HP 8971B and local oscillator. This additional bus frees you from having to write computer code to control an instrument on the SIB (like the local oscillator) when used in an automated set-up. Pass-through capability allows other instrument controllers to send messages through the meter to any other instrument on the SIB.

### Simple Calibration and Second Stage Correction

Noise figure measurement accuracy is enhanced because the meter measures its own noise figure (and that of the rest of the measurement system) at up to 181 points. It stores this information, interpolates where necessary, and corrects for it when displaying the device-under-test noise figure. The HP 8970B also measures the test device gain.

### Display

The HP 8970B's front panel LEDs display frequency, gain, and noise figure. Rear panel BNC connectors allow swept display of noise figure and gain versus frequency on an oscilloscope or x-y recorder. You can also get the noise figure and gain vs. frequency display sent to a digital plotter over the HP 8970B's System Interface Bus. All display modes are easily and accurately scaled to the desired resolution from the meter's front panel. The swept oscilloscope display allows you to optimize your test device in real time for both noise figure

and gain. You can easily change the noise figure display from noise figure to effective noise temperature ( $T_e$ ) or Y factor.

### Front Panel and Special Functions

The HP 8970B front panel keys control the number entry, calibration, and measurement functions. STORE, RECALL, and SEQ keys allow up to 9 front panel settings to be stored and sequenced automatically or manually to save set-up time. Smoothing INCREASE and DECREASE keys are used to average up to 512 readings before display. This increases accuracy and eliminates display flicker.

For those who need greater measurement power than that provided by the HP 8970B's simple front panel, there are more than 200 special functions selected by pressing a numerical code and the special function key. Two examples are hot-cold measurements and automatic compensation for losses at the input of the test device. One of the special functions is a catalog that quickly shows you the current special functions being used. Three pull-out cards serve as a mini-reference manual for the instrument. They include most of the special functions, the HP-IB formats and codes, error messages, and typical measurement set-ups.

### HP 8970B Partial Specifications

(See technical data sheet for complete specifications)

**Noise figure (gain) measurement range:** 0 to 30 dB (-20 to at least 40 dB).

**Noise figure (gain) instrumentation uncertainty:**  $\pm 0.1$  dB for 0 to 55° C ( $\pm 15$  dB).

**Noise figure resolution:** .01 dB (.001 dB over HP-IB).

**Gain resolution:** .01 dB (.001 dB over HP-IB).

**Frequency range:** tunable from 10 to 1600 MHz.

**Tuning accuracy (from 10 to 40°C):**  $\pm (1\text{MHz} + 1\%$  of frequency), 6MHz maximum.

**Frequency resolution:** 1 MHz.

**Noise figure (for input power levels below -60 dBm):** <7 dB + .003 dB/MHz.

**Maximum operating input power:** -10 dBm.

**Maximum net external gain:** >65 dB between noise source and HP 8970B RF input.

**Noise source drive:** 28.0  $\pm$  .1 volt.

**Operating temperature:** 0° C to 55° C.

**Storage temperature:** -55° to 75° C.

**Power:** 100, 120, 220, or 240 V (+5%, -10%); 48-66 Hz; 150 VA maximum.

**Dimensions:** 143 H x 425 W x 476 mm D (5.68" x 16.75" x 18.38").

**Weight:** Net, 15.5 kg (34 lb). Shipping, 18.5 kg (40 lb).



# NOISE FIGURE METER

## Noise Figure Measurement System

### Models 8970S/T, 8971B

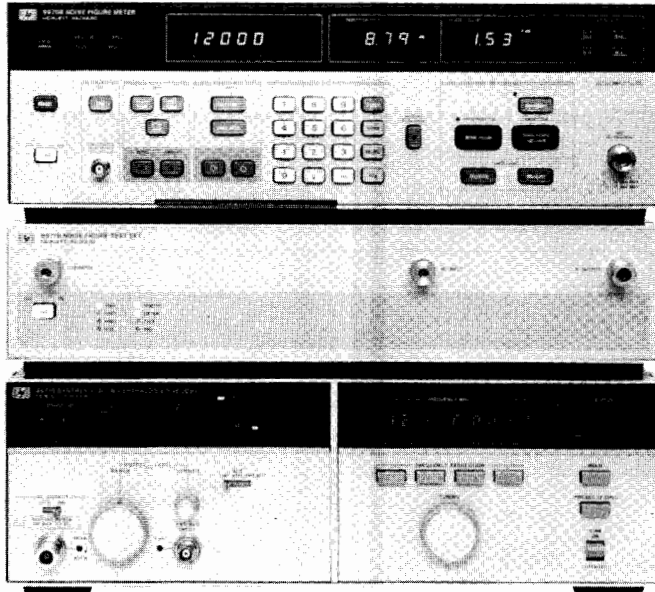

HP 8970 S/T

### HP 8970S/T Microwave Noise Figure Measurement Systems

Until now, there was no standardized way to make a microwave noise figure measurement, users had to design and support their own microwave system, and measurements crossing from RF to microwave were difficult because they required multiple system configurations.

Hewlett Packard's answer to these problems is the HP 8970S and HP 8970T noise figure measurement systems. Each system consists of the HP 8970B Noise Figure Meter, the HP 8971B Noise Figure Test Set, and a synthesized local oscillator. (The recommended LOs for the 8970S are listed in the 8970S Partial Specifications; the HP 8970T uses the HP 8671B Synthesized CW Generator as its local oscillator.)

The HP 8970S/T system eliminates the tedious job of designing the measurement system and selecting components. The HP 8970B acts as the controller to the system so all system operation is transparent to you, the user. To insure specified performance, the HP 8970S/T systems are given specifications just like an RF noise figure meter (i.e. HP 8970B).

#### HP 8970S/T Partial Specifications

(See 8970S technical data sheet for complete specifications)

**Frequency range:** 10 MHz to 18 GHz.

**Noise figure measurement range:** 0 to 30 dB.

**Noise figure instrumentation uncertainty:**  $\pm 0.25$  dB (for a 14 to 16 dB ENR noise source in a 0 to 55°C environment).

**Gain instrumentation uncertainty:**  $\pm 0.45$  dB.

**Noise figure (max):** 10 to 1600 MHz: 12 dB + .003 dB/MHz

1.6 to 2.4 GHz: 24 dB

2.4 to 12 GHz: 22 dB

12 to 15 GHz: 24 dB

15 to 18 GHz: 28 dB

**Input SWR:** 10 to 1600 MHz: 1.7

1.6 to 2.4 MHz: 2

2.4 to 18 GHz: 2

**Gain/noise figure repeatability:** .2 dB.

**Recommended local oscillators:** HP 8671B, 8672A, 8673B/C/E, 8340B, and 8341B.

- 10 MHz to 18GHz
- Fully specified system
- Removes double-sideband inaccuracies
- As easy to operate as the 8970A or B

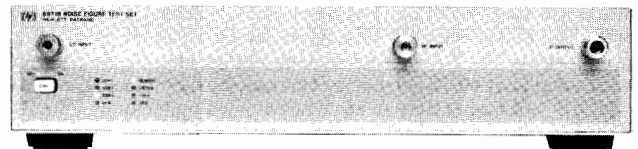

HP 8971B

### HP 8971B Noise Figure Test Set

The HP 8971B Noise Figure Test Set brings the simplicity of double sideband measurements and the accuracy of single sideband measurements together in one package. Careful design and high performance components, including a stable YIG filter, allow broadband single-sideband measurements from 10 MHz to 18 GHz with a single calibration and sweep.

Measurement modes in the HP 8970B allow for double down-conversion using the HP 8971B as the second down-converter. These new modes can be used for millimeter-wave measurements of amplifiers and transistors and measurements of receivers and mixers with IFs above 1.6 GHz.

HP recommends using an isolator and preamplifier between the test device and measurement system. This reduces two of the largest sources of noise figure measurement uncertainty - mismatch uncertainty and second stage noise figure.

#### HP 8971B Partial Specifications

(See 8970S technical data sheet for complete specifications)

**Frequency range:** 10 MHz to 18 GHz.

**Gain/noise figure repeatability:**  $\pm 0.2$  dB.

**Input SWR:** 1.5 (10 MHz to 1.6 GHz)

2 (1.6 to 2.4 GHz)

2 (2.4 to 18 GHz)

**Image and odd-harmonic rejection:** 20 dB.

**Accessories supplied:**

1 LO-to-HP 8971B cable - SMA(f), 300 mm

1 HP 8971B-to-HP 8970B cable - N(m), 190 mm

1 N(m)-to-SMA(m) adapter

2 HP-IB cables - .5 m

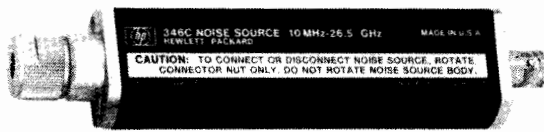

HP 346C

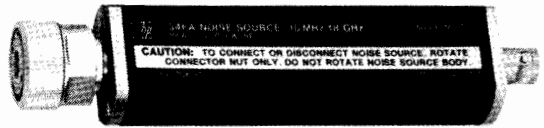

HP 346A (option 002)

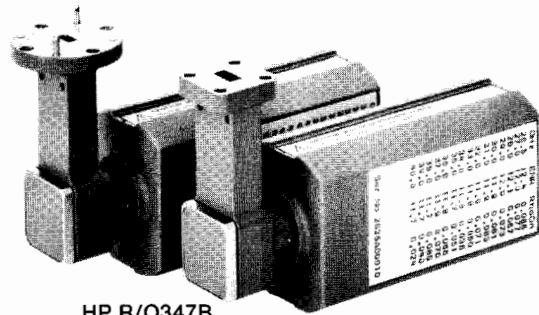

HP R/Q347B

### HP 346A/B/C Broadband Noise Sources

The ideal companion to the HP's noise figure meter and systems is the HP 346 family of noise sources. Since they are broadband (10MHz to either 18 or 26.5 GHz), they eliminate the necessity for several sources at different frequency bands. Each source has individually calibrated ENR values at specific frequencies. The calibration is printed on its label (see illustration) for easy loading into the HP 8970B. The low SWR of each noise source reduces a major source of measurement uncertainty - re-reflections of test signals. In addition, the variety of connectors available reduces the need for degrading accuracy with connector adapters.

The HP 346 family of noise sources are designed for a broad range of measurement applications. The HP 346C covers the broadest frequency range, 10 MHz to 26.5 GHz. The HP 346B's high ENR, low SWR, and variety of connectors make it a general purpose noise source. The HP 346A is designed especially for accurate characterization of input-impedance-sensitive devices (like GaAsFETs and many UHF amplifiers). Its very small change in reflection coefficient (<0.01) from ON to OFF minimizes errors when measuring noise figure and gain as a function of input impedance.

FREQ GHz	ENR dB
0.01	15.18
0.10	15.49
1.0	15.26
2.0	15.17
3.0	14.93
4.0	14.86
5.0	14.91
6.0	14.83
7.0	14.90
8.0	15.05
9.0	15.26
10.0	15.39
11.0	15.43
12.0	15.50
13.0	15.41
14.0	14.93
15.0	15.51
16.0	15.95
17.0	15.62
18.0	15.94
SERIAL NO. 2037A0042B	

Example label of HP 346B Noise Source

### HP 346 A/B/C Partial Specifications

(See technical data sheet for complete specifications.)

**Frequency range:** 10 MHz to 18 GHz for HP 346A/B; 10 MHz to 26.5 GHz for HP 346C.

**Excess noise ratio (ENR) limits:** HP 346A: 5 to 7 dB; HP 346B: 14 to 16 dB; HP 346C: 12 to 16 dB (10 MHz to 12 GHz) and 14 to 17 dB (12.0 to 26.5 GHz).

**Maximum SWR (reflection coefficient) on and off:**

**HP 346A/B:** 10 to 30 MHz — 1.3 (0.13); 30 to 5000 MHz — 1.15 (0.07); 5 to 18 GHz — 1.25 (0.11).

**HP 346C:** 10 MHz to 18 GHz — 1.25 (0.11); 18 to 26.5 GHz — 1.35 (0.15).

**Power required:** 28 ± 1 Vdc.

**Dimensions:** 140 H x 21 W x 30 mm D (5.5" x 0.8 x 1.2").

**Weight:** net, 0.108 kg (3.5 oz). Shipping, 0.5 kg (1 lb).

**Standard connector:** APC - 3.5(m)

### HP R & Q347B Solid-state Noise Sources

The performance and reliability you have come to expect from Hewlett-Packard RF and microwave solid-state noise sources, is now extended to millimeter-wave frequencies with the HP R347B (26.5 to 40 GHz) and HP Q347B (33 to 50 GHz) noise sources. A new GaAs avalanche diode specifically designed for high noise output and long term reliability was developed for the HP R/Q347B Noise Sources. This results in excellent ENR stability over time. In turn, this insures long recalibration cycles and very accurate noise figure measurements.

### HP R & Q347B Noise Sources

(See technical data sheet for complete specifications)

**Frequency Range:** R347B - 26.5 to 40 GHz  
Q347B - 33 to 50 GHz

**Excess Noise Ratio (ENR) Range:**

HP R347B: 10 to 13 dB

HP Q347B: 10 to 13 dB (33 to 42 GHz)  
6 to 12.5 dB (42 to 50 GHz)

**Max. SWR (reflection coefficient):**

HP R347B: <1.42 (.17)

HP Q347B: <1.57 (.22)

**Supplemental Characteristics**

**ENR Variation with temperature:** <.009 dB/C

**ENR Variation with time:**

R 347B: .15 dB typ. (over 2000 hrs.)

Q 347B: .15 dB typ. (over 2000 hrs.)

### Ordering Information

HP 8970B Noise Figure Meter \$10,900

**Option H18:** Increases upper frequency from 1600 to 1800 MHz + \$350

**Option 907:** Front panel handle kit + \$55.00

**Option 908:** Rack mounting flange kit + \$32.50

**Option 909:** Both options 907 and 908 + \$80.00

HP 8971B Noise Figure Test Set \$16,000

HP 8970T Noise Figure Measurement System \$50,900

HP 8970S Noise Figure Measurement System See HP8970S (Ordering Guide)

HP 346A Noise Source \$1,590

HP 346B Noise Source \$1,490

HP 346C Noise Source \$1,990

**Option 001** (HP 346A/B only): Type N (m) connector N/C

**Option 002** (HP 346A/B only): APC-7 connector + \$25

**Option 004** (HP 346A/B only): Type N (f) connector N/C

HP R347B Noise Source \$2,200

HP Q347B Noise Source \$2,800

# MICROWAVE TEST EQUIPMENT

## Microwave Measurements and Products



### Microwave measuring techniques

Hewlett-Packard offers a complete line of microwave coaxial and waveguide measuring equipment. Measuring systems can be assembled from this equipment to make accurate reflection and transmission measurements on other components such as filters, mixers, cables, etc. Signal characteristics such as frequency, power, or spectral content may be measured using other associated equipment.

HP equipment capability ranges from inexpensive systems for point-by-point, narrow-band work to powerful analyzers which furnish dynamic displays of error-corrected network scattering parameters across wide frequency bands. Equipment selection and measuring techniques depend primarily on the accuracy, speed, and cost requirements of the application.

Some applications require complete phase and amplitude characterization of microwave components. These vector measurements are usually made in design labs to aid in component design or in evaluating performance to phase specifications. Such phase measurements require relatively sophisticated equipment and techniques.

But the majority of microwave measurements made in production, test, maintenance, and calibration require only amplitude (scalar) characteristics. Scalar test procedures are popular because they are straightforward, easy-to-use, and low cost, yet yield an excellent measure of the quality of the test device part.

### Coaxial/Waveguide Measurement Accessories Catalog Available

More detailed information is available in the Coaxial & Waveguide Measurement Accessories Catalog, literature number 5954-6401. The catalog includes product and applications information on more than 400 products operating from dc to 110 GHz. Seventeen product sections include attenuators, detectors, couplers, filters, power sensors, scalar analyzer accessories, noise figure equipment and even 75 ohm accessories.

More than 27 pages of this 112 page catalog are devoted to microwave measurement techniques and reference information, summarizing common scalar techniques of attenuation and SWR, as well as other measurements in component and system test such as power, frequency, noise figure, spectrum, waveform, carrier noise and modulation analysis. Waveguide and Coax band designations and flange data are included in the reference section, along with 9 pages of associated equipment descriptions.

This catalog will prove useful for design engineers, production test personnel, quality assurance and metrology engineers, field-test and system-maintenance engineers.

### Confidence in Component Performance

The performance of HP's microwave accessories are verified on an error-correcting automatic network analyzer that has been calibrated with standards that are directly or indirectly traceable to the National Bureau of Standards. This means you can be assured that the product you receive has been properly tested and meets the specifications you expect.

# MICROWAVE TEST EQUIPMENT

## 2.4 mm Coaxial Connector Family Adapters and Standards

Models HP 11900-11904, 85138, 85140, 85141

- DC-50 GHz frequency range
- Rugged instrument and metrology grades

- Adapters to all common connector types
- Standards for reflection calibration

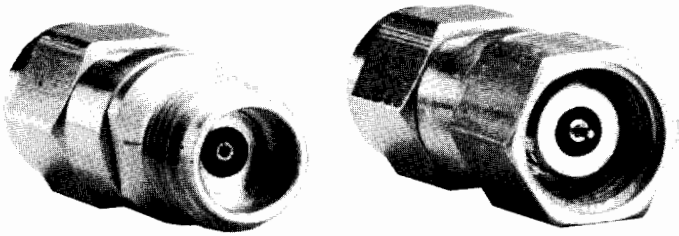

HP 11900A/C

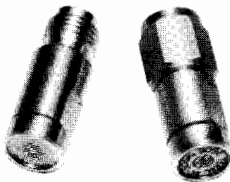

HP 85138 A/B



The 2.4 mm connector permits microwave components and systems to operate with coaxial interconnections at frequencies up to 50 GHz. Such systems need no longer be restricted to waveguide. Using the 2.4 mm connector, broadband devices operating from DC to 50 GHz are possible, simplifying and speeding the design and manufacture of components and systems.

The 2.4 mm connector interface was conceived by Hewlett-Packard and has been jointly developed by HP, Amphenol Products, and M/A-COM Omni Spectra. Supporting this development are products from HP, Amphenol Products, M/A-COM Omni Spectra and Maury Microwave.

Design goals for this connector included: a rugged interface with excellent return loss characteristics, a connector with very repeatable performance, and reasonable connector cost in systems applications. By foregoing compatibility with existing connector types, a design was achieved that optimizes performance over the entire DC to 50 GHz range, not just at the higher frequencies.

Implementation of the 2.4 mm connector concept is in the form of three levels or grades of the connector series, each of which is totally compatible with the others because each conforms to the connector interface dimensions. Three connector grades permit best application fit, with trade-offs in performance versus cost. M/A-COM Omni Spectra offers the "production-grade" OS-50 series for use in components, cabling and microstrip. Its design emphasizes economy and assembly simplicity. The "instrument-grade" APC-2.4 series from Amphenol Products is intended for use with test and measurement equipment where the connector must withstand many connect/disconnect cycles. Designed for traceability to national measurement standards, the "metrology-grade" connector will be used by HP on calibration standards.

### HP 11900A/B/C, 11901A/B/C/D, 11902A/B, 11903A/B/C/D, 11904A/B/C/D Between-Series Adapters

The HP 11900 series of 2.4 mm connector adapters allow 2.4 mm connectors of either sex to be mated to other types of connectors. These metrology-grade adapters are recommended for use where high precision and repeatability are required. The electrical lengths of the adapters are matched within the same adapter families (e.g., all 2.4 mm to APC-3.5), allowing accurate non-insertable device measurements. For information on 2.4 mm coax to R- and Q-band waveguide adapters, refer to page 349.

### HP 11900A/B/C, 11901A/B/C/D, 11902A/B, 11903A/B/C/D, 11904A/B/C/D Specifications

Type (from)	Sex <sup>1</sup>	Type (to)	Sex <sup>1</sup>	Model #	Return Loss <sup>2</sup> (dB)	Repeatability <sup>2,3</sup> Typically Better Than:	U.S. Price
2.4 mm	(m)	2.4 mm	(m)	11900A	≥32 (DC to 26.5 GHz) ≥25 (26.5 to 40 GHz) ≥20 (40 to 50 GHz)	-50 dB	\$450
2.4 mm	(f)	"	(f)	11900B		-45 dB	
2.4 mm	(m)	"	(f)	11900C		-40 dB	
2.4 mm	(m)	APC-3.5	(m)	11901A	≥32 (DC to 20 GHz) ≥28 (20 to 26.5 GHz) " " " "	-45 dB	\$375
2.4 mm	(f)	"	(f)	11901B		-45 dB	
2.4 mm	(m)	"	(f)	11901C		-45 dB	
2.4 mm	(f)	APC-3.5	(m)	11901D		-45 dB	
2.4 mm	(m)	APC-7*	-	11902A	≥30 (DC to 18 GHz)	-50 dB	\$450
2.4 mm	(f)	"	-	11902B		-50 dB	
2.4 mm	(m)	type-N	(m)	11903A	≥28 (DC to 18 GHz) ≥28 (DC to 18 GHz) ≥28 (DC to 18 GHz) ≥28 (DC to 18 GHz)	-48 dB	\$450
2.4 mm	(f)	type-N	(f)	11903B		-48 dB	
2.4 mm	(m)	type-N	(f)	11903C		-48 dB	
2.4 mm	(f)	type-N	(m)	11903D		-48 dB	
2.4 mm	(m)	K-2.92**	(m)	11904A	≥24 (DC to 40 GHz)	-40 dB	\$500
2.4 mm	(f)	"	(f)	11904B		-40 dB	
2.4 mm	(m)	"	(f)	11904C		-40 dB	
2.4 mm	(f)	"	(m)	11904D		-40 dB	

### HP 85138A/B, 85140A/B, 85141A/B Calibration Accessories

The HP 85138A/B terminations are instrument-grade, 50 ohm loads designed for device termination and reference calibration where high performance is important. The HP 85140A/B and HP 85141A/B are metrology-grade, precision shielded open and short circuits for maximum reflection calibration accuracy for vector and scalar network analyzers. The open circuit utilizes a specially designed plastic center conductor support, to provide the proper center pin setback and uniform open circuit capacitance required for a high level of performance.

### HP 85138A/B, 85140A/B, 85141A/B Specifications

Type	Sex <sup>1</sup>	Model #	Electrical Specifications	Repeatability <sup>3</sup> Typically Better Than:	U.S. Price	
2.4 mm Short	(m)	85140A	At 50 GHz, ±6° from nominal <sup>4,5</sup>	-50 dB	\$250	
2.4 mm Short	(f)	85140B		"	-50 dB	275
2.4 mm Open	(m)	85141A		At 50 GHz, ±6° from nominal <sup>4,6</sup>	-44 dB	275
2.4 mm Open	(f)	85141B	"		-44 dB	300
2.4 mm 50Ω Termination	(m)	85138A	≥30 dB (DC to 26.5 GHz) ≥25 dB (26.5 to 40 GHz) ≥20 dB (40 to 50 GHz)		-40 dB	475
2.4 mm 50Ω Termination	(f)	85138B	≥30 dB (DC to 26.5 GHz) ≥25 dB (26.5 to 40 GHz) ≥20 dB (40 to 50 GHz)	-40 dB	525	

<sup>1</sup>f=jack, m=plug

<sup>2</sup>At the 2.4 mm port only

<sup>3</sup>Repeatability = 20 Log |ΔΓ|, where |ΔΓ| = |Γ<sub>m</sub> - Γ<sub>m'</sub>|. This is the difference between two measurements Γ<sub>m</sub> and Γ<sub>m'</sub>, before and after one disconnect/connect cycle. Repeatability depend upon proper torque and pin-depth.

<sup>4</sup>This specification applies to the location of the effective shorting plane.

<sup>5</sup>Nominal, in this case, is the center of the distribution of all parts manufactured over time.

<sup>6</sup>The phase shift of any HP 85141 A&B open relative to any HP 85140 A&B short is 180° ± 12°.

\*APC-7 is a U.S. registered trademark of the Bunker Ramo corporation.

\*\*The K connector is developed and manufactured by the Wiltron Company (Morgan Hill, CA).

# MICROWAVE TEST EQUIPMENT

## Coaxial Fixed Attenuators

Models 8490D, 8491A/B, 8492A, 8493A/B/C, 8498A, 11581/2/3A/3C, 33340A/B/C/D

- Flat frequency response
- Low SWR
- Specifications traceable to NBS

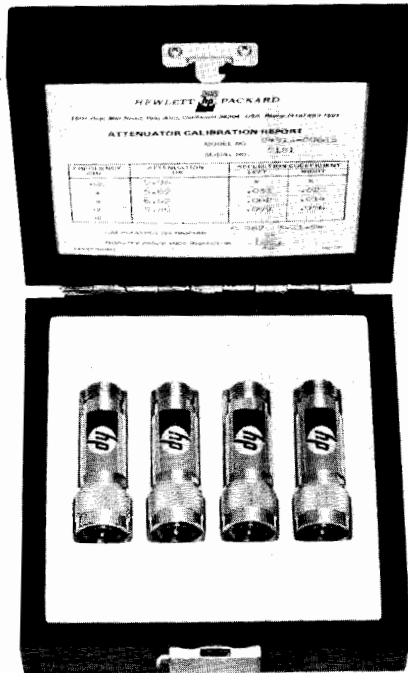

HP 11581A

### HP 8490D, 8491A/B, 8492A, 8493A/B/C Fixed Attenuators

Hewlett-Packard coaxial fixed attenuators provide precision attenuation, flat frequency response, low SWR over broad frequency ranges (dc-50.0 GHz) at low prices. Attenuators are available in nominal attenuations of 3-dB and 6-dB, also 10-dB increments from 10 dB to 60 dB. These attenuators are swept-frequency tested to ensure meeting specifications at all frequencies. Calibration points are provided on a nameplate chart attached to each unit.

### HP 11581A, 11582A, 11583A/C Attenuator Sets

A set of four Hewlett-Packard attenuators—3, 6, 10 and 20 dB—are furnished in a handsome walnut accessory case. The HP 11581A set consists of HP 8491A Attenuators; the HP 11582A set, HP 8491B Attenuators; the HP 11583A set, HP 8492A Attenuators; and the HP 11583C set, HP 8493C Attenuators. The set includes calibration reports certified traceable to the National Bureau of Standards, containing both the attenuation and the reflection coefficients for each attenuator at the frequencies indicated under "Option 890" calibration data on the next page. Thus it is not required to specify Option 890.

These sets are ideal for calibration labs or where precise knowledge of attenuation and SWR is desired.

### HP 8498A High Power Attenuator

The HP 8498A Option 030 is designed to meet the needs of high power attenuation applications in the RF and microwave frequency range. It is specified from dc to 18 GHz at 25 watts average, 500 watts peak, from dc to 5.8 GHz and 125 watts peak from 5.8 to 18 GHz. Available only in a 30 dB model (option 030), the unit offers low SWR (<1.30 at 18 GHz) and good accuracy ( $\pm 1$  dB at 18 GHz). The unit also features 'human engineered' cooling fins that prevent operator burns even under continuous maximum input power conditions.



HP 33340C

HP 8490D

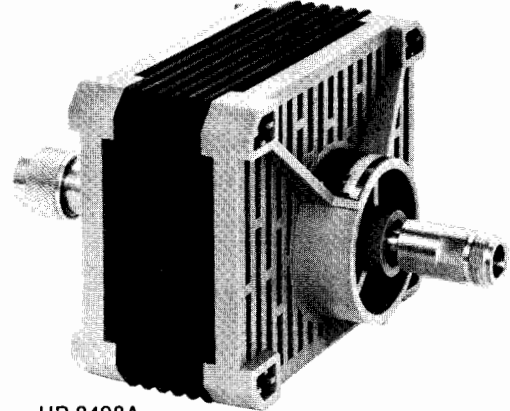

HP 8498A  
Option 030

### Option 890 Calibration Data

Extensive calibration data is available on HP attenuators at low cost. When option 890 is specified for the fixed attenuators or microwave step attenuators, standardized calibration data in frequency steps no larger than 500 MHz is provided over the frequency range of the units. This data is generated from measurements made on an HP 8542 Automatic Network Analyzer and features excellent accuracy (traceable to NBS) and low cost. Data is given for attenuation and the SWR (reflection coefficient for the HP 8493C) of each port and is provided in a protective plastic envelope.

Calibration data has important uses in applications such as RF substitution measurements and test system verification. Using the actual calibration data rather than data sheet specifications allows the attenuation uncertainty to be reduced 60% or more. Also, the calculated mismatch uncertainty for a test system is lower if the actual SWR data for the attenuators is used. Similar calibration data is used in HP production areas to verify the performance of manual and automated test systems. For automated system checkout, the calibrated unit is tested and the results are compared to the previously stored calibration data. If the differences are within the measurement uncertainty, proper operation is ensured. For step attenuators, the calibration data can be used in automated test systems to more accurately characterize a device's characteristics. By storing the calibration data for the individual steps, the measurement results can be adjusted by the actual amount of attenuation (for example, when a nominal 10 dB step is actually 9.6 dB).

The calibration data frequencies, prices, and ordering information for fixed attenuators are on the next page, and the same information for step attenuators is on page 337.

### HP 33340A/B/C/D Fixed Attenuators

The HP 33340A, 33340B, 33340C, and 33340D are Coaxial Fixed Attenuators intended for OEM and systems use. Frequency range specifications are dc—12.4 GHz, dc—18 GHz, dc—26.5 GHz and dc—50 GHz respectively. These OEM attenuators are similar to the HP 8493 and HP 8490 Series Attenuators.

For more information regarding the HP 33340 series refer to the data sheet (5952-8279).

### Ordering Information

	Price*
HP 33340A Coaxial Fixed Attenuator (SMA)	\$90
Option 890	+ \$20
HP 33340B Coaxial Fixed Attenuator (SMA)	\$120
Option 890	+ \$25
HP 33340C Coaxial Fixed Attenuator (APC-3.5)	\$250
Option 890	+ \$40
HP 33340D Coaxial Fixed Attenuator (2.4 mm)	\$375

\*Note: Prices are for quantities of 1-9. OEM discounts are available.





HP 8491A/B series



HP 8492 series



HP 8493A/B/C series

**Ordering Example**

Include appropriate frequency range/connector and attenuation designations from the ordering example below with every attenuator order.

**Calibration Data**

Include "Option 890" or "Option 894" in addition to attenuation option when ordering calibration data.

8491B Option 010 Option 890 or 894

**Connectors and Frequency Range**

- 0D:** 2.4mm (m,f), dc-50.0 GHz
- 1A:** Type N (m,f), dc-12.4 GHz
- 1B:** Type N (m,f), dc-18 GHz
- 2A:** APC-7, dc-18 GHz
- 3A:** SMA (m,f), dc-12.4 GHz
- 3B:** SMA (m,f), dc-18 GHz
- 3C:** APC 3.5 (m,f), dc-26.5 GHz
- 8A:** Type N (m,f), dc-18 GHz

8498 is available in a 30 dB model only

\* Not available for HP 8493A/B \*\* Not available for HP 8493C and HP 8490D

**Attenuation**

- 003:** 3 dB
- 006:** 6 dB
- 010:** 10 dB
- 020:** 20 dB
- 030:** 30 dB
- 040:** 40 dB\*
- 050:** 50 dB\*\*
- 060:** 60 dB\*\*

**Option 890 Example**

HEWLETT PACKARD CALIBRATION REPORT			
MODEL: 8493B OPT 006/890	SER NO: 02521		
DATE: 11-08-83	TECHNICIAN: 33886		
MEAS SYSTEM: 8542B SYSTEM A			
PORT IDENTIFICATION: With the label facing the user, PORT 1 is on the left and PORT 2 is on the right.			
FREQUENCY (MHz)	ATTENUATION (dB)	SWR PORT 1	SWR PORT 2
100.00	5.84	1.004	1.009
300.00	5.85	1.005	1.009
500.00	5.86	1.005	1.009
700.00	5.85	1.005	1.009
900.00	5.87	1.005	1.009
1000.00	5.86	1.005	1.009
1250.00	5.89		
1500.00	5.91		
1750.00			
2000.00			

**Ordering Information**

- HP 11581A** 3, 6, 10, 20 dB HP 8491A set
- HP 11582A** 3, 6, 10, 20 dB HP 8491B set
- HP 11583A** 3, 6, 10, 20 dB HP 8492A set
- HP 11583C** 3, 6, 10, 20 dB HP 8493C set

**Price**

- \$550
- \$675
- \$1,240
- \$1,360

**HP 8490D, 8491A/B, 8492A, 8493A/B/C, 8498A, Option 890 Specifications**

HP Model	Frequency Range GHz	SWR Maximum	Maximum Input Power	Attenuation Accuracy								Connector	Price (Specify option)	
				3 dB (Option 003)	6 dB (Option 006)	10 dB (Option 010)	20 dB (Option 020)	30 dB (Option 030)	40 dB (Option 040)	50 dB (Option 050)	60 dB (Option 060)			
8490D	dc-50.0	dc-8 GHz: 1.1 8-12.4 GHz: 1.15 12.4-26.5 GHz: 1.25 (1.27 Opt.006)	2 W Avg. 100 W Peak	±0.5 dB dc-18 GHz	±0.6 dB	±0.3 dB	±0.5 dB	±0.7 dB	±1.0 dB	±1.3 dB	—	—	APC 2.4 (m,f)	\$375
				±1.0 dB 18-26.5 GHz	±0.6 dB	±0.5 dB	±0.6 dB	±1.0 dB	±1.3 dB	—	—			
8491A 3-30 dB 40-60 dB	dc-12.4	dc-8 GHz: 1.2 8-12.4 GHz: 1.3	2 W Avg. 100 W Peak	±0.3 dB	±0.4 dB	±0.6 dB	±0.6 dB	±1 dB	—	—	—	N(m,f)	\$125	
				—	—	—	—	—	±1.5 dB	±1.5 dB	±2 dB		\$175	
8491B 3-30 dB 40-60 dB	dc-18	dc-8 GHz: 1.2 8-12.4 GHz: 1.3 12.4-18 GHz: 1.5	2 W Avg. 100 W Peak	±0.3 dB dc-12.4 GHz ±0.4 dB 12.4-18 GHz	±0.4 dB dc-12.4 GHz ±0.5 dB 12.4-18 GHz	±0.6 dB	±0.6 dB dc-12.4 GHz ±1.0 dB 12.4-18 GHz	±1 dB	—	—	—	N(m,f)	\$150	
				—	—	—	—	±1.5 dB	±1.5 dB	±2 dB	\$210			
8492A 3-30 dB 40-60 dB	dc-18	dc-8 GHz: 1.15 dc-12.4 GHz: 1.25 12.4-18 GHz: 1.35	2 W Avg. 100 W Peak	±0.3 dB dc-12.4 GHz ±0.4 dB 12.4-18 GHz	±0.4 dB dc-12.4 GHz ±0.5 dB 12.4-18 GHz	±0.6 dB	±0.6 dB dc-12.4 GHz ±1.0 dB 12.4-18 GHz	±1 dB	—	—	—	APC-7	\$275	
				—	—	—	—	±1.5 dB	±1.5 dB	±2 dB	\$340			
8493A 3-20 dB 30 dB	dc-12.4	dc-8 GHz: 1.2 8-12.4 GHz: 1.3	2 W Avg. 100 W Peak	±0.3 dB	±0.4 dB	±0.6 dB	±0.6 dB	—	—	—	—	SMA (m,f)	\$120	
				—	—	—	—	±1 dB	—	—	—		—	
8493B 3-20 dB 30 dB	dc-18	dc-8 GHz: 1.2 8-12.4 GHz: 1.3 12.4-18 GHz: 1.5	2 W Avg. 100 W Peak	±0.3 dB dc-12.4 GHz ±0.4 dB 12.4-18 GHz	±0.4 dB dc-12.4 GHz ±0.5 dB 12.4-18 GHz	±0.6 dB	±0.6 dB dc-12.4 GHz ±1.0 dB 12.4-18 GHz	—	—	—	—	SMA(m,f)	\$145	
				—	—	—	—	±1 dB	—	—	—		—	
8493C	dc-26.5	dc-8 GHz: 1.1 8-12.4 GHz: 1.15 12.4-26.5 GHz: 1.25 (1.27 Opt. 006)	2 W Avg. 100 W Peak	±0.5 dB dc-18 GHz	±0.6 dB	±0.3 dB	±0.5 dB	±0.7 dB	±1.0 dB	—	—	APC 3.5 (m,f)	\$250	
				±1.0 dB 18-26.5 GHz	±0.6 dB	±0.5 dB	±0.6 dB	±1.0 dB	±1.3 dB	—	—			
8498A Option 030	dc-18	dc-2 GHz: 1.1 2-12.4 GHz: 1.2 12.4-18 GHz: 1.35	25 W Avg. 500 W Peak (dc-7 GHz) 125 W Peak (7-18 GHz) 500 watt-µs max. per pulse	—	—	—	—	±1 dB	—	—	—	N(m,f)	\$975	
Option 890 Calibration Data		HP Models		Calibration Frequencies (MHz)								Option 890 Price		
		8491A, 8493A		.2 GHz to 12.4 GHz in 200 MHz steps								add \$20		
		8491B, 8492A, 8493B, 8498A		.2 GHz to 18.0 GHz in 200 MHz steps								add \$25		
		8493C		1.5 GHz to 26.5 GHz in 250 MHz steps								add \$40		

☎ Fast-Ship product — see page 766.

# MICROWAVE TEST EQUIPMENT

## Coaxial Step Attenuators, Attenuator/Switch Driver

Models 355 Series, 8494/5/6/7 Series, 11713A, 11716A/B, 11717A

- Excellent repeatability
- Manual and programmable
- Calibration data available

- 5-million-cycle-per-section reliability

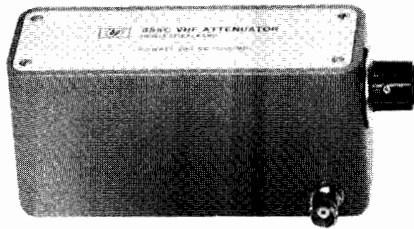

HP 355C

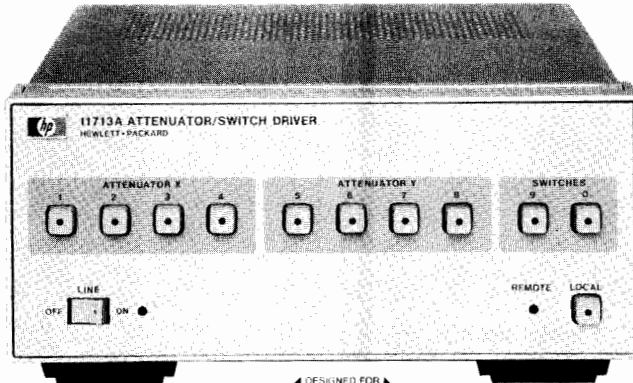

HP 11713A



### HP 355C/D/E/F Manual and Programmable Step Attenuators, dc to 1000 MHz

Precision attenuation from dc to 1000 MHz is available with these Hewlett-Packard attenuators. HP 355C/E provide 0 to 12 dB in 1-dB steps and HP 355D/F provide 0 to 120 dB in 10-dB steps. For the HP 355E and 355F models, attenuation programming is done through a 7-pin connector. All standard models are equipped with BNC connectors.

### HP 8494A/B/G/H, 8495A/B/D/G/H/K, 8496A/B/G/H, 8497K Manual and Programmable Step Attenuators, dc to 26.5 GHz

Four attenuation ranges are available: 0 to 11 dB in 1-dB steps (HP 8494), 0 to 70 dB in 10-dB steps (HP 8495), 0 to 110 dB in 10-dB steps (HP 8496) and 0 to 90 dB in 10 dB steps (HP 8497). There is choice of three connectors: Type N (f), SMA (f), and APC-7 (APC-3.5 on HP 8495D/K and 8497K only). Manual and programmable versions are available as well as coverage of three frequency ranges (dc-4 GHz, dc-18 GHz, and dc-26.5 GHz). Calibration data (SWR and attenuation) is available on the HP 8494/5/6/7 models as option 890. The data is generated by an automatic network analyzer test system and is given for each step of the attenuator at 14 frequencies (dc-4 GHz models), 47 frequencies (dc-18 GHz models), or 72 frequencies (dc-26.5 GHz); see frequency lists on next page. This data is very useful for improving measurement accuracy in manual and automated test systems.

Each attenuator consists of three or four attenuation sections connected in cascade. Attenuator sections are inserted and removed by cam-actuated "edge line" contacts. These contacts are gold-plated leaf-springs that ensure long life (over a million steps) and high repeatability (typically 0.01 dB).

The G, H, and K programmable models offer the same high performance as the manual models with the addition of fast switching solenoids. Attenuation programming is done through a 12-pin con-

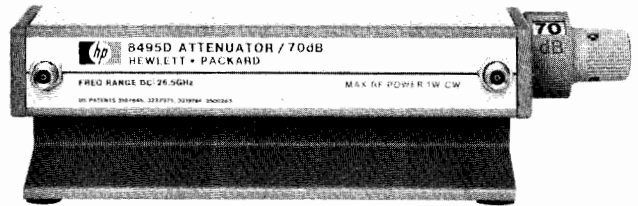

HP 8495D option 004

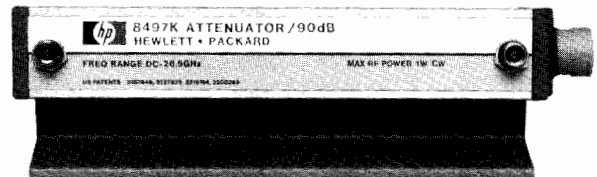

HP 8497K option 004

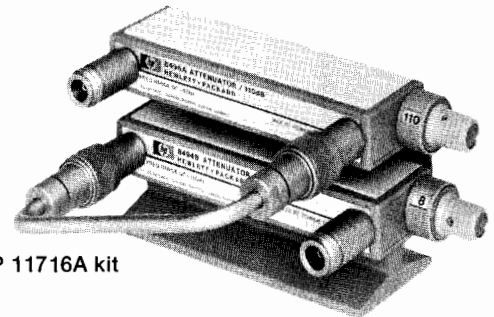

HP 11716A kit

ductor. For ease of connection to the driving circuit, each attenuator is provided with a five-foot cable assembly that includes the mating connector. With the HP 11713A Attenuator Driver, the attenuators are easily integrated into a Hewlett-Packard Interface Bus (HP-IB) automated system.

Equivalent versions of these attenuators for incorporation in equipment (i.e., "OEM") are available under model numbers HP 33320, 33321, 33322 and 33323. See following pages.

### HP 11716A/B Interconnection Kit

Convenient interconnection of 1-dB and 10-dB models is provided with the HP 11716A/B. These kits provide a rigid RF cable, mounting bracket, and screws to connect any pair of HP 8494/5/6 attenuators in series (see picture above). Attenuators must be ordered separately.

### HP 11713A Attenuator/Switch Driver

This instrument has all of the necessary features to provide HP-IB control of up to two programmable attenuators of the HP 8494/5/6/7 or HP 33320/1/2/3 series and concurrently up to two electro-mechanical switches (e.g., HP 8761B or 33311 series). Alternatively, the HP 11713A can be used to supply +24 V common and ten pairs of transistor switches (total current less than 1.25A) to control up to ten relays. The HP 11713A includes an integral power supply with short circuit protection that can simultaneously provide 125 milliamps at 24 volts to all contacts for control of the attenuators and switches, so no external power supply is needed. For convenience in connecting HP 8490 or HP 33320-series Attenuators, two 5-foot cables with appropriate connectors are supplied.

A local mode and front-panel push buttons allow switches and attenuator sections to be operated manually. Switching time for the drivers is less than 10 milliseconds.

### Ordering Information

	Price
HP 11713A Attenuator/Switch Driver	\$1700
HP 11716A Interconnection Kit for Type N (f) Connectors	\$200
HP 11716B Interconnection Kit for APC-7 Connectors	\$290
HP 11717A Attenuator/Switch Rack Mount Support Kit	\$55

**How to Order the HP 8494/5/6/7 Series Attenuators**

Each order must include basic model number, suffix letter, and connector option.

Optional calibration data.

**HP 8494 A Option 001 Option 890**

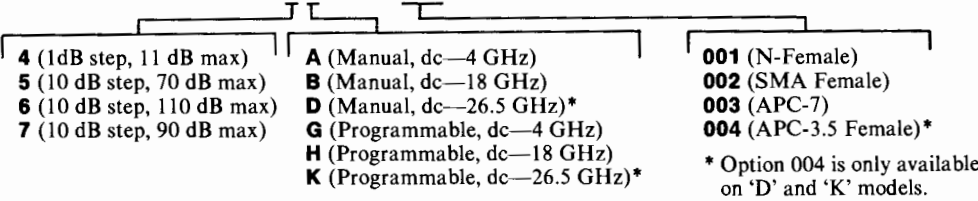

**HP 355 Series, 8494/5/6/7 Series Specifications**

HP Model and (Switching Mode)	Frequency Range (GHz)	Incremental Attenuation (dB)	SWR Maximum (50 Ω Nominal)	Insertion Loss (0 dB setting)	Attenuation Accuracy	Power Rating, Minimum Life	Solenoid Voltage Speed Power	Size, Shipping Weight	Connector Options Available	Price
<b>355C</b> (Manual)	dc—1	0—12 1 dB steps	dc—0.25 GHz: 1.2 dc—0.5 GHz: 1.3 dc—1.0 GHz: 1.5	0.11 dB + 1.39 dB/GHz	±0.1 dB @ 1000 Hz ±0.25 dB: dc—0.5 GHz ±0.35 dB: dc—1.0 GHz	0.5 W avg 350 W peak 0.3 million cycles per section	— 15—18 V <65 ms 3.0 W	67 H x 70 W x 152 mm D (2.6" x 2.75" x 6") 1.4 kg (3 lb)	BNC (f) See Note 1	\$500 \$825
<b>355E</b> (Programmable)										
<b>355D</b> (Manual)	dc—1	0—120 10 dB steps	dc—0.25 GHz: 1.2 dc—0.5 GHz: 1.3 dc—1.0 GHz: 1.5	0.11 dB + 1.39 dB/GHz	±0.3 dB @ 1000 Hz ±1.5 dB to 90 dB, and ±3 dB to 120 dB @ 1 GHz	0.5 W avg 350 W peak 0.3 million cycles per section	— 15—18 V <65 ms 3.0 W	67 H x 70 W x 152 mm D (2.6" x 2.75" x 6") 1.4 kg (3 lb)	BNC (f) See Note 1	\$500 \$825
<b>355F</b> (Programmable)										
<b>8494A</b> (Manual)	dc—4	0—11 1 dB Steps	1.5	0.6 dB + 0.09 dB/GHz	±0.2 dB: 1—2 dB ±0.3 dB: 3—6 dB ±0.4 dB: 7—10 dB ±0.5 dB: 11 dB	1 W avg 100 W peak 10 μs max. 5 million cycles per section	— 20—30 V <20 ms 2.7 W	43 H x 73 W x 159 mm D (1.7" x 2.9" x 6.2") 0.9 kg (2 lb) 43 H x 73 W x 142 mm D (1.7" x 2.9" x 5.6")	001 002 003 See Note 2	\$620 \$845
<b>8494G</b> (Programmable)										
<b>8494B</b> (Manual)	dc—18	0—11 1 dB steps	dc—8 GHz: 1.5 dc—12.4 GHz: 1.6 dc—18 GHz: 1.9	0.6 dB + 0.09 dB/GHz	dc—12.4 GHz ±0.3 dB: 1—2 dB ±0.4 dB: 3—4 dB ±0.5 dB: 5—6 dB ±0.6 dB: 7—10 dB ±0.7 dB: 11 dB dc—18 GHz ±0.7 dB: 1—5 dB ±0.8 dB: 6—9 dB ±0.9 dB: 10—11 dB	1 W avg 100 W peak 10 μs max. 5 million cycles per section	— 20—30 V <20 ms 2.7 W	43 H x 73 W x 159 mm D (1.7" x 2.9" x 6.2") 0.9 kg (2 lb) 43 H x 73 W x 142 mm D (1.7" x 2.9" x 5.6")	001 002 003 See Note 2	\$915 \$1,400
<b>8494H</b> (Programmable)										
<b>8495A</b> (Manual)	dc—4	0—70 10 dB steps	1.35	0.4 dB + 0.07 dB/GHz	±1.7% of setting or ±0.4 dB, whichever is greater	1 W avg 100 W peak 10 μs max. 5 million cycles per section	— 20—30 V <20 ms 2.7 W	43 H x 73 W x 130 mm D (1.7" x 2.9" x 5.1") 0.9 kg (2 lb) 43 H x 73 W x 114 mm D (1.7" x 2.9" x 4.5")	001 002 003 See Note 2	\$515 \$720
<b>8495G</b> (Programmable)										
<b>8495B</b> (Manual)	dc—18	0—70 10 dB steps	dc—8 GHz: 1.35 dc—12.4 GHz: 1.5 dc—18 GHz: 1.7	0.4 dB + 0.07 dB/GHz	±3%: dc—12.4 GHz ±4%: dc—18 GHz % in dB from Atten. Setting	1 W avg 100 W peak 10 μs max. 5 million cycles per section	— 20—30 V <20 ms 2.7 W	43 H x 73 W x 130 mm D (1.7" x 2.9" x 5.1") 0.9 kg (2 lb) 43 H x 73 W x 114 mm D (1.7" x 2.9" x 4.5")	001 002 003 See Note 2	\$670 \$1,030
<b>8495H</b> (Programmable)										
<b>8495D</b> (Manual)	dc—26.5	0—70 10 dB steps	dc—12.4 GHz: 1.6 12.4—18 GHz: 1.9 18—26.5 GHz: 2.2	0.5 dB + 0.13 dB/GHz	±3%: dc—12.4 GHz ±4%: dc—18 GHz ±7%: dc—26.5 GHz % in dB from Atten. Setting	1 W avg 100 W peak 10 μs max. 5 million cycles per section	— 20—30 V <20 ms 2.7 W	43 H x 52 W x 159 mm D (1.7" x 2.1" x 6.2") 0.9 kg (2 lb) 43 H x 52 W x 168 mm D (1.7" x 2.1" x 6.6")	004 APC-3.5 See Note 2	\$875 \$1,300
<b>8495K</b> (Programmable)										
<b>8496A</b> (Manual)	dc—4	0—110 10 dB steps	1.5	0.6 dB + 0.09 dB/GHz	±1.7% of setting or ±0.4 dB, whichever is greater	1 W avg 100 W peak 10 μs max. 5 million cycles per section	— 20—30 V <20 ms 2.7 W	43 H x 73 W x 159 mm D (1.7" x 2.9" x 6.2") 0.9 kg (2 lb) 43 H x 73 W x 142 mm D (1.7" x 2.9" x 5.6")	001 002 003 See Note 2	\$620 \$845
<b>8496G</b> (Programmable)										
<b>8496B</b> (Manual)	dc—18	0—110 10 dB steps	dc—8 GHz: 1.5 dc—12.4 GHz: 1.6 dc—18 GHz: 1.9	0.6 dB + 0.09 dB/GHz	±3%: dc—12.4 GHz ±4%: dc—18 GHz % in dB from Atten. Setting	1 W avg 100 W peak 10 μs max. 5 million cycles per section	— 20—30 V <20 ms 2.7 W	43 H x 73 W x 159 mm D (1.7" x 2.9" x 6.2") 0.9 kg (2 lb) 43 H x 73 W x 142 mm D (1.7" x 2.9" x 5.6")	001 002 003 See Note 2	\$915 \$1,400
<b>8496H</b> (Programmable)										
<b>8497K</b> (Programmable)	dc—26.5	0—90 10 dB steps	dc—6 GHz: 1.25 6—12.4 GHz: 1.45 12.4—18.0 GHz: 1.6 18.0—26.5 GHz: 1.8	0.6 dB + 0.09 dB/GHz	±0.3 dB at 6 GHz 10 dB attenuation to ±2.8 dB at 26.5 GHz 90 dB attenuation. See Data Sheet 5952-8278 for details.	1 W avg 100 W peak 10 μs max. 5 million cycles per section	5 V or 24V	43 H x 52 W x 143 mm D (1.7" x 2.1" x 5.6") 0.9 kg (2 lb)	004 APC-3.5 See Note 2	\$1,600
<b>Option 890 Calibration Data</b>		<b>Option 890 Frequency List (MHz)</b>				<b>Models</b>			<b>Option 890 Price</b>	
		DC to 4 GHz Models: 100, 300, 500, 700, 900, 1000, 1250, 1500, 1750, 2000, 2500, 3000, 3500, 4000				DC to 26.5 GHz Models: every 500 MHz 2 to 16 GHz every 250 MHz 16 to 26.5 GHz			8494A/G, 8496A/G, 33320A/G, 33322A/G 8495A/G, 33321A/G	
		DC to 18 GHz Models: Same as above to 4000 MHz, every 500 MHz to 16000 (plus 12400 MHz), every 250 MHz from 16000 to 18000.				8494B/H, 8496B/H, 33320B/H, 33322B/H 8495B/H, 33321B/H 8495D/K, 8497K			add \$25 add \$25  add \$35 add \$35 add \$50	
Note 1: 355C/D/E/F connector options (BNC (f) standard)		Price Option 001 N(f) add \$25 Option 005 TNC(f) add \$10 Option 007 Transistor protection (355E/F only) add \$55				Note 2: 8494/5/6/7 orders must specify connector option. See ordering example above.			N/C N/C add \$50 N/C	
						Option 001 N(f) Option 002 SMA(f) Option 003 APC-7 Option 004 APC-3.5 (HP 8495D/K, 8497K only)				

Fast-ship product—see page 766.

# MICROWAVE TEST EQUIPMENT

## OEM Step Attenuators and Multi-port Switches

Models 33300 Series, 33320 Series, 33360 Series

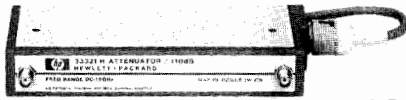

HP 33321H

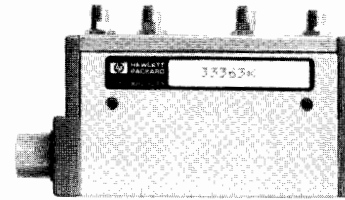

HP 33363K

### HP 33300 Series, 33320 Series

#### OEM Step Attenuators

HP 33300 Series Step Attenuators provide wideband programmable signal level control. Magnetic latching solenoids switch individual attenuating elements into and out of contact with a 50-ohm transmission line. D models have separate indicator contacts and B models have no indicator contacts. Three three-digit connector options (OXY) must be specified. X is the input connector, Y is the output connector, first digit is always 0. See specifications table for option numbers.

HP 33320 series Step Attenuators are compact versions of the HP 8494/5/6/7 bench Attenuators on page 337 (same specifications) and are configured for designing into microwave systems and instruments. Manual or electrically-actuated versions are available. The manual models take less than 1.5 square inches of panel space. OEM quantity discounts are available for HP 33300 and 33320 series. HP 33320 series have 5-million-step reliability specification. Programmable models are supplied with a 5-foot cable with a round 12-pin connector (Viking Co.) convenient for use with the HP 11713A Attenuator/Switch Driver. Optionally, a flat ribbon cable with DIP-type connector compatible with standard 14 Pin DIP IC sockets may be ordered.

#### Ruggedized Versions

For applications in harsh environments, the HP 33320H, 33321H, and 33322H Programmable Step Attenuators are available as an Option H22. These special ruggedized configurations have been type tested to meet the requirements of MIL-STD-202 for salt spray (method 101, test conditions B) and humidity (method 103, test condition A). In addition, operation is warranted over the -40 to +75°C temperature range.

### HP 33300 Series, 33320 Series Specifications

HP Model	Freq Range (GHz)	Mode	Range	Remarks	Price*
33304 B D	dc-18	Prog.	0-11 dB 1 dB steps	Connector options available.	\$1600 \$1665
33305 B D	dc-18	Prog.	0-110 dB 10 dB steps	0: N(f), 1: N(m) 2: 7mm(f), 3: 7mm(m) 5: SMA(f), 6: SMA(m)	\$1615 \$1665
33320A B	dc-4 dc-18	Manual	1-11 dB 1dB steps	Specifications identical to 8494 series page 330	\$ 600 \$ 895
33320G/ H	dc-4 dc-18	Prog.			\$ 825 \$1380
33321A B D	dc-4 dc-18 dc-26.5	Manual	0-70 dB 10 dB steps	Specifications identical to 8495 series page 330	\$ 495 \$ 650 \$ 860
33321G H K	dc-4 dc-18 dc-26.5	Prog.		SMA (f) connectors (APC-3.5 on D/K)	\$ 700 \$1010 \$1280
33322A B	dc-4 dc-18	Manual	0-110 dB 10 db steps	Specifications identical to 8496 series page 330	\$ 600 \$ 895
33322G H	dc-4 dc-18	Prog.			\$ 825 \$1380
33323K	dc-26.5	Prog.	0-90 dB 10 dB steps	Specifications identical to 8497K page 330 APC-3.5 only	\$1570

Note: Prices are for quantities of 1-9, OEM discounts are available.

#### Ordering Information

##### Options for Programmable HP 33320 Series

Option 008 - 8" ribbon cable with DIP connector

#### Price

-\$50

Option 016 - 16" ribbon cable with DIP connector

-\$50

### HP 33360 Series Single-Pole, Multi-Throw Switches

For applications requiring a single-pole, 3-throw, 4-throw, or 5-throw coaxial switch HP has developed modified versions of the edge-line design which offer dc to 26.5GHz performance.

These compact switches offer the same excellent reliability, repeatability (typically 0.01dB), and long life (5 million switching cycles per section) as the HP 33320 Series Step Attenuators.

The switches are fully programmable with HP-IB using the HP 11713A Attenuator/Switch Driver. The switches are also available with flat ribbon cable and DIP-type connector compatible with standard 14 Pin DIP IC sockets may be ordered.

Isolation, VSWR, and insertion loss vary with frequency and the port selected as shown in the following chart and tables. The important thing to note is that, depending on the application, port selection can be important to optimize performance at higher frequencies.

#### Isolation of HP 33363/4/5 Switches

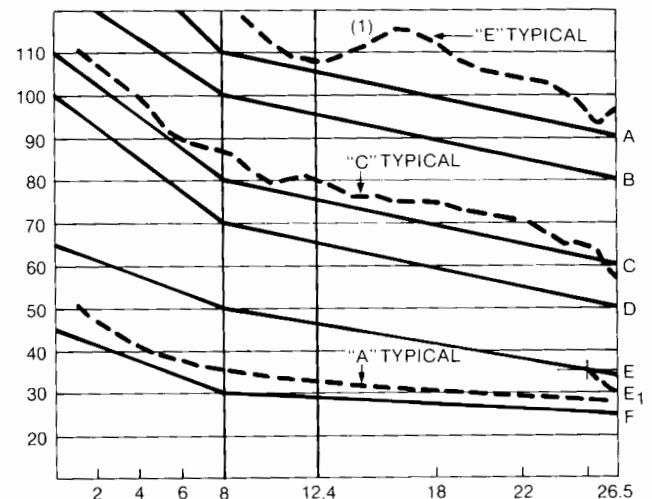

Port Selected	Isolation to other Ports (1) (See curves A,B,C,E,E <sub>1</sub> ,F above)				
	1	2	3	4	5
1	-	E	C	B	A
2	F	-	E <sub>1</sub>	C	B
3	F	F	-	E	D
4	F	F	F	-	F
5	F	F	F	F	-

Note: Ports are numbered sequentially beginning next to the input port.

(1) Ripple varies according to return of loss of devices connected to ports.

(2) This table shows 5-throw (HP 33365) performance, for 3-, 4-, or 6-throw characteristics, the right hand column remains as last port isolation.

#### HP 33363/4/5K Multiport Switches

HP Model	SWR	Insertion Loss	Power Rating and Solenoid Voltage Speed and Power same as HP 33320 Series	Price*
33363K SP3T	dc to 8GHz	Port 1 0.2dB+0.05dB/GHz		\$550
33364K SP4T	1.3 Maximum 1.2 Typical	Port 2 0.2dB+0.06dB/GHz		
	8 to 12.4GHz	Port 3 0.2dB+0.08dB/GHz	\$625	
	1.5 Maximum 1.3 Typical			
	12.4 to 18GHz	Port 4 0.25dB+0.095dB/GHz	\$725	
	1.6 Maximum 1.4 Typical			
33365K SP5T	18 to 26.5GHz	Port 5 0.25dB+0.108dB/GHz		
	1.8 Maximum 1.5 Typical			

\*For quantities of 1-9, EM discounts available.

# MICROWAVE TEST EQUIPMENT

## Coaxial Switches

Models 8761A/B, 33311B/C, 33312B/C, 33313B/C

339

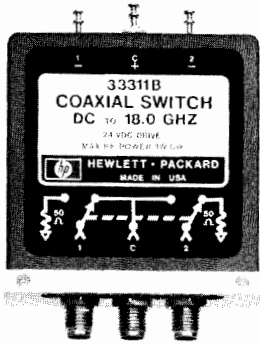

HP 33311B

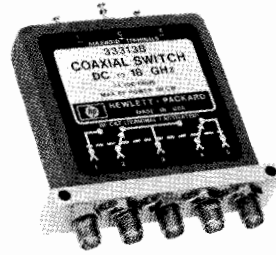

HP 33313B

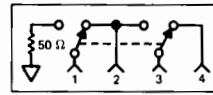

HP 33312B/C

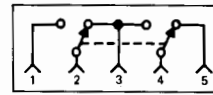

HP 33313B/C

Wiring Diagrams

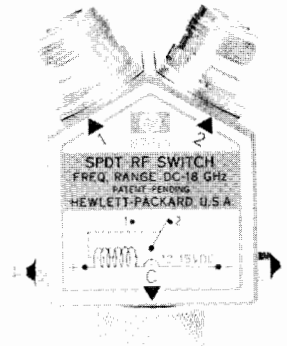

HP 8761A

### HP 8761A/B, 33311B/C, 33312B/C, 33313B/C Coaxial Switches

HP coaxial switches all feature low SWR, low insertion loss, and excellent isolation. The HP 8761A/B is an SPDT switch for dc to 18 GHz. It is controlled by latching solenoids and is break-before-make. Six connector options plus a 50-ohm termination may be specified for each port, making switch "trees" possible.

The HP 33311B (dc - 18 GHz) and 33311C (dc - 26.5 GHz) switches are also SPDT type. They feature exceptional isolation of >90 dB to 18 GHz, as well as internally-switched 50-ohm loads resulting in all ports maintaining a 50-ohm match. They use latching solenoids and the switching current is automatically cut off when switching is complete. Their compact size and high repeatability and reliability make them very suitable for OEM use.

HP 33312B/C (4-port) and 33313B/C (5-port) serve a variety of uses such as "transfer" switches to insert or remove a component from a signal path. They can also be used as the intersection switching element in a larger microwave matrix as shown at left. HP 33312B/C features one internal 50-ohm switched load while HP 33313B/C brings all 5 ports to 5 connectors. B-models cover dc - 18 GHz and C-models, dc - 26.5 GHz. Ask for Application Notes 332 and 332-1 for more information on microwave switching.

### HP-IB Compatible

The HP 33311B/C, 33312B/C, 33313B/C, and the 8671A/B Switches can be remotely controlled by the HP-IB with either the HP 11713A Attenuator/Switch Driver, the HP 59306A Relay Actuator, the HP 3235A Switch/Test Unit, or the HP 3488A Switch/Control Unit. See the catalog index for page reference.

### How to Order HP 8761A/B Switches

Specify solenoid voltage and connectors (including built-in 50-ohm termination) by the alphabetic suffix on the switch model number and the appropriate three-digit option number.

A Model: 12-15 V Connector Option Number 0 0 1  
B Model: 24-30 V (See table) Port 1 Port 2 Port C

Option Code	Connector Type	Option Code	Connector Type
0	N (f)	4	APC-7 for UT-250 Coax
1	N (m)	5	SMA (f)
2	APC-7	6	SMA (m)
3	w/Threaded sleeve APC-7 w/Coupling nut	7	50Ω Termination

### HP 33311B/C, 33312B/C, 33313B/C, 8761A/B Specifications

HP Models	Freq. Range (GHz)	SWR 50 ohm nominal	Insertion Loss	Isolation	Switching Speed	RF Connector	Dimensions H * W * D (mm)	Shipping Weight (grms)	Price*
33311B	dc - 18	<1.25: to 12.4 GHz <1.4: to 18.0 GHz	< 0.5 dB @ 18 GHz	>90 dB to 18 GHz	30 msec	SMA (f)	54 * 53 * 14	220	\$500
33311C	dc - 26.5	<1.4: to 18 GHz <1.9: to 26.5 GHz	< 1.4 dB @ 26.5 GHz	>90 dB to 18 GHz >50 dB to 26.5 GHz	30 msec	APC-3.5 (f)	54 * 53 * 14	220	\$575
33312B	dc - 18	<1.25: to 12.4 GHz <1.4: to 18 GHz	< 0.5 dB @ 18 GHz	>90 dB to 18 GHz	30 msec	SMA (f)	54 * 53 * 14	220	\$550
33312C	dc 26.5	<1.4: to 18 GHz <1.9: to 26.5 GHz	< 1.4 dB @ 26.5 GHz	>90 dB to 18 GHz >50 dB to 26.5 GHz	30 msec	APC-3.5 (f)	54 * 53 * 14	220	\$625
33313B	dc - 18	<1.25: to 12.4 GHz <1.4: to 18 GHz	< 0.5 dB @ 18 GHz	>90 dB to 18 GHz	30 msec	SMA (f)	54 * 53 * 14	220	\$550
33313C	dc - 26.5	<1.4: to 18 GHz <1.9: to 26.5 GHz	< 1.4 dB @ 26.5 GHz	>90 dB to 18 GHz >50 dB to 26.5 GHz	30 msec	APC-3.5 (f)	54 * 53 * 14	220	\$625
8761A	dc - 18	1.2: to 12.4 GHz 1.25: to 18GHz	0.8 dB @ 18 GHz	>50 dB to 12.4 GHz >45 dB to 18 GHz	35-50 msec	See table: How to Order the HP 8761A/B	41 * 38 * 38	300	\$325
8761B	dc - 18	1.2: to 12.4 GHz 1.25: to 18 GHz	0.8 dB @ 18 GHz	>50 dB to 12.4 GHz >45 dB to 18 GHz	35-50 msec		41 * 38 * 38	300	\$325

### SPECIFICATIONS

Life: > 1,000,000 switchings for HP 33311, 12, 13 B/C

Life: > 200,000 switchings for HP 8761A/B

Max Power Input: 1 W average, or 100 W Peak (Max. 10 μsec P.Width) Except HP 8761A/B, 10 W average, 5kW peak

Solenoid voltage (dc or pulsed): 24 volts for HP 33311B/C;12B/C;13B/C (diode protected to reduce transients)

12 to 15 volts for HP 8761A  
24 to 30 volts for HP 8761B

15 volt solenoid voltage: Option 015 for HP 33311B/C; 12B/C; 13B/C

5 volt solenoid voltage: Option 011 for HP 33311B/C; 12B/C; 13B/C

\*Quantity (1-9), OEM discounts available.



# MICROWAVE TEST EQUIPMENT

## Step Attenuator/Switch Combinations and Matrix Switches

Models 33323K, Option K Series

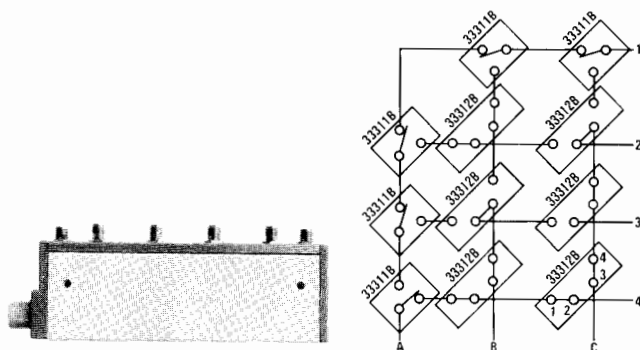

Dual-transfer switch

Figure 4. Typical matrix application.

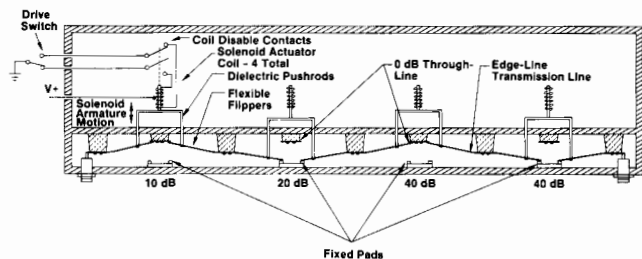

Figure 1. HP 33320-Series Step Attenuator

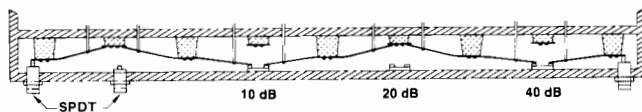

Figure 2. > 0 dB plus SPDT.

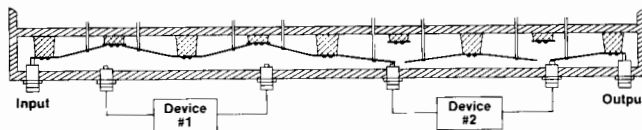

Figure 3. Dual transfer switch showing device #2 inserted in signal path.

### Custom Step Attenuator and Switch Combinations

Many unique combinations are possible with the edgeline design in the HP 33320 Series package (Figure 1). Custom functions can be as simple as modifying a standard 70dB step attenuator (a 10-20-40dB internal arrangement) by adding a SPDT switch on either end as shown in Figure 2. Or a SPDT switch can be placed on each end.

For a designer, this combination replaces a need to add a separate external SPDT switch which might be used to route a signal alternately to a detector or a counter, then to the output. Or, the SPDT switch might select from two different signal sources.

By operating two adjacent solenoids in parallel a separate transfer switch function may be configured as shown in Figure 3. This may be used to create a dual transfer switch or a single transfer switch with a single pole 3 throw switch.

Isolation and insertion loss for these products vary with frequency (see HP 33360 Series Multithrow Switches page 338). For a transfer switch typical isolations of 40 to 50dB can be expected.

One to four step attenuator functions with pad values of 10, 20, or 30dB to 26.5GHz, and values of 1, 2, 4, 5, or 40dB to 18GHz may be combined with one or more transfer or single pole switches.

These novel combinations offer the microwave design engineer many alternatives which can reduce coaxial cabling and component count, all in one compact package, with the 5-million-step reliability of the HP 33323K product. For more information on custom combination step attenuators and switches, request Application Note 332-1.



Figure 5. Custom matrix switch.

### Selection Guide for Typical Functions

Function	HP Model	
	Viking Connector	16-pin Ribbon Connector
Single Pole Six Throw	33323K Opt.K16	33323K Opt.K26
Dual-transfer	33323K Opt.K30	33323K Opt.K40
Dual-transfer plus <sup>1</sup> SPDT	33323K Opt.K31	33323K Opt.K41
70dB Steps plus <sup>1</sup> SPDT	33323K Opt.K32	33323K Opt.K42
110dB Steps plus <sup>1</sup> SPDT	33323K Opt.K33	33323K Opt.K43
20dB Steps plus <sup>1</sup> transfer switch plus <sup>1</sup> SPDT	33323K Opt.K34	33323K Opt.K44
70dB Steps plus <sup>1</sup> SPDT	33323K Opt.K35	33323K Opt.K45

<sup>1</sup>Contact HP for prices, specifications, and other combinations.

### Matrix Switching for Automatic System Test

HP offers a variety of mechanical microwave switching solutions for use in configuring automatic test systems. The switches have high electrical performance and well-proven reliability. Matrix switches provide for multiple path routing of stimulus and measurement signals under computer control, and often add calibration paths for running "health checks" of the system instruments and switching.

Figure 4 shows a simple 3-path full-access switch matrix, configured from standard HP 33311B and 33312B Coaxial Switches. Full-access means that 3 concurrent signal paths are available. In such matrices, the key requirement of the intersection switching elements is high-isolation, since signal paths cross each other inside the same intersection. HP 33311/12/13 switches are ideal since they provide 90dB isolation up to 18GHz and 50dB to 26.5GHz.

Application Note 332, "Microwave Switching from SPDT to Full-Access Matrix", covers design considerations for such switch configurations. It addresses such concerns as insertion losses and the need for terminating unused coax line segments to prevent resonances.

### Custom Matrixes

Figure 5 shows a typical custom matrix designed by HP engineers for a specific automatic test application. This package included more than 30 of the HP 33311/12 Coaxial Switches, some used in a 4 x 4 matrix and others used for expanding the matrix. Other internal functions included were a power sensor and a noise source for calibration, as well as several signal paths for step attenuators and a detector output path.

The custom switches were programmed with HP 11713A Attenuator/Switch Drivers as shown in the figure. Provisions are made for easy connection to other switch drivers as well. The feature of HP coaxial switches that internally cuts off drive power after transition means that power dissipation is considerably reduced.

To order, contact HP.

# MICROWAVE TEST EQUIPMENT

Transmission Reflection Test Sets, Power Splitters, Power Dividers

Models 8721A, 85044A/B, 11850C/D, 11667A/B, 11636A/B

341



HP 85044A

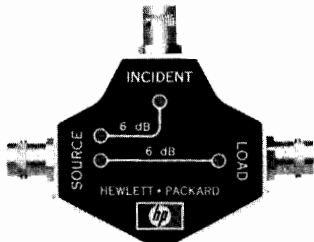

HP 8721A

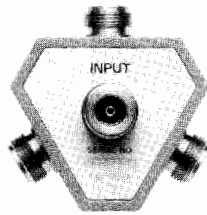

HP 11850C

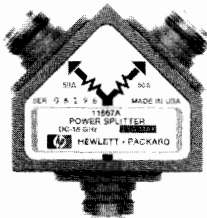

HP 11667A

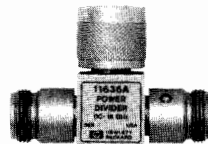

HP 11636A

## Description

Accurate broadband measurements of transmission and reflection parameters are highly dependent on the device used to separate signals for the measurement. Some devices separate the reflected and transmitted signals and some split power for ratio and comparison measurements.

### HP 8721A Directional Bridge

#### HP 8721A Option 008 75 Ohm Version

**Frequency range:** 0.1 - 110 MHz.

**Directivity:** >40 dB, 1 - 110 MHz, typically >30 dB, 0.1 - 1 MHz.

**Load port match:** >30 dB (VSWR <1.07).

**Transmission arm:** Nominal loss, 6 dB. Frequency response, <0.2 dB.

**Coupling arm:** Nominal coupling, 6 dB. Frequency response, <0.6 dB.

**Maximum input power:** +20 dBm.

**Weight:** net, 0.55 kg (0.25 lb); shipping, 1.1 kg (0.5 lb).

**Size:** 59 H x 39 W x 123 mm D (1.5 x 1 x 3.13 in.).

### HP 85044A 50 Ohm Transmission Reflection Test Set

#### HP 85044B 75 Ohm Transmission Reflection Test Set

The HP 85044 contains a power splitter and directional bridge that permits simultaneous transmission and reflection measurements with over 30 dB directivity from 300 kHz to 3.0 GHz. Detailed specifications on the HP 85044A and HP 85044B appear on page 244.

### HP 11850C 50 Ohm Power Splitter

#### HP 11850D 75 Ohm Power Splitter

These three-way power splitters are designed for ratio measurements from dc to 3.0 GHz (11850C) or 2 GHz (11850D). One output port provides the reference and the other two output ports can be used for independent transmission measurements. They provide 0.25 dB tracking and >20 dB output match. Detailed specifications are on page 245.

### HP 11667A Power Splitter (Type N)

#### HP 11667B Power Splitter (APC-3.5)

These two-way, two-resistor splitters provide good input and output source match in ratio measurement and source leveling applications. The HP 11667A operates from dc to 18 GHz with output match >17 dB and tracking <0.25 dB. The HP 11667B operates from dc to 26.5 GHz and has output source match >18 dB and tracking <0.4 dB. Detailed specifications are on page 225.

### HP 11636A/B Power Dividers/Combiners

The HP 11636A/B are two-way, three-resistor power dividers for use in non-ratio measurements. They can also be used as power combiners for combining two independent signals. They are ideal for fault location measurements made with the HP 8757S and the HP 85016A software.

#### Frequency Range

HP 11636A: DC to 18 GHz.

HP 11636B: DC to 26.5 GHz.

**Impedance:** 50 ohms nominal.

**Insertion loss:** 6 dB nominal.

	DC-10 GHz	DC-18 GHz	DC-26.5 GHz
<b>Input SWR</b>			
HP 11636A	<1.25	<1.35	
HP 11636B	<1.22	<1.29	<1.29
<b>Output SWR</b> (non-ratio measurements)			
HP 11636A	<1.25	<1.35	
HP 11636B	<1.22	<1.29	<1.29
<b>Output Tracking</b> (between output arms)			
HP 11636A	<0.4 dB	<0.5 dB	
HP 11636B	<0.25 dB	<0.25 dB	<0.5 dB
<b>Typical Phase Tracking</b> (between output arms)			
HP 11636A	2°	2°	
HP 11636B	2°	2.5°	3°
<b>Maximum Input Power</b>			
HP 11636A	+30 dBm		
HP 11636B	+27 dBm		
<b>Connectors</b>			
HP 11636A:	Type N male input port, female output ports.		
HP 11636B:	APC-3.5 female on all ports.		
<b>Dimensions</b>			
HP 11636A:	42 H x 45 W x 18 mm D (1.64 x 1.75 x 0.69 in.)		
HP 11636B:	40 H x 47 W x 10 mm D (1.6 x 1.9 x 0.4 in.)		
<b>Weight</b>			
HP 11636A:	net, 0.14 kg (0.31 lb); shipping, 0.45 kg (1 lb)		
HP 11636B:	net, 0.06 kg (0.13 lb); shipping, 0.14 kg (0.3 lb)		

## Ordering Information

	Price
HP 8721 Directional Bridge	\$325
Option 008: 75 Ohm Version	add \$50
HP 85044A 50 Ohm Transmission Reflection Test Set	\$3,000
HP 85044B 75 Ohm Transmission Reflection Test Set	\$3,500
HP 11850C 50 Ohm Power Splitter	\$900
HP 11850D 75 Ohm Power Splitter	\$1,400
HP 11667A Power Splitter (DC - 18GHz)	\$930
Option 001: Type N Male Input, Type N Female Outputs	N/C
Option 002: Type N Female Input, APC-7 On Outputs	add \$75
HP 11667B Power Splitter (DC - 26.5 GHz)	\$950
HP 11636A Power Divider (DC - 18 GHz)	\$450
HP 11636B Power Divider (DC - 26.5 GHz)	\$950

# MICROWAVE TEST EQUIPMENT

## Coaxial Crystal Detectors

Models 423B, 8470B, 8472B, 8473B/C/D/E, 33330B/C/D/E

- 10 MHz to 50 GHz
- Flat frequency response
- High burnout protection
- Low SWR
- Field replaceable detector elements



HP 33330B



HP 8473E



HP 423B



HP 8473D

## HP 423B, 8470B, 8472B, 8473B/C, 33330B/C Low Barrier Schottky Diode (LBSD) Detectors

The low-barrier Schottky diode (LBSD) detectors are a state-of-the-art addition to the HP family of high performance detectors. Various models provide coverage to 12.4, 18, and 26.5 GHz and input connectors are Type N, APC-7, or APC-3.5 depending on frequency range. Output connector is BNC (f) except for the HP 33330B/C (SMC).

Matched pairs (Opt 001), square-law load (Opt 002), and positive polarity output (Opt 003) are available for most models.

## HP 8473D/E, 33330D/E Planar-Doped-Barrier (PDB) Detectors

These detectors are the newest addition to HP's family of high performance detectors. They feature a broadband, very flat frequency response ( $\pm 1.0$  dB from 0.01 to 50.0 GHz) as well as superior SWR performance ( $< 1.4$  to 26.5 GHz,  $< 2.3$  to 50.0 GHz), exceptional temperature stability (typically  $< 1.0$  dB variation from  $-40$  C to  $+100$  C), and superior square law response vs. frequency.

Positive polarity output (Opt 003) is available for the HP 8473D and HP 33330D. Due to their exceptional frequency response, any two standard HP 8473D or E's or HP 33330D or E's are a matched pair (the matched pair, Opt 001, is not needed).

### Coaxial Crystal Detector Specifications

HP Model	Frequency Range (GHz)	Frequency Response (dB)	SWR Maximum (50 $\Omega$ Nom.)	Low Level Sensitivity	Maximum Input (Peak or Average)	Short-Term Maximum Input (<1 min.)	Option 001 Matched Pair (order 2 units for each pair)	Options Available	Input Connector	Output Connector	Price
423B	0.01-12.4 LBSD	$\pm 0.2$ /octave to 8 GHz $\pm 0.3$ overall	$< 1.15$ to 4 GHz $< 1.3$ to 12.4 GHz	$> 0.5$ mV/ $\mu$ W	200 mW	1 watt	$\pm 0.2$ dB to 12.4 GHz	001 002	N (m) 003	BNC (f)	\$245
8470B	0.01-18.0 LBSD	$\pm 0.2$ /octave to 8 GHz $\pm 0.3$ to 12.4 GHz $\pm 0.6$ to 18 GHz	$< 1.15$ to 4 GHz $< 1.3$ to 15 GHz $< 1.4$ to 18 GHz	$> 0.5$ mV/ $\mu$ W	200 mW	1 watt	$\pm 0.2$ dB to 12.4 GHz $\pm 0.3$ dB to 18 GHz	001 002 003	APC-7	BNC (f)	\$310
8470B Opt 012									N (m)		
8472B	.01-18 LBSD	$\pm 0.3$ to 12.4 GHz $\pm 0.5$ to 15 GHz $\pm 0.6$ to 18 GHz	$< 1.20$ to 4.5 GHz $< 1.35$ to 7 GHz $< 1.50$ to 12.4 GHz $< 1.70$ to 18 GHz	$> 0.5$ mV/ $\mu$ W	200 mW	1 watt	$\pm 0.2$ dB to 12.4 GHz $\pm 0.3$ dB to 18 GHz	002 003	SMA (m)	BNC (f)	\$310
8473B	0.01-18.0 LBSD	$\pm 0.2$ /octave to 8 GHz $\pm 0.6$ to 18 GHz	$< 1.2$ to 4.0 GHz $< 1.5$ to 18 GHz	$> 0.5$ mV/ $\mu$ W	200 mW	1 watt	$\pm 0.2$ dB to 12.4 GHz $\pm 0.3$ dB to 18 GHz	001 003	APC-3.5 (m)	BNC (f)	\$320
8473C	0.01-26.5 LBSD	$\pm 0.6$ to 20 GHz $\pm 1.5$ with a $-3.5$ dB slope, 20 to 26.5 GHz	$< 1.2$ to 4 GHz $< 1.5$ to 18 GHz $< 2.2$ to 26.5 GHz	$> 0.5$ mV/ $\mu$ W to 18 GHz $> 0.18$ mV/ $\mu$ W to 26.5 GHz	200 mW	1 watt	$\pm 0.2$ dB to 12.4 GHz $\pm 0.3$ dB to 18 GHz $\pm 0.5$ dB to 26.5 GHz	001 003	APC-3.5 (m)	BNC (f)	\$360
8473D	0.01-33.0 PDB	$\pm 0.25$ to 14 GHz $\pm 0.4$ to 26.5 GHz $\pm 1.25$ to 33 GHz	$< 1.20$ to 14 GHz $< 1.36$ to 26.5 GHz $< 2.96$ to 33 GHz	$> 0.5$ mV/ $\mu$ W	200 mW	1 watt	N/A	003	APC-3.5 (m)	BNC (f)	\$430
8473E	0.01-50.0 PDB	$\pm 0.6$ to 40 GHz $\pm 1.0$ to 50 GHz	$< 1.40$ to 33 GHz $< 1.90$ to 50 GHz $< 2.30$ to 50 GHz	$> 0.4$ mV/m W to 40 GHz	200 mW	1 watt	N/A	003	APC-2.4 (m)	BNC (f)	\$575
33330B	0.01-18.0 LBSD	$\pm 0.6$	$< 1.2$ to 4.0 GHz $< 1.5$ to 18 GHz	$> 0.5$ mV/ $\mu$ W	200 mW	1 watt	$\pm 0.2$ dB to 12.4 GHz $\pm 0.3$ dB to 18 GHz	001 003	APC-3.5 (m)	SMC (m)	\$300*
33330C	0.01-26.5 LBSD	$\pm 0.6$ to 20 GHz $\pm 1.5$ with a $-3.5$ dB slope 20 to 26.5 GHz	$< 1.5$ to 18 GHz $< 2.2$ to 26.5 GHz	$> 0.5$ mV/ $\mu$ W to 18 GHz Degrades to 0.18 mV/ $\mu$ W at 26.5 GHz	200 mW	1 watt	$\pm 0.3$ dB to 18 GHz $\pm 0.5$ dB to 26.5 GHz	001 003	APC-3.5 (m)	SMC (m)	\$335*
33330D	0.01-33.0 PDB	$\pm 0.35$ to 14 GHz $\pm 0.4$ to 26.5 GHz $\pm 1.25$ to 33 GHz	$< 1.20$ to 14 GHz $< 1.36$ to 26.5 GHz $< 2.96$ to 33 GHz	$> 0.5$ mV/ $\mu$ W	200 mW	1 watt	N/A	003	APC-3.5 (m)	SMC (m)	\$395*
33330E	0.01-50 PDB	$\pm 0.6$ to 40 GHz $\pm 1.0$ to 50 GHz	$< 1.40$ to 33 GHz $< 1.90$ to 40 GHz $< 2.30$ to 50 GHz	$> 0.34$ mV/m W to 50 GHz	200 mW	1 watt	N/A		APC-2.4 (m)	SMC (m)	\$500*

\*Note: HP 33330B, C, D, E prices are for quantities of 1-9, OEM discounts are available.

#### Options

**Option 001:** Matched response. Must order two (2) option 001s for a pair of detectors with matched frequency response. add \$25

**Option 002:** Optimum square law load. add \$25

**Option 003:** Positive polarity output. add \$35

Planar Doped Barrier Diodes		Low Barrier Schottky Diodes			
HP Model	Opt. 003	HP Model	Opt. 001	Opt. 002	Opt. 003
8473D	add \$25	423B	add \$25	add \$25	add \$35
33330D	add \$30	8470B	add \$25	add \$25	add \$35
		8472B	n/a	n/a	add \$35
		8473B	add \$25	n/a	add \$35
		8473C	add \$25	n/a	add \$35
		33330B	add \$20	n/a	add \$30
		33330C	add \$20	n/a	add \$30

☎ Fast-ship product -- see page 766

# MICROWAVE TEST EQUIPMENT

## Waveguide Crystal Detectors, Mixers

Models 422A/C, 11970/11971 Series, 10514/34A

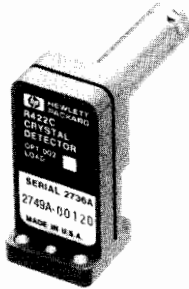

HP R422C

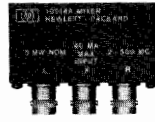

HP 10514A

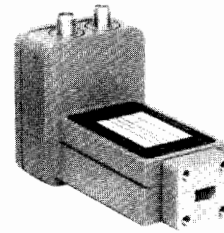

HP 11970/11971 Series

### HP 422 Series Crystal Detectors

The HP 422A/C Crystal Detectors combine high sensitivity with flat frequency response and low SWR to provide waveguide band coverage from 18.0 to 60 GHz. They deliver between 0.2 and 0.5 mV/ $\mu$ W output at low level and handle 100 mW peak input. SWR ranges from 1.3 at 6K-band to 3 at R-band.

The HP K422C detector uses a planar doped barrier (PDB) diode. This superior diode technology results in a frequency response 5 times better than the former HP K422A ( $\pm 0.4$  dB vs.  $\pm 2.0$  dB).

The HP R422C detector also uses a GAAS planar-doped-barrier (PDB) diode. This detector features much flatter frequency response and greatly reduced SWR than the HP R422A it replaces ( $\pm 0.6$  dB vs.  $\pm 1.0$  dB, 1.78 SWR vs. 3.0 SWR).

HP Q/U422 Series millimetre-wave detectors use Low-Barrier Schottky diodes for low video impedance and low junction capacitance. Their SWR is below 2.0, low-level sensitivity is 0.2 mV/ $\mu$ W.

For reflectometer applications in which both flat frequency response and square-law characteristics are important, these models can be supplied as matched pairs (Option 001) and with optimum square-law loads (Option 002). Due to its exceptionally flat frequency response, and any two standard HP K422Cs become a matched pair, and therefore the matched pair option, Option 001, is not needed.

### HP 422 Series Waveguide Crystal Detector Specifications

HP Model	Frequency Range (GHz)	Frequency Response (dB)	Option 001 Matched Response (dB)	LowLevel Sensitivity mV/ $\mu$ W	SWR	Waveguide & Equivalent Flange	Price
K422C	18.0-26.5	$\pm 0.4$	N/A	>0.5	1.36	WR42 UG-595/U	\$875
R422A	26.5-40.0	$\pm 2$	$\pm 1$ dB	>0.3	3.0	WR28 UG-599/U	\$875
R422C	26.5 to 40	$\pm 0.6$	N/A	7.5	1.78	WR28 UG-599/U	\$800
Q422A	33.0-50.0	$\pm 1.5$	N/A	>0.25	2.0	WR-22 UG-383/U	\$1200
U422A	40.0-60.0	$\pm 1.5$	N/A	>0.20	2.0	WR-19 UG-383/U (mod)	\$1400

Option 001: Matched response. Must order two (2) option 001's for a pair of detectors with matched frequency response.  
 Option 002: optimum square-law load.  
 Option 003: positive polarity output. (available with Q/U422A)

Option Prices			
HP Model	Opt. 001	Opt. 002	Opt. 003
K422C	N/A	add \$20	N/A
R422A	add \$45	add \$20	N/A
R422C	N/A	-\$20	N/A
Q442A	N/A	N/A	N/C
U422A	N/A	N/A	N/C

### HP 10514A, 10534A Double Balanced Mixers

These mixers are excellent in a variety of mixing applications as well as AM, pulse, and square-wave modulation applications. The careful balancing of the hot carrier diodes in the HP 10514A and 10534A provides excellent output suppression of the local oscillator and input frequencies. Frequency ranges are 0.2-500 MHz for the HP 10514A and 0.05-150 MHz for the HP 10534A. Connectors are BNC.

### HP 11970 and 11971 Series Harmonic Mixers

Although designed for operation with HP spectrum analyzers, these broadband mixers also serve a wide variety of general-purpose uses for the frequency bands from 18 to 110 GHz. Such uses include down-conversion for noise figure and network analysis measurements.

As down-conversion mixers for test receivers, the HP 11970 and 11971 offer flat response, low SWR, and low conversion loss without requiring bias. These mixers can also serve as harmonic generators with input signals from 2 to 6.1 GHz (depending on the model). Outputs are at the band specified, and each mixer is individually calibrated for conversion loss over its complete band. See page 143 for more technical performance information.

### Ordering Information

HP 10514A Double Balanced Mixer (0.2-500 MHz)	Price \$204
HP 10534A Double Balanced Mixer (0.05-150 MHz)	Price \$146

### HP 11970/11971 Series Specifications

HP Models	Frequency Range (GHz)	Freq. Response (dB)	Waveguide and Equivalent Flange	Price
11970K 11971K	18 - 26.5	$\pm 1.9$ $\pm 2.1$	WR-42 UG-595/U	\$1650 \$1650
11970A 11971A	26.5 - 40	$\pm 1.9$ $\pm 2.1$	WR-28 UG-599/U	\$1700 \$1700
11970Q 11971Q	33 - 50	$\pm 1.9$ $\pm 2/3$	WR-22 UG-383/U	\$1850 \$1850
11970U 11971U	40 - 60	$\pm 1.9$ $\pm 2.3$	WR-19 UG-383/U (mod)	\$2050 \$2050
11970V 11971V	50 - 75	$\pm 2.1$ $\pm 2.5$	WR-15 UG-385/U	\$2500 \$2500
11970W	75 - 110	$\pm 3.0$	WR-10 UG-385/U (mod)	\$2850

# MICROWAVE TEST EQUIPMENT

Coaxial Connector Gage Kits, Blocking Capacitors, Air Line Extensions Terminations  
Models 11752C/E, 11742A/E, 11566/7/A, 908A, 909 Series, 85138A/B

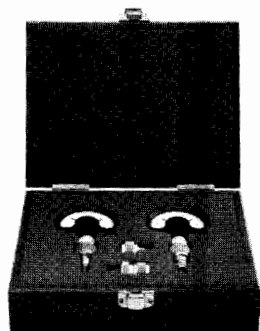

HP 11752D/E



HP 11742A



HP 11566A



HP 909C



HP 909D

## HP 908A, 909A/C/D/E/F, 85138A/B Coaxial Fixed Terminations (50 and 75 Ω)

The HP 908A, 909A and 909D Terminations are low reflection loads for terminating 50 Ω coaxial systems in their characteristic impedance. The HP 909C (50 Ω) and HP 909E (75 Ω) are precision ultra low reflection terminations intended for use as calibration standards.

### HP 11752D/E Coaxial Connector Gage Kits

When using the newest 2.4 and 3.5mm precision connectors, pin depth control is necessary to assure repeatable measurements and to prevent connector damage which could lead to costly repairs and down time.

The HP 11752D/E Gage Kits each contain two gages and two gage masters for measuring the center conductor setback on male and female center conductors. The HP 11752D is for use with APC 3.5 and 2.4mm connectors. The HP 11752E is for use with 2.4mm connectors. These gages feature thread-on measurements for insuring accurate, repeatable connector pin depth measurements.

The gages also feature rugged mechanical indicators graduated in 0.0001 inch increments for accurate adjustment of center conductor setbacks (setback tolerance on a 2.4mm connector is +0/-0.0015 inch). The kits are supplied in a handsome walnut case and include a user's manual.

### HP 11742A/E Blocking Capacitor

The HP 11742A is a high performance outside blocking capacitor. It features broadband performance, low SWR (1.2 from .01 to 26.5 GHz) and low insertion loss (.6dB from .01 to 26.5 GHz). The HP 11742A comes with APC-3.5 connectors. It is ideal for use with high frequency oscilloscopes and in bias circuits for the attenuation of low frequencies and D.C. voltages from signal paths where D.C. voltages do not exceed 50V. The HP 11742E is a blocking capacitor with 2.4 mm connectors for use to 50 GHz.

### HP 11566A, 11567A Air Line Extension

**Impedance:** 50 ohms.

**Frequency:** dc-18 GHz.

**Reflection coefficient:** 0.018 + (0.001 x frequency in GHz).

**Connector:** APC-7.

**Length:** 11566A, 10.21 cm (4 in.); 11567A, 20.21 cm (8 in.)

**Shipping weight:** 0.45 kg (1 lb).

#### Ordering Information

HP 11752D Coaxial Connector Gage Kit

HP 11752E Coaxial Connector Gage Kit

HP 11742A Blocking Capacitor

HP 11742E Blocking Capacitor

HP 11566A Air line extension

HP 11567A Air line extension

#### Price

\$1,300

\$1,400

\$170 ☎

\$285 ☎

\$325 ☎

\$375 ☎

### HP 908A, 909A/C/D Specifications

HP Model	Frequency Range (GHz)	Impedance (ohms)	SWR	Power Rating	Connector	Price
908A	dc-4	50	1.05	½ W avg. 1 kW pk	N (m)	\$115
909A	dc-18	50	1.05: 0-4 GHz 1.1: 4-12.4 GHz 1.25: 12.4-18 GHz	2 W avg. 300 W pk	APC-7	\$180
909A Option 012 Option 013			1.06: 0-4 GHz 1.11: 4-12.4 GHz 1.3: 12.4-18 GHz		Opt. 012 N (m) Opt. 013 N (f)	Less \$15
909C	dc-2	50	1.005	½ W avg. 100 W pk	APC-7	\$310
909C Option 012 Option 013			1.01		Opt. 012 N (m) Opt. 013 N (f)	Less \$25
909C Option 200	dc-0.2	50	1.005	½ W avg. 100 W pk.	Must be ordered with Opt. 012 N (m) or Opt. 013 N(f)	N.C.
909C Option 201			1.01		Must be ordered with Opt. 012 N(m)	Less \$20
909D	dc-26.5	50	1.07: dc-4 GHz 1.12: 4-12.4 GHz 1.22: 12.4-26.5 GHz	2 W avg. 100 W pk.	APC-3.5 (m)	\$230
909D Option 011					Opt. 011 APC-3.5 (f)	N.C.
909D Option 040			1.02:dc-4GHz 1.12:4-12.4GHz 1.22:12.4-26.5GHz		APC-3.5 (m) Opt. 011 APC-3.5 (f)	add \$15
909E Option 201	dc-0.2	75	1.01	½ W avg. 100 W pk.	N(m)	\$265
909F	dc-6	50	1.005:dc-5 GHz 1.01:5-6 GHz	½ W	APC-7	\$325
909F Option 012	dc-6	50	1.007:dc-2 GHz 1.01:2-3 GHz 1.02:3-6 GHz	½ W	N(m)	-\$25
909F Option 013					N(f)	
85138A	dc-50	50	1.22	½ W	2.4 mm (m)	\$475
85138B	dc-50	50	1.22	½ W	2.4 mm (f)	\$525



# MICROWAVE TEST EQUIPMENT

## Coaxial and Waveguide Terminations

Models HP 905, 910, 911, 914, 920, 921

345

- Precision loads and shorts for measurements to 60 GHz



HP U921A



HP Q914C



HP X910B



HP 911D/E



### HP 911D/E Sliding Loads and 911F/G Sliding Mismatches

The HP 911D/E/F/G family of sliding loads and mismatches represent an advance in calibration and verification of network analyzers. The new loads and mismatches utilize integral male (HP 911D/G) and female (HP 911E/F) connectors to form a near perfect airline without the discontinuities, which cause reflections, associated with changeable connectors. The sliding load element is highly stable, with a reflection coefficient variation of less than .00032 as the location of the element is varied, providing a very accurate and consistent reflection which greatly increases the integrity of a calibration. The sliding mismatches exhibit the same load stability, but provide a higher reflection, as is desired for calibration of scalar network analyzers.

A new center-conductor locking mechanism is used to locate and lock the center conductor reference plane to within .00005" of the outer conductor reference plane. The HP 911D/Gs have a unique nut which was designed to reduce the translation of torque from the nut to the body, reducing the possibility of connector damage.

### HP 911D/E/F/G Specifications

HP Model	Freq. Range (GHz)	Moveable Load SWR	Load Stability + Connect & Airline	Power Rating	Length (mm) in.	Shipping Weight	Price
911D (m) Load	3-26	1.066	1.066	1W Avg. 5kW Pk.	(256) 10.1	(.95kg) 2.1 lbs	\$1700
911E (f) Load	3-26	1.066	1.066	1W Avg. 5kW Pk.	(256) 10.1	(.95kg) 2.1 lbs	\$1700
911F (f) Mismatch	3-20 20-26.5	1.1 Nom.	1.005	1W Avg. 5kW Pk.	(256) 10.1	(.95kg) 2.1 lbs	\$1950
		1.083	1.008				
911G (m) Mismatch	3-20 20-26.5	1.1 Nom.	1.005	1W Avg. 5kW Pk.	(256) 10.1	(.95kg) 2.1 lbs	\$1950
		1.083	1.008				

### HP 905A, 911C Coaxial Sliding Loads

The HP 905A is a movable, low reflection 50 Ω loads for precision measurements. It is supplied with three interchangeable connectors, N-male, N-female and APC-7.

The HP 911C is a sliding load designed for 3.5 mm coaxial transmission lines and uses the APC-3.5 connector. This permits mode-free operation to 26.5 GHz. The HP 911C is furnished with interchangeable male and female connectors in a carrying case.

### HP 905A, 911A, 911C Specifications

HP Model	Frequency Range (GHz)	Load SWR	Power Rating	Length (mm) in.	Shipping Weight	Price
905A	1.8-18	1.05	1 W avg. 5 kW pk	(440) 17.25	(1.4 kg) 3 lb	\$790
911C	2-26.5	1.2, 2-10 GHz; 1.07, 10-26.5 GHz	1 W avg. 5 kW pk	(266) 10.5	(1.7 kg) 3.8 lb	\$1300

### HP 920C, 921A Waveguide Shorts

The HP R920C, Q920C and U920C are low-loss movable shorts for waveguide systems operating from 26.5 to 60.0 GHz.

The HP 921A, Q921A and U921A are fixed shorts for waveguide systems.

### HP 920C, 921A Specifications

HP Model	Frequency Range (GHz)	Type	Waveguide Size EIA	Price
R920C	26.5-40.0	movable	WR28	\$775
Q920C	33.0-50.0	movable	WR22	\$775
U920C	40.0-60.0	movable	WR19	\$785
R921A	26.5-40.0	fixed	WR28	\$ 75
Q921A	33.0-50.0	fixed	WR22	\$ 75
U921A	40.0-60.0	fixed	WR19	\$ 75

### HP 910A/B/C, 914B/C Waveguide Fixed and Movable Terminations

The HP 910A/B/C are fixed terminations for waveguide systems. The HP 914A/B are similar to the HP 910A/B/C, except that their absorptive elements are movable and locking plungers control the position of the elements. HP 914C models use micrometer adjustment.

### HP 910A/B/C, 914A/B/C Specifications

HP Model	Frequency Range (GHz)	SWR	Power Rating	Type	Waveguide Size (EIA)	Price
X910B	8.2-12.4	1.015	1 watt	fixed	WR90	\$275
P910A	12.4-18.0	1.02	1 watt	fixed	WR62	\$275
R910A	26.5-40.0	1.03	1 watt	fixed	WR42	\$250
Q910A	33.0-50.0	1.03	1 watt	fixed	WR22	\$260
U910A	40.0-60.0	1.04	1 watt	fixed	WR19	\$260
V910C	50.0-75.0	1.025	0.3 watt	fixed	WR15	\$610
W910C	75.0-110.0	1.03	0.2 watt	fixed	WR10	\$630
X914B	8.2-12.4	1.01	1 watt	sliding	WR90	\$575
P914A	12.4-18.0	1.01	½ watt	sliding	WR62	\$630
K914B	18.0-26.5	1.01	½ watt	sliding	WR42	\$800
R914C	26.5-40.0	1.01	½ watt	sliding	WR28	\$735
Q914C	33.0-50.0	1.01	½ watt	sliding	WR22	\$795
U914C	40.0-60.0	1.01	½ watt	sliding	WR19	\$840

### HP 11511A, 11512A, 11565A Coaxial Shorts & Opens

These shorts and opens are used for establishing measurement planes for known reflection phase and magnitude in 50 Ω and 75 Ω coaxial systems for various connectors.

### Ordering Information

HP 11511A N-(f) short (50 ohm)	\$60
HP 1250-1531 N-(f) short (75 ohm)	\$44
HP 11512A N-(m) short (50 ohm)	\$60
HP 1250-1530 N-(m) short (75 ohm)	\$55
HP 11565A APC-7 short (50 ohm)	\$110
HP 0960-0054 SMA-(f) short (50 ohm)	\$22.50
HP 0960-0055 SMA-(m) short (50 ohm)	\$11
HP 11652-60001 BNC (m) 50 ohm Termination	\$120
HP 85138A 2.4mm (m) 50 ohm Termination	\$475
HP 85138B 2.4mm (f) 50 ohm Termination	\$525
HP 85140A 2.4mm (m) short	\$250
HP 85140B 2.4mm (f) short	\$275
HP 85141A 2.4mm (m) open	\$275
HP 85141B 2.4mm (f) open	\$300

Fast-Ship product—see page 766.

# MICROWAVE TEST EQUIPMENT

## Coaxial Single and Dual-Directional Couplers

Models 770 Series, 11691D, 11692D

- Broadband coverage
- High directivity
- Close tracking

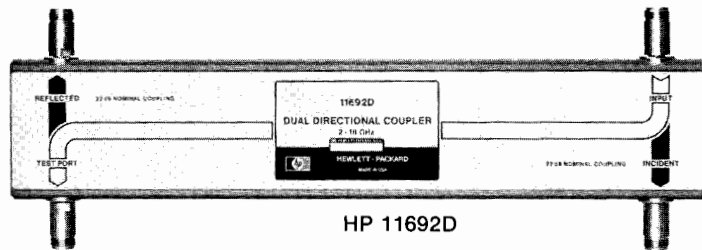

HP 11692D

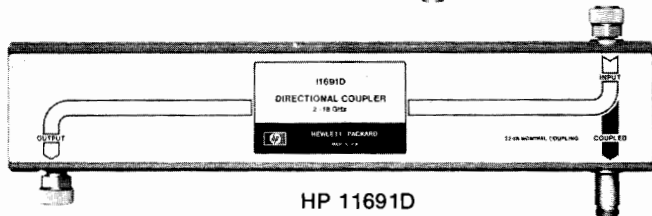

HP 11691D

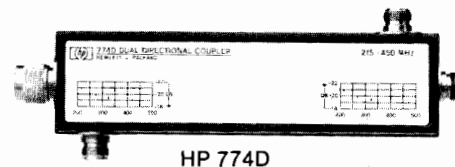

HP 774D

### HP 779D Directional Coupler

The HP 779D spans more than two octaves from 1.7 to 12.4 GHz with excellent directivity. With increased coupling factors (typically 24 dB), the HP 779 is useful down to 500 MHz. Upper frequency usefulness extends to 18 GHz with directivity reduced to about 15 dB. Various connector options are available.

### HP 11691D Directional Coupler

The HP 11691D is an ultra-wide-band single directional coupler covering 2 to 18 GHz with high directivity. It is useful as a power monitoring or leveling coupler, or for making reflection measurements. Couplers are preferred over broadband bridges in reflectometer applications in situations where the power level of the source is limited, or where simultaneous measurement of return loss and insertion loss is desired.

### HP 774D-777D Dual-Directional Couplers (octave bands)

The economical HP 774D-777D Couplers cover frequency spreads of more than two-to-one, each centered on one of the important VHF/UHF bands. With their high directivity and a mean coupling accuracy of  $\pm 0.5$  dB, these couplers are ideal for reflectometer applications. Furthermore, the close tracking of the auxiliary arms makes these couplers particularly useful for reflectometers driven by sweep oscillators such as the HP 8350B with its appropriate plug-in. Power ratings are 50 W average, 500 W peak.

### HP 778D, 11692D Dual-Directional Couplers (multi-octave bands)

These couplers are ideal for swept-frequency reflectometer testing of broadband coaxial components. The HP 778D covers 100 MHz to 2 GHz and the HP 11692D covers 2 to 18 GHz. High directivity and close tracking of the auxiliary arms are featured. Various connector options are available. Both couplers handle 50 W average power. Peak power: HP 778D, 500 W; HP 11692D, 250 W.

### HP 774D, 775D, 776D, 777D, 778D, 11692D Specifications

HP Model	Frequency Range (GHz)	Nominal Coupling (dB)	Maximum Coupling Variation (dB)	Minimum Directivity (dB)	SWR Primary Line Maximum (50Ω Nom.)	Price
774D	0.215-0.450	20	$\pm 1$	40	1.15	\$1000
775D <sup>1</sup>	0.450-0.940	20	$\pm 1$	40	1.15	\$1000
776D <sup>1</sup>	0.940-1.90	20	$\pm 1$	40	1.15	\$1000
777D	1.90-4.0	20	$\pm 0.4$	30	1.2	\$1100
778D	0.10-2.0	20	$\pm 1.5$	0.1-1 GHz: 36 <sup>2</sup> 1-2 GHz: 32	1.1	\$1100
11692D	2.0-18.0	22	$\pm 1$ incident to test port	2-8 GHz: 30 8-18 GHz: 26 <sup>3</sup>	2-12.4 GHz: 1.3 12.4-18 GHz: 1.4	\$3000

#### HP 774D-777D Standard connectors

Primary Line: N(m), N(f)

Auxiliary Arm: N(f), N(f)

#### HP 778D Standard connectors

Primary Line: N(m), N(f); Auxiliary Arms: N(f), N(f)

Option 011: Primary Line, APC-7, N(f) - \$25

Option 012: Primary Line, N(m), N(f) N/C

#### HP 11692D Standard connectors

Primary line: N(f), APC-7; Auxiliary Arms: N(f), N(f)

Option 001: Primary Line, N(f), N(f) - \$15

Option 002: Primary Line, N(f), N(m) - \$15

<sup>1</sup>Maximum auxiliary arm tracking: 0.3 dB for HP 776D; 0.5 dB for HP 777D

<sup>2</sup>30 dB, 0.1 to 2 GHz, input port.

<sup>3</sup>24 dB with Type N connector on the test port.

### HP 779D, 11691D Specifications

HP Model	Frequency Range (GHz)	Mean Output Coupling (dB)	Output Coupling Variation (dB)	Minimum Directivity (dB)	Equivalent <sup>1</sup> Source Match	Price
779D	1.7-12.4	20 $\pm$ 0.5	$\pm 0.75$	1.7-4 GHz: 30 4-12.4 GHz: 26	1.2	\$1200
11691D	2-18	22 Nominal	$\pm 1.0$	2-8 GHz: 30 dB 8-18 GHz: 26 dB	1.2	\$1650

#### HP 779D Standard connectors

Primary Line N(m) input, N(f) output; auxiliary arm N(f)

Option 010: Primary Line N(f) input, N(m) output; auxiliary output N(f) N/C

Other options: APC-7 on any or all ports Contact HP

#### HP 11691D Standard connectors

Primary line: APC-7, APC-7; Auxiliary Arm: N(f)

Option 001: All N(f) - \$30

Option 005: All APC-7 + \$25

<sup>1</sup>Apparent SWR at the output port of a coupler when used in a closed-loop leveling system.

# MICROWAVE TEST EQUIPMENT

Frequency Meters, Isolators and Waveguide Directional Couplers

Models 365 Series, 532 Series, 537A, 752 Series

347

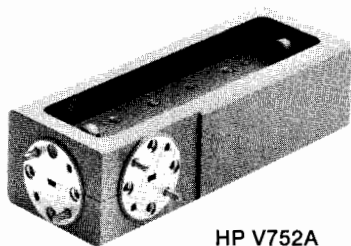

HP V752A

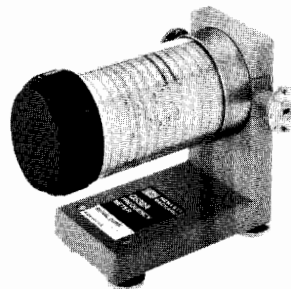

HP Q532A



HP Q365A

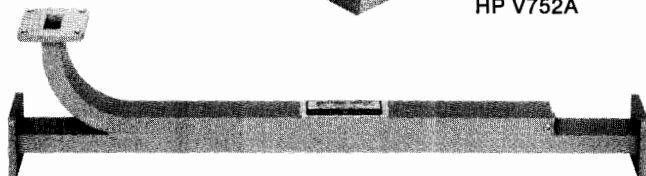

HP X752A

## HP 752 Series Waveguide Directional Couplers

The HP 752 series Couplers are specified to meet a wide variety of microwave applications. Every coupler has a minimum directivity of 40 dB over its entire frequency range. Each coupler is swept-frequency tested to ensure that the main guide SWR and directivity specifications are accurate. Performance characteristics are unaffected by humidity, temperature, and time, making these units especially useful in microwave "standards" measurements.

The HP 752 Couplers are an essential part of many waveguide measurement systems. Attenuation measurements, reflectometer setups, power measurements, source leveling and network analysis are just a few areas in which these couplers are used.

### HP 752 Series Specifications

HP Model	Frequency Range (GHz)	Nominal Coupling (dB)	Mean Coupling Accuracy (dB)	Maximum Coupling Variation (dB)	Minimum Directivity (dB)	Waveguide & Flange	Price
X752A	8.2-12.4	3	±0.4	±0.6	40	WR90 UG-135/U	\$800
X752C		10					
X752D		20					
P752A	12.4-18.0	3	±0.4	±0.5	40	WR62 UG-419/U	\$800
P752C		10					
P752D		20					
K752A	18.0-26.5	3	±0.7	±0.5	40	WR42 UG-595/U	\$1000
K752C		10					
K752D		20					
R752A	26.5-40.0	3	±0.7	±0.6	40	WR28 UG-599/U	\$1050
R752C		10					
R752D		20					
R752AS	26.5-40.0	3	±0.7	±0.6	40	WR28 UG-599/U	\$800
R752CS		10					
R752DS		20					
Q752A	33.0-50.0	3	±0.7	±0.7	36	WR-22 UG-383/U	\$800
Q752C		10					
Q752D		20					
U752A	40.0-60.0	3	±0.7	±0.7	36	WR-19 UG-383/U (Mod.)	\$850
U752C		10					
U752D		20					
V752C	50.0-75.0	10	±1.0	±1.0	33	WR 15 UG-381/U	\$850
V752D	75.0-110.0	20	±1.0	±1.0	30	WR 18 UG-387/U (Mod)	\$850

## HP 365A Millimetre-Wave Waveguide Isolators

The HP Q and U365A Isolators use a Faraday-rotation-type design consisting of a section of waveguide containing low-loss ferrite material and impedance matching elements. A permanent magnet supplies the external magnetic bias field to the ferrite core. This results in excellent broadband isolation ratios of at least 25 dB along with low SWR and insertion loss.

### HP 365A Waveguide Isolator Specifications

HP Model	Frequency Range (GHz)	SWR (Max.)	Maximum Insertion Loss (dB)	Minimum Isolation (dB)	Maximum Input Power (Avg)	Waveguide & Equivalent Flange	Price
R365A	26.5-40.0	1.4	1.5	25	1.5W	WR-28 UG-599/U	\$825
Q365A	33-50	1.4	1.5			WR-22 UG-383/U	\$1040
U365A	40-60	1.4	1.8			WR-19 UG-383/U(Mod)	\$1240
V365A	50-75	2.0	3.0			WR-15 UG-381/U	\$1530
W365A	75-110	2.0	3.0			WR-10 UG-387/U(Mod)	\$2000

## HP 532 Series, 537A Frequency Meters

These direct-reading frequency meters measure frequencies from 33.0 to 60.0 GHz in waveguide and from 3.7 to 12.4 GHz in coax quickly and accurately. Their long scales and numerous calibration marks provide high resolution which is particularly useful when measuring frequency differences or small frequency changes. Frequency is read directly in GHz so neither interpolation nor charts are required.

The instruments comprise a special transmission section with a high-Q resonant cavity which is tuned by a choke plunger. A 1 dB or greater dip in output indicates resonance; virtually full power is transmitted off resonance. Overall accuracy of each frequency meter includes allowance for 0 to 100 percent relative humidity and temperature variation from 13 to 33°C.

### HP 532 Series, 537A Specifications

HP Model	Frequency Range (GHz)	Overall Accuracy (%)	Calibration Increment (MHz)	W/G-Coax Equivalent Flange (Connector)	Price
537A	3.7-12.4	0.170	10	Coax Type N(f)	\$1300
Q532A	33.0-50.0	0.12	20	WR-22 UG-383/U	\$2020
U532A	40.0-60.0	0.15		WR-19 UG-383/U (Mod.)	\$2125

# MICROWAVE TEST EQUIPMENT

## Waveguide Variable, Fixed Attenuators, Stands, Filters

### Models 382 Series, 362 Series, 370 Series, 11540 Series



HP Q382A

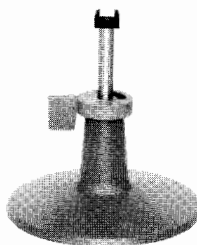

HP 11540A



HP X362A



HP Q370A

### HP 382 Series Waveguide Attenuators

Operation of these HP 382 series rotary-vane, continuously-variable attenuators depends on a mathematical law rather than on the resistivity of the attenuator card. They are direct-reading and provide accurate attenuation from 0 to 50 dB regardless of temperature and humidity.

#### HP 382 Series Specifications

HP Model	Frequency Range (GHz)	Accuracy	Attenuation Range (dB)	Waveguide & Equivalent Flange	Price
X382A	8.2-12.4	±2% of reading or 0.1 dB whichever greater	0-50	WR 90 UG-135/U	\$1900
P382A	12.4-18.0	±2% of reading or 0.1 dB whichever greater	0-50	WR 62 UG-419/U	\$1800
K382A	18.0-26.5	±2% of reading or 0.1 dB whichever greater	0-50	WR 42 UG-597/U	\$3000
R382A	26.5-40.0	±2% of reading or 0.1 dB whichever greater	0-50	WR 28 UG-599/U	\$3000
Q382A	33.0-50.0	±2% of reading or 0.1 dB (whichever greater)	0-50	WR-22 UG-383/U	\$2100
U382A	40.0-60.0			WR-19 UG-383/U (Mod.)	\$2125

### HP 11540 Series Waveguide Stand, Waveguide Holders

The HP 11540A Waveguide Stand locks HP waveguide holders at any height from 70 to 133 mm (2.75 in. to 5.25 in.). The waveguide holders are offered in five sizes to hold waveguide covering frequencies from 22 to 40 GHz.

#### Ordering Information

HP 11540A Waveguide stand

Price

HP 11545A X-Band,

\$75

HP 11546A P-Band, 11547A K-Band, 11548A R-Band

each \$45

Waveguide holders

each \$45

### HP 362 Series Waveguide Low Pass Filters

These Hewlett-Packard low-pass filters facilitate microwave measurements by eliminating undesirable signals (such as harmonics) from the measurement system. Suppression of such signals is particularly important in applications such as broadband reflection and transmission measurements or slotted line measurements where harmonics generated by the signal source could otherwise impair measurement accuracy.

#### HP 362 Waveguide Low Pass Filter Specifications

HP Model	Passband (GHz)	Stopband (GHz)	Passband Insertion Loss	Stopband Rejection	SWR Maximum	Waveguide Size	Equivalent Flange	Length mm (in)	Shipping Weight kg (lb)	Price
X362A	8.2-12.4	16-37.5	<1 dB	At least 40dB	1.5	WR 90	UG-39/U	136 (5.4)	0.9 (2)	\$1350
P362A	12.4-18.0	23-54			1.5	WR 62	UG-419/U	94 (3.7)	0.37 (13 oz)	\$1250
K362A <sup>1</sup>	18.0-26.5	31-80			1.5	WR 42	UG-595/U	64 (2.5)	0.15 (5.3 oz)	\$1150
R362A <sup>1</sup>	26.5-40.0	47-120	<1 dB	>35 dB	1.7	WR 28	UG-599/U	42 (1.7)	0.11 (4 oz)	\$1450
<sup>1</sup> Circular Flange Adapters: For K-Band, specify HP 11515A (UG-425/U). For R-Band, specify HP 11516A (UG-381/U).										\$250

### HP 370A/B/C Millimetre-Wave Fixed Attenuators

The HP Q and U 370 Fixed Attenuators offer precise attenuation, flat frequency response, and low SWR. Their ruggedness, reliability, and small size make them ideal for bench systems applications. They are also useful for general purpose applications, like the reduction of power levels to sensitive components and systems.

#### HP 370A/B/C Fixed Attenuator Specifications

HP Model	Frequency Range (GHz)	SWR (Max)	Max. Input Power	Attenuation	Attenuation Accuracy	Waveguide & Equivalent Flange	Price
Q370A	33-50	1.2	5W Avg. 100W Peak	3dB	±0.3dB	WR-22 UG-383/U	\$450
Q370B				6dB	±0.6dB		
Q370C				10dB	±0.3dB		
U370A	40-60	1.2	5W Avg. 100W Peak	3dB	±0.3dB	WR-19 UG-383/U (Mod.)	\$480
U370B				6dB	±0.6dB		
U370C				10dB	±0.6dB		

### HP 373D/G Millimetre-Wave Fixed Attenuators

The HP R, Q, U, V, and W 373 Precision Fixed Attenuators offer very precise attenuation, flat frequency response, very low SWR, and low attenuation drift with age. The split block design offers this excellent performance in a rugged, reliable package. Intended for use on the bench in applications requiring very precise signal reduction, or where a precise attenuation standard is needed. Available in 20 and 50 dB values.

#### HP 373D/G Fixed Attenuator Specifications

HP Model	Frequency Range (GHz)	SWR (Max)	Max. Input Power	Attenuation	Attenuation Accuracy	Attenuation Variation	Waveguide & Equivalent Flange	Price
R373D	26.5-40	1.05	5W Avg. 100W Peak	20dB	±.7dB	±.7dB	WR28 UG-599/U	\$750
R373G				50dB				
Q373D	33-50	1.05	5W Avg. 100W Peak	20dB	±.7dB	±.7dB	WR22 UG-383/U	\$750
Q373G				50dB				
U373D	40-60	1.05	5W Avg. 100W Peak	20dB	±.7dB	±.7dB	WR19 UG-383/U(mod)	\$800
U373G				50dB				
V373D	50-75	1.08	3W Avg. 60W Peak	20dB	±1.0dB	±.7dB	WR15 UG-385/U	\$800
V373G				50dB				
W373D	75-110	1.08	.2W Avg. 40W Avg.	20dB	±1.0dB	±.7dB	WR18 UG-387/U(mod)	\$800
W373G				50dB				

# MICROWAVE TEST EQUIPMENT

Adapters, Bends, Twists, Straights, Mismatches

Models 281A/C, 292A/B, 11515/6A, 897A/B, 898A/B, 899A/B

349

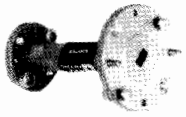

HP UV292A

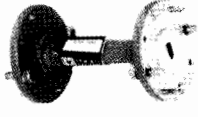

HP Q898A



HP Q899A

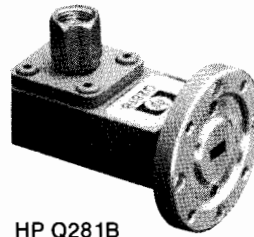

HP Q281B



HP Q897A

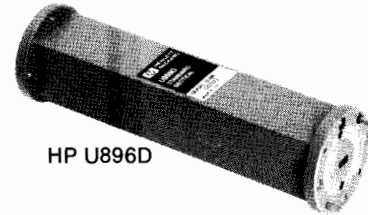

HP U896D

## HP 281A/C, 292A/B, 11515A/6A Coax and Waveguide Adapters

HP 281A Adapters transform waveguide transmission line into 50-ohm coaxial line. The HP 281C family has improved SWR. HP R/Q281 Adapters use the new 2.4 mm coaxial connector capable of non-modulating performance all the way to 50 GHz.

HP 292A/B Waveguide-to-Waveguide Adapters connect two different waveguide sizes with overlapping frequency ranges. HP 11515A/16A adapt circular to rectangular flanges in K-band and R-band.

### HP 281A/B/C Specifications

HP Model	SWR	Frequency Range (GHz)	Waveguide Size EIA	Coaxial Connector	W/G Flange UG(-) U	Price
S281A	1.25	2.60-3.95	WR284	N (f)	584	\$275
G281A	1.25	3.95-5.85	WR187	N (f)	407	\$250
J281A	1.25	5.30-8.20	WR137	N (f)	441	\$200
H281A	1.25	7.05-10.0	WR112	N (f)	138	\$175
X281A	1.25	8.20-12.4	WR90	N (f)	135	\$150
X281C	1.05	8.20-12.4	WR90	APC-7	135	\$375
Option 012				N (m)		-\$15
Option 013				N (f)		-\$15
P281B	1.25	12.4-18.0	WR62	APC-7	419	\$250
Option 013				N (f)		-\$15
P281C	1.06	12.4-18.0	WR62	APC-7	419	\$400
Option 012				N (m)		-\$15
Option 013				N (f)		-\$15
K281C	1.07	18.0-26.5	WR42	APC-3.5 (f)	597	\$450
Option 012				APC-3.5 (m)		N/C
R281A				2.4 mm (f)		\$850
R281B	1.1	26.5 - 40.0	WR-28	2.4 mm (m)	381	\$800
Q281A				2.4 mm (f)		\$850
Q281B	1.1	33.0 - 50.0	WR-22	2.4 mm (m)	383	\$800

### HP 292A/B, 11515A, 11516A Specifications

HP Model	Frequency Range (GHz)	SWR	W/G Size Flange	to	W/G Size Flange	Price
HX292B	8.2-10.0	1.05	WR 112 UG-51/U		WR 90 UG-39/U	\$250
MX292B	10.0-12.4	1.05	WR 75 Cover		WR 90 UG-39/U	\$315
MP292B	12.4-15.0	1.05	WR 75 Cover		WR 62 UG-419/U	\$250
NP292A	15.0-18.0	1.05	WR 51 Cover		WR 62 UG-419/U	\$250
NK292A	18.0-22.0	1.05	WR 51 Cover		WR 42 UG-595/U	\$250
RQ292A	33.0-40.0	1.15	WR-28 UG-381/U		WR-22 UG-383/U	\$470
QU292A	40.0-50.0	1.15	WR-22 UG-383/U		WR-19 UG-383/U(Mod.)	\$480
UV292A	50.0-60.0	1.15	WR-19 UG-383/U(Mod.)		WR-15 UG-385/U	\$490
11515A	18.0-26.5	-	WR 42 UG-425/U		WR 42 UG-595/U	\$250
11516A	26.5-40.0	-	WR 28 UG-381/U		WR 28 UG-599/U	\$250

### HP 894, 896, 897, 898, 899

#### Millimetre-Wave Waveguide Accessories

Waveguide accessories, such as E- & H-Plane bends, twists, and straight sections, are necessary and useful for assembling waveguide measurement systems.

HP offers HP R/Q/U/V/W 897A/B E-Plane and H-Plane bends of 90 degrees. HP R/Q/U/V/W 898A/B twists can be specified for either right rotation (A-Model) or left rotation (B-Model) of 90 degrees. And, finally, several HP R/Q/U/V/W 899A/B straight sections are available in 2.5 and 5.0 cm lengths to fill out the proper dimensions of complicated test set-ups.

Network analysis calibration is verified by measuring a precise and traceable reference impedance. HP's R/Q/U/V/W 896 standard sections and R/Q/U/V/W 894 standard mismatches are this kind of references.

They have very low SWR, less than 1.016. Their impedance is traceable to the National Bureau of Standards, using laser interferometry to accurately measure waveguide dimensions.

The HP Q/U896 have a unique precision flange design. When mating with a standard MIL-spec flange, this design improves repeatability by about a factor of two (when mating two HP precision flanges, repeatability is improved by a factor of five).

### HP 897A/B, 898A/B, 899A/B Waveguide Accessories Specifications

Frequency Range (GHz)	Description and HP Model	SWR	W/G	Equiv. Flange	Price
Bends					
33 - 50 40 - 60	H-Plane Q897A	1.1	WR-22	UG-383/U	180
	E-Plane Q897B	1.1	WR-19	UG-383/U(mod)	195
33 - 50 40 - 60 50 - 75 75 - 110	90°R.H. Q898A	1.1	WR-22	UG-383/U	195
	90°L.H. Q898B	1.1	WR-19	UG-383/U(mod)	185
	V898A	1.1	WR-15	UG-385/U	175
	W898A	1.15	WR-10	UG-387/U(mod)	175
Straights					
26.5 - 40 33 - 50 40 - 60 50 - 75 75 - 110	2.5cm	1.016 1.1 1.016 1.1 1.016 1.02 1.03	WR-28 WR-22 WR-22 WR-19 WR-19 WR-15 WR-10	UG-599/U UG-383/U UG-383/U UG-383/U(mod) UG-383/U(mod) UG-385/U UG-387/U(mod)	\$470 \$500 \$175 \$510 \$155 \$530 \$610 \$640
	5cm				
	10cm				
	Q899A				
Mismatches					
26.5 - 40 33 - 50 40 - 60 50 - 75 75 - 110	5cm	Mismatch Reflection (each port)	WR-28 WR-22 WR-19 WR-15 WR-10	UG-599/U UG-383/U UG-383/U(Mod) UG-385/U UG-385/U(Mod)	\$500 \$510 \$530 \$610 \$640
	R894D				
	Q894D				
	U894D				
	V894B				



# DIMENSIONAL MEASUREMENTS

## Laser Position Transducer System

### Model 5527A

- High Accuracy
- High Stability
- High Resolution



5507A



### HP 5527A Laser Position Transducer System

The HP 5527A Laser Position Transducer System makes extremely accurate and repeatable sub-micron distance measurements for precision systems. Continuous introduction of new products for this system has improved its accuracy, resolution, repeatability, and stability as well as its slew rate and the number of axes per system.

The HP 10936A Servo-Axis Board is the latest electronic product to be added to the system. It provides the HP 5527A system with flexible high performance positioning capability.

Application areas include IC wafer steppers, IC inspection equipment, E-beam pattern generator systems, flat panel display steppers, disc track writers, near field antenna measurements, precision cutting machines, coordinate measuring machines, and many more.

### System Components

#### Laser Heads

The HP 5517B Laser Head offers 25% higher slew rates in a 50% smaller footprint than the HP 5517A Laser Head. It uses the same laser tube for proven stability and reliability. The HP 5517B is electrically and optically compatible with the HP 5517A. The HP 5517B beam height is different than the HP 5517A, but can be made to be the same via a mounting bracket. The HP 5517A Laser Head is still available.

#### Optics

More new optics have enhanced the system's performance. The new HP 10716A High Resolution Interferometer extends the resolution of this system to 2.5 nm.

Additional optics include the HP 10717A Wavelength Tracker, the HP 10715A Differential Interferometer (for extremely stable measurements), and the HP 10706B High Stability Plane Mirror Interferometer for use in precision systems. The HP 10702A Linear Interferometer and HP 10703A Linear Retroreflector are designed for general applications, and the HP 10705A Single Beam Interferometer and HP 10704A Single Beam Retroreflector are designed for space-limited applications.

Beam bending and splitting optics are also available. The HP 10706A/B and HP 10715A are used with plane (flat) mirrors that must be supplied by the user for individual applications.

#### Electronics

The HP 5507A Laser Position Transducer Electronics combine superior performance, enhanced reliability, and ease-of-use. The HP 5507A offers a noise-free environment with RF shielding, ground loop protection, and a built-in power supply and fan. It is fully HP-IB

- High Slew Rate
- High Reliability
- Small Size

controlled to simplify programming, and the HP 10941A Prototyping Kit enables you to include your own electronics.

The new HP 10936A Servo-Axis Board provides a complete, closed loop solution for applications requiring very accurate positioning. The new servo board is an easy-to-tune, software programmable, digital servo with built-in motion control algorithms. Once a system is set up, the servo can be tuned in minutes using trace data, without complex analytical modeling.

Additional electronics include the HP 10932A Axis Board, the HP 10946B Automatic Compensation Board that works with the HP 10717A Wavelength Tracker or the HP 10751A Air Sensor and the HP 10757A Material Temperature Sensor to automatically compensate for wavelength of light and temperature effects. The HP 10780B High Sensitive Receiver enables the system to have up to six measurement axes.

### HP 5527A Specifications

**Laser:** Two frequency HeNe, 1.0mW maximum output power.

**Accuracy:**  $\pm 0.1$  parts per million (in vacuum). ( $\pm 0.02$ ppm if laser head is factory calibrated to MIL STD 45662.)

**Stability:** 0.002ppm short term, 0.02ppm lifetime (typical).

**Resolution:** Linear or Single Beam optics, 10nm (0.4 $\mu$ in.). Plane or Differential optics, 2.5nm (0.1 $\mu$ in.).

**Measurement Velocity (optics slew rate) with HP 5517B Laser Head:** Linear or Single Beam optics: 50.7cm/s (20in./s).

Plane or Differential optics: 25.3cm/s (10in./s).

**Number of Measurement Axes:** Up to six, depending on optical layout.

**Output:** 32-bit parallel position and position error output updated at 1.9-2.4 MHz (with HP 5517B). HP-IB interface to controller, input (destination and commands) at 75-350 Hz dependent on data format; output (position and status) at 80-1500 Hz, dependent on software and configuration.

The HP 10936A Servo-Axis Board offers a 16-bit binary output for faster I-O applications and three additional outputs for motor drive,  $\pm 10$ V analog, pulse-width-modulation, and 16-bit digital.

**Power:** 115V ac +10%, -25%; 230V ac +10%, -25%, 48-66Hz.

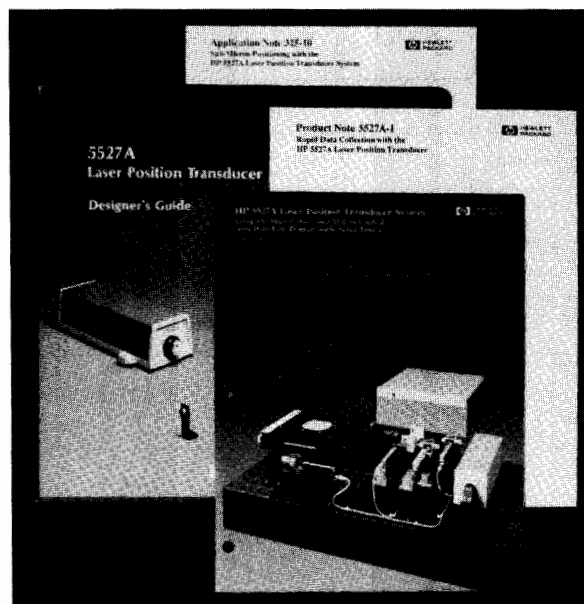

### Ordering Information

For complete ordering information, please contact your local Hewlett-Packard sales office (see page 771). The HP 5527A data sheet (02-5952-7916) is available for more details. Everything you need to know to design the HP 5527A into your application is described in the HP 5527A Designer's Guide (P/N 05527-90003). System prices range from \$16,100 to \$57,000.

# DIMENSIONAL MEASUREMENTS

## Laser Transducer and Laser Measurement Systems

Models 5501A, 5528A

351

### HP 5501A

- Flexible, high performance electronics
- Proven reliability

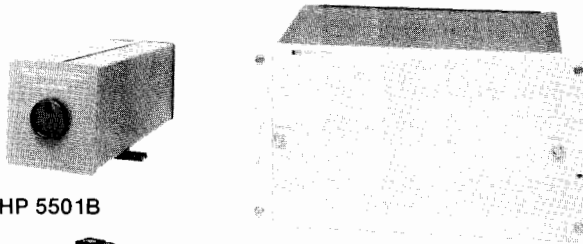

HP 5501B



10715A



10740A

10706B

### HP 5501A Laser Transducer System

The HP 5501A uses the same laser heads and optics as the HP 5527A Laser Transducer System. It has different electronics to perform additional applications compared to the HP 5527A system. It takes advantage of the new optics and receivers developed for the HP 5527A system to offer improved accuracy, stability, and number of axes.

Typical applications include installation in IC wafer steppers, E-beam pattern-generators, IC inspection devices, precision cutting machines, coordinate measuring machines, disc drive track-writers, and near-field antenna measurement systems.

#### Electronics

The HP 5501A features electronics for position or position error output, A-quad-B output for standard position controllers, and pulse output. These electronics plug directly into the HP 10740A Coupler. Interfacing to a controller is provided by the HP 10746A Binary Interface. Automatic wavelength of light and material temperature compensation are available.

#### HP 5501A Specifications

**Laser:** Two frequency HeNe. 1.0mW maximum power output.

**Accuracy:**  $\pm 0.1$  parts per million (in vacuum). ( $\pm 0.02$ ppm if laser head is factory calibrated to MIL STD 45662.)

**Stability:** 0.002ppm short term, 0.02ppm lifetime (typical).

**Resolution:** From 0.16  $\mu\text{m}$  (6.0  $\mu\text{in.}$ ) to 2.7nm (0.1  $\mu\text{in.}$ ), depending on electronics and optics used.

**Measurement Velocity (optics slew rate):** Up to 18.3m/min. (720 in./min.) maximum, depending on optics and resolution used.

**Number of Measurement Axes:** up to six, depending on system design.

**Maximum data output rate:** 700Hz - 300KHz, depending on number of axes, system electronics, and type of controller used.

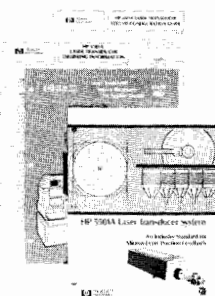

#### Ordering Information

For complete ordering information, please contact your local Hewlett-Packard sales office (see page 771). Further details are available in these HP 5501A Laser Transducer System publications; system brochure (02-5952-7930), system electronics (02-5952-7749), and system configuration guide (02-5952-7932).

**System prices range from \$15,000 to \$45,000.**

### HP 5528A

- Transportable and easy to use
- Optimized for machine tool calibration
- Acceptance test new machine tools
- Improve productivity and part quality
- Reduce scrap, rework, and inspection costs

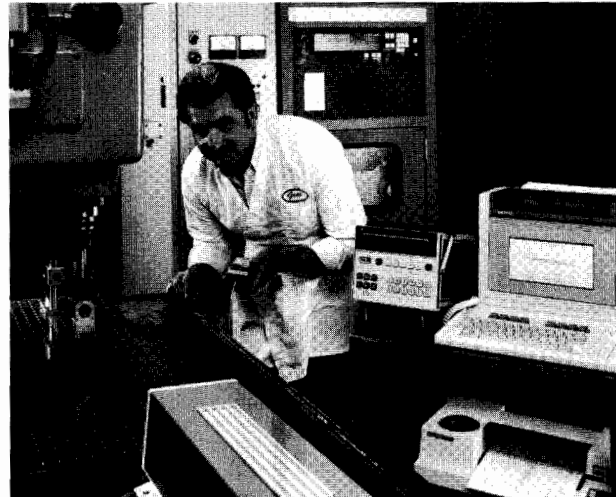

### HP 5528A Laser Measurement System

The HP 5528A Laser Measurement System is a transportable, stand-alone system that is optimized for machine tool calibration. In addition to calibration of machine tools, coordinate measuring machines, and printed-circuit board drilling machines, it is also used extensively in metrology standards labs and R&D applications, where its ease of use is important for fast, accurate results.

#### Modular Design

Although the HP 5528A measures distance and velocity, additional optics are available to also measure pitch, yaw, flatness, straightness, squareness and parallelism. The basic system consists of the HP 5508A Measurement Display, HP 5518A Laser Head, and applicable measurement optics. Available optics kits are:

- HP 55280A Linear Measurement Kit (distance and velocity);
- HP 55281A Angular Optics Kit (pitch and yaw);
- HP 55282A Flatness Accessory Kit (surface plate flatness);
- HP 55283A Straightness Measurement Kit (straightness and parallelism); and
- HP 10777A Optical Square (squareness).

Additional accessories allow compensation for wavelength of light changes (HP 10751A Air Sensor) and material temperature variations (HP 10757A Material Temperature Sensor). The HP 55288S Dimensional Metrology Analysis System provides a controller and software to collect, store, analyze, and plot the data taken by the HP 5528A.

#### HP 5528A Specifications

**Accuracy:**  $\pm 0.1$  parts per million (ppm) in vacuum  
 $\pm 0.02$  ppm in vacuum if the laser head is factory calibrated to MIL STD 45662  
 $\pm 1.7$  ppm using the HP 10751A Air Sensor (15-25 C.)

**Resolution:** 0.01  $\mu\text{m}$  (1.0  $\mu\text{in.}$ )

**Measurement Range:** 40m (130 ft) 80m (260 ft) with CO1-5518A Long Range Special

**Measurement Velocity:** 27.4m/min (1080in./min)

**Display Update Rate:** 40Hz nominal

**Power:** 100, 120, 220, 240V AC, (+%5, -10%), 48-66Hz, 175VA max.

#### Ordering Information

For complete specifications and ordering information, please see the system data sheet (02-5952-7935) or contact your local Hewlett-Packard sales office (see page 771).

**System prices range from \$17,500 to \$49,500.**

# PRESSURE & TEMPERATURE

## Quartz Pressure Probe, Quartz Pressure Set, & Pressure Signal Processor Models 2813E/D, 2816A

- 0.001 psi resolution (6,9 Pa)
- High performance

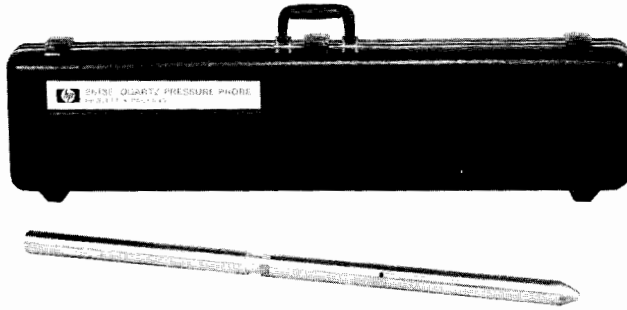

HP 2813E Quartz Pressure Probe

### HP 2813E/D Quartz Pressure Probe and Pressure Set

The quartz technology that Hewlett-Packard first introduced to the oil- and gas-well industry in 1970 is still the standard for pressure measurement applications requiring extremely high accuracy, resolution and repeatability. These features, combined with its rugged construction, make the 2813E probe ideally suited for petroleum applications, oceanographic research and subterranean hydrodynamic studies.

### High Precision, Resolution and Repeatability

Capable of sensing wellbore pressure changes as small as 0.001 psi, the probe's measurements can be instantly observed and recorded on the surface. With an accuracy better than  $\pm 1.0$  psi and  $\pm 0.01\%$  of the pressure reading, the HP 2813E/D gives you confidence in the precision of your measurements. Also, with a repeatability of 0.4 psi over the full calibrated pressure range (200 - 11,000 psia) at constant temperature, you can be confident that changes in successive measurements are due to changes in the well, not probe measurement error.

### Advanced Calibration Procedures

Advanced calibration procedures also contribute to the probe's high performance, with each probe being checked at 105 discrete calibration points over its full operating pressure and temperature range. The calibration data is processed by computer to yield coefficients of an equation that describe the relationship between frequency output, applied pressure and temperature.

### Faster Thermal Restabilization

Based on the earlier Model HP 2813B/C, the HP 2813E thermally restabilizes four to ten times faster than the HP 2813B/C. This performance, due to a redesigned mechanical package, shortens costly test time.

### Higher Temperature Range

Improvements in the sensor crystal's processing have increased the probe's temperature range from 302°F to 350°F.

### Rugged and Reliable

Though a precision instrument, the HP 2813E is rugged and reliable in an oil field environment. Housed in a 1 $\frac{1}{8}$  inch OD case made of Nitronic 50 stainless steel, the probe can withstand pressures of up to 12,000 psia and temperatures of up to 350°F.

### Easy to Use and Service

The simplicity of the HP 2813E's mechanical design makes it easy to use and service in the field.

### Quick Factory Service

Your probe receives immediate attention when we receive it. An exchange set of the reference crystal, sensor crystal and electronics pc board is available, reducing repair time to one week. Standard recalibrations and repairs take four weeks or less.

- Rugged and reliable
- Simple operation



HP 2813D Quartz Pressure Set

### Adapt to Your Own Instrumentation System

The reference crystal, sensor crystal and electronics pc board are available as matched components in the HP 2813D Quartz Pressure Set. This enables designing the essential pressure-measuring components of the HP 2813E into your own downhole instrumentation package.

### How It Works

The essential pressure-measuring components of the HP 2813E Quartz Pressure Probe are its sensor crystal, reference crystal and electronics pc board. The sensor crystal, which is in direct fluid communication with the well, changes the frequency of its oscillations in response to pressure. The reference crystal, which is protected from applied pressure, subtracts the effects of temperature changes from the sensor crystal's frequency.

The resulting frequency is then transmitted by the electronics pc board through a center conductor, armored-electric line to an HP 2816A Signal Processor on the surface. This processor conditions the pressure-related signal to drive a frequency counter. The counter's signal can then be converted to a pressure reading when processed with the calibration data in a desktop computer.

The sensor crystal's high resolution is essentially constant and independent of operating pressure and temperature. Its stability minimizes hysteresis and zero drift, thus eliminating the need for frequent recalibration.

### HP 2816A Signal Processor

Specifically designed to process the pressure-related signal from the HP 2813E/D, this processor conditions the signal to drive a frequency counter. The processed output frequency changes about 105 Hz/psi, allowing a resolution of 0.001 psi. It also supplies dc operating power to the probe through a center conductor, armored-electric line.

### HP 2813E/D Specifications

#### Operating Environment

**Calibrated pressure range:** 200-11,000 psi (1,38-75,8 MPa).

**Calibrated temperature range:** 95-350°F (35-177°C).

#### Static Measurement (pressure and temperature are constant)

**Accuracy:**  $\pm 1.0$  psi (6,9 kPa) (due to curve fit error) + 0.01% of actual pressure (due to calibration system error)].

**Repeatability:**  $\pm 1.0$  psi (6,9 kPa) over the entire calibrated pressure and temperature range; or,  $\pm 0.4$  psi (2,76 kPa) over the entire calibrated pressure range with temperature held to a single value.

**Aging:** Error due to aging of sensor and reference crystal pair is typically less than  $\pm 0.5$  psi (3,45 kPa) per year.

**Temperature uncertainty error:**  $(\Delta T) * (0.28 \text{ psi} + 0.02\% \text{ of actual pressure in psi})$  for temperature in degrees F.

**Resolution:** 0.001 psi (6,9 Pa) when sampling for 1 second.

**Sensitivity:** 105 Hz/psi (15,2 Hz/kPa) nominal at output of HP 2816A Signal Processor. The HP 2816A multiplies the incoming signal from the HP 2813E/D by 72 as part of the signal processing.

#### Non-Operating Characteristics (HP 2813E)

**Outside diameter:** 1 $\frac{1}{8}$  in. (37 mm.).

**Length:** 39.3 in. (998 mm.).

**Weight:** 11 lb (5 kg).

**Static Tensile Pull Strength:** >20,000 lb (9070 kg)

**Steel Case Material:** Nitronic 50 high strength.

HP 2813E Quartz Pressure Probe	\$22,900
HP 2813D Quartz Pressure Set	\$17,900
HP 2816A Signal Processor	\$2,700

# PRESSURE & TEMPERATURE

## Quartz Thermometer

### Model 2804A

353

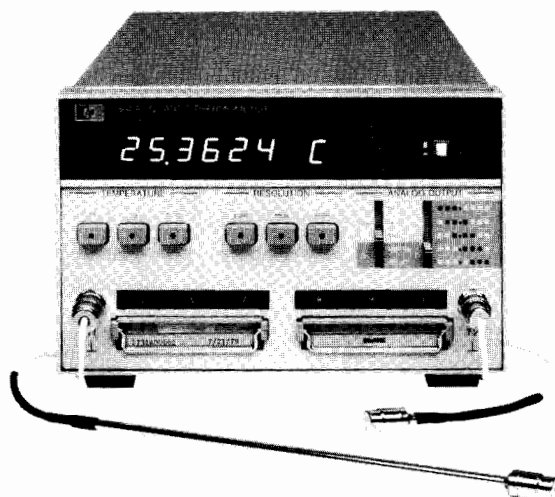

HP 2804A

- $\pm 0.04^{\circ}\text{C}$  absolute accuracy
- $0.0001^{\circ}\text{C}$  or  $0.001^{\circ}\text{F}$  resolution
- $-80^{\circ}$  to  $+250^{\circ}\text{C}$  range
- Display of absolute or differential temperature
- Flexible HP-IB system interface
- Variable resolution analog output
- Easy ice-point or triple-point adjustment



### HP 2804A Quartz Thermometer

The HP 2804A Quartz Thermometer allows you to easily measure temperature with exceptionally high accuracy and resolution. Absolute accuracy is  $\pm 40$  millidegrees Celsius over the range of  $-50^{\circ}\text{C}$  to  $150^{\circ}\text{C}$ , NBS traceable to IPTS-68. The useable resolution of  $0.0001^{\circ}\text{C}$  allows you to measure temperature changes that could not be detected by other digital thermometers.

The HP 2804A can be used with one or two temperature sensing probes. The temperature of either probe, or their difference, can be measured and displayed under pushbutton control. Display resolution is selectable from  $0.01$  to  $0.0001^{\circ}\text{C}$  ( $0.1$  to  $0.001^{\circ}\text{F}$ ) by pushbuttons. An internal switch allows you to easily select measurement in the Celsius or Fahrenheit temperature scale.

Temperature is measured and displayed automatically with the microprocessor and electronics provided in the HP 2804A package. There is no need to balance a bridge, perform calculations using resistance- or voltage-temperature tables or curves, or to use calibration correction tables. The only adjustment necessary to remove effects of thermal history on the sensor is a simple ice point or triple point calibration adjustment using the front panel thumbwheel switches.

### How It Works

The HP 2804A temperature sensor is a quartz crystal whose precise angle of cut gives a stable and repeatable relationship between resonant frequency and temperature. Each quartz sensor is individually calibrated at the factory over the full temperature range. The calibration data for each sensor is processed and stored in a calibration module which is supplied with the probe.

In operation, a microprocessor in the thermometer performs the complex control and calculation operations to accurately measure temperature from the quartz sensor frequency and probe calibration information in the calibration module. The microprocessor also performs self-checks to detect fault conditions. If a problem occurs that would give an improper measurement, an error message is displayed to indicate the source of the problem.

### System Oriented Design

The HP-IB (standard) offers you a simple, yet flexible, way to connect the Quartz Thermometer to either an HP computing controller or printer. Temperature data can easily be sent to a computer for processing and recording. All front-panel controls can be operated automatically by commands sent on the bus.

The analog output (standard) converts any three consecutive digits to a voltage between  $0$  and  $+10$  volts to drive a chart recorder. Front-panel controls allow easy adjustment of pen zero and full scale as well as normal or offset (center-zero) operation. Any three digits can be selected for conversion, allowing you to change the full scale value on the recorder.

### HP 2804A Specifications

#### Performance

**Range:**  $-80$  to  $250^{\circ}\text{C}$ .

**Absolute accuracy:** HP 2804A with HP 18110A, or HP 18111A Quartz Probe —

$\pm 0.040^{\circ}\text{C}$  from  $-50$  to  $150^{\circ}\text{C}$

$\pm 0.075^{\circ}\text{C}$  from  $-80$  to  $250^{\circ}\text{C}$

NBS traceable to IPTS-68

**Resolution:** three levels can be selected:

Level of selection	Resolution		Nominal time between readings in seconds	
	$^{\circ}\text{C}$	$^{\circ}\text{F}$	T1 or T2	T1 - T2
Low	0.01	0.1	0.1	0.2
Medium	0.001	0.01	1	2
High	0.0001	0.001	10	20

#### General

**Display:** 7-digit LED with polarity, decimal, and degree C or F annunciator.

**Probes:** laboratory probes are available for use with the HP 2804A. Refer to the data sheet for specifications and sheath configurations.

#### Power Required

100, 120, 220, or 240 Vac,  $+5\%$ – $10\%$ , 48 to 66 Hz,  $<30$  VA.

#### Accessories and Probes

	Price
HP 18107A External Oscillator	\$490
HP 18110A Laboratory Probe and cal module, 25 mm (1 in.), Opt 001 Extra Prom	\$2300
HP 18111A Laboratory Probe and cal module, 230 mm (9.1 in.), Opt 001 Extra Prom	\$75
Opt 002 Threaded Probe Connector	\$2300
	\$75
	\$50

HP 2804A Quartz Thermometer

\$6600





## SOURCES

<b>Signal Generators.....</b>	<b>356</b>
<b>Sweep Oscillators .....</b>	<b>392</b>
<b>Amplifiers.....</b>	<b>406</b>
<b>Frequency, Function &amp; Waveform</b>	
<b>Synthesizers .....</b>	<b>410</b>
<b>Pulse Generators .....</b>	<b>432</b>
<b>Power Supplies .....</b>	<b>446</b>
<b>Frequency &amp; Time Standards .....</b>	<b>484</b>

## Sources

Many of Hewlett-Packard's products generate an output used as a stimulus in measurement. Examples include a constant or controlled dc voltage, a swept-frequency signal used to test a filter, or a modulated RF or microwave signal used in communications test. These test and measurement instruments include power supplies; signal generators and sweep oscillators; pulse, function and waveform generators; frequency and time standards; and amplifiers.

# SIGNAL GENERATORS

## Signal Generators to 60 GHz

Hewlett-Packard offers the widest selection of high-performance signal sources from dc to 60 GHz. They cover every application range from low-frequency navigation signals, through cellular mobile radio to millimeter-wave satellite systems. Each offers calibrated frequency and level and a wide range of modulation capabilities.

Signal generators can be mechanically tuned, synthesized or more recently, digitally synthesized. Mechanically-tuned generators combine fundamental cavity-tuned oscillators with solid-state circuitry to yield spectrally pure signals with very good spurious performance and low residual FM. Collectively covering a frequency range from 10 kHz to 26.5 GHz (and to 60 GHz with multipliers), synthesized signal generators offer programmability and high frequency stability and accuracy. Modulation capabilities range from AM, FM,  $\phi$ M, and pulse to complex formats such as QPSK, 16- and 64-QAM up to 150 Mbaud.

HP offers three new signal generators, all members of the new Performance Signal Generator Series. The HP 8644A/B, 8645A/B, and HP 8665A/B offer benefits such as selectable performance, greater reliability, modular support strategy and an easier programming language.

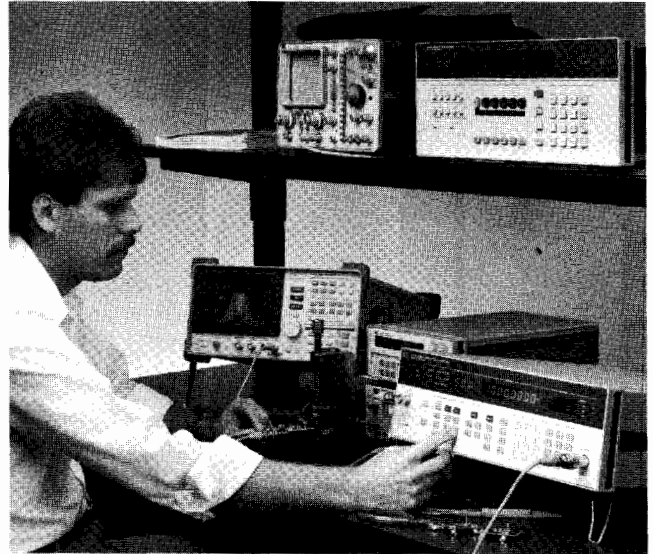

### Signal Generator Summary

Frequency Range	HP Model	Characteristics	Page
dc to 50 MHz	8770A/S Arbitrary Waveform Synthesizer	Simulates highly complex baseband and modulated carriers for radar/EW, communications, disc drive, and other applications. 12-bit resolution, excellent spectral purity, 125 MHz clock rate. HP 11776A Waveform Generation Software runs on HP Technical Desktop Computer.	378
0.5 to 1024 MHz	8640B, 8640B Opt. 004 Signal Generators	Calibrated and leveled output from +19 to -145 dBm. AM, FM, and external pulse modulation. Built-in counter and phase lock capability. Avionics option available (Opt. 004).	375
dc to 1030 MHz dc to 2060 MHz	8644A Synthesized Signal Generator	<-128 dBc/Hz @ 1 GHz SSB phase noise (<-137 dBc optional). <-100 dBc spurious. AM, FM, pulse modulation. Advanced modulation source. <0.05 $\mu$ V leakage.	361
.252 to 1030 MHz .252 to 2060 MHz	8645A Agile Signal Generator	15 $\mu$ sec switching speed. Spectral purity. AM, FM, pulse modulation. FM deviation to 20 MHz. Flexible control of frequency.	363
0.1 to 1057.5 MHz 0.1 to 2115 MHz	8642A, 8642B Synthesized Signal Generators	High spectral purity. 1 Hz frequency resolution. $\pm$ 1 dB absolute output level accuracy. AM, FM, $\phi$ M and pulse. Sweep. 2 hour-On-site repair.	367
0.1 to 990 MHz	8656B Synthesized Signal Generator	$\pm$ 1.0 dB absolute level accuracy from +13 to -127 dBm in 0.1 dB steps. Calibrated AM and FM. Frequency resolution of 10 Hz. Time base aging rate of $\pm$ 2 ppm/year.	357
.1 to 1040 MHz	8657A Synthesized Signal Generator	<-130 dBc/Hz @ 500 MHz SSB phase noise. <-60 dBc spurious. Electronic attenuator. $\pm$ 1 dB level accuracy. AM and FM.	359
0.01 to 1280 MHz	8662A Synthesized Signal Generator	Low close-in noise. 0.1 Hz frequency resolution, $5 \times 10^{-10}$ /day stability. Calibrated and leveled output from +13 to -140 dBm. Digital sweep. Completely HP-IB programmable. AM/FM modulation. Fast switching.	369
0.1 to 2560 MHz	8663A Synthesized Signal Generator	Low close-in noise. 0.1 Hz frequency resolution, $5 \times 10^{-10}$ /day stability. Calibrated and leveled output from +16 to -130 dBm. Digital sweep. Completely HP-IB programmable. AM, FM, $\phi$ M, pulse modulation. Fast switching.	369
0.01 to 110 MHz 1 to 1300 MHz 1 to 2600 MHz	8660D Synthesized Signal Generator	1 Hz frequency resolution, $3 \times 10^{-8}$ /day stability. Calibrated and leveled output from +13 to -146 dBm. HP-IB and BCD programmable. AM, FM, $\phi$ M, pulse modulation. Plug-ins determine frequency range and modulation capability.	372
.1 to 4.2 GHz	8665A Synthesized Signal Generator	Spectral purity to 4.2 GHz. AM and FM. Advanced modulation source.	365
10 to 3000 MHz	8780A Vector Signal Generator	Synthesized signal generator for wideband and complex modulation formats. Digital formats from BPSK to 64 QAM. Vector (quadrature) bandwidths dc to 350 MHz, +10 to -100 dBm.	380
2.3 to 6.5 GHz 5.4 to 12.5 GHz	8683/84 B Signal Generators	High spectral purity, stability. $\pm$ 2.5 dB absolute level accuracy from +10 to -110 dBm. AM, FM standard. High perf. internal pulse modulator and pulse generator. Portable, rugged (19.1 kg).	384
2.3 to 13 GHz 5.4 to 18 GHz	8683/84D Signal Generators	Same as B model except with wideband frequency coverage. DC coupled FM with $\pm$ 10 MHz deviations available. -3dBm standard output power in doubled frequency band. +10 dBm available with option 001.	384
2 to 18 GHz	8671B Synthesized CW Generator	1 to 3 kHz frequency resolution, $5 \times 10^{-10}$ /day stability, +8 to -120 dBm output. Completely HP-IB programmable.	386
2 to 18 GHz	8673E Synthesized Signal Generator	1 to 3 kHz frequency resolution, $1.5 \times 10^{-9}$ /day stability. +8 to -120 dBm output. Pulse, amplitude and frequency modulation. Digital sweep. Completely HP-IB programmable.	387
2 to 18 GHz	8672A Synthesized Signal Generator	1 to 3 kHz frequency resolution, $5 \times 10^{-10}$ /day stability. Calibrated and leveled output from +3 to -120 dBm. Completely HP-IB programmable. Metered external AM and FM.	390
0.01 to 18 GHz	8672S Synthesized Signal Generator	1 to 3 kHz frequency resolution, $5 \times 10^{-10}$ /day stability. Internal pulse modulator. Calibrated and leveled output from +2 to -120 dBm. Metered external AM and FM. Completely HP-IB programmable.	390
0.05 to 18.6 GHz 0.05 to 26.5 GHz	8673C, 8673D Synthesized Signal Generators	Harmonics and sub-harmonics <-60 dBc. 1 to 3 kHz resolution, C-model; 1 to 4 kHz, D-model; +2 to -100 dBm output, C-model; +5 to -100 dBm, D-model. Pulse, amplitude and frequency modulation. Digital sweep. Completely HP-IB programmable.	388
0.01 to 20 GHz	8341B Synthesized Sweeper	1-3 Hz frequency resolution, $1 \times 10^{-9}$ /day stability, +12 to -110 dBm output. Pulse, frequency and amplitude modulation. Continuous analog sweep with spans from 100 Hz to 19.99 GHz. Low harmonic option. Completely HP-IB programmable.	383
2 to 26.5 GHz	8673B Synthesized Signal Generator	1 to 4 kHz frequency resolution, $5 \times 10^{-10}$ /day stability, +8 to -100 dBm output. Pulse, amplitude and frequency modulation. Digital sweep. Completely HP-IB programmable.	388
10 to 3000 Hz	86792A Agile Upconverter	Synthesized generator for IF upconversion applications. In conjunction with HP 8770A/S provides modern multiple signal simulations for system test. Switches in 100 nanosec. Contact HP for more technical information.	382
0.01 to 26.5 GHz	8340B Synthesized Sweeper	1 to 4 Hz frequency resolution, $1 \times 10^{-9}$ /day stability, +12 to -110 dBm output. Pulse, frequency and amplitude modulation. Continuous analog sweep with spans from 100Hz to 26.49 GHz. Completely HP-IB programmable.	383
26.5 to 40 GHz 33 to 50 GHz 40 to 60 GHz	83554A, 83555A, 83556A Millimeter-Wave Source Modules	Effectively extends the performance of an 11 to 20 GHz microwave source 8673B/C/D, 8340, 8341, 8350B) to the millimeter-wave frequency ranges.	403

# SIGNAL GENERATORS

## Synthesized Signal Generator

### Model 8656B

357

- 100 kHz to 990 MHz
- $\pm 1.0$  dB absolute level accuracy
- Amplitude offset and phase adjustment capability
- 150 millisecond frequency switching speed
- Versatile simultaneous modulation including dc FM
- Fully HP-IB programmable

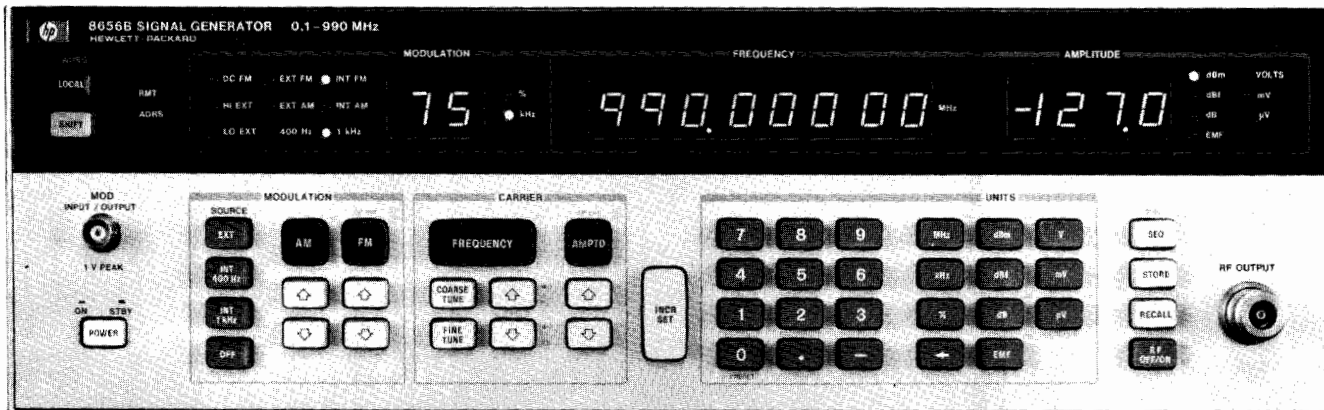

HP 8656B



### HP 8656B Synthesized Signal Generator

The HP 8656B is a programmable synthesized signal generator that offers exceptional value through a powerful combination of performance, quality and economy.

### Communication Band Frequency Coverage

The HP 8656B provides frequency coverage from 0.1 to 990 MHz (with under-range to 10 kHz). This wide range covers the IF and LO frequencies as well as the RF frequencies of most receivers. It also allows testing in a variety of communication systems including the 800 MHz FM mobile band and some telemetry bands. For automated testing, the 150 ms frequency switching speed of the HP 8656B (specified to be within 100 Hz of the final frequency) increases throughput. Frequency resolution of 10 Hz allows convenient setting of increments including narrow channel spacings, while characterization of phase sensitive devices is made easier with the help of the phase increment/decrement feature. The standard internal reference has an aging rate of 2 ppm/year. Improved stability and accuracy can be achieved by adding the optional  $1 \times 10^{-7}$ /day high stability time base (Option 001) or using an external reference of 1, 5 or 10 MHz.

### Precise Output Control

The output attenuator of the HP 8656B has been designed with high volume automatic test system use in mind. The 8656B also features  $\pm 1.0$  dB absolute level accuracy and 0.1 dB resolution for accurate receiver sensitivity tests, circuit characterization and R&D applications. The output levels are calibrated from +13 dBm (over-range to +17 dBm) to -127 dBm and may be set and displayed in any one of 14 convenient units including dBm, volts, dB $\mu$ V or Vemf. The output level can also be offset to compensate for cable and/or other losses external to the generator, or turned on or off with a dedicated key. Shielding keeps leakage at  $< 1.0 \mu$ V for testing RFI susceptible devices, and standard resettable reverse power protection for up to 25 watts guards against accidental damage from transmitters.

### Versatile Modulation

The HP 8656B's modulation capabilities include simultaneous and mixed modulation modes (AM/AM, FM/FM and AM/FM) from internal (1 kHz and 400 Hz) and external sources. AM is ac coupled while FM can be either ac or dc coupled. The new, patented dc coupling technique used in the HP 8656B provides exceptional long term stability ( $< 10$  Hz/hour) and center frequency accuracy ( $\pm 500$  Hz) eliminating the need for retuning in the dc FM mode. For calibrated external modulation, a 1V peak signal is required, and HI/LO annunciators on the HP 8656B indicate when the external signal is within 5% of the correct amplitude.

### Ease of Operation For Improved Productivity

The HP 8656B is designed for efficient operation in a bench environment. Features such as being able to change Frequency, Modulation and Level without having to access "hidden" displays or menus will streamline your testing. Additionally, the Frequency, Modulation and Level functions each have their own UP/DOWN arrow keys for rapid front-panel setup and tuning.

Up to ten complete front-panel setups can be stored in the HP 8656B's memory for recall during testing. These setups can be accessed sequentially by pushing one front-panel key or by using the rear-panel SEQ port. (The SEQ port can be connected to a foot switch or other operator-controlled device.)

### Programmability for High Volume Testing

Full HP-IB programmability is standard with the HP 8656B. Each programming command has an easy-to-remember, two-character, alpha-numeric HP-IB code. All functions are quickly and easily programmed using the same function/data/units format used on the front panel.

Additionally, the HP 8656B program codes are 100% upwards compatible with the new HP 8657A Synthesized Signal Generator. This provides you with even more flexibility in system configuration without having to modify any program code.

# SIGNAL GENERATORS

## Synthesized Signal Generator (cont'd)

### Model 8656B

#### HP 8656B Specifications

##### Frequency

**Range:** 100 kHz to 990 MHz (8 digit LED display).  
**Frequency underrange:** 10 kHz with uncalibrated output.  
**Resolution:** 10 Hz.  
**Accuracy and stability:** same as internal time base.

##### Time Base Characteristics

Typical Characteristics	Standard Time Base	Option 001 Time Base
Aging Rate	$\pm 2$ ppm/year	$1.5 \times 10^{-8}$ /day
Frequency	50 MHz	10 MHz
External Reference Input (rear panel)	Accepts any 1, 5, or 10 MHz ( $\pm 0.002\%$ ) frequency standard at a level $> 0.15$ Vrms into 50 ohms.	

**Frequency switching speed (to be within 100 Hz of final frequency):**  $< 150$  ms.

**Phase Offset:** adjustable via HP-IB or from the front panel in nominal 1 degree increments.

##### Spectral Purity

##### Spurious Signals ( $\leq +7$ dBm output levels)

**Harmonics:**  $< -30$  dBc.  
**Non-harmonic spurious (greater than 5 kHz from carrier in CW mode):**  $< -60$  dBc.  
**Sub-harmonics:** none.

##### Residual FM

Post Detection Noise Bandwidth	Frequency Range (MHz)			
	0.1 to 123.5	123.5 to 247	237 to 494	494 to 990
0.3 to 3 kHz	$< 7$ Hz rms	$< 2$ Hz rms	$< 4$ Hz rms	$< 7$ Hz rms
0.05 to 15 kHz	$< 15$ Hz rms	$< 4$ Hz rms	$< 8$ Hz rms	$< 15$ Hz rms

**Residual AM (0.05 to 15 kHz post detection noise bandwidth):** 0.025%.

##### SSB Phase Noise (CW only)

Offset from Carrier	0.1 to 123.5 MHz (dBc/Hz)	123.5 to 247 MHz (dBc/Hz)	247 to 494 MHz (dBc/Hz)	494 to 990 MHz (dBc/Hz)
20 kHz	$< -114$	$< -126$	$< -120$	$< -114$

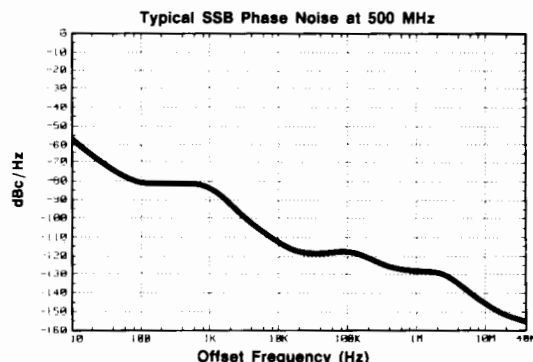

##### Output

**Level range (into 50 ohms):** 13 dBm to  $-127$  dBm (3½ digit LED display; uncalibrated output to 17 dBm).

**Resolution:** 0.1 dB.

**Absolute level accuracy:**  $< \pm 1.0$  dB; 123.5 to 990 MHz  $< \pm 1.5$  dB;  $f_c < 123.5$  MHz, levels  $> +7$  dBm and  $< -124$  dBm.

**Level flatness (100 kHz to 990 MHz):**  $\pm 1.0$  dB at an output level setting of 0.0 dBm.

**Reverse power protection:** protects signal generator from application of up to 25 watts (from a 50Ω source) of RF power to 990 MHz into generator output; dc voltage cannot exceed 25V.

##### Amplitude Modulation (2 digit LED display)

**AM depth<sup>1</sup>:** 0 to 99% to  $+7$  dBm and 0 to 30% to  $+10$  dBm.

**Resolution:** 1%.

**AM rate:** internal 400 Hz and 1 kHz,  $\pm 3\%$ ; external (1 dB bandwidth), 20 Hz to 40 kHz.

**AM distortion (at internal rates):**  $< 1.5\%$ , 0-30% AM;  $< 3\%$ , 31-70% AM;  $< 4\%$ , 71-90% AM.

**Indicator accuracy (for depths  $< 90\%$  internal rates and levels  $< +7$  dBm):**  $\leq \pm(2\% + 4\%$  of reading).

**Incidental phase modulation (at 30% AM depth and internal rates):**  $< 0.3$  radian peak.

##### Frequency Modulation (2 digit LED display)

##### FM Peak Deviation

Center Frequency	Maximum Peak Deviation	
	AC Mode	DC Mode
0.1 to 123.5 MHz	The lesser of 99 kHz or 4000 x rate (Hz)	99 kHz
123.5 to 247 MHz	50 kHz or 1000 x rate (Hz)	50 kHz
247 to 494 MHz	99 kHz or 2000 x rate (Hz)	99 kHz
494 to 990 MHz	99 kHz or 4000 x rate (Hz)	99 kHz
FM not specified for $f_c - (\Delta f_{pk}) < 100$ kHz		

**Resolution:** 100 Hz for deviations less than 10 kHz; 1 kHz for deviations greater than 10 kHz.

**FM rate:** internal 400 Hz and 1 kHz,  $\pm 3\%$ ; external (1 dB BW), dc coupled, dc to 50 kHz; ac coupled, 20 Hz to 50 kHz.

**Center frequency accuracy in dc FM mode:**  $< \pm 500$  Hz.

**Center frequency stability in dc FM mode:**  $< 10$  Hz/hour.

**FM distortion (internal rates and  $\geq 3$  kHz peak deviations):**  $< 0.5\%$ .

**Indicator accuracy<sup>1</sup>:**  $\pm 5\%$  of reading at internal rates.

**Incidental AM (for center frequency  $\geq 500$  kHz, peak deviation  $< 20$  kHz and internal rates):**  $< 0.1\%$ .

##### Remote Programming

**Interface:** HP-IB (Hewlett-Packard's implementation of IEEE - 488).

**HP-IB interface functions:** SH0, AH1, T0, L2, SR0, RL1, PP0, DC1, DT0, C0 and E1. (For more on these codes, refer to the HP-IB section of this catalog.)

##### General

**Operating temperature range:**  $0^\circ$  to  $+55^\circ$  C.

**Leakage:** conducted and radiated interference is within the requirements of methods RE02 of MIL STD 461B, FTZ 1115. Furthermore, RF leakage of less than  $1.0 \mu\text{V}$  is induced in a two-turn loop, 2.5 cm in diameter, held 2.5 cm away from the front surface.

**Power requirements:** 100, 120, 220, or 240 Vac;  $+5\%$ ,  $-10\%$ ; 48 to 440 Hz, 125 VA maximum.

**Weight:** net, 18.2 kg (40 lb); shipping, 23.6 kg (52 lb).

**Size:** 133 H x 425 W x 520 mm D (5.25" x 16.75" x 20.5"). HP System II module size: 5¼ H x 1 MW x 17 D. For cabinet accessories, see page 748.

**Rack slides and transit case:** HP part numbers are: slide kit, 1494-0018; tilt slide kit, 1494-0025; full module transit case, 9211-2661.

##### Ordering Information

HP 8656B Signal Generator	Price
Opt 001 High stability time base	\$6,250 + \$865
Opt 002 RF connectors on rear panel only	+ \$180
Opt 907 Front handle kit (5061-9689)	+ \$55
Opt 908 Rack flange kit (5061-9677)	+ \$33.50
Opt 909 Rack flange and front handle kit (5061-9683)	+ \$82.50
Opt W30 2 years additional hardware service	+ \$150
Opt 910 2 sets of operational/calibration (08656-90204) and service manuals (08656-90205)	+ \$350
Opt 915 Service manual (08656-90205) supplied with instrument	+ \$150

<sup>1</sup>AM depth and FM deviation are further limited by Indicator Accuracy specifications.

# SIGNAL GENERATORS

## Synthesized Signal Generator

### Model 8657A

359

- 100 kHz - 1040 MHz frequency coverage
- -130 dBc/Hz SSB phase noise at 20 kHz offsets
- Fully HP-IB programmable
- Solid-state output attenuator
- $\pm 1$  dB absolute level accuracy (typically  $\pm 0.5$  dB)
- Versatile, simultaneous AM/FM modulation

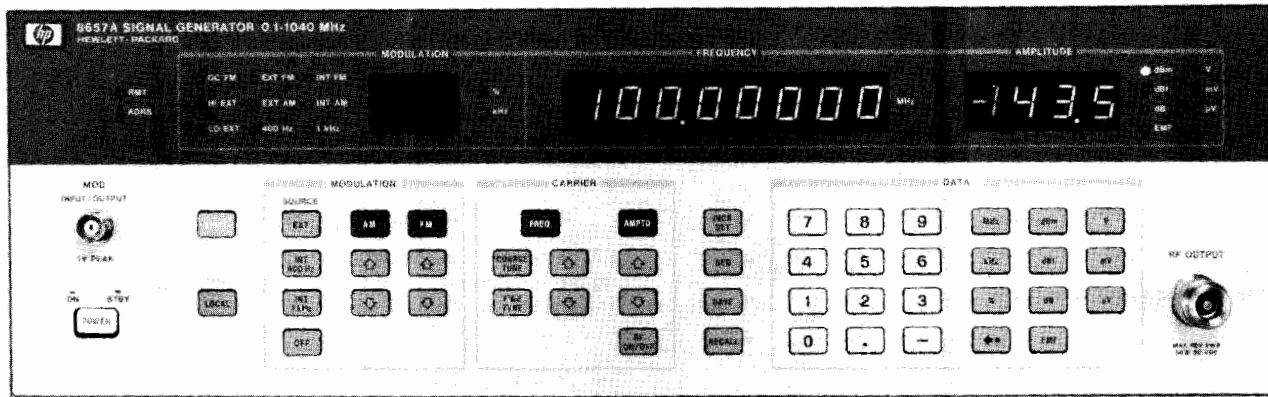

HP 8657A



### HP 8657A Synthesized Signal Generator

The HP 8657A is a 100 kHz to 1040 MHz synthesized signal generator that offers truly outstanding performance at an economical price. The HP 8657A gives enhanced performance above the HP 8656B signal generator to form a complementary set of low cost/high performance RF signal generators from Hewlett-Packard.

#### Spectral Purity for Demanding Applications

The HP 8657A provides excellent phase noise performance across its full 100 kHz to 1040 MHz range. When characterizing an RF receiver, the SSB phase noise of the HP 8657A ( $-130$  dBc/Hz at 500 MHz), provides the performance for almost all measurements requiring test signals at adjacent or out-of-channel offsets.

Additionally, due to a new oscillator design, the HP 8657A has a residual FM specification of  $< 4$  Hz rms (typically  $< 2$  Hz rms) when measured in a 300 Hz to 3 kHz detection bandwidth. Lower residual FM means lower measurement uncertainty in key measurements such as: distortion, signal-to-noise, and hum and noise.

Nonharmonic spurious performance is worst case  $< -60$  dBc with no subharmonics across the full frequency range of the HP 8657A.

#### RF Output with Electronic Attenuator

The HP 8657A has a patented, solid-state attenuator that provides accurate output levels to  $\pm 1.0$  dB (typically  $\pm 0.5$  dB). The electronic attenuator has an estimated 3 million hour MTBF (Mean Time Between Failures) yielding an estimated 0.2% failure rate. The HP 8657A instrument is backed with a 5-year warranty against attenuator failure, providing you with the highest level of insurance for trouble free performance.

The HP 8657A provides high RF output power (+13 dBm with over-range to +17 dBm) for driving mixers and overcoming cable losses without the use of an external amplifier. The unique RF leveling-loop design also lowers intermodulation distortion to typically better than  $-50$  dBc. Reverse power protection is provided standard for protection up to 50 watts and 50 Vdc.

#### Versatile Modulation

The HP 8657A can combine modulation modes for AM+AM, FM+FM, and AM+FM from both internal and external modulation sources. Like the HP 8656B, the HP 8657A has ac coupled AM and ac/dc coupling for FM.

The patented dc coupling technique provides excellent long term stability ( $< 10$  Hz/hour drift) as well as center frequency accuracy ( $\pm 500$  Hz worst case). When dc FM is enabled, SSB phase noise and residual FM performance are not degraded as with other generators. DC FM can allow the HP 8657A to be used as an ideal VCO in a design application or to be used to faithfully reproduce digital squelch tones when modulating the carrier signal.

### Designed for Ease of Operation

The HP 8657A contains many features that streamline operation in both the manual/bench or ATE environments. The easy-to-use front panel, for example, has up/down arrow keys to control frequency, amplitude, and modulation independently. Up to 100 of your front panel settings can be stored in non-volatile storage registers with recall capability through the numeric keypad or sequentially with the SEQ key. Sequencing through the storage registers can also be done by attaching a momentary contact switch to the rear panel SEQ port of the HP 8657A for remote sequence control by, for example, a foot switch.

The HP 8657A is designed for ATE applications with its  $< 130$  ms switching speed for high throughput in a production environment. Like the HP 8656B, the HP 8657A's programming codes are easy to remember (silk-screened on the front panel) and to implement.

The HP-IB program codes for the HP 8656B are 100% upwards compatible with the HP 8657A. This provides you with maximum flexibility when considering upgrading your system from the HP 8656B to the enhanced performance of the HP 8657A.

### HP 8657A Specifications

#### Frequency

**Range (8 digit display):** 100 kHz to 1040 MHz. Underrange to 10 kHz with uncalibrated level and modulation.

**Resolution:** 10 Hz.

**Display resolution:** 10 Hz (100 Hz,  $f_c > 1000$  MHz).

**Switching speed** (to be within 100 Hz of final frequency):  $< 130$  ms.

**Accuracy and stability:** Same as time base used.

#### Typical Timebase Characteristics

	Standard	Option 001
Aging rate	$\pm 2$ ppm/year	$1.5 \times 10^{-8}$ /day
Temperature (0-55° C)	$\pm 10$ ppm	$7 \times 10^{-9}$
Line Voltage	—	$2 \times 10^{-9}$ (+5%, -10%)
Frequency	50 MHz	10 MHz
Timebase Reference Signal (Rear Panel)	Available at a level of $> 0.15 V_{RMS}$ into 50 $\Omega$ . (Output of 10, 5 or 1 MHz is selectable via internal jumper). If external reference is used, output will be the same frequency.	
External Reference Input (Rear Panel)	Accepts any 10, 5 or 1 MHz ( $\pm 0.002\%$ ) frequency standard at a level $> 0.15 V_{RMS}$ into 50 $\Omega$ .	



# SIGNAL GENERATORS

## Synthesized Generator (cont'd)

Model 8657A

### Spectral Purity

**Spurious Signals ( $\leq +7$  dBm Output Levels)**

**Harmonics:**  $< -30$  dBc.

**Sub-harmonics:** none.

**Non-harmonics (CW mode, 5 kHz - 2 MHz offsets):**

–60 dBc,  $f_c$ : 0.1 - 130 MHz and 520 - 1040 MHz;

–66 dBc,  $f_c$ : 260 - 520 MHz;

–72 dBc,  $f_c$ : 130 - 260 MHz.

**Residual FM (in CW mode):**

Frequency Range	Post Detection BW (rms detector)	
	300 Hz to 3 kHz	50 Hz to 15 kHz
0.1- 130 MHz	4 Hz	6 Hz
130- 260 MHz	1 Hz	1.5 Hz
260- 520 MHz	2 Hz	3 Hz
520-1040 MHz	4 Hz	6 Hz

**Residual AM (50 Hz to 15 kHz BW in CW mode):**  $< 0.04\%$  AM.

**SSB phase noise (in CW mode):**

Carrier Frequency	SSB $\beta$ -Noise 20 kHz Offset
0.1 to 130 MHz	$< -124$ dBc/Hz
130 to 260 MHz	$< -136$ dBc/Hz
260 to 520 MHz	$< -130$ dBc/Hz
520 to 1040 MHz	$< -124$ dBc/Hz

Typical HP 8657A SSB Phase-Noise at 500 MHz

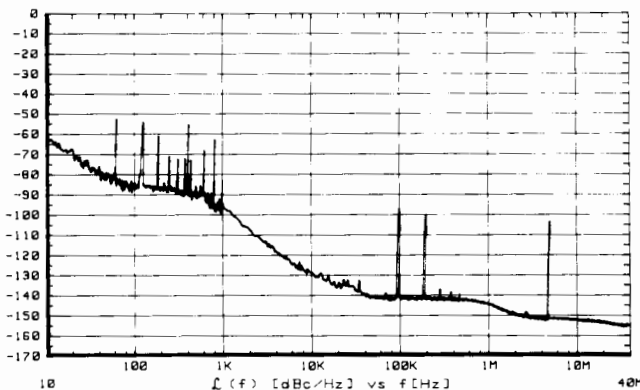

### Output

**Level range (3 1/2-digits):** +13 dBm to –143.5 dBm into 50 $\Omega$ , +10 dBm to –143.5 dBm for frequencies from 100 kHz to 1 MHz.

**Resolution:** 0.1 dB.

**Absolute level accuracy<sup>1</sup>:**  $< \pm 1.0$  dB, +7 to –127 dBm;  $< \pm 1.5$  dB,  $> +7$  dBm.

**Typical absolute level accuracy:**  $< \pm 1.5$  dB, output levels  $< -127$  dBm;  $< \pm 0.5$  dB, 25° C  $\pm 10^\circ$  C, +7 to –127 dBm.

**Level flatness (0.1 - 1040 MHz):**  $< \pm 0.5$  dB, at 0 dBm.

**SWR ( $f_c \geq 400$  kHz):**  $< 1.5$ , level  $< -3.5$  dBm;  $< 2.0$ , level  $\leq +13$  dBm.

**Reverse power protection:** protection up to 50W from a 50 $\Omega$  source. DC voltage cannot exceed 50V.

### Amplitude Modulation

**AM depth (2-digit display):** 0 to 99%, level  $\leq +7$  dBm,  $f_c \geq 400$  kHz. 0 to 30%, level  $\leq +10$  dBm,  $f_c \geq 400$  kHz<sup>2</sup>.

**Resolution:** 1%.

**AM rate, internal:** 400 Hz and 1 kHz,  $\pm 2\%$ . External: 20 Hz to 40 kHz (1 dB bandwidth, AC coupled).

**AM distortion (at internal rates):**  $< 1.5\%$ , 0 to 30% AM;  $< 3.0\%$ , 30 to 70% AM,  $< 4.0\%$ , 70 to 90% AM.

**Indicator accuracy** (for depths  $< 90\%$  and internal rates and levels  $< +7$  dBm):  $< \pm(2\% + 6\%$  of setting).

**Incidental  $\theta$ M** (at 30% AM, internal rates):  $< 0.3$  radians peak.

<sup>1</sup> Absolute level accuracy includes allowances for output linearity, temperature, flatness, attenuator accuracy and measurement error.

<sup>2</sup> 0 - 30% for  $f_c < 400$  kHz, levels  $\leq +7$  dBm.

### Frequency Modulation

**Maximum FM peak deviation (2-digit LED display):**

Center Frequency	Maximum Peak Deviation	
	AC Mode (the lesser of)	DC Mode
0.1- 130 MHz	99 kHz or 4000 $\times$ rate (Hz)	99 kHz
130- 260 MHz	50 kHz or 1000 $\times$ rate (Hz)	50 kHz
260- 520 MHz	99 kHz or 2000 $\times$ rate (Hz)	99 kHz
520-1040 MHz	99 kHz or 4000 $\times$ rate (Hz)	99 kHz

FM not specified for  $f_c - (\Delta f_{pk}) < 100$  kHz.

**Resolution:** 100 Hz, dev.  $< 10$  kHz; 1 kHz, dev.  $\geq 10$  kHz.

**FM rate:** Internal: 400 Hz and 1 kHz,  $\pm 2\%$ . External: dc/5 Hz - 100 kHz, 3 dB BW; dc/20 Hz - 50 kHz, 1 dB BW.

**Center frequency accuracy in DC mode:**  $< \pm 500$  Hz.

**Center frequency stability in DC mode:**  $< 10$  Hz per hour.

**FM distortion (at internal rates, pk. dev.  $\geq 3$  kHz)<sup>3</sup>:**  $< 0.5\%$ .

**Indicator accuracy (internal rates):**  $< \pm 5\%$  of setting.

**Incidental AM** (dev.  $< 20$  kHz, 400 and 1 kHz,  $f_c \geq 500$  kHz):  $< 0.1\%$ .

### Remote Programming

**Interface:** HP-IB (Hewlett-Packard's implementation of IEEE Standard 488).

**HP-IB functions:** SH0, AH1, T0, L2, SR0, RL1, PP0, DC1, DT0, C0, E1.

### General

**Operating temperature:** 0 to +55°C.

**Storage temperature:** –55 to +75°C.

**Leakage:** Conducted and radiated interference is within the requirements of RE02 of MIL STD 461B, and FTZ 1046. Furthermore, RF leakage of  $< 1 \mu$ V is induced in a two-turn loop, 2.5 cm in diameter, held 2.5 cm away from the front surface (typically  $< 0.05 \mu$ V,  $f_c \leq 500$  MHz).

**Save/recall/sequence storage registers:** 100 non-volatile registers are available that save front panel settings.

**Power requirements:** 100, 120, 220, or 240V (+5%, –10%) from 48 to 440 Hz, 175 VA maximum.

**Weight:** net 18.2 kg (40 lb); shipping 23.6 kg (52 lb).

**Size:** 133H  $\times$  425W  $\times$  520 mmD (5.25"  $\times$  16.75"  $\times$  20.5").

**HP System II module size:** 5/4 H  $\times$  1 MW  $\times$  17D.

### Accessories Available

HP 11721A Frequency Doubler extends HP 8657A range to 2080 MHz.

HP 11687A 50-75 $\Omega$  adapter is recommended for 75 $\Omega$  systems.

Transit case, HP 9211-2655 provides protection in transportation.

Rack slide kit, HP 1494-0060 allows easy access in a system.

HP 8347A 100 kHz - 3 GHz, +2 to +20 dBm RF amplifier.

### Ordering Information

Part Number	Description	Price
HP8657A	Synthesized Signal Generator <sup>3</sup>	\$7,900
Opt 001	High stability timebase	+\$865
Opt 002	RF connections on rear panel only	+\$180
Opt 907	Front handle kit (5061-9689)	+\$55
Opt 908	Rack flange kit (5061-9677)	+\$33
Opt 909	Rack flange kit and front handle kit (5061-9683)	+\$80
Opt 910	2 sets of operation/calibration (08657-90003) and service manuals (08657-90004)	+\$350
Opt 915	Service manual supplied with instrument	+\$150
Opt W30	2 years additional hardware service	+\$150

<sup>3</sup> Power cable and operating manual supplied. HP-IB cables are not provided.

- 252 kHz to 2060 MHz frequency range
- -137 dBc/Hz phase noise at 20 kHz offset, 1 GHz carrier
- -100 dBc/Hz nonharmonic spurious

- Internal modulation source for complex waveforms
- Options to configure for specific applications
- On-site repair and calibration
- Optional electronic attenuator

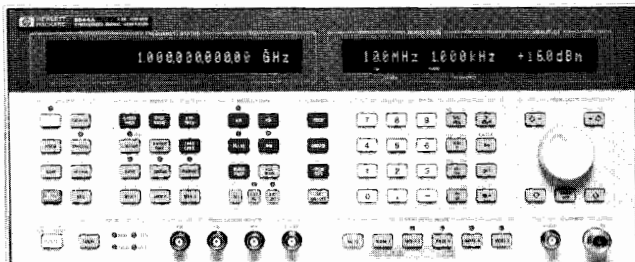

HP 8644A



### HP 8644A Synthesized Signal Generator

The HP 8644A Synthesized Signal Generator is a high performance, 252 kHz to 2060 MHz generator that provides excellent spectral purity for confidence in RF measurements. For R&D or stringent testing of communications equipment, the low phase noise and low spurious provide the measurement margin necessary for repeatability and accuracy.

The HP 8644A is a modular platform that can be configured for specific applications. Performance like spectral purity, frequency range, leakage, and modulation capabilities can all be enhanced with options to the standard instrument to match the signal generator with the application.

#### Superior Spectral Purity

For receiver testing or RF design, the HP 8644A provides both low phase noise and low nonharmonic spurious. At 20 kHz offset, 1 GHz carrier, specified phase noise is -128 dBc/Hz standard or -137 dBc/Hz with Option 004. With spurious specified at <-100 dBc, these unwanted signals will not interfere with the measurement results.

#### High Performance Modulation

For receiver measurements the HP 8644A offers AM, FM, and pulse modulation. FM deviations up to 20 MHz combined with specified rates to 100 kHz can test most communication receivers. AM performance includes 0-100% depth and rates to 100 kHz.

#### Advanced Internal Modulation Source

The standard HP 8644A internal source has four modulation tones of 300, 400, 1k, and 3 kHz. Option 007, an optional modulation synthesizer, is available for complex waveforms with frequency coverage from 0.1 Hz to 400 kHz. This source uses digital synthesis to generate waveforms of sine, sawtooth, squarewave, and white Gaussian noise; all with variable frequency, amplitude, and relative phase. The source has the ability to generate four waveforms simultaneously and combine them together with summation and modulation. These complex waveforms are available externally and can be used to extend the frequency range of the HP 8644A down to .1 Hz with complete AM/FM/PM and pulse.

#### Lowest Specified Leakage of Any Signal Generator

The standard HP 8644A has typical leakage of <1 μV induced in a two-turn loop, which is sufficient for most R&D or production testing. For sensitive measurements, Option 010, a low leakage configuration, provides more RF shielding and has leakage specified at <0.05 μV.

#### On-Site Repair and Calibration

The HP 8644A contains its own firmware and hardware for cali-

bration, troubleshooting, and monitoring instrument performance. Built-in sensors continually monitor internal voltages to notify the user of temperature drift, hardware failures, or the need for recalibration. When hardware failures do occur, internal firmware uses these sensors to find a defective module or cable and instruct the operator which hardware to replace. The recommended calibration cycle for the HP 8644A is 3 years.

### HP 8644A Specifications

#### Frequency

**Range:** 251.46485 kHz to 1030 MHz; 251.46485 kHz to 2060 MHz with Opt 002. See Optional Internal Modulation Source for coverage below 252 kHz.

**Frequency bands:** The exact endpoints of each frequency band can be determined by dividing the 1030 to 2060 MHz band by two for each band decrease. The specifications use approximate endpoints.

**Stability, Opt 001:** <5X10<sup>-10</sup>/day aging after 10 day warm-up.

#### Spectral Purity

##### Phase noise (CW, AM, or FM<sup>1</sup> operation)

##### Standard/Option 004

Carrier Frequency (MHz)	Offset Frequency		
	1 kHz (dBc/Hz)	20 kHz (dBc/Hz)	100 kHz (dBc/Hz)
1030 - 2060	-84/-94	-121/-131	-131/-141
515 - 1030	-91/-101	-128/-137	-138/-144
257 - 515	-96/-106	-134/-143	-141/-145
128 - 257	-101/-111	-138/-145	-142/-145
64 - 128	-106/-116	-140/-145	-144/-145
32 - 64	-111/-121	-142/-145	-145/-145
16 - 32	-117/-127	-144/-145	-145/-145
8 - 16	-120/-130	-145/-145	-145/-145
4 - 8	-125/-135	-145/-145	-145/-145
2 - 4	-129/-135	-145/-145	-145/-145
1 - 2	-133/-135	-145/-145	-145/-145
0.5 - 1	-137/-135	-145/-145	-145/-145
0.25 - 0.5	-140/-135	-145/-145	-145/-145

#### Spurious Signals

**Harmonics:** -30 dBc, output <+8 dBm; -25 dBc, 1030 to 2060 MHz, output <+8 dBm.

**Subharmonics:** none, 0.25 to 515 MHz; <-60 dBc, 515 to 1030 MHz; <-40 dBc, 1030 to 2060 MHz.

**Nonharmonics:** <-100 dBc, >15 kHz offset, 0.25 to 1030 MHz; <-94 dBc, >15 kHz offset, 1030 to 2060 MHz.

#### Residual FM<sup>2</sup> (CW, AM, FM<sup>3</sup> operation)

##### Standard/Option 004

Carrier Frequency (MHz)	Post Detection Bandwidth	
	0.3 to 3 kHz (Hz rms)	0.05 to 15 kHz (Hz rms)
0.25- 257	<1 / <.5	<1.2/ <.5
257- 515	<1.2/ <.5	<2 / <1
515- 1030	<2 / <1	<4 / <2
1030- 2060	<4 / <2	<8 / <4

<sup>1</sup> FM at 1% maximum specified deviation for offsets >1 kHz, FM at minimum deviation for offsets <1 kHz.

<sup>2</sup> Specified for 40 to 63 Hz power line. Typical for 400 Hz power line.

<sup>3</sup> Deviation <0.1% of maximum available.

# SIGNAL GENERATORS

## Synthesized Signal Generator (cont'd)

Model 8644A

### Typical SSB phase noise and spurs at 1 GHz.

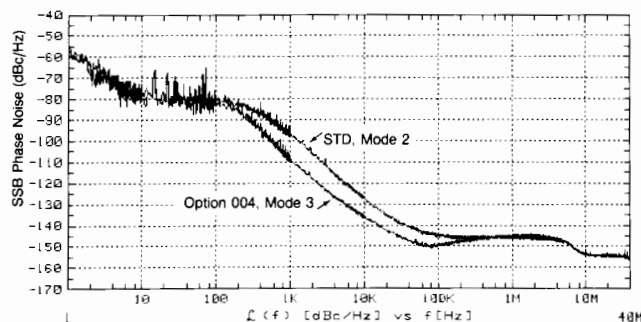

**Residual AM:** <0.01% AM rms, 0.3 to 3 kHz post detection bandwidth.

### Output

**Maximum level:** +16 dBm, 0.25 to 1030 MHz; +13 dBm with Opt 005; Opt 002: +14 dBm, 0.25 to 1030 MHz; +13 dBm, 1030 to 2060 MHz.

**Minimum level:** -137 dBm; resolution 0.1 dB.

**Absolute accuracy:**  $\pm 1$  dB, output  $> -127$  dBm.

**Reverse power protection:** 50W from a 50 $\Omega$  source, 25 Vdc.

**Typical third order intermodulation:**  $< -50$  dBc, outputs  $< 8$  dBm.

**Typical output level overrange:** 2 dB more than maximum level.

**Typical SWR:**  $< 1.7:1$ , output  $< -2$  dBm.

### Modulation

**External modulation inputs:** AC or DC, 600 $\Omega$ . Pulse, DC only.

### Amplitude Modulation

**AM depth:** 0 to 100%, for output  $< +7$  dBm. 0.1% resolution.

**AM Indicator accuracy:**  $\pm(6\%$  of setting  $+1\%)$ , up to 90% depth, 1 kHz rate.

### AM distortion, at 400 Hz and 1 kHz rates:

Depth	0.25 - 1030 MHz	1030 - 2060 MHz
0 - 70%	3%	4%
70 - 90%	5%	6% AM

**3 dB bandwidth:**  $> 5$  kHz, 0.25 to 8 MHz.  $> 50$  kHz, 8 to 128 MHz;  $> 100$  kHz, 128 to 2060 MHz.

### Frequency Modulation

**FM deviation range:** 20 MHz for carriers from 1030 to 2060 MHz. Maximum deviation divides in half for each carrier band lower.

**FM maximum rate:**

100 kHz, 8-2060 MHz	19.5 kHz, 1-2 MHz
78 kHz, 4-8 MHz	9.7 kHz, .5-1 MHz
39 kHz, 2-4 MHz	4.8 kHz, .25-.5 MHz

### FM indicator accuracy:<sup>4</sup>

Accuracy	% of Deviation	Rates
5%	$\leq 10\%$	0-30 kHz
10%	$\leq 10\%$	0-100 kHz
12%	100%	0-30 kHz

### FM distortion, rates 20 Hz to 100 kHz:

FM Deviation	Standard
0-5%	3%
5-100%	5%

**Carrier frequency accuracy in FM:**  $\pm 0.5\%$  of FM deviation setting.

<sup>4</sup> Accuracy for rates that do not exceed maximum rate.

### Pulse Modulation

**On/off ratio:**  $> 35$  dB;  $> 80$  dB for 1030 to 2060 MHz.

**Rise fall time:**  $< 100$  nsec, between 10% and 90% response points.

**Maximum pulse repetition frequency:** 1 MHz.

**Minimum pulse width:** 0.5  $\mu$ sec.

### Internal Modulation Source

**Rates:** .3, .4, 1, 3 kHz. Accuracy  $\pm 5\%$ .

### Optional Internal Modulation Source

**Frequency range:** 0.1 Hz to 400 kHz; 0.1 Hz resolution.

**Maximum output level:** 0 to 2  $V_{pk}$  into 600  $\Omega$ ; 2 mV resolution.

### Frequency Sweep

#### Phase continuous sweep

**Sweep type:** linear, phase continuous.

**Sweep time:** 20 msec to 10 sec.

**Maximum sweep span:** twice maximum FM deviation.

#### Digitally Stepped Sweep

**Sweep type:** linear or log, frequency stepped.

### Remote Programming

**Interface/language:** HP-IB/HP-SL (Hewlett-Packard Systems Language)

### General

**Power requirements:**  $\pm 10\%$  of 100, 120, 220, or 240V; 48 to 440 VA maximum.

**Operating temperature range:** 0 to 55°C.

**Storage temperature range:** -55 to +75°C.

**Leakage:** Typical leakage is  $< 1$   $\mu$ V induced in a two-turn loop 1 inch from any surface with output level  $< 0$  dBm;  $< 0.05$   $\mu$ V with Opt 010.

**Calibration interval:** 3 years (MTBC).

**Storage registers:** 10 full function and 40 frequency/amplitude registers.

**Weight:** net, 26 kg (57 lb); shipping, 37 kg (81 lb).

**Size:** 178H x 425W x 648 mmD (7" x 16.75" x 23.5"). Opt 010 adds 35 mm (1.4 in.) to the depth.

### Ordering Information

	Price
HP 8644A Synthesized Signal Generator	\$17,000
Opt 001 High stability time base	+\$1,500
Opt 002 2 GHz doubled output	+\$7,000
Opt 003 RF connectors on rear panel only	+\$400
Opt 004 Enhanced spectral purity	+\$4,000
Opt 005 Electronic attenuator	+\$500
(5 year warranty on attenuator, cannot be used with Opt 002)	
Opt 007 Synthesized audio oscillator	+\$1,000
Opt 010 Reduced leakage configuration	+\$1,000
Opt 011 Transit case (9211-2662)	+\$300
(includes handles and wheels)	
Opt 907 Front handle kit (5061-9690)	+\$65
Opt 908 Rack flange kit (5061-9678)	+\$35
Opt 909 Combined front handle/rack flange kit (5061-9684)	+\$90
Opt 910 Extra manual set (includes service manual)	+\$190
Opt 915 Add service manual	+\$65
Opt W03 90 day on-site warranty	NC
(instead of standard 1 year return to Hewlett-Packard)	
Opt W30 2 years additional hardware support	+\$380
1494-0059 Rack slide kit	\$100
08645-61116 Service kit	\$500

# SIGNAL GENERATORS

## Synthesized Signal Generator

### Model 8645A

363

- 252 kHz to 2060 MHz frequency range
- 15  $\mu$ sec frequency switching
- Stand alone control of frequency agility

- Specified performance while fast hopping
- FM rates to 10 MHz, deviations to 20 MHz
- Low spurious and phase noise

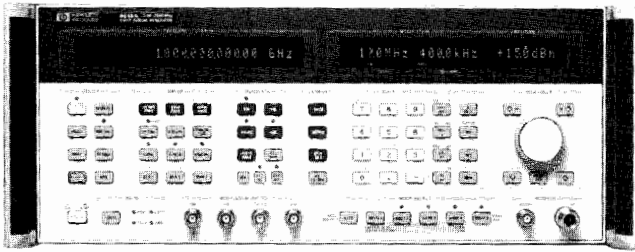

HP 8645A



### HP 8645A Agile Signal Generator

The HP 8645A Agile Signal Generator combines high performance with frequency agility for new fast-switching test requirements. These capabilities are important for performance testing of such devices as frequency agile radios and surveillance receivers. Besides extending traditional receiver testing to agile applications, the HP 8645A can be used to create complex signal simulations involving several modulation types and frequency agility. These complex RF signals can quantitatively exercise a receiver's vulnerability to a jamming transmission. The HP 8645A can also be a fast-switching stimulus needed to decrease production test times. The high performance and frequency agility of the HP 8645A provide capability for both static and agile test requirements with just one calibrated signal generator.

#### Specified Agile Performance

The HP 8645A provides specified signal performance in both static and agile operation. Fully-synthesized outputs with high timebase accuracy are standard when not frequency hopping. The Fast Hop mode activates a frequency-lock loop to allow frequency switching as fast as 15  $\mu$ sec from 128 to 2060 MHz. Over the frequency range of 8 to 2060 MHz, the fastest switching time is 85  $\mu$ sec and outputs below 8 MHz require 500  $\mu$ sec. Frequency accuracy of each output is better than  $\pm 2$  ppm while in Fast Hop mode. At each frequency, a specific amplitude can be assigned within a 20 dB range for performance tests versus amplitude while frequency hopping. For a full test of a receiver, up to 2400 frequencies can be entered and sequences of up to 4000 frequency settings can be specified. Performance parameters such as phase noise, spurious, amplitude accuracy, and modulation remain high quality and are completely specified while fast hopping to insure confident test results.

#### Flexible, High Performance Modulation

For receiver measurements the HP 8645A offers independent or simultaneous FM and AM for both static and hopped frequency tests. The modulating signal can be the internal 0.1 Hz to 400 kHz synthesizer or an external input that allows FM deviations up to 20 MHz at rates up to 10 MHz. In Fast Hop operation, maximum deviation is 3.5 MHz with 10 MHz rates. AM is available with up to 100 kHz rates and 99% depth. Pulse modulation allows a 35 dB on/off ratio with 100 nsec rise/fall times.

#### Complete Control of Frequency Hopping

The HP 8645A offers flexible and comprehensive control of the frequency hopping output. Parameters can be entered from the front panel, through the HP-IB port or using TTL inputs on the rear panel. Extensive hopped frequency simulations including hop frequencies, dwell times, hop rate, modulation, etc. can be entered into non-volatile memory from the front panel. Activating a hop sequence requires only a press of the Hop key. Agile control is available by a computer with the added advantage of using the new Hewlett-Packard Systems Language (HP-SL). For real-time control, rear panel inputs accept TTL signals for triggering, dwell time and frequency selection to allow direct connection with the hardware under test. With this wide

choice of control, use of the HP 8645A can be readily customized to a wide variety of test situations from benchtop use to ATE systems.

### HP 8645A Specifications

#### Frequency

**Range:** 251.46485 kHz to 1030 MHz; 251.46485 kHz to 2060 MHz with Option 002 or with HP 11845A 2 GHz Retrofit Kit installed.

**Frequency bands:** The exact endpoints of each frequency band can be determined by dividing the 1030 to 2060 MHz band by two for each band decrease. The specifications use approximate endpoints.

**Phase offset:** adjustable in 1 degree increments.

**Reference oscillator stability, Option 001:**  $< 5 \times 10^{-10}$ /day aging.

#### Fast Hop Operation

**Frequency switching time:** 128 to 2060 MHz:  $< 15 \mu$ sec, 8 to 2060 MHz:  $< 85 \mu$ sec, 0.25 to 2060 MHz:  $< 500 \mu$ sec. Opt. 002: add 5  $\mu$ sec.

**Frequency hop range:** 0.25 to 2060 MHz. With FM on, limited to any three consecutive frequency bands.

**Frequency accuracy<sup>1</sup>:**  $\pm 2$  ppm of carrier frequency.

**Channel and sequence tables:** In Fast Hop, each specific frequency and amplitude to be output is entered into a Channel Table. The order of channels to be output is entered into a Sequence Table.

**Maximum number of channels:** 2400.

**Maximum number of channels in Sequence Table:** 4000.

**Hop rate range:** fixed rates from 8 Hz to 50 kHz using internal timer. An external input allows more range and variable rates.

**Dwell time range:** fixed times of 6.4  $\mu$ sec to 99 msec using the internal timer. External input allows longer and variable dwell.

**Learn cycle time:** typically, 10 sec. to 2 min., depending on sequence size.

**Fast Hop bus:** allows real-time selection of any channel for output. Typically, frequency switching time increases by 5  $\mu$ sec.

**Modulation:** internal or external AM, FM, or simultaneous AM/FM.

**Output level:** Allowed amplitude variation of all channels entered is 0 to 20 dB. Output level is reduced by  $> 60$  dB while switching between channels. External dc AM can be used to shape the output.

#### Spectral Purity

##### SSB phase noise (CW, AM, or FM<sup>2</sup> operation):

Carrier Frequency (MHz)	Standard Operation		Fast Hop 20 kHz (dBc/Hz)
	20 kHz (dBc/Hz)	100 kHz (dBc/Hz)	
1030 to 2060	-120	-127	-116
515 to 1030	-127	-134	-123
257 to 515	-132	-137	-130
128 to 257	-136	-140	-133
64 to 128	-139	-141	-137
32 to 64	-141	-141	-139
16 to 32	-142	-142	-141
8 to 16	-143	-143	-142
4 to 8	-144	-144	-143
Less than 4 MHz	-144	-144	-144

**Harmonics:**  $< -30$  dBc, output  $\leq 10$  dBm. Opt. 002, output  $> 8$  dBm:  $< -30$  dBc, 0.25 to 1030 MHz;  $< -25$  dBc, 1030 to 2060 MHz.

**Subharmonics:** none,  $< 515$  MHz.  $< -70$  dBc, 515 to 1030 MHz.  $< -40$  dBc,  $> 1030$  MHz.

**Nonharmonics:**  $> 20$  kHz offset<sup>3</sup>:  $< -100$  dBc,  $< 1030$  MHz.  $< -94$  dBc,  $> 1030$  MHz.

<sup>1</sup>Typically, +2 ppm of carrier frequency multiplied by the temperature change in  $^{\circ}$ C must be added if ambient temperature changes occur between the learn operation and the conclusion of frequency hopping. FM at minimum deviation.

<sup>2</sup>FM at minimum deviation.

<sup>3</sup>Typically, nonharmonic spurs at all offsets are  $< 30$  dB above the instrument's phase noise level as measured in a 1 Hz bandwidth.

# SIGNAL GENERATORS

## Synthesized Signal Generator (cont'd)

### Model 8645A

#### Residual FM<sup>4</sup> (CW, AM, FM<sup>5</sup> operation):

Carrier frequency (MHz)	Post detection bandwidth	
	0.3 to 3 kHz (Hz rms)	0.05 to 15 kHz (Hz rms)
0.25 to 257	<1	<1.2
257 to 515	<1.2	<2
515 to 1030	<2	<4
1030 to 2060	<4	<8

#### Typical SSB phase noise and spurs at 1 GHz:

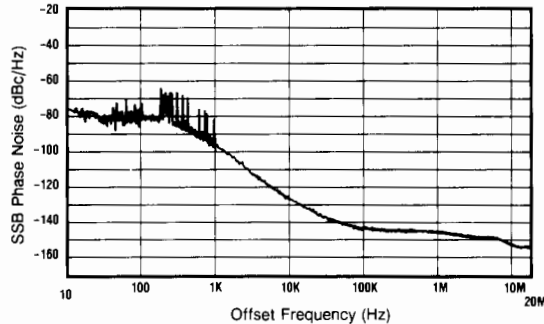

**Residual AM:** <0.01% AM rms, 0.3 to 3 kHz post detection BW.  
**Typical SSB AM noise floor, offsets >100 kHz:** <-157 dBc/Hz at +16 dBm output, 0.25 to 1030 MHz. <-150 dBc/Hz at +13 dBm output, 1030 to 2060 MHz.

#### Output

**Maximum level:** +16 dBm, 0.25 to 1030 MHz; Opt. 002: +14 dBm, 0.25 to 1030 MHz. +13 dBm, above 1030 MHz.  
**Minimum level:** -137 dBm.  
**Absolute accuracy:** ±1 dB, output ≥ -127 dBm.  
**Reverse power protection:** 50 watts from a 50Ω source, 25 Vdc.  
**Typical third order intermodulation:** <-55 dBc, outputs <8 dBm.  
**Typical output level overrange:** 2 dB more than maximum level.  
**Typical SWR and output impedance:** <1.7:1, 50Ω.

#### Modulation

**External modulation input:** Coupling is ac or dc for AM, FM and phase modulation. Pulse modulation input is dc coupled. Displayed deviation or depth corresponds to ±1V external input.  
**Simultaneous modulation:** AM/FM, AM/Phase, AM/Pulse, FM/Pulse, Phase/Pulse, AM/FM/Pulse, AM/Phase/Pulse.  
**Simultaneous internal/external modulation:** FM and Phase.

#### Amplitude Modulation

**Depth:** 0 to 99.9%, for output <±7 dBm.  
**Indicator accuracy:** ±(6% of setting + 1% AM), for <90% and <1 kHz.  
**Distortion, at 400 Hz and 1 kHz rates:**

Depth	Carrier frequency	
	0.25 to 1030 MHz	1030 to 2060 MHz
0 to 30%	<2%	<2%
30 to 70%	<3%	<4%
70 to 90%	<4%	<6%

**3 dB bandwidth<sup>6</sup>:** >5 kHz, 0.25 to 8 MHz. >50 kHz, 8 to 128 MHz. >100 kHz, 128 to 2060 MHz.

**Incidental phase modulation:** <0.2 rad peak, at 30% depth and 1 kHz.

**Typical external input impedance:** 600Ω.

#### Frequency Modulation

**FM deviation and rate:** In the highest frequency band of 1030 to 2060 MHz, the maximum FM peak deviation is 20 MHz for standard operation and 3.52 MHz for Fast Hop. Maximum FM rate (3 dB bandwidth) in the 515 to 1030 MHz band and above is 10 MHz. Divide rate and deviation by two for each frequency band decrease.

**FM indicator accuracy<sup>6</sup>:** ±10%, <50 kHz rate and <10% of maximum deviation (<50% of maximum deviation in Fast Hop.)

**FM distortion:** Rates 20 Hz to 100 kHz: <1%, deviation <2% of maximum available (Fast Hop: <10% of maximum deviation.)

**Carrier frequency accuracy in FM:** ±0.4% of deviation setting, ac or dc coupled. Typically add 1% of deviation in Fast Hop.

**Incidental AM:** <0.5%, deviation limited to <6% of max. or 20 kHz.

**Typical external FM group delay:** 30 μsec for rates 20 Hz to 20 kHz, decreases to <1 μsec at rates >200 kHz. Fast Hop: <1 μsec.

**Typical external FM input impedance:** 50 or 600Ω.

#### Pulse Modulation

**On/off ratio:** >35 dB.

**Rise/fall time:** <100 nsec, between 10% and 90% response points.

**Maximum pulse repetition frequency:** 1 MHz.

**Minimum pulse width:** 0.5 μsec.

**Typical output level accuracy:** ±2 dB.

**Typical external input levels and impedance:** on: >3.0V peak; off: <0.8V peak. Damage level: ≥±10V peak. 600Ω.

#### Internal Modulation Source

**Waveforms:** sine, square, sawtooth and white Gaussian noise.

**Frequency range:** sine, white Gaussian noise: 0.1 Hz to 400 kHz. Square, sawtooth: 0.1 Hz to 50 kHz.

**Frequency accuracy:** same as internal reference oscillator.

**Output level:** Typically, 1 V<sub>pk</sub> max. into 600Ω. Accuracy: ±20 mV.

**Output level resolution:** 2 mV. Typical impedance: 600Ω.

**Distortion:** <0.1%, output at 1V peak and ≤15 kHz.

#### Frequency Sweep

**Phase continuous sweep:** linear sweep with times from 10 msec to 10 sec, not dependent on span. Maximum span is 40 MHz from 1030 to 2060 MHz frequency band, divided by two for each band decrease.

**Fast Hop sweep:** linear or log stepped with times from 10 msec to 100 sec. Number of steps varies with time selected. Typical time per step is 30 μsec for outputs within 128 to 2060 MHz, 170 μsec for 8 to 2060 MHz, and 650 μsec for 0.25 to 2060 MHz.

**Sweep control and markers:** X-axis: 0 to +10V. Z-axis: +5V trace, +1V trace, 0V markers. Three markers available.

#### General

**Remote control:** HP-IB (IEEE-488.2-1987). The control language used is the Hewlett-Packard Systems Language (HP-SL). All front panel functions except power switch and knob. A unique Fast Hop bus interface accepts TTL levels for frequency agile control.

**Operating temperature range:** 0 to +55° F.

**Leakage:** meets Mil Std 461B RE02 and FTZ 1046.

**Storage registers:** 10 full function and 40 freq./ampl. locations.

**Memory erasure:** all memory contents according to Mil Std 380-380.

**Weight:** net, 31 kg (69 lbs); shipping, 42 kg (95 lbs).

**Size:** 177H x 426W x 624mmD (7" x 16.8" x 24.6").

#### Ordering Information

	Price
HP 8645A Agile Signal Generator	\$32,000
Opt 001 High stability time base	+\$1,500
Opt 002 2 GHz output	+\$6,000
Opt 003 RF connectors on rear panel only	+\$300
Opt 907 Front handle kit (5061-9690)	+\$65
Opt 908 Rack flange kit (5061-9678)	+\$35
Opt 909 Combined front handle/rack flange kit (5061-9684)	+\$90
Opt 910 Extra manual set (includes service manual)	+\$190
Opt 915 Add service manual	+\$65
Opt W03 90-day on-site warranty (replaces standard 1-year)	N/C
Opt W30 2 years additional hardware service	+\$775
HP 11845A 2 GHz Retrofit Kit	\$6,000
08645-61116 Service kit	\$500
9211-2662 Transit case	\$550
1490-0913 Transit case wheels	\$210
1494-0059 Non-tilting rack slide kit	\$100
1494-0063 Tilting rack slide kit	\$190

<sup>4</sup>Specified for 48 to 63 Hz power line. Typical for 400 Hz power line and Fast Hop operation.

<sup>5</sup>Deviation <0.1% of maximum available.

<sup>6</sup>Lower 3 dB bandwidth limit is 0 Hz for dc coupling and typically 20 Hz for ac coupling.



# SIGNAL GENERATORS

## Synthesized Signal Generator

Model 8665A

365

- 100 kHz to 4.2 GHz
- $< -134$  dBc/Hz SSB phase noise at 20 kHz offset

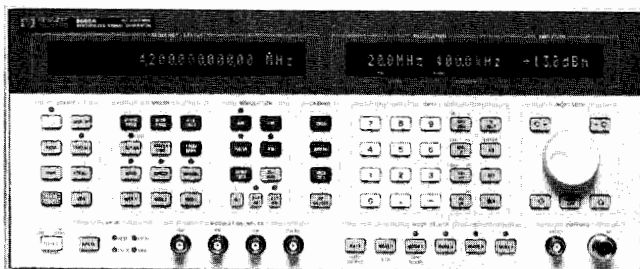

HP 8665A



### HP 8665A Synthesized Signal Generator

The HP 8665A Synthesized Signal Generator is a high performance, programmable signal generator intended for out-of-channel RF receiver measurements, particularly receiver measurements such as spurious rejection, which often require frequency coverage to 4.2 GHz. A frequency range from 100 kHz to 4.2 GHz allows the HP 8665A to be used in all out-of-channel receiver measurements.

#### Excellent Spectral Purity

The HP 8665A exhibits excellent spectral purity by having both low SSB phase noise and low spurious. Low SSB phase noise of  $< -134$  dBc/Hz at 20 kHz offset and 1 GHz carrier is for high performance characterization of receiver selectivity while low spurious of  $< -100$  dBc is for characterization of receiver spurious rejection. This spectral purity, coupled with the HP 8665A's frequency coverage to 4.2 GHz, provides a solution to measurements that often could be done only by two separate signal generators.

#### AM, FM and Optional Pulse Modulation

The HP 8665A offers AM, FM and optional pulse modulation across its full frequency range. FM rates of up to 2 MHz and deviations to 20 MHz peak (at 4.2 GHz and 800 kHz rate) allow the HP 8665A to be used in many applications, such as telemetry, requiring higher FM performance. An optional pulse modulator with ON/OFF ratio  $> 80$  dB and rise and fall times  $< 5$  ns is offered on the HP 8665A. Pulse width and delay can be internally adjusted between 50 ns and 999 msec, eliminating the need for an external pulse generator.

#### Internal Modulation Synthesizer

The HP 8665A provides an internal modulation synthesizer with a frequency range from 0.1 Hz to 400 kHz. Sine, square, sawtooth and white gaussian noise waveforms are available. A second internal source, identical to the source described above, may also be selected and summed with the first source. This provides variable two-tone capability. Plus, the first source can be internally modulated with AM, FM, phase modulation, pulse modulation and double sideband modulation to further enhance this internal modulation synthesizer.

### HP 8665A Specifications

#### Frequency

**Range:** 100 kHz to 4200 MHz. See internal modulation source for coverage below 100 kHz.

**Resolution:** 0.01 Hz.

**Accuracy and stability:** in CW, same as reference oscillator.

#### Relative Phase Adjust

**Preset:** adjustable in  $1^\circ$  increments.

**Analog:** 200 radians/volt in 515 to 1030 MHz band from an internal or external input through phase modulation input.

**Analog bandwidth:** STD mode: 150 Hz; low noise mode, Option 004: 20 Hz.

**External input impedance:** Typically, 50 $\Omega$ .

#### Internal Reference Oscillator

**Typical stability:** standard: aging rate;  $\pm 2$  ppm/year; Option 001:  $< 10^{-9}$ /day aging rate after 10 days warmup.

- $< -100$  dBc non-harmonic spurious
- FM rates to 2 MHz
- Optional pulse modulation

#### Spectral Purity

SSB phase noise (CW, AM, or FM<sup>1</sup> operation) measured in a 1 Hz BW in dBc/Hz

Carrier Frequency Range (MHz)	Offset Frequency					
	1 kHz		20 kHz		100 kHz	
	STD	Opt 004	STD	Opt 004	STD	Opt 004
4120 to 4200	-60	-81	-105	-116	-121	-121
3000 to 4120	-63	-87	-105	-122	-121	-127
2060 to 3000	-66	-87	-111	-122	-127	-127
1500 to 2060	-69	-93	-111	-128	-127	-133
1030 to 1500	-72	-93	-117	-128	-133	-133
750 to 1030	-75	-99	-117	-134	-133	-139
515 to 750	-78	-99	-123	-134	-139	-139
375 to 515	-81	-105	-123	-140	-139	-144
257.5 to 375	-84	-105	-129	-140	-144	-144
187.5 to 257.5	-87	-111	-129	-143	-144	-145
30 to 187.5	-72	-93	-117	-128	-132	-133
.1 to 30	-75	-99	-117	-131	-132	-134

#### Typical SSB phase noise at 1 GHz comparing STD with Low Noise Opt 004

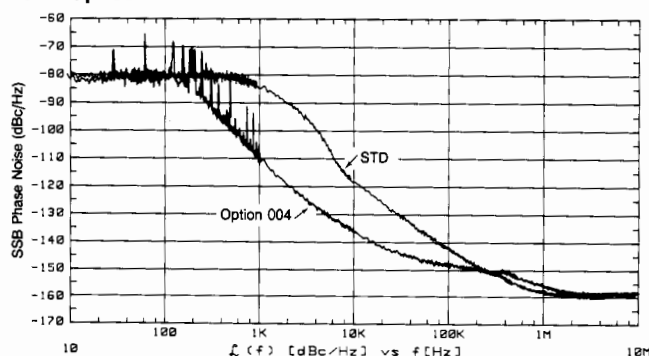

**SSB broadband noise floor:** in 1 Hz BW at  $> 1$  MHz offset from carrier with  $> 5.1$  dBm output level.

- $< -145$  dBc for carrier frequencies  $> 187.5$  MHz,  $< 4200$  MHz;
- $< -140$  dBc for carrier frequencies  $> 10$  MHz,  $< 187.5$  MHz

#### Spurious Signals

**Harmonics:**  $< -30$  dBc, output level  $< +10$  dBm;  $< -25$  dBc, output level  $< +13$  dBm.

**Sub-harmonics:**  $< 75$  dBc, 100 kHz to  $< 1500$  MHz;  $< 40$  dBc, 1500 to  $< 3000$  MHz;  $< 50$  dBc, 3000 to 4200 MHz.

**Non-harmonics:**  $< 100$  dBc,  $> 10$  kHz offset, 187.5 to 2060 MHz, STD mode and low noise mode, Opt 004;  $< 90$  dBc,  $> 10$  kHz offset, 0.1 to 187.5 MHz, STD mode and low noise mode, Opt 004;  $< 90$  dBc,  $> 10$  kHz offset, 2060 to 4200 MHz, STD mode and low noise mode, Opt 004.

**Residual FM<sup>2</sup>: (CW, AM, FM Operation)**  $< 15$  Hz STD mode,  $< 2.5$  Hz low noise mode Opt 004, 750 to 1500 MHz, .3 to 3 kHz BW.

**Residual AM:**  $< 0.02\%$  AM rms, 0.3 to 3 kHz post detection bandwidth.

**SSB AM noise floor, offsets  $> 100$  kHz with AM off:**  $< -140$  dBc/Hz at  $+13$  dBm output, 0.1 to 187.5 MHz;  $< -150$  dBc/Hz at  $+13$  dBm output, 187.5 to 4200 MHz.

#### Output

**Maximum level:**  $+13$  dBm, 0.1 to 4200 MHz;  $+9$  dBm with pulse modulation, Opt 008.

<sup>1</sup> FM at minimum deviation.

<sup>2</sup> Specified for 48 to 63 Hz power line. Typical for 400 Hz power line.

# SIGNAL GENERATORS

## Synthesized Signal Generator (cont'd)

### Model 8665A

**Minimum level:** -139.9 dBm.

**Display resolution:** 0.1 dB.

**Absolute accuracy:**  $\pm 1$  dB, output  $> -119.9$  dBm, 0.1 to 3000 MHz;  $\pm 1.5$  dB, output  $> -119.9$  dBm, 3000 to 4200 MHz.

**Reverse power protection:** 25W into 50 $\Omega$ , .1 to 2060 MHz. 1W into 50 $\Omega$ , 2060 to 4200 MHz.

**Third order intermodulation:** typically,  $< -50$  dBc with two signals at +8 dBm and 25 kHz apart, passing through a resistive combiner.

**Output level overrange:** typically, 2 dB more than maximum level.

**VSWR:**  $< 1.5:1$ , output  $< 0$  dBm;  $< 1.75:1$ , output  $> 0$  dBm; 0.1 to 3000 MHz;  $< 1.75:1$ , output  $< 0$  dBm,  $< 2.0:1$ , output  $> 0$  dBm, 3000 to 4200 MHz.

**Output impedance:** nominally 50 $\Omega$ .

#### Modulation

**External modulation input:** Coupling is ac or dc for AM and FM modulation. Pulse modulation input is dc coupled. 1V peak input is required for calibrated operation in AM and FM.

#### Amplitude Modulation

**AM depth:** 0 to 99.9%, for output  $< +7$  dBm.

**AM resolution:** 0.1%.

**AM indicator accuracy:**  $\pm(6\%$  of setting + 1% AM), up to 90% depth at 1 kHz rate.

**AM distortion, at 400 Hz and 1 kHz rates:**  $< 4\%$  for depths 30 to 70%.

**AM 3 dB bandwidth:**  $> 5$  kHz, 1 to 10 MHz;  $> 10$  kHz, for  $> 10$  MHz carrier frequencies.

**Incidental phase modulation:** at 30% depth and 1 kHz rate.  $< 0.2$  radians peak, 0.1 to 2000 MHz  $f_c$ ;  $< 0.4$  radians peak, 2000 to 4200 MHz  $f_c$ .

**External AM input impedance:** 600 $\Omega$ .

#### Frequency Modulation

##### FM Deviation and Rate:

Carrier Frequency (MHz)	Maximum Peak Deviation		
	STD Mode (kHz)	Low Noise Mode Option 004 (kHz)	Maximum Rate <sup>3</sup> (3 dB BW) (kHz)
3000 to 4200	20000	400	800
1500 to 3000	10000	200	800
750 to 1500	5000	100	800
375 to 750	2500	50	800
187.5 to 375	1250	25	800
10 to 187.5	5000	100	800
$< 10$			800

**FM resolution:** 2.5% of setting.

**FM indicator accuracy<sup>4</sup>:** DC to 20 kHz rates.  $\pm 9\%$  of FM deviation setting plus 10 Hz, STD mode;  $\pm 11\%$  of FM deviation setting, low noise mode, Opt 004.

**FM distortion:**  $< 1\%$  for rates 20 Hz to 20 kHz.

**Carrier frequency accuracy in FM:**  $\pm 0.5\%$  of deviation setting, ac or dc coupled.

**Incidental AM:**  $< 0.1\%$ , at  $< 20$  kHz deviation, 1 kHz rate.

**External FM group delay:**  $< 30$   $\mu$ sec for rates  $< 20$  kHz, decreases to  $< 1$   $\mu$ sec at rates above 200 kHz.

**External FM input impedance:** 600 $\Omega$ .

#### Pulse Modulation (Option 008)

**On/Off ratio:**  $> 80$  dB.

**Rise/Fall time:**  $< 5$  nsec, between 10% and 90% response points.

**Pulse repetition frequency:** internal, 0.1 Hz to 400 kHz; external, DC to 10 MHz.

**Pulse width:** internally variable between 50 ns and 999 ms.

**Pulse delay:** internally variable between 50 ns and 999 ms.

**Output level accuracy:** same as with no pulse modulation.

**External input level:** TTL.

**External input impedance:** 50 $\Omega$  or Schottky TTL.

#### Internal Modulation Source

**Number of sources:** Source 1, source 2, simultaneously available through summation, independently adjustable in frequency, phase, amplitude and waveform. Source 1 may also be internally modulated

<sup>3</sup> Typically the 3 dB BW is  $> 2$  MHz for deviations  $< \text{maximum peak deviation}/10$ .

<sup>4</sup> Typical accuracy up to 20 kHz rates and maximum deviations is better than  $\pm 7\%$ .

independently with AM, FM, phase modulation, pulse modulation and double sideband modulation.

**Waveforms:** sine, square, sawtooth and white gaussian noise.

**Frequency range:** 0.1 Hz to 400 kHz, sine and white gaussian noise. 0.1 Hz to 50 kHz, square and sawtooth.

**Frequency resolution:** 0.1 Hz.

**Frequency accuracy:** same as internal reference oscillator.

**Maximum output level:** 1 V<sub>pk</sub> into 600 $\Omega$ .

**Output level resolution:**  $< 2$  mV. Typically,  $< 1$  mV.

**Output impedance:** Typically, 600 $\Omega$ .

**Total harmonic distortion:**  $< 0.1\%$ , output at 1 V<sub>pk</sub> and  $< 20$  kHz. Typically,  $< .1\%$  to 100 kHz.

#### Frequency Sweep

##### Phase Continuous Sweep

**Sweep time:** 10 msec to 10 sec.

**Maximum sweep span:** up to 40 MHz in the 3000 to 4200 MHz band.

##### Digitally Stepped Sweep

**Sweep type:** linear or log, frequency stepped.

**Sweep time range:** 500 msec to 1000 sec. Typical time per step is 90 msec.

**X-Axis output:** nominal 0 to +10V.

**Z-Axis output:** nominal +5V during retrace.

**Markers available:** 3.

#### Remote Programming

**Interface:** HP-IB (Hewlett-Packard's implementation of IEEE-488.2-1987). HP-IB select code range: 00 to 30. Interface function is listener and talker.

**Control language:** Hewlett-Packard Systems Language (HP-SL).

**Functions controlled:** all front panel functions except power switch and knob.

**HP-IB functions:** SH1, AH1, T6, TE0, L4, LE0, SR1, RL1, PP0, DC1, DT0, C0, E2.

#### General

**Power requirements:**  $\pm 10\%$  of 100, 120, 220, or 240V; 48 to 440 Hz; 500 VA maximum.

**Operating temperature range:** 0 to  $+55^\circ\text{C}$ .

**Leakage:** Conducted and radiated interference meets MIL STD 461B RE02 and FTZ 1046. RF leakage is typically 1  $\mu\text{V}$  below 1 GHz  $f_c$ , induced in a two-turn loop antenna 2.5 cm in diameter held 2.5 cm away from the front panel for output levels  $< 0$  dBm. Option 010 reduces RF leakage to typically  $< 0.5$   $\mu\text{V}$ .

**Calibration interval:** 3 years (MTBC).

**Storage registers:** 10 full function and 40 frequency/amplitude registers.

**Memory erasure:** All memory contents, except generic calibration data, can be erased according to Mil Std 380-380.

**Weight:** net, approx. 29 to 31 kg (63 to 69 lb); shipping, 40 to 42 kg (88 to 94 lb) depending on the options ordered.

**Size:** approx. 178H x 425W x 648 mmD (7" x 16.75" x 25.5"). Opt 010 adds 35 mm (1.4") to the depth.

#### Ordering Information

	Price
HP 8665A Synthesized Signal Generator	\$35,000
Opt 001 High stability time base (includes EFC)	+\$1,500
Opt 003 RF inputs on rear panel only	+\$400
Opt 004 Low noise mode	+\$4,000
Opt 008 Pulse modulation	+\$3,000
Opt 010 Reduced leakage configuration	+\$1,000
Opt 907 Front handle kit (5061-9690)	+\$65
Opt 908 Rack flange kit (5061-9678)	+\$35
Opt 909 Combined front handle/rack flange kit (5061-9684)	+\$90
Opt 910 Extra manual set (includes service manual)	+\$190
Opt 915 Add service manual	+\$65
Opt W03 90 day on-site warranty (replaces 1 year standard warranty)	\$0
Opt W30 2 years additional hardware service	+\$640
08665-61116 Service kit	\$500
9211-2662 Transit case	\$550
1490-0913 Transit case wheels	\$210
1494-0059 Non-tilting rack slide kit	\$100
1494-0063 Tilting rack slide kit	\$190

# SIGNAL GENERATORS

## Synthesized Signal Generators

### Models 8642A and 8642B

367

- 100 kHz to 2.115 GHz
- $< -134$  dBc/Hz SSB phase noise at 20 kHz offset
- $-100$  dBc nonharmonic spurious

- $+20$  dBm maximum output level
- AM, FM,  $\Phi$ M and pulse modulation
- On-site repair and calibration

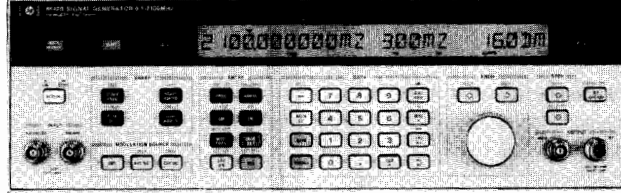
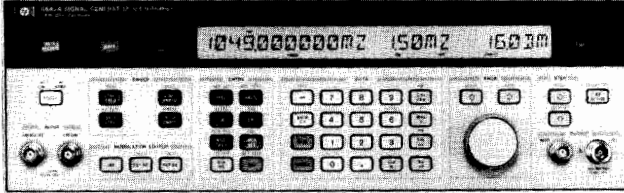

HP 8642A

HP 8642B

### HP 8642A/B Synthesized Signal Generators

The HP 8642A and HP 8642B synthesized signal generators are high performance programmable signal generators intended for the most demanding out-of-channel RF receiver measurements and other stringent RF applications. The HP 8642A covers the frequency range from 100 kHz to 1057.5 MHz and the HP 8642B to 2115 MHz.

#### Low SSB Phase Noise

The HP 8642A/B provide state-of-the-art in SSB phase noise at 20 kHz offsets of  $-134$  dBc/Hz at 1 GHz.

#### $-100$ dBc Spurious

Nonharmonic spurious are held to below  $-100$  dBc on the HP 8642A/B up to 1 GHz and to below  $-94$  dBc above 1 GHz. These two generators allow receiver spurious rejection tests to be fully automated with the utmost confidence in test results.

#### Repeatability and Level Accuracy

In addition to a high-reliability attenuator, absolute output level accuracy is  $\pm 1$  dB down to  $-127$  dBm ( $0.1 \mu\text{V}$ ). In R&D or on the production line, the HP 8642A/B will accurately measure receiver sensitivities.

#### Up to $+20$ dBm Output Level

Up to  $+20$  dBm is available from the HP 8642A/B to perform a variety of high level measurements, often eliminating the need for external amplifiers.

This extra power can be used to overcome cabling losses. With the relative amplitude feature, the display can be offset to show correct output level at the end of the cable.

#### AM, FM, $\Phi$ M and Pulse Modulation

The HP 8642A/B offer AM, FM,  $\Phi$ M and pulse modulation across their full frequency ranges.

A low distortion internal modulation oscillator can be used to modulate the HP 8642A/B up to 100 kHz rates. The internal audio oscillator can also be used as a stand-alone audio source with variable rates and levels.

### HP 8642A/B Specifications

#### Frequency

**Range:** 100 kHz to 1057.5 MHz, HP 8642A; 100 kHz to 2115 MHz, HP 8642B.

**Bands:** Both generators cover their ranges in one continuous span. However, many other specifications are dependent on carrier frequency. To simplify such specifications, the HP 8642A and 8642B carrier frequency ranges are divided into bands shown in the table below.

Band	Carrier Frequency (MHz)	Band	Carrier Frequency (MHz)
10	1057.500001-2115 (HP 8642B)	4	16.523438- 33.046875
9	528.750001-1057.5	3	8.261719- 16.523437
8	264.375001- 528.75	2	4.130860- 8.261718
7	132.187501- 264.375	1	0.1 - 4.130859
6	66.093751- 132.1875	HET	0.1 -132.1875
5	33.046876- 66.09375		

**Resolution:** 1 Hz, 0.1 Hz with special function.

**Stability:** same as reference oscillator.

#### Internal Reference Oscillator

**Standard:** aging rate:  $\pm 2$  ppm/year; **Option 001:**  $< 10^{-9}$ /day aging rate after 8 days warm-up.

#### Spectral Purity

**Residual FM** (in CW, AM or Angle Modulation  $< 1/3$  Max. Dev.):

**500 MHz:**  $< 1.2$  Hz (0.3 - 3 kHz BW),  $< 2$  Hz (0.05 - 15 kHz BW);

**1000 MHz:**  $< 2$  Hz (0.3 - 3 kHz BW),  $< 5$  Hz (0.05 - 15 kHz BW);

**2000 MHz:**  $< 5$  Hz (0.3 - 3 kHz BW),  $< 9$  Hz (0.05 - 15 kHz BW).

**SSB Phase Noise at 20 kHz offset** (CW, AM or FM/ $\Phi$ M  $< 1/60$  Maximum Deviation):

**125 MHz:**  $-144$  dBc/Hz;

**250 MHz:**  $-141$  dBc/Hz;

**500 MHz:**  $-137$  dBc/Hz;

**1000 MHz:**  $-134$  dBc/Hz;

**2000 MHz:**  $-125$  dBc/Hz.

**Residual AM:**  $< 0.01\%$  AM rms, 0.3 - 3 kHz BW.

#### Spurious

**Harmonics:**  $-30$  dBc, level  $\leq +10$  dBm,  $-25$  dBc  $f_c > 1057.5$  MHz.

**Subharmonics:** none,  $f_c \leq 1057.5$  MHz,  $-45$  dBc ( $f_c > 1057.5$  MHz).

**Nonharmonics** ( $> 10$  kHz offsets):  $-100$  dBc, ( $-94$  dBc  $f_c > 1057.5$  MHz).

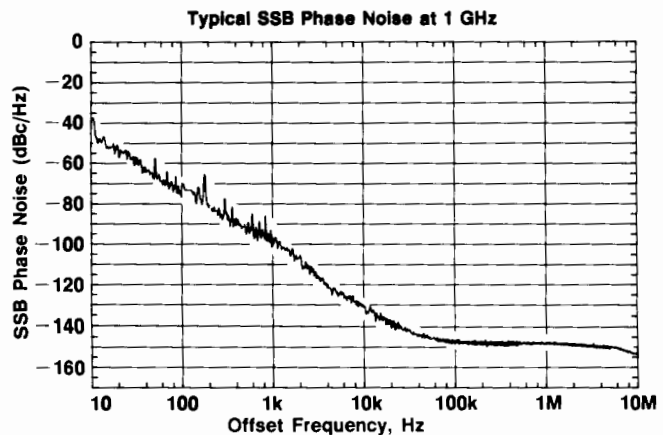

# SIGNAL GENERATORS

## Synthesized Signal Generators (cont'd)

### Models 8642A and 8642B

#### Output

**Level range:** from maximum available to -140 dBm (0.023  $\mu$ V).

#### Maximum Level Available:

	HP 8642A	HP 8642B
+20 dBm (2.24V)	bands 1 thru 7	bands 1 thru 7
+19 dBm (2.00V)	n/a	band 8
+18 dBm (1.78V)	bands 8 & HET	HET
+17 dBm (1.58V)	n/a	band 9
+16 dBm (1.41V)	band 9	band 10

**Resolution:** 0.1 dB.

**Absolute accuracy:**  $\pm 1$  dB, output level  $\geq -127$  dBm.

**Flatness:**  $\leq \pm 0.75$  dB, +10 dBm output level.

**Impedance:** 50 ohms nominal.

**SWR:** <1.5:1, level <0 dBm; <2.0:1, level  $\geq 0$  dBm.

**Reverse power protection:** 50W, from a 50 $\Omega$  source 25 Vdc, (25W, 5Vdc, HP 8642B).

**Third order intermodulation:** <-55 dBc at +10 dBm, two generators 25 kHz apart into a resistive combiner. Typically decreases 10 dB for every 5 dB of combined level decrease.

#### Amplitude Modulation

**AM depth:** 0 to 99.9%, output level  $\leq +10$  dBm.

**AM resolution:** 0.1%.

**AM indicator accuracy at 1 kHz rate and up to 90% AM:**

$\pm(3.5\%$  of setting +1% AM),  $f_c \leq 528.75$  MHz;

$\pm(5\%$  of setting +1% AM),  $f_c > 528.75$  MHz.

**AM distortion at 1 kHz rate:**

Depth	Distortion	
	8642A; $f_c \leq 528.75$ MHz 8642B; $f_c \leq 1057.5$ MHz	8642A; $f_c > 528.75$ MHz 8642B; $f_c > 1057.5$ MHz
0 to 30% AM	<1%	<2%
30 to 70% AM	<2%	<4%
70 to 90% AM	<4%	<6%

**AM 3 dB bandwidth, depth  $\leq 90\%$ :**

**External dc/ac coupling:** dc/20 Hz to 100 kHz,  $f_c$ : 01-4.13 MHz, 33.04-2115 MHz; dc/20 Hz to 20 kHz,  $f_c$ : 4.13-33.04

**Internal:** same as external ac.

**Incidental  $\theta$ M at 1 kHz rate and 30% AM:** <0.2 radians peak.

#### Frequency Modulation

#### Maximum FM deviation:

Carrier Frequency Band	Maximum Deviation DC Coupled	Maximum Deviation AC Coupled or Internal
		(the smaller of)
10	3 MHz	3 MHz or $f_{mod} \times 2160$
9	1.5 MHz	1.5 MHz or $f_{mod} \times 1080$
8	750 kHz	750 kHz or $f_{mod} \times 540$
7	375 kHz	375 kHz or $f_{mod} \times 270$
6	187 kHz	187 kHz or $f_{mod} \times 135$
5	93.8 kHz	93.8 kHz or $f_{mod} \times 67.5$
4	46.9 kHz	46.9 kHz or $f_{mod} \times 33.75$
3	23.4 kHz	23.4 kHz or $f_{mod} \times 16.88$
2	11.7 kHz	11.7 kHz or $f_{mod} \times 8.44$
1	93.8 kHz	93.8 kHz or $f_{mod} \times 67.5$
HET	1.5 MHz	1.5 MHz or $f_{mod} \times 1080$

**FM resolution:** 0.7% of setting or 0.0004% of maximum deviation, whichever is larger.

**FM indicator accuracy:**  $\pm(5\%$  of setting +10 Hz).

**FM distortion:** 4% for max. dev., 2% for  $1/2$  max. dev., 0.4% for  $1/15$  maximum dc coupled deviation.

**FM 3 dB bandwidth: (dc/ac coupling):** dc/20 Hz to 200 kHz.

**Incidental AM:** 0.3%, 20 kHz peak dev., 1 kHz rate,  $f_c > 400$  kHz.

#### Phase Modulation

#### Maximum phase deviation:

Carrier Frequency Band	Maximum Deviation (Radians)
10	200
9	100
8	50
7	25
6	12.5
5	6.25
4	3.13
3	1.56
2	0.78
1	6.25
HET	100

**$\theta$ M accuracy:**  $\pm(5\%$  of setting +0.09 radians), 1 kHz rate.

**$\theta$ M resolution:** Greater of 0.7% of setting or 0.0004% of max. dev.

**$\theta$ M distortion:** <0.4%, 1 kHz rate.

**$\theta$ M 3 dB bandwidth:** dc/20 Hz to 15 kHz.

**Pulse Modulation (for output levels  $\leq +15$  dBm)**

**Pulse on/off ratio:** >40 dB; >80 dB,  $f_c > 1057.5$  MHz.

**Rise/fall time:** <400 ns, 10% to 90%.

**Maximum repetition frequency:** 100 kHz.

**Minimum pulse width:** 2  $\mu$ s.

#### Internal Modulation Oscillator

**Rates:** 20 Hz to 100 kHz.

**Frequency resolution:** 1% of setting.

**Frequency accuracy:** 2% of setting.

**Output level range:** 0 to 3V peak into 600 ohms.

**Output level resolution:** 4 mV.

**Distortion:** <0.02%, 0.02 kHz to 15.8 kHz; <0.15%, >15.8 kHz.

**Output level accuracy:**  $\pm(4\%$  +15 mV) within 1 second.

**Output impedance:** 600 ohms  $\pm 10\%$ .

#### Frequency Sweep

**Modes:** Start-Stop, Span, and Phase continuous.

**X axis output:** 0 to 10 Vdc,  $\pm 10\%$ .

**Z axis output:** TTL positive true for crt display blanking during retrace.

#### Remote Programming

**Interface:** HP-IB (IEEE-488-1978).

**HP-IB functions:** listener, talker, and controller. SH1, AH1, T5, TE0, L3, LE0, SR1, RL1, PP1, DC1, DT1, C1, C3, C28, E2.

#### General

**Operating temperature range:** 0° to 55° C.

**Storage temperature:** -55° C to +75° C.

**Leakage:** conducted and radiated interference is within the requirements of MIL STD 461B method RE02. Interference is also within the standards set by FTZ 1115. Also, RF leakage of <0.5  $\mu$ V is induced in a two turn loop 2.5 cm in diameter, held 2.5 cm away from any surface for output levels  $\leq 0$  dBm.

**Power requirements:** 100V, 120V, 220V, or 240V; +5%, -10%; 48 to 440 Hz; 300 VA max.

**Size:** 133H X 425W X 617D mm (5.25" X 16.75" X 24.3").

**HP System II module size:**  $5/4$ H X 1MW X 23D.

**Weight:** Net, 32.7 kg (71.5 lb); shipping, 43 kg (95 lb).

#### Ordering Information

**HP 8642A Synthesized Signal Generator** \$24,050

**HP 8642B Synthesized Signal Generator** \$33,050

**Opt 001** High stability time base +\$2,100

**Opt 002** RF connectors on rear panel only +\$160

**Opt 710** On-site repair manual +\$72

**Opt 907** Front handle kit (5061-9689) +\$55

**Opt 908** Rack flange kit (5061-9677) +\$32.50

**Opt 909** Front handle kit & rack flange kit (5061-9683) +\$80

**Opt 910** 2 sets of operation/calibration and service manuals +\$550

**Opt 915** Service manual supplied with instrument +\$250

**Opt W03** 90 day on-site warranty conversion \$0

**Opt W30** 2 years additional hardware service +\$450

HP 8642A Opt W30 +\$600

HP 8642B Opt W30 +\$600

**HP 11801A** On-site repair kit for HP 8642A \$20,500

**HP 11801B** On-site repair kit for HP 8642B \$27,000

**HP 11801C** On-site repair kit for HP 8642A/B \$28,500

# SIGNAL GENERATORS

## Synthesized Signal Generators

Models 8662A, 8663A

369

- 10 kHz to 1280 MHz frequency range
- $< -147$  dBc/Hz SSB phase noise at 10 kHz offset
- 0.1 Hz frequency resolution

- 100 kHz to 2560 MHz frequency range
- AM/FM/ØM/pulse in one generator
- Internal variable modulation oscillator

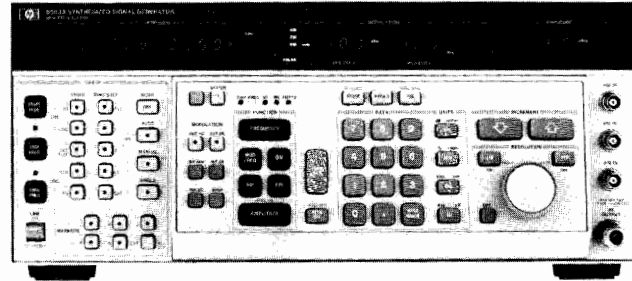

HP 8662A



HP 8663A



### HP 8662A Synthesized Signal Generator

The HP 8662A derives exceptional RF performance from an indirect frequency synthesis technique that results in frequency resolution of 0.1 Hz from 10 kHz to 640 MHz and 0.2 Hz from 640 MHz to 1280 MHz.

Output level accuracy is held to  $\pm 1$  dB using microprocessor correction. This makes the HP 8662A an ideal generator for performing precise receiver sensitivity tests either manually or in automated systems.

The HP 8662A offers versatile phase-locked AM/FM using either internal 400 Hz and 1 kHz rates or externally applied modulating signals, which can be either dc or ac coupled. Several different modes of simultaneous modulation (such as AM + FM or FM + FM) are possible.

### Exceptional Spectral Purity

The key contribution of the HP 8662A is spectral purity. Fast-tuning, switched-inductance, voltage-controlled oscillators combined with a low noise reference multiplication chain result in very low SSB phase noise, especially at small offsets from the carrier. The phase noise at 20 kHz to 50 kHz offsets is comparable to that of the best cavity-tuned fundamental oscillators. Such excellent noise performance makes possible complete automation of receiver out-of-channel measurements.

With its excellent long and short-term frequency stability, high output power, fine frequency resolution, and broad frequency range the HP 8662A also meets the requirements of the most critical low noise local oscillator applications. In addition, its fast frequency switching and sweep capabilities also permit its use in many frequency agile and swept local oscillator applications.

An advanced microprocessor-based controller allows convenient keyboard control of all HP 8662A functions. For example, all functions can be incremented and decremented in any user-defined step size within the resolution of the synthesizer using the increment keys and the knob. Up to nine full front panel setups can be stored in the HP 8662A's memory and recalled for later use in any user-defined sequence at the touch of a pushbutton. This permits time-saving semi-automation of generator operation in production setups where the generator must perform many different tests.

### Precision Digital Sweep

Fast frequency switching combined with microprocessor control gives the HP 8662A a powerful sweep capability. Automatic, single, and manual modes are available for both linear and logarithmic sweeps with user-selectable step size and number of steps. Five different sweep speeds can be chosen and up to five amplitude or Z-axis markers can be set. All sweep parameters can be controlled with full synthesizer resolution.

### HP 8663A Synthesized Signal Generator

The HP 8663A provides all the features and the exceptional spectral purity of the HP 8662A with increased frequency range and modulation capability.

The HP 8663A also has U.S. Air Force MATE (Modular Automatic Test Equipment) system compatibility, Option 700. Option 700 is an external translator that provides the HP 8663A with the capability to be controlled by the MATE language CIIL (Control Interface Intermediate Language).

### Broad Frequency Range

The HP 8663A utilizes the complete frequency synthesis portion of the HP 8662A with the addition of an internal frequency doubler to achieve a broad frequency range of 100 kHz to 2560 MHz in a single instrument. In the HP 8663A, the exceptional spectral purity of the HP 8662A is maintained up to 1280 MHz. Above this, phase noise is typically increased 6 dB to a level of  $-124$  dBc/Hz at 10 kHz offset from a 2.5 GHz carrier. High output power of +16 dBm (with over-range to 19.9 dBm) is available for efficiently driving frequency translators when low noise microwave signals are needed. Combined with a microwave synthesizer such as the HP 8673A, full frequency coverage from 100 kHz to 26 GHz is possible.

### Flexible Modulation

Complete modulation capability across a wide carrier frequency range is the key contribution of the HP 8663A. AM and FM characteristics are similar to those offered in the HP 8662A. The HP 8663A adds high performance pulse and biphasic modulation with wide bandwidth linear phase modulation available with Option 002. For complete flexibility the HP 8663A Option 002 has the capability to simultaneously provide AM+FM+pulse+phase modulation across its entire frequency range. AM, FM, and linear phase are either AC or DC coupled while biphasic and pulse are DC coupled. This modulation flexibility assures exact signal simulation when testing complex systems such as those involving pulsed doppler radar and electronic warfare. An internal 100 kHz sinusoidal modulation synthesizer phase locked to the 10 MHz time base is standard. Microprocessor flexibility allows the sweep functions to be applicable to the internal audio synthesizer, as well as the RF synthesizer, making applications involving swept modulation possible with a single instrument.

### Similarity to the HP 8662A

Because the HP 8663A has been designed to be upward compatible with the HP 8662A, the two generators have identical control and performance characteristics for those functions that are common. Either generator can be combined with the HP 11729A Microwave Converter and the HP 3048A Phase Noise Measurement System to perform microwave phase noise measurements simply and quickly.



# SIGNAL GENERATORS

## Synthesized Signal Generators (cont'd)

### Models 8662A, 8663A

#### HP 8662A Specifications

##### Frequency

**Range:** 10 kHz to 1280 MHz (1279.999998 MHz).

**Resolution:** 0.1 Hz (0.2 Hz above 640 MHz).

**Accuracy and stability:** same as reference oscillator.

**Internal reference oscillator:** 10 MHz quartz oscillator. Aging rate  $< 5 \times 10^{-10}$ /day after 10 day warm-up (typically 24 hrs in normal operating environment).

##### Spectral Purity

##### Residual SSB Phase Noise in 1 Hz BW ( $320 \leq f_c < 640$ MHz)

Offset from Carrier				
10 Hz	100 Hz	1 kHz	10 kHz	100 kHz
-100 dBc	-112 dBc	-121 dBc	-131 dBc	-132 dBc

**SSB broadband noise floor in 1 Hz BW at 3 MHz offset from carrier:**  $< -146$  dBc for  $f_c$  between 120 and 640 MHz at output levels above +10 dBm.

##### Spurious Signals

	Frequency Range (MHz)				
	0.01 to 120	120 to 160	160 to 320	320 to 640	640 to 1280
Spurious non-harmonically related <sup>1,2</sup>	-90 dBc	-100 dBc	-96 dBc	-90 dBc	-84 dBc
Sub-harmonically related ( $\frac{1}{2}, \frac{3f}{2}$ , etc.)	none	none	none	none	-75 <sup>3</sup> dBc
Power line (60Hz) related or microphonically generated (within 300 Hz) <sup>4</sup> .	-90 dBc	-85 dBc	-80 dBc	-75 dBc	-70 dBc
Harmonics	$< -30$ dBc				

##### Output

**Level range:** +13 to -139.9 dBm (1V to 0.023  $\mu$ V<sub>rms</sub> into 50 $\Omega$ ).

**Resolution:** 0.1 dB.

**Absolute level accuracy (+15° to +45°C):**  $\pm 1$  dB between +13 and -120 dBm,  $\pm 3$  dB between -120 and -130 dBm.

**SWR:** typically from 1.5 to 1.8 depending on output level and frequency.

**Reverse power protection:** typically up to 30W or  $\pm 8$  Vdc.

##### Amplitude Modulation

**Depth:** 0 to 95% at output levels of +8 dBm and below (+10 dBm in uncorrected mode). AM available above these output levels but not specified.

**Resolution:** 1%, 10 to 95% AM; 0.1%, 0 to 9.9% AM.

**Incidental PM (at 30% AM):** 0.15-640 MHz,  $< 0.12$  radian peak; 640-1280 MHz,  $< 0.09$  radian peak.

**Incidental FM (at 30% AM):** 0.15-640 MHz,  $< 0.12 \times f_{mod}$ ; 640-1280 MHz,  $< 0.09 \times f_{mod}$ .

**Indicated accuracy:**  $\pm 5\%$  of reading  $\pm 1\%$  AM. Applies for rates given in table below, internal or external mode, for depths  $\leq 90\%$ .

##### Rates and Distortion with Internal or External Modulating Signal

Frequency range	AM rate	AM Distortion		
		0-30% AM	30-70% AM	70-90% AM
0.15-1 MHz	dc-1.5 kHz	2%	4%	5.75%
1-10 MHz	dc-5 kHz	2%	4%	5.75%
10-1280 MHz	dc-10 kHz	2%	4%	5.75%

##### Frequency Modulation

**FM rates (1 dB bandwidth):** external ac, 20 Hz to 100 kHz; external dc, dc to 100 kHz.

**FM deviation:** from 25 to 200 kHz depending on carrier frequency.

**Indicated FM accuracy:**  $\pm 8\%$  of reading plus 10 Hz (50 Hz to 20 kHz).

**FM resolution:** 100 Hz for deviations  $< 10$  kHz, 1 kHz for deviations  $\geq 10$  kHz.

**Incidental AM (AM sidebands at 1 kHz rate and 20 kHz deviation):**  $< -72$  dBc,  $f_c < 640$  MHz;  $< -65$  dBc,  $f_c \geq 640$  MHz.

**FM distortion:**  $< 1.7\%$  for rates  $< 20$  kHz,  $< 1\%$  for rates  $< 1$  kHz.

**Center frequency accuracy and long term stability in AC mode:** same as CW mode.

##### Supplemental Characteristics

##### Typical Absolute and Residual SSB Phase Noise, 639 MHz Carrier.

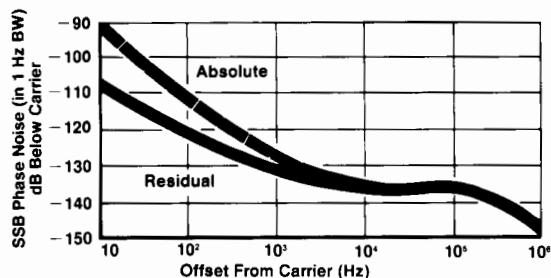

**Frequency switching speed:**<sup>5</sup> From 420  $\mu$ sec to 12.5 msec, depending on the programming mode.

#### HP 8663A Specifications

The HP 8663A signal generator is related to the HP 8662A in both concept and structure. The HP 8662A concept of an extremely low phase noise signal source incorporating signal generator modulation capabilities and output characteristics is carried even further by the HP 8663A. While maintaining high spectral purity, the HP 8663A offers increased frequency range to 2560 MHz, increased output level to +16 dBm, and the addition of phase and pulse modulation. The result is a highly flexible and powerful signal generator that utilizes and extends the proven circuitry of the HP 8662A. Thus, the HP 8662A and HP 8663A share many of the same specifications as shown below:

##### Frequency

**Range:** 100 kHz to 2560 MHz (2559.9999996 MHz)

**Resolution:** 0.1 Hz ( $f_c < 640$  MHz)

0.2 Hz ( $640 \text{ MHz} \leq f_c < 1280$  MHz)

0.4 Hz ( $f_c \geq 1280$  MHz)

**Accuracy, stability, and internal reference oscillator:** identical to HP 8662A.

<sup>1</sup>In the remote mode it is possible to have microprocessor clock related spurious signals spaced 3 MHz apart at an absolute level of typically less than -145 dBm.

<sup>2</sup>Spurious signals can be up to 3 dB higher in the dc FM mode.

<sup>3</sup>1/2 spurs not specified for carrier frequencies above 850 MHz.

<sup>4</sup>At a 50 Hz line frequency, power line or microphonically related spurious signals may be up to 3 dB higher and appear at offsets as high as 1 kHz from the carrier.

<sup>5</sup>Due to automatic leveling loop bandwidth changes, brief (30 msec) level inaccuracies may occur when switching through 150 kHz and 1 MHz RF output frequencies.

**Spectral Purity**

**Residual SSB phase noise in 1 Hz BW ( $320 \leq f_c < 640$  MHz):** identical to HP 8662A.

**Typical SSB phase noise:** identical to the HP 8662A for  $f_c$  between 100 kHz and 1280 MHz (see graph). For  $f_c$  between 1280 and 2560 MHz, the noise will be approximately 12 dB higher than the 639 MHz curve on the "typical SSB phase noise" graph.

**Absolute SSB phase noise in a 1 Hz BW:** identical to the HP 8662A for  $f_c$  between 100 kHz and 1280 MHz. For  $f_c$  between 1280 and 2560 MHz, the specified noise is 6 dB higher than the 640 to 1280 MHz specification in the table.

**Spurious signals:** identical to HP 8662A except for  $f_c$  between 1280 and 2560 MHz the spurious non-harmonics are  $-78$  dBc, the sub-harmonically related ( $f/2$ ,  $3f/2$ , etc.) between 640 and 1280 MHz are  $-70$  dBc and between 1280 and 2560 MHz are  $-40$  dBc, and the power line (60 Hz) or microphonically generated spurious are  $-65$  dBc.

**Harmonics:**  $< -30$  dBc,  $\leq +13$  dBm output,  $< -25$  dBc,  $+13$  dBm to  $+16$  dBm output,  $f_c < 1280$  MHz;  $< -25$  dBc,  $f_c \geq 1280$  MHz

**Output**

**Level range:**  $+16$  dBm to  $-129.9$  dBm

**Resolution:** 0.1 dB

**Absolute level accuracy ( $+15^\circ$  to  $+45^\circ\text{C}$ ):**  $\pm 1$  dB,  $+16$  dBm to  $-119.9$  dBm;  $\pm 3$  dB for  $-120$  dBm and below.

**SWR:**  $< 1.5$

**Amplitude Modulation**

**Depth:** 0 to 95% at levels of  $+10$  dBm and below

**Resolution:** 0.1%

**Incidental FM (at 30% AM):** identical to HP 8662A except:  $< 0.3 \times f_{\text{mod}}$  for  $1280 \leq f_c < 2560$  MHz

**Indicated accuracy:**  $\pm 6\%$  of reading  $\pm 1\%$  AM (400 Hz and 1 kHz, depth 90%)

**AM Bandwidth (1dB):**

DC to  $> 1.5$  kHz,  $0.15$  MHz  $\leq f_c < 1$  MHz; DC to  $> 5$  kHz,  $1$  MHz  $\leq f_c \leq 10$  MHz; DC to  $> 10$  kHz,  $f_c > 10$  MHz; External dc coupling. External ac coupling or internal; low frequency coupling is 20 Hz.

**Distortion (400 Hz and 1 kHz):**  $< 2\%$  (0–30% AM);  $< 4\%$  (30–70% AM);  $< 6\%$  (70–90% AM).

**Frequency Modulation**

**FM rates (1 dB bandwidth):** external ac, 20 Hz to 100 kHz, external dc, dc to 100 kHz.

**Maximum allowable peak deviation:** identical to HP 8662A for  $f_c$  between 100 kHz and 1280 MHz. Up to 400 kHz for  $f_c$  between 1280 and 2560 MHz.

**Indicated FM accuracy (50 Hz to 20 kHz):**  $\pm 9\%$  of setting  $+10$  Hz.

**FM resolution:** 100 Hz to 1 kHz depending on  $f_c$  and deviation setting.

**Incidental AM (AM sidebands at 1 kHz rate and 20 kHz deviation):**  $< -72$  dBc ( $10 \leq f_c < 640$  MHz);  $< -65$  dBc ( $640 \leq f_c < 2560$  MHz).

**FM distortion:**  $< 1.25\%$  (400 Hz and 1 kHz rates);  $< 1.75\%$  (rates less than 20 kHz).

**Phase Modulation (Option 002)**

**Maximum peak phase deviation:** from  $\pm 25^\circ$  for  $f_c$  between 120 and 160 MHz up to  $\pm 400^\circ$  for  $f_c$  between 1280 and 2560 MHz.

**Maximum rate:** from 10 kHz for  $f_c$  between 0.15 and 10 MHz up to 10 MHz for  $f_c$  between 250 and 2560 MHz.

**Phase deviation resolution:**  $1^\circ$  ( $0.1 \leq f_c < 640$  MHz);  $2^\circ$  ( $640 \leq f_c < 1280$  MHz);  $4^\circ$  ( $1280 \leq f_c < 2560$  MHz).

**Phase modulation distortion:** 10% at maximum rate.

**Biphase Modulation**

Biphase modulation is available on the standard HP 8663A for  $f_c$  less than 640 MHz and available for all  $f_c$  with Option 002.

**Deviation:**  $\pm 90^\circ$ .

**Carrier null when modulated with 1 MHz, 50% duty cycle square wave:**  $> 25$  dBc.

**Modulation input required:** TTL positive true. The internal modulation oscillator can be used for 50% duty cycle modulation. External input is on rear panel.

**Pulse Modulation<sup>1</sup>**

**Pulse on/off ratio:**  $> 80$  dB (50–2560 MHz).

**Pulse rise/fall time:**  $< 250$  ns (50–120 MHz);  $< 800$  ns (120–640 MHz);  $< 100$  ns ( $f_c \geq 640$  MHz).

**Pulse Repetition Frequency (50% duty cycle):**

Internal: 10 Hz to 99.9 kHz.

External: 10 Hz to 2 MHz,  $50$  MHz  $< f_c < 640$  MHz; 10 Hz to 5 MHz,  $f_c > 640$  MHz.

**Internal Modulation Oscillator**

**Rates:** 10 Hz to 99.9 kHz.

**Frequency resolution:** 3 digits.

**Frequency accuracy:** same as reference oscillator.

**Output level (available on rear panel):** 1 volt peak into 600 $\Omega$ .

**Output impedance:** 600 $\Omega$ .

**Flatness (referenced to 1 kHz):**  $< \pm 1\%$ .

**Distortion:**  $< 1\%$ .

**Other HP 8662A and HP 8663A Information**

**Remote programming:** the HP-IB interface is standard on the HP 8662A and HP 8663A signal generators. All functions controlled from the front panel with the exception of the line switch are programmable with the same accuracy and resolution as in manual mode.

**Operating temperature range:**  $0^\circ$  to  $+55^\circ\text{C}$ .

**Leakage:** meets radiated and conducted limits of MIL STD 461A methods RE02 and CE03 as well as VDE 0871.

**Power requirements:** 115 (90-126) V or 230 (198-252) V; 48 to 66 Hz; 450 VA max.

**Weight:** HP 8662A: net, 30 kg (65.5 lb.); shipping, 36 kg (80 lb.).

HP 8663A: net, 33.8 (74 lb.); shipping, 40 kg (88 lb.).

**Size:** HP 8662A: 178H x 425W x 572 mmD (7" x 16.75" x 22.5").

HP 8663A: 178H x 425W x 642 mmD (7" x 16.75" x 25.3"). Note: depth includes front panel depth of 45 mm (1.75").

**Ordering Information**

	<b>Price</b>
HP 8662A 1280 MHz Signal Generator <sup>2</sup>	\$35,100
Opt 001 RF connectors on rear panel only	+ \$375
Opt 003 Specified SSB phase noise for 640 MHz output	+ \$525
Opt 907 Front Handle kit (5061-9690)	+ \$65
Opt 908 Rack flange kit (5061-9678)	+ \$35
Opt 909 Rack flange & front handle kit (5061-9684)	+ \$90
Opt 910 A total of two sets of operating and service manuals (HP PN 08662-90069)	+ \$135
HP 11721A External frequency doubler for operation to 2.56 GHz (HP 8662A only)	\$700
HP 8663A 2560 MHz Signal Generator <sup>2</sup>	\$48,700
Opt 001 RF connectors on rear panel only	+ \$375
Opt 002 Wideband linear phase modulation	+ \$5,500
Opt 003 Specified SSB phase noise for 640 MHz output.	+ \$525
Opt 700 External MATE translator	+ \$6,850
Opt 907 Front handle kit (5061-9690)	+ \$65
Opt 908 Rack flange kit (5061-9678)	+ \$35
Opt 909 Rack flange & front handle kit (5061-9684)	+ \$90
Opt 910 A total of two sets of operation/calibration (HP PN 08663-90069) and service manuals (HP PN 08663-90071)	+ \$350
Opt 915 One copy of service manual (HP PN 08663-90071)	+ \$150
HP 11714A Service Support Kit (required for servicing HP 8662A/8663A)	\$1,510

<sup>1</sup>Pulse modulation is available for  $f_c < 50$  MHz but is unspecified.

<sup>2</sup>HP-IB cables not supplied. For description and price, see HP-IB section.

# SIGNAL GENERATORS

## Synthesized Signal Generators

### Model 8660D

- 10 kHz to 2600 MHz
- Synthesizer stability and accuracy
- 1 Hz resolution (2 Hz above 1300 MHz)

- Ten digit display
- Calibrated output over > 140 dB range
- AM, FM,  $\Phi$ M, or pulse modulation



HP 8660D

## HP 8660D Synthesized Signal Generator

### System Concept

The HP 8660 is a modular, solid-state, plug-in system. Each system includes: 1) a programmable, synthesized signal generator mainframe, 2) an RF section plug-in, and 3) a modulation section. Synthesized accuracy and stability, along with complete programmability, make the HP 8660 ideal for automated receiver, subsystem and component testing.

### Mainframes

The HP 8660D offers front panel and HP-IB or BCD control of center frequency and frequency sweep. An external reference may be used to replace the internal, high stability reference oscillator.

### Plug-In RF Sections

The HP 86601A (0.01 – 110 MHz), HP 86602B (1 – 1300 MHz), and HP 86603A (1 – 2600 MHz) are the three RF section choices. The HP 11661B Frequency Extension Module (mainframe Option 100) must be used with the HP 86602B and HP 86603A and is installed internally to an HP 8660 mainframe. (When using the HP 8660A mainframe, the HP 86603A plug-in must be ordered with Option 003.)

### Plug-In Modulation

There are five modulation sections from which to choose. The HP 86631B Auxiliary Section provides external AM and pulse modulation. The HP 86632B offers AM and FM and utilizes a free-running VCO to provide high FM deviations and rates while the HP 86633B provides AM and phase locked FM. The HP 86634A offers high performance phase modulation with rates to 10 MHz while the HP 86635A provides both FM and phase modulation. (The HP 86634A and HP 86635A must be used with Option 002 RF Section.)

## HP 8660D Mainframe Specifications

**Frequency accuracy and stability:** CW frequency accuracy and long term stability are determined by internal reference oscillator, or by external reference.

### Reference Oscillator

**Internal:** 10 MHz quartz oscillator. Aging rate less than  $\pm 3$  parts in  $10^9$  per 24 hours.

**External:** rear panel switch allows operation from 5 MHz or 10 MHz frequency standard at a level between 0.5 and 2.5 Vrms into 170 ohms.

**Reference output:** rear panel BNC connector provides output of reference signal selected at level of at least 0.5 Vrms into 170 ohms.

**Digital sweep:** auto, single, or manual. Selectable speeds 0.1, 1, or 50 seconds.

### Remote Programming

#### Functions

**HP 8660D:** CW frequency, frequency stepping (STEP $\uparrow$ , STEP $\downarrow$ ), output level, and most modulation functions are programmable.

#### Programming Input

**Connector type:** 36-pin Cinch type 57 (mating connector supplied). 24-pin Cinch type 57 for HP-IB control. BCD and HP-IB control internal jumper selectable.

**Logic:** TTL compatible (negative true).

**Switching time:** less than 5 ms to be within 100 Hz of any new frequency selected. (Less than 100 ms to be within 10 Hz.)

### General

**Operating temperature range:** 0° to +55°C.

**Power:** 100, 120, 220, or 240 volts +5%, -10%, 48-400 Hz; approximately 350 watts.

**Weight (mainframe only):** net, 23.8 kg (53 lb). Shipping, 29.6 kg (65 lb).

## Supplemental Characteristics

### Typical Single Sideband Phase Noise

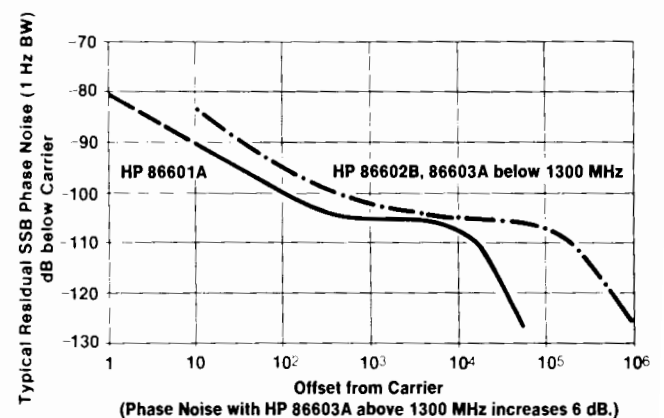

# SIGNAL GENERATORS

## Synthesized Signal Generators

Models 86601A-86603A

373

10 kHz to 110 MHz

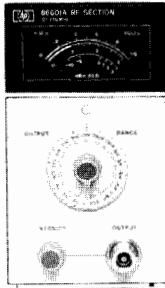

HP 86601A

1 MHz to 1300 MHz

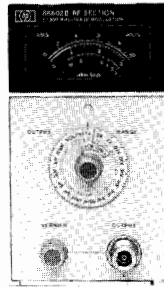

HP 86602B (HP 11661B required)

1 MHz to 2600 MHz

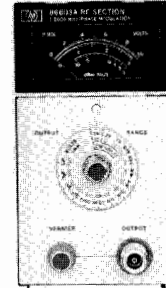

HP 86603A (HP 11661B required)

### RF Section Specifications (installed in HP 8660D mainframe)

		HP 86601A	HP 86602B (requires HP 11661B)	HP 86603A (requires HP 11661B)		
FREQUENCY CHARACTERISTICS	Frequency Range	0.01–110 MHz (109.999999 MHz)	1–1300 MHz (1299.999999 MHz)	1–2600 MHz (2599.999998 MHz)		
	Frequency Resolution	1 Hz	1 Hz	CF <1300 MHz	CF ≥1300 MHz	
	Harmonics	≤−40 dBc	≤−30 dBc (<−25 dBc above +3 dBm)		≤−20 dBc <sup>1</sup>	
	Spurious Non Harmonically Related (greater than 10 KHz offsets)	≤−80 dBc	≤−80 dBc below 700 MHz ≤−80 dBc above 700 MHz within 45 MHz of carrier ≤−70 dBc above 700 MHz >45 MHz from carrier		<−74 dBc within 45 MHz of carrier <sup>1</sup> ≤−64 dBc >45 MHz from carrier	
	Power Line Related (CW, AM, φM only) <sup>2</sup>	≤−60 dBc	≤−50 dBc on +10 dBm range ≤−60 dBc		≤−60 dBc	
Signal To Phase Noise Ratio (CW, AM, φM only, offsets >300 Hz)	>50 dB	>45 dB		>39 dB		
OUTPUT CHARACTERISTICS	Output Level (into 50Ω)	+13 dBm to −146 dBm	+10 to −146 dBm	+10 to −136 dBm	+7 to −136 dBm <sup>3</sup>	
	Output Accuracy (local and remote)	±1 dB, +13 to −66 dBm ±2 dB, −66 to −146 dBm	±1.5 to −76 dBm ±2.0 to −146 dBm	±2.5 dB to −76 dBm <sup>3</sup> ±3.5 dB to −136 dBm		
	Flatness (output level variation with frequency)	<±0.75 dB	<±1.0 dB	<±2.0 dB (1–2600 MHz)		
	Impedance	50Ω				
MODULATION CHARACTERISTICS	AM	AM Modulation Depth	0 to 95%		0 to 50% <sup>4</sup>	
		3 dB Bandwidth:	0–30%	200 Hz, CF<0.4 MHz 10 kHz, 0.4≤CF<4 MHz 100 kHz, CF≥4 MHz	10 kHz, CF<10 MHz 100 kHz, CF≥10 MHz	5 kHz
			0–70%	125 Hz, CF<0.4 MHz 6 kHz, 0.4≤CF<4 MHz 60 kHz, CF≥4 MHz	6 kHz, CF<10 MHz 60 kHz, CF≥10 MHz	N/A
			0–90%	100 Hz, CF<0.4 MHz 5 kHz, 0.4≤CF<4 MHz 50 kHz, CF≥4 MHz	5 kHz, CF<10 MHz 50 kHz, CF≥10 MHz	N/A
	Distortion, <sup>5</sup> THD at 30% AM at 70% AM at 90% AM	<1%, 0.4–110 MHz <3%, 0.4–110 MHz <5%, 0.4–110 MHz	<1% <3% <5%		<5% N/A N/A	
	FM	FM Rate	dc to 1 MHz with HP 86632B and HP 86635A 20 Hz to 100 kHz with HP 86633B	dc to 200 kHz with HP 86632B and HP 86635A 20 Hz to 100 kHz with HP 86633B		
		Maximum Deviation (peak)	1 MHz with HP 86632B and HP 86635A 100 kHz with HP 86633B	200 kHz with HP 86632B and HP 86635A 100 kHz with HP 86633B	400 kHz w/HP 86632B, 86635A 200 kHz w/HP 86633B	
		Distortion, THD (at rates up to 20 kHz)	<1% up to 200 kHz dev. <3% up to 1 MHz dev.	<1% up to 200 kHz dev.		<1% up to 400 kHz dev.
	PULSE	Pulse Rise/Fall Time	200 ns		50 ns	
		ON/OFF Ratio (with pulse level control at max.)	>50 dB		>40 dB	>60 dB
φM	φM Rate	N/A	dc to 1 MHz with HP 86635A dc to 1 MHz for CF <100 MHz dc to 10 MHz for CF ≥100 MHz with HP 86634A			
	Maximum Peak Deviation	N/A	0 to 100 degrees		0 to 200 degrees	
	Distortion, THD	N/A	<5% up to 1 MHz rates <7% up to 5 MHz rates <15% up to 10 MHz rates			
GENERAL	Weight	Net 5 kg (11 lb) Shipping 6.8 kg (15 lb)	Net 4.1 kg (9 lb) Shipping 5.5 kg (12 lb)	Net 5 kg (11 lb) Shipping 6.4 kg (14 lb)		
		HP 11661B: Net 2.3 kg (5 lb); shipping 2.7 kg (6 lb)				

<sup>1</sup>For output levels +3 dBm and below; slightly higher +3 to +7 dBm.

<sup>2</sup>Measured in a 30 kHz band centered on the carrier excluding a 1 Hz band centered on the carrier.

<sup>3</sup>For +3 to +7 dBm output levels, output accuracy and flatness will be slightly degraded (above 1300 MHz only)

<sup>4</sup>For RF output level meter readings from +3 dB to −6 dB and only at +3 dBm and below.

<sup>5</sup>Applies only at 400 Hz and 1 kHz rates with output meter set between 0 and +3 dB. At −6 dB meter setting the distortion approximately doubles.

<sup>6</sup>Phase modulation is only possible with Option 002 RF Sections.

# SIGNAL GENERATORS

## Synthesized Signal Generators (Cont'd)

Models 86631B-86633B, 86634A-86635A

Pulse/AM

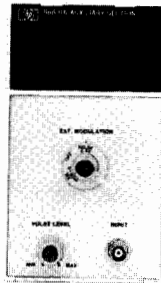

HP 86631B

AM/High Deviation FM

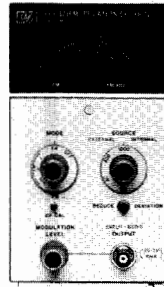

HP 86632B

AM/ $\phi$  Locked FM



HP 86633B

High rate  $\phi$ M

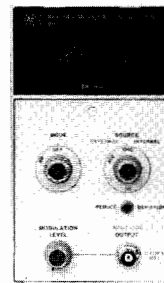

HP 86634A

$\phi$ M/FM

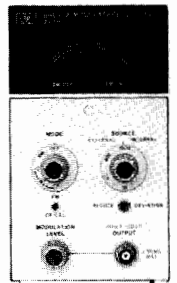

HP 86635A

### Modulation Section Specifications

		HP 86631B	HP 86632B	HP 86633B	HP 86634A	HP 86635A
	Functions	Ext. Only	Int. and Ext.	Int. and Ext.	—	—
AM	Indicated Accuracy (at 400 and 1000 Hz rates)	—	$\pm 5\%$ of full scale With HP 86601A RF Section: $\pm 7\%$ , center frequency $\geq 100$ MHz. With HP 86603A RF Section: $\pm 10\%$ , center frequency $\geq 1300$ MHz.		—	—
FM	Functions	—	Int. and Ext., FM CF CAL	Int. and Ext.	—	Int. and Ext., FM CF CAL
	Center Frequency Long Term Stability	—	Typically less than 200 Hz/hr	Same as in CW Mode ( $3 \times 10^{-8}$ /day)	—	Typically less than 200 Hz/hr
	Indicated Accuracy (up to 20 kHz rates)	—	$\pm 5\%$ of full scale		—	$\pm 5\%$ of full scale
Pulse	Functions	Ext. Only	—	—	—	—
$\phi$ M	Functions	—	—	—	Int. and Ext.	Int. and Ext.
	Indicated Accuracy (15°C to 35°C)	—	—	—	$\pm 5\%$ of full scale up to 100 kHz rates $\pm 8\%$ of full scale up to 2 MHz rates $\pm 15\%$ of full scale up to 10 MHz rates	
Meter		—	0–100% AM 0–10, 100, 1000 kHz FM Pk. Dev. (0–20, 200, 2000 kHz FM for CF $\geq 1300$ MHz)	0–100% AM 0–10, 100 kHz FM Pk. dev. (0–20, 200 kHz FM for CF $\geq 1300$ MHz)	0–100° Peak $\phi$ M (0–200° for CF $\geq$ 1300 MHz)	0–10, 100, 1000 kHz FM, 0–100° Pk. $\phi$ M (0–20, 200, 2000 kHz FM, 0–200° Pk. $\phi$ M for CF $\geq 1300$ MHz)
Internal Modulation Source Output		None —	400 Hz and 1 kHz $\pm 5\%$ 200 mV minimum into 10 k $\Omega$ . Available at front panel BNC connector			
Input Impedance		50 $\Omega$ Pulse 600 $\Omega$ AM	600 $\Omega$	600 $\Omega$	50 $\Omega$	600 $\Omega$
Weight		Net, 1.4 kg (3 lb) Shipping, 2.3 kg (5 lb)	Net, 2.7 kg (6 lb) Shipping, 4.1 kg (9 lb)	Net, 2.7 kg (6 lb) Shipping, 4.1 kg (9 lb)	Net, 1.8 kg (4 lb) Shipping, 3.2 kg (7 lb)	Net, 2.7 kg (6 lb) Shipping, 4.1 kg (9 lb)

### Ordering Information

**HP 8660D** Synthesized Signal Generator mainframe \$14,600

**Opt 001**  $\pm 3 \times 10^{-9}$ /day internal reference oscillator \$0

**Opt 002** No internal reference oscillator – \$300

**Opt 003** operation from 50 to 400 Hz line \$0

**Opt 005** Factory configured for HP-IB programming operation. \$0

**Note:** HP-IB cables not supplied, see page 561.

**Opt 100** HP 11661B factory installed inside main frame + \$6,100

**Opt 908** Rack Flange Kit (08660-60347) + \$110

**Opt 910** 2 sets of operation/calibration (08660-90103) and service (08660-90104) manuals + \$250

**Opt 915** Service manual (08660-90104) supplied with instrument + \$100

**Opt W30** 2 years additional hardware service + \$300

**HP 86601A** 0.01–110 MHz RF Section \$8,000

### Price

**HP 86602B** 1–1300 MHz RF Section \$8,650

**HP 86603A** 1–2600 MHz RF Section \$10,700

**Note:** HP 86602B and 86603A RF sections require an HP 11661B for operation.

**Opt 002** adds phase modulation capability + \$2,350

(HP 86602B, 86603A only)

**Opt 003** allows operation of HP 86603A with + \$250

HP 8660A mainframe

**HP 86631B** Auxiliary Section \$750

**HP 86632B** AM/FM Modulation Section \$3,600

**HP 86633B** AM/FM Modulation Section \$3,600

**HP 86634A**  $\phi$ M Modulation Section \$2,850

**HP 86635A**  $\phi$ M/FM Modulation Section \$3,950

**Note:** Opt 910, 2 sets of operation and service manuals, is available for each modulation section. Contact your HP sales representative for part numbers and prices.

**HP 11661B** Frequency Extension Module \$6,050

**HP 11672A** Service Accessory Kit \$1,350

**HP 11707A** Test Plug-in \$2,650



# SIGNAL GENERATORS

## Mechanically Tuned VHF Signal Generators

### Models 8640B and 8640B Option 004

375

- 0.5 to 512 MHz frequency range with optional coverage to 1024 MHz
- +19 to -145 dBm output power range
- Low SSB phase noise
- Calibrated, metered AM, FM and pulse modulation
- Internal phase lock/synchronizer, digital frequency readout, external count capability to 550 MHz
- Avionics version

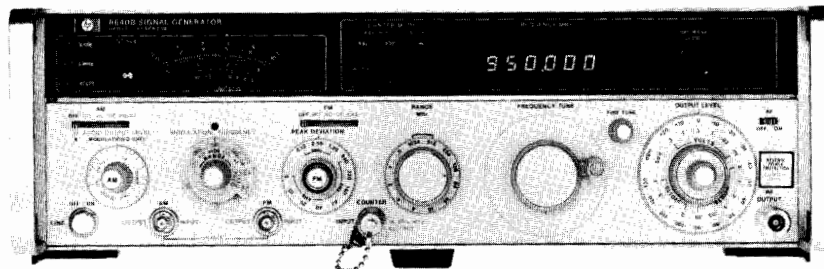

HP 8640B (with Option 001, 002, 003)

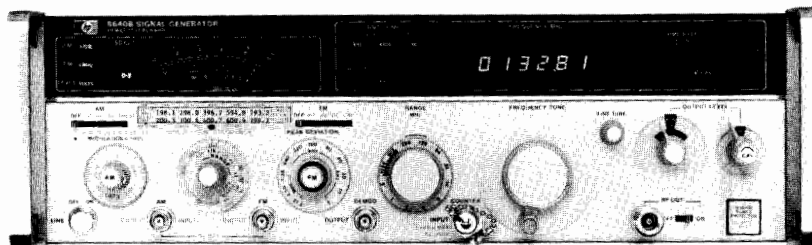

HP 8640B Option 004 (with Option 001, 003)

### HP 8640B Signal Generator

The HP 8640B Signal Generator covers the frequency range 500 kHz to 512 MHz and can be extended to 1024 MHz with an internal doubler (Option 002). Using the HP 11710B Down Converter, the HP 8640B frequency range can be extended down to 10 kHz. An optional internal audio oscillator has a frequency range of 20 Hz to 600 kHz.

The HP 8640B has an output level range of +19 to -145 dBm (2V to 0.013  $\mu$ V) which is calibrated, metered, and leveled to within +0.5 dB across the full frequency range of the instrument. The output is protected against up to 50W of reverse power (with Option 003).

The 8640B also has AM, FM, and pulse modulation for a wide range of receiver test applications.

### Spectrally Pure Output Signals

Noise of the HP 8640B is extremely low beyond 10 kHz offsets. At a 20 kHz offset from the carrier, SSB phase noise is <-130 dBc at 450 MHz and <-122 dBc at 550 MHz. Broadband noise floor is better than -140 dBc/Hz (-130 dBc/Hz for Option 004).

### Phase Locked Stability

The HP 8640B can phase lock to the RF output frequency of the crystal timebase used in the counter (resulting in drift that is better than  $5 \times 10^{-8}$ /hr) while still maintaining its spectral purity. The HP 8640B can also be locked to an external 5 MHz standard.

In the phase locked mode, FM capability and spectral purity are maintained while providing FM rates from 50 Hz to 250 kHz.

### HP 8640B Avionics Option 004 Signal Generator

The HP 8640B Option 004 NAV/COM Signal Generator is an HP 8640B AM/FM signal generator specially adapted for testing ILS, VOR, and VHF receivers. Option 004 is designed with low distortion modulation circuitry for use with suitable VOR/ILS audio generators.

### Demodulated Output

RF peak detected AM is available from the front panel for precise AM settings. A choice of combined ac/dc at 1V rms or ac only at 5V rms is provided.

### Output Level Setting

Option 004 provides excellent demodulated output linearity by using a 10 dB and a 1 dB step attenuator and vernier. Output levels from +15 dBm to -142 dBm (1.3V to 0.018  $\mu$ V).

### Low Distortion Modulation

Option 004 provides flat AM response and minimum phase shift at 30 Hz and 9960 Hz as well as constant group delay between 9 kHz and 11 kHz for accurate VOR and ILS testing.

Operation and specifications of the HP 8640B Option 004 are the same as the standard HP 8640B except where noted.

### HP 8640B Specifications

#### Frequency

**Range:** 500 kHz to 512 MHz in 10 octaves, (1024 MHz with Option 002 internal frequency doubler).

**Resolution:** (Dependent upon phase lock mode and frequency ranges).

#### Fine Tuning

**Unlocked:** >1000 ppm total range.

**Locked mode:**  $\pm 20$  ppm by varying internal time base vernier.

**Accuracy:**  $6\frac{1}{2}$  digit LED display with X10 and X100 expand; accuracy depends on internal or external reference used.

#### Stability (after 2 hr warmup):

Normal: <10 ppm/10 min. Locked: <0.05 ppm/hr.

#### Restabilization time after frequency change:

Normal: <15 min. Locked: <1 min. to be within 0.1 ppm.

#### Output

**Range with Opt. 003 (10 dB steps and 18 dB vernier provide the following output power settings into 50 ohms):**

**Standard:** +18.5 to -145 dBm.

**Opt. 002:** +18 to -145 dBm,  $f_c$ : 0.5 - 512 MHz; +12 to -145 dBm,  $f_c$ : >512 MHz.

**Option 004:** +15 dBm to -142 dBm (1.3 to 0.018  $\mu$ V).

**Option 004 attenuators:** 10 dB and 1 dB step attenuators with a >2 dB vernier.

**Level flatness with Opt. 003 (referred to 1V at 50 MHz at top 10 dB of vernier):**

**Standard:** +0.75 dB, -1.25 dB.

**Opt. 002:** +1.0 dB, -2.0 dB, ( $\pm 2$  dB for  $f_c$  >512 MHz).

# SIGNAL GENERATORS

## Mechanically Tuned VHF Signal Generators (cont'd)

### Models 8640B and 8640B Option 004

**Opt. 004 (referred to 190 MHz and  $\pm 10$  to  $-10$  dBm):**  $\leq \pm 0.75$  dB;  $f_c$ : 0.5 to 512 MHz,  $\leq \pm 0.5$  dB;  $f_c$ : 108 to 336 MHz.

#### Level accuracy:

**Standard:**  $\pm 1.5$  dB to  $\pm 4.5$  dB depending on level and frequency.

**Option 004:**  $\pm 2$  dB;  $+15$  to  $-10$  dBm,  $\pm 2.5$  dB;  $-10$  to  $-50$  dBm;  $\pm 3.0$  dB;  $-50$  to  $-142$  dBm (subtract 0.5 dB for 108 - 336 MHz).

#### Spectral Purity

##### Harmonics (at 1V, +10 dBm output range and below):

$< -30$  dBc, 0.5 to 512 MHz;

$< -12$  dBc, 512 to 1024 MHz (Option 002).

##### Spurious (greater than 15 kHz offsets):

**Nonharmonically related:**  $< -100$  dBc;

**Subharmonically related:**  $< -100$  dBc,  $< -20$  dBc;  $f_c > 512$  MHz

##### Residual AM (averaged rms in a 0.3 - 3 kHz BW):

$< -85$  dBc.

##### Residual FM (averaged rms in a 0.3 - 3 kHz BW):

$< 5$  Hz, ( $< 10$  Hz;  $f_c > 512$  MHz).

**Measured SSB phase noise (typical):** triangles are specified limits.

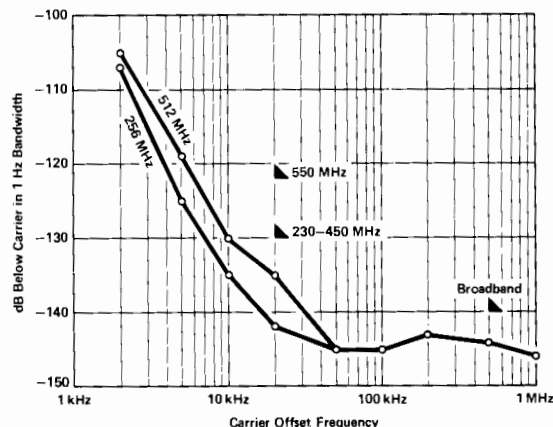

#### Modulation

**General:** internal AM, FM, external AM, FM and Pulse.

##### Simultaneous AM and FM or Pulse and FM.

**Frequency:** fixed 400 Hz and 1 kHz  $\pm 3\%$ ; also, 20 Hz to 600 KHz,  $\pm 15\%$  with Opt. 003.

**Output level:** Standard: 10 mV to 1  $V_{rms}$  into 600 $\Omega$ .

Opt. 003: 1 mV to 3  $V_{rms}$  into 600 $\Omega$ .

##### Amplitude Modulation

(Option 004 specifications apply to output settings of +10 dBm and below)

**Depth:** 0 to 100%, amplitude  $< +13$  dBm; 0 to 100%, amplitude  $< +7$  dBm (excluding top 6 dB of vernier) at  $f_c > 512$  MHz.

##### AM Bandwidth

**Standard:** 3 dB bandwidth (lower ac limit is 20 Hz)

Frequency Ranges	0 to 50% AM	50 to 90% AM
0.5 to 2 MHz	dc - 20 kHz	dc - 12.5 kHz
2 to 8 MHz	dc - 40 kHz	dc - 25 kHz
8 to 512 MHz	dc - 60 kHz	dc - 50 kHz
512 to 1024 MHz	dc - 60 kHz	dc - 50 kHz

**Option 004 frequency response:** (lower ac limit is 20 Hz);

$\leq \pm 0.04$  dB; 90 Hz to 150 Hz,  $f_c$ : 108 - 118 and 329 - 335 MHz;

$\leq \pm 0.1$  dB; 9 kHz to 11 kHz,  $f_c$ : 108 - 118 MHz.

##### AM distortion (400 Hz and 1 kHz rates):

$< 1\%$ , 0 - 50% AM;  $< 3\%$ , 50 - 90% AM;

$< 10\%$ , 0 - 30% AM ( $f_c > 512$  MHz);

$< 20\%$ , 30 - 90% AM ( $f_c > 512$  MHz).

##### External input impedance:

**Standard:** 600 $\Omega$ .

**Opt. 004:** 2 k $\Omega$  nominally.

##### AM sensitivity (400 Hz and 1 kHz rates into 600 $\Omega$ ):

0.1% AM/mV peak; (0.1 $\pm 0.005$ )% AM/mV pk when  $f_c < 512$  MHz.

**AM accuracy:** (400 and 1 kHz rates)

$\pm (5.5\%$  of reading  $+ 1.5\%$  of full scale),  $f_c < 512$  MHz.

**Incidental  $\theta M$  (at 30% AM):**  $< 0.15$  rad,  $f_c < 128$  MHz;  $< 0.3$  rad,  $f_c < 512$  MHz; 0.6 rad,  $f_c > 512$  MHz.

#### General Option 004 AM Specifications

**Demodulated output:** output vernier in CAL position, 108 to 118 MHz and 329 to 336 MHz and 20% - 80% AM.

**AC only output:** proportional to AM depth; 90 to 150 Hz AM rates.

**% AM equals:** (20  $\pm 0.6$ )% per  $V_{rms}$ ; 0 to 55 $^{\circ}$ C, (20  $\pm 0.4$ )% per  $V_{rms}$ ; 20 to 30 $^{\circ}$ C, (20  $\pm 0.2$ )% per  $V_{rms}$  using CAL data.

**AC and dc output:** proportional to AM depth; 90 to 150 Hz AM rates. DC output equals (1.41  $\pm 0.01$ ) V dc with vernier in CAL position.

**% AM equals:** (100  $\pm 3$ )% per  $V_{rms}$ ; 0 to 55 $^{\circ}$ C, (100  $\pm 2$ )% per  $V_{rms}$  20 to 30 $^{\circ}$ C, (100  $\pm 1$ )% per  $V_{rms}$  using DEMOD CAL data.

**Phase shift from audio input to demodulated output (108 - 118 MHz, AM EXT DC mode):**  $\leq \pm 0.01^{\circ}$ ; 30 Hz rate,  $\pm 3^{\circ}$ ; 30 Hz to 10 kHz,  $\pm 2^{\circ}$ ; 9 kHz to 11 kHz.

**Pulse Modulation**

**Rise/fall time:**  $< 1$   $\mu$ sec,  $f_c$ : 8 - 512 MHz, 1  $\mu$ sec typ. for  $f_c > 512$  MHz, 1 to 9  $\mu$ sec for  $f_c < 8$  MHz (depending on carrier frequency).

**Rate:** 50 Hz to 500 kHz at 512 MHz.

**On/off ratio:**  $> 40$  dB;  $f_c < 512$  MHz,  $> 60$  dB;  $f_c > 512$  MHz.

##### Frequency Modulation

**Deviation:** 640 kHz,  $f_c$ : 64 to 128 MHz. (Deviation doubles at each octave above 128 MHz and halves at each octave below 64 MHz.)

**FM rate (3 dB BW):** dc/20 Hz - 250 kHz (50 Hz min. in locked mode).

**FM distortion (400 and 1 kHz):**  $< 3\%$ , ( $< 1\%$ , dev.  $< 1/8$  maximum).

**FM sensitivity:** 1V peak into 600 $\Omega$ .

**FM accuracy (400 and 1 kHz):**  $\pm (7\% + 1.5\%$  of full scale).

**Incidental AM (400 and 1 kHz):**  $< 1\%$  AM, ( $< 0.5\%$  AM, dev.  $< 1/8$  max.),  $< 7\%$ ,  $f_c > 512$  MHz ( $< 1\%$ , dev.  $< 1/8$  maximum).

#### Counter

**Frequency range:** 1 Hz to 550 MHz.

**Sensitivity:**  $> 200$  mV $_{rms}$  from a 50 source impedance, ac only.

**Resolution (6 digit LED display with X10 and X100 expand mode):** 100 Hz for  $f_c$ : 0 - 10 MHz; 10 kHz for  $f_c$ : 10 - 550 MHz.

#### General

**External reference input:** 5 MHz, nominally  $> 0.5$  V $_{pp}$  into 1 k $\Omega$ .

**Internal reference (after 2 hr. warmup at 25 $^{\circ}$ C):**

**Aging rate:**  $< 0.05$  ppm/hr;  $< 2$  ppm/90 days.

**Drift:**  $\leq \pm 2$  ppm; 15 to 35 $^{\circ}$ C,  $< +10$  ppm; 0 to 50 $^{\circ}$ C.

**Typical accuracy:**  $\pm 2$  ppm; 15 to 35 $^{\circ}$ C.

**Operating temperature:** 0 to 55 $^{\circ}$ C.

**Power requirements:** 100, 120V ( $+5\%$ ,  $-10\%$ ); 48 to 440 Hz, 220,

240V ( $+5\%$ ,  $-10\%$ ); 48 to 66 Hz. 175 VA max (Opt. 002: 190 VA max).

**Weight:** net, 20.8 kg (46 lb); shipping, 24.1 kg (53 lb).

**Size:** 140H x 425W x 467 mmD (5.5" x 16.75" x 18.75").

#### Ordering Information

	Price
8640B Signal Generator	\$12,000
Opt 001 20 - 600 kHz internal audio oscillator	+\$525
Opt 002 Internal doubler 512 - 1024 MHz	+\$1,050
Opt 003 Reverse power protection	+\$375
Opt 004 Avionics version	+\$1,575
Opt 908 Rack mount kit (5060-8740)	+\$37.50
Opt 910 2 sets of operation/calibration (08640-90208) and service manuals (08640-90215)	+\$340
Opt 915 Service manual supplied with instrument (08640-90215)	+\$150

# SIGNAL GENERATORS

## Accessories, Frequency Doublers

Models 11509A, 11687A, 11690A, 11710B, 11721A

377

- Additional capabilities for signal generators



HP 11687A



HP 11509A

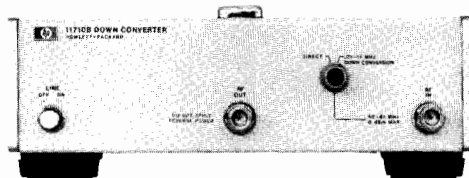

HP 11710B



HP 11690A



HP 11721A

### HP 11509A Fuseholder

Accidental burnout of attenuators in HP 8640 and HP 8654 signal generators can be prevented by using this fuse element between the signal generator and a transceiver. The fuseholder has a frequency range of dc to 480 MHz, insertion loss of  $\leq 1$  dB, SWR of  $\leq 1.35$  (50 $\Omega$  load), and Type N connectors. Ten extra fuses are furnished.

### HP 11687A 50-75 $\Omega$ Adapter

This 50-75 $\Omega$  adapter with Type N connectors is recommended for use with HP 8640, 8642, 8654, 8660, 8656, and 8662 signal generators for measurements in 75 $\Omega$  systems. The voltage calibration on the output level meter is unaffected by use of the adapter, but 1.76 dB must be subtracted from the dB scale on the meter to determine the output in dBm into 75 $\Omega$ . Frequency range is dc to 1300 MHz.

### HP 11690A Frequency Doubler

The HP 11690A extends the frequency range of all HP 8640 series signal generators by doubling the 256-512 MHz frequency band up to 1024 MHz (to 110 MHz with band overrange). All HP 8640s indicate the correct doubled output frequency on a dial or counter when the 512-1024 MHz range is selected. The HP 11690A will also perform well with any source meeting the input requirements of 200-550 MHz at +10 to +19 dBm. Conversion loss is  $< 13$  dB, output flatness has  $< 4$  dB total variation, and the first and third input harmonics are suppressed  $> 20$  dB. Connectors are BNC.

### HP 11710B Down Converter

The HP 11710B Down Converter is an accessory for the HP 8640 and HP 8654 series signal generators. Frequency inputs from 50.01 to 61 MHz are down converted to the 10 kHz to 11 MHz range respectively. The output level and modulation functions of the HP 8640 and HP 8654 remain calibrated. A straight-through selection switch allows the input to pass through unchanged, and thus minimizes the necessity to move cables when testing. Option 001 provides rails and semi-rigid coax for combining the HP 11710B with an HP 8654A/B Signal Generator.

### HP 11710B Specifications

#### Input

**Down-conversion mode:** 50.01 to 61.00 MHz at  $\leq 0$  dBm.

**Straight-through mode:** 0.01 to 1100 MHz (dc coupled).

#### Down-Converted Output

**Frequency range:** 10 kHz to 11 MHz.

**Level range:** 0 to  $-107$  dBm

**Level flatness:** RF source flatness  $\pm 0.5$  dB (referred to 4.0 MHz).

**Total level accuracy:**  $\pm 1$  dB plus input level accuracy).

**Harmonics:**  $> 35$  dB below the carrier (dBc).

**Intermixing spurious:**  $> 60$  dBc.

**Local oscillator feed-through (50 MHz):**  $< -100$  dBm.

### Internal Reference Characteristics

**Time base output:** 1 MHz or 5 MHz selectable, nominally  $> 0.5$  V p-p into 500 $\Omega$ . This will drive an HP 8640B external time base input.

**Typical overall accuracy:** (within 3 months of calibration and from 15 $^{\circ}$  C to 35 $^{\circ}$  C):  $\pm 2$  ppm.

### General

**Operating temperature range:** 0 $^{\circ}$  to 55 $^{\circ}$  C.

**Power requirements:** 100, 120, 220, 240 V (+5%, -10%), 48 to 440 Hz; 25 VA maximum.

**Weight:** net, 3.2 kg (7 lb); shipping, 4.5 kg (9 lb).

**Size:** 102 H  $\times$  266 W  $\times$  295 mm D (4"  $\times$  10.5"  $\times$  11.6"). 1/2 MW  $\times$  4 H  $\times$  11 D System 1 Module.

### HP 11721A Frequency Doubler

The HP 11721A Doubler is an ideal accessory for extending the usable frequency range of signal generators, frequency synthesizers, or other signal sources. Operating on input frequencies of 50 MHz to 1300 MHz, it provides a doubled output in the range of 100 MHz to 2600 MHz. The HP 11721A will work well with any RF source with an output in the range 50 to 1300 MHz.

The 50 $\Omega$  passive circuit of the HP 11721A offers low conversion loss, low spurious, and excellent flatness over its entire frequency range when operated above +10 dBm.

### HP 11721A Specifications

**Input frequency range:** 50 to 1300 MHz.

**Output frequency range:** 100 to 2600 MHz.

**Conversion loss (+13 dBm input, 50 to 1280 MHz):**  $< 15$  dB.

**Spurious referenced to desired output frequency f (+13 dBm input with harmonics  $< -50$  dBc, 50 to 1280 MHz):**  $f/2$ ,  $-15$  dB;  $3f/2$ ,  $-15$  dB.

**Input SWR:** 1.5 typical.

**Input/output impedance:** 50 $\Omega$  nominal.

**Operating temperature range:** 0 $^{\circ}$  to +50 $^{\circ}$  C.

**Connectors:** input, type N male; output, type N female.

**Size:** 161 L  $\times$  30 W  $\times$  20.5 mm H (6 3/8"  $\times$  1 3/16"  $\times$  13/16").

**Weight:** net, .02 kg (0.5 lb); shipping, 0.4 kg (1 lb).

### Ordering Information

HP 11509A Fuseholder	\$275
HP 11687A 50 $\Omega$ -75 $\Omega$ Adapter	\$215
HP 11690A Frequency Doubler	\$315
HP 11710B Down Converter	\$3200
Opt 001 Combining Kit	\$160
Opt 910 Additional operating & service manual	\$3.50
HP 11721A Frequency Doubler	\$700
☎ Fast ship product — see pg. 766	

### Price

# SIGNAL GENERATORS

## Signal Simulator System, dc - 50 MHz

### Models 8770S, 8770A, 11776A

- A new source of "real-life" signals to 50MHz
- Excellent spectral purity
- Accurate margin tests with precise degradations
- The standard for simulating complex signals



#### Simulate Signals for Radar, EW, Communications, Magnetic Disk and Other Applications

Today's sophisticated electronic systems require "real-life" functional testing to ensure that they will perform properly under their intended operating conditions. The HP 8770S accurately simulates real-life signals in radar, EW, communications, magnetic disk and other applications. The HP 8770S helps test if your radar can detect multiple targets. It tests if your EW receiver can correctly identify possible threats. It tests if your digital receiver can reconstruct transmitted signals in the presence of jamming. And, in magnetic disk applications, it simulates the signals necessary to test sensitive read/write and servo circuitry.

#### Description

The HP 8770S Signal Simulator System consists of the:

- HP 8770A Arbitrary Waveform Synthesizer
- HP 9000 Series 300 Technical Computer
- HP 11776A Waveform Generation Software.

Design waveforms with the software, then generate the waveforms with the HP 8770A. Use this advanced simulation system to generate complex baseband and IF signals from dc to 50 MHz. Add precise amounts of distortion and noise to test the operating margins of your system early in the development cycle. All signal parameters are under complete software control, allowing quick changes to meet new test demands. The HP 8770A has a complete HP-IB command set for full automatic control and easy downloading of waveform data previously defined by the HP 11776A or by other means. Regardless of your application, the use of precise complex test signals improves the evaluation of your circuits and systems.

The HP 8770A Arbitrary Waveform Synthesizer (AWS) forms the heart of the HP 8770S. Advanced digital synthesis techniques ensure precise waveform generation.

#### Features

- 8 ns Sample Update Rate
- 12-bit Words
- 125 MHz Internal Clock (phase-locks to crystal osc.)
- Special "Deglitching" Circuits
- 110 dB RF Attenuator
- 512K Memory

#### Benefits

- Rapid Signal Parameter Changes
- High Amplitude Resolution
- Time Base with Synthesizer Accuracy
- Low Harmonic and Spurious Distortion Levels
- 12-bit Resolution Even at Low Signal Levels
- Highly Complex Waveforms, Longer Waveform Sequences

- Accelerate R & D turnaround
- Reduce artificial guardbands
- 125MHz sample rate
- 12-bit resolution, 512K word memory

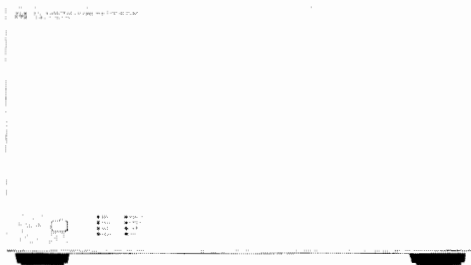

The HP 11776A Waveform Generation Software operates on the HP 9000 Series 300 technical computers. It consists of the Waveform Generation Language (WGL), an HP BASIC 5.1 operating system, and application disks for powerful waveform development. Use over 100 easy commands and math functions to create and manipulate waveforms as desired. Add noise or spurs to generate real-life test signals. Add waveforms together to create harmonically distorted waves, or multiply waves to create complex modulated signals. Create waves in either the frequency or time domain and quickly convert from one to the other. Capture data from other instruments such as spectrum analyzers and oscilloscopes. Once waveforms have been developed, you can download them into the HP 8770A for immediate generation or store them on a disk for later use in multiple stations. Thus, WGL makes "what if" testing to determine a device's performance easy and affordable.

#### Build Waveform Libraries for Complete Tests

Any HP-IB computer can control the HP 8770A and download previously defined waveform data. Generate a library of test waveforms with the HP 11776A software. Then download them to the HP 8770A from the computer in your ATE system for use in your applications.

#### Stretch Memory with Sequencing

Certain parts of waveforms often repeat themselves and quickly fill up even the largest memory. This leaves less memory to define the rest of the desired test signal. The HP 8770A avoids this problem by allowing sections of memory (packets) to be repeated any number of times and in any order. This sequencing capability and the large 512K word memory free large amounts of memory for greater flexibility when defining complex waves. Many test signals can also be stored simultaneously in the memory and accessed at any time with the sequencer. In a production ATE environment, this substantially decreases download time, reducing costs.

#### Applications Overview

##### Radar

The HP 8770S simulates multiple targets for more effective radar testing. Simulate complex radar video and IF signals. Add noise, pulse jitter, and clutter. Shape radar chirps to exact specifications. Stagger multiple radar pulses. Vary the PRF as a function of time. Control radar pulse parameters with extremely precise resolution. Finally, manipulate doppler shift and range or superimpose multiple targets together, resulting in complex, demanding test signals.

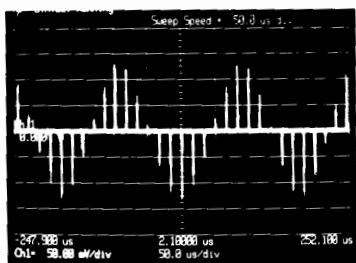

Doppler shifted return of moving target

### Electronic Warfare

Simulate MOP, exotic threats, and other complex modulated signals to test next-generation EW receivers and signal processors. Vary pulse amplitudes, rise and fall times, pulse width, PRI, and stagger, of individual radars.

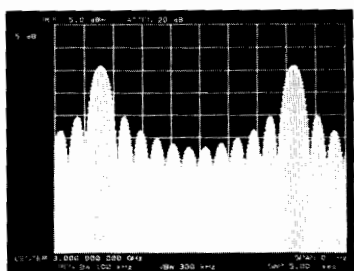

Antenna scan pattern

### Communications

The HP 8770S is an excellent signal simulator for conventional analog communication systems, digital microwave radios, and satellite communications systems. Design and generate amplitude-, frequency-, and phase-modulated communications signals with digital precision. Exploit memory sequencing to hop from one frequency to the next with fast frequency switching speed and phase continuity. Simulate Nyquist filter responses in software to eliminate time-consuming and costly hardware filters.

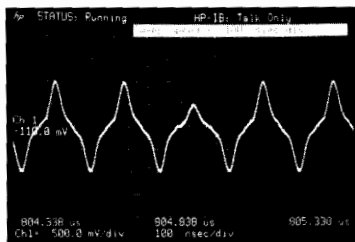

Missing bit

### Magnetic Disk

The signal simulation system continues to be extremely successful in magnetic disk applications. Replace the head disk assembly to test read/servo channel boards for design integrity, calibrate disk media certifiers, or verify board operation in production test. Test bit shift susceptibility to less than 50ps shift resolution.

### Other Applications

- Video and Imaging
- Component Test

### HP 8770A Performance Characteristics

#### Frequency

**Range:** dc to 50 MHz

**Frequency Switching Speed:** 8 ns, phase continuous

#### RF output

**Power range:** +10 dBm to -110 dBm

**Attenuator:** 110 dB in 10 dB steps

**Max Output Voltage:** 2 V p-p into 50 or 75 ohms

**Number of DAC bits:** 12 true bits, monotonic

**Amplitude Resolution:** .024% of full scale

**Amplitude Flatness:**  $< \pm 0.65$  dB ( $< 0.1$  dB w/predistortion)

**Phase Linearity (dc - 50MHz):**  $\pm 5^\circ$  ( $< \pm 1^\circ$  w/predistortion)

**Output Impedance:** 50  $\Omega$  (75  $\Omega$  for option 002)

**Output SWR:**  $< 1.2:1$

**Connector:** Type N (female)

### Spectral Purity

**Harmonic Distortion (output level = +10dBm):**

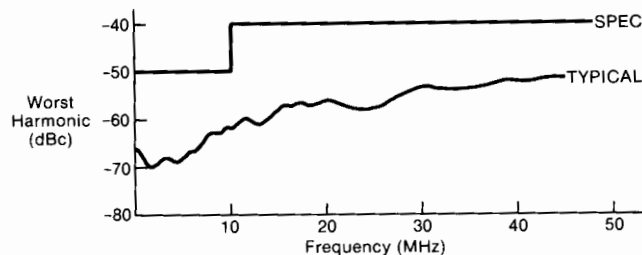

### Inband Spurious and Nonharmonic Distortion:

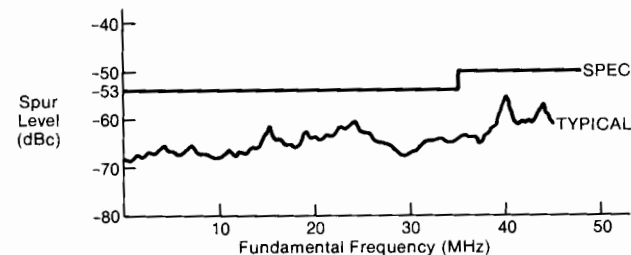

**Two-Tone Intermodulation Distortion:**  $< -65$  dBc for a 10.000 MHz and 10.124 MHz signal at +4 dBm each.

**SSB Phase Noise @ 10MHz:**  $< -120$  dBc/Hz @ 10kHz offset.

### Modulation Capabilities

AM, FM,  $\Phi$ M, Chirp, Pulse, Digital (BPSK, QPSK, BPSK, QAM), Antenna Scan, I/Q.

### External System Triggering:

Repetitive, Single-Shot, Gated;  
**Outputs:** Scan Start, Packet Start, Sequence Start, Equal Address, Packet Advance Ready.

**Inputs:** Packet Advance Trigger, System Start Trigger, System Stop Trigger.

### Clock

**Sampling Clock Rate:** 125 MHz (externally variable)

**Reference Oscillator:** 10 MHz quartz crystal. Aging rate  $< 5 \times 10^{-10}$ /day after a 24 hour warmup and an oscillator time-off of less than 24 hours.

### Remote Operation

HP-IB, 16-bit GPIO parallel port

### General

**Operating Temperature:** 15-40 C

**Power:** 445 VA

**Weight:** Net, 23.6 kg (52 lb), Shipping, 29.5 kg (65 lb)

**Size:** 235 H x 425.5 W x 622 mm D (9.25" x 16.75" x 24.5")

### Ordering Information

HP 8770S Signal Simulator System

To ensure coordination of shipments and compatibility of instruments, computers and software, use the system model number when ordering individual components. Obtain the HP 8770A and HP 11776A Data Sheet and an HP 8770S Ordering Guide from your local sales office.

HP 8770A Arbitrary Waveform Synthesizer

**Option 002:** 75 ohm Output Impedance

HP 11776A Waveform Generation Software (5.25"

Diskettes Standard)

**Option 630:** 3.5" Diskettes Only

### Price

\$0

\$25,000

N/C

\$6,500

N/C



# SIGNAL GENERATORS

## Vector Signal Generator

### Model 8780A

- 700 MHz of arbitrary modulation using vector or "I,Q" inputs
- 10 MHz to 3 GHz IF testing
- Pulse modulation with 1 ns rise times
- Coherent Carrier Output
- BPSK, QPSK, 8PSK, 16QAM, 64QAM, digital modulation and Pulse
- Wideband FM: over 50 MHz p-p deviations
- Linear amplitude modulation with >50 dB dynamic range and 350 MHz bandwidth

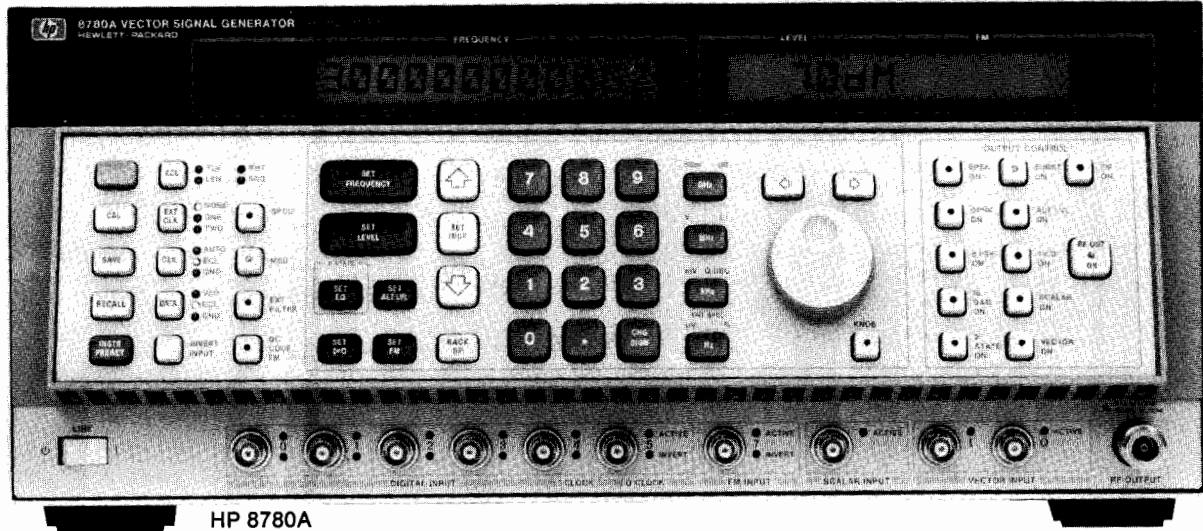

### Description

The HP 8780A Vector Signal Generator is a synthesized IF source with exceptional modulation for modern receiver and component testing. It is capable of modulation bandwidths almost 100 times wider than previous synthesizers, and has built-in DACs (digital-to-analog-converters) to simplify generation of common digital modulations. Its extra-wide modulation bandwidth comes from a vector modulator that effectively doubles baseband modulation bandwidths for 700 MHz of output modulation. The Vector Signal Generator's wideband modulation is complemented with an unmodulated coherent carrier output for demodulation of test signals.

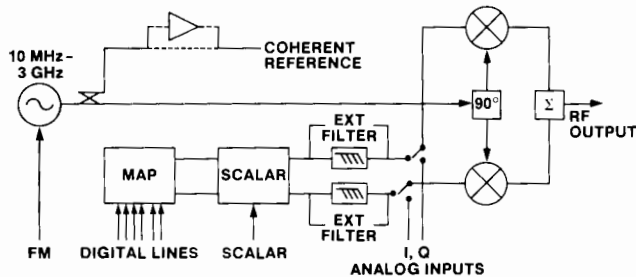

HP 8780A Block Diagram

The Vector Signal Generator offers a wide variety of modulation using both digital and analog inputs. It generates many standard digital modulations like QPSK and 16QAM and traditional modulations like FM, AM and pulse. By combining the different modulation types, signals as diverse as Barker-coded radar pulses and doppler-shifted satellite signals can be simulated.

### Applications

The Vector Signal Generator is well suited to receiver measurements where wideband or complex modulations are required. Its coherent carrier output makes it particularly valuable for systems employing vector demodulators and for pulsed phase measurements of components.

### Modulation

The Vector Signal Generator vector modulation capabilities are some of its most valuable. The 350 MHz I and Q (In-phase and Quadrature-phase) analog inputs combine to generate arbitrary phase and amplitude modulation within a 700 MHz output band-

width. With the proper I and Q signals, the Vector Signal Generator can generate an infinite variety of modulations. Some of the most likely sources for I and Q driving signals are two HP 8770A Arbitrary Waveform Synthesizers, the output of a signal generator and quadrature hybrid or other baseband waveform generators.

The HP 8780A generates extremely wideband AM (350 MHz) with typical dynamic range and accuracy of 50 dB and 2% respectively. A variety of amplitude-only modulations like gaussian-shaped pulses and pulse trains of different amplitudes can be easily generated using this technique.

### Digital modulation

HP 8780A offers a more convenient way to generate modulations using only digital inputs. The Vector Signal Generator generates several standard modulations (BPSK, QPSK, 8PSK, 16QAM, and 64QAM with Opt. 064) using digital inputs, and other common modulations can be generated by combining the Vector Signal Generator modulations. For example, the HP 8780A can generate TDMA (time-division-multiple-access) modulation by combining Burst modulation with one of the PSK modulations. Radar Barker codes and spread spectrum modulations can be generated in similar ways.

The Vector Signal Generator frequency modulation capabilities are also wideband with peak-to-peak deviations up to 50 MHz and rates up to 12 MHz. The FM performance has low distortion and good low frequency response for satellite video applications. If wider deviations are required, the FM input can be safely overdriven for typical deviations of >200 MHz p-p.

The Vector Signal Generator also generates simultaneous modulations to simplify receiver tests and IF measurements. For example, the envelope of a digitally modulated signal can be varied to test receiver AGC performance, or a Barker-coded radar modulation can be simultaneously frequency modulated to simulate doppler shifts. The table below shows which modulations can be combined and some applications for the combinations.

	FM	Scalar
Digital	Receiver carrier recovery loop characterization	Receiver AGC testing and compression measurements
Vector	Simulating doppler shifts	N/A
FM	N/A	Receiver AGC testing
Scalar	Receiver AGC testing	N/A

## HP 8780A Specifications

### Frequency

**Range:** 10 MHz to 3 GHz.

**Resolution:** 1 Hz.

**Switching speed:** typically <220 ms normally

**Accuracy and stability:** Same as reference oscillator ( $<5 \times 10^{-10}$ /day after 10 day warm up for internal reference).

### Output

**Level range:** +10 to -100 dBm <2.5 GHz,  
+4 to -100 dBm  $\geq$ 2.5 GHz.  
(+12 dBm  $\leq$  3 GHz with Opt 064)

**Resolution:** 0.1 dB.

**Accuracy:**  $\pm 2.5$  dB for levels  $\geq -30$  dBm,  
 $\pm 3.5$  dB for levels  $< -30$  dBm and  $> -100$  dBm.

**SWR:** typically < 1.3:1.

**Flatness:**  $\pm 1$  dB.

### Coherent Carrier Output

Unmodulated (except for FM) and leveled version of front panel RF output available at rear panel.

**Frequency range:** 10 MHz to 3 GHz.

**Output level:** typically  $> -20$  dBm (+10 dBm with Opt. 002), specified  $> -20$  dBm from 10 MHz to 200 MHz. Harmonics may be  $> -5$  dBc with Opt. 002.

### Spectral Purity

#### Residual phase noise

Offset from carrier	CW* specified at 1 GHz	CW* typical 10 MHz-3 GHz	DCFM typical 10 MHz-3 GHz	ACFM typical 10 MHz-3 GHz
100 Hz	-84dBc	-93dBc	-74dBc	-
1 KHz	-100dBc	-107dBc	-103dBc	-55dBc
100 KHz	-110dBc	-115dBc	-115dBc	-106dBc
1 MHz	-114dBc	-117dBc	-117dBc	-117dBc
10 MHz (>+7dBm)	-130dBc	-130dBc	-130dBc	-130dBc

\*Digital, vector, and scalar residual phase noise is the same as CW.

**Harmonics:**  $< -35$  dBc for output levels  $\leq +7$  dBm to 2.5 GHz.

**Non-harmonically related spurious for CW, digital, vector, and scalar modulated signals  $> -40$  dBm:**

- $< -60$  dBc for 10 MHz to 3 GHz,  $\geq 20$  MHz from carrier
- $< -55$  dBc for 10 MHz to 3 GHz,  $< 20$  MHz from carrier
- $< -55$  dBc for  $< 10$  MHz &  $> 3$  GHz to 18 GHz.

**Residual FM for CW, digital, vector or scalar modulated signals:**  
 $< 4$  Hz rms for 300 Hz to 3 kHz detection BW at 50 MHz.

### AC Coupled Frequency Modulation

**Rates** (3 dB frequencies): 20 Hz to 12 MHz.

**Deviation ranges:** 50 kHz to 50 MHz peak-to-peak (up to  $> 200$  MHz p-p possible with slightly higher distortion by overdriving FM input).

**Sensitivity:** 1V peak-to-peak for displayed deviation.

**Sensitivity Accuracy:**  $< 7.5\%$  for rates 50 Hz to 6 MHz and deviations  $< 30$  MHz p-p.

**Input impedance:** 50 ohms nominal.

**Residual FM for 300 Hz to 3 kHz BW and 50kHz deviation range:**  
 $< 200$  Hz rms.

#### Supplemental Characteristics

**Distortion to 3 MHz rates at 10 MHz p-p:**  $< .75\%$ .

**Carrier spurious responses ( $> 20$  kHz offset):**  $< -60$  dBc.

**Frequency flatness (50 Hz to 8 MHz):**  $< \pm 0.5$  dB.

**Differential gain at 27.6 MHz p-p:**  $< 2\%$ .

**Differential phase at 27.6 MHz p-p:**  $< 1$  degree.

**Field time distortion:**  $< 1\%$ .

**Luminance-to-chrominance delay:**  $< 20$  ns.

### DC Coupled Frequency Modulation

**Maximum rate** (3 dB frequency): 10 kHz.

**Deviation ranges:** 150 Hz to 150 kHz peak-to-peak.

**Sensitivity:** 1V peak-to-peak for displayed deviation.

**Sensitivity Accuracy:**  $< 10\%$  for rates  $< 1$  kHz and deviations  $< 150$  kHz p-p.

**Distortion at 1kHz rate and 150 kHz p-p deviation:**  $< 5\%$

**Input impedance:** 50 ohms nominal.

**Residual FM for 300 Hz to 3 kHz BW and 150kHz deviation range:**  
 $< 5$  Hz rms.

#### Supplemental Characteristics

**Carrier spurious responses:**  $< -60$  dBc for  $> 1$  kHz offsets,  
 $< -50$  dBc for 100 Hz - 1 kHz off-sets.

### Digital Modulation

**Modulation types:** BPSK, QPSK, 8PSK, 16QAM (64QAM with Opt. 064), Arbitrary 2-State, Burst.

**Simultaneous burst:** Available with BPSK, QPSK, 8PSK, or CW (Burst/8PSK not available with Opt. 064).

**Alternate level:** Available with BPSK, QPSK, BPSK and Burst, QPSK and Burst (last two not available with Opt. 064.)

**I<Q:** Available with all digital modulations.

**Clock modes:** Single, separate I and Q (except with Opt. 064), or asynchronous.

**Parallel data rates:** 0 to 150 MHz clocked (except 64 QAM),  
0 to 100 MHz clocked 64QAM w/Opt. 064,  
0 to 50 MHz asynchronous.

**Serial data rates** (only with Opt. 064): 0 to 150 MHz clock and data line for 0 to 25 MHz 64QAM clock rate.

**Data input levels:** ECL ( $-2V$  termination), ground, or variable  $-2.5V$  to  $2.5V$ .

**Baseband filters:** Three internal; external ports supplied.

**Data and clock input impedances:** 50 ohms nominal.

**Data and clock drive requirements:** 0.3 to 3.0 Vp-p.

**Data dc accuracy at 140 MHz carrier and  $\leq +7$  dBm levels:**  
 $\pm 1.0\%$  of full scale for BPSK, QPSK,  $\pm 1.2\%$  of full scale for 8PSK,  $\pm 2\%$  of full scale for 16QAM, 2-state, alt-lvl, I<Q.

**Burst dc on/off ratio:**  $> 50$  dB for 140 MHz carrier.

#### Supplemental Characteristics 10 MHz to 3 GHz

**Data asymmetry:**  $< 1$  ns for clocked modes.

**Data skew:**  $< 1$  ns for single clock operation.

### Pulse Modulation (Burst)

**Pulse rates:** 0 to 75 MHz.

**Pulse dc on/off ratio:**  $> 50$  dB for 140 MHz carrier (except Opt. 064).

**Pulse rise/fall times:**  $\leq 1$  ns

### Scalar Modulation/AM

Traditional AM modulation requires a dc offset of 0.5 V to be added to the scalar input.

**Sensitivity:** 0 to +1 volt for 0 to full scale envelope modulation

**DC accuracy:**  $< 2\%$  of full scale for 140 MHz carrier and for +7 dBm levels.

**DC offsets:**  $< 1\%$  of full scale

**Frequency response:** dc to 500 kHz ( $-3$  dB).

**Input impedance:** 10k ohms nominal.

### Vector Modulation (using analog I/Q inputs)

**Frequency response:** dc to 350 MHz ( $-3$  dB) at 1 GHz carrier frequency.

**DC accuracy:**  $< 1.5\%$  of full scale for 140 MHz carrier at  $\leq +7$  dBm and  $\sqrt{I^2 + Q^2} \leq 0.5V$ .

**DC offsets:**  $< 1\%$  of full scale for 140 MHz carrier.

**Sensitivity:**  $\pm 0.5V$  into 50 ohms for  $\pm 100\%$  I and Q.

#### Supplemental Characteristics over 10 MHz to 3 GHz frequency range

**Input impedance:** 50 ohms.

**SWR:**  $< 1.5:1$  dc to 350 MHz.

**Frequency Response:** dc to 350 MHz for carriers 400 MHz to 3 GHz.

### Remote Programming

All functions HP-IB programmable except line switch. The HP 8780A can output over the interface frequency and output level settings, error/malfunction codes, and operational status codes.

**Interface Functions:** SH1, AH1, T6, TE0, L3, LE0, SR1, RL1, PP1, DC1, DT0, C0.

### General

**Operating temperature range:** 0 degrees C to +55 degrees C.

**Power:** 100, 120, 220, 240 V, +5%, -10%, 48-440 Hz; 500 VA max.

**Weight:** net, 31.5 kg (70 lb). Shipping, 35.5 kg (78 lb).

**Size:** 177 mm H  $\times$  425 mm W  $\times$  637 mm D (7.0"  $\times$  16.7"  $\times$  25.1").

### Ordering Information

	Price
HP 8780A Vector Signal Generator	\$58,000
<b>Option 001:</b> Rear panel output and modulation inputs	\$450
<b>Option 002:</b> +10 dBm Coherent Carrier output	\$1,900
<b>Option 064:</b> 64 QAM modulation	\$0
<b>Option 907:</b> Front Panel Handles	\$65
<b>Option 908:</b> Rack Mount Flanges	\$35
<b>Option 909:</b> Handles and Flanges	\$90
<b>Option 915:</b> Service Manual	\$45
<b>Option 916:</b> Extra Operating Manual	\$25

# SIGNAL GENERATORS

## Signal Simulation for Agile and Wideband Modulation Systems

Models 86792A, 8770A, 8780A



### Frequency Agile Signal Simulator

#### Description

Combining the modulation flexibility of direct-digital synthesis with a frequency-agile direct synthesizer sets a new standard in high-performance signal simulation. Especially suited for radar/EW threat simulation and secure communications transceiver test, the Frequency Agile Signal Simulator switches from 10 MHz to 3 GHz in less than 250 nanoseconds. With a 40-MHz modulation bandwidth and 0.125 Hz carrier resolution, this system has arbitrary and independent control of carrier modulation including FM,  $\phi$ M, AM, and pulse. Real-time data downloading facilitates generation of signals whose characteristics change dynamically.

#### Instruments-on-a-Disk (ID's)

To exploit the broad variety of potential applications, the simulator includes an easy-to-use system interface that supports Instruments-on-a-Disk. These ID's make the system test-specific, such as the Radar Simulator ID suited for simulating agile threats including antenna scans, windows, exotic profiles, and unintentional modulation-on-pulse.

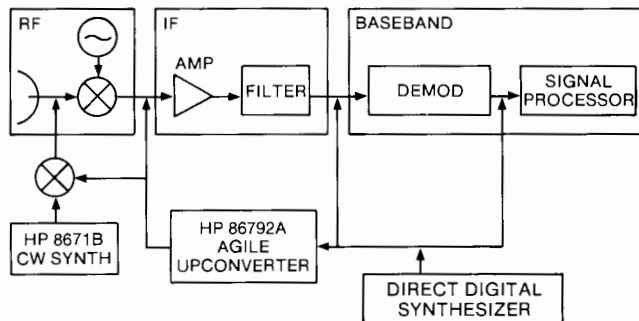

A complete simulation system for your EW, radar, and communication testing requirements

#### Specifications

##### Frequency

**Range:** 10 MHz to 3 GHz

**Resolution:** 0.125 Hz

**Switching Speed:** 250 nsec over full 3-GHz agile bandwidth

##### Modulation Capability

**Bandwidth:** 40 MHz p-p

**Types:** Simultaneous FM,  $\phi$ M, AM, pulse, agility, user-defined

##### Output

**Power Range:** +10 to -107 dBm

##### Spectral Purity

**SSB Phase Noise:** -120 dBc/Hz (typical @ 10 kHz offset from 2 GHz carrier)

**Harmonics:** < -35 dBc

**Spurious:** < -55 dBc

Contact HP for more technical and performance information.

### Vector Arbitrary Waveform Synthesizer

#### Simulation of Complex Wideband Signals with I/Q Modulation

The Vector Arbitrary Waveform Synthesizer (VAWS) simulates extremely complex signals which allow the functional testing of non-agile communications, radar and EW systems and subsystems. Two HP 8770A Arbitrary Waveform Generators provide the complex modulating signals to an HP 8780A Vector Signal Generator's I and Q modulation inputs. Because I/Q or Vector modulation is used, the signal can be completely defined in terms of phase, magnitude and frequency. The modulation can be arbitrarily defined, and the effects of actual hardware and environment on a signal can be simulated.

#### A sample of communications simulation capabilities:

- BPSK to 256 QAM
- QPR
- GMSK
- TDMA
- Filter Simulation
- Compression
- Static and Dynamic Multipath Fading
- Doppler
- System (RF) or subsystem (IF and BB) level signals
- Coherent reference and Baseband I & Q signals

These capabilities allow the functional testing of complete receivers or receiver subsystems. Dynamic equalizers, carrier recovery, and dynamic linearization circuits are among those that can be fully stressed with calibrated repeatable signals from VAWS.

#### A sample of Radar simulation capabilities:

- Fully synthesized 100 MHz chirps
- Phase coded signals
- Coherent transmitter simulation
- Coherent reference and Baseband I & Q signals

These capabilities allow the testing of compression radar receivers at the system or subsystem level. Compressors and other components can be characterized with a precise synthesized signal. The coherent reference and baseband I & Q signals simplify coherent receiver testing.

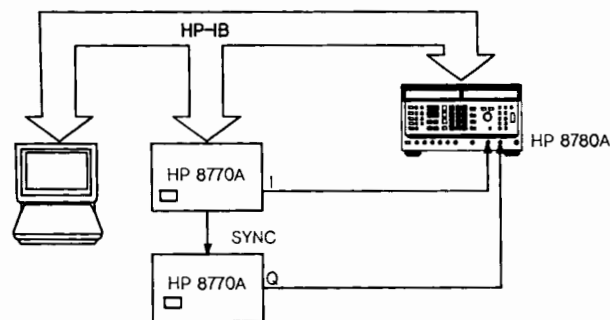

- HP Series 200/300 Computer
- 2 Arbitrary Waveform Synthesizers
- Vector Signal Generator
- HP 11775A/76A Waveform generation Software

Contact HP for more technical and performance information.

# SIGNAL GENERATORS

## Synthesized Sweepers

Models 8340B, 8341B

383

- 1 to 4 Hz frequency resolution
- Low spurious and phase noise
- 100 ns leveled pulse width capability
- +10 dBm to -110 dBm calibrated output

- Complete analog sweeper
- DC to 100 kHz amplitude modulation
- < -50 dBc harmonics 1.4 to 20 GHz, on HP 8341B opt. 003

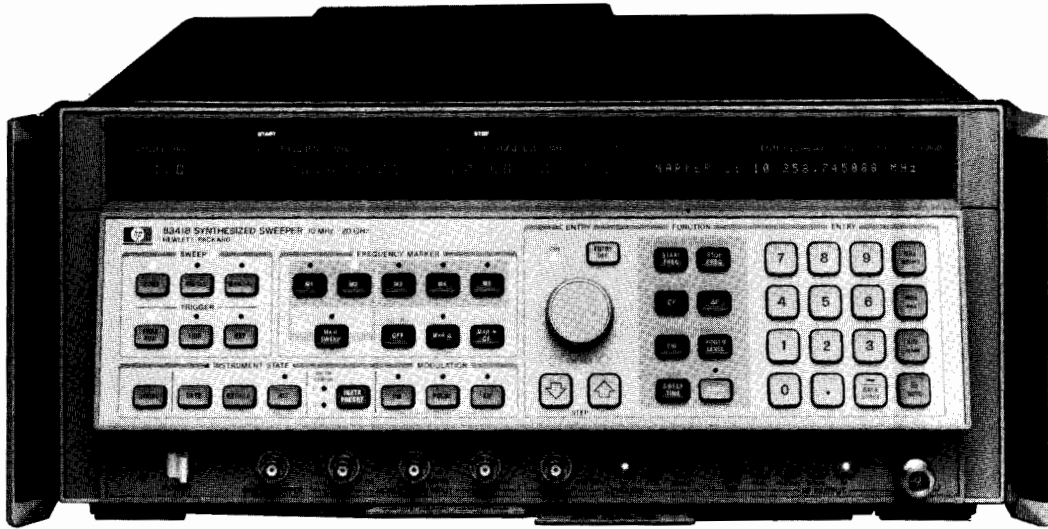

HP 8341B

### HP 8340B/8341B Synthesized Sweepers

The HP 8340B/8341B Synthesized Sweepers deliver the combined high-performance of a synthesizer and a broadband sweep oscillator in one instrument that is completely controllable via the Hewlett-Packard Interface Bus (HP-IB). This efficient combination of performance and versatility is ideal for manual or automatic test systems and enables the HP 8340B/8341B to replace a sweep oscillator, a frequency counter, an RF synthesizer, and a microwave synthesizer.

### Frequency Precision and Spectral Purity

The synthesized broadband frequency coverage and the precise 1 to 4 Hz frequency resolution (depending on frequency band) are generated by indirect synthesis techniques, enabling HP 8340B/8341B to achieve the same low single-sideband phase noise performance as the HP 8671B, 8672A and 8673 series Synthesized Signal Generators.

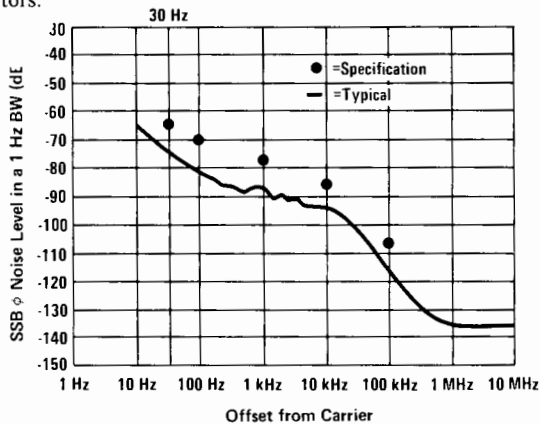

HP 8340B Phase Noise performance from 2.3 to 7.0 GHz.

### Stepped CW Switching Times

The HP 8340B/8341B feature CW switching times of better than 50 ms (typically <35 ms). Additionally, a Fast Phase-lock programming command can be used to reduce typical CW switching times to between 11 and 22 ms (depending on frequency step size and absolute frequency value).

### Output Power

The HP 8340B/8341B provide high output power which can be varied all the way down to the minimum level (-110 dBm) with .05 dB resolution and feature power sweep capability with >20 dB dynamic range for complete characterization of level-sensitive devices.

### Pulse, Amplitude, and Frequency Modulation

The HP 8340B/8341B have high-performance pulse modulators with ON/OFF ratio >80 dB and rise and fall times <25 ns. Pulse amplitude is leveled and can be as narrow as 100 ns. The HP 8340B/8341B also feature dc-coupled amplitude modulation with a 3 dB bandwidth of 100 kHz and a minimum depth of 90%. Pulse and amplitude modulation can be used simultaneously.

The HP 8340B/8341B also offer frequency modulation capability, with modulation rates from 50 kHz to 10 MHz and peak deviations to 10 MHz.

### HP 8341B Option 003: < -50 dBc Harmonics

Option 003 on the HP 8341B delivers excellent harmonic performance with harmonics at least 50 dB below the carrier from 1.4 to 20 GHz.

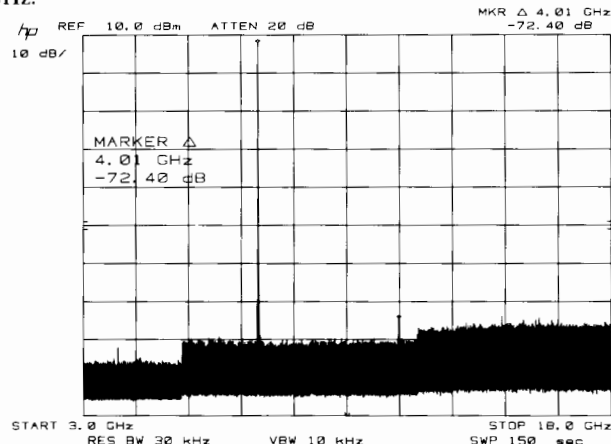

Harmonic Performance of the HP 8341B Opt. 003

For additional performance and ordering information about the HP 8340B/8341B, refer to page 394.

# SIGNAL GENERATORS

## Solid-State Microwave Signal Generators

### Models 8683/8684B,D

- Portable signal generators with high performance modulation
- Wide frequency ranges from 2.3-18 GHz
- Wideband FM for satellite video  $\pm 10$  MHz peak deviation
- dc-10 MHz FM rates



HP 8684D

### HP 8683/8684 Microwave Signal Generators

The HP 8683 and 8684 are rugged portable signal generators designed for demanding benchtop and field maintenance environments. Operating in four overlapping frequency ranges, with a choice of features including a high performance internal pulse generator, the family provides a wide range of benefits for various radar, communications and electronic warfare applications.

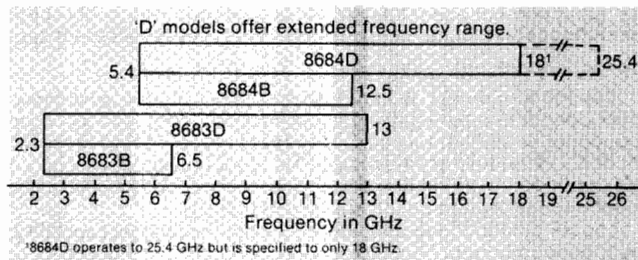

### Clean, Stable, Cavity-Tuned Oscillator

At the heart of each signal generator is a mechanically tuned cavity oscillator. State-of-the-art electronics teamed with sophisticated mechanical design provide excellent frequency stability, spectral purity and quick warm-up times necessary for accurate measurements. With low spurious outputs and a low noise floor, the HP 8683 and 8684 are excellent for receiver sensitivity measurements and out-of-channel communications receiver measurements where high performance at low signal levels is required.

### Microprocessor-Enhanced Measurement Accuracy

Characteristics of microwave components such as oscillators, amplifiers, and attenuators vary considerably with frequency and power level. An internal microprocessor effectively compensates for these variations, providing accurate output level in dBm, dB relative to a user-selected power level, or power level with a specified cable offset. These conveniences translate to faster measurements and reduced possibility of operator error in interpreting observations.

### Reliability and Serviceability

The HP 8683 and 8684 were designed with high reliability and serviceability as major considerations. The instruments exceed rigorous military specifications (MIL-T-28800C Class V) for operating and non-operating temperature, humidity, condensation, shock and vibration, and EMI. The instruments success in these tests is an indication

that they are rugged enough to provide accurate, reliable measurements in environments where many instruments would fail. For added reliability Option 002 may be selected for reverse power protection. With this option the possibility of instrument failure due to operator error is substantially reduced, allowing for as much as 10 watts average or 2000 watts peak reverse power with no damage to the instrument. The reliability of these generators is reflected in a demonstrated MTBF in excess of 20,000 hours.

Confidence in signal generator performance is provided by diagnostic tests which automatically execute at turn-on and monitor most critical nodes prior to entering the operation mode. If a failure is detected, in most cases it can be isolated to at least the circuit function level with the aid of the front panel display. The generators' open, accessible internal design and complete service manuals result in excellent serviceability, minimizing repair time if a failure should occur.

### HP 8683/8684 B,D Features

A variety of modulation capabilities, frequency ranges, and power specifications are available in the HP 8683/8684 Microwave Signal Generator family.

With high performance AM, FM and pulse modulation, including a built in pulse generator, the HP 8683/84 provides the capability to test modern communications, radar and EW systems. The calibrated FM with rates from dc to 10 MHz and peak deviations to 5 MHz is ideal for communications receiver testing. Combine the high performance FM with the fast (<10ns rise and fall) and deep (>80 dB ON/OFF) pulse modulation and simulate radar chirps. Simultaneous AM and pulse modulation simulate antenna scan patterns or use the AM to simulate fading on an FM, chirped or pulse modulated signal. Basic receiver sensitivity and AGC measurements can be performed easily.

For users with multi-band, broadband or general purpose applications, the D models, with twice the frequency coverage of the B models, offer exceptional performance, versatility and economy in a single box. Not only is frequency coverage increased, but in doubled mode, FM peak deviation is also doubled to 10 MHz at dc to 10 MHz rates making possible the direct test of satellite video receivers. If required, the high-power Option 001 may be selected to boost maximum output power in the frequency-doubled bands from -3 dBm to the +10 dBm level already provided in the main bands. By combining proven, rug-



ged, dependable design with the versatility of twice the frequency coverage and wideband FM, the D models offer cost-effective, high performance solutions to radar and communications receiver test problems.

Distinguishing features of the B, & D models.		
	B	D
Output Power	+10 dBm	+10 dBm, -3 dBm <sup>1</sup>
Opt 001 Power	N/A	+10 dBm <sup>1</sup>
Internal Pulse Generator/Modulator	Yes	Yes
FM Deviation (DC To 10MHz Rate)	5 MHz	10 MHz <sup>1</sup>

<sup>1</sup> These specifications for the doubled mode

## HP 8683B/D, HP 8684B/D Specifications

### Frequency Specifications

#### Range

**HP 8683B:** 2.3–6.5 GHz.

**HP 8683D:** 2.3–13.0 GHz.

**HP 8684B:** 5.4–12.5 GHz.

**HP 8684D:** 5.4–18.0 GHz.

**Resolution:** HP 8683, 5 MHz using a 4 digit LED display; HP 8684, 10 MHz using a 3 1/2 digit LED display.

**Calibration accuracy:** HP 8683B/D,  $\pm 1.25\%$  < 4.0 GHz,  $\pm 0.75\%$  4.0 to 6.5 GHz; HP 8683D x2 band,  $\pm 1.25\%$  6.5 to 8.0 GHz,  $\pm 0.75\%$  > 8 GHz; HP 8684B/D,  $\pm 1.25\%$  5.4 to 9.0 GHz,  $\pm 0.75\%$  9.0 to 12.5 GHz; HP 8684D x2 band,  $\pm 1.25\%$  12.5 to 18.0 GHz.

#### Stability (typical)

**vs. time (20 min. after turn-on):** < 30 kHz/min.

**vs. time (60 min. after turn-on):** < 100 kHz/hr.

**vs. temperature (0 to 55°C):** HP 8683, < 15 MHz; HP 8684, < 30 MHz.

**vs. line voltage (transients of +5%/–10%):** < 20 ppm.

### Spectral Purity

**Harmonics (<18GHz, at specified max output):** < –25 dBc.

HP 8683/84D harmonics are unspecified in x2 frequency band.

**Fundamental feedthrough (at specified max. output):** HP 8683D, < –25 dBc 6.5–9.5 GHz; HP 8684D, < –25 dBc 12.5–18.0 GHz. Not specified for D models with Option 001.

**Spurious (non-harmonically related):** < –80 dBc; typ., < –90 dBc.

**Residual FM (50 Hz to 15 kHz post detection BW):** < 5 kHz peak. HP 8683/84D in doubled band: < 10 kHz peak.

**Single-sideband phase noise (avg. rms, 1 Hz BW, 10 kHz offset from carrier, typical):** HP 8683B, < –72 dBc; HP 8683D, < –66 dBc; HP 8684B, < –65 dBc; HP 8684D, < –59 dBc.

**Residual AM (avg. rms, 300 Hz to 15 kHz post detection BW):** < 0.15%.

### Output Specifications

**Range (leveled into 50Ω):** HP 8683/84B, +10 to –130 dBm; HP 8683/84D, +10 to –130 dBm (main band), –3 to –130 dBm (x2 band), +10 dBm in x2 bands available with Option 001.

**Resolution:** 0.1 dB using a 3 1/2 digit LED display.

**Accuracy:**  $\pm 2.5$  dB from maximum specified output power to –110 dBm (to –100 dBm in x2 bands);  $\pm 3.5$  dB to –120 dB and 0 to +10 dBm for Opt 001. Typ.  $\pm 0.9$  dB at –100 dBm. Option 002 affects level accuracy  $\pm 0.5$  dB.

**Flatness (power level > –10 dBm):**  $\pm 1.0$  dB. (Not for Opt. 001)

**Reverse power protection:** the standard models typically accept 1 watt avg. or 100 watts peak power with no damage resulting. Option 002 (on B models only) increases this protection to 10 watts avg. or 2kW peak.

**Auxiliary output:** rear panel, typically > –15 dBm into 50Ω, prior to AM, pulse, or frequency doubling; source impedance approx. 50Ω.

### Amplitude Modulation

**Depth (1 kHz rate):** 0–70%.

**Rates (3 dB BW at 40% depth):** dc to 10 kHz (dc coupled); 50 Hz to 10 kHz (ac coupled).

**Distortion (THD):** < 10% at 40% depth and 1 kHz rate.

**Indicated AM accuracy (depth 50%, 1 kHz rate):**  $\pm 5\%$  of full scale.

**Incidental FM (30% AM depth):** < 15 kHz peak to peak. (< 30 kHz p-p in doubled band, HP 8683/84D.)

**Internal AM:** fixed 1 kHz nom. square wave with 50  $\pm 5\%$  duty cycle.

### Frequency Modulation

**Peak deviation:** HP 8683/84 B,  $\pm 5$  MHz; HP 8683/84D,  $\pm 5$  MHz (main);  $\pm 10$  MHz (x2 band).

**Rates (3 dB BW):** dc to 10 MHz, 100 Hz to 10 MHz (ac coupled).

**Distortion:** < 5% at 100 kHz rate and < 1 MHz peak deviation.

**Indicated accuracy (typ., 10 MHz/V range):**  $\pm 10\%$  of full scale, deviations < 5 MHz, 100 kHz rate.

**Incidental AM (rate < 100 kHz, peak deviation < 1 MHz):** < 6%.

**Internal FM:** FM sawtooth with a fixed sweep rate of 1 kHz nom. and variable deviation up to  $\pm 5$  MHz ( $\pm 10$  MHz for D models, x2 bands).

**Phase lock input:** typical sensitivity of –5 MHz/V.

### Pulse Modulation

#### HP 8683/84 B/D Internal Pulse Generator

**Rate:** 10 Hz to 1 MHz continuously adjustable in 5 ranges.

**Width:** 50 ns to 100 ms continuously adjustable in 7 ranges.

**Delay (time between sync out and video out):** < 50 ns to 100 ms in 7 ranges with continuous adjustment within ranges.

**Accuracy:** calibration accuracy is 20% of full scale.

#### HP 8683/84 B/D External Pulse Input Requirements

**Rate:** 0 to 1 MHz.

**Width:** > 100 ns.

**Level:** on > +1.0 V peak; off < +0.4 V peak.

#### HP 8683/84 B/D RF Pulse Specifications

**Rise/fall time:** < 10 ns.

**On/off ratio:** > 80 dB.

**Minimum pulse width:** < 100 ns.

**Maximum pulse repetition frequency:** > 1 MHz.

**Peak pulse power:**  $\pm 0.5$  dB of level set in CW mode.

### General

**Operating temperature range:** 0° to 55°C.

**EMI:** MIL-STD-461, VDE0871, CISPR Pub. 11.

**Safety:** meets the requirements of IEC 348.

**Power:** 100, 120, 220 or 240V, +5%, –10%; 48 to 66 Hz; (Opt. 003 adds 400 Hz operation at 100 or 120 V); < 200 VA max.

**Dimensions:** 145 H x 457 W x 472 mm D (5.7" x 18" x 18.6").

**Weight:** HP 8683, 17.9kg (39 lb) net, 23.4 kg (51 lb) shipping; HP 8684, 16.5 kg (36 lb) net, 22.0 kg (48 lb) shipping.

### Ordering Information

	Price
HP 8683B Microwave Signal Generator	\$16,400
HP 8684B Microwave Signal Generator	\$16,400
HP 8683/84B	
Option W30: Two years additional return-to-HP warranty	+\$300
HP 8683D Microwave Signal Generator	\$20,500
Option 001 +10 dBm in x2 band, HP 8683D	+\$3000
HP 8684D Microwave Signal Generator	\$20,500
Option 001: +10 dBm in x2 band, HP 8684D	+\$5000
HP 8683/84D	
Option W30: Two years additional return-to-HP warranty	+\$380
Option 002: Reverse power protection (except D models)	+\$725
Option 003: 400 Hz line frequency operation (all models)	+\$180
Option 910: Extra operating and service manual	+\$25
Option 913: Rack mounting flange kit	+\$35
HP 11727A Support kit	\$475

# SIGNAL GENERATORS

## Synthesized CW Generator

### Model 8671B

- 2 to 18 GHz frequency range
- +8 dBm calibrated output power
- Low spurious signals

- Low phase noise
- 128 dB dynamic range
- 1 to 3 kHz frequency resolution



HP 8671B

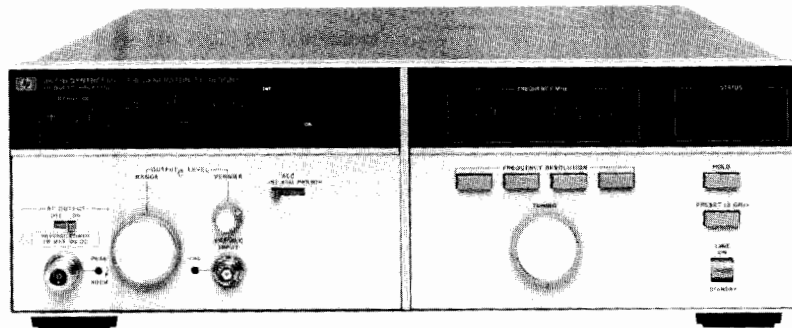

### HP 8671B Synthesized CW Generator

The HP 8671B is an economy 2.0 to 18.0 GHz synthesized CW generator. It meets all the requirements for a clean CW source. It features synthesized output with 1, 2 or 3 kHz resolution, 128 dB dynamic range, +8dBm calibrated output power, full programmability, low phase noise and low spurious signals.

#### General Purpose Measurements

For applications requiring a microwave local oscillator, the HP 8671B is the ideal solution. A simple, uncluttered, easy to use generator, the HP 8671B provides accurate, clean signals to upconvert and downconvert signals into the desired measurement frequency range.

The +8dBm output capability (with plenty of reserve) is just what you need to drive mixers. You can now take full advantage of the entire 2.0 to 18.0 GHz frequency range from a single instrument. The HP 8671B provides broadband synthesizer capability for the price of a non-synthesized source.

As a microwave source for downconversion, important measurements like noise figure and modulation analysis become more affordable. The HP 8671B with an external mixer allows you to make these measurements at an IF with the HP 8970A and 8970B Noise Figure Meters and the HP 8901A/B and HP 8902A Modulation Analyzers. Other downconverted measurements may include network, spectrum, and waveform analysis.

#### ATE Systems

The +8dBm output capability of the HP 8671B provides the extra margin you need for automated systems. Higher power at the source means sufficient power at the unit under test, even after losses through cables and switches. For automated systems, the requirements for low phase noise, low spurious signals, and precise frequency settability are easily accommodated by the HP 8671B.

### HP 8671B Specifications

#### Frequency Characteristics

**Frequency range:** 2.0–18.0 GHz (18.6 GHz overrange).

**Frequency bands and resolution:** band 1: 2.0 to 6.2 GHz 1 kHz  
band 2: 6.2 to 12.4 GHz 2 kHz  
band 3: 12.4 to 18.0 GHz 3 kHz

**Time base:** internal 10 MHz ( $<5 \times 10^{-10}$ /day aging rate) or external 5 or 10 MHz.

**Frequency switching time:** <15 ms to be within specified resolution, all bands.

#### Spectral Purity

##### Single-sideband phase noise (1 Hz BW, CW mode):

F <sub>c</sub>	Offset from F <sub>c</sub>				
	10 Hz	100 Hz	1 kHz	10 kHz	100 kHz
Band 1	-58 dBc	-70 dBc	-78 dBc	-86 dBc	-110 dBc
Band 2	-52 dBc	-64 dBc	-72 dBc	-80 dBc	-104 dBc
Band 3	-48 dBc	-60 dBc	-68 dBc	-76 dBc	-100 dBc

**Harmonics (up to maximum frequency, output level meter readings <0 dB on 0 dBm range and below):** <-25 dBc.

**Sub-harmonics and multiples thereof:** <-25 dBc.

#### Spurious

**Non-harmonically related:** <-70 dBc, Band 1; <-64 dBc, Band 2; <-60 dBc, Band 3.

**Power line related and fan rotation related within 5 Hz below line frequency and multiples thereof:**

F <sub>c</sub>	Offset from F <sub>c</sub>		
	<300 Hz	300 Hz to 1 kHz	>1 kHz
Band 1	-50 dBc	-60 dBc	-65 dBc
Band 2	-44 dBc	-54 dBc	-59 dBc
Band 3	-40 dBc	-50 dBc	-55 dBc

#### Output Characteristics

**Output level (+15°C to +35°C):** +8 to -120 dBm

**Flatness (0 dBm range, +15°C to +35°C):** ±0.75 dB, Band 1, ±1.00 dB, Band 2, ±1.25 dB, Band 3.

**Output level switching time:** <20 ms, internally leveled  
<10 ms, typical within one output level range

**Source impedance:** 50 ohms nominal.

#### Remote Operation

**Frequency:** Programmable over full range with same resolution as manual mode

**Output Level:** Programmable in 1 dB steps

**RF:** Choice of either ON or OFF

**ALC:** Choice of either internal leveling, diode leveling, or power meter leveling

#### Interface functions:

SH1, AH1, T6, TE0, L4, LE0, SR1, RL0, PP2, DC1, DT0, C0, E1.

#### General

**Operating temperature range:** 0°C to +55°C.

**Power:** 100, 120, 220, 240 V, +5%, -10%, 48-66 Hz; 300 VA max.

**Weight:** net, 27 kg (60 lb). Shipping, 32.5 kg (72 lb).

**Size:** 133 mm H x 425 mm W x 603 mm D (5.25" x 16.75" x 23.75").

#### Ordering Information

	Price
HP 8671B Synthesized CW Generator	\$24,000
Option 907: Front panel handle kit	+ \$55
Option 908: Rack mounting flange kit	+ \$33
Option 909: Front panel handle kit plus rack mounting flange kit	+ \$80
Option 910: Extra operating and service manual	+ \$60
Option W30: Two additional years of return to HP warranty	+ \$470

- 2 to 18 GHz
- +8 to -120 dBm calibrated output
- 0.1 dB resolution, digitally displayed

- AM/FM/Pulse Modulation
- Low spurious and phase noise
- 1 to 3 kHz frequency resolution



HP 8673E



### HP 8673E Synthesized Signal Generator

The HP 8673E is a synthesized signal generator that delivers value-oriented performance in precise microwave signal simulation. It is optimized for applications requiring high performance signal generation in the 2.0 to 18.0 GHz frequency range while also providing 128 dB dynamic output range. The HP 8673E includes the necessary modulation features required in a full performance microwave synthesizer.

#### Exceptional Output Performance

The HP 8673E provides frequency coverage from 2.0 to 18.0 GHz with resolution of 1, 2, or 3 kHz depending upon frequency band. Optimized for output level flexibility, power is internally (or externally) leveled and calibrated from -120 dBm to +8 dBm. Adding to your measurement convenience, the output level is displayed on the front panel with 0.1 dB resolution with a digital display.

#### Flexible Modulation

As a full performance synthesized signal generator, the HP 8673E includes amplitude, frequency, and pulse modulation capability. AM depth up to 75% at rates up to 10 kHz is ideal for most applications. The HP 8673E features two types of FM: locked and unlocked operation. In the locked mode, operation is like other synthesizers providing up to 3 MHz deviation that is dependent upon modulation index. The unlocked mode allows up to 10 MHz deviation at rates as low as 50 Hz. Internally leveled pulse modulation over the entire 2 to 18 GHz range with ON/OFF ratios >70 dB is available with any externally supplied TTL-level input signals. Output pulses will have rise/fall times typically less than 50 ns.

#### Many More Features

The HP 8673E includes many more features including excellent spectral purity and a YIG-tuned oscillator phase-locked to a 10 MHz quartz crystal reference. Full HP-IB and digital sweep capability identical to the HP 8673B/C/D is also included.

### HP 8673E Specifications

#### Frequency Characteristics

<b>Range:</b>	2.0 - 18.0 GHz (1.95 - 18.6 GHz overrange)
<b>Resolution:</b>	1kHz, 2.0 - 6.6 GHz
	2kHz, 6.6 - 12.3 GHz
	3kHz, 12.3-18.0 GHz

#### Spectral Purity

**Single-sideband phase noise (1Hz BW, 1kHz offset, CW mode):**  
 ≤ -60dBc  
**Harmonics:** ≤ -40dBc at +3dBm  
**Subharmonics and multiples thereof:** -35dBc at +3dBm

#### Output Characteristics

**Output level (+15°C to +35°C):** +8 to -120 dBm  
**Resolution:** 0.1dB, digital display

#### Pulse Modulation

**ON/OFF ratio:** ≥70 dB  
**Rise/fall times:** <50 ns, typical  
**Pulse repetition frequency:** 50 Hz to 1MHz  
**Minimum duty cycle:** <0.0001 for leveled performance

#### Amplitude Modulation

**Depth:** 0 to 75%, at 0dBm maximum carrier level, 15°C to 35°C  
**Rate (30% depth):** 10 Hz - 50kHz, ±3dB  
**Sensitivity:** 30%/V and 100%/V ranges

#### Frequency Modulation

Deviation Range	Rate (±3 dB BW)	Maximum Peak Deviation
30 kHz/V	100 Hz - 2 MHz	the smaller of 3 MHz or: $f_{mod} \times 5, 2.0 - 6.6 \text{ GHz}$ $f_{mod} \times 10, 6.6 - 12.3 \text{ GHz}$ $f_{mod} \times 15, 12.3 - 18.0 \text{ GHz}$
100 kHz/V	100 Hz - 2 MHz	
300 kHz/V	3 kHz - 2 MHz	
1 MHz/V	3 kHz - 2 MHz	
3 MHz/V	3 kHz - 2 MHz	
10 MHz/V (unlocked)	50 Hz - 2 MHz, (typical)	10 MHz

#### Digital Sweep Characteristics

Identical to HP 8673B/C/D

#### Remote Programming

All functions HP-IB programmable except line switch.

**Interface functions:** SH1, AH1, T5, TE0, L3, LE0, SR1, RL1, PP1, DC1, DT1, C0, E1

#### General

**Operating temperature range:** 0°C to +55°C  
**Power:** 100, 120, 220, 240V, +5%, -10%; 48-66Hz; 400 VA max  
**Weight:** 29kg (64 lb.) net  
**Size:** 620mm D x 425mm W x 146mm H (24.4" x 16.8" x 5.7")

#### Ordering Information

	Price
HP 8673E Synthesized Signal Generator	\$36,500
<b>Option 907:</b> Front panel handle kit	+\$55
<b>Option 908:</b> Rack mounting flange kit	+\$33
<b>Option 909:</b> Front panel handle with rack mounting flange kit	+\$80
<b>Option 910:</b> Extra manual	+\$65
<b>Option W30:</b> Two additional years of return to HP warranty	+\$730

# SIGNAL GENERATORS

## Synthesized Signal Generators (cont'd)

Models 8673B, 8673C, 8673D, 8673G

- 10 MHz to 26.5 GHz frequency range
- $< -60$  dBc harmonics/subharmonics
- Low spurious and phase noise

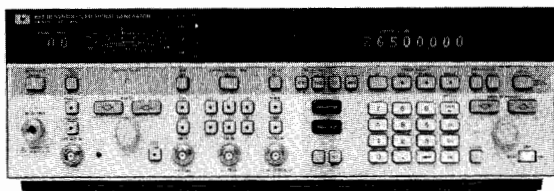

HP 8673B

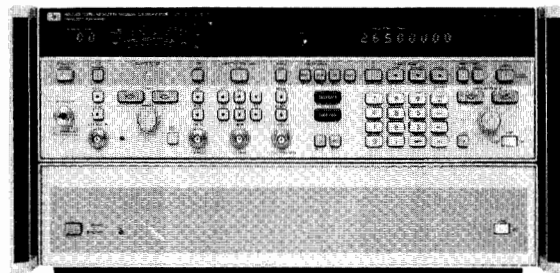

HP 8673D



### HP 8673B, 8673C, 8673D and 8673G Synthesized Signal Generators

The HP 8673B/C/D/G Synthesized Signal Generators are full performance synthesizers designed to generate precise microwave signals over the 50 MHz to 26.5 GHz frequency range. These generators offer calibrated and leveled power, AM, FM, pulse modulation (except HP 8673G), digital sweep, programmability, and frequency extension capability to 60 GHz. The HP 8673B/G pair cover the 2.0 to 26.5 GHz range, while the HP 8673C/D pair cover from 50 MHz to 18.6 GHz and 26.5 GHz respectively.

#### Exceptional Value CW Generator

The new HP 8673G is the world's lowest priced 2.0-26.0 GHz synthesized CW generator. Satisfying all the requirements for a clean CW source, it features the same excellent spectral purity, output range, mm drive capability, digital sweep, and HP-IB programmability featured in all the HP 8673 family. The HP 8673G is the ideal CW generator for local oscillator, up/down conversion, and exciter applications to 26 GHz.

#### Excellent Spectral Purity

A variety of applications ranging from microwave radar to communications systems require the frequency stability available from the HP 8673B/C/D/G. The broadband frequency coverage is derived from multiplying a fundamental 2.0 to 6.6 GHz YIG-tuned oscillator. This technique provides the wide frequency coverage in a single instrument. Indirect synthesis phase-locks the YIG-tuned oscillator to a 10 MHz quartz crystal reference to provide excellent long term and short term stability (frequency drift  $< 5 \times 10^{-10}$  per day). Phase locked loops are optimized for lowest possible single-sideband phase noise. The HP 8673C and HP 8673D include an internal tracking YIG-filter to further reduce unwanted harmonic, subharmonic, and nonharmonic spurious signals above 1.2 GHz to  $< -60$  dBc.

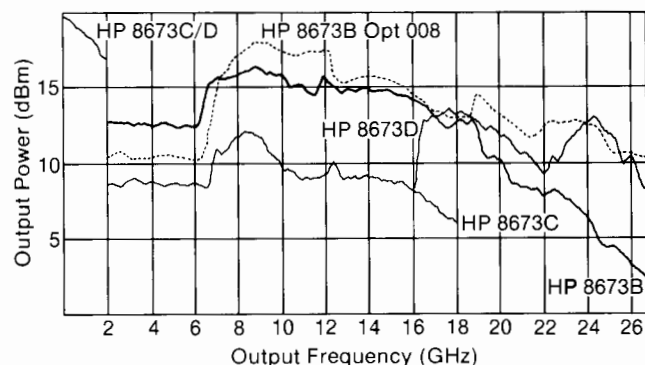

Figure 1. Maximum power typically available from HP 8673D, 8673C, 8673B/G, and 8673B/G Option 008 at 25°C

- +8 to  $-100$  dBm calibrated output
- Internally leveled AM/FM/pulse modulation
- Frequency extension capability to 60 GHz

#### Wide Dynamic Output Range

For broadband component and receiver testing applications, the HP 8673B/C/D/G delivers exceptionally flat power output across the full frequency ranges. For receiver sensitivity measurements, power is internally (or externally) leveled to  $-100$  dBm. Maximum available power varies with frequency as shown in Figure 1.

#### Internally Leveled Pulse Modulation (except HP 8673G)

The HP 8673B/C/D features an internal pulse modulator that provides high-quality pulse modulation over the entire 50 MHz - 26.5 GHz range. Since the modulation is done before the frequency multiplication, the peak pulsed power can be leveled and calibrated to within typically  $+1.5$ – $-1.0$  dBm of the set level referenced to CW. External TTL level pulse rates up to 1 MHz and pulse widths as narrow as 100 ns can be easily accommodated by the HP 8673B/C/D to provide ON/OFF ratios in excess of 80dB.

#### Calibrated AM/FM Modulation (except HP 8673G)

AM and FM capability is included in the HP 8673B/C/D to expand the versatility in receiver testing applications. AM depth at rates up to 100 kHz can be accurately set using the front panel meter. Six ranges of metered FM are available at rates and peak deviations up to 10 MHz. Both AM depth and FM deviation are linearly controlled by varying the externally supplied modulating input voltage up to 1V peak. Simultaneous modulation of AM, FM, and pulse is possible to simulate complex environments.

#### Frequency Extension to 60 GHz

The HP 8673B/C/D/G can be used as microwave drivers for the HP 83550-series millimeter wave source modules. This combination (with the addition of the HP 8349B Microwave Amplifier) can provide leveled output signals up to 60 GHz with the "System Leveling" mode. The resultant output frequency can be displayed on the HP 8673B/C/D/G front panel by entering the multiplication factor of the source module.

#### Full Programmability and Digital Sweep

The HP 8673B/C/D/G provides full programmability of all front panel functions for automatic test applications. Output level can be controlled in steps as fine as 0.1dB. An internal microprocessor is used to simplify HP-IB program code generation and follow front-panel keystroke sequences. This design allows the implementation of digital sweep. Sweep spans can be set over the entire frequency range with variable rates, step sizes, and selectable markers available.

## HP 8673B/C/D/G Specifications

### Frequency Characteristics

**Frequency Range:** HP 8673B/G: 2.0–26.0 GHz (1.95 to 26.5 GHz in overrange).

HP 8673C: 0.05–18.6 GHz (0.01–18.6 GHz in overrange).

HP 8673D: 0.05–26.0 GHz (0.01–26.5 GHz in overrange).

**Frequency Bands:** Band 0: 0.05–2.0 GHz

Band 1: 2.0–6.6 GHz

Band 2: 6.6–12.3 GHz

Band 3: 12.3–18.6 GHz

Band 4: 18.6–26.0 GHz

**Frequency Resolution:** 1 kHz Band 0 and 1      3 kHz Band 3  
2 kHz Band 2      4 kHz Band 4

**Time base:** internal 10 MHz ( $<5 \times 10^{-10}$ /day aging rate) or external 5 or 10 MHz.

**Frequency switching time:** <25 ms (HP 8673B/G) and <50 ms (HP 8673C/D) to be within specified resolution, all bands.

### Spectral Purity

#### Single-sideband phase noise (1 Hz BW, CW mode):

F <sub>c</sub>	Offset from F <sub>c</sub>				
	10 Hz	100 Hz	1 kHz	10 kHz	100 kHz
Band 0	-64 dBc	-70 dBc	-78 dBc	-86 dBc	-105 dBc
Band 1	-58 dBc	-70 dBc	-78 dBc	-86 dBc	-110 dBc
Band 2	-52 dBc	-64 dBc	-72 dBc	-80 dBc	-104 dBc
Band 3	-48 dBc	-60 dBc	-68 dBc	-76 dBc	-100 dBc
Band 4	-46 dBc	-58 dBc	-66 dBc	-74 dBc	-98 dBc

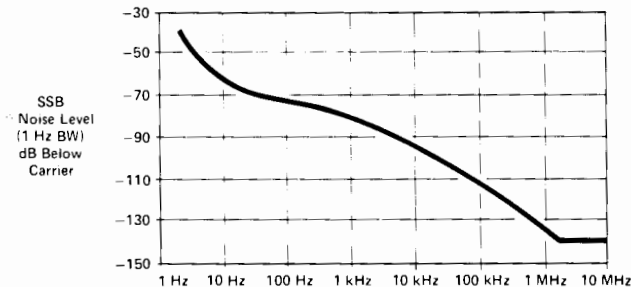

Figure 2. Typical HP 8673B/C/D/G single-sideband phase noise performance using the internal standard, Band 1.

**Harmonics (up to maximum frequency, output level meter readings <0 dB on 0 dBm range and below):** <-40 dBc (HP 8673B/G), <-40 dBc, 50MHz–1.2GHz, <-60 dBc, 1.2–26.0 GHz (HP 8673C/D).

**Sub-harmonics and multiples thereof:** <-60 dBc (HP 8673C/D) <-25 dBc, Bands 1–3; <-20 dBc, Band 4 (HP 8673B/G).

#### Spurious (CW and AM modes)

**Non-harmonically related:** <-60 dBc, Band 0; <-70 dBc, Band 1; <-64 dBc, Band 2; <-60 dBc, Band 3; <-58 dBc, Band 4.

**Power line related and fan rotation related within 5 Hz below line frequency and multiples thereof:**

F <sub>c</sub>	Offset from F <sub>c</sub>		
	<300 Hz	300 Hz to 1 kHz	>1 kHz
Band 0	-50 dBc	-60 dBc	-65 dBc
Band 1	-50 dBc	-60 dBc	-65 dBc
Band 2	-44 dBc	-54 dBc	-59 dBc
Band 3	-40 dBc	-50 dBc	-55 dBc
Band 4	-38 dBc	-48 dBc	-53 dBc

### Output Characteristics

#### Output level (+15°C to +35°C):

8673B/G		8673C		8673D	
Level (dBm)	Freq. (GHz)	Level (dBm)	Freq. (GHz)	Level (dBm)	Freq. (GHz)
+8 to -100	2-18	+11 to -100	.05-2.0	+11 to -100	.05-2.0
+4 to -100	18-22	+5 to -100	2-16	+5 to -100	2-22
0 to -100	22-26	+2 to -100	16-18.6	+6 to -100	22-26

**Flatness (0 dBm range, +15°C to +35°C):** ±0.5 dB through Band 0, ±0.75 dB through Band 1, ±1.0 dB through Band 2, ±1.25 dB through Band 3, ±1.75 dB through Band 4.

**Remote programming output level resolution:** 0.1 dB.

**Source impedance:** 50 ohms nominal.

### Pulse Modulation (except HP 8673G)

**ON/OFF ratio:** >80 dB.

**Rise/fall times:** <20 ns, Band 0; <35 ns, Bands 1–4.

**Minimum leveled pulse width:** <100 ns.

**Pulse repetition frequency:** dc–1 MHz.

**Maximum peak power:** same as in CW mode.

**Peak level accuracy (relative to CW, +15°C to +35°C):** ±1.5 dB.

**Pulse modulation input requirements:** normal mode, positive-true TTL levels; complement mode, negative-true TTL levels.

**Video feedthrough:** typically <-50 dBc.

### Amplitude Modulation (except HP 8673G)

**Rates (3 dB BW, 30% depth):** 20 Hz–100 kHz.

**Sensitivity:** 30%/V, 100%/V ranges. Max. input 1 V peak into 600 Ω.

### Frequency Modulation (except HP 8673G)

Sensitivity	Rate (3 dB BW, typical)	Maximum Peak Deviation the smaller of 10 MHz or: fmod x 5, Band 0 fmod x 5, Band 1 fmod x 10, Band 2 fmod x 15, Band 3 fmod x 20, Band 4
30 kHz/V	50 Hz to 10 MHz	
100 kHz/V	50 Hz to 10 MHz	
300 kHz/V	1 kHz to 10 MHz	
1 MHz/V	1 kHz to 10 MHz	
3 MHz/V	1 kHz to 10 MHz	
10 MHz/V	1 kHz to 10 MHz	

### Digital Sweep Characteristics

**Sweep function:** start/stop or ΔF (span) sweep.

**Sweep modes:** manual, auto, or single sweep.

**Step size:** maximum of 9999 frequency points per sweep; minimum step size equals frequency resolution.

**Dwell time:** set from 1 to 255 ms per frequency.

**Markers:** 5 independent, settable frequency markers.

**Sweep outputs:** 0 to +10 V ramp start to stop; 0.5 V/GHz ramp; Z-axis blanking/markers; tone marker; penlift.

### Remote Programming

All functions HP-IB programmable except line switch. The HP 8673B/C/D/G can output over the interface frequency and output level settings, error/malfunction codes, and operational status codes.

### Interface functions:

SH1, AH1, T5, TE0, L3, LE0, SR1, RL1, PP1, DC1, DT1, C0, E1.

### General

**Operating temperature range:** 0°C to +55°C.

**Power:** 100, 120, 220, 240 V, +5%, -10%, 48–66 Hz; 400 VA max. (HP 8673B/G), 500 VA max. (HP 8673C/D)

**Weight:** HP 8673B/G: net 29 kg (64 lb); shipping 34.5 kg (76 lb).

HP 8673C/D: net 42.4 kg (94 lb.); shipping 46.5 kg (103 lb).

**Size:** HP 8673B/G: 133 mm x 425 mm x 603 mm (5.25" x 16.75" x 23.75") HxWxD. HP 8673C/D: 234 mm x 425 mm x 613 mm (9.2" x 16.8" x 24.1") HxWxD.

### Ordering Information

Item	Price
HP 8673G Synthesized Signal Generator	\$29,000
HP 8673B Synthesized Signal Generator	\$42,000
Option 001: Delete RF output attenuator*	-\$600
Option 002: Delete reference oscillator*	-\$735
Option 003: Operation at 400 Hz line*	+\$460
Option 004: Rear panel RF output	+\$75
Option 005: Rear panel RF output without RF attenuator*	-\$525
Option 006: Chassis slide kit	+\$75
Option 008: +7 dBm output level	+\$7,000
Option 008: +8 dBm output level (HP 8673G only)	+\$5,000
Option 907: Front panel handle kit	+\$55
Option 908: Rack mounting flange kit	+\$33
Option 909: Combination of Opt. 907 plus 908	+\$80
Option W30: Two additional years of return-to-HP warranty	+\$900
Option 910: Extra operating and service manual	+\$65
Option 915: Service manual for HP 8673G only	+\$65
HP 8673C Synthesized Signal Generator	\$48,000
Options 001, 002, 003, 004, 005, and 006: same as HP 8673B	
Option 908: Rack mounting flange kit	+\$55
Option 913: Rack flanges for standard front handles	+\$45
Option 910: Service and extra operating manual	+\$85
Option 915: Service manual	+\$20
Option 916: Extra operating manual	+\$65
Option W30: Two additional years of return to HP warranty	+\$870
HP 8673D Synthesized Signal Generator	\$53,000
Options 001, 002, 003, 004, 005, 006, 908, 913, 910, 915, and 916: Same as HP 8673C	
Option W30: Two additional years of return to HP warranty	+\$950
HP 11726A Support Kit (for HP 8673B)	\$1,005

\*Consult factory for HP 8673G



# SIGNAL GENERATORS

## Synthesized Signal Generators

### Models 8672A and 8672S

- 2 to 18 GHz frequency range
- Low spurious and phase noise
- Metered AM/FM

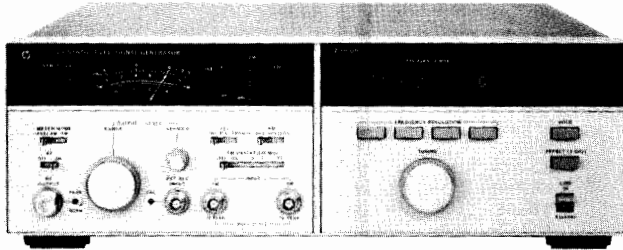

HP 8672A



### HP8672A and 8672S Synthesized Signal Generators

The HP 8672A Synthesized Signal Generator delivers precise microwave signals over the 2.0 to 18.0 GHz frequency range. It features calibrated and leveled output power, AM/FM modulation capability, and full HP-IB programmability.

The HP 8672A delivers exceptionally flat power across the full frequency range. For receiver sensitivity measurements, power is internally (or externally) leveled and calibrated to  $-120$  dBm.

The HP 8672S consists of an HP 8672A and an HP 86720A frequency extension unit. This unit uses a heterodyne technique to extend the frequency coverage down to 10 MHz. It also adds pulse modulation capability over the entire 10 MHz to 18.0 GHz frequency range. Calibrated output level in this mode is available up to 2 GHz, while  $>80$  dB ON/OFF ratio is available across the entire 18 GHz frequency range.

Specifications for the HP 8672S are identical to those of a standard HP 8672A for the 2 to 18 GHz frequency range with the exception of 1 dB less maximum output power and no AM modulation below 2 GHz.

Existing HP 8672A Signal Generators can be retrofitted to the HP 8672S configuration by ordering the HP 86720A Frequency Extension Unit and an HP 11731A or 11732A Frequency Extension Retrofit Kit.

### HP 8672A and 8672S Specifications

#### Frequency Characteristics

**Frequency range:** HP 8672A: 2.0–18.0 GHz (18.6 GHz overrange)  
HP 8672S: 0.01–18.0 GHz (18.6 GHz overrange)

#### Frequency bands and resolution:

Band 0:	0.01 - 2.0 GHz	1 kHz
Band 1:	2.0 - 6.2 GHz	1 kHz
Band 2:	6.2 - 12.4 GHz	2 kHz
Band 3:	12.4 - 18.0 GHz	3 kHz

**Time base:** internal 10 MHz ( $<5 \times 10^{-10}$ /day aging rate) or external 5 or 10 MHz.

**Frequency switching time:**  $<20$  ms to be within specified resolution, all bands.

#### Spectral Purity

**Single-sideband phase noise:** same as HP 8673B/C/D

**Harmonics (up to maximum frequency, output level meter readings  $<0$  dB on 0 dBm range and below):**  $<-25$  dBc.

**Sub-harmonics and multiples thereof:**  $<-25$  dBc, Bands 1-3.

**Spurious (CW and AM modes):** Same as HP 8673B/C/D

#### Output Characteristics

**Output level ( $+15^\circ\text{C}$  to  $+35^\circ\text{C}$ ):** HP 8672A:  $+8$  to  $-120$  dBm  
HP 8672S:  $+13$  dBm to  $-120$  dBm, 0.01–2.0 GHz;  $+2$  dBm to  $-120$  dBm, 2.0–18.0 GHz

**Flatness (0 dBm range,  $+15^\circ\text{C}$  to  $+35^\circ\text{C}$ ):**

HP 8672A: same as HP 8673B/C/D

HP 8672S: same as HP 8672A degraded by  $\pm 0.25$  dB

**Remote programming output level resolution:** 1.0 dB.

**Source impedance:** 50 ohms nominal.

- 10 MHz-18 GHz frequency range
- Internal pulse modulator
- HP-IB programmability

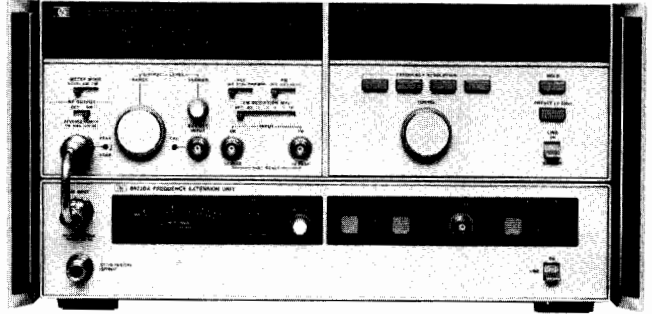

HP 8672S



### Modulation Characteristics

**Amplitude Modulation:** same as HP 8673B/C/D (2-18 GHz)

**Frequency Modulation:** same as HP 8673B/C/D

**Pulse Modulation:** HP 8672S only

$>80$  dB ON/OFF ratio;  $<15$  ns rise/fall times; peak pulsed power within 1.0 dB of level selected in CW mode for 0.01–2 GHz, uncalibrated for 2.0–18.0 GHz.

### General

**Programming:** all functions HP-IB programmable except line switches and meter mode.

**Interface functions:** SH1, AH1, T6, TE0, L4, LE0, SR1, RL0, PP2, DC1, DT0, C0, E1.

**Operating temperature range:** 0 to  $+55^\circ\text{C}$ .

**Power:** 100, 120, 220, 240V,  $+5\%$ ,  $-10\%$ , 48–66 Hz; 400 VA max.

**Weight:** HP 8672A: net 27 kg (60 lb); shipping 32.5 kg (72 lb).

HP 8672S: net 39.5 kg (87 lb); shipping 43.6 kg (96 lb).

**Size:** HP 8672A: 133 mm  $\times$  425 mm  $\times$  603 mm (5.25"  $\times$  16.75"  $\times$  23.75") H  $\times$  W  $\times$  D

HP 8672S: 222 mm  $\times$  425 mm  $\times$  620 mm (8.8"  $\times$  16.8"  $\times$  24.4") H  $\times$  W  $\times$  D

### Ordering Information

	Price
HP 8672A Synthesized Signal Generator	\$39,000
Option 001: Delete RF output attenuator	–\$600
Option 002: Delete reference oscillator	–\$550
Option 003: Operation at 50/60/400 Hz line	+\$250
Option 004: Rear panel RF output	+\$75
Option 005: Rear panel RF output without RF attenuator	–\$525
Option 006: Chassis slide kit	+\$45
Option 907: Front panel handle kit	+\$55
Option 908: Rack mounting flange kit	+\$33
Option 909: Combination of Opt. 907 plus 908	+\$80
Option W30: Two additional years of return to HP warranty	+\$760
Option 910: Extra operating and service manual	+\$60
HP 8672S Synthesized Signal Generator	\$55,000
Options 001 and 002: same as HP 8672A	
Option 004: Rear panel RF output	+\$150
Option 005: Rear panel RF output w/o RF attenuator	–\$450
Option 006: Chassis slide kit	+\$80
Option 009: Delete internal pulse modulator	–\$1,100
Option 010: Delete pulse modulator and step attenuator	–\$1,700
Option 908: Rack flange kit	+\$55
Option 913: Rack flanges for standard front panel handles	+\$45
Option 910: Extra operating and service manuals	+\$80
HP 86720A Frequency Extension Unit	\$17,000
HP 11731A Frequency Extension Retrofit Kit	\$1,000
HP 11732A Frequency Extension Retrofit Kit	No Charge
HP 11712A Support Kit	\$800

# SIGNAL GENERATORS

## PIN Modulators, Pulse Driver, Pulse Modulator

### Models 8730 Series, 8403A, 11720A

391

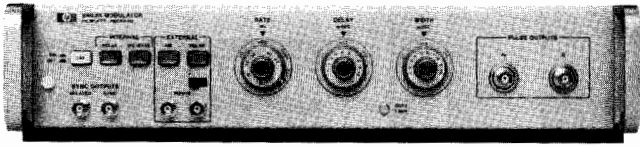

HP 8403A

### HP 8730 Series PIN Modulators

With HP 8730 series PIN Modulators, signal sources, including klystrons, can be pulse-modulated, leveled or amplitude-modulated with sinusoidal and complex waveforms. Fast rise times, low incidental FM and a nearly constant impedance match to source and load are typical of these absorption-type modulators.

### HP 8403A Modulator

The HP 8403A provides complete control of the HP 8730 Series PIN modulators, supplying the appropriate modulation wave shapes and bias levels for fast rise times, rated on/off ratios and amplitude modulation. An internal square-wave and pulse modulator with PRF of 50 Hz to 50 kHz and adjustable pulse width and delay also provide square wave and pulses for general pulse applications. For applications requiring an absorption-type modulator plus controls in a single unit, a PIN modulator can be installed inside the HP 8403A, for any specified frequency range.

### HP 8403A Specifications

**Output Characteristics** (available separately at front panel).  
**For driving HP 8730 PIN modulators:** AM and pulse output, pulse output specially shaped for optimum RF rise and decay times.  
**For general pulse applications:** positive dc-coupled pulse 25 to 30 volts in amplitude, approximately symmetrical about 0 volt; no AM signal.

### Modulation

#### Internal Square Wave

**Frequency:** variable from 50 Hz to 50 kHz.  
**Symmetry:** better than 45/55%.

#### Internal Pulse

**Repetition rate:** variable from 50 Hz to 50 kHz.  
**Delay:** variable from 0.1  $\mu$ s to 100  $\mu$ s, between sync out pulse and RF output pulse.  
**Width:** variable from 0.1  $\mu$ s to 100  $\mu$ s.

### General

**Power:** 115 or 230 volts  $\pm$ 10%, 50 to 400 Hz, approximately 10 watts.  
**Size:** 96 H x 425 W x 467 mm D (3.75" x 16.73" x 18.4").  
**Weight:** net, 7.4 kg (16.5 lb). Shipping, 9 kg (20 lb).

### Ordering Information

HP 8403A Modulator Price \$3200

### Options

**002:** HP 8731B PIN Modulator installed in **HP 8403A** +\$1900  
**004:** HP 8732B PIN Modulator installed in **HP 8403A** +\$2000  
**006:** HP 8733B PIN Modulator installed in **HP 8403A** +\$2150  
**008:** HP 8734B PIN Modulator installed in **HP 8403A** +\$2150  
**009:** Input and Output Connectors on rear panel +\$50  
**908:** Rack flange kit +\$35  
**910:** Extra Manual +\$7.50

### HP 8730 Series Specifications

HP Model	Frequency Range (GHz)	Attn Min/Max (dB)	SWR On/Off	Rise time/Fall time nanosec	Price
8731B-H10 <sup>†</sup>	0.4 - 1.2	2.0/35	1.5/2.0	40/30	\$1950
8731B	0.8 - 2.4	2.0/80	1.6/2.0	30/20	\$1950
8732B	1.8 - 4.5	4.0/80	2.0/2.0	30/20	\$2050
8733B	3.7 - 8.3	3.0/80	2.0/2.2	30/20	\$2200
8734B	7.0 - 12.4	5.0/80	2.0/2.2	30/20	\$2200

<sup>†</sup>External high-pass filter required.

### 2 to 18 GHz Pulse Modulator

- < 10 ns rise and fall times
- > 80 dB ON/OFF ratio

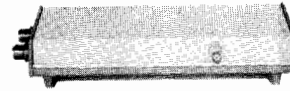

HP 8730B Series

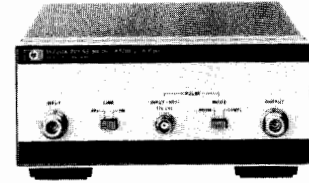

HP 11720A

### HP 11720A Pulse Modulator

The HP 11720A Pulse Modulator is a high performance microwave pulse modulator covering the range of 2 to 18 GHz. Because of this wide frequency coverage, it can be used to increase the modulation capabilities of many microwave sources (sweepers or signal generators) and eliminate the need for several individual modulators in broadband applications.

In addition to wide frequency coverage, the HP 11720A features extremely short rise and fall times (<10 ns) and a high on/off ratio (>80 dB), making it suitable for almost any pulsed RF application.

The modulator used in the HP 11720A is a unique series-shunt PIN diode switch offering superior performance to that of a simple shunt-diode switch which reflects the input power back to the source in the "off" state. In the HP 11720A the series components reduce this reflection without significantly increasing the insertion loss.

The HP 11720A contains all the necessary modulator drive circuitry to achieve specified performance so that a standard pulse generator, or any other source that can deliver > 3 V peak into 50 ohms, can supply the input. In addition, a normal/complement function is provided to adapt the HP 11720A to positive-true or negative-true logic inputs.

### HP 11720A Specifications

**Frequency range:** 2 to 18 GHz.  
**ON/OFF ratio:** >80 dB.  
**Rise and fall times:** <10 ns.  
**Insertion loss:** <6 dB, 2 to 12.4 GHz; <10 dB, 2 to 18 GHz.  
**Maximum RF input power:** +20 dBm.  
**Maximum repetition rate:** >5 MHz.  
**Minimum RF pulse width:** <50 ns.  
**Video feedthrough:** <60 mV peak-to-peak.  
**Pulse Input**  
**Normal mode:** >3 V (on), <0.5 V (off).  
**Complement mode:** <0.5 V (on), >3 V (off).  
**Impedance:** 50  $\Omega$  nominal.  
**Operating temperature:** 0°C to +55°C.  
**Power:** 100, 120, 220, 240 V +5, -10%; 48-400 Hz; 25 VA max.  
**Weight:** net, 2.6 kg (5 lb 12 oz); shipping, 3.6 kg (8 lb).  
**Size:** 101 mm H x 212 mm W x 290 mm D (4.0" x 8.4" x 11.4").  
 $\frac{1}{2}$  MW x  $3\frac{1}{2}$  H x 11 D System II Module.

### Ordering Information

HP 11720A Pulse Modulator Price \$3350  
**Option 910:** Extra manual +\$5.00  
**Option W30:** Two additional years of return to HP warranty +\$70.00

# SWEEP OSCILLATORS

## General Information

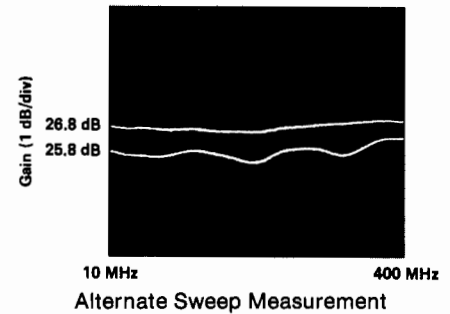
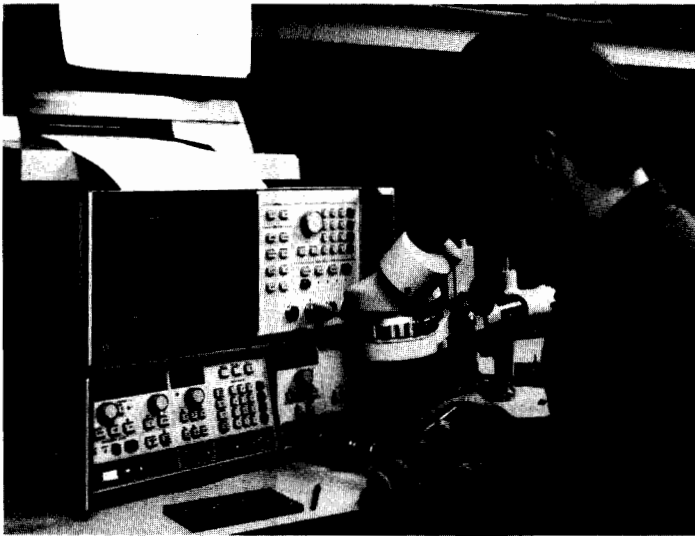

### Sweep Oscillators

Sweep oscillators are important in a number of applications where the characteristics of a device or system must be determined over a continuous range of frequencies. By replacing laborious point-by-point techniques, swept measurements increase the speed and convenience of broadband testing. The continuous frequency characterization of the unknown device or system also eliminates the chance of missing important information between frequency points.

Hewlett-Packard sweepers cover the entire frequency spectrum from dc to 60 GHz. The HP 8620 and HP 8350 family of solid state oscillators provide a versatile choice of configurations—single band, straddle band, or very wide band plug-ins. The HP 8340B and the HP 8341B are broadband synthesizers that combine the excellent stability, frequency accuracy, and phase noise of a synthesizer with the versatile characteristics of a sweep oscillator. And for coverage in the millimeter-wave frequency range, the HP 83550-series frequency multipliers effectively extend the excellent performance of Hewlett-Packard's sweep oscillator family to 60 GHz.

A chart of the complete frequency coverage of Hewlett-Packard's line of sweep oscillators is shown on page 393.

#### Sweep Flexibility

Every HP sweeper has several different sweep modes available for setting the frequency limits of the instrument. A full band or independently adjustable start/stop frequency sweep can be selected. Alternately, a marker sweep or a symmetrical  $\Delta F$  sweep about the desired center frequency can be chosen. Sweep times from 0.01 to more than 100 seconds are possible.

Marker capability, both Z-axis intensity dots and RF pips, are available on HP sweepers to note important measurement frequencies. Two or more independent markers are offered on all sweepers with up to five markers on the HP 8340B/41B and HP 8350 mainframe. Crystal markers are also offered on the HP 86222B, 83522A, and 83525A/B RF plug-ins.

Another powerful feature available on the HP 8340B/8341B and 8350 sweeper mainframe is Save/Recall Mode where up to nine complete front panel states can be stored in memory and later recalled when the measurement is repeated.

The HP 8340/8341, 8350 sweep oscillator mainframe and 83500 series RF plug-ins offer total HP-IB control of all front panel functions.

#### Power Output and Leveling

Power output is continuously adjustable at the front panel with built-in attenuators available on most plug-ins for greater power control. Internal or external leveling capability ensures high accuracy when making swept measurements.

For applications that require high power, the HP 83550A with the HP 8350 sweep oscillator mainframe offers at least +20 dBm of leveled output power from 2 to 18.6 GHz and +18 dBm to 20 GHz.

When higher output is required from an existing source, the HP 8349B microwave amplifier (2 to 20 GHz) can be driven by the RF output of the sweeper to provide a full +20 dBm of output power from 2 to 18.6 GHz. The amplifier can be easily leveled via its built-in directional detector and the automatic level control (ALC) circuitry of the sweeper.

Power as well as frequency can be swept with the HP 8340B/8341B or the HP 8350 and 83500 series plug-ins using the Power Sweep function. This means that both the frequency response and power response of level sensitive devices like transistors and amplifiers can be measured using the same test set-up. Using the power sweep function the 1 dB gain compression can easily be measured at a CW frequency. Also, the ability to alternate between two successive sweeps allows a swept measurement of the 1 dB gain compression point.

### Modulation

Modulation capabilities further extend the sweeper's usefulness both as a sweeper and a signal generator for signal simulations. The sweep oscillators described here offer versatile pulse, FM and AM modulation capabilities.

All HP 83500 and most 86200 series plug-ins (when used with the HP 8350 sweep oscillator mainframe) are capable of producing the 27.8 kHz square wave modulation required by the HP 8757A scalar network analyzer directly, eliminating the need for an external modulator. The HP 8340B/8341B may be externally modulated with the 27.8 kHz square wave, via the scalar analyzer's modulator drive.

#### Low Harmonics

For those measurements requiring low harmonics from a swept source there are several choices available. The HP 83592C RF plug-in for the HP 8350 sweep oscillator mainframe offers -55 dBc harmonic suppression from 3.5 to 20 GHz. The HP 83596A/83597A RF plug-ins provide -50 dBc harmonic suppression from 2.4 to 20 GHz, and -40 dBc from 20 to 40 GHz. The HP 8341B Option 003 specifies -50 dBc harmonics from 1.4 to 20 GHz.

#### Covering Millimeter-wave Frequencies

The new HP 83550-series millimeter-wave source modules answer the growing need for high-performance sweep oscillators in the millimeter-wave frequency ranges. The source modules are frequency multipliers that effectively extend the excellent performance of HP sweep oscillators covering the 11 to 20 GHz range to the 26.5 to 40 GHz (HP 83554A), the 33 to 50 GHz (HP 83555A), and the 40 to 60 GHz (HP 83556A) millimeter-wave frequency ranges.

### Sweeper Applications

Sweepers are an integral part of many kinds of test applications. Their versatility and extensive feature set make them the perfect choice for scalar/vector network analysis, noise figure measurements, frequency translation measurements, signal simulation and many other applications. The sweepers described here are designed to be compatible with all relevant measurement solutions from HP.

Sweepers are used extensively with swept scalar network analyzers to characterize the amplitude responses of broadband devices or with vector network analyzers when the amplitude and phase characteristics of the device (i.e. s-parameters) are needed. Examples of such analyzers are the HP 8757A scalar network analyzer and the HP 8510 vector network analyzer. The HP 8340B/8341B and HP 8350B sweepers can be controlled by these analyzers via a private "system interface bus." This makes use of the sweepers full programmability and creates synergistic performance.

For scalar measurements requiring more dynamic range, the HP 8349B microwave amplifier can be used to extend the dynamic range from 76 dB to typically > 90 dB.

For measurements that require an entirely spurious-free environment and phase information, sweepers may be used with vector

network analyzers such as the HP 8510. Extremely high performance vector measurements can be made with the HP 8340B/8341B and the HP 8510.

Noise figure measurements above 1600 MHz can be made using the HP 8970 noise figure meter with either the HP 8340B/8341B or the HP 8350 serving as the local oscillator. With this equipment noise figure and gain measurements can be made

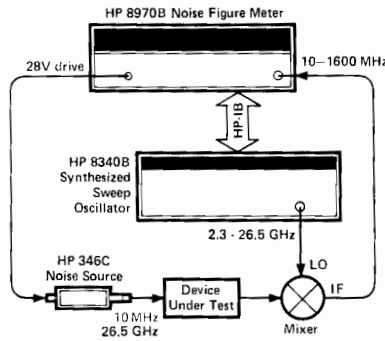

on microwave components such as amplifiers, transistors or mixers. The HP 8340B/41B can also be used as a microwave LO in an HP 8902S and 8952S measurement systems that makes several important measurements on microwave sources.

Two-tone sweep testing of devices such as mixers and receiver front ends requires two

signals offset from each other by the IF. This is accomplished by phase-locking the difference frequency of two sweep oscillators to a very stable source. The sweepers may then be swept across the band of interest.

In communications applications where up-converter simulation is required in conjunction with the HP Microwave Link Analyzer, several of the HP 86200 series plug-ins are compatible (as an option) with such a system to permit very accurate RF to RF, RF to IF and RF to BB distortion measurements.

The modulation and built-in attenuator features of Hewlett-Packard sweep oscillators make them useful in many traditional CW signal generator applications. The excellent stability, phase noise, frequency range and modulation capability of the HP 8340B and 8341B make them well suited for most of these applications. In addition, the accuracy, linearity, and flatness of the HP 83500/86200 series broadband plug-ins make them more than adequate in many applications requiring a general purpose CW generator. For wideband applications these RF plug-ins feature performance that rivals octave band oscillators in the areas of frequency purity and accuracy, harmonics, flatness, and power.

A Product Line Summary of Swept Microwave Sources (HP Part No. 5956-4350), as well as specific data sheets, application notes and product notes are available from your local Hewlett-Packard sales office.

### Sweep Oscillator—Summary Chart

Frequency Range*	Model Number			Frequency										
	8350 Series	8620 Series**	Other Sweepers	10 MHz	100 MHz	1 GHz	2 GHz	4 GHz	8 GHz	12 GHz	18 GHz	26 GHz	40 GHz	50 GHz
10 MHz-2.4 GHz 10 MHz-8.4 GHz 10 MHz-20 GHz 10 MHz-26.5 GHz 10 MHz-40 GHz	83522A 83525A/B 83592A/B/C 83595A 83597A	86222A/B	8341B 8340B	[Frequency range bars]										
1.7-4.3 GHz 2-8.4 GHz 3.6-8.6 GHz 2-18.6 GHz 2-20 GHz 2-22 GHz 2-26.5 GHz 2.4-40 GHz	83540A/B  83590A 83594A 83596A	86235A 86240A/B 86240C 86290B/C 86290B Opt H08		[Frequency range bars]										
3.2-6.5 GHz		86241A		[Frequency range bars]										
5.9-9.0 GHz 5.9-12.4 GHz 7-11 GHz 7.5-18.6 GHz 8-12.4 GHz 8-20 GHz	83545A  83550A	86242D 86245A 86250D Opt H08 86251A 86250D		[Frequency range bars]										
10-15.5 GHz 12.4-18 GHz 17-22 GHz 18-26.5 GHz 26.5-40 GHz	83570A 83572A/B	86260B 86260A 86260C		[Frequency range bars]										
26.5-40 GHz*** 33-50 GHz*** 40-60 GHz***			83554A 83555A 83556A	[Frequency range bars]										

\*Other Special Frequency Ranges Can Be Provided Upon Request.

\*\*HP 86200 Series RF Plug-ins are usable with the HP 8350B Mainframe via the HP 11869A Adapter.

\*\*\*The HP 83550-series millimeter-wave source modules are frequency multipliers that require a +17 dBm microwave input. See page 403.

# SWEEP OSCILLATORS

## Synthesized Sweepers

Models 8340B, 8341B

- 1 to 4 Hz frequency resolution
- Low spurious and phase noise
- +10 dBm to -110 dBm calibrated output
- Pulse, Amplitude, and Frequency Modulation
- Complete analog sweeper
- < -50 dBc harmonics 1.4 to 20 GHz on HP 8341B Option 003

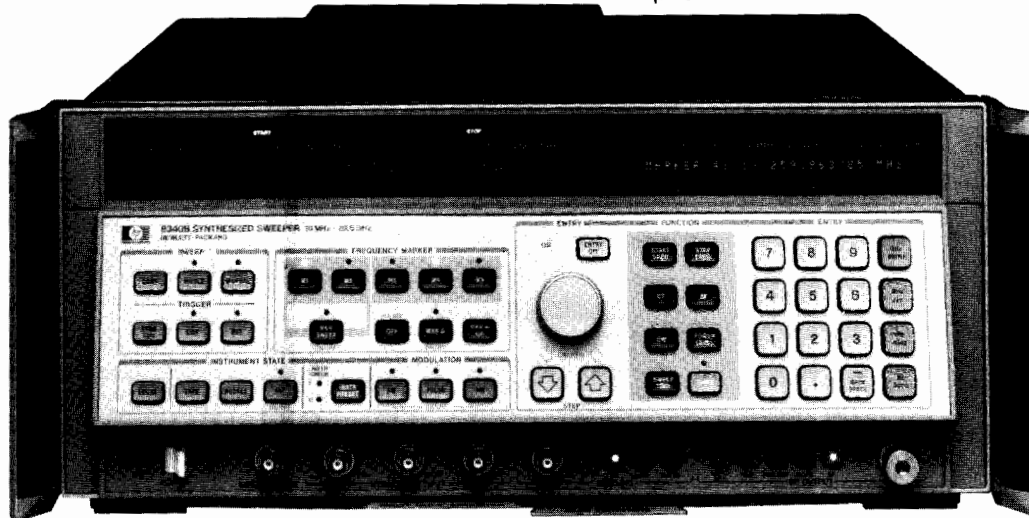

HP 8340B

### HP 8340B/8341B Synthesized Sweepers

The HP 8340B and 8341B Synthesized Sweepers deliver the combined high performance of a synthesizer and a broadband sweep oscillator in one instrument that is completely controllable via the Hewlett-Packard Interface Bus (HP-IB). This efficient combination of performance and versatility is ideal for manual or automatic test systems and in many cases enables the HP 8340B/8341B to replace a sweep oscillator, a frequency counter, an RF synthesizer, and a microwave synthesizer.

### Frequency Precision and Spectral Purity

The synthesized broadband frequency coverage (10 MHz to 26.5 GHz on the HP 8340B and 10 MHz to 20 GHz on the HP 8341B) and the precise 1 to 4 Hz frequency resolution (depending on frequency band) are generated by indirect synthesis techniques, enabling the HP 8340B/8341B to achieve the same low single-sideband phase-noise performance as the HP 8671B, 8672A and 8673 series Synthesized Signal Generators. The HP 8340B/8341B long-term stability is also outstanding at  $1 \times 10^{-9}$ /day.

The HP 8340B/8341B feature CW switching times of better than 50 ms (typically <35 ms). Additionally, a "Fast Phase-lock" programming command can be used to reduce typical CW switching times to between 11 and 22 ms (depending on frequency step size and absolute frequency value).

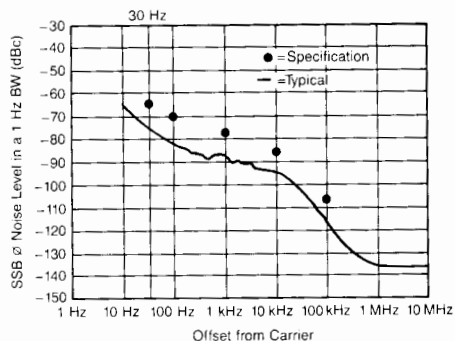

HP 8340B/8341B Phase Noise performance from 2.3 to 7.0 GHz.

### HP 8341B Option 003: -50 dBc Harmonics

Option 003 on the HP 8341B delivers excellent harmonic performance, at least 50 dB below a 1.4 to 20 GHz carrier. This low-harmonics option is particularly useful for demanding EW receiver testing, and scalar analysis of frequency selective devices such as filters.

### Output Power

The HP 8340B/8341B provide high output power which can be controlled down to -110 dBm with 0.05 dB resolution. High power resolution is complemented by outstanding accuracy and flatness. The HP 8340B/8341B also feature power sweep capability with >20 dB dynamic range for complete characterization of level-sensitive devices.

### Pulse, Amplitude, and Frequency Modulation

The HP 8340B/8341B have a high-performance pulse modulator with ON/OFF ratio >80 dB and rise and fall times <25 ns. Pulse amplitude is leveled and can be as narrow as 100 ns. The HP 8340B/8341B also feature dc-coupled amplitude modulation with a 3 dB bandwidth of 100 kHz and a minimum depth of 90%, and frequency modulation with rates from 50 kHz to 10 MHz and peak deviations to 10 MHz. And with the HP 8340B/8341B, pulse, amplitude, and frequency modulation can be used simultaneously.

### Swept Capability

Analog sweep widths as narrow as 100 Hz or as broad as the full frequency range of the HP 8340B/8341B permit rapid and thorough testing of any device within their broad frequency ranges. To simplify swept measurements, five frequency markers are provided along with useful marker functions such as marker sweep, marker to center frequency (MKR-CF), and marker difference.



**Network Analyzer Companions**

Besides being excellent stand-alone general purpose sources, the HP 8340B/8341B are also ideal sources for precision microwave network analysis, where a significant part of measurement accuracy depends on the frequency accuracy, stability, signal purity, and source/analyzer interface of the sweeper used. As well as being the preferred HP 8510 vector network analyzer source, the HP 8340B/8341B can be teamed with the HP 8757/8756 Scalar Network Analyzers for precision scalar analysis, magnitude-only applications where data at accurate frequencies is needed. In addition to frequency accuracy, the HP 8340B/8341B have a "phase-locked sweep." For sweep widths of  $n \times 5$  MHz or less ( $n$  = frequency band number), one of the phase-locked loops is swept, producing synthesizer-class frequency accuracy and stability in a continuous sweep. As an example, see the figure at right, where an 832 MHz SAW resonator is swept over a width of 400 kHz by an HP 8341B with less than 60 Hz of residual FM.

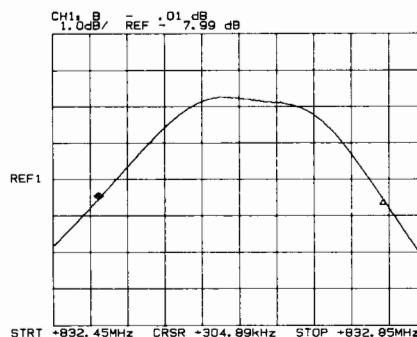

HP 8341B 400 kHz sweep of 832 MHz SAW resonator

**HP 8340B/8341B Specifications Summary**

(see technical data sheet for complete specifications)

(All specifications apply to the 8341B up to 20 GHz)

**Frequency**

**Range:** HP 8340B, 10 MHz to 26.5 GHz  
HP 8341B, 10 MHz to 20.0 GHz

**Resolution (CW Mode):**

- 1 Hz, 0.01 to <7.0 GHz
- 2 Hz, 7.0 to <13.5 GHz
- 3 Hz, 13.5 to <20.0 GHz
- 4 Hz, 20.0 to 26.5 GHz

**Time Base:** Internal 10 MHz time base. Aging rate: less than  $1 \times 10^{-9}$ /day and  $2 \times 10^{-7}$ /year after 30 day warm-up.

**Swept Capability:** Analog sweep,  $\Delta F$  from 100 Hz to 26.49 GHz (19.99 GHz on 8341B); sweep times from 45 ms to 200 sec full span.

**Spectral Purity**

**Harmonics** (up to 26.5 GHz) of output frequency:  
<-35 dBc

**Subharmonics and Multiples thereof** (up to 26.5 GHz) of output frequency:

- <-25 dBc, 7.0 to <20.0 GHz
- <-20 dBc, 20.0 to 26.5 GHz

**HP 8341B Option 003 Harmonics, Subharmonics and Multiples thereof** (up to 20.0 GHz):

- <-35 dBc, 0.01 to < 1.4 GHz
- <-50 dBc, 1.4 to 20.0 GHz

**Non-Harmonically Related Spurious** (CW and Manual Sweep mode only):

- 50 dBc, 0.01 to <2.3 GHz
- 70 dBc, 2.3 to <7.0 GHz
- 64 dBc, 7.0 to <13.5 GHz
- 60 dBc, 13.5 to <20.0 GHz
- 58 dBc, 20.0 to 26.5 GHz

**Single-Sideband Phase Noise** (dBc/1 Hz Noise BW, CW Mode):

Frequency Range (GHz)	Offset from Carrier				
	30 Hz	100 Hz	1 kHz	10 kHz	100 kHz
0.01 to < 2.3	-64	-70	-78	-86	-107
2.3 to < 7.0	-64	-70	-78	-86	-107
7.0 to <13.5	-58	-64	-72	-80	-101
13.5 to <20.0	-54	-60	-68	-76	-97
20.0 to 26.5	-52	-58	-66	-74	-95

**RF Output**

**Range:** -110 dBm to +20 dBm  
**Resolution:** 0.05 dB in ENTRY DISPLAY

**Maximum Levelled Power:**

- +10.0 dBm, 0.01 to <2.3 GHz
- +12.0 dBm, 2.3 to <7.0 GHz
- +10.0 dBm, 7.0 to <13.5 GHz
- +9.0 dBm, 13.5 to <20.0 GHz
- +3.0 dBm, 20.0 to <23.0 GHz
- +1.0 dBm, 23.0 to 26.5 GHz

**RF Output Connector:** APC-3.5 Male on HP 8340B, Type N Female on HP 8341B; nominal 50 ohm output impedance.

**Modulation**

**Pulse Modulation**

- ON/OFF Ratio:** >80 dB
- Rise and Fall Times:**  $\leq 25$  ns
- Minimum Internally Levelled RF Pulse Width:**  $\leq 100$  ns
- Minimum Unlevelled RF Pulse Width:** typically  $\leq 25$  ns

**Amplitude Modulation**

- Rates (3 dB BW):** DC to 100 kHz
- Depth:** 0 to 90%
- Sensitivity:** 100%/V

**Frequency Modulation**

- Modulation Rate (3 dB BW):** 50 kHz to 10 MHz
- Peak Deviation:** The lesser of 10 MHz or
  - $5 \times$  Mod Rate, 0.01 to <7.0 GHz
  - $10 \times$  Mod Rate, 7.0 to <13.5 GHz
  - $15 \times$  Mod Rate, 13.5 to <20.0 GHz
  - $20 \times$  Mod Rate, 20.0 to 26.5 GHz
- Sensitivity:** either 1 MHz/Volt or 10 MHz/Volt, user selectable.

**Ordering Information**

	<b>Price</b>
<b>HP 8340B Synthesized Sweeper</b>	\$57,500
Opt 001: Front RF Output without Attenuator	less \$2,000
Opt 004: Rear RF Output with Attenuator	add \$200
Opt 005: Rear RF Output Without Attenuator	less \$1,800
Opt 008: 1 kHz Frequency Resolution	less \$8,000
<b>HP 8341B Synthesized Sweeper</b>	\$39,500
Opt 003: Low Harmonics	add \$1,500
Opt 004: Rear RF Output with Attenuator	add \$200

Higher power and other special options are available. Please contact your local Hewlett-Packard sales representative for specifications and ordering information.

# SWEEP OSCILLATORS

## Model 8350 Series: 10 MHz to 40 GHz

### Model 8350 Series

- Versatile microprocessor-controlled mainframe
- Single-band, straddle-band and broad band plug-ins
- 10 MHz to 40 GHz from a single plug-in
- 10 mW output power to 26.5 GHz
- Total HP-IB programmability

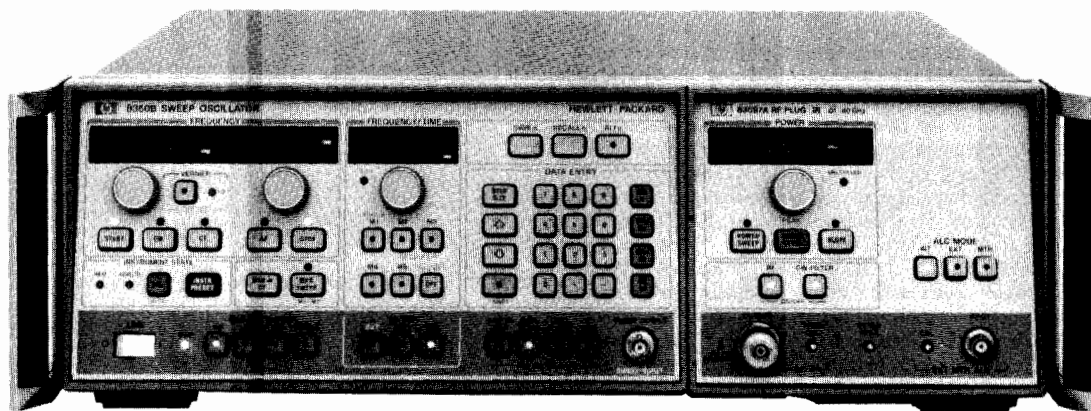

HP 8350B



### HP 8350 System

The HP 8350 is a powerful general-purpose source for swept microwave measurements, wideband CW signal generation and automatic testing. It incorporates the efficiency of microprocessor control with state-of-the-art YIG-tuned oscillators and GaAs FET amplifiers to produce a high performance sweep oscillator system ideally suited for either manual or automatic measurements.

You can easily configure a source to meet your application's frequency coverage and power requirements. Just combine the versatile HP 8350 mainframe with any of the 34 standard RF plug-ins (see table at right) and you are ready to make measurements. Both the advanced HP 83500 series plug-ins and the existing HP 86200 series plug-ins (via the HP 11869A adapter) are accepted by the HP 8350 mainframe.

### HP 8350 Mainframe

The HP 8350 has been designed to include many features that not only speed up and simplify measurements but also improve accuracy. In addition, it is compatible with HP network analyzers, counters, noise figure meters, power meters, and microwave link analyzers to provide complete solutions.

All function values (sweep limit frequencies, marker frequencies, etc.) are indicated on high resolution digital displays. Function values are easily modified using the appropriate knob, step keys, or data entry keyboard.

Five independent, continuously variable markers are available to note your measurement frequencies. The active marker frequency or the difference frequency between any two markers is read easily from a high resolution digital display. You can also use marker sweep to zoom in on a particular frequency span while retaining your original sweep limits.

Another particularly useful feature in making repetitive measurements is the HP 8350's Save/Recall Mode. Once the sweeper has been set for a particular measurement, all front panel settings (HP 8350 and HP 83500 series plug-in) can be *Saved* and later *Recalled* to repeat the measurement by accessing one of nine internal storage registers.

In the past, HP-IB programming of sweepers was limited to a series of CW frequencies. With the HP 8350 all front panel functions, e.g. sweeps, markers, sweep time, even output power (HP 83500 series plug-ins) can be programmed. This means there are no limitations in designing your own customized test systems. Utilizing the Learn Mode function, the HP 8350 becomes a "talker" as well as "listener" on the bus, transferring all manually entered front panel controls to the computer.

Full compatibility with both the HP 8510 Network Analyzer, the HP 8757A Scalar Network Analyzer are provided for convenient vector and scalar measurements with the HP 8350. The HP 5343A Counter can be combined with the HP 8350 to measure Start, Stop, or marker frequencies with up to 100 kHz accuracy while sweeping. Microwave noise figure measurements may be made using the HP 8350 with the HP 8970 Noise Figure Meter. In addition, the HP 8350B, with an appropriate plug-in driving the HP 8349B microwave amplifier, provides up to +20 dBm of output power across a 2 to 18.6 GHz range.

### HP 83500 Series Plug-Ins

Broadband frequency coverage from 10 MHz to 40 GHz with high output power is provided in the HP 83500 series RF plug-ins. One plug-in, the HP 83597A covers the entire 10 MHz to 40 GHz frequency range with  $-50$  dBc harmonics from 2.4 to 20 GHz and  $-40$  dBc from 20 to 40 GHz. The HP 83595A, operates from 10 MHz to 26.5 GHz without sacrificing frequency accuracy ( $\pm 12$  MHz at 26.5 GHz). The HP 83592C, 10 MHz to 20 GHz RF plug-in has  $-55$  dBc harmonics and subharmonics from 2 to 20 GHz. The HP 83550A provides +20 dBm of output power from 8.0 to 18.6 GHz, +18 dBm from 18.6 to 20.0 GHz and also has a built-in source module interface to drive the HP 83550-series millimeter-wave source modules. The 18 GHz to 26.5 GHz band is filled by the HP 83570A RF plug-in and boasts a 10 mW power level (comparable to most BWOs). The millimeter-wave bands are covered by the HP 83550-series millimeter-wave source modules, frequency multipliers that provide coverage in the 26.5 to 40 GHz (HP 83554A), 33 to 50 GHz (HP 83555A), and 40 to 60 GHz (HP 83556A) bands by effectively extending the characteristics of an 11 to 20 GHz microwave source to the millimeter frequency range.

The HP 83500 series plug-ins offer output power level control previously unavailable on a swept source. Power level control is calibrated with 0.1 dB resolution and up to 80 dB range (with Opt 002 attenuator). Calibrated power sweeps are available for characterizing device performance as a function of power. Slope and internal leveling controls are standard on all units. The HP 83500 series plug-ins (except the HP 83572A/B) are also capable of power meter leveling with the HP 432A/B/C, 436A, and 438A power meters.

All HP 83500 series front panel functions are HP-IB programmable including power level. This means your automatic test systems can now characterize a device both as a function of frequency and input power level.

### HP 86200 Series Plug-Ins

Simply combining the HP 86200 series plug-in (including the one you may already own) with an HP 11869A Adapter makes all the convenient digital controls, markers, and HP-IB capability of the HP 8350 immediately available to you. The HP 86200 series are a particularly attractive plug-in choice when economical single-band operation is desired with the HP 8350 mainframe. For measurements with HP Microwave Link Analyzers, specially characterized HP 86200 series plug-ins can be used with the HP 8350 to create an upconverter for communications distortion measurements.

The HP 86290B/C plug-ins cover the 2-18 GHz frequency range with 10 mW and 20 mW of output power respectively. Frequency accuracy at 18 GHz is 20 MHz, exceeding that available on most single-band plug-ins. Both HP 83500 series and HP 86200 series plug-ins compatible with the HP 8350 mainframe are summarized in the table. Note that the HP 11869A Adapter is required with all HP 86200 series plug-ins.

- Accurate, high resolution, digital displays
- Five markers with marker  $\Delta$  and marker sweep
- Save/recall 9 complete front panel states

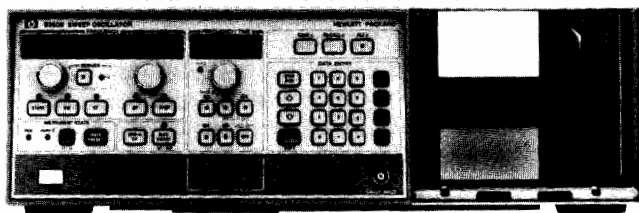

HP 8350B



- Accepts all HP 83500 series plug-ins
- Total HP-IB programmability
- Compatible with HP Network Analyzers

**CF Resolution:** 0.00038% (262,144 points across band).  
 **$\Delta F$  Resolution:** 0.1% of full band (1024 points across band),  
 0.012% of band for  $1/8$  of band or less, 0.0015% of  
 band for  $1/64$  of band or less.

**Display resolution:** 5 digits.

**CW operation:** single frequency RF output.

**CW resolution:** same as CF.

**Vernier:** adjusts CW frequency or swept center frequency up to 0.05% of RF plug-in band being swept.

**Vernier resolution:** 4 ppm (64 points between each CW point; 262,144 points across band).

**Offset:** allows the CW frequency or center frequency to be offset by any amount up to the full range of the plug-in.

**Frequency markers:** five frequency markers are independently adjustable and fully calibrated over the entire sweep range. Amplitude or intensity markers available.

**Resolution:** 0.4% of selected sweep width (256 points/sweep).

### Sweep and Trigger Modes

**Internal:** sweep recurs automatically.

**Line:** sweep triggered by ac power line frequency.

**External trigger:** sweep is actuated by external trigger signal.

**Single:** selects mode and triggers a single sweep.

**Sweep time:** continuously adjustable from 10 ms to 100 seconds.

**Manual sweep:** continuous manual adjustment of frequency between end frequencies.

**External sweep:** sweep is controlled by external signal applied to SWP OUTPUT/SWP INPUT connector.

**Sweep output:** direct-coupled sawtooth, zero to approximately +10 volts, concurrent with swept RF output.

### Instrument State Storage

**Save n/recall n:** 9 different front panel settings can be stored.

**Alt n:** causes the RF output to alternate on successive sweeps between the current front panel setting and a setting stored in memory.

### Modulation

**External AM:** refer to RF unit specifications.

**Internal AM:** Selectable to 27.8 kHz or 1 kHz. On/off ratio, refer to RF unit specifications.

**External FM:** refer to RF unit specifications.

### Remote Programming (HP-IB)

The HP 8350B has both input and output capability. All front panel controls except the ac line power switch are programmable.

**Frequency resolution:** same as CF/ $\Delta F$  plus vernier.

**Power resolution:** see HP 83500 Series Plug-ins.

**HP-IB interface functions:** SH1, AH1, T6, L4, SR1, RL1, PPO, DC1, DT1, CO, E1.

### General Specifications

**Nonvolatile memory:** continuous memory that retains the contents of all instrument state storage registers, the HP-IB address, and current instrument state when ac line power is off.

**Operating temperature range:** 0°C to +55°C.

**Power:** 100, 120, 220 or 240 volts  $\pm 10\%$ , 50 to 60 Hz (Option 400, 60 to 400 Hz). Approximately 270 volt-amperes including RF unit.

**Weight (not including RF unit):** Net 16.5 kg (36.4 lb). Shipping 22.7 kg (50 lb).

**Dimensions:** 425 mm wide, 133.3 mm high, 422 mm deep (16.75" x 5.25" x 16.6").

### Ordering Information

**HP 8350B Sweep Oscillator Mainframe**

**Price**

\$4,900

#### Options

**803:** HP 5343A Interface Cables

add \$60

**910:** Extra Manual

add \$80

**W30:** Two Years Extended Service

add \$100

For transit cases see page 742

## HP 8350B

Sweep Oscillator applications are greatly enhanced by the features of the HP 8350B. Along with the traditional swept and CW frequency functions, the HP 8350B adds extensive marker capabilities, versatile data entry and complete HP-IB programmability. Besides the popular HP 83500-series RF plug-ins, the HP 8350B also accepts the HP 86200-series plug-ins via the HP 11869A adapter. And the HP 8350B is directly compatible with such measurement systems as the HP 8510 vector network analyzer and the HP 8757A scalar network analyzer. Frequency accuracy is easily enhanced by using the HP 5343A counter to count the START, STOP, or ACTIVE MARKER frequencies.

The HP 8350B has three methods of changing function values: control knobs, keyboard entry, or step key entry.

Five markers are available with the HP 8350B. These markers, combined with the high resolution digital readout, make the accurate location of important frequency responses easy. A key marker feature, marker $\Delta$ , computes the difference between any two markers. The markers can also modify the center frequency (marker $\rightarrow$ CF) or the START/STOP frequency (Marker Sweep).

A necessity in making repetitive measurements or automatic tests is the Save/Recall feature. This feature supplies nine memory locations, each storing a complete front panel set-up. Nonvolatile memory is included so that all memories are retained even when line power is removed.

The HP 8350B makes "simultaneous" comparison of two separate frequency ranges or power levels easy via the alternate sweep mode. When the alternate sweep mode is activated, the HP 8350B alternates between the current front panel setting and any stored memory setting on successive sweeps. The output from this function may be processed through a network analyzer such as the HP 8757A and viewed on a two channel display.

All front panel controls (except the ac line switch) may be programmed or controlled via the HP-IB. The HP 8350B may interact as a listener or as a talker on the HP-IB.

A self test is performed at turn on or whenever the instrument pre-set function is activated. This function verifies that the HP 8350B is functioning properly. If there is a problem, error codes are displayed on the front panel to help locate the problem quickly to the board and component level.

## HP 8350B Specifications

### Frequency Control Functions

Refer to RF plug-in for frequency range, linearity and accuracy specifications.

**START/STOP sweep:** sweeps up from the START frequency to the STOP frequency.

**CF/ $\Delta F$  Sweep:** sweeps symmetrically upward, centered on CF.

**$\Delta F$ :** frequency width of sweep continuously adjustable from zero to 100% of frequency range.

# SWEEP OSCILLATORS

## Model 8350 Series: RF Plug-Ins

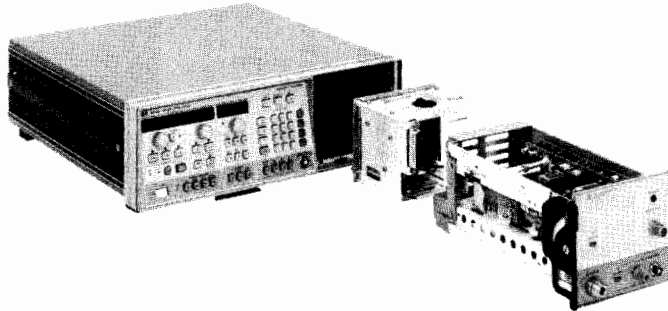

### HP 11869A Adapter

The HP 11869A adapter provides the electrical and mechanical interface between the HP 8350 and 86200 series plug-ins. All of the HP 8350's standard operating features, including HP-IB remote programming, are available. However, specific plug-in functions (output power level, RF on/off, etc.) cannot be controlled or remotely programmed by the HP 8350 mainframe.

See page 405 for HP 86200 series plug-in specifications.

### Plug-ins Compatible With The HP 11869A Adapter

The HP 11869A adapter attaches to the back of the HP 86200 series plug-in and is equipped with a switch for setting the specific interface code for the plug-in being used.

The following plug-ins will operate in the HP 8350 by using the HP 11869A.

HP 86220A <sup>1,2</sup>	HP 86240A/B/C	HP 86250A <sup>1</sup> /B <sup>1</sup> /C/D <sup>2</sup>
HP 86222A/B	HP 86241A <sup>1</sup>	HP 86251A <sup>3</sup>
HP 86230B <sup>1,2</sup>	HP 86242A <sup>1</sup> /C/D <sup>2</sup>	HP 86260A <sup>1</sup> /B <sup>3</sup> /C <sup>3</sup>
HP 86235A	HP 86245A	HP 86290A <sup>2</sup> /B/C

### Ordering Information

#### HP 11869A Adapter

**Price**

\$700

#### Options

**004:** Extension Cables for Plug-ins with Rear Panel RF Output add \$200

**006:** Type N Aux Out Interface Connector for HP 86251A and 86290A<sup>2</sup>/B/C add \$200

<sup>1</sup> Not compatible with 27.8 kHz square wave modulation.

<sup>2</sup> Models HP 86230B, 86290A, 86250A/B/C, and 86242A/C are obsolete. However, existing models can interface to HP 8350B mainframe via the HP 11869A adapter.

<sup>3</sup> Requires a special PROM for the HP 11869A, which is shipped with every HP 86251A, 86260 B/C.

### RF Plug-in Summary

	HP Model number	Frequency range (GHz)	Leveled power output	Frequency accuracy (MHz)	Complete specifications on page
Broad-band Plug-ins	83597A	0.01-40	1 mW	±20	401
	83596A	2.4-40	1 mW	±20	401
	83595A	0.01-26.5	2.5 mW	±12	399
	83594A	2-26.5	2.5 mW	±12	399
	83592A/B	0.01-20	10 mW/20 mW*	±10	399
	83592C	0.01-20	4 mW	±10	399
	83590A	2-20	10 mW	±10	399
	83525A/B	0.01-8.4	20 mW/10 mW	±12	402
	83522A	0.01-2.4	20 mW	±5	402
	86222A/B	0.01-2.4	20 mW	±10	405
Straddle-band Plug-ins	86290B	2-18.6	10 mW	±30	405
	86290C	2-18.6	20 mW	±30	405
	83540A/B	2-8.4	40 mW/20 mW	±12	402
	86240A	2-8.4	40 mW	±20	405
	86240B	2-8.4	20 mW	±20	405
	86240C	3.6-8.6	40 mW	±20	405
Single-band Plug-ins	86251A	7.5-18.6	10 mW	±20	405
	83550A	8.0-20.0	100 mW/63 mW**	±20	402
	86235A	1.7-4.3	40 mW	±20	405
	86241A	3.2-6.5	5 mW	±30	405
	86242D	5.9-9	10 mW	±35	405
	83545A	5.9-12.4	50 mW	±20	402
	86245A	5.9-12.4	50 mW	±40	405
	86250D	8.0-12.4	10 mW	±40	405
	86260B	10-15.5	10 mW	±50	405
	86260A	12.4-18	10 mW	±50	405
86260C	17-22	10 mW	±50	405	
83570A	18-26.5	10 mW	±30	402	
83572A	26.5-40	1.6 mW (Opt 001)	±100	402	
83572B	26.5-40	4 mW (Opt 001)	±100	402	

NOTE: The HP 11869A Adapter is required to interface HP 86200 series plug-ins with the HP 8350B mainframe.

\*HP 83592B: 20 mW to 18.6 GHz.

\*\*HP 83550A: 100 mW to 18.6 GHz.

# SWEEP OSCILLATORS

## Model 8350 Series: Broadband RF Plug-Ins

Models 83595A, 83592A/B/C, 83594A, 83590A

399

- Calibrated output power with 0.1 dB resolution
- +13 dBm from 0.01 to 18.6 GHz
- 12 MHz frequency accuracy at 26.5 GHz

- -55 dBc harmonics and subharmonics from 3.5 to 20 GHz
- Internal leveling and slope standard
- HP-IB

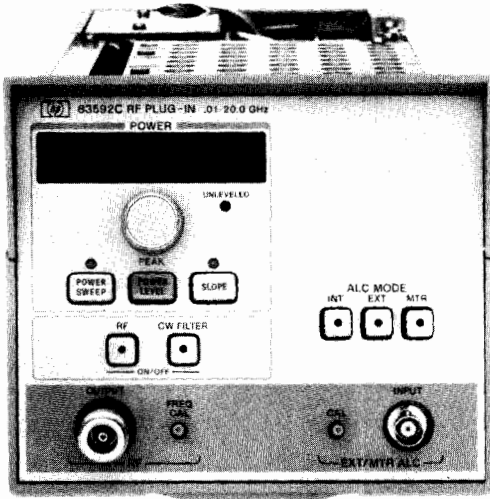

HP 83592C

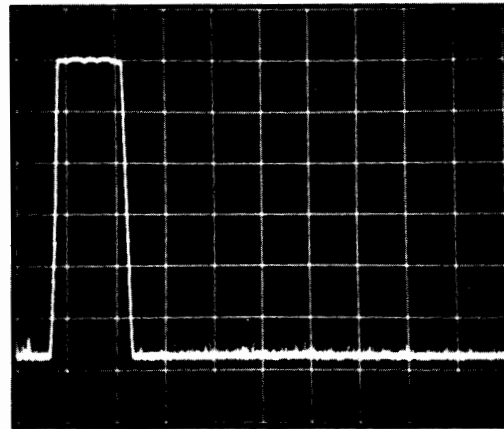

2.0 GHz      1.8 GHz/DIV      20.0 GHz

The HP 83590 series plug-ins feature wideband frequency coverage as exemplified by the HP 83595A which covers 0.01–26.5 GHz in a single sweep. While the HP 83590 series feature broadband sweeps, they still maintain narrowband precision. The frequency output exhibits excellent stability and accuracy. At 26.5 GHz the HP 83595A maintains an accuracy of  $\pm 12$  MHz. The HP 83592B does not sacrifice power for broadband high frequency coverage; the output power is internally leveled for a minimum +13 dBm (to 18.6 GHz) output with  $\pm 0.9$  dB flatness. The HP 83592C provides a clean test signal with -55 dBc harmonic and subharmonic levels (3.5-20 GHz) to maximize dynamic range. Power output capabilities have been expanded to provide power sweep and slope control. In addition, the HP 83590 series plug-ins are completely HP-IB programmable.

The most outstanding feature of the HP 83590 series plug-ins is their broad frequency range. Innovative technology is used to create this precision frequency range. The principle behind this technology is the Switched YIG Tuned Multiplier circuit (SYTM). The YTM circuit uses the output of a fundamental oscillator to drive a high-efficiency multiplier that has been integrated with a tracking YIG filter in order to create and select high order harmonics to be used as output frequencies.

A figure of merit for the HP 83590 series is their flat output power over the entire frequency range. The output power is internally leveled within 0.9 dB with a displayed resolution of 0.1 dB. The power level may be controlled to a minimum settable power level of -5 dBm (-2 dBm for the HP 83592B). This level may be extended to -75 dBm on the HP 83592A and HP 83590A or to -72 dBm on the HP 83592B with Option 002 (70 dB Step Attenuator), or to -60 dBm on the HP 83592C, the HP 83595A and HP 83594A with Option 002 (55 dB Step Attenuator).

Since power parameters are critical to high frequency measurements, the HP 83590 Series (along with all HP 83500 series plug-ins) offer many modes of power output. In addition to a single power output, the HP 83590 Series offer a Power Sweep function. The Power Sweep function sweeps a power range for characterizing level sensitive devices like amplifiers and transistors. The Slope mode is supplied to provide compensation for cable or test set losses. In all these modes the power output is internally monitored and leveled. If preferred, the power may be externally leveled. The HP 83590 Series plug-ins are capable of power meter leveling with the HP 432A/B/C, 436A, and 438A power meters.

HP-IB programmability is an essential feature when one of the HP 83590 series is used in automatic test systems. For example, the automated tests of amplifiers for gain compression are possible. These plug-ins are completely programmable, which means the power mode may be selected and the power level may be set with .01 dB resolution.

### Output Characteristics

#### Output Power Resolution

**Displayed:** 0.1 dB  
**Programmable/Settable:** 0.01 dB  
**Power Sweep** (with Option 002 Power Sweep cannot cross an attenuator step)

**Calibrated Range:** > 15 dB (> 9 dB<sup>1</sup>)

**Accuracy** (including linearity), typical: 1.5 dB

**Power Slope** (with Option 002 Power Slope cannot cross an attenuator step)

**Calibrated Range:** Up to 5 dB/GHz; up to 15 dB (9 dB<sup>1</sup>) for full sweep

**Linearity**, typical: 0.2 dB (0.3 dB<sup>1</sup>)

**Residual AM in 100 kHz Bandwidth**, typical: -50 dBc

**Source Output VSWR** (50 ohm nominal): < 1.9

### Modulation Characteristics

#### External AM

**Frequency Response**, typical: 100 kHz

**Range of Amplitude Control**, typical: 15 dB

**Sensitivity**, typical: 1 dB/V

#### Internal Square Wave Modulation

1 kHz of 27.8 kHz square wave modulation selectable by internal jumper in HP 8350B. The 27.8 kHz modulation ensures operation with all Hewlett-Packard scalar network analyzers.

**On/Off Ratio:** > 30 dB

**Symmetry:** 40/60

**External Pulse Modulation** (HP 83592A/B/C, 83595A specifications only)

**Pulse Input:** TTL compatible

**Rise/Fall Time**, typical: 15 nsec (0.01-2.5 GHz)

10 nsec (2.5-20 GHz or 26.5 GHz)

#### Minimum RF Pulse Width:

**Internally Leveled**, typical: 1 nsec

**Unleveled**, typical: 200 nsec (0.01-2.5 GHz)

100 nsec (2.5-20 GHz or 26.5 GHz)

#### External FM

##### Maximum Deviations for Modulation Frequencies:

DC to 100 Hz:  $\pm 75$  MHz

100 Hz to 1 MHz:  $\pm 7$  MHz

1 MHz to 2 MHz:  $\pm 5$  MHz

2 MHz to 10 MHz:  $\pm 1$  MHz

**Sensitivity** (switch selectable), typical

FM Mode: -20 MHz/V

Phase-lock Mode: 6 MHz/V



# SWEEP OSCILLATORS

## Model 8350 Series: Broadband RF Plug-Ins (cont'd)

Models 83595A, 83592A/B/C, 83594A, 83590A

### General Specifications

#### Minimum Sweep Time

HP 83590A, 83592A/B/C: 10 msec for single band, 25 msec for full sweep

HP 83594A, 83595A: 10 msec for single band, 30 msec for full sweep

**Auxiliary Output** (rear panel fundamental oscillator output, nominally 0 dBm):

HP 83590A, 83594A: 2.0-7.0 GHz

HP 83592A/B/C, 83595A: 2.3-7.0 GHz

**Frequency Reference Output** (rear panel BNC output, switch selectable):

1 V/GHz (<18 GHz) or 0.5 V/GHz (<20 GHz or <26.5 GHz)  $\pm$  25 mV

#### RF Output Connector

HP 83590A, 83592A/B/C: Type N female

HP 83594A, 83595A: Type APC 3.5 male

#### Weight:

HP 83590A, 83594A: Net 5.7 kg (12.45 lb), Shipping 8.75 kg (19.25 lb)

HP 83592A/B/C, 83595A: Net 6.0 kg (13.2 lb), Shipping 9.2 kg (20 lb)

### Ordering Information

HP 83590A 2.0 to 20 GHz RF Plug-in \$18,500

HP 83592A 0.01 to 20 GHz RF Plug-in \$20,500

HP 83592B 0.01 to 20 GHz (high power) RF Plug-in \$23,500

HP 83592C 0.01 to 20 GHz (low harmonics) RF Plug-in \$22,000

HP 83594A 2.0 to 26.5 GHz RF Plug-in \$24,200

HP 83595A 0.01 to 26.5 GHz RF Plug-in \$26,000

Option 002 Rear Panel RF Output Add \$200

Option 004: 70 dB Step Attenuator (HP 83590A, 83592A/B) Add \$1,500

55 dB Step Attenuator (HP 83592C, 83594A, 83595A)

	Band 0	Band 1	Band 2	Band 3	Band 4	Full Band
<b>Frequency Characteristics</b>						
<b>Range</b>						
HP 83590A	-	2-7	7-13.5	13.5-20	-	2-20
HP 83592A/B/C	.01-2.4	2.4-7	7-13.5	13.5-20	-	.01-20
HP 83594A	-	2-7	7-13.5	13.5-20	20-26.5	2-26.5
HP 83595A	.01-2.4	2.4-7	7-13.5	13.5-20	20-26.5	.01-26.5
<b>Accuracy (MHz, 25°C)</b>						
CW Mode	$\pm 5$	$\pm 5$	$\pm 10$	$\pm 10$	$\pm 12$	
All Sweep Modes (sweep time >100 ms)	$\pm 15$	$\pm 20$	$\pm 25$	$\pm 30$	$\pm 35$	$\pm 35$ ( $\pm 50^1$ )
<b>Linearity (MHz), typical</b>	$\pm 2$	$\pm 2$	$\pm 4$	$\pm 6$	$\pm 10$	$\pm 10$ ( $\pm 15^1$ )
<b>Stability, typical</b>						
With Temperature (MHz/°C)	$\pm 0.2$	$\pm 0.2$	$\pm 0.4$	$\pm 0.6$	$\pm 0.8$	
With 10 dB Power Change (kHz)	$\pm 200$	$\pm 200$	$\pm 400$	$\pm 600$	$\pm 800$	
With 3:1 Load SWR (kHz)	$\pm 100$	$\pm 100$	$\pm 200$	$\pm 300$	$\pm 400$	
With Time <sup>2</sup> (kHz)	$\pm 100$	$\pm 100$	$\pm 200$	$\pm 300$	$\pm 400$	
<b>Residual FM (kHz peak, 10 Hz-10 kHz bandwidth)</b>	<5	<5	<7	<9	<12	
<b>Output Characteristics</b>						
Maximum Leveled Power (mW, 25°C)	10 (20 <sup>3</sup> )	10 (20 <sup>3</sup> , 4 <sup>4</sup> )	10 (20 <sup>3</sup> , 4 <sup>4</sup> )	10 (2.5 <sup>5</sup> )	2.5	10 (2.5 <sup>5</sup> )
With Option 002	10 (16 <sup>6</sup> )	7 (14 <sup>3</sup> , 3.2 <sup>4</sup> )	6.3 (13 <sup>3</sup> , 2.5 <sup>5</sup> )	5 (1.4 <sup>4</sup> )	1.25	5 (1.25 <sup>5</sup> , 1.4 <sup>4</sup> )
<b>Power Level Accuracy (dB)</b>						
Internally Leveled	$\pm 1.5$	$\pm 1.3$	$\pm 1.3$	$\pm 1.4$	$\pm 1.7$	$\pm 1.5$ ( $\pm 1.8^7$ )
<b>Power Variation (dB, max specified power)</b>						
Internally Leveled	$\pm 0.9$	$\pm 0.7$	$\pm 0.7$	$\pm 0.8$	$\pm 0.9$	$\pm 0.9$ ( $\pm 1.0^7$ )
Externally Leveled <sup>8</sup>	$\pm 0.2$ (0.25 <sup>9</sup> )	$\pm 0.2$ (0.25 <sup>9</sup> )	$\pm 0.2$ (0.25 <sup>9</sup> )	$\pm 0.2$ (0.25 <sup>9</sup> )	$\pm 0.2$ (0.25 <sup>9</sup> )	
<b>Minimum Settable Power (dBm)</b>						
With Option 002	-5 (-2 <sup>1</sup> )	-5 (-2 <sup>1</sup> )	-5 (-2 <sup>1</sup> )	-5 (-2 <sup>1</sup> )	-5 (-2 <sup>1</sup> )	
	-60	-60	-60	-60	-60	
	(-72 <sup>1</sup> , -75 <sup>1</sup> )	(-72 <sup>1</sup> , -75 <sup>1</sup> )	(-72 <sup>1</sup> , -75 <sup>1</sup> )	(-72 <sup>1</sup> , -75 <sup>1</sup> )	(-72 <sup>1</sup> , -75 <sup>1</sup> )	
<b>Spurious Signals (dBc, max specified power)</b>						
Harmonically Related	<-25	<-25	<-25	<-25	<-20	
Non-harmonics	(-20 <sup>1</sup> , -45 <sup>7</sup> )	(-55 <sup>7</sup> )	(-55 <sup>7</sup> )	(-55 <sup>7</sup> )		
	<-25	<-50 (-55 <sup>7</sup> )	<-50 (-55 <sup>7</sup> )	<-50 (-55 <sup>7</sup> )	<-50	

<sup>1</sup> HP 83594A, 83595A specifications only.

<sup>2</sup> 10 minute period after one hour warm-up at same frequency.

<sup>3</sup> HP 83592B specifications only.

<sup>4</sup> HP 83592C specifications only.

<sup>5</sup> Negative crystal detector (sweep time > 100 msec) or HP 432A/B/C, 436A or 438A Power Meter (sweep time  $\geq$  100 sec), excludes coupler/detector variation.

<sup>6</sup> HP 83592A specifications only.

<sup>7</sup> HP 83592C only: <-25 dBc (0.1-1.4 GHz)  
<-45 dBc (1.4-2.4 GHz)  
<-50 dBc (2.4-3.5 GHz)  
<-55 dBc (3.5-20 GHz)

# SWEEP OSCILLATORS

## Model 8350 Series: Broadband RF Plug-ins

**Models 83597A, 83596A**

- 10 MHz to 40 GHz frequency coverage with the 2.4 mm coaxial connector
- -50 dBc harmonics and subharmonics from 1.5 to 20 GHz, -40 dBc from 20 to 40 GHz

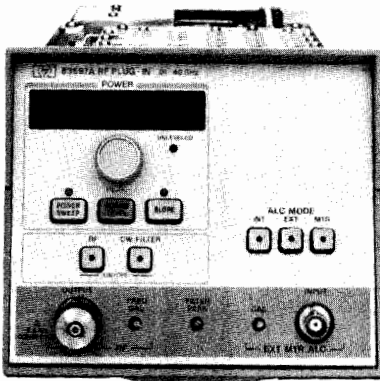

HP 83597A

The HP 83597A and 83596A RF plug-ins provide the highest performance and reliability available up to 40 GHz from a swept source. They feature high output power, as well as excellent harmonic performance. They also incorporate the 2.4 mm connector which makes high performance broadband coaxial measurements possible. The superiority of the 2.4 mm connector lies in its ruggedness, repeatable performance and excellent match over the entire frequency range.

A 40 GHz broadband swept scalar measurement system is easy to configure using this sweep oscillator with the HP 8757A Scalar Network Analyzer, and the appropriate 2.4 mm scalar network analyzer accessories. With -50 dBc of harmonic and subharmonic suppression from 1.5 to 20 GHz, and -40 dBc from 20 to 40 GHz, these plug-ins are the ideal choice for scalar network analysis.

The broadband frequency coverage and high output power of the HP 83597A and 83596A plug-ins make them ideal as local oscillators for down-converting high frequency signals to a lower intermediate frequency. These plug-ins provide the broadest frequency coverage for mixer measurement systems or coaxial noise figure measurements with the HP 8970B Noise Figure Meter.

The outstanding performance of the HP 83597A and 83596A plug-ins make them especially attractive as stand-alone sources for various signal generation and simulation applications. Frequency accuracies of better than  $\pm 5$  to  $\pm 20$  MHz are specified depending on the frequency of operation. These plug-ins additionally have very flexible amplitude, frequency and pulse modulation capabilities.

### Output Characteristics

#### Output Power Resolution

Displayed: 0.1 dB

Programmable/Settable: 0.01 dB

**Minimum Settable Power:** -15 dBm

#### Power Variation:

Externally Leveled (excluding coupler/detector variation)

Negative Crystal detector<sup>2</sup> or HP 432A/B/C, 436A or 438A

Power Meter<sup>3</sup>:  $\pm 0.2$  dB, typical

### Power Sweep

Calibrated Range: >19 dB (<18.6 GHz), >15 dB (>18.6 GHz)

Accuracy (including linearity):  $\pm 1.5$  dB, typical

Resolution (displayed): 0.1 dB

### Power Slope

Calibrated Range: up to 5 dB/GHz, up to 15 dB for full sweep

Linearity: 0.2 dB, typical

Resolution (displayed): 0.01 dB/GHz

**Residual AM in 100 kHz Bandwidth:** -50 dBc, typical

**Source Output VSWR** (50 Ohm, nominal impedance): <2.0:1, typical

### Modulation Characteristics

#### External AM

Frequency Response: 100 kHz, typical

Maximum Input: 15V

Range of Amplitude Control: 15 dB, typical

Sensitivity: 1 dB/V, typical

Input Impedance: approximately 25 k $\Omega$

#### Internal Square Wave Modulation

1 kHz or 27.778 kHz square wave modulation selectable by internal jumper in HP 8350B. The 27.778 kHz modulation ensures operation with all Hewlett-Packard scalar network analyzers.

On/Off Ratio: >30 dB

#### External Pulse Modulation:

Rise/Fall Time (neglecting overshoot): <50 nsec, typical

Minimum RF Pulse Width:

Internally Leveled: <1.5  $\mu$ sec, typical

Unleveled: <1  $\mu$ sec, typical

On/Off Ratio: >60 dB, typical

#### External FM

Maximum Deviations for Modulation Frequencies:

DC to 100 Hz:  $\pm 75$  MHz (cross-over coupled),  
 $\pm 12$  MHz (direct coupled)

100 Hz to 1 MHz:  $\pm 7$  MHz

1 MHz to 2 MHz:  $\pm 5$  MHz

2 MHz to 10 MHz:  $\pm 1$  MHz

Sensitivity (switch selectable):

FM Mode: -20 MHz/V, typical

Phase-lock Mode: -6 MHz/V, typical

### General Specifications

**Minimum Sweep Time:** 30 ms for a single band, 75 ms for <20 GHz sweep width, 150 ms for >20 GHz sweep width.

**Auxiliary Output:** Rear panel 2.3-7.0 GHz fundamental oscillator output, nominally 0 dBm.

**Frequency Reference Output:** Switch selectable 0.5 V/GHz (0.01-38 GHz) or 0.25V/GHz (0.01-40 GHz),  $\pm 25$  mV (<2.4 GHz) or  $\pm 100$  mV (>2.4 GHz).

**RF Output Connector:** Type 2.4 mm male.

**Weight:** Net 6.5 kg (14.4 lb), Shipping 9.5 kg (21 lb).

### Ordering Information

HP 83597A 10 MHz to 40 GHz RF Plug-In \$33,500

HP 83596A 2.4 GHz to 40 GHz RF Plug-In \$30,000

Opt. 004 Rear Panel RF Output add \$200

	Band 0	Band 1	Band 2	Band 3	Band 4	Full Band
<b>Frequency Characteristics Range</b>						
HP 83597A	0.01-2.4 GHz	2.4-7.0 GHz	7.0-13.5 GHz	13.5-20.0 GHz	20.0-40.0 GHz	0.01-40.0 GHz
HP 83596A		2.4-7.0 GHz	7.0-13.5 GHz	13.5-20.0 GHz	20.0-40.0 GHz	2.4-40.0 GHz
<b>Accuracy<sup>1</sup></b>						
CW Mode:	$\pm 5$ MHz	$\pm 5$ MHz	$\pm 10$ MHz	$\pm 10$ MHz	$\pm 20$ MHz	
All Sweep Modes: <sup>2</sup>	$\pm 15$ MHz	$\pm 20$ MHz	$\pm 25$ MHz	$\pm 30$ MHz	$\pm 50$ MHz	$\pm 75$ MHz
<b>Residual FM (peak):<sup>3</sup></b>	<5 kHz	<5 kHz	<7 kHz	<9 kHz	<18 kHz	
<b>Output Characteristics</b>						
<b>Maximum Leveled Power<sup>4</sup></b>	2.5 mW	2.5 mW	2.5 mW	2.5 mW (<18.6 GHz) 1 mW (>18.6 GHz)	1 mW	
<b>Power Level Accuracy<sup>1,5,6</sup></b>	$\pm 1.5$ dB	$\pm 1.3$ dB	$\pm 1.3$ dB	$\pm 1.4$ dB	$\pm 2.0$ dB	$\pm 2.0$ dB
<b>Power Variation<sup>1,7</sup></b>	$\pm 0.9$ dB	$\pm 0.7$ dB	$\pm 0.7$ dB	$\pm 0.8$ dB	$\pm 1.2$ dB	$\pm 1.3$ dB
<b>Spurious Signals<sup>8</sup></b>						
Harmonics and Subharmonics	<-25 dBc (<1.5 GHz) <-50 dBc (>1.5 GHz)	<-50 dBc	<-50 dBc	<-50 dBc	<-40 dBc <sup>9</sup>	
Non-harmonics:	<-25 dBc	<-50 dBc	<-50 dBc	<-50 dBc	<-50 dBc	

1. 25°C  $\pm 5$ °C.

2. For sweep times  $\geq 100$  ms.

3. 10 Hz to 10 kHz bandwidth, CW mode with CW filter on.

4. Typically degrades 0.1 dB/°C above 25°C.

5. Includes power level variations.

6. Degrades typically  $\pm 0.05$  dB/°C outside the 20°C-30°C range.

7. At specified maximum leveled power.

8. Typically <-40 dBc above 40 GHz.

9. For sweep times  $\geq 10$  sec and  $\geq 2.5$  sec/GHz.

# SWEEP OSCILLATORS

## Model 8350 Series RF Plug-Ins

HP 8350 Series Plug-Ins: Specifications Summary	Broadband			Straddle-Band			Single-Band			
	HP 83522A <sup>1</sup>	HP 83525A <sup>1</sup>	HP 83525B <sup>1</sup>	HP 83540A	HP 83540B	HP 83550A	HP 83545A	HP 83570A <sup>2</sup>	HP 83572A <sup>3</sup>	HP 83572B <sup>3</sup>
<b>Frequency Characteristics</b>										
Range (GHz)	0.01-2.4	0.01-8.4	0.01-8.4	2-8.4	2-8.4	8-20	5.9-12.4	18-26.5	26.5-40	26.5-40
Accuracy (MHz, 25°C)										
CW Mode	±5	±12 <sup>4</sup>	±12 <sup>4</sup>	±12	±12	±20	±20	±30	±100	±100
All Sweep Modes (sweep time >100 ms)	±15	±20 <sup>4</sup>	±20 <sup>4</sup>	±20	±20	±50	±35	±55	±150	±150
Residual FM (kHz peak, 10 Hz-10 kHz bandwidth)	<5	<7 <sup>4</sup>	<7 <sup>4</sup>	<7	<7	<25	<15	<30	<60	<60
<b>Output Characteristics</b>										
Maximum Leveled Power (mW, 25°C)	>20	>20	>10	>40	>20	>100 <sup>5</sup>	>50	>10	>2 <sup>6</sup>	>5 <sup>6</sup>
Power Level Accuracy (dB)										
Internally Leveled	±1	±1.5	±1.5	±1.5	±1.5	±1.5	±1	±1.8	±1.5 <sup>7</sup>	±1.5 <sup>7</sup>
Power Variation (dB, at max specified power)										
Internally Leveled	±0.25	±1	±1	±1	±1	±1.25	±0.6	±1.4	±3 <sup>8</sup>	±3 <sup>8</sup>
Externally Leveled, typical (excluding coupler/detector variations)	±0.1	±0.1	±0.1	±0.1	±0.1	±0.1	±0.1	±0.1	±0.2	±0.2
Spurious Signals (dBc, at max specified power)										
Harmonically Related	<-25	<-20	<-45 <sup>9</sup>	<-20	<-45	<-20 <sup>9</sup>	<-30 <sup>10</sup>	<-25	<-20	<-20
Non-harmonics	<-25	<-60 <sup>9</sup>	<-60 <sup>9</sup>	<-60	<-60	<-50	<-60	<-50	<-50	<-50
Source SWR, typical (50 ohms nominal, internally leveled)	<1.5	<1.6 <sup>9</sup>	<1.6 <sup>9</sup>	<1.6	<1.6	<2.5	<1.6	<2.5	<1.5 <sup>7</sup>	<1.5 <sup>7</sup>
<b>Modulation Characteristics</b>										
External Pulse, typical										
Rise/Fall Time (ns)	n/a	20 <sup>4</sup>	20 <sup>4</sup>	20	20	25	15	20	300/50 <sup>11</sup>	300/50 <sup>11</sup>
Minimum RF Pulse Width										
Leveled (µs)	n/a	1 <sup>4</sup>	5 <sup>4</sup>	1	5	1	1	1	n/a	n/a
Unleveled (ns)	n/a	100 <sup>4</sup>	100 <sup>4</sup>	100	100	100	100	100	500 <sup>11</sup>	500 <sup>11</sup>
External FM										
Maximum Deviation (MHz)										
DC to 100 Hz Rates	±75	±75	±75	±75	±75	±75	±75	±75	±150	±150
100 Hz to 200 kHz Rates	±7	±7	±7	±7	±7	±12	±7	±7	±3.5	±3.5
200 kHz to 1 MHz Rates	±7	±7	±7	±7	±7	±12	±7	±7	n/a	n/a
1 MHz to 2 MHz Rates	±5	±5	±5	±5	±5	±12	±5	±5	n/a	n/a
2 MHz to 6 MHz Rates	±1	±1	±1	±1	±1	±12	±1.5	±1	n/a	n/a
6 MHz to 10 MHz Rates	±1	±1	±1	±1	±1	±1	±1.5	±1	n/a	n/a
Sensitivity (MHz/volt), typical	-20/-6	-20/-6	-20/-6	-20/-6	-20/-6	-20/-6	-20/-6	-20/-6	-20/-6	-20/-6
External AM										
Frequency response (kHz), typical	100	100	100	100	100	100	100	100	10	10
Range (dB), typical	>15	>15	>15	>15	>15	>20	>15	>11	>7 <sup>7</sup>	>11 <sup>7</sup>
Sensitivity (dB/volts)	+1	+1	+1	+1	+1	-1	+1	+1	+1 <sup>7</sup>	+1 <sup>7</sup>
Internal AM (1 kHz/27.8 kHz square wave)										
On/Off Ratio (dB)	>30	>40 <sup>4</sup>	>40 <sup>4</sup>	>30	>30	>30	>40	>25	>20 <sup>11</sup>	>20 <sup>11</sup>
<b>Prices</b>										
Plug-in	\$8,200	\$12,800	\$14,000	\$9,900	\$10,500	\$16,000	\$9,900	\$17,500	\$15,000	\$18,000
With Opt 001 (Calibrated External Leveling)	n/a	n/a	n/a	n/a	n/a	n/a	n/a	n/a	\$1,605	\$1,600
With Opt 002 (70 dB Attenuator)	+ \$1,005	+ \$1,105	+ \$1,105	+ \$1,105	+ \$1,105	+ \$1,305	+ \$1,105	n/a	n/a	n/a
With Opt 004 (Rear Panel RF Output)	+ \$200	+ \$200	+ \$200	+ \$200	+ \$200	+ \$200	+ \$200	n/a	n/a	n/a
With Opt 006 (Internal Pulse/Square Wave Modulation)	n/a	n/a	n/a	n/a	n/a	n/a	n/a	n/a	\$1,805	\$1,800
With Opt W30 (Two Years Extended Service)	+ \$170	+ \$250	+ \$270	+ \$200	+ \$210	+ \$300	+ \$200	+ \$240	+ \$290	+ \$350

<sup>1</sup> Enhanced frequency accuracy is provided by internal crystal markers of 10 MHz and 50 MHz (over full range for HP 83522A, and below 2 GHz for HP 83525A/B). 1 MHz harmonic markers are available below 1 GHz.

<sup>2</sup> WR42 waveguide RF output connector type.

<sup>3</sup> WR28 waveguide RF output connector type.

<sup>4</sup> Specifications apply from 2-8.4 GHz only. 0.01-2 GHz specifications are the same as the HP 83522A plug-in.

<sup>5</sup> 63 mW from 18.6-20 GHz.

<sup>6</sup> Unleveled output power.

<sup>7</sup> Externally leveled (requires option 001 which consists of a calibrated crystal detector, external coupler, and BNC cable).

<sup>8</sup> Specifications apply only from 2-8.4 GHz.

<sup>9</sup> -15 dBc from 8-11 GHz.

<sup>10</sup> -17 dBc from 5.9-7 GHz.

<sup>11</sup> Requires option 006 which provides internal pulse and square wave modulation capability.

<sup>12</sup> 50 dB step attenuator.

# SWEEP OSCILLATORS

## HP 83550 Series Millimeter-Wave Source Modules

**Models 83554A, 83555A and 83556A**

- 26.5 to 60 GHz frequency range
- Internally-leveled high output power
- Can be driven by many HP microwave sources

- Source module remotable up to a meter length
- Low entry cost



The three HP 83550 series millimeter-wave source modules provide a simple approach to extend the frequency range of 11 to 20 GHz sources to cover 26.5 to 40 GHz (HP 83554A), 33 to 50 GHz (HP 83555A) and 40 to 60 GHz (HP 83556A) bands. The HP 83550 series source modules offer internally-leveled high output power, full waveguide band frequency coverage, and the high frequency accuracy and resolution of the driving microwave source.

As shown in Figure 1, there are two basic ways of configuring a millimeter-wave source to best suit your specific needs. Your choice can range from a sweep oscillator (HP 8350B/83550A) to a sophisticated synthesized sweeper (HP 8341B/8349B).

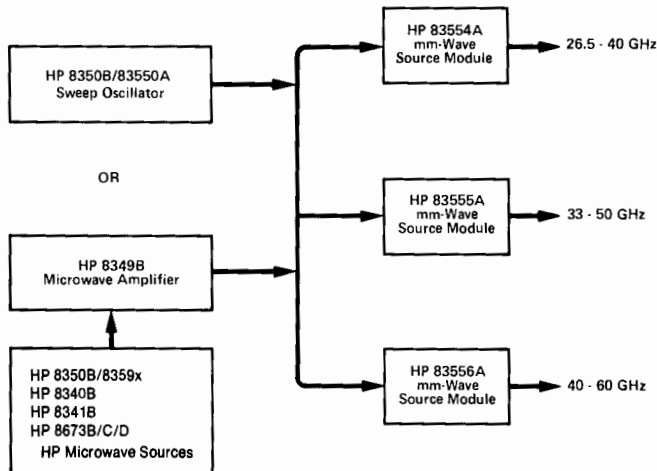

### Frequency Precision and Spectral Purity

An advantage of using frequency multiplication to generate millimeter-wave signals is that the module output translates many of the capabilities and features of the microwave source driver. The frequency accuracy and resolution are multiplied by a factor of two or three depending on whether the drive frequency is doubled or tripled. For example, a millimeter-wave source based on the HP 8341B/8349B will have frequency resolution of 6 Hz from 26.5 to 40 GHz, and 9 Hz from 40 to 60 GHz.

The HP 83550 series source modules offer 20 to 50 dBc of harmonic and subharmonic suppression depending on the source configuration used. The high stability and low phase noise characteristics of the HP 8340B/8341B or HP 8673B/C/D synthesizers (combined with the required HP 8349B amplifier) are also translated through the source modules and are available for a variety of signal simulation applications.

### High Output Power

Internally-leveled output power from the source modules is rated at +8 dBm for the HP 83554A, +3 dBm for the HP 83555A and +3 dBm for the HP 83556A. This high output power can permit the source module to serve as a mixer LO in some applications, and also expands the available dynamic range in frequency response measurements.

### Pulse, AM and FM Modulation

The high performance pulse modulators of the HP synthesized sources offer >80 dB ON/OFF ratio and <50 ns rise and fall times. Pulse amplitudes are leveled for pulse widths as narrow as 1  $\mu$ s.

The HP 8340B/8341B also feature dc-coupled AM with a 3 dB bandwidth of 100 kHz. Pulse and amplitude modulation can be used to simultaneously simulate antenna scan patterns.



HP 8340B/8349B/83554A Pulse Performance at 35 GHz. Pulse width = 5  $\mu$ s.

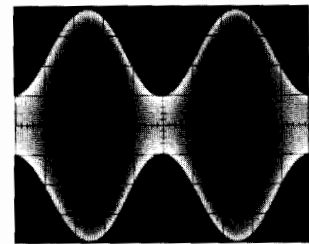

HP 8341B/8349B/83554A AM Performance at 30 GHz. AM rate is 17 kHz and depth is 70%.

FM rates between 100 Hz and 10 MHz may be applied to the HP 8673B/C/D synthesizer input to achieve deviations up to 20 MHz (HP 83554A) and 30 MHz (HP 83555A, 83556A) at millimeter-wave frequencies.

### Operational Simplicity

Simple front panel operations let you enter a display multiplier, so that the actual output frequency of the source module may be entered and displayed directly on the microwave source driver. The output power of the source module is displayed on the source or amplifier (depending on your millimeter-wave source configuration) and can be controlled again from the microwave driver.

In addition, the small size of the HP 83550-series source modules allows you to use them even on a crowded benchtop. The source modules may be placed up to 1 meter from the driving source allowing you to bring your source to your test system instead of the other way around.

This combination of performance and versatility, plus total HP-IB programmability (via the microwave source driver), makes the HP millimeter-wave sources ideal in many automatic test or bench applications.

### All at a Lower Cost

The HP 83550-series source modules combines performance and quality with a low cost of entry. This is possible because the source modules are backward-compatible with existing HP microwave sources. Thus, you can generate a full waveguide band of millimeter-wave frequencies for just the cost of the HP 8349B and a source module. Also, the cost of ownership to you is reduced even further by the two-year warranty on the microcircuits of the HP 83550-series source modules and the HP 8349B microwave amplifier.

# SWEEP OSCILLATORS

## HP 83550 Series Millimeter-Wave Source Modules (cont'd)

Models 83554A, 83555A and 83556A

HP 83554A Output Characteristics <sup>1</sup>	HP 8350B/83550A	HP 8350B/ 83590 Series/8349B	HP 8340B/8349B, HP 8341B/8349B	HP 8673B/C/D/8349B
<b>Maximum Leveled Power</b> (25°C±5°C)	+8 dBm, 26.5-37.2 GHz +7 dBm, 37.2-40.0 GHz -5 dBm	+8 dBm, 26.5-37.2 GHz +7 dBm, 37.2-40.0 GHz -5 dBm	+8 dBm, 26.5-37.2 GHz +7 dBm, 37.2-40.0 GHz -5 dBm	+8 dBm, 26.5-37.2 GHz +7 dBm, 37.2-40.0 GHz -5 dBm
<b>Minimum Settable Power:</b>				
<b>Power Level Accuracy<sup>2</sup></b> (25°C±5°C)	±2.00 dB	±2.00 dB	±2.00 dB	±2.00 dB
<b>Power Flatness</b> (at max leveled power)	±1.50 dB	±1.50 dB <sup>3</sup>	±1.50 dB <sup>3</sup>	±1.50 dB <sup>3</sup>
<b>Source Output SWR</b>	<2.0	<2.0	<2.0	<2.0
<b>Spurious Signals</b> (expressed in dB relative to the carrier level (dBc)). Harmonically related spurious: 26.5 to 26.7 GHz 26.7 to 40.0 GHz	<-25 dBc <-50 dBc	<-25 dBc <-20 dBc <sup>4</sup>	<-25 dBc <-20 dBc <sup>5</sup>	<-25 dBc <-20 dBc <sup>6</sup>

HP 83555A Output Characteristics <sup>1</sup>	HP 8350B/83550A	HP 8350B/ 83590 Series/8349B	HP 8340B/8349B, HP 8341B/8349B	HP 8673B/C/D/8349B
<b>Maximum Leveled Power</b> (25°C±5°C)	+3 dBm -5 dBm	+3 dBm -5 dBm	+3 dBm -5 dBm	+3 dBm -5 dBm
<b>Minimum Settable Power:</b>				
<b>Power Level Accuracy<sup>2</sup></b> (25°C±5°C)	±2.00 dB	±2.00 dB	±2.00 dB	±2.00 dB
<b>Power Flatness</b> (at max leveled power)	±1.50 dB	±1.50 dB <sup>3</sup>	±1.50 dB <sup>3</sup>	±1.50 dB <sup>3</sup>
<b>Source Output VSWR</b>	<2.0	<2.0	<2.0	<2.0
<b>Spurious Signals</b> (expressed in dB relative to the carrier level (dBc)). Harmonically related spurious: 33.0 to 37.5 GHz 37.5 to 49.5 GHz 49.5 to 50.0 GHz	<-20 dBc <-50 dBc <-20 dBc	<-20 dBc <-20 dBc <sup>4</sup> <-20 dBc	<-20 dBc <-20 dBc <sup>5</sup> <-20 dBc	<-20 dBc <-20 dBc <sup>6</sup> <-20 dBc

HP 83556A Output Characteristics <sup>1</sup>	HP 8350B/83550A	HP 8350B/ 83590 Series/8349B	HP 8340B/8349B, HP 8341B/8349B	HP 8673B/C/D/8349B
<b>Maximum Leveled Power</b> (25°C±5°C)	+3 dBm -5 dBm	+3 dBm -5 dBm	+3 dBm -5 dBm	+3 dBm -5 dBm
<b>Minimum Settable Power:</b>				
<b>Power Level Accuracy<sup>2</sup></b> (25°C±5°C)	±2.25 dB	±2.25 dB	±2.25 dB	±2.25 dB
<b>Power Flatness</b> (at max leveled power)	±1.75 dB	±1.75 dB <sup>3</sup>	±1.75 dB <sup>3</sup>	±1.75 dB <sup>3</sup>
<b>Source Output VSWR</b>	<2.0	<2.0	<2.0	<2.0
<b>Spurious Signals</b> (expressed in dB relative to the carrier level (dBc)). Harmonically related spurious: 40.0 to 45.0 GHz 45.0 to 60.0 GHz	<-20 dBc <-50 dBc	<-20 dBc <-20 dBc <sup>4</sup>	<-20 dBc <-20 dBc <sup>5</sup>	<-20 dBc <-20 dBc <sup>6</sup>

<sup>1</sup>All specifications apply to internally leveled operation only.

<sup>2</sup>Specified with respect to HP 83550A or HP 8349B power display. Includes power level flatness.

<sup>3</sup>Must have 0.5 V/GHz modification on microwave source.

<sup>4</sup>Except for the HP 83592C which is -45 dBc.

<sup>5</sup>Except for the HP 8341B Option 003 which is -40 dBc.

<sup>6</sup>Except for the HP 8673C/D which are -50 dBc.

### Other Specifications

**Frequency Resolution:** 2 (HP 83554A) or 3 (HP 83555A, 83556A) times the resolution of the input frequency.

**Frequency Accuracy and Stability:** 2 (HP 83554A) or 3 (HP 83555A, 83556A) times the accuracy and stability of the input frequency for sweep oscillator. Same as the time base for synthesized sources.

**Single-Sideband Phase Noise** (synthesized sources only): Same as the input signal plus 6 dB (HP 83554A) or 10 dB (HP 83555A, 83556A).

### External Pulse Modulation:

**On/Off Ratio:** >80 dB (>60 dB, for HP 8350B/83550A)

**Minimum Leveled RF Pulse Width:** 1μs (5μs, for HP 8673)

**Minimum Unleveled RF Pulse Width:** 100 ns (50 ns, for HP 8673)

### Amplitude Modulation:

**Rate** (3 dB BW): DC-100 kHz (DC-80 kHz, for HP 8673)

**Sensitivity:** 1 dB/V (100%/V, for synthesized sources)

### Frequency Modulation:

**Maximum Deviations:** Follows input with 2 (HP 83554A) or 3 (HP 83555A, 83556A) times the deviation.

**Output Sensitivity:** 2 (HP 83554A) or 3 (HP 83555A, 83556A) times the input sensitivity.

### General Specifications

#### Waveguide Output Connector

HP 83554A: EIA size WR 28 waveguide; JAN UG-599 flange.

HP 83555A: EIA size WR 22 waveguide; JAN UG-383 flange.

HP 83556A: EIA size WR 19 waveguide; JAN UG-383 (mod.) flange.

**Weight:** Net, 1.7 kg (4 lb).

**Dimensions:** Module, 80 mm W x 80 mm H x 210 mm D (3.15" x 3.15" x 8.27")

**Furnished with Each Source Module:** Operating and Service Manual, Modification Procedures for 0.5 V/GHz output, Type-N RF Cable, Module Base Assembly, Synthesizer Interface Cable.

### Ordering Information

HP 83554A 26.5-40.0 GHz mm-Wave Source Module \$9,000

HP 83555A 33.0-50.0 GHz mm-Wave Source Module \$9,000

HP 83556A 40.0-60.0 GHz mm-Wave Source Module \$9,000

Opt 910: Extra Manual add \$40

Opt W30: Two Years Extended Service add \$160



# SWEEP OSCILLATORS

Model 8350 Series: RF Plug-Ins

Model 86200 Series

405

HP 86200 Series Plug-Ins: Specifications Summary	Broadband		Straddle-Band					Single-Band						
	HP 86222B <sup>1</sup>	HP 86290B <sup>2</sup>	HP 86240A	HP 86240B	HP 86240C	HP 86251A	HP 86235A	HP 86241A	HP 86242D	HP 86245A	HP 86250D	HP 86260B	HP 86260A	HP 86260C
<b>Frequency Characteristics</b>														
<b>Range (GHz)</b>	0.01-2.4	2.0-18.6	2.0-8.4	2.0-8.4	3.6-8.6	7.5-18.6	1.7-4.3	3.2-6.5	5.9-9.0	5.9-12.4	8.0-12.4	10.0-15.5	12.4-18.0	17.0-22.0
<b>Accuracy (MHz, 25°C)</b>														
CW Mode	±10	±30	±25	±25	±25	±60	±20	±30	±35	±40	±40	±50	±50	±50
Remote Programming, typical	±1.5	±2.5	±3.5	±3.5	±3.5	±20	±2.5	±10.5	±5.0	±20	±20	±25	±25	±25
All Sweep Modes (sweep time >100 ms)	±15	±40	±40	±50	±35	±60	±30	±33	±40	±50	±50	±70	±70	±70
<b>Residual FM</b> (kHz peak, 10 Hz-10 kHz bandwidth)	<5	<25	<25	<25	<15	<15	<15	<7	<7	<30	<9	<9	<9	<20
<b>Output Characteristics</b>														
<b>Maximum Leveled Power</b> (mW, 25°C)	>20	>10	>40	>20	>40	>10	>40	>5	>10	>50	>10	>10	>10	>10
<b>Power Variation (dB, at max specified power)</b>														
Internally Leveled	±0.25	±0.7	±2	±2	±2	±0.8	±2	±0.8	±0.5	±0.6	±0.5	±0.7	±0.7	±0.7
Externally Leveled (excluding coupler and detector variations)	±0.1	±0.15	±0.1	±0.1	±0.1	±0.15	±0.1	±0.1	±0.1	±0.1	±0.1	±0.1	±0.1	±0.1
<b>Spurious Signals (dBc, at max specified power)</b>														
Harmonically Related	<-25	<-25	<-16	<-45	<-16	<-35	<-20	<-16	<-30	<-17	<-30	<-25	<-25	<-25
Non-harmonics	<-25	<-50	<-60	<-60	<-60	<-50	<-60	<-60	<-60	<-60	<-60	<-50	<-50	<-50
<b>Source SWR</b> (50 ohms nominal, internally leveled)	<1.5	<1.9	<1.6	<1.6	<1.6	<1.9	<1.6	<1.6	<1.6	<1.6	<1.6	<1.6	<1.6	<1.6
<b>Modulation Characteristics</b>														
<b>External Pulse</b>														
Rise/Fall Time, typical (ns)	n/a	n/a	20	20	20	n/a	20	n/a	n/a	n/a	n/a	n/a	n/a	n/a
On/Off Ratio (dB)			40	40	40		40							
For Input (volts)			+6	+6	+6		+6							
<b>External FM<sup>3</sup></b>														
Maximum Deviation (MHz)														
DC to 100 Hz Rates	±75	±75	±75	±75	MLA <sup>3</sup>	±75	±75	±25	±150	±150	±150			
100 Hz to 1 MHz Rates	±5	±5	±5	±5		±5	±5	±2	±15	±15	±15			
1 MHz to 2MHz Rates	±2	±5	±2	±2		±5	±2		±5	±5	±5			
DC to 200 Hz Rates												±75	±75	±75
200 Hz to 200 kHz Rates												±5	±5	±5
Sensitivity, nominal (MHz/volt)	-20/-6	-20/-6	-20/-6	-20/-6	-20/-6	-20/-6	-20/-6	-6	-20/-6	-20/-6	-20/-6	-20/-6	-20/-6	-20/-6
<b>External AM</b>														
Linear Mode														
Frequency Response, Typical (kHz)	150	300	50	50	50	300	50	30	30	30	300	300	300	300
Attenuation (dB), typical, For Input (volts)	>30 +6	>30 +5	>30 +5	>30 +5	>30 +5	>30 +5	>30 +5	>25 -10	>20 +6	>20 +6	>20 +6	>25 -10	>25 -10	>25 -10
Square Wave Mode On/Off Ratio (dB), For Input (volts)	n/a +6	>30 +6	n/a	n/a	n/a	>30 +6	n/a	n/a	>40 +6	>40 +6	>40 +6	n/a	n/a	n/a
Compatible with HP 8757/8756 Mod Drive signal	Yes	Yes	Yes	Yes	Yes	Yes	Yes	No	Yes	Yes	Yes	No	No	No
<b>Internal AM</b>														
1 kHz Square Wave On/Off Ratio (dB)	>30	>25	>40	>40	>40	>25	>40	>25	>40	>40	>40	>25	>25	>25
<b>Prices</b>														
Plug-in	\$7,000 (86222A: \$6,000)	\$15,600 (86290C: \$20,000)	\$6,600	\$7,800	\$7,600	\$12,500	\$6,200	\$5,400	\$6,400	\$8,100	\$6,300	\$7,700	\$7,500	\$9,950
With Opt 002 (70 dB Attenuator)	+ \$750	n/a	+ \$905	+ \$905	+ \$905	n/a	+ \$850	n/a	n/a	n/a	n/a	n/a	n/a	n/a
With Opt 004 (Rear Panel RF Output)	+ \$200	+ \$200	- \$200	+ \$200	- \$200	+ \$200	+ \$200	+ \$200	- \$200	- \$200	- \$200	+ \$200	+ \$200	+ \$200

<sup>1</sup>HP 86222A specifications identical to HP 86222B, except that the HP 86222B has 1, 10, and 50 MHz crystal markers which allow enhancement of frequency accuracy to better than ±200 kHz.

<sup>2</sup>HP 86290C specifications identical to HP 86290B, except that the HP 86290C has maximum leveled power > 20 mW. HP 86290B specifications listed apply to frequencies 6 to 12.4 GHz.

<sup>3</sup>Many HP 86200 series plug-ins have optional Microwave Link Analyzer (MLA) compatibility capabilities.

# AMPLIFIERS

## RF Amplifier

### Model 8347A

- Broadband 100 kHz to 3 GHz coverage
- +20 dBm output power
- Low harmonics
- 25 dB gain
- Internally leveled



HP 8347A



The HP 8347A is a general-purpose broadband instrumentation amplifier capable of providing gain and power to overcome systematic RF losses, drive high-power devices, or improve measurement system performance.

Switching and signal routing in ATE systems, frequency conversion, and long transmission paths to remote devices like antennas on towers are examples of systematic power losses. With more than 25 dB of gain, the HP 8347A can overcome such losses, and its internal leveling loop can reduce mismatch and reflection effects in a system.

Many devices, like mixers, power amplifiers, and optical modulators, require high-power drive signals. These devices are often very level-sensitive as well. The flat, leveled, +20 dBm output power of the HP 8347A allows proper device operation or complete characterization.

EMI, surveillance, and other demanding small-signal measurements sometimes stretch the capabilities of even the best test equipment. The HP 8347A can be used as a preamplifier to increase sensitivity in spectrum analysis and frequency counting applications, and can also extend dynamic range and increase low-level sweep speed in network analysis.

#### Improve HP 8753 Dynamic Range or Sweep Time

Using the illustrated configuration, the HP 8753 RF network analyzer dynamic range can be improved from 100 to 120 dB, or alternatively, sweep time increased by almost 100 times.

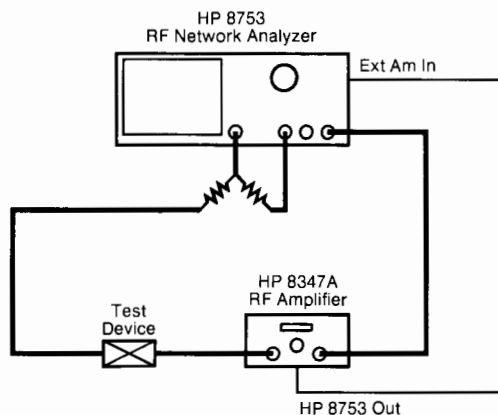

Simplified Block Diagram

#### Specifications

- Frequency Range:** 100 kHz to 3 GHz
- Maximum Leveled Output Power:**  $\geq +20$  dBm
- Output Power Leveling Range ( $\geq 300$  kHz):** +2 to +20 dBm
- Power Flatness (internally-leveled,  $\pm 300$  kHz):**  $\pm 1.5$  dB
- Gain:**  $\geq 25$  dB
- Harmonics (at +20 dBm output)**
- Internal Leveling Off (ALC Off):**  $\leq -25$  dBc
- Internal Leveling On (ALC On):**  $\leq -20$  dBc

#### Supplemental Characteristics

- Maximum Input for Minimum Internally-Leveled Output:** -14 dBm
- 1 dB Compression Point:** +22 dBm
- Third-Order Intercept:** +30 dBm
- RF Input and Output Impedances:** 50 ohms
- VSWR**
- Input:** 2.0:1
- Output**
- Internally-Leveled:** 1.5:1
- Unleveled**
- Below 2 GHz: 2.0:1
- 2 to 3 GHz: 3.0:1
- Reverse Isolation:** 60 dB
- Noise Figure**
- 10 MHz to 3 GHz: 15 dB
- Below 10 MHz: 20 dB

#### General

- RF Input and Output Connectors:** Type N female.
- Dimensions:** 102 H X 213 W X 298 mm D (4.0" X 8.4" X 11.8").
- Weight:** Net 4 kg (8 lb). Shipping 5 kg (11 lb).

Extended Dynamic Range Configuration

#### Ordering Information

HP 8347A RF Amplifier

Price  
\$3,950

- 2 to 22 GHz
- 28 dB gain
- 10 dB noise figure

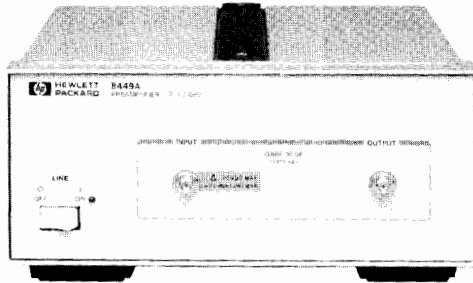

HP 8449A



- 2 to 8 GHz wideband frequency coverage
- 40 milliwatt (+16 dBm) output power
- Adjustable, calibrated power level

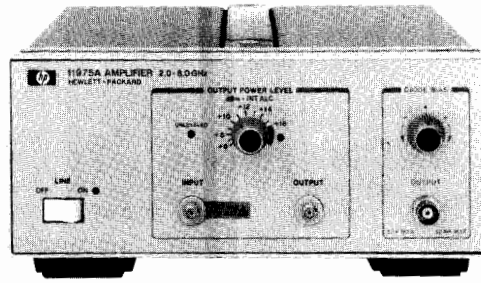

HP 11975A



### Improve Sensitivity and Reduce Measurement Time

#### HP 8449A Preamp

This 2 to 22 GHz high gain, low noise preamp increases the sensitivity of any microwave spectrum analyzer. By improving sensitivity, you can detect and analyze very low level signals in dramatically reduced measurement time. Ordinarily, detecting low level signals requires the use of narrow bandwidths. As bandwidths are narrowed, however, sweep time becomes longer and measurement speed is reduced. The improved sensitivity added by the HP 8449A lets you widen bandwidths and measure low level signals using much shorter sweep times.

#### Frequency Specifications

**Range:** 2.0 to 22.0 GHz

**Flatness:** ±2.5 dB, 2 to 22 GHz

#### Input and Output Specifications

**Minimum Small Signal Gain:** 23 dB; 28 dB (25°C)

**Noise Figure:** <10 dB

#### Typical System Performance With Addition of HP 8449A (25°C):

Frequency	Displayed Average Noise Level (dBm)	
	8566B (10 Hz Res BW)	8562A (100 Hz Res BW)
4 GHz	-155	-145
8 GHz	-152	-139
16 GHz	-148	-135
22 GHz	-144	-130

**Output Power:** At 1 dB gain compression; +5 dBm (typical)

**Input:** SMA, 50 Ω characteristic

**Output:** SMA, 50 Ω characteristic

**Maximum Safe Power Input:** +20 dBm (100 mW)

**Maximum DC Input:** 20V

**VSWR:** (Typical) 2:1, 2 to 18 GHz, input & output

2.5:1, 18 to 22 GHz, input

2.2:1, 18 to 22 GHz, output

**Reverse Isolation:** >70 dB (typical)

**Spectral Purity:** TOI = +15 dBm at output (typical)

#### General Specifications

**Power Requirements:** 100, 120, 220, or 240 Volts (+10%), 47-440 Hz

**Temperature Range:** 0° to +55°C operation; -40° to +75°C storage

**Environmental:** MIL-T-28800C, Type III, Class 5, Style E

**EMI:** MIL-STD-461B CE03 and RE02 of; CISPR Publication 11 (1975); FTZ 1046

**Weight:** 2.9 kg (6.4 lbs.)

**Size:** 102Hx213Wx297mmD (4.0"x8.4"x11.7")

### Ordering Information

#### HP 8449A Preamp

**Option 907** Front Handle Kit

**Option 908** Rack Mount Kit

**Option 910** Extra Manual

**Option W30** 2 Years Additional Hardware Service

### Price

\$7500

add \$50

add \$49

add \$25

add \$150

#### HP 11975A Microwave Amplifier

This general purpose, leveled microwave amplifier has a frequency range of 2 to 8 GHz and an adjustable output of +6 to +16 dBm. In addition, the amplifier has an adjustable bias current output port that supplies a maximum of ±11 milliamps at ±3 volts. This bias current is needed by some external harmonic mixers. The amplifier has automatic leveling control (ALC) that can be switched on and off. An "unleveled" light indicates that ALC is off.

Use the HP 11975A as a LO driver for the HP 11970/71 series harmonic mixers to achieve maximum performance.

#### Frequency Specifications

**Range:** 2 to 8 GHz

**Flatness:** ±1.0 dB, ±0.5 dB typical

#### Input and Output Specifications

**Minimum small-signal gain:**

**Frequency**

**Gain**

2.0 to 4.5 GHz

15 dB

4.5 to 6.1 GHz

11 dB

6.1 to 8.0 GHz

9 dB

**Noise Figure:** 13 dB typical

**Output power:** +6 to +16 dBm adjustable

**Input:** SMA connector (female)

**Output:** SMA connector (female)

**Maximum Input:** +30 dBm; ±35 Vdc.

**VSWR:** 1.7:1 (ALC on)

**Reverse isolation:** >40 dB

**Spectral purity:** TOI = +25 dBm typical

#### General specifications

**Power Requirements:** 100, 120, 220, or 240 Vac, 48 to 440 Hz, 36 VA.

**Environmental:** MIL-T-28800C, Type III, Class # 5, Style E.

**EMI:** CE03 and RE02 of MIL STD 461A and CISPR Pub 11 (1975).

**Weight:** 3.904 kg (8.6 lb). Shipping 5.45kg (12.2 lb)

**Size:** 102Hx213Wx297mmD (4.0"x8.4"x11.7")

### Ordering Information

#### HP 11975A Amplifier

**Option 001** Type N Connectors

**Option W30** 2 Years Additional Hardware Service

ice

**Option 907** Front Handles

**Option 910** Extra Manual

**HP P/N 5061-0072** Rack Mount Kit

### Price

\$4500

add \$100

add \$90

add \$50

add \$5

add \$53

# AMPLIFIERS

## Microwave Amplifier

### Model 8349B

- Continuous 2 to 20 GHz coverage
- 15 dB gain to 18.6 GHz



HP 8349B

The HP 8349B Microwave Amplifier delivers increased microwave power performance across a 2 to 20 GHz frequency range. This general-purpose broadband power amplifier is designed for maximum reliability and configured for the greatest convenience in interfacing with Hewlett-Packard's microwave sources, the HP 8350B Sweep Oscillator, HP 8340B/8341B Synthesized Sweepers, and HP 8671B, 8672A, or 8673 series Synthesized Signal Generators.

Providing 100 mW (+20 dBm) of unleveled output power from 2 to 18.6 GHz, 63 mW (+18 dBm) from 18.6 to 20 GHz, the HP 8349B offers one of the broadest operating bandwidths available from a solid-state power amplifier. This performance is achieved using a multiple stage GaAs FET design, resulting in >15 dB of gain from 2 to 18.6 GHz, and >12 dB of gain from 18.6 to 20 GHz.

The HP 8349B can also provide externally-leveled output power without using an external coupler and detector, since these components are built-in and are compatible with Hewlett-Packard microwave sources. The HP 8349B is also equipped with an output power display, minimizing the need for an external power meter and enhancing the amplifier's utility. For example, the HP 8349B can be placed at the end of a long RF cable where the microwave output needs to be amplified, leveled and monitored.

Naturally, the versatile power control features of the microwave source (e.g., calibrated power, power sweep, power slope and remote power control via the Hewlett-Packard Interface Bus) can be accurately transmitted through the HP 8349B during external leveling operations.

The HP 8349B also has a built-in source module interface, enabling it to properly bias and control the HP 83550 series millimeter-wave source modules. Using the HP 8349B and a millimeter source module extends the capabilities of any 11 to 20 GHz HP microwave source to millimeter-wave frequencies.

### Applications

The broadband high power of the HP 8349B is ideal, whether in a versatile bench-top arrangement or a dedicated rack-mount system. In antenna testing, the HP 8349B can be placed at the end of long RF cables, delivering high power right to the device under test. In EW/ECM systems, the HP 8349B can be combined with the HP 8340B/8341B, or the HP 8673 series Synthesized Signal Generators to provide high power pulses with little degradation in pulse performance. The HP 8349B is also an excellent choice as a microwave driver for TWTs, high power amplifiers, or mixers. And with a typical noise figure <13 dB, the HP 8349B is often used as a pre-amplifier for spectrum analyzers and frequency counters.

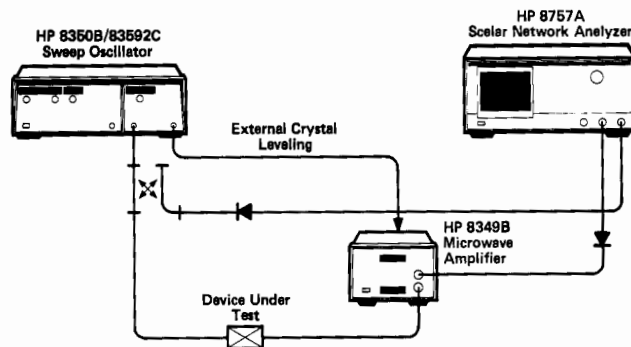

Extended Dynamic Range Configuration

- 100 milliwatts across 2 to 18.6 GHz
- <13 dB typical noise figure

The dynamic range of a scalar network analyzer measurement system is limited by the maximum output power of the microwave source and the sensitivity of the detectors. Using the illustrated configuration, up to 100 dB of dynamic range can be achieved by combining the calibrated dynamic range of the reference detector (R) with that of the transmission detector (B) in a ratio measurement (B/R). The HP 8349B makes this possible by extending the external crystal leveling power control of the microwave source. Hewlett-Packard Application Note 327-1 discusses this application in detail.

RFI susceptibility tests can also greatly benefit from the high quality amplifying characteristics of the HP 8349B.

### Frequency Specifications

**Range:** 2-20 GHz

### Output and Input Specifications (25°C ±5°C)

**Minimum Output Power** (at +5dBm input):

Frequency Range (GHz)	Output	
	Leveled	Unleveled
2.0 to 18.6	19 dBm (80mW)	20 dBm (100mW)
18.6 to 20.0	17 dBm (50mW)	18 dBm (63mW)

**1 dB Compression Point:** +21 dBm, nominal

**Power Flatness** (Leveled): ±1.25 dB

**Minimum Small Signal Gain** (at -5 dBm input):

2.0 to 18.6 GHz: 15dB

18.6 to 20.0 GHz: 12dB

**Noise Figure:** <13 dB, typical

**Impedance** (Input and Output): 50 ohms, nominal

**VSWR:**

Frequency Range (GHz)	Input	Output	
		Leveled	Unleveled (typical)
2.0 to 5.0	≤2.8	≤2.5	≤4.8
5.0 to 11.0	≤2.8	≤2.5	≤3.8
11.0 to 18.0	≤2.8	≤2.5	≤3.2
18.0 to 20.0*	≤2.8	≤2.5	≤3.2

\*VSWR from 18.0 to 20.0 GHz is typical

**Maximum Continuous Input, to the input or output ports:**

+27 dBm (RF), ±10V (DC)

### Spectral Purity

**Harmonics** (at +20 dBm output):

2.0 to 11.0 GHz: <-20 dBc

11.0 to 20.0 GHz: <-30 dBc typical

**Non-Harmonic Spurious:** ≤-55 dBc.

**Third Order Intercept:** +33 dBm, nominal.

### Pulse Transmission Capability

**Rise/Fall Time:** <10 ns typical

### General

**Reverse Isolation:** >50 dB, typical

**RF Input/Output Connectors:** Type N Female

**Size:** 133 H x 214 W x 366 mm D (5.2" x 8.36" x 13.6").

**Weight:** Net, 7 kg (15 lb); shipping, 14 kg (31 lb).

### Ordering Information

HP 8349B 2 to 20 GHz Microwave Amplifier

Opt 001 Rear Panel RF Input/Output

Opt 002 Rear Panel RF Input with Front Panel RF Output

### Price

\$7,850

add \$100

add \$100

- Wide band (multi-decade)
- Low noise
- Flat response

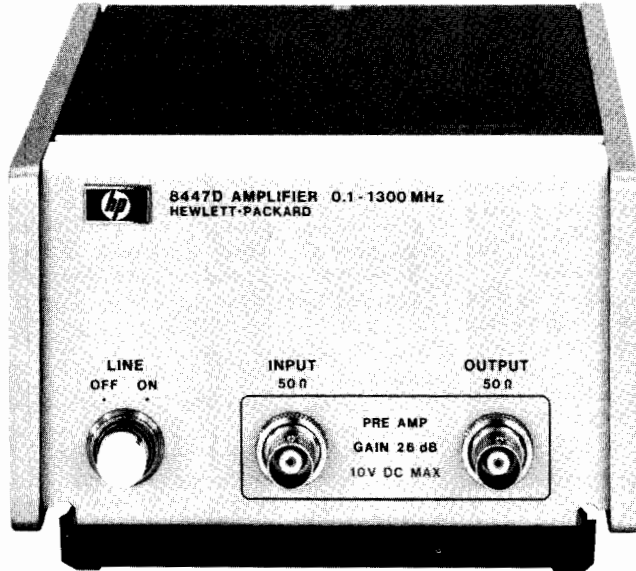

HP 8447D

The HP 8447 series of general-purpose amplifiers offers high reliability and the convenience of a small, lightweight package.

### High Performance

These low noise, high gain amplifiers provide the flat frequency response and low distortion required for a wide range of uses. They can be used to improve the sensitivity of counters, spectrum analyzers,

RF voltmeters, EMI meters, power meters, and other devices; or to increase the maximum power available from a signal generator or sweeper.

### Broadband Frequency Coverage

The HP 8447 series offers an amplifier for nearly every application in the 100 kHz to 1.3 GHz frequency range. The amplifiers' wide bandwidths are compatible with other wideband instruments used for making measurements involving broadband spectra.

### Options

Standard connectors are BNC (f) on all amplifiers.  
 Option 010 ..... N (f) connectors on single channel amplifier.  
 Option 001 ..... Dual channel amplifier, BNC (f) connectors.  
 Option 011 ..... Dual channel amplifier, N (f) connectors.  
**Note:** dual-channel amplifiers are ideal for dual-channel systems such as oscilloscopes or network analyzers. Channels may also be cascaded for increased small-signal gain.

### General

**Weight:** net, 1.56 kg (3.4 lb). Shipping, 2.30 kg (5.1 lb).  
**Size:** 85.8 H x 130 W x 216 mm D (3.4" x 5.1" x 8.5").  
**Power requirements:** 110 or 230 V ac  $\pm$  10%, 48-440 Hz, 15 watts.

### Ordering Information

	Price
<b>HP 8447A</b> Preamp	\$1300
<b>Opt 910:</b> Extra Operating and Service Manual (HP 8447A)	\$2
<b>HP 8447D</b> Preamp	\$1400
<b>HP 8447E</b> Power Amp	\$1600
<b>HP 8447F</b> Preamp-Power Amp	\$2400
<b>Opt H64:</b> 9 KHz - 1300 MHz Preamp	\$0
<b>Opt 910:</b> Extra Operating and Service Manual (HP 8447D/E/F)	\$4

### Specifications

	HP 8447A Preamp	HP 8447D Preamp	HP 8447E Power Amp	HP 8447F Preamp-Power Amp
Frequency Range	0.1-400 MHz	100 kHz-1.3 GHz	100 kHz-1.3 GHz	100 kHz-1.3 GHz
Typical 3 dB Bandwidth	50 kHz-700 MHz	75 kHz-1.7 GHz	75 kHz-1.4 GHz	50 kHz-1.4 GHz
Gain (Mean, per channel)	20 dB $\pm$ 1.0 dB at 10 MHz (20°C-30°C) 20 dB $\pm$ 1.7 dB at 10 MHz (0°C-55°C)	>25 dB (20°C-30°C)	22 dB $\pm$ 1.5 dB (20°C-30°C)	
Gain Flatness Across Full Frequency Range	$\pm$ 1.8 dB $\pm$ 0.7 dB (0°-55°C) (20°-30°C) Characteristic	$\pm$ 1.5 dB	$\pm$ 1.5 dB	
Noise Figure	<7 dB	<8.5 dB	<11 dB typical	
Output Power for 1 dB Gain Compression	>+6 dBm	>+7 dBm typical	>+12.5 dBm 100 MHz - 1 GHz	
Harmonic Distortion	-32 dB for 0 dBm output	-30 dB for 0 dBm output (typical)	-30 dB for +8 dBm output	
Output for <-60 dB Harmonic Distortion	-25 dBm (Characteristic)	-30 dBm	-20 dBm	
VSWR	<1.7	<2.0 input <2.2 output 1-1300 MHz	<2.2 input <2.5 output 1-1300 MHz	
Impedance	50 $\Omega$	50 $\Omega$	50 $\Omega$	
Reverse Isolation	>30 dB	>40 dB	>40 dB	
Maximum DC Voltage Input	$\pm$ 10 V	$\pm$ 10 V	$\pm$ 10 V	
Options Available	001	001, 010, 011	010	
Option Prices	add \$600	add \$650, \$100, \$1000	add \$100	add \$385

↑ HP 8447D AND 8447E COMBINED IN A SINGLE PACKAGE ↓



# FREQUENCY, FUNCTION & WAVEFORM SYNTHESIZERS

## General Information

### Introduction

Hewlett-Packard offers a wide variety of signal sources for almost any application, including function generators, and frequency or waveform synthesizers. Output frequencies range from 1  $\mu$ Hz to 80 MHz.

For higher frequency applications, refer to the "Signal Generators" and "Sweep Oscillators" sections of this catalog.

### Standard

Standard function generators typically offer a variety of waveforms, such as sine-wave, square, triangle and ramp.

The HP 8111A offers, in addition, pulse capabilities and the HP 3312A has modulation and sweeping capabilities. Both generators can be used in manual operation only.

### Multi-Functional

Functionality describes function generators which are capable of more than generating a variety of waveforms. For example up to 150 vectors can be defined with the HP 3314A for the generation of arbitrary signals.

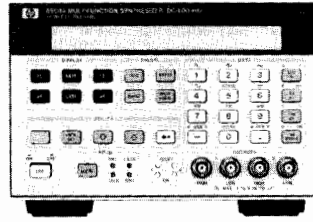

### Analog/Digital Arbitrary Waveforms

The HP 8175A Digital Signal Generator is a data generator, which provides, with the option 002, arbitrary signals on two analog channels. Digital pattern and analog signals can also be generated simultaneously.

### Synthesized Arbitrary Waveforms

The HP 8770A in conjunction with an HP 9000 series 300 Desktop Computer and the HP 11776A Waveform Generation Software is a complete system for the generation of most complex arbitrary waveforms with synthesizer accuracy. Waveforms can be created in both the time and frequency domain.

### Multifunction Synthesized Waveforms

The HP 8904A Multifunction Synthesizer digitally creates a multitude of complex signals from six simple waveforms. It begins with a Synthesizer/Function generator offer-



ing standard waveforms, DC and noise. Option 001 adds three channels which can modulate the first synthesizer, option 002 adds a second independent synthesizer output. Modulation capabilities include AM, FM, PM, DSB and pulse.

### Fast

These instruments offer all of the standard waveforms over the full frequency range up to 50 MHz. The HP 8116A and HP 8165A combine these features with different modes, modulation and sweep capabilities. Both instruments can be used as pulse generators. The HP 8165A with its frequency stability of 1 ppm/day has synthesizer quality.

## HP Function Generators Summary I

HP Models	Standard		Multi-Functional				Fast	
	8111A	3312A	3314A	8904A	8175A	8770A	8116A	8165A
Sine Wave Min. Frequency Max. Frequency	1Hz 20MHz	0.1Hz 13MHz	1mHz 20MHz	0Hz 600kHz	DC 25MHz	DC 50MHz	1mHz 50MHz	1mHz 50MHz
Waveforms Square Triangle Ramp Pulse Arbitrary	1Hz-20MHz 1Hz-20MHz 1Hz-20MHz 1Hz-20MHz	0.1Hz-13MHz 0.1Hz-13MHz 0.1Hz-13MHz	1mHz-20MHz 1mHz-20MHz	0.1Hz-50kHz 0.1Hz-50kHz 0.1Hz-50kHz	Full Arbitrary Waveform	Full Arbitrary Waveform	1mHz-50MHz 1mHz-50MHz 1mHz-50MHz 1mHz-50MHz	1mHz-50MHz 1mHz-50MHz 1mHz-50MHz 1mHz-20MHz
Modes Trigger Gate Counted Burst	ext ext 1 to 1999	int/ext int/ext	int/ext int/ext 1 to 1999	Creates signals from six basic Waveforms	Full Arbitrary Waveform	Full Arbitrary Waveform	int/ext ext 1-1999	ext ext 1-1999
Modulation AM FM PM PWM		int/ext int/ext	ext ext	int int int	Full Arbitrary Waveform	Full Arbitrary Waveform HP 11776A	ext ext ext ext	ext ext
Sweep Lin. Log. VCO		int/ext int/ext	int int ext	int int	Full Arbitrary Waveform	Full Arbitrary Waveform	int/ext ext	ext int/ext ext
Output (into 50 Ohms) Amplitude (p-p) DC Offset Output Impedance- $\Omega$	16V $\pm 8V$ 50	10V $\pm 5V$ 50	10V $\pm 5V$ 50	10V $\pm 5V$ 50	16V $\pm 8V$ 50	2V 50	16V $\pm 8V$ 50	20V $\pm 10V$ 50/1000
Programmability			HP-IB	HP-IB	HP-IB	HP-IB	HP-IB	HP-IB
Notes			also 1/2 cycle bursts, phase lock	4 internal channels. One is modulated or sequenced	2 analog outputs dig./analog signals simultaneously	HP Series 300 Controller, plus HP 11776A Software recommended		
Catalog page	425	426	427	412	420	378	423	422

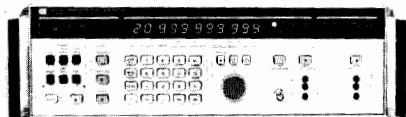

## Synthesizers

Synthesizers provide sinewaves with the focus on a very high frequency stability and excellent level accuracy. You can choose among different output impedances. The HP 3335A generates sinewaves up to 81 MHz and the HP 3336A/B/C has modulation capabilities.

## Synthesized Function Generators

Synthesized function generators combine the frequency stability of a synthesizer with the feature set of the function generator. The HP 3325B has excellent synthesizer performance and versatile sweep modes which are phase continuous over the full frequency range. In addition, the HP 3325B provides various modulation capabilities. The HP 3326A plays a special part because of its two channels, which can be combined in various ways to produce two-tone signals or calibrated two-phase signals.



## Which function generator do you need?

HP's function generators and synthesizers are the best solution for most applications. The tables shown on these two pages will help you to determine the right one for your application. The instruments are split into categories, depending on their main specifications. For an explanation of the instrument's full range of capabilities, see the following information.

## HP Function Generators Summary II

HP Models	SYNTHESIZERS		SYNTHESIZED FUNCTION GENERATORS			
	3335A	3336A/B/C	8904A	8165A	3325B	3326A
Sinewave Min. Frequency Max. Frequency	200Hz 81MHz	10Hz 21MHz	0Hz 600kHz	1mHz 50MHz	1μHz 21MHz	DC 13MHz
Frequ. Stability	10 <sup>-9</sup> /day	1.5x10 <sup>-9</sup> /day	50x10 <sup>-6</sup>	10 <sup>-9</sup> /day	10 <sup>-7</sup> /month	10 <sup>-7</sup> /month
Frequ. Resolution	1mHz	1μHz	100mHz	1μHz	1μHz	1μHz
Waveforms Square Triangle Ramp Pulse			DC - 50 kHz DC - 50 kHz DC - 50 kHz	1mHz-50MHz 1mHz-50MHz 1mHz-50MHz	DC - 11MHz DC - 11kHz DC - 11kHz	DC - 13MHz
Modulation AM FM PM PWM		ext	int int int	ext ext	int/ext int/ext	int/ext int/ext ext
Sweep Lin. Log. Discrete VCO	int	int int	int int	ext int/ext ext	int int int	int
Level Range - 50 Ω	-87 to +13dBm	-71 to + 8dBm	10V(p-p)	20V(p-p)	10V(p-p)	10V(p-p)
Level Resolution	0.01 dB	0.001 dB	3½ digits	3 digits	4 digits	4 digits
Level Accuracy	±0.1 dB	±0.08 dB	±0.09 dB	±0.7 dB	±0.9 dB	±1.0 dB
DC Offset-50Ω			±5V	±10V	±5V	±5V
Output impedance-Ω	50/75/124/ 135	50/75/124/ 135/150/600	50	50	50	50
Spurious	-75 dBc	-70 dBc	-63 dBc	-40 dBc	-70 dBc	-70 dBc
Phase noise	-58 to -70 dBc	-64 dBc			-60 dBc	-66 dBc
Notes			up to 4 channels and two outputs for two phase signals		Modulation source can be used separately	2 channels, two-tone and two phase signals
Catalog page	418	419	412	422	414	416

## Broad application range

If your applications involve a large variety of measurements then one of HP's standard function generators is the right solution.

## Simulating real life signals

HP's Arbitrary Function Generators are dedicated for the simulation of real-life signals. Ranging from disc drive or video test signals to mechanical vibration simulation. Applications such as VOR, FM stereo and communications signalling are covered by the Multifunction Synthesizer HP 8904A.

## Versatility and speed

Many applications require standard waveforms over the full frequency range up to 50 MHz and with versatile operating modes. These requirements can be fulfilled with the HP 8116A and HP 8165A. Especially for those applications requiring 50 MHz in conjunction with good frequency stability the HP 8165A can be recommended.

## Highly accurate reference sources

Applications such as PLL-testing, calibration of measurement instruments and testing of Frequency Division Multiplex equipment are ideally suited for HP's synthesizers. The very stable frequency source and the excellent level accuracy make these synthesizers the right choice if a reference source is required.

## Accuracy and versatility

Synthesized function generators are for those applications which require a combination of an accurate frequency source and a versatile function generator. Sweeping over the entire frequency range without any phase discontinuity makes the HP 3325B and the HP 3326A ideal for applications such as simulation of rotation signals and filter testing. Even the calibration of phase measuring instruments is possible by programming a certain phase offset between two generators or using the HP 3326A's two outputs.

# FREQUENCY, FUNCTION & WAVEFORM SYNTHESIZERS

## Multifunction Synthesizer

### Model 8904A

- Sinewaves dc to 600 kHz
- Square, ramp, triangle dc to 50 kHz
- Direct digital synthesis
- Tone, DTMF, digital sequence modes
- One or two outputs
- One to four internal channels
- AM, FM,  $\emptyset$ M, DSBSC and pulse modulation
- External timing control for fast hop

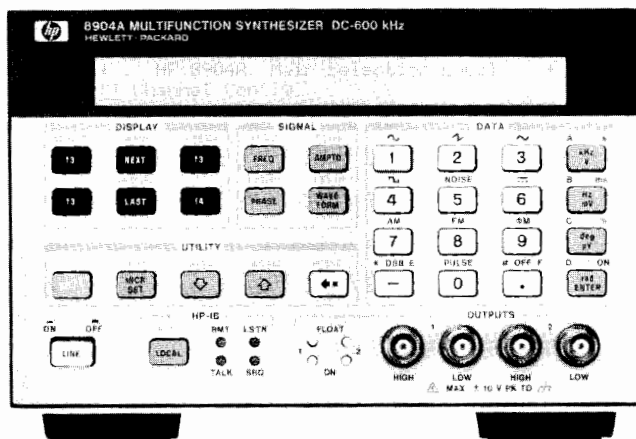

HP 8904A



### HP 8904A Multifunction Synthesizer

The HP 8904A Multifunction Synthesizer uses the latest VSLIC technology to create complex signals from six fundamental waveforms. The standard HP 8904A digitally synthesizes precise sine, square, triangle, ramp, white noise, and dc waveforms and routes these signals to a single output. Option 001 adds three more identical internal synthesizers (channels) which either can modulate the first synthesizer or be summed to the output. Frequency, amplitude, waveform, phase, and destination can be set independently for each synthesizer. Available modulation types for channel A include AM, FM,  $\emptyset$ M, DSBSC, and pulse modulation. Option 002 adds a second output, providing a second, separate signal for two-channel applications. Option 003 adds fast hop and digital modulation capability to the HP 8904A. All this unique capability makes the HP 8904A a powerful new tool for demanding applications like VOR, ILS, FM Stereo, and communications signaling.

#### Function Synthesizer

The HP 8904A Multifunction Synthesizer delivers synthesizer accuracy, along with six waveforms in a compact, economical package. Broad sinewave frequency coverage from 0 Hz to 600 kHz with 0.1 Hz resolution make the HP 8904A ideal for a number of low-frequency applications. In addition to sinewave generation, the HP 8904A has five other standard functions: square, triangle, ramp, dc, and Gaussian white noise. Of these five, square, ramp, and triangle functions are available from 0 Hz to 50 kHz. All waveform values in the HP 8904A are DIGITALLY calculated in real time by Hewlett-Packard's Digital Waveform Synthesis IC. The use of this chip results in signals with very well-defined accuracy and exact repeatability.

#### Two Outputs

Option 002 adds a second, identical synthesizer and floating output section to make the HP 8904A TWO synthesizers in one half-rack width instrument. Frequency, amplitude, waveform, and phase can be independently set for each of the two synthesizers.

Although both synthesizers are independent, the relative phase between the two outputs can be controlled precisely. Either synthesizer can be varied in phase from 0 degrees to 359.9 degrees with a resolution of 0.1 degree. Testing phase detectors, servo systems, shaft encoders, sonar, and other phase sensitive two-port devices is easy and accurate with the HP 8904A Option 002.

#### Complex Signal Generation

By adding three more (total of four) internal synthesizers which can modulate or be summed with synthesizer A (channel A), Option

001 is the key to complex signal generation for the HP 8904A Multifunction Synthesizer. All four internal synthesizers can be set to generate different waveforms, frequencies, amplitudes, and phase offsets at the same time. These signals then can be DIGITALLY summed before routing to the output. In addition to summing, Option 001 allows channels B, C, and D to be used as modulation sources for channel A. The allowable modulation types for channel A are: AM, FM,  $\emptyset$ M, DSBSC (Double Sideband Suppressed Carrier) and pulse modulation. Using summation and modulation, the HP 8904A Option 001 can generate precise VOR composite, ILS composite, and FM Stereo Multiplex composite signals. Only your imagination limits the possibilities for signal generating with the HP 8904A Multifunction Synthesizer.

#### Communication Signaling

In addition to the extra channels, Option 001 also adds three sequence modes to the HP 8904A: tone sequence mode, DTMF sequence mode, and digital sequence mode. These modes make the HP 8904A a powerful tool for generating sequences used in communications signaling. Tone sequence mode allows entry of sixteen unique sine wave tones, each with an "on-time" and "off-time". From these sixteen tones, sequences can be built up to a length of 250 tones. The minimum on and off time duration is 800  $\mu$ s with 10  $\mu$ s resolution while the maximum value is 655.35 ms. Digital sequence mode can generate digital bit streams up to 1000 bits in length. Minimum period in the digital mode is 100  $\mu$ s with 10  $\mu$ s resolution. On and off "levels" in the digital mode can be set to any value for simulating different logic families and asserted "high" or asserted "low" logic conventions. For ease of entry, data may be entered in binary, octal, or hexadecimal formats. All three modes contain extensive sequence-editing features and three control modes: single sequence, continuously repeat sequence, and manual step-through the sequence.

#### Fast Hop

Option 003 adds the ability to hop the HP 8904A in frequency, phase, and/or amplitude. Up to 16 frequency/phase/amplitude states can be entered into the "HOP RAM" memory. To hop, an external device must address the four-bit TTL-level address bus provided on the digital port connector on the rear panel. As the address supplied to the bus is varied, the HP 8904A will hop to the frequency/phase/amplitude state that corresponds to that address of the HOP RAM memory. Fast hop can be performed only on channel A. Phase continuous frequency switching can be done in as little as 8  $\mu$ s.

## HP 8904A Specifications

### Frequency

#### Range:

**Sinewave:** 0 Hz to 600 kHz.

**Square, triangle, ramp:** 0 Hz to 50 kHz.

**Resolution:** 0.1 Hz.

#### Accuracy:

**Internal 10 MHz timebase:**  $\pm 50$  ppm.

### AC Amplitude

**Range:** 0 to 10V p-p into a 50 $\Omega$  load.

**Resolution:** 3 1/2 digits.

**Accuracy (>40 mV p-p into 50 $\Omega$ ):**

**Sine:** 1%, 0.1 Hz to 100 kHz; 3%, 100 kHz to 600 kHz.

**Flatness (>630 mV p-p into 50 $\Omega$ ):**  $\pm 0.1\%$  ( $\pm 0.009$  dB), 0.1 Hz to 100 kHz.  $\pm 1.0\%$  ( $\pm 0.09$  dB), 100 kHz to 600 kHz.

### DC Amplitude

**Range:** 0 to  $\pm 10$ V open circuit.

**Resolution:** 3 1/2 digits.

**Accuracy:**  $\pm 6$  mV or  $\pm 0.6\%$ , whichever is greater.

### Spectral Purity (sine wave)

**THD+N (including spurs, amplitude >50 mV rms):**

-63 dBc rms (0.07%), 20 Hz to 7.5 kHz, 30 kHz BW.

-63 dBc rms (0.07%), 7.5 kHz to 20 kHz, 80 kHz BW.

-55 dBc rms (0.18%), 20 kHz to 100 kHz, 750 kHz BW.

*Typical THD+Noise in 80 kHz measurement BW at 5V<sub>p-p</sub> into a 50 $\Omega$  Load.*

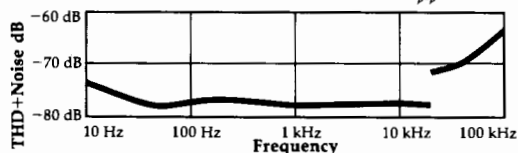

### Phase (sine wave)

**Range:** 0° to 359.9°.

**Resolution:** 0.1°.

**Increment accuracy (relative to 0° for a fixed frequency):**

$\pm 0.05^\circ$ , 0.1 Hz to 100 kHz.

### Gaussian Noise

**Spectral characteristic:** Equal energy per unit bandwidth ("white").

**Flatness (>100 mV p-p into 50 $\Omega$ ):** typically

$\pm 0.5$  dB, 0.1 Hz to 100 kHz.

$\pm 1.0$  dB, 100 kHz to 600 kHz.

## Option 001 Specifications

Modulation for channel A ONLY, and specified for sinewave carrier and modulation. Internal channels B, C, and D can be used to modulate channel A either collectively with one modulation type, or to provide simultaneous modulation of channel A with any of the available modulation types. External modulation is NOT possible.

### Amplitude Modulation (with Option 001)

**Rate:** 0 Hz to 600 kHz.

**Depth range:** 0% to 100% of carrier amplitude.

**Resolution:** 0.1% of carrier amplitude.

### Frequency Modulation (with Option 001)

**Range:** 0 Hz to 600 kHz.

**Deviation range:** 0 Hz to 600 kHz.

**Resolution:** 0.1 Hz or 3 1/2 digits, whichever is less.

### Phase Modulation (with Option 001)

**Rate:** 0 Hz to 600 kHz.

**Range:** 0° to 179.9°/channel, except:

$\{(\text{mod. freq.} \times \text{deviation}/57.3) + \text{carrier freq.}\} \leq 600$  kHz.

**Resolution:** 0.1° or 0.001 radians.

### Pulse or DSBSC Modulation (with Option 001)

**Rate:** 0 Hz to 50 kHz (up 600 kHz for DSBSC).

### Summation (with Option 001)

Two, three or four channels may be summed into a single output. Two or three channels may be summed for modulation of channel A. All combinations of channels are acceptable, EXCEPT FOR: [A+C and B+D at the same time] or [A+D and B+C at the same time].

**FM stereo multiplex separation (L-R):** typically >65 dB, audio frequency 20 Hz to 15 kHz.

**Channel to channel phase accuracy (equal amplitude sinewaves summed to one output):**  $\pm 0.1^\circ$  or 30 ns, 0.1 Hz to 100 kHz, whichever is greater.

### Tone Sequence (with Option 001)

**Number of different frequencies:** 16 user-definable tones each with an individual on time and off time.

**On/off time duration:** 0 ms, 0.80 ms to 655.35 ms.

**Sequence length:** 250 tones, user-definable from front panel or HP-IB programmable.

### DTMF Sequence (with Option 001)

**Number of tone pairs:** 16 standard DTMF tone pairs

(0-9, A-D, #, \*).

**On/Off time duration:** 0 ms, 1.0 ms to 655.35 ms.

**Sequence length:** 250 DTMF tones, user-definable from front panel or HP-IB programmable.

### Digital Sequence (with Option 001)

**User definable:** On level, Off level, and period.

**Sequence entry:** Binary, Octal, or Hexadecimal.

**Sequence length:** up to 1000 bits.

**Period duration:** 0.10 ms to 655.35 ms.

### General

**Output impedance:** 50 $\Omega \pm 3\%$  typically, 0.1 Hz to 600 kHz.

**Output type:** floating or grounded, HP-IB programmable.

**Maximum float voltage (signal+float):** 10V peak maximum from high or low side to chassis ground.

**Operating temperature range:** 0° C to 50° C.

**Storage temperature range:** -20° C to 70° C.

**Humidity range:** 95% RH, 0° C to 40° C.

**Remote operation:** HP-IB. All functions except the line switch are remotely controllable.

**HP-IB functions:** SH1, AH1, T6, TE0, L4, LE0, SR1, RL1, PP1, DC1, DT0, C0.

**Power requirements:** 100V, 120V;  $\pm 10\%$ ; 48 to 440 Hz.

220V, 240V;  $\pm 10\%$ ; 48 to 66 Hz. 80 VA max.

**Weight:** Net, 5.9 kg (12.8 lb); shipping, 13 kg (28.6 lb).

**Size:** 133H X 213W X 513 mmD (5.25" X 8.36" X 20.2").

### Ordering Information

	Price
HP 8904A Multifunction Synthesizer (one output standard)	\$2,600
Opt 001 Add three (two when ordered with option 002) internal channels, Channel A modulation, summation, and sequence capability	+\$1,500
Opt 002 Add second internal synthesizer and output	+\$1,200
Opt 003 Add fast hop and digital modulation capability	+\$500
Opt 004 Connectors on rear panel only	+\$50
Opt 907 Front Handle Kit (5061-9689)	+\$55
Opt 910 2 sets of operating and service manuals	+\$120
Opt 915 Service manual supplied with instrument	+\$35
Opt W30 2 years additional hardware service	\$95
08955-60014 560 $\Omega$ feedthrough barrel for 600 $\Omega$ output impedance	\$170
5061-9657 Rack Mount Adapter Kit (for rack mounting a single HP 8904A)	\$60
5061-9697 Support Shelf Kit (for rack mounting two HP 8904s side by side)	\$195
HP 8904A Retrofit Kits (customer retrofittable):	
HP 11816A Retrofit Kit for option 001	\$1,850
HP 11817A Retrofit Kit for option 002	\$1,475
HP 11818A Retrofit Kit for option 003	\$600

# FREQUENCY, FUNCTION & WAVEFORM SYNTHESIZERS

## 1 $\mu$ Hz to 21 MHz Synthesizer/Function Generator

### Model 3325B

- Synthesizer
- Function Generator
- Internal Modulation Source
- Log, Lin, Discrete Sweep
- Excellent Signal Purity
- HP-IB or RS232 Programmable

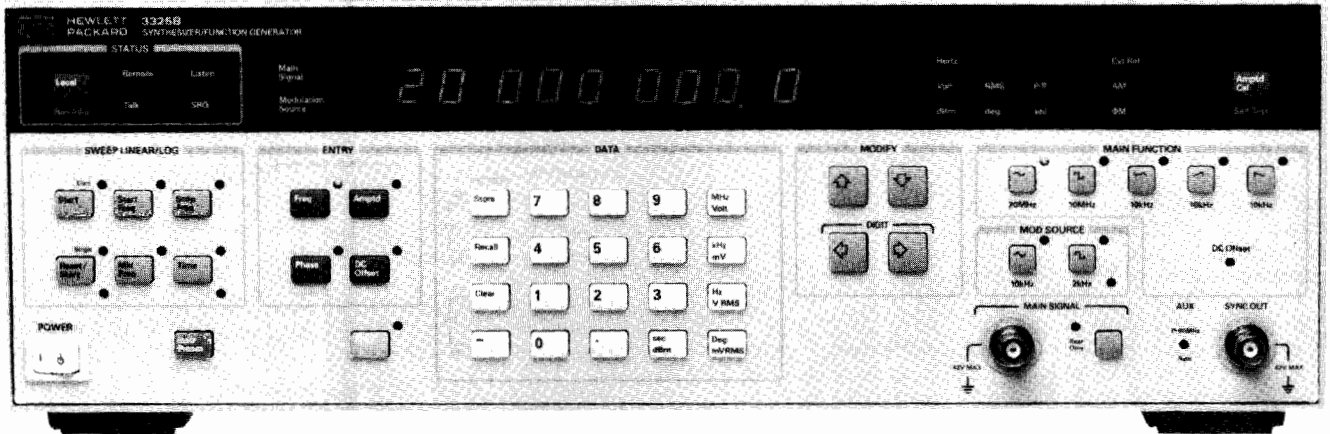

HP 3325B



The HP 3325B is a 1  $\mu$ Hz to 21 MHz Synthesizer/Function Generator with high performance, exceptional versatility and value. Testing is made fast and efficient in general purpose applications whether on the bench or in ATE systems.

#### Synthesizer Precision

HP 3325B frequency accuracy is determined by a precision frequency reference and can be set with a resolution of 1  $\mu$ Hz. It has up to  $-65$  dBc harmonic and  $-70$  dBc spurious levels for precision measurements. The phase of the output signal can be precisely controlled  $\pm 719.9$  deg with 0.1 deg resolution, and multiple HP 3325B's can be locked together for multi-phase applications.

#### Function Generator Versatility

Precision squarewaves to 10.999,999 MHz have 20 ns risetimes with synthesizer accuracy and precision. Triangle and ramp waveshapes are also available with .05% linearity up to 10.999,999 kHz. DC and phase offset can be added to these waveshapes. The modulation source can be used as an arbitrary function generator via HP-IB, providing user-defined waveshapes. These features make the HP 3325B one of the most versatile sources for bench or ATE system applications. Save-recall memory includes 10 non-volatile memory locations, for simple and rapid access to frequently used test setups.

#### Discrete Sweep

The enhanced feature set of the HP 3325B includes 100-segment discrete sweep capability which allows arbitrarily defined multi-segment linear or stepped sweeps and tone sequences. This compliments its linear and log, phase continuous sweep capability.

#### Internal Modulation Source

A built-in programmable modulation source provides sine, square and arbitrary waveshapes for internal amplitude or phase modulation, or for use as a second source. In addition, a rear panel sync output provides a TTL compatible dc to 60 MHz signal with 1  $\mu$ Hz resolution for use as a precision, high resolution clock signal, and extended frequency coverage.

#### ATE Systems Compatibility

All functions, including frequency, amplitude, phase, modulation, sweep and waveshapes are programmable via HP-IB or RS232 interface. The HP 3325B is fully compatible in form, fit and function, with the HP 3325A. All HP-IB programs written for the HP 3325A are fully compatible with the HP 3325B. An isolated interface, combined with floating outputs and inputs assures trouble free operation in a systems environment. The main output can be switched to the rear panel by a simple front panel keystroke, or under program control for optimum systems configuration.

#### Easy to Maintain

General or specific self-tests can be initiated from the front panel or by remote control. Pass/fail indications and specific self-test status reports are provided on the display and through the remote interfaces. Elapsed time and instrument identification information is available from the HP 3325B's memory to determine when calibration is required.

#### Specifications

##### Waveforms

Sine, Square, Triangle, negative and positive Ramps.

##### Frequency

##### Range

**Sine:** 1  $\mu$ Hz to 20.999 999 999 MHz

**Square:** 1  $\mu$ Hz to 10.999 999 999 MHz

**Triangle/ramps:** 1  $\mu$ Hz to 10.999 999 999 kHz

**Resolution:** 1  $\mu$ Hz, < 100 kHz  
1 mHz  $\geq$  100 kHz

**Accuracy:**  $\pm 5 \times 10^{-6}$ , 20° to 30°C at time of calibration

**Warm-up time:** 20 minutes to within specified accuracy

##### Main Signal Output (all waveforms)

**Impedance:** 50  $\Omega$

**Connector:** BNC; switchable to front or rear panel, nonswitchable with option 002, except by internal cable change.

## Amplitude

**Range:** 1 mV to 10 V<sub>p-p</sub> in 8 amplitude ranges, 1-3-10 sequence (10 dB steps), into 50 Ω load.

Function	Sine		Square		Triangle/Ramps	
	min	max	min	max	min	max
Units Displayed						
peak-peak	1.000 mV	10.00 V	1.000 mV	10.00 V	1.000 mV	10.00 V
rms	0.354 mV	3.536 V	0.500 mV	5.000 V	0.289 mV	2.887 V
dBm (50 Ω)	-56.02	+23.98	-53.01	+26.99	-57.78	+22.22

**Resolution:** 0.03% of full range or 0.01 dB (4 digits).

**Amplitude Accuracy** (without dc offset, relative to programmed amplitude and accuracy)

### Sinewave Amplitude Accuracy

1 mHz to 100 kHz:  $\pm 0.1$  dB,  $\geq 3$  V<sub>pp</sub>;  $\pm 0.2$  dB,  $< 3$  V<sub>pp</sub>

100 kHz to 20 MHz:  $\pm 0.4$  dB,  $\geq 3$  V<sub>pp</sub>;  $\pm 0.6$  dB, 0.1 to 3 V<sub>pp</sub>

### Squarewave Amplitude Accuracy

1 mHz to 100 kHz: 1%,  $\geq 3$  V<sub>pp</sub>; 2.2%,  $< 3$  V<sub>pp</sub>

100 kHz to 10 MHz: 11.1%,  $\geq 3$  V<sub>pp</sub>; 13.6%,  $< 3$  V<sub>pp</sub>

### Triangle Amplitude Accuracy

1 mHz to 2 kHz: 1.5%,  $\geq 3$  V<sub>pp</sub>; 2.7%,  $< 3$  V<sub>pp</sub>

2 kHz to 10 kHz: 5%,  $\geq 3$  V<sub>pp</sub>; 6.2%,  $< 3$  V<sub>pp</sub>

### Sinewave Spectral Purity

**Phase noise:** -60 dB for a 30 kHz band centered on a 20 MHz carrier (excluding  $\pm 1$  Hz about the carrier) with high-stability option 001 installed.

**Spurious:** all non-harmonically related output signals will be more than 70 dB below the carrier (60 dB with dc offset), or less than -90 dBm, whichever is greater.

**Sinewave harmonic distortion:** harmonically related signals will be less than the following levels (relative to the fundamental) at full output for each range:

Frequency Range	Harmonic Level
0.1 Hz to 50 kHz	-65 dB
50 kHz to 200 kHz	-60 dB
200 kHz to 2 MHz	-40 dB
2 MHz to 15 MHz	-30 dB
15 MHz to 20 MHz	-25 dB

### Squarewave Characteristics

**Rise/fall time:**  $\leq 20$  ns, 10% to 90% at full output

**Overshoot:**  $\leq 5\%$  of peak to peak amplitude, at full output

**Settling time:**  $< 1$  μs to settle to within .05% of final value.

### Phase Offset

**Range:**  $\pm 719.9^\circ$  with respect to arbitrary starting phase or assigned zero phase

**Resolution:** 0.1°

**Accuracy:**  $\pm 0.2^\circ$

### DC Offset

**Range:** dc only (no ac signal): 0 to  $\pm 5.0$  V/50 Ω.

dc + ac: Maximum dc offset  $\pm 4.5$  V on highest range, decreasing to  $\pm 4.5$  mV on lowest range.

**Resolution:** 4 digits

### Sinewave Amplitude Modulation

**Modulation depth at full output for each range:** 0-100%

**Modulation frequency range:** dc to 400 kHz (0-21 MHz carrier frequency)

**Sensitivity:**  $\pm 5$  V peak for 100% modulation

### Sinewave Phase Modulation

**Range:**  $\pm 850^\circ$ ,  $\pm 5$  V input

**Modulation frequency range:** dc -5 kHz

### Frequency Sweep

#### Sweep Time

**Linear:** 0.01 s to 1000s.

**Logarithmic:** 1 s to 1000s single, 0.1 s to 1000s continuous.

#### Discrete Sweep

**Number of Segments:** 100 maximum.

**Time/Segment:** 0.01 s to 1000s, 0.01 s resolution.

**Maximum sweep width:** full frequency range of the main signal output for the waveform in use, except minimum log start frequency is 1 Hz.

**Phase continuity:** sweep is phase continuous over the full frequency range of the main output.

### Modulation Source

**Frequency Range:** Sine 0.1 Hz to 10 kHz, square 0.1 Hz to 2 kHz.

**Frequency Accuracy:** 0.1%, typical.

**Amplitude Range:** 0.1 V<sub>p-p</sub> to 12 V<sub>p-p</sub>.

**Amplitude Accuracy:**  $\pm 200$  mV, typical.

**Impedance:** Drives 10 kΩm or greater load.

**Sinewave Purity:** -34 dBc or better, typical.

**Waveforms:** Sine, square, arbitrary.

### Auxiliary Inputs and Outputs

**Reference input:** for phase-locking HP 3325A to an external frequency reference signal from 0 dBm to +20 dBm into 50 Ω. Reference signal must be a subharmonic of 10 MHz from 1 MHz to 10 MHz.

**Auxiliary frequency output:** 21 MHz to 60.999 999 999 MHz, under range coverage to 19.000 000 001 MHz, frequency selection from front panel; 0 dBm; output impedance 50 Ω.

**Sync Output:** Square wave with V (high)  $\geq 1.2$  V, V (low)  $\leq 0.2$  V into 50 Ωm. Frequency range is the same as main signal for front panel sync and dc to 60 MHz for rear panel sync.

**X-Axis drive:** 0 to  $> +10$  V dc linear ramp proportional to sweep frequency, linearity, 10-90%,  $\pm 0.1\%$  of final value.

**1 MHz reference output:** 0 dBm output for phase-locking additional instruments to the HP 3325B.

**10 MHz oven output:** 0 dBm internal high stability frequency reference output for phase-locking HP 3325B. (Opt. 001 only)

**HP-IB Interface Functions:** SH1, AH1, T6, L3, SR1, RL1, PP0, DC1, DT1, C0, E1.

### Option 001 High Stability Frequency Reference

**Aging rate:**  $\pm 5 \times 10^{-8}$ /week (72-h warm up);  $\pm 1 \times 10^{-7}$ /month (after 15 days continuous operation).

**Ambient stability:**  $\pm 5 \times 10^{-8}$  (0° to +55°C).

**Warm-up time:** reference will be within  $\pm 1 \times 10^{-7}$  of final value 15 minutes after turn-on for an off time of less than 24 hours.

### Option 002 High Voltage Output

**Frequency range:** 1 μHz to 1 MHz

#### Amplitude

**Range:** 4.00 mV<sub>pp</sub> to 40.00 V<sub>pp</sub> ( $\geq 500$  Ω,  $\leq 500$  pF load).

**Accuracy:**  $\pm 2\%$  of full output for each range at 2 kHz.

**Flatness:**  $\pm 10\%$  relative to programmed amplitude

**Sinewave distortion:** harmonically related signals will be the same as the standard instrument to 1 MHz

**Maximum output current:** 20 mA pk.

**Output impedance:**  $< 2$  Ω at dc,  $< 10$  Ω at 1 MHz

**DC offset range:** 4 times the specified range of the standard instrument.

### General

#### Operating environment

**Temperature:** 0°C to 55°C.

**Relative humidity:** 95%, 0°C to 40°C.

**Altitude:**  $\leq 15,000$  ft.

**Power:** 100/120/220/240 V, +5%, -10%, 48 to 66 Hz; 90 VA, 120 VA with all options; 10 VA standby.

**Weight:** 9 kg (20 lb) net; 14.5 kg (32 lb) shipping.

**Size:** 132.6 H x 425.5 W x 497.8 mm D (5.25" x 16.75" x 19.63").

### Ordering Information\*

	Price
HP 3325B Frequency Synthesizer	\$4,590
<b>Opt 001:</b> High Stability Frequency Reference	\$765
<b>Opt 002:</b> High Voltage Output	\$255
<b>Opt 907:</b> Front Handle Kit (standalone orders P/N HP 5061-0089)	\$56
<b>Opt 908:</b> Rack Flange Kit (standalone orders P/N HP 5061-0077)	\$33
<b>Opt 909:</b> Rack Flange and Handle Combination Kit (standalone orders P/N HP 5061-0083)	\$82
<b>Opt W30:</b> Extended Warranty	\$170

\*HP-IB cable not supplied. See page 561.

☞ Fast-Ship product—see page 766.



# FREQUENCY, FUNCTION & WAVEFORM SYNTHESIZERS

## Two-Channel Synthesizer, DC to 13 MHz

Model 3326A



HP 3326A

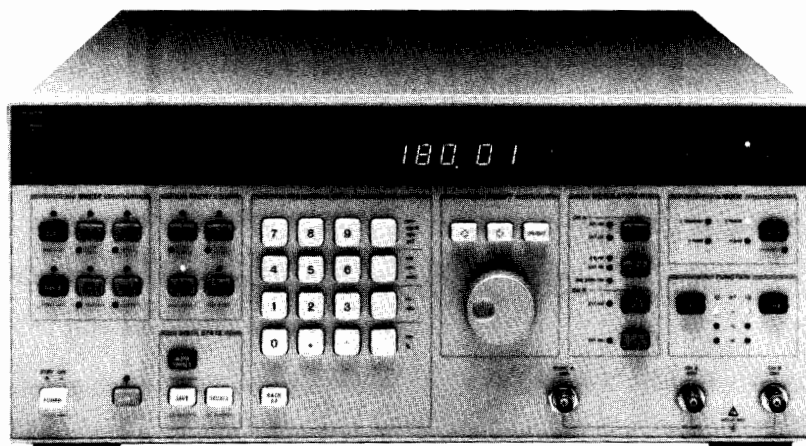

The HP 3326A Two-Channel Synthesizer combines two independent synthesizers, flexible modulation, and control circuitry into a single, powerful package. This single instrument can provide precise phase offset, two-tone sweep, fast frequency switching, internal modulation, and pulse signals for bench or systems use.

### Complete Two-Phase Solution

The HP 3326A can provide two signals whose phase is adjustable and calibrated anywhere in its 13 MHz frequency range without an external phasemeter.

Self-calibration can be performed internally or externally and yields accuracy of  $\pm 0.2$  degrees below 100 kHz. Phase can be set with 0.01 degree resolution at all frequencies. Using its unique phase-calibration circuitry, calibrated multi-phase signals are easily achieved with two or more HP 3326As.

### Powerful Two-Tone Capability

The HP 3326A is the single-source answer for producing a wide variety of broadband two-tone signals. It's two channels can be offset up to  $\pm 100$  kHz, either in the CW mode or while sweeping.

Channel amplitudes and functions (sine or square) can be selected independently and provided from separate outputs or through the built-in signal combiner. Low sinewave distortion (harmonics are at least  $-70$  dBc below 100 kHz) makes low-distortion intermodulation measurements a simple task.

### Versatile ATE Source

With two complete synthesizers in a single instrument, rack space and power are conserved. Features like internal amplitude and phase modulation, two-tone, and pulse modes allow this one instrument to do the job of several sources.

All functions, modes, and parameters of the HP 3326A are completely programmable over the HP-IB. Maximum accuracy is ensured with amplitude/phase calibrations that can be enabled, disabled and initiated under remote control.

### High Performance Modulation and Pulses

Precise amplitude and phase modulation is easy with both channels of the HP 3326A. Each channel can be used with simultaneous AM and PM, or one channel can modulate the other. Amplitude modulation frequency is dc to 100 kHz and envelope distortion is better than  $-46$  dB.

In the pulse mode both pulse and pulse-complement outputs are provided. Symmetry range is 1% to 99% and is settable in 0.1% increments. In addition, both pulse amplitudes and their offsets are independently controllable.

### Other Features

The HP 3326A has a host of convenience features to speed and simplify signal generation. Nine complete setup states can be stored in non-volatile memory, along with automatic storage of the power-off state. A discrete sweep mode is available to generate from 2 to 63

frequency pairs with dwell times individually selectable for each frequency and each channel. Several flexible triggering modes allow hardware or software triggers to initiate frequency, amplitude, or phase changes, and sweeps.

DC offset is available in all modes, and all outputs are floating. Frequency resolution is 11 digits, and all sweeps and frequency changes are phase-continuous.

### Specifications

For complete specifications refer to the HP 3326A data sheet.

### Operating Modes

**Two Channel:** Channels A and B are independent.

**Two-Phase:** Channels A and B are the same frequency, with calibrated phase offset between the two signals.

**Two-Tone:** Channel B frequency offset 0 to 100 kHz from channel A frequency.

**Pulse:** Channel B is the complement of Channel A.

### Frequency (Waveforms are Sine, Square, Pulse, and DC)

**Range:** 0 Hz to 13 MHz.

**Resolution:** 1  $\mu$ Hz below 100 kHz, 1 mHz at and above 100 kHz.

**Stability:**  $\pm 5 \times 10^{-6}$ /year, 20° to 30°C. See also option 001, High Stability Frequency Reference.

**Accuracy:**  $\pm 5 \times 10^{-6}$  of selected value, 20° to 30°C, at time of calibration with standard frequency reference.

### Sinewave Spectral Purity

**Harmonics:** Harmonically related signals will be less than the following levels relative to the fundamental, or  $< -90$  dBm, whichever is greater:

	10 Hz	50 kHz	100 kHz	1 MHz	13 MHz
+23.98 dBm	-----	-----	-----	-----	-----
	-80 dBc	-70 dBc	-55 dBc	-30 dBc	
+13.98 dBm	-----	-----	-----	-----	-----
	-80 dBc	-80 dBc	-65 dBc	-50 dBc	
-56.02 dBm	-----	-----	-----	-----	-----

**Integrated Phase noise:**  $-63$  dBc (Option 001 only, for a 30 kHz band centered on a 10 MHz carrier excluding  $\pm 1$  Hz about the carrier).

### Main Signal Outputs (Channels A & B, All Waveforms Unless Noted)

**Connectors:** Front panel BNC female.

**Impedance:** 50  $\Omega$ ; output may be floated to  $\pm 42$  V peak.

**Sync A:** TTL level squarewave at Channel A frequency.

### Output Amplitude (Sine Mode)

**Range:** 1 mVpp to 10 Vpp in 8 ranges without DC offset. See also option 002 High Voltage Output.

**Units:** Volts peak-peak, Volts rms, dBm (50  $\Omega$ ), dBV.

**Resolution:** 0.1% of full range for peak-peak entry.  
0.3% of full range for rms entry.

**Accuracy:** Relative to programmed value after self-calibration

	0.001 Hz	100 kHz	1 MHz	13 MHz
+23.98 dBm	-----	-----	-----	-----
	±0.1 dB	±0.3 dB	±0.6 dB	
+3.98 dBm	-----	-----	-----	-----
			±0.8 dB	
-36.02 dBm	±0.2 dB	±0.5 dB	-----	-----
			±1.0 dB	
-56.02 dBm	-----	-----	-----	-----

#### Squarewave and Pulse Characteristics

**Rise/fall time:** ≤15 ns, 10% to 90% at full output.  
**Overshoot:** ≤5% of peak-to-peak amplitude at full output.  
**Pulse width range:** 1% to 99% of period or 20 ns, whichever is greater.  
**Pulse width resolution:** 0.01% of period.  
**Pulse width accuracy:** ≤±1% of period ±20 ns.  
**Amplitude accuracy:** ±2%, 0.001 Hz to 100 kHz, 100 mVpp-1.00 Vpp  
±1% .001 Hz to 100 kHz, 1.00 Vpp-10.00 Vpp

#### DC Offset

**Range:** (See also option 002, high voltage output).  
**DC only:** 0 to ±5 V.  
**DC+AC:** DC+AC peak ±5V; Max. DC offset is affected by AC range, Maximum is ±4.5 V decreasing to ±4.5 mV on lowest range.  
**Resolution:** 3 digits.  
**Accuracy:** (After self-calibration).  
**DC only:** ±75 mV.  
**DC+AC:** (Sinewave) 10 Hz to 1 MHz: ±2% of range.  
1 MHz to 13 MHz: ±5% of range.

#### Phase Offset

(Channel A vs B in Two-Phase mode)  
**Range:** ±720 degrees.  
**Resolution:** 0.01 degree.  
**Accuracy:** After self-calibration, for equal-level sinewaves 1 V to 10 V peak-peak

0.1 Hz to 10 Hz	±0.5 degrees
10 Hz to 100 kHz	±0.2 degrees
100 kHz to 1 MHz	±0.3 degrees
1 MHz to 13 MHz	±2.0 degrees

#### Amplitude Modulation

Specifications apply to Channel A and Channel B with external modulation or to Channel A internal modulation with Channel B as the modulation source. External modulation is allowed in all modes; internal modulation is allowed only in the two-channel mode.  
**Waveforms:** Sine, square, or (external only) pulse, DC, etc.  
**Frequency Range:** Carrier: DC to 13 MHz  
Modulation: DC to 100 kHz.  
**Modulation Depth:** 0 to 100%.

#### Phase Modulation

Specifications apply to Channel A and Channel B with external modulation or to Channel A internal modulation with Channel B as the modulation source. External modulation is allowed in all modes; internal modulation is allowed only in the two-channel mode.  
**Waveforms:** Sine, square, or (external only) pulse  
**Frequency Range:** Carrier: DC to 13 MHz  
Modulation: DC to 5 kHz.  
**Phase Deviation:** 0° to 360°.

#### Frequency Sweep

**Sweep Types:** Linear, discrete.  
**Sweep Forms:** Triangle, ramp.  
**Sweep Time:** 5 ms to 1000 s.  
**Sweep Elements** (Discrete): 2 to 63 frequency pairs and dwell times, user defined; dwell times = 5 ms to 1000 s/element.  
**Maximum Sweep Width:** 13 MHz.

#### Output Combiner

Channel A and B are combined on the Channel A output. B output is off. Combiner may be used in the two-channel, two-phase, and two-tone modes. DC offset is automatically set to 0 V.

**Frequency Range:** DC to 13 MHz.

**Return Loss:** >20 dB.

#### Auxiliary Outputs (All Connectors are Rear-Panel BNC)

**10 MHz reference:** +3 dBm output to phase lock other instruments to the HP 3326A.

**10 MHz oven output:** +3 dBm oven-stabilized frequency reference (option 001 only).

**X-axis drive:** Linear ramp proportional to sweep time.

**Z-axis blank:** TTL low during sweep.

**Sweep Marker:** TTL low at selected marker frequency in sweep.

**20-33 MHz LO:** >100 mVpk square wave output offset 20 MHz from Channel B output.

#### Auxiliary Inputs (All Connectors are Rear-Panel BNC)

**Reference Input:** For phase-locking to an external frequency reference. Signal of 1,2,5, or 10 MHz, ±10 ppm, 0 to +20 dBm.

**External Trigger Input:** TTL level to initiate linear or discrete sweep on high to low transition.

**Channel A and B external phase calibration inputs**

**Channel A and B external amplitude modulation inputs**

**Channel A and B external phase modulation inputs**

#### HP-IB Remote Control

Compatible with IEEE Standard 488-1978.

#### Interface Functions:

SH1,AH1,T6,L4,SR1,RL1,PP0,DC1,DT1,C0,E1.

#### Option 001 High Stability Frequency Reference

**Stability:** ±5×10<sup>-8</sup>/week after 72 hours continuous operation.  
±1×10<sup>-7</sup>/month after 15 days continuous operation.

#### Option 002 High Voltage Output

Multiplies the output level by 4 and expands the allowable DC offset range. Specifications apply to both channels in all modes with the internal combiner off.

**Frequency range:** DC to 1 MHz.

**Output impedance:** <2 Ω, DC to 50 kHz; <10 Ω, 50 kHz to 1 MHz.

**Amplitude range:** 4 mV to 40 Vpp into >1 k Ω, <200 pF load without DC offset (must be entered in peak-to-peak units only).

**DC offset:** ±20 V, independent of amplitude range. DC + AC peak must not exceed 20 V.

#### Option 003 Rear Terminal Outputs

Provides Channel A and B main outputs only on rear panel BNC's. Front panel main outputs are removed. Specifications unchanged.

#### General

**Power:** 100/120/220/240 V, +5%, -10%, 48 to 66 Hz; 290 VA max.

**Weight:** 27 kg (60 lb) net, 37 kg (81 lb) shipping.

**Dimensions:** 177 mm H x 425.5 mm W x 497.8 mm D (7" x 16<sup>3</sup>/<sub>4</sub>" x 19<sup>5</sup>/<sub>8</sub>").

#### Accessories Available

**HP 15507A Isolator:** For isolation of signal ground between frequency reference and instrument input/output.

**HP 9211-2656 transit case** for protection in transportation and storage.

#### Ordering Information

	Price
<b>HP 3326A Two-Channel Synthesizer</b>	<b>\$9,760</b>
<b>Opt 001:</b> High Stability Frequency Reference	\$665
<b>Opt 002:</b> High Voltage Output	\$305
<b>Opt 003:</b> Rear Terminal Outputs (Rear only)	N/C
<b>Opt 907:</b> Front Handle Kit	\$61
<b>Opt 908:</b> Rack Flange Kit	\$36
<b>Opt 909:</b> Rack Flange and Handle Combination Kit	\$92
<b>Opt 910:</b> Extra Operating Manual	\$102
<b>Opt 914:</b> Delete Service Manual	less \$115
<b>Opt W30:</b> Extended Warranty	\$190

# FREQUENCY, FUNCTION & WAVEFORM SYNTHESIZERS

## Synthesizer/Level Generator 200 Hz to 81 MHz

### Model 3335A

- High spectral purity
- Precision amplitude control
- 1 mHz resolution

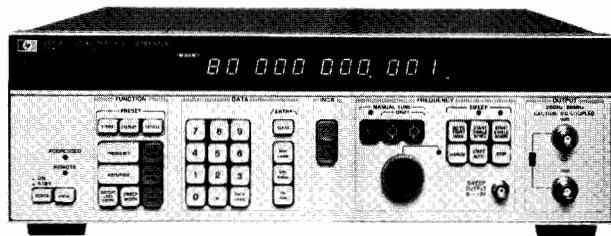

HP 3335A



### Description

Covering a frequency range of 200 Hz–81 MHz, the HP 3335A Synthesizer/Level Generator has performance characteristics that make it ideally suited for the telecommunications industry, as well as for traditional synthesizer applications, including testing of Frequency Division Multiplex (FDM) equipment and R & D and production testing of communications systems. It features precision level control, millihertz resolution, high spectral purity, internal frequency sweep, HP-IB programmability and numerous user conveniences.

### Internal Storage

Up to 10 different front panel settings (frequency, level,  $\phi$  incr, etc.) can be stored in internal memory registers for later recall. The DISPLAY key allows viewing of register contents without altering the synthesizer output.

### Precision Amplitude

Increasing channel capacity of Frequency Division Multiplex (FDM) systems is continually placing more stringent requirements on the testing of transmission parameters. To meet these performance standards, the HP 3335A incorporates a state-of-the-art attenuator resulting in attenuator accuracies of up to  $\pm 0.025$  dB over the 81 MHz frequency range.

### HP-IB Programmability

IEEE STD 488-1978 Definition SH0, AH1, T0, L2, SR0, RL1, PP0, DC1, DT0, C0.

### Frequency Stability

The HP 3335A synthesizes its output frequency from an internal temperature-controlled crystal oscillator which provides  $\pm 1 \times 10^{-8}$ /day frequency stability ( $\pm 5 \times 10^{-10}$  is optional). The HP 3335A can also be phase-locked to any external frequency standards.

### Automatic Frequency Sweep

The HP 3335A combines the precision frequency accuracy and stability of a synthesizer with the time-saving convenience of a digital sweeper.

### SLMS - Tracking Generator

The HP 3335A operates as a tracking generator with the HP 3746A/B Selective Level Measuring Set (SLMS), or the HP 3586A/B/C Selective Level Meter for automatic or semi-automatic testing of FDM systems. For closed-loop tracking where the HP 3335A and HP 3746A/B are in the same location, the frequency of the generator is controlled by the microprocessor in the SLMS.

### Options

**Standard:** Equipped with switch-selectable 50 $\Omega$  and 75  $\Omega$  outputs (BNC connectors).

**001:** High-stability frequency reference.

**002/004:** Equipped with 75 $\Omega$  unbalanced and 124 $\Omega$  and 135 $\Omega$  balanced connectors as follows.

	Option	Fits WECO Type	Spacing	Accepts WECO Type
75 $\Omega$	002	477B	N/A	358A
	004	560A		439A/440A
124 $\Omega$	002	477B	16 mm (.625")	372A
	004	560A	12.7 mm (0.5")	443A
135 $\Omega$	002/004	223A	16 mm (.625")	241A

**003:** 75 $\Omega$  unbalanced BNC output and 150  $\Omega$  balanced output using a pair of BNC connectors at 20 mm (0.80 in.) spacings.

Note: only one connector option (Opt. 002/003/004) may be ordered per instrument.

### Abbreviated Specifications

(For complete specifications, refer to the HP 3335A data sheet.)

#### Frequency Range

**Standard:** 200 Hz–81 MHz;

**Option 002/004:** 75 $\Omega$ , 200 Hz–81 MHz; 124 $\Omega$ , 10 kHz–10 MHz; 135/150 $\Omega$ , 10 kHz - 2 MHz.

**Option 003:** 75 $\Omega$ , 200 Hz–81 MHz; 150 $\Omega$ , 10 kHz - 2 MHz.

**Frequency resolution:** .001 Hz.

**Stability, long term:**  $\pm 1 \times 10^{-8}$ /day;  $\pm 1 \times 10^{-7}$ /month.

**Option 001** (high stability frequency reference).

**Aging rate:**  $\pm 5 \times 10^{-10}$ /day;  $\pm 2 \times 10^{-8}$ /month;  $\pm 1 \times 10^{-7}$ /year.

**Warmup:** Within  $5 \times 10^{-9}$  of final value 20 minutes after turn-on at 25°C.

#### Spectral Purity

**Harmonic distortion:** 200 Hz–10 MHz:  $< -45$  dBc; 10 MHz–80 MHz;  $< -40$  dBc.

**Phase noise** (30 kHz band, excluding  $\pm 1$  Hz, centered on the carrier): 9.9 MHz:  $< -63$  dBc; 20 MHz;  $< -70$  dBc; 40 MHz:  $< -64$  dBc; 80 MHz:  $< -58$  dBc.

**Spurious:** Nonharmonically related signals: the greater of  $-75$  dBc or  $-125$  dBm (50/75  $\Omega$ ),  $-97$  dBm (124  $\Omega$ ),  $-68$  dBm (135/150  $\Omega$ ).

#### Amplitude Range

**Standard:** 50 $\Omega$ :  $+13.01$  dBm to  $-86.98$  dBm; 75 $\Omega$ :  $+11.25$  dBm to  $-88.74$  dBm.

**Option 002/004:** 75/124/135 $\Omega$ :  $+11.25$  dBm to  $-88.74$  dBm.

**Option 003:** 75/150 $\Omega$ :  $+11.25$  dBm to  $-88.74$  dBm.

**Signal balance (124 $\Omega$ , 135 $\Omega$ , 150 $\Omega$  balanced outputs):**  $> 60$  dB at 100 kHz.

**Resolution:** 0.01 dB.

**Absolute level accuracy (max. output at 100 kHz, 10°C to 35°C):** 50/75  $\Omega$   $\pm 0.05$  dB; 124/135/150  $\Omega$ :  $\pm 0.1$  dB.

**Flatness (relative to 100 kHz, full amplitude):** 50/75 $\Omega$ : 1 kHz – 25 MHz:  $\pm 0.07$  dB, 200 Hz - 80 MHz:  $\pm 0.15$  dB; 124 $\Omega$ : 50 kHz - 10 MHz:  $\pm 0.15$  dB, 10 kHz - 10 MHz  $\pm 0.4$  dB; 135/150 $\Omega$ : 10 kHz - 2 MHz:  $\pm 0.18$  dB.

#### Attenuator:

Range: 0 to 98 dB in 2 dB steps

Accuracy: (1 year)

50 $\Omega$ :	ATTENUATION	FREQUENCY
	0 to 38 dB	$\pm 0.25$ dB
40 to 58 dB	$\pm 0.03$ dB	
60 to 98 dB	$\pm 0.09$ dB	

75 $\Omega$ :	ATTENUATION	FREQUENCY	
		200Hz	25 MHz - 80 MHz
0 to 18 dB	$\pm 0.04$ dB	$\pm 0.15$ dB	$\pm 0.50$ dB
20 to 58 dB	$\pm 0.09$ dB	$\pm 0.25$ dB	
60 to 98 dB	$\pm 0.20$ dB	$\pm 0.50$ dB	

### Ordering Information

HP 3335A Synthesizer/Level Generator	Price
<b>Opt 001:</b> High-stability reference $\pm 5 \times 10^{-10}$ /day	\$1235
<b>Opt 002:</b> Connector (75/124/135 $\Omega$ )	\$560
<b>Opt 003:</b> Connector (75/150 $\Omega$ )	\$355
<b>Opt 004:</b> Connector (75 $\Omega$ , miniature WECO on 124/135 $\Omega$ )	\$560
<b>Opt W30:</b> Extended Warranty	\$400

# FREQUENCY, FUNCTION & WAVEFORM SYNTHESIZERS

Synthesizer/Level Generator

Model 3336C

419

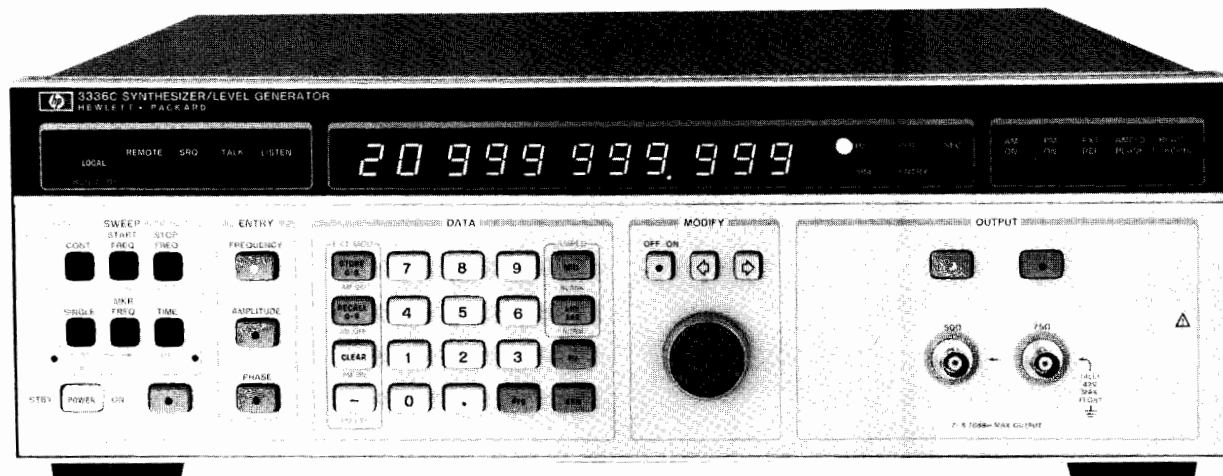

HP 3336C



## Description

Covering a frequency range of 10 Hz to 20.999 MHz, the HP 3336C is designed for traditional synthesizer applications as well as R & D and production testing of systems or components. It features precision level control, high spectral purity, optional frequency stability of  $\pm 5 \times 10^{-8}$ /week, internal frequency sweep and numerous user conveniences. All models include HP-IB.

## Precision Frequency Measurements

Major advances in HP technology have provided a single loop, fractional-N synthesis technique which allows synthesizer accuracy with 11 digits of resolution, with completely phase continuous frequency sweep over any of the instrument's frequency ranges. Microhertz resolution below 100 kHz allows precise frequency measurements over a range of 10 Hz to 20.999 999 999 MHz. Harmonics are below -60 dBc over the range from 50 Hz to 1 MHz (-50 dBc to 20 MHz), with spurious signals below -70 dBc or -100 dBm in the standard instrument, -115 dBm with an option. Integrated Phase Noise is -64 dBc (30 kHz BW).

## $\pm 0.05$ dB Amplitude Accuracy

New HP attenuator technology coupled with custom designs in leveling loops and thermal converters produce amplitude accuracies seen only in instruments at much greater cost. The fast leveling loop makes extremely flat sweeps possible at high sweep speeds. External leveling is also available for those custom applications where a control loop is desired.

## Other Features

Models HP 3336 A & B are also available for the telecommunications industry (see page 502). All three models (the HP 3336A, B & C) have 10 storage registers; amplitude blanking capability during frequency switching; linear or logarithmic phase continuous sweep capabilities; RPG (rotary pulse generator) to simplify modification of any digit in the display; phase offset capability; output connector and impedance flexibility; AM and PM modulation; and many other features. Refer to the data sheet for complete information.

## Abbreviated Specifications

### Frequency

**Range:** 10 Hz to 20.999 999 999 MHz.

**Resolution:** 1  $\mu$ Hz for frequencies <100 kHz, 1 mHz for frequencies  $\geq 100$  kHz.

**Aging rate:**  $\pm 5 \times 10^{-6}$ /year (20° to 30°C).

**Warm-up time:** 30 minutes to within specified accuracy.

### Amplitude

**Range:** 50  $\Omega$ : -71.23 to +8.76 dBm; 75  $\Omega$ : -72.99 to 7.00 dBm.

**Absolute accuracy:**  $\pm 0.05$  dB, 20° to 30°C (for the top 9.99 dB of amplitude range at 10 kHz),  $\pm 0.08$  dB, 0° to 55°C.

**Flatness:** 50/75  $\Omega$ ,  $\pm 0.1$  dB ( $\pm 0.07$  dB with option 005) referenced to 10 kHz.

**Attenuator Accuracy:** (Instruments without option 005).

10 Hz      1 MHz      10 MHz      20.9 MHz

10 to 19.99 dB	$\pm 1$ dB	$\pm 15$	$\pm 2$ dB
20 to 39.99 dB	$\pm 15$ dB	$\pm 2$ dB	$\pm 25$ dB
40 to 79.99 dB	$\pm 2$ dB	$\pm 25$ dB	$\pm 3$ dB

Note: Amplitude Accuracy is the sum of the Absolute Accuracy and, as necessary, Flatness and Attenuator Accuracy.

## Phase Offset

**Range:**  $\pm 719.9^\circ$  with respect to arbitrary reference phase.

## Amplitude Modulation

**Modulation depth:** 0 to 100%.

**Modulation frequency range:** 50 Hz to 50 kHz.

**Envelope distortion:**  $< -30$  dB to 80% modulation (1 kHz modulating freq.).

## Phase Modulation

**Range:** 0° to  $\pm 850^\circ$ .

**Linearity:**  $\pm 0.5\%$  from best fit straight line.

**Modulation frequency range:** DC to 5 kHz.

**Input sensitivity:**  $\pm 5$  V peak for 850° phase shift (170°/volt).

## Frequency Sweep

**Sweep time:** Linear; 0.01 s to 99.99 s. Single Log; 2 s to 99.99 s. Continuous Log; 0.1 s to 99.99 s.

**Maximum sweep width:** Specified frequency range of selected output.

**Minimum sweep width:** Log; 1 decade. Linear; minimum BW (Hz) = .1 (Hz/s) x Sweep Time (s).

**Phase continuity:** Phase is continuous over full frequency range.

**Sweep flatness:** Fast leveling  $\pm 0.15$  dB, 10 kHz to 20 MHz, .03 s sweep time. Normal leveling;  $\pm 0.15$  dB, 50 Hz to 1 MHz, 0.5s sweep time.

## HP-IB Interface Functions:

SH1, AH1, T6, L3, SR1, RL1, PP0, DC1, DT0, C0, E1.

## General

### Operating Environment

**Temperature:** 0° to 55°C.

**Relative humidity:**  $\leq 85\%$ , 0° to 40°C.

**Altitude:**  $\leq 15,000$  ft, (4600 metres).

**Storage temperatures:** -50° to +65°C.

**Storage altitude:**  $\leq 50,000$  ft, (15,240 metres).

**Power requirements:** 100/120/220/240 V, +5%, -10%, 48 to 66 Hz, 60 VA, (100 VA with all options), 10 VA standby.

**Size:** 132.6 mm H x 425.5 mm W x 497.8 mm D, (5.2" x 16.8" x 19.6").

**Weight:** Net, 10 kg. (22 lb). Shipping, 15.5 kg. (34 lb).

## Ordering Information

### HP 3336C Synthesizer/Level Generator (General Purpose)

	Price
Opt 004 High Stability Frequency Reference	\$665
Opt 005 High Accuracy Attenuator	\$665
Opt 907 Front Handle Kit	\$56
Opt 908 Rack Flange Kit	\$33
Opt 909 Rack Flange and Handle Kit	\$82
Opt W30 Extended Warranty	\$190

# FREQUENCY, FUNCTION & WAVEFORM SYNTHESIZERS

## Dual Arbitrary Waveform Generator

Model 8175A Option 002

- 2 analog channels / 1 kpoints ea / 50 MHz ea
- individual datapoint durations 20 ns to 9.99 s
- 10 bit amplitude resolution
- digital and analog signals simultaneously
- 4 waveform entry modes; calculator, graphical editing, abs. and rel. levels, various codings
- up to 32 Vp-p output voltage (into open), separately programmable offset (max  $\pm 16$  V)

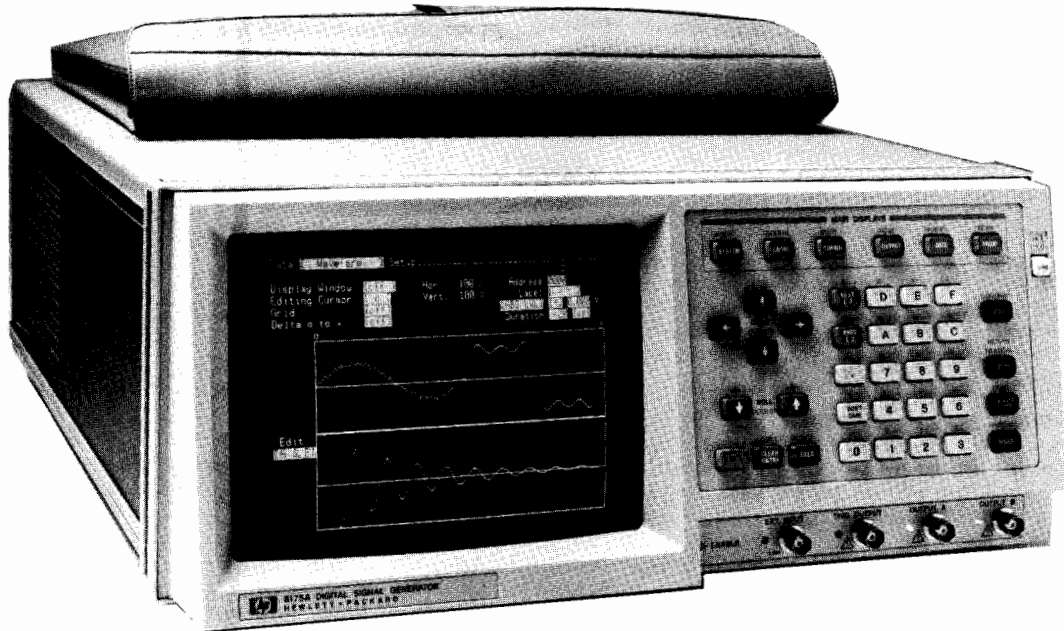

HP 8175A, Option 002; Data Page:  
Waveform Setup

With the Option 002, the Dual Arbitrary Waveform Generator, the HP 8175A offers the new Arbitrary Waveform mode in addition to the existing Parallel and Serial modes. In the Arbitrary Waveform mode, you have: Dual arbitrary waveform channels, and simultaneous equivalent digital signals. This means you have the ideal source for difficult applications, for example:

- simulation of two dependent variables, like force and distance, at the same time.
- digital and analog stimulation of devices like programmable filters.
- stimulus and compare signals at the same time for DACs or ADCs.

The arbitrary outputs are 50 Mpoints/s, synchronous, but independent in shape and amplitude (max 16 V p-p into 50 Ohm and max 32 V p-p into open), and the waveforms can be set up by means of: a) algorithms (a fundamental set of mathematical functions are available, including noise), b) interpolations (linear and spline), c) graphic or tabular entry of instantaneous level (or amplitude and offset), d) tabular entry of equivalent digital pattern. Additionally, any existing waveform can be modified. One way is simply by tabular or graphical editing. A more powerful alternative is the "Combine" feature. This allows you to combine an algorithm arithmetically with any desired part of the current waveform.

### Application Examples

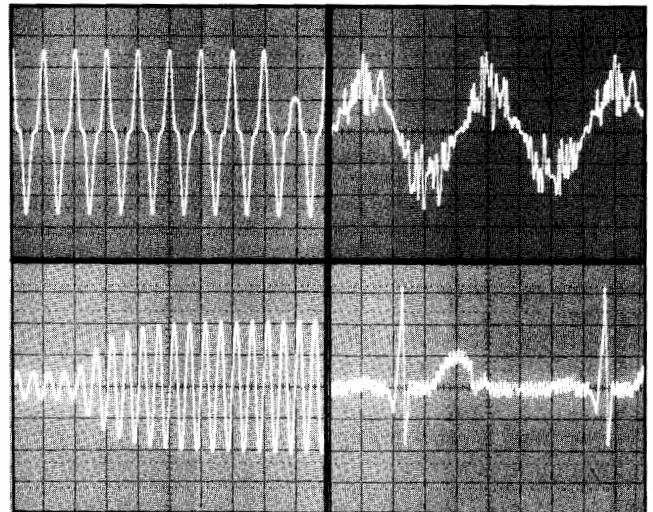

The comprehensive feature set, together with the outstanding memory management and interaction capability, mean that "real-life" simulation for the most exacting circuits is within your grasp.



```

Data [ Calculator ] Page-----Use Main Display Keys-----
Status: Awaiting Command-----
Step Algorithm of the Waveform

0 FOR 10 MS STEP 20 US ↓
1 (0.125*RND+0.5*SIN(2*PI*100*Tx)) ↓
> 2 FOR 10 MS STEP 20 US ↓
3 (SIN(2*PI*100*Tx)+0.33*SIN(2*PI*300*Tx)+0.2*SIN(2*
4 PI*500*Tx))

[ Edit ] [ Param ] [ Run ] [ ] [ ] [ ]

```

### Data Page: Calculator

The built in Calculator provides a comfortable method of setting up very complex, mathematically-definable waveforms by simply entering the formula. Softkeys support most of the fundamental mathematical functions. The Combine capability allows any previously generated function to be combined with the current calculated function. By this means, noise can be introduced into any desired parts of the waveform.

```

Data Page (ARB)-----
Data [ Pattern/Level ] Setup
Used Format Allocation [ DUAL ]

ARB A: Amplitude Range: [ 16 V ] Upper Limit: + 8.00 V
Lower Limit: - 5.52 V
ARB B: Amplitude Range: [ 200 mV ] Upper Limit: + 102.2 mV
Offset: + 33.0 mV Lower Limit: - 102.4 mV

Address Name --- ARB A --- --- ARB B --- --TRG-- --Duration--
[ ABS. LEVEL ] [ REL. LEVEL ] A B
1023 + 3.24 V + 0.0 mV 0 0 9.99 s
0000 + 1.66 V + 4.2 mV 0 0 20 μs
0001 + 1.76 V + 5.2 mV 1 0 20 μs
0002 + 2.10 V + 8.6 mV 1 0 20 μs
0003 + 2.04 V + 8.0 mV 1 0 100 μs
0004 [ + ] 01.50 V [ + ] 003.2 mV 1 0 05.0 [ ms ]
0005 + 2.20 V + 9.6 mV 0 0 20 μs
0006 + 2.00 V + 8.4 mV 0 0 1.0 ms
0007 + 2.10 V + 8.6 mV 0 0 20 μs
0008 + 2.00 V + 7.6 mV 0 0 20 μs
0009 + 2.15 V + 9.2 mV 0 0 20 μs

```

### Data Page: Pattern/Level Set-Up

Data Points of a waveform can be entered and displayed in absolute or relative levels or in various codes. Comprehensive waveform editing support is provided. For instance, segments of data points can be moved or copied to other memory locations or waveform segments can easily be exchanged between the two analog channels. In this way it is easy to produce phase shifted signals. Graphical editing of the waveform, including interpolation between data points, is possible on this menu.

### Specifications

apply for operating temperatures from 0° to 55°C.

### Option 002 Dual Arbitrary Waveform Generator (can be retrofitted in HP service office)

**Number of Analog Outputs:** 2

**Number of Bits:** 10

**Number of Data Points:**

**Horizontal:** 1024 points

**Vertical:** 1000 points with additional 24 points override

800 points for 16 V p-p Output Voltage Range

640 points for 32 V p-p Output Voltage Range

**Differential Non-Linearity:** ≤1 LSB (monotonic)

**Output Impedance:** 50 Ohm ±5%

### Output Levels

**Load Impedance:** 50 Ohm:

**7 Output Voltage Ranges:** 0.2 V to 16 V, Res. 0.2 mV to 20 mV

**2 Offset Ranges:** ±0.8 V and ±8 V (Output Volt. Range >1 V)

**Load Impedance:** ≥50 kOhm

**7 Output Voltage Ranges:** 0.5 V to 32 V, Res. 0.5 mV to 50 mV

**2 Offset Ranges:** ±1.6 V and ±16 V (Output Volt. R. >2V)

### Accuracy (Output A and Output B)

**Amplitude Accuracy:** ±4% ±4 LSB

**Offset Accuracy:** ±1% of programmed value

±2% of (progr. High Level of p-p Output Volt. +

progr. Low Level of p-p Output Volt.) (if High and

Low Level are identical in magnitude, but opposite in sign, this error

will be zero).

plus:

**into 50 Ohm:** ±10 mV for 0.2 V, 0.5 V and 1 V ranges

**or:** ±25 mV for 2 V and 5 V range

**or:** ±50 mV for 10 V and 16 V range

**into ≥50 kOhm:** ±20 mV for 0.5 V, 1 V and 2 V ranges

**or:** ±50 mV for 5 V and 10 V range

**or:** ±100 mV for 20 V and 32 V range

### Timing (for Output A and B)

The maximum sample update rate is 50 MHz.

The Data Point Duration is 20 ns to 9.99 s.

### Trigger Output Characteristics:

**Number of Trigger Output Channels:** 2

**Trigger Output Impedance:** 50 Ohm ±5%

**Trigger Output Levels:** ECL into 50 Ohm

TTL into 50 Ohm and ≥50 kOhm

**Trigger Pulse Width:** The trigger can be set for each individual

data point to High Level or Low Level. The

trigger width depends on the programmed

Data Point Duration.

### Ordering Information

### Price

**HP 8175A Digital/Analog Signal Generator** \$11200

**Note: HP 8175A must be ordered with at least option #002 or one of the digital options (refer to page 319).**

**Opt. 002 Dual Arbitrary Waveform Generator** \$3465

**Opt. 908 Rack Flange Kit (P/N 5061-9678)** \$36

**Opt. 910 Additional Operating/** \$204

Programming/Service Manual

**Opt. 916 Additional Programming Manual** \$36

☛ Fast-Ship product—see page 766



# FREQUENCY, FUNCTION & WAVEFORM SYNTHESIZERS

## 50 MHz Programmable Signal Source

Model 8165A

- Pulse/function capability
- Sine, triangle, square to 50 MHz
- Pulses and ramps to 20 MHz
- Trigger, gate and counted burst
- Synthesizer stability, precision amplitude
- Storage of operating parameters

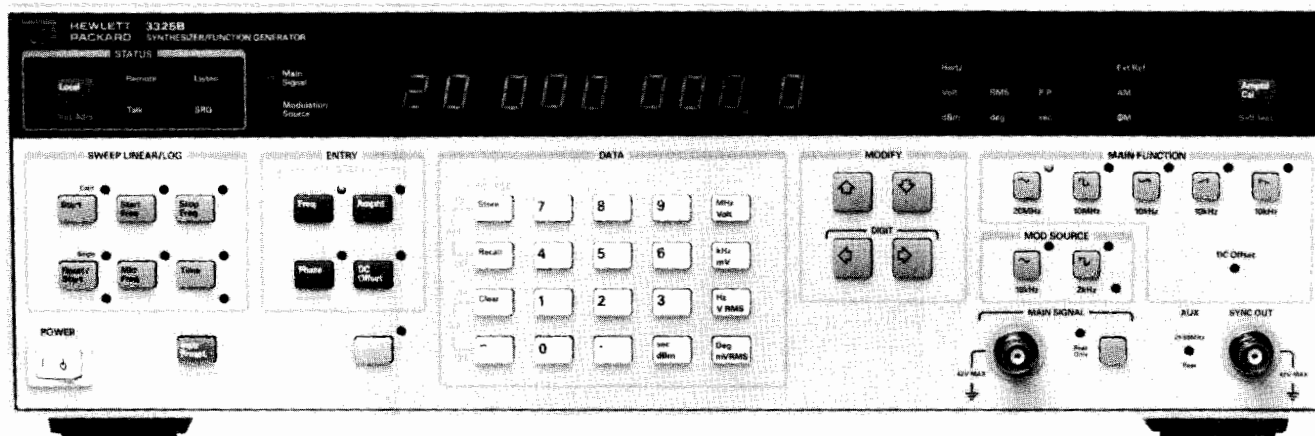

Picture shows 8165A with option 002, AM and Logarithmic Sweep.

### Versatility and Simplicity for Systems and Bench

The HP 8165A Programmable Signal Source is a versatile function generator with good accuracy and many trigger features. Microprocessor control assures rapid, accurate setup whether programming locally or via HP-IB.

### Operating Set Storage

Ten complete sets of operating information can be stored and recalled. In the event of power failure, battery back up retains all data plus the active settings.

### Stability and Resolution

Stable frequency is ensured with an internal crystal. The four-digit frequency display provides a 1  $\mu$ Hz resolution in the 1 to 9.999 MHz range. In Normal mode, the accuracy is 0.001% with a stability of  $\pm 1 \times 10^{-6}$ .

## Specifications

### Waveforms and Frequency Range

**Sine, square, triangle (50% duty cycle):** 1.000 mHz to 50.00 MHz.

**Pulse/ramp (20, 80% symmetry):** 1.000 mHz to 19.99 MHz.

**Haversine/havertriangle:** please inquire for special option.

### Output Characteristics

**Range:** amplitude and offset independently variable within  $\pm 10$  V window.

**Source impedance:** selectable 50  $\Omega \pm 1\%$  or 1 k $\Omega \pm 10\%$

**Amplitude:** 10.0 mVpp to 10.0 Vpp (50  $\Omega$  into 50  $\Omega$ )  
2.00 Vpp to 20.0 Vpp (1 k $\Omega$  into 50  $\Omega$ )

Accuracy	Sine V Vrms	Square	Triangle (50%)	Ramp (20%-80%)	Pulse (20%-80%)
<1kHz	$\pm 3\%$	$\pm 2\%$	$\pm 3\%$	$\pm 3\%$	$\pm 2\%$
1kHz-4.99MHz	$\pm 3\%$	$\pm 2\%$	$\pm 3\%$	$\pm 5\%$	$\pm 2\%$
5 MHz-19.9MHz	$\pm 8\%$	$\pm 5\%$	$\pm 10\%$	$\pm 10\%$	$\pm 5\%$
20MHz-50MHz	$\pm 8\%$	$\pm 5\%$	+5% to -20%	-	-

**Offset:** 0  $\pm 10$  mV to  $\pm 5.00$  V (50  $\Omega$  into 50  $\Omega$ )  
0  $\pm 20$  mV to  $\pm 10.0$  V (1 k $\Omega$  into 50  $\Omega$ )

**Accuracy:**  $\pm 1\%$  programmed value  $\pm 1\%$  signal Vpp  $\pm 20$  mV.

### Sine Characteristics

**Distortion:** total harmonic distortion (THD) for fundamental up to 1 MHz: 38 dBc.

**Harmonic signals:** (fundamental above 1 MHz):  $\leq -30$  dB.

### Square/Pulse Characteristics

**Transition times:** (10% to 90%):  $\leq 5$  ns (50  $\Omega$  into 50  $\Omega$ ),  $\leq 7$  ns (1 k $\Omega$  into 50  $\Omega$ )

**Preshoot/Overshoot/Ringing:**  $\leq \pm 5\%$  (50  $\Omega$  into 50  $\Omega$ ),  $\pm 10\%$  (1 k $\Omega$  into 50  $\Omega$ ).

### Triangle/Ramp Characteristics

**Linearity:** (10% to 90%):  $\leq \pm 1\%$  ( $\leq \pm 5\%$  above 5 MHz).

### Operating Modes

**Norm** (continuous phase locked), **VCO** (external sweep voltage), **Trig** (ext or man. one-shot), **Gate**, **Burst** (1-9999 counted cycles),

### Frequency Modulation

**HP-IB:** control and learn capability for all modes and parameters.

**Interface functions\*:** SH1, AH1, T6, L4, SR1, RL1, PP0, DC0, DT1, C0, E1.

### General

**Memory:** non volatile. 10 addressable locations plus one for active operating state. Each location can store a complete set of operating parameters and modes.

**Power:** 100/120/220/240 Vrms;  $\pm 5\%$ , -10%; 48 to 66 Hz, 200 VA max.

**Operating temperature:** 0° to 50°C

**Weight:** net 12 kg (26.5 lbs). Shipping 16 kg (35.3 lbs).

**Size:** 133 H x 426 W x 422 mm D (5.2" x 16.8" x 16.6").

### Ordering Information

**HP 8165A Programmable Signal Source\*\*** \$8350

**Opt. 002:** AM and logarithmic sweep add \$1070

**Opt. 003:** Rear Panel Connectors N/C

**Opt. 907:** Front Handle Kit (Part No HP 5061-9689) add \$56

**Opt. 908:** Rack Mount Flange Kit (Part No HP 5061-9677) add \$33

**Opt. 909:** Opt 907, 908 combined (Part No HP 5061-9683) add \$82

**Opt. 910:** Additional Operating and Service Manual add \$71

**Opt. W30:** 2 years additional hardware service \$200

\*For more on these codes refer to the HP-IB section of this catalog.

\*\*HP-IB cables not supplied, see page 561.

☎ Fast-Ship product—see page 766

# FREQUENCY, FUNCTION & WAVEFORM SYNTHESIZERS

1 mHz–50 MHz Pulse/Function Generator

Model 8116A

423

- Sine, triangle, square, haversine functions and dc
- 1 mHz–50 MHz, 32 Vpp for all waveforms
- Variable (10 ns min) pulse width, 6 ns transitions
- Wide range of operating capability
- Self-prompting operating concept
- Error recognition and self test



Picture shows 8116A with Option 001, Burst and Logarithmic Sweep.

The fully programmable HP 8116A features pulse as well as function generator capabilities in one small unit. A broad 1 mHz–50 MHz band for all waveforms and a wide choice of operating and modulating modes assure high flexibility. These factors, plus good repeatability, make the HP 8116A a sound, long-term investment.

## Unique Operating Concept Saves Engineering Time

HP's custom IC's have made it feasible to put the many HP 8116A capabilities into such a small volume. Handling is simplified by a unique, microprocessor-controlled, operating concept which ensures a clear overview of the compact front panel at all times. When the mode and waveform have been selected, illuminated labels show which parameters must be set. There's no clutter, no confusion.

**Auto vernier.** In normal mode, the HP 8116A's auto-vernier increments any desired parameter continuously until a stop signal is applied. This means that thresholds can be measured automatically, without a controller.

**Level or amplitude programming.** The HP 8116A's output can be programmed in terms of high and low levels or in terms of amplitude and offset. Consequently a direct, automatic, conversion is always feasible so that the HP 8116A can be programmed in the same terms as the device is specified.

**Safe limit.** Devices can be protected by the limit feature. This prevents the output from exceeding a given magnitude.

## Rectangular Waveforms

For applications such as laser diodes or dc motors, square waves can be programmed for constant duty cycles from 10% to 90%. For digital test, or for simulating very low duty-cycle events, pulse width can be programmed down to 10 ns. Square wave and Pulse modes provide clean 6 ns edges that are ideal for many technologies. Pulse width modulation and pulse recovery capability are available in Pulse mode.

## Sine and Triangle Functions

10% to 90% duty cycle, programmable in 1% steps, provides ramps and asymmetrical sine waves for testing VCO's, servos, amplifier linearity and industrial process control systems. Haversine functions,

available in External Trigger, Gate and Burst modes, extend the applications to areas such as telephone line and vibration testing.

## Modulation

All waveforms can be amplitude or frequency modulated. VCO operation allows frequency variation over two decades with an external voltage; consequently transducer output can be conditioned for mag tape recording, or frequency-shift keying or linear sweep can be carried out.

## Option 001

**10 1/2-decade log sweep.** Sweep mode covers the wide 1 mHz – 50 MHz band in a single up sweep. Test setups require no more than an X-Y recorder or scope because all necessary control signals are available. The HP 8116A sweeps can be internally triggered, if desired.

**Accurate, counted bursts.** A preprogrammed number of cycles of any waveform can be generated in Burst mode. With sine, triangle and square functions, bursts can be triggered internally as well as externally.

**Hold capability.** For material stress testing, low frequency functions can be held at instantaneous levels. Hold is controlled by an external signal.

## Low-Cost Automation for Bench and Systems

Powerful capability, small size and wide specified temperature range make the HP 8116A a good choice for automatic test systems. Also, the low cost means that it's now realistic to automate those routine bench jobs and leave more time for design. Comfortable software features such as easy syntax and flexible format contribute to rapid system design.

## Operating Confidence

There's reliance in the HP 8116A's output because proper operation is always ensured by the instrument's error detector. This helps the user to recover from an incorrect front panel or programming operation by indicating the offending parameter. Also, the built-in test and diagnosis feature verifies correct function each time the instrument is switched on.

# FREQUENCY, FUNCTION & WAVEFORM SYNTHESIZERS

## 1 mHz–50 MHz Pulse/Function Generator (cont'd)

### Model 8116A

#### Specifications

Specifications apply with 50-ohm load and temperatures in the range 0°C to 55°C.

#### Functions

Sine, triangle, ramp, square, pulse, haversine, havertriangle, dc.

#### Timing

##### Frequency

**Range:** 1 mHz to 50 MHz (3-digit resolution).

**Accuracy<sup>1</sup>** (pulse mode, 50% d/c):  $\pm 3\% \pm 0.3$  mHz below 100 kHz,  $\pm 5\%$  above 100 kHz.

**Jitter** (pulse mode, 50% d/c):  $< 0.1\% + 100$  ps.

**Stability:**  $\pm 2\%$  (1 hour),  $\pm 5\%$  (24 hours).

**Duty cycle:** (sine, triangle, square, haversine, havertriangle).

**Range:** 10% to 90% (20% to 80% above 1 MHz), 2-digit resolution.

**Accuracy<sup>1</sup>:**  $\pm 0.5$  digits ( $\pm 3$  digits above 1 MHz).

##### Pulse Width

**Range:** 10.0 ns to 999 ms (3-digit resolution).

**Accuracy<sup>1</sup>:**  $\pm 5\% \pm 2$  ns.

**Jitter:**  $< 0.1\%$  ( $0.2\% + 200$  ps for width  $\leq 10$   $\mu$ s).

#### Output Characteristics

(voltages double into high impedance).

##### Amplitude

**Range:** 10.0 mVpp to 16.0 Vpp (3-digit resolution).

**Accuracy<sup>1</sup>:**  $\pm 5\%$  (at 1 kHz for sine and triangle).

**Flatness (sine):**  $\pm 3\%$  ( $\pm 5\%$  above 1 MHz,  $+5$ – $15\%$  above 10 MHz).

**Flatness (triangle):**  $\pm 3\%$  ( $\pm 5\%$  above 1 MHz,  $+5$ – $25\%$  above 10 MHz).

##### Offset and dc Mode

**Range:** 0.00 to  $\pm 7.95$  V (0 to  $\pm 795$  mV for amplitude  $< 100$  mVpp).

**Resolution:** 3 digits.

**Accuracy<sup>1</sup>:** 0.5% of setting  $\pm 1\%$  of ampl  $\pm 40$  mV ( $+2$  mV if ampl  $< 100$  mVpp,  $\pm 20$  mV in dc mode).

**Distortion** (sine, normal mode, 50% duty cycle).

**Total harmonic distortion (10 Hz–50 kHz):**  $< 1\%$  ( $-40$  dB)\*.

**Harmonic related signals (50 kHz–1 MHz):**  $< -34$  dB,  
(1 MHz–50 MHz):  $< -23$  dB\*.

\*May increase by 3 dB below 10°C and above 45°C.

**Non-linearity** (triangle, ramp, 100 mHz–1 MHz):  $< \pm 3\%$ .

#### Pulse and Square Wave Characteristics

**Transitions:**  $< 7$  ns.

**Pulse perturbations:**  $< \pm 5\% \pm 2$  mV.

**Output impedance:** 50 ohm  $\pm 5\%$ .

#### Operating Modes

Normal, trigger\*, gate\*, external width.

#### Additional Modes in HP 8116A Option 001

**Logarithmic Up Sweep** (for all waveforms).

**Range:** Start and stop frequencies selectable up to full range (1 mHz–50 MHz).

**Sweep time:** selectable in 1-2-5 sequence from 10 ms to 500 seconds per decade.

**Sweep repetition:** continuous sweeps (internal sweep) or externally triggered.

**Counted Burst\*** (for all waveforms).

**Burst length:** 1 to 1999 cycles.

**Burst repetition:** internally triggered at selectable intervals from 100 ns to 999 ms (except in Pulse mode), or externally triggered, up to 40 MHz.

\*Selectable ( $-90^\circ$ ) start-phase for haversine, havertriangle.

#### Control Modes

**Frequency modulation:**  $\pm 5\%$  max deviation.

**Sensitivity:** 1 V for 1% deviation.

**Modulating frequency:** dc to 20 kHz.

#### Amplitude Modulation

**Sensitivity:**  $\pm 2.5$  V for 100% mod. ( $+2.5$  V to  $-7.5$  V for DSBSC).

**Modulating frequency:** dc to 1 MHz.

<sup>1</sup>Applies from 15°C to 35°C, %-error increases 0.05 per °C outside this range.

#### Pulse Width Modulation

**Range:** 10 ns to 1 s in 8 non-overlapping decade ranges.  
Max. width ratio: 10:1.

**Sensitivity:**  $\pm 9$  V for 1:10 ratio.

#### Voltage-Controlled Oscillator

**Range:** 2 decades in range 1 MHz–50 MHz.

**Sensitivity:** 0.1 V to 10 V for 2 decades.

**Modulating frequency:** dc to 1 kHz.

#### Auxiliary Modes

**Manual:** simulates external input.

**1 cycle (option 001):** triggers single output cycle in Trigger, Gate and Ext Burst modes.

**Auto vernier:** continuous vernier which can be remotely or manually stopped.

**Limit:** programmable maximum output levels to protect DUT.

**Complement:** selectable normal/complement output.

**Disable:** relay disconnects output.

#### Auxiliary Inputs and Outputs

##### External Input

**Threshold:**  $\pm 10$  V adjustable.

**Max input voltage:**  $\pm 20$  V.

**Sensitivity:** 500 mVpp.

**Min pulse width:** 10 ns.

**Input impedance:** 10 k $\Omega$  typ.

**Trigger slope:** positive, negative and off.

##### Control Input

**Max input voltage:**  $\pm 20$  V.

**Input impedance:** 10 k $\Omega$  typ.

##### Trigger Output

**Output levels:** 0/2.4 V typ.

**Output impedance:** 50 ohm typ.

**X-Output** (Option 001) for sweep X-Y recording (rear panel).

**Output levels:** 0 V (= start frequency) to 10 V max.

**Slope:** 1.5 V per sweep decade.

**Marker Output** (Option 001) for sweep (rear panel).

**Output levels:** TTL

**Leading edge:** positive at selected marker frequency.

**Hold Input** (Option 001), rear panel.

**Input levels:** TTL

**Leading edge:** positive transition causes HP 8116A output

( $f < 10$  Hz) to hold at instantaneous level. Output droop 0.01% per second.

**Max input voltage:**  $\pm 20$  V

#### HP-IB Capability

All manual key operations are programmable. Talk mode provides learn, status byte and error report capabilities.

#### Memory

Battery-backup RAM retains current operating state.

#### General

**Repeatability:** factor 4 better than accuracy.

#### Environmental

**Storage temperature:**  $-40^\circ\text{C}$  to  $+70^\circ\text{C}$ .

**Operating temperature:**  $0^\circ\text{C}$  to  $55^\circ\text{C}$ .

**Humidity:** 95% RH,  $0^\circ\text{C}$  to  $40^\circ\text{C}$ .

**Power:** 100/120/220/240 V rms;  $+5\%$ ,  $-10\%$ ; 48 to 440 Hz; 120 VA max.

**Weight:** net, 5.9 kg (13 lb). Shipping, 8.0 kg (18 lb).

**Size:** 89 H x 212.3 W x 422 mm D (3.5" x 8.36" x 16.6").

#### Ordering Information

**HP 8116A Programmable Pulse/Function Generator\***

**Opt. 001:** Burst and Logarithmic Sweep

**Opt. 910:** Extra Operating & Service Manual

**HP 5061-9701:** Bail Handle Kit

**HP 5061-9672:** Rack Mount Kit (single HP 8116A)

**HP 5061-9674:** Rack Mount Kit (two instruments)

**HP 5061-9694:** Lock Link Kit (for use with

HP 5061-9674)

#### Prices

\$3775

add \$510

add \$41

\$38

\$51

\$31

\$25

\*HP-IB cables not supplied, see page 561.

☞ Fast-Ship product — see page 766

# FREQUENCY, FUNCTION & WAVEFORM SYNTHESIZERS

1 Hz–20 MHz Pulse/Function Generator

Model 8111A

425

- Sine, triangle, square, haversfunctions
- 20 MHz, 32 Vpp for all waveforms
- Variable duty cycle or pulse width

- Trigger, gate, VCO and optional burst
- Digital display for all parameters
- Error recognition

Picture shows 8111A with Option 001, Counted Burst.



The HP 8111A combines pulse generator and function generator capabilities in a single, compact unit. Triggered operation for all waveforms, and the ability to define rectangular waveforms in terms of pulse width or duty cycle, are examples of the HP 8111A's versatility.

## Saves Space and Equipment

Small size and manifold capability make the HP 8111A an ideal source for service and bench. Digital display, error detector and good repeatability assure high operating confidence. This reduces the need for output monitoring and consequently saves equipment.

## Flexible

Operating modes include VCO which permits frequency-shift keying and dc-to-frequency conversion as well as sweep and FM applications. Option 001's Burst mode simplifies tone burst generation and digital preconditioning by generating a precise number of waveform cycles. An "extra cycle" feature activated after a burst allows critical events to be examined.

Pulse mode's variable width down to 25 ns and clean 10 ns transitions provide useful digital test capability. High analog flexibility is assured because all waveforms can be generated in trigger, gate and burst modes. Adjustable duty cycle up to 999 kHz means that CRT sawtooth waveforms and rectangular signals for dc motor control can be simulated.

## Specifications (50-ohm load resistance)

### Waveforms

sine, triangle, ramp, square, pulse, haversfunctions.

### Timing

#### Frequency

**Range:** 1.00 Hz to 20.0 MHz (3-digit resolution).

**Accuracy (50% duty cycle):** 5% ( $\pm 10\%$  below 10 Hz).

**Jitter:**  $< 0.1\% + 50$  ps.

**Stability:**  $\pm 0.2\%$  (1 hour),  $\pm 0.5\%$  (24 hours).

#### Duty Cycle (sine, triangle, square, haversfunctions):

	Calibrated	Variable (below 1 MHz)
Range:	50% nominal	10% to 90%.
Resolution:	2 digits	2 digits.
Accuracy:	$\pm 1$ digit	$\pm 6$ digits ( $\pm 3$ in range 20 to 80%).

#### Pulse Width

**Range:** 25.0 ns to 100 ms (3-digit resolution).

**Accuracy:**  $\pm 5\% \pm 2$  ns.

## Output Characteristics

(voltages double into high impedance)

### Amplitude

**Range:** 1.60 mVpp to 16.00 Vpp (3½ digit resolution).

**Accuracy:**  $\pm 5\%$  (at 1 kHz for sine and triangle).

**Flatness (sine, triangle):**  $\pm 3\%$  ( $+10\%$ ,  $-15\%$  above 1 MHz).

### Offset

**Range:** 0.00 mV to  $\pm 8.00$  V (3-digit resolution).

**Accuracy:**  $\pm 5\%$  setting  $\pm 2\%$  amplitude  $\pm 20$  mV

(ampl  $\geq 160$  mVpp),

$\pm 5\%$  setting  $\pm 2\%$  amplitude  $\pm 1$  mV

(ampl  $< 160$  mVpp).

**Distortion:** THD (1 Hz–1 MHz)  $< 3\%$  ( $-30$  dB); harmonics

(1 MHz–20 MHz)  $< -26$  dB. Distortion may increase by 3 dB below  $10^\circ\text{C}$  and above  $45^\circ\text{C}$ .

**Linearity (triangle):**  $< \pm 3\%$  ( $< \pm 1\%$  below 1 MHz)

### Pulse and Squarewave Performance

**Transitions:**  $< 10$  ns.

**Perturbations:**  $< \pm 5\%$  ( $< \pm 10\%$  below 0.16 Vpp).

**Output impedance:**  $\pm 50$  ohm  $\pm 5\%$ .

### Modes

normal, trigger\*, gate\*, VCO and (Option 001) burst\*.

\*Adjustable start-phase for haversine, haverstriangle

**VCO range:** 2 decades, ext. signal 0.1 V to 10 V (dc to 1 kHz).

**Burst length:** 1 to 1999 periods for all waveforms.

### General

**Repeatability:** factor 2.5 better than accuracy.

### Environmental

**Storage temperature:**  $-40^\circ\text{C}$  to  $+75^\circ\text{C}$ .

**Operating temperature:**  $0^\circ\text{C}$  to  $55^\circ\text{C}$ .

**Humidity:** 95% RH,  $0^\circ\text{C}$  to  $40^\circ\text{C}$ .

**Power:** 100/120/220/240 V rms;  $+5\% - 10\%$ ; 48 to 440 Hz; 70 VA max.

**Weight:** net, 4.6 kg (10 lb). Shipping, 6.6 kg (15 lb).

**Size:** 89 H x 212.3 W x 345 mm D (3.5" x 8.36" x 13.6").

### Ordering Information

HP 8111A Pulse/Function Generator

Opt. 001: Burst

Opt. 910: Extra Operating and Service Manual

HP 5061-9701: Bail Handle Kit

HP 5061-9672 Rack Mount Kit (single HP 8111A)

HP 5061-9674 Rack Mount Kit (two instruments)

HP 5061-9694 Lock Link Kit (for use with HP 5061-9674)

### Price

\$2500

add \$480

add \$39

\$38

\$51

\$31

\$25

Fast-Ship product—see page 766

# FREQUENCY, FUNCTION & WAVEFORM SYNTHESIZERS

## Function Generator

### Model 3312A

- Two function generators in one instrument
- AM-FM, sweep, trigger, gate and burst (internal and external)

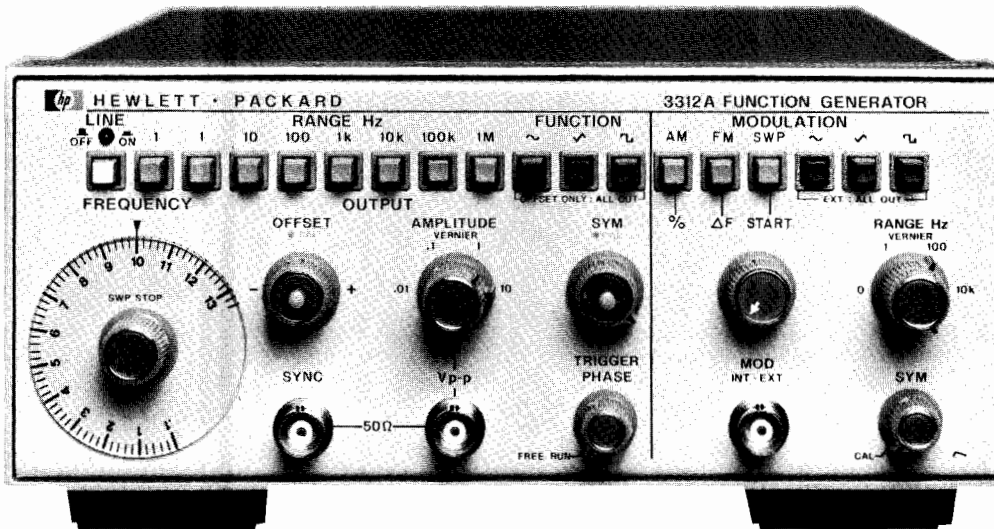

HP 3312A

### Description

Hewlett-Packard's 3312 A Function Generator combines two separate, independent function generators with a modulator section in one compact instrument.

The main generator can—via pushbutton control—be triggered by the modulation generator to provide sweep functions, AM, FM or tone burst.

Ten Vp-p into 50  $\Omega$  provides adequate power for most applications. The output attenuator has a range of more than 10,000:1 so clean low-level signals from 10 V to 1 mVp-p into 50  $\Omega$  can be obtained. The main generator includes dc offset up to 10 volts p-p into 50  $\Omega$ .

The HP 3312A is an effective low cost solution for generating a multitude of functions.

### Specifications

**Output waveforms:** Sine, square, triangle,  $\pm$  ramp, pulse, AM, FM, sweep, triggered and gated.

#### Frequency Characteristics

**Range:** 0.1 Hz to 13 MHz in 8 decades ranges.

**Dial accuracy:**  $\pm 5\%$  of full scale. Unspecified in Uncal Mode.

**Square wave rise or fall time (10% to 90%):** <20 ns.

**Aberrations:** <10%.

**Triangle linearity error:** <1% at 100 Hz.

**Variable symmetry:** 80:20:80 to 1 MHz.

**Sine wave distortion:** <0.5% (-46 dB) THD from 10 Hz to 50 kHz. (10 kHz range maximum). >30 dB below fundamental from 50 kHz to 13 MHz, at full-rated output.

#### Output Characteristics

**Impedance:** 50  $\Omega$   $\pm 10\%$ .

**Level:** 20 Vp-p into open circuit, >10 Vp-p into 50  $\Omega$  at 1 kHz.

**Level flatness (sine wave):**  $<\pm 3\%$  from 10 Hz to 100 kHz at full rated output (1 kHz reference).  $<\pm 10\%$  from 100 kHz to 10 MHz.

**Attenuator:** 1:1, 10:1, 100:1, 1000:1 and >10:1 continuous control.

**Attenuator error:** <5%.

**Sync output:** Impedance: 50  $\Omega$   $\pm 10\%$ , >1 Vp-p square wave into open circuit. Duty cycle varies with symmetry control.

**DC offset:** Variable up to  $\pm 10$  volts. Instantaneous ac voltage + Vdc offset cannot exceed  $\pm 10$  V (open circuit) or  $\pm 5$  V (terminated 50 ohm).

#### Modulation Characteristics

**Types:** Internal AM, FM, sweep, trigger, gate or burst; external AM, FM, sweep, trigger, gate or burst.

**Waveforms:** Sine, square, triangle, ramp or variable symmetry pulse.

**Frequency range:** 0.01 Hz to 10 kHz.

**Output level:** >1.0 Vp-p into 10 k $\Omega$ .

#### Amplitude Modulation

**Depth:** 0 to 100%.

**Modulation frequency:** 0.01 Hz to 10 kHz (internal). DC to >1 MHz (external).

**Carrier 3 dB bandwidth:** <100 Hz to >5 MHz.

**Carrier envelope distortion:** <2% at 70% sine wave modulation with  $f_c = 1$  MHz,  $f_m = 1$  kHz.

**External sensitivity:** <10 Vp-p for 100% modulation.

#### Frequency Modulation

**Deviation:** 0 to  $\pm 5\%$  (internal).

**Modulation frequency:** Internal: 0.01 Hz to 10 kHz; external: DC to >50 kHz.

**Distortion:** <-35 dB at  $f_c = 10$  MHz,  $f_m = 1$  kHz, 100 KHz peak deviation.

#### Sweep Characteristics

**Sweep width:** >100:1 on any range.

**Sweep rate:** 0.01 Hz to 10 kHz, 90:10 ramp, and 0 Hz Range (provides manual setting of "Sweep Start" without modulation generator oscillating).

**Sweep mode:** Repetitive linear sweep between start and stop frequency settings. Retrace time can be increased with symmetry control.

**Ramp output:** 0 to >-4 V into 5 k $\Omega$ .

#### Gate Characteristics

**Start/stop phase range:** +90° to -80°.

**Frequency range:** 0.1 Hz to 1 MHz (useful to 10 MHz).

**Gating signal frequency range (external):** DC to 1 MHz, TTL compatible.

#### External Frequency Control

**Range:** 1000:1 on any range.

**Input requirement:** With dial set at 10, 0 to -2 V  $\pm 20\%$  will linearly decrease frequency >1000:1. An ac voltage will FM the frequency about a dial setting within the limits (0.1 < f < 10) x range setting.

**Linearity:** 0.5% of Fmax for Fmax  $\leq 1$  MHz 5.0% of Fmax for Fmax > 1 MHz. Deviation is from a best fit straight line. VCO frequency span  $\leq 100:1$ .

**Input impedance:** 2.8 k $\Omega$   $\pm 5\%$ .

#### General

**Operating temperature:** 0°C to +55°C; specifications apply from 0°C to 40°C.

**Storage temperature:** -40°C to +75°C.

**Power:** 100 V, 120 V, 220 V, 240 V +5%, -10%, switchable; 48 Hz to 440 Hz;  $\leq 30$  VA.

**Size:** 102 mm H x 213 mm W x 377 mm D (4" x 8.4" x 14.8").

**Weight:** Net, 3.8 kg (8.4 lb). Shipping, 5.9 kg (13 lb).

#### HP 3312A Function Generator

**Option W30:** Extended Warranty

**Fast-Ship product** — see page 766.

**\$1,450**

**\$80**



# FREQUENCY, FUNCTION & WAVEFORM SYNTHESIZERS

## 1 MHz to 20 MHz Function Generator with Arbitrary Waveforms

### Model 3314A

427

- Lin/Log sweeps
- AM/FM/VCO
- Phase lock  $\times N$  and  $\div N$

- Gate and counted burst
- 1/2 cycle mode
- Arbitrary waveform generator



HP 3314A

### HP 3314A Multi-Waveform Generator

The HP 3314A is a Function/Waveform Generator with the precision and versatility to produce numerous waveforms. Its feature set includes accurate sine, square, and triangle waves, with ramps and pulses available using variable symmetry. Additional features include counted bursts, gate, lin/log sweeps, AM, FM/VCO, dc offset, and phase lock. For increased versatility, the Arbitrary waveform mode allows a countless number of user defined waveforms. Since complete programmability is provided, all of these capabilities are available for ATE systems, as well as bench applications.

### Precise Functions

The HP 3314A provides sine, square, and triangle waveforms from 0.001 Hz to 19.99 MHz with an amplitude range of 0.01 mV to 10 V<sub>p-p</sub> into 50 ohms, with optional 30 V<sub>p-p</sub> into > 500 ohms.

Continuous waveforms are provided with high accuracy and low distortion, with frequency accuracy on the upper ranges of 0.01% and sine distortion < -55 dBc to 50 kHz.

Pulses and ramps are provided to 2 MHz using the variable symmetry control over the full 5% to 95% symmetry range. This provides narrow pulses with 9 ns rise/fall times for digital circuit testing, and positive or negative ramps for amplifier testing and process control.

Independent dc offset to  $\pm 5$  V (into 50 ohms) can be added to any ac signal. A post-attenuator summing technique is used to provide large ac signals with small offsets and vice versa.

### Burst and Gate

The HP 3314A's N Cycle burst mode generates an integer number of complete cycles at each trigger. Bursts of 1 to 1999 cycles are possible for use in applications ranging from sonar testing to digital circuits. Variable symmetry and start/stop phase can be used to produce single ramps and haverwaves.

Like burst mode, gate mode can be triggered internally or externally. In gate, the HP 3314A output consists of complete cycles, pulses or arbitrary waveforms which start when the trigger is true, and stop after the trigger goes false. In gate and burst modes, the full frequency range applies for sine, square, triangle, pulse, and ramp waveforms.

### New 1/2 Cycle and "Integer" Phase Lock Modes

The new 1/2 Cycle burst mode allows simulation of specialized signals found in electronics. At each trigger, alternating 1/2 cycles of sines or triangles are produced. With the addition of variable start/stop phase and symmetry, pulses with variable rise/fall time and overshoot can be produced. Repetition rate, 1/2 cycle frequency, symmetry, and phase can be set independently to produce a variety of waveforms.

The  $\text{Fin} \times N$  and  $\text{Fin} \div N$  modes provide powerful phase locking capability. With "integer" phase lock, fractions or multiples of the reference signal can be provided, and  $\pm 200$  deg of phase offset is available. Since the HP 3314A phase locks to the plus or minus edge of the trigger signal, it can lock to a variety of signals such as sines, squares, pulses, ramps, and others—with complete control of output function, symmetry, N, phase, amplitude and offset.

### Modulation and Sweep

Complete AM, FM/VCO modulation give the HP 3314A versatile signal modifying capabilities. With 100 kHz bandwidths, AM and FM/VCO can be used separately or simultaneously to produce a multitude of waveforms.

Multi-frequency measurements can be made with the HP 3314A's sweep capabilities. Linear, logarithmic, and manual sweep make measurements of filters, amplifiers, and other networks convenient and accurate. X drive, marker, and trigger output signals are also provided.

### Arbitrary Waveforms

For specialized low frequency applications, the HP 3314A's Arbitrary (ARB) waveform mode lets you create custom waveforms as a series of voltage ramps or vectors. Values are easy to enter from the front panel using the modify knob as a "pencil" and an oscilloscope as a "pad". For remote programming, use a desktop or mainframe computer to calculate the values, then program them using the HP-IB. Arbitrary waveforms are automatically stored in non-volatile memory for quick recall.

### Two Sources in One

A square wave trigger source is included for generation of complex waveforms with a single HP 3314A. The 0.5 MHz to 500 kHz internal trigger is useful in gated, burst, and phase locked waveforms. This signal is provided as an output for synchronizing the HP 3314A to other devices.

### Source for your System

Because all front panel controls are programmable, the HP 3314A's precision and versatility can be utilized in automated test systems.

System efficiency can be improved with standard features such as Service Request (SRQ) interrupt capability and buffered transfer mode.

In production test environments, the HP 3314A's Query commands can be used when an operator and computer are sharing control of the instrumentation. Parameters can be read from the HP 3314A into the computer where its computational capabilities can be utilized.



# FREQUENCY, FUNCTION & WAVEFORM SYNTHESIZERS

## 1 MHz to 20 MHz Function Generator with Arbitrary Waveforms (cont'd)

### Model 3314A

#### SAMPLE WAVEFORMS

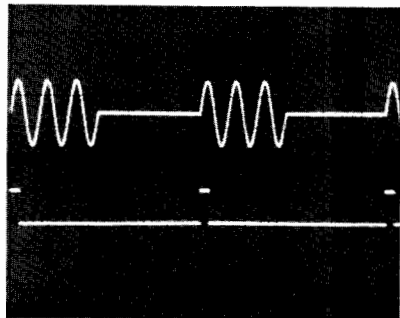

Counted burst with ext. trigger

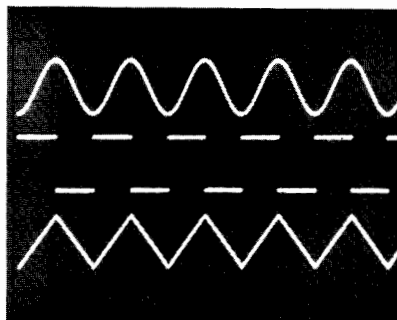

Sine, square, and triangle to 20 MHz

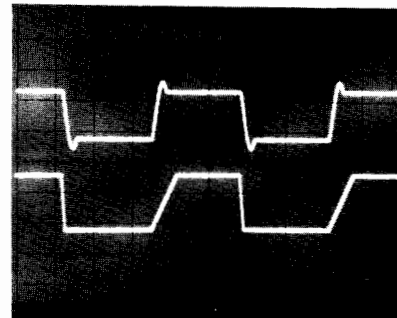

1/2 cycle mode simulating overshoot and variable rise/fall pulses

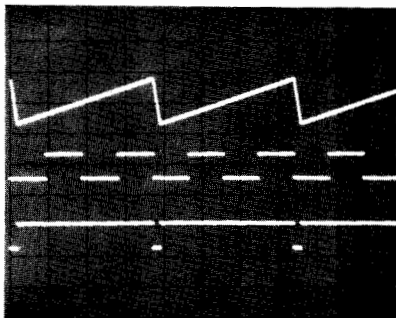

Ramp output phase locked to internal trigger. Shown with sync output.

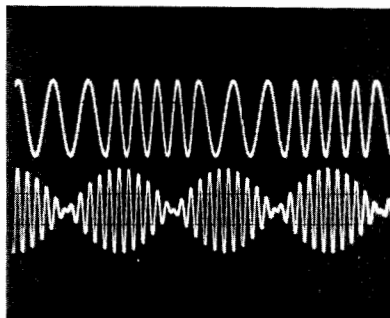

FM and AM (suppressed carrier)

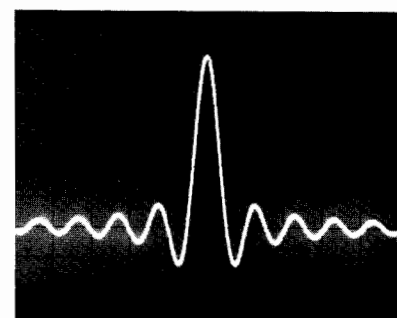

$\frac{\text{sine } x}{x}$  arbitrary waveform

#### Arbitrary Waveforms Made Easy

With complete control of each vector, the modify knob is used as a "pencil" to draw the waveform on an oscilloscope.

1. After ~20 unit vectors have been inserted, use modify to set the marker, VMKR, to #1. Then set the height of #1 to 400.

2. Press V LEN and use modify to set the length to 3.

3. Press V HGT twice, and set the height of #2 to -190.

4. Continue to use V HGT and V LEN to create the desired waveform, and INS (insert) or DEL (delete) vectors as needed. Amplitude and frequency can now be set without affecting the vector values. Waveform parameters are automatically stored in non-volatile memory while they are being created.

5. Later, if a slightly different waveform is needed, just use the marker to select an individual vector, and modify its height and length without affecting the height and length of other vectors!

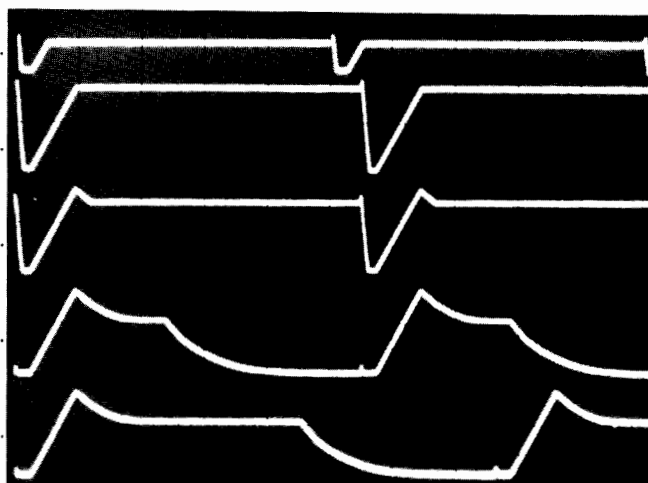

#### Specifications

##### Frequency

**Frequency range:** 0.001 Hz to 19.99 MHz-sine, square and triangle waveforms, 0.001 Hz through 2 MHz range when symmetry  $\neq$  50%.

**Resolution:** 3½ digits.

##### Frequency Accuracy

HP-IB #	Range	Minimum Frequency		Maximum Frequency	Accuracy
		Range Hold	Autorange		
1	2 Hz	.001 Hz	.001 Hz	1.999 Hz	±(0.4% setting + 0.2% range)
2	20 Hz	0.01 Hz	1.50 Hz	19.99 Hz	
3	200 Hz	00.1 Hz	15.0 Hz	199.9 Hz	±(0.2% setting + 0.1% range)
4	2 kHz	001. Hz	150. Hz	1999. Hz	
5	20 kHz	0.01 kHz	1.50 kHz	19.99 kHz	
6	200 kHz	00.1 kHz	15.0 kHz	199.9 kHz	
Synthesized					
7	2 MHz	001. kHz	150. kHz	1999. kHz	±(0.01% setting +50 ppm/year)
8	20 MHz	0.01 MHz	1.50 MHz	19.99 MHz	

Accuracy applies in the Free Run mode, with VCO Off, and Symmetry = 50% (Fixed).

##### Amplitude

**Amplitude range:** 0.01 mVp-p to 10 Vp-p into 50 Ω.

**Resolution:** 3½ digits.

HP-IB #	Range	Minimum	Maximum	Step Attenuator
1	10 mV	0.00 mV	10.00 mV	60 dB
2	100 mV	10.0 mV	100.0 mV	40 dB
3	1 V	.100 V	1.000 V	20 dB
4	10 V	1.00 V	10.00 V	0 dB

**Absolute Amplitude Accuracy** 10 kHz, 1.00-10.00 Vp-p, Auto-range ON

±(1% of display + 0.035 Vp-p), sine and square wave.

±(1% of display + 0.06 Vp-p), triangle.

**Flatness-sine wave:** Relative to 10 kHz, 1.00 V to 10.0 V (Range 4).

20 Hz	50 kHz	1 MHz	19.99 MHz
.07 dB	.33 dB	1.5 dB	

**Frequency Sweep**

	Range (decades)	Start Freq	Stop Freq	Sweep Time
linear	0 to 2	≥.001 Hz	≤19.99 MHz	7.2 ms to 1999 s/sweep
log	1 to 7 (integer only)	≥0.2 Hz	≤19.99 MHz	40 ms to 1999 s/decade

**Manual Sweep**

Modify knob tunes between start and stop frequencies. X drive follows sweep.

**X Drive Start/Stop Voltage**

-5 V to +5 V into 1 kΩ load.

**Z Axis Output**

Blanking Pulse, > +5 V.

Baseline, 0V ± 1 V.

Marker Pulse, < -5 V into 1 kΩ load.

**Modulation Inputs**

	Bandwidth	Sensitivity	Range	Z
AM	dc to 100 kHz	2 Vp-p for 100% -1 Vdc for suppressed carrier	>100%	10 kΩ
FM	100 Hz to 100 kHz	±1 Vp for ±1% of range deviation	1% of Freq. range	10 kΩ
VCO	dc to 100 kHz	10%/volt	+1 to -10V	10 kΩ

**Waveform Characteristics**

**Sine Harmonic Distortion**

Individual harmonics will be below these levels, relative to the fundamental. Offset = 0V. Function Invert = OFF. Range Hold = OFF.

20 Hz	50 kHz	1999 kHz	19.99 MHz
-55 dB*	-40 dB	-25 dB	

\*add 4 dB for ambient temperature 0 to 5°C and 45 to 55°C, 20 Hz to 50 kHz

**Square Wave Rise/Fall Time**

< 9 ns, 10% to 90% at 10 Vp-p output.

**N Integer**

N = 1 to 1999, Preset to 1.

For Phase-lock  $F_{in} \div N$ ,  $F_{in} \times N$

or N CYCLE (counted burst).

**Function Invert**

Inverts ac portion of signal outputs.

Sine, square, triangle, ramp, pulse, and ARBs.

Does not affect Sync and Trigger outputs or dc offset setting.

**Phase**

**Phase Offset—Phase Lock Modes**

**Resolution:** 0.1°.

**Range:** ±199.9°.

**Accuracy:** ±2° (50 Hz to 25 kHz).

**Phase Offset is Referenced to**

Signal output for  $F_{in} \div N$ .

Signal input for  $F_{in} \times N$ .

**Start/Stop Phase—Burst Modes**

**Resolution:** 0.1°.

**Range:** ±90.0° for frequencies to 19.99 MHz.

**Accuracy:** ±3° (applies from .001 Hz to 1 kHz).

**Trigger**

**Internal Trigger**

**Range:** .002 ms (500 kHz) to 1999 s (0.5 mHz) square wave.

**Period Accuracy:**

± (0.01% + 50 ppm/year) of displayed interval (excluding sweep intervals).

**Trigger output:** Low <0.5 V, high > 2.5 V; output resistance 1 kΩ.

**External Trigger**

For Gate, N Cycle, ½ Cycle,  $F_{in} \times N$ ,  $F_{in} \div N$ , and external sweep triggers.

**Frequency range:** 50 Hz to 20 MHz.

**Trigger slope:** Selectable, positive or negative.

**Trigger level:** Selectable to 0 V or +1 V.

**Trigger level hysteresis:** ±0.15 V.

Input resistance = 1 kΩ.

**Symmetry**

**Symmetry range:** 5% to 95% of period.

**Frequency range:** 2 Hz to 2 MHz ranges.

**Arbitrary Waveforms**

Output consists of a series of voltage ramps called vectors. Arbitrary waveforms can be composed of 2 to 150 vectors. A maximum of 160 vectors can be stored in six available storage registers with a minimum of 2 vectors per waveform (#1 and return-to-start vectors).

**Waveform Parameters**

Key	Range	Description
Δt	0.2 ms to 19.99 ms	sets the time value for each unit of V LEN (length)
V HGT	0 to ±1999	sets the relative height of an individual vector
V LEN	1 to 127	sets the length in time of an individual vector in integral multiples of Δt
V MKR	1 to 150	marker is used to select an individual vector
INS		insert is used to add a vector immediately after the marker location
DEL		deletes the vector at marker location
FREQ	.002 Hz to 2.5 kHz	$Freq = \frac{1}{\Delta t(VLEN_1 + VLEN_2 + \dots VLEN_n)}$
AMPTD	.01 mV to 10 Vp-p	sets amplitude window for ARB waveform
OFFSET	0 to ± 5 Vdc	offsets the ARB waveform independent of AMPTD setting
PHASE	+90° to -90°	sets wave start/stop voltage within the window defined by AMPTD

**Marker output:** Located on Z axis rear panel connector.

**Sync output:** Low during the return-to-start vector.

**Gate mode:** Allows external gating of ARB output (complete ARB waveforms only).

**Option 001 - Voltage Multiplier**

Simultaneous ×3 amplitude output on rear panel (into >500 Ω).

30 Vp-p max, dc to 1 MHz.

**General**

**Specifications Apply When**

Main signal output terminated into 50 ± 0.1 Ω.

Warm-up > 30 minutes.

Within ±5°C and 24 hours of last internal calibration.

**Temperature:** 0 to 55°C.

**Relative humidity:** <95% at 40°C.

**Altitude:** <15,000 ft.

**Storage temperature:** -40 to +75°C.

**Power**

100/120/220/240 V + 5% -10%, 48 to 66 Hz

95 VA maximum.

**Weight:** Net, 7.3 kg (16 lb). Shipping, 10.5 kg (23 lb).

**Dimensions:** 132.6 mm (5.22 in.) H x 212.3 mm (8.36 in.) W x 419.0 mm (16.50 in.) D.

**HP-IB**

IEEE Standard 488-1978 abbreviated definition.

SH1 AH1 T6 TE0 L3 LE0 SR1 RL1 PP0 DC1 DT1 C0 E2.

**Accessories**

Transit case for one HP 3314A.

HP P/N9211-2677.

**Ordering Information**

**HP 3314A Function Generator**

**Opt 001:** Simultaneous X3 Output

**Opt W30:** Extended Warranty

**Price**

**\$4,485**

\$255

\$190

# FREQUENCY, FUNCTION & WAVEFORM SYNTHESIZERS

## Universal Source

HP 3245A

- Precision DC Outputs with 6½ Digits of Resolution
- Synthesized AC With 0.4% Amplitude Accuracy
- Sine, Square, Triangle, and ARB to 1 MHz
- Ramp and Pulse to 100 KHz
- Non volatile storage of up to 14 setups
- Second Channel Output Available
- Phase Continuous Frequency Changes
- Optional Software for Waveform Modification

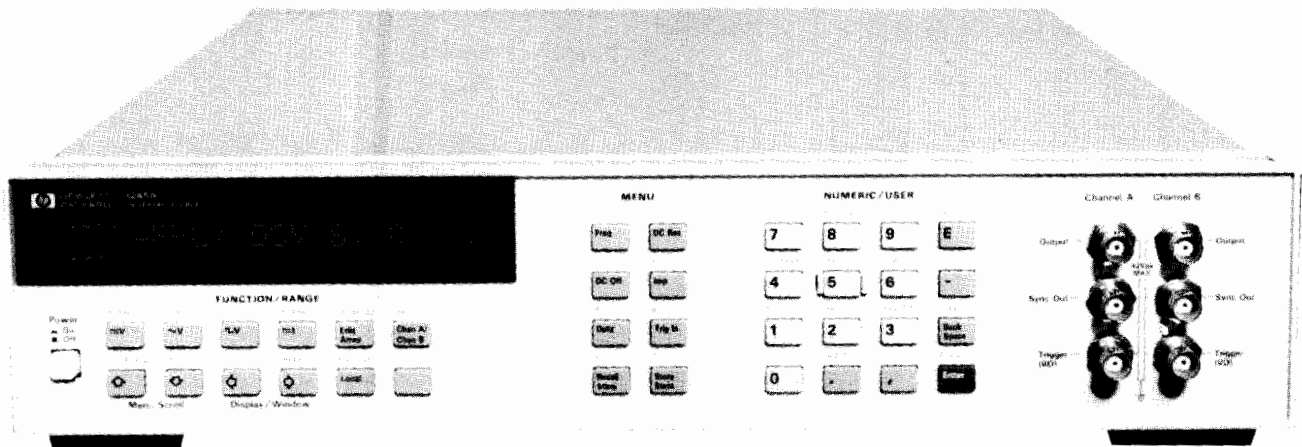

Model 3245A



### Description

The HP 3245A Universal Source offers a unique mix of precision DC capabilities with versatile AC performance, including arbitrary waveform generation. This versatility can be put to advantage on the bench, where the HP 3245A may well be all the source you will ever need. The HP 3245A can also fit into your Computer Aided Test System, providing the capabilities of AC, DC, and second channel options in a single 3.5" tall instrument.

#### Precision DC

The HP 3245A provides precision DC outputs of both voltage and current. In the high-resolution mode, you get 24-bit resolution with 60 ppm, 90-day accuracy. The low-resolution mode provides 12-bit resolution with 100 usec settling times. This type of precision means you can use the HP 3245A to test A/D converters, Voltage to Frequency converters, VCO's, transducers, and anywhere that a highly accurate DC voltage or current is required. There are two output ranges in the high resolution mode;  $\pm 1$  volt and  $\pm 10$  volts. In the low resolution mode, there are 7 ranges. In current, there are four ranges of output, from 0.1 mA to 100 mA. Output impedance is selectable as either zero ohms or 50 ohms.

#### Accurate AC

The HP 3245A can generate AC voltage outputs, including sine, triangle, and square waves, at frequencies of up to 1 MHz. Variable duty-cycle pulse and ramp outputs can be generated at up to 100 kHz. In the AC mode, the HP 3245A can make phase continuous frequency changes "on-the-fly". All AC waveforms are synthesized, and have 0.001 Hz resolution and 50 ppm frequency accuracy. 90-day amplitude accuracy for Sine, Ramp, and ARB is 0.35% of output + 0.41% of range.

#### Second Channel Option

The addition of a second channel allows for the generation of two waveforms, either independent, or phase related to one another. The second channel output can be phase synchronized to the first channel, or to an external input. Such capabilities are especially useful if you are doing modem testing, tone sequence generation, DTMF generation, or FSK generation, or anywhere where two outputs are required.

#### Arbitrary Waveform

The HP 3245A offers arbitrary waveform operation at a full 1 MHz bandwidth. This is accomplished by a sampling technique whereby the values loaded into RAM are sampled at approximately 4.3 MHz and then run through a 1.25 MHz 5-pole low-pass filter. This allows full 1 MHz rep rate while maintaining 0.001 Hz resolution at any frequency. The HP 3245A can also store multiple arrays that can be accessed for arbitrary waveform generation. Array depth is 2048 bytes.

#### Waveform Generation Software

A powerful software package, useful for creating specialized waveforms, is available as an option to the HP 3245A. This menu driven software facilitates the capture of a waveform using a separate hardware digitizer, such as the HP 3458A. The waveform can then be modified, if desired. The waveform can then be played back via the HP 3245A. The use of a graphics tablet makes the modifying of waveforms especially easy. The software also contains a library of standard waveforms which can be used as is, or mixed with other waveforms to generate complex outputs.

#### System Operation

The HP 3245A includes features that make it especially powerful in system applications. Because it contains many BASIC-like constructs, such as IF . . THEN and FOR . . NEXT, it is possible to have the HP 3245A do much of the work that normally would require intervention from the host computer. Now, subroutines can be downloaded to the HP 3245A, which can then run stand-alone, minimizing host computer interaction. Built in math capabilities add to the power of the HP 3245A. Electronic calibration is both easy and accurate, and does not require that the instrument be removed from a rack or opened up to perform a calibration.

All the above features combine to make the HP 3245A a truly universal source, combining precision DC outputs, accurate AC waveforms, and arbitrary waveform capabilities, all in a single instrument.

**DC Volts Output****High Resolution Mode**

Range	0 $\Omega$ Mode Resolution	50 $\Omega$ Mode Resolution
1V	1 $\mu$ V	.5 $\mu$ V
10V	10 $\mu$ V	5 $\mu$ V

**Low Resolution Mode**

Range	0 $\Omega$ Mode Resolution	50 $\Omega$ Mode Resolution
.078125V	—	40 $\mu$ V
.15625V	79 $\mu$ V	79 $\mu$ V
.3125V	157 $\mu$ V	157 $\mu$ V
.625V	313 $\mu$ V	313 $\mu$ V
1.25V	625 $\mu$ V	625 $\mu$ V
2.5V	1250 $\mu$ V	1250 $\mu$ V
5V	2.5 mV	2.5 mV
10V	5.0 mV	—

**Noise and spurious responses (to 250 kHz):**

	Peak-to-Peak	RMS
High Resolution Mode	2mV	.6mV
Low Resolution Mode	.2% of range + 2 mV	.02% of range + 60 $\mu$ V

**Current Compliance:** 100 mA on all ranges**Settling Time (Delay 0):****High Resolution Mode:**

- .1% of step: 20 mSEC
- .001% of step: 40 mSEC
- (1 SEC if function changed)

**Low Resolution Mode:**

- .1% of step (0  $\Omega$  Mode): 100  $\mu$ SEC
- (50  $\Omega$  Mode): 25  $\mu$ SEC
- .5% of step (50  $\Omega$  Mode): 5  $\mu$ SEC

**Overshoot:**

- High Resolution Mode: <5% of step + .15% of range
- Low Resolution Mode: <30% of step + 2% of range

**24 Hour: Tcal  $\pm$  1C**

Range	High Resolution Mode	Low Resolution Mode
10 V	0.0007% + 85 $\mu$ V	0.09% of Output + .02% of range
1 V	0.0008% + 15 $\mu$ V	(for all ranges)

**DC Volts Accuracy** (<10 Hz noise):  $\pm$  (% of programmed output + volts), impedance mode, >1Mohm load. Tcal is the temperature of calibration from 18°C to 28°C. One hour warm-up.

**90 DAY: Tcal  $\pm$  5°C**

High Resolution Mode		Low Resolution Mode	
Range	Accuracy	Range	Accuracy
10V	.0038% + 180 $\mu$ V	10V	.17% + 37mV
1V	.0042% + 31 $\mu$ V	5V	.17% + 19mV
		2.5V	.17% + 9.2mV
		1.25V	.17% + 4.6mV
		.625V	.17% + 2.5mV
		.3125V	.17% + 1.3mV
		.15625V	.17% + .73mV

**DC Current Output Resolution**

Range	High Resolution	Low Resolution
0.1mA	0.1nA	50nA
1mA	1nA	500nA
10mA	10nA	5 $\mu$ A
100mA	100nA	50 $\mu$ A

**90 DAY: Tcal  $\pm$  5C.** After one hour warm-up.

High Resolution Mode		Low Resolution Mode	
Range	Accuracy	Range	Accuracy
100mA	.0202% + 3.3 $\mu$ A	100mA	.32% + 400 $\mu$ A
10mA	.0074% + 220 nA	10mA	.30% + 52 $\mu$ A
1mA	.0052% + 20 nA	1mA	.25% + 3.8 $\mu$ A
0.1mA	.0052% + 3.3 nA	0.1mA	.25% + .38 $\mu$ A

**AC Volts Output Characteristics** (sine, square, ramp, arbitrary)**Frequency Range:**

- 0 to 1 MHz for sine, arbitrary and square (at 50% duty cycle)
- 0 to 100 kHz for ramp
- 0 to 100 kHz for square w/Duty cycle not equal to 50%

**Amplitude and/or Offset Resolution:**

Range (Peak-Peak)	50 $\Omega$ Mode Resolution	0 $\Omega$ Mode Resolution
.15625V	79 $\mu$ V	—
.3125V	157 $\mu$ V	157 $\mu$ V
.625V	313 $\mu$ V	313 $\mu$ V
1.25V	625 $\mu$ V	625 $\mu$ V
2.5V	1250 $\mu$ V	1250 $\mu$ V
5V	2.5 mV	2.5 mV
10V	5.0 mV	5.0 mV
20V	—	10.0 mV

Amplitude can be set from 10% to 100% of range.

**AC Amplitude Accuracy (Sine, Ramp, Arbitrary)**

- 24 Hour: Tcal  $\pm$  1C 0.16% of output + .25% of range
- 90 Day: Tcal  $\pm$  5C 0.29% of output + .36% of range

**Sinewave Characteristics (50  $\Omega$  Mode):**

Frequency	Harmonic and Spurious Levels (amp1 $\geq$ 50% of range)*	THD (amp1 $\geq$ 50% of range)	Flatness in reference to 1 kHz
<3kHz	< -62 dB	< -56 dB	.07 dB
to 10 kHz	< -62 dB	< -50 dB	.07 dB
to 30 kHz	< -55 dB	< -48 dB	.07 dB
to 100 kHz	< -46 dB	< -46 dB	.20 dB
to 300 kHz	< -40 dB	—	.60 dB
to 1 MHz	< -40 dB	—	2.00 dB

\*additional fixed spurious response >4MHz: 500  $\mu$ Vrms**Squarewave Characteristics (50  $\Omega$  Mode):**

- risetime: <250 nSEC, 10% to 90%
- settling time: <1  $\mu$ SEC to 1% of amplitude
- overshoot: < 5% of peak-to-peak amplitude
- duty cycle range: 5% to 95%, 0 to 100 kHz
- 50% above 100 kHz
- duty cycle accuracy:  $\pm$ (0.8% of period + 120nSEC)

**Frequency Resolution:** .001 Hz**Frequency Accuracy:**  $\pm$ 50 ppm, 18 to 28 C**Frequency Temperature Coefficient:**  $\pm$ 1 ppm/C**Phase Offset:**

- Range: -360 to +360 degrees
- Resolution: < .001 degrees

**Ramp Linearity to 1 kHz (50  $\Omega$  Mode):**

- .3% of p-p value measured @ 50% duty cycle from 10% to 90% point

**Ramp Duty Cycle Range:** 5% to 95% with < .1% resolution)**Ordering Information**

<b>HP 3245A</b> Universal Source	\$4200
<b>Option 001</b> Second Channel Output	\$2500
<b>Option 005</b> Waveform Generation Software	\$400
<b>Option 907</b> Front Handle Kit	\$51
<b>Option 908</b> Rack Flange Kit	\$31
<b>Option 909</b> Rack flange and Handle Combination Kit	\$73
<b>Option W30</b> Extended Warranty	\$126

# PULSE GENERATORS

## General Information

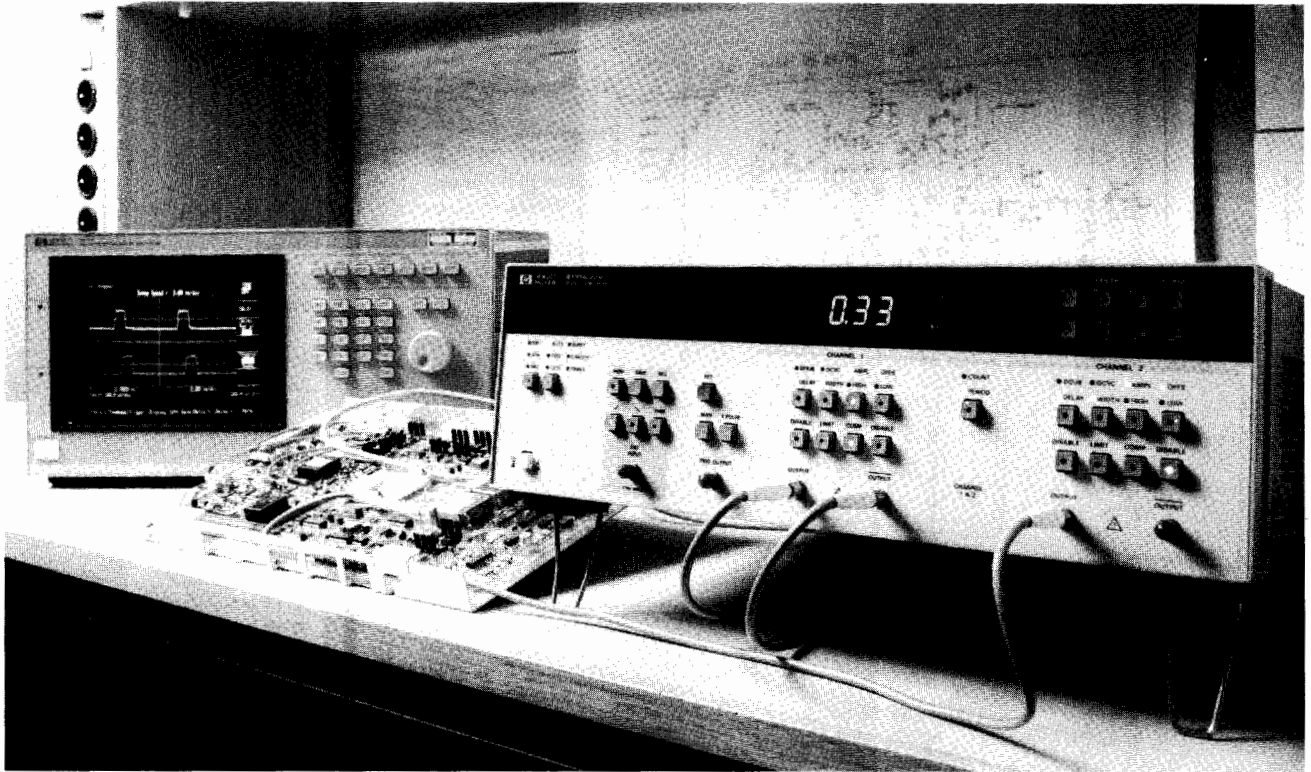

### Analog and Digital Test

HP's *pulse generators* range from simple, inexpensive units to high performance, microprocessor-based instruments offering precision pulse generation. Depending on model, variable clock speeds to 1 GHz and variable amplitudes up to 100 V are available.

Pulse parameters are independently variable for thorough characterization and worst-case testing. Variable pulse transitions permit parametric analysis like trigger circuit hysteresis, and the fastest settings are ideal for at-speed logic test and amplifier transient investigations.

*Pulse/function generators* combine pulse capability with all features expected of a function generator. The benefits are high flexibility for analog requirements plus an entry into logic test.

### Operating Comfort

Clear front panel layout, guided parameter selection, and error detection and recovery features, mean quick familiarization and rapid, error-free use. In addition, great emphasis is placed on ruggedness, reliability and serviceability. The generators are developed and produced using high quality standard components and custom-designed ICs. Resultant technical benefits are, for exam-

ple, broad operating temperature range and clean 50-Ohm output impedance.

Selectable polarity, complement and offset help make hook-up simpler and, for further flexibility, *inverters, adders and splitters* are available (page 444\*).

Complex waveform capability allows glitches, ringing and multi-level signals to be simulated. Constant numbers of pulses, unaffected by other parameters are available in HP's counted burst mode.

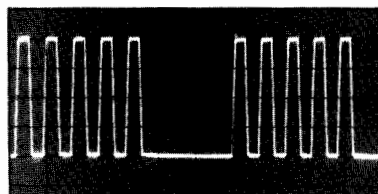

### Bench and Automatic Test

A new generation of very versatile models offer good repeatability and high operating comfort for fast, accurate testing. These instruments also offer HP-IB which makes bench automation a reality for time-consuming tests. Setup time is a minimum because the syntax is simple and uses the same command sequence as the front panel.

Straight-forward syntax helps develop ATS software quickly; good repeatability and error reporting eliminate the need for software measurement loops. Specified performance over the entire 0°C to 55°C operating temperature range guarantees reliability in system racks.

### Time Synthesis (page 445\*)

Time Synthesizers are mainly used in radar and laser ranging, component and circuit testing, and precise triggering and calibrating applications. They give a precisely timed output pulse with an accurate, adjustable delay which may be incremented in steps as small as 50 pico-seconds. A fixed, virtually jitter-free insertion delay allows phase locking to equipment under test.

### Technologies Covered

**CMOS:** HP 8011A, 8111A, 8112A, 8115A, 8116A, 8160A, 8165A

**HCMOS:** HP 8131A, 8161A

**TTL:** HP 8012B, 8013B, 8111A, 8112A, 8115A, 8116A, 8160A, 8165A

**LS-TTL:** HP 8082A, 8131A, 8161A

**ECL:** HP 8080A, 8082A, 8131A, 8161A

**GaAs:** HP 8131A

Pulse Generator Selection Chart

HP Model Page	Pulse Generators											Pulse/Function Generators		
	214B 441	8011A 442	8012B 442	8013B 442	8082A 443	8080A 444	HP-IB 8112A 434	HP-IB 8115A 435	HP-IB 8160A 438	HP-IB 8161A 438	HP-IB 8131A 436	8111A 425	8116A 423	8165A 422
Timing														
Max frequency (MHz)	10	20	50	50	250	300/1000	50	50	50	100	500	20	50	50
Transition time (ns)	15	10	5 var	3.5	1 var	0.8/0.3	5 var	6.5 var	6 var	1.3 var	0.2	10	6	5
Var width (ns) min	25	25	10	10	2	Sp Opt	10	10	10	4	0.5	25	10	10
Square/duty cycle (%)	1-10	Sq	Sq	Sq	Sq	Sq	1-99	1-99			1-70	10-90	10-90	20/50/80
Variable delay	•		•	•	•	•	•	•	•	•	•			
Output (max values are quoted: see specifications for conditions).														
Amplitude (V)	100	16	10	10	5	4/2.4	32	32	20	5	5	32	32	20
Offset/Window (V)			±2.5/±7.5	±2.5/±7.5	±2/±5	±2/±4	±16/±16	±16/±16	±20/±20	±5/±5	±2.5/±5	±16/±16	±16/±16	±10/±10
Format	+/-	•	•	•	•	•	•	•	•	•	•	•	•	•
• = positive, negative, symmetrical, normal and complement formats.														
Outputs	1	1	1	+ and -	1	Configurable	1	2	2-chan option	2-chan option	2-chan option	1	1	1
Channel addition														
Additional outputs					Compl					Compl	Compl			
Operating Modes														
Trigger	•	•	•	•	•	•	•	•	•	•	•	•	•	•
Ext width			•	•	•	•	•	•	•	•	•	•	•	•
Gate	•	•	•	•	•	•	•	•	•	•	•	•	•	•
Ext burst	Option	Option					•	•	•	•	•	Option	Option	•
Int burst													Option	
Double pulse	•		•	•	•	•		•	•	•	•			
Control (Modulation) Modes							•	•				•	•	•

Pulse Generator Definitions

**Time Reference Point:** Median (50% amplitude point on pulse edge).

**Pulse Period:** The time interval between the leading edge medians of consecutive trigger output pulses.

**Trigger Delay:** Interval between trigger point of input signal and the trigger output pulse's leading edge median. Applies in trigger, external width, gate and burst modes.

**Pulse Delay:** Interval between leading edge medians of trigger output pulse and output pulse.

**Double Pulse:** Interval between leading edge medians of the double pulse.

**Interchannel Delay/Skew:** Interval between corresponding leading edge medians.

**Pulse Width:** Interval between leading- and trailing-edge medians.

**Additional Information for Pulse Generators with Variable Transition Times**

**Pulse Width:** The specified and displayed value is that obtained with fastest edges; essentially equal to the interval from the start of the leading edge to the start of the trailing edge.

By designing so that the pulse edges turn about their start points, the interval from leading edge start to trailing edge start stays unchanged\* when transition times are varied. This is more convenient for programming and the width display is easy to interpret.

\*In practice, start points may shift with change in transition time.

**Delay:** The specified and displayed value is that obtained with the fastest leading edge. For a slower edge, the actual delay exceeds the displayed delay by the combined shift of start-point and median.

**Transition Time:** Interval between the 10% and 90% amplitude points on the leading/trailing edge.

**Linearity:** Peak deviation of an edge from a straight line through the 10% and 90% amplitude points, expressed as percentage of pulse amplitude.

**Jitter:** Short-term instability of one event with respect to another. Unless stated otherwise, value is p-p, expressed as a percentage of the main parameter.

**Stability:** Long-term average instability, expressed as percentage of main parameter over a specific time duration, e.g. hour, year. Excludes jitter.

**Pulse Level:** High level and low level. Any limitation is expressed by an amplitude specification.

**Pulse Amplitude (alternative to level definition):** Pulse amplitude and offset\* are specified. Any limitation is expressed by a window (max high level, min low level).

\*Pulse generators use baseline offset. Function generator outputs are symmetrical and consequently use median offset.

**Preshoot, Overshoot, Ringing:** Preshoot and overshoot are peak distortions preceding/following an edge. Ringing is the positive peak and negative peak distortion excluding overshoot, on pulse top or base. A combined preshoot overshoot, ringing specification of e.g. ± 5% implies:

- Overshoot/undershoot < 5%
- Largest pulse-top oscillation < ± 5% of pulse amplitude.

**Settling Time:** Time taken for pulse levels to settle within level specification, measured from 90% point on leading edge.

**Duty Cycle:** Percentage ratio of pulse width to period. In pulse/function generators, this term is also used to define sine and triangle symmetry.

**Output Impedance/Resistance:** Effective pulse source impedance/dc resistance.

**Reflection Coefficient:** Reflection at pulse generator output expressed in percent of incident pulse amplitude. (Test pulse edges correspond to generator's fastest transitions).

**Repeatability:** When an instrument operates under the same environmental conditions, and with the same settings, the value of a parameter will lie within a band inside the accuracy window. Repeatability defines the width of this band.

**HP-IB Programming Times**

**Listen Time:** The time an instrument occupies the bus to receive and verify a message. The NRFD signal is active during this period.

**Setting Time:** The time taken by the instrument to execute an HP-IB message, and for the output to settle within the accuracy specification. NRFD inactive.

**Execution Time:** The sum of Listen Time and Settling Time.

**Talk Time:** The time an instrument occupies the bus to output a specified string. Output data is typically instrument error status, or current or stored parameters.



# PULSE GENERATORS

## Programmable Low Cost Pulse Generator

### Model 8112A

- Full pulse capability
- Modulation
- Ramps and haversines
- Width/duty cycle
- Device protection
- Error recognition and self test

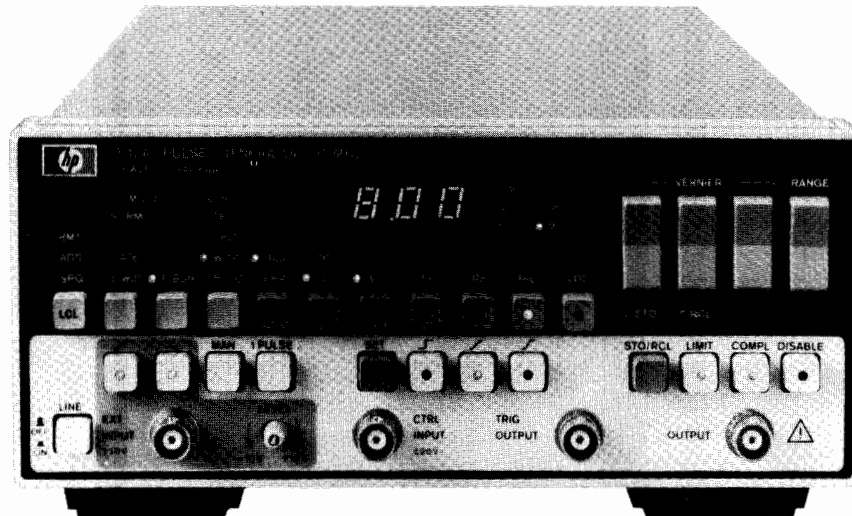

HP 8112A



The HP 8112A is a fully programmable 50 MHz pulse generator with 5 ns transitions and 32 V<sub>pp</sub> (into open circuit) max output amplitude. All pulse parameters are variable including delay and double pulse spacing.

Besides the comprehensive trigger modes, external modulation capabilities extend applicability. 3-level signals and upper level, width, period and delay-modulated signals are available. These can be combined with the trigger modes so that complex real-life signals like modulated bursts are simulated easily.

Step response and trigger hysteresis measurements require fast transitions or sawtooth signals as obtained in the HP 8112A's linear transition mode—either fixed 5 ns or variable from 6.5 ns. The new cosine transitions, also variable from 6.5 ns, mean that band-filtered signals are now just as simple to obtain.

Sensitive devices are protected by programming output limits and the upper level can be controlled by the device supply. Also, constant energy or constant width can be programmed.

Dual channel operation is feasible by operating HP 8112A's in a master/slave combination.

For really easy operation a green button gives error-free settings. A new softkey operating concept plus detailed error recognition make the HP 8112A's powerful versatility easy to handle.

### Specifications

Specifications apply with 50-ohm load, and temperatures in the range 0°C to 55°C.

#### Timing (specifications apply for min transition times)

**Period:** 20.0 ns to 950 ms.

**Delay:** 75.0 ns to 950 ms.

**Double pulse:** 20.0 ns to 950 ms.

**Width:** 10.0 ns to 950 ms.

**Accuracy:** ± 5% of progr value ± 2 ns (delay: ± 4 ns).

**Duty cycle:** 1% to 99% (Min: 10 ns. Max: period -10 ns).

Accuracy: ± 10% of progr value.

**Pulse Characteristics** (voltages double when driving into open circuit)

#### Levels

High level: -7.90 V to 8.00 V.

Low level: -8.00 V to 7.90 V.

Accuracy: ± 1% of progr value ± 3% amplitude ± 40 mV.  
Settling time: 100 ns + transition time.

#### Transition times

Fixed: 5 ns typical

Linear and Cosine: 6.5 ns to 95.0 ms (max edge ratio 1:20 within a 1.5-decade range. Ranges overlap by 0.5 decade).

Accuracy: ± 5% of programmed value ± 2 ns.

**Preshoot, overshoot, ringing:** ± 5% ± 10 mV (variable transitions), ± 10% ± 10 mV (fixed transitions).

**Output resistance:** 50 ohm ± 5%.

**Operating modes:** Normal, Trigger, Gate, Ext Width (pulse restoration), Ext Burst (1 to 1999 pulses).

#### Control (Modulation) Modes

**Period, delay, width** covered in 8 non-overlapping decades (max input frequency 8 kHz.).

**High level:** -8 V to +8 V, independent of progr low level (min input transition 200 μs).

#### General

**HP-IB:** all keys programmable. Learn, status and error reporting capability. Interface functions: SH1, AH1, T6, L4, SR1, RL1, PP0, DC1, DT1.

**Memory:** retains current operating state. 9 store/recall locations, 1 fixed set of parameters.

**Repeatability:** factor 4 better than accuracy.

#### Environmental

Storage temperature: -40°C to +65°C.

Operating temperature: 0°C to 55°C.

Humidity: 95% RH, 0°C to 40°C.

**Power:** 100/120/220/240 V rms; +5%; -10%; 48 to 440 Hz; 120 VA max

**Weight:** net, 5.9 kg (13 lb). Shipping, 8.0 kg (18 lb).

**Size:** 89 H x 212.3 W x 450 mm D (3.5" x 8.36" x 17.7").

#### Ordering Information

HP 8112A Programmable Pulse Generator\* \$5600

Opt. 910 Extra Operating and Service Manual add \$49

HP 5061-9701 Bail Handle Kit \$38

HP 5061-9672 Rack Mount Kit (single HP 8112A) \$51

HP 5061-9674 Rack Mount Kit (two instruments) \$31

HP 5061-9694 Lock Link Kit (for use with HP 5061-9674) \$25

\* HP-IB cables not supplied, see page 561

☎ Fast-Ship product—see page 766

# PULSE GENERATORS

## 50 MHz Dual Channel Pulse Generator

### Model 8115A

435

- Two 50 MHz output channels
- Variable transitions, width, delay
- Variable high and low level

- Channel addition mode
- Control capabilities
- CRT for convenient operation

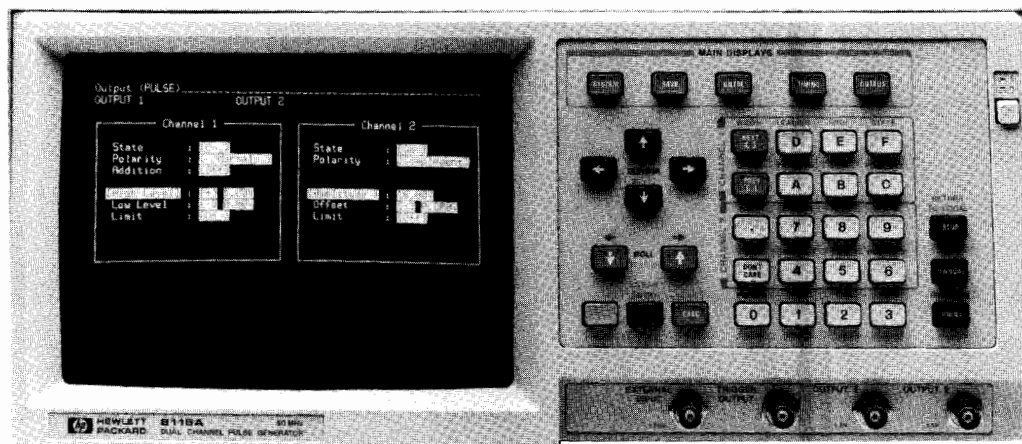

HP 8115A



### Bench and ATE-System suitable

The HP 8115A is a fully programmable 50 MHz dual channel pulse generator, which delivers pulse trains with up to 32 Vp-p into high impedance and variable transitions from 6.5 ns up to 95 ms.

The HP 8115A is suitable to operate as a stand-alone instrument or in an ATE-System. The specifications are for a wide temperature range, 0°C to 55°C, useful for ATE-Systems. Much higher accuracy is achieved in the limited temperature range 20°C to 30°C; this is useful for bench-top applications which require higher accuracy. The high and low level for each channel is independently programmable. The output voltages can also be programmed as amplitude and offset.

### Two Channels / Channel Addition

Two channels are available; they are designed as parameter-independent but synchronous outputs. With the delay capability, phase-shifted signals can be achieved. The two channels can be added, thus 3-level, 4-level signals or spikes can be created.

### Specifications

Specifications describe the instrument's warranted performance (30 minutes warm-up, 50-ohm load) at 0°C to 55°C [20°C to 30°C] ambient temperature.

### Timing Parameters

(measured at 50% of amplitude with fastest edges).

#### Common Specifications:

Resolution	3 digits (best case 100 ps)
Repeatability	factor 4 better than accuracy
RMS-jitter*	0.05% of programmed value + 30 ps
<b>Period (PER)</b>	20 ns to 950 ms
Accuracy	±5% of progr. value ±2 ns [±2% ±1 ns]
<b>Delay (DEL)</b>	75 ns to 950 ms (max: PER + 55 ns)
Accuracy	±5% of progr. value ±4 ns [±2% ±4 ns]

\*see page 433

### Double Pulse (DOUB)

20 ns to 950 ms (max: PER - WID)  
Accuracy ±5% of progr. value ±2 ns [±2% ±2 ns]

### Width (WID)

DEL and DOUB are mutually exclusive  
10 ns to 950 ms (max: PER - 10 ns)

Accuracy ±5% of progr. value ±2 ns [±2% ±2 ns]

### Linear Transitions (between 10% and 90% of ampl)

Range 6.5 ns to 95 ms

Accuracy ±5% of progr. value ±2 ns [±5% ±2 ns]

### Output (voltages double when driving into open)

**High Level** -7.90 V to +8.00 V

**Low Level** -8.00 V to +7.90 V

Resolution 3 digits (best case 10 mV)

Level-Accuracy ±1% of progr. value ±3% of ampl.

±40 mV [±1% ±1% ±20 mV]

Repeatability factor 4 better than accuracy

### Supplemental Specifications

**Trigger Modes** Manual, Auto, Trigger, Gate

**Addition** Adds up channel 2 to channel 1.

**Control Modes** High level, Period, Delay, Width

### General

**Storage Temperature** -40°C to +65°C

**Operating Temperature** 0°C to 55°C

**Power** 100-120/220-240 Vrms, ±10%, 450 VA

max., 48-66 Hz

**Weight** 16 kg (35.5 lb)

**Dimensions (H\*W\*D)** 190 mm \* 426 mm \* 584 mm,

[7.5 in \* 16.75 in \* 23 in]

**Recalibration Period** 1 year recommended

### Ordering Information

**HP 8115A 50 MHz Dual Channel Pulse Generator** Price \$9,800

#### Options

**908** Rack Flange Kit (P/N 5061-9678) \$36

**910** Set of Operating/Programming and Service Manuals \$138

**915** Service Manual (P/N 08115-90001) \$106

**916** Additional Operating and Programming Manual (P/N 08115-90011) \$32

**H01** Prepared for Rack Slide Kit (P/N 1494-0059 required) N/C

**W30** Two additional years of HP service \$100

#### Accessories

**P/N 1494-0059** Rack Slide Kit (requires #H01) \$100

☎ Fast-Ship product—see page 766.

# PULSE GENERATORS

## 500 MHz High-speed Pulse Generator

### Model 8131A

- 1/2 (optional) channels / 500 MHz repetition rate
- <200 ps fixed transitions
- minimum resolutions: 10 ps; 10 mV

- suitable for BICMOS, ECL, and GaAs technology
- 1 GHz Transducer Mode
- fully HP-IB programmable

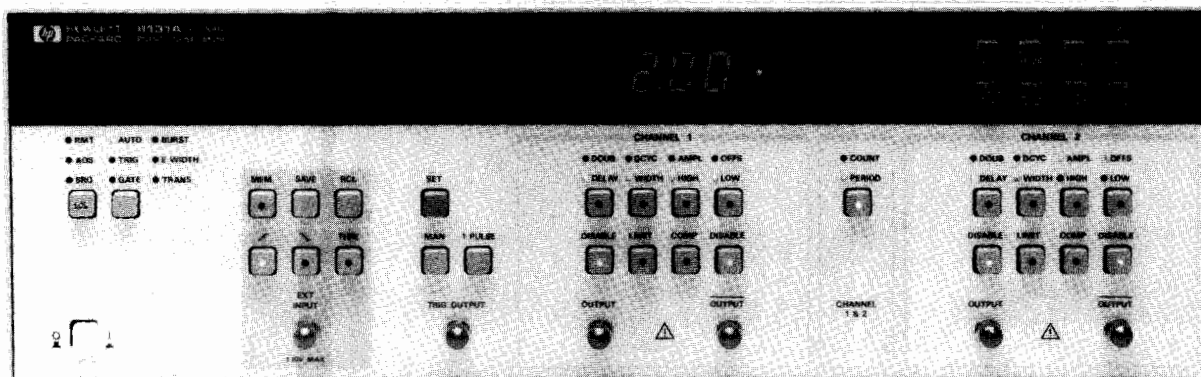

HP 8131A



#### 200 ps Transition Times

The HP 8131A delivers excellent performance to help you solve high-speed measurement problems. Transition times of less than 200 ps from the 10% to 90% amplitude (20% to 80% of amplitude: typical 150 ps) enable repeatable and reliable timing measurements on high speed digital circuits. Since compromises in edge speed directly affect your measurement accuracy, the clean and sharp edges offered by the HP 8131A minimize errors due to threshold uncertainties. Matching the requirements of the most advanced ECL and GaAs devices, you now can characterize components and circuits with repetition rates up to 500 MHz (in Transducer Mode up to 1 GHz). The HP 8131A is the first product that offers 200 ps edge speed in a fully programmable product which makes it extremely useful not only in R&D environments but also in high speed production test applications.

#### 10 ps Timing Resolution

The high timing resolution allows precisely measure timing parameters like setup and hold times. Especially in the two channel version, the ability to precisely position sharp pulses anywhere within a period with independent delay and width makes the HP 8131A a very useful tool in evaluating fast digital circuits. With a timing resolution that is about one order of magnitude higher than the typical gate delay of ECL devices, it is easy to detect trends when varying a critical pulse parameter without losing a required timing relation. Spikes can be simulated with 500 ps small pulses, and in combination with the 10 ps width resolution, timing and energy related failures can be examined.

#### 5V Amplitude and 10 mV Resolution

The 5V amplitude makes it possible to stimulate high speed circuits such as ECL, GaAs, or BICMOS devices. In addition, you now can test the excess-voltage immunity of your high speed components and evaluate crosstalk caused by 5 V, 200 ps transitions. The 10 mV resolution helps to slowly approach the threshold levels of digital circuits. The minimum amplitude of 100 mV is enough to check for minimum signal swing up to a 500 MHz (1 GHz in Transducer Mode) repetition rate. In combination with the full programmability, you now can do detailed analysis of critical level conditions in an automated test routine.

#### 500 MHz Repetition Rate

The 500 MHz repetition rate of the HP 8131A establishes a new class of high speed programmable pulse generator, which allows testing at the maximum toggle rate of your ECL, CMOS and complex GaAs devices. Now it is possible to perform functional and parametric tests of fast digital circuits under program control. In R&D, this means more reliable tests under repeatable conditions and easy documentation of test results. In production, the programmability opens new possibilities to functionally test high speed digital components with significantly higher throughput under well defined conditions. For the first time, the HP 8131A can test digital components at rated speed, thus increasing your confidence in the performance of your device and ensuring high quality of your product.

#### 1 GHz Transducer Mode

If you need to functionally test your component at frequencies beyond 500 MHz, the 1 GHz transducer mode allows to shape an externally provided sinewave into a squarewave with transition times of 200 ps. Especially if you need a very fast, programmable clock source, the combination of the HP 8131A and a microwave signal generator is ideal. This way, you can test maximum toggle frequency with a true digital 1 GHz signal and still have parametric capabilities up to 500 MHz for in-depth characterization of your circuit.

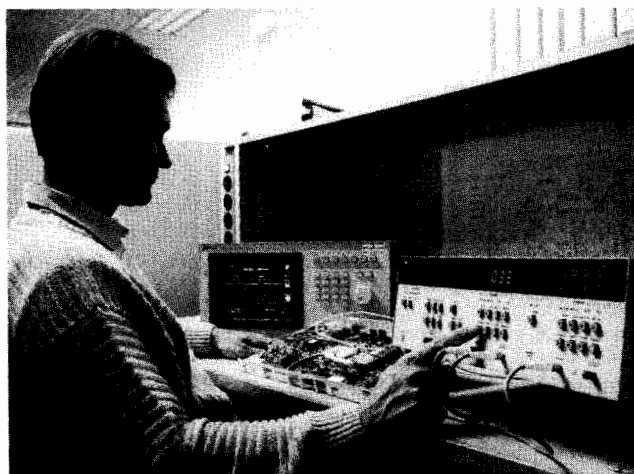

## Specifications

Specifications describe the instrument's warranted performance (30 minutes warm-up, 50-Ohm load) at 0°C to 55°C ambient temperature.

### Timing Parameters (measured at 50% of amplitude)

Common Specification

Resolution: 3 digits (best case: 10 ps)

Period: 2 ns to 99.9 ms

Delay: 20 ns to 99.9 ms

measured between trigger out and main out.

**Double Pulse:** 2 ns to 99.9 ms

Double Pulse and Delay are mutually exclusive.

**Width:** 500 ps to 99.9 ms

**Constant Duty Cycle:**

Range: 1% to 70%, min. width 0.5 ns

Resolution: 1%

**Transition Times:** (fixed leading and trailing edges)

10%-90% of amplitude: <200 ps

20%-80% of amplitude: <150 ps typically

Differential outputs

**Output Levels:** (into 50 Ω, output levels double when driving into open circuits, instrument disables outputs if voltage exceeds 6 V)

**Amplitude:** 100 mVpp to 5.0 Vpp

**Offset:** -4.95 V to +4.95 V

Resolution: 3 digits (best case: 10 mV)

Settling Time: 10 ns

### Supplementary Characteristics

(values describe typical, non-warranted performance)

#### Inputs and Outputs

##### External Input:

Trigger slopes can be selected pos/neg.

Input impedance: 50 Ohm

Threshold: -5 V to +5 V

Input Frequency: dc to 500 MHz

Min. pulse width: 1 ns

Input sensitivity: ≥ 300 mV (p-p)

##### Transducer Input:

Input Impedance: 50 Ohm

Input transition: <50 ns.

Input Frequency: 10 MHz to 1 GHz

Input sensitivity: ≥ 600 mV (p-p)

##### Trigger Output:

Levels: high 0V, Low-0.6 V

Delay from external input to trigger output: <10 ns

source impedance: 50 Ohm

### HP-IB Capabilities

All modes and parameters are fully HP-IB programmable.

## Operating Modes

**Auto:** Continuous pulse stream

**Trigger:** Each active input transition generates a single output pulse  
**Gate:** External signal enables period generation. First output pulse synchronous with leading edge. Last pulse always completed.

**E. Width:** Restoration of external signal with selectable output levels  
**E. Burst:** Each active input transition generates a preprogrammed number of pulses (1 to 9999), max. burst frequency is 200 MHz.

**Transducer:** Restoration of external sinewave signal (up to 1 GHz) with fixed transition times and selectable output levels.

**Limit:** Max. high and low levels into 50 Ohm can be limited to protect the device under test. Pushing the limit key will set limits to actual levels which then can not be exceeded as long as the mode is active.

**Manual:** Simulates an external input signal

**Complement:** Both channels can be switched to normal/complement separately

**Disable:** Relays can enable/disable both channels separately

**Set:** Sets parameters to fixed ratio relative to period.

**Store:** Stores complete setting in displayed location

**Recall:** Recalls complete setting in displayed location.

### General

**Storage Temperature:** -40°C to +65°C

**Operating Temperature:** 0°C to 55°C

**Power:** 100-120/220-240 Vrms, ±10%, 400 VA max., 48-66 Hz

**Weight:** 20 kg (44.4 lb)

**Dimensions (H\*W\*D)** 145 mm \* 426 mm \* 525 mm,  
[5.7 in \* 16.75 in \* 20.65 in]

**Recalibration Period:** 1 year recommended

### Ordering Information

#### HP 8131A 500 MHz Pulse Generator

**Price**  
\$14,300

#### Options

Opt. 001 Rear Panel Connectors	N/C
Opt. 020 Second channel	\$7,450
Opt. 908 Rack Mount Flange Kit (P/N 5061-9678)	\$36 ☎
Opt. 910 Set of Operating/Programming and Service Manual	\$138
Opt. 915 Service Manual (P/N 08131-90001)	\$106
Opt. 916 Additional Operating and Programming Manual (P/N 08131-90011)	\$32
Opt. W30 Two additional years of Return-to HP service	\$200

#### Accessories

HP 8493A Option 010; 10 dB Attenuator	\$120 ☎
HP 8493A Option 020; 20dB Attenuator	\$120
P/N 8120-4948 Cable, Coax (SMA)	\$180 ☎

☎ Fast-ship product - see page 766

# PULSE GENERATORS

## Programmable Precision Pulse Generators

### Models 8160A, 8161A

- 50 MHz repetition rate
- 6.0 ns variable transition time
- 20 V output amplitude
- 1-3% pulse parameter accuracy
- Full dual channel capability (option 020)
- 1 year recalibration period

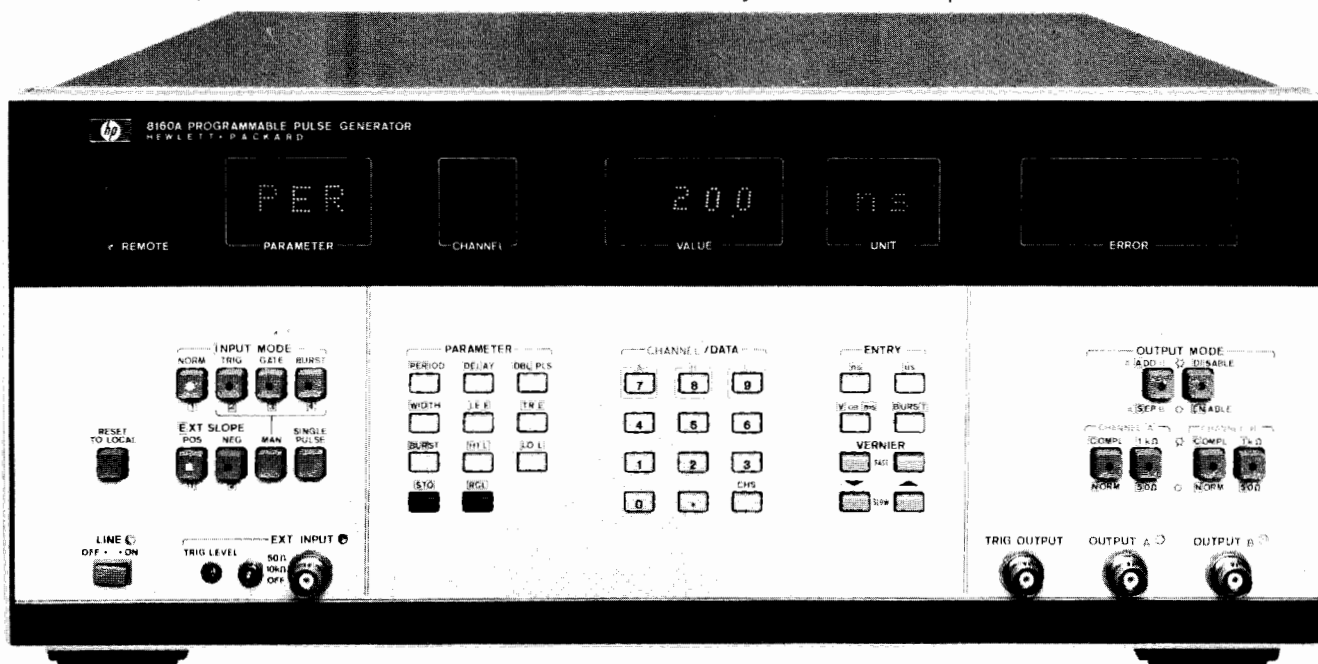

Designed For  
MATE  
Systems



Picture shows 8160A  
with Option 020, Dual Channel  
with Option 700, MATE/CIIL compatibility

- 100 MHz repetition rate
- 1.3 ns variable transition time
- 5 V amplitude
- 1-3% basic timing accuracy
- Full dual channel capability (option 020)
- 1 year recalibration period

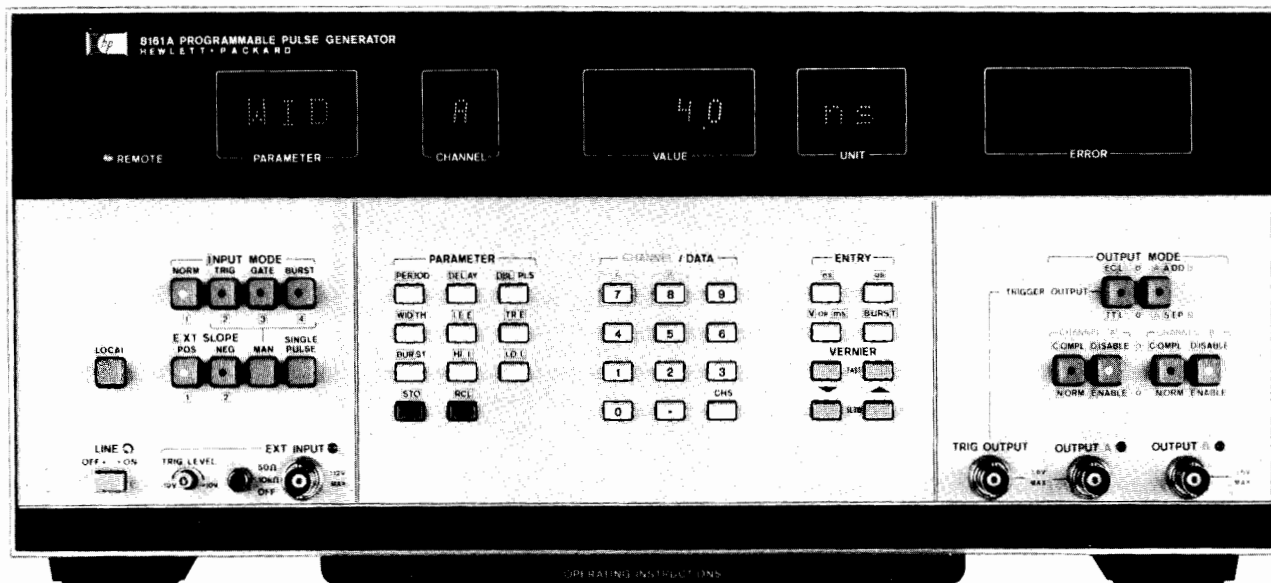

Designed For  
MATE  
Systems



Picture shows 8161A  
with Option 020, Dual Channel  
with Option 700, MATE/CIIL compatibility

The HP 8160A and 8161A are fully programmable pulse generators designed for high performance applications on the bench and in automatic test systems. Operation is made easy because the pulse parameters are controlled independently and do not inter-react. Dual channel options permit synchronous or complex waveforms to be generated. With its 50 MHz repetition rate, 20 V output, and 6 ns variable transition times, the HP 8160A is a general purpose pulse generator. The HP 8161A covers the high end of technology with its 100 MHz, 5 V and 1.3 ns variable transition times. Measured between the 20% to 80% amplitude points, these transitions are faster than 1 ns and meet ECL requirements.

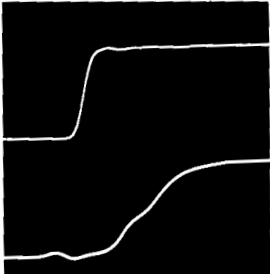

HP 8161A input pulse (upper) and ECL memory output pulse (lower).

Combining high programming accuracy with microprocessor-based control capabilities, pulses can be set up without a measuring instrument. Pulse parameters are entered and displayed numerically, and generated with a basic timing accuracy of 1-3%, depending upon parameter.

An easy-to-use HP-IB interface brings high-accuracy pulses to automatic test. All parameters and operating modes are remotely programmable using straight-forward command sequences. Faster, easier program generation and reduced software costs are direct benefits.

### Precision Pulse Generation

Both models provide precision control over all parameters of their output pulses. The HP 8160A's leading and trailing edge transition times may be independently programmed down to 6 ns. The HP 8161A's transitions have a common control from 1.3 ns to 5 ns, and are independent above 5 ns. Variable transition times are indispensable when digital IC's need to be characterized: either the IC's data sheeted input transition time is required, or the IC's functioning range with various transitions needs to be evaluated.

Direct entry of the high and low levels of the output pulse enables easy adjustment to the logic levels concerned. Pulse width is variable from 4 ns (HP 8161A) or 10 ns (HP 8160A) to 1 s, giving a wide range of duty cycle programmability. Delay shifts the output pulse in relation to the trigger output or, in double pulse mode, defines the pulse spacing.

In the dual-channel versions, double pulse can be selected in either or both channels. This means, for example, that simultaneous clock and data signals can be generated.

### Complex Signals

Independent pulse parameters plus individual programmability of the Option 020's dual outputs are augmented by the A ADD B mode. Summation allows complex signals to be precisely and easily set up. Here are some examples:

Applications such as radar coincidence circuits and special codes in communications require 3- and 4-level signals. These are conveniently generated by combining channel A and channel B pulses.

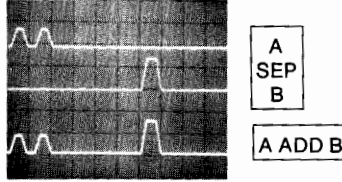
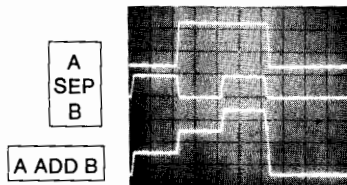

Transponder circuits need accurate delays, often with respect to a double-pulse interrogation signal. In the HP 8160A, this is arranged by operating one channel in double pulse mode and setting up the transponder delay in the other.

A critical test for digital circuits and IC's is its glitch and noise sensitivity, which can be easily performed with the A ADD B mode.

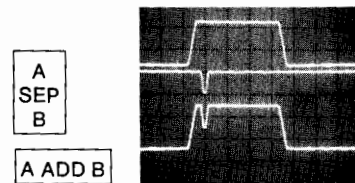

### Counted Burst

Using Burst Mode, a predetermined number of pulses is generated independent of frequency. Bursts from 0 to 9999 pulses in length may be produced, and can be triggered via an external signal manually or with an HP-IB command.

### Wide Temperature Range for System Reliability

The HP 8160A's and 8161A's 0-50°C operating range ensures calculable performance. Indeed, temperatures will generally be between 20-40°C where there is no derating factor.

### User Features

#### Fast, Reliable Setup

Microprocessor control promotes highly accurate pulses. Parameters are directly entered via the instrument's keyboard, and are then displayed on numeric LED's with 3-digit resolution.

In bench applications, the vernier controls give a fine adjust capability to "tweak-in" any pulse parameter. You can increment or decrement the selected parameter either in single steps or at speed.

Error detection by the microprocessor further simplifies pulse setup by solving the old problem of incompatible settings. Should pulse width exceed pulse period, for example, the microprocessor indicates a TIMING error. All possible mis-settings are detected and the type of error is indicated to aid rapid correction.

#### HP-IB Programming

Microprocessor control over all interface functions makes remote programming as easy and straight-forward as manual control. The instruments employ keystroke programming so that data entry via the HP-IB is an exact simulation of manual entry. Bus commands for each front panel key simply replace manual keystrokes.

#### Parameter Storage

Complete parameter and mode information for 9 independent instrument set-ups can be stored. Waveforms may be stored and recalled either manually or via the HP-IB.

By utilizing a single command to recall an entire instrument set-up, controller time is saved. In simple repetitive testing applications, storage of test waveforms gives a high degree of user convenience without an external controller.

Specifications overleaf



# PULSE GENERATORS

## Programmable Precision Pulse Generators (cont'd)

Models 8160A, 8161A

### Learn Mode

When interrogated by the system controller, the instruments output a character string to the interface bus. This string completely describes the pulser's current set-up or any one of its stored parameter sets. Using Learn Mode, you can enter and try out waveforms manually and then automatically transfer them via the HP-IB to the controller for storage in a program.

### Verification Software for the 8160A

Test system accuracy is guaranteed by accessory software which verifies the HP 8160A's performance standards. The software is fully documented and comes recorded on a cassette suitable for HP Model 9825A Desktop Computer.

In the event of a failure, downtime is minimized because the software also delivers diagnostic information to accelerate repair and calibration.

### Specifications

(50-ohm source into 50-ohm load). Standard instruments are single channel. Option 020 provides independent dual channels with common pulse period.

Timing (with minimum transitions)	HP Model 8160A	HP Model 8161A
<b>Period</b> Range: Accuracy: Max Jitter:	20 ns to 999 ms. ±3% of progr value ±0.3 ns (period < 100 ns); ±2% of progr value (period ≥ 100 ns). 0.1% of progr value + 50 ps.	10 ns to 980 ms. ±3% of progr value ±0.5 ns (period < 100 ns); ±2% of progr value (period ≥ 100 ns). 0.1% of progr value + 50 ps.
<b>Delay, Double Pulse, Width</b> Delay Range: Double Pulse Range: Width Range: Accuracy: Max Jitter:	0.0 ns to 999 ms. 20.0 ns to 999 ms. 10.0 ns to 999 ms. ±1% of progr value ±1 ns. 0.1% + 50 ps (≤999 ns); 0.05% (999 ns < -≤9.99 μs); 0.005% (>9.99 μs).	0.0 ns to 990 ms. 8.0 ns to 990 ms. 4.0 ns to 990 ms. ±1% of progr value ±1 ns. 0.1% + 50 ps (≤999 ns); 0.05% (999 ns < -≤9.99 μs); 0.005% (>9.99 μs).
<b>Output Characteristics</b> <b>Output levels</b> High Level Range: Low Level Range: Amplitude: Level Accuracy: Settling Time:	<b>50 Ω into 50 Ω</b> -9.89 V to 9.99 V. -9.99 V to 9.89 V. 0.10 V min, 9.99 V max. ±1% of progr value ±1% of ampl ±50 mV. 40 ns.	<b>50 Ω into open or 1 kΩ into 50 Ω</b> -19.7 V to 19.9 V -19.9 V to 19.7 V 0.2 V min, 19.9 V max -4.95 V to 5.00 V. -5.00 V to 4.95 V. 0.06 V min, 5.00 V max. ±1% of progr value ±3% of ampl ±25 mV. 20 ns plus transition time.
<b>Transition Times (10 – 90% amplitude)</b> Leading Edge: Trailing Edge: Accuracy: Linearity:	6.0 ns to 9.99 ms. 6.0 ns to 9.99 ms. ±3% of progr value ±1 ns. ±3% for transitions > 30 ns.	1.3 ns to 900 μs. 1.3 ns to 900 μs. ±10% of progr value ±1 ns. ±5% for transitions > 30 ns.
<b>Preshoot, Overshoot, Ringing:</b>	±5% of ampl ±10 mV.	±5% of ampl ±10 mV (may increase to ±10% of ampl ±10 mV for transitions < 2.5 ns).
<b>A ADD B:</b>	Adds channel A and B outputs (Opt 020 only).	Adds channel A and B outputs (Opt 020 only).
<b>Output Format:</b>	Normal/Complement Selectable. (Independently selectable in each channel in Option 020.)	Simultaneous Normal and Complement Outputs. (Independently selectable in each channel in Option 020.)
<b>Source Impedance:</b>	50 ohm/1 kohm selectable.	50 ohm.

**Operating modes:** Normal, Trigger, Gate, Ext Burst (0–9999 pulses).

**HP-IB capability:** all modes and parameters can be programmed. Talk mode for status, error messages, stored parameters.

**Memory:** 9 programmable locations\*,  
1 location for active operating state\*,  
1 location with fixed parameter set.

**Capacity:** 1 complete operating state per location.  
\* Battery back-up for power-off storage

### General

**Recalibration period:** 1 year.

**Repeatability:** factor 2 better than specified accuracy.

**Operating temperature:** 0°C to 50°C (Specifications apply from 20°C to 40°C. Accuracy derating factors for 0°C to 20°C and 40°C to 50°C).

**Power:** 115/230 V ac + 10%, -22%, 48-66 Hz; 675 VA max.

**Weight:** net 20.8 kg (46 lbs). Shipping 25 kg (55 lbs).

**Size:** 178 H x 426 x 530 mm D (7" x 16.8" x 20.9").

### Ordering Information

### Price

	HP 8160A	HP 8161A
<b>HP 8160A/8161A Programmable Pulse Generator*</b>	\$15,100	\$17,500
<b>Opt. 001:</b> Rear panel inputs and outputs	N/C	N/C
<b>Opt. 020:</b> Second channel (Rate common)	\$7,040	\$7,550
<b>Opt. 700:</b> Built-in MATE/CIIL compatibility	\$3,060	\$3,060
<b>Opt. 907:</b> Front handle kit (P/N HP 5061-9690)	\$66	\$66
<b>Opt. 908:</b> Rack flange kit (P/N HP 5061-9678)	\$36	\$36
<b>Opt. 909:</b> Opt 907, 908, combined (P/N HP 5061-9684)	\$92	\$92
<b>Opt. 910:</b> Additional Operating Manual	\$122	\$153
<b>Opt. W30:</b> Two additional years of HP service	\$450	\$450

\* HP-IB cables not supplied, see page 561

☎ Fast-Ship product—see page 766

# PULSE GENERATORS

## Fast, High Power Pulse Generator

### Model 214B

441

- High power 100 V, 2 A output
- 10 MHz repetition rate

- Constant duty cycle
- Counted pulse burst option

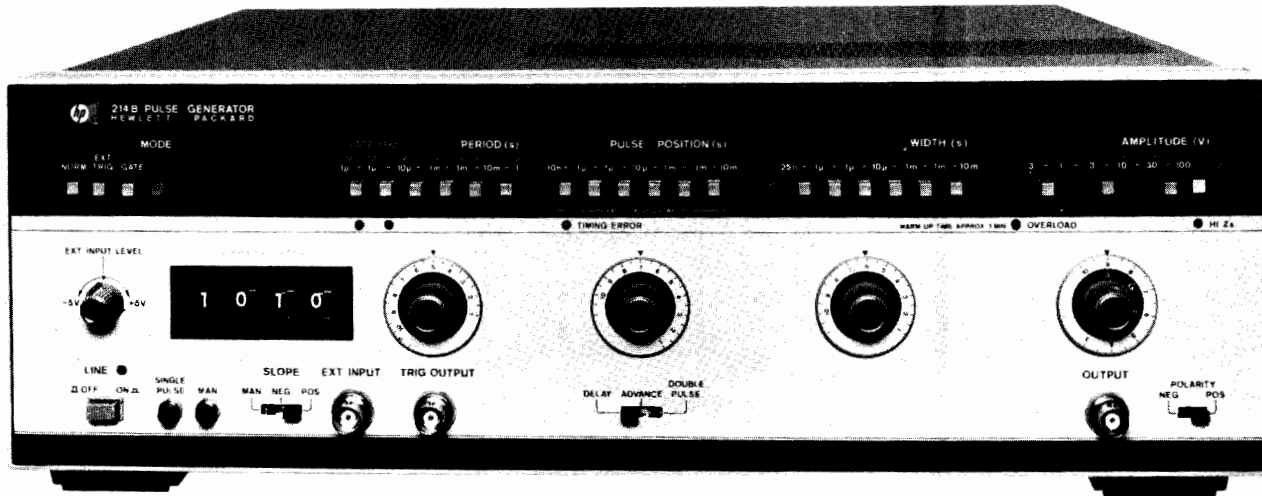

Picture shows 214B with Option 001, Counted Burst.

The HP 214B pulse generator employs semiconductor technology for high power pulse generation at up to 10 MHz repetition rate. Delivering 100 V pulses with 15 ns risetimes, the HP 214B meets the speed demands of today's applications.

State-of-the-art VMOS FETS used as current sources for the output amplifier tubes enable pulse width to be specified down to 25 ns. The HP 214B is thus well-equipped for low duty cycle applications such as laser diode pulsing or transient simulation.

Where changing duty cycle threatens destruction to the device under test, the HP 214B Constant Duty Cycle (CDC) mode provides device protection. In CDC operation the duty cycle, hence power, remains constant as frequency is varied. The HP 214B is itself protected against excessive duty cycles via an overload protect circuit.

Easy operation is assured by the timing error indication. Calibrated dials enable fast accurate adjustments. Operating into unmatched loads, clean pulse shape is guaranteed by the low reactance 50  $\Omega$  source impedance. Pulse distortions such as preshoot and overshoot are specified as 5% at all amplitudes.

## Specifications

### Timing

**Repetition rate:** 10 Hz to 10 MHz in 6 ranges. In 30 V - 100 V amplitude range, maximum rep. rate is 4 MHz. Calibrated vernier provides continuous adjustment within ranges. **Vernier accuracy:**  $\pm(10\%$  of setting + 1% full scale). **Period Jitter:**  $\leq 0.1\% + 300$  ps.

**Pulse delay/advance:** pulse can be delayed/advanced with respect to the trigger output from 10 ns to 10 ms ( $\pm$  fixed delay of 45 ns) in 5 ranges. Calibrated vernier provides continuous adjustment within ranges. **Vernier accuracy:**  $\pm(10\%$  of setting + 1% full scale) + fixed delay. **Position Jitter:**  $\leq 0.1\% + 500$  ps

**Maximum pulse position duty cycle:**  $\geq 50\%$

**Double pulse:** 5 MHz maximum in all ranges except 30 V - 100 V range which is max. 2 MHz. Minimum separation is 100 ns.

**Pulse width:** 25 ns to 10 ms in 6 decade ranges. Calibrated vernier provides continuous adjustment within ranges. **Accuracy:**  $\pm(10\%$  of setting + 1% full scale) + 5 ns. **Width Jitter:**  $\leq 0.1\% + 500$  ps.

**Max. duty cycle:**  $\geq 10\%$  for 30 - 100 V range.  $\geq 50\%$  all other ranges.

**Constant duty cycle mode (disabled in ext. trigger mode):** duty cycle of output pulse remains constant as the period is varied. The duty cycle limits in this mode are typically 8% fixed for the 10 M - 1 MHz range (max. 4 MHz); 2.5% to 10% for 1 MHz - .1 MHz range; .25% to 10% for .1 MHz - 10 kHz range; 0.1% for all other ranges. Calibrated vernier provides continuous adjustment within ranges.

**Accuracy:**  $\pm(15\%$  of setting + 1% of full scale).

### Trigger Output

**Amplitude:**  $\geq +5$  V (50 ohm into open circuit).

**Pulse width:** 10 ns typical.

### External Operating Modes

#### External Input (impedance 10 k ohm, dc coupled)

**Repetition rate:** dc to 10 MHz. **Sensitivity:** 500 mVpp, dc coupled.

**Slope:** pos. or neg. **Trigger level:** +5 V to -5 V adjustable.

**Maximum input level:**  $\pm 100$  V. **Trigger pulse width:**  $\geq 10$  ns.

**EXT TRIG mode:** an output pulse is generated for each input pulse.

**GATE mode:** gate signal turns on rep. rate generator synchronously. Last pulse always completed.

**BURST mode (optional):** preselected number of pulses generated on receipt of trigger signal. **Number of pulses:** 1 to 9999. Minimum spacing between bursts: 200 ns.

**Manual:** pushbutton can be used for triggering single pulses (EXT TRIG mode), generating gate signals (GATE mode) or triggering pulse bursts (BURST mode).

### Output

**Amplitude:** 0.3 V to 100 V in 5 ranges. Calibrated vernier provides adjustment within ranges. **Vernier accuracy:**  $\pm 10\%$  of setting.

**Source impedance:** fixed 50  $\Omega$  nominal on ranges up to 10 V. Selectable 50  $\Omega$  nominal or HI-Z on 10 - 30 - 100 V ranges (with 50  $\Omega$  / 50  $\Omega$  impedance, amplitude decreases to 5 - 15 - 50 V).

**Polarity:** pos. or neg. selectable.

**Transition times:**  $\leq 15$  ns for leading and trailing edges.

**Pulse top perturbations:**  $\leq \pm 5\%$  of amplitude.

### General

**Operating temperature:** 0°C to 55°C.

**Power:** 100/120/220/240 Vrms; +5%, -10%, 48 to 66 Hz, 360 VA max.

**Size:** 133 mm H x 426 mm W x 422 mm D (5.2" x 16.8" x 16.6").

**Weight:** net 13.6 kg (30 lb). Shipping 15.6 kg (34.3 lb).

### Ordering Information

HP 214B Pulse Generator

Opt. 001: Counted Burst

Opt. 002: Rear Panel Connectors

Opt. 003: 48-440 Hz Line

Opt. 907: Front Handle Kit (part number HP 5061-9689).

Opt. 908: Rack Mount Kit (part number HP 5061-9677).

Opt. 909: Opt 907, 908 Combined (part number HP 5061-9683).

Opt. 910: extra Operating and Service Manual

☎ Fast-Ship product—see page 766

### Prices

\$4800

add \$660

n/c

add \$120

add \$56 ☎

add \$33 ☎

add \$82 ☎

add \$34

# PULSE GENERATORS

## 20/50 MHz Pulse Sources

Models 8011A/8012B & 8013B

- Repetition rates up to 50 MHz
- Fixed transitions down to 3.5 ns
- Variable transitions from 5 ns to 0.5 s
- Output voltage up to 16V
- Up to 2 ch., select. output formats
- Selectable source impedance



HP 8011A

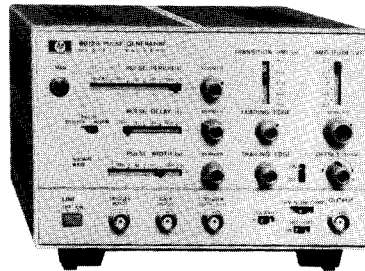

HP 8012B



HP 8013B

### Specifications

Model Parameter	HP 8011A	HP 8012B	HP 8013B
Period	50ns to 10s	20ns to 1s	20ns to 1s
Pulse width	25ns to 100ms	10ns to 1s	10ns to 1s
Duty Cycle in pulse compl.	>50% 100%	40% to 75% 100%	40% to 75% 100%
Pulse delay	—	35ns to 1s	35ns to 1s
Transition Times (int. Load IN)	<10ns fixed —	6ns to 0.5s 5ns to 0.5s	5ns fixed 3.5ns fixed
jitter	0.1% of prog. value + 50ps	0.1% of prog. value + 50ps	0.1% of prog. value + 50ps
max. out. voltage 50 Ohm source to 50 Ohm load into open offset overshoot, ringing may increase to:	8V 16V — <±5% <±10% if ccw of vernier	5V 10V ±2.5V <±5% <±10% for int. load OUT	5V 10V ±2.5V <±5% <±10% for int. load OUT
switchable Source impedance 50 Ohm / high imp	yes	yes	yes
Square wave, max frequency	10MHz	25MHz	25MHz

### Supplemental Specifications

(values describe typical, non-warranted performance)

### Operating Modes

#### HP 8011A

**Manual:** front panel pushbutton for generating single pulse

**Ext. Repetition Rate:** 0 Hz to 20 MHz. In square wave mode, output frequency is half the input frequency.

**Trigger source:** manual or ext. signal. Min. ext. signal width > 10 ns.

**Pulse burst mode (option 001):** preselected number (up to 9999) of pulses generated on receipt of trigger.

**Burst trigger source:** man. or ext. signal. Min. signal width is 25 ns.

#### HP 8012B & HP 8013B

**Manual:** front panel pushbutton for generating single pulse

**Ext. Repetition Rate:** 0 Hz to 50 MHz. In square wave mode, output frequency is half the input frequency.

**Trigger source:** manual or ext. signal. Min. ext. signal width > 7 ns.

**Gate mode:** Last pulse is completed even if the gate signal ends during pulse.

The HP 8011A 20 MHz, HP 8012B and HP 8013B 50 MHz Pulse Sources are versatile and reliable low-cost pulse generators. They provide the suitable solution to almost all digital logic testing problems. The simple and logical operation, which is achieved by a clearly designed front panel, guarantees rapid familiarization; the risk of setting up incompatible parameters is minimized. The instruments feature normal and complement output modes and a switchable internal 50 Ohm source. These features and performance emphasize the cost effectiveness of these models for many applications.

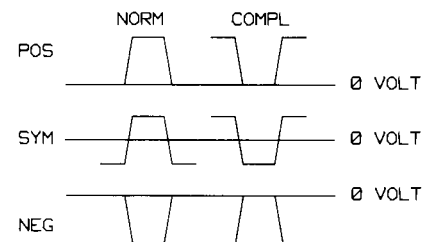

### General

**Operating temperature:** 0°C to 55°C

**Humidity:** 95% RH from 0°C to 40°C

**Power:** 100/120/220/240 Vrms, +5%, -10%, 48 to 440 Hz, 70 VA max.

**Weight:** 4 kg (9 lbs)

**Dimensions (HxWxD):** 142 mm x 200 mm x 330 mm  
5.6 in x 7.9 in x 13 in

### Ordering Information

**HP 8011A** 20 MHz Pulse Generator

**HP 8012B** 50 MHz Pulse Generator

**HP 8013B** 50 MHz Pulse Generator

### Options

**001** Counted Burst for HP 8011A

**910** Additional Operating and Service Manual  
for HP 8011A or HP 8012B

### Price

\$1250

\$1950

\$1900

\$370

\$20

\$13

### Accessories

**HP 15179** Rack Mounting Kit

Adaptor for rack-mounting one or two pulse  
generators HP 8011A, HP 8012B or HP  
8013B

\$235

☎ Fast-Ship Product — see page 766.

# PULSE GENERATORS

## 250 MHz Fast Pulse Source

### Model 8082A

443

- < 1 ns variable transition times
- Ultra-clean 50 ohm source

- Switch-selectable ECL levels
- Dual  $\pm 5$  V outputs

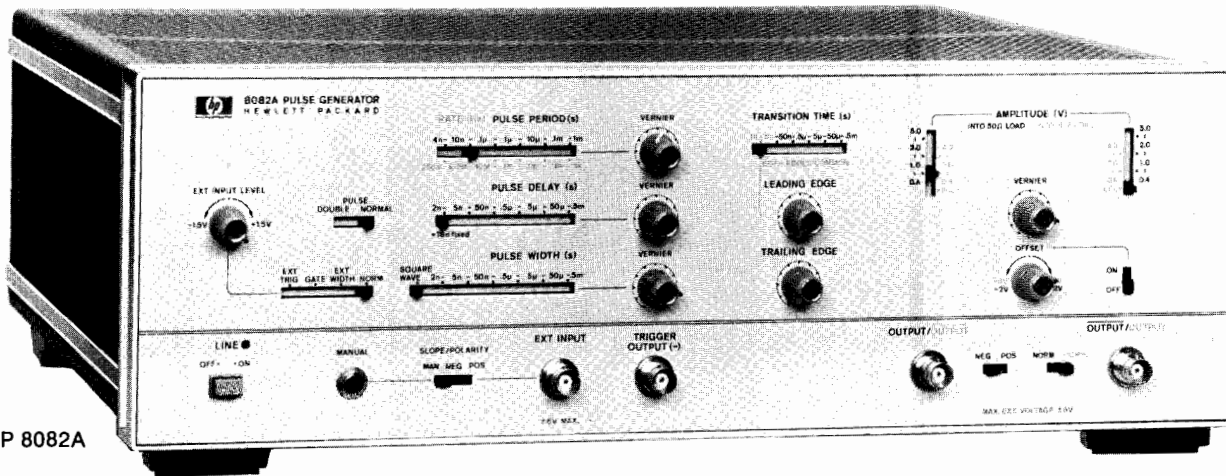

HP 8082A

The HP 8082A is a fast pulse generator with all pulse parameters variable. With repetition rates to 250 MHz, transition times down to 1 ns and amplitudes to 5 V, the HP 8082A is ideally suited for state-of-the-art TTL and ECL logic designs. Using the HP 8082A, you can rapidly test logic circuits under all operating conditions by simply varying pulse parameters. Although a highly sophisticated instrument, the HP 8082A is still easy to operate because of its logical front panel layout and switch selectable ECL output levels. Another feature that contributes to ease of operation is the square wave mode. You can, for example, carry out toggle rate tests in this mode up to 250 MHz without having to worry about pulse duty cycle.

Hybrid IC's, manufactured by Hewlett-Packard, are used extensively in the design of the HP 8082A. These ICs eliminate the need for fans, reduce power consumption and enable a low reactance 50 ohm source impedance to be used. This source impedance absorbs 98% of reflections from signals up to 4 V amplitude.

### Specifications

#### Pulse Characteristics (50 $\Omega$ source and load impedance)

**Transition times:** (10% to 90%): 1 ns to 0.5 ms in 6 ranges at amplitudes  $> 1.8$  V and  $> 4.5$  V respectively in the two upper output ranges. Minimum value may increase to 1.2 ns at other amplitudes. Leading/trailing times are common on fastest range, and independently variable over 1:10 ratio on other ranges.

**Overshoot and ringing:**  $\leq \pm 10\%$  of pulse amplitude may increase to  $\pm 10\%$  with amplitude vernier CCW.

**Preshoot:**  $\leq \pm 5\%$  of pulse amplitude.

**Linearity:** linearity aberration for both slopes  $\leq 5\%$  for transition times  $> 5$  ns.

**Output:** maximum amplitude is 5 V from 50  $\Omega$  into 50  $\Omega$ . Maximum output voltage is  $\pm 5$  V (amplitude + offset).

**Offset:**  $\pm 2$  V, into 50  $\Omega$ .

**DC-source impedance:** 50  $\Omega$  +5% -10%.

**Reflection coefficient:** 5% in ECL setting, increasing to 15% in 5 V range.

**Output protection:** cannot be damaged by open or short circuits or application of ext.  $\leq \pm 6$  V or  $\pm 200$  mA independent of control settings.

**Attenuator:** two separate three step-attenuators reduce the outputs to 1 V. Vernier is common for both outputs and reduces the output to 0.4 V minimum. A further position provides ECL-compatible outputs ( $-0.9$  V to  $-1.7$  V typ. open circuit).

#### Timing

**Repetition rate:** 250 MHz to 1 kHz in 6 ranges.

**Period jitter:**  $< 0.1\%$  of setting +50 ps.

**Delay:** 2 ns -0.5 ms in 6 ranges plus typ. 17 ns fxd. with respect to trigger output. Duty cycle  $> 50\%$ .

**Delay jitter:**  $< 0.1\%$  of setting +50 ps.

**Double pulse:** up to 125 MHz max. (simulates 250 MHz).

**Pulse width:** 2.4 ns to 0.5 ms in 6 ranges.

**Width jitter:**  $< 0.1\%$  of setting +50 ps.

**Width duty cycle:**  $> 50\%$ .

**Square wave:** delay and double pulse are disabled, max. Rep. Rate 250 MHz. Duty cycle is  $50\% \pm 10\%$  up to 100 MHz,  $50\% \pm 15\%$  for  $> 100$  MHz.

**Trigger output:** negative going Square Wave (50% duty cycle typ.)  $> 500$  mV from 50  $\Omega$  into 50  $\Omega$ . Internal 50  $\Omega$  can be switched off by slide-switch on PC-board. Amplitude up to 1 V into 50  $\Omega$  up to 200 MHz.

**Trigger output protection:** cannot be damaged by short circuit or application of external  $\pm 200$  mA.

#### External Operating Modes

##### External Input

**Input impedance:** 50  $\Omega$   $\pm 10\%$ . dc coupled.

**Maximum input:**  $\pm 6$  V.

**Trigger level:** adjustable  $-1.5$  V to  $+1.5$  V.

**Slope control:** positive, negative or manual selectable. In the manual position all ext. functions can be controlled by push button. Button pushed in simulates an "on-signal."

**Sensitivity:** sine-wave  $> 200$  mV p-p pulses  $> 200$  mV.

**Repetition rate:** 0 to 250 MHz.

##### External-Controlled Modes

**External trigger:** there is approximately 7 ns delay between the external input and the trigger output. Rep. rate is externally controlled (is triggered by external signal). Trigger output provides the pulse-shaped input signal.

**Synchronous gating:** gating signal turns rep. rate generator on. Last pulse normal width even if gate ends during pulse.

**External width:** output pulse width determined by width of drive input. Rep. rate and delay are disabled. Trigger output provides shaped input signal.

#### General

**Operating temperature:**  $0^\circ\text{C}$  to  $55^\circ\text{C}$ .

**Power:** 100/120/220/240 Vrms; +5%, -10%; 48-440 Hz. 85 VA max.

**Weight:** net, 7.9 kg (17.44 lb). Shipping 8.9 kg (19.63 lb).

**Size:** 133 mm H x 426 W x 345 mm D (5.2" x 16.75" x 13.6").

#### Ordering Information

HP 8082A Pulse Generator

#### Price

\$5810

Opt. 907: Front Handle Kit (part number HP 5061-9689).

add \$55 ☎

Opt. 908: Rack Flange Kit (part number HP 5061-9677).

add \$33 ☎

Opt. 909: Opt 907, 908 Combined (part number HP 5061-9683).

add \$82 ☎

Opt. 910: Additional Operating and Service Manual

add \$28

☎ Fast-Ship product—see page 766

# PULSE GENERATORS

## Configurable Pulse/Data Stimuli

### HP 8080A Series

Example: HP 8080A SO4

- 1 GHz, 300 ps transitions
- Interchannel delay

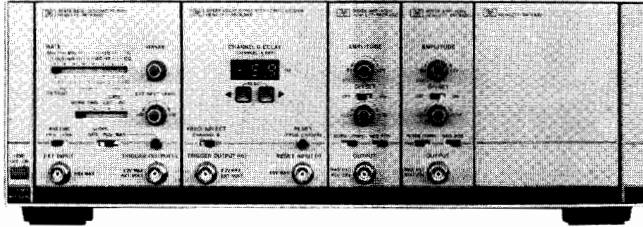

HP 8091A Rate Generator    HP 8092A Delay Generator    CHA CHB HP 8093A Output Amplifiers    HP 15400A Blank Panel

Example: HP 8080A DO1

- 300 MHz, 800 ps transitions
- Manually programmable data

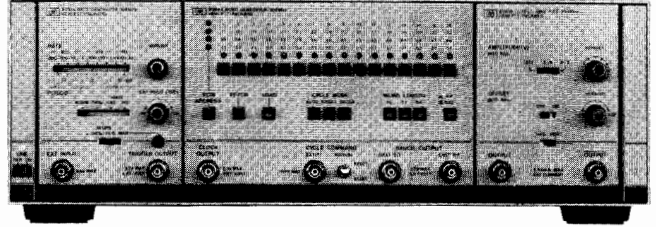

HP 8081A Rate Generator    HP 8084A Word Generator    HP 8083A Output Amplifier

Research and development in advanced technologies such as subnanosecond ICs, fiber optics and nucleonics, require fast pulses for thorough characterization. HP 8080A configurations can generate simultaneous 1 GHz clock and simulated NRZ data for testing today's fastest memories. (see 8080A#S04, above). Another example (8080A#D03) is simultaneous normal and complement data with up to 64 bits and fast 300 ps edges.

A series of Multi-channel Data and Pulse Generator configurations are available, and further variations can be factory-systemized on request.

Full details on all the modules and some of the factory-systemized configurations are contained in the HP8080A data sheet. Users who wish to do their own systemizing should request the Systemizing Guide (publication number 5952-9546).

### Leading Characteristics (50-ohm load)

#### HP 8080A SO4

##### Timing

**Repetition rate:** 100 Hz – 1 GHz.

**Interchannel delay:**  $\pm 9.9$  ns in 0.1 ns steps.

**Channel B divider:** 0.5 f selectable for simulating NRZ data.

**Width:** Square wave.

**Modes:** Int, Ext Width, Gate, Manual.

##### Independent 50-ohm Outputs

**Amplitude:** 0.6 V to 1.2 V<sub>pp</sub>.

**Offset:**  $\pm 1.2$  V.

**Transitions times (10% to 90%):** <300 ps.

**Polarity:** selectable

**Format:** Normal/Complement selectable

#### HP 8080A DO1

##### Timing

**Repetition rate:** 10 Hz–300 MHz.

**Width:** square wave (RZ) or NRZ.

**Modes:** Int, Ext/Manual Width.

**Data cycle modes:** Ext/Man Single and Gated Cycle, Auto Cycle.

**Data:** Serial, 16/32/64 bit selectable.

##### Simultaneous Normal and Complement 50-ohm Outputs

**Amplitude:** 0.2 V to 2 V.

**Offset:**  $\pm 1$  V.

**Transition times (10% to 90%):** <800 ps.

**Polarity:** selectable.

### General

**Operating temperatures:** 0°C to 55°C.

**Power:** 115/230 V rms; +10%, -22%; 48 to 66 Hz, 200 VA max.

**Weight:** (typical, HP 8080A Mainframe plus full complement of modules) 9.4 kg (16.6 lbs) net; 19.7 kg (43.3 lbs) shipping.

**Size:** (HP 8080A Mainframe): 133 H x 426 W x 422 mm D (5.24" x 16.77" x 16.61").

### Ordering Information

HP 8080A Mainframe

**Opt. 907:** Front handle kit (P/N HP5061-9689)

**Opt. 908:** Rack flange kit (P/N HP5061-9677)

**Opt. 909:** Opt 907, 908 combined (P/N HP5061-9683)

**Opt. Series S:** Single- and Multi-Channel Pulse Generator systems

**Opt. Series D:** Single- and Multi-Channel Data Generator systems

HP 8081A 300 MHz Rate Generator module

HP 8083A 300 MHz Output Amplified module

HP 8084A 300 MHz Word Generator module

HP 8091A 1 GHz Rate Generator module

HP 8092A 1 GHz Delay Generator module

HP 8093A 1 GHz Output Amplifier module

HP 8093A **Opt H01:** Variable-width operation (requires HP 8092A)

**Additional manuals:** Opt 910, per module

### Accessories Available

HP 15400A Blank Panel, 1/4 mainframe width

HP 15401A Blank Panel, 1/8 mainframe width

HP 15402A BNC Feedthru panel, 1/8 width

### Pulse Generator Accessories



HP 15104A/15115A    HP 15116A

HP 15104A Pulse Adder/Splitter dc to 2 GHz

HP 15116A Pulse Inverter 3 MHz to 2 GHz

HP 15115A Pulse Splitter/Inverter 3 MHz to 2 GHz

☎ Fast-Ship product — see page 766

\$3,000

add \$55 ☎

add \$33 ☎

add \$82 ☎

ask for information and prices

ask for information and prices

\$1,785

\$1,785

\$4,280

\$5,400

\$4,280

\$2,955

add \$480

add \$28

\$130

\$92

\$290

\$120

\$220

\$220

# PULSE GENERATORS

## High Resolution Time Synthesizer

Model 5359A

445

- Precise digital delays 0-160 ms
- 50 ps increments
- Jitter < 100 ps
- Programmable
- Fully synchronous to external trigger
- Automatic calibration

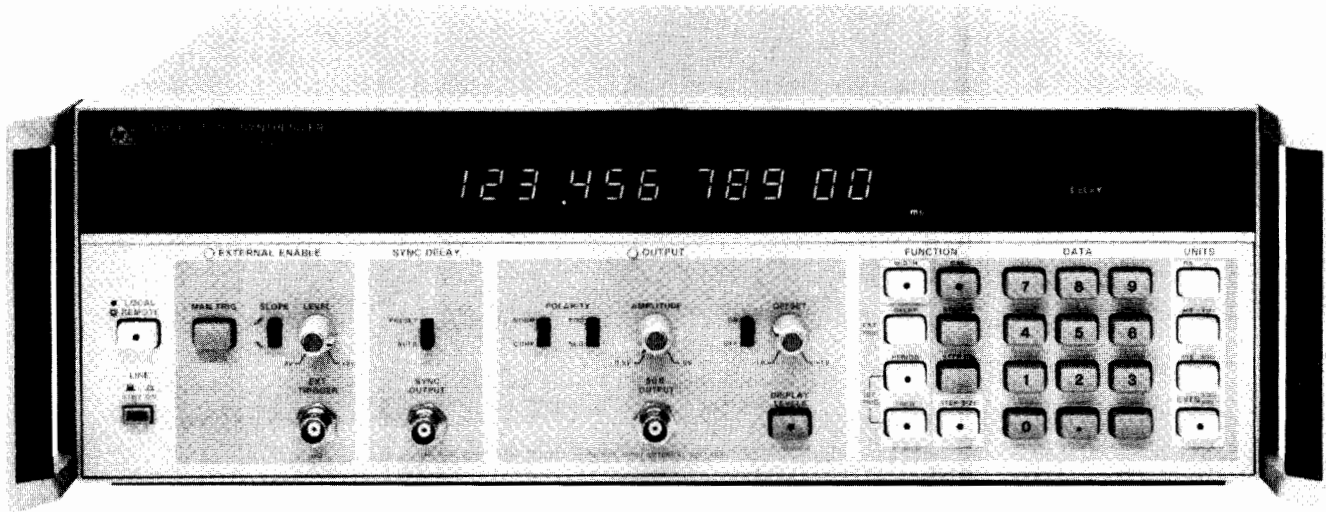

HP 5359A



### HP 5359A Time Synthesizer

The HP 5359A Time Synthesizer produces two extremely precise, low jitter time delays. These delays,  $T_d$  and  $T_w$ , are individually selectable by means of the keyboard, in 50 ps or greater steps to generate delays of up to 160 ms.

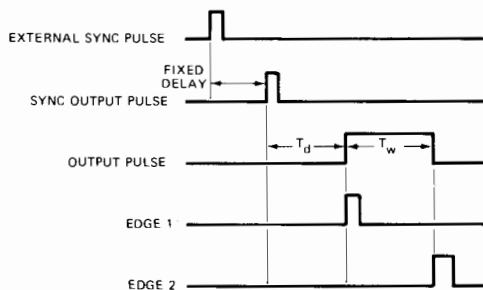

The HP 5359A has many applications and may be used for the calibration of Radar, Loran, DME and Tacan Systems, or for precision generation of delayed sweeps in oscilloscopes, and for extremely accurate "time positioning" control of external gates on frequency counters. In component and circuit test, the instrument may be used for extremely accurate delay line simulation.

### Condensed Specifications

#### Modes

**External trigger mode:** the delays from the sync out to the beginning of the output pulse, and the width of the output pulse, are selected.

**Internal trigger mode:** the "period" or "frequency", and the width of the output pulse, are selected.

#### Range

**Delay  $T_d$ :** 0 ns to 160 ms.

**Width  $T_w$ :** 5 ns to 160 ms (width & delay  $\leq$  160 ms).

**Period:** 100 ns min or width + 85 ns; 160 ms max.

**Frequency:** same as corresponding "period".

**Repetition rate:** 10 MHz max.

**Accuracy:**  $\pm 1$  ns  $\pm$  time base error ( $\pm 100$  ps  $\pm$  time base error after external calibration).

**Insertion delay:** fixed at < 150 ns; selectable as < 50 ns for delays > 100 ns.

**Jitter:** typical 100 ps rms; maximum 200 ps rms (delays to 10 ms).

**External trigger input:**  $-2$  V to  $+2$  V slope selectable.

**Sync output:** 1 V  $- 50 \Omega$ ; 5 V  $- 1$  M $\Omega$ . Width 35 ns nominal.

#### Output Pulse

**Amplitude:** 0.5 V to 5 V into  $50 \Omega$ .

**Polarity:** positive or negative.

**Offset:**  $-1$  V to 1 V, or OFF.

**Transition time:** < 5 ns.

External voltage must not be applied. Offset and Amplitude voltage into  $50 \Omega$  may be displayed.

**EDGE 1 OUTPUT (rear panel):** occurs in Sync with leading edge of output pulse (same spec. as Sync out).

**EDGE 2 OUTPUT (rear panel):** occurs in Sync with falling edge of output pulse (same spec. as Sync out).

**Events mode:** substitutes external input (to 100 MHz) for the internally counted clock (delay and width must both be specified in terms of events instead of time).

**Triggered frequency mode:** the same as internal frequency mode except the output is a burst beginning in synchronism with an external trigger signal, and continues for the duration of this signal.

**Calibrate mode:** performs an internal calibration to remove the effects of internal delay differences.

**External probes:** provides outputs to control the HP 5363B probes and accepts inputs from the probes to include external devices in the calibration loop.

**HP-IB:** All controls except trigger levels are programmable as standard.

#### Time Base

High Stability Oven Oscillator

**Frequency:** 10 MHz.

**Aging:**  $< 5 \times 10^{-10}$ /day.

**Temperature:**  $< 2.5 \times 10^{-9}$ ,  $0^\circ\text{C}$  to  $50^\circ\text{C}$ .

**Line voltage:**  $< 1 \times 10^{-10}$ ,  $\pm 10\%$  from nominal.

**Size:** 133 H x 426 W x 521 mm D (5.25 in. x 16.75 in. x 20.50 in.).

**Weight:** 13.6 kg (30 lb).

**Power requirements:** 100, 120, 220, or 240 Vac  $\pm 5\%$   $-10\%$ , 48 to 66 Hz, less than 250 VA.

**Front handles:** supplied with instrument.

#### Ordering Information

**HP 5359A** Time Synthesizer

**Opt 908** Rack Flange Kit for use without handles

**Opt 913** Rack Flange Kit for use with supplied handles

**HP 10870A** Service Kit

#### Price

\$13,200

+ \$32.50

+ \$35

\$930



# POWER SUPPLIES

## General Information

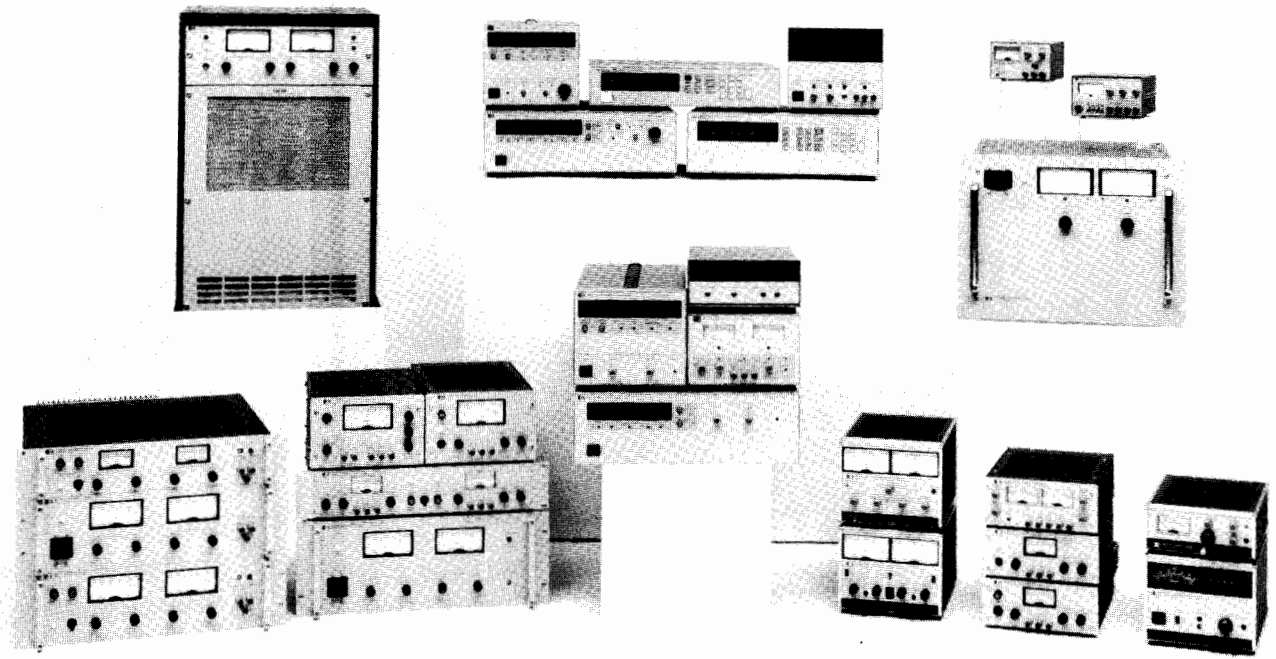

### Introduction

Hewlett-Packard's extensive variety of power supplies serve a wide range of applications, in research and development, industrial applications, and computer automated test systems. All power supplies are designed for high reliability and ease of use. Hewlett-Packard provides advanced capabilities through innovative technology.

### Power Supply Selection Tables - Page 450

There are three selection tables

- HP-IB Programmable Power Supplies
- Analog Programmable Power Supplies
- Special Purpose and Laboratory Bench Power Supplies

Choose the table that most closely fits your requirements. Each table is structured in ascending order of maximum output voltage. Upon selection of a model which fits your needs reference the appropriate page number for further information. If you are unsure of a selection or require additional information contact the nearest Hewlett-Packard sales office. A complete listing of Hewlett-Packard sales offices can be found toward the rear of this catalog.

### The "One-Box Solution"

Hewlett-Packard has power supplies which can be remotely programmed via resistance, voltage, or directly through the HP-IB. The new "One-Box Solution" system power supplies (HP models 6030A-6038A, 6621A-6627A, 6632A-6634A) have built-in HP-IB programmers for voltage and current. Also included is a built-in DVM and precision current shunt for measured read-back of voltage and current via the HP-IB.

### New 1989/90 Power Supply Catalog

For more details concerning Hewlett-Packard power supplies, ask your HP sales representative for a DC Power Supply Catalog, or fill in the card at the rear of this catalog.

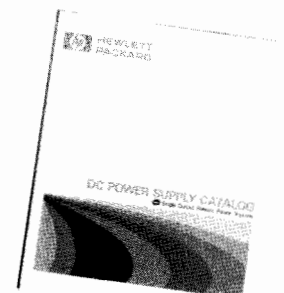

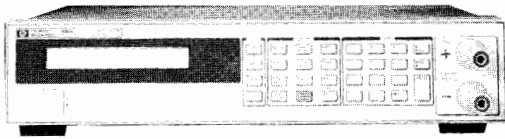

### Electronic Loads

Page 448

- HP-IB Control and Readback
- Analog Programming
- Built-in Pulse Waveform
- 300 Watt Single Input
- 1800 Watt Multiple Input



### HP-IB Programmable Power Supplies

Pages 454 to 469

- 100 Watt Single Output
- Multiple Output
- 200 and 1000 Watt Autoranging
- CILL Programming
- Precision Bipolar

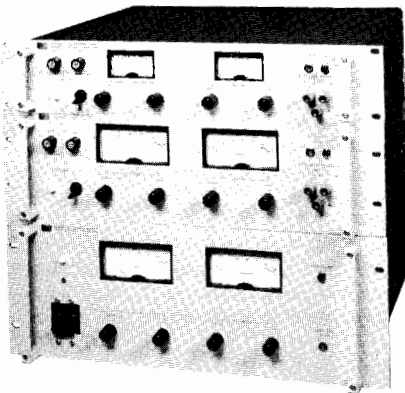

### Analog Programmable Power Supplies

Pages 470 to 477

- HP-IB Programmer for Analog Programmable Power Supplies
- General Purpose 25-200 Watt
- 200 and 1000 Watt Autoranging
- General Purpose 120-2000 Watt
- General Purpose 300-11,000 Watt

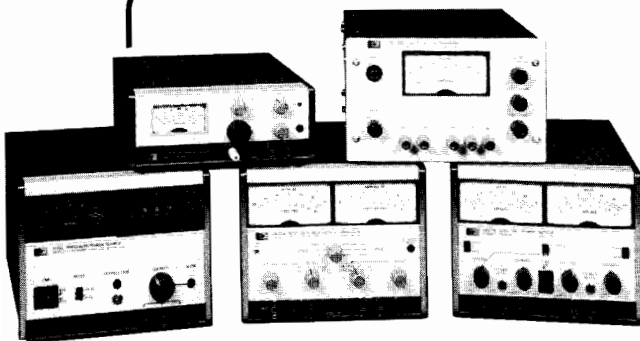

### Special Purpose and Laboratory Bench Supplies

Pages 478 to 483

- Bipolar/Amplifiers
- Single Output Bench
- Dual Output Bench
- Triple Output Bench
- Precision Voltage and Current Sources

# POWER SUPPLIES

## Model 6060A 300 Watt Single Input Electronic Load

- 300 Watt load: 0-60 A, 3-60 V Autoranging
- HP-IB control of current, voltage, and resistance
- HP-IB readback of current, voltage, and power
- External analog programming of current in Constant Current mode
- Built-in programmable pulse waveform generation.
- Protection from overpower, overtemperature, overcurrent, overvoltage and reverse polarity

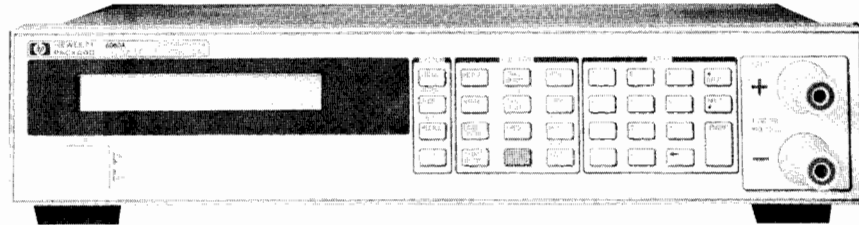

HP 6060A With Option 020 front panel binding posts

### Description

#### HP 6060A 300 Watt Single Input Electronic Load Key Features

- Parallelable in constant current mode
- Software calibration
- Non-volatile user-defined power-up state
- Front panel voltmeter, ammeter, and full feature keypad
- IEEE 488.2 and HP-SL compatible instruction set
- Trigger for external synchronization
- Analog voltage & current monitors
- Remote voltage sensing
- Control signal for external disconnect or shorting relay
- Rack mountable (3.5")
- Fan speed control for low acoustic noise

The new HP 6060A 300 Watt Single Input Electronic Load is designed for test, evaluation, and burn-in of DC power supplies, batteries, and power components. It is suitable for applications in areas such as R&D, production test, and field repair. The Electronic Load Family offers advantages in performance, quality, reliability, and price/performance. The built-in HP-IB interface further simplifies system integration and allows control and readback of all load functions.

The features and instruction set of the HP 6060A Single Input Load are compatible with the HP 6050A mainframe load products (see page 449). For example, test programs developed for an HP 6060A 300 Watt Single Electronic Load can be used later for an HP 60502A 300 Watt Module Load in another application.

The HP 6060A 300 watt load is suitable for bench use too. The front panel keypad allows easy, repeatable and reliable control of the load when it is used manually. Front panel settings are remembered after AC power is removed. The front panel LCD meters indicate voltage, current, and power readings. Connection to the load is made at the rear panel; front panel binding posts are available as an option.

### HP 6060A Electrical Specifications

**Modes:** Constant current (CC), constant voltage (CV), and constant resistance (CR)

**Autoranging input:** 0-60 A, 3-60 V, (current derated from 0-3 volts) power limited to 300 W at 40 C (225 watts at 55 C)

**Programmable ranges in CC mode:** 0-6 A, 0-60 A

**Programmable ranges in CR mode:** 0.033-1.0 ohm, 1-1000 ohms, 10-10,000 ohms

**Programming Accuracy:**  $\pm 0.1\% \pm 65\text{mA}$  (in 60A CC range)

**Programming Resolution:** 16mA (in 60A CC range)

**Current Readback Resolution:** 16mA

**Voltage Readback Resolution:** 16mV

**Current Readback Accuracy:** 0.05%  $\pm 65\text{ ma}$

**Voltage Readback Accuracy:** 0.05%  $\pm 45\text{ mv}$

#### Built-in pulse waveform generation:

Frequency (0.25 Hz - 10 kHz);

Duty cycle (9-91%);

Slew rate (1.0 A/mS to 5 A/ $\mu$ S) in 60 A range

**Analog programming bandwidth in CC mode:** 10 kHz

**Programmable electronic short:** 33 milliohms (20 mohms typical)

**Programmable electronic open:** 30 k ohms (typical)

### Ordering Information

Ordering Information	Price
<b>HP 6060A:</b> 300 Watt Single Input Load	\$1995
<b>Option 100:</b> 87-106 Vac, 48-63 Hz, (for Japan only)	N/C
<b>Option 120:</b> 104-127 Vac, 48-63 Hz	N/C
<b>Option 220:</b> 191-233 Vac, 48-63 Hz	N/C
<b>Option 240:</b> 209-250 Vac, 48-63 Hz	N/C
<b>Option 020:</b> Front Panel Binding Posts	\$80
<b>Option 908:</b> Rack Mount Kit for one unit with no handles	\$31
<b>Option 909:</b> Rack Mount Kit for one unit with handles	\$74
<b>Option 910:</b> Extra Manuals	\$31

## Model 6050A 1800 Watt Multiple Input Electronic Load Mainframe

- HP 60502A Module: 0-60 A, 3-60 V Autoranging (power limited to 300 W)
- HP 60501 Module: 0-30 A, 3-60 V Autoranging (power limited to 150 W)
- HP-IB control of current, voltage, and resistance
- HP-IB readback of current, voltage, and power
- External analog programming of current in Constant Current mode
- Built-in pulse/continuous waveform generation

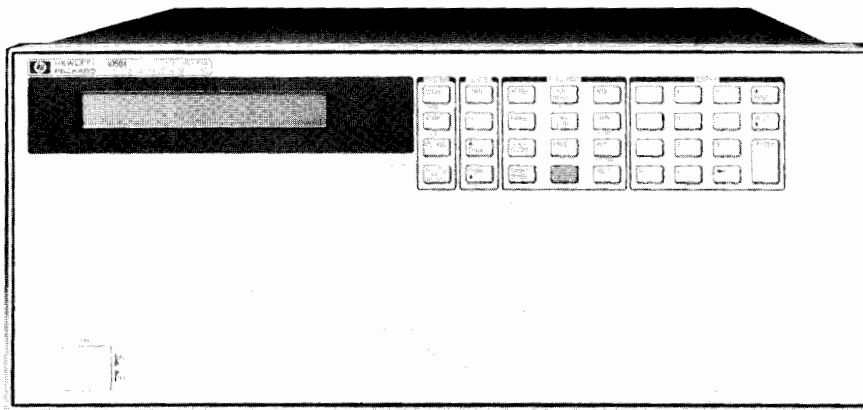

HP 6050A Load Mainframe

### Description

#### HP 6050A 1800 Watt Multiple Input Electronic Load Mainframe

##### Key Features

- Programmable amplitude, frequency, duty cycle and slew rate
- Protection from overpower, overtemperature, overcurrent, overvoltage and reverse polarity
- Load modules are parallelable in constant current mode
- Software calibration
- Non-volatile state storage, including user-defined power-up state
- Front panel voltmeter, ammeter, and full feature keypad
- IEEE 488.2 and HP-SL compatible instruction set
- Hardware and software triggering for synchronization
- Analog voltage and current monitors
- Remote voltage sense
- Digital I/O port for external disconnect relay and/or short relay
- Fan speed control for low acoustic noise

The new HP 6050A 1800 Watt Electronic Load Mainframe, the HP 60502A 300 Watt Module and the HP 60501A 150 Watt Module are designed for test, evaluation, and burn-in of DC power supplies, batteries, and power components. They are suitable for applications in areas such as R&D, production test, and field repair.

The Electronic Load Family offers advantages in performance, quality, reliability, and price/performance. The HP 6050A Mainframe's built-in HP-IB interface simplifies system integration and allows control and readback of each module's functions using a single HP-IB address. The load modules are user installable for easy initial installation, reconfiguration, or service. The mainframe has six slots. The HP 60502A and HP 60501A occupy one slot each.

The features and instruction set of the HP 60502A and HP 60501A Load Modules are compatible with the HP 6060A Single Input Load. For example, test programs developed for an HP 6060A 300 Watt Single Electronic Load or an HP 60502A 300 Watt Module Load are interchangeable. Programming meets all currently defined HP-SL standards and therefore assures programming compatibility with future products.

The HP 6050A 1800 Watt Load Mainframe is suitable for bench use too. The front panel keypad allows easy, repeatable, and reliable front panel control of the load when it is used manually. Front panel settings are remembered after AC power is removed. The front panel LCD meters indicate voltage, current, and power readings of the selected channel.

#### HP 60502A Electrical Specifications:

- Autoranging input:** 0-60 A, 3-60 V, (current derated from 0-3 volts) power limited to 300 W
- Programmable ranges in CC mode:** 0-6 A, 0-60 A
- Programmable ranges in CR mode:** 0.033-1.0 ohm, 1-1000 ohms, 10-10,000 ohms
- Programming Accuracy:**  $\pm 0.1\% \pm 65$  mA (in 60A CC range)

- Programming Resolution:** 16mA (in 60A CC range)
- Programmable electronic short:** 33 milliohms (20 mohms typical)
- Current Readback Resolution:** 16mA
- Voltage Readback Resolution:** 16mV
- Current Readback Accuracy:**  $0.05\% \pm 65$  mA
- Voltage Readback Accuracy:**  $0.05\% \pm 45$  mV
- Modes:** Constant Current (CC), constant voltage (CV), constant resistance (CR)
- Built-in pulse waveform generation:** Frequency (0.25-10 kHz); Duty cycle (9-91%); Slew rate (1.0 A/ms - 5 A/ $\mu$ s) in 60A range
- Analog programming bandwidth in CC mode:** 10 kHz

#### HP 60501A Electrical Characteristics:

The HP 60501A 150 Watt Load Module is the second member of a growing family of HP loads. The HP 60501A final specifications were unavailable at the time this catalog was printed; expected electrical characteristics are:

- Autoranging input:** 0-30 A, 3-60 V, (current derated from 0-3 volts) power limited to 150 Watts
- Programmable ranges in CC mode:** 0-3 A, 0-30 A
- Programmable ranges in CR mode:** 0.067-2 ohm, 2-2000 ohms, 20-20,000 ohms
- Modes:** Constant Current (CC), constant voltage (CV), constant resistance (CR)
- Pulse waveform programmable modes:** frequency, duty cycle, and slew rate

#### Mainframe Mechanical Specifications:

A full-rack Systems II compatible load mainframe system. Occupies 7 inches vertical rack space. Fan-cooled. Mainframe accommodates up to six 300W, six 150W, or any combination of modules up to 1800 watts total power.

#### Ordering Information

	<b>Price</b>
<b>HP 6050A:</b> 1800 Watt Load Mainframe	\$1995
<b>(NOTE:</b> Line voltage option (100, 120, 220, 240) must be specified)	
<b>Option 100:</b> 87-106 Vac, 48-63 Hz, (for Japan only)	N/C
<b>Option 120:</b> 104-127 Vac, 48-63 Hz	N/C
<b>Option 220:</b> 191-233 Vac, 48-63 Hz	N/C
<b>Option 240:</b> 209-250 Vac, 48-63 Hz	N/C
<b>Option 908:</b> Rack Mount Kit for one mainframe w/out handles	\$31
<b>Option 909:</b> Rack Mount Kit for one mainframe with handles	\$89
<b>Option 910:</b> Extra Operating and Service Manual	\$31
<b>HP 60502A:</b> 300 Watt Single Input Load Module	\$1550
<b>Option 910:</b> Extra Operating and Service Manual	\$31
<b>HP 60501A:</b> 150 Watt Single Input Load Module	\$1250
<b>Option 910:</b> Extra Operating and Service Manual	\$31

# POWER SUPPLIES

## Voltage Rating Index



### HP-IB Programmable Supplies

The power supplies listed in this table are directly programmable via the HP-IB. Their system oriented features include remote programming and readback in a single unit.

Max Volts (DC)	Max Amps (DC)	Type	HP Model Number	Page
6.7	30	HP-IB Autoranging	6033A	460
7	5	Multiple Output Linear	6623A 6624A	456 456
7	0.5	Precision Multiple Linear	6625A 6626A	458 458
7	10	Multiple Output Linear	6621A 6623A	456 456
7	120	HP-IB Autoranging	6031A	460
±10	0.01	DAC Programmer	59501B	469
16	2	Precision Multiple Linear	6625 6626	458 458
20	2	Multiple Output Linear	6623A 6624A 6627A	456 456 456
20	4	Multiple Output Linear	6621A 6622A 6623A	456 456 456
20	5	Single Output Linear	6632A	454
20	10	High Performance Autoranging†	6002A	456
20	10	HP-IB Autoranging	6033A	460
20	10	HP-IB Autoranging	6038A	460
20	50	HP-IB Autoranging	6031A	460
20	50	HP-IB Autoranging	6032A	460
50	0.8	Multiple Output Linear	6623A 6624A 6627A	456 456 456
50	1	Precision Multiple Linear	6625A 6626A	458 458
±50	±1	Precision Bipolar Voltage*	6130C	468
50	2	Multiple Output Linear	6622A	456
50	2	Single Output Linear	6633A	454
50	4	High Performance Autoranging	6002A	467
±50	±5	Precision Bipolar Voltage*	6129C	468
60	3.3	HP-IB Autoranging	6038A	460
60	17	HP-IB Autoranging	6030A	460
60	17.5	HP-IB Autoranging	6032A	460
±100	±0.16	Precision Bipolar Current*	6140A	468
±100	±0.5	Precision Bipolar Voltage*	6131C	468
100	1	Single Output Linear	6634A	454
200	17	HP-IB Autoranging	6030A	460

\* Does not include remote programming and readback in a single unit

† Option 001 must be ordered to operate the HP 6002A on the HP-IB.

### Analog Programmable Supplies

The power supplies listed in this table are programmable with either an analog voltage or resistance signal. They may be incorporated into a system application or a laboratory or bench environment.

Max Volts (DC)	Max Amps (DC)	Type	HP Model Number	Page
6.7	30	Autoranging	6023A	472
7	120	Autoranging	6011A	472
7.5	5	CV/CC	6281A	470
8	1000	CV/CC	6464C	476
10	10	CV/CC	6282A	470
10	50	CV/CC	6259B	474
10	100	CV/CC	6260B	474
15	200	CV/CC	6453A	476
16	600	CV/CC	6466C	476
18	500	CV/CC	6466C	476
20	0.6	Dual Output (20 V, 20 V)	6205C	479
20	1.5	CV/CC	6200B	479
±20	±2	Bipolar PSA	6825A	478
20	3	CV/CC	6284A	470
20	3	Dual Output (20 V, 20 V)	6253A	470
20	10	Autoranging	6023A	472
20	10	Autoranging	6024A	472
20	10	CV/CC	6263B	474
20	10	CV/CC	6286A	470
20	20	CV/CC	6264B	474
20	50	Autoranging	6011A	472
20	50	Autoranging	6012B	472
20	50	CV/CC	6261B	474
25	2	Dual Output (25 V, 25 V)	6227B	470
30	1	CV/CC	6206B	479
36	100	CV/CC	6456B	476
36	300	CV/CC	6469C	476
40	0.3	Dual Output (40 V, 40 V)	6205C	479
40	0.75	CV/CC	6200B	479
40	1.5	CV/CC	6289A	470
40	1.5	Dual Output (40 V, 40 V)	6255A	470
40	5	CV/CC	6266B	474
40	5	CV/CC	6291A	470

Max Volts (DC)	Max Amps (DC)	Type	HP Model Number	Page
40	5.7	Autoranging	6024A	472
40	10	CV/CC	6267B	474
40	25	CV/CC	6434B	476
40	30	Autoranging	6012B	472
40	30	CV/CC	6268B	474
40	50	CV/CC	6269B	474
50	0.5	Precision Current	6177C	483
50	1	Dual Output (50 V, 50 V)	6228B	470
±50	±1	Bipolar PSA	6826A	478
60	0.5	CV/CC	6206B	479
60	1	CV/CC	6294A	470
60	3	CV/CC	6296A	470
60	3.3	Autoranging	6024A	472
60	15	CV/CC	6274B	474
60	17	Autoranging	6010A	472
60	17.5	Autoranging	6012B	472
64	50	CV/CC	6459A	476
64	150	CV/CC	6472C	476
100	0.25	Precision Current	6181C	483
±100	±0.5	Bipolar PSA	6827A	478
100	0.75	CV/CC	6299A	470
110	100	CV/CC	6475C	476
120	2.5	CV/CC	6443B	476
200	5	Autoranging	6010A	472
220	50	CV/CC	6477C	476
300	0.1	Precision Current	6186C	475
300	35	CV/CC	6479C	476
320	0.1	CV/CC	6209B	479
440	25	CV/CC	6483C	476
500	20	CV/CC	6483C	476
600	1.5	CV/CC	6448B	476
600	15	CV/CC	6483C	476



# POWER SUPPLIES

## Voltage Rating Index (cont'd)

### Special Purpose and Laboratory Bench Power Supplies

The power supplies listed in this table include special purpose (current sources, bipolar, four-quadrant power supplies and precision power supplies) and laboratory bench power supplies. Although some of the special purpose supplies may be programmed with an analog signal, most of the power supplies listed here are controlled manually.

Max Volts (DC)	Max Amps (DC)	Type	HP Model Number	Page
6	1	Triple Output (6, $\pm 18$ V)	6235A	479
6	2.5	Triple Output (6, $\pm 20$ V)	6236B	479
10	1	CV/CC	6214C	479
18	1	Triple Output (18, $\pm 20$ V)	6237B	479
$\pm 18$	0.2	Triple Output (6, $\pm 18$ V)	6235A	479
$\pm 20$	0.5	Triple Output (6, $\pm 20$ V)	6236B	479
$\pm 20$	0.5	Triple Output (18, $\pm 20$ V)	6237B	479
$\pm 20$	$\pm 2$	Bipolar Amplifier	6825A	478
20	2	Precision Voltage	6114A	482
25	0.2	Dual Output (25, 25 V)	6234A	479
25	0.4	CV/CC	6216C	479
40	1	Precision Voltage	6114A	482
50	0.2	CV/CC	6218C	479
50	0.5	Precision Current	6177C	483
50	0.8	Precision Voltage	6115A	482
$\pm 50$	$\pm 1$	Bipolar Amplifier	6824A	478
$\pm 50$	$\pm 1$	Bipolar Amplifier	6826A	478
100	0.1	CV/CC	6212C	479
100	0.25	Precision Current	6181C	483
100	0.4	Precision Voltage	6115A	482
$\pm 100$	$\pm 0.5$	Bipolar Amplifier	6827A	478
300	0.1	Precision Current	6186C	483

### Power Supply Terms

**Ambient temperature:** the temperature of the air immediately surrounding the power supply.

**Auto-parallel operation:** a master-slave connection of the outputs of two or more supplies used for obtaining a current output greater than can be obtained from one supply.

**Autoranging power supply:** a power supply that can provide maximum rated power over a wide range of voltage and current without external intervention to change range.

**Auto-series operation:** a master-slave connection of the outputs of two or more supplies used for obtaining a voltage greater than can be obtained from one supply.

**Auto-tracking operation:** a master-slave connection of two or more supplies each of which has one of its output terminals in common with one of the output terminals of all of the other supplies.

**Complementary tracking:** a master-slave interconnection of two supplies in which the voltage of the slave is equal to or proportional to that of the master and of opposite polarity with respect to a common point.

**Compliance voltage:** the output voltage of a power supply operating in the constant-current mode.

**Constant-current (CC) power supply:** a power supply that stabilizes output current with respect to changes in influence quantities. Thus, for a change in load resistance, the output current remains constant while the output voltage changes by whatever amount necessary to accomplish this.

**Constant-voltage (CV) power supply:** a power supply that stabilizes output voltage with respect to changes in influence quantities. Thus, for a change in load resistance, the output voltage remains constant while the output current changes by whatever amount necessary to accomplish this.

**Constant-voltage/constant-current (CV/CC) power supply:** a power supply that operates as a constant voltage power supply or a constant-current power supply depending on load conditions. It acts as a constant-voltage source for comparatively large values of load resistance and as a constant-current source for comparatively small values of load resistance.

**Constant-voltage/current-limiting (CV/CL) power supply:** a power supply similar to a constant-voltage/constant-current supply except that at comparatively small values of load resistance, its output current is limited instead of being stabilized.

**Crowbar:** see overvoltage protection.

**Current limiting:** the action of limiting the output current of a constant-voltage supply to some predetermined maximum value (fixed or adjustable) and automatically restoring the output voltage to its normal value when the overload or short circuit is removed. There are three types of current limiting: 1) by constant-voltage/constant-current crossover, 2) by decreasing the output voltage as the current increases, 3) by decreasing both voltage and current as the load resistance decreases (referred to as foldback or cutback current limiting).

**Drift:** the maximum change of an output voltage or current during an 8-hour period following a 30-minute warmup, with all influence and control quantities maintained constant during the warm-up time and the period of drift measurement. Drift includes both periodic and random deviations over the bandwidth from zero frequency (dc) to a specified upper frequency limit (usually 20 Hz).

**Load effect:** formerly known as load regulation, load effect is the change in the steady-state value of the stabilized output voltage or current resulting from a full-load change in the load current of a constant-voltage supply or the load voltage of a constant-current supply, with all other influence quantities maintained constant.

**Load effect transient recovery time:** the time interval between a specified step change in the load current of a constant-voltage supply (usually a full-load or 5-ampere change, whichever is smaller) or in the load voltage of a constant-current supply and the instant when the stabilized output quantity returns to and stays within the specified transient recovery band.

**Master-slave operation:** a method of interconnecting two or more supplies such that one of them (the master) serves to control the others (the slaves). The outputs of the slave supplies always remain equal to or proportional to the output of the master. The outputs of

the master supply and of one or more slaves may be connected in series, in parallel, or with just their negative or positive output terminals in common. (See also complementary tracking.)

**Nominal value:** the value that exists "in name only," not the actual value. For example, in the case of a power supply with a calibrated output control, the nominal value is the value indicated by the control setting. For a supply with a fixed output, the nominal output is the output indicated on the nameplate. The nominal value of a 120-volt  $\pm$  10% line voltage is 120 volts.

**Output impedance:** the complex ratio of a sinusoidal voltage and sinusoidal current at the output terminals, the one being caused by the other and being of external origin.

**Overcurrent protection:** protection of the power supply and/or connected equipment against excessive output current.

**Overtemperature protection:** protection of the power supply or parts of it against temperatures exceeding specified values.

**Overvoltage protection:** protection of the power supply and/or connected equipment against excessive output voltage. Overvoltage protection is usually by means of a crowbar protection circuit, which rapidly places a low resistance shunt across the supply's output terminals to reduce output voltage to a low value if a predetermined voltage is exceeded. A supply equipped with an overvoltage crowbar must also be protected by a means of limiting or interrupting output current.

**PARD (acronym for periodic and random deviation):** the term PARD replaces the former term ripple and noise. PARD is the periodic and random deviation of a dc output voltage or current from its average value, over a specified bandwidth (20 Hz to 20 MHz) and with all influence and control quantities maintained constant.

**Programming speed:** the maximum time required for the programmed output voltage or current to change from a specified initial value (usually zero or maximum output) to a value within a specified tolerance band of a specified newly programmed value (for most models 99.9% or 0.1% of maximum output, respectively; 99% and 1% for the HP 6114A, 6115A, 6177C-6186C, and HP 6434B-6483C) following the onset of a step change in an analog programming signal, or the gating of a digital signal.

**Remote control:** also referred to as remote programming, remote control is the setting of the power supply voltage, current, or other function by means of an external control quantity such as a variable resistance, voltage, or current, or a digital signal.

**Remote sensing:** remote sensing, or remote error sensing, is a means by which a power supply monitors the stabilized voltage directly at the load using extra sensing leads. The resulting circuit action compensates for voltage drops in the load leads (up to a specified limit).

**Resolution:** for a bench supply, the smallest change in output voltage or current that can be obtained using the front panel controls. For a system supply, the smallest change that can be obtained using either the front panel controls or a computer.

**Reverse voltage protection:** protection of the power supply against reverse voltage applied at the output terminals.

**Slave operation:** see master-slave operation.

**Source effect:** formerly known as line regulation, source effect is the change in the steady-state value of the stabilized output voltage on current resulting from any change in the source voltage within its specified range, with all other influence quantities maintained constant. Source effect may be measured at any output voltage and current within rating.

**Temperature effect coefficient:** the maximum steady-state change in a power supply's output voltage or current per degree Celsius following a change in the ambient temperature within specified limits, with all other influence quantities maintained constant.

**Voltage limiting:** the action of limiting the output voltage of a constant-current supply to some predetermined maximum value (fixed or adjustable) and automatically restoring the output current to its normal value when the load conditions are restored to normal. There are two types of voltage limiting: 1) by constant-voltage/constant-current crossover, 2) by decreasing the output current as the voltage increases.

**Warm-up time:** the time interval after switching on a power supply until it complies with all performance specifications.

# POWER SUPPLIES

## Single Output Linear System Power Supplies

Models 6632A, 6633A and 6634A

- 100 Watt Linear Output
- Current Sinking Capability
- Built-in HP-IB Interface
- Overvoltage & Overcurrent Protection
- Readback Measured Voltage and Current Output Via HP-IB

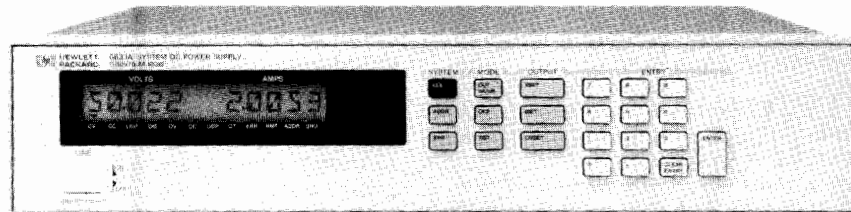

HP 6633A



### Description

#### HP Models 6632A-6634A

HP Models 6632A-6634A are 100 Watt, single output, series pass regulated power supplies optimized for systems applications. They provide a high performance output with a full set of programmable features.

The following voltage and current combinations are available:

HP 6632A: 0-20 V	0 $\pm$ 5 A
HP 6633A: 0-50 V	0 $\pm$ 2 A
HP 6634A: 0-100 V	0 $\pm$ 1 A

Most importantly, these models are one-box solutions for system power supply requirements. Both the voltage and current output can be programmed for either CV or CC operation. A built-in DVM and precision current shunt measure (readback) the actual power supply output. The internal HP-IB interface allows for complete programmability, including status reporting and interrupt generation with user designated fault conditions. In addition, programming commands (such as VSET for voltage programming) are easy-to-use and self-documenting.

#### Current Sinking

HP Models 6632A-6634A sink as well as source current. This provides very fast down programming times and speeds throughput in production test applications. The negative current setting tracks the user-programmed positive current (CC) setting.

#### Remote Sensing

Remote sense terminals allow for precise voltage regulation at the load. This feature will compensate for load lead IR drops of up to 2 volts per lead.

#### Protection Features

HP Models 6632A-6634A have Overvoltage and Overcurrent protection. Both features are programmable via the front panel keypad and HP-IB. The Overvoltage protection includes an SCR crowbar.

#### Selftest

HP Models 6632A-6634A have a built-in selftest capability. This feature verifies the function of all HP-IB circuitry, D/A's, and A/D's at power on and upon HP-IB command.

#### Software Calibration

Software calibration eliminates shock sensitive potentiometers normally used for calibration of power supplies and programmers. This

feature enables calibration of these models via the HP-IB while mounted in the rack. An internal jumper is provided which, when removed, prevents recalibration of the power supply.

#### Fast/Normal Mode Operation

A rear-panel switch designates one of two operating modes. In Fast Mode, the output capacitors are disconnected to speed up the output response time. Normal Mode is optimized for minimal output PARD. See specifications for more information.

#### Front Panel Binding Posts (Option 020)

Option 020 adds a front panel output in parallel with the rear panel output terminal strip. These front panel binding posts provide flexibility in accessing the power supply output, and are very useful in bench applications and system development.

#### Isolation, Polarity Reversal Relay and DFI/RI (Option 760)

Optional built-in relays provide output connect/disconnect and polarity reversal. Discrete Fault Indicator and Remote Inhibit lines are included along with a quick disconnect DC output terminal connector. See page 465 for more detail.

#### HP-IB Functions

The following functions can be programmed via the HP-IB:

Programmable Functions	Readback Functions
— Voltage Output	— Actual Measured Voltage Output
— Current Output	— Actual Measured Current Output
— Overvoltage Protection	— Present Status
— Overcurrent Protection	— Accumulated Status
— Output Enable/Disable	— Programming Error Codes
— Fault Interrupt	— Fault Codes
— Software Calibration	— Service Request
— Selftest	

#### Specifications (Data Subject to Change)

**HP-IB Interface Functions:** The following HP-IB functions are implemented:

SH1, AH1 T6, L4, SR1, RL1, PP1, DC1, DT0 and E1.

**Safety Agency Compliance:** HP Models 6632A-6634A power supplies are designed to comply with the following regulatory standards:

IEC 348, VDE 0411, UL 1244 and CSA Electrical Bulletin 556B.

**Weight kg (lb) (all models):** Net 10.5 (23), Shipping 12.3 (27)

**Input Current:** 100 VAC 120 VAC 220 VAC 240 VAC  
(Max. rms all models) 3.3 A 2.9 A 1.7 A 1.6 A

**Input requirements:** 350 VA max.  
250 watts max.

**Specifications (Data Subject to Change)**

Note: Specifications are worst case unless otherwise noted.

	Volts	0-20 V	0-50 V	0-100 V	
	Amps	0-5 A	0-2 A	0-1 A	
	Watts	100 W	100 W	100 W	
<b>Hewlett-Packard Model</b> Specified over an operating temperature range of 0-55°C.		<b>6632A</b>	<b>6633A</b>	<b>6634A</b>	
<b>Load Effect (Load Regulation):</b> For a load change from zero to maximum rated voltage or current of the supply.**	Voltage	2 mV	4 mV	5 mV	
	Current	1 mA	1 mA	1 mA	
<b>Source Effect (Line Regulation):</b> Given for any change within the rated line voltage for any output within the rated output voltage, current, and power of the supply.	Voltage	0.5 mV	1 mV	1 mV	
	Current	0.5 mA	0.25 mA	0.25 mA	
<b>PARD (Ripple and Noise):</b> rms/peak-peak (20 Hz - 20 MHz).	Voltage(Normal)	0.3 mV/3 mV	0.5 mV/3 mV	0.5 mV/3 mV	
	Voltage(Fast)	1 mV/10 mV	1 mV/15 mV	2 mV/25 mV	
	Current(rms)	2 mA	2 mA	2 mA	
<b>Drift (Stability):</b> Change in output over 8-hour interval under constant line, load, and ambient temperature following 30-minute warm-up.	Voltage	0.01%+0.5 mV	0.01%+1 mV	0.01%+1 mV	
	Current	0.01%+1 mA	0.01%+0.5 mA	0.01%+0.3 mA	
<b>Load Effect Transient Recovery:</b> Maximum time required for output voltage to recover within a band of 0.1% of rated voltage around the nominal voltage following a 50% change in load current.	Normal	100 μs	100 μs	100 μs	
	Fast	50 μs	50 μs	50 μs	
<b>Programming:</b> (25±5°C) Given for control of the output over the HP-IB or with front panel controls.	Voltage	Resolution	5 mV	12.5 mV	25 mV
		Accuracy	0.05%+10 mV	0.06%+20 mV	0.05%+50 mV
	+Current	Resolution	1.25 mA	0.5 mA	0.25 mA
		Accuracy	0.15%+7 mA	0.15%+2 mA	0.15%+1 mA
Minimum CC programming current.		20 mA	8 mA	4 mA	
<b>Temperature Coefficient:</b> Output change per degree Celsius change in ambient following 30-minute warm-up.	Voltage	70ppm+0.25 mV	70ppm+0.5 mV	70ppm+1 mV	
	+Current	150ppm+500 μA	150ppm+150 μA	150ppm+75μA	
<b>Output Response:</b> Maximum time for output voltage to change within ±0.025% of final value (LSB), and from 10% to 90%, or 90% to 10% of voltage excursion (Tr/Tf).	Normal	Tr/Tf	15 ms	15 ms	15 ms
		LSB	60 ms	60 ms	60 ms
	Fast	Tr/Tf	400 μs	400 μs	400 μs
		LSB	2 ms	2 ms	2 ms
<b>HP-IB Programming Command Processing Time:</b> (Display disabled)	Typical	10 ms	10 ms	10 ms	
<b>Voltmeter:</b> (25±5°C) Refers to data read back to the controller from the HP-IB and as viewed via the front panel display.	Resolution	5 mV	12.5 mV	25 mV	
	Accuracy	0.07%+15 mV	0.07%+30 mV	0.06%+70 mV	
<b>Ammeter:</b> (25±5°C) Refers to data read back to the controller from the HP-IB and as viewed via the front panel display.	Resolution	1.25 mA	0.5 mA	0.25 mA	
	Accuracy	0.18%+9 mA	0.17%+3 mA	0.15%+2 mA	
<b>DC Output Isolation:</b> Maximum voltage either output terminal (±) may be from chassis ground.		±240 VDC	±240 VDC	±240 VDC	
<b>Remote Sensing:</b> Maximum allowable voltage drop per load lead.		2 VDC	2 VDC	2 VDC	

\*\*Specification under Local Sensing.

**Ordering Information**

- 6632A: 20 volts, 5 amperes
- 6633A: 50 volts, 2 amperes
- 6634A: 100 volts, 1 amperes

**Price\***

- \$1600
- \$1600
- \$1600

(NOTE: Line voltage Option (100, 120, 220 or 240) must be specified)

- 100: 87-106 Vac, 48-63 Hz, (for Japan only) N/C
- 120: 104-127 Vac, 48-63 Hz. N/C
- 220: 191-233 Vac, 48-63 Hz. N/C
- 240: 209-250 Vac, 48-63 Hz. N/C

- 020: Front Output Binding Posts \$77
- 760: Isolation and Polarity Reversal Relay \$395
- 908: Rack Mount Kit for one unit. add \$31 (HP P/N 5061-9674)

- 909: Rack Mount Kit with Handles \$74 (HP P/N 5061-9675)

Accessory: Rack Slide Kit (HP P/N 1494-0059) \$100

- 910: One each extra operating and service manuals. add \$31 (Operating manual only is shipped with standard unit.)

W30: 2 Year Additional Hardware Service \$50

\*Prices apply for domestic U.S.A. customers only.

**Dimensions**

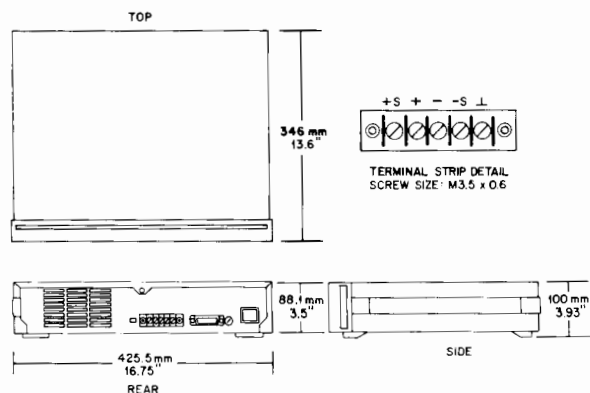

# POWER SUPPLIES

## Multiple Output Linear System Power Supplies

Models 6621A, 6622A, 6623A, 6624A and 6627A

- 2, 3 or 4 Independent Isolated Outputs per Model
- 160 Watts Total Output Power per Model
- HP-IB Programming of Voltage and Current
- HP-IB Measurement of Voltage and Current
- Full Local Control or Local Lockout
- Programmable Overvoltage and Overcurrent Protection

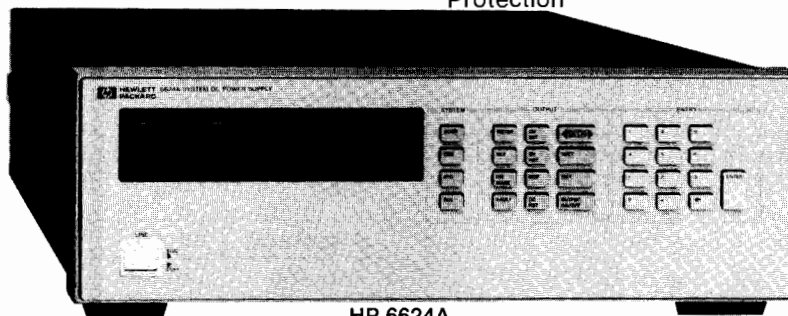

HP 6624A

### Description

These HP-IB multiple output series regulated system power supplies feature a combination of intelligence, performance and low price which makes them the choice for power systems applications.

Five models, each offering a total of 160 watts output power, offer a variety of output combinations of 40 and 80 watts with voltages up to 50 volts and currents to 10 amps. Each output can produce power in two ranges (see fig. 1). For example, model 6622A has two 80 watt outputs. Each of these can produce 80 watts at either 20 volts or 50 volts. When operating below 20 volts, each output can source or sink up to 4 amps. When operating between 20 volts and 50 volts, it can source or sink up to 2 amps. Output combinations include:

6621A - 2 outputs at 80 watts, either 0-7 or 0-20 volts

6622A - 2 outputs at 80 watts, either 0-20 or 0-50 volts

6623A - 1 output at 80 watts, 0-7 or 0-20 volts; 1 at 40 watts, 0-20 or 0-50 volts; 1 at 40 watts, 0-7 or 0-20 volts

6624A - 4 outputs at 40 watts: two at 0-7 or 0-20 volts and two at 0-20 or 0-50 volts

6627A - 4 outputs at 40 watts, either 0-20 or 0-50 volts

The built-in interface is tailored to the power supply, resulting in simpler programming. Specifications supplied with these power supplies already take both the power supply and programming interface into account as a system. Self-contained measurement and readback capabilities eliminate the need for scanning the output or using a separate DVM.

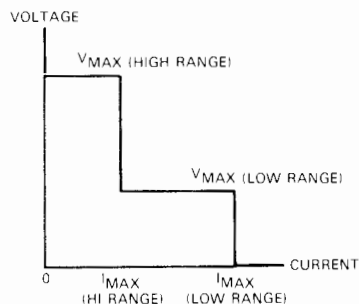

Fig 1. Output Characteristic Curve for HP 662X Series Power Supplies

### Programming Capabilities

These power supplies share the programming command set of HP Models 6632A-6634A and 6030A-6038A programmable power supplies. (see page 460) The following functions are implemented:

- Output Voltage and Current Programming
- Output Voltage and Current Measurement and Readback Present and Accumulated Status Readback
- Programmable Service Request Mask
- Programmable Overcurrent Protection
- Programmable Overvoltage Protection
- Storage and Recall of Programmed Value Sets (all outputs)
- Echo Queries of Programmable Functions/Settings
- Output Channel Enable/Disable
- Programming Syntax Error Detection
- Reprogramming Delay Time for Service Request Mask

Operating voltage and current range is selected programmatically, with the last parameter programmed (voltage or current) determining the range. No separate command is required to switch output range.

Programmed command processing time is typically 7 milliseconds. Response time to within settling band is additional.

### Protection Features

Local lockout capability enables the programmer to disable all front panel controls over the HP-IB except the channel select (to allow display of the output voltage and current of any channel.)

Protection against overcurrent conditions is provided by either the current limit or overcurrent protection. Current limit will prevent the output current from exceeding a programmed value, while overcurrent protection will disable the supply if that value of current is reached. Current limit is always active, while overcurrent protection can be enabled or disabled.

As an example of its use, consider testing PC board subassemblies with a programmable power supply. A shorted component would cause current to be drawn from the power supply at the current limit value, possibly burning the board. Enabling overcurrent protection would cause the power supply to disable itself when the current limit value is reached, thus minimizing damage.

Protection against output overvoltage conditions is also provided. Normally, the power supply voltage will not exceed the programmed voltage setting. Programmable overvoltage protection guards your load against hardware faults by disabling and down-programming the power supply output if the programmed overvoltage setting is exceeded. A crowbar circuit is activated and shorts the output under these conditions.

This series also provides protection from unregulated output in the event of line voltage dropout and also guards against overtemperature conditions. The output is disabled when either of these conditions exists.

A service request can be generated to inform the controller in the event of any user-defined combination of overvoltage, overcurrent, overtemperature or mode change.

Fault trips which disable the output can be reset over the HP-IB.

### Output Ratings And Combinations

OUTPUT	CHANNEL	NUMBER OF OUTPUTS PER MODEL				
		6627A (4 output)	6624A (4 output)	6623A (3 output)	6622A (2 output)	6621A (2 output)
Hi Range Volts/ Amps	Low Range Volts/ Amps					
0-20/ 0-2	0-7/ 0-5	-	2	1	-	-
0-50/ 0-0.8	0-20/ 0-2	4	2	1	-	-
0-20/ 0-4	0-7/ 0-10	-	-	1	-	2
0-50/ 0-2	0-20/ 0-4	-	-	-	2	-

### Software Calibration And Selftest

With this series of power supplies, calibration is performed without removing the instrument's cover. All that is required is a shunt, a dvm, a controller and a few lines of code. Simple commands instruct the power supply to go to preset adjustment points, where voltages or currents are read with the dvm and shunt. Then the readings are sent to the power supply, which adjusts its calibration. Calibration is maintained through line voltage cycling.

Calibration integrity can be assured by using a jumper inside the box which, when removed, will prevent the supply from accepting calibration commands.

These supplies also have considerable selftest capability, which is exercised at power on and upon receipt of the selftest command over the HP-IB. Running selftests over the HP-IB will not cause the output to change.

### System Configuration

This series of power supplies offers a number of significant benefits in the area of simplicity and flexibility of system configuration.

A convenient rear panel line voltage module allows switching of input line voltage without removing the covers. (The line voltage option determines line cord plug configuration.)

For applications which require different combinations of voltage and current for different loads, the dual range full power feature will be useful (see fig. 1). If this is not enough, two outputs can be combined in parallel or series combinations for more power at a given voltage or current level.

Where a precisely regulated voltage is required at the load, remote sensing at the load can be used. This capability will compensate for load lead IR drops of up to 1 volt per load lead. Add 1mV to the load effect specification for each 200 mV drop in the negative load lead when remote sensing.

All outputs of these power supplies are isolated for up to 240 volts dc from chassis ground and each other.

For applications which require a hardware trip signal separate from the HP-IB remote disable, terminals are provided on the rear panel barrier block of each output which provide bidirectional overvoltage protection trip capability. These terminals can be used to monitor for an OVP trip signal, strapped together to disable all outputs when one OVP is tripped or used as a remote disable separate from the HP-IB.

These models can sink as well as source current. This means that downprogramming without a load takes the same time as upprogramming. Quick discharging of reactive loads is another benefit resulting from this capability.

### Front Panel Control

To aid in system program development, the following capabilities of these power supplies are controllable from the front panel:

- Output Channel Select (Controls and Display)
- OVP Setting
- Overcurrent Protection Enable
- Storage and Recall of Programmed Settings
- Voltage Setting
- Current Setting
- SRQ Mask Delay Time
- Output Enable/Disable
- OVP, OCP Reset
- Local

The alphanumeric LCD display will normally display output voltage and current for the channel selected. When programming from the front panel, the function being programmed and the present value will be displayed. Fault conditions will be spelled out in alpha characters. Output channel is indicated by an annunciator.

Changing the HP-IB address is done from the front panel, using the address key and the numeric keypad.

### CIIL Programming (Option 700)

Enables programming in CIIL, Control Intermediate Interface Language. Includes Option 750. Consult page 466 for more detail.

### Relay Controls, Fault Indicator, and Remote Inhibit Option 750

The new Option 750 for the HP 662XA series includes protection features and relay controls. The protection features include the discrete fault indicator line (FLT) and the remote inhibit line (INH). The relay controls (RLY), together with external user-supplied relay such as the HP 59510A or HP 59511A, physically disconnect the power supply outputs from the load (or system). Each of the four open collector RLY controls can sink 120 mA. They can be programmed over HP-IB with the RELAY and OUT commands or operated with the front panel OUTPUT ON/OFF function key. See pages 464 for further information.

### General Specifications

**HP-IB interface functions:** SH1, AH1, T6, L4, SR1, RL1, PP1, DC1, DT0.

**Safety agency compliance:** This series of power supplies is designed to comply with the following regulatory standards: IEC 348, VDE 0411, UL 1244, ANSI C39.5, and CSA Electrical Bulletin 556B.

**Dimensions (all models):** 132.6 mm H x 425.5 mm W x 497.8 mm D. (5.22 in. H x 16.75 in. W x 19.6 in. D)

**Input current:** 100 VAC 120 VAC 220 VAC 240 VAC  
(max.rms, all models) 6.3 A 5.4 A 3.0 A 3.0 A

**Weights kg(lb) (all models):** Net 17.4(38) Shipping 22.7(50)

### Prices And Option Descriptions

- 6621A:** Dual output system power supply. \$3400
- 6622A:** Dual output system power supply. \$3400
- 6623A:** Triple output system power supply. \$3900
- 6624A:** Quad output system power supply. \$4400
- 6627A:** Quad output system power supply. \$4400
- (NOTE: Line voltage option (100, 120, 220 or 240) must be specified)**
- 100:** 87- 106 Vac, 47-66 Hz. (for Japan only) N/C
- 120:** 104-127 Vac, 47-66 Hz. N/C
- 220:** 191-233 Vac, 47-66 Hz. N/C
- 240:** 209-250 Vac, 47-66 Hz. N/C
- 700:** CIIL programming for MATE in place of HP-IB add \$510
- 750:** Protection Feature and Relay Controls add \$255
- 908:** Rack Mount Kit for one unit (no handles) add \$31
- 909:** Rack kit with handles add \$82
- 910:** One each extra operating and service manuals. (Operating manual only is shipped with standard unit.) add \$31
- W30:** 2 Years Additional Hardware Service \$75

### Output Channel Specifications (READ ACROSS FROM PREVIOUS PAGE) (at 0° to 55° C unless otherwise specified)

HP-IB OUTPUT SETTINGS				HP-IB MEASUREMENT READBACK ACCURACY**		PARD (p-p/rms)		REGULATION				PROGRAMMING SPEED		
RESOLUTION		ACCURACY**						LOAD EFFECT		SOURCE EFFECT		TIME CONSTANT	RESPONSE TIME	SETTLING BAND
VOLTAGE	CURRENT	VOLTAGE	CURRENT	VOLTAGE	CURRENT	VOLTAGE	CURRENT	VOLTAGE	CURRENT	VOLTAGE	CURRENT			
6 mV	25 mA	19 mV + 0.06%*	50 mA + 0.16%*	20 mV + 0.05%*	10 mA + 0.1%*	3 mV/500 uV	1 mA rms	2 mV	1 mA	1 mV + 0.01%*	1 mA + 0.06%*	250 μs	2 ms	20 mV
15 mV	10 mA	50 mV + 0.06%*	20 mA + 0.16%*	50 mV + 0.05%*	4 mA + 0.1%*	3 mV/500 uV	1 mA rms	2 mV	0.5 mA	1 mV + 0.01%*	1 mA + 0.06%*	750 μs	6 ms	50 mV
6 mV	50 mA	19 mV + 0.06%*	100 mA + 0.16%*	20 mV + 0.05%*	20 mA + 0.1%*	3 mV/500 uV	1 mA rms	2 mV	2 mA	1 mV + 0.01%*	2 mA + 0.06%*	250 μs	2 ms	20 mV
15 mV	20 mA	50 mV + 0.06%*	40 mA + 0.16%*	50 mV + 0.05%*	8 mA + 0.1%*	3 mV/500 uV	1 mA rms	2 mV	1 mA	1 mV + 0.01%*	2 mA + 0.06%*	750 μs	6 ms	50 mV

\*% of setting. \*\* For a ±5°C range about the calibration temperature



# POWER SUPPLIES

## Precision Multiple Output System Power Supplies

Models HP 6625A and HP 6626A

- 2 or 4 Independent Isolated Outputs per Model
- 14 bit Programming of Voltage or Current
- Two ranges cover: 0.5 mv to 50 volts; 1  $\mu$ a to 2 amps

- HP-IB Control and Measurement of Voltage and Current
- Current Sinking Capability for Fast Response
- Extensive Protection for DUT and Power Supply



HP 6626A

### Description

These HP-IB precision multiple output series regulated system power supplies provide a combination of features and performance that make them an excellent choice for automated component testing and other system applications requiring precision control.

Most importantly, these models are one-box solutions for those applications that require both sourcing and measurement of the load voltage and current. The built in DVM and precision current shunt allow readback of actual power supply output variables over the HP-IB.

Two models provide different combinations of two output types: the 25 watt output offers 50 volts at 0.5 amps with a rectangular output characteristic; the 50 watt output offers 50 volts or 2 amps, with an L-shaped output characteristic (see fig. 1.). The HP 6625A is a dual output supply offering one of each output type for a total of 75 watts. The HP 6626A is a quad output supply offering two of each output type for a total of 150 watts.

Each output offers a high and low range of operation for both voltage and current. These ranges may be selected independently, and the resulting output combinations are shown in the table on the facing page.

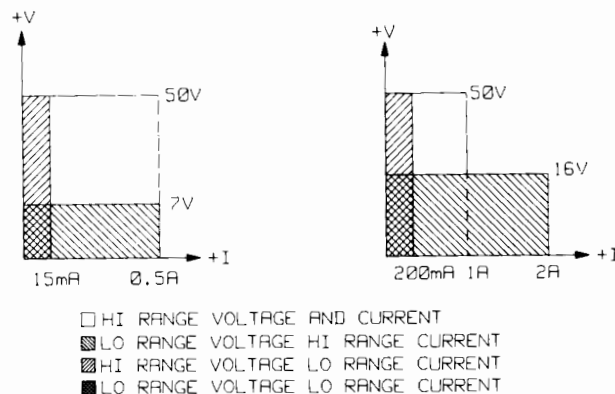

Figure 1: Output characteristics for HP 6625A and HP 6626A

### Current Sinking

Each output has the capability to sink well as source current, so that voltage down-programming can be accomplished as quickly as up-programming, even without a load.

### Remote Sensing

Remote sense terminals allow for precise voltage regulation at the load. These power supplies can accommodate up to 10 volts of sense lead drop (within a maximum of 50 volts at the output terminals of the power supply).

### Output Configuration Flexibility

Outputs of the same type can be operated in series or parallel combinations for increased output voltage or current capability. All outputs of these supplies are isolated for up to 240 volts dc from chassis ground and from each other.

Bi-polar operation can be achieved by connecting two outputs of the same type in a series opposing mode.

### Programming Capabilities

The internal HP-IB interface allows complete programmability, including status reporting and interrupt generation with user designated fault conditions. Programming commands (such as VSET for voltage programming) are easy to use and self documenting. These power supplies share the programming command set of HP Models 6621A-6624A, 6632A-6634A, and 6030A-6038A programmable supplies as described on page 462. The following functions are implemented:

- Output Voltage and Current Programming
- Voltage and Current Range Programming
- Output Voltage and Current Measurement and Readback
- Present and Accumulated Status Readback
- Programmable Service Request Mask
- Programmable Overvoltage and Overcurrent Protection
- Storage and Recall of Programmed Voltage and Current Values for all outputs
- Echo Queries of Programmable Functions and Settings
- Output Enable or Disable
- Programming Syntax Error Detection
- Programmable Delay Time for Service Request and Over Current Protection Mask
- Software Calibration of Voltage, Current, and Overvoltage
- HP-IB Interface Selftest
- Message Display Capability on the Front Panel
- Programmed command processing time is typically 7 milliseconds.
- Response time to within settling band is additional (see Output Response specification on the facing page).

### Front Panel Control

To aid in system program development, a wide range of control capabilities are provided from the front panel.

- \* Output Channel Select (Controls and Display)
- \* Output Range Setting
- \* Output Enable/Disable
- \* OVP, OCP Reset
- \* Local / HP-IB Operation
- \* Overcurrent Protection Enable
- \* Storage and Recall of Programmed Settings
- \* Setting the HP-IB Address
- \* Voltage and Current Setting
- \* Output Range Setting
- \* Output Enable/Disable
- \* OVP, OCP Reset
- \* Local / HP-IB Operation

The alphanumeric LCD display will normally display output voltage and current for the channel selected. When programming from the front panel, the function being programmed will be displayed. Fault conditions will be spelled out in alpha characters. Output channel is indicated by annunciators.

### Protection Features

Local lockout capability enables the programmer to disable all front panel controls over the HP-IB except the channel select (for monitoring purposes).

All outputs have both Overvoltage and Overcurrent protection. The Overcurrent protection will disable the supply if the programmed current limit is reached. Programmable Overvoltage protection guards your load against hardware faults by disabling and down-programming the power supply if the programmed overvoltage setting is exceeded. A crowbar circuit is activated and shorts the output under these conditions.

This series also provides protection from unregulated output in the event of line voltage dropout, and guards against overtemperature. The output is disabled when either of these conditions exists.

A service request can be generated to inform the controller in the event of any user-defined combination of overvoltage, overcurrent, overtemperature or mode change. Fault trips which disable the output can be reset over the HP-IB.

For applications which require a hardware trip signal separate from the HP-IB remote disable, terminals are provided on the rear panel barrier block of each output which have bi-directional trip capability. These terminals can be used to monitor for an OVP trip signal, can be strapped together to disable all outputs when one OVP is tripped, or can be used as a remote disable, separate from the HP-IB.

### Relay Controls, Discrete Fault Indicator, and Remote Inhibit

Option 750 for the Models 6625A and 6626A includes additional protection features and relay controls. Included is a discrete fault indicator line (FLT) and the remote inhibit line (INH). The relay controls (RLY), together with external user supplied relays or accessory relays such as the HP 59510A or HP 59511A, physically disconnect the power supply outputs from the load (or system). Each of the four open collector RLY controls can sink 120 ma. They can be programmed over HP-IB with the RELAY and OUT commands or operated with the front panel OUTPUT ON/OFF function key. See page 464 for a complete description of the Models 59510A and 59511A Relay Boxes.

### Software Calibration and Selftest

Just as on the HP 662XA and 663XA series, calibration can be performed without removing the instrument's cover. All that is required is a shunt, a DVM, a controller and a few lines of code. Simple commands instruct the power supply to go to preset adjustment points, where voltages or currents are read with the DVM and shunt. Then the readings are sent to the power supply which adjusts its calibration.

Calibration is maintained through input line voltage cycling. An internal jumper can be removed to prevent the supply from accepting unintentional calibration commands.

The selftest is exercised at power on and upon receipt of the selftest command over the HP-IB. Running selftests over the HP-IB will not cause the output to change.

### General Specifications

For additional output channel specifications, see table below.

**Output Response:** (all outputs)

**Max Output Programming Time:** 6 ms

**Max Time Constant:** 750  $\mu$ s

**Settling Band:** Within 50 mV of programmed value

**Command Processing Time:** Typically 7 ms (with front panel display disabled)

**Load Transient Recovery:** (all outputs) Time to recover within 75 mV of nominal value: 75  $\mu$ s

**Current Sink Capability:** (for any voltage above 4 volts)

**50 watt outputs:** 1 amp (2 amp below 16 volts)

**25 watt outputs:** 0.5 amps

**HP-IB interface functions:** SH1, AH1, T6, L4, SR1, RL1, PP1, DC1, DT0, C0, E1. For more information on these codes, refer to the HP-IB section of this catalog.

**Safety agency compliance:** This series of power supplies is designed to comply with the following regulatory standards: IEC 348, VDE 0411, UL 1244, ANSI C39.5, and CSA Electrical Bulletin 556B.

**Size (all models):** 132.6 mm H x 422.5 mm W x 497.8 mm D.

(5.22" x 16.75" x 19.6")

**Input current:** 100 VAC 120 VAC 220 VAC 240 VAC  
(max. rms, all models) 6.3 A 5.4 A 3.0 A 3.0 A

**Weight kg (lb) (all models):** Net 17.4 (38) Shipping 22.7(50)

### Prices and Option Descriptions

**6625A:** Dual output system power supply. \$4500

**6626A:** Quad output system power supply. \$7500

**NOTE: Line voltage option (100, 120, 220, 240) must be specified.**

**100:** 87- 106 VAC, 47-66 Hz. (for Japan only) N/C

**120:** 104-127 VAC, 47-66 Hz. N/C

**220:** 191-233 VAC, 47-66 Hz. N/C

**240:** 209-250 VAC, 47-66 Hz. N/C

**750:** Relay Control and DFI/RI add \$255

**908:** Rack Mount Kit for one unit (no handles) add \$31

**909:** Rack Kit with handles add \$82

**910:** One each extra operating and service manuals add \$31  
(Operating manual only is shipped with standard unit.)

### Output Channel Specifications (at 0°C to 50°C unless otherwise specified)

TYPE	OPERATING RANGE	OUTPUT			READBACK		PAR D rms/p-p	REGULATION	
		SETTING	RESOLUTION	ACCURACY*	RESOLUTION	ACCURACY*		LOAD EFFECT	SOURCE EFFECT
25 watt	Lo Range/Voltage	0-7 volts	0.5 mV	1.5 mV +0.016%	0.5 mV	2 mV +0.016%	0.5 mV/3 mV	0.5 mV	0.5 mV
	Lo Range/Current	0-15 mA	1 $\mu$ A	15 $\mu$ A +0.04%	1 $\mu$ A	15 $\mu$ A +0.03%	0.1 mA/-	5 $\mu$ A	5 $\mu$ A
	Hi Range/Voltage	0-50 volts	4 mV	10 mV +0.016%	4 mV	10 mV +0.016%	0.5 mV/3 mV	0.5 mV	0.5 mV
	Hi Range/Current	0-0.5 amps	40 $\mu$ A	100 $\mu$ A +0.04%	50 $\mu$ A	130 $\mu$ A +0.03%	0.1 mA/-	5 $\mu$ A	5 $\mu$ A
50 watt	Lo Range/Voltage	0-16 volts	1 mV	3 mV +0.016%	1 mV	3.5 mV +0.016%	0.5 mV/3 mV	0.5 mV	0.5 mV
	Lo Range/Current	0-0.2 amps	15 $\mu$ A	185 $\mu$ A +0.04%	15 $\mu$ A	250 $\mu$ A +0.04%	0.1 mA/-	10 $\mu$ A	10 $\mu$ A
	Hi Range/Voltage	0-50 volts	4 mV	10 mV +0.016%	4 mV	10 mV +0.016%	0.5 mV/3 mV	0.5 mV	0.5 mV
	Hi Range/Current	0-2 amps	160 $\mu$ A	500 $\mu$ A +0.04%	160 $\mu$ A	550 $\mu$ A +0.04%	0.1 mA/-	10 $\mu$ A	10 $\mu$ A

\* For a  $\pm 5^\circ$ C range about the calibration temperature

# POWER SUPPLIES

## Autoranging System Power Supplies

Models 6030A, 6031A, 6032A, 6033A, and 6038A

- HP-IB programming of voltage and current
- Readback of voltage, current and status
- Overvoltage and overcurrent protection

- Optional CIIL programming
- Built-in self-test and diagnostics
- Up to 1200 watts output
- Full local control enable/disable

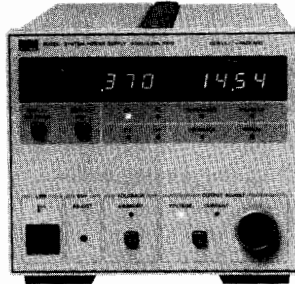

HP 6033A, 6038A

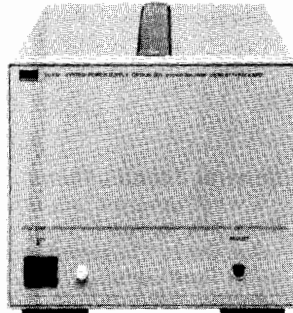

HP 6033A and 6038A  
with Opt 001

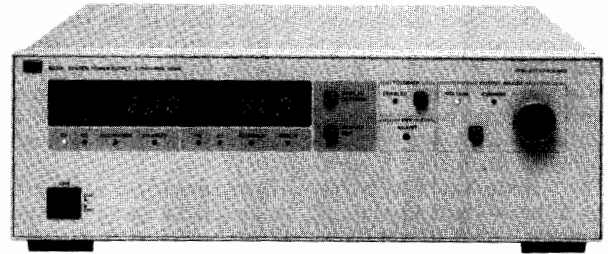

HP 6030A, 6031A and 6032A

### Description

These HP-IB CV/CC dc power supplies have many productivity-oriented features which make them easy to program, integrate into systems and use.

A conventional power supply subsystem capable of monitoring and controlling power supply voltage and current requires a variety of hardware in addition to the actual supply. These new power supplies, however, have built-in capabilities which eliminate the need for D/A programmers, DVMs, and associated auxiliary circuitry. Fewer instruments mean less rack space, easier calculation of system specifications, quicker configurations, higher system reliability, more rapid troubleshooting, and simpler software. As autoranging power supplies, these models can provide a wide and continuous range of voltage and current combinations at the maximum rated power. This often allows both present and future requirements to be satisfied with fewer supplies, also reducing the number of instruments in the system.

### Front Panel Control

Most of the extensive programmable instruction set can be simulated with front panel controls, thus facilitating design and debugging of system hardware and software. During system operation, if local control is not needed, the front panel controls can be disabled with a computer command. If operator interaction is required, a computer command can place limits on the output voltage and current available. Often, control and monitoring via the front panel is very useful during system development, but not needed afterwards. If the system is reproduced without further development, power supplies without front panel controls and meters (Option 001) can then be used. Ordering your power supplies with Option 001 significantly decreases the cost.

### Protection Features

Because of the delicate nature of most loads, these system power supplies provide several different types of protection. Since they are CV/CC supplies, both the output voltage and current will be automatically limited to the programmed values. If reaching a programmed value indicates an undesirable condition, the power supply can be instructed to automatically down-program to zero output. For example, if the programmed current limit is reached while testing a PC board assembly, it may indicate a shorted component. In this case, the FOLDBACK feature, if enabled, would be able to serve as an overcurrent protection circuit and down-program the power supply automatically. FOLDBACK can be enabled and reset over the HP-IB.

The built-in overvoltage protection circuit is adjustable with a front panel control. The set trip level can be displayed on the front panel meter and also can be read back over the HP-IB, thus making adjusting the level easy. The OVP circuit, once tripped, can be reset over the HP-IB.

Production procedures sometimes require the operator to adjust the output voltage or current of a power supply locally with the front panel controls. If this is done, programmed levels can be set to limit the available adjustment range to a safe margin.

Potentially harmful conditions, such as overtemperature and high or low ac input, will trigger the power supply to automatically down-program to zero output. When these conditions occur, or the FOLDBACK or OVP circuits trip, LEDs on the front panel light to indicate the failure. This status can also be read back to the computer over the HP-IB and can be used to generate interrupts.

### Specifications

Ratings		Autoranging Output*								Regulation				10% Change Transient Recovery
										Load Effect		Source Effect		
Volts	Amperes	V <sub>1</sub>	P <sub>1</sub>	V <sub>2</sub>	P <sub>2</sub>	V <sub>3</sub>	P <sub>3</sub>	HP Model	Voltage	Current	Voltage	Current		
0-20	0-30	20V	200W	14V	242W	6.7V	200W	6033A	0.01% +2mV	0.01% +9mA	0.01% +1mV	0.01% +6mA	1ms / 50mV	
0-20	0-120	20V	1000W	14V	1064W	7V	840W	6031A	0.01% +3mV	0.01% +15mA	0.01% +2mV	0.01% +25mA	2ms / 100mV	
0-60	0-10	60V	200W	40V	240W	20V	200W	6038A	0.01% +3mV	0.01% +5mA	0.01% +2mV	0.01% +2mA	1ms / 75mV	
0-60	0-50	60V	1000W	40V	1200W	20V	1000W	6032A	0.01% +5mV	0.01% +10mA	0.01% +3mV	0.01% +10mA	2ms / 100mV	
0-200	0-17	200V	1000W	120V	1200W	60V	1020W	6030A	0.01% +5mV	0.01% +10mA	0.01% +5mV	0.01% +5mA	2ms / 150mV	

\*See the generalized autoranging output characteristic curve.

**Programmable Features**

Below are the parameters which can be programmed on the HP 6030A — 6038A and the information which is available for readback over the HP-IB. All of these features are included with the standard user-friendly programming language.

**Programmable Functions**

- Output Voltage
- Output Current
- Output Disable/Enable
- Soft Voltage Limit
- Soft Current Limit
- Group Trigger
- Foldback Mode
- Device Clear
- Interrupt Mask
- Interrupt Delay
- Preset Power Supply States
- Self-Test
- Local Lockout

**Readback Functions**

- Programmed Voltage
- Programmed Current
- Actual Voltage
- Actual Current
- OVP Trip Level
- Soft Voltage Limit
- Soft Current Limit
- Foldback Mode
- Present Status
- Accumulated Status
- Interrupt Mask
- Programming Error Codes
- Self Test Error Codes
- Output Disable/Enable
- Device ID

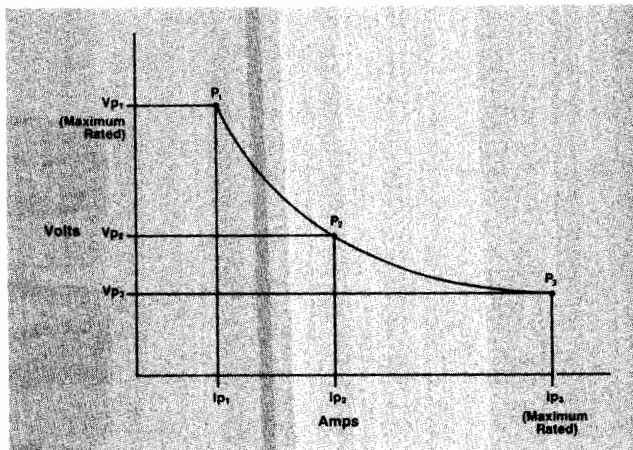

Generalized autoranging output characteristic curve

For added flexibility now a CIIL programming language, Option 700, is available.

**System Configuration**

If your application requires more power than the output capability of a single unit, you can use an auto-series connection for greater output voltage or an auto-parallel connection for greater output current. Consult your local HP sales office regarding restrictions/limitations for auto-series and auto-parallel operation.

Remote sensing can be used to maintain the CV load effect specification at the load with up to 0.5 volt drop per load lead, and sense wires which are less than 0.2 ohm per lead. Operation is possible with up to 2.0 volts drop per lead; however, the load effect specification may be degraded.

Either terminal may be grounded, or may be floated up to  $\pm 240$  ( $\pm 550$  volts for the HP 6030A) volts from chassis ground.

Analog programming inputs and monitoring terminals are provided on the rear panel in addition to the HP-IB programming capabilities. Zero to full scale voltage or current can be programmed with either 0-5 volt voltage signals, or 0-4000 ohm resistance signals. The monitoring terminals present 0-5 volt buffered signals which are proportional to the output voltage and current.

HP models 6030A, 6031A, 6032A, and 6038A are stable when operating in CC into inductive loads up to 100 mH, and the HP 6033A and 6038A can handle up to 1 H. A special modification is available for HP Models 6030A, 6031A and 6032A to ensure stable operation when operating into inductive loads up to 10 H.

**General Specifications**

HP-IB interface functions: SH1, T6, AH1, L4, SR1, RL1, PP1, DC1, DT1.

Dimensions: HP 6033A and 6038A: 177.0 mm H x 212.3 mm W x 443.6 mm D (6.97" x 8.36" x 17.872")

HP 6030A, 6031A and 6032A: 132.6 mm H x 425.5 mm W x 503.7 mm D (5.2" x 16.75" x 19.83")

**Fault Indicator and Remote Inhibit**

These HP-IB DC power supplies include a discrete fault indicator line (FLT) and remote inhibit line (INH). FLT is a two pin TTL output port that will go true whenever the power supply goes into

fault mode. INH is a two pin TTL input port that provides a means for disabling the power supply directly. Both the Fault Indicator and Remote Inhibit Lines are separate from, and in addition to, the HP-IB programming control; See page 466 for more details.

**Isolation/Polarity Reversal Relay Control**

These models can control HP Models 59510A, 59511A relay devices with HP-IB commands. This applies to HP 603XA series products manufactured after May 1, 1988. Consult HP regarding retrofit kit for older HP 603XA series power supplies. See page 464 for more details.

**CIIL Programming Language (Option 700)**

Option 700 enables programming in CIIL (Control Interface Intermediate Language). CIIL is a test instrument module programming language standard used in military test equipment applications. See page 466 for more details.

**Option Descriptions**

- 001:** Front panel which has only line switch, line indicator, and OVP adjust. less \$300
- 100:** 87-106 Vac, 48-63 Hz. This option is for use in Japan only. The power supply output power is 75% of the output power available with the other line voltage options. N/C
- 120:** 104-127 Vac, 48-63 Hz. N/C
- 220:** 191-233 Vac, 48-63 Hz. N/C
- 240:** 208-250 Vac, 48-63 Hz. N/C
- 700:** CIIL programming language add \$510
- 800:** Rack mount kit for two units side by side. This applies to HP 6033A and 6038A only. add \$ 77
- 908:** Rack mount kit for a single unit. A blank filler panel is supplied when this option is ordered with HP 6033A and 6038A.
  - HP 6033A and 6038A add \$ 82
  - HP 6030A, 6031A and 6032A add \$ 31
- 910:** One extra operating and service manual shipped with each power supply. add \$ 31
- W30:** 2 Years Additional Hardware Service add \$ 50

**Specifications cont.**

PARD (rms/p-p) 20 Hz-20 MHz		Remote Control				General						
		Resolution		Accuracy		AC Input Current				Weight - kg (lbs)		Price
Voltage	Current	Voltage	Current	Voltage	Current	100 Vac	120 Vac	220 Vac	240 Vac	Net	Shipping	
3mV/30mV	15mA/-	5mV	7.5mA	0.035% +9mV	0.15% +20mA	6.0A	6.5A	3.8A	3.6A	9.6(21)	11.4(25)	\$2575
8mV/50mV	120mA/-	5mV	30mA	0.035% +15mV	0.25% +250mA	24A	24A	15A	14A	17.2(38)	22.7(50)	\$3400
3mV/30mV	5mA/-	15mV	2.5mA	0.035% +40mV	0.085% +10mA	6.0A	6.5A	3.8A	3.6A	9.6(21)	11.4(25)	\$2575
8mV/40mV	25mA/-	15mV	12.5mA	0.035% +40mV	0.2% +85mA	24A	24A	15A	14A	16.3(36)	21.8(48)	\$3400
22mV/50mV	15mA/-	50mV	4.25mA	0.035% +145mV	0.2% +25mA	24A	24A	15A	14A	16.3(36)	21.7(48)	\$3400

# POWER SUPPLIES

## System Power Supply Programming Features



HP-IB system power supplies are extremely easy to program. The following tables are a complete list of the available programming and readback commands. These commands only apply to the models as listed.\*

### Core Commands

Command	Header	Description	HP 6030A to HP 6033A, HP 6038A	HP 6621A to HP 6627A	HP 6632A to HP 6634A
Set voltage	VSET	Programs output voltage setting	X	X	X
Set current	ISET	Programs output current setting	X	X	X
Voltage readback	VOUT?	Returns measured voltage value	X	X	X
Current readback	IOUT?	Returns measured current value	X	X	X
Service request	SRQ	Enable or disable service request capability	X	X	X
Status	STS?	Returns contents of present status register	X	X	X
Accumulated status	ASTS?	Returns contents of accumulated status register	X	X	X
Fault	FAULT?	Returns contents of fault register	X	X	x
Error	ERR?	Returns programming error code	X	X	X
Clear supply	CLR	Clears all settings and returns power supply to initial power-on values	X	X	X
Output on/off	OUT	Enable or disable output	X	X	X
Unmask	UNMASK	Defines conditions which generate a fault that is latched into the fault register	X	X	X
Reprogram delay (in seconds)	DLY	Delays the power supply from registering a fault when these fault conditions are true temporarily	X	X	X
Model number	ID?	Returns model number	X	X	X
Selftest	TEST?	Initiate selftest	X	X	X
Reset overvoltage	OVRST	Resets OVP once it's been triggered	1	X	1
Reset overcurrent	OCRST	Resets OCP once it's been triggered	1	X	1
Reset	RST	Resets OVP, OCP or foldback when triggered	X		X

1. Reset (RST) performs the identical function as both OVRST and OCRST.

### Extended Commands

Command	Header	Description	HP 6030A to HP 6033A, HP 6038A	HP 6621A to HP 6627A	HP 6632A to HP 6634A
Set overvoltage	OVSET	Sets overvoltage trip level		X	X
OC protection on/off	OCP	Enable or disable over current protection	1	X	X
Power-on SRQ on/off	PON	Enable or disable service request capability at power-on		X	X
Display on/off	DSP	Turns on/off the front panel display		X	X
Calibration mode	CMODE	Turns calibration mode on or off		X	X
Voltage setting	VSET?	Returns programmed voltage value	X	X	
Current setting	ISET?	Returns programmed current value	X	X	
OVP setting	OVSET?	Returns programmed OVP trip level	X*	X	
OC protection on/off	OCP?	Returns condition of OCP (enabled/disabled)	1	X	
Output on/off	OUT?	Returns condition of the output (on/off)	X	X	
Unmask setting	UNMASK?	Returns a number corresponding to the unmasked settings in the fault register	X	X	
Delay setting	DLY?	Returns delay setting	X	X	
Store settings	STO	Stores voltage and current settings	X	X	
Recall settings	RCL	Recalls stored settings	X	X	
Trigger	TRG	Implements values stored using hold command	X		
Hold	HOLD	Stores values which are implemented by the trigger command	X		
Voltage maximum	VMAX	Sets maximum voltage value power supply will accept	X		
Current maximum	IMAX	Sets maximum current value power supply will accept	X		
Foldback	FOLD	Enable or disable foldback	X		
Service request setting	SRQ?	Returns condition of SRQ (enabled/disabled)	X	X	
Power-on SRQ on/off	PON?	Returns condition of the SRQ at power-on (enabled/disabled)		X	
Display on/off	DSP?	Returns condition of front panel display (enabled/disabled)		X	
Display character	DSP	Displays messages of up to 12 characters on the front panel display		X	
Foldback setting	FOLD?	Reports foldback setting	X	1	1

### Isolation & Polarity Reversal Relay Commands

Relay Open/Close	Relay	Enables and disables relay	X	X	X
Relay State	Relay?	Returns open/close condition	X	X	
DC Output	DC	Enables/disables power supply output	X	X	X
DC Output State	DC?	Returns enable/disable condition of power supply output	X	X	
Output	OUT	Enables/disables both relay and power supply output	X	X	X
Output State	OUT?	Returns condition of relay and power supply output	X	X	
Polarity Reverse	POL	Reverses polarity of relay	X		X
Polarity State	POL?	Returns condition of relay normal/reverse	X		
Power-on setting	DCPON	Sets condition (enable/disable) at power-on of relay and power supply output		X	
Power-on setting	RLYPON	Sets condition (enable/disable) at power-on of relay			X

1. Foldback (HP Models 6030A-6033A, 6038A) is a protection feature similar to overcurrent protection (HP 6621A-6627A and HP 6632A-6634A).

\* Header is OVP? (HP Models 6030A-6033A, 6038A)



# POWER SUPPLIES

## DC Output Connect/Disconnect and Polarity Reversal Relays

Models HP 59510A and HP 59511A

- DC Output Isolation from Load
- DC Output Polarity Reversal (HP 59511A only)
- Remote Control

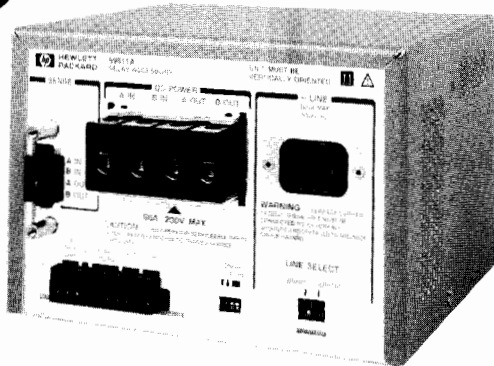

HP 59511A

### Description

HP Models 59510A and 59511A are remote controllable isolation relay devices. These devices are connected between the dc power supply and the load. They provide physical isolation of the power supply or any test instrument from the load. The HP 59511A also provides the capability of reversing the output polarity of the power supply for reverse bias applications. These devices can be configured to switch dc power to multiple test fixtures and can be used to provide an extra measure of protection in the case of a fault condition where emergency shutdown is required. An internal power supply provides power for the relay coils.

### Compatibility

HP Models 59510A and 59511A can be used with any dc power supply subject to the relay devices voltage and current operating range.

### Reliability

Both power and sense relays use mercury contacts for high reliability and long life.

### Mounting

Both models can be mounted on any one of three sides with machine screws. Rack mount kit (Option 850) facilitates mounting either to the rear (e.g., behind the power supply) or front of an equipment rack. Two relay devices can be mounted side by side with two rack mount kits. Relay devices must be mounted vertically.

### Sequencing

The internal microprocessor sequences the switching of power and sense leads. This protects the load by minimizing possible voltage overshoots.

### Protection

The relay device can be inhibited (returned to normally open contact state) by asserting the remote inhibit line. This provides an added emergency shutdown mechanism that can be daisy-chained with other instruments. In the event of a power loss the relay will return to the normally open contact state.

### Remote Control

HP Models 59510A and 59511A are controlled through a TTL signal port. This provides the user flexibility in method of control. Relay

- Switches and Sequences Power and Sense Leads
- Switches Up to 200 Vdc
- Switches Up to 60 Amperes

device control using HP-IB commands, allowing control of power supply and relay as one unit, is possible when used with an HP system power supply.

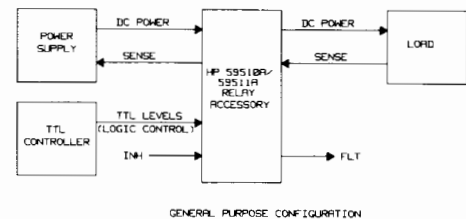
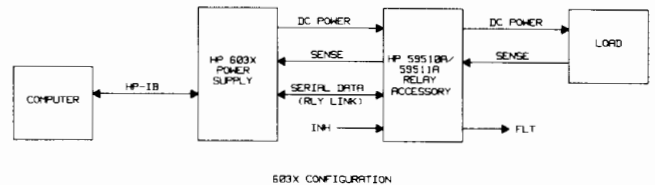

### HP 59510A/59511A Configurations

### Application

A common application for the 59510A and 59511A is to isolate the device under test from the power source. Before applying power to the DUT a system voltmeter or the built-in readback feature of the HP Systems Power Supplies is used to verify that the output voltage is at its intended value. With the isolation relays open, the power supply is programmed to the test value and measured with the system voltmeter. If the value is correct the relays are closed and power is applied to the DUT. Similarly, when the test is completed, a measurement with the system voltmeter reconfirms that the power supply voltage is correct before opening the isolation relays and disconnecting the DUT.

### HP 6030A-6033A and HP 6038A

When connected to the HP 59510A or 59511A through the signal port, HP-IB relay commands\*\* can be sent directly to the power supply to control the relay device. This saves time and effort by eliminating the need to control the relay device separately. One bus address controls both power supply and relay. This applies to HP Models 6030A-6033A and 6038A manufactured after May 1, 1988. Consult HP regarding a retrofit kit for older models.

The HP 59510A and 59511A are provided with filters that reduce the maximum output noise (PARD) of the HP 6032A, 6033A and 6038A to 20 mV p-p.

### HP 6621A-6624A and HP 6627A with Option 750 Relay Control and DFI/RI

This option provides a 12 pin logic port located on the rear of the power supply which provides control of up to four external relays (HP 59510A) and provides Discrete Fault Indicator and Remote Inhibit\*. Two HP 59511A isolation/polarity reversal relays can be controlled. Power supply front panel and HP-IB commands\*\* can control relay devices. See page 457 for ordering information.

\* Refer to page 466 for more details regarding Discrete Fault Indicator and Remote Inhibit.

\*\* Refer to page 463 for a listing of HP-IB relay commands.

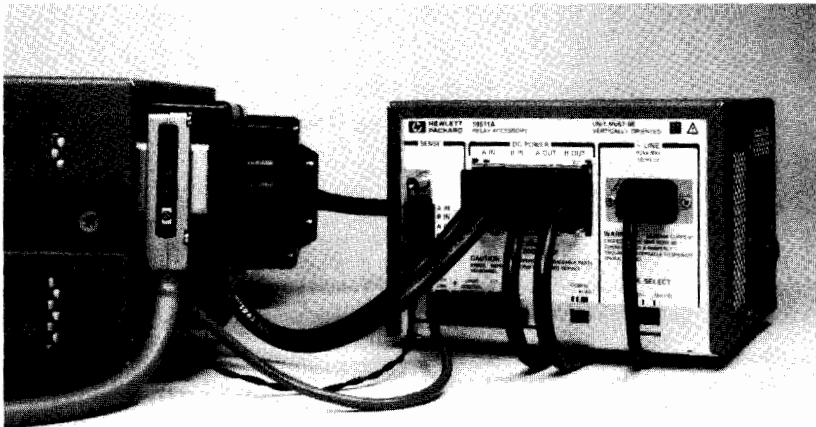

HP 59511A Connected to an HP 6030A System DC Power Supply

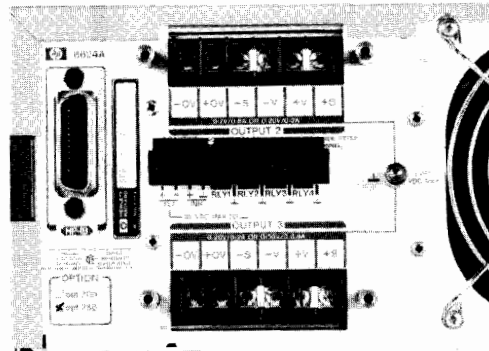

Rear panel of HP 6624A equipped with 12 pin logic port and DFI/RI (Option 750)

**HP 59510A, 59511A Specifications**

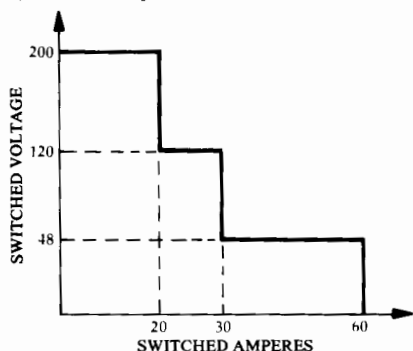

Operating Range: (Both Models)

**Inductive Load:** 10 mH maximum

**Isolation:**

**Input to Output:** 200 Vdc

**Input/Output to Ground:** 500 Vdc

**Control (TTL) to Ground:** 240 Vdc

**Settling Time (TTL Control):**

**Connect:** 440 ms

**Disconnect:** 160 ms

**Polarity Reversal:** 600 ms

**DC Voltage Drop (at 60 A):** 0.5 V maximum (each relay)

**AC Input:** 100 Vac, 120 Vac, 220 Vac, 240 Vac

**Maximum Input Power:** 60 VA

**Dimensions:** (All Models) 130.6 mm H x 185.4 mm W x 198.6 mm D (5.14" x 7.26" x 7.81")

**Weight:** HP 59510A 2.3 kg (5 lb.) net

HP 59511A 3.6 kg (8 lb.) net

**Mounting Orientation:** within  $\pm 10^\circ$  from vertical

**Option Descriptions**

**HP 59510A:** DC Output Connect/Disconnect Relay

**HP 59511A:** DC Output Connect/Disconnect and Polarity Reversal Relay

**Note:** Line voltage option (100, 120, 220, or 240) must be specified

**100:** 87-106 Vac, 48-63 Hz (for Japan only)

**120:** 104-127 Vac, 48-63 Hz

**220:** 191-233 Vac, 48-63 Hz

**240:** 208-250 Vac, 48-63 Hz

**850:** Rack Mount Kit

**910:** One extra operating and service manual

**W30:** 2-years Additional Hardware Service

**Prices**

HP 59510A \$895.00

HP 59511A 1,195.00

N/C

N/C

N/C

N/C

75.00

25.00

50.00

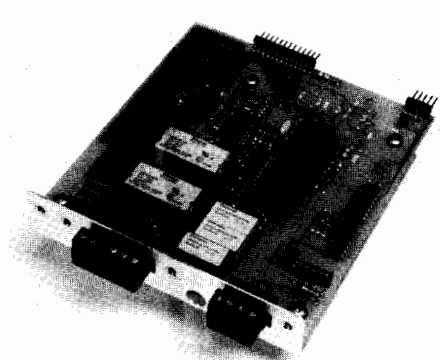

Relay card built into HP Models 6632A-6634A when equipped with Option 760.

**HP 6632A-6634A with Option 760**

**Built-in Relay and DFI/RI**

This option provides isolation and polarity reversal relays built into the power supply. Discrete Fault Indicator and Remote Inhibit\* capabilities are included. HP-IB commands\*\* sent to the power supply control the relay functions. Both switched and unswitched output terminals are provided on the rear panel of the power supply. (Front Panel Binding Posts on models equipped with Option 020 are unswitched.) See page 455 for ordering information.

\* Refer to page 466 for more details regarding Discrete Fault Indicator and Remote Inhibit.

\*\* Refer to page 463 for a listing of HP-IB commands.

# POWER SUPPLIES

## Protection Features and CIIL Programming

### CIIL Programming for the Multiple Output and Autoranging System DC Power Supplies

CIIL (Control Interface Intermediate Language) is now a test instrument module programming language standard for many military test equipment programs, including all new U.S. Air Force programs and some U.S. Navy and U.S. Marine programs.

CIIL, which is a compiled form of ATLAS, provides a uniform programming format for all basic test instrumentation. The CIIL standard reduces the effort required for system upgrades and modifications, such as those needed to keep a system up to date with the latest technology.

One difficulty with CIIL is how to handle instrument capabilities that do not fit in with any approved CIIL command. Such commands are handled in the instrument's native language which is accessible through the CIIL Go to Alternate Language <GAL> command.

The CIIL programmable HP Power Supply (ordered as Option 700) contains a CIIL interpreter in ROM internal to the power supply.

HP system DC power supplies with Option 700 are designed to follow the guidelines of CIIL standard 2806763 Rev. B. The signal type produced by a DC power supply is designated by the CIIL noun <DCS>. Of the many noun modifiers defined by CIIL, five apply to the DC signal produced by an HP system power supply. These are voltage <VOLT>, current <CURR>, voltage limit <VLTL>, current limit <CURL>, and settling time <SETT>.

The following CIIL commands are accepted: FNC, SET, SRX, SRN, INX, FTH, RST, OPN, CLS, STA, IST, CNF, and GAL.

All of the basic functions of a standard HP system power supply can be implemented with the Option 700 unit. Output voltage and current measurement readback is implemented with the CIIL <INX> and <FTH> commands. Some features, such as the Foldback protection available with the HP 603XA series or the Over-Current Protection available with the HP 662XA series, must be programmed in the alternate language because CIIL does not provide for them. The alternate language also contains most of the standard HP system DC power supply commands, including all of the output setting commands, the measurement readback commands, the echo query commands, the output disable command, and the self test, status, reset, and clear commands.

Option 700 is available with HP's line of programmable system DC power supplies, Models HP 6030A-6033A and 6038A, 6621A, 6622A, 6623A, 6624A and 6627A.

The FLT and INH lines can be chained together to cause a network of power supplies to shut down if a fault occurs.

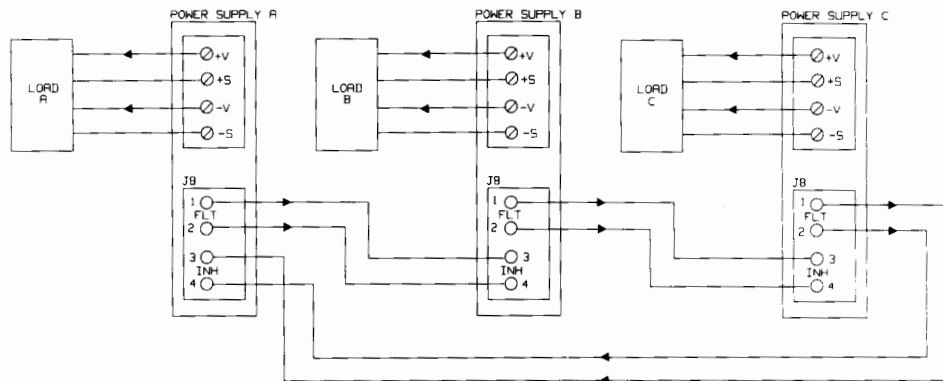

### Protection Features for Programmable System Power Supplies

#### Discrete Fault Indicator or Status Monitor Line

The fault indicator line, FLT, is a two pin TTL output port accessible on the rear panel of our system DC power supplies. The FLT line will go true whenever the power supply has gone into Fault Mode. The conditions which could cause the supply to enter Fault Mode are listed below.

Status, Accumulated Status, and Fault Register Contents

		HP 6030A to HP 6033A, HP 6038A	HP 6621A to HP 6624A, HP 6627A	HP 6632A to HP 6634A
+CV	Constant Voltage Mode	X	X	X
+CC	Constant Current Mode	X	X	X
-CC	Negative Constant Current		X	X
OV	Oversvoltage Protection Tripped	X	X	X
OT	Overtemperature Protection Tripped	X	X	X
UNR	Unregulated		X	X
OC	Overcurrent Protection Tripped		X	X
FOLD	Same as OC (Overcurrent)	X		
ERR	Programming Error	X	*	X
RI	Remote Inhibit	X	X	X

\* Can be accessed from Serial Poll Register only.

By programming a special mask register, the programmer can select which of these nine conditions will cause the power supply to enter Fault Mode. For example, if constant voltage operation is preferred, then the user can set up the power supply to enter Fault Mode if it goes into constant current. Any or all of the conditions in the status register can be masked to cause a fault if they occur.

Both the FLT line and the HP-IB SRQ line are set by the same fault register. The FLT line will provide redundancy for the SRQ line in the event of an HP-IB or controller interruption or failure.

#### Remote Inhibit Line

The remote inhibit line, INH, is a two pin TTL input port accessible from the rear panel of our system DC power supplies. This line provides the means for disabling the power supply directly, without involving the HP-IB. When the INH line is invoked, the power supply output goes to zero and the Remote Inhibit (RI) bit is set in the status register.

Together, the FLT and INH lines can be used in a variety of configurations to provide added protection.

These features are standard with HP's line of programmable system DC power supplies, Models HP 6030A-6033A and 6038A. HP Models 6621A-6627A incorporate these features in Option 750. See pages 456 through 459 for ordering information. HP Models 6632A-6634A incorporate these features in option 760. See page 455 for ordering information.

- 200 watt autoranging dc output
- Constant-voltage/constant-current operation
- HP-IB programming option



HP 6002A

### Description

The HP 6002A dc power supply offers an exceptional combination of performance and flexibility. It employs a unique control concept which provides for an autoranging output with the performance characteristics of linear regulation. The HP 6002A is a 200 watt CV/CC power supply, which may be remotely programmed via the HP-IB when equipped with Option 001.

As an autoranging power supply, the HP 6002A can provide 200 watts over a wide range of voltage and currents without external intervention. This allows it to take the place of multiple conventional power supplies. For example, the HP 6002A can replace both a 50 volt, 4 ampere supply and a 20 volt, 10 ampere supply.

### System Features/Remote Control

Analog programming of output voltages and current can be accomplished through the use of remotely controlled resistance or voltage applied to rear panel terminals. Additional control terminals are provided for remote load voltage sensing, auto-series or parallel operation, and for remotely activating the crowbar circuit. A pulse output from the crowbar terminal indicates the overvoltage circuit has been self-activated. A voltage step change appearing on terminal indicates a changeover to or from constant-current operation.

### HP-IB Option

Digital programming via Option 001 permits control of output voltage or current by the Hewlett-Packard Interface Bus (HP-IB). Two programmable ranges allow better resolution below 10 volts or 2 amperes. The selection of HP-IB control of either voltage or current is done by rear panel switches. The IEEE 488 interface functions supported by the HP 6002A with Option 001 are basic listener (L2) and acceptor handshake (AH1). Complete explanation of these interface functions is available in the IEEE Std. 488-1978.

### Specifications

**DC output:** voltage and current output can be adjusted over the ranges indicated by front panel controls, analog programming, or an optional HP-IB interface.

**Voltage:** 0-50 V. **Current:** 0-10 A.  
Maximum 200 watts output from 20 V to 50 V.

- Built-in overvoltage protection crowbar
- CV/CC operating status indicators
- Remote analog programming and sensing

### Autoranging Output Characteristic

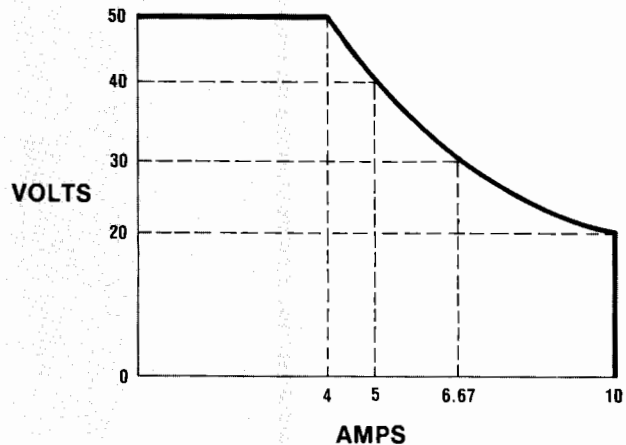

**Load effect:** constant-voltage, 0.01% +1 mV. Constant-current, 0.01% + 1 mA.

**Source effect:** CV, 0.01% +1 mV; CC, 0.01% + 1 mA.

**PARD (ripple and noise):** rms/p-p, 20 Hz to 20 MHz; CV, 1 mV/10 mV; CC, 5 mA rms.

**Temperature coefficient:** CV, 0.02% +200  $\mu$ V/°C; CC 0.02% +5 mA/°C.

**Drift:** CV, 0.05% +1 mV/8 h; CC, 0.05% +5 mA/8 h.

**Load transient recovery:** 100  $\mu$ s for output voltage to recover within 15 mV of nominal voltage setting following a load current change of 50% to 100% or 100% to 50% of full load current.

**Response time:** maximum time for output voltage to change between 0 to 99.9% or 100% to 0.1% of maximum rated output voltage. Up Programming: no load, 100 ms; full load, 100 ms. Down Programming: no load, 400 ms; full load, 200 ms.

**Overvoltage protection:** trip voltage adjustable from 2.5 V to 60 V. **DC output isolation:** 150 V dc.

**Power:** 100, 120, 220, or 240 V ac (-13%, +6%), 48-63 Hz.

**Temperature rating:** 0°C to 55°C operating, -40°C to +75°C storage. Supply is cooled by built-in fan.

**Size:** 180 H x 212 W x 422 mm D (6.97" x 8.36" x 16.6").

**Weight:** net, 14.5 kg (32 lb); shipping, 15.9 kg (35 lb).

### HP-IB Option

**Programmable ranges:** high: 0-50 V or 0-10 A,  
low: 0-10 V or 0-2 A.

**Programming speed:** same as response time.

**Accuracy:** hi range: CV, 0.2% +25 mV; CC, 0.2% +25 mA.  
lo range: CV, 0.2% + 10 mV; CC, 0.2% +25 mA.

**Resolution:** hi range: CV, 50 mV; CC, 10 mA. (12 bit)  
lo range: CV, 10 mV; CC, 2 mA. (12 bit)

**Isolation:** 250 volts dc from bus data lines to power supply.

### Options

Options	Price
<b>001:</b> HP-IB interface	add \$570
<b>800:</b> rack flange kit to mount 2 locked HP 6002As	\$77
<b>908:</b> rack mounting adapter kit for one HP 6002A; includes blank filler panel.	\$82
<b>910:</b> one extra operating and service manual	add \$10
<b>W30:</b> 2 Years Additional Hardware Service	\$50

**HP 6002A Autoranging DC Power Supply** **\$2500**

# POWER SUPPLIES

## Precision Bipolar System Supplies

### Models 6129C-6131C & 6140A

- Fast, accurate, high resolution programming
- Bipolar output
- Current sink or source

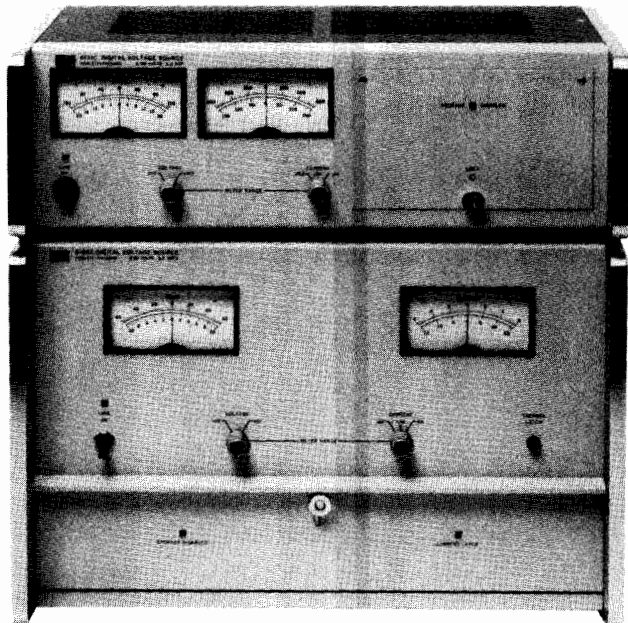

HP 6131C (top) & 6129C

### Description

The family of Precision Bipolar System Supplies consists of three voltage sources (HP 6129C, 6130C and 6131C) and one current source (HP 6140A). They provide easy, fast and accurate programming of their dc outputs, with many features oriented specifically towards efficient integration in automatic systems.

### Isolation

All digital inputs are completely isolated from the analog outputs.

### Programmable Current Limit (Voltage Source)

Valuable loads can be protected by a user programmable current latch. Output power goes to zero when the latch circuit is tripped. The reaction time to the latch can be adjusted, if desired, to avoid tripping when reprogramming with a capacitive load. There is also a fixed current limit at 110% of rated current output.

### Current Monitoring Terminals (Voltage Sources)

A voltage is available at the rear barrier strip which is proportional to the output current.

### Analog Input

An ac signal may be injected into the output amplifier to simulate various noise and ripple conditions.

### Precision Bipolar System Current Source

The HP 6140A Current Source has features which correspond to the voltage sources. It has a programmable voltage limit, voltage monitoring terminal, as well as isolation, and analog input capabilities.

### Accessories Furnished

HP 1251-0086 50-contact rear plug.  
 HP 5060-7948 Plug-in extender board for voltage source.  
 HP 5060-7948/5060-7982. Two plug-in extender boards for current source.

- Programmable current latch (on voltage sources) or voltage limit (on current sources)
- Isolated output

### Specifications

	Binary Instruments Option J20 & P05		BCD Instruments Option J99	
	X1 Range	X10 Range	X1 Range	X10 Range
<b>HP 6129C</b>				
Output	±16.384 V, 5 A	±50.00 V, 5 A	±9.999 V, 5 A	±50.00 V, 5 A
Accuracy	1.5 mV	15 mV	1.5 mV	15 mV
Resolution	0.5 mV	5 mV	1 mV	10 mV
<b>HP 6130C</b>				
Output	±16.384 V, 1 A	±50.00 V, 1 A	±9.999 V, 1 A	±50.00 V, 1A
Accuracy	1.5 mV	10 mV	1 mV	10 mV
Resolution	0.5 mV	5 mV	1 mV	10 mV
<b>HP 6131C</b>				
Output	±16.384 V, 0.5 A	±100.00 V, 0.5 A	±9.999 V, 0.5 A	±99.99 V, 0.5 A
Accuracy	1.5 mV	10 mV	1 mV	10 mV
Resolution	0.5 mV	5 mV	1 mV	10 mV
<b>HP 6140A</b>				
Output	±16.384 mA, 100 V	±163.84 mA, 100 V	±9.999 mA, 100 V	±99.99 mA, 100 V
Accuracy	1 μA ±0.01%	10 μA, ±0.01%	10 μA, ±0.01%	10 μA, ±0.01%
Resolution	0.5 μA	5 μA	1 μA	10 μA

### Options

#### AC Power Option

**028:** transformer tap change for 230 V ac ±10%, single-phase input on HP 6130C and 6131C. (HP 6129C and 6140A are 115/230 switch selectable.)  
**J20:** 16 bit binary interface for HP 12661A I/O programmer card for Hewlett-Packard computers.

#### Price

N/C

N/C

#### Accessories Available

**HP 14533B:** Pocket programmer permits manual programming of all input functions by switch closure. \$500  
**HP 14534A:** Pocket programmer extension cable (3 ft). \$250  
**HP 14535A:** HP computer interface kit includes HP 12661A computer I/O card, HP 14539A cable, verification software and RTE Driver. Up to eight PBSS's may be controlled from one HP 14535A. \$2,000  
**HP 14536A:** Chaining cable connects an additional PBSS to the existing chain of PBSS's. \$350

#### Ordering Information

An interface option must be ordered.  
**HP 6129C:** Digital Voltage Source \$10,000  
**Opt 908:** Rack Flange Kit add \$51  
**HP 6130C, 6131C:** Digital Voltage Source \$5,500  
**HP 6140A:** Digital Current Source \$10,000  
**Opt 908:** Rack Flange Kit add \$38  
**Opt 910:** One extra operating and service manual shipped with each power supply \$15

- HP-IB power supply control
- HP-IB-to-power-supply isolation
- Programmable range

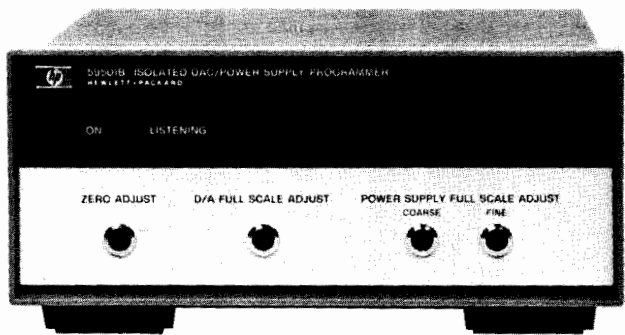

HP 59501B



### Description

The HP 59501B is an isolated digital-to-analog converter designed to provide a convenient interface between the Hewlett-Packard Interface Bus and HP power supplies. With the HP 59501B, a wide range of dc voltages and currents becomes automatically controllable via the HP-IB. With proper wiring, the built-in isolation devices protect other instrumentation on the HP-IB from damage that could be caused by power supply outputs. In addition, an internal control circuit holds the output level near zero until programmed data is received. A programmable High/Low range control improves resolution by ten-to-one.

Power supply control is accomplished through the HP 59501B's programmable output voltage and programming network (see below). By making the appropriate connections between the 59501B's rear terminals and the remote programming terminals on the supply, the output voltage (or current) of the supply can be programmed from zero to its full rated output. The HP 59501B front panel controls provide fast and easy calibration of power supply outputs. The Zero Adjust enables the user to correct for small offsets in power supply response to programmed inputs. The Power Supply Full Scale Adjust (part of programming network) enables the user to set the maximum output desired from the power supply when the HP 59501B is programmed to its maximum value. For example, this adjustment would normally be used to calibrate the maximum programmable output of a 320Vdc power supply to 320 volts. However, it could also be used to set the maximum to 200 volts.

The HP 59501B also can be used directly as a low level dc signal source. Unipolar and bipolar output modes are available with output voltages programmable from zero to 9.99 volts, or minus 10.0 to plus 9.98 volts. Output current up to 10 milliamperes is available and is automatically limited to protect the HP 59501B and user equipment. The HP 59501B produces a full scale voltage change in approximately 250  $\mu$ s from the time the digital data is received.

- Programmable 10-volt dc output
- Unipolar/bipolar operation
- Fast digital to analog conversion

### Specifications

#### Digital to Analog Converter

**DC output voltage:** programmable in high or low ranges within the voltage limits shown below. Output mode is unipolar or bipolar and is selected by a rear panel switch.

**Unipolar:** 0 to 9.99 V (low range, 0 to 0.999 V).

**Bipolar:** -10 to +9.98 V (low range, -1 to +0.998 V).

**DC output current:** 10 mA maximum.

**PARD (ripple and noise):** 2 mV rms/10 mV p-p.

**Resolution:** unipolar, 10 mV (low range, 1 mV). Bipolar, 20 mV (low range, 2 mV).

**Accuracy:** specified at 23°C  $\pm$ 5°C.

**Unipolar:** 0.1% + 5 mV (low range, 0.1% + 1 mV).

**Bipolar:** 0.1% + 10 mV (low range, 0.1% + 2 mV).

**Stability:** change in output over 8 hour interval under constant line, load, and ambient following a 30 minute warm-up. Stability is included in accuracy specification measurements over the temperature range indicated.

**Unipolar:** 0.04% + 0.5 mV (low range, 0.04% + 0.1 mV).

**Bipolar:** 0.04% + 1 mV (low range, 0.04% + 0.2 mV).

**Temperature coefficient:** unipolar, 0.01%/°C + 0.5 mV/°C (low range, 0.1%/°C + 0.1 mV/°C). Bipolar, 0.01%/°C + 0.5 mV/°C (low range, 0.01%/°C + 0.1 mV/°C).

**Zero adjust:** plus or minus 250 millivolts.

**D/A full scale adjust:** plus or minus 5%.

**Programming speed:** the time required for output to go from zero to 99% of programmed output change is 250  $\mu$ s (measured with resistive load connected to output terminals).

#### Power Supply Programming

**Programming network specifications:** in the following specifications, M represents the calibrated full scale value of the supply being programmed and P is the actual programmed output. The full scale value (M) can be any value within the supply's output range and is calibrated with the HP 59501B programmed to its maximum high range output.

**Accuracy:** specified at 23°C  $\pm$ 5°C.

**Unipolar:** 0.05% M + 0.25% P (low range, 0.01% M + 0.25% P).

**Bipolar:** 0.1% M + 0.25% P (low range, 0.02% M + 0.25% P).

**Isolation:** 600 V dc between HP-IB data lines and output terminals.

**Temperature coefficient:** 0.005% M/°C + 0.015% P/°C (low range, 0.01% M/°C + 0.015% P/°C).

**Programming resolution:** 0.1% M (low range, 0.01% M).

**Programming speed:** D/A programming speed plus the programming speed of the power supply.

#### General

**Temperature range:** operation, 0 to 55°C; storage, -40 to 75°C.

**Power:** 100, 120, 220, or 240 Vac (+6% -13%) 47-63 Hz, 10 VA (selectable on rear panel).

**Size:** 101.6 H x 212.9 W x 294.6 mm D (4" x 8.38" x 11.6").

**Weight:** net, 1.82 kg (4 lb); shipping, 2.27 kg (5 lb).

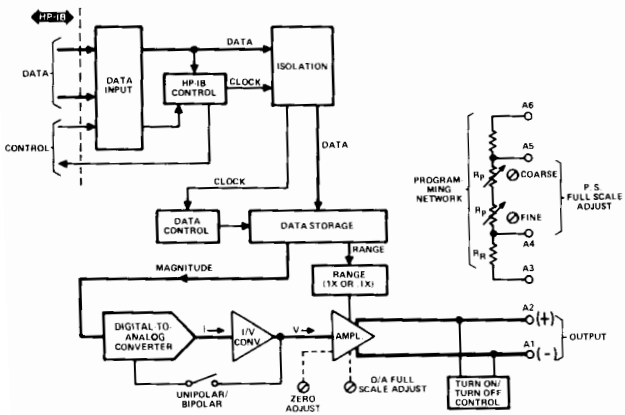

Several programming notes are available to assist in operating the HP 59501B Power Supply Programmer with the HP desktop computers. For more on free publications, see page 792.

#### Accessories

HP 5060-0173: rack mounting adapter kit for one HP 59501B Price \$80

HP 5060-0174: rack mounting adapter kit to connect two HP 59501B's Price \$87.50

#### Ordering Information

HP 59501B HP-IB Isolated D/A Power Supply Programmer Price \$850



# POWER SUPPLIES

General Purpose: 25–200 W Output

Models 6227B–6299A

- Constant voltage/constant current operation
- Remote sensing and programming
- Auto-series, -parallel, & -tracking operation

- Front and rear output terminals
- Floating output—use as positive or negative source
- Bench or rack mounting



HP 6281A, 6284A, 6289A,  
6294A, 6299A

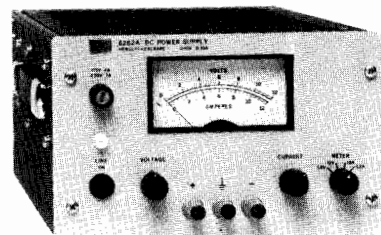

HP 6282A, 6286A,  
6291A, 6296A

## Description

### HP 6281A–6299A Single Output

This series of medium-power constant voltage/constant current power supplies is available in two power ranges: 37–75 watts (packaged in 3½-inch high half-rack cases) and 100–200 watts (packaged in 5¼-inch high half-rack cases). All models except HP 6294A and 6299A have separate coarse and fine voltage and current controls that allow the voltage and current outputs to be varied from zero to the maximum rated values. The latter two models have ten-turn voltage controls. Crossover from constant voltage to constant current operation occurs automatically when the load current exceeds the value established by the current control settings. A four-position meter function switch selects either of two output voltage or output current ranges (X1, X0.1) for display on the panel meter.

The 37–75 watt models are of the series-regulated type. They have excellent regulation and ripple characteristics and include a special output-capacitor discharge circuit for improved programming speed. The 100–200 watt models employ a series-regulator/SCR-preregulator configuration to achieve the high efficiency necessary for a convection-cooled package of this size. They also have excellent regulation, low ripple and noise, and moderate programming speeds.

## Specifications

RATINGS			PERFORMANCE							
DC Output		HP Model	Load Effect		Source Effect		PARD (rms/p-p)		Drift (stability)	
Volts	Amperes		Voltage	Current	Voltage	Current	Voltage	Current	Voltage	Current
0-7.5	0-5	6281A	5 mV	0.01% + 250 $\mu$ A	0.01% + 2 mV	0.01% + 250 $\mu$ A	200 $\mu$ V/1 mV	4 mA rms	0.1% + 2.5 mV	0.1% + 12.5 mA
0-10	0-10	6282A	0.01% + 1 mV	0.05% + 1 mA	0.01% + 1 mV	0.05% + 1 mA	500 $\mu$ V/25 mV	5 mA rms	0.1% + 2.5 mV	0.1% + 25 mA
0-20	0-3	6253A*	0.01% + 4 mV	0.01% + 250 $\mu$ A	0.02% + 2 mV	0.01% + 250 $\mu$ A	200 $\mu$ V/1 mV	2 mA rms	0.1% + 2.5 mV	0.1% + 7.5 mA
0-20	0-3	6284A	0.01% + 4 mV	0.01% + 250 $\mu$ A	0.01% + 2 mV	0.01% + 250 $\mu$ A	200 $\mu$ V/1 mV	2 mA rms	0.1% + 2.5 mV	0.1% + 7.5 mA
0-20	0-10	6286A	0.01% + 1 mV	0.05% + 1 mA	0.01% + 1 mV	0.05% + 1 mA	500 $\mu$ V/25 mV	5 mA rms	0.1% + 2.5 mV	0.1% + 25 mA
0-25	0-2	6227B*	0.01% + 1 mV	0.01% + 250 $\mu$ A	1 mV	100 $\mu$ A	250 $\mu$ V/4 mV	250 $\mu$ A/2 mA	0.2% + 2 mV	0.2% + 3 mA
0-40	0-1.5	6255A*	0.01% + 2 mV	0.01% + 250 $\mu$ A	0.01% + 2 mV	0.01% + 250 $\mu$ A	200 $\mu$ V/1 mV	500 $\mu$ A rms	0.1% + 2.5 mV	0.1% + 4 mA
0-40	0-1.5	6289A	0.01% + 2 mV	0.01% + 250 $\mu$ A	0.01% + 2 mV	0.01% + 250 $\mu$ A	200 $\mu$ V/1 mV	500 $\mu$ A rms	0.1% + 2.5 mV	0.1% + 4 mA
0-40	0-5	6291A	0.01% + 1 mV	0.05% + 1 mA	0.01% + 1 mV	0.05% + 1 mA	500 $\mu$ V/25 mV	3 mA rms	0.1% + 2.5 mV	0.1% + 12.5 mA
0-50	0-1	6228B*	0.01% + 1 mV	0.01% + 250 $\mu$ A	1 mV	100 $\mu$ A	250 $\mu$ V/4 mV	250 $\mu$ A/2 mA	0.2% + 2 mV	0.2% + 1.5 mA
0-60	0-1	6294A	0.01% + 2 mV	0.01% + 250 $\mu$ A	0.01% + 2 mV	0.01% + 250 $\mu$ A	200 $\mu$ V/1 mV	500 $\mu$ A rms	0.1% + 2.5 mV	0.1% + 2.5 mA
0-60	0-3	6296A	0.01% + 1 mV	0.05% + 1 mA	0.01% + 1 mV	0.05% + 1 mA	500 $\mu$ V/25 mV	3 mA rms	0.1% + 2.5 mV	0.1% + 7.5 mA
0-100	0-0.75	6299A	0.01% + 2 mV	0.01% + 250 $\mu$ A	0.01% + 2 mV	0.01% + 250 $\mu$ A	200 $\mu$ V/1 mV	500 $\mu$ A rms	0.1% + 2.5 mV	0.1% + 2 mA

\*Models 6227B, 6228B, 6253A, and 6255A contain two identical, independently-adjustable power supplies.

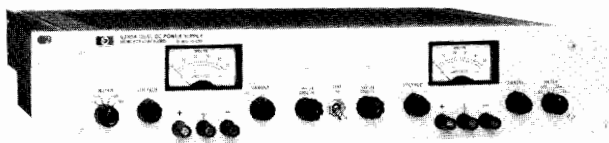

HP 6253A, 6255A



HP 6227B, 6228B

Each side of the dual supply can be operated as a constant voltage or constant current source, and each has its own crowbar for overvoltage protection. In the tracking mode, an overvoltage condition in either supply trips both crowbars. The power supply outputs are isolated up to 300 V from output to chassis or output to output.

**Specifications—General**

**Load effect transient recovery:** time, 50 μs; level, 15 mV.  
**Meter accuracy:** 3% of full scale.  
**Power:** standard input voltage is 115 V ac ± 10%. Order Option 028 for 230 V ac ± 10% operation. Input power frequency, maximum input current, maximum power consumption are:  
 HP 6227B and 6228B, 48–63 Hz, 2.7 A, 260 W;  
 HP 6253A, 48–440 Hz, 2.6 A, 235 W; HP 6255A, 48–440 Hz, 2.6 A, 235 W; HP 6281A, 48–440 Hz, 1.3 A, 118 W; HP 6282A, 57–63 Hz, 3.5 A, 200 W; HP 6284A, 48–440 Hz, 1.5 A, 128 W; HP 6286A, 57–63 Hz, 5.5 A, 320 W; HP 6289A, 48–440 Hz, 1.3 A, 110 W; HP 6291A, 57–63 Hz, 5.5 A, 280 W; HP 6294A, 48–440 Hz, 1.3 A, 114 W; HP 6296A, 57–63 Hz, 4.5 A, 250 W; HP 6299A, 48–440 Hz, 1.5 A, 135 W.  
**Size:** 6227B, 6228B: 155 H x 197 W x 309.55 mm D (6<sup>1</sup>/<sub>2</sub>" x 7<sup>7</sup>/<sub>32</sub>" x 12<sup>7</sup>/<sub>16</sub>").  
 HP 6253A, 6255A: 87 H x 483 W x 403 mm D (3<sup>7</sup>/<sub>16</sub>" x 19" x 15<sup>7</sup>/<sub>8</sub>").  
 HP 6281A, 6284A, 6289A, 6294A, 6299A: 87 H x 209 W x 398 mm D (3<sup>7</sup>/<sub>16</sub>" x 8<sup>7</sup>/<sub>32</sub>" x 15<sup>7</sup>/<sub>8</sub>").  
 HP 6282A, 6286A, 6291A, 6296A: 131 H x 210 W x 435 mm D (5<sup>1</sup>/<sub>2</sub>" x 8<sup>1</sup>/<sub>4</sub>" x 17<sup>1</sup>/<sub>8</sub>").

**Option Descriptions**

**005:** 50 Hz ac input: optimizes power supplies that require adjustment/modification for 50 Hz operation. N/C  
**010:** Chassis slides. Enable convenient access to rack-mounted power supply for maintenance. add \$87

**011:** Internal overvoltage protection crowbar. Protects sensitive loads against power supply failure or operator error. Monitors the output voltage and places a virtual short circuit (conducting SCR) across load after preset trip voltage is exceeded.

HP 6281A, 6284A, 6289A, 6294A, 6299A add \$128  
 HP 6282A, 6286A, 6291A, 6296A add \$209  
 HP 6253A, 6255A add \$209

**028:** 230 Vac ± 10%, single-phase input. Factory modification reconnects the multi-tap input power transformer for 230 V operation.

add N/C

**040:** Interfacing for Multiprogrammer operation. Prepares standard HP power supplies for resistance programming by the HP 6940B, 6942A, 6944A or 6954A. Price per output.

**910:** one additional operating and service manual shipped with the power supply

HP 6227 add \$10

HP 6253A, 6255A, 6228B add \$7.65

HP 6281A, 6282A, 6284A, 6286A, 6289A, 6291A, 6294A, 6296A, 6299A add \$5.20

**Accessories**

**HP 14513A:** 3.5 in. high rack kit for one HP 6281A, 6284A, 6289A, 6294A, 6299A \$57

**HP 14523A:** 3.5 in. high rack kit for two above supplies \$31

**HP 14515A:** 5.25 in. high rack kit for one HP 6282A, 6286A, 6291A, 6296A \$62

**HP 14525A:** 5.25 in. high rack kit for two above supplies \$36

**HP 5060-8760:** blank filler panel for HP 6227B, 6228B \$44

**HP 5060-8762:** adapter frame for rack mounting one or two HP 6227B, 6228B \$150

**Specifications, continued**

REMOTE CONTROL FEATURES								GENERAL						
Resistance Coefficient		Voltage Coefficient		Speed, UP*		Speed, DOWN*		Overvoltage		Weight			Options▲	Price
Voltage	Current	Voltage	Current	NL	FL	NL	FL	Range	Margin	Net	Shipping			
200 Ω/V ±1%	200 Ω/A ±10%	1 V/V ±1%	0.2 V/A ±10%	1 ms	2 ms	10 ms	6 ms	2.5-10 V	4% + 2 V	6.4 kg/14 lb	7.2 kg/16 lb	11, 28, 40	\$1000	
200 Ω/V ±1%	100 Ω/A ±10%	1 V/V ±1%	100 mV/A ±10%	70 ms	200 ms	9 s	40 ms	1-13 V	7% + 1 V	11.3 kg/25 lb	13.6 kg/30 lb	5, 11, 28, 40	\$1200	
200 Ω/V ±1%	500 Ω/A ±10%	1 V/V ±1%	0.33 V/A ±10%	30 ms	80 ms	400 ms	100 ms	2.5-23 V	4% + 2 V	12.7 kg/28 lb	17.7 kg/39 lb	10, 11, 28, 40	\$1650	
200 Ω/V ±1%	500 Ω/A ±10%	1 V/V ±1%	0.33 V/A ±10%	30 ms	80 ms	400 ms	100 ms	2.5-23 V	4% + 2 V	6.4 kg/14 lb	7.2 kg/16 lb	11, 28, 40	\$850	
200 Ω/V ±1%	100 Ω/A ±10%	1 V/V ±1%	100 mV/A ±10%	150 ms	150 ms	9 s	70 ms	2-22 V	7% + 1 V	10.8 kg/26 lb	13.1 kg/29 lb	5, 11, 28	\$1250	
200 Ω/V ±1%	500 Ω/A ±10%	1 V/V ±1%	.5 V/A ±10%	40 ms	200 ms	400 ms	75 ms	5-28 V	7% + 1.5 V	11 ka/24 lb	12.9 kg/28 lb	40	\$1930	
200 Ω/V ±1%	500 Ω/A ±10%	1 V/V ±1%	0.66 V/A ±10%	15 ms	45 ms	200 ms	40 ms	2.5-44 V	4% + 2 V	12.7 kg/28 lb	17.7 kg/39 lb	10, 11, 28, 40	\$1650	
200 Ω/V ±1%	500 Ω/A ±10%	1 V/V ±1%	0.66 V/A ±10%	15 ms	45 ms	200 ms	40 ms	2.5-44 V	4% + 2 V	6.4 kg/14 lb	7.2 kg/16 lb	11, 28, 40	\$850	
200 Ω/V ±1%	200 Ω/A ±10%	1 V/V ±1%	200 mV/A ±10%	275 ms	275 ms	13 s	275 ms	6-43 V	7% + 1 V	11.3 kg/25 lb	12.7 kg/28 lb	5, 11, 28	\$1250	
200 Ω/V ±1%	1 kΩ/A ±10%	1 V/V ±1%	1 V/A ±10%	50 ms	350 ms	1 s	50 ms	5-55 V	7% + 1.5 V	11 ka/24 lb	12.9 kg/28 lb	40	\$1930	
300 Ω/V ±1%	1 kΩ/A ±10%	1 V/V ±1%	1 V/A ±10%	25 ms	80 ms	2 s	175 ms	5-65 V	4% + 2 V	5.9 kg/13 lb	6.8 kg/15 lb	11, 28, 40	\$900	
300 Ω/V ±1%	500 Ω/A ±10%	1 V/V ±1%	333 mV/A ±10%	600 ms	600 ms	5 s	200 ms	9-66 V	7% + 1 V	11.3 kg/25 lb	12.7 kg/28 lb	5, 11, 28	\$1250	
300 Ω/V ±1%	1 kΩ/A ±10%	1 V/V ±1%	1.3 V/A ±10%	25 ms	200 ms	1.5 s	200 ms	20-106 V	4% + 2 V	5.9 kg/13 lb	6.8 kg/15 lb	11, 28, 40	\$900	

\*UP = increasing output voltage. NL = No output load current. FL = Full rated output load current.

# POWER SUPPLIES

## Autoranging Power Supplies

Models 6010A, 6011A, 6012B, 6023A, and 6024A

- Complete front panel control/display
- Constant voltage/constant current operation
- Remote programming and sensing
- Autoranging output
- High efficiency, compact, and light weight
- Ten-turn voltage and current controls

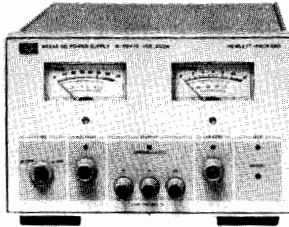

HP 6024A

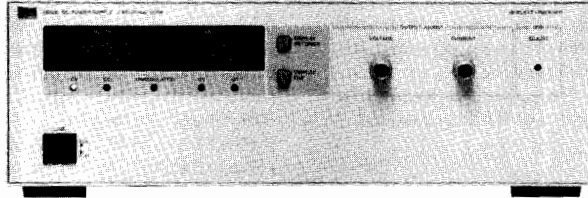

HP 6010A, 6011A, 6012B

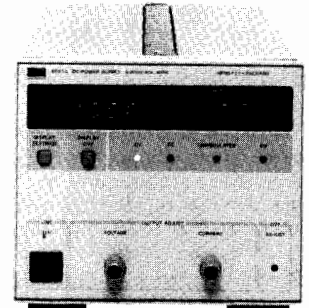

HP 6023A

### Description

#### HP Models 6010A, 6011A, 6012B, and 6023A

This versatile family of dc power supplies provides laboratory grade performance along with many features to meet both laboratory and system needs.

Ten-turn front panel controls provide the means to precisely adjust the output voltage and current. The settings of these controls can be observed on the front panel meters by pressing the Display Settings button. This allows the current limit to be set when operating in the CV mode without shorting the output terminals and the voltage limit to be set when operating in the CC mode without opening the load leads.

Three and one-half digit front panel meters provide a convenient means for monitoring the output voltage and current. The accuracy of these meters allow them to replace external DVMs and monitor resistors in many applications that require monitoring of the power supply output.

The overvoltage protection (OVP) trip level can also be displayed on the front panel meters, allowing the trip level to be accurately adjusted without actually activating the OVP circuitry or disconnecting loads. In addition to the protection provided to the power supply and load by the OVP, these supplies also have protection against operating under excessive ac line or thermal conditions.

As autoranging power supplies, these units can operate at their maximum rated power over a wide and continuous range of voltage and current combinations. This often allows both present and future requirements to be satisfied with fewer supplies.

HP Model 6023A is stable when operating in the CC mode into inductive loads up to one henry. HP Models 6010A, 6011A and 6012B are stable when operating in the CC mode into inductive loads up to 100 mH, and a special modification is available for these three models to assure stability with loads up to ten henries.

### System Features

The output voltage and current of these supplies can be remotely controlled with either 0-5 volt or 0-4000 ohm analog programming signals. The actual output levels can be monitored without complicated external circuitry by connecting DVMs to the buffered 0-5 volt monitor outputs. All programming and monitoring signals are referenced to the same common and are accessed through the rear panel barrier strip.

Either terminal may be grounded, or floated up to  $\pm 240$  volts from chassis ground for the HP 6011A, 6012B and 6023A, and  $\pm 550$  volts for the HP 6010A.

If more output voltage or current is needed than a single unit can provide, auto-series or auto-parallel configurations can be used. Up to four 1000-watt units, or up to two 200-watt units can be connected in auto-parallel, and any combination can be used in auto-series providing up to 240 volts total (550 Vdc for HP 6010A) from chassis ground including output voltage. Remote sensing can be used to maintain the CV load effect specification at the load with up to 0.5 volt drop per load lead and sense wires that are less than 0.2 ohm per lead. Operation is possible with up to 2.0 volts per lead; however, load effect specification may be degraded. For more system control and monitoring capabilities, see Option 002.

### Specifications

Ratings*		Autoranging Output*								Regulation				10% Change Transient Recovery
										Load Effect		Source Effect		
Volts	Amperes	V <sub>1</sub>	P <sub>1</sub>	V <sub>2</sub>	P <sub>2</sub>	V <sub>3</sub>	P <sub>3</sub>	HP Model	Voltage	Current	Voltage	Current	Time / Level	
0-20	0-30	20V	200W	14V	242W	6.7V	200W	6023A	0.01% +2mV	0.01% +9mA	0.01% +1mV	0.01% +6mA	1ms / 50mV	
0-20	0-120	20V	1000W	14V	1064W	7V	840W	6011A	0.01% +3mV	0.01% +15mA	0.01% +2mV	0.01% +25mA	2ms / 100mV	
0-60	0-10	60V	200W	40V	240W	20V	200W	6024A	0.01% +3mV	0.01% +3mA	0.01% +5mV	0.01% +5mA	1ms / 75mV	
0-60	0-50	60V	1000W	40V	1200W	20V	1000W	6012B	0.01% +5mV	0.01% +10mA	0.01% +3mV	0.01% +10mA	2ms / 100mV	
0-200	0-17	200V	1000W	120V	1200W	60V	1020W	6010A	0.01% +5mV	0.01% +10mA	0.01% +5mV	0.01% +5mA	2ms / 150mV	

\*See the generalized autoranging output characteristic curve.

### HP Model 6024A

As an autoranging dc power supply, the HP 6024A can provide 200 watts over a wide and continuous range of voltage and current combinations, with maximums of 60 volts and 10 amperes. This provides greater flexibility than traditional power supplies that have only one maximum power point.

Ten-turn potentiometers provide precise control of the output voltage and current. The output levels can be observed on the separate front panel voltage and current meters. Terminals are available on both the front and rear panel for load connections.

The built-in OVP is adjustable from the front panel. Other protection features include over-temperature and high ac line detection.

The HP 6024A has many system oriented features. It can be remotely programmed with 0-5 volt or 0-2500 ohm analog signals. The output current can be easily monitored without an external shunt with the proportional 0-5 volt buffered monitor output. Remote sensing can be used to eliminate the effects of voltage drops in the load leads, and either terminal may be floated up to  $\pm 240$  volts from chassis ground. Several units can be combined in auto-series, auto-parallel, and auto-tracking configurations, further increasing the HP 6024A's flexibility.

For more system features, see Option 002.

### General Specifications

#### Dimensions

**HP 6010A, 6011A and 6012B:** 132.6 mm H x 425.5 mm W x 516.4 mm D (5.2" x 16.75" x 20.33").

**HP 6023A:** 177.0 mm H x 212.3 mm W x 443.6 mm D (6.97" x 8.36" x 17.872").

**HP 6024A:** 133.4 mm H x 212.3 mm W x 415.33 D (5.25" x 8.36" x 16.35").

### Ordering Information

#### Option Descriptions

**002:** provides extra programming and monitoring capabilities for system use. A card inserted into the power supply is accessible through a 37-pin connector on the rear panel. It provides easy access to the control and monitor signals available on standard units, as well as these additional features:

- OVP trip and reset
- power supply inhibit
- status bits indicating CV mode, CC mode, unregulated output, OVP tripped, overtemperature condition, and ac line drop-out
- remote programming via a 0-2 mA current sink
- bias supplies for your circuitry: +5 volts at 100 mA, +15 volts at 75 mA, and -15 volts at 75 mA.
- buffered 0-5 volt outputs representing both the output voltage and output current. (HP 6010A, 6011A, 6012B, and 6023A provide this feature standard, but HP 6024A only provides a scaled 0-5 volt output to represent the output current, not the output voltage.)
- programmable remote/local for use when programming with a current sink.

#### Price

\$335.00

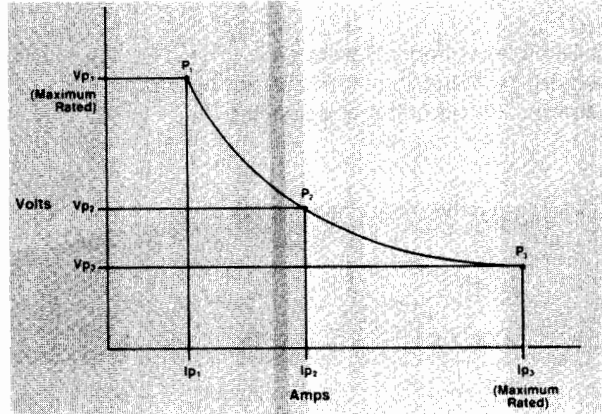

Generalized autoranging output characteristic curve

These features can all be taken advantage of with an HP 6940B or 6942A Multiprogrammer instrument sub-system configured with an HP 69520A or 69709A Power Supply Programming Card. The Multiprogrammer provides a cost-effective solution for controlling a group of power supplies, and also can provide many other digital and analog monitoring and control functions, all on the HP-IB. The voltage and current programming resolution available with either card is 1/1000th of full scale.

The features available with Option 002 can also be interfaced to your own external circuitry rather than an HP Multiprogrammer.

- 100:** 87-106 Vac, 48-63 Hz. HP 6024A Only! This option is for use in Japan only. The power supply output power is 75% of the output power available with the other line voltage options. For HP 6024A only. N/C
- 120:** 104 to 127 Vac, 48-63 Hz. N/C
- 220:** 191 to 233 Vac, 48-63 Hz. N/C
- 240:** 208 to 250 Vac, 48-63 Hz. N/C
- 800:** Rack-mount kit for two units side by side. This applies to HP 6023A and 6024A only.
  - HP 6023A \$77.00
  - HP 6024A \$71.00
- 908:** Rack-mount kit for a single unit. A blank filler panel is supplied when ordered for half rack width units.
  - HP 6010A, 6011A, 6012B \$31.00
  - HP 6023A \$82.00
  - HP 6024A \$55.00
- 910:** One extra operating and service manual shipped with each power supply.
  - HP 6024A \$10.00
  - HP 6010A, 6011A, 6012B, 6023A \$20.00

PAR (rms/p-p) 20Hz-20MHz		Programming Response Time						General*					Price	
		UP			DOWN			AC Input Current				Weight kg (lbs)		
		Settling Band	Full Load	No Load	Full Load	Light Load		100 Vac	120 Vac	220 Vac	240 Vac	Net		Shipping
Voltage	Current				Time	Load								
3 mV 30 mV	15 mA —	5 mV	100 ms	100 ms	200 ms	500 ms	50 Ω	—	6.5 A	3.8 A	3.6 A	8.6 (19)	10.5 (23)	\$1900
8 mV 50 mV	120 mA —	30 mV	300 ms	300 ms	500 ms	1.5 sec	50 Ω	—	24 A	15 A	14 A	16.8 (37)	22.2 (49)	\$2800
3 mV 30 mV	5 mA —	60 mV	200 ms	200 ms	300 ms	600 ms	Open	5.3 A	5.3 A	2.9 A	2.7 A	5.4 (12)	7.3 (16)	\$1550
8 mV 40 mV	25 mA —	90 mV	300 ms	300 ms	2.0 sec	3.0 sec	100 Ω	—	24 A	15 A	14 A	15.9 (35)	21.3 (47)	\$2800
22mV 50mV	15mA —	300mV	300ms	300ms	600ms	3.5 sec	Open	—	24 A	15 A	14 A	16.3 (36)	21.7 (48)	\$2800

\* An ac input option must be specified when ordering.

# POWER SUPPLIES

General Purpose: 200–2000 W Output

Models 6259B-6274B

- Built-in overvoltage protection
- Constant voltage/constant current operation
- Remote programming and sensing

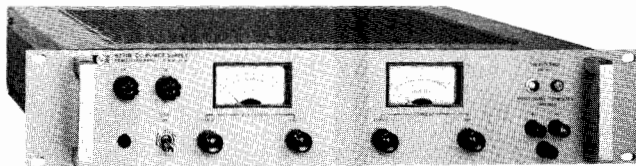

HP 6263B, 6266B

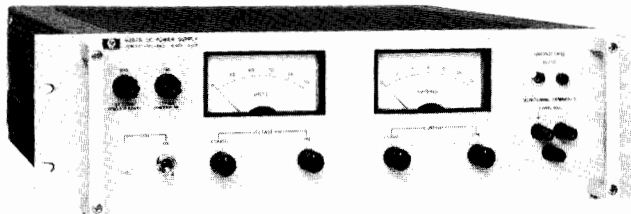

HP 6264B, 6267B

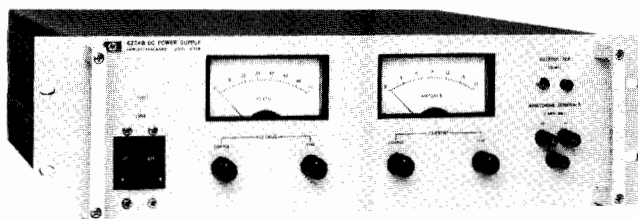

HP 6274B

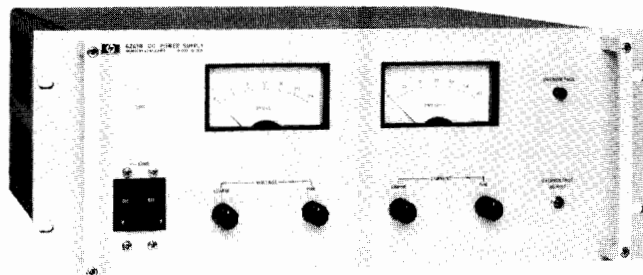

HP 6259B, 6260B, 6261B, 6268B, 6269B

- Remote sensing
- Auto-series, -parallel, and -tracking operation
- $\leq 50 \mu\text{s}$  load transient recovery

## Description

### Models 6259B-6274B

This series of high-performance constant voltage/constant current supplies includes twelve models with output rating from 10 to 60 V. All models employ a transistor series-regulator/triac-preregulator circuit to achieve high efficiency, excellent regulation, low ripple and noise, and moderate programming speeds in a compact full-rack width package.

Separate coarse and fine voltage and current controls allow the voltage and current outputs to be varied from zero to the maximum rated value, crossover from constant voltage to constant current operation occurs automatically when the load current exceeds the value established by the current control settings.

Additional features include built-in overvoltage crowbar protection; remote error sensing; and auto-series, auto-parallel, and auto-tracking operation. The crowbar trip point adjustment and associated overvoltage indicator are conveniently located on the front panel.

Auto-series, auto-parallel, and auto-tracking connections should ordinarily include no more than three supplies. If a specific application requires the use of more than three supplies in any of the three connections, consult your local HP Field Engineer for additional information.

All dc output, ac input, sensing, control, and programming connections are made to rear-panel terminals. Either the positive or negative output terminal may be grounded or the supplies may be operated floating at up to 300 volts above ground. Models 6263B, 6264B, 6266B and 6267B are convection cooled. All other models in this series employ cooling fans. Models which output more than 200 watts are equipped with terminal blocks for ac input and are not shipped with line cords.

## Specifications†

RATINGS			PERFORMANCE							
DC Output		HP Model	Load Effect		Source Effect		PARD (rms/p-p)		Drift (stability)	
Volts	Amperes		Voltage	Current	Voltage	Current	Voltage	Current	Voltage	Current
0-10	0-50	6259B	0.01% + 200 $\mu\text{V}$	0.02% + 1 mA	0.01% + 200 $\mu\text{V}$	0.02% + 1 mA	500 $\mu\text{V}/5 \text{ mV}$	25 mA rms	0.03% + 2 mV	0.03% + 10 mA
0-10	0-100	6260B	0.01% + 200 $\mu\text{V}$	0.02% + 2 mA	0.01% + 200 $\mu\text{V}$	0.02% + 2 mA	500 $\mu\text{V}/5 \text{ mV}$	50 mA rms	0.03% + 2 mV	0.03% + 20 mA
0-20	0-10	6263B	0.01% + 200 $\mu\text{V}$	0.02% + 500 $\mu\text{A}$	0.01% + 200 $\mu\text{V}$	0.02% + 500 $\mu\text{A}$	200 $\mu\text{V}/10 \text{ mV}$	3 mA rms	0.03% + 500 $\mu\text{V}$	0.03% + 6 mA
0-20	0-20	6264B	0.01% + 200 $\mu\text{V}$	0.02% + 500 $\mu\text{A}$	0.01% + 200 $\mu\text{V}$	0.02% + 500 $\mu\text{A}$	200 $\mu\text{V}/10 \text{ mV}$	5 mA rms	0.03% + 500 $\mu\text{V}$	0.03% + 6 mA
0-20	0-50	6261B	0.01% + 200 $\mu\text{V}$	0.02% + 1 mA	0.01% + 200 $\mu\text{V}$	0.02% + 1 mA	500 $\mu\text{V}/5 \text{ mV}$	25 mA rms	0.03% + 2 mV	0.03% + 10 mA
0-40	0-5	6266B	0.01% + 200 $\mu\text{V}$	0.02% + 500 $\mu\text{A}$	0.01% + 200 $\mu\text{V}$	0.02% + 500 $\mu\text{A}$	200 $\mu\text{V}/10 \text{ mV}$	3 mA rms	0.03% + 500 $\mu\text{V}$	0.03% + 3 mA
0-40	0-10	6267B	0.01% + 200 $\mu\text{V}$	0.02% + 500 $\mu\text{A}$	0.01% + 200 $\mu\text{V}$	0.02% + 500 $\mu\text{A}$	200 $\mu\text{V}/10 \text{ mV}$	3 mA rms	0.03% + 2 mV	0.03% + 3 mA
0-40	0-30	6268B	0.01% + 200 $\mu\text{V}$	0.02% + 2 mA	0.01% + 200 $\mu\text{V}$	0.02% + 2 mA	1 mV/5 mV	20 mA rms	0.03% + 2 mV	0.03% + 5 mA
0-40	0-50	6269B	0.01% + 200 $\mu\text{V}$	0.02% + 2 mA	0.01% + 200 $\mu\text{V}$	0.02% + 2 mA	1 mV/5 mV	25 mA rms	0.03% + 2 mV	0.03% + 10 mA
0-60	0-15	6274B	0.01% + 200 $\mu\text{V}$	0.02% + 500 $\mu\text{A}$	0.01% + 200 $\mu\text{V}$	0.02% + 500 $\mu\text{A}$	200 $\mu\text{V}/20 \text{ mV}$	5 mA rms	0.03% + 2 mV	0.03% + 5 mA

†Refer to page 453 for complete specification definitions.



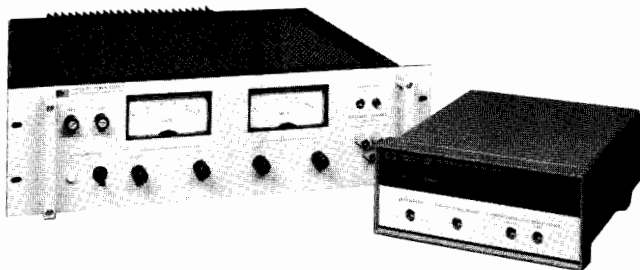

Models 6259B - 6274B can be HP-IB controlled by using the HP 59501B HP-IB Programmer.

**Specification—General**

**Load effect transient recovery:** time, 50  $\mu$ s; Level, 10 mV.  
**Resolution:** voltage control, less than 0.02%; current control, less than 0.15%.  
**Temperature coefficient per °C:** 0.01% of output plus 200  $\mu$ V.  
**Temperature ratings:** operating, 0 to 55°C; storage, -40 to 75°C.  
**Remote control programming:** these power supplies are capable of being programmed in constant voltage and constant current operation by using an external resistance or dc voltage with coefficients as shown in the table below.

Rear terminal wiring configurations for remote control operation are specified in the operating and service manual supplied with the power supply. For remote control programming procedures and timing considerations, contact your local HP field engineer.

**Power:** input voltage tolerance is  $\pm$ 10%, 57-63 Hz. For other input voltage and frequency options available, see option listing in the specifications table below. Standard input voltage, maximum input current, and maximum power are:

- HP 6259B, 230 V ac, 6 A, 850 W;
- HP 6260B, 230 V ac, 12 A, 1600 W;
- HP 6263B, 115 V ac, 4.5 A, 350 W;
- HP 6266B, 115 V ac, 4 A, 325 W;
- HP 6268B, 230 V ac, 12 A, 1600 W;
- HP 6261B, 230 V ac, 12 A 1500 W;
- HP 6264B, 115 V ac, 8 A, 600 W;
- HP 6267B, 115 V ac, 8 A, 550 W;
- HP 6269B, 230 V ac, 18 A, 2500 W;
- HP 6274B, 115 V ac, 15 A, 1200 W;

**AC line connections:** three wire, five foot ac power cord included—HP 6263B and 6266B.

Three-terminal barrier strip provided on power supply for ac power connections—HP 6259B, 6260B, 6261B, 6264B, 6267B, 6268B, 6269B and 6274B.

**Size**

- HP 6263B, 6266B: 83.7 H x 483 W x 479.4 mm D (3.296" x 19" x 18.875").
- HP 6264B, 6267B, 6274B: 127 H x 483 W x 479.4 mm D (5.00" x 19" x 18.875").
- HP 6259B, 6260B, 6261B, 6268B, 6269B: 173 H x 483 W x 479.4 mm D; (6.812" x 19" x 18.875").

**Option Descriptions**

- 005:** 50 Hz ac input: optimizes power supplies that require adjustment/modification for 50 Hz operation. N/C
- 010:** chassis slides. For access to rack mounted power supplies: HP 6263B, 6264B, 6266B, 6267B add \$88  
 HP 6274B, 6259B, 6260B, 6261B, 6268B, 6269B add \$163
- 016:** Model 6260B only. 115 Vac  $\pm$  10% single phase input. Consists of replacing power transformer and circuit breaker, and reconnecting bias transformer, RFI choke and fans. add \$122
- 022:** voltage and current programming adjust. Allows the V and I programming coefficients and zero output to be conveniently adjusted to 0.1% accuracy via access holes in the rear panel. Consists of four potentiometers and resistors located inside the rear panel. add \$62
- 026:** 115 Vac  $\pm$  10%, single phase input. Consists of replacing the input circuit breaker and reconnecting the power transformer, bias transformer, RFI choke, and fans. Models 6259B, 6261B and 6268B only. N/C
- 027:** 208 Vac,  $\pm$  10%, single phase input. Consists of reconnecting power transformer taps, and other components where necessary. N/C
- 028:** 230 Vac  $\pm$  10%, single phase input. Consists of reconnecting power transformer taps, and other components where necessary. N/C
- 040:** Multiprogrammer interface. Prepares standard HP power supplies for resistance programming by the HP 6940B, 6942A, 6944A or 6954A Multiprogrammers. This option includes Option 022, special calibration, and protection check-out procedures (where required). add \$78
- 910:** one additional operating and service manual shipped with each power supply. HP 6259B-6274B add \$7.65

**Specifications, Continued**

REMOTE CONTROL FEATURES								GENERAL					
Resistance Coeff.		Voltage Coeff.		Speed Up*		Speed Down*		Overvoltage		Weight		Options	Price
Voltage	Current	Voltage	Current	NL	FL	NL	FL	Range	Margin	Net	Shipping		
200 $\Omega$ /V $\pm$ 1%	4 $\Omega$ /A $\pm$ 10%	1 V/V $\pm$ 1%	10 mV/A $\pm$ 10%	70 ms	70 ms	200 ms	100 ms	2-12 V	5% + 2V	31.3 kg/69 lb	35.3 kg/78 lb	5, 10, 22, 26, 27, 40	\$2100
200 $\Omega$ /V $\pm$ 1%	2 $\Omega$ /A $\pm$ 10%	1 V/V $\pm$ 1%	5 mV/A $\pm$ 10%	70 ms	70 ms	200 ms	75 ms	2-12 V	5% + 2 V	43.9 kg/97 lb	48 kg/106 lb	5, 10, 16, 22, 27, 40	\$2450
200 $\Omega$ /V $\pm$ 1%	100 $\Omega$ /A $\pm$ 10%	1 V/V $\pm$ 1%	50 mV/A $\pm$ 10%	150 ms	150 ms	7 s	350 ms	2-23 V	5% + 1 V	15.4 kg/34 lb	18.6 kg/41 lb	5, 10, 22, 27, 28, 40	\$1625
200 $\Omega$ /V $\pm$ 1%	10 $\Omega$ /A $\pm$ 10%	1 V/V $\pm$ 1%	25 mV/A $\pm$ 10%	140 ms	140 ms	10 s	150 ms	2.5-23V	5% + 1 V	21.3 kg/47 lb	24.5 kg/54 lb	5, 10, 22, 27, 28, 40	\$1750
200 $\Omega$ /V $\pm$ 1%	4 $\Omega$ /A $\pm$ 10%	1 V/V $\pm$ 1%	10 m V/A $\pm$ 10%	150 ms	150 ms	250 ms	250 ms	2-23 V	5% + 2 V	35.3 kg/78 lb	39.4 kg/87 lb	5, 10, 22, 26, 27, 40	\$2250
200 $\Omega$ /V $\pm$ 1%	200 $\Omega$ /A $\pm$ 10%	1 V/V $\pm$ 1%	100 mV/A $\pm$ 10%	275 ms	275 ms	13 s	1.5 s	2.5-45 V	5% + 1 V	15.4 kg/34 lb	18.6 kg/41 lb	5, 10, 22, 27, 28, 40	\$1625
200 $\Omega$ /V $\pm$ 1%	100 $\Omega$ /A $\pm$ 10%	1 V/V $\pm$ 1%	50 mV/A $\pm$ 10%	275 ms	275 ms	13 s	750 ms	2.5-45 V	5% + 1 V	17.7 kg/39 lb	20.8 kg/46 lb	5, 10, 22, 27, 28, 40	\$1750
200 $\Omega$ /V $\pm$ 1%	6 $\Omega$ /A $\pm$ 10%	1 V/V $\pm$ 1%	16.7 mV/A $\pm$ 10%	300 ms	300 ms	1 s	650 ms	4-45 V	5% + 1 V	34.4 kg/76 lb	38.1 kg/84 lb	5, 10, 22, 26, 27, 40	\$2250
200 $\Omega$ /V $\pm$ 1%	4 $\Omega$ /A $\pm$ 10%	1 V/V $\pm$ 1%	10 mV/A $\pm$ 10%	350 ms	350 ms	1 s	600 ms	4-45 V	5% + 1 V	40.3 kg/89 lb	44 kg/98 lb	5, 10, 22, 27, 40	\$2350
300 $\Omega$ /V $\pm$ 1%	67 $\Omega$ /A $\pm$ 10%	1 V/V $\pm$ 1%	33.3 mV/A $\pm$ 10%	600 ms	600 ms	40 s	800 ms	6-66 V	5% + 1 V	21.7 kg/48 lb	24.5 kg/54 lb	5, 10, 22, 27, 28, 40	\$1800

\*Up = increasing output voltage. NL = No output load current. FL = Full rated output load current



# POWER SUPPLIES

General Purpose: 300—11,000 W Output

Models 6434B—6483C

- Outstanding value—low cost/watt
- Up to 75% efficiency at full output
- Constant voltage/constant current operation

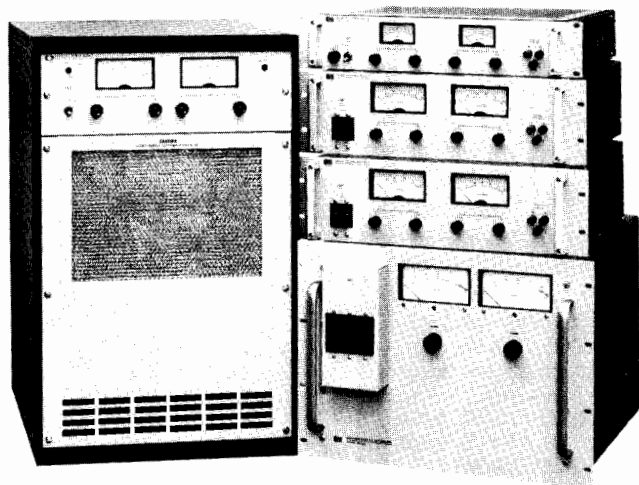

HP 6434B—6483C

## Description

This series of SCR-regulated power supplies is designed for medium to high-power applications requiring a fixed or variable dc source with moderate regulation and ripple. For supplies with better regulation, faster response time, and lower ripple, see models HP 6259B—6274B on page 474.

## Operating Features

All supplies in this series are of the constant voltage/constant current type. Large easy-to-read panel meters continuously monitor output voltage current.

Input and output power, remote sensing, remote programming, and auto-series, -parallel, and -tracking connections are made to bus bars and terminal blocks on the rear panel.

## Specifications†

RATINGS			PERFORMANCE						
DC Output		HP Model	Load Effect		Source Effect		PAR Δ rms/p-p	Temperature Coefficient	Drift
Volts‡	Amperes‡		Voltage	Current	Voltage	Current			
0-8	0-1000	6464C	0.05% + 5 mV	0.1% + 1 A	0.05% + 5 mV	0.1% + 1 A	80 mV/1 V	0.03% + 100 μV	0.03% + 1 mV
0-15	0-200	6453A	0.2% + 10 mV††	1% or 2 A††	0.2% + 10 mV††	1% or 2 A††	150 mV rms	0.05% + 2 mV	0.25% + 10 mV
0-16 or 18	0-600 or 500*	6466C	0.05% + 5 mV	0.1% + 0.6 A	0.05% + 5 mV	0.1% + 0.6 A	180 mV/1 V	0.03% + 200 μV	0.2% + 1 mV
0-36	0-100	6456B	0.2% + 10 mV††	1% or 1 A††	0.2% + 10 mV††	1% or 1 A††	180 mV rms	0.05% + 2 mV	0.25% + 10 mV
0-36	0-300	6469C	0.05% + 5 mV	0.1% + 0.3 A	0.05% + 5 mV	0.1% + 0.3 A	180 mV/1 V	0.03% + 400 μV	0.15% + 1 mV
0-40	0-25	6434B	40 mV	200 mA	18 mV	200 mA	40 mV/500 mV	0.03% + 5 mV	0.1% + 20 mV
0-64	0-50	6459A	0.2% + 10 mV††	1% or 0.5 A††	0.2% + 10 mV††	1% or 0.5 A††	160 mV rms	0.05% + 2 mV	0.25% + 10 mV
0-64	0-150	6472C	0.05% + 100 mV	0.1% + 0.15 A	0.05% + 100 mV	0.1% + 0.15 A	160 mV/2 V	0.03% + 4 mV	0.15% + 16 mV
0-110	0-100	6475C	0.05% + 100 mV	0.1% + 0.1 A	0.05% + 100 mV	0.1% + 0.1 A	200 mV/2 V	0.03% + 5 mV	0.15% + 20 mV
0-120	0-2.5	6443B	120 mV	25 mA	60 mV	25 mA	240 mV/400 mV	0.03% + 20 mV	0.1% + 60 mV
0-220	0-50	6477C	0.05% + 100 mV	0.1% + 50 mA	0.05% + 100 mV	0.1% + 50 mA	330 mV/2 V	0.03% + 8 mV	0.15% + 35 mV
0-300	0-35	6479C	0.05% + 100 mV	0.1% + 35 mA	0.05% + 100 mV	0.1% + 35 mA	330 mV/3 V	0.03% + 11 mV	0.15% + 45 mV
0-440, 500 or 600	0-25, 20, 15*	6483C	0.05% + 100 mV	0.1% + 35 mA	0.5% + 100 mV	0.1% + 35 mA	600 mV/5 V	0.03% + 20 mV	0.15% + 80 mV
1-600	5 mA-1.5 A	6448B	1 V	40 mA	600 mV	15 mA	600 mV/2 V	0.03% + 100 mV	0.1% + 300 mV

† Refer to page 453 for complete specification definitions.

†† Specified for combined line and load regulation.

Δ For operation with a 50 Hz input (possible only with Option 005), the rms ripple and transient response specifications are increased by 50%.

\* The output current rating is given in the same order corresponding with the voltage rating.

## Protective Features

In addition to the overload protection inherent in constant voltage/constant current operation, there are many other built-in protective features included in these supplies. The features vary within the three model classifications as follows:

**HP 6434B—6448B:** (1) Reverse voltage protection. (2) Fused ac input.

**HP 6453A, 6456B, 6459A:** (1) AC line loss protection circuit monitors 3-phase input and cuts off SCR's and opens output bus if a phase drops out; operation resumes when ac input returns to normal. (2) 3-phase input circuit breaker. (3) Optional internal crowbar (Option 006) protects load from overvoltage condition.

**HP 6464C—6483C:** (1) High-temperature protection thermostat opens input to power transformer and lights front panel indicator if supply overheats. (2) Prolonged overload protection circuit is activated and lights front panel indicator if output current exceeds approximately 115% of maximum rating. (3) Optional internal crowbar (except on HP 6464C) protects load from overvoltage condition. (4) Turn-on circuit limits peak line current during start-up into low impedance loads. (5) Phase-balance circuit permits operation with line-to-line input voltage imbalance up to 8%. (6) Overcurrent and over-voltage circuits of master slave supplies used in auto-series, -parallel, or -tracking operation can be interlocked.

## Auto-Series, -Parallel, -Tracking Operation

Supplies may be connected in auto-series, or auto-tracking (except HP 6448B and 6483C, which cannot be connected in auto-series).

Up to three lower-power models (HP 6434B—6448B) may be connected in any of the above configurations. Higher-power model (HP 6453A/6483C) interconnection should ordinarily include no more than two supplies.

## Remote Programming

The voltage and current outputs of the supplies can be programmed by a remote resistance, or for most models, a remote voltage source. Programming speeds and coefficients are detailed in the specifications table.

## AC Power Requirements

The ac power requirements vary with the three model classifications (see option listings). When powered from a 50 Hz source (possible with option 005), the rms ripple and transient response specifications increase by 50%. The p-p ripple specification is unchanged by line frequency.

§ Under light loading conditions, power supply may not meet all published specifications. The graph on the next page defines the permissible operating regions for CV and CC modes of operation.

For operation with a 50 Hz input (possible only with Option 005), output current is linearly derated from 100% at 40°C to 80% at 50°C.

POWER SUPPLY OUTPUT RESTRICTIONS AS A FUNCTION OF LOADING

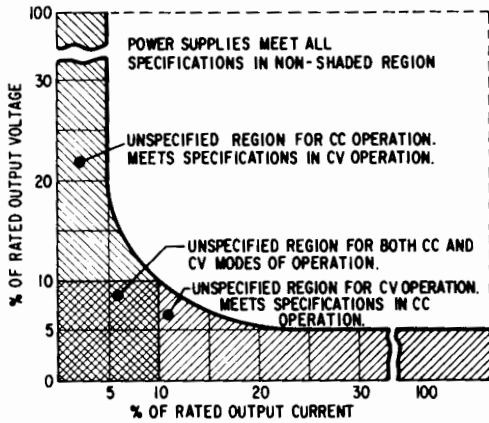

An ac input option must be specified when ordering.

**Line Cords**

Line cords are not supplied with models 6434B, 6448B and 6453A-6483C.

**Size**

- Model 6443B:** 89 H x 483 W x 445 mm D (3.5" x 19" x 17.5").
- Models 6434B, & 6448B:** 133 H x 483 W x 432 mm D (5.25" x 19" x 17").
- Models 6453A, 6456B, & 6459A:** 356 H x 483 W x 500 mm D (14" x 19" x 19.7").
- Models 6464C, 6466C, 6469C, 6472C, 6475C, 6477C, 6479C, & 6483C:** 705 H x 483 W x 715 mm D (27.75" x 19" x 28.12").

**Option Descriptions**

**HP 6434B-6448B**

- Std:** 115 V ac, ± 10%, single phase, 57-63 Hz
- 005:** realignment for 50 Hz operation
- 010:** chassis slides
- 027:** 208 V ac, ± 10%, single phase, 57-63 Hz
- 028:** 230 V ac, ± 10%, single phase, 57-63 Hz
- 910:** one extra operating and service manual shipped with each power supply

- Price**
- N/C
- N/C
- add \$163
- N/C
- N/C
- add \$10

**Specifications, continued**

REMOTE CONTROL										GENERAL				
Resolution		Load Transient Recovery $\Delta$	Resistance Coefficient		Voltage Coefficient		Up		Down		Net Weight		Options	Price
			Voltage	Current	Voltage	Current	NL	FL	NL	FL	Kg	lb		
8 mV	1 A	100 ms, 500 mV	200 $\Omega/V \pm 2\%$	1 $\Omega/A \pm 2\%$	1 V/V $\pm 1\%$	6.2 mV/A $\pm 7\%$	1.6 s	0.6 s	6 s	0.1 s	235	518	1, 2, 3, 5, 23, 31, 32, 40	\$12500
65 mV	1 A	50 ms, 150 mV	200 $\Omega/V \pm 2\%$	1 $\Omega/A$	0.4 V/V	30 mV/A	1 s	0.5 s	20 s	0.2 s	108	238	1, 2, 3, 5, 6, 10, 31, 32	\$6200
18 mV	0.5 A	100 ms, 500 mV	200 $\Omega/V \pm 2\%$	1.66 $\Omega/A \pm 2\%$	1 V/V $\pm 1\%$	10.3 mV/A $\pm 7\%$	1.6 s	0.6 s	15 s	0.2 s	226	500	1, 2, 3, 5, 6, 23, 31, 32, 40	\$12000
90 mV	0.5 A	50 ms, 300 mV	200 $\Omega/V \pm 2\%$	2 $\Omega/A$	166 mV/V	60 mV/A	1 s	0.5 s	60 s	0.5 s	108	238	1, 2, 3, 5, 6, 10, 31, 32	\$5800
36 mV	0.3 A	100 ms, 500 mV	200 $\Omega/V \pm 2\%$	3.33 $\Omega/A \pm 2\%$	1 V/V	20.6 mV/A $\pm 7\%$	1.6 s	3 s	20 s	0.5 s	226	500	1, 2, 3, 5, 6, 23, 31, 32, 40	\$11500
10 mV	12.5 mA	200 ms, 200 mV	200 $\Omega/V \pm 2\%$	12 $\Omega/A$	1 V/V	**	0.3 s	1.2 s	75 s	1.2 s	30.4	67	5, 10, 27, 28	\$2150
100 mV	0.25 A	50 ms, 600 mV	300 $\Omega/V \pm 2\%$	4 $\Omega/A$	94 mV/V	120 mV/A	1 s	0.5 s	45 s	0.7 s	108	238	1, 2, 3, 5, 6, 10, 31, 32	\$5800
64 mV	0.15 mA	100 ms, 750 mV	300 $\Omega/V \pm 2\%$	6.7 $\Omega/A \pm 2\%$	1 V/V $\pm 3\%$	41.2 mV/A $\pm 7\%$	1.4 s	2.5 s	55 s	0.7 s	226	500	1, 2, 3, 5, 6, 23, 31, 32, 40	\$11500
22 mV	0.1 A	100 ms, 1 V	300 $\Omega/V \pm 2\%$	10 $\Omega/A \pm 2\%$	1 V/V $\pm 3\%$	62 mV/A $\pm 7\%$	1.5 s	2 s	80 s	0.7 s	226	500	1, 2, 3, 5, 6, 23, 31, 32	\$11500
30 mV	1.3 mA	200 ms, 600 mV	300 $\Omega/V \pm 2\%$	120 $\Omega/A$	1 V/V	**	0.5 s	2 s	210 s	2 s	14	31	5, 10, 27, 28	\$1850
44 mV	50 mA	100 ms, 2 V	300 $\Omega/V \pm 2\%$	20 $\Omega/V \pm 2\%$	1 V/V $\pm 3\%$	124 mV/A $\pm 7\%$	1.5 s	2 s	95 s	1 s	226	500	1, 2, 3, 5, 6, 23, 31, 32	\$11500
60 mV	35 mA	100 ms, 3 V	300 $\Omega/V \pm 2\%$	28.6 $\Omega/A \pm 2\%$	1 V/V $\pm 3\%$	177 mV/A $\pm 7\%$	1.5 s	2 s	75 s	1.6 s	226	500	1, 2, 3, 5, 6, 23, 31, 32	\$11500
60 mV	25 mA	100 ms, 5 V	40 $\Omega/V \pm 2\%$	40 $\Omega/A \pm 2\%$	1 V/V $\pm 3\%$	0.25 V/A $\pm 7\%$	1.5 s	2 s	120 s	2 s	226	500	1, 2, 3, 5, 6, 23, 31, 32	\$12000
60 mV	0.75 mA	200 ms, 3 V	300 $\Omega/V \pm 2\%$	600 $\Omega/A$	1 V/V	**	0.2 s	1 s	45 s	2 s	27.6	61	5, 10, 27, 28	\$2150

$\Delta$ For operation with a 50 Hz input (possible only with Option 005), the rms ripple and transient response specifications are increased by 50%.

\*\*This feature is not available.

\*An ac input option must be specified when ordering these 3-phase models.

†Special Option J30 must be ordered with models 6434B-6448B and 6466C-6483C to be programmed with an HP 59501B Power Supply Programmer. Contact your local HP Field Engineer for ordering instructions.

**HP 6453A, 6456B, 6459A**

An ac input option must be specified when ordering.

AC input connections are by means of a 4-conductor connector at rear of unit. Low voltage (208 V, 230 V) models are furnished with an Arrow Hart and Hageman plug (HP 1251-6896). High voltage (380 V, 400 V, 460 V) models are furnished with an Arrow Hart and Hageman plug (HP 1251-6897).

- 001:** 208 V ac, ± 10%, 3-phase, 15.5 A/phase, 57-63 Hz
- 002:** 230 V ac, ± 10%, 3-phase, 14 A/phase, 57-63 Hz
- 003:** 460 V ac, ± 10%, 3-phase, 7 A/phase, 57-63 Hz
- 005:** realignment for 50 Hz operation
- 006:** overvoltage protection crowbar for HP 6453A, 6459A
- 010:** chassis slides
- 031:** 380 V ac, ± 10%, 3-phase, 8.5 A/phase, 57-63 Hz
- 032:** 400 V ac, ± 10%, 3-phase- 8.0 A/phase, 57-63 Hz
- 910:** one extra operating and service manual shipped with each power supply.

**HP 6464C-6483C**

An ac input option must be specified when ordering.

AC input connections are by means of enclosed 4-wire terminal block

- 001:** 208 V ac, ± 10%, 3-phase, 55 A/phase, 57-63 Hz
- 002:** 230 V ac, ± 10%, 3-phase, 50 A/phase, 57-63 Hz
- 003:** 460 V ac, ± 10%, 3-phase, 25 A/phase, 57-63 Hz
- 005:** realignment for 50 Hz operation
- 006:** internal overvoltage protection crowbar for HP 6477C, 6479C, 6483C
- 023:** rack mounting attachments for standard 19" rack
- 031:** 380 V ac, ± 10%, 3-phase, 30 A/phase, 57-63 Hz
- 032:** 400 V ac, ± 10%, 3-phase, 28.5 A/phase, 57-63 Hz
- 040:** prepares power supply to be programmed with resistance by an HP 6940B, 6942A, 6944A or 6954A.
- 910:** one extra operating and service manual shipped with each power supply.

**Accessory**

- 14545A:** casters for HP 6464C-6483C—set of four

# POWER SUPPLIES

## Special Purpose: DC Power Supply/Amplifiers

Models 6824A–6827A

- High speed remote programming
- Overload protection
- Wide-band response

- Bipolar voltage
- Current sink or source

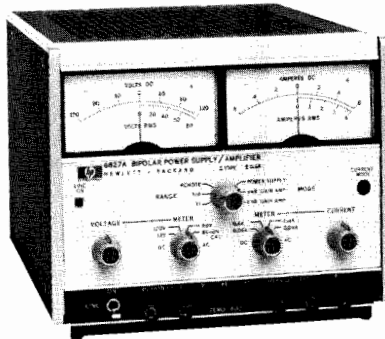

HP 6825A–6827A

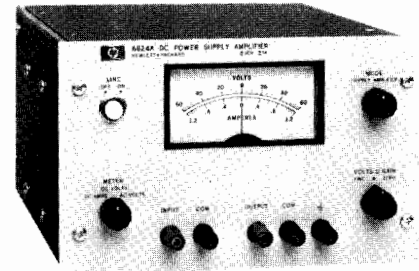

HP 6824A

### Description

The Power Supply/Amplifier is a general-purpose instrument useful in any laboratory engaged in research and development of electronic systems, circuitry, or components. The unit can be operated in one of two basic operating modes: power supply or amplifier. Terminals at the rear permit access to various internal control points to further expand the operational capabilities of the instrument. The resulting flexibility lends the Power Supply/Amplifier to an almost unlimited number of applications.

### Models 6825A Through 6827A

These models feature dual-range output and constant-voltage/constant-current operation. Output voltage and current as a dc supply, or gain as a power amplifier, are remotely controllable and are compatible with Hewlett-Packard Multiprogrammer Systems.

The unit can furnish a bipolar, constant-voltage or constant-current output. It can be remotely programmed with a resistance, voltage, or current and its high speed programming characteristics adapt it to a wide variety of laboratory and production testing applications. The unit can sink, as well as source, current permitting it to serve as a variable load device.

As a direct-coupled power amplifier, each unit offers a signal-to-noise ratio of approximately 80 dB at full output with low distortion and a frequency response up to 40 kHz in the fixed gain mode.

### Model 6824A

Although this model does not provide quite the level of performance and flexibility of Models 6825A through 6827A, it is lower in cost and is suitable for many applications.

As a power supply, this unit offers constant-voltage/current-limiting operation, remote programming, and auto-series, auto-parallel operation.

As a power amplifier, the unit exhibits a high signal-to-noise ratio with a 20 dB gain from dc to 10 kHz. It is useful in servo systems, as a pulse or oscillator amplifier, for motor control, and a variety of other applications.

### General Specifications

**Temperature:** operating, 0 to 55°C; storage, -40 to +75°C.

**Power:** HP 6824A, standard input voltage is 104–127 V ac, 48–63 Hz. Order Option 028 for 230 V  $\pm$ 10% operation. HP 6825A, 6826A, 6827A, switchable, 100, 120, 220, or 240 V ac, -13% +6%, 48–63 Hz, 150 W.

**Size:** HP 6824A, 131 H x 209 W x 303 mm D ( $5\frac{1}{32}$ " x  $8\frac{7}{32}$ " x  $11\frac{1}{16}$ ""). HP 6825A, 6826A & 6827A, 155 H x 198 W x 316 mm D ( $6\frac{1}{32}$ " x  $7\frac{25}{32}$ " x  $12\frac{7}{16}$ "").

**Weight:** HP 6824A, 7.7 kg (17 lb); 6825A, 6826A & 6827A, 8.2 kg (18 lb).

### Specifications

RATINGS			POWER SUPPLY PERFORMANCE						POWER AMPLIFIER PERFORMANCE							
DC Output		HP Model	PAR (rms/p-p)		Transient Recovery		Resolution		Voltage Gain		Frequency Response, +1, -3 dB		Distortion at full output		Options	Price
Volts	Amperes		Voltage	Current	Time	Level	Voltage	Current	Fixed	Variable	Fixed Gain	Variable Gain	100 Hz	10 kHz		
-5 V to +5 V/ -20 V to +20 V	0–2.0 A Both Ranges	6825A	10/30 mV	5/15 mA	100 $\mu$ s	20 mV	40 mV	6 mA	1X 4X	0-2X 0-8X	dc -40 kHz	dc -15 kHz	0.1% THD	0.5%	910	\$2750
-5 V to +5 V/ -50 V to +50 V	0–1.0 A Both Ranges	6826A	6/35 mV	0.8/5 mA	100 $\mu$ s	50 mV	100 mV	3 mA	1X 10X	0-2X 0-20X	dc -40 kHz	dc -15 kHz	0.1% THD	0.5%	910	\$2750
-10 V to +10 V/ -100 V to +100 V	0–0.5 A Both Ranges	6827A	10/50 mV	0.4/5 mA	100 $\mu$ s	100 mV	200 mV	1.5 mA	2X 20X	0-4X 0-40X	dc -30 kHz	dc -15 kHz	0.1% THD	1%	910	\$2750
-50 V to +50 V	0–1.0 A	6824A	10 mV rms	—	100 $\mu$ s	0.02% +5 mV	—	—	—	0-10X	—	dc -10 kHz	0.1% THD	—	910	\$1825

### Options Descriptions

**028:** 230 V ac  $\pm$  10%, single phase input

**910:** one additional manual shipped with each power supply

HP 6824A,  
HP 6825A, 6826A, 6827A

### Prices

N/C

add \$5.20  
add \$15

### Accessories

**HP 5060-8762:** adapter frame for rack mounting one or two HP 6825A-6827A units

**HP 5060-8760:** blank filler panel to be used with above units \$44

**HP 14515A:** rack mounting kit for one HP 6824A \$62

**HP 14525A:** rack mounting kit for two HP 6824As \$36

# POWER SUPPLIES

Laboratory: Single & Multiple Output, 10W to 38W  
Models 6200C-6218C and 6234A-6237B

479

- HP 6212C-6218C . . . 10 watts output
- Compact, impact-resistant stackable case
- Short-circuit proof

- HP 6200B-6209B . . . 30 watts output
- Auto series, parallel, and tracking
- Remote sensing

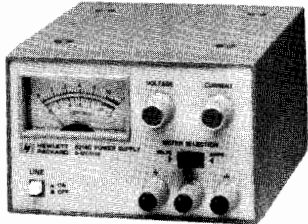

Single Output: HP 6212C-6218C

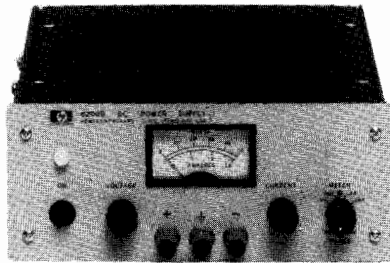

Single Output: HP 6200B-6209B

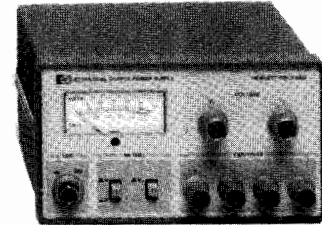

Dual Output: HP 6234A

## Description—Single Output Models

### Models 6212C-6218C

These popular low-cost CV/CC bench supplies are designed for general laboratory use and are equipped with front-panel mounted voltage and current controls, a combination volt/ammeter, and output binding posts. Output voltage and current are continuously variable, via coarse and fine controls from 0 to 15% above the maximum rated output. A switch selects either output voltage or current for display on the panel meter.

Load connections are made via three binding posts. Either the + or the - post may be grounded through an adjacent GND terminal or the supply may be operated floating at up to 300 volts above ground.

The supplies can also be operated as constant current sources with 500  $\mu$ A load regulation. All of these models can be connected in series or parallel.

The molded, impact-resistant case includes an interlocking feature for stacking several units vertically, thus minimizing bench space required for multiple supplies. Alternatively, up to three units can be mounted side by side in a 19" rack using Rack Mounting Kit HP 14521B. These supplies measure 86 H x 133 W x 368 mmD (3.40" x 5.25" x 8") and weigh 2 kg (4.4 lb).

### Models 6200B-6209B

This series of low-cost bench supplies includes three models covering an output voltage range from 0–20 V to 0–320 V. All models are equipped with ten-turn voltage and current controls, (except the HP 6206B, which does not have a current control), volt/ampere meter, meter function/range switch, and front and rear output terminals. In addition, on the dual-range models (HP 6200B and 6206B), an output range switch permits the selection of either a high or a low output voltage range.

The constant voltage/current limiting supply, HP 6206B, is short-circuit protected by a fixed current limiting circuit which is activated at approximately 110% of rated load current. The current-limit point can be reduced by changing the value of a single internal resistor. For the constant voltage/constant current supplies, ten-turn current controls allow the current-limit point to be set to any value within the current rating. Using these controls the CV/CC supplies can also be operated as constant-current sources.

Units may be bench operated or rack mounted individually or in pairs using accessory rack mounting hardware.

All models in this group of supplies measure 89 H x 216 W x 317 mm D (3.50" x 8.50" x 12.50") and weigh 4.5 kg (10 lb).

## Description—Dual Output Models

### Model 6234A

Model 6234A is a low-cost, dual-output bench power supply with two independently adjustable and isolated power sources in one compact unit. Both of the dc power sources are of the constant voltage/current limit type with each output voltage being adjustable continuously over a 0 to 25 V range. The maximum current available per output is 0.2 A and is limited automatically to prevent overload.

The HP 6234A offers considerable flexibility to the user with output voltages that can be arranged to provide identical or different voltages in any polarity combination with respect to 0 or other common positive or negative voltage points. The outputs can also be connected in series to provide up to 50 V at 0.2 A. Both sources are fully isolated to permit either of the output terminals to be grounded.

With pushbutton switches, users can select either voltage or current for each output to be monitored on the unit's meter. Other features include two multiple-turn controls for precise voltage setting, regulation to 0.01%, and ripple and noise of less than 200 microvolts rms.

With dimensions of only 93 mm high, 157 mm wide and 210 mm deep (3.64" x 6.17" x 8.25"), the HP 6234A supply takes up a minimum amount of bench space. Its weight is 2.3 kg (5 lb). The unit can be powered from a 115 V or an optional 230 V, 47-63 Hz ac input, (Option 028).

### Model 6205C

This low-cost bench supply is equipped with ten-turn output voltage controls, volt/ampere meter, meter function/ range switch, and front and rear output terminals. In addition, an output range switch permits the selection of either a high or a low output voltage range.

Model 6205C combines the versatility of a dual power supply with the flexibility of auto-parallel and auto-series operation to extend the output ratings of this supply to 20 V/1.2 A, 40 V/0.6 A, and 80 V/0.3 A. In addition, using the supply's auto-tracking capability, opposite

## POWER SUPPLIES

Laboratory: Single & Multiple Output, 10W to 38W (cont'd)

Models 6200B-6218C and 6234A-6237B

- Dual output to 24 watts
- Short-circuit proof
- Independent voltage controls
- Triple output to 38 watts
- Short circuit proof
- Tracking  $\pm 20$  volt outputs

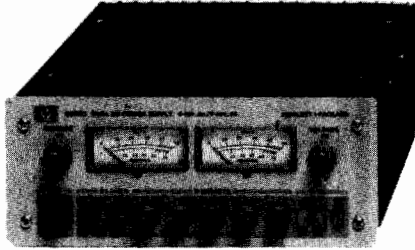

Dual Output: HP 6205C

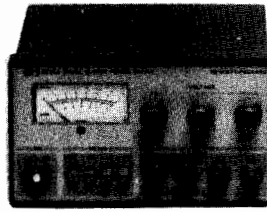

Triple Output: HP 6235A

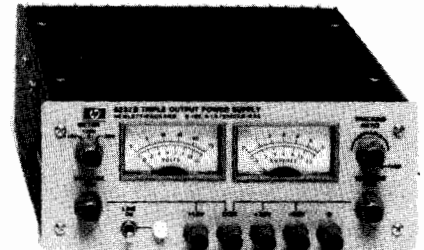

Triple Output: HP 6236B, 6237B

polarity voltages ( $\pm 20$  V,  $\pm 40$  V) can conveniently be obtained from this one supply.

This constant voltage/current limiting supply is short-circuit protected by a fixed current limiting circuit which is activated at approximately 110% of rated load current. The current-limit point can be reduced by changing the value of a single internal resistor. Units may be bench operated or rack mounted individually or in pairs using accessory rack mounting hardware.

### Description—Triple Output Models

#### HP 6235A

This compact, low-cost, three-in-one power supply is a handy addition to the lab bench where single or multiple voltages are needed for designing and testing breadboards and prototypes. The HP 6235A delivers three adjustable dc output voltages: 0 to +6 V at 1 A, 0 to +18 V at 0.2 A, and 0 to -18 V at 0.2 A. A single 0 to 36 volt output at 0.2 A can also be obtained by connecting across the +18 V and -18 V terminals.

The controls, meter, and binding posts are conveniently arranged on the front panel. One voltage control simultaneously adjusts the +18 V and -18 V outputs, which track one another and can be used to power operational amplifiers and other circuits requiring balanced positive and negative voltages. The supply's dual outputs have added versatility with an adjustable tracking ratio control (TRACK) that can set the negative output to a lower voltage than the positive output. Once the tracking ratio control has established a voltage ratio between the positive and negative outputs, the ratio remains constant as the +18 V voltage control is adjusted. A third control sets the 0 to +6 V output voltage.

The supply is a constant voltage/current limit type with each output voltage continuously adjustable over its range, while the maximum current available is automatically limited to prevent overloading. The power supply's outputs share a common terminal and are isolated from chassis ground so that any output terminal can be grounded if desired. Each output voltage or current can be quickly selected and monitored with the push-button meter switches.

Model 6235A measures 89 H x 157 W x 210 mm D (3.5" x 6.17" x 8.25") and weighs 2.3 kg (5 lb).

#### HP 6236B and 6237B

Microprocessors, digital and linear integrated circuits, and displays used in lab development frequently require triple output power supplies for operating prototypes. The HP 6236B and 6237B are valued additions to the design bench due to their multiple output voltages, small size, ease of operation and application-related performance.

These compact constant voltage/current limiting supplies combine 0 to  $\pm 20$  V tracking outputs rated at 0.5 A with a single output rated at 0 to +6 volts at up to 2.5 A in the HP 6236B, and 0 to +18 volts at 1 A in the HP 6237B.

Controls, meters, and binding posts are logically arranged on a neatly laid out front panel. One voltage control simultaneously adjusts the 20 V and -20 V outputs, which track within 1% to power operational amplifiers and circuits requiring balanced voltages. A tracking ratio control can disable the 1:1 tracking feature and set the negative output to a lower voltage than that of the positive output. Once the tracking ratio control has established a voltage ratio between the positive and negative outputs, the ratio remains constant as the  $\pm 20$  V voltage control varies both outputs. Another voltage control sets the 0 to +6 V (HP 6236B) or 0 to +18 V (HP 6237B) output.

All outputs are protected against overload and short-circuit damage by fixed current limiting circuits. For any overload condition, the +20 V and -20 V outputs in both models are limited to 0.55 A and the +18 V output in the HP 6237B is limited to 1.1 A. The overload protection circuit for the +6 V output in the HP 6236B has a current foldback characteristic that reduces the maximum available current from about 2.75 A at a 6 V terminal voltage to 1 A at zero volts (or short circuited). This foldback limiting characteristic maximizes the available current in the important 5 to 6-volt range while minimizing dissipation during overloads.

Another protective feature safeguards sensitive load circuitry by preventing an output voltage overshoot when the supply is turned on or off.

Separate dual-range panel meters allow both the voltage and current of any output to be monitored simultaneously. A three-position switch selects the output which the meters will monitor.

Both models measure only 89 H x 216 W x 319 mm D (3.5" x 8.5" x 12.5") and weigh 4.3 kg (9.5 lb).

**Specifications**

RATINGS		PERFORMANCE							GENERAL	
DC Output		HP Model	Load Effect	Source Effect	PAR D rms/p-p	Control Mode and Resolution	Remote Control Coefficients	Power 115 V ac ± 10%	Options	Price
Volts	Amps									
<b>SINGLE OUTPUT—10 WATTS</b>										
0-10	0-1	6214C	4 mV	4 mV	200 μV/1 mV	CV/CC 5mV/75μA	**	48-440 Hz 0.3 A, 28 W	28	\$370
0-25	0-0.4	6216C	4 mV	4 mV	200 μV/1 mV	CV/CC 5mV/20μA	**	48-440 Hz 0.3 A, 28 W	28	\$370
0-50	0-0.2	6218C	4 mV	4 mV	200 μV/1 mV	CV/CC 10mV/10μA	**	48-440 Hz 0.3 A, 28 W	28	\$370
0-100	0-0.1	6212C	8 mV	4 mV	200 μV/1 mV	CV/CC 20mV/10μA	**	48-440 Hz 0.3 A, 28 W	28	\$450
<b>SINGLE OUTPUT—UP TO 30 WATTS</b>										
Dual range 0-20 or 0-40	0-1.5 0-0.75	6200B	0.01% + 4 mV	0.01% + 4 mV	200 μV/1 mV	CV/CC 10 mV/2 mA	2000/V ± 1% 0.5 kΩ/A ± 10% or 1 kΩ/A ± 10%	48-440 Hz 0.9 A, 70 W	11, 28	\$825
Dual range 0-30 or 0-60	0-1 0-0.5	6206B	0.01% + 4 mV	0.01% + 4 mV	200 μV/1 mV	CV/CL 10 mV/*	3000/V ± 1%	48-440 Hz 1 A, 66 W	11, 28	\$825
0-320	0-0.1	6209B	0.02% + 2 mV	0.02% + 2 mV	1 mV/40 mV	CV/CC 40 mV/200 μA	3000/V ± 1% 150 kΩ/A ± 10%	48-63 Hz 1 A, 60 W	28	\$975
<b>DUAL OUTPUT—10 WATTS</b>										
Dual output 0-25 and 0-25	0.2 0.2	6234A	0.01% + 1 mV	0.01% + 1 mV	200 μV/1 mV	CV/CL	**	104-127 Vac 47-63 Hz 0.26A, 35 W	28	\$550
<b>DUAL OUTPUT—24 WATTS</b>										
Two dual ranges 0-20/0-40 and 0-20/0-40	0-0.6/0.3 0-0.6/0.3	6205C	0.01% + 4 mV	0.01% + 4 mV	200 μV/1 mV	CV/CL 10 mV/*	2000/V ± 1%	48-440 Hz 0.5 A, 50 W	11, 28 40	\$825
<b>TRIPLE OUTPUT—13 WATTS</b>										
Triple output 0 to 6 and 0 to 18 and 0 to -18	0-1 0-0.2 0-0.2	6235A	8 mV 10 mV 10 mV	8 mV 15 mV 15 mV	1 mV/5 mV 1 mV/5 mV 1 mV/5 mV	CV/CL	** ** **	47-63 Hz 0.26 A, 35 W	28	\$500
<b>TRIPLE OUTPUT—35 WATTS*</b>										
Triple output 0 to +6 and 0 to +20 and 0 to -20	2.5 0.5 0.5	6236B	0.01% + 2 mV	0.01% + 2 mV	350 μV/1.5 mV	CV/CL 70 mV/*	**	104-127 Vac 47-63 Hz 1.2 A, 112 W	100 120 220 240	\$800
<b>TRIPLE OUTPUT—38 WATTS*</b>										
Triple Output 0 to +18 and 0 to +20 and 0 to -20	1 0.5 0.5	6237B	0.01% + 2 mV	0.01% + 2 mV	350 μV/1.5 mV	CV/CL 70 mV/*	**	104-127 Vac 47-63 Hz 1.2 A, 112 W	100 120 220 240	\$800

\*fixed current limit

\*\*remote control not available

\*ac input voltage option must be specified when ordering

**Option Descriptions**

**011:** internal overvoltage protection crowbar. Protects delicate loads against power supply failure or operator error. Dual output model has dual crowbar.

HP 6200B, 6206B

add \$102

HP 6205C

add \$204

**028:** 230 Vac ± 10%, single phase input. Consists of reconnecting power transformer taps, and other components where necessary.

NC

**040:** Multiprogrammer interface. Prepares HP 6205C power supplies for resistance programming by the HP 6940B or 6942A Multiprogrammer

add \$78

**100:** 87-106 Vac, 47-63 Hz, single phase input

NC

**120:** 104-127 Vac, 47-63 Hz, single phase input

NC

**220:** 191-233 Vac, 47-63 Hz, single phase input

NC

**240:** 208-250 Vac, 47-63 Hz, single phase input

NC

**910:** one additional operating and service manual is shipped with each power supply

HP 6200B-6237B

add \$5.20

**Accessories**

**HP 14513A:** rack kit for one HP 6200-6209B, 6236B, or 6237B supply

\$57

**HP 14523A:** rack kit for two of the above power supplies

\$31

**HP 14521C:** rack kit for one, two or three HP 6212C-6218C power supplies

\$87

☎ Fast-Ship product — see page 766.



# POWER SUPPLIES

## Special Purpose; Precision Voltage Sources

### Models 6114A and 6115A

- 0.025% output voltage accuracy
- Pushbutton voltage control
- Five minute warm-up



HP 6114A & 6115A

### Description

#### HP Models 6114A and 6115A

These 40-watt precision power supplies are high-accuracy instruments designed for use as low-cost calibrators, working voltage standards, systems reference supplies, or high-performance lab supplies. They are ideal for applications where an accurate, highly stable, and easy-to-use source of dc voltage is required.

#### Output Ratings

Both models feature automatic dual-range operation. For example, the HP 6114A can supply 0-20V at 0-2A, and 20-40V at 0-1A, without manual range switching. Automatic output current range cross-over occurs when the supply is providing greater than one-half of the maximum rated output voltage.

#### Output Voltage Controls

Pushbutton voltage controls allow the output voltage to be set rapidly and accurately. The setting is displayed in large, easy-to-read numerals. A four-digit pushbutton switch increases or decreases the output voltage in unit steps, and the switches go directly from "9" to "0" without backing down. A fifth digit, set via a separate front-panel control, provides output voltage resolution of 200  $\mu$ V.

The output voltage accuracy is 0.025% (250 ppm) plus 1 mV — for example, at 40 volts output, the output voltage of Model 6114A is accurate within  $\pm 11$  mV. This accuracy is attained after only five minutes' warmup, thus making these supplies especially suitable as portable calibrators.

#### Output Current Controls

A front-panel current control allows the maximum output current of these supplies to be set to any desired value within the maximum rating. Using this control, the supplies can be operated as constant-current sources with 0.01% current regulation. A current mode indicator (a light-emitting diode) immediately lights when the supply is operated in the gross current limit region or when the output current level established by the setting of the front-panel control is reached. When the indicator is lighted, the output voltage is uncalibrated, but the front panel voltmeter continues to indicate the output voltage with an accuracy of 2%. A ten-turn current control with a three-digit graduated dial provides 2 mA current resolution.

#### Remote Programming

Models 6114A and 6115A are designed to be programmed with either the HP Multiprogrammer or the HP-IB Isolated D/A Power Supply Programmer. Interfacing for Multiprogrammer operation is included as a standard feature in these models; therefore, the addition of Option 040 is not required. See pages 469, 598 and 603 for additional information on digital programming interfaces for power supplies. Both supplies can also be remote programmed by means of an external voltage or resistance. However, most specifications will change to those of the programming source.

The output capacitor can be disconnected to reduce current surges, thereby improving the performance of the supply as a constant-current source; this also increases the programming speed by approximately an order of magnitude. Note, however, that some capacitance

- May be used with HP-IB Power Supply Programmer
- Overvoltage and overcurrent indicators
- Built-in overvoltage crowbar

at the load may be required to maintain power supply stability under all loading conditions when the output capacitor is disconnected.

#### Overvoltage Protection

A built-in overvoltage protection circuit (an SCR crowbar) monitors the output and reduces the output voltage and current to zero whenever a preset voltage limit (adjustable from the front panel) is exceeded. This feature provides a convenient method of limiting the maximum output voltage supplied to voltage-sensitive loads.

#### Specifications

**DC Output:** voltage and current output can be adjusted over the range indicated by front-panel controls or analog programming.

**HP 6114A:** 0-20 volts, 0-2 amperes  
20-40 volts, 0-1 amperes

**HP 6115A:** 0- 50 volts, 0-0.8 amperes  
50-100 volts, 0-0.4 amperes

Both models feature automatic dual-range operation, which eliminates manual range switching.

**Load effect:** constant-voltage deviation, 0.0005% + 100  $\mu$ V. constant-current deviation, 0.01% + 500  $\mu$ A.

**Source effect:** over the rated input voltage range: constant-voltage, 0.0005% + 100  $\mu$ V; constant-current, 0.005% + 40  $\mu$ A.

**PAR (ripple and noise):** rms/p-p, 20 Hz to 20 MHz; CV 40  $\mu$ V/200  $\mu$ V, CC 200  $\mu$ A/1 mA.

**Temperature coefficient:** CV, 0.0001% + 15  $\mu$ V/ $^{\circ}$ C; CC, 0.02% + 50  $\mu$ A/ $^{\circ}$ C.

**Drift:** CV, 0.0015% + 15  $\mu$ V per 8 hours, 0.0075% + 30  $\mu$ V per 90 days.

**Output voltage accuracy:** output voltage accuracy obtained from front-panel controls at  $23 \pm 3^{\circ}$ C at any ac line voltage and load current within rating and following a five-minute warm-up: 0.025% + 1.0 mV.

**Resolution:** front-panel voltage control, 200  $\mu$ V; front-panel current control, 2 mA.

**Output impedance:** typical value is approximated by 0.05 m $\Omega$  in series with 3 mH.

**Load transient recovery time:** less than 50  $\mu$ s is required for output voltage (constant voltage operation) to recover within 50 mV of the nominal output level following a change in output current equal to the current rating of the supply.

**Remote programming speed:** up programming of voltage at full load: HP 6114A, 1.75s; HP 6115A, 4.5s. Down programming, no load: HP 6114A, 350 ms; HP 6115A, 500 ms.

**Overvoltage protection crowbar:** adjustable front-panel screwdriver control from 0.5 to 45 volts on the HP 6114A and 0.5 to 110 volts on the HP 6115A.

**Power:** 104-127 or 208-254 Vac (switchable), 48-440Hz, 150 VA max.

**Temperature rating:** operating, 0 to 50 $^{\circ}$ C; storage, -40 to +75 $^{\circ}$ C.

**Size:** 197 mm W x 165 mm H x 337mm D (7.75" x 6.5" x 13.25")

**Weight:** 7.7 kg (17 lb) net, 9.5 kg (21 lb) shipping.

#### Accessories

**5060-8762:** adapter frame for rack mounting one or two 1/2 rack width units. This frame applies to HP 6114A, 6115A \$150

**5060-8760:** blank filler panel. This 1/2 rack width panel applies to HP 6114A, 6115A \$44

#### Ordering Information

**HP 6114A** Precision Power Supply \$1900  
**HP 6115A** Precision Power Supply \$1900

# POWER SUPPLIES

## Special Purpose: Precision Constant Current Sources

### Models 6177C, 6181C & 6186C

- Continuously variable voltage limit
- Output useful to micro-ampere region

- High output impedance—no output capacitor

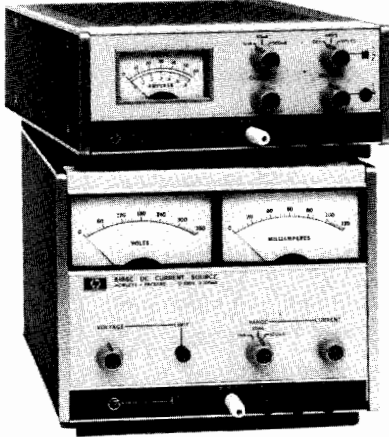

HP 6177C, 6181C

HP 6186C

voltage to vary from zero to maximum.

**Source effect (line regulation):** less than 25 ppm of output + 5 ppm of range switch setting for any change in the line voltage between 104 and 127 V ac at any output current and voltage within rating.

**Load effect transient recovery:** less than 800  $\mu$ s for recovery to within 1% of nominal output current following a full load change in output voltage. (On HP 6186C, recovery time for 100 mA/10 mA/1 mA ranges is 1 ms/1.6 ms/4 ms, respectively.)

**Temperature coefficient:** output change per degree C is less than 75 ppm of output current +5 ppm of range switch setting.

**Drift (stability):** less than 100 ppm of output current +25 ppm of range switch setting. Stability is measured for eight hours after one hour warm-up under conditions of constant line, load, temperature, and output setting.

**Resolution:** 0.03% of range switch setting.

**Temperature rating:** operating 0, to 55°C; storage, -40 to +75°C.

### Description

These solid-state constant-current sources are ideal for semiconductor circuit development, component testing, and precision electroplating applications.

Their high-speed remote programming characteristics make these supplies useful in testing and sorting semiconductors, resistors, relays, meters, etc. The ability to superimpose ac modulation on the dc output permits the supplies to be used for measurement of dynamic or incremental impedance of circuit components. When remotely programmed, accuracy, stability and some other specifications change to those of the programming source.

### Accessories

**HP 5060-8764:** rack adapter for rack mounting one or two HP 6177C or 6181C supplies

**HP 5060-8762:** rack adapter for rack mounting one or two HP 6186C supplies

**HP 5060-8530:** filler panel for HP 6177C, 6181C

**HP 5060-8760:** filler panel for HP 6186C

### Price

\$150

\$150

\$77.50

\$44

### Options

**028:** 230 Vac  $\pm$ 10%, single-phase input.

**910:** one additional operating and service manual

N/C

add \$7.65

### Specifications

**Load effect (load regulation):** less than 25 ppm of output + 5 ppm of range switch setting for a load change which causes the output

### Ordering Information

**HP 6177C, 6181C** Constant Current Source

**HP 6186C** Constant Current Source

\$1750

\$2650

Model		HP 6177C	HP 6181C	HP 6186C
Output Current ††		0-500 mA	0-250 mA	0-100 mA
Voltage Compliance $\Delta$		0-50 V dc	0-100 V dc	0-300 V dc
Output Ranges	A	0-5 mA	0-2.5 mA	0-1 mA
	B	0-50 mA	0-25 mA	0-10 mA
	C	0-500 mA	0-250 mA	0-100 mA
AC Input		115V ac $\pm$ 10%, 48-63 Hz; 0.6 A, 55 W at 115 V ac For 230 V ac see Option 028	115 V ac $\pm$ 10%, 48-63 Hz; 0.6 A, 55 W at 115 V ac For 230 V ac see Option 028	115/230 V ac, 48-63 Hz; 0.9 A, 90 W at 115 V ac 115/230 V ac switch
Constant Current	Voltage Control (accuracy: 0.5% of output current +.04% of range)	Range A	200 mV/mA	1 V/mA
		Range B	20 mV/mA	100 mV/mA
		Range C	2 mV/mA	10 mV/mA
Remote Programming	Resistance Control (accuracy: 1% of output current +0.04% of range)	Range A	400 ohms/mA	2 k $\Omega$ /mA
		Range B	40 ohms/mA	200 ohms/mA
		Range C	4 ohms/mA	20 ohms/mA
Voltage Limit Remote Programming	Voltage Control (Accuracy: 20%)		1 V/V	1 V/V
		Resistance Control	870 ohms/V	435 ohms/V
		Accuracy	25%	25%
Typical Output Impedance (R in parallel with C)*	Range A	R = 330 Meg, C = 500 pF	R = 1330 Meg, C = 10 pF	R = 10,000 Meg, C = 900 pF
	Range B	R = 33 Meg, C = 0.005 $\mu$ F	R = 133 Meg, C = 100 pF	R = 1,000 Meg, C = 700 pF
	Range C	R = 3.3 Meg, C = 0.05 $\mu$ F	R = 13.3 Meg, C = 1000 pF	R = 100 Meg, C = 1500 pF
PARD (Ripple and Noise): rms/p-p (20 Hz to 20 MHz) with either output terminal grounded	Range A	1.6 $\mu$ A rms/40 $\mu$ A p-p	0.8 $\mu$ A rms/20 $\mu$ A p-p	0.2 $\mu$ A rms/5 $\mu$ A p-p
	Range B	16 $\mu$ A rms/200 $\mu$ A p-p	8 $\mu$ A rms/100 $\mu$ A p-p	2 $\mu$ A rms/50 $\mu$ A p-p
	Range C	160 $\mu$ A rms/1 mA p-p	80 $\mu$ A rms/500 $\mu$ A p-p	20 $\mu$ A rms/500 $\mu$ A p-p
Programming Speed: from 0 to 99% of range switch setting with a resistive load ** (Output Current Modulation)		6 ms	6 ms	10 ms
Dimensions:		7.75" (W) x 3.44" (H) x 12.38" (D) 197 mm (W) x 88 mm (H) x 315 mm (D)	7.75" (W) x 3.44" (H) x 12.38" (D) 197 mm (W) x 88 mm (H) x 315 mm (D)	7.75" (W) x 3.44" (H) x 12.38" (D) 197 mm (W) x 158 mm (H) x 315 mm (D)
Weight: (Net/Shipping)		4.53 kg (10 lb)/5.9 kg (13 lb)	4.53 kg (10 lb)/5.9 kg (13 lb)	5.9 kg (13 lb)/7.7 kg (17 lb)

\* This network is a simplified representation of a complex network. The formula  $Z = R X_C / \sqrt{R^2 + X_C^2}$  is used for frequencies up to 1 MHz by substituting the values given for R and C. Above 1 MHz, the output impedance is greater than the formula would indicate.

\*\* Output current can be modulated 100% up to 50 Hz, percent modulation decreases

linearly to 10% at 50 Hz.

†† For operation above 40°C the maximum output current must be reduced linearly to 80% of rating at 55°C (maximum temperature).

$\Delta$  Minimum voltage obtainable with voltage limit control is 0.5 V.

# FREQUENCY & TIME STANDARDS

## General Information

Hewlett-Packard offers frequency standards and clocks which provide accurate frequency, time interval and timekeeping capabilities. Further, Hewlett-Packard standards provide means for comparing these quantities against national standards such as the National Bureau of Standards (NBS) and the U.S. Naval Observatory. Units of frequency or time cannot be kept in a vault for ready reference. They must be generated for each use, hence be regularly compared against recognized primary standards.

Frequency standards and clock systems manufactured by Hewlett-Packard are used for control and calibration at observatories, national centers for measurement standards, physical research laboratories, missile and satellite tracking stations, communication systems, radio navigation systems, manufacturing plants and radio monitoring and transmitting stations.

### Types of Frequency Standards

At the present time, three types of frequency standards are in common use. These are:

1. The cesium atomic beam controlled oscillator.
2. The rubidium gas cell controlled oscillator, and
3. The quartz crystal oscillator.

Hewlett-Packard manufactures all three types of frequency standards. Of these three standards, the first is a primary frequency standard and the last two are secondary frequency standards. The distinction between a primary standard and a secondary standard is that the primary standard does not require any other reference for calibration; whereas the secondary standard requires calibrations both during manufacturing and at intervals during use depending on the accuracy desired.

### Cesium Beam Frequency Standard

Cesium beam standards are in use wherever the goal is a very high accuracy primary frequency standard. In fact, the NBS frequency standard itself is of the cesium beam type. The cesium beam standard is an atomic resonance device which provides access to one of nature's invariant frequencies in accord with the principles of quantum mechanics. The cesium standard is a true primary standard and requires no other reference for calibration.

### Rubidium Frequency Standard

Rubidium frequency standards feature a high order of both short-term and long-term frequency stability. These are both important in certain fields such as deep-space communications, satellite ranging, and doppler radar.

Rubidium standards are similar to cesium beam standards in that an atomic resonant element prevents drift of a quartz oscillator through a frequency lock-loop. Yet the rubidium gas cell is dependent upon gas mixture and gas pressure in the cell. It must be calibrated and then it is subject to a small degree of drift. The drift is typically 100 times less than the best quartz crystal standard.

TABLE 1 Comparison of Frequency Standards

Standard	Principal construction feature	Principal advantage
Cesium Atomic Beam Resonator Controlled Oscillator.	Beam of free cesium atoms, spatially state selected, is subjected to a microwave signal at resonance frequency.	High intrinsic reproducibility and long-term stability. Designated as primary standard for definition of time interval.
Rubidium Gas Cell Resonator Controlled Oscillator.	Gas buffered resonance cell with optically pumped state selection.	Compact and light weight. High degree of short-term stability.
Quartz Crystal Oscillator.	Piezoelectrically active quartz crystal with electronic stabilization.	Very compact, light and rugged. Inexpensive.

### Quartz Crystal Oscillators

Quartz oscillators are used in virtually every frequency control application including atomic standards. The excellent short-term stability and spectral purity of the quartz oscillators used in Hewlett-Packard atomic standards contribute to the high quality of the output signal of these standards. For less demanding applications where some long-term drift can be tolerated, quartz oscillators are used as independent frequency sources.

### Frequency Standards and Clocks

Frequency standards and clocks have no fundamental differences—they are based upon dual aspects of the same phenomenon. Time and frequency are intangible quantities which can be measured only with respect to some physical quantity. The basic unit of time, the second, is defined as the duration of 9,192,631,770 periods of transition within the cesium atom. Conversely an unknown frequency is determined by counting the number of cycles over the period of a second. The Master Clock at the U.S. Naval Observatory, one of the world's most accurate clocks, is made of an ensemble of more than a dozen Hewlett-Packard cesium beam frequency standards. The USNO directly controls the distribution of precise time and time interval (frequency) from Naval radio stations, Loran-C (operated by U.S. Coast Guard), Omega and Satellite Navigation Systems. Hewlett-Packard portable cesium standards, "flying clocks," are used to periodically check the synchronization between these stations and the Master Clock.

Hewlett-Packard cesium beam standards are widely used to drive precision clocks because of the extremely good long-term stability and reliability of this primary standard. If a quartz oscillator or other secondary standard is used, it must be evaluated for rate of drift and be corrected periodically.

### Time Scale

The time interval of the atomic time scale is the International Second, defined in October 1967 by the Thirteenth General Conference of Weights and Measures. Since January 1972 the frequency offset between UTC and Atomic Time has been zero and the UTC time scale is kept in synchronism with the rotation of the earth to within  $\pm 0.9$  second by step-time adjustments of exactly 1 second, when needed (see Hewlett-Packard Application Note 52-2).

The U.S. National Bureau of Standards (NBS) and USNO provide the official basis for Standard Time for the United States. The UTC signal is broadcast from the NBS stations WWV and WWVB and by several other stations throughout the world. (See Hewlett-Packard Application Note 52-1, Fundamentals of Time and Frequency Standards, for a list of stations broadcasting time signals).

### Standby Power Supplies

Minimum down-time, important for any system, is vital to a time standard. Its worth depends directly on continuity of operation. Noninterrupted operation is also important to ultra-precise quartz oscillators.

Hewlett-Packard standby power supplies ensure continued operation despite line interruptions, and operate over a range of ac line voltage to supply regulated dc to operate frequency standards and frequency dividers and clocks. The batteries in the supplies assume the full load immediately when ac power fails.

### Hewlett-Packard Time and Frequency Standard

The Hewlett-Packard House Standard at the Santa Clara Division consists of an ensemble of five Hewlett-Packard Cesium Beam Standards each with the Option 004 High Performance Tube.

The standard is compared to the U.S. Naval Observatory Master Clock in Washington, D.C. by means of the Global Positioning (GPS) navigation system. It is also compared with the U.S. National Bureau of Standards Frequency Standard (NBS FS) at Boulder, Colorado by means of GPS through the Naval Observatory. The frequency uncertainty of the standard is within a few parts in  $10^{13}$  with respect to the standards maintained by the NBS and the USNO.

Time is maintained relative to the Naval Observatory and the National Bureau of Standards master clocks to an accuracy of better than  $\pm 1.0$  microseconds. This accuracy is verified with flying clock trips from the Naval Observatory to both Hewlett-Packard Santa Clara Division and Hewlett-Packard Geneva. Both locations have been designated U.S. Naval Observatory Time Reference Stations.

# FREQUENCY & TIME STANDARDS

## Primary Standards

Models 5061B

485

- HP 5061B
- Improved accuracy  $\pm 3 \times 10^{-12}$
- Primary standard
- Proven reliability

- HP 5061B, Opt 004
- Accuracy  $\pm 2 \times 10^{-12}$
- Settability  $\pm 1 \times 10^{-13}$
- Time domain stability  $5 \times 10^{-12}$  (1 s avg)

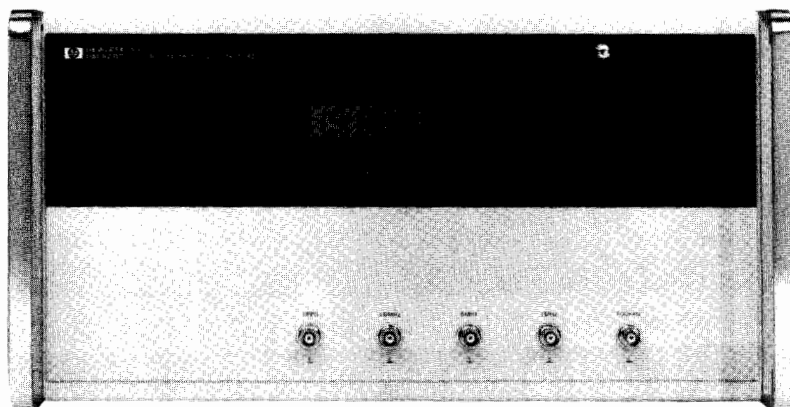

HP 5061B



### HP 5061B Cesium Beam Standard

The first Hewlett-Packard Cesium Beam Standard, the HP 5060A, was introduced in 1964. This was followed in 1967 with the improved HP 5061A, in 1973 with the high performance beam tube option for the HP 5061A and in 1986 with the 5061B. Since this time the accuracy and reliability of Hewlett-Packard cesium beam standards continues to be demonstrated and these standards have become the world-wide standard for frequency and time keeping. The HP 5061B has provision for an optional digital divider and reliable, easy-to-read LCD clock (Option 003) and for a battery with  $\frac{3}{4}$  hour standby power capacity with automatic charging.

**Reliability and warranty:** over 100 million operation hours have proven the performance and reliability of Hewlett-Packard cesium beam standards in various world-wide applications. The units have provided dependable microsecond accuracy in aircraft, ship and fixed environments.

A five-year warranty on the HP 5061B standard cesium beam tube is provided as a result of proven field reliability. This warranty includes replacement of the cesium beam tube if it should fail within the warranty period.

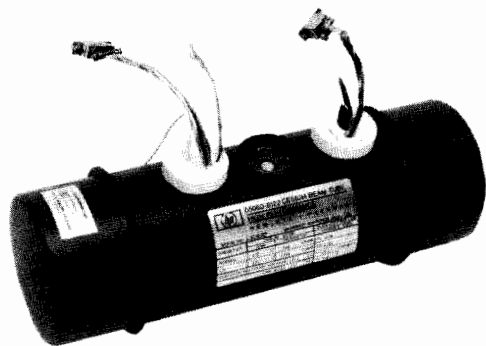

Option 004, High Performance Cesium Beam Tube with three-year warranty

### HP 5061B with Opt 004, High Performance Cesium Beam Tube

The Hewlett-Packard 5061B primary frequency standard with the Option 004 Cesium Beam Tube offers increased stability and accuracy in the instrument which has become the worldwide standard of frequency and time keeping since its introduction in 1967. Improvements in magnetic shielding, ruggedization and environmental performance permit improved performance and expansion of navigation and communication systems.

The design concept of the high-performance beam tube includes unique HP designed dual-beam optics with higher beam intensity to accomplish better short-term stability and greater immunity to effects of shock and vibration. A 50 percent increase in resonance cavity length without change in the overall beam tube size contributes to better accuracy and settability because of the high Q of the narrower resonant line width. This tube retains the unique cesium standard feature of virtually no long term instability or aging.

The intrinsic accuracy is improved to  $\pm 2 \times 10^{-12}$  which provides an excellent reference standard without need of calibration. If desired, as in many timekeeping applications, two or more units may be calibrated to determine the difference in rate or may be adjusted to the same frequency. With the improved settability specifications of  $1 \times 10^{-13}$  small changes in frequency are accomplished rapidly and accurately. A provision for degaussing the tube without adversely affecting the instrument operation allows removal of any residual magnetic field in the tube. This is important in achieving the settability performance.

The short term stability specification is improved by a factor of ten with this tube. The  $5 \times 10^{-12}$  (1 s avg.) performance compares very favorably with that of rubidium type standards which are noted for their excellent short term stability. An important advantage from the better short term stability is the capability to make measurements to 1 sigma precision of  $1 \times 10^{-12}$  in about one minute compared to the two hours required previously. The HP 5061B with the Option 004 High Performance Tube has the same high reliability as the HP 5061B with the standard tube. The new high performance tube is warranted for three years, but is designed to have the same long life as the standard tube.\*

### HP E21-5061B Flying Clock

The HP E21-5061B consists of a HP 5061B Cesium Beam Standard with Option 003 LCD Clock and Special Option E21, all fastened to an HP 5089A Standby to form a portable unit. The power supply, which can be operated from 11 to 30 V dc, 85 to 255 V ac, will provide approximately 10 hours standby power (from sealed immobilized electrolyte lead calcium batteries) for the HP 5061B Cesium Beam Standard.

This wide range of operating power capabilities enable the HP E21-5061B to operate on local power in virtually any country in the world. The 10 hours standby capability makes it possible to travel where there is no power available and, of course, allows the HP E21-5061B to conveniently be transported between power sources and operated in almost any air or surface vehicle as a "flying clock" (see Hewlett-Packard Journal, August 1966 and December 1967).

The Option 004 tube, because of the improved shielding, offers a significant increase in accuracy under the varying earth's magnetic field conditions experienced by flying clocks and is a desirable addition to the HP E21-5061B. In addition, the better short term stability permits more accurate and rapid comparison of standards.

\*See page 488 for ordering information.

# FREQUENCY & TIME STANDARDS

## Secondary Standards

### Model 5065A

- Compact, high reliability, proven performance
- Long term drift rate  $< 1 \times 10^{-11}$ /month
- Time domain stability  $< 5 \times 10^{-13}$  (100 s, avg)
- High reliability
- Proven performance
- Compact
- Long-term drift rate  $< 1 \times 10^{-11}$ /month
- Time domain stability  $< 5 \times 10^{-13}$  (100 s, avg.)

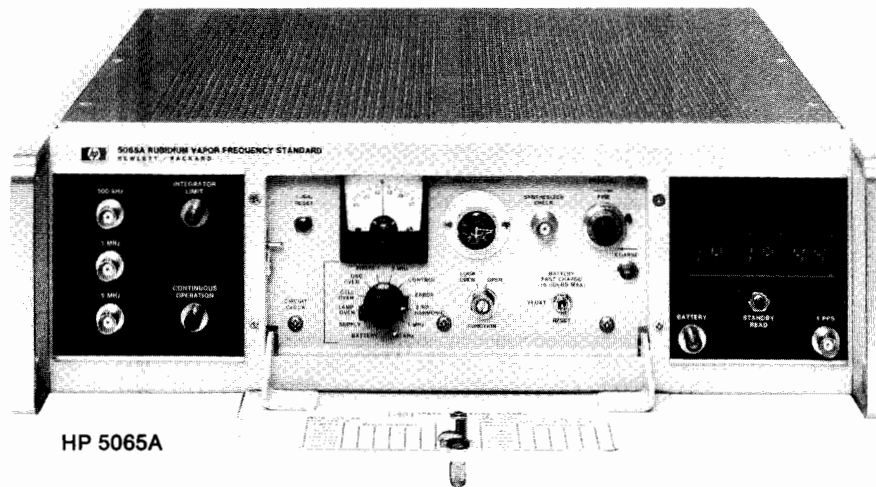

HP 5065A

#### HP 5065A Rubidium Frequency Standard

The HP 5065A is an atomic-type secondary frequency standard which uses a rubidium vapor resonance cell as the stabilizing element. As a result, it has long-term stability of better than  $1 \times 10^{-11}$  per month which exceeds that of high quality quartz oscillator frequency standards by 50 to 100 times. Furthermore, it has excellent short-term stability. These features contribute to its desirability as a coherent signal source, as a master oscillator for radio and radar systems where special requirements for stability and/or narrow bandwidth must be met, as a precision time keeper where the better performance of a cesium beam primary standard is not required, and as a house frequency standard for improved accuracy with fewer NBS calibrations compared to that required with quartz standards.

Front panel controls and circuit check meter of the HP 5065A are protected by a panel door. The magnetic field control provides fine frequency adjustment with which the frequency can be set to a precision of better than  $2 \times 10^{-12}$  without reference to a chart. The low noise quartz oscillator is phase-locked to the atomic frequency and provides the standard 5 MHz, 1 MHz, and 100 kHz outputs. The circuit check meter with selector switch monitors key voltages and currents for routine maintenance readings, calibration procedures, and fault finding.

The HP 5065A is designed for assured operation—to give the user confidence that the standard output signals are correct and locked to the atomic frequency. Logic within the unit maintains power to a “continuous” operation light on the front panel. If operation is interrupted, even momentarily, for any reason the light goes out and stays out until manually reset. An integrator limit light warns when the frequency correcting servo loop is approaching the limit of its dynamic range.

The HP 5065A is contained in a small-size package and is lightweight in comparison to a cesium beam standard. Additionally the rubidium resonance cell is much more frequency stable than quartz oscillators while subjected to shock and vibration, EMC, humidity, and magnetic field effects.

**Reliability and warranty:** the most significant module in the HP 5065A in terms of performance is the Rubidium Vapor Frequency Reference (RVFR). This temperature controlled, magnetically shielded unit includes the Rb gas cell and a photo sensitive detector

designed for maximum possible reliability. Field experience, including several million hours of operation, have demonstrated this reliability and the RVFR is now warranted for a period of three years. This increased warranty protects the owner in the event of random failure.

The Option 001 Digital Clock has an easy to read LED time-of-day display. The olive black upper panel provides a dark background around the readout for excellent contrast and readability. Initial clock setting is accomplished by means of pushbuttons easily accessible by removing the top cover. The LED display offers high reliability, freedom from errors due to mechanical shock, and performance over the full environmental range of the HP 5065A. A sync button on the digital divider permits automatic synchronization of this 1 PPS pulse to an external pulse. The clock 1 PPS is adjustable in decade steps from  $1 \mu\text{s}$  to 1 s, with respect to the synchronized reference, with 6 thumbwheel switches. A screwdriver adjustment allows fine continuous adjustment over a range of  $1 \mu\text{s}$ .

To conserve battery power, the display is not illuminated when ac power is not available. A STANDBY READ pushbutton below the display is used for readout when operating on the internal battery or external dc.

The Option 002 Standby Battery provides the HP 5065A with a minimum of 10 minutes standby power at  $25^\circ\text{C}$ . Switchover from line to battery is automatic so there is no interruption of operation if ac line power should fail. A front panel ac interruption light warns when ac power has failed or has been disconnected. Fast or float charging rates may be selected when ac power is available.

The Option 003 combines the Option 001 Clock and Option 002 Battery and should be specified if both Options 001 and 002 are required.

#### HP E21- 5065A Portable Time Standard

HP E21- 5065A Portable Time Standard is a complete system for precision timekeeping and for transporting time from one location to another. It consists of the HP 5065A Rubidium Standard with digital clock and divider (Option 001) and the HP 5089A Power Supply with 6 or more hours standby capability. The component units are held together by side bars, and the interconnecting cables are protected by a back cover.



# FREQUENCY & TIME STANDARDS

Secondary Standards

Model 105B

487

- High spectral purity
- Well-buffered outputs
- Aging  $< 5 \times 10^{-10}$  per day

- Excellent stability
- High reliability
- Built-in 8-hour standby battery

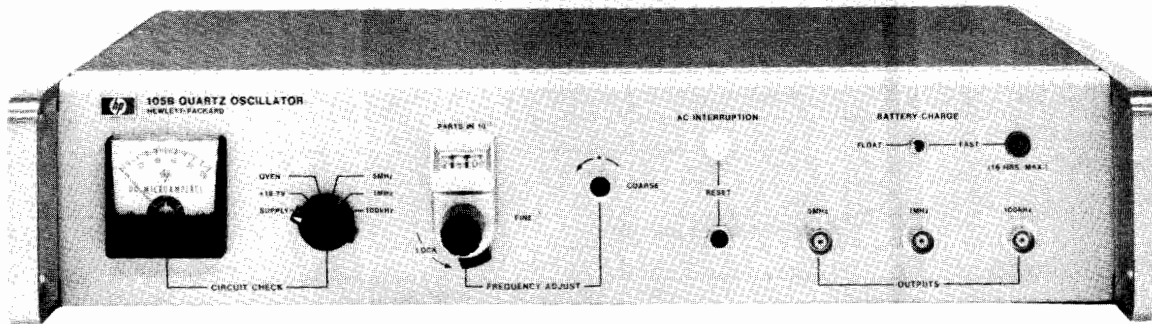

HP 105B

## HP 105B Quartz Oscillator

The HP 105B Quartz Oscillator provides state-of-the-art performance in precision frequency and time systems because of its excellent long and short term stability characteristics, spectrally pure output, unexcelled reliability, and ability to operate under a wide range of environmental conditions. The HP 105B fills a need for a small and economical yet highly stable precision quartz oscillator for frequency and time standards. The HP 105B can be operated from the ac line. It also has a built-in 8-hour standby battery for uninterrupted operation should line power fail. The 5 MHz, 1 MHz and 100 kHz buffered sinusoidal outputs have excellent short term stability (5 parts in  $10^{12}$  rms for 1 s averaging time) and aging rate ( $< 5$  parts in  $10^{10}$  per day).

The HP 105B features rapid warm-up. Typically, the oscillator will be within 5 parts in  $10^9$  of the final frequency in 15 minutes after an "off" period of 24 hours. The basis of these oscillators is an extremely stable "SC" cut quartz crystal developed by Hewlett-Packard. New technologies in the crystal mounting and packaging have resulted in a cleaner crystal which in turn has a lower aging rate. The crystal, oscillator and AGC circuit are all enclosed in a proportional oven which reduces the temperature effects on these components and circuits.

Particular care was taken to provide a spectrally pure 5 MHz output which, when multiplied high into the microwave region, provides signals with spectra only a few cycles wide. Spectra less than 1 Hz wide can be obtained in X-band (8.2 to 12.4 GHz). The stability and purity of the 5 MHz output make it suitable for doppler measurements, microwave spectroscopy, and similar applications where the reference frequency must be multiplied by a large factor.

## Specifications

**Outputs:** 5 MHz, 1 MHz, 100 kHz; 1 V rms into 50  $\Omega$  front and rear connectors.

**Clock output:** 1 MHz or 100 kHz; 0.5 V rms into 1 k $\Omega$ , rear connector. Normally supplied wired for 1 MHz output.

## Frequency Stability

**Aging rate:**  $< 5 \times 10^{-10}$  per 24 hours.

**Short-term stability:** for 5 MHz output only.

$\tau$ (sec)	$\sigma_{\Delta f/f(2,\tau)}$
$10^{-2}$	$1.5 \times 10^{-10}$
$10^{-1}$	$1.5 \times 10^{-11}$
$10^0$	$5 \times 10^{-12}$

**Temperature:**  $< 2.5 \times 10^{-9}$  total change  $0^\circ\text{C}$  to  $50^\circ\text{C}$ .

**Load:**  $\pm 1 \times 10^{-10}$  open to short circuit, 50  $\Omega$  R, L or C load change.

**Supply voltage:**  $\pm 5 \times 10^{-11}$  for 22–30 V dc from 26 V dc reference and for 115/230 V  $\pm 10\%$ .

**Warm-up (at  $25^\circ\text{C}$ ):** to within  $5 \times 10^{-9}$  of final frequency in 15 min.

## Distortion (5 MHz, 1 MHz, 100 kHz) Below Rated Output

**Harmonic:**  $> 40$  dB.

**Non-harmonic:**  $> 80$  dB.

## Frequency Adjustments

**Fine:**  $\pm 5 \times 10^{-8}$  range with digital dial reading parts in  $10^{10}$ .

**Coarse:**  $1 \times 10^{-6}$  front-panel screwdriver control.

**Phase locking:** external +5 V to –5 V allows  $> 2 \times 10^{-8}$  frequency control for locking to external source.

## Environmental

**Temperature, operating:**  $0^\circ\text{C}$  to  $+50^\circ\text{C}$ .

**Temperature, storage:**  $-40^\circ\text{C}$  to  $+50^\circ\text{C}$  ( $+75^\circ\text{C}$  without standby battery).

**Altitude:** 15.24 km (50,000 ft.).

**Standby supply capacity:** 8 hours at  $25^\circ\text{C}$  ambient temperatures.

**Power requirements:** 115/230 V  $\pm 10\%$ , 50–400 Hz at 18 W (70 W warm-up) Add 1 W for float charge and 12 W for fast charge. 22–30 V dc at 8 W (16 W warm-up).

**Size:** 88 mm H x 425 mm W x 286 mm D ( $3\frac{1}{2}$  in. x  $16\frac{3}{4}$  in. x  $1\frac{1}{4}$  in.).

**Weight:** 105B—net, 11 kg (24 lb). Shipping, 14 kg (31 lb).

## Ordering Information

**HP 105B** Quartz Oscillator

**Opt 908** Rack Flange Kit

**Opt 910** Extra manual

## Price

\$7500

+ \$45

+ \$25



# FREQUENCY & TIME STANDARDS

## Frequency Standards

Models 5061B, 5065A, 105B

### Specifications — Frequency Standards

Instrument:	HP 5061B Option 004	HP 5061B	HP 5065A	HP 105B
Type of Standard:	Cesium	Cesium	Rubidium	Quartz
Accuracy: maintained in a dc magnetic field to 2 gauss over a temperature range of 0-50°C	$\pm 3 \times 10^{-12}$	$\pm 5 \times 10^{-12}$		
Accuracy: limited temp. range <sup>(1)</sup>	$\pm 2 \times 10^{-12}$	$\pm 3 \times 10^{-12}$		$5 \times 10^{-10}$ /day
Reproducibility	$\pm 1.5 \times 10^{-12}$	$\pm 3 \times 10^{-12}$		
Retrace	$\pm 5 \times 10^{-13}$	$\pm 3 \times 10^{-12}$		
Settability (frequency)	$\pm 1 \times 10^{-13}$	$\pm 7 \times 10^{-13}$	$\pm 2 \times 10^{-12}$	$1 \times 10^{-10}$
Long-term Stability	$\pm 2 \times 10^{-12}$ <sup>(4)</sup>	$\pm 2 \times 10^{-12}$ <sup>(4)</sup>	$\pm 1 \times 10^{-11}$ /month	
DC Magnetic Field Stability, freq. change, any orientation in a 2 gauss field	$< \pm 2 \times 10^{-13}$	$< \pm 2 \times 10^{-12}$	$< \pm 5 \times 10^{-12}$ (1 gauss field)	
Time Constant, quartz OSC. control loop	1s	1s		
Warm-up Time at 25°C	30 min	45 min	$5 \times 10^{-11}$ 4 hrs <sup>(2)</sup>	$5 \times 10^{-9}$ /15 min
Tube Warranty	3 yrs.	5 yrs.	3 yrs.	
Sinusoidal Outputs	10 MHz, 5 MHz, 1 MHz, 100 kHz		5 MHz, 1 MHz, 100 KHz	5M, 1M, 100k, Clock (1M)
Output Voltage	1 volt into 50 $\Omega$			
Harmonic Distortion	>40 dB (from rated output)			
Non-Harmonic Distortion	>80 dB (from rated output)			
Temperature, Operating	0-50°C			
Temperature, Non-operating	-40 to 70°C <sup>(3)</sup>			-40 to 50°C
Power, AC	50, 60 or 400 Hz $\pm 10\%$ , 115/230V $\pm 10\%$ , 44W (Cesium), 49W (Rb),			19W(71W Warm-up)
Power, DC	22 to 30V, 30W		23 to 30V, 35W	8W (16W Warm-up)
Power, AC/DC with options - add	5 to 16W		0 to 16W	
Dimensions (HxWxD): mm:	221x425x416		133x425x416	88.2x425x286
inches:	8.7x16.7x16.4		5.2x16.7x16.4	3 <sup>5</sup> / <sub>32</sub> x16 <sup>3</sup> / <sub>4</sub> x11 <sup>1</sup> / <sub>4</sub>
Weight (lb/kg)	68/30.9	64/29.1	34/15.4	24/10.9
Option 002			2/0.9	
Option 003	6/2.7	6/2.7	3.5/1.6	
Time Standard (Clock)				
1 PPS Outputs: Master:	Front and Rear BNC		Front BNC	
Clock:	10V Peak into 50 $\Omega$ load			
Amplitude	20 $\mu$ s min.			
Width	<50 ns			
Rise Time	<50 ns			
Fall Time	<50 ns			
Jitter, pulse-to-pulse	<1 ns, rms			
Synchronization	Automatic, 100 $\pm$ 100 ns delay			
Clock Pulse Adjustment Range:	.1 $\mu$ s to 1s			
Clock Display:	LCD	LCD	LED	
Standby Power Supply-Capacity at 25°C w/clk	45 min.	45 min.	10 min.	6 hrs
Recharge	Automatic		switch	fast/float
(1) Static mechanical and atmospheric and electromagnetic environment $\pm 2.5^\circ\text{C}$ range at any temperature between 15 and 35°C.				
(2) After 24 hours off @ 25°C.				
(3) If options installed in HP 5065A, Non-Op. Temp -40°C to +50°C.				
(4) For life of Cesium Beam tube.				
NOTE: Tubes are intrinsically capable of meeting these specifications when installed in HP 5061B's currently in production.				

#### Ordering Information

**HP 5061B** Cesium Frequency Standard

**Opt 003** Clock and Standby Power Supply

**Opt 004** High Performance Beam Tube

**Opt 908** Rack Flange Kit

**Special Option HP E21-5061B** Flying Clock

**Consists of:** HP5061B, Opt 003, E21, + 5089A.

(The 5061B, + Opt 003 are not included in the E21 price.)

**Weight:** 64 kg (141 lb).

**Size:** 425 H x 405 W x 546 mm D (16.7 in. x 15.9 x 21.5 inches) includes handles.

**HP 10638A** Degasser

#### Price

\$33,500

\$4,400

\$5,700

\$45

+ \$6,950

\$1,550

**Special Option K34-59991A** Phase Comparator

**HP 5065A** Rubidium Frequency Standard

**Opt 001** Clock

**Opt 002** Standby Power Supply

**Opt 003** Clock and Standby Power Supply

**Opt 908** Rack Flange Kit

**Special Option HP E21-5065A** Portable Standard

**Consists of:** HP 5065A, E21, Opt 001 + 5089A

Standby power supply. (The 5065A, + Opt 001 are not included in the E21 price.)

**Weight:** 50 kg (110 lb).

**Size:** 314 H x 425 W x 546 mm D (8.4 x 16.7 x 21.5 inches) includes handles.

\$1,700

\$28,300

\$3,600

\$850

\$4,500

\$45

+ \$7,075

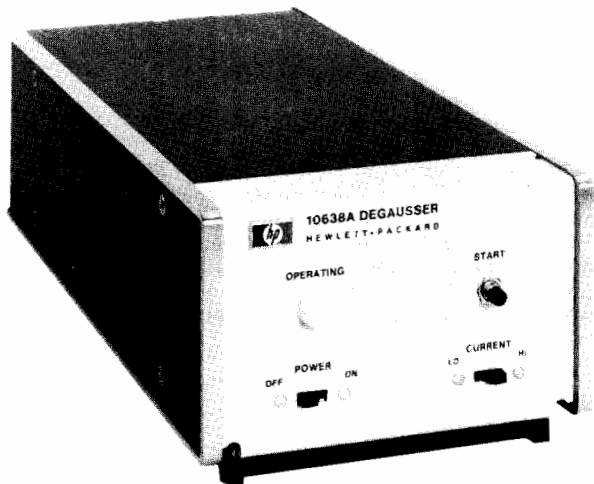

HP 10638A

#### HP 10638A Degausser

The HP 10638A Degausser is designed for use with the Option 004 High Performance Cesium Beam Tube without interrupting normal operation. The degausser removes residual magnetism in the shields of the beam tube which can build up over time, due to a changing magnetic environment, and can cause a frequency offset. Relaxation of the residual magnetism insures a settability of  $\pm 1 \times 10^{-13}$ , allowing stable precise changes in output frequency and a reproducibility of  $\pm 1.5 \times 10^{-12}$ . The degausser should be used when initially setting up the HP 5061B with Option 004 or after the instrument has been moved or adjusted.\*

#### HP 5061B with Option 003, Time Standard and Standby Power Supply

The HP 5061B has provision for an optional digital divider and reliable, easy to read LCD, time-of-day, 24-hour digital clock (Option 003). By including this option, the number of applications and the versatility of the cesium standard is increased. The one-pulse-per-second output can simplify the comparison with other standards (such as portable and secondary standards) as well as GPS and Loran Systems. The techniques for such comparisons are described in Application Note AN-52. Option 003 also includes an internal battery power supply which will provide at least 45 minutes of standby power if the line power should fail. This will prevent phase and frequency interruptions due to intermittent or an extended power failure. Battery power also enables moving the cesium beam standard to locations of other secondary standards without losing time.\*

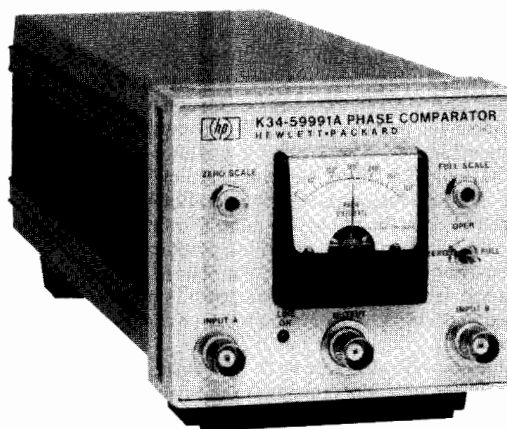

HP K34-59991A

#### HP K34-59991A Phase Comparator

The HP K34-59991A Broadband Linear Phase Comparator accurately compares the phase relationship of the output signals of two frequency standards having the same nominal frequency. This will enable resolving extremely small differences between precision frequency sources. The Phase Comparator operates over a frequency range of 10 kHz to 50 MHz and input levels between 100 mV and 10 V rms. A linear dc output voltage, proportional to the phase differences between the two standards, is available at both the front and rear panels. This voltage is also monitored on a front-panel meter and is suitable for driving a stripchart recorder, thus allowing longterm monitoring of the frequency standards. By using this comparator, very small frequency differences can be detected and adjustments can be made to frequency standards to correct for timekeeping errors.\*

#### HP J45-5061 Certified Stability of $1 \times 10^{-13}$

The HP J45-5061B is a special option which will certify that the Model HP 5061B with standard Options 003 and 004 has stability performance of better than or equal to  $1 \times 10^{-13}$  in a day, when measured each day for any five consecutive days. This means that the cesium standards absolute deviation from the HP Santa Clara Division House Standard is less than or equal to 8.64 ns per day on each of the five consecutive days during the certification. The certification applies only to original shipments and is performed under calibration laboratory conditions with the cesium beam tube degaussed and operating in a stable magnetic environment and over a restricted temperature range of  $\pm 2.5$  degrees range at any temperature between 15 and 35 degrees C.\*

\* See page 488 for ordering information.

# FREQUENCY & TIME STANDARDS

## Accessories (cont'd)

### Model 5087A

- Versatile with 3 input and 12 output channels
- Low noise, high stability, and isolation
- Exceptional phase stability
- Plug-in modular construction

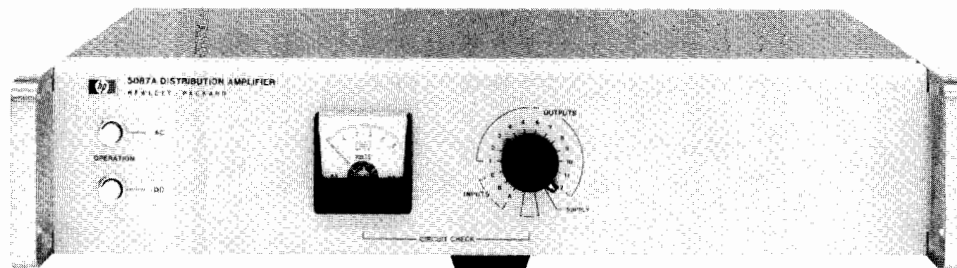

HP 5087A

### HP 5087A Distribution Amplifier

The Hewlett-Packard 5087A Distribution Amplifier provides the isolation and flexibility required for distribution of the output of high-quality frequency standards. Low distortion and excellent isolation make it ideal for providing multiple outputs from atomic or crystal frequency standards. The 3 input channels will accept 10 MHz, 5 MHz, 1 MHz or 100 kHz in any combination. The number of outputs for each channel is selectable up to a total of 12 outputs. The output levels are individually adjustable from 0 to 3 V rms. All input and output levels are monitored on a front-panel meter.

The Distribution Amplifier features plug-in modular construction, short circuit isolation, exceptional phase stability, low noise and cross-talk, and uninterrupted switchover to standby dc in event of ac power failure.

The shielding around each input and output plug-in amplifier assures minimum noise and crosstalk. The tuned output amplifiers provide clean signals and high channel-to-channel isolation.

The instrument is designed for maximum versatility and can be supplied to meet a wide variety of special requirements. The standard configuration of input and output amplifiers is shown in Figure 1.

Several other commonly used configurations are also available and special combinations of the various input and output modules can be supplied. Input and output amplifiers can be added or the configuration easily changed at any time.

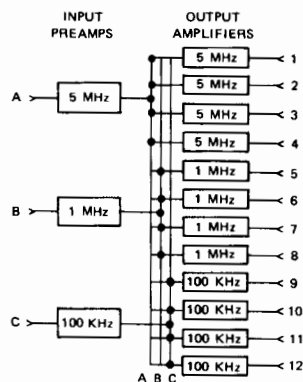

Figure 1. HP 5087A Distribution Amplifier with Option 031, Standard Configuration input and output amplifiers.

### Specifications

**Inputs:** (up to three, rear panel BNC).

**Frequencies:** 10 MHz, 5 MHz, 1 MHz or 100 kHz.

**Level:** 0.3 to 3.0 V rms, 50 ohms.

**Outputs** (up to 12 rear panel BNC).

**Frequencies:** 10 MHz, 5 MHz, 1 MHz or 100 kHz.

**Level:** 0–3 V into 50 ohms (screwdriver adjustment).

**Harmonic distortion:** >40 dB below rated output.

**Non-harmonic distortion:** >80 dB below rated output.

### Isolation

**Load** (open or short on any other channel)

**Amplitude change:** 0.1%.

**Phase change:** <0.1 ns at 5 or 10 MHz.

<0.5 ns at 1 MHz.

<5.0 ns at 100 kHz.

**Injected signal:** 1 V signal up to 50 MHz applied to any output except 10 MHz, will be down more than 60 dB in all other outputs; 10 MHz output channel will be down more than 50 dB.

**SSB phase noise (5 MHz):** >145 dB below signal in 1 Hz BW for frequencies > 1 kHz from carrier.

**Short term stability degradation (5 MHz):** <  $1 \times 10^{-12}$  in 10 kHz band. (1 s average).

### Environmental

**Temperature:** MIL-E-16400, Class 4.

**Operating:** 0–50°C; storage: –62° to +75°C.

### Stability

**Amplitude:** ±0.5 dB, 0° to 50°C.

**Phase:** <0.1 ns/°C., 5 and 10 MHz.

**Humidity:** 95% at 40°C.

**Altitude:** up to 30,000 ft.

### General

**Power:** 115 or 230 V ±10%, 48 to 440 Hz, 20 VA, max, or 22–30 V dc, 500 milliamperes, max.

**Dimensions:** 88 mm H x 425 mm W x 286 mm D (3.5 in. x 16.7 in. x 11.3 in.).

**Weight:** typical, Opt 031–Net 7 kg (15 lb).

### Ordering Information

**HP 5087A Distribution Amplifier Mainframe**

**Price**

\$2200

**Normal Configurations** (input and output amplifiers)

**Opt 031** 5, 1 and 0.1 MHz inputs and 4 outputs at each frequency + \$2220

**Opt 032** Single 5 MHz input and 12 outputs + \$2060

**Opt 033** Single 10 MHz input and 12 outputs + \$2060

**Opt 034** Single 5 MHz input, 4 each outputs at 5, 1 and 0.1 MHz + \$2270

### Special Configurations

**Input Preamplifiers** (up to 3 total)

**Opt 004** Input Preamplifier (0.1 to 10 MHz) + \$80

**Opt 005** 5 to 1 MHz Input Divider + \$180

**Opt 006** 1 to 0.1 MHz Input Divider + \$250

**Opt 011** 5 to 10 MHz Input Doubler + \$250

**Opt 013** 10 to 5 MHz Input Divider + \$210

**Opt 014** 10 to 1 MHz Input Divider + \$310

**Output Amplifiers** (up to 12 total)

**Opt 001** 5 MHz Output Amplifier + \$165

**Opt 002** 1 MHz Output Amplifier + \$165

**Opt 003** 0.1 MHz Output Amplifier + \$180

**Opt 012** 10 MHz Output Amplifier + \$210

**Opt 908** Rack Flange Kit + \$35

- 15 ampere-hour capacity
- Maintenance free lead-calcium batteries
- Used in "Flying Clocks"
- Automatic recharge

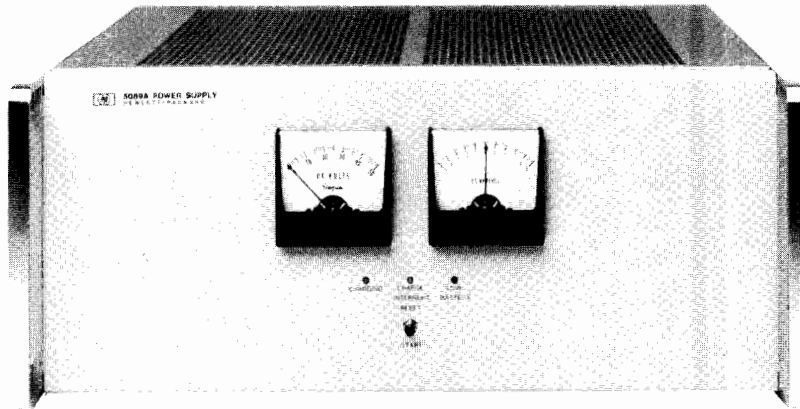

HP 5089A

## HP 5089A Standby Power Supply

The HP 5089A Standby Power Supply furnishes dc power to keep frequency or time standard systems operating during extended interruptions of ac line power. For applications where it is essential to maintain continuous operation and avoid loss of precise time, the use of a standby power supply is an absolute necessity. This unit is designed for use with Hewlett-Packard Cesium Beam Standards, Rubidium Vapor Standards, Quartz Standards, and other equipment which will operate from 22 to 28 V dc. No switching is used in transferring power from line to battery operation and back again, thus assuring uninterrupted operation.

## Versatility

The HP 5089A is an extremely versatile unit. It was designed both as a portable power supply for the HP 5061B and HP 5065A "flying clocks", and as a standby supply for stationary applications.

## Portable Applications

Portable or "flying clock" applications require a power supply to operate from a wide range of power sources, along with the standby capability to maintain continuous operation where no external power is available. A special inverter permits operation from a 12 V dc automobile battery. In addition, the 85 to 255 V ac, and 11 to 30 V dc capability enables the HP 5089A to operate from almost any power source in the world. The 15 ampere-hour standby batteries are the double sealed lead-calcium type, and thus are virtually spillproof. Mounting hardware is available to attach the HP 5089A to either the HP 5061B or the HP 5065A standards to make a portable frequency time standard package. These portable packages are available from Hewlett-Packard under HP E21-5061B and HP E21-5065A.

## Stationary Applications

Stationary applications require long periods of power supply operation in a float or standby mode. Then, when an ac supply failure occurs, the supply must provide full standby capability. The charging circuits inside the HP 5089A are designed to charge the batteries in such a way that they will provide both long, trouble-free, reliable operation, and full standby power. After use, when ac power is restored, the HP 5089A will fully recharge its batteries. The double sealed batteries will not leak or require maintenance of any kind. Thus, the HP 5089A allows you to add standby capability to your system with very little increase in maintenance costs.

## Ease of Operation

In normal operation there is virtually no required operator intervention. The HP 5089A automatically maintains the batteries in a fully charged state, ready to supply standby power. Should regular line power fail, the HP 5089A will provide uninterrupted dc power (to the limit of its standby capacity) for your equipment. After normal operating power is restored, the HP 5089A will automatically recharge its batteries back to the standby level.

The HP 5089A tells you its operational status at a glance through three LED lamps: GREEN indicates the battery is being charged; YELLOW indicates there has been an ac line failure; a RED lamp lights when the battery is almost fully discharged. Two front-panel meters show battery voltage and charge/discharge current.

## Batteries

The HP 5089A utilizes the "immobilized electrolyte" technology in its maintenance-free lead-calcium batteries. The lead-calcium grid gives these batteries longer life with better reliability than conventionally designed batteries. The batteries are double sealed to provide virtually leakproof, and thus maintenance-free operation.

## HP 5089A Specifications

### Input Voltage

**AC charging:** 85 V to 130 V ac rms, 48 to 440 Hz, 300 VA max.

85 V to 255 V ac rms, 48 to 66 Hz, 300 VA max.

**DC operation:** 11 V to 30 V dc, 110 W max.

**Output voltage:** 22 V to 28 V dc (nominal). 2 A maximum.

**Standby capacity:** 15 AH at +25°C when fully charged.

**Recharge:** complete recharge in 24 hours when operating from ac line.

**External low battery voltage alarm:** floating contact closure at rear-panel barrier block for external visible or audible "low battery" warning. Contact rating is 30 V dc at 2 amperes.

### Operating Environment

**Temperature:** 0°C to 50°C.

**Humidity:** up to 95% at 40°C (with no internal condensation).

**Altitude:** 12,000 metres (40,000 feet).

### Storage Environment

**Temperature:** -40°C to +65°C.

**Humidity:** up to 95% noncondensing.

**Altitude:** 15,000 metres (50,000 feet).

**Dimensions:** 177 mmH x 425 mmW x 416 mmD (7 in. x 16.7 in. x 16.4 in.).

**Weight:** net weight 30.5 kg (67 lb).

## Accessories Supplied

- HP 05061-6091: AC Power Input Cable Assembly
- HP 05089-60102: DC Power Input Cable Assembly
- HP 05089-60101: DC Output Cable Assembly
- HP 5060-0169: Extender Board Assy (Dual 25 Pin)

## Ordering Information

- HP 5089A** Standby Power Supply \$6100
- Opt 001** Spare AI Board Assembly (HP 05089-60001) +\$800
- Opt 908** Rack Mounting Adapter Kit +\$45
- Opt 910** Extra Operating and Service Manual +\$25

## Price

- \$6100
- +\$800
- +\$45
- +\$25

THE  
MIDDLE  
CLASS  
IN  
AMERICA  
A  
SOCIOLOGICAL  
STUDY  
OF  
THE  
MIDDLE  
CLASS  
IN  
AMERICA  
BY  
WALTER DILL  
MILES  
PH.D.  
UNIVERSITY OF CALIFORNIA  
BERKELEY  
1924

## **TELECOM/DATACOM TEST**

<b>Telecommunications</b>	
<b>Test Equipment.....</b>	<b>494</b>
<b>Data Communications</b>	
<b>Test Equipment.....</b>	<b>511</b>

Testing of data-communication and telecommunication equipment is significantly different from the testing of other equipment and devices. These measurement instruments often deal with specialized signal formats and may be portable, standalone, or programmable. Therefore, we have separated the equipment for making these tests from the rest of the product groups. This group consists of the largely analog test equipment needed for telecommunications test, as well as the digital sources and analysis equipment needed for datacom test.

**Telecom/Datacom  
Test**



# TELECOMMUNICATIONS TEST EQUIPMENT

## Digital Communications Measurement

### PCM Conversion Measurements

Today's circuit-switched integrated digital networks (IDN) are almost all based on 64 kb/s PCM voice channels using either CEPT A-law or Bell  $\mu$ -law coding formats. These circuits can also carry multiplexed, low-speed or wide-band high-speed data. The key to testing these circuits is the ability to measure PCM voice and analog data transmission performance at both analog and digital access points, that is, in a mixed analog/digital network.

The HP 3776A/B Terminal Test Set, for use mainly in installation and commissioning, can make both PCM voice and analog data measurements in both analog and digital domains. It can also be connected to test ports of digital cross-connect switches. The HP 3779A/B Primary Multiplex Analyzer is optimized for R & D, production test and commissioning of line cards and PCM multiplexers/channel banks.

### Digital Transmission (TDM)

Transmission measurements have shifted from basic measures of bit error ratio and peak-peak jitter towards more thorough analysis of systems in terms of error performance or distribution with time. There is an increasing emphasis on evaluating "availability" of digital circuits.

### CEPT Hierarchy

The CEPT digital hierarchy has four currently defined levels for network interconnection and test: 2, 8, 34 and 140 Mb/s.

The HP 3764A Digital Transmission Analyzer is available in a number of variants to cater for different testing needs: a 2, 8, 34, and 140 Mb/s BER version for general network test; a 140 Mb/s BER only version for high-capacity trunk testing, and a 140 Mb/s BER and jitter version for troubleshooting and manufacturing applications.

All versions of the instrument provide 6.821 error analysis and there is a choice of built-in printer or cassette for logging measurement and analysis results.

For testing on lower-capacity systems, the HP 3780A Pattern Generator/Error Detector provides flexible operation at rates up to 50 Mb/s in a single package. The HP 3781A Pattern Generator and HP 3782A Error Detector give similar capability with a two-box package that is useful in field trial testing or when multiple generators are needed to test load a system. HP-IB control is provided for system test applications.

### North American Hierarchy

The North American hierarchy has three levels: DS1 (1.544 Mb/s), DS2 (6.312 Mb/s) and DS3 (44.736 Mb/s).

As the network has evolved, DS3 has become the high-capacity building block, while DS1 has become the local distribution unit. For testing all three hierarchy levels, the HP 3781B Pattern Generator and HP 3782B Error Detector can interface and measure at DS1, DS2 and DS3. The two-box configuration gives flexibility for end-to-end trials or for tests where multiple generators are required.

The HP 3789 DS3 Transmission Test Set is available in two models - the HP 3789A has the basic pattern generation and error detection capability required for installation and network maintenance applications.

The HP 3789B is a more sophisticated set that not only measures BER and jitter on a DS3 signal, but also extracts and measures BER and jitter on each of the component DS1 digroups, making it an ideal troubleshooting aid.

For further analysis, any DS1 stream can be demultiplexed and output to either the HP 3776 PCM Terminal Test Set or HP 3787B Digital Data Test Set for PCM voice frequency or digital channel measurements respectively.

### Digital Leased Service Measurements

In North America, digital leased services include T1 (1.544 Mb/s) and digital data system (2.4/4.8/9.6/56 kb/s). The

HP 3787B Digital Data Test Set measures both error and jitter performance on these T1 and DDS services. It has subrate drop and insert capability to allow connection to DS1 crossconnect, Access Switch to Digital Crossconnect Systems (DCS) and can perform measurements on customer subrate primary and secondary channels.

### Jitter and Digital Networks

When digital networks were small and transmission paths relatively short, timing jitter was not a major problem to system providers. However, the rapid deployment of digital networks has resulted in jitter-associated problems. For example, faults associated with aging of components and the use of digital transmission equipment from different manufacturers has led to jitter becoming recognized as a major source of errors and other transmission impairments. Dedicated jitter test sets such as the HP 3785 Jitter Generator and Receiver have both jitter generation and measurement capability to help manufacturers design equipment to achieve satisfactory jitter performance. In operational digital networks, jitter accumulation varies with the traffic pattern content. Incorporating jitter measurements into BER test sets such as the HP 3764A, HP 3787B and HP 3789B couples the analysis of timing jitter with error analysis to pinpoint fault mechanisms efficiently.

	NORTH AMERICAN INTERFACES	CEPT INTERFACES	GENERAL PURPOSE	MEASUREMENTS	DATA LOGGING	REMOTE CONTROL
	DS0/DSS DS1 (1.544 Mb/s)	DS1 (6.312 Mb/s) DS2 (6.312 Mb/s)	DS3 (44.736 Mb/s) TDM 2 Mb/s 8 Mb/s 34 Mb/s 140 Mb/s	INSERVICE ERRORS OUT OF SERVICE ERRORS ≤ 50 Mb/s ≤ 70 Mb/s	BUILT-IN CASSETTE/DISK DRIVE DATA IMPAIRMENTS V/F PCM JITTER	BUILT-IN PRINTER HP-IB RS-232C
HP 3764A Opt 001			•	•	•	•
HP 3764A Opt 002			•	•	•	•
HP 3776A			•			•
HP3776B		•				•
HP 3779C			•			•
HP 3779D			•			•
HP 3780A	•	•	•	•	•	•
HP 3781/82A			•	•	•	•
HP 3781/82B			•	•	•	•
HP 3785A			•	•	•	•
HP 3785B			•	•	•	•
HP 3787B	•	•	•	•	•	•
HP 3789A			•	•	•	•
HP 3789B	*		•	•	•	•

▲ See options 101, 102, 103

\*DS1 access/measurement via built-in demultiplexer

# TELECOMMUNICATIONS TEST EQUIPMENT

## PCM Terminal Test Set, Primary Multiplex Analyzer, Channel Selector

Models 3776A, 3776B, 3779C, 3779D, 3777A

495

### HP 3776A/B

- Voice, PCM and data (option 001) measurements in one portable instrument
- Network test of 4 kHz channels at VF and 2/1.5 Mb/s PCM interfaces
- A-A, A-D & D-A measurements (for full & half-channel tests)
- Direct output to printer or plotter
- Set and monitor framing and signaling bits

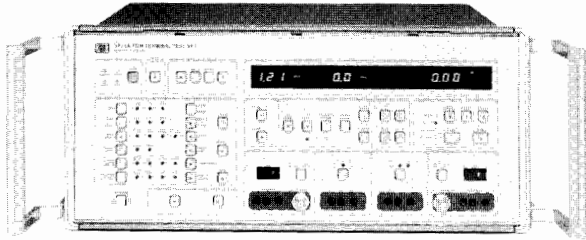

HP 3776A



### HP 3779C/D

- Manufacturing/R&D test of digital line cards/channel banks
- A-A, A-D & D-A measurements (for full & half-channel tests)
- Comprehensive PCM in-band and out-of-band measurements (to 40 kHz)
- Limit checking, sequencing, and direct control of printer and channel selector for ease of system integration
- Complex impedance terminations

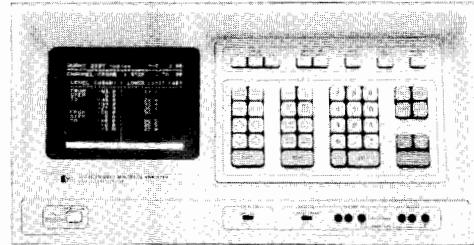

HP 3779C

### HP 3776A/B PCM Terminal Test Set

The HP 3776A is designed for CEPT/CCITT compatible networks. Model 3776B is designed for Bell/Japanese/CCITT compatible networks. Full ordering details and specifications are contained in the data sheet and specification booklet.

- HP 3776A has 30/31 channel voice testing capability
- HP 3776B has Bell extended superframe (ESF) & B8ZS line coding capability

#### HP 3776A

The HP 3776A has 30/31 channel voice test capability. The VF and PCM interfaces allow multiplexers to be tested to CCITT G.712 to G.714 recommendations. Data Option (001) measurements conform to relevant CCITT '0' Series recommendations.

#### HP 3776B

The HP 3776B has selectable Bell standard or Bell extended superframe (ESF) capability. Line coding is either AMI or B8ZS (clear channel). HP 3776B Option 002 has modified measurements and I-214 connectors for Japan. The VF and PCM interfaces allow channel banks to be tested to BSTR PUB 43801 specifications. Data Option (001) measurement methods conform to IEEE STD 743 - 1984.

### HP 3777A Channel Selector

- DC to 110 kHz
- 2-wire/4-wire balanced switching
- Remote control only (HP-IB)

The HP 3777A is a 4-pole access switch for telecom applications. It may be configured as a single 4-wire switch or as two, independent, 2-wire switches. Channel capacity is arranged by adding standard modules. Unselected channels are switched to 600 ohm terminations. Special options are available with other termination values including none (open circuit).

#### HP 3777A Options

No. of Channels	Connectors	
	Siemens 3-Pin	WECO 310
6	Opt H07	Opt H16
12	Opt 002	Opt 003
18	Opt H13	Opt H17
24	Opt H14	Opt 001
30	Std	Opt H05

#### Ordering Information

	Price
HP 3776A PCM Terminal Test Set (CEPT)	\$12,100
HP 3776B PCM Terminal Test Set (Bell)	\$13,300
HP 3777A Channel Selector	\$5,300

### HP 3779C/D Primary Multiplex Analyzer

The HP 3779C is designed for CEPT/CCITT compatible networks. Model 3779D is designed for Bell/Japanese/CCITT compatible networks. Full ordering details and specifications are contained in the data sheet and specification booklet.

- The standard PMA has VF interfaces for A-A measurements and E&M signaling distortion capability.
- A-D and D-A measurements are optional providing all measurement modes and a single-channel TTL-compatible interface for codec and line card testing.

#### HP 3779C

The HP 3779C performs A-A measurements to CCITT G.712/3 standards. A-D and D-A measurements are performed to CCITT G.714. Multiplex alignment and alarm functions can be tested automatically in D-A mode.

#### 3779D

The HP 3779D tests channel bank performance as specified in BSTR PUB 43801 in A-A, A-D and D-A measurement modes.

#### Accessories

- HP 15518A/B: dual-port loop-holding accessory for HP 3776A/B
- HP 15515B: loop-holding unit, 24 mA current sink; WECO connectors
- HP 15512A: 1m length 600 ohm bal cable; Siemens 3-pin connector both ends
- HP 15513A: 1m length 600 ohm bal cable; WECO 310 jack plug both ends

#### Ordering Information

	Price
HP 3779C Primary Multiplex Analyzer (CEPT)	\$22,200
HP 3779D Primary Multiplex Analyzer (Bell)	\$17,100
HP 15512A Cable	\$80
HP 15513A Cable	\$60
HP 15515B Loop Holding Unit	\$320
HP 15518A/B/C Loop Holding Accessory	\$490

# TELECOMMUNICATIONS TEST EQUIPMENT

## Dedicated PCM/TDM Error Measuring Sets

Models 3781A, 3782A, 3781B, 3782B

### HP 3781A/B

- Versatile selection of test patterns
- Internal jitter modulation
- Additional delayed data output

### HP 3782A/B

- Binary and code error measurements
- Error ratio, error count, error seconds and error-free seconds displayed
- Powerful error distribution analysis

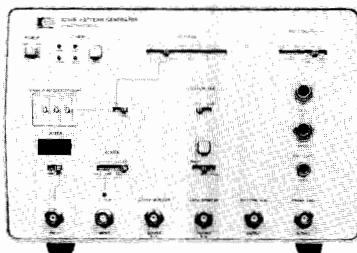

HP 3781B

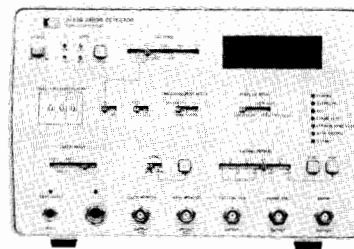

HP 3782B



The HP 3781A Pattern Generator and HP 3782A Error Detector form a high performance error measuring system which complements the HP 3780A Pattern Generator/Error Detector. Designed to conform with CEPT and CCITT standards, the HP 3781A/3782A provide four bit rates (up to 50 Mb/s) of the digital hierarchy in one compact system. Applications of the system are in R&D, field trial and production testing, especially where an automatic and remote measurement capability via the HP-IB is required.

In the HP 3781A, binary or code errors can be injected as single shot or at  $10^{-3}$  or  $10^{-5}$  rates into a wide range of PRBS and 16-bit WORD test patterns coded in AMI or HDB3. The test patterns provided include standard  $2^9-1$ ,  $2^{15}-1$ , and  $2^{23}-1$  bit PRBS to CCITT Recommendations, fully programmable 16-bit WORD, and two 8-bit WORDS which may be alternated under the control of an external signal. Zero substitution (up to 120 zeros) for PRBS patterns is included to examine, for example, the clock recovery performance of regenerators. 75  $\Omega$  unbalanced and 120  $\Omega$  balanced pseudo-ternary outputs and binary TTL monitor outputs are provided. A jitter modulation input facility is provided for simple oscillator connection, with direct LED display of pk-pk bits of jitter. This can be used to measure the input jitter tolerance of digital transmission equipment. A second data output with 12 bits delay provides adequate simulation of an independent sequence for thorough testing of digital radio systems. As an option, four extra data outputs coded in AMI or HDB3 can be included on the rear panel for driving adjacent radio channels.

The HP 3782A detects binary or code errors which can be displayed in the form of error ratio, error count, error seconds, and error-free seconds over a wide choice of gating periods. All four results are computed simultaneously over the same gating period. For ease of use there is a built-in automatic check for compatibility of switch position combinations. An error code flashes on the display if incompatibility is detected. When the monitor mode is used, the HP 3782A can be used for in-service monitoring of digital transmission links.

Measurement results are available on the HP-IB and a rear panel result threshold switch allows pre-selection of an error threshold above which results will be printed. This provides useful data reduction and a first order error distribution analysis. With a built-in real-time clock, results can be output with time, if required.

The HP 3781B Pattern Generator and HP 3782B Error Detector form a dedicated error measurement system for testing and evaluating the performance of Bell digital transmission terminal and link equipment, up to and including the DS-3 level in the digital hierarchy. The HP 3781B/3782B can be used in production testing, field installation, and maintenance of the Bell digital transmission system, including PCM/TDM transmission over cable, radio, satellite, and fibre optic links. The principal application is at the DS-3 level in the Bell digital hierarchy.

The HP 3781B/3782B are designed to interface at Bell System standard cross connect points with appropriate ternary coding and interface voltage levels at each hierarchical level. Interfacing at the DS-1C and DS-2 levels is limited to T1-C and T2 line systems. At the DS-3 level, a choice of four data formats is available. Alternatively, binary ECL interfaces can be used.

The HP 3781B Pattern Generator provides a selection of standard  $2^9-1$ ,  $2^{15}-1$ , and  $2^{20}-1$  bit PRBS and fixed WORD test patterns with a choice of single error or 1 in  $10^5$  error simulation on the digital data stream for normal measurements and troubleshooting. A pattern of 17 ones/15 zeros and zero substitution (up to 999 zeros) for PRBS patterns are included to examine phase sensitive circuitry such as clock recovery of regenerators. A jitter modulation input facility is provided for simple oscillator connection, with direct LED display of pk-pk bits of jitter. This can be used to measure the input jitter tolerance of digital transmission equipment. A second DS-3 output channel with 22 bits delay provides adequate simulation of an independent sequence for thorough testing of digital radio systems. As an optional extra, four DSX-3 BNC outputs on the rear panel can be included for driving adjacent radio channels.

The HP 3782B Error Detector detects any binary or code errors generated by the system under test. At the DS-3 level, it can perform in-service or out-of-service measurements of parity errors within the digital transmission system. The HP 3782B can measure simultaneously error rate, error count, error seconds, and error free seconds over a single gating period. When the DS-3 MON facility is used, in-service measurements (eg parity errors) of live traffic are possible. For ease of use, there is a built-in automatic check for compatibility of switch position combinations. An error code flashes on the display if incompatibility is detected. Hard copies of results can be obtained on a printer via HP-IB control, either in the "talk-only" or "addressable" modes. In addition, a preselectable error rate threshold and a real time clock allows selection for printing results which exceed a defined threshold (with local time, if required).

### Ordering Information

HP 3781A Pattern Generator	\$8,750
Option W30: 2 years Additional Hardware Service	\$140
HP 3782A Error Detector	\$8,000
Option W30: 2 years Additional Hardware Service	\$130

### Prices

HP 3781B Pattern Generator	\$9,400
Option W30: 2 years Additional Hardware Service	\$160
HP 3782B Error Detector	\$8,700
Option W30: 2 years Additional Hardware Service	\$140

### Ordering Information

HP 3781B Pattern Generator	\$9,400
Option W30: 2 years Additional Hardware Service	\$160
HP 3782B Error Detector	\$8,700
Option W30: 2 years Additional Hardware Service	\$140

### Prices

HP 3781B Pattern Generator	\$9,400
Option W30: 2 years Additional Hardware Service	\$160
HP 3782B Error Detector	\$8,700
Option W30: 2 years Additional Hardware Service	\$140

# TELECOMMUNICATIONS TEST EQUIPMENT

## PCM/TDM Error Measuring Set & Digital Transmission Analyzer

Models 3780A, 3764A

### HP 3780A

- Easy-to-use portable unit
- Binary and code error measurements
- Clock frequency offset generation and measurement
- Ternary coded and binary interfaces
- Data logging and graphs to external printer

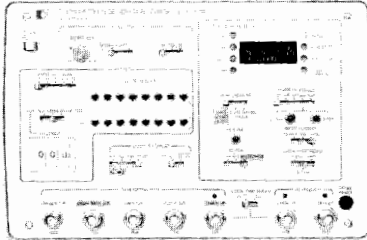

HP 3780A  
Option 001

### HP 3780A Pattern Generator/Error Detector

The HP 3780A Pattern Generator/Error Detector is a Comprehensive error measuring set in one portable package for use in manufacturing, field trials, commissioning and maintenance of digital transmission terminal and link equipment.

The instrument measures binary errors and code errors in digital transmission equipment operating at rates between 1 kb/s and 50 Mb/s. Frequency offset generation and measurement are provided at the standard PCM/TDM transmission rates.

A range of standard PRBS test patterns and automatic pattern recognition/synchronisation are provided for simple performance checks. It also has flexible WORD generation and zero substitution to explore regenerator timing recovery performance and detect systematic errors.

Binary clock and data or ternary coded data interfaces can be selected with automatic equalisation at 2, 8 and 34 Mb/s on the Receiver.

Results are displayed as error COUNT or BER over a range of gating periods, and can be logged or presented graphically on an external printer.

#### Ordering Information

	<b>Price</b>
<b>HP 3780A Standard:</b> internal fixed rates of 2048, 8448 & 1536 kb/s; HDB3/HDB2 ternary coding.	\$8,600
<b>Option 232:</b> RS-232 printer port replaces BCD printer and plotter outputs.	NC
<b>Option W30:</b> 2 years Additional Hardware Service	\$140

#### Frequency/Ternary coding Options

<b>Option 100:</b> internal fixed rates of 2048, 8448 & 34368 kb/s; HDB3/HDB2 ternary coding.	\$270
<b>Option 101:</b> internal fixed rates of 1544, 6312 & 44736 kb/s; B6ZS/B3ZS ternary coding.	NC
<b>Option 102:</b> internal fixed rates of 1544, 6312 & 3152 kb/s; B6ZS/B3ZS ternary coding.	NC
<b>Option 103:</b> internal fixed rates of 2048, 8448 & 34368 kb/s; 2 <sup>23</sup> -1 PRBS replaces 2 <sup>9</sup> -1; HDB3 ternary coding.	\$650
<b>Option 104:</b> as option 103 but with Siemens 1.6 mm connectors.	\$750

#### Frequency Offset Option

<b>Option 099:</b> frequency offset measurement only, frequency offset generation deleted.	-\$180
--------------------------------------------------------------------------------------------	--------

#### Word/Connector Options

<b>Option 001:</b> all words replaced by a 16 bit front panel programmable word.	\$270
<b>Option 002:</b> Siemens 1.6 mm connectors.	\$110
<b>Option 003:</b> options 001 and 002 combined.	\$320

### HP 3764A

- Error analysis at 2, 8, 34 & 139 Mbit/s based on latest G.821 Recommendation or error & jitter measurement and analysis at 139 Mbit/s only
- Powerful data logging facilities
- Single key measurement set-up using preset memory
- Portable single-unit construction

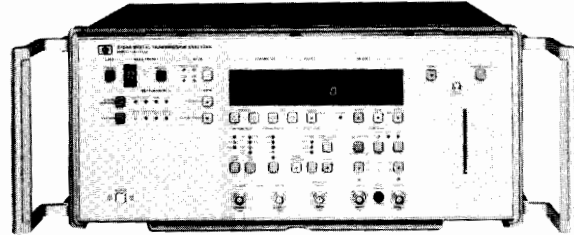

HP 3764A  
Option 001



### HP 3764A Digital Transmission Analyzer

The HP 3764A Digital Transmission Analyzer is available in three versions. The standard instrument offers a low-cost solution to users who want to perform error measurements at 139 Mb/s only. The option 001 instrument is a multirate error analyzer in a single, rugged, low-weight case particularly suited to field installation and maintenance applications. The option 002 instrument performs a full set of bit error and jitter measurements at 139 Mb/s to match development or manufacturing requirements.

#### Specifications Summary

##### Generator Section

**Clocks:** Standard & Opt 002, 139.264 MHz with fixed frequency offsets; Opt 001, 139.264, 34.368, 8.448 & 2.048 MHz, with fixed frequency offsets available as Opt 005.

**Data outputs:** CMI format at 139 Mb/s; HDB3 format at 34, 8 & 2 Mb/s; binary-RZ from 1 kb/s to 150 Mb/s, NRZ from 1 kb/s to 170 Mb/s (using external clock source), ECL levels, 75 ohm unbalanced.

**Data patterns:** PRBS 2<sup>15</sup>-1 and 2<sup>23</sup>-1; word, programmable 16-bit or two alternating 8-bit words; errors, single error or fixed 1 x 10<sup>-3</sup> rate.

##### Receiver Section

**Recovered clock:** 139.264 Mb/s ± 3 Mb/s; 34, 8, 2 Mb/s ± 100 ppm.

**Binary clock:** 1 kHz to 170 MHz.

**Data inputs:** 75 ohm terminated; monitor (25 dB additional gain); binary, RZ or NRZ, ECL levels.

**Error analysis:** Error count, error ratio, error seconds, error-free seconds, % unavailability, % errored seconds, % severely-errored seconds, % degraded minutes. All measurements made simultaneously and in accordance with CCITT Recommendation G.821.

**Jitter analysis:** Peak-to-Peak, hit count, hit seconds, hit-free seconds. Further analysis possible using internal jitter filters and demodulated jitter output.

**Internal printer:** Any combination of analysis parameters can be selected for printing.

#### Ordering Information

	<b>Price</b>
<b>HP 3764A Standard:</b> Error analysis at 139 Mb/s.	\$10800
<b>Option 003:</b> Standard with 3 additional delayed outputs.	\$860
<b>Option 002:</b> Error & jitter analysis at 139 Mb/s.	\$2700
<b>Option 001:</b> Error analysis at 2, 8, 34 & 139 Mb/s.	\$860
<b>Option 005:</b> Multirate fixed-frequency offsets for Option 001.	\$1460
<b>Option 010:</b> Tape cartridge unit replaces the printer.	NC
<b>Option W30:</b> 2 years Additional Hardware Service	\$190

# TELECOMMUNICATIONS TEST EQUIPMENT

## Dedicated PCM/TDM Jitter Generator and Receiver

Models 3785A, 3785B

- Jitter generation and measurement on data and clock
- Jitter specifications designed to CCITT recommendation 0.171
- Transient-free sweeping of internal CCITT defined jitter tolerance masks
- Single portable unit for up to 4 internal bit rates
- Built-in measurement filters to CCITT recommendations
- Comprehensive jitter analysis against real-time and jitter amplitude

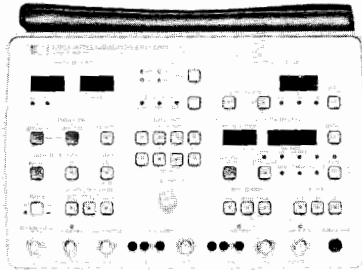

HP 3785A (2048, 8448, 34368 and, optionally, 25776 kHz)  
CEPT

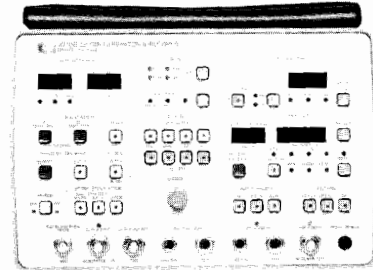

HP 3785B (DS-1, DS-1C, DS-2 and DS-3)  
Bell



The HP 3785A/B Jitter Generator and Receiver is a dedicated jitter measurement system for testing and evaluating the performance of CEPT or Bell digital transmission terminal and link equipment up to and including the third level (34368 kb/s or DS-3) in the digital hierarchy. The HP 3785A/B can be used in production testing, field installation and maintenance of the CEPT or Bell digital transmission system including PCM/TDM transmission over cable, radio, satellite, and fiber optic links. The principal application is thorough testing to current CCITT Recommendations at each level in the digital hierarchy.

In addition to providing a comprehensive measurement capability which includes in-service jitter measurements, the microprocessor-controlled Jitter Generator and Receiver is easy to use with ergonomic layout of switches and connectors on the front panel. The instrument is designed to interface fully with the HP-IB, allowing bus-controlled operation and automatic measurement sequencing.

The Jitter Generator may be used to phase modulate an internally provided crystal clock, an externally applied clock (at a nominal digital hierarchy bit rate) or an externally applied data stream. Sinusoidal modulation is provided by an internal synthesizer whose amplitude and frequency can be set manually or swept, transient-free, through a CCITT shaped jitter tolerance mask programmed into the instrument. Alternatively, external modulating signals can be applied. The amplitude of generated jitter in unit intervals (U.I.) pk-pk and the frequency of internal modulation are in accordance with CCITT Recommendation 0.171 and are displayed on the front panel.

The modulated clock output can be applied to an external pattern generator such as the HP 3780A, 3781A or 3782B. For jitter transfer function measurements, the CCITT standard 1000 repetitive pattern is provided within the HP 3785A/B. Jitter modulation can also be applied to a test signal passing through the instrument from Data Input to Data Output in Thru-data mode. This feature is particularly useful when measuring the jitter tolerance and transfer function of equipment which requires framing and control bits, for example a demultiplexer.

### Measurements

The Jitter Receiver offers six types of measurement:

- Absolute jitter amplitude in U.I. pk-pk
- Jitter peak, positive or negative
- Jitter hit count of the number of times received jitter exceeds a user-defined hit threshold in U.I. pk

- Jitter hit seconds count of the number of seconds in which one or more jitter hits occur
- Jitter hit-free seconds count of the number of seconds which are free of jitter hits
- Maximum absolute jitter amplitude in U.I. pk-pk is held during the jitter analysis gating period

Simultaneous measurement of all six parameters is possible with result display selection. The Receiver has a built-in real-time clock and interval timer which can be used to log time varying jitter amplitude for later analysis.

The measurements can be made on clock or data inputs with or without internal filtering. Two high pass filters and one low pass filter as specified by CCITT are provided for each of the four bit rates. In addition, external filters can be connected between the demodulated jitter output and the measuring circuitry input. The demodulated jitter output can also be used to measure rms jitter amplitude on an external voltmeter or to display jitter spectrum on an external analyzer.

The clock reference for the jitter measurements can be internally derived from the applied data or clock via a narrow band phase-locked loop or externally derived from an applied reference.

The data input allows out-of-service or in-service measurements. The MON facility for in-service measurements has built-in additional gain to compensate for the flat loss at the protected monitor points.

### HP-IB Operation

The capabilities of the HP 3785A/B can be enhanced by using the HP-IB to provide remote operation and automatic sequencing of results.

The HP-IB facility offers several principal features:

- Remote control of front panel switches and pushbuttons using programming codes
- Control codes which are set to default values on power-on and can be user-defined with the controller
- The ability to transfer instrument measurement configurations to an external storage medium so that they can be used to set the instrument up at a later time.
- Output of the result data to a printer (eg HP Thinkjet Printer) or storage memory

### Ordering Information

	Price
HP 3785A Jitter Generator and Receiver (CEPT)	\$14,000
HP 3785B Jitter Generator and Receiver (Bell)	\$16,000
HP 3785A Option W30: 2 years Additional Hardware Service	\$240
HP 3785B Option W30: 2 years Additional Hardware Service	\$270



# TELECOMMUNICATIONS TEST EQUIPMENT

## DS3 Transmission Test Sets

Models 3789A/B

499

- Binary bit-by-bit error detection
- Parity, Frame and BPV error measurements
- Error analysis to latest recommendations
- Portable, single-unit construction
- Single-key measurement setup using preset memory
- Integrated access switch controller

- Built-in DS3 to DS1 demultiplexer (B only)
- Error & Jitter tests at DS1 & DS3 (B only)
- External Events and Voltages monitor inputs
- Optional DC operation from station batteries
- Full remote control via HP-IB and RS-232-C
- Optional built-in data logger

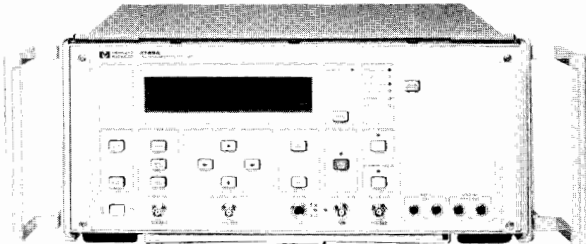

HP 3789A  
RS-232-C

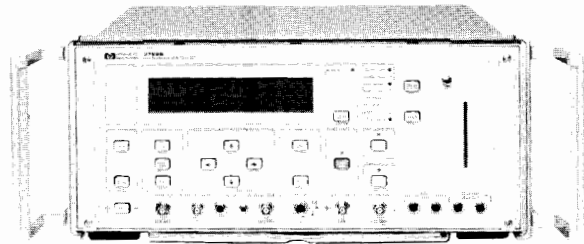

HP 3789B Option 003/010  
RS-232-C

### HP 3789A/B DS3 Transmission Test Set

The HP 3789A and HP 3789B are new DS3 test sets which provide users with a choice of how best to satisfy all of their main test requirements with one integrated instrument.

#### Applications

- System turn up checks
- Routine testing of trunks
- Fault sectionalization
- Identifying fault mechanisms
- Preventive maintenance
- Service quality verification
- Outage detection & isolation
- Trouble referral verification
- Equipment & route assessment
- Longterm performance monitoring

The HP 3789A has all the basic pattern generation and error measurement capability required for the installation, commissioning and maintenance of DS3 transmission systems. The integrated package is easy-to-use manually and has HP-IB and RS-232-C ports for automated test and remote monitoring applications. A built-in access switch controller to select from a number of DS3 inputs is included as standard. Its capability can be extended with an optional built-in printer and 24/48 volt DC operation.

The HP 3789B is a more powerful and sophisticated test set which offers extraordinary troubleshooting capability. It has all the power of the HP 3789A but in addition it has a built-in demultiplexer which allows it to perform measurements on both DS1 and DS3 signals from a DS3 access point. Optional enhancements include: jitter measurements at DS1 and DS3; the ability to perform and display any two measurements simultaneously; DC operation from 24/48 volt station batteries; and a choice of built-in printer or disc drive for data logging.

Specification Summary (for both the A & B models except as noted)

#### Measurements

**DS3 Errors:** Bit, Frame, Parity and Code (BPV) in the form of Error Count, Error Ratio, Error Secs/Error Free Secs.

**DS3 Analysis:** %Availability, %Unavailability, %Error Secs, %Degraded Mins. These can be configured to give numeric results or Pass/Fail results for go/no go tests.

**DS3 Jitter (HP 3789B only):** Jitter Hit Count, Hit Bit Count, Hit Bit Ratio, Hit Second/Hit Free Second Count, Maximum Peak Amplitude.

**DS1 Errors (HP 3789B only):** Bit, Frame, CRC (Extended Superframe Format only)

**DS1 Jitter (HP 3789B only):** Max pk-pk, Max Positive Peak, Max Negative Peak, Jitter Hit Count.

**Error Bursts:** The number of bursts with >100 errors is counted.

**Error Second Distribution:** Error Seconds containing 1 error, 2 to 10 errors and >10 errors are counted. The total for each group is counted.

#### Generator

**Data Outputs:** DS3 Hi; DSX-3; DS3 900' levels, selectable. Six outputs are provided. **Framing:** On or off, selectable.

**Patterns:** PRBS: 2<sup>15</sup>-1; WORD: 8 bit programmable; Blue Signal Clock: Internal: 44.736 MHz ± 20ppm; External: 44.736 MHz ± 2%

#### Receiver

**Data Input:** Line Code: B3ZS; Rate: 44.736 MHz; Levels: DS3 Hi; DSX-3; DS3 Lo; DSX-3 Lo; 900'; 900' Lo.

**DS1 Output (HP 3789B Only):** This output provides a selected DS1 digroup signal demultiplexed by the HP 3789B from the input DS3 signal which may be further demultiplexed by external equipment for testing at lower rates. Both WECO 310 and bantam jacks are provided.

**Level/Impedance/Shape:** As per Bell Compatibility Bulletin No. 119 for the DS1 crossconnect.

**Coding:** AMI or B8ZS selectable

#### External Control

Both HP-IB and RS-232-C ports are fitted as standard. Either can be used to control the HP 3789A/B remotely and to dump measurement results to an external printer.

#### General

**Power Supply:** AC: 90 to 126V and 196 to 253V; 48 to 66 Hz; approx 175 watts consumption. DC: -22V to -57V (with option 005); approx 210 watts consumption.

**Dimensions:** 191mm high; 426mm wide; 559mm deep (7.5 × 16.75 × 22 ins.)

**Net Weight:** 16kg (35lb) approx depending on option structure

**Operating Temperature:** 0° to +50°C

**Storage Temperature:** -20° to +70°C

#### Ordering Information

**HP 3789A:** The standard package consists of receiver; generator with 6 O/P's; both HP-IB and RS-232-C ports fitted; real-time clock; WECO 560A type connectors fitted to Rx and Tx; integral access switch controller. For additional capability select from the following:

<b>Option 005:</b> Built-in operation from 24/48V DC supplies	\$850
<b>Option 010:</b> 24-col built-in printer	\$550
<b>Option 100:</b> WECO 477 type connectors on the Tx and Rx	\$0
<b>Option 200:</b> BNC connectors on the Tx and Rx	\$0
<b>Option 908:</b> 19-inch rack mount	\$45
<b>Option W30:</b> 2 Years Additional Hardware Service	\$165

#### HP 3789B

The standard package consists of receiver; generator with 6 O/P's; built-in demultiplexer to DS1; DS1 output port; both HP-IB and RS-232-C ports fitted; real-time clock; WECO 560A type connectors fitted to Rx and Tx; integral access switch controller. For additional capability select from the following:

<b>Option 003:</b> 2nd measurement capability (including jitter measurements at DS1 and DS3)	\$1400
<b>Option 005:</b> Built-in operation from 24/48V DC supplies	\$850
<b>Option 010*:</b> 24-col built-in printer	\$550
<b>Option 011*:</b> Built-in 3.5-inch disc drive	\$700
<b>Option 100:</b> WECO 477 type connectors on the Tx and Rx	\$0
<b>Option 200:</b> BNC connectors on the Tx and Rx	\$0
<b>Option 908:</b> 19-inch rack mount	\$45
<b>Option W30:</b> 2 Years Additional Hardware Service	\$220

\*NOTE: Options 010 and 011 are mutually exclusive. HP 3789B

<b>HP 3789A DS3 Transmission Test Set</b>	\$8,300
<b>HP 3789B DS3 Transmission Test Set</b>	\$11,200



# TELECOMMUNICATIONS TEST EQUIPMENT

## A total Solution for Digital Data Services and Equipment Testing

### Model 3787B

- ISDN 'B' or 'D' channel Protocol Analyzer interface
- Comprehensive bit error measurements and analysis at DS1C, DS1, DS0 and DDS interfaces.
- Sub-rate drop and insert capability.
- Built-in data logging capability.
- DS1 Jitter analysis.

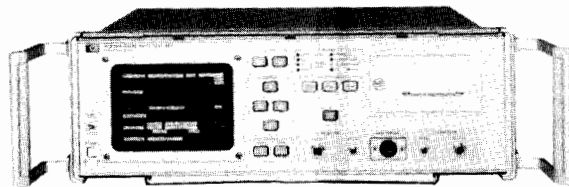

HP 3787B



RS-232-C

## HP 3787B Digital Data Test Set

### Description

The HP 3787B Digital Data Test Set is a Bit Error Rate Tester (BERT) designed for use on T1 leased, Digital Data System (DDS), 56kbit/s switched and Packet Switched services transmission line and multiplexing equipment.

Digital data circuits are sold with a guaranteed Quality-of-Service (eg DDS circuits offer >99.5% Error Free Seconds in a 24 hour period and 99.95% Availability). To maintain this high quality of service, Service Providers need test equipment that will provide in-service network monitoring and fast out-of-service testing.

The HP 3787B has a comprehensive range of in-service features (eg. Frame, CRC, BPV and Jitter analysis, alarm monitoring, internal printer for data logging etc) which maximizes circuit availability by detecting circuit deteriorations and intermittents, before they seriously affect the service.

The HP 3787B also provides comprehensive out-of-service features (eg Logic (binary) test patterns, Frame Slips, full range of T1/DDS loopback codes etc) which are used to provide qualitative results for circuit troubleshooting and end-to-end test results which relate to actual in-service performance.

### Signaling System No. 7 and DMI testing

For the development or maintenance of DMI (Digital Multiplexed Interface) and Signaling Systems No. 7, you can connect a protocol analyzer to the HP 3787B and substitute the BER test pattern with one from the protocol analyzer. In this mode, the HP 3787B acts like a DS1 Channel Access Unit - enabling any 'B' or 'D' channel to be accessed for protocol analysis.

### Who needs an HP 3787B?

If you are involved in manufacturing, installing, commissioning or maintaining combined DS1/1C/DDS systems you have the problem of buying test gear to match your test requirements. You need DS1/1C testers, DDS testers and DS1/1C channel access equipment etc.

The HP 3787B solves this problem by satisfying all of these test requirements and more in a single unit. The combination of three test sets in one is not the end of our total solution - we also have a built-in printer, many methods for presenting the error information (e.g. Count, BER, ES, EFS etc) and error analysis (e.g. % Availability, %EFS, %Severely Errored Seconds, Consecutive SES etc.).

### Specifications

For details, ask your local HP sales Office for an HP 3787B data sheet and specification booklet.

### Drop and Insert

If the Transmitter/receiver signal is suitably framed (eg a DS1 ESF signal), test patterns or control codes can be inserted to/extracted from the following:

An individual customer timeslot (64k and 56kbit/s).

DDS 2.4k, 4.8k, 9.6k, 19.2k and 56 kbit/s primary and secondary channels (DS0A and DS0B).

4kbit/s Datalink (DS1 ESF).

4kbit/s Fs channel (DS1 Ft).

8kbit/s R-channel (DS1 T1DM).

### Measurement Capability

**Operating Frequency:** DS0 (64kbit/s), DS1 (1.544Mbit/s), DS1C (3.152Mbit/s).

**Framing:** DS1 (SF, ESF, T1DM and Ft only), DS1C and DS0B.

**Line Code:** B8ZS, AMI.

**Error Types:** Logic (Binary), Bipolar Violations, Frame Word, CRC-6 Word.

**Error Results:** Error Count, Error Ratio, Error Seconds, Error Free Seconds, % Error Free Seconds.

**Error Analysis:** % Availability, % Unavailability, % Severely Errored Seconds, % Error Seconds, % Degraded Minutes. Count Consecutive SES, Count SES, Count ES, Count Deg Min.

**Alarm Seconds:** Instrument Power Loss Seconds, Signal Loss Seconds, AIS Seconds, Frame Loss Seconds (ie DS1C, DS1 or DS0B), Test Pattern Loss Seconds.

**Frame Slips (Controlled):** Duplicated frames are indicated as positive frame slips. Deleted frames are indicated as negative frame slips.

**Protocol Analyzer Interface:** RS-232-C 4-wire synchronous interface. When interfacing at DS1 or DS0, the following channels can be accessed: DDS primary and secondary channels, ISDN 'B' or 'D' channels (64/56 kbit/s), ESF datalink or D4 Fs channel.

**DS1/DS1C Signal Voltage:** Positive and Negative peak voltage displayed.

**DS0 Bit Monitor:** Selected received customer bytes displayed.

**Signalling Bits:** A,B (SF) or A,B,C,D (ESF) signalling bits can be set and displayed when 56kbit/s circuit switched is selected.

### DS1 Jitter Measurement (Option 001)

**Peak-to-Peak Jitter:** Range 0.00 to 10.00 Unit Intervals (UI) pk-to-pk, in 0.01 UI steps.

**Jitter Filters:** LP=2Hz to 40kHz, HP1+LP=10Hz to 40kHz, HP2+LP=8kHz to 40kHz.

**Jitter Threshold:** 0.05 to 10.00 UI pk-to-pk in 0.01 UI pk-to-pk increments.

**Jitter Hit Measurements:** Jitter Hit Count, Jitter Hit Bit Count, Jitter Hit Bit Ratio, Jitter Hit seconds, Jitter Hit Free Seconds.

### Ordering Information

HP 3787B Digital Data Test Set.

### Prices

\$8000

### HP 3787B Options

**001:** DS1 Jitter. \$800

**002:** DC Capability. \$500

**909:** 19-inch Rackmount. \$150

**910:** Extra Operating and Service Manuals. \$100

**Option W30:** 2 Years Additional Hardware Service. \$160

### Accessories available

**HP 15668A:** Front Panel DDS Clock Cable. \$125

**HP 15669A:** Rear Panel DDS Clock Cable. \$125

### Digital Radio System Measurements

Digital microwave systems form part of many communications networks. They are cost effective and simpler to install than cable or fiber. A digital radio carries a stream of digital information by modulating an RF carrier to a number of discrete amplitude and phase states. To handle increasing data requirements, carriers have adopted higher order modulation schemes. More complex schemes such as 64 QAM and 256 QAM are less resilient to impairments than less complex modulation formats. Satellite and military users adopt low order modulation schemes such as QPSK because they are less susceptible to error and data corruption.

Some analog measurements are suitable for digital radio systems, but specific dedicated measurements are also required to fully characterize digital radio performance. For example, the evaluation of Bit Error Ratio (BER) performance under flat fade conditions and at residual noise levels. New techniques are now available to allow in-service performance evaluation; Constellation analysis provides detailed information about overall radio performance at a glance, without the need to take the radio out of service. More powerful than eye pattern analysis, constellation analysis provides more information in greater detail.

### HP 3708A

The HP 3708A Noise and Interference Test Set provides accurate C/N and C/I ratio conditions for making out-of-service C/N vs BER and C/I vs BER measurements. These tests simulate noise and interference conditions experienced in radio equipment and over radio links. In one portable package, this instrument provides noise and interference simulation and is used to predict background (residual) BER in a short time. The HP 3708A also has direct application in satellite and narrowbandwidth systems. Designed for R&D, manufacturers and operators, this versatile instrument provides calibrated measurements for accurate performance assessment, in both factory and field conditions.

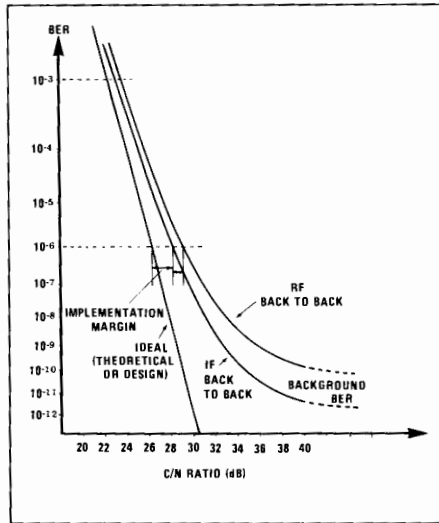

Standard out-of-service measurements made using the HP 3708A HP 3709B

The HP 3709B Constellation Analyzer provides the power of constellation analysis in one portable package. This instrument detects and isolates radio impairments, and quantifies distortions into constellation closure, lock and quad angle error and eye reduction measurements. It also provides detailed non-linear distortion measurements which provide rapid radio pre-distorter & RF amplifier optimisation. Thinkjet printer connection provides hardcopy constellation display and measurement output for building radio impairment 'catalogs'. Permanent results storage is possible with this feature. HP-IB control provides measurement result access to a remote computer. This permits partial remote operation. The HP 3709B provides measurement analysis for all common modulation schemes: QPSK, 16 QAM, 64 QAM, 256 QAM, 9 QPR, 25 QPR, 49 QPR and 81 QPR. Designed for manufacturers and operators, this easy to use, low cost instrument finds application in manufacture, installation, commissioning and maintenance of digital radio systems. It is also used in FDMA SCPC satellite systems.

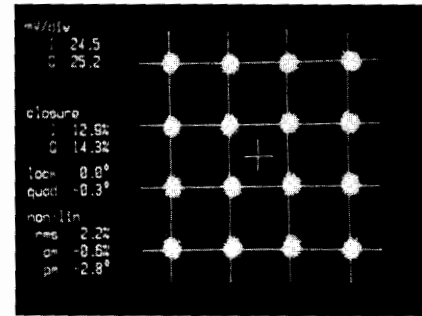

Constellation Pattern from the HP 3709B showing measurements (16 QAM radio) FDM Measurements

Frequency Division Multiplex (FDM) systems are the traditional method of transmitting a number of telecommunications channels over a single wideband transmission medium. Each channel is allocated part of the frequency spectrum, from 12-24 channels in narrow satellite or radio systems, to 2700 or 3600 channels in high capacity systems.

The HP 3746A Selective Level Measurement SET (SLMS), developed from the HP 3586A/B, has been optimized for FDM maintenance measurements, particularly in automatic network monitoring systems. Customers expect high network performance levels so rapid fault location and system degradation analysis is necessary. Hewlett-Packard offers two automatic FDM network monitoring systems designed around the HP 3746A SLMS: the HP 37051S based on the HP 9000 series 300, and the HP 37050S system based on the HP 1000 A-series computer. The HP 37051 S is a low-cost measurement system for smaller networks providing control of up to 10 remote measurement subsystems. The system stores database information on the test points and allows running of an automatic measurement system using sequencing files. These can be interrupted at any time for demand measurements.

The HP 37050 S system has all of these features and in addition can control up to 16 remote subsystems per computer. It provides comprehensive data reduction and results reporting - for the larger system this is essential. The computer utilizes powerful Real-Time Executive (RTE) operating system software, so (unlike the HP 37051 S) can provide simultaneous measurements at multiple sites and support several users at local or remote terminals. The HP 37050 S can be readily extended to cover a very large network by linking computers using distributed system software.

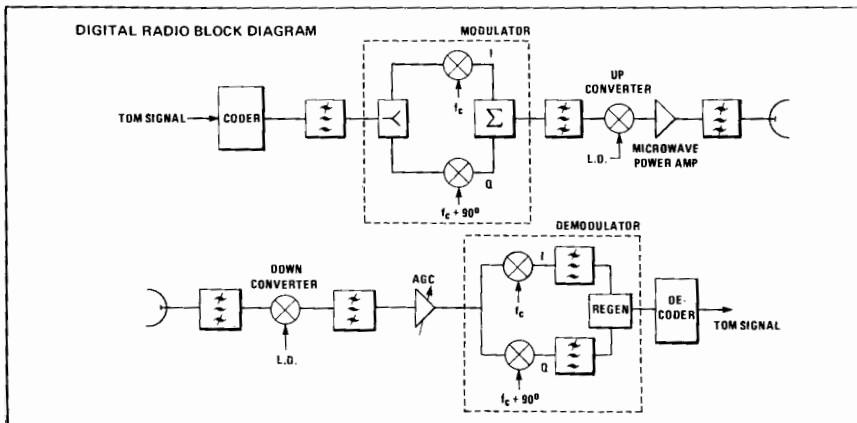

Digital Radio Block diagram

# TELECOMMUNICATIONS TEST EQUIPMENT

## Selective Level Meter and Synthesizer

Models 3586A/B & 3336A/B

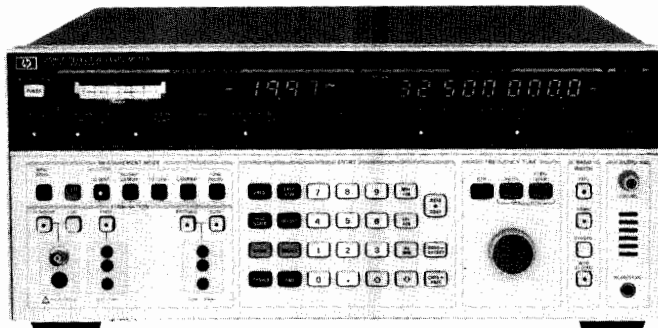

HP 3586A Selective Level Meter (CCITT)



### General

The HP 3586A/B Selective Level Meters and HP 3336A/B Tracking Synthesizers offer the high performance necessary to meet the demanding requirements in the design, manufacture, commissioning and maintenance of Frequency Division Multiplex (FDM) systems. The HP 3586 and HP 3336 "A" models meet CCITT requirements, and the "B" models meet North American (Bell) standards. Both are fully programmable over the HP Interface Bus. The HP 3586A & B Selective Level Meter provides a unique combination of features, including wideband power and optional telephone impairment measurement of impulse noise, phase jitter, noise with tone, and signal-to-noise with tone ratio. The HP 3586A & B's wide frequency coverage to 32.5 MHz allows measurements to be made at both voice channel and carrier frequencies. Microprocessor control adds many ease-of-use features such as amplitude offset measurements of tone and noise level in units of dBmO, dBnCO, or dBpWO. Convenience features include simultaneous analog and digital level displays, precise frequency setting with HP's fractional N synthesized local oscillator, accurate frequency counter and tone measurements with automatic channel alignment for 800 Hz (CCITT) or 1004 Hz (Bell) test tone or carrier frequency reference.

The HP 3336 A/B Synthesizer/Level Generator is an excellent precision tracking signal source for the HP 3586A and B Selective Level Meter. When the Selective Level Meter and Synthesizer are in the tracking mode, the frequency of the synthesizer is automatically set to the frequency of the SLM. Frequency coverage is 10 Hz to 20.9 MHz, making the HP 3336 A and B useful for telephone circuit loop testing on most FDM systems, transfer function and distortion measurements in telecommunications manufacturing.

### Carrier Frequency and Voice Channel

The HP 3586A & B can make both carrier frequency measurements to 32.5 MHz and voice channel measurements from 50 Hz to 100 kHz.

You can measure tone levels, idle channel noise or weighted noise at voice channel, then compare at carrier frequency.

### Transmission Impairments

The Transmission Impairments capability permits phase jitter, weighted noise, noise-with-tone, signal-to-noise-with-tone ratio, and single level impulse noise measurements. The HP 3586A & B capability to make these transmission impairment measurements at both FDM voice channel and carrier frequencies is unique.

### Frequency and Amplitude Precision

The HP 3336 A/B provides frequency resolution of one microhertz (.000001 Hz) up to 100 kHz and one millihertz (.001 Hz) to 20.9 MHz. Level accuracy is  $\pm 1.5$  dB at full output over the full frequency range with  $\pm 1.2$  dB optional. Harmonic levels are more than 60 dB down up to 1 MHz and more than 50 dB down up to 20.9 MHz, performance not previously available in a synthesizer.

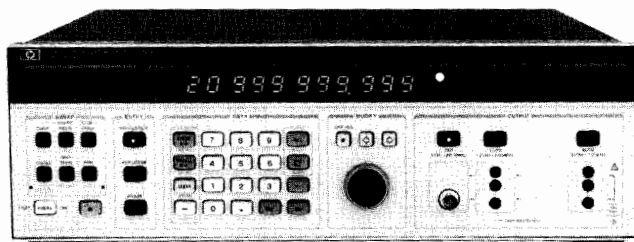

HP 3336A Synthesizer/Level Generator (CCITT)

### FDM Testing

The flexible output section allows different connectors to be provided either by option or special request. Frequency entry is accomplished by keyboard or analog control for manual tuning or frequency stepping of any digit.

The Amplitude Blanking feature allows testing of operational FDM systems without disturbing adjacent channels while the frequency is changed. The output is blanked to less than  $-85$  dBm until the next desired frequency is reached.

### General Purpose Features

The HP 3336 A/B Synthesizer provides wide band sweep capability—sweep the full frequency range (or as little as two microhertz), log or linear, single or continuous. Single phase lock loop design means the sweep is phase continuous and you can modulate with AM to 50 kHz or PM to 5 kHz. Ten storage registers can be used to keep different test settings available for repetitive test. All necessary functions on the HP 3336 A/B can be remotely programmed by HP-IB control for automatic testing.

### Designed-In Serviceability

The HP 3586 A/B Selective Level Meter and the HP 3336 A/B Synthesizer/Level Generator have been designed for reliable operation and excellent accessibility with many useful service features.

### North American (Bell) and CCITT Requirements

The HP 3586A & B Selective Level Meter and HP 3336 A & B Synthesizer/Level Generator are designed to meet most world-wide connector and impedance requirements for both carrier and voice channel measurements. Special or regional connectors can be provided by option or special request.

### Input Configuration

#### CCITT Requirements

HP 3586A SLM	75 $\Omega$ /10 k $\Omega$ Unbalanced 150 $\Omega$ , 600 $\Omega$ /10 k $\Omega$ Balanced
HP 3336A Synthesizer	75 $\Omega$ Unbalanced 150 $\Omega$ , 600 $\Omega$ Balanced

#### North American (Bell) Requirements

HP 3586B SLM	75 $\Omega$ /10 k $\Omega$ Unbalanced 124 $\Omega$ , 135 $\Omega$ , 600 $\Omega$ /10 k $\Omega$ Balanced
HP 3336B Synthesizer	75 $\Omega$ Unbalanced 124 $\Omega$ , 135 $\Omega$ , 600 $\Omega$ Balanced

### Fully Programmable

HP-IB control is standard, allowing automatic operation to be controlled by a desktop calculator such as the HP 9816A, Series 200, or 300, or by a mainframe computer, such as the HP 1000. FDM tests such as surveillance can be made from a remote location to reduce maintenance costs and increase troubleshooting efficiency.

### High Impedance Accessory Probes

Models HP 15580A and HP 15581B unbalanced high impedance probes are available for use with the HP 3586A/B to facilitate bridging measurements.

**HP 3586A/B Abbreviated Specifications**

**Frequency**

Signal Input	HP 3586A	HP 3586B
75 Ω Unbalanced	50 Hz to 32.5 MHz	
124 Ω Balanced		4 kHz to 10 MHz
135 Ω Balanced		4 kHz to 1 MHz
150 Ω Balanced	4 kHz to 1 MHz	
600 Ω Balanced	100 Hz to 108 kHz	

The 124 Ω, 135 Ω, 150 Ω and 600 Ω inputs are usable over wider frequency ranges, but are not specified in under and overrange operation.

**Frequency resolution:** 0.1 Hz.

**Center frequency accuracy:**  $\pm 1 \times 10^{-5}$ /year ( $\pm 2 \times 10^{-7}$ /year with option 004).

**Counter accuracy:**  $\pm 1.0$  Hz in addition to center frequency accuracy for signals within the 60 dB bandwidth of the IF filter chosen or greater than -100 dBm (largest signal measured).

**Frequency display:** 9 digit LED.

**Selectivity**

**3 dB Bandwidth,  $\pm 10\%$**

HP 3586 (CCITT)	HP 3586B (N. American)
20 Hz	20 Hz
400 Hz	400 Hz
3100 Hz	3100 Hz
Psophometric Noise Weighting	C-Message Noise Weighting

**Adjacent channel rejection:** 75 dB minimum at  $\pm 2850$  Hz, 3100 Hz BW.

**Passband flatness:**  $\pm 0.3$  dB.

**Amplitude**

**Measurement range:** +20 to -130 dBm.

**Amplitude resolution:** .01 dB.

**Level accuracy:** 10 dB autorange, low distortion mode, after calibration. 20 Hz and 400 Hz BW below -80 dBm.

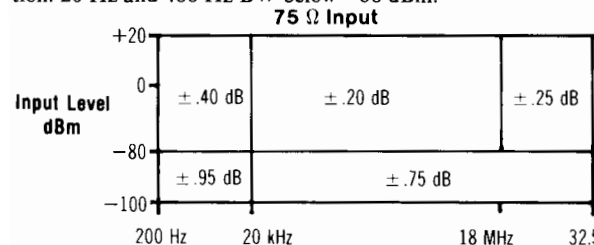

124 Ω Input (HP 3586B):  $\pm 0.6$  dB, 4 kHz to 10 kHz;  $\pm .35$  dB, 50 kHz to 5 MHz;  $\pm .50$  dB, 10 kHz to 50 kHz, and 5 MHz to 10 MHz for +20 to -80 dBm.

135 Ω/150 Ω input (HP 3586A or B):  $\pm 0.6$  dB, 4 kHz to 10 kHz;  $\pm .35$  dB, 50 kHz to 1 MHz;  $\pm .50$  dB, 10 kHz to 50 kHz for +20 to -80 dBm.

600 Ω input (3586 A/B):  $\pm .35$  dB, 100 Hz to 108 kHz for +20 to -80 dBm.

**Level accuracy: 100 dB range (after calibration):** Add correction to 10 dB auto-range accuracy for dB below full scale. (Not required when in 10 dB autorange).

dB Below Full Scale	Accuracy Correction
0 to -20 dB	$\pm .25$ dB
-20 to -40 dB	$\pm .50$ dB
-40 to -80 dB	$\pm 2.00$ dB

**Dynamic Range**

**Spurious Responses**

**Image rejection (100-132 MHz):** -80 dBc.

**IF rejection:** 15625 Hz, -80 dBc; 50 MHz, -60 dBc.

**Non-harmonic spurious signals:** >1600 Hz offset, -80 dBc; 300 Hz to 1600 Hz offset, -75 dBc.

**Distortion**

**Harmonic distortion:** -70 dB below full scale (>4 kHz on 75 Ω and 600 Ω inputs), low distortion mode.

**Intermodulation distortion:** Two-tone second and third order, separation 7 kHz to 1 MHz, 75 dB below full scale. Either tone  $\geq 10$  MHz, -70 dB.

**Wideband power accuracy:** After calibration, 100 dB range, averaging on, -45 to +20 dBm.

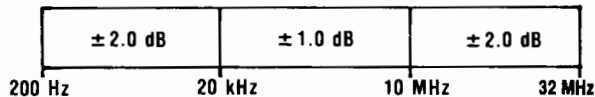

**Noise Floor (full scale setting -35 to -120 dBm)**

Frequency	Bandwidth	Noise Level
100 kHz to 32.5 MHz	3100, 1740, 2000 Hz	-116 dBm
	20 Hz, 400 Hz	-120 dBm
10 kHz to 100 kHz	All	-105 dBm

The noise floor for full scale settings of -30 to +25 dBm will be 80 dB below full scale for >100 kHz, or 60 dB below full scale for 2 kHz-100 kHz.

**Signal Inputs**

HP Model	Impedance	Frequency	Mating Connector
3586A	75 ohms unbalanced	50 Hz to 32.5 MHz	BNC
	150 ohms balanced	4 kHz to 1 MHz	Siemens 3-prong 9 Rel 6 AC
	600 ohms balanced	100 Hz to 108 kHz	
3586B	75 ohms unbalanced	50 Hz to 32.5 MHz	WECO 439/440A
	124 ohms balanced	4 kHz to 10 MHz	WECO 443A
	135 ohms balanced	4 kHz to 1 MHz	WECO 241A
	600 ohms balanced	100 Hz to 108 kHz	WECO 310

**Connector Options**

**Opt 001 (HP 3586A):** 75 ohms mates with Siemens 1.6/5.6 mm coaxial.

**Opt 001 (HP 3586B):** 75 ohms mates with WECO 358A. 124 ohms mates with WECO 372A.

(Contact local sales office for other special connectors.)

**Return loss:** -30 dB (50/75 Ω); -25 dB (600 Ω).

**Balance**

Input	Frequency	Balance
124 Ω	10 kHz to 10 MHz	-36 dB
135 Ω or 150 Ω	10 kHz to 1 MHz	-36 dB
600 Ω	50 Hz to 108 kHz	-40 dB

**Demodulated Audio Output**

**Output Level:** 0 dBm into a 600 Ω load, adjustable.

**Output Connector:** Mates with WECO 347A.

**Additional Options**

**HP 3586A (CCITT)**

**Opt 001:** 75 Ω input connector option. Siemens 1.6/5.6 mm coaxial connector replaces BNC.

**Opt 004:** High Stability Frequency reference 10 MHz oven stabilized reference oscillator improves frequency stability to  $\pm 2 \times 10^{-7}$ /year.

**HP 3586B (N. American)**

**Opt 001:** 75 Ω and 124 Ω input connector option. Changes 75 Ω input connector to mate with WECO 358A and 124 Ω input to mate with WECO 372A.

**Opt 004:** High Stability Frequency reference. Same as Opt 004-HP 3586A.

**Auxiliary Signal Inputs/Outputs**

**Tracking Generator:** 0 dBm rear panel tracking output.

**External Reference Input:** 10 MHz  $\div n$ , where  $n = 1, 2, 3 \dots 10$ .

**Reference Output:** 10 MHz, +8 dBm output.

# TELECOMMUNICATIONS TEST EQUIPMENT

## Selective Level Meter and Synthesizer (cont'd)

### Models 3586A/B & 3336 A/B

**Probe power:** Front panel dc output for HP active high impedance accessory probes.

**HP-IB Interface Functions:** Rear panel interface meeting IEEE 488-1978 for remote operation. Used for tracking synthesizer interface. SH1, AH1, T6, L3, SR1, RL1, PP1, DC1, C0, E1.

**Additional outputs:** Rear panel demodulated audio; phase jitter; meter;  $F_0$  (0-32 MHz).

#### General

#### Operating Environment

**Temperature:** 0° to 55°C.  
**Relative humidity:** 95%, 0° to 40°C.  
**Altitude:** ≤15,000 ft; ≤4600 metres.

#### Storage Environment

**Temperature:** -40°C to 75°C.  
**Altitude:** ≤50,000 ft; ≤15,240 metres.  
**Power:** 100/120/220/240 V, +5%, -10% 48 to 66 Hz, 150 VA.  
**Weight:** 23 kg (50 lb) net; 30 kg (65 lb) shipping.  
**Size:** 177 mm H x 425.5 mm W x 466.7 mm D (7" x 16.75" x 18.38").

### HP 3336 A & B Abbreviated Specifications

(See data sheet or manual for complete specifications)

#### Frequency

#### Frequency Range of Signal Outputs

Signal Output	HP 3336A	HP 3336B
75 Ω Unbalanced	10 Hz to 20.999 999 999 MHz	
124 Ω Balanced		10 kHz to 10.999 999 999 MHz
135 Ω Balanced		10 kHz to 2.099 999 999 MHz
150 Ω Balanced	10 kHz to 2.099 999 999 MHz	
600 Ω Balanced	200 Hz to 109.999 999 kHz	

All balanced outputs are usable over wider frequency ranges but are not specified in under and overrange operation.

**Resolution:** 1 μHz for frequencies < 100 kHz, 1 mHz for frequencies ≥ 100 kHz.

**Aging rate (instruments without option 004):** ±5 x 10<sup>-6</sup>/year (20° to 30°C).

**Warm-up time:** 30 minutes.

#### Amplitude

**Range:** 75 and 600 Ω outputs: -72.99 to +7.00 dBm.  
 124, 135 and 150 Ω outputs: -78.23 to +1.76 dBm.

**Level accuracy, 20° to 30°C**

75 Ω Output				75 Ω Output with Option 005*				
dBm	10Hz	2MHz	10MHz	20.9MHz	10 Hz	20.9 MHz		
+7.00	±.15 dB				±.12 dB			
-3.00	±.25 dB	±.30 dB	±.35 dB		±.16 dB			
-13.00	±.30 dB	±.35 dB	±.40 dB		±.18 dB			
-33.00	±.35 dB	±.40 dB	±.45 dB		±.22 dB			
-72.99								

\*high accuracy attenuator  
 124 Ω output: 50 kHz to 10.9 MHz ±.15 dB -8.23 to 1.76 dBm, ±0.3 dB -18.23 to -8.24 dBm, ±.35 dB -38.23 to -18.24 dBm ±.4 dB -78.23 to -38.24 dBm.  
 135 Ω/150 Ω output: 10 kHz to 2.09 MHz, ±.17 dB -8.23 to +1.76 dBm, ±.32 dB -18.23 to -8.24 dBm, ±.37 dB -38.23 to -18.24 dBm, ±.42 dB -78.23 to -38.24 dBm.  
 600 Ω output: 200 Hz to 109.9 kHz, ±.30 dB -3.00 to +7.00 dBm/ ±.40 dB -13.00 to 2.99 dBm, ±.45 dB -33.00 to -12.99 dBm ±.50 dB -72.99 to -32.99 dBm.

1. Add ±0.08 dB for 0° to 55°C operation.  
 2. Warm-up time is 30 minutes.

**Amplitude blanking:** <-85 dBm output during blanking.

#### Spectral Purity

**Phase noise:** <-72 dB, HP 3336A and HP 3336B, for a 3 kHz band, 2 kHz either side of a 20 MHz carrier.

**Harmonic level:** -35 dB, 10 Hz to 30 Hz; -50 dB, 30 Hz to 50 Hz; -60 dB, 50 Hz to 1 MHz; -55 dB, 1 MHz to 5 MHz; -50 dB, 5 MHz to 20 MHz.

**Spurious:** All non-harmonically related signals will be more than 70 dB below the fundamental or -100 dBm (-115 dBm with option 005 except 150 or 600 Ω), whichever is greater.

#### Phase Offset

**Range:** ±719.9° with respect to arbitrary starting phase or assigned zero phase.

**Resolution:** 0.1°.

**Increment accuracy:** ±0.2°.

**Ambient stability:** ±1.0 degree of phase per degree C.

#### Frequency Sweep

**Sweep time:** Linear sweep, 0.01 s to 99.99 s; single log sweep, 2 s to 99.99 s; continuous log sweep, 0.1 s to 99.99 s.

**Maximum sweep width:** Specified frequency range of selected output.

**Minimum sweep width:** Log sweep, 1 decade; linear sweep, minimum sweepwidth (Hz) = 0.1 (Hz/s) x sweep time(s).

**Phase continuity:** Sweep is phase continuous over full frequency range.

**Sweep flatness:** ±0.15 dB, fast leveling, 10 kHz to 20 MHz, 0.03 s sweep time; ±0.15 dB, normal leveling, 50 Hz to 1 MHz, 0.5 s sweep time.

**Amplitude modulation:** Modulation depth, 0 to 100%. Modulation frequency range, 50 Hz to 50 kHz.

**Phase modulation:** Range, 0 to ±850°. Linearity, ±0.5% from best fit straight line. Modulation frequency range, dc to 5 kHz.

**External leveling:** Input from an external voltage source to regulate the signal amplitude at a remote point.

**HP-IB Interface Functions:** Rear panel interface meeting IEEE 488-1978 for remote operation. Used for tracking synthesizer interface. SH1, AH1, T6, L3, SR1, RL1, PP0, DC1, C0, E1.

#### Options

#### Option 001, HP 3336A/B Synthesizer/Level Generator

1.6/5.6 mm 75Ω input, (HP 3336A). 75Ω mates with WECO 358A, (HP 3336B). 124Ω connector mates with WECO 372A, (HP 3336B).

#### Option 004, High Stability Frequency Reference

**Aging rate:** ±5 x 10<sup>-8</sup>/week after 72 hours continuous operation ±8 x 10<sup>-7</sup>/month after 15 days continuous operation.

**Ambient stability:** ±5 x 10<sup>-7</sup> maximum, 0° to 55°C.

**Option 005, high accuracy attenuator:** Improves level accuracy and spurious level. See main specifications.

#### General

#### Operating Environment

**Temperature:** 0° to 55°C.  
**Relative humidity:** ≤85%, 0° to 40°C.  
**Altitude:** ≤15,000 ft., ≤4600 metres.

#### Storage Environment

**Temperature:** -50° to +65°C.  
**Altitude:** ≤50,000 ft., ≤15,240 metres.  
**Power requirements:** 100/120/220/240 V, +5%, -10%, 48 to 66 Hz, 60 VA, (100 VA with all options), 10 VA standby.

**Size:** 132.6 mm high x 425.5 mm wide x 425.5 mm deep (5¼" x 16¾" x 16¾").

**Weight:** Net wt., 10 kg (22 lb). Shipping wt., 15.5 kg (34 lb).

#### Ordering Information

#### Price

<b>HP 3586A Selective Level Meter (CCITT)</b>	<b>\$11,200</b>
<b>Opt 001:</b> 1.6/5.6 mm 75 Ω Connector	\$100
<b>Opt 004:</b> High Stability Frequency Reference	\$750
<b>HP 3586B Selective Level Meter (N. American)</b>	<b>\$11,200</b>
<b>Opt 001:</b> 75 Ω Connector mates with WECO 358A and 124 Ω Connector mates with WECO 372A	\$100
<b>Opt 004:</b> Same as HP 3586A	\$750
<b>HP 3336A Synthesizer/Level Generator (CCITT)</b>	<b>\$5,200</b>
<b>Opt 001:</b> 1.6/5.6 mm 75 Ω Connector	\$102
<b>Opt 004:</b> High Stability Frequency Reference	\$665
<b>Opt 005:</b> High Precision Attenuator	\$665
<b>HP 3336B Synthesizer/Level Generator (N. American)</b>	<b>\$5,200</b>
<b>Opt 001:</b> 75 Ω WECO 358A, 124 Ω WECO 372A	\$102
<b>Opt 004, 005:</b> Same as HP 3336A	

# TELECOMMUNICATIONS TEST EQUIPMENT

15 Hz to 50 kHz Selective Voltmeter

Model 3581C

505

- Voice grade testing
- Wideband data circuit testing
- Single frequency interference
- Spectrum analysis

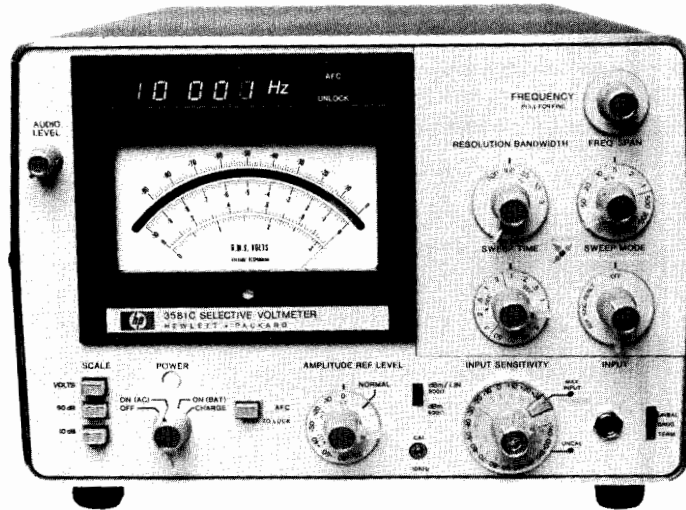

HP 3581C

## Description

The HP 3581C Selective Voltmeter has found wide application in testing special service circuits in both inside and outside plant maintenance. The HP 3581C is used to do spectrum analysis, measure non-linear distortion (harmonic distortion) and to locate and measure unwanted spurious and induced tones. The unit can be operated from ac line or from optional internal batteries.

## Specifications

**Frequency range:** 15 Hz to 50 kHz.  
**Display:** 5 digit LED readout. Resolution: 1 Hz. Accuracy:  $\pm 3.5$  Hz.  
**Typical stability:**  $\pm 10$  Hz/h after 1 hour.  $\pm 5$  Hz/ $^{\circ}$ C.  
**Automatic frequency control (AFC), hold-in range:**  $\pm 800$  Hz.  
**Pull-in range:**  $> 5 \times$  bandwidth for 3 Hz to 100 Hz bandwidth;  $> 500$  Hz for 300 Hz bandwidth for full-scale signal.  
**Lock frequency:** Center of passband  $\pm 1$  Hz.

## Amplitude

### Instrument Range

**Linear:** 30 V to 100 nV full scale.

**Log:** +30 dBm or dBV to -150 dBm or dBV.

### Amplitude Accuracy\*

	Log	Linear
15 Hz-50 kHz, frequency response	$\pm 0.4$ dB	$\pm 4\%$
Switching between bandwidths (@ 25 $^{\circ}$ C)	$\pm 0.5$ dB	$\pm 5\%$
Amplitude display	$\pm 2$ dB	$\pm 2\%$
Input attenuator	$\pm 0.3$ dB	$\pm 3\%$
Amplitude reference level, Most sensitive range	$\pm 1$ dB	$\pm 10\%$
All other ranges	$\pm 1$ dB	$\pm 3\%$

**Dynamic range:**  $> 80$  dB.

**Noise sidebands:** Greater than 70 dB below CW signal. 10 bandwidths away from signal.

**IF feedthrough:** Input level  $> 10$  V: -60 dB; input level  $< 10$  V: -70 dB.

**Spurious responses:**  $> 80$  dB below input reference level.

## Sweep

**Scan width:** 50 Hz to 50 kHz. These scans can be adjusted to cover a group of frequencies within the overall instrument range.

**Sweep error light:** This LED indicates a sweep that is too fast to capture full response.

\*Note: these specifications cover the full temperature frequency and amplitude range, and represent worst case. Accuracy is significantly better for measurements not at the extremes.

**External trigger:** A short to ground stops normal sweep. Opening the short then enables a sweep.

## Input

### Unbalanced (UNBAL)

**Impedance:** 1 M $\Omega$ /40 pF.

### Balanced/Bridged (BRDG)

**Impedance:** 10 k $\Omega$ .

**Frequency response:** 40 Hz-20 kHz,  $\pm 0.5$  dB for signals  $< 20$  dBm.

### Balanced/Terminated (TERM)

**Impedance:** 600  $\Omega$ /900  $\Omega$  balanced.

**Frequency response:** Same as balanced/bridging.

**Input connector:** Accepts WECO 310 plug.

## Output Characteristics

**Tracking generator output** (Also known as BFO or tracking oscillator output). Switchable on rear panel to restored output (HP 3581C acts as a narrow band amplifier).

**Range:** 0 to 2 V rms.

**Frequency response:**  $\pm 3\%$  15 Hz to 50 kHz.

**LO output:** 100 mV signal from 1 MHz to 1.5 MHz as input is tuned from 0 to 50 kHz.

**Output connector:** WECO 310, for connection to tracking generator output or restored output. In addition to monitoring restored output with headphones, an internal speaker also provides an audio indication of signal content.

**Restored output:** Acts as a narrow band amplifier.

**X-Y recorder analog outputs:** 0 to +5V  $\pm 2.5\%$ .

## General

**Operating temperature range:** 0 $^{\circ}$ C to 55 $^{\circ}$ C.

**Humidity:** 95% relative, maximum at 40 $^{\circ}$ C.

**Power requirements:** 100 V, 120 V, 220 V, 240 V +5% -10%, 10 VA typical, 48 Hz to 440 Hz.

**Size:** 203.2 mm H x 285.8 mm W x 412.8 mm D (8" x 11 $\frac{1}{4}$ " x 16 $\frac{1}{4}$ ").

**Weight:** 11.5 kg (23 lb); Option 001, 13.5 kg (30 lb).

**Accessory available:** HP 7090A Measurement Plotting System.

**Option 001: rechargeable battery:** Used to make floating measurements; 12 hours to fully charge. Also includes front panel dust cover.

## Ordering Information

**HP 3581C Selective Voltmeter**  
**Opt 001:** Battery Pack, Dust Cover  
**Opt 003:** Rack Mount  
**Opt W30:** Extended Warranty

## Price

**\$6,900**  
**\$700**  
**\$335**  
**\$300**



# TELECOMMUNICATIONS TEST EQUIPMENT

## Selective Level Measuring Set, Access/Distribution Switches

Models 3746A, 3754A, 3755A, 3756A, 3757A

### HP 3746A

- Fast, accurate measurements on frequency division multiplex (FDM) systems
- Selective filters for pilot, channel and (optionally) group power and weighted noise measurements
- Automatic tuning to stored frequency plans with comparison of measured level to stored limits

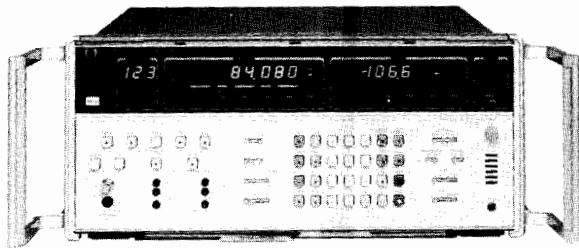

HP 3746A

### HP 3746A Selective Level Measuring Set (SLMS) (50 Hz to 32 MHz)

The HP 3746A SLMS makes fast, accurate selective level measurements. A built-in synthesiser gives high tuning accuracy and 1 Hz resolution across the entire 50 Hz to 32 MHz frequency range. Tuning can be performed by: entering a single frequency, stepping between frequency limits, stepping through a set of unrelated frequencies, or by FDM plan description.

The instrument's measurement filters are purpose designed for FDM testing. The flat-topped 3.1 kHz channel filter extracts a voice channel while rejecting adjacent carriers, pilots and other traffic. The 38 Hz pilot filter is flat topped over 22 Hz so AFC is not required, but rejects adjacent tones so that carrier leak can be tested on an active system. A built-in counter can be used to check tone frequencies. Options include: group power, C-message or psophometric noise measurements, noise-with-tone, phase jitter and single-level impulse noise.

The SLMS is optimised for FDM maintenance measurements and network monitoring. It has built-in "intelligence" to allow scanning of FDM signals and limit checking of measured levels. Special hot-tone search routines can rapidly detect high-level signals (See Application Note AN 323). The SLMS can directly control access switches for system applications, and has a built-in real-time clock and printer drivers for data logging. It is fully HP-IB programmable, and can be used as the heart of a self-contained measurement system, or integrated into a computer-controlled systems such as the HP 37050S FDM Network Monitoring System or HP 37051S Measurement System.

#### Ordering Information

	<b>Price</b>
<b>HP 15580A</b> Active Probe	\$490
<b>HP 15581B</b> Passive Probe	\$400
<b>HP 15582A</b> Return Loss Kit	\$710
<b>HP 15589A</b> Instrument Cart	\$830

#### HP 3746A Options

<b>001:</b> Siemens series 1.6/5.6 mm 75 ohm connectors	N/C
<b>005:</b> WECO 477B/223A (equivalent) connectors	\$70
<b>011:</b> 48 kHz group filter	\$1,150
<b>012:</b> tracking generator	\$360
<b>014:</b> high stability frequency reference	\$760
<b>015:</b> channel impairments - CCITT	\$520
<b>016:</b> channel impairments - North America	\$520

**HP 3746A Selective Level Measuring Set** **\$13,600**

### HP 3754A, 3755A, 3756A, 3757A

- Select 1 from a possible 10 RF inputs/outputs
- Cascade up to 111 switches to allow selection from 1000 inputs/outputs
- Mix different switches for the most cost-effective solution



HP 3757A



HP 3754A



HP 3756A



HP 3755A

### HP 3754A, HP 3756A, HP 3757A Switches and HP 3755A Switch Controller

The HP 3754A, 3756A and 3757A Switches and the HP 3755A Switch Controller have been developed to meet the requirements of four main areas:

1. Frequency division multiplex (FDM) system surveillance and maintenance - the switch arrangement is used in conjunction with a selective level measuring set (SLMS), such as the HP 3746A, to monitor pilot and traffic levels at various points in the multiplex. The HP 3746A SLMS can control the access switches directly without needing the HP 3755A Switch Controller.
2. Production testing - where automatic selection or distribution of RF signals is required.
3. IF access and distribution - 70 MHz IF signals can be switched using the HP 3756A for connection to the HP 3717A 70 MHz Modulator/Demodulator.
4. Access and distribution of digital communications signals up to 34 Mb/s (CEPT) or 44.7 Mb/s (DS-3).

**Options:** The standard versions of these switches have BNC connectors and 75 ohm terminations. Different connectors are available as options on some models and 50 ohm versions are available as options or to special order on all models - see data sheet for full details.

#### Ordering Information

	<b>Price</b>
<b>HP 3754A</b> 25 MHz Access Switch	\$2,900
<b>HP 3755A</b> Switch Controller	\$2,800
<b>HP 3756A</b> 90 MHz Bi-directional Switch	\$3,600
<b>HP 3757A</b> 8.5 MHz Access Switch	\$1,150

# TELECOMMUNICATIONS TEST EQUIPMENT

## Microwave Link Analyzer

Models 3711A/3712A, 3730B, 3717A, 8350B, 86200 Series RF Plug-ins

507

- Comprehensive testing of microwave radio links and components.
- Baseband and IF (70/140 MHz) interface on MLA.
- Extension to RF (0.5 to 18 GHz) with up/down converter.

- Baseband qualitative measurements via 70 MHz modulator/demodulator.
- Test analog and digital radios.

### 70/140 MHz IF MLA System

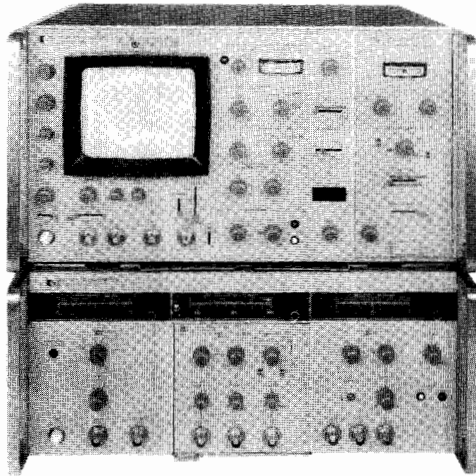

- HP 3711A IF/BB Transmitter
- HP 3791B BB Transmitter (Plug-in)
- HP 3712A IF/BB Receiver
- HP 3793B Diff. Phase Detector (Plug-in)

### 70 MHz Modulator/Demodulator

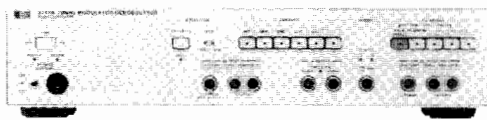

HP 3717A

### HP 3711A/3712A Microwave Link Analyzer

The HP 3711A/3712A MLA system provides a comprehensive range of microwave radio measurements at baseband and IF (70 or 140 MHz) including: amplitude and group delay response, modulator/demodulator linearity and sensitivity, differential gain and phase, power and frequency. The MLA measures individual components of an analog or digital radio system or a complete link, without needing a reference channel.

The HP 8350B Sweeper with HP 86200 series of MLA Upconverter Simulation Plug-ins upconverts the MLA transmitter signal to RF channels in the range 0.5 to 18 GHz. (The HP 11869A Adapter is required for HP 8350B.)

The HP 3730B RF Down Converter with plug-ins converts RF signals in the 1.7 to 14.5 GHz range to a 140 MHz or 70 MHz IF. (This range can be extended with external LOs.)

Together, the HP 8350B and HP 3730B extend the MLA system to make measurements on RF channels and devices over bandwidths of up to 1 GHz.

At non-demodulating repeater stations, the HP 3717A 70MHz Modulator/Demodulator allows qualitative baseband tests such as white-noise loading, TV waveform testing and baseband-frequency response to complement the MLA swept IF measurements. The HP 3717A is a high-quality modem which can be substituted for operational equipment to isolate system faults.

### RF to IF Down Conversion

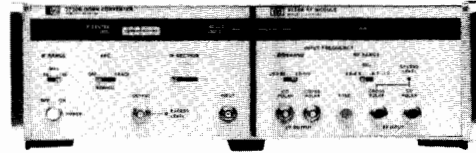

HP 3730B Mainframe HP 3737B plug-in

### MLA Upconverter Simulation

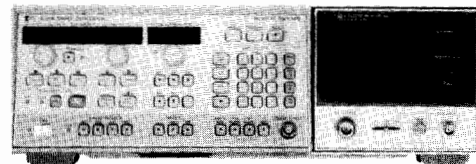

HP 8350B/86245A

### Ordering Information

### Price

#### MLA System:

HP 3711A IF/BB Transmitter	\$8,500
HP 3791B BB Transmitter (Plug-in)	\$1,850
HP 3712A IF/BB Receiver	\$10,500
HP 3793B Diff. Phase Detector (Plug-in)	\$2,000

See data sheet for details of connector, test tone and other options, and accessories.

HP 3730B Down Converter	\$5,200
HP 3736B RF Module 1.7 to 4.2 GHz	\$6,600
HP 3737B RF Module 3.7 to 8.5 GHz	\$7,900
HP 3738B RF Module 5.9 to 11.7 GHz	\$9,300
HP 3739B RF Module 10.7 to 14.5 GHz	\$13,400

See data sheet for details of options and accessories.

HP 8350B Sweeper Mainframe	\$4,900
HP 11869A Adapter	\$700

### HP 86200 MLA Upconverter Simulation Plug-ins

Plug-in Model Number	MLA Option Number	Freq Range (GHz)
86222A/B	H80	0.5 - 2.4
86235A	008	1.7 - 4.3
86240C	-	3.6 - 8.6
86242D	008	5.9 - 9.0
86245A	008	5.9 - 12.4
86250D	008	8.0 - 12.4
86260B	H82	10.0 - 15.5
86260A	H82	12.0 - 18.0

### HP 3717A 70 MHz Modulator/Demodulator \$14,500

See data sheet for details of connector, emphasis network and other options.

# TELECOMMUNICATIONS TEST EQUIPMENT

## Microwave Radio Noise and Interference Test Set; Digital Radio Constellation Analyzer

Models 3708A, 3709B, 15709A

### HP 3708A

- Carrier tracking maintains accurate & repeatable C/N & C/I conditions
- Fast, alternative residual BER measurement
- Accurate simulation of radio system interference

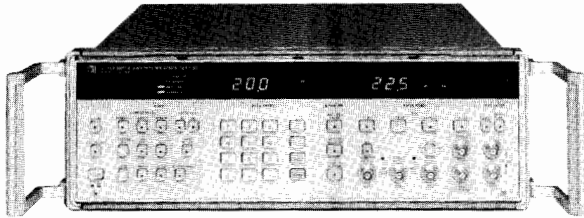

HP 3708A



### HP 3708A Noise and Interference Test Set

To minimise lost transmission revenue and the cost of equipment repair, an accurate, overall performance assessment of radio systems is required. This allows potential faults to be corrected before they begin to cause problems. The HP 3708A provides an accurate method of assessing performance of microwave radio and satellite modem systems by providing the Carrier to Noise (C/N) and Carrier to Interference (C/I) conditions necessary to make C/N & C/I vs Bit Error Ratio (BER) measurements.

The instrument is designed for easy access to the IF section of the radio system. The carrier level is monitored and calibrated levels of interference and Gaussian noise are added to stress the system in a controlled way. Accurate and repeatable C/N and C/I ratios can be maintained even in the presence of severe signal variations.

The HP 3708A has the flexibility to accommodate a wide variety of radio designs, a selection of calibrated internal filters giving accurately specified Carrier to Noise ratios in any noise bandwidth. The interference facility allows the addition of a wide variety of interference signals to accurately simulate the effects of radio interference on system performance.

CCIR recommendations 594 recognize the importance of residual BER in assessing the overall performance of digital radio systems. The HP 3708A provides the capability to significantly reduce residual BER measurement time, and increase the confidence in measurement accuracy.

From initial manufacturing test to final commissioning and routine maintenance, the HP 3708A makes a significant contribution to radio testing, improving your measurements, and saving you money. It provides a valuable addition to your tool kit.

#### Options

**Std:** 75 ohm unbalanced connector, Reference tone oscillator frequency is 70/140 MHz.

**001:** 50 ohm unbalanced connector.

**Special options:** Reference tone oscillator frequencies, specifically for portable application of the HP 3708A in determining residual BER, are available on a special order basis.

**HP 3708A Noise and Interference Test Set**

\$15,900

### HP 3709B

- For troubleshooting, fine-tuning and preventive maintenance
- Identifies digital radio impairments
- Analyzes magnitude of distortions

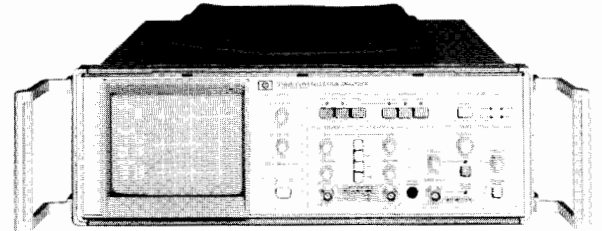

HP 3709B

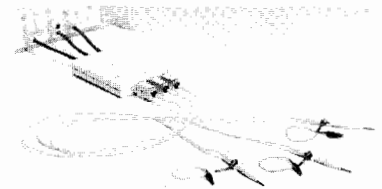

HP 15709A

### HP 3709B Constellation Analyzer

The HP 3709B is used to characterize the performance and condition of digital radios both in-service and out-of-service by analysis of constellation patterns. In addition to displaying constellation patterns, the HP 3709B can measure the linear and non-linear distortions revealed by the patterns, and can provide a formatted report containing the pattern and measurement results on a ThinkJet printer.

#### Measurements

**Constellation:** closure, lock angle error, quad angle error, non-linear distortion: rms non-linear distortion, am-am, am-pm

**Modulation schemes:** QPSK, 16QAM, 64QAM, 256QAM, 9QPR, 25QPR, 49QPR, 81QPR.

#### Monitor Points

**(1) I and Q signals:** Any of the above schemes with signal levels in the range 30 to 400 mV p-p across the constellation. (dc offset must be no more than  $0.5 \times$  signal amplitude).

**(2) Clock:** 1 MHz to 80 MHz (100 mV to 1 V p-p)

**Impedance level:** All HP 3709B inputs are 75 ohm terminated.

#### Options

**001:** 50 ohm unbalanced input connectors

**003:** Siemens series 1.6/5.6 mm input connectors

**130:** High Impedance Interface Kit. Contains 1 x HP 15709A High Impedance Interface and 3 x HP 10435A/10017A 1 metre 10:1 probes

**Special Options:** A low bit rate version (0.1 – 8 MHz) is available to special order.

#### HP 15709A High Impedance Interface

This specially designed accessory provides three high impedance, filtered inputs which allow the HP 3709B to be connected to radios without protected 75 or 50 ohm monitor points, using standard oscilloscope passive probes (eg HP 10017A 10:1, 1 metre probe).

**Gain:**  $\times 5$  (= overall  $\times 0.5$  gain when used with 10:1 probes)

**Impedance:** 1 Mohm.

**HP 3709B Constellation Display**

\$11,200

# TELECOMMUNICATIONS TEST EQUIPMENT

## Vector Signal Generator and Analyzers, I\*Q Tutor

Models 8780A, 8980A, 8981A, 11736A/B

509

### HP 8780A

- 10 MHz to 3 GHz synthesizer
- BPSK, QPSK, 8PSK, 16QAM, Optional 64QAM
- Burst digital modulation

### HP 8980A

- Analyzes coherent phase and amplitude modulation
- 350 MHz I vs. Q bandwidth
- Markers for measuring phase, amplitude and time
- 12-bit digitizing for HP-IB measurements

### HP 8981A

- Adds 50 MHz to 200 MHz I/Q demodulator
- Demodulates up to 70 MHz B.W. communications signals
- $<0.5^\circ$  quadrature error and  $<0.1$  dB amplitude imbalance

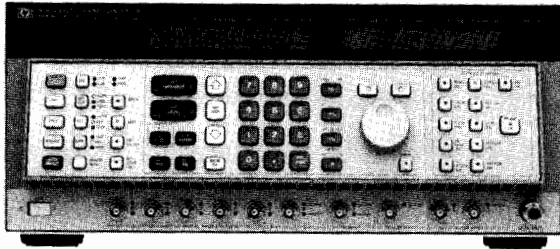

HP 8780A

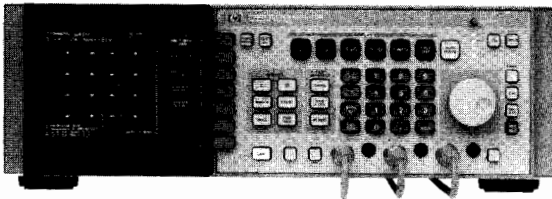

HP 8980A/8981A



### HP 8780A Vector Signal Generator

The HP 8780A Vector Signal Generator is a synthesized source with exceptional modulation for modern digital microwave radio and satellite communications testing. The Vector Signal Generator offers a wide variety of modulation using both digital and analog inputs. It generates standard formats from BPSK to 64QAM and traditional modulation like FM, AM, and pulse, as well as sophisticated complex modulation.

### HP 8980A Vector Analyzer and HP 8981A Vector Modulation Analyzer

The HP Vector Analyzer are two-channel X-Y sampling oscilloscopes designed to analyze the in-phase (I) and quadrature phase (Q) components of modern digital microwave radio signals such as QPSK, 16QAM, and 256QAM. The HP 8981A adds a 50 MHz to 200 MHz demodulator.

### Applications

The vector signal generator, vector analyzer and vector modulation analyzer are well suited to testing modern terrestrial and satellite receivers and transmitters.

The HP 8780A standard modulation patterns — BPSK, QPSK, 8PSK, 16QAM and 64QAM (with Opt. 064) — are easily generated using standard data generators. Asynchronous TDMA modulation can be simulated using the Burst feature along with one of the PSK modulations. A coherent carrier output simplifies quadrature and gain alignment of vector (I/Q) demodulators.

The HP 8980A constellation analysis feature gives non-intrusive measures of closure, quadrature error, and lock angle error for partial response and QAM formats from QPSK to 256QAM. In addition, the HP 8981A extends these measurements to I.F. signals by accurately demodulating them to measure modulators.

For more information about the HP 8780A, HP 8980A and the HP 8981A, refer to the Signal Generator and Signal Analyzer section of this catalog.

### I\*Q Tutor

- Models a modern digital microwave radio system
- Shows time, vector, and constellation diagrams
- Simulates system degradations such as noise, multipath fades, and nonlinearities
- Includes training manual with lab exercises



I\*Q Tutor is available on the HP 9000 Series 200 computers, or on the HP Vectra or IBM PC, PC/XT, or PC/AT.

### I\*Q Tutor

Imagine a practice workbench that simulates a full digital communications system from voice channel through transmission and back to voice. I\*Q Tutor is just that — it's an interactive software training package that simulates the major building blocks of a modern digital communications system. Whether used in a university setting or R&D lab, I\*Q Tutor provides insight to the trade-offs of modern digital communications designs.

On the computer screen, the user selects the system node to be examined. Time and frequency domain signals can be viewed at that node, as well as vector signals. Notebook pages for each system node explain what is happening to the signal.

The power and versatility of I\*Q Tutor come from the ease of changing system parameters, and then viewing the effects of those changes. For instance, the user can change signal-to-noise ratio, or select from several different filter alphas, to examine how these changes affect the system error rate and bandwidth. An advanced design screen is available for exploring multipath fades, AM-AM, and AM-PM distortion effects.

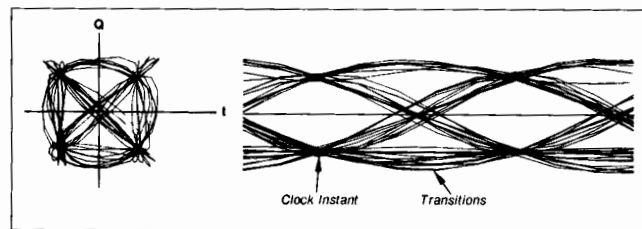

Eye diagram and vector diagram of a QPSK Signal as viewed on the I\*Q Tutor screen.

### Ordering Information

**HP 11736A** runs on the HP 9000 Model 216A, 217A, and 236A computers with 640 Kbytes of memory, or the model 236C with 896 Kbytes. It requires BASIC 2.0 or BASIC 3.0 with Graph and GraphX extensions. **Price \$95.00**

**HP 11736B** runs on the HP Vectra and most IBM PC-compatible computers (PC/XT/AT) with a monochrome or color graphics card. **Price \$95.00**

# TELECOMMUNICATIONS TEST EQUIPMENT

## Operational Support Systems

Models 37050S, 37051S, 37100S

HP 37050S, HP 37051S

- Continually monitor FDM network performance
- Early identification of degradations allows effective preventative maintenance
- Collect performance statistics on leased facilities
- Minimize repair time through rapid fault identification

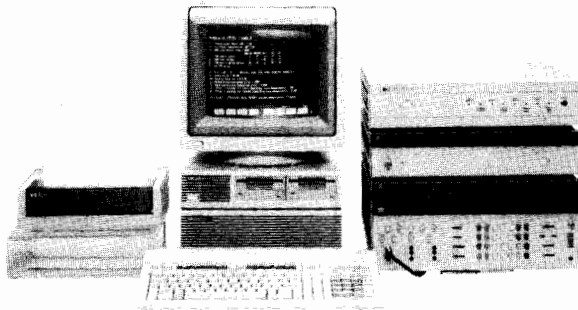

By continually monitoring the performance of an FDM transmission network, the HP 37050S and HP 37051S systems allow deteriorations or faults to be isolated and rectified in the shortest possible time. The HP 37050S has been designed to meet the demands of large, high-capacity FDM networks, whereas the HP 37051S provides a low-cost solution for small FDM networks.

Both systems combine the extensive measurement capability and built-in intelligence of HP 3746A Selective Level Measuring Sets (SLMSs) with access switches and dedicated control software to provide comprehensive measurements which include:

Pilots	Channel noise
Carrier leaks	Inter-supergroup slot noise
Power	Fast 'hot tone' searches

Automatic measurement sequences can be created for network monitoring. User-initiated measurements, temporarily interrupting any sequence, can be made to investigate a problem highlighted through monitoring.

### HP 37050S FDM Network Monitoring System

The HP 37050S is a flexible, automatic measurement system designed for comprehensive performance monitoring of large FDM transmission networks.

The system operates under the direct control of an HP 1000 A-Series computer system which simultaneously gathers measurement data from up to 16 remote sites. Simultaneous access to system facilities by a number of users is accommodated. Specialized results modes are provided that reduce the mass of data available to only that which is relevant.

Two or more computer systems can be linked together enabling an HP 37050S system to be expanded beyond 16 sites.

### HP 37051S FDM Measurement System

The HP 37051S is the ideal answer for the operator of a small FDM network who wishes to make measurements at several remote FDM installations and present the information obtained at one central location.

This system operates under the control of an HP 9000 Series 300 computer that provides control of up to 10 remote sites in succession.

HP 37051S operators can expand their monitoring system to the HP 37050S as their network grows or needs change.

HP 37100S

- Remotely test private circuits from a convenient central site without moving from the keyboard of a computer terminal
- Dramatically improve the productivity of telephone maintenance operations by reducing troubleshooting and technician-travel time
- User-friendly software means no special keyboard skills are required
- Software-generated reports and features which save time and effort

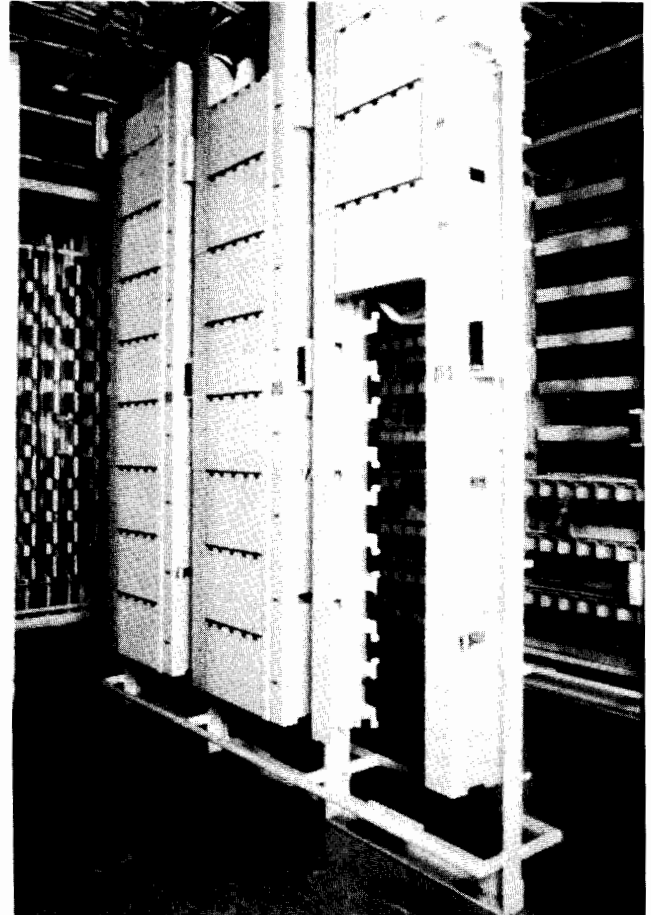

### The HP 37100S Remote Access and Test System

The HP 37100S Remote Access and Test System (HP RATES) provides the hardware, software and support for nationwide testing and troubleshooting of special-service metallic telephone lines. Applications include testing of 2, 4, 6 or 8-wire private circuits which are permanently routed through the equipment and can be accessed and tested at a remote site under the control of a central-site operator.

The HP RATES system uses the well-proven HP 1000 A-Series computer as the system controller running applications software packages, controlling the remote site access and test equipment via modem connections over dedicated or dial-up telephone lines. An operator using a terminal connected to the central site computer, interacts with the applications software to verify circuit performance, accessing the circuit at a remote location and performing the tests from the central location. Extensive use is made of a graphics screen presentation to ensure a user-friendly man/machine interface which relates directly to the tests being performed.

The HP RATES system has been designed to be modular at all levels, providing solutions for the large and small telephone companies. The modularity allows expansion throughout: additional circuits, extra test features and more test personnel are all easily accommodated.



### Protocol Analyzers

In data communications, protocol can be defined as "rules governing the exchange of information between two pieces of data processing equipment". Different test applications and environments require different protocol analyzers. Hewlett-Packard offers a family of five powerful, general purpose protocol analyzers with software and accessories to meet your special needs. Modern high-speed multivendor, real-time, complex networks make tools for network management a must. A protocol analyzer can make complex testing and network optimization easy with protocol analysis tools for management, installation, maintenance and research and development.

### Wide Area Network (WAN) Protocol Analysis

Hewlett-Packard offers a family of three protocol analyzers to meet different wide area networking application requirements. While maintaining family compatibility, each analyzer is tailored for a different environment with different features and characteristics. The **HP 4951C**, **HP 4952A** and **HP 4954A** have common operating, setup, mass store, remote transfer and display characteristics. An overview of the differences can be seen in the chart below.

### Local Area Network (LAN) Protocol Analysis

In addition to the family of three WAN protocol analyzers, Hewlett-Packard offers two versatile local area network (LAN) protocol analyzers to assist you with IEEE 802.3, Ethernet, TCP/IP, StarLAN and MAP networks.

The **HP 4972A** is a high performance protocol analyzer for managing performance and troubleshooting problems on your IEEE 802.3,



Ethernet, TCP/IP or StarLAN networks. The **HP 4974S** is a development performance tool for MAP 3.0.

**Individual product specific information can be found on the following pages.**

	HP 4951C	HP 4952A	HP 4954A
Size (HWD-cm) (HWD-inches)	16.0x27.9x34.3 cm 6.3x11.0x13.5 in.	Same As HP 4951C	19.6x42.5x56.5cm 7.7x16.7x22.2 in.
Display Size	5-in. diagonal	Same As HP 4951C	9-in. diagonal
Weight	6.7 kg (14.8 lb)	7 kg (15.4 lb)	21.17 kg (46.7 lb)
Price (typical)	\$4,400	\$7,250	\$17,000
Operating Speeds	50 bps-19.2 kbps	50 bps-64 kbps	50 bps-72 kbps
Autoconfigure	Yes	Yes	No
Data Buffer Size	32K byte	32K byte, Opt. 3/4 M byte	256K byte
Mass Storage	3.5-in. floppy	3.5-in. floppy	3.5-in. floppy 20M byte hard disc
BERT	Yes	Yes	No
SNA Decode	FID 2 only	All FID types, User definable	All FID types
SNA Testing	3270 tester	3270 tester	SNA development language, 3270 development, LU6.2 development
SNA Performance Analysis	Link level stats	Link level stats	SNA/Bisync network performance analysis
X.25 Decode	Complete	Complete, User definable, Facility decode	Complete
X.25 Testing	X.25 prewritten menu programs	X.25 test library and emulator	Monitor/Simulate
X.25 Performance Analysis	Link level stats	Link level stats	X.25 network performance analysis
DDCMP	Monitor/Simulate	Monitor/Simulate	Monitor/Simulate
X.21	—	Monitor/Simulate, Prewritten tests	Monitor/Simulate, State language
Signalling System #7	—	—	Monitor/Simulate
Programming Language	Menus	Enhanced menus	Menus



# DATA COMMUNICATIONS TEST EQUIPMENT

## Protocol Analyzers

Model HP 4951C and HP 4952A

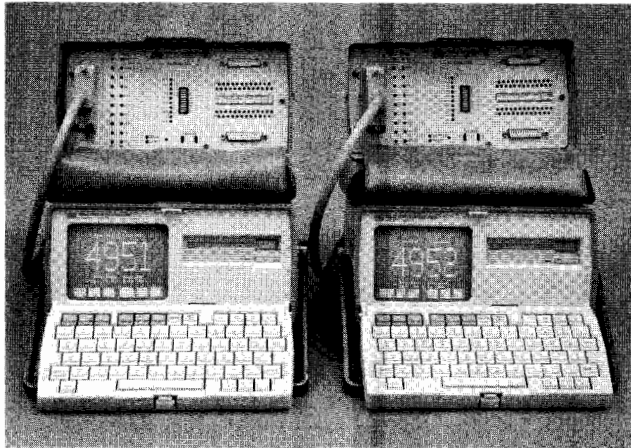

HP 4951C/HP 4952A

### HP 4951C and HP 4952A Protocol Analyzers

The HP 4951C (19.2 kbps) and HP 4952A (64 kbps synchronous) are portable protocol analyzers used for troubleshooting during installation, maintenance and design of data communication networks and equipment.

#### Applications

The HP 4951C and HP 4952A allow you to monitor and decode data transmission, test remote facilities from your location, simulate network components, and perform bit error rate tests. They can also be used as asynchronous terminals or to install and maintain 3270 equipment, and to perform link level performance analysis. Protocols that can be tested include Async, BSC, SDLC (NRZI), HDLC, X.25, SNA, DDCMP and user-defined protocols. The HP 4952A also tests X.21.

#### HP 4951C and HP 4952A Features

- **Autoconfigure** to automatically determine line parameters and to monitor data with the push of a key.
- **3 1/2" microfloppy disc** to store 618K bytes of data, timing, lead status, programs and configurations.
- **RS-170 video port** to view data externally.
- **Printouts** to all RS-232C/V.24 ASCII printers via a separate port.
- **Nonvolatile memory** to store data, programs and configurations.

#### Additional HP 4952A Features

- **64 kbps**
- **1/4M byte extended volatile capture buffer** (Option 002)
- **128K bytes nonvolatile application storage** (Option 002)
- **Unattended remote testing** except 3/4 M byte optional buffer
- **Cursor timing** to allow timing measurements to be made on screen
- **Enhanced programming features:** run time user comments, softkey triggering, subroutines
- **Buffer data filtering** to maximize capture buffer
- **Selective store to disc** to capture only events of interest
- **Complete disc copying capability**

### Datcomm Testing Solutions

#### X.25 and SNA Link Level Performance Analysis

Link level statistics packages, the HP 18333D for the HP 4951C and the HP 18264A for the HP 4952A, transform the instruments into statistical performance analyzers for the link level (level 2) of SNA and X.25 networks (SDLC and HDLC).

These solutions provide a new way for network troubleshooters to look at data communication links. Key link events indicate the health of the network and are displayed in columns. Bar charts show line utilization real time. These statistics can be stored to disc and reviewed at a later time.

#### 3270 Installation and Maintenance

If you have IBM 3270 or compatible terminal systems, you know that problems with newly installed or suspect systems can devastate hosts and users. The HP 18332D (HP 4951C) and HP 18263A (HP 4952A) 3270 installation and maintenance software packages provide easy, automatic, offline testing of multiple 3270 clusters by emulating many of the functions of a host computer.

#### Data Communications Test Library

This library of prewritten tests, is standard with every HP 4951C and HP 4952A at no additional cost. The library contains 58 general purpose monitor and simulate programs on a single 3 1/2" diskette to help you evaluate your network quickly and easily. Programs are written to diagnose common datcomm problems. The tests can be tailored for special configurations and applications. The library also contains installation and acceptance tests for printers and terminals.

#### X.25 Troubleshooting

Both analyzers provide X.25 troubleshooting. The HP 4952A also has an enhanced X.25 analysis package (HP 18266A) which allows you to create five custom X.25 decode displays. A decode is also provided to decode all components of each packet including facilities, calling/called addresses, cause and diagnostic codes, registration and call user data. The HP 18267A X.25 Test Library and Emulator provides a library of X.25 tests written in an emulator, and a procedure for using tests to troubleshoot X.25 installations.

#### Ordering Information

	<b>Price</b>
<b>HP 4951C Protocol Analyzer</b> (interface pod not included)	\$3,825

<b>Opt 101</b> HP 18174A RS-449/422A/423A interface pod	\$500
---------------------------------------------------------	-------

<b>Opt 102</b> HP 18180A RS-232C/V.24 and RS-449/422A/423A interface pod	\$900
--------------------------------------------------------------------------	-------

<b>Opt 103</b> HP 18179A RS-232C/V.24 interface pod with full breakout box	\$650
----------------------------------------------------------------------------	-------

<b>Opt 105</b> HP 18177A V.35 interface pod	\$800
---------------------------------------------	-------

<b>Opt 106</b> HP 18160A RS-232C/V.24 and V.35 interface pod	\$1,350
--------------------------------------------------------------	---------

<b>Opt W30</b> 2 Years additional hardware service	\$170
----------------------------------------------------	-------

<b>HP 18331D</b> SNA, DDCMP, X.25 analysis	\$350
--------------------------------------------	-------

<b>HP 18332D</b> 3270 installation and maintenance	\$350
----------------------------------------------------	-------

<b>HP 18333D</b> X.25 and SNA link level performance analysis	\$350
---------------------------------------------------------------	-------

<b>HP 18347A/X</b> HP 4951C training course	\$300
---------------------------------------------	-------

<b>HP 4952A Protocol Analyzer</b> (interface pod not included)	\$6,750
----------------------------------------------------------------	---------

<b>Opt 002</b> Extended memory plus	\$1,500
-------------------------------------	---------

<b>Opt 101</b> HP 18174A RS-449/422A/423A interface pod	\$500
---------------------------------------------------------	-------

<b>Opt 102</b> HP 18180A RS-232C/V.24 and RS-449/422A/423A interface pod	\$900
--------------------------------------------------------------------------	-------

<b>Opt 103</b> HP 18179A RS-232C/V.24 interface pod with full breakout box	\$650
----------------------------------------------------------------------------	-------

<b>Opt 104</b> HP 18260A X.21 and RS-232C/V.24 interface pod	\$1,000
--------------------------------------------------------------	---------

<b>Opt 105</b> HP 18177A V.35 interface pod	\$800
---------------------------------------------	-------

<b>Opt 106</b> HP 18160A RS-232C/V.24 and V.35 interface pod	\$1,350
--------------------------------------------------------------	---------

<b>Opt W30</b> 2 Years additional hardware service	\$210
----------------------------------------------------	-------

<b>HP 18261A</b> SNA analysis	\$350
-------------------------------	-------

<b>HP 18263A</b> 3270 installation and maintenance	\$350
----------------------------------------------------	-------

<b>HP 18264A</b> X.25 and SNA link level performance analysis	\$500
---------------------------------------------------------------	-------

<b>HP 18265A</b> DDCMP analysis	\$350
---------------------------------	-------

<b>HP 18266A</b> Enhanced X.25 analysis	\$500
-----------------------------------------	-------

<b>HP 18267A</b> X.25 test library and emulator	\$500
-------------------------------------------------	-------

#### HP 4951C and HP 4952A Common

##### Accessories

<b>HP 18190A</b> Soft vinyl carrying case	\$125
-------------------------------------------	-------

<b>HP 92192A</b> Box of 10 3 1/2" double sided discs	\$49
------------------------------------------------------	------

<b>HP 2225D</b> RS-232C/V.24 ThinkJet printer	\$495
-----------------------------------------------	-------

<b>9211-1291</b> Hard transit case	\$420
------------------------------------	-------

<b>HP 92204N</b> Data tracker breakout box	\$240
--------------------------------------------	-------

#### HP 4954A Protocol Analyzer

The HP 4954A is a high speed, (72 kbps) multi-protocol, expandable protocol analyzer for designing datacomm products and analyzing network performance. Softkey driven operation combined with a variety of display formats allows you to quickly and efficiently identify problems, perform tests and solve complex problems. The general purpose capability of the HP 4954A can be expanded through application software to offer enhanced capability for currently supported, or new and emerging protocols. The standard mass storage, a 20 M byte hard disc and 3.5-in. floppy, may be extended through HP-IB to literally hundreds of megabytes of on-line data storage.

#### Features

**High speed state-of-the art multiprocessor design** guarantees reliable sophisticated analysis and simulation of full duplex bit oriented protocols to 72 kbps and data capture of bit oriented protocols at lower line utilizations up to 256 kbps.

**Multi-protocol testing capabilities** allow you to monitor, analyze, and simulate popular protocols such as X.25, SNA/SDLC, Bisync, Async, DDCMP, X.75, HDLC, BSC-framed X.25, and character oriented synchronous protocols. X.21, and CCITT 7/CCS7 support is also available through easy to use application software.

**Mass storage** with an integral 20 M byte hard disc and 613K byte 3.5 in. floppy disc provide easy access to setup menus, user written programs, buffer data, application programs, and data codes. Any HP 4954A file may be autoloaded at power-on to instantly configure the protocol analyzer for your individual needs. The 4954A's mass storage capacity can be further extended through HP-IB subset 80 disc drives. Setup menus, user written programs and buffer data stored to floppy disc may be shared with the HP 4951C and HP 4952A.

**The internal 256 K byte data capture buffer** can be expanded through the integral hard disc up to 20 M bytes. Even greater data capture buffers are possible with external HP-IB driven disc drives.

**Programming flexibility** through high level protocol analysis and simulation is a standard capability of the HP 4954A. Custom measurements and tests are easy to perform with softkey driven entry of monitor and simulation programs with triggering based upon datacomm events. The HP 4954A gives you programmatic control of send strings, timers and counters.

**Electromagnetic Compatibility:** Tested for compliance with VDE 0871 Level B, radiated and conducted.

#### Datacomm Solutions

Expandability is provided with extensive application software memory which makes the HP 4954A one of the most expandable protocol analyzers available. Many software and hardware accessories are now available to broaden the HP 4954A analysis and simulation capabilities. For example, the SNA Emulation Language eases the development and testing of SNA compatible products. A variety of physical interface pods enables the HP 4954A to access the most common datacomm interfaces such as RS-232C/V.24, V.35, RS-449, and MIL-188C and X.21.

#### SNA Development System

**The HP 18360A SNA Emulation Language** is an HP 4954A software solution that is specifically designed to aid in the development of SNA compatible devices. It consists of an SNA specific softkey driven programming language combined with complete link and path control emulators. The HP 18361A SNA 3270 Device Exerciser and HP 18362A LU6.2 Node Exerciser are user-modifiable tests written in the SNA Emulation Language to thoroughly test 3270 and LU6.2 devices.

#### X.21 Development System

**The HP 18352A X.21 State Simulator** is an HP 4954A software solution that is specifically designed to aid in the development of X.21 DTEs and DCEs. It consists of an X.21 specific softkey driven programming language combined with a state level decode. This state level decode explicitly shows the current and past states of the interface in terms of the actual CCITT X.21 state number.

Included with the X.21 state simulator is the X.21 DTE analysis pack; a set of user modifiable tests written in the X.21 state simulator language that thoroughly tests an X.21 DTE for protocol conformance.

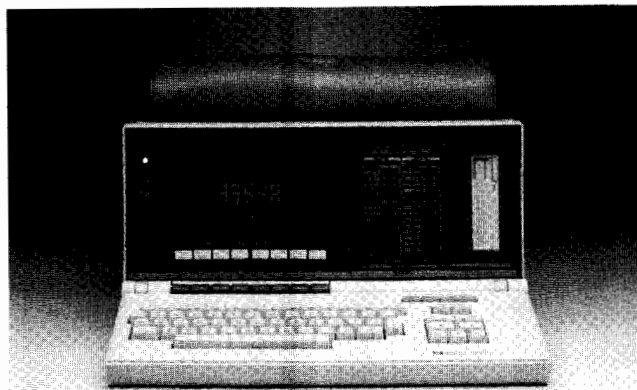

HP 4954A

#### X.25 Network Performance Analyzer

**The HP 18370A X.25 Network Performance Analyzer** is an HP 4954A software solution that gathers statistical information about the performance of an X.25 data link. The following information is available in both tabular and graphical format:

**Efficiency:** Throughput, Utilization, Packets/Seconds, and Data Packet Size

**Error and Incidents:** Link Setups, Link Disconnects, Bad FCSs, Abort Sequences, REJ Frames, FRMR Frames, Resets, Restarts, and Unsuccessful Calls

**Response Times:** Link Setup, Link Disconnect, Call Setup, Call Clear, Reset, and Restart

#### SNA/Bisync Network Performance Analyzer

The HP 18371A SNA/Bisync network performance analyzer consists of two software programs designed to aid in the management of IBM and IBM compatible data networks. Statistical information can be gathered about the performance of an SNA or Bisync data link. When analyzing an SNA data link, the following information is available in both tabular and graphical format:

• **Utilization:** Session Control BIU, Data Flow Control BIU, Function Management Data BIU, Total BIU, and Total Line Utilization.

• **Error and Incidents:** Bad and Aborted Frames, Rejects, Frame Rejects, Negative Response RUs, Link Setups, Link Disconnects, Binds, Unbinds, and Sense Data of a definable value.

• **Response Times:** System Response, Confirmation Response and Transaction Response.

Similar bisync related measurements are provided when analyzing a bisync data link.

#### Physical Specifications

##### Dimensions

44.9 cm x 43.1 cm x 55.8 cm (7.75 in. x 17 in. x 22 in.) Rack mountable

##### Weight

20 kg (44 lb)

#### Ordering Information

HP 4954A: Protocol Analyzer (interface pod not included)	Price
Opt. 100 Adds RS-232C/V.24 interface pod	\$1,150
Opt. 101 Adds RS-449 interface pod	\$1,150
Opt. 102 Adds V.35 interface pod	\$1,450
Opt. 103 Adds MIL-188C interface pod	\$1,150

#### Application Software

HP 18352A X.21 State Simulator	\$3,500
HP 18353A Password Security	\$450
HP 18355A CCITT#7/CCS7 Analysis	\$900
HP 18360A SNA Emulation Language	\$2,500
HP 18361A 3270 Device Exerciser	\$1,000
HP 18362A LU6.2 Node Exerciser	\$2,000
HP 18369A Asynchronous Terminal Emulator	\$300
HP 18370A X.25 Network Performance Analysis	\$1,200
HP 18371A SNA/BSC Network Performance Analysis	\$1,200

# DATA COMMUNICATIONS TEST EQUIPMENT

## LAN Protocol Analyzers

Model HP 4972A and HP 4974S/A



HP 4972A

### HP 4972A LAN Protocol Analyzer

The HP 4972A is a high-performance protocol analyzer for managing performance and for troubleshooting problems on your IEEE 802.3, Ethernet, or StarLAN local area network. The HP 4972A provides accurate and complete information under all operating conditions.

#### Performance Measurement

To assist in the management of network performance, the HP 4972A provides statistical information on network, node and connection levels. Errors and other operating parameters are measured and counted for each node. Automatic test sequences make it easy to set up long term tests and repeat the tests at regular intervals. A background traffic generator allows you to measure network performance under different loading conditions, and thereby anticipate and plan for future growth. Graphical displays (color with option) make your network activity easy to understand. The performance management software will help you fine-tune your Ethernet, IEEE 802.3 and StarLAN networks.

#### Troubleshooting Features

- **Softkey guided programming language** to write application programs and to selectively capture frames from the network. It makes programming easy even for the first time user. Network conditions can be tested and logged to disc for further evaluation.
- **20M byte internal disc** to store test setups, programs and statistical or frame data.
- **Hardcopy output** of all displays with an HP 2225A ThinkJet or HP 3630A PaintJet (color) printer.
- **Optional remote interface** to control the analyzer or transfer files with another HP 4972A or IBM PC-compatible via RS-232C/V.24 link.
- **Upper layer protocol analysis tools** to provide protocol decodes and performance measurements for upper layer protocols of TCP/IP and other protocols.

#### Physical Specifications

**Dimensions:** 44.9 x 43.1 x 55.8 cm (7.75 x 17 x 22 in.)

**Weight:** 19 kg (42 lb)

#### Ordering Information

HP 4972A Protocol Analyzer	Price
Opt 011 RGB color video outputs	\$17,000
Opt 002 Remote interface (RS-232C/V.24)	\$1,500
Opt 005 StarLAN (Daisy-chain interface)	\$600
Opt 908 Rack mount kit	\$500
HP 18221A TCP/IP protocol analysis pack	\$30
	\$To Be Announced



HP 4974S

### HP 4974S MAP Protocol Analyzer

The HP 4974S is an HP Vectra-based protocol analyzer for testing and debugging MAP communications software. The analyzer connects directly to IEEE 802.4 broadband or carrierband networks. Frames are captured as they occur on the network and decoded in accordance with the MAP protocol specifications.

Protocols supported by the MAP protocol analyzer include IEEE 802.4, IEEE 802.2 Link Layer, ISO Network, ISO Transport Class 4, ISO Session, ISO Presentation, ACSE, FTAM, MMS, DS and NM.

#### Applications

The HP 4974S MAP protocol analyzer provides an independent view of protocol events and a summary representation of protocol data unit header values. This time-saving information is helpful in network troubleshooting situations.

Interoperability testing is easier when protocol data units from two dissimilar devices are viewed in the same format.

Communications software debugging is faster when protocol transactions can be seen as they appeared on the network.

Configuration and integration of equipment is simplified by viewing exchange negotiation and configuration values as they affect your network.

Common protocol and configuration mismatches are identifiable - often saving hours of guesswork and experimentation.

#### Ordering Information

The HP 4974S can be ordered as a complete system, or the MAP interface equipment and software can be ordered for installation in a PC/AT compatible computer.

**HP 4974S MAP Protocol Analyzer System** **Price**  
**HP 4974A Protocol Analyzer** \$To Be Announced

**Includes:** HP MAP analysis software  
 HP MAP network interface card  
 HP MAP network interface pod  
 Vectra windows

**HP D1342A Vectra ES/12 PC, Model 42** \$4,690

**Includes:** 640K byte RAM, 5/4" 1.2M byte flexible disc, flexible disc controller, 40M byte hard disc, hard disc controller, serial/parallel interface, HP-HIL port, HP terminal program, IBM compatible keyboard, EGA card, system documentation.

**HP 45951B Vectra DOS 3.2** \$95

**HP 35743A EGA display** \$845

**HP 46060A HP mouse** \$148

**HP 45944A Vectra ES/12 expanded memory card**

**Opt 001 2M byte expanded memory** \$1,695

# DATA COMMUNICATIONS TEST EQUIPMENT

Signaling Test Set  
Model 37900A/B

515

- A powerful test solution for No. 7 Common Channel Signaling
- Non-intrusive monitoring and analysis of signaling link data
- Level 3 & 4 decoding of data to CCITT-defined mnemonics and descriptions
- Programmable No. 7 device emulation using SDL language commands

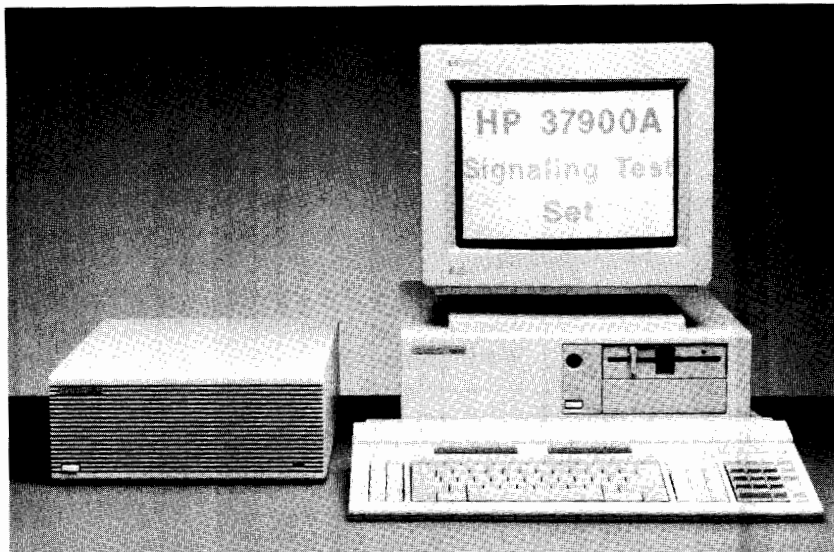

HP 37900A/B



## Description

The HP 37900A/B Signaling Test Set is a high-performance solution for testing the demanding CCITT No. 7 Common Channel Signaling protocol (Signaling System No. 7). The powerful multi-processor design consists of three major elements:

**Signaling link processor** - containing the modular interfaces and the Signaling System No. 7 Level 1 & 2 processors;

**Controller** - providing data processing and storage; and

**Software** - giving "user friendly" displays to control the extensive measurement/analysis features and configure the modular interfaces.

**Major features** - non-intrusive monitoring and recording of signal units from up to four signaling links (37900B) optional interfaces for datacom and telecom application; real-time and post analysis of No. 7 data; level 3/4 data display with decoding; and emulation for response testing or simulation of No. 7 devices.

## Assessing No. 7 network performance

Troubleshooting and assessing the efficiency of No. 7 signaling links is achieved by using the HP 37900A/B to non-intrusively monitor signaling links and record No. 7 signal units. Real-time analysis of the signaling data, with dynamic display of loading levels and error rate, allows problems to be assessed quickly. Accurate performance measures are obtained by analyzing recorded data to provide statistical reports of signaling message types, signal unit loading levels, and error types/rates. Easily defined triggers and filters simplify troubleshooting faults by ensuring only the data of interest is captured. Understanding recorded signaling data is simplified by automatic decoding of level 3 (message transfer part) and level 4 (user part) messages to CCITT-defined mnemonics or descriptions. Many search and display features aid examination of recorded data, thus reducing both evaluation time and troubleshooting effort.

## Improving test efficiency

Conducting commissioning, acceptance, qualification, conformance or production tests on No. 7 equipment can be labour intensive and time consuming. By programming the HP 37900A/B to automatically carry out test procedures, test time will be reduced and productivity increased. Programs are written in specification and description language (SDL) commands, standardized by the CCITT to simplify definition of device interactions.

Stimulating No. 7 equipment during response tests requires sending message signal units (MSUs) containing specific signaling information. The HP 37900A/B allows creation of named MSUs with user-selectable Level 3 & 4 content. Lower level functions, like signaling link alignment and error control, are handled automatically by the signaling link processor. Created MSUs can be transmitted or used to verify the data in responses.

The HP 37900A/B generates reports of the message interactions during response tests allowing documentation of test performance or fault tracing.

## Developing new designs faster

The cost and time involved in developing new designs can be reduced by programming the HP 37900A/B to emulate the operation of the new software or hardware. New designs can easily be tested in realistic network conditions by programming the HP 37900A/B to emulate the network responses of signaling points (SPs), signaling transfer points (STPs), service switching points (SSPs) or signaling control points (SCPs). The performance of new designs can also be verified using the HP 37900A/B to perform loading or other "stress" tests like error handling.

## Ordering Information

Please contact your local Hewlett-Packard Sales & Support Office. See page 771.

# DATA COMMUNICATIONS TEST EQUIPMENT

## General Information: Data and Voice Testing

### Data Network Testing

There are a wide variety of tests that can be made on a data communications system. Depending on the point in the system at which the tests are made, quite different philosophies and techniques apply.

Protocol analysis is usually concerned with overall network performance, determined through monitoring or simulating network software (protocol and/or data). Digital testing involves measuring modem-channel-modem efficiency in terms such as Bit Error Rate (BER) and Block Error Rate (BLER). Analog testing measures the tariffed and other key parameters of the transmission line itself.

The interrelationships of these measurement results are complicated and difficult to understand. For example, how is envelope delay distortion of the line related to the BER or the throughput of the system? Generally speaking, the three measurement techniques are related in a hierarchical fashion. Nonintrusive network monitoring by protocol analyzers gives an indication of overall performance and can often isolate problems to the component or section. When monitoring is insufficient, such as during software debugging or systems integration, protocol analyzers also can be used to simulate network components such as front-end processors or terminals. Once sectionalized, BER testers are used to verify and quantify the link dysfunction, and analog measurements determine which tariffed parameter is out of specification should the telephone line be the problem.

Combined protocol, digital, and analog tests can be used synergistically to restore the network quickly and efficiently. Protocol Analysis has been previously described. The next sections detail the analog and digital testing.

### Digital Measurements

Data error analyzers are used to test the quality of both the modem and the transmission facility. They provide information about the modem and transmission line, but no information about the DTE they replace.

The overall quality of the link is indicated by its BER. A good link will have an error rate better than  $1 \times 10^{-5}$  per bit. This measurement will include the effect of both transmission line impairments and the modem's ability to overcome them. Modems vary widely in their sensitivity to line impairments. Low speed (less than 300 bps) and adaptively equalized modems are less sensitive than high speed (more than 4800 bps) and non-adaptively equalized modems.

Since data communications systems transmit data and control information in blocks, these instruments also measure BLER and Percent Error Free Seconds (%EFS). BER, BLER and %EFS can be used together to examine the statistics of the error mechanism.

If the BER and BLER are both high, and %EFS low, the impairment is random and probably due to noise. If the BER and %EFS are high but the BLER is low, the impairment is more bursty. This happens when lines are switched, synchronization is temporarily lost, or impulse noise is too high.

		In-Service Testing	Bell	Basic Testing							Conditioned Circuit Testing			Additional Testing for Complete Troubleshooting					
				V.A.I.F	Loss Continuity	Noise Loss vs. Freq.	Signal/Noise Ratio	Impulse Noise	Wideband Impulse Noise	P/AR	Envelope or Group Delay	Attenuation Distortion	NLD or Intermodulation Distortion	Phase Jitter	Amplitude Jitter	Hits Dropouts	Return Loss	Loop Holding	Signaling Testing
Instruments	3551A																		
	4935A																		
	4937A																		
	4938A																		
	4947A																		
	3776B*																		
	4945A																		
	3552A																		
	4936A																		
3776A*																			
4948A**																			
Private Line Access & Test System	37100S*																		

\*Information about the HP 3776A, HP 3776B and HP 37100S can be found in the Telecommunications Test Equipment section.

\*\*In-service Testing is discussed in the description of the HP 4948A in this section.

Error rates are quantitative checks of the data communications system that can be made in a few minutes. If the system is bad, diagnostic measurements are provided to help isolate the problem. Dropouts, clock slips, error skew, jitter, and total peak distortion indicate some of the problems that can occur with a modem or on a link. These measurements are made simultaneously with the error rate measurements and can be printed out in automatic unattended mode if desired.

Catastrophic failures can usually be found with self-tests and loop-back switches built into the modem. Data error analyzers can find failures that are not illuminated by internal self-tests.

Modem dynamics are another source of data transmission problems. Modern modems have automatic equalization circuits to compensate for telephone line distortions. It is important to let the equalization process settle, particularly with switched carrier modems, so data is not transmitted too soon.

Measurements that verify modem dynamics are RTS-CTS delay and modem start up tests such as ping-pong.

### Analog Impairments Affect Performance

Analog impairments on the telephone line can significantly affect the efficiency of data communications. What the user notices is a slow down in throughput (because of frequent retransmission of blocks of data), gar-

bled data or no data at all. These effects are a result of the line impairments distorting the modem signal so that the receiving modem cannot make correct decisions. Data bits and blocks are received in error.

The various modem types are susceptible to each impairment in differing degrees. Low speed modems generally use simple modulation schemes and are mostly affected by problems of *continuity, loss, signal-to-noise ratio, and impulse noise*.

As modem speeds increase, the modulation schemes become more complex and so they are more susceptible to impairments. Automatic equalization helps take care of bandwidth reduction, and envelope (group) delay distortion problems. But to significantly reduce the impairing effects and improve error performance, specially selected and conditioned leased telephone lines are used.

A number of levels of conditioning are available to suit the circuit to the speed of the modem, each tariffed at a different rate. Conditioning can minimize noise, hits, dropouts, phase jitter, non-linear (inter-modulation) distortion, bandwidth reduction and envelope (group) delay distortion.

So there is a need for testing: by the circuit supplier, when he installs or repairs a conditioned circuit, to check if impairment levels are within the agreed limits; by the circuit user, to ensure he is getting the quality of circuit he is paying for.



# DATA COMMUNICATIONS TEST EQUIPMENT

## Transmission Impairment Measuring Sets

Model 4945A, 4947A

517

### HP 4945A

- Complete analog testing to North American standards for: voice grade data circuits, program circuits, metallic digital circuits
- Versatile I/O for systems use
- Master/Slave capability for flexible end-to-end testing

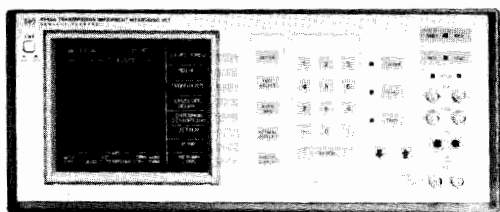

RS 232



HP 4945A

### HP 4947A

- Voice grade data circuit testing to North American Standards
- High performance at an affordable price
- Automatic sequence for end-to-end testing

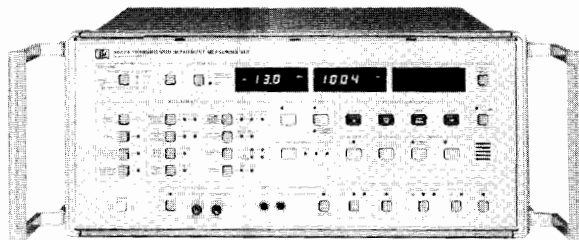

HP 4947A

### HP 4945A Product Description

In one portable package, the HP 4945A Transmission Impairment Measuring Set provides the complete set of measurements needed to install, maintain and troubleshoot circuits for voice, data or broadcast transmission up to 110 kHz and local distribution of digital data services up to 56 kbit/s. All measurements are compatible with Pub 41009 and IEEE 743-1984 and are listed in the table below. The use of softkeys makes the HP 4945A extremely flexible while maintaining ease of operation.

### Full Master/Slave Capability

The HP 4945A has Master/Slave capability for remote control and data collection. Master/Slave saves time and money. This HP pioneered and patented technique allows the master HP 4945A to completely and flexibly control and collect data from the remote slave HP 4945A over the lines under test, so that end-to-end tests can be run automatically from the master instrument.

### Versatile Remote Control and Hardcopy

The HP 4945A lends itself to a systems environment by providing three remote control interfaces, HP-IB, HP-IL, and RS-232-C as accessory modules. These modules also provide you with date and time stamped hardcopy results on HP-IB, HP-IL or RS-232-C printers.

Measurement	HP 4945A	HP 4947A
Level/Frequency	to 110 kHz	to 5 kHz
Attenuation Distortion	yes	yes
Intermodulation Distortion	yes	yes
Envelope Delay Distortion	yes	yes
Gain Slope	yes	yes
Signal-to-Noise & Notched Noise	yes	yes
Message Circuit Noise & Noise-to-Ground	yes	yes
Noise Filters:		
C-Message & 3 kHz	yes	yes
15 kHz, Program, 50 kbit	yes	no
P/AR	yes	yes
2/4-Wire Return Loss:		
ERL, SRL Hi, SRL Lo	yes	yes
Sinewave	yes	no
Equal Level Echo Path Loss	no	yes
Phase Jitter	yes	yes
Amplitude Jitter	yes	no
Gain Hits, Phase Hits, Dropouts	yes	yes
3-Level Impulse Noise	yes	yes
Impedance	135/600/900/1200	600/900/1200

\* The Intermodulation Distortion technique is licensed under Hekimian Laboratories, Inc. US Patent No. 3862380

### HP 4947A Product Description

The HP 4947A Transmission Impairment Measuring Set (TIMS) is a test set with the high measurement capability required to test a long distance data circuit. With built-in DTMF dialing and many other time and labor saving features it offers high productivity in line testing. Its operation is modeled on the proven HP 4935A TIMS which makes it simple to use. Its measurement methods are in accordance with IEEE 743-1984 and are listed below.

### Easy End-to-End Testing

The HP 4947A has a simple solution for fast, trouble-free end-to-end testing. You only need to use two HP 4947As and the circuit under test. With a couple of keystrokes you can run a sequence of tests which measure all the key data transmission parameters. And the system is robust enough to support remote start-up and auto restart on power failure or signal loss. Each HP 4947A stores the results of its own measurements in non-volatile memory. Later, results can be dumped to a printer or controller, or read from the display.

The measurements made in the sequence are: P/AR, Gain Slope, Frequency, Noise with Tone, S/N, Idle Channel Noise, Intermodulation Distortion (both uncorrected and corrected for S/N), Level, Frequency, Phase Jitter, Phase and Gain Hits, Dropouts and Impulse Noise.

### Print/Plot to HP ThinkJet

The HP 4947A can print results on a HP ThinkJet, and can even generate plots using its graphics mode. You can record graphs of EDD, level and attenuation vs frequency.

### Ordering Information

**HP 4945A Transmission Impairment Measuring Set** \$16,300

#### Measuring Set

**Option 001:** 100/200 Volt operation \$0

**Option 101:** Adds HP 18162A HP-IB module \$540

**Option 102:** Adds HP 18163A RS-232-C module \$540

**Option 103:** Adds HP 18165A HP-IL module \$380

**Option 104:** Adds HP 18169A 19" rack mount kit \$80

**Option 105:** Adds HP 18170A soft vinyl case \$220

#### HP 4947A Transmission Impairment Measuring Set

\$8,900

**Option 908:** 19" rack mount kit \$40

**Option 910:** Extra set of manuals \$50

#### Accessories for HP 4945A and HP 4947A

**HP 18176A:** 23" rack mount kit HP 4945A \$175

**HP 18182A:** 1.5m cable with Weco 310 to alligator clips \$65

**HP 15513A:** 1m cable with Weco 310s on each end \$55

**9211-2850:** Hard transit case for HP 4945A or HP 4947A \$480



# DATA COMMUNICATIONS TEST EQUIPMENT

## In-Service Transmission Impairment Measuring Set Model 4948A

- Voice-grade data circuit testing - without disturbing traffic
- True preventive maintenance
- Network management information - without special modems
- Suitable for North American and CCITT environments

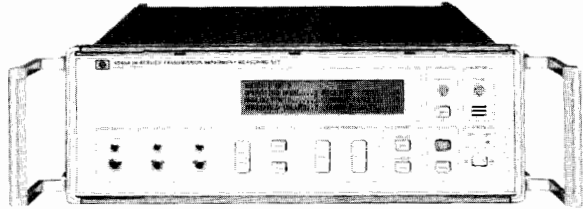

HP 4948A



### Description

The HP 4948A is a unique Transmission Impairment Measuring Set (TIMS) which lets you test data circuits carrying voice grade modem traffic while they are still in service. This opens up new cost-saving test strategies for managing data circuits.

A simple connection to the data circuit carrying the modem signal, at a voice frequency access point, is all that is required for the HP 4948A to measure the impairments that have been added between signal generation and the measurement point.

The HP 4948A is very simple to use: with one keystroke the HP 4948A can automatically identify the modem type and measure all the transmission impairments simultaneously. It remembers all the previous test conditions so no time need be wasted setting up a test, and flexible printout capabilities let you document test results with ease.

### The HP 4948A Simplifies Testing

The HP 4948A lets you see if the analog signal is good where you are testing. Because you are measuring on the live modem signal, only one instrument need be used, which removes the problem of coordinating an end-to-end test. This helps you quickly establish who has the responsibility to repair a fault in today's multi-vendor networks.

You can respond to trouble reports immediately without taking the line from service. The HP 4948A sees the line like a modem sees it (same bandwidth, same response) letting you identify the impairments that are really causing data errors. All the impairments are measured at the same time so you can quickly recognize the real problem. With the HP 4948A you can implement a preventive maintenance policy and routinely check lines against a benchmark while the circuits are still operating. You will see any degradations and be able to clear problems before they cause data errors. Testing can be done at convenient times, even when the circuits are under most stress.

All the capability of the HP 4948A can be remotely controlled and can be used to build a network monitoring system. The HP 4948A is an economic means of producing accurate data for private network management - even for small networks, or networks using a variety of modem types.

### Networks

You can use the HP 4948A at any point along a datacommunications circuit. In multi-point circuits, testing the host-to-slave link is as easy as testing a point-to-point circuit. To test a slave-to-host link, the slave modem must be transmitting data while the HP 4948A analyzes the signal.

### Measurement Capability

Level Frequency S/N Phase Jitter [4-20Hz, 20-300Hz] Amplitude Jitter [4-20Hz, 20-300Hz]	Dropouts Gain Hits Phase Hits Impulse Noise	On modem signals only: Attenuation Distortion Delay Distortion
-----------------------------------------------------------------------------------------------------------	------------------------------------------------------	----------------------------------------------------------------------

The results are all computed simultaneously, with the received signal constellation available from the rear panel XY outputs.

### Compatible Modems

The HP 4948A has been designed to operate with many of the common high speed modems in use to-day.

Data rate	Compatible Modem Types (4-Wire) - Examples
14400 bp/s (optional)	CCITT V.33 (Trellis coded) V.33 with 1700 Hz carrier
960 bp/s	CCITT V.29, AT&T 209, AT&T 2096 V.29 with 1800 Hz carrier 4x4 QAM with 1700 Hz carrier
4800 bp/s	CCITT V.27, AT&T 208, AT&T 2048
2400 bp/s	CCITT V.26 A&B, AT&T 201 B&C

NOTE: It is expected that further schemes will be added to this list.  
AT&T is a trademark of the American Telephone and Telegraph Company.

### Measuring Impairments on a Modem Signal

The HP 4948A measures the effects of the same line impairments that are measured by a conventional, intrusive TIMS. A TIMS measures the effects on a simple known signal (tone) but the HP 4948A measures the effects on the full bandwidth of the transmitted modem signal. In addition, the HP 4948A measures impairments as a modem would see them. From these measurements the HP 4948A predicts conditions on the line and presents its results in conventional form. In most practical situations, the results from the HP 4948A are very similar to those from a TIMS. However, they cannot be directly equated because of the different techniques involved.

### Data Logging

Result data can be stored in the test set's own internal non-volatile memory for later interrogation and printout. The HP 4948A can be left unattended for long periods monitoring a line. This lets you trap intermittents or comprehensively characterize a circuit's performance over time.

### Out-of-Service Testing

The HP 4948A can transmit and measure on a tone, so it can interwork with tone sources and conventional test sets. It can also transmit a simulation of a high-quality modem signal of each of the compatible modem types. This allows out-of-service testing and circuit benchmarking with another HP 4948A.

### Ordering Information

	Transmit & Receive Connectors	
	WECO 310 & Bantam	Siemens 3-pin
Stand-alone front connectors adjustable legs	HP 4948A Standard	HP 4948A Option 003
For rack mounting front connectors flat base	HP 4948A Option 001	HP 4948A Option 004
For rack mounting rear connectors flat base	HP 4948A Option 002	HP 4948A Option 005

<b>Option 006:</b> 14.4 kbit/s V.33 capability	\$1000
<b>Option 908:</b> 19" rack mount kit	\$32.50
<b>Option 910:</b> Extra set of manuals	\$60
<b>9211-2661:</b> Hard transit case	\$550

### HP 4948A In-Service Transmission Impairment Measuring Set

\$13,300

# DATA COMMUNICATIONS TEST EQUIPMENT

## Bit Error Rate Test Set, Data Error Analyzer

Models 4925B, 1645A

519

- Test up to 72 kb/s
- Choice of RS-232-C/V.24 with breakout box or V.35 interface
- Handheld, only 3 lbs with batteries

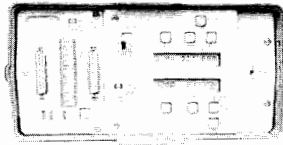

HP 4925B

### HP 4925B Description

The HP 4925B is more than just a bit error rate test set. In addition to the standard bit and block error tests, the HP 4925B measures errored seconds, percent error-free seconds, timing delay, and parity errors over both RS-232-C/V.24 and V.35. Now complete data testing to 72 kb/s is available making the HP 4925B ideally suited for complete DDS testing.

Increased flexibility is afforded by a complete breakout box. You can manipulate and monitor individual signal lines on the RS-232-C/V.24 interface or crosspatch any line from the DCE side of the interface to the DTE side of the interface. The HP 4925B also transmits the FOX message to terminals and printers. Three separate start-up tests enable dynamic testing of modems. This makes the unit extremely useful in isolating faults related to automatic equalization.

### HP 4925B Specifications

**Data Rates:** 75, 110, 134.5, 150, 200, 300, 600, 1200, 1800, 2400, 3600, 4800, 7200, 9600, 14400, 19200 bps for asynchronous systems (framed and unframed) or synchronous systems where the HP 4925B provides the clock. Up to 72 kb/s for synchronous systems.

**Patterns:** 63, 511, or 2047 bit pseudo-random binary sequence, FOX message.

**Bit Error Testing:** simultaneous detection of bit errors, block errors and errored seconds.

**Parity Error Analysis:** characters analyzed for odd or even parity errors.

**FOX Message Transmission:** use a 5-bit baudot code, 6-bit EBCDIC code, 7-bit ASCII code, or 8-bit EBCDIC code.

#### Character Oriented Network Testing

Data: 5, 6, 7 or 8 bits/character. Parity: Odd, Even, or None.

#### Detection and Annunciation of Dropouts and Clock Slips

##### RTS-CTS Delay Time

**Resolution:** 1 ms. **Maximum Reading:** 999 ms.

**Accuracy:**  $\pm 4\%$  of reading.

**Startup Testing:** end-to-end test, loopback, Bell 208B modem.

**Power:** six 9-volt alkaline transistor batteries; battery life exceeds 50 hours using RS-232-C/V.24 only. AC module (HP 18185A) or (HP 18194A) recommended for use with V.35 interface.

**Weight:** 1.5 kg (3 lb) with batteries.

**HP 18183A Interface/Breakout Box (RS-232-C/V.24):** hard-wired activity indicators for TD, RD, TC, RC, DTR, DSR, RTS, CTS, CD, RI; one non-dedicated mark/space tri-state activity monitor.

**HP 18184A V.35:** interface provides the physical level interface for data circuits operating to 72 kb/s.

### Ordering Information

HP 4925B Bit Error Rate Test Set (does not include interface)	\$1280
<b>Option 001:</b> Adds HP 18192A carrying case	\$115
<b>Option 101:</b> Adds HP 18183A RS-232-C/V.24 interface	\$410
<b>Option 102:</b> Adds HP 18184A V.35 interface and HP 18185A 115V power module	\$600
<b>Option 104:</b> Adds HP 18184A V.35 interface and HP 18194A 220V power module	\$640
<b>Option W30:</b> 2 Years Additional Hardware Service	\$30

- Test up to 5 Mb/s
- 6 simultaneous measurements
- Choice of interfaces

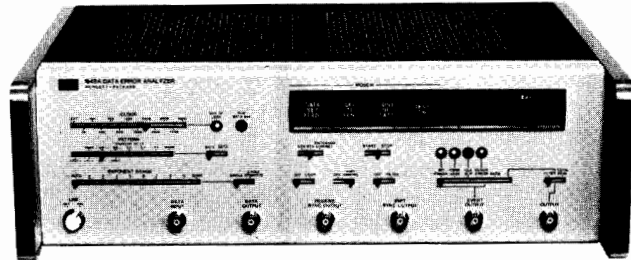

HP 1645A

### HP 1645A Description

Hewlett-Packard's Model 1645A Data Error Analyzer quickly isolates data communications link problems through six simultaneous measurements. During test, the HP 1645A can be left totally unattended because it automatically maintains synchronization even in the presence of dropouts.

Bit-error and block-error rate tests are autoranged and displayed directly on an LED readout; there is no need to perform any calculation. Additionally, the HP 1645A measures jitter or total peak distortion (the sum effect of jitter and bias), counts the number of times carrier loss or dropouts occur, measures data error skew, and counts the number of clock slips resulting from phase hits or modem synchronization problems.

### HP 1645A Specifications

#### Transmitter and Receiver Bit Rate

**Asynchronous Modem Operation:** selectable 75, 150, 200, 300, 600, 1200, 1800, 2400, 3600, 4800, 7200, 9600 b/s.

**Synchronous Modem Operation:** to 5 Mb/s. (Modem supplies transmit and receive clocks).

#### Indicators

Out of lock; received data inverted; bit error; carrier loss; clock slip; block error; Data Set Ready (DSR); Clear To Send (CTS); loss of data; test on.

#### General

**Power:** 115 or 230 Vac, 48 to 440 Hz, 150 VA max.

**Dimensions:** 133 H x 425 W x 286 mm D (5.25 x 16.75 x 11.25 in.).

**Weight:** net, 8.2 kg (18 lb); shipping, 10.9 kg (24 lb).

**Accessories Supplied:** one 3 m (10 ft) RS-232-C/V.24 interconnecting cable to connect the HP 1645A to the modem (HP P/N 01645-61605), one 2.3 m (7.5 ft) 3-wire power cord (HP P/N 8120-1378); one Operating and Service manual.

### Ordering Information

HP 1645A Data Error Analyzer	\$5100
<b>Interfaces</b>	
HP 10387A: for Type 303 modems (with cable)	\$770
HP 10388A: for CCITT V.35 (with cable)	\$610
HP 10389A: Breakout Box (RS-232-C/V.24) (with cable)	\$430
HP 18063A: RS-449 interface (with cable)	\$390

### HP 4925B

#### Accessories

HP 18183A: RS-232-C/V.24 interface	\$410
HP 18184A: V.35 interface	\$480
HP 18185A: 115V power module	\$120
HP 18191A: Rack mount	\$190
HP 18192A: Carrying case	\$110
HP 18194A: 220V power module	\$160

# DATA COMMUNICATIONS TEST EQUIPMENT

## Transmission Impairment Measuring Sets (TIMS)

Models HP 4935A/4936A HP 3551A/3552A

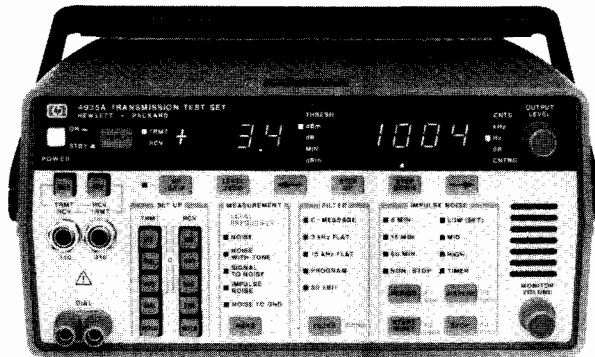

HP 4935A

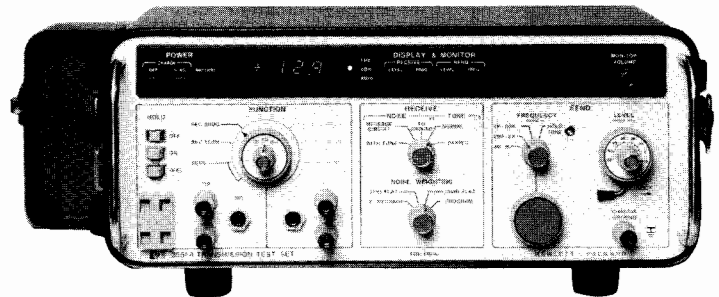

HP 3551A

### Product Description

#### Qualify Circuits for Voice, Data or Program

The HP 4935A/4936A Transmission Impairment Measuring Sets and the HP 3551A/3552A Transmission Test Sets are rugged, portable test sets that provide the basic analog tests to isolate faults and to qualify circuits for voice, data, and broadcast service. In addition, the HP 4935A, with its 110 kHz bandwidth, performs the required tests to qualify the local loop for Digital Data System (DDS) up to 56 kbps. The Peak-to-Average Ratio (P/AR) measurement option on the HP 4935A gives users a powerful, yet simple measure of the combined factors that affect the overall data transmission quality of the line.

#### Different Instruments for Different Standards

The HP 4935A and HP 3551A perform measurements compatible with the Bell standards (BSTR 41009) and IEEE standards (IEEE 743-1984). These standards are primarily used in North America. The HP 4936A and HP 3552A are compatible with the recommendations of the CCITT.

#### HP 4935S Data Transmission Test System

The HP 4935S combines the analog test power of the HP 4935A with the compact, yet powerful digital test abilities of the HP 4925B to form a complete data installation and maintenance tool. This is especially useful for those technicians who have both analog and BERT test needs. See page 00.00 for more information.

#### Capability Summary

##### HP 4935A/4936A

##### Measurements

##### Level

##### Frequency

##### Circuit Noise

##### Noise-with-Tone

##### Signal-to-Noise Ratio

##### 3 Level Impulse Noise (quiet) ('36A)

##### 3 Level Impulse Noise (with tone)

##### Noise-to-Ground ('35A)

##### P/AR (option '35A)

##### Ranges

Trans. Level: -40 to +13 dBm

Trans. Freq.: 20 Hz to 110 kHz

Rec. Level: -60 to +13 dBm ('35A)  
-70 to +13 dBm ('36A)

Rec. Freq.: 20 Hz to 110 kHz

##### Message Circuit Noise

(600 and 900 ohm): 0 to 100 dBrn ('35A)  
-90 to +10 dBm ('36A)

##### Noise-with-Tone:

(600 and 900 ohm): 10 to 100 dBrn ('35A)  
-80 to +10 dBm ('36A)

Noise-to-Ground: 50 to 130 dBrn ('35A)

Signal-to-Noise Ratio: 10 to 45 dB

##### Impulse Noise Threshold:

30 to 109 dBrn ('35A)  
-60 to +16 dBm ('36A)

Impulse Noise Separation: 4 dB ('35A)  
3 dB ('36A)

P/AR Range: 0 to 120 P/AR units ('35A)

##### General

Impedances: 135, 600, 900 ohms ('35A)  
150, 600, 900 ohms ('36A)

##### Filters

##### 4935A:

##### C-Message

3 kHz flat

Program

15 kHz flat

50 kbit

1010 Hz notch

##### 4936A:

##### Psophometric (P.53)

275-3250 Hz flat (0.71 impulse noise)

Sound unweighted (J.16)

Sound weighted (J.16)

820 Hz notch (1020 Hz optional)

Size: 127 x 279 x 381 mm (5.0 x 11.0 x 15.0 in.)

Weight: 5.0 kg (11 lb), 6.5 kg (14 lb) with battery

##### 3551A/3552A:

##### Measurements

##### Level

##### Frequency

##### Circuit Noise

##### Noise-with-Tone

##### Noise-to-Ground

##### Range

Trans. Level: -60 to +10 dBm

Trans. Freq.: 40 Hz to 60 kHz

Rec. Level: -70 to +15 dBm

Rec. Freq.: 40 Hz to 60 kHz

##### Message Circuit Noise:

0 to 85 dBrn ('51A)

-90 to -5 dBm ('52A)

##### Noise-with-Tone:

(600 and 900 ohm) 10 to 85 dBrn ('51A)  
-80 to -5 dBm ('52A)

Noise-to-Ground: 40 to 125 dBrn ('51A)

-50 to +35 dBm ('52A)

##### General

Impedances: 135, 600, 900 ohms ('51A)  
150, 600, 900 ohms ('52A)

##### Filters

##### 3551A:

##### C-Message

3 kHz flat

Program

15 kHz flat

##### 3552A:

##### Psophometric

3 kHz flat

Program

15 kHz flat

1010 Hz notch

Size: 159 H x 368 W x 273mm D (6.3" x 14.5" x 10.8")

Weight: 6.6 kg (14 lb)

#### Ordering Information

HP 3551A Transmission Test Set \$4,000

HP 3552A Transmission Test Set \$4,700

(CCITT)

HP 4935A Transmission \$3,500

Impairment Measuring Set\*

Option 001: Adds Rechargeable \$370

Battery Pack

Option 002: Adds P/AR \$150

Measurement in place of Noise-to-

Ground \$450

Option 003: Adds both Battery \$450

Pack and P/AR, deletes Noise-to-

Ground \$30

Option 910: Adds extra HP 4935A \$30

Operating and Service Manual

HP 4936A Transmission \$4,500

Impairment Measuring Set

Option 001: Includes 820 Hz tone \$520

with rechargeable Battery Pack

Option 002: 1020 Hz tone NC

Option 003: Includes 1020 Hz tone \$520

with rechargeable Battery Pack

Option 910: Adds extra HP 4936A \$40

Operating and Service Manual

\* There are quantity discounts on 5 or more of the HP 4935A

# DATA COMMUNICATIONS TEST EQUIPMENT

## Network Circuit Access Test Set, Transmission Impairment Measuring Set

Models 4938A/4937A

521

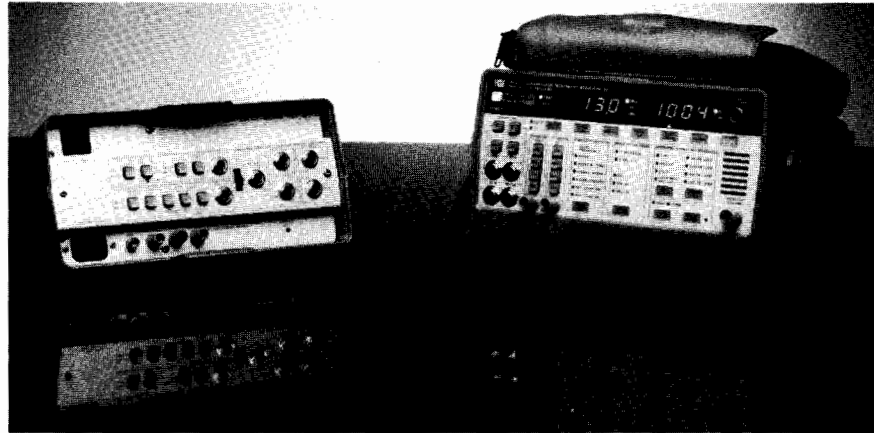

<b>HP 4935S Data Transmission Test Set</b>	\$4,900
<b>Option 001:</b> Adds rechargeable Battery Pack to HP 4935A	\$375
<b>Option 002:</b> Adds P/AR measurement in place of Noise-to-Ground in HP 4935A	\$150
<b>Option 003:</b> Adds both battery Pack and P/AR to HP 4935A, deletes Noise-to-Ground	\$450
<b>Option 101:</b> Adds RS-232C/V.24 Interface to HP 4925B	\$410
<b>Option 102:</b> Adds V.35 Interface and HP 18184A Power Module (115V) to HP 4925B	\$600
<b>Option 104:</b> Adds V.35 Interface and HP 18194A Power Module (220V) to HP 4925B	\$640
<b>Option 910:</b> Adds extra HP 4935A and HP 4925B Operating and Service Manuals	\$65

### HP 4937S Network Access Transmission Test Set

HP 4937S = HP 4937A + HP 4938A

#### A Transmission Test Set With Signaling

The HP 4937S Network Access Transmission Test Set provides transmission tests, supervisory signaling simulation, and network access capabilities for installation and maintenance of networks and PBXs. It is a field-service, portable test set designed for craft-level use. All the transmission measurements are compatible with current Bell standards.

#### One Instrument for Installation/Maintenance of PBXs and Networks.

The HP 4937A contains a set of voiceband transmission tests — level/frequency measurement, noise, and 2- and 4-wire return loss measurements. It also has the ability to seize and hold three types of E/M lines. In addition, the HP 4937A simulates signaling both from the central office and from the PBX at the network interface.

The HP 4938A provides additional network access and margin testing capabilities. It includes access to 4-wire simplex leads, generating ringing signal, and providing access for loop current and ringing voltage measurement.

#### HP 4937A Specifications Level/Frequency

<b>Transmitter</b>
<b>Level:</b> -40 dBm to +13 dBm
<b>Frequency:</b> 20 Hz to 9999 Hz
<b>Receiver</b>
<b>Level:</b> -60 dBm to +13 dBm
<b>Frequency:</b> 20 Hz to 9999 Hz

#### Noise Measurements

**Noise:** 0 to 99 dBm  
**Noise-with-Tone:** 10 dBm to 99 dBm  
**Signal-to-Noise Ratio:** 10 to 45 dB  
**Noise-to-Ground:** 50 to 99 dBm  
**Filters:** C-Message, 3 kHz flat, 1010 Hz notch

#### Return Loss

**Impedances:** 600 and 900 ohms  
**Signal Spectra:** Echo return loss, singing return loss high, singing return loss low.

#### Return Loss, 2-Wire

**Transmitter Level:** -26 dBm to -2 dBm  
**Receiver Range:** 0 to 40 dB

#### Return Loss, 4-Wire

**Transmitter Level:** -26 dBm to -2 dBm  
**Receiver Range:** 0 to 50 dB

**Transhybrid Loss Compensation:** -29.9 to +29.9 dB

#### Supervisory Signaling

**E/M Signaling:** Types I, II, III  
**Loop Signaling:** Loop start, Ground start, Loop Reverse Battery  
**Battery:** -48 Vdc current limited to 29 mA  
**Hold Circuit:** 2 each drawing 20 mA at a minimum voltage of 8.5 Vdc  
**Wink:** Idle state, 100 ms; off-hook state, 200 ms

#### General

**Battery Supply (Optional):** Typically 5 hours of continuous operation at +25°C. Complete recharging in 14 hours with unit in STBY  
**Dimensions:** 127 H x 279 W x 380 mmD (5.0" x 11.0" x 15.0")  
**Weight:** 5.3 kg (12 lb), 7.6 kg (17 lb) with batteries

#### HP 4938A Specifications

**Ringing Voltage Generator**  
**Output Level:** 86 Vrms into a REN-3 load  
**Frequencies:** 20 Hz and 30 Hz  
**Ring Trip Threshold:** 17 mA typical  
**Ringing Termination:** REN-3 load, ring trip closure (330 ohms)

**Loop Signaling Network:** loop start, 430 ohms; ground start, 550 ohms from ring to ground

**4-Wire Network Access:** 2 dual center-tapped simplex transformers

**Battery Simulator:** 48 Vdc maximum current 100 mA

#### General

**Dimensions:** 91 H x 261 L x 126 mm W (3.6 x 10.3 x 4.9 in.)  
**Weight:** 1.5 kg (3.2 lb)

#### Ordering Information

<b>HP 4937S Network Access Transmission Test Set</b>	\$5,700
<b>Option 001:</b> Rechargeable batteries for HP 4937A	\$270
<b>Option 002:</b> Replace 900 ohms with 150 ohms on HP 4937A	N.C.
<b>Option 910:</b> Adds extra HP 4937A and HP 4938A Operating and Service Manuals.	\$55
<b>HP 4937A Transmission Impairment Measuring Set</b>	\$4,700
<b>Option 001:</b> Rechargeable batteries	\$270
<b>Option 002:</b> Replace 900 ohms with 150 ohms	N.C.
<b>HP 4938A Network Circuit Access Test Set</b>	\$1,150

#### Accessories

<b>HP 18132A:</b> 19 in. rack mount for HP 4935A and HP 4937A	\$165
<b>HP 18134A:</b> Soft Vinyl Carrying Case for HP 4935A or HP 4935S	\$140
<b>HP 15512A:</b> 1 m audio cable with two 3-pin connectors (Siemens type) (for the HP 4936A)	\$80
<b>HP 15513A:</b> 1 m audio cable with two WECO 310 jack plugs (for the HP 4935A and HP 4937A)	\$60
<b>HP 18182A:</b> 1.5 m audio cable, WECO 310 plug to alligator clips	\$65
<b>HP 18064A:</b> Noise-to-ground adapter for the HP 4935A. Allows P/AR instruments (options 002 and 003) to measure noise-to-ground	\$135
<b>HP 18161A:</b> Ladder bracket for HP 4935A and HP 4937A	\$30

See also HP 4925B



## **SEMICONDUCTOR TEST & BOARD TEST**

<b>Semiconductor Test Equipment .....</b>	<b>524</b>
<b>Board Test Systems .....</b>	<b>546</b>

This product group covers test equipment for semiconductor device testing (for engineering and manufacturing applications) and circuit board testing (primarily for manufacturing applications). Semiconductor test equipment, available as individual instruments and systems, is designed for ASIC device characterization, parametric measurement and analysis, and linear/mixed signal device test. Electronic circuit board test systems, with links to CAE systems, include functional test systems and systems with both in-circuit and functional test capabilities.

**Semiconductor  
Test &  
Board Test**



# SEMICONDUCTOR TEST EQUIPMENT

## General Information Parametric Measurement

### Semiconductor Parametric Measurement

Semiconductor parametric measurement instruments are used for measuring and evaluating the electrical characteristics of semiconductors.

Competition within the semiconductor field is fierce, and major goals are: developing new products rapidly, improving yield and reducing costs.

HP semiconductor parametric measurement instruments provide:

1. Precise, high-resolution measurements for accurate and reliable evaluation and
2. Automated operation from measurement through analysis.

Semiconductor measurement applications vary widely, from device R&D to large-volume manufacture on mass-production lines. Measurement equipment must fit the measurement functions required.

In R & D, parametric testers make comprehensive physical and electrical evaluations of new materials, prototype devices and evaluation test patterns. As the integration and performance of semiconductors advance, measurement instruments must have the expandability to adapt to the high resolution and precision demanded by new evaluation methods.

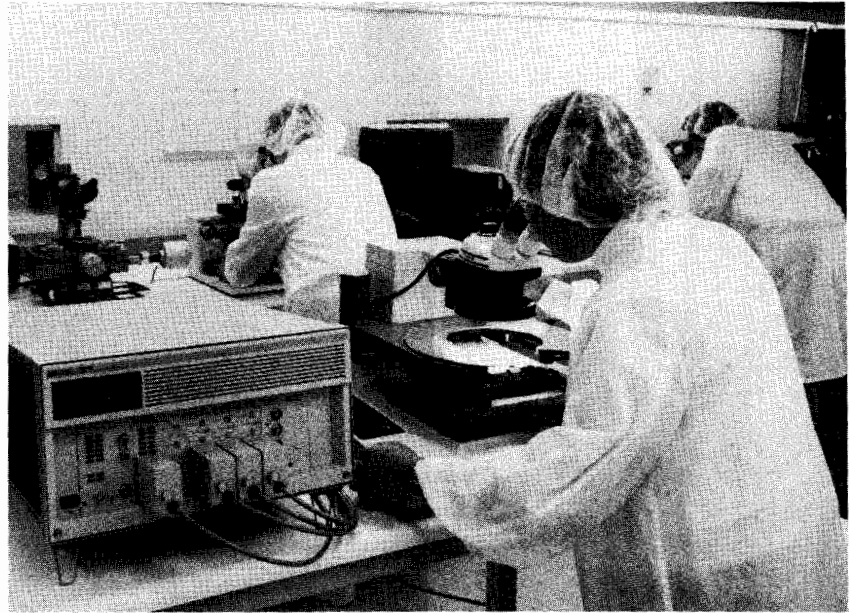

For production departments, parametric testing helps stabilize new processes for mass production and helps make process yield improvements. Functional testing is used mostly

in outgoing inspection. Cost reduction for both types of test requires high-speed, multiple-pin measurements and reduced down-time. The yield of new VLSI devices is less than 10 percent, and bad devices must be discarded. The accurate parametric testing provided by HP parametric testers can help improve processes and raise yields.

Parametric measurements are generally divided into capacitance (C) and DC, AC, and functional measurements. The following summarize each type of measurement.

1. Capacitance measurements include, primarily, capacitance vs voltage (C-V) and capacitance vs time (C-t). These capacitance measurements require correct measurement timing and good capacitance measurement resolution.

2. DC measurements measure the DC current vs voltage (I-V). DC parameter evaluation is based on I-V curve evaluation (eg. threshold voltage, breakdown voltage, leakage current). These measurements require high speed and resolution.

3. AC measurements evaluate the dynamic characteristics of the semiconductor device. With a digital IC, timing measurements such as rise time and propagation delay are the primary ones, so timing resolution is important. Determining the AC gain characteristics of linear ICs requires a wide dynamic range over a wide frequency band.

4. Functional testing evaluates the input/output operation and digital characteristics of semiconductor devices, especially logical devices. This measurement creates an input/output truth table and determines whether the desired output is attained or not.

Table 1 shows the parametric measurements required by each application area, with the HP parametric-measurement products that apply.

		Lab/R&D			Production		User
		Base Technology	Process Development	Circuit Design	Process Engineering	Testing/Quality Assurance	Incoming Inspection
C	C-V	●	●		●		
	C-t	●	●				
D	I-V	●	●	●	●		
C	Parameter	●	●	●	●	●	
AC Parameter				●		●	●
Functional				●		●	●
Instruments	C-V	HP 4274A HP 4275A	_____		_____		
		HP 4284A	_____		_____		
	C-t	HP 4280A	_____		_____		
	I-V	HP 4140B	_____		_____		
		HP 4141B HP 4142B HP 4145B	_____		_____		
HP 4145B & HP 4085M		_____		_____			
Systems	I-V	HP 4061A	_____		_____		
	C-V	HP 4062B/C	_____		_____		
	C-t	HP 82000 HP 81810S HP 9480		_____		_____	

Table 1. Measurements and HP instruments/systems by application area.

## Parameter Extraction

### CAD Software for Parameter Extraction

HP recently enhanced TECAP (Transistor Electrical Characterization and Analysis Program), used with the company's parametric-measurement equipment. This software package greatly simplifies the task of using mathematical models in circuit design. It measures real devices and computes the parameters needed for circuit-simulation programs such as SPICE.

### TECAP Automatically Generates Physically Meaningful Parameters

There are three steps to TECAP's model parameter extraction methodology. First, TECAP identifies regions of device operation to be modeled and measures devices in those regions of operation. You may accomplish parameter "weighting" simply by selecting more data points in each region you wish to emphasize. The model parameters are then automatically grouped into subsets that most directly affect the device characteristics in each of the selected regions of operation. TECAP selects the regions of operation and parameter groupings for the UCB Level 2 and 3 MOS Models and the UCB Gummel-Poon Bipolar Model, but you also have the flexibility to tailor these to your own extraction strategy.

In the second step, powerful, pre-defined functions quickly extract model parameters directly from the measured data points. This step ensures that you generate a physically meaningful set of final model parameter. Again, you can tailor these functions to your own extraction strategy if necessary.

Finally, if you wish, you can "fine-tune" your model parameters using TECAP's powerful optimizer. This optimizer determines parameter values that minimize the difference between measured and simulated device characteristics. You have the option of setting "boundaries" on each parameter value prior to optimization. These user-defined constraints decrease optimization time and

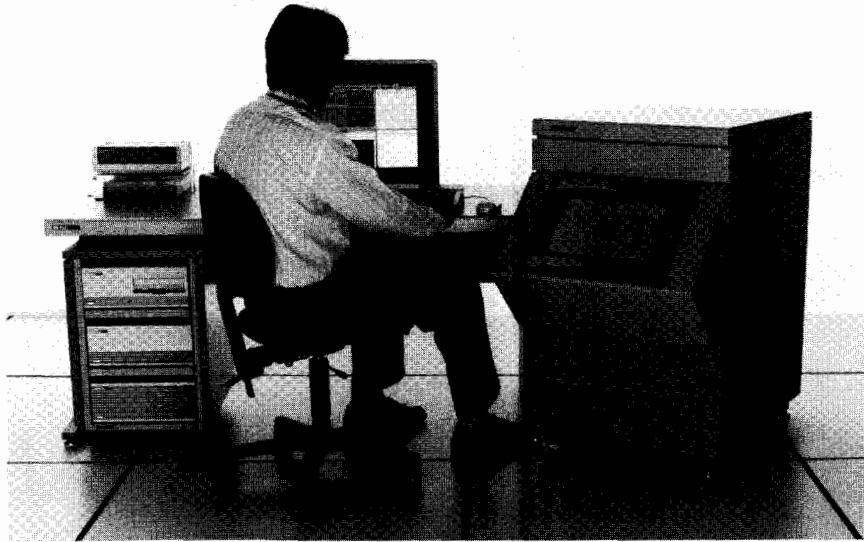

**HP 82000 IC Evaluation System**

guarantee that your final model parameters will be physically meaningful. The non-linear, least-squares-fit algorithm combines the Gauss-Newton and steepest-descent optimization methods for the most accurate fit.

TECAP provides the environment for complete, automated device characterization inside your company. You have the flexibility to use the standard extraction methodologies, or you can customize the program and use TECAP as a "shell" to integrate and automate your own particular extraction strategies. Either way, TECAP provides a practical, universally-satisfying solution to all of your parameter extraction needs. (See page 544.)

### Digital IC Test

#### Digital IC Test

The need for testing occurs several times during the development of digital IC's. First prototypes encounter functional debugging,

and critical path analysis to prove what simulation predicted. Afterwards, in volume production, a series of tests is conducted to isolate defective parts. Devices failing as a result of a faulty manufacturing process are subject to thorough failure analysis. Results obtained, can be used to optimize the process for an improved production yield. In addition to established quality control procedures at the manufacturer's site, customers can use test systems to analyze samples in incoming inspection and for vendor qualification.

### Application specific IC's create new tester demands

Two systems are available to address the demands created by the growing number of Application Specific IC's. Both provide functions for easy in-depth analysis of IC's and are optimized to switch quickly from one prototype test to another.

### The HP 81810S

This is a highly modular Design Verification System that can be adapted to various IC test applications in a very flexible manner. It is a dedicated tool for the IC designer to diagnose chip faults at the prototype stage. System configurations range from stand-alone benchtop instruments to systems complete with Test Head and Operating Software. See page 320 for more details.

### The new HP 82000 IC Evaluation System

The HP 82000 is a compact, fully integrated solution for ASIC prototype verification, IC characterization and low volume production test. IC manufacturers and ASIC users will appreciate the HP 82000's capabilities to reduce time-to-market in IC development. Automated tests combined with superior measurement performance, provide the resources to test high speed, high pin count devices quickly. Please see the next page for details on this product.

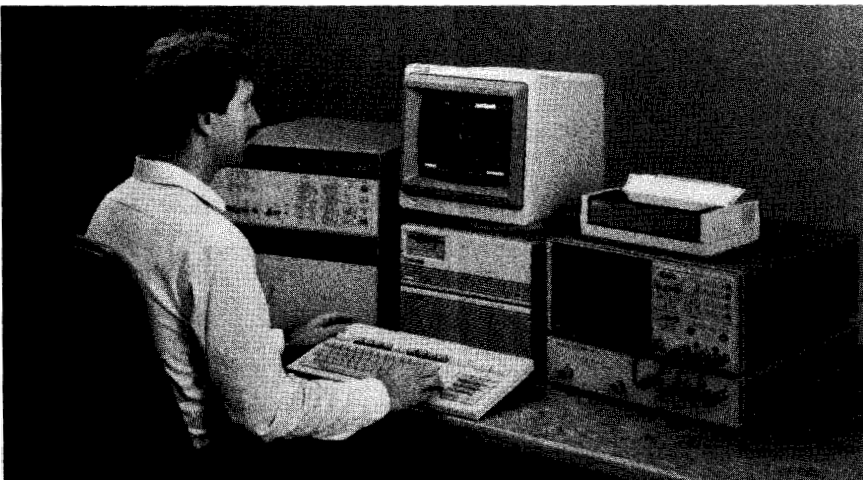

**Now, IC designers can save valuable design time by using HP's powerful TECAP system to analyze DC, C-V, and AC behavior of MOS, Bipolar, and Gallium Arsenide devices in an integrated, accurate, and interactive environment.**

# SEMICONDUCTOR TEST EQUIPMENT

IC Evaluation System  
HP 82000 Model D200

- 200 MHz max. vector rate
- $\pm 250$  ps edge placement accuracy, 50 ps resolution
- Tester-per-pin architecture
- Interactive test control with X Windows
- Automatic functional tests
- Automatic AC/DC characterization



HP 82000

## Addressing high performance testing needs

With the HP 82000 model D200, Hewlett-Packard offers a system to satisfy the IC evaluation requirements of both IC manufacturers and designers. For evaluation tasks such as characterization or failure analysis, engineers now have a solution for testing high speed and high pin count devices with excellent accuracy. For design centers and chip foundries, it can be a cost efficient alternative to production ATE.

It is a fully integrated system introducing 200 MHz speed and 128K vector depth on up to 384 true I/O channels. The tester-per-pin architecture contributes to flexibility and  $\pm 250$  ps accuracy, while the real windowing software adds ease-of-use. With it, ASICs and VLSI devices can be evaluated quickly, reducing time-to-market and cost to a minimum.

## Application flexibility

Combining performance, ease of use, and an acceptable price in one system makes the HP 82000 a superior fit in many IC testing applications. The most important ones are outlined below.

## Prototype Verification

Unlike large and complicated production ATE, the HP 82000 is a personal tester dedicated to your verification requirements. The ability to create a functional test program from the EDA (Electronic Design Automation) workstation database means faster time-to-market in prototype verification.

The earlier that design problems are detected, the lower the overall product development cost. Professional verification enables you to analyze IC functionality and parameters at the prototype stage of the design cycle. This reduces to a minimum the risk of ASIC problems in later board level integration.

## IC Characterization

To optimize design throughput, Hewlett-Packard developed the automatic characterization functions as standard with every system. There are numerous testfunctions, which provide test patterns, the appropriate system setup, and automatically sweep test parameters for complete characterization tests. Measurements of AC and DC characteristics such as hold time or leakage current, are started quickly from menus and are completed instantly.

Engineering testing of prototype IC's is the main application area of the characterization functions. Other applications include Incoming Inspection and Failure Analysis of parts rejected by production ATE. For the latter, the HP 82000 can be used as a dedicated system to diagnose the process problems that caused rejection.

## Production Testing

If throughput is not a major concern, the HP 82000 can be a very cost efficient alternative to ATE because its high timing and level accuracies allow tight guardbands for higher test yield. Also, 128K vector depth is sufficient to run long tests without vector reloading. With systems in production and in the engineering department, test programs can be shared over a LAN (Local Area Network) without extra effort.

## Tester-per-pin architecture provides best flexibility and accuracy

Bidirectional timing and level capabilities are provided for every channel without sharing resources. Each channel also has dedicated memory for the tristate and masking information, and can have its own data format (RZ, R1, DNRZ, and so on). All tester channels can be calibrated individually at the DUT pin. For best results, you can calibrate using the actual test parameter set - giving an accuracy of  $\pm 250$  ps. This is especially useful when performing fast go/no go tests, for example in production.

### Best time-to-test with windows software

Productivity is increased with a highly interactive user interface based on the X Window standard. The mouse operated software is used to enter and modify parameters for pin timing and levels, and to modify the vector data. Thanks to the tester-per-pin architecture, parameters can be defined and changed for each channel individually without limitations through shared resources. Error map, timing diagram and shmoo plot displays show results in a graphic form familiar to the engineer. Simultaneous access to different windows lets you see immediately the results of changes made in the setup. "Change and see" avoids recompilation of test programs and gives you the shortest possible debug cycle.

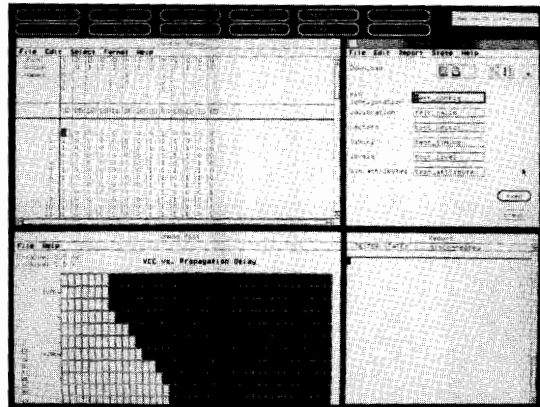

### Automatic test program generation

You can easily link to the workstations from leading EDA system vendors such as Mentor, Daisy and HP, and transfer data with high speed over the LAN. The computing power of a 32-bit workstation, and translation programs optimized for speed, maintain high throughput in the automatic test program generation.

Software fully supporting the testers' hardware resources, generates a functional device test without user programming. Test vectors, timing setup and pin setup are generated automatically.

### Test control includes Scan Path testing

To support "Design for testability", a scan path testing mode is integral to the system. The memory of up to 128 tester channels can be serialized via a software command, increasing vector depth on user-selected channels. A programmable vector sequencer has functions such as vector repeat, looping and branching on real time test results or external events.

### Minimum DUT wiring

"Instant wired" DUT boards for the popular pin layouts reduce the time for I/O wiring to zero and are available in various sizes to allow you to optimize board size and cost for the pin-count of your DUT. A controlled impedance environment from the testers' I/O circuits to the DUT provides excellent signal fidelity up to 200 MHz. To cover special IC packages, HP also offers boards which give maximum flexibility for user wiring.

### Cost efficient configurations

For applications requiring a maximum of 80 I/O pins, the benchtop version of the HP 82000 can be a cost efficient and even more compact alternative to the standard size system. The system components, including DUT boards, are compatible with the standard frame, making later upgrade to higher pin count easy. With built-in selftest and calibration, on-site board exchange is made easy. Expansion to a full performance 384 channel system is possible by adding extra mainframes.

### More Information

For Ordering and Technical Information, Technical data Sheets and Application Notes, please contact your nearest HP sales office.

SYSTEM CHARACTERISTICS:		
Max. Vector rate:	200 MHz	PMU's:
Vector depth:	128K	available as add-on boards.
Max. I/O pincount:	384	Software:
Edge placement accuracy:		Interactive, automatic tests & AC/DC characterization, color graphics.
at standard calibration:	±500 ps	Controller:
at calibrated user settings:	±250 ps	HP 9000 series 300 workstation.
Timing resolution:	50 ps	
Level resolution:	5 mV	
Level range:	-4 .. 8V	
Architecture:		
Tester-per-pin with individual timing and level resources, including per pin formatting, tristate and masking. Three different channel operating modes provide best fit for your requirements.		

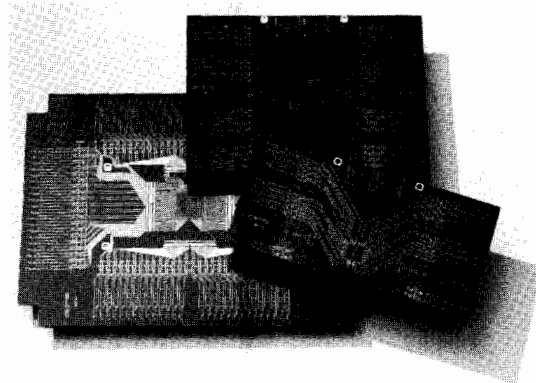



# SEMICONDUCTOR TEST EQUIPMENT

## Analog LSI Test System

Model 9480

- 128 MHz Analog and Digital Synchronized Testing
- 1 GHz Bandwidth, 1 ps Sampling Resolution
- AC Testing at the Wafer Level
- Digital Signal Processing (DSP) Based System
- Flexible Modular Architecture
- Powerful Debugging Tools
- Distributed Workstation Environment



### Description

The HP 9480 Analog LSI Test System integrates powerful test hardware and software to perform precise high frequency signal measurements. You can use the HP 9480 to test and characterize a wide variety of devices, from mixed signal devices such as flash ADCs, video DACs, telecommunication devices, etc., to purely analog or purely digital ICs. The HP 9480 provides full data sheet test coverage in a single insertion, thus eliminating the problem of time-consuming and costly multiple insertion testing. The HP 9480 can also perform high frequency AC tests on wafers.

The HP 9480's modular architecture allows you to combine many state-of-the-art hardware and software features into a configuration that best suits your measurement needs. The system can generate digital stimulus patterns and analog stimulus waveforms up to 128 MHz, and can capture DUT digital response patterns up to 128 MHz. For

analog DUT response, the system offers 16 and 12-bit real time waveform digitizers and 1 GHz bandwidth samplers with 1 ps resolution. The system also offers 18 and 10 bit arbitrary waveform generators. Digital patterns, DC voltage, and DC current can be input or output to up to 128 pins. Analog signals can be input or output using up to 4 channels each. Digital Signal Processing (DSP) allows complex waveform generation and high speed signal analysis via a full floating point array processor. The HP 9480's system software is based on the HP-UX operating system. Powerful debugging tools, including an off-line debugger, virtual panel, and virtual scope, significantly minimize debugging time. Further, HP 9480 software is easy to operate because it incorporates menus, a user-friendly multi-window environment, and mouse capability. These features increase test throughput and minimize time spent on program development.

## Hardware

### Device Testing Under In-circuit Conditions

The HP 9480's analog and digital signal test capability enables you to test the dynamic parameters of devices under their true operating conditions. The HP 9480 can also perform high frequency tests on wafers because of its coaxial cable environment and very low system noise.

For AC signal stimulus, the HP 9480 generates low distortion sine waves (up to 128 MHz), arbitrary waveforms with 10-bit resolution (up to 128 MHz clock rate), and arbitrary waveforms with 18-bit resolution (up to 1 MHz clock rate). For recording high frequency signals up to 1 GHz, with 12 bit resolution, the system offers 4 sampler channels that sample a signal with 1 ps resolution. For recording signals in real time, the system offers two choices—20 MHz/12-bit and 1 MHz/16-bit digitizers. For digital testing, the system offers up to 128 I/O pins, and features 64 kword memory for each pin. The system can generate digital stimulus patterns and clocks, and can analyze response patterns from the test device at a data rate of 128 Mwords/s with 100 ps resolution. And because the HP 9480 can synchronize analog waveforms with digital signals, and can automatically execute timing adjustments, you can perform precise tests on mixed signal devices under actual operating conditions. The HP 9480 allows you to perform DC parametric testing on each pin independently. This allows efficient testing because you can simultaneously perform different tests on different pins.

### Digital Signal Processing (DSP) Technology

The HP 9480 uses Digital Signal Processing to generate and analyze analog and digital signals.

For example, you can easily and quickly modify and create waveforms in the frequency domain by using FFT commands. The HP 9480 can easily synchronize analog signals with system clocks because the waveform data is recorded into system memory. Multiple parameters such as THD, SNR, differential nonlinearity, etc., can be extracted from the recorded data without running the test again. A 32-bit full floating point array processor minimizes system controller loading by performing complex matrix computations for digital signal processing. DSP technology shortens test times by allowing multiple parameter extraction from a single test, and minimizes hardware costs because analog and digital processing are performed by the same modules.

### Modular Architecture

The modular system architecture of the HP 9480 allows easy adaptability to your changing test needs. This means that the system's usefulness and value are maintained well into the future, because system upgrades and enhancements are easy and cost-effective. Also, maintenance costs are minimized because only faulty modules need to be repaired or replaced in the event of a system malfunction.

### Software

HP 9480 software is based on the HP-UX operating system, and operates on HP 9000 Series 300 Engineering Work Stations. HP-UX is fully compatible with standard UNIX systems, and incorporates an advanced multi-window system with a mouse and pop-up menus. This provides graphics oriented test development, testing, and data analysis environments, which facilitate smooth and efficient operation. You can easily set up conditions and values for test execution and data analysis, with the HP 9480's fill-in-the-blanks format. One simply enters the appropriate information into the mask fields displayed on the screen.

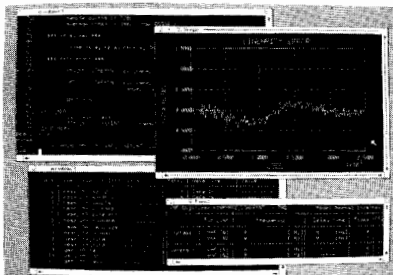

Multi-window Environment

## Test Development

The HP 9480 features two debugging modes and three useful tools for you to use the test hardware effectively, and reduce the amount of time spent on test program development.

The debugging modes available are off-line and the standard on-line debugging. A hardware simulator is used with off-line debugging. Therefore, off-line debugging and device test execution can be performed at the same time because the test hardware is not used for off-line debugging. This guarantees efficient system utilization.

Available tools are the symbolic debugger, virtual panel, and virtual scope. The symbolic debugger offers a number of features that enable the user to debug at the source code level. The symbolic debugger decreases debugging time because it allows you to modify test conditions without program recompilation. The virtual panel displays the hardware settings and output conditions in real time when debugging, thereby allowing you to confirm program measurement conditions. The multi-window function displays hardware information on a module-by-module basis. The virtual scope displays the stimulus waveform or pattern data specified in the program, and the response waveform output from the test device. These tools minimize the test development time and maximize engineering productivity.

## Testing

The HP 9480 provides easy operation in the test execution environment. The test conditions are set in a fill-in-the-blanks format displayed on the screen, and tests start by the press of a function key or the start button on the operator console. The operator console is a compact terminal to control test execution, such as test start, re-test, and test stop.

For monitoring tests quickly, the virtual scope and summary logging are useful tools. The virtual scope displays waveform output from the test device. The summary logging collects data during device testing, and makes test summary, bin summary, and lot summary reports.

## Data Analysis

The HP 9480's software capabilities are complemented by a comprehensive set of data analysis functions. These functions allow you to make effective use of all test data collected during device testing. The following reports can be set up and displayed so that you can easily analyze measurement results: Tabular Reports, Scatter Diagrams, Control Charts, Wafer Maps, X-Y Graphs, Shmoo Plots, and Bar Charts.

## Tester Workstations (sold separately)

The HP 9000 Series 300 computer, the HP 9480 system controller, can connect directly to the Ethernet/IEEE802.3 Local Area Network (LAN).

When networked, HP 9480 tasks can be distributed between workstations in the network. This increases system efficiency because tasks previously managed by one computer are now distributed between workstations. For example, you can use a Test Development Station (TDS) as a stand-alone workstation for test program development, such as editing, compiling, and off-line debugging, while testing, without degradation of test performance.

HP Semiconductor System Centers (SSCs) offer quality application support for quick start up of your HP 9480 system. Application support packages include consultation with expert HP personnel, and the tailoring of test program software and hardware to your specific test requirements.

## System Specification Summary

**128 pin I/O, 128 MHz (1  $\mu$ Hz resolution) clock rates**

### Analog signals analysis

16 bit (1MHz)/12 bit (20MHz) real time digitizer

1GHz (12 bit) high frequency sampler

### AC signal stimulus

18 bit (1MHz)/10 bit (128MHz) AWG

### Digital test

64K word (128MHz) WG/WM

DC test per pin



# SEMICONDUCTOR TEST EQUIPMENT

## Semiconductor Parametric Test System

### Model 4062C

- 25ms  $V_{th}/hFE$  Extraction (typical)
- $\pm 20fA$  to  $\pm 1A$  Precise Wafer Measurements



HP 4062C

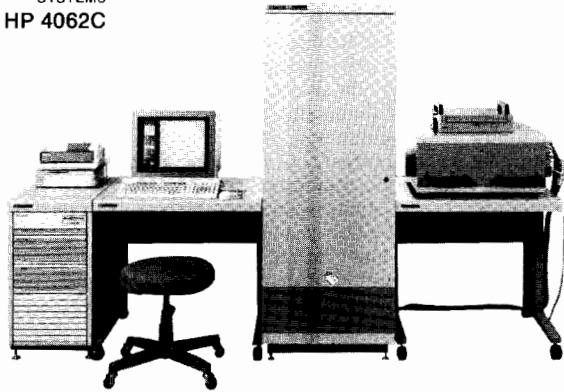

(System controller, printer and tables are sold separately.)

### Description

The HP 4062C Semiconductor Parametric Test System is a high throughput, high resolution computer-controlled system for measuring the DC voltage and current, and 1MHz capacitance and conductance parameters of wafer-state devices, as well as discrete and packaged devices. Based on its predecessor, the HP 4062B, this enhanced system will enable you to significantly improve IC yield and quality, and increase efficiency during new process development.

Precise 20fA, 4 $\mu$ V, and 1fF measurements to  $\pm 200V$  and  $\pm 1A$  are possible through the 4062C's low-noise, reliable switching matrix, which you can configure with up to 96 DUT pins. And specifications are guaranteed at all DUT pins. The heart of the HP 4062C, the high speed HP 4142B Modular DC Source/Monitor, provides fast throughput over a wide measurement range—without sacrificing resolution—for wafer process monitoring and evaluation. Highly reliable wafer measurement results can quickly be fed back to design and process engineers to improve your IC yield and quality.

The HP 4062C's language system is the simple, yet powerful, HP BASIC. Parameter measurements, such as threshold voltage and current gain, can be performed with a simple two-line program thanks to the HP 4062C's measurement utility subprograms. By including the optional Test Management Shell software, you can create, execute, and manage tests through a completely menu-driven BASIC interface to even further minimize programming requirements. For analyzing measurement results, the HP 4062C's optional TekBase relational database software provides you with maximum data flexibility and allows you to analyze data in a wide variety of formats. Maximize software development capabilities, reduce development time, and increase engineering efficiency with the HP 4062C's powerful, easy-to-use software.

### High Speed Measurements over a Wide Measurement Range

In production environments where measurement speed is prerequisite, the HP 4062C comes through. The HP 4062C's DC measurement subsystem provides high speed device/process parameter extractions, while maintaining measurement resolutions down to 20fA and 4 $\mu$ V. For example, by using the DC measurement subsystem's Analog Feedback Unit (AFU), such key device parameters as threshold voltage ( $V_{th}$ ) and forward current gain ( $hFE$ ) can be obtained in as little as 25ms: roughly 4 times faster than the HP 4062B.

The HP 4062C's switching matrix subsystem enables reliable measurement results by virtually eliminating the effects of environmental noise, while minimizing leakage current and stray capacitance. Also, the HP 4062C's expanded measurement range of  $\pm 20fA$  to  $\pm 1A$  and  $\pm 4\mu V$  to  $\pm 200V$  is guaranteed to the tip of each switching matrix DUT pin. This exacting performance ensures precise, reliable semiconductor parameter measurements through the switching matrix for each system instrument.

- Interactive Programming (option)
- Powerful Database integrated with Graphics Presentation

### Easy To Program

The HP 4062C's Test Instruction Set (TIS) software makes programming easy, and the fast execution of TIS programs ensures high speed measurements. By using the furnished measurement library, you can quickly create and execute programs. For example, to perform a  $V_{th}$  or  $hFE$  measurement requires only one or two program lines.

### Fast, Easy Test Generation and Integrated Database Capabilities

The optional Test Management Shell (TMS) software provides an elaborate HP 4062C user interface, eliminating the need to generate application programs. All test generation functions are accomplished through a series of menus that first determine the task you wish to perform, followed by the information required to perform the task. No programming knowledge is required to generate test programs when using TMS.

The HP 4062C's optional TekBase relational database software provides enhanced data analysis capabilities. With TekBase, you can quickly retrieve measurement results using a powerful QUERY language, and can then present these results in a number of useful formats, including wafer maps, trend charts, histograms, etc.

HP 16269A TEST MANAGEMENT SHELL MAIN MENU  
 Time: 09:00 Station: 4062C Date: 1 Nov 1988  
 Instrument Config: NONE Mass Storage Config: STANDARD

DEFINE TEST	DEFINE PART TYPE	REPORT TEST
Measurement Sequence Test Plan	Device Type Module Die Type Wafer	Report Results
BUILD TEST		SHELL UTILITIES
Build Test Plan	DEFINE HARDWARE	Backup Form Types Restore Form Types Configure System
EXECUTE TEST	Test Fixture Mass Storage Configuration Instrument Configuration	Modify Users Install Algorithm
Execute Test Plan	Instrument Units	

Use the TAB or ARROW keys to select the desired form

### System Configuration (Standard)

Modular DC Source/Monitor (HP 4142B)  
 Switching Matrix (48-pin configuration)  
 Switching Matrix Controller  
 1MHz C Meter/C-V Plotter (HP 4280A)  
 Rack Cabinet

### Specifications

**Measurement Functions:** I, V, I-V, C-G-V, C-G-t, Pulse I/V, Pulse I-V, Analog Search

### Switching Matrix

#### Number of pins (to DUT):

48 pins of 48-pin Switching Matrix (as standard).  
 12, 24 and 36 pins configuration as option.  
 96 pins of 96-pin Switching Matrix with options for 24, 36, 48, 64, 72, 84 and 96 pins.

#### Number of ports (to instrument):

9 ports  
**High Resolution Source/Monitor Unit:** 1 port  
**High Power Source/Monitor Unit:** 1 port  
**Source/Monitor Units:** 2 ports  
**Ground Unit:** 1 port  
**Auxiliary:** 4 ports (for V Sources/V Monitors and C Meter)

**Maximum voltage at each port:**  $\pm 200V$  (SMU ports)  
 $\pm 100V$  (Aux. ports)

**Maximum current through ports to pins:**  $\pm 1.6A$  (GNDU port)  
 $\pm 1A$  (SMU ports)

**DC Source/Monitor Units (SMUs)**

**High Resolution SMU:** 1 unit

V: ±40µV to ±100V Basic accuracy: ±0.05%  
 I: ±20fA to ±100mA Basic accuracy: ±0.2%

**High Power SMU:** 1 unit - Kelvin

V: ±40µV to ±200V Basic accuracy: ±0.05%  
 I: ±2pA to ±1A Basic accuracy: ±0.2%

**SMUs:** 2 units - Kelvin

V: ±40µV to ±100V Basic accuracy: ±0.05%  
 I: ±2pA to ±100mA Basic accuracy: ±0.2%

\*V force resolution is 100µV

\*I force resolution is 50fA (High Resolution SMU) and 5pA (other SMUs)

**Ground Unit (GNDU):** 1 unit

±1.6A Accuracy: ±1mV

**Voltage Sources (VSs):** 2 units

±1mV to ±40V Basic Accuracy: ±0.1%

**Voltage Monitors (VMs):** 2 units

±40µV to ±40V Basic Accuracy: ±0.05%

\*Differential Voltage Measurements are possible with 4µV resolution

All SMUs can function as a DC voltage source/current monitor or as a DC current source/voltage monitor. Pulse measurements can be performed with SMUs and VSs.

**Capacitance-Conductance Measurements**

**Test frequency:** 1MHz, ±0.01%

**OSC level:** 30mVrms ±10%, and 10mVrms ±10%

**Measurement range:** (maximum resolution to full scale)

C: 0.001pF to 1.2nF Basic accuracy: ±0.5%

G: 0.01µS to 12mS Basic accuracy: ±1.5%

**DC bias voltage for capacitance measurements:** ±100V

**Reference Data (typical)**

**Command Execution Time**

**Connect (relays):** 4.5ms

**DC Source/Monitor<sup>1</sup>:**

**Force (current or voltage):** 4.5ms

**Measure (current or voltage):** 6ms

**Analog Search<sup>2</sup>:** 25ms

<sup>1</sup>When integration time is short and range is not 1nA/10nA. Does not include wait time set by user.

<sup>2</sup>Analog search controls the output of one SMU to set the output of another SMU to a specified value.

**General Specifications**

**Operating temperature range:** 5°C to 40°C, 55% to 70% RH

**Permissible temperature change:** ≤3°C after calibration

**Air cleanliness:** class 100,000 or higher clean room required

**Power requirements:** 100V (90V to 110V), 120V (108V to 127V),  
 220V (198V to 242V), 240V (216V to 252V),  
 48Hz to 66Hz, 1150VA maximum

**Dimensions:**

**Cabinet:** 600mm (W) by 1600mm (H) by 800mm (D)

**48-pin matrix:** 406mm (W) by 210mm (H) by 380mm (D)

**96-pin matrix:** 620mm (W) by 250mm (H) by 600mm (D)

**Weight:**

**Cabinet with instruments:** approx. 230kg

**48-pin matrix:** approx. 22kg (48 pin config.)

**96-pin matrix:** approx. 55kg (96 pin config.)

**HP 4142B power limitation:** 32W

**Furnished Accessories**

(for 48-pin matrix/for 96-pin matrix)

**HP 16066A/16370A:** Test Fixture Adapter

**HP 16067A/16371A:** 24-pin DIP Low Leakage Fixture

**HP 16068A/16372A:** 48-pin DIP Low Leakage Fixture

**HP —/16373A:** 64-pin SHRINK DIP Low Leakage Fixture

**HP 16069A/16374A:** Universal Low Leakage Fixture

**HP 16070A/16375A:** General Purpose DIP Fixture

**HP 16071A/16376A:** Universal Fixture

**HP 16072A/16377A:** Personality Board

**HP 16077A/16378A:** Extension Cable Fixture

**HP 16075A/16355A:** Relay Test Adapter

**HP 16076A/16356A:** System Test Module

**Available Accessories**

(for 48-pin matrix/for 96-pin matrix)

**HP 16320B/16320C:** Pin Board

**HP 16071B/16376B:** Universal Fixture

**HP 16072B/16377B:** Personality Board

**System Controller**

**Required controller:** HP 9000 Series 300 Model 310, 320, 330, or 350

**System language:** BASIC 5.1

**Memory size:** 2M byte

**Interface:** In addition to internal HP-IB I/O, 2 extra HP-IB I/O's (98624A's) are required.

**Prober Interface**

Automatic wafer probers used with the HP 4062C must be equipped with HP-IB capability. Hardware for mounting the switching matrix on the prober is also required. Contact the prober manufacturer for details concerning necessary mounting hardware. Control software for Electroglas 1034X/2001X and TSK A-PM6000/7000 probers is furnished.

**Ordering Information**

**HP 4062C Semiconductor Parametric Test System Price \$125,000**  
 (does not include controller)

**OPT. 050/060:** for 50/60Hz Line Frequency N/C

**OPT. 100/120/220/240:** for 100/120/220/240V Line Voltage N/C

**OPT. 001:** 12 pin Configuration of 48 pin Matrix -\$21,600

**OPT. 002:** 24 pin Configuration of 48 pin Matrix -\$14,400

**OPT. 003:** 36 pin Configuration of 48 pin Matrix -\$7,200

**OPT. 004:** Add Spare Pin Board of 48 pin Matrix \$600

**OPT. 012:** 24 pin Configuration of 96 pin Matrix \$11,000

**OPT. 013:** 36 pin Configuration of 96 pin Matrix \$19,000

**OPT. 014:** 48 pin Configuration of 96 pin Matrix \$27,000

**OPT. 015:** 64 pin Configuration of 96 pin Matrix \$38,000

**OPT. 016:** 72 pin Configuration of 96 pin Matrix \$43,000

**OPT. 017:** 84 pin Configuration of 96 pin Matrix \$51,000

**OPT. 018:** 96 pin Configuration of 96 pin Matrix \$59,000

**OPT. 019:** Add Spare Pin Board of 96 pin Matrix \$670

**OPT. 020:** Replace HP41420A with HP41421B -\$750

**OPT. 021:** Add spare HP41421B SMU \$3,540  
 (100V/100mA)

**OPT. 022:** Add spare HP41420A SMU (200V/1A) \$4,300

**OPT. 023:** Add spare HP41424A Vs/Vm \$3,220

**OPT. 024:** Delete one HP41421B SMU -\$3,540  
 (100V/100mA)

**OPT. 025:** Delete one HP41420A SMU (200V/1A) -\$4,300

**OPT. 026:** Delete one HP41424A Vs/Vm -\$3,220

**OPT. 027:** Delete one 41425A AFU -\$1,720

**OPT. 102:** Delete HP4280A -\$10,600

**OPT. 110:** Delete Package Fixtures for 48 pin Matrix -\$4,190

**OPT. 115:** Delete Package Fixtures for 96 pin Matrix -7,500

**OPT. 130:** Delete System Rack -\$3,800

**OPT. 310:** Add HP4274A \$12,900

**OPT. 311:** ±35V Internal DC Bias for HP4274A \$890

**OPT. 312:** ±100V Internal DC Bias for HP4274A \$830

**OPT. 405:** HP4062C's System Software Right-To-Copy -\$2,250

**OPT. 410:** Test Management Shell Software (TMS) \$6,000

**OPT. 411:** TMS Right-To-Copy \$4,390

**OPT. 420:** TekBase Software for Model 310 Computer \$3,500

**OPT. 421:** TekBase For Model 320/330/350 Computers \$3,500

**OPT. 503:** Personality Board for Electroglas Probers N/C

**OPT. 910:** Extra System Library \$320

For further Configuration and Ordering Information, please contact your next HP sales office.

Note: 1) Either option 050 or 060 must be ordered.  
 2) Either option 100, 120, 220 or 240 must be ordered.  
 3) Option 012-018 replace 48 pin Switching Matrix and its' accessories with the 96 pin Switching Matrix and its' accessories.  
 4) Option 311 and 312 can not be ordered at the same time. Option 310 must be ordered when option 311 or 312 is ordered.  
 5) Option 110 deletes HP 16066A, 16067A, 16068A, 16069A, 16070A and 16071A.  
 6) Option 115 deletes HP 16371A, 16372A, 16373A, 16374A, 16375A and 16376A.

# SEMICONDUCTOR TEST EQUIPMENT

## Semiconductor Parametric Test System

### Model 4062B

- Precise, high speed probed wafer measurements
- 1pA resolution at all 48 pins

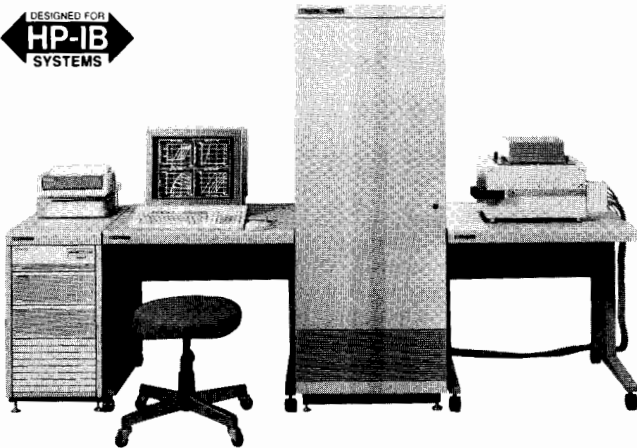

HP 4062B  
(System controller, printer and tables are sold separately.)

### Description

The HP 4062B Semiconductor Parametric Test System will help you improve IC yield and quality in production plus increase engineering efficiency. The system measures DC voltage/current and 1 MHz capacitance/conductance of wafers with high resolution and speed.

Precise 1pA and 1fF measurements are performed using a low noise switching matrix with up to 48 DUT pins. All specifications are guaranteed on these DUT pins. High speed measurement units provide fast throughput of high resolution measurements for wafer process monitoring and evaluation. Highly reliable measurements performed on wafers can be fed back to design and process engineers to improve your IC yield and quality.

The HP 4062B is programmed with the simple and powerful HP BASIC. Parameter measurements such as threshold voltage or current gain can be made by a two line program using the HP 4062B's measurement utility subprograms. Prober control software is supplied to allow users to easily operate a wafer prober with the HP 4062B. The system software features an extensive program library that includes statistical analysis, trend charts, and the Virtual Front Panel (VFP) for convenient manual measurement. The HP 4062B will help you reduce software development time and increase engineering efficiency with easy programming.

### Software Library

Virtual Front Panel (VFP)  
Test Instruction Set (TIS)  
Graphics Library  
Parameter Measurement Library  
Auto Prober Control Library  
Data Processing Library  
Diagnostic Program

### System Configuration

DC Source/Monitor (HP 4141B)  
Switching Matrix (48-pin configuration)  
Switching Matrix Controller  
1 MHz C Meter/C-V Plotter (HP 4280A)  
Rack Cabinet

### Specifications

#### Switching Matrix

**Number of pins (to DUT):** 48 pins (standard) with options for 12, 24 and 36 pins.

**Number of ports (to instrument):** 9 ports

- Easy to program with Probing Pattern Generator
- Virtual front panel simplifies operation

### DC Source and Monitor Units

**High resolution source and monitor unit (SMU1):** 1 unit  
**Output/Measurement Range:** Current,  $\pm 1\text{pA} - \pm 100\text{mA}$ , Basic Accuracy, 0.3%; Voltage,  $\pm 1\text{mV} - \pm 100\text{V}$ , Basic Accuracy, 0.1%

**Source and monitor units (SMU2-4):** 3 units  
**Output/Measurement Range:** Current,  $\pm 100\text{pA} - \pm 100\text{mA}$ , Basic Accuracy, 0.3%; Voltage,  $\pm 1\text{mV} - \pm 100\text{V}$ , Basic Accuracy, 0.1%

**Ground unit:** 1 unit  
**Output Voltage:** 0V; Accuracy,  $\pm 2\text{mV}$

**Voltage source (Vs):** 2 units  
**Output Range:** 1mV -  $\pm 20\text{V}$ ; Basic Accuracy, 0.5%

**Voltage monitor (Vm):** 2 units  
**Measurement Range:**  $\pm 100\mu\text{V} - \pm 20\text{V}$ , Basic Accuracy, 0.2%

### Capacitance-Conductance Measurements

**Test frequency:** 1 MHz  $\pm 0.01\%$   
**OSC level:** 30 mVrms  $\pm 20\%$  and 10 mVrms  $\pm 20\%$   
**Measurement range:** (Maximum resolution to full scale)  
**C:** 0.001 pF - 1.2 mF; basic accuracy, 0.5%  
**G:** 0.01  $\mu\text{S}$  - 12 mS; basic accuracy, 1.5%  
**DC bias voltage for capacitance measurements:**  $\pm 100\text{V}$

### General Specifications

**Operating temperature range:** 10°C - 40°C,  $\leq 70\%$  RH at 40°C  
**Power requirements:** 100V, 120V, 200V  $\pm 10\%$ ; 240V  $+5\% - 10\%$ ; 48-66 Hz, 510 VA max.  
**Dimensions:** cabinet, 600 mm(W) x 1600 mm(H) x 800 mm(D); switching matrix, 406 mm(W) x 210 mm(H) x 380 mm(D)  
**Weight:** cabinet with instruments, approximately 200 kg; switching matrix, approximately 25.3 kg

### System Controller

**Required Controller:** HP 9000 Series 200 Model 236A, 236C, 236S or 236CS, or Series 300 Model 310, 330 or 350  
**System Language:** BASIC 5.0 or 5.1 for Series 200/300

### Ordering Information

HP 4062B Semiconductor Parametric Test System (does not include controller)		\$100,000
<b>Opt. 050/060:</b> For 50/60Hz Line Frequency <sup>1</sup>		N/C
<b>Opt. 100/120/220/240:</b> For 100/120/220/240 Line Voltage <sup>2</sup>		N/C
<b>Opt. 001:</b> 12-pin Configuration (delete 36 pins)		\$-17,400
<b>Opt. 002:</b> 24-pin Configuration (delete 24 pins)		\$-11,600
<b>Opt. 003:</b> 36-pin Configuration (delete 12 pins)		\$-5,800
<b>Opt. 004:</b> Additional Pin Board		\$490
<b>Opt. 011:</b> SMU Board		\$1,325
<b>Opt. 030:</b> For HP 9000 Series 300 Controller <sup>3</sup>		N/C
<b>Opt. 036:</b> For HP 9000 Model 236 A/S/C/CS Controller <sup>4</sup>		N/C
<b>Opt. 310:</b> Add HP 4274A		\$12,900
<b>Opt. 311:</b> $\pm 35\text{V}$ Internal DC Bias for HP4274A		\$890
<b>Opt. 312:</b> $\pm 100\text{V}$ Internal DC Bias for HP4274A		\$830
<b>Opt. 405:</b> Right-to-copy		\$1,720
<b>Opt. 102:</b> Delete HP4280A		\$-10,600
<b>Opt. 110:</b> Delete Test Fixtures for Packaged Devices		\$-4,190
<b>Opt. 401:</b> SPN Data File Creation Software		\$1,935
<b>Opt. 503:</b> Personality Board for EG 1034X, EG 2001X		N/C
<b>Opt. 920:</b> Extra System Library		\$335

<sup>1</sup>Must select Opt. 050 according to the power line frequency used.

<sup>2</sup>Must select Opt. 100, 120, 220 or 240 according to the power line voltage used.

<sup>3</sup>Must select Opt. 503 if using an Electroglas Prober.

<sup>4</sup>Must select Opt. 030 or 036 according to the system controller used.

# SEMICONDUCTOR TEST EQUIPMENT

## Semiconductor/Component Test System

Model 4061A

533

- Ready to use—supplied with 7 turn-key application pacs
- Reliable impedance and current measurements with one probing
- Productivity improvement through accurate and fast measurement over wide range

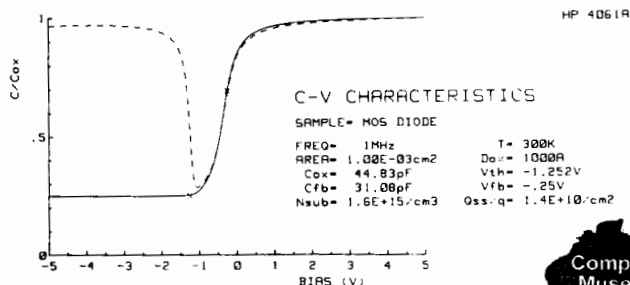

DESIGNED FOR  
**HP-IB**  
SYSTEMS

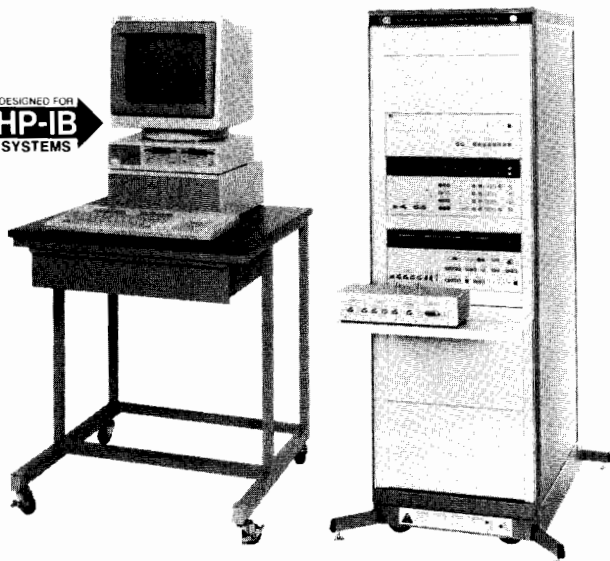

HP 4061A

System controller and table are sold separately

### Description

The HP 4061A Semiconductor/Component Test System is a dedicated system for making efficient, automatic evaluation of the fundamental characteristics of semiconductor and electronic components required in R & D and production areas. This system employs reliable, accurate measurements and high speed data processing to perform more reliable evaluations with speed and less manpower. The HP 4061A is supplied with 7 sophisticated applications programs and is flexible in both software and hardware. Thus, the system can output measurement results in nearly any required data format.

The switching subsystem, designed especially for use with the HP 4061A, allows both impedance and current measurement without changing DUT connection. Using this new switching subsystem, and by making impedance measurements, the HP 4061A performs evaluation of Doping profile, Oxide capacitance, Flat band condition, Threshold voltage, Surface charge, and Minority carrier life time/surface generation velocity. The HP 4061A also measures leakage current and reverse/forward current-voltage characteristics. Surface state density evaluation, using both high (e.g., 1 MHz) and low frequency (Quasi-static) C-V measurements and data processing are also possible by making modifications to system software.

The system offers significant improvement in both yield and quality in production through fast and reliable measurements and evaluations. It is also a valuable evaluation tool for the development of new materials and devices. The HP 4061A provides the flexibility to meet the future measurement requirements of the electronics industry.

### System Configuration

- pA Meter/DC Voltage Source (4140B)
- Multi-frequency LCR Meter (4275A)
- Switching Subsystem
- Rack Cabinet (29402C)

### Furnished Application Software

Semiconductor high/low frequency C-V characteristics, I-V characteristics, C-t characteristics and Zerst analysis, Impedance Frequency/Bias characteristics, Ideal C-V curve.

### Specification

For detailed specifications on each of the instruments used in the HP 4061A, refer to the individual data sheets.

### Switching Subsystem

The switching subsystem consists of a switch control module and switching module with interconnecting cables.

**Function:** Switches connection from DUT to either Multi-frequency LCR Meter or the pA Meter/DC Voltage source.

**System Measurement Range** (only deviations from individual instrument specifications are listed.)

### Impedance Measurements (HP 4275A)

**Frequency range:** ≤ 1 MHz

**Measurement parameters:** C-G

**Capacitance:** ≤ 2000 pF (with D ≤ 0.1)

**\*Accuracy:** (accuracy of HP 4275A) × 1.5 + ΔC (at 23°C ± 5°C).

$$\Delta C = 1.4 \times 10^{-3} C \times f^2 \text{ (pF)} + 5 \text{ counts}$$

**Conductance:** ≤ 12mS (D ≤ 0.1)

**\*Accuracy:** (accuracy of 4275A) × 1.5 + ΔG (at 23°C ± 5°C)

$$\Delta G = 6 \times 10^{-3} C \times f(S) + 5 \text{ counts}$$

\* f: frequency in MHz

Cx: Measured capacitance value in pF

At 5°C to 40°C, ΔC and ΔG doubles. Example: Assuming Cx = 1000 pF and f = 1 MHz, C = (1.4 × 10<sup>-3</sup> · 10<sup>3</sup> · (1)<sup>2</sup>)pF + 5 counts = 1.4 pF + 5 counts

### Current Measurements (HP 4140B)

**Accuracy:** (accuracy of HP 4140B) × 1.5 + 5 counts

After one-hour warmup and at DUT terminal of switching module

### Impedance Measuring Section (HP 4275A)

See the HP 4275A's page 290.

### Current Measurement Section (HP 4140B)

See the HP 4140B's page 537.

### General Information

**Operating temperature:** 5°C to 40°C, ≤ 70%RH at 40°C

**Power:** 100, 120, 220, and 240V, +5% - 10%, 48 to 66 Hz, 520 VA

**Size:** 535mm W x 1635 mm H x 770 mm D

**Weight:** Approximately 125 kg.

### System Controller

HP 9000 Series 200 Model 226A, 226S, 236A or 236S, or Series 300 Model 310 or 330

### Ordering Information

**HP 4061A Semiconductor/Component Test System** (does not include controller)

**Price**  
\$44,250

**Opt. 001:** ±100 V dc Bias for HP 4275A

N/C

**Opt. 002:** 1-3-5 Frequency Steps for HP 4275A

N/C

**Opt. 026\*:** For HP 9000 Model 226 A/S controller

N/C

**Opt. 031\*:** For HP 9000 Model 310 or 330 controller

N/C

**Opt. 036\*:** For HP 9000 Model 236 A/S controller

N/C

\*Must order either OPT. 026, 031 or 036.

# SEMICONDUCTOR TEST EQUIPMENT

## Modular DC Source/Monitor Model 4142B

- Flexible, Modular Architecture
- Wide Measurement Range with High Resolution  
V:  $\pm 4\mu\text{V}$  -  $\pm 200\text{V}$ , 0.05%  
I:  $\pm 20\text{fA}$  -  $\pm 1\text{A}$ , 0.2%
- Pulse Measurement Capabilities  
Pulse Width 1ms - 50ms, 100 $\mu\text{s}$  Resolution

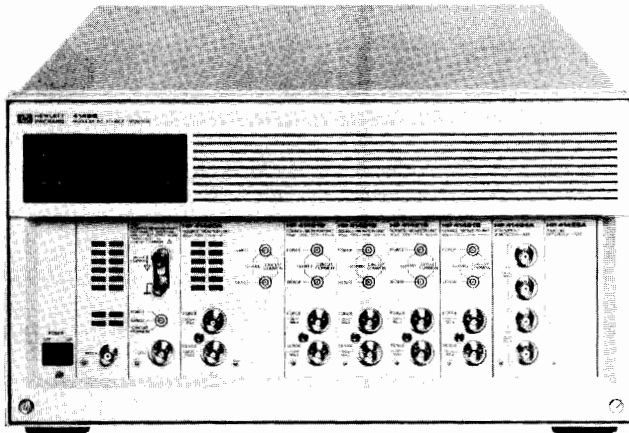

HP 4142B



### Description

Offering a wide measurement range and excellent sensitivity, the HP 4142B Modular DC Source/Monitor is a system-use DC measurement instrument especially designed for high throughput DC semiconductor testers. A completely user-definable system component, the HP 4142B's modular architecture allows you to build a custom-configuration to suit your measurement needs.

Eight plug-in module slots can accommodate any combination of the four presently available modules, and as new modules become available, you can upgrade your measurement capabilities with ease. Choose from two types of Source/Monitor Units (SMUs) to force or measure up to  $\pm 200\text{V}$  and  $\pm 1\text{A}$ ; a Voltage Source/Voltage Monitor Unit (VS/VMU); and an Analog Feedback Unit (AFU). Also, the HP 4142B's instrument command and measurement data storage capabilities, coupled with the high speed HP-IB interface, minimize computer loading, enhance throughput, and simplify systemization.

### Versatile SMUs and Reliable Measurement

For general purpose DC or Pulsed measurement, use the HP 41421B Source Monitor Unit. The equivalent of four instruments, this precision module forces voltage up to  $\pm 100\text{V}$  and simultaneously measures currents down to 20fA. It can also force currents up to  $\pm 100\text{mA}$  while measuring voltage down to 40 $\mu\text{V}$ .

If you test high power components or desire an extra wide measurement range, apply the HP 41420A Source Monitor Unit. This versatile SMU can source  $\pm 200\text{V}$  or  $\pm 1$  ampere (14W, DC or pulsed) and still maintain an incredible measurement resolution of 40 $\mu\text{V}$  and 20fA. Both SMUs include a compliance feature which limits output

- High Speed Measurement (Typical)  
Sourcing or Monitoring: 4ms  
Vth, hFE extracting: 12ms
- Internal Memory  
Program Memory: >500 Commands (Typical)  
Data Memory: 4004 Measurement Points

voltage, current, or power to prevent damage to your device. Each SMU (HP 41420A or HP 41421B) acts as either a voltage source/current monitor or current source/voltage monitor. These complimentary operating modes let you change the stimulus on a device without modifying the physical connections. This versatility reduces test time and eliminates instabilities caused by changing connections at the DUT.

### High Speed Parameter Extraction by Analog Feedback Technique

To find important parameters that are specified at a given voltage or current, such as  $V_t$  or hFE, connect the HP 41425A Analog Feedback Unit to two SMUs. The AFU modulates the output voltage of one SMU while monitoring the current or voltage of the second SMU. Target currents and voltage are found with blazing speed (12ms). This unique analog feedback network rapidly measures  $V_t$ , hFE,  $\Delta L$ , or  $\Delta W$ ; parameters which would require excessive test times on other parametric testers.

You can also use AFUs for biasing and testing microwave devices. It can be integrated into the Network Analyzer System.

By using AFUs, you can eliminate the effect of device thermal drift and can hold initial setting bias for AC measurement time.

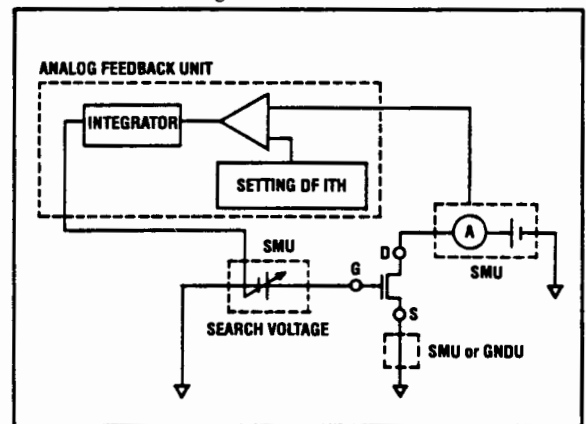

### Pulsed Measurements

The HP 4142B performs pulsed spot measurement, pulsed sweeps, or even sweeps with a pulsed bias, over its entire measurement range. Now you can safely evaluate GaAs FETs, power MOSFETs, and bipolar transistors under high power conditions.

The pulsed measurements will not damage your devices or test fixtures, and more importantly, it will reduce thermal drift.

**Specifications**

**4142B Modular DC Source/Monitor**

**Ground Unit (GNDU)**

Use as measurement ground.

0V, Kelvin connection

**Offset voltage:** ±500µV max

**Current range:** ±1.6 amperes

**Maximum cable resistance:**

**FORCE terminal:** ≤1Ω\*

**SENSE terminal:** ≤10Ω\*

**Maximum capacitive load:** 10µF max\*

**Spot Measurements**

Source and monitor DC current or voltage.

**Sweep Measurements**

- One channel (HP 41420A SMU, HP 41421B SMU, or HP 41424A VS/VMU) can sweep current or voltage while up to 8 channels measure current or voltage.

- A second sweep channel can be slaved to the first sweep channel (dual synchronous sweep).

**Sweep modes:** Linear or logarithmic.

Single or double staircase.

**Sweep parameters:** Start, stop, number of steps, or steps per decade.

**Maximum number of steps:** 1000

**Hold time:** 0 to 655.35 sec, 10 msec resolution

**Delay time:** 0 to 65.535 sec, 1 msec resolution

**Setting accuracy:** 0.5% + 1 msec\*

**Measurement Unit**

**HP 4142B Modules**

Model Number	Slot Req'd	Voltage Range	Current Range	Measurement Resolution	Output Power	Accuracy V	Accuracy I
HP 41420A SMU <sup>1</sup>	2	±100µV to ±200V	±50IA to ±1amp	40µV 20fA	14W	0.05%	0.2%
HP 41421B SMU <sup>1</sup>	1	±100µV to ±100V	±50IA to ±100mA	40µV 20fA	2W	0.05%	0.2%
HP 41424A VS/VMU	1	±1mV to ±40V	±20mA, ±100mA	4µV <sup>2</sup> 20µA	2W	0.05%	3%
HP 41425A AFU	1	Searches for a specified current or voltage on one SMU by controlling the voltage output of another SMU.					

<sup>1</sup>Provides Kelvin connections (remote sensing).

<sup>2</sup>Differential measurement mode (40µV resolution in normal mode).

**SMU Range, Resolution and Accuracy (at 18°C-28°C)**

Voltage Range	Set Res.	Meas Res.	Accuracy	Max. Current
±2V	100µV	40µV	±0.05%±1mV	1A
±20V	1mV	400µV	±0.05%±10mV	1A(V≤14V) 0.7A(V>14V)
±40V	2mV	800µV	±0.05%±20mV	350mA
±100V	5mV	2mV	±0.05%±50mV	125mA
±200V	10mV	4mV	±0.05%±100mV	50mA

Current Range	Set Res.	Meas Res.	Accuracy	Max. Voltage
±1nA	50fA	20fA	±1%±(0.1+0.2 x Vo/100)%±5pA	200V
±10nA	500fA	200fA	±0.5%±(0.1+0.2 x Vo/100)%	
±100nA	5pA	2pA		
±1µA	50pA	20pA	±0.2%±(0.1+0.2 X Vo/100)%	
±10µA	500pA	200pA		
±100µA	5nA	2nA		
±1mA	50nA	20nA		
±10mA	500nA	200nA	±0.5%±(0.1+0.2 X Vo/100)%	
±100mA	5µA	2µA		
±1A	50µA	20µA		
				100V (I>50mA)
				200V (I≤50mA)
				100V (125mA ≥I>50mA)
			40V (350mA ≥I>125mA)	
			20V (0.7A ≥I>350mA)	
14V (I>0.7A)				

\*Vo is the SMU output voltage, in volts

**Pulsed Measurements**

Force and measure pulsed current or voltage.

**Ranges:** 2V range: 10nA to 1A range  
20V to 200V range: 100µA to 1 A range

**V pulse:** 2V range: 1 compliance ≥ 2nA  
20V to 200V range: 1 compliance ≥ 20A

**I pulse:** 10nA to 10 A range: V compliance ≤ 2V  
100 A to 1A range: V compliance ≤ 200V

**Pulse width:** 1-50 msec, 100µsec resolution

**Pulse period:** 10-100 msec, 100µsec resolution

**Setting accuracy:** 0.5% + 100µsec\*

**Pulsed Sweeps**

- Sweep and measure pulsed current or voltage.
- Sweep DC current or voltage while pulsing current or voltage. Use Pulse and Sweep specification.

**Memory**

**Program memory:** Stores approximately 500\* HP-IB commands which can be grouped into 99 subroutines.

**Data memory:** 4004 measurement points (binary).  
1001 points (ASCII format).

**General Specifications**

**Auto Calibration**

Automatically calibrates the offset errors in each measurement unit every 30 minutes.\*

**Environmental Information**

**Operating Temperature:** 5°C to 40°C

**Allowable Temperature Drift:** ±3°C\*

**Operating Humidity:** 5% to 80% RH

**Storage Temperature:** -40°C to 65°C

**Storage Humidity (at 65°C):** ≤90% RH

**Operating Inclination:** ±20° from horizontal

**Power Requirements**

100/120/220V ±10%, 240V-10%+5%, 48 to 66Hz, 750 VA max

**Dimensions**

426 mm W x 235 mm H x 676 mm D

**Weight**

**HP 4142B:** Approximately 23kg

**HP 41420A:** Approximately 4kg

**HP 41421B/41424A/41425A:** Approximately 2kg

**Recommended Computer**

HP 9000 Series 200 or 300 computer.  
BASIC Operating System (Version 3.0 or later).

**Software**

**Parameter Measurement Library:** Current gain, Breakdown voltage (2), Drain current, Threshold voltage (3), and Resistance.

**Test Instruction Set:** Initialize, Force, Measure, Pulse, Graphics, and Data storage.

\* Reference data only.

**Ordering Information**

Product Name	Price
<b>HP 4142B Modular DC Source/Monitor</b>	\$11,510
<b>Opt. 001:</b> System Cable for Use with 16058A	\$226
<b>Opt. 002:</b> Accessory Kit for System Use GDU/Interlock Cables, Conn. Plate	\$361
<b>Opt. 400:</b> Install 41420A (needs 2 slots)	\$4,510
<b>Opt. 401:</b> Triaxial Cable for 41420A	\$175
<b>Opt. 402:</b> Quadaxial Cable for 41420A	\$600
<b>Opt. 410:</b> Install 41421B (needs 1 slot)	\$3,725
<b>Opt. 411:</b> Triaxial Cable for 41421B	\$175
<b>Opt. 412:</b> Quadaxial Cable for 41421B	\$600
<b>Opt. 440:</b> Install 41424A (needs 1 slot)	\$3,390
<b>Opt. 442:</b> Vs/Vm Cables (coaxial)	\$340
<b>Opt. 450:</b> Install 41425A (needs 1 slot)	\$1,810
<b>HP 41420A Source/Monitor Unit</b>	\$4,510
<b>Opt. 402:</b> Quadaxial Cable	\$600
<b>HP 41421B Source/Monitor Unit</b>	\$3,725
<b>Opt. 412:</b> Quadaxial Cable	\$600
<b>HP 41424A Voltage Source/Voltage Monitor Unit</b>	\$3,390
<b>Opt. 442:</b> Vs/Vm Cables (coaxial)	\$340
<b>HP 41425A Analog Feedback Unit</b>	\$1,810
<b>HP 16058A Test Fixture</b>	\$2,770
<b>Opt. 001:</b> System Cable for 4142B	\$60



# SEMICONDUCTOR TEST EQUIPMENT

## Semiconductor Parameter Analyzer Model 4145B

- Fully automatic, high-speed dc characterization of semiconductor devices.
- High resolution, wide range sourcing and measurement.  
I: 50fA – 100mA, V: 1mV – 100V
- Maximum 1150 measurement and display points for precise measurement and analysis.
- Flexible graphic analysis functions for quick parameter extraction.
- Built-in micro flexible disc drive for storage of 240 user programs or 105 measurement results.

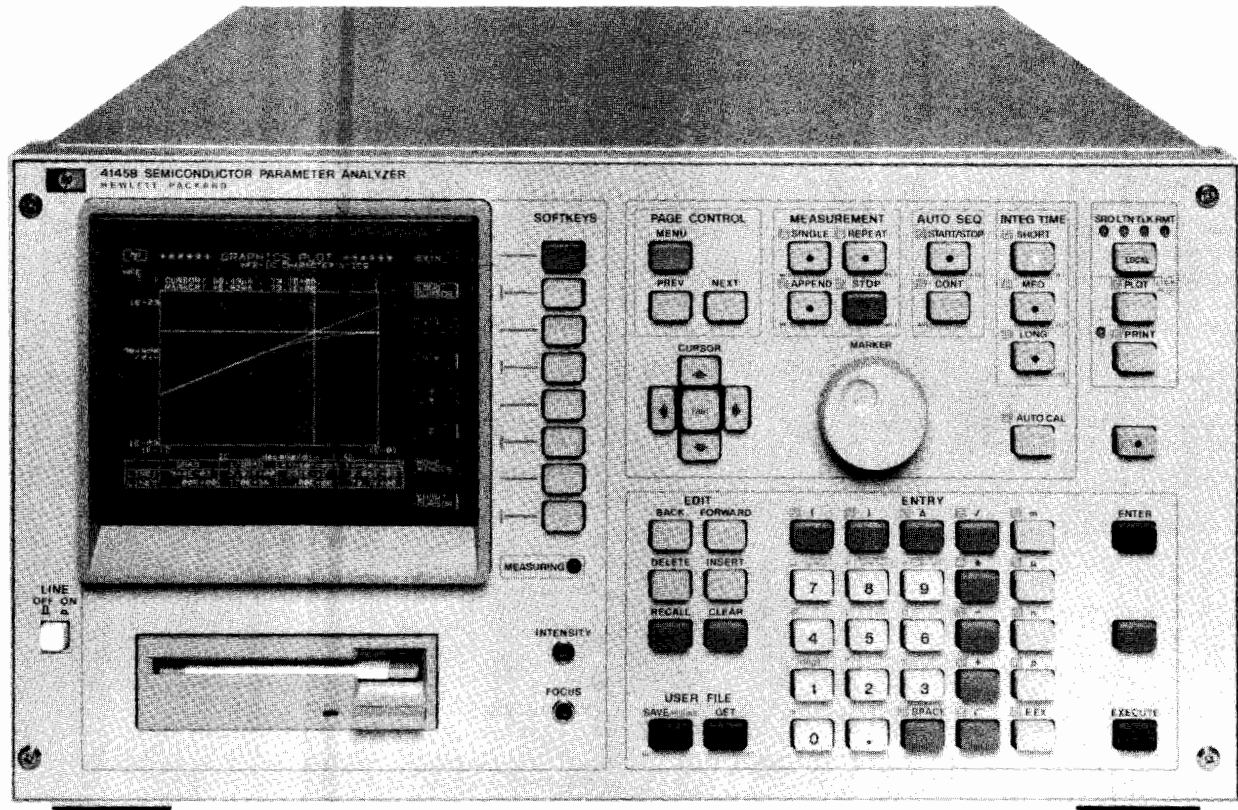

HP 4145B



### Description

Designed for production line and laboratory use, the HP 4145B is the electronics industry's first stand-alone instrument capable of complete dc characterization of semiconductor devices and materials. It stimulates voltage and current sensitive devices, measures the resulting current and voltage responses, and displays the results in a user-selectable format (graph, list, matrix or schmo) on a built-in CRT display. An on-board programmable calculator provides real-time calculation of voltage/current dependent parameters, such as the current gain ( $h_{FE}$ ) and transconductance ( $g_m$ ) of transistors, which also can be displayed on the CRT. A number of powerful graphic analysis tools—marker, cursor, line function, interpolation—enhance the HP 4145B's basic capabilities and provide fast, accurate analysis of semiconductor devices, leading to increased production yields and improved device quality.

Four built-in source monitor units (SMUs) are the heart of the HP 4145B. Each SMU can be independently programmed to function as either a voltage source/current monitor or a current source/voltage monitor. Thus, a bipolar transistor, for example, can be completely characterized in common-base, common-emitter, and common-collector configurations without changing connections—only changing the SMUs' operating modes is required. The HP 4145B is also equipped with two voltage sources and two voltage monitors for measurements on devices having more than four terminals, such as ICs.

The HP 4145B can be controlled from the front panel, via the HP-IB (standard), or by measurement setups stored on micro flexible discs.

Displayed information—measurement setups, auto-sequence programs, measurement results—can be dumped directly onto an external graphics printer/plotter to obtain publication quality hard copies. Additionally, the built-in 3½" flexible disc drive enables you to store measurement setups and measured data, which can be accessed by another compatible HP disc drive for further processing.

### Auto Sequence Programs

Measurement programs stored on a HP 4145B micro flexible disc can be linked by an auto sequence program, making it possible to perform a series of measurements with just one keystroke.

### Four User-Selectable Display Formats to Suit the Evaluation

Measurement results can be displayed in one of four display formats: GRAPHICS, LIST, MATRIX or SCHMOO. After measurement has been made and the results displayed, the softkeys can be used to access various analysis functions for complete device evaluation. These functions include MARKER for numeric readout of measured value at any point along a plotted curve, CURSOR for numeric readout of value at any graphic point and for line positioning, STORE/RECALL for overlay comparisons, AUTO SCALE for optimum graphic scaling, and LINE FUNCTION for direct readout of line gradient and X-Y axes intercept values.

## Specifications

### Measurement

**Source/Monitor unit (SMU):** four SMUs are built into the HP 4145B. Each SMU can be programmed to source voltage and monitor current, or conversely to source current and monitor voltage. Each SMU can also be programmed to COM mode. This sets voltage at 0 volts and current compliance at 105 mA.

**Output/measurement resolution:** voltage, 4½ digits; current, 4 digits

**Voltage measurement input resistance/current source output resistance:**  $\geq 10^{12}\Omega$

**Maximum capacitive load:** 1000 pF

### SMU Voltage Range, Resolution and Accuracy

Voltage Range	Resolution	Accuracy <sup>1,2</sup>	Max. Current
±20V	1mV	$\pm(0.1\%+10mV+0.4\times I_0)$	100mA
±40V	2mV	$\pm(0.1\%+20mV+0.4\times I_0)$	50mA
±100V	5mV	$\pm(0.1\%+50mV+0.4\times I_0)$	20mA

\* $I_0$  is SMU output current in amps.

### SMU Current Range, Resolution and Accuracy

Current Range	Resolution	Accuracy <sup>1,2</sup>	Max. Voltage
±100mA	100µA	$\pm(0.3\%+100\mu A+2\mu A\times V_0)$	20V(>50mA)
			40V(>20mA)
±10mA	10µA	$\pm(0.3\%+10\mu A+200nA\times V_0)$	100V(≤20mA)
±1000µA	1µA	$\pm(0.3\%+1\mu A+20nA\times V_0)$	
±100µA	100nA	$\pm(0.3\%+100nA+2nA\times V_0)$	
±10µA	10nA	$\pm(0.3\%+10nA+200pA\times V_0)$	
±1000nA	1nA	$\pm(0.5\%+1nA+20pA\times V_0)$	
±100nA	100pA	$\pm(0.5\%+100pA+2pA\times V_0)$	
±10nA	10pA	$\pm(1\%+15pA+200fA\times V_0)$	
±1000pA	1pA	$\pm(1\%+6pA+20fA\times V_0)$	

\* $V_0$  is SMU output voltage in volts.

\*\* 50 fA resolution in current monitor mode.

- Accuracy specifications are given as  $\pm\%$  of reading or setting value  $\pm\%$  of range.
- Accuracy tolerances are specified at 25°C  $\pm 5^\circ\text{C}$ , after a 40 minute warm-up time, with AUTO CAL on, and specified at the rear panel connector terminals referenced to SMU common. Tolerances are doubled for the extended temperature range of 10°C to 40°C.

### SMU Voltage/Current Compliance

**Maximum voltage compliance:** 20 V, 40 V, or 100 V, depending on the output current range.

**Maximum current compliance:** 20 mA, 50 mA, or 100 mA, depending on the output voltage range.

**Compliance setting resolution:** same as current and voltage output/measurement resolution. Maximum current compliance resolution, however, is 50 pA.

**Compliance accuracy:** voltage compliance accuracy is the same as voltage output/measurement accuracy. Current compliance accuracy is current output/measurement accuracy  $\pm (1\%$  of range + 10 pA).

### Voltage/Current Sweep Characteristics

Output from up to three SMUs or voltage sources can be swept in one of three modes: VAR1, VAR2, or VAR1'.

**VAR1:** linear or logarithmic staircase sweep

**VAR2:** linear staircase sweep. Output from the VAR2 source is incremented after completion of each VAR1 sweep.

**VAR1':** output from the VAR1' source is synchronized with VAR1 but at levels proportional to a user-selectable ratio or offset relative to VAR1.

**Ratio:**  $\pm 0.01$  to  $\pm 10$

**Offset:** any value that will not cause VAR1' to exceed maximum allowable output.

**Hold time:** 0 to 650 seconds,  $\pm(0.5\% + 9\text{ ms})$  with 10 ms resolution

**Delay time:** 0 to 6.5 seconds,  $\pm(0.1\% + 5\text{ ms})$  with 1 ms resolution

**No. of Measurement Steps:** 1024 for a single VAR 1 sweep, 1150 for a multiple sweep

### Voltage Sources (Vs) Characteristics

**Number of sources:** two

**Output resistance:**  $\leq 0.2\Omega$

**Maximum capacitive load:** 1000 pF

### Voltage Output Range, Resolution and Accuracy

Output Voltage Range	Resolution	Accuracy	Max. Output Current
±20 V	1 mV	$\pm(0.5\%$ of setting + 10 mV)	10 mA

### Voltage Monitors (Vm) Characteristics

**Number of monitors:** two

**Input resistance:** 1 M $\Omega$   $\pm 1\%$  shunted by 100 pF  $\pm 10\%$

### Voltage Measurement Range, Resolution and Accuracy

Measurement Voltage Range	Resolution	Accuracy
± 2 V	100 µV	$\pm(0.5\%$ of reading + 10 mV)
±20 V	1 mV	$\pm(0.2\%$ of reading + 10 mV)

### Characteristics Common to SMUs, Voltage Sources & Voltage Monitors

**Maximum allowable terminal voltage:** 100 V peak across SMU and  $V_m$  input terminals, or SMU and  $V_S$  output terminals, or between those terminals and guard; and 42 V maximum from Common to Ground.

### Display

CRT size and screen resolution: 152.4 mm (6 inch) diagonal; 2048 x 2048 points.

**Display modes:** Graphics, Schmo, List, Matrix, and Time Domain  
**External CRT analog output:** X, Y and Z outputs of 0 to 1 Vdc into 330  $\Omega$  (X and Y) and 240  $\Omega$  (Z).

### Analysis

**Calculation:** two user functions can be input and keyboard calculations can be done using the following 11 operators: +, -, \*, /,  $\sqrt{\quad}$ , EXP, LOG, LN, \*\* (power), ABS (absolute) and  $\Delta$  (differential).

### Constants Available on the Keyboard

**q:** Electron charge ( $1.602189 \times 10^{-19}$  coulomb)

**k:** Boltzmann's Constant ( $1.380662 \times 10^{-23}$  J/°K)

**e:** Dielectric constant of vacuum ( $8.854185 \times 10^{-12}$  F/m)

**Analysis functions:** overlay comparison with STORE/RECALL, Marker, Interpolate, Cursor, Auto scale, Zoom function ( $\leftarrow$ ,  $\rightarrow$ ,  $\uparrow$ ,  $\downarrow$ ) Line and Move Window.

### General Specifications

**Operating temperature range:** +10°C to +40°C;  $\leq 70\%$  RH at 40°C, permissible temperature change  $\leq 1^\circ\text{C}/5\text{ min}$ .

**Power requirements:** 100/120/220 V  $\pm 10\%$ ; 240 V - 10% + 5%; 48 to 66 Hz; 270 VA max.

**Dimensions:** 426 mm W x 235 mm H x 612 mm D (16.75" x 9.06" x 24.1").

**Weight:** 27 kg (59 lb) approximately.

### Reference Data

**SMU measurement time:** measurement time = response time + ranging time + integration time.

### SMU Response Time

Current Range	Setup/Settling Time	SMU Wait Time
100 nA to 100 mA	2.7 ms	0.2 ms
1 nA and 10 nA		47.5 ms

**Ranging time:** varies from 4 ms to 74 ms

**Integration time:** SHORT, MED and LONG

	SHORT	MED	LONG
50 Hz	3.6 ms	20 ms	320 ms
60 Hz		16.7 ms	267 ms

### Accessories Furnished

HP 16058A Test Fixture

HP 04145-61501 System Disc

HP 04145-60001 Connector Plate

HP 04145-61622 Triaxial Cable (3m), 4 ea.

HP 04145-61630 BNC Cable (3m), 4 ea.

HP 04145-61623 Shorting Connector

### Ordering Information

HP 4145B Semiconductor Parameter Analyzer \$25,660

Opt. 050/060: 50Hz/60Hz Line Frequency \$N/C

Opt. W30: 2 Years Additional Hardware Service \$600

# SEMICONDUCTOR TEST EQUIPMENT

## Switching Matrix

### Model 4085M

- 48 pins with 1pA resolution

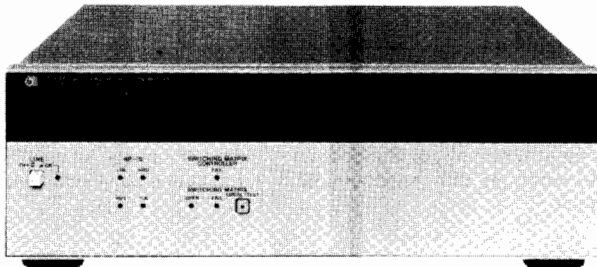

Switching Matrix Controller

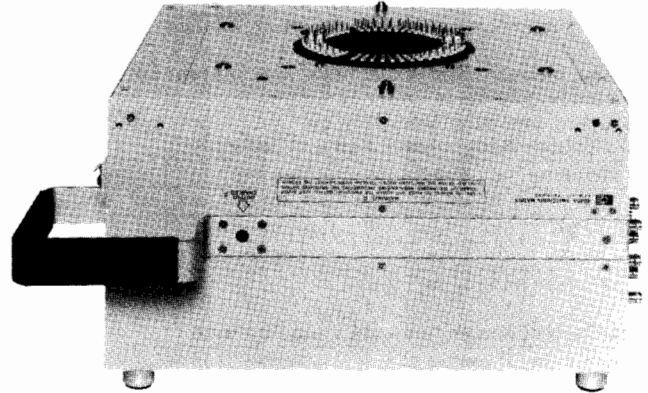

Switching Matrix

HP 4085M

### HP 4085M Description

Combining the HP 4085M switching matrix with the HP 4145B Semiconductor Parameter Analyzer produces a 1 pA, 1 mV switching system capable of 48-pin high resolution semiconductor testing.

A design which minimizes both noise and leakage current means exceptional built-in dc measurement capabilities and the realization of 1 pA resolution measurements at any one of the 48 pins.

The software included with the system makes it possible to freely switch any one of the eight instrument ports to any one of the test pins from the system controller. A number of fixtures are available for wafer and various packaged device measurements. The HP 4085M retains the HP 4145B's full measurement capabilities to obtain highly reliable wide range dc parameter measurements.

### Specifications

#### Switching Matrix

**DUT Pins:** From 12 to 48 pins can be installed.

**Instrument Ports:**\* Eight instrument ports are included.

**Low Leakage SMU Port:** 1 ea. (Port 1)

**SMU Ports** : 3 ea. (Port 2 - 4)

**Vs Ports** : 2 ea. (Vs Port 1 and 2)

**Vm Ports** : 2 ea. (Vm Port 1 and 2)

\*SMU: Stimulus Measurement Unit

Vs : Voltage Source

Vm : Voltage Monitor

**Maximum Voltage between Instrument Ports:**  $\pm 220$  Vdc

**Maximum Current at each DUT Pin:**  $\pm 500$  mA dc

#### General Specifications

**Operating temperature:** 10°C to 40 °C;  $\leq 70\%$  RH at 40°C

**Air cleanliness:** class 100,000 or higher clean room required.

**Power requirements:** 100, 120, 220V  $\pm 10\%$ ; 240V  $+5\% - 10\%$ ; 48 to 66 Hz, 130VA max

**Size:** Switching Matrix, 406W  $\times$  210H  $\times$  380D mm; Switching Matrix Controller, 426W  $\times$  134H  $\times$  432D mm

**Weight:** Switching Matrix, approximately 25.3kg; Switching Matrix Controller, approximately 8kg

#### System Controller

**Required Controller:** HP 9000 Series 200 Model 216S, 236A or 236S, or Series 300 Model 310, 330 or 350

**System Language:** Basic 2.0 or later version

**Memory Size:**  $\geq 320$ k byte

#### Ordering Information

**HP 4085M Switching Matrix** (does not include controller) \$48,100

**Opt. 001:** 12-pin system \$-18,360

**Opt. 002:** 24-pin system \$-12,240

**Opt. 003:** 36-pin system \$-6,120

**Opt. 004:** Add one pin \$510

**Opt. 016:**\* For HP 9000 Model 216A/S controller N/C

**Opt. 030:**\* For HP 9000 Model 310 controller N/C

**Opt. 036:**\* For HP 9000 Model 236 A/S controller N/C

\* Must select Opt. 016, 030 or 036 according to the system controller used.

### System Configuration Example

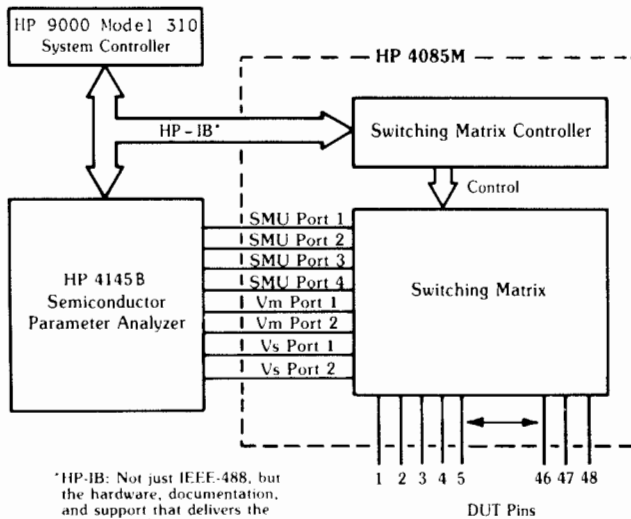

\*HP-IB: Not just IEEE-488, but the hardware, documentation, and support that delivers the shortest path to a measurement system.

# SEMICONDUCTOR TEST EQUIPMENT

DC Source/Monitor

Model 4141B

539

- High speed measurements down to the pA range
- High reliability at low cost

- High accuracy and resolution  
V:  $\pm 100\mu\text{V} - \pm 100\text{V}$ , 0.1%  
I:  $\pm 50\text{fA} - \pm 100\text{mA}$ , 0.3%

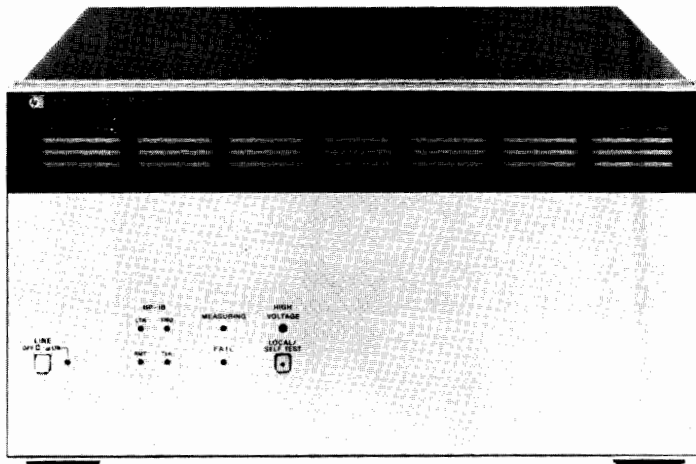

HP 4141B



## Description

The HP 4141B DC Source/Monitor is designed for use as a system component in user-designed semiconductor I-V or DC parametric test systems. With its wide DC measurement range, high resolution, high-speed measurement capabilities, remote sensing, and high accuracy, the HP 4141B will contribute towards quality improvement and increased measurement throughput in the lab or on the production line.

## High Speed Measurements with High Resolution

Four source/monitor units (SMU's) coupled with two voltage-source units (Vs's), two voltage monitor units (Vm's), and one ground unit (GNDU) make the HP 4141B equivalent to twenty one instruments. A stand-alone instrument capable of measuring dc parameters, the HP 4141B features high resolution measurements (50fA/100 $\mu\text{V}$ ) and a built-in timing controller. Typical time for a current or voltage measurement, which includes data transfer, is approximately 25ms. A swept measurement (51 points) takes approximately 490ms. High accuracy and high speed measurements, especially in the low current range, are exclusive features of the HP 4141B.

## High Reliability

The HP 4141B's high reliability significantly simplifies maintenance and reduces maintenance costs. To reduce system down time, the HP 4141B is designed for on-site service. Performance verification and diagnostics software for user troubleshooting is also available.

## Specifications

### Measurement Unit

**Source and monitor units (SMU):** 4 channels (Kelvin connection) Each SMU can be programmed to source voltage and monitor current, or conversely to source current and monitor voltage.

### SMU Range, Resolution and Accuracy

Voltage range	Resolution	Accuracy	Max. Current
$\pm 20\text{V}$	1mV	0.1% + 0.05%	100mA
$\pm 40\text{V}$	2mV		50mA
$\pm 100\text{V}$	5mV		20mA
Current Range	Resolution	Accuracy	Max. Voltage
$\pm 100\text{mA}$	100 $\mu\text{A}$	0.3% + (0.1 + 0.2 x Vout*/100)%	20V (I > 50mA)
$\pm 10\text{mA}$	10 $\mu\text{A}$		40V (20mA < I $\leq$ 50mA)
$\pm 1000\mu\text{A}$	1 $\mu\text{A}$		100V (I $\leq$ 20mA)
$\pm 100\mu\text{A}$	10nA		
$\pm 1000\text{nA}$	1nA	0.5% + (0.1 + 0.2 x Vout*/100)%	100V (I $\leq$ 20mA)
$\pm 100\text{nA}$	100pA		
$\pm 10\text{nA}$	10pA		
$\pm 1000\text{pA}$	1pA**	1% + (0.1 + 0.2 x Vout*/100)% + 5pA	

\*Vout is the SMU output voltage, in volts.

\*\*Max. Measurement Resolution is 50fA.

1. Accuracy specifications are given as % of reading when measuring or % of setting when reading.
2. Accuracy tolerances are specified at 23°C  $\pm$  5°C, after a 40-minute warm-up, with AUTO CAL on, and are specified at the rear panel connector terminals referenced to SMU common. Tolerances double for the extended temperature range of 10°C to 40°C.

**Output/Measurement resolution:** Voltage - 4 1/2 digits  
Current - 4 digits

**Voltage source units (Vs):** 2 channels

### Voltage Range, Resolution, and Accuracy

Output voltage range	Resolution	Accuracy	Max. Current
$\pm 20\text{V}$	1mV	0.5% of setting + 10mV	10mA

**Voltage monitor units (Vm):** 2 channels

### Voltage Range, Resolution and Accuracy

Measurement voltage range	Resolution	Accuracy
$\pm 2\text{V}$	100 $\mu\text{V}$	0.5% of reading + 10mV
$\pm 20\text{V}$	1mV	0.2% of reading + 10mV

**Ground Unit:** 1 channel (kelvin connection)

**Current range:**  $\pm 500\text{mA}$

## General Specifications

**Operating Temperature Range:** +10°C to +40°C,  $\leq 70\%$  RH at 40°C. Permissible temperature change  $\leq 1^\circ\text{C}/5\text{min}$ , Maximum wet-bulb temperature is 29°C.

**Power requirements:** 100/120/220V  $\pm 10\%$ , 240V-10%+5%, 48 to 66Hz, 240/VA max.

**Dimensions:** Approximately 426mm (16.77in)W x 235mm (9.25in)H x 612mm (24.1in)D

**Weight:** Approximately 19kg (41.5 lbs)

## Accessories Furnished

**HP 04085-61651** Interconnect Cable Assembly

**HP 04141-60001** Connector Plate

**HP 04145-61630** BNC Cable (3m) 4ea.

## Accessories Available

**HP 16058A** Test Fixture

**HP 16059A** Adapter (Using with 16058A)

## Price

\$2,770

\$650

## Ordering Information

**4141B DC Source/Monitor**

**Opt.011:** Extra SMU Board

**Opt.050/060:** \*50Hz/60Hz Line Frequency

## Price

\$21,990

\$1,385

N/C

\*Must select Opt. 050 or 060 according to the power line frequency used.

# SEMICONDUCTOR TEST EQUIPMENT

## pA Meter/DC Voltage Source Model 4140B

- 3 basic semiconductor measurements:  
I, I-V and quasi-static C-V
- Two programmable voltage sources
- Basic accuracy: 0.5%
- High resolution:  $0.001 \times 10^{-12}$  A
- HP-IB standard

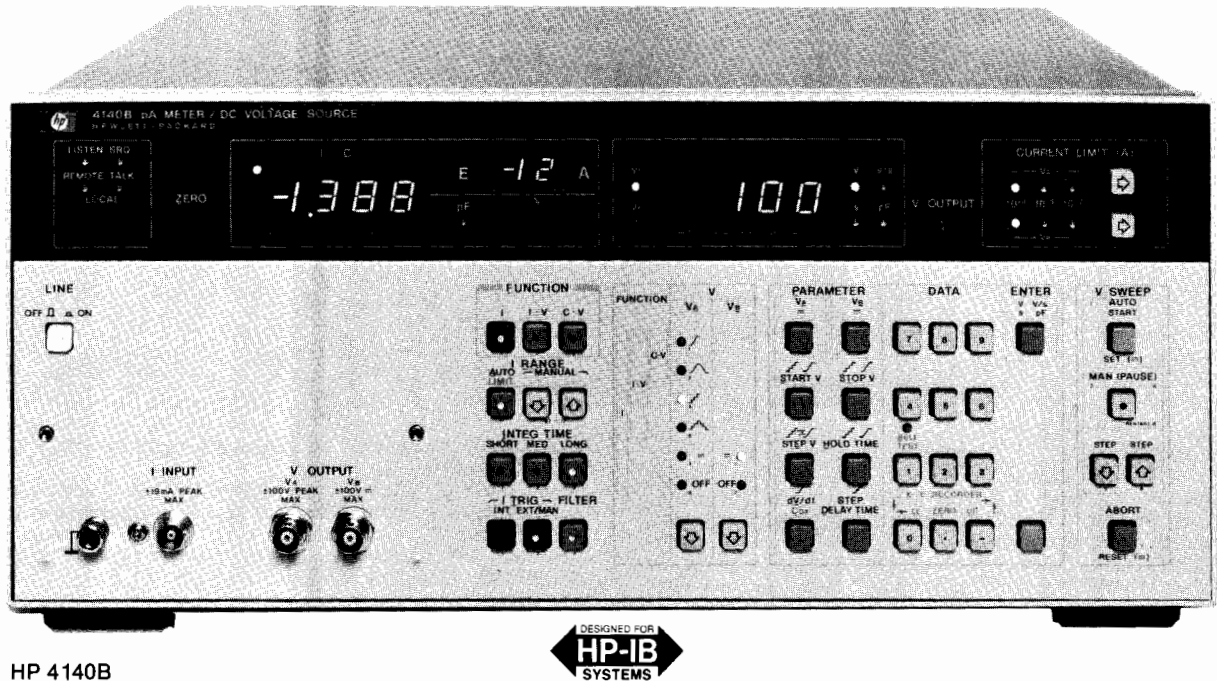

HP 4140B

### Description

The HP 4140B pA Meter/DC Voltage Source is another in Hewlett-Packard's new generation of Component Measurement instrumentation. It consists of an extremely stable picoampere meter and two programmable dc voltage sources, one of which operates as a ramp and staircase generator as well as a dc source. These features make the HP 4140B ideal for making dc characteristic measurements such as leakage current, current-voltage characteristics and quasi-static C-V measurements required by the semiconductor industry for new product development and for improving production yields. It is equally useful in measurements of electronic components and materials to determine leakage currents or insulation resistances.

The HP 4140B can contribute to the development, production and quality control of semiconductor devices and to the improvement in the reliability of electronic components and equipment.

### Stable pA Measurements

Stable picoampere measurements can be made with the HP 4140B with a maximum resolution of  $10^{-15}$  A. This is made possible by a new measurement technique in conjunction with an offset current capability, low noise test leads, and an electrostatic and light shielded test fixture. These features provide both stable and fast picoampere measurements.

This measurement technique is very useful in making small leakage current measurements and determining dc parameters of semiconductor devices or measuring the insulation resistance and leakage current for dielectric absorption measurements necessary in the analysis of capacitors or insulation materials.

### Synchronized I-V Measurements

The HP 4140B makes automatic, synchronized current-voltage measurements that have required a large instrumentation system in the past.

The two voltage sources in the HP 4140B operate over a range of  $-100$  V to  $+100$  V with a maximum resolution of 10 mV. One operates only as a stable dc source while the other generates a staircase voltage, a precise ramp or a stable dc level.

By adding precise, programmable timing capability, we can now make fast, accurate I-V and C-V measurements. Device stabilization times, (time between the applied voltage and the subsequent current

measurement) can now be programmed from the front panel of the HP 4140B or via the HP-IB bus.

### Quasi-Static C-V Measurements

Automatic quasi-static C-V measurements are easily accomplished by the ramp voltage capability of the HP 4140B. This measurement is highly significant in evaluating basic semiconductor characteristics.

The HP 4140B operates over a capacitance range of 0.1 pF to 1999 pF with a dc voltage ramp rate of 1 mV/s to 1 V/s in 1 mV/s increments. Capacitance, which is calculated from the measured current divided by the ramp rate, can also be provided as a percent of the capacitance of the oxide film ( $C_{ox}$ ) over a range of 0.0 to 199.9%. By providing the output voltage at each capacitance measurement point, we have the dc (quasi-static) C-V characteristics of the device under test.

### HP-IB Capability

Interfacing the HP 4140B to an HP-IB system improves measurement efficiency and takes advantage of its high speed (approx 5 ms) measurement rate. Such a system will minimize measurement time of dc parameters of semiconductors and the insulation resistance and leakage current of electric components and materials. This allows rapid feedback to production for fast evaluation of a new device in the development stage.

### Specifications

**Measurement functions:** I, I-V and C-V

**Voltage sources:** two separate sources ( $V_A$  and  $V_B$ )

$V_A$ :  $\pm 100$  V programmable source/function generator

$V_B$ :  $\pm 100$  V programmable dc voltage source

### Measurement Function/Source Selection

Function	$V_A$	$V_B$
I		== (DC)
I-V		== (DC)
C-V		== (DC)



**Voltage sweep:** auto or manual (pause)

#### Current Measurements

**Displays:** current, 3½ digits with 2 character annunciator. Voltage, 3½ digits.

**Measurement range:**  $\pm 0.001 \times 10^{-12}$  A to  $1.000 \times 10^{-2}$  A full scale in 11 ranges.

**Overrange capability:** 99.9% on all ranges.

**Range selection:** auto (lowest current range is selectable) and manual

#### Measurement Accuracy/Integration Time

Range	Accuracy* ± (% of rdg. + counts)	Integration Time** (ms)		
		Short	Medium	Long
$10^{-2} - 10^{-9}$	0.5 + 2	20	80	320
$10^{-10}$	2 + 2			
$10^{-11}$	5 + 3	80	320	1280
$10^{-12}$	5 + 8	160	640	2560

\* Accuracy for long integration time. 23°C ± 5°C, humidity ≤ 70%. For short and medium integration time, see reference data section.

\*\* Integration times specified at 50 Hz. For 60 Hz operation, multiple time by 1/6.

**Zero offset:** cancels leakage current of test leads or test fixtures.

**Offset range:** 0 to  $\pm 100 \times 10^{-15}$  A.

**Trigger:** INT, EXT and HOLD/MAN

**Input terminal:** triaxial

#### Capacitance-Voltage (C-V) Measurement

**Measurement ranges:** 0.0 pF – 100.0 pF and 200 pF – 1000 pF full scale in two ranges; 99.9% overrange

**Ranging:** auto

**% C:** capacitance change of device under test is displayed as a percent of the set value of the oxide capacitance ( $C_{ox} = 100\%$ )

**% C range:** 0.0% – 199.9%

**Cox setting ranges (2 ranges):** 0.1 pF – 199.9 pF and 200 pF – 1999 pF

**Capacitance calculation accuracy:** accuracy is dependent on accuracy of both the current measurement and ramp voltage.

**Zero offset:** cancels stray capacitances of test fixtures and test leads.

**Offset range:** 0 to 100 pF

**High speed I data output:** available with HP-IB interface only. Outputs current measurement data at 4 ms intervals (max rate).

#### DC Voltage Sources

##### Output Modes, $V_A$ and $V_B$

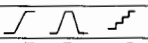
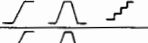
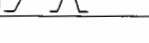
Function	$V_A$	$V_B$
I		--- (DC)
I-V		--- (DC)
C-V		--- (DC)

**Voltage ranges ( $V_A$  and  $V_B$ ):** 0 to  $\pm 10.00$  V and 0 to  $\pm 100.0$  V in 2 ranges, auto range only.

**Maximum current:** 10 mA, both sources.

**Voltage sweep:** auto and manual (pause), up/down step in manual (pause) mode. Sweep abort standard.

#### Operating Parameter Setting Ranges

**Start voltage and stop voltage:** 0 –  $\pm 10.00$  V, 0.01 V steps; 0 –  $\pm 100.0$  V, 0.1 V steps

**Step voltage:** 0 –  $\pm 10.00$  V, 0.01 V steps; 0 –  $\pm 100.0$  V, 0.1 V steps

**Hold time:** 0 – 199.9 seconds in 0.1 s increments; 0 – 1999 seconds in 1.0 s increments

**Step delay time:** 0 – 10.00 seconds in 0.01 s increments; 0 – 100.0 seconds in 0.1 s increments

**Ramp rate (dV/dt):** 0.001 V/s – 1.000 V/s in 0.001 V/s increments

#### Accuracy (at 23°C ± 5°C)

**Output voltage:**  $\pm 10$  V,  $\pm(0.07\% + 11$  mV);  $\pm 100$  V,  $\pm(0.09\% + 110$  mV)

**Linearity:** typically 0.5%, 0 –  $\pm 10$  V; < 5%, > 10 V.

**Current limit:** 100  $\mu$ A, 1 mA and 10 mA,  $\pm 10\%$  ( $V_A$  and  $V_B$ )

**Output terminals:** BNC; L-GND

## Reference Data

### Current Measurement

#### Current Measurement Accuracy\*

Range	Integration Time	
	Short	Medium
$10^{-2} - 10^{-8}$	0.5 + 3	0.5 + 2
$10^{-9}$	0.5 + 3	0.5 + 3
$10^{-10}$	2 + 4	2 + 3
$10^{-11}$	5 + 10	5 + 4
$10^{-12}$	5 + 20	5 + 10

\*  $\pm$  (% of rdg. + counts), 23°C

**Current ranging times\*:** 20 ms to 7.76 s. (longer ranging time needed for large changes in input signal level, especially on lowest current ranges).

\*When FILTER is on, current ranging time increases 60 ms (50 Hz power line) or 50 ms (60 Hz power line)

**Warm-up time:**  $\geq 1$  hour

**Common mode rejection ratio:**  $\geq 120$  dB ( $\leq 2$  counts)

#### Analog Output I, C and $V_A$

**Accuracy:**  $\pm(0.5\% + 20$  mV)

**Low pass filter:** 3 position: OFF, 0.22 s  $\pm 20\%$  and 1 s  $\pm 20\%$  applied to both  $V_A$  and I/C data outputs

**Pen lift output:** TTL low level ( $\leq 0.8$  V) during sweep period in I-V and C-V functions

**Recorder output scaling:** pushbutton scaling of lower left and upper right limits of X-Y recorder

#### HP-IB Interface

**Remote controlled functions:** measurement function, current range, integration time, I data output trigger, voltage sweep controls, current limit,  $V_A$  and  $V_B$  voltages, zero (offset), self test and parameter settings (voltages, sweep/hold/delay times)

#### Data Output

Measured data (I, C and  $V_A$ ),

Voltage setting ( $V_A$  and  $V_B$ ),

Parameter settings

#### General Information

**Power:** 100, 120, 220, V  $\pm 10\%$ , 240 V +5% – 10%; 48-66 Hz, 135 VA max

**Size:** 426 mm W x 177 mm H x 498 mm D (16.5" x 7" x 19.6")

**Weight:** 14.4 kg (31.7 lb)

#### Accessories Furnished

**HP 16053A test leads:** consists of one triaxial cable, two each BNC-BNC cables and one connection plate with mating female panel-mount connectors. Cables are one meter in length.

**HP 16055A test fixture:** for general device measurements. Provides electrostatic and light shielding for stable pA measurements.

#### Accessories Available

**HP 16054A connection selector:** provides a simple method to select appropriate connection of low lead for the pA meter section.

**HP 16056A current divider (10:1):** for use only on the 10 mA range to extend the measurement capability to 100 mA.

#### Ordering Information

##### Accessories

HP 16054A Connection Selector

HP 16056A Current Divider (10:1)

##### Options

Opt 907 Front Handle Kit (HP P/N 5061-0090)

Opt 908 Rack Flange Kit (HP P/N 5061-0078)

Opt 909 Rack & Handle Kit (HP P/N 5061-0084)

Opt 910 Extra Manual

Opt W30 2 Years Additional Hardware Service

**HP 4140B pA Meter/DC Voltage Source**

☛ Fast-Ship product — see page 766.

#### Price

\$400 ☛

\$210 ☛

\$66

\$36

\$92

\$51

\$120

**\$10,200**



# SEMICONDUCTOR TEST EQUIPMENT

## 1 MHz C Meter/C-V Plotter

### Model 4280A

- Built-in sweepable dc bias source and timer for C-V (Capacitance-Voltage)/C-t (Capacitance-Time) measurements
- High speed C-t measurements with minimum measurement interval of 10 ms (10  $\mu$ s if an external pulse generator is used)
- Basic C measurement accuracy: 0.1%
- Test lead extension up to 5 m
- 5½-digit display resolution (option) for C measurement

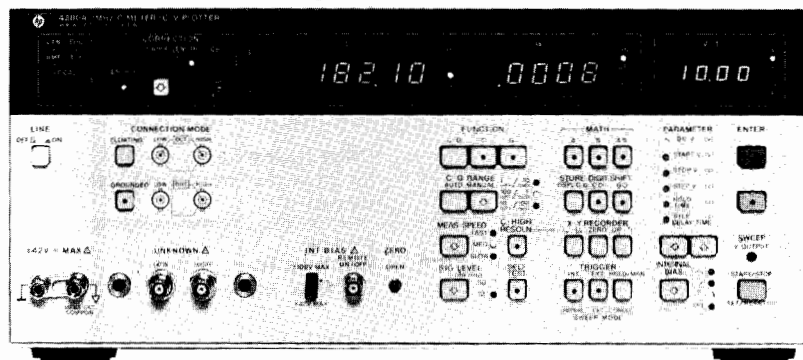

HP 4280A



### Description

The HP 4280A 1 MHz C Meter/C-V Plotter measures the capacitance and conductance of semiconductor devices and materials as functions of applied voltage (C-V) or time (C-t). The HP 4280A consists of a precision 1 MHz C-G meter, a programmable dc bias source that can be swept in staircase fashion, and accurate timing control.

### C-V and C-t Measurements

The HP 4280's internal dc bias source has a range of 0 V to  $\pm 100$  V with 1 mV resolution on the most sensitive range. Various measurement parameters for C-V and C-t measurements—hold time (bias pulse width) and delay time (measurement interval)—can be manually set from the front panel. Or these parameters can be set under program control via the HP-IB. Settable range for C-t measurement interval is 10 ms to 32s with a best case resolution of 10  $\mu$ s. If an external pulse generator is used, however, measurement intervals as short as 10  $\mu$ s can be set. Up to 9999 readings can be set for a C-t measurement. These capabilities make it possible for the HP 4280A to measure the C-t characteristics of virtually any device.

### High Speed C-t Measurement

A special sampling integration technique employed in the HP 4280A provides measurement intervals as short as 10  $\mu$ s using an external pulse generator, such as the HP 8112A or HP 8160A, to provide the bias pulse. Short measurement interval makes the HP 4280A applicable to Deep Level Transient Spectroscopy (DLTS) measurements, which are commonly used to analyze the physical characteristics of semiconductors.

### Precision, High Resolution Measurements

The HP 4280A measures capacitances up to 1.900 nF, over three ranges, with 0.001 pF resolution on the most sensitive range. Conductance up to 12 mS can be measured with a maximum resolution of 10  $\mu$ S.

C and G measurements are made at 1 MHz. AC signal level is selectable between 10 mVrms or 30 mVrms, suitable for semiconductor measurements. Basic measurement accuracy is 0.1%. Maximum display resolution is 4½ digits. With Option 001, however, display resolution for capacitance is 5½ digits.

The accuracy and resolution of the HP 4280A satisfy the stringent requirements of laboratory and R and D measurements, which require the detection of minute changes in device characteristics.

### Probed Measurements On Wafers

HP 4280A has an automatic error correction function that makes

it possible to use test leads up to 5 m long (HP P/N 8120-4195). The HP 4280A can measure either floating or grounded devices. Thus, the HP 4280A can be connected to a wafer prober and still provide stable, accurate C and G measurements.

### Easy, Low Cost Systemization

HP-IB is standard on the HP 4280A. So, a process evaluation system or a lab automation system capable of evaluating the physical characteristics of semiconductor devices can be easily constructed.

The HP 4280A is equipped with analog outputs to allow users to plot device characteristics on an X-Y recorder or large screen display.

### Specifications (refer to data sheet to complete specifications)

#### Measurement functions: C, C-V and C-t

Function		Available Internal dc Bias Function
Basic Function	Selection	
C	C only, G only C-G only	OFF, --- (DC)
C-V	C-V G-V C & G-V	
C-t	C-t G-t C & G-t	

### C Measurement

#### Test Signal

**Frequency:** 1 MHz  $\pm 0.01\%$

**OSC level:** 30 mVrms or 10 mVrms  $\pm 10\%$

**Measurement terminals:** two-terminal-pair configuration (High, Low and Guard).

**Connection mode:** sets connection configuration between DUT (floating/grounded) and measurement circuit.

**Ranging:** auto or manual

#### Error Compensation

**Cable length:** 0 m, 1 m or 0–5 m. The standard cable (HP P/N 8120-4195) up to 5 m can be internally compensated.

**Zero open:** compensate stray capacitance and conductance at the test fixture.

**External error compensation:** compensate errors by external computer to eliminate other error factors not listed above.

**Measurement speed:** FAST, MED or SLOW

**Trigger:** Internal, External or Hold/Manual

**Internal dc bias mode:** OFF or --- (DC)

**Measurement Range/Resolution/Accuracy**

Range <sup>1</sup>	Resolution <sup>2</sup>	Max. Display <sup>3</sup>	Accuracy <sup>4</sup> ±(% of rdg + counts)	
			OSC: 30 mV	OSC: 10 mV
10 pF/100 μS	0.001 pF 0.01 μS	19.000 pF 120.00 μS	±(0.1% + 5) ±(0.2% + 5)	±(0.2% + 5) ±(0.3% + 5)
100 pF/1 mS	0.01 pF 0.1 μS	190.00 pF 1.2000 mS	±(0.1% + 3) ±(0.2% + 3)	±(0.2% + 3) ±(0.3% + 3)
1 nF/10 mS <sup>5</sup>	0.1 pF 0.001 mS	1.9000 nF 12.000 mS	±(0.1% + 3) ±(1.2% + 3)	±(0.2% + 3) ±(1.2% + 3)

<sup>1</sup> 100 pF/1 mS and 1 nF/10 mS ranges only in grounded measurement.  
<sup>2</sup> When measurement speed is set to FAST (10 mV/30 mV) or MED (10 mV), resolution and Max. display become 1 digit less (3 1/4 digit display).  
<sup>3</sup> Approx. 50 pF at 100 pF/1 mS range and 1.76 nF at 1 nF/10 mS range in grounded measurement. Error correction to offset residuals will reduce maximum value which can be measured.  
<sup>4</sup> Accuracy is specified at UNKNOWN terminals and at the end of HP 16082A Test Leads (1 m) after warm-up ≥30 min., at temperature 23°C ±5°C, zero open calibration is performed, and CORRECTION is enabled. Front panel settings are C-G, FLOATING and 0 m or 1 m (CABLE LENGTH). Some errors will be added at other settings (refer to data sheet). C accuracy is specified when D < 0.05 and G accuracy is specified when counts of C < 1/100 of range. Error double at 0°C-55°C.  
<sup>5</sup> Add 0.1% of rdg for C and 0.2% of rdg for G when HP 16082A is used.

**C-V Measurement**

**Function:** measures C-V, G-V or C & G-V characteristics using internal staircase bias.  
**Measurement speed:** FAST, MED or SLOW

**C-t Measurement**

**Function:** measures C-t, G-t or C & G-t characteristics using internal and/or external pulse bias source.  
**Internal measurement mode:** Burst or Sampling Mode automatically selected.

**Burst mode:** apply one pulse then make repetitive measurement with specified time interval between measurements.  
**Sampling mode:** repeated pulse with single samples between pulses. Delay between application of measure voltage and sample can be specified.

**Measurement speed:** FAST or MED

**DC Bias Source**

**Output Mode:** , , , (DC) or OFF  
**Output Voltage Range/Resolution/Accuracy**

Voltage Range	Resolution	Accuracy* ±(% of setting + volts)
±1.999 V	1 mV	±(0.2% + 0.01 V)
±19.99 V	10 mV	±(0.1% + 0.02 V)
±100.0 V	100 mV	±(0.1% + 0.1 V)

\*at 23°C ±5°C, at 0°C -55°C error doubles

**Staircase Sweep Parameter Settings (C-V Basic Function Only)**

**Start/stop voltage:** 0 V-±100 V (max. 1 mV resolution)  
**Step voltage:** 0 V-200 V (max. 1 mV resolution)  
**Hold/step delay time (th/td):** 3 ms-650s (max. 1 ms resolution)  
**Pulse Bias Parameter Settings (C-t basic function only)**  
**DC/pulse/measurement voltage:** 0 V-±100 V (max. 1 mV resolution)

**Number of readings:** 1-9999  
**Hold time (th):** max. 10 μs resolution  
**Internal bias:** 10 ms-32 s  
**Ext bias slow:** 50 μs-32 s  
**Ext bias fast:** 10 μs-32 s

**Delay time (td):** 10 μs-32 s (max. 10 μs resolution)

**Burst Mode**

Function	Meas. Speed	Block Mode	Non Block Mode	
			Data Format	
			Binary	ASCII
C-t G-t	FAST	10 ms-32 s	20 ms-32 s	150 ms-32 s
	MED			
C & G-t	FAST	100 ms-32 s		200 ms-32 s
	MED			250 ms-32 s

**Sampling Mode**

**Ext bias slow:** 200 μs-5 s  
**Ext bias fast:** 10 μs-5 s  
**Math functions:** displays measured C/G values as differential values (Δ), % ratio (%) or differential % (Δ%) of the reference value.

**Other**

**HP-IB:** not just IEEE-488, but the hardware, documentation and support that delivers the shortest path to a measurement system.

**Data output format:** ASCII or Binary  
**Block mode output:** can make C-V/t characteristics measurement and store measured data (C-V/t or G-V/t Function: 680 data, C & G-V/t Function: 400 data) into the internal data buffer. Then, packed data can be output.

**Recorder Output**

**Output voltage:** ±10 V for C, G and V/t data  
**Accuracy:** ±(% of output voltage + V)  
**C or G:** ±(0.5% + 20 mV)  
**V or t:** ±(0.15% + 40 mV)

**Self test:** verifies normal measurement operations (not including calibration)

**Options**

**Option 001:** High Resolution Offset Capacitance Measurement  
**Function:** increase C measurement resolutions by one digit with offset reference value.  
**C offset range:** 0 pF-1023 pF (1 pF increment). C offset value can be set by measured data or numeric key.

**General Specifications**

**Operating temperature range:** 0°C to 55°C; 95% RH at 40°C  
**Power requirements:** 100/120/220 V ±10%, 240 V + 5% - 10%; 48 to 66 Hz; 140 V A max.  
**Dimensions:** 426 mm W x 177 mm H x 498 m D (16.5" x 7" x 19.5")  
**Weight:** 15.3 kg (33.7 lb)

**Accessories Furnished**

**HP 16080A:** Direct Coupled Test Fixture

**Reference Data**

**Measurement Time**

MEAS SPEED	Measurement Function					
	C-G		C		G	
FAST	30	(70)	10	(30)	10	(30)
MED	70	(110)	40	(60)	35	(55)
SLOW	400	(440)	270	(290)	220	(240)

When measured values are displayed on the front panel and the recorder outputs are used, measurement times in parentheses apply.

**Residual L-R compensation:** error compensation for residual L-R (max. 19 μH/190 Ω) is available using an external controller.

**Internal DC Characteristics of High and Low Unknown Terminals (Without DC Bias)**

**Maximum offset voltage:** ±1 mV  
**Maximum allowable current:** 100 mA

**Internal DC Bias**

**Settling time (99.9% of final value):** 0.05 × voltage swing (V) + 1.7 (ms)  
**Maximum output current:** ±6 mA  
**Hold time/step delay time/th/td:** 0.02% (basic accuracy)  
**Response time of the EXT SLOW bias circuit (99.9% of final value):** 100 μs

**Option 001**

**C offset accuracy:** ±(2% of reference value + 0.5 pF) can be compensated by CORRECTION ENABLE key.

**Ordering Information**

HP 16081A Test Leads, 2 m double shielded, BNC	\$745 ☎
HP 16082A Test Leads, 1 m, BNC	\$255 ☎
HP 16083A Pulse Bias Noise Clipper	\$405

HP 4280A 1 MHz C Meter/C-V Plotter	\$10600
Opt. 001: C-High Resolution (not field installable)	\$420
Opt. W30: 2 Years Additional Hardware Service	\$95
☎ Fast-Ship product -- see page 766.	

# SEMICONDUCTOR TEST EQUIPMENT

## Parameter Extraction Software TECAP Characterization System

- Shortens IC design time
- Improves circuit designs
- Lowers chip costs
- Maximizes yields
- Accurate circuit simulations
- Device AC and DC measurements

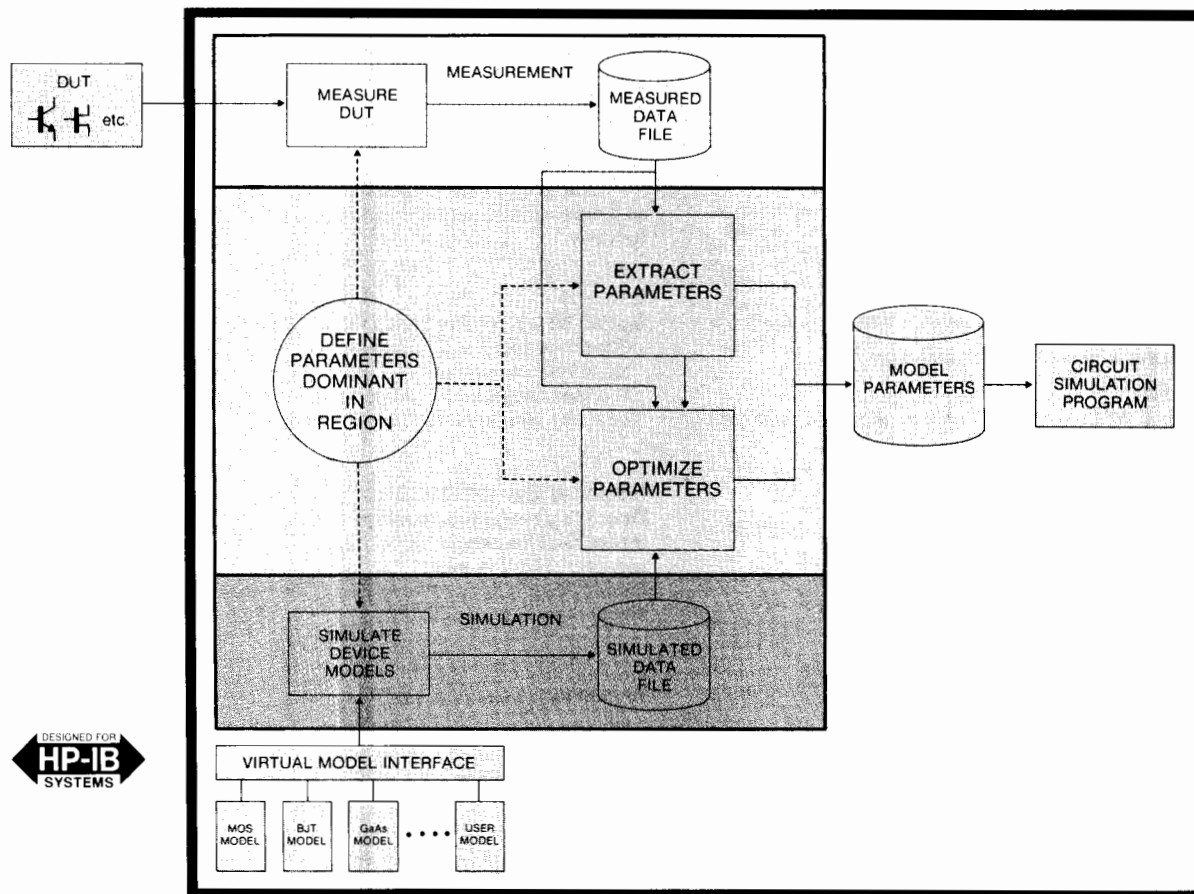

TECAP automatic parameter extraction methodology

### TECAP Lets You Design New IC's in Less Time - With Less Cost

Hewlett-Packard's TECAP characterization System shortens your IC design cycles and lowers design costs. TECAP - Transistor Electrical Characterization and Analysis Program - provides fast, reliable analysis of device behavior. Model parameters generated with the TECAP system will improve your circuit simulation and IC designs.

TECAP provides engineers with a complete system for device characterization. The easy-to-use display environment and extensive set of calibration and measurement drivers streamlines data collection. Simple commands allow you to quickly extract model parameters from measured data. Integrated, powerful simulation tools allow you to perform real-time analysis of your device performance.

### Design IC's and New Devices Faster

TECAP lets you perform your design revisions using CAE analysis. Because this is more economical and much faster than multiple fabrication runs, you save valuable engineering and production resources. Accurate model parameters form the foundation for error-free circuit simulation and precise IC design. TECAP's integrated measurement, extraction, and simulation tools provide you with accurate model parameters in seconds. Because you can now begin wafer fabrication with a superior design, you minimize passes through the fab line, slash your design cycles, and deliver products to your customers in a timely manner.

### Develop and Understand New Device Models

You can implement your own transistor models into TECAP to be completely compatible with proprietary circuit simulation programs or emerging new semiconductor technologies. You can use the versa-

tile simulation tools to develop and test new model equations. TECAP gives you the immediate feedback you need to evaluate and understand equation behavior. TECAP replaces pages of batch printouts with vivid, colorful graphics so you may clearly visualize the effects of model parameters and complex, multi-order equations.

### Get Maximum Performance From Your Process

TECAP allows you to significantly improve the performance of your existing IC process. With TECAP, you can determine those parameters which have the greatest effects on performance measures such as speed, power, and logic levels. Using TECAP's statistical tools, you can accurately determine worst case performance of your process using those dominant parameters. TECAP gives you the vehicle to construct worst case models which will allow you to increase the performance of your process with minimal process development and lower cost.

### TECAP Extracts Model Parameters in Seconds

TECAP software can automatically extract UCB Level 2, 3, 4, MOS, UCB Bipolar, or GaAs model parameters in seconds. These models can simulate second-order effects, such as channel-length modulation, and offer direct compatibility with the UCB SPICE circuit simulator developed at the University of California, Berkeley.

The TECAP system can also extract parameters for your new transistor models. Newly implemented models have the same parameter extraction, optimization, and simulation capabilities as standard TECAP models. You can even add a custom extraction module to the program to fully automate parameter extraction for your model.

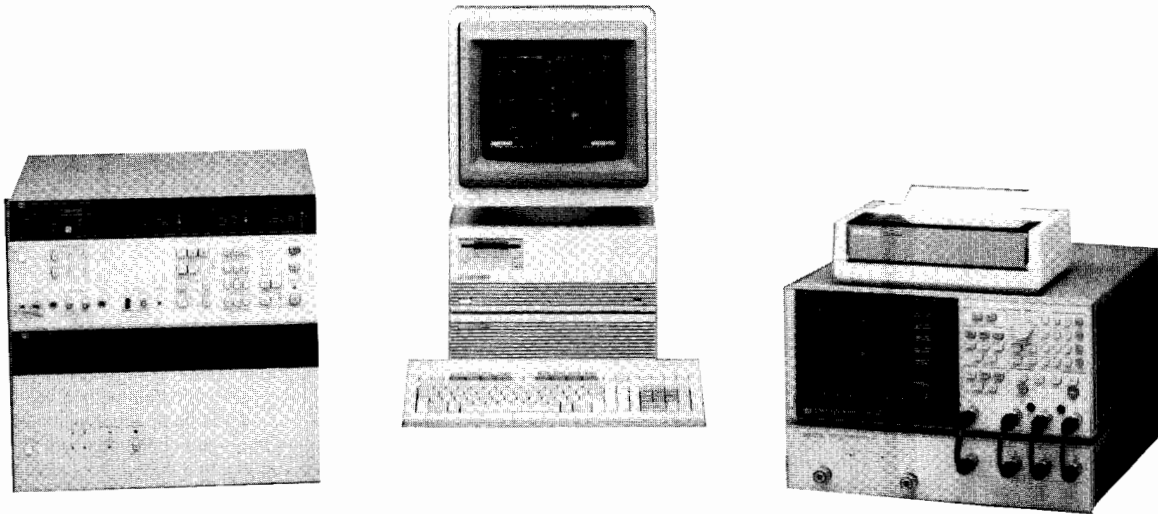

TECAP software is fully compatible with a wide range of standard HP-IB instrumentation.

### Configure System Hardware to Satisfy Your Price and Performance Requirements

The TECAP system works with a wide range of standard Hewlett-Packard computers and HP-IB instrumentation, allowing you to choose the equipment which meets your exact needs. You can build an entry level system to start with. Then, as your requirements expand, you can add the latest in high performance measurement tools to fit your changing situation.

### TECAP Is Easy to Use

TECAP provides both ease-of-use for the occasional user and advanced features and capabilities for the expert user. You can access any TECAP command from one convenient menu - so you don't get lost in menu hierarchies. The "main menu" always displays program status to keep you updated on program action. These human-engineering features have been designed into TECAP to automate the process of parameter extraction and new model development.

To measure a device, extract model parameters, or simulate device performance, you select the appropriate command. If the system needs more information from you, it will supply a diagram or table for you to edit. Every table is already furnished with default values or configurations. The table entry method allows you to have immediate access to all of your characterization routines - this lets you use the design tools more productively.

### Integrated System Saves Time

TECAP's integrated environment lets you concentrate on evaluating results, so you don't waste time figuring out how to get them. You can measure devices, extract parameters, simulate device models, and plot results all with the same program.

TECAP minimizes setup preparation time so each user can immediately begin extracting parameters from their devices. For example, you can save a complete system environment on a disc and use it in seconds. You can retrieve instrument setups, extraction routines, and device models with a single command. You can create system configurations for every process in your company. You can quickly setup an environment to perform characterization on NMOS, CMOS, bipolar, or GaAs devices - using the SAME system.

You can operate the TECAP system without knowledge of the computer hardware, the computer operating system, or the measurement instruments. The system automatically adapts to handle all the

instrument setups and measurements you need for device characterization. To give you maximum flexibility, the software lets you control a wide variety of measurement and computation hardware.

### TECAP Software Specifications

**Operating system:** Pascal Workstation language system, Version 3.2.

**Measurement:** voltage, current, capacitance, and 2-port ac parameters vs. bias and frequency.

#### Model Parameter Generation

##### Extraction:

- direct extraction from measured data
- predefined routines for automatic extraction
- interactive parameter extraction mode
- user definable extraction routines

##### Optimization:

- numerical fine tuning of extracted parameters using integrated SPICE-like simulator for highly accurate fits
- compatible with user defined models
- Levenberg-Marquardt algorithm for nonlinear, least-squares fit
- constrained optimization

**Simulation:** voltage, current, capacitance, and 2-port ac parameters vs. bias and frequency.

#### Available models:

- UCB MOS Levels 1, 2, 3 and 4 (BSIM)
- UCB bipolar (Gummel-Poon)
- Curtice GaAs MESFET Levels 1 (quadratic) and 2 (cubic)
- Yaeger-Dutton GaAs HEMT
- UCB JFET
- Diode
- PN Junction Capacitance
- MOS Gate Capacitance
- Classical MOS
- Up to 7 user definable models

### Ordering Information

Please call your local HP Sales Office listed on page 771 for a data sheet, prices, or applications assistance.

# BOARD TEST SYSTEMS

## Model 3065 Board Test Family

- Combinational Testers
- Guaranteed 99% Uptime Service

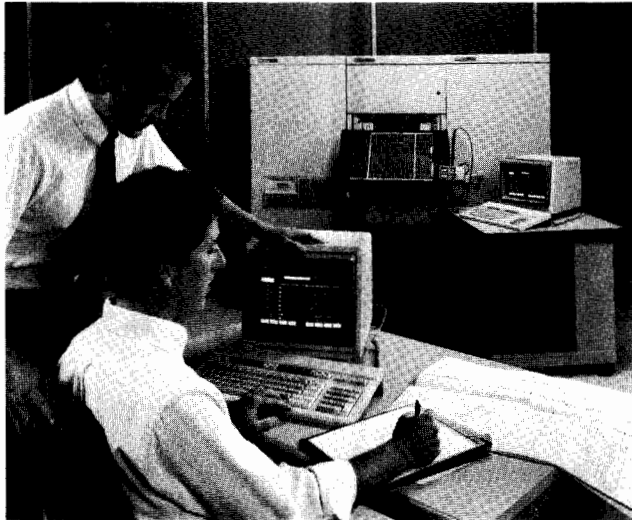

### Description

The HP 3065 Board Test Family is the result of many years of experience in automatic testing and advanced computer technology. The entire HP 3065 Family features high speed digital testing, our proven 6-wire analog in-circuit testing and analog functional testing. Adding the HP Advanced Technologies Hardware (HP 44680A) and Software (HP 44683A) Modules to the L- and X-Series testers provides high speed combinational (combined in-circuit and functional) testing capabilities as well. A distributed intelligence architecture and true multitasking environment allows a single controller to support multiple test stations, multiple programming and repair stations, and a variety of peripherals without sacrificing high throughput in production test.

The HP 3065 Family offers a choice of two controllers (HP 3065CL/CX PLUS), two test stations (HP 3065HL/HX), the HP 3065ST Standard Technologies Tester, the HP 3065AT Advanced Technologies Combinational Tester, and the newest member of the family... the HP 3065CT Communications Technologies Board Test System.

The wide selection and varied capabilities of the HP 3065 Family allow you to configure a test system to meet the challenge of solving your most complex testing problems... in an environment of world competition and rapidly changing technologies.

### New Technologies

Electronic manufacturers are faced with two important problems... how to remain competitive and profitable in today's electronics marketplace. Worldwide competition, shorter product life cycles, demands for customization, and rapidly advancing technologies all contribute to complicate the problem. Due to worldwide economic conditions, many manufacturers are competing against companies that either didn't exist five years ago, or didn't distribute their products worldwide. With more companies competing, product life cycles are being dramatically reduced and an increasing number customers are demanding that products meet their specific requirements. In order to meet these external pressures, manufacturers are turning to new technologies and manufacturing processes that promise shorter product development times and product flexibility.

The most rapid technological growth is taking place in the use of advanced device technologies including SMDs, ASICs, and VLSI circuitry in PC board manufacturing. Surface mount technology is used to reduce the physical size of PC boards, creating challenges in test access and requiring combined in-circuit and functional testing. In the telecommunications industry, the use of Integrated Services Digital Networks (ISDN) is causing revolution in the design and testing of new products. While these new technologies have cost and capability advantages, they have also introduced a unique set of process and test problems into the manufacturing area. As an innovator in the

design and use of advanced technologies, Hewlett-Packard is a leader in the manufacture of design and test systems to address these problems. The HP 3065 Family members were designed to test these new technologies as well as existing ones.

### Telecommunications Testing

The telecommunications industry, due to deregulation, is faced with increased competition worldwide, making product cost and test efficiency a major issue. The test department has more pressure to develop new tests, on new designs, in shorter time, with the same staff. For this reason, telecom managers must re-examine their existing test strategy in order to develop a flexible strategy for testing existing products and the new ISDN technologies within the same test workcell. The HP 3065CT Communications Technologies Board Test System was specifically designed to solve this problem.

The HP 3065CT is a completely integrated one-stage test system for the telecommunications industry. It is based on the solid foundation of the HP 3065AT combinational test system and the HP Telecomtest software. Additional test instrumentation, new software, and integrated library elements allow the HP 3065CT to perform CCITT specification tests on telecom products. Prior to specification testing, production induced faults can be detected with the digital, analog, and combinational test capabilities that the HP 3065CT shares with other members of the HP 3065 Family.

### Advanced Device Technologies

Advanced technologies, such as surface mount devices (SMDs), application specific integrated circuits (ASICs) and VLSI circuits, allow the manufacturer to place greater capabilities into smaller geometries. This poses not only problems in testing the advanced circuitry, but problems in accessing the test nodes on the PC board as well. Hewlett-Packard has the test systems, fixturing and applications software to solve these problems.

SMT has led to PC board designs with 50 mil or less node spacing, reduced test node access and dual-sided boards. The HP 44203 SimPlate Series of test fixtures were designed to accurately access circuitry on the PC assemblies with these smaller geometries. Dual-sided fixtures based on the SimPlate Series are also available from HP.

The HP 3065 Family of testers provide hardware and software to test the most complex VLSI circuitry. Microprocessor bus emulation, clock synchronization, and automatic backtrace capabilities are some of the tools available in the totally integrated functional and in-circuit test systems.

ASICs are unique, complex custom devices that do not exist in any test system library. Therefore, your tester must access the designer's CAE simulation data base for usable test data. The HP 3065 Family's Pattern Capture Format software allows the user access to 18 leading CAE systems at present with an open interface to proprietary in-house design systems. This common format enables you to translate the CAE system data and download it directly into the HP 3065 tester for digital test generation.

### Protect Your Investment

The modularity and flexibility of the HP 3065 Family of test systems allow the user to keep pace with today's rapidly changing technologies. System compatibility within the family ensures that test programs and fixtures developed on one system are easily transported to other HP 3065 test systems. Therefore, training, test programs and fixtures are not abandoned when the need for additional capacity arises.

Hewlett-Packard has over 85 board test service offices worldwide, so we're there wherever you are. HP's SupportNet Applications Centers offer complete solutions to your application, hardware and software support needs anywhere in the world.

### HP 3065 Board Test Family

For more information on the HP 3065 Board Test Family, call 1-800-752-0900 Ext. F232 in the U.S., or your local Hewlett-Packard Sales and Service office.

**Prices start at \$95,000.**



- Complete Test System
- Low Cost . . . Easy to Program



### Description

The HP 3065ST Standard Technologies Board Test System is the basic in-circuit test member of the HP 3065 Family of testers. It is a complete, low-cost board test system that includes a test station, controller, two terminals, repair message printer, and automatic, easy-to-use software. Everything you need is included in one system: proven digital in-circuit testing; outstanding analog test capability; built-in analog functional test instruments; simultaneous testing and program development; automatic program generation; quick turn-on of tests; and build-in SQC software.

### Digital In-circuit Testing

The HP 3065ST digital in-circuit test capability provides safe, repeatable tests for both parts faults and manufacturing defects. Digital in-circuit tests are automatically generated by HP IPG-II for a wide variety of SSI, MSI, LSI and VLSI devices. The basis for this wide coverage and easy programming is a library of over 4500 HP-developed device tests which includes most logic families. Tests are available for the most popular microprocessor families (68000, 80286, 80386, etc.), static and dynamic RAMs, and ASICs when using the optional HP Pattern Capture Format Module.

The 2.5 MHz pattern application rate of the HP 3065ST allows a greater number of today's LSI and VLSI devices to be tested. Currents of up to 500 mA can be applied to test high current logic devices such as the FAST family. The HP 3065ST's digital in-circuit tests are easy to develop and provide fast, accurate diagnostics to pinpoint defective devices on the board under test.

### Analog Test Capability

Analog in-circuit testing techniques used on the HP 3065ST are widely considered to be the industry standard for comparison. The proven 6-wire measurement technique allows the HP 3065ST to test a wide variety of components in complex circuit configurations by reducing the measurement error from parallel impedances, fixture impedances and system errors. Analog measurements are also enhanced by the use of phase synchronous detection, enhanced measurement mode, and extra digit mode.

Analog functional test instrumentation is a standard part of the HP 3065ST. Sources and detectors are available to further enhance testing of the analog portion of the board under test. Programming of these devices is via HP BT-BASIC programming language.

### Simultaneous Testing and Program Development

The HP 3065ST provides the user with simultaneous testing and program development capability. The HP 3065ST provides two workstations controlled by its multi-tasking operating system, each with its own display terminal. This allows the test programmer to enter board data, use the automatic program generator, edit test programs and analyze test data . . . without slowing down production testing.

The automatic programming station is provided for the development of new test programs or modifying existing ones. Board topology is entered through HP Board Forms, which provides easy entry of wire and parts lists through twelve softkey selected screens. Program modification is made easy with HP BT-BASIC with its full-screen editor and automatic syntax checking. HP Q-STATS is provided for production process evaluation using Statistical Quality Control analysis techniques.

The test station includes the testhead, display terminal, message printer, and operator keypad. Its primary function is the production testing of loaded printed circuit assemblies. When the test station terminal is not being used for production testing, it can be used as an automatic programming station.

### Automatic Program Generation

The HP 3065ST provides an automatic in-circuit program generator (IPG II) to generate both analog and digital in-circuit tests quickly and easily. The circuit description can be entered either manually into the standard HP Board Forms screens or through the optional HP CAD-VANTAGE software that automatically extracts the parts and wire lists from most CAD systems. In addition, test vectors can be downloaded into the HP 3065ST from many CAE/CAD systems using the HP Pattern Capture Format Module. Once the board topology and device information has been entered into the system, the automatic in-circuit program generator does the rest.

Programming digital in-circuit tests, even for complex devices, is easy. The program selects the library tests for the devices to be tested. It then automatically adjusts each test to compensate for circuit topology as the test plan is generated. In addition, to avoid the possibility of device damage during testing, the HP 3065ST provides the HP Safeguard In-circuit analysis package. This software analyzes each digital test as it is generated, taking into consideration device parameters such as package type, power dissipation, voltage overshoot, and overdrive currents. If unsafe conditions exist, the programmer is notified and corrective action can be taken.

Programming analog in-circuit tests on the HP 3065ST is just as simple. HP IPG-II generates tests for all components on the board, analyzing the entire circuit and automatically specifying any needed measurement enhancements. These tests provide accurate, repeatable measurements on the device under test. Concise diagnostic information as to which part failed, and how it failed, greatly reduces repair times.

### Test The Latest Technologies

Economic and competitive pressures on electronic manufacturers have led to rapid growth in complex devices, including advanced VLSI and ASICs. In addition, the trend is now away from through-hole and toward surface mount technology for PC boards. The HP 3065ST digital library is continually updated to contain the most advanced VLSI devices as they become available. With the optional HP Pattern Capture Format Module, data from design simulators are formatted and compiled into HP 3065 executable code, allowing vital design information to be used for production testing of ASIC devices.

The use of surface mount devices has led to several unique problems in the production testing of PC boards. These include restricted access to component test nodes, smaller targets for test pins and components mounted on both sides of the board. The new HP 44203 SimPlate Fixture Series used on the HP 3065ST was designed for SMT applications and provides the accuracy and access required by the new technology. An HP SimPlate fixture is also available for access to dual-sided PC boards.

### Protect Your Investment

Because the HP 3065ST Standard Technologies Board Test System is a member of the HP 3065 Family, it provides the same protection for your investment. It offers proven performance demonstrated at hundreds of sites throughout the world. The reliability of the HP 3065ST allows it to participate in the 99% Guaranteed Uptime Service offered in many parts of the world. Since Hewlett-Packard has over 85 service locations worldwide, we are there when you need us.

The HP 3065ST provides an automatic, easy-to-program test system with unsurpassed reliability and test repeatability for your manufacturing operation.

**Prices start at \$95,000.**



# BOARD TEST SYSTEMS

## HP Q-STAR Test Network Software System



### Description

Automatic testing is not the total solution to productivity or product quality. Software applications must exist to form the framework for using board test data to improve product quality as well as provide timely feedback to improve the manufacturing process using Statistical Quality Control (SQC) techniques. There must also be an overall strategy for linking computer-aided solutions throughout the entire manufacturing facility. Hewlett-Packard offers Computer Integrated Manufacturing (CIM) products and services linking all areas within the facility. Timely communication among production, engineering and administration is essential if control of the manufacturing facility is to be maintained.

The HP Q-STAR Test Network offers the basis for implementing SQC and CIM in the manufacturing process while providing the optimum solution for your test workcell needs. It provides the tools to implement quality management techniques, paperless repair across the network, and test program management at minimal additional cost to you.

The modular structure of the applications software in the HP Q-STAR Network provides the flexibility to select only the capability you need now and then add others as your needs expand. Some of the basic applications (PRR, Q-STATS) are provided as a standard part of the system software. Then, as your needs increase, test management software (NS/3065 and BTL PLUS), network-wide paperless repair (PR PLUS), and more sophisticated quality management software (Q-STATS II) can be added.

### Test Software Management

HP NS/3065 (HP 44670C/L/X) provides transparent network services for multiple HP 3065 board test systems using HP AdvanceNet (HDLC) as its foundation. Recent enhancements to HP NS/3065 has added new LAN Capabilities to provide a smooth transition to Local Area Networks, extending its networking capabilities beyond the test workcell. HP NS/3065 now gives you the flexibility to create a network that meets your needs today and expands to cover your networking needs in the future. The HP NS/3065 LAN Capabilities support the IEEE 802.3 network interface standard and, with its bus architecture, all systems supporting the standard are linked via a single cable.

The ability to network the HP 3065 to other test systems, quality management systems and computer systems gives you the advantage of:

- File sharing, for automatic archiving and downloading of data
- Resource sharing, lowering your investment in peripherals
- File security, ensuring revision control of test programs, protection of proprietary programs, and prevention of accidental data loss
- Distributed data processing for more efficient utilization of resources
- Test and repair data sent automatically to the quality management system for processing
- Direct download of parts and connectivity information and digital test patterns from CAD/CAE systems to the HP 3065 test system for immediate translation and use.

The new HP NS/3065 LAN Capabilities and the standard HP NS/3065 are completely compatible within the HP 3065 environment. Both the HDLC dedicated links and IEEE 802.3 industry standard links are supported by the new HP NS/3065.

HP BTL PLUS links the HP 3061A/3062A into the HP Q-STAR Network via the HP-IB (IEEE-488) interface. The software package (HP 44582A) is an enhanced version of the standard HP 3061A/3062A system software, so compatibility with existing software is preserved. Networking the HP 3061A/3062A systems with the HP 3065CL/CX controllers that have Network Services (NS/3065) allows these systems to become an integral part of your test workcell.

### Paperless Repair Software

Two paperless repair software packages are available as a part of HP's Q-STAR Network. The first, Paperless Repair/Reporting (PRR), is a standard part of the HP 3065 Family software. HP PRR with its bar code capability automates the diagnostics flow between the test and repair areas of a board test cluster (test stations and systems tied to a single HP 3065 Controller) and provides board tracking through the test/repair cycle. Actual failure data from the board test cluster is collected and sent to the HP Q-STATS data base for analysis. Alarms are built in to alert the operator to repeated defects to minimize repair and scrap.

HP PR PLUS (HP 44671C/L/X) has all the benefits of PRR plus additional features to provide the most efficient use of available resources. It allows paperless repair across the entire board test network so boards can be repaired on any available terminal. Failure data is transferred into the HP Q-STATS II data base from any repair terminal on the network. In addition, HP PR PLUS supports local language screens to allow the repair operator to quickly understand the problem.

HP's paperless repair software streamlines the repair operation while providing timely feedback to improve production processes.

### Quality Management Software

Analysis of data gathered in the test/repair loop is performed by HP Q-STATS, another standard feature of the HP 3065 Family software. Statistical analysis of raw data from a board test cluster provides useful information required by programmers, test engineers, and managers. For example, producibility reports provide a statistical measure of the quality and repeatability of a test. HP Q-STATS provides production management information in several different formats based on Statistical Quality Control concepts. Tabular reports highlight production parameters such as yield, volume of boards tested, and average wait, test and repair times. Pareto charts give detailed information such as board failures by component designator.

HP Q-STATS II (HP 44672A) extends the SQC-analysis features across the entire test workcell that may include HP 3065's, 3061/62A's, and other automatic test systems. It integrates data from all these sources into one data base and analyzes all this data to produce useful SQC information. HP Q-STATS II contains reporting features that HP Q-STATS does not have, including presentation-quality graphical formats and new reports such as control charts, overview histograms, and various other production summaries.

Two additional features of HP Q-STATS II are SQL ad hoc queries of the data base and the use of an HP 9000 workstation with an HP-UX operating system as the host computer. The use of the separate workstation allows the data to be analyzed and reports generated without impacting the throughput of the test systems. With the IEEE 802.3 industry standard LAN Network interface, the data in HP Q-STATS II can be integrated into a facility-wide quality data base.

Since HP Q-STATS II implements a turnkey data collection function, test managers will find it easier to implement SQC practices to improve quality and increase the productivity of the production processes.

### Ordering Information

	<b>Price</b>
HP 44582A BTL PLUS Software	\$5,610
HP 44670C/L/X NS/3065 Software	\$4,680-\$7,800
HP 44671C/L/X PR PLUS Software	\$4,680-\$7,800
HP 44672A Q-STATS II Software	\$40,800



## Model 3065 Board Test Family Fixturing Products

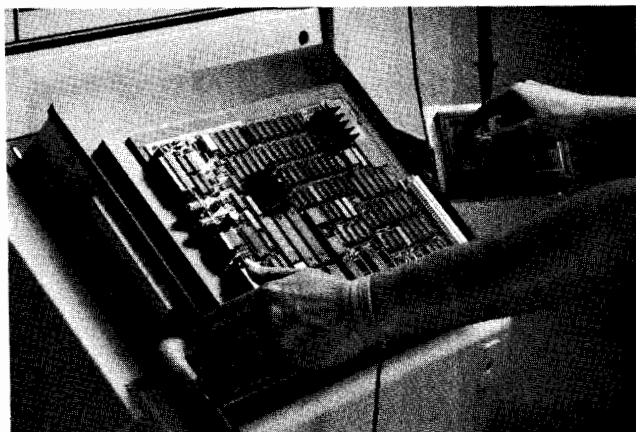

### Description

A new series of vacuum-actuated test fixtures, the HP 44203 SimPlate Series, now offers higher probing accuracy, greater reliability and easier maintenance than the conventional dual plate design. The HP SimPlate fixtures have an easily removable support plate instead of the familiar top plate. This support plate is slightly larger than the board under test, providing support to the board while acting as a vacuum seal between it and the bottom plate. The elimination of the top plate and associated hardware reduces the parts count by 35 percent and decreases the weight of the fixture up to 23 percent. Fewer parts mean lower assembly costs and higher reliability.

### Performance

Improved probe location accuracy gives the HP SimPlate fixtures the ability to contact boards with tight physical tolerances. The result is a ten-fold improvement in probing accuracy, making these fixtures an excellent choice for testing both conventional and surface mount technologies.

The accuracy and the repeatability of the probing is accomplished by referencing both the board and the probes to the same plate. The probes are mounted in the bottom plate to allow full travel while minimizing unsupported probe height. To further control probing accuracy, hardened steel tooling pins to guide the travel of the board are mounted on the same plate as the probes.

The support plate assembly is positioned in the lower left corner of the fixture to optimize both mechanical and electrical performance. This locates the support assembly directly above the vacuum port to maximize air flow, resulting in quick actuation and reliable probe contact. The board is located directly above the scanner cards, reducing wire lengths for improved signal integrity.

### Easy Maintenance

When routine maintenance is required, the simple design of the HP SimPlate fixtures provides immediate probe access without tools. The support plate simply lifts off the fixture, allowing easy probe access for cleaning or replacement. For high volume applications, a spare support assembly (HP 44203K) is available. Using this spare, testing can continue while PC board gasket and vacuum seal maintenance is performed on the original unit.

### Test Fixtures Available in Three Sizes

The HP SimPlate Series is available in three sizes. The standard fixture, HP 44203S, accepts boards up to 28.2 cm x 37.1 cm (11.1" x 14.6"). The HP 44203L handles boards up to 37.1 cm x 59.9 cm (14.6" x 23.6"). The dual fixture, HP 44203D, accepts two boards the same size as the standard test fixture. All three of these fixtures are compatible with all HP 306X Board Test Systems.

### Test Fixture Accessories

#### Probes

Four different probe styles are available, each with two spring tension ratings. The "H" suffix is the eight ounce tension, the "L" indicates a four ounce tension. The probes can be ordered with sixty degree single point tips (HP 44561H/L), crown or star point tips (HP 44563H/L), serrated multi-point tips, (HP 44562H/L), and the spear point tips (HP 44564H/L). The 8-ounce probe tensions are recommended for all but high pin density applications. In high probe

density applications, the 4-ounce spring tension should be used. Probes are available in bags of 100.

#### Receptacles

The sockets (HP 44274S) are specially designed for low air leakage and reliability. The sockets are made of nickel silver to minimize contact resistance. They are press-fitted into the fixture without adhesives. Therefore, they do not degrade the high isolation resistance of the fixture plate material.

#### Patch Panel Plugs

HP UniPlug patch panel plugs provide positive contact between the test fixture and the system scanner. Every HP plug uses gold plated barrels for low contact resistance. Plug tips are made from acetel to insure that the plug doesn't scratch or leave a residue on the scanner paddle pins. HP plugs are available in three wiring styles: pre-wired twisted pair for digital testing, pre-wired single wire for analog testing, and unwired. Both analog and digital pre-wired plugs are available in various configurations to simplify the fixture construction.

#### Extenders

HP extenders provide additional space inside the test fixture for wiring or for custom test circuitry. They are available in two types. The HP 44560S extender adds 3" to the vertical height of the standard test fixture and the HP 44560D adds 1.6" to the large or dual fixtures. An angled extender is available in both sizes (HP 44560SA and 44560DA) and provide a horizontal mounting surface needed for interfacing to robotics or automated board handling.

#### Spare Parts Kit

A spare support assembly can be constructed for each fixture used in high volume applications. The Fixture Spare Parts Kit (HP 44203K) provides all parts necessary to construct the support assembly.

#### Conversion Parts

The HP 44203C Conversion parts kit makes it possible to convert existing HP 445XXA Fixture Kits to the HP SimPlate fixture. It contains all the parts necessary to change the upper head assembly of the standard (Option 1), the large (Option 2), and the dual (Option 3) fixtures.

#### Assembly Tools

The HP 44210A Assembly Tools contain the hardware and tools required to assemble the HP 44203 SimPlate fixtures. Only one tool kit is needed for each assembly station.

#### Advanced Technologies Fixture Accessory

The HP 44685A Advanced Technologies Fixture Accessory contains components commonly used with the HP 3065AT tester for combinational test fixturing. One HP 44685A is recommended for each HP 3065AT test fixture.

### Availability

For same day shipment of the products listed below, with the exception of the HP 44203C, 44589DA and 44589DD, call Hewlett-Packard's Direct Marketing Division at 1-800-538-8787.

### Ordering Information

	Price
HP 44203S SimPlate Standard Test Fixture Kit	\$622
HP 44203D SimPlate Dual Well Fixture Kit	\$915
HP 44203L SimPlate Large Fixture Kit	\$831
HP 44203C SimPlate Conversion Kit	
Option 001 For Standard Fixture	\$352
Option 002 For Large Fixture	\$440
Option 003 For Dual Fixture	\$450
HP 44203K SimPlate Spare Parts Kit	\$210
HP 44210A SimPlate Assembly Tools	\$146
HP 44685A Advanced Technologies Fixture Accessory	\$205
HP 44274S HP SimPlate Receptacle, 100 per bag	\$36
HP 44561L/H LF or HF Single (60) point, 100 per bag	\$102
HP 44562L/H LF or HF Serrated point, 100 per bag	\$102
HP 44653L/H LF or HF Star point, 100 per bag	\$102
HP 44564L/H LF or HF Spear (30) point, 100 per bag	\$163
HP 44589S Single Plug non-wired, 100 per bag	\$61
HP 44589SA UniPlug-single wire analog, 50 per bag	\$87
HP 44589DA UniPlug-dual wire analog, 50 per bag	\$117
HP 44589SD UniPlug-single pair digital, 50 per bag	\$87
HP 44589DD UniPlug-dual pair digital, 50 per bag	\$117
HP 44590D Dual Plug non-wired, 100 per bag	\$163
HP 44590DW Dual Plug pre-wired, 100 per bag	\$189
HP 44591A HP 3065 DUT Power Pin Kit, 18 per bag	\$66
HP 44592G Hybrid Ground Plug, 10 per bag	\$82



## **CONTROLLERS & CAT**

<b>Controllers .....</b>	<b>552</b>
<b>Hewlett-Packard Interface Bus .....</b>	<b>556</b>
<b>Data Acquisition Systems.....</b>	<b>564</b>
<b>Computer Aided Test .....</b>	<b>582</b>
<b>Automatic Test.....</b>	<b>612</b>

Hewlett-Packard manufactures a broad line of computers used in instrument-control applications, most of which use a form of the BASIC language especially designed for instrument control. Products in this group include those dependent upon a controller for their use. Most HP instruments have HP-IB, Hewlett-Packard's implementation of the IEEE-488 standard. This capability turns controller and instruments into a powerful, flexible and versatile general-purpose automated system, easily adapted to many applications. HP also makes software and hardware specifically designed for product and process characterization, including card-cage instruments and data-acquisition products used for switching, monitoring, and control. Also included here are test management and test executive software, and automatic test system integration services.

**Controllers  
& CAT**

# CONTROLLERS

## HP 9000 Family Measurement Automation Controllers and Systems

### General Information



Breadth and flexibility make HP's family of instrument controllers more capable than any other solution available for a broad range of measurement automation needs. HP has more than 15 years experience in building instrument controllers, together with more than 1,400 HP instruments, and HP-IB, the industry-standard instrument control interface.

#### Instrument Controllers

Hewlett-Packard has for many years been a leading supplier of instrument controllers for data acquisition and electronic test.

Today, the breadth and flexibility of Hewlett-Packard's family of instrument controllers makes it the best answer to your measurement automation needs.

Hewlett-Packard developed the company's HP-IB industry standard interface, also known as IEEE-488 or GP-IB, in the early 1970's to provide a standard bus for instrumentation and peripherals. Since then, this interface has grown to become the standard way to communicate with instruments throughout the measurement automation community.

With over fifteen years of experience in building instrument controllers, HP has optimized these systems to work with over 1,400 Hewlett-Packard instruments and peripherals via this industry standard interface. No family of controllers makes it easier to build a measurement system to meet your needs. Furthermore, all components can come from a single company long known for its high standards of quality.

#### Computer Aided Test

HP instrument controllers, coupled with data acquisition systems and instruments you'll find in this catalog, make it easy to build custom test systems for use in R&D environments for unattended testing, or for manufacturing test and quality control applications outside the R&D lab. Software packages such as HP's new Interactive Test

Generator, FTM/300, DACQ/300 and DACQ/PC (see pages 606, 610 and 608) take full advantage of features of HP instrument controllers to aid you in the development and execution of your computer aided test and data acquisition applications.

#### Manufacturing and Industrial Monitoring

Accurate monitoring of analog and digital signals is key to product quality in both manufacturing and industrial environments. HP 9000 computers, and the HP 1000 real-time systems described on page 670, combine computational speed and reliability for real-time data acquisition, even in harsh environments. Engineers can immediately spot trends or deviations in critical variables or processes. HP controllers are well known for their reliability and ruggedness.

#### Laboratory Monitoring and Analysis

Analytical applications can also be automated using HP controllers. The ChemStation family of analytical systems make use of the power of HP instrument controllers as well. (see page 676)

#### A Wide Range of Controllers

Hewlett-Packard offers the widest range of instrument controllers in the industry today. Each controller system has been optimized to meet the needs of measurement automation customers.

Controllers are available for price sensitive users as well as for applications requiring the absolute highest performance from the instrument controller. You have a variety of

controller operating systems to choose from as well, each with their own unique advantages.

#### HP BASIC Controllers

A Hewlett-Packard controller in conjunction with the HP BASIC language offers a highly optimized environment for the development and execution of instrument control applications.

HP BASIC offers a programming environment unsurpassed in ease of use and user friendliness. You do not have to be an expert computer programmer to develop very sophisticated software for your instrument control application. An advanced program editor proofreads your program as you type it in to check for syntax errors. You do not have to wait until your program executes to realize that you have made a typing error. Advanced commands for moving and copying program lines are fully integrated into HP BASIC as well as features useful in producing very readable, self-documenting, programs. Features like automatic program indentation, string search and replacement and automatic renumbering of program lines are a standard part of the HP BASIC environment.

Access to the most highly optimized device I/O subsystem available is just a few statements away. Full interrupt processing is supported offering fifteen levels of user definable software priorities. Data transfer of various data types is also fully supported. Data



formatting is handled automatically for data types such as REAL, INTEGER, COMPLEX, STRING and arrays of these data types as well.

In addition to supporting multiple data types, the HP BASIC I/O system has been refined over time to be able to determine the optimal data transfer method available based upon system configuration. For example, data transfer will take advantage of Direct Memory Access if DMA hardware is present in the system. No programming changes are required to take advantage of this DMA transfer technique, simply adding the DMA hardware will suffice.

Support of separate context subprograms within HP BASIC allows you to develop modular, reusable program segments that may be loaded and unloaded during program execution. This helps to increase programmer productivity since modules are easily reused or replaced with new modules in future controller software applications.

HP BASIC also provides the capability of using compiled subprograms, or CSUBS, that have been developed using the Pascal Workstation system. These CSUBs provide increased performance of many operations while still providing the benefit of execution within the HP BASIC environment. Program modules are written in either HP Pascal or MC68000 assembly language, compiled or assembled, and then the optional CSUB utilities are used to transform these program segments into compiled subprograms that are loaded into the HP BASIC environment and executed.

**HP BASIC** runs on a variety of hardware systems.

The HP 9000 Series 300 controller systems (see pages 647 to 649) take full advantage of Motorola MC68010, MC68020 and very high performance MC68030 microprocessors to provide the highest performance HP BASIC controllers possible. These systems offer a variety of interface cards, display systems and peripherals which allows you to configure a controller system which best meets your individual needs.

With the HP BASIC Language Processor (see page 656), the HP Vectra Personal Computer also offers the added benefit of a full implementation of HP BASIC. The language processor board contains a MC68000 microprocessor, system RAM, HP-IB and support electronics required to emulate a Series 200/300 controller while taking advantage of the Vectra's keyboard, display and internal mass storage. This language processor provides the advantages of HP BASIC while offering access to DOS based peripherals and application software. The addition of HP BASIC to a DOS based instrument controller provides a clear path between PC-DOS systems and the higher performance Series 200 and Series 300 HP BASIC instrument controllers.

The recently introduced HP BASIC/UX system software provides a full implementation of HP BASIC running on the HP-UX operating system. HP BASIC/UX is compatible with existing HP BASIC programs but adds significant new capabilities via the power of HP-UX. HP BASIC/UX provides multitasking, full networking, and multiuser capabilities for the most demanding instrument control applications.

Available on Series 300 HP-UX controllers, HP BASIC/UX offers the ideal bridge between the high performance I/O of HP BASIC and the high functionality of the industry standard HP-UX operating system.

**DOS Based Controllers**

For low-cost instrument control, Hewlett-Packard provides a controller which provides the advantages of native DOS within its family of instrument controllers. The HP Vectra Personal Computer (See page 656) provides IBM PC/AT compatibility and more for those instrument controller users developing measurement automation software in the native DOS environment.

Use of the HP-IB Interface and Command Library provides PC's, such as the Vectra, with the capability to perform sophisticated instrument control. Support of a variety of standard PC-DOS programming languages is available from the HP-IB Command Library as well.

**HP-UX Based Controllers**

High performance UNIX workstations are quickly becoming the standard platform for Computer Aided Design and Engineering applications. Hewlett-Packard's HP-UX offering is a complete UNIX System V implementation with selected enhancements added to provide HP-UX systems with features necessary for use in the measurement automation environment. A number of programming languages, including HP BASIC, are

available for the development of your instrument controller application. Access to powerful networking and database tools are also readily available within HP-UX.

One such HP-UX enhancement is the Device I/O Library, or DIL. This library gives HP-UX systems the capability of providing very high performance instrument control. Direct support of DMA and burst mode I/O is available from DIL. Interrupt response time is minimized in a number of ways. Real-time extensions have been added to HP-UX to allow the user to determine which programs have the highest priorities.

The addition of the HP Series 300 DOS Coprocessor (see page 669) provides Series 300 controller systems with the capability of running PC/AT compatible application software. Running in an HP-UX environment, the DOS Coprocessor bridges the gap between UNIX and DOS worlds, creating a dual purpose system.

The Series 300 (see page 647) offers a wide range of performance to meet the needs of your HP-UX controller application. The Model 310 provides the lowest cost HP-UX system within the Series 300 line ranging up through the Model 370 HP-UX system which takes full advantage of the 32 bit architecture of the Motorola MC68030 microprocessor. An additional feature of the Series 300 HP-UX systems is the ability of HP BASIC to share files and even disks with HP-UX. HP BASIC revision 5.1 uses the same file system (HFS) as the Series 300 HP-UX systems, and you can simply reboot from HP-UX to HP BASIC and back again to take advantage of the features of each operating system as desired.

Please refer to the chart on the following page which details feature availability within the various controller families.





# CONTROLLERS

## Overview Comparison Matrix

**HP Instrument Controller Comparison Matrix**

<i>PC Controllers</i>				<i>HP BASIC Controllers</i>						<i>HP-UX Controllers</i>		
VECTRA CS	VECTRA ES/12	VECTRA RS/20	PC-† 305ML	PC-† 308ML	310 MMA	330 MMA	360 MMA	360‡ MMAX	330M	360M	370M	
<b>INTERFACES</b>												
HP-IB	•	•	•	•	•	•	•	•	•	•	•	
GPIB				•	•	•	•	•	•	•	•	
RS-232	•	•	•	•	•	•	•	•	•	•	•	
RS-232/MUX								•	•			
BCD						•	•	•				
Custom						•	•	•				
VME						•	•	•	•	•	•	
<b>NETWORKING</b>												
LAN	•	•	•	•	•				•	•	•	
SRM				•	•	•	•	•	•	•	•	
X.25	•	•	•	•	•				•	•	•	
<b>GENERAL I/O (ms)</b>												
HP-IB	60.0	47.8	35.8	76.4	76.4	63.1	40.2	30.7	34.5	24.4	22.8	22.5
<b>DMA RATES (KBytes/sec)</b>												
HP-IB	243	243	243	NA §	NA §	318	338	358	358	338	358	378
GPIB	NA §	NA §	NA §	NA §	NA §	768	904	1560	1560	904	1560	1810
<b>INTERRUPTS</b>												
POLLING	•	•	•	•	•	•	•	•	•	•	•	•
FULL				•	•	•	•	•	•	•	•	•
<b>INTERRUPT RESPONSE</b>												
AVERAGE (ms)	NA §	NA §	NA §	1.5	1.5	1.25	1.0	1.0	1.1	1.2	1.1	1.1
<b>COMPUTATION</b>												
MIPS	.6	1	3	.5	.5	.6	2	4.5	4.5	2	4.5	7

† - PC-305 and PC-308 bundles are capable of both MS-DOS and HP BASIC operation. Data is for use with the HP BASIC Language Processor.

‡ - 360 MMAX bundle is capable of both HP BASIC and HP-UX operation. Data is for use with the HP BASIC/UX environment.

§ - NA - Not Applicable

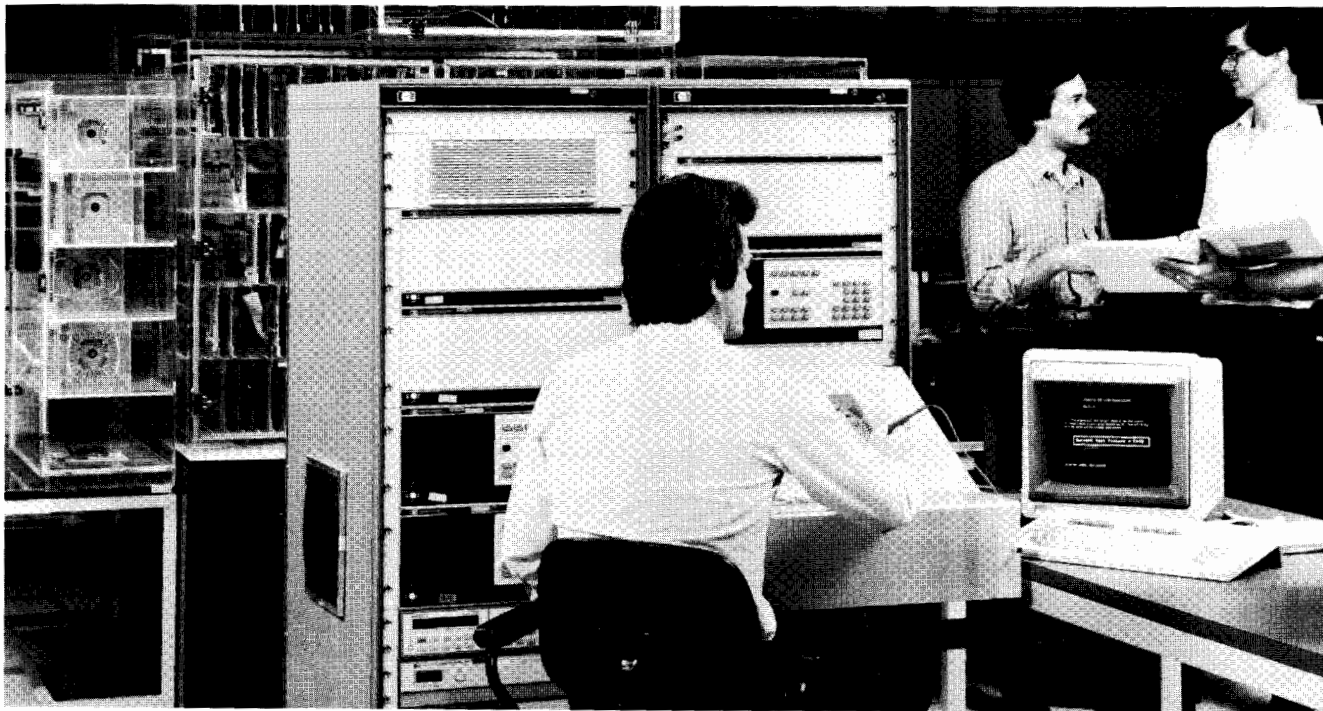

A number of bundled systems have been established to simplify ordering of the best instrument controller for your application.

**82316DX Model PC-305 M Low Cost HP BASIC Controller** (see page 656)

This low cost controller system provides the capabilities of a general purpose PC with the power of HP BASIC. This controller includes a 1.4 MB 3 1/2" floppy drive and monochrome VGA display system. The system takes advantage of the HP BASIC Language Processor. The language processor included in this bundle contains a ROM based version of the HP BASIC language.

**81317DX Model PC-305 ML Low Cost HP BASIC Controller** (see page 656)

This controller system includes all of the features of the PC-305 M with the addition of a 20 MB Winchester disc. This addition provides you with higher performance mass storage and the capability of storing large amounts of data and programs.

**82314DX Model PC-308 ML HP BASIC Controller** (see page 656)

This controller system is also based upon the combination of a PC and the HP BASIC Language Processor. Based upon the Vectra ES/12 PC-AT compatible system, this controller provides extra power to your test and measurement application. Also included is a 1.4 MB 3 1/2" floppy drive and a 20 MB Winchester disc to meet your mass storage requirements.

**82315DX Model PC-308 CL HP BASIC Color Controller** (see page 656)

This controller system is also based upon the Vectra ES/12 system in conjunction with the HP BASIC Language Processor. The addition of a VGA color graphics display system provides color capabilities to this controller solution. A 1.4 MB 3 1/2" floppy drive and a 20 MB Winchester disc are included.

**82319DX Model PC-308 CM HP BASIC Color Controller** (see page 656)

This controller system is identical to the PC-308 CL listed above except that a 40 MB Winchester disc is included instead of the 20 MB version. This extra mass storage capacity expands your capability for data and program storage.

**98580B Model 310 MMA HP BASIC Controller** (see page 647)

This powerful controller offers a 12" monochrome display and the performance you would expect from a MC 68010 microprocessor. Four available DIO slots allow for the addition of RAM, DMA, floating point match and other Series 200/300 interface cards. This system also includes HP BASIC operating system.

**98581B Model 310 CMA Color HP BASIC Controller** (see page 647)

A color version of the 98580B, this controller answers the need for color in an instrument control application.

**98580S Model 330 MMA HP BASIC Controller** (see page 648)

This instrument controller provides all the power of an MA68020 microprocessor and MC68881 floating point match coprocessor. This system also includes a 12 inch monochrome display system. The built in fast disc interface and DMA in addition to a standard HP-IB interface enables you to separate your instrumentation from your mass storage while increasing overall performance.

**98581S Model 330 CMA Color HP BASIC Controller** (see page 648)

Another instrument controller based upon the powerful MC68020, this controller provides all the advantages of the 98580S in addition to a 12" color display system to further enhance your instrument control application.

**98580W Model 360 MMA HP BASIC Controller** (see page 648)

This instrument control solution also provides a 12 inch monochrome display system, fast disc interface, DMA and HP BASIC present in the 98580S above with the exceptional performance of the newly introduced MC68030 microprocessor. This system provides the additional power required for extensive data manipulation tasks. The standard 4 MB RAM is expandable to 16 MB to handle the most complex test and measurement application.

**98581W Model 360 CMA Color HP BASIC Controller** (see page 648)

This controller is also based upon the high performance Model 360 system. The addition of the 12 inch color display system provides color capability for your application.

**98580WX Model 360 MMAX HP BASIC/UX Controller** (see page 648)

Also based upon the Model 360, this controller solution provides exceptional performance. This controller provides the power of the HP BASIC environment with the extended capabilities of HP-UX. The system provides a 17" hi resolution monochrome display system to take full advantage of the multi-tasking, windowed environment of HP BASIC/UX. A 152 MB disc option is available for this bundle which provides a very high performance disc with HP-UX and HP BASIC-UX pre-installed and customized for HP BASIC/UX operation. This disc option insures that your HP BASIC/UX system is operational in the shortest amount of time possible.

**98581WX Model 360 CMAX HP BASIC/UX Controller** (see page 648)

This instrument control solution also combines the power of HP BASIC with the extended capabilities of HP-UX. The high resolution 16" color display system used in this controller bundle provides a perfect platform for complex measurement automation tasks. The pre-installed 152 MB disc option is also available for this controller system.

# HEWLETT-PACKARD INTERFACE BUS

## Versatile Interconnect System for Instruments and Controllers

### General Information

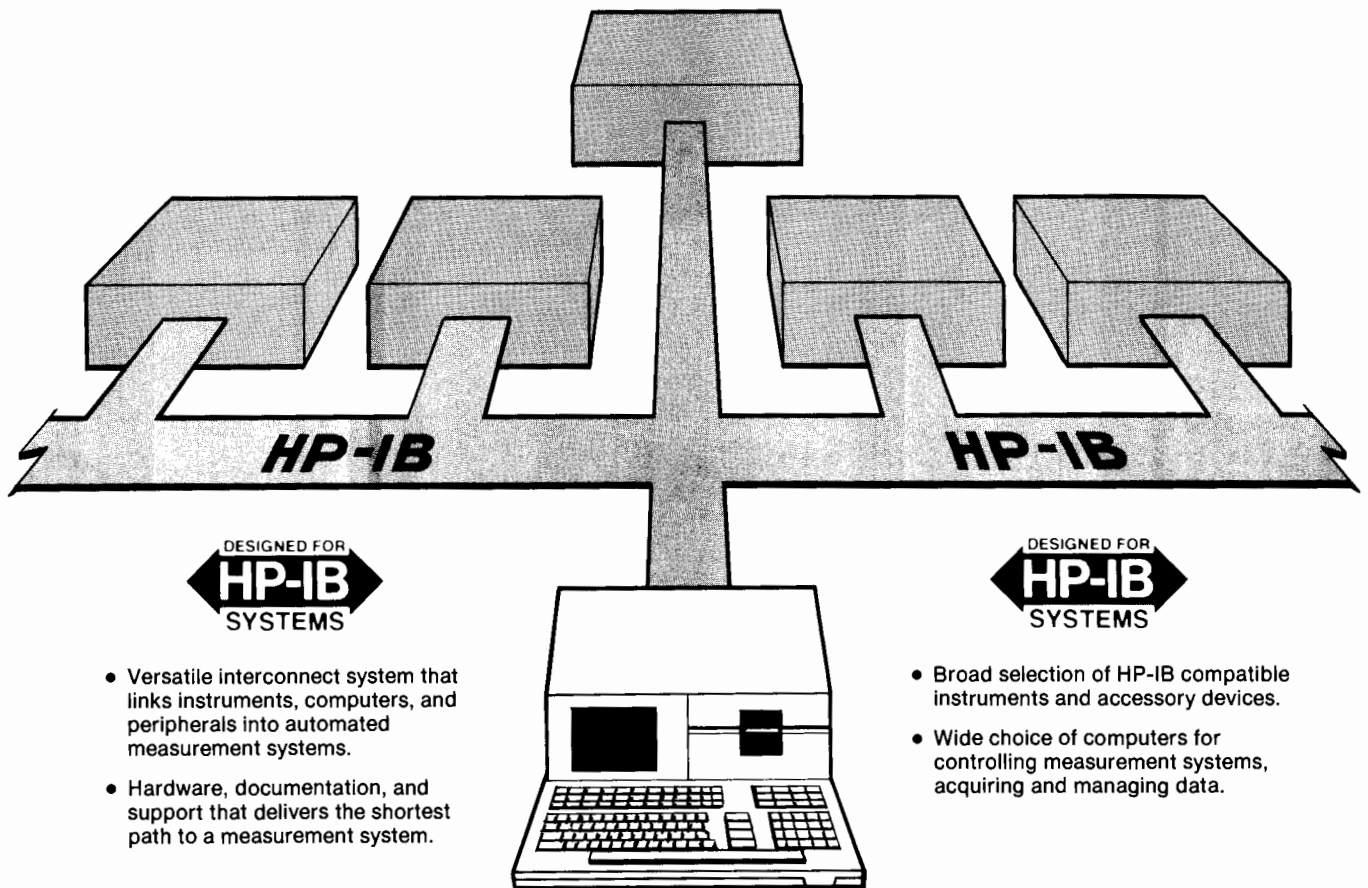

- Versatile interconnect system that links instruments, computers, and peripherals into automated measurement systems.
- Hardware, documentation, and support that delivers the shortest path to a measurement system.

- Broad selection of HP-IB compatible instruments and accessory devices.
- Wide choice of computers for controlling measurement systems, acquiring and managing data.

### Advantages of HP-IB Systems

There are many applications where the measurement power of interactive instruments can be further enhanced by coupling them to desktop or minicomputers. Operating in a remote mode can provide more exact, error-corrected results as compared with conventional manual operation techniques.

Presently, three major parameters combine to reduce significantly the engineering development costs of configuring measurement systems:

1. The Hewlett-Packard Interface Bus, also known as "HP-IB";
2. Distributed computing through the growing number of "smart" instruments with internal microprocessors;
3. The broad choice of computers ranging from "friendly", easy-to-program desktop computers to more sophisticated computer systems capable of managing multi-station instrument clusters and complex data bases.

### Relationship Between HP-IB and Other Interface Standards

Hewlett-Packard is committed to the overall advancement of measurement technology and has for some time been working on the problems of simplifying and standardizing means of instrumentation interfacing. An example of such an effort is the intimate involvement with the HP-IB from its conception at HP to its present status as a world instrumentation interface standard (IEEE 488-1978 and IEC 625-1).

In mid-1972, Hewlett-Packard began to participate in various international standardization bodies. The U.S. Advisory Committee, composed of diverse interests represented by both users and manufacturers, first established initial goals, then adopted the interface concept utilized by the HP Interface Bus as an appropriate starting point. A draft document was subsequently written and evaluated by members of the Committee, then submitted as the U.S. Proposal to the IEC (International Electrotechnical

Commission) Working Group in the autumn of 1972. Since then, the interface definition has undergone a number of minor changes to accommodate various needs at the international level.

In September 1974, the parent technical committee, IEC TC66, approved the main interface draft document for a formal ballot among the member nations of the IEC. Balloting took place in 1976, and IEC recommendation 625-1 was adopted. The IEC recommendation, using a different connector, is totally compatible with the present definition of the HP-IB.

Meanwhile, the IEEE Standards Board approved IEEE Standard 488-1975 "Digital Interface for Programmable Instrumentation", first published in 1975 and again published in 1978 with minor editorial changes as IEEE Standard 488-1978. The IEEE standard is also fully compatible with the HP-IB. In January 1976, the American National Standards Institute adopted the

IEEE Standard and published it initially as ANSI Standard MC 1.1.

The standardized interface concept is now widely accepted. Hundreds of manufacturers in more than fourteen countries offer thousands of products that use the HP-IB concepts articulated in IEEE-488. As more instrumentation interface standards evolve from the HP-IB, we will clearly indicate the relationship of the Hewlett-Packard Interface Bus to those standards, just as we have done with ANSI/IEEE Standard 488 and IEC Publication 625-1.

### Why the HP Interface Bus Name?

As the list of HP products available with the "new digital interface" grew, our customers sought a convenient way to identify those products having the interface capability. In response, in 1974 we adopted the name "Hewlett-Packard Interface Bus" or simply "HP-IB". We will continue to use the identifying name and this symbol:



Both are used with appropriate HP products so that their interface capabilities may be readily identified.

The Hewlett-Packard Interface Bus fully complies with IEEE Standard 488. As such, it incorporates the mechanical, electrical and functional specifications of the Standard. A fourth and vital element of any interface system is the operational aspect of a product at both the human-machine interface and the machine-machine interface at the HP-IB port. HP-IB capability provides additional

user benefits that are beyond the scope of IEEE Standard 488. Typical user conveniences include high-level language implementation of interface functions, underscored program codes on instrument front panels for easy programming, convenient data output formats, and designed-in learn modes. In addition, we provide complete support documentation in the form of programming and interfacing guides, application notes and operators' manuals that illustrate the added benefits for users of products with HP-IB capability.

### Single-Source Systems Approach

The decision to use a "system" instead of conventional manual methods must be based on an engineering evaluation of benefits versus costs. The many benefits associated with a systems approach include:

- More consistent results in repeated measurements because a system is not subject to operator fatigue.
- Greater throughput because systems are generally faster.
- More thorough testing because system speed allows more parameters to be measured in a shorter time.
- Results expressed in engineering or scientific units because many systems controllers are capable of on-line data manipulation.
- Greater accuracy because system errors can be measured automatically, stored and accounted for in the results.
- "Adaptive" data acquisition wherein a system can be programmed to branch to other measurements to help pinpoint an abnormal condition.
- Measurement results stored in computer memory or on hard copy.



Hewlett-Packard offers a broad range of controllers and software solutions to meet your measurement automation needs. HP E2000A Interactive Test Generator software works with instrument drivers to provide a uniform, user-friendly interface to a wide variety of HP-IB instruments.

It is our objective to make the integration of instrumentation systems easier by providing instruments and computers designed for systems applications. Computers are designed with HP-IB options that allow easy hook-up to the bus and incorporate easy-to-use bus commands in their software. HP's policy when designing HP-IB compatible instruments is to eliminate interfacing ambiguities associated with controllers and instruments operating per the ANSI/IEEE and IEC standards by adopting guidelines for consistent interface design.

Proper training on system components is very important for efficient use of any interface system. Therefore, we offer training at sales and service offices worldwide on HP desktop computers, computer systems and instruments as they relate to the HP-IB. In the area of HP-IB support documentation, we offer general interface technical descriptions, Operating and Service Manuals with programming information, Instrument/Controller Introductory Operating Guides, Quick Reference Guides and Application Notes.

Technical assistance during system development is available at most local HP sales and service offices from resident systems engineers who specialize in desktop computers, computer systems and instruments.

### How the HP Interface Bus Operates

All active interface circuitry is contained within the various HP-IB devices, and the interconnecting cable (containing 16 signal lines) is entirely passive. The cable's role is

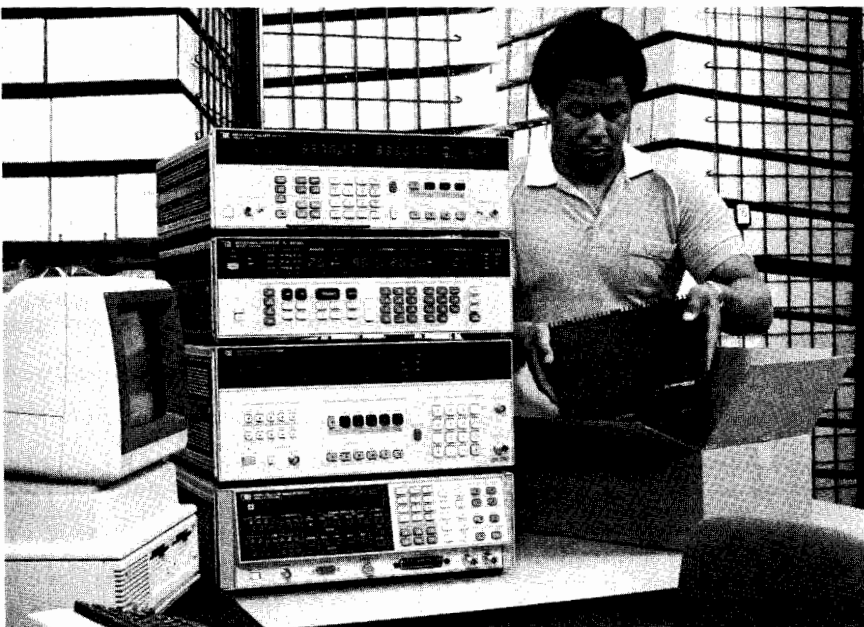

Automation provides the speed needed for production environments. This HP 8957S Cellular Test System produces accurate, hard-copy test results in minutes.

# HEWLETT-PACKARD INTERFACE BUS

## Versatile Interconnect System for Instruments and Controllers (cont'd)

### General Information



limited to that of interconnecting all devices in parallel so that any one device may transfer data to one or more other participating devices.

Every participating device (instrument, controller, accessory module) must be able to perform at least one of the roles of TALKER, LISTENER or CONTROLLER. A TALKER can transmit data to other devices via the bus, and a LISTENER can receive data from other devices via the bus. Some devices can perform both roles (e.g., a programmable instrument can LISTEN to receive its control instructions and TALK to send its measurement results).

A minimum HP-IB system consists of one TALKER and one LISTENER, without a CONTROLLER. In this configuration, data transfer is limited to direct transfer between one device manually set to "talk only" and one or more devices manually set to "listen only" (e.g., a measuring instrument talking to a printer for semi-automatic data logging).

A CONTROLLER manages the operation of the bus system primarily by designating which devices are to send and receive data, and it may also command specific actions within other devices.

The full flexibility and power of the HP-IB become more apparent, however, when one device that can serve as CONTROLLER/TALKER/LISTENER (e.g., calculator or computer) is interconnected with other devices that may be either TALKERS or LISTENERS, or both (e.g., frequency synthesizers, counters, power meters, relay actuators, displays, printers), depending on the application. An HP-IB *controller* participates in the measurement by being programmed to schedule measurement tasks, set up individual devices so that they can perform these tasks, monitor the progress of the measurement as it proceeds, and interpret the results of the measurement. HP offers controllers that can be programmed in high-level languages such as BASIC, FORTRAN, HPL, and Pascal.

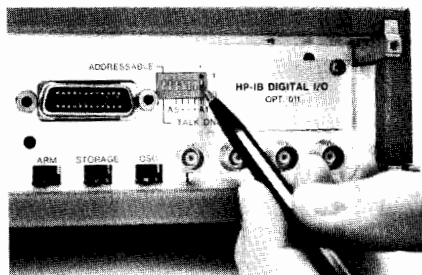

Rear panel switches are set so instrument will either be addressable by controller in a multi-device system, or will simply "talk only" to another device such as a printer.

### HP-IB Connections and Structure

The HP-IB has a party-line structure wherein all devices on the bus are connected in parallel. The 16 signal lines within the passive interconnecting HP-IB cable are grouped into three clusters according to their functions:

1. Data Bus (8 signal lines)
2. Data Byte Transfer Control Bus (3 signal lines)
3. General Interface Management Bus (5 signal lines).

The DATA BUS consists of eight signal lines that carry data in bit-parallel, byte-serial format across the interface. These signal lines carry addresses, program data, measurement data, universal commands and status bytes to and from devices interconnected in a system. Identification of the type of data present on the DIO signal lines is indicated by the ATN (attention) signal. When the ATN signal is true (asserted), either addresses or universal commands are present on the data bus and all connected devices are required to monitor the DIO lines. When the ATN message is false, device-dependent data (e.g., programming data) is carried between devices previously addressed to talk and listen.

Transfer of each byte on the Data Bus is accomplished via a set of three signal lines: DAV (data valid), NRFD (not ready for data), and NDAC (not data accepted). These signals operate in an interlocked handshake mode. Two signal lines, NRFD and NDAC, are each connected in a logical AND (wired OR) to all devices connected to the interface. The DAV signal is sent by the talker and received by potential listeners whereas the NRFD and NDAC signals are sent by potential listeners and received by the talker.

The General Interface Management Lines manage the bus to effect an orderly flow of messages. The IFC (interface clear) message places the interface system in a known quiescent state. SRQ (service request) is used by a device to indicate the need for attention or service and to request an interruption of the current sequence of events. REN (remote enable) is used to select between two alternate sources of device program data. EOI (end or identify) is used to indicate the end of a multiple byte transfer sequence or, in conjunction with ATN, to execute a polling sequence.

It is not possible in this limited space to go into detail on each signal line's role. But you should note that every HP-IB device need not be able to respond to all the lines. As a practical and cost-effective matter, each HP-IB device usually responds only to those lines that are pertinent to its typical function on the bus. (Details are covered in each device's operating manual.)

As with IEEE 488.1, Hewlett-Packard was active in the development of IEEE 488.2. Many of the new HP instruments introduced this year already follow this new standard, and many more HP instruments to be introduced in the near future will also follow IEEE 488.2.

### HP-IB and the new IEEE 488.2

This new standard addresses issues involved with sending messages between devices on the bus. Its features include:

- A required minimum set of IEEE 488.1 capabilities.
- Reliable transfer of complete messages between a computer and an instrument.
- A precise description of the syntax in those messages.
- A set of commands useful in all instruments.
- Common status reporting capability using serial poll.
- Techniques for guaranteeing synchronization of application programs with instrument functions.
- A way of automatically assigning addresses.

The desired benefit from these features is to make the job of an instrument system designer easier. IEEE 488 standardized the electrical and mechanical interface. This new standard ensures compatibility at the next higher level.

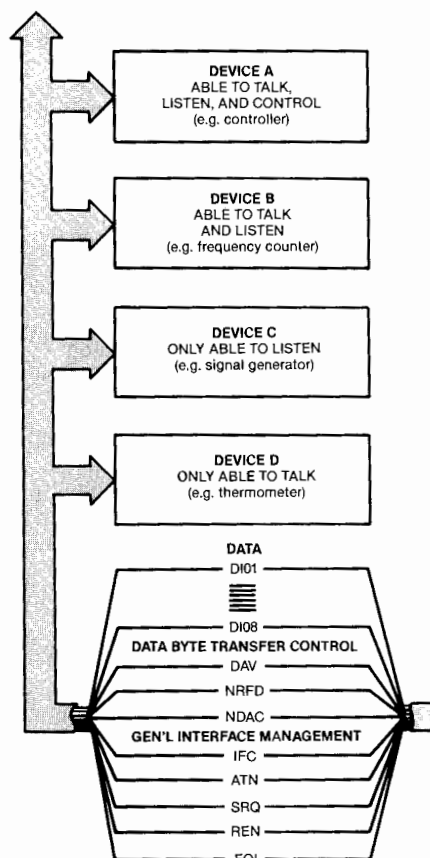

Interface connections and bus structure.



### 488.1 Requirements

The IEEE 488.2 Standard requires that each device provide a minimum set of 488.1 interface capabilities. In essence, this means that each device must be able to source and accept bytes, talk and listen, do service request, and respond to device clear.

IEEE 488.2 allows more freedom by making other capabilities optional. However, it requires a minimum capability when these functions are implemented. This applies to the Remote Local, Parallel Poll, Device Trigger, and Controller capabilities.

### Message Exchange

IEEE 488.1 provides a reliable means of transferring bytes between a talker and a listener. In addition, devices need a reliable means of transferring programming commands and measurement results. IEEE 488.2 provides this means.

### Syntax

IEEE 488.2 requires that devices listen in a "forgiving" manner. The level of forgiveness is, however, precisely defined. The meaning of every data byte is well defined, while several characters sometimes have the same meaning.

Whereas the listening syntax may be forgiving, an instrument is required to talk precisely. Talking precisely greatly increases the chances of a message being accepted by any controller.

### Common Commands

Certain functions are useful across all types of instruments. IEEE 488.2 defines a set of commands that all instruments must implement. Required commands include identifying the instrument by manufacturer and model number, resetting the instrument to a known state, and performing a self-test.

Other commands that may be useful in some instruments are also described in the standard. They are included so that if the functions are implemented, they will be done in standard ways. For example, there are commands for calibration, triggering, macros, and passing control. There are a total of 13 required commands and 26 optional commands.

### Status Reporting

IEEE 488.1 exactly describes how the Request Service (RQS) message behaves, but it says very little about the status byte, STB. The meanings of the bits are left to the designer. Some instruments clear the status byte after a serial poll, others do not. Many instruments allow the programmer to configure what causes a service request, but here too the techniques for doing so are varied.

IEEE 488.2 describes a hierarchical status reporting model in which the contents of other data structures are summarized in the status byte. It does not specify the exact meaning of all of the bits in the status byte. However, it does describe the meaning of two more of the bits, Message Available (MAV) and Event Status (ESB).

### Synchronization

Many instruments can accept commands faster than they can execute them. While this feature can improve system throughput, it also creates a need to know when the instrument actually completes all of its commands. IEEE 488.2 requires three common commands that enable the application program to detect when all pending operations are complete.

### Auto-configuration

Whenever a test system is assembled, the addresses of the instruments must be set so there are no collisions. Additionally, the application has to know the address of every instrument. Currently, addresses have to be set manually via the front panel or a bank of switches. IEEE 488.2 describes a protocol between the controller and all the auto-configurable instruments on the bus that identifies each instrument and assigns it an address.

### Future

Codes, formats, protocols, and common commands cover new ground for instrument-to-computer communication. Most of the concepts involved can be used on any physical interface whether HP-IB, RS232, or VME. If a new physical interface should displace or co-exist with HP-IB, the syntax of messages, the common commands, the status reporting, and the synchronization techniques can all survive.

### HP-IB Training and Support

To assist you in configuring HP-IB measurement systems, Hewlett-Packard has field sales people trained in electronic instruments, desktop computers and computer systems. Also available for technical consultation are computing controller systems engineers and HP-IB instrumentation specialists.

HP-IB training courses on HP-IB controllers and instruments are listed below. Courses are conducted at a convenient HP location. Some courses can be taught at your site with special arrangements.

- HP-IB Theory
- HP-IB for MOS-DOS Personal Computers
- HP-IB Instrument Control Using HP Series 200/300 BASIC
- HP-IB Instrument Control Using HP 1000E/F Series Controllers

### HP-IB Service and Warranty

Hewlett-Packard has dedicated measurement system service people who perform on-site maintenance of HP instrumentation on customer-configured systems as well as HP-configured systems. Service contract coverage is available to meet your specific measurement system service needs and can be tailored to include extended warranty, calibration and extended hours of coverage. Contact your local sales and service office for further information on HP-IB service contract information.

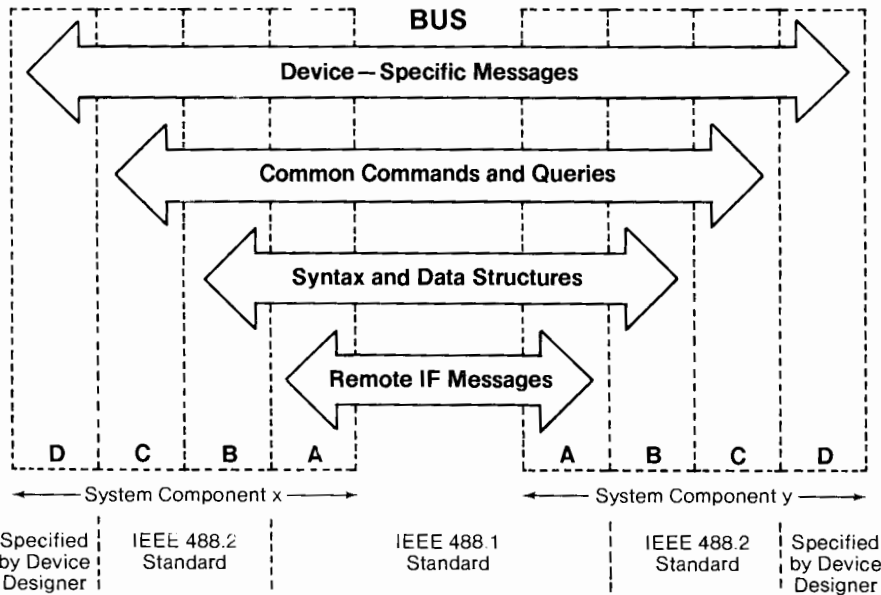

This diagram shows the relationship between the IEEE-488.1 standard and the new IEEE 488.2 standard. The new standard expands and complements IEEE 488.1 by addressing issues involved with sending messages between devices on the bus. Layer D represents device functions, layer C represents common system functions, layer B represents message communications functions, and layer A represents interface functions. Layers D, C and B contain IEEE 488.1 device-dependent messages and layer A contains IEEE 488.1 interface messages.



# HEWLETT-PACKARD INTERFACE BUS

## Versatile Interface Bus for Instruments and Controllers (cont'd)



### General Information

Every HP-IB device and HP-configured system carries a standard Hewlett-Packard warranty appropriate to that product. The warranty period for each product will be provided on request at the time of sale and is specified in documentation supplied with the product. HP takes responsibility for standard HP-IB systems performing as specified. However, software or interfacing that has not been provided by Hewlett-Packard as part of a standard system delivered by HP is not covered by this warranty.

In all cases, overall operational responsibility for those HP-IB systems assembled by a customer from individual HP-IB devices rests with the customer.

### HP-IB Specifications Summary

#### Interconnect Devices

Up to 15 maximum on one contiguous bus.

#### Interconnection Path

Star or linear bus network; total transmission path length 2 metres times number of devices or 20 metres, whichever is less. Operating distances can be extended; see page 563.

#### Message Transfer Scheme

Byte-serial, bit-parallel asynchronous data transfer using locked 3-wire handshake technique.

#### Data Rate

One megabyte per second maximum over limited distance; 250-500 Kbytes per second typical over full transmission path (actual data rate depends on individual device characteristics).

#### Address Capability

Primary addresses, 31 TALK and 31 LISTEN; secondary (2-byte) addresses, 961 TALK and 961 LISTEN. Maximum of 1 TALKER and up to 14 LISTENERS at a time.

#### Control Shift

In systems with more than one controller, only one can be active at a time. A currently active controller can pass control to another, but only the designated system controller can assume control over others.

#### Interface Circuits

Driver and receiver circuits are TTL-compatible.

#### HP-IB Interface Functions

HP-IB functions are the predefined capabilities that can be designed into an HP-IB device. These capabilities and their alphanumeric codes are summarized in the table. Because the codes completely describe interface capability and are therefore particularly useful to system designers and specifiers, they are more and more frequently appearing in technical data and on system components. On HP system-ready products they are listed near the HP-IB connector, and they are included in the specifications for most of the HP-IB products in this catalog.

### HP-IB Connector Lock Screw Compatibility

HP-IB products delivered now and in recent years are equipped with connectors having ISO metric-threaded lock screws and stud mounts. Very early HP-IB products have non-metric parts, but are readily distinguished from the metric by color: metric-threaded parts are black, whereas non-metric parts have a shiny nickel finish. HP-IB Metric Conversion Kit (HP P/N 5060-0138) is available to convert these early instruments.

### HP-IB Reference Publications

- *Tutorial Description of the Hewlett-Packard Interface Bus*. This 118-page reference chronicles the development of byte-serial, bit-parallel interface system stan-

dards, describes their relationship to HP-IB, presents a working overview of HP-IB, and includes useful information. Free copies are available from your nearest HP office. Ask for publication number 5952-0156.

- *ANSI/IEEE 488.1-1987, Digital Interface for Programmable Instrumentation, and IEEE Std. 488.2-1987, Codes, Formats, Protocols, and Common Commands*, published by the Institute of Electrical and Electronics Engineers, 345 East 47th Street, New York, NY 10017.
- *IEC 625-1, An Interface System for Programmable Measuring Apparatus (Byte Serial Bit Parallel)*, published by the International Electrotechnical Commission, 1 rue de Varembe, 1211 Geneva 20, Switzerland.

### HP-IB Interface Capability Codes for HP Products

Interface Function	Basic Code	Capability Code		
Source Handshake	SH	SH0 No capability		
		SH1 Full capability		
Acceptor Handshake	AH	AH0 No capability		
		AH1 Full capability		
Talker (Extended Talker)	T(TE)	T(TE)0 No capability		
		T(TE)1 Basic talker, serial poll, talk only		
		T(TE)2 Basic talker, serial poll		
		T(TE)3 Basic talker, talk only		
		T(TE)4 Basic talker		
		T(TE)5 Basic talker, serial poll, talk only, unaddresses if MLA <sup>1</sup>		
		T(TE)6 Basic talker, serial poll, unaddresses if MLA <sup>1</sup>		
		T(TE)7 Basic talker, talk only, unaddresses if MLA <sup>1</sup>		
Listener (Extended Listener)	L(LE)	L(LE)0 No capability		
		L(LE)1 Basic listener, listen only		
		L(LE)2 Basic listener		
		L(LE)3 Basic listener, listen only, unaddresses if MTA <sup>2</sup>		
		L(LE)4 Basic listener, unaddresses if MTA <sup>2</sup>		
		Service Request	SR	SR0 No capability
				SR1 Full capability
		Remote Local	RL	RL0 No capability
RL1 Full capability				
RL2 No local lockout				
Parallel Poll	PP	PP0 No capability		
		PP1 Remote configuration		
		PP2 Local configuration		
Device Clear	DC	DC0 No capability		
		DC1 Full capability		
		DC2 Omit selective device clear		
Device Trigger	DT	DT0 No capability		
		DT1 Full capability		
Driver Electronics	E	E1 Open collector (250kb/s max)		
		E2 Tri state (1Mb/s max)		
Controller <sup>3</sup>	C	C0 No capability		
		C1 System controller		
		C2 Send IFC and take charge		
		C3 Send REN		
		C4 Respond to SRQ		
		C5 Send interface messages, receive control, pass control to self, parallel poll, take control synchronously		

<sup>1</sup>MLA: My Listen Address

<sup>2</sup>MTA: My Talk Address

<sup>3</sup>There are 29 controller levels. These are the more significant levels.



# HEWLETT-PACKARD INTERFACE BUS

Versatile Interconnect System for Instruments and Controllers

Models 59401A, 10833A/B/C/D, 10834A

561

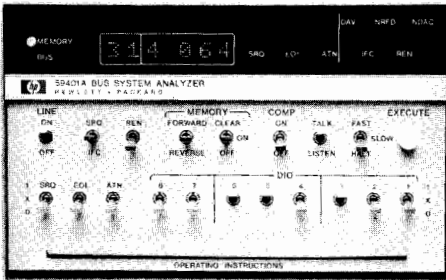

HP 59401A

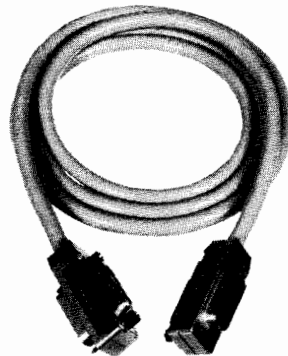

HP 10833A/B/C/D

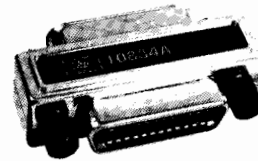

HP 10834A

## HP 59401A Bus System Analyzer

The HP-IB (IEEE 488) concept has greatly simplified many of those things which have in the past made instrument interfacing a burdensome task. Even so, software errors can occur if the system designer does not completely understand the bus system or the capabilities of the instruments and other devices being interfaced. Hardware problems can occur if the instruments/devices are not functioning properly, or if they are not completely compatible with the bus standard.

The HP 59401A Bus System Analyzer is especially useful in design and service work. It simplifies and speeds up the diagnosis of software and hardware problems by allowing the user to see the status of all bus lines, including the actual characters on the bus data lines. Because the HP 59401A can also drive all bus lines, it can completely exercise another Talker, Listener or Controller—which is especially useful in verifying compatibility of new or user-designed products with the HP-IB.

There are several choices of analyzer operating speed. It may be operated at one character at a time (useful for software debugging), at 2 characters per second, or at regular bus speed. It may also be operated at a variable rate as determined by the external clock input.

The analyzer's 32 character memory can be used to store bus characters in the Listen mode, or to output characters to the bus in the Talk mode. When the analyzer is in the Compare mode, a stream of bus traffic may be stopped on a pre-selected character—and at that time a trigger pulse is available, which is very useful when analyzing transient or timing problems related to the bus.

## HP 59401A Specifications

**Display:** monitors all bus lines. Represents data lines, any memory location, or DIO front panel switch settings; in octal code and ASCII character.

**Listen mode:** stores up to 32 characters of bus traffic in memory for real time and repetitive testing. In Compare mode, halts bus traffic when a selected character is present, and user can display any one of the previous 31 characters stored in memory.

**Timing:** accept <750 ns; ready <750 ns.

**Talk mode:** bus lines can be driven directly from front panel switches; memory can be loaded from front panel switches for driving bus with a 32 character sequence.

**Timing:** (1) data changed >500 ns before DAV pulled low; (2) ATN driven low >1 μs before DAV pulled low; (3) DAV driven high <700 ns after NDAC is false; (4) DAV driven low <700 ns after NRFD is false, if conditions 1 and 2 are met.

**Operating speeds:** one character at a time, 2 characters per second, regular bus speed, or variable rate determined by external clock input; in either Listen or Talk mode.

**External clock input:** 1 standard power TTL gate input; ≤10 MHz repetition rate.

**Compare output:** provides 1 standard power TTL gate output (LOW TRUE) sync pulse when bus character is same as front panel switches.

**HP-IB load:** 1 bus load (capable of driving 14 other bus devices).

## General

**Temperature ranges:** operating, 0 to 50°C; storage, -40 to +75°C.

**Humidity:** 95% relative, 0 to 40°C.

**Power requirements:** 100, 120, 220, or 240 V +5%, -10%; 48 to 66 Hz; ≤42 VA.

**Size:** 145.5 H, 205.1 W, 495.3 mm D (5.730" x 8.075" x 19.500").

**Weight:** net, 5.64 kg (12.44 lb).

## Accessories

**HP 5061-9689**(metric) front handle kit

**HP 10833B** 2 m (6.6 ft) bus cable, furnished

## Price

\$55 ☛

**HP 59401A Bus System Analyzer**

**\$4170**

## HP-IB Interconnection Cables

Cables for interconnecting HP-IB devices are available in four different lengths. The connector block at both ends of each HP-IB cable (photo above) has a plug on one side and a matching receptacle on the other, so that several cables may be conveniently connected in parallel, thus simplifying system interconnection. Lock screws provide for secure mounting of each connector block to an HP-IB instrument, or to another cable connector block.

**SPECIAL NOTE:** HP-IB cables are not always included with individual HP-IB devices, particularly those that normally connect directly to an HP computing controller. (The HP-IB interface for HP computing controllers contains the necessary cable and connector). Product listings in this catalog should be checked to see if HP-IB cables are furnished.

The HP 10833 series of cables feature an improved shielding design to help improve RFI levels in systems. This series of cables, with the RFI shielding, exhibits significantly lower radiated emissions than previous HP-IB cables.

The HP 10834A adapter is a shielded HP-IB to HP-IB adapter. It provides additional clearance (approximately 2.3 cm) between the HP-IB cable and the rear panel of the instrument. This allows easier access to switches, cables, and other connectors that may be in close proximity to the HP-IB connector.

## Ordering Information

**HP 10833A** HP-IB Cable, 1m (3.3 ft)

**HP 10833B** HP-IB Cable, 2m (6.6 ft)

**HP 10833C** HP-IB Cable, 4m (13.2 ft)

**HP 10833D** HP-IB Cable, 0.5m (1.6 ft)

**HP 10834A** Adapter

☛ Fast-Ship product — see page 766.

## Price

\$80 ☛

\$90 ☛

\$100 ☛

\$80 ☛

\$31 ☛

# HEWLETT-PACKARD INTERFACE BUS

## Versatile Interconnect System for Instruments & Controllers

Models 59306A, 59307A, 59309A, 59501B

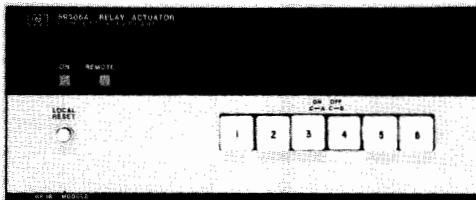

HP 59306A

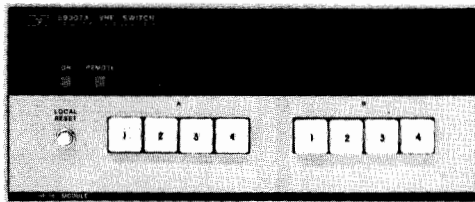

HP 59307A

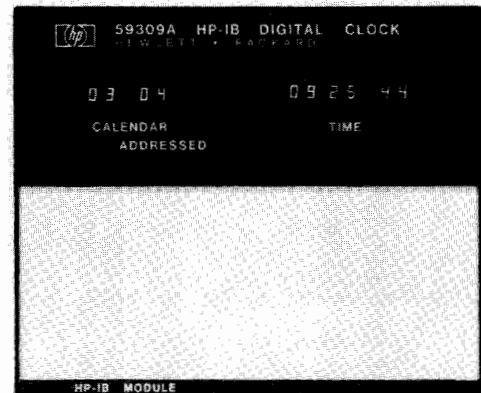

HP 59309A

### HP-IB Accessory Modules

Modules in the HP 59300, 59400 and 59500-series are ideal building blocks for use with instruments to extend measurement capabilities. Modules listed here can be interconnected via the HP-IB to HP measuring instruments, signal sources and recording devices capable of operating directly on the HP-IB. In addition, these modules frequently serve as useful ways to interconnect with devices which are not themselves capable of direct HP-IB operation.

#### HP 59306A Relay Actuator

Has six Form-C relays that provide for control of external devices either manually from front panel pushbuttons or remotely from the HP-IB. Relay contacts are specified to switch 24 V dc or 115 V ac at 0.5 A. Each relay can be programmed independently or multiple relays can be switched together. Front panel pushbuttons light to indicate the state of each relay.

The HP 59306A is ideal for providing control of microwave coaxial switches (HP 8761 A/B) as well as control of microwave programmable step attenuators (HP 8494 through 8496 G/H) using external dc power supplies.

#### HP 59307A Dual VHF Switch

This module provides two single pole 4-throw switches controlled from front panel pushbuttons or remotely from the HP-IB. The HP 59307A is a dc to 500 MHz 50  $\Omega$  switch designed to maintain fast pulse transition times. The switches are independent and bidirectional for optimum use in multiplexing 50  $\Omega$  signal lines into measuring instruments. The HP 59307A is ideal to switch a standard delay, frequency, or voltage into a measurement loop for purposes of system calibration.

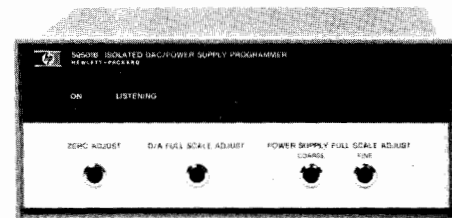

HP 59501B

#### HP 59309A HP-IB Digital Clock

Displays month, day, hour, minute, and second, and upon command will output time via the interface bus. Time can be set into the clock by local control, or by remote commands received from the HP-IB. The clock accepts a small internal battery which can provide more than a day's standby in case of short power interruptions. Additionally, an auxiliary power supply such as the K10-59992 can sustain the clock for up to one year.

#### HP 59501B Power Supply Programmer (isolated DAC)

This single-channel digital-to-analog converter can control a wide range of power supplies (output voltage, or current), as well as other analog programmable devices. It may also be used as a low level signal source, depending on the speed of the controller. It has two output ranges (0–1 and 0–10 V dc in unipolar mode; –1 to +1 and –10 to +10 V dc in bipolar mode), as well as photo-isolators which electrically separate HP-IB control and data lines from power supply circuitry by up to 600 V dc. (For additional details see page 469).

HP Model	Description	Dimensions—max. height x width x depth mm (inches)	Net Weight kg (lb)	Shipping Weight kg (lb)	Price
59306A	Relay Actuator	101.6 x 212.9 x 294.6 (4 x 8.38 x 11.6)	2.64 (5.87)	3.23 (7.18)	\$1810
59307A	VHF Switch	101.6 x 212.9 x 294.6 (4 x 8.38 x 11.6)	2.64 (5.87)	3.23 (7.18)	\$1600
59309A	HP-IB Digital Clock	101.6 x 105.9 x 294.6 (4 x 4.17 x 11.6)	1.70 (3.78)	2.84 (6.31)	\$2640
59401A	Bus System Analyzer	145.5 x 205.1 x 495.3 (5.73 x 8.08 x 19.5)	5.64 (12.44)	9.1 (20)	\$4170
59501B	Power Supply Programmer	101.6 x 212.9 x 294.6 (4 x 8.38 x 11.6)	2.61 (5.80)	3.17 (7.04)	\$ 850

# HEWLETT-PACKARD INTERFACE BUS

## Versatile Interconnect System for Instruments and Controllers

563

Models 37201A, 37204A/B

### HP 37204B

- High-speed HP-IB extension up to 1250 metres on coaxial cable and 3000 metres on fiber optic cable
- Cost effective multi-drop capability with up to 30 remote sites
- Extends a system without software changes
- Error-free transmission and chain truncation ensure uninterrupted operation of the controller
- Industry standard fiber optic connectors
- Compatible with 50/125 to 100/140  $\mu\text{m}$  fiber diameters



HP 37204A/B



FIBER OPTIC INTERFACES

### HP 37201A

- Long-distance HP-IB extension over telephone lines (leased or dial-up)
- Data acquisition systems can operate over unlimited distances
- Multi-drop capability (leased lines only)
- Use with full-duplex synchronous/asynchronous modems from 300 to 19,200 bit/s
- RS-366 or CCITT V.25 autodial capability

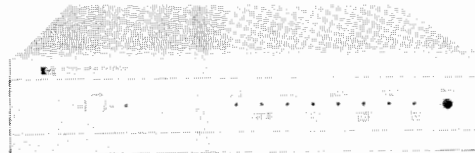

HP 37201A



### HP 37204A Multi-point HP-IB Extender

Adding HP 37204As to an HP-IB system allows the 2-metre separation between HP-IB devices to be extended up to 1250 metres/3000 metres. The HP 37204A is "transparent" to HP-IB commands and data, therefore, software changes are not needed to turn a bench-top system into an extended system. Multi-point capability means remote sites can be daisy-chained together, using only one HP 37204A at each site. Chain truncation allows the computer site to continue operation, even in the event of remote power failure or link failure.

The HP 37204A has a maximum HP-IB transfer rate of 60 kbyte/s, however, the maximum achievable rate depends on many factors, such as speed and behaviour of each device connected to the HP-IB, number of remote sites, and distance. Increased absolute transmission delay affects parallel poll response time, and makes HP-IB extension inadvisable for some high-speed memory peripherals.

The following table shows some examples of maximum transfer rate. It should be noted that the serial transmission rate over coaxial cable must be reduced to 1/10th speed for distances greater than 250 metres.

Average Inter-extender Cable Length	Number of Extenders per Chain		
	2	3	5
100 metres - coaxial cable	54 kbyte/s	26 kbyte/s	14 kbyte/s
optical fiber	52 kbyte/s	25 kbyte/s	13 kbyte/s
500 metres - coaxial cable	5.9 kbyte/s	2.8 kbyte/s	1.4 kbyte/s
optical fiber	36 kbyte/s	17 kbyte/s	9 kbyte/s

**HP 37204B:** The HP 37204B is specifically intended for supported configurations of HP 3000 computers and certain high end printers, e.g. HP 256x A/B, 2680A, providing bus extension up to 250 metres on coaxial cable only.

### Ordering Information

- HP 37204A:** Equipped with dual coaxial ports. **Price** \$1,060
- Option 003:** Fiber optic interface. Adds a single fiber optic port with SMA connectors. **Price** \$460
- Option 004:** Fiber optic interface. Adds dual fiber optic ports with SMA connectors. Required for the middle of a multi-drop optical fiber serial link. **Price** \$860
- Option 013:** Fiber optic interface. Adds a single fiber optic port with ST connectors. **Price** \$460
- Option 014:** Fiber optic interface. Adds dual fiber optic ports with ST connectors. Required for the middle of a multi-drop optical fiber serial link. **Price** \$860
- HP 37204B:** Equipped with dual coaxial ports. **Price** \$1,300
- Options common to HP 37204A and HP 37204B**
- Option 303:** Half-width rack mount adapter for mounting adjacent to instruments with an HP SYSTEM II cabinet. **Price** \$85
- Option 305:** Standard 19-inch rack mount adapter. Holds one or two HP 37204A's (includes pop-out blanking panel). **Price** \$85
- ☛ Fast-ship product—see page 766.

### HP 37201A HP-IB Extender

The HP 37201A allows HP-IB devices to be interconnected over virtually unlimited distances.

The HP 37201A is "transparent" to most HP-IB commands, therefore in most cases, software modifications will not be needed to add HP 37201As into a system. Exceptions are that parallel poll and pass control functions are not supported. Software commands are required to use auto-dial, multi-drop, and idle facilities described below. Error correction ensures trouble-free performance over the worst phone lines. Multi-drop operation is possible using leased lines and modems with transmission (carrier) controlled by "request-to-send". Unlike the HP 37204A, remote sites must be accessed sequentially. The HP 37201A has an idle mode to allow faster operation at the computer site when remote communication is not required.

The data interface is compatible with RS-232-C/CCITT V.24 and V.28 standards. Full-duplex asynchronous or synchronous modems may be used. Asynchronous data rates provided are 150, 300, 600, 1200 bit/s. It should be noted that asynchronous modems must be capable of supporting 11-bit words (9 bits + start & stop bits). Although most asynchronous modems are insensitive to word length, some BELL 212 type modems only support up to 10-bit words, and so must be operated in synchronous mode. Synchronous modems can be operated at any bit rate up to 19.2 kbit/s.

The HP 37201A has an RS-366/CCITT V.25 autodial interface. For many applications, the HP 37212B Modem offers an alternative autodial solution. It requires a spare RS-232-C port on your computer, but obviates the need for a separate RS-366/CCITT V.25 autodialer. Manually-dialled connections are also supported.

The data byte transfer rate of the HP 37201A depends primarily on the serial data rate, data link length, and data link error rate. The following nominal transfer rates are for a short error-free link.

Synchronous modem interface: 744 data byte/s at 19.2 kbit/s, and pro-rata at lower serial rates.

Asynchronous modem interface: 38 data byte/s at 1200 bit/s, and pro-rata at lower serial rates.

### Ordering Information

- HP 37201A HP-IB Extender** **Price** \$2,600
- Option 907:** Front handle kit **Price** \$57
- Option 908:** Rack flange kit **Price** \$37
- Option 909:** Front handle/rack flange kit **Price** \$81.50

# DATA ACQUISITION SYSTEMS

## General Information

- Reduce Manufacturing Costs
- Reduce Product Development Time
- On-Going Payback

- Improve Product Quality
- Higher Process Throughput
- More Process Up-Time

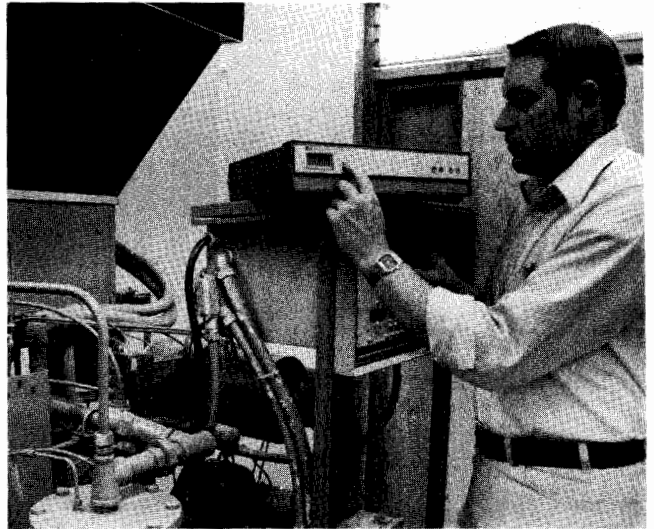

Data Acquisition is the generally accepted term for the procedure of characterizing a product or a process using electronic instruments. A "process" is defined as any procedure used to build a product or provide a service. A product or process is characterized by measuring it in minute detail so that all significant operating parameters are accurately known. Once characterized, improvements can be made that reduce costs and/or increase a product's performance/price ratio. A data acquisition system is a tool for increasing your bottom-line profitability.

Experience has shown that profit robbing inefficiencies are usually caused by many small errors rather than a few large ones. Today's modern electronic data acquisition systems can perform thousands of measurements per second, detect changes smaller than one part in one million and respond to those changes in less than 1/100th of a second. This high performance allows even large products and processes to be characterized in detail so that very high efficiencies can be attained.

The products and processes that can benefit from data acquisition are very broad. Producers of everything from automobiles to zucchini, research and development labs, utilities, educators, and the military services all have found that data acquisition is a cost effective technique.

The block diagram at the right shows how a typical data acquisition system is configured. A test program is stored in the computer. When executed, the program adjusts the product or process to a desired condition through the control functions in the data acquisition instrument. Then the computer directs the data acquisition instrument to take measurements. The measurements are analyzed and a report printed that describes the characteristics being tested. Based on the results, the product or process is modified to improve its performance. This cycle continues until optimization is achieved. Once the

critical control parameters and measurements are determined, the computer can be further programmed to automatically control the process or product at its optimum point.

Hewlett-Packard has been building electronic data acquisition systems for over 20 years. More than 150,000 systems have been installed worldwide. In addition to a broad

range of high quality computers and instruments, Hewlett-Packard has an ever-expanding offering of software and support services that provide a total data acquisition system solution. The following data acquisition system components from Hewlett-Packard can handle most applications in manufacturing, R&D, education, utilities and military/aerospace.

Product/Process Characterization Block Diagram

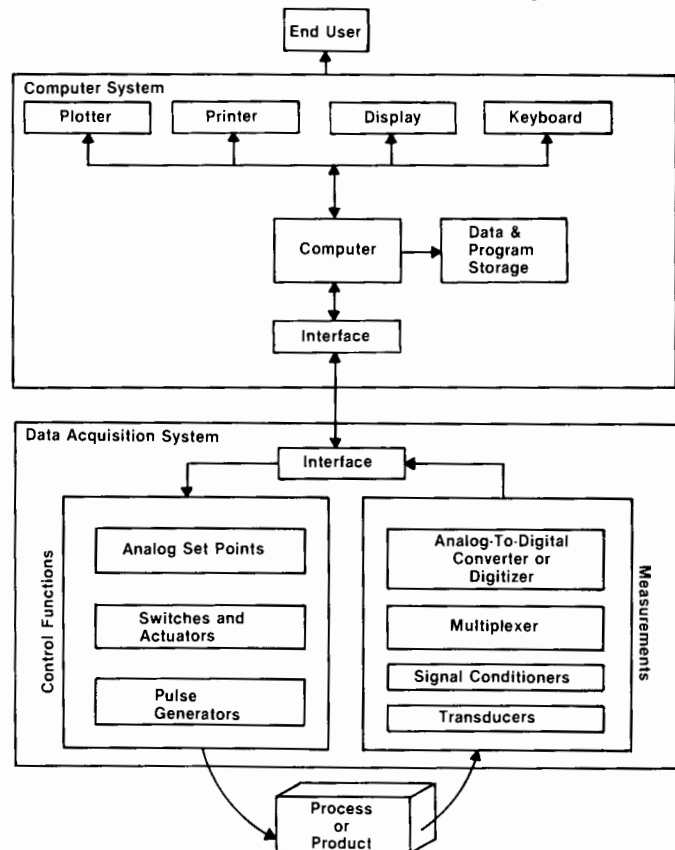



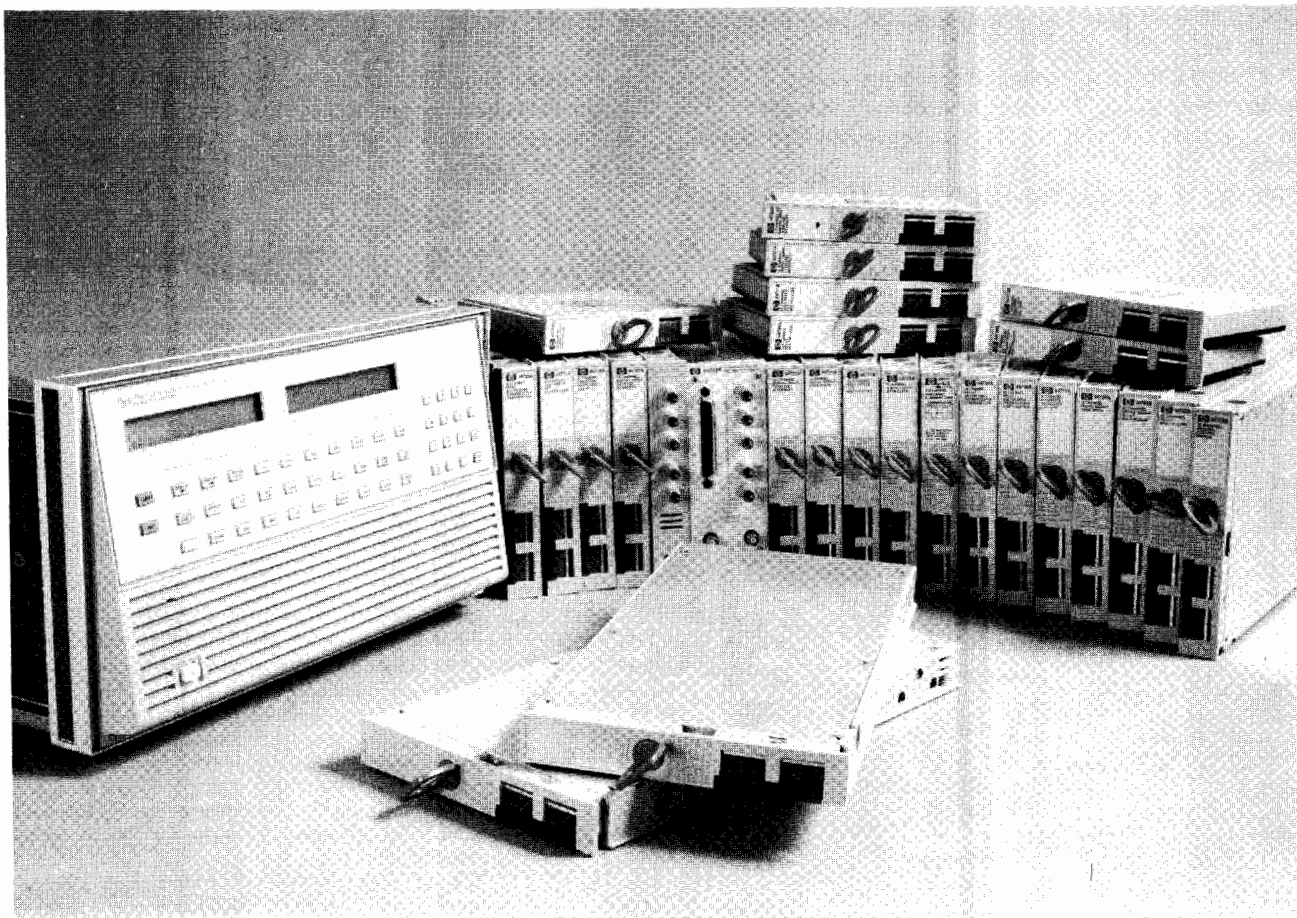

### HP Data Acquisition System Components

#### Instruments

HP 3421A Data Acquisition Unit

- Low Cost
- Portable

HP 3497A Data Acquisition/Control Unit

- Built-in DVM and RS-232
- Large Selection of Plug-in Accessories

HP 3852A Data Acquisition/Control Unit

- Powerful Built-in Operating System
- Broad Functionality with Complete Line of Plug-in Accessories

HP 48000 Remote Terminal Unit

- Designed for Industrial Environments
- Remotely Locatable

#### Computers

HP Vectra Personal Computer

- IBM PC/AT Compatible
- Independent HP BASIC Language Processor

HP 9000 Series 300 Technical Computer

- High Performance
- Modular

HP 1000 Real-Time Computer

- Real-Time Processing
- Multi-User Operating System

#### Software

HP DACQ/PC Data Acquisition Manager

- Data Acquisition Software Tools
- Use with HP Vectra PC

HP DACQ/300 Data Acquisition Manager

- Data Acquisition Software Tools
- Use with HP Series 300 Technical Computer

Value Added Suppliers

- Software Packages Available for All HP Computers
- Expanding Selection

### The Total Data Acquisition System Solution

Every data acquisition system requires a combination of computers, instruments, transducers and software. The extent to which these pieces are packaged together is dependent upon your individual needs. Whether its a completely integrated turnkey system, system components, plug-in board products or a customized in-house system, Hewlett-Packard can help. Turnkey solutions can be provided by HP's own Customer Support Group or through an expanding net-

work of independent Systems Integrators and Software Suppliers. Contact your local HP sales office for more information about these programs.

Information on data acquisition plug-in board products for Series 1000 and Series 9000 computers can be found on pages 670 and 647. Information on temperature transducers can be found on page 647. Data acquisition software products are described on pages 606-609. Information on instru-

ments and computers for custom-built systems can be found under the headings for those products. The remainder of this section contains detailed information on data acquisition component systems. These systems provide solutions for a very broad range of applications. Contact your local Hewlett-Packard sales office for more information on how these systems can work for you.



# DATA ACQUISITION SYSTEMS

## Instruments for Measurement and Control

### HP Model 3421A

- Up to 30 differential channels, 56 single-ended channels
- Electronic calibration for repeatable answers
- Built-in 5½ digit A/D converter with 1  $\mu$ V sensitivity
- HP-IL (standard) and HP-IB (optional) with rear panel switch
- Optional 12 volt remote charging adapter
- "Sleep mode" for extended battery life in remote locations
- Front terminals for convenient DCV, ACV, 2 & 4-wire ohms, frequency and temperature
- Display shows channels closed, digital states and self-test conditions

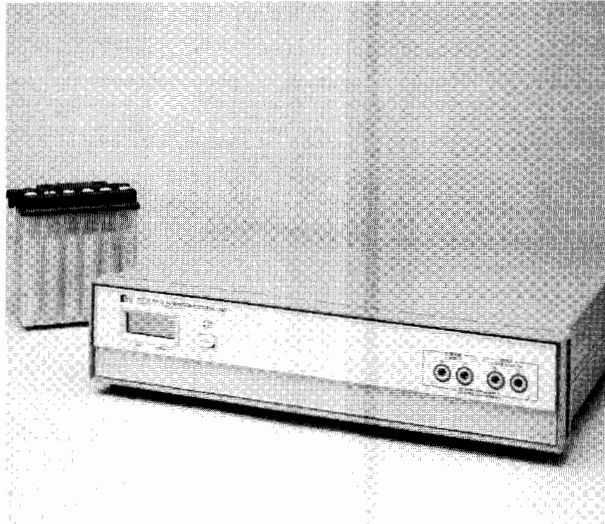

HP 3421A

### Description

If your measurement needs exceed the capabilities of plug-in cards but don't quite call for a top-of-the-line data acquisition unit, the HP 3421A is just what you are looking for. The HP 3421A is the instrument that beats the high cost of data logging. Use it for small data acquisition projects with the assurance that it will quickly pay its own way. The HP 3421A can be configured with several different computers into a variety of systems designed for low to medium sized applications.

### The HP 3421A with the Vectra Personal Computer

The HP 3421A is an ideal instrument companion for the Vectra Personal Computer. The HP 3421A and Vectra PC containing the BASIC language processor offer lab-quality measurements with PC convenience at an affordable price. DACQ/PC Data Acquisition Manager software (see page 608) provides powerful software tools for gathering, storing, analyzing, and presenting measurement data from more sophisticated data acquisition applications.

### The HP 3421A with the Series 300 Technical Computer

For data acquisition applications that are computation intensive, the HP 3421A can be coupled with a Series 300 Technical Computer. DACQ/300 Data Acquisition Manager software (see page 565) offers the same powerful tool set as DACQ/PC with enhanced data transfer, system configuration routines, and color graphics.

### The Instrument

The HP 3421A scans up to 30 channels, measuring DCV, ACV, 2- and 4-wire Ohms, Frequency, and Temperature. It also reads and writes digital information and stores up to 30 analog readings. The standard HP 3421A comes with an HP-IL interface for battery-powered flexibility or optionally HP-IB for more computational power.

Up to three of the following assemblies may be added to the HP 3421A mainframe:

- 10-channel analog multiplexer/actuator assembly with thermocouple compensation,
- 8-bit input/8-bit output digital assembly,
- Breadboard assembly for custom circuitry.

### Measurement Integrity

With its 5½, 4½, 3½ digit A/D converter, the HP 3421A can resolve 1  $\mu$ V out of 300 mV to monitor thermocouples and other low-level transducers. Or it can read higher level signals by auto-ranging up to 300 volts dc.

### System Versatility

Each HP 3421A can scan up to 30 differential channels or 56 single-ended channels of analog information. The HP 3421A is battery-powered with latching relays that will not change state when the ac line power is removed. Battery power gives the HP 3421A its own uninterruptible power supply.

The HP 3421A is not limited to portable applications. It is equally useful in laboratory situations, where its 0.01% accuracy, 1 microvolt sensitivity and 5½ digit resolution assure you of reliable answers.

Digital inputs, actuator outputs and a breadboard assembly give the laboratory designer a great deal of instrument flexibility while HP-IB compatibility adds the option of a more powerful instrument controller.

### System Specifications

These rates assume 30 readings taken on a fixed range with no function change. Speeds are independent of channel sequence. These rates reflect the time to read and store information in the 30-reading buffer of the HP 3421A. They do not include computer transfer time.

### Approximate Maximum Reading Rates (readings/second)

	DCV, $\Omega$		ACV		Frequency	Type T Thermocouple
	Auto Zero On	Auto Zero Off	Auto Zero On	Auto Zero Off		
5½ Digit	2	3.8	—	—	0.1	0.95
4½ Digit	13	18	0.3	0.3	0.9	0.95
3½ Digit	21	24	0.4	0.4	7.0	0.95

### HP 3421A Mainframe Specifications

The HP 3421A mainframe comes with:

- A 5½, 4½, and 3½ digit integrating A/D converter
- Thermocouple compensation
- Type T thermocouple linearization built in
- HP-IL
- 30-reading storage buffer
- LCD 30 channel display with power and error indicators
- Electronic calibration
- Rechargeable battery
- High level command set

All specifications apply for relative humidity less than 85% at 30 degrees C.

### DC Voltage

**Ranges:** 300 mV, 3 V, 30 V, 300 V, Autorange  
**Basic accuracy:**  $\pm(.009\%$  reading + 3 counts); 5½ digits  
**Reading rates:** 2 to 35 readings/second

### Resistance

**Ranges:** 300  $\Omega$ , 3 k $\Omega$ , 30 k $\Omega$ , 300 k $\Omega$ , 3 M $\Omega$ , 30 M $\Omega$ ; Autorange  
**Basic accuracy:**  $\pm(.012\%$  reading + 3 counts); 5½ digits  
**Reading rates:** 2 to 35 readings/second

### AC Voltage

**Ranges:** 3 V, 30 V, (300 V with HP 44469A divider)  
**Converter type:** averaging  
**Resolution:** 3½ or 4½ digits  
**Basic accuracy:** 4½ digits:  $\pm(0.5\%$  reading + 60 counts), 45 Hz to 500 Hz;  $\pm(1\%$  reading + 60 counts), 30 Hz to 1 kHz; providing the input voltage is at least 10% of range.

### Counter

The counter is part of the mainframe circuit, and is multiplexed through the channel relays.  
**Resolution:** 65,535 counts  
**Frequency:** 1 Hz to 10 kHz  
**Modes:** frequency, totalize

### Thermocouple Thermometer

Type T thermocouple linearization is built in. For other thermocouple types, the reference junction temperature is available on each multiplexer assembly.

### Temperature Errors

These errors include the linearization error of the HP DACQ/PC software, thermal offset voltages, A/D error and reference junction error. They do not include transducer errors.

J,E,T Thermocouples

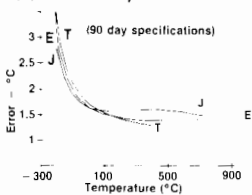

K,R,S Thermocouples

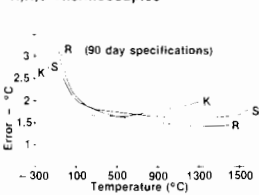

2.2 k $\Omega$  Thermistor

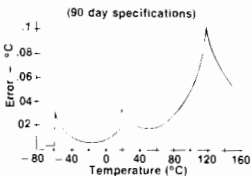

100  $\Omega$  Platinum RTD  $\alpha = .00385$

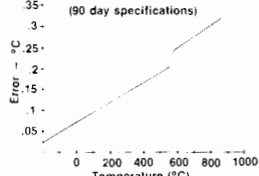

### Option 020, 021, 022 Multiplexer/Actuator Assemblies

The configuration of multiplexer and actuators depends on the option you order. Option 020 has 8 multiplexer/2 actuator channels; Option 021 has 9 multiplexer/1 actuator channels; Option 022 has 10 multiplexer channels. The actuators are capable of switching 252 Vac. One HP 3421A mainframe can hold up to 3 assemblies.

### Option 040 Breadboard Assembly

The breadboard assembly is convenient for constructing custom circuitry. It comes complete with a manual describing the circuit that enables the HP 3421A to communicate directly with an 8-bit microprocessor.

### Option 050 Digital I/O Assembly

Option 050 has 8 isolated input lines and 8 isolated output lines for both monitoring and controlling external digital devices.

### Option 201 HP-IB

The Option 201 adds an HP-IB interface to the HP 3421A. This allows the use of either HP-IB or HP-IL. HP-IB Interface function includes: SH1, AH1, T6, TE0, LE0, L4, SR1, RL0, PP0, DC1, DT1, C0. For more on these codes, see the HP-IB section of this catalog.

### Option 214 12 Volt Remote Charging Adapter

This optional assembly provides the necessary isolation and regulation for a 12 volt automotive battery or system to charge the batteries of the HP 3421A, HP 71B Handheld Computer, and peripherals such as the HP 9114B Portable 3½" Microfloppy and HP 2225B Thinkjet Personal Printer. Option 214 is mutually exclusive with Option 201 (HP-IB).

### Ordering Information

#### Input and I/O Assembly Options

Option	Description	Price
020:	8 Channel Multiplexer/2 Channel Actuator Assembly	\$395
021:	9 Channel Multiplexer/1 Channel Actuator Assembly	\$395
022:	10 Channel Multiplexer Assembly	\$395
040:	Breadboard Assembly with connector block	\$100
050:	8 bit in, 8 bit out Digital I/O Assembly with connector block	\$395
201:	add HP-IB interface. Allows use of EITHER an HP-IB or HP-IL controller	\$285
214:	add 12 volt remote charging adapter. Cannot be added if opt 201 is specified	\$415

#### Rack Mount and Manual Options

401:	Side Handle Kit	\$40
907:	Front Handle Kit	\$55
908:	Rack Mount Kit	\$35
909:	Rack Mount with Handle	\$80
910:	Extra Manuals	\$95

#### Field Installation Kits\*

HP 44461A:	Add HP-IB interface. Allows use of either an HP-IB or HP-IL Controller (same as Opt 201)	\$315
HP 44462A:	8-Channel Multiplexer/2 Channel Actuator Assembly with thermocouple compensation, connector block. (Same as Opt 020. Can be reconfigured to same as Opt 021 or Opt. 022)	\$395
HP 44463A:	extra connector block for HP 44462A	\$50
HP 44464A:	Breadboard Assembly with connector block (same as Opt 040)	\$100
HP 44465A:	8 bit in, 8 bit out digital I/O assembly with connector block (same as Opt 050)	\$395
HP 44466A:	Extra connector block for digital or breadboard assembly	\$17
HP 44469A:	Seven 10:1 dividers for measuring 300 Vac	\$17

### Accessories

HP 2225B:	Thinkjet Personal Printer (HP-IL)	\$488 ☎
HP 9114B:	Portable 3½" Microfloppy (HP-IL)	\$635 ☎
HP 11340A:	20-metre HP-IL Cable	\$100
HP 11340B:	50-metre HP-IL Cable	\$190
HP 11340C:	100-metre HP-IL Cable	\$385
HP 82161A:	Digital Cassette Drive (HP-IL)	\$547 ☎
HP 82162A:	Printer/Plotter (HP-IL)	\$450 ☎
<b>Related Products</b>		
HP 3468A	Digital Multimeter	\$765 ☎

### HP 3421A Data Acquisition/Control Unit

**\$1,750**

\* Field installation is recommended to be performed only by service trained personnel.  
 ☎ Fast-ship product — see page 767.

# DATA ACQUISITION SYSTEMS

## Instruments for Measurement and Control

### HP Model 48000 RTU Family

- For Industrial Monitoring and Control
- Stand-Alone or System Operation
- Radio/Modem/Wireline Datacom

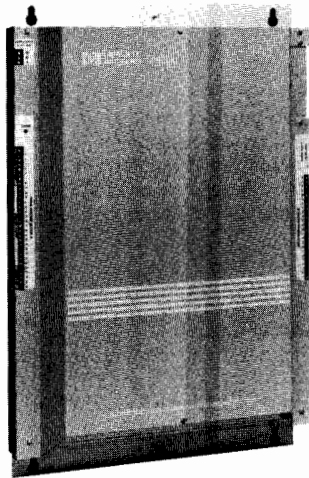

HP 48050A RTU

#### Description

The HP 48000 Remote Terminal Unit (RTU) are intelligent, microprocessor-based measurement and control units designed to operate in harsh industrial and remote environments. The HP 48000 RTU starts with 16 I/O points which can be increased to 256 I/O points with optional expansion modules.

The HP 48050A RTU is the newest member of the HP 48000 RTU product family, addressing applications that require small point counts. The HP 48050A RTU starts with 23 I/O points which can be increased to 45 I/O points with an expansion board.

Applications for the HP 48000 RTU family include:

- Oil and gas production
- Pipeline SCADA systems
- Water treatment systems
- Electrical utility SCADA systems
- Facility/energy management
- Process monitoring & control

#### Built-in Intelligence

Intelligent processing is easy to implement on the HP 48000 RTU, because HP provides the right tools: built-in signal-processing functions, along with a built-in BASIC compiler. Both can be accessed through the Application Development Software, which runs on a variety of HP personal computers.

To offload host-computer processing, the HP 48000 incorporates over 50 of the most commonly required signal-processing functions. These include PID loop control, AGA flow calculations, engineering unit conversion, and alarm checking. When the database of the HP 48000 is being configured, these functions can be chained to perform multiple processing of input and output signals.

#### Easy to Program

The HP 48000 contains a built in BASIC that can be used for more complex signal processing, and for custom control routines. The BASIC is incrementally compiled, providing fast program execution in a multi-tasking environment. Up to eight BASIC tasks may reside in a single HP 48000 RTU.

The HP 48071A/72A menu-driven Application Development Software for the HP 48000 lets system designers quickly configure the RTU database to their own specifications. This software runs on the HP Vectra and the HP Portable Plus. To configure the database, the user simply selects the field on the display screen and keys in values relating to his specific application. (The database can also be configured from the HP 3081A Portable Operator Panel or a host computer.)

- Rugged Design for Harsh Environments
- Menu Driven Configuration
- Multi-Tasking BASIC

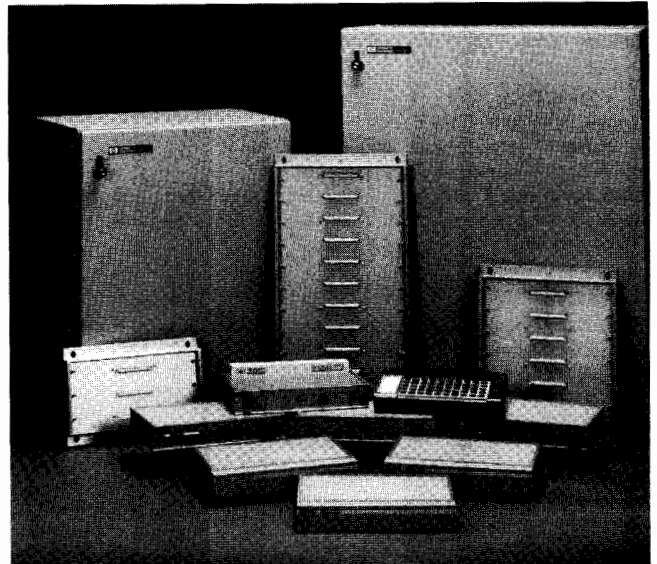

HP 48000 RTU Family

#### High Quality and Reliability

The HP 48000 RTU is designed to withstand harsh environments. It is so rugged and reliable that a typical configuration has a Mean Time Between Failures of over five years!

Here are some features that make such performance possible.

- Use of CMOS technology contributes to the wide operating temperature specifications
- Aluminum module enclosures shield circuit boards from physical contact and ESD damage
- Transient voltage suppressors protect the electronics from electrical surges on the power line and field terminal wiring
- I/O modules are internally protected from field-wiring shorts
- Pin-and socket connectors provide reliable interconnection

#### General Specifications

**Temperature Range:**  $-40^{\circ}\text{C}$  to  $+65^{\circ}\text{C}$  (operating);  $-65^{\circ}\text{C}$  to  $+85^{\circ}\text{C}$  (storage)

**Humidity Range:** 5 to 95% non-condensing

**RFI Susceptibility:** 1 volt/meter from 14 KHz to 1 GHz

**EMI Emissions:** Meets VDE 0871 level B

**Vibration:** Random vibration 0.30 Grms 5 to 500 Hz (functional). Random vibration 2.41 Grms 5 to 500 Hz (survival).

**Shock:** Half-sine shock pulse of  $<3$  ms duration with 175 cm/s velocity change (functional). Trapezoidal shock pulse of 30 G with 742 cm/s velocity change (survival).

**Transient Protection:** Meets IEEE 472/ANSI-C37.90a for ability to withstand surges at all communications and field wiring points. Meets IEEE 587 standards for ability to withstand power-line surges.

**Dimensions:** 330mm W x 215mm D x 55mm H (13" x 8.5" x 2.17")

**Electrical Classification:** General Non-Hazardous Area (CSA, FM- & TUV approved).

### Communications Flexibility

The diagram to the right shows some of the typical networks that can be configured with the HP 48000 RTU. Remote data acquisition and control systems are easily implemented using twisted-pair wireline, radio-communication links or telephone company facilities.

The host computer accesses data in a network of remote units in one of three modes:

- Standard poll/response
- Polled Report-By-Exception (PRBX)
- Spontaneous Report-By Exception (SRBX)

This choice of communication modes, and the availability of both HEX ASCII and Radix-64 ASCII protocols, lets users maximize communication efficiency for their applications.

Other data communication features of the HP 48000 RTU products include:

- A Modem Module 202T or CCITT frequency
- A RS232 C port that supports smart auto-dial modems
- A FCC and DOC approved Radio Datacom Module
- A data link Repeaters to extend wireline communications
- Communication Handler software for HP host computer interface
- Multi-drop networking capabilities of up to 90 RTUs over a maximum distance of 3.6 kilometers (2.25 miles)
- The capability of communications protocol emulation

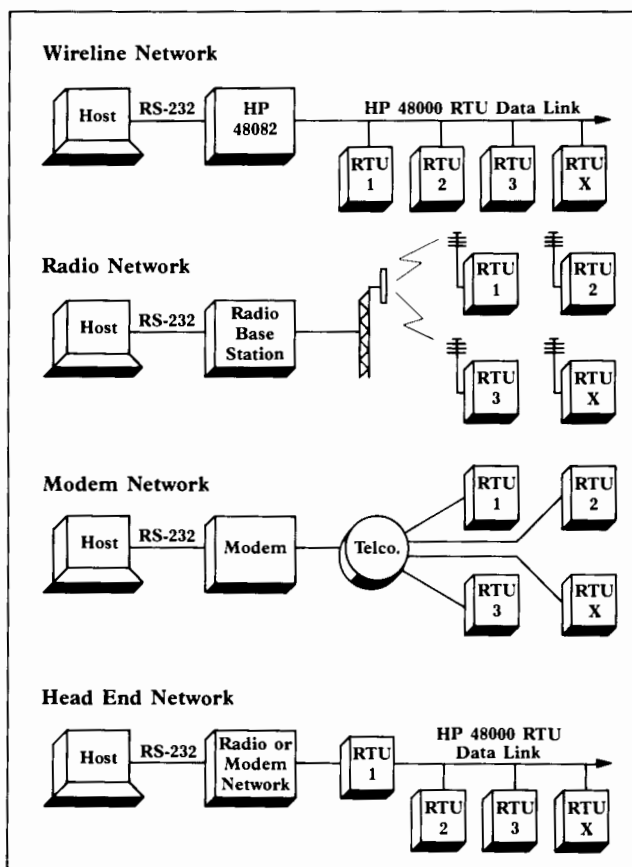

### HP 48000 RTU Ordering Information

#### Price

HP 48001A 3-Slot Backplane	\$204
HP 48002A 6-Slot Backplane	\$255
HP 48003A 11-Slot Backplane	\$355
HP 48004A NEMA-4 Cabinet (3/6 slot)	\$510
HP 48005A NEMA-4 Cabinet (11 slot)	\$510
HP 48010A Master Controller Module	\$2600
HP 48020A Configurable I/O Module (16 ch)	\$1760
HP 48021A Analog Output Module (4 ch)	\$1630
HP 48022A Low Level Input (16 ch) (with thermocouple compensation)	\$3310
HP 48023A Isolated Digital Relay Output Module (8 ch)	\$1225
HP 48024A Digital Input Module (32 ch)	\$1250
HP 48025A Isolated Digital Input Module (16 ch)	\$1225
HP 48026A Isolated Digital Triac Output Module (8 ch)	\$1325
HP 48030A Power Supply Module	\$1350
HP 48040A Radio Datacom Module	\$2345
HP 48041A Modem Module	\$865
HP 48085A-001 Manual Set	\$215

### Common Accessories

#### Price

#### Application Development Software

HP 48071A HP Portable Plus Version	\$255
HP 48072A HP Vectra PC Version	\$255

#### Communication Handlers

HP 48073A HP 1000 A-Series Version	\$127
HP 48075A HP 9000 Series 200/300 Version	\$76
HP 48076A HP Vectra PC Version	\$76
HP 48077A HP 9000 Series 300 HPUX Version	\$153
HP 48078A DEC VAX/VMS Version	\$153
HP 48082A Datacommunications Adapter	\$790
HP 48085A Manual Set	\$240

### HP 48050A RTU Ordering Information

#### Price

HP 48050A Standard Unit with 23 I/O Points	\$2950
Option 001 Adds I/O Expansion Board	\$1050
011 Adds RS-232-C/RS422 Port	\$370
012 Adds HP 48000 Datalink Port	\$315
013 Adds Bell 202 Modem Port	\$470
021 Adds 64K RAM (max)	\$170
022 Adds 128K EPROM	\$85
023 Adds 256K EPROM (max)	\$170
HP 48004A NEMA-4 Cabinet	\$510
HP 48033A External Power Supply (+24 VDC)	\$660
HP 48085A-002 Manual Set	\$115

# DATA ACQUISITION SYSTEMS

## Instruments for Measurement and Control

### HP Model 3497A

- Relay multiplexing
- DVM
- FET multiplexer
- Real time clock
- Bridge completion

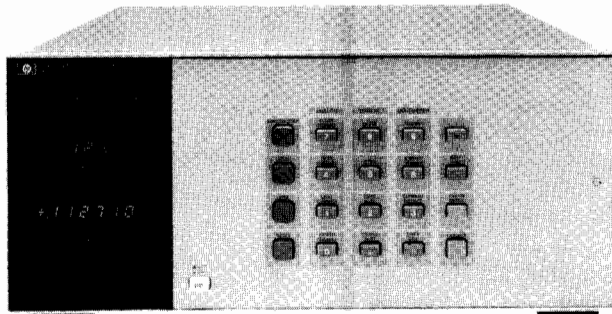

HP 3497A

### Description

The HP 3497A Data Acquisition/Control Unit combines the capabilities of several instruments and is a basic building block of an automatic data acquisition and control system. The HP 3497A will be used in an HP-IB automated system and can be viewed as a precision measurement and control computer peripheral.

The HP 3497A has been designed to be a very versatile and very powerful instrument. A basic HP 3497A consists of a mainframe that includes a front panel keyboard and display, a non-volatile real time clock, and an HP-IB interface. Available as an option is a 5½ digit integrating digital voltmeter and current source that occupies a dedicated slot in the HP 3497A chassis. Capability is added to the HP 3497A by using any combination of plug-in assemblies. Available plug-in assemblies are:

- Relay Multiplexers with or without thermocouple compensation
- FET Multiplexer
- Digital Input/Interrupt
- Counters
- Strain gage/bridge completion
- Actuators
- Programmable voltage and current D/As
- Breadboard Assembly

Up to 5 assemblies can be added to a HP 3497A and the HP 3498A Extender chassis can hold up to 10 more plug-in assemblies.

### High Performance

The HP 3497A DVM can resolve 1 microvolt signals and is ideal for the precise measurement of the outputs of thermocouples, strain gauges and other transducers. Included on the DVM is a programmable current source that allows four-terminal resistance measurements. The multiplexer assemblies switch 3 wires (Hi, Lo, and Guard) and add less than 2 microvolts of thermal offset to the measured signal.

### Flexible Hardware Configuration

The HP 3497A card cage can hold 5 of any combination of the plug-in assemblies. This allows the multiplexing of up to 100 3-wire inputs to the DVM in a single HP 3497A or a single HP 3497A might contain 60 multiplexer channels, 16 digital inputs, 16 actuator outputs, and a DVM. By using HP 3498A Extenders, up to 1000 analog channels or 1360 digital channels can be controlled, all at a single bus address.

### Ease of Use

The HP 3497A keyboard and display make the HP 3497A very easy to use and make debugging of a HP 3497A based system easy. The calibration adjustments for the HP 3497A DVM are located behind a hinged front panel; this allows complete calibration of the DVM without removing it from the test rack. Connections to all of the HP 3497A assemblies are made using screw terminals, eliminating the need for soldering.

### Real Time Clock

The HP 3497A mainframe includes a quartz-referenced, non-volatile, real-time clock. In addition to providing timing data, the clock can mea-

- Digital inputs/outputs
- Counter
- Programmable D/As
- Optional RS-232C interface

sure elapsed time, interrupt at a presettable time, and output a programmable pulse train.

### Clock Format

Month:Day:Hours:Minutes:Seconds (U.S. Format)

Day:Month:Hours:Minutes:Seconds (European Format)

### Option 001—5½ Digit DVM and Current Source

The HP 3497A DVM assembly is a systems quality, 5½ digit, 1 microvolt sensitive dc voltmeter. The DVM is fully guarded and uses an integrating A/D conversion technique; this yields excellent common and normal mode noise rejection.

Included on the DVM assembly is a three level programmable current source. The current source, when used simultaneously with the DVM, can be used to make high accuracy four terminal resistance measurements with 1 milliohm resolution. Maximum speed is 300 readings per second in 3½ digit mode.

**Buffer size:** packed format: 100 readings; ASCII format: 60 readings

Scanning Speeds	Number of Digits Selected	Series 200/300	1000A*
Sequential Channels using external increment	5½ digits	39	39 (25)
	4½ digits	103	108 (79)
	3½ digits	123	127 (99)
Random Channels using software	5½ digits	27	24 (20)
	4½ digits	51	41 (34)
	3½ digits	55	43 (36)

\*A600+ speeds in FORTRAN

### Option 010—20 Channel Relay Multiplexer

This assembly uses reed relays to multiplex signals to the DVM or other instruments. Each assembly switches 20 channels, each channel consists of Hi, Lo, and Guard lines. Two channels may be closed per assembly and relays may be closed in a random sequence or incremented between programmable limits. The low thermal offset of the relays make it suitable for measuring the outputs of strain gage and other transducers. Each channel can be configured with a filter or current shunt for additional flexibility.

### Option 020—Relay Multiplexer with Thermocouple Compensation

The option 020 assembly uses the same relay multiplexer as option 010 but incorporates a special isothermal connector block to allow thermocouple compensation. Two types of compensation (selectable by the user) are available. A temperature-dependent voltage is generated for software compensation; this voltage is then used in a computer program to compensate the thermocouple voltage. Hardware compensation involves inserting a voltage in the measurement circuit that automatically compensates the thermocouple voltage.

### Option 030—20 Channel FET Multiplexer Assembly

The option 030 assembly is used to multiplex input signals to a DVM in a manner similar to option 010. The option 030 assembly provides high speed, low level multiplexing. Maximum signal levels are 12 volts peak between any high, low or guard input and any other guard input, guard common or chassis ground.

**Maximum sequential scanning rate:** 4800 readings/s (at 60 Hz) using an HP 3437A Voltmeter and HP Series 200 computer (4000 readings/s at 50 Hz power).

### Option 050—16 Channel Isolated Digital Input/Interrupt

The option 050 assembly can sense up to 16 channels of digital data. The first 8 channels can also be used as interrupt lines to detect transient signals. The assembly can accept inputs of 5, 12 or 24 volts and all functions and masks are fully programmable. A five-volt supply is provided for driving external contact closures and open collector outputs.

### Option 060—100 kHz Reciprocal Counter

This option can be used to measure mechanical and low frequency electronic signals. The counter can measure the period of signals up to 100 kHz and the pulse width of signals down to 18  $\mu$ s. The counter can also count up or down from a programmable start point. It can accept inputs of 5, 12, or 24 volts including CMOS, open collector TTL and passive contact closures.

### Option 070—120 Ohm Strain Gage/Bridge Completion Assembly

### Option 071—350 Ohm Strain Gage/Bridge Completion Assembly

The option 070/071 assemblies may be used to provide bridge completion for measuring strain gages, RTDs pressure sensors and load cells. Each card uses an internal shared half bridge and can complete 10 channels of  $\frac{1}{4}$  and  $\frac{1}{2}$  and full bridges in any combination. When used with a +5 V excitation supply (such as the HP 6214A) and the HP 3497A DVM, the assembly provides 0.1  $\mu$ e sensitivity with 1  $\mu$ e accuracy. Provisions are made for shunt calibration and checking gage leakage and lead resistance.

### Option 110—16 Channel Actuator

### Option 115—8 Channel High Voltage Actuator

Option 110 consists of 16 mercury wetted form C (single pole-double throw) relays. Each relay can be individually closed and can switch 1A at 100V. The actuator assembly can be used to switch test fixture power or to actuate alarm bells. This flexibility of this assembly allows it to be used as a digital output or matrix switch.

Option 115 is an 8 channel high voltage actuator assembly that can switch voltages up to 252 Vrms and currents up to 2 amperes. The Option 115 assembly is ideal for switching power line voltages to small motors, alarm bells and lights, motor starters and solenoids.

	Option 110	Option 115
Switch Form	C	A
Contact Type	Mercury Wetted	Dry
Number of channels	16	8
Maximum Voltage	100 V Peak	252 Vrms 48 Vdc
Maximum Current	1 A	2 Arms or dc
Maximum Power	100 VA	500 VA ac 60 VA dc

### Option 120—Dual Voltage D/A

### Option 130—Dual Current D/A

Option 120 consists of two 0 to  $\pm 10$  V programmable voltage sources. These sources can be used to provide a programmable test stimulus or to control voltage programmed devices like power supplies and VCOs.

Option 130 consists of two 0 to 20 mA or 4 to 20 mA programmable current sources. These sources, especially when using the 4 to 20 mA range, can be used as transmitters in industrial current loops and can drive up to 600 ohms of total loop resistance.

### Option 120

**Output:** 13 bits including polarity

**Least significant bit:** 2.5 mV

**Output range:** -10.2375 V to +10.2375 V

**Maximum output current:** 15 mA (output within specifications)

### Option 130

**Output:** 12 bits

**Least significant bit:** 5  $\mu$ A (0 to 20 mA range)  
4  $\mu$ A (4 to 20 mA range)

**Output range:** 0 to 20.475 mA or 4 to 20.380 mA (each source jumper selectable)

**Compliance voltage:** 12.0 volts

### Option 140 Breadboard Card

Option 140 is a breadboard card compatible with the HP 3497A cardage. Using this card, HP 3497A users can construct special purpose assemblies that communicate with the HP 3497A backplane.

### Option 232—RS232C Interface

Option 232 to the HP 3497A deletes the standard HP-IB interface and adds an RS232C (CCITT/V.24) compatible interface allowing you to remotely locate the HP 3497A. The option 232 interface is also compatible with the new RS423 (CCITT/V.10) version of the RS449 interface.

### Option 298—HP 3498A Extender

The HP 3498A Extender chassis allows low cost expansion of HP 3497A-based systems. Each HP 3498A can hold up to ten HP 3497A

plug-in assemblies. Use of one or more HP 3498As requires an HP 3497A (for control); all required connecting cables are supplied with the HP 3498A. Up to 13 HP 3498As can be controlled by a single HP 3497A.

### Software

**HP DACQ/PC Data Acquisition Manager (HP 44459A/B/R):** Powerful software tools for gathering, storing, analyzing, and presenting measurement data with a Vectra Personal Computer and the BASIC language processor. (see page 608).

**HP DACQ/300 Data Acquisition Manager (HP 44458A/B/R):** Sophisticated software tools that provide all of the power of HP DACQ/PC plus enhanced data transfer, system configuration routines, and color graphics on Series 300 Technical Computers (see page 608).

### General

**Size** (HP 3497A or HP 3498A): 190.5 mm H x 428.6 mm W x 520.7 mm D (7 $\frac{1}{2}$ " x 16 $\frac{7}{8}$ " x 20 $\frac{1}{2}$ ").

**Net weight:** HP 3497A, 20.4 kg (45 lb) and 3498A, 20.4 kg (45 lb) with assemblies in all slots.

**Shipping weight:** HP 3497A and HP 3498A maximum with assemblies in all slots are 26.3 kg (58 lb.)

Operating temperature: 0°C to 55°C

Non-operating temperature: -40°C to 75°C

Humidity: to 95% at 40°C except as noted

Operating power: switch selection of 110, 120, 220 and 240 volts  $\pm 10\%$ , 48-66 Hz, 150 VA 3497A and 3498A.

### Ordering Information

### Price

Each HP 3497A can hold one DVM assembly (Opt 001) and up to 5 plug-in assemblies. Each HP 3498A (Opt 298) can hold 10 additional plug-ins. To order plug-ins without a mainframe, order as 444XXX Field Installation Kits as shown below.

Clock format and power line frequency and voltage will be set at the factory based on the country from which the order was placed.

<b>Opt 001 or 44420A:</b> 5 $\frac{1}{2}$ Digit DVM and Current Source	\$1,720
<b>Opt 010 or 44421A:</b> 20 Channel Relay Multiplexer Assembly	\$680
<b>Opt x20 or 44422x:</b> Relay Multiplexer Assembly Substitute A in place of x for software compensation. For hardware compensation, substitute the thermocouple type B, E, J, K, R, S, or T for x.	\$780
<b>Opt 030 or 44423A:</b> 20 channel FET Multiplexer Assembly	\$780
<b>Opt 050 or 44425A:</b> 16 channel Isolated Digital Input/Interrupt Assembly	\$575
<b>Opt 060 or 44426A:</b> 100 kHz Reciprocal Counter	\$625
<b>Opt 070 or 44427A:</b> 120 Ohm Strain Gage/Bridge Completion Assembly	\$935
<b>Opt 071 or 44427B:</b> 350 Ohm Strain Gage/Bridge Completion Assembly	\$935
<b>Opt 110 or 44428A:</b> 16 Channel Actuator/Digital Output Assembly	\$780
<b>Opt 115 or 44431A:</b> 8 Channel High Voltage Actuator Assembly	\$575
<b>Opt 120 or 44429A:</b> Dual Output Voltage DAC Assembly	\$1,040
<b>Opt 130 or 44430A:</b> Dual Output Current DAC Assembly	\$1,040
<b>Opt 140 or 44432A:</b> Breadboard Card	\$160
<b>Opt 232:</b> Delete HP-IB Interface, add RS232C Interface	\$275
<b>Opt 260:</b> Delete Keyboard and Display	less \$350
<b>Opt 298:</b> Add HP 3498A Extender & connecting cables	\$2,350

**HP 3497A Data Acquisition/Control Unit**

**\$3,225**



# DATA ACQUISITION SYSTEMS

Instruments for Measurement and Control

Model 3852A

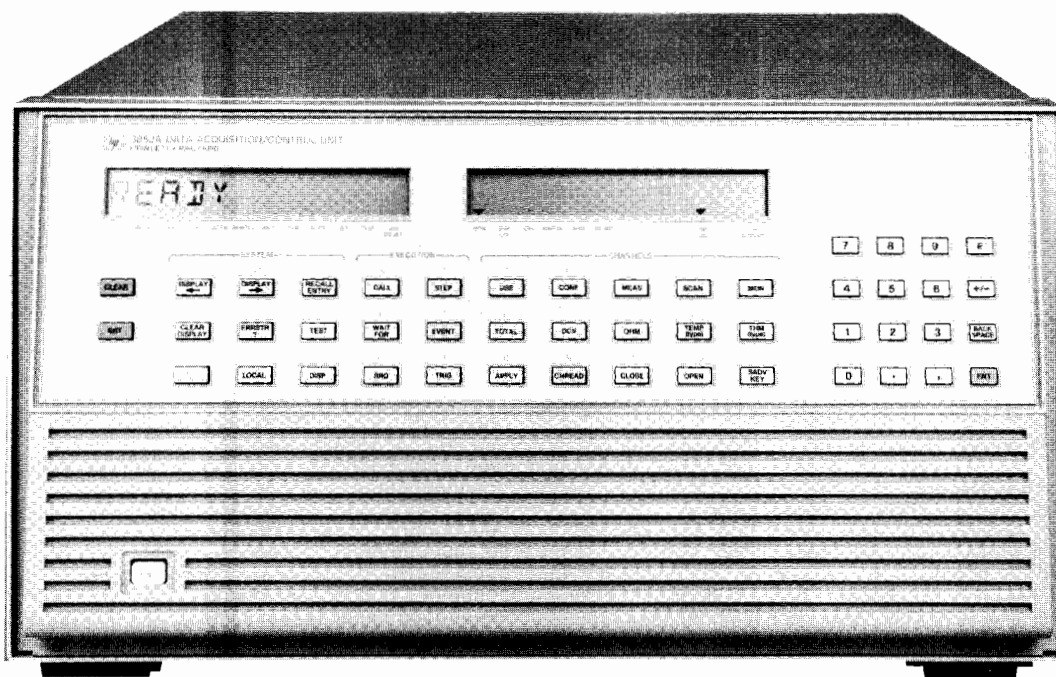

HP 3852A



## Configure the Capabilities You Need

You can easily configure an HP 3852S Data Acquisition and Control System to meet your needs for measuring physical parameters through transducers, and for providing control outputs. The HP 3852A Data Acquisition/Control Unit (mainframe) has eight slots for plug-in function modules. If more slots are needed, up to seven extenders can be added, each with ten additional slots. You can choose any combination of capabilities that include precision and high-speed plug-in voltmeters and a variety of analog and digital input/output functions.

A system clock and programmable pacer are built-in to drive your system. The clock — non-volatile for four years; 1 msec resolution—allows data to be time-stamped and events to be timed. The pacer—0.25  $\mu$ sec resolution—provides powerful capabilities to initiate and pace measurements, scans, or events.

## Include High-Speed and Accurate Analog Measurements in One System

Choose from two digital voltmeters to meet your measurement needs. For applications that require sensitive, accurate measurements in the presence of noise (for example, thermocouples), use the 5½-Digit Integrating Voltmeter and Relay Multiplexers. If you need speed, the 13-Bit High-Speed Voltmeter and High-Speed FET Multiplexers are the answer, providing single-channel bursts, channel-to-channel, random channel, full auto-ranging, and direct DMA transfers to a hard disc at an honest 100,000 readings/sec. The system voltmeters can be used in the mainframe or any extender, and multiple voltmeters are allowed per card-cage.

## Add Versatility and Expandability to Your System

With the HP 3852A Data Acquisition and Control System, you'll have available a complete set of input and output plug-in modules for interfacing to measurements and for controlling and sequencing your tests. Modules are available to handle physical measurements of temperature, flow, pressure, level, and strain. The HP-IB controller module gives you the capability to autoboot subroutines stored on a disc and to store data to the disc without computer assistance.

## Take Advantage of Extensive Front-End Intelligence

The HP 3852A mainframe has considerable built-in intelligence to increase the speed of collecting measurement and control data. Control decisions can be handled faster using subroutines running within the mainframe. This intelligence can be used to *return only significant data* to the computer, increasing its efficiency.

- Up to 5,500 readings can be stored in the standard HP 3852A mainframe. Expand this memory (used for storage of user routines as well as readings) to 256 kbytes, 1 Mbytes, 2 Mbytes, or 4 Mbytes with an Extended Memory board. Extended memory fits inside the mainframe controller module without using an I/O slot.

The power of this front-end intelligence in combination with an HP Series 300 Computer and the optional data acquisition software adapts easily to testing your complex product or characterizing your process. Of course, the mainframe can be also used with HP 1000 computers, HP Vectra PC, other IEEE-488 controllers and instruments, and a variety of computer peripherals.

## Reduce Your Test Development Investment

Optional data acquisition software for an HP Series 300/200 computer or HP Vectra PC gets your application running quickly and easily by providing off-the-shelf solutions for:

- Data base management — store large amounts of data in files that are easy to identify and access later.
  - Graphics presentations — display or plot color graphs, display a real-time strip chart, plot data with linear, log, semilog, or automatic axis scaling.
  - Data analysis — This software provides high-level subroutines as tools to be used in a test system program running with HP BASIC. Ease-of-use is exemplified by:
    - automatic creation of a data base for storing data using only one subroutine,
    - fast access to a single data item or a block of data items using only one subroutine,
    - manipulation and formatting of gathered data any way you wish.
- Program development time is leveraged using this software, while allowing a powerful, highly customized system to be developed. Furthermore, the software can be used with any HP-IB instrument.

## Data Acquisition and Control Unit — HP 3852A

### Mainframe Supports:

- Eight Function Module Slots
- Data Acquisition Operating System
- System Timer
- Measurement Pacer
- Full Alphanumeric Keyboard, Command and Result Displays

### Benefits

- **Make real-time decisions and reduce data without burdening your computer:**
  - Multitasking operating system prioritizes and timeslices tasks
  - Powerful HP 3852A command statements simplify complex measurements.
  - Execution speed of command sequences are enhanced by executing subroutines stored in the HP 3852A memory.
  - Built-in, easy-to-use transducer conversions are supported for thermocouples, thermistors, RTDs, and strain gages.
  - Post-processing and data reduction before transferring results to a computer are achievable by first storing data to the HP 3852A internal memory.
  - Limit checking of analog measurements is performed in real time or after the measurements have been stored in mainframe memory.
- **Optimize measurement timing and throughput to meet your needs:**
  - Real-time interrupts allow higher priority tasks and external inputs to be serviced at any time
  - Asynchronous communication with a computer is achieved through input and output buffering.
  - Control can be timed using built-in clock and alarm capabilities (can cause an interrupt).
  - A built-in pacer simplifies measurement timing and triggering.
  - Multiple voltmeters can be used. The high-speed voltmeter can control scanning, timing, and triggering of its own high-speed FET multiplexer subsystem via ribbon cable. Several of these subsystems can run simultaneously.

## Data Acquisition Operating System Multitasking

Several subroutines called "run tasks" can be assigned equal priority and the operating system will timeslice them such that it appears they are running simultaneously. "Queued tasks" can be defined to run after certain conditions are met. Priority assignment allows complete control over front panel, HP-IB, interrupt, and run task execution.

### Real-time Interrupts

Interrupts from the front panel, HP-IB, plug-in accessories, or higher priority tasks are serviced immediately after the current command is done executing.

### Commands:

Powerful data acquisition commands are easy to remember and use. For example, "MEAS TEMPK <channel list>" performs K-type thermocouple measurements, cold-junction compensation, linearization, and channel scanning—ALL AUTOMATICALLY. In addition, <channel list> may be a short list of channels—or possibly the name of an array containing a much longer list.

### Down-Loaded Subroutines:

FOR...NEXT, IF...THEN...ELSE, WHILE...ENDWHILE Enhanced BASIC language constructs are available.

User subroutines with variables can be called for execution by a computer, other subroutines, or conditional interrupts.

### Transducer Conversions:

Transducer conversions have been optimized to support high system accuracy and speed for these transducers:

- \* Thermocouples
- \* Thermistors
- \* Platinum RTDs
- \* Strain Gages

### Special Conversions:

A special function permits user-defined tables of X,Y pairs to be used for linear interpolation (at a small price in memory usage, this function will typically execute much faster than high-order polynomial calculations).

### Limit Testing:

Perform limit testing in real-time (data is tested as it is measured) or as a post-process (data previously stored in arrays is tested). Limit test failures can cause an interrupt if enabled.

### Interrupts:

Time alarms, events that have just occurred, or limit tests of measurements can cause an HP-IB Service Request or a call to a stored subroutine.

### Math Operations:

+, -, \*, /, <, >, ATN, BINAND, BINCOMP, BINEOR, BINIOR, BIT, COS, EXP, LOG, SIN, SQR

### Scaling:

Offset and scale factors (mx + b) can be performed on an entire array using just one command.

### Statistics:

An easy-to-use function finds MIN, MAX, MEAN, and SIGMA (standard deviation) of the values stored in arrays.

## Extender Chassis — HP 3853A

### Extender Supports:

- Ten Function Module Slots

### Benefit

- **Expand your system with no loss of functional capability:**
  - Up to seven extenders may be used with each HP 3852A mainframe.
  - Any slot can be used for any function module and multiple voltmeters can be used with parallel triggering.
  - All mainframe functions, including interrupts and triggering, are available through the extender control cable.

### PRIORITY SCALE

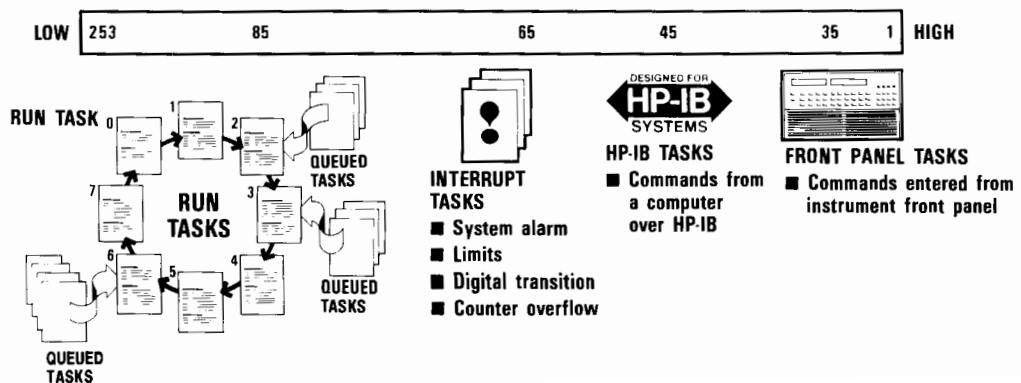

# DATA ACQUISITION SYSTEMS

## Instruments for Measurement and Control (cont'd)

### Model 3852A

### 5½ to 3½ Digit Integrating Voltmeter -

#### HP 44701A

Directly Measures:

- DC Voltage
- Resistance
- AC Voltage

#### Benefits

- **Accurately measure small signal changes in noisy environments:**
  - Integrating A/D rejects normal mode noise at multiples of the power line frequency.
  - Guarded input maximizes common-mode rejection.
- **Choose the resolution, accuracy, and noise rejection needed, while maximizing measurement speed:**
  - Integration selection (number of power line cycles) is key to optimizing these performance parameters.
  - This voltmeter provides the fastest DC reading rates available with power line-related noise rejection.
- **Optimize resistance measurements to the accuracy you need:**
  - Use two-wire ohms for measurements where lead resistance is not critical.
  - Use four-wire ohms where inaccuracies due to measurement leads cannot be tolerated (*most accurate measurement technique for RTDs*).
  - Use offset-compensated ohms to correctly measure resistance in the presence of series voltages (often caused by thermocouple effects).

#### DC Voltage

#### Accuracy:

± (% of reading + volts), rear terminal input, one-hour warm-up, specified over time since last calibration, and operating temperature.

#### 90 Days, 18 to 28°C, Auto-zero On

Integration Time in Number of Power Line Cycles (NPLC)

	1	0.1	0.005	0.0005
<b>Range:</b>				
30 mV	0.02% + 6 μV	0.02% + 8 μV	0.02% + 20 μV	0.02% + 60 μV
300 mV	0.008% + 6 μV	0.008% + 10 μV	0.008% + 40 μV	0.008% + 400 μV
3 V	0.008% + 8 μV	0.008% + 40 μV	0.008% + 400 μV	0.008% + 4 mV
30 V	0.008% + 300 μV	0.008% + 700 μV	0.008% + 4 mV	0.008% + 40 mV
300 V	0.008% + 700 μV	0.008% + 4 mV	0.008% + 40 mV	0.008% + 400 mV

#### Reading Rate/Noise Rejection:

Integration Time in Number of Power Line Cycles (NPLC)

	1	0.1	0.005	0.0005
<b>Integration Time</b> 60 Hz (50 Hz)	<b>16.7</b> <b>(20.0)</b> <b>msec</b>	<b>1.67 (2.0)</b> <b>msec</b>	<b>100</b> <b>(100)</b> <b>μsec</b>	<b>10</b> <b>(10)</b> <b>μsec</b>
Number of Converted Digits	6½	5½	4½	3½
Reading Rate (readings/sec) with auto-zero, auto-range off 60 Hz (50 Hz)	57 (48)	415 (360)	1350 (1350)	1600 (1600)
Min Noise Rejection (dB)				
Normal Mode Rejection at 50 or 60 Hz ± 0.09%	60	0	0	0
DC Common Mode Rejection with 1 kΩ in low lead	120	120	120	120
Effective Common Mode Rejection, at 50 or 60 Hz ± 0.09% with 1 kΩ in low lead	150	90	90	90

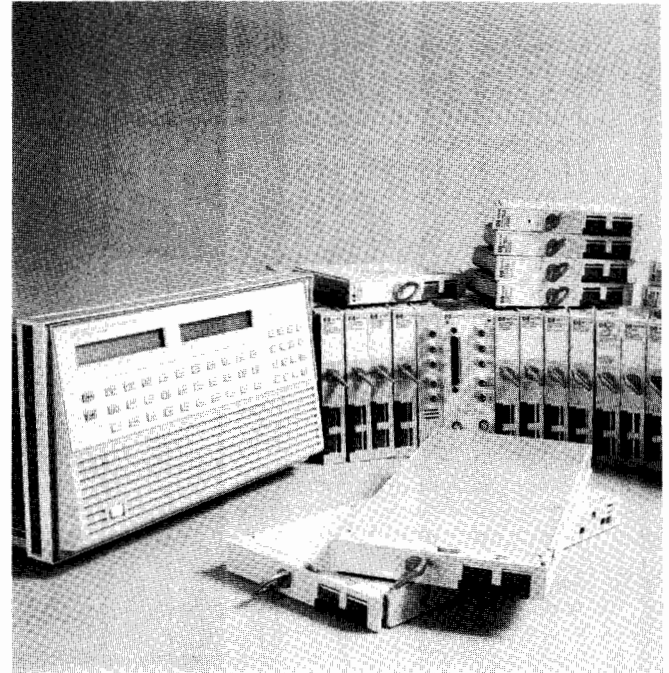

### 13-Bit High-Speed Voltmeter —

#### HP 44702A/B

Directly Measures:

- DC Voltage
- DC Resistance

#### Benefits

- **Collect data quickly:**
  - A measurement rate of 100,000 readings/sec with auto-ranging is achieved by directly controlling up to six (eight in an extender) High-Speed FET Multiplexers through a dedicated ribbon cable.
  - Multiple High-Speed Voltmeters can be triggered simultaneously and operate independently.
- **Maximize your measurement throughput:**
  - On-board buffer is included for over 8,000 readings (HP 44702A) or over 64,000 readings (HP 44702B) that can be transferred to mainframe internal memory or to hard disc via GPIO and a DMA controller while taking measurements.
  - Dedicated triggering is achieved with on-board pacers.
  - Balanced input, equal impedance between high-to-chassis and low-to-chassis, gives good common mode noise rejection.

#### DC Voltage

#### Accuracy:

± (% of reading + volts), rear terminal input, one-hour warm-up, specified over time since last calibration, and operating temperature, with auto-zeroing performed within one minute of measurement.

90 Days, 18 to 28°C

	Accuracy
<b>Range:</b>	
40 mV	0.05% + 68 μV
320 mV	0.05% + 234 μV
2.56 V	0.05% + 1.88 mV
10.24 V	0.05% + 7.5 mV

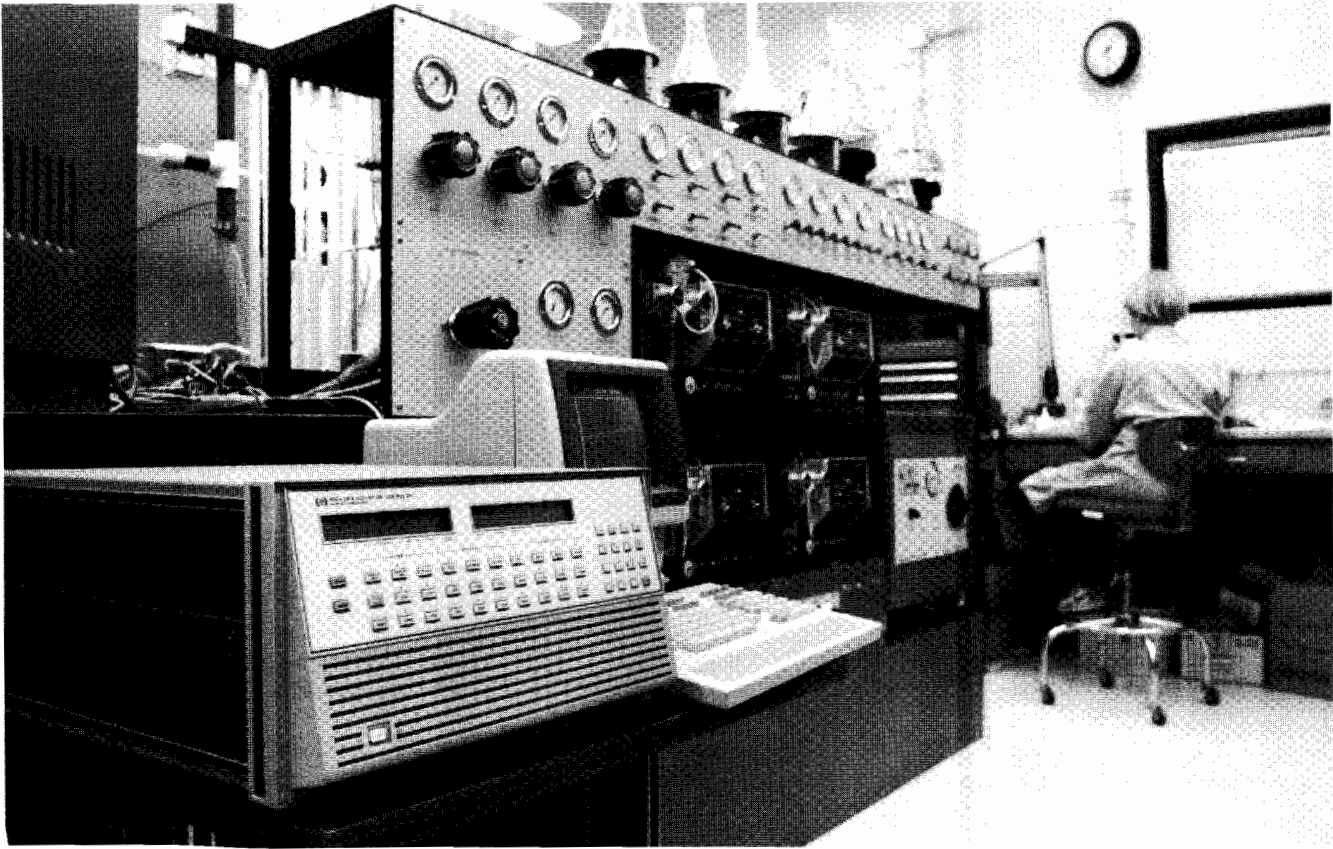

**Reading Rates:**

100,000 readings/sec with auto-ranging. Proper auto-ranging is ensured as long as a single-channel signal changes no more than 600 volts/sec during auto-ranging.

**Noise Rejection:**

Min effective common mode rejection specified in dB for DC to 60 Hz with 1 kΩ in low lead; maximum signal (high to low) + common mode voltage (low to chassis) for proper operation is ±10.24 volts.

**ECMR**

Range:		
	40 mV	90
	320 mV	80
	2.56 V	70
	10.24 V	70

**Relay Multiplexers — HP 44705A/44705H/44706A/44708A/44708H/44717A/44718A**

Directly Multiplexes:

- Voltage
- Resistance
- Thermocouples
- Strain Gages

**Benefits**

- **Reduce the effects of real-world measurement errors in a multi-channel system:**
  - Relay multiplexers minimize errors due to thermal DC offsets, crosstalk, and injected (bias) currents.
  - The relay multiplexers have high, low, and guard terminals to maximize common mode noise rejection.
  - A single-ended multiplexer (HP 44706A) lowers your cost per channel.
  - With shunt and series jumpers in each channel of the HP 44705A/H and 44708A/H multiplexers, you can easily install a one-pole low-pass filter for additional noise rejection, a voltage divider to extend relay lifetime, or a shunt resistor to measure current.

- Differential or common mode voltages up to 350 V peak or 250 Vdc can be handled by the HP 44705H and 44708H modules.
- Scanning is break-before-make to prevent inadvertent connections of circuits being measured.
- Each lead to the back-plane and common terminals has a 100Ω resistor in series to prolong the lifetime of the relay contacts. Due to placement, these resistors contribute no error when measuring 2-wire ohms resistance using the HP 44701A Integrating Voltmeter. The resistor can be shorted, but this can seriously shorten relay contact life if relatively high voltages or currents are switched.
- Tree switch relays automatically isolate each bank of relays from the back-plane to reduce crosstalk and improve settling time.
- **Optimize thermocouple measurement accuracy:**
  - Thermocouple types can be mixed on the HP 44708A/H multiplexer to optimize accuracy over the temperature ranges needed.
  - Thermocouple compensation is handled automatically with no extra wiring.
- **Measure strain accurately:**
  - Strain sensitivity can be optimized using finger-moveable jumpers to select between ¼-, ½-, and full-bridge configurations. The HP 44717A and 44718A multiplexers each support 10 bridges for 120Ω and 350Ω strain gages.
  - No manual adjustments are required to balance the bridge.
  - Strain accuracy is independent of long-term bridge excitation voltage changes because the excitation voltage is automatically measured and included in the strain calculations.
  - The excitation voltage is always applied, never switched, reducing errors due to dynamic heating and cooling of the gages.
  - Connection to an available Wagner ground reduces errors due to gage leakage current.

# DATA ACQUISITION SYSTEMS

## Instruments for Measurement And Control (cont'd)

### Model 3852A

#### FET Multiplexers — HP 44709A/44710A/ 44711A/44712A/44713A/44719A/44720A

Directly Multiplexes:

- Voltage
- Thermocouples
- Resistance
- Strain Gages

#### Benefits

- **Maximize your measurement throughput:**

- A throughput rate of 100,000 readings/sec is realized using High-Speed FET Multiplexers (HP 44711A/44712A/44713A) directly controlled through a dedicated ribbon cable by the 13-Bit High-Speed Voltmeter.
- Up to six (eight in an extender) High-Speed FET Multiplexers can be controlled through this ribbon cable.
- The 24-channel multiplexers switch high and low only. Each floating input is balanced (that is, equal impedance between high-to-chassis and low-to-chassis) to provide good common mode noise rejection.
- For lower costs per channel, single-ended multiplexing of 48 channels (HP 44712A) is also available (has no common mode noise rejection, however).

- **Increase system reliability:**

- FETs have no mechanical limitations (no wear out due to switching).
- Similar to their relay counterparts, the HP 44709A/44710A/44719A/44720A FET multiplexers have high, low, and guard connections for better common mode rejection than the high-speed FET multiplexers.

#### 4-Channel Track/Hold with Signal Conditioning -

##### HP 44730A

#### 4-Channel Dynamic Strain Gage Multiplexers -

##### HP 44732A/44733A

#### Directly Multiplexes

- Transient DC voltages
- Dynamic strain gages
  - The Track/Hold Multiplexers have powerful capabilities for applications in acoustic analysis, environmental tests and the testing of engines, electromechanical products, mechanical products, rubber belts, elevators, hydraulics, motors, pressure transducers and materials.
  - Dynamic strain applications include seismology/ground characterization, machine control and characterization, and physical tests of engines, aircraft, mechanical products, hydraulics and motors. Tests using strain gages include operating and burst tests, as well as the simultaneous detection of "glitches."

#### Benefits

- Enhance dynamic signal measurement accuracy by measuring a number of channels simultaneously via internal or external strobes.
- Set gains of 1, 10, or 100 on each channel to amplify low level signals and improve measurement accuracy.
  - Select offset voltage nulling on each channel, minimizing computation time to obtain higher reading rates.
  - Reduces settling errors when switching between low-level and high-level signals.
- Use the analog peak detect/hold feature to capture either positive or negative peaks without having to sample at a high rate of speed.

- Boost system throughput in some applications by reducing the requirements to over-sample. Using the ribbon cable, it connects to the HP 44702 high speed voltmeter for high speed operations.
- Measure dynamic strain accurately.
  - Utilize on-board excitation that is provided separately for each bridge.
  - Select quarter, half, or full-bridge configurations.
  - Eliminate offsets with electronic nulling.

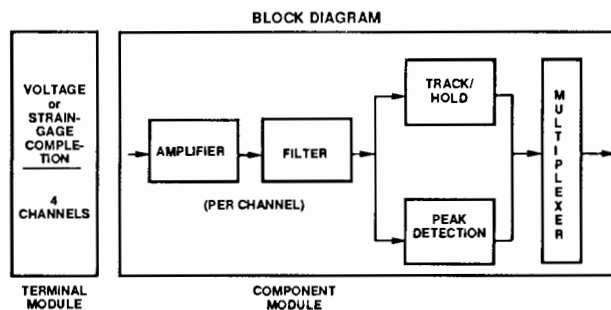

#### Arbitrary Waveform Digital to Analog Converter -

##### HP 44726A

#### Directly Outputs

- Arbitrary Waveforms
- DC Voltages

This 2-channel non-isolated module provides arbitrary waveforms and stimulus signals for product test and characterization applications. Applications include the testing of satellites, engines, electromechanical products, aircraft, automobiles, mechanical products, materials, chemicals and elevators.

#### Benefits

- Provides a stimulus voltage signal with a step rate of up to 800 kHz.
  - Outputs a DC voltage or any arbitrary waveform stores in its own memory.
  - Output waveforms, once initiated, can run continuously regardless of the activities being performed by the HP 3852A mainframe.
  - Channels have independent timebases that can be synchronized with each other or with external events. External timebases can also be used.
  - Waveforms can be single-shot (one cycle of the waveform) or continuous. Channel 0 can also perform n repetitions of the waveform (n = 1 to 65,536).
  - Sine, triangle and square (50% duty cycle) waveforms can be calculated and loaded from the HP 3852A with one command.
- Random access memory is available for each channel on this accessory.
  - Each channel has enough memory for 32,400 waveform points in which each point is defined as both a voltage level and length of time at that level. As a result, memory is used efficiently.
  - Up to 64 different waveforms on each channel can be stored in memory.
  - Arbitrary waveforms can be loaded from a user-defined array or a real array or high-speed voltmeter readings.

## Digital to Analog Converters —

### HP 44727A/44727B/44727C

Directly Outputs:

- DC Voltage
- DC Current

#### Benefit

- **Simplify your test system by providing test or control of devices with one data acquisition control system:**
  - Four channels are provided on each module.
  - Each channel can be configured using finger-movable jumpers to output either unipolar or bipolar voltage, or unipolar current. Reconfiguration may require recalibration of the changed channel. Recalibration consists of adjustments to zero offset and gain potentiometers, and can be performed with the HP 44701A Integrating Voltmeter or equivalent. Three configurations (4-Channel Voltage—HP 44727A; 4-Channel Current—HP 44727B; 2-Channel Voltage, 2-Channel Current—HP 44727C) are available to make reconfiguration unnecessary in most cases.
  - Channels are isolated and can be connected in parallel for current or in series for voltage to expand the usable ranges.
  - Each channel configured for voltage has remote sense capabilities to ensure accurate voltages at the device.

#### DC Voltage

**Ranges:** 0 to +10.235 V or -10.235 to +10.235 V

**Resolution:** 2.5 mV (12 bits plus a sign bit for bipolar range)

#### DC Current

**Ranges:** 0 to +20.16 mA or +4 to +20.16 mA

**Resolution:** 2.5  $\mu$ A (13 bits)

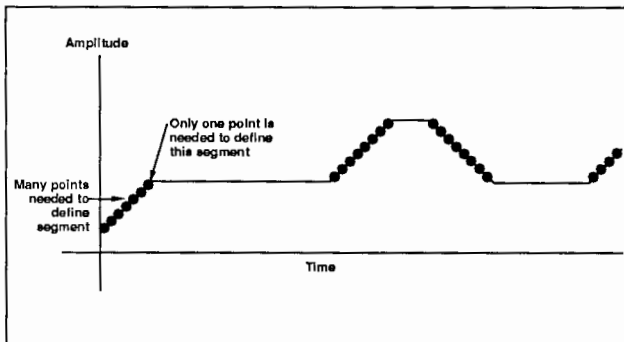

### 3-Channel Stepper Motor Controller - HP 44714A

Directly Provides:

- Stepper Motor Control Signals
- Limit Inputs
- Built-in Quadrature Counters
- Pulse Output

#### Benefit

- **Completely control three stepper motors with one module:**
  - Output a continuous stream or a fixed number of pulses.
  - Program separate acceleration and deceleration rates for trapezoidal motion profiles.
  - Halt output pulses when limits are reached or from the emergency stop input.
  - Built-in quadrature counter on each channel gives position feedback.

- **Use the module as a pulse generator.**

- Output a set number of pulses or a continuous stream.
- Set, accelerate, and decelerate both pulse width and pulse rate.

#### Trapezoidal Motion Profile

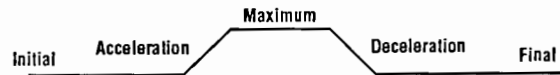

### 5-Channel Counter/Totalizer — HP 44715A

Directly Provides:

- Count Measurements
- Period Measurements
- Frequency Measurements
- Interrupts

#### Benefit

- **Reduce your costs by taking advantage of frequency counting versatility:**
  - The counter/totalizer accurately measures logic or RMS inputs with frequencies up to 200 kHz.
  - By multiplexing between five isolated channels and five non-isolated channels, a total of ten connected channels is possible (only five can operate simultaneously).
  - Each DC logic channel independently counts on either positive or negative signal transitions. Non-isolated, low-level RMS inputs are measured using a zero-crossing detector.
  - Any channel that is totalizing can be programmed to set an interrupt for a counter roll-over to zero.
  - For isolated DC inputs, nominal voltages are separately selected for each channel by finger-movable jumpers. For non-isolated inputs, either TTL or low-level RMS inputs are also separately selected for each channel by finger-movable jumpers.
  - Debounce times (common to all channels) can be programmed to prevent false counts.
  - With shunt and series jumpers in each channel, you can easily install a one-pole low-pass filter for rejection of unwanted signals.

## Digital Inputs with Totalize and Interrupt -

### HP 44721A/44722A

Directly Provides:

- Logic Readings
- Totalize Count Measurements
- Interrupts

#### Benefit

- **Conveniently read a variety of digital values in your system:**
  - Isolated inputs detect the presence of DC (HP 44721A 16-channel digital input) or AC (HP 44722A 8-channel digital input) inputs based on nominal voltages selected by finger-movable jumpers.
  - Each channel can independently totalize positive or negative (whichever is selected) logic transitions.
  - Voltage selection and function can be set independently on each channel.
  - Any channel can be programmed to set an interrupt for an edge occurrence (positive or negative) or a counter roll-over to zero.
  - Debounce circuitry that is common to all channels prevents erroneous readings on inputs that are still changing after a logic level transition.
  - For detecting whether switches are opened or closed, the HP 44721A has a non-isolated five volt supply at the terminal module with 9.4 k $\Omega$   $\pm$ 10% pull-up resistors on each input.



# DATA ACQUISITION SYSTEMS

## Instruments for Measurement and Control (Cont'd)

Model 3852A

### 32-Channel High-Speed Digital Sense/Control

#### -HP 44723A

Directly Provides:

- High-speed Digital Input and Output
- Triggered Input and Output
- Interrupts
- Output Handshaking

#### Benefit

- Input 16 channels or output 16 channels over 150,000 times per second.
- Capture and load 16-bit patterns with external triggers.
- Interrupt on any input channel on any transition or on a user-specified 16-bit pattern.

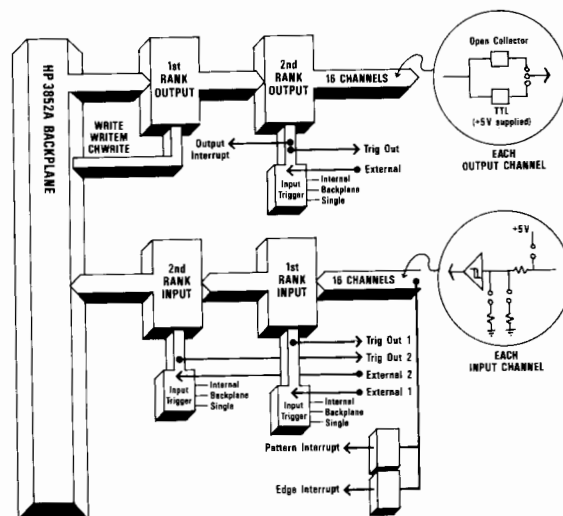

High-Speed Digital Sense/Control

### 16-Channel Digital Output — HP 44724A

Directly Provides:

- Open Drain Digital Outputs

#### Benefit

- Conveniently control DC devices or logic levels:
  - Open drain outputs are used to control DC devices with up to 55 V, or drive TTL logic levels. An external power supply and external pull-up resistors are required.

#### Characteristics

##### Max Input Voltage:

Between High and Low Terminal of Each Channel — 55 V DC  
Between Channels or Between Any Terminal and Chassis — 354 V peak or 250 V DC

**Max Sink Current:** 500 mA DC per channel (1 A fuse protection)

**Max Reverse Polarity Current:** 500 mA DC per channel

**TTL Compatibility:** 200 mA per channel with  $V_{out} \leq 0.4$  volts

### Switching — HP 44725A/44728A/44729A

Directly Switches:

- Voltage
- Current
- Power

#### Benefit

- **Reliability switch the voltage, current, or power you need:**
  - Both the HP 44725A and 44728A use single-pole double-throw (SPDT) Form-C relays that return to their normally

closed positions at power down. The HP 44725A 16-channel general purpose relays are for switching low-level power or moderate voltages and currents in an experiment while minimizing errors due to cross talk and thermal DC offsets. More DC or AC power can be switched with the HP 44728A 8-channel relay actuator.

- The HP 44729A 8-channel AC power controller distributes AC power. It switches “on” at the zero voltage crossing and “off” at the zero current crossing for long device life and low transient generation. Each channel has a relay and solid state switch in parallel to provide an exceptional combination of switch life and low on-resistance.

### Characteristics

	Module		
	HP 44725A	HP 44728A	HP 44729A
Max Input Voltage ( $V_{max}$ ) Per Channel	30 V DC or RMS, 42 V peak	300 V DC, 250 V RMS	— 250 V RMS, 354 V peak
Max Input Current Per Channel	1.5 A DC, 1.5 A RMS	2 A DC, 3 A RMS (5 A fuse protection)	2.5 A RMS (3 A RMS if module is limited to 16 A RMS total; 4 A fuse protection per channel)
Max Sum of the Squared RMS Currents In Each Channel (per module; for any load type)	24 A <sup>2</sup>	26 A <sup>2</sup>	—
Max On Resistance	175 m $\Omega$	200 m $\Omega$	125 m $\Omega$ @ 3 A RMS; 200 m $\Omega$ @ 100 mA RMS
Switch Life (on/off cycles) Full Load	10 <sup>9</sup> ( $\leq 2$ switches per second)	10 <sup>9</sup>	5 $\cdot$ 10 <sup>6</sup>
Min Load	10 <sup>9</sup> ( $\leq 2$ switches per second)	—	—
Max Wire Size	16 AWG	14 AWG	12 AWG (power in terminals); 14 AWG (power distribution terminals)

### HP-IB Controller - HP 44788A

Directly controls:

- HP-IB disc drives (CS80/SS80)
- HP-IB printers
- HP-IB instruments

#### Benefits

- Remote operations without a computer
- At power-up, load subroutines into an HP 3852A from an HP-IB disc drive and start executing them.
- Send data to an HP-IB disc drive without using a computer.
- Print out data stored in the HP 3852A without using a computer.
- Control other HP-IB instruments directly with HP 3852A.

## Ordering Information

To order, specify an HP 3852S System with the appropriate software, controller, mainframe, extenders, function modules, racks, and extra terminal modules. The HP 3852S itself has no cost—each component of the system is priced individually.

### Data Acquisition Manager

	Price
<b>HP 44458A</b> Data Acquisition and Control Software for Series 300/200 Computers on 3½" Flexible Discs (BASIC 4.0 and 5.0)	\$1995
<b>HP 44458B</b> Data Acquisition and Control Software for Series 200 Computers on 5¼" flexible Discs (BASIC 4.0 and 5.0)	\$1995
<b>HP 44458R</b> License to Reproduce HP 44458A or 44458B. Includes one set of software manuals.	\$1220
<b>HP 44459A</b> Data Acquisition and Control software for HP Vectra Computers on 3½" flexible discs (BASIC 5.0)	\$1485
<b>HP 44459B</b> Data Acquisition and Control software for HP Vectra Computers on 5¼" flexible discs (BASIC 5.0)	\$1485
<b>HP 44459R</b> License to reproduce HP 44459A/44459B. Includes one set of software manuals.	\$925

### Mainframe

<b>HP 3852A</b> Data Acquisition and Control Unit	\$3800
<b>HP 44703A</b> Mainframe Extended Memory Card—256 kbytes*	\$625
<b>HP 44703B</b> Mainframe Extended Memory Card—1 Mbyte*	\$1510

\*Only one extended memory option may be added per mainframe.

Extended memory cards for 2 Mbytes and 4 Mbytes can be ordered from Infotek Systems, 1400 N. Baxter Street, Anaheim, CA 92806-1201, as AM220B and AM244B, respectively. These products have been *functionally tested, but are not warranted or supported by HP* (no RFI or environmental tests were conducted). Warranty for two years and support of individual cards are provided by Infotek.

### Extender Chassis

<b>HP 3853A</b> Extender Chassis with ten additional slots for function modules. A 1-meter extender control cable, and two 1-meter (3 wires each) analog signal extender cables are included. A total of seven extenders may be added to a mainframe. Extender control cables are always needed. Analog signal extender cables are needed if analog voltages must be switched to the mainframe or another extender.	\$2505
---------------------------------------------------------------------------------------------------------------------------------------------------------------------------------------------------------------------------------------------------------------------------------------------------------------------------------------------------------------------------------------------------------------------	--------

### Voltmeters

<b>HP 44701A</b> ½ to 3½-Digit Integrating Voltmeter	\$1560
<b>HP 44702A</b> 13-Bit High-Speed Voltmeter (100,000 readings/sec; buffer for over 8,000 readings)	\$2610
<b>HP 44702B</b> 13-Bit High-Speed Voltmeter (100,000 readings/sec; buffer for over 64,000 readings)	\$3125
<b>HP 44703C</b> High Speed Extended Memory Card for expanding HP 44702A Buffer to over 64,000 readings	\$570

### Relay Multiplexers

<b>HP 44705A</b> 20-Channel Relay Multiplexer	\$780
<b>HP 44705H</b> 20-Channel High-Voltage Relay Multiplexer	\$985
<b>HP 44706A</b> 60-Channel Single-Ended Relay Multiplexer	\$940
<b>HP 44708A</b> 20-Channel Relay Multiplexer with Thermocouple Compensation	\$885
<b>HP 44708H</b> 20-Channel High-Voltage Relay Multiplexer with Thermocouple Compensation	\$1085
<b>HP 44717A</b> 10-Bridge 120 Ohm Static Strain Gage Relay Multiplexer	\$1040
<b>HP 44718A</b> 10-Bridge 350 Ohm Static Strain Gage Relay Multiplexer	\$1040

### FET Multiplexers

<b>HP 44709A</b> 20-Channel FET Multiplexer	\$835
<b>HP 44710A</b> 20-Channel FET Multiplexer with Thermocouple Compensation	\$940
<b>HP 44719A</b> 10-Bridge 120 Ohm Static Strain Gage FET Multiplexer	\$1100
<b>HP 44720A</b> 10-Bridge 350 Ohm Static Strain Gage FET Multiplexer	\$1100
<b>HP 44711A</b> 24-Channel High-Speed FET Multiplexer	\$940
<b>HP 44712A</b> 48-Channel High-Speed Single-Ended FET Multiplexer	\$1100
<b>HP 44713A</b> 24-Channel High-Speed FET Multiplexer with Thermocouple Compensation	\$1040
<b>HP 44730A</b> 4-Channel Track/Hold Multiplexer with Signal Conditioning	\$1500
<b>HP 44732A</b> 4-Channel 120 Ohm Dynamic Strain Gage Multiplexer	\$1700
<b>HP 44732A</b> 4-Channel 350 Ohm Dynamic Strain Gage Multiplexer	\$1700

### Analog Outputs

<b>HP 44726A</b> 2-Channel Arbitrary Waveform DAC	\$1900
<b>HP 44727A</b> 4-Channel Voltage DAC	\$1255
<b>HP 44727B</b> 4-Channel Current DAC	\$1255
<b>HP 44727C</b> 2-Channel Voltage; 2-Channel Current DAC	\$1255

### Stepper Motor Controller

<b>HP 44714A</b> 3-Channel Stepper Motor Controller/Pulse Output	\$1900
------------------------------------------------------------------	--------

### Counter

<b>HP 44715A</b> 5-Channel Counter/Totalizer (200 kHz)	\$990
--------------------------------------------------------	-------

### Digital Inputs/Outputs—Switching

<b>HP 44721A</b> 16-Channel Digital Input with Totalize and Interrupt	\$680
<b>HP 44722A</b> 8-Channel AC Digital Input with Totalize and Interrupt	\$680
<b>HP 44723A</b> 32-Channel High-Speed Digital Sense/Control	\$950
<b>HP 44724A</b> 16-Channel Digital Output	\$680
<b>HP 44725A</b> 16-Channel General Purpose Switch	\$780
<b>HP 44728A</b> 8-Channel Relay Actuator	\$625
<b>HP 44729A</b> 8-Channel Power Controller	\$940
<b>HP 44788A</b> HP-IB Controller	\$600

### Breadboard

<b>HP 44736A</b> Breadboard	\$365
-----------------------------	-------

### High-Speed Accessories

<b>HP 98620B</b> 2-Channel DMA Controller for HP Series 300/200 Computers	\$500
<b>HP 98622A</b> GPIO Interface for HP Series 300/200 Computers	\$355
<b>HP 98625B</b> High-Speed HP-IB Disc Interface for HP Series 300/200 controllers	\$680
<b>HP 44744A</b> 2-Meter GPIO Cable with Mating for HP 44702A/B and HP 98622A	\$260
<b>HP 44744B</b> 4-Meter GPIO Cable with Mating for HP 44702A/B and HP 98622A	\$310
<b>HP 44745A</b> 4-Meter GPIO Cable with Mating for HP 44702A/B and HP 12006A (GPIO interface for HP 1000 Computers)	\$310

### Service and Support Products and Courses

<b>HP 44743F</b> Service Kit consists of specially designed hardware and software for operationally verifying and calibrating the HP 3852A. Fixtures for testing individual plug-in modules should be ordered separately.	\$1480
<b>HP 50011B</b> HP-IB Course for HP Series 300/200 Computers	\$1320
<b>HP 50015A</b> Data Acquisition and Control Fundamentals Course	\$900
<b>HP 50016E</b> HP-IB Course for HP 1000 Computers	\$1200
<b>HP P/N 03852-88703</b> ROM Update Kit	\$360

# DATA ACQUISITION SYSTEMS

## Temperature Transducers Models 40652, 40653 and 40654 Series

- Thermocouples, thermistors and RTDs
- Supported by HP hardware and software

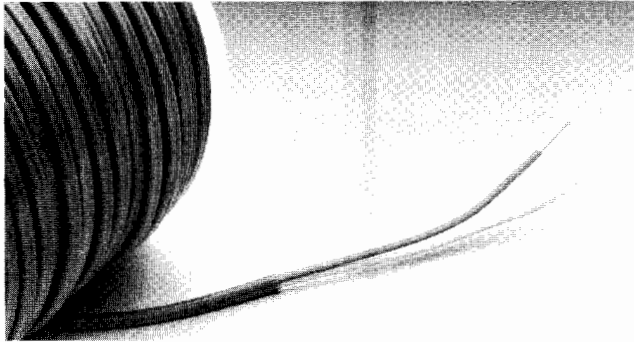

HP 40652 Series Thermocouple Wire

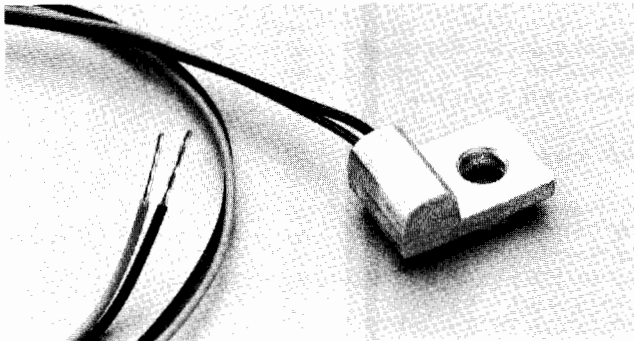

HP 40653 Series Thermistor Assemblies

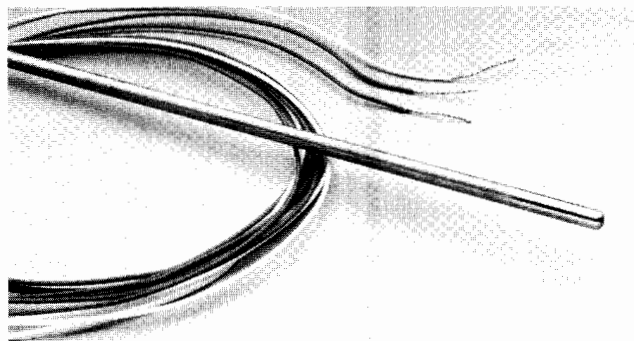

HP 40654A Stainless Steel Platinum RTD Probe

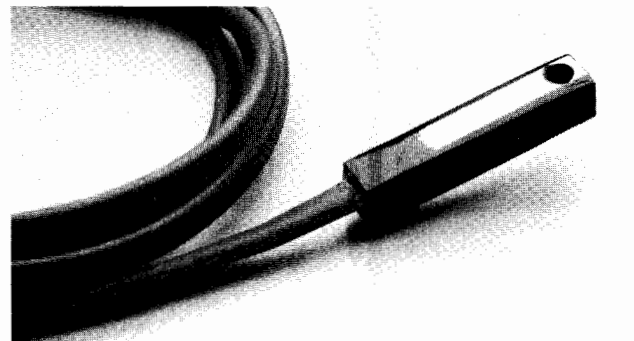

HP 40654B Surface Mounted Thin Film RTD

### HP 40652 Series Thermocouple Wire

Thermocouples are rugged and inexpensive and cover a wide temperature range. All products come in 30 metre (100 feet) rolls.

- Temperature range-267°C to 260°C (-450°F to 500°F)
- 20 AWG wire size for durability and low series resistance
- Excellent resistance to abrasion, water submersion, solvents, acids and bases, flame and humidity with very good flexibility.

### HP 40653 Series Thermistor Assemblies

Thermistors give you fast response for real-time measurements. The epoxy encapsulated sensor is housed in a screw mounted aluminum housing for easy surface mounting.

- 100°C maximum temperature
- Accurate ( $\pm 0.1^\circ\text{C}$ ) measurements
- 305 mm (12") Teflon® insulated leads
- Size: 12 H x 5 W x 8 mm D ( $\frac{1}{2}'' \times \frac{3}{16}'' \times \frac{5}{16}''$ )

### HP 40654A Stainless Steel Platinum RTD Probe

RTDs are the most stable, most linear and most accurate temperature transducers.

- 304 stainless steel sheath is impervious to most environments
- Pre-wired for 4-wire  $\Omega$  measurements for maximum accuracy
- 100  $\Omega$  nominal resistance minimizes self-heating errors
- Conforms to European "E" curve ( $\alpha=0.00385$ )
- Probe: 318 mm (12.5") long. OD: 3 mm ( $\frac{1}{8}''$ )
- Teflon coated leads are 914 mm (36") long
- Maximum temperature 500°C (932°F)
- Ideal for fluids; install unmounted, potted or retain with set screw or compression fitting

### HP 40654B Surface Mounted Thin Film RTD Probe

The large surface area/volume ratio means quick response time. The accurate platinum element is insensitive to vibration.

- Moisture proof, screw mounted housing is ideal for surface measurements
- Thin ceramic substrate has high thermal conductivity for good measurement of gases
- Conforms to European "E" curve ( $\alpha=0.00385$ )
- Wired for easy 2-wire  $\Omega$  measurement
- -200°C to 125°C (-326°F to 257°F)
- Dimensions: 6 H x 6 W x 32 mm D ( $\frac{1}{4}'' \times \frac{1}{4}'' \times 1\frac{1}{4}''$ )
- Silicone rubber coated leads are 610 mm (24") long

### Ordering Information

HP 40652A Type K Thermocouple  
 HP 40652B Type J Thermocouple  
 HP 40652C Type T Thermocouple  
 HP 40652D Type E Thermocouple

HP 40653A 2252  $\Omega$  Thermistor  
 HP 40653B 5000  $\Omega$  Thermistor  
 HP 40653C 10,000  $\Omega$  Thermistor

HP 40654A RTD Probe

HP 40654B Surface Mounted RTD

☛ Fast-Ship Product-See page 766

### Price

(1-2 units)	(3-9 units)	
\$90.00 ea.	\$80.00 ea.	☛
\$80.00 ea.	\$70.00 ea.	☛
\$67.00 ea.	\$60.00 ea.	☛
\$100.00 ea.	\$90.00 ea.	☛
(1-4 units)	(5-9 units)	
\$62.00 ea.	\$55.00 ea.	☛
\$62.00 ea.	\$55.00 ea.	☛
\$62.00 ea.	\$55.00 ea.	☛
(1-4 units)	(5-19 units)	
\$100.00 ea.	\$90.00 ea.	☛
(1-4 units)	(5-9 units)	
\$75.00 ea.	\$65.00 ea.	☛

- Complete kits
- Modally tuned hammers
- Accelerometers for many diverse applications

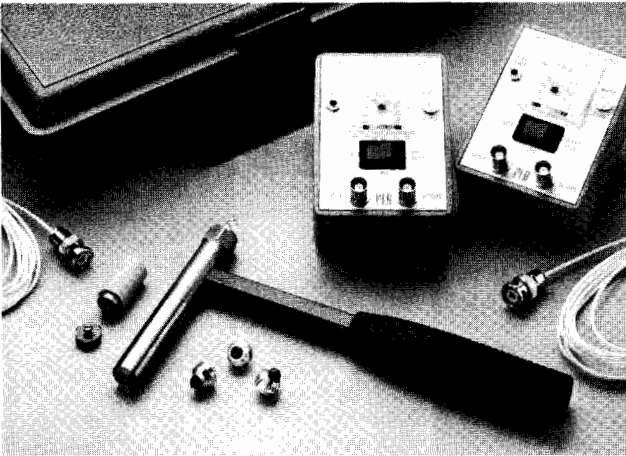

HP 40651A Hammer Kit

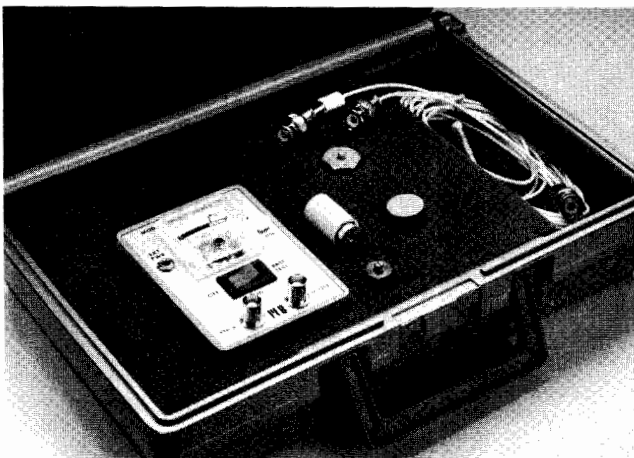

HP 40651G Accelerometer Kit

Accelerometers are used in many applications to convert mechanical motion into an electric signal. Typical applications include machine monitoring to prevent catastrophic failures and shock testing of new products to prevent damage in shipment.

Hammers are used in modal analysis which determines the dynamic properties of mechanical structures, such as machine tools, automobile subassemblies, and power line towers.

#### Complete kits

Each product number contains all the accessories necessary for testing and monitoring: all cables, all appropriate mounting hardware including petro wax for temporary mounting, and complete operating instructions and calibration data. The hammer kits even come with accelerometers, selected to be appropriate for the same application as the hammer.

All kits come in a sturdy plastic case with a convenient handle. Custom cut-outs in the foam rubber insert hold each piece in place during transport.

#### Accelerometers

The HP accelerometers are of the ICP (integrated circuit piezoelectric) type for ease of use and simple cable connections since the charge amplifiers are built in.

HP offers a wide selection of accelerometers to fit many applications from moderately small structures, such as disc drive actuator arms, to very large structures; such as buildings or bridges.

The 40651C/D/E and F kits do not include power supplies. They are especially designed for use with the HP 3561A Dynamic Signal Analyzer which features an internal supply.

The 40651G/H/J and K kits include a battery-operated supply (even the battery is included) for use with other analyzers, such as the HP 3582A and HP 3562A.

#### Modally tuned hammers

In modal analysis the object being tested is struck by an impact hammer and the resulting vibration is measured with an accelerometer. The force of the impact is measured by a force transducer attached to the head of the hammer.

HP's hammers are modally tuned, meaning that they do not have structural resonances in the frequency range they are specified for. Therefore, the signal output from the force transducer on the hammer is truly representative of the force being applied to the structure.

#### Specifications

##### Hammer Kits:

###### Weight:

HP 40651A: 0.14 kg (0.3 lb) for small to medium structures

HP 40651B: 1.4 kg (3.0 lb) for medium to large structures

**Accessories furnished:** Accelerometers HP 40651C and D (A Kit) or E and F (B Kit). 2 ea power supplies, 3 ea removable impact tips, all cables and mounting hardware, operating instructions, calibration data and plastic case.

##### Accelerometer Kits:

Without power supplies With power supplies	HP 40651C HP 40651G	HP 40651D HP 40641H	HP 40651E HP 40651J	HP 40651F HP 40651K
Sensitivity (mV/g)	10±2%	10 (nom)	100±2%	1,000±5%
Amplitude Range (+g pk)	500	500	50	5
Frequency Range (Hz, ±5%)	1-3,000	1-10,000	1-3,000	2.5-3,000
Maximum Shock (g pk)	5,000	2,000	5,000	5,000
Resonant Frequency (kHz)	45	70	25	25
Weight (gram)	25	1.9	87	68

**Accessories furnished:** All cables, mounting hardware including petro wax, operating instructions, calibration data, and plastic case. Power supplies with batteries are included in the G, H, J and K kits.

#### Ordering information

HP 40651A Hammer Kit	\$1,675.00 ☎
HP 40651B Hammer Kit	\$2,155.00 ☎
HP 40651C Accelerometer Kit without power supply	461.00 ☎
HP 40651D Accelerometer Kit without power supply	322.00 ☎
HP 40651E Accelerometer Kit without power supply	410.00 ☎
HP 40651F Accelerometer Kit without power supply	550.00 ☎
HP 40651G Accelerometer Kit with power supply	595.00 ☎
HP 40651H Accelerometer Kit with power supply	456.00 ☎
HP 40651J Accelerometer Kit with power supply	545.00 ☎
HP 40651K Accelerometer Kit with power supply	685.00 ☎

☎ Fast-Ship product - See page 766

# COMPUTER AIDED TEST

## Switching/Interface Hardware

The philosophy behind Computer Aided Test (CAT) is simple. If you can raise the quality of your product without raising its cost, your customer is happier and your company is more productive. The formula for executing this plan is equally simple: Monitor incoming parts, manufacturing processes and final products in great detail, and make corrections to improve them.

While the philosophy is simple, the implementation can sometimes be complex. That's where HP can help, with a full complement of computers, software, instruments, switches, and interconnect hardware designed specifically to make your CAT task easier.

A good CAT system is designed to improve manufacturing productivity. It minimizes the design time to build fixtures, write software and configure systems, and it also minimizes the time required to test devices.

### What to Look for in Hardware Cardcages

Performance is the main criteria in selecting instruments and switches. The switch and instruments must meet your stringent requirements. It's a good idea to select an in-

strument and switch with slightly more performance than the initial specification requires. That way you can easily adapt to changing manufacturing specifications. Another consideration is throughput speed. An intelligent cardcage system, such as the HP 3235A, can run subroutines and make decisions, thereby off-loading the host computer to do the test sequencing and data reporting.

The HP Series 6900 Multiprogrammers are high performance CAT products offering very high-speed stimulus and response functions. The broad function versatility and inter-card communication of its I/O cards give the Multiprogrammer the required adaptability to make time-critical measurements. Series 6900 Multiprogrammer I/O cards can be used in either the HP 6954A, the HP 6944A or the HP 6942A mainframes. These I/O cards give the Multiprogrammer abilities such as digital I/O rates up to 1 MHz and analog acquisition rates up to 500 kHz that can be synchronized with application dependent events.

If your budget or application is relatively small, look to the HP 3488A Switch/Control Unit.

### Switching

If your application involves switching signals  $>1$  MHz, you need to look at the HP 3235A for large point counts ( $>100$ ) and the HP 3488A for low point counts. Both products offer high performance switching in various topologies covering DC to 26.5 GHz.

### Interfacing and Cabling

For years, the cabling and fixturing of a CAT system have been neglected by CAT manufacturers. Test engineers and technicians had to build their own connection systems. But, today HP has commercial units to do most of the critical switching and cable management necessary in a CAT system. The availability of these switch units can save hundreds of hours of design time.

The interface system to the HP 3235A standardizes the way you cable your Unit-under-test to the test system. It adapts to complex components, pc boards, subassemblies and systems.

For those who need help in configuring, implementing or supporting a complex CAT system, HP offers the ATS 2000 which provides an integrated solution (including hardware, software, racking, cabling and system-level support).

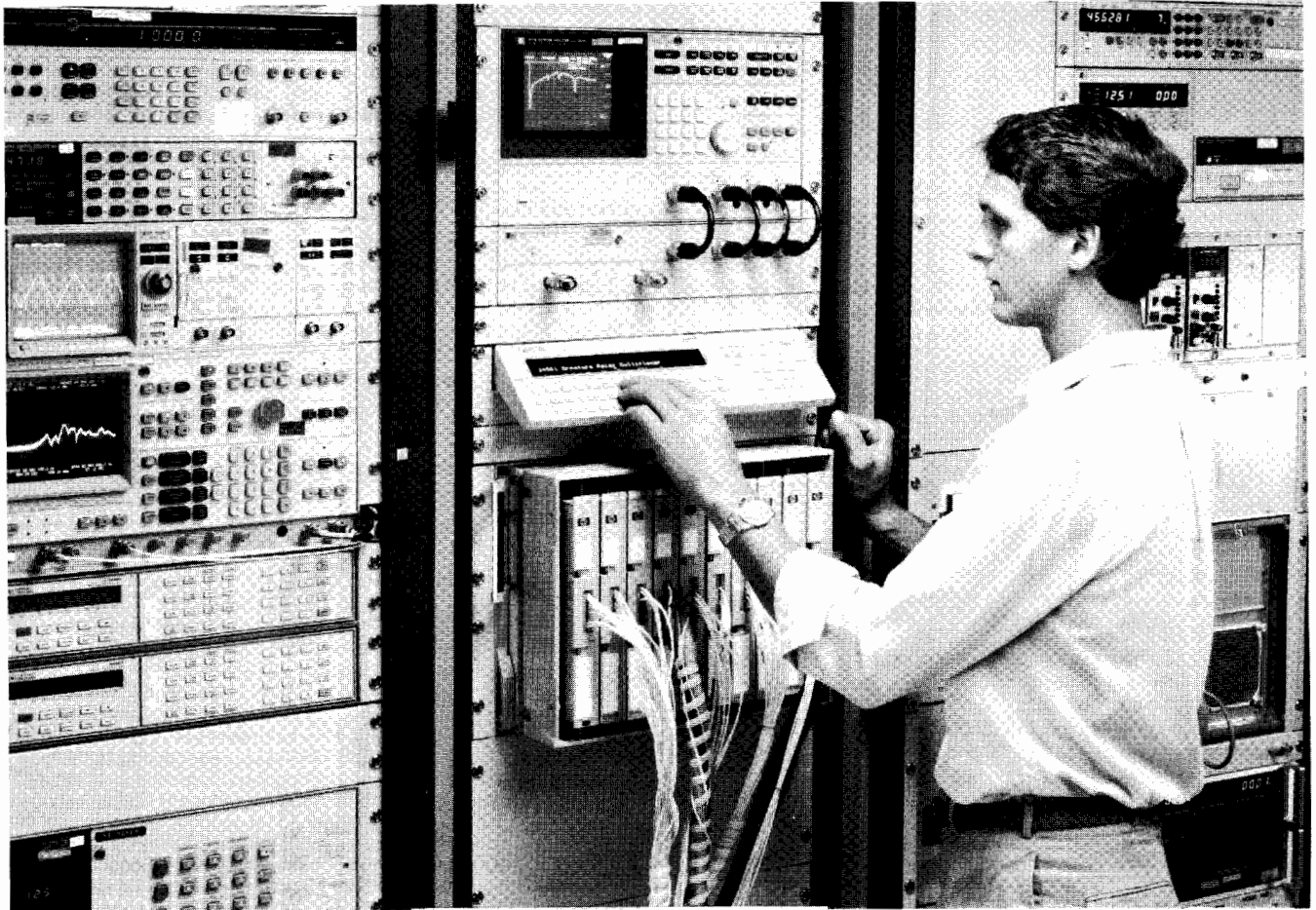

The HP 3235A Switch/Test Unit performs high integrity switching for signals from dc to 26.5 GHz. With its mass interconnected fixture, the HP 3235A can route signals from a multitude of instruments to the device under test, saving the test engineer the chore of designing a custom switch, and greatly simplifying cable management.

Programming the HP 3235A is extremely efficient, with high level BASIC commands. Faster test throughput speed is created by downloading test setups, and by direct communication between the internal switches and the internal  $6\frac{1}{2}$  digit multimeter or internal stimulus.



# COMPUTER AIDED TEST

## High Performance Switching and Control

### HP Model 3235A

583

- For Medium to Large Systems
- 10-Slot, Intelligent Card Cage
- 20-Switch Modules for DC to 26.5 GHz Signals
- DMM, AC/DC Source, 4-channel D/A Digital I/O, Breadboard Modules
- Quick Interconnect Fixture
- Control Panel for Debugging

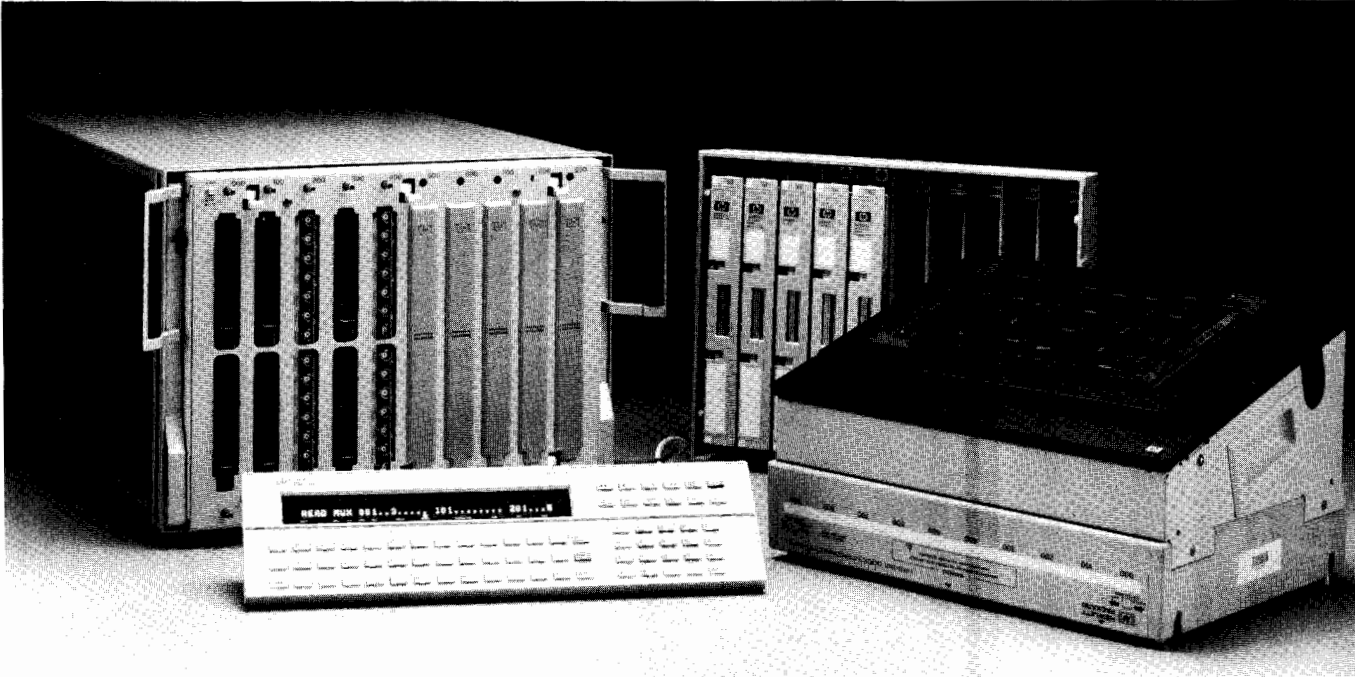

HP 3235A

### Description

The HP 3235A Switch/Test Unit reduces test development of HP-IB production test systems by providing high performance off-the-shelf switching and interfacing to a wide variety of Devices Under Test (DUT).

This new Switch/Test Unit routes signals between your DUT and source/receiver instruments such as digital multimeters, counters, signal sources and analyzers.

Speed your test system development with:

- off-the-shelf tools
- easy programming
- reduced cabling

Your test system throughput increases with the HP 3235A's:

- intelligence
- plug-in digital multimeter module
- internal bus structure
- Quick Interconnect Fixture

### A Reconfigurable Architecture

The HP 3235A chassis is a 10-slot cardcage driven by a 16-bit processor backed with 256k of firmware. You control the cardcage over HP-IB using high level commands for easy programming. Twenty different switch modules in various matrix and multiplexer topologies switch signals up to 10 Amps and from DC to 26.5 GHz. Also available are digital I/O, breadboard, four-channel D/A, DMM, and AC/DC source modules that are true "instruments-on-a-card."

For applications demanding numerous switch points, up to seven 10-slot HP 3235E Extenders can be slaved to the HP 3235A mainframe. 20,480 two-wire analog points can now be controlled from one HP-IB address.

The Quick Interconnect Fixture allows easy reconfiguration of the customer's test system for different test devices. Operator errors are also reduced by minimizing the number of connections that must be made before starting a new test.

Four analog and two trigger buses link the switch and instrumentation modules. These internal paths provide a "soft-wired" connection

that can be redefined by your test software. Analog signals get routed conveniently from a multiplexer to the digital multimeter module during scanning. Or, a trigger generated by the digital I/O module can be routed to the digital multimeter module.

To aid in system set up and debugging, a control panel with a full alpha-numeric keypad and electro-luminescent display is available.

### Intelligence of a Computer

The powerful firmware of the HP 3235A instructs the plug-in modules with high level commands from the host computer. Storage and recall of hundreds of HP 3235A setups saves sending command sequences from the computer. BASIC language commands in the mainframe such as IF . . . THEN and FOR . . . NEXT, plus variables and math functions keep computer to switch interactions to a minimum, thereby increasing throughput. Use up to 480K bytes of mainframe memory for downloaded subroutines and stored values. Downloaded programs, including user defined data conversions or setups, execute rapidly.

### Complete Modularity Means In-Rack Service

The HP 3235A is completely in-rack serviceable, so you never need to remove the card cage from the rack. All assemblies, including power supply, controller, and HP-IB, remove easily because of the modular design.

### Simple Operational Verification Before Your Test

The HP 3235A offers three levels of internal self-test as well as a fixtured functional test for the individual plug-in modules. The fixtured test is performed using diagnostic terminal blocks that attach to the modules. These diagnostic fixtures, together with the internal DMM module, verify the integrity of the relay contacts in your system.

### HP 3235A Plug-in Modules

A full complement of functional plug-in modules is available for use with the HP 3235A 10-slot mainframe or the HP 3235E 10-slot extender.



# COMPUTER AIDED TEST

## High Performance Switching and Control (cont'd)

Model 3235A

### Low Frequency Relay Multiplexers

These modules can be used either as input or output multiplexers to switch signals to and from a device under test (DUT). The multiplexers are two-wire, switching both High and Low. They have different voltage and current switching capabilities, and use different relay types. The HP 34501T/34502T/34507T can also be used with thermocouples. For matrix applications, see below.

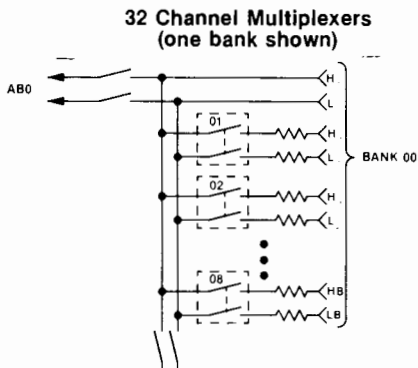

	HP 34501	HP 34502	HP 34507	HP 34511	HP 34515
Max Voltage (AC RMS)	250 VDC 250 VAC	125 VDC 90 VAC	250 VDC 250 VAC	130 VDC 130 VAC	1000 VDC 1000 VAC
Max Current	2A	25 mA	100 mA	1 A	1 A
No. of Channels	32	32	32	64	10
Relay Type	Armature	Reed	Mercury	Armature	Reed
Thermal Offset	<3 $\mu$ V	<3 $\mu$ V	<20 $\mu$ V	<7 $\mu$ V	<30 $\mu$ V

### High Frequency Relay Multiplexers

These multiplexers provide broadband switching of high frequency analog or digital signals. The HP 34504 switches both the center conductor and the shield. In the HP 34505 and HP 34508, the three multiplexer banks are isolated from each other and from ground, preventing ground loops.

### Switched-Shield Coaxial Multiplexer (one bank shown)

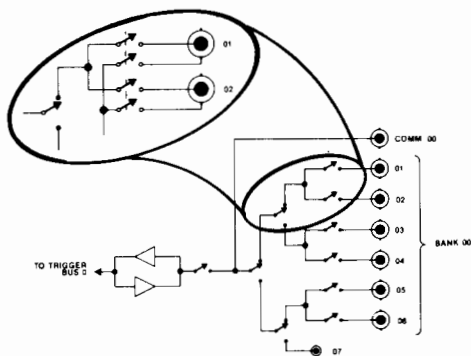

### RF Multiplexer (one bank shown)

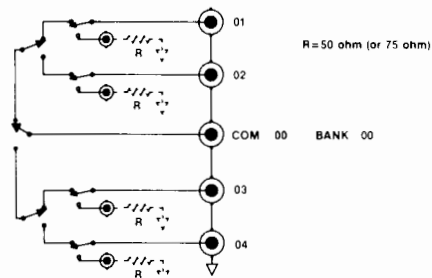

### High Frequency Relay Multiplexers

	HP 34504	HP 34505	HP 34508
Bandwidth	100 MHz	1.3 GHz	1.3 GHz
Number of Channels	Dual 1x6	Two 1x4 One 1x3	Two 1x4 One 1x3
Impedance	50 ohms	50 ohms	75 ohms
Maximum Voltage (AC RMS)	42 VDC 30 VAC	42 VDC 30 VAC	42 VDC 30 VAC
Maximum Current	1 A	1 A	1 A
Switched Shield	Yes	No	No

### Microwave Switches

These 50 ohm coaxial switches provide excellent electrical performance from DC to microwave frequencies. The HP 34530A goes to 18 GHz, while the HP 34530B goes to 26.5 GHz. The HP 34531A/B 18 GHz multiplexers are configured as 1x6. The HP 34531B has internal 50 ohm terminations for the open channels, while the HP 34531A does not. All of these microwave switches use SMA connectors. A variety of rack panel mounting kits are available. Up to four HP 34530A/B 3-port switches can also be mounted in the HP 34530T terminal block kit.

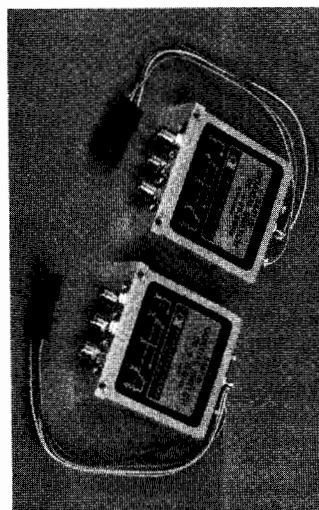

HP 34530A/B



HP 34531A

### Relay Matrix Modules

These matrix cards come in a variety of configurations, densities, and bandwidths. For the highest density, consider the HP 34511M or the HP 34516M/N. If low leakage is a requirement, the HP 34512C features 10 pA/volt leakage, 2 pA/V typical. For higher bandwidth applications, look at the HP 34506 Switched Shield Matrix. Finally, for very high frequency applications, consider using the HP 34513C or the HP 34514C General Purpose RF relay modules (described in a later section) to build up your own custom high frequency matrices. Special cable kits allow many of these modules to easily expand into larger matrix configurations.

#### Switched-Shield Coaxial Multiplexer (one bank shown)

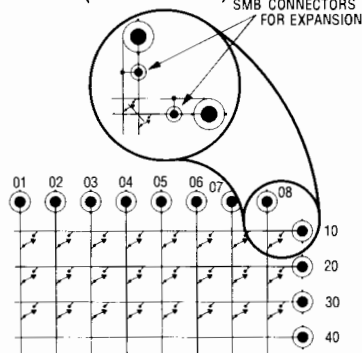

#### HP 34516N Two-Wire 256 Crosspoint Matrix

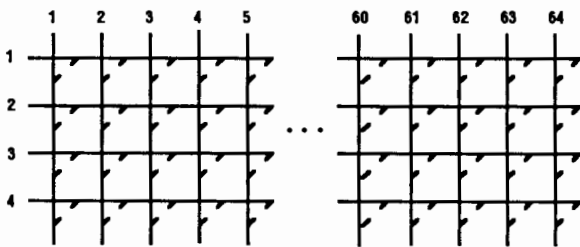

#### Relay Matrix Modules

	HP 34501M	HP 34506	HP 34511M	HP 34512	HP 34516
Crosspoints	32	32	64	32	256
Matrix Configuration	4x8	4x8	8x8 4x16	4x8	8x32 4x64
Bandwidth	1 MHz	30 MHz	1 MHz	30 MHz	1 MHz
Max voltage (AC RMS)	42 VDC 30 VAC	42 VDC 30 VAC	130 VDC 130 VAC	250 VDC 170 VAC	42 VDC 30 VAC
Max Current	2 A	1 A	1 A	1 A	1 A
Connectors	Two-wire	Coaxial	Two-wire	Triaxial	Two-wire
Switched Shield	No	Yes	No	Yes	No

### General Purpose Relay Modules

There are several general purpose modules available for different applications. The HP 34503 has 16 Form C relays. The HP 34510 has 8, but can switch 10 amps per relay. The HP 34513 and HP 34514 are essentially building blocks, allowing you to build up custom switching topologies to fit your requirements. These cards contain 32 independently operated double-pole double-throw high frequency relays. All contacts are brought out to board mounted SMB connectors. Interconnection between relays are made via coaxial cables.

### General Purpose Relay Modules

	HP 34503	HP 34510	HP 34513	HP 34514
Number of relays	16	8	32	32
Contact Config	SPDT (Form C)	SPDT (Form C)	DPDT	DPDT
Maximum Voltage (AC RMS)	250 VDC 250 VAC	125 VDC 250 VAC	42 VDC 30 VAC	42 VDC 30 V AC
Maximum Current	3 A	10 A	1 A	1 A
Bandwidth	1 MHz	1 MHz	1 GHz	300 MHz
Use	General Purpose	Power Actuator	50 ohm RF Switching	75 ohm RF Switching

### Digital I/O Modules

The HP 34509 has a total of 32 open-drain MOS-FET outputs available, which can switch voltages up to 42 volts and currents up to 0.5 A. This card also contains two internal power supplies of 15V and 28V, making the module ideal for driving relay coils or other devices. This card is also used in conjunction with the HP 34530 and HP 34531 Microwave switches.

The HP 34522 is a 32 Bit Digital I/O module, featuring 32 bi-directional TTL-compatible data lines, 8 edge-triggered interrupt lines, 16 high-power FET outputs, and a read/write rate > 40 kHz. The 32 data lines are configured as four 8-bit ports, each with their own handshake lines. Each port can be operated independently as a read or write port, or can be combined to handle 16 or 32 bit parallel data.

### Analog Source Cards

The HP 34521 AC/DC Source card offers 24-bit (6.5 digit) resolution in the DC voltage mode, highly accurate amplitudes in the AC voltage mode, and versatile high speed outputs in the arbitrary waveform mode. Maximum voltage output is  $\pm 10$  volts, while maximum frequency is 1 MHz. Standard AC outputs include sine, square, and triangle waveforms, with variable duty cycle on both triangle and square waves. AC outputs are generated by direct digital synthesis which provides high accuracy and resolution down to 0.001 Hz. Arbitrary waveform memory depth is 2048 bytes. ARB's can be generated at a full 1 MHz bandwidth.

The HP 34524 contains four completely independent 14-bit plus sign digital-to-analog converters. In the voltage mode, each DAC can supply  $\pm 10.24$  volts. In current mode, each can provide  $\pm 20.16$  mA. Because the four DACs are isolated from one another, they can be connected in series or parallel for greater output voltages or currents.

### Breadboard Module (HP 34523)

The breadboard module furnishes a convenient way to incorporate special purpose circuits into your test system. This module lets you interface directly the HP 3235A's backplane control signals and backplane analog and trigger buses.

### 6½ Digit Multimeter Module (HP 34520)

With the DMM module, you can integrate a high performance system multimeter into your test system without extensive cabling and software programming. The DMM module offers seven functions:

- DC volts with five ranges from 0.03V to 250V and reading rates >1450 rdgs./sec in the 3½ digit mode.
- AC Volts with 1MHz AC Bandwidth
- Two and four-wire resistance measurements
- DC current up to 1.5A, with reading rates as fast as DC Volts and ohms
- AC Current up to 100kHz and 1A.
- Frequency and period from 10 Hz to 1.5MHz with 6½ digit resolution.

The DMM module combines superb analog measurement capability with powerful system flexibility. Measurement inputs can be switched directly from the front of the module or, with the exception of current inputs, from any of the four internal HP 3235 analog buses.

# COMPUTER AIDED TEST

## High Performance Switching and Control (cont'd)

### Model 3235A

#### DC Voltage (90 day, Tcal $\pm 5^\circ\text{C}$ )

Range	Best 6½ Digit Accuracy <sup>1</sup> $\pm$ (% of reading + volts)	Input Resistance
30mV	.0053% + 5.40 $\mu\text{V}$	>10 G $\Omega$
300mV	.0038% + 5.7 $\mu\text{V}$	>10G $\Omega$
3.0V	.003% + 8 $\mu\text{V}$	>10G $\Omega$
30V	.0048% + 220 $\mu\text{V}$	10 M $\Omega$ $\pm$ 1%
250V	.0063% + 700 $\mu\text{V}$	10 M $\Omega$ $\pm$ 1%

#### DC Current (90 day, Tcal $\pm 5^\circ\text{C}$ )

Range	Best 6½ Digit Accuracy <sup>1</sup> $\pm$ (% of reading + amps)	Max. Burden Voltage at Fullscale
300 $\mu\text{A}$	.025% + 15.4 nA	0.35 V
3mA	.025% + 15.4 nA	0.35 V
30mA	.025% + 1.54 $\mu\text{A}$	0.35 V
300mA	.088% + 25.4 $\mu\text{A}$	0.6 V
1.5A	.088% + 654 $\mu\text{A}$	1 V

#### Resistance (2 and 4-wire ohms)<sup>2</sup> (90 day, Tcal $\pm 5^\circ\text{C}$ )

Range	Best 6½ Digit Accuracy <sup>1</sup> $\pm$ (% of reading + ohms)	Current Output
30 $\Omega$	.0078% + 5.4m $\Omega$	1mA
300 $\Omega$	.0058% + 5.7m $\Omega$	1mA
3k $\Omega$	.0048% + 9m $\Omega$	1mA
30k $\Omega$	.0048% + 90m $\Omega$	100 $\mu\text{A}$
300k $\Omega$	.006% + 1 $\Omega$	10 $\mu\text{A}$
3M $\Omega$	.008% + 15 $\Omega$	1 $\mu\text{A}$
30M $\Omega$	.032% + 830 $\Omega$	100 nA
300M $\Omega$ <sup>3</sup>	2.5% + 100k $\Omega$	100 nA
3G $\Omega$ <sup>3</sup>	25% + 1M $\Omega$	100 nA

- After one hour warm up, integration time 100 PLC. Tcal is the temperature of the calibration environment between 18 and 28°C.
- For two-wire ohms, add 200M $\Omega$  to count error specifications.
- For two-wire ohms only accuracy is specified following auto-cal (ACAL), under stable conditions ( $\pm 1^\circ\text{C}$ ).

#### AC Voltage (RMS AC and RMS AC+DC)

ACV Bandwidth: 20 Hz to 1 MHz

Crest Factor: 3.5 to 1 at fullscale

Common Mode Rejection with 1 k $\Omega$  imbalance in the low lead, DC to 60 Hz. Guarded: >86dB; non-guarded >66dB.

#### AC Volts (90 day, Tcal $\pm 5^\circ\text{C}$ )

Range	(100Hz to 20kHz) Best 5½ Digit Accuracy <sup>1</sup> $\pm$ (% of reading + % of range)		Input Impedance
	AC Coupled	DC Coupled	
30mV	.15% + .0441%	.19% + .169%	1M $\Omega$ $\pm$ 1% shunted by <90pF
300mV	.15% + .0441%	.19% + .169%	
3.0V	.15% + .0441%	.19% + .169%	
30V	.15% + .0441%	.19% + .169%	
300V	.21% + .053%	.25% + .203%	

- Accuracy specified for sine wave inputs, >10% of range. DC component <10% of AC component after one hour warm up and within one week of autocal. AC band set to <400 Hz.

#### AC Current (RMS AC and RMS AC+DC)

ACI Bandwidth: 20 Hz to 100 kHz

Crest Factor: 3.5 to 1 at fullscale

**Frequency and Period:** Measures the frequency or period of the AC component of the AC or DC coupled voltage or current input. The counter uses a reciprocal counting technique to give constant resolution independent of input frequency.

**Frequency Range:** 10 Hz to 1.5 MHz (voltage input)  
10 Hz to 100 kHz (current input)

**Period Range:** .1 s to 667 ns (voltage input)  
.1 s to 3.33  $\mu\text{s}$  (current input)

**Sensitivity:** 10 mV RMS or 100  $\mu\text{A}$  RMS (sinewave)

**Triggering:** Triggers and counts on zero crossings.

#### SimPlate Board Test Fixture (HP 34597A)

The HP 34597A SimPlate Board Test Fixture is a vacuum actuated bed-of-nails test fixture kit for the HP 3235A Switch/Test Unit. SimPlate and the HP 3235A are tools developed for your "rack-and-stack" functional test systems. Unlike an edge connector test, SimPlate gives you access to all component leads to provide more functional test flexibility and improved fault isolation. Because of its unique single plate design, SimPlate can provide the close tolerance probing required for interfacing to Surface Mount Technology (SMT) boards.

SimPlate is delivered as a kit, that you must drill, wire, and assemble. The components in this kit are designed to probe printed circuit boards from a single side, with test pads as small as 0.030" diameter on 0.050" centers. Probes, receptacles and extra HP 3235A terminal blocks are ordered separately.

#### Environmental:

Operating Temperature: 0-55 C (32-130 F)

Storage Temperature: -40 -75 C (-40 -165F)

Humidity Range: 95% R.H., 0 to 40 C

#### Power:

Line Voltage: 90-132V (115V) or 192-264 (230V) switch selectable 47-66 Hz. Fused at 5A (115V) or 2.5A (230V).

#### Size:

HP 3235 Cardcage: 310mm H (without feet) x 426mm W x 594 mm o (12.25"x16.75"x23.4")

Height with Feet: 325mm (12.8")

Depth with Terminal Blocks: 693mm (27.3")

#### Weight

HP 3235 Cardcage (max.)  
Each Module (max.)

#### Net

21 kg (46 lbs)  
5.5 kg (12 lbs)

#### Shipping

28 kg (61 lbs)  
6.6 kg (14.5 lbs)

#### Ordering Information

**HP 3235A** Switch/Test Unit

**Opt 560** Add System Expansion Card

**Opt 580** GPIB Controller

**Opt 590** Add Quick Interconnect

**Opt 908** Rack Mount Kit (HP P/N 03235-80908)

**HP 3235E** Switch/Test Unit Extender

**HP 34550A** Control Panel

**HP 34551A** Control Panel Rack Mount Kit

#### Price

\$4590

\$370

\$600

\$780

\$100

\$3830

\$590

\$55

**Plug-in Accessories** are supplied with your choice of terminal blocks. "A" suffix designates solder lugs, "B" suffix designates screw terminals, "C" suffix deletes the terminal block, "M" and "N" suffixes designate matrices, and "T" suffix is used to measure thermocouples. Prices are shown below for the "B" suffix.

**HP 34501A/B/M/T** 32-chan Armature Rly Mux/Matrix \$1410

**HP 34502A/B/M/T** 32-chan Reed Rly Mux/Matrix \$1410

**HP 34503A/B** General Purpose Relay Module \$985

**HP 34504A/B/C** Switched-Shield Coax Mux \$1710

**HP 34505A/B/C** 50 Ohm RF Mux \$1510

**HP 34506A/B/C** Switched-Shield Coax Matrix \$1910

**HP 34507A/B/M/T** 32-chan Mercury Rly Mux/Matrix \$1600

**HP 34508A/B/C** 75 Ohm RF Mux \$1650

**HP 34509A/B/C** 32 Channel Relay Driver Module \$1120

**HP 34510B** 10-amp, 8-Channel Power Actuator \$750

**HP 34511B/M** 64-channel Relay Mux/Matrix \$2200

**HP 34512C** Switched-Shield Triaxial Matrix \$2700

**HP 34513C** General Purpose 50 Ohm RF Module \$2700

**HP 34514C** General Purpose 75 Ohm RF Module \$3000

**HP 34515B** 10-channel 1000 Volt Mux \$1900

**HP 34516M/N** 256-crosspoint Matrix \$4600

**HP 34520A/B** 6.5 Digit Multimeter Module \$2710

**HP 34521A/B** AC/DC Source Module \$2650

**HP 34522A/B** 32 Bit Digital I/O Module \$1300

**HP 34523A/B** Breadboard Module \$520

**HP 34524A/B** 4 Channel D/A Converter Module \$1750

**HP 34530A/B** Microwave Switch \$625

**HP 34531A/B** 1x6 Microwave Switch \$1350

# COMPUTER AIDED TEST

## Low Cost, Versatile HP-IB Switching & Control

HP Model 3488A

587

- DC—26.5 GHz signal switching
- Matrix, multiplexer, & general purpose relays
- Digital I/O control & actuation
- Up to 50 channels
- 40 configuration storage registers
- 11 switch & control modules

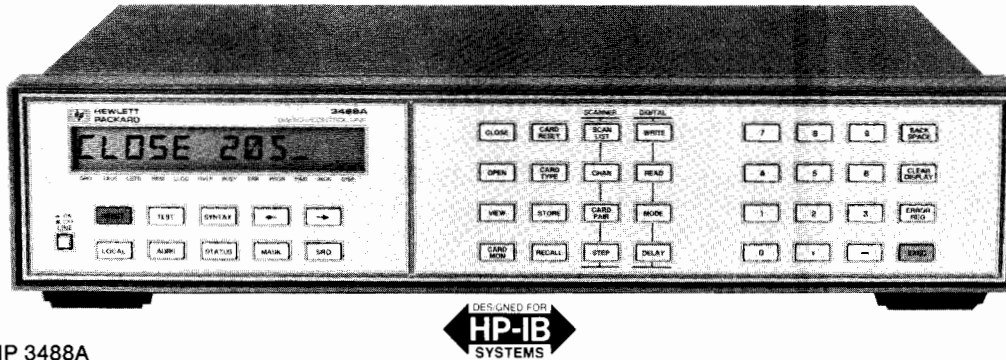

HP 3488A

### Description

The HP 3488A Switch/Control Unit brings versatile, HP-IB programmable switching to tests requiring multi-channel measurements. The HP 3488A provides signal switching with the integrity and isolation needed for high performance test systems in production. It also offers a flexible, low cost interconnection solution for automating experiments on the bench and for development testing in the lab. The HP 3488A is designed to hold any combination of up to 5 of the following optional switch and control modules:

- 10 Channel Relay Multiplexer
- 10 Channel General Purpose Relay
- Dual 4 Channel VHF Switch
- 4 x 4 Matrix Switch
- 16 Bit Digital Input/Output
- Breadboard
- 3 Channel 18 GHz Switch
- 7 Channel Form-C Relay
- 2 Channel Microwave Switch
- 1.3 GHz 50 and 75 ohm Multiplexers

### Flexible Switching

The HP 3488A offers an economical approach to switching flexibility through plug-in modules. The user can select the right combination of switching functions to meet both performance and budget requirements. Testing is simplified by having one solution for connections of low level DVM inputs, high level dc and ac power, and microwave signals to 26.5 GHz. Additional devices such as microwave relays and programmable attenuators are easily controlled with digital I/O functions. Custom circuitry can also be implemented on breadboard modules.

### Versatile Performance

The HP 3488A can store up to 40 complete switch configurations for convenient recall in automated test programs. Switch operation can be with multiple relay closures or with selectable channels in a break-before-make mode. Break-before-make closures and recallable complete switch configurations can be combined in a programmable scan list. The HP 3488A uses removable screw terminal connectors that provide easily interchangeable wiring configurations for each test. Built-in self-test capability assures proper operation.

### Multiplexer (Opt. 010/HP 44470A)

Option 010 is a 10 channel multiplexer for scanning or multiple signal connections. Channels switch 2 wires (Hi & Lo) with 2PST relays for DVM inputs and other signals up to 250 V and 2A. This module can also be used to multiplex signals to other switching functions such as the matrix module.

### General Purpose Relay (Opt. 011/HP 44471A)

This module consists of 10 SPST independent relays for general signal switching and control of external devices. The quality connections provided make this module ideal for switching signals when multiplexing isn't required or for supplying switchable power to the device under test.

### VHF Switch (Opt. 012/HP 44472A)

The VHF module provides broadband switching capability for high frequency and pulse signals. The 2 independent groups of bidirectional 1 x 4 switches can be used for signals from dc to 300 MHz. All channels have 50 ohm characteristic impedance and are break-before-make within a group of 4 channels. Each group is isolated from the other and from ground to prevent ground loops. Excellent isolation makes this module ideal for high frequency signal analyzer measurements requiring a large dynamic range.

### Matrix Switch (Opt. 013/HP 44473A)

Option 013 offers highly flexible switching with a 4 x 4, 2 wire matrix. Any combination of 4 input channels may be connected to any combination of 4 output channels. Each cross point or node in the matrix uses a 2PST relay to switch 2 lines (Hi & Lo) at a time. Multiple 4 x 4 modules can be connected to form larger matrices. Multiplexers can be used in conjunction with this module to effectively expand the number of inputs and outputs of the matrix.

### Digital I/O (Opt. 014/HP 44474A)

This module offers 16 very flexible bidirectional I/O lines and 4 TTL compatible handshake lines for sensing and control of external devices. The digital inputs can be used to sense contact closures to ground. Each channel provides current sinks for remote switching of external relays such as the HP 33311 series of coaxial switches.

### Breadboard (Opt. 015/HP 44475A)

The breadboard module provides a convenient way to implement custom circuits and special functions that interface directly with the HP 3488A's backplane control signals.

### Microwave Switch (Opt. 016/HP 44476A)

This microwave switch furnishes three independent SPST 50-ohm coaxial switches with excellent performance from DC to 18 GHz. The 3-mm SMA connector allows the user to easily connect cables for multiple system configurations.

### Form-C Relay (Opt. 017/HP 44477A)

This module provides seven separate SPDT channels for general purpose switching and control of external devices. Using a power supply, the module can drive programmable attenuators and non-HP coaxial switches.

# COMPUTER AIDED TEST

## Low Cost, Versatile HP-IB Switching & Control (cont'd)

HP Model 3488A

### Microwave Switch (Opt. 018/HP 44476B)

The module brings multi-port 50-ohm coaxial switching to your test system. The module can mount any two HP 3331XX Coaxial Switches. The HP coaxial relays come in three-, four-, and five-port configurations, different switches for a variety of applications. HP Coaxial Switches that can be used are listed on the following table.

HP Coaxial Switch	Port	Frequency
HP 33311B/Opt.011	3	dc - 18 GHz
HP 33311C/Opt.011	3	dc - 26.5 GHz
HP 33312B/Opt.011	4	dc - 18 GHz
HP 33312C/Opt.011	4	dc - 26.5 GHz
HP 33313B/Opt.011	5	dc - 18 GHz
HP 33313C/Opt.011	5	dc - 26.5 GHz

### 1.3 GHz 50 ohm Multiplexer (Opt. 019/HP 44478A)

### 1.3 GHz 75 ohm Multiplexer (Opt. 020/HP 44478B)

These modules bring bi-directional switching of signals from DC to 1.3 GHz, with high channel isolation (> 55 dB @ 1 GHz). Each module consists of two groups of 1x4 multiplexers. All test connections are made to BNC's on the module's edge. Off-channels can be resistively terminated.

### Specifications for Opt. 010/HP 44470A Multiplexer, Opt. 011/HP 44471A General Purpose Relay, and Opt. 013/HP 44473A Matrix Switch and Opt. 017/HP 44477A Form-C Relay Switch Modules

#### Input Characteristics

**Maximum voltage (terminal-terminal or terminal-chassis):** 250 V dc, 250 Vac rms, 350 Vac peak

**Maximum current:** 2A dc, 2A ac rms

**Maximum power:** 60 W dc, 500 VA ac

**Thermal offset:** < 3  $\mu$ V

#### DC Isolation (40°C, 60% RH)

**Channel-channel, open channel:** > 10<sup>11</sup>  $\Omega$

#### AC Isolation/Performance

(50 $\Omega$ termination)	100 kHz	1 MHz	10 MHz
Insertion Loss (dB)	<0.30	<0.35	<0.90
Crosstalk (dB)	<-73	<-53	<-33

### Specifications For Opt. 012/HP 44472A VHF Switch Module

#### Input Characteristics

##### Maximum Voltage

Center-center, center-low: 250 Vdc, 30 Vac rms, 42 Vac Peak

Low-chassis, low-low: 42 V dc

**Maximum current (per channel):** 30 mA dc, 300 mA ac rms

**Thermal offset:** <15  $\mu$ V per channel

**Characteristic impedance:** 50  $\Omega$

#### AC Isolation/Performance

	30 MHz	100 MHz	300 MHz
Crosstalk (dB) Chan-Chan	<-100	<-85	<-65
Group-Group	<-85		<-50
Insertion Loss (dB)	<0.5	<0.75	<1.25
VSWR	<1.06	<1.12	<1.43

All channels break-before-make within a group of 4 channels.

### Specifications for Opt. 014/HP 44474A

#### Digital I/O Module

##### I/O Lines

**Maximum voltage** = +30 Vdc (line-chassis)

**Output characteristics:** V (high)  $\geq$  2.4 V; V (low)  $\leq$  0.4V

**I (low) maximum** = 125 mA @ V (low)  $\leq$  1.25 V; fused at 250 mA.

**Input characteristics:** V (high)  $\geq$  2 V; V (low)  $\leq$  0.8 V

**External increment:** advances HP 3488A to next programmed configuration on falling edge of TTL pulse.

**Channel closed:** indicates completion of new configuration; TTL pulse.

### Specifications for Opt. 016/HP 44476A

#### Microwave Switch Module

**Frequency Range:** dc to 18 GHz

**Isolation:** >90 dB

**Impedance:** 50 Ohms

**Insertion Loss:** <0.05 dB

**SWR:** 1.40

### Specifications for Opt. 018/HP 44476B

#### Microwave Switch Module

Refer to HP 3331XX specifications.

### Specifications for Opt. 019/HP 44478A and Opt. 020/HP 44478B 1.3 GHz Multiplexers

#### Input Characteristics

**Maximum Voltage:** 42V DC + AC Peak

**Maximum Current per channel:** 1 A DC or AC RMS

**Maximum Power per channel:** 24W, 24VA, or 44 dBm

**Impedance:** 50 ohms (Opt. 019/HP 44478A)

75 ohms (Opt. 020/HP 44478B)

#### AC Performance

	$\leq$ 10 MHz	$\leq$ 100 MHz	$\leq$ 500 MHz	$\leq$ 1.3 GHz
Insertion Loss (dB)				
$\leq$ (40°C, 95% RH)	<0.3	<0.7	<1.5	<3.0
$\leq$ (25°C, 40% RH), (Typ.)	<0.2	<0.5	<1.1	<1.9
Crosstalk (dB) <sup>1</sup>				
Channel-Channel				
Channel-Common	<-90	<-80	<-65	<-55
Group-Group, Module-Module	<-90	<-80	<-70	<-60
VSWR	<1.2	<1.25	<1.35	<1.55

### General Specifications

#### Environmental

Temperature: 0 to 55°C; humidity: 95%, 0 to 40°C

**Power:** 86-132 V/195-250 V, switch selectable; 48 - 440 Hz; 18 VA.

**Interface:** SH1AH1T6TE0L4LE0SR1RL1PP0DC1DT1E2

**Size:** 89 mm H (without feet) x 425 mm W x 292 mm D (3.5 " x 16.75" x 11.5"). Allow 76 mm (3") additional depth for wiring.

**Weight:** net: 8.5 kg (18.5 lb). Shipping: 16 kg (36.5 lb).

**Connectors** Removable screw terminal connector. Each terminal accepts 18-26 gauge (16-40 mils) wire, with strain relief for wiring. Option 012/HP 44472A VHF Switch: BNC connectors. Opt. 0161 HP 44476A and Opt. 018/HP 44476B Microwave Switch: SMA connectors.

### Ordering and Configuration Information

Switch Modules-Includes Terminal Connectors	Price
<b>Opt. 010/HP 44470A:</b> 10 Channel Relay Multiplexer Module	\$420
<b>Opt. 011/HP 44471A:</b> 10 Channel General Purpose Relay Module	\$420
<b>Opt. 012/HP 44472A:</b> Dual 4 Channel VHF Switch Module	\$625
<b>Opt. 013/HP 44473A:</b> 4x4 Matrix Switch Module	\$520
<b>Opt. 014/HP 44474A:</b> 16 Bit Digital Input/Output Module	\$420
<b>Opt. 015/HP 44475A:</b> Breadboard Module	\$180
<b>Opt. 016/HP 44476A:</b> Microwave Switch Module	\$1975
<b>Opt. 017/HP 44477A:</b> Form-C Relay Module	\$420
<b>Opt. 018/HP 44476B:</b> Microwave Switch Module	\$420
<b>Opt. 019/HP 44478A:</b> 1.3 GHz 50 ohm Mux	\$800
<b>Opt. 020/HP 44478B:</b> 1.3 GHz 75 ohm Mux	\$875

### Rack Mounting and Manuals

<b>Opt. 401:</b> Side Handle Kit (HP P/N 5061-1171)	\$40
<b>Opt. 907:</b> Front Handle Kit (HP P/N 5061-1170)	\$51
<b>Opt. 908:</b> Rack Flange Kit (HP P/N 5061-1168)	\$32
<b>Opt. 909:</b> Rack Flange with Handles (HP P/N 5061-1169)	\$75
<b>Opt. 910:</b> Extra Operating & Service Manuals	\$81
<b>Opt. W30</b> Three Year Hardware Support	\$90
<b>HP 3488A Switch/Control Unit</b>	\$125

- Ensure VXIbus Compatibility
- Develop VXIbus Products Fast
- Use HP Quality to Ensure Success



### Create Your Custom Designs in an Industry Standard Architecture

VMEbus Extensions for Instrumentation (VXIbus) is an instrumentation standard that has gained rapid industry acceptance. It is based on the IEEE 1014 (VMEbus) with enhancements to provide a powerful environment for instrumentation development and use.

HP is offering development tools that provide the knowledgeable VMEbus user with fast development of VXIbus products. These tools provide an environment that simplifies and speeds your development effort.

If you are developing instrumentation systems, you may require a few unique modules. Because the VXIbus is an open standard, you can design custom VXIbus products for your application and you can simplify this effort by using HP's development tools.

If you are a manufacturer of VXIbus products, you can use HP tools to speed product development and minimize your time to market.

### Design in the Most Popular VXIbus Sizes

Four instrumentation sizes are allowed in the VXIbus specification. The smaller A and B sizes are standard VMEbus card sizes. The larger C&D sizes are added by the VXIbus standard for higher performance instrumentation needing larger circuit boards. Smaller cards can be used in larger mainframes and can be securely mounted using carrier modules. Attributes of each size are:

- A and B sizes for medium performance, portability and lowest cost.
- C size for high performance, reasonable portability and medium cost.
- D size for specialized applications, highest performance and cost.

HP's VXIbus Development Tools aid you in designing C-size and smaller VXIbus modules. Using a C-size carrier you can develop A and B-size modules in a C-size mainframe.



# COMPUTER AIDED TEST

## Development Tools for VXIbus Products (cont'd)

These tools consist of the following:

- C-size VXIbus Mainframe
- C-size Slot 0/Translator Module
- C-size Register-Based Breadboard Module (with schematic)
- C-size Carrier for A or B-sized Modules
- C-size Chassis Shield (for RFI reduction between modules)
- VXIbus Development Software (for HP 9000 Series 300 computers)
- VMEbus Interface for HP 9000 Series 300 Computers
- VMEbus Preprocessor for HP 1650A and 16500A Logic Analyzers

### Save Design Time and Cost

These Hewlett-Packard Development Tools allow you to start your product development immediately without wasting time and resources creating your own development aids. Use these tools to quickly develop your circuitry on our register-based bread boards. Communicate with your module using an HP 9000 Series 300 computer and a VMEbus interface. Smooth this communication path further with special development software that runs on the HP 9000 Series 300 using Rocky Mountain BASIC (HP's advanced, interactive programming language).

### Ensure VXIbus Compatibility

These are the tools HP is using to develop VXIbus products. We are making these same tools available to aid you with fast product development and to ensure compatibility between VXIbus products. Many VXIbus specification requirements are incorporated directly into the tool set. You can concentrate on your unique product designs with less time spent learning the detailed requirements of the standard. For instance, we specify the necessary VXIbus communications circuitry for the breadboard. All you need to do is to load the board and concentrate on your own design.

The following capabilities and protocols are available and supported:

#### VXIbus Slot 0 and VMEbus System Controller

The Slot 0/Translator module provides the complete slot 0 and VME System Controller capabilities needed for a functioning backplane. These capabilities can be turned off, allowing this module to be used in any slot.

#### Resource Manager

Resource Manager functionality is built into the development software. This program can execute the VXIbus autoconfiguration procedure and display autoconfiguration, identification, and self test information for each device.

#### SYNC and ASYNC Trigger Protocols

The Slot 0/Translator module implements the SYNCHRONOUS and ASYNCHRONOUS trigger protocols for the VXIbus TTLTRG\* lines. These protocols may be interfaced to external sources or initiated internally.

#### Register Based Devices

Register based device development is simplified by the software tools and the HP 98646A VMEbus interface which can access the entire A16 and A24 address space. HP's register based breadboard (and schematic) aid in speedy development. On-board jumpers allow setting of device type and manufacturer's identification codes.

#### Message Based Devices

The Slot 0/Translator module together with the software development tools and the HP 98646A VMEbus interface implement the VXIbus word serial protocol. Use them to stimulate and test your message based devices. The Slot 0/Translator module can also be used with most VMEbus computers to execute the word serial protocol.

### HP Quality Lets You Concentrate on Your Design

As a product designer, you'll want to minimize any system problems that can distract you from your design effort. HP is dedicated to providing the highest quality development environment possible. High quality means a top-of-the-line VXIbus C-size mainframe with a 12 layer backplane that provides the best possible noise immunity, thus minimizing system integration problems. A positive pressure air flow system ensures clean air to all modules and eliminates the need to install panels on unused slots. Variable speed fans keep your modules cool without excessive fan noise and state-of-the-art logic analysis helps analyze any communication problems in your VMEbus or VXIbus system.

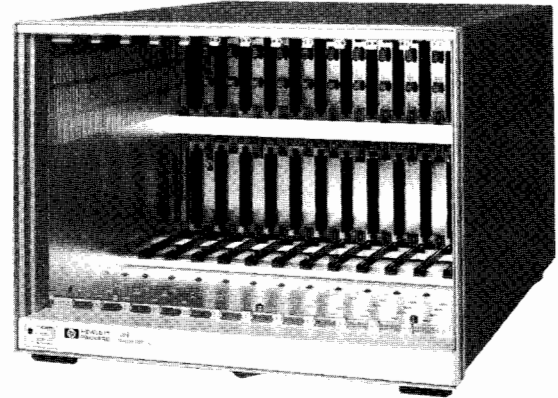

- 12 layer backplane gives the best performance and reliability.
- Positive pressure cooling system allows the designer the most flexibility.
- Variable speed fans mean a quieter design environment.
- All seven power supplies provide the reliability of over-voltage and over-current protection.
- Dip switches replace the usual VMEbus jumpers.

### Ordering Information

	* Price
<b>HP E1400A</b> C-Size VXIbus Mainframe	\$6600
<b>HP E1404A</b> C-Size VXIbus Slot 0/Translator Module	\$850
<b>HP E1490A</b> C-Size VXIbus Register-Based Breadboard Module	\$500
<b>HP E1408A</b> C-Size VXIbus A or B-Size Module Carrier	\$170
<b>HP E1409A</b> C-Size VXIbus Stainless Steel Chassis Shield	\$150
<b>HP E1495A</b> VXIbus Development Software	\$500
<b>HP 98646A</b> VMEbus Interface for HP 9000 Series 300 computers	\$1295
<b>HP 10344A</b> VMEbus Preprocessor Interface (16 bit address)**	
<b>HP 10344B</b> VMEbus Preprocessor Interface (32 bit address)**	
<b>HP P/N E1400-90003</b> VXIbus Specification	
<b>HP P/N E1400-90004</b> VMEbus Specification	

\*OEM and Volume discounts are available

\*\*Works with HP 1650A and 16500A Logic Analyzers

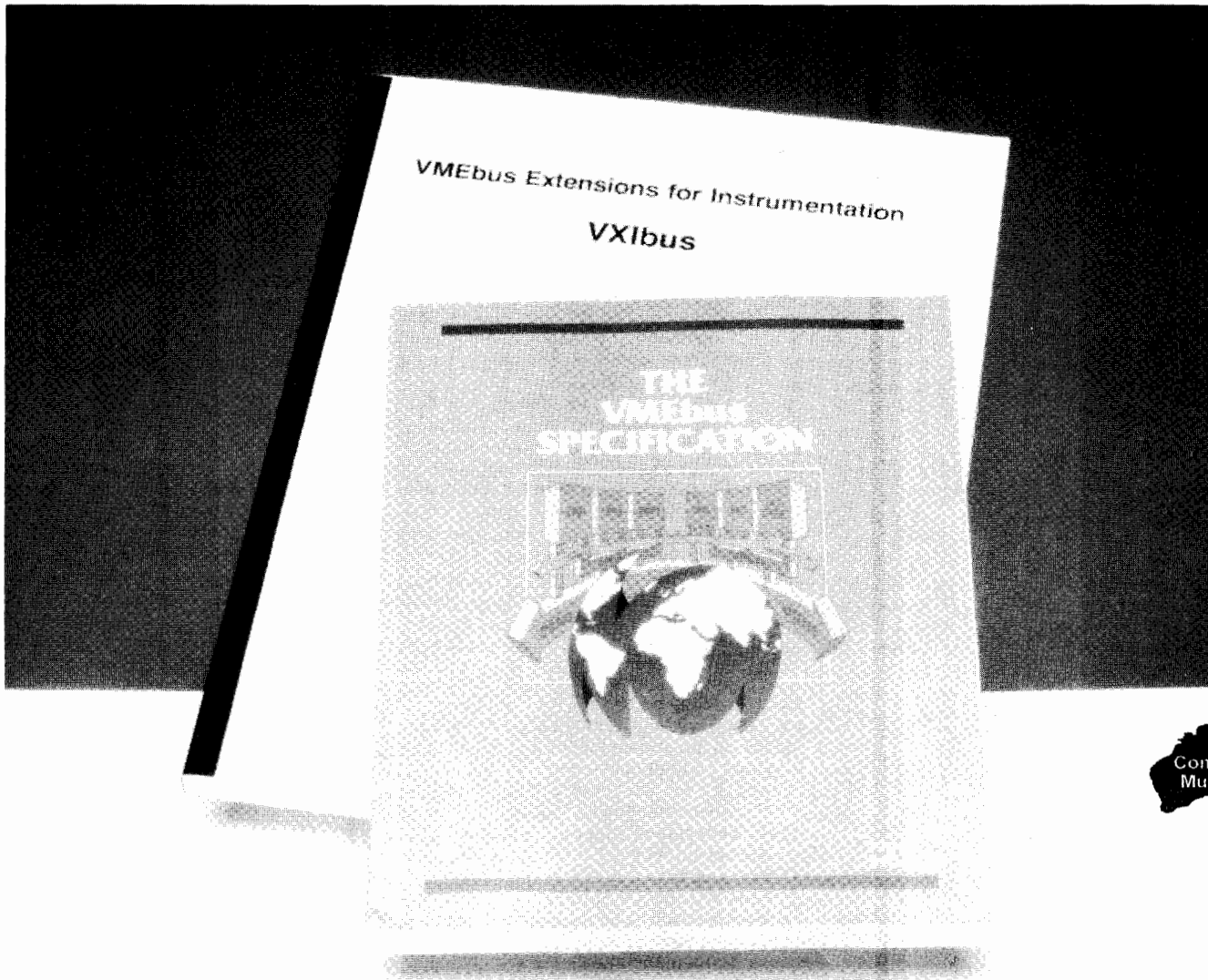

### The VMEbus

The architectural concepts of the VMEbus date back to Motorola's development of the 68000 microprocessor in the late 1970's. In late 1979, Motorola published a brief description of a 68000 oriented bus known as VERSAbus. Several revisions followed, the last being in July 1981.

At the same time, a new printed circuit board standard (IEC 297-3) was being developed, known as the "Eurocard" standard. In October 1981, Motorola, Mostek, and Signetics announced their agreement to support a line of cards based on the VERSAbus with Eurocard module dimensions, which was renamed VMEbus. There have been three releases of the VMEbus specifications, with the most recent, Revision C.1, published in April 1985. The VMEbus was recently standardized as IEEE 1014.

### VMEbus Definition

The VMEbus is an open system architecture primarily focused at computer systems, though there presently is a limited offering of instrumentation. VMEbus modules are approximately six inches deep and come in two

heights, about four inches and nine inches. The VXIbus specification refers to these as the A and B sizes respectively. The precise dimensions are specified by the Eurocard standard, which describes a family of printed circuit boards and their associated DIN connector locations. VMEbus modules are designed for 0.8 inch slot to slot spacing. The A size board has a single 96 pin connector known as P1, while the B size may include a P1 and P2 connector. Each of these DIN connectors consists of three rows of 32 pins a piece on 0.1 inch centers. Typically, these boards are positioned vertically in a frame with the P1 connector closest to the top. Neither the VMEbus nor the VXIbus mandates a physical orientation, since orientation is only an implementation issue not needed for compatibility. Many VMEbus systems are designed to accept boards horizontally.

The VMEbus specification allows a maximum of 21 modules. However, if installed vertically in a mainframe intended for mounting in a standard 19 inch rack, 20 is the practical maximum. VMEbus makes no particular provision for an extension chassis or frame to frame communication. Multiple

frame systems can be created by electrically buffering the VMEbus (at the loss of some bandwidth between cages) or by using standard data communication links that disguise the underlying VMEbus architecture. There are no EMC (electromagnetic compatibility) requirements dictated by VMEbus, either conducted or radiated, nor are there power dissipation limits or chassis cooling requirements. VMEbus has left these issues to the system integrator, while VXIbus addresses these issues more rigorously.

Although electrically and logically similar to the 68000 microprocessor architecture, the VMEbus interface has been specified broadly enough that it is not dependent on any particular processor, and many processors are already supported on VMEbus, including Intel's 80386. Many of the simpler VMEbus boards do not have processors at all.

A minimum VMEbus system requires only the P1 connector. All handshaking, arbitration, and interrupt support exists on P1, with P2 used to expand the system to 32 bits of address and data (A32 and D32). P1 will support 16 bit and 24 bit addressing

# COMPUTER AIDED TEST

## VXibus Tutorial (cont'd)

(A16 and A24), as well as 8 and 16 bit data paths (D08 and D16). The extra lines needed for A32 and D32 are contained on the center row of P2, while the outer rows are user defined. These undefined pins are typically used for interface connections, such as allowing a module to drive a chassis mounted connector, access an internal disk drive, or provide for module to module communication. VSB (VMEbus Subsystem Bus) is a standard "subsystem bus" that has defined P2 as an additional communication path for up to six modules. Multiple VSBs may exist within any one VMEbus system. This is important to note, because VXibus defines a subsystem of up to 13 modules and, like VSB, multiple VXibus subsystems may exist within any one VXibus system.

### VMEbus Market

The marketplace has demonstrated the open system nature of VMEbus. There are thousands of VMEbus cards available from a multitude of vendors. These cards are primarily computer oriented cards, though there are some data acquisition cards available which are primarily aimed at industrial processing and control.

There have been numerous requests for instrumentation modules for VMEbus. Size reduction and open standards are reasons driving customers toward VMEbus, though the high bandwidth of the VMEbus backplane is also considered a benefit, particularly for digital test and digital signal processing applications.

The most serious impediment to VMEbus based instrumentation is the lack of standards beyond that of VMEbus. In the spring of 1987, technical representatives from Hewlett Packard, Colorado Data Systems, Racal Dana, Tektronix, and Wavetek formed an ad hoc committee to engineer the additional standards necessary for an open architecture instrumentation bus based on VMEbus, the Eurocard standard, and other instrumentation standards such as IEEE 488.2. In July of 1987, they announced their agreement to support a common architecture of VMEbus Modular Instrumentation, named the VXibus.

### The VXibus

The VXibus is a modular instrument standard based on the VMEbus that is open to all manufacturers and is compatible with present industry standards.

VXibus is an acronym for VMEbus Extensions for Instrumentation. The VXibus specification details the technical requirements of VXibus compatible components, such as mainframes, backplanes, power supplies, and modules.

### The VXibus Extensions

VXibus retains P1 and the center row of P2 exactly as defined by VMEbus. This includes the 5 volt and  $\pm 12$  volt power pins on P1, and the additional 5 volt pins on P2. VXibus includes the A and B card sizes, and these modules remain totally VMEbus compatible. However, VXibus has made substantial additions to the VMEbus

specification oriented towards instrumentation that can best be described as an electromechanical superset and a logical subset.

### VXibus Modules

VXibus has added two Eurocard module sizes of about 13 inch depth referred to as the C and D sizes. These modules are 9 and 14 inches high respectively, and are placed on 1.2 inch centers. The C Eurocard is the same height as the VMEbus B size board, and may sport both the P1 and P2 connectors. The D size module is a triple high Eurocard that may include a P3 connector in addition to P1 and P2. The 1.2 inch module width allows feasible implementation of high density instrumentation modules while allowing enough space for shielding both sides of a module and inserting an optional chassis shield. It also has the added benefit of allowing a high degree of compatibility with the shorter and narrower A and B sizes by allowing them to be mounted on full length board carriers or adapters. These carriers/adapters may also shield the sides of standard VMEbus cards, giving them a high degree of electromagnetic compatibility with VXibus systems.

### VXibus Subsystems

A VXibus system may have up to 256 devices, including one or more VXibus subsystems. A VXibus subsystem consists of a central timing module referred to as Slot 0 with up to 12 additional instrument modules. P2 and P3 are completely defined in a VXibus subsystem. These 13 modules conveniently fill a standard 19 inch cabinet when mounted vertically on 1.2 inch centers. Many VXibus systems will consist only of a single frame with these 13 modules. A common configuration will load the Slot 0 module with system resources such as the VXibus mandated timing generation, the VMEbus required system controller functions, and a data communication port such as IEEE 488 or RS-232. Slot 0 may also include optional instrumentation. The other positions are general purpose slots for the user to mix and match modules. A single VXibus subsystem may have less than 12 additional slots, but may not have more. Any combination of VXibus subsystems may exist within a VXibus system. For instance, one VXibus system may consist of a frame with one Slot 0 and 12 VXibus modules extended to another frame that has a Slot 0 adjacent to three instrument slots, another Slot 0 with five instrument slots, and four standard VMEbus slots of undefined P2.

### P2 Connector Definition

As mentioned previously, a VXibus subsystem defines all P2 and P3 pins. The VXibus P2 adds a 10 MHz ECL clock, ECL and analog supply voltages, ECL and TTL trigger lines, an analog summing bus, a module identification line, and a daisy chain structure known as the local bus. The trigger lines serve primarily as resources for signaling between instruments in a VXibus subsystem, while the local bus lines are preferred for use within a multiple module instrument set (adjacent slots). The daisy chain local bus

use is left to the module manufacturer to define, and several classes of electrical signals are permitted. Allowed signals are TTL, ECL, low voltage analog, and analog up to 42 volts. A keying mechanism near the faceplate indicating that module's local bus class prevents incompatible classes from accidentally being placed adjacently and potentially causing a destructive condition. Typical uses of the local bus include creating an internal analog bus or a chain of serial digital signal processors. There are a total of 24 local bus pins on P2, 12 lines in and 12 lines out for each slot; thus creating a 12 line bus that may or may not be passed on to adjacent slots.

### P3 Connector Definition

The VXibus P3 connector adds many of the same resource types as described for P2, but is aimed at higher performance instrumentation. Included on P3 is a 100 MHz clock and sync signal, additional power pins of the same supply voltages, more ECL trigger lines, and 24 additional lines (48 pins) of daisy chain local bus. Also defined on P3 is a "star" trigger system where precision ECL trigger signals are routed through Slot 0 acting as a cross point switch. This allows very precisely matched trigger timing between modules regardless of module position.

### VXibus System Architecture

The VXibus device protocols define how modules are granted non-conflicting portions of the VMEbus address space. A device is typically a single module, but this is not required. Several devices may exist on a single module, and a single device may consist of multiple modules. 256 devices may exist in any one VXibus system, and are referred to by logical device addresses ranging from 0 to 255. A VXibus system configuration space is defined in the upper 16K of the 64K A16 address space. Each device is granted a total of 64 bytes in this space, which is sufficient for many of the simpler devices. Devices requiring additional address space have their address requirements readable in a defined register in the A16 address space. A "resource manager" reads this value shortly after power-on, and then assigns the requested memory space by writing the module's new VMEbus address into the device's offset register. This method positions a device's additional memory space in the A24 (16 Mbyte) or A32 (4 Gbyte) address space. If present day VMEbus cards are used in a system, the resource manager must position the VXibus devices around the space taken by the standard VMEbus cards.

Higher level communication protocols are defined to allow sharing of interface modules and other devices by multiple manufacturers.

Further information is available in the VMEbus and VXibus specification books. These are available through multiple sources. They can be ordered through HP as follows:

HP P/N E1400-90003 VXibus Specification  
HP P/N E1400-90004 VMEbus Specification

# COMPUTER AIDED TEST

## Multiprogrammer: User-Adaptable Instrumentation

Models 6940B, 6942A, 6944A and 6954A

593

- Build a test system tailored to your specific application
- Broad range of function-oriented I/O cards with a unified design
- Simultaneous and independent functions

- A cost-effective way to automate your test needs
- Isolated power supplies for analog functions
- Mainframe extenders for increased I/O capacity
- High-speed data capture and throughput

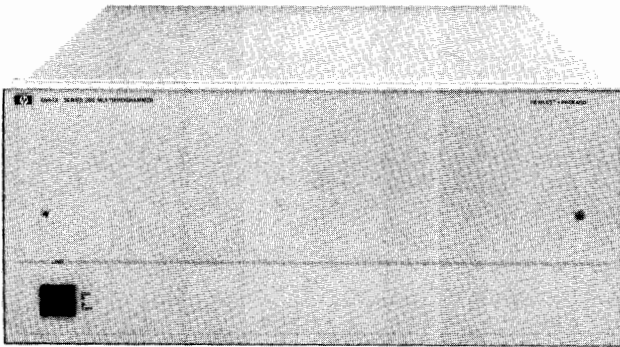

HP 6954A and HP 6944A

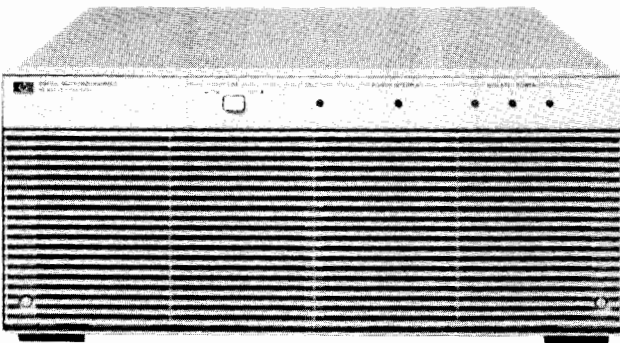

HP 6942A

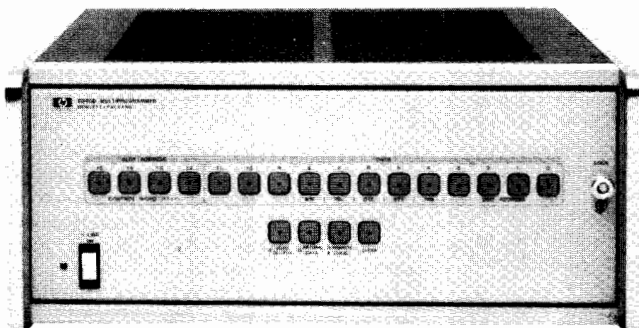

HP 6940B

### Introduction

Hewlett-Packard Multiprogrammer products provide solutions for a variety of data acquisition, control and test applications. The application flexibility is due to the architectural features of these products. The plug-in Multiprogrammer I/O cards allow card-to-card communication, isolated inputs and external triggering and provide a wide range of functions. The HP 6940B coupled with the Multiprogrammer Series I I/O cards offers low-cost solutions when operated on the GP-IO Bus. The HP 6942A Multiprogrammer and the Series II I/O cards are a medium-performance, medium-speed, HP-IB solution. For applications requiring a higher level of performance and more speed, the HP 6944A or HP 6954A Multiprogrammer should be considered for use with the Series II I/O cards.

The I/O cards have many benefits. Multiple-card configurations can be established that provide instrument-like functions. For example: high-speed scanning and multiple simultaneous-buffered analog-to-digital converters. Other features provide precise crystal-controlled timing or pacing of I/O operations. This allows the modular construction of instrumentation functions such as frequency measurement, time interval measurement and programmable pulse generation. The card-to-card communication feature allows the I/O operation of the Multiprogrammer to operate independently of the computer. The computer is then free to perform other tasks until it receives an interrupt from the Multiprogrammer. If the application requires the process to control data collection, it can be accomplished via the external trigger feature. This feature allows the process to time or pace operations independently of the computer. In addition, I/O data can be stored in the Multiprogrammer's plug-in memory system, allowing high-speed operation of other tasks the computer must perform.

### HP 6954A Features

- A Rugged Rack-mountable Test System in a Single Unit
- Built-in HP 9000 Series 310 Computer and 20 Megabyte Hard Disc
- Includes BASIC 5.0 and HP 14753A CAT Programming Package
- HP-IB, HP-HIL, RS-232, Audio and Video Interfaces
- Local or Remote Control via HP-HIL or RS-232
- Standard HP Multiprogrammer Series II I/O Cards
- Accepts HP 9000 Series 200/300 Memory, Accessory, and I/O Cards

### HP 6944A Features

- Data transfer rate of 220,000 readings/second
- HP 98633A interface to HP Series 200/300 computers
- Direct to disc at 200,000 words/second
- HP 14753A CAT programming package
- HP Multiprogrammer Series II I/O cards

### HP 6942A Features

- Data transfer rate 18,000 readings/second
- HP-IB interface
- HP 14753A CAT programming package
- HP Multiprogrammer Series II I/O cards

### HP 6940B Features

- Front panel control
- GP-IO or optional HP-IB interfacing
- Data transfer rate 20,000 readings/second
- HP multiprogrammer Series I I/O cards
- Temperature measurement capability



# COMPUTER AIDED TEST

## Multiprogrammer: User-Adaptable Instrumentation

Models 6940B, 6942A, 6944A and 6954A

### The Power of the Multiprogrammers

HP Multiprogrammers are used mostly for automatic testing applications for many industries including manufacturers of communications products, circuit boards, aircraft instrumentation, electronic ignitions, dashboard electronics and missile guidance systems. Whether it's high speed data gathering that's needed or the ability to perform parallel tasks while the data is being captured, an HP Multiprogrammer can provide the solution.

### Testing Final Assemblies and Subassemblies

HP Multiprogrammers let you configure a flexible, reliable and powerful automatic test and control system for the production environment. HP Multiprogrammers test the final product as well as subassemblies at different stages of the manufacturing process.

The increasing level of sophisticated electronic devices and circuits found in today's automobiles challenges the auto manufacturer to explore equally sophisticated test techniques. High-speed measurements and analyses of multiple channels are key requirements in order to keep the constantly moving assembly lines supplied with high-quality components. Multiprogrammer A/Ds and scanning systems provide this high-speed measurement and multiple channel capability. Output functions, such as the Voltage and Current D/A cards and relay cards in matrix configurations, are used to stimulate electronic subassemblies.

### Measure Vibration in Machinery

In vibration analysis applications, the ability to capture waveforms in a wide frequency range, analyze the data and present it using a single system is an important requirement. The 500,000 samples/second digitizing capability of the Multiprogrammer and its local memory cards allow a large range of frequencies to be acquired.

For applications such as oil exploration and electrical power generation where large rotating machinery is used, vibration analysis is critical in ensuring trouble-free operation. Multiprogrammers can capture data and store it in memory while the computer analyzes previously captured data. This results in an uninterrupted stream of information being presented to the tester. In addition, the Multiprogrammers can be set to be event-triggered so that an event-related condition starts the data gathering process without operator intervention.

### Product Development and Evaluation

Multiprogrammers are used for developing state-of-the-art products for many aerospace and defense applications. These types of industries require powerful and flexible test systems because of their constant stream of new projects with unique requirements. When testing newly developed prototypes, large quantities of data are usually required in order to fully characterize the behavior of a unit when subjected to differing stimuli. The HP 6944A Multiprogrammer captures data and continuously stores it to an external hard disc at rates up to 200,000 samples/second.

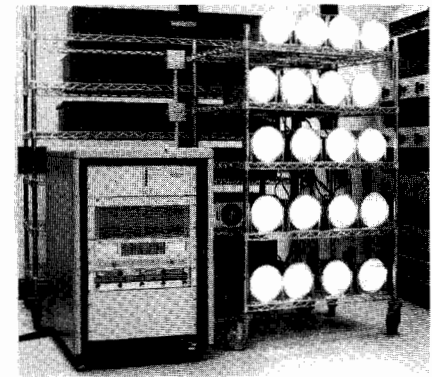
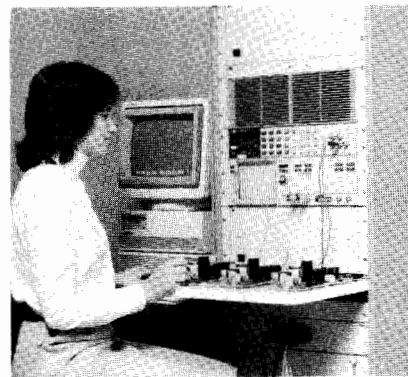
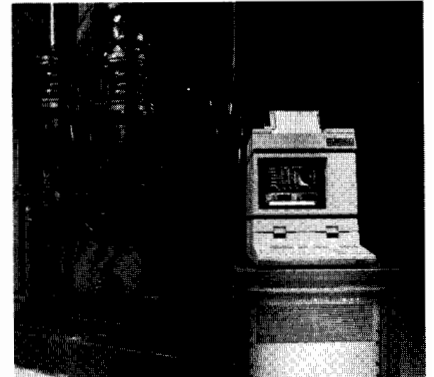
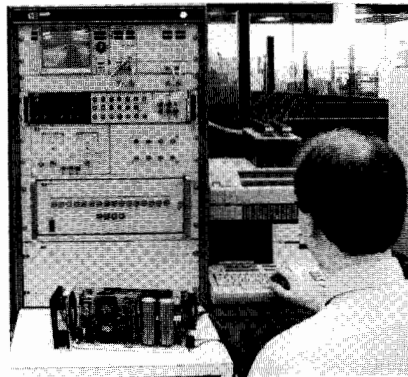
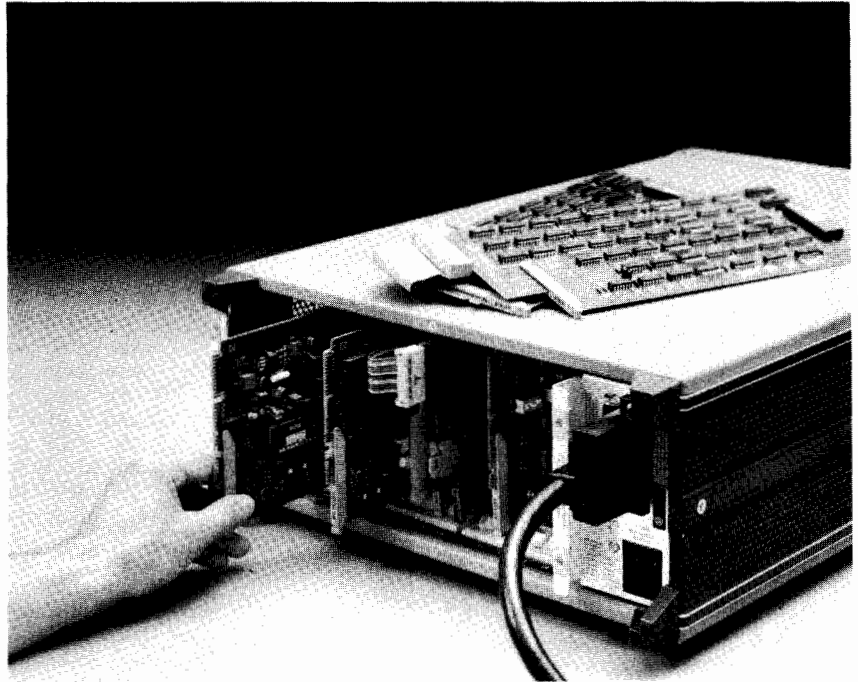

Failure analysis is another important product development process in military applications. A Multiprogrammer system can collect large quantities of data without the presence of an operator. If a failure does occur, the Multiprogrammer can stop the test and signal the operator.

### Component Evaluation

There is an increasing push for automation in the production environment to improve efficiency at all stages of the manufacturing process. For example, quality-conscious

manufacturers recognize the importance of thorough incoming component inspection that doesn't sacrifice smooth production flow.

Multiprogrammers satisfy these needs because of their speed and flexibility. Testing can be centrally controlled by a single operator or by several testers by linking a multiple-user computer system, such as the HP 1000 series, to HP 6942A Multiprogrammers. As a result, the manufacturing flow is uninterrupted and enhanced which leads to reduced manufacturing costs.

# COMPUTER AIDED TEST

## Multiprogrammer: User Adaptable Instrumentation

595

Model 6954A

- Built-in HP 9000 Series 300 Computer and 20 Megabyte Hard Disc
- Includes BASIC 5.0 and HP 14753A CAT Programming Package
- Controls up to 14 HP-IB instruments or peripherals

- Local or Remote Control via HP-HIL or RS-232
- Accepts standard HP Multiprogrammer Series II I/O Cards
- Accepts standard HP 9000 Series 200/300 Memory, Accessory, and I/O Cards

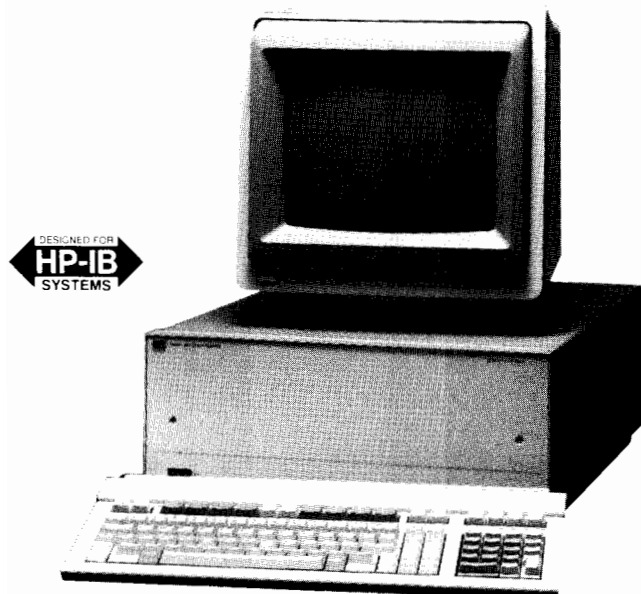

HP 6954A Option 001

### Description

The HP 6954A Multiprogrammer is the newest and most powerful addition to HP's family of Computer Aided Test products. The HP 6954A is a complete high speed data acquisition and control system in a single, compact, rack-mountable unit. The HP 6954A Multiprogrammer is suitable for applications in fields such as: electronic production test, automated electronic test, data acquisition, process control, and process/product characterization.

The HP 6954A Multiprogrammer features a built-in HP 9000 Series 300 System Processing Unit, One Megabyte of RAM, a 20 Megabyte Winchester disc drive, HP 98620B DMA card, RS-232, and HP-IB interfaces. The built-in HP-IB interface allows the HP 6954A to control up to 14 HP-IB instruments or peripherals. Connecting a keyboard and monitor to the HP 6954A allows it to be controlled locally. Or, you can control the system remotely via an RS-232 link to a terminal such as the HP 2623A or HP 3082A, a computer running a terminal software package such as The PORTABLE computer, or a host computer such as the HP 1000.

The HP 6954A has two card cages, one that accepts up to eight Multiprogrammer Series II I/O cards, and another that accepts up to three additional Series 200/300 memory, accessory, or I/O cards. You can expand the HP 6954A Multiprogrammer system's I/O capability by adding up to seven HP 6944A Multiprogrammers as extenders to give you 120 slots for standard Multiprogrammer Series II I/O cards. And when HP 6944A Multiprogrammers are used as extenders for the HP 6954A, no extra interface is required because a Multiprogrammer Interface is built into the HP 6954A.

The wide spectrum of capabilities offered by the Multiprogrammer Series II I/O cards gives the Multiprogrammer the capability to digitize analog data at up to 500 KHz, acquire up to 1 Megabyte of 16 bit data at rates up to 760 kHz, or continuously log data directly to internal disc at rates up to 54 kHz. Other I/O card stimulus and response functions include current output, voltage output, pulse output, switching, analog multiplexing, event counting, event sensing, and additional measurement and control functions offered on pages 598 through 600.

The HP 6954A can be used as a development station by simply adding the optional local control kit consisting of an HP keyboard and monitor. HP 9000 Series 200/300 BASIC 5.0 and the HP 14753A Computer Aided Test Programming package are included with the HP 6954A to give you one of the easiest to use instrument-oriented program development environments available. The HP 6954A is compatible with HP 9000 Series 200/300 software packages such as the DACQ/300 Data Acquisition Manager (HP 44458A/B) that features data management, data analysis, and data presentation.

HP has integrated and assembled the complete system into one rack-mountable unit: a powerful SPU and HP-IB interface for instrument control, a 20 Mbyte disc drive for program and data storage, 1 Mbyte of RAM, BASIC 5.0 and the CAT Programming package for easy program development, and two types of card cages for versatility and a large selection of I/O functions. The HP 6954A is one of the easiest, most cost effective ways to build an automated test system that is tailored to your specific application.

### Specifications

Plug in I/O card positions: A maximum of 8 Multiprogrammer Series II I/O card slots and 3 available HP 9000 Series 200/300 interface and accessory card slots (a fourth slot is occupied by the DMA card).

**Controller Interface:** Not applicable. Controller is built in.

**I/O Interfaces:** HP-IB, RS-232, HP-HIL, audio and composite video.

**Extender units:** Up to seven HP 6944A's can be linked to the HP 6954A using HP 14704A, B, or C interface cables.

**Maximum length of a link:** A link of up to seven HP 6944A's can extend nine meters long, maximum. This maximum length is the sum of all the HP 14704A, B, or C Interface cables.

**System Data Acquisition rate:** High data acquisition rates can be attained using Multiprogrammer I/O cards. For example, digital acquisition rates up to 1 MHz are possible using the HP 69791A Memory card and analog acquisition rates up to 500 kHz can be attained using the HP 69759A 500 kHz A/D.

**Data transfer rate:** Using the HP 98620B DMA card (takes up one slot of the four HP 9000 Series 200/300 interface and accessory card slots), data transfer rate between the Multiprogrammer I/O cards and the computer is up to 220,000 readings per second and direct to disc transfer of 200,000 words per second over HP-IB.

**Power Supplies:** All necessary power supplies for up to eight Multiprogrammer Series II cards, the controller, and up to four HP 9000 Series 200/300 interface and accessory cards are built into the HP 6954A. Three  $\pm 18$  V supplies (isolated from each other and from ground) are available for powering isolated I/O cards.

**Input Power:** 100/120/220/240 Vac (switch selectable), +5% to -10%, 47 to 63 Hz, 630 VA.

**Operating Temperature Range:** 0 degrees C to +55 degrees C.

**Dimensions:** 177.0 mm high x 425.5 mm wide x 597.0 mm deep (7 in. x 16.25 in. x 23.5 in.)

**Weight (without I/O cards):** Net, 26.4 kg (58 lb.) Shipping, 33.6 kg (74 lb.)

### Ordering Information

	Price
<b>HP 6954A Multiprogrammer</b>	<b>\$10400</b>
Option 001: Local Control Kit	\$595
Option 002: Delete BASIC 5.0 and HP 14753A	-\$1000
Option W30: Two Year additional warranty (cannot be ordered with Option W03)	\$200
Option W03: Warranty conversion to 90-day on-site	N/C
Option 908: Rack mount kit	\$45
Option 910: Extra Installation and Service Manual	\$35



# COMPUTER AIDED TEST

## Multiprogrammer: User Adaptable Instrumentation

Model 6944A

- Data transfer rate 220,000 readings/second
- Dedicated interface (HP 98633A) to HP Series 200/300 Computers

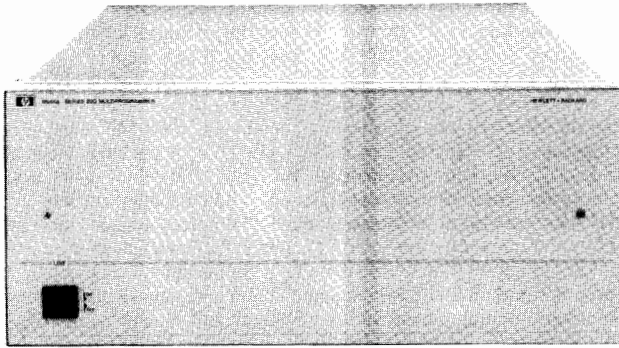

HP 6944A

### Description

The HP 6944A Multiprogrammer is a high-speed data acquisition and control system designed exclusively for use with HP Series 200/300 computers. The HP 6944A capitalizes on the HP Series 200/300 computer architecture by using the dedicated HP 98633A Multiprogrammer Interface and the HP 98620B DMA Controller to achieve high-speed data transfers.

The powerful HP Multiprogrammer Series II I/O cards provide a broad variety of I/O functions for the HP 6944A. These cards allow the user to configure the HP 6944A to implement many instrumentation functions such as high-speed scanning, analog waveform synthesis, limit checking and transient analysis.

The HP 6944A is programmed exclusively with the HP 14753A Computer Aided Test Programming Package. This software package effectively couples the flexible hardware architecture of the HP 6944A with the BASIC language system of the HP Series 200/300 Computers. The friendliness of this system is such that the system programmer only needs to be able to program in BASIC. The control statements are test oriented and closely linked to the application by a list of "Names" supplied by the user. An easy-to-use, menu-driven configuration process correlates the user-assigned "Names" to the system's I/O functions automatically from the BASIC program. The software, through the same menu-driven process, then leads the system programmer through the hardware configuration. The net result is fast program development, self-documented programs and the ability to maintain different configuration files on one disc.

### Features

The primary features of the HP 6944A evolve around the architecture of the HP 6944A, HP Series 200/300 Computers, and the Multiprogrammer Series II I/O cards.

The key feature of the HP 6944A is high-speed data transfer. With the HP 6944A, HP 69759A 500 kHz A/D, HP 69791A/92A High-Speed Memory I/O System, and the HP 98620B DMA Controller Card, data may be transferred to an HP Series 200/300 Computer at rates of 200,000 readings/second. Without the HP 98620B DMA Controller Card, transfer rates of nine kilowords/second are achieved.

A second key feature of the HP 6944A is its ability to unburden the HP Series 200/300 Computer from controlling each I/O task of the HP 6944A. This allows the HP Series 200/300 Computer time to perform numerical analysis or manage other instruments during these time periods.

- Direct-to-disc transfer rate of 200,000 words/second
- HP 14753A CAT programming package
- HP Multiprogrammer Series II I/O cards

### HP 6944A Specifications

**Plug in I/O card positions:** Maximum of 15 plug-in output or input cards per mainframe. Removable rear cover provides access to card slots.

**Computer interface:** The HP 6944A is connected to an HP Series 200/300 Computer via the HP 98633A Multiprogrammer Interface Card and HP 14704A, B or C cable.

**Extender units:** Up to eight HP 6944A Multiprogrammers can be connected to the Series 200/300 computer's HP 98633A Multiprogrammer Interface Card by using HP 14704A, B or C Interface Cables.

**Maximum length of a link:** A link of up to eight HP 6944A Series 200/300 Multiprogrammers can be nine metres long, maximum. This maximum length is the sum of the lengths of all the HP 14704A, B or C Interface Cables in the link.

**Power supplies:** All necessary power supplies for up to 16 I/O cards are built into each HP 6944A frame. Three  $\pm 18$  V supplies are isolated from each other and from ground, and are available for powering isolated I/O card circuits.

**Cooling:** Built-in forced air cooling draws air in through the side vents and exhausts air through the rear cover.

**Operating temperature range:** 0 degrees C to +55 degrees C.

**Power:** 100/120/220/240 Vac (switch, selectable), +5% to -10%, 47 to 63 Hz, 650 VA.

**Dimensions:** 177.0 mm high x 425.5 mm wide x 597.0 mm deep (7.0 in high x 16.25 in wide x 23.5 in deep).

**Weight** (without I/O cards): Net, 21 kg (46 lb); shipping, 28.6 kg (63 lb).

### Ordering Information

### Price

#### Step 1: Select the necessary quantity of HP 6944As.

HP 6944A Series 200/300 Multiprogrammer	\$3800
Option 908: rack mount kit	\$36
Option 910: extra operating and service manual	\$41
Option W03: converts 1 yr return-to-HP warranty to a 90-day on-site warranty	N/C

#### Step 2: Select the HP Series 200 Multiprogrammer Interface Card for HP 6944A.

HP 98633A Multiprogrammer Interface Card	\$400
------------------------------------------	-------

#### Step 3: Select number and lengths of cables required for connecting HP 98633A Interface to first frame.

An additional cable is needed for each HP 6944A frame used as an extender.

HP 14704A Multiprogrammer Interface Cable, 1 m (3.3 ft)	\$140
HP 14704B Multiprogrammer Interface Cable, 2 m (6.6 ft)	\$140
HP 14704C Multiprogrammer Interface Cable, 4 m (13.2 ft)	\$150

#### Step 4: Select HP 14753A to receive necessary CAT software and documentation (mandatory).

Select the option appropriate for the system controller.

HP 14753A Computer Aided Test Programming Package	\$2050
Option 044: software provided on 3 1/2" flexible discs	N/C
Option 042: software provided on 5 1/4" flexible discs	N/C
Option 910: extra set of documentation	\$76
HP 14753R: right to reproduce HP 14753A CAT programming package (documentation provided)	\$1020

# COMPUTER AIDED TEST

## Multiprogrammer: User Adaptable Instrumentation

Model 6942A

597

- Action-oriented instructions
- Isolated analog inputs and outputs
- Built-in self test

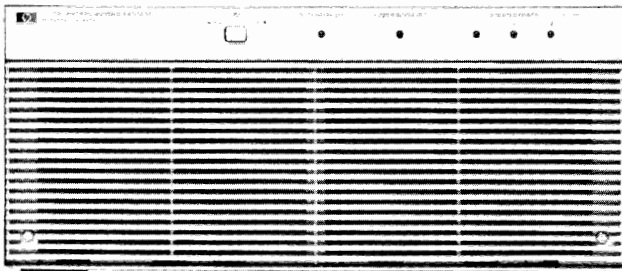

HP 6942A



### The Multiprogrammer Performs Operations in Parallel

With this one instrument you can control several processes at once. And, while you are controlling the processes, the Multiprogrammer can also be watching for interrupt conditions. The internal microprocessor manages all the parallel operations and monitors the alarm lines; when the operations have completed or if an alarm condition occurs, the Multiprogrammer interrupts the controller.

### How does the HP 6942A Connect With Your Controller?

The HP 6942A Multiprogrammer interfaces with your controller (desktop or minicomputer) using the HP-IB, Hewlett-Packard's implementation of IEEE Standard 488 and the identical ANSI Standard MC1.1. Data and status readback make use of the extended bus addressing features of the HP-IB.

### Programming Flexibility

Mnemonic, action-oriented instructions make the HP 6942A Multiprogrammer simple to learn and use. For instance, the output instruction "OP" works with all output cards. When you send an instruction, the internal microprocessor checks which type of card you are addressing and automatically converts the data to the proper format for that card. You select the units with which you want to program each card. Whether you want to use volts, millivolts, amps, degrees, feet, or any other units, the Multiprogrammer does the converting for you.

### Mainframe Memory Unburdens The Controller

The mainframe memory of the HP 6942A will accept up to 76 instructions from the controller at one time. This leaves your controller free for other processing activities while the Multiprogrammer works on the I/O operations. This mainframe memory may also be used to collect up to 1440 data readings and hold them until the controller is free to take them. (For even more data storage, up to 1 Meg words of data may be stored using the HP 69791A and HP 69792A Memory System Cards.

### Real Time Clock

Built-in real-time clock gives you time-of-day readings and pacing of measurements. The clock detects which power line frequency you are using, 50 Hz, or 60 Hz, and automatically synchronizes itself to this frequency. The range of the clock is 65,534 days, with resolution to a tenth of a second.

### Computers and Documentation

The HP 6942A can be operated with a wide variety of computers, including the HP Series 80, Series 200, Series 300, Series 1000, 9825, and 9845 computers. Documentation packages are available for these computers. Each one contains a User's Guide with programming examples, a utility program tape or flexible disc, operating and service manuals, and a binder to hold this material. One no-charge documentation option must be specified to select the documentation appropriate for your computer.

- Overlapped input and output
- Internal or external pacing
- Easy to configure

### Accessories

**HP 14700A extender kit:** this kit contains the transmission boards which go into the master mainframe (HP 6942A) and the last extender mainframe (HP 6943A) in the chain.

**HP 14701A intermediate extender kit:** when more than two mainframes are in a chain, the card in this kit must be used in each intermediate extender mainframe.

**HP 14702A chaining cable:** this is the cable which chains together the master and extender mainframes. One cable is required for each extender mainframe. Length: 1.5 m (5 ft).

**HP 14703A card edge connector:** extra connectors for the I/O cards may be ordered in addition to the one supplied with each I/O card.

### HP 6942A/6943A Specifications

**Plug-in I/O card positions:** maximum of 16 plug-in output or input cards per mainframe. Removable rear cover provides access to card slots.

**Computer interface (HP 6942A only):** the Multiprogrammer is connected to a controller via the Hewlett-Packard Interface Bus (HP-IB), Hewlett-Packard's implementation of IEEE Std. 488.

**Real time clock (HP 6942A only):** the built-in real time clock is automatically synchronized with the 50/60 Hz ac power line frequency. The clock is read and set with data in the form of days, hours, minutes and seconds with a resolution of 0.1 second.

**Extender interface kits (HP 6943A only):** each HP 6943A Extender requires one HP 14700A or 14701A Interface Kit and one HP 14702A Chaining Cable for operation with the HP 6942A.

**Maximum number of mainframes per chain:** up to seven HP 6943A Multiprogrammer Extenders may be placed in a chain with one HP 6942A Multiprogrammer.

**Maximum chain length:** a chain of mainframes can be up to 152 meters (500 feet) long. This maximum length is the sum of the lengths of all HP 14702A Chaining Cables used in one chain.

**Power supplies:** all power supplies for up to 16 I/O cards are built-in including three  $\pm 18$  V supplies isolated from each other and from the ground.

**Cooling:** built-in forced air cooling draws air in through the front panel and exhausts air through the ventilated rear cover.

**Front panel indicators:** five light emitting diodes on the front panel indicate power supply and self-test status.

**Operating temperature range:** 0°C to 55°C.

**Power:** 100/120/220/240 Vac (selectable), +5%, -10%, 47 to 63 Hz, 600 VA.

**Dimensions:** 177.0 mm high x 425.5 mm wide x 597.0 mm deep, (6.969 in. high x 16.250 in. wide x 23.500 in. deep).

**Weight (without I/O cards):** net, 20 kg (45 lb); shipping, 27 kg (60 lb).

**Accessories furnished:** PC board Extender Card (HP Part No. 5060-2792).

### Ordering Information







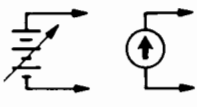

	Price
<b>Opt 010-233:</b> One Set Documentation/Software	N/C
<b>Opt 908:</b> Rack Flange Kit	\$41
<b>Opt 910:</b> Extra Manual	\$31
<b>Opt W03:</b> Converts 1 yr return-to-HP warranty to a 90-day on-site warranty	N/C
<b>Opt W30:</b> Two years additional hardware service	\$150
<b>HP 14700A</b> Extender Interface Kit	\$705
<b>HP 14701A</b> Extender Interface Kit	\$760
<b>HP 14702A</b> Chaining Cable	\$350
<b>HP 14703A</b> Spare Card Connector	\$85
<b>HP 6942A Multiprogrammer</b>	<b>\$5255</b>
<b>HP 6943A Multiprogrammer Extender</b>	<b>\$3860</b>

# COMPUTER AIDED TEST

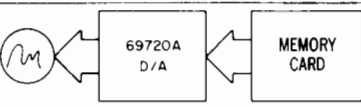
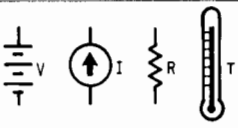
## Multiprogrammer Series II I/O Cards: Broad Functionality with a Unified Approach Models 69700A-69793A

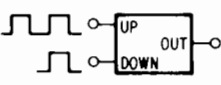
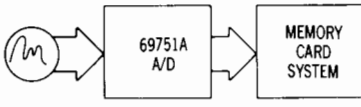
### Multiprogrammer Series II I/O Cards for the HP 6954A, 6944A, and 6942A

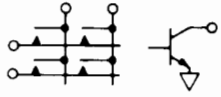
For a complete description of the Multiprogrammer Series II I/O Cards, ask for publication 5952-4175.

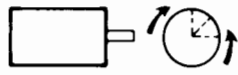
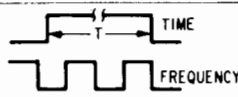
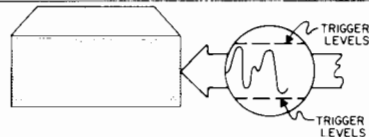
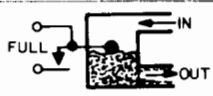
	Functions	Applications	Cards Used
STIMULUS	 <p>Programmable DC Voltage and Current</p>	The output voltage (up to 250V) and current (up to 1000A) of forty different HP power supplies can be programmed to provide bias in automatic test systems or control of electromechanical process equipment.	Resistance Output, HP 69700A-69706A; Power Supply Control, HP 69709A.
	 <p>Digital-to-Analog Conversion</p>	Twelve-bit voltage DAC's provide outputs for strip chart, x-y, and analog tape recorders as well as control of analog programmable instruments and stimulus of units under test. Control process equipment with 4-20 mA output.	Voltage DAC, HP 69720A; Current DAC, HP 69721A.
	 <p>Analog Waveform Synthesis</p>	The Memory card can continually supply pre-loaded data to the D/A card at rates of up to 100 kHz. Special waveforms may be loaded into the Memory card from the computer and used as stimuli for test and processes. The analog output is isolated from digital ground.	Memory card, HP 69790B; 69791A, 69792A Voltage DAC, HP 69720A; or Current DAC, HP 69721A.
MEASUREMENT	 <p>Voltage, Current, Resistance, and Temperature Measurements</p>	A/D converters may be used to measure voltages from $\pm 50\mu\text{V}$ to $\pm 100\text{V}$ in the presence of 250 V of common-mode noise. Connecting a resistor across the input permits current measurements for 4-20 mA current loops used in process control. Combine the A/D with the current DAC for resistance measurements.	High Speed ADC, HP 69751A, HP 69759A Integrating DMM HP 69761A
	 <p>Frequency Measurements</p>	The Pulse Counter card accumulates counts over a precise time interval when a Timer card is connected to the enable line of the Counter. The program divides the count by the time interval to measure frequencies from 1 MHz to less than 0.001 Hz.	Counter, HP 69775A; Timer HP 69736A, HP 69774A
	 <p>Pulse Counting Preset Up/Down</p>	The Counter may be preset to any value within the count range of 0 to 65,535 and can cause an interrupt when it rolls over. The Counter may be enabled and disabled by pulses or levels. The computer may read the count without disturbing the counting process.	Counter, HP 69775A, HP 69774A
	 <p>Offline Analog Acquisition</p>	Differential or single-ended signals may be digitized at rates up to 500 kHz by the A/D, and stored in the Memory system. Each Memory system can store up to one megawords. The digitizing process can take place independent of other Multiprogrammer activity.	High Speed ADC, 69751A; Memory cards, 69790B, 69791A/69792B. Integrating DMM HP 69761A.
	 <p>Scanner Systems</p>	Analog measurements from up to 960 channels may be acquired at 25,000 readings per second depending upon the scanner system configuration. Random access to any channel, as well as continuous scanning, are easily accomplished. (See Application Note AN316-3.)	Cards used: Scan Control, HP 69750A; FET Scanners, 69752A or 69755A; Relay Scanner, HP 69754A. Temp-scan HP 69753A; DMM HP 69761A; High Speed ADC HP 69751A; Memory card HP 69790B, or 69791A/92A
CONTROL	 <p>Digital Output and Switching</p>	Sixteen-bits of data in TTL, open collector, or SPST relay-contact form provide digital control of instruments and indicators. AC power, up to 6, can be switched to 12 loads with a HP 69731B, and HP 14570A AC Power Controller.	Digital Output, HP 69731B; Relay Output, HP 69730A; AC Power Controller, HP 14570A.
	 <p>Digital Input</p>	Digital input cards accept 16-bits of data from digital measuring instruments, push-buttons, switches, relays, and other digital devices in the form of logic levels or contact closures. Digital data sources with more than 16-bits of data use several digital input cards.	Digital Input, HP 69771A; Isolated Digital Input, HP 69770A.
	 <p>Stepping Motor Control</p>	The Stepping Motor card can produce from 1 to 32767 pulses at either of two outputs (CW or CCW) to control motor translators. Output pulses are also used for pulse-train update of supervisory control stations. The pulse rate (motor speed) is also programmable.	Pulse Train/Stepping Motor, HP 69735A, HP 69734A
	 <p>Time and Frequency Reference</p>	Crystal controlled timing pulses, programmable from 100 ns to 18 hours, may be used as a time-base reference for control, measurement, and data acquisition. Period, duty cycle, and number of pulses are all programmable.	Timer, HP 69736A or Pulse Train, HP 69735A, HP 69734A
ALARM	 <p>Level Detecting</p>	When signals cross preset levels, the Digital Input card can trigger the interrupt card to interrupt the computer. The alarm trigger levels can be programmed with the D/A or fixed with resistors.	Digital Input HP 69771A; Interrupt card, HP 69776A.
	 <p>Event Sensing</p>	A digital word may be used to trigger quick computer response with the interrupt card. The computer responds to the interrupt with a software routine. The interrupt may also cause immediate local response by triggering a preloaded output card.	Interrupt card, HP 69776A.

**HP 69752A 64 Channel FET Scanner Card**

Scans 64 single-ended channels ( $\pm 10.24$  V input signal range) at up to 25,000 readings per second. Cards cascable to 960 channels in a single mainframe.

**HP 69755A 16 Channel FET Scanner Card**

Same as 69752A, except scans 16 channels.

**HP 69754A 32 Channel Relay Scanner Card**

Scans 32 single-ended (16 double-ended) channels with a  $\pm 100$  V input signal range at speeds up to 1000 readings per second (625 readings double-ended). Switches currents up to 50 mA.

**HP 69750A Scan Control/Pacer Card**

Provides all pacing and control functions for the scanner cards listed above. One required for each group of scanner cards (maximum of 15 cards—see data sheet for further clarification).

**HP 69709A Power Supply Control Card**

Used for full system control of 6024A and 6012A Autoranging Power Supplies.

**HP 14728A Buffered A/D Cable**

Used to connect 69751A and 69790B in a buffered A/D configuration.

**HP 69700A-69706A Resistance output cards:** the output of each of these cards is a programmable resistance value. Twelve mercury wetted relay contacts close across binary weighted precision resistors in a series string. The cards are designed to program the voltage or current output of an HP power supply with option 040.

**HP 69720A D/A voltage converter card:** provides a high speed, bipolar output voltage programmable from  $-10.240$  V to  $+10.235$  V up to 5 mA load current.

**HP 69721A D/A current converter card:** provides a bipolar  $-20.480$  mA to  $+20.475$  mA current output.

**HP 69730A Relay output card:** provides sixteen independent, normally open, mercury wetted relay contacts. Contacts rated at 100 Vdc; or 1 Amp; and 28 VA.

**HP 69731B Digital output card:** provides sixteen TTL or CMOS compatible outputs, or sixteen 100 mA open-collector switches.

**HP 69735A Pulse train output/stepping motor control card:** generates up to 32767 pulses at a programmable frequency.

**HP 69736A Timer/pacer card:** outputs a programmable pulse from one microsecond to eighteen hours or a programmable square wave.

**HP 69751A A/D converter card:** this card measures bipolar dc voltages in one of four ranges,  $\pm 100$  mV,  $\pm 1$  V,  $\pm 10$  V, or  $\pm 100$  V, with 12 bit resolution at up to 33,000 readings per second.

**HP 69770A Isolated digital input card:** breaks the path of potential ground loops with an optically coupled isolator in each of the sixteen digital input lines.

**HP 69771A Digital input/analog comparator card:** monitors up to sixteen contact closures, switches, TTL signals, CMOS signals, or analog signals. The switching threshold can be set to any value between  $\pm 9.5$  volts by a screwdriver-adjustable potentiometer on the card or may be externally programmed.

**HP 69775A Counter/totalizer card:** counts contact closures, TTL or CMOS logic level pulses, or analog waveform transitions in the range of 0 to 65,535.

**HP 69776A Interrupt card:** compares up to sixteen logic level or contact closure inputs with a sixteen-bit reference word and interrupts for =,  $\neq$ , <, > conditions.

**HP 69790B Memory card** (occupies 2 I/O slots): provides 4096 16-bit words for use with the DAC cards or the ADC cards or for other input/output tasks that need to run independent of other Multiprogrammer or computer tasks. Several Memory cards may be used to implement truly simultaneous operations.

**HP 69793A Breadboard card:** the generalized grid area on this card may be used for mounting custom circuits.

\$1,235

\$565

\$930

\$670

\$980

\$255

\$565-615

\$720

\$930

\$565

\$415

\$515

\$515

\$980

\$670

\$615

\$745

\$565

\$1,010

\$153

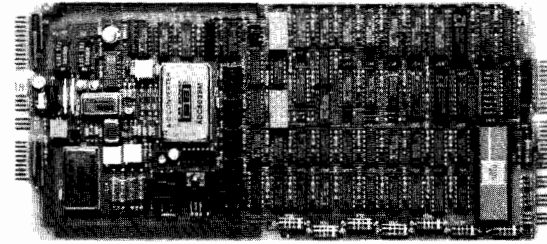

HP 69759A

**HP 69759A - 500 kHz A/D**

The HP 69759A 500 - kHz A/D converter measures bipolar voltages in four programmable ranges,  $\pm 100$  V,  $\pm 10$  V,  $\pm 1$  V, and  $\pm 100$  mV. The digitized values may be read directly by the controller or transferred into HP 69791A and HP 69792A memory buffer cards available for the Multiprogrammer system. Use of memory buffers permits simultaneous digitization at rates up to 500 kHz per channel. Scanning subsystems designed specifically to work with the HP 69759A card provide additional measurement flexibility and permit expansion up to 7168 channels. Timebase and triggering functions may be added using other Multiprogrammer cards to form a complete analog measurement system that is precisely tailored to the requirements of the specific application.

Application Note 316-5, Data Capture, describes several ways that the HP 69759A can be used with other Multiprogrammer cards to solve several different applications. These descriptions include cable diagrams and program listings for both the HP 14752A and the HP 6942A native instructions.

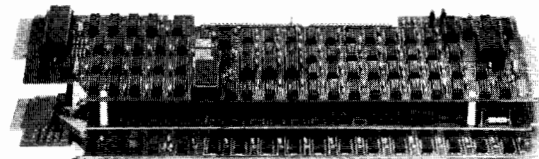

HP 69791A

**HP 69791A/92 - Memory System**

The HP 69791A and HP 69792A Memory Cards form a buffer used to perform input and output tasks without intervention from the controller. A memory card buffer can be used for inputs or outputs, or both. Data can be acquired at up to 760 kilowords/second or sent at up to 400 kilowords/second.

A memory card buffer has one HP 69791A Memory Card and up to five HP 69792A Memory Expansion Cards for a maximum memory size of 1M (1,048,576 16-bit words). The HP 69791A holds 64k (65,536 16-bit words) and the HP 69792A holds 192k (196,608 16-bit words). The memory card buffer functions as a single memory, regardless of how many HP 69792As are added.

The memory card subsystem can be used with the HP 69751A or HP 69759A A/D cards to input digitized analog measurements. Up to eight HP 69759A A/D Cards can be multiplexed into a single HP 69791A/69792A memory buffer. The A/Ds can be triggered by the same timebase for truly simultaneous readings which are then stored in sequential memory locations. This reduces memory costs and the number of mainframe slots required.

**Ordering Information**

HP 69759A A/D Converter  
HP 69791A Memory Card  
HP 69792A Memory Card

**Price**

\$2350  
\$1530  
\$1020

**COMPUTER AIDED TEST****Multiprogrammer Series II I/O Cards**

Models 69700A-69793A



HP 69734A

**Description****HP 69734A Timebase**

The HP 69734A Timebase card is a fully programmable timing or pacing source for a wide range of applications. It has over twenty timing modes including one-shot, squarewave, pulse and a variety of triggered modes. The HP 69734A Timebase is capable of generating pulses from 100 ns to 18.2 hours or squarewaves from 5 MHz to 7.6  $\mu$ Hz. In DUAL mode the output waveform switches between two frequencies in response to triggers or detection of burst completions. Using external data allows generation of arbitrary serial waveforms with individual half-cycle durations determined by data supplied to the edge connector.

Positive and negative true outputs are available with 50-ohm drive capability. The HP 69734A Timebase can drive a wide variety of industry standard stepper motor translators with either CW/CCW pulse trains or pulse/direction requirements. The HP 69734A Timebase card provides closed loop stepper motor control when it is used in conjunction with the quadrature detection capability of the HP 69774A Universal Counter card.

Version A.01 or newer is required when using the HP 14753A CAT Programming Package.

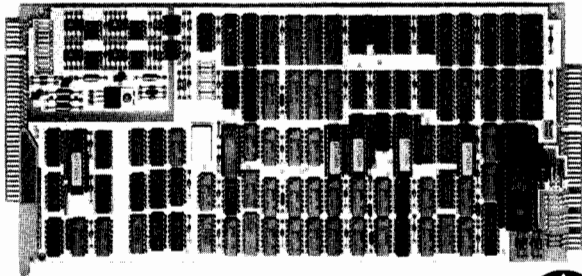

HP 69774A

**HP 69774A Universal Counter**

The HP 69774A Universal Counter is a fully programmable counter with the following five functions: frequency, period, time interval, event counting, and quadrature detection. The analog inputs of the counter can be programmed to respond to either levels or transitions. The polarities of the inputs are also programmable.

The card has three operating modes: single 32-bit, dual 16-bit, or continuous. In the 32-bit mode the card functions as a cascade counter capable of counting  $2^{32}-1$ . All measurement functions can be used in 32-bit cascade mode. In dual 16-bit mode, the card can measure two independent frequencies, accumulate event counts from two independent sources, or measure the period of one input while counting events on the other. Continuous mode allows instantaneous measurement of frequency, period, or time interval. Because the continuous mode eliminates "dead-time" (the time that the gate is closed for housekeeping tasks) the HP 69774A frequency pulse train as is found in the operation of rotating machinery.

Version A.01 or newer is required when using the HP 14753A CAT Programming Package.

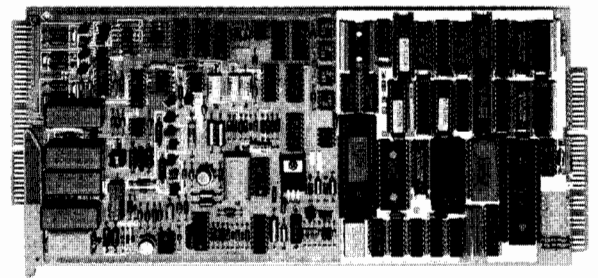

HP 69761A

**HP 69761A Integrating DMM**

The HP 69761A Integrating Digital Multimeter is a fully programmable general purpose DMM that features an on-board memory capable of storing up to 13K readings with 16-bit resolution. The DMM card occupies only a single Multiprogrammer I/O slot making it ideal for applications where card slots are at a premium.

The HP 69761A has the following functions: DC volts (6 ranges), true RMS AC volts (5 ranges), and 2-wire or 4-wire ohms (6 ranges). The measurement ranges are as follows:

- 2 microvolts to 250 volts in DC
- 5 microvolts to 250 volts in true RMS AC
- 2 milliohms to 16 Megohms in 2 or 4-wire ohms
- AC frequency bandwidth is 32 Hz to 50 kHz to 15 readings/second with 13-bit resolution. For increased accuracy the DMM card has an autozero feature that can be enabled either on command or interleaved between scan periods.

The HP 69761A also has the ability to control up to 15 HP 69753A Temperature Scanner cards. An on-card pacer controls the rate of scan and time between bursts. The DMM is optimized for temperature measurement applications because part of the on-board memory buffer can be used for downloaded thermocouple normalization tables allowing the DMM to make temperature readings directly in degrees Centigrade.

Version A.02 or newer is required when using the HP 14753A CAT Programming Package.

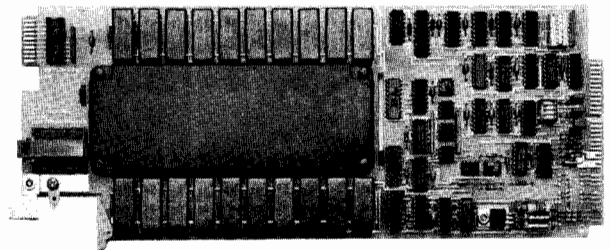

HP 69753A

**HP 69753A Temperature Scanner**

The HP 69753A Temperature Scanner card provides increased flexibility to your Multiprogrammer system when used with an HP 69761A Integrating DMM or HP 69750A Scan Control/Pacer card. This combination allows 16-channel temperature measurements and is expandable to 240 channels. The HP 69753A performs Hi/Lo 2-wire switching for thermocouple measurements and allows 4-wire RTD measurements as well. The on-board isothermal block contains a temperature reference. The HP 69753A can be used in temperature measurement applications where low thermal offset is required, as in heat flow analysis or thermal mapping.

Version A.01 or newer is required when using the HP 14753A CAT Programming Package.





- Easy to use menu entry
- Faster software development
- Improved HP 6942A performance

#### Description

The HP 6954A, HP 6944A and the HP 6942A are easy to use computer-aided test systems that improve productivity by enabling you to implement your testing requirements more quickly. This is achieved through the use of a companion software package. The HP 14753A is a powerful CAT programming package which replaces the standard two-letter mnemonics of the HP 6942A Multiprogrammer and is the standard programming language for the HP 6944A and HP 6954A Multiprogrammers.

These systems are friendly and easy to use. Mnemonic-type language is not needed to program either the HP 6954A or the HP 6944A. In addition, the HP 14753A will increase the performance speed of the HP 6942A. The CAT programming package supports all of the Multiprogrammer Series II I/O cards.

#### CAT Programming Package

The CAT programming package is a comprehensive collection of software routines that provide the ATE system designer with a high-performance linkage between the BASIC language and Multiprogrammer hardware. Both friendliness and higher performance are combined in the software through an architecture which optimizes total system performance.

Friendliness is achieved by replacing traditional "computer language" statements with test-oriented commands. Communication with all supported instrumentation is via "functional names", chosen by the user, which have a close relationship with the function performed. For example, in the menu below, the name "value", is used to program a HP 69720A Voltage D/A Converter. This lets you program in terms that are familiar to you resulting in programs which are virtually self-documenting. Friendliness is further enhanced by convenient menu entries, which make it easy to enter all function names and parameters.

The CAT programming package reduces the amount of software written by the user thus speeding program development. Productivity is improved by shortening test development time. To create test software, the user enters functional names and other data into a series of menus. Then a program is written in Series 200/300 BASIC to handle all sequencing, computational, and decision-making operations. Whenever a stimulus, acquisition or control function is desired, the BASIC program is instructed to call a routine from the CAT programming package.

#### Features

Some of the CAT programming package features are highlighted in a menu below. The timeout feature can generate an error if an operation has not completed in a specified time. Since the error can be trapped like any other BASIC error, corrective action can be programmed to occur automatically. Limit-checking prevents out of range values from being executed, and data conversion permits programming with user specified units. Initial values can also be specified and, at run time, sent to all instrumentation with a single command.

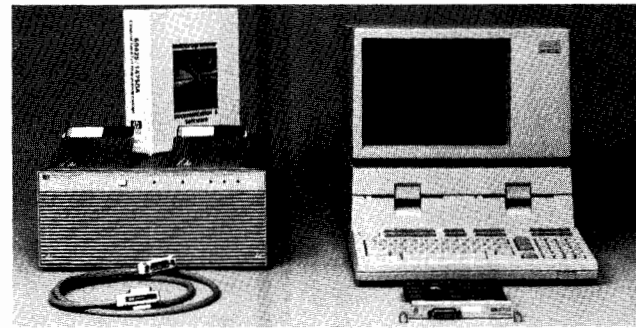
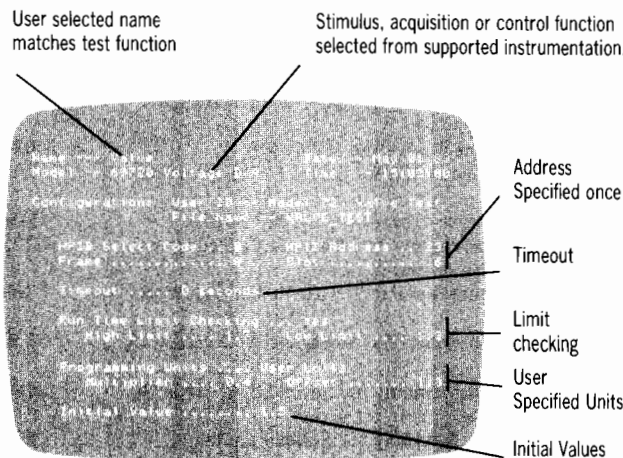

#### Multiprogrammer Series II I/O Cards

The CAT programming package supports the Multiprogrammer Series II I/O card functions, described on pages 593 and 604, and four popular multiple-card functions. These include combinations such as using a high-speed scanner, A/D, and memory card together. In addition, the HP 3478A 5 1/2-digit Multimeter is supported for applications requiring high-accuracy and high-resolution measurements.

#### HP 6900 Series Multiprogrammer

The Multiprogrammer is a high-performance mainframe that provides the necessary interface for up to sixteen plug-in cards. Optional Multiprogrammer Extenders can be added to a system to further expand its capabilities. Up to seven Extenders, each holding up to sixteen plug-in cards, can be chained to one mainframe.

The new HP 6954A is a Multiprogrammer mainframe and controller in a single compact unit that contains an HP Model 310 Computer, a 20 Mbyte hard disc (containing HP BASIC 5.0, 14753A CAT Software, and utilities), built-in HP-IB, RS-232, HP-HIL, and video interfaces. An internal HP 98633A type interface is also included. The HP 6954A, capable of being the system controller in an HP-IB system, comes with a DMA card for high-speed data transfer and supports up to 3 additional DIO cards for flexibility. It accepts up to eight Multiprogrammer Series II I/O cards and, if more card slots are needed, just add up to seven HP 6944A Multiprogrammers as extender units.

The HP 6944A Multiprogrammer is a high-speed mainframe that has 16 slots available for Series II I/O cards. Up to eight HP 6944A Multiprogrammers can be controlled by a Series 200/300 computer via an HP 98633A interface.

The HP 6942A Multiprogrammer has 16 card slots for Series II I/O cards. Up to 128 card slots become available by adding HP 6943A Multiprogrammer Extender units. Although the HP 6942A can be programmed by any HP-IB computer using the HP 6942A internal instruction set, programming the HP 6942A is simplified by using the HP 14753A CAT Programming Package and a Series 200/300 computer.

#### System Performance Specifications

Mainframe	HP 6942A	HP 6954/44A
Interface	HP 98624A	HP 98633A
CAT Programming Package	HP 14753A	HP 14753A
Single Data Point Input	1.9 ms	1.5 ms
Single Data Point Output	2.1 ms	1.4 ms
Scaling to User Units	add 0.35 ms	add 0.35 ms
Interrupt Response Time	13.7 ms	13.7 ms
Maximum Block Transfer Input	12,500	180,000*
Maximum Block Transfer Output	18,000	30,000

\*HP 98620A DMA controller required.

#### Product Selection Guides

To order the HP 6954A, 6944A or 6942A, it is recommended that technical data sheet 5952-4175 be used.

#### Ordering Information

Ordering Information	Price
HP 14753A Computer Aided Test Programming Package	\$2050
Opt 044 3 1/2" Flexible Discs	N/C
Opt 042 5 1/4" Flexible Discs for 9826/9836	N/C
Opt 910 Extra Set of Documentation	\$ 76
HP 14753R Right to Reproduce HP 14753A CAT Programming Package (Interface and Documentation provided)	\$1020



# COMPUTER AIDED TEST

## Multiprogrammer: Automatic Test, Data Acquisition and Control

Model 6940B

- Front panel control
- GPIO or HP-IB
- Data transfer rate 20,000 readings/second

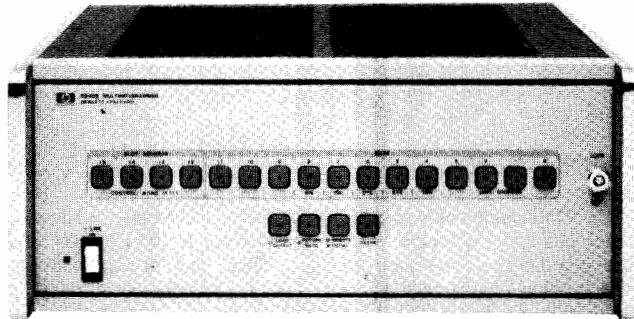

HP 6940B

### Description

The HP 6940B Multiprogrammer is a low-cost, medium-speed data acquisition and control system designed to be used with controllers or computers via the GP-IO, a 16-bit parallel interface bus. The HP 6940B is supported by a full complement of I/O cards. These I/O cards provide a broad range of instrumentation functions for acquisition, stimulus, measurement and control.

The HP 6940B is programmed by a set of word formats and octal coding. There are three word formats: a control word that selects the operating mode, a data word used to select and control output cards, and an address word to select and control an input card.

The HP 6940B may also be used as an HP-IB product. This requires an HP 59500A Multiprogrammer Interface Kit. This kit provides conversion of the HP-IB format to 16-bit parallel format.

### Features

A full-feature, front-panel switch register permits manual programming of all Multiprogrammer output, input and control functions. Fault isolation or manual system checkout of the computer, multiprogrammer or external devices is accomplished from the front panel.

Another feature of the HP 6940B is isolation of analog cards. Isolation from system ground is provided on analog cards. The HP 6940B has four isolated bias power supplies available to independently power the output circuitry of up to four groups of cards.

The HP 6940B Multiprogrammer has the capability of growing to meet the user's needs. Up to 15 HP 6941B extenders can be added to the system, allowing up to 240 I/O slots to be programmed from a single computer interface. The HP 6941B Multiprogrammer Extender has a blank front panel and all interfacing is provided in the HP 6940B Multiprogrammer.

### Specifications

**Plug-in I/O card position:** Maximum of 15 plug-in input or output cards per mainframe.

**Computer Interface:** Can be interfaced using the GP-IO, which requires an I/O slot of the computer and a GP-IO interface card. An HP 59500A Multiprogrammer Interface Kit is required for use on the HP-IB.

**Extender Units:** Up to 15 HP 6941B extenders can be chained together to create 240 programmable I/O slots. Extenders may be separated from one another by up to 30 metres.

**Data transfer rate:** 20,000 readings/second using the GP-IO interface.

**Cooling:** Natural convection

**Operating temperature range:** 0 to +55 degrees Celsius.

**Power:** 100/120/220/240 Vac (selectable), +5%, -10%, 48 to 440 Hz, 230 watts.

**Dimensions:** 172.2 mm high x 425.4 mm wide x 539.8 mm deep (6.78 in high x 16.75 in wide x 21.25 in deep).

**Weight (without I/O cards):** 15.9 kg (35.0 lb) net, 19.5 kg (43.0 lb) shipping.

- Temperature measurement capability
- Multiprogrammer Series I I/O cards

### Ordering Information

#### Step 1 - Select controller

Controller	ROM HP P/N	Description
HP-85B		HP-IB: Option 085 GP-IO: Option 185
HP-86B	00087-15003*	HP-IB: Option 085 GP-IO: Option 185
HP-87XM	00087-15003*	HP-IB: Option 085 GP-IO: Option 185
HP 9826A	N/A	BASIC: Option 016 HPL: Option 016
HP 9836A	N/A	Option 016
HP 1000	N/A	Option 010

\*Requires HP 8936A ROM drawer.

#### Step 2 - Select interface

Interface	GP-IO	HP-IB
HP-85B	HP 6940B Opt 185	HP 59500A and HP-85B Opt 007
HP-86B*	HP 6940B Opt 185	HP 59500A
HP-87XM*	HP 6940B Opt 185	HP 59500A
HP 9826A	HP 98622A Opt 003	HP 59500A, includes 2-metre HP-IB cable
HP 9836A	HP 98622A Opt 003	HP 59500A
HP 1000A	HP 14550B	HP 59500A and HP 59310B

\*When ordering an HP-86B or HP-87XM and using HP-IB interface, an HP-IB cable must be ordered.

#### Step 3 - Determine I/O card set

Select I/O functions from Series I I/O cards (See page 603).

#### Step 4 - Select number of mainframes

	Price
HP 6940B - holds up to 15 I/O cards plus one HP 69351C voltage regulator card.	\$3675
<b>Option 10:</b> HP-1000	N/C
<b>Option 85:</b> HP-85B HP-IB	N/C
<b>Option 185:</b> HP-85B GP-IO	\$615
<b>Option 016:</b> Consists of these four items: HP 9826A BASIC, HP 9826A HPL, HP 9836A BASIC, HP 9836A HPL	N/C
<b>Option 908:</b> Rack Mount Hardware for HP 6941B Extender, additional 15 I/O slots	\$41
<b>Option 908:</b> Rack Mounting Hardware	\$3030
HP 14541A Extender Cable; one for each HP 6941B	\$41
	\$225

#### Step 5 - Determine accessories

HP 59500A Multiprogrammer Interface; required for each HP 6940B on the HP-IB	\$1820
------------------------------------------------------------------------------	--------

### Accessories

HP 14540A Main Input Cable Assembly, 3.6 m (12 ft)	\$335
HP 14541A Chaining Cable, HP 6940B to HP 6941B	\$225
HP 14550B Multiprogrammer Interface Kit for the HP 1000	\$2120
HP 14551A Service Kit for the HP 6940B	\$3030
HP 14555A Connector Kit for Series I Multiprogrammer I/O cards	\$25
HP 14556A Software Library for the HP 9825A	\$204
HP 14557A Power Supply Interconnect Cable for the HP 69520A Programming Card	\$295
HP 14558A Termination Panel; with 40 dual-screw terminals	\$230
HP 14560A Cable Assembly for Series I I/O cards; 15 conductors	\$130
HP 14561A Cable Assembly for Series I I/O cards; 30 conductors	\$180
HP 14562A Cable Assembly for Series I analog I/O cards; two shielded conductors	\$90

### Power Supply Programming

#### HP 69500A-69513A Resistance Programming Cards

\$405-\$475

HP 69500A is supplied without resistors. The HP 69501A-69506A are single output, 12-bit resolution cards designed to program a single HP power supply equipped with Option 040. The HP 69510A-69513A are dual-output cards with six-bit resolution designed to program the current output of HP power supplies equipped with Option 040.

#### HP 69520A Power Supply Programming Card

\$590

Provides full system control of HP 6023A, 6024A and HP 6011A, 6012A autoranging power supplies. Requires HP 14557A interconnect cable.

### Temperature Measurement

#### HP 69423A Low Level A/D and Scanner Card

\$885

Six channels of thermocouples or other low-level dc sources in the range of  $\pm 20$  mV can be measured with resolution of  $5 \mu\text{V}$ . A seventh channel is used to read the temperature of the isothermal input terminal block. An HP 69351C Voltage Regulator Card is required to provide the regulated isolated bias voltage to the HP 69423A. One HP 69351C will support up to four analog input cards.

### Analog Input

#### HP 69336B High Speed Scanner Card

\$595

This card features a FET multiplexer with 16 single-ended voltage input channels that can be scanned at 20,000 channels/second. Input voltage range is  $\pm 10.24$  volts with 100 V isolation from data common. Several cards can be cascaded to provide up to 224 channels.

#### HP 69422A High Speed A/D Card

\$835

The High Speed A/D Card measures bipolar dc voltages in one of four ranges,  $\pm 100$  mV,  $\pm 1$  V,  $\pm 10$  V, and  $\pm 100$  V. The three lower ranges are switch selectable. The  $\pm 100$  V input range is connected to an on-board divide-by-ten attenuator. Data conversion rate is 33,000 readings/second.

### Analog Output

#### HP 69321B D/A Voltage Converter Card

\$585

This model provides a high-speed (33 kHz), bipolar output voltage ( $\pm 10.24$  volts at 5 mA) that is the analog of the digital input data. Dual-rank storage, a feature that allows all D/A cards in a system to change their outputs simultaneously, is provided on the HP 69321B.

#### HP 69322A Quad D/A Voltage Converter Card

\$705

This D/A card provides four individually programmable, bipolar output voltages ( $-10.24$  V to  $+10.22$  V at 5 mA, 16 kHz maximum) that are the analog of the digital data input. Two of the 12 data-bits address the DACs, and the remaining ten data-bits provide the digital input data.

#### HP 69370A D/A Current Converter Card

\$1145

This model provides a high-speed (33 kHz), constant-current output (0 to 20.475 mA at up to 10.5 V) that is the analog of the digital data input. Dual-rank storage, a feature that allows all D/A models in the system to change their outputs simultaneously, is provided on the HP 69370A.

#### HP 69351C Voltage Regulator Card

\$295

The Voltage Regulator Card provides four regulated, isolated bias supplies for the analog models and is inserted into the voltage regulator slot of the HP 6940B and HP 6941B. The HP 69351C is required for proper operation of the analog input and output models. It will support up to four of these models.

### Digital Input

#### HP 69430A Isolated Digital Input Card

\$295

This card employs photoisolators to provide up to 100 V RMS isolation between the 12 data lines and chassis ground. The model is designed to monitor only circuits that are active. This model may be ordered with any of three different logic options. One of these options must be specified when ordering this model:

**Option 069:** negative-true TTL logic levels

**Option 073:** positive-true TTL logic levels

**Option 088:** positive-true Hi level =  $\pm 12$  to 25 V.

#### HP 69431A Digital Input Card

\$295

The Digital Input Card provides 12 data lines that can be used to monitor contact closure or logic levels referenced to ac earth ground. Gate/flag circuitry provides the HP 69431A with the interface to the computer interrupt system. An option must be specified when ordering this model.

**Option 069:** negative-true TTL logic levels

**Option 073:** positive-true TTL logic levels

**Option 070:** positive-true Hi level = 6 to 14 volts



### Digital Output

#### HP 69331B Digital Output Card

\$355

This model is a general-purpose, 12-bit card with power-on preset, system enable/disable, and gate/flag capabilities. The output lines are jumper selectable for TTL or +12 volt logic levels. The HP 69331B digital output is shipped with TTL logic level configuration.

#### HP 69332A Open Collector Output Card

\$235

This card is similar to the HP 69331B except it can switch up to 30 volts dc and currents up to 40 mA. The HP 69332A open collector output card is designed to drive lamps and relay coils utilizing an external dc power source. The outputs of the HP 69332A may be random at power-on.

#### HP 69433A Relay Output with Readback Card

\$365

The relay card provides 12 independent SPST, mercury-wetted, normally-open contact pairs. The HP 69433A also allows the computer to examine the status of the relay coil drive circuits, before and after the contacts are changed. No external handshaking is available with this product.

### Functional

#### HP 69335A Stepping Motor Control Card

\$355

This model can be programmed to generate from 0 to 2047 square-wave pulses at either of two output terminals. The user may also configure the card to generate 0 to 4095 square-wave pulses. An 11-bit binary data word specifies the total steps and Bit-12 specifies direction of rotation.

#### HP 69435A Pulse Counter Card

\$350

This card will count pulses, up or down, with a maximum square-wave input frequency of 200 kHz. Carry and borrow pulses are generated so that the HP 69435A may be cascaded for greater counting capabilities.

#### HP 69602A Timer/Pacer Card

\$475

The Timer/Pacer Card provides a full programmable, crystal-controlled time base that can be used to pace Multiprogrammer I/O operations or generate accurate one-shot pulses. The HP 69602A coupled with the HP 69435A can satisfy requirement for frequency measurement (maximum of 200 kHz). Time interval measurement (10  $\mu\text{s}$  to 34 minutes) and time of day (2.8 minutes to 1084 years).

### Interrupt

#### HP 69434A Event Sense Card

\$1050

The Event Sense Card monitors up to 12 external contact closures and interrupts the computer when one or more contacts change state with respect to the 12 reference bits stored on the card. Jumpers allow for reconfiguration to provide four logical arguments: equal to, not equal to, greater than, or less than.

#### HP 69436A Process Interrupt Card

\$480

This card provides an interrupt to the computer when any one or more of the 12 data lines being monitored change state. The HP 69436A has TTL and open collector compatible edge detectors and can detect any logic transition lasting 100 nanoseconds or longer.

### Breadboard

#### HP 69280A Breadboard Card

\$295

The Breadboard Card provides a generalized grid pattern for mounting custom circuitry. The HP 69280A plugs into the HP 6940B and HP 6941B, allowing access to the data lines and power supply lines of the Multiprogrammer backplanes.

#### HP 69380A Breadboard Output Card

\$235

This breadboard card is similar to the HP 69280A and has output storage buffer circuits that allow the Multiprogrammer backplane output data to drive external or custom circuits. A large portion of the printed circuit board has a plated grid and general-purpose circuit pattern.

#### HP 69480A Breadboard Input Card

\$295

The Breadboard Input Card is identical to the HP 69380A, except the on-board logic is the input buffer gates for driving the Multiprogrammer backplane.

# COMPUTER AIDED TEST

## Multiprogrammer Technical Publications

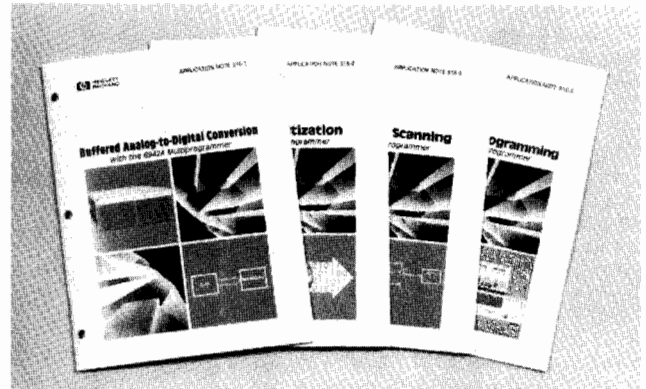
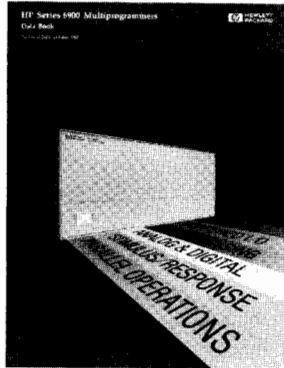
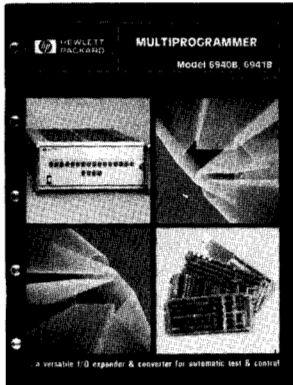

### Technical Data

In addition to a broad range of products for integration of data acquisition, control and test systems, Hewlett-Packard provides a selection of technical literature as further support of the Multiprogrammer products. These technical brochures provide detailed operating specifications of the Multiprogrammer product family and are extremely helpful in configuring the best Multiprogrammer package for your application. Other literature available are Product Notes describing a specific product application and Application Notes.

This technical literature will provide information to help you choose the right Multiprogrammer products for your application. The Product Notes augment the Operating and Service Manuals and provide additional information on product configurations and actual applications. The Application Notes are more specific "how to" information aimed at a specific application and product configuration.

This technical literature is provided at no charge upon request. Ask your local Hewlett-Packard field engineer, or use the card at the rear of this catalog.

Publication Title	Publication Number
Multiprogrammer Model 6940B, 6941B	5952-4077
Multiprogrammer Databook	5952-4175
Models 6942A, 6944A & 6954A	

### Product Notes

A series of product notes is available for the Multiprogrammers. The first two, 6940B-1 and 6940B-2, are product oriented, and describe how to use particular Multiprogrammer cards. The others are product "Application Stories" which describe how Multiprogrammer customers have implemented specific applications.

#### 6940B-1 Scanning with the 6940B Multiprogrammer

Describes use of the HP 69336B FET scanning card for high-speed data acquisition.

#### 6940B-2 Power Supply Control

Describes use of the HP 69520A power supply programming card to control HP autoranging power supplies.

#### 6940B-3 Subassembly Testing

Details Ford Motor Company's use of a building block approach to increase the flexibility of Ford's systems testing while reducing cost and design times.

#### 6940B-4 Automating Manual Equipment

Describes the implementation of the HP 6940B in a radiation monitoring system.

#### 6940B-5 Basic Research

Describes the interfacing of an HP 6940B and HP 9845A to a scanning electron beam microscope.

#### 6940B-6 Product Evaluation

Describes the use by BF Goodrich of the HP 6940B to test the true effectiveness of tires for the different ice, snow, soil and load conditions.

#### 6942A-1 Production Line Testing

Describes Solitron Devices Inc. use of the HP 6942A for hybrid device testing.

#### 6942A-2 Heavy Industry

Describes Northwest Culvert Company's use of the HP 6942A to control metal pipe production and improve process control.

#### 6942A-3 Instrument Control

Describes the use of an HP 6942A to control RF test equipment in an automatic modem test system.

#### 6942A-4 Research and Development

Describes the use of an HP 6942A as control and data acquisition system for a heavy oil pump development test rig.

#### 6942A-5 Materials Evaluation

Describes the use of an HP 6942A to automate the measurement of fluid viscosities.

### Application Notes

A series of application notes introduces a beginner to computer aided test, and makes it easier for any user to implement the most common Multiprogrammer configurations. Each of the notes contains a comprehensive study of an application, and includes theory, wiring information, and software listings for the basic functions. Information on advanced techniques is also provided. Although the programming information is oriented toward the HP 9826A and HP 9836A computers, the concepts are discussed in a general way that allows application to other computers. Copies of these application notes are available through your local HP sales office.

#### AN316-0 Introduction to Computer Aided Test

This introductory note is designed to take a computer aided test novice through the steps of evaluating, planning, and implementing a sample computer aided test system.

#### AN316-3 High-Speed FET Scanning

High speed data acquisition from many channels is easily accomplished with the Multiprogrammer scanner system consisting of an HP 69750A or HP 69755A scanner cards. This note covers sequential and random access scanning methods.

#### AN316-4 Power Supply Programming

Full system control of a power supply, including output voltage and current readback, is possible with a single Multiprogrammer card. The HP 69709A power supply control card is designed for control of HP 6023, HP 6024A, HP 6011, and HP 6012A power supplies equipped with Option 002.

#### AN316-5 Data Capture

This Application Note covers the full range of data capture capability of the HP 6942A, HP 6944A and the HP 6954A Multiprogrammers. The emphasis is on analog data capture but digital techniques are also presented. AN316-5 includes sections on random and burst scanning as well as buffering and multiplexing using the Multiprogrammer Memory system. Examples are presented using the HP 14753A CAT Programming statements, as well as Native Instruction programming for the HP 6942A. This Application Note also covers continuous data acquisition to an external hard disc drive. One section deals with performing accurate analog measurements using the Multiprogrammers' I/O cards.

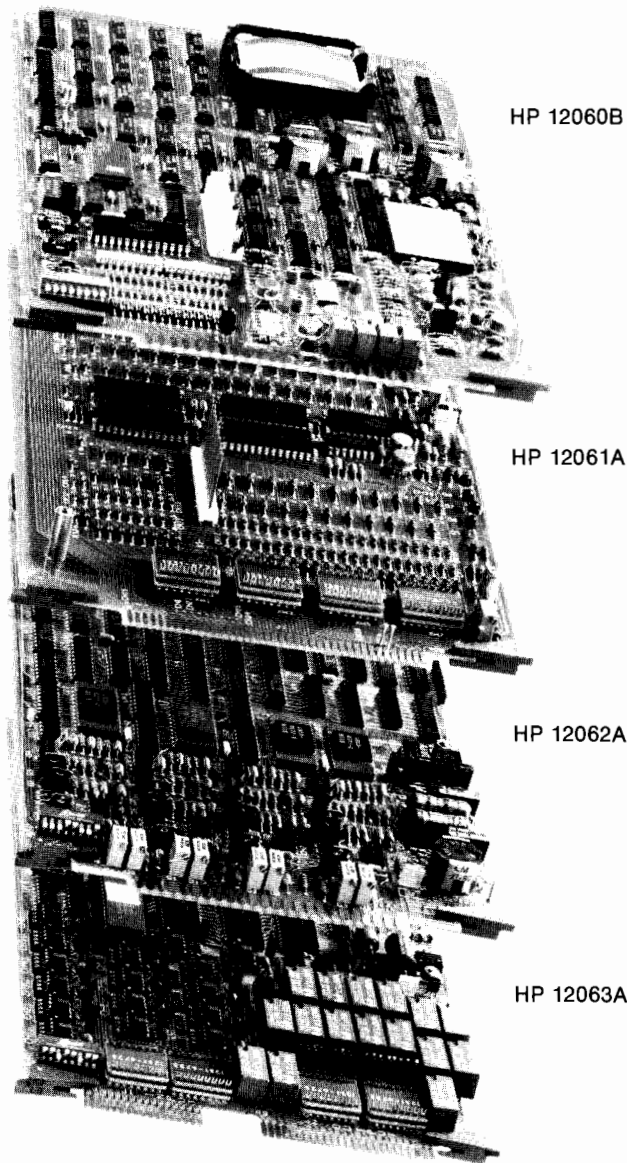

HP 12060B

HP 12061A

HP 12062A

HP 12063A

### Description

The HP 12060B, 12061A, 12062A, and 12063A are plug-in cards for HP 1000 A-Series Computers. They provide low cost, high performance, analog and digital I/O for use in distributed measurement and control applications. The A-series product in which these cards are used must have a 25 kHz power supply. Hood connectors with each card allow users to build cables for connection to their applications.

### 12060B 8 Channel Analog Input Card

The HP 12060B is capable of acquiring up to 55,000 readings per second with 12-bit resolution. Auto scanning or single-channel sampling is possible to 55 kHz. Provisions for external pacing/trigging of sampling and scanning is provided. The HP 12060B includes four programmable full scale ranges from plus or minus 1.28 V to plus or minus 10.24 V. Maximum resolution is 0.625 mV on the 1.28 V range. A separate "zero reference" on the card allows the user to measure actual offset due to temperature drift, and correct readings on all channels for higher accuracy. The card has 8 differential channels.

### HP 12061A 32 Channel Analog Input Expansion Card

The HP 12061A provides 32 additional differential inputs for the HP 12060B card. The HP 12061A card fastens directly onto the HP 12060B card, creating a two-board unit that occupies two I/O slots in an HP 1000 A-series computer. Programming information is passed from the HP 12060B directly to the HP 12061A; analog signals on the additional 32 channels are in turn passed back to the HP 12060B for digitizing. The HP 12061A includes removable plug-in headers so the user can add current sense resistors for current loop measurements. These headers allow the board to be adapted to the specific application without soldering components directly on the board and are easily removable for repair purposes.

### HP 12062A 4 Channel Analog Output Card

The HP 12062A Analog Output Card provides 4 independent bipolar voltage outputs. Remote sensing per channel provides accurate output voltages to compensate for long distances of field wiring. Undedicated digital outputs may be used in pen up/down control, CRT display, or X-Y plotters. DMA compatibility provides fast analog updates on a per-channel basis or between channels. Programmable time delay between DMA updates provides signal reconstruction capability with a full power bandwidth of 20 kHz.

### HP 12063A 32 Channel Digital Multifunction Card

#### Input Characteristics

The HP 12063B provides 16 fully isolated digital inputs via voltage threshold opto-couplers. Input voltage levels are selectable by the user for each channel by installing the appropriately valued resistors on removable plug-in headers (8 resistors per header = 8 channels). These headers allow the board to be adapted to the specific application without soldering components directly on the board, and are easily removed for repair purposes. Plug-in opto-couplers (supplied) allow user selection of ac or dc coupling for each channel by merely installing the opto-coupler in the ac position or dc position. For ac coupling, a plug-on jumper is provided for each channel to select 60 Hz ac filtering of the rectified input if desired.

#### Event Detection

In addition to status, any input may be user programmed to function as an interrupt to be generated on the rising edge or falling edge of the input or both (whichever occurs first). This capability is easily activated by the user via loading the appropriate pattern into the three registers. The on-card microprocessor takes over to cause the interrupt to be generated when that event occurs. User programming is required to service the interrupt.

#### Debounce Delay

The same microprocessor also provides the user-programmable debounce delay up to 246 ms on any input when monitoring contact closures and may be used in both status mode and event sense mode.

#### Output Characteristics

Sixteen form C (SPDT) relay outputs are provided on the same card. Both the normally open (NO) and normally closed (NC) contacts are available to users. Two removable headers allow for arc suppression devices to be added by the user for *each channel* without soldering directly to the board. Each header handles 8 output channels. Plug-on jumpers select the arc suppression across the NO or NC contacts. An on-card isolated power supply derived from the 25 kHz ac supply in the A-Series processor provides coil power for the relays. This technique minimizes any coupling of relay contact noise in the computer itself.

#### Ordering Information

	Price
HP 12060B 8 Channel Analog/Digital Converter	\$1885
HP 12061A 32 Channel Analog Input Expansion	\$940
HP 12062A 4 Channel Digital/Analog Converter	\$1360
HP 12063A 32 Channel Digital Multifunction Card	\$1730

# COMPUTER AIDED TEST

## CAT Software

### Interactive Test Generator

- Accelerates HP BASIC Test Development
- Universal, Mouse-Driven Interface To All HP-IB Instruments
- Eliminates Need To Learn HP-IB Mnemonics
- Generate Code Automatically
- For program development on HP BASIC Workstation or HP-UX (1) controllers
- For program execution on HP BASIC workstation, HP-UX, or DOS (2) controllers.



HP's Interactive Test Generator (ITG) software package accelerates HP BASIC test development with a windowed, mouse driven interface designed specifically for controlling HP-IB instruments.

Designed for test engineers, independent of their programming skill, ITG reduces test development time by providing interactive program development with on-screen instrument panels. Menu selections made with the "click" of a mouse prescribe settings of instruments and initiate and display measurements. ITG also automatically generates the HP BASIC code necessary to perform these same tasks in your test program.

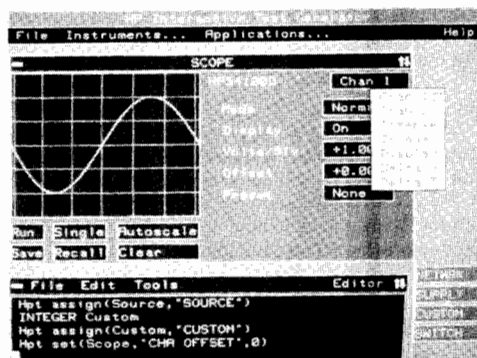

Menu selections expedite instrument setups and reduce costly errors

### Hassle Free Instrument Control For Both Beginners And Experienced Professionals

ITG simplifies measurement automation because it is no longer necessary to write code that requires knowledge of instrument-specific HP-IB mnemonics or search through volumes of manuals for the right command string. Instead of writing code, you use a mouse to adjust control settings and make measurements. Clicking the mouse on a control pulls down a menu of valid settings, clicking again selects the desired setting. Incorrect instrument settings and data entry errors that lengthen test development time are virtually eliminated through the use of the mouse and menu selections.

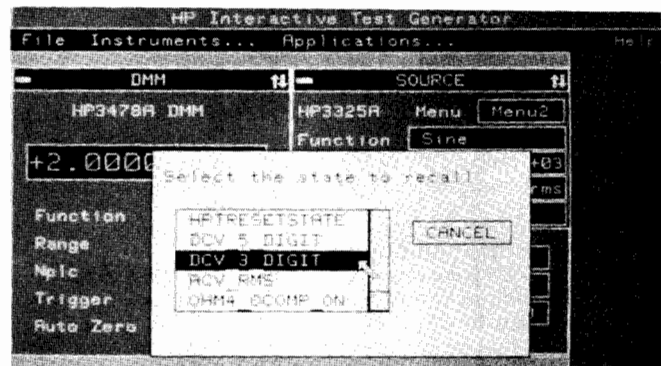

Store and recall instrument states with names you assign. You don't have to remember state names to recall them, ITG presents you with a list of valid choices.

\*1 Using HP BASIC/UX

\*2 Using the HP BASIC Language Processor Card



To avoid setting controls one by one, you can store and recall complete instrument states by names you assign. A library of states is rapidly generated, and states can be browsed and re-used to build new applications with even less effort. User-entered comments are printed along with descriptions of the states to provide permanent, high-quality documentation of the test application.

At the "click" of a mouse, on-line help keeps the job moving with information on the operation of HP ITG as well as the specific instruments available. And with instruments connected to the HP-IB bus, immediate feedback on the instrument's operation saves you time debugging your instrument setups.

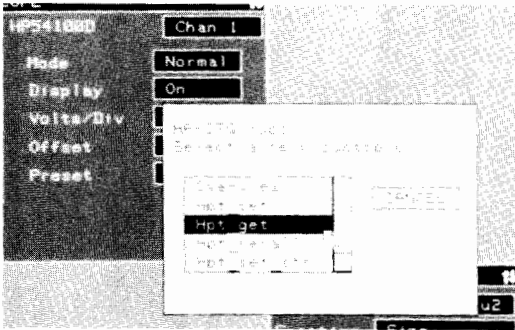

On-line help is available if you happen to have a question.

### Automatic Code Generation

Automatic code generation guarantees consistent, structured, error-free programming by even inexperienced software developers. And because the code generated is HP BASIC, it retains the friendliness, power, and high performance test developers have come to expect for instrument control. Full access to all HP BASIC math, graphics, and I/O capability gives ITG the edge as a friendly development environment without sacrificing application performance.

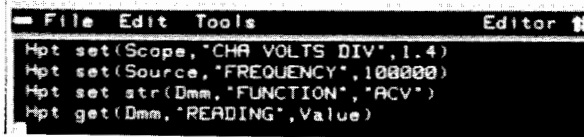

Automatically generate HP BASIC program statements for controlling your instruments and making measurements.

### Optimized For Test Throughput

ITG optimizes test throughput by automatically providing incremental state programming. ITG tracks the current instrument state and sends only the necessary commands to reach the next state. This eliminates time spent sending superfluous commands over HP-IB, as well as the time required for an instrument to interpret and respond to the command. In addition, ITG optionally generates ordinary HP BASIC "OUTPUT" and "ENTER" statements that use explicit instrument mnemonics.

### Universal Instrument Drivers

ITG instrument drivers provide a uniform and user-friendly interface to all instruments, with complete control being exercised by a mouse or the keyboard, instead of a multitude of different operating methods found on stand-alone instruments.

HP provides instrument drivers for many of the popular HP-IB test and measurement instruments, and plans a continuous program to make drivers available as they are developed. While HP written drivers address most applications, drivers for custom black-boxes or non-supported instruments are easily created using any text editor. These

text files can be easily modified and serve as examples for rapidly creating drivers for new or different models of instruments.

With ITG's driver technology, you can also create virtual instruments in software by enhancing or combining the features of several different instruments. For cardcage instruments in particular, these alternative user interfaces allow even the inexperienced to begin making measurements quickly.

### Protected Software Investment

Because software development can easily cost as much as the instrumentation in a test system, protecting that software investment is as important as minimizing it.

Whether you use custom written HP BASIC programs or HP's Functional Test Manager software to create new applications, ITG serves as an easy and efficient tool for developing the measurement-specific part of your test. Used in conjunction with these programs, ITG saves development time without abandoning your present software investment.

### Flexible Choice of Operating Systems

In today's competitive business atmosphere, low cost controllers, such as PCs, are highly desirable. But many times, complex test programs are more expediently developed on sophisticated, high-powered machines and then executed on a low-cost target machine. ITG's capability to generate code that will run on personal computers such as the HP Vectra, IBM PC-AT, and compatibles using the HP BASIC Language processor, on HP's proprietary controllers that use HP BASIC, and on UNIX® controllers, affords a wide choice of controller platforms. This compatibility also assures that you can start small, and as your test needs change move to faster, more powerful controllers without having to develop new test software.

### ITG Moves Into The Future

The unique structure of ITG allows the instrument drivers to be independent of specific programming languages, operating systems, or applications. ITG is the first in a family of compatible software products which use these drivers. Similarly, user-developed drivers or instrument states will also move forward without requiring new program development.

### System Requirements

#### Development System

Runs on HP BASIC/WS, HP BASIC/UX, and HP BASIC Language Processor systems with HP BASIC 5.1 or greater including:

HP 9000 Series 300s and Series 200 Model 217\*

HP PC 305/308 BASIC Controllers

Additional requirements: HP-HIL mouse, at least 3 Mbytes of RAM, and at least 4 Mbytes of hard disc space.

#### Execution System

In addition to the systems mentioned above, code developed with HP ITG may be executed on any Series 200 system running HP BASIC 5.1 or greater and containing a total of 1.5 Mbytes or more of RAM.

### Ordering Information

**E2000A HP Interactive Test Generator.** Requires HP BASIC Rev. 5.1 or later. Must order HP E2001D Instrument Drivers separately. \$988

**AA0** Software on 1/4-inch tape cartridge

**AA6** Software on 5 1/4 disc

**AA7** Software on 3 1/2 inch single-sided discs

**AA8** Software on 3 1/2 inch double-sided discs

**E2001D** HP Instrument Drivers. (One set of all available) \$492

**AA0** Software on 1/4 inch tape cartridge

**AA6** Software on 5 1/4 disc

**AA7** Software on 3 1/2 inch single-sided discs

**AA8** Software on 3 1/2 inch double-sided discs

\*No support for HP 98548A monochrome display system.



# COMPUTER AIDED TEST

## Software Solutions

Data Acquisition Manager - DACQ/300 and DACQ/PC, HP Model 44458A/B and 44459A/B

- Reduce Your Software Development Time
- Customize Your Data Management Needs
- Optimize Your Software Performance

- Use With the Controller of Your Choice: Either HP 9000 Series 200/300 or HP Vectra PC
- Use With Any HP-IB Instrument

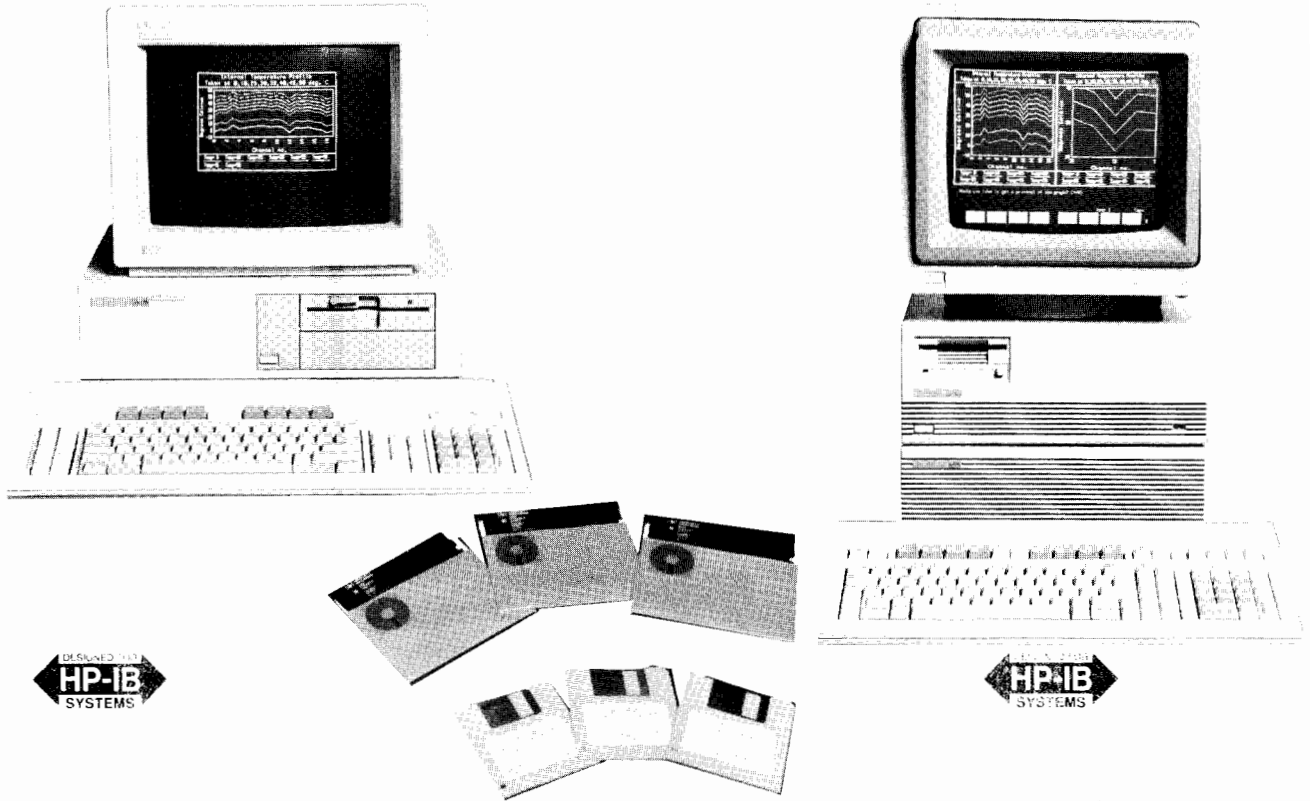

### Description

HP Data Acquisition Manager is a general-purpose subroutine library for the HP 9000 Series 200/300 controllers (HP DACQ/300) or the HP Vectra Personal Computer equipped with the HP BASIC language processor (HP DACQ/PC). The software reduces your development time by providing you with software tools (subroutines written in HP BASIC and compiled Pascal) that you can add to your HP BASIC program to handle up to 90% of your data management functions. Customize your data management programs by adding these subroutines to match your final application needs. Optimize your software performance through HP Data Acquisition Manager's compiled subroutines and use of memory volumes (electronic disc). Eliminate the need to have several software packages because HP Data Acquisition Manager provides you with subroutines that cover a wide range of data acquisition and control tasks and works with any HP-IB instrument. Use HP Data Acquisition Manager with the controller of your choice - either the HP 9000 Series 200/300 controller or the HP Vectra Personal Computer. Both controllers offer you the HP BASIC language (on the HP Vectra PC through use of the HP BASIC Language Processor - HP 82300B) for one of the most powerful and easy-to-use programming environments available for instrument control.

### Data Management

Use HP Data Acquisition Manager to:

- Set up a data base organized into archives, books and pages
- Specify the format of books and pages
- Collect data over HP-IB, GPIO, from the program, or the keyboard
- Time-stamp and store the data into the data base
- Document the data
- Retrieve the data from the data base to display, analyze or transmit it elsewhere

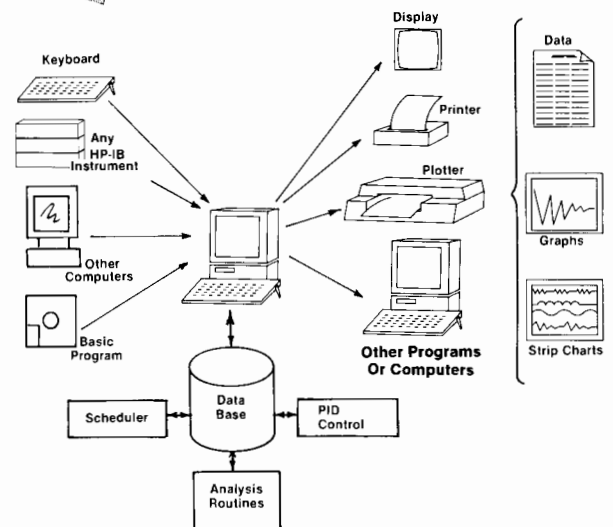

### Data Analysis

Entire arrays of data captured over HP-IB or retrieved from the data base can be analyzed quickly using the data analysis subroutines. Analysis functions available are:

- Scaling ( $mx+b$ )
- Limit checking
- Statistics (high, low, mean, standard deviation)
- Math (+, -, \*, /)
- FFT and inverse FFT
- Temperature conversions (thermocouples, thermistors, RTDs)
- Strain gage conversions
- User-defined look-up tables
- Unpacking packed HP 3852 high speed voltmeter readings

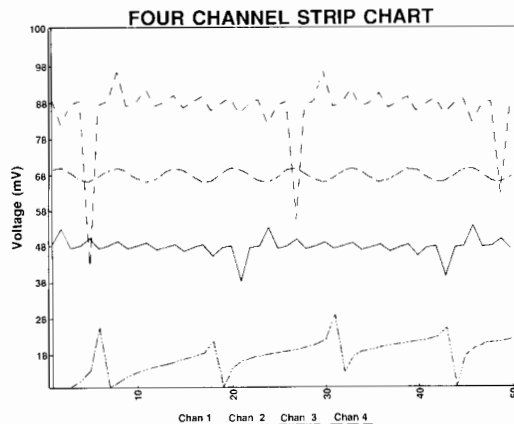
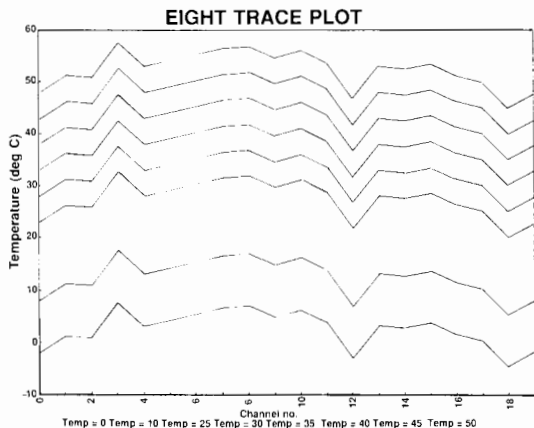

**Data Presentation**

**Printing:**

Captured data and sections of the data base can be formatted and printed on the controller display or to a supported printer.

**Plotting:**

Plot subroutines allow you to plot up to eight traces per chart on either the controller display or an HP plotter. Labels, size, location, color (HP DACQ/300 only), and orientation of the chart are programmable, allowing you to have more than one chart per screen or page. Linear and logarithmic scaling (with or without grid lines) are available as well as auto-scaling of the entire chart.

**Real-time Stripcharting:**

The stripchart subroutines allow you to plot up to four traces on the controller display as the readings are being received from the instrument (color traces for HP DACQ/300, monochrome for HP DACQ/PC). Once the screen is full, the data scrolls on the display from right to left. A file can be reserved to store values that scroll off the display. Data from the instrument can be plotted versus time or a user-defined array. If a hard copy of the stripchart is desired, the data can be saved and later sent to an HP plotter with the Plot subroutines.

**Data Transmission**

Transmit data from the data base to another computer over RS-232 using the data transmission subroutines. These subroutines can be used to set up the HP 9000 Series 200/300 Datacomm Card (HP 98628A) with the desired protocols. The ENQ/ACK and X-ON/X-OFF protocols, baud rate, handshaking and the use of modems are all supported with these subroutines. Files of data can be transmitted using a default ASCII format or you can create your own format. When the default format is used, the files transferred can be used by Lotus 1-2-3™ or Wordstar™. The transferred ASCII file can also be transmitted to other computers using the HP Vectra PC's Advance-Link software.

**Process Control**

Calculate up to 10 PID algorithms with one HP Data Acquisition Manager subroutine call. You specify the PID constants and send the measured values from your process to the subroutine. The subroutine performs the PID calculation and returns the final values. "Bumpless" control allows a smooth transition from manual to automatic control of your process using the PID subroutines. You can cascade two or more of the PID loops and adjust the PID constants ("tune your process control loops") while the process is still under automatic control.

**Task Scheduling**

The scheduler subroutine assists you in scheduling tasks (in the form of subroutines) within your program. The software creates a table of up to 99 tasks and allows you to designate each task name and number, starting time, time interval between task runs, number of times the task is to be run and its priority. When the scheduler subroutine is called, it returns the number of the task with the highest priority scheduled for that time. Your program can then run that task by calling the appropriate subroutine.

**Configuration/Verification (HP DACQ/300)**

The HP 9000 Series 200/300 version of HP Data Acquisition Manager (HP DACQ/300) also contains a menu-driven program that you can use to help document your equipment set-up and application. The program allows you to write a description of your application and prompts you to list the peripherals and instruments attached. The program automatically reads the configuration (processor, memory, plug-in interface cards, operating system) of the HP 9000 Series

200/300 controller and an HP3852 data acquisition unit (if present). When you are finished, the entire set-up and description will be saved in a file. The program even contains a routine to verify that the present configuration matches a configuration stored in a file.

**Summary**

HP Data Acquisition Manager is a powerful software package that provides you with "tools" to handle up to 90% of your data acquisition/control program. This leaves you time to concentrate on other aspects of your application. Collecting, storing, analyzing, transmitting, and scheduling data collection and subroutines are all handled by this software. Add only the routines that you need to customize your program and allow HP Data Acquisition Manager to optimize your software performance. Use this software with any HP-IB instrument on the controller of your choice, either the HP 9000 Series 200/300 or the HP Vectra PC, with the HP BASIC language processor, for virtually all of your data acquisition data management needs.

**Recommended and Supported Hardware**

**Controllers For HP DACQ/300:** HP 9000 Models 310, 320, 330, 350, 216, 217, 220 and 236\* Controllers running BASIC 5.x equipped with 1 Mbyte RAM.

**HP 3059A Technical Data Acquisition System**

This is a complete system bundle including an HP 3852A Data Acquisition/Control Unit, an HP 310 Color Instrument Controller, HP BASIC 5.x, 1 Mbyte of memory and the HP 44458A DACQ/300 software.

**Controllers For HP DACQ/PC:** HP Vectra or 100% compatible computer equipped with the HP 82300B BASIC Language Processor.

The following HP Vectra based bundles contain the HP 82300B, 640 kByte DOS memory, Vectra SPU, 1.44 MByte 3.5" flexible and 20 MByte hard disc drives (PC-308CM has 40 MByte hard disc drive), HP BASIC 5.x, serial and parallel interfaces, display, keyboard and Vectra DOS.

**Color\* PC Systems**

HP 82315D Model PC-308CL HP 82317D Model PC-305ML  
 HP 82319D Model PC-308CM HP 82314D Model PC-308ML

**Monochrome PC Systems**

**HP 3058A HP BASIC/PC Data Acquisition System**

This is a complete system bundle including an HP 3852A Data Acquisition/Control Unit, an HP PC-308CL Color\* BASIC Controller, HP BASIC 5.x and HP 44459A DACQ/PC software.

**Peripherals:** Any supported by the HP Vectra or HP Series 300 running BASIC 5.x (plotters must use HP-GL)

**Instruments:** Any HP-IB instruments

**Ordering Information**

	<b>Price</b>
HP 44458A: HP DACQ/300 on 3 1/2" disc	\$1995
HP 44458B: HP DACQ/300 on 5 1/4" disc	\$1995
HP 44458R: HP DACQ/300 right-to-reproduce	\$1220
HP 44459A: HP DACQ/PC on 3 1/2" discs	\$1485
HP 44459B: HP DACQ/PC on 5 1/4" discs	\$1485
HP 44459R: HP DACQ/PC right-to-reproduce	\$925
HP 3058A: HP BASIC/PC Data Acquisition System	\$10900
HP 3059A: Technical Data Acquisition System	\$13100

\*Stripcharting not supported on HP Model 236C or in color on the HP PC-308CL and PC-308CM. The HP 98627A RGB Color Video Board is not supported.

# COMPUTER AIDED TEST

## Functional Test Manager Software

### FTM/300 & FTM/PC

- Substantially reduce your test system development time.



Developing functional test software on an HP Series 300 using HP FTM/300

### Description

HP Functional Test Manager (FTM) software is designed especially for:

- Professionals writing test software for rack-and-stack HP-IB production systems
- Functional testing of analog components, subassemblies and final products

HP FTM substantially reduces your functional test system software development time. It does this by replacing up to 65% of your code with HP FTM's standard turnkey features and gives you productivity boosting development tools to finish the application specific portion of your system.

### Powerful Turnkey Features

Start your functional test system software development with HP FTM, and start out "already finished" with many of your most difficult development tasks. HP FTM provides you with up to 65% of your test system software. It does this by taking care of the non-application specific portions of the system software; parts that are typically the same from one test system to another. Develop your next test system quicker using all of HP FTM's powerful turnkey features:

- Turnkey System Security
- Turnkey Test Scheduling
- Turnkey Test Sequencing
- Turnkey Test Debug Mode
- Turnkey Database Management
- Turnkey SQC Data Analysis
- Turnkey Networking

Standardize On The  
Complete Set Of  
HP FTM Turnkey Features

Use these flexible features to quickly build test systems that will do more than most custom-coded systems. Many customers have already standardized on HP FTM's turnkey features for all their functional test systems.

### Test Development And System Configuration Tools

Using HP FTM's turnkey tools means you can concentrate harder on your application specific tasks. Application specific tasks typically include defining tests and test parameters and coupling HP FTM's turnkey features into your overall application environment. HP FTM has system configuration and test development tools to help you in these application specific areas.

HP FTM's development tools are both easy to use and extremely powerful. They combine the friendliness of menu's and forms with the ultimate power and flexibility of HP's renown BASIC programming language. Quickly finish the application specific portion of your functional test software using HP FTM's:

### • Menu of Forms

Use HP FTM's forms to conveniently document, access and modify your test parameter and test system configuration data.

### • Library of Optimized Subs

Use these subs and quickly build individual tests tailored to your specific needs.

### • Full Access to HP BASIC

With HP BASIC, add custom test capabilities to HP FTM or use your existing subprograms.

Combining HP FTM's turnkey features with its development tools, you retain all the advantages of writing custom software while substantially reducing your development time and effort.

### Optimized For Test Throughput

While HP FTM provides high level testing capabilities in real time (e.g., HP-IB driver I/O, pass/fail limit testing, data archiving, test sequencing, test progress reporting, etc.), HP FTM still executes HP-IB I/O and test sequencing just as fast as most custom written test software. However, for even faster program speed or higher flexibility, custom code critical test segments using powerful HP BASIC. HP FTM's structure allows straight forward integration of HP BASIC callable custom code.

Further optimize your overall testing speed by taking advantage of HP FTM's intelligent test sequencer. Set up HP FTM's Test Plan Form so that certain tests are executed only under certain conditions. For example, execute an overall functional test first. Whenever this test fails, then execute a set of troubleshooting tests to gather more information on the cause of the failure. You don't need to execute the troubleshooting tests every time. Or, specify a lengthy set of tests as "audit tests" to be executed only on every Nth device under test. With HP FTM's intelligent test sequencer you get more of your product out the door faster.

### Flexible Test Program Scheduling

Your test system tasks may need to be executed upon specific events or at specific times. With HP FTM, schedule your tasks to be executed upon the wave of a barcode wand, at specific times of day, or upon operator menu selection. At the same time HP FTM will save important information with your test result data, information such as serial numbers, time of test, operator information and networked test station #.

For your less sophisticated operators, use HP FTM's security levels to tailor HP FTM's operator menu to each operator, allowing only specific menus to be seen and executed by specific operators. HP FTM's turnkey security and scheduler features give you flexibility to display, schedule and initiate tasks the way you want.

### Data Analysis and Report Generation

Analyze and improve your production process in addition to testing your products. Use HP FTM to monitor trends in your process with its turnkey statistical quality control (SQC) analysis features. Improve your process and your profits by monitoring test result trends as you tune your production process. And HP FTM will generate important SQC reports and graphs. Use HP FTM's SQC overview page as your management summary. It lists yield, units passed or failed, and presents information graphically. For more detailed reporting, use HP FTM to produce the following SQC charts and graphs:

- Pareto charts for failure analysis
- Histograms of test results
- Control Charts (p, X-bar and s) as process monitors

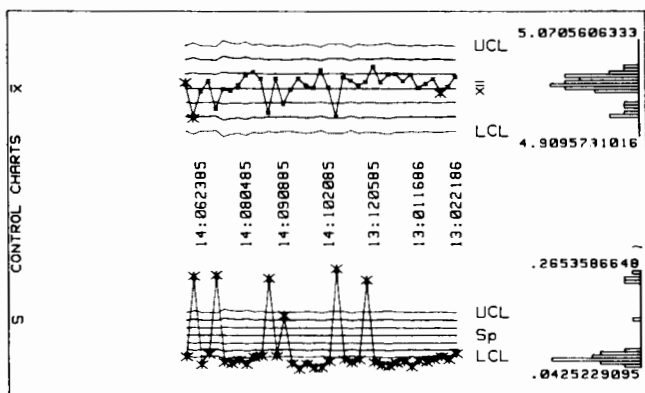

### Networking and Data Transfers to Other Computers

Format your test results and transfer them to other computing environments for further analysis or archiving. HP FTM formats test data files in the standard ASCII formats (CSV and DIF) used by nearly all major software packages.

HP FTM networking features let you use any common file transfer means including RS-232, HP-IB, HP's Shared Resource Manager (SRM), or IEEE 802.3 (using HP's SRM network and a co-existing HP-UX environment). Use HP AdvanceLink and HP FTM for total turnkey transfers of data over RS-232C to DOS computers. The resultant DOS files are ready for access by spreadsheets such as Lotus 1-2-3 and database managers such as dBASE III Plus.

HP FTM software is specially designed to take full advantage of HP's SRM network. Multiple HP FTM systems can be linked to share a common data base for data storage and SQC analysis. HP FTM's SRM networking can also be used to transfer test data from HP FTM to HP Q-STATS II area-wide information manager. HP Q-STATS II, working with the HP 306X Board Test Systems and HP FTM at functional and final test provides a comprehensive "board-test-to-final-test" statistical quality control solution.

### Standardize On HP FTM For All Your Test Systems

Implement just one test system using HP FTM and see the time saving benefits of reduced software development time, maintenance and documentation. Standardize on HP FTM and experience the additional effect of having your newer test engineers understand and maintain both new AND old systems. Using and training your new test engineers on HP FTM's standard database, data structures and other turnkey features gives them a big headstart in understanding and maintaining all your HP FTM based systems. Examining the information in HP FTM's forms will complete the picture, making it easy and quick for new engineers to grasp the inner application specific elements of any previously unfamiliar system.

### Summary

HP's Functional Test Manager is a sophisticated, comprehensive and flexible software package fine tuned for functional test applications in production environments using HP-IB test instrumentation. It provides the set of features most needed to run a modern, versatile production operation. HP FTM has the breadth and depth needed to be considered as your standard test system executive.

Use HP FTM to beat your functional test software development deadlines while simultaneously expanding the functionality and flexibility of your test systems.

### Product Requirements

#### Supported Computers

HP 9000 Models 216\*, 217, 220\*, 236, 237, 310, 320, 330, 350 and HP Vectra (or 100% IBM AT compatible PC) equipped with the HP BASIC Language Processor.

#### Security Device

HP 46084A HP-HIL ID Module is required for the FTM version with HP-HIL code security. An HP-IB code security module is supplied with the HP FTM with HP-IB security. The HP-HIL version of FTM is recommended for computers with HP-HIL.

#### Operating System

HP BASIC 5.X. Must order HP BASIC HFS binary (HP 82313A) separately for HP FTM/PC unless using SRM.

#### Memory

3 Mbytes recommended for development system (2.25 Mbytes minimum), 2 Mbytes for run-only. For HP FTM/PC this memory must reside on the HP BASIC Language Processor.

#### Hard Disc

Local hard disc required unless using SRM. Recommend 20 MBytes (40 Mbytes for HP FTM/PC if hard disc is shared with DOS applications).

#### Printer

Optional. HP-IB, RS-232 or Centronics (on PC) interfaces with HP Raster Interface Standard capability. For example, HP ThinkJet, HP LaserJet and HP PaintJet.

#### Plotter

Optional. HP-IB, HPGL (automatic sheet feed desirable).

#### Bar Code Reader

Optional. Use HP 92916A (HP-HIL).

#### 32-Button Box

Optional. Use HP 46086A (HP-HIL).

\*HP Models 216 and 220 require display enhancements.

### Ordering Information

HP FTM/300 is available for HP 9000 Series 200/300 Computers under HP BASIC 5.X. HP FTM/PC is available for HP Vectra PCs (and compatibles) using the HP Basic Language Processor (HP 82300B). Each are available for two different source code security schemes and in both 3.5" and 5.25" media sizes.

HP FTM/300 (for HP BASIC 5.X)	Price
<b>HP 34804A</b> - 3.5" media, for computers with HP 46084A HP-HIL ID Module (order separately), includes training.	\$4800
<b>HP 34805A</b> - 3.5" media, for computers without HP-HIL, includes HP-IB security module and training.	\$4950
<b>HP 34805B</b> - 5.25" media, for computers without HP-HIL, includes HP-IB security module and training.	\$4950
<b>HP FTM/PC</b> (for HP Vectra PC with HP BASIC Language Processor)	
<b>HP 34804C</b> - 3.5" media, for PCs with HP 46084A HP-HIL ID Module (order separately), training not included.	\$3200
<b>HP 34804D</b> - 5.25" media, for PCs with HP 46084A HP-HIL ID Module (order separately), training not included.	\$3200
<b>HP 34805C</b> - 3.5" media, for PCs without HP-HIL, includes HP-IB security module, training not included.	\$3350
<b>HP 34805D</b> - 5.25" media, for PCs without HP-HIL, includes HP-IB security module, training not included.	\$3350

### Multiple Copy/Right-To-Use Licenses, Upgrade Kits, Training & Support Materials

Economical multiple copy/right-to-use licenses, upgrade kits for Rev 1.0 and 2.0, user training and Software Materials Subscription (SMS) are available for HP FTM/300 and HP FTM/PC. For more information on these products ask your local HP Sales Representative for the HP FTM Brochure (PN 5953-7020) and the Rev 3.0 Ordering and Configuration Information Insert (5953-7046, dated 5/88). Lotus and 123 are registered trademarks of Lotus Development Corporation. MS-DOS is a registered trademark of Microsoft, Incorporated.

# AUTOMATIC TEST

## System Integration

HP ATS 2000



- Modular Systems Using Standard Test Instrumentation for Cost Reduction and Configuration Flexibility
- Manufacturing and Maintenance Applications
- Complete Integration, Installation and Support Services
- Single-vendor Solution

### A Modular Approach to Solving Test Problems

With ATS 2000, HP provides a customized solution for complex functional test needs. Based upon the integration of standard HP instruments and controllers, HP ATS 2000 offers test solutions for manufacturing and maintenance of boards and modules in communications systems, PBX, radar, navigational/guidance and other avionics, and pre-flight satellite checkout.

HP's broad range of computation and instrumentation resources is backed up by 20 years of experience in providing fully-integrated systems to meet the requirements of commercial and military testing applications, with the added benefits of a single-vendor solution.

HP works with each customer to configure a system to custom-fit the test application, and then performs all the many hardware and software functions to fully integrate the system. In addition, HP offers user training and long-term support of the customer's system.

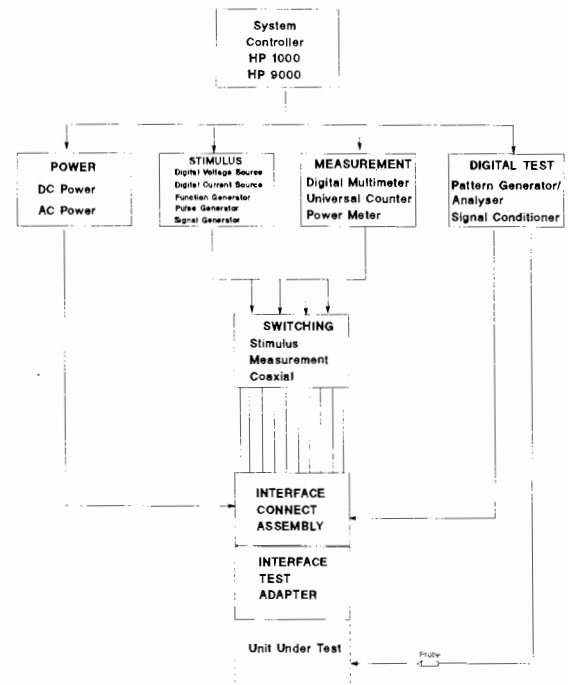

ATS 2000 Block Diagram

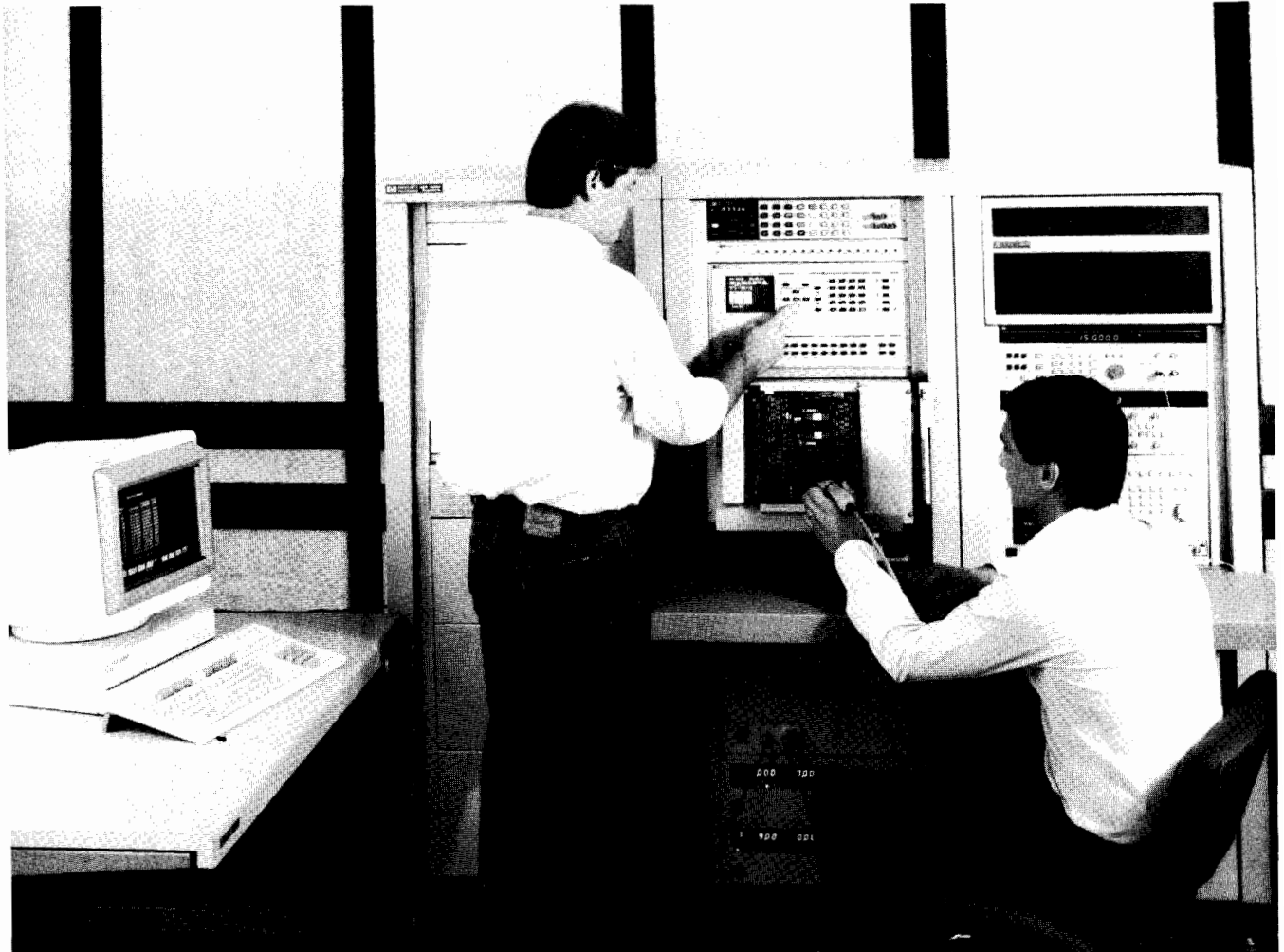

### System Controller

A host controller drives the test system. The choice of a controller is based upon current computing and testing requirements as well as anticipated future expansion of the system. The ATS 2000 offers two standard HP offerings:

The HP 1000 is supported by a powerful real-time operating system (RTE-A), and features fast efficient handling of I/O. The HP 1000 controller has a complete device subroutine library supporting over 200 instruments:

The HP 9000 is supported by HP-UX, Hewlett-Packard's UNIX-based operating system. HP-UX allows up to 84 independent virtual processes to execute simultaneously, but this number can be modified according to the user's particular application requirements.

### Standard HP Stimulus and Response Instrumentation

HP brings to the ATS 2000 a wealth of standard, programmable instruments for UUT stimulus and response measurement, such as digital multimeters, counters, signal sources, and analyzers together with a selection of programmable power supplies. Integration of off-the-shelf instruments substantially reduces system cost and facilitates modifications to the system configuration to accommodate changes in the customer's application that may occur with time.

### Switching

The switching module routes signals between the UUT and analog stimulus/response instruments. The HP 3235A Switch/Test Unit is used for switching in the ATS 2000 systems. This switch comprises a 10-slot intelligent card-cage, with 13 different switch modules available in various matrix and multiplexer topologies to switch signals up to 10 Amps and from DC to 26.5 GHz.

### Digital Test Unit

Required for digital test capability, a digital test unit (DTU) generates input patterns to the UUT and analyzes the output responses at real-time functional speeds. Two major components comprise the ATS 2000 DTU: a pattern generator analyzer and a signal conditioner.

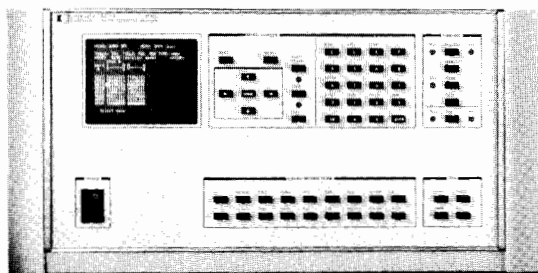

The HP 9417A Pattern Generator/Analyzer controls digital testing, performing stimulus and response analysis functions. From 64 to 128 non-multiplexed, bi-directional channels are provided by the HP 9417A, which may be expanded to 512 channels with the HP 9418A Expansion Chassis. Up to five independent 4K memories (output, expected, tristate, mask, response) are provided per channel for real-time response comparison. Linear or algorithmic stimulus and response allows efficient test programming. Measurement accuracy is enhanced through adjustable skews for compensation of all propagation delays. An HP 94180A Guided Probe is available for backtracing and fault diagnosis.

The HP 9419A Signal Conditioner serves as the interface between the HP 9417A and the test adapter or UUT, providing multiple logic levels with maximum signal integrity. The HP 9419A supports logic families in the range of  $\pm 15V$ , including TTL, ECL, CMOS, and DTL.

### Digital Test Software

The DTU is controlled by the Digital Test Executive (DTE), a modular family of software components which integrates various simulators with the DTU hardware for simulator-based testing. The DTE consists of a run-time analyzer, file configurator, file reporter, and a file generator if simulator-based testing is required.

The HP 9423A Run-Time Analyzer extracts test data, such as stimulus and response vectors, circuit topology, node state, timing information and fault diagnosis data, from the user's circuit simulation software.

The HP 9425A File Reporter allows access to the DTE file at any time during the test process for the test pattern verifications.

A variety of file generators are available to map simulator output into a DTE-compatible format.

User programming of the ATS 2000 DTU is simplified using a set of over 120 subroutines in the HP 9426A Digital Device Subroutine Library.

### System Resource Interface

A unit-under-test interface provides the signal path between a test system and a UUT. The ATS 2000 System Resource Interface (SRI) provides a well-defined, high-integrity interconnect path for digital, analog, and RF stimulus and response signals between the test system and the UUT.

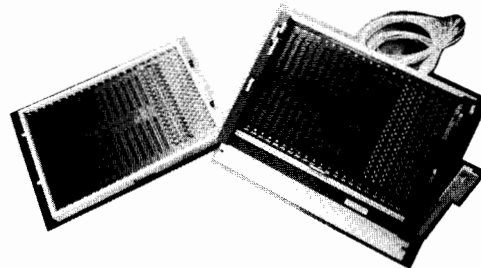

The SRI consists of two subassemblies: the HP 9420A Interface Connect Assembly (ICA), and the HP 9421A Interface Test Adapter (ITA).

The SRI is offered in 4,000-pin (single-tier) and 8,000-pin (dual-tier) configuration. A single customized ICA is used with multiple low-cost ITAs for different UUTs or families of UUTs.

### System Software

System software includes the operating system, a device subroutine library for programming more than 200 HP instruments from Pascal, BASIC or FORTRAN, and a system functional test program.

### System Integration

Integration services for the ATS 2000 are initiated with a study of the customer's test application to arrive at a system configuration. The integration process includes system design hardware and software configuration, system assembly, racking and cabling, design of a system functional test program and hardware adapter, optional pre-shipment customer acceptance, site preparation and installation, on-site testing, comprehensive system-level documentation, and other support services. ATS 2000 Customer Training Courses are also available.

### Ordering Information

Each ATS 2000 system is designed specifically to meet individual customer needs. For more information, consult your local HP Sales Office.



1870

1871

1872

1873

1874

1875

1876

1877

1878

1879

1880

1881

1882

1883

1884

1885

1886

1887

1888

## **DESIGN AUTOMATION & TECHNICAL COMPUTERS**

<b>Design Automation.....</b>	<b>616</b>
<b>Technical Computer Systems.....</b>	<b>638</b>

Hewlett-Packard offers a large family of design automation solutions integrated under a common design environment — HP DesignCenter — that allows electronic, mechanical and software projects to be linked together throughout the design process. Hewlett-Packard also offers a broad range of technical computers and workstations for design, measurement automation, manufacturing, and real-time monitoring and control, including several new models using HP's Precision Architecture.

**Design Automation  
& Technical  
Computers**

# DESIGN AUTOMATION

## HP DesignCenter

### General Information

#### Design Automation

Design automation is the process of using computer-automated productivity tools to improve the quality of new products and the speed with which they can be moved through the design cycle and into manufacturing. When implemented effectively, design automation has a powerful, positive effect not only on quality and time to market, but on production costs, product reliability and other factors that ultimately affect the competitive position and profitability of your company.

Design automation has become something much greater than an opportunity for aggressive firms looking for a competitive edge. It is now crucial for survival in a growing number of markets.

Hewlett-Packard's approach to design automation has been to develop an integrated design environment that enables engineering teams in electronic, mechanical and software projects to link their efforts through the entire design process, from concept through manufacturing.

#### HP DesignCenter

HP DesignCenter is an integrated design environment for electronic, mechanical and software engineers, where tasks can be planned, executed and managed more effectively. HP DesignCenter includes tools for data management, documentation and communication, not just design automation software. It runs on a family of powerful workstations that link, through industry-standard networks, to computers from HP and other vendors.

DesignCenter will help the individual design engineer by providing an integrated set of tools to speed the design process from idea to final production, while also improving overall quality. DesignCenter comes with the support, documentation and training to ensure productive use of design tools.

#### HP Design Automation Products

HP Distributed Computer Foundation Page 619

#### HP DesignCenter Electronic Engineering CAE/CAD Products

HP 64000-UX Microprocessor Development Environment	621
HP Teamwork SW Analysis and Design Environment	627
HP Electronic Design System	622
HP Microwave Design System	625
HP Programmable Logic Device Design System	626
HP Printed Circuit Design System	632
HP Engineering Graphics System	634

#### HP DesignCenter Mechanical Engineering CAD/CAM Products

HP ME Series 5, 10 & 30 636

#### Value-added Solutions

HP Technical Software Catalog 620

#### HP 9000 Family

The HP 9000 family of technical computers is the foundation for HP DesignCenter. HP 9000 products include the Series 200, 300, 500 and 800 Technical Computers. This includes the Series 800 Precision Architecture computers (see page 640). The use of these computers in the design automation environment is discussed on page 619. Another section of this catalog is devoted to detailed discussions of HP technical computer products, beginning on page 638) HP's 9000 family features the HP-UX operating system which adheres to AT&T's UNIX\* System V interface definition, Issue 1. Individual workstations as well as total systems can be configured in a powerful IEEE 802.3 local-area network (LAN). See page 660 for networking information.

#### Electronic CAE/CAD Products

HP 64,000-UX Microprocessor Development Environment is a natural evolution of HP's 64000 Logic Development System. This family of microprocessor development tools is fully compatible with the existing 64000 family, but adds a number of new capabilities. HP 64000-UX is fully integrated into the DesignCenter family and uses the same computer platform, and provides links to other DesignCenter solutions. The system provides versatile networking to popular software on systems such as DEC VAX and the IBM PC. In-circuit emulators, language systems and analysis tools are now available for 8-, 16- and 32-bit microprocessors. A broad selection of price/performance options helps to select the best system for your needs. See page 627.

\*UNIX is a registered trademark of AT&T in the U.S.A. and other countries.

#### HP DesignCenter EE CAE/CAD Solutions

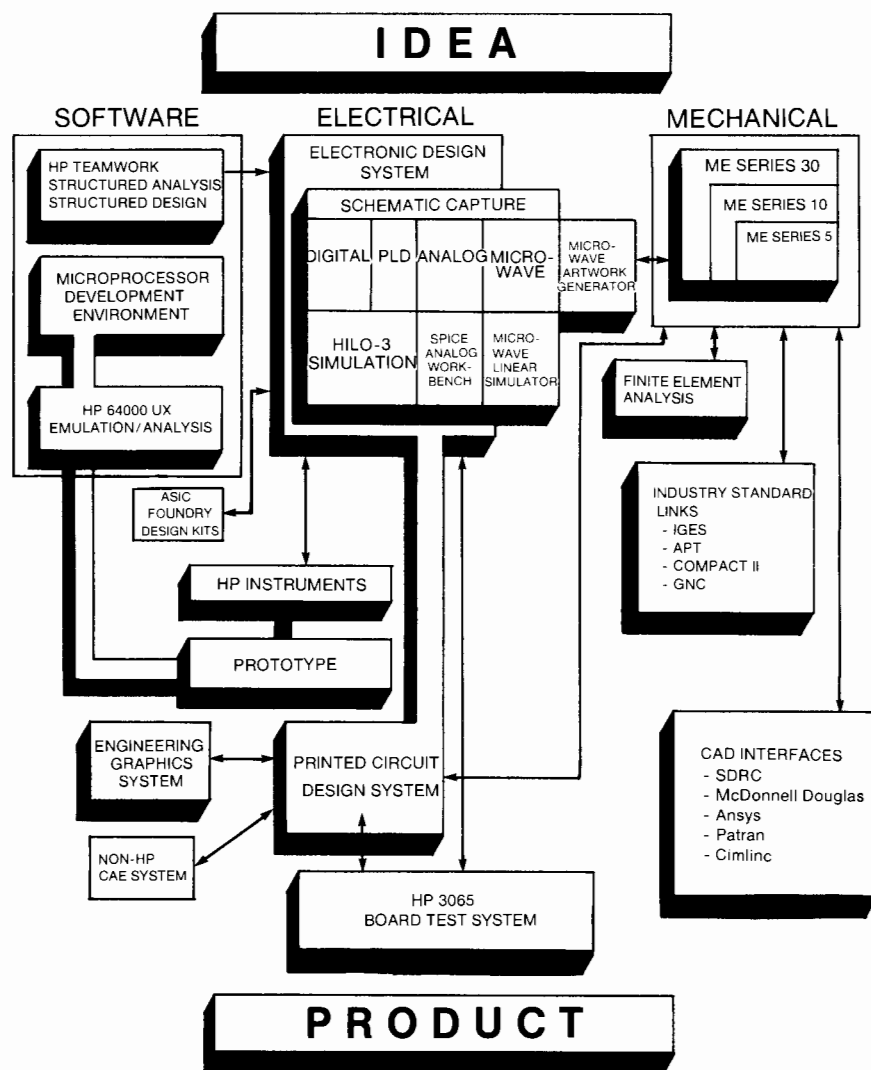

**HP Teamwork Software Specification and Design Environment** helps software engineers develop and manage software specifications and designs. HP Teamwork/SA,SD, RT, and ACCESS provide tools for structured analysis with realtime extensions, structured design, and integration of the resulting database with other software development tools. These teamwork products help to reduce the costs of software development by allowing rapid capture and maintenance efforts for software applications including embedded microprocessor systems, measurement automation, instrument control, and general scientific. See page 622.

**HP Electronic Design System** provides integrated tools for all phases in the development of digital, analog, and microwave circuitry. The system includes more than 7000 logic and analog component library parts, a powerful schematic editor, HILO-3 logic simulation, analog simulation through the Analog Workbench, links to the HP 16500A prototype test, to HP's PLD Design System, and to physical layout systems, and a user interface that simplifies interaction with the design and verification tools. The HP Electronic Design System is available as a high-end system for use on the HP 9000 Series 300 technical workstation. See page 622.

**HP Microwave Design System** is a powerful tool for designers of hybrid- and microwave-integrated circuits. The system consists of three fully integrated modules for schematic entry of the circuit, linear-circuit simulation and optimization, and circuit artwork generation. Extensive capabilities for documenting the design also are integrated into the program. The system also links to other HP electronic- and mechanical-engineering design systems. See page 625.

**HP's Programmable Logic Device Design System** is a device-independent design tool that supports the entire design process of Programmable Logic Devices (PLDs) — from conceptual and functional design, through device selection, pin/resource assignment, to debugging and fusesmap generation. The system automatically fits designs into the most efficient PLD and automatically partitions large designs into multiple PLDs to shorten design time. A bidirectional link with HP's Electronic Design System allows schematics to be transferred to the HP PLD Design System for PLD realization. Once the design has been fitted into one or more PLDs, the system will automatically generate HILO®-3 models for design verification on the HP Electronic Design System. See page 626.

**HP Printed Circuit Design System** couples printed-circuit-board layout to electrical engineering design, manufacturing and test. Tightly coupled with HP's Electronic Design System, the Printed Circuit Design System allows PCB designers to create highly manufacturable boards that perform as the design engineer intended. HP Printed Circuit Design System provides packing, placing and routing features to automatically lay out digital, analog and mixed digital/analog

boards with through-hole and surface-mount technologies, with facilities for thick-film hybrid design. The system has links to HP's ME Series products and to schematic capture systems from HP, P-CAD, FutureNet and others. The system also generates a complete range of manufacturing and test reports. HP Printed Circuit Design System software is derived from Northern Telecom Incorporated (NTI), and its subsidiary, Bell Northern Research (BNR). See page 632.

**HP Engineering Graphics System (EGS)** provides powerful tools for thick-film hybrid circuit design, interactive printed circuit board layout and schematic drawing, as well as mechanical drafting for the enclosures to house PCB designs. The product also includes a general drawing module for artwork such as overhead slides, project planning diagrams and floor plans. HP EGS can be easily customized to perform specialized CAD tasks. All HP EGS modules run on HP 9000 Series 200 and 300 workstations and on the HP Vectra personal computer. See page 634.

**HP Design Data Controller** provides flexible data management and file security for HP Electronic and Printed Circuit Design System data. This data includes schematic drawings, simulation stimulus and results, documentation, board layout graphics, back annotation and engineering changes, material lists, and manufacturing and tooling files. Large design teams can keep track of data revision, control access to files, and lock data at project checkpoints to prevent unauthorized or unsynchronized updates. The HP Design Data Controller is available on HP 9000 Series 300 and 800 computers.

**HP EE Test solutions** are the most highly rated in the business. HP is a leading supplier of logic analyzers, digitizing oscilloscopes, radio and microwave frequency sources and analyzers, low-frequency dynamic signal analyzers, board test systems and other products. For example, test vectors generated for HILO-3 simulation within the HP Electronic Design System can be sent to the HP 16500A Logic Analyzer for use with a design prototype, to the HP 81810S IC Design Verification System for verification of ASIC designs, or to an HP 3065 Board Test System as ready-to-use board test programs. See the alphabetical index of this catalog for the specific instruments of interest to you.

**Mechanical CAD/CAM Products**  
**HP Series 5, 10 & 30 Mechanical Engineering Systems** are a family of CAD products for mechanical drafting, 2D design and solids modeling, respectively. All three use the same user interface, developed to dramatically reduce system learning time to quickly improve designer productivity. ME Series 5, 10 & 30 provide a range of functions for design through modeling and drafting of complex mechanical parts and assemblies. The result is reduced prototyping requirements and faster creation and modification of drawings. See page 636.

**HP Mechanical Engineering Test Products** have grown out of the company's longstanding involvement with state-of-the-art instrumentation for vibration and structural analysis and test. In addition to the CAD/CAM products listed below, HP offers a large family of mechanical testing solutions. See page 147.

HILO is a U.S. registered trademark of GenRad, Inc.

**Mechanical CAD Solutions**

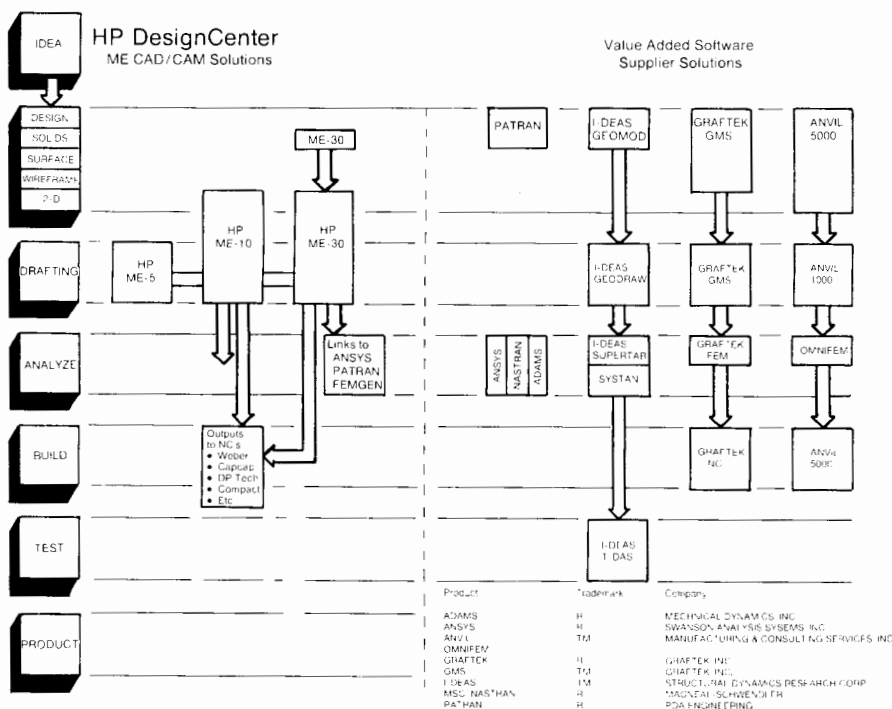

# DESIGN AUTOMATION

## HP DesignCenter (cont'd)

### General Information



#### Lots of Links

Ideally, a new product design should work right the first time, but many companies average six iterations. Integration is the key to reducing the number of times designs must be reworked. HP EE DesignCenter products can be tightly linked. See diagram on page 616.

HP Electronic Design System provides strong links to HP Technical Office Automation, HP EGS, HP 64000-UX Microprocessor Development Environment, HP Printed Circuit Design System, HP Programmable Logic Device Design System, and the HP 3065 Board Test System, with additional links to Racal Redac, RINF, Calay, Computervision, GenRad HiChip physical modeling and ASIC foundry links to NEC, Motorola, TI and others. HP Printed Circuit Design System not only receives net lists and parts information from HP Electronic Design System, but sends back engineering changes and back-annotation data.

#### Value-added Solutions

To increase the breadth of solutions available to HP customers, Hewlett-Packard actively seeks out and relies upon the expertise of Value-Added Software Suppliers to augment HP's proprietary solutions. More than 300 independent software vendors are work-

#### Sensitivity of Profits Over Product Life

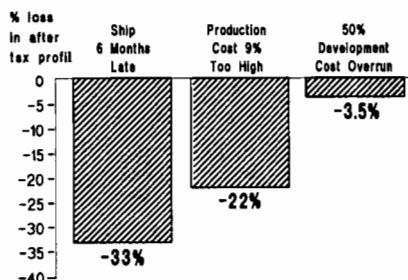

ing with HP to provide a large selection of software products for technical applications. See page 620.

#### Why CAE/CAD/CAM?

During the past few years, several factors have influenced the typical product design process in ways that make the design engineer's task more demanding. Increasing global competition has compressed product development time as well as product life cycles, making the time saved in development even more critical than in the past.

The shorter the development time, the sooner the product goes to market and the longer the sales life of the product. A recent electronics industry study compared the impacts on product profitability of development costs, product costs and late product introduction.\*

Using a representative high-growth market with 5-year product life, 12% annual price erosion, and 20% growth per year, an overrun of 50% in product development costs will decrease after-tax profits by 3.5%. In contrast, a production-cost overrun of only 9% results in a 22% decrease in after-tax profits. Even more significant, a six-month delay in introduction costs 33% of the after-tax profits.

(\* Figure from Donald Reinstein, McKinsey & Co, Los Angeles, CA, Electronic Business, July 1983, P. 86. Copyright 1983, Cahners Publishing Company)

#### CAE/CAD/CAM

##### A Strategic Decision

Purchase of any computer system is an important decision that requires looking beyond today's needs and currently available product features to expected future requirements and growth paths. This is especially true in CAE/CAD/CAM since the user's entire design-to-manufacturing cycle can be linked to the selection of a CAE vendor. With technology and design requirements changing at an ever-increasing pace, the strategic directions

of alternative CAE vendors are an important factor in the selection process.

HP's product strategy is founded on a major corporate commitment to the CAE/CAD/CAM business. The company's engineering expertise, reputation for quality and experience in test, measurement and technical computing, as well as its respected worldwide support organization, all contribute to HP's position as a leading supplier of CAE/CAD/CAM solutions.

#### Summary

Hewlett-Packard has for many years been a leading supplier of computers and engineering workstations for measurement automation, data acquisition, automatic test, factory automation and many other technical applications.

Today, by combining its expertise in technical computers with its experience in state-of-the-art electronic design, HP supplies high-quality design systems to help improve the productivity of electronic, mechanical and software engineers.

Computer-aided engineering and design capabilities applied throughout the design cycle improve efficiency and quality at each step in the process and enhance communication and coordination between steps. With the increased capabilities and lower costs of technical workstations, peripherals, test equipment and application software, it is becoming feasible for every area of the factory to use these tools in collaboration so each can truly influence products in appropriate stages of design and development.

With the HP DesignCenter, an engineer will have access to a comprehensive offering of CAE/CAD/CAM solutions for electronic, mechanical and software development. Along with this comes the support, training and service that has distinguished Hewlett-Packard over the years, and that is so important to the successful use of these complex systems.

When the best solutions may be available through applications software from third parties and independent software vendors, HP cultivates relationships with other leaders in the market. This combination of the HP DesignCenter offerings complemented by renowned third-party products, provides the customer with the widest possible range of design automation solutions.

HP is committed to a technical and business relationship with CAE/CAD/CAM customers, which begins when the HP field engineer helps to define and analyze the customers' specific needs. This continues through system installation and implementation and extends through the life of the system and beyond as needs expand and new products become available.

#### Contact HP

HP's CAE/CAD/CAM offerings are continually expanding as new products are introduced at a rapid pace. The products on the following pages represent the current state of the HP DesignCenter family, but are by no means the whole story.

Contact your nearest Hewlett-Packard sales office (see page 771) for more detailed information on HP's growing family of products for design automation solutions in CAE/CAD/CAM.



### HP 9000 Computers—The Foundation for Design Automation



#### The Foundation

Success in implementing CAE/CAD/CAM depends not only on software solutions to design problems, but on using a family of computers and workstations that meets the demands of those solutions, both today and tomorrow. Engineers in these fields must have a broad selection of computer systems to meet the needs of a number of applications, both for their own development work, and as delivery vehicles for developed products.

These computer systems must provide flexibility in configuration choices for performance levels, programming languages and operating systems. HP provides all this in its HP 9000 family of computers, and offers a range of supporting products for networking, graphics, artificial intelligence, interfacing and technical office automation.

#### Distributed Computing Environment

Hewlett-Packard's distributed computing environment, shown in the diagram on this page, is comprised of computing systems, networking, high-resolution graphics, advanced data management systems, languages and a wide range of peripherals. HP is committed to the UNIX® operating system as a standard, and to industry networking standards such as IEEE 802.3 and ARPA/Berkeley. Conformance to these and other standards allows systems to be configured into a powerful local area network (LAN), and provides an open system environment to support multi-vendor solutions.

#### Low Cost of Ownership

Hewlett-Packard's low cost of ownership reflects the quality of its computers, developed over years of computer design, manufacturing and support, that have placed more than 250,000 HP 9000 computers in businesses around the world.

#### HP-UX

HP-UX is the primary operating system offered on the HP 9000 family. HP-UX adheres to AT&T's System V Interface Definition, Issue 2, and offers compatibility with a large number of other UNIX operating systems.

Along with HP-UX, many HP 9000 computers run Hewlett-Packard's BASIC and Pascal language systems. HP BASIC offers the ease-of-use of an interpreted language, yet features exceptional operating speed, while HP Pascal can help design engineers to fine-tune programs close to machine level.

#### Networking

HP is dedicated to maintaining compatibility across the HP 9000 family. Nearly all members of the HP 9000 family are available with an industry-standard operating system. See page 658 for details on languages and operating systems.

ARPA/Berkeley and NFS networking services add another level of capability to the HP 9000 family, making these defacto networking standards available on the Series 300 and 800 for communication between computers, and with non-HP computers, including products from DEC and Sun. See page 660 for details.

UNIX is a registered trademark of AT&T in the U.S. and other countries.

#### Software Developers

The flexibility and scalability built into the HP 9000 family will make the software developer's job easier. Whether developing solutions for in-house use or for delivery to customers, software developers will find it much easier and faster to design software products on a system that is well equipped, and which is fully compatible with a broad range of other computer systems.

#### HP 9000 Family

Hewlett-Packard's HP 9000 family of technical computers and workstations has evolved to meet a variety of needs. The computer family now covers a broad range that includes:

- The latest in superminicomputers, superworkstations and mini-computers; the HP 9000 Series 800s, all based on HP's Precision Architecture RISC technology.
- Supermicro/minicomputers, including the HP 1000 family for manufacturing automation.
- Instrument controllers, including the HP 9000 Series 300 Models 310, 319, and 330, and the HP Vectra.
- Low-to mid-range engineering workstations, including the HP 9000 Series 300 Models 310, 319, 360 and 370.
- Personal computers, including HP Vectra, Industrial Vectra, The Integral PC and HP 9000 Series 300 Model PC-308.

For more detailed information on the HP 9000 family of technical computers, please see the Technical Computer Systems pages of this catalog:

HP 9000 Technical Computer Systems	Page
HP 9000 General Information and Selection Guide	638
HP Precision Architecture	640
HP 9000 Series 800 Superminicomputers	643-642
HP 9000 Series 800 Superworkstations	646
HP 9000 Series 300 General Information	647
HP 9000 Series 300 Graphics Subsystems	650
HP 9000 Series 300 Entry Level Workstations	652
HP Technical Vectra	653
HP Integral PC	657
Languages and Operating Systems	658
Networking	660
X Window System	665
Artificial Intelligence	666
Peripherals	667
Interfacing Summary	668
DOS Coprocessor	669
HP 1000 Minicomputers	670

#### Controllers

The same flexibility that makes HP 9000 computers excel in design automation applications has provided superior performance in measurement automation applications for many years. Computer-aided test, test and engineering evaluation and analysis, manufacturing and industrial monitoring and laboratory monitoring and analysis are just a few of the applications. See page 552 for more information.

HP DesignCenter  
Distributed Computing Environment

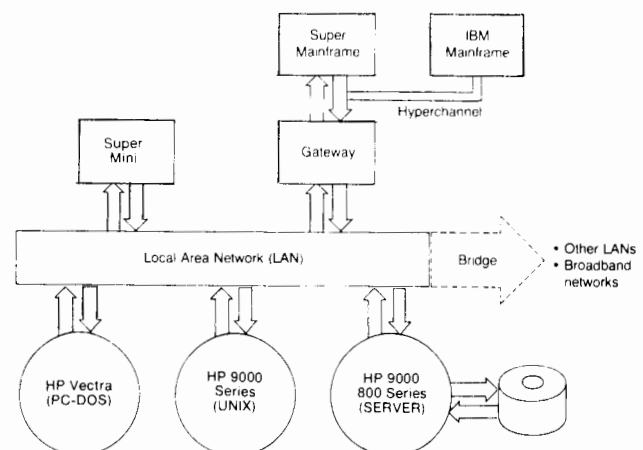



# DESIGN AUTOMATION

## HP Technical Software Catalogs

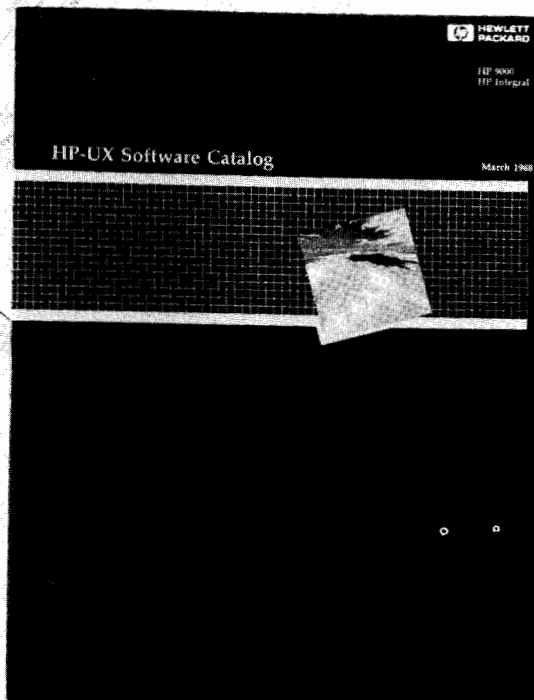

### Technical Software Solutions

Hewlett-Packard publishes several software catalogs that list technical solutions available on the full line of HP technical workstations. The software listed in these catalogs comes from two sources:

1. Software submitted by independent software suppliers to the HP Valued Added Channels HP PLUS Program. More than 1500 products from over 500 vendors currently are involved in this third party software supplier program - from aerospace simulators to water utility operations.

2. HP Proprietary software (which offers a broad selection of HP-proven technical applications), utilities, and integrated solutions.

Applications areas in these catalogs range from engineering graphics systems to AC circuit analysis and from statistical analysis to data communications. Software from fourteen different HP manufacturing divisions is included in these catalogs.

Software products listed in these catalogs run on the HP 9000, HP 1000, Series 80, HP Portable and HP Vectra hardware families. The operating systems include BASIC, Pascal, HP-UX, RTE and MS-DOS.

### HP Technical Software Catalog

The HP Technical Software Catalog (published annually in May) contains more than 1,000 software solutions for HP 9000, HP 1000, Series 80 and other HP technical computers running BASIC, Pascal, RTE and MS-DOS operating systems. The catalog includes product descriptions, vendor information and pricing.

### HP-UX Software Catalog

The HP-UX Software Catalog (published semi-annually in February and August) contains more than 500 products specifically designed to run on the HP-UX operating system. These listings include both technical and commercial products.

### HP Vectra Technical Software Guide

The HP Vectra Technical Software Guide (published annually in April) contains more than 1,500 IBM PC-compatible technical products tested to run on the HP Vectra Personal Computer. This catalog includes recommended configurations, product descriptions, and vendor information. The Technical Software Guide is available from your local HP Vectra PC Dealer.

### HP PLUS Program

To service its more than 500 independent technical software suppliers, HP relies on a third party vendor program called HP PLUS. This program is administered by the HP Field Sales organizations.

HP PLUS offers software in three different categories: Listed, Referenced and Distributed/National Accounts. The Listed category is for the supplier with the lowest level of HP involvement in marketing his products. The Referenced category is for those products on which HP has received favorable user feedback and is providing some merchandising assistance. The Distributed or National Account status is for software that HP has elected to provide assistance in marketing, merchandising, and selling.

Contact your local HP Sales Office for complete details on the HP PLUS Program.

### Ordering Information

Hewlett-Packard technical software catalogs are free to HP customers and independent software vendors. For your copy of the Technical Software Catalog, please contact your local HP Sales Office and ask for HP Publication Number 5952-6696. For the HP-UX Software Catalog, ask for HP Publication Number 5951-6794. For the Vectra Software Guide, ask for Publication Number 5951-6821.

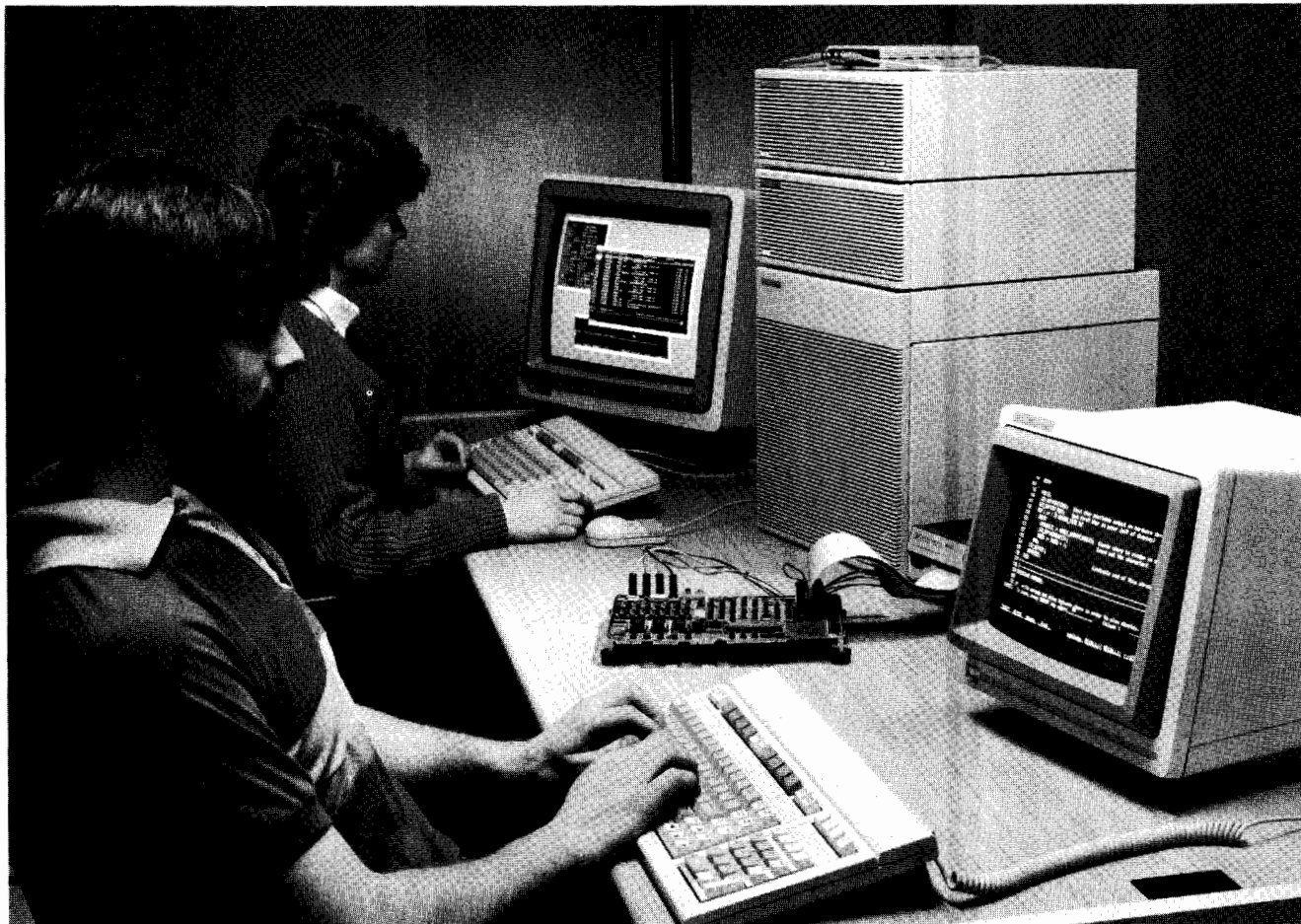

#### HP 64000-UX Microprocessor Development Environment

The HP 64000 Microprocessor Development Environment provides a powerful solution to the development of microprocessor-based systems. The modular structure gives you the ability to select only the subsystems needed for a cost-effective solution to your development application. You also have the flexibility to expand the development environment as your need for additional measurements grows.

This modular system can be easily configured for single- or multi-user design environments. A wide selection of platforms, memory, peripherals, as well as hardware, software, and integration design tools ensures that the optimum configuration is available to solve your design problem. For intensive hardware/software designs, there are links to host computers, schematic capture, simulation, physical modeling and board test.

#### Increase Productivity

The HP 64000-UX is an effective solution to shortening the microprocessor based system design cycle. It combines advanced software development, realtime emulation, sophisticated hardware/software analysis capabilities and the power of the UNIX operating system.

Configuration flexibility combines with ease of operation to form a system that allows you to develop your product rapidly. Software project management tools running under the HP-UX operating system ensure smooth progress during the development cycle. Software engineers benefit from tightly coupled, high level development, debug, and analysis tools. Realtime performance analysis tools quickly point to system bottlenecks, allowing significant improvements in performance in a fraction of the time required when using conventional techniques.

Powerful, interactive, yet easy-to-use emulation and timing analysis speeds hardware development. The HP 64000-UX environment allows many engineers to share the same data base and combines interactive tools for hardware/software design tasks. System integration, often the most time consuming system development phase, is greatly enhanced. All this means product development schedules are

shorter and better products get to market sooner. The HP 64000-UX can grow with your needs and provide complete assurance that your investment is protected.

#### A System to Match Your Needs

HP 64000-UX workstations are capable of performing standalone or in clusters sharing peripherals. Expansion of a single, hard-disc-based station to a multistation system is as simple as connecting another station to the bus.

Large design environments can benefit from the HP 9000 series of workstations by running the UNIX\* operating system. The workstation connects directly to an HP 64120A instrumentation card cage system bus so that it shares the same data base with the development system.

HP 9000 series workstations offer powerful networking capabilities for easy sharing of data between teams while preserving team independence for project management purposes. The UNIX operating system provides software revision control systems and automatic compiling and linking to ensure that only the current version of a module is used by team members.

HP 64000-UX cross-development and debug, and data communications software is available to run on DEC-VAX series computers. This means that you can protect existing investments and still take advantage of all the power of the HP microprocessor development environment. For very intensive microprocessor based system designs, there are links to host computers, schematic capture, simulation physical modeling, and board test, which makes the HP 64000-UX an integral part of the HP DesignCenter environment.

#### Modularity Provides Flexibility and Economy

A variety of system configurations are possible with the modular components in the HP 64000-UX microprocessor development environment. Starting with the powerful HP 9000 series 300 workstation as the controller, you can build a flexible development environment that supports a single user, a small development team, or a large team linked over a LAN. The series 300 workstation controls access to the instrumentation card cage which houses up to 10 feature cards for HP emulators and analyzers.

# DESIGN AUTOMATION

## HP DesignCenter (cont'd)

### HP 64000-UX Microprocessor Development Environment

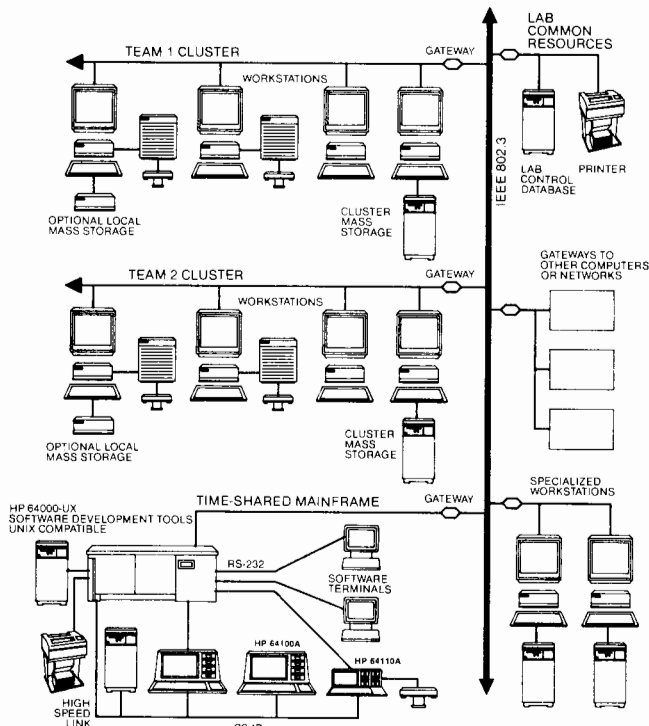

The HP 64000-UX Microprocessor Development Environment is easy to tailor to your design needs. Up to six stations can be assembled in a single cluster for small- to medium-sized teams with a central data base. Larger teams link to a multi-user HP-UX computer.

#### Hosted on HP 9000 Series 300

The HP 64000-UX Microprocessor Development Environment offers significant capabilities:

- Integration with HP's DesignCenter design automation system to support CAE/CAD/CAEE solutions on a platform common with the microprocessor development system.
- An open system with versatile networking to popular microprocessor software development environments such as DEC VAX and IBM PC.
- In-circuit emulators, language systems, high-level debuggers, and powerful analysis tools for 8-, 16-, and 32-bit microprocessors including custom processors and bit slice design.
- HP Computer-aided Software Engineering tools (CASE) that address the entire microprocessor software design cycle.
- An outstanding range of performance options, ranging from low cost RS-232 terminals to powerful, dedicated workstations. Small to large design teams are supported with equal flexibility.

#### HP 64000-UX Microprocessor Development Environment

Up to four card cages can be controlled by a single workstation. One station can support up to ten users performing a variety of development tasks such as coding, compilation, emulation, analysis, etc.

#### Systems Environment Features

An HP 64120A instrumentation cardcage houses the HP 64000 emulators and analyzers. Feature control software for these tools runs on the HP 9000 Technical Workstation. User interfaces on RS-232 terminals and Series 300 displays are consistent with the HP 64100/64110 stations, eliminating the need for current users to learn a new interface.

Users can choose from the most comprehensive language support available today for microprocessor development. Cross assemblers and compilers are available for more than 40 popular microprocessors and custom designs.

MICROPROCESSOR		EMULATOR	CROSS ASSEMBLER/LINKER	PASCAL CROSS COMPILER	C CROSS COMPILER	STATE ANALYSIS	PRE-PROCESSOR	HIGH-LEVEL ANALYSIS
Fairchild	F9450	■	■	■	■			
Hitachi	HD 6301V/6303R	■	■	■	■			
	HD6303R/X/Y	■	■	■	■			
	64180	■	■					
Intel	8048/8049	■	■					
	8051/8751/8031	■	■					
	8080*	■	■	■	■			
	8085	■	■	■	■			
	8086/80C86†	■	■	■	■			
	8088/80C88†	■	■	■	■			
	80186†	■	■	■	■			
	80C186‡	■	■	■	■			
	80188†	■	■	■	■			
	80C188‡	■	■	■	■			
	80C196KA‡	■	■					
80286*	■	■	■	■				
80386**	■	■	■	■				
Motorola	6800/68A00/68B00*	■	■	■	■			
	6802/6808*	■	■	■	■			
	6801/6803	■	■	■	■			
	6805R/6805U	■	■					
	6805P	■	■					
	6809/68A09/68B09	■	■	■	■			
	6809E/68A09E/68B09E	■	■	■	■			
	146805E2	■	■					
	146805G2	■	■					
	68000†	■	■	■	■			
	68008	■	■	■	■			
68010†	■	■	■	■				
68020**	■	■	■	■				
68HC11	■	■						
NEC	70116/70216	■	■	■	■			
	70108/70208	■	■	■	■			
National	NSC800	■	■	■	■			
PACE	PACE 1750	■	■					
Texas Instruments	TMS32010/320M10*	■	■					
	TMS32020/320C25‡	■	■					
Zilog	Z8001	■	■	■	■			
	Z8002	■	■	■	■			
	Z80†	■	■	■	■			
User Definable		■						
ROM		■	■					
Microprogrammable* (bit slice)		■	■					

\* Supported on HP 64100 stations only.

\*\* Supported on HP 64120 only.

† Also supported on HP 64700 series.

‡ Supported on HP 64700 series only.

Summary of processors supported by the HP 64000 Microprocessor Development Environment.

#### Compatibility with Existing HP 64000 Systems

HP cross compilers and assemblers currently running on the HP 9000 Series 500 and HP 9000 Series 300 computers, DEC VAX computers and HP 64000 stations are fully compatible with the HP 64000-UX microprocessor development environment.

There are high-level software debug subsystems that provide an integrated design system. This integrated design capability includes structured analysis with real-time extensions, structured design, advanced technology language systems, debugging with either emulation control or simulation, coverage test, and software performance analysis.

#### Emulation - 8, 16 & 32 BIT

The HP 64000 Logic Development System offers a wide selection of emulators to support microprocessor-based product development. These emulators provide an essential link between the software development environment and the target system. Programs developed on the HP 64000 system or compatible computers are run on the emulator subsystem for real-time debug and analysis. Processor run controls in the emulator allow you to single-step, display and modify memory. Modifications and improvements to software are made quickly and easily in the early design phases; emulation gives you the flexibility to experiment before committing a product to firmware.

For microprocessors that are not presently supported with a dedicated HP 64000 system emulator, a custom emulator can be developed using Model 64274S User Definable Emulator as a base. For ROM-based systems, there is a ROM Emulator, Model 64272S, to provide a controlled environment for software execution and analysis. Both user-defined emulators are powerful alternative tools for applications not served by processor-specific HP 64000 system emulators.

## Analysis

Analysis and system integration are major functions when designing and developing superior microprocessor based products. The HP 64000 System offers five analysis subsystems to meet measurement needs for troubleshooting, debugging, and optimizing target systems. The HP 64302A Emulation Bus Analyzer is a basic real-time analyzer used with an emulation subsystem. As well as providing the displays and triggering conditions for the emulator, the HP 64302A analyzer is the emulator's access point for interactive emulation/analysis; in addition, it supports the High-Level Software Analyzer (HP 64330) in an HP 64000 station for analysis in high-level programming languages of C and Pascal. The HP 64340 Real-time, High-level Analyzer is a hardware and software package that operates with an appropriate HP 64000 emulation subsystem and HP 64100A station. HP 64310A Software Performance Analyzer is also used with an emulator, providing overview measurements that aid in system-level evaluations. For complex problem solving, HP 64610S Logic Timing/State Analyzer and HP 64620S Logic State/Software Analyzer are high performance analyzers that may be used separately or interactively.



### Basis Branch Analyzer

HP's basis branch analyzer (BBA) is a test coverage tool that provides an integrated, straightforward way to measure the effectiveness of software tests within the cross development environment. The BBA uses the actual prototype hardware, running the program under test, to produce metrics. Comprehensive reports provide detailed feedback on the thoroughness of test cases for an embedded microprocessor product.

### Software Performance Analysis

Model 64310A Software Performance analyzer provides overview measurements to aid in evaluating total system effectiveness of programs operating in real time. Global measurements let software designers determine where system resources are being used, in terms of execution times, memory usage and interaction traffic. Software performance measurements aid in determining where to focus optimization efforts for maximum effect on system performance.

- Histogram displays for quick comparisons of software activity
- Tabular displays with continually updated means and standard deviations on current measurement
- Measurement modes of memory and program activity
- Measurement modes of event duration
- Measurement modes of intermodule linkages

### Logic State Analysis

Model 64620S Logic State/Software Analyzer offers real-time, transparent state software analysis for microprocessor systems. A modular system, the analyzer can be configured for 20 to 120 input channels.

- Multiple trigger parameters using symbols, ranges, NOT, and "don't care" terms as well as file names and line numbers
- Selective data storage for edited state listings
- Powerful 15-level sequencer that may also be used to form one or two measurement windows
- Extensive symbolic tracing for quick setups and easy interpretation
- Real-time, nonintrusive analysis feature set supports debug for high-level programming languages
- Two software performance overview modes for code optimization

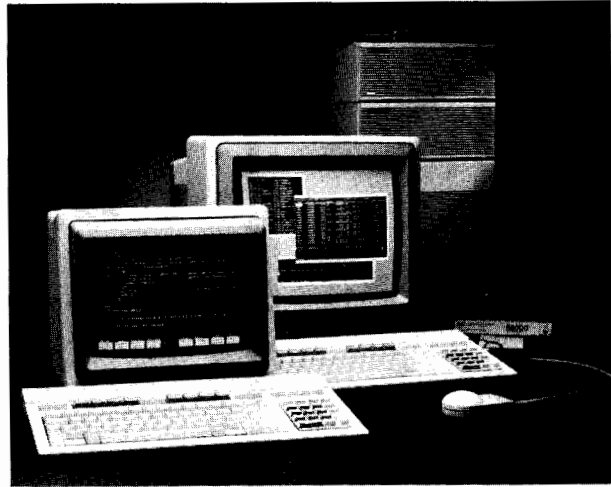

The HP 64000-UX Microprocessor Development Environment is a natural evolution of the HP 64000 family and is compatible with existing 64000 systems. The development environment offers many capabilities, and shares a common workstation platform with many HP DesignCenter products.

### Preprocessors and Interfaces

Preprocessors and interface modules tailor the HP 64620S Logic State/Software Analyzer for use with specific microprocessor systems. Preprocessors provide quick, convenient connections between target systems and the logic analyzer. Control software and inverse assemblers are included with the processor specific interface modules that are installed in a general purpose preprocessor. The interface modules contain interface circuits and cabling to connect to the target system. Both processor-specific and userdefinable interface modules are available.

### Timing Analysis

Model 64610S High-speed Timing/State Analyzer subsystem offers powerful, high resolution, asynchronous and synchronous analysis with extensive postprocessing capabilities. Many triggering modes allow precise positioning of the display window to locate timing margin, state, execution and interaction problems. Postprocessing adds another dimension to timing/state analysis with the ability to perform operations on acquired data, such as automated compare and statistical analysis of raw data. To analyze the operation of high speed logic in bit slice, microprogrammable, and state machines in real time:

- Asynchronous sampling from 2 Hz to 400 MHz for excellent resolution
- Synchronous sampling to 125 MHz
- Compare level, range and fault qualifications for state and timing listings
- Memory depth of 4060 samples in wide sample mode and 8140 samples in fast sample mode
- Glitch capture and trigger for glitches as narrow as 3 ns to quickly locate transients
- Dual threshold mode for checking transition times, loading problems, and noise margins.

# DESIGN AUTOMATION

## HP DesignCenter (cont'd)

### HP 64000-UX Microprocessor Development Environment

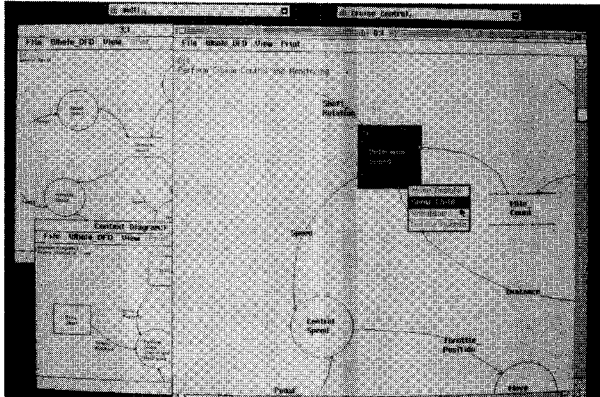

HP Teamwork/SA user interface windows provide a simultaneous view of data flow diagram from a variety of viewpoints. Pull-down menus permit easy function selection.

#### HP Teamwork An Environment for Structured Systems Development and Reduced Life Cycle Cost

HP Teamwork is an integrated environment for structured systems development and reduced life cycle cost. The system developer uses HP Teamwork products to clearly define what functions the system will perform and how these functions will be accomplished. Various views of the system are supported to allow the developer a high degree of flexibility when approaching each new project. HP Teamwork/IM for information modeling helps analysts and designers model the entities, relationships, and attributes of all application data at the conceptual level — Retained Data View. HP Teamwork/IM supports entity relationship diagrams as described by Chen. HP Teamwork/SA implements structured analysis techniques and methods defined by Yourdon and DeMarco to model the Functional View of the system.

HP Teamwork/RT provides real-time extensions to HP Teamwork/SA for modeling the Control/State View of the system. HP Teamwork/RT supports combinational and sequential finite state modeling notation as defined by Hatley. HP Teamwork/SD for structured design supports the design phase of the system life cycle. Systems analysts and designers are provided with facilities for modeling the Design View of the system. HP Teamwork/SD supports the methodology prescribed by Yourdon and Constantine. HP Teamwork/ACCESS opens the HP Teamwork models with documentation, project management, and software development tools. The open architecture of HP Teamwork/ACCESS is the key to unlocking the full power of the HP Teamwork computer-aided systems engineering environment.

#### Software Quality and Reduced Life Cycle Cost

The structured methods supported by HP Teamwork products encourage the creation of quality software throughout the entire system life cycle. Most of the cost of software in use today is incurred after the initial release, during the maintenance phase. HP Teamwork products assist the developer in creating a useful description of what the system will do (analysis phase) and then how the system will perform its functions (design phase). The resulting analysis and design models play a large role in understanding the current state of the system and in proposing the next state of the system during each revision cycle. Because these system models are based on standard methodologies, they are extremely useful for new programmers and analysts assigned to the project team to learn the what and the how of the system. The overall result is improved software quality and reduced system life cycle cost.

#### Project Database

Data dictionary entries, diagrams, specifications, notes, and project management data are contained in an extensive project database. To improve team communication and eliminate redundancy, a single

database can be accessed by designers on a project team, each working on separate workstations. In this multiple-designer environment, file locking and write-access protection safeguard project data. Only one user is allowed write access to an object at a time, but the object can be viewed in a read-only mode by several users.

#### Intelligent Editing System and Consistency Checker

HP Teamwork gives you all the benefits of manual structured methods while automating the tedious tasks usually associated with manual implementation. An intelligent editing system, with model-building rules and consistency checker, allows users to quickly create, edit, and correct diagrams and text according to the rules of the methodology. The checker allows the analysis and design team to gauge its progress step-by-step, to resolve problems early, and to ensure that the system adheres to the targets set for it.

Automated checking saves the analysis team many hours that can be devoted to a specification's meaning, rather than its form. Although powerful and intelligent, the checker never restricts a designer's creativity. It does not intrude during the analysis process, but responds only when called upon.

#### Selecting a Logic Development System

The HP 64000-UX Microprocessor Development Environment is a complex and dynamic family of microprocessor-based system support tools. Consequently, it is recommended that an HP Field Engineer be contacted for a suggested system configuration that will fit your application. For a copy of our latest HP 64000 brochure, in the U.S., call 1-800-447-3282 (in Colorado call collect 719-590-5540). Outside the U.S., call your local HP sales office.

#### Ordering Information

The system model numbers HP 64131S and 64132S are base numbers for bundled systems. Option numbers are used to specify the target processor for the development environment.

Model	Description	Price
HP 64131S	HP 64000-UX development environment with HP 9000 Model 330 workstation and 8-bit emulation	\$37,550
HP 64131S	HP 64000-UX development environment with HP 9000 Model 330 workstation and 16-bit emulation	\$40,610
HP 64131S	HP 64000-UX development environment with HP 9000 Model 330 workstation and 32-bit emulation	\$62,050
HP 64132S	HP 64000-UX development environment with HP 9000 Model 350 workstation and 8-bit emulation	\$53,000
HP 64132S	HP 64000-UX development environment with HP 9000 Model 350 workstation and 16-bit emulation	\$56,060
HP 64132S	HP 64000-UX development environment with HP 9000 Model 350 workstation and 32-bit emulation	\$74,950
HP 64702S Opt 004	adds HP Teamwork/ACCESS to HP Teamwork/SA/SD	\$900
HP 64710S Opt 004	HP Teamwork/SA	\$7500
HP 64712S Opt 004	adds HP teamwork/SD to HP Teamwork/SA	\$2500
HP 64714S Opt 004	adds HP Teamwork/IM to HP Teamwork/SA/SD	\$2500
HP 64715S Opt 004	adds HP Teamwork/RT to HP Teamwork/SA/SD	\$2500
HP 64716S Opt 004	HP Teamwork/IM	\$7500
HP 64717S Opt 004	adds HP Teamwork/SA to HP Teamwork/SD	\$2500
HP 64720S Opt 004	HP Teamwork/SD	\$7500



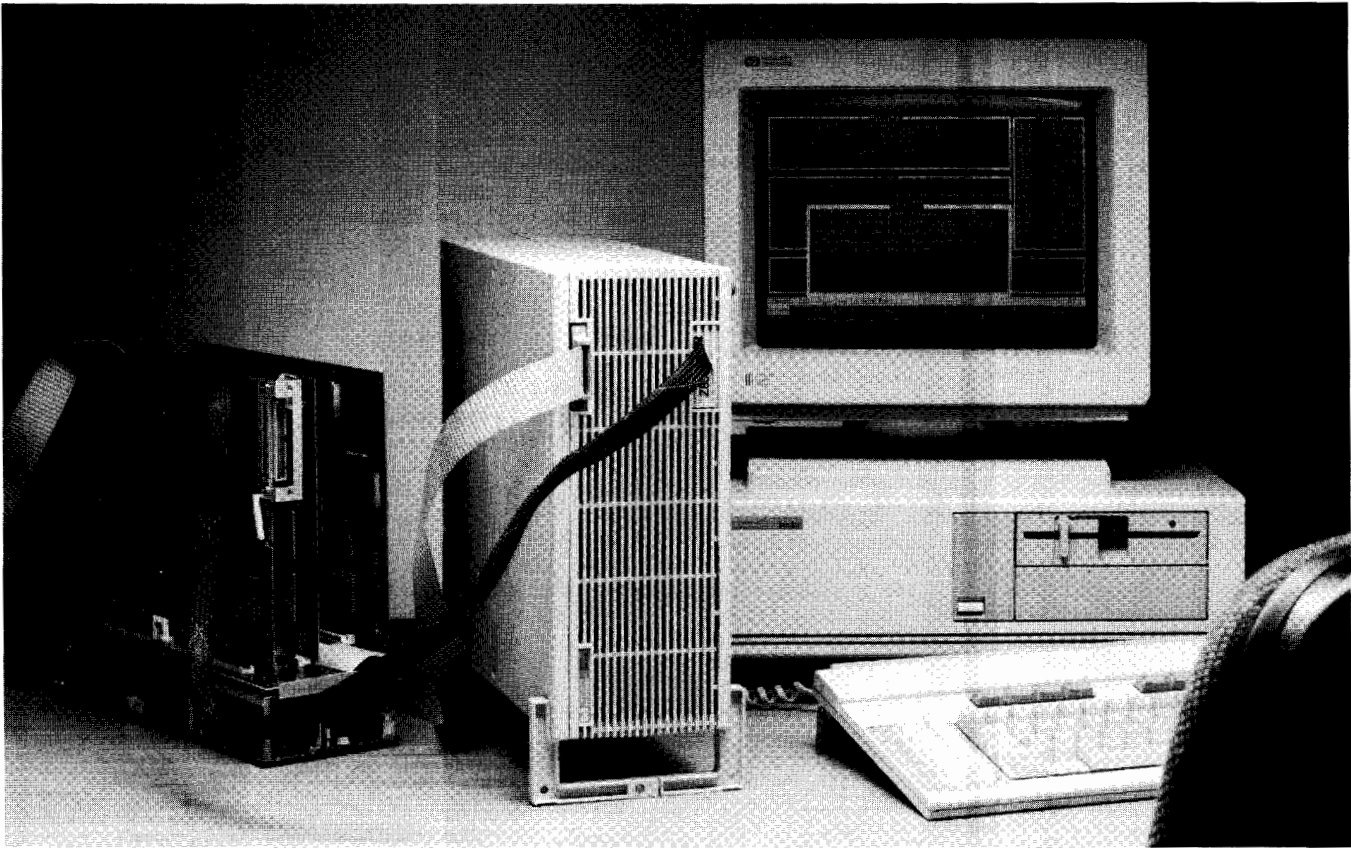

### HP 64000-PC Personal Integration Environment

The HP 64000-PC Personal Integration Environment provides the solution for the microprocessor software development and analysis needs of individual engineers and small design teams, as well as large teams developing complex, multiprocessor systems. High-performance tools at entry-level costs include an IBM PC-compatible, HP 64700 Series emulators with emulation user interfaces, and software development tools. Together these tools constitute a complete development environment tailored for small design teams and those desiring personal development systems.

#### High Performance

- Real-time, transparent emulation at full processor speeds
- Triggering capabilities in an emulation bus analyzer support eight-level sequencing, time tags, prestore analysis for establishing software interrelationships
- An optional 16-channel external analyzer that can function as a fully independent 100 MHz timing analyzer as well as a 25 MHz state analyzer
- Synchronized operation and cross triggering between multiple emulators for multiple processor designs
- Real-time code coverage analysis for efficient, thorough software testing and design
- A high-speed RS-422 interface greatly improves emulator download and upload times
- Dual-bus architecture and dual-port emulation memory to ensure nonstop, real-time emulation
- Fully tested to rugged electrical, temperature, and shock standards to ensure continued reliability and performance
- Meets international requirements for RFI/EMI emissions

#### Low Cost

- IBM PC-compatible-based system with emulator and integrated analyzers for a high-performance environment at entry-level costs
- Comprehensive software and hardware migration path to HP 64000-UX Advanced Integration Environment for high-performance, large team-oriented designs while preserving investment in HP 64000-PC

#### Ease of Use

- A friendly PC-hosted emulation interface — with windows, single-letter keystroke command entry, and menus
- Two RS-232-C communications ports, one with embedded RS-422 capability, offering standard interfaces plus high speed for connections to a host or terminal, with pass-through modes of operation
- Low-profile, emulation probes with cables up to one meter long ease plug-in to target microprocessor sockets in hard-to-reach places
- Pair of handles to suspend or prop up the small, light-weight emulator as close to the target system as possible
- Resident, host-independent user interface with on-line help
- Ability to synchronize and cross trigger other HP 64700 emulators/analyzers



#### HP 64700 Series Architecture

The HP 64700 Series consist of in-circuit emulation and logic analysis products for popular 8- and 16-bit microprocessors. These stand-alone emulators/analyzers can be controlled from a terminal or integrated into environments ranging from IBM PC-compatible-based environments to networked, high-performance, large, team-oriented workstation environments. HP 64700 series emulators offer the features necessary for emulation and analysis in a single unit.

#### Emulation Memory

Each HP 64700 Series emulator for 16-bit processors contains 128 kbytes of dual-port emulation memory; 8-bit emulators have 64 kbytes. The memory runs at maximum processor speeds with no wait states, for accurate duplication of target system performance. The dual-port memory allows emulation displays and modifications of emulation memory without halting the processor during emulation. Memory can be mapped in 256-byte, 512-byte, or 1-kbyte blocks, depending on the processor, and configured as either emulation or target RAM, emulation or target ROM, or guarded memory.

# DESIGN AUTOMATION

## HP DesignCenter (cont'd)

### HP 64000-UX Microprocessor Development Environment

#### Popular File Formats

Popular absolute file formats are accepted by the HP 64700 Series emulators — extended Tektronix hexadecimal, Intel hexadecimal, Motorola S record formats, and HP absolute format. The HP absolute format is a binary format, providing added upload and download speed over typical ASCII absolute file formats.

#### Host-independent User Interface

A firmware-resident ASCII terminal interface is embedded in each HP 64700 Series emulator, supplying commands for all emulation and analysis features. Commands are ASCII strings; file transfers using industry-standard formats are accepted. Since a terminal can access these commands, host independence is realized. This interface is ideal for remote field applications, portable computers, field service, or any other application where a host is impractical or unavailable.

#### Simple connection to target systems

HP 64700 Series offer real-time execution with no wait states at full processor speeds. Target system connection is made with flexible, slim emulator probes which are up to three feet long. This is accomplished without bulky, active circuits at the probe tip, aiding plug-in into tight, hard-to-reach target systems. Full signal fidelity is maintained at maximum-rated processor speeds. Multiple package types are supported, where applicable. For example both PGA and DIP packages for the Motorola MC68000 and LCC and PGA packages for the Intel 80186 are supported.

#### Emulation bus analysis

Each HP 64700 Series emulator includes an emulation bus analyzer for tracing microprocessor code flow. Based on the same "logic-analyzer-on-a-chip" used in the HP 1650A/1651A Logic Analyzers and the HP 16500A Logic Analysis System, the analyzer has abundant resources for solving the most complex system problems. Up to eight hardware resources, each consisting of address, data, and status event comparators, can be combined in several fashions. Those resources can be grouped to establish complex sequential trace specifications using "find A, followed by B . . ." constructs up to eight levels deep. A range comparator can be applied to address or data events at any one of the levels. Each event is tagged with an execution time, for easy measurement of code execution times. A dual-bus architecture allows all traces to be set up and reviewed without breaking processor execution. A prestore function allows tracking of relationships between a given software element and one or more other software events that influence that element. For example, prestore helps pinpoint which of several different tasks accessing a variable is responsible for corrupting it.

#### Software Coverage Analysis

HP 64700 Series emulators have code coverage analysis implemented in hardware. Code coverage analysis is valuable during initial coding and software test. Coverage analysis provides a history of the memory addresses that are either written to or read from during program execution. For example, you can quickly determine how exhaustive a test suite is by using coverage analysis to measure what percentage of code is being accessed. Since the coverage analyzer is built into hardware, it does not rely on statistical sampling of code space and allows running in real time.

#### Logic Analysis

An optional 16-channel, state/timing analyzer can be included in the HP 64700 series emulator. The analyzer can be configured as a 100 MHz timing analyzer with 5 ns glitch detection or as a 25 MHz state analyzer. In state mode, the analyzer can be clocked by the microprocessor clock or by an independent synchronous source. Based on the same logic analyzer chip as the emulation bus analyzer, the logic analyzer also has full triggering and qualification capabilities. The analyzer can serve as a stand-alone logic analyzer or can be

coupled with the emulation bus analyzer for correlation of microprocessor activity with other target system activity. The two analyzers can cross trigger or arm each other on the basis of hardware or software events that one analyzer detects. Target system probing is through a 1.4 meter cable with 18 probe leads (16 data channels and two clock channels). There are 36 miniature probe tips included for easy connection of both signal and ground lines of each lead to target system ICs or test points.

#### Coordinated Measurements

Designs involving multiple microprocessors are often quite complex in their interactions. The coordinated emulation of several target system processors can greatly enhance the efficiency of designers doing system integration. Synchronized execution (start/stop) of multiple emulators enables users to finely control the interactions while watching the behavior of the system. To allow the user to understand and isolate the relationships between the various processors, the emulators and analyzers can be set up to cross trigger one another. HP provides these capabilities by allowing up to 32 HP 64700 Series emulators to be interconnected over a dedicated Coordinated Measurement Bus (CMB).

#### PC Interface

The PC interface combines ease of use, speed, and power to make the HP 64700 Series Emulator/Analyzer an effective tool for both experienced and first time users. The PC Interface provides access to symbols for powerful debug capability and displays timing diagrams for emulators with the external logic analyzer. PC Interface windows provide views of several areas of interest at once, eliminating time wasted in repeatedly switching contexts or running commands. The interface supports color and monochrome displays and uses directed syntax with menus and submenus for quick selection of commands.

#### Ordering Information

Following is a listing of the emulators presently available. The HP 64000-PC Personal Integration Environment is a dynamic family of processor-based system support tools, therefore, it is recommended that an HP field engineer be consulted for a suggested configuration that will fit your application. This will assure that you obtain the software to complete your emulation system. Also, there are bundled systems available to simplify ordering that include an HP Vectra PC. For a copy of our latest HP 64000-PC brochure or a copy of the HP 64000-PC demo disc in the U.S., call 1-800-447-3282 (in Colorado, call collect 719-590-5540). Outside the U.S., call your local HP sales office. The demo disc is a 5/4 in. flexible disc that runs on an IBM PC/AT or compatible with graphics card.

Model	Supported processor	Price
64742A	68000 DIP	\$11,300
64742B	68000 PGA	\$11,300
64745A	68010 DIP	\$11,300
64745B	68010 PGA	\$11,300
64753A	Z80	\$8,900
64762A	8086/87	\$11,300
64763A	8088/87	\$11,300
64764A	80186	\$11,300
64764D	80C186	\$17,300
64765A	80188	\$11,300
64765D	80C188	\$17,300
64771A	80C196-KA	\$13,200
64786A	TMS32020	\$13,300
64787A	TMS320C25	\$13,900

NOTE: To order the Logic Analyzer Option for any of the listed emulators, add an L after the model number. The price is an additional \$2600 for the listed emulators.



**HP Electronic Design System**

Hewlett-Packard's computer-aided engineering system for electronic design provides tightly integrated tools for all phases in the development of digital, analog, and microwave circuitry — design capture, verification, netlist generation for physical layout, links to test, and documentation. The easily-learned interface to these tools ensures that valuable time is spent creating designs instead of learning the syntax and operation of a computer system. Using a mouse and pop-up menus simplifies command entry. Multiple windows provide simultaneous views of different parts of a design and access to other tools in the design and verification environment.

Available on the HP 9000 Series 300 workstations, the HP Electronic Design System includes the following: HP Design Capture System, Design Verification System with HILO® -3, Analog Workbench® by Analog Design Tools, Inc., Parts Libraries, Design Interfaces to physical layout systems, and links to HP's Programmable Logic Device Design System and to prototype and manufacturing test systems. This integrated set of tools addresses the total electronic product development process.

**Design Capture System**

The HP Design Capture System is the cornerstone of HP's Electronic Design System, providing schematic capture and design database management capabilities to improve the electronic design process. It forms the database and user interface foundation upon which other elements of the HP Electronic Design System are built. Engineers can use this same intuitive user interface to access a variety of tools for entering and editing schematics for digital, analog, and microwave circuits.

The HP Design Capture System also provides on-line checking of design parameters such as fan-out, incompatible outputs, unused pins, unconnected wires, wire loops, and symbol pin mismatch. Finding design errors as soon as they are entered helps avoid costly rework at later stages of the design cycle. Additional features designed to enhance productivity include automatic orthogonal routing of signals and the use of color to help organize complex circuits by highlighting different signal types or different areas of functionality on a circuit.

With full support for top-down, bottom-up, or flat circuit design, the HP Design Capture System provides the flexibility for you to work the way you want. For top-down design, you can create symbols "on the fly" without leaving the circuit page on which you are working. An automatic symbol-creation facility speeds the process of bottom-up design. Flat designs spread over several pages become easier to handle with automatic part or signal locating functions.

Regardless of the design methodology you choose, the advanced database structure provides access to other design information such as physical references. This access makes interfaces with physical layout systems faster, more complete, and reliable. It also makes comparison of simulation data with a prototype or production device quick and easy.

**Comprehensive Parts Libraries**

Extensive, ANSI-compatible parts libraries support a wide variety of digital and analog design requirements. These libraries contain both symbolic and parametric information for more than 5,000 digital and 2,200 analog parts, including off-the-shelf TTL, ECL, MOS, microprocessor, and passive and active analog devices. In addition to providing a graphical symbol for schematic drawing, each part entry contains information used in other functions of electronic design, including titles and revision levels, load information, scions or related parts, and physical design information.

In addition, you can associate custom information such as cost, availability, power requirements, or capacitance to any graphical element in the database. This information can be displayed visibly or hidden until called, or accessed and formatted via the Design Database Language to create custom reports. This user-defined information, together with the variety of pin types, symbol shapes, and text heights that can be stored in the database, allows you to address virtually any documentation standard.

The object-oriented structure of the HP Design Capture System database simplifies access and increases the speed at which information can be found, extracted, updated, or created. With object-oriented structure wires, components, pins, symbols, and other elements used in electrical design are not merely graphics inside the database but "objects" containing all the connective or textual information to define a wire, component, pin, or symbol.

**Design Database Language**

Design Database Language provides the vehicle for direct read and write access to the database. By constructing simple programs, you can extract and format data into net lists or parts lists, generate documentation, and create custom reports. You also can update information in the parts library to reflect changes in manufacturing data, costs, or the addition or deletion of a part from a corporate preferred parts list. To take full advantage of system capabilities, you can invoke HP-UX processes from within a Design Database Language program. If you write a program that you use regularly, you can even add it as a command directly to the HP Design Capture System menu structure.

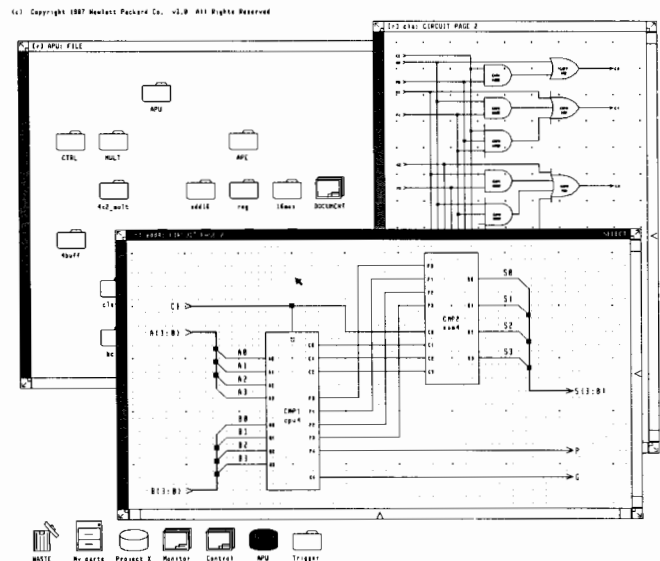

Hierarchical design techniques allow easy segmentation of complex circuits.

# DESIGN AUTOMATION

## EE DesignCenter (cont'd)

### HP Electronic Design System

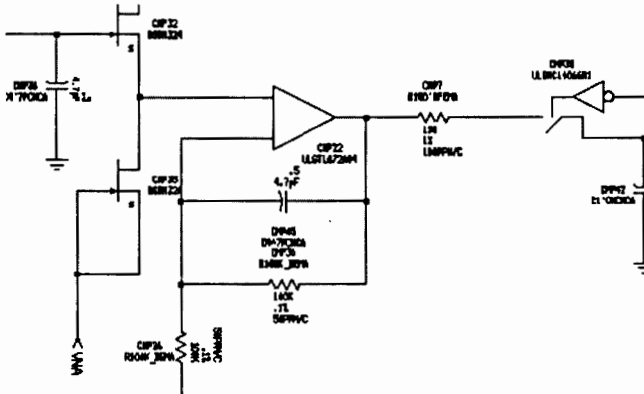

Libraries of over 5,000 digital parts and 2,200 analog parts are available.

In addition to the Design Database Language, HP's support of the Electronic Design Interchange Format (EDIF) standard provides further capability for interfacing with the HP Design Capture System database. A bidirectional EDIF link transfers designs and symbols between the internal database format and other CAE systems that support EDIF version 2.0.0.

#### Integrated Forms and Documentation

The HP Design Capture System's integrated forms and documents tools automate the documentation process. In addition to providing the ability to merge text and graphics, these tools provide a documentation system that tracks changes in the design by automatically updating schematics in a document when the original design is modified.

Forms are used to establish a standard outline and format for engineering documents. Documents may contain one of these forms, portions of a design, notes explaining the circuit, or text inserted from an external file. Printer and plotter output is available in ANSI or ISO industry-standard page size. This output can be automatically scaled or rotated at print time to best fit the page size or orientation.

#### Design Verification System

HP's Design Verification System, based on industry-proven HILO-3 simulation products, provides logic simulation, extensive model libraries, timing analysis, fault simulation, and physical modeling capabilities.

By using the intelligent database, connectivity information of the complete circuit is maintained at all times. Because this electrical circuit representation is available on line, it is easy to move back and forth between design and simulation when making circuit modifications. You don't need to flatten the schematic before beginning a new simulation. When this capability is combined with the streamlined data flow and common user interface between design and verification tools, the design cycle time is shortened and engineering productivity is improved.

The flexible simulator interface provides a choice of waveform or textual formats for input specification and output display. A Simulation Data File Comparator can be used to compare any two user-created or simulated trace files, or to compare measured files from the HP 16500A logic analyzer. The logic simulator incorporates a five-state, fifteen-value logic strength algorithm to accurately model MOS bidirectional gates, wired ANDs, wired ORs, or tristate pullups and pulldowns. Timing analysis tools provide checks for set-up, hold, and pulse-width violations using single or dual-delay simulation modes.

Simulation models are mapped one-to-one with the symbols in the HP Design Capture System parts libraries, which provide the graphic and parametric information for the design. This close coupling of the graphics and the simulation models provides complete and consistent access to commercially available parts throughout the logic design cycle, including TTL, ECL, and MOS parts as well as a many complex microprocessors such as the Intel 8086 or the Motorola 68000. In addition, ASIC design kits containing programs, symbols, and models are available for specific ASIC vendors.

#### Flexible Constructs for Functional Modeling

HILO-3's modeling provides flexible, functional modeling constructs such as event expressions, register transfer functions, Boolean and arithmetic operators, loop constructs, and conditionals. Since the modeling language is an event-driven, nonprocedural language, asynchronous signals such as interrupts can be modeled exactly as they occur in hardware. Multilevel support in HILO-3 allows simulation of designs, even when some parts are specified at a functional level only.

#### Link Hardware and Software Design Tools

Designs containing a microprocessor with associated RAM/ROM models can be checked for hardware/software integration problems through the tight linkage of HP 64000-UX software development tools and the HILO-3 simulator. The HP Software Link (see page 621) provides an effective means to test software and hardware interaction while still in the simulation phase of development.

#### Save Modeling Effort with Hardware Modeling

The HICHIP® Hardware Modeling System provides an efficient method for modeling complex LSI/VLSI devices within the HP Electronic Design System. HICHIP simplifies board-level simulation by integrating hardware models, using the actual device, into logic simulation.

In simulations involving microprocessors, other hardware modeling systems merely help model the complex device, which requires many cumbersome, error-prone tasks to simulate even simple hardware/software interaction. As an integrated part of the HP Electronic Design System, HICHIP combines with the HP Software Link to simulate the hardware device running software developed in the HP 64000-UX environment.

#### System Design Including Programmable Logic Devices

For designs including programmable logic devices (PLDs), HP offers a complete PLD Design System (see page 630), including sophisticated PLD design editors and debuggers. A bidirectional interface transfers designs created on the HP Design Capture System to the HP PLD Design System for PLD realization. This is especially useful when redesigning an existing design to reduce board space and power consumption. When the HP PLD Design System fits the design into a PLD or multiple PLDs, this information can be transferred back to the HP Electronic Design System for design layout and documentation. HP PLD Design System also automatically creates HILO-3 models for more thorough system simulation of printed-circuit boards containing PLDs.

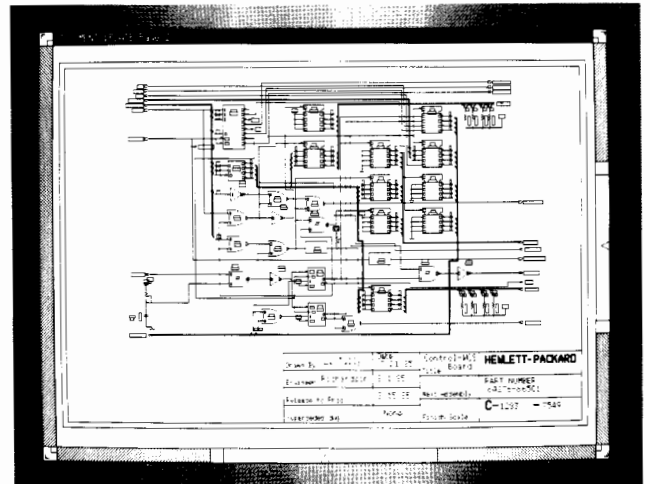

Schematics in a document are automatically updated when the original design is modified.

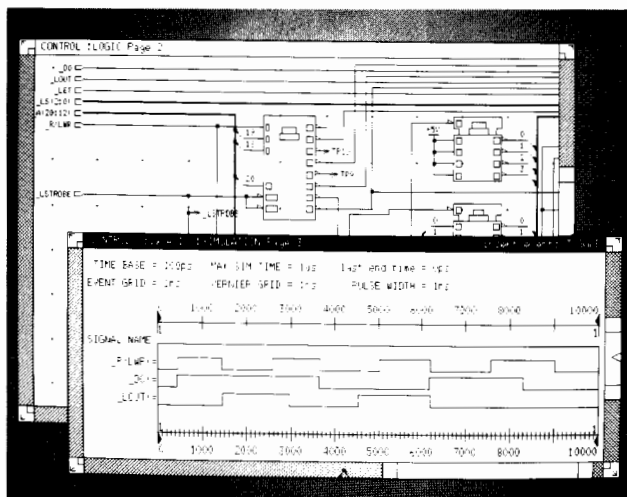

HP logic design verification tools, based on the industry standard Hilo-3 simulator, are tightly coupled to the HP Design Capture System.

#### Analog Simulation

For analog designs, you can use the advanced simulation capabilities of Analog Workbench from Analog Design Tools. A bidirectional schematic interface allows the analog design engineer to take advantage of the specialized analysis tools while maintaining the powerful schematic editing, documentation, and data management capabilities of the HP Design Capture System. The Analog Workbench System can reside either on the same workstation as the HP Design Capture System or on a networked system.

#### Microwave Design

The HP Design Capture System is particularly well-suited for microwave design because the layout of microwave circuits is intimately associated with electrical performance. When combined with HP's Microwave Linear Simulator and Microwave Artwork Generator (see page 625), the HP Design Capture System provides a tightly integrated set of tools for microwave design, allowing you to move effortlessly from one tool to another. Integrating microwave design tools with documentation, networking, and design management functions maximizes the productivity of entire design teams.

#### Links to Test and Instrumentation

The HP EDS/16500A CAE Link lets you send simulation test vectors to the HP 16500A logic analyzer (see page 258) to use in debugging a prototype of the design. This link eliminates the manual test generation and typing in of test vectors into the HP 16500A analyzer. After the test vectors are run through the prototype, measured results can be sent back to the simulation environment to be compared against simulated results using the HP Simulation Data File Comparator. All data translation and instrument configuration occurs within the HP Electronic Design System Environment.

You can achieve more efficient testing of ASIC prototypes by transferring HILO-3 test vectors to the HP 81810S IC Design Verification System (see page 320).

When design test vectors are developed with the fault simulator and the prototype environment, they can be transferred to an HP 3065 Board Test System (see page 546), as ready-to-use board test programs. During translation, the results are automatically checked, ensuring that no timing violations occurred during simulation that would render the patterns unusable on the HP 3065. The HP EDS/3065 test Program Generator also provides name translation capabilities to ease the translation requirements and to accelerate test generation.

#### Links to Physical Layout

Design interfaces link the HP Electronic Design System with SCICARDS®, Calay, Racal-Redac RINF, and Prime/Computervision printed-circuit CAD systems. Interface capabilities between the HP Design Capture System and the HP Printed Circuit Design System (see page 632) are built into both systems. This combination provides automatic transfer of design information, including back annotation or the initiation of engineering change orders. The HP Design Capture System also includes an interface to the HP Engineering Graphics System (see page 634) as a standard feature.

#### Hardware Configurations

The HP Design Capture System is available on a wide range of HP 9000 Series 300 workstations. For larger design teams that need to share information across systems, these workstations can be networked together using NS/ARPA or Network File System services and supporting either IEEE 802.3 or Ethernet LAN standards. In addition, such networks can include HP 9000 Series 800 Precision Architecture computers dedicated to compute-intensive tasks such as simulation or printed circuit board routing.

#### Ordering Information

HP Design Capture System	HP 74210A	\$8,160
HP Bidirectional EDIF Schematic Interface	HP 74220A	\$15,000
HP Design Verification Sub-System	HP 74230S	\$23,000
HP Design Verification Interface (includes HP Software Link)	HP 74230A	\$5,000
HILO-3 Logic Simulator	HP 74230B	10,000-45,000
HILO-3 Simulation Models	HP 74230C	8,000-15,300
HILO-3 Fault Simulator	HP 74230D	\$8,000
HICHIP Hardware Modeling System	HP 74231A	\$49,000
HP EDS/16500A CAE Link	HP 74240A	\$2,000
Simulation Data File Comparator	HP 74240B	\$2,000
HP EDS/3065 Test Program Generator	HP 74241A	\$4,000
Analog Workbench	HP 74610A	\$14,550

HILO and HICHIP are registered trademarks of GenRad.  
Analog Workbench is a trademark of Analog Design Tools, Inc.  
SCICARDS is a registered trademark of Scientific Calculations, Inc.

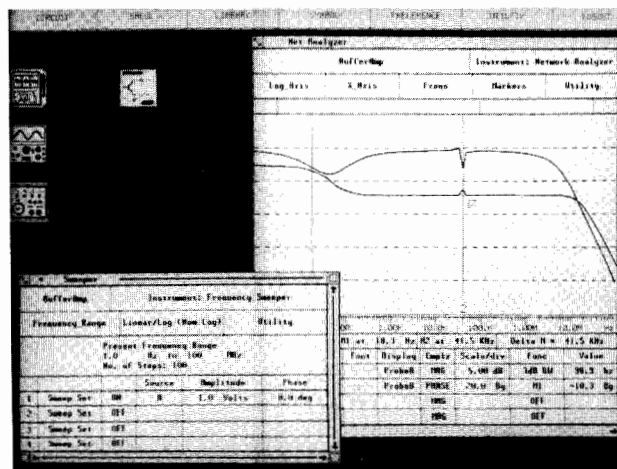

Analog design information can be transferred to the Analog Workbench module for analog simulation and analysis.



# DESIGN AUTOMATION

## EE Design Center

### HP Programmable Logic Device Design System

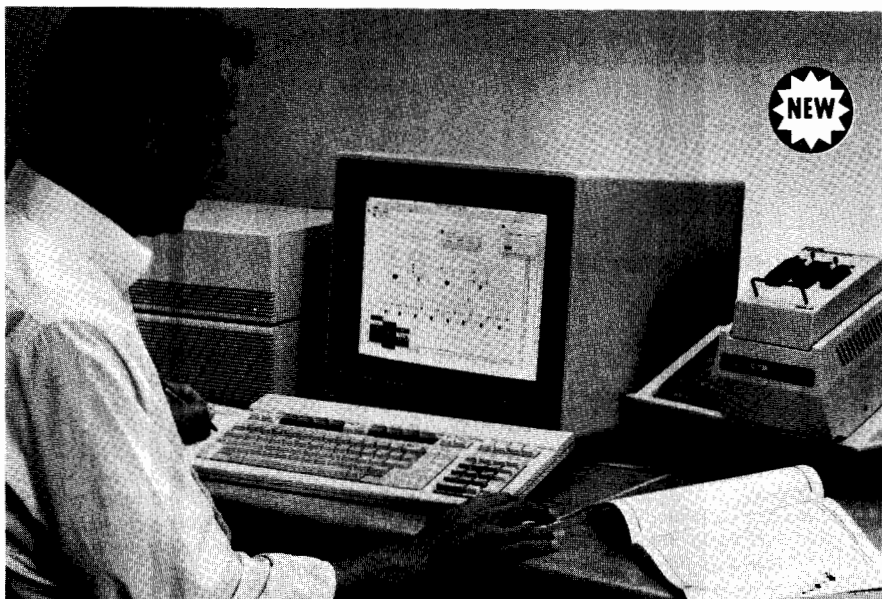

HP PLD Design System picks the most appropriate device or sets of devices for a design.

#### HP PLD Design System

Hewlett-Packard's PLD Design System provides new capabilities in adapting PLDs (programmable logic devices) to electronic designs. A new breed of PLD design tool, HP PLD Design System provides a device-independent design environment. Designers can develop and verify logic without the constraints of a particular PLD architecture. The system automatically fits complex designs into the most efficient PLD, and if necessary, partitions designs into multiple devices. HP PLD Design System supports the entire design process of PLDs — from conceptual and functional design, through automatic device selection and pin/resource assignment, to debugging and fusemap generation.

As part of HP DesignCenter, HP PLD Design System is available on the full range of HP 9000 Series 300 workstations, and is closely linked with HP's Electronic Design System. A design or part of a design can be transferred from the HP Electronic Design System and submitted to HP PLD Design System for PLD realization. After device selection, this information can be transferred back to the HP Electronic Design System for design layout and documentation. In addition, HP PLD Design System automatically creates HILO®-3 models for more thorough system simulation of printed circuit boards containing PLDs.

#### PLD Design Entry and Verification

Without considering the target device, engineers enter designs with schematic symbols, graphical state diagrams, truth tables, waveforms, or Boolean equations. PLD debuggers specific to each design entry method are tightly integrated to quickly verify PLD designs at the same level of abstraction.

The HP PLD Design System also supports hierarchical design to allow complex PLD designs to be split into sub-designs or blocks. Each block can be described according to the most appropriate design method: state diagram or waveform entry. Once designed and verified, the blocks can be interconnected and the entire design simulated. A design block also can be entered into the library for future use in other designs.

#### Waveform Entry

In the design of asynchronous circuits, a timing diagram often exits showing the desired functionality in terms of certain input activity causing output activity. The HP PLD Design System automatically

creates the necessary logic from this timing diagram. The waveform debugger checks all causalities for any contradictions and then reports contradictions along with inconsistent waveforms.

#### Device Independence

The HP PLD Design System automatically selects the most appropriate PLD — or multiple PLDs — from a prioritized list of the most efficient devices for your design. Devices for this list come from a comprehensive part library that includes over seventy popular architectures from the leading PLD vendors. You can also modify the system's choice of devices.

You can implement an existing PLD design on a new, perhaps more efficient device, by simply re-compiling the design rather than having to modify it. A Foreign Tool Interface (FTI) allows you to transfer PLDs designed on other systems via the JEDEC standard for PLD fusemaps.

#### Programming and Test Generation

For device programming, the HP PLD Design System transfers fusemap information in JEDEC standard format directly to a variety of PLD programmers, eliminating the need for programmer commands. The system automatically creates electrical test patterns to evaluate the behavior of programmed devices before designs are released to production. In addition, the PLD timing-analysis tools include state machine-glitch detection. Automatically generated test patterns can be merged with the fusemap and downloaded for programming and testing.

#### Ordering Information

HP PLD Design System, complete software **HP 74150A** \$13,700 including editor, compiler, programming modules, FTI, and HP EDS design interface  
Advanced PLD Utilities, includes automatic test generation capabilities, timing, estimator and glitch sweeper **HP 74153A** \$4,100

Options are also available for individual copies of the editor and other software modules. Discounts are available for additional copies. Contact your local Hewlett-Packard sales office for information on related products and for detailed configuration and ordering information (see page 771).



- Design with mainframe power on a desktop
- Minimize prototyping with accurate models
- Generate artwork from schematic, automatically
- Document designs effortlessly
- Interact with the schematic, analysis, and artwork simultaneously

**Integrated CAE tools for microwave designers**

The HP 85150A Microwave Design System is a fully integrated solution for microwave designers. It combines microwave circuit simulation and optimization with schematic entry, layout generation, and documentation utilities into one cohesive, user-friendly system. It is a member of the HP DesignCenter, a broad family of electronics and mechanical engineering productivity tools. The Microwave Design System, together with Hewlett-Packard computers and networks, instruments, and support, form the most complete design system available for microwave engineers.

**Entering the schematic**

The HP 74210A Design Capture System (DCS) is a graphics-based system that allows designers to draw circuit schematics on the computer screen. Schematics are far more intuitive than other forms of data entry, and save considerable effort over the life of a design because they are used for circuit simulation, layout, and documentation.

**Simulating the circuit**

The HP 85151A Microwave Linear Simulator (MLS) simulates and optimizes linear circuits. Input to the simulator comes from the HP DCS module, permitting interactive schematic-based circuit tuning. The MLS uses the latest verified microwave models as well as state-of-the-art software technology, including sparse matrix reduction, adjoint matrix optimization, and full nodal noise analysis. Additionally, a comprehensive, flexible graphics package is integrated with the Microwave Design System to display, manipulate, and generate hardcopy of simulation results. These results can include S-, Y-, and Z-parameters, voltage and current transfer functions, other useful parameters, as well as arbitrary expressions combining any of the above parameters.

**Generating artwork**

The HP 85152A Microwave Artwork Generator (MAG) automatically generates artwork for circuits based on their schematic representation in the HP DCS module. Layout equivalents for any circuit element or subcircuit can be easily customized and stored in a library, and thereafter used by the automatic layout facilities. The artwork may then be enhanced using the graphics editor functions of the MAG. Drawings can be output in a form compatible with HP EGS, ME-10, and ME-30, HP's professional drafting packages. These products are a gateway to a complete array of mechanical engineering CAD tools. Additionally, translators are available to convert drawings into the IGES, GDS-II stream, and other popular artwork formats.

**Documenting the design**

Documentation is an essential part of every project, yet it is often inadequate. Each schematic, plot, or piece of artwork generated by the Microwave Design System may be annotated with text and copied to a special documentation area, where each is continually updated to reflect changes to the design. Designers can, for example, create a standard format having a company logo at the top and print results on a high resolution laser printer in a uniform, professional format.



The HP 85150A Microwave Design System runs on a compact workstation to design microwave components quickly and accurately.

**Ordering Information**  
**Configured Systems**

Two configured systems are available that contain, under a single model number, the hardware and software needed to use the MDS system. They each contain a HP 9000 Series 300 color workstation, hard disc, HP-UX operating system, and HP 85150A Microwave Design System software. The software is factory installed so that designers can be more productive from the day the system arrives. The HP 85150T is based on a high performance Series 300 workstation, while the HP 85150E is a lower cost entry-level system.

<b>HP 85150T</b> Microwave Design System	\$74,600
<b>HP 85150E</b> Microwave Design System	\$50,900

**Software**

<b>HP 85150A</b> Microwave Design System	\$29,000
The HP 85150A includes the following:	
HP 74210A Design Capture System software	
HP 85151A Microwave Linear Simulator software	
HP 85152A Microwave Artwork Generator software	
Two enrollments in the MDS User Course	

<b>HP 85150AR</b> Right-to-Reproduce the MDS software	\$24,650
The right-to-reproduce product allows users purchase additional software systems at a reduced price. It does not include additional tapes or MDS User Course enrollments.	

<b>HP 85153A</b> GDS-II Translator	\$5,000
Artwork created with the Microwave Artwork Generator can be easily translated into the GDS-II binary format for use on other drafting and manufacturing systems. The translator is bi-directional.	

# DESIGN AUTOMATION

## EE Design Center

### HP Printed Circuit Design System

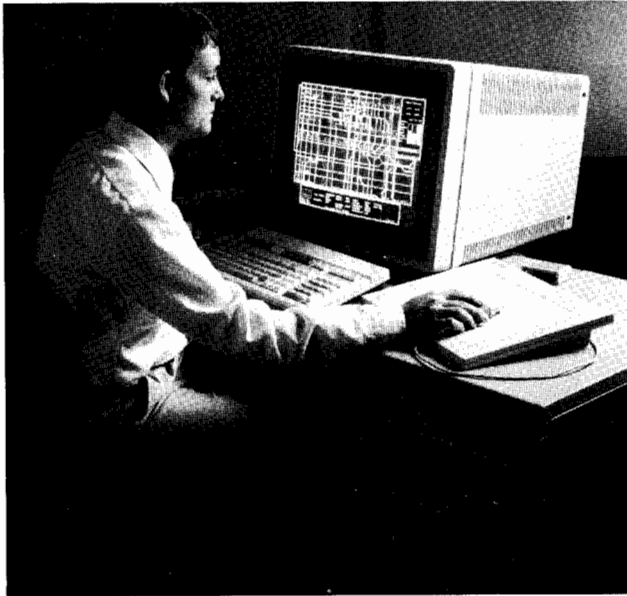

HP Printed Circuit Design System

#### HP Printed Circuit Design System

Hewlett-Packard's Printed Circuit Design System is a computer-aided design (CAD) solution that couples printed circuit board layout to electrical engineering design, manufacturing, and test. HP Printed Circuit Design System is a part of HP DesignCenter, an integrated design environment for electrical, mechanical, and software engineering teams. HP Printed Circuit Design System consists of systems, software, and support in computer-aided engineering, design and manufacturing (CAE/CAD/CAM).

Based on the modular HP 9000 Series 300 technical workstations and HP-UX operating system, individual workstations as well as total systems can be configured for particular applications in a powerful local area network. HP-UX is derived from UNIX System V interface definition (UNIX is a trademark of AT&T in the U.S.A. and other countries).

HP Printed Circuit Design System transfers all the functionality of a mainframe-based system to a networked workstation environment. This software has been evolving for over 10 years, and provides a refined and highly tuned base for HP's integrated CAD solution. The system is the physical design link between logic design and manufacturing that allows printed circuit board designers to create highly manufacturable boards that perform as the electrical engineer intended. The open and documented design-file format eliminates redundant data entry and reduces chances for errors by making it easy to enter circuit data and to generate manufacturing and test reports and files.

#### Features and Capabilities

HP Printed Circuit Design System packing, placing, and routing features can automatically lay out digital, analog and mixed digital/analog boards with through-hole and surface-mount technologies, and also contain facilities for thick-film hybrid design.

Designers use a keyboard and either a four-button puck and A- or B-size graphics tablet or a mouse to step through a dynamic, hierarchical menu. The menu structure logically groups commands for quick entry into design areas, and each successive menu displays only the functions appropriate to the current design area. Projects can be quickly initiated by using or modifying the many spacing and placement rules, manufacturing parameters, and board blanks provided by the system. On-line design rule checking notifies board designers of violations as they occur, but immediate correction is optional to allow opportunities for subsequent layout adjustments. To assure all violations are corrected eventually, a batch design rule checker can assess a completed board, automatically noting all previously uncorrected violations.

#### Entering Circuit Data and Board Blank Information

Fully automatic transfer of netlist and part information is available for schematics created on the HP Electronic Design System (see page 627). This link also features automated back annotation and bi-directional engineering change.

Synchronization of logical and physical parts libraries eliminates the need for translation files while automatic parts transfer eliminates redundant data entry. Designers also can bring in circuit data from the HP Engineering Graphics System (HP EGS) — See page 634), as well as data from any vendor's system that supports the Electronic Design Interchange Format (EDIF). In addition to common EDIF features, HP Printed Circuit Design System EDIF format also supports packaging information and parts mapping between data bases.

HP Printed Circuit Design System also accepts circuit data through a variety of customized paths, and provides links to Hewlett-Packard's 2-D and 3-D CAD systems. Custom links to virtually any CAE system are available either as off-the-shelf products or from HP project and consulting services. In addition, a link exists for users of schematic capture systems from P-CAD. Through this link, engineers can develop schematics on HP Vectra personal computers (see page 656) and then transfer the netlist for layout and routing on high-performance workstations running HP Printed Circuit Design System.

Finally, circuit data can be interactively entered through the Schematic Netlist Editor. This function-key, menu-driven editor allows easy, error-free entry of part and connection information into HP Printed Circuit Design System format.

Design teams with special board blank requirements can begin to design their boards on ME 10, HP's 2-D mechanical design system, and then transfer the board blank to HP Printed Circuit Design System. ME 10 allows designers to specify precise dimensioning, custom shapes, and pre-defined locations for mechanically significant information such as connectors or transformers. Once transferred, these board blanks can be saved as separate designs and reused across a family of products with similar board specifications.

#### Flexible System and Data Management

Management of system and network resources through the HP Design System Manager provides printed circuit board designers with easy access to application software, data files, and peripheral devices, which frees designers to concentrate on design work.

The HP Design Data Controller provides flexible data management and file security for users of HP Electronic and Printed Circuit Design Systems. Large design teams can control data revisions, access to files, and also lock data at project checkpoints to prevent unauthorized or unsynchronized updates.

#### Modular Software Design

HP Printed Circuit Design System is functionally divided into three modules: Design Module, Autorouter Module, and Library Module and Parts Library.

#### Design Module

Most of a designer's interaction with the system is through the Design Module, which includes powerful automatic tools to aid the designer during printed circuit board layout. Among these tools are the automatic packer, placer and the interactive router, as well as routines for improving parts placement to ensure the highest possible router completion. To speed interactive tasks, designers can move across the board and zoom in on a particular area as quickly as they can move their pointing device. Rubberbanding and trace-snapping make it easy to manually route selected traces. Designers can also add dimensions in their choice of design units, including metric units.

The Design Module also includes routines for creating highly manufacturable boards, such as "Tidy." Tidy improves the manufacturability of boards by tear-dropping traces into pads to insure solid electrical connections, widening traces to increase electrical reliability and eliminating unnecessary vias to reduce costs.

The HP Printed Circuit Design System includes special features for placing, part swapping, and routing of surface mount devices (SMDs). Physical descriptions of over 800 SMDs are available in

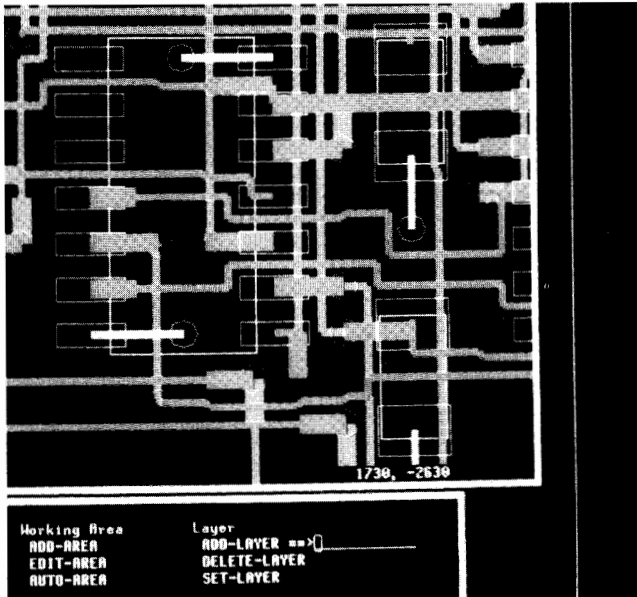

The Design Module provides special features for placing, part swapping and routing of surface mount devices. A pad and breakout for an SMD are shown here.

the Parts Library. Placement on both sides of a board and swapping between sides decreases logic length and ensures higher Autorouter completion. Breakouts to power and ground planes and a user-definable routing grid also aid the routing task, while definable SMD spacing parameters increase reliability and manufacturing yields.

### Autorouter Module

The automatic router employs rip-up and re-try technologies in addition to a look-ahead algorithm that preplans the most effective routing strategy for both through-hole and surface-mount devices. This strategy recognizes and preserves critical traces already set down by the designer.

The multiple-pass Autorouter Module routes up to four layers in one pass, with 90- and 45- degree angles to create easier-to-manufacture boards. Users can specify automatic routing and via grids to allow zero, one, two, or more traces between IC legs or SMD pads. The Autorouter Module can also handle areas of surface mount technology (SMT) on both sides of the board, including hidden or buried vias. It will also route signals on buried layers.

Autorouter Module provides user-definable routing grid to allow fineline technology.

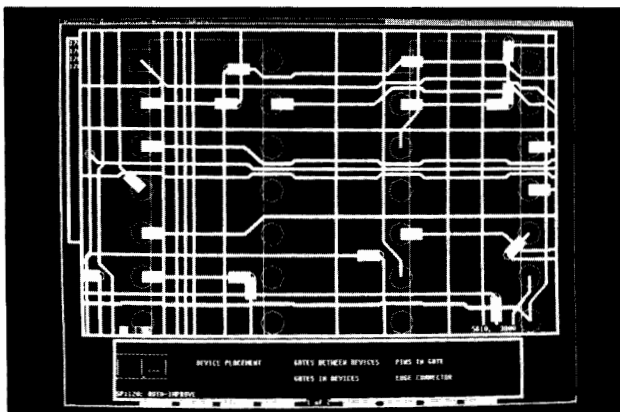

For manual routing, you can use separate dimensions, which allow you to route analog, ECL, and critical board areas separately. At any time, designers may interrupt the automatic routing, check on progress, and restart the routing as needed.

### Library Module and Parts Library

More than 7,000 physical parts are included in the starter library. Designers can create, modify, validate, store and access these parts quickly and easily. The system provides strict centralized control over component usage to assure data integrity and standardization of parts.

### Manufacturing and Test Links

HP Printed Circuit Design System does not stop with physical layout, but helps assure that the design is accurately transferred to manufacturing by automatically generating a range of reports and files such as photoplotter command files, drill tapes for numerical control and production reports. In addition, an output file in Board Configuration Format (BCF) can be sent to the HP 3065 board test family to verify board connectivity and component values. The BCF file also lists X,Y locations of device pins and test pads for the board test operator.

For additional documentation or development of production drawings, designs can be transferred to ME 10 (see page 636), a 2-D mechanical design package for creating more complex assembly drawings. Once transferred to the ME 10, HP Printed Circuit Design System drawings can move through an Initial Graphics Exchange Specification (IGES) link to any other CAD system which supports the IGES 3.0 standard.

### Configuration

The flexibility of the modular HP 9000 Series 300 technical workstations and HP Printed Circuit Design System allow a design team to configure a particular system, then upgrade and extend individual workstations or add to the overall system in a local area network.

For example, a design team may start with one complete HP Printed Circuit Design System, with all three modules running on a Series 300 and a high-resolution color monitor. Later the team can add more workstations with only the Design Module running on a more economical Series 300, sharing data over industry-standard networking (IEEE 802.3). The automatic router can be moved to separate Series 300 workstation with only a small monochrome monitor to serve all the Design Module workstations on the network. A stand-alone router station may also reside on a Model 835 HP Precision Architecture computer. Designers can then delegate the compute-intensive task of routing to these powerful compute servers while dedicating themselves to the more interactive tasks of printed circuit design.

Teams who combine board-layout with 3-D mechanical design can maximize their hardware resources by using both HP Printed Circuit Design System and ME 30 (see page 636) on a single high-performance 350SRX solids modeling display system. They also can transfer completed bands or individual parts from HP Printed Circuit Design System for 3D viewing in the ME 30 system.

### Ordering Information

74400A HP Printed Circuit Design System, complete software for HP 9000 Series 300 \$37,000

In addition to the complete software, you can order the Design, Library, and Autorouter modules separately, and order right-to-copy options for each module. The Autorouter Module is available on both Series 300 and Series 800 computers. Support products including Account Management Support, Response Center Support, and Software Materials Subscription are also available. Contact your local Hewlett-Packard Sales Office for current price and ordering information (see page 771 for sales offices).

# DESIGN AUTOMATION

## EE Design Center

### HP Engineering Graphics System



HP Engineering Graphics System

#### HP EGS Engineering Graphics System

Hewlett-Packard's Engineering Graphics System (HP EGS) is an easy-to use, entry-level computer-aided design (CAD) system for complete product design. HP EGS consists of several modules that enable the user to create schematic drawings, perform interactive PCB layout, design thick-film hybrid circuits, and generate general artwork ranging from card cage drawings and assembly diagrams to block diagrams and presentation slides. Designs created on the system can be used directly or moved to more sophisticated design automation tools such as HP Printed Circuit Design System (HP PCDS). See page 632.

Among the built-in productivity tools provided by HP EGS are an on-line HELP facility, customizable screen and tablet menus, and user definable macros, or "super-commands." These macros allow a user to supply a familiar name to a sequence of often-used commands. In addition, users can develop custom modules for specific applications, defining everything from specialized macros to menus and on-line message prompts.

HP EGS is currently in use at more than 4,400 installations worldwide. It runs on the HP 9000 Series 300 workstations, bundled with a Pascal operating system. EGS also works with the HP Vectra Personal Computer (See page 652), running on a coprocessor board. Users may run HP EGS as a standalone system or as a Shared Resource Management (SRM) system. The SRM system allows multiple workstations or personal computers to share disc drives, printers and plotters, which can dramatically reduce total system cost. The SRM network also enables HP EGS users to easily share data such as drawings and library parts — offering significant productivity improvement. In addition, users can configure a local disc as a Hierarchical File System (HFS). The HFS configuration allows multiple operating systems to share the file system on a single disc. For example, an HP EGS file may contain a special suffix which makes it readable by HP-UX, HP's version of the UNIX® operating system.

The HP Vectra fits smoothly into existing personal computer environments, providing the interactive power of HP EGS for schematic capture and hybrid circuit design, and the links to workstation CAD systems for logic simulation and PCB layout. For users who demand the highest graphics performance, High-Performance HP EGS provides a specially optimized version of HP EGS that takes advantage of high-end hardware capabilities available on Series 300 workstations. The customizability of HP EGS along with hardware platforms that range from the HP Vectra to the most advanced HP 9000 Series 300 workstations provides users with a single-vendor, cost-effective solution to their design automation problems.

#### Features and Capabilities

At the heart of HP EGS is the graphics editor, the tool used to generate drawings on the screen. Drawings are created using elements such as lines, circles, rectangles, polygons, arcs, and text. Complex, frequently used shapes can be stored as library parts and called up as needed. Shapes on the screen can be altered with screen editing commands. It is easy to copy, delete, scale, rotate or stretch lines and objects. New drawings may also be created by modifying existing drawings. By storing these new drawings in separate files, you can easily maintain multiple revisions.

Pen plots of drawings can be obtained from any one of the full line of HP plotters — from an inexpensive A-size plotter to a roll-feed E-size drafting plotter. Many printers are supported on HP EGS, from the inexpensive ThinkJet printer to the HP LaserJet printer, which provide documentation-quality output for text as well as graphics.

#### Work Environments

Five specialized work environments or modules are available with HP EGS. The Hybrid Circuit Design Module combines interactive and automatic features for designing thick-film hybrid circuits. The Printed Circuit Board Layout and Schematic Drawing Modules are designed to increase the productivity of electronic engineers and designers developing printed circuit boards. The Mechanical Drawing Module assists users in creating drawings of mechanical assemblies, and the Engineering Graphics Module allows the creation of general-purpose artwork.

#### Hybrid Circuit Design Module

The Hybrid Circuit Design Module (HCD) tunes the extensive feature set of HP EGS to the needs of hybrid circuit designers, combining industry-tested interactive graphics with automatic tools that make this HP EGS module a great productivity aid for thick-film hybrid circuit designers. They can easily move from manual and other methods of hybrid circuit layout to this menu-driven CAD environment that fully employs their design expertise while reducing errors and speeding changes.

Designers can create and store standard substrate outlines, then readily modify or create new outlines as needed. Adding parts to a design is relatively automatic when using a connection list or material list derived from a schematic. Alternatively, part information can be entered directly from the keyboard or a tablet menu without using a list.

To generate resistors, designers can draw on a library of resistor-paste curves that stores a set of values based on manufacturer-supplied data or on measurements unique to a manufacturing process. For automatic resistor design, HCD uses the resistor value and reference designators from the Schematic Drawing Module. HCD then selects the optimum paste from the resistor paste curves, determines the required active resistor surface size, generates the resistor, and stores it on the display screen. If schematic data is not available, the designer can enter resistor information from the keyboard. Once a designer selects a resistor paste curve and specifies a resistor value, the module will generate an appropriate resistor.

For parts placement and conductor routing, designers use the flexible editing features of HP EGS to move, rotate, stretch, or mirror one or more parts at a time with grid resolution to .00001 mil. Conductor width can vary along individual conductors and from conductor to conductor, and dielectric layers can be added with a single menu selection.

After finishing the layout, designers can use the Connection List Compare routine to verify that the finished design matches the connectivity of the schematic. Designers can also create a manufacturing material list for information such as part numbers and prices. In addition, an area-calculating utility can help estimate material usage by measuring the paste area on each layer (resistive, conductive, and insulating) and then generating information for calculating how much ink will be needed.



### Printed Circuit Board Layout Module

The Printed Circuit Board Layout Module facilitates the creation of printed circuit board artwork for electronic designs. Among the productivity features in this module is the Rat's Nest Generator. From a schematic connection list, it produces 'airline' connections between placed PCB components. Users can move components to eliminate trace congestion, and, as components are moved, the connections remain intact. Then, with a ROUTE macro, users can select an airline and route it, locking the routed trace to pre-specified angles. In the process of routing the trace, users can change layers as necessary to complete the connection. A connection list routine compares the schematic connection list and the PCB connection list. A report is generated that notes any discrepancies, providing the user with a validation of the design.

Users who want to simulate schematics before starting the physical design may want to use HP Electronic Design System, a schematic capture system with links to logic simulators. That system will generate a net list in HP EGS format for users who want to use HP EGS for physical design.

### Schematic Drawing Module

The Schematic Drawing Module includes a library of common electronic schematic symbols. Users may also create their own parts, using any logic symbol representation and assigning unique attribute information to components. In this way users can create, modify, and expand their own custom symbol libraries. Once the schematic design is captured, the resulting connection list information can be passed to the HP EGS PCB Layout Module, the HP EGS Hybrid Circuit Design Module, or to another PCB layout system, such as HP Printed Circuit Design System.

### Engineering Graphics Module

The Engineering Graphics Module may be used for a multitude of applications . . . from diagramming PCB card cage assemblies, generating overhead slides, creating project scheduling diagrams, to any other general artwork. This module is where many new users begin to learn how to use HP EGS, and where many sophisticated users come to create their own applications.

### Mechanical Drawing Module

The Mechanical Drawing Module is designed to assist engineers and draftspersons in preparing 2-D mechanical drawings. The isometric grid capability allows the user to easily create 2-D representations of 3-D objects. The library for this module includes drawing paper templates, tolerancing and surface texture symbols, and macros for defining families of screws and bolts. Both metric and English units are available.

A library of resistor-paste curves aids automatic resistor design.

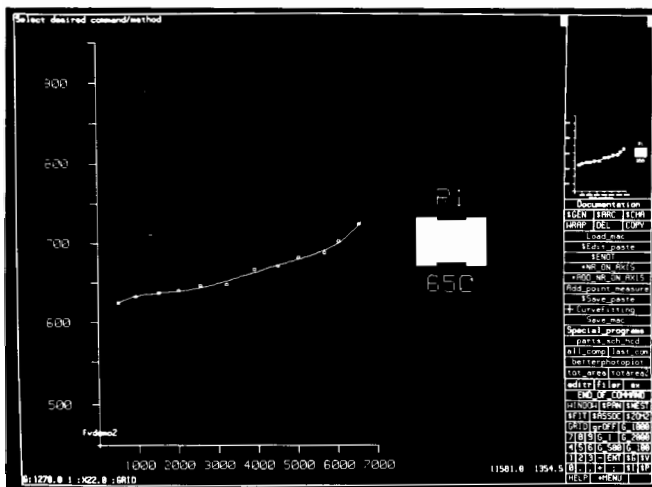

Powerful interactive and automatic features for thick-film hybrid design

### Additional Products

**HP TechWriter** — Documenting engineering tasks, writing reports, and developing presentation-quality materials that include illustrations consume a major portion of an engineer's time. HP EGS combined with HP TechWriter helps the user deliver high-quality documentation, reports, and presentation materials. This optional document editor works with the entire Series 300 family of workstations and with the HP Vectra and electronically merges text with the graphics created by HP EGS. HP TechWriter may also be used independently from HP EGS.

**Photoplot/NC Drill** — HP's optional photoplot/NC drill feature makes it easy to convert PCB and hybrid designs into Gerber photoplotter format or to provide PCB drilling information for Excellon drill machines.

**IGES Translator** — Conforming to the Initial Graphics Exchange Specification (IGES 3.0), HP's IGES Translator allows users to move HP EGS drawings to other CAD systems or move drawings from other systems to HP EGS. HP EGS can be used as a low-cost front end to your expensive CAD systems.

### Ordering Information

		Price
Standard, modular HP EGS	HP 74305A	\$6,000
HP EGS add-on modules for schematic capture, PCB layout, or mechanical engineering	HP 74306A	2,000
Hybrid Circuit Design Module	HP 74307A	6,000
High Performance HP EGS	HP 74308A	8,000
HP EGS Photoplotter/NC Drill Utility	HP 98310A	4,000
HP EGS IGES Translator	HP 98311A	6,000
HP TechWriter	HP 98819A	995
Vectra HP EGS	HP 74309A	3,000

The above products are also available in right-to-copy options, which offer an approximate 15% discount off the listed price, and in media options for 5 1/4-inch or 3 1/2-inch flexible discs. Please consult your local HP Sales Office (see page 771) for current prices and detailed ordering information.

# DESIGN AUTOMATION

## ME DesignCenter

ME Series 10 and 30

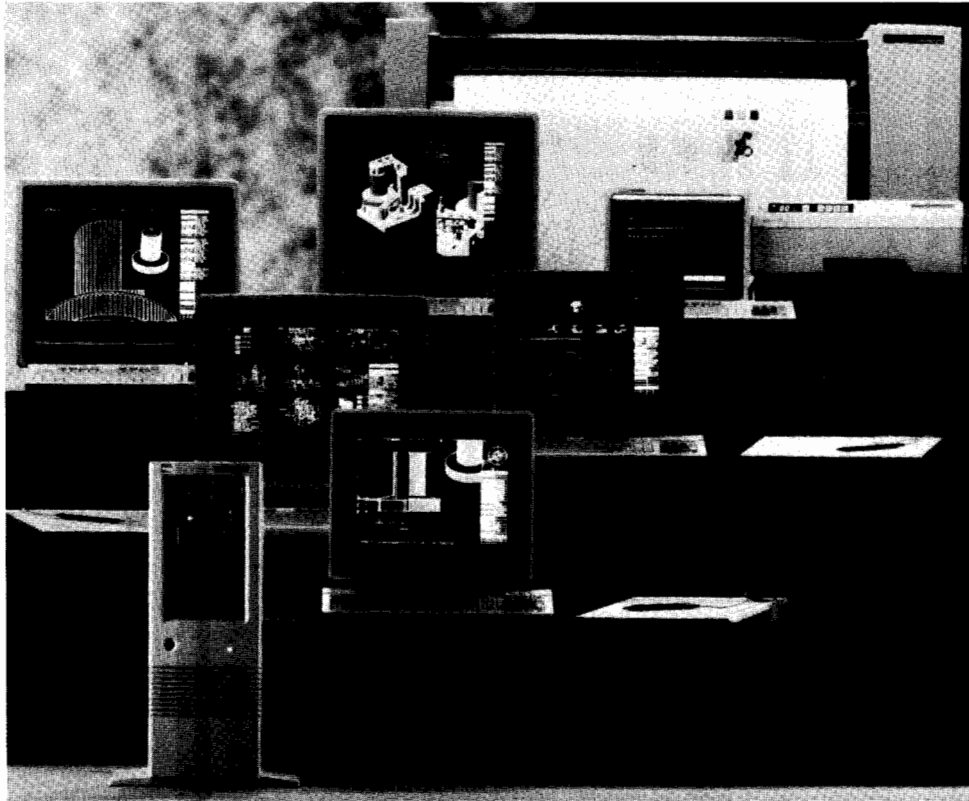

HP's DesignCenter Series 10 and 30 offer advanced drafting, 2D design, and solids modeling systems for mechanical engineering applications. These CAD systems run on a distributed computing environment of HP workstations.

### ME Series 10 & 30

HP DesignCenter Series 10 and 30 offer the full functionality required for drafting, documentation, 2D design and solid modeling. Both products use the same, easy-to-use user interface that drastically reduces the learning time to allow greater designer productivity. The systems operate on a complete range of hardware platforms and under the major industry standard operating systems.

### Functionality Overview

#### Drafting and Documentation

The ME Series 10 provides comprehensive drafting functionality and extensive 2D design capabilities. It also provides a complete set of functions to accelerate the production of drawings and other engineering documentation, while ensuring a standard of accuracy.

#### Design

ME Series 10 offers users an advanced set of tools for 2D design. Powerful creation and modification commands, combined with interactive variational design for creation of families of parts, enhance the design process. An on-line design checking capability enables designers to quickly and easily develop accurate designs from a given set of constraints.

Major features of ME Series 10 include:

- Full dimensioning capabilities according to international standards (ANSI, ISO, DIN, etc.)
- Automated detail creation
- Full text input and editing capability
- Comprehensive set of drafting symbols
- Semi-automatic isometric drawing creation
- Parts and assembly creation
- Unlimited number of layers available for drawing organization
- Parametric design capability
- Advanced geometry modification for adapting designs
- Associated information and attributes for material specifications and pricing details

### Modeling

The ME Series 30 Modeling, Design, and Drafting system integrates full solid modeling with 2D design. Design accuracy within the 3D models provides the ability to simulate real prototypes. This substantially reduces the need for design modifications as a result of errors in prototypes, thus allowing greater design department throughput.

ADDITIONAL major features of ME Series 30 include:

- "Workplane" technique allows 3D model creation from 2D geometry
- Machining functions for model creation, including mill and stamp to support use of 2D geometry for model creation
- Full assembly modeling capability
- Extensive design checking capability, including mass properties and interference

### Data Management

Manage all design engineering information with HP's mechanical engineering data management solution. Based on relational database management technology, data management gives CAD users the tools needed to locate, retrieve, manage and control the design office information — with the same, easy to use, ME CAD user interface.

### View-only Stations

View-only stations provide instant access to graphical and textual information on the shop floor and at the manager's desk. Timely and accurate information minimizes the risk of costly miscommunications.

### User Interface

The key to success with computer tools is complete functionality and convenient access to that functionality. Computer tools must present functionality in a form understandable to the user.

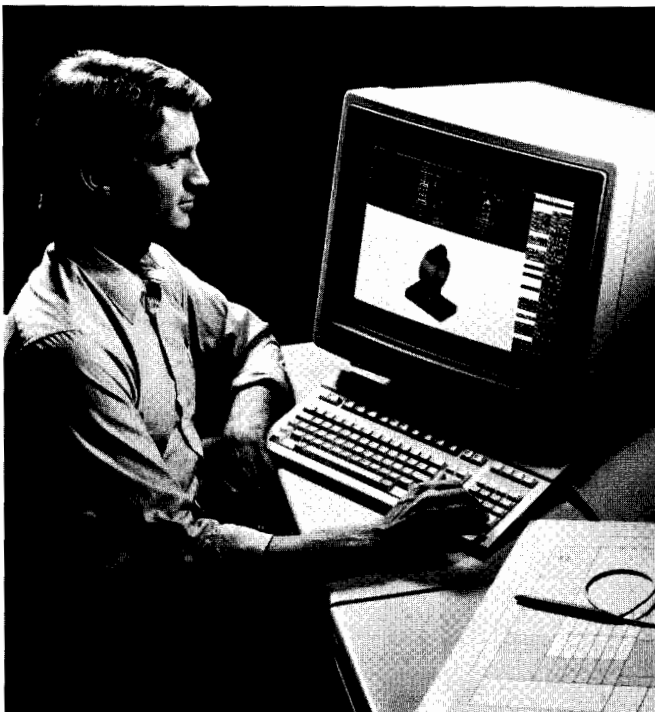

HP's DesignCenter ME Series 30 is an integrated 3D solid modeling, 2D design and drafting system for mechanical engineering applications. The system shown is operating on an HP 9000 Model 350SRX which provides dynamic rotation of hidden line and shaded models.

Nowhere is this more important than in the design environment where years of experience have led to the development of well proven design techniques.

Short learning cycles and friendly system handling are essential for engineering productivity. The HP ME Series products are menu-driven and provide the ease of use beginners require. In addition, they provide customizing capabilities for special applications.

The ME Series 10 and 30 user interface was specifically designed to ease user interaction by emulating traditional design techniques. As a result, the combined tablet and screen menu interface provides easy access to commands that use standard mechanical engineering terminology - commands such as fillet and mill are easy to understand and use. Interaction is further simplified by grouping the commands into functional blocks and the use of descriptive prompts. An on-line HELP facility is included to provide detailed descriptions of commands whenever necessary.

In both products, the user interface is optimized for mechanical design:

- System functions are directly accessible from the graphics tablet, complemented by screen menu subfunctions
- Multi-viewport capability eases handling of large and complex models, designs, and drawings
- On-line HELP facility provides detailed explanation of the use of commands
- Feedback mechanisms such as rubber banding and dynamic component tracking aid creation and modification operations

### Integrating and Interfacing Your CAD System

The CAD system is an important place of your total Computer Integrated Manufacturing concept. It is the foundation for the product development that allows a range of capabilities to grow around it. With the HP ME Series CAD systems, that foundation can be easily built upon, allowing you to add expanded capability as your requirement grows.

ME Series integration capabilities include:

- Parts list information for stock control systems
- Drawing data included in documentation systems
- 2D geometry link to NC programming systems
- 2D geometry link to finite element analysis systems

- IGES translator
- DXF translator

ME Series 30 ADDITIONAL integration capabilities include:

- 3D geometry link to NC programming systems
- 3D geometry link to finite element analysis systems
- IGES output

### HP's Proven Platform: Hardware and Support

The HP ME Series CAD systems support a complete set of price/performance leading computers. These networkable systems range from the MS-DOS\*-based HP Vectra RS to the UNIX\*\*-based HP 9000 Series 300 and 800 workstations and superworkstations. Complemented with a large selection of peripherals and graphics displays, HP offers a complete CAD solution.

Networking capabilities such as LAN enables users to set up a distributed system featuring both products to address the full range of mechanical engineering CAD requirements. Networking capabilities also allow further integration of CAD stations into manufacturing environments.

### Training

A complete set of training courses is available for the ME Series 10 and 30 to help your engineers become increasingly productive. Structured to match the increasing capability of the ME Series CAD family, the courses allow you to choose the correct level of training for each engineer. Additional training in your environment is supported by engineering consulting and a comprehensive set of documentation.

HP offers a range of services to ensure that the initial period after system delivery is trouble free. HP engineers are available to install all components of your CAD system. They also will tailor the system to your specific needs.

Your local HP sales office has full details of the training and support programs available in your area. Contact them for details.

### Ordering Information

For up-to-date ordering and pricing information you should contact your local HP sales office (see page 771).

- \* MS-DOS is a trademark of Microsoft Corporation
- \*\*UNIX is a trademark of AT&T Bell Laboratories

HP's DesignCenter ME Series 10 is an advanced 2D design and drafting system for mechanical engineering applications. ME Series 10 runs on HP 9000 Series 300 32-bit engineering workstations under the HP-UX operating system and, as shown here, HP Vectra RS 32-bit PC workstations under the MS-DOS operating system.

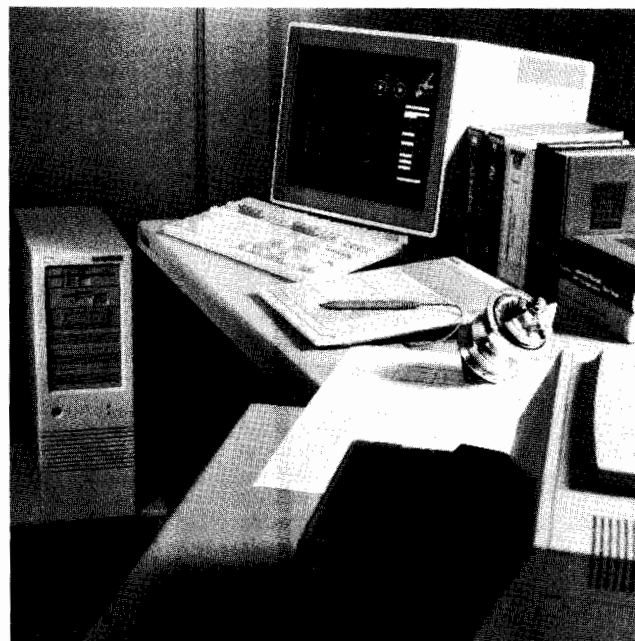

# TECHNICAL COMPUTER SYSTEMS

Measurement & Design Automation, Manufacturing & Real-Time Monitoring & Control

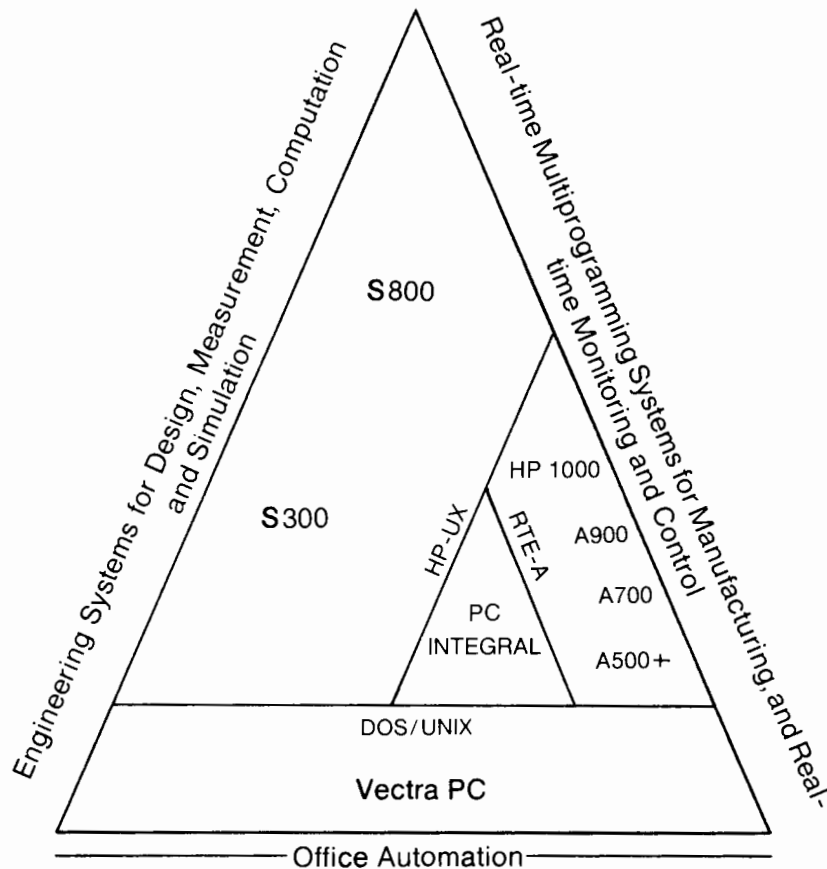

## Technical Computer Systems

Hewlett-Packard offers a wide range of technical computer systems for design, measurement automation, manufacturing, and real-time monitoring and control, as illustrated in the diagram above. The table on the facing page provides comparative data on the variety of technical systems available from HP.

### HP 9000 Series 800

Hewlett-Packard offers eleven different models based on the RISC-based HP Precision Architecture technology. All offer superior price/performance when compared with alternative systems. All provide extremely high compatibility with other HP systems and industry standards. All provide the low cost of ownership and high reliability expected from HP.

The new HP 9000 Model 855S superminicomputer is the fastest member of the Series 800 family, with approximately 50% better CPU performance and greater expandability than the Model 850S and three to four times the performance of the Model 825S. Model 850S and 855 uses HP's proprietary NMOS III VLSI technology and runs the HP-UX operating system, equipped with HP's real-time enhancements to make it a top performer in applications of either the HP 9000 or HP 1000 families. The Model 850S provides 2 to 2.5 times the performance of the Model 825S. It offers a large I/O fan out and can support up to 300 users. Applications demanding high multi-user throughput are easily met with a Model 850S. A Model

850S can be easily upgraded to an 855S with a simple CPU board swap.

HP 9000 Model 840S falls in the mid-range of the Series 800 minicomputer line, with three times the CPU performance of an HP 1000 A900 or HP 9000 Model 350 system. It provides all the industry standard software advantages of the Model 850S/855S with 1.5 times the performance of an 825S. The new Models 835S and 835SE provide a broader midrange to the Series 800. These systems provide support for thirty to seventy-eight users, respectively. They feature extremely high CPU performance in very compact packaging. A simple board upgrade from 825 systems is available. Both the 835S and 835SE offer 1.5 to 2 times the performance of an 825S.

HP 9000 Model 825S is the entry-level member of the Series 800 minicomputer family, with 1.5 to 2 times the performance of the HP 1000 A900 or HP 9000 Model 350 systems. Like all the Series 800 products, it is object code compatible with all other Series 800 systems, and source code compatible with HP 9000 Series 300 products, with PORT/HP-UX facilities for application migration from HP 1000 systems.

The 825 graphics superworkstations perform at 8.2 times the speed of a VAX 11/780, and the 835 performs at fourteen times a VAX 11/780. The 825 offers .65 MFLOPS; the 835 offers 2 MFLOPS double-precision Linpacks performance. The CHX, SRX, and the TurboSRX graphics subsystems provide the user with a choice of 2D (wireframe), 3D solids, or high-performance solid rendering capabilities.

### HP 9000 Series 300

The HP 9000 Series 300 is a flexible, scalable computer system offering a wide range of price/performance alternatives. With a low entry price, the low-end workstations are well-suited for dedicated instrument control applications as well as for entry-level engineering and technical office automation applications.

On the high end, Series 300 workstations provide complex engineering design capability and increased computation performance. From the Model 370 TurboSRX premier graphics workstation to mid-range Model 330, the Series 300 offers a choice of workstations for every application. The addition of the HP DOS Coprocessor makes the Series 300 workstation IBM PC AT compatible—both an engineering and personal computer in one box.

### Technical PC Systems

The Integral PC is an HP-UX-based transportable computer that supports large and sophisticated applications programs for field-delivery applications. The Vectra PC and Vectra Industrial PC support the full range of DOS technical and commercial applications. Using the HP Language Processor, they can also support BASIC and Pascal.

### HP 1000 A-Series Systems

HP 1000 A-Series systems provide real-time operation at four different performance levels (A900, A700, A600+, and A400), as listed in the facing table. Predictable response to real-time events equips these systems to function effectively as factory floor workcell controllers, or in other applications that require real-time responsiveness.

### Communications

HP technical computer systems can communicate with each other, via various networking protocols, a topic discussed on page 660.

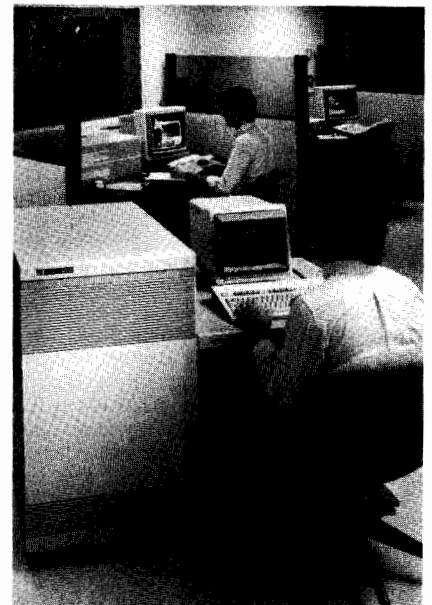

**Hewlett-Packard Technical Computer Systems Summary**

Processor	Base Speed	Fltg Pt Speed (KWIPS-B1D)	Main Memory	Virtual Memory	Oper. Systems	Number of Users	Program Languages	System Software	Networking	Application Environments						
HP 9000 Series 800 pages 643-646	3-14 MIPS	2092 to 6600	8-128*	28100 GB	HP-UX	1-400	C FORTRAN Pascal Ada COBOL	X-Window Starbase GKS HP Allbase HP Today HP Visor NFS	ARPA/Berkeley Network Structures HP/NS to HP 1000 & HP 9000	Workstation Telecommunications Industrial Automation Design Automation Multi-user Scientific Computation Commercial						
HP 9000 Series 300 page 647	0.4 to 8 MIPS	150 to 2600	1 to 48 MB	16 MB or 4 GB	HP-UX	1 to 32	C FORTRAN Pascal LISP Ada Prolog BASIC	HP Windows; X Window; Technical Office Automation HPtoday; HP-GKS; Starbase; and DGL/AGP Graphics; HP Allbase DOS Coprocessor	LAN Link to HP 1000, HP 3000, & HP 9000; and uucp comm to other UNIX systems ARPA/Berkeley Network Services Discluss nodes NFS, IBM SNA	Workstation  Multi-user  Software Engineering						
											BASIC	1	BASIC		SRM IBM 3270	Instrument Control
											Pascal	1	Pascal	DGL Graphics	IBM 2780/3780 RJE	
HP Vectra, RS/16, RS/20 page 653	0.3 MIPS	45 To 100	1 MB to 16 MB	not appl.	MS-DOS 3.1 HP BASIC Pascal	1	BASIC, Assembler Pascal	IBM PC/AT compatible software, incl. design & industrial applications software	RS-232C comm with host computers, 802.3/ARPA capabilities and SRM	Personal Productivity Design Automation Instrument Control						
HP 1000 A900 page 670	1.2 MIPS	820	0.75 to 32 MB	128 MB for data,	RTE-A	Up to 20	FORTRAN Pascal BASIC  Ada	IMAGE DBMS; DGL/AGP Graphics;  QDM/1000; PCIF/1000; & Datapair/1000	LAN Link to HP 1000, HP 3000, & HP 9000; NS/1000 pt-pt comm.  w/HP 1000 & HP 3000; and RJE, MRJE, & Prog-to-Prog comm. with IBM & plug-compatible systems	Manufacturing Control/Test  Data Acquisition  Telecommunications  (Multi-user)						
HP 1000 A700 page 670	0.4 MIPS	340	0.5 to 32 MB	7.75 MB for code												
HP 1000 A600+ and A400 page 670	0.4 MIPS	113 122	0.5 to 32 MB 0.5 to 32 MB													
HP Integral PC page 657	Not Spec'd	Not Spec'd	512 KB to 7.4 MB	not appl.	HP-UX/ RO 5.0	1	C BASIC FORTRAN Pascal	Standard HP-UX Software	RS-232C Communication with host computers, HP-UX serial Networking under $\mu$ CP	Software Engineering  Instrument Control						

\*Models 825/835 Superworkstations have a maximum of 96 MB  
Models 825/835 servers have a maximum of 112 MB



# TECHNICAL COMPUTER SYSTEMS

## HP Precision Architecture: Simpler Means Better

### Overview

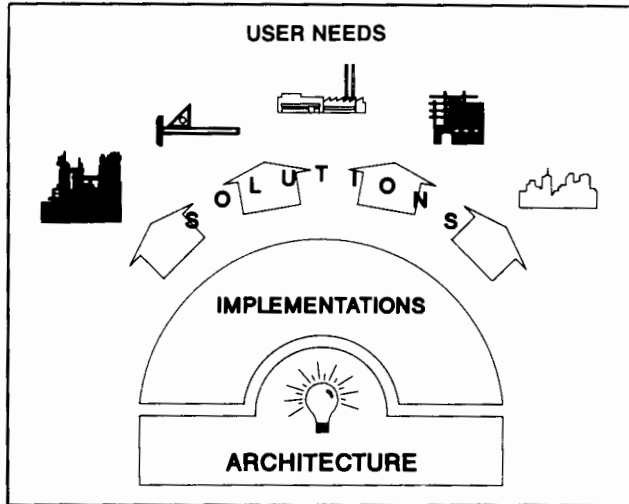

Figure 1: Relationship of Computer Architecture to User Needs

### What Is Computer Architecture?

Computer architecture is the foundation upon which a computer and its solutions are built. The architecture defines the instruction set, the length of the instruction, the formats of data and instructions, and memory format. The design of the organization and interconnection of the hardware components is specified by the architecture.

Above the architecture is the implementation. For a given architecture, there may be several implementations. Implementation refers to the organization of the architecture in hardware and software. The implementation will vary with the goals of the system.

Finally, the system is implemented using some technology. For example, the system might use processors made from various IC families, such as, CMOS, TTL, NMOS, ECL, etc.

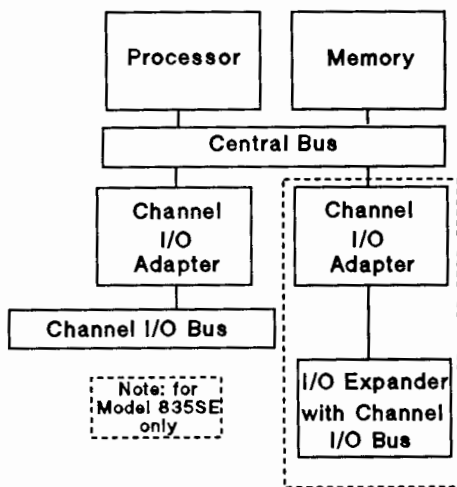

Figure 2: Sample SPU Organization

### Why Is Architecture Important?

Solutions presented by a computer system are based upon the hardware and software implementations. These implementations are constrained by the underlying architecture. Hence, the architecture must take into account today's and tomorrow's solutions needs.

### HP Precision Architecture

As computer systems have evolved, they have progressed from very simple architectures to complex systems with hundreds of instructions and several means of accessing data. Each move to more complexity was intended to simplify the efforts of the programmer. High-

level languages were implemented to make communication with the computer easier. In turn, these led to having many instructions so that the compilers would be able to more closely parallel the high-level language functions.

In the late 1970's, several industry experts began an analysis of what real computers do when running real solutions. The results were not surprising. Complex Instruction Set Computers, CISC's, spend 80% of their time executing 20% of the instruction set. In addition, the most often used instructions were the simplest. What this means is that the complexity of a CISC system is not really a boon to the programmer. Instead, CISC causes a performance penalty whenever these simple instructions are being accessed. Hardware and software necessary to allow the complex instructions are rarely used.

This led to the development of RISC (Reduced Instruction Set Computer) architectures. A RISC system allows reduced complexity while increasing performance. The result is a faster, less expensive, more reliable system. The main features of a RISC system are:

1. Reduced instruction set
2. Single cycle execution of most instructions
3. Hardwired instructions (no microcode)
4. Register intensive operation
5. Fixed instruction size
6. Short-cycle load/store design

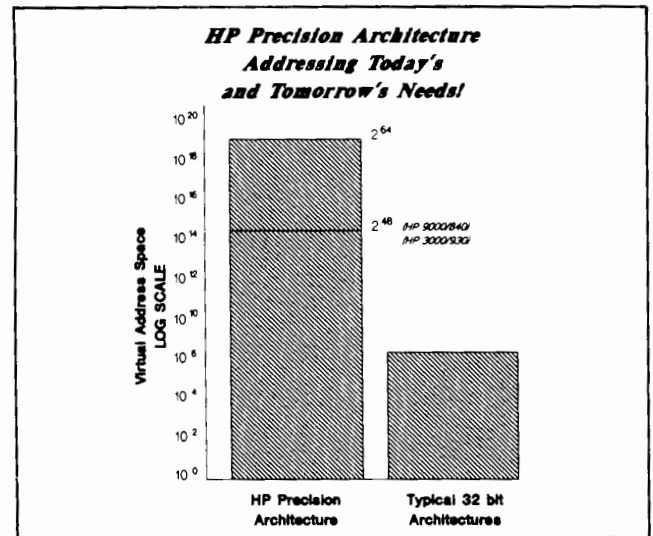

Figure 3: HP-PA Addressability

The result of these features is that the system is able to run faster, since extra decoding logic and data paths are eliminated; hardwired instructions execute faster than microcoded instructions. Simpler hardware also means lower cost and higher reliability.

HP Precision Architecture is RISC and much more. HP Precision Architecture is scalable, allowing implementations in many technologies. Systems are available using TTL logic and NMOS VLSI chips. Other technologies, such as CMOS or ECL are also possible.

The architecture also accommodates attached processors and coprocessors. This means that implementations can be tuned to specific applications, such as when fast floating point calculations are required.

Finally, memory addressing needs are increasing rapidly. Modern programming techniques and artificial intelligence are using virtual address space at an almost alarming rate. To solve this problem, HP Precision Architecture offers a virtual address space sixty-four thousand times as big as other 32-bit systems. That's not all, to meet even the most ambitious projections for the future, the architecture allows a whopping total of 18.4 BILLION GBytes!

### The Bottom Line

HP Precision Architecture offers leading performance at reasonable prices today. In addition, a growth path to the future is assured by the scalability, provision for special processors, and vast virtual address space. In short, HP Precision Architecture is lasting value.

# TECHNICAL COMPUTER SYSTEMS

HP 9000 Technical Computers

HP 9000 Series 800 Model 855S System

641

- More powerful super-minicomputer performance
- Price/performance leadership
- Standards-based software



HP's Model 855S Superminicomputer is the most powerful HP-UX-based system in Hewlett-Packard's history.

## HP Precision Architecture's High End System

The new HP 9000 Model 855S is the fastest member of the Series 800 family. It offers up to 50% better CPU performance and more expandability than the Model 850S, and it supports up to 400 users.

The Model 855S utilizes HP's proprietary VLSI NMOS III technology and runs under the HP-UX operating system. With enhancements added to equip the operating system for real-time superminicomputer applications, the 855S represents a high capacity, high performance extension to both the HP 9000 and HP 1000 product lines.

The 855S is object code compatible with the other Series 800 systems, making applications migration simple and fast. The entire Series 800 family is highly compatible with the HP 9000 Series 500, 300, and 200 systems at the source code level.

## High-end Performance for a Wide Range of Applications

The Model 855S offers clear price and performance advantages over other systems in its class. It has the power to serve a department of scientific, engineering, or business users performing computation- or transaction-based tasks.

The computing power of the 855S makes it a good choice for technical applications such as scientific modeling. For business applications, the system fits well in large MRP environments or other applications requiring a central database. In telecommunications, the high data throughput capabilities of the 855S meet the needs of diverse applications such as network management and message switching.

## Standard Operating System and More

The Model 855S, like the other members of the Series 800 family, executes the HP-UX operating system, which adheres to AT&T's UNIX\* System V Interface Definition (SVID), Issue 2 Volume 1. HP-UX also fully complies with the System V Verification Suite, which tests conformance with the SVID. HP-UX includes optimizing C, FORTRAN 77 and Pascal language compilers, a symbolic debugger, and all of the other application development support features normally included with a full-featured UNIX system. Popular Berkeley features such as the C shell, sockets, job control, and the McKusick fast file system have been incorporated as well.

Additionally, HP-UX includes real-time capability, a necessity for many industrial automation applications that require fast response to interrupts. Pre-emptive scheduling of the kernel allows execution of high priority processes immediately.

## The Power of Industry Standards

In addition to an industry standard operating system, the Series 800 systems support IEEE 802.3, ARPA/Berkeley and TCP/IP networking standards. The ALLBASE database management system supports both IBM's Structured Query Language (SQL) relational data base, the de facto standard, and the IMAGE network data base. HP today can be added for fast, easy development of transaction entry and reporting applications. Graphics support includes the Starbase 2-D and 3-D graphics library, an implementation of the ANSI CG-VDI specifications, and the DGL/AGP graphics libraries for compatibility with existing applications using those libraries.

HP's Native Language Support (NLS), which enables localization and use of applications in 18 different languages, was adopted as the internationalization standard for X/OPEN.

## Networking

The Model 855S communicates with HP 9000 and HP 1000 systems via LAN/9000 Series 800 and NS/9000 Series 800 communications products. Additional capability for communications with other UNIX systems, including non-HP systems, is offered by the ARPA Services/855 network services product.

## Ordering Information

Please contact your local HP sales office for additional information (see page 771).



\*UNIX is a registered trademark of AT&T in the U.S. and other countries.

\*\*A system console and system disc, ordered separately, are required to operate the HP 855S.

# TECHNICAL COMPUTER SYSTEMS

## HP 9000 Technical Computers (cont'd)

### HP 9000 Series 800 Models 835S and 835SE



### The New Models 835S and 835SE

#### Industry Leading Mid-range Performance

The new HP 9000 Model 835S and Model 835SE are mid-range members of Hewlett-Packard's Series 800 line of superminicomputers, which are based on HP Precision Architecture. The Models 835S and 835SE run the HP-UX operating system and offer an average of fourteen times the performance of a DEC VAX 11/780. The Models 835S and 835SE are object code compatible with the Models 825S, 840S, and 850S HP Precision Architecture systems, so applications are completely portable. The Models 835S and 835SE offer three to four times the performance of the HP 1000 A900 and HP 9000 Model 350. HP-UX is the real-time implementation of the UNIX® operating system and contains PORT/HP-UX facilities for applications migration from HP 1000 systems. The HP-UX based HP 9000 Series 500, 300, and 200 systems are highly source code compatible with the Models 835S and 835SE, so application migration and data exchange is virtually effortless among HP 9000 systems.

#### Superior Price/Performance

Because HP Precision Architecture is based on reduced complexity principles, the Models 835S and 835SE offer superior price/performance over other superminicomputers in their class. At 2.02 double precision Mflops, as measured by the Linpack benchmark, these new systems have competitive floating point performance. The 835S is ideally suited for applications requiring up to thirty users. The 835SE offers the same performance with additional connectivity up to seventy-eight users. Also, both systems support up to 112 megabytes of memory and 9.1 gigabytes of disc capacity with HP-FL. These characteristics, together with UNIX-based HP-UX, make the 835S and 835SE powerful software development engines for multiple engineers who need simultaneous access to a high-speed system. The high compute power makes the Model 835S attractive for scientific users doing simulation, finite element analysis, and laboratory analysis. The 835SE is well-suited for office workgroup computing, business graphics, and general purpose transaction processing. In manufacturing, the real-time capabilities of HP-UX and configurability make the 835S and 835SE effective as an area manager in the CIM hierarchy. Its real-time functionality, capacity, and power also equip the Model 835S for real-time monitoring and control jobs, such as energy management systems or communications switch controllers.

#### Real-time Functionality for Real-World Applications

HP-UX incorporates true real-time functionality. Predictable response to interrupts gives the Models 835S and 835SE the ability to keep critical real-world processes under control. Standard automatic powerfail recovery restarts the Model 835SE at the program statement whose execution was interrupted by a power failure. This functionality is available as an option to the 835S. Priority-based pre-

emptive scheduling gives execution preference to the most important programs so they can run immediately, if necessary. Process locking can keep programs and data in memory for fastest real-time response.

#### Industry Standard Software

True real-time performance of HP-UX has been achieved without compromising the compliance of HP-UX with the AT&T System V Interface Definition Issue 2 (SVID). HP-UX includes an optimizing C language compiler, a powerful symbolic debugger, and all application development support features normally included with a full-featured UNIX system. Additional optimizing compilers are available for FORTRAN 77 and Pascal programming. Add HP VISOR to provide easy access to HPSQL data. Graphics support includes the Starbase 2-D and 3-D graphics library, an implementation of the ANSI CG-VDI specifications, and the DGL and AGP graphics libraries for compatibility with existing applications that use those libraries. HP-UX and its supported software subsystems comply with official and de facto standards to the maximum extent practicable to assure the widest possible useability of programs.

#### Networking and National Language Support

The Model 835S and 835SE communicate with HP 9000 and HP 1000 systems via LAN/9000 Series 800 and NS/9000 Series 800 communications products. Additional capability for communication with other UNIX systems, including non-HP systems, is offered by the ARPA Services/800 network services product. HP-UX supports localization and use of applications in sixteen different national languages.

#### Ordering Information

HP 9000 Series 800 Model 835S SPU with 8MB memory, floating point coprocessor, HP-UX operating system with 16-user license, 6-channel multiplexer, and HP-IB interfaces, installation and manuals	<b>HP A1035A</b>	\$45,000
HP 9000 Series 800 Model 835SE SPU with 24 MB memory, floating point coprocessor, HP-UX operating system with 64-user license, 6-channel multiplexer, and HP-IB interfaces, I/O expander, powerfail battery backup system	<b>HP A1040A</b>	\$99,000
HP FORTRAN 77/HP-UX	<b>HP 92443A</b>	\$4,775
HP Pascal/HP-UX	<b>HP 92444A</b>	\$4,775
HP VISOR HPSQL Interface	<b>HP 92533A</b>	\$6,830
HP TODAY Developer Pack	<b>HP 35305A</b>	\$17,400
HP TODAY Runtime Environment	<b>HP 35306A</b>	\$3,500
Starbase Graphics Library	<b>HP 92445A</b>	\$2,600
DGL/AGP, and Starbase Graphics Libraries	<b>HP 92446A</b>	\$3,750
HP GKS	<b>HP 92521A</b>	\$2,000
X Window System	<b>HP 92524A</b>	\$2,100
Development system bundle, including FORTRAN 77 and Pascal compilers and DGL/AGP, and Starbase Graphics Libraries	<b>HP 92447A</b>	\$10,300
ALLBASE/HP-UX	<b>HP 92460A</b>	\$17,050
ALLBASE/HP-UX and HP TODAY Developer Pack	<b>HP 92459A</b>	\$30,700
LAN/9000 Series 800 Link (interface and software)	<b>HP 91786A</b>	\$4,120
NS/9000 Series 800 Software	<b>HP 91787A</b>	\$2,060
ARPA Services 800	<b>HP 50981A</b>	\$2,142
HP-UX Gateway SNA/3270	<b>HP 36918A</b>	\$3,150
NFS Services 800	<b>HP 50970A</b>	\$1,400

UNIX is a U.S. registered trademark of AT&T in the U.S.A. and in other countries.

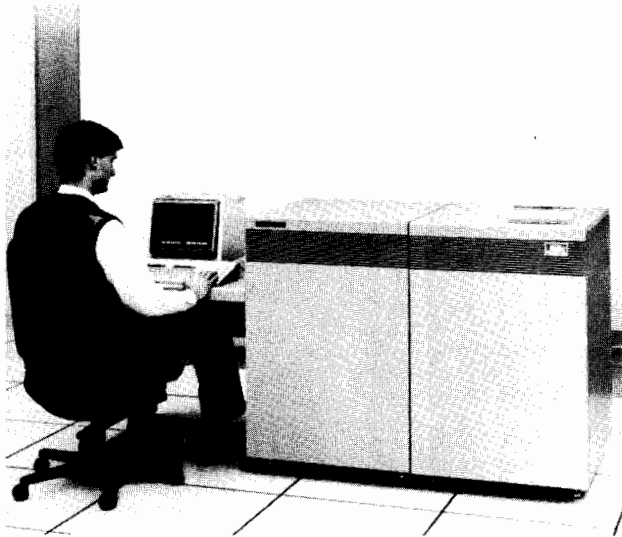

The HP 9000 Model 850S is a high-end superminicomputer in the UNIX-based Hewlett-Packard Precision Architecture (HPPA) family. The 850S offers 1.6 times the multi-user throughput of the Model 840S and floating point performance of 1.86 MFLOPS DP Linpacks, outperforming competitive superminis in its class.

#### High-end Performance

The Model 850S offers large terminal support, fast and expandable I/O, and an easy growth path to more powerful processing power, in addition to fast multi-user performance at a low price. The optional Floating Point Upgrade provides 25 times faster floating point performance than the standard coprocessor. The Terminal Expander increases the number of supported terminals from 102 to 300.

The 850S utilizes HP's proprietary VLSI NMOS III technology and runs under the HP-UX operating system. It is object code compatible with the other Series 800 systems, making applications migration simple and fast. The entire Series 800 family is highly compatible with the HP 9000 Series 500, 300, and 200 systems at the source code level.

#### Price/Performance Leadership in Multi-user Applications

The Model 850S is clearly a price leader when compared to superminis with comparable specifications. With estimated relative throughput of 7.2 (to the 840S' 4.5), the 850S outperforms other superminis in its price class.

The 850S has the power to serve an entire computing or transaction processing department. The compute power of the 850S makes it a good choice for technical applications such as electronics modeling, geological mapping, and monitoring control systems. In telecommunications, the high data throughput capabilities of the 850S and industry standard HP-UX operating system meet the needs of network management and message switching applications. The 850S offers more connectivity and I/O capacity for use in transaction processing applications, such as MRP or business applications requiring access to a central database.

#### Standard Operating System and More

The Model 850S, like the other members of the Series 800 family, executes the HP-UX operating system, which adheres to AT&T's UNIX\* System V Interface Definition (SVID), Issue 2 Volume 1. HP-UX also fully complies with the System V Verification Suite, which tests conformance with the SVID. HP-UX includes optimizing C, FORTRAN 77 and Pascal language compilers, a symbolic debugger, and all of the other application development support features normally included with a full-featured UNIX system. Popular Berkeley features such as the C shell, sockets, job control, and the McKusick fast file system have been incorporated as well.

Additionally, HP-UX includes real-time capability, a necessity for many industrial automation applications that require fast response to interrupts. Pre-emptive scheduling of the kernel allows execution of high priority processes immediately.

#### The Power of Industry Standards

In addition to an industry standard operating system, the Series 800 systems support IEEE 802.3, ARPA/Berkeley and TCP/IP networking standards. The ALLBASE database management system supports both IBM's Structured Query Language (SQL) relational data base, the de facto standard, and the IMAGE network data base. HP today can be added for fast, easy development of transaction entry and reporting applications. Graphics support includes the Starbase 2-D and 3-D graphics library, an implementation of the ANSI CG-VDI specifications, and the DGL/AGP graphics libraries for compatibility with existing applications using those libraries.

HP's Native Language Support (NLS), which enables localization and use of applications in 18 different languages, was adopted as the internationalization standard for X/OPEN.

#### Networking

The Model 850S communicates with HP 9000 and HP 1000 systems via LAN/9000 Series 800 and NS/9000 Series 800 communications products. Additional capability for communications with other UNIX systems, including non-HP systems, is offered by the ARPA Services/850 network services product.

#### Ordering Information

	Price
HP9000 Series 800 Model 850S System**	HP 9742A \$188,500
with 32MB memory, floating point coprocessor, 2 bus converters, 2 channel adapters, 6-channel multiplexor, HP-IB interface, and 64-user HP-UX license.	
Additional Channel Adapter	HP A1101A \$15,750
Additional 16MB Main Memory	HP A1104A \$32,000
Floating Point Upgrade Kit	HP A1108A \$25,000
CIO Terminal Expander	HP A1122A \$35,000
Expansion Module Kit	HP A1123A \$28,000
Add-on Expander	HP A1124A \$32,500
Cable Management Rack for up to 288 terminals	HP A1125A \$5,000
Cable Management System for up to 66 terminals, including a table for the system console.	HP 19749A \$945
HP-IB Interface	HP 27110B \$1,540
Parallel Asynchronous FIFO Interface	HP 27114A \$1,630
Asynchronous 6-channel Multiplexor	HP 98196A \$2,525
Unlimited HP-UX License	HP 92455A \$34,125
Credit for upgrade from 64-user license.	Opt. 0A3 -\$18,375
HP Native Language I/O and Stick Kanji Font	HP 92439A \$2,625
HP Simplex Kanji Font	HP 92433A \$1,260
HP FORTRAN 77/HP-UX for Model 850S	HP 92461A \$10,300
HP Pascal/HP-UX for Model 850S	HP 92462A \$10,300
HP Starbase/HP-UX Graphics Library for 850S	HP 92463A \$5,600
HP DGL/AGP/HP-UX Graphics Library for 850S	HP 92464A \$ 8,050
HP GKS for 850S	HP 92529A \$4,620
X Window System for 850S (X client only)	HP 92532A \$4,500
ALLBASE/HP-UX and HPToday Developer Pack/HP-UX for 850S	HP 92468A \$70,000
ALLBASE/HP-UX for 850S	HP 92469A \$36,750
ALLBASE/Query for 850S	HP 92535A \$14,700
ALLBASE/4GL Developer Pack/HP-UX for 850S	HP 35307A \$37,500
ALLBASE/4GL Run-time Environment/HP-UX for 850S	HP 35308A \$7,500
LAN/9000 Series 800 Link for 850S	HP 91788A \$7,720
NS/9000 for 850S	HP 91789A \$6,180
ARPA/BSD Services for 850S	HP 50982A \$7,497
NS for the DEC VAX Computer	HP 50950A \$6,300
NFS Services for 850S	HP 50972A \$6,500
HP-UX Gateway SNA/3270 for 850S	HP 36919A \$10,500

\*UNIX is a registered trademark of AT&T in the U.S. and other countries.

\*\*A system console and system disc, ordered separately, are required to operate the HP 9742A.

# TECHNICAL COMPUTER SYSTEMS

## HP 9000 Model 840S System



HP 9000 Model 840S is shown here in expanded configuration, with new memory cards, I/O expander, 96 MB and 128 terminal or serial ports.

### HP Precision Architecture Performance

The HP 9000 Series 800 Model 840S is based on HP Precision Architecture. Running under the HP-UX operating system, the Model 840S offers up to three times the CPU performance available on the HP 9000 Series 500 Model 550 or HP 1000 A900 system. Significant enhancements equip HP-UX to support real-time applications, making the Model 840S system a logical, high-capacity, high-performance extension of both the HP 9000 and HP 1000 computer system product lines. The Model 840S as an extension of the HP 1000 product line is specifically supported by extensive PORT/HP-UX facilities for applications migration from HP 1000 systems. The HP-UX based HP 9000 Series 500, 300, and 200 systems are highly compatible with the Model 840S because they operate under the same operating system, making data interchange and applications migration among HP 9000 systems virtually effortless. In addition, the Model 840S is object code compatible with the other members of the Series 800 family.

### Superior Price/Performance for Wide Applicability

The inherent design economy of HP Precision Architecture makes the performance of the Model 840S more affordable than other superminis with comparable specifications. The Model 840S is thus readily applicable to support computation-intensive applications found in engineering, scientific, business and industrial environments. Its large capacity and industry-standard HP-UX operating system affords an excellent environment for application developers.

### Real-time Functionality for Real-World Applications

HP-UX incorporates true real-time functionality. Predictable response to interrupts gives the Model 840S the ability to keep critical real-world processes under control. Automatic power-fail recovery restarts the Model 840S at the program statement whose execution was interrupted by a power failure. Priority-based pre-emptive scheduling gives execution preference to the most important programs so they can run immediately, if necessary. Process locking can keep programs and data in memory for fastest real-time response.

### Industry-Standard Software

As important as the true real-time performance of HP-UX is the fact that it has been achieved without compromising the compliance of HP-UX with the AT&T System V Interface Definition Issue 2 (SVI2). HP-UX includes an optimizing C language compiler, a powerful symbolic debugger, and all of the other application development support features normally included with a full-featured UNIX® system. Additional optimizing compilers are available for FORTRAN 77 and Pascal programming. HP's new ALLBASE DBMS, which supports both industry-standard SQL relational data management and IMAGE network-model data management, is available. HPtoday can be added for fast, easy development of transaction entry and reporting applications. HP VISOR can be added to provide easy access to HPSQL data. Graphics support includes the Starbase 2-D and 3-D graphics library, an implementation of the ANSI CG-VDI specifications, and the DGL and AGP graphics libraries for compatibility with existing applications that use those libraries.

HP-UX and its supported software subsystems comply with official and de facto standards to the maximum extent practicable, to assure the widest possible usability of programs within the HP 9000 and HP 1000 system families and with respect to non-HP computer systems.

### Networking and National Language Support

The Model 840 communicates with HP 9000 and HP 1000 systems via LAN/9000 Series 800 and NS/9000 Series 800 communications products. Additional capability for communication with other UNIX systems, including non-HP systems, is offered by the ARPA Services/800 network services product. HP-UX supports localization and use of applications in 16 different national languages and is available only from Hewlett-Packard.

### Memory and Graphics Support

The Model 840S has six available memory slots, and can be configured for up to 96MB of memory. Graphics software capabilities similar to the Series 300 offerings, including the Solid Rendering Display System (SRX), are also available.

### Model 840S I/O Expander

The Model 840S can be configured to include a two-bay system with the I/O Expander (option 601 or HP 19746B). The configurability with the 840S expander now supports up to 26 available CIO slots (28 including the MUX and HP-IB that come with the system), and can support up to 128 users.

### Ordering Information

	Price
HP 9000 Series 800 Model 840S SPU* 8MB memory, Floating Point, HP-UX, 6-channel MUX and HP-IB interface I/S	HP 9741A \$55,350
Add 8MB of RAM	Opt 508 \$16,000
Replace 8MB RAM with 32MB RAM	Opt 531 \$39,000
Add 32MB of RAM	Opt 532 \$48,000
With 840S I/O Expander	Opt 601 \$28,350
Additional 8MB of RAM	HP 19748A \$29,000
Additional 32MB of RAM	HP 19733A \$64,000
Model 840S I/O Expander	HP 19746B \$31,800
Cable Management System for u66 terminals, includes console table	HP 19749A \$945
HP-IB Interface	HP 27110B \$1,540
Parallel Asynchronous FIFO Interface	HP 27114A \$1,600
Asynchronous 6-channel Multiplexer	HP 98196A \$2,825
32-user HP-UX License	HP 92453A \$10,800
Credit for upgrade from 16-user license	Opt 0A0 \$5,250
64-user HP-UX License	HP 92454A \$18,375
Credit for upgrade from 16-user license	Opt 0A1 \$5,250
Credit for upgrade from 32-user license	Opt 0A2 \$10,800
HP-UX Unlimited License	HP 92455A \$34,125
Credit for upgrade from 16-user license	Opt 0A1 \$5,250
Credit for upgrade from 32-user license	Opt 0A2 \$10,800
Credit for upgrade from 64-user license	Opt 0A3 \$18,375
HP FORTRAN 77/HP-UX	HP 92430A \$7,350
HP Pascal/HP-UX	HP 92431A \$7,350
ALLBASE/HP-UX	HP 36217A \$26,250
HPtoday Developer Pack	HP 92440A \$26,800
HPtoday Run Time Environment	HP 92441A \$5,400
Starbase Graphics Library	HP 92436A \$4,000
DGL/AGP, and Starbase Graphics Libraries	HP 92437A \$5,750
X Window System	HP 92528A \$3,200
Development system bundle, including FORTRAN 77 and Pascal compilers and DGL/AGP, and Starbase Graphics	HP 92438A \$15,850
ALLBASE/HP-UX & HPtoday Developer Pack	HP 92442A \$42,000
HP Display List	HP 92526A \$1,500
HP VISOR Interface to HP SQL	HP 92534A \$10,500
HP Simplex (KANJI font)	HP 92433A \$1,200
Native Language I/O & Stick KANJI Font	HP 92439A \$1,625
LAN/9000 Series 800 Link (with software)	HP 98194A \$5,660
NS/9000 Series 800 Software	HP 98195A \$3,605
HP-UX Gateway SNA/3270	HP 36911A \$7,497
NFS Services	HP 50971A \$3,500
ARPA Services/800	HP 50980A \$4,284
Solid Rendering Display System with D Solid Graphics Accelerator	HP 98720A \$11,350
Display Controller Interface	HP 98721A \$10,350
8-plane Frame Buffer Memory	HP A1017A \$2,500
	HP 98722A \$1,645

\*The HP 9741A requires system console and system disc for operation



# TECHNICAL COMPUTER SYSTEMS

## HP 9000 Technical Computers

### HP 9000 Model 825S

645



#### Superminicomputer Performance

The new HP 9000 Model 825S is the midrange member of Hewlett-Packard's Series 800 line of superminicomputers based on HP Precision Architecture. Running under the HP-UX operating system, the Model 825S offers .5 to .7 times the supermini throughput of the Model 835S, Model 835SE, or Model 840S. The Model 825S is object code compatible with all series 800 HP Precision Architecture systems so applications are completely portable. The Model 825S offers 1.5 to 2 times the performance of the HP 1000 A900 and HP 9000 Model 350. The Model 825S is a logical, high capacity, high performance extension of both the HP 1000 and HP 9000 product lines. HP-UX is the real-time implementation of the UNIX™ operating system and contains PORT/HP-UX facilities for application migration from HP 1000 systems. The HP-UX based HP 9000 Series 500, 300 and 200 systems are highly source code compatible with the Model 825S so application migration and data exchange is virtually effortless among HP 9000 systems.

#### Superior Price/Performance

Because HP Precision Architecture is based on reduced complexity principles, the Model 825S offers superior price/performance over other superminicomputers in its class. At 2.4 Million Double Precision Whetstone Instructions per Second, and 12.6 Million Dhrystone Instructions per Second, the Model 825S has very high CPU performance. In addition, the system offers a high degree of expandability with up to 64 users, 6.85 Gigabytes of disc memory with HP-IB interface and 9.14 Gigabytes with HP-FL interface, up to 14 I/O slots and 2 I/O channels. These characteristics along with UNIX-based HP-UX make Model 825S a powerful software development engine for multiple engineers who need simultaneous access to a high speed system. The high computation power make the Model 825S attractive for scientific users doing simulation, imaging or modeling. These characteristics also make the Model 825S well suited for seismic analysis, mapping and other earth resources applications. In manufacturing, the real-time capabilities of HP-UX and configurability make the Model 825S effective as an Area Manager in the CIM hierarchy. Its real-time functionality, capacity and power also equip the Model 825S for real-time monitoring, and control jobs, such as energy management systems or communications switch controllers. Powerful multiuser performance also makes the Model 825S well-suited for transaction-based business applications.

#### Industry-Standard Software

As important as the true real-time performance of HP-UX is the fact that it has been achieved without compromising the compliance of HP-UX with the AT&T System V Interface Definition Issue 1 (SVID). HP-UX includes an optimizing C language compiler, a powerful symbolic debugger, and all of the other application development support features normally included with a full-featured UNIX® system. Additional optimizing compilers are available for FORTRAN 77 and Pascal programming. HP's new ALLBASE DBMS, which supports both industry-standard SQL relational data management and IMAGE network-model data management, is available. HPtoday can be added for fast, easy development of transaction entry and reporting applications. HP VISOR can be added to provide easy access to HPSQL data. Graphics support includes the Starbase 2-D and 3-D graphics library, an implementation of the ANSI CG-VDI specifications, and the DGL and AGP graphics libraries for compatibility with

existing applications that use those libraries. HP-UX and its supported software subsystems comply with official and de facto standards to the maximum extent practicable, to assure the widest possible usability of programs within the HP 9000 and HP 1000 system families and with respect to non-HP computer systems.

#### Networking and National Language Support

The Model 825 communicates with HP 9000 and HP 1000 systems via LAN/9000 Series 800 and NS/9000 Series 800 communications products. Additional capability for communication with other UNIX systems, including non-HP systems, is offered by the ARPA Services/800 network services product. HP-UX supports localization and use of applications in 16 different native languages and is available only from Hewlett-Packard. See page 660 for more information.

HP's National Language Support (NLS), which enables localization and use of applications in 18 different languages, was adopted as the internationalization standard for X/OPEN.

#### Ordering Information

HP 9000 Series 800 Model 825S SPU w/8MB memory, Floating Point coprocessor, HP-UX operating system with 16 user license, 6 channel multiplexor and HP-IB interfaces, installation and manuals.	HP A1004A	
Additional 2MB of RAM (max of 6 per 825S)	HP A1004A Opt 001	\$3,500
Additional 8MB of RAM (max of 6 per 825S)	HP A1004A Opt 002	\$8,000
Add Model 825S CIO Expander Adds 7 CIO slots and includes channel adapter interface and cable	HP A1004A Opt 003	\$14,000
Add Battery Backup Unit	HP A1004A Opt OE1	\$4,500
Delete 8MB RAM, add 16MB	Opt 515	\$8,000
Add 16MB RAM	Opt 516	\$16,000
Delete 8MB RAM, add 32MB	Opt 531	\$18,000
Access Port Kit	HP A1015A	\$5,500
19 inch Rack Mount Kit for 825S	HP 97099A	\$560
19 inch Rack Mount Kit for Battery Backup	HP 19500B	\$85
HP-IB Interface	HP 27110B	\$1,540
Parallel Asynchronous FIFO Interface	HP 27114A	\$1,680
Asynchronous 6-channel Multiplexor	HP 27140A	\$2,450
32-user HP-UX License	HP 92453A	\$10,500
Credit for upgrade from 16-user license	Opt 0A0	-\$5,250
64-user HP-UX License	HP 92454A	\$18,375
Credit for upgrade from 16-user license	Opt 0A1	-\$5,250
Credit for upgrade from 32-user license	Opt 0A2	-\$10,500
X Window System	HP 92524A	\$2,100
HP FORTRAN 77/HP-UX	HP 92443A	\$4,775
HP Pascal/HP-UX	HP 92444A	\$4,775
ALLBASE/HP-UX	HP 92460A	\$17,050
HPVISOR HPSQL Interface	HP 92533	\$6,830
HPtoday Developer Pack	HP 35305A	\$17,400
HPtoday Run Time Environment	HP 35306A	\$3,500
Starbase Graphics Library	HP 92445A	\$2,600
DGL/AGP, and Starbase Graphics Libraries	HP 92446A	\$3,750
NS for DEC VAX Computer	HP 50950A	\$6,303
NFS Service	HP 50970A	\$1,400
HP-UX Gateway SNA/3270	HP 36918A	\$3,150
Development system bundle, including FORTRAN 77 and Pascal compilers and DGL/AGP, and Starbase Graphics Libraries	HP 92447A	\$10,300
ALLBASE/HP-UX & HPtoday Developer Pack	HP 92459A	\$30,700
LAN/9000 Series 800 Link (interface and software)	HP 91786A	\$4,120
NS/9000 Series 800 Software	HP 91787A	\$2,060
ARPA Services/800	HP 50981A	\$2,142

\*The HP 9741A requires system console and system disc for operation.  
© UNIX is a trademark of AT&T in the U.S.A. and other countries.



# TECHNICAL COMPUTER SYSTEMS

## HP Precision Architecture

### HP 9000 Series 800 Superworkstations

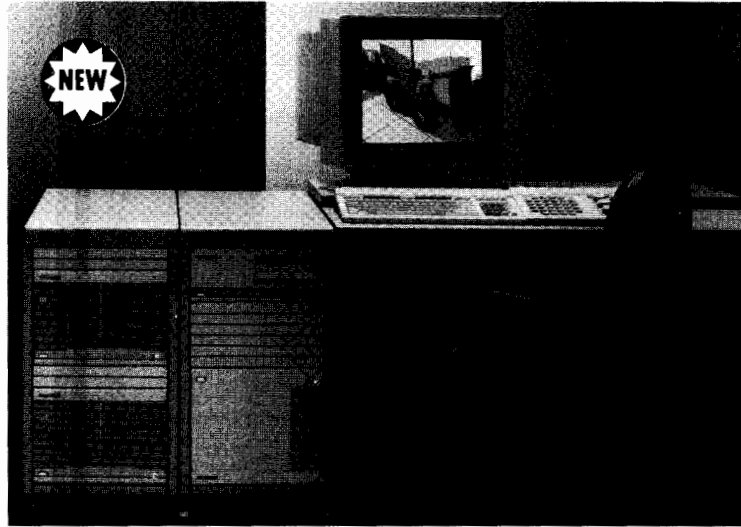

HP 9000 Model 835 TurboSRX Superworkstation integrates powerful computation with interactive and photorealistic graphics.

## HP 9000 Series 800 Superworkstations

### Mainframe Power Plus High-Performance Graphics

The Series 800 superworkstations combine high-performance computation with interactive graphics. Source code compatibility with the Series 300 family and object code compatibility within the Series 800 facilitate choosing the levels of graphics and system processing power appropriate for your application environment. Upgrade paths from the Model 825 to the Model 835 and from the SRX to the TurboSRX allow the superworkstation performance to grow as your application needs grow.

### Model 825CHX

The Model 825CHX combines advanced bit-mapped graphics with a high-performance computational engine to meet the interactive needs of computer-aided engineering applications such as integrated circuit and printed circuit board layout. It features the Model 825 system processing unit (SPU), the A1020H graphics controller with eight planes of frame buffer memory and two overlay planes, the 98556A 2D integer-based graphics accelerator, A1017A graphics interface and cable, 46021A keyboard, 46060A HP-HIL 2-button mouse, 46081A HP-HIL Extension with audio, 46084A HP-HIL ID module, and a choice of either the 98752A 1280 x 1024 resolution 19-inch monitor or the 98789A 1280 x 1024 resolution 16-inch monitor. The system also includes 92452A 1-16 user HP-UX license and software, 92445A Starbase Graphics Library, 91786A LAN/9000 and 50981A ARPA Services, and the X Window System.

**HP A1008A** \$49,500

### Model 835CHX

The Model 835CHX provides 50% more SPU power than the Model 825CHX for integer calculations and more than three times the floating point performance. It features the Model 835 SPU, the A1020H graphics controller with eight planes of frame buffer memory and two overlay planes, the 98556A 2D integer-based graphics accelerator, A1017A interface and cable, 46012A keyboard, 46060A HP-HIL 2-button mouse, 46081A HP-HIL Extension with audio, 46084A HP-HIL ID module, and a choice of either the 98752A 1280 x 1024 resolution 19-inch monitor or the 98789A 1280 x 1024 resolution 16-inch monitor. The system also includes 92452A 1-16 user HP-UX license and software, 92445A Starbase Graphics Library, 91786A LAN/9000 and 50981A ARPA Services, and the X Window System.

**HP A1050A** \$59,500

### Model 825SRX

The Model 825SRX combines interactive 3D solids rendering capabilities with high-performance computational engine to meet the interactive needs of 3D mechanical computer-aided engineering applications and mapping. It includes the Model 835 SPU, the 98720A Solid Rendering Display Controller with four overlay planes, the 98721A 3D Solids Graphics Accelerator, eight planes of frame buffer memory, expandable to twenty-four planes, 98752A 1280 x 1024 resolution 19-inch monitor (or 98789A 1280 x 1024 resolution 16-inch monitor), A1017A interface card and cable, 98290A RGB cable, 46021A keyboard, 46060A HP-HIL 2-button mouse, 46081A HP-HIL Extension with audio, 46084A HP-HIL ID module, 92452A 1-16 user HP-UX license and software, 92445A Starbase Graphics Library, 91786A LAN/9000 and 50981A ARPA Services, and the X Window System.

**HP A1005A** \$59,500

### Model 835SRX

The Model 835SRX provides 50% more SPU power than the Model 825SRX for integer calculations and more than three times the floating point performance. It includes the Model 835 SPU, the 98720A Solid Rendering Display Controller with four overlay planes, the 98721A 3D Solids Graphics Accelerator, eight planes of frame buffer memory, expandable to twenty-four planes, 98752A 1280 x 1024 resolution 19-inch monitor (or 98789A 1280 x 1024 resolution 16-inch monitor), A1017A interface card and cable, 98290A RGB cable, 46012A keyboard, 46060A HP-HIL 2-button mouse, 46081A HP-HIL Extension with audio, 46084A HP-HIL ID module, 92452A 1-16 user HP-UX license and software, 92445A Starbase Graphics Library, 91786A LAN/9000 and 50981A ARPA Services, and the X Window System.

**HP A1045A** \$69,500

### Model 835 TurboSRX

The Model 835 TurboSRX incorporates powerful SPU performance with interactive and photorealistic 3D solids rendering capabilities to meet the interactive needs of 3D mechanical computer-aided engineering applications, imaging, and mapping. A fully configured 835 TurboSRX includes the Model 835 SPU, the 98730A Solid Rendering Display Controller with four overlay planes, three 98732A 3D Solids Graphics Accelerator, twenty-four planes of frame buffer memory, 98752A 1280 x 1024 resolution 19-inch monitor (or 98789A 1280 x 1024 resolution 16-inch monitor), A1017A interface card and cable, 98290A RGB cable, 46021A keyboard, 46060A HP-HIL 2-button mouse, 46081A HP-HIL Extension with audio, 46084A HP-HIL ID module, 92452A 1-16 user HP-UX license and software, 92445A Starbase Graphics Library, 91786A LAN/9000 and 50981A ARPA Services, and the X Window System.

**HP A1055A** \$91,500  
**Opt #624**

# TECHNICAL COMPUTER SYSTEMS

## HP 9000 Technical Computers

HP 9000 Series 300

647



HP 9000 Series 360 TurboSRX solid modeling workstation

### HP 9000 Series 300

A modular family of high performance technical workstations designed for computer-aided design and instrument control applications, the Series 300 was developed with maximum flexibility in mind. Two levels of product structure are available: pre-configured systems to easily automate a wide range of design and measurement automation tasks. Or, for users with more customized requirements, a full range of individual component products are available making it feasible to build a system matched exactly to their specific needs.

Based on the Motorola 68010, 68020, and 6830 line of processors. Compatibility throughout the Series 300 family is ensured via object code compatibility.

#### System Processing Units

The basis for any Series 300 system is the system processing unit (SPU), which includes the CPU, RAM, floating point and standard system interfaces: HP-IB, RS-232, Battery-backed clock, HP-HIL, and timers. System expanders allow you to grow your Series 300 systems as your needs change.

#### Model 370

The Model 370 is based on the 33MHz MC68030 processor and includes the MC68882 floating point co-processor also running at 33MHz. Its performance is 7 MIPS and has the ability to address up to four Gbytes of virtual memory. The Model 370 houses four system slots, which contain the processor board; eight megabyte of parity RAM; and the system interface board, which includes the standard interfaces plus the choice of either AUI LAN connector or ThinLAN interface, two-channel DMA controller and the high-speed HP-IB or optional SCSI disc interface. One system slot is available for installing a graphics board, floating point accelerator, or 2-slot DIO backplane. The Model 370 features a full 32-bit I/O bus (DIO-II) and a dedicated "System Bus"; a high speed connection to RAM. Up to 32-megabytes of parity RAM or 48 megabytes of ECC RAM are supported.

HP 98579B \$21,900

Ideal applications: 3-D solid modeling, 3D design/analysis, wireframe design, PC circuit board design and routing, EE simulation and verification, AI program development, scientific simulation.

#### Model 360

The Model 360 is based on the 25MHz MC68030 processor and includes the MC68882 floating point co-processor, which also runs at 25 MHz. The system features performance of 5 MIPS. The Model 360 has room for four system boards. Two of the slots are occupied with the processor/RAM sandwich assembly and the system interface board, which includes the standard system interfaces plus a choice of AUI LAN connector or ThinLAN interface and optional HP-IB or SCSI disc interface. Two system slots are available for installing a graphics board, floating point accelerator, or 2-slot DIO backplane. A full 32-bit DIO-II I/O bus is supported and up to 16 megabyte maximum RAM, which is tightly coupled to the processor board through a "sandwich connection."

HP 98579A \$14,365

#### Upgrades

Products are available to transform a Model 330 into a Model 360 and a Model 350 into a Model 370 by exchanging the processor boards with new customer installable 68030 based processors.

#### Model 330

The Model 330 is a 2 MIPS computer based on the Motorola: 16.67 MHz MC68020 processor, MC68881 floating point coprocessor, and MC 68851 Paged Memory Management Unit. Maximum system performance is ensured by operating 4 Mbytes of on-board RAM synchronously with the MC68020 processor. The 330 features a 32-bit Memory Bus, 32-bit DIO-II I/O Bus, plus the same system interface board as the 350. Two system slots are available for adding a RAM board, a graphics board or a 2-slot DIO backplane for accessories. Users can add an additional 4 Mbytes of RAM to this system.

HP 98562A \$10,850

Ideal applications: data manipulation and general computation, microprocessor system development, EE schematic capture, 2D mechanical design, personal productivity, computer-aided software engineering, data acquisition/analysis.

#### Model 310

The Model 310 is a .4 MIPS computer consisting of a 10 MHz MC68010 processor, operating synchronously with one Mbyte built-in RAM. Configured with 16 Mbytes virtual memory, 16 bit memory bus, 512 x 400 B/W bit-mapped display interfaces, VLSI Memory Management Unit and standard interfaces. Box includes system slot for CPU, system slot for display board, plus 4 I/O slots for additional memory or interface cards.

HP 98561A \$5,055

Ideal application: Instrument Control, Architectural and Engineering Construction, Facilities Layout

#### Series 300 Systems

**Design Automation:** The following Design Automation workstations are based on the UNIX® System V operating system, bringing together the high-powered 350 and 330 SPU's with industry leading graphics subsystems.

#### Model 370 TurboSRX

The 370 TurboSRX consists of the 98579A 360 SPU; 8 megabytes RAM standard; 32 megabytes (maximum) of parity RAM or 48 megabytes (maximum) of ECC RAM; high-speed HP-IB; fast HP-IB disc interface; 98730A 3D display controller; 98752A 19-inch color monitor (1280 x 1024); RGB cable; keyboard; HP-HIL 2-button mouse; HP-HIL extension with audio; HP-HIL ID module; and 98549L HP-UX license-to-use AXE, PE, NS-ARPA and NFS Services/300.

HP 98587H \$44,250

#### Model 370CH

The Model 370CH couples high-power computation with industry-leading 2D graphics for such applications as printed circuit board and VLSI design, 2D mechanical design, 2D mapping, and architectural and engineering constructions. The 370CH features the 98579A SPU; 8 megabytes RAM standard; fast HP-IB disc interface; 32 megabytes (maximum) of parity RAM or 48 megabytes (maximum) of ECC RAM; 98550A 1280 x 1024 color graphics board with eight-plane frame buffer, two overlay planes and 19-inch color monitor; RGB cable; keyboard; HP-HIL 2-button mouse; HP-HIL extension with audio; HP-HIL ID module; and 98549L HP-UX license-to-use AXE, PE, NS-ARPA, and NFS Services/300. With the optional integer graphics accelerator, the 370CH becomes the 370CHX with increased graphics performance for 2D applications.

HP 98588G \$31,900

#### Model 370MH

The Model 370MH is a high-performance monochrome system well-suited for software engineering and AI application development, analog circuit design, and logic design and simulation. Based on the 98579A SPU, the 370MH features 8 megabytes RAM standard; fast HP-IB disc interface; 32 megabytes (maximum) of parity RAM or 48 megabytes (maximum) of ECC RAM; 98548A 1280 x 1024 monochrome graphics board with 19-inch high-resolution monochrome monitor, video cable, keyboard, HP-HIL 2-button mouse, HP-HIL extension with audio, HP-HIL ID module, and 98549L HP-UX license-to-use AXE, PE, NS-ARPA, and NFS Services/300.

HP 98589G \$24,500

# TECHNICAL COMPUTER SYSTEMS

## HP 9000 Technical Computers (cont'd)

### HP 9000 Series 300



#### Model 360 TurboSRX

The Model 360 TurboSRX provides up to ten times the graphics performance of the previous SRX for photorealistic 3D images. The 360 TurboSRX consists of the 98579A 360 SPU, 8 megabyte RAM total, high-speed HP-IB, 98730A 3D display controller, 98752A 19-inch color monitor (1280 x 1024), 98726A 32-bit display controller interface, 3 accelerators for 3D solids with full 16-bit Z-buffer, RGB cable, keyboard, HP-HIL 2-button mouse, HP-HIL extension with audio, HP-HIL ID module, and 98549L HP-UX license-to-use AXE, PE, NS-ARPA, and NFS Services/300.

HP 98587T \$35,995

#### Model 360SRX

The Model 360SRX provides true interactive performance for design applications that require 3/D images and shaded solid models. The 360SRX consists of the 98579A 360 SPU, 4 megabytes RAM total, 98720A solid rendering display controller with four-plane memory overlay, 3D solid graphics accelerator, eight-plane frame buffer memory, 98752A (1280 x 1024) 19-inch color monitor, 98725A interface card and cable, RGB cable, keyboard, HP-HIL 2-button mouse, HP-HIL extension with audio, HP-HIL ID module, and 98549L HP-UX license-to-use AXE, PE, NS-ARPA, and NFS Services/300.

HP 98587W \$34,965

#### Model 360CH

The Model 360CH couples high-power computation with industry leading 2D graphics for such applications as printed circuit board and VLSI design, 2D mechanical design, 2D mapping, and architectural and engineering constructions. The 360CH features the 98579A SPU, 98550A (1280 x 1024) color graphics board with eight-plane frame buffer, two overlay planes, and 16-inch color monitor, RGB cable, keyboard, HP-HIL 2-button mouse, HP-HIL extension with audio, HP-HIL ID module, and 98549L HP-UX license-to-use AXE, PE, NS-ARPA and NFS Services/300. With the optional integer graphics accelerator, the 360CH becomes the 360CHX with increased graphics performance for 2D applications.

HP 98588W \$19,510

#### Model 360MH

The Model 360MH is a high-performance monochrome system well-suited for software engineering and AI application development, analog, circuit design, and logic design and simulation. Based on the 98579A SPU, the 360MH consists of the 98548A (1280 x 1024) monochrome graphics board with 19-inch high-resolution monochrome monitor, video cable, keyboard, HP-HIL 2-button mouse, HP-HIL extension with audio, HP-HIL ID module, and 98549L HP-UX license-to-use AXE, PE, NS-ARPA, and NFS Services/300.

HP 98589W \$16,010

#### Model 330CH Color Workstation

The Model 330CH high-resolution system provides powerful personal computing for UNIX-based applications. It includes the 98562A 330 SPU, plus 98550A 8-plane color graphics board with two overlay planes and RGB cable, 98789A 16-inch color monitor (1280 x 1024) 46021A HP-HIL keyboard, 46060A HP-HIL mouse, 46081A HP-HIL buffer box, 46084A HP-HIL ID module.

HP 98588S \$17,450

#### Model 330MH Monochrome Workstation

The Model 330M high-resolution system provides personal, powerful computing for HP-UX applications. Based on the 98562A 330 SPU, the 330M adds a 98544B monochrome graphics board, 98788A 19-inch monochrome monitor (1280 x 1024), 46021A HP-HIL keyboard, 46060A HP-HIL mouse, 46084A HP-HIL ID module, 1 meter HP-IB cable, RS-232 cable, HP-HIL cable.

HP 98589S \$13,100

#### Model 319C+

The Model 319C+ uses the same 16.6 MHz CPU board as the Model 330 in a low-cost, restricted configuration, 2-board computer system. The 319C+ includes the MC68881 floating point co-processor, 4 megabyte RAM, 32-bit memory bus, six-plane color graphics board with 16-inch (1024 x 768) color monitor. Standard interfaces included are HP-IB, RS-232C, IEEE 802.3/Ethernet LAN interface with ThinMAU and "T" connector, two channel DMA controller. The 319C+ also includes HP-IB, RGB, and HP-HIL cables.

HP 98564A \$9,785

#### Model 318M Monochrome Workstation

Utilizing the same 16.6 MHz CPU board as the Model 330, the Model 318M is a low-cost, restricted configuration, 2-board computer system. It includes a MC68881 Floating Point Coprocessor, four Mbyte RAM, 32-bit memory bus, 1024 x 768 bit-mapped monochrome display, IEEE-488 HP-IB interface, RS-232C Serial Interface, IEEE 802.3/Ethernet LAN interface with ThinMAU and "T" connector, HP Human Interface Link (HIL), Two-channel DMA controller, HP-IB and HP-HIL cables.

HP 98563A \$5,140

#### Measurement Automation

Combining the highest performance BASIC Language System found in the market today with the versatile, low-cost 330, 310 and 308 systems, the following workstations address applications in a wide range of measurement automation arenas.

#### Model 330MMA Monochrome Instrument Controller

The Model 330MMA consists of the 98562A 330 SPU, Opt. 010 98262A high-speed disc interface, Opt. 006 98242B 2-slot DIO backplane, 98542A medium resolution monochrome graphics board, 35731A 12-inch monochrome monitor, 46021A HP-HIL keyboard, 98616A Opt. 045 BASIC 5.0, 1 meter HP-IB cable, RS-232 adaptor cable.

HP 98580S \$12,900

#### Model 330CMA Color Instrument Controller

The Model 330CMA is based on the 98562A Model 330 SPU, plus Opt. 010 98262A high-speed disc interface, Opt. 006 98242B 2-slot DIO backplane, 98543A medium resolution color graphics board with RGB cable, 35741A 12-inch color monitor, 46021A HP-HIL keyboard, 98616A Opt. 045 BASIC 5.0, 1 meter HP-IB, RS-232 adaptor cable.

HP 98581S \$16,000

#### Model 310C Low-Cost Color Workstation

Based on the Model 310, this workstation consists of 98561A SPU, 98543A medium resolution color graphics board with RGB cables, 35741A 12" Color Monitor, 46021A keyboard, and BASIC 5.0. Includes a 10 MHz 68010 processor, HP-IB, RS-232, HP-HIL Interfaces.

HP 98581A \$8,610

#### Model 310M Measurement Automation Workstation

Based on Model 310, this MA workstation consists of a 35731A 12" monochrome monitor, 46021A keyboard, 98616A Opt. 044 BASIC 5.0. Includes a 10 MHz MC68010 Processor, HP-IB, RS-232, HP-HIL and medium resolution monochrome graphics interfaces.

HP 98580A \$5,900

\*UNIX is a registered trademark of AT&T in the U.S. and other countries

**Graphics Components****Graphics Boards**

Monochrome Graphics Board (512 x 400); use with 35741A/B monitor	<b>HP 98542A</b>	\$825
Color Graphics Board (512 x 400); use with 35741A/B monitor	<b>HP 98543A</b>	\$2,480
Monochrome Graphics Board (1024 x 768); use with 98786A monitor	<b>HP 98544B</b>	\$1,450
Monochrome Alpha/Graphics Board (512 x 390); set for Series 200 display compatibility	<b>HP 98546A</b>	\$875
Color Graphics Board (1024 x 768); 6-plane; use with 98785A or 98751A monitor	<b>HP 98547A</b>	\$4,645
Monochrome Graphics Board (1280 x 1024); hardware scan conversion for high performance; use with 98788A monitor	<b>HP 98548A</b>	\$2,225
Color Graphics Board (1024 x 768); 6-plane; hardware scan conversion for high performance; use with 98785A or 98751A monitor	<b>HP 98549A</b>	\$4,500
Color Graphics Board (1280 x 1024); used in CH/CHX; 8-plane with 2 overlay planes; hardware scan conversion; use with 98789A or 98752A monitor	<b>HP 98550A</b>	\$5,570
2D Integer-based Graphics Accelerator, for systems that include 98549A or 98550A boards	<b>HP 98556A</b>	\$6,070
<b>Graphics Subsystems</b>		
3D Display Controller (1280 x 1024) used in SRX workstations; 4-planes upgradeable to 24 image planes; 4 overlay planes and hardware Z-buffer	<b>HP 98720A</b>	\$11,350
3D Graphics Accelerator for use with 98720A; includes transform engine, scan converter, microcode to provide interactive 3D solid rendering	<b>HP 98721A</b>	\$10,340
3D Display Controller (1280 x 1024) used in TurboSRX workstations; 4 overlay planes plus 8 image planes upgradeable to 24 image planes	<b>HP 98730A</b>	\$17,500
3D Graphics Accelerator for use with 98730A; includes triple transform engine, scan converter, full 16-bit Z-buffer, microcode to provide interactive 3D solid rendering, and photorealism	<b>HP 98732A</b>	\$24,000
<b>Monitors</b>		
12-inch (310mm) Monochrome Monitor (512 x 400); 60 Hz, 115/200 Vac; use with 98542A or 98546A graphics boards	<b>HP 35731A/B</b>	\$340
12-inch (310mm) Color Monitor (512 x 400); 60 Hz, 115/200 Vac ("A" Version supports 115 Vac only); use with 98543A or 98546A graphics boards	<b>HP 35741A/B</b>	\$1,195
19-inch (480mm) Color Monitor (1024 x 768); 60 Hz, 115/230 Vac; use with 98547A or 98549A graphics boards	<b>HP 98751A</b>	\$6,650
19-inch (480mm) Color Monitor (1280 x 1024); 60 Hz, 115/230 Vac; use with 98550A graphics board or 98720A/98730A subsystems	<b>HP 98752A</b>	\$6,650
16-inch (406mm) Color Monitor (1024 x 768); 60 Hz, 115/230 Vac; use with 98547A or 98549A graphics boards	<b>HP 98785A</b>	\$3,615
17-inch (432mm) Monochrome Monitor (1024 x 768); 60 Hz, 115/230 Vac; use with 98548A graphics board	<b>HP 98786A</b>	\$2,065
19-inch (480mm) Monochrome Monitor (1280 x 1024); 60 Hz, 115/230 Vac; use with 98548A graphics board	<b>HP 98788A</b>	\$2,125
16-inch (406mm) Color Monitor (1280 x 1024); 60 Hz, 115/230 Vac; use with 98550A graphics board or 98720A/98730A subsystems	<b>HP 98789A</b>	\$3,615
<b>HP-HIL Input Devices</b>		
Digitizer (11 x 11)	<b>HP 45911A</b>	\$510
Keyboard (U.S. ASCII version)	<b>HP 46021A</b>	\$210
Keyboard with rotary knob for BASIC/Pascal	<b>HP 98203C</b>	\$805

Mouse, 2-button	<b>HP 46060A</b>	\$210
Mouse, 3-button	<b>HP 46060B</b>	\$195
Mouse, 3-button (uses Quadrature Port)	<b>HP 46095A</b>	\$145
Quadrature Port	<b>HP 46094A</b>	\$165
2.4 meter HP-HIL extension	<b>HP 46080A</b>	\$85
2.4 meter HP-HIL extension with audio	<b>HP 46081A</b>	\$220
15 meter HP-HIL extension with audio & RGB	<b>HP 46082A</b>	\$770
30 meter HP-HIL extension with audio & RGB	<b>HP 46082B</b>	\$1,085
Knob	<b>HP 46083A</b>	\$200
ID Module	<b>HP 46084A</b>	\$195
Control Dial Module	<b>HP 46085A</b>	\$1,410
32-Button Box programmable function keys	<b>HP 46086A</b>	\$935
Digitizer, ANSI A/ISO A4-size	<b>HP 46087A</b>	\$850
Digitizer, ANSI B/ISO A3-size	<b>HP 46088A</b>	\$1,365
4-button Cursor for 46087/88	<b>HP 46089A</b>	\$280
Touchscreen Bezel	<b>HP 35723A</b>	\$505
Bar Code Reader	<b>HP 92916A</b>	\$600

**Upgrades**

4-Slot DIO Backplane; converts DIO II to DIO in Option 004 of 98570A/561A or 98562A	<b>HP 98242A</b>	\$465
2-Slot DIO Backplane; converts DIO II DIO in 98562A/B SPU or 98570A Option 004	<b>HP 98242B</b>	\$390
Model 310 to 320 Processor Board Upgrade	<b>HP 98243B</b>	\$5,930
Model 330 to 350 Processor Board Upgrade	<b>HP 98244A</b>	\$14,900

The following upgrade trade-in credits vary with the computer configuration returned. Consult your HP Sales Representative for details.

Model 310 trade-in for Model 330

Model 320 trade-in for Model 350

Series 500 trade-in for Series 800

**SPU Accessories**

Direct-Connect 8-slot I/O Expander	<b>HP 98568A</b>	\$1,965
Direct-Connect DIO II Expander; adds two DIO II and four DIO slots to 330 or 350 SPU	<b>HP 98570A</b>	\$2,385
16-slot DIO expander	<b>HP 9888A</b>	\$4,155
EIA 19-inch rack mount kit for 35731A	<b>HP 98567A</b>	\$233
EIA 19-inch rack mount kit for 35741A	<b>HP 98567B</b>	\$233
EIA 19-inch rack mount kit for S/300 SPU	<b>HP 98569A</b>	\$243

**RAM**

1 MB RAM board for 310 and 320 only	<b>HP 98257A</b>	\$1,500
4 MB RAM controller for 330 and 370	<b>HP 98258A</b>	\$5,630
4 MB RAM Add-on for 370 (use with 98258A)	<b>HP 98258B</b>	\$5,115
12 MB RAM Add-on for 370 (use with 98258A)	<b>HP 98258C</b>	\$14,425
8 MB Error-Checking and Correcting (ECC) RAM for 370 only	<b>HP 98264A</b>	\$12,960
16 MB Error-Checking and Correcting (ECC) RAM for 370 only	<b>HP 98264B</b>	\$20,230

**DOS Coprocessor**

The Series 300 DOS Coprocessor System provides IBM PC AT DOS software compatibility for HP 9000 Series 300 Technical Workstations. DOS COPROCESSOR SYSTEM - includes DOS Coprocessor, interface card, and DOS Coprocessor software.

<b>HP 98286S</b>	\$1,335
------------------	---------

Please refer to page 669 for more detailed information on the DOS Coprocessor.

**VMEbus Connection**

HP 9000 VMEbus Interface - Includes DIO interface card, VME card, cable and manual.	<b>HP 98646A</b>	\$1,312
VMEbus Software Drivers -		
Pascal Opt. 24X	<b>HP 98358A</b>	\$116
HP-UX Opt. 34X	<b>HP 98358A</b>	\$217
BASIC Opt. 44X	<b>HP 98358A</b>	\$116

**HP Networking**

HP 9000 Series 300 and 800 computers using the HP-UX operating system offer a wide range of networking products such as Ethernet/IEEE 802.3 local area network. Please refer to page 660 for additional information.



# TECHNICAL COMPUTER SYSTEMS

## HP 9000 Technical Computers (cont'd)

### HP 9000 Graphics Systems



#### HP 9000 Graphics Hardware

HP offers a variety of graphics display options for the Model 9000 workstations, which allows users to customize the workstation to provide the desired graphics performance.

#### 2D Graphics Subsystems

The modularity of the Series 300 allows the system to be configured into one of four different display options providing medium and high resolution graphics on either monochrome or color displays. The graphics display options are supported by the BASIC, PASCAL and HP-UX operating systems. The 98550A can be ordered as the A1020A for the HP 9000 Models 825 and 835.

**HP 98550A** is a high resolution 1280 x 1024 color graphics board for 2D color applications such as EE physical design and 2D mapping. It contains a hardware scan converter for high speed generation of vectors, polygons, and circles. It provides eight color planes and two overlay planes. The color planes may be used in a double buffered mode for sixteen displayed colors. The 98550A operates with the 98556A Graphics Accelerator. It uses the 98789A or 98752A monitor. \$5,570

**HP 98548A** is a high resolution 1280 x 1024 monochrome graphics board ideally suited for applications such as Computer Aided Software Engineering and Computer Aided Publishing. The 98548A contains a hardware scan converter for high speed generation of vectors, polygons, and circles. It will operate with the 98788A 19-inch monochrome monitor. \$2,225

**HP 98549A** is a high resolution 1024 x 768 color graphics board for applications requiring fewer colors and lower resolution than the 98550A. The 98549A contains a hardware scan converter for high-speed generation of vectors, polygons, and circles. It provides six color planes for sixty-four colors; these planes may be used alternatively as four color planes and two overlay planes. The 98549A may be used with the 98556A Graphics Accelerator. It operates with the 98785A or 98751A monitors. \$4,500

**HP 98556A** is an integer-based graphics accelerator that may be used with the 98550A and 98549A graphics display boards. The

98556A provides sharply improved performance for 2D vector-intensive application by providing a hardware transform engine. The 98556A is ideally suited for *integer-based* applications that require real-time pan and zoom capability. It also provides improved window performance through a dedicated Graphics Processing Unit. This product will not operate with the Model 310 or Model 320 systems. \$6,070

#### 3D Graphics Subsystems

**HP 98720A** is a high-performance 3D solid rendering subsystem for applications such as Mechanical Computer Aided Engineering and mapping. For full performance, the system is configured with twenty-four planes (3 - 98722As), a full 16-bit Z-buffer (98722A) and a graphics accelerator (98721A). For less demanding requirements, the system can be configured with a strip Z-buffer, without the graphics accelerator, and with eight or sixteen planes. The four overlay planes are standard.

<b>HP 98720A</b>	\$11,350
<b>HP 98721A</b>	\$10,350
<b>HP 98722A</b>	\$4,645

**HP 98730A** is a high-performance 3D solid-rendering subsystem that provides three to ten times the performance of the 98720A. The 98730A provides the most advanced and extensive 3D solid rendering feature set available in the industry. These features dramatically increase the users' competitiveness by maximizing graphics interactivity and displaying photorealistic images.

For customers with the imaging applications, the system can be configured without the graphics accelerator and Z-buffer (98732A). This system provides the user with frame buffer memory (98722A), overlay planes, pixel pan, and zoom and blending capabilities.

<b>HP 98730A</b>	\$17,500
<b>HP 98722A</b>	\$4,465
<b>HP 98732A</b>	\$24,000

The 98720A and 98730A support both the 98752A (19-inch) and the 98789A (16-inch) 1280 x 1024, 60Hz noninterlaced color monitors.

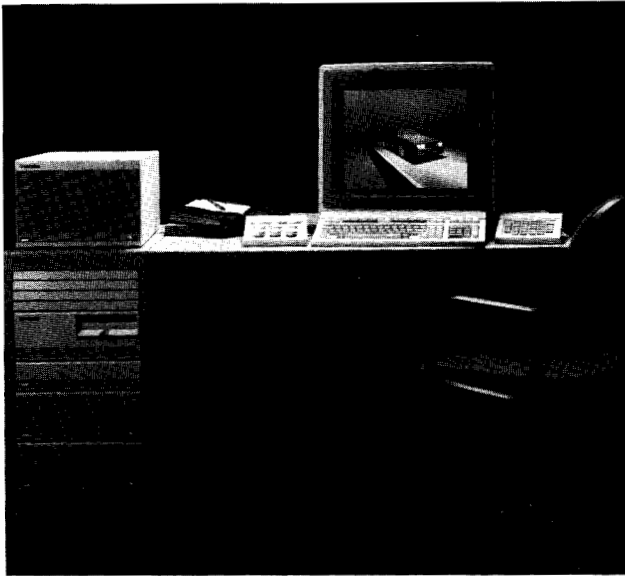

### HP 9000 Graphics Software

HP provides a set of software tools which allow the application programmer to interact with, and send graphics output to, a wide variety of graphics display devices and peripherals. They are based on CG-VDI, GKS and other industry standards. The intent of these standards is to provide a common interface to graphics devices.

**Starbase Graphics Library** is a high performance 2-D and 3-D graphics library for the HP 9000 family. It is an extension of the ANSI CGI standard currently under development. Starbase provides procedures to perform basic graphics operations including lines, markers, text, polygons and B-splines. Control functions, inquiry functions and echoing are also supported. Starbase is capable of applying 2-D and 3-D transformations to output primitives, generating high quality text and shaded polygons and providing synchronous and asynchronous input to the application. Starbase provides the interface

to the high performance lighting models, shading, non-uniform rational B-splines of the SRX workstations. Starbase is part of the Series 300 HP-UX programming environment, but an option product for the Series 800.

**HP 92445A** \$2,600

**HP 92445R** \$1,820

**HP 92521A/98672A/98673A HP-GKS** graphics library is fully compatible with Level 2b of the ANSI/ISO Graphical Kernel System standard. The library provides application portability and high performance for HP-UX, accessible from FORTRAN, C and Pascal.

**Series 300 HP 98672A** \$1,000

**Series 800 HP 92521A** \$2,000

**HP 92521R** \$1,400

**HP 92446A/98520A/600A** consists of two sets of procedure libraries: DGL (Device-independent Graphics Library) and AGP (Advanced Graphics Package). The libraries must be used in conjunction with the HP-UX operating system.

**Series 300 HP 98250A** \$1,000

**Series 800 HP 92446A** \$3,750

**HP 92446R** \$2,625

**HP 98674A/98522A** is an optional extension to the Starbase library: Starbase Display List. It allows graphics data and commands to be stored and later re-executed and provides the ability to create, modify and manipulate a hierarchy of segments.

**Series 300 HP 98764A** \$500

**Series 800 HP 92522A** \$1,000

**HP 92522R** \$700

**HP 97009A** Starbase Driver Development Guide is documentation for creating a Starbase driver for devices not supported by HP (PPL).

**Series 300 HP 97009-10220** \$250

**HP 98053A** Versatec Hardcopy Support is a software interface and cable to allow color hardcopy dump from Series 300 bit-mapped displays to Versatec C2500 color plotters.

**Series 300 HP 98053A** \$1,000

**HP 98683X/84X** DGL Skeleton Device Handler allows interfacing to non-HP peripherals. The Skeleton Handler is largely a FORTRAN source code template.

**Series 300 HP 98603X** \$495

### HP 9000 Graphics Hardware Summary

Graphics Subsystem	98542A	98543A	98544B	98546A	98547A	98548A	98549A	98550A*	98720A	98730A
Resolution	512 x 400	512 x 400	1024 x 768	512 x 400	1024 x 768	1280 x 1024	1024 x 768	1280 x 1024	1280 x 1024	1280 x 1024
Overlay Planes	0	0	0	0	0-2	0	0-2	2	4	4
Color Planes	1	4	1	1	6-4	1	6-4	8	8-24	8-24
Colors***	Mono-chrome	16	Mono-chrome	Mono-chrome	64-16	Mono-chrome	64-16	256	256-16M	256-16M
Double Buffer Planes	No	No	No	No	No	No	3	4	4, 8, or 12	4, 8, or 12
Monitors/Size	35731A/B 12"	35741A/B 12"	98786A 17"	35731A/B 12"	98751A 19" 98785A 16"	98788A 19"	98751A 19" 98785A 16"	98752A 19" 98789A 19"	98752A 19" 98789A 16"	98752A 19" 98789A 16"
Options										
- 8 planes graphics memory	N/A	N/A	N/A	N/A	N/A	N/A	N/A	N/A	98722A	98722A
- Graphics accelerator	N/A	N/A	N/A	N/A	N/A	N/A	98556A	98556A	98721A	98732A
- Z-buffer	N/A	N/A	N/A	N/A	N/A	N/A	N/A	N/A	98722A	inc with 98732A
Systems Supported										
- Series 300	All**	All**	All**	All**	All**	330/350 /360 No	330/350 /360 No	319/ 330/350 /360 825/835	350/360 825/835	350/360 825/835
- Series 800	No	No	No	No	No					
Operating Systems Supported										
- HP-UX	Yes	Yes	Yes	Yes	Yes	Yes	Yes	Yes	Yes	Yes
- BASIC	Yes	Yes	Yes	Yes	Yes	Yes	Yes	Yes-	No	No
- Pascal	Yes	Yes	Yes	Yes	Yes	Yes	Yes	Not 98556A Yes-	No	No
								Not 98556A Yes-		

\* Order the A1020H for the Series 800.

\*\* Not on the Model 318 or Model 319.

\*\*\* Displayable colors from a palette of 16 million. This refers to single buffered mode.

# TECHNICAL COMPUTER SYSTEMS

**HP 9000 Technical Computers**  
**Series 300 Entry Level Workstations**



Model 349 Workstation

## Series 300 Entry Level Workstations

The new Model 349 entry level workstations feature a choice of graphics subsystems ranging from 2D monochrome to 3D color and an optional accessory slot for series 300 interface cards. These features make the Model 349 family the most flexible entry level systems available in the workstation industry. These systems are based on Motorola's MC68030 32-bit microprocessor and the MC68881 floating point coprocessor both running at 16.7 MHz.

Included with each workstation are on-board HP-IB, HP-HIL and RS-232C interfaces, as well as either a ThinLAN interface with built-in ThinMAU or an AUI LAN interface.

Industry standards, such as the X Window System and TCP/IP-based ARPA and Berkeley networking services, are fully supported on all HP workstations. Each system contains an HP-UX license-to-use Application Execution Environment (AXE), Programming Environment (PE), NS-ARPA and Network File System (NFS) Services/300.

Options are available to add either a DIO accessory slot or an HP-IB or SCSI disc interface, an HP-HIL 2-button mouse, an HP-HIL ID module and to expand memory from 4 megabytes RAM to 16 megabytes RAM.

### Monochrome System

The Model 349M and 349 MH systems are ideal for applications such as EE schematic capture, mechanical design and drafting and software engineering.

The Model 349M features a 17-inch monochrome monitor with 1024 x 768 resolution and the Model 349MH features a 19-inch monitor with 1280 x 1024 resolution.

**Ordering Information**  
**Model 349M**  
**Model 349 MH**

**Price**  
 TO BE ANNOUNCED  
 TO BE ANNOUNCED

### 2D Color Systems

The Model 349C+ and Model 349CH entry-level 2D color systems are attractive for entry-level printed circuit board design and routing applications.

The Model 349C+ features a 16-inch color monitor with 1024 x 768 resolution and six graphics planes.

The Model 349CH features a 16-inch color monitor with 1280 x 1024 resolution, eight graphics planes and two overlay planes. An optional integer graphics accelerator is available with the Model 349CH.

### Ordering Information

**Model 349C+**  
**Model 349CH**

**Price**  
 TO BE ANNOUNCED  
 TO BE ANNOUNCED

### 3D Color System

Solid rendering applications can be run on the Model 349 TurboSRX entry-level 3D system featuring full 3D functionality and a 19-inch color monitor with 1280 x 1024 resolution and a 3D display controller.

**Ordering Information**  
**Model 349SRX**

**Price**  
 TO BE ANNOUNCED

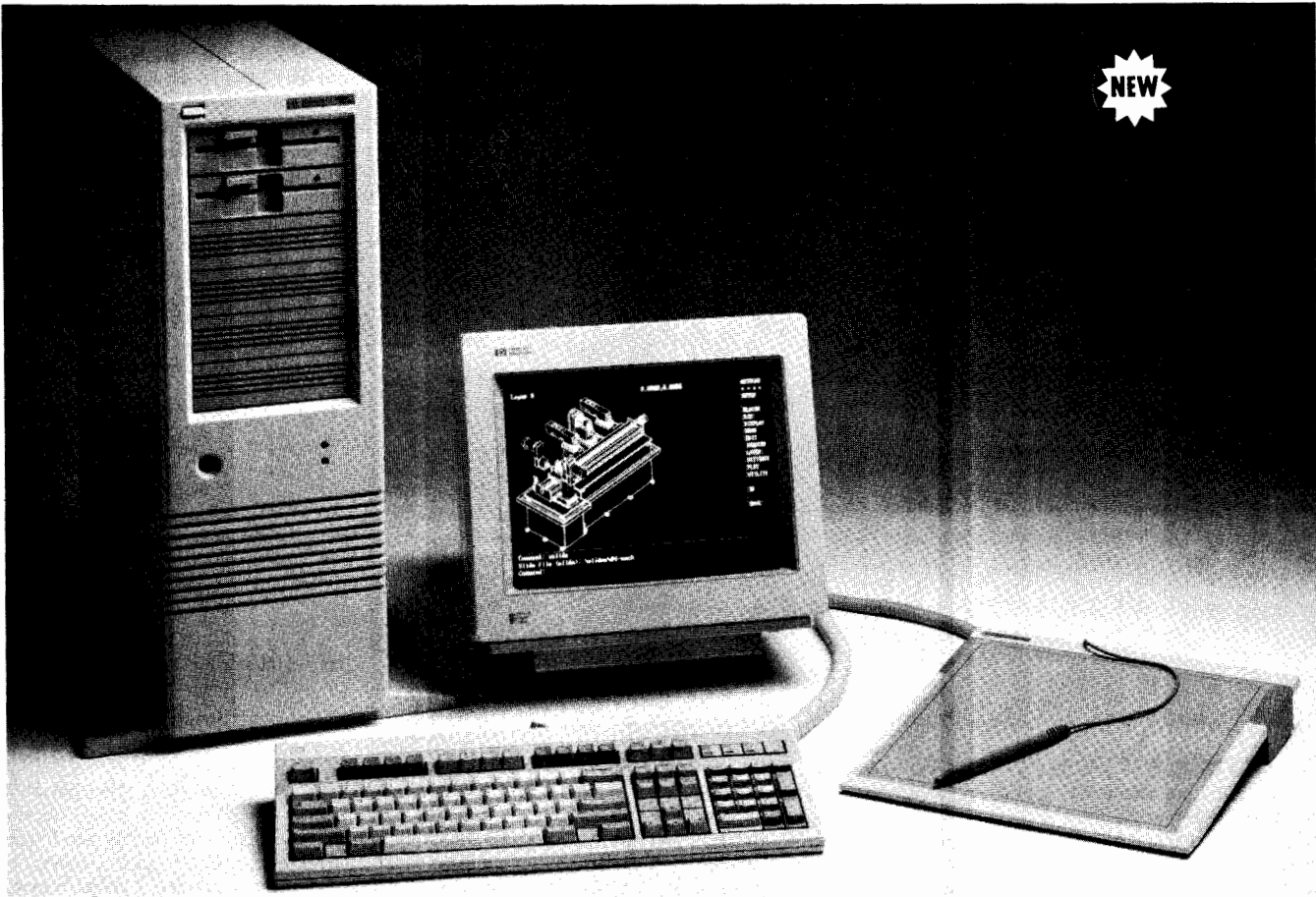

Vectra RS20 Personal Computer

### HP Vectra PC Workstations

The HP Vectra RS PC workstations are based on the Intel 80386 processor running at 20 MHz. Each workstation includes a hard disc controller; one 5.25-inch, 1.2-megabyte flexible disc drive; a flexible disc controller; serial, parallel, and HP-HIL ports; HP Expanded Memory Manager/386; HP disc cache software; HP Volume Expansion Utility; HP Terminal program; the Enhanced Vectra PC keyboard; and system documentation. System memory and hard disc storage are included as indicated (See Ordering Information).

### HP Vectra RS System Software

Microsoft Window/386 Presentation Manager. 5.25-inch flexible discs. Requires HP Vectra DOS 3.2 or higher. For HP Vectra RS PCs only.

### Monitors and Video Adapters

#### VGA:

14-inch HP Video Graphics Display (HP Video Graphics Adapter required)

#### Monochrome:

14-inch monochrome monitor (HP Video Graphics Adapter required)

#### Color:

12-inch color monitor (Multimode video adapter and Multimode color adapter required)

#### Monochrome Plus:

12-inch HP Monochrome Plus video display. Compatible with IBM monochrome drivers. (Monochrome Plus video adapter required)

#### High Resolution Color:

1024 x 768 graphics interface card featuring sixteen colors from a palette of 4096 colors and an optional EGA graphics compatibility card (emulation module).

### Ordering Information

#### HP Vectra RS/20

Model 40 PC — 1 megabyte RAM, 40 megabyte hard disc	<b>HP D1600A</b>	\$6,595
Model 100 PC — 2 megabyte RAM, 103 megabyte hard disc	<b>HP D1602A</b>	\$7,595
Model 106 PC — Same as Model 100 with VGA Adapter	<b>HP D1601A</b>	\$7,995
Model 150 PC — 2 megabyte RAM, 155 megabyte hard disc	<b>HP D1603A</b>	\$8,195
Model 300 PC — 2 megabyte RAM, 310 megabyte hard disc	<b>HP D1604A</b>	\$10,495

#### Monitors and Video Adapters

##### VGA:

HP Video Graphics Adapter	<b>HP D1180A</b>	\$445
Additional 256 Kbytes RAM for VGA	<b>Opt. 1A7</b>	\$150
14-inch HP Video graphics display	<b>HP D1182A</b>	\$695

##### Monochrome:

14-inch VGA monochrome display	<b>HP D1181A</b>	\$250
--------------------------------	------------------	-------

##### Color:

Multimode Video Adapter	<b>HP 45981A</b>	\$325
Multimode color adapter	<b>HP 45984A</b>	\$50
12-inch color monitor	<b>HP 35741A</b>	\$1,195

##### Monochrome Plus:

HP Monochrome Plus video adapter	<b>HP 35732A</b>	\$325
12-inch monochrome monitor	<b>HP 35731D</b>	\$325

##### High Resolution Color:

Intelligent Graphics Controller	<b>HP 82328A</b>	\$1,695
16-inch color monitor (1024 x 768)	<b>HP 98785A</b>	\$3,615
19-inch color monitor (1024 x 768)	<b>HP 98751A</b>	\$6,650
EGA Emulation Module	<b>HP 82329A</b>	\$595

# TECHNICAL COMPUTER SYSTEMS

## HP Entry-Level Controllers

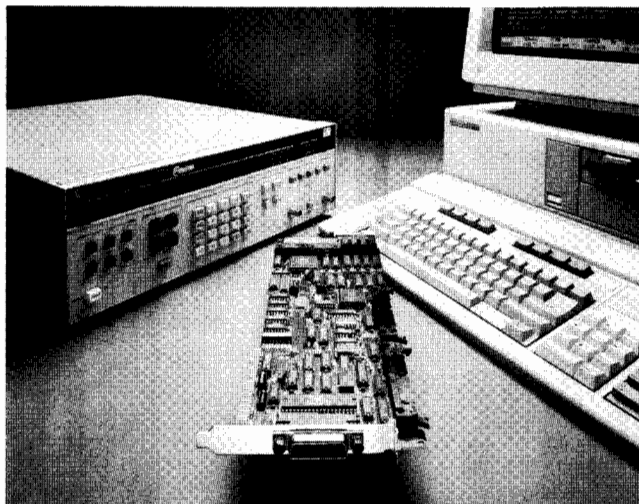

### HP BASIC and Pascal Language Processors

#### For HP Vectra and Other Personal Computers

Now these popular HP programming environments are available on personal computers. The HP BASIC and Pascal Language Processors provide the capabilities of HP Series 200/300 BASIC and HP Workstation Pascal to owners of HP Vectra CS, ES and RS Personal Computers and PC/AT compatible computers produced by other manufacturers.

These HP Language Processor subsystems consist of an MC 68000 processor card, HP BASIC or HP Pascal, and emulator software. The processor card fits into one backplane slot on industry standard MS-DOS personal computers. Together with the appropriate software, the processor subsystems allow the HP Vectra to emulate an HP Series 200/300 BASIC or Pascal workstation while retaining all the capabilities of an MS-DOS personal computer.

The HP BASIC or Pascal Language Processor affords the user the benefits of a superior scientific/technical computing environment, easy yet flexible I/O capabilities, excellent performance, and a clear HP growth path while providing access to a wealth of PC-DOS application software.

The HP BASIC Language Processor runs HP BASIC 5.1, and will execute HP Series 200/300 BASIC programs with essentially no change. Likewise, the HP Pascal Language Processor runs HP Workstation Pascal Release 3.2, and will execute Series 200/300 Pascal software with few changes. In many cases recompiling is not necessary.

The language processors are equipped with 512 K bytes of RAM memory (standard) but may be expanded to a maximum of 4 M bytes of RAM through the use of available RAM Expansion Board and RAM Kits. They are equipped with a built-in HP-IB interface for communicating with HP-IB instruments or for use of external disc drives, etc. GPIO and Shared Resource Manager (SRM) Interfaces are optionally available.

The HP BASIC Language Processor is supported for use on the following personal computers: HP Vectra CS, ES, and RS, IBM-AT Model 339, AT&T Model 6312, Zenith Model 248, Compaq Portable III & 386/20, Compaq Deskpro 286 & 386/16, and Wyse pc-286.

The HP Pascal Language Processor is supported for use on the following personal computers: HP Vectra CS, ES, and RS, IBM-AT Model 339.

Refer to page 656 for ordering information for these products.

#### Trademark Declarations:

Zenith 248 is a registered trademark of Zenith Data Systems Inc. Vectra CS, ES, ES/12 and RS are registered trademarks of Hewlett-Packard Company

IBM-AT is a registered trademark of IBM Corp.

Compaq Deskpro 286, Deskpro 386, Portable III, and Portable 386 are registered trademarks of Compaq Computer Corp.

AT&T 6312 is a registered trademark of American Telephone & Telegraph

### HP 82302A Using HP BASIC for Instrument Control

#### A Self-Study Course

If you want to use your HP BASIC system to control HP-IB instruments, this self-paced learning course is ideal for you. It will enable you to learn HP BASIC programming techniques quickly and begin writing your own instrument-control programs. Designed to meet the needs of the beginner as well as the more experienced programmer, the course introduces a wide range of HP BASIC techniques.

The course includes practical examples of instrument-control programs, which are described in the lessons and are also provided on flexible disc. These programs control real HP-IB instruments, such as the HP 3456A Digital Voltmeter, the HP 3325A Synthesizer/Function Generator, and the HP 438A Power Meter. You can modify these programs and use them for your own applications.

The course consists of 3 parts, each having 10 lessons:

- **Part I** covers general programming techniques, starting at the beginner's level. You don't need to do all of the lessons if you already have some experience with HP BASIC. You can start at your own level and do the lessons at your own pace.
- **Part II** introduces HP-IB concepts and I/O programming techniques. Topics include outputting data and commands, entering data and device status, formatting data, and bus control techniques. The "top-down" approach to I/O programming is described.
- **Part III** presents some additional I/O programming techniques including handling interrupts, passing parameters, buffered I/O, sending custom bus commands, and optimizing the performance of your program.

You can use the course with any HP BASIC system, such as an HP 82300B BASIC Language Processor installed in an HP Vectra PC, a PC 305 or PC 308 system, or an HP 9000 Series 200 or Series 300 computer. Course materials include two binders containing the 30 lessons (over 700 pages in all), plus 3.5-inch and 5.25-inch flexible disc media. The course can be completed in about 55 hours.



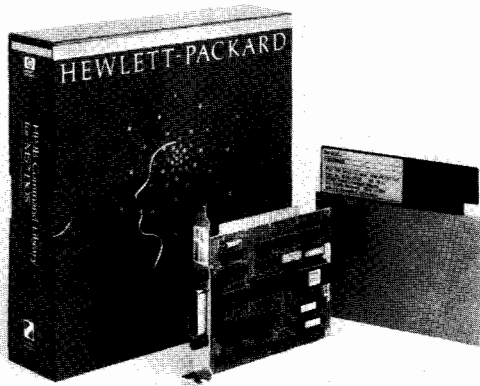

### HP 82990A/E HP-IB Interface and Command Library For the HP Vectra and Other Personal Computers

Now there's a low-cost alternative for controlling HP-IB devices with industry-standard programming languages. The HP 82990A HP-IB Interface and Command Library provides HP-IB Interface hardware and Command Library software for control of HP-IB (IEEE-488) instruments and the use of HP-IB printers and plotters with HP Vectra PCs, IBM PC/XT/AT and other compatible MS-DOS computers, using a variety of MS-DOS languages. The HP-IB interface card fits into a backplane slot on industry standard MS-DOS personal computers.

The HP-IB Command Library software supports the following languages: HP Vectra BASIC, MS QuickBASIC, MS GW BASIC, IBM BASICA, Microsoft C, Microsoft Pascal, and Lattice C (4 versions). It lets you include commands in your BASIC, Pascal or C programs to control HP-IB instruments, and provides the capability for high-speed string transfers (DMA). You learn only one set of commands for all supported languages. For example, this allows you to use the features of Interpreted BASIC for application development and later convert to Compiled BASIC for increased performance.

The HP-IB Command Library is compatible with HP PC Instruments System Software for the HP PC Instruments BUS (PCIB). This lets you control a combination of HP-IB instruments and PC instruments from the same BASIC program. Support for disc and tape backup units is available using an auxiliary software product (HP 88500B).

In addition, the HP Peripheral Driver is included to add HP-IB capability directly to the operating system. By using MS-DOS commands, outputs and inputs can be re-directed to HP-IB printers and plotters.

Ordering Information	Price
<b>82990A</b> HP-IB Interface and Command Library. Includes Plug-in HP-IB interface card, HP-IB Command Library on 5.25 in. disc and User's Manual.	\$415.00
<b>82990E</b> HP-IB Command Library. Same as 82990A above, except HP-IB interface card is not included.	\$305.00
<b>88500B</b> HP-IB Command Library for support of HP-IB discs and tape Back-ups. Includes HP-IB Command Library on 5.25 in. disc and User's Manual. (HP-IB interface card not included).	\$97.00

Vectra BASIC is a registered trademark of Hewlett-Packard Company.

MS QuickBASIC, MS GW BASIC, Microsoft C, and Microsoft Pascal are registered trademarks of Microsoft Corp. IBM BASICA is a registered trademark of IBM Corporation. Lattice C is a registered trademark of Lattice, Inc.

### PC-300 Instrument Controllers

Hewlett-Packard's PC-305 and PC-308 HP BASIC Controllers are for engineers and scientists who need a powerful, easy-to-use controller and an IBM compatible personal computer — all in one affordable package. The Instrument Controller in these systems is the HP BASIC Language Processor card, the 82300B. These systems include HP BASIC 5.0 in ROM and can automatically boot BASIC without having to use the PC-DOS operating system.

Software installation is greatly simplified, and PC-DOS can be accessed directly. The user can execute popular personal computer application software for a variety of tasks including data analysis and text and graphical reporting. With the presence of PC-DOS, the user is able to take advantage of the large quantity of available PC-DOS software.

The PC-305 Controller uses the 8 MHz HP Vectra CS Personal Computer. The PC-308 Controller uses the 12 MHz HP Vectra ES/12 Personal Computer. All versions of these two Controllers include 640 Kbytes of RAM, a 1.44 Mbyte 3.5 inch Flexible Disc Drive, a VGA video adapter card and 14" VGA display, and a serial/parallel interface.

The PC-305M is a monochrome VGA system. For this and other monochrome Controllers, there are three color options:

- option 001: white
- option 002: green
- option 003: amber

The PC-305ML is a monochrome system with a 20 MByte hard disc drive.

The PC-308ML is a monochrome system based on the Vectra ES/12. The Vectra ES/12 provides improved controller performance.

The PC-308CL and PC-308CM are color VGA systems. The PC-308CL has a 20 MByte hard disc and the PC-308CM has a 40 MByte hard disc.

### Ordering Information

- 82314D** PC-308ML HP BASIC Controller. Vectra ES/12, Monochrome VGA, 20 MByte Hard Disc System.
- 82315D** PC-308CL HP BASIC Controller. Vectra ES/12, Color VGA, 20 MByte Hard Disc System.
- 82319D** PC-308CM HP BASIC Controller. Vectra ES/12, Color VGA, 40 MByte Hard Disc System
- 82316D** PC-305M HP BASIC Controller. Vectra CS, Monochrome VGA, Flexible Disc System.
- 82317D** PC-305ML HP BASIC Controller. Vectra CS, Monochrome VGA, 20 MByte Hard Disc System.

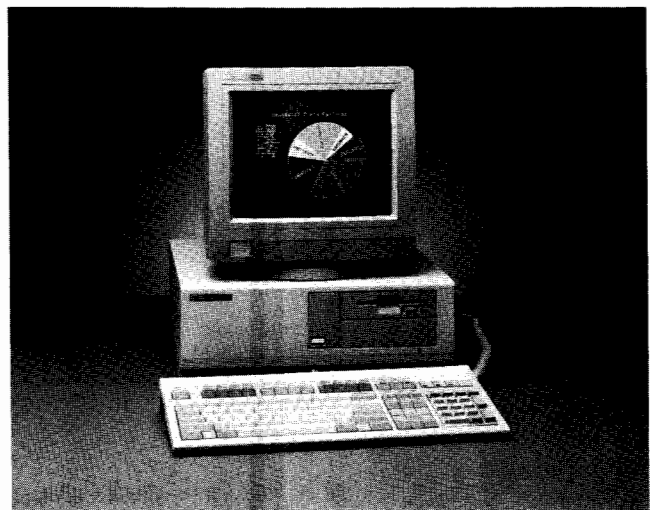

# TECHNICAL COMPUTER SYSTEMS

## HP 9000 Technical Computers

Vectra PC HP BASIC, HP Pascal, & CAD Workstations



### Vectra PC Controllers

Hewlett-Packard offers prepackaged versions of the Vectra PC specially configured for our technical customers.

The PC-308 Vectra ES/12 HP-BASIC Controllers provide the unequalled power of HP BASIC on a personal computer that can run the enormous variety of solutions available for the IBM® PC/AT® and its compatibles. The key to this match is the **HP BASIC Language Processor System**.

The Language Processor features a built-in HP-IB, and an optional GP-IO card for high-speed I/O access. An optional Shared-Resource-Manager (SRM) card allows a Vectra using the Language Processor System to act as a node on an SRM network. The Language Processor System allows up to 4 megabytes of RAM, for customers with large HP BASIC or Pascal programs.

Together, the Vectra ES/12 PC and the Language Processor provide the best of both worlds: compatibility with the wealth of hardware and software available for the Vectra, and the convenience, speed, and power of HP's premier BASIC instrument-control language.

The Language Processor System (and accessories) can be purchased separately, allowing customers to convert their Vectra PCs into HP BASIC Controllers. (HP Pascal can also run on the Language Processor, and Pascal Software and Pascal Language Processor Systems can also be purchased separately.)

Hewlett-Packard also offers the PC-305 Vectra CS HP-BASIC Controllers which are lower in cost and performance than the PC-308 Vectra ES/12 Controller. The HP BASIC Language Processor is also included, with a built-in HP-IB, and the controllers have access to thousands of solutions available on an IBM PC/XT.

### Vectra System Configurations

- PC-305M Vectra CS with 640 kilobytes RAM single 1.4 megabyte 3.5-inch floppy drive, Serial/parallel, BASIC Language Processor with HP-IB, 512K RAM, BASIC 5.1 ROM, VGA Monochrome Display, VGA Video Adapter, DOS with PAM.
- PC-305ML Adds 20 megabyte hard disc subsystem to above
- PC-308ML Vectra ES/12 PC with 640 kilobytes RAM single 1.4 megabyte 3.5-inch floppy drive, Serial/parallel, 20 megabyte hard-disc drive, DOS with PAM, BASIC Language Processor with HP-IB, HP BASIC 5.1 ROM, VGA Display, VGA Video Adapter.
- PC-308CL Vectra ES/12 PC with 640 kilobytes RAM single 1.4 megabyte 3.5-inch floppy drive, 20 megabyte hard-disc drive, DOS with PAM, BASIC Language Processor with HP-IB, 512K RAM, HP BASIC 5.1 ROM, Serial/Parallel interface, VGA Video Adapter, VGA Color Display with tilt/swivel base.
- PC-308CM Vectra ES/12 PC with 640 kilobytes RAM, single 1.4 megabyte 3.5-inch floppy drive, 40 megabyte hard-disc drive, DOS with PAM, HP BASIC Language Processor with HP-IB, 512K RAM, HP BASIC 5.1 ROM, Serial/Parallel interface, VGA Video Adapter, VGA Color Display with tilt-swivel base.

### Language Processor System Specifications

- System Processing Unit: Motorola 68000, 8 MHz
- Operating System: HP BASIC/HP Pascal
- Memory: 512 kilobytes RAM on main board, expandable to 1 megabyte on main board. Piggyback board with 512K RAM, expandable to 3 megabytes — for maximum system RAM of 4 megabytes.
- I/O Interfaces: Built-in HP-IB. Optional SRM and GP-IO interfaces on separate boards. (Uses host Vectra for display, keyboard, mass storage, real-time clock, serial and printer ports.)
- Size: Standard PC/AT® 8-bit full-length board (4.75" by 13")
- Power Consumption: 1.1 amperes at 5 volts (typical)

### Ordering Information

	<b>Price</b>
<b>82314D</b> Vectra ES/12 PC-308ML HP BASIC Controller	\$6155
<b>82315D</b> Vectra ES/12 PC-308CL HP BASIC Controller	\$6695
<b>82316D</b> Vectra CS PC-305M HP BASIC Controller	\$4300
<b>82317D</b> Vectra CS PC-305ML HP BASIC Controller	\$4855
<b>82319D</b> Vectra ES/12 PC-308CM HP BASIC Controller	\$7095
<b>82300B</b> HP BASIC Language Processor System (with built-in HP-IB, 512K RAM, software, and documentation).	\$1595
<b>82301B</b> HP BASIC (software only)	\$595
<b>82303A</b> 512K RAM Expansion Kit	\$510
<b>82304B</b> HP BASIC ROM 5.1	\$595
<b>82305A</b> RAM Expansion Board	\$615
<b>82306A</b> GP-IO Interface	\$510
<b>82307A</b> GP-IO Cable	\$197
<b>82310A</b> HP Pascal Language Processor System (with built-in HP-IB, 512K RAM, software, and documentation).	\$1995
<b>82311A</b> HP Pascal (software only)	\$995
<b>50963A</b> SRM Interface	\$895
<b>82312A</b> HP BASIC/Pascal Right-to-Execute	\$1485
<b>82313A</b> Hierarchical File System	\$395

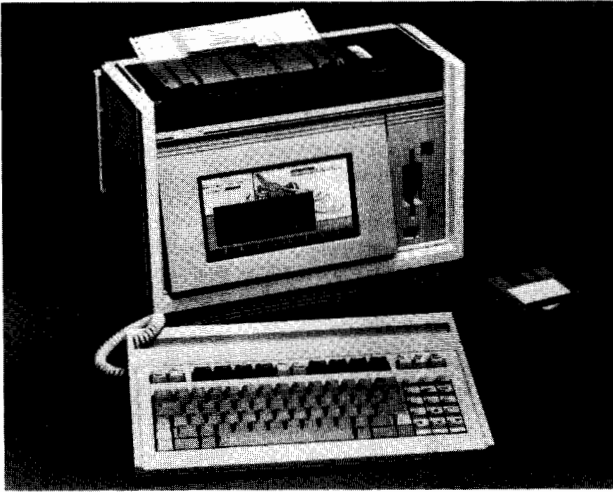

The HP Integral Personal Computer is a transportable, HP-UX computer system for solution creators developing workstation-class software for mobile applications.

#### The HP Integral Personal Computer

The HP Integral Personal Computer delivers the performance of an HP-UX operating system in a fully integrated, affordable and easy-to-use package. The HP-UX operating system adheres to AT&T's System V Interface Definition, Issue 1. Everything you need for full computing power—a printer, keyboard, monitor, mass storage, and an optional HP Mouse—is provided in the transportable Integral PC.

The standard 512K bytes of memory is expandable to 7M bytes. And, there's 512K bytes of ROM, containing the HP-UX operating system built in. Also included in ROM is the Personal Applications Manager (PAM), a friendly user interface, and the HP Windows multi-window manager.

PAM simplifies the user approach to the powerful operating system, and has been customized for the Integral PC's multi-tasking environment. For high-end users, the Integral PC also offers traditional UNIX operating system shells.

In addition, an optional Software Engineering ROM Module provides over 150 of the most commonly used HP-UX commands including a complete "C" compiler and symbolic debugger; text editing, formatting, and spelling checker; data communications; maintenance tools; and system utilities. This provides a fast, reliable, truly transportable, low cost, integrated software development solution.

#### The Integral PC Features

- Motorola 68000, 16/32-bit microprocessor, 8 MHz
- 16-bit graphics processor
- 512K byte ROM contains:
  - HP-UX kernel
  - HP Windows
  - Personal Applications Manager (PAM)
- Standard 512K bytes of RAM expands to: 7M bytes
- Microfloppy 3½ inch disc drive, 710K byte
  - Amber/black electroluminescent 9-inch display
  - Two Hewlett-Packard Human Interface Loop (HP-HIL) connectors
- Built-in HP ThinkJet Printer
- Fully functional, typewriter-style keyboard
- HP-IB interface
- Two expansion ports; extendable to ten with bus expander option
- Compatible with HP 9000 family of HP-UX computers

#### HP-UX and the Integral PC

The HP-UX kernel is stored in ROM, providing the Integral PC with on-board power. You can run UNIX-operating-system-based software programs and applications installed on 3½ inch floppy discs, or stored in EPROM or ROM on the EPROM/ROM Module, eliminating the necessity of a Winchester hard disc.

#### UNIX Operating System Software Library

A substantial number of UNIX-based tools are available, especially for software development, text processing, and communications. The library includes Pascal, FORTRAN, and "C" compilers, designed primarily for programming experts. Additionally, a Device Independent Library (DIL) provides high-level language control of instruments through compiled languages. This saves time when programming high-performance computer-aided test solutions.

Real-time extensions are available through HP-UX to provide reliable interrupt handling and priority setting in a multi-tasking instrument control environment.

#### Graphics Display

The Integral PC features a 9-inch, 24-line x 80-column, amber and black electroluminescent (EL) display. The flat panel display is tilt-adjustable, compact, and very readable. The Integral PC's bit-mapped display uses square pixels, which produce excellent, high-quality graphics. It has 255 pixels vertically and 512 pixels horizontally. The 16-bit graphics processor supports high-speed line drawing and can change windows rapidly.

#### Specifications

**Microprocessor/CPU:** Motorola 68000, 16/32-bit processor running at 8 MHz

**Graphics Processor:** 16-bit, with 32K bytes of dedicated RAM

**Operating System:** HP-UX (UNIX System V)

**Memory:** 512K bytes ROM

512K bytes RAM, expandable to 2.5M bytes in main system and to 7M bytes with I/O expanders

**Mass Storage:** Single 710K byte double-sided, double-density 3½ inch microfloppy

**Display:** 9-inch electroluminescent (EL), 24-line x 80-column screen with adjustable tilt; 256 x 512 pixels

**Keyboard:** Fully spaced, 90-key, full-travel typewriter-style HP-HIL compatible

Eight function keys

Numeric pad

**Internal Printer:** Built-in ThinkJet

150 cps

1K byte buffer

11 x 12 dot character matrix text print resolution

96 x 96 or 192 x 96 dots per inch graphics resolution

Bold and underline print modes

Less than 50 dB sound pressure printing noise

**Input/Output:** HP-IB, two HP-HIL, and two expansion ports (can be extended to ten ports using two Bus Extenders)

**Weight:** 25 pounds (11.4 kilograms)

**Dimensions:** 7 x 13 x 16 inches (178 x 330 x 406 mm)

#### How to Order Your Integral Personal Computer

For more information on the Integral PC, contact your HP sales representative or your local HP personal computer dealer.

#### Ordering Information

**HP 9807A** The Integral Personal Computer

The Integral PC comes complete with the HP-UX operating system, 16/32-bit microprocessor and graphics processor, 512K-byte ROM, 512K-byte RAM, 710K-byte 3½ inch microfloppy disc drive, 9-inch EL display, built-in ThinkJet Printer that includes 50 sheets of paper and a printhead, low-profile 90-key keyboard with numeric keypad, internal clock and speaker, power cable, six applications and utilities discs, and comprehensive documentation.

**Price**  
\$5162

# TECHNICAL COMPUTER SYSTEMS

## HP 9000 Technical Computers Languages and Operating Systems

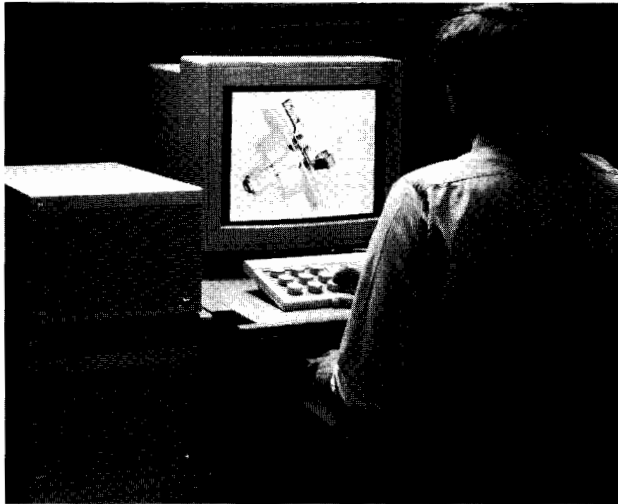

### HP-UX

HP-UX is an exceptionally powerful, standards-based operating system offering high capacity, high performance, and excellent transportability of applications between systems operating under the UNIX® system, including systems from different vendors.

HP-UX is based on AT&T's UNIX System V in compliance with the SVVS2 assuring portability of applications developed on other SVID compliant systems. HP-UX also incorporates features from U.C. Berkeley's 4.2 BSD (Berkeley Software Distribution).

In addition, HP-UX includes many innovations to extend the capabilities of the UNIX system. Those HP-UX features include: real-time enhancements, high performance file access, device I/O libraries, Native Language Support, and the X Window System.

Hewlett-Packard supplies industry-recognized languages to give you a broad span of programming capability including: Pascal, C, FORTRAN 77, Cobol, Ada®, Common LISP, PROLOG, and BASIC. These languages all run on our HP-UX operating system.

### HP Pascal

HP Pascal is a software tool for structured application software. Pascal has gained wide acceptance among software professionals as a block-structured, strong-typed language that produces easily read source code.

The system features include:

- a Hierarchical File System (HFS) for tree-structured directories and subdirectories.
- Powerful and versatile data and programming structures including program segmentation
- An I/O Procedure Library providing sophisticated device I/O
- A Graphics Library with full peripheral support
- A Librarian allowing the user to create custom procedure libraries.

The Pascal 3.2 Language System gives you all the advantages of a compiled language, a small, tightly controlled execution environment, and more. It offers you high speed and protection from program modification, plus extensive enhancements not found in other Pascal systems.

### C Language

The C language is the HP-UX system programming tool and a vehicle for transporting software from other UNIX systems. C has a syntax which incorporates certain data and control structures similar to those of Pascal. It also provides very low-level operations and the weak type checking of assembly language. The increased flexibility of the C language offers system programmers a closer, more efficient interface to the hardware than does Pascal.

### HP FORTRAN 77

The HP 9000 FORTRAN 77 compilers are supersets of the ANSI X3.9-1978 FORTRAN standard commonly referred to as FORTRAN 77 and have been validated by the Federal General Services Administration. These compilers are designed to provide a well-defined language standard for software portability and to feature extensions that enhance the flexibility and power of the FORTRAN language. The result is a modern programming language for the engineer that allows for growth on the large base of available FORTRAN software.

### Cobol

Cobol is a popular programming language currently used in developing business applications. Cobol/HP-UX is compliant with ANSI X3.23. 1985 HIGH.

### Ada®

Ada® is a programming language designed in accordance with requirements defined by the U.S. Department of Defense and adopted as an ANSI standard (ANSI/MIL-STD-1815A). Ada is the only programming language approved for DoD mission-critical applications.

A modern programming language, Ada is designed to decrease the development and maintenance costs of large-scale software systems and can be used in commercial, industrial and education environments.

### HP Common LISP

HP offers a complete development environment for Common LISP, a software product designed for the development of LISP-based applications. The HP integrated development environment balances the capabilities of symbolic computing with the capabilities of a general purpose workstation.

### HP PROLOG

The development environment for HP PROLOG allows the programmer to describe problems using symbolic logic in much the same way that humans reason. PROLOG allows the programmer to develop programs that deal with the logical content of a problem without being overly concerned about the manner in which it is solved. The benefits of PROLOG include: integration into the same environment as Common LISP; access to multiple PROLOG dialects; and extensions such as declarative determinism, procedural programming and floating point and rational numbers.

### HP Technical BASIC

HP Technical BASIC is a BASIC interpreter for the Integral PC, HP 9000 Series 300 and Series 500 HP-UX computer systems. HP Technical BASIC offers an easy to use, interpretive BASIC language and development environment suitable for rapid prototyping, personal programming and program development.

The HP 9000 family of computers is also available on the BASIC or Pascal operating systems. Both are independent of the HP-UX operating system.

### HP BASIC

HP BASIC 5.1 Language System adds to the inherent simplicity of BASIC the computational power usually found in FORTRAN, ALGOL, and APL. Beyond that, high-performance, I/O intensive constructs are incorporated giving BASIC 5.1 the highest performance found in interactive instrument control systems on the market today.

BASIC 5.1 provides a Hierarchical File System (HFS), complex numbers, support for 32-bit workstations, and additional peripherals (such as *PaintJet*). Additional features, along with a host of other additions in the areas of human interface, matrix operations and back-up and restore capabilities, are available with the 5.1 release while maintaining compatibility with the previous releases.



## Series 800 Languages and Operating Systems

Hewlett-Packard's Precision Architecture HP 9000 Series 800 is based on HP's HP-UX operating system, which complies with the AT&T System V Interface Definition Issue 2. Each machine in the Series 800 comes standard with an HP-UX operating system. The size of the license included with the hardware depends on the particular Series 800 machine ordered. The Models 825 and 840 come standard with a 16-user HP-UX license. The Model 850 comes standard with a 32-user HP-UX license.

There are four HP-UX operating system products for the Series 800 computers:

HP-UX 16-user license for the Series 800	<b>HP 92452A</b>	\$5,250
Opt AA0 Software on 1/4" cartridge tape		\$0
Opt AA1 Software on 1/2" 1600 cpi tape		\$0
Opt 0B0 Delete manuals		-\$300
Opt 0CC Revision upgrade for users not on support services		-\$2,900
HP-UX 1-32 user license for the Series 800	<b>HP 92453A</b>	\$10,500
Opt 0A0 Upgrade from current 16-user (92452) system (Requires prior or concurrent purchase of 92452A)		-\$5,250
Opt AA0 Software on 1/4" cartridge tape		\$0
Opt AA1 Software on 1/2" 1600 cpi tape		\$0
Opt 0B0 Delete manuals		-\$300
Opt 0CC Revision upgrade for users not on support services		-\$7,660
HP-UX 1-64 user license for the Series 800	<b>HP 92454A</b>	\$18,375
Opt 0A1 Upgrade from current 16-user (92452) system (Requires prior or concurrent purchase of 92452A)		-\$5,250
Opt 0A2 Upgrade from current 32-user (92453) system (Requires prior or concurrent purchase of 92452A)		-\$10,500
Opt AA0 Software on 1/4" cartridge tape		\$0
Opt AA1 Software on 1/2" 1600 cpi tape		\$0
Opt 0B0 Delete manuals		-\$300
Opt 0CC Revision upgrade for users not on support services		-\$12,600
HP-UX unlimited user license for the Series 800	<b>HP 92455A</b>	\$34,125
Opt 0A1 Upgrade from current 16-user (92452) system (Requires prior or concurrent purchase of 92452A)		-\$5,250
Opt 0A2 Upgrade from current 32-user (92453) system (Requires prior or concurrent purchase of 92452A)		-\$10,500
Opt 0A3 Upgrade from current 64-user (92454) system (Requires prior or concurrent purchase of 92452A)		-\$18,375
Opt AA0 Software on 1/4" cartridge tape		\$0
Opt AA1 Software on 1/2" 1600 cpi tape		\$0
Opt 0B0 Delete manuals		-\$300
Opt 0CC Revision upgrade for users not on support services		-\$22,540
Native Language I/O and Stick Kanji Font for Series 800	<b>HP 92439A</b>	\$2,500
Opt AA0 Software on 1/4" cartridge tape		\$0
Opt AA1 Software on 1/2" 1600 cpi tape		\$0
Simplex Kanji Font for Series 800 (Requires current version of 92439A)	<b>HP 92433A</b>	\$1,200
Opt AA0 Software on 1/4" cartridge tape		\$0
Opt AA1 Software on 1/2" 1600 cpi tape		\$0

The HP-UX Operating System for the Series 800 comes standard with a C compiler. In addition, FORTRAN and Pascal are available for the Series 800 systems.

	Model 825/835	Model 840	Model 850
<b>FORTRAN/77</b>	<b>92443A</b> \$4,775	<b>92430A</b> \$7,350	<b>92461A</b> \$10,300
<b>Pascal</b>	<b>92444A</b> \$4,775	<b>92431A</b> \$7,350	<b>92462A</b> \$10,300
<b>Cobol</b>	<b>35328A</b> \$10,750	<b>35326A</b> \$16,500	<b>35330A</b> \$23,100

## Series 300 Languages and Operating Systems

### HP-UX Operating System

HP-UX Application Execution Environment License. Includes HP-UX Kernel, installation software, HP Windows/9000 and Personal Applications Manager (PAM). Media and manuals are available separately.

1 - 2 user	<b>HP 98515L</b>	\$150
1 - 16 multi-user	<b>HP 98595L</b>	\$500
1 - 32 multi-user	<b>HP 98596L</b>	\$3,000
HP-UX Programming Environment. Includes commands, C Compiler, MC680X0 assembler, Symbolic Debugger, RS-232 Data Communications, Device I/O and Starbase Graphics Library. Requires 98515L (single-user), 98595L (1 - 16 users) or 98596L (1 - 32 multi-users).	<b>HP 98597L</b>	\$650
HP-UX FORTRAN 77 Compiler. Requires 98597L.	<b>HP 98598L</b>	\$600
HP-UX Pascal Compiler. Requires 98597L.	<b>HP 98599L</b>	\$600
Ada® Software for HP-UX Single-user	<b>HP 97054A</b>	\$3,185
Multi-user	<b>HP 97055A</b>	\$4,360
HP Common LISP I	<b>HP 98678L</b>	\$3,060
HP Common LISP II	<b>HP 98688L</b>	\$3,500
HP PROLOG (requires HP 98678L)	<b>HP 79232U</b>	\$4,180

### BASIC Language

RAM-based BASIC 5.1 Language System with Hierarchical file system. Includes one system disc set, BASIC 5.1 Utilities and manuals for Series 200 and 300.

Single user	<b>HP 98616A</b>	\$875.
ROM-based BASIC 5.1 Language System. Includes on ROM board, BASIC 5.1 Manual Kit and BASIC 5.1 Utilities (for Series 200 and 300).	<b>HP 98603A/B</b>	\$1,920.
Single-user BASIC 5.0/5.1 Compiler. Includes compiler disc and manual (for Series 200 and 300).	<b>HP 98618A</b>	\$505.
Single-user RAM-based BASIC 4.0 Language System. Includes one system disc set, BASIC 4.0 Utilities and manuals (for Series 200 and 300).	<b>HP 98613B</b>	\$875.

### Pascal Language

RAM-based Pascal 3.2 Language System. Includes system disc set and Pascal 3.2 Manual Set (for Series 300).

Single-user	<b>HP 98617A</b>	\$1,015.
RAM-based Pascal 3.1 Language System. Includes system disc set and Pascal 3.1 Manual Set (for Series 300).	<b>HP 98615C</b>	\$1,015.

### HPL Language

ROM-based HPL 2.0 Language System. Includes one system ROM board, HPL 2.0 Language Manual Kit and HPL 2.0 Utilities (not available for Models 220 or 236C).

Single-user	<b>HP 98604A</b>	\$1,445.
RAM-based HPL 2.1 Language System. Includes system flexible disc, HPL 2.0 Language Manual Kit and HPL 2.0 Utilities (not available for Models 220 or 236C)	<b>HP 98614A</b>	\$360.



# TECHNICAL COMPUTER SYSTEMS

## HP 9000 Technical Computers

### Networking

## Model Networking Environment

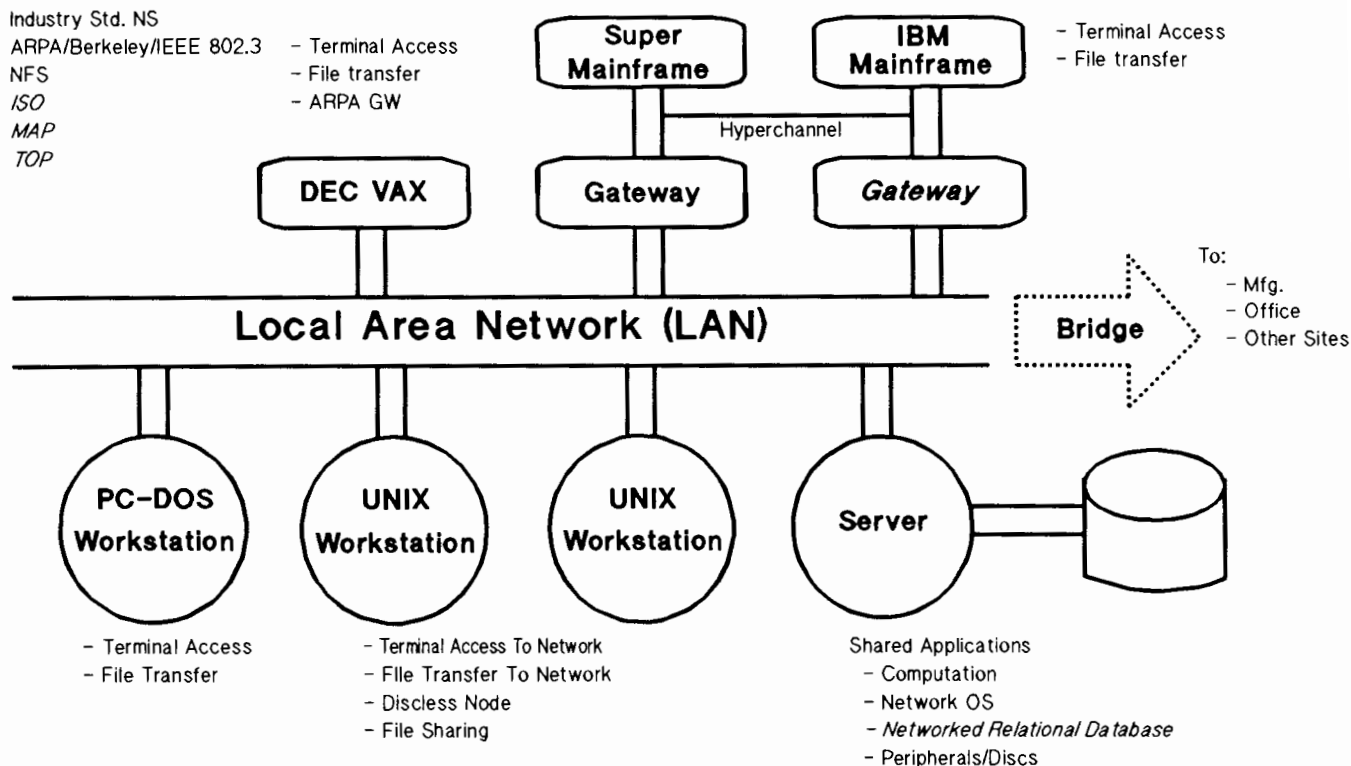

Note: Slanted text denotes future product direction.

### Model Networking Environment

#### HP AdvanceNet: The Networking Solution

Hewlett-Packard's AdvanceNet is a communications strategy and network architecture designed to provide a broad range of networking alternatives. HP AdvanceNet is a modular, scalable network that improves communication and productivity. To increase productivity, HP AdvanceNet links engineering workstations through a high-speed LAN so engineers can move large design files quickly. We then connect workstations to larger computers by using industry standard protocols.

While the network improves communications, it also lowers costs by allowing everyone to share expensive peripherals, thus minimizing the cost per user.

Using HP AdvanceNet, engineers can share transparent access to files, data bases and sophisticated peripherals like printers, plotters and disks.

In the HP-UX environment, a user on any engineering workstation can access resources on any other network station. A workstation can also act as a dedicated peripheral server for heavy use.

HP AdvanceNet is solidly based on industry standards, which protects your investment. We provide multivendor communications by supporting industry and de facto standards important to the engineering community, including IEEE 802.3 and Ethernet, Transmission Control Protocol and Internet Protocol (TCP/IP), ARPA, Berkeley, and NFS networking services.

Hewlett-Packard's membership in standards organizations guarantees that HP AdvanceNet will continue to provide a solution that adheres to new, evolving standards.

In addition, HP AdvanceNet supports other protocols commonly used in mainframe computer centers, such as SNA and HYPERchannel, providing easy access to these essential resources. Additional services provide such capabilities as file and peripheral sharing and the ability to develop customized network protocols.

As a full-range computer supplier, Hewlett-Packard provides network solutions that connect your entire company, including manufacturing and business offices.

#### HP AdvanceNet: A Modular, Step-by-step Implementation

HP AdvanceNet's modular approach makes it easy to implement your network step by step. Each solution is designed to help solve a particular networking problem in workgroups, engineering computer centers, site computer center access, companywide access and facility wiring.

#### Workgroup Solution

HP AdvanceNet connects engineering workstations and personal computers into workgroups. These workgroups can be connected to each other and to other resources.

The solution provides strong peer-to-peer capabilities, which connect multivendor equipment through an IEEE 802.3 or an Ethernet LAN. HP AdvanceNet utilizes industry standard TCP/IP, along with ARPA/Berkeley, NFS, and HP's Network Services, to provide compatibility with a wide range of engineering computer systems.

Files can be shared through Remote File Access and NFS. Programs can communicate with other programs using industry-standard Berkeley services.

Since workgroups change as projects are completed and new ones begun, the workgroup solution allows easy modification. Workstations running the HP-UX operating system are connected using IEEE 802.3 and ThinLAN cable. This cabling allows easy addition and deletion of stations since workstations are connected to the cable with simple BNC connectors. A peripheral server can be configured as part of the workgroup.

Workstations running BASIC or PASCAL operating systems are connected using the Shared Resource Manager (SRM), which allows users to share peripherals and files among these different operating systems.

The SRM also supports booting of the operating systems over the network, allowing BASIC and PASCAL systems to operate without the need for local disks - further reducing the cost per user.

The HP-UX environment is supported on both the SRM and IEEE 802.3 networks and can serve as a means to tie both networks together.

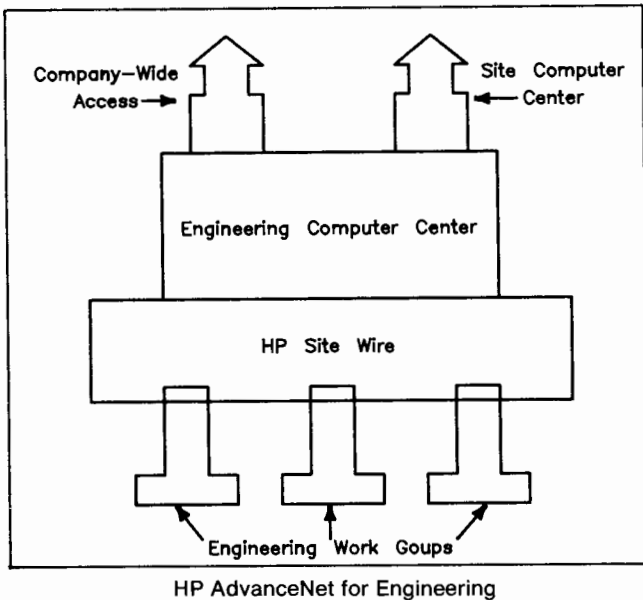

#### Engineering Computer Center Function

HP AdvanceNet provides a flexible and powerful network solution for the multiuser systems and workstation servers typically found in engineering computer centers.

Communications with a wide variety of common minicomputers and superminicomputers are provided via standard ARPA networking services. In addition, HP's Network Services can connect with VAX computers through a product that is compatible with DECnet and features file transfers between VAX computers and all HP computer families and virtual terminal connections to HP 9000 and HP 1000 systems.

#### Site Computer Center Function

To handle complex engineering computations, this solution provides access to mainframes and supercomputers in the site computer center.

A wide range of network protocols is supported, providing compatibility with most existing computer networks. This minimal impact approach eliminates costly and time-consuming changes inside your computer center.

The module includes a gateway to access IBM mainframes via either SNA or HYPERchannel. Bisync capabilities offer an alternative connection to IBM and many other types of mainframes.

#### Company-wide Access Solution

For remote connections, this solution provides standard UNIX communications via uucp and cu. These services are supported over both dial-up asynchronous lines and X.25 packet-switched networks. The module gives engineers access to information located anywhere in the company.

#### HP SiteWire Solution

HP AdvanceNet uses a flexible and efficient wiring plan to connect workstations and provide access to other computing resources elsewhere in the facility. HP SiteWire is designed to be compatible with the wiring in your existing engineering networks, while establishing a foundation for future growth.

Workstations are wired together into workgroups using ThinLAN. Workgroups are connected together and to the rest of the facility with ThickLAN.

Both baseband and broadband cabling are available. Repeaters and bridges permit interconnection of multiple LAN segments and extend the LANs to cover longer distances.

## Ordering Information

### Engineering Work Group

ARPA Services/Vectra	<b>HP D1800A</b>	\$1,150
ARPA ThinLAN Link/Vectra	<b>HP D1801A</b>	\$1,150
Keyboard (ASCII) for Server	<b>HP 46021A</b>	\$195
12-in. Video Monitor for Server	<b>HP 82913A</b>	\$195
Network Services/200	<b>HP 50956A/57A</b>	\$115/1045
Network Services-ARPA Services/300	<b>HP 50952CL</b>	\$100/900
LAN/300 Link	<b>HP 98643A</b>	\$1,150
Network Services/500	<b>HP 50954A/R</b>	\$1,200
LAN/500 Link	<b>HP 27125B</b>	\$300
ARPA Services/840	<b>HP 50980A/R</b>	\$1,384/3,643
Network Services/840	<b>HP 98195A/R</b>	\$3,005/3,065
LAN/840	<b>HP 98194A</b>	\$1,600
ARPA Services/825	<b>HP 50981A/R</b>	\$2,142/1,822
NS/825	<b>HP 91787A/R</b>	\$2,600/1,750
LAN/825 Link	<b>HP 91786A</b>	\$410
ARPA Services/850	<b>HP 50982A/R</b>	\$2,497/3,374
NS/850	<b>HP 91789A/R</b>	\$6180/5,250
LAN/850 Link	<b>HP 91788A</b>	\$770
NS for DEC VAX Computer	<b>HP 50950A</b>	\$6,800/11,550
ThinMAU	<b>HP 28641A</b>	\$150
MAU	<b>HP 30241A</b>	\$430
Shared Resource Management	<b>HP 50960A/61A/62A/63A</b>	\$5,950/2,445 \$800/800
NFS/300	<b>HP 50969A/L</b>	\$1,000/495
NFS/840	<b>HP 50971A/R</b>	\$3,500/2,975
NFS/825	<b>HP 50970A/R</b>	\$1,400/1,180
NFS/850	<b>HP 50972A/R</b>	\$6,600/5,525

### Non-HP Products

Fusion® From Network

Research Corp.

for Vectra PC

**NRC FNS-PC-TCP** \$350

ARPA/Berkeley

Services for Series 500

from Wollongong

**WIN/H9000** \$1,500

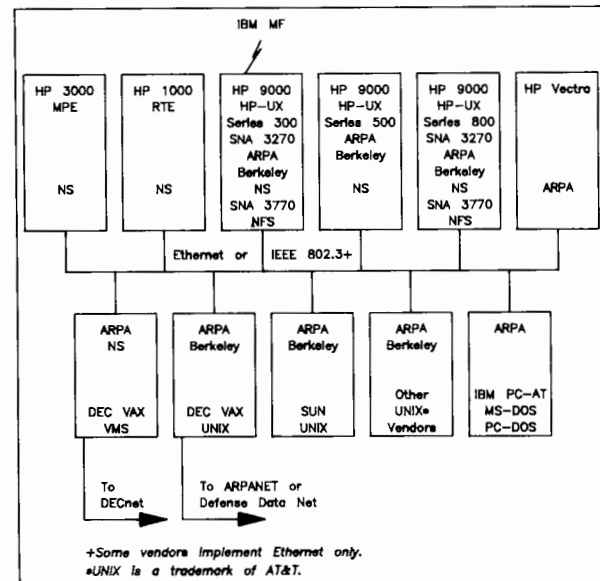

HP 9000 Series 200, 300, 500 and 800 computers using the HP-UX operating system can connect directly to the Ethernet/IEEE 802.3 local area network (LAN).

# TECHNICAL COMPUTER SYSTEMS

## HP 9000 Technical Computers (cont'd)

### Networking

#### Engineering Computer Center

NS/500	HP 50954A	\$4200
LAN/500 Link	HP 27125B	\$2675
NS for DEC VAX Computer	HP 50950A	\$6300/11,550
ARPA Services/840	HP 50980A	\$4284
LAN/840 Link	HP 98194A	\$5660
NS/840	HP 98195A	\$3605
ARPA Services/825	HP 50981A/R	\$2142/1822
NS/825	HP 91787A/R	\$2060/1750
LAN/825 Link	HP 91786A	\$4120
ARPA Services/850	HP 50982A/R	\$7497/6374
NS/850	HP 91789A/R	\$6180/5250
LAN/850 Link	HP 91788A	\$7720

#### Non-HP Products

ARPA/Berkeley Services for Series 500 from Wollongong	WIN/H9000	\$7500
-------------------------------------------------------------	-----------	--------

#### Site Computer Center Access

3278 Emulator for HP Vectra PC	HP 50920A	\$1255
SNA/Link/3270 (Remote 3270 SNA Terminal Emulator for HP Vectra)	HP 50921A	\$1040
Advancelink 2392 for Vectra PC	HP 68333F	\$325
HP-UX SNA3270 for HP 9000 Series 300 Computer Systems	HP 36590A	\$1050
HP-UX Gateway/SNA3270 for HP 9000 Series 300 Computer Systems	HP 36591A	\$1050
HP-UX SNA Link for HP 9000 Series 300 Computer Systems	HP 36592A	\$2040/5985
HP-UX Gateway/ SNA Link for HP 9000 Series 300 Computer Systems	HP 36593A	\$6120/6495
HP-UX Gateway/SNA 3270 for HP 9000 Series 800 Model 825 Computer	HP 36918A/R	\$3090/2625
HP-UX Gateway/SNA 3270 for HP 9000 Series 800 Model 850 Computer	HP 36919A/R	\$10,300/8500
HP-UX Gateway/SNA 3270 for HP 9000 Series 800 Model 840 Computer Systems	HP 36911A/R	\$7350/6250
HP-UX SNA 3770 for HP 9000 Series 300 Computer Systems	HP 98188A	\$1020
HP-UX Gateway/SNA 3770 for HP 9000 Series 300 Computer Systems	HP 98184A	\$1020
HP-UX Gateway/SNA 3770 for HP 9000 Series 800 Model 825 Computer	HP 98185A/R	\$3000/2500
HP-UX Gateway/SNA 3770 for HP 9000 Series 800 Model 840 Computer	HP 98186A/R	\$7140/6079
HP-UX Gateway/SNA 3770 for HP 9000 Series 800 Model 850 Computer	HP 98187A/R	\$10,000/8500
HP 5080 Emulator	HP 98855A	Contact Local HP Sales Office
3278 Display Station Emulator	HP 50955A	\$1605
HP 9000 RJE Emulator for Series 300	HP 50967A	\$1606

RJE Interface for Series 200/300	HP 98641A	\$1315
HP 9000 RJE Emulator for Series 500	HP 50968A	\$2677
RJE Interface for Series 500	HP 27122A	\$2220

#### Non-HP Products

Network Systems® HYPERchannel® Software	Contact Local HP Sales Office
-----------------------------------------------	----------------------------------

Host-to-Adapter Interfaces for HYPERchannel®	Contact Local HP Sales Office
----------------------------------------------------	----------------------------------

ARPA/Berkeley Services for Series 500 Wollongong	WIN/H9000	\$7500
Network Server/Mitek Systems Corp.	M/2030/M2130	\$29,000 \$21,000

#### Company Wide Access

HP-UX Asynchronous Data Communications: cu, uucp, uux X.25 Multiplexer	Bundled with HP-UX HP 2334A PLUS	\$2300
---------------------------------------------------------------------------------	----------------------------------------	--------

#### HP SiteWire

LAN/300 Link	HP 98643A	\$1325
LAN/500 Link	HP 27125B	\$2600
LAN/840 Link	HP 98194A	\$5660
LAN/825 Link	HP 91786A	\$4120
LAN/850 Link	HP 91788A	\$7720
Shared Resource Management	HP 50960A/ 61A/62A/63A	\$4995/2395 \$845/845
ThinMAU	HP 28641A	\$350
MAU	HP 30241A	\$400
10 Mbps-10 Mbps LAN Bridge	HP 28648A	\$8000
Seicor® Fiber Optic MAU	Model 10-222	\$750

#### Miscellaneous Connections

RS-232C Asynchronous Serial Interface for Series 200 and 300	HP 98626A	\$380
Data Communications Interface for Series 200 and 300	HP 98628A	\$485
4-channel Multiplexer for Series 200 and 300	HP 98642A	\$600
RS-232C Asynchronous Serial Interface for Series 200 and 300	HP 98644A	\$190
HP 2392 and VT100 Terminal Emulator for Series 200 and 300	HP 98791B	\$500
HP-UX Asynchronous Data Communications: cu, uucp, uux	Bundled with HP-UX	
Asynchronous Serial Interface for Series 500	HP 27128A	\$930
Asynchronous 8-channel Multiplexer for Series 500	HP 27130B	\$2100
Asynchronous 6-channel Modem Multiplexer for Series 500	HP 27140A	\$2450
Programmable Data Communication Package	HP 98690A/91A	TBD/650
Asynchronous Terminal Emulator for Series 500 Basic	HP 97056A	\$530

#### Non-HP Products

Communications Server/ Terminal Controllers	CS100	\$5400
Bridge Communications, Inc.	LS-1	\$16,000

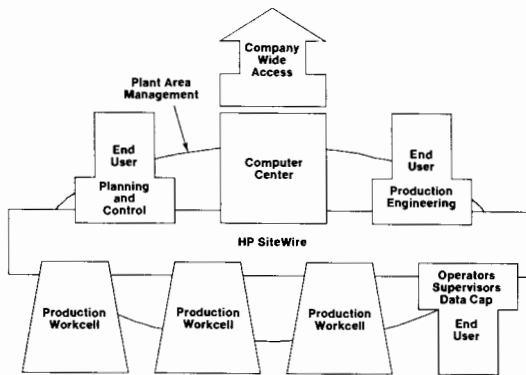

**CIM Networking Modules**

### HP AdvanceNet: The Information Network for Computer Integrated Manufacturing

To lower your operating costs, HP AdvanceNet provides instant information exchange among all your manufacturing functions, including planning and control, financial systems, production processes, production engineering and product design. Computer Integrated Manufacturing (CIM) is the key to gaining the competitive edge by improving quality, productivity and flexibility.

HP AdvanceNet also solves the problem of making terminal connections to a wide range of systems and applications. By keeping terminal transactions separate from system to system communication, the network allows many terminal types to access a variety of computers throughout the site.

Our peer-to-peer services are based on the Open Systems Interconnect model (OSI) developed by the International Standards Organization (ISO). These services overcome one of the principal obstacles to CIM by providing full networking functionality for multivendor information management, no matter where systems are located in the factory. Our Manufacturing Automation Protocol (MAP) products are only one example of our OSI commitment.

HP AdvanceNet's modular approach makes it easy to implement your network step by step. Each module is designed to help solve a particular networking problem in the wiring system, departmental subnets, data centers and plant-wide integration. Like any good CIM plan, HP AdvanceNet lets you implement the network in affordable, manageable steps.

#### HP SiteWire Module

HP AdvanceNet is built on a communications wiring infrastructure called HP SiteWire, which creates a plant-wide network backbone to connect people with information.

Subnetworks gain easy access to the backbone from anywhere in the plant. As your plant configurations change, the network backbone easily accommodates them.

The primary and most versatile HP SiteWire backbone option is based on the IEEE 802.7 broadband standard. This option meets the most demanding needs and allows multiple voice, video and data channels. It lets you mix terminals, point-to-point links, LANS's and more on a single backbone cable, and it supports MAP.

An IEEE 802.3 backbone is available for less complex situations that do not require video, voice or specialized data services.

For your subnetwork needs, HP SiteWire offers inexpensive twisted pair solutions for terminals and LANs. Where additional ruggedness is required, IEEE 802.3 ThinLAN is supported on all our factory systems. Our experienced network consultants will custom design HP SiteWire to meet your unique requirements.

#### End-user Modules

HP AdvanceNet offers a wide range of end-user solutions to enhance departmental productivity while providing access to information throughout the plant. Options include multivendor terminal clusters and the latest in industry-standard LANs. Each option solves problems in specific areas like planning and control, the shop floor and production engineering.

HP AdvanceNet helps improve the productivity and effectiveness of your planning and control staff with industry-standard StarLAN,

which connects PCs with information systems over low-cost, unshielded twisted pair.

To provide operators and supervisors with plant-wide information, we connect terminals to systems from different vendors through terminal cluster solutions. Data collection and retrieval are simple when one terminal or bar code reader can access MRP, JIT or quality applications no matter where they're running.

To connect UNIX workstations, we use industry-standard IEEE 802.3 with ARPA and Berkeley networking services. Production engineers can then share files and expensive peripherals. They can also access mainframe resources and product design groups. With tight communications between production engineering and design, new products get to market faster.

#### Production Workcell Module

Before you can achieve CIM, you must establish effective islands of automation. But CIM is easier to accomplish if these islands are initially designed to communicate with the rest of the plant. Planning ahead eliminates the high cost of retro fitting your islands for plant-wide communications.

HP AdvanceNet helps you build effective workcells with extensive connectivity to factory floor devices. For common shop floor devices like PLCs and numerical control equipment, we offer a broad range of EIA RS-232 interfaces, from low-cost to user-programmable.

For the product test and data acquisition, Hewlett-Packard combines its leading position as an instrument supplier with its workcell controllers, connecting instruments via IEEE 488 (HP-IB).

The network also makes it easy to create workcell clusters. Our real-time UNIX and DOS PCs connect easily with IEEE 802.3 ThinLAN. An ideal choice for product test clusters is the Shared Resource Manager (SRM), which connects our popular BASIC and PASCAL systems.

When you're ready, HP AdvanceNet connects your workcells and clusters to the rest of the plant. Even if you have systems from many different vendors, HP AdvanceNet supports MAP, HP Network Services (NS), NS for DECVAX, ARPA, and SNA network links and services.

#### Computer Center Module

For your data center, we provide IEEE 802.3 ThinLAN subnets for Hewlett-Packard and DEC equipment and SNA products for connections to IBM and compatible mainframes. With HP AdvanceNet, you get improved flexibility in application deployment and development, better access to data bases and peripheral sharing.

By connecting your data center to the entire plant, we eliminate isolated subnets. All end-user and workcell subnets gain access through one or more options in our plant area management module to create the complete CIM foundation.

#### Plant Area Management Module

Application integration is CIM's major benefit, and we provide it plant-wide among multiple vendors. We offer a choice of services, including HP Network Services for communications via IEEE 802.3 and TCP/IP protocols across our baseband or broadband backbone.

For industry-standard multi-vendor applications in production engineering and links to product design, we offer industry-standard ARPA and Berkeley services for UNIX systems and workstations.

All HP AdvanceNet services are based on the Open Systems Interconnect model, ensuring that future services and protocols can easily be added to your network, preventing the obsolescence of existing equipment.

If you're currently implementing an effective CIM plan, our new HP precision architecture UNIX systems are the ideal area managers for distributed plant information management systems.

#### Company-wide Access Module

HP AdvanceNet's industry-standard X.25 wide area networking gives you instant communications with headquarters, suppliers and customers. These extensive connections keep you in touch so you don't find out three weeks later what caused you to miss that critical shipment and lose an important account.

You can also improve productivity and lower costs with worldwide electronic mail, even if you have a SNA company network.

# TECHNICAL COMPUTER SYSTEMS

## HP 9000 Technical Computers (cont'd)

### Networking for Computer Integrated Manufacturing

#### HP Sitewire

MAU	HP 30241A	\$400
ThinMAU	HP 28641A	\$350
Repeater Kit	HP 92223A/C	\$4080
ThinLAN Hub	HP 28645A	\$3010
StarLAN Hub	HP 27212A	\$1375
StarLAN Bridge	HP 28647A	\$5000
Buffered Repeater	Ungermann-Bass	
Terminal Server HP Network Planning Design	Ungermann-Bass	Custom Quote

#### End User

##### Operators, Supervisors, Data Capture

Terminal Servers for HP 3000		
Advanced Terminal Processor	Ungermann-Bass	
ATP Direct Connect Package	HP 30273A	\$7660
ATP Direct Port Controller	HP 30145A	\$6720
ATP System Interface Board	HP 30144A	\$3240
ATP Modem Expansion Package	HP 30274A	\$9240
ATP Modem Port Controller	HP 30155A	\$8300
ATP 37/M for HP 1000	HP 40290A	\$3670
8-Channel Asynch. Multiplexer for HP 9000/200,300	HP 12040D	\$2175
Direct I/O Serial Interface	HP 98642A	\$610
Terminal Emulator for HP 9000/500	HP 98791B	\$510
Channel I/O Asynchronous 6-Channel Multiplexer	HP 27140A	\$2450
Channel I/O Asynchronous 8-Channel Multiplexer	HP 27130B	\$2100
Advancelink 2392 (Terminal Emulator for HP VECTRA)	HP 68333F	\$300

##### Planning and Control

AdvanceLink 2392 (for Vectra/IBM PC)	HP 68333F	\$300
LAN3000/V Link	HP 30242A	\$3085
NS3000/V Network Services	HP 32344A	\$1020
StarLAN Configurator/Diagnostics Software	HP 50906A	\$795
StarLAN/ThinLAN Configurator	HP 50912A	\$1830-\$3665
Diagnostics Software	50912R	\$1280-\$2565
StarLAN HUB	HP 27212A	\$1375
StarLAN Server Kit	HP 50904F	\$1375
StarLAN User Link Kit	HP 50905F	\$595
StarLAN Bridge	HP 28647A	\$595
Buffered Repeater	Ungermann-Bass	

##### Production Engineering

Buffered Repeater	Ungermann-Bass	
ThinLAN Hub Multiport Repeater	HP 28645A	\$3010
Network Services-ARPA/300	HP 50952B	\$1015
Network Services for the DEC VAX	HP 50950A	\$6120-\$11220
Network Services/200	HP 50956A, 57A	\$405/\$1015
Network Services/500	HP 50954A	\$4080
LAN/300 Link	HP 98643A	\$1325
LAN/500 Link	HP 27125B	\$2600
ARPA Services/800	HP 50980A	\$10200
Network Services/9000/800	HP 98195A	\$4080
LAN/9000 Series 800 Link	HP 98194A	\$6120

##### Production Workcell

For HP 1000 A-Series		
8-Channel Asynch. Multiplexer	HP 12040D	\$2175
Programmable Serial Interface	HP 12042B	\$2070
PSI Firmware Dev. Package	HP 24602A	\$1020
8-Channel Multiuse Asynchronous Multiplexer	HP 12041A/B	\$2730
HP-IB I/O (Series 200/300)	HP 12009A	\$1120
Direct I/O HP-IB Interface	HP 98624A	\$610
Programmable Datacomm I/O	HP 98691A	\$665
VECTRA Prog./Datacomm	HP 98690A	\$415
HP-IB I/O and Command Library for SRM	HP 82990A	\$410
SRM Coax Network for HP 9000 200/300 running BASIC or PASCAL	HP 50960A	\$5090
	61A	\$2445
	62A	\$860
	63A	\$860

##### Computer Center

NS3000/V Network Services	HP 32344A	\$1020-\$5610
NS3000/XL Network Services	HP 36920A	\$3825-\$7650
ThinLAN Hub	HP 28645A	\$3010

ThinLAN 3000/V Link	HP 30240A	\$3085-\$7140
ThinLAN 3000/XL Link	HP 36921A	\$9180
Advanced Terminal Processor		
ATP for Meridian SL-I I/O	HP 30276A, 77A	\$8305/\$9240
Distributed Terminal Controller	HP 2345A	\$7240
	2346A/B	\$2775/\$3500
	C	\$2775

Terminal Server	Ungermann-Bass	
Buffered Repeater	Ungermann-Bass	

#### Plant Area Management

##### HP Network Services

For HP 9000 Systems		
Network Services/800	HP 98195A	\$4080
Network Services/500	HP 50954A	\$2855
Network Services-ARPA/300	HP 50952B	\$1015
Network Services/200 (HP 3000)	HP 50956A, 57A	\$405/\$1015
NS3000/XL Network Services	HP 36920A	\$3825-\$7650
NS3000/V Network Services	HP 32344A	\$1020-\$5610
For HP 1000 A-Series Systems		
Network Services/1000	HP 91790A	\$1530-\$7140

##### ARPA/Berkeley Services

HP NS/ARPA/300	HP 50952B	\$1015
ARPA Services/800	HP 50980A	\$10200

##### IBM Connectivity

HP-UX SNA 3270	HP 36590A	\$1020
HP-UX Gateway SNA/3270	HP 36591A	\$1020
HP-UX SNA Link	HP 36592A	\$5610
HP-UX Gateway/SNA Link	HP 36593A	\$6120
HP-UX Gateway/SNA 3270	HP 36911A	\$7140
3278 Display Station Emulator	HP 50955A	\$1530
HP-UX RJE Emulator 300	HP 50967A	\$1530
RJE Interface	HP 98641A	\$1275
HP-UX RJE Emulator 500	HP 50968A	\$2550
RJE Interface	HP 27122A	\$2155
RJE/1000-II	HP 91781A	\$1630-\$5100
MRJE/1000	HP 91782A	\$2040-\$6120

#### Company-wide Access

##### Access to an X.25 Company-Wide Network

NS3000/V Network Services	HP 32344A	\$1020-\$5610
X.25 Link/3000; X.25 Line Concentrator (Dynapac) (for U.S. Only)		
LAN 3000/V Link	HP 32187A	\$3630-\$8220
SNA/IMF	HP 30242A	\$3055-\$7140
SNA/NRJE	HP 30247A	\$3570-\$8975
SNA Link	HP 30245A	\$2450-\$6120
SNA Link	HP 30246A	\$2090-\$8820

##### Access to an SNA Company-Wide Network

SNA/IMF	HP 30247A	\$3570-\$8980
SNA/NRJE	HP 30245A	\$2450-\$6120
SNA Link	HP 30246A	\$2090-\$8820
HP LU 6.2 Base	HP 30252A	\$3265-\$8160
SNA Server	HP 30254A/55A	\$1020/\$1020
	HP 30256A	\$610-\$1225
HP Office Connect to DISOSS	HP 27515A	\$1430-\$3570
NS 3000/V Network Services	HP 32344A	\$1020-\$5610
LAN 3000/V Link	HP 30242A	\$3085-\$7140
NS Point-to-Point Link/3000	HP 30284A, 85A	\$2140/\$5865
HP Serial Network	HP 50910A	\$300
	HP 50905F	\$605
	HP 50906A	\$810
	HP 50912A	\$3665

#### Network Support

Network Planning & Design/Prepare	Custom Quote
Network Startup/NetAssure	Custom Quote

#### Additional Products

HP 1000 A-Series Async Serial	HP 12005B	\$865
HDLN Network I/F for DS/1000-IV	HP 12007B	\$2295
HP 1000-A Multiuse Serial	12044A	\$2295
DS/1000-IV Data Link Slave	HP 12043A	\$2370
Binary Synchronous Modem & Direct Connect Interfaces	HP 12072A	\$1450
HP 1000-A LAP-B Modem	HP 12073A	\$2275
LAN/1000 Link and DDA LAN	12082A	\$2600
Interface Controller	HP 12075A	\$2070
Data Link/Multiport Master	HP 12076A	\$3160
Channel I/O RJE Interface	12079A	\$510
Channel Asynchronous Serial	HP 12092A	\$2295
	HP 27122A	\$2155
	HP 27128A	\$930



# TECHNICAL COMPUTER SYSTEMS

## HP 9000 Technical Computers

### The X Window System™

665

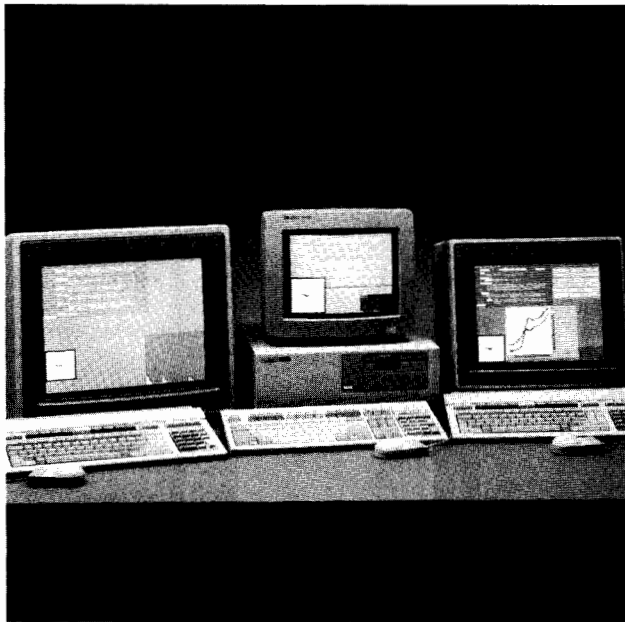

### The X Window System: Windows for a New Computing Environment

The X Window System provides HP's Series 300 Series 800, and Vectra PC family with a network-compatible "windowing" system that allows interconnection between HP computers and computers from other vendors.

With the X Window System, you can create multiple windows on your computer's display to allow you to interact with programs running on your computer - or another HP computer, or computers from other vendors, connected to your system over a network. Programs compiled on another vendor's computer to use X ("clients") can use the X windowing software on HP computers ("servers") for their input and output - and the reverse.

### Why X?

X has emerged as the industry standard for supporting windowed user interfaces across the network. Industry acceptance of the X Window System is widespread, as evidenced by over 20 computer vendors who have publicly endorsed X as the de facto industry standard. With X, it is possible to have a program "run" on one computer, and use the display, windowing, and user input of another computer on the same network.

X software adjusts for differences in display or computer architecture automatically as packets of interactive graphical information are exchanged between application and display. This exchange takes place according to an efficiently-designed protocol which is at the heart of the X Window System. Since applications written to this protocol participate through a standard programmatic interface library, applications are highly portable to other computer systems supporting X. This protects investments in software, training and support.

### Hewlett-Packard: A Technology Leader

HP's X11 fully implements the MIT X11 Release 2 specification; in addition, HP has added tools and performance enhancements for application developers and end users. Software developers are provided with three levels of tools: Xlib, Xt intrinsics, and HP X Widgets.

Widgets are interactive user interface tools, such as menus and scroll bars, based on the Xt intrinsics. The industry has endorsed the Xt intrinsics as a standard part of the X Window System to be provided by all vendors of X products. The HP X Widgets provide large productivity gains by providing developers with a set of tools for constructing easy-to-use applications.

### HP Supports X11 across a Wide Range of Systems

HP's X Window System products are available across the entire family of HP 9000 Series 300 and Series 800 computers, as well as for the Vectra PC. HP's X11 product for the Vectra PC provides the server (display and input) functions of X11 and thus can integrate the Vectra into the X environment.

Because HP supports X on a wide price/performance range of hardware platforms, application developers can have a broader platform base for their applications and end users can enjoy more freedom and flexibility in their choice of hardware.

### For More Information . . .

. . . please contact your nearest HP technical sales representative.

### Ordering Information

	Price
<b>B1151A</b> X Window System Version 11 License-to-Use for Series 300	\$100
<b>B1152A</b> Media and Documentation for B1151A Requires prior or concurrent purchase of B1151A	
<b>Opt AA0</b> Software on 1/4-inch tape cartridge	\$715
<b>Opt AA8</b> Software on 3 1/2-inch double sided disc	\$800
<b>B1155A</b> X Window System Version 11 for Model 825/35	\$2,100
<b>Opt AA0</b> Software on 1/4-inch tape cartridge	\$0
<b>Opt AA1</b> Software on 1/2-inch 1600 cpi 9-track tape	\$0
<b>B1156A</b> Right to Copy B1155A X Window System Version 11 for Model 825/835	\$1,785
<b>Opt 0B0</b> Delete manual set	-\$50
<b>B1157A</b> X Window System Version 11 for Model 840	\$3,200
<b>Opt AA0</b> Software on 1/4-inch tape cartridge	\$0
<b>Opt AA1</b> Software on 1/2-inch 1600 cpi 9-track tape	\$0
<b>B1158A</b> Right to Copy B1157A X Window System Version 11 for Model 840	\$2,720
<b>Opt 0B0</b> Delete manual set	-\$50
<b>B1159A</b> X Window System Version 11 for Model 850/855	\$4,500
<b>Opt AA0</b> Software on 1/4-inch tape cartridge	\$0
<b>Opt AA1</b> Software on 1/2-inch 1600 cpi 9-track tape	\$0
<b>B1160A</b> Right to Copy B1159A X Window System Version 11 for Model 850/855	\$3,825
<b>Opt 0B0</b> Delete manual set	-\$50
<b>B1161A</b> User Documentation for Series 300, 800 and X/PC	\$160
<b>B1162A</b> Programmer Documentation for Series 300 and 800	\$440
<b>D1851A</b> X Window System/PC	\$495
<b>Opt ABA</b> US/English	\$0
<b>D1800A</b> ARPA Services (required For D1851A)	\$150
<b>D1801A</b> ARPA ThinLan Link (required With D1851A)	\$795

# TECHNICAL COMPUTER SYSTEMS

HP 9000 Technical Computers  
Artificial Intelligence Development Environments

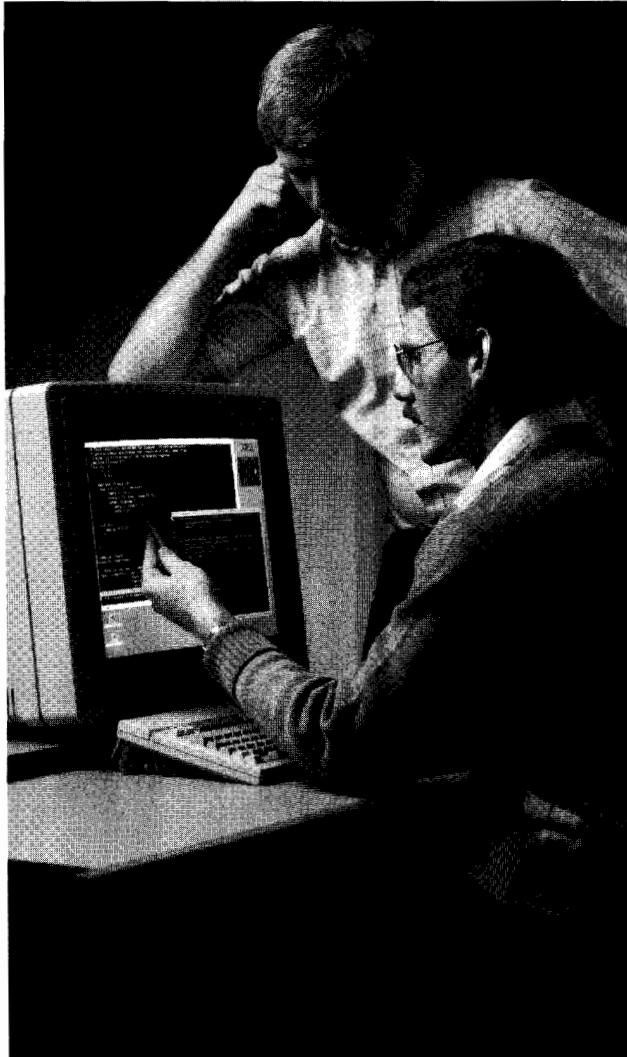

## Artificial Intelligence

HP has recognized the need for specialized software to help in the design and creation of applications using AI. HP has taken an approach of offering a balance of AI and conventional computing technology in a single system. This offers the application designer the best of both technologies.

## Integrated Environment

HP offers a powerful browser-oriented multi-language development environment called NMODE in its HP Common LISP I product. NMODE's features include:

- Integration - allows access to HP-UX; C, FORTRAN, Pascal, LISP and PROLOG; editing, debugging and windowing
- Modeless Editing - the editor is EMACS-based
- Customizable - the editor and environment can be extended to meet individual needs
- On-Line Help - full documentation, context-sensitive help, and a tutorial

## Symbolic Programming

LISP provides improved symbolic computing, automatic management of dynamic data structures, ease of language extension, equivalence between data and source code and a combination of features which allow incremental software development.

HP Common LISP II is HP's newest symbolic programming product. It is an implementation of Lucid Common LISP on the HP 9000 Series 300 computers. Common LISP II provides:

- Support for industry standards - Lucid Common LISP is widely available on a variety of hardware systems
- Traditional language access - you can link in C and FORTRAN programs
- The Flavors System - widely-used paradigm for object-oriented programming
- Full editing and debugging support

## Logic Programming

Unlike conventional programming languages which force the programmer to write programs that are prescriptions of how to solve a problem, PROLOG lets the programmer describe the problem via symbolic logic in much the same way humans reason.

HP PROLOG is written in LISP and runs on top of HP Common LISP I's NMODE environment. Thus, you can combine the best aspects of both languages and have full access to the environment's functionality. Benefits of the HP PROLOG include:

- Ability to blend PROLOG and Common LISP code
- One development environment to learn for both languages
- Combination of Edinburgh C-PROLOG syntax for portability and an s-expression syntax more similar to LISP
- A more powerful implementation for serious applications with extensions including improved I/O, more data types, a package system and a richer set of control structures.

## Knowledge Based Programming

The field of Artificial Intelligence has been greatly enhanced by independent software companies. This is especially true in knowledge-based programming and expert system tools. Check the HP Software Supplier Catalog under "AI" and you will find the leading vendors represented (see page 620).

## Ordering Information

		Price
HP Common LISP (NMODE)		
License-to-use	HP 98678L	\$3,060
Media/manuals	HP 98678A	\$1,020
HP Common LISP II		
License-to-use	HP 98688L	\$3,500
Media/manuals	HP 98688A	\$500
HP PROLOG	HP 79232U	\$4,180

In addition to the software products, HP has created AI Development Systems, which are bundles of hardware (excluding discs) and software tailored to the needs of software developers at a more attractive price.

# TECHNICAL COMPUTER SYSTEMS

## HP 9000 Technical Computers

### Peripherals

667

Description	Product Number	Series			Series 800 HP-UX
		BASIC	300 Pascal	HP-UX	
3 1/2-in. flexible disc (HP-IB)	9122C	•	•	•	•
5 1/4-in. flexible disc (HP-IB)	9127A	•	•	•	•
20/20 Mbyte cartridge disc (HP-IB)	7907A	•	•	•	•
10/20/40 Mbyte winchester discs (HP-IB)	9153C	•	•	•	•
81/152/304 Mbyte discs (HP-IB)	7957/58/59B	•	•	•	•
107/161/323 Mbyte discs (SCSI)	7957/58/59S	•	•	•	•
404 Mbyte removable disc (HP-IB)	7935H	•	•	•	•
571 Mbyte disc (HP-IB)	7937H	•	•	•	•
571 Mbyte disc (Fiber Link)	7937FL	•	•	•	•
Asian System Printer	C1200A	•	†	•	•
Asian workstation printer	41063A	•	•	•	•
DeskJet printer	2276A	•	•	•	•
LaserJet Series-II printer	33440A	•	•	•	•
LaserJet 2000 printer	2684A/D/P	•	•	•	•
PaintJet color graphics printer	3630A	•	•	•	•
QuietJet printer (RS-232C)	2227/28A	•	•	•	•
QuietJet Plus printer (HP-IB)	2227B	•	•	•	•
RuggedWriter printer	2235B/D	•	•	•	•
ThinkJet printer (HP-IB)	2225A	•	•	•	•
ThinkJet printer (RS-232C)	2225D	•	•	•	•
300..1200 lpm impact line printers	2563B..67B	•	•	•	•
Daisywheel impact printer	2603A	•	•	•	•
700/22 Terminal	C1004A/G/W	•	•	•	•
700/41 Terminal	C1003A/G	•	•	•	•
700/43 Terminal	C1006A/G/W	•	•	•	•
700/92 Terminal	C1001A/G/W	•	•	•	•
Graphics terminals	2393/97A	•	•	•	•
Industrial 2397A terminal	9666A	•	•	•	•
700/94 Terminal	C1002A/G/W	•	•	•	•
CHX Graphics controller	98550A/A1020H	•	•	•	•
SRX Graphics controller	98720A	•	•	•	•
Turbo SRX Graphics controller	98730A	•	•	•	•
2/3-button mouse (HP-HIL)	46060A/B	•	•	•	•
Trackball (HP-HIL)	M1309A	•	•	•	•
11x11-in. tablet (HP-HIL)	45911A	•	•	•	•
A/B-size digitizers (HP-HIL)	46087/88A	•	•	•	•
Bar code reader (HP-HIL)	92916A	•	•	•	•
Control Dial Module (HP-HIL)	46085A	•	•	•	•
32 Button Box (HP-HIL)	46086A	•	•	•	•
ColorPro plotter, A-size	7440A	•	•	•	•
A/B-size 6-pen plotter	7475A	•	•	•	•
A/B-size 8-pen autoseed plotter	7550A	•	•	•	•
DraftPro plotter, C/D-size	7570A	•	•	•	•
DraftMaster plotter, A/E-size	7595/96A	•	•	•	•
300/1200 baud modem	37212B	•	•	†	•
HP-IB Extender (RS-232C/twisted pair)	37201A	•	•	•	•
HP-IB Extender (Coax/Fiber Optic)	37204A	•	•	•	•
X.25 Multi-MUX	2334A	•	•	•	•
67 Mbyte 1/4-inch cartridge tape	9144A	•	•	•	•
134 Mbyte 1/4-inch cartridge tape	9145A	•	•	•	•
536 Mbyte 1/4-inch tape autochanger	35401A	•	•	•	•
1600 cpi 9-track autoloader tape	7979A	•	•	•	•
6250/1600 cpi 9-track autoloader tape	7980A/XC	•	•	•	•

† Not determined at publication time. Please consult your HP Sales Office for current support status.----

# TECHNICAL COMPUTER SYSTEMS

## HP 9000 Technical Computers

### HP 9000 Interface Summary

#### Series 800 Interfaces

The following interfaces and memory enhancements are available for HP 9000 Series 800 Technical Computers:

<b>HP-IB Interface</b> —Allows communication with as many as 31 HP-IB-compatible device addresses and 15 standard device loads	Series 800 & 500	HP 27110B	\$1,010
	Series 800	HP 27114A	1,600
<b>Parallel AFI Interface</b>	Series 800 & 500	HP 27110B	\$1,010
<b>HP-CIO Service Extender</b> —Extender card for out-of-card-cage access to HP-CIO interface card.	Series 800 & 500	HP 27116A	400
<b>Six-channel Modem Multiplexer Interface</b> —Supports up to six RS-232C/CCITT-V.22-compatible devices	Series 800 & 500	HP 27140A	2,400
<b>Lan/800 Link and Transport protocols</b>	Series 800	HP 98194A	6,000

#### Series 800 RAM

<b>RAM Memory Card</b> , 8 megabyte ECC RAM board		HP A1010A	10,000
<b>RAM Memory Card</b> , 16 megabyte ECC RAM board		HP A1037A	20,000

#### Series 300 Interfaces

<b>3278 Display Station Emulator</b>	Series 300	HP 50955A	1,605
<b>SRM Coax Interface</b> —Provides connection to Shared Resource Management (SRM) System	Series 300	HP 50962A	895
<b>EPROM Programmer Interface</b> —EPROM programmer card for installation in any HP-DIO backplane slot.	Series 300	HP 98253A	1,550
<b>EPROM Card</b> —Contains 16 sockets for EPROMs to allow up to 256 kbytes of storage using INTEL 27128 EPROMs.	Series 200	HP 98255A	310
<b>Bubble Memory Interface</b> , 128 kbytes—Non-volatile memory that appears like flexible disc to operating system	Series 300	HP 98259A	1,965
<b>Series 300 DOS Coprocessor Hardware</b>	Series 300	HP 98286A	980
<b>HP-UX Gateway/SNA Link for S/300 Gateway</b>		HP 36593A	6,120
<b>SCSI Interface</b> , Single-ended for 330/360/370		HP 98265A	1,100
<b>Interface to connect 98720A</b>		HP 98725A	1,035
<b>Interface to connect 98730A</b>		HP 98726A	1,035
<b>DMA Controller</b> , 2-channel	Model 310, 320	HP 98620B	515
<b>GPIO Interface</b> —Provides 16 bits of latched input and output data for bidirectional information transfer, and permits interfacing to GPIO-compatible equipment.	Series 300	HP 98622A	360

**BCD Interface**—Connects Series 300 with bit-parallel, digit-parallel, binary-coded decimal services for data input.

	Series 300	HP 98623A	395
<b>HP-IB Interface</b> —Provides communication with as many as 14 HP-IB-compatible instruments.	Series 300	HP 98624A	335
<b>High-Speed Disc Interface</b> —Connects disc drives and other high-speed HP-IB devices.	Series 300	HP 98625B	665
<b>Serial Interface, RS-232C</b> —Simple, asynchronous serial communications.	Series 300	HP 98626A/44A	385/194
<b>RGB Color Video Output Interface</b> —Graphics output device with programmable display formats up to 512 × 512 resolution	Series 300	HP 98627A	1,095
<b>Data Communications Interface</b> —Protocol management and electrical levels for asynchronous serial communications	Series 300	HP 98628A	495
<b>Breadboard Interface</b> —Backplane buffering circuits and dual-inline holes for user-mounted circuit components.	Series 300	HP 98630A	330
<b>6944A Multiprogrammer Interface</b>	Series 300	HP 98633A	400
<b>Floating Point Math Board</b> —Provides hardware floating point capability for Series 200 and Model 310 computers.	Series 300	HP 98635A	1,005
<b>Analog-to-Digital Card (ADC)</b> —Provides seven channels of 55,000 readings per second for data acquisition	Series 300	HP 98640A	1,010
<b>RJE Interface</b> —Emulates IBM 2780/3780 when used with 50967A/R software in an HP-UX system with asynchronous modem.	Series 300	HP 98641A	1,275
<b>RS-232C MUX Interface</b> , 4-port—Three direct connect and one modem port.	Series 300	HP 98642A	610
<b>LAN 300 Link</b> —Connects to IEEE 802.3 or Ethernet, 10-Mbyte/second ThinLAN.	Series 300	HP 98643A	1,325
<b>VME Interface</b> —Connects Series 200/300 computers to VMEbus card cage.	Series 300	HP 98646A	1,312
<b>Programmable Datacommunication Interface (PDI) Development Package for 98691A</b>	Series 300	HP 98690A	425
<b>Programmable Datacommunication Interface (PDI)</b> . Development package for special data communications or serial interfacing.	Series 300	HP 98691A	665

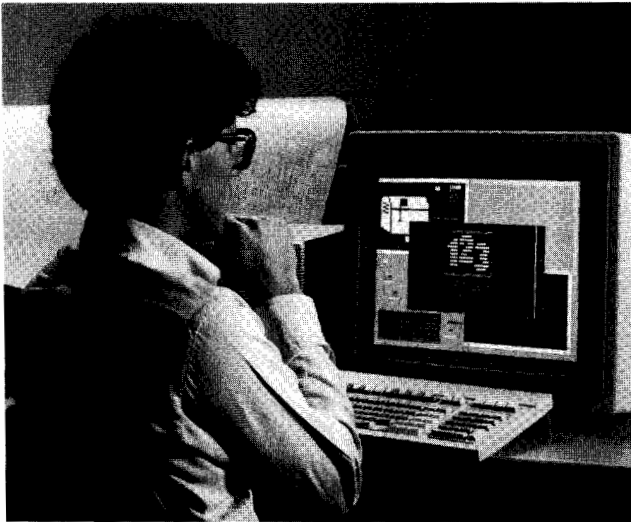

HP's new Series 300 DOS Coprocessor bridges the gap between UNIX® and MS-DOS® operating systems.

#### Series 300 DOS Coprocessor

The HP Series 300 DOS Coprocessor System provides IBM PC AT software compatibility for the Series 300. Running in an HP-UX environment, the HP Series 300 DOS Coprocessor bridges the gap between the world's most popular but otherwise incompatible operating systems, UNIX and MS-DOS. With the addition of the DOS Coprocessor, the Series 300 customer has access to literally thousands of standard, "off-the-shelf", MS-DOS based software applications. Compatible applications include such popular DOS applications as Lotus 1-2-3®, WordPerfect®, and R:Base for DOS®.

#### IBM PC AT on a Plug-in-Card

The DOS Coprocessor System is comprised of an 80286 based Coprocessor DIO-I card (with socket for an optional 80287 numeric coprocessor) and the DOS Coprocessor Software. The system requires HP-UX version 6.2 or later, with a minimum of the single-user AXE (Application Execution Environment) and works with Series 300 systems that can accept a DIO-I based card. A variety of Series 300 system configurations are supported. The system allows DOS to function as a true HP-UX task that can operate either in the X Window System (Version 11), HP Windows 9000, or with no windowing system.

The DOS coprocessor software consists of many elements, including a PC-AT compatible version of MS-DOS 3.3, Vectra's Personal Applications Manager (PAM), an extensive utility set, and utilities to interchange HP-UX ASCII files with MS-DOS format. The system allows use of "off-the-shelf" 360K 5¼-inch and both 720K and 1.44 megabytes 3½-inch DOS applications via, respectively, the HP 9127A and all HP 3½-inch drives that support these densities.

A great deal of effort has been made to improve the interactive performance of the DOS System. While the majority of systems of this type offer undesirable interactive performance, the DOS Coprocessor System has evolved to offer impressive interactive performance on the majority of host machines.

#### Shared-system Resources

The DOS coprocessor system is designed to take advantage of shared-system resources wherever possible. The following components, for example, are shared between HP-UX and MS-DOS: keyboard, memory, display, printers and plotters, mouse, file system, and

RS-232-C ports. Designing the system in this fashion provides a degree of DOS/UNIX operating systems integration unapproached in the industry.

In fact, the majority of the DOS file system exists entirely within the HP-UX file system. File System Access software provides a 'view' of the entire resident HP-UX file system. The user can then use standard DOS commands to manipulate the HP-UX file system. For example, the DOS user could make directories and store and retrieve the majority of his DOS files directly in the HP-UX file system. Drive C: is configured to appear to DOS as a standard PC AT 20Mbyte hard disc. Using this drive, even applications that directly manipulate DOS's file system data structures are compatible. To HP-UX, this drive appears as a standard file.

The system emulates many IBM PC interface cards using specialized software and existing Series 300 hardware resources. System memory, for example, is shared between DOS and HP-UX and can be allocated to the DOS Coprocessor as Conventional, Extended and Expanded memory (according to the Lotus®/Intel®/Microsoft® Expanded Memory Specification, version 4.0). EMS emulation allows DOS applications that support EMS (i.e. Lotus 1-2-3) running on the DOS Coprocessor System to access memory beyond the Conventional PC memory limitation of 640K. Many PC display adapters are also emulated (MDA, CGA, EGA, and Hercules Graphics) with multiple window sizes, dithered gray scaling (with CGA emulation on Monochrome monitors), and greatly improved alpha fonts using various Series 300 video interfaces and displays. Common PC I/O capabilities are also provided allowing Series 300 interfaces (RS-232, HP-IB, HP-HIL) to emulate standard PC I/O interfaces (RS-232, Centronics Parallel)

#### NewWave Support

The system has been specifically designed to provide for the ability to use the HP NewWave System. In addition to the EMS driver mentioned above, other enhancements have been added to guarantee operation of HP's new office automation environment, NewWave. An MS Mouse driver is supplied that allows the HP-HIL mouse to function as an MS Mouse when in the DOS window.

#### BASIC/Pascal Integration

Although the system requires HP-UX, it has been developed so that it can also be used in BASIC/Pascal environments. The system only requires a minimum of the AXE (Application Execution Environment) portion of the HP-UX system to operate. Using this lost cost version of HP-UX, the system can easily be used in conjunction with another operating system such as Basic or Pascal. With the most recent revisions of the BASIC and Pascal operating systems, the entire HP-UX/DOS/BASIC and/or Pascal system can be placed on a single hard disc where all systems share the same file system.

#### Ordering Information

		Price
HP Series 300		
DOS coprocessor system (includes card and software)	HP 98286S	\$1,335
HP Series 300		
DOS/Memory Enhancement Kit (includes 1 megabyte of RAM and HP 98286S)	HP 98286T	\$2,270
DOS Coprocessor Discless Node Kit	HP 98286D	\$1,245
HP 360 Kbyte		
5¼-inch IBM-compatible floppy	HP 9127A	\$1,090
HP numeric coprocessor (80287)	HP D1387A	\$450

Lotus and 1-2-3 are U.S. registered trademarks of Lotus Development Corporation, R:Base for DOS is a U.S. registered trademark of Microrim, WordPerfect is a U.S. registered trademark of WordPerfect Corporation, Microsoft and MS are U.S. registered trademarks of Microsoft Corporation, Intel is a U.S. registered trademark of Intel Corporation.



# TECHNICAL COMPUTER SYSTEMS

## HP 1000 Computers for Real-Time Applications

- Computer-aided manufacturing
- Computer-aided test
- Real-time monitoring and control
- Real-time data acquisition

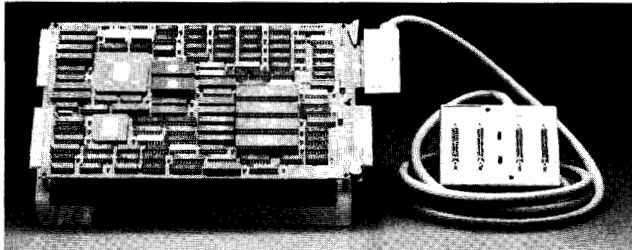

HP 12100A A400 Minicomputer packs a complete A-Series CPU, 0.5 megabyte of memory, and a four-port serial I/O multiplexer on one card

### Versatile Design for Real-Time Uses

HP 1000 computers are open, modular machines that are designed for real-time multiprogramming, multi-user applications in manufacturing, communications, research, and other fields that require real-time response. A choice of four processors and a wide variety of interfaces and software equips HP 1000 computers to solve many different applications, taking advantage of these HP 1000 real-time performance features:

**Fast, Efficient Handling of I/O.** External sensors, measurement instruments, and other I/O devices connect to HP 1000 systems via I/O interfaces and an I/O system with multi-level, vectored hardware interrupt that expedites I/O. Each I/O channel has its own interrupt priority level, from which interrupts directly initiate service programs. Direct memory access controlled under a distributed intelligence I/O design speeds data transfers to and from memory with minimal involvement of the CPU.

**Fast Processing of Data.** HP 1000 systems can process data at base instruction rates to 1.3 MIPS and floating point processing speeds to 820 KWIPS-BID. This minimizes the time needed to process input data, evaluate results, and initiate real-time action.

**Clocked Operations Timing** is provided by time base generator interrupts that maintain a real-time clock.

**Large Main Memory Capacity.** Up to 32 megabytes of main memory can be provided to keep most critical programs resident and ready to execute quickly, avoiding the delays inherent in moving programs to and from disc.

**A Powerful Real-Time Operating System.** The RTE-A system supports memory-based or disc-based real-time multiprogramming operation with easy, efficient inter-process communication, and priority-based scheduling of programs in response to event interrupt, time-of-day, or program or user request. RTE-A manages sharable memory-resident data arrays up to 2 megabytes and virtual data arrays up to 128 megabytes in main memory and on disc. With its VC+ extension, RTE-A supports execution of programs as large as 7.75 megabytes.

### A Choice of Processors for Diverse Applications

Performance Level	HP 1000 Processor	Base Speed (MIPS)	Floating Point Speed (KWIPS-BID)	I/O B/W (MB/Sec)
1	A400	0.4	120	4.3
	A600+	0.4	110	4.3
2	A700	0.4	370	4.0
3	A900	1.3	820	3.7

**The A400 Minicomputer** packs an 0.4 MIPS CPU, double precision floating point firmware, 0.5 megabyte of memory, and a four-port serial I/O multiplexer on a single plug-in board computer (SBC). At a price close to what you'd expect to pay for a personal computer, the A400 SBC delivers full A-Series functionality, including support under the RTE-A real-time executive operating system and complete compatibility with all other members of the A-Series family.

**The A600+ Minicomputer** offers 0.4 MIPS base execution speed and double-precision floating point firmware. Unlike the A400 minicomputer, the A600+ can support ECC memory as well as parity memory. The A600+ processor consists of a CPU card and a memory controller card.

**The A700 Computer** adds floating point hardware with scientific and vector instruction sets to the basic capability of the A400 and A600+ minicomputers, thus offering superior support of computer simulation, graphics, and other computation-intensive uses. The A700 is a five-board computer.

**The A900 Computer** incorporates a pipeline implementation and a cache memory scheme providing three times the performance of an A700 computer. The A900's floating point processor and scientific and vector instruction sets are built-in and 768k bytes of ECC memory is standard for maximum system integrity. The five-board A900 is the ultimate computation machine designed to meet the most demanding needs of OEMs, system designers, and end users.

**Exceptional Applications Flexibility.** Programs can be developed on any member of the A-Series family and executed without change on any other member, from the A400 on up to the A900. Processing power, capacity, and cost can be closely matched to application requirements with the guaranteed ability to grow as and whenever necessary. When upgrading, A400, A600+, and A700 computers can receive trade-in credit toward the purchase of A900 computers.

### Flexible Packaging — from Board Computers to System Processor Units

HP 1000 A-Series processors are available in a variety of packages to meet the requirements of many different applications, as shown in the photo on the next page and as summarized below.

Processor	A400	A600+	A700	A900
Board Computer	12100A	2106CK/DK	Not Avail.	Not Avail.
Micro 14/16 6-Slot Box Computer	2424A	2426G/H	Not Avail.	Not Avail.
Micro 24/26/27/29 14-Slot - Box Computer - System Proc. Unit	2434A	2436G/H	2437B	2439B
	2484B	2486B/C	2487B	2489B
20-Slot Box Computer	2134A	2156C/D	2137B	2139B
Model 26/27/29 System Proc. Unit	Not Avail.	2196G/H	2197E	2199E

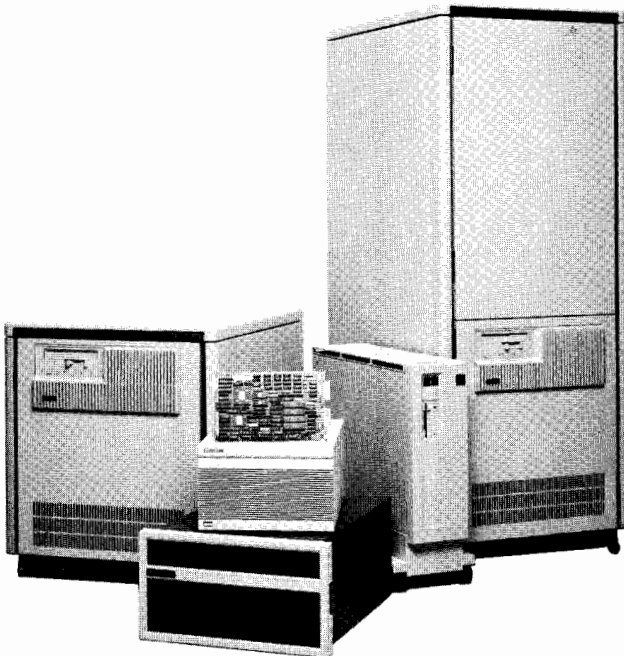

**Board Computers** make the A400 or A600+ processor available to OEMs or system designers in a minimal package for embedded controller applications, or other uses in which custom integration is required to fit into a particular physical package or to meet cost objectives.

**Box Computers** incorporate the CPU card(s) and memory in a fully-powered card cage that can be installed in a rack cabinet. Because a system console and system disc are not prerequisite to purchase, the box computer offers OEMs and system designers more configuration flexibility than the System Processor Unit.

**System Processor Units (SPUs)** include a box computer, interfaces to the system console and system disc, the RTE-A operating system and diagnostics, site prep consultation and installation/checkout services, and 90-day on-site warranty. The higher level of integration of the SPU simplifies design, ordering, and implementation of systems that use a system console and a system disc. The SPU also complies with FCC and VDE EMI regulations.

**The Micro 14/16 Box Computer** provides the A400 or A600+ processor in a low-cost 6-slot box for low-end systems. Exceptionally efficient cooling makes possible operation in ambient temperatures to 60°C. This and a 1.5G operating shock spec make the Micro 14/16 ideal for use in tough environmental conditions.

**The Micro 24/26/27/29 Box Computer or System Processor Unit** provides the A400, A600+, A700, or A900 processor in the versatile 14-slot Micro/1000 package. The Micro/1000 package can be placed on a table or bench, installed in a space-saving vertical floor mount with roll-about mobility (as shown in the photo above), or rack-mounted in a larger cabinet. In addition to its compactness and convenience, the Micro/1000 package can incorporate integrated mass storage (a 20 megabyte mini Winchester disc and a 630 kilobyte microfloppy disc).

**The 20-Slot Box Computer** provides the A400, A600+, A700, or A900 processor in the largest available package for applications that need more card cage slots than the Micro/1000 package provides.

**The Model 26/27/29 System Processor Unit** provides the A600+, A700, or A900 processor in the 20-Slot box computer that is intended to be rack mounted in either a tall or a short rack cabinet (HP 29431G or HP 29429A).

#### High Density Memory

HP now offers HP 1000 memory using 1M bit RAMs: 2, 4, and 8 megabyte parity memory boards for the A400, A600+, and A700 computers and an 8 megabyte ECC memory board for the A900 computer. Four of these memory boards can give 32 megabytes of memory to A-Series computers or SPUs.

Parity checking memory is standard in HP 1000 memory systems for the A400 and A600+. For large systems in critical applications, Error Correcting Code (ECC) memory, standard in A900 and optional in A600+ and A700, detects and corrects all single-bit errors and detects all double-bit errors to provide the best possible system integrity.

#### HP 1000 Software

HP 1000 software products for program development, data base management, graphics, distributed systems networking, quality decision management, programmable controller communications, and process monitoring and control are supported in all HP 1000 A-Series computers. This universality of HP 1000 software helps you to tailor comprehensive, coherent solutions to your specific application needs. Further help is available from a growing array of HP 1000 software products offered by third party suppliers under the HP PLUS software program.

#### Program Development

With a hard disc and optional software, HP 1000 systems can be used to develop programs in BASIC, FORTRAN 77, Pascal, Ada, and Macro/1000 Assembly language. Symbolic Debug/1000, program profiling, and user microprogrammability (of the A900 processor) provide extra capability that can be used to gain extra performance.

#### Plant Automation

HP's wide range of hardware and software supports automation of instruments and machines as well as monitoring and control of real-time processes. The HP 1000 can help improve productivity and reduce costs. For low point-count data acquisition, A-Series Measurement and Control Cards provide many analog interfacing functions right in the computer, without the need for an add-on peripheral device.

#### Computer Networking

HP's AdvanceNet networking software makes it easy to connect HP1000 systems across a city or a continent, sharing vital information throughout the network. LAN link is now available for fast Local Area communications with other HP systems or with DEC VAX systems.

#### Compatibility with HP 9000 Series 800 Systems

PORT/HP-UX applications migration tools supplied with the HP 1000 A-Series and HP 9000 Series 800 systems promote compatibility of HP 1000 systems with HP 9000 Series 800 systems. Multiple HP 1000 systems used as factory floor cell controllers can thus benefit from supervision and support by HP 9000 Series 800 systems used as Area Managers at Level 2 in the CIM hierarchy, or in similar supporting host roles.

#### Automated Test Systems

HP Automated Test Systems can be configured from HP 1000 A-Series computers and a wide range of electronic instruments to perform virtually any electronic test application.

#### Prices

Range from \$2550 for an HP 12100A A400 Single Board Computer with 0.5 MB parity memory and four-port multiplexer to \$39,800 for an HP 2489B A900 Micro/1000 system with 3 MC ECC memory, RTE-A/VC+ operating system, 20 MB integral disc, and system console connected via an eight-port multiplexer.



## **COMPUTERS, PERIPHERALS & OTHER KEY PRODUCTS**

<b>Solid State Devices .....</b>	<b>674</b>
<b>Analytical Instruments for Chemistry .....</b>	<b>676</b>
<b>Medical Instrumentation .....</b>	<b>678</b>
<b>X-Ray Equipment .....</b>	<b>680</b>
<b>Personal Computers &amp; Terminals .....</b>	<b>682</b>
<b>Calculator Products .....</b>	<b>692</b>
<b>Business Computer Systems .....</b>	<b>696</b>
<b>Computer Peripherals .....</b>	<b>706</b>

Hewlett-Packard offers other important products for industry, including LED solid-state devices, fiber optic components, analytical instruments for chemical applications, medical electronics, and scientific and industrial x-ray systems.

HP is a major business-computer manufacturer. Our offering includes calculators, portable computers, personal computers and minicomputers. In 1986 HP introduced the first in a series of new, high-performance computers based on HP Precision Architecture, allowing the company to develop a broad range of compatible computers of outstanding price/performance, compared to conventional designs.

**Computers,  
Peripherals &  
Other Key Products**

# SOLID STATE DEVICES

## Components

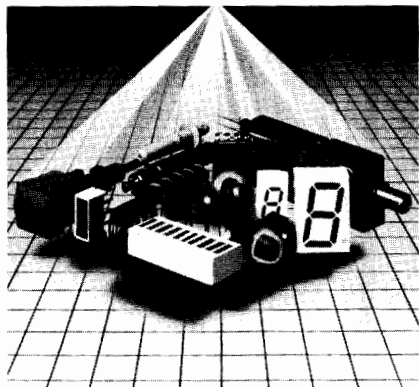

HP's Growing Optoelectronic Family

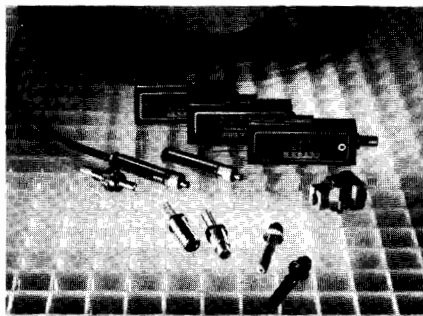

Fiber Optic Family



Hermetic Optocouplers

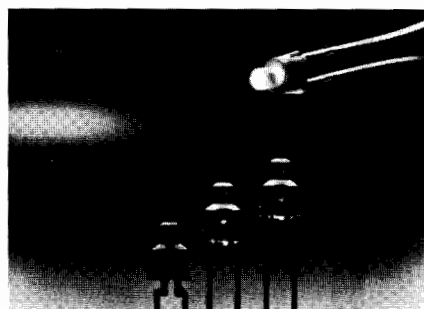

LED Lamps

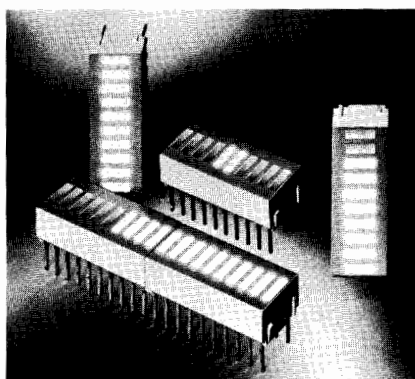

Light Bars

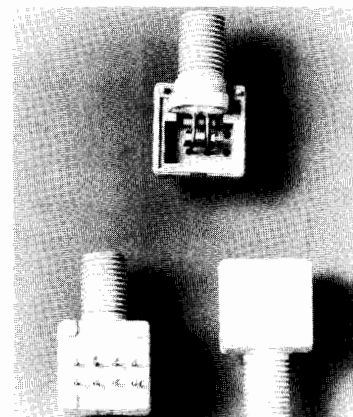

Low-Price Miniature  
Fiber Optic Components

### LED Solid State Lamps, Light Bars & Arrays

Hewlett-Packard is a world leader in the area of LED technology, and offers a broad variety of LED indicator products available in red, high efficiency red, yellow and high performance green. Emphasizing high brightness and superior reliability, Hewlett-Packard's most recent product introductions include a family of high-performance green indicators, ultrabright LED lamps (125 mcd at 20mA), and LED bar graph arrays of 10- and 101-elements. Recent advancements in the fundamental semiconductor material have generated new areas of contribution, particularly in sunlight viewability, low power consumption, and brightness.

### Solid State Displays

Hewlett-Packard offers a complete line of seven-segment displays in red, high efficiency red, yellow and high performance green and in a wide variety of package sizes. The newest member is the micro-bright display which has a 0.3-inch character height in a 0.5-inch by 0.3-inch package.

LED alphanumeric displays in monolithic and dot matrix versions are also available. Some of these rugged displays are screened and tested for use in military applications and harsh environments.

The aesthetic appearance and reliable performance of LED displays make them appropriate for use in instruments, point-of-sale,

appliance, automobile, telephone and other high-ambient light front-panel displays.

### Optocouplers

Hewlett-Packard's family of logic compatible, high-performance optocouplers provides solutions to problems caused by ground loops and induced common mode noise for both analog and digital applications in commercial, industrial and military products.

Types of optocouplers available include high-speed and high-gain devices ac/dc to logic interface optocouplers, and optocouplers which interface directly with microprocessors.

### Fiber Optic Components

Hewlett-Packard offers three families of fiber optic components which include transmitters, receivers, cable, connectors and connector assembly tools.

### Plastic Snap-In Link Components

Low cost and ease of use make this family of link components well-suited for applications connecting computers to terminals, printers, plotters and industrial-control equipment. These links use rugged, 1 millimetre diameter plastic fiber cable. Assembling the plastic snap-in connectors onto the cable is extremely easy. The HFBR-0500 evaluation kit contains a complete working link including transmitter, receiver, 5 metres of connected cable, extra connectors, polishing kit and technical literature.

### Miniature Link Components

This family offers a wide range of price/performance choices for computer, industrial-control and military applications. The unique design of the lensed optical coupling system makes this family of components very reliable. The low cost miniature line (HFBR-0400 series) features a Dual-in-line package which requires no mounting hardware or receptacle for use with SMA-style connectors. The standard miniature line (HFBR-0200 series) features a precision metal package for rugged applications. Both HP-style and SMA-style connectors are available for this line. An evaluation kit is available for sampling purposes. The HFBR-0200 kit contains transmitter, receiver, 10 metres of cable and technical literature.

### High Performance Modules

Transparent TTL-TTL link capability and independence from data format restrictions make this family of modules easy to use in a variety of applications. A link monitor on the receiver provides a digital indication of link continuity, independent of the presence of data. The modules are compatible with HP-style connectors and small-diameter glass fiber cable. A transmitter, receiver, 10 metres of connected cable and technical literature are contained in the HFBR-0010 evaluation kit.



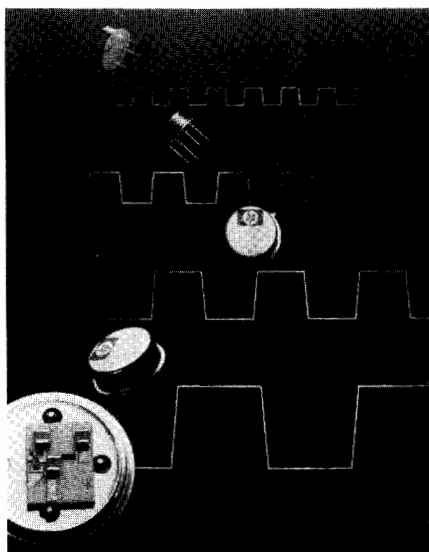

Hybrid Cascadable Amplifiers

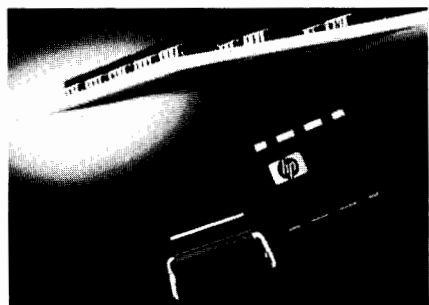

Surface Mount Optocouplers

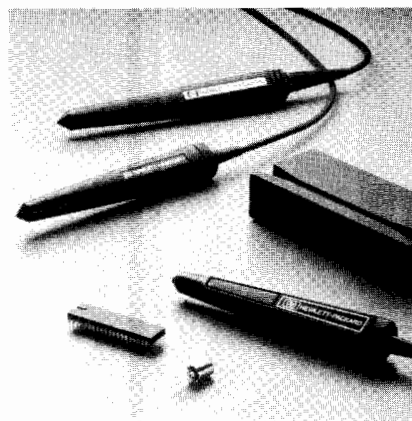

Bar Code Components



Bipolar Transistors

### Silicon Bipolar Transistors

Device-to-device uniformity and superior performance are combined in the HXTR series of microwave transistors which have been individually designed for low noise (HXTR-6000 series), high gain (HXTR-2000 series), low distortion linear power (HXTR-5000 series). With guaranteed RF performance specifications from 1000 to 4000 MHz, these devices are well suited for high-reliability, space military, and industrial applications at frequencies up to 6000 MHz.

### Diodes

Schottky Barrier Diodes combine extremely high rectification efficiency with picosecond switching speeds, low series resistance, and low noise characteristics. This combination makes the Schottky an excellent mixer/detector diode.

**PIN Diodes:** PIN diodes function as variable resistors at microwave frequencies. By controlling the dc bias, the RF resistance of a PIN diode can be varied from 1 ohm to about 10 ohms. This property of the PIN diode makes it extremely useful as a switch attenuator, modulator, phase shifter, limiter or AGC element at all frequencies from 1 MHz to 18 GHz and above.

**Step Recovery Diodes:** The step recovery diode is most graphically described as a

charge-controlled switch. That is, a forward bias stores charge, a reverse bias depletes this stored charge, and when fully depleted the SRD ceases to conduct current.

**Diodes for Hybrid Integrated Circuits:** These circuits are used to achieve circuits with light weight, small size, operation to high frequencies, repeatable characteristics and lower end-product costs. HP offers a wide range of PIN, Schottky and SRD single diodes in beam lead and chip configurations as well as Schottky lead pair and quad diodes.

**Integrated Products:** Hewlett-Packard manufactures a broad line of components for the control, conversion, and generation of RF and microwave signals. This line of integrated products (combinations of chip and beam lead diodes with hybrid thin film circuit technology) includes SPST switches, absorptive modulators, attenuators, limiters, comb generators, double-balanced mixers, and mixer/detectors.

### Bar Code Products

Designed to meet the OEM's bar code needs, Hewlett-Packard's bar code line includes digital bar code wands, two decoder IC's, optical reflective sensors, slot readers, and bar code readers. The expanding line of digital wands contains HP's Low Current Digital Bar Wand, which draws less than 5

mA of current at 5 volts, and the HP Smart Wand, an optical programmable contact bar code reader for the HP-94 Industrial Handheld Computer. The Digital Slot Reader, introduced in 1986 and available in both an infrared (880 nm) and a visible red (660 nm) version, is ideal for use in security or industrial applications. The Multi-Purpose Decoder IC offers a simple and inexpensive solution of adding bar code decoding capabilities to OEM products.

### High Reliability Testing

Many Hewlett-Packard components are space qualified. The reliability of these devices is established by one of the finest high reliability testing facilities in the microwave component industry. Hewlett-Packard's High Reliability Test Group maintains military approved JAN and JANTX parts in stock and can recommend HP standard screening programs, patterned after MIL-S-19500, for any HP component.

### Write For More Information

Specifications of Hewlett-Packard's component products are available in individual data sheets or complete designer catalogs. These are available free of charge from your local HP sales office or authorized distributor, or return the Information Request Card located at the back of this catalog.

## ANALYTICAL INSTRUMENTS FOR CHEMISTRY

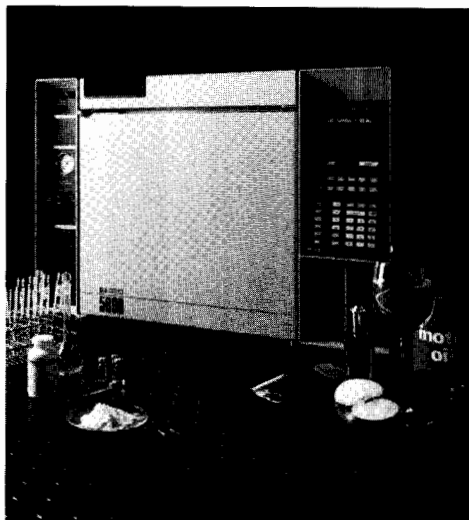

HP 5890A Gas Chromatograph



HP 3396 Integrator

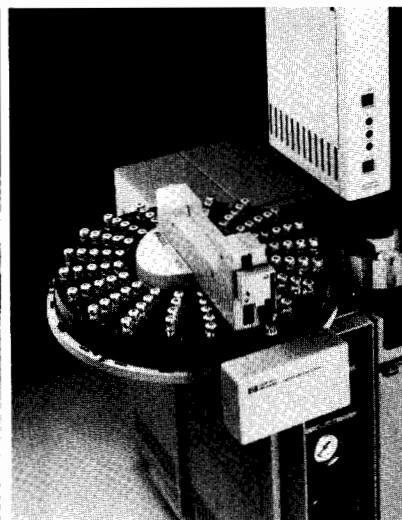

HP 18587A Bar-code Reader



HP 3359A Worksystem

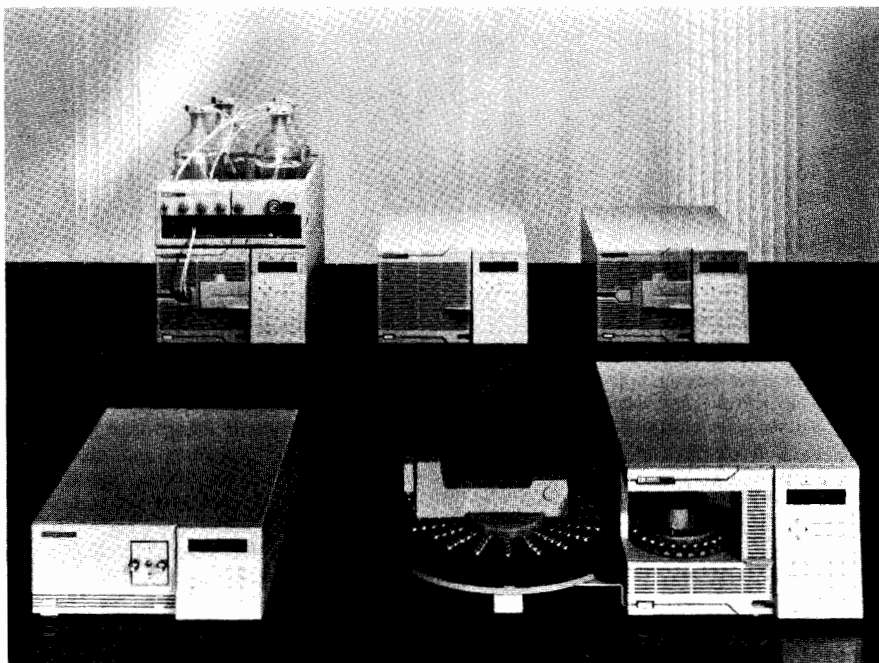

HP 1050 Series HPLC Modules

**Hewlett-Packard**, a manufacturer of both laboratory instruments and computers, can meet the needs of most labs—from instruments for routine analysis, to multi-instrument, multi-user systems.

**Integrators.** The HP family covers a wide range on the first rung of the data handling ladder. The new HP 3396A low-priced integrator lists advanced software and permanent inkjet printing among its standard features.

**Workstations.** If your analysis techniques include GC, GC/MS, UV/VIS Spectrophotometry or LC/MS, there is a powerful HP ChemStation to control your instruments and handle your data.

**Laboratory Data Systems.** Multi-user, multi-instrument lab automation and lab information management systems. Based on the HP 1000 computer system, they provide easy-to-use, yet sophisticated data acquisition, data reduction and control, with a flexible upgrade

path. They help you manage the flow of samples, information and materials throughout your lab.

**Gas Chromatographs.** The HP 5890A GC has earned its place as the pacesetter of the industry. Used with the HP GC ChemStation, it is a powerful tool for research and development. Moreover, it is the most reliable GC available.

**GC Sample Identification.** The new HP 18587A Bar Code Identification System can be added to your HP 7673A Automatic Sampler. Bar code technology greatly reduces errors in tray loading and sample number entry.

**Natural Gas Analysis.** The HP 5890A is also available in a special configuration for the analysis of natural gas. This low-cost system is attractive to labs that monitor the processing and handling of natural gas.



HP AminoQuant, Amino Acid Analyzer

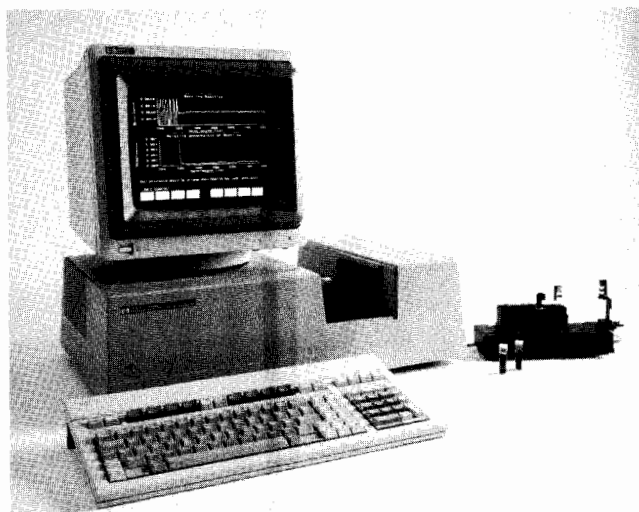

HP 8452A UV/VIS Spectrophotometer

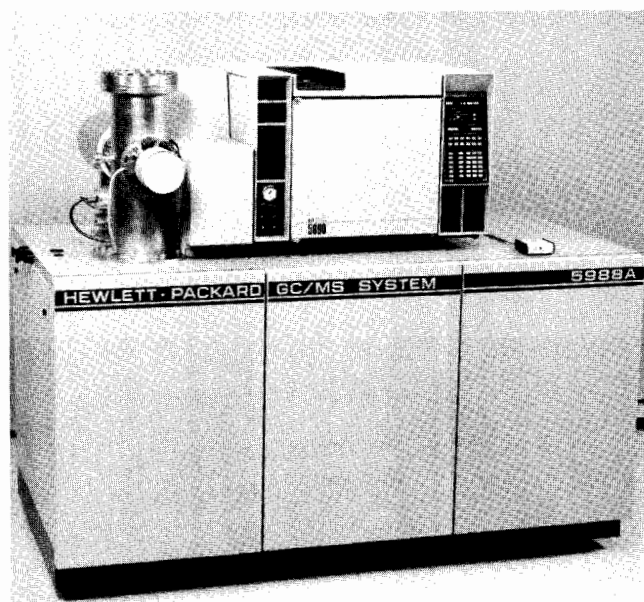

HP 5988A GC/MS System

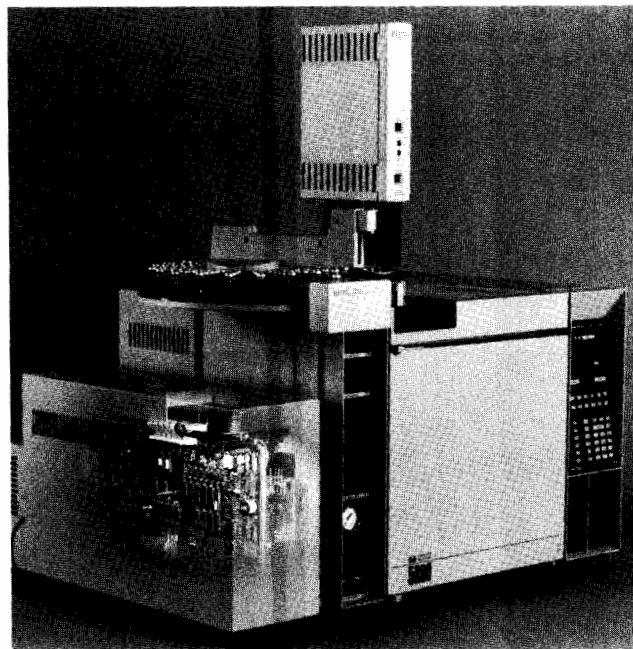

HP 5971A Mass Selective Detector

**Liquid Chromatography.** Adding to the proven capabilities of the HP 1090 integrated LC system, and the HP 1040 series of HPLC detectors—HP introduces the HP 1050 Series of HPLC Modules. Now you can upgrade the quality of your HPLC system a-piece-at-a-time. The HP 1050 Series includes an isocratic pump, a quaternary pumping system, an autosampler, a variable wavelength detector and a multiple wavelength detector.

If you need a fully integrated system, the HP 1090 Series is the choice. It offers some powerful and convenient data handling options. The HP 1090L has a single, built-in keyboard for easy control of the whole system. It's ideal for routine and high volume automated analysis. The HP 1090 Series M, which incorporates the HPLC ChemStation, offers exceptional versatility for methods development.

**Amino Acids Analysis.** HP AminoQuant, an HP 1090-based system, performs automated analysis of 17 primary and secondary amino acids. It includes extensively tested chemistries and methodologies which provide biochemists with precise, accurate and sensitive results.

**GC/MS and LC/MS.** Hewlett-Packard is leading the way in making mass spectrometry available in economically priced, compact systems. First, the new HP 5971A Mass Selective Detector (MSD). It is

smaller than any previous MSD, and offers surprising capability at a low price. It fits against the side of the HP 5890A GC, taking only seven linear inches of counter space.

The HP 5970B MSD is the most widely used, most proven MSD. It comes with a wide range of data system options. It takes only 18 inches of counter space.

The HP 5988A is HP's most powerful research-grade system. It comes in many configurations, including LC/MS.

**Drug analysis** is only one of the demanding applications addressed by HP's GC/IRD/MSD system. It combines the HP 5890A GC, the HP 5965A Infrared Detector, and the HP 5970 MSD. Therefore it provides three dimensions of data: retention times, infrared spectra and mass spectra. Data handling is provided by two HP ChemStations.

**UV/VIS Spectrophotometry.** The HP 8452 UV/VIS Spectrophotometer makes diode array technology accessible to labs where budgets are tight. It works with a variety of controllers, including the HP UV/VIS ChemStation, HP Vectra PC, and the IBM PC, XT or AT. **For further information** write to Hewlett-Packard Company, Analytical Products, 1820 Embarcadero Road, Palo Alto, CA 94303.

# MEDICAL INSTRUMENTATION

## Diagnostic Cardiology and Echocardiography

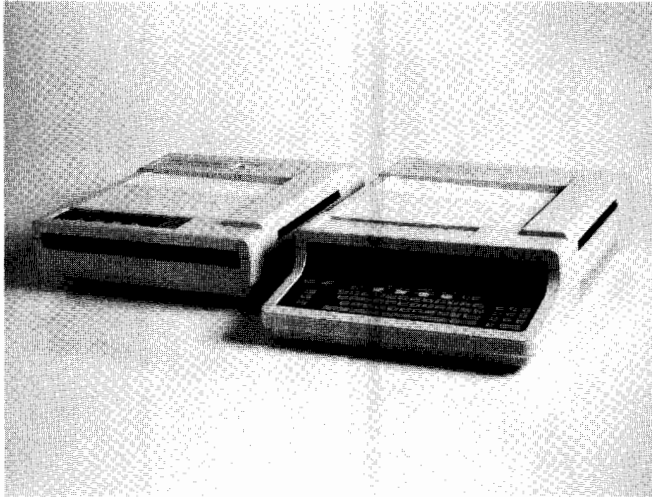

### Cardiography Instrumentation

- New HP 4765A PageWriter II Interpretive Cardiograph
- ECG Management Systems for computer-aided management of electrocardiograms
- ECG Workstations for PC-based ECG department management



### Ambulatory ECG

- True, two-channel analysis and ST-segment measurement
- System includes HP Vectra PC, custom software, two patient analyzers and an HP LaserJet Series II printer
- Optional HP 43405A Memory Module for full disclosure

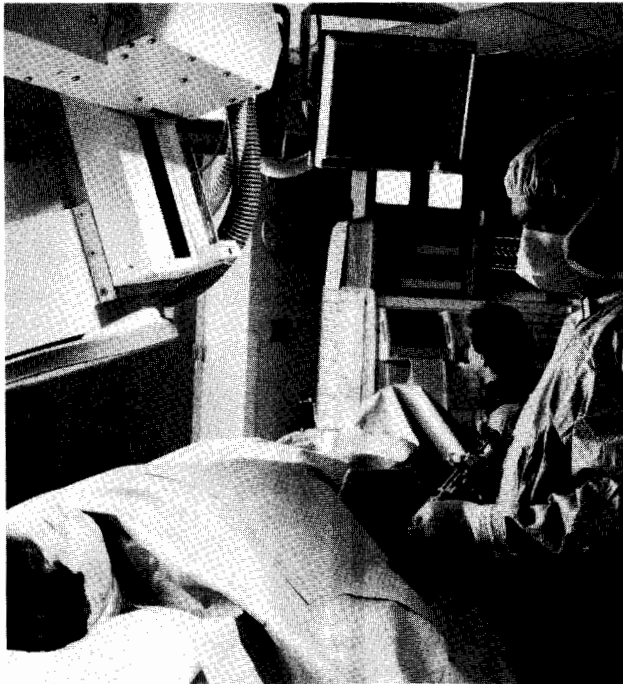

### Cardiovascular Instrumentation

- Computerized catheterization data analysis system automates on-line data collection analysis
- Comprehensive data base for generating both clinical and administrative reports
- Complete choice of plug-in signal conditioners and transducers

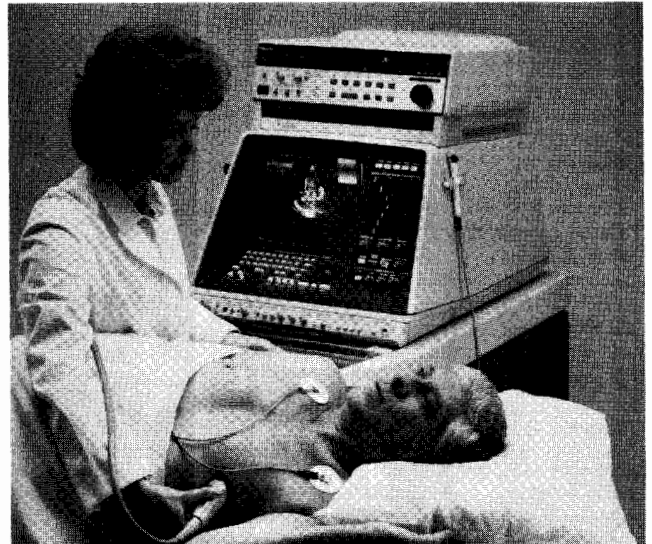

### Phased-Array Ultrasound Imaging

- Highly sensitive color flow imaging
- Superior 2-D, M-mode, and PW/CW Doppler imaging
- Dynamically focused phased-array transducers from 2.5 to 5 MHz
- Transesophageal imaging transducer option
- Upgradable to future advances in ultrasound technology
- Proven reliability and unsurpassed customer support



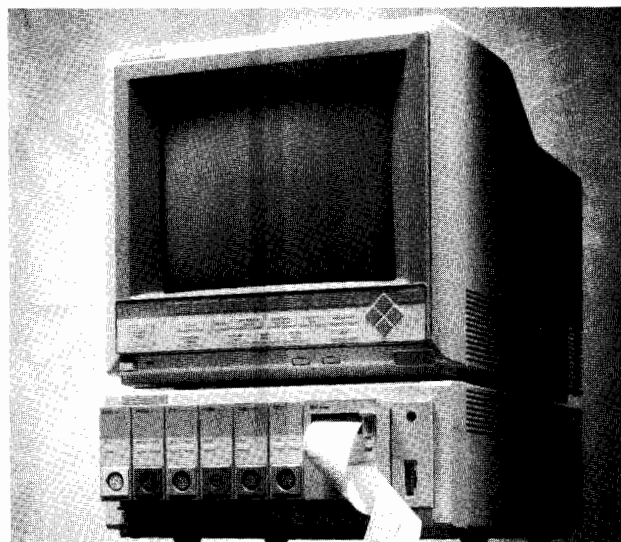

### Arrhythmia Monitoring

- Detection and classification by algorithm
- Advanced information management capabilities
- Patient Information Centers
- Telemetry



### HP Component Monitoring System

- Patient monitoring system for the OR, CCU, and ICU
- Monitors up to 16 parameters simultaneously
- Choose 4, 6, or 8 waveforms, color or monochrome
- Intuitive, 2-levels of operation
- Comprehensive data management
- Interface to HP Critical Care Network



### Resuscitation

- Easy to use, 3-step operation
- Lightweight, reliable design

### Obstetrical and Neonatal Instrumentation

- Fetal/maternal monitoring equipment includes antepartum and intrapartum fetal monitors, and central stations
- Telemetry for birthing centers
- Neonatal monitoring includes heart rate, temperature, respiration, pressure, and transcutaneous blood gas

For Additional Information on HP Medical instrumentation, request literature in one or more of the following categories:

- Patient Monitoring
  - Ultrasound Imaging
  - Cardiography Instrumentation
  - Cardiovascular Instrumentation
  - Obstetrical and Neonatal Instrumentation
  - Arrhythmia Monitoring
  - OR Monitoring
  - Resuscitation
  - Healthcare Information Systems
  - Healthcare Personal Computers
  - Supplies, Consumables, Pressure Transducers
- Please use request card at back of catalog.

An Invitation for you to become a subscriber to ADVANCES FOR MEDICINE, the Hewlett-Packard medical products magazine. To receive ADVANCES free of charge, simply fill in and return the request card at the back of this catalog.



# X-RAY EQUIPMENT

## Cabinet X-Ray Systems

Models 43855A, 43855B and 43856A

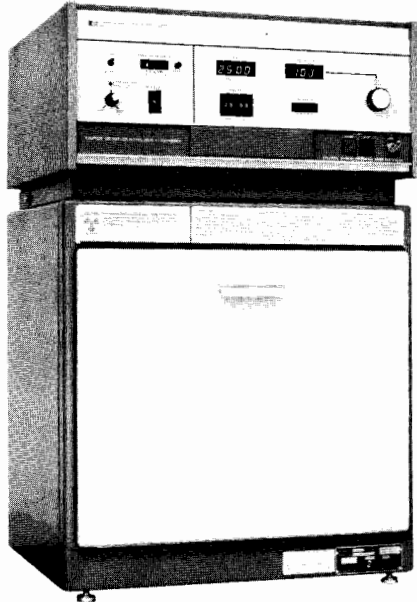

FAXITRON MODEL 43855A  
WITH OPTION A02



FAXITRON MODEL 43856A

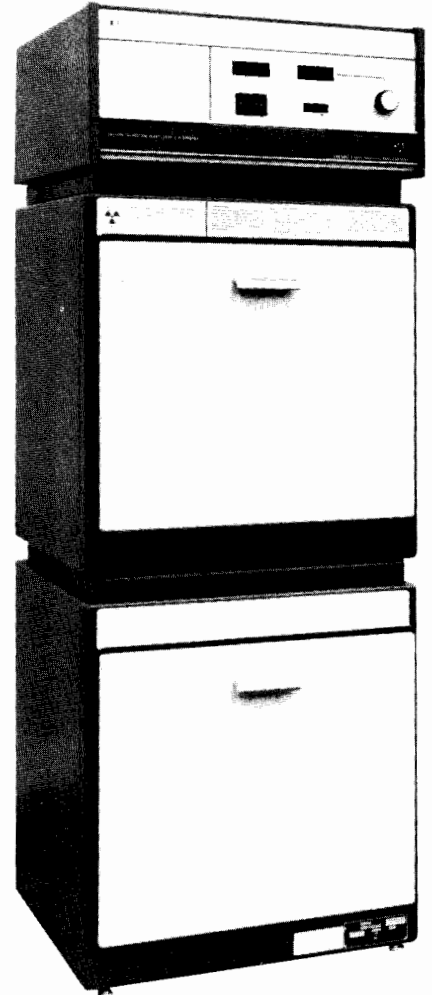

FAXITRON MODEL 43855B

### Faxitron® Cabinet Systems

Radiography, the art and science of making pictures with X-rays, has an important place in modern technology. It is one of the major nondestructive test methods available to industry, provides an indispensable tool in scientific investigations and is a valuable aid to law enforcement agencies. Hewlett-Packard makes a major contribution to these activities with X-ray equipment that offers a "better way" through advanced technology and design. This equipment makes radiographs easier and safer to take.

### Scientific Applications

Oceanography, geology, marine biology, paleontology, pathology, botany, forestry and agricultural research are a few examples of scientific disciplines that use X-rays. Applications range from the study of the interior anatomy of fossils to determining the viability of seeds.

These are among the many applications served by HP Faxitron Cabinet X-ray Systems. They offer a unique combination of high quality radiographic capability, simplicity of operation and convenience of use which is expanding the capabilities of scientific and industrial concerns throughout the world.

### Industrial Inspection

Industrial quality control and inspection procedures, especially in the field of electronics, benefit from nondestructive testing by radiography. The advantages of a testing method which does not harm the test objects are obvious. Radiography, therefore, offers benefits in design engineering, incoming inspection, production quality control, product reliability and failure analysis. X-rays are used to detect misregistration or plate-thru problems in multi-layer P.C. boards; porosity, poor substrate bonding and wiring or lead location in transistors and integrated circuits; voids and other encapsulation problems in potted components; and solder balls or other defects in sealed relays.

Die casting is another industry that benefits from the nondestructive aspects and ability to "see inside" provided by radiography. Porosity, gas void, tramp metal inclusion and other common defects can be easily detected and the cause determined. Expensive machining time can be avoided for castings found to be defective through X-ray inspection. The integrity of welds, alignment of connectors, inspection for proper assembly and mechanical defects are further examples of tests which radiography performs for industry. The benefits of X-ray testing are reduced production costs, better quality assurance and product safety. The results are increased profits.

### Medical Applications

HP Faxitron Cabinet X-ray Systems are used by the medical profession for specimen radiography in support of diagnostic surgical procedures and in biological research. Specimen radiographs of biopsy samples are correlated with preoperative mammograms, for example, and in the evaluation of mastectomy specimens. Typical research applications include microradiography of thin bone specimens and microangiographic studies of vasculature.

# X-RAY EQUIPMENT

## Flash X-ray Systems

Models 43703B, 43710A, 43731A, 43733A, 43734A

681

MODEL 43731A  
150kV

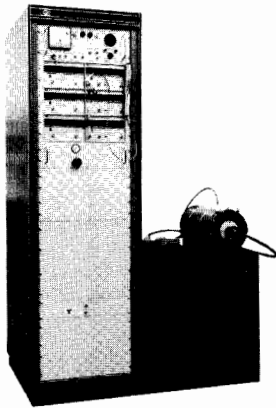

MODEL 43733A  
300kV

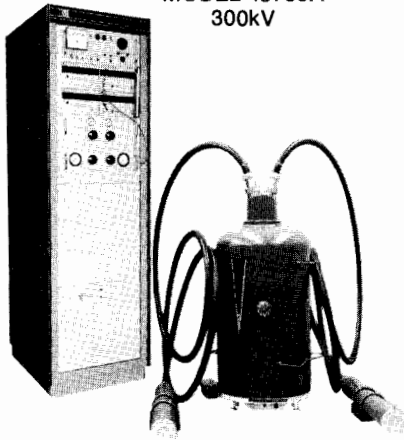

MODEL 43734A  
450kV

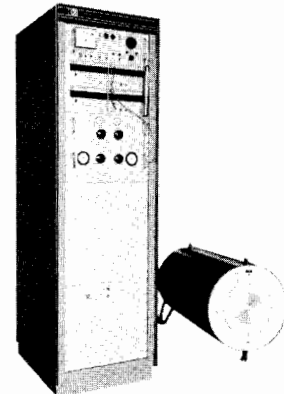

Option 035 - Dual Remote Tubehead

High-speed (flash) radiography is used to record and study dynamic events where interposed material, smoke, flame, debris, or pressure variations exclude the use of high-speed cameras. Typical events include ballistics, shaped charges, explosives, behind-armor studies, shock waves in solids, aerospace phenomena, and crash-injury studies.

The basic performance requirement of a flash X-ray system used for the study of transient mechanisms is to provide high resolution radiographs with exposure times short enough to eliminate motion blur. HP series 43700 Flash X-ray systems produce X-ray pulses of sub-microsecond duration and are designed specifically for "stop motion" radiographic applications. All HP 43700 series systems utilize the same basic components, the same electrical theory, and are modular in concept. Standard systems include 150 kV, 300 kV, 450 kV, 1 MV, and 2.3 MV models.

An HP basic single "channel" flash X-ray system, composed of a pulse generator, high voltage power supply, cold-cathode field emission X-ray tube, and associated controls, provides a single radiograph per event. Additional pulser/X-ray tube sets (add-on channels) may be combined with the initial single-channel system to provide multiple-channel "systems." Multiple channel systems may be of identical output voltage or may use varied output voltage pulser/tube combinations.

For specific information and consultation regarding HP X-ray systems, contact Hewlett-Packard, 1700 S. Baker Street, McMinnville, Oregon 97128. Telephone (800) 952-2212.

**ROCKVILLE (Sales)**  
#2 Choke Cherry Road  
Rockville, Maryland 20850  
Telephone (301) 948-6370

**ALBUQUERQUE**  
7801 Jefferson Street, N.E.  
Albuquerque, New Mexico 87109  
Telephone (505) 823-6100

**IRVINE**  
9800 Muirlands Avenue  
Irvine, California 92718  
Telephone (714) 472-3000

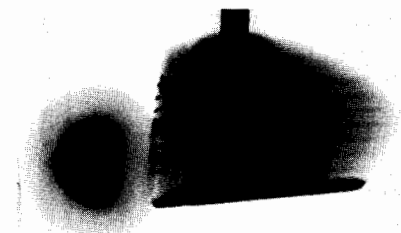
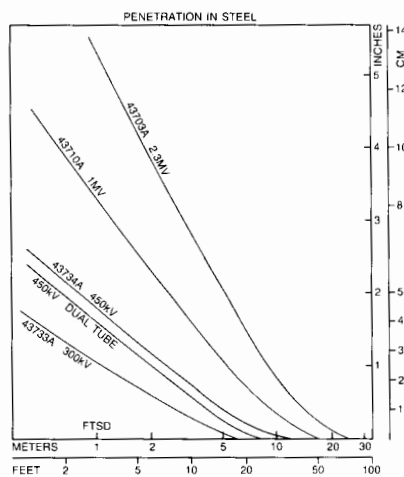
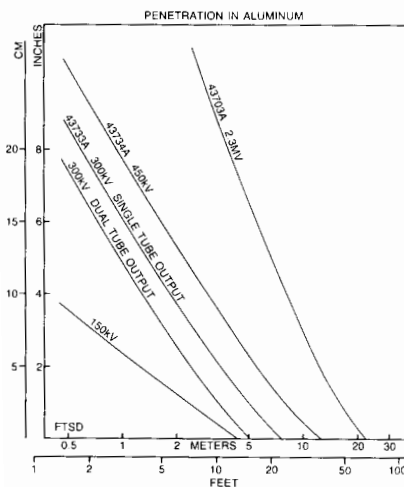

Compression of golf ball  
when hit with club

# PERSONAL COMPUTERS & TERMINALS

## Overview and Matrix



The HP Vectra PC Family now offers a full line of products, from portables to high-powered standalone systems.

### Products for Every Need

Hewlett-Packard's PC and terminal product line offers a broad range of excellent price/performance choices that are designed to meet a wide variety of needs, from entry-level ASCII terminals to advanced 80386 PC workstations.

The top of the line HP Vectra RS personal computers provide exceptional power and expansion capabilities, and are ideal for business, engineering or scientific applications. For CAD/CAM applications, combining an HP plotter and HP graphics tablet with an HP Vectra RS PC provides a high-performance engineering system. As a LAN server, the HP Vectra RS PC delivers outstanding throughput when using high-capacity, high-performance discs up to 310 Mbytes.

Our mid-range HP Vectra ES PC family is designed for a broad range of solutions. The HP Vectra ES/12 PC is ideal for desktop publishing applications, providing exceptional speed with an extensive selection of high-performance Hewlett-Packard software, accessories and peripherals.

The cost-effective HP Vectra CS PC provides surprising power for a variety of typical office applications. And should your needs grow, the superior expansion capability of the Vectra CS PC lets you expand your system to meet those needs.

For professionals on-the-go, HP's Portable Vectra CS provides the best of both worlds; it features full PC functionality in a battery-powered portable package.

If your computing environment requires terminals, Hewlett-Packard now has a complete line of terminals for all your system

needs within the HP environment as well as within DEC, IBM and other system environments. These products are designed with state-of-the-art ergonomics, including keyboards with tactile feedback, tilt and swivel displays, and a choice of phosphor colors.

And because all HP PC's meet industry standards, you can be assured that your future needs will be met as well as your needs are met today. All Vectra PC's support the MS-DOS® operating system, and our 80286 and 80386 models run both Microsoft® OS/2® and Santa Cruz Operation (SCO™) Xenix®.

Hewlett-Packard's new VGA video subsystem provides a new level of power across the entire product line. With performance up to four times faster than other available VGA systems, and features such as full 640 x 480 x 256 color capability and a 132-column capability mode, HP's VGA solution is unsurpassed among PC vendors. And because it is register- and BIOS-compatible, users can be assured of maximum compatibility.

For example, automatic disc caching, a technology typically found in minicomputers, dramatically reduces the time needed to access information stored on a disc, which increases the time you spend working on results. This feature is available on HP Vectra RS PCs. In addition, the Vectra RS PC systems support some of the fastest disc drives available, featuring an average disc-access time of 17 milliseconds.

Hewlett-Packard also boosts performance through implementation of expanded memory. All system memory on the HP Vectra ES/12 PC runs at the accelerated 12 MHz speed of the 80286 processor, further increasing system performance.

For large database, spreadsheet, and windowing applications, Hewlett-Packard's support of the Lotus®-Intel®-Microsoft® (LIM) 4.0 Expanded Memory Specification (EMS) provides even greater performance and versatility when breaking through the 640 Kbyte memory "barrier."

### HP Personal Computers

Hewlett-Packard has a personal computer system to match any application need. From our entry-level 8086-compatible PC through our mid-range 80286-based PCs, and up to our top-of-the-line 80386-based systems, HP provides computers that excel in their class.

### Power Throughout the Product Line

To achieve the highest system performance possible, each component of the HP Vectra PC is designed to optimize the performance of all other parts of the system. There are several innovative technologies that contribute to the overall power of the family.

Lotus is a U.S. registered trademark of Lotus Development Corporation.

Intel is a U.S. registered trademark of Intel Corporation. Microsoft, MS-DOS, Xenix and OS/2 are U.S. registered trademarks of Microsoft Corporation.

SCO is a trademark of Santa Cruz Operation.

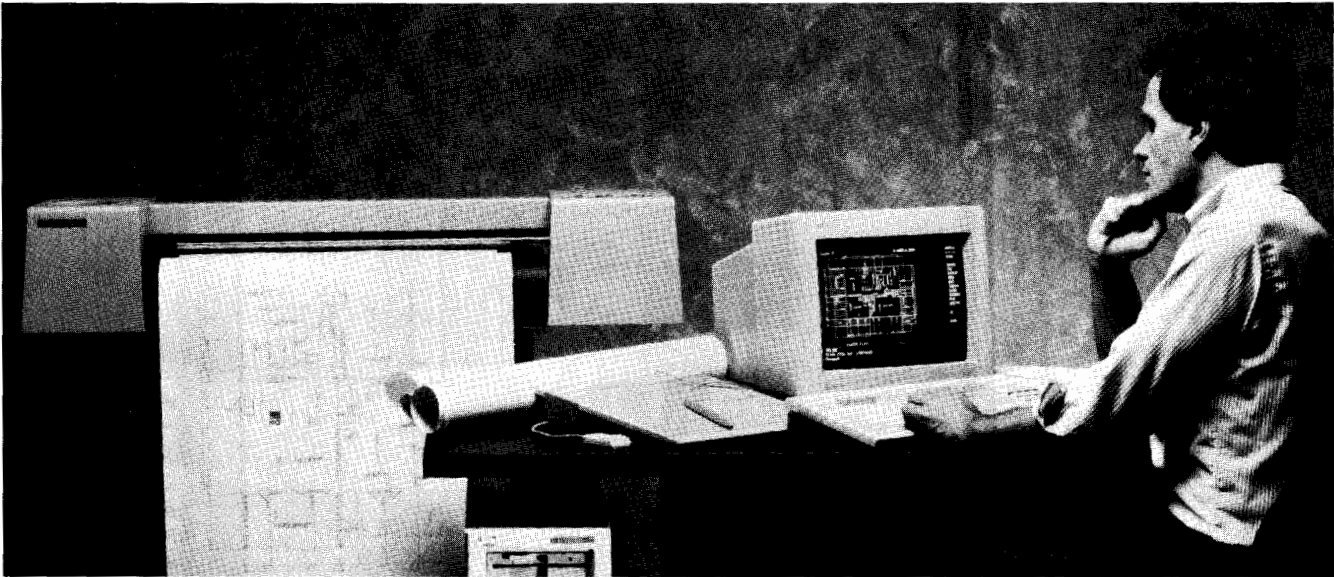

The HP Vectra RS personal computers are ideal for business, engineering or scientific applications.

### Personal Computer Matrix

PC	Model Number	Product Number	Processor	Standard RAM	Package Type	Flexible Disc size/(bytes)	Hard Disc (Mbytes)	Video Adapter (VGA)	Price
<b>CS</b>	Model 10	D1110A	8086	640 KB	D	5.25-in. (360-KB)		none	\$1,195.00
	Model 15	D1115A	Compatible	640 KB	D	3.5-in. (1.44-MB)		none	\$1,295.00
	Model 16	D1116A		640 KB	D	2 5.25-in. (360-KB)		VGA	\$1,695.00
	Model 20	D1120A	640 KB	D	5.25-in. (360-KB)	20	none	\$1,895.00	
	Model 26	D1126A	640 KB	D	5.25-in. (360-KB)	20	VGA	\$2,295.00	
	Model 27	D1127A	640 KB	D	3.5-in. (1.44-MB)	20	VGA	\$2,295.00	
<b>ES</b>	Model 10	D1210A	80286	640 KB	D	5.25-in. (1.2-MB)		none	\$2,395.00
	Model 15	D1215A	(8-MHz)	640 KB	D	3.5-in. (1.44-MB)		none	\$2,395.00
	Model 20	D1220A	640 KB	D	5.25-in. (1.2-MB)	20	none	\$2,795.00	
	Model 26	D1226A	640 KB	D	5.25-in. (1.2-MB)	20	VGA	\$3,195.00	
	Model 27	D1227A	640 KB	D	3.5-in. (1.44-MB)	20	VGA	\$3,195.00	
<b>ES/12</b>	Model 10	D1310A	80286	640 KB	D	5.25-in. (1.2-MB)		none	\$2,795.00
	Model 15	D1315A	(12-MHz)	640 KB	D	3.5-in. (1.44-MB)		none	\$2,795.00
	Model 20	D1320A	640 KB	D	5.25-in. (1.2-MB)	20	none	\$3,195.00	
	Model 26	D1326A	640 KB	D	5.25-in. (1.2-MB)	20	VGA	\$3,595.00	
	Model 27	D1327A	640 KB	D	3.5-in. (1.44-MB)	20	VGA	\$3,595.00	
	Model 40	D1340A	640 KB	D	5.25-in. (1.2-MB)	40	none	\$3,595.00	
	Model 46	D1346A	640 KB	D	5.25-in. (1.2-MB)	40	VGA	\$3,995.00	
	Model 47	D1347A	640 KB	D	3.5-in. (1.44-MB)	40	VGA	\$3,995.00	
<b>RS/16</b>	Model 40	D1500A	80386	1 MB	F	5.25-in. (1.2-MB)	40	none	\$5,995.00
	Model 100	D1502A	(16-MHz)	2 MB	F	5.25-in. (1.2-MB)	103	none	\$6,995.00
	Model 106	D1501A	2 MB	F	5.25-in. (1.2-MB)	103	VGA	\$7,395.00	
<b>RS/20</b>	Model 40	D1600A	80386	1 MB	F	5.25-in. (1.2-MB)	40	none	\$6,595.00
	Model 100	D1602A	(20-MHz)	2 MB	F	5.25-in. (1.2-MB)	103	none	\$7,595.00
	Model 106	D1601A	2 MB	F	5.25-in. (1.2-MB)	103	VGA	\$7,995.00	
	Model 150	D1603A	2 MB	F	5.25-in. (1.2-MB)	155	none	\$8,195.00	
	Model 300	D1604A	2 MB	F	5.25-in. (1.2-MB)	310	none	\$10,495.00	
	Power User	D1606B	4 MB	F	5.25-in. (1.2-MB)/ 3.5-in. (1.44-MB)	103	VGA plus 512K Video RAM	\$13,095.00	
<b>Vectra</b>	Portable CS	D1001A	8086	640 KB	P	2 3.5-in. (1.44-MB)		none	\$2,495.00
<b>Portable CS</b>	Model 20	D1009A	Compatible	640 KB	P	3.5-in. (1.44-MB)	20	none	\$3,675.00

D = Desktop F = Floor mount P = Portable

# PERSONAL COMPUTERS & TERMINALS

## Vectra RS Personal Computers



The top-of-the-line HP Vectra RS personal computers provide exceptional power and expansion capabilities.

### Top-of-the-Line Power and Expandability

The Hewlett-Packard Vectra RS personal computers are the most powerful and expandable members of the HP Vectra PC family. Using the power of the Intel 80386 microprocessor, these systems have the performance and growth potential to match the most demanding personal computer applications.

Both the HP Vectra RS/20 PC (20 MHz, 80386) and the Vectra RS/16 PC (16 MHz, 80386) systems rely on a combination of advanced microprocessor, memory and hard disc designs that result in performance several times that of 80286 systems.

The HP Vectra RS PCs can meet today's most demanding needs, as well as tomorrow's. They are designed to be fully compatible with existing industry standards (IBM PC/AT), as well as with new software that will more fully use the power of the 80386 - such as the Microsoft® OS/2 operating system. The HP Vectra RS PCs also support Microsoft Windows®/386 Presentation Manager, providing multi-tasking of your existing MS-DOS® 3.X applications.

The HP Vectra RS PCs use finely-tuned subsystems to achieve superior performance. At the center of the system is the most powerful microprocessor in the PC industry, the Intel 80386, which provides processing power three to four times that of the 16-bit 80286.

The HP Vectra RS PCs boost system performance with an advanced memory architecture. In addition, high-speed coprocessors enhance the computational power of the system.

Similarly, mass storage subsystems have been developed with performance in mind. The HP Vectra RS PCs support high performance (17-ms seek time), high capacity (up to 310 Mbytes) hard discs, using the Enhanced Small Device Interface (ESDI). These discs, which are designed and manufactured by Hewlett-Packard, provide the performance, compatibility and reliability for solutions that require up to 620 Mbytes of storage.

In addition, the HP Vectra RS PCs have processing power for up to 16 Mbytes of 32-bit memory, large power supplies, six mass-storage shelves and eight industry-standard accessory slots to accommodate your growing needs.



## Vectra RS PC Features

### System Processing Unit

- Intel 80386 32-bit microprocessor running at 20-MHz or-16 MHz clock rate, switchable to 8 MHz from the keyboard
- Eight PC/AT-compatible accessory slots:
  - two 8-bit slots
  - six 16-bit slots
- Four-function controller card: includes hard disc and flexible disc controller, one serial port, and one parallel port (occupies one 16-bit slot)
- Socket for Intel 80387 numeric coprocessor or Weitek 1167 floating point accelerator board
- System clock/calendar/system configuration with CMOS Random Access Memory (RAM) and battery backup
- Six half-height data storage shelves, all with front access
- One HP-Human Interface Link (HP-HIL) port allows up to six HP-HIL devices such as a mouse, graphics tablet, barcode reader and touchscreen to be connected simultaneously
- Dual locks secure cover and prevent input from keyboard and HP-HIL input devices

### Internal Memory

- Interleaved, page-mode memory subsystem architecture supports zero wait state memory reads on open pages. Average number of wait states depends on the application being run.
- Fast memory chips (80 ns for 20-MHz systems, 100 ns for 16-MHz systems)
- 1, 2, or 4 Mbytes of 32-bit memory standard, expandable to 16 Mbytes on processor board
- 64 Kbytes of Read Only Memory (ROM)
- Sockets for two additional Read Only Memory (ROM) chips

### Data Storage

#### Internal

Five internal data storage devices are supported: up to two hard discs and up to four flexible disc devices.

- 3½ inch, 1.44-Mbyte flexible disc drive (HP 45813A)
- 5¼ inch, 1.2-Mbyte flexible disc drive (HP 45812A)
- 5¼ inch, 360-Kbyte flexible disc drive (HP 45811A)
- 40-Mbyte ST-506 hard disc mechanism (HP D1297A)
- 103-Mbyte ESDI hard disc mechanism (HP D1674A)
- 155-Mbyte ESDI hard disc mechanism (HP D1675A)
- 310-Mbyte ESDI hard disc mechanism (HP D1676A)
- Four-function ESDI disc controller card (HP D1677A); includes hard disc and flexible disc controller, one serial port, and one parallel port
- Flexible disc expander (HP D1678A), required for support of third and fourth flexible disc interface devices
- 40-Mbyte internal tape backup mechanism (HP D1671A)

### External

- 67-Mbyte ¼-inch cartridge tape drive (HP 9144A), requires HP-IB disc/tape interface (HP 88500A)

### Video

- The HP Vectra RS PCs support the high-performance HP Video Graphics Subsystem

### System Software

- Microsoft MS-DOS® 3.3 for the HP Vectra Personal Computer
- Microsoft Windows®/386 Presentation Manager
- Microsoft Windows for the HP Vectra PC, Version 2.0
- Microsoft Operating System/2 1.0, Version A

### Terminal Emulation

- HP Terminal program software included with each HP Vectra RS PC

### HP-HIL Input Devices

- HP Mouse (HP 46060A)
- HP Touch Accessory (HP 35723A)  
Note: for Monochrome Monitor only (HP 35731A)
- HP-HIL extension module (HP 46080A)
- Bar code reader (HP 92916A)
- A-size digitizer (HP 46087A)
- B-size digitizer (HP 46088A)
- HP Graphics tablet, 11-inch x 11-inch tablet (HP 45911A)

### Other Input Devices

- HP SketchPro digitizing tablet (HP 7060A), requires RS-232C port

Microsoft, Microsoft Windows, and MS-DOS are U.S. registered trademarks of Microsoft Corporation.

# PERSONAL COMPUTERS & TERMINALS

## Vectra ES and ES/12 Personal Computers



The HP Vectra ES PC provides powerful, yet economical desktop publishing capabilities.

### Computing Power for Your Current and Future Needs

The HP Vectra ES and the ES/12 Personal Computers provide the power, compatibility and growth capability to meet your current and future personal computing needs.

The HP Vectra ES/12 Personal Computer delivers superior power and performance in an 80286-based desktop system. Its 12-MHz microprocessor has been designed to speed through challenging office and technical applications.

In addition, the Vectra ES/12 features a proprietary design allowing the HP Vectra ES PC Expanded Memory Card to run at 12 MHz with one wait state. This is significantly faster than the 8 MHz at which most expanded memory cards run today. Hence, the HP Vectra ES/12 often out-performs the competition with software applications written to take advantage of the Lotus®/Intel®/Microsoft® Expanded Memory Specification (LIM EMS 4.0).

The HP Vectra ES PC, Hewlett-Packard's 8 MHz, 80286-based personal computer, delivers economical IBM PC/AT compatibility and performance. It can easily handle many spreadsheet, database and sophisticated word processing applications.

### Vectra ES and ES/12 PC Features

#### System Processing Unit

- Vectra ES: Intel 80286 16-bit microprocessor running at 8-MHz clock rate
- Vectra ES/12: Intel 80286 16-bit microprocessor running at 12-MHz clock rate, switchable to 8 MHz from the keyboard
- 640 Kbytes RAM standard
- Seven IBM PC/AT-compatible accessory slots:
  - Two, 8-bit slots
  - Five, 16-bit slots (one occupied by Four-Function Controller Card)
- HP Expanded Memory Slot for use with HP Vectra ES Expanded Memory Card
- Four-Function Controller Card: includes ST-506 hard disc and flexible disc controller, one serial port and one parallel port
- Three half-height data storage shelves: two shelves suitable for flexible disc drives, the third shelf for a hard disc drive

- Socket for Intel 80287 numeric coprocessor
- Sockets for two additional ROM chips
- System clock/calendar/system configuration with CMOS Random Access Memory (RAM) and battery backup
- One HP-Human Interface Link (HP-HIL) port allows up to seven HP-HIL devices (such as a mouse, graphics tablet or barcode reader) to be connected simultaneously without using an accessory slot
- Optional keylock provides system security

#### Internal Memory

- 64 Kbytes of ROM
- 640 Kbytes of RAM
- Memory expandable to 8 Mbytes

#### Data Storage

##### Internal

- 5¼ inch, 360-Kbyte flexible disc drive (HP 45811A)
- 5¼ inch, 1.2-Mbyte flexible disc drive (HP 45812A)
- 3½ inch, 1.44-Mbyte flexible disc drive (HP 45813A)
- 20-Mbyte hard disc drive (HP D1296A)
- 40-Mbyte hard disc drive (HP D1297A)

##### External

- 67-Mbyte ¼-inch cartridge tape drive (HP 9144A)

#### Video

- The HP Vectra ES and ES/12 PCs support the high-performance HP Video Graphics Subsystem

Lotus is a U.S. registered trademark of Lotus Development Corporation.  
Intel is a U.S. registered trademark of Intel Corporation.  
Microsoft and MS-DOS are U.S. registered trademarks of Microsoft Corporation.

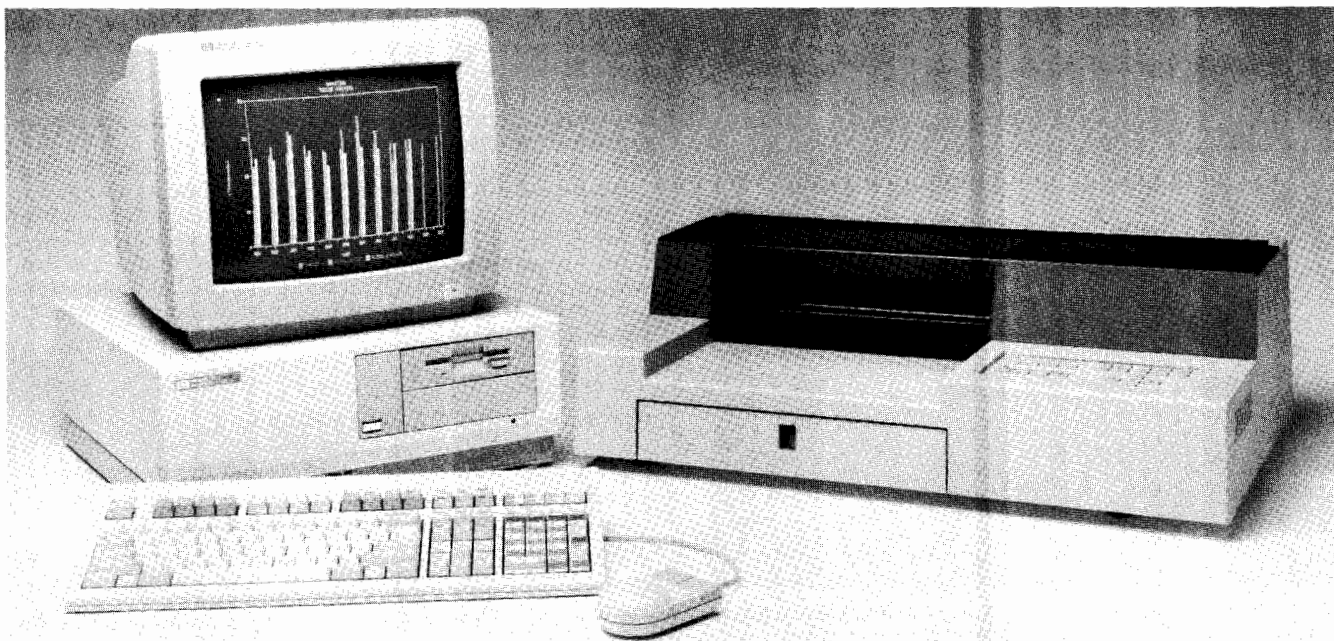

The HP Vectra CS PC is an excellent entry-level system for basic graphics, word processing, spreadsheet analysis, file management and data communications tasks.

### Exceptional Value

The Hewlett-Packard Vectra CS Personal Computer delivers exceptional value in integrated computing environments by providing high performance at an excellent price. Designed to support industry standards, the HP Vectra CS PC offers IBM PC/XT compatibility with access to an extensive selection of off-the-shelf software, accessories and peripherals.

The HP Vectra CS PC is an excellent entry-level system for basic PC tasks: word processing, spreadsheet analysis, graphics, file management, and data communications. Its 7.16-MHz processor, fast memory data path (16-bit memory bus), and 640 Kbytes of standard memory make the HP Vectra CS PC an excellent choice for these applications. A serial and parallel port are also standard equipment with the system.

As your needs grow, the HP Vectra CS PC can keep pace with your changing needs. As an entry-level system, it offers unsurpassed room for growth; seven expansion slots are provided for accessories and three mass storage shelves accommodate up to two flexible disk drives and one hard disc.

### Vectra CS PC Features

#### System Processing Unit

- 8086-compatible 16-bit CMOS microprocessor running at 7.16-MHz clock rate, zero wait states
- 16-bit memory bus; 8-bit I/O bus
- 640 Kbytes of zero-wait-state memory
- Passive backplane with eight, 8-bit I/O slots
  - One slot reserved for CPU board (required)
- Seven IBM PC/XT-compatible accessory slots
  - One slot reserved for hard disc controller (optional)
- Three half-height data storage shelves
  - Two are suitable for flexible disc drives
- One serial port and one parallel port (9-pin RS-232 and Centronics)
- DIN keyboard interface
- Flexible disc controller

- Clock/calendar and system configuration in CMOS RAM with battery backup
- Socket for Intel 8087 numeric coprocessor
- Optional keylock (HP 45986A) provides system security

#### Internal Memory

- 64 Kbytes of Read Only Memory (ROM) for system BIOS
- 640 Kbytes of Random Access Memory (RAM)

#### Data Storage

##### Internal

- 5¼ inch, 360-Kbyte flexible disc drive (HP 45811A)
- 3½ inch, 1.44-Mbyte flexible disc drive (HP 45813A)
- 20-Mbyte hard disc subsystem (HP D1173A)
- 40-Mbyte internal tape backup mechanism (D1671A)

##### External

- 67-Mbyte, ¼-inch cartridge tape drive (HP 9144A), requires HP-IB disc/tape interface (HP 88500A)

#### Video

- The HP Vectra CS PC supports the high-performance HP Video Graphics Subsystem

#### System Software

- Microsoft MS-DOS® 3.3 for the HP Vectra Personal Computer
- Microsoft Windows® for the HP Vectra PC, Version 2.0

#### Terminal Emulation

- HP Terminal program included with each HP Vectra CS PC
- HP Terminal ROM Card (HP 24531A)

Microsoft, Microsoft Windows and MS-DOS are U.S. registered trademarks of Microsoft Corporation.

# PERSONAL COMPUTERS & TERMINALS

## Portable Vectra CS PC



The HP Portable Vectra CS PC meets all your business computing needs . . . on the move, with a client, or in your office.

### The Portable Vectra CS Personal Computer

The Portable Vectra CS PC is compatible with the IBM PC/XT, is as functional as desktop PCs, and is flexible to meet your unique requirements. HP Portable Vectra PCs offer you the power to get the job done with a wide selection of software and hardware. With their quality and versatility, they meet your needs today and can adapt to the changing business environment to meet your needs tomorrow.

### Full Functionality in a Portable Package

Desktop computer functionality is provided without sacrificing battery-powered portability. Designed with the professional in mind, the HP Portable Vectra PCs feature a full-size keyboard with a separate numeric keypad, high-density flexible disc drives, CGA (Color Graphics Adapter), compatible high-resolution graphics using the high-contrast supertwist LCD (Liquid Crystal Display) or an external color or monochrome monitor. With up to 10 hours of battery life

on full charge, the HP Portable Vectra CS personal computer can do a full day's work without recharging. The HP Portable Vectra CS Model 20 PC has up to four hours of battery life and adds the increased mass-storage capacity and fast access speed of a 20-Mbyte hard disc.

With four I/O slots (a display/printer adapter standard and three additional expansion slots), you can choose the adapters you need today and add adapters in the future to keep pace with advancing technology and your changing business environment. The three additional I/O slots on the HP Portable Vectra CS PC and the two I/O slots on the HP Portable Vectra CS Model 20 PC, enable you to choose from a dual-serial/EMS (Expanded Memory Specification) adapter, a 1200 bps asynchronous modem and a 2400 bps synchronous/asynchronous modem. The removable display allows convenient use of external monitors, such as the HP 35731D Monochrome Display or the HP 35743A Enhanced Graphics Display.

### Portable Vectra CS PC Features

- HP Portable Vectra CS Personal Computer (HP D1001A)
  - 640 Kbytes system RAM
  - two 3½ inch, 1.44-Mbyte flexible disc drives
  - keyboard
  - display/printer adapter
  - supertwist LCD display
  - battery module
  - recharger
  - power cord
- HP Portable Vectra CS Model 20 Personal Computer (HP D1009A)
  - 640 Kbytes system RAM
  - one 20-Mbyte hard disc drive
  - one 3½ inch, 1.44-Mbyte flexible disc drive
  - display/printer adapter
  - hard disc controller
  - supertwist LCD display
  - battery module, recharger and power cord
- 8086-compatible 16-bit CMOS microprocessor running at 7.16-MHz clock rate; zero wait states
- Flexible disc controller
- Socket for 8087 numeric coprocessor
- User-replaceable battery module with built-in battery gauge
- Four I/O slots with a display/printer adapter standard and three additional I/O slots for optional adapters (two additional I/O slots in Model 20)

# PERSONAL COMPUTERS & TERMINALS

Software Choices

HP Vectra Family of Personal Computers

689

## Hewlett-Packard: Your Source for Software Solutions

The programs listed in this section are for use on the HP Touchscreen II, HP Vectra, HP Portable PLUS, HP Portable Vectra CS PC, IBM, and IBM-compatible personal computers. Refer to *Software and Accessories for the HP Touchscreen and Portable Personal Computers* for additional information.

The Hewlett-Packard *Software Selection Guide* features listings of HP software products that can be used to automate test and measurement applications. Associated computer-aided engineering software packages are also included.

## Software Package Order Number Designations

The last letter in each software package order number indicates the personal computer(s) that supports the package. (Does not apply to numbers ending with †.)

### Order No. Personal Computer

A	Touchscreen II
C	Portable PLUS
D	Touchscreen II and Portable PLUS
F,E	Vectra, Portable Vectra CS PC, and IBM PC-compatibles
K	Portable PLUS Plug-In ROM
M	Peripherals

### Order No. Description Price

#### Programming

HP 45445D	BASIC by Microsoft®	\$300
HP 82862K†	BASIC by Microsoft, Opt. 400	\$300
HP 45446D	Compiled BASIC by Microsoft	\$395
HP 45450D	GW™.BASIC by Microsoft	\$395
HP 45448A	COBOL by Microsoft	\$750
HP 92248BA	Cross-Reference Utility	\$49
HP 45449D	FORTRAN by Microsoft	\$395
HP 45447D	Pascal by Microsoft	\$350
HP 45435A	Touchscreen Programmer's Tools	\$295
HP 45310A	BASIC Programmer's Library	\$110
HP 45419C	Programmer's Tools	\$325
HP 45452D	Lattice® C Compiler	\$495
HP 45311A	ICON Design System	\$99
HP 45443A	Forms Master	\$295

#### Data Communications and Networking

HP 45431A	AdvanceLink	\$300
HP 68333F	AdvanceLink	\$395
HP 68333F	AdvanceLink, Opt. 003	\$395
HP 27534A	AdvanceMail	\$395
HP 82870K	AdvanceMail, Opt. 400	\$295
HP 27535F	AdvanceMail	\$395
HP 45641B†	Touchscreen 3278 Emulation Accessory with File Transfer	\$1200
HP 82863K	REFLECTION I™, Opt. 400	\$395
HP 45640A	Touchscreen Internal Modem	\$475
HP 45412A	VT100 Terminal Emulator	\$180
HP 36569E	HPMessage	\$300
HP 36568A	HPMessage	\$300
HP 35177M	JetStart (for use with ThinkJet personal printer)	\$45
HP 35178M	LaserStart (for use with LaserJet printer)	\$95
HP 82867K	YTERM 3278 Emulation, Opt. 630	\$95

#### Data Base Management

HP 36898A	HP Access	\$625
HP 36898F	HP Access	\$625
HP 45421A	Executive Card Manager	\$300
HP 68331F	Executive Card Manager	\$300
HP 45555K	Executive Card Manager, Opt. 400	\$295
HP 68331F	Executive Card Manager, Opt. 003	\$300

#### Integrated Solutions

HP 45498A	Symphony® from Lotus®	\$695
HP 68339F	Symphony from Lotus	\$695

## Electronic Spreadsheets

HP 45566A	Lotus® 1-2-3®	\$595
HP 45539K	Lotus 1-2-3 V2.01, Opt. 400	TBS
HP 68340F	Lotus 1-2-3 V2.01	\$495
HP 68340F	Lotus 1-2-3 V2.01, Opt. 003	\$495

## Personal Solutions

HP 35151D†	The Calendar	\$49.95
HP 35152D†	The List Manager	\$49.95
HP 35153D†	The Writer	\$49.95
HP 35154D†	The Speller	\$49.95
HP 35155D†	The Planner	\$49.95
HP 35156D†	The Personal Correspondence Pack	\$125
HP 35157D†	The Personal Organizer Pack	\$125

## Localization (Translation)

HP 82866KD	Localization, German—Opt. 400	\$150
HP 82866KF	Localization, French—Opt. 400	\$150
HP 82866KZ	Localization, Italian—Opt. 400	\$150

## Word Processing

HP 27546F	AdvanceWrite PLUS	\$710
HP 45427D	WordStar® Professional®	\$605
HP 45418A	Executive MemoMaker	\$295
HP 68330F	Executive MemoMaker	\$295
HP 68330F	Executive MemoMaker, Opt. 003	\$295
HP 45504K	MemoMaker/Time Management, Opt. 400	\$195
HP 45549K	Microsoft WORD™, Opt. 400	\$375
HP 45474D	Microsoft WORD	\$495
HP 45554K	MultiMate™, Opt. 400	\$495
HP 27505A	HP Word/PC	\$450
HP 27536F	HP Word/PC	\$450

## Graphics

HP 45437A	The Gallery Collection	\$695
HP 68352F	Gallery Collection	\$695
HP 68350F	Charting Gallery	\$295
HP 68351F	Drawing Gallery	\$395
HP 68352F	The Gallery Collection	\$695
HP 68324F	Office Activities Portfolio	\$95
HP 68325F	Chemical/Petrochemical Portfolio	\$150
HP 68326F	Business Management Portfolio	\$95
HP 68327F	HPDraw Figures Portfolio	\$195

## Host Services

HP 36890F	Print Central	\$180
-----------	---------------	-------

## The following products, available through HP's Direct Marketing Division, are vendor-supported.

HP 35190J†	LaserControl 100 (for Vectra and LaserJet printer)	\$150
HP 35184A†	Sideways (for Touchscreen and ThinkJet printer)	\$79.95
HP 35188A	Laser Plotter (for Vectra and LaserJet printer)	\$150
HP 35188D	iPrint (for Vectra and LaserJet printer)	\$349.95

## Corporate Site License for Personal Computer Software

HP's worldwide Corporate Site License Program offers substantial discounts on specified Vectra and Touchscreen PC software, along with the benefit of software standardization, immediate availability, distribution control, and unbundled documentation. Total dollar savings can be estimated by combining the Site License discount percentage and Purchase Agreement discount percentage. For ordering information and savings, contact your local sales office.

GW-BASIC and Microsoft WORD are U.S. trademarks of Microsoft Corporation. REFLECTION 1 is a U.S. trademark of Walker Richer & Quinn, Inc. MultiMate is a U.S. trademark of Multimatte International Corporation, a subsidiary of Ashton-Tate Corporation. Microsoft is a U.S. registered trademark of Microsoft Corporation. Lattice is a U.S. registered trademark of Lattice, Inc. Lotus, 1-2-3, and Symphony are U.S. registered trademarks of Lotus Development Corporation. WordStar and WordStar Professional are U.S. registered trademarks of MicroPro International Corporation.



# PERSONAL COMPUTERS & TERMINALS

## Computer Peripherals, Monitors and Accessories

Models 35731, 35741, D1181, D1180, D1182, 35723, D1030, D1183

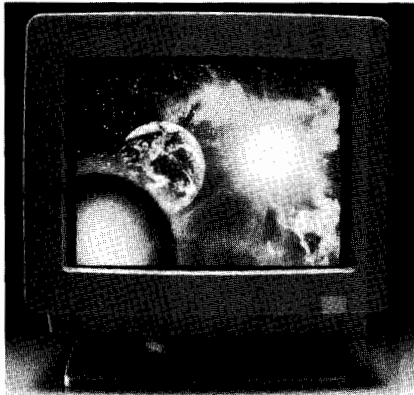

The D1182A Color VGA Display is a 14-inch, medium-resolution monitor that offers excellent graphics display and very high quality text character formation.



The D1181 A/G/W Monochrome VGA Display is a 14-inch, medium-resolution monitor that offers the user 640 x 480 graphics, 64 shades of gray and a choice of amber, green or white phosphor.

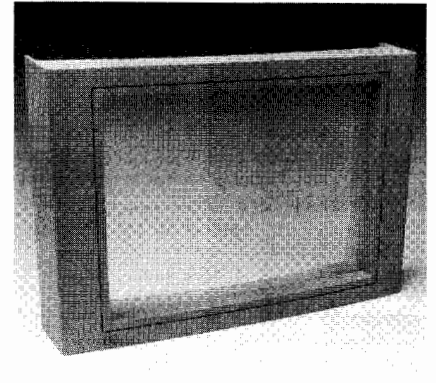

The D1183A Touchscreen Plus, for use with the D1182A Display, provides the user with an intuitive and natural interface with the computer.



### HP D1180A Video Graphics Adapter

The HP Video Graphics Adapter (D1180A) is the driving component for Hewlett-Packard's Video Graphics Subsystem. This IBM VGA register-compatible video card features software compatibility with MDA, Hercules, CGA, EGA and VGA video standards. The HP Video Graphics Adapter is fully compatible with the HP Video Graphics Color Display, the HP Monochrome Video Graphics Display, and other monitors compatible with IBM's VGA video interface.

The HP Video Graphics Adapter (HP VGA) offers a number of modes beyond the IBM VGA definition. These modes include 800 x 600 graphics resolution, 132-column text, and 640 x 480 graphics resolution with 256 colors. In each mode, colors can be selected from a palette of 262,144 colors.

### HP D1181A Monochrome Video Graphics Display

The HP Monochrome Video Graphics Display (HP D1181) is specifically designed for use with the Vectra family of personal computers. It is plug-compatible with the industry-standard VGA monochrome monitors. HP's Monochrome Video Graphics Display is designed for use with the HP Video Graphics Adapter (D1180A).

The Monochrome Display offers a choice of screen colors, including amber, green and soft-white. The display supports resolutions varying from 320 x 200 to 640 x 480 and can display up to 64 shades of gray. It is ideal for text, graphics and image applications.

### HP D1182A Color Video Graphics Display

The HP D1182 Color Video Graphics Display is a 14-inch, medium-resolution color display. It is designed for use by business professionals or by low-end CAD users. The high quality of the screen and the fine resolution of the display tube are ideal for use in environments requiring a high daily system utilization. This combination provides both excellent graphics (in resolutions up to 640 x 480) and very high quality text character formation.

The D1182 display offers an optional tilt/swivel mechanism (PN 82959S) for enhancing ease of use.

### HP D1183A Touchscreen Plus

The HP D1183A Touchscreen Plus is a touchscreen interface designed for use with the HP D1182A Color Video Graphics Display. It transforms the display into an interactive touchscreen and provides an easy and comfortable method for interacting with the system.

### HP 35723A Touch Accessory

The 35723A HP Touch Accessory is a 12-inch, user-installable touchscreen bezel. Adding the HP Touch Accessory to an HP-HIL-supported terminal transforms an ordinary screen into an interactive touchscreen and provides an easy and comfortable way of interacting with the system.

HP Touch has a maximum resolution of 2,451 touch points (43 vertical by 57 horizontal), which allows users to define touch areas of various shapes and sizes and allows programming flexibility for a wide range of applications.

### HP 35731 Monochrome Monitors

The 35731 HP Monochrome Monitor is a 12-inch, medium-resolution monochrome video display unit used as an integral component of HP terminals and workstations.

The monitor features an easy-to-read green phosphor display as well as compatibility with HP systems that use 512 x 390 or 640 x 400 resolutions. It supports the HP Touch Accessory via the HP-HIL interface.

Ergonomic features on the monitor include an anti-glare screen and built-in tilt and swivel for adjusting the screen viewing angle. The monitor also has front panel brightness and contrast controls to make display adjustments more convenient.

### HP 35741 Color Monitors

The 35741 HP Color Monitor provides a 12-inch RGB analog color video display with a 640 x 400 resolution. Like the 35731 Monochrome Monitor, this monitor is used with many HP computer systems, terminals and workstations.

The color monitor features RGB P22 color phosphor, with analog video inputs capable of providing a continuous spectrum of colors. The HP-HIL interface supports the HP Touch Accessory.

With convenient front panel controls, a non-glare screen and integrated tilt and swivel, the color monitor offers state-of-the-art ergonomics.

### Ordering Information

		Price
HP D1182A/B	VGA Color Monitor	\$695
HP D1183A	HP Touch Accessory	\$530
HP 35723A	Touch Accessory	\$530
HP D1030A	EGA Cable	\$39.95
HP D1184A	VGA Cable	\$60
HP 35731A	Monochrome Monitor	\$325
HP 35731B	Monochrome International	\$340
HP 35741A/B	Color Monitor	\$1195
HP D1180A	HP Video Graphics Adapter	\$445
HP D1181A/G/W	Monochrome Monitor	\$250

# PERSONAL COMPUTERS & TERMINALS

## Overview and Matrix

691

Terminals should provide a comfortable interface with the computer. Hewlett-Packard terminals are designed to work in harmony with the user, offering features like crisp, clear characters, smooth tilt/swivel positioning and excellent tactile feedback from keyboards to add to your comfort and increase your productivity.

To select the right terminal to meet your needs (whether it's an HP, IBM, DEC or other ASCII system), refer to the matrix below.

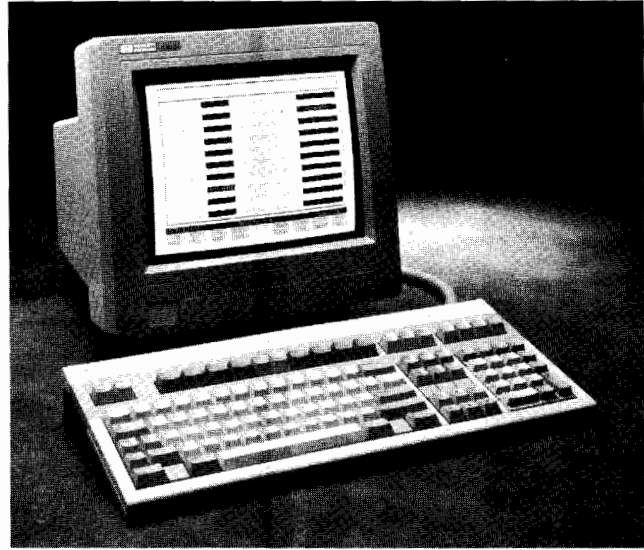

	HP SYSTEMS		ASCII SYSTEMS 		PC SYSTEMS	DEC SYSTEMS	IBM SYSTEMS	HP SYSTEMS (GRAPHICS)	
	HP 700/92	HP 700/94	HP 700/41	HP 700/43	HP 700/44	HP 700/22	HP 700/71	2393A	2397A
<b>Compatibility Modes</b>	2392A DEC VT220 DEC VT100 DEC VT52	2394A DEC VT220 DEC VT100 DEC VT52	Wyse 30 TV905,910+,925E ADM 3A,5 Hazeltine 1500 ADDS VP A2 Qume 101	Wyse 30.50 TV905,910+,925E, 950, ADM 3A,5,31 Hazeltine 1500 ADDS VP A2 Qume 101	PC Term DEC VT220 DEC VT100 DEC VT52	DEC VT220 DEC VT100 DEC VT52	IBM 3191 Model A,B	TEK 4010/4014 ANSI x 3.64	TEK 4010/4014 ANSI x 3.64
<b>Phosphor Colors</b>	Green, Amber, Soft White	Green, Amber, Soft White	Green, Amber	Green, Amber, Soft White	Green, Amber, Soft White	Green, Amber, Soft White	Green, Amber, Soft White	Green	Color 8/64
<b>Pages of Memory</b>	8	16	1	4	4	4	1	9	9
<b>132 Column</b>	yes	yes	no	yes	yes	yes	no	Scrolled	Scrolled
<b>Printer Port</b>	yes	yes	yes	yes	yes	yes	no	Opt: serial,HPiB Centronix Parallel	
<b>Keyboard Layout</b>	HP	HP	ASCII	ASCII	PC AT2	DEC VT220	IBM 3191, 102 or 122 Typewriter ASCII Data Entry	HP	HP
<b>Warranty</b>	1 Year	1 Year	1 Year	1 Year	1 Year	1 Year	1 Year	90 Day	90 Day
<b>Additional Features</b>	VPLUS Compatible Bar Code reader support	VPLUS Compatible Forms Cache Local Edit checks Modified data tag Bar Code reader support	58 Programmable keys	58 Programmable keys Bidirectional printer port	IBM PC character set Bidirectional printer port 75 Programmable function keys in PC term mode	30 Programmable keys in VT220 mode Bar Code reader support	Keylock	I/O Device Support: Touch Screen, Graphics Tablet, Mouse, Bar Code reader	
<b>Price</b>	\$895	\$1095	\$375	\$475	\$575	\$499	\$695	\$2295	\$3595

DEC VT220, VT100 and VT52 are products of Digital Equipment Corporation.  
IBM is a registered trademark of International Business Machines.  
WY-30 and WY-50 are products of Wyse Technologies Systems.  
TeleVideo 905, 910+, 925E and 950 are products of TeleVideo Systems, Inc.

ADM3A, ADM5 and ADM 31 are products of Lear Siegler Corporation.  
Hazeltine 1500 is a product of Esprit Systems, Inc.  
ADDS Viewpoint A2 is a product of Applied Digital Data Systems, Inc.  
QUME QVT-101 is a product of Qume Corporation.

# CALCULATOR PRODUCTS

Personal Computation

Models HP-19B, HP-17B, HP-14B, HP-12C

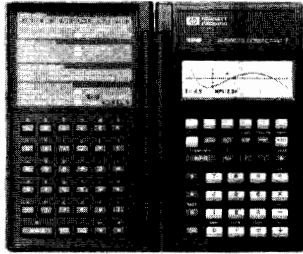

HP BUSINESS CONSULTANT II



HP-17B

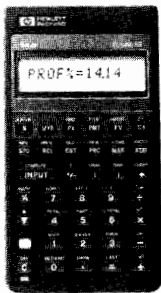

HP-14B



HP-12C

Whether it's a business or scientific calculator, Hewlett-Packard products can provide the sense of pride that comes from owning a computational tool that has been designed—in every detail—to be the finest of its kind.

Business calculators include the well-known HP-12C and the new HP Business Consultant II, HP-17B and HP-14B. The HP-12C features HP's traditional RPN (Reverse Polish Notation) entry system, while the others are designed for people who prefer algebraic entry calculators. Scientific calculators that feature RPN include the popular HP-41 and new HP-28S, HP-42S and HP-32S. The new HP-27S and HP-22S have algebraic-entry systems.

The HP Business Consultant II, HP-17B, HP-28S, HP-27S and HP-42S have menus and softkeys for easy access to functions and a solver function to make working with equations easier. The HP-14B, HP-32S and HP-22S also feature menus.

An optional infrared printer can be used with the HP Business Consultant II, HP-17B, HP-28S, HP-27S, HP-42S and HP-41CV/X. A wide range of peripherals, plug-in modules and software allow customization of the HP-41 for personalized application solutions.

## Business Calculators

### HP-19B HP Business Consultant II Professional Calculator

This top-of-the-line business calculator has the most comprehensive set of business and financial functions found in any calculator, yet it is easy to use because of its menu and softkey approach to problem solving. It offers a graphics package that plots histograms, scatter diagrams, and four different curve-fitting models for statistics and forecasting, plus net present value versus interest rate for investment analysis. In addition, the HP Business Consultant II offers HP Solve; data- and time-management functions, including an application to manage name and address lists, a clock and calendar, and an appointment scheduler with alarms; number lists with running totals and sub-totals; conversion applications for 39 world currencies and 63 different unit measurements; advanced math; and a built-in ROM that allows messages and prompts to be displayed in German, Spanish, French, Italian and Portuguese, in addition to English. The calculator has a 4-line by 23-character alphanumeric display with separate keyboards for numbers and letters, 6500 bytes of RAM and an infrared printer interface. Application books are available.

### HP-17B Business Calculator

The HP-17B is function-packed and easy to use. It offers a powerful package of business and financial functions, including TVM, cash flows, bonds and depreciation; number lists with running totals and sub-totals; HP Solve; and appointments and time calculations. The HP-17B has a 2-line by 22-character alpha-numeric display, 6500 bytes of RAM and an infrared printer interface. Application books are available.

### HP-14B Business Calculator

The HP-14B offers the most frequently needed functions for business students and professionals at an economical price. It also has extras such as forecasting with four different curve fits, list-based cash flows, return on investment, breakeven analysis and inventory turnover rate. Other features include TVM with amortization; two-variable statistics with linear regression; interest rate conversions; margin and markup; percent change and percent of total; and an alphanumeric display. The HP-14B has a one-line, 12-character dot-matrix LCD. Application books are available.

### HP-12C Programmable Financial Calculator

The HP-12C is a powerful financial calculator that is a favorite of business professionals in banking, real estate and investment. It features Time Value of Money functions, discounted cash flow functions (NPV and IRR), plus bond functions that calculate yield-to-maturity and price. The HP-12C has a numeric one-line, 10-digit LCD and 20 storage registers. Application books are available.

# CALCULATOR PRODUCTS

## Personal Computation

Models HP-28S, HP-41CV/CX, HP-42S, HP-27S, HP-32S

693



HP-28S

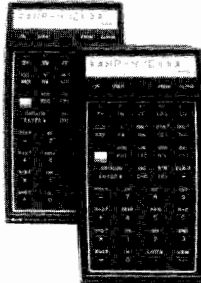

HP-41CV/CX



HP-42S



HP-27S



HP-32S



### Scientific Calculators

#### HP-28S Advanced Scientific Calculator

The HP-28S is the state-of-the-art tool for scientific professionals and students. It can calculate symbolic algebra and calculus as well as plot equations on its display. It has 32K bytes of RAM; memory management features for organizing information stored in memory; an advanced graphics package with graphics storage and recall; matrix, vector and complex-number arithmetic; and advanced programmability through a high-level programming language. The HP-28S performs unit conversions among arbitrary products, powers and ratios of 120 built-in units and user-defined units. Other features include menus and softkeys that make access to functions faster and easier, HP Solve for use in personalizing the HP-28S without programming, and enhanced RPN with optional algebraic entry. The HP-28S has a 4-line by 23-character alphanumeric display with separate keyboards for numbers and letters and a wireless infrared printer interface. Application books are available.

#### HP-41CV and HP-41CX Advanced Programmable Calculators

The HP-41CV and HP-41CX provide the heart of expandable computational systems. In addition to input/output capability, they provide portability and touch-key simplicity.

In addition to all the built-in functions of the HP-41CV, the HP-41CX features built-in Time and Extended Functions/Memory modules, a text-file editing function and 19 other functions.

A broad range of HP-written Application Pacs and Solutions Books is available. The HP-41CV/CX have 2,233 bytes of RAM (319 registers) built in, with 6,433 bytes (919 registers) maximum. The HP-41CX has 868 bytes (124 registers) of built-in extended memory. The optional HP 82180A Extended Functions/Memory Module adds 868 bytes (124 registers) to the HP-41CV and the optional HP 82181A Extended Memory Module adds 1,666 bytes (238 registers) to the HP-41CV/CX. There are over 200 built-in functions in the HP-41CX and over 128 in the HP-41CV. Both calculators have 10-digit, 12-alpha character (scroll to 24) LCDs.

#### HP-42S RPN Scientific Calculator

The powerful HP-42S has a complete set of math and science functions and a sophisticated matrix editor that prompts for input, which is useful for solving simultaneous equations. The matrix editor also allows complex numbers to be used as matrix elements. Variables, including real and complex numbers and matrices, can be named. A variable and function catalog keeps track of them, and they can be used directly from the catalog. Access and use of all functions, programs and variables in the calculator is possible via the catalog by simply scrolling to the desired function and executing it. The HP-42S also features equation solver and numerical integration functions. Custom menus can be created and assigned to the top-row keys. The HP-42S also runs thousands of keystroke programs available for the HP-41C/CV calculators. The HP-42S has a 2-line by 22-character dot matrix LCD, 64K-bytes of ROM, 8K-bytes of RAM and an infrared printer interface. Application books are available.

#### HP-27S Scientific Calculator

The HP-27S is a two-in-one calculator for technical professionals and students who also need to perform business calculations. It offers scientific functions, including logarithms, trigonometry and hyperbolic; financial functions for TVM and amortization schedules; number lists with running totals for statistics, forecasting and adding columns of numbers; base conversions; HP Solve; appointments and time calculations. The HP-27S has a 2-line by 22-character alphanumeric display, 6.5K bytes of RAM and an infrared printer interface. Application books are available.

#### HP-32S RPN Scientific Calculator

The HP-32S for technical professionals and students has a complete set of math and science functions, an equation solver that solves for any variable once the equation is set equal to zero, numerical integration and complex number functions and programming capabilities for solving repetitive problems. It incorporates labeled variables for input and output, and looping, tests and flags for problems that require logical decision making. The HP-32S has a one-line, 12-character dot-matrix LCD, 390 bytes of user RAM and 27 storage registers. An application book is available.

# CALCULATOR PRODUCTS

## Personal Computation

### Model HP-22S, Enhancements & Peripherals



HP-22S

#### HP-22S Scientific Calculator

The easy-to-use HP-22S, designed for science students, has a solve function that lets users solve for any variable without re-entering an equation. It also has a library of 16 commonly-used equations including roots of a quadratic equation, pressure of a fluid and kinetic energy. Variables and messages, instead of cryptic keycodes, appear in the one-line, 12-character dot-matrix LCD. The HP-22S also has 16K bytes of ROM, 371 bytes of user RAM and 26 storage registers. An application book is available.

#### Ordering Information

	Price
HP-19B HP Business Consultant II	\$175.00
HP-17B Business Calculator	110.00
HP-14B Business Calculator	69.95
HP-12C Programmable Financial Calculator	79.95
HP-28S Advanced Scientific Calculator	235.00
HP-41CV Advanced Programmable Calculator	175.00
HP-41CX Advanced Programmable Calculator	249.00
HP-42S RPN Scientific Calculator	110.00
HP-32S RPN Scientific Calculator	69.95
HP-27S Scientific Calculator	110.00
HP-22S Scientific Calculator	59.95

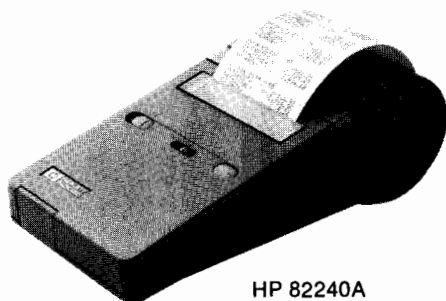

HP 82240A

#### Enhancements and Peripherals

##### HP-19B, HP-17B, HP-41CV/CX, HP-28S, HP-27S and HP-42S:

##### HP 82240A Infrared Printer

An infrared beam provides a cordless connection with the calculator from up to 18 inches away. Prints 24 characters per line in 5x8 dot matrix using the Roman-8 character set plus 10 additional special math characters. Uses batteries or optional AC adapter. When used with the HP-41, an HP 82242A Infrared Printer Interface Module is required.

##### HP-41:

##### HP 82182A Time Module

With this module (built into the HP-41CX), the HP-41CV can become a time-scheduled system controller, alarm clock, appointment reminder, calendar, timer or even an advanced stopwatch.

##### HP 82160A HP-IL Interface Module

Plugs into any one of the four ports in the HP-41, connecting it with HP-IL peripherals and instruments, and to HP-IB, RS-232C and GPIO devices using interface converters. Gives the HP-41 control of up to 30 devices on the loop. Typical HP-41 transfer rate: 150 bytes/second.

##### HP 82183A Extended I/O Module

Provides 59 I/O functions beyond those provided by the HP 82160A HP-IL Module.

##### HP 82104A Card Reader

Allows programs and data to be saved on magnetic cards which contain 32 registers, 16 per side. Adds over 30 control functions to the HP-41.

##### HP 82242A Infrared Printer Interface Module

Provides an interface that allows the HP-41 to be used with the HP 82240A Infrared Printer. Permits numeric, upper- and lower-case alpha, double-wide characters, high-resolution plotting capabilities and intensity control. Allows user-defined special characters to be transmitted to the printer.

##### 00041-15043 HP-IL Development Module

Allows the contents of any control register to be changed, certain status bits to be polled, and the addition of a second HP-41 to monitor the status of the HP-IL loop.

##### HP 82161A Digital Cassette Drive

Uses a digital-quality mini-cassette to store up to 128K bytes of information. Number of tracks, 2; Density, 335 bits/cm (850 bits/inch); format, 256 bytes/record (8 bits/byte); formatted capacity, 512 records (131,072 bytes).

##### HP 82162A Thermal Printer/Plotter

Provides numeric upper- and lower-case alpha, doublewide characters and intensity control.

The chief feature of the HP 82162A is that it has a 101-character buffer for enhanced graphics and bar code printing capabilities and a FORMAT function which automatically centers or justifies copy to the left and right margins.

##### HP 2225B ThinkJet Personal Printer

See numerical index for page number.

##### HP 9114B Disc Drive

See numerical index for page number.

#### Ordering Information

##### HP-19B, HP-17B, HP-41CV/CX, HP-28S, HP-27S and HP-42S:

	Price
HP 82240A Infrared Printer (110V)	\$135.00 ☎
HP 82241A Adapter, U.S. (110V)	15.00 ☎
HP-41:	
HP 82240A Infrared Printer (110V)	135.00 ☎
HP 82242A Infrared Printer Interface Module	65.00 ☎
HP 82180A Extended Functions/Memory Module	75.00 ☎
HP 82181A Extended Memory Module	75.00 ☎
HP 82182A Time Module	75.00 ☎
HP 82160A HP-IL Interface Module	125.00 ☎
HP 82183A Extended I/O Module	75.00 ☎
HP 82104A Card Reader	195.00 ☎
00041-15043 HP-IL Development Module	75.00 ☎

☎ Fast-Ship product—see page 766.





## Interfaces

### HP-41

#### HP 82164A HP-IL/RS-232C Interface

Translates HP-IL signals into RS-232C signals, and vice versa, for connection of HP-IL systems with RS-232C systems. Provides bit-serial asynchronous data communication. AC adapter included.

#### HP 82169A HP-IL/HP-IB Interface

Permits linkage of HP-IL systems with HP-IB (IEEE 488, 1978) computers and lab equipment. When a controller is used, it can be either an HP-IL or HP-IB device. AC adapter included.

#### HP 82165A HP-IL/GPIO Interface

Allows HP-IL to control equipment operating with parallel bus structures. Contains I/O buffering and a built-in power supply that operates from an HP standard AC adapter that is included.

### Ordering Information

	Price
<b>HP-41:</b>	
HP 82164A HP-IL/RS-232C Interface	\$295.00 ☎
HP 82169A HP-IL/HP-IB Interface	395.00 ☎
HP 82165A HP-IL/GPIO Interface	295.00 ☎

### Accessories

Accessories such as owner's manuals, programming pads, magnetic cards, thermal paper, battery packs, rechargers and software manuals are readily available for all types of HP calculators.

### Software

HP offers software packages as application pacs, solutions books and application booklets. Application pacs come with a manual, plug-in module, and when applicable, prerecorded magnetic cards, a keyboard overlay and quick reference card. Solutions books come with complete documentation. Application booklets stand alone. Available from dealers and HP Representatives.

### HP-19B, HP-17B and HP-27S

#### Application Books

00017-90019 Real Estate, Banking, and Leasing	\$9.95 ☎
00017-90020 Business Finance and Accounting	9.95 ☎
00017-90021 Marketing and Sales	9.95 ☎
00017-90022 Personal Investment and Tax Planning	9.95 ☎

### HP-19B and HP-27S

#### Application Book

00027-90044 Technical Applications	\$9.95 ☎
------------------------------------	----------

### HP-28S

#### Application Books

00028-90111 Mathematical Applications (HP-28S)	\$9.95 ☎
00028-90105 Vectors and Matrices (HP-28C/S)	9.95 ☎
00028-90101 Algebra and College Math (HP-28C/S)	9.95 ☎
00028-90102 Calculus (HP-28C/S)	9.95 ☎
00028-90104 Probability and Statistics (HP-28C/S)	9.95 ☎

### HP-41

#### Application Pacs

00041-15055 HP-41 Advantage	\$49.00 ☎
00041-15006 Circuit Analysis	40.00 ☎
00041-15004 Financial Decisions	40.00 ☎
00041-15049 Math/Statistics	45.00 ☎
00041-15022 Games	40.00 ☎
00041-15016 Real Estate	45.00 ☎
00041-15019 Thermal & Transport Science	40.00 ☎
00041-15039 Petroleum Fluids	75.00 ☎
00041-15001 Standard Applications	40.00 ☎
00041-15027 Stress Analysis-Mechanical Engineering	40.00 ☎
00041-15021 Structural Analysis-Civil Engineering	45.00 ☎
00041-15005 Surveying	40.00 ☎
00041-15020 Machine Design	40.00 ☎

#### Solutions Books\*

##### Business:

00041-90094 Business Statistics/Marketing/Sales	15.00 ☎
00041-90096 Home Construction Estimating	15.00 ☎
00041-90086 Lending, Savings, & Leasing	15.00 ☎
00041-90136 Real Estate	15.00 ☎
00041-90137 Small Business	15.00 ☎

##### Engineering:

00041-90093 Antennas	15.00 ☎
00041-90100 Chemical Engineering	15.00 ☎
00041-90089 Civil Engineering	15.00 ☎
00041-90092 Control Systems	15.00 ☎
00041-90088 Electrical Engineering	15.00 ☎
00041-90139 Fluid Dynamics & Hydraulics	15.00 ☎
00041-90140 Heating, Ventilating & Air Conditioning	15.00 ☎

##### Conditioning

00041-90090 Mechanical Engineering	15.00 ☎
00041-90138 Solar Engineering	15.00 ☎
00041-90441 Structural Design (cassette based)	35.00 ☎

##### Computation:

00041-90084 Geometry	15.00 ☎
00041-90083 High-Level Math	15.00 ☎
00041-90082 Test Statistics	15.00 ☎

##### Other:

00041-90102 Chemistry	15.00 ☎
00041-90099 Games I	15.00 ☎
00041-90443 Games II	15.00 ☎
00041-90142 Physics	15.00 ☎
00041-90141 Surveying	15.00 ☎
00041-90395 Time Module Solutions I	15.00 ☎

\*As originals are depleted, photo copies will be supplied at same prices

### HP-42S

#### Application Book

00042-90020 Programming Examples and Techniques	\$9.95 ☎
-------------------------------------------------	----------

### HP-32S

#### Application Book

00032-90057 Engineering Applications	\$9.95 ☎
--------------------------------------	----------

### HP-22S

#### Application Book

00022-90034 Science Student Applications	\$9.95 ☎
------------------------------------------	----------

For additional information or a demonstration of Hewlett-Packard professional calculators and handheld computers, visit your nearest HP sales representative or HP dealer. In the US, for the location and number of the one nearest you call toll-free 1-800-752-0900.

☎ Fast-Ship product—see page 766.

# BUSINESS COMPUTER SYSTEMS

## HP 260 Business Computers



The user-friendly, reliable HP 260 is designed for small businesses requiring a powerful computing system.

### HP 260 Business Computers

HP 260 business computers are multi-user, multi-tasking systems designed to meet the needs of small- to mid-size businesses. They are user-installable, and feature uncomplicated operation — facilitated by softkey-driven processing and the use of full-screen displays that resemble standard business forms. The IMAGE/260 database management system, included with HP 260 computers, provides data accuracy, protection from unauthorized access, and savings in data-storage costs. It also enables information retrieval and reporting by non-programmers.

### HP 260 Series 30 and Series 40

The low-end Series 30 and the high-end, high-performance Series 40 are fully compatible and can each be connected to the same number of peripheral devices. The very affordable Series 30 is recommended for configurations with one to four users. The Series 40 features disc caching, which results in increased system performance, and supports up to 15 concurrent users/tasks. To allow connection with the greatest possible number of peripheral devices, Hewlett-Packard offers an I/O extender that provides slots for additional I/O boards.

### Growth Opportunities

Hewlett-Packard offers a wide range of high-quality peripherals, including mass storage devices, workstations, data-entry terminals, printers, and plotters, that provide an economical way to expand your HP 260 system. Also, both the Series 30 and the Series 40 are upgradable to higher-performance systems. The two series are software-compatible, so it's quick and easy to upgrade from the Series 30 to the more powerful Series 40.

There is also a compatible growth path from the HP 260 computers to HP 3000 systems, because the HP Business BASIC/V language enables HP 260 programs to run on HP 3000 systems. To protect your investment in hardware, HP offers upgrade allowances for any hardware that cannot be integrated into an HP 3000 system.

### PC Integration

The latest release of the HP 260 operating system provides support of terminal emulators running on several popular personal computers, including AdvanceLink on the HP Touchscreen II PC, AdvanceLink 2392 on the HP Vectra PC and IBM® PC/XT™/AT®, and REFLECTION 1™ on the HP Portable PLUS.

Any of the personal computers can be used as direct- or modem-connect HP 260 workstations with bidirectional file-transfer capabilities. Hewlett-Packard personal computers are especially easy to use with an HP 260 system, because they include a Personal Applications Manager (PAM) that can initiate HP 260 applications. This makes it easy to incorporate a personal computer's personal productivity capabilities, such as word processing, spreadsheet analysis, and decision-support graphics, into the multi-user HP 260 environment.

### Data Communications

HP 260 systems can communicate with personal computers, HP 3000 systems, HP 250 systems, and other HP 260 systems. They can also emulate IBM 2780/3780 batch terminals.

### Application Software

The friendly yet powerful BASIC/260 programming language makes HP 260 systems very useful tools for program development. Programmer productivity is enhanced by the comprehensive FORMS/260 program and the QUERY/260 database inquiry system.

A wide selection of application software is available from HP Value-Added System Suppliers. Value-Added System Suppliers are independent companies that use their industry expertise to provide innovative HP-260-based solutions. They have applications that address the specific needs of many different types of businesses, from manufacturing plants to medical practices. In addition, the System Suppliers can provide services such as system installation, system management training, application software training, application software maintenance and support, and business consulting.

### Specifications

**Microprocessor:** 16-bit Hewlett-Packard proprietary

**Operating System:** BASIC Operating System

**Memory:** Series 30 standard with 512K bytes; Series 40 standard with 1M byte

**Expansion Capability:** Two integrated RS-232C ports standard on both models; with I/O extender, slots are available for up to 2M-bytes memory, two 4-port video MUX boards, two 5-port ASI boards, one peripheral interface channel (HP-IB parallel interface), and one INP board

**Weight:** Series 30, Series 40, I/O extender (each): 12 kg (approx. 26.5 lbs.)

**Dimensions:** Series 30, Series 40, I/O extender (each): 128(h) x 325(w) x 380(d) mm (approx. 5.0 x 12.8 x 15.0 inches)

### Ordering Information

**HP 45070A** HP 260 Series 30 SPU includes 512K-bytes memory, two RS-232C ports, one peripheral interface channel (HP-IB), system software, and a standard manual set.

**HP 45072A** HP 260 Series 40 SPU includes disc caching, 1M-byte memory, two RS-232C ports, one peripheral interface channel (HP-IB), system software, and a standard manual set.

**HP 45071A** I/O extender: provides five additional board slots.

For more information on HP 260 solutions, contact your HP sales representative or your local HP 260 Value-Added System Supplier.



HP 3000 business computers protect your investment in information management systems.

### Integrated Information Systems

Hewlett-Packard pioneered distributed data processing for keeping track of inventories and payables, generating invoices, organizing payrolls, and producing timely reports. Collection, access, and dissemination of data are made easy for any organization, from large corporate headquarters to branch offices and departments. HP also developed business automation systems that meet all the transaction processing demands of today's offices. This includes functions such as word processing, electronic mail, and report writing.

HP's productivity solutions for your office include the HP 3000 family of integrated information systems. The strength of HP communications products along with the flexibility of these systems lets you place cost-efficient, task-oriented computers where you need them.

### The HP 3000 Family

The HP 3000 family of business computers combines hardware, software, communications, and support in one integrated information management system. Over 30,000 HP 3000 systems are used in a wide range of office and manufacturing environments worldwide. Well known for reliability and ease of use, HP 3000 systems simultaneously manage on-line transaction processing, batch processing, programming, and data communications. HP 3000 systems provide both the performance advantages of leading-edge technology and the security of a fully compatible growth path.

To complement the HP 3000, Hewlett-Packard provides comprehensive networking capabilities, high-quality peripheral devices and workstations, personal computers, and a wide range of ready-to-run software. And because the HP 3000 has been well established for more than a decade, numerous third-party products are available for it.

### The HP 3000 Family Tradition

Hewlett-Packard continues to implement the strategy that has guided the development of the HP 3000 family from its beginning. This strategy integrates:

**Software compatibility.** All members of the HP 3000 family share a common operating environment, so applications can be run on higher-performance models.

**Expanding product line.** The HP 3000 family continues to expand, providing you with a broad, compatible range of systems from which to choose.

**Easy growth path to higher performance.** HP 3000 systems are always upgradable to higher-performance systems. Software and peripheral compatibility, as well as generous upgrade allowances, make it easy for you to adjust your computing power to handle growing workloads and meet new demands.

**Ease of use.** Among system operators, end users, and programmers, the HP 3000 has a well-deserved reputation of being easy to use. HP 3000 systems extend beyond data processing to increase the productivity of all of your end users. By combining the flexibility of personal computers with the processing power of the HP 3000, Hewlett-Packard allows you to enhance the information-processing capabilities of your entire organization.

**Comprehensive network solutions.** The HP 3000 offers a wide variety of workstation-to-system, system-to-system, and system-to-mainframe communications capabilities.

**Lasting value.** By protecting your investment in software and hardware through compatibility and upgradability, and by maximizing your productivity with easy-to-use systems, Hewlett-Packard ensures that you get a maximum return on your investment in HP 3000 solutions.

To complement its superior software and hardware, HP provides a full range of documentation, training, and consulting programs, ensuring that you get the maximum benefit from your HP 3000.

### HP 3000 Business Computer Systems

The HP 3000 family features a compatible growth path and a wide choice of systems, ranging from small distributed office systems to large database hosts that can handle your company's business computing needs. The HP 3000 family includes the MICRO 3000LX, MICRO 3000GX, MICRO 3000XE, Series 52, Series 58, Series 925LX, Series 925, Series 70, Series 935, Series 950, and Series 955 systems.

# BUSINESS COMPUTER SYSTEMS

## HP 3000 Business Computers (cont'd)

The 900 Series systems are based on HP Precision Architecture (HP PA), a new architecture that represents a fundamental change in computer design, producing a high-performance, highly reliable system at a low cost. HP PA incorporates Reduced Instruction Set Computing (RISC), a design approach that delivers greatly simplified computers that are optimized to provide the highest performance for a given integrated circuit (IC) technology. In addition, the inherent simplicity of HP PA means lower cost and higher reliability due to the need for fewer components.

### MICRO 3000LX and MICRO 3000GX



Specifically designed for an office environment, the MICRO 3000LX and MICRO 3000GX are ideal for small businesses, branch offices and departments. As with all HP 3000 systems, the MICRO 3000LX and MICRO 3000GX can concurrently handle on-line transaction processing and program development, batch processing, office applications, and data communications. In addition to its stand-alone capabilities, it can serve as a node in a network of computers.

### MICRO 3000XE

The powerful, cost-effective MICRO 3000XE can be the primary computer for a small company, can be dedicated to a single application in a large company, or can serve as a node in a network of computers.

### Series 52

Designed as a departmental computer system, the mid-range Series 52 can also meet a small company's data processing needs. In addition to its stand-alone capabilities, it can serve as a node in a network of computers.

### Series 58

A mid-range system, the Series 58 can operate as a stand-alone system or as the central computer (or major node) in a distributed-processing system.

### Series 925LX and Series 925



The Series 925LX and Series 925 are ideal computer systems for small-to-medium sized businesses, departments, and remote offices. The Series 925LX and Series 925 deliver superminicomputer performance in a surprisingly small package. Both process at 3.2 Million Instructions Per Second (MIPS).

### Series 70

The Series 70 is a high-performance system for large business applications. It is suitable for stand-alone operations or as the central computer (or major node) in large distributed networks.

### Series 935



The Series 935 offers breakthrough high-end performance for a remarkably low price and small size. It brings impressive computing power to the branch office or departmental environment, and is also offered as a simple board swap upgrade for Series 925 customers.

### Series 950

The first of a new generation of high-performance HP 3000 systems, the Series 950 processes at 7 MIPS. Based on a simplified technologically advanced design, the Series 950 is smaller, consumes less power, and is more reliable than typical systems in its performance class.

### Series 955



The Series 955 is the highest performance member of the broad family of compatible HP 3000 business computers. A convenient board swap upgrade from the high-performance Series 950, the Series 955 delivers significant, incremental growth with a modular approach to extending the HP 3000 system family.

The Series 955 provides exceptional performance and functionality in multi-user, multi-tasking, interactive, and batch environments. The Series 955 processes at 11 MIPS.

### The MPE Operating System

All members of the HP 3000 family use the MPE (Multiprogramming Executive) operating system, a very powerful, multi-user, multi-tasking operating system. MPE/V is the version used by MICRO 3000LX, MICRO 3000GX, MICRO 3000XE, and Series 52, 58, and 70 systems. MPE/XL, an enhanced version of MPE for the 900 Series systems, has been designed to take advantage of the high-performance capabilities of HP Precision Architecture. The MPE operating system allows easy system management and productive application development.

### Programming Languages

HP 3000 systems are optimized for on-line transaction processing environments. Programmers can choose from a wide variety of high-level languages such as COBOL, FORTRAN, RPG, C, BASIC, Pascal and ALLBASE/4GL to best fit their application requirements.

### Software to Manage Your Information Processing Needs

Hewlett-Packard was the first in the industry to put a database management system on a minicomputer: IMAGE on the HP 3000. With more than 30,000 active installations of IMAGE, HP has one of the largest installed bases of database management systems in the industry. Continuing its leadership role in database technology, HP has developed ALLBASE/XL, a new database offering for the 900 Series systems.

**ALLBASE/XL** is a combination of a network model and a relational model database management system. HP TurboIMAGE/XL, the network model DBMS, is a native mode implementation of the previous versions of IMAGE. It provides optimal performance for applications with high-volume, repetitive transactions such as production planning.

**HP SQL**, the relational model DBMS, is fully compatible with the de facto industry standard, SQL (Structured Query Language). HP SQL provides users with increased flexibility and programmer productivity.

For the MICRO 3000LX, MICRO 3000GX, MICRO 3000XE, Series 52, 58, and 70 systems, the network and relational database management systems are available separately. HP TurboIMAGE/V, the network model, is included in the fundamental operating system software; HP SQL/V, the relational model, is available as a separate product.

Hewlett-Packard's database management systems are complemented by and integrated with other tools that combine to form HP's "Information Management Framework."

**System Dictionary** provides a single source for documenting all aspects of the system, from data definitions to configuration information. This makes it easier to develop and maintain applications, and to manage system resources. System Dictionary can be customized to meet your business needs.

**Business Report Writer** allows the development of sophisticated reports through easy-to-use menus, and makes it easy to combine data from several sources in a single report.

**Inform** is an interactive inquiry and report-generation facility designed for managers, purchasers, clerks, and secretaries. It allows easy access to data.

**Information Access** is a personal computer application that lets users access information on HP minicomputers and IBM mainframes. It then automatically translates the data into popular PC applications such as Lotus® 1-2-3® and dBASE® II.

**VPLUS** and **HP Toolset** are tools that increase programming productivity. VPLUS is an easy-to-use forms-design and screen-handling tool for programmers. HP Toolset provides a high-productivity, integrated environment for application development. It includes facilities for full-screen editing, symbolic debugging, and version management of source code.

**Virtuoso** is a COBOL code generator. It increases applications development productivity by allowing developers to reuse existing blocks of code. Virtuoso provides the productivity associated with fourth generation languages, with the runtime performance of COBOL.

**ALLBASE/4GL** is an advanced fourth-generation language for developing transaction processing applications. It is a tightly integrated environment containing a screen painter, report writer, data dictionary, test utility and logic commands. ALLBASE/QUERY is an easy-to-use query and reporting tool for HP SQL databases.

**Silhouette/3000** is HP's most complete high-availability solution for the HP 3000. It automatically duplicates IMAGE and TurboIMAGE databases on multiple HP 3000 systems. Silhouette/3000 is customer-installable and easy-to-use. It provides high system availability, application availability during system backup, and load balancing across HP 3000 systems.

### Hewlett-Packard Application Software

Hewlett-Packard features a wide range of worldwide business solutions for the HP 3000 family of business computers. Manufacturing, accounting, financial planning and maintenance management are just a few of the applications available today in several languages.

HP's Customizer Technology provides the flexibility to easily tailor HP manufacturing, financial, and maintenance solutions to meet your unique needs. Modifications to your application are achieved without altering source code, thereby maintaining HP's industry-leading support.

**HP Manufacturing Management II** is a fully integrated MRP II solution for managing a world-class manufacturing operation - from purchasing to sales orders and corporate finance. Within HP Manufacturing Management II, the following functions are provided: Planning, Production Control, Manufacturing Specifications, Shop Floor Control, Inventory Control, Purchasing, Sales Order Management, Cost Management, Accounts Receivable, Accounts Payable, and General Ledger. Lot Control and Just-In-Time functionality can be added to enhance your manufacturing solution.



# BUSINESS COMPUTER SYSTEMS

## HP 3000 Business Computers (cont'd)

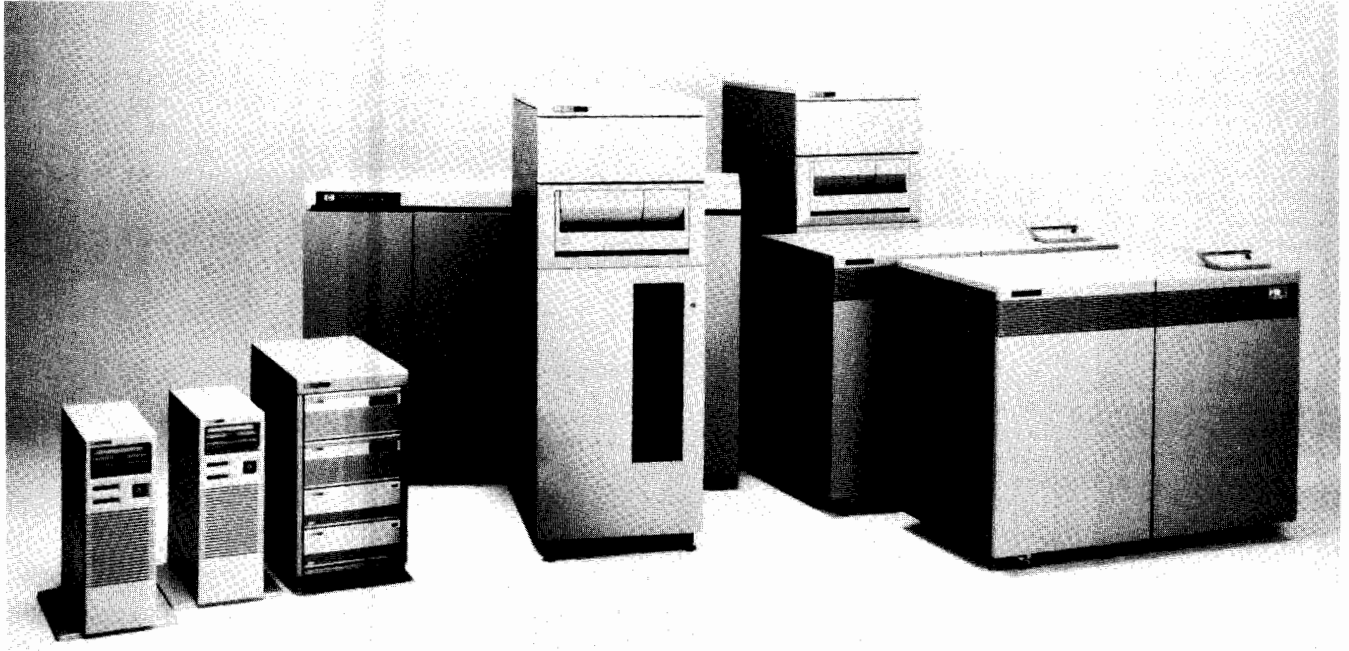

The HP 3000 family features a compatible growth path and a wide choice of systems.



**HP Manufacturing Management II/CORE** is a fully integrated MRP II solution for managing a world-class manufacturing operation that already has successful financial and sales order management systems. HP Manufacturing Management II/CORE serves the following operational areas: Planning, Production Control, Manufacturing Specifications, Shop Floor Control, Inventory Control, Purchasing, Cost Management, and Accounts Payable. Lot Control and Just-In-Time functionality can be added to enhance your manufacturing solution.

**HP Financial Accounting** is an on-line, totally integrated software application composed of seven accounting modules: General Ledger, Accounts Payable, Accounts Receivable, Dual Ledger, Allocator, Interface Facility, and Business Report Writer. HP Financial Accounting provides you with immediate on-line access to the financial information you need to efficiently run your business.

**HP Financial Budgeting** is an interactive application for budgeting, planning, and expense control. It provides capabilities similar to three-dimensional spreadsheets, which can be linked hierarchically and consolidated.

**HP Maintenance Management** assists maintenance and facilities managers in improving their operations. Capabilities such as preventive maintenance scheduling, work order control, inventory control, purchase order tracking, and equipment catalog help to minimize equipment downtime and reduce costs.

Hundreds of high-quality software products encompassing a broad range of applications are also available for the HP 3000 from independent software suppliers.

### Networking and Data Communications

Hewlett-Packard's AdvanceNet is a communications strategy based on standards designed to provide a broad range of networking alternatives. HP AdvanceNet products enable you to link all of your company's data resources - workstations, minicomputers, and mainframes - in a high-speed, user-transparent network.

HP AdvanceNet unites two data processing methods: HP's distributed processing and IBM's centralized batch processing. The HP AdvanceNet approach interfaces HP equipment with IBM and IBM plug-compatible products for both SNA® and Bisync environments.

Local area networks (LANs) are the links that connect individual personal computers, mainframes, minicomputers, and related peripherals. A network is a data and resource sharing system; each individual network node can easily and reliably communicate and exchange information with other nodes.

HP 3000 users can increase productivity through high-speed LANs. Hewlett-Packard's LAN/3000 Link and NS/3000 (Network Services) software form a powerful local network that's easy to install, use, maintain, and expand. The LAN/3000 Link includes everything you need to connect your HP 3000 to an industry-standard LAN, and the NS/3000 software provides sophisticated networking capabilities.

The components most suitable for your application can be selected from different vendors without compromising the unique needs of your data communications environment. The compatibility of future hardware and software additions to your HP AdvanceNet system is ensured by HP's commitment to industry standards.



	MICRO 3000LX or MICRO 3000GX	MICRO 3000XE	Series 52	Series 58	Series 925LX/ Series 925	Series 70	Series 935	Series 950	Series 955
<b>Technology</b>	NMOS III	NMOS III	TTL	TTL	NMOS III	ECL	NMOS III	NMOS III	NMOS III
<b>Main Memory (MB)</b>	2-4	2-8	4-8	4-8	24-48/32-48	8-16	48-96	64-128	64-128
<b>Workstation**</b>	8/16	56	92	152	32/152	400	240	400	400*
<b>Disk Storage</b>	0.3/2.0	4.5	4.5	4.5	4.6/9.1	13.7	13.7	17.1	27.4
<b>Database Management Systems</b>	TurboIMAGE/V HP SQL/V	TurboIMAGE/V HP SQL/V	TurboIMAGE/V HP SQL/V	TurboIMAGE/V HP SQL/V	ALLBASE/XL TurboIMAGE/XL HP SQL/XL	TurboIMAGE/V HP SQL/V	ALLBASE/XL TurboIMAGE/XL HP SQL/XL	ALLBASE/XL TurboIMAGE/XL HP SQL/XL	ALLBASE/XL TurboIMAGE/XL HP SQL/XL

\*Maximum configuration at first release.

\*\*Maximum number of configurable workstations will depend on the application.

# BUSINESS COMPUTER SYSTEMS

## Integrated Information Solutions

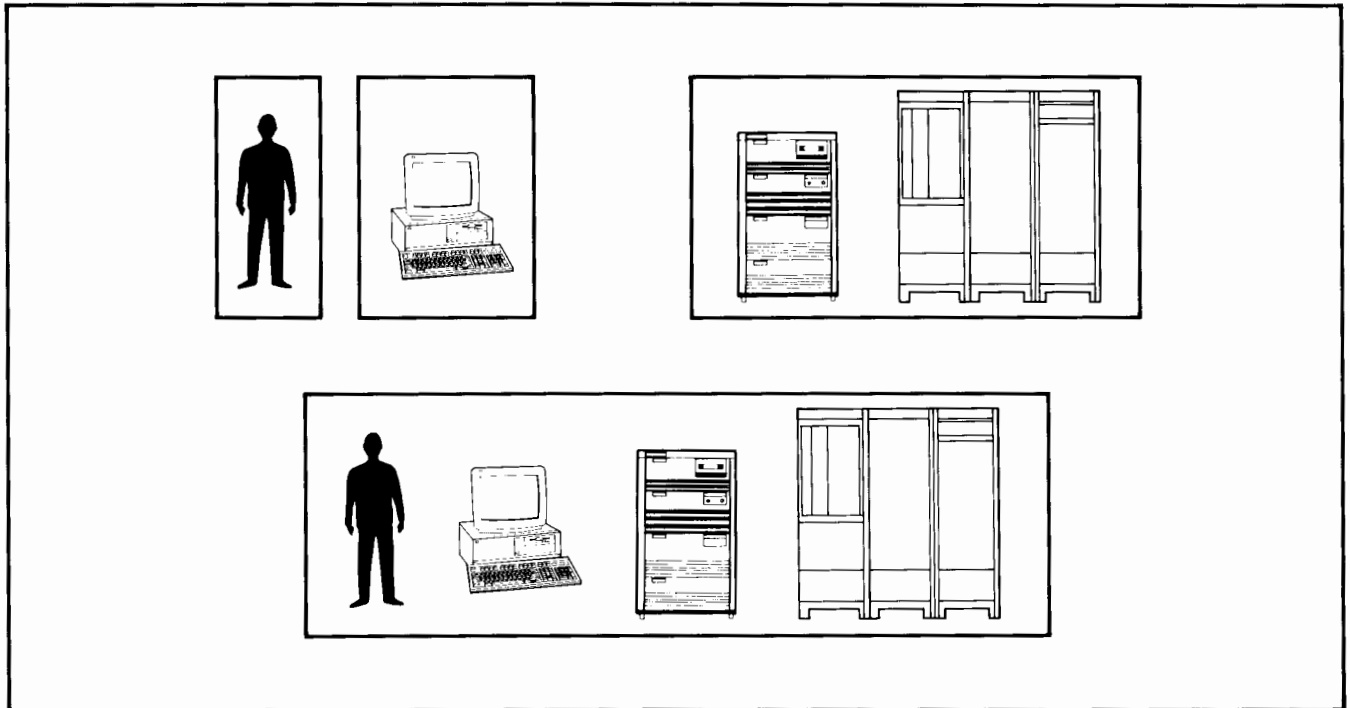

Hewlett-Packard integrates your company's information resources into a single, tightly knit information network.

### Better Use of Information and Computing Resources

By making information more useful and HP 3000 systems more effective, Hewlett-Packard's Integrated Information Solutions enhance your entire investment in information resources. The solutions combine products that utilize the advantages of personal computing, networking, and HP 3000 distributed data processing into one complete integrated business system.

Furthermore, HP's Integrated Information Solutions are completely tied to your organization's application environment, providing immediate access to departmental, corporate and even global information resources. Functional end users at all levels are better able to access, analyze, manipulate, share, and distribute vital information.

### The HP NewWave Environment

The HP NewWave environment is an advanced personal computer application environment providing a single window, or view, into your entire network of information and computing resources. This open environment is based on industry standards and is designed to allow the end user to focus on completing tasks rather than on learning and using individual applications. Furthermore, the HP NewWave environment presents a major opportunity for the developer to deliver greater benefits to customers.

Users working in the HP NewWave environment can move quickly and easily from one application to another because applications are integrated seamlessly. The Object Management Facility (OMF) allows end users to link, combine, or manipulate different forms of data such as text, spreadsheets, graphics, scanned images and voice by treating it as a single object; to the end user, these objects are represented as "icons." By manipulating the icons, a user can create compound objects by using the mouse to move one icon on top of another.

Once completed, these objects can be electronically mailed to other users in the organization.

In addition, the HP NewWave environment also provides the user with services such as computer-based training and context-sensitive help.

### HP NewWave Developer Products

There are three key products designed to enable developers to begin immediate design work on new applications or to integrate their current applications with the HP NewWave architecture: the Developer Kit, Developer Training and Technical Support.

### The HP NewWave Developer Kit

The HP NewWave Developer Kit contains all the HP components needed to write applications for this new environment. It includes the HP NewWave environment software, software development tools, and documentation.

### HP NewWave Developer Training

This is an invaluable course for software developers who will be writing applications under the HP NewWave environment. Although the HP NewWave environment is based upon Microsoft Windows 2.0, it consists of many extensions to Windows. This course provides the concepts and information on both Microsoft Windows 2.0 and those extensions needed by any HP NewWave application developer.

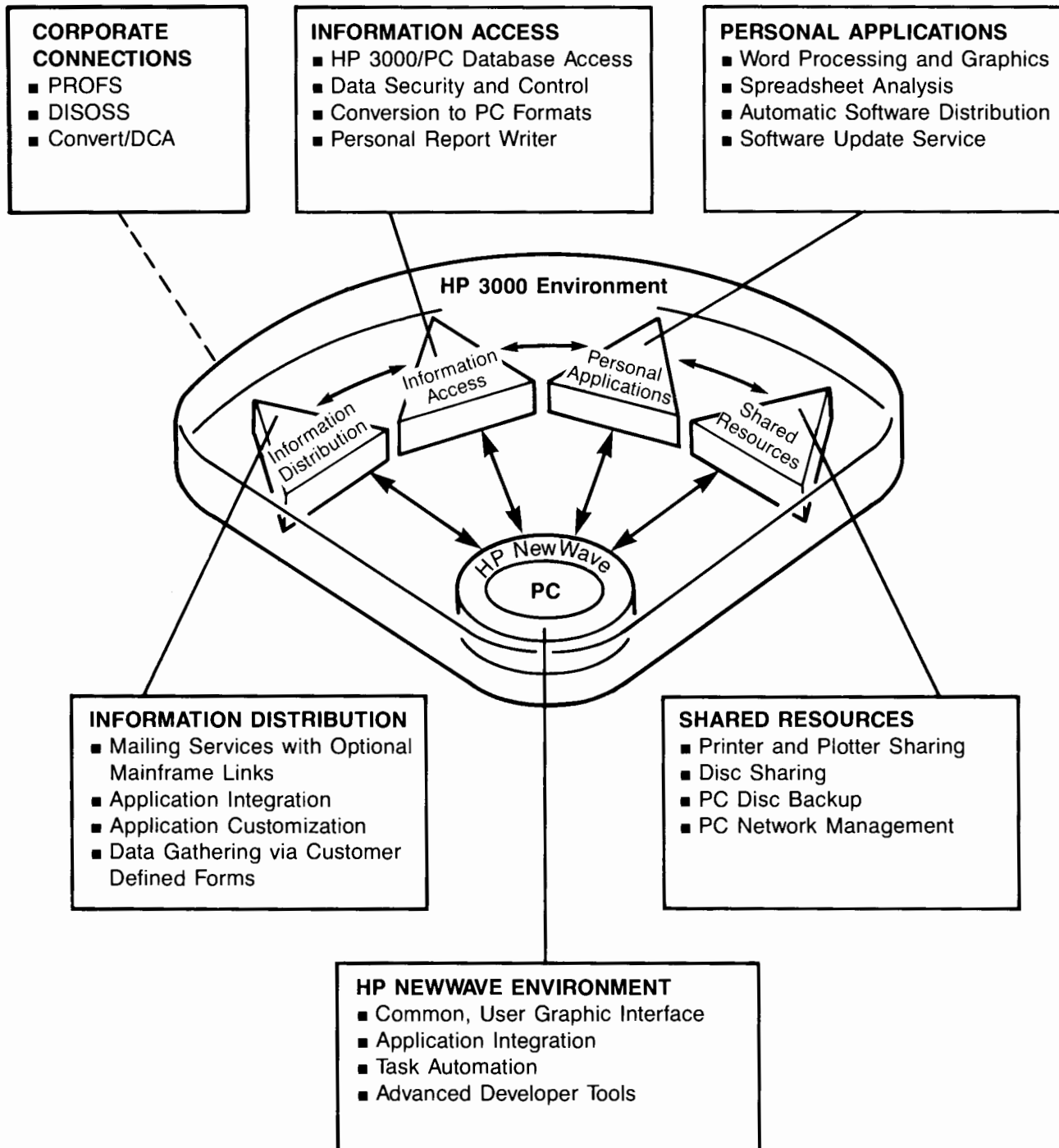

Hewlett-Packard's Integrated Information Solutions framework.

# BUSINESS COMPUTER SYSTEMS

## Integrated Information Solutions (cont'd)

### PC Integration and Departmental Services

PC integration and specific departmental services, such as access to information, system-wide communication, and shared resources, increase the effectiveness of workgroups by linking personal computers, terminals, minicomputers, mainframes and peripherals. Shared printers, plotters and disc storage maximize return on peripheral investments. Backing up PC hard discs to HP 3000 systems increases data security, and centralized distribution of PC applications increases MIS control.

Integrating PC resources with the HP 3000 minicomputer concentrates the power of each computer on the tasks it performs best. For example, the HP 3000 is designed for transaction-based processing and the PC is designed to enhance individual productivity.

### HP Business System Plus

HP's Business System Plus incorporates these PC integration and departmental service capabilities into a centrally managed system. Business System Plus, which is a single-software product, enhances the HP 3000 environment with resource sharing, information access, information distribution and popular PC applications capabilities. For example, with Business System Plus, users can extract data from HP 3000 applications, analyze and describe the information on their PC, and distribute the results electronically throughout the organization. The result: significantly improved use of computer resources and more timely, accurate decision making.

Specific features of Business System Plus include:

- PC Backup
- Information Distribution
- Printer and Plotter Sharing
- Disc Sharing
- Centralized PC Software Distribution
- Access to Information
- PC Network Management
- Advanced PC Applications

In addition, customers who do not need the complete capabilities of Business System Plus can purchase the departmental services of information access and information distribution, as well as PC application components individually.

### Departmental Services Components

#### HP Information Access

Information Access is a unique information management software package that provides access to information, facilitates reporting and data exchange, and coordinates distribution between personal computers, HP 3000 minicomputers and IBM mainframes. It is an information server that extends the reach of your data processing systems by delivering key business data throughout your organization. Information Access provides the means for end users to make better-informed decisions based on up-to-the-minute information by providing simple, yet secure, access to information wherever it resides.

Information Access provides the most current information to PC users by allowing access to local and remote HP 3000 systems as well as PCs and databases. Results can be output directly to many popular PC applications, including Lotus 1-2-3. Additionally, MIS professionals are no longer burdened by requests for custom reports because end users have direct access to the crucial information they require.

### HP DeskManager

HP DeskManager manages the flow of information throughout your network via electronic mail, and lets you integrate data processing applications such as for finance, payroll and order processing functions. It simplifies administration of the electronic mail system with central directory keeping, and provides security features such as password protection, access limitation, and message scrambling.

With HP DeskManager, data processing reports can be sent automatically to predefined distribution lists, forms can be circulated and returned, and financial data can be collected from multiple locations. All types of messages, from simple tax files to complex documents, programs and data files, can be sent and received as near as down the hall or as far away as around the world.

The following products augment the standard departmental services with advanced capabilities to further enhance the effectiveness of workgroups, departments or entire companies. These products can be added to systems that already have Business System Plus or its individual components.

### Additional Departmental Services Products

#### HP File/Library

HP File/Library is a complete electronic filing solution for the entire department. Any file, even a paper file, can be indexed in the HP File/Library catalog. Users can access documents wherever they are located, thus eliminating the need to duplicate files in multiple locations and saving valuable disc space by archiving documents onto inexpensive cartridge or tape.

#### HP Schedule

HP Schedule keeps track of schedules and coordinates the busy calendars of an entire department or even a group of departments. It sets up meetings and can schedule resources located anywhere on the network — from conference rooms and audio-visual equipment to corporate jets.

#### PROFS

HP OfficeConnect to PROFS provides a transparent electronic mail link between HP systems running DeskManager and IBM's Professional Office System, allowing users of these two systems to communicate with each other through their own electronic mail systems.

#### DISOSS

HP OfficeConnect to DISOSS provides a transparent electronic mail link between these two systems and IBM's Distributed Office Support System. Users on either system can communicate with each other using their standard address formats. Also, users on both systems have open access to distribution lists and DISOSS document libraries.

#### CONVERT/DCA

HP Convert/DCA enables HP and IBM users to exchange and edit documents in both Final and Revisable Form Text DCA (Document Content Architecture). IBM PC users with DisplayWrite can exchange revisable documents with HP Vectra PC users using AdvanceWrite and Executive MemoMaker software.



### **Cooperative Services**

Cooperative Services is a software development tool designed to create cooperative processing applications between personal computers and an HP 3000 minicomputer. The product comprises an MS-DOS procedure library and an HP 3000 intrinsic server, and it supports popular PC development languages.

### **HP AdvancePrint**

AdvancePrint provides low-cost, shared printing for PC users by allowing HP Vectra, IBM, and HP 150 PC users to share printers and plotters connected to an HP 3000 system. AdvancePrint takes advantage of low-cost basic serial connections; no expensive networking is required. With AdvancePrint, PC users can print to shared devices as if the printers or plotters were directly attached to their PCs (including full graphics support).

### **PC Applications**

Hewlett-Packard PC applications provide users access to a wide range of word processing, spreadsheet analysis, database management, and graphics capabilities. Designed for easy integration, these PC applications, combined with any of Hewlett-Packard's industry-leading printers and plotters, provide professionals with high-quality memos, reports, presentations and sophisticated documents.

### **Graphics Gallery Collection**

The Graphics Gallery Collection provides professional quality presentation capabilities to PC users. Users are able to create colorful pie, bar and line charts as well as complex text charts, flow charts, organization charts, logos and presentation slides.

### **AdvanceMail**

AdvanceMail is a personal computer mailing application that enhances the integration of PCs with HP DeskManager. End users are able to utilize the full range of electronic mail capabilities while remaining entirely in their PC environments.

### **AdvanceLink**

AdvanceLink provides terminal emulation and file transfer capabilities to a host computer across a variety of data communication links. AdvanceLink terminal emulation enables users to run applications on HP 3000 and HP 1000 systems, and even DEC VAX systems. AdvanceLink file transfer functions allow users to share data, text files, memos, and even graphics between the PC and host computers. With the AdvanceLink command language, users can build macros to coordinate and automate routine tasks.

### **Executive MemoMaker**

Executive MemoMaker (EMM) is a full-functioned, easy-to-use word processor designed for business professionals and managers. EMM includes features such as on-screen graphics integration, a spelling checker, and search and replace functions, allowing the user to create professional-quality memos and reports.

### **Executive Card Manager**

Executive Card Manager (ECM) is a file management program designed with a Rolodex-like card file interface. Users can manage almost any kind of information, from addresses and phone numbers to client contact records and purchase histories. Each file can contain up to 64,000 cards and each card can contain up to 11 screens of information. ECM also provides a built-in report writer that lets users present information in a variety of formats, including mailing labels.

### **Lotus 1-2-3**

Lotus 1-2-3 is a top-selling spreadsheet package that has become an industry standard for personal computer users worldwide. Offering speed, power, and ease of use, Lotus 1-2-3 helps all types of managers and professionals gather, organize and analyze information better than ever before.

### **AdvanceWrite Plus**

AdvanceWrite Plus is designed for individuals who require the advanced functionality of a sophisticated word processor with text, graphics and image integration. Providing a level of performance and functionality traditionally found only in dedicated word processors, AdvanceWrite Plus includes capabilities such as table of contents and index generation, equation processing, forms processing and integrated spreadsheets.

### **Implementation and Support**

To help you get the most out of your Integrated Information Solutions system, Hewlett-Packard offers a consulting service called HP OFFICE-ASSIST. The HP OFFICE-ASSIST program provides an experienced systems engineer and a day of customer education to help you implement your company's goals through the use of the appropriate office applications.

# COMPUTER PERIPHERALS

## Terminals - Rugged

### Models 9666A and 3082A

- Rugged (Meets NEMA 12)
- Over Temperature Sensor
- Touchscreen
- High Quality Color Display



HP 9666A

### Operator Interface Unit

The HP 9666A OIU is a compact, low-cost rugged terminal specifically designed for factory floor applications. Its 12" high-resolution color display and state-of-the-art interactive touchscreen is incorporated in a compact dust and drip protected enclosure.

The unique HP-HIL interface lets you connect multiple input devices like HP-Touch, Mouse, Graphics Tablet and Bar Code Reader. Eight basic colors can be displayed from a palette of 64 making user-defined colors easily accessible, including those that match HP plotter pens.

The OIU also provides color alphanumerics. Up to eight color pairs (foreground/background) can be used on a per character basis to differentiate text and identify critical fields.

The terminal can operate at temperatures ranging from 0 to 60 degrees C and its enclosure meets NEMA 12 standards. The OIU is also aided by an over-temperature sensor that prevents equipment loss through automatic shutdown.

The versatility of the OIU is enhanced with the ability to interface with HP 1000, 3000 and 9000 computer systems. In addition, the OIU has ANSI X3.64 and TEKTRONIX 4010/4014 compatibility so that it can be used on a variety of computer systems.

Software support for the OIU includes popular HP packages like DSG/3000, HP DRAW, HP EASYCHART, HP MAP, Graphics 1000/II and Graphics 9000. In addition, you can use the OIU with many third-party software packages, including Precision Visuals DI-3000 and GRAFMAKER, ISSCO's DISSPLA and TELL-A-GRAF, and SAS Institute's SAS/GRAPH.

The standard OIU offers two RS 232 ports. Port 1 moves data at a speed of up to 19.2 kbps with handshaking. For additional flexibility, Port 2 provides a peripheral port for hardcopy output.

Allowing the OIU to be conveniently located on the factory floor, HP features two mounting options: A tilt and swivel base or a 19" rack mounting kit.

### Ordering Information

HP 9666A Operator Interface Unit  
Opt 001 Bar Code Reader

### Price

\$5,924.00  
+\$622.00

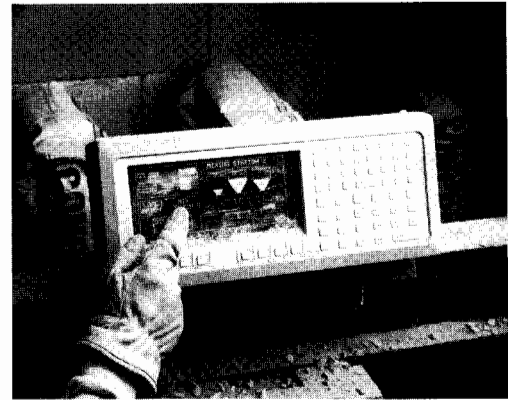

HP 3082A

- Compact
- Simple
- Rugged (Meets NEMA 4,12,13)

### Industrial Touch Display Terminal

HP Industrial Touch is a compact, sealed and rugged display terminal designed to enhance the speed and accuracy of data capture and display on the factory floor. It is plug-compatible with HP computer systems and emulates DEC VT100/VT52 terminals.

HP Industrial Touch is ideal for planning, production, control and maintenance applications in process and discrete manufacturing industries. It is easy to use, easy to install, easy to develop applications for, and provides high reliability for operation in harsh industrial environments.

### Features

#### Easy to Use

- Touchscreen Input
- Barcode Input (wand, laser scanner, slot-reader)
- Function Keys
- ABC keypad

#### Easy to Install

- Plug-compatible with HP computer systems
- Emulates DEC VT100/VT52 terminals
- Compact in Size
- Flexible mounting alternatives (wall, pole, 19" rack)

#### Easy Application Development

- Firmware-based and Menu-Driven Screen Editors
- Forms, oversized characters, character graphics, touch target editors
- Compatible with VPLUS, FORMS1000, HPTODAY
- Quick Screen Design with HP Mouse or HP QWERTY Keyboard
- High Quality and Reliability
- NEMA 4,12,13 enclosure
- Rugged, fan-free cast aluminum
- Designed for the factory floor

### Ordering Information

	Price
HP 3082A Industrial Touch Display Terminal	\$3,450.00
Option 001 Adds Touchscreen	+\$450.00
Option 002 Adds Barcode Decoder	+\$300.00
Option 003 Adds Touchscreen and Barcode Decoder	+\$750.00
Option 801 Water Tight Option (Canada)	\$0
Option 802 Water Tight Option (US)	+\$225.00
Option 803 Water Tight Option (Other Countries)	+\$125.00
Option 908 19" Rack Mount Kit	+\$60.00
Option 910 Complete Manual Set	+\$85.00
Option W03 Substitute 90-day Onsite for 1-year Warranty	\$0
HP 3082U Value-Added Business Development Kit	\$4,660.00

# COMPUTER PERIPHERALS

Dial-Up Modem

Model 37212B

707

- 2400/1200/300 bps full duplex
- Error correcting (MNP) protocol
- Auto-dial/auto-answer

- PSTN or leased line selection
- Synchronous or Asynchronous
- Alternative control channel for DS and synchronous applications

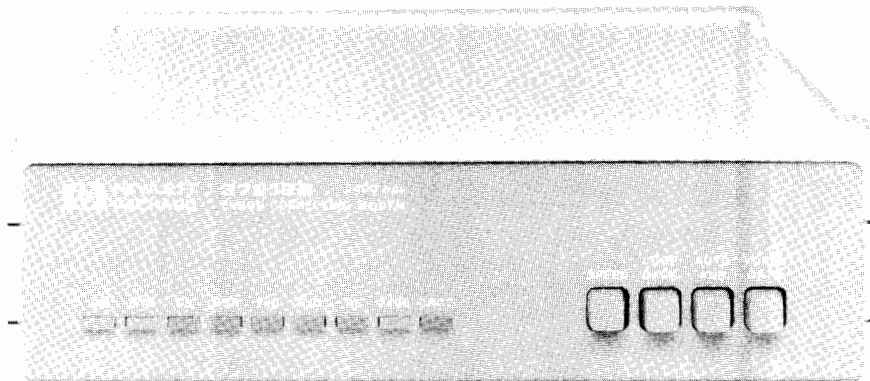

HP 37212B

## Universal V22 Bis Modem

The new HP37212B modem is a high performance multi-function modem offering a wide range of features to suit virtually any application. Numerous configuration options ensure optimum performance for both HP and non-HP systems.

## For Corruption Free Data Links

Without error control, transmission on a typical 2400 bps line would probably result in an error every minute. The HP 37212B uses the industry standard MNP error correcting protocol which allows data to be transferred reliably and without errors regardless of noisy phone lines.

With error correction enabled, the 37212B can automatically drop back to transparent communication when connecting to a non-error correcting modem. Alternatively it can be set to lock-out communication with non-error correcting modems.

Given an error free line, no noticeable degradation of speed results from using error correction. There is a choice of Flow control methods CTS, ENQ/ACK or XON/XOFF.

## Three Command Modes

**Terminal Mode** provides a user friendly way to operate the 37212B directly from the keyboard of a terminal or PC. The user is prompted for correct key sequences to obtain particular functions and status information.

**Computer mode** is optimized to simplify the programming required for a computer to control the modem automatically. Commands are accepted by the modem, but it will not echo or reply unless specifically requested to do so. This ensures that the computer will not receive any unexpected characters from the modem. Status information is represented by a string of eight ASCII characters instead of descriptive text.

**Manual command mode** allows the HP 37212B to be operated using front panel control switches.

## Two Control Channels

Normally, the control channel is through the RS-232-C (CCITT V.24) data interface, however, some computers or devices (eg. DS cards) are unable to output configuration or dialing commands through their data channel. For this reason, the HP 37212B offers an alternative control channel to be selected on the RS-232-C port. A 'Y' cable (Part number HP 15614A) can be used to break out the secondary control channel onto a separate RS-232-C port.

## Four Modulation Standards

Can communicate with a broad spectrum of industry standard modems.

Bell 103 (FSK) at 300 bps	Asynchronous
Bell 212A (DPSK) at 1200 bps	Asynchronous/Synchronous
CCITT V.22 (DPSK) at 1200 bps	Asynchronous/Synchronous
CCITT V.22 bis (QAM) at 2400 bps	Asynchronous/Synchronous

## Worldwide Regulatory Approvals

The 37212B conforms to the regulations of telephone approval authorities in several countries. The local HP field office will be able to provide up-to-date information on the connection approval status in your country.

## Flexible Telephone Connection

Both North American and UK style telephone sockets are provided. In addition to sockets for the modem/telephone line, extra sockets are provided for use with an adjacent telephone. This allows telephone communication to take place while the modem is not in use and also enables manual-dial or manual-answer operation.

## Convenience Features

**NON-VOLATILE MEMORY** stores telephone numbers, log-on strings and modem configuration for speedy operation.

**PULSE OR TONE DIALING** ensures dialing compatibility with most telephone systems.

**LEASED LINE OPERATION** a single modem for both leased line (2-wire) or dial-up operation.

**INTEGRAL LOUDSPEAKER** monitors call progress without requiring an adjacent telephone.

**DIAGNOSTIC AND SELF TESTS** allow users to verify both line quality and modem operation without the need for special equipment.

**INTEGRAL 120/240V POWER SUPPLY** eliminates the need for an external transformer.

**RACK MOUNT KIT** allows one or two 37212Bs to be mounted in standard 19" equipment racks.

**DC POWER OPTION** simplifies incorporation into systems isolated from an AC (line) supply.

**SHORT-HAUL APPLICATIONS** For applications up to 3000m. connecting computers, instruments or printers on HP-IB, consider the HP 37204A/B HP-IB bus extenders. See page 563 for further information.

## Ordering Information

HP 37212B Stand Alone Modem

Price

\$920

# COMPUTER PERIPHERALS

## Personal Data Storage

Models 9114B, 9122C, 9123D, 9127A, 9153C

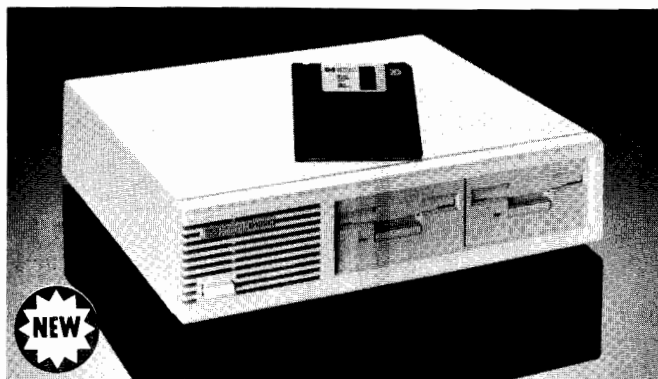

HP 9122C

Hewlett-Packard offers a full line of data storage solutions to fit a wide range of personal or technical computer requirements. HP's disc drives cover a variety of prices, capacities and performance levels.

### 3.5" Microfloppy Personal Data Storage Solutions

#### HP 9114B Portable 3.5" Disc Drive

Designed for HP's Portable computer family as well as the Series 40 and Series 70, the HP 9114B provides up to 710 Kbytes of formatted capacity in a lightweight, battery-operated package. The 3.5" disc drive reads, writes, and initializes double-sided media in both single-sided and double-sided formats. This feature allows data exchange with single-sided drives currently in use.

#### HP 9122C 3.5" Drive

The new HP 9122C is a 3.5" microfloppy disc drive with an unformatted capacity size of 2 megabytes (1.42 megabytes, formatted). It is tailored for the measurement automation and technical system markets and comes in a single - or dual - drive configuration.

The 2 megabyte capacity size is twice that found in previous models but is offered at the same price. It is ideal for backup, increased storage and file transfers among systems of the same type.

The HP 9122C employs an ANSI-standard format-sensing mechanism to differentiate 2-megabyte diskettes from those of other capacities. Existing 1-megabyte and 0.5-megabyte media can be used in the HP 9122C, but new 2-megabyte media must be used only in 2-megabyte drives.

#### Features

- 2-megabyte (unformatted) 3.5" microfloppy
- Doubled capacity at yesterday's price
- Quiet operation
- Reliable Design
- Supported on HP 9000 Series 200/300
- Supported on HP 1000 A Series

#### HP 9123D Dual 3.5" Drive (for HP Touchscreen II Personal Computers)

Designed exclusively for the HP Touchscreen II, the HP 9123D provides users with 1 megabyte of unformatted storage. It relies on the Touchscreen II for its power supply.

### Hard Disc Personal Data Storage Solutions

#### HP 9153C - 10, 20 and 40 Megabyte Winchester Hard Discs

The HP 9153C is a highly reliable and rugged desktop disc drive offering users a choice of capacities, ability to expand storage size and optional 2-megabyte 3.5" microfloppy.

The drive is well-suited for industrial, office automation, factory-floor and low-end CAD environments.

By offering the HP 9153C in 10, 20 and 40 megabytes, HP lets customers choose the capacity size most beneficial to their needs. Customers initially purchasing the 10 or 20 megabyte models may elect to expand their capacities to 30 or 40 megabytes, respectively, with the HP 9153M. This product is a 20-megabyte upgrade kit that is installed on the original HP 9153C package. The HP 9153M mechanism is priced less than a disc subsystem of equal capacity.

The exceptional design of the HP 9153C is due to the integration of HP's own 3.5" Winchester. This Winchester has proven its resiliency in even the harshest environments.

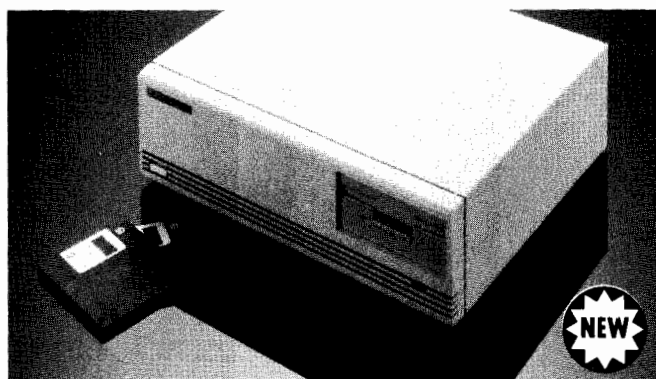

HP 9153C

An optional 2-megabyte (unformatted) 3.5" microfloppy is available with any hard disc model.

#### Features

- 10, 20 or 40 megabytes
- Optional 2-megabyte (unformatted) 3.5" microfloppy
- Integrates HP's own 3.5" Winchester
- HP 9153M expands capacities of 10- and 20-megabyte models
- Rugged and reliable
- Data protection
- Supported on HP 150C
- Supported on HP 9000 Series 200/300 and HP 1000 A Series
- Supported on HP 64000

### Data Interchange

#### HP 9127A—Single 5.25" Flexible Disc Drive

The HP 9127A is a single 5.25" disc drive that gives the HP Touchscreen and Touchscreen II data compatibility with the IBM-PC via 5.25" discs. Connected by HP-IB to the Series 300 (via DOS coprocessor card) and Touchscreen computers, the drive can read, write, and initialize discs in IBM-PC format as well as HP format. The discs can be moved between IBM and HP computer systems for easy data exchange. The 9127A can also read copy-protected DOS software with the HP Series 300 DOS coprocessor card.

### Ordering Information

	Price
HP 9114B Double-sided 3.5" Disc Drive	\$810
HP 9122C Dual 2 Mbyte 3.5" Microfloppy	\$1465
Opt 001 Deletes one microfloppy mechanism	\$-315
HP 9123D Double-sided 3.5" Dual Drive	\$1005
HP 9127A Single-sided 5.25" Flexible Disc Drive	\$1090
HP 9153C	
Opt 010 10 Mbyte hard disc plus floppy	\$1980
Opt 011 10 Mbyte hard disc only	\$1725
Opt 020 20 Mbyte hard disc plus floppy	\$2795
Opt 021 20 Mbyte hard disc only	\$2435
Opt 040 40 Mbyte hard disc plus floppy	\$3640
Opt 041 40 Mbyte hard disc only	\$3305
WO 3 Subs 90-day on-site warranty for 1-year return to HP warranty	\$0
HP 9153M 20 Mbyte mechanism Upgrade Kit	\$1015
HP 88500A IBM Disc/Tape Interface	\$410
HP 91290A 5.25" HP Qualified Media (Box of 10)	\$25
HP 92192A 3.5" 1.0-Mbyte Double-sided Microfloppy (Box of 10)	\$39
HP 92192X 3.5" 2.0-Mbyte Double-sided Microfloppy (Box of 10)	\$79
HP 19500B Rack Slide Kit to mount 9122C or 9153C in 19" EIA cabinet	\$125

☎ Fast ship product see page 766

# COMPUTER PERIPHERALS

## Data Storage For Technical/Commercial System-Removable

Models 7907A, 7935H, 7935XP

709

- Rugged Design
- Reliability
- Serviceability



HP 7907A



### HP 7907A Fixed/Removable Disc Drive

The HP 7907A is a complete mass storage subsystem featuring 20.5 megabytes of formatted removable storage in an easy-to-use front loading configuration. Add to this an additional 20.5 megabytes of formatted fixed storage, and you have a workable on-line and backup storage solution in one compact package.

This high performance, environmentally rugged disc subsystem is ideal for applications such as automatic test, on-site data logging and computer-aided engineering. Its small lightweight package allows easy placement on a desk or in a 19" EIA rack enclosure.

### Features

- 41 Mbytes of formatted disc storage
- 20.5 Mbytes of fixed storage/20.5 Mbytes of removable storage in an easy to use front-loading 8" cartridge
- 30 ms average seek time
- Ramp-loaded heads for added reliability
- Front panel or system activated image backup/restore in less than 3 minutes
- Environmentally rugged design
- 19" EIA rackmount kit 19507A also available
- Customer installable
- Compact packaging (180Hx325Wx467mmD)

### Electromagnetic Emissions

Radiated and conducted interference:

- For U.S.A., designed to meet FCC Docket 20780 for Class B computing devices.
- For Europe, designed to meet applicable VDE 0871 requirements for computing devices.

### Safety

The HP 7907A meets all applicable safety standards of the following:

- IEC 380 and 435
- UL 114 and 478
- CSA C22.2 No. 154

- Integral Self Test and Diagnostics
- Internal Microprocessor Controller
- Removability

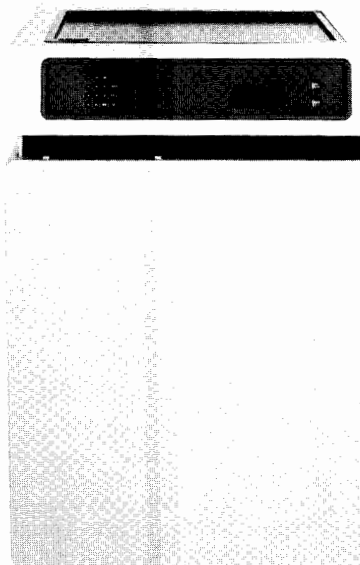

HP 7935H,  
7935XP



### HP 7935H Disc Drive

The HP 7935H Disc Drive is a removable media device that provides 404 Mbytes of removable media for increased system flexibility and greater system uptime for private data volume configurations and disc-to-disc backup/restore operations.

### HP 7935XP Disc Drive

The 7935XP is the same as the disc drive above, but includes one megabyte of controller cache memory for higher performance.

### Electromagnetic Emissions

Radiated and conducted interference:

- For U.S.A., designed to meet FCC docket 20780 for Class A computing devices.
- For Europe, designed to meet VDE 0871 for Level A computing devices and are FTZ licensed on some HP systems.

### Safety

Both models of the HP 7935 and 7935XP meet all applicable safety standards of the following:

- IEC 380 and 435
- UL 114 and UL 478
- CSA 22.2 No. 154

### Ordering Information

	Price
HP 7907A (41 Mbytes)	\$13,420
Opt 015: 240V/50Hz	\$0
Opt 550: Delete HP-IB Cable	\$-85
HP 7935H (404 Mbytes)	\$24,000
HP 7935XP (404 Mbytes)	\$25,500
Standard Input Power: 208 volts	\$0
Opt 120: For 120-volt operation in U.S.A., Canada	\$0
Opt 210: For 208-volt operation in Canada	\$0
Opt 220: For 220-volt operation in Canada	\$0
Opt 221: For 220-volt operation in continental Europe	\$0
Opt 222: For 220-volt operation in Switzerland	\$0
Opt 223: For 220-volt operation in Denmark	\$0
Opt 241: For 240-volt operation in United Kingdom	\$0
Opt 242: For 240-volt operation in Australia, New Zealand	\$0
HP 97907A 20.5 Mbyte removable disc cartridge	\$225



# COMPUTER PERIPHERALS

## Data Storage for Technical/Commercial Systems

Models 7957B, 7958B, 7959B, 7962B, 7963B

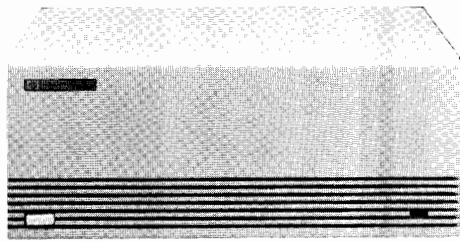

HP 7959B

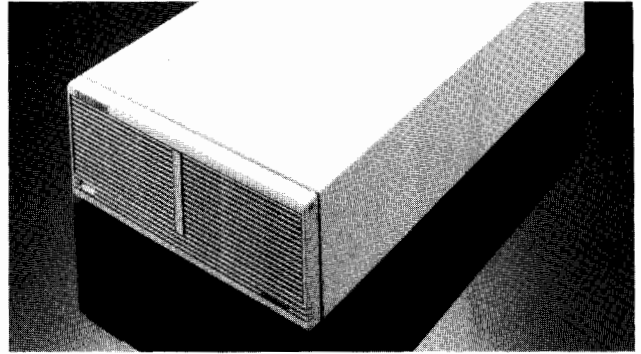

HP 7963B



### HP 7957B, 7958B and 7959B Disc Drives

The HP 7957B (81 megabytes), 7958B (152 megabytes) and 7959B (304 megabytes) are 5.25" disc drives that offer the capacity and performance demanded by today's commercial and technical multi-user systems and engineering workstations. These disc subsystems each feature an average seek time of 17 ms and burst data transfer rate of 1.25 megabytes per second.

The compact packaging of the HP 7957B, 7958B and 7959B allows them to be tucked away in HP's attractive mini-rack cabinetry, or placed unobtrusively on a desktop. There is, of course, a rack-mount kit available for 19" EIA cabinetry, and, with a sound power level of 52 dB(A), each drive is suitable for the office or lab environment.

The foundation of this new product family is HP's own designed and built 5.25" Winchester mechanism. This high performance mechanism features a special track positioning system that essentially eliminates seek errors. Plus, it enhances read/write accuracy over the entire operating range. The ability to service the products is enhanced by error-logging, autosparing and self-test capabilities. And low monthly maintenance costs contribute to low overall cost of ownership.

#### Features

- 81 megabytes (formatted), HP 7957B
- 152 megabytes (formatted), HP 7958B
- 304 megabytes (formatted), HP 7959B
- 17 ms average seek time
- 1.25 megabyte/second burst transfer rate
- Compact packaging (132H x 325W x 285mmD)
- Quiet operation
- Integrates HP's own 5.25" Winchester
- Automatic error correction and error logging
- Quick access to all replaceable assemblies
- CS/80 instruction set

### HP 7962B and 7963B

Available in initial configurations of 152 and 304 megabyte capacities, the HP 7962B and 7963B disc drives provide lasting value at an affordable price.

The efficient package design accommodates up to three HP Winchester mechanisms. Users initially purchasing a subsystem with one mechanism can later install as many as two additional stand-alone mechanisms - all to the original package.

These stand-alone mechanisms are available as 152 or 304 megabyte upgrade kits. Both upgrade kits are attractively priced to provide a growth path that's lower in price than equivalent, but separately packaged, disc drive subsystems.

The HP 7962B and 7963B integrate HP's own designed and manufactured 5.25" Winchester mechanism. This mechanism provides a fast seek time, high reliability and excellent performance.

Channel optimization is another key feature of this disc family. Similar to rotational position sensing, channel optimization increases performance by allowing multiple discs to better utilize a single HP-IB channel.

#### Features

- 152 megabytes (formatted), HP 7962B
- 304 megabytes (formatted), HP 7963B
- Additional capacity can be placed in original package at a later date
- 152 and 304 megabyte upgrade kits available
- Integrates HP's own 5.25" Winchester
- 17 ms average seek time
- 1.25 Mbyte/s burst transfer rate
- Compact size (132H x 325W x 554mmD)

#### Electromagnetic Emissions

Radiated and conducted interference:

- For U.S.A., meets FCC docket 20780 for Class B computing peripheral devices.
  - For Europe, meets EMI level FTZ 1046/84 and provides a Manufacturer's Declaration.
- For more information, contact your local HP office.

#### Safety

The HP 7957B, 7958B, 7959B, 7962B and 7963B meet all applicable safety standards of the following:

- IEC 380 and 435
- UL 114 and 478
- CSA C22.2 no. 154
- CSA C22.2 no. 220 (7957B, 7958B, 7959B)

#### Ordering Information

	Price
HP 7957B (81 megabytes)	\$3,850
HP 7958B (152 megabytes)	\$5,475
HP 7959B (304 megabytes)	\$9,350
HP 7962B (152 megabytes with upgrade capability)	\$6,300
HP 7963B (304 megabytes with upgrade capability)	\$10,750
Opt 015 for non-U.S.A. shipments, voltage set for 230V operation	\$0
Opt 550 Delete 1-metre HP-IB cable	\$-80
Opt W03 Converts 1-year return-to-HP warranty to 90-day on-site warranty	\$0
HP 97962B (152 megabyte upgrade kit with controller)	\$4,150
HP 97963B (304 megabyte upgrade kit with controller)	\$7,050
Opt D02 Deletes HP installation	\$-100
Opt W03 Converts 1-year return-to-HP warranty to 90-day on-site warranty	\$0
HP 19500B Rack kit for mounting HP 7957B, 7958B or 7959B in 19" EIA rack enclosure	\$125
HP 19560B Rack kit for mounting HP 7962B or 7963B in 19" EIA rack enclosure (HP 12679C rack rails required)	\$125

# COMPUTER PERIPHERALS

## Data Storage for Technical/Commercial Systems

Models 7936H, 7937H, 7936XP, 7937XP, 7936FL and 7937FL

711

- High reliability
- Compact size
- Low power consumption
- Choice of controllers

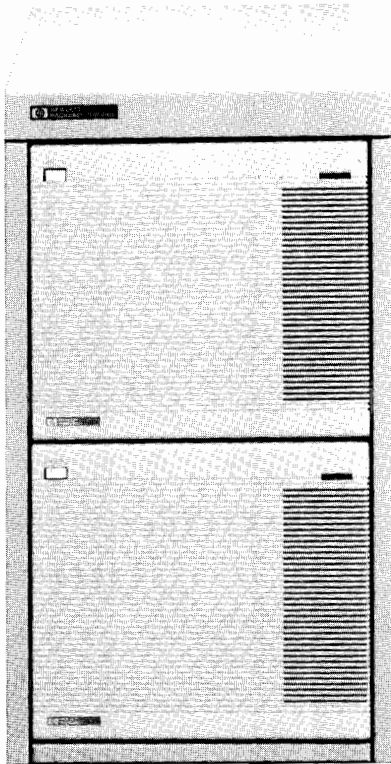

2 HP 7937s in HP 19511A cabinet



### HP 7936H and HP 7937H

The HP 7936H and HP 7937H disc drives are fixed media storage devices that provide formatted storage capacity of 307 and 571 megabytes, respectively. These Winchester disc drives incorporate sealed head/disc assembly (HDA), extensive VLSI, and HP-developed sputtered thin film media. As a result, excellent performance, reliability, and floorspace utilization are available at an attractive price.

Designed to meet the performance demands of present as well as future computer systems, the HP 7936H and HP 7937H disc drives offer high density storage and compact size. Ideal for a broad range of multi-user computer systems, these disc drives provide low per-megabyte storage costs and require low power consumption. Compatibility with the basic standard of HP-IB and CS/80 guarantees operations on existing and future HP 3000, HP 9000 and HP 1000 computers.

### HP 7936XP and HP 7937XP

These disc drives are the same as those described above, but contain controller cache as an included feature. The cache contains two megabytes RAM for read cache coupled with a single-instruction write cache. Performance can increase 10-20% on most systems.

### HP 7936FL and HP 7937FL

These disc drives integrate the new HP-FL controller, one of four components found in the HP-FL fiber-optic link. This link is supported only on HP Precision Architecture Systems and is made up of the disc drive controller, CPU interface card, a fiber-optic cable, and PBus cable to daisychain multiple discs. The HP-FL link provides

support of large mass storage configurations (up to 32 drives on some models), and cable lengths of up to 500 metres. In addition, the CPU interface to disc controller burst transfer rate is 5 megabytes per second. And because data is transmitted via light, the fiber-optic cable is immune to electromagnetic interference and does not emit radio frequency energy.

### Features

- 307 megabytes, HP 7936  
571 megabytes, HP 7937
- 20 ms seek; 8.33 latency; less than 1.0 ms controller overhead
- 2.35 megabytes/second internal burst data transfer rate
- Modular packaging
- Choice of controllers
- Available in large mass storage configurations
- MTBF of 70,000 hours

### HP 19521, 19522 and 19524

Multiple 7937s plus a cabinet can now be ordered as one product with HP's new large mass storage configurations, the HP 19521, 19522 and 19524. Standard ("H"), cache ("XP"), or fiber-optic ("FL") models can be purchased in 1.1-Gbyte, 2.2-Gbyte and 4.5-Gbyte solutions.

### Electromagnetic Emissions

Radiated and conducted interference:

- For U.S.A., designed to meet FCC Docket 20780 for Class A computing peripherals devices.
  - For Europe, designed to meet applicable FTZ 1046/84 requirements and provides a Manufacturer's Declaration.
- For more information, call your local HP office.

### Safety

The HP 7936H/7937H, HP 7936XP/7937XP and HP 7936FL/7937FL meet all applicable safety standards of the following:

- IEC 380 and 435
- UL 114 and 478
- CSA C22.2 no 143 and 154

### Ordering Information

	Price
HP 7936H (307 megabytes)	\$14,250
HP 7937H (571 megabytes)	\$15,700
HP 7936XP (307 megabytes + 2 Mbytes cache)	\$16,000
HP 7937XP (571 megabytes + 2 Mbytes cache)	\$17,450
HP 97520XP (Controller cache upgrade)	\$3,315
HP 7936FL (307 Mbytes + HP-FL controller)	\$15,500
HP 7937FL (571 Mbytes + HP-FL controller)	\$16,950
HP 97522FL (HP-FL controller upgrade)	\$3,315
HP 19511A (Cabinet for 2 HP 7936/37 drives)	\$1000
HP 19512A (Mounting kit for 19" EIA cabinet)	\$265
HP 19514A (Cabinet for 8 HP 7936/37 drives)	\$5,000
HP 19521H (2 7937H drives with 19511A cabinet)	\$31,825
HP 19522H (4 7937H drives with 19514A cabinet)	\$65,300
HP 19524H (8 7937H drives with 19514A cabinet)	\$125,600
HP 19521XP (2 HP 7937XP drives with HP 19511A cabinet)	\$35,325
HP 19522XP (4 HP 7937XP drives with HP 19514A cabinet)	\$72,300
HP 19524XP (8 HP 7937XP drives with HP 19514A cabinet)	\$139,600
HP 19521FL (2 HP 7937FL drives with HP 19511A cabinet)	\$34,325
HP 19522FL (4 HP 7937FL drives with HP 19514A cabinet)	\$70,300
HP 19524FL (8 HP 7937FL drives with HP 19514A cabinet)	\$135,600
Opt 015 (50 Hz operation)	\$0
Opt 017 (230 VAC operation)	\$0

# COMPUTER PERIPHERALS

## Tape Drives

Models 35401A, 9144A, 9145A, 7980XC, 7980A, 7979A

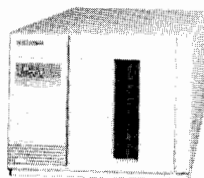

HP 35401A 1/4-inch  
Cartridge Autochanger  
Tape Drive

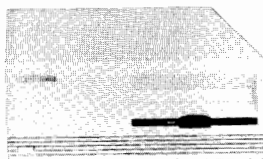

HP 9144A 1/4 inch  
Cartridge Tape Drive

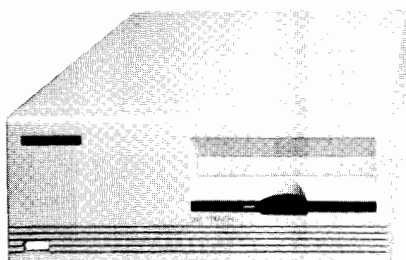

HP 9145A 1/4 inch Cartridge Tape Drive

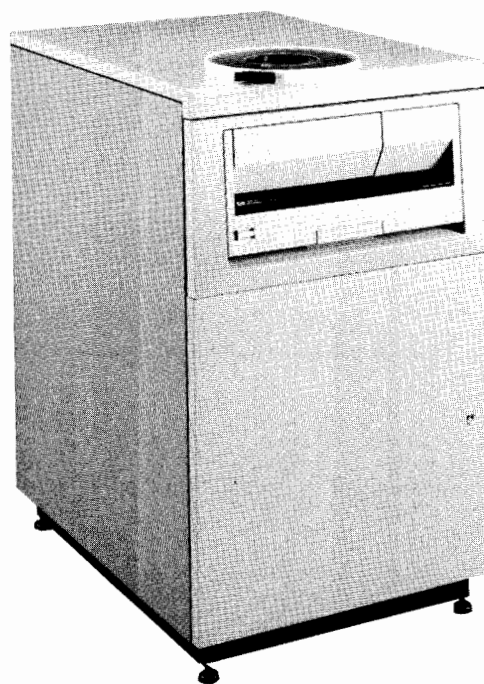

HP 7980XC, HP 7980A and HP 7979A 1/2-inch Magnetic Tape  
Backup Systems

### 1/4-inch Tape Backup Solutions

HP offers a range of 1/4-inch cartridge tape drive solutions which are suitable for PCs, technical and business systems. Products are available which offer low cost, high performance and high capacity.

#### HP 9144A 1/4-inch Cartridge Tape Drive

The HP 9144A provides a low cost backup solution for technical and small business systems, providing 67 Mbytes of data storage on each 16-track cartridge tape. The HP 9144A provides a more convenient and reliable backup alternative to multiple floppy discs.

#### HP 9145A 1/4-inch Cartridge Tape Drive

The HP 9145A is a high performance cartridge tape drive for technical and small business systems. The HP 9145A has a transfer rate of 4 Mbytes per minute and stores 133 Mbytes of data per cartridge tape. The HP 9145A reads and writes data to 32-track cartridges but is still able to read 16-track cartridges maintaining backwards compatibility with existing 1/4-inch cartridge tape drives.

#### HP 35401A 1/4-inch Cartridge Autochanger Tape Drive

The HP 35401A provides a high capacity unattended backup solution for business systems and technical workstation networks.

This 1/4-inch cartridge drive can store up to 536 Mbytes of data with no operator intervention necessary. It uses 16-track cartridge tapes and has the same cartridge and data format as the HP 9144A.

The HP 9144A and HP 9145A are available in built-in versions for Micro 3000 GX/LX systems.

#### Ordering information

	Price
HP 9144A 1/4-inch cartridge tape drive (16-track)	\$2550
HP 9145A 1/4-inch cartridge tape drive (32-track)	\$3980
HP 35401A 1/4-inch cartridge autochanger tape drive (16-track)	\$8000

### 1/2-inch Tape Backup Solutions

#### HP 7980XC, HP 7980A and HP 7979A 1/2-inch Tape Drives

These compact autoloader tape drives offer high reliability, reducing basic monthly maintenance costs as much as 50%. The drives are mounted horizontally in a one-meter high, standard 19-inch wide rack. Another tape drive or disc drive can be mounted beneath the existing drive. The HP 7979A provides a low-cost backup solution for systems requiring between 100 and 500 megabytes of disc backup. It offers 1600 cpi density for industry standard interchange. The HP 7980A provides backup solution for systems in the 400 megabyte to 2 gigabyte range. It operates with both 6250 cpi and 1600 cpi industry-standard densities. The HP 7980XC has an advanced method of data compression built into the tape drive electronics allowing more information to be stored on standard 1/2-inch tape reels. It writes and reads tapes in industry-standard 1600 and 6250 cpi densities. The compressed format, not an industry standard, is an option on the 6250 cpi density only. Backup times for large systems can be dramatically reduced by pairing two or more HP 7980XC tape drives with HP's TurboSTORE backup utility program. TurboSTORE, available with HP 3000 systems, gathers data from discs and writes it to one or more tape drives simultaneously. The entire line of tape drives is field upgradeable. Select the one to meet your current needs and upgrade as your system's disc capacity increases. Support is provided on most HP 3000, HP 1000, and HP 9000 systems.

#### Ordering Information

	Price
HP 7980XC 1/2 inch tape drive (1600/6250/6250XC cpi)	\$32,200
HP 7980A 1/2 inch tape drive (1600/6250 cpi)	\$23,200
HP 7979A 1/2 inch tape drive (1600 cpi)	\$13,400
HP 88703A Field Upgrade Kit (HP 7979A-to-HP 7980A)	\$11,400
HP 88705A Field Upgrade Kit (HP 7980A-to-HP 7980XC)	\$11,000

See technical data sheet #5953-6897 for detailed product information.

- Flatbed design for image source variety
- Variable resolutions insure high-quality output
- IBM and Macintosh compatibility

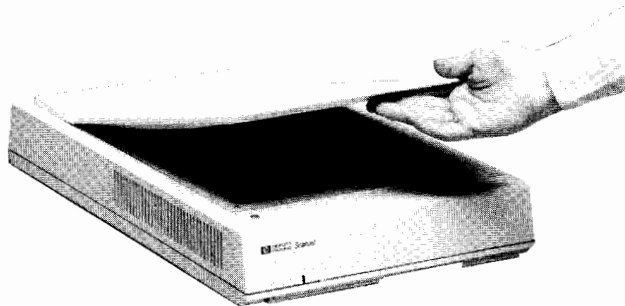

### HP ScanJet Desktop Scanner

The HP ScanJet scanner provides high-quality reproductions of photographs, line art or illustrations. These images can be incorporated into word processing and desktop publishing packages as well as presentation graphics and spreadsheets. Adding images to newsletters, manuals, reports and catalogs helps capture the reader's attention and adds impact and understanding to the printed message.

In addition to final documents, the HP ScanJet can also be used to develop proofs for professionally-printed literature. This provides better control over the design process, eliminates steps and saves time for designers.

### Flatbed Design

ScanJet's flatbed design can handle a wide variety of documents, from a wallet-sized photograph to a full-size, single sheet drawing - even oversized documents. The image lays flat on the glass. There are no rollers to damage your original or let it slip out of position. The flatbed accommodates both bound and loose-leaf documents. Pages in books and magazines can be easily scanned.

### Scaling/Resolution

Scanned images can be enlarged or reduced to fit the space available in your document - from 13% to 200% of the original. Images can be scanned at any resolution from 38 dpi to 600 dpi. This allows you to scan images at the same resolution as your printer for the highest-quality output.

### IBM Compatibility

The HP ScanJet desktop scanner is supported on the HP Vectra PC, IBM XT/AT and compatibles. Operation with these systems requires the ScanJet PC Interface Kit, HP 88290A. It is supported on the IBM PS/2 (Models 50, 60 and 80) with the ScanJet PS/2 Interface Kit, HP 88490A. Support for IBM PS/2 Model 30 systems is provided with the PC Interface Kit, HP 88290A, and an accessory kit, HP 88293A.

At the heart of ScanJet's operation in the IBM environment is HP's Scanning Gallery software. The software is included with both the PC Interface Kit and the PS/2 Interface Kit and allows easy scanning, cropping and storage of images for use in a wide variety of application software.

### Macintosh Compatibility

The HP ScanJet desktop scanner is supported on the Macintosh Plus, Macintosh SE and Macintosh II with the HP 88390B Interface Kit for the Macintosh.

The DeskGallery software package included with the Macintosh Interface Kit consists of two components, DeskScan and DeskPaint™. Together they provide easy scanning, editing and enhancement of images. The DeskGallery software may be used as desk

- Extensive software support broadens applications
- Optical Character Recognition (OCR) capability
- Optional Automatic Document Feeder

accessories or as applications. Desk accessories allow you to scan images and incorporate them into your work without leaving your application software. This makes scanning images significantly easier and faster than using separate scanning applications. However, if you prefer to use the software as applications, you have the freedom to do so.

### Extensive Software Support

By supporting most of today's popular file formats, the HP ScanJet desktop scanner is capable of operating with a wide variety of application software packages including publishing, word processing, image processing, painting and drawing, and facsimile packages.

With the PC Interface, files are stored and brought to application software via the four industry-standard file formats: TIFF, MS Paint, GEM, and PC PaintBrush. Scanning Gallery works under both the MS-DOS (Ver. 3.0 and above) and MS Windows (Ver. 1.03 and above) operating environments.

The Interface Kit for the Macintosh provides extensive software support for a variety of software packages through storage of images in the popular Macintosh DTP file formats: TIFF, MacPaint, PICT and a Clipboard.

### OCR Capability

Optical character recognition (OCR) software and the HP ScanJet scanner allow you to enter typed text into your computer without rekeying, saving you valuable time. You'll achieve a new level of productivity when entering large volumes of typed text into your computer. For IBM and compatible systems, HP 88400A ReadRight OCR software gives your ScanJet OCR capabilities. OCR solutions for the Macintosh market are provided through third-party vendors.

### Automatic Document Feeder

Productivity is increased even more when the OCR software is coupled with an HP 88190A Automatic Document Feeder. Just set up to 20 pages of text into the document feeder, start the scanning process, and the images on the pages are automatically converted to computer-readable text.

### Ordering Information

	<b>Price</b>
HP 9190A ScanJet Desktop Scanner	\$1495
HP 88290A Personal Computer Interface Kit	495
HP 88390B Macintosh Interface Kit	495
HP 88490A PS/2 Interface Kit	495
HP 88293A PS/2 Model 30 Accessory Kit	68
HP 88190A Automatic Document Feeder	595
HP 88400A ReadRight™ OCR Software	595
HP 88401A ReadRight International™ OCR Software	895

# COMPUTER PERIPHERALS

## Tablet—A-size Graphics Tablet

### HP SketchPro, RS-232-C Model

- New technology for unparalleled reliability
- Includes stylus and four-button cursor
- Supported by major PC CAD software on the HP Vectra PC, IBM AT, IBM PC/XT, and compatibles
- Competitive Price
- Compact design with overlay hold-down/protector
- Superior resolution - up to 1200 lines per inch
- Multifunction softkeys with Mouse Mode

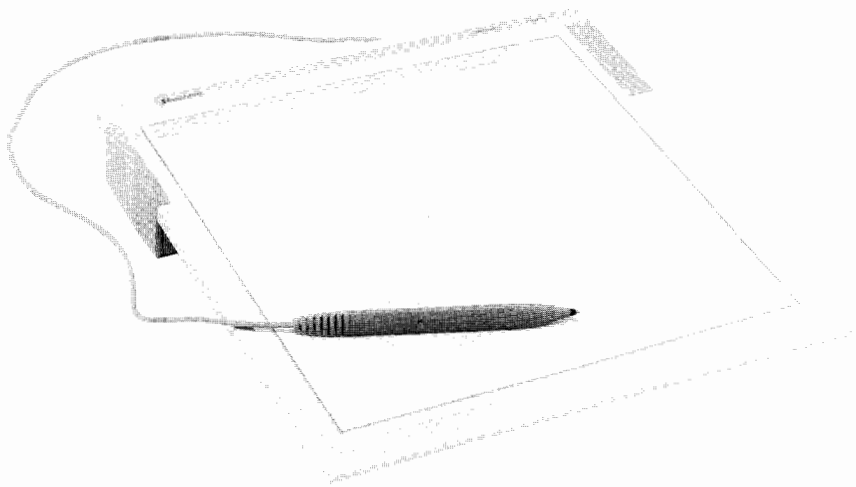

The HP 7060A SketchPro Graphics Tablet is a small format (11 x 11 in.) tablet for personal CAD systems. It is used for quick menu selection, and rapid cursor movements, as well as tracing and drawing. Primary applications include mechanical, electrical, and electronics CAD, and AEC (Architecture/Engineering/Construction). Secondary applications include business graphics and desktop publishing (DTP).

#### Unparalleled Reliability

Due to a patent-pending Permuted Trace Ordering (PTO) technology, Hewlett-Packard can minimize parts, making the HP SketchPro tablet one of the most reliable tablets on the market. The SketchPro tablet meets HP's standards, at a low price.

#### Supports Top PC CAD Packages

The HP SketchPro tablet is designed to work with the software and hardware you have selected. The HP SketchPro tablet's industry-standard RS-232-C/CCITT V.24 interface enables users to connect the SketchPro tablet to the HP Vectra PC, IBM AT, IBM PC/XT, and compatibles.

The HP SketchPro tablet has four operating modes: Hewlett-Packard, Summagraphics Bit Pad 2 (emulation), Hitachi HDG1111B (emulation), and Microsoft Mouse (emulation). With these modes, the SketchPro tablet supports the most popular CAD and graphics software, such as AutoCAD, VersaCAD, and CADKEY.

#### A Complete Package

The HP SketchPro tablet provides everything you need in the box - For operation, both a comfortable stylus and four-button cursor; for interfacing, an RS-232-C/CCITT V.24 cable for the HP Vectra PC or the IBM AT and compatibles, a cable adapter for the IBM PC/XT and compatibles, and set-up instructions for configuring your software; for tablet menus, a clear anti-static overlay to hold menus securely in place without tape.

#### Intelligent Design

The HP SketchPro has been designed with special attention to ergonomics and aesthetics. The tablet's slope and shape provide maximum user comfort. The anti-static overlay and recessed menu area mean menus without messy tape. Plus the small footprint saves valuable desk space. Both a power on/off LED and a point-digitizing LED provide positive feedback.

#### Superior Resolution

The HP SketchPro tablet has a resolution that is programmatically selectable up to 480 lines per cm (1219 lines per in.), and is accurate up to within 0.5 mm (0.02 in.) of the selected point. The HP SketchPro tablet's resolution meets the most stringent requirements.

#### Multifunction Softkeys

The HP SketchPro tablet includes several softkeys to provide commonly used functions; variable active areas, aspect ratio adjustments, and mouse mode. These softkeys are predefined. Additional, programmable softkeys are provided for future software vendor support.

#### Specifications

**Size:** height, 50 mm (2.0 in.); width, 325 mm (12.8 in.); depth, 343 mm (13.5 in.); tablet tilt, 7 degrees

**Net weight:** 1.8 kg (4 lbs)

**Power requirements:** source, 110-120 V or 230-240 V (depending on country); frequency, 60 Hz or 50 Hz (depending on country); power, 1.8 Watts

**Resolution:** 480 lines per cm (1219.05 lines per in.)

**Accuracy:**  $\pm 0.5$  mm (0.02 in.); repeatability,  $\pm 0.25$  mm (0.01 in.)

**Proximity:** 2.5 mm (0.01 in.); jitter, 0 pixels

**Stylus tilt:** any degree  $< 90^\circ$

**Active area:** 278 mm x 278 mm (11 in. x 11 in.)

**Technology:** capacitive with Permuted Trace Ordering (PTO)

**Data rate:** up to 19,200 baud

**Product regulations:** safety, UL Listed, CSA certified; RFI, tested at system level to FCC class B and VDE level B; Acoustics, less than 40 db sound per A-weighted scale

**Environmental range:** operating temperature,  $0^\circ$  to  $55^\circ$  C; non-operating,  $-40^\circ$  to  $70^\circ$  C; relative humidity, 5% to 95%; shock,  $\frac{1}{2}$  sine shock pulse  $< 3$  m duration, 160 in./sec delta V, non-operating Trapezoidal pulse, 30 g, 292 in./sec delta V

#### Ordering Information

HP 7060A HP SketchPro Graphics Tablet

#### Price

\$599



# COMPUTER PERIPHERALS

## Tablets — A-size Graphics Tablet

HP 45911A, HP-HIL Model

715

- Low cost: \$499
- Works with HP Vectra, Touchscreen, and HP 9000 Series 300 systems

- High-resolution: up to 1200 lines/inch
- Easy connection using HP-HIL

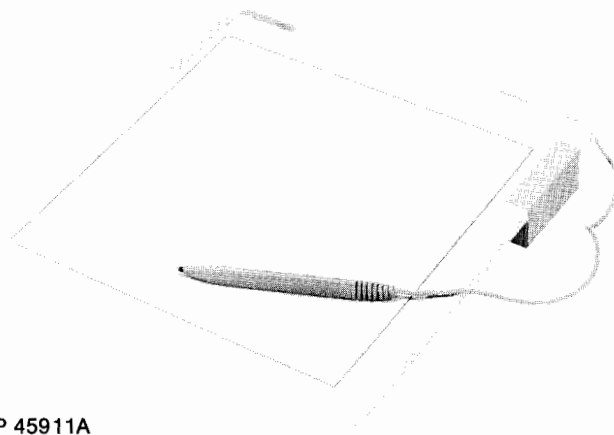

HP 45911A

The HP 45911A is a high-performance, low-cost graphics tablet. When it is installed on a computer supporting the Hewlett-Packard Human Interface Link (HP-HIL), you have a very effective pointing device to increase your productivity with interactive graphics applications such as:

- CAD/CAM
- Presentation Graphics
- Computer Art

The HP Graphics tablet is ideal for tasks such as menu picks, graphics placement, drawing, and tracing. Overlays, like the ones provided with many software packages, can be used on the tablet allowing you to choose menu items conveniently without using screen space. With the tablet's stylus you can make fast movements and create complex drawings as easily as with a pencil and paper.

### Unparalleled Reliability

Due to a patent-pending new Permuted Trace Ordering (PTO) technology, Hewlett-Packard can minimize parts, making the HP 45911A one of the most reliable tablets on the market. The tablet meets the reliability standards you expect from Hewlett-Packard, at a low price.

### Excellent Performance

The HP Graphics tablet has very high resolution, up to 1200 lines per inch. And its fast response time and high accuracy make it easy to use. The tablet is based on capacitive technology and is immune to the effects of magnetic fields.

### Easy to Install and Use

The stylus is as easy to use as a pencil. Movements of the stylus tip on the tablet surface will be tracked on the computer monitor. The stylus tip can be activated by a gentle push of its tip onto the tablet surface.

The HP Graphics tablet can be used with computers and applications which support the HP-HIL interface. HP-HIL allows you to daisy chain up to 7 input devices (such as a mouse, tablet, bar code reader, keyboard, and others) without using a serial port. Simply plug the HP Graphics tablet into the keyboard, HP-HIL port, or another input device. The HP-HIL interface provides power from the host computer or terminal, eliminating the need for additional power cords.

### Saves a Serial Port

Since HP-HIL input devices have their own port and they daisy chain together, your serial ports are free so you can use other peripherals, such as plotters and printers. If you want to use input devices

and output devices at the same time, you won't need multiple serial port cards or costly switch boxes.

### Software Support

The HP Graphics tablet is supported by many popular software packages including ME 10, Graphics Gallery, AutoCAD™ (version 2.52 and above), and Versacad (version 5.1 and above).

### Superb Design

The HP Graphics tablet has been designed with special attention to ergonomics and aesthetics. The tablet slope and stylus shape have been chosen to make it comfortable in use. And the tablet is so compact in size it uses less desk space than most tablets with equivalent active area.

### Specifications

**Size:** height, 50 mm (2.0 in.); width, 325 mm (12.8 in.); depth, 343 mm (13.5 in.)

**Active area:** 278 mm x 278 mm (11 in. x 11 in.)

**Tablet tilt:** 7 degrees

**Net Weight:** 1.8 kg (4 lbs)

**Power requirements:** source voltage, 100, 120, 200, 240 V~±10%, +5%; current 150 mA maximum; power, 1.8 Watts

**Resolution:** 480 lines per cm (1219.05 lines per in.)

**Accuracy:** ±0.5 mm (.02 in.)

**Repeatability:** ±0.25 mm (.01 in.)

**Proximity:** 2.5 mm (.1 in.)

**Stylus tilt:** any angle <90°

**Data output rate:** up to 130 pairs per second

**Document material:** non-conductive

**Product regulations:** safety, UL Listed, CSA certified; RFI, tested at system level to FCC class B and VDE level B; Acoustics, less than 4.0 Bels sound per A-weighted scale

**Environmental range:** operating temperature, 0° to 50° C; non-operating, -55° to 70° C; relative humidity, 6% to 95%; shock, 1/2 sine shock pulse <3 msec duration, 140 in./sec delta V, non-operating Trapezoidal pulse, 30 G, 292 in./sec delta V

### Accessories Supplied

**Stylus:** 16 cm with .75 m attached cable

**Overlay:** 295 mm x 295 mm (11 3/8 in. x 11 3/8 in.)

HP-HIL Cable

### Ordering Information

**HP 45911A Graphics Tablet**  
AutoCAD is a trademark of Autodesk, Inc.

**Price**  
\$499

# COMPUTER PERIPHERALS

## Printers — Versatile Color Graphics and High-Speed NLQ Text Printer

### HP PaintJet Color Graphics Printer

- Color overhead transparencies
- Fast throughput for both text and graphics
- Quiet operation

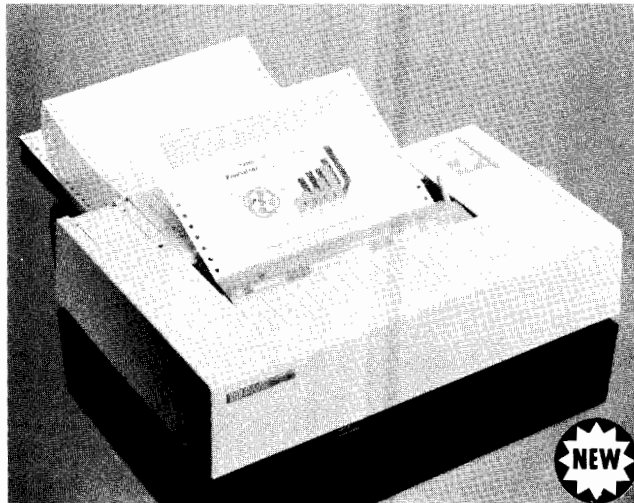

The HP PaintJet (HP 3630A) printer is designed especially for business and PC Engineering professionals who need both high-resolution color graphics and fast NLQ text from a personal printer. The HP PaintJet offers crisp, dark text; merged text and graphics for reports or schedules; and full-page color graphics on either paper or overhead transparency film.

#### High-Resolution Color Graphics

The PaintJet printer has a resolution of 180 dots per inch, so it produces sharp, solid color graphics. With a PaintJet printer, users can create colorful presentation overheads, project schedules, or 3D CAD drawings from the same device that provides their convenience printing.

#### NLQ Text

With a 15 x 30-dot character cell, the PaintJet printer produces clear, sharp near-letter-quality text — perfect for memos, status reports, and project updates. And the PaintJet printer offers a choice of 10-pitch Courier, 12-pitch and 18-pitch Letter Gothic, plus bold, underline, superscript, subscript, and color text capability.

#### Fast Throughput

At 167 characters per second, the PaintJet printer can generate a typical page of near-letter-quality text in less than 40 seconds! And a full-page of color graphics takes less than four minutes on paper and under eight minutes on overhead transparency film.

#### Bright Colors in Disposable Cartridges

The PaintJet printer's two disposable print cartridges hold four specially-formulated inks (cyan, yellow, magenta, and black). With these inks, the PaintJet printer produces 330 shades of color. And the same print cartridges work on both paper and overhead transparency film.

#### Multiple Character Sets

The PaintJet printer supports 12 distinct character sets including Roman8, PC-8, US ASCII, Spanish, French, PC-8 (Danish/Norwegian), German, Italian, United Kingdom, Norwegian I, Swedish Names, and ECMA-94.

#### Hardware and Software Compatibility

The PaintJet printer comes with three interface options — Centronics Parallel, RS-232-C/CCITT V.24, and HP-IB (IEEE 488-1978) — so it works with most popular personal computers. And it is supported by leading business graphics, word processing, productivity, PC CAD, and utility software.

#### Specifications

**Print Speed (NLQ):** 167 characters per second at 10 pitch; 200 characters per second at 12 pitch; 30–40 seconds per typical page of text; full-page color graphics, 4 minutes or less on paper, 8 minutes or less on transparency film.\*

- Extensive software support
- Three interface options
- High resolution

**Print Resolution:** character structure, 15 x 30-dot print character cells; graphics, 180 x 180 dpi; 330 colors at 90 dpi; 7 colors at 180 dpi.

**Character Sets:** Roman8, PC-8, US ASCII, Spanish, French, PC-8 (Danish/Norwegian), German, Italian, United Kingdom, Norwegian I, Swedish Names, and ECMA-94.

**Print Styles:** Courier, 12 point (10 cpi); Letter Gothic, 12 point (12 cpi); Letter Gothic, 8 point (18 cpi); also bold, underline, superscript, subscript, and color text.

**Paper Handling:** friction and sprocket feed; Z-fold and CutSheet paper; single sheet transparency film; CutSheet paper, 210 x 297 mm and 8½ x 11 in.; Z-fold paper, 210 x 304.8 mm and 8½ x 11 in.; single-sheet film, 210 x 297 mm and 8½ x 11 in. HP PaintJet paper and transparency film are recommended for best results. Other printer papers may be used for draft-quality output and provide satisfactory print quality for many applications.

**Print Method:** color inkjet non-impact dot-matrix printing; unidirectional and bidirectional text printing; unidirectional color printing on paper and transparency film.

**Print Mechanism:** cartridges, one black, one color; nozzles, total of 60 in two print cartridges (30 black, 10 cyan, 10 magenta, 10 yellow); typical cartridge lifetime, black pen, 1100 text pages (approximately 1.1 million characters); color pen, 180 pages of color graphics (with typical use of solid area fill) or 160 overhead transparencies.

**Printable Characters Per Line:** 144 at 18 characters per inch; 96 at 12 characters per inch; 80 at 10 characters per inch.

**Controls and Indicators:** power on, paper out, top-of-form, line feed, and form feed.

**Interfaces:** Centronics Parallel; RS-232-C/CCITT V.24; HP-IB (IEEE 488-1978).

**Power Requirements:** supply, 48–66 Hz; 100, 120, 220, 240, VAC + 10%; consumption, 20 W maximum.

**Environmental Ranges:** operating temperature, 15° to 30° C (60° to 86° F); non-operating temperature, –40° to 70° C (–40° to 158° F); operating relative humidity (paper), 20% to 80% (at 10° to 30° C); operating relative humidity (transparency film), 20% to 70% (at 10° to 30° C).

**Acoustics:** 5.3 bels(A); typically quoted sound pressure <50 dB (A).

**Physical Specifications:** height, 98 mm (3.86 in.); width, 442 mm (17.4 in.); depth, 302 mm (11.89 in.); net weight, 5 kg (11 lb); shipping weight, 10.6 kg (23.3 lb).

**Buffer Size:** 8K bytes.

**Product Certifications:** CSA approved, CSA C22.2 No. 154; UL Listed, UL-478; TUV Approved, GS Mark, IEC-380; FCC Certified, Class B; VDE Radio Protection Mark, Level B; VCCI Approved, Class 2.

**Estimated Average Usage:** 10 pages per day.

#### Supplies and Accessories

	Price
HP 51606A Black print cartridge	27.95
HP 51606C Color print cartridge	34.95
HP 51630P Z-fold paper, 8½ x 11 in., 250 sheets	17.95
HP 51630R Z-fold paper, 210 x 304.8 mm, 250 sheets	17.95
HP 51630Y CutSheet paper, 8½ x 11 in., 250 sheets	22.95
HP 51630Z CutSheet paper, 210 x 297 mm, 250 sheets	22.95
HP 51630Q Single sheet transparency film, 8½ x 11 in., 50 sheets (with plastic sleeves)	64.95
HP 51630S Single sheet transparency film, 210 x 297 mm, 50 sheets (with plastic sleeves)	64.95

#### Ordering Information

	Price
HP 3630A PaintJet Color Graphics Printer	\$1395.00
<b>Options</b>	
001 RS-232-C/CCITT V.24 interface	N/C
002 HP-IB interface (IEEE 488–1978)	N/C
004 Centronics Parallel interface	N/C

\*Specifications quoted for a centronics parallel printer.

Models HP 2225A/B/C/D/P, HP 2276A, HP 2227A/B, HP 2228A, HP 2235A, HP 33440A, HP 33447A

### ThinkJet Portable Printers HP 2225A/B/C/D/P

- Quiet, compact 150-cps printing
- Easy-to-read draft and NLQ printing
- Disposable print cartridges
- Excellent software support
- Battery powered models offer 200 pages printing between recharges

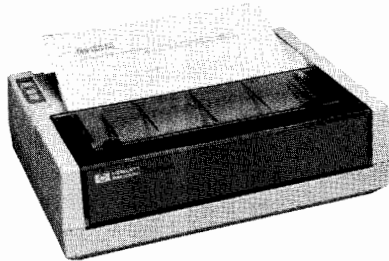

This convenient desktop printer is quiet and unobtrusive, yet quick and efficient, delivering crisp, easy-to-read text and graphics for letters, reports, even spreadsheets. Two battery powered versions (HP-IL and Centronics-type interfaces) allow you to match this very durable and lightweight printer with the smallest of computers.



### DeskJet Printer HP 2276A

- True letter-quality 300 dpi
- Attractive desktop design
- Multiple fonts, high resolution graphics
- 240 cps draft and 120 cps letter-quality printing
- Built-in sheet feeder

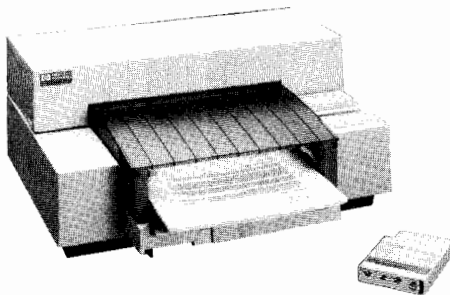

The new DeskJet Printer offers laser-quality output at an affordable price. Create professional-looking letters and office documents using common office papers and watermarked letterhead. Simple operation, compact size, friendly control panel and font cartridge accessories assure superior printing for individual personal computing applications.

### QuietJet and QuietJet Plus Printers HP 2227A/B, HP 2228A

- Quiet, quality desktop printing
- 192-cps draft and 48-cps NLQ
- Excellent software support
- Disposable print cartridges

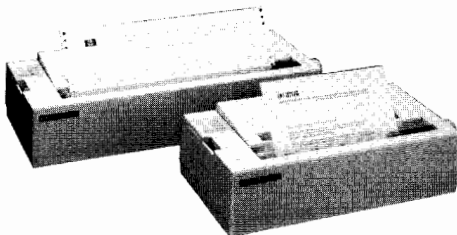

You get exceptionally quiet, quality printing for word processing, data base management, and computer graphics. The narrow-carriage QuietJet Printer is just big enough to handle standard 8.5 x 11-inch and A-4 size paper, a real space saver for personal computer and terminal users. The QuietJet Plus Printers have a wide carriage for paper up to 15".

### RuggedWriter 480 Printer HP 2235 series

- Fast, 480-cps rugged printing
- 24-wire impact dot matrix
- Three independent paper paths
- Paper handling flexibility
- Built-in dual I/O
- 6 part forms

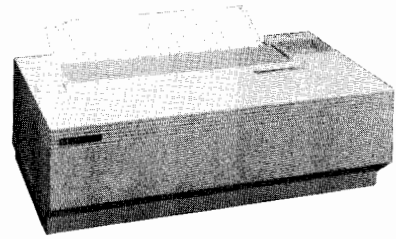

The wide carriage HP RuggedWriter 480 Printer offers top-quality printing that's fast (480-cps draft and 240-cps letter-quality). It's rugged (unlimited duty cycle and 20,000 hours mean time between failures), designed for use as a shared printer on minicomputers or PC networks, or as an individual PC printer for high-volume applications.

### LaserJet Series II

- Publications-quality print at eight pages/minute
- LaserJet PLUS compatibility—two font cartridge slots; downloadable fonts/forms
- Expandable memory—up to 4.5 megabytes
- Easy-to-use front control panel

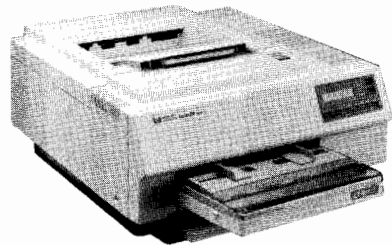

The LaserJet Series II printer improves on the features of the popular LaserJet PLUS printer. Printing up to 8 pages per minute on paper sizes including letter, legal, executive, and European A4, the printer is compatible with over 600 of the most popular software packages. The LaserJet Series II prints text and graphics at 300 x 300 dots/inch and provides whisper-quiet operation with virtually all PCs and PC networks. The printer is especially well-suited for desktop publishing.

### LaserJet IID Printer



- Publication-quality print at eight pages per minute
- Two paper input trays handle bigger print volumes
- Envelope feeder accessory adds a third input source
- Two-sided page printing for excellent paper usage
- 24 fonts standard

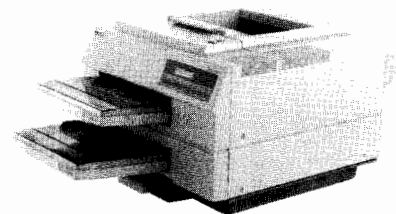

The LaserJet IID printer offers the same quiet, high resolution printing as the LaserJet Series II printer, but adds the flexibility and paper capacity to serve several users or one high-volume user. Multiple input trays and duplex (two-sided) printing allow the printer to run longer between paper refills. Like the HP LaserJet Series II printer, it is excellent for applications such as general, technical and legal word processing, spreadsheets, reports, forms and desktop publishing.

# COMPUTER PERIPHERALS

## Departmental and Systems Printers

Models HP 2684A/D/P, HP 2932/34A, HP 2563/64/66/67B, HP 2680A, HP 2685C, HP 2689A and Output Design Service

### LaserJet 2000

- Publication-quality print at up to 20 pages/minute
- LaserJet PLUS compatibility for office/departmental use
- Optional double-sided (duplex) printing
- Optional 2000-sheet input paper deck

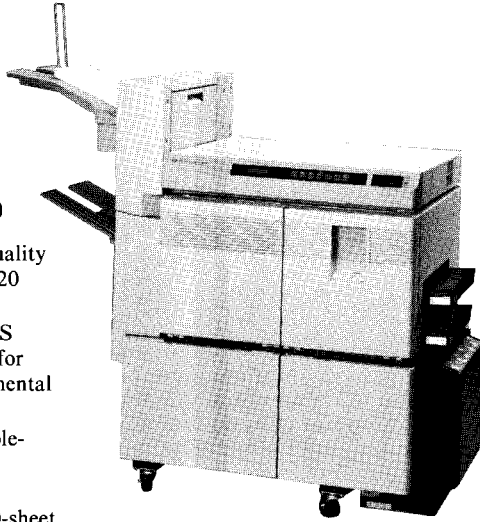

The LaserJet 2000 printer offers high-volume, high-speed printing for the minicomputer and PC network environment. The LaserJet 2000 has upgradeable memory to 5.5 megabytes—ideal for multiple users requiring full-page graphics at 300 x 300 dots/inch and many downloadable fonts. Paper cassettes are available for printing on six paper sizes, including letter, legal, executive, ledger, and European A4 and A3. Includes thirty-four resident fonts and 3 LaserJet font cartridge slots.

### LaserJet Fonts and Memory Boards

A large selection of LaserJet-compatible font cartridges and downloadable soft fonts are available in many typefaces, styles and point sizes. The LaserJet Series II, LaserJet IID and LaserJet 2000 printers also offer upgradeable memory for increased font downloading and graphics capability. For information about available fonts and printer memory, contact your HP sales representative.

### TEMPEST Printer Family

TEMPEST versions of selected peripherals are available for government applications requiring security protection. International distribution is limited; contact your local HP sales representative for availability and ordering information.

### HP 2934A Printers

- 200-cps, 136-column impact printing
- Up to 6-part forms
- Handles up to 12,000 pages/month
- Interface flexibility

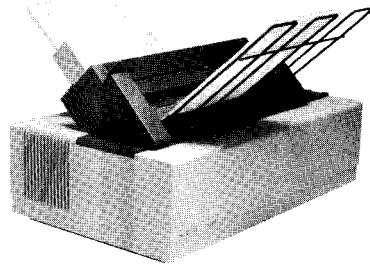

Speed, reliability, simplicity of operation, and unlimited duty cycle allow the HP 2934A to meet heavy duty printing needs. The HP 2934A offers all the print features of the HP 2932A plus near-letter quality (NLQ), font cartridges, bar codes, OCR, large character generation, and optional single bin sheetfeeder (see picture).

### HP 2563B, 2564B, 2566B, 2567B

- 300, 600, 900, or 1200/1600 lpm
- Bar code and multi-part forms printing
- 16-channel vertical format control
- 55 dBA cabinets for standard HP 2563/64B models

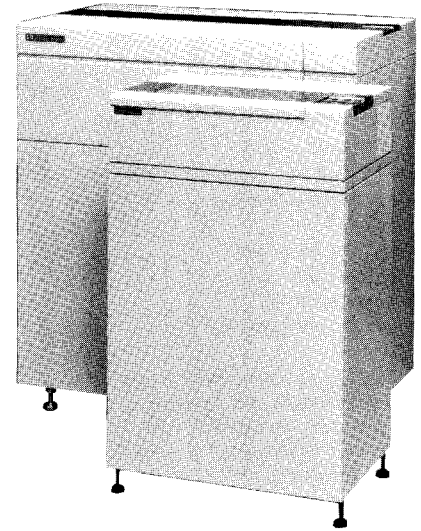

The HP 2563B, 2564B, 2566B, and 2567B are a fully supported line impact dot matrix printer family for minicomputer, microcomputer, or mainframe computer systems. They feature high density and compressed text, graphics, bar code and OCR capabilities, and multiple character sets. High reliability is assured through battery backed-up printer memory, microprocessor control, and few moving parts. Enhanced bar code capabilities are available with the HP Label Card option.

### HP 2680A Laser Printing System

- 45 ppm; up to 1,000,000 sheets monthly
- 8.5 x 11-inch fanfold paper
- Electronic forms and graphics
- High-volume label printing

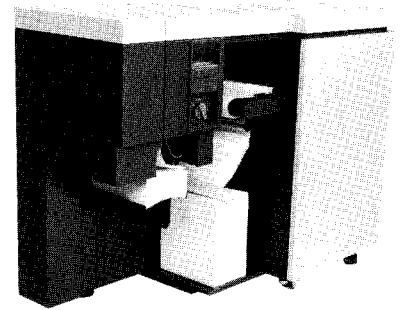

The HP 2680A Laser Printing System is the solution for HP 3000 and Precision Architecture computer systems. It features continuous paper feed for paper-handling reliability, non-contact fusing, and a data control system that handles variable size characters and up to four pages of print on one sheet of paper. Merged text and graphics as well as electronics forms capabilities are available using IFS/3000, IDIFORM/3000 and other software applications.

### HP 2685C Laser Print Station

The HP 2685C Laser Print Station is a local or remote solution for large host mainframe computer systems. It consists of the HP 2680A laser printer and a system controller, terminal, disc drive, and magnetic tape.

### Output Design Service

The Output Design Service provides custom forms design, logos, and signature-scanning services for all HP laser printers, including the HP 2680A and HP 2685C.

### ORDERING INFORMATION FOR HEWLETT-PACKARD PRINTERS

#### Literature

For additional information, ask your HP sales representative or your dealer for the following literature:

Product (s)	Part Numbers
Computer Peripherals Selection Guide	5954-9305
PaintJet Color Graphics Printer	5954-8752
ThinkJet/QuietJet Family Printers	5954-9952
DeskJet Printer	5954-9942
JetScript Accessory Kit	5951-6896
LaserJet Series II Printer	5951-6901
LaserJet IID Printer	5951-6897
HP LaserJet 2000 Printer	5951-6899
TEMPEST LaserJet Family	5954-9482
HP 2930 Family Printers	5954-7007
RuggedWriter 480 Printer	5954-9944
HP 256XB Family of Line Impact Dot Matrix Printers	5954-7326
HP Label Card	5954-7327
HP 2680/85/89 High Speed Laser Printer Family	5954-8973
Output Design Service	5954-8961

#### Product Line

#### Products

#### ThinkJet Family Printers

HP 2225A: HP-IB Interface	\$495
HP 2225B: HP-IL Interface, battery power	\$495
HP 2225C: Parallel Interface	\$495
HP 2225D: RS-232 Interface	\$495
HP 2225P: Centronics Interface, battery power	\$495
Accessory:	
922197 Cable	+\$49

#### QuietJet Family Printers

HP 2227A: Dual I/O (Centronics/RS-232), wide carriage	\$799
HP 2227B: HP-IB Interface, wide carriage	\$799
HP 2228A: Dual I/O (Centronics/RS-232)	\$599

#### DeskJet Printer

HP 2276A: Dual I/O (Centronics/RS-232)	\$995
----------------------------------------	-------

#### LaserJet Family Printers

HP LaserJet Series II Printer	\$2695
HP LaserJet IID Printer	\$4295
HP LaserJet 2000 Printer	\$19,995-\$25,695
Accessory:	
JetScript	\$2795

#### HP 2934A Printer

HP 2934A: RS-232 standard	\$2995
Interface options:	
RS-422 (#035)	+50
SNS/Data Link (#039)	+200
Centronics-type (#042)	+50
HP-IB (#046)	+150
Multipoint Asynchronous (#034)	+200
Accessory:	
HP 29340S: single-bin sheet feeder (2934 only)	+395

#### RuggedWriter 480 Printers

HP 2235A: Dual I/O (Centronics/RS-232)	\$1695
HP 2235B: Dual I/O (HP-IB/RS-232)	\$1895
HP 2235C: Dual I/O (Centronics/RS-232) w/sheet feeder	\$1945
HP 2235D: Dual I/O (HP-IB/RS-232) w/sheet feeder	\$2145
Accessories:	
HP 12239A (sheet feeder - US letter-size tray)	\$250
HP 12239B (sheet feeder - EUR A4 size tray)	\$250
HP 12235A (font cartridge - 4 fonts and 16K RAM)	\$150

#### Line Impact Dot Matrix Printers

HP 2563B: 300 lpm	\$6190-\$7790
HP 2564B: 600 lpm	\$11,450-\$12,950
HP 2566B: 900 lpm	\$22,641
HP 2567B: 1200/1600 lpm	\$29,170
Accessory:	
HP Label Card: option #024	\$2205

#### High Volume Laser Printers

HP 2680A Laser Printing System	\$87,750
HP 2685C Laser Print Station	\$95,423-\$124,428



# COMPUTER PERIPHERALS

## Plotters—Scientific Measurement/Business Plotter

### ColorPro Plotter

- 8-pen carousel
- Handles A4/A-size\* paper, transparency film



The HP ColorPro eight-pen plotter is designed to provide quick, presentation-quality color visuals for business and scientific applications. It draws with fiber-tip pens on overhead transparency film and regular and glossy paper.

The ColorPro plotter is designed for professionals who make decisions from numbers and make presentations with numbers. Whether you're drawing overheads for a meeting or recording data from a smart instrument, output quality is important. The exceptional line quality of the ColorPro plotter makes drawings and charts perfect for most professional presentations or reports.

#### High-Quality Output

With an addressable step size of 0.025 mm (0.001 in.), the ColorPro plotter can draw up to 1000 points in a 1-inch line. That means you get ruler-straight lines, even on the diagonal. And when commanded to return to the same point with no pen change, the plotter achieves this repeatability within 0.1 mm (0.004 in.). This precision helps ensure that circles are closed and bar and pie charts are properly aligned.

#### Eight-pen Carousel for Color and Convenience

Once you load the ColorPro plotter's eight-pen carousel, you have access to a spectrum of colors in two different widths — thick pens for headings, thin pens for details. And the pens are capped when not in use to prolong pen life.

#### Programming Features

If you plan on creating your own graphics programs, you can utilize the HP-GL instructions resident in the ColorPro plotter. HP-GL (Hewlett-Packard Graphics Language) is a simple but powerful command set that controls plotting functions such as pen movement, labeling, character set selection, and axis placement. Order the HP ColorPro Programming Manual (Part No. 07440-90001) for complete explanations and examples of the plotter's graphics and interfacing instructions.

\*A4 Size is 210 x 297 mm; A Size is 8½ x 11 in.

- High-quality output
- ROM cartridge slot

#### Compatibility

With a choice of two interfaces, RS-232-C/CCITT V.24 or HP-IB (IEEE 488-1978), the HP ColorPro plotter works with virtually all personal computers. It can also be connected to a variety of HP and non-HP minicomputers or mainframes, but does not provide eavesdrop capability in these environments.

#### ROM Cartridge Slot

To keep up with your expanding needs (such as emerging graphics standards), the ColorPro plotter has a ROM cartridge slot. HP offers a Graphics Enhancement Cartridge as an accessory to the ColorPro plotter. The cartridge adds more advanced capabilities to your ColorPro plotter such as additional HP-GL instructions to draw arcs, circles and polygons; a larger RS-232-C buffer (1024 bytes); and 14 ISO character sets.

#### Graphics Software

The ColorPro plotter is supported by a wide variety of graphics application packages for HP as well as non-HP computer systems. Details are available from any HP sales and support office.

#### Specifications

**Resolution:** smallest addressable step size, 0.025 mm (0.001 in.)

**Repeatability:** with a given pen, 0.1 mm (0.004 in.)

**Pen velocity (each axis):** pen up, approx. 52.0 cm/s (20.5 in./s); pen down, maximum, approx. 40.0 cm/s (15.7 in./s); programmable, 1.0 to 40.0 cm/s in 1.0 cm/s increments

**Acceleration:** approximately 1.2 g's

**Environmental range:** operating, 0°C to 55°C, 5% to 95% Rh (at 40°C), non-operating, -40°C to 75°C

**Maximum plotting area:** pen axis, 191 mm (7.5 in.) for A and A4\*; paper axis, 272 mm (10.7 in.) for A4, 257 mm (10.1 in.) for A

**Interfaces:** HP-IB (IEEE 488-1978) interface which implements IEEE 488-1978 standards; RS-232-C/CCITT V.24, asynchronous serial ASCII with switch selectable baud rates of 75, 110, 150, 200, 300, 600, 1200, 2400, 4800, 9600; 60-byte buffer

**Power requirements:** source, 100, 120, 200, 240 V ~ -10%, +5%; frequency, 48-66 Hz; consumption, 20 W maximum

**Size:** height, 125 mm (4.9 in.); width, 460 mm (18.1 in.); depth, 308 mm (12.1 in.)

**Weight:** net, 5.5 kg (12.0 lb); shipping, approx. 8.6 kg (19.0 lb)

**FCC:** FCC certified to conform to limits set for radio frequency interference when used with a class B computing device. Meets or exceeds IEC-380, IEC-435, UL-478

#### Accessories Supplied

HP ColorPro Graphics Plotter Operating Manual  
Power supply

An assortment of pens and media are also supplied with the plotter. The media size and appropriate power supply are determined by plotter destination.

NOTE: Interface cables are not supplied with the plotter. They must be ordered separately.

#### Ordering Information

**HP 7440A** ColorPro Plotter

**Price**  
\$1295.00 ☎

**HP 17440A** Graphics Enhancement Cartridge

\$150.00 ☎

#### Options

**001** RS-232-C/CCITT V.24 (cable not included)

N/C

**002** HP-IB (IEEE 488-1978) (cable not included)

N/C

#### Interface Cables

**HP 13242G** M-M special RS-232-C cable for use with Option 001, HP 150 Personal Computers, HP Vectra PC with HP 24541A interface

\$69.00 ☎

**HP 17255D** M-F special RS-232-C cable for use with Option 001, IBM PC, AT & T Personal Computers

\$40.00 ☎

**HP 24542G** M-M special RS-232-C cable for use with Option 001, HP Vectra PC with HP 24540A interface, IBM AT

\$50.00 ☎

**HP 10833A** HP-IB 1-metre cable for use with Option 002

\$80.00 ☎

☎ Fast-Ship product — see page 766.

# COMPUTER PERIPHERALS

## Plotters—Technical/CAD Professional Plotter

### Model 7475A

721

- High-quality output
- Drafting capability
- Choice of A3/B\*\* and A4/A\* media sizes

- Six-pen carousel
- Plots on paper, transparency film, polyester film
- Plots using fiber-tip and liquid-ink pens

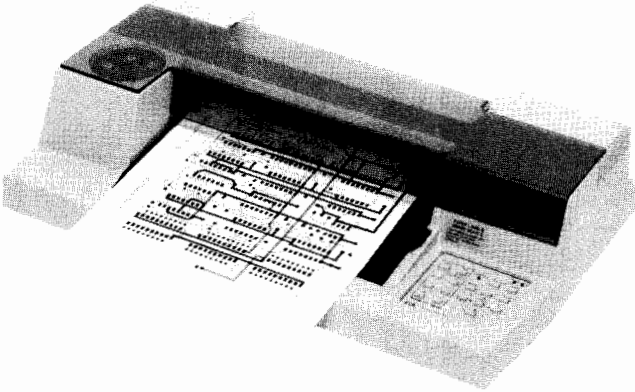

The HP 7475A is a low-cost plotter that provides the kind of graphics excellence and versatility you would expect to find in a much more expensive plotter. The HP 7475A produces fast, high-quality drawings for business, design, and measurement professionals.

With the HP 7475A, you have your choice of two media sizes — A4/A-size\* for colorful report and presentation graphics, and A3/B-size\*\* plots for PERT charts, schematics, engineering drawings, and design applications. You can switch chart sizes with the push of a button.

If you need a vertical format, you can use the front panel keys to rotate the chart 90 degrees. And if you need to digitize, you can do that from the front panel, too.

The HP 7475A accepts four different types of media — chart paper, glossy presentation paper, overhead transparency film and double-matte polyester film. And you have a choice of two different pen types — fiber-tip pens for paper and overhead transparencies and liquid-ink drafting pens for high-quality drawings on polyester film. Fiber-tip pens are available in ten colors and two tip widths. Refillable short-body drafting pens come in three different tip widths.

#### Applications

**Business:** The A3/B-size\*\* capability of the HP 7475A makes it the ideal plotter for PERT charts, organization charts, flow charts, or small flip charts. And the HP 7475A produces colorful A4/A-size\* charts for reports, meetings, and presentations.

**Design:** Perfect as an entry level drafting plotter or an inexpensive companion to your design system, the HP 7475A creates liquid-ink drawings on polyester film for frequently handled archival copies or check plots using fiber-tip pens on paper.

**Measurement:** The HP 7475A adds hardcopy graphics capability to intelligent instruments and instrument systems with an HP-IB (IEEE 488-1978) interface. Many systems (with or without display screens) can have the benefits of high-quality, hardcopy graphics plotted directly from measured data.

#### High-Quality Output

With an addressable step size of 0.025 mm (0.001 in.), the HP 7475A can plot up to 1000 points in a 1-inch line. When commanded to return to the same point with no pen change, the plotter achieves this repeatability within 0.1 mm (0.004 in.). Because of the outstanding resolution and repeatability, the HP 7475A produces straight, professional-quality lines.

\* A4 Size is 210 x 297 mm; A Size is 8½ x 11 in.

\*\* A3 Size is 297 x 420 mm; B Size is 11 x 17 in.

#### Special Programming Features

If you create your own graphics programs, you'll be glad to learn that the HP 7475A contains over 50 HP-GL (Hewlett-Packard Graphics Language) instructions to control such functions as arc and circle generation, and area fill in pie and bar charts. Plus, the HP 7475A has 19 internal character sets, including ISO European sets, Katakana, ASCII, and Roman 8 extensions.

#### Interface Options

The HP 7475A is easy to interface with most HP and non-HP computers because you have the choice of two interface options — either RS-232-C/CCITT V.24 or HP-IB (IEEE 488-1978). By adding an cavedrop cable you can connect the HP 7475A in series with a computer and a terminal.

#### Graphics Software

The HP 7475A is supported on a wide variety of business and design graphics application packages for HP as well as non-HP computer systems. Details are available from any HP sales and service office.

#### Specifications

**Resolution:** Smallest addressable step size, 0.025 mm (0.001 in.)

**Repeatability:** with a given pen, 0.1 mm (0.004 in.); from pen to pen, 0.2 mm (0.008 in.)

**Pen velocity (each axis):** pen up, 50.8 cm/s (20 in./s); pen down, maximum, 38.1 cm/s (15 in./s); programmable, 1 to 38 cm/s in 1 cm/s increments

**Acceleration:** approximately 2 g's

**Environmental range:** operating, 0°C to 55°C; non-operating, -40°C to 75°C

**Plotting area:** x-axis, 258 mm (10.2 in.), A/B; 275 mm (10.8 in.), A4/A3; y-axis, 198 mm (7.80 in.), A; 192 mm (7.56 in.), A4; 414 mm (16.3 in.), B; 402 mm (15.8 in.), A3

**Interfaces:** HP-IB (IEEE 488-1978) implements the following functions as defined in IEEE 488-1978 — SH1, AH1, T2, TE0, LE0, SR1, RL0, DC1, DT0, L2, PP0 (listen only or address less than 7, otherwise PP2); RS-232-C/CCITT V.24, asynchronous serial ASCII with switch selectable baud rates of 75, 110, 150, 200, 300, 600, 1200, 2400, 4800, 9600. External clock input capabilities with intermediate baud rates of up to 9600 baud; 1024 byte buffer

**Power requirements:** source, 100, 120, 220, 240 V~ -10%, +5%; frequency, 48-66Hz

**Size:** height, 127 mm (5 in.); width, 568 mm (22.4 in.); depth, 367 mm (14.5 in.)

**Weight:** net, 7 kg (16.0 lb); shipping, approx. 11 kg (24.0 lb)

**FCC:** FCC certified to limits set for radio frequency interface when used with a class B computing device

#### Accessories Supplied

HP 07475-90002 Operation and Interconnection Manual

HP 07475-90003 Reference Card

Power cords and an assortment of pens and drawing media are also supplied with the plotters. The media size and appropriate power supply are determined by plotter destination.

NOTE: Interface cables are not supplied with the plotter. They must be ordered separately.

#### Accessories Available

HP 07475-90001 Interfacing and Programming Manual

Price

\$20

#### Ordering Information

##### Options

001 RS-232-C/CCITT V.24 (cable not included)

N/C

002 HP-IB (IEEE 488-1978) (cable not included)

N/C

HP 7475A Six-pen Graphics Plotter

\$1895

Available from Instruments Direct 800-523-2121 (U.S. only)

☎ Fast-Ship product — see page 766.

# COMPUTER PERIPHERALS

## Plotters — High Speed/High Performance Plotter

### Model 7550A

- Ideal for high-volume, shared environments
- Requires minimum operator supervision
- Uses drafting media, pens
- High throughput
- 6 g acceleration, 80 cm/s (31.5 in./s)
- Accepts A3/B- and A4/A-size media

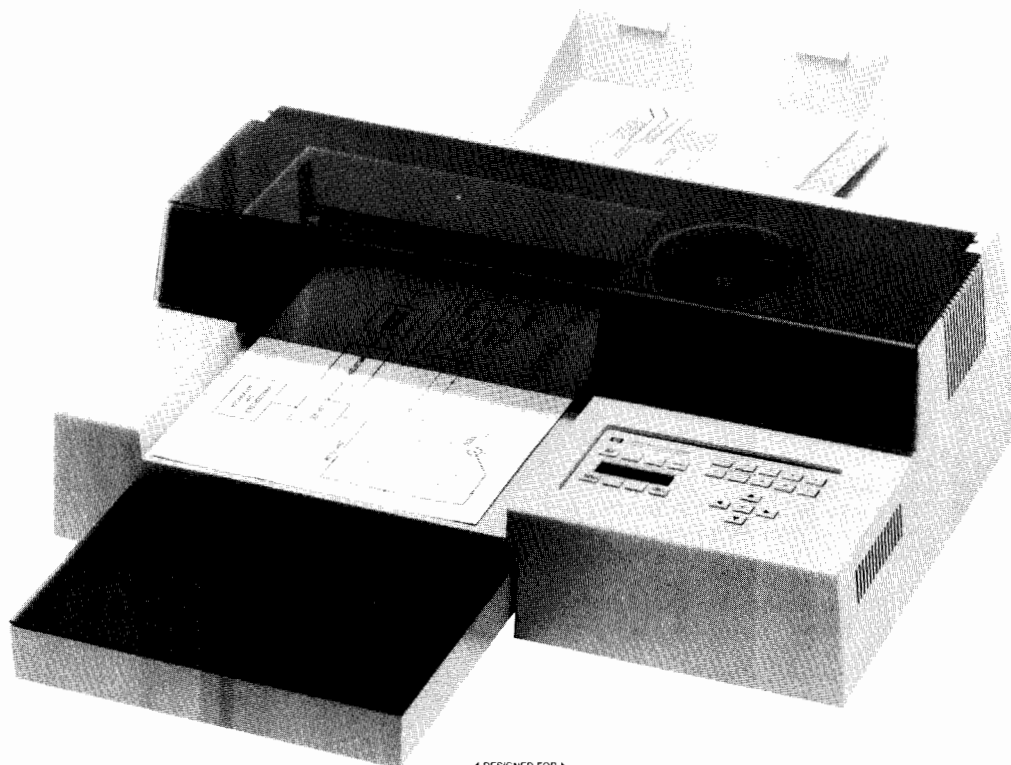

HP 7550A

Hewlett-Packard's sheet feed 7550A plotter is an innovative graphics tool for business and technical users alike. Automatic cut sheet feed capability for paper and transparencies makes the HP 7550A ideal for unattended plotting or multiple color copies. With an unmatched 6 g of acceleration, the HP 7550A can produce quick graphs for problem-solving or decision making, or working drawings for drafting or design systems. And the HP 7550A meets Hewlett-Packard's high performance standards, so it creates professional-looking graphs for reports and presentations.

#### Fast Throughput

The HP 7550A's fast acceleration and pen speed mean shorter plotting time. The HP 7550A draws in any direction at 80 cm/s (31.5 in./s) and letters at approximately 7-9 characters per second. It uses the powerful MC68000 16-bit microprocessor. The HP 7550A is also equipped with a replot capability so if an entire plot will fit in the replot buffer ( $\approx$  12K bytes), the HP 7550A can produce up to 99 original color copies without rerunning the program, freeing your computer to go on with other tasks.

#### Minimum Operator Supervision

The HP 7550A eliminates manual paper handling of A3/B- and A4/A- size sheets of paper, and transparency film. The carousel allows eight pens to be loaded at once, and the plotter caps the pens when not in use to keep ink fresh. The HP 7550A automatically senses the type of carousel loaded, then sets the optimal pen speed and force. It also senses what paper size is being used.

#### High Quality Output

With an addressable resolution of 0.025 mm (0.001 in.) and mechanical resolution of 0.006 mm (0.00025 in.), the HP 7550A makes smooth arcs and draws lines that meet precisely. It also has a curved line generator which can be invoked when exceptionally smooth curves are required.

With 20 character sets, the HP 7550A is ideal for international business. Choices include Katakana and ISO European languages for Denmark, France, Germany, Italy, Norway, Portugal, Spain, Sweden, and the United Kingdom. The HP 7550A letters in two fonts: arc font with proportional spacing for maximum readability and stick font with fixed character spacing for speed.

#### Features

The front-panel display and function keys guide users through each plotter setup, report plotter status, and give program messages. The HP 7550A rotates graphs 90 degrees for a choice of either horizontal or vertical formats, and aligns graphs to pre-printed forms and grids, all from the front panel.

The HP 7550A accepts standard A4/A- and A3/B-size paper, double-matte polyester film, vellum, and A4/A-size transparency film. Pen choices include liquid-ink, roller-ball, paper, and transparency pens. Because of its complete device control command set and dual interface - HP-IB (IEEE-488) and RS-232-C/CCITT V.24, the HP 7550A is adaptable to most system environments.

### Technical Applications

The drawing quality, media flexibility, automatic sheet feed and fast plotting time of the HP 7550A make it ideal for quick working drawings or small format final drawings in computer-aided design, or for technical graphics in manufacturing, testing, or research and development. The HP 7550A is supported by many technical graphics software packages; the HP 7550A can draw A3/B-size check plots and working drawings to help relieve overburdened drafting plotters, produce quick, problem-solving graphs or engineering analyses, and plot charts and graphs on transparency film for technical presentations. And the HP 7550A does it all quickly and easily.

### Business Applications

The HP 7550A is suited to business graphics users who appreciate the value of color hardcopy graphics, need quality graphics in quantity, and want a plotter that requires a minimum of operator supervision. Financial graphs, project schedules, forecasts and text charts are typical uses for a HP 7550A in a business environment. And both HP and non-HP graphics software packages make it easy for anyone to use the HP 7550A.

### Software

Software support is available for the HP 7550A on many HP and non-HP computer systems, as well as HP and non-HP personal computers. In addition to HP's Industry Standard Plotting Package, a variety of graphics packages for nonprogrammers is available. These software packages cover both business and technical applications. Complete information is available from any HP Sales and Support office.

### Specifications

**Media sizes:** accommodates ISO A4 (210 x 297 mm), ANSI A (8.5 x 11 in.), ISO A3 (297 x 420 mm), and ANSI B (11 x 17 in.)

**Maximum plotting area:** pen axis, 254 mm (9.97 in.) for A/B, 272 mm (10.65 in.) for A4/A3; paper axis, 411 mm (16.12 in.) for B, 399 mm (15.65 in.) for A3, 196 mm (7.68 in.) for A, 190 mm (7.45 in.) for A4.

**Resolution:** smallest addressable step size is 0.025 mm (0.001 in.); mechanical resolution is 0.006 mm (0.00025 in.)

**Repeatability:** with a given pen, 0.1 mm (0.004 in.)

**Pen velocity:** pen down, maximum, 80 cm/s (31.5 in./s) in increments of 1 cm/s, from the front panel 10 to 80 cm/s (4 to 31.5 in./s) in increments of 5 cm/s; pen up 80 cm/s (31.5 in./s)

**Acceleration:** maximum approximately 6 g's; programmable from 1 to 6 g's in increments of 1 g.

**Pen force:** 15 to 66 grams

**Power requirements:** source, 100, 120, 220, 240 V, -10%, +5%; frequency, 48 - 66 Hz; consumption, 100 W maximum

**Interfaces:** HP-IB implements the following HP-IB functions as defined in IEEE 488-1978: SH1, AH1, T6, L3, SR1, RL0, DC1, DT0, C0, PP0, for listen only, PP1 for address greater than 7, and PP2 for address of 7 or less, device address front panel selectable, default value - 5; RS-232-C/CCITT V.24, asynchronous serial ASCII with front panel selectable baud rates of 75, 110, 150, 200, 300, 600, 1200, 2400, and 9600, default value - 2400

**Buffer size:** default, 1024 bytes; from the program expandable to 12K bytes

**Character sets:** 20 sets, each in two character fonts, including, the following ISO registered sets: International Reference Version (002); United Kingdom (004), U.S. ASCII (006), Swedish (010), Swedish for Names (011), Katakana (013), JIS ASCII (014), Italian (015), Portuguese (016), Spanish (017), German (021), French (025), Norwegian (060), Norwegian II (061), plus HP 9825 character set, French/German, Scandinavian, Spanish/Latin America, Special Symbols, and Roman 8 Extensions

**Environmental range:** operating, 0°C to 55°C; nonoperating, -40°C to 75°C; automatic sheet feeder, operating with paper, 10 - 40 C and 0 - 80% RH, with transparency film, 15 - 35°C and 25 - 75% RH

**Size:** height, 215 mm (8.5 in.); width, 670 mm (26.4 in.); depth with A4/A loading tray/no catcher, 432 mm (17.0 in.), A4/A loading tray with catcher, 682 mm (26.8 in.), A3/B loading tray/no catcher, 635 mm (25.0 in.), A3/B loading tray with catcher, 896 mm (35.3 in.)

**Weight:** net approximately 17.3 kg (38.0 lb), shipping approximately 25.0 kg (55.0 lb)

**Pens:** 8 per carousel: fiber-tip, roller-ball, and liquid-ink

**Media:** manual feed, chart paper, high-gloss paper, transparency film, vellum, double-matte polyester mylar film; automatic sheet-feed, chart paper and transparency film.

### Accessories Supplied

Accessories Supplied	HP Part Number
Operation and Interconnection Guide	07550-90002
Pocket Guide	07550-90003
A-size Media Loading Tray	17561A
A4 Media Loading Tray	17562A
A4/A Paper Catcher	17563A
Pen carousel for fiber-tip transparency pens	07550-60050
Pen carousel for fiber-tip paper pens	07550-60051

A power cord and an assortment of fiber-tip pens, paper and transparency media are also supplied with the plotter. The media size and appropriate power cord are determined by destination. Drafting pens and drafting media are available; please refer to the Computer Users Catalog for a complete listing.

### Ordering Information

Interface cables	Price
HP 17355D Male-female RS-232-C/CCITT V.24 cable for use in remote modem environments; pins 1-25 wired end-to-end	\$60 ☛
HP 17255F Female-female RS-232-C/CCITT V.24 cable, adapted for use with IBM personal computer interface	\$40 ☛
HP 17255D Male-female RS-232-C/CCITT V.24 cable, adapted for use with HP 150 personal computer interface	\$40 ☛
HP 17855A RS-422-A adapter cable	\$200 ☛
HP 10833A or 45529A HP-IB 1-metre cable; RFI shielded	\$80 ☛
HP 10833B or 45529B HP-IB 2-metre cable; RFI shielded	\$90 ☛

### Accessories Available

HP 17526A A3-size Media Handling Kit, including media loading tray, media catcher, 50 sheets A3-size plotter paper	\$160 ☛
HP 17525A B-size Media Handling Kit, including media loading tray, media catcher, 50 sheets B-size plotter paper	\$160 ☛
HP 17564A B-size Loading Tray	\$110
HP 17565A A3-size Loading Tray	\$110
HP 17566A B-size Media Catcher	\$42
HP 07550-90001 Interfacing and Programming Manual	\$35

### HP 7550A Graphics Plotter

☛ Fast-Ship product — see page 766.

**\$3900 ☛**

## COMPUTER PERIPHERALS

### Plotters Low-cost, Eight-pen Drafting Plotter

#### HP DraftPro Plotter

- Professional, quality output
- Solid software support
- Pens and media for every application
- A2/C/Architectural C- and A1/D/Architectural D-size media

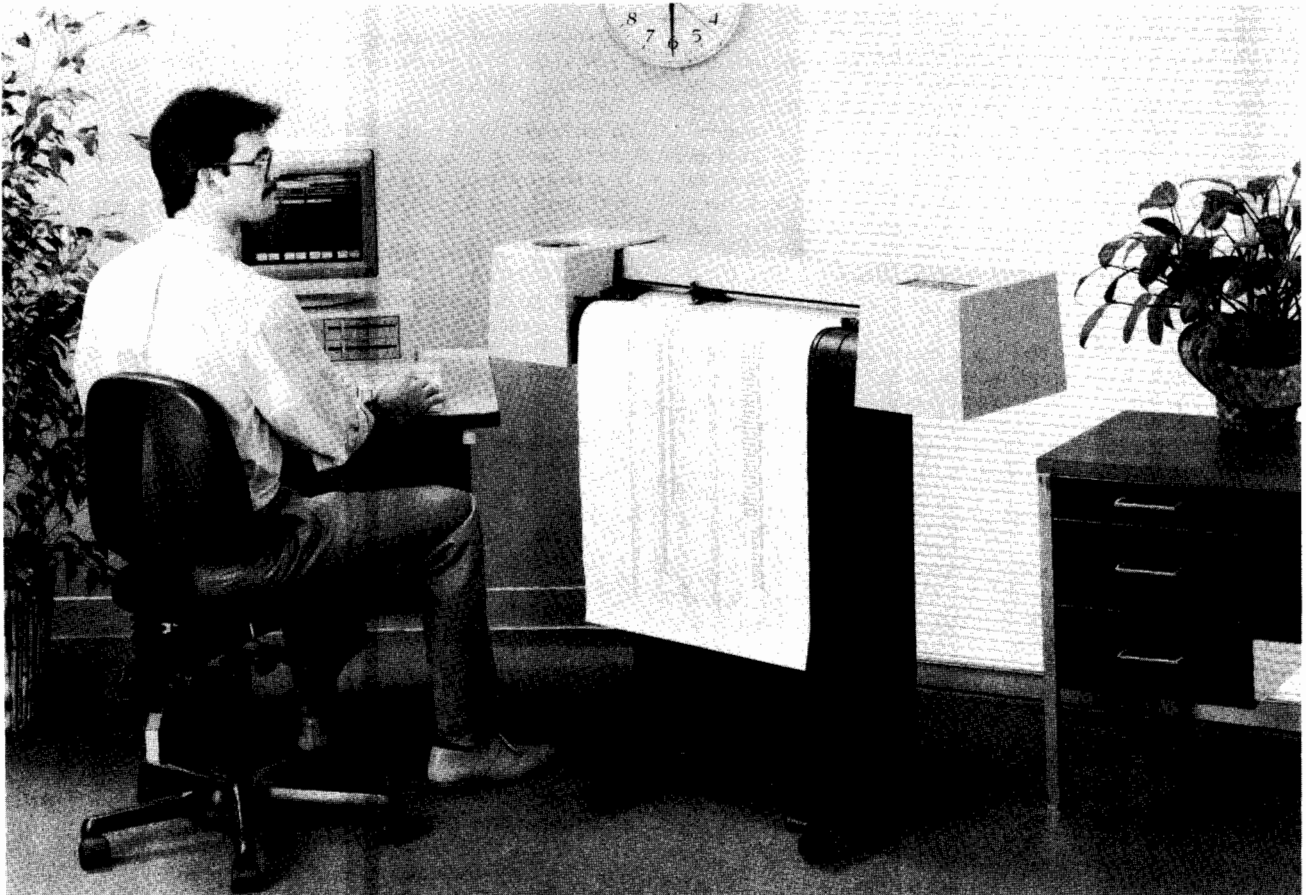

The HP DraftPro plotter is an 8-pen drafting plotter that's been designed especially for you and your personal CAD system. The HP DraftPro plots on single sheets with widths from 550 mm to 640 mm and lengths from 400 mm to 1000 mm. That includes ISO A2 and A3 sizes, ANSI C and D sizes, and Architectural C and D sizes.

Whether you create electrical schematics, floor plans, part renderings, or topographical maps, the DraftPro plotter offers the professional-quality output your work deserves — at a price you can afford.

#### High-Quality Output

When your drawings look good, you look good. So you need high-quality output that reflects the professional nature of your work. The DraftPro plotter provides the high-quality output you expect from a Hewlett-Packard product.

The DraftPro plotter has a mechanical resolution of 0.013 mm (0.0005 in.) and an addressable resolution of 0.025 mm (0.001 in.) to ensure you get smooth arcs and crisp letters. And with DraftPro's repeatability of 0.10 mm (0.004 in.), your drawings will have precise corners and circles that close.

For applications that require precision plotting, accuracy is an important specification. Accuracy refers to the difference in length between distance the plotter is instructed to draw and the distance it actually draws. The DraftPro plotter is accurate to within 0.5 mm (0.02 in.) or 0.2% of the specified line length, whichever is greater.

#### Media and Pen Flexibility

Different types of media are appropriate for different applications. And for best results, it's important to use pens that are compatible with your media. The DraftPro plotter plots on paper, vellum, and polyester film. And it draws with fiber-tip pens, disposable liquid-ink pens, and refillable liquid-ink pens.

The HP DraftPro also allows you to choose one of eight different plotting speeds right from the front-panel. You can select the speed that is most appropriate for your pen/media combination.

#### Eight-pen Carousel

The DraftPro plotter's eight-pen carousel means you have access to a wide variety of colors and line widths for every drawing. During a plot, pens are changed automatically and they are automatically capped when not in use. Two carousels come with every DraftPro plotter — one for fiber-tip pens, and one for drafting pens.

#### High Throughput

Hewlett-Packard knows that you don't have time to sit around and wait for your plots to finish. In addition to its maximum 2.8 g acceleration and 40 cm/s (15.7 in./s) velocity, the DraftPro plotter has several features that help minimize plotting time.

The DraftPro plotter has a "pen sorting" feature; the plotter minimizes the number of pen picks by grouping lines of the same color together and drawing them at the same time. In addition, the HP DraftPro has strong communication abilities.



### Easy-to-Use

With the HP DraftPro, you can start producing drawings the same day you unpack the plotter. The paper and pen loading procedures are simple, and the front-panel controls can be mastered in minutes. And when you're loading media, the HP DraftPro automatically senses the sheet size and sets the margins accordingly.

The DraftPro plotter is small and lightweight, so it fits almost anywhere. And because it has its own set of wheels, the DraftPro is easy to move and easy to share.

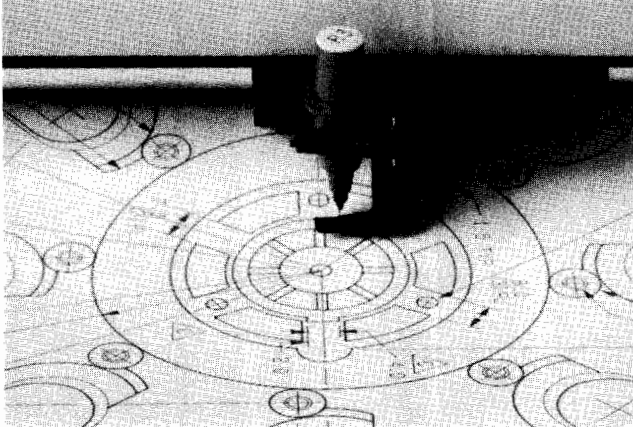

### Powerful Command Set

Programmers will be glad to know the HP DraftPro supports more than 80 HP-GL (Hewlett-Packard Graphics Language) commands. With just a few commands, you can label; draw lines, arcs, and circles; or select one of 20 international character sets.

### Hardware and Software Compatibility

The DraftPro plotter connects easily to almost any HP or other personal computer or workstation. An RS-232-C/CCITT V.24 interface comes standard; HP-IB (IEEE 488-1978) can be ordered as an accessory.

Like all HP drafting plotters, the DraftPro is supported by the leading software vendors. Check with your local HP sales and support office for complete software information. Or contact your current software vendor about their support for the DraftPro.

### Specifications

**Media sizes:** accommodates widths from 550 mm to 640 mm, lengths from 400 mm to 1000 mm. These measurements include A2/C/Architectural C- and A1/D/Architectural D-size media.

**Margins:** Expanded mode, 5 mm (0.2 in.) on three edges, 31 mm (1.2 in.) on the fourth; Normal mode, 15 mm (0.59 in.) on three edges, 39 mm (1.5 in.) on the fourth.

**Resolution:** smallest addressable move, 0.025 mm (0.001 in.); mechanical resolution, 0.013 mm (0.0005 in.)

**Repeatability:** (for the same pen): 0.10 mm (0.004 in.); (pen to pen): 0.20 mm (0.008 in.). These specifications are for 0.08 mm (0.003 in.) polyester film.

**Accuracy:** 0.5 mm (0.02 in.) or 0.2% of the specified line length, whichever is greater. These specifications are for 0.08 mm (0.03 in.) polyester film.

**Pen Velocity:** pen down, 40 cm/s (15.7 in./s); pen up, 50 cm/s (19.7 in./s)

**Acceleration:** maximum, 2.8 g

**Pen Cycle Time:** 100 ms

**Power requirements:** source, 100, 120, 220, 240 V  $\pm$  10%; frequency, 47.5-66 Hz; consumption, less than 80 W maximum.

**Interfaces:** RS-232-C/CCITT V.24, HP-IB (IEEE 488-1978) available as an accessory. HP-IB (IEEE 488-1978), implements the following HP-IB functions as defined in IEEE 488-1978: SH1, AH1, T6, L3, SR1, RL0, DC1, DT0, C0, PP0 for listen-only, PP1 for address greater than 7, and PP2 for address of 7 or less. For more on these codes, refer to the HP-IB section of this catalog.

**Buffer size:** 7448 bytes (to be shared between user-definable I/O, polygon, and pen sort buffers)

**Environmental Range:** operating temperature, 0° C to 55° C; non-operating temperature, -40° C to 75° C; relative humidity, 5% to 95% (in 0° C to 40° C)

**Size:** height, 1030 mm (40.6 in.); width, 1140 mm (44.9 in.); depth, 520 mm (20.5 in.)

**Weight:** 30 kg (66 lb)

**Pens:** 8-pen carousel: fiber-tip, disposable liquid-ink, and refillable liquid-ink drafting pens.

**Media:** Paper, vellum, and double-matte polyester film.

### Accessories Supplied

User's Guide

Pocket Guide

Power Cord

Media Sampler Kit

5 sheets of architectural D-size paper

Fiber-tip pens (0.3 mm)

Pkg of 5 (black, green, red, and yellow)

Carousels

Fiber-tip pen carousel

Liquid-ink drafting pen carousel

Grit Wheel Brush

Hewlett-Packard Drafting Supplies Catalog

(P/N 5957-3776 [D] or 5957-3777)



### Ordering Information

HP 7570A DraftPro Plotter

HP 17570A HP-IB Cartridge

### Price

\$3,995

\$295

### Accessories Available

Description	Part Number
HP-IB Installation Instructions	07570-90014
Programmer's Reference (available in English only)	07570-90001
Programmer's Pocket Guide (available in English only)	07570-90003
Hardware Support Manual	07570-90000

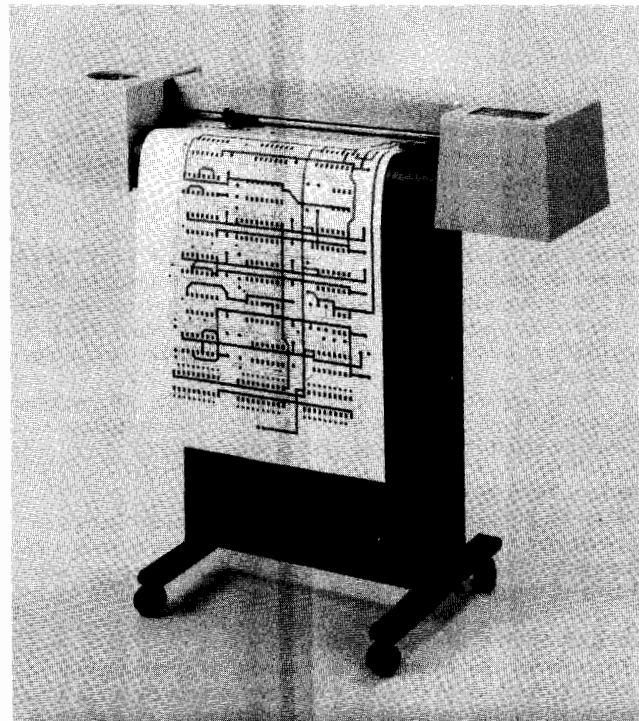

# COMPUTER PERIPHERALS

## Plotters—Large-Format Drafting Plotters

### HP DraftPro DXL and EXL

- Excellent line quality
- Medium throughput
- One- and two-megabyte buffer options
- Compatible with a wide variety of hardware and software
- Powerful HP-GL command set
- Media and pen flexibility
- HP quality and reliability
- Attractive price

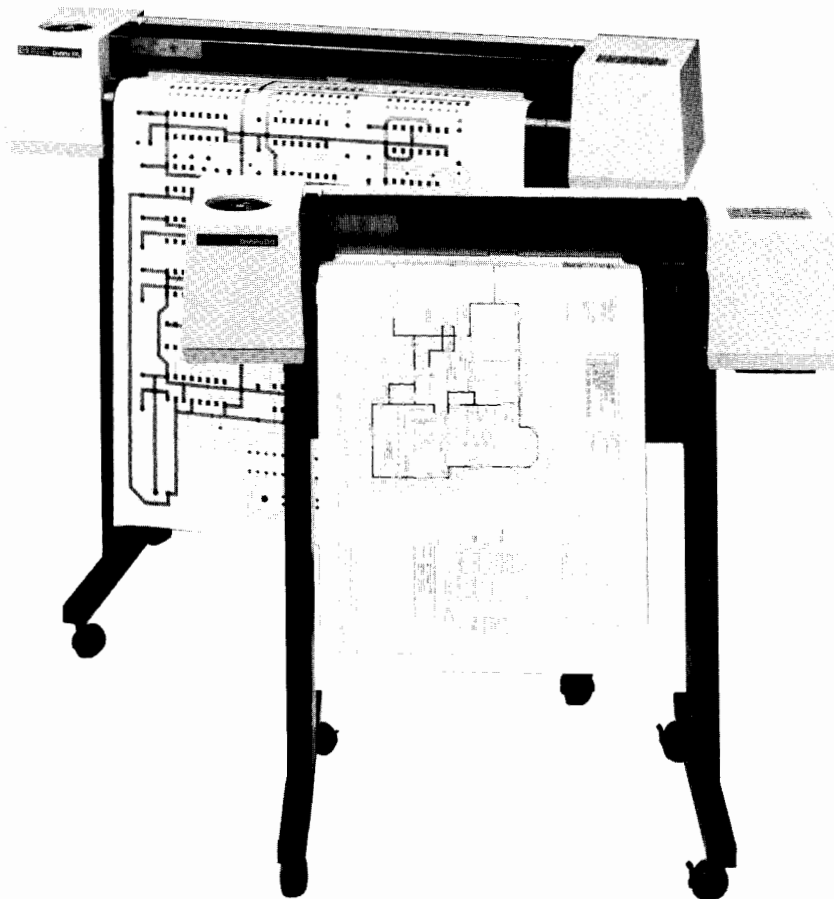

The HP DraftPro DXL and EXL plotters are designed to meet the needs of today's CAD professionals.

The HP DraftPro DXL accepts A4/A- through A1/D-media; the DraftPro EXL accepts A4/A- through A0/E-media. (Standard ISO, ANSI, and architectural sizes.)

#### Excellent Line Quality

With a mechanical resolution of 0.0127 mm (0.0005 in.) and an addressable resolution of 0.0254 mm (0.001 in.), the DraftPro DXL and EXL plotters draw well-defined lines, smooth curves, and crisp characters that help you and your designs look their best. The 0.10 mm (0.004 in.) repeatability means your drawings have the professional quality you need.

For many applications, accuracy is important. The HP DraftPro DXL and EXL plotters are accurate to within 0.5 mm (0.02 in.) or 0.2% of the specified line length, whichever is greater.

#### Medium Throughput

With 2.8 g maximum (diagonal) acceleration and 80 cm/s (32 in/s) velocity, the DraftPro DXL and EXL plotters produce your plots quickly. Both plotters include a pen sorting feature that minimizes pen changes for more efficient plotting.

#### Two Extended Buffer Options

Two extended buffer options are available as accessories for increased productivity. Available in one- and two-megabyte options, these easy-to-install cartridges let you quickly download an entire

plot, freeing your computer for other tasks. (Available for use with RS-232-C interface only.)

#### Hardware and Software Compatibility

The HP DraftPro DXL and EXL plotters connect easily to almost any HP or other personal computer/workstation. An RS-232-C serial interface is standard; HP-IB (IEEE 488-1978) can be ordered as an accessory.

The DraftPro DXL and EXL fit into most office environments. And because DraftPro plotters have their own set of wheels, they're easy to move and share.

Over 100 software packages work with the HP DraftPro DXL and EXL plotters. All the leading vendors in architectural, mechanical, and electronic PC CAD software support the DraftPro DXL and EXL plotters.

#### Powerful Command Set

Programmers will be glad to know the HP DraftPro DXL and EXL use HP-GL (Hewlett-Packard Graphics Language). With just a few commands you can label, draw lines, arcs, and circles, or select one of 22 international character sets.

While most plotter manufacturers claim to have HP-GL compatibility, only HP plotters have HP-GL that's been tested and approved by Hewlett-Packard.

### Output for Every Application

The HP DraftPro DXL and EXL plotters have the pen and media flexibility you need to get the job done. The DraftPro DXL handles A4/A- through A1/D-media; the DraftPro EXL handles A4/A- through A0/E-media. (Standard ISO, ANSI, and architectural sizes.)

The DraftPro DXL and EXL plot on paper, vellum, and polyester film. For presentations, you can use glossy paper or transparency film. The DraftPro DXL and EXL plotters draw with fiber-tip paper pens, transparency pens, disposable drafting pens, and refillable drafting pens.

From the front panel you can select the pen speed that optimizes performance and line quality for your pen/media combination. And the eight-pen carousel lets you use a variety of colors and line widths with ease. Pens are changed automatically during plotting. And to increase the life of your pens, they're automatically capped when not in use.

### HP Quality and Reliability

Equipment downtime costs you time and money. That's why the HP DraftPro DXL and EXL plotters meet the same tough standards for quality and reliability that have made HP pen plotters *leaders* in the industry. Solid HP engineering and sophisticated electronics reduce the number of parts and increase product reliability.

The HP DraftPro DXL and EXL plotters are subjected to mechanical and electrical abuse, shock, vibration, and extreme temperature cycling — all to make sure your HP drafting plotter can handle the most demanding workload.

We feel so strongly about the reliability of our DraftPro DXL and EXL plotters, we back them with a one year, on-site warranty. And if you'd like an on-site service contract after the first year, you'll pay the lowest prices in the industry.

### All at an Attractive Price

The HP DraftPro DXL and EXL give you HP quality at an attractive price. The combination of reliability, quality, performance, flexibility, and support make these plotters an *excellent* value and a *smart* choice in drafting plotters.

### Specifications

**Media sizes:** DraftPro DXL accommodates widths from 205 mm to 485 mm and from 555 mm to 645 mm, lengths from 215 mm to 1140 mm, including A4/A- through A1/D-media (standard ISO, ANSI, and architectural sizes); DraftPro EXL accommodates widths from 207 mm to 634 mm and from 837 mm to 927 mm, lengths from 215 mm to 1230 mm, including A4/A- through A0/E-media (standard ISO, ANSI, and architectural sizes).

**Pens:** number, 8 in carousel; type, Fiber-tip paper, fiber-tip transparency, disposable drafting, refillable drafting.

**Media:** paper, vellum, double-matte polyester film, glossy paper, and transparency film.

**Character sets:** French/German, HP 9825, Scandinavian, Spanish/Latin American, Roman Extensions, Special Symbols, Drafting, Kanji, and these ISO registered sets: ANSI ASCII (006), ECMA 94 Extensions (100), French (025), German (021), International Reference Version (002), Italian (015), JIS ASCII (014), Katakana (013), Norwegian I (060), Norwegian II (061), Portugese (016), Spanish (017), Swedish (010), Swedish for Names (011), United Kingdom (004).

**Resolution:** addressable, 0.0254 mm (0.001 in.); mechanical, 0.0127 mm (0.0005).

**Repeatability:** for the same pen: 0.10 mm (0.004 in.) (These specifications are for 0.08 mm (0.003 in.) double-matted polyester film at 10-30°C, 20-80% relative humidity.)

**Accuracy:** 0.5 mm (0.02 in.) or 0.2% of the specified line length, whichever is greater. (These specifications are for 0.08 mm (0.003 in.) polyester film at 10-30°C, 20-80% relative humidity.)

**Maximum pen velocity:** 80 cm/s (32 in./s).

**Maximum acceleration:** diagonal, 2.8 g; axial, 2.0 g.

**Pen cycle time:** 67 ms.

**Margins:** expanded mode, 5.0 mm (0.2 in.) on three edges, 31.0 mm (1.2 in.) on the fourth; normal mode, 15.0 mm (0.59 in.) on three edges, 39.0 mm (1.5 in.) on the fourth.

**Buffer size:** 31Kbytes (shared between user-definable polygon and pen sort buffers); optional 1 and 2 megabyte expandable buffers available as accessories (for use with RS-232-C interface only).

**Environmental ranges:** operating temperature, 0 to 55 degrees C (32 to 131 degrees F); storage temperature, -40 to 75 degrees C (-40 to 167 degrees F); humidity, 5 to 95% (in 0 to 40 degrees C).

**Power requirements:** source, 100, 120, 220, 240 V +10%, -10%; frequency, 47.5-66 Hz; consumption, less than 80 W maximum.

**Size:** DraftPro DXL, height, 1105 mm (43.3 in.); width, 1145 mm (45 in.); depth, 570 mm (22.5 in.). DraftPro EXL, height, 1120 mm (47.5 in.); width, 1450 mm (57 in.); depth, 620 mm (24.5 in.).

**Weight:** DraftPro DXL, net weight, 34 kg (76 lb); shipping weight, 54 kg (120 lb). DraftPro EXL, net weight, 41 kg (91 lb); shipping weight, 61 kg (135 lb).

### Accessories Supplied

User's Guide

Power cord (appropriate to plotter destination)

Media sample kit

5 sheets of metric

A1-size paper (594 x 841 mm)

Fiber-tip pens (0.3 mm)

Package of 5 (black, blue, green, red, and yellow)

Disposable drafting pens (0.35 mm)

Package of 4 (black, blue, red, green)

Carousels

Fiber-tip pen carousel

Drafting pen carousel

Grit wheel brush

Supplies catalog

### Ordering Information

HP 7575A DraftPro DXL drafting pen plotter

HP 7576A DraftPro EXL drafting pen plotter

### Price

\$4,995

\$6,495

### Accessories Available

17573A 1 Megabyte extended buffer\*

17574A 2 Megabyte extended buffer\*

17570A HP-IB interface cartridge

17571A HP-IB interface cartridge with Kanji

07570-90014 HP-IB cartridge installation instructions

07575-90001 *Programmer's Reference* (English only)

07575-90000 *Hardware Support Manual*

\*Available for RS-232-C interface only.

# COMPUTER PERIPHERALS

## Plotters—High Performance, A4/A through A0/E size Drafting Plotters

### HP DraftMaster I and DraftMaster II

- High throughput; up to 5.7 g acceleration
- Built-in intelligence
- Superb line quality
- Triple interface: RS-232-C, RS-422-A, HP-IB
- HP 758XB emulation
- Accepts eight standard media sizes

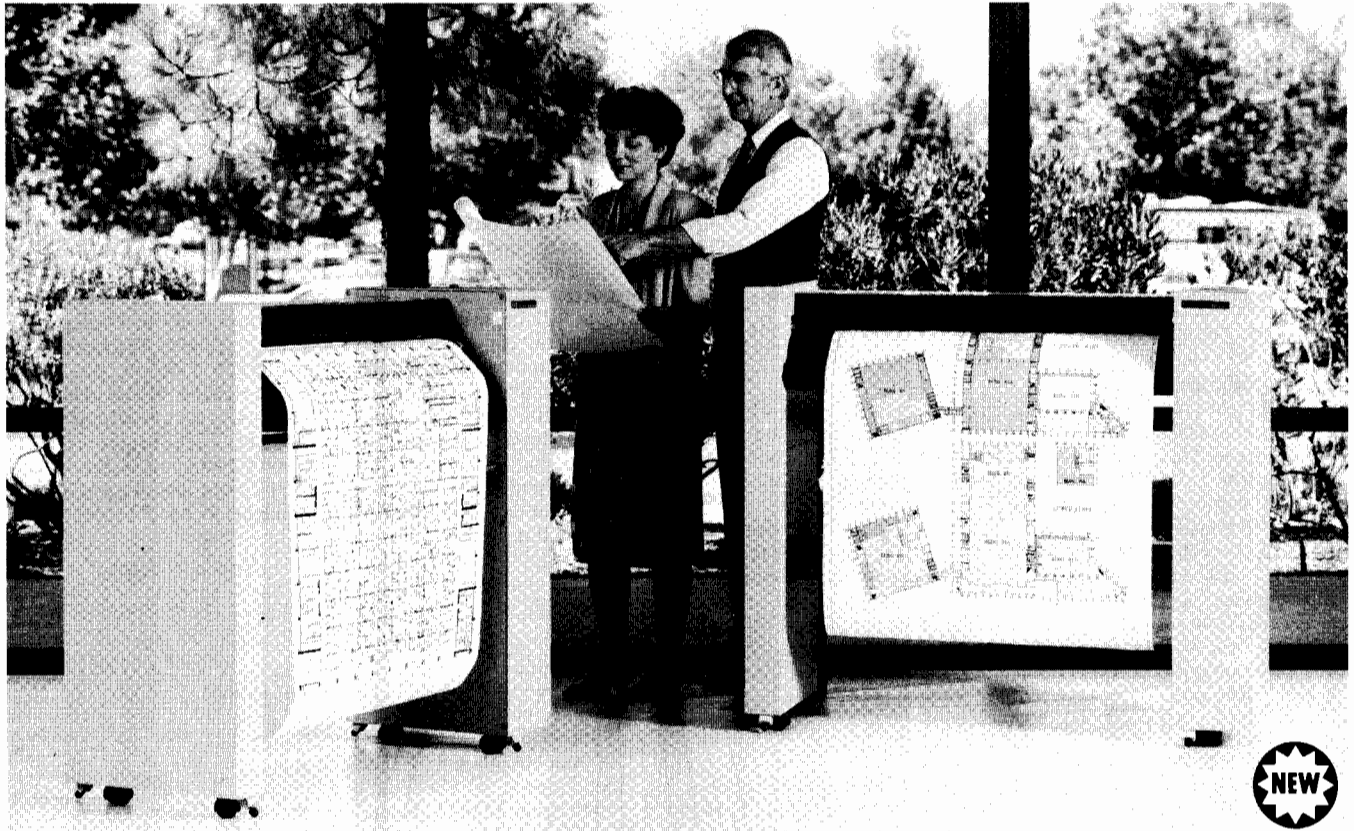

Hewlett-Packard has created a new generation of drafting plotters to meet the high-performance requirements that today's CAD environments demand — the DraftMaster I and the roll-feed DraftMaster II plotters. HP DraftMaster plotters combine state-of-the-art hardware with the latest in drafting technology at a price that's less than you'd expect.

#### Exceptional Performance

Your drafting productivity is directly affected by plotter throughput. With a maximum pen speed of 60 cm/s (24 in./s) acceleration of up to 5.7 g, and a host of built-in intelligence features, the HP DraftMaster's plotting power gets the job done fast to keep you on schedule.

HP's pen sorting function trims plotting time by minimizing pen changes. The DraftMaster plotter scans your entire plot program to combine pen-up moves wherever possible. The bi-directional plotting feature further increases drawing efficiency by automatically starting the next line segment at its nearest endpoint. And the powerful 10 MHz 16-bit microprocessor enables the HP DraftMaster to draw numerous short lines quickly, a real advantage for lettering.

High throughput is essential in shared environments, especially when several users who share a plotter are facing the same deadlines. HP DraftMaster is designed to meet the increased demands of a multi-user system.

#### Superb Line Quality

No matter how demanding your application — a complex IC or PCB plot, a precise mechanical part design, a detailed architectural drawing — HP DraftMaster showcases your work with the best line quality available. With an addressable resolution of 0.025 mm (0.00098 in.) and repeatability of 0.10 mm (0.004 in.), you can be sure your design will have a first-class presentation.

#### Roll-feed Capability on HP DraftMaster II Plotter

HP DraftMaster II is designed for high-volume, continuous feed, and long-axis plotting. HP DraftMaster II's roll-feed capability keeps productivity humming at peak levels when several user's share a plotter. You can store the completed drawings neatly on the take-up roll, or cut them off one at a time with the built-in media cutter.

When your work requires unattended roll-feed plotting, you can use the DraftMaster plotter's "group pen" function. You can plot up to eight times longer on single-color plots (or four times longer on two-color plots) without stopping to reload the pen carousel. After the first pen has plotted a preset distance, the DraftMaster plotter automatically switches to the next pen in that group. A roll-feed upgrade kit is available for the HP DraftMaster I.

#### Simple Operation

HP DraftMaster plotters are designed for fast and convenient operation with easy, common-sense controls. The 32-character liquid crystal display (LCD) presents easy-to-follow command menus in six major languages.

A convenient loading lever makes media handling fast and uncomplicated. Plus, HP DraftMaster senses media size and automatically scales plot size to fit, so there's no worry about pens drawing off the page. DraftMaster's generous eight-pen carousels eliminate time-consuming manual pen changes. And pens are always capped automatically to prevent ink from drying out. You won't have to reset pen speed and force when you change carousels, either — HP DraftMaster senses the type of carousel and automatically adjusts speed and force.

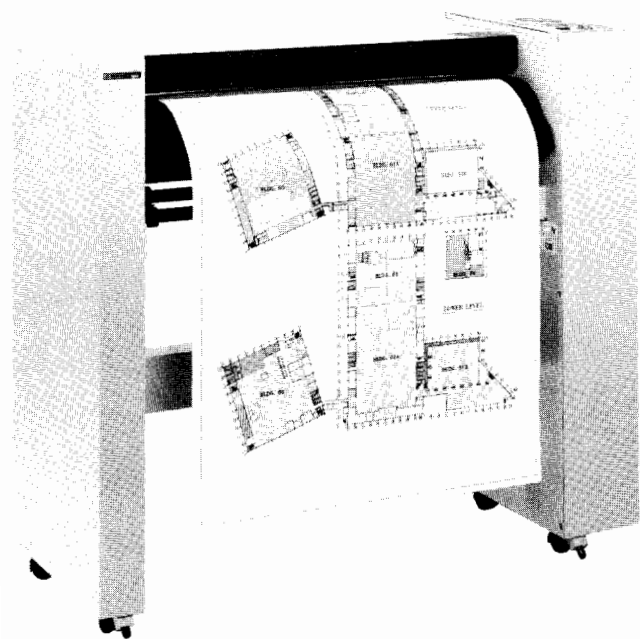

### Pen, Media Flexibility

With the HP DraftMaster Plotter, you can choose from vellum, polyester film, tracing bond, paper, and even transparency film and glossy paper, in A4/A through A0/E-size cut sheets. The HP DraftMaster II also plots on continuous rolls for high-volume, unattended operation, as well as long-axis plotting.

All HP pens and media are carefully designed and tested to give you top-quality results from your HP plotter. HP pens are available in a wide variety of point sizes and colors; the DraftMaster plotter accepts your choice of fiber-tip, roller-ball, and drafting pens (both disposable and refillable).

### Compatibility

Whether you have a personal computer, technical workstation, minicomputer, or mainframe, you can add an HP DraftMaster plotter to your system. For maximum hardware compatibility, all HP DraftMaster plotters come with a triple interface — both RS-232-C/CCITT V.24 and HP-IB (IEEE 488-1978), as well as RS-422-A for longer distance computer connections. And HP DraftMaster plotters have full eavesdrop capability (dual serial I/O for terminal configurations).

### HP 758XB Emulation Mode

There's a tremendous amount of software already available for the DraftMaster plotters because all of the software written for the HP 7585B and 7586B drafting plotters will run on the HP DraftMaster I and II. Just the touch of a button engages HP's proprietary software emulation feature.

### International Design

The LCD menu can prompt in any of six languages: English (default), French, German, Italian, Spanish, and Japanese. The front-panel buttons are labeled with symbols instead of words. And when programming with HP-GL (Hewlett-Packard Graphics Language) commands, users can select from over 20 international character sets in three fonts.

### Specifications

**Media sizes:** ranges include ISO sizes A0 through A4, ANSI sizes A through E, and architectural sizes, as well as oversized media. DraftMaster I (sheets only); acceptable media widths; 207-381 mm (8.15-15 in.), 539-713 mm (21.22-28.07 in.), 753-927 mm (29.65-36.5 in.). DraftMaster II (same sheet sizes as listed above, plus these roll sizes); width, 609.6 mm (24 in.), 914.4 mm (36 in.); length, 46

metres (150 ft). Maximum frame lengths, 609.6 mm (24 in.) rolls, 914.4 mm (36 in.), 938.4 mm (36.9 in.) rolls, 1243.2 mm (48.9 in.)

**Margins (sheets only):** normal mode; three margins approx. 15 mm (0.59 in.) each, fourth margin approx. 39 mm (1.54 in.). Expanded mode; three margins approx. 5 mm (0.2 in.) each, fourth margin approx. 29 mm (1.14 in.)

**Resolution:** smallest addressable step size, 0.025 mm (0.00098 in.)

**Repeatability (for a given pen):** 0.025 mm (0.00098 in.)

**Accuracy:** 0.09% of the move or 0.25 mm (0.0098 in.), whichever is greater.

**Pen velocity:** pen up/down, 60 cm/s (24 in./s) independent of vector direction

**Acceleration:** maximum, 5.7 g (55.6 m/s<sup>2</sup>) on diagonal; 4 g per axis; programmable, 2 or 4 g (19.4 or 39 m/s<sup>2</sup>)

**Pen force:** programmable or front panel selectable; 15-66 grams

**Power requirements:** Source, 100, 120, 220, 240, V $\pm$ 10%; frequency 48-66 Hz; consumption, 105 W maximum.

**Interfaces:** HP-IB (IEEE 488-1978), RS-232-C/CCITT V.24, RS-422-A

**Buffer size:** 25 K (configurable)

**Environmental range:** operating temperature, 0° to 55° C; non-operating temperature, -40° to -75° C; relative humidity, sheets, 5-95%; rolls, 30-70%.

**Size:** height, 119.4 cm (47 in.); width, 134.6 cm (53 in.); depth, 50.8 cm (20 in.)

**Weight:** DraftMaster I, 73 kg (160 lb); DraftMaster II, 75 kg (164 lb)

**Pens:** 8 in carousel; automatic pen changing and capping; automatic setting. Fiber-tip, roller-ball, long-body drafting (refillable or disposable)

**Media:** Vellum, double-matte polyester film, tracing bond, plotter paper, transparency film, and glossy paper.

### Accessories Supplied

Description	HP Part No.
User's Guide	07595-90002
Pocket Guide (available in English only)	07595-90003
Drafting Supplies Catalog	5957-3776D
	5957-3777
Paper sampler, Architectural D size (5)	9280-9050
Adjustable carousel (2)	5062-1576
Disposable pen adapters (4)	5061-7578
Disposable vellum pens (4)	5061-7566
Roller-ball pens (4)	5061-5037
Fiber-tip pens (10)	17845P
Grit-wheel brush	07595-20085
Power cord (appropriate cord supplies based on destination)	

### Additional Accessories Supplied with DraftMaster II

Description	HP Part No.
914.4 mm (36 in.) paper spool	9300-1069
Paper roll sampler, 914.4 mm (36 in.) wide, 1143 mm (45 ft) long	9280-0736
Media cutters (5)	07596-60008

### Ordering Information

	Price
<b>HP 7595A</b> DraftMaster I plotter (sheet feed only)	\$8,495
<b>HP 7596A</b> DraftMaster II plotter (sheet feed and roll-feed)	\$10,995

### Accessories Available

Description	HP Part No.
Programmer's Reference (available in English only)	07595-90001
Roll-feed Upgrade Kit (HP DraftMaster I only; must be installed by qualified serviceperson)	17520A
Kanji Retrofit Kit (must be installed by qualified serviceperson)	17521A
HP Industry Standard Plotting Package (software)	17580C



# COMPUTER PERIPHERALS

## Plotters—Monochrome Electrostatic Plotters

### Models 240D and 240E

- Fast plotting speed
- Excellent resolution
- Built-in vector-to-raster converter
- Three standard interfaces and HP-GL compatibility
- Long-axis plotting
- Installation included

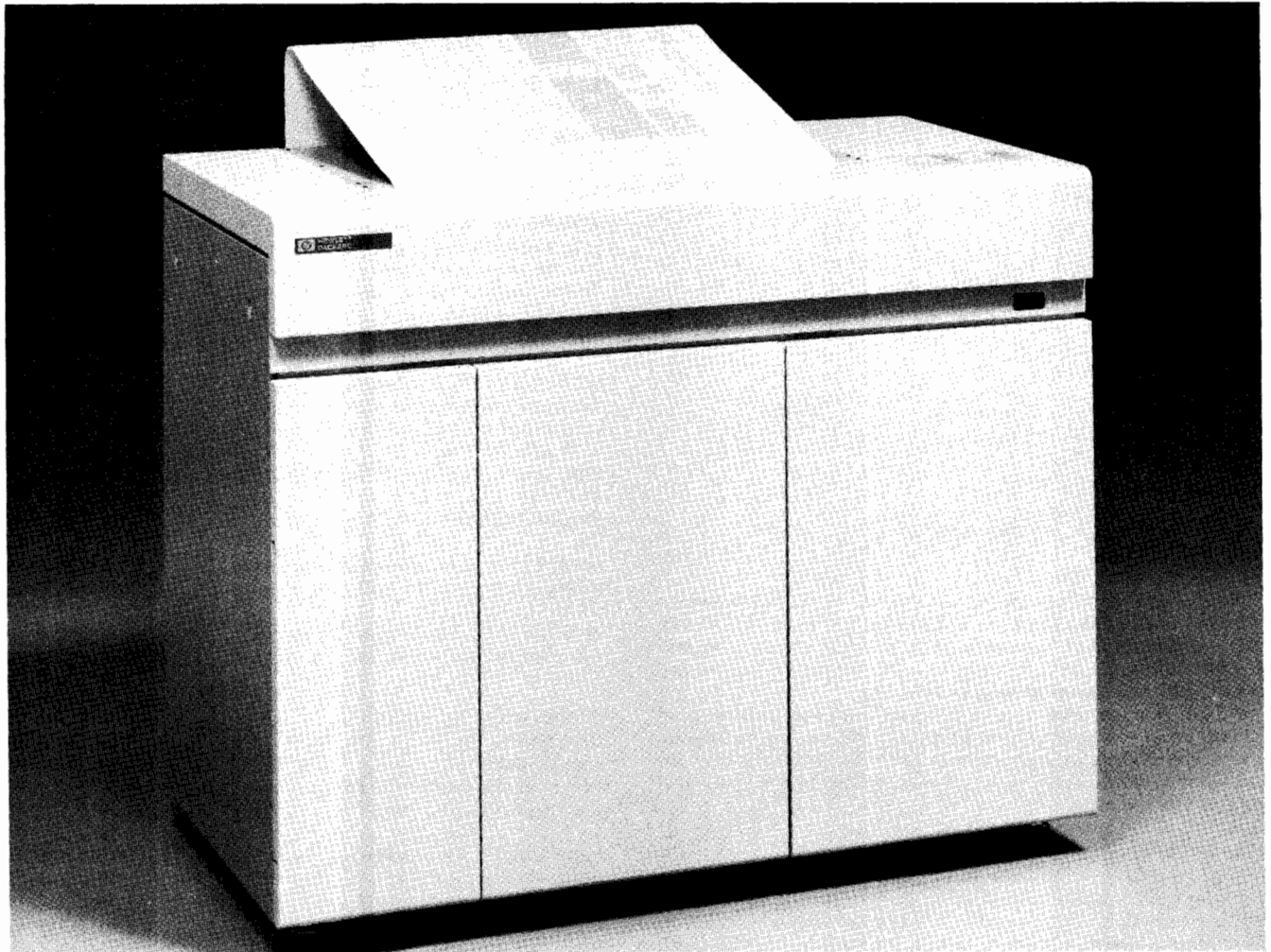

The HP 7600 Series, Models 240D and 240E monochrome electrostatic plotters are designed to meet the high performance and volume demands of a department using a computer-aided-design (CAD) system. The HP 7600 Series plotters are also well suited for any CAD user in an application involving complex, intricate images or large amounts of area fill. The HP 7600 Series plotters meet the same stringent standards for quality and reliability that have made HP pen plotters leaders in the industry.

The HP 7600 Series, Model 240D accepts media 609 mm (24 in.) wide, and the Model 240E uses media 914 mm (36 in.) wide. And one low price includes the plotter, the vector-to-raster converter (VRC), and installation by a qualified representative.

#### Fast Plotting Speed

Whether you need final drawings to meet a tight deadline or quick working plots for immediate feedback during the design process, the HP 7600 Series plotters can meet the challenge.

The HP 7600 Series electrostatic plotters have a fast print speed—actual plotting time for a typical full-size drawing is less than one minute, including the vector-to-raster conversion time. And the powerful VRC keeps rasterization time short to help maximize total throughput.

#### Top Quality Output

With a resolution of 406 dots per inch (160 dots per cm), the HP 7600 Series plotters produce well-defined lines, smooth curves, and crisp characters that help you and your designs look their very best.

Our media and toner products are completely compatible and have been extensively tested together to make sure you get clear, sharp, smudge-resistant drawings every time you plot.

For users with special needs, the control panel has two handy features—"Enhance" for thicker, bolder lines; and "Darker" for plots requiring the blackest possible black.

#### Meant to be Shared

One HP 7600 Series plotter can easily serve the needs of an entire department. It has a high-volume setup and is designed to run with minimal operator supervision.

Media and toner changes can be done in a snap. Once the supplies are loaded, the plotter can run virtually unattended. A single roll of paper can produce as many as 150 A1/D-size plots on the Model 240D or 125 A0/E-size drawings on the Model 240E.

A simple, straightforward control panel minimizes the need for user/plotter interaction. Even in a shared work group, you can be sure the HP 7600 Series plotter will be properly configured and ready to go. The control panel has a series of LEDs, so it only takes a quick glance to check on the paper supply.



### Powerful, Built-in VRC

Since most graphics software programs output data in vector formats and electrostatic plotters are raster devices, we've included a built-in vector-to-raster converter (VRC) with each HP 7600 Series plotter. The HP 7600 Series VRC is based on the powerful 32-bit Motorola 68020 processor. It was designed with performance as the number one goal—and it shows!

For typical plots, rasterization and printing are performed simultaneously. The VRC is so efficient that the print engine doesn't have to stop mid-plot and wait for input, so you get consistent plot quality.

### Easy System Integration

HP 7600 Series electrostatic plotters connect easily to almost any computer system—personal computers, workstations, and large systems. Every HP 7600 plotter comes with three standard interfaces—RS-232-C/CCITT V.24, Centronics Parallel, and HP-IB (IEEE 488-1978). The HP 7600 Series also has RS-422-A capability for long-distance communication.

Like our drafting pen plotters, HP 7600 Series plotters are HP-GL (Hewlett-Packard Graphics Language) compatible, making them ready to use on hundreds of software packages. The HP 7600 plotters also introduce the next generation of the HP-GL command language, HP-GL/2. HP-GL/2 offers higher throughput and greater overall performance, plus compatibility for the future.

### Output for Every Application

An extra wide plotting width [600 mm (23.6 in.) for the Model 240D and 896 mm (35.3 in.) for the Model 240E] enables these plotters to accommodate architectural drawings, in addition to standard ISO A1 and A0 and ANSI D and E sizes.

With the built-in 40-megabyte hard disc, you can produce long-axis plots up to 15.3 m (50 ft) in length—perfect for "life-size" parts. And the disc automatically stores the current drawing so you can redraw the plot with the touch of a button or a simple software command when you need multiple copies.

The media set for the HP 7600 Series includes report grade paper, premium grade paper, translucent paper\* and vellum, so you have media for all your plotting needs: working copy, final output, or archival drawings.

### Designed to Fit Right In

A sturdy, compact design makes these plotters an easy addition to almost any department. Set on casters, the HP 7600 Series plotters can be moved from one place to another. The convenient narrow width helps the plotters slide easily through all standard doorways.

A wide range for environmental specifications makes the HP 7600 Series plotters appropriate for many work area settings. Departments can keep the plotter close by for on-the-spot output.\*\*

### Simple Maintenance

Maintenance procedures are simple and take only a few minutes. HP 7600 Series maintenance supplies are designed to help keep the toner system and writing head clean and trouble-free for the life of the plotter. All mechanical and electrical adjustments are set at the factory, and no special periodic maintenance requiring outside service personnel is necessary.

### Installation Included

When you buy an HP 7600 Series plotter, a qualified representative will come out to your site to install and test the product to make sure you get up and running. You'll even get tips on media and toner loading, built-in confidence plots, control panel functions, maintenance procedures, and plotter operation.

\* Scheduled availability for translucent paper is Winter 1989.

\*\* Optimal plot quality achieved at 23°C (73°F), 40 to 60% RH. Extremes in temperature or humidity can affect plot quality. See "Specifications" for acceptable environmental ranges.

### Specifications

**Media width:** Model 240D, 609 mm (24 in.); Model 240E, 914 mm (36 in.).

**Plot width:** Model 240D, 600 mm, ±2.4 mm (23.6 in., ±0.1 in.); Model 240E, 896 mm, ±3.6 mm (35.3 in., ±0.1 in.).

**Toner capacity:** 5 litres (1.3 gal)

**Print speed:** Model 240D: normal mode, 1.6 cm per second (0.64 inches per second); high density mode, 0.8 cm per second (0.32 inches per second). Model 240E: normal mode, 2.2 cm per second (0.86 inches per second); high density mode, 1.1 cm per second (0.43 inches per second).

**Resolution\*:** mechanical, 160 dots per cm (406 dots per inch); addressable, 0.025 mm (0.00098 in.)

**Maximum accumulated error\*:** ±0.2%

**Pin electrodes:** configuration, dual array; diameter, 0.0060 cm (0.0024 in.); spacing, 0.00625 cm (0.0025 in.); pin electrodes per unit area, 25,600 dots per square cm (164,836 dots per square inch); total pin electrodes, Model 240D, 9600; Model 240E, 14,336.

**Environmental ranges:** heat dissipation, 1200 BTUs/hour maximum; operating temperature, 10 to 35°C (50 to 95°F)\*\*; operating humidity, 30 to 80% RH\*\* Hardware: storage temperature, -10 to 60°C (14 to 140°F)\*\*; storage humidity, 15 to 85% RH\*\*. Media: storage temperature, -10 to 40°C (14 to 104°F)\*\*; storage humidity, 30 to 80% RH\*\*, high temperature, no more than 48 hours over 40°C (104°F). Toner: storage temperature, 5 to 40°C (41 to 104°F)\*\*; high temperature, no more than 72 hours over 50°C (122°F); no more than 48 hours over 60°C (140°F)\*\*.

**Power requirements:** source—100 VAC, range—90-110 VAC, frequency—47-53, 57-63 Hz; source—120 VAC, range—108-132 VAC, frequency—47-53, 57-63 Hz; source—220 VAC, range 198-242 VAC, frequency—47-53, 57-63 Hz; source—240 VAC, range 216-252 VAC, frequency—47-53, 57-63 Hz. Consumption: operating, 365 W max (1245 BTUs/hour); standby, 200 W max (682 BTUs/hour)

**Size:** Model 240D, height, 900 mm (35.4 in.); width, 1100 mm (43.3 in.); depth, 620 mm (24.4 in.). Model 240E, height, 900mm (35.4 in.); width, 1400 mm (55.1 in.); depth, 620 mm (24.4 in.).

**Weight:** Model 240D, net weight—plotter, 185 kg (407 lb), VRC, 17.3 kg (38 lb); shipping weight—plotter, 220 kg (484 lb), VRC, 20 kg (45 lb); accessories, 16 kg (35 lb). Model 240E, net weight—plotter, 220 kg (484 lb), VRC, 17.3 kg (38 lb); shipping weight—plotter, 260 kg (572 lb), VRC, 20 kg (45 lb); accessories, 21.8 kg (48 lb)

**Product certifications:** safety approvals, CSA approved, CSA C22.2 No. 220; UL listed, UL-478, 5th edition; Compliance with IEC-380, TUV approval in progress (GS-Mark), electromagnetic interference, FCC Verified Class A; FTZ 1046/84 VDE 0871-B/with Manufacturer Declaration; VCCI registered, Class 1

\* At 23°C (73°F), 40 to 60% RH with dimensionally stable media

\*\* Non-condensing (Note: Never operate the plotter in the presence of condensation or damage will occur to the writing head.)

### Ordering Information

HP Part No.	Description	Price
C1600A	HP 7600 Series Model 240D A1/D-size electrostatic plotter	\$22,900
C1601A	HP 7600 Series Model 240E A0/E-size electrostatic plotter	\$27,500

Note: Interface cables must be ordered separately

### Accessories Included

User's Guide, Programmer's Reference, Power cord (appropriate to plotter destination), Premium Grade Paper (one roll), Pre-mixed Liquid Toner, Writing Head Cleaner, Writing Head Polish, Lint-free Cleaning Wipes, Media Cutter, Empty 5 litre (1.3 gal) bottle.

# COMPUTER PERIPHERALS

## Pen Plotters — Comparison Guide

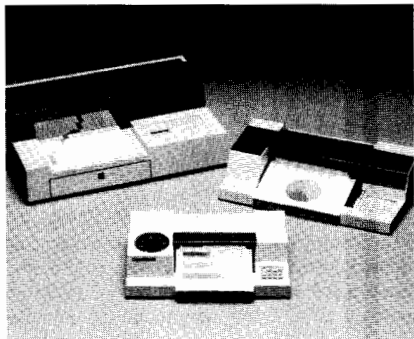

HP 7550A, 7475A, and ColorPro

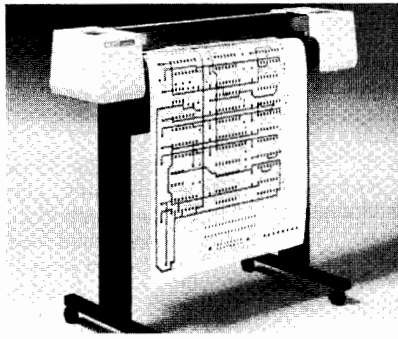

HP DraftPro EXL

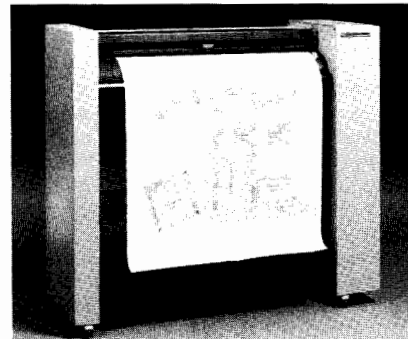

HP DraftMaster I

### HP Pen Plotter Comparison Guide

HP Model	Number of pens	Pen types	Media sizes	Media types	Media load methods	Interfaces	Page
ColorPro (HP 7440A)	8 in carousel	Paper, transparency	A4/A	Paper, transparency film	Manual sheet loading for all media types	RS-232-C/CCITT V.24 or (HP-IB) IEEE-488	720
HP 7475A	6 in carousel	Paper, transparency, liquid-ink	A4/A, A3/B	Paper, transparency film, polyester film	Manual sheet loading for all media types	RS-232-C/CCITT V.24 or (HP-IB) IEEE-488	721
HP 7550A	8 in carousel	Paper, transparency, liquid-ink, roller-ball	A4/A, A3/B	Paper, transparency film, vellum, polyester film	Automatic sheet feed for paper, transparency film  Manual sheet loading for all media types	RS-232-C/CCITT V.24 and (HP-IB) IEEE-488	722
DraftPro (HP 7570A)	8 in carousel	Paper, liquid-ink	A2/C to A1/D	Paper, vellum, polyester film	Manual sheet loading for all media types	RS-232-C/CCITT V.24 (standard) (HP-IB) IEEE-488 (optional)	724
DraftPro DXL (HP 7575A)	8 in carousel	Paper, transparency, liquid-ink	A4/A to A1/D*	Paper, transparency film, vellum, polyester film	Manual sheet loading for all media types	RS-232-C/CCITT V.24 (standard) (HP-IB) IEEE-488 (optional)	726
DraftPro EXL (HP 7576A)	8 in carousel	Paper, transparency, liquid-ink	A4/A to A1/D*	Paper, transparency film, vellum, polyester film	Manual sheet loading for all media types	RS-232-C/CCITT V.24 (standard) (HP-IB) IEEE-488 (optional)	727
DraftMaster I (HP 7595A)	8 in carousel	Paper, transparency, liquid-ink, roller-ball	A4/A to A0/E*	Paper, transparency film, vellum, tracing bond, polyester film	Manual sheet loading for all media types	RS-232-C/CCITT V.24, RS-422-A, and (HP-IB) IEEE-488	728
DraftMaster II (HP 7596A)	8 in carousel	Paper, transparency, liquid-ink, roller-ball	A4/A to A0/E,* 24" and 36" rolls	Paper, transparency film, vellum, tracing bond, polyester film	Automatic roll feed for all media types except tracing bond and transparency film  Manual sheet loading for all media types	RS-232-C/CCITT V.24, RS-422-A, and (HP-IB) IEEE-488	728

\* Standard ISO, ANSI, and architectural sizes.

- Designer color system

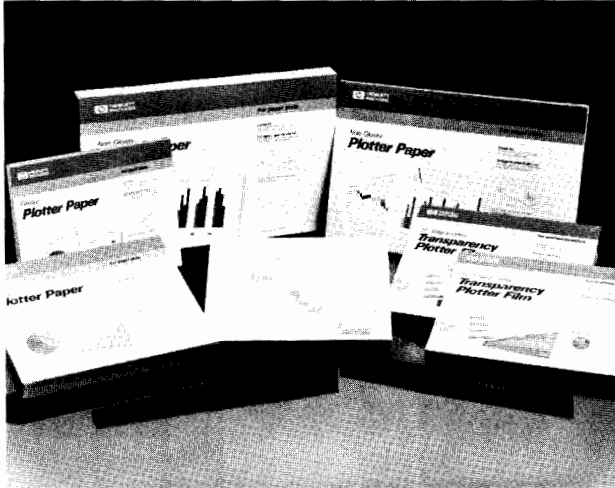

Hewlett-Packard offers a complete line of pens, drawing media, and accessories for both business and technical graphics applications. And all these supplies are manufactured in the HP tradition of quality — quality that you'll see reflected in your work.

### Designer Color System

HP's family of compatible plotter supplies consists of fiber-tip paper pens and transparency pens, plotter paper, glossy plotter paper and transparency plotter film. The fiber-tip pens are available in 10 matching colors so that you can create paper duplicates of your transparencies. Pen colors are black, green, aqua, blue, violet, red-violet, red, orange, yellow and brown. Pens are available in narrow and wide line widths (0.3 mm and 0.7 mm for paper pens; 0.3 mm and 0.6 mm for transparency pens).

Paper pens can be used on all plotters. You can obtain high quality results with HP plotter paper for graphs and large quantities. Use HP glossy paper for reports and presentations. Transparency pens can be used on the HP ColorPro, DraftMaster, 7470, 7475, 7550, 7090, 9872, 7220/7221, and 7225 plotters with HP transparency film for overhead presentations or with HP glossy paper for presentation handouts.

Quality color overheads help you make a point, sell a product or idea, enhance an image. Research proves that:

- presentations using visual aids are 43% more effective than unaided presentations,
- color is more persuasive than black and white for visuals,
- an average speaker using visuals can be as effective as a better speaker using no visuals.

Overall, presenters using color overheads were rated as more credible and more interesting by the audience.

### Technical Drafting Applications

Hewlett-Packard offers three different types of pens and four different types of media so you can select the pen/media combination that's right for your application. Fiber-tip pens are available in ten colors for use on plotter paper. Roller-ball pens come in four colors. In addition to four line widths for disposable drafting pens, HP offers long-body and short-body drafting pens in six line widths.

Sheets of plotter paper, vellum, tracing bond, and polyester film, are available in a range of sizes, both English (A to E) metric (A4 to A0) and architectural (C-E). Polyester film, vellum, and plotter paper come in 914.4 mm (36 in.) and 609.6 mm (24 in.) rolls for use with the HP 7586B and DraftMaster II roll-feed drafting plotters.

- Disposable drafting pens

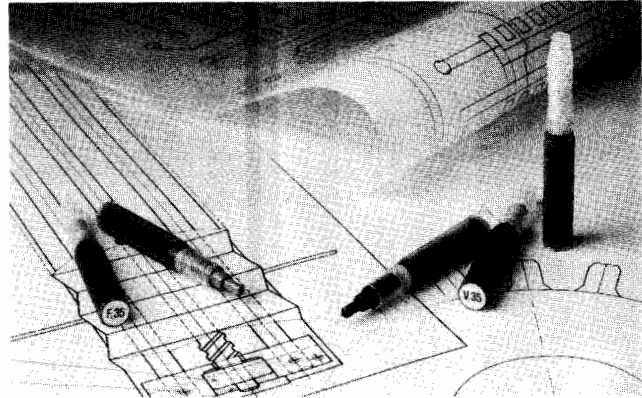

### Disposable Drafting Pens

These pens are designed especially for preliminary drawings and checkplots on plotter paper or final drawings on vellum. Disposable drafting pens come in four line widths and eight colors. Our pens for use with polyester film produce the same, final plot, archival drawings you've come to expect with a refillable drafting pen but without the messy cleaning or refilling.

### Ordering Information

Plotter supplies may be ordered through HP's direct telephone ordering service, from any HP sales and support office, or from your local retail dealer. The HP Computer User's Catalog (P/N 5953-2450) describes the complete range of plotter supplies and accessories.

### For Best Results

	Paper	Glossy Paper Transparency Film	Tracing Bond	Vellum	Polyester Film
Fiber-tip pens (paper)	HP ColorPro HP 7475 HP 7550 HP DraftPro HP DraftMaster HP 7580 HP 7585 HP 7586				
Fiber-tip pens (transparency)		HP ColorPro HP DraftMaster HP 7475 HP 7550			
Roller-ball pens			HP 7550 HP DraftMaster HP 7580 HP 7585 HP 7586		
Disposable drafting Pens	HP 7550 HP DraftMaster HP 7580 HP 7585 HP 7586			HP 7550 HP DraftPro HP DraftMaster HP 7580 HP 7585 HP 7586	HP 7550 HP DraftPro HP DraftMaster HP 7580 HP 7585 HP 7586
Refillable drafting pens				HP 7550 HP DraftPro HP DraftMaster HP 7580 HP 7585 HP 7586 HP 7475	HP 7550 HP DraftPro HP DraftMaster HP 7580 HP 7585 HP 7586 HP 7475

# COMPUTER PERIPHERALS

## Furniture Design Plus

- Furniture that fits your Hewlett-Packard system like a glove.

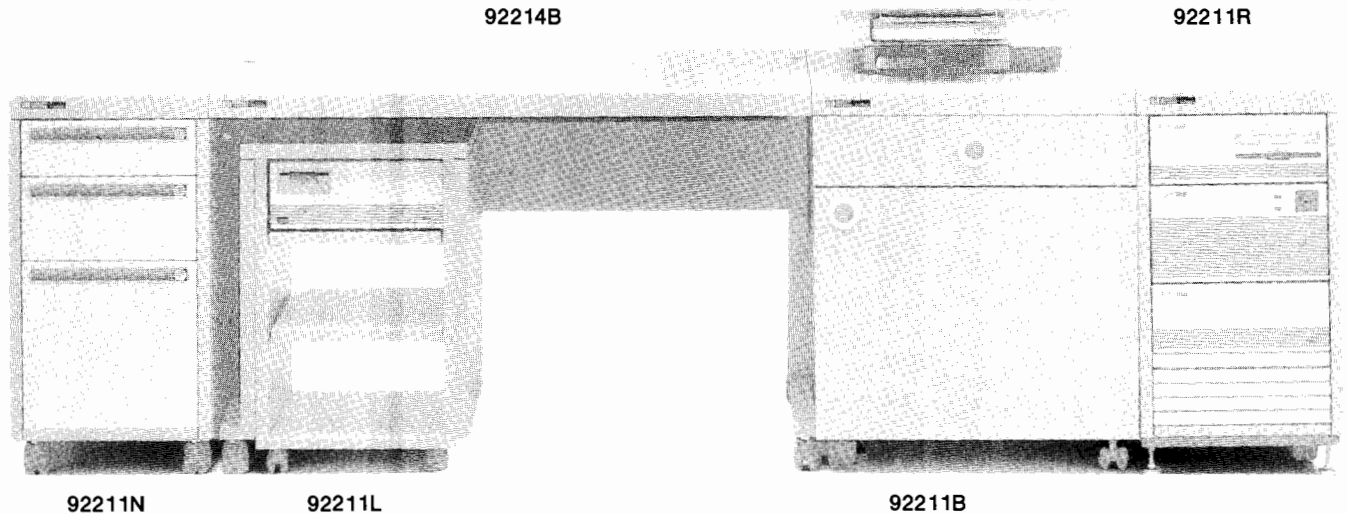

Shown from left to right: Mobile Drawer Unit, System Table with Mobile Support Cabinet tucked underneath, Mobile LaserJet Cabinet and Mini-Rack Cabinet. For complete details, see chart on the next page.

### Design Plus

Design Plus fits HP computers and peripherals perfectly, becoming an integral part of your total computer solution.

It's constructed of the highest quality materials. Die-cast metal legs withstand the weight of your equipment and the pressure of normal office moves, without danger of buckling or breaking. Matte surfaces resist scratches and stains, while protecting your eyes from the glare of overhead lighting.

### Mini-Rack Cabinet

Designed to hold the CPU and disc drive of your HP 9000 Series 200, 300 or 500 computer, also the HP 3000 Series 37, HP 260 or MICRO 3000. It matches the height and depth of our tables and can be locked into place. This results in additional work surface, flush-fitted and without troublesome gaps or height discrepancies.

### Mobile Drawer Units

Store your files, documentation and other valuables. These units match the height of our tables exactly.

### Mobile Support Cabinets

Storage for hard-disc drives and tape back-up systems that fit conveniently under our tables.

### Mobile Sound Enclosure Cabinet

Choose this cabinet for HP serial impact dot matrix printers.

### Universal Support Stand

Printers and small plotters are supported, and rolled about easily on self-locking casters.

#### HP Ergonomic executive chair with arm support

Part no.	Color	Seat	Chair back	Price
92208M	Gray	Height 16.25-19 in. (413-483 mm)	Height 18-20.25 in. (457-514 mm)	(1-2).....\$475.00 ea.
92208N	Blue	Depth 18 in. (457 mm)	Width 17.5 in. (445 mm)	(3+)..... 440.00 ea.
92208P	Beige	Width 19 in. (483 mm)		
92208Q	Cylinder for 92208M/N/P			(1-2)..... 40.00 ea.
				(3+)..... 37.00 ea.

#### HP Ergonomic workstation/managerial chair

Part no.	Color	Seat	Chair back	Price
92208E	Gray	Height 16.25-20.75 in. (413-527 mm)	Height 10.50-15.50 in. (267-394 mm)	(1-2).....\$245.00 ea.
92208F	Blue	Depth 18 in. (457 mm)	Width 16 in. (406 mm)	(3+)..... 225.00 ea.
92208G	Beige	Width 18.50 in. (470 mm)		
92208K	Dk Brown	Arm set		(1-2)..... 79.00 ea.
92208H	Cylinder for 92208E/F/G			(3+)..... 69.00 ea.
				(1-2)..... 40.00 ea.
				(3+)..... 37.00 ea.

#### HP Ergonomic workbench chair

Part no.	Color	Seat	Chair back	Price
92208S	Blue	Height 19-25.50 in. (483-648 mm)	Height 10.50-15.50 in. (267-394 mm)	(1-2).....\$365.00 ea.
		Depth 18 in. (457 mm)	Width 16 in. (406 mm)	(3+)..... 340.00 ea.
92208L	Dk Brown	Width 18.50 in. (470 mm)		(1-2)..... 39.00 ea.
92208U	Cylinder for 92208S			(3+)..... 35.00 ea.
		Caster set/5 per set		(1-2)..... 55.00 ea.
				(3+)..... 51.00 ea.

Part number	Description	Height	Width	Depth	Price
92214A	<i>Design Plus</i> Mobile terminal support and transport system table. Designed to safely move terminals and small systems.	28.4 in. (720 mm)	29.5 in. (750 mm)	28.0 in. (711 mm)	(1-2 tables).....\$445.00 ea. (3+)..... 415.00 ea.
92214B	Medium <i>Design Plus</i> System table. Comes with cable management, locking casters, and is same height as 92211R mobile rack system cabinet.	28.4 in. (720 mm)	44.3 in. (1125 mm)	28.0 in. (711 mm)	(1-2 tables).....\$495.00 ea. (3+)..... 465.00 ea.
92214C	Large <i>Design Plus</i> System table. Comes with cable management, adjustable leveling glides, and is same height as 92211R mobile rack system cabinet.	28.4 in. (720 mm)	59.0 in. (1500 mm)	28.0 in. (711 mm)	(1-2 tables).....\$545.00 ea. (3+)..... 520.00 ea.
92213B	<i>Design Plus</i> CAD Mini-workstation. For use with the HP 9000 Series 300/500 computers. Comes with 14.25-in. (362 mm) wide raised monitor platform, pull-out work surface that extends to 36-in. (914 mm) deep, pull-out keyboard drawer and cable management. Same height as 92211R mobile mini-rack; 92211L/M fits underneath.	28.4 in. (720 mm)	44.3 in. (1125 mm)	28.0 in. (711 mm)	(1-2 units).....\$799.00 ea. (3+)..... 759.00 ea.
92213F	<i>Design Plus</i> CAD workstation is designed for use with HP CAD systems. It comes with a pull-out work surface, keyboard drawer, raised monitor platform and cable management. It attaches to other <i>Design Plus</i> Furniture.	28.4 in. (720 mm)	59.0 in. (1500 mm)	28.0 in. (711 mm)	(1-2 tables).....\$849.00 ea. (3+)..... 799.00 ea.
92213Q	<i>Design Plus</i> ergonomic task lamp. Specifically designed for computer workstations. Two nine-watt emitters produce the same light as 80-watts incandescent. Lamp stem fits <i>Design Plus</i> tables. UL listed and CSA approved.	N/A	N/A	N/A	(1-2 units).....\$229.00 ea. (3+)..... 214.00 ea.
92213R	<i>Design Plus</i> clamp. Designed for the <i>Design Plus</i> lamp (92213Q.) For use on non- <i>Design Plus</i> table tops. Maximum clamp opening is 5 inches, (127 mm.) Use this clamp for HP standard tables.	N/A	N/A	N/A	(1-2 units).....\$24.00 ea. (3+)..... 22.00 ea.
92213D	"C" and "D" sized drawing holder. Mounts to workstation and system tables. Two-section arm for height and tilt position extends from 13.0 in. (330 mm) to 22.25 in. (565 mm).	20.0 in. (508 mm)	30.0 in. (762 mm)	2.6 in. (6 mm)	(1-2 units).....\$199.00 ea. (3+)..... 189.00 ea.
92214J	90-degree <i>Design Plus</i> Corner turn. Used for joining two system tables together for a larger work area. <b>NOTE:</b> not intended to support CAD monitors.	Each side	28.0 in. (711 mm)		(1-2 units).....\$245.00 ea. (3+)..... 225.00 ea.
92214K	<i>Design Plus</i> CAD corner workstation. Perfectly fitted for use with HP CAD systems. Workstation comes with a keyboard drawer and cable management. It can be joined to <i>Design Plus</i> furniture.	28.4 in. (720 mm)	44.3 in. (1125 mm)	44.3 in. (1125 mm)	(1-2 tables).....\$849.00 ea. (3+)..... 799.00 ea.
92211U	<i>Design Plus</i> joining bracket kit. For use on all <i>Design Plus</i> furniture pieces to anchor one to another. Comes with needed screws and instructions for assembly and use.	N/A	N/A	N/A	(1-2 units).....\$40.00 ea. (3+)..... 37.00 ea.
92211C	<i>Design Plus</i> Mobile sound enclosure cabinet. For use with all 293X serial impact dot matrix printers.	28.4 in. (720 mm)	29.5 in. (750 mm)	19.7 in. (500 mm)	(1 unit).....\$675.00 ea. (3+)..... 620.00 ea.
92211L	<i>Design Plus</i> Mobile support cabinet. Rolls easily under the 92214B/C <i>Design Plus</i> system tables. Can be used as a stand-alone system cabinet for the HP 9000 Series 200/300/500, has open back. Comes with two sets of mounting rails, a cable routing kit (92199F), and a storage shelf. Internal dimensions are 12.8 in. (325 mm) wide x 20.40 in. (520 mm) high.	24.4 in. (620 mm)	16.7 in. (425 mm)	20.7 in. (525 mm)	(1-2 units).....\$250.00 ea. (3-9)..... 235.00 ea. (10+)..... 220.00 ea.
92211M	<i>Design Plus</i> small Mobile support cabinet. Rolls easily under the 92214B/C <i>Design Plus</i> system tables. Can be used as a stand-alone system cabinet for the Series 200, Model 237 or 300. Comes with one set of mounting rails, a cable routing kit (92199F), and a pad to put under the Model 237. Internal dimensions are 12.8 in. (325 mm) wide x 13.26 in. (338 mm) high.	17.1 in. (435 mm)	16.7 in. (425 mm)	16.7 in. (425 mm)	(1-2 units).....\$190.00 ea. (3-9)..... 185.00 ea. (10+)..... 175.00 ea.
92211N	<i>Design Plus</i> Mobile drawer unit. Rolls easily and sits next to all <i>Design Plus</i> system tables (also same height as tables). Comes with three drawers, 4 in., 6 in. and 12 in. (104 mm, 156 mm, and 312 mm).	28.4 in. (720 mm)	14.8 in. (375 mm)	28.0 in. (711 mm)	(1-2 units).....\$645.00 ea. (3-9)..... 610.00 ea. (10+)..... 575.00 ea.
92211R	<i>Design Plus</i> Mobile mini-rack system cabinet for HP modular peripherals and systems. Comes fully assembled with casters. Back opens for easy access. Accessories available are the 92211S mounting rail and module lock kit, 92211T filler panel kit, and 92199B power strip. Internal dimensions are 12.8 in. (325 mm) wide x 22.44 in. (572 mm) high.	28.4 in. (720 mm)	14.8 in. (375 mm)	28.0 in. (711 mm)	(1-2 racks).....\$585.00 ea. (3-9)..... 550.00 ea. (10+)..... 515.00 ea.
92211E	Small (4 inch) drawer unit for 92211R Mobile mini-rack system cabinet.	4 in. (102 mm)	12.75 in. (324 mm)	18.62 in. (473 mm)	(1-2 units).....\$129.00 ea. (3+)..... 119.00 ea.
92211F	Medium (6 inch) drawer unit for 92211R Mobile mini-rack system cabinet.	6 in. (152 mm)	12.75 in. (324 mm)	18.62 in. (473 mm)	(1-2 units).....\$139.00 ea. (3+)..... 129.00 ea.
92211G	Large (12 inch) drawer unit for 92211R Mobile mini-rack system cabinet.	12 in. (305 mm)	12.75 in. (324 mm)	18.62 in. (473 mm)	(1-2 units).....\$149.00 ea. (3+)..... 139.00 ea.
92211S	Rail kit for 92211R Mobile mini-rack cabinet. Comes with four sets of rails and module locks. Used to mount up to four HP computer and peripheral equipment modules.			Rail length—25.1 in. (638mm)	(1-2 kits).....\$50.00 ea. (3-9)..... 45.00 ea. (10+)..... 40.00 ea.
92211T	Filler panel kit for 92211R mobile mini-rack cabinet. Kit contains 20 snap-in panels used to fill empty space not occupied by computer equipment modules.	0.9 in. (23 mm)	12.8 in. (325 mm)	0.9 in. (23 mm)	(1-2 kits).....\$40.00 ea. (3-9)..... 35.00 ea. (10+)..... 30.00 ea.
92214P	<i>Design Plus</i> Universal support stand. For use with HP LaserJet, HP 2932/33/34, HP 2563A printers and small HP plotters. Comes with printout catcher shelf, casters and leveling glides. Has slot in top for bottom feeding and slot in door top for front feeding. Also has sound control pad.	28.4 in. (720 mm)	23.6 in. (600 mm)	17.7 in. (450 mm)	(1-2 units).....\$295.00 ea. (3+)..... 265.00 ea.
92211B	<i>Design Plus</i> Mobile LaserJet Printer cabinet. Features a drawer designed to hold fonts and manuals, a deep cabinet with a shelf, and an exterior shelf.	28.3 in. (720 mm)	23.6 in. (600 mm)	28.0 in. (711 mm)	(1-2 units).....\$585.00 ea. (3+)..... 545.00 ea.



# COMPUTER PERIPHERALS

## Furniture

### HP Standard Furniture

- Solid, Expandable, Economical





92210H Stand-up printer/terminal stand

92210T Mobile workstation table

92210P Printer stand

#### HP Standard furniture

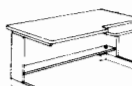
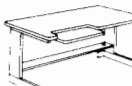
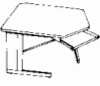
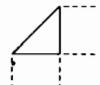
	Part no.	Description	Height	Width	Depth	Price
	92210A	Compact workstation table, with leg levelers and modesty panel. 7-in. (178 mm) shelf standard. See 92210L casters next page to adapt table height to 28.4 in. (720 mm).	27.0 in. (686 mm)	48.0 in. (1220 mm)	30.0 in. (762 mm)	(1-2 units).....\$305.00 ea. ☎ (3 +)..... 285.00 ea. ☎
	92210B	Standard workstation table, with leg levelers and modesty panel. 7-in. (178 mm) shelf standard. See 92210L casters next page to adapt table height to 28.4 in. (720 mm).	27.0 in. (686 mm)	60.0 in. (1524 mm)	30.0 in. (762 mm)	(1-2 units).....\$360.00 ea. ☎ (3 +)..... 340.00 ea. ☎
	92210C	Workstation table with right-hand adjustable keyboard section. Leg levelers, modesty panel and 7-in. (178 mm) shelf standard. Keyboard section starts 3 in. (76 mm) from the right side, adjusts down a total of 2.1 in. (53 mm) from table top and can be tilted 10 degrees from the horizontal. Manual adjustments. See 92210L casters next page to adapt table height to 28.4 in. (720 mm).	29.0 in. (736 mm)	60.0 in. (1524 mm)	30.0 in. (762 mm)	(1-2 units).....\$405.00 ea. ☎ (3 +)..... 375.00 ea. ☎
		<b>Adjustable keyboard dimensions</b>	1.2 in. (30 mm)	24.0 in. (610 mm)	10.0 in. (254 mm)	
	92210D	Workstation table with left-hand adjustable keyboard section. Leg levelers, modesty panel and 7-in. (178 mm) shelf standard. Keyboard section starts 3 in. (76 mm) from the left side, adjusts down a total of 2.1 in. (53 mm) from the table top and can be tilted 10 degrees from the horizontal. Manual adjustments. See 92210L casters next page to adapt table height to 28.4 in. (720 mm).	29.0 in. (736 mm)	60.0 in. (1524 mm)	30.0 in. (762 mm)	(1-2 units).....\$390.00 ea. ☎ (3 +)..... 350.00 ea. ☎
		<b>Adjustable keyboard dimensions</b>	1.2 in. (30 mm)	24.0 in. (610 mm)	10.0 in. (254 mm)	
	92210U	The standard CAD corner workstation is perfectly fitted for use with HP CAD systems. Workstation comes with a keyboard drawer. Part of the HP standard furniture line.	29 in. (736 mm)	45 in. (1143 mm)	45 in. (1143 mm)	(1-2 tables).....\$569.00 ea. ☎ (3 +)..... 539.00 ea. ☎
	92210V	Workstation tabletop connector. 90-degree triangle. Joins two 92210A/B/C/D tables together.	Each side	30.0 in. (763 mm)		(1-2 units).....\$120.00 ea. ☎ (3 +)..... 110.00 ea. ☎













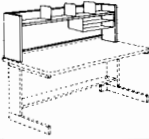

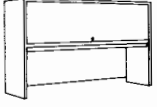

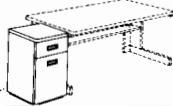

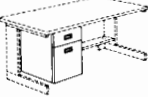

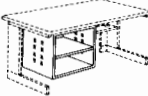





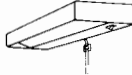



# COMPUTER PERIPHERALS

Furniture

HP Standard Furniture

737

## HP Standard furniture (continued)

Part no.	Description	Height	Width	Depth	Price
 <b>92210F</b>	Desktop storage shelf for <b>92210A</b> workstation table. Includes two book supports and back-wall message board. 11 in. (279 mm) storage shelf adjusts from 15 in. (381 mm) to 21 in. (533 mm) above work surface of table. Convenient paper/storage shelf included.	23.0 in. (584 mm)	47.0 in. (1194 mm)	12.0 in. (305 mm)	(1-2 units) ..... \$215.00 ea.  (3+) ..... 195.00 ea. 
 <b>92210G</b>	Desktop storage shelf for <b>92210B/C/D</b> workstation table. Includes three book supports and back-wall message board. 11 in. (279 mm) storage shelf adjusts from 15 in. (381 mm) to 21 in. (533 mm) above work surface of table. Convenient paper/storage shelf included.	23.0 in. (584 mm)	59.0 in. (1499 mm)	12.0 in. (305 mm)	(1-2 units) ..... \$235.00 ea.  (3+) ..... 215.00 ea. 
 <b>92210Z</b>	Newly revised desktop wide-flipper door storage unit for <b>92210B/C/D</b> workstation table. Includes lockable flipper door and back-wall fabric-covered message board. Space from table top to shelf bottom is 19.5 in. (495 mm).	34.0 in. (864 mm)	59.0 in. (1499 mm)	14.0 in. (356 mm)	(1-2 units) ..... \$475.00 ea.  (3+) ..... 440.00 ea. 
 <b>92210N</b>	Mobile drawer unit, on casters. Two drawers, with identical key lock all units. Deep bottom drawer like <b>92210Q</b> below. Unit rolls easily to any workstation; top same height as <b>92210A/B</b> .	27.0 in. (686 mm)	15.4 in. (391 mm)	20.0 in. (508 mm)	(1-2 units) ..... \$295.00 ea.  (3+) ..... 280.00 ea. 
 <b>92210Q</b>	Suspended drawer unit. Two drawers, with identical key lock units. Deep bottom drawer can store three types of hanging files: letter-size, legal-size, and computer printout binders. Fits right or left side of <b>92210A/B/C/D</b> tables.	21.0 in. (533 mm)	14.8 in. (375 mm)	19.4 in. (493 mm)	(1-2 units) ..... \$215.00 ea.  (3+) ..... 195.00 ea. 
 <b>92210R</b>	Storage module unit, with three-position adjustable shelf. Rear of module is open for ventilation and access to <b>92210A/B/C/D</b> cable management system, when module used to hold electronic equipment. Fits right or left side of <b>92210A/B/C/D</b> tables.	19.0 in. (483 mm)	21.0 in. (534 mm)	19.4 in. (493 mm)	(1-2 units) ..... \$95.00 ea.  (3+) ..... 87.00 ea. 
		<b>Inside module dimensions</b>			
		17.0 in. (432 mm)	19.4 in. (493 mm)	19.4 in. (493 mm)	
 <b>92210E</b>	Work surface extension (return), with leg levelers and modesty panel. Fits right or left side of <b>92210B</b> table, left side of <b>92210C</b> , right side of <b>92210D</b> . Requires use of 'Z' bracket (included) when mounting on <b>92210C/D</b> . <b>Not for 92210A</b> .	27.0 in. (686 mm)	40.0 in. (1016 mm)	24.0 in. (610 mm)	(1-2 units) ..... \$185.00 ea.  (3+) ..... 170.00 ea. 
 <b>92210W</b>	Task light unit. Screws into place underneath the <b>92210F/G/Z</b> desktop storage units. Includes 20-watt fluorescent bulb, lens and power cord wire management clips. UL listed and CSA approved.	2.0 in. (50.8 mm)	24.0 in. (610 mm)	6.6 in. (168 mm)	(1-2 units) ..... \$99.00 ea.  (3+) ..... 89.00 ea. 
 <b>92210L</b>	Set of four heavy-duty, double-wheel casters. Use in place of leg levelers on <b>92210A/B/C/D</b> tables or <b>92210P</b> stand where mobility is desired. Caster height 1.75 in. (45 mm). Adapts height of tables to 28.4 in. (720 mm).				(1-2 units) ..... \$26.00 set  (3+) ..... 21.00 set 
 <b>92210H</b> (see photo previous page)	Standup printer/terminal stand. Design matches HP 92210-series workstation system. Same slotted top and rear printout catcher as <b>92210P</b> (see below). Height is 38 in. (965 mm), ideal for walk up operation of equipment. Cable management slots, 7-in. (178 mm) shelf standard.	38 in. (965 mm)	<b>Work surface</b> 30 in. (762 mm)	24 in. (610 mm)	(1-2 units) ..... \$265.00 ea.  (3+) ..... 250.00 ea. 
		29.5 in. (749 mm)	<b>Printout catcher</b> 17 in. (432 mm)	13.5 in. (343 mm)	
 <b>92210P</b> (see photo previous page)	Printer stand. Design matches HP 92210 series workstation system. Convenient paper feed slot (4 x 19 in., 102 x 483 mm) in top allows bottom paper feed. Also features rear printout catcher with 1.5-in. (38 mm) slot to allow paper transport to rear feed printers. Cable management slots, 7-in. shelf standard.	27 in. (686 mm)	<b>Work surface</b> 30 in. (762 mm)	24 in. (610 mm)	(1-2 units) ..... \$265.00 ea.  (3+) ..... 245.00 ea. 
		18.5 in. (470 mm)	<b>Printout catcher</b> 17 in. (432 mm)	13.5 in. (343 mm)	
 <b>92210T</b> (see photo previous page)	Mobile workstation table for terminals. Design matches HP 92210 series workstation system. Features a dropped, pull-out keyboard surface. Cable management slots, locking casters and 7-in. (178 mm) shelf standard.	28.3 in. (720 mm)	<b>Work surface</b> 30 in. (762 mm)	28 in. (712 mm)	(1-2 units) ..... \$310.00 ea.  (3+) ..... 290.00 ea. 
		26.4 in. (670 mm)	<b>Keyboard surface</b> 23.5 in. (597 mm)	12 in. (305 mm)	

 Fast-ship product - see page 766

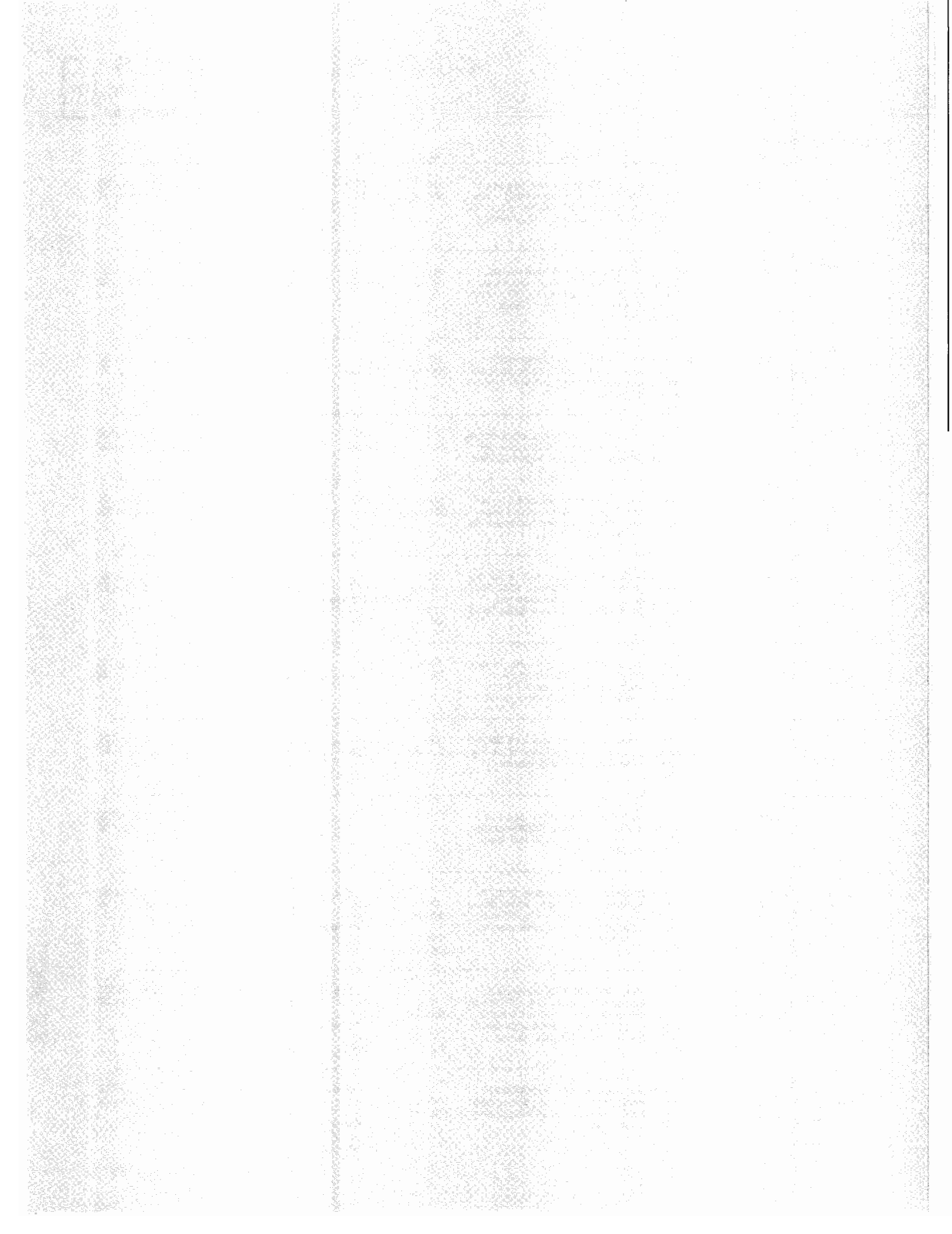

## **ACCESSORIES, SUPPORT, ORDERING & OFFICES**

<b>Cables &amp; Adapters .....</b>	<b>740</b>
<b>Transit Cases .....</b>	<b>742</b>
<b>Operating Cases .....</b>	<b>746</b>
<b>Cabinets &amp; Cabinet Accessories.....</b>	<b>748</b>
<b>Customer Support.....</b>	<b>756</b>
<b>Instrument Financing .....</b>	<b>768</b>
<b>Ordering Information .....</b>	<b>769</b>
<b>Operating Environments &amp; Warranty.....</b>	<b>770</b>
<b>Sales &amp; Support Offices .....</b>	<b>771</b>
<b>Application Notes.....</b>	<b>780</b>
<b>Free Publications.....</b>	<b>792</b>

This group includes information on accessories for measurement, shipping, rack mounting and installation for test and measurement instruments and systems. It also includes a description of HP's service and support offering and a list of sales and support offices worldwide. There is also information on placing an order and communicating with HP, as well as descriptions of some of the free publications available.

**Accessories,  
Support, Ordering  
& Offices**

# CABLES & ADAPTERS

## Cables, Adapters & Typical SWR Performance

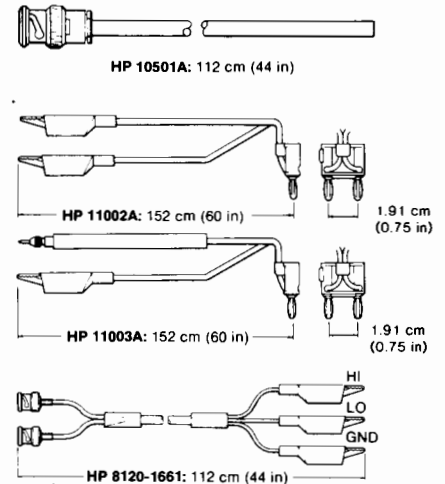
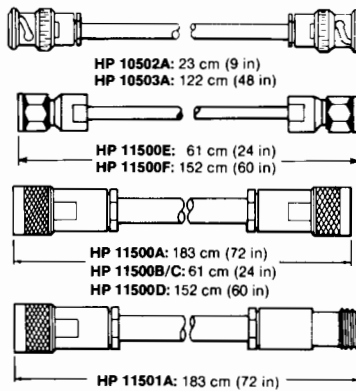
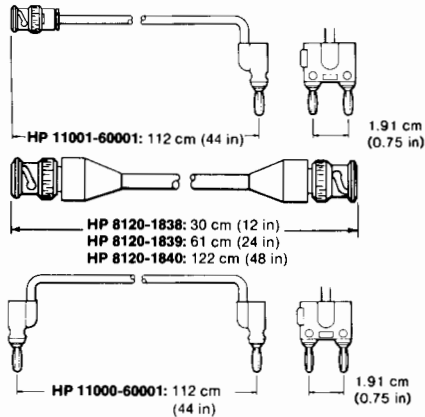

- |                                                                                                                                                                                                                                                                                                   |                                                                                                                                                                 |                                                                                                                                                                                         |                                                                                                                                                                                                                                                                                                                 |                                                                                                                                                                                  |                                                                                                                                                                 |                                                                                                                                                  |
|---------------------------------------------------------------------------------------------------------------------------------------------------------------------------------------------------------------------------------------------------------------------------------------------------|-----------------------------------------------------------------------------------------------------------------------------------------------------------------|-----------------------------------------------------------------------------------------------------------------------------------------------------------------------------------------|-----------------------------------------------------------------------------------------------------------------------------------------------------------------------------------------------------------------------------------------------------------------------------------------------------------------|----------------------------------------------------------------------------------------------------------------------------------------------------------------------------------|-----------------------------------------------------------------------------------------------------------------------------------------------------------------|--------------------------------------------------------------------------------------------------------------------------------------------------|
| <p>HP 1250-0780<br/>HP 1250-1535<br/>HP 1250-1476</p> <p>HP 1250-0082<br/>HP 1250-1533<br/>HP 1250-1473</p> <p>HP 1250-0077<br/>HP 1250-1534<br/>HP 1250-1477</p> <p>HP 1250-0778<br/>HP 1250-1528<br/>HP 1250-1475</p> <p>HP 1250-0777<br/>HP 1250-1529<br/>HP 1250-1472</p> <p>HP 1250-0597</p> | <p>HP 1250-0559</p> <p>HP 1250-0846</p> <p>HP 1250-0176</p> <p>HP 1250-1250</p> <p>HP 1250-1636</p> <p>HP 1250-1562</p> <p>HP 1250-1772</p> <p>HP 1250-1158</p> | <p>HP 1250-1159</p> <p>HP 11524A</p> <p>HP 11525A</p> <p>HP 11533A<br/>HP 11902A</p> <p>HP 11534A<br/>HP 11902B</p> <p>HP 1250-1743<br/>HP 11903A</p> <p>HP 1250-1750<br/>HP 11903D</p> | <p>HP 1250-1746</p> <p>HP 1250-1747</p> <p>HP 1250-1748<br/>HP 11900A<br/>HP 11901A<br/>HP 11904A</p> <p>HP 1250-1749<br/>HP 11900B<br/>HP 11901B<br/>HP 11904B</p> <p>HP 11900C<br/>HP 11901C/D<br/>HP 11904C/D<br/>HP 1250-1866</p> <p>HP 1250-0216<br/>HP 1250-1288</p> <p>HP 1250-0080<br/>HP 1250-1287</p> | <p>HP 1250-0781</p> <p>HP 1250-0076<br/>HP 1250-1286</p> <p>HP 1250-0069</p> <p>HP 1250-0071</p> <p>HP 1250-0595</p> <p>HP 1250-1830</p> <p>HP 1250-0591</p> <p>HP 1250-0832</p> | <p>HP 1250-0831</p> <p>HP 1250-1023</p> <p>HP 1250-1153</p> <p>HP 1250-1236</p> <p>HP 1250-1237</p> <p>HP 1250-1263</p> <p>HP 1250-1264</p> <p>HP 1251-2816</p> | <p>HP 1251-2277</p> <p>HP 1250-1474<br/>HP 1250-1536</p> <p>HP 1250-1152</p> <p>HP 1250-1744<br/>HP 11903D</p> <p>HP 1250-1745<br/>HP 11903B</p> |
|---------------------------------------------------------------------------------------------------------------------------------------------------------------------------------------------------------------------------------------------------------------------------------------------------|-----------------------------------------------------------------------------------------------------------------------------------------------------------------|-----------------------------------------------------------------------------------------------------------------------------------------------------------------------------------------|-----------------------------------------------------------------------------------------------------------------------------------------------------------------------------------------------------------------------------------------------------------------------------------------------------------------|----------------------------------------------------------------------------------------------------------------------------------------------------------------------------------|-----------------------------------------------------------------------------------------------------------------------------------------------------------------|--------------------------------------------------------------------------------------------------------------------------------------------------|

Some part numbers are not pictured.

### Coaxial Connector & Adapter Performance

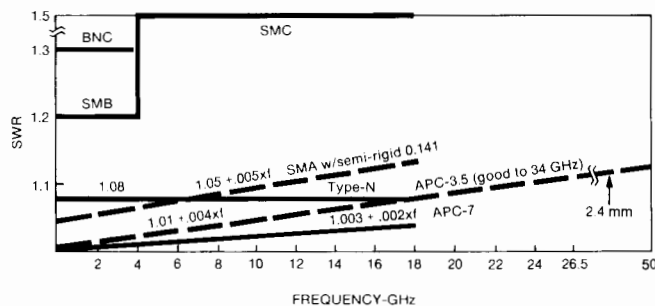

Typical SWR for connector pairs.

The performance curves in the graph will help you in choosing and applying HP cables, connectors and adapters. SWR curves show design specifications for mated pairs of connectors of the type indicated. You can expect typical performance in that range.

For cross-series adapters, use the curve with the highest SWR in each case. For applications of Tee-adapters such as HP 1250-0559, 1250-0846 and 1250-0781, be sure to consider the extra shunt capacitance of the Tee.

Of course when HP mounts various connectors onto RF and microwave products, the product specification predominates and SWR is often far superior to that shown in these utility curves. For example, the HP "precision" Type-N adapters shown on these pages are for high accuracy use dc-1.3 GHz where SWR < 1.03.

For more information on history and performance of various coax connectors, see HP's *Coaxial & Waveguide Measurement Accessories Catalog*. (Lit # 5954-6401).



HP Part Number	Price
<b>Cable Assemblies</b>	
<b>HP 10501A:</b> 112 cm 50Ω coax with one UG-88C/U BNC (m) connector	\$30.00
<b>HP 10502A:</b> 23 cm 50Ω coax with UG-88C/U BNC (m) connectors	\$28.00
<b>HP 10503A:</b> like HP 10503A, but 122 cm	\$32.00
<b>HP 8120-1838:</b> 30 cm 50Ω coax with two BNC (m) connectors	\$19.50
<b>HP 8120-1839:</b> like HP 8120-1838, but 61 cm	\$20.00
<b>HP 8120-1840:</b> like HP 8120-1838, but 122 cm	\$23.50
<b>HP 11000-60001:</b> 112 cm 50Ω coax with dual banana plugs	\$30.00
<b>HP 11001-60001:</b> 112 cm 50Ω coax, UG-88C/U BNC (m) to dual banana plug	\$30.00
<b>HP 11002A</b> Test Leads: 152 cm, alligator clips to dual banana plug	\$20.00
<b>HP 11003A</b> Test Leads: 152 cm, probe and alligator clip to dual banana plug	\$20.00
<b>HP 8120-1661:</b> 112 cm, dual BNC (m) to alligator clips	\$90.00

HP Model	Frequency Range (GHz)	Length cm (in)	Connectors	SWR	Ins. Loss (dB)	Price
11500A	dc - 12.4	183 (72)	N(m) (2)	—	—	\$110
11500B	dc - 12.4	61 (24)	N(m) (2)	—	—	110
11501A	dc - 18	183 (72)	N(m)-N(f)	—	—	110
11500C	dc - 18	61 (24)	Precision N(m) (2)	1.4	1.5	550
11500D	dc - 18	152 (60)	Precision N(m) (2)	1.4	3.0	650
11500E	dc - 26.5	61 (24)	APC-3.5 (m) (2)	1.4	2.0	600
11500F	dc - 26.5	152 (60)	APC-3.5 (m) (2)	1.4	4.0	700

### Adapters, 2.4 mm

(See page 333 for technical description and performance)

<b>11900A</b> 2.4 mm (m) to 2.4 (m)	\$450.00
<b>11900B</b> 2.4 mm (f) to 2.4 (f)	\$450.00
<b>11900C</b> 2.4 mm (m) to 2.4 (f)	\$450.00
<b>11901A</b> 2.4 mm (m) to APC-3.5 (m)	\$375.00
<b>11901B</b> 2.4 mm (f) to APC-3.5 (f)	\$375.00
<b>11901C</b> 2.4 mm (m) to APC-3.5 (f)	\$375.00
<b>11901D</b> 2.4 mm (f) to APC-3.5 (m)	\$375.00
<b>11902A</b> 2.4 mm (m) to APC-7	\$425.00
<b>11902B</b> 2.4 mm (f) to APC-7	\$425.00
<b>11903A</b> 2.4 mm (m) to Type N (m)	\$450.00
<b>11903B</b> 2.4 mm (f) to Type N (f)	\$450.00
<b>11903C</b> 2.4 mm (m) to Type N (f)	\$450.00
<b>11903D</b> 2.4 mm (f) to Type N (m)	\$450.00
<b>11904A</b> 2.4 mm (m) to K (m) <sup>[5]</sup>	\$500.00
<b>11904B</b> 2.4 mm (f) to K (f) <sup>[5]</sup>	\$500.00
<b>11904C</b> 2.4 mm (m) to K (f)	\$500.00
<b>11904D</b> 2.4 mm (f) to K (m)	\$500.00

### Adapters Type N, Standard 50 Ω

<b>1250-0077</b> N(f) to BNC(m)	\$13.25
<b>1250-0082</b> N(m) to BNC(m)	\$14.75
<b>1250-0176</b> N(m) to N(f) right angle (use < 12 GHz)	\$21.00
<b>1250-0559</b> N tee, (m)(f)(f)	\$38.00
<b>1250-0777</b> N(f) to N(f)	\$13.25
<b>1250-0778</b> N(m) to N(m)	\$12.00
<b>1250-0780</b> N(m) to BNC(f)	\$14.25
<b>1250-0846</b> N tee (f)(f)(f)	\$20.25
<b>1250-1250</b> N(m) to SMA(f)	\$35.00
<b>1250-1562</b> N(f) to SMA(m)	\$65.00
<b>1250-1636</b> N(m) to SMA(m)	\$130.00
<b>1250-1772</b> N(f) to SMA(f)	\$70.00

### Adapters Type N, Precision 50 Ω<sup>[1]</sup>

<b>1250-1472</b> N(f) to N(f)	\$40.00
<b>1250-1473</b> N(m) to BNC(m)	\$45.00
<b>1250-1474</b> N(f) to BNC(f)	\$30.00
<b>1250-1475</b> N(m) to N(m)	\$60.00
<b>1250-1476</b> N(m) to BNC(f)	\$41.00
<b>1250-1477</b> N(f) to BNC(m)	\$35.00

### Adapters Type N, Standard 75 Ω<sup>[2]</sup>

<b>1250-0597</b> N(m) (50Ω) to N(f)(75Ω)	\$30.00
<b>1250-1528</b> N(m) to N(m)	\$60.00
<b>1250-1529</b> N(f) to N(f)	\$40.00
<b>1250-1533</b> N(m) to BNC(m)	\$41.00
<b>1250-1534</b> N(f) to BNC(m)	\$36.00
<b>1250-1535</b> N(m) to BNC(f)	\$38.00
<b>1250-1536</b> N(f) to BNC(f)	\$34.00

HP Part Number	Price
<b>Adapters APC-3.5</b>	
<b>1250-1743</b> APC-3.5(m) to N(m)	\$135.00
<b>1250-1744</b> APC-3.5(f) to N(m)	\$165.00
<b>1250-1745</b> APC-3.5(f) to N(f)	\$115.00
<b>1250-1746</b> APC-3.5(m) to APC-7	\$150.00
<b>1250-1747</b> APC-3.5(f) to APC-7	\$160.00
<b>1250-1748</b> APC-3.5(m) to APC-3.5(m)	\$160.00
<b>1250-1749</b> APC-3.5(f) to APC-3.5(f)	\$175.00
<b>1250-1750</b> APC-3.5(m) to N(f)	\$135.00
<b>1250-1866</b> APC-3.5(mm) to APC-3.5(f)	\$350.00

### Adapters SMA

<b>1250-1158</b> SMA(f) to SMA(f)	\$18.00
<b>1250-1159</b> SMA(m) to SMA(m)	\$18.00
<b>1250-1249</b> SMA Right angle (m) (f)	\$32.00
<b>1250-1397</b> SMA Right angle (m) (m)	\$36.00
<b>1250-1462</b> SMA(m) to SMA(f)	\$24.50
<b>1250-1698</b> SMA tee(m) (f) (f)	\$50.00
<b>1250-1787</b> SMA(m) to BNC(m)	\$35.00
<b>1250-2015</b> SMA(f) to BNC(m)	\$36.00

### Adapters APC-7<sup>®</sup>

<b>11524A</b> APC-7 to N(f)	\$170.00
<b>11525A</b> APC-7 to N(m)	\$170.00
<b>11533A</b> APC-7 to SMA (m)	\$235.00
<b>11534A</b> APC-7 to SMA (f)	\$235.00

### Adapter Banana Plug

<b>1251-2816</b> Dual banana plug	\$6.00
-----------------------------------	--------

### Adapters BNC, Standard 50 Ω

<b>1250-0069</b> BNC(m) to UHF(f)	\$30.00
<b>1250-0071</b> BNC(f) to UHF(m)	\$15.00
<b>1250-0076</b> Right angle BNC(UG-306/D)	\$10.75
<b>1250-0080</b> BNC(f) to BNC(f) (UG-914/U)	\$6.50
<b>1250-0216</b> BNC(m) to BNC(m)	\$10.50
<b>1250-0591</b> BNC(f) to WECO Video (m)	\$23.50
<b>1250-0595</b> BNC(f) to BNC Triaxial (m)	\$20.00
<b>1250-0781</b> BNC tee(m)(f)(f)	\$12.00
<b>1250-1263</b> BNC(m) to single banana plug	\$55.00
<b>1250-1264</b> BNC(m) to dual banana plug	\$27.00
<b>1250-1830</b> BNC(f) to BNC Triaxial (f)	\$60.00
<b>1251-2277</b> BNC(f) to dual banana plug	\$15.50

### Adapters BNC, Standard 75 Ω<sup>[3]</sup>

<b>1250-1286</b> Right angle BNC	\$20.25
<b>1250-1287</b> BNC(f) to BNC(f)	\$10.25
<b>1250-1288</b> BNC(m) to BNC(m)	\$13.25

### Adapters SMB, SMC<sup>[4]</sup>

<b>1250-0670</b> SMC tee(m) (m) (m)	\$30.00
<b>1250-0671</b> SMB(m) to N(m)	\$57.50
<b>1250-0672</b> SMB(f) to SMB(f)	\$14.50
<b>1250-0674</b> SMB(m) to SMA(f)	\$37.00
<b>1250-0675</b> SMC(m) to SMA(f)	\$33.00
<b>1250-0813</b> SMB(m) to SMB(m)	\$62.50
<b>1250-0827</b> SMC(m) to SMC(m)	\$8.25
<b>1250-0831</b> SMC(m) to BNC(m)	\$26.00
<b>1250-0832</b> SMC(f) to BNC(f)	\$30.00
<b>1250-0837</b> SMC tee(m) (m) (m)	\$27.00
<b>1250-0838</b> SMC tee(f) (m) (m)	\$23.00
<b>1250-1023</b> SMC(m) to N(m)	\$37.00
<b>1250-1113</b> SMC(f) to SMC(f)	\$12.50
<b>1250-1152</b> SMC(f) to N(m)	\$55.00
<b>1250-1153</b> SMC(f) to N(f)	\$62.50
<b>1250-1236</b> SMB(f) to BNC(f)	\$32.00
<b>1250-1237</b> SMB(m) to BNC(f)	\$37.00
<b>1250-1391</b> SMB tee(f) (m) (m)	\$31.00
<b>1250-1857</b> SMB(f) to BNC(m)	\$57.50

[1] "Precision": typically ≥36 dB return loss to 1.3 GHz.

[2] Type N outer conductor; center pin sized for 75 Ω characteristic.

[3] BNC outer conductor; center pin sized for 75 Ω characteristic.

[4] SMB & SMC are used often inside HP instruments for inter-module RF connections.

SMB is snap-on configuration. SMC is screw-on configuration.

[5] The K-connector is developed & manufactured by the Wiltron Co, Morgan Hill, CA.

© APC-7 is a registered trademark of the Bunker Ramo Corporation

☎ Fast-Ship product—see page 766.

# TRANSIT CASES

## Rugged Protection for Instruments

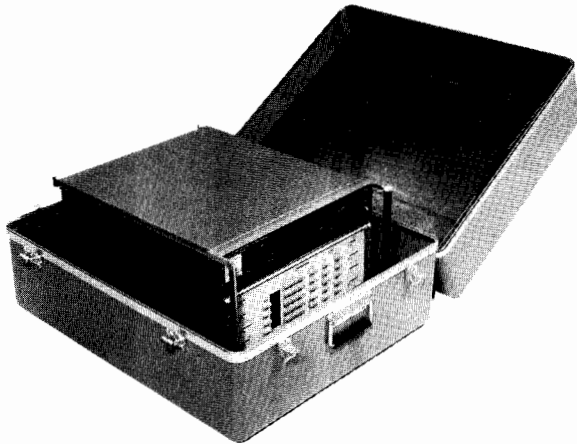

Typical System II Transit Case

Hewlett-Packard transit cases are rugged protective outer shells for use when instruments must be frequently transported or used away from laboratory conditions. HP cases protect your instruments from hostile environments, shock, vibration, moisture and impact, while providing a secure enclosure for shipping. The cases are molded from a structural composite which is 65% lighter than aluminum, yet provides excellent strength and durability. Tests of the composite show tensile and compressive strength exceeding 33,000 PSI and flexural strength exceeding 45,000 PSI.

### Typical Uses

Transit cases are a necessity whenever equipment is frequently transported from one operating location or test site to another, or is shipped for testing and calibration. Transit cases are particularly valuable for instruments used by service and repair personnel. For example, telephone companies frequently use transit cases for the

instruments they use to repair line faults. Transit cases are also valuable when instruments must be transported over rough roads, or are used in dusty environments or outdoors.

### Product Detail

HP transit cases are pressure-molded of an extremely strong and light fiberglass and resin laminate which provides an excellent strength-to-weight ratio. All cases seal tightly with O-ring gaskets and clamping latches. They are rainproof under the test conditions of MIL-STD-108. Carrying handles are conveniently placed and fold flat when not in use.

Transit cases are typically provided with foam cushions that are designed to cradle the instrument securely. Maximum protection is provided against damage from handling, dropping or crushing. The cushion inserts are typically molded polyurethane, or are fabricated from slabs of polyurethane or polyethylene flexible foams. Each case/cushion unit is designed as its own shock and vibration damping system.

Hewlett-Packard's standard transit cases provide effective protection from all but the most abusive treatment. To ensure maximum protection for your instrument, transit cases are also available in versions that meet the specified requirements of MIL-STD-108, MIL-T-21200, MIL-T-28800, MIL-T-4734 and MIL-C-4150.

Removable swivel casters are available as an option on certain HP transit cases. These cases are identified with an asterisk (\*) in the case selection tables on pages 744 and 745.

### How to Select the Proper Transit Case

Transit cases are available for almost all HP instruments. If you are ordering a case for one of HP's 80 most popular instruments and computation products, you can use the quick cross-reference table below. To order a case for any other instrument, please refer to "Accurate Measurements Assure Proper Fit", and use the tables for ordering System I and System II style cases.

HP Product Number to Transit Case Number Cross-Reference

Product	Transit Case	Product	Transit Case	Product	Transit Case	Product	Transit Case	Product	Transit Case
141T	9211-1294	3586A/B/C	9211-2650	4191A	9211-2663	8340A/B	9211-2662	8660A/C	9211-2662
853A	9211-5439	3708A	9211-2655	4192A	9211-2663	8341A/B	9211-2662	8662A	9211-2662
11713A	9211-2671	3708A(Opt.1)	9211-2661	4328A	9211-1318	8349A/B	9211-2667	8663A	9211-2662
11729C	9211-2654	3709A	9211-2661	4935A	9211-1290	8350B	9211-2649	8671A/B	9211-2661
1630A	9211-1294	3711A	9211-1293	4937A	9211-1289	8403A	9211-1292	8672A	9211-2661
1645A	9211-1289	3712A	9211-1294	4945A	9211-2650	8405A	9211-1293	8673B/E	9211-2661
1725A	9211-2459	3717A	9211-2654	4947A	9211-2650	8445B	9211-1292	8673C/D	9211-2663
1740A	9211-2459	3730B	9211-0839	4948A	9211-2650	85B	9211-4120	8683A/B/D	9211-2649
1741A	9211-2459	3746A	9211-2656	4951C	9211-1290	8501A	9211-2660	8684A/B/D	9211-2649
197B	9211-2675	37461A	9211-2678	4952A	9211-1290	8505A	9211-2665	8702A	9211-2656
262X Series	9211-4677	3764A	9211-2650	4953A	9211-2650	8508A	9211-2649	8720A	9211-2658
264X Series	9211-4676	3776A/B	9211-2650	4954A	9211-2657	8508A (opt. 001)	9211-2655	8753A/B	9211-2656
2671G	9211-2649	3777A	9211-2644	4955A	9211-2663	8510A/B <sup>1</sup>	9211-2661	8754A	9211-2661
2673G	9211-2649	3779C/D	15514A	4972A	9211-2657	8511A-8515A	9211-2661	8756A	9211-2656
2816A	9211-1315	3780A	18055A	5061A	9211-1294	8555A	9211-2671	8757A	9211-2656
334A	9211-1289	3781A/B	18055A	5065A	9211-0839	8562A/B	9211-5604	8770A	9211-2663
339A	9211-2643	3782A/B	18055A	5150A	9211-2673	8565A	9211-2656	8780A	9211-2662
3325A	9211-2655	3785A/B	18055A	5316A	9211-2681	8566A/B <sup>1</sup>	9211-2655	8901A/B	9211-1293
3336A/B/C	9211-2655	3787B	9211-2655	5328A	9211-2648	8566A/B <sup>2</sup>	9211-2661	8970A/B	9211-2649
3421A	9211-2642	3789A/B	9211-2656	5334A	9211-2642	8567A	9211-2665	8971B	9211-2648
3455A	9211-2654	3787B	9211-2656	5335A	9211-2643	8568A/B	9211-2655	8980A	9211-2661
3456A	9211-2654	3852A	9211-2657	5340A	9211-1292	8569B	9211-2656	8981A	9211-2661
3457A	9211-2642	3964A	9211-2557	5342A	9211-2682	8570A	9211-2656	8901A/B	9211-1293
3478A	9211-2676	3968A	9211-2557	5343A	9211-2682	8620C	9211-1289	9826A	9211-2662
3488A	9211-2642	432A/B	9211-1318	5423A	9211-2661	8640B	9211-1296	9836A <sup>1</sup>	9211-2652
3561A	9211-2459	435B	9211-1318	59306A	9211-2667	8642A/B	9211-2661	9836A <sup>2</sup>	9211-2662
3562A	9211-2663	436A	9211-2667	59313A	9211-2671	8654A	9211-1895	9876A	9211-4679
3577A	9211-2663	436B	9211-2671	59401A	9211-2682	8654B	9211-1290	11713A	9211-2671
3582A	9211-2656	438A	9211-2676	82509B	9211-4684	8656B	9211-2661	11720A	9211-2671
3585A	9211-2663	4145A	9211-2663						

<sup>1</sup>Top half    <sup>2</sup>Bottom half    <sup>3</sup>Instrument requires two cases

### Instrument Cabinet System Styles

Hewlett-Packard produces two styles of cabinet systems: System I and System II. The most visible difference is handle configuration; the handles on System I instruments are a part of the instrument side frame, and project at 90 degrees from the instrument face. The handles on System II modules also project at 90 degrees from the instrument face, but are not a part of the instrument frame, are easily removable, and are turned outward at the handle grip. Each of the cabinet styles requires a different cushion insert configuration. This difference makes it important to order your case from the correct selection table.

### Transit Case Styles

Each transit case is coded according to its style in the following tables: Valise (V), hinged with the handle opposite the hinge; Transit (T), a completely removable cover with a handle at each end; and Valise Transit (VT), a hinged transit case with a handle opposite the hinge and a handle at each end. Each case is designed and manufactured in the style that best suits the configuration of its instrument. If a style other than the standard is more appropriate for your application, a special case can be ordered.

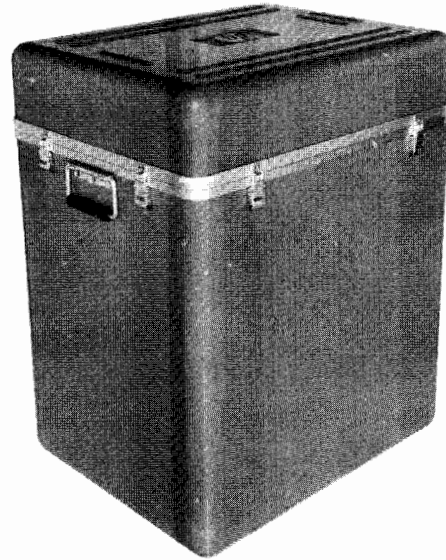

Typical transit (T) style case

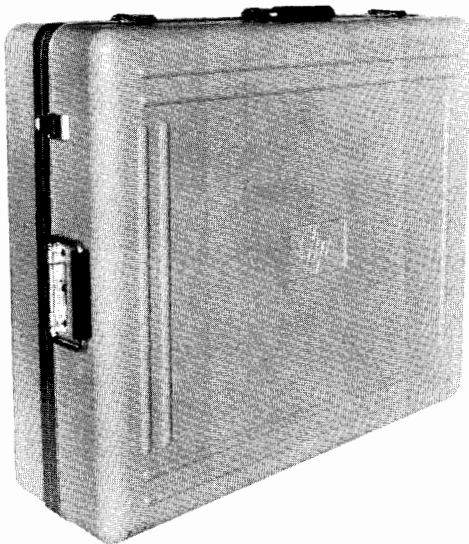

Typical valise transit (VT) style case



Typical valise (V) style case

### Special or Custom Transit Cases

When HP began providing standardized cases, it was understood that there would be certain instruments that would not fit into the standard cases. For that reason, special or custom cases are available.

Proper fit is very important in protecting your instrument, and the dimensional measurements of your instrument are critical. It is recommended, when ordering a custom case, that you provide your Hewlett-Packard sales office with the instrument's exact height, width and depth, the serial and model number, and any other pertinent information that may affect the design of the case or cushions. In designing your own case, you may wish to have additional space available for the protected storage of materials necessary for your instrument's on-site operation. Space can be provided for storing power/data cables, operating supplies, accessories, additional printed circuit boards and documentation or manuals. All specifications and measurements should be on hand when discussing your needs with a representative from your local HP sales office.

### Colors

HP transit cases are produced in "Hewlett-Packard Pearl Gray Cabinet," a standard color used in whole or in part on a majority of the instruments HP produces. Transit cases in any other color must be a special order at additional cost.

### Accurate Measurements Assure Proper Fit

To assure proper fit, each instrument must be measured carefully. The three measurements necessary are:

**WIDTH:** The distance across the entire body of the instrument, not including rack mounting accessories. Instruments set up to be rack mounted require special cushion designs (custom transit cases).

**DEPTH:** The depth of the instrument from the front panel face to the rearmost projection at the back of the instrument. On a System II instrument, add two inches if the instrument has handles.

**HEIGHT:** The actual instrument height from the base to the top of the cabinet.

The selection tables include American standard and metric measurements. The addition of any options, accessories or standoff devices will affect the instrument's overall configuration and must be taken into consideration when ordering a transit case.

# TRANSIT CASES

## Rugged Protection for Instruments (cont'd)

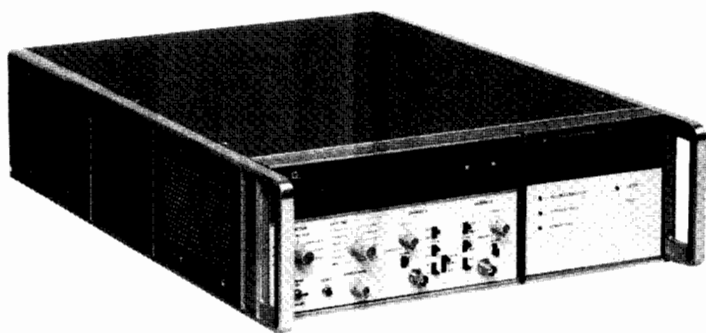

Typical full module System I style cabinet

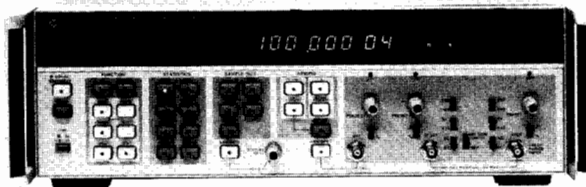

Typical full module System II style cabinet

### System I Cabinet Style Transit Cases

Full Module Width Instruments					
Instrument Width - 16.75 in. 425.5 mm					
Instrument Depth - 11.25 in. 285.8 mm					
Inst. Height		Style	HP Part Number	**Price	
In.	mm			1-4	5-49
3.50	88.9	VT*	9211-1288	\$370	330
5.25	133.4	VT*	9211-1289	\$380	340
7.00	177.8	VT*	9211-1290	\$390	360
8.75	222.3	T*	9211-1291	\$420	380
Instrument Depth - 16.25 in. 412.8 mm					
Inst. Height		Style	HP Part Number	**Price	
In.	mm			1-4	5-49
3.50	88.9	VT*	9211-1292	\$400	370
5.25	133.4	VT*	9211-0839	\$420	380
7.00	177.8	VT*	9211-1293	\$430	390
8.75	222.8	VT*	9211-1294	\$430	390
10.50	266.7	T*	9211-1295	\$430	390
12.25	311.2	T*	9211-1313	\$450	410
Instrument Depth - 19.25 in. 489.0 mm					
Inst. Height		Style	HP Part Number	**Price	
In.	mm			1-4	5-49
5.25	133.4	VT*	9211-1296	\$440	400
7.00	177.8	VT*	9211-1735	\$450	410
Instrument Depth - 22.25 in. 565.2 mm					
Inst. Height		Style	HP Part Number	**Price	
In.	mm			1-4	5-49
12.25	311.2	T	9211-1297	\$480	430

\*Removable casters are an option.

Two-thirds Module Width Instruments					
Instrument Width - 10.50 in. 266.7 mm					
Instrument Depth - 11.00 in. 270.4 mm					
Inst. Height		Style	HP Part Number	**Price	
In.	mm			1-4	5-49
6.5	165.1	V	9211-1895	\$330	300

Half Module Width Instruments					
Instrument Width - 7.75 in. 196.9 mm					
Instrument Depth - 8.00 in. 203.2 mm					
Inst. Height		Style	HP Part Number	**Price	
In.	mm			1-4	5-49
6.5	165.1	V	9211-1316	\$300	270
Instrument Depth - 11.00 in. 279.4 mm					
Inst. Height		Style	HP Part Number	**Price	
In.	mm			1-4	5-49
6.5	165.1	V	9211-1315	\$310	280
Instrument Depth - 16.00 in. 406.4 mm					
Inst. Height		Style	HP Part Number	**Price	
In.	mm			1-4	5-49
6.5	165.1	V	9211-1734	\$330	300

\*\*Prices shown are subject to change.

One-third Module Width Instruments					
Instrument Width - 5.125 in. 130.2 mm					
Instrument Depth - 8.00 in. 203.2 mm					
Inst. Height		Style	HP Part Number	**Price	
In.	mm			1-4	5-49
6.5	165.1	V	9211-1317	\$290	260
Instrument Depth - 11.00 in. 279.4 mm					
Inst. Height		Style	HP Part Number	**Price	
In.	mm			1-4	5-49
6.5	165.1	V	9211-1318	\$300	270

### System II Cabinet Style Transit Cases

Full Module Width Instruments					
Instrument Width - 16.75 in. 425.5 mm					
Instrument Depth - 15.25 in. 387.4 mm					
Inst. Height		Style	HP Part Number	**Price	
In.	mm			1-4	5-49
3.50	88.9	VT	9211-2642	\$430	390
5.25	133.4	VT	9211-2643	\$430	390
7.00	177.8	VT	9211-2644	\$430	390
8.75	222.3	VT	9211-2645	\$430	390
10.50	266.7	T*	9211-2646	\$430	390
12.25	311.2	T*	9211-2647	\$430	390
Instrument Depth - 18.25 in. 463.6 mm					
Inst. Height		Style	HP Part Number	**Price	
In.	mm			1-4	5-49
3.50	88.9	VT	9211-2648	\$480	430
5.25	133.4	VT	9211-2649	\$480	430
7.00	177.8	VT	9211-2650	\$480	430
8.75	222.3	T*	9211-2651	\$480	430
10.50	266.7	T*	9211-2652	\$480	430
12.25	311.2	T*	9211-2653	\$480	430
Instrument Depth - 21.50 in. 546.1 mm					
Inst. Height		Style	HP Part Number	**Price	
In.	mm			1-4	5-49
3.50	88.9	VT	9211-2654	\$520	470
5.25	133.4	VT	9211-2655	\$520	470
7.00	177.8	VT	9211-2656	\$520	470
8.75	222.3	T*	9211-2657	\$520	470
10.50	266.7	T*	9211-2658	\$520	470
12.25	311.2	T*	9211-2659	\$520	470
Instrument Depth - 24.50 in. 622.3 mm					
Inst. Height		Style	HP Part Number	**Price	
In.	mm			1-4	5-49
3.50	88.9	VT	9211-2660	\$550	500
5.25	133.4	VT	9211-2661	\$550	500
7.00	177.8	T*	9211-2662	\$550	500
8.75	222.3	T*	9211-2663	\$550	500
10.50	266.7	T*	9211-2664	\$550	500
12.25	311.2	T*	9211-2665	\$550	500

\*Removable casters are an option.



Typical System II half module instrument

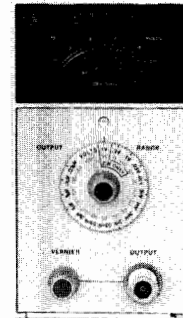

Typical System II quarter module instrument



**System II Cabinet Style Transit Cases (Continued)**

Half Module Width Instruments Instrument Width – 8.50 in. 215.9 mm					
Instrument Depth – 9.75 in. 247.7 mm					
Inst. Height in.	mm	Style	HP Part Number	**Price	
				1-4	5-49
3.50	88.9	V	9211-2666	\$330	300
5.25	133.4	V	9211-2667	\$330	300
7.00	177.8	V	9211-2668	\$330	300
8.75	222.3	V	9211-2669	\$330	300
10.50	266.7	V*	9211-2670	\$330	300
Instrument Depth – 12.75 in. 323.9 mm					
Inst. Height in.	mm	Style	HP Part Number	**Price	
				1-4	5-49
3.50	88.9	V	9211-2671	\$390	350
5.25	133.4	V	9211-2672	\$390	350
7.00	177.8	V	9211-2673	\$390	350
8.75	222.3	V	9211-2674	\$390	350
10.50	266.7	V	9211-2675	\$390	350
Instrument Depth – 15.75 in. 400.1 mm					
Inst. Height in.	mm	Style	HP Part Number	**Price	
				1-4	5-49
3.50	88.9	V	9211-2676	\$400	360
5.25	133.4	V	9211-2677	\$400	360
7.00	177.8	V	9211-2678	\$400	360
8.75	222.3	V	9211-2679	\$400	360
10.50	266.7	V	9211-2680	\$400	360
Instrument Depth – 18.75 in. 476.3 mm					
Inst. Height in.	mm	Style	HP Part Number	**Price	
				1-4	5-49
3.50	88.9	V	9211-2681	\$400	360
5.25	133.4	V	9211-2682	\$400	360
7.00	177.8	V	9211-2683	\$400	360
8.75	222.3	V	9211-2684	\$400	360
10.50	266.7	V	9211-2685	\$400	360

\* Removable casters are an option.  
 \*\* Prices shown are subject to change.

Quarter Module Width Instruments Instrument Width – 4.125 in. 104.8 mm					
Instrument Depth – 9.75 in. 247.7 mm					
Inst. Height in.	mm	Style	HP Part Number	**Price	
				1-4	5-49
3.50	88.9	V	9211-2686	\$280	250
5.25	133.4	V	9211-2687	\$280	250
7.00	177.8	V	9211-2688	\$280	250
Instrument Depth – 12.75 in. 323.9 mm					
Inst. Height in.	mm	Style	HP Part Number	**Price	
				1-4	5-49
3.50	88.9	V	9211-2689	\$290	260
5.25	133.4	V	9211-2690	\$290	260
7.00	177.8	V	9211-2691	\$290	260
Instrument Depth – 15.75 in. 400.1 mm					
Inst. Height in.	mm	Style	HP Part Number	**Price	
				1-4	5-49
3.50	88.9	V	9211-2692	\$350	310
5.25	133.4	V	9211-2693	\$350	310
7.00	177.8	V	9211-2694	\$350	310

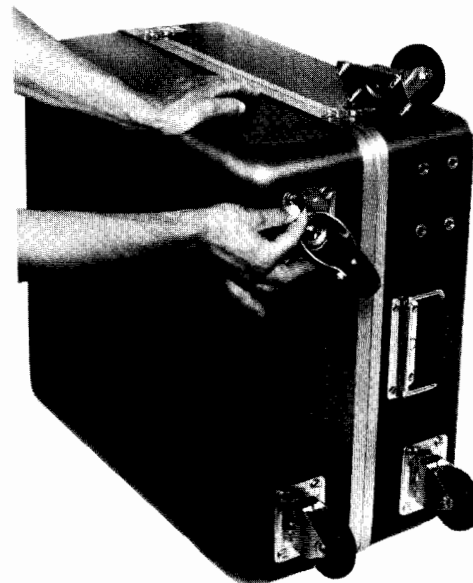

Field-installed swivel caster kit. HP part number 1490-0913



# OPERATING CASES

## Rugged Protection for Instruments

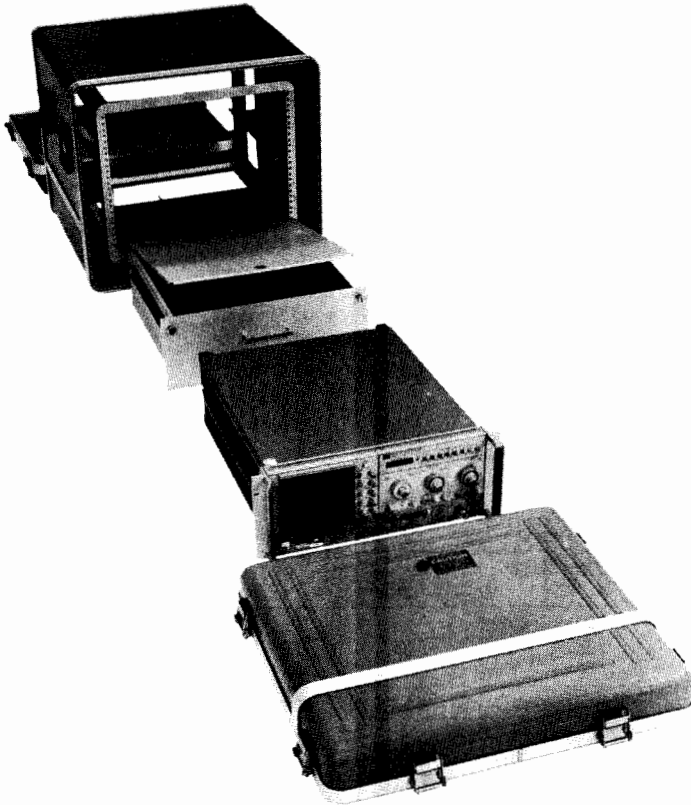

Exploded view of an Operating Case with an instrument and drawer ready for mounting.

### Operating Cases

Hewlett-Packard operating cases are rugged protective enclosures, used when instruments are transported and used on-site. They are constructed of the same pressure-molded fiberglass/resin laminate as Hewlett-Packard transit cases. Hewlett-Packard's standard hardware provides excellent protection from damage and the elements. Conveniently placed handles fold flat when not in use. Front and back covers seal with O-ring gaskets and clamping latches. All transit cases are rainproof under MIL-STD-108.

### Interior Configuration

Operating cases are equipped with shock-mounted aluminum frames that accept any standard 19-inch rack mounting instrument (EIA-RETMA standard) up to the height of the frames. Most full-sized instruments and modular combinations of instruments can be rack mounted in one of our operating cases. The frame arrangement and the ability to remove the front and back covers allows the convenience of operation without removing the instrument. As a result, the instrument can be set up for operation with a minimum of delay. At the same time, environmental protection is afforded. Both Hewlett-Packard System I and System II cabinet styles can be mounted in operating cases (including System I module combining cases).

Rack mounting offers a number of conveniences. Total systems configured of individual instruments and accessories can be combined in one or more operating cases. Patch cable, HP-IB and HP-IL connections can be left in place within the case, so that instruments are ready to be put into use with a minimum of delay.

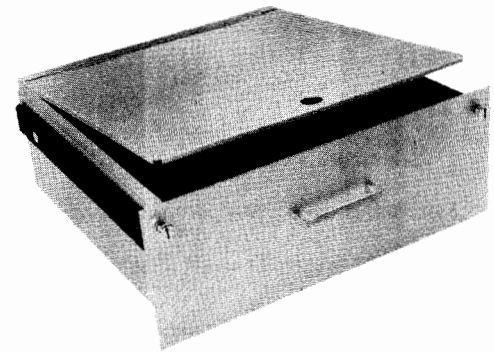

Sturdy drawers that accommodate various HP accessories and operating supplies are available in three sizes and come with smooth-operating ball bearing slides.

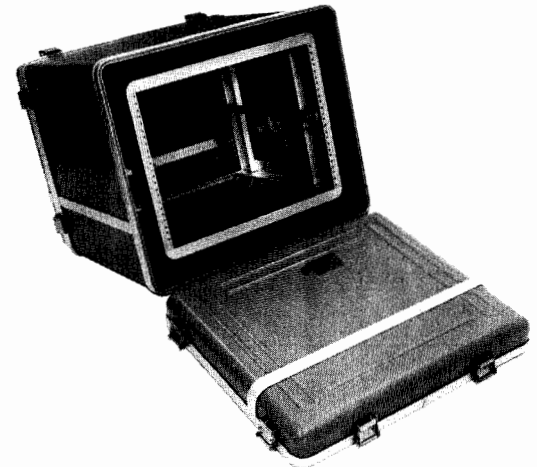

Elastomeric shock-mounted frames provide outstanding shock and vibration attenuation. A set of standard shock mounts can be provided for any equipment weight and fragility.

### Accessories and Options

A number of accessories and options are available to provide maximum flexibility. Drawers are available in three heights, so that small accessories, supplies and tools can be kept inside the case with the instrument (cut foam cushions can be designed to accommodate any of these items). Aluminum skids, stacking feet, internal power receptacles and many other items are available as options on special orders, or as accessories for customer installation when ordered separately.

### How to Order

Operating cases, like transit cases, are ordered through your local HP sales office. Because of the wide variety of options available and the number of configurations possible, it is recommended that you discuss your needs with an HP representative before you order.

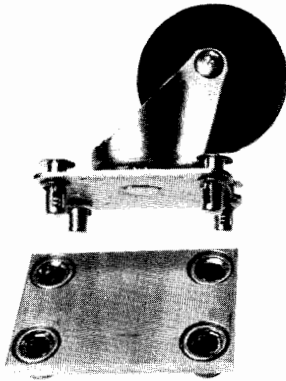

Heavy-duty removable caster and mounting plate

### Operating Case Selection Guide

Case Width = 24.00 in./609.6 mm (standard)

Case Depth = 28.50 in./723.9 mm (standard)

Nominal Rack Height in. ISO	Instrument Weight				Case Height in. mm	HP Part Number	*Price	
	maximum lbs	kg	minimum lbs	kg			1-4	5-49
5.25 3U	75	34.0	20	9.1	10.75 273.1	9211-1302	\$1,350	1,080
8.75 5U	75	34.0	20	9.1	15.20 386.1	9211-1303	\$1,450	1,160
10.50 6U	130	59.0	30	13.6	17.00 431.8	9211-2635	\$1,650	1,320
12.25 7U	130	59.0	30	13.6	18.87 479.3	9211-1163	\$1,750	1,400
14.00 8U	130	59.0	30	13.6	20.50 520.7	9211-1241	\$1,800	1,450
15.75 9U	130	59.0	30	13.6	22.25 565.2	9211-1242	\$1,800	1,450
17.50 10U	130	59.0	30	13.6	24.00 612.1	9211-1243	\$1,800	1,450
19.25 11U	130	59.0	30	13.6	25.75 654.1	9211-1244	\$1,800	1,450
21.00 12U	250	113.4	50	22.7	28.00 711.2	9211-1245	\$1,800	1,450
22.75 13U	250	113.4	50	22.7	29.75 755.7	9211-2636	\$1,800	1,450
24.50 14U	250	113.4	50	22.7	31.50 800.1	9211-1911	\$2,200	1,750
26.25 15U	250	113.4	50	22.7	33.25 844.6	9211-2637	\$2,200	1,750
28.00 16U	250	113.4	50	22.7	35.00 889.0	9211-2638	\$2,200	1,750
29.75 17U	250	113.4	50	22.7	36.75 933.5	9211-2639	\$2,200	1,750
31.50 18U	250	113.4	50	22.7	38.50 977.9	9211-2640	\$2,200	1,750
33.25 19U	250	113.4	50	22.7	40.25 1022.4	9211-1713	\$2,200	1,750
47.25 27U	320	145.2	70	31.8	53.88 1368.6	9211-2641	\$2,700	2,150

\*Prices shown are subject to change.

### Standard Features

Inner rack frame with provision for infinitely adjustable T-bar instrument support bracket. Standard 20" depth.

Inner rack frame with RETMA hole pattern drilled in rear rails.

Standard color: pearl grey cabinet.

Manual pressure relief valve.

### Special Features Available

- A. Mating feet for stacking one case on top of another. \$50
- B. Special color. Please specify. \$40
- C. Modified inner rack frame depth. Standard depth 20" from front panel mounting surface to rear surface of frame. This option includes an appropriate change in the overall depth of the enclosure. Please specify desired inner frame depth. Maximum 23", minimum 12". \$300
- D. Instrument slide pair to mount on either side of inner frame using RETMA hole pattern drilled in front and rear rails. \$90
- E. Special shock mounts for unusual instrument weights. Please specify weights. \$40
- F. Increased front cover depth. Maximum depth 6". Please specify. \$250
- G. Increased rear cover depth. Maximum depth 6". Please specify. \$250
- H. Latches recessed into the surface of the case. \$250
- I. Handles recessed into the surface of the case. \$90
- J. Hermetically-sealed case tested by the hot water method. \$90
- K. MIL-C-4150 certification with the exception of design and preproduction testing. Case will have increased wall thickness, hardware anodized to military specification, and will be hermetically tested using the hot water method. \$290
- L. Automatic pressure relief valve. \$50
- M. Addition of four permanently mounted, 3½" diameter swivel casters. \$120
- N. Addition of four removable, 3½" diameter swivel casters. Also available in kit form. \$250
- O. Addition of two aluminum hat-section skids to the case bottom. \$120
- P. Addition of lift rings to either side of the case. \$50
- Q. 3½ H (88.9 mm) Drawer with ball bearing slides. \$330
- R. 5¼ H (133.4 mm) Drawer with ball bearing slides. \$350
- S. 7 H (177.8 mm) Drawer with ball bearing slides. \$370
- T. Pair of T-Bar instrument support brackets. \$30
- U. AC power receptacle strip with four outlets mounted on bottom rear of inner rack frame. Power cord 1 meter (3' 3") long, NEMA connectors. \$50

### Accessories (when ordered separately)

- 9211-1164** 3½ H (88.9 mm) Drawer with ball bearing slides. \$380
- 9211-1165** 5¼ H (133.4 mm) Drawer with ball bearing slides. \$400
- 9211-1166** 7 H (177.8 mm) Drawer with ball bearing slides. \$480
- 0950-0122** AC power receptacle strip with four outlets mounted on bottom rear of inner rack frame. Power cord 1 meter (3'3") long, NEMA connectors. \$50
- 9211-1173** Pair T-Bar instrument support brackets. \$46
- 1490-0913** Caster kit, four removable, 3½" (88.9 mm) swivel casters. For transit cases only. Recommended to be removed before transit. \$210
- 5081-5831** Operating Case Latch. \$7.75 each
- 5081-5832** Aluminum hat-section skids (2) for case bottom. \$155
- 5081-5834** Caster kit, four removable, 3½" (88.9 mm) swivel casters. Heavy duty for Transit or Operating Cases. Recommended to be removed before transit. \$300

On request, cases can be fabricated that meet the environmental requirements of military specifications. Specifications other than military are subject to change without notice.

# CABINETS & CABINET ACCESSORIES

## System II Plus—Handles and Rack Flanges, Bail Handle Kit

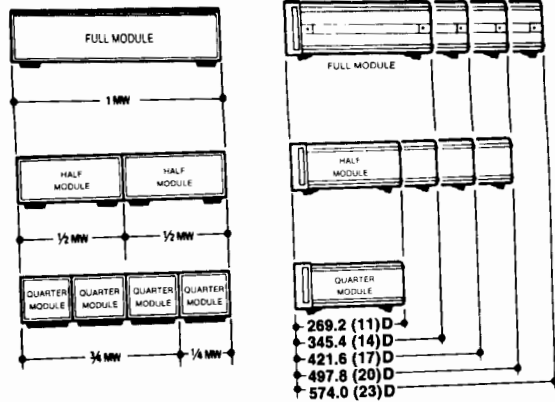
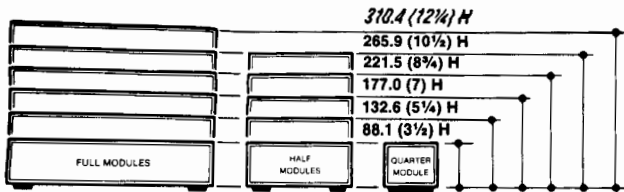

### System II Cabinet Design

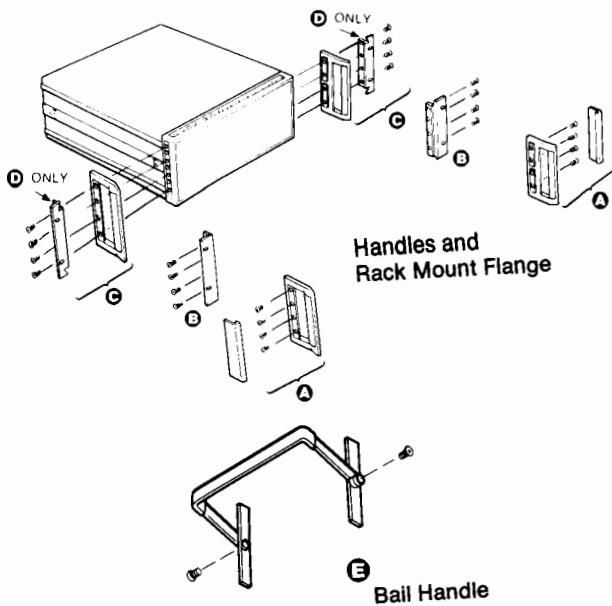

**NOTICE**—Most of the cabinet accessory kits shown on these pages include both inch and metric fasteners to make them compatible with the new metric-fastener-cabinets, as well as the older inch-fastener-cabinets which are still in service. It is most important for the user to be aware of these different fasteners to avoid thread damage when attaching the accessory kits. Metric-fastener-cabinets are identified with a yellow label on the rear which reads “Caution—metric and inch hardware”, a “metric” embossment in the front bezel casting under the plastic trim strip, and on the middle of the rear bezel casting.

### System II and System II Plus Cabinet Design

HP’s modular cabinet system offers bench-stacking and rack mounting versatility. These cabinets are designed for compatibility with EIA and IEC standards, both in width and height.

System II Plus cabinets and accessories are identical in form, fit, and function as System II, but are different colors for improved visual continuity. This catalog lists System II Plus part numbers only. Old System II parts are available until May 1989. For old part numbers, refer to previous edition of this catalog.

### Handles and Rack Mount Flanges

Handles and rack flanges are available for all System II cabinets, although they find most use on full width modules or combinations of narrower modules locked together to form 1 MW (module width).

Certain instruments are supplied with front handles as part of the selling price. Handles and rack flanges can be supplied with most instruments by specifying the appropriate option from the following list, at the time of order. The extra cost of each option is usually specified on the instrument data sheet.

- Option 907 Front Handles
- Option 908 Rack Mount Flanges
- Option 909 Handles with Rack Flanges
- Option 913 Rack Mount Flanges (If handles already furnished) (HP 5062-4069 Version)

The table below describes kits available for use after receipt of equipment. Field installation is very straight-forward. A plastic trim strip is easily removed and the handle or flange attached with screws supplied in the kit. Before rack mounting, bottom feet must be removed.

### Bail Handle Kit

For 1/2 MW cabinets, you can attach this front bail handle for easy portability. Attaching hardware furnished.

HP Part No.	Name	Price
5062-4001	Bail Handle Kit for 88.1 (3 1/2) Module	\$38.00
5062-4002	Bail Handle Kit for 132.6 (5 1/4) Module	35.00
5062-4003	Bail Handle Kit for 177.0 (7) Module	33.00

### Handle and Rack Flanges

Instrument Module Height mm (inch)	A Front Handle Kit		B Rack Mount Flange Kit [3]		C Rack Mount Flange Kits with Handles		D Rack Mount Flange Kit for Instruments With Previously Supplied Handles	
	HP Part No.	Price	HP Part No.	Price	HP Part No.	Price	HP Part No.	Price
88.1 (3 1/2)H	5062-3988	\$ 50.00	5062-3974[1]	\$31.00	5062-3975[1]	\$ 72.50	5062-4069[1]	\$21.00[4]
88.1 (3 1/2)H	—	—	5062-3976[2]	31.00	5062-3982[2]	72.50	5062-4070[2]	36.00[4]
132.6 (5 1/4)H	5062-3989	55.00	5062-3977	33.50	5062-3983	82.50	5062-4071	28.00
177.0 (7)H	5062-3990	65.00	5062-3978	36.00	5062-3984	95.00	5062-4072	32.00
221.5 (8 3/4)H	5062-3991	75.00	5062-3979	40.00	5062-3985	105.00	5062-4073	36.00
265.9 (10 1/2)H	5062-3992	95.00	5062-3980	45.00	5062-3986	120.00	5062-4074	40.00
310.4 (12 1/4)H	5062-3993	140.00	5062-3981	50.00	5062-3987	160.00	5062-4075	49.00
<b>Kit includes</b>	2 Handles + 2 Trim Strips + Mtg. Screws		2 Flanges + Mtg. Screws		2 Handles + 2 Flanges + Mtg. Screws		2 Flanges + Mtg. Screws	

[1] HP 5062-3974/3975/4069 Kits use standard flanges with 1.75" hole spacing.  
 [2] HP 5062-3976/3982/4070 Kits use special flange with 3.00" hole spacing.

[3] Will not fit onto instruments with previously supplied handles.

[4] Option 913 ordered on instruments supplies HP 5062-4069. For 3.00" spacing order HP 5062-4070 instead of Opt. 913.

# CABINETS & CABINET ACCESSORIES

## System II Plus—Support Shelves, Filler Panels

**NOTICE**—Most of the cabinet accessory kits shown on these pages include both inch and metric fasteners to make them compatible with the new metric-fastener-cabinets, as well as the older inch-fastener-cabinets which are still in service. It is most important for the user to be aware of these different fasteners to avoid thread damage when attaching the accessory kits. Metric-fastener-cabinets are identified with a yellow label on the rear which reads "Caution—metric and inch hardware", a "metric" embossment in the front bezel casting under the plastic trim strip, and on the middle of the rear bezel casting.

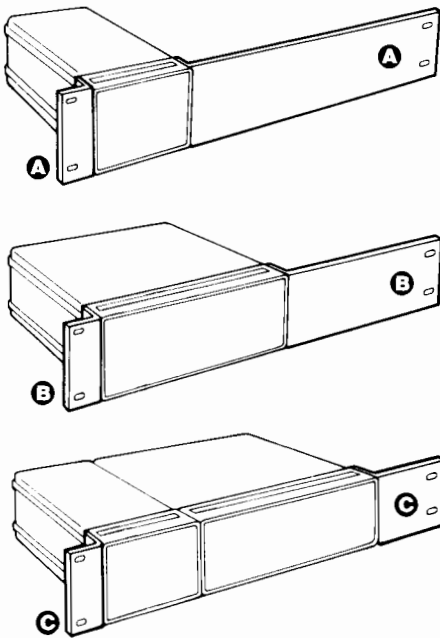

### Rack Mount Adapter Kits

Modules of less than 1 MW can be rack mounted using these kits. Individual ¼ MW or ½ MW modules use the kits shown below directly. Combinations of ¼ MW and ½ MW (of equal depth) are first joined side-by-side with the Lock Link Kit (HP 5062-3994) (following page), then have end flanges applied. Combinations adding to 1 MW use regular rack flange kit (previous page). Kits include attaching screws but not front panel rack mounting screws. Hole patterns conform to EIA and IEC standards.

### Rack Mount Adapter Kits

Module Height mm (Inch)	A Mounts ¼ MW Module		B Mounts ½ MW or 2 ea. ¼ MW[2] Modules		C Mounts ¾ MW (3 ea. ¼ MW[1]) or ¼ & ½ MW side-by-side[2]	
	HP Part No.	Price	HP Part No.	Price	HP Part No.	Price
88.1 (3½)H	5062-3973	\$56.00	5062-3972	\$51.00	5062-3971	\$43.00
132.6 (5¼)H	—	—	5062-3957	62.00	5062-3958	50.00
177.0 (7)H	—	—	5062-3960	67.00	5062-3961	70.00
265.9 (10½)H	—	—	5062-3966	77.50	5062-3967	72.50
<b>Kit includes</b>	1 ea. rack flange 1 ea. ¾ MW extension adapter flange and screws		1 ea. rack flange 1 ea. ½ MW extension adapter flange and screws		1 ea. rack flange 1 ea. ¼ MW extension adapter flange and screws	

[1] ¼ MW can be center mounted using 2 of these kits.  
[2] Side-by-side modules of equal depth require lock link kit (HP 5062-3994).

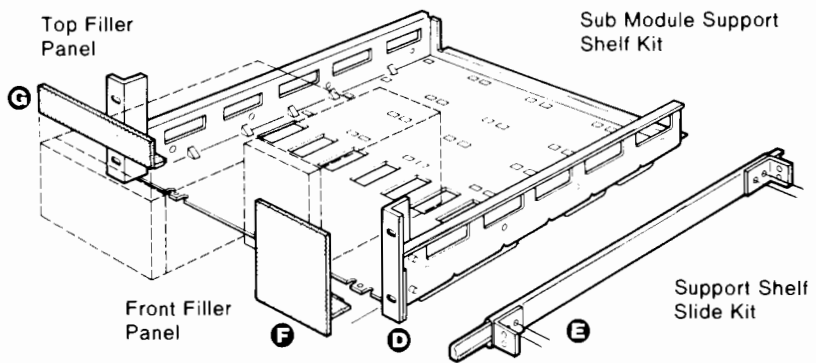

### Support Shelf, Slide, and Filler Panels

Submodules of differing heights, widths, and depths (up to 20 D) may be rack-mounted using these support shelves. Any combination of ¼ MW and ½ MW will fit side-by-side up to 1 MW. Filler panels close up vacant spaces either on top of short modules or side-by-side. The slide kit provides ready access to internal shelf areas and is designed for HP racks with 24-inch depth vertical support rails. Slide kit includes brackets and mounting screws.

HP Part No.	Name	Price
5062-3996	D Support Shelf for 88.1 (3½)H Modules	\$195.00
5062-3997	D Support Shelf for 132.6 (5¼)H Modules	195.00
5062-3998	D Support Shelf for 177.0 (7)H Modules	210.00
1494-0015	E Slide Kit (2 ea slides, brackets, hardware)	120.00

### Filler Panels

Description	Size	HP Part No.	Price
F For 88.1 (3½) H support shelf partially filled with instruments, and having the following front panel space to fill:	¼ MW to fill	5062-4021	\$67.50
	½ MW to fill	5062-4022	80.00
	¾ MW to fill	5062-4023	92.50
F For 132.6 (5¼) H support shelf, and having the following front panel space to fill:	¼ MW to fill	506-4024	\$80.00
	½ MW to fill	5062-4025	87.50
F For 177.0 (7) H support shelf, and having the following front panel space to fill:	¼ MW to fill	5062-4066	\$75.00
	½ MW to fill	5062-4027	110.00
G For ¼ MW and having the following vertical space to fill:	43.2 (1¾)H	5062-2035	\$50.00
	87.6 (3½)H	5062-2036	50.00
G For ½ MW and having the following vertical space to fill:	43.2 (1¾) H	5062-2037	\$50.00
	87.6 (3½) H	5062-2038	50.00

☞ Fast-Ship product. See page 766

# CABINETS & CABINET ACCESSORIES

## System II Plus—Lock Link Kits, Rack Mount Slide Kits

**NOTICE**—Some of the cabinet accessory kits shown on these pages include both inch and metric fasteners to make them compatible with the new metric-fastener-cabinets, as well as the older inch-fastener-cabinets which are still in service. It is most important for the user to be aware of these different fasteners to avoid thread damage when attaching the accessory kits. Metric-fastener-cabinets are identified with a yellow label on the rear which reads “Caution—metric and inch hardware”, a “metric” embossment in the front bezel casting under the plastic trim strip, and on the middle of the rear bezel casting. Due to design considerations, the slide-mount kits shown on this page are offered in both inch and metric fastener versions.

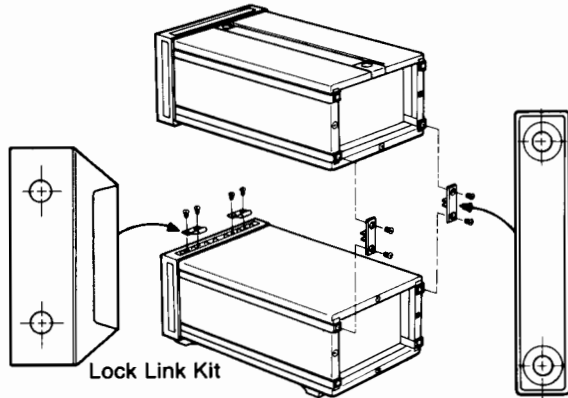

Lock Link Kit

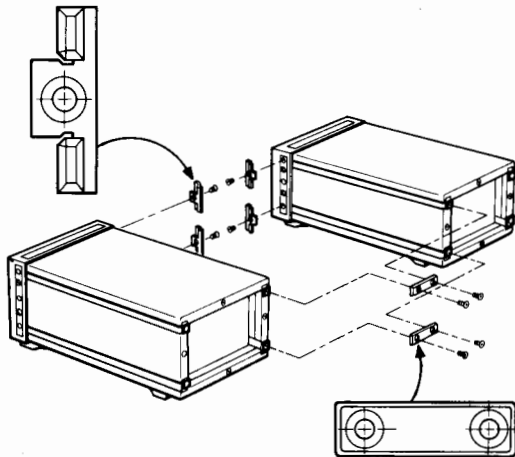

### Lock Link Kits HP 5062-3994 (includes inch screws)

All sub-module cabinets of *equal depths* can be linked together over-under or side-by-side with hardware in the lock link kit. Cabinet frames are already pre-threaded to allow quick assembly. For side-by-side connections the kit contains 12 front hooks and six rear links, enough for 3 side-by-side joints. For vertical connections, the kit also contains four front hooks and four rear links enough for two over-under joints. Kit includes screws. Locking cabinets together horizontally in a configuration wider than 1 MW is not recommended.

If the over-under linked combination is to include rear standoff feet (HP 5062-4009), then the over-under locking feet kit HP 5062-3999 (next page) should be used for over-under connection.

The HP 5062-3994 Lock Link Kit is not recommended for full module over/under combinations. Use Kit HP 5061-9699 Locking Feet Kit (next page) to handle those larger weights.

### Slide Kits and Rack Brackets

Rack slides are available for full-width System II cabinets to permit easy access to internal spaces. Each kit consists of two slides which mount directly to System II cabinet side handle recess spaces (after removing side handles). The slides also mount directly to vertical support rails in HP-racks. HP 1494-0060 mounts 345.4D and 421.6D depth System II cabinets. HP 1494-0059; 497.8D and 574.0D.

Standard weight slides carry 38.6 kg (85 lbs) max. load. Tilting versions are available in standard duty only. (HP 1494-0062 and 1494-0063.)

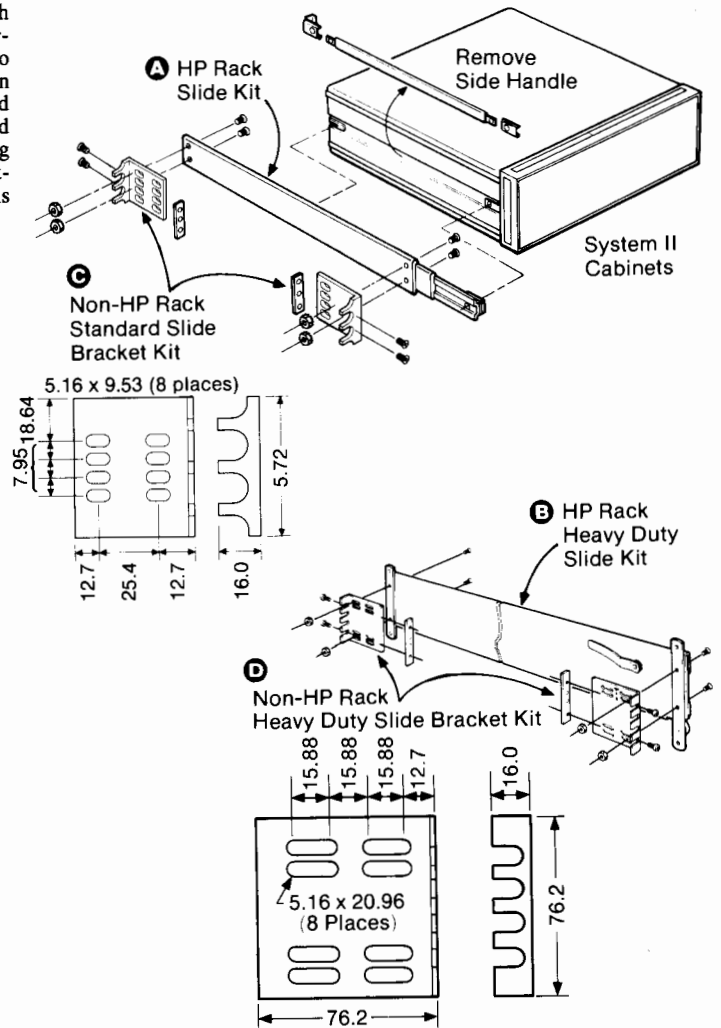

For non-HP-racks, end bracket kits are available for both standard and heavy duty slide kits. Slotted hole arrays in the brackets provide for front-to-back rack rail spacing of 24, 26, and 28-inch nominal centers. They also allow choice of two vertical positions. Each kit of four brackets includes screws and four bar nuts. These general purpose mounting brackets fit most common non-HP-racks such as GE, Honeywell, etc.

HP Part No.	Name	Price
<b>Metric (Inch)</b> 5062-3994	Lock Link Kit	\$ 25.00 ☎
1494-0060 (1494-0018)	A Non-Tilting, Std. Slide Kit, Fits 345.4D & 421.6D Cabinets	100.00 ☎
1494-0059 (1494-0017)	A Non-Tilting, Std. Slide Kit, Fits 497.8D & 574.0D Cabinets	100.00 ☎
1494-0062 (1494-0025)	Tilting, Std. Slide Kit, Fits 345.4D & 421.6D Cabinets	190.00 ☎
1494-0063 (1494-0026)	Tilting, Std. Slide Kit, Fits 497.8D & 574.0D Cabinets	190.00 ☎
1494-0058 (1494-0016)	B Non-Tilting, Heavy Duty Slide Kits (497.8D & 574.0D Cabinets Only)	290.00 ☎
1494-0061 (1494-0023)	C (4) End Brackets for Non-HP Racks, Std. Slides	46.00 ☎
1494-0064 (1494-0042)	D (4) End Brackets for Non-HP Racks, Heavy Duty Slides	70.00 ☎

☎ Fast-Ship product. See page 766



**NOTICE**—Most of the cabinet accessory kits shown on these pages include both inch and metric fasteners to make them compatible with the new metric-fastener-cabinets, as well as the older inch-fastener-cabinets which are still in service. It is most important for the user to be aware of these different fasteners to avoid thread damage when attaching the accessory kits. Metric-fastener-cabinets are identified with a yellow label on the rear which reads “Caution—metric and inch hardware”, a “metric” embossment in the front bezel casting under the plastic trim strip, and on the middle of the rear bezel casting.

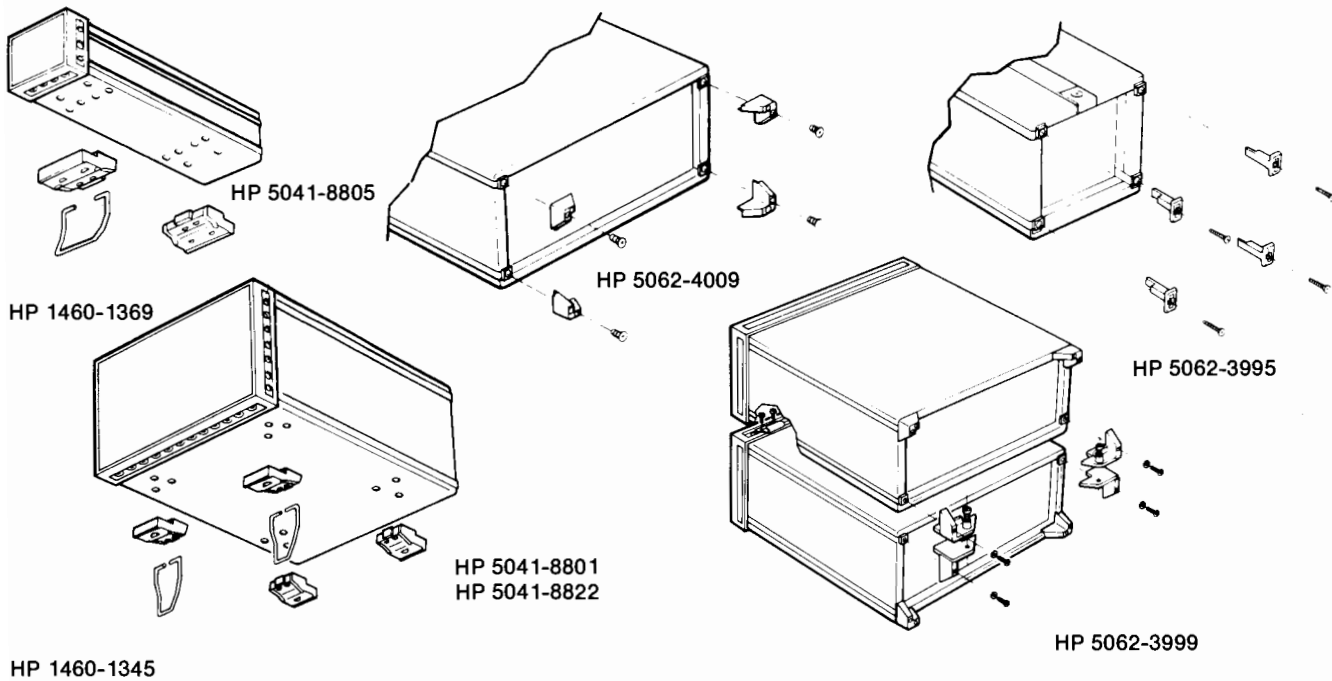

### Bottom and Rear Cabinet Feet

#### Cabinet Rear Standoff Feet HP 5062-4009 (includes inch screws)

Kit HP 5062-4009 provides four corner feet which give 25.4 mm (1-in.) stand-off protection to the rear panel of instruments. It is used when instruments are to be operated or stored vertically on their rear panels. (Fits all but 1/4 MW by (88.1) 3½H). Includes mounting screws.

#### Cord Wrap Feet Kit HP 5062-3995 (includes inch screws)

Kit HP 5062-3995 contains four ribbed corner posts on which you can wrap power cords or signal cables for transport or storage. (Recommended for 1/4 MW and 1/2 MW cabinets weighing less than 11 kg, (24 lbs). Includes mounting screws.

#### Cabinet Bottom Feet and Tilt Stands

The standard foot HP 5041-8801 fits the bottom of full width and 1/2 MW cabinets. It fits front or rear and four are required. HP 5041-8822 foot is a non-skid version. Used in pairs it can prevent bench-top creeping. Tilt-stand HP 1460-1345 fits into the standard or non-skid foot and is used in pairs (front or rear) to tilt the instrument up or down for better viewing.

For 1/4 MW cabinets, foot HP 5041-8805 fits front or rear (two required). Tilt stand HP 1460-1369 fits the standard 1/4 MW foot and can be used front or rear depending on whether you want an upward or downward display.

#### Rear Panel Locking Foot Kit

When full module cabinets are to be linked vertically, and rear standoff feet are planned, use this kit. It consists of right and left foot linking pairs and 2 front hooks, enough for one over-under joint.

Also requires one HP 5062-4009 foot kit to supply the remaining 4 corner feet.

HP Part No.	Name	Price
5062-4009	Rear Standoff Feet Kit (4 Feet)	\$8.75
5062-3995	Cord Wrap Feet Kit (4 Feet)	\$25.00
5041-8801	Standard Foot	\$2.50
5041-8822	Non-Skid Foot	\$4.00
1460-1345	Tilt Stand	\$1.50
5041-8805	1/4 MW Foot	\$7.00
1460-1369	1/4 MW Tilt Stand	\$10.00
5062-3999	1 MW Cabinet Lock-Foot Kit	\$60.00

☎ Fast-Ship product - See page 766

# CABINETS & CABINET ACCESSORIES

## SYSTEM 1—Rack Hardware and Accessories

### System 1 Cabinet Design

System 1 Cabinets are still used on older HP instruments. System 1 can be identified by its front handles being integral with the side casting frame. These two pages describe accessories for use with System 1 Cabinets and small modular instruments.

HP 1051A

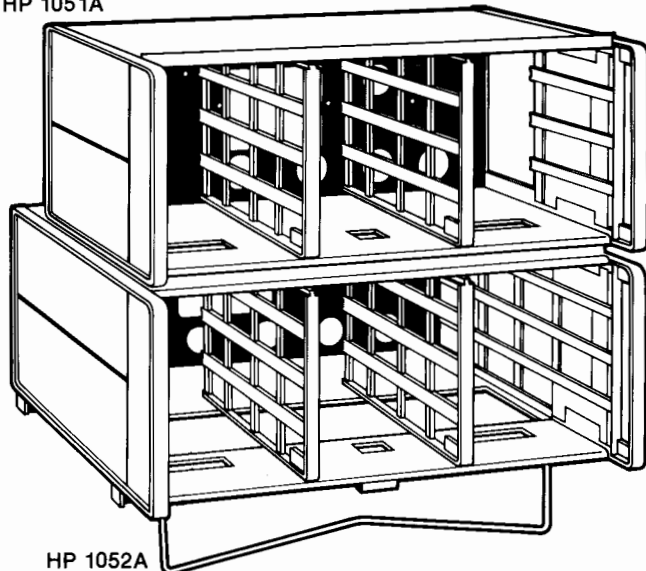

HP 1052A

### Combining Cases, HP 1051A, 1052A

HP 1051A and HP 1052A combining cases conveniently rack or bench mount combinations of small modular Hewlett-Packard SYSTEM 1 instruments. Both cases accept  $\frac{1}{3}$  or  $\frac{1}{2}$  instrument modules, 130mm or 198 mm wide ( $5\frac{1}{8}$  or  $7\frac{7}{8}$  inches). The basic difference is that the HP 1052A is 130 mm ( $5\frac{1}{8}$  in.) deeper and will accept modules up to 416mm deep ( $16\frac{5}{8}$  in.). The HP 1051A accepts instruments up to 286mm deep ( $11\frac{1}{4}$  in.). Each case is furnished with two dividers.

Accessory drawer HP 5060-8756 supplies storage space  $\frac{1}{3}$  width and 77 mm ( $3\text{-}1/32$ " ) high. Use an HP 5060-8758 filler panel above or below.

#### HP 1051A, 1052A, 5060-8756 Specifications

Size	Price
HP 1051A: 178 H x 482.6 W x 337 mm D (7" x 19" x 13 $\frac{1}{4}$ ).	\$750.00
HP 1052A: 178 H x 482.6 W x 467 mm D (7" x 19" x 18 $\frac{3}{8}$ ).	\$750.00

#### Weight

HP 1051A: net, 4.5 kg (10 lb). Shipping, 6.7 kg (15 lb).

HP 1052A: net, 5.4 kg (12 lb). Shipping, 8.1 kg (18 lb).

Opt 908: Rack Mount Kit \$40.00

Opt 910: Extra Manual \$1.00

### Rack Mounting Kits, HP 5060-8739 to 5060-8744

With these kits all Hewlett-Packard products in full rack-width cabinets of the integral side frame-handle style (see HP 1051A, 1052A, Combining Cases above) can be easily prepared for rack mounting. Each kit contains two flanges, a filler strip, and mounting screws.

#### Rack Mounting Kit Ordering Information

HP Part Number	Nominal Cabinet Height		Price
	Millimetres	Inches	
5060-8739	88.1	3 $\frac{1}{2}$	\$40.00 ☎
5060-8740	132.6	5 $\frac{1}{4}$	\$40.00 ☎
5060-8741*	177	7	\$40.00 ☎
5060-8742	221.5	8 $\frac{3}{4}$	\$45.00 ☎
5060-8743	265.9	10 $\frac{1}{2}$	\$45.00 ☎
5060-8744	310.4	12 $\frac{1}{4}$	\$50.00 ☎

\*Also used to rack mount Combining Kits HP 1051A & 1052A shown above.

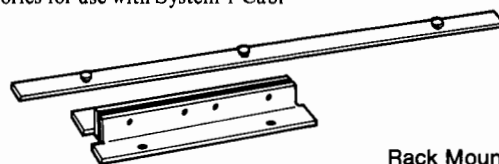

Rack Mounting Kits (HP 5060-8739 To 5060-8744)

HP 5040-6678

HP 5060-8764

HP 5060-8762

HP 5040-6680

### Rack Adapter Frames, HP 5060-8762, 5060-8764

These frames can be used to hold combinations of  $\frac{1}{3}$  and  $\frac{1}{2}$  module-width HP instruments. Each frame is furnished with mounting hardware and three dividers. Two models are available for different instrument heights. Adapter frames are for permanent or semi-permanent rack mounting. Where quick removal and reinstallation of instruments is desirable, the HP 1015A and HP 10152A should be used.

HP 5060-8762 is 178 mm (7 in.) high and accepts instruments heights of  $\frac{1}{4}$ H,  $\frac{1}{2}$ H, and 1H. HP 5060-8764 is 89 mm ( $3\frac{1}{2}$  in.) high and accepts instruments of  $\frac{1}{4}$ H and  $\frac{1}{2}$ H.

HP Part No.	Name	Price
5060-8762	Rack Adapter 178mm (7-in)	\$150.00 ☎
5060-8764	Rack Adapter 89mm (3 $\frac{1}{2}$ -in)	\$150.00 ☎
5040-6678	Extra Vertical Dividers for 5060-8764	\$28.00 ☎
5040-6680	Extra Vertical Dividers for 5060-8762	\$12.00 ☎

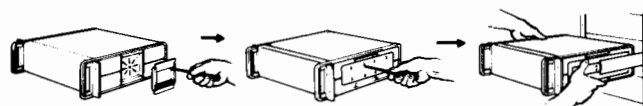

Remove Handles and Feet

Attach Adapter

Mount Slides

### Rack Mount Slide Kits and Cabinet Adapters

By removing the side handle of full width system 1 cabinets, rack mount slides can be attached for easy access to internal space. Both tilting and non-tilt are available, while max. load factor is 31.7 kg (70 lb). The cabinet adapter plate attaches to the handle recess then to the slide. Slide kits include four angle brackets which mount to rack rails with front-to-back nominal spacings of 24, 26 and 28-inches.

### Cabinet Adapters

HP Part No.	Name	Price
1490-0722	Adapter plate for 88.9mm H(3 $\frac{1}{2}$ in.) cabinets	\$135.00 ☎
1490-0721	Adapter plate for 133mm H(5 $\frac{1}{4}$ in.) and higher cabinets	\$260.00 ☎

☎ Fast-Ship product. See page 766

# CABINETS & CABINET ACCESSORIES

System 1 - Slide Kits, Fans, Joining Brackets, Cases

753

## Rack Mount Slide Kits, HP 1490-0713 to 1490-0720

HP Part Number <sup>1</sup>	Slide Type	Cabinet Depth	Extension Length	Price
1490-0713	fixed	All Sizes	482.6 (19) <sup>2</sup>	\$140.00 🚚
1490-0714	fixed	All Sizes	635.0 (25) <sup>3</sup>	\$160.00 🚚

1. Cabinet Adapters, below, must be added to slides
2. Slide's stationary mounting depth: 406.4 (16)
3. Slide's stationary mounting depth: 558.8 (22)

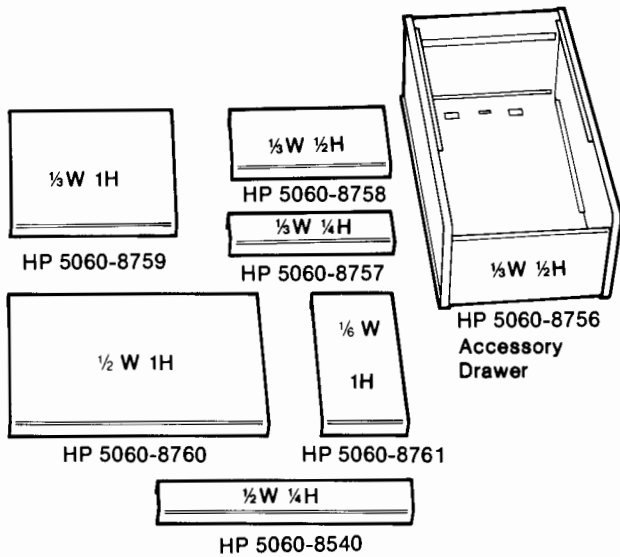
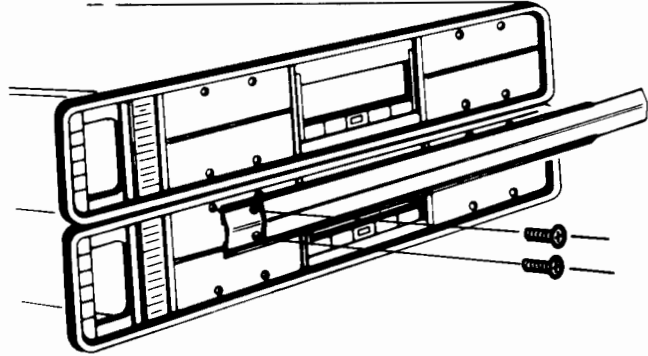

## Joining Bracket Kits, HP 5060-8541 to 5060-8545

These kits join HP System 1 instruments of the same width and length into easily handled single stacks. Each kit consists of two brackets, mounting hardware and trim. They are available to fit the three most common instrument depths:

HP Part Number	Price
5060-8541: 279 mm (11 in.) EIA panel depth	\$160.00 🚚
5060-8543: 406 mm (16 in.) EIA panel depth	\$160.00 🚚
5060-8545: 480 mm (19 in.) EIA panel depth	\$170.00 🚚

## Filler Panels, HP 5060-8540, 5060-8757 to 5060-8761

Filler panels can be used to close off any leftover space after instruments are mounted in combining cases (left) or adapter frames (below). Panels are available in a variety of widths and heights.

HP Part No.	Module Case Height x Width	Filler Panel Dimensions		Price
		Millimetres	Inches	
5060-8540	1/4 x 1/2	38 x 198	1 1/2 x 7 25/32	\$54.00 🚚
5060-8757	1/4 x 1/3	38 x 130	1 1/2 x 5 1/8	\$75.00 🚚
5060-8758	1/2 x 1/3	77 x 130	3 1/32 x 5 1/8	\$43.00 🚚
5060-8759	full x 1/3	155 x 130	6 3/32 x 5 1/8	\$43.00 🚚
5060-8760	full x 1/2	155 x 198	6 3/32 x 7 25/32	\$44.00 🚚
5060-8761	full x 1/6	155 x 63	6 3/32 x 2 31/64	\$70.00 🚚

🚚 Fast-Ship product. See page 766.

# CABINETS & CABINET ACCESSORIES

## EIA Racks

### HP 46298-Series

- Functional fit with HP instruments
- Same design as HP Design Plus work station furniture
- Quality construction

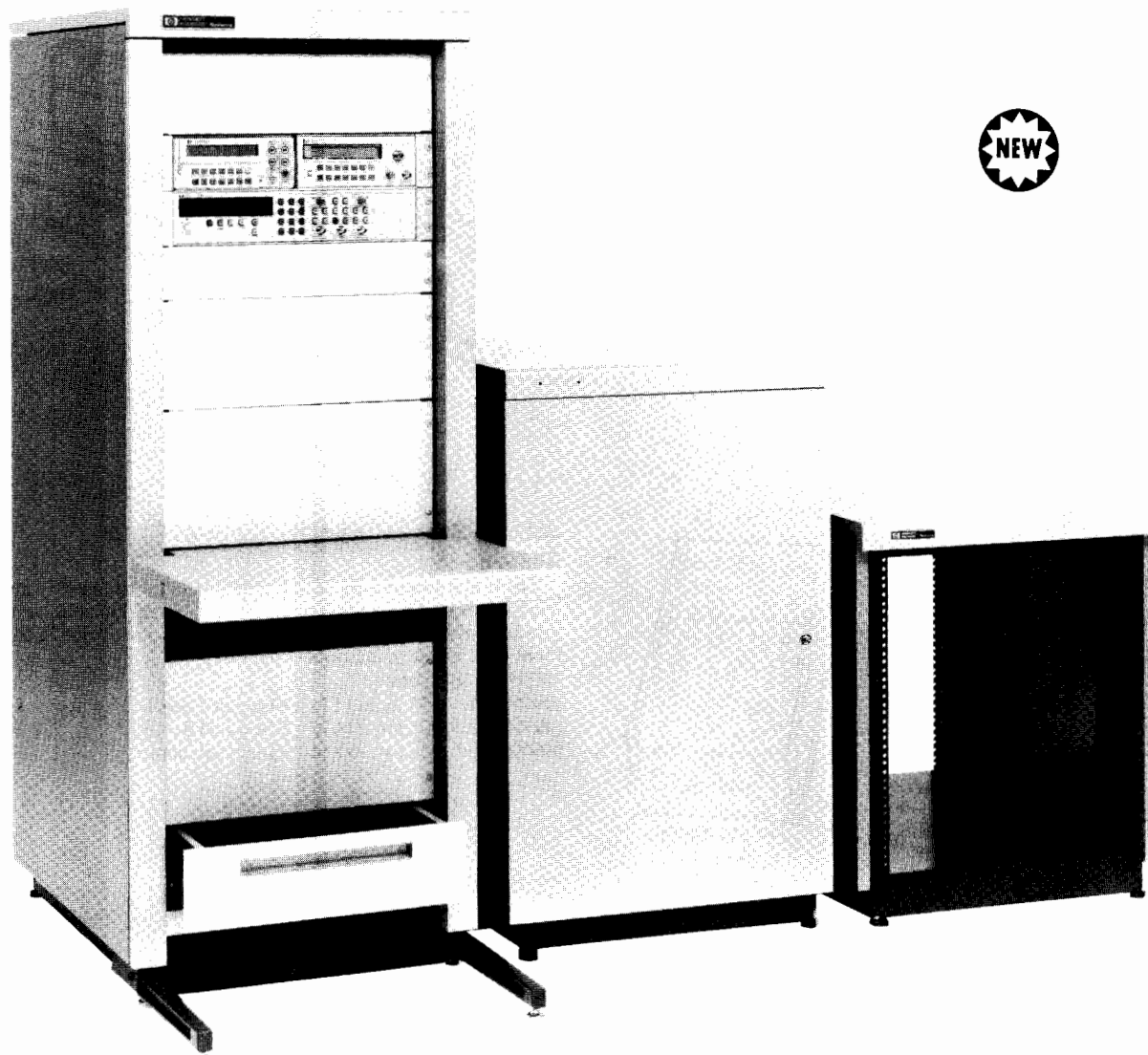

Modularity lets you select only the parts you really need: doors, anti-tip feet, a work surface or a convenient drawer for small system parts.

With the addition of these racks, Hewlett-Packard can now offer you a total system of test instruments, rack cabinets, computers and work stations. All these pieces are designed to be compatible — both in form and function.

These 19-inch commercial/industrial EIA rack cabinets easily accommodate HP test instruments and incorporate the same design elements as HP's Design Plus work station furniture (see page 734). You can create work places which are easy to install, look good and incorporate the latest in ergonomic features.

The rack system is modular. Choose from three heights: 1600mm (63.0"), 1000mm (39.4") or 720mm (28.4"). Then purchase doors, filler panels or other products only as you need them. You can select from blank front doors, ventilated rear doors, front caps, blank filler panels, a sliding drawer and anti-tip feet. We can even provide you with the proper mounting hardware.

The basic rack consists of the frame, two side panels and a top panel. The frame includes a base plate, the four corner struts, to which

the instruments are attached, and a top plate. Everything is manufactured from folded, welded steel. This all-steel, one-piece construction offers incredible strength compared to racks which are merely bolted together. The colors are selected to blend with old and new HP instrumentation. The HP custom paint matches perfectly the newer instrument colors (known as System II Plus).

The racks offer many additional features:

- Convenient lift hooks are included with all cabinets. Use them to lift the empty cabinet into place.
- If you have a large system you can mount instruments both from the front and the rear, since the EIA hole pattern appears on all four corner struts.
- The leveler pads are located at the extreme outer corners of the frame to provide the largest base possible for safety.
- Swivel casters mounted to the base let you roll the racks easily into position.

### Lockable doors

Blank front and louvered rear doors come in three different sizes for each of the rack heights. Both are lockable with a key, so that the instruments can be protected from unauthorized access. Even with the rear door closed, power to the system can still be furnished.

The rear door is fully ventilated for maximum convection cooling. However, some configurations will require additional ventilation from user supplied fan units.

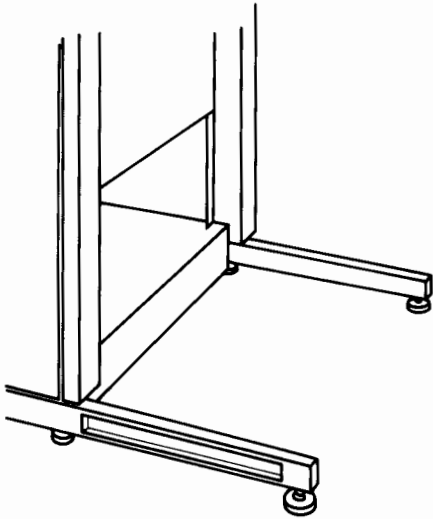

### Anti-tip foot kit

Each kit contains two feet with leveler pads. The cast steel feet can be mounted either to the front or the rear using existing holes. Bolting the feet to the frame is easy with a wrench and the hardware supplied.

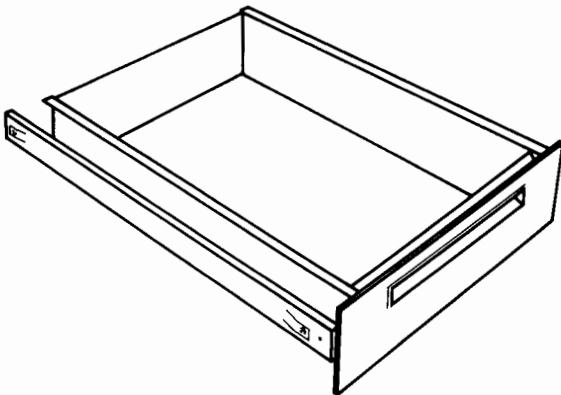

### Sliding drawer

Keep your instrument manuals or system software close to you in this convenient 5/4" high drawer.

Construction is folded, painted sheet metal and it glides easily out on a set of slides. A plastic bezel in the front recess protects your fingers.

### Front caps

The front caps visually "clean up" the front of the rack by covering the corner struts and the edge of the side panels. You will still have complete access to the instruments and the mounting ears.

The caps are made of folded, painted steel and only a wrench is necessary for mounting. Mounting hardware is included.

### Name plate and mounting hardware

If you wish, you can attach a Hewlett-Packard system nameplate in the existing indentation in the upper left corner of the racks. The plate features the HP logo, the words "Hewlett-Packard" and "System". These labels are furnished with each rack.

A kit of sheet metal nuts and 10-32 screws is all you need to complete the system. Each rack mount kit comes with hardware to mount the rack ears to the instruments. These screws and nuts mount the ears to the frame. There is enough in the kit to mount the maximum number of instruments in the tallest (1600mm) rack.

### Specifications

Exterior height: 720mm (28.4"), 1000mm (39.4"), or 1600mm (63.0")

Usable rack height: 553mm (21.8"), 833mm (32.8"), or 1433mm (56.4")

Exterior depth: 800mm (31.5")

Max. instrument depth: 710mm (28")

Exterior width: 600mm (23.6")

Net weights: 720mm: 51kg (113lb)

1000mm: 59kg (130lb)

1600mm: 75kg (166lb)

Hole spacing: EIA standard

Caster load weight: 180kg (400lb) each

### Ordering information

HP 46298A Rack, 720mm

HP 46298B Rack, 1000mm

HP 46298C Rack, 1600mm

HP 46298E Front door for 720mm rack

HP 46298F Front door for 1000mm rack

HP 46298G Front door for 1600mm rack

HP 46298H Rear door for 720mm rack

HP 46298J Rear door for 1000mm rack

HP 46298K Rear door for 1600mm rack

HP 40112A Front Cap Kit, 720mm

HP 40113A Front Cap Kit, 1000mm

HP 40115A Front Cap Kit, 1600mm

HP 40101A Filler panel, 1.75"

HP 40102A Filler panel, 3.50"

HP 40103A Filler panel, 5.25"

HP 40104A Filler panel, 7.00"

HP 40105A Filler panel, 8.75"

HP 40106A Filler panel, 10.50"

HP 46298M Drawer and slides

HP 46298N Work surface

HP 40100A Anti-tip foot kit

HP 46298R Mounting hardware

☛ Fast-Ship product — see page 766.

### Price

\$850 ☛

\$900 ☛

\$975 ☛

\$175 ☛

\$190 ☛

\$215 ☛

\$175 ☛

\$190 ☛

\$215 ☛

\$85 ☛

\$90 ☛

\$95 ☛

\$36 ☛

\$37 ☛

\$38 ☛

\$40 ☛

\$41 ☛

\$42 ☛

\$235 ☛

\$270 ☛

\$130 ☛

\$26.60 ☛

# CUSTOMER SUPPORT

## General Information

### Supporting Your Success

You're developing a system built on HP's equipment because it best meets your test, measurement, and computing needs. Hewlett-Packard wants you to be successful and we're committed to helping you achieve the best results from your system for years to come. We don't stop serving you once the sale is complete. Our flexible support solutions—in hardware, software, customer education, and consulting services—bring you many benefits. Our support services will:

- Shorten the period between purchase and effective use of an HP product.
- Deepen your understanding of your HP equipment and its capabilities.
- Customize hardware and software for application-specific requirements.
- Make available unique resources for maintenance and troubleshooting.

Measure the results in greater overall productivity and lower cost of ownership.

Maximizing the return from your equipment investment can be seen as a three-phase process of planning and design, implementation, and operation. Hewlett-Packard offers support services to ensure that you obtain maximum performance from your measurement system during each of these phases.

### Performance by Design

A thorough design will ensure that your test and measurement system performs to your expectations and meets your needs. Whether you're planning a single instrument

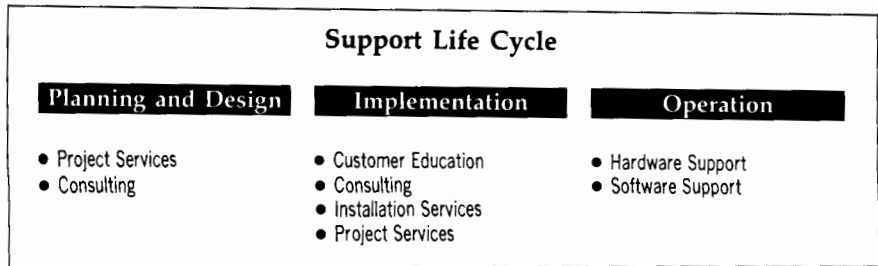

system or a complete factory, Hewlett-Packard can offer you technical assistance through Consulting Services or design the system for you through Project Services.

### Smooth Implementation Through Knowledge

A thorough understanding of your equipment's capabilities is essential to achieving maximum performance from your investment. That's why we back our products with education courses and materials to ensure that you learn the best way to apply our equipment to your environment.

We also offer installation services to ensure that your system is installed correctly and quickly.

### Continuous Operation Through Maintenance

To help you minimize equipment downtime, Hewlett-Packard maintains a world-

wide service organization staffed with trained engineers and technicians who are backed by factory designers and a large inventory of replacement parts. We supply repair and calibration services. We will focus the necessary resources to keep your equipment operating at peak performance.

With computers playing a larger role in today's measurement systems, software support plays an essential role in maintaining your system's performance. Hewlett-Packard keeps you up-to-date on the latest software improvements to ensure your system continues performing to its maximum potential.

### Support for Your Needs

The following pages provide more details on Hewlett-Packard's wide range of support services. Ask your local HP representative to help you select the services that best meet your needs in maximizing your measurement system's performance.

### Service Selection Guide

Services	Major Benefits	Best Fit
<b>Hardware Support</b> (pg. 757) <ul style="list-style-type: none"> <li>• Return-to-HP Services</li> <li>• On-site Services</li> <li>• W30: Two Additional Years Hardware Service</li> </ul>	<ul style="list-style-type: none"> <li>• Fast turnaround time</li> <li>• Cost savings</li> <li>• Dependable measurement accuracy</li> <li>• Peak instrument performance</li> </ul>	<ul style="list-style-type: none"> <li>• Most instruments, especially those in critical applications or frequently used</li> </ul>
<b>Customer Education</b> (pg. 760) <ul style="list-style-type: none"> <li>• Wide variety of courses covering latest HP products and technology</li> </ul>	<ul style="list-style-type: none"> <li>• Fast learning</li> <li>• Time and cost savings over learning independently</li> <li>• Up-to-date instruction</li> </ul>	<ul style="list-style-type: none"> <li>• Whenever new products or technology are introduced in your environment</li> </ul>
<b>Software Support</b> (pg. 763) <ul style="list-style-type: none"> <li>• Software Materials Subscription</li> <li>• Software Notification Service</li> <li>• Response Center Support</li> <li>• Account Management Support</li> </ul>	<ul style="list-style-type: none"> <li>• New software releases</li> <li>• Up-to-date software information</li> <li>• Fast, accurate support</li> <li>• Personalized support</li> </ul>	<ul style="list-style-type: none"> <li>• Instruments with software</li> <li>• Instrument controllers</li> </ul>
<b>Consulting Services</b> (pg. 764) <ul style="list-style-type: none"> <li>• HP-ASSIST</li> <li>• Installation Services</li> <li>• Project Services</li> <li>• Time and Materials Consulting</li> </ul>	<ul style="list-style-type: none"> <li>• Expert implementation assistance</li> <li>• Quick startup of instrument systems</li> <li>• <i>Increased productivity</i></li> </ul>	<ul style="list-style-type: none"> <li>• Fast, efficient implementation of instrument system required</li> </ul>





### Return-to-HP Hardware Support

We are committed to maintaining your HP equipment in peak condition so that it continues to work for you in years to come. Our wide range of quality support is highly respected by industry experts. If you want to learn more about how we can keep your hardware performing now and in the future, take a look at our Customer Service Center offerings.

### Precise Calibration, Comprehensive Repair

Our maintenance and repair technology comes right out of the original design centers for our products. We know all the inner workings and when things do go wrong we correct them quickly and cost-effectively.

### Expert Technicians

Our technicians have an average of 14 years experience in servicing HP products. They receive factory training on all new products and technologies regularly, and are backed up by well-supplied, highly-automated service centers.

### Extensive Automation

HP Customer Service Centers rely on automated processes to calibrate instruments and diagnose problems. Our investment in automation enhances the quality of repair and repeatability of calibration. This efficiency results in savings for you.

### High In-stock Inventory

Each HP Customer Service Center manages its spare parts inventory so that over 85 percent of required parts are immediately available. We can usually get any other required part very quickly.



### Efficient Problem Escalation Management

Most of the time hardware problems can be solved quickly. In the few cases that require special attention, we will call upon our worldwide technical and managerial network to rapidly develop a permanent solution.

### Minimum Downtime

We know turnaround time is important to you. No one wants a production line disabled because an instrument is out for service. HP strives to reduce downtime—we work quickly and accurately, enabling you to get back to business promptly. We're even willing to specify our turnaround time. Here are our standards:

### Five-day Service for Instruments

We will repair or calibrate any HP instrument covered by an HP Service Agreement in most parts of the world within five working days of receiving it.

### Three-day Service for Workstations

We will repair any HP workstation covered by a Repair Agreement usually within three working days of receiving it.

For more information, ask your HP Customer Service Center for additional details.

### An Outstanding Array of Services

Whatever your needs we aim to be as flexible as possible in meeting them. We offer repair and calibration, to commercial or military requirements, on a per-incident basis and under each of our agreement services:

- Repair Agreement
- Calibration Agreement
- Full-Service Agreement

In summary, HP's service programs offer the benefits of factory support, highly trained technicians, automated repair and calibration, problem escalation management, engineering upgrades, and fast turnaround time. We're proud of our capabilities and customer service record.

# CUSTOMER SUPPORT

## Hardware Support (cont'd)

### A Variety of Service Agreements

#### Comprehensive and Economical

Our services maximize the performance of your HP equipment. You can choose an HP support agreement that best fits your application and type of equipment. Service Agreements are for you if:

- You want to know in advance exactly what you'll be paying for an entire year of support.
- You want your equipment calibrated according to factory-recommended procedures and timetables.
- You want the security of continuous coverage by experienced HP personnel.

Read on about HP's Service Agreements and consider the ways they can keep your equipment at peak performance.

#### Repair Agreement

Our Repair Agreement covers equipment failures. Similar to an extension of your product's warranty, it is significantly more economical than equivalent per-incident repairs on instruments and workstations. Products covered under the Agreement are sent to the nearest HP Customer Service Center, where they are repaired within the timespan stated in the Agreement, generally three to five days. Return freight, parts, and labor are included. [Please note: failures resulting from abuse or damage are not covered by Agreements.]

#### Calibration Agreement

Periodic calibrations at factory-recommended intervals lead to confidence in measurements. The factory-suggested timetable of our Cal Agreement results in a history of more accurate measurements. In addition, the agreement is much more economical than purchasing per-incident calibration. If you change instrument use or operating conditions often, we can provide calibrations at an interval you request. Return freight is included, of course.

#### Full Service Agreement

If you want both repair and scheduled calibration, we have combined them in our Full Service Agreement. This agreement is 3 to 9 percent less expensive than separate Repair and Cal Agreements, and about 15 percent lower than equivalent per-incident service.

#### Military Standard Agreements

Military Standard Calibration and Full Service Agreements are also available for approximately 1,300 HP instrument products in the United States. Other government certification programs are available in other parts of the world.

#### Volume Service Agreement Discounts

You may be eligible for a volume Service Agreement discount. Call your local HP Customer Service Center for details.

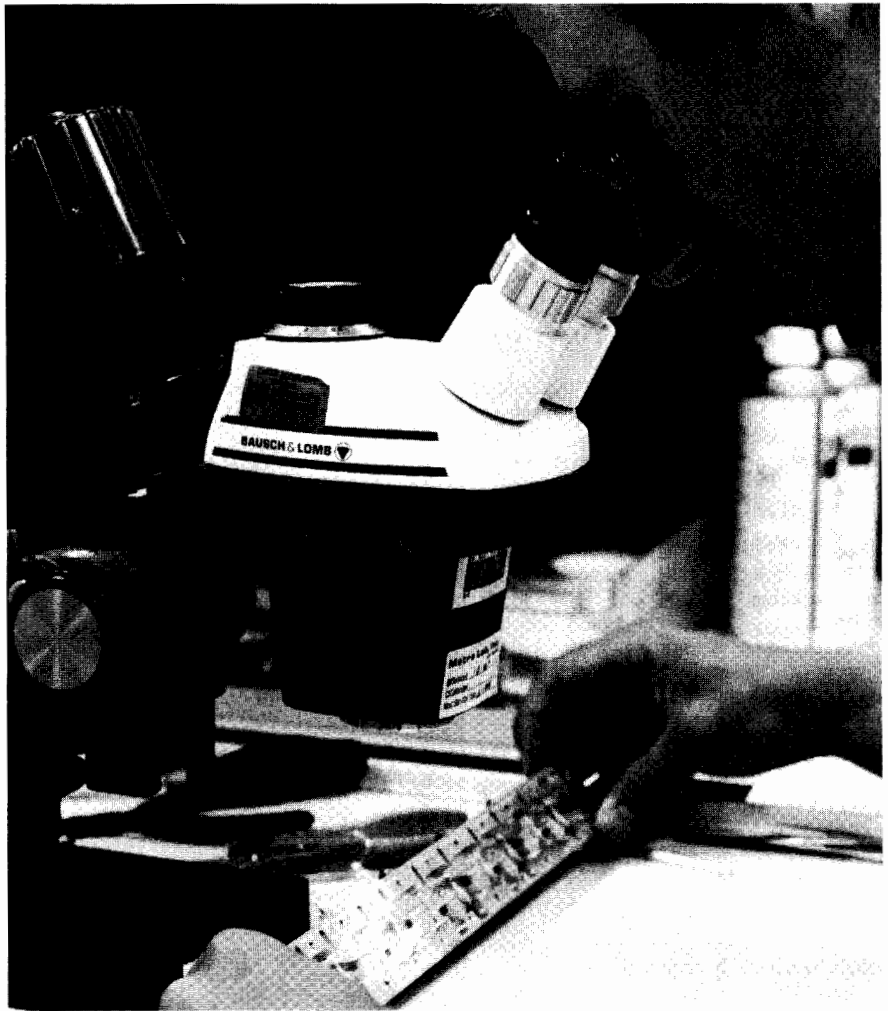

Service Agreement Selection Guide

	Features	Major Benefits	Best Fit
<b>Repair Agreement</b>	<ul style="list-style-type: none"> <li>• Complete repair coverage</li> <li>• Fixed annual price</li> <li>• No parts exclusions</li> <li>• Preventive maintenance and engineering upgrades when appropriate</li> <li>• Return surface shipment included</li> <li>• Priority service, 5 days or less</li> </ul>	<ul style="list-style-type: none"> <li>• Single, budgetable expense</li> <li>• Typically 10% lower price than equivalent per-incident service</li> <li>• Elimination of quotation approval delays</li> </ul>	<ul style="list-style-type: none"> <li>• Instruments not requiring calibration</li> <li>• Frequently used products</li> <li>• Critical applications</li> <li>• Workstations requiring cost-effective coverage</li> </ul>
<b>Calibration Agreement</b>	<ul style="list-style-type: none"> <li>• Periodic calibration at HP-recommended intervals</li> <li>• Fixed annual price</li> <li>• NBS traceability</li> <li>• Military standard option</li> <li>• Return surface shipment included</li> <li>• Customer-specified cal cycle for an adjusted price</li> <li>• Priority service, 5 days or less</li> </ul>	<ul style="list-style-type: none"> <li>• Dependable measurement accuracy</li> <li>• Typically 15% lower price than annual Standard Cal</li> </ul>	<ul style="list-style-type: none"> <li>• Accuracy critical applications</li> <li>• Traceability required</li> <li>• All instruments requiring regular calibration</li> <li>• Military standard compliance required</li> </ul>
<b>Full Service Agreement</b>	<ul style="list-style-type: none"> <li>• Features of Repair and Cal Agreement combined</li> <li>• Military standard option</li> <li>• Priority service, 5 days or less</li> </ul>	<ul style="list-style-type: none"> <li>• Peak instrument performance</li> <li>• Typically 20% lower price than equivalent per-incident service</li> <li>• 3% to 9% lower price than other agreements combined</li> <li>• Lower self-support parts inventory and training costs</li> <li>• Less demand on self-support personnel</li> </ul>	<ul style="list-style-type: none"> <li>• Most instruments</li> <li>• Critical applications</li> </ul>

### **On-site Hardware Support Basic System Maintenance Service**

This service agreement provides next-day on-site service coverage from 8 am to 5 pm Monday through Friday (excluding HP holidays) for customers within 100 miles of a support responsible office. Service includes an account-assigned customer engineer (CE) who becomes familiar with your environment and takes personal responsibility for managing your measurement system's maintenance program.

Also, your CE will perform preventive maintenance on a regular basis, scheduled in advance, to maintain your system at its optimal performance specifications.

Desktop computers configured with measurement systems gain the account management and system support essential for those configurations.

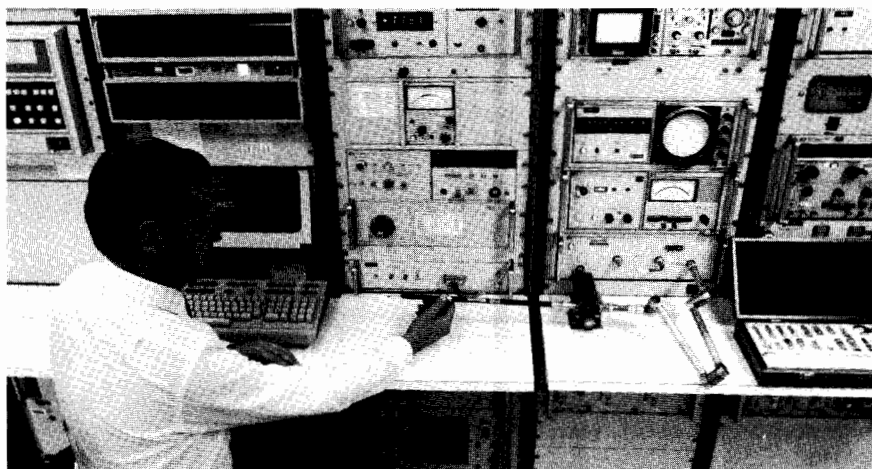

### **Standard System Maintenance Service**

This agreement provides coverage from 8 am to 9 pm, Monday through Friday (excluding HP holidays). This coverage allows all scheduled maintenance services to be performed after normal working hours. Customers within 100 miles of an HP Support Responsible Office will receive an on-site visit within four hours. Extended coverage options can provide service up to seven days per week, 24 hours per day.

### **Measurement System Calibration Service**

For HP instrument products configured into measurement systems, calibration service can be added to the Standard or Basic System Maintenance agreements. Some products can be calibrated at your site, while others will need to be returned to an HP Customer Service by your CE. Customer Service Centers will calibrate your equipment so it is traceable to the U.S. National Bureau of Standards (or other international standards organization, where applicable).

### **System Installation Services**

When you purchase an HP computer or measurement system, support services begin even before your system is installed. A customer engineer routinely provides site planning, site environmental survey, and installation services.

### **Option W30: Two Years Additional Hardware Service**

Economically priced, this service is easy to purchase along with your hardware. Similar to a warranty extension, it keeps your investment in good working condition three years after delivery. Services include diagnosis and correction of hardware problems as well as services to enhance and extend your product's useful life, including cleaning, inspecting, testing, and installation of engineering improvement modifications.

### **Other Services**

In addition, we will make our best effort to repair or calibrate any HP product, whatever its age, even if the product has passed through its support life. Charges will be made on a Time and Materials basis.



# CUSTOMER SUPPORT

## Customer Education

### Customer Education

We are committed to offering training that will permit you to get the best possible use of HP equipment. We recognize that both initial instruction and ongoing education contribute to your success: that's why we offer courses in operation, applications, and software and hardware maintenance for HP instrument and computer products.

### Quality Training Our Instructors Understand Your Industry

They speak the language. We make sure our instructors have a deep understanding of the subject and can effectively explain—in clear, concise terms—everything you need to know, from specialized test techniques to the physics behind the measurements.

Backing them up are HP class-development teams. Product specialists, industry experts, curriculum engineers, course writers, and instructors develop training materials and design courses with the goal of maximizing your learning experience.



### Courses That Work For You

Our courses are consistently updated to keep pace with evolving technology and industry changes. HP designs instructional materials—including student training manuals and lab and instructor materials—to serve as long-term references. A course can't cover everything, but it can help guide your thinking on the subject matter. Our texts will help you keep in focus long after the class has ended.

### Limited Class Sizes

Classes are limited to six to ten students. We believe small classes encourage closer interaction with the teacher and other students, thus permitting them to share learning experiences and applications expertise.



### It's Not All Books

Hands-on training is important to your success. That's why we provide lab equipment in our classes. Each course has lab time as a key training benefit.

### The Payback

Our experience shows that you'll learn faster with HP education courses. The benefits are twofold: the equipment can be used sooner and the time you would have spent on independent learning can be used for other opportunities.

### Worldwide Training

#### Worldwide Training Center Network

HP has training centers throughout the world, with classes in continuous progress. Training schedules are published throughout the year.

#### On-site Training

All HP courses can be scheduled and taught at your site. This option may prove more attractive to you, bringing the advantages of training in a familiar environment with your own equipment.

#### Off-schedule Training

Additional HP classroom courses can be arranged beyond those published in the local training schedule. These classes can accommodate your emerging training needs.

## Hewlett-Packard Customer Education Locations

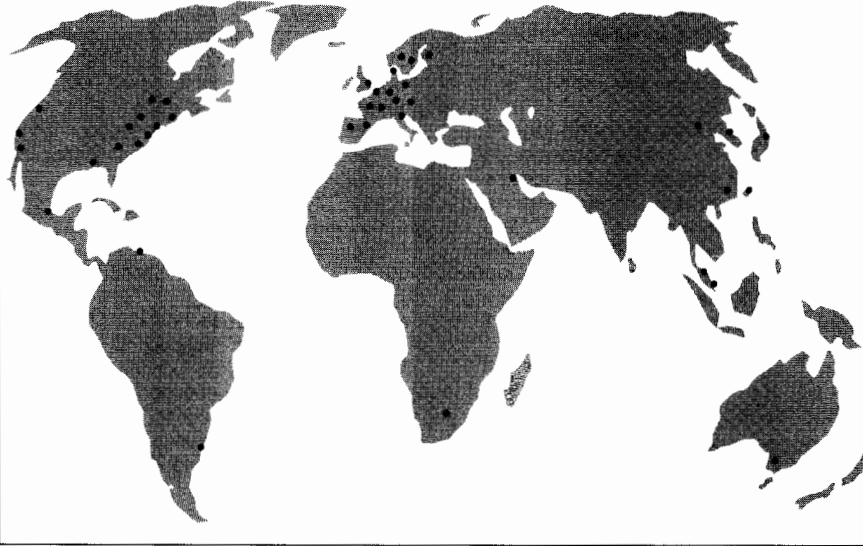

- Argentina -Buenos Aires
- Australia -Melbourne  
Sydney
- Austria -Vienna
- Belgium -Brussels
- Canada -Mississauga  
Montreal
- China -Beijing
- Denmark -Birkerød
- Finland -Espoo
- France -Ecully
- France -Evry  
Villepinte
- Germany -Bad Homburg  
Sindelfingen
- Hong Kong -Hong Kong
- Italy -Cernusco
- Japan -Tokyo
- Korea -Seoul
- Malaysia -Kuala Lumpur
- Mexico -Xochimilco
- Netherlands -Amstelveen
- Norway -Osterås
- Saudi Arabia -Riyadh
- Singapore -Singapore
- Spain -Barcelona  
Madrid
- South Africa -Sandton
- Sweden -Spanga
- Switzerland -Geneva  
Winden
- Taiwan -Taipei
- United Kingdom -Uxbridge
- United States -Atlanta  
Boston  
Chicago  
Dallas  
Detroit  
Los Angeles  
New York  
San Jose  
Seattle  
Washington, DC
- Venezuela -Caracas

### Customized Classes

We can meet special training needs by developing custom training classes. These changes may include modification of class materials, development of special labs, integration of new sections in the course, and even the development of entirely new classes.

### Specialized Training Materials

HP education is typically based on classroom training, led by professional instructors with solid engineering experience. Other HP training formats include computer-based training, videotape sessions, satellite-broadcast instructions, and self-paced training modules.



## Curriculum

### Instrument Control and Data Acquisition

HP 51409A	1 day	HP-IB Theory
HP 50011C	5 days	HP-IB Instrument Control Using 200/300 BASIC
HP 3852A+24D	4 days	Data Acquisition Training
HP 51412A	1 day	HP-IB with MS-DOS™

### Programming Languages

HP 98501B	5 days	Introduction to Workstation BASIC
HP 98510D	5 days	Series 200/300 BASIC Operating and Advanced Programming
HP 31112A	5 days	Introduction to Pascal
HP 98511C	4 days	Series 200/300 Pascal Operating and Advanced Programming
HP 50697A	5 Days	Programming in FORTRAN 77
HP 35130B	5 Days	Programming in C

### Programming Tools

HP 05096A	3 days	SA/SD for Test & Measurement Software
HP 51473A	2 days	Architecture for Test & Measurement Software
HP 34800A+24D	3 days	Developing Test Plans Using FTM/300
HP 50959A	1 day	Using SRM from BASIC and Pascal

### General Instrumentation

HP 1631D+24D	2 days	Logic Analysis Measurement Techniques
HP 18347A	1 day	HP 4951C Protocol Analyzer Users Course
HP 35629A	3 days	HP 3562A Users Course
HP 6944S+24D	3 days	HP 6944S Multiprogrammer System Users Course
HP 55280A+24A	1 day	Basic Laser Measurement System Course
HP 55283A+24A	1 day	Advanced Laser Measurement System Course
HP 37050S+24A	5 days	HP 37050S User & System Manager Course
HP 4062C+24D	3 days	HP 4062C Operating & Programming Course

### RF and Microwave

HP 11776A+24D	2 days	HP 11776A Waveform Generation Language Software Users Course
HP 85668A	4 days	Spectrum Analyzer Operation
HP 8753A+24A	1 day	HP 8753A RF Network Analyzer Course
HP 8510B+24D	3 days	Basic Measurements Using HP 8510 Network Analyzer System
HP 85150A+24D	2 days	Intro to HP Microwave Design System
HP 3048A+24A	2 days	HP 3048A Phase Noise Measurement

### HP-UX

HP 51434A	5 days	HP-UX for Programmers
HP 51435A	5 days	Advanced HP-UX Tools
HP 51432A	5 days	HP-UX Fundamentals for General Users
HP 51433A	5 days	Shell Programming for General Users
HP 51439A	1 day	Advanced Editing with VI
HP 51438X	2 days	SSCS and make
HP 51489A	2 days	HP-UX Basics for Application Users



# CUSTOMER SUPPORT

## Customer Education (cont'd)

### System Administration

HP 22861A	2 days	Arpa/Berkeley Services for Series 300
HP 51436A	5 days	HP-UX System Administration for Series 300
HP 35073A	3 days	Series 200 System Administration
HP 35129B	3 days	Series 500 System Administration
HP 51482A	5 days	Series 800 System Administration

### Board Test Systems

HP 3065C+24D	10 days	HP 3065 Board Test System User Training
HP 44531A	10 days	HP 3060A/61A/62A Users
HP 44850A	5 days	HP 3065 Advanced User
HP 44851A	10 days	HP 3065AT Users Course

### Logic Development

HP 64100A+24D	2 days	HP 64000 Logic Development Concepts and Measurements
HP 64120T	2 days	HP DesignCenter 64000-UX Users Course
HP 64121T	1 day	HP-UX for HP 64000-UX Users
HP 64310A+24D	1 day	Software Performance Analysis Training
HP 64600S+24D	1 day	Timing/Hardware Analysis Training
HP 64620S+24D	1 day	State/Software Analysis Training
HP 64810A+24D	2 days	Pascal/64000 on 8080/8085 Course
HP 64812A+24D	2 days	HP 64000/Pascal on Z80 Microprocessors
HP 64814+24D	2 days	Pascal on 8086/8088 Microprocessors
HP 64815A+24F	2 days	HP 64000/Pascal on 68000 Microprocessors
HP 64817A+24F	3 days	HP 64000 System HOST Pascal Programming

### Design Engineering

HP 74298A	2 days	Electronic Design System Overview
HP 74298B	3 days	Electronic Design Capture, Verification
HP 74298C	3 days	Electronic Design Modeling Course
HP 74298D	2 days	Electronic Design System Administration
HP 74300A	3 days	Introduction to HP EGS
HP 74301A	2 days	PCB Design with HP EGS
HP 74302A	3 days	Customizing HP EGS
HP 74490A	5 days	PCB Design with PCDS
HP 74493A	3 days	Building Parts with PCDS
HP 74494A	2 days	PCDS System Management
HP 74836T	5 days	HP DesignCenter ME 30 Users Course
HP 9836A+24D	3 days	HP DesignCenter ME 5 Users Course

### Schedules and Literature

Training schedules are published quarterly (for regularly scheduled classes). Contact your HP Sales Office or HP Education Center for a copy of local training schedules.

Your sales office can also provide the following training literature:

**Course Data Sheets.** Every HP class has a data sheet which describes the course in detail. Included are key topics, target audience, course outline, prerequisites, and ordering information.

**Training Schedules.** HP training schedules are published throughout the world and list class schedules for each education center, by country.

**Education Planning Guide (EPG).** The EPG presents information on HP's entire course range, including curriculum flow diagrams, course objectives, outlines, and course content. It is your tool for planning the best possible education for yourself and other members of your organization.

**Curriculum Path Brochures.** These brochures show the curriculum layout and give class descriptions for the following markets:

- Test & Measurement
- Engineering Systems
- HP-UX
- Technical Computing
- Personal Computers

**Maximize Your Training Dollars.** This brochure highlights the benefits of HP's customer education in terms of accelerated learning, productivity gains, and time and cost savings. A worksheet is included to help you quantify the payback available to your organization from HP training.

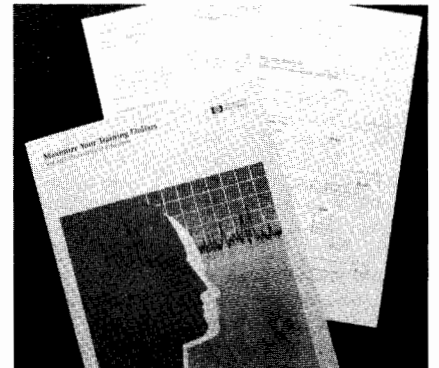
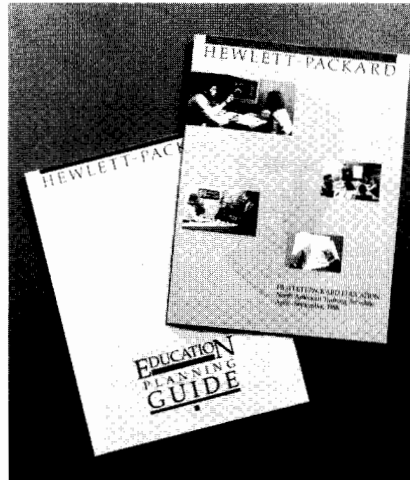

### How to Order

Call your local sales office or contact the nearest HP Education Center to register for any HP class.

**HP Education . . .  
Engineered for Your Success**



### Software Support

Increasing sophistication of instrumentation has led many designers to implement new features in software. At HP, this software undergoes ongoing development, leading not only to the resolution of specific anomalies, but ultimately to improvements in overall performance.

Software is a key part of your investment and forms an increasingly significant portion of the initial purchase price. Keeping your software up-to-date ensures maximum utility from your instruments and test systems. Using the latest HP software will ensure you don't lose time and money resolving unnecessary applications difficulties.

### Software Materials Subscription (SMS)

Our Software Materials Subscription (SMS) program helps you get as much out of our products as we put in them. Software Materials Subscription is for you if:

- You want your software kept up-to-date with the latest performance improvements.
- You want to remain current on possible software anomalies and their solutions.
- You want to receive the latest updates automatically.

#### Automatic Updates Direct to User

SMS automatically provides you with the latest software and documentation updates so you can take advantage of the newest features. Updates are delivered directly to the person you name, not just your company's address. This allows you to maintain your instrumentation investment and provides you with the opportunity to achieve ever-increasing standards of equipment performance.

#### Software Improvements

Each new update to your software automatically includes any improvements added by HP. This means better measurement methods where it counts: accuracy, resolution, and speed. In some cases additional features and enhancements may be added to improve the versatility of your software. SMS brings them all to you, at no additional cost.

#### Problems? We May Have Already Solved Them

As specific discrepancies in HP software and documentation are resolved, we include them in new releases of the software. You'll also receive a status report on resolved problems, temporary fixes, and work-around procedures for all known software difficulties. If you come across a software problem this information can serve as a quick reference to discover whether a solution already exists. This way you don't waste time on a problem that's already been solved.

#### Easy to Budget For

Because SMS is purchased on a contractual basis, you can plan your software budget a year in advance. Your costs are known up front and fixed for the contract period.

#### Available for Many Software-Based Instrumentation Products

Here are some of the popular instrument products for which HP offers Software Materials Subscription:

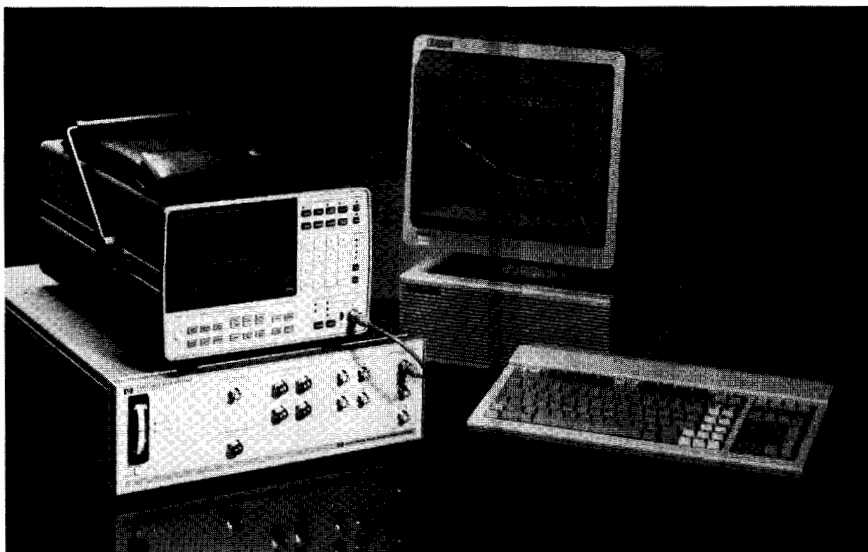

#### • Microwave/Communication

- 85810A Microwave Design System
- 3048A Phase Noise Measurement System
- 11805A Transceiver Test System

#### • Metrology

- 11806B Attenuator Test System
- 11808A Signal Generator Test System

#### • General Instrumentation

- 5180T Waveform Recorder
- 5183A Waveform Recorder
- Transistor Characterization (TECAP)
- 11776A Waveform Generation Language
- 35630A VISTA Signal Processing
- 35680A Instrument-BASIC

#### • Telecommunications/ Datacommunications

- 4972A Protocol Analyzer
- 37011A Telecom System Software

#### • Computer-Aided Test/Data Acquisition

- 34800A Functional Test Manager
- 44458A DAC Manager
- 3852A DAC Unit
- 3235A Switch/Test Unit
- 4062B/C Parametric Test System
- 16269A Test Management Shell/ TekBase

Your local HP systems engineer will be happy to check on SMS availability for your specific instrument software.

In summary, here's what you get by buying SMS:

**New Software Releases.** You automatically receive all software releases for your supported software as soon as they become available, and all information necessary to ensure a smooth software transition.

**Reference Manual Updates.** SMS guarantees that your documentation is as up-to-date as your software, including all manual updates and revisions.

**Software Status Bulletin.** The *Software Status Bulletin* (SSB) contains information on all reported discrepancies in HP software and documentation. Since it also includes temporary corrections or workarounds, it provides you with a convenient resource to check if you have a question or problem with HP software or manuals. One copy will be sent to you periodically.

#### Software Notification Service

If you are unable to take advantage of the benefits of SMS, but want to stay current on changes to HP software, then Software Notification Service (SNS) is for you. SNS provides information about the changes to HP software through the Software Status Bulletin, without providing updated software or documentation. Thus SNS subscribers can make informed decisions about updating their software. SNS can also be used to obtain additional copies of the Software Status Bulletin for other members of your organization.

#### Instrument Controller Support

Your instrument's software is updated over time. The same is true for your controller's operating system and its software for other applications. Instrument software releases must conform to these changes to stay compatible with the current version of the controller's operating system. They may not operate properly on an older version. That's why it's wise to stay current on your controller's software in addition to your instrument's software.

Our most comprehensive service for controller support, **Account Management Support**, provides you with the personalized expertise of an account-assigned systems engineer and fast response via telephone access to Hewlett-Packard's **Response Center**. HP's Response Center is staffed with technical experts on individual software products. They will provide fast, accurate answers to questions on product usage, and help resolve problems you may encounter.

Access to the Response Center is also available as a separate level of support. With Account Management Support or with Response Center Support, you'll also receive all the benefits of Software Materials Subscription. Similar programs are available for system products such as Design Automation (CAE/CAD), Board Test Systems, and Microprocessor Development Systems. Your local HP systems engineer can suggest the proper support level to best meet your specific needs.

New support services are in development to meet the unique needs of test-and-measurement customers. Your local HP field engineer and systems engineer will help you select the best program to improve the utility of your HP software and the effectiveness of the people who use it.

# CUSTOMER SUPPORT

## Consulting Services

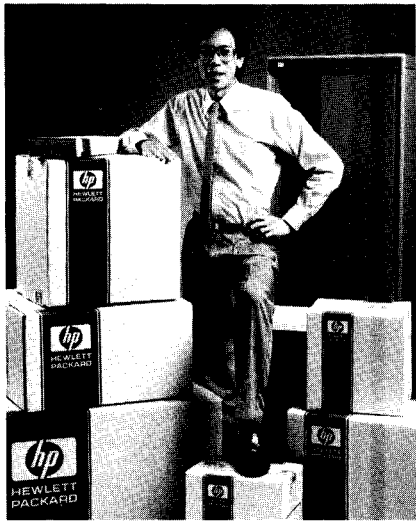

### Consulting Services

As measurements and technology have become more complex, HP's equipment has become more sophisticated. Now that you've selected the best hardware that money can buy, let HP help you put it to work. Our wide range of consulting services helps you fully take advantage of your equipment's capabilities. We help you quickly advance from installation to optimal system use. Whether you need a few hours of guidance from an experienced consultant or a complete custom plan, our Application Engineering Organization and Project Centers are ready to help, through the following services.

### Installation Services

HP's Installation Services, available for selected products, allow you to concentrate on your new system's applications, not the process of installation. We'll set up your HP 9000 hardware and ensure that your operating system and application software are up and ready to run.

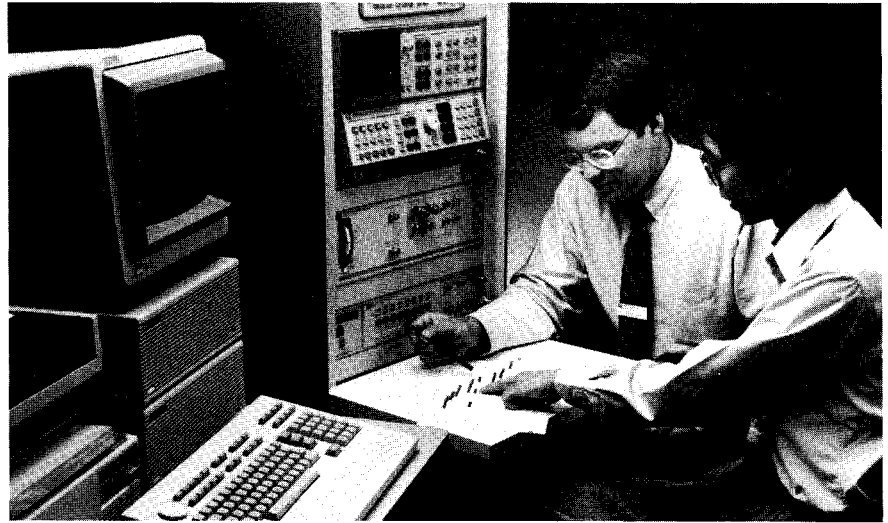

### Installation Services Products

HP 98595A+42A	HP-UX Application Execution Environment Installation
HP 98597B+42A	HP-UX Programming Environment Installation
HP 74210A+42A	HP Electronic Design System Installation
HP 74400A+42A	HP Printed Circuit Design System Installation
HP 64801S+42A	HP 64000-UX Microprocessor Development Environment Installation
HP 64710S+42A	HP Teamwork Products Installation
HP 98366A+42A	HP ME-5, 10, & 30 CAD System Installation
HP 35630A+42A	HP Signal Processing System Installation

HP 85150A+42A	85150A Microwave Design System Installation Service
HP 51414A	Additional Time and Materials Consulting

### HP Project Center Services

When your requirements are unique, investigate custom solutions from HP's Project Centers. Backed by the full resources of Hewlett-Packard, Project Center teams deliver on-time, on-budget solutions to your specifications. Look to our experts to save the time, expense, and worry of devising custom solutions yourself.

Hewlett-Packard Project Centers have a proven track record in providing cost-effective, reliable, and supportable solutions. We use structured methodologies for project analysis, design, development, and management.

### Technical Expertise

Project Center expertise in test automation results from extensive experience in test-system analysis and design. Project Center engineers are also adept in the design of other applications, including data acquisition and control, in-circuit and functional circuit testing, semiconductor testing, and microwave/RF testing.

HP Project Centers integrate the broad range of HP products, ranging from schematic capture and simulation to manufacturing test. With Project Services, Hewlett-Packard offers you a one-vendor solution backed by experience and quality.

### General Consulting Problem Solving

Sometimes a few hours of time with an expert can help you overcome what seems to be an insurmountable roadblock. Consulting can be used to help you develop, customize, or optimize your instrument system. On-site consulting is available on an hourly, weekly, and off-hours basis. Ask for HP 51414A.

## Consulting Services Compared

When you need:	Ask for:	Applications:	Features:	Benefits:
Installation of hardware, software, or operating system	Installation Services	HP 9000 UX & applications	Customized operating system, system verification and review	Quick startup
Implementation assistance for HP's computer-aided applications	HP-ASSIST	ME-CAD, quality management, manufacturing	Active planning, tools, consulting, training, structured process	Quick startup, efficient use of system, less risk
Additional resources, custom coding, performance improvement, general help	Time and Materials Consulting	All	Flexible uses, experienced and trained resources	Quick access to expertise, efficient use of system
Integrated custom solutions, project management, third-party management, custom software development, functional specs, requirements definition	Project Services	Computer-aided test, factory automation, design systems integration	HP quality and partnership, custom solutions, proven performance, single-vendor solution, added expert resources	Specific needs reliably met, time and cost savings, productivity increase

### HP-ASSIST

Our years of proven success in system implementation are packaged in HP-ASSIST, a structured consulting framework. This distillation of wisdom gained from implementing hundreds of systems becomes available to you in the form of consulting, tools, and training.

### Teamwork Spells Success

Your people bring their knowledge of your business; HP applications engineers bring specific expertise and years of implementation experience. Jointly we plan ahead, using HP-ASSIST's checklists and recommended activity guidelines to cover analysis, training, and final implementation. Taken together these ensure a smooth transition. If you are looking for an efficient, cost-effective startup, one backed by Hewlett-Packard's consulting resources, then the HP-ASSIST implementation service is for you.

### HP-ASSIST Products

HP 98365A+60A	ME-5/10 ASSIST Base Unit (1st workstation)
HP 98365A+60B	ME-5/10 ASSIST Two Additional Workstations
HP 98365A+60C	ME-ASSIST Network
HP 98365A+60D	ME-ASSIST Add to Network
HP 98365A+65Z	ME-5/10 ASSIST Additional Service Units
HP 74836A+60A	ME-30 ASSIST Base Unit (1st workstation)
HP 74836A+60B	ME-30 ASSIST Two Additional Workstations
HP 74836A+60C	SRX-ASSIST
HP 74836A+65Z	ME-30 ASSIST Additional Service Units
HP 44672A+60A	HP Q-STATS II/HP PR PLUS ASSIST
HP 44672A+65Z	HP Q-STATS II ASSIST Additional Service Units



### How to Order

Your HP Sales Representative can help you select a combination of support services to help you gain maximum use from your new HP system in the minimum time possible. Ask your local HP Sales Representative for more details.

# CUSTOMER SUPPORT

## Fast-Ship Service

- Convenient catalog shopping
- Computer supplies/accessories
- Test & measurement accessories (U.S. only)
- Quick, easy telephone ordering
- Fast shipment

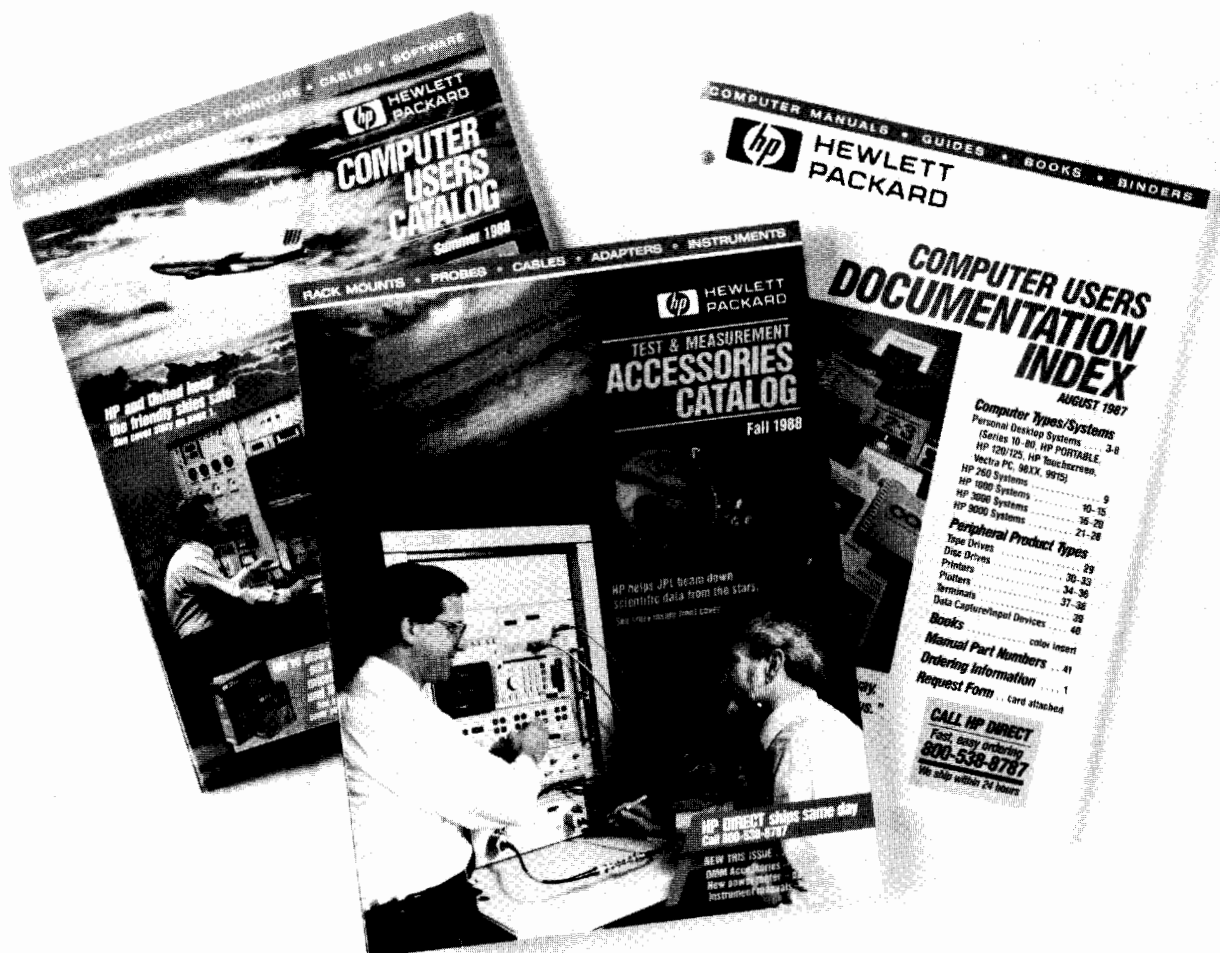

### What Is Fast Ship Service?

**Fast-Ship Service** is the quick way for you to choose from thousands of HP products, order them by phone and receive expedited delivery. Three catalogs offer an array of supplies and accessories, add-on peripheral devices and test instruments.

Now, with **Fast-Ship Service**, you can call **HP DIRECT** distribution centers (see opposite page) and receive fast shipment from our complete stock of supplies, accessories and add-on products.

### Computer Users Catalog (Worldwide)

This biannual publication provides a fast, easy way for HP customers to shop for nearly 2,000, supplies, accessories and add-on products. These products are HP manufactured, tested or approved to operate at maximum efficiency with HP equipment. Detailed descriptions, charts, full-color photographs and equipment guides provide all the information necessary to select the best products for your application.

Information is easily accessible, with new products grouped together in front and four convenient indexes for easy referencing.

#### To Get A Catalog

In the U.S.: Call 800-538-8787 or call your local HP Sales Office and request publication #5953-2450D.

Outside the U.S.: In the following countries, call the listed phone number (see below) and request the appropriate publication:

- U.K. 5953-2450UK
- Germany 5953-2450GE
- France 5953-2450FR
- Italy 5953-2450IT

In Japan request publication #9320-0761 from your local HP Sales Office. In all other countries, call HP DIRECT or ask your local HP Sales Office for publication #5953-2450.

### HP Direct Order Phones (Worldwide)

In the U.S. call:	800-538-8787
Outside the U.S. call:	
Australia	(03) 895-2645
Austria	(0222) 25 00614/615/616
Belgium	(02) 761 3111
Canada	(416) 671-8383
Denmark	(043) 01 640
Finland	(90) 887 2361
France	(01) 69 8617 25
German Federal Republic	01 30 3322
Greece	(01) 6726090
Italy	(02) 92369702
Japan	0427 59 1321 06 300 3150
Netherlands	(020) 547 6606
Norway	(02) 246090
South Africa	
Johannesburg	(011) 802 5111
Cape Town	(021) 537 954
Spain	(91) 6374013 (91) 6370011
Sweden	(08) 7502400
Switzerland	(057) 3124 91/94/95
United Kingdom	(0734) 697 201

In countries where HP DIRECT is not yet available, order from your HP Sales Office.

### Documentation Index (Worldwide)

More than 2500 manuals, binders, books and guides for HP computer systems and peripherals as well as instruments are listed in this annual publication. For ease of use, the index is conveniently divided into three sections. You can find a manual easily — even if you don't know the part number — because the first two sections list the publication under the computer or peripheral to which they belong. The third section lists the publications in numerical order and includes the title, latest print date and the latest update (if this information is available).

#### To Get an Index

In the U.S.: Call 800-538-8787 or contact your local HP Sales Office and request publication #5953-2460D.

Outside the U.S.: Call your local HP Sales Office. Request publication #5953-2460.

### Test & Measurement Accessories Catalog (U.S. only)

This catalog features a broad line of electronic test and measurement accessories, such as oscilloscope probes, rack mount hardware, logic probes, and microwave power sensors, detectors and attenuators.

It is designed to make selection of accessories as easy as possible and features full-color photographs, detailed descriptions, and selection guides. Three different indexes make products easy to find.

The catalog also contains a selection of HP's most popular test instruments — all available off-the-shelf and shipped the same day if your order is received by 1 PM.

#### To Get a Catalog (available in U.S. only)

Call 800-538-8787 or contact your local HP Sales Office and request publication #5954-0193D.

### Fast-Ship Service in the U.S.

Throughout the pages of this catalog you will notice the telephone symbol. This symbol identifies a wide variety of products available to you through the U.S. **Fast-Ship Service**, as well as through your local HP Sales Office:

- Test and Measurement Accessories
- Cables and adapters
- Microwave Accessories
- Basic Instruments
- PC Instruments
- Data communications
- Handheld calculators and computers
- Personal computers and software
- Peripherals and terminals
- Furniture and accessories
- Printers
- Plotters and their supplies
- Magnetic media.

### What Makes Fast-Ship Convenient?

When you call our HP Direct Phone Order Service weekdays between 6 AM and 5 PM Pacific Time, from anywhere in the U.S., you receive immediate confirmation of product availability, pricing and delivery. And remember, our prices include regular UPS or truck delivery. Expedited air service is also available. We usually can charge your order with an HP DIRECT Open Account (P.O.'s), or with your VISA, MasterCard or American Express credit card. We want you to be absolutely satisfied with our products. All supplies and accessories are designed and tested to meet the high quality standards you expect from Hewlett-Packard. All products in our catalog come with our guarantee of satisfaction. Any product in our catalogs not meeting your expectations can be returned — no questions asked.

# INSTRUMENT FINANCING

## Rental, Lease and Gradual Purchase Plans

### Leasing-vs.-Buying

#### Cost Savings . . .

To decide if you should lease or buy your equipment, start by comparing costs.

Figure 1, for example, shows the after-tax cost in today's dollars of instruments leased and purchased outright.

It also shows how HP Financing's low rates always make leasing more attractive than buying. Whether you keep the equipment or return it.

#### Plus Four More Advantages

Leasing also can help you:

- **Acquire new technology without a large cash outlay.** Simply pay in affordable, monthly payments.
- **Solve short-term project needs.** Rentals and leases allow you to quickly complete temporary projects — and assign expenses precisely.
- **Upgrade and add-on with ease.** By leaving ownership in the hands of HP, you can upgrade and add-on smoothly. This provides a hedge against obsolescence and an easy avenue for growth.
- **Obtain new technology in spite of tight capital budget restrictions.** "Off-balance sheet" financing allows you to expense your monthly payments. Reducing the strain on your capital budget.

### Why HP Financing?

#### Excellent Rates

Compare our rates with anyone in the marketplace. HP uses its low cost of funds to offer you extremely competitive rates. And these rates are fixed — they will not vary throughout your lease term.

#### Backed 100% by HP

Your equipment is installed and supported by the company that knows it best — Hewlett-Packard.

#### Generous Equity Accrual

As a manufacturer, HP is motivated to help you acquire your equipment. Nearly two-thirds of every payment accrues towards purchase. This means buyout terms that make very good sense for lessees.

#### Flexibility

HP Financing can help you match your payment stream with your revenue stream. We understand that every organization has individual needs.

## Lease-vs.- Buy Comparison

After-tax cost of \$100,000 instrument acquisition, using a 10% discount rate.

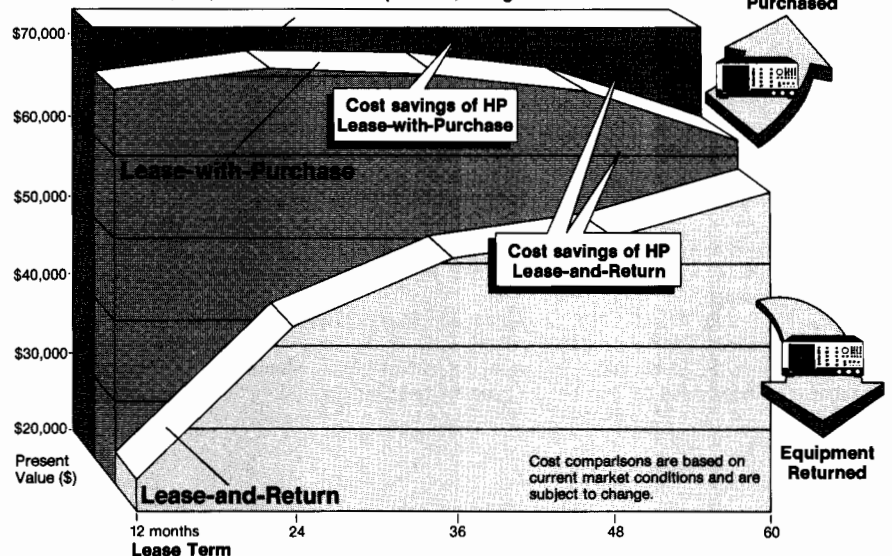

Figure 1

### A Full Range of Plans:

#### HP Rental Plan

This plan is designed for shorter-term needs or transition purposes. 12-month terms. Low rates. Nearly two-thirds of every payment accrues towards purchase.

#### HP Operating Lease Plan

An excellent way to hedge against obsolescence. HP offers two-thirds of each payment to accrue towards purchase at term end, and "off-balance sheet" financing. 12- to 48-month terms. Some plans include flexibility to discontinue.

#### HP Lease With Option to Purchase

This 60-month plan offers our lowest rates and the option to buy the equipment at term end — for just 10% of the amount financed.

#### HP Payment Plan

Similar to a bank loan — at rates many banks can't match. No down payment is needed. 36- to 60-month terms.

#### HP State and Local Government Plan

Low rates offered to eligible customers. Structured as a \$1 lease or an installment contract. Permits cancellation if funding is discontinued. 12- to 60-month terms.

#### HP Federal Government Lease to Ownership Plan

This plan is designed for Federal agencies and authorized contractors. "Pass-through" of GSA purchase discounts available. Permits cancellation for convenience. 12- to 60-month terms for "off-GSA" leases. "On-schedule" terms, too.

### HP Financial Advisors

HP Financing provides professional advisors to help you analyze and tailor a plan for your individual needs.

### For a Quote

To compare a lease versus cash purchase for your instruments, simply contact your closest HP sales office.

Just ask an HP Financing representative to help you weigh your options and structure a plan that's best for you.





## Communicating With HP

Hewlett-Packard is committed to providing convenient local support and the best possible attention to customer needs on a worldwide basis. There are more than 149 sales and support offices in the U.S. and some 334 sales and support offices and distributorships in 77 other countries; a listing of these offices starts on page 771.

Your entry point to the resources of Hewlett-Packard is through the HP office nearest you. Our sales representatives and order support specialists there are well-equipped to provide you with pre-sale assistance in product selection, as well as related business information such as current product availability and price delivered to your location. In the U.S. you can also call our Customer Information Center at 1-800-752-0900 extension 779E for the same information or for the location of your nearest sales office.

Most HP sales offices are tied into a sophisticated intra-company communications system. This not only means prompt transmission of orders to any HP product responsible division—it also speeds the flow of regular messages among HP sales offices and factories. The objective, of course, is to provide the fastest possible response to your product interests.

## Pricing and Quotations

Price information which may be supplied with this catalog provides you with helpful budgetary guidance.

Please call your nearby Hewlett-Packard sales office to determine a product's delivered price.

Prices furnished with this catalog are U.S. list prices prevailing at the time of printing. In many cases HP can offer special limited

time prices which cannot be reflected in this catalog. Hewlett-Packard reserves the right to change prices, and those prices prevailing at the time an order is received will apply.

Destination prices and other details you may need to know before ordering can be quickly obtained via telephone. Just call your nearest HP office.

If you are an international customer requiring formal paperwork such as pro forma invoices or quotations, please contact the Hewlett-Packard office or representative serving your area.

## Placing Your Order

Since many products or configurations are changed or improved during the life of this catalog, we suggest that you always contact your nearest HP sales office for current product and pricing information prior to placing your order.

Hewlett-Packard people at the sales office nearest you will be pleased to provide assistance in selecting the HP equipment most appropriate to your needs, and to help you prepare your order.

The information in this catalog will, in many cases, be sufficient for you to decide to buy a particular HP product. In those instances, a telephone call to the nearest HP office will provide you with information on the product's availability and price.

To ensure maximum satisfaction with HP's products and services we ask that you order in the country of end use. Orders for end use inside the USA may be placed with your nearest U.S. sales office. Orders for end use outside the USA should be placed with

an HP sales office in the country of end use. More information on placing such orders is available from the HP headquarters offices listed on page 771.

HP wants to be sure the product delivered to you is exactly the one you want. Therefore, when placing your order, please specify the product's catalog (model, accessory, or part) number, as well as the product's name. Be as complete as possible in specifying exactly what you'd like, including standard options.

If you want special features or capabilities, such as different color or a non-standard power line voltage, ask your HP sales representative about availability and cost of these "specials" first—and then, to prevent misunderstandings, include special instructions and specification details with your order.

## Terms of Sale

**Inside the USA:** Hewlett-Packard's standard credit terms for established customers in the USA are net 30 days from invoice date.

Leasing and extended financial terms are available. However, the associated costs are not included in any product prices furnished with this catalog. Your nearby HP office will be pleased to discuss your requirements and work with you in setting up an appropriate program.

**Outside the USA:** Please contact the nearest Hewlett-Packard international sales office or an authorized HP subsidiary or distributor regarding terms for orders placed with them.

## U.S. Government Sales

Many products in this catalog are covered on GSA federal supply schedule multi-award contracts.

## Product Changes

Although product information and illustrations in this catalog were current at the time it was approved for printing, Hewlett-Packard, in a continuing effort to offer excellent products at a fair value, reserves the right to change specifications, designs, and models without notice.

## Shipping Methods

**Inside the USA:** All prices include HP standard transportation and routing to any U.S. destination. If a different shipping method is needed, we will gladly ship to satisfy your requirements. In this case, the shipment will typically be sent freight collect.

**Outside the USA:** Shipments to destinations outside the USA are made by either surface or air, as requested.

# OPERATING ENVIRONMENTS & WARRANTY

## Operating Environments

Hewlett-Packard provides solutions to customer needs through products that must operate in the expected environmental conditions. In an attempt to meet our customer needs effectively, all new hardware designs are tested to internal HP standards on operating environments before they are released for customer sales. These internal HP standards are derived from our experience with the environments existing at customer installations and from other well-known standards, such as IEC, ISO, ANSI and MILITARY standards. These internal HP standards provide guidance to all divisions producing new hardware products and systems. The classification codes, used to identify expected environments where HP products or systems may be used, are as follows:

- A1 - Rugged Environment
- A2 - Outdoor Environment (Portable)
- B1 - Portable General Purpose Environment
- B2 - General Purpose Environment
- C1 - Controlled Office Environment
- C2 - Controlled Computer Room Environment

The classes range from the severe environments found in heavy industrial areas unsuitable for operating personnel (Class A1) to the controlled environments found in dedicated computer rooms (Class C2). Most HP hardware products are designed to meet Class B2, applying test limits commonly found in general purpose applications of light industrial and commercial facilities.

Several parameters of the operating environment are evaluated during the design process. The major ones are as follows:

- Operating temperature
- Storage temperature
- Humidity
- Altitude
- Shock
- Vibration
- Power line variation (frequency and voltage)
- Power line surge
- Power line sag and dropout
- Power line distortion susceptibility (THD)
- Electromagnetic interference (radiated and conducted)
- Magnetic interference
- Magnetic susceptibility
- Radiated susceptibility
- Electrostatic discharge
- Acoustics

Though the details of these internal HP standards are the property of HP and are treated as proprietary material, information on the classes and the test limits appropriate for each class is available for those considering the use of HP equipment at their own facility. To obtain this information contact your HP sales representative. If you are considering the use of a specific model product then ask your sales rep what environmental class it was designed to (A1, A2, B1, B2, C1, C2) and the limits it met for the environmental parameter of concern. The information you receive must not be construed as an implied warranty because the classification codes are used for guiding the design of new products and not for evaluation of production units. Only those specific parameters identified in the technical data sheet (specifications) for the model number of interest will be warranted by Hewlett-Packard according to the terms of the published warranty information.

## Warranty—

As an expression of confidence that our products will continue to meet the high standards of reliability and performance that our customers expect, Hewlett-Packard products carry the following warranty:

*HP hardware products are warranted against defects in materials and workmanship. If HP receives notice of such defects during the warranty period, HP shall, at its option, either repair or replace hardware products which prove to be defective.*

*HP software and firmware products which are designated by HP for use with a hardware product, when properly installed on that*

*hardware product, are warranted not to fail to execute their programming instructions due to defects in materials and workmanship. If HP receives notice of such defects during the warranty period, HP shall repair or replace software media and firmware which do not execute their programming instructions due to such defects. HP does not warrant that the operation of the software, firmware or hardware shall be uninterrupted or error free.*

*If HP is unable, within a reasonable time, to repair or replace any product to a condition as warranted, Buyer shall be entitled to a refund of the purchase price upon return of the product to HP.*

*a. SUPPLEMENTAL STATEMENT: Supplemental statements setting forth the duration and implementation of warranty and installation are available for most product types. These statements, if applicable to purchased products, are attached hereto and incorporated herein.*

*b. DURATION AND COMMENCEMENT OF WARRANTY PERIOD: The warranty period for each product is specified in the supplemental statement of warranty and installation attached hereto and incorporated herein. The warranty period begins either on the date of shipment or, where the purchase price includes installation by HP, on the date of installation. If Buyer schedules or delays installation more than thirty (30) days after delivery, the warranty period begins on the thirty-first (31st) day from the date of shipment.*

*c. PLACE OF PERFORMANCE: Within HP service travel areas, warranty and installation services for products installed by HP and certain other products designated by HP will be performed at Buyer's facility at no charge. Outside HP's service travel areas, warranty and installation services will be performed at Buyer's facility only upon HP's prior agreement and Buyer shall pay HP's round trip travel expenses and applicable additional expenses for such services.*

*On-site warranty services are provided only at the initial installation point. If products eligible for on-site warranty and installation services are moved from the initial installation point, the warranty will remain in effect only if Buyer purchases additional inspection or installation services at the new site.*

*Installation and on-site warranty services are available outside the country of initial purchase only if Buyer pays HP international prices. If Buyer transports a product from the country of initial purchase without having paid HP international prices, any remaining warranty covers just parts and labor and applies only if the product is returned to the country of initial purchase. Warranties requiring return to HP are limited to the country of purchase unless the product is portable (battery powered) or the customer paid HP international prices.*

*For product warranties requiring return to HP, products must be returned to a service facility designated by HP. Buyer shall prepay shipping charges (and shall pay all duties and taxes) for products returned to HP for warranty service. Except for products returned to Buyer from another country, HP shall pay for return of products to Buyer.*

*d. LIMITATION OF WARRANTY: The foregoing warranty shall not apply to defects resulting from:*

- 1. Improper or inadequate maintenance by Buyer;*
- 2. Buyer-supplied software or interfacing;*
- 3. Unauthorized modification or misuse;*
- 4. Operation outside of the environmental specifications of the product; or*
- 5. Improper site preparation and maintenance.*

**THE WARRANTY SET FORTH ABOVE IS EXCLUSIVE AND NO OTHER WARRANTY, WHETHER WRITTEN OR ORAL, IS EXPRESSED OR IMPLIED. HP SPECIFICALLY DISCLAIMS THE IMPLIED WARRANTIES OF MERCHANTABILITY AND FITNESS FOR A PARTICULAR PURPOSE.**

## EXCLUSIVE REMEDIES

*The remedies provided herein are Buyer's sole and exclusive remedies. In no event shall HP be liable for direct, indirect, special, incidental or consequential damages (including loss of profits) whether based on contract, tort, or any other legal theory.*

## HEADQUARTERS OFFICES

If there is no sales office listed for your area, contact one of these headquarters offices.

### ASIA

Hewlett-Packard Asia Ltd.  
22/F Bond Centre, West Tower  
89 Queensway, Central  
**HONG KONG**  
G.P.O. Box 863, Hong Kong  
Tel: 5-8487777  
Telex: 76793 HPA HX  
Cable: HPASIAL TD

### CANADA

Hewlett-Packard (Canada) Ltd.  
6877 Goreway Drive  
**MISSISSAUGA**, Ontario L4V 1M8  
Tel: (416) 678-9430  
Telex: 069-8644

### EASTERN EUROPE

Hewlett-Packard Ges.m.b.h.  
Lieblgasse 1  
P.O. Box 72  
A-1222 **VIENNA**, Austria  
Tel: (222) 2500-0  
Telex: 13 4425 HEPA A

### NORTHERN EUROPE

Hewlett-Packard S.A.  
V. D. Hooplaan 241  
P.O. Box 999  
NL-118 LN 15 **AMSTELVEEN**  
The Netherlands  
Tel: 20 5479999  
Telex: 18919 hpner

### SOUTH EAST EUROPE

Hewlett-Packard S.A.  
World Trade Center  
110 Avenue Louis-Casai  
1215 Cointrin, **GENEVA**, Switzerland  
Tel: (022) 98 96 51  
Telex: 27225 hpser  
Mail Address:  
P.O. Box  
CH-1217 Meyrin 1  
**GENEVA**  
Switzerland

### MIDDLE EAST AND CENTRAL AFRICA

Hewlett-Packard S.A.  
Middle East/Central  
Africa Sales H.Q.  
7, rue du Bois-du-Lan  
P.O. Box 364  
CH-1217 Meyrin 1  
**GENEVA**  
Switzerland  
Tel: (022) 83 12 12  
Telex: 27835 hmea ch  
Telefax: (022) 83 15 35  
European Operations  
Hewlett-Packard S.A.  
150, Route du Nant d'Avril  
CH-1217 Meyrin 2  
**GENEVA**, Switzerland  
Tel: 41 22/838111

### UNITED KINGDOM

Hewlett-Packard Ltd.  
Nine Mile Ride  
**WOKINGHAM**  
Berkshire, RG113LL  
Tel: 0344 773100  
Telex: 848805/8488 14/8489 12

### UNITED STATES OF AMERICA

Customer Information Center  
(800) 752-0900  
6:00 AM to 5 PM Pacific Time

### EASTERN USA

Hewlett-Packard Co.  
4 Choke Cherry Road  
**ROCKVILLE**, MD 20850  
Tel: (301) 948-6370

### MIDWESTERN USA

Hewlett-Packard Co.  
5201 Tollview Drive  
**ROLLING MEADOWS**, IL 60008  
Tel: (312) 255-9800

### SOUTHERN USA

Hewlett-Packard Co.  
2000 South Park Place  
**ATLANTA**, GA 30339  
Tel: (404) 955-1500

### WESTERN USA

Hewlett-Packard Co.  
5161 Lankerthim Blvd.  
**NORTH HOLLYWOOD**, CA 91601  
Tel: (818) 505-5600

### OTHER INTERNATIONAL AREAS

Hewlett-Packard Co.  
Intercontinental Operations  
3495 Deer Creek Road  
**PALO ALTO**, CA 94304  
Tel: (415) 857-5027  
Telex: 034-8300  
Cable: HEWPACK

### ALGERIA

Hewlett-Packard Trading S.A.  
Bureau de Liaison Alger  
Villa des Lions  
9, Hai Galloui  
**DZ-BORDJ EL BAHRI**  
Tel: 76 03 36  
Telex: 63343 dlion dz

### ANGOLA

Telectra Angola LDA  
Empresa Técnica de Equipamentos  
16 rue Cons. Julio de Vilhema  
**LUANDA**  
Tel: 35515,35516  
Telex: 3134

### ARGENTINA

Hewlett-Packard Argentina S.A.  
Montanases 2140/50  
**1428 BUENOS AIRES**  
Tel: 541-11-1441  
Telex: 22796 HEW PAC-AR

Biotron S.A.C.I.M.a.I.  
Av. Paso Colon 221, Piso 9  
**1399 BUENOS AIRES**  
Tel: 541-333-490,  
541-322-587  
Telex: 17595 BIONAR  
Laboratorio Rodriguez  
Corswant S.R.L.  
Misiones, 1156 - 1876  
Bernal, Oeste  
**BUENOS AIRES**  
Tel: 252-3958, 252-4991

Intermaco S.R.L.  
Florida 537/71  
Galeria Jardin - Local 28  
**1005 BUENOS AIRES**  
Tel: 393-4471/1928  
Telex: 22796 HEW PAC-AR

Argentina Esanco S.R.L.  
A/ASCO 2328  
**1416 BUENOS AIRES**  
Tel: 541-58-1981, 541-59-2767  
Telex: 22796 HEW PAC-AR

All Computers S.A.  
Montanases 2140/50 5 Piso  
**1428 BUENOS AIRES**  
Tel: 781-4030/4039/783-4886  
Telex: 18148 Ocme

### AUSTRALIA

**Adelaide, South Australia Office**  
Hewlett-Packard Australia Ltd.  
153 Greenhill Road  
**PARKSIDE**, S.A. 5063  
Tel: 61-8-272-5911  
Telex: 82536  
Cable: HEWPARD Adelaide

### Brisbane, Queensland Office

Hewlett-Packard Australia Ltd.  
10 Payne Road  
**THE GAP**, Queensland 4061  
Tel: 61-7-300-4133  
Telex: 42133  
Cable: HEWPARD Brisbane

### Canberra, Australia Capital Territory Office

Hewlett-Packard Australia Ltd.  
Thynne Street, Fern Hill Park  
**BRUCE**, A.C.T. 2617  
P.O. Box 257,  
**JAMISON**, A.C.T. 2614  
Tel: 61-62-80-4244  
Telex: 62650  
Cable: HEWPARD Canberra

### Melbourne, Victoria Office

Hewlett-Packard Australia Ltd.  
31-41 Joseph Street  
P.O. Box 221  
**BLACKBURN**, Victoria 3130  
Tel: 61-3-895-2895  
Telex: 31-024  
Cable: HEWPARD Melbourne

### Perth, Western Australia Office

Hewlett-Packard Australia Ltd.  
Herdsman Business Park  
**CLAREMONT**, W.A. 6010  
Tel: 61-9-383-2188  
Telex: 93859  
Cable: HEWPARD Perth

### Sydney, New South Wales Office

Hewlett-Packard Australia Ltd.  
17-23 Talavera Road  
P.O. Box 308  
**NORTH RYDE**, N.S.W. 2113  
Tel: 61-2-888-4444  
Telex: 21561  
Cable: HEWPARD Sydney

### AUSTRIA

Hewlett-Packard Ges.m.b.h.  
Verkaufsbuero Graz  
Grottenhofstrasse 94  
A-8052 **GRAZ**  
Tel: 43-316-291-5660  
Telex: 312375

Hewlett-Packard Ges.m.b.h.  
Lieblgasse 1  
P.O. Box 72  
A-1222 **VIENNA**  
Tel: 43-222-2500  
Telex: 134425 HEPA A

### BAHRAIN

Green Salon  
P.O. Box 557  
**MANAMA**  
Tel: 255503-250950  
Telex: 84419

Wael Pharmacy  
P.O. Box 648  
**MANAMA**  
Tel: 256123  
Telex: 8550 WAEI BN

Zayani Computer Systems  
218 Shaik Mubarak Building  
Government Avenue  
P.O. Box 5918  
**MANAMA**  
Tel: 276278  
Telex: 9015 plans bn

### BELGIUM

Hewlett-Packard Belgium S.A./N.V.  
Blvd de la Woluwe, 100  
Woluwedal  
B-1200 **BRUSSELS**  
Tel: (02) 32-2-761-31-11  
Telex: 23494 hewpac

### BERMUDA

Applied Computer Technologies  
Atlantic House Building  
P.O. Box HM 2091  
Par-La-Ville Road  
**HAMILTON** 5  
Tel: 295-1616  
Telex: 380 3589/ACT BA

### BOLIVIA

Arrellano Ltda  
Av. 20 de Octubre #2125  
Casilla 1383  
**LA PAZ**  
Tel: 368541

### BRAZIL

Tesis Informatica S.A.  
Alameda Rio Negro, 750-I. AND.  
**ALPHAVILLE**  
06400 Barueri SP  
Tel: (011) 421.1311  
Telex: (011) 71351 HPBR BR  
Cable: HEWPACK Sao Paulo

Hewlett-Packard do Brasil S.A.  
Praia de Botafago 228-A-614  
6. AND.-CONJ. 601  
Edificio Argentina - Ala A  
**22250 RIO DE JANEIRO, RJ**  
Tel: (021) 552-6422  
Telex: 21905 HPBR BR  
Cable: HEWPACK Rio de Janeiro

Van Den Cientifica Ltda.  
Rua Jose Bonifacio, 458  
Todos os Santos  
**20771 RIO DE JANEIRO, RJ**  
Tel: (021) 593-8223  
Telex: 33487 EGLB BR

ANAMED I.C.E.I. Ltda.  
Rua Verqueiro, 360  
**04012 SAO PAULO, SP**  
Tel: (011) 572-1106  
Telex: 1124740 AMED BR

### BRUNEI

Komputer Wisman Sdn Bhd  
G6, Chandrawaseh Cmplx,  
Jalan Tutong  
P.O. Box 1297,  
**BANDAR SERI BEGAWAN**  
**NEGARA BRUNI DARUSSALAM**  
Tel: 673-2-2000-70/26711

### CAMEROON

Beriac  
B. P. 23  
**DOUALA**  
Tel: 420153  
Telex: 5351

### CANADA

**Alberta**  
Hewlett-Packard (Canada) Ltd.  
3030 3rd Avenue N.E.  
**CALGARY**, Alberta T2A 6T7  
Tel: (403) 235-3100

Hewlett-Packard (Canada) Ltd.  
11120-178th Street  
**EDMONTON**, Alberta T5S 1P2  
Tel: (403) 486-6666

### British Columbia

Hewlett-Packard (Canada) Ltd.  
10691 Shellbridge Way  
**RICHMOND**,  
British Columbia V6X 2W8  
Tel: (604) 270-2277  
Telex: 610-922-5059

Hewlett-Packard (Canada) Ltd.  
121 - 3350 Douglas Street  
**VICTORIA**, British Columbia V8Z 3L1  
Tel: (604) 381-6616

### Manitoba

Hewlett-Packard (Canada) Ltd.  
1825 Inkster Blvd.  
**WINNIPEG**, Manitoba R2X 1R3  
Tel: (204) 694-2777

# SALES OFFICES

Arranged alphabetically by country (cont'd)

## CANADA (Cont'd)

### New Brunswick

Hewlett-Packard (Canada) Ltd.  
814 Main Street  
MONCTON, New Brunswick E1C 1E6  
Tel: (506) 855-2841

### Nova Scotia

Hewlett-Packard (Canada) Ltd.  
Suite 111  
900 Windmill Road  
DARTMOUTH, Nova Scotia B3B 1P7  
Tel: (902) 469-7820

### Ontario

Hewlett-Packard (Canada) Ltd.  
3325 N. Service Rd., Unit W03  
BURLINGTON, Ontario L7N 3G2  
Tel: (416) 335-8644

Hewlett-Packard (Canada) Ltd.  
552 Newbold Street  
LONDON, Ontario N6E 2S5  
Tel: (519) 686-9181

Hewlett-Packard (Canada) Ltd.  
6877 Goreway Drive  
MISSISSAUGA, Ontario L4V 1M8  
Tel: (416) 678-9430  
Telex: 069-83644

Hewlett-Packard (Canada) Ltd.  
2670 Queensview Dr.  
OTTAWA, Ontario K2B 8K1  
Tel: (613) 820-6483

Hewlett-Packard (Canada) Ltd.  
3790 Victoria Park Ave.  
WILLOWDALE, Ontario M2H 3H7  
Tel: (416) 499-2550

### Quebec

Hewlett-Packard (Canada) Ltd.  
17500 Trans Canada Highway  
South Service Road  
KIRKLAND, Quebec H9J 2X8  
Tel: (514) 697-4232  
Telex: 058-21521

Hewlett-Packard (Canada) Ltd.  
1150 rue Claire Fontaine  
QUEBEC CITY, Quebec G1R 5G4  
Tel: (418) 648-0726

### Saskatchewan

Hewlett-Packard (Canada) Ltd.  
130 Robin Crescent  
SASKATOON, Saskatchewan S7L 6M7  
Tel: (306) 242-3702

### CHILE

ASC Ltda.  
Austria 2041  
SANTIAGO  
Tel: 223-5946, 223-6148  
Telex: 392-340192 ASC CK

Jorge Calcagni y Cia  
Av. Italia 634 Santiago  
Casilla 16475  
SANTIAGO 9  
Tel: 9-011-562-222-0222  
Telex: 392440283 JCYCL CZ

Metrolab S.A.  
Monjitas 454 of. 206  
SANTIAGO  
Tel: 395752, 398296  
Telex: 340866 METLAB CK

Olympia (Chile) Ltda.  
Av. Rodrigo de Araya 1045  
Casilla 256-V  
SANTIAGO 21  
Tel: 225-5044  
Telex: 340892 OLYMP  
Cable: Olympiachile Santiagochile

### CHINA, People's Republic of

China Hewlett-Packard Co., Ltd.  
22/F Bond Centre, West Tower  
89 Queensway, Central  
HONG KONG  
Tel: 5-8487777  
Telex: 76793 HPA HX  
Cable: HP ASIA LTD

China Hewlett-Packard Co., Ltd.  
P.O. Box 9610, Beijing  
4th Floor, 2nd Watch Factory Main  
Shuang Yu Shou, Bei San Huan Road  
Hai Dian District  
BEIJING  
Tel: 33-1947 33-7426  
Telex: 22601 CTSHP CN  
Cable: 1920 Beijing

China Hewlett-Packard Co., Ltd.  
CHP Shanghai Branch  
23/F Shanghai Union Building  
100 Yan An Rd. East  
SHANG-HAI  
Tel: 265550  
Telex: 33571 CHPSB CN  
Cable: 3416 Shanghai

### COLOMBIA

Instrumentación  
H. A. Langebaek & Kier S.A.  
Carrerra 4A No. 52A-26  
Apartado Aereo 6287  
BOGOTA 1, D.E.  
Tel: 212-1466  
Telex: 44400 INST CO  
Cable: AARIS Bogota

Nefromedicas Ltda.  
Calle 123 No. 9B-31  
Apartado Aereo 100-958  
BOGOTA D.E., 10  
Tel: 213-5267, 213-1615  
Telex: 43415 HEGAS CO

Compumundo  
Avenida 15 # 107-80  
BOGOTA D.E.  
Tel: 57-214-4458  
Telex: 39642450 COMPU CO

### DOMINICAN REPUBLIC

Microprog S.A.  
Juan Tomás Mejía y Cotes No. 60  
Arroyo Hondo  
SANTO DOMINGO  
Tel: 565-6268  
Telex: 4510 ARENTA DR (RCA)

### ECUADOR

CYEDE Cia. Ltda.  
Avenida Eloy Alfaro 1749  
y Belgica  
Casilla 6423 CCI  
QUITO  
Tel: 9-011-593-2-450975  
Telex: 39322548 CYEDE ED

Medtronics  
Valladolid 524 Madrid  
P.O. 9171, QUITO  
Tel: 2-238-951  
Telex: 2298 ECUAME ED

Hospitalar S.A.  
Robles 625  
Casilla 3590  
QUITO  
Tel: 545-250, 545-122  
Telex: 2485 HOSPTL ED  
Cable: HOSPITALAR-Quito

### CONGO

Ecuador Overseas Agencies C.A.  
Calle 9 de Octubre #818  
P.O. Box 1296, Guayaquil  
QUITO  
Tel: 39343873 ECUOVE ED  
Telex: 3361 PBCGYE ED

### COSTA RICA

Cientifica Costarricense S.A.  
Avenida 2, Calle 5  
San Pedro de Montes de Oca  
Apartado 10159  
SAN JOSÉ  
Tel: 9-011-506-243-820  
Telex: 3032367 GALGUR CR

O. Fischel R. Y. Cia. S.A.  
Apartados 434-10174  
SAN JOSE  
Tel: 23-72-44  
Telex: 2379  
Cable: OFIR

### CYPRUS

Telerexa Ltd.  
P.O. Box 1152  
Valentine House  
8 Stassandrou St.  
NICOSIA  
Tel: 45 628, 62 698  
Telex: 5845 tirx cy

### DENMARK

Hewlett-Packard A/S  
Kongevejen 25  
DK-3460 BIRKEROD  
Tel: 45-02-81-6640  
Telex: 37409 hpas dk

Hewlett-Packard A/S  
Rølgheedsvej 32  
DK-8240 RISSKOV, Aarhus  
Tel: 45-06-17-6000  
Telex: 37409 hpas dk

### ETHIOPIA

Seric-Ethiopia  
P.O. Box 2764  
ADDIS ABABA  
Tel: 185114  
Telex: 21150

### FINLAND

Hewlett-Packard Finland  
Field Oy  
Niittyanpolku 10  
00620 HELSINKI  
Tel: (90) 757-1011  
Telex: 122022 Field SF

Hewlett-Packard Oy  
Piispankalliontie 17  
02200 ESPOO  
Tel: (90) 887-21  
Telex: 121563 HEWPA SF

### FRANCE

Hewlett-Packard France  
Z.I. Mercure B  
Rue Berthelot  
13763 Les Milles Cedex  
AIX-EN-PROVENCE  
Tel: 33-42-59-4102  
Telex: 410770F

Hewlett-Packard France  
64, Rue Marchand Saillant  
F-61000 ALENCON  
Tel: (33) 29 04 42

Hewlett-Packard France  
Batiment Levitan  
2585, route de Grasse  
Bretelle Autoroute  
06600 ANTIBES  
Tel: (93) 74-59-19

### EGYPT

Sakro Enterprises  
P.O. Box 259  
ALEXANDRIA  
Tel: 802908, 808020, 805302  
Telex: 54333

International Engineering Associates  
6 El Gamea Street  
Agouza  
CAIRO  
Tel: 71-21-68134-80-940  
Telex: 93830 IEA UN  
Cable: INTEGASSO

Sakro Enterprises  
70 Mossadak Street  
Dokki, Giza  
CAIRO  
Tel: 706 440, 701 087  
Telex: 9337

S.S.C. Medical  
40 Gezerat El Arab Street  
Mohandessin  
CAIRO  
Tel: 803844, 805998, 810263  
Telex: 20503 SSC UN

### EL SALVADOR

IPESA de El Salvador S.A.  
29 Avenida Norte 1223  
SAN SALVADOR  
Tel: 9-011-503-266-858  
Telex: 301 20539 IPESA SAL

### ETHIOPIA

Seric-Ethiopia  
P.O. Box 2764  
ADDIS ABABA  
Tel: 185114  
Telex: 21150

### FINLAND

Hewlett-Packard Finland  
Bâtiment Ampère  
Rue de la Commune de Paris  
Boite Postale 300  
93153 LE BLANC-MESNIL  
Tel: (1) 865-44-52  
Telex: 211032F

Hewlett-Packard France  
Parc d'activités Cadéra  
Quartier Jean-Mermoz  
Avenue du Président JF Kennedy  
33700 MÉRIGNAC (Bordeaux)  
Tel: 33-56-34-0084  
Telex: 550105F

Hewlett-Packard France  
3, Rue Graham Bell  
BP 5149  
57074 METZ Cedex  
Tel: (87) 36-13-31  
Telex: 860602F

Hewlett-Packard France  
Miniparc-ZIRST  
Chemin du Vieux Chêne  
38240 MEYLAN (Grenoble)  
Tel: (76) 90-38-40  
980124 HP Grenoble

Hewlett-Packard France  
Bureau vert du Bois Briand  
Cheman de la Garde  
- CP 212 212  
44085 NANTES Cedex  
Tel: (40) 50-32-22  
Telex: 711085F

Hewlett-Packard France  
28 Rue de la République  
Boite Postale 503  
25026 BESANÇON CEDEX, FRANCE  
Tel: (81) 83-16-22  
Telex: 361157

Hewlett-Packard France  
ZA Kergardec  
Rue Fernand Forest  
F-29239 GOUESNOU  
Tel: (98) 41-87-90

Hewlett-Packard France  
Chemin des Mouilles  
Boite Postale 162  
69131 ECULLY Cedex (Lyon)  
Tel: 33-78-33-8125  
Telex: 310617F

Hewlett-Packard France  
Parc d'activités du Bois Briard  
2 Avenue du Lac  
F-91040 EVRY Cedex  
Tel: 3311/6077 9660  
Telex: 692315F

Hewlett-Packard France  
Application Center  
5, avenue Raymond Chanas  
38320 EYBENS (Grenoble)  
Tel: (76) 62-57-98  
Telex: 980124 HP GRENOB EYBE

Hewlett-Packard France  
Parc Club des Tanneries  
Batiment B4  
4, Rue de la Faisanderie  
67381 LINCOLSHEIM  
(Strasbourg)  
Tel: (88) 76-15-00  
Telex: 890141F

Hewlett-Packard France  
Centre d'affaires Paris-Nord  
Bâtiment Ampère  
Rue de la Commune de Paris  
Boite Postale 300  
93153 LE BLANC-MESNIL  
Tel: (1) 865-44-52  
Telex: 211032F

Hewlett-Packard France  
Parc d'activités Cadéra  
Quartier Jean-Mermoz  
Avenue du Président JF Kennedy  
33700 MÉRIGNAC (Bordeaux)  
Tel: 33-56-34-0084  
Telex: 550105F

Hewlett-Packard France  
3, Rue Graham Bell  
BP 5149  
57074 METZ Cedex  
Tel: (87) 36-13-31  
Telex: 860602F

Hewlett-Packard France  
Miniparc-ZIRST  
Chemin du Vieux Chêne  
38240 MEYLAN (Grenoble)  
Tel: (76) 90-38-40  
980124 HP Grenoble

Hewlett-Packard France  
Bureau vert du Bois Briand  
Cheman de la Garde  
- CP 212 212  
44085 NANTES Cedex  
Tel: (40) 50-32-22  
Telex: 711085F

Hewlett-Packard France  
125, Rue du Faubourg Bannier  
45000 ORLÉANS  
Tel: 33-38-62-2031

Hewlett-Packard France  
Zone Industrielle de Courtaboëuf  
Avenue des Tropiques  
91947 LES ULIS Cedex (Orsay)  
Tel: 33-6-907 7825  
Telex: 600048F

Hewlett-Packard France  
15, Avenue de L'Amiral-Bruix  
75782 PARIS Cedex 16  
Tel: 33-15-02-1220  
Telex: 613663F

Hewlett-Packard France  
242 Ter, Ave J Mermoz  
64000 PAU  
Tel: 33-59-80-3802  
Telex: 550365F

Hewlett-Packard France  
6, Place Sainte Croix  
86000 POITIERS  
Tel: 33-49-41-2707  
Telex: 792335F

Hewlett-Packard France  
47, Rue de Chativiesle  
51100 REIMS  
Tel: 33-26-88-6919

Hewlett-Packard France  
Parc d'activités de la Poterie  
Rue Louis Kerautel-Botmel  
35000 RENNES  
Tel: 33-99-51-4244  
Telex: 740912F

Hewlett-Packard France  
98 Avenue de Bretagne  
76100 ROUEN  
Tel: 33-35-63-5766  
Telex: 770035F

Hewlett-Packard France  
4, Rue Thomas-Mann  
Boîte Postale 56  
67033 STRASBOURG Cedex  
Tel: (88) 28-56-46  
Telex: 890141F

Hewlett-Packard France  
Le Péripole III  
3, Chemin du Pigeonnier de la Cèpière  
31081 TOULOUSE Cedex  
Tel: 33-61-40-1112  
Telex: 531639F

Hewlett-Packard France  
Les Cardoulines  
Batiment B2  
Route des Dolines  
Parc d'activité de Valbonne  
Sophia Antipolis  
06560 VALBONNE (Nice)  
Tel: (93) 65-39-40

Hewlett-Packard France  
9, Rue Baudin  
26000 VALENCE  
Tel: 33-75-42-7616

Hewlett-Packard France  
Carolor  
ZAC de Bois Briand  
57640 VIGY (Metz)  
Tel: (8) 771 20 22

Hewlett-Packard France  
Parc d'activité des Prés  
1, Rue Papin Cedex  
59658 VILLENEUVE D'ASCO  
Tel: 33-20-91-4125  
Telex: 160124F

Hewlett-Packard France  
Parc d'activités Paris-Nord 11  
Boîte Postale 60020  
95971 Roissy Charles de Gaulle  
VILLEPINTE  
Tel: (1) 48 63 80 80  
Telex: 211032F

## GABON

Sho Gabon  
P.O. Box 89  
LIBREVILLE  
Tel: 721 484  
Telex: 5230

## GERMAN FEDERAL REPUBLIC

Hewlett-Packard GmbH  
Vertriebszentrum Mitte  
Hewlett-Packard-Strasse  
D-6380 BAD HOMBURG  
Tel: (06172) 400-0  
Telex: 410 844 hpbhg

Hewlett-Packard GmbH  
Geschäftsstelle  
Keithstrasse 2-4  
D-1000 BERLIN 30  
Tel: (030) 21 99 04-0  
Telex: 018 3405 hpbld

Hewlett-Packard GmbH  
Verbindungsstelle Bonn  
Friedrich-Ebert-Allee 26  
5300 BONN  
Tel: (0228) 234001  
Telex: 8869421

Hewlett-Packard GmbH  
Vertriebszentrum Südwest  
Schickardstrasse 2  
D-7030 BÖBLINGEN  
Postfach 1427  
Tel: (07031) 645-0  
Telex: 7265 743 hep

Hewlett-Packard GmbH  
Zenerabereich Mktg  
Herrenberger Strasse 130  
D-7030 BÖBLINGEN  
Tel: (07031) 14-0  
Telex: 7265739 hep

Hewlett-Packard GmbH  
Geschäftsstelle  
Schleefstr. 28a  
D-4600 DORTMUND-41  
Tel: (0231) 45001  
Telex: 822858 hepdod

Hewlett-Packard GmbH  
Reparaturzentrum Frankfurt  
Bernar Strasse 117  
6000 FRANKFURT/MAIN 60  
Tel: (069) 500001-0  
Telex: 413249 hpffm

Hewlett-Packard GmbH  
Vertriebszentrum Nord  
Kapstadtring 5  
D-2000 HAMBURG 60  
Tel: 49-40-63-804-0  
Telex: 021 63 032 hphhd

Hewlett-Packard GmbH  
Geschäftsstelle  
Heidering 37-39  
D-3000 HANNOVER 61  
Tel: (0511) 5706-0  
Telex: 092 3259 hphan

Hewlett-Packard GmbH  
Geschäftsstelle  
Rosslauer Weg 2-4  
D-6800 MANNHEIM  
Tel: 49-0621-70-05-0  
Telex: 0462105 hpmhm

Hewlett-Packard GmbH  
Geschäftsstelle  
Messerschmittstrasse 7  
D-7910 NEU ULM  
Tel: 49-0731-70-73-0  
Telex: 0712816 HP ULM-D

Hewlett-Packard GmbH  
Geschäftsstelle  
Emmericher Strasse 13  
D-8500 NÜRNBERG 10  
Tel: (0911) 5205-0  
Telex: 0623 860 hpnbg

Hewlett-Packard GmbH  
Vertriebszentrum Ratingen  
Berliner Strasse 111  
D-4030 RATINGEN 4  
Postfach 31 12  
Tel: (02102) 494-0  
Telex: 589 070 hprad

Hewlett-Packard GmbH  
Vertriebszentrum Muchen  
Eschenstrasse 5  
D-8028 TAUFKIRCHEN  
Tel: 49-89-61-2070  
Telex: 0524985 hpmch

Hewlett-Packard GmbH  
Geschäftsstelle  
Ermilisallee  
7517 WALDBRONN 2  
Postfach 1251  
Tel: (07243) 602-0  
Telex: 782 838 hep

## GREAT BRITAIN See United Kingdom

## GREECE

Hewlett-Packard A.E.  
178, Kifissias Avenue  
6th Floor  
Halandri-ATHENS  
Greece  
Tel: 301116473 360, 301116726 090  
Telex: 221 286 HPHLGR

Kostas Karayannis S.A.  
8, Omirou Street  
ATHENS 133  
Tel: 32 30 303, 32 37 371  
Telex: 215962 RKAR GR

Impexin  
Intellect Div.  
209 Mesogion  
11525 ATHENS  
Tel: 6474481/2  
Telex: 216286

Haril Company  
38, Mihalakopoulou  
ATHENS 612  
Tel: 7236071  
Telex: 218767

Hellamco  
P.O. Box 87528  
18507 PIRAEUS  
Tel: 4827049  
Telex: 241441

## GUATEMALA

IPESA DE GUATEMALA  
Avenida Reforma 3-48, Zona 9  
GUATEMALA CITY  
Tel: 316627, 317853, 66471/5  
9-011-502-2-316627  
Telex: 3055765 IPESA GU

## HONG KONG

Hewlett-Packard Hong Kong, Ltd.  
22/F Bond Centre, West Tower  
89 Queensway, Central  
G.P.O. Box 863  
HONG KONG  
Tel: 5 848 7777  
Telex: 76793 HPA HX  
Cable: HEWPACK HONG KONG

CET Ltd.  
10th Floor, Hua Asia Bldg.  
64-66 Gloucester Road  
HONG KONG  
Tel: (5) 200922  
Telex: 85148 CET HX

Schmidt & Co. (Hong Kong) Ltd.  
18th Floor, Great Eagle Centre  
23 Harbour Road, Wanchai  
HONG KONG  
Tel: 5-8330222  
Telex: 74766 SCHMC HX

## ICELAND

Hewlett-Packard Iceland  
Hoefdabakka 9  
112 REYKJAVIK  
Tel: 354-1-67-1000  
Telex: 37409

## INDIA

Computer products are sold through  
Blue Star Ltd. All computer repairs  
and maintenance service is done  
through Computer Maintenance Corp.

Blue Star Ltd.  
B. D. Patel House  
Near Sardar Patel Colony  
AHMEDABAD 380 014  
Tel: 403531, 403532  
Telex: 0121-234  
Cable: BLUE FROST

Blue Star Ltd.  
40/4 Lavelle Road  
BANGALORE 560 001  
Tel: 57881, 867780  
Telex: 0845-430 BSLBIN  
Cable: BLUESTAR

Blue Star Ltd.  
Band Box House  
Prabhadevi  
BOMBAY 400 025  
Tel: 4933101, 4933222  
Telex: 011-71051  
Cable: BLUESTAR

Blue Star Ltd.  
Sahas  
414/2 Vir Savarkar Marg  
Prabhadevi  
BOMBAY 400 025  
Tel: 422-6155  
Telex: 011-71193 BSSS IN  
Cable: FROSTBLUE

Blue Star Ltd.  
Kalyan, 19 Vishwas Colony  
Alkapuri, BARODA, 390 005  
Tel: 65235, 65236  
Cable: BLUE STAR

Blue Star Ltd.  
7 Hare Street  
P.O. Box 506  
CALCUTTA 700 001  
Tel: 230131, 230132  
Telex: 031-61120 BSNF IN  
Cable: BLUESTAR

Blue Star Ltd.  
133 Kodambakkam High Road  
MADRAS 600 034  
Tel: 472056, 470238  
Telex: 041-379  
Cable: BLUESTAR

Blue Star Ltd.  
13 Community Center  
New Friends Colony  
NEW DELHI 110 065  
Tel: 682547  
Telex: 031-2463  
Cable: BLUEFROST

Blue Star Ltd.  
15/16 C Wellesley Rd.  
PUNE 411 011  
Tel: 22775  
Cable: BLUE STAR

Blue Star Ltd.  
2-2-47/1108 Bolarum Rd.  
SECUNDERABAD 500 003  
Tel: 72057, 72058  
Telex: 0155-459  
Cable: BLUEFROST

Blue Star Ltd.  
T.C. 7/603 Poornima  
Maruthunkuzhi  
TRIVANDRUM 695 013  
Tel: 65799, 65820  
Telex: 0884-259  
Cable: BLUESTAR

Computer Maintenance Corporation  
Ltd.  
115, Sarojini Devi Road  
SECUNDERABAD 500 003  
Tel: 310-184, 345-774  
Telex: 031-2960

Hewlett-Packard India  
Meridian Commercial Complex  
6th Floor  
8 Windsor Place  
Janpath  
NEW DELHI 110 001  
INDIA  
Tel: 91-11384911  
Telex: 31-4935 HPNDIN

# SALES OFFICES

Arranged alphabetically by country (cont'd)

## INDONESIA

BERCA Indonesia P.T.  
P.O.Box 496/Jkt.  
Jl. Abdul Muis 62  
**JAKARTA**  
Tel: 21-373009  
Telex: 46748 BERSAL IA  
Cable: BERSAL JAKARTA

BERCA Indonesia P.T.  
P.O.Box 2497/Jkt  
Antara Bldg., 12th Floor  
Jl. Medan Merdeka Selatan 17  
**JAKARTA-PUSAT**  
Tel: 21-340417  
Telex: 46748 BERSAL IA

BERCA Indonesia P.T.  
Jalan Kutai 24  
**SURABAYA**  
Tel: 67118  
Telex: 31146 BERSAL SB  
Cable: BERSAL-SURABAYA

## IRAQ

Hewlett-Packard Trading S.A.  
Service Operation  
Al Mansoor City 9B/3/7  
**BAGHDAD**  
Tel: 551-49-73  
Telex: 212-455 HEPAIRAQ IK

## IRELAND

Hewlett-Packard Ireland Ltd.  
Temple House, Temple Road  
Blackrock, Co. **DUBLIN**  
Tel: 88/333/99  
Telex: 30439

Hewlett-Packard Ltd.  
75 Belfast Rd, Carrickfergus  
Belfast BT38 8PH  
**NORTHERN IRELAND**  
Tel: 09603-67333  
Telex: 747626

## ISRAEL

Eldan Electronic Instrument Ltd.  
P.O.Box 1270  
**JERUSALEM** 91000  
16, Ohaliav St.  
**JERUSALEM** 94467  
Tel: 533 221, 553 242  
Telex: 25231 AB/PAKRD IL  
Computation and Measurement  
Systems (CMS) Ltd.  
11 Masad Street  
67060  
**TEL-AVIV**  
Tel: 388 388  
Telex: 33569 Motil IL

## ITALY

Hewlett-Packard Italiana S.p.A.  
Traversa 99C  
Via Giulio Petroni, 19  
I-70124 **BARI**  
Tel: (080) 41-07-44  
Hewlett-Packard Italiana S.p.A.  
Via Emilia, 51/C  
I-40011 **BOLOGNA** Anzola Dell'Emilia  
Tel: 39-051-731061  
Telex: 511630

Hewlett-Packard Italiana S.p.A.  
Via Principe Nicola 43G/C  
I-95126 **CATANIA**  
Tel: (095) 37-10-87  
Telex: 970291

Hewlett-Packard Italiana S.p.A.  
Via G. di Vittorio 10  
20094 **CORSICO** (Milano)  
Tel: 39-02-4408351

Hewlett-Packard Italiana S.p.A.  
Viale Brigata Bisagno 2  
16129 **GENOVA**  
Tel: 39-10-541141  
Telex: 215238

Hewlett-Packard Italiana S.p.A.  
Viale G. Modugno 33  
I-16156 **GENOVA PEGLI**  
Tel: (010) 68-37-07  
Telex: 215238

Hewlett-Packard Italiana S.p.A.  
Via G. di Vittorio 9  
I-20063 **CERNUSCO SUL NAVIGLIO** (Milano)  
Tel: (02) 923691  
Telex: 334632  
Hewlett-Packard Italiana S.p.A.  
Via Nuova Rivoltana 95  
20090 **LIMITO** (Milano)  
Tel: 02-92761

Hewlett-Packard Italiana S.p.A.  
Via Nuova San Rocco a  
Capodimonte, 62/A  
I-80131 **NAPOLI**  
Tel: (081) 7413544  
Telex: 710698

Hewlett-Packard Italiana S.p.A.  
Via Orazio 16  
80122 **NAPOLI**  
Tel: (081) 7611444  
Telex: 710698

Hewlett-Packard Italiana S.p.A.  
Via Pellizzo 15  
35128 **PADOVA**  
Tel: 39-49-664-888  
Telex: 430315

Hewlett-Packard Italiana S.p.A.  
Viale C. Pavese 340  
I-00144 **ROMA EUR**  
Tel: 39-65-48-31  
Telex: 610514

Hewlett-Packard Italiana S.p.A.  
Via di Casellina 57/C  
500518 **SCANDICCI-FIRENZE**  
Tel: 39-55-753863

Hewlett-Packard Italiana S.p.A.  
Corso Svizzera, 185  
I-10144 **TORINO**  
Tel: 39-11-74-4044  
Telex: 221079

## IVORY COAST

S.I.T.E.L.  
Societe Ivoirienne de  
Telecommunications  
Bd. Giscard d'Estaing  
Carrefour Marcory  
Zone 4.A.  
Boite postale 2580  
**ABIDJAN** 01  
Tel: 353600  
Telex: 43175

S.I.T.I.  
Immeuble "Le General"  
Av. du General de Gaulle  
01 BP 161  
**ABIDJAN** 01  
Tel: 321227  
Telex: 22149

## JAPAN

Yokogawa-Hewlett-Packard Ltd.  
152-1, Onna  
**ATSUGI**, Kanagawa, 243  
Tel: (0462) 25-0031

Yokogawa-Hewlett-Packard Ltd.  
Meiji-Seimei Bldg, 6F  
3-1 Motochiba-Cho  
**CHIBA**, 280  
Tel: (0472) 25 7701

Yokogawa-Hewlett-Packard Ltd.  
Yasuda-Seimei Hiroshima Bldg.  
6-11, Hon-dori, Naka-ku  
**HIROSHIMA**, 730  
Tel: (082) 241-0611

Yokogawa-Hewlett-Packard Ltd.  
Towa Building  
2-2-3 Kaigan-dori, Chuo-ku  
**KOBE**, 650  
Tel: (078) 392-4791

Yokogawa-Hewlett-Packard Ltd.  
Kumagaya Asahi 82 Bldg.  
3-4 Tsukuba  
**KUMAGAYA**, Saitama 360  
Tel: (0485) 24-6563

Yokogawa-Hewlett-Packard Ltd.  
Asahi Shinbun Daiichi Seimei Bldg.  
4-7, Hanabata-cho  
**KUMAMOTO**, 860  
Tel: 96-354-7311

Yokogawa-Hewlett-Packard Ltd.  
Shin-Kyoto Center Bldg.  
614, Higashi-Shioji-cho  
Karasuma-Nishiru  
**KYOTO**, 600  
Tel: 075-343-0921

Yokogawa-Hewlett-Packard Ltd.  
Mito Mitsui Bldg.  
1-4-73, Sanno-maru  
**MITO**, Ibaraki 310  
Tel: (0292) 25-7470

Yokogawa-Hewlett-Packard Ltd.  
Meiji-Seimei Kokubun Bldg.  
7-8 Kokubun, 1 Chome, Sendai  
**MIYAGI**, 980  
Tel: (0222) 25-1011

Yokogawa-Hewlett-Packard Ltd.  
Gohda Bldg. 2F  
1-2-10 Gohda Okaya-Shi  
Okaya-Shi  
**NAGANO**, 394  
Tel: (0266) 23 0851

Yokogawa-Hewlett-Packard Ltd.  
Nagoya Kokusai Center Building  
1-47-1, Nagono, Nakamura-ku  
**NAGOYA, AICHI** 450  
Tel: (052) 571-5171

Yokogawa-Hewlett-Packard Ltd.  
Sai-Kyo-Ren Building  
1-2 Dote-cho  
**OOMIYA-SHI SAITAMA** 330  
Tel: (0486) 45-8031

Yokogawa-Hewlett-Packard Ltd.  
Chuo Bldg., 5-4-20 Nishi-Nakajima  
4-20 Nishinakajima, 5 Chome,  
Yodogawa-ku  
**OSAKA**, 532  
Tel: (06) 304-6021  
Telex: YHPOSA 523-3624

Yokogawa-Hewlett-Packard Ltd.  
1-27-15, Yabe  
**SAGAMIHARA** Kanagawa, 229  
Tel: 0427 59-1311

Yokogawa-Hewlett-Packard Ltd.  
Hamamatsu Motoshiro-Cho Daichi  
Seimei Bldg 219-21, Motoshiro-Cho  
Hamamatsu-shi  
**SHIZUOKA**, 430  
Tel: (0534) 56 1771

Yokogawa-Hewlett-Packard Ltd.  
Shinjuku Daiichi Seimei Bldg.  
2-7-1, Nishi Shinjuku  
Shinjuku-ku, **TOKYO** 163  
Tel: 03-348-4611

Yokogawa Hewlett-Packard Ltd.  
9-1, Takakura-cho  
Hachioji-shi, **TOKYO**, 192  
Tel: 81-426-42-1231

Yokogawa-Hewlett-Packard Ltd.  
3-29-21 Takaido-Higashi, 3 Chome  
Suginami-ku **TOKYO** 168  
Tel: (03) 331-6111  
Telex: 232-2024 YHPTOK

Yokogawa Hokushin Electric Corp.  
(YEW)  
Shinjuku-NS Bldg. 10F  
9-32 Nokacho 2 Chome  
Shinjuku-ku  
**TOKYO**, 163  
Tel: (03) 349-1859  
Telex: J27584

Yokogawa-Hewlett-Packard Ltd.  
Meiji-Seimei  
Utsunomiya Odori Building  
1-5 Odori, 2 Chome  
**UTSUNOMIYA**, Tochigi 320  
Tel: (0286) 33-1153

Yokogawa-Hewlett-Packard Ltd.  
Yasuda Seimei Nishiguchi Bldg.  
30-4 Tsuruya-cho, 3 Chome  
Kanagawa-ku, **YOKOHAMA** 221  
Tel: (045) 312-1252

## JORDAN

Scientific and Medical Supplies Co.  
P.O. Box 1387  
**AMMAN**  
Tel: 24907, 39907  
Telex: 21456 SABCO JO

## KENYA

ADCOM Ltd., Inc., Kenya  
P.O.Box 30070  
**NAIROBI**  
Tel: 331955  
Telex: 22639

## KOREA

Samsung Hewlett-Packard Co. Ltd.  
Dongbang Yeoeuido Building  
12-16th Floors  
36-1 Yeoeuido-Dong  
Youngdeungpo-Ku  
**SEOUL**  
Tel: 784-4666, 784-2666  
Telex: 25166 SAMSAN K  
Young In Scientific Co., Ltd.  
Youngwha Building  
547 Shinsa Dong, Kangnam-Ku  
**SEOUL** 135  
Tel: 546-7771  
Telex: K23457 GINSCO

Dongbang Healthcare  
Products Co. Ltd.  
Suite 301 Medical Supply Center  
Bldg. 1-31 Dongsungdong  
Jong Ro-gu, **SEOUL**  
Tel: 764-1171, 741-1641  
Telex: K25706 TKBKO  
Cable: TKBEEPKO

## KUWAIT

Al-Khaldiya Trading & Contracting  
P.O. Box 830  
**SAFAT**  
Tel: 424910, 411726  
Telex: 22481 AREEG KT  
Cable: VISCOUNT

Gulf Computing Systems  
P.O. Box 25125  
**SAFAT**  
Tel: 435969  
Telex: 23648

Photo & Cine Equipment  
P.O. Box 270  
**SAFAT**  
Tel: 2445111  
Telex: 22247 MATIN KT  
Cable: MATIN KUWAIT

W.J. Towell Computer Services  
P.O. Box 5897  
**SAFAT**  
Tel: 2462640/1  
Telex: 30336 TOWELL KT

## LEBANON

Computer Information Systems S.A.L.  
Chammas Building  
P.O. Box 11-6274 Dora  
**BEIRUT**  
Tel: 89 40 73  
Telex: 42309 chaxis le

## LIBERIA

Unichemicals Inc.  
P.O. Box 4509  
**MONROVIA**  
Tel: 224282  
Telex: 4509



**LUXEMBOURG**

Hewlett-Packard Belgium S.A./N.V.  
Blvd de la Woluwe, 100  
Woluwedal  
B-1200 **BRUSSELS**  
Tel: (02) 762-32-00  
Telex: 23-494 paloben bru

**MADAGASCAR**

Technique et Precision  
12, rue de Nice  
P.O. Box 1227  
101 **ANTANANARIVO**  
Tel: 22090  
Telex: 22255

**MALAYSIA**

Hewlett-Packard Sales (Malaysia)  
Sdn. Bhd.  
9th Floor  
Chung Khiaw Bank Building  
46, Jalan Raja Laut  
50736 **KUALA LUMPUR, MALAYSIA**  
Tel: 03-2986555  
Telex: 310111 HPSM MA

Protel Engineering  
P.O.Box 1917  
Lot 6624, Section 64  
23/4 Pending Road  
Kuching, **SARAWAK**  
Tel: 36299  
Telex: 70904 PROMAL MA  
Cable: PROTELENG

**MALTA**

Phillip Toledo Ltd.  
Kirkirkara P.O. Box 11  
Notabile Rd.  
**MRIEHEL**  
Tel: 447 47, 455 66, 4915 25  
Telex: Media MW 649

**MAURITIUS**

Blanche Birger Co. Ltd.  
18, Jules Koenig Street  
**PORT LOUIS**  
Tel: 20828  
Telex: 4296

**MEXICO**

Hewlett-Packard de Mexico,  
S.A. de C.V.  
Rio Nio No. 4049 Desp. 12  
Fracc. Cordoba  
**JUAREZ, Mexico**  
Tel: 161-3-15-62

Hewlett-Packard de Mexico,  
S.A. de C.V.  
Condominio Kadereyta  
Circuito del Mezon No. 186 Desp. 6  
Col. Del Prado - 76030  
**QRO, Mexico**  
Tel: 463-6-02-71

Hewlett-Packard de Mexico,  
S.A. de C.V.  
Monti Morelos No. 299  
Fraccionamiento Loma Bonita 45060  
**GUADALAJARA, Jalisco**  
Tel: 36-31-48-00  
Telex: 0684 186 ECOMÉ

Microcomputadoras Hewlett-Packard,  
S.A. de C.V.  
Hewlett-Packard de Mexico,  
S.A. de C.V.  
Monte Pelvoux No. 111  
Lomas de Chapultepec  
11000 **MEXICO, D.F.**  
Tel: 596 8077/596 7933  
Telex: 17-74-507 HEWPACK MEX

Hewlett-Packard de Mexico,  
S.A. de C.V.  
Czda. del Valle  
409 Ote. 4th Piso  
Colonia del Valle  
Municipio de Garcia  
66220 **NUEVO LEON**  
Tel: 83-78-42-40  
Telex: 382410 HPMY

Infograficas y Sistemas  
del Noreste, S.A.  
Rio Orinoco #171 Oriente  
Despacho 2001  
Colonia Del Valle  
**MONTERREY**  
Tel: 559-4415, 575-3837  
Telex: 483164

Hewlett-Packard de Mexico,  
S.A. de C.V.  
Blvd. Independencia No. 2000 Ote.  
Col. Estrella  
**TORREON, COAH.**  
Tel: 171-8 2201

**MOROCCO**

Etablissement Hubert Dolbeau & Fils  
81 rue Karatchi  
B.P. 11133  
**CASABLANCA**  
Tel: 3041-82, 3068-38  
Telex: 23051, 22822

Gerep  
2, rue Agadir  
Boite Postale 156  
**CASABLANCA 01**  
Tel: 272093, 272095  
Telex: 23 739

Sema-Maroc  
Dept. Seric  
6, rue Lapébie  
**CASABLANCA**  
Tel: 260980  
Telex: 21641

**NETHERLANDS**

Hewlett-Packard Nederland B.V.  
Startbaan 16  
NL-1187 XR **AMSTELVEEN**  
P.O. Box 667  
NL-1180 AR **AMSTELVEEN**  
Tel: (020) 547-6911  
Telex: 13 216 HEPANL

Hewlett-Packard Nederland B.V.  
Bongerd 2  
P.O. Box 41  
NL 2900AA **CAPELLE A/D IJSSSEL**  
Tel: 31-20-51-6444  
Telex: 21261 HEPAC NL

Hewlett-Packard Nederland B.V.  
Pastoor Petersstraat 134-136  
P.O. Box 2342  
NL 5600 CH **EINDHOVEN**  
Tel: 31-40-32-6911  
Telex: 51484 hepae nl

**NEW ZEALAND**

Hewlett-Packard (N.Z.) Ltd.  
5 Owens Road  
P.O. Box 26-189  
Epsom, **AUCKLAND**  
Tel: 64-9-687-159  
Cable: HEWPAK Auckland

Hewlett-Packard (N.Z.) Ltd.  
184-190 Willis Street  
**WELLINGTON**  
P.O. Box 9443  
Courtenay Place, **WELLINGTON 3**  
Tel: 877 199  
Cable: HEWPAK Wellington

Northrop Instruments & Systems Ltd.  
131 Khyber Pass Road  
Northrup House - 2nd Floor  
Private Bag  
Newmarket, **AUCKLAND**  
Tel: 794-091  
Telex: 60605

Northrop Instruments & Systems Ltd.  
110 Mandeville St.  
P.O. Box 8388  
**CHRISTCHURCH**  
Tel: 488-873  
Telex: 4203

Northrop Instruments & Systems Ltd.  
Sturdee House  
85-87 Ghuznee Street  
P.O. Box 2406  
**WELLINGTON**  
Tel: 850-091  
Telex: NZ 3380

**NIGERIA**

Elmecc Nigeria Ltd.  
45 Saka Tirubud St.  
Victoria Island  
**LAGOS**  
Tel: 61-98-94  
Telex: 20-117

**NORTHERN IRELAND**

See United Kingdom

**NORWAY**

Hewlett-Packard Norway A/S  
Oesterndalen 16-18  
P.O. Box 34  
N-1345 **OESTERAAS**  
Tel: 47-2-24-6090  
Telex: 76621 hpnas n

Hewlett-Packard Norway A/S  
Boemertg. 42  
Box 2470  
N-5037 **SOLHEIMSVIK**  
Tel: 0047/5/29 00 90

Hewlett-Packard Norway A/S  
Baadegt. 2  
N-4006 **STAVANGER**  
Tel: 47-4-52-29-03  
Telex: 47-4-52-09-39

Hewlett-Packard Norway A/S  
Sluppennv. 5  
P.O. Box 1508, Nidarvoll  
N-7002 **TRONDHEIM**  
Tel: 47-7-96-47-75  
Telex: 47-7-96-47-76

**OMAN**

Khimjil Ramdas  
P.O. Box 19  
**MUSCAT/SULTANATE OF OMAN**  
Tel: 795 901  
Telex: 3489 BROKER MB MUSCAT

Suhail & Saud Bahwan  
P.O.Box 169  
**MUSCAT/SULTANATE OF OMAN**  
Tel: 734 201-3  
Telex: 5274 BAHWAN MB

Imtac LLC  
P.O. Box 9196  
**MINA AL FAHAL/SULTANATE OF OMAN**  
Tel: 70-77-27, 70-77-23  
Telex: 3865 Tawoos On

**PAKISTAN**

Mushko & Company Ltd.  
House No. 16, Street No. 16  
Sector F-6/3  
**ISLAMABAD**  
Tel: 824545  
Telex: 54001 Muski Pk  
Cable: FEMUS Islamabad

Mushko & Company Ltd.  
Oosman Chambers  
Abdullah Haroon Road  
**KARACHI 0302**  
Tel: 524131, 524132  
Telex: 2894 MUSKO PK  
Cable: COOPERATOR Karachi

**PANAMA**

Electronico Balboa, S.A.  
Calle Samuel Lewis, Ed. Alfa  
Apartado 4929  
**PANAMA CITY**  
Tel: 9-011-507-636613  
Telex: 368 3483 ELECTRON PG

**PERU**

Cia Electro Médica S.A. (ERMED)  
Los Flamencos 145, Ofc. 301/2  
San Isidro  
Casilla 1030  
**LIMA 1 Peru**  
Tel: 9-011-511-4-414325, 41-3705  
Telex: 39425257 PE PB SIS

SAMS S.A.  
Arenida Republica de Panama 3534  
San Isidro, **LIMA**  
Tel: 9-011-511-4-229332/413984/  
413226  
Telex: 39420450 PE LIBERTAD

**PHILIPPINES**

The Online Advanced Systems Corp.  
2nd Floor, Electra House  
115-117 Esteban Street  
P.O. Box 1510  
Legaspi Village, Makati  
Metro **MANILA**  
Tel: 815-38-10 (up to 16)  
Telex: 63274 ONLINE PN

**PORTUGAL**

Mundinter Intercambio  
Mundial de Comércio S.A.R.L.  
Av. Antonio Augusto Aguiar 138  
Apartado 2761  
**LISBON**  
Tel: (19) 53-21-31, 53-21-37  
Telex: 16691 munter p

Soquimica  
Av. da Liberdade, 220-2  
1298 **LISBOA Codex**  
Tel: 56-21-82  
Telex: 13316 SABASA

Telectra-Empresa Técnica de  
Equipamentos Eléctricos S.A.R.L.  
Rua Rodrigo da Fonseca 103  
P.O. Box 2531  
**LISBON 1**  
Tel: (19) 68-60-72  
Telex: 12598

C.P.C.S.I.  
Rua de Costa Cabral 575  
4200 **PORTO**  
Tel: 499174/495173  
Telex: 26054

**PUERTO RICO**

Hewlett-Packard Puerto Rico  
101 Muñoz Rivera Av  
Esu. Calle Ochoa  
**HATO REY, Puerto Rico 00918**  
Tel: (809) 754-7800

**QATAR**

Computer Arabia  
P.O. Box 2750  
**DOHA**  
Tel: 428555  
Telex: 4806 CHPARB

Nasser Trading & Contracting  
P.O.Box 1563  
**DOHA**  
Tel: 422170  
Telex: 4439 NASSER DH

**SAUDI ARABIA**

Modern Electronics Establishment  
Hewlett-Packard Division  
P.O. Box 281  
Thuobah

**AL-KHOBAR 31952**  
Tel: 895-1760, 895-1764  
Telex: 671 106 HPMEEK SJ  
Cable: ELECTA AL-KHOBAR

Modern Electronics Establishment  
Hewlett-Packard Division  
P.O. Box 1228  
Redec Plaza, 6th Floor  
**JEDDAH**

Tel: 644 96 28  
Telex: 4027 12 FARNAS SJ  
Cable: ELECTA JEDDAH

Modern Electronics Establishment  
Hewlett-Packard Division  
P.O.Box 22015  
**RIYADH 11495**  
Tel: 491-97 15, 491-63 87  
Telex: 202049 MEERYD SJ

# SALES OFFICES

Arranged alphabetically by country (cont'd)

## SAUDI ARABIA (Cont'd)

Abdul Ghani El Ajou Corp.  
P.O. Box 78  
**RIYADH**  
Tel: 40 41 717  
Telex: 200 932 EL AJOU

## SCOTLAND See United Kingdom

## SENEGAL

Societe Hussein Ayad & Cie.  
76, Avenue Georges Pompidou  
B.P. 305  
**DAKAR**  
Tel: 32339  
Cable: AYAD-Dakar

Moneger Distribution S.A.  
1, Rue Parent  
B.P. 148  
**DAKAR**  
Tel: 215 671  
Telex: 587

Systeme Service Conseil (SSC)  
14, Avenue du Parachois  
**DAKAR ETOILE**  
Tel: 219976  
Telex: 577

## SINGAPORE

Hewlett-Packard Singapore (Sales)  
Pte. Ltd.  
1150 Depot Road  
**SINGAPORE, 0410**  
Tel: 273 7388  
Telex: 34209 HPSGSO RS  
Cable: HEWPACK, Singapore

Dynamar International Ltd.  
Unit 05-11 Block 6  
Kolam Ayer Industrial Estate  
**SINGAPORE 1334**  
Tel: 747-6188  
Telex: 26283 RS

## SOUTH AFRICA

Hewlett-Packard So Africa (Pty.) Ltd.  
P.O. Box 120  
Howard Place, **CAPE PROVINCE**  
7450 South Africa  
Tel: 27 121153-7954  
Telex: 57-20006

Hewlett-Packard So Africa (Pty.) Ltd.  
2nd Floor Juniper House  
92 Overport Drive  
**DURBAN 4067**  
Tel: 27-31-28-4178  
Telex: 6-22954

Hewlett-Packard So Africa (Pty.) Ltd.  
Shop 6 Linton Arcade  
511 Cape Road  
Linton Grange  
**PORT ELIZABETH 6001**  
Tel: 27141130 1201  
Telex: 24-2916

Hewlett-Packard So Africa (Pty.) Ltd.  
Fountain Center  
Kalkoen Str.  
Monument Park Ext 2  
**PRETORIA 0105**  
Tel: (012) 45 5725  
Telex: 32163

Hewlett-Packard So Africa (Pty.) Ltd.  
Private Bag Wendywood  
**SANDTON 2144**  
Tel: 27-11-802-5111, 27-11-802-5125  
Telex: 4-20877 SA  
Cable: HEWPACK Johannesburg

## SPAIN

Hewlett-Packard Española, S.A.  
Calle Entenza, 321  
**E.-BARCELONA 29**  
Tel: 3/322 24 51, 321 73 54  
Telex: 52603 hpbee

Hewlett-Packard Española, S.A.  
Calle San Vicente S/N  
Edificio Albia II-7B  
**48001 BILBAO**  
Tel: 4/423 83 06

Hewlett-Packard Española, S.A.  
Crt. N-VI, Km. 16, 400  
Las Rozas  
**E.-MADRID**  
Tel: (1) 637.00.11  
Telex: 23515 HPE

Hewlett-Packard Española, S.A.  
Avda. S. Francisco Javier, S/N  
Planta 10. Edificio Sevilla 2  
**E.-SEVILLA 5, SPAIN**  
Tel: 54/64 44 54  
Telex: 72933

Hewlett-Packard Española, S.A.  
Isabel La Catolica, 8  
**E.-46004 VALENCIA**  
Tel: 34-6-361 1354  
Telex: 63435

Hewlett-Packard Española, S.A.  
Av. de Zugazarte, 8  
Las Arenas-Guecho  
**E.-48930 VIZCAYA VIZCAYA**  
Tel: 34-423-83 06  
Telex: 33032

## SWEDEN

Hewlett-Packard Sverige AB  
Östra Tullgatan 3  
S-20011 **MALMÖ**  
Box 6132  
Tel: 46-40-702-70  
Telex: (854) 17886 (via Spånga office)

Hewlett-Packard Sverige AB  
Elementvagen 16  
S-7022 7 **ÖREBRO**  
Tel: 49-019-10-4820  
Telex: (854) 17886 (via Spånga office)

Hewlett-Packard Sverige AB  
Skalholtsgatan 9, Kista  
P.O. Box 19  
S-16393 **SPÅNGA**  
Tel: (08) 750-2000  
Telex: (854) 17886  
Telefax: (08) 7527781

Hewlett-Packard Sverige AB  
Box 266  
Topasgatan 1A  
S-42123 **VÄSTRA-FRÖLUNDA**  
(Gothenburg)  
Tel: 46-031-89-1000  
Telex: (854) 17886 (via Spånga office)

## SUDAN

Mediterranean Engineering  
& Trading Co. Ltd.  
P.O. Box 1025  
**KHARTOUM**  
Tel: 41184  
Telex: 24052

## SWITZERLAND

Hewlett-Packard (Schweiz) AG  
Clarastrasse 12  
CH-4058 **BASEL**  
Tel: 41-61-33-5920

Hewlett-Packard (Schweiz) AG  
7, rue du Bois-du-Lan  
Case postale 365-1366  
CH-1217 **MEYRIN 1**  
Tel: (0041) 22-83-8-11  
Telex: 27333 HPAG CH

Hewlett-Packard (Schweiz) AG  
Allmend 2  
CH-8967 **WIDEN**  
Tel: 41-57-31-2111  
Telex: 53933 hpag ch  
Cable: HPAG CH

Hewlett-Packard (Schweiz) AG  
Schwamendingenstrasse 10  
CH-8050 **ZURICH**  
Tel: 41-1-315-8181  
Telex: 823 537 HPAG CH

## SYRIA

General Electronic Inc.  
Nuri Basha Ahnaf Ebn Kays Street  
P.O. Box 5781  
**DAMASCUS**  
Tel: 33-24-87  
Telex: 44-19-88  
Cable: ELECTROBOR DAMASCUS

Middle East Electronics  
P.O. Box 2308  
Abu Rumaneh  
**DAMASCUS**  
Tel: 33 45 92  
Telex: 411 771 Meesy

## TAIWAN

Hewlett-Packard Taiwan Ltd.  
THM Office  
2, Huan Nan Road  
**CHUNG LI, Taoyuan**  
Tel: (034) 929-666

Hewlett-Packard Taiwan Ltd.  
Kaohsiung Office  
11/F, 456, Chung Hsiao 1st Road  
**KAOSHIUNG**  
Tel: (07) 2412318

Hewlett-Packard Taiwan Ltd.  
8th Floor, Hewlett-Packard Building  
337 Fu Hsing North Road  
**TAIPEI**  
Tel: (02) 712-0404  
Telex: 24439 HEWPACK  
Cable: HEWPACK Taipei

Ing Lih Trading Co.  
3rd Floor, No. 7, Sect. 2  
Jen Ai Road  
**TAIPEI 100**  
Tel: (02) 394-8191  
Telex: 22894 SANKWANG

## THAILAND

Unimesa Co. Ltd.  
2540 Sukumvit Avenue  
Bangna  
**BANGKOK 10260**  
Tel: 662-398-6953  
Telex: 84439 Simonco TH  
Cable: UNIMESA Bangkok

Bangkok Business Equipment Ltd.  
5/5-6 Dejo Road  
**BANGKOK**  
Tel: 234-8670, 234-8671  
Telex: 87699-BEQUIPT TH  
Cable: BUSIQUIPT Bangkok

## TOGO

Societe Africaine De Promotion  
Immeuble Sageb  
Rue d'Atakpame  
P.O. Box 4150  
**LOME**  
Tel: 21-62-88  
Telex: 5357

## TRINIDAD & TOBAGO

Caribbean Telecoms Ltd.  
Corner McAllister Street &  
Eastern Main Road, Laventille  
P.O. Box 732  
**PORT-OF-SPAIN**  
Tel: 624-4213  
Telex: 22561 CARTEL WG  
Cable: CARTEL, PORT OF SPAIN

Computer and Controls Ltd.  
P.O. Box 51  
1 Taylor Street  
**PORT-OF-SPAIN**  
Tel: (809) 622-7719/622-7985  
Telex: 38722798 COMCON WG  
LOGO AGENCY 1264

Feral Assoc.  
8 Fitzgerald Lane  
**PORT-OF-SPAIN**  
Tel: 62-36864, 62-39255  
Telex: 22432 FERALCO  
Cable: FERALCO

## TUNISIA

Tunisie Electronique S.A.R.L.  
31 Avenue de la Liberte  
**TUNIS**  
Tel: 280-144

Tunisie Electronique S.A.R.L.  
94, Av. Jugurtha, Mutuelleville  
1002 **TUNIS-BELVEDERE**  
Tel: 280144  
Telex: 13238

Corema S.A.  
1 ter. Av. de Carthage  
**TUNIS**  
Tel: 253-821  
Telex: 12319 CABAM TN

## TURKEY

E.M.A  
Mediha Eldem Sokak No. 41/6  
Yenisehir  
**ANKARA**  
Tel: 319175  
Telex: 42321 KTX TR  
Cable: EMATRADE ANKARA

Teknim Company Ltd.  
Iran Caddesi No. 7  
Karaklidere  
**ANKARA**  
Tel: 275800  
Telex: 42155 TKNM TR

Kurt & Kurt A.S.  
Mithatpasa Caddesi No. 75  
Kat 4 Kizilay  
**ANKARA**  
Tel: 318875/6/7/8  
Telex: 42490 MESR TR

Saniva Bilgisayar Sistemleri A.S.  
Buyukdere Caddesi 103/6  
Gayrettepe  
**ISTANBUL**  
Tel: 1673180  
Telex: 26345 SANI TR

Best Inc.  
Esentepe, Gazeteciler Sitesi  
Keskin Kalem  
Sokak 6/3, Gayrettepe  
**ISTANBUL**  
Tel: 172 1328, 173 3344  
Telex: 42490

## UNITED ARAB EMIRATES

Emitac Ltd.  
P.O. Box 1641  
**SHARJAH**  
Tel: 591181  
Telex: 68136 EMITAC EM  
Cable: EMITAC SHARJAH

Emitac Ltd.  
P.O. Box 2711  
**ABU DHABI**  
Tel: 820419-20  
Cable: EMITACH ABUDHABI

Emitac Ltd.  
P.O. Box 8391  
**DUBAI,**  
Tel: 377591

Emitac Ltd.  
P.O. Box 473  
**RAS AL KHAIMAH**  
Tel: 28133, 21270

## UNITED KINGDOM ENGLAND

Hewlett-Packard Ltd.  
Miller House  
The Ring, **BRACKNELL**  
Berks RG12 1XN  
Tel: 44/344/424-898  
Telex: 848733

Hewlett-Packard Ltd.  
Customer Sales & Support  
Building 1  
Filton Road  
Stoke Gifford  
**BRISTOL, BS12 6QZ**

Hewlett-Packard Ltd.  
Oakfield House, Oakfield Grove  
Clifton **BRISTOL**, Avon BS8 2BN  
Tel: 44-272-736 806  
Telex: 444302

Hewlett-Packard Ltd.  
9 Bridewell Place  
**LONDON EC4V 6BS**  
Tel: 44-01-583-6565  
Telex: 298163

**Hewlett-Packard Ltd.**

Pontefract Road  
**NORMANTON**, West Yorkshire WF6 1RN  
 Tel: 44/924/895 566  
 Telex: 557355

**Hewlett-Packard Ltd.**

The Quadrangle  
 106-118 Station Road  
**REDHILL**, Surrey RH1 1PS  
 Tel: 44-737-686-55  
 Telex: 947234

**Hewlett-Packard Ltd.**

Avon House  
 435 Stratford Road  
 Shirley, **SOLIHULL**, West Midlands  
 B90 4BL  
 Tel: 44-21-745-8800  
 Telex: 339105

**Hewlett-Packard Ltd.**

Heathside Park Road  
 Cheadle Heath, Stockport  
 SK3 0RB, United Kingdom  
 Tel: 44-061-428-0828  
 Telex: 668068

**Hewlett-Packard Ltd.**

Harman House  
 No. 1 George Street  
**UXBRIDGE**, Middlesex UB8 1YH  
 Tel: 895 720 20  
 Telex: 893134/5

**Hewlett-Packard Ltd.**

King Street Lane  
 Winnersh, **WOKINGHAM**  
 Berkshire RG11 5AR  
 Tel: 44/734/784774  
 Telex: 8471789

**NORTHERN IRELAND**

Hewlett-Packard (Ireland) Ltd.  
 Carrickfergus Industrial Centre  
 75 Belfast Road, Carrickfergus  
**CO. ANTRIM** BT38 8PM  
 Tel: 09603 67333

**Cardiac Services Company**

95A Finaghy Road South  
**BELFAST**, BT10 0BY  
 Tel: 0232-625566  
 Telex: 747626

**SCOTLAND**

Hewlett-Packard Ltd.  
 1/3 Springburn Place  
 College Milton North  
**EAST KILBRIDE**, G74 5NU  
 Tel: 041-332-6232  
 Telex: 779615

**Hewlett-Packard Ltd.**

**SOUTH QUEENSFERRY**  
 West Lothian, EH30 9TG  
 Tel: 031 331 1188  
 Telex: 72682 HPSQFYG

**UNITED STATES**

Hewlett-Packard Co.  
 Customer Information Center  
 Tel: (800) 752-0900  
 Hours: 6:00 AM to 5:00 PM  
 Pacific Time

**Alabama**

Hewlett-Packard Co.  
 2100 Riverchase Center  
 Building 100 - Suite 118  
**BIRMINGHAM**, AL 35244  
 Tel: (205) 988-0547  
 Fax: (205) 988-0547 X207

Hewlett-Packard Co.  
 420 Wynn Drive  
**HUNTSVILLE**, AL 35805  
 Tel: (205) 830-2000  
 Fax: (205) 830-1427

**Alaska**

Hewlett-Packard Co.  
 4000 Old Seward Highway  
 Suite 101  
**ANCHORAGE**, AK 99503  
 Tel: (907) 563-8855  
 Fax: (907) 561-7409

**Arizona**

Hewlett-Packard Co.  
 8080 Pointe Parkway West  
**PHOENIX**, AZ 85044  
 Tel: (602) 273-8000  
 Fax: (602) 273-8080

Hewlett-Packard Co.  
 3400 East Britannia Dr.  
 Bldg. C, Suite 124  
**TUCSON**, AZ 85706  
 Tel: (602) 573-7400  
 Fax: (602) 573-7429

**Arkansas**

Hewlett-Packard Co.  
 10816 Executive Center Dr  
 Conway Bldg. Suite 116  
**LITTLE ROCK**, AR 72211  
 Tel: (501) 376-1844  
 Fax: (501) 221-3614

**California**

Hewlett-Packard Co.  
 26701 W. Argoura Rd.  
**CALABASAS**, CA 91302  
 Tel: (818) 880-3400  
 Fax: (818) 880-3437

Hewlett-Packard Co.  
 353 Lakeside Dr  
**FOSTER CITY**, CA 94404  
 Tel: (415) 378-8400  
 Fax: (415) 378-8405

Hewlett-Packard Co.  
 1907 North Gateway Blvd.  
**FRESNO**, CA 93727  
 Tel: (209) 252-9652  
 Fax: (209) 456-9302

Hewlett-Packard Co.  
 1421 S. Manhattan Av.  
**FULLERTON**, CA 92631  
 Tel: (714) 999-6700  
 Fax: (714) 778-3033

Hewlett-Packard Co.  
 7408 Hollister Ave. #A  
**GOLETA**, CA 93117  
 Tel: (805) 685-6100  
 Fax: (805) 685-6163

Hewlett-Packard Co.  
 9800 Muirlando Ave.  
**IRVINE**, CA 92718  
 Tel: (714) 472-3000  
 Fax: (714) 581-3607

**Hewlett-Packard Co.**

2525 Grand Avenue  
**LONG BEACH**, CA 90815  
 Tel: (213) 498-1111  
 Fax: (213) 494-1986

**Hewlett-Packard Co.**

5651 West Manchester Ave.  
**LOS ANGELES**, CA 90009  
 Tel: (213) 337-8000  
 Fax: (213) 337-8338

**Hewlett-Packard Co.**

321 E. Evelyn Ave.  
 Bldg. 330  
**MOUNTAIN VIEW**, CA 94039  
 Tel: (415) 694-2000  
 Fax: (415) 694-0600

**Hewlett-Packard Co.**

5161 Lankershim Blvd.  
**NORTH HOLLYWOOD**, CA 91601  
 Tel: (818) 505-5600  
 Fax: (818) 505-5875

**Hewlett-Packard Co.**

5725 W. Las Positas Blvd.  
**PLEASANTON**, CA 94566  
 Tel: (415) 460-0282  
 Fax: (415) 460-0713

**Hewlett-Packard Co.**

4244 So. Market Court, Suite A  
**SACRAMENTO**, CA 95852  
 Tel: (916) 929-7222  
 Fax: (916) 927-7152

**Hewlett-Packard Co.**

9606 Aero Drive  
**SAN DIEGO**, CA 92123  
 Tel: (619) 279-3200  
 Fax: (619) 541-7376

**Hewlett-Packard Co.**

50 Fremont St. Suite 200  
**SAN FRANCISCO**, CA 94105  
 Tel: (415) 882-6800  
 Fax: (415) 882-6805

**Hewlett-Packard Co.**

3003 Scott Boulevard  
**SANTA CLARA**, CA 95054  
 Tel: (408) 988-7000  
 Fax: (408) 988-7103

**Hewlett-Packard Co.**

5280 Valentine Rd. Suite 205  
**VENTURA**, CA 93003  
 Tel: (805) 658-6898  
 Fax: (805) 650-0721

**Colorado**

Hewlett-Packard Co.  
 2945 Center Green Court South  
 Suite A  
**BOULDER**, CO 80301  
 Tel: (303) 499-6655  
 Fax: (303) 938-3025

**Hewlett-Packard Co.**

24 Inverness Place, East  
**ENGLEWOOD**, CO 80112  
 Tel: (303) 649-5000  
 Fax: (303) 649-5787

**Connecticut**

Hewlett-Packard Co.  
 3 Parkland Dr.  
**DARIEN**, CT 06820  
 Tel: (203) 656-0040  
 Fax: (203) 656-5563

**Hewlett-Packard Co.**

115 Glastonbury Blvd  
**GLASTONBURY**, CT 06033  
 Tel: (203) 633-8100  
 Fax: (203) 659-6087

**Florida**

Hewlett-Packard Co.  
 5900 N. Andrews, Suite 100  
**FORT LAUDERDALE**, FL 33309  
 Tel: (305) 938-9800  
 Fax: (305) 938-2293

**Hewlett-Packard Co.**

6800 South Point Parkway  
 Suite 301  
**JACKSONVILLE**, FL 32216  
 Tel: (904) 636-9955  
 Fax: (904) 636-9955

**Hewlett-Packard Co.**

255 East Drive, Suite B  
**MELBOURNE**, FL 32901  
 Tel: (407) 729-0704  
 Fax: (407) 723-4557

**Hewlett-Packard Co.**

6177 Lake Ellenor Drive  
**ORLANDO**, FL 32809  
 Tel: (407) 859-2900  
 Fax: (407) 826-9309 (2)

**Hewlett-Packard Co.**

4700 Bayou Blvd.  
 Building 5  
**PENSACOLA**, FL 32503  
 Tel: (904) 476-8422  
 Fax: (904) 476-4116

**Hewlett-Packard Co.**

5550 Idlewild, #150  
**TAMPA**, FL 33634  
 Tel: (813) 884-3282  
 Fax: (813) 889-4445

**Georgia**

Hewlett-Packard Co.  
 1995 North Park Pl  
**ATLANTA**, GA 30348  
 Tel: (404) 955-1500  
 Fax: (404) 980-7669

**Hewlett-Packard Co.**

3607 Parkway Lane  
 Suite 300  
**NORCROSS**, GA 30092  
 Tel: (404) 448-1894  
 Fax: (404) 246-5206

**Hawaii**

Hewlett-Packard Co.  
 Pacific Tower  
 1001 Bishop St.  
 Suite 2400  
**HONOLULU**, HI 96813  
 Tel: (808) 526-1555  
 Fax: (808) 536-7873

**Idaho**

Hewlett-Packard Co.  
 11309 Chinden Blvd.  
**BOISE**, ID 83707  
 Tel: (208) 323-2700  
 Fax: (208) 323-2528

**Illinois**

Hewlett-Packard Co.  
 2205 E. Empire St.  
**BLOOMINGTON**, IL 61704  
 Tel: (309) 662-9411  
 Fax: (309) 662-0351

**Hewlett-Packard Co.**

525 W. Monroe St., Suite 1308  
**CHICAGO**, IL 60606  
 Tel: (312) 930-0010  
 Fax: (312) 930-0986

**Hewlett-Packard Co.**

1200 East Diehl Road  
**NAPERVILLE**, IL 60566  
 Tel: (312) 357-8800  
 Fax: (312) 357-9896

**Hewlett-Packard Co.**

5201 Tollview Drive  
**ROLLING MEADOWS**, IL 60008  
 Tel: (312) 255-9800  
 Fax: (312) 259-5878

**Indiana**

Hewlett-Packard Co.  
 11911 N. Meridian St.  
**CARMEL**, IN 46032  
 Tel: (317) 844-4100  
 Fax: (317) 843-1291

**Hewlett-Packard Co.**

111 E. Ludwig Road  
 Suite 108  
**FT. WAYNE**, IN 46825  
 Tel: (219) 482-4283  
 Fax: (219) 482-9907

**Iowa**

Hewlett-Packard Co.  
 4050 River Courte Dr.  
**CEDAR RAPIDS**, IA 52402  
 Tel: (319) 393-0606  
 Fax: (319) 378-1024

**Hewlett-Packard Co.**

4201 Corporate Dr.  
**WEST DES MOINES**, IA 50265  
 Tel: (515) 224-1435  
 Fax: (515) 224-1870

**Kansas**

Hewlett-Packard Co.  
 North Rock Business Park  
 3450 N. Rock Rd.  
 Suite 300  
**WICHITA**, KS 67226  
 Tel: (316) 636-4040  
 Fax: (316) 682-8155

**Kentucky**

Hewlett-Packard Co.  
 305 N. Hurstbourne Lane,  
 Suite 100  
**LOUISVILLE**, KY 40222  
 Tel: (502) 426-0100  
 Fax: (502) 426-0322

**Louisiana**

Hewlett-Packard Co.  
 160 James Drive East  
**ST. ROSE**, LA 70087  
 Tel: (504) 467-4100  
 Fax: (504) 467-4100 x 5986

# SALES OFFICES

Arranged alphabetically by country (cont'd)

## UNITED STATES (Cont'd)

### Maryland

Hewlett-Packard Co.  
3701 Koppers Street  
**BALTIMORE, MD** 21227  
Tel: (301) 644-5800  
Fax: (301) 362-7650

Hewlett-Packard Co.  
2 Choke Cherry Road  
**ROCKVILLE, MD** 20850  
Tel: (301) 948-6370  
Fax: (301) 258-5986

### Massachusetts

Hewlett-Packard Co.  
1775 Minuteman Road  
**ANDOVER, MA** 01810  
Tel: (617) 682-1500  
Fax: (617) 682-1500 x 2619

Hewlett-Packard Co.  
29 Burlington Mall Rd  
**BURLINGTON, MA** 01803-4514  
Tel: (617) 270-7000  
Fax: (617) 221-5240

### Michigan

Hewlett-Packard Co.  
3033 Orchard Vista S.E.  
**GRAND RAPIDS, MI** 49506  
Tel: (616) 957-1970  
Fax: (616) 956-9022

Hewlett-Packard Co.  
39550 Orchard Hill Place Drive  
**NOVI, MI** 48050  
Tel: (313) 349-9200  
Fax: (313) 349-9240

Hewlett-Packard Co.  
560 Kirks Rd.  
Suite 101  
**TROY, MI** 48084  
Tel: (313) 362-5180  
Fax: (313) 362-3028

### Minnesota

Hewlett-Packard Co.  
2025 W. Larpenteur Ave.  
**ST. PAUL, MN** 55113  
Tel: (612) 644-1100  
Fax: (612) 344-5273

### Mississippi

Hewlett-Packard Co.  
1675 Lakeland Dr., Suite 102  
**JACKSON, MS** 39216  
Tel: (601) 982-9365  
Fax: (601) 362-8958

### Missouri

Hewlett-Packard Co.  
6601 Westchester Ave.  
**KANSAS CITY, MO** 64131  
Tel: (816) 737-0071  
Fax: (816) 737-4690

Hewlett-Packard Co.  
13001 Hollenberg Drive  
**BRIDGETON, MO** 63044  
Tel: (314) 344-5100  
Fax: (314) 344-5273

### Nebraska

Hewlett-Packard  
11626 Nicholas St.  
**OMAHA, NE** 68154  
Tel: (402) 493-0300  
Fax: (402) 493-4334

### New Jersey

Hewlett-Packard Co.  
120 W. Century Road  
**PARAMUS, NJ** 07652  
Tel: (201) 265-5000  
Fax: (201) 599-5382

Hewlett-Packard Co.  
10 Silyn Way  
**PARSIPPANY, NJ** 07054  
Tel: (401) 682-4000  
Fax: (401) 682-4031

Hewlett-Packard Co.  
20 New England Av. West  
**PISCATAWAY, NJ** 08854  
Tel: (201) 562-6100  
Fax: (201) 562-6246

### New Mexico

Hewlett-Packard Co.  
7801 Jefferson N.E.  
**ALBUQUERQUE, NM** 87109  
Tel: (505) 823-6100  
Fax: (505) 823-1243

Hewlett-Packard Co.  
1362-C Trinity Dr.  
**LOS ALAMOS, NM** 87544  
Tel: (505) 662-6700  
Fax: (505) 662-4312

### New York

Hewlett-Packard Co.  
5 Computer Drive South  
**ALBANY, NY** 12205  
Tel: (518) 458-1550  
Fax: (518) 458-1550 x 0393

Hewlett-Packard Co.  
130 John Muir Dr.  
**AMHERST, NY** 14228  
Tel: (716) 689-3003  
Fax: (716) 636-7034

Hewlett-Packard Co.  
200 Cross Keys Office Park  
**FAIRPORT, NY** 14450  
Tel: (716) 223-9950  
Fax: (716) 223-6331

Hewlett-Packard Co.  
7641 Henry Clay Blvd.  
**LIVERPOOL, NY** 13088  
Tel: (315) 451-1820  
Fax: (315) 451-1820 x 255

Hewlett-Packard Co.  
No. 1 Pennsylvania Plaza  
55th Floor  
34th Street & 7th Avenue  
**MANHATTAN NY** 10119  
Tel: (212) 971-0800  
Fax: (212) 330-6967

Hewlett-Packard Co.  
Executive Square Office Bldg.  
66 Middlebush Rd.  
**WAPPINGERS FALLS, NY** 12590  
Tel: (914) 298-9125  
Fax: (914) 298-9154

Hewlett-Packard Co.  
2975 Westchester Ave  
**PURCHASE, NY** 10577  
Tel: (914) 935-6300  
Fax: (914) 935-6497

Hewlett-Packard Co.  
3 Crossways Park West  
**WOODBURY, NY** 11797  
Tel: (516) 682-7800  
Fax: (516) 682-7806 (2)

### North Carolina

Hewlett-Packard Co.  
305 Gregson Dr.  
**CARY, NC** 27511  
Tel: (919) 467-6600  
Fax: (919) 469-9441

Hewlett-Packard Co.  
9401 Arrow Point Blvd  
Suite 100  
**CHARLOTTE, NC** 28217  
Tel: (704) 527-8780  
Fax: (704) 523-7857

Hewlett-Packard Co.  
5605 Roanne Way  
**GREENSBORO, NC** 27420  
Tel: (919) 852-1800  
Fax: (919) 547-1997

### Ohio

Hewlett-Packard Co.  
2717 S. Arlington Road  
**AKRON, OH** 44312  
Tel: (216) 644-2270  
Fax: (216) 644-7415

Hewlett-Packard Co.  
4501 Erskine Road  
**CINCINNATI, OH** 45242  
Tel: (513) 891-9870  
Fax: (513) 891-0033

Hewlett-Packard Co.  
15885 Sprague Road  
**STRONGSVILLE, OH** 44136  
Tel: (216) 243-7300  
Fax: (216) 234-7230

Hewlett-Packard Co.  
9080 Springboro Pike  
**MIAMISBURG, OH** 45342  
Tel: (513) 433-2223  
Fax: (513) 433-3633

Hewlett-Packard Co.  
One Maritime Plaza, 5th Floor  
720 Water Street  
**TOLEDO, OH** 43604  
Tel: (419) 242-2200  
Fax: (419) 241-7655

Hewlett-Packard Co.  
675 Brooksedge Blvd.  
**WESTERVILLE, OH** 43081  
Tel: (614) 891-3344  
Fax: (614) 891-1476

### Oklahoma

Hewlett-Packard Co.  
3525 N.W. 56th St.  
Suite C-100  
**OKLAHOMA CITY, OK** 73112  
Tel: (405) 946-9499  
Fax: (405) 942-2127

Hewlett-Packard Co.  
6655 South Lewis,  
Suite 105  
**TULSA, OK** 74136  
Tel: (918) 481-6700  
Fax: (918) 481-2250

### Oregon

Hewlett-Packard Co.  
9255 S. W. Pioneer Court  
**WILSONVILLE, OR** 97070  
Tel: (503) 682-8000  
Fax: (503) 682-8155

### Pennsylvania

Hewlett-Packard Co.  
Heatherwood Industrial Park  
50 Dorchester Rd.  
Route 22  
**HARRISBURG, PA** 17112  
Tel: (717) 657-5900  
Fax: (717) 657-5946

Hewlett-Packard Co.  
111 Zeta Drive  
**PITTSBURGH, PA** 15238  
Tel: (412) 782-0400  
Fax: (412) 963-1300

Hewlett-Packard Co.  
2750 Monroe Boulevard  
**VALLEY FORGE, PA** 19482  
Tel: (215) 666-9000  
Fax: (215) 666-2034

### South Carolina

Hewlett-Packard Co.  
Brookside Park, Suite 122  
1 Harbison Way  
**COLUMBIA, SC** 29210  
Tel: (803) 732-0400  
Fax: (803) 732-0606

Hewlett-Packard Co.  
545 N. Pleasantburg Dr.  
Suite 100  
**GREENVILLE, SC** 29607  
Tel: (803) 232-8002  
Fax: (803) 232-8739

### Tennessee

Hewlett-Packard Co.  
One Energy Centr. Suite 200  
Pelissippi Pkwy.  
**KNOXVILLE, TN** 37932  
Tel: (615) 966-4747  
Fax: (615) 966-4747 x 138

Hewlett-Packard Co.  
889 Ridge Lake Blvd.,  
Suite 100  
**MEMPHIS, TN** 38119  
Tel: (901) 763-4747  
Fax: (901) 762-9723

Hewlett-Packard Co.  
44 Vantage Way,  
Suite 160  
**NASHVILLE, TN** 37228  
Tel: (615) 255-1271  
Fax: (615) 726-2310

### Texas

Hewlett-Packard Co.  
1826-P Kramer Lane  
**AUSTIN, TX** 78758  
Tel: (512) 835-6771  
Fax: (612) 835-6739

Hewlett-Packard Co.  
5700 Cromo Dr  
**EL PASO, TX** 79912  
Tel: (915) 833-4400  
Fax: (915) 581-8097

Hewlett-Packard Co.  
10535 Harwin Drive  
**HOUSTON, TX** 77036  
Tel: (713) 776-6400  
Fax: (713) 776-6495

Hewlett-Packard Co.  
3301 West Royal Lane  
**IRVING, TX** 75063  
Tel: (214) 869-3377  
Fax: (214) 830-8951

Hewlett-Packard Co.  
109 E. Toronto, Suite 100  
**McALLEN, TX** 78501  
Tel: (512) 630-3030  
Fax: (512) 630-1355

Hewlett-Packard Co.  
930 E. Campbell Rd.  
**RICHARDSON, TX** 75081  
Tel: (214) 231-6101  
Fax: (214) 699-4437

Hewlett-Packard Co.  
14100 San Pedro Ave., Suite 100  
**SAN ANTONIO, TX** 78233  
Tel: (512) 494-9336  
Fax: (512) 491-1299

### Utah

Hewlett-Packard Co.  
3530 W. 2100 South St.  
**SALT LAKE CITY, UT** 84130  
Tel: (801) 974-1700  
Fax: (801) 974-1780

### Virginia

Hewlett-Packard Co.  
840 Greenbrier Circle  
Suite 101  
**CHESAPEAKE, VA** 23320  
Tel: (804) 424-7105  
Fax: (804) 424-1494

Hewlett-Packard Co.  
4305 Cox Road  
**GLEN ALLEN, VA** 23060  
Tel: (804) 747-7750  
Fax: (804) 747-6580

Hewlett-Packard Co.  
2800 Electric Road Suite 100  
**ROANOKE, VA** 24018  
Tel: (703) 774-3444  
Fax: (703) 989-8049

### Washington

Hewlett-Packard Co.  
15815 S.E. 37th Street  
**BELLEVUE, WA** 98006  
Tel: (206) 643-4000  
Fax: (206) 643-8748

Hewlett-Packard Co.  
N. 1225 Argonne Rd  
**SPOKANE, WA** 99212  
Tel: (509) 922-7000  
Fax: (509) 927-4236

**West Virginia**

Hewlett-Packard Co.  
501 56th Street  
**CHARLESTON, WV 25304**  
Tel: (304) 925-0492  
Fax: (304) 925-1910

**Wisconsin**

Hewlett-Packard Co.  
275 N. Corporate Dr.  
**BROOKFIELD, WI 53005**  
Tel: (414) 792-8800  
Fax: (414) 792-0218

**URUGUAY**

Pablo Ferrando S.A.C. e I.  
Avenida Italia 2877  
Casilla de Correo 370  
**MONTEVIDEO**  
Tel: 59-82-802-586  
Telex: 398802586

Olympia de Uruguay S.A.  
Maquinas de Oficina  
Avda. del Libertador 1997  
Casilla de Correos 6644  
**MONTEVIDEO**  
Tel: 91-1809, 98-3807  
Telex: 6342 OROU UY

**VENEZUELA**

Hewlett-Packard de Venezuela C.A.  
3A Transversal Los Ruices Norte  
Edificio Segre 1-2 & 3  
Apartado 50933  
**CARACAS 1050**  
Tel: (582) 239-5664  
Telex: 251046 HEWPACK  
  
Analytical Supplies, CA  
Quinta #103 Impermes  
Av El Centro  
Los Chorros  
Apartado 75472  
**CARACAS**  
Tel: 364904, 2394047  
Telex: 26274 CABIC

Tecnologica Medica del Caribe, C.A.  
Multicentro Empresarial del Este  
Ave. Libertador  
Edif. Libertador  
Nucleo "C" - Oficina 51-52  
**CARACAS**  
Tel: 339867/333780

Hewlett-Packard de Venezuela C.A.  
Residencias Tia Betty Local 1  
Avenida 3 Y con Calle 75  
**MARACAIBO**, Estado Zulia  
Apartado 2646  
Tel: 586175669  
Telex: 62464 HPMAR

Hewlett-Packard de Venezuela C.A.  
Urb. Lomas de Este  
Torre Trebol — Piso 11  
**VALENCIA**, Estado Carabobo  
Apartado 3347  
Tel: (5841) 222992

**YUGOSLAVIA**

Do Hermes  
General Zdanova 4  
YU-11000 **BEOGRAD**  
Tel: (011) 342 641  
Telex: 11433

Do Hermes  
Celovska 73  
YU-61000 **LJUBLJANA**  
Tel: (061) 553 170  
Telex: 31583

Elektrotehna  
Titova 51  
YU-61000 **LJUBLJANA**

Do Hermes  
Kralja Tomislava 1  
YU-71000 **SARAJEVO**  
Tel: (071) 35 859  
Telex: 41634

**ZAIRE**

Computer & Industrial Engineering  
25, Avenue de la Justice  
B.P. 12797  
**KINSHASA**, Gombe  
Tel: 32063  
Telex: 21552

**ZAMBIA**

R.J. Tilbury (Zambia) Ltd.  
P.O. Box 32792  
**LUSAKA**  
Tel: 215590  
Telex: 40128

**ZIMBABWE**

Field Technical Sales (Private) Limited  
45, Kelvin Road North  
P.O. Box 3458  
**SALISBURY**  
Tel: 705 231  
Telex: 4-122 RH

September 1988

# APPLICATION NOTES

## Free Aids to Solving Your Test and Measurement Problems

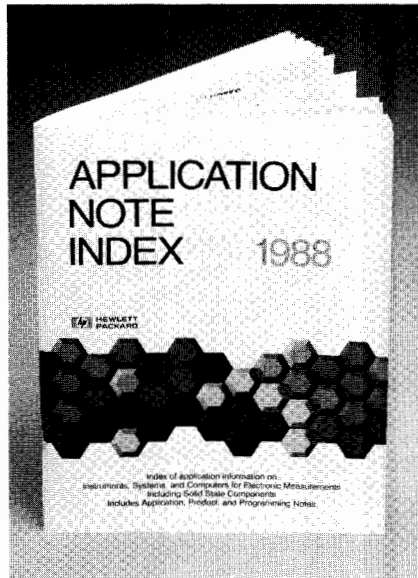

### Application Notes

HP's free Application Notes help you solve your measurement, computation and design problems. Some notes are tutorial, others describe how-to procedures. All are generic or multiple-product oriented.

### Application Note Index

The listing of Application Notes on the following pages is condensed from HP's Application Note Index, which contains a comprehensive list of all Application Notes, Application Briefs, Application Bulletins, Product Notes and Programming Notes available from Hewlett-Packard.

### How to Order Application Notes

To obtain a free copy of the HP Application Note Index and any of the Application Notes listed on the following pages, just call your HP Customer Information Center (CIC) or contact your nearest HP office. Locations and phone numbers of HP CICs and offices are listed on the back pages of this catalog. You may also order the AN index and Application Notes with the information request card inside the rear cover of this catalog. When requesting the AN index or Application Notes, please include the appropriate ordering numbers from the table at the end of this listing.

### A to D Converters

- AN 313-10 Radar System Characterization and Testing
- AN 340-1 Using the HP 5183T to Characterize Sonar Transducers and Systems

### Air Navigation

- AN 243-2 Control System Development Using Dynamic Signal Analyzers

### Amplifiers

- AN 57-1 Fundamentals of RF and Microwave Noise Figure Measurement
- AN 57-2 Noise Figure Measurement Accuracy

- AN 95-1 S-Parameter Techniques for Faster, More Accurate Network Design
- AN 286-2 Accurate Mixer/Amplifier Compression Measurement Using the 8901A Modulation Analyzer
- AN 327-1 Extended Dynamic Range of Scalar Transmission Measurements Using the HP 8757A, 8756A or 8755C Scalar Network Analyzers
- AN 345-1 Amplifier Measurements Using the Scalar Network Analyzer

### Amplitude Modulation

- AN 91 How Vector Measurements Expand Design Capabilities - 1 to 1,000 MHz
- AN 150 Spectrum Analyzer Basics
- AN 150-1 Spectrum Analysis... AM and FM
- AN 150-7 Spectrum Analysis... Signal Enhancement
- AN 286-1 Applications and Operation of the 8901A Modulation Analyzer

### Audio

- AN 243 The Fundamentals of Signal Analysis
- AN 245-2 Measuring the Coherence Function with the HP 3582A Spectrum Analyzer
- AN 245-3 Third Octave Analysis with the HP 3582A Spectrum Analyzer
- AN 245-5 Log Sweep with the HP 3582A Spectrum Analyzer
- AN 356 High Speed Measurement of Semiconductor Devices from Sub-PA to 1A

### Automatic Test Systems

- AN 218-1 Applications & Performance of the HP 8671A and 8672A Microwave Synthesizers
- AN 222-12 A Signature Analysis Based Test System for ECL Logic
- AN 283-3 Low Phase Noise Applications of the HP 8662A and 8663A Synthesized Signal Generators
- AN 289 A Stimulus for Automatic Test
- AN 290-2 Using the HP 3497A to Control Industrial Wastewater Treatment
- AN 297-1 8161A Programmable Pulse Generator
- AN 297-2 Automated Reverse Recovery Time Measurements of Diodes
- AN 313-10 Radar System Characterization and Testing
- AN 314-1 Receiver Testing with the HP 8770S Arbitrary Waveform Synthesizer System
- AN 314-2 Synthesizing Magnetic Disc Read and Servo Signals with the HP 8770S Arbitrary Waveform Synthesizer System
- AN 316-0 Introduction to Computer Aided Test

- AN 316-5 Data Capture with the 6942A/6944A Multiprogrammers
- AN 319 Parametric Characterization of Digital Circuits up to 50 MHz
- AN 328-1 Practical Test System Signal Switching
- AN 330-1 Automatic MIL-STD EMI Testing Using the HP 85864A/B EMI Measurement Software
- AN 331-1 Automatic CISPR EMI Testing for Conducted Emissions
- AN 332 Microwave Switching from SPDT to Full Access Matrix
- AN 340-1 Using the HP 5183T to Characterize Sonar Transducers and Systems
- AN 340-1 Reducing Fixture-Induced Test Failures
- AN 370-1 Mixed Signal Transmission Tests Using an HP 3065CT
- AN 421-5 Jet Engine Controller Testing
- AN 421-7 Environmental/Autoclave Testing
- AN 421-8 Communications Cable Testing
- AN 421-12 Materials Development
- AN 421-16 Jet Engine Testing
- AN 421-18 Large Product Characterization
- AN 421-19 Missile System Testing
- AN 421-20 Machine Monitoring and Control
- AN 421-24 Appliance Testing

### Battery Charging/Discharging

- AN 250-2 Battery Charging/Discharging
- AN 421-14 Battery Testing

### Board Test Systems Networking

- AN 314-2 Synthesizing Magnetic Disc Read and Servo Signals with the HP 8770S Arbitrary Waveform Synthesizer System

### Bode Plot

- AN 243-2 Control System Development Using Dynamic Signal Analyzers

### CRT Displays

- AN 366-1 How to Measure Insertion Loss of Optical Components

### Cable

- AN 62 TDR Fundamentals for use with HP 54120T Digitizing Oscilloscope and TDR
- AN 91 How Vector Measurements Expand Design Capabilities - 1 to 1,000 MHz
- AN 174-10 Measuring Electrical Length Delay of Cables
- AN 191-6 Precise Cable Length and Matching Measurements Using the HP 5370B Universal Time Interval Counter and HP 5363B Time Interval Probes
- AN 302-1 Direct Radio Frequency Impedance Measurements Using the 4191A RF Impedance Analyzer



- AN 421-8 Communications Cable Testing
- Calibration**
- AN 57-2 Fundamentals of RF and Microwave Power Measurement
- AN 77-3 Measurement of Complex Impedance 1 - 1000 MHz
- AN 150-8 Spectrum Analysis . . . Accuracy Improvement
- AN 170-1 HP 8640A/B Signal Generator Output Level Accuracy
- AN 183 High Frequency Swept Measurements
- AN 187-6 Performance of the HP 8620C Sweep Oscillator Under Remote Programming
- AN 191-1 Automatic Zero Calibration of the HP 5359A Time Synthesizer at a Designated Remote Location
- AN 221A Automating the HP 8410B Microwave Network Analyzer
- AN 243-1 Effective Machinery Maintenance Using Vibration Analysis
- AN 245-2 Measuring the Coherence Function with the HP 3582A Spectrum Analyzer
- AN 286-1 Applications and Operation of the 8901A Modulation Analyzer
- AN 332 Microwave Switching from SPDT to Full Access Matrix
- AN 340-1 Using the HP 5183T to Characterize Sonar Transducers and Systems
- AN 341-2 Simulating Sensor Signals
- AN 358-1 Characterization of Frequency Agile Sources with the HP 5371A Frequency and Time Interval Analyzer
- AN 358-2 Jitter and Wander Analysis in Digital Communication with the HP 5371A Frequency and Time Interval Analyzer
- Coaxial Systems**
- AN 62 TDR Fundamentals for use with HP 54120T Digitizing Oscilloscope and TDR
- AN 77-3 Measurement of Complex Impedance, 1 - 1000 MHz
- AN 91 How Vector Measurements Expand Design Capabilities - 1 to 1,000 MHz
- AN 183 High Frequency Swept Measurements
- AN 187-6 Performance of the HP 8620C Sweep Oscillator Under Remote Programming
- AN 221A Automating the HP 8410B Microwave Network Analyzer
- AN 229-11 Protocol Converters: Linking HP Graphics Peripherals with IBM Networks/Systems
- AN 312-1 Configuration of a Two-tone Sweeping Generator
- AN 326 Principles of Microwave Connector Care (for Higher Reliability and Better Measurements)
- AN 327-1 Extended Dynamic Range of Scalar Transmission Measurements Using the HP 8757A, 8756A or 8755C Scalar Network Analyzers
- AN 332 Microwave Switching from SPDT to Full Access Matrix
- AN 332-1 Novel Combinations of Microwave Switches and Step Attenuators for Programming Applications
- Communications**
- AN 181-2 Voltage Controlled Oscillators Characterization Using the HP 5350B, 5351B, 5352B CW Microwave Frequency Counter
- AN 191-7 High Speed Timing Acquisition and Statistical Jitter Analysis Using the HP 5370B Universal Time Interval Counter
- AN 283-3 Low Phase Noise Applications of the HP 8662A and 8663A Synthesized Signal Generators
- AN 314-1 Receiver Testing with the HP 8770S Arbitrary Waveform Synthesizer System
- AN 314-4 Exceptionally Complex Signal Simulation for Multi-Signal Environments in Radar/EW Test
- AN 318-1 The Benefits of P/AR
- AN 332 Microwave Switching from SPDT to Full Access Matrix
- AN 336 An Introduction to Signaling Measurements Applications for Digital Microwave Radio
- AN 343-1 Characterization of Frequency Agile Sources with the HP 5371A Frequency and Time Interval Analyzer
- AN 358-1 Jitter and Wander Analysis in Digital Communication with the HP 5371A Frequency and Time Interval Analyzer
- AN 359 Selecting a Jitter Test Set
- AN 366-2 How to Measure Return Loss of Connectorized Optical Components
- AN 421-8 Communications Cable Testing
- AN 421-18 Large Product Characterization
- AN 421-19 Missile System Testing
- AN 422 X.25 Data Communications
- Component Test**
- AN 57-1 Fundamentals of RF and Microwave Noise Figure Measurement
- AN 57-2 Noise Figure Measurement Accuracy
- AN 91 How Vector Measurements Expand Design Capabilities - 1 to 1,000 MHz
- AN 181-2 Voltage Controlled Oscillators Characterization Using the HP 5350B, 5351B, 5352B CW Microwave Frequency Counter
- AN 191-5 Measurement of Propagation Delays Using the HP 5370B Time Interval Counter and HP 5363B Time Interval Probes
- AN 238 Semiconductor Measurements with the HP 4140B Picoammeter/DC Voltage Source
- AN 238-1 Ultra Low Current Semiconductor DC Parameter Measurement System Using HP 4140B
- AN 286-2 Accurate Mixer/Amplifier Compression Measurement Using the 8901A Modulation Analyzer
- AN 289 A Stimulus for Automatic Test
- AN 302-1 Direct Radio Frequency Impedance Measurements Using the 4191A RF Impedance Analyzer
- AN 302-2 Impedance Characterization of High Q Devices from 1 MHz to 1000 MHz with 1 Hz Resolution
- AN 315 DC Parametric Analysis of Semiconductor Devices, Practical Applications of the 4145A Semiconductor Parameter Analyzer
- AN 316-4 Power Supply Programming with the 6942A Multi-programmer
- AN 316-5 Data Capture with the 6942A/6944A Multiprogrammers
- AN 317 Practical Design and Evaluation of High Frequency Circuits Using the HP 4193A Vector Impedance Meter
- AN 319 Parametric Characterization of Digital Circuits up to 50 MHz
- AN 321 High Speed Testing and Multi-Bin Sorting of Varactor Diodes Using the HP 4277A
- AN 322 Analysis of Semiconductor Capacitance Characteristics Using the HP 4280A 1 MHz C Meter/C-V Plotter
- AN 332 Microwave Switching from SPDT to Full Access Matrix
- AN 339 Parametric Analysis for Electronic Components and Circuit Evaluation Using the HP 4194A
- AN 339-20 Role of DC Parametric Test in High Speed Digital and Microwave Component Manufacturing
- AN 343-2 Dynamic Component Test Using Vector Modulation Analysis
- AN 345-1 Amplifier Measurements Using the Scalar Network Analyzer
- AN 345-2 Mixer Measurements Using the Scalar Network Analyzer

# APPLICATION NOTES

## Free Aids to Solving Your Test and Measurement Problems (Cont'd)

- AN 358-1 Characterization of Frequency Agile Sources with the HP 5371A Frequency and Time Interval Analyzer
- AN 366-1 How to Measure Insertion Loss of Optical Components
- AN 366-2 How to Measure Return Loss of Connectorized Optical Components
- Computer Aided Engineering - EE**
- AN 350-4 Line Quality and Accuracy - What They Are and How to Achieve Them
- AN 350-5 Using an External Plotter Buffer with your Plotter and PC
- AN 420 EPROM Card Troubleshooting for the HP 9000 Series 200/300 Pascal and BASIC Workstations
- Computer Aided Engineering - ME**
- AN 243-3 The Fundamentals of Modal Testing
- AN 350-4 Line Quality and Accuracy - What They Are and How to Achieve Them
- AN 350-5 Using an External Plotter Buffer with your Plotter and PC
- Computer Aided Test**
- AN 421 Data Acquisition and Computer Aided Test Application Summary Series
- Crystal Filters**
- AN 91 How Vector Measurements Expand Design Capabilities - 1 to 1,000 MHz
- AN 171-1 Crystal Testing with the 8640A/B and 8405A
- Computer Crystals**
- AN 91 How Vector Measurements Expand Design Capabilities - 1 to 1,000 MHz
- AN 171-1 Crystal Testing with the 8640A/B and 8405A
- AN 200-2 Fundamentals of Quartz Oscillators
- AN 302-1 Direct Radio Frequency Impedance Measurements Using the 4191A RF Impedance Analyzer
- AN 302-2 Impedance Characterization of High Q Devices from 1 MHz to 1000 MHz with 1 Hz Resolution
- AN 317 Practical Design and Evaluation of High Frequency Circuits Using the HP 4193A Vector Impedance Meter
- DC**
- AN 238-1 Ultra Low Current Semiconductor DC Parameter Measurement System Using HP 4140B
- AN 315 DC Parametric Analysis of Semiconductor Devices, Practical Applications of the 4145A Semiconductor Parameter Analyzer
- Data Acquisition**
- AN 191-7 High Speed Timing Acquisition and Statistical Jitter Analysis Using the HP 5370B Universal Time Interval Counter
- AN 243-3 The Fundamentals of Modal Testing
- AN 290 Practical Temperature Measurements
- AN 290-1 Practical Strain Gauge Measurements
- AN 290-2 Using the HP 3497A to Control Industrial Wastewater Treatment
- AN 313-10 Radar System Characterization and Testing
- AN 316-0 Introduction to Computer Aided Test
- AN 316-5 Data Capture with the 6942A/6944A Multiprogrammers
- AN 339-20 Role of DC Parametric Test in High Speed Digital and Microwave Component Manufacturing
- AN 420 EPROM Card Troubleshooting for the HP 9000 Series 200/300 Pascal and BASIC Workstations
- AN 421-1 Data Acquisition and Computer Aided Test Application Notes for 32 Industries in Series
- AN 421-2 Fan Testing
- AN 421-3 Vehicle Body Testing
- AN 421-4 Waste Water Treatment
- AN 421-5 Jet Engine Controller Testing
- AN 421-6 Internal Combustion Engine Testing
- AN 421-7 Environmental/Autoclave Testing
- AN 421-8 Communications Cable Testing
- AN 421-9 Residential Facility Monitoring
- AN 421-10 Canning Process Characterization
- AN 421-11 Explosion Testing
- AN 421-12 Materials Development
- AN 421-13 Plating Line Control
- AN 421-14 Battery Testing
- AN 421-15 Pilot Plant Monitoring
- AN 421-16 Jet Engine Testing
- AN 421-17 Facility Management
- AN 421-18 Large Product Characterization
- AN 421-19 Missile System Testing
- AN 421-20 Machine Monitoring and Control
- AN 421-21 Pharmaceutical Process Control
- AN 421-22 Paper Process Control
- AN 421-23 Rolling Mill
- AN 421-24 Appliance Testing
- AN 421-25 Air Frame Testing
- AN 421-26 On-Road Vehicle Testing
- AN 421-27 Pumping Station Control
- AN 421-28 Receiver Testing
- AN 421-29 Bed of Nails Test: DA Converter
- AN 421-30 Environmental Test Auto Radio
- AN 421-31 Sonar System Testing
- AN 421-32 Environment Test Electrical Subassembly
- Digital Communications**
- AN 191-7 High Speed Timing Acquisition and Statistical Jitter Analysis Using the HP 5370B Universal Time Interval Counter
- AN 231-2 Codec Testing with the 3779C/D Primary Multiplex Analyzer
- AN 314-1 Receiver Testing with the HP 8770S Arbitrary Waveform Synthesizer System
- AN 341-1 Testing a Complex LSI/VLSI IC with a Low-Cost Measurement Set-up
- AN 343-1 Measurements Applications for Digital Microwave Radio
- AN 343-4 Measuring Demodulator Image Rejection Using the HP 8980A Vector Analyzer
- AN 343-5 Simulating Sensor Signals
- AN 355 Digital Radio Theory and Measurements
- AN 358-1 Characterization of Frequency Agile Sources with the HP 5371A Frequency and Time Interval Analyzer
- AN 358-2 Jitter and Wander Analysis in Digital Communication with the HP 5371A Frequency and Time Interval Analyzer
- AN 359 Selecting a Jitter Test Set
- AN 360 Jitter Tolerance Testing Using Phase/Frequency Modulated Services and Bit Error Rate Test Sets
- Digital Data Transmission**
- AN 191-7 High Speed Timing Acquisition and Statistical Jitter Analysis Using the HP 5370B Universal Time Interval Counter
- AN 318-1 The Benefits of P/AR
- AN 341-1 Testing a Complex LSI/VLSI IC with a Low-Cost Measurement Set-up
- AN 358-2 Jitter and Wander Analysis in Digital Communication with the HP 5371A Frequency and Time Interval Analyzer
- AN 360 Jitter Tolerance Testing Using External Phase/Frequency Modulated Sources and Bit Error Rate Test Sets
- AN 366-1 How to Measure Insertion Loss of Optical Components
- Digital Troubleshooting**
- AN 163-2 New Techniques of Digital Troubleshooting
- AN 191-2 Determining Digital Circuit Timing Tolerance to Optimize Adjustment or Design

- AN 191-5 Measurement of Propagation Delays Using the HP 5370B Time Interval Counter and HP 5363B Time Interval Probes
- AN 222-0 An Index to Signature Analysis Publications
- AN 222-2 Application Articles on Signature Analysis
- AN 222-3 A Manager's Guide to Signature Analysis
- AN 222-4 Guidelines for Signature Analysis: Understanding the Signature Measurement
- AN 222-6 Troubleshooting with Composite Signatures
- AN 222-12 A Signature Analysis Based Test System for ECL Logic
- AN 324-1 Understanding Your Test Fixture
- AN 340-1 Reducing Fixture-induced Test Failures
- AN 341-1 Testing a Complex LSI/VLSI IC with a Low-Cost Measurement Set-up
- AN 358-2 Jitter and Wander Analysis in Digital Communication with the HP 5371A Frequency and Time Interval Analyzer
- AN 360 Jitter Tolerance Testing Using External Phase/Frequency Modulated Sources and Bit Error Rate Test Sets
- AN 370-1 Mixed Signal Transmission Tests Using the HP 3065CT
- Distortion**
- AN 150-11 Spectrum Analysis... Distortion Measurements
- AN 170-2 The 8640A/B Third Order Intermodulation Product Characteristics
- AN 246-1 Optimizing the Dynamic Range of the HP 3585A Spectrum Analyzer
- EMI**
- AN 150-10 Spectrum Analysis... Field Strength
- AN 330-1 Automatic MIL-STD EMI Testing Using the HP 85864A/B EMI Measurement Software
- AN 331-1 Automatic CISPR EMI Testing for Conducted Emissions
- Electrical Length**
- AN 191-6 Precise Cable Length and Matching Measurements Using the HP 5370B Universal Time Interval Counter and HP 5363B Time Interval Probes
- Electronic Warfare (EW)**
- AN 181-2 Voltage Controlled Oscillators Characterization Using the HP 5350B, 5351B, 5352B CW Microwave Frequency Counter
- AN 191-7 High Speed Timing Acquisition and Statistical Jitter Analysis Using the HP 5370B Universal Time Interval Counter
- AN 218-1 Applications & Performance of the HP 8671A and 8672A Microwave Synthesizers
- AN 218-5 Obtaining Leveled Pulse-Modulated Microwave Signals from the HP 8672A
- AN 290-1 Practical Strain Gauge Measurements
- AN 313-10 Radar System Characterization and Testing
- AN 314-4 Exceptionally Complex Signal Simulation for Multi-Signal Environments in Radar/EW Test
- AN 332 Microwave Switching from SPDT to Full Access Matrix
- AN 358-1 Characterization of Frequency Agile Sources with the HP 5371A Frequency and Time Interval Analyzer
- Emulation, Microprocessors**
- AN 150-8 Spectrum Analysis... Accuracy Improvement
- AN 341-1 Testing a Complex LSI/VLSI IC with a Low-Cost Measurement Set-up
- Error Analysis**
- AN 64-1 Fundamentals of RF and Microwave Power Measurement
- AN 77-3 Measurement of Complex Impedance, 1 - 1000 MHz
- AN 170-1 HP 8640A/B Signal Generator Output Level Accuracy
- AN 183 High Frequency Swept Measurements
- AN 191-7 High Speed Timing Acquisition and Statistical Jitter Analysis Using the HP 5370B Universal Time Interval Counter
- AN 221A Automating the HP 8410B Microwave Network Analyzer
- AN 302-1 Direct Radio Frequency Impedance Measurements Using the 4191A RF Impedance Analyzer
- AN 358-2 Jitter and Wander Analysis in Digital Communication with the HP 5371A Frequency and Time Interval Analyzer
- Factory Data Collection**
- AN 290-2 Using the HP 3497A to Control Industrial Wastewater Treatment
- AN 316-0 Introduction to Computer Aided Test
- AN 316-5 Data Capture with the 6942A/6944A Multiprogrammers
- AN 420 EPROM Card Troubleshooting for the HP 9000 Series 200/300 Pascal and BASIC Workstations
- AN 421-4 Waste Water Treatment
- AN 421-10 Canning Process Characterization
- AN 421-13 Plating Line Control
- AN 421-15 Pilot Plant Monitoring
- AN 421-18 Large Product Characterization
- AN 421-20 Machine Monitoring and Control
- AN 421-22 Paper Process Control
- AN 421-23 Rolling Mill
- Fiber Optics**
- AN 191-7 High Speed Timing Acquisition and Statistical Jitter Analysis Using the HP 5370B Universal Time Interval Counter
- AN 351 Characterization of High-Speed Optical Components with an RF Network Analyzer
- AN 358-2 Jitter and Wander Analysis in Digital Communication with the HP 5371A Frequency and Time Interval Analyzer
- AN 362 Bit Error Rate Measurements on Optical Fiber Systems
- AN 366-2 How to Measure Return Loss of Connectorized Optical Components
- Fourier Analysis**
- AN 243 The Fundamentals of Signal Analysis
- AN 243-1 Effective Machinery Maintenance Using Vibration Analysis
- AN 243-2 Control System Development Using Dynamic Signal Analyzers
- AN 243-3 The Fundamentals of Modal Testing
- AN 245-2 Measuring the Coherence Function with the HP 3582A Spectrum Analyzer
- AN 245-3 Third Octave Analysis with the HP 3582A Spectrum Analyzer
- AN 245-4 Accessing the HP 3582A Memory with HP-IB
- AN 245-5 Log Sweep with the HP 3582A Spectrum Analyzer
- AN 313-10 Radar System Characterization and Testing
- Frequency**
- AN 150-8 Spectrum Analysis... Accuracy Improvement
- AN 171-1 Crystal Testing with the 8640A/B and 8405A
- AN 174-6 Measuring the Stability of a Frequency Source
- AN 174-7 Measuring Fractional Frequency Standard Deviation (Sigma) Versus Averaging Time (TAU)
- AN 174-8 Measuring FM Peak-to-Peak Deviation
- AN 174-12 Measuring Frequency Sweep Linearity of Sweep Generators
- AN 174-14 Radar System Characterization and Testing Using the HP 5345A/55A/56A, B, C, D Counter
- AN 181-2 Voltage Controlled Oscillators Characterization Using the HP 5350B, 5351B, 5352B CW Microwave Frequency Counter
- AN 187-6 Performance of the HP 8620C Sweep Oscillator Under Remote Programming

# APPLICATION NOTES

## Free Aids to Solving Your Test and Measurement Problems (Cont'd)

- AN 191-4 Using the HP 5370B Universal Time Interval Counter to Characterize Pulse Width, Repetition Rate, and Jitter
- AN 200-1 Fundamentals of Microwave Frequency Counters
- AN 200-2 Fundamentals of Quartz Oscillators
- AN 200-4 Understanding Frequency Counter Specifications
- AN 207 Understanding and Using Phase Noise in the Frequency Domain
- AN 243-3 The Fundamentals of Modal Testing
- AN 246-2 Measuring Phase Noise with the HP 3585A Spectrum Analyzer
- AN 286-1 Applications and Operation of the 8901A Modulation Analyzer
- AN 287-2 Frequency Profile Using an HP 5345A Time Synthesizer
- AN 287-3 Frequency Profile Using an HP 5370A Universal Time Interval Counter and an HP 5359A Time Synthesizer

### Frequency Modulation

- AN 150 Spectrum Analyzer Basics
- AN 150-1 Spectrum Analysis . . . AM and FM
- AN 174-8 Measuring FM Peak-to-Peak Deviation
- AN 181-2 Voltage Controlled Oscillators Characterization Using the HP 5350B, 5351B, 5352B CW Microwave Frequency Counter
- AN 290-1 Practical Strain Gauge Measurements
- AN 291-1 User's Guide to the 5355/56 Automatic Frequency Converter
- AN 358-1 Characterization of Frequency Agile Sources with the HP 5371A Frequency and Time Interval Analyzer
- AN 360 Jitter Tolerance Testing Using External Phase/Frequency Modulated Sources and Bit Error Rate Test Sets

### Frequency Multiplication

- AN 283-2 External Frequency Doubling of the 8662A Synthesized Signal Generator

### Frequency Stability (Short-Term)

- AN 174-7 Measuring Fractional Frequency Standard Deviation (Sigma) Versus Averaging Time (TAU)
- AN 181-2 Voltage Controlled Oscillators Characterization Using the HP 5350B, 5351B, 5352B CW Microwave Frequency Counter
- AN 191-7 High Speed Timing Acquisition and Statistical Jitter Analysis Using the HP 5370B Universal Time Interval Counter

### Frequency Standards

- AN 52-4 Contribution of HP Clocks to the DII I's International Atomic Time Scale
- AN 171-1 Crystal Testing with the 8640A/B and 8405A
- AN 174-6 Measuring the Stability of a Frequency Source
- AN 174-7 Measuring Fractional Frequency Standard Deviation (Sigma) Versus Averaging Time (TAU)

### Frequency Synthesizers

- AN 91 How Vector Measurements Expand Design Capabilities - 1 to 1,000 MHz
- AN 164-4 Digital Phase Modulation (PSK) and Wideband FM
- AN 187-6 Performance of the HP 8620C Sweep Oscillator Under Remote Programming
- AN 218-1 Applications & Performance of the HP 8671A and 8672A Microwave Synthesizers
- AN 218-2 Obtaining Millihertz Resolution from the 8671A and 8672A
- AN 218-5 Obtaining Leveled Pulse-Modulated Microwave Signals from the HP 8672A
- AN 283-2 External Frequency Doubling of the 8662A Synthesized Signal Generator
- AN 283-3 Low Phase Noise Applications of the HP 8662A and 8663A Synthesized Signal Generators
- AN 289 A Stimulus for Automatic Test Spectral Purity Characteristics of HP Microwave Signal Sources
- AN 329
- AN 340-1 Using the HP 5183T to Characterize Sonar Transducers and Systems
- AN 360 Jitter Tolerance Testing Using External Phase/Frequency Modulated Sources and Bit Error Rate Test Sets
- AN 401-15 8672A Synthesized Signal Generator - HP 1000 HP-IB Programming

### Graphics

- AN 229-11 Protocol Converters: Linking HP Graphics Peripherals with IBM Networks/Systems
- AN 350-1 Using Your HP Plotter with an IBM Mainframe - For ISSCO Software Users
- AN 350-3 Using Your Plotter with an IBM Mainframe - For SAS/Graph Software Users
- AN 350-4 Line Quality and Accuracy - What They Are and How to Achieve Them
- AN 350-5 Using an External Plotter Buffer with your Plotter and PC

### Group Delay

- AN 123 Floating Measurements and Guarding
- AN 221A Automating the HP 8410B Microwave Network Analyzer

### IC Testing

- AN 191-7 High Speed Timing Acquisition and Statistical Jitter Analysis Using the HP 5370B Universal Time Interval Counter
- AN 339-20 Role of DC Parametric Test in High Speed Digital and Microwave Component Manufacturing
- AN 341-1 Testing a Complex LSI/VLSI IC with a Low-Cost Measurement Set-up

### Impedance

- AN 62 TDR Fundamentals for use with HP 54120T Digitizing Oscilloscope and TDR
- AN 62-1 Improving Time Domain Network Analysis Measurements
- AN 77-3 Measurement of Complex Impedance, 1 - 1000 MHz
- AN 154 S-Parameter Design
- AN 183 High Frequency Swept Measurements
- AN 221A Automating the HP 8410B Microwave Network Analyzer
- AN 231-3 Making Telecommunication Measurements in Complex Impedances
- AN 302-1 Direct Radio Frequency Impedance Measurements Using the 4191A RF Impedance Analyzer
- AN 302-2 Impedance Characterization of High Q Devices from 1 MHz to 1000 MHz with 1 Hz Resolution
- AN 317 Practical Design and Evaluation of High Frequency Circuits Using the HP 4193A Vector Impedance Meter
- AN 321 High Speed Testing and Multi-Bin Sorting of Varactor Diodes Using the HP 4277A
- AN 322 Analysis of Semiconductor Capacitance Characteristics Using the HP 4280A 1 MHz C Meter/C-V Plotter
- AN 339 Parametric Analysis for Electronic Components and Circuit Evaluation Using the HP 4194A
- AN 339-3 Crosstalk and Impedance Measurements of PC Board Pattern
- AN 339-6 Static Head Testing for Disk Drives
- AN 340-1 Using the HP 5183T to Characterize Sonar Transducers and Systems
- AN 343-2 Dynamic Component Test Using Vector Modulation Analysis
- AN 356 High Speed Measurement of Semiconductor Devices from Sub-PA to 1A

### Insertion Gain/Loss

- AN 57-1 Fundamentals of RF and Microwave Noise Figure Measurement
- AN 57-2 Noise Figure Measurement Accuracy

- AN 154 S-Parameter Design  
 AN 183 High Frequency Swept Measurements  
 AN 221A Automating the HP 8410B Microwave Network Analyzer  
 AN 327-1 Extended Dynamic Range of Scalar Transmission Measurements Using the HP 8757A, 8756A or 8755C Scalar Network Analyzers  
 AN 345-1 Amplifier Measurements Using the Scalar Network Analyzer  
 AN 345-2 Mixer Measurements Using the Scalar Network Analyzer  
 AN 366-1 How to Measure Insertion Loss of Optical Components  
 AN 366-2 How to Measure Return Loss of Connectorized Optical Components

#### Interface Bus (HP-IB)

- AN 318-1 The Benefits of P/AR  
 AN 332 Microwave Switching from SPDT to Full Access Matrix  
 AN 401-15 8672A Synthesized Signal Generator - HP 1000 HP-IB Programming

#### Jitter

- AN 174-5 Determining Probability Densities (Histograms) with the HP 5345A Electronic Counter  
 AN 191-4 Using the HP 5370B Universal Time Interval Counter to Characterize Pulse Width, Repetition Rate, and Jitter  
 AN 191-7 High Speed Timing Acquisition and Statistical Jitter Analysis Using the HP 5370B Universal Time Interval Counter  
 AN 313-11 Using Digital Filtering Techniques to Improve Analog-to-Digital Converter Measurements  
 AN 314-2 Synthesizing Magnetic Disc Read and Servo Signals with the HP 8770S Arbitrary Waveform Synthesizer System  
 AN 358-2 Jitter and Wander Analysis in Digital Communication with the HP 5371A Frequency and Time Interval Analyzer  
 AN 358-3 Time Domain Characterization of Magnetic Disc Drives  
 AN 359 Selecting a Jitter Test Set  
 AN 360 Jitter Tolerance Testing Using External Phase/Frequency Modulated Sources and Bit Error Rate Test Sets

#### Logic, Logic Test

- AN 163-2 New Techniques of Digital Troubleshooting  
 AN 191-2 Determining Digital Circuit Timing Tolerance to Optimize Adjustment or Design  
 AN 222-0 An Index to Signature Analysis Publications  
 AN 222-2 Application Articles on Signature Analysis  
 AN 222-3 A Manager's Guide to Signature Analysis

- AN 222-4 Guidelines for Signature Analysis: Understanding the Signature Measurement  
 AN 222-6 Troubleshooting with Composite Signatures  
 AN 222-12 A Signature Analysis Based Test System for ECL Logic  
 AN 297-1 8161A Programmable Pulse Generator  
 AN 319 Parametric Characterization of Digital Circuits up to 50 MHz  
 AN 341-1 Testing a Complex LSI/VLSI IC with a Low-Cost Measurement Set-up

#### Loop Gain

- AN 243-2 Control System Development Using Dynamic Signal Analyzers  
 AN 245-5 Log Sweep with the HP 3582A Spectrum Analyzer

#### Manufacturing

- AN 314-1 Receiver Testing with the HP 8770S Arbitrary Waveform Synthesizer System  
 AN 314-2 Synthesizing Magnetic Disc Read and Servo Signals with the HP 8770S Arbitrary Waveform Synthesizer System  
 AN 316-0 Introduction to Computer Aided Test  
 AN 316-4 Power Supply Programming with the 6942A Multiprogrammer  
 AN 316-5 Data Capture with the 6942A/6944A Multiprogrammers  
 AN 325-10 Sub-Micro Positioning with the HP 5527A Laser Position Transducer System  
 AN 332 Microwave Switching from SPDT to Full Access Matrix  
 AN 339-20 Role of DC Parametric Test in High Speed Digital and Microwave Component Manufacturing  
 AN 341-1 Testing a Complex LSI/VLSI IC with a Low-Cost Measurement Set-up  
 AN 421-2 Fan Testing  
 AN 421-3 Vehicle Body Testing  
 AN 421-4 Waste Water Treatment  
 AN 421-6 Internal Combustion Engine Testing  
 AN 421-7 Environmental/Autoclave Testing  
 AN 421-10 Canning process Characterization  
 AN 421-12 Materials Development  
 AN 421-14 Battery Testing  
 AN 421-15 Pilot Plant Monitoring  
 AN 421-17 Facility Management  
 AN 421-18 Large Product Characterization  
 AN 421-20 Machine Monitoring and Control  
 AN 421-21 Pharmaceutical Process Control  
 AN 421-22 Paper Process Control  
 AN 421-23 Rolling Mill  
 AN 421-24 Appliance Testing

#### Materials Measurements

- AN 421-10 Canning Process Characterization  
 AN 421-11 Explosion Testing  
 AN 421-12 Materials Development  
 AN 421-22 Paper Process Control  
 AN 421-23 Rolling Mill

#### Measurement and Control

- AN 290-1 Practical Strain Gauge Measurements  
 AN 290-2 Using the HP 3497A to Control Industrial Wastewater Treatment  
 AN 316-5 Data Capture with the 6942A/6944A Multiprogrammers  
 AN 325-10 Sub-Micro Positioning with the HP 5527A Laser Position Transducer System  
 AN 339-20 Role of DC Parametric Test in High Speed Digital and Microwave Component Manufacturing  
 AN 420 EPROM Card Troubleshooting for the HP 9000 Series 200/300 Pascal and BASIC Workstations  
 AN 421-1 Data Acquisition and Computer Aided Test Application Notes for 32 Industries in Series  
 AN 421-2 Fan Testing  
 AN 421-3 Vehicle Body Testing  
 AN 421-4 Waste Water Treatment  
 AN 421-5 Jet Engine Controller Testing  
 AN 421-6 Internal Combustion Engine Testing  
 AN 421-7 Environmental/Autoclave Testing  
 AN 421-8 Communications Cable Testing  
 AN 421-9 Residential Facility Monitoring  
 AN 421-10 Canning Process Characterization  
 AN 421-11 Explosion Testing  
 AN 421-12 Materials Development  
 AN 421-13 Plating Line Control  
 AN 421-14 Battery Testing  
 AN 421-15 Pilot Plant monitoring  
 AN 421-16 Jet Engine Testing  
 AN 421-17 Facility Management  
 AN 421-18 Large Product Characterization  
 AN 421-19 Missile System Testing  
 AN 421-20 Machine Monitoring and Control  
 AN 421-21 Pharmaceutical Process Control  
 AN 421-22 Paper Process Control  
 AN 421-23 Rolling Mill  
 AN 421-24 Appliance Testing  
 AN 421-25 Air Frame Testing  
 AN 421-26 On-Road Vehicle Testing  
 AN 421-27 Pumping Station Control  
 AN 421-28 Receiver Testing  
 AN 421-29 Bed of Nails Test: DA Converter  
 AN 421-30 Environmental Test Auto Radio  
 AN 421-31 Sonar System Testing  
 AN 421-32 Environment Test Electrical Subassembly

# APPLICATION NOTES

## Free Aids to Solving Your Test and Measurement Problems (Cont'd)

### Microprocessors

- |           |                                                                            |          |                                                                 |           |                                                                                                    |
|-----------|----------------------------------------------------------------------------|----------|-----------------------------------------------------------------|-----------|----------------------------------------------------------------------------------------------------|
| AN 222-0  | An Index to Signature Analysis Publications                                | AN 95-1  | S-Parameter Techniques for Faster, More Accurate Network Design | AN 329    | Spectral Purity Characteristics of HP Microwave Signal Sources                                     |
| AN 222-2  | Application Articles on Signature Analysis                                 | AN 150   | Spectrum Analyzer Basics                                        | AN 330-1  | Automatic MIL-STD EMI Testing Using the HP 85864A/B EMI Measurement Software                       |
| AN 222-3  | A Manager's Guide to Signature Analysis                                    | AN 150-1 | Spectrum Analysis... AM and FM                                  | AN 332    | Microwave Switching from SPDT to Full Access Matrix                                                |
| AN 222-4  | Guidelines for Signature Analysis: Understanding the Signature Measurement | AN 150-2 | Spectrum Analysis... Pulsed RF                                  | AN 339-20 | Role of DC Parametric Test in High Speed Digital and Microwave Component Manufacturing             |
| AN 222-6  | Troubleshooting with Composite Signatures                                  | AN 150-4 | Spectrum Analysis... Noise Measurements                         | AN 358-1  | Characterization of Frequency Agile Sources with the HP 5371A Frequency and Time Interval Analyzer |
| AN 222-12 | A Signature Analysis Based Test System for ECL Logic                       | AN 150-7 | Spectrum Analysis... Signal Enhancement                         | AN 364-1  | Quality Gains in Telecom Australia's Digital Microwave Network                                     |

### Microwave Component Measurements

- |          |                                                                                                                 |           |                                               |           |                                                                |
|----------|-----------------------------------------------------------------------------------------------------------------|-----------|-----------------------------------------------|-----------|----------------------------------------------------------------|
| AN 181-2 | Voltage Controlled Oscillators Characterization Using the HP 5350B, 5351B, 5352B CW Microwave Frequency Counter | AN 150-8  | Spectrum Analysis... Accuracy Improvement     | AN 401-15 | 8672A Synthesized Signal Generator - HP 1000 HP-IB Programming |
| AN 343-2 | Dynamic Component Test Using Vector Modulation Analysis                                                         | AN 150-9  | Spectrum Analysis... Noise Figure Measurement |           |                                                                |
| AN 345-1 | Amplifier Measurements Using the Scalar Network Analyzer                                                        | AN 150-10 | Spectrum Analysis... Field Strength           |           |                                                                |
| AN 345-2 | Mixer Measurements Using the Scalar Network Analyzer                                                            | AN 150-11 | Spectrum Analysis... Distortion Measurements  |           |                                                                |

### Microwave Modulation

- |          |                                                                                                    |           |                                                                                    |  |  |
|----------|----------------------------------------------------------------------------------------------------|-----------|------------------------------------------------------------------------------------|--|--|
| AN 164-4 | Digital Phase Modulation (PSK) and Wideband FM                                                     | AN 154    | S-Parameter Design                                                                 |  |  |
| AN 343-5 | A Calibrated Signal Simulation System Utilizing I/O Modulation Techniques                          | AN 170-2  | The 8640A/B Third Order Intermodulation Product Characteristics                    |  |  |
| AN 355   | Digital Radio Theory and Measurements                                                              | AN 174-13 | Measuring the Tuning Step Transient Response of VCOs to 18 GHz                     |  |  |
| AN 358-1 | Characterization of Frequency Agile Sources with the HP 5371A Frequency and Time Interval Analyzer | AN 174-14 | Radar System Characterization and Testing Using the HP 5345A/55A/56A,B,C,D Counter |  |  |

### Microwave Signal Sources

- |          |                                                                                                    |          |                                                                                                                 |  |  |
|----------|----------------------------------------------------------------------------------------------------|----------|-----------------------------------------------------------------------------------------------------------------|--|--|
| AN 164-4 | Digital Phase Modulation (PSK) and Wideband FM                                                     | AN 181-1 | Measuring Linearity of VCOs from 10 Hz to 23 GHz                                                                |  |  |
| AN 343-5 | A Calibrated Signal Simulation System Utilizing I/O Modulation Techniques                          | AN 181-2 | Voltage Controlled Oscillators Characterization Using the HP 5350B, 5351B, 5352B CW Microwave Frequency Counter |  |  |
| AN 355   | Digital Radio Theory and Measurements                                                              | AN 183   | High Frequency Swept Measurements                                                                               |  |  |
| AN 358-1 | Characterization of Frequency Agile Sources with the HP 5371A Frequency and Time Interval Analyzer | AN 187-6 | Performance of the HP 8620C Sweep Oscillator Under Remote Programming                                           |  |  |
| AN 364-1 | Quality Gains in Telecom Australia's Digital Microwave Network                                     | AN 200-1 | Fundamentals of Microwave Frequency Counters                                                                    |  |  |

### Microwave Signal Sources

- |          |                                                                                                                 |          |                                                                                      |  |  |
|----------|-----------------------------------------------------------------------------------------------------------------|----------|--------------------------------------------------------------------------------------|--|--|
| AN 181-2 | Voltage Controlled Oscillators Characterization Using the HP 5350B, 5351B, 5352B CW Microwave Frequency Counter | AN 221A  | Automating the HP 8410B Microwave Network Analyzer                                   |  |  |
| AN 329   | Spectral Purity Characteristics of HP Microwave Signal Sources                                                  | AN 286-1 | Applications and Operation of the 8901A Modulation Analyzer                          |  |  |
|          |                                                                                                                 | AN 286-2 | Accurate Mixer/Amplifier Compression Measurement Using the 8901A Modulation Analyzer |  |  |
|          |                                                                                                                 | AN 290-1 | Practical Strain Gauge Measurements                                                  |  |  |
|          |                                                                                                                 | AN 291-1 | User's Guide to the 5355/56 Automatic Frequency Converter                            |  |  |

### Microwave Signal Sources

- |          |                                                                                                                 |          |                                                                                                                        |  |  |
|----------|-----------------------------------------------------------------------------------------------------------------|----------|------------------------------------------------------------------------------------------------------------------------|--|--|
| AN 181-2 | Voltage Controlled Oscillators Characterization Using the HP 5350B, 5351B, 5352B CW Microwave Frequency Counter | AN 302-1 | Direct Radio Frequency Impedance Measurements Using the 4191A RF Impedance Analyzer                                    |  |  |
| AN 329   | Spectral Purity Characteristics of HP Microwave Signal Sources                                                  | AN 312-1 | Configuration of a Two-tone Sweeping Generator                                                                         |  |  |
|          |                                                                                                                 | AN 326   | Principles of Microwave Connector Care (for Higher Reliability and Better Measurements)                                |  |  |
|          |                                                                                                                 | AN 327-1 | Extended Dynamic Range of Scalar Transmission Measurements Using the HP 8757A, 8756A or 8755C Scalar Network Analyzers |  |  |

### Microwaves

- |         |                                                                         |           |                                                                                                            |  |  |
|---------|-------------------------------------------------------------------------|-----------|------------------------------------------------------------------------------------------------------------|--|--|
| AN 57-1 | Fundamentals of RF and Microwave Noise Figure Measurement               | AN 313-11 | Using Digital Filtering Techniques to Improve Analog-to-Digital Converter Measurements                     |  |  |
| AN 62   | TDR Fundamentals for Use with HP 54120T Digitizing Oscilloscope and TDR | AN 358-1  | Characterization of Frequency Agile Sources with the HP 5371A Frequency and Time Interval Analyzer         |  |  |
| AN 62-1 | Improving Time Domain Network Analysis Measurements                     | AN 358-2  | Jitter and Wander Analysis in Digital Communication with the HP 5371A Frequency and Time Interval Analyzer |  |  |
| AN 64-1 | Fundamentals of RF and Microwave Power Measurement                      |           |                                                                                                            |  |  |
| AN 64-2 | Extended Applications of Automatic Power Meters                         |           |                                                                                                            |  |  |
| AN 77-3 | Measurement of Complex Impedance, 1 - 1000 MHz                          |           |                                                                                                            |  |  |
| AN 91   | How Vector Measurements Expand Design Capabilities - 1 to 1,000 MHz     |           |                                                                                                            |  |  |

### Microwaves

- |         |                                                                         |  |  |  |  |
|---------|-------------------------------------------------------------------------|--|--|--|--|
| AN 57-1 | Fundamentals of RF and Microwave Noise Figure Measurement               |  |  |  |  |
| AN 62   | TDR Fundamentals for Use with HP 54120T Digitizing Oscilloscope and TDR |  |  |  |  |
| AN 62-1 | Improving Time Domain Network Analysis Measurements                     |  |  |  |  |
| AN 64-1 | Fundamentals of RF and Microwave Power Measurement                      |  |  |  |  |
| AN 64-2 | Extended Applications of Automatic Power Meters                         |  |  |  |  |
| AN 77-3 | Measurement of Complex Impedance, 1 - 1000 MHz                          |  |  |  |  |
| AN 91   | How Vector Measurements Expand Design Capabilities - 1 to 1,000 MHz     |  |  |  |  |

### Mixers

- |          |                                                                                      |  |  |  |  |
|----------|--------------------------------------------------------------------------------------|--|--|--|--|
| AN 57-1  | Fundamentals of RF and Microwave Noise Figure Measurement                            |  |  |  |  |
| AN 286-2 | Accurate Mixer/Amplifier Compression Measurement Using the 8901A Modulation Analyzer |  |  |  |  |
| AN 312-1 | Configuration of a Two-tone Sweeping Generator                                       |  |  |  |  |
| AN 345-2 | Mixer Measurements Using the Scalar Network Analyzer                                 |  |  |  |  |

### Modulation

- |           |                                                                                                                 |  |  |  |  |
|-----------|-----------------------------------------------------------------------------------------------------------------|--|--|--|--|
| AN 150-1  | Spectrum Analysis... AM and FM                                                                                  |  |  |  |  |
| AN 150-2  | Spectrum Analysis... Pulsed RF                                                                                  |  |  |  |  |
| AN 164-4  | Digital Phase Modulation (PSK) and Wideband FM                                                                  |  |  |  |  |
| AN 181-2  | Voltage Controlled Oscillators Characterization Using the HP 5350B, 5351B, 5352B CW Microwave Frequency Counter |  |  |  |  |
| AN 286-1  | Applications and Operation of the 8901A Modulation Analyzer                                                     |  |  |  |  |
| AN 286-2  | Accurate Mixer/Amplifier Compression Measurement Using the 8901A Modulation Analyzer                            |  |  |  |  |
| AN 313-11 | Using Digital Filtering Techniques to Improve Analog-to-Digital Converter Measurements                          |  |  |  |  |
| AN 358-1  | Characterization of Frequency Agile Sources with the HP 5371A Frequency and Time Interval Analyzer              |  |  |  |  |
| AN 358-2  | Jitter and Wander Analysis in Digital Communication with the HP 5371A Frequency and Time Interval Analyzer      |  |  |  |  |

### Motion Control

- |          |                                                           |  |  |  |  |
|----------|-----------------------------------------------------------|--|--|--|--|
| AN 243-2 | Control System Development Using Dynamic Signal Analyzers |  |  |  |  |
|----------|-----------------------------------------------------------|--|--|--|--|



- AN 325-10 Sub-Micro Positioning with the HP 5527A Laser Position Transducer System  
 AN 421-19 Missile System Testing

### Network Analysis

- AN 77-3 Measurement of Complex Impedance, 1 - 1000 MHz  
 AN 91 How Vector Measurements Expand Design Capabilities - 1 to 1,000 MHz  
 AN 95-1 S-Parameter Techniques for Faster, More Accurate Network Design  
 AN 154 S-Parameter Design  
 AN 171-1 Crystal Testing with the 8640A/B and 8405A  
 AN 243 The Fundamentals of Signal Analysis  
 AN 243-2 Control System Development Using Dynamic Signal Analyzers  
 AN 245-2 Measuring the Coherence Function with the HP 3582A Spectrum Analyzer  
 AN 245-5 Log Sweep with the HP 3582A Spectrum Analyzer  
 AN 302-1 Direct Radio Frequency Impedance Measurements Using the 4191A RF Impedance Analyzer  
 AN 332 Microwave Switching from SPDT to Full Access Matrix  
 AN 340-1 Using the HP 5183T to Characterize Sonar Transducers and Systems  
 AN 343-2 Dynamic Component Test Using Vector Modulation Analysis  
 AN 345-1 Amplifier Measurements Using the Scalar Network Analyzer  
 AN 345-2 Mixer Measurements Using the Scalar Network Analyzer  
 AN 351 Characterization of High-Speed Optical Components with an RF Network Analyzer

### Noise

- AN 150-4 Spectrum Analysis . . . Noise Measurements  
 AN 150-9 Spectrum Analysis . . . Noise Figure Measurement  
 AN 174-2 Measuring Differential Non-linearity of a Voltage Controlled Oscillator  
 AN 174-3 Measuring Integral Non-linearity of a Voltage Controlled Oscillator  
 AN 207 Understanding and Using Phase Noise in the Frequency Domain  
 AN 340-1 Using the HP 5183T to Characterize Sonar Transducers and Systems  
 AN 358-3 Time Domain Characterization of Magnetic Disc Drives  
 AN 364-1 Quality Gains in Telecom Australia's Digital Microwave Network

### Non-Linear Systems Measurements

- AN 339-20 Role of DC Parametric Test in High Speed Digital and Microwave Component Manufacturing

### Oscillators

- AN 95-1 S-Parameter Techniques for Faster, More Accurate Network Design  
 AN 174-1 Measuring the Transfer Characteristic of a Voltage Controlled Oscillator  
 AN 174-2 Measuring Differential Non-linearity of a Voltage Controlled Oscillator  
 AN 174-3 Measuring Integral Non-linearity of a Voltage Controlled Oscillator  
 AN 174-4 Measuring Dual VCO Tracking Error  
 AN 174-7 Measuring Fractional Frequency Standard Deviation (Sigma) Versus Averaging Time (TAU)  
 AN 174-11 Measuring Warm-Up Characteristics and Aging Rates of Oscillators  
 AN 174-13 Measuring the Tuning Step Transient Response of VCOs to 18 GHz  
 AN 200-2 Fundamentals of Quartz Oscillators  
 AN 286-1 Applications and Operation of the 8901A Modulation Analyzer  
 AN 329 Spectral Purity Characteristics of HP Microwave Signal Sources

### Oscilloscopes

- AN 62 TDR Fundamentals for Use with HP 54120T Digitizing Oscilloscope and TDR  
 AN 313-11 Using Digital Filtering Techniques to Improve Analog to Digital Converter Measurements  
 AN 344 Bandwidth and Sampling Rate in Digitizing Oscilloscopes  
 AN 348 Voltage and Time Resolution in Digitizing Oscilloscopes

### Phase Linearity

- AN 181-2 Voltage Controlled Oscillators Characterization Using the HP 5350B, 5351B, 5352B CW Microwave Frequency Counter  
 AN 302-1 Direct Radio Frequency Impedance Measurements Using the 4191A RF Impedance Analyzer

### Phase Modulation

- AN 150-1 Spectrum Analysis . . . AM and FM  
 AN 164-4 Digital Phase Modulation (PSK) and Wideband FM  
 AN 174-14 Radar System Characterization and Testing Using the HP 5345A/55A/56A, B, C, D Counter  
 AN 343-1 Measurements Applications for Digital Microwave Radio  
 AN 343-2 Dynamic Component Test Using Vector Modulation Analysis

- AN 343-3 Coherent Pulsed Tests of Radar and EW Systems  
 AN 343-4 Measuring Demodulator Image Rejection Using the HP 8980A Vector Analyzer  
 AN 358-1 Characterization of Frequency Agile Sources with the HP 5371A Frequency and Time Interval Analyzer  
 AN 358-2 Jitter and Wander Analysis in Digital Communication with the HP 5371A Frequency and Time Interval Analyzer  
 AN 359 Selecting a Jitter Test Set  
 AN 360 Jitter Tolerance Testing Using External Phase/Frequency Modulated Sources and Bit Error Rate Test Sets

### Phase Shift

- AN 171-1 Crystal Testing with the 8640A/B and 8405A  
 AN 174-9 Making Automatic Phase Measurements with the HP 5345A Electronic Counter  
 AN 340-1 Using the HP 5183T to Characterize Sonar Transducers and Systems  
 AN 358-2 Jitter and Wander Analysis in Digital Communication with the HP 5371A Frequency and Time Interval Analyzer

### Phase Stability

- AN 358-2 Jitter and Wander Analysis in Digital Communication with the HP 5371A Frequency and Time Interval Analyzer  
 AN 421-8 Communications Cable Testing

### Power Measurement

- AN 183 High Frequency Swept Measurements  
 AN 221A Automating the HP 8410B Microwave Network Analyzer

### Power Supplies

- AN 90B DC Power Supply Handbook  
 AN 236-2 Two Power Supply Redundancy Schemes  
 AN 250-2 Battery Charging/Discharging  
 AN 316-4 Power Supply Programming with the 6942A Multiprogrammer

### Process Control

- AN 290-2 Using the HP 3497A to Control Industrial Wastewater Treatment  
 AN 316-0 Introduction to Computer Aided Test  
 AN 316-4 Power Supply Programming with the 6942A Multiprogrammer  
 AN 316-5 Data Capture with the 6942A/6944A Multiprogrammers  
 AN 339-20 Role of DC Parametric Test in High Speed Digital and Microwave Component Manufacturing  
 AN 421-4 Waste Water Treatment  
 AN 421-7 Environmental/Autoclave Testing

# APPLICATION NOTES

## Free Aids to Solving Your Test and Measurement Problems (Cont'd)

- AN 421-10 Canning process Characterization  
 AN 421-12 Materials Development  
 AN 421-13 Plating Line Control  
 AN 421-15 Pilot Plant monitoring  
 AN 421-20 Machine Monitoring and Control  
 AN 421-21 Pharmaceutical Process Control  
 AN 421-22 Paper Process Control  
 AN 421-23 Rolling Mill
- Production Test**  
 AN 245-4 Accessing the HP 3582A Memory with HP-IB  
 AN 290-1 Practical Strain Gauge Measurements  
 AN 314-1 Receiver Testing with the HP 8770S Arbitrary Waveform Synthesizer System  
 AN 314-2 Synthesizing Magnetic Disc Read and Servo Signals with the HP 8770S Arbitrary Waveform Synthesizer System  
 AN 316-0 Introduction to Computer Aided Test  
 AN 316-4 Power Supply Programming with the 6942A Multiprogrammer  
 AN 316-5 Data Capture with the 6942A/6944A Multiprogrammers  
 AN 321 High Speed Testing and Multi-Bin Sorting of Varactor Diodes Using the HP 4277A  
 AN 324-1 Understanding Your Test Fixture  
 AN 339 Parametric Analysis for Electronic Components and Circuit Evaluation Using the HP 4194A  
 AN 339-20 Role of DC Parametric Test in High Speed Digital and Microwave Component Manufacturing  
 AN 340-1 Using the HP 5183T to Characterize Sonar Transducers and Systems  
 AN 340-1 Reducing Fixture-Induced Test Failures  
 AN 370-1 Mixed Signal Transmission Test Using the HP 3065CT  
 AN 421-2 Fan Testing  
 AN 421-5 Jet Engine Controller Testing  
 AN 421-6 Internal Combustion Engine Testing  
 AN 421-7 Environmental/Autoclave Testing  
 AN 421-14 Battery Testing  
 AN 421-16 Jet Engine Testing  
 AN 421-18 Large Product Characterization  
 AN 421-19 Missile System Testing  
 AN 421-24 Appliance Testing
- Protocol Analysis**  
 AN 424 Keeping Your Big Blue Network in the Pink  
 AN 425 The Care and Feeding of Your X-25 Network
- Pulse Measurements**  
 AN 150-2 Spectrum Analysis... Pulsed RF  
 AN 174-14 Radar System Characterization and Testing Using the HP 5345A/55A/56A, B, C, D Counter  
 AN 191-4 Using the HP 5370B Universal Time Interval Counter to Characterize Pulse Width, Repetition Rate, and Jitter  
 AN 297-2 Automated Reverse Recovery Time Measurements of Diodes  
 AN 313-10 Radar System Characterization and Testing  
 AN 313-11 Using Digital Filtering Techniques to Improve Analog-to-Digital Converter Measurements  
 AN 343-2 Dynamic Component Test Using Vector Modulation Analysis  
 AN 358-1 Characterization of Frequency Agile Sources with the HP 5371A Frequency and Time Interval Analyzer
- Pulse Modulation**  
 AN 150-2 Spectrum Analysis... Pulsed RF  
 AN 313-11 Using Digital Filtering Techniques to Improve Analog-to-Digital Converter Measurements  
 AN 314-1 Receiver Testing with the HP 8770S Arbitrary Waveform Synthesizer System
- RFI Testing**  
 AN 150-10 Spectrum Analysis... Field Strength  
 AN 330-1 Automatic MIL-STD EMI Testing Using the HP 85864A/B EMI Measurement Software  
 AN 331-1 Automatic CISPR EMI Testing for Conducted Emissions
- Radar**  
 AN 174-14 Radar System Characterization and Testing Using the HP 5345A/55A/56A, B, C, D Counter  
 AN 181-2 Voltage Controlled Oscillators Characterization Using the HP 5350B, 5351B, 5352B CW Microwave Frequency Counter  
 AN 191-3 Precision Time Interval Measurements in Radar Applications  
 AN 218-1 Applications & Performance of the HP 8671A and 8672A Microwave Synthesizers  
 AN 218-5 Obtaining Leveled Pulse-Modulated Microwave Signals from the HP 8672A  
 AN 283-3 Low Phase Noise Applications of the HP 8662A and 8663A Synthesized Signal Generators  
 AN 291-1 User's Guide to the 5355/56 Automatic Frequency Converter  
 AN 313-10 Radar System Characterization and Testing
- AN 313-11 Using Digital Filtering Techniques to Improve Analog to Digital Converter Measurements  
 AN 314-1 Receiver Testing with the HP 8770S Arbitrary Waveform Synthesizer System  
 AN 314-4 Exceptionally Complex Signal Simulation for Multi-Signal Environments in Radar/EW Test  
 AN 332 Microwave Switching from SPDT to Full Access Matrix  
 AN 343-3 Coherent Pulsed Tests of Radar and EW Systems  
 AN 345-1 Amplifier Measurements Using the Scalar Network Analyzer  
 AN 345-2 Mixer Measurements Using the Scalar Network Analyzer  
 AN 358-1 Characterization of Frequency Agile Sources with the HP 5371A Frequency and Time Interval Analyzer
- Radar Cross-section Measurements**  
 AN 313-11 Using Digital Filtering Techniques to Improve Analog to Digital Converter Measurements
- Receivers**  
 AN 57-1 Fundamentals of RF and Microwave Noise Figure Measurement  
 AN 164-4 Digital Phase Modulation (PSK) and Wideband FM  
 AN 170-1 HP 8640A/B Signal Generator Output Level Accuracy  
 AN 170-2 The 8640A/B Third Order Intermodulation Product Characteristics  
 AN 218-1 Applications & Performance of the HP 8671A and 8672A Microwave Synthesizers  
 AN 312-1 Configuration of a Two-tone Sweeping Generator  
 AN 314-1 Receiver Testing with the HP 8770S Arbitrary Waveform Synthesizer System  
 AN 343-1 Measurements Applications for Digital Microwave Radio  
 AN 343-4 Measuring Demodulator Image Rejection Using the HP 8980A Vector Analyzer
- Reflectometers**  
 AN 77-3 Measurement of Complex Impedance, 1 - 1000 MHz  
 AN 154 S-Parameter Design  
 AN 183 High Frequency Swept Measurements  
 AN 221A Automating the HP 8410B Microwave Network Analyzer  
 AN 366-2 How to Measure Return Loss of Connectorized Optical Components
- Remote Control**  
 AN 187-6 Performance of the HP 8620C Sweep Oscillator Under Remote Programming  
 AN 290-2 Using the HP 3497A to Control Industrial Wastewater Treatment

**S-Parameters**

- AN 95-1 S-Parameter Techniques for Faster, More Accurate Network Design
- AN 154 S-Parameter Design
- AN 221A Automating the HP 8410B Microwave Network Analyzer

**SWR**

- AN 77-3 Measurement of Complex Impedance, 1 - 1000 MHz
- AN 221A Automating the HP 8410B Microwave Network Analyzer
- AN 327-1 Extended Dynamic Range of Scalar Transmission Measurements Using the HP 8757A, 8756A or 8755C Scalar Network Analyzers

**Semiconductors**

- AN 238 Semiconductor Measurements with the HP 4140B Picoammeter/DC Voltage Source
- AN 238-1 Ultra Low Current Semiconductor DC Parameter Measurement System Using HP 4140B
- AN 289 A Stimulus for Automatic Test
- AN 297-1 8161A Programmable Pulse Generator
- AN 297-2 Automated Reverse Recovery Time Measurements of Diodes
- AN 315 DC Parametric Analysis of Semiconductor Devices, Practical Applications of the 4145A Semiconductor Parameter Analyzer
- AN 319 Parametric Characterization of Digital Circuits up to 50 MHz
- AN 321 High Speed Testing and Multi-Bin Sorting of Varactor Diodes Using the HP 4277A
- AN 322 Analysis of Semiconductor Capacitance Characteristics Using the HP 4280A 1 MHz C Meter/C-V Plotter
- AN 325-10 Sub-Micro Positioning with the HP 5527A Laser Position Transducer System
- AN 334 Automation of Semiconductor Parameter Analysis
- AN 339-20 Role of DC Parametric Test in High Speed Digital and Microwave Component Manufacturing

**Signal Sources**

- AN 170-1 HP 8640A/B Signal Generator Output Level Accuracy
- AN 170-2 The 8640A/B Third Order Intermodulation Product Characteristics
- AN 171-1 Crystal Testing with the 8640A/B and 8405A
- AN 187-6 Performance of the HP 8620C Sweep Oscillator Under Remote Programming
- AN 218-1 Applications & Performance of the HP 8671A and 8672A Microwave Synthesizers
- AN 218-2 Obtaining Millihertz Resolution from the 8671A and 8672A
- AN 218-5 Obtaining Leveled Pulse-Modulated Microwave Signals from the HP 8672A

- AN 283-2 External Frequency Doubling of the 8662A Synthesized Signal Generator
- AN 283-3 Low Phase Noise Applications of the HP 8662A and 8663A Synthesized Signal Generators
- AN 312-1 Configuration of a Two-tone Sweeping Generator
- AN 314-4 Exceptionally Complex Signal Simulation for Multi-Signal Environments in Radar/EW Test
- AN 327-1 Extended Dynamic Range of Scalar Transmission Measurements Using the HP 8757A, 8756A or 8755C Scalar Network Analyzers
- AN 340-1 Using the HP 5183T to Characterize Sonar Transducers and Systems

**Signature Analysis**

- AN 222-0 An Index to Signature Analysis Publications
- AN 222-2 Application Articles on Signature Analysis
- AN 222-3 A Manager's Guide to Signature Analysis
- AN 222-4 Guidelines for Signature Analysis: Understanding the Signature Measurement
- AN 222-6 Troubleshooting with Composite Signatures
- AN 222-12 A Signature Analysis Based Test System for ECL Logic

**Smith Chart**

- AN 77-3 Measurement of Complex Impedance, 1 - 1000 MHz
- AN 95-1 S-Parameter Techniques for Faster, More Accurate Network Design
- AN 154 S-Parameter Design

**Spectrum Analysis**

- AN 150 Spectrum Analyzer Basics
- AN 150-1 Spectrum Analysis ... AM and FM
- AN 150-2 Spectrum Analysis ... Pulsed RF
- AN 150-4 Spectrum Analysis ... Noise Measurements
- AN 150-7 Spectrum Analysis ... Signal Enhancement
- AN 150-8 Spectrum Analysis ... Accuracy Improvement
- AN 150-9 Spectrum Analysis ... Noise Figure Measurement
- AN 150-10 Spectrum Analysis ... Field Strength
- AN 150-11 Spectrum Analysis ... Distortion Measurements
- AN 207 Understanding and Using Phase Noise in the Frequency Domain
- AN 243 The Fundamentals of Signal Analysis
- AN 243-1 Effective Machinery Maintenance Using Vibration Analysis
- AN 243-3 The Fundamentals of Modal Testing
- AN 245-2 Measuring the Coherence Function with the HP 3582A Spectrum Analyzer

- AN 245-3 Third Octave Analysis with the HP 3582A Spectrum Analyzer
- AN 245-4 Accessing the HP 3582A Memory with HP-IB
- AN 245-5 Log Sweep with the HP 3582A Spectrum Analyzer
- AN 246 Using the HP 3585A Spectrum Analyzer with the HP 9825A Computing Controller
- AN 246-1 Optimizing the Dynamic Range of the HP 3585A Spectrum Analyzer
- AN 246-2 Measuring Phase Noise with the HP 3585A Spectrum Analyzer
- AN 313-10 Radar System Characterization and Testing
- AN 313-11 Using Digital Filtering Techniques to Improve Analog to Digital Converter Measurements
- AN 330-1 Automatic MIL-STD EMI Testing Using the HP 85864A/B EMI Measurement Software
- AN 331-1 Automatic CISPR EMI Testing for Conducted Emissions

**Stripline Device Measurements**

- AN 62 TDR Fundamentals for use with HP 54120T Digitizing Oscilloscope and TDR

**Swept-Frequency Measurements**

- AN 150 Spectrum Analyzer Basics
- AN 187-6 Performance of the HP 8620C Sweep Oscillator Under Remote Programming
- AN 246-1 Optimizing the Dynamic Range of the HP 3585A Spectrum Analyzer
- AN 283-3 Low Phase Noise Applications of the HP 8662A and 8663A Synthesized Signal Generators
- AN 312-1 Configuration of a Two-tone Sweeping Generator
- AN 313-11 Using Digital Filtering Techniques to Improve Analog to Digital Converter Measurements
- AN 327-1 Extended Dynamic Range of Scalar Transmission Measurements Using the HP 8757A, 8756A or 8755C Scalar Network Analyzers
- AN 329 Spectral Purity Characteristics of HP Microwave Signal Sources
- AN 340-1 Using the HP 5183T to Characterize Sonar Transducers and Systems
- AN 345-1 Amplifier Measurements Using the Scalar Network Analyzer
- AN 345-2 Mixer Measurements Using the Scalar Network Analyzer
- AN 351 Characterization of High-Speed Optical Components with an RF Network Analyzer
- AN 366-2 How to Measure Return Loss of Connectorized Optical Components

# APPLICATION NOTES

## Free Aids to Solving Your Test and Measurement Problems (Cont'd)

### Switching

- AN 328-1 Practical Test System Signal Switching
- AN 332-1 Novel Combinations of Microwave Switches and Step Attenuators for Programming Applications
- AN 421-1 Data Acquisition and Computer Aided Test Application Notes for 32 Industries in Series
- AN 421-19 Missile System Testing

### Synthesizers/Signal Generators

- AN 164-4 Digital Phase Modulation (PSK) and Wideband FM
- AN 218-1 Applications & Performance of the HP 8671A and 8672A Microwave Synthesizers
- AN 218-2 Obtaining Millihertz Resolution from the 8671A and 8672A
- AN 218-5 Obtaining Leveled Pulse-Modulated Microwave Signals from the HP 8672A
- AN 283-2 External Frequency Doubling of the 8662A Synthesized Signal Generator
- AN 283-3 Low Phase Noise Applications of the HP 8662A and 8663A Synthesized Signal Generators
- AN 289 A Stimulus for Automatic Test
- AN 314-4 Exceptionally Complex Signal Simulation for Multi-Signal Environments in Radar/EW Test
- AN 329 Spectral Purity Characteristics of HP Microwave Signal Sources
- AN 360 Jitter Tolerance Testing Using External Phase/Frequency Modulated Sources and Bit Error Rate Test Sets
- AN 401-15 8672A Synthesized Signal Generator - HP 1000 HP-IB Programming

### Tape Recording

- AN 89 Magnetic Tape Recording Handbook
- AN 314-2 Synthesizing Magnetic Disc Read and Servo Signals with the HP 8770S Arbitrary Waveform Synthesizer System
- AN 358-3 Time Domain Characterization of Magnetic Disc Drives

### Telecommunications

- AN 191-7 High Speed Timing Acquisition and Statistical Jitter Analysis Using the HP 5370B Universal Time Interval Counter
- AN 218-1 Applications & Performance of the HP 8671A and 8672A Microwave Synthesizers
- AN 231-2 Codec Testing with the 3779C/D Primary Multiplex Analyzer
- AN 231-3 Making Telecommunication Measurements in Complex Impedances
- AN 313-11 Using Digital Filtering Techniques to Improve Analog to Digital Converter Measurements

- AN 314-1 Receiver Testing with the HP 8770S Arbitrary Waveform Synthesizer System
- AN 314-4 Exceptionally Complex Signal Simulation for Multi-Signal Environments in Radar/EW Test
- AN 318-1 The Benefits of P/AR
- AN 323 Detection of High Level Signals In FDM Networks
- AN 335 Return Loss and the HP 4937A
- AN 336 An Introduction to Signaling
- AN 345-1 Amplifier Measurements Using the Scalar Network Analyzer
- AN 345-2 Mixer Measurements Using the Scalar Network Analyzer
- AN 351 Characterization of High-Speed Optical Components with an RF Network Analyzer
- AN 355 Digital Radio Theory and Measurements
- AN 356 High Speed Measurement of Semiconductor Devices from Sub-PA to 1A
- AN 359 Selecting a Jitter Test Set
- AN 360 Jitter Tolerance Testing Using External Phase/Frequency Modulated Sources and Bit Error Rate Test Sets
- AN 364-1 Quality Gains in Telecom Australia's Digital Microwave Network
- AN 366-1 How to Measure Insertion Loss of Optical Components
- AN 366-2 How to Measure Return Loss of Connectorized Optical Components
- AN 370-1 Mixed Signal Transmission Tests Using the HP 3065CT

### Television

- AN 313-11 Using Digital Filtering Techniques to Improve Analog to Digital Converter Measurements

### Temperature Measurement

- AN 421-4 Waste Water Treatment
- AN 421-5 Jet Engine Controller Testing
- AN 421-6 Internal Combustion Engine Testing
- AN 421-7 Environmental/Autoclave Testing
- AN 421-8 Communications Cable Testing
- AN 421-9 Residential Facility Monitoring
- AN 421-11 Explosion Testing
- AN 421-12 Materials Development
- AN 421-14 Battery Testing
- AN 421-15 Pilot Plant Monitoring
- AN 421-16 Jet Engine Testing
- AN 421-17 Facility Management
- AN 421-18 Large Product Characterization
- AN 421-19 Missile System Testing
- AN 421-20 Machine Monitoring and Control
- AN 421-21 Pharmaceutical Process Control
- AN 421-22 Paper Process Control
- AN 421-23 Rolling Mill
- AN 421-24 Appliance Testing

### Throughput Analysis

- AN 191-7 High Speed Timing Acquisition and Statistical Jitter Analysis Using the HP 5370B Universal Time Interval Counter

### Time-Interval

- AN 174-14 Radar System Characterization and Testing Using the HP 5345A/55A/56A,B,C,D Counter
- AN 191-1 Automatic Zero Calibration of the HP 5359A Time Synthesizer at a Designated Remote Location
- AN 191-2 Determining Digital Circuit Timing Tolerance to Optimize Adjustment or Design
- AN 191-3 Precision Time Interval Measurements in Radar Applications
- AN 191-4 Using the HP 5370B Universal Time Interval Counter to Characterize Pulse Width, Repetition Rate, and Jitter
- AN 191-5 Measurement of Propagation Delays Using the HP 5370B Time Interval Counter and HP 5363B Time Interval Probes
- AN 191-6 Precise Cable Length and Matching Measurements Using the HP 5370B Universal Time Interval Counter and HP 5363B Time Interval Probes
- AN 200-3 Time Interval Measurement Using an Electronic Counter
- AN 200-4 Understanding Frequency Counter Specifications
- AN 297-2 Automated Reverse Recovery Time Measurements of Diodes Using Digital Filtering Techniques to Improve Analog to Digital Converter Measurements
- AN 313-11 Time Domain Characterization of Magnetic Disc Drives

### Timing Analysis

- AN 313-10 Radar System Characterization and Testing

### Transistor Parameters

- AN 57-1 Fundamentals of RF and Microwave Noise Figure Measurement
- AN 95-1 S-Parameter Techniques for Faster, More Accurate Network Design
- AN 334 Automation of Semiconductor Parameter Analysis
- AN 339-20 Role of DC Parametric Test in High Speed Digital and Microwave Component Manufacturing

### Transistors

- AN 339-20 Role of DC Parametric Test in High Speed Digital and Microwave Component Manufacturing

### Transmission Lines

- AN 62 TDR Fundamentals for use with HP 54120T Digitizing Oscilloscope and TDR
- AN 62-1 Improving Time Domain Network Analysis Measurements

**Troubleshooting**

- AN 163-2 New Techniques of Digital Troubleshooting
- AN 222-0 An Index to Signature Analysis Publications
- AN 222-2 Application Articles on Signature Analysis
- AN 222-3 A Manager's Guide to Signature Analysis
- AN 222-4 Guidelines for Signature Analysis: Understanding the Signature Measurement
- AN 222-6 Troubleshooting with Composite Signatures
- AN 222-12 A Signature Analysis Based Test System for ECL Logic
- AN 326 Principles of Microwave Connector Care (for Higher Reliability and Better Measurements)

**Vector Measurements**

- AN 95-1 S-Parameter Techniques for Faster, More Accurate Network Design
- AN 154 S-Parameter Design
- AN 170-1 HP 8640A/B Signal Generator Output Level Accuracy
- AN 221A Automating the HP 8410B Microwave Network Analyzer

- AN 364-1 Quality Gains in Telecom Australia's Digital Microwave Network

**Vector Modulation Measurements**

- AN 314-4 Exceptionally Complex Signal Simulation for Multi-Signal Environments in Radar/EW Test
- AN 343-1 Measurements Applications for Digital Microwave Radio
- AN 343-2 Dynamic Component Test Using Vector Modulation Analysis
- AN 343-3 Coherent Pulsed Tests of Radar and EW Systems
- AN 343-4 Measuring Demodulator Image Rejection Using the HP 8980A Vector Analyzer
- AN 343-5 A Calibrated Signal Simulation System Utilizing I/Q Modulation Techniques

**Video Receivers**

- AN 356 High Speed Measurement of Semiconductor Devices from Sub-PA to 1A

**Voltage**

- AN 286-1 Applications and Operation of the 8901A Modulation Analyzer

**Voltage-Controlled Oscillators (VCOs)**

- AN 174-1 Measuring the Transfer Characteristic of a Voltage Controlled Oscillator
- AN 174-2 Measuring Differential Non-linearity of a Voltage Controlled Oscillator
- AN 174-3 Measuring Integral Non-linearity of a Voltage Controlled Oscillator
- AN 174-4 Measuring Dual VCO Tracking Error
- AN 174-11 Measuring Warm-Up Characteristics and Aging Rates of Oscillators
- AN 174-13 Measuring the Tuning Step Transient Response of VCOs to 18 GHz
- AN 181-1 Measuring Linearity of VCOs from 10 Hz to 23 GHz

**Wave Analysis**

- AN 207 Understanding and Using Phase Noise in the Frequency Domain
- AN 344 Bandwidth and Sampling Rate in Digitizing Oscilloscopes
- AN 348 Voltage and Time Resolution in Digitizing Oscilloscopes

**Ordering Numbers for Applications Notes**

AN Number	Ordering Number	AN Number	Ordering Number	AN Number	Ordering Number	AN Number	Ordering Number	AN Number	Ordering Number
<b>AN Index</b>	<b>5954-0203</b>	174-8	5952-0885	238	5952-8840	314-4	5952-3702	344	5954-2631
52-4	5952-7855	174-9	5952-7325	238-1	5953-8873	315	5953-6900	345-1	5954-1599
57-1	5952-8255	174-10	5952-7326	243	5953-8898	316-0	5952-4102	345-2	5954-8369
57-2	5952-3076	174-11	5952-7327	243-1	5953-5113	316-4	5952-4075	348	5954-2652
62	5954-2681	174-12	5952-7328	243-2	5952-5136	316-5	5952-4116	350-1	5954-7174
62-1	5954-2682	174-13	5952-7329	243-3	5952-7957	317	5953-6910	350-3	5954-8748
64-1	5952-8178	174-14	5952-7892	245-2	5952-8768	318-1	5952-4996D	350-4	5954-7132
64-2	5952-8197	181-1	5952-7321	245-3	5952-8800	319	5952-9549	350-5	5954-8843
64-4	5954-7363	181-2	5952-7852	245-4	5952-8804	321	5953-6937	351	5954-8352
77-3	5952-0991	183	5952-9200	245-5	5952-8805	322	5953-6939	355	5954-9554
89	5952-2820	187-6	5952-9271	246	5952-8765	323	5953-5411	356	5950-2930
90B	5952-4020	191-1	5952-7487	246-1	5952-8815	324-1	5953-6951	358-1	5952-7924
91	5952-0917	191-2	5952-7488	246-2	5952-8838	325-10	5952-7942	358-2	5952-7925
95-1	5952-1130	191-3	5952-7491	250-2	5952-4033	326	5954-1566	358-3	5952-7928
123	5952-2153	191-4	5952-7505	283-2	5952-8217	327-1	5953-8882	359	5954-9563
150	5954-9130	191-5	5952-7563	286-1	5952-8208	328-1	5953-6962	360	5954-9564
150-1	5952-1051	191-6	5952-7568	286-2	5952-8245	329	5954-8349	362	5952-9650
150-2	5952-1039	191-7	5952-7908	283-3	5952-8435	330-1	5954-2705	364-1	5954-9572
150-4	5952-1147	200-1	5952-7484	287-2	5952-7530	331-1	5954-2724	366-1	5952-9660
150-7	5952-9205	200-2	5952-7507	287-3	5952-7549	332	5953-6466	366-2	5952-9661
150-8	5952-9210	200-3	5952-7561	289	5952-9517	332-1	5953-8892	370-1	5954-8697
150-9	5952-9229	200-4	5952-7522	290	5952-8801	334	5952-7765	401-15	5953-2814
150-10	5952-9234	207	5952-8708	290-1	5952-8880	335	5952-5033	420	5954-8292
150-11	5952-9235	218-1	5952-8219	290-2	5953-6921	336	5952-5034	421-1	5954-9631
154	5952-1087	218-2	5952-8184	291-1	5952-7541	339	5950-2856	Thru	Thru
163-2	5952-7558	218-5	5952-8251	297-1	5952-9540	339-3	5952-7863	421-32	5954-9662
164-4	5952-8143	221A	5952-9300	297-2	5952-9542	339-6	5952-7871	422	5954-8579
170-1	5952-1218	222-0	5952-7625	298-3	5953-2745	339-20	5952-7936	424	5952-5131
170-2	5952-8129	222-2	5952-7542	298-4	5953-2746	340-1 <sup>1</sup>	5952-7805	425	5952-5132
171-1	5952-8117	222-3	5952-7592	302-1	5952-8853	340-1 <sup>2</sup>	5954-8672		
174-1	5952-0879	222-4	5952-7595	302-2	5952-8872	341-1	5952-9572		
174-2	5952-0879	222-6	5952-7684	312-1	5952-9316	341-2	5952-9651		
174-3	5952-0880	222-12	5952-7667	313-10	5952-7905	343-1	5954-6365		
174-3	5952-0880	229-11	5953-9874	313-11	5952-7945	343-2	5954-6367		
174-5	5952-7564	231-2	5953-5426	314	5953-3898	343-3	5954-6366		
174-6	5953-0883	231-3	5953-5484	314-1	5954-6358	343-4	5952-3703		
174-7	5952-7344	236-2	5952-5484	314-2	5954-6357	343-5	5952-6471		

<sup>1</sup>Reducing Fixture-induced Failures

<sup>2</sup>Testing a Complex LSI/VLSI IC...

# FREE PUBLICATIONS

## Aids to Selecting, Using & Maintaining HP Products



### Free aids to selecting, using and maintaining HP products

HP offers a variety of free publications to help you choose the HP products that best fill your needs, to help you benefit from applications knowledge acquired by users inside and outside of HP, and to help you maintain your HP products. These publications range from new-product announcements, catalogs, product family brochures, and single-product technical data through application notes, product notes, and programming aids to service notes and general maintenance periodicals. Because the number and types of free publications vary with product family, a summary of available publications is provided below. Brief descriptions of some of the listed publications follow the summary.

### Instruments and Systems

**Product Information**  
 Test & Measurement News  
 Data sheets and brochures  
 Catalogs

Test & Measurement Accessories  
 Catalog (U.S. only, 5954-0193D)  
 DC Power Supplies (5952-4174D)  
 Coaxial & Waveguide Measurement  
 Accessories (5954-6401)  
 Digital IC Tester Program (5952-7790)  
 DesignCenter magazine  
 HP Journal

### Application Information

Application Notes  
 Product Notes  
 Programming Notes

### Service Information

Service Notes  
 Bench Briefs

### Computers, Peripherals & Calculators

**Product Information**  
 Test & Measurement News  
 Data sheets & brochures  
 Selection guides  
 Catalogs

Computer Users Catalog (5953-2450D)  
 Computer Users Documentation Index  
 (5953-2460D)  
 HP Technical Software (5954-8289)  
 HP Vectra Technical Software Guide  
 (5951-6821)  
 Software and Accessories Guide for the  
 Touchscreen PC (5954-7198D)  
 Supplies Catalog for HP Plotters and the  
 HP PaintJet Color Graphics Printer  
 (5957-3776D, 5957-3777)  
 Software and Hardware Solutions for the  
 HP Plotter Family (5954-8835D)

HP Journal

### Application Information

Application Notes  
 Application Briefs  
 Plotter Notes  
 Set-Up Instructions (for plotters)

### Components

#### Product Information

Catalogs  
 Microwave and RF Designer's Catalog  
 (5954-2091)  
 Optoelectronics Designer's Catalog  
 (5954-8450)

Data sheets  
 HP Journal

### Application Information

Application Notes  
 Application Bulletins

### Test & Measurement News

Six times a year *Test & Measurement News* announces HP's latest electronic measuring instruments and accessories; computer/controller, component, and telecom products; and new no-charge literature such as catalogs and application notes.

### HP DesignCenter

*HP DesignCenter* is published for users of HP systems for electronic design, printed circuit board layout, and microprocessor-based development. This full-color magazine features customer application stories, answers to common customer questions, and announcements of new product enhancements.

### Hewlett-Packard Journal

Published six times a year to communicate technical information from the laboratories of HP to all of the fields served by HP, the Journal contains in-depth design descriptions of current hardware and software products as well as research papers and more general information such as advances in technology.

### Application Note Index

The AN index lists and describes the contents of all Application Notes, Programming Notes, and Product Notes on electronic instruments, instrument systems, and solid-state components.

### Application Briefs, Bulletins, and Notes

These aids to solving your measurement, computation, and design problems offer the benefit of the applications research and experience of both HP customers and HP engineers. Some are tutorial, others describe how-to procedures. All are generic or multiple-product oriented.

### Product Notes

Product Notes are product-specific and augment the operating and service manuals supplied with HP instruments. They cover applications of the specific instrument and analyze specifications and characteristics with the goal of obtaining improved performance over limited operating conditions and narrower environmental limits.

### Programming Notes

Programming Notes provide product-specific information on the use and operation of instruments in HP-IB systems. Some notes address the needs of inexperienced users and cover basic operation of an HP-IB instrument using a specific HP desktop computer. Others address the needs of experienced users.

### Service Notes

Service Notes contain product-specific service information for HP's electronic products. Subjects include product improvements, modifications, and procedures for troubleshooting, maintenance, and repair. Service Notes are published as appropriate throughout the life of a product. All new Notes are announced in Bench Briefs.

### Bench Briefs

Bench Briefs provides those who maintain HP instruments with timely information that has both specific and general application. Subjects include troubleshooting tips and descriptions of new technologies, components, tools, and equipment. Also, new Service Notes are listed in Bench Briefs as they become available.

### How to Obtain Free Publications

To obtain any of the publications described on this page:

In the U.S.A., phone 1-800-752-0900, extension 779E. Outside the U.S.A., contact your Customer Information Center (CIC) or nearest HP office. Locations of HP offices and CICs are listed on the back pages of this catalog.

When requesting any of the catalogs listed on this page, please include the number in parenthesis following the catalog's title.



Dear HP Customer,

**Let me introduce you to an important benefit that starts working for you even before you buy from Hewlett-Packard.**

The new HP Customer Information Center (CIC) is your single point of contact for information about any Hewlett-Packard product or service. At the CIC, you will find helpful, friendly people with the knowledge to get you the information and answers that you need. If we don't have the answers we can put you in touch with someone who does.

**To take advantage of the CIC, just call 1-800-752-0900, ext. 779E.**

Our customer representatives staff this phone number every working day of the year. Plus, our customer representatives are available to serve you from 6:00 a.m. to 5:00 p.m. PST. These hours make it possible for you to get information conveniently from Hewlett-Packard no matter where you are in the United States.

**What are the services that you can expect to find?**

Here are some of the benefits offered by the CIC:

- Fast, convenient ordering of sales literature on HP products and services.
- Easy location of your nearest HP sales office.
- Accurate, responsive answers to your product information questions.

Why not call the CIC soon? When you do, I am sure that you will find the CIC is another important reason to do business with Hewlett-Packard.

Sincerely,  
Hewlett-Packard



Jack Caffey  
CIC General Manager

P.S. Remember, the key to using the CIC is 1-800-752-0900, ext. 779E.



Test &  
Measurement  
Catalog  
1989

