

## Errata

**Document Title:** TDR Fundamentals for Use With the 54120T Digitizing Oscilloscope and TDR (AN 62)

**Part Number:** 5951-0062

**Revision Date:** January 1964

---

### HP References in this Application Note

This application note may contain references to HP or Hewlett-Packard. Please note that Hewlett-Packard's former test and measurement, semiconductor products and chemical analysis businesses are now part of Agilent Technologies. We have made no changes to this application note copy. The HP XXXX referred to in this document is now the Agilent XXXX. For example, model number HP8648A is now model number Agilent 8648A.

### About this Application Note

We've added this application note to the Agilent website in an effort to help you support your product. This manual provides the best information we could find. It may be incomplete or contain dated information, and the scan quality may not be ideal. If we find a better copy in the future, we will add it to the Agilent website.

### Support for Your Product

Agilent no longer sells or supports this product. You will find any other available product information on the Agilent Test & Measurement website:

[www.tm.agilent.com](http://www.tm.agilent.com)

Search for the model number of this product, and the resulting product page will guide you to any available information. Our service centers may be able to perform calibration if no repair parts are needed, but no other support from Agilent is available.

HEWLETT-PACKARD CO.  
SANTA ROSA LIBRARY

AGILENT TECHNOLOGIES  
RESEARCH LIBRARY  
1400 FOUNTAIN GROVE PARKWAY  
SANTA ROSA, CA 95403



HEWLETT-PACKARD COMPANY / APPLICATION NOTE 62

**TIME DOMAIN  
REFLECTOMETRY**

APPLICATION NOTE 62

TIME DOMAIN REFLECTOMETRY

Copyright HEWLETT-PACKARD COMPANY 1964  
1501 PAGE MILL ROAD, PALO ALTO, CALIFORNIA, U.S.A.

TABLE OF CONTENTS

Section	Page
I INTRODUCTION . . . . .	1-1
II PROPAGATION ON A TRANSMISSION LINE . . . . .	2-1
III STEP REFLECTION TESTING . . . . .	3-1
The Measuring System . . . . .	3-1
Locating Mismatches . . . . .	3-1
Analyzing Reflections . . . . .	3-2
A Suggestion for Measuring the Time Constant of the Reflected Wave Returning from Complex Loads . . . . .	3-4
Discontinuities on the Line vs Mismatches at the Load . . . . .	3-4
Evaluating Cable Loss . . . . .	3-5
Multiple Discontinuities . . . . .	3-7
Step Generator Source Impedance . . . . .	3-7
IV PRACTICAL MEASURING CONSIDERATIONS . . . . .	4-1
Rise Time . . . . .	4-2
Resolution . . . . .	4-2
Small Inductors and Capacitors . . . . .	4-2
An Additional Precaution Regarding Rise Time . . . . .	4-3
TDR Systems . . . . .	4-4
Applications . . . . .	4-4



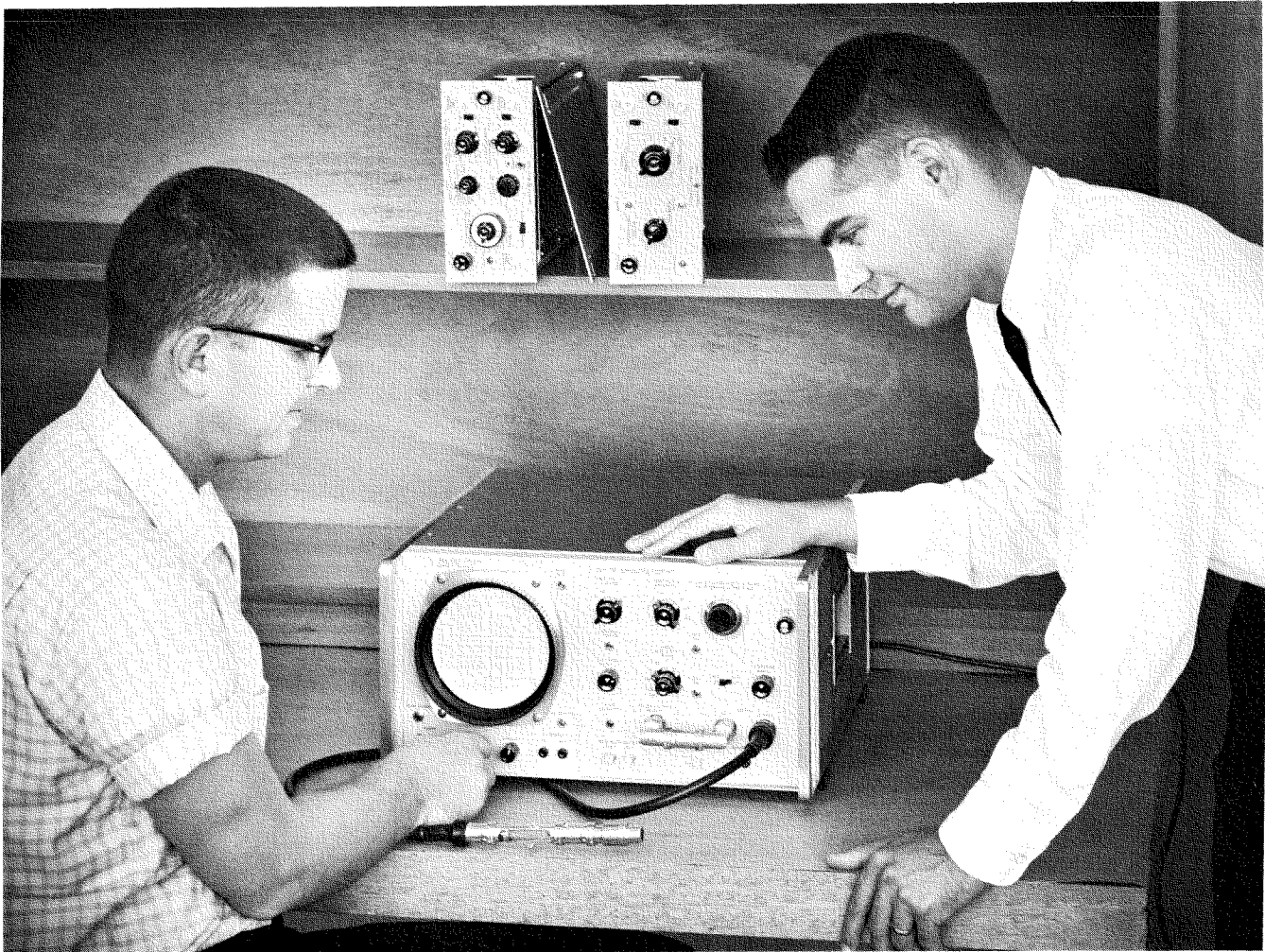

Time Domain Reflectometry, illustrated in the photo above, is an extremely powerful technique for analyzing transmission systems. The basic principles of this technique are described in this Application Note, along with some suggestions for accurate measurements.

## SECTION I INTRODUCTION

The most common method for evaluating a transmission line and its load has traditionally involved feeding a sine wave into the system and measuring the maximum and minimum amplitudes of the standing waves resulting from discontinuities on the line. From these measurements, the standing wave ratio ( $\sigma$ ) is calculated and used as a figure of merit for the transmission system. When the system includes several discontinuities, however, the SWR measurement fails to isolate them. Consider a case where the load is well matched to the transmission line (i.e.,  $Z_L = Z_0$ ) but several connectors joining segments of the line act as minor discontinuities. (This is a realistic situation since BNC connectors, for example, will typically look like small inductors in series with the line.) The SWR measurement does not single out the component or components causing the discontinuity; it only indicates their aggregate effect. Any attempt to improve the system, therefore, reduces to a trial and error substitution of components. In addition, SWR techniques fail to demonstrate whether or not one discontinuity is generating a reflection of the proper phase and magnitude to cancel (at a particular frequency) the reflection from a second discontinuity. When the broadband quality of a transmission system is to be determined, SWR measurements must therefore be made at many frequencies, and this method soon becomes very time consuming and tedious.

Time Domain Reflectometry avoids all of these disadvantages of the SWR method. TDR, as it is commonly abbreviated, employs a step generator

and an oscilloscope in a system best described as "closed-loop radar." A voltage step is propagated down the transmission line under investigation, and the incident and reflected voltage waves are monitored by the oscilloscope at a particular point on the line (see Figure 1).

This echo technique reveals at a glance the characteristic impedance of the line. Moreover, it shows both the position and the nature (resistive, inductive, or capacitive) of each discontinuity along the line. TDR also demonstrates whether losses in a transmission system are series losses or shunt losses. All of this information is immediately available from the oscilloscope's display. Furthermore, TDR gives more directly meaningful information concerning the broadband response of a transmission system than any other measuring technique.

Since the basic principles of Time Domain Reflectometry are easily grasped, even those with limited experience in high frequency measurements will find that they can quickly master this technique. This Application Note attempts a concise presentation of the fundamentals of TDR and then relates these fundamentals to the parameters that can be measured in actual test situations. Before discussion these principles further, however, it would be well to briefly review transmission line theory.

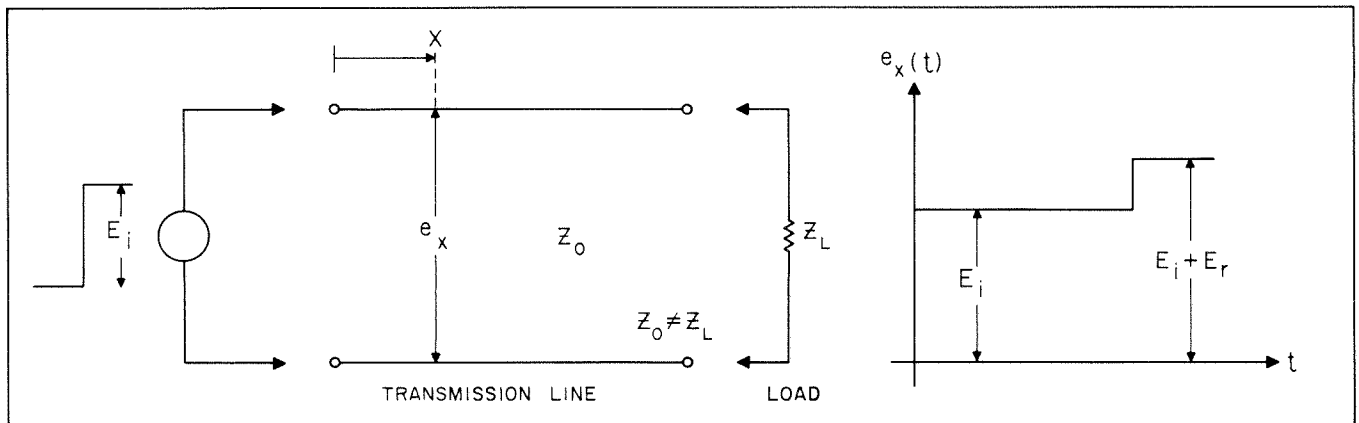

Figure 1. Voltage vs time at a particular point on a mismatched transmission line driven with a step of height  $E_i$

## SECTION II PROPAGATION ON A TRANSMISSION LINE

The classical transmission line is assumed to be made up of a continuous structure of R's, L's and C's, as shown in Figure 2. By studying this equivalent circuit, several characteristics of the transmission line can be determined.<sup>1</sup>

If the line is infinitely long and R, L, G, and C are defined per unit length, then

$$Z_{in} = Z_0 = \sqrt{\frac{R + j\omega L}{G + j\omega C}} \quad (1)$$

where  $Z_0$  is called the characteristic impedance of the line.

A voltage introduced at the generator will require a finite time to travel down the line to a point x. The phase of the voltage moving down the line will lag behind the voltage introduced at the generator by an amount  $\beta$  per unit length. Furthermore, the voltage will be attenuated by an amount  $\alpha$  per unit length by the series resistance and shunt conductance of the line. The phase shift and attenuation are defined by the propagation constant  $\gamma$ , where

$$\begin{aligned} \gamma &= \alpha + j\beta \\ &= \sqrt{(R + j\omega L)(G + j\omega C)} \end{aligned} \quad (2)$$

and  $\alpha$  = attenuation in nepers per unit length  
 $\beta$  = phase shift in radians per unit length

The velocity at which the voltage travels down the line can also be defined in terms of  $\beta$ :

$$v_p = \frac{\omega}{\beta} \text{ unit lengths per second.}$$

The velocity of propagation approaches the speed of light,  $v_c$ , for transmission lines with air dielectric. For the general case

$$v_p = \frac{v_c}{\sqrt{k}} \quad (3)$$

where k is the dielectric constant.

The propagation constant  $\gamma$  can be used to define the voltage and the current at any distance x down an infinitely long line by the relations

$$E_x = E_{in} e^{-\gamma x} \quad \text{and} \quad I_x = I_{in} e^{-\gamma x} \quad (4)$$

Since the voltage and the current are related at any point by the characteristic impedance of the line

$$Z_0 = \frac{E_{in} e^{-\gamma x}}{I_{in} e^{-\gamma x}} = \frac{E_{in}}{I_{in}} = Z_{in} \quad (5)$$

<sup>1</sup>See a text such as H. H. Skilling's Electric Transmission Lines for a rigorous development of the relationships in this section.

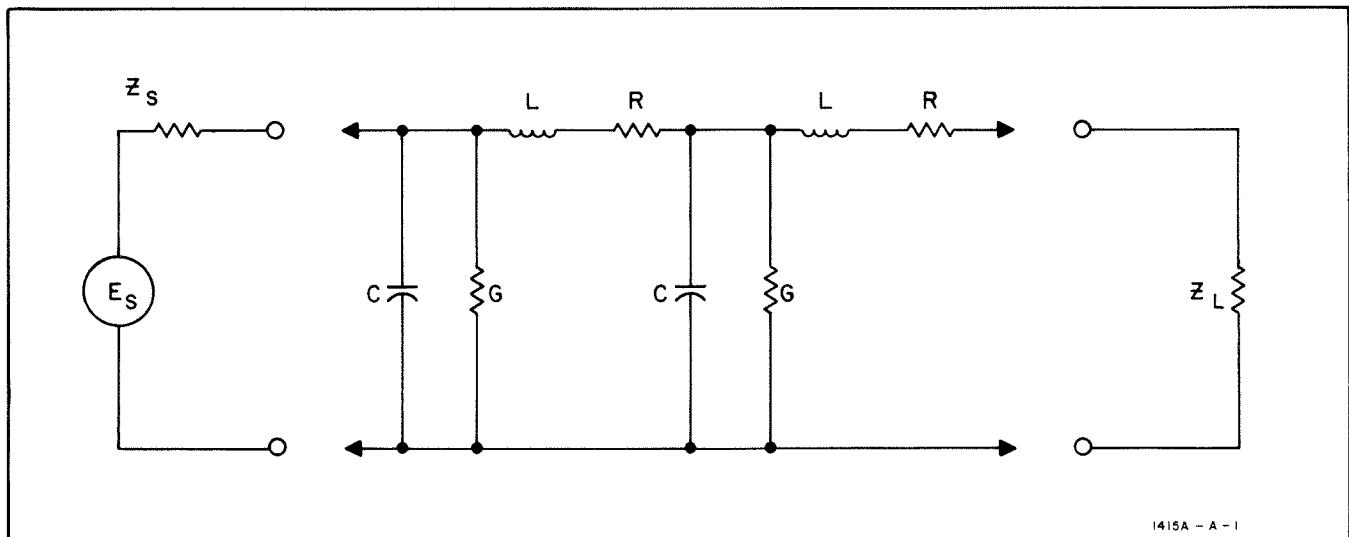

Figure 2. The classical model for a transmission line

When the transmission line is finite in length and is terminated in a load whose impedance matches the characteristic impedance of the line, the voltage and current relationships are satisfied by the preceding equations.

If the load is different from  $Z_0$ , these equations are not satisfied unless a second wave is considered to originate at the load and to propagate back up the line toward the source. This reflected wave is energy that is not delivered to the load. Therefore, the quality of the transmission system is indicated by the ratio of this reflected wave to the incident wave originating at the source. This ratio is called the voltage reflection coefficient,  $\rho$ , and is related to the transmission line impedance by the equation:

$$\rho = \frac{E_r}{E_i} = \frac{Z_L - Z_0}{Z_L + Z_0} \quad (6)$$

The magnitude of the steady-state sinusoidal voltage along a line terminated in a load other than  $Z_0$  varies periodically as a function of distance between a maximum and minimum value. This variation, called a standing wave, is caused by the phase

relationship between incident and reflected waves. The ratio of the maximum and minimum values of this voltage is called the voltage standing wave ratio,  $\sigma$ , and is related to the reflection coefficient by the equation

$$\sigma = \frac{1 + |\rho|}{1 - |\rho|} \quad (7)$$

As has been said, either of the above coefficients can be measured with presently available test equipment. But the value of the SWR measurement is limited. Again, if a system consists of a connector, a short transmission line and a load, the measured standing wave ratio indicates only the overall quality of the system. It does not tell which of the system components is causing the reflection. It does not tell if the reflection from one component is of such a phase as to cancel the reflection from another. Thus, the measure of quality is good for only the one frequency at which the reflection coefficient is measured. The engineer must make detailed measurements at many frequencies before he can know what must be done to improve the broadband transmission quality of the system.



## SECTION III STEP REFLECTION TESTING

### THE MEASURING SYSTEM.

A Time Domain Reflectometer is set up as shown in Figure 3.

The step generator produces a positive going incident wave which is fed into the transmission system under test. The oscilloscope's high impedance input bridges the transmission system at its junction with the step generator. The step travels down the transmission line at the velocity of propagation of the line. If the load impedance is equal to the characteristic impedance of the line, no wave is reflected, and all that will be seen on the oscilloscope is the incident voltage step recorded as the wave passes the point on the line monitored by the oscilloscope (see Figure 4).

If a mismatch exists at the load, part of the incident wave is reflected. The reflected voltage wave will appear on the oscilloscope display algebraically added to the incident wave (see Figure 5).

### LOCATING MISMATCHES.

The reflected wave is readily identified since it is separated in time from the incident wave. This time is also valuable in determining the length of the transmission system from the monitoring point to the mismatch. Letting  $D$  denote this length:

$$D = v_p \cdot \frac{T}{2} = \frac{v_p T}{2}$$

where:  $v_p$  = velocity of propagation  
 $T$  = transit time from monitoring point to the mismatch and back again, as measured on the oscilloscope (see Figure 5).

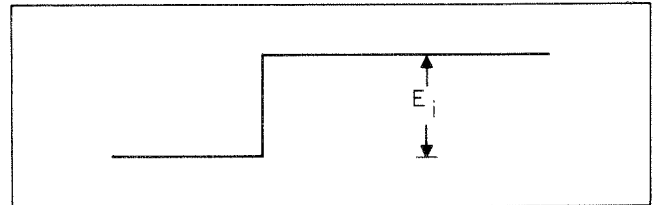

Figure 4. Oscilloscope display when  $E_r = 0$

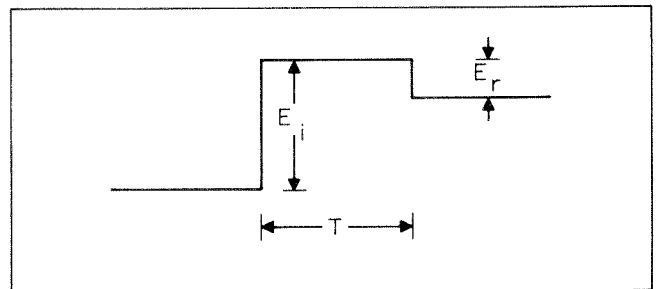

Figure 5. Oscilloscope display when  $E_r \neq 0$

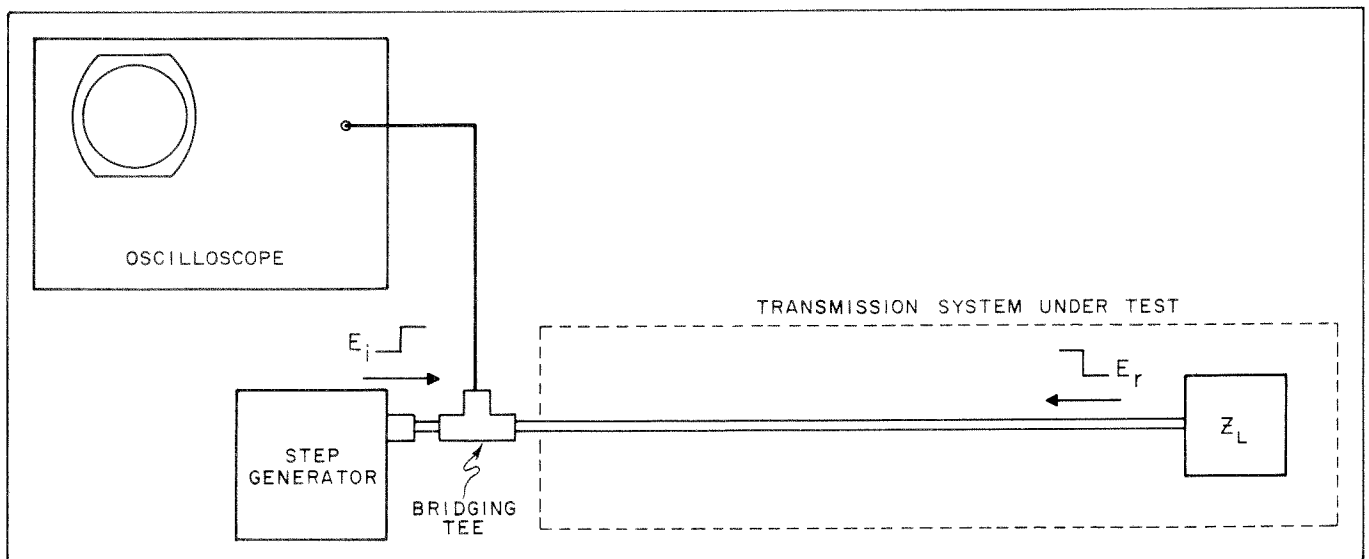

Figure 3. A Time Domain Reflectometer

The velocity of propagation can be determined from an experiment on a known length of the same type of cable (e.g., the time required for the incident wave to travel down and the reflected wave to travel back from an open circuit termination at the end of a 120 cm piece of RG-9A/U is 11.4 nanoseconds, giving  $v_p = 21 \text{ cm/nsec} = 2.1 \times 10^{10} \text{ cm/sec}$ ). Knowing  $v_p$  and reading T from the oscilloscope determines D. The mismatch is then located down the line.

**ANALYZING REFLECTIONS.**

The shape of the reflected wave is also valuable since it reveals both the nature and magnitude of the mismatch. Figure 6 shows four typical oscilloscope displays and the load impedance responsible for each.

These displays are easily interpreted by recalling Equation (6):

$$\rho = \frac{E_r}{E_i} = \frac{Z_L - Z_0}{Z_L + Z_0}$$

Knowledge of  $E_i$  and  $E_r$ , as measured on the oscilloscope, allows  $Z_L$  to be determined in terms of  $Z_0$ , or vice versa. In Figure 6, for example, we may

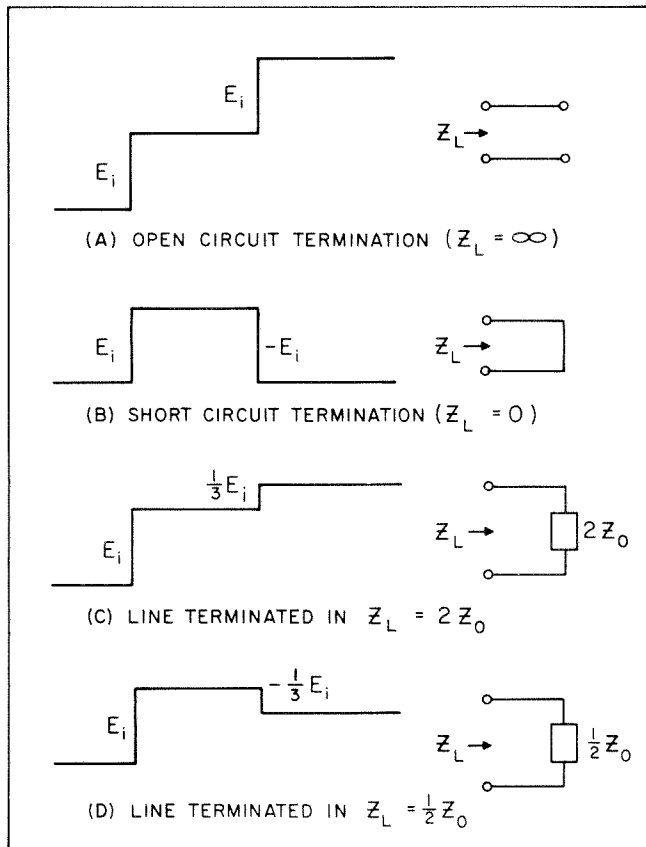

Figure 6. TDR displays for typical loads

verify that the reflections are actually from the terminations specified.

(A)  $E_r = E_i$  Therefore  $\frac{Z_L - Z_0}{Z_L + Z_0} = +1$

which is true as  $Z_L \rightarrow \infty$

$\therefore Z_L = \text{OPEN CIRCUIT}$

(B)  $E_r = -E_i$  Therefore  $\frac{Z_L - Z_0}{Z_L + Z_0} = -1$

which is only true (for finite  $Z_0$ ) when  $Z_L = 0$

$\therefore Z_L = \text{SHORT CIRCUIT}$

(C)  $E_r = +\frac{1}{3}E_i$  Therefore  $\frac{Z_L - Z_0}{Z_L + Z_0} = +\frac{1}{3}$

and  $Z_L = 2Z_0$

(D)  $E_r = -\frac{1}{3}E_i$  Therefore  $\frac{Z_L - Z_0}{Z_L + Z_0} = -\frac{1}{3}$

and  $Z_L = \frac{1}{2}Z_0$

Assuming  $Z_0$  is real (approximately true for high quality commercial cable), it is seen that resistive mismatches reflect a voltage of the same shape as the driving voltage, with the magnitude and polarity of  $E_r$  determined by the relative values of  $Z_0$  and  $R_L$ .

Also of interest are the reflections produced by complex load impedances. Four basic examples of these reflections are shown in Figure 7.

These waveforms could be verified by writing the expression for  $\rho(s)$  in terms of the specific  $Z_L$  for each example (i.e.,  $Z_L = R + sL$ ,  $\frac{R}{1 + RCs}$ , etc.), multiplying  $\rho(s)$  by  $\frac{E_i}{s}$ , the transform of a step function

of height  $E_i$ , and then transforming this product back into the time domain to find an exact expression for  $e_r(t)$ . This procedure is useful, but a simpler analysis is possible without resorting to Laplace transforms. The more direct analysis involves evaluating the reflected voltage at  $t = 0$  and at  $t = \infty$  and assuming and transition between these two values to be exponential. (For the sake of simplicity, time is chosen to be zero when the reflected wave arrives back at the monitoring point.) In the case of the series R-L combination, for example, at  $t = 0$  the reflected voltage is  $+E_i$ . This is because the inductor will not accept a sudden change in current; it initially looks like an infinite impedance, and  $\rho = +1$  at  $t = 0$ . Then current in L builds up exponentially and its impedance

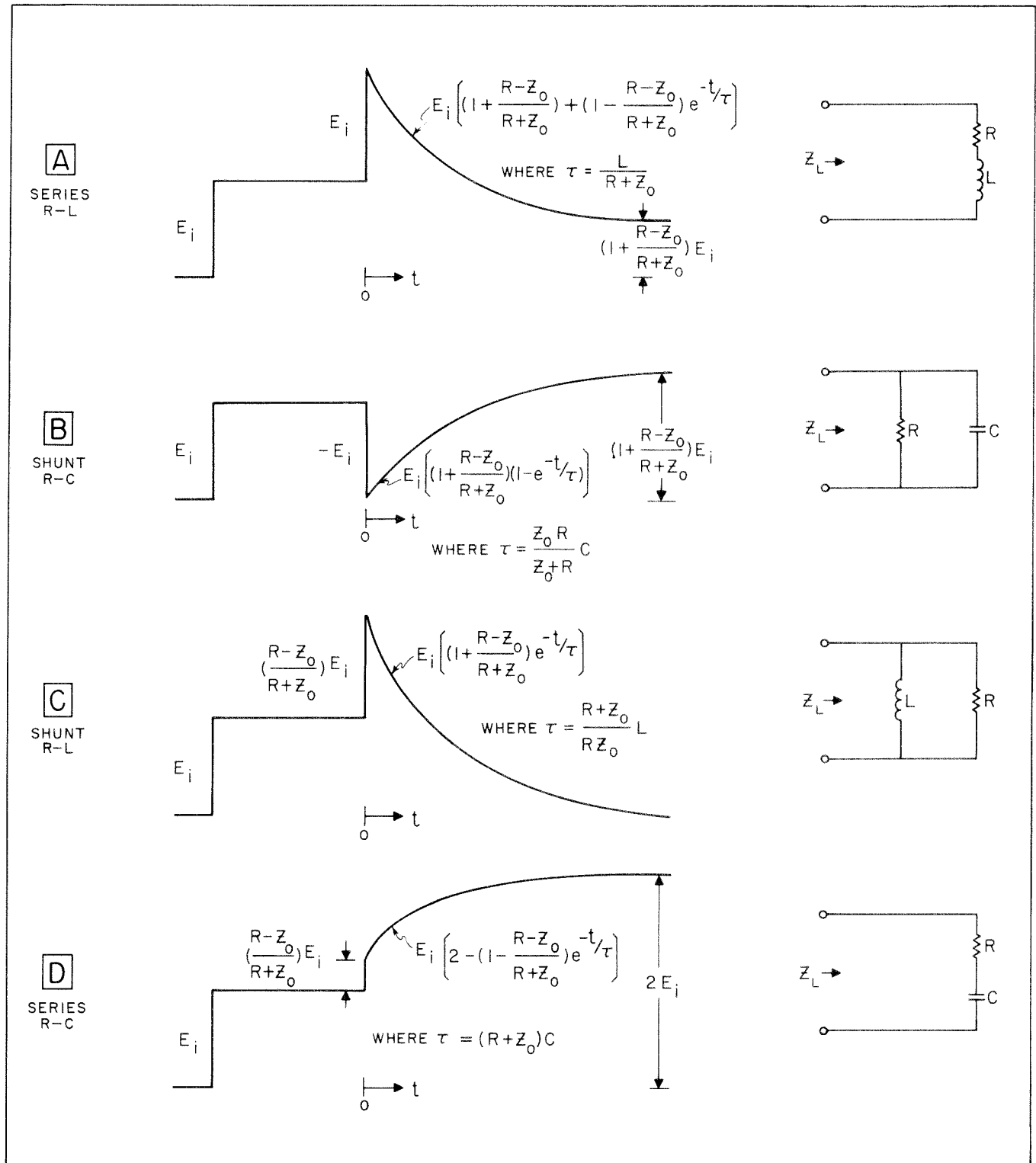

Figure 7. Oscilloscope displays for complex  $Z_L$

drops toward zero. At  $t = \infty$ , therefore,  $e_r$  is determined only by the value of  $R$  ( $\rho = \frac{R - Z_0}{R + Z_0}$  when  $t = \infty$ ). The exponential transition of  $e_r(t)$  has a time constant determined by the effective resistance seen by the inductor. Since the output impedance of the transmission line is  $Z_0$ , the inductor sees  $Z_0$  in series with  $R$ , and  $\tau = \frac{L}{R + Z_0}$ .

A similar analysis is possible for the case of the parallel R-C termination. At time zero, the load appears as a short circuit since the capacitor will not accept a sudden change in voltage. Therefore,  $\rho = -1$  when  $t = 0$ . After some time, however, voltage builds up on C and its impedance rises. At  $t = \infty$ , the capacitor is effectively an open circuit:

$$Z_L = R \quad \text{and} \quad \rho = \frac{R - Z_0}{R + Z_0}$$

The resistance seen by the capacitor is  $Z_0$  in parallel with  $R$ , and therefore the time constant of the exponential transition of  $e_r(t)$  is  $\left(\frac{Z_0 R}{Z_0 + R}\right) C$ .

The two remaining cases can be treated in exactly the same way. The results of this analysis are summarized in Figure 7.

### A SUGGESTION FOR MEASURING THE TIME CONSTANT OF THE REFLECTED WAVE RETURNING FROM COMPLEX LOADS.

When one encounters a transmission line terminated in a complex impedance, determining the element values comprising  $Z_L$  involves measuring two things:

(1) Either  $e_r$  at  $t = 0$  or at  $t = \infty$  and

(2) The time constant of the exponential transition from  $e_r(0)$  to  $e_r(\infty)$

Number (1) is a straight forward procedure from the information given in Figure 7. Number (2) is most conveniently done by measuring the time to complete one half of the exponential transition from  $e_r(0)$  to  $e_r(\infty)$ . The time for this to occur corresponds to  $0.69 \tau$ , where  $\tau$  again denotes the time constant of the exponential. Adjusting the deflection sensitivity of the oscilloscope in the TDR system so that the exponential portion of the reflected wave fills the full vertical dimension of the graticule makes this measurement very easy, as shown in Figure 8.

### DISCONTINUITIES ON THE LINE VS. MISMATCHES AT THE LOAD.

So far, mention has been made only about the effect of a mismatched load at the end of a transmission line. Often, however, one is not only concerned with what is happening at the load but also at intermediate positions along the line.

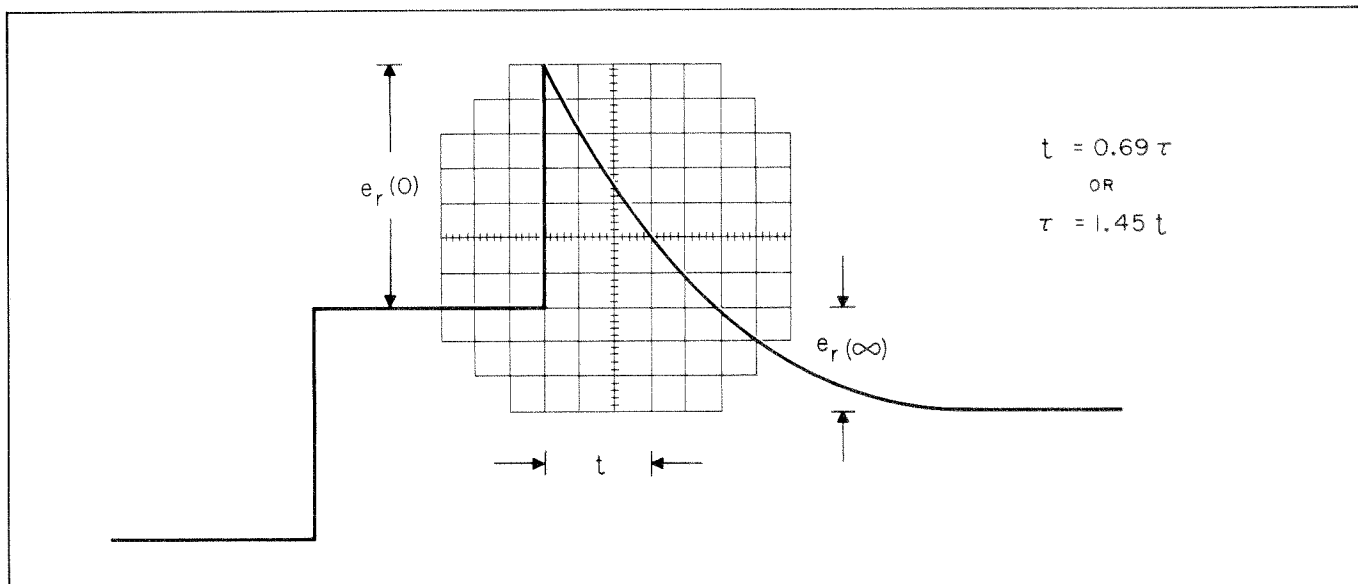
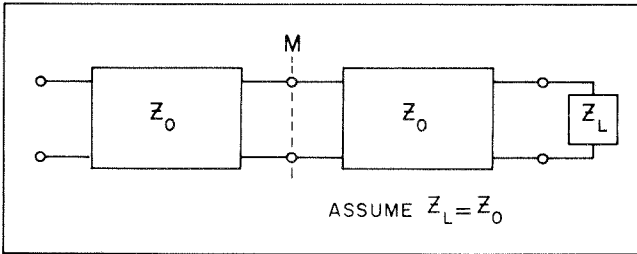

Figure 8. Determining the time constant of a reflected wave returning from complex  $Z_L$



Consider, for example, the transmission system below.



The junction of the two lines (both of characteristic impedance  $Z_0$ ) employs a connector of some sort. Let us assume that the connector adds a small inductor in series with the line. Analyzing this discontinuity on the line is not much different from analyzing a mismatched termination. In effect, one treats everything to the right of M in the figure as an equivalent impedance in series with the small inductor and then calls this series combination the effective load impedance for the system at the point M. Since the input impedance to the right of M is  $Z_0$ , an equivalent representation is:

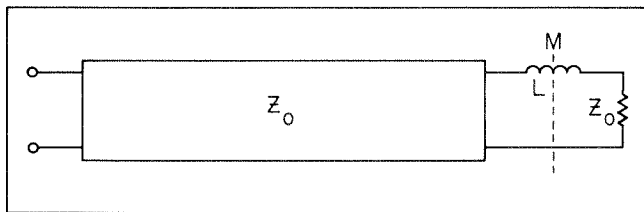

and the pattern on the oscilloscope is merely a special case of Figure 7(A).

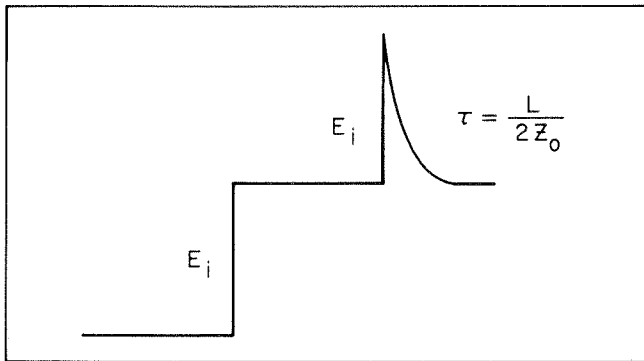

**EVALUATING CABLE LOSS.**

Time Domain Reflectometry is also useful for comparing losses in transmission lines. Cables in which series losses predominate reflect a voltage wave with an exponentially rising characteristic, while those in which shunt losses predominate reflect a voltage wave with an exponentially decaying characteristic. This can be understood by looking at the input impedance of the lossy line.

Assuming that the lossy line is infinitely long, the input impedance is given by Equation (1), repeated below:

$$Z_{in} = Z_0 = \sqrt{\frac{R + j\omega L}{G + j\omega C}} \quad (1)$$

Treating first the case where series losses predominate, G is so small compared to  $\omega C$  that it can be neglected:

$$Z_{in} \approx \sqrt{\frac{R + j\omega L}{j\omega C}} = \sqrt{\frac{L}{C}} \left(1 + \frac{R}{j\omega L}\right)^{\frac{1}{2}}$$

Recalling the approximation  $(1 + x)^a \approx (1 + ax)$  for  $x < 1$ ,  $Z_{in}$  can be approximated by:

$$Z_{in} \approx \sqrt{\frac{L}{C}} \left(1 + \frac{R}{j2\omega L}\right) \quad \text{when } R < \omega L$$

Since the leading edge of the incident step is made up almost entirely of high frequency components, R is certainly less than  $\omega L$  for  $t = 0^+$ . Therefore the above approximation for the lossy line, which looks like a simple series R-C network, is valid for a short time after  $t = 0$ . It turns out that this model is all that is necessary to determine the transmission line's loss.

In terms of an equivalent circuit valid at  $t = 0^+$ , the transmission line with series losses is shown in Figure 9.

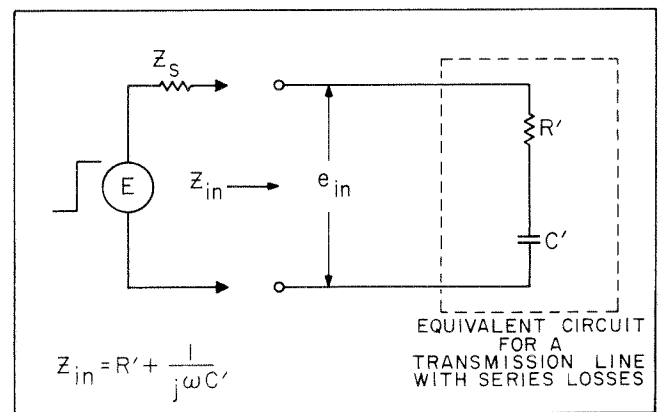
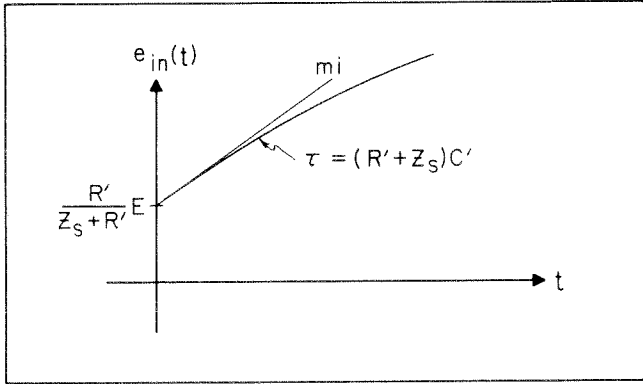

Figure 9. A simple model valid at  $t = 0^+$  for a line with series losses

The response to a step of height E appears as:



where  $Z_s$  = source impedance, assumed resistive.

In the case where  $Z_s = R'$ ,  $\tau = 2Z_s C'$  and the initial slope of  $e_{in}(t)$  is given by:

$$m_i = \frac{E}{4R'C'} = \frac{E}{8L} R$$

The series resistance of the lossy line ( $R$ ) is a function of the skin depth of the conductor and therefore is not constant with frequency. As a result, it is difficult to relate the initial slope with an actual value of  $R$ . However, the magnitude of the slope is useful in comparing cables of different loss.

A similar analysis is possible for a cable where shunt losses predominate. Here the input admittance of the lossy cable is given by:

$$Y_{in} = \frac{1}{Z_{in}} = \sqrt{\frac{G + j\omega C}{R + j\omega L}} = \sqrt{\frac{G + j\omega C}{j\omega L}}$$

since  $R$  is assumed small. Re-writing this expression for  $Y_{in}$ :

$$Y_{in} = \sqrt{\frac{C}{L}} \left(1 + \frac{G}{j\omega C}\right)^{\frac{1}{2}}$$

Again approximating the polynomial under the square root sign:

$$Y_{in} \approx \sqrt{\frac{C}{L}} \left(1 + \frac{G}{j2\omega C}\right) \text{ when } G < \omega C$$

Going to an equivalent circuit (Figure 10) valid at  $t = 0^+$ ,

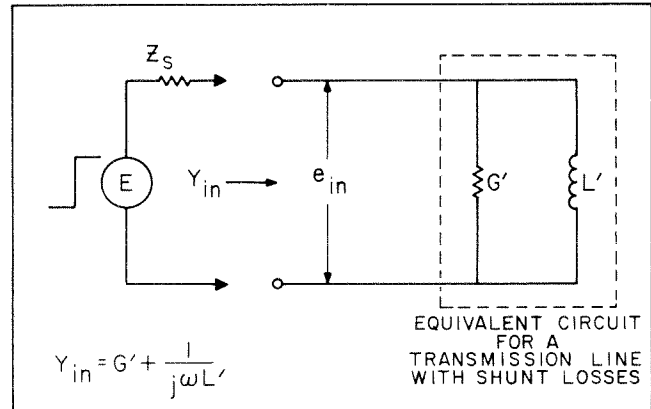
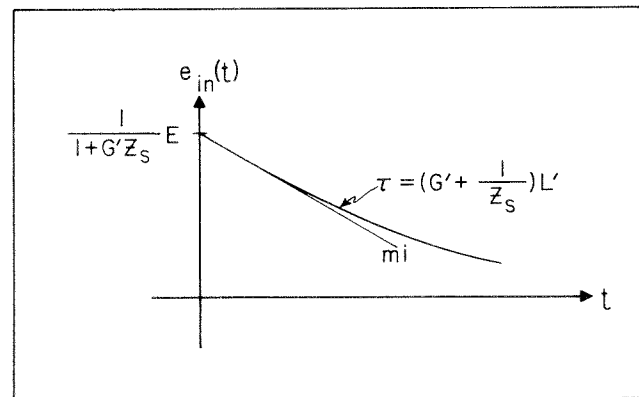

Figure 10. A simple model valid at  $t = 0^+$  for a line with shunt losses

$e_{in}(t)$  will look like:



Assuming  $G' = \frac{1}{Z_s}$ ,  $\tau = 2G' L'$  and the initial slope of  $e_{in}(t)$  is given by:

$$m_i = -\frac{E}{4G'L'} = -\frac{E}{8C} G$$

Again  $G$  depends on frequency, but relative loss can be estimated from the value of  $m_i$ .

A qualitative interpretation of why  $e_{in}(t)$  behaves as it does is quite simple in both these cases. For series losses, the line looks more and more like an open circuit as time goes on because the voltage wave traveling down the line accumulates more and more series resistance to force current through. In the case of shunt losses, the input eventually looks like a short circuit because the current wave traveling down the line sees more and more accumulated shunt conductance to develop voltage across.

**MULTIPLE DISCONTINUITIES.**

One of the virtues of TDR is its ability to handle situations involving more than one discontinuity. An example of this appears below:

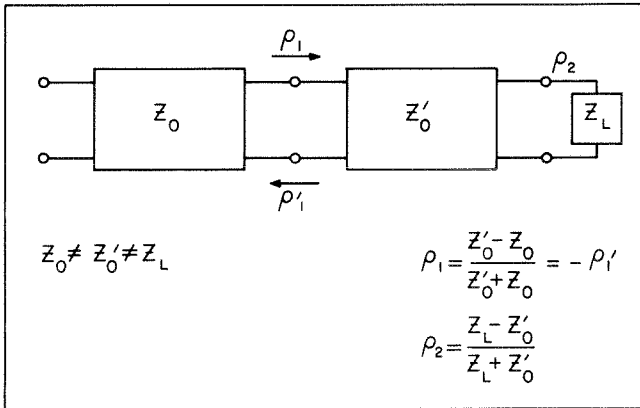

The oscilloscope's display for this situation would be similar to the diagram below (drawn for the case where  $Z_L > Z_0 > Z'_0$ ):

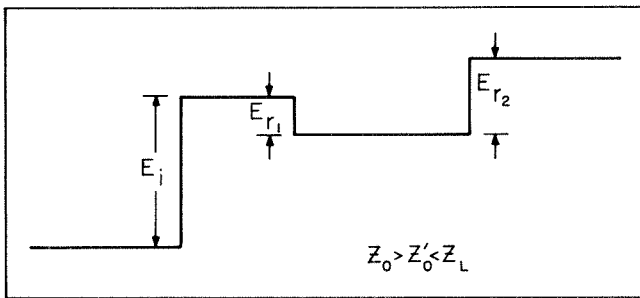

It is seen that the two mismatches produce reflections that can be analyzed separately. The mismatch at the junction of the two transmission lines generates a reflected wave,  $E_{r1}$ , where

$$E_{r1} = \rho_1 E_i = \left( \frac{Z'_0 - Z_0}{Z'_0 + Z_0} \right) E_i$$

Similarly, the mismatch at the load also creates a reflection due to its reflection coefficient ( $\rho_2 =$

$\frac{Z_L - Z'_0}{Z_L + Z'_0}$ ). Two things must be considered, however, before the apparent reflection from  $Z_L$ , as shown on the oscilloscope, is used to determine  $\rho_2$ . First, the voltage step incident on  $Z_L$  is  $(1 + \rho_1) E_i$ , not merely  $E_i$ . Second, the reflection from the load is

$$\left[ \rho_2 (1 + \rho_1) E_i \right] = E_{r2}$$

since a re-reflection occurs at the mismatched junction of the two transmission lines. The wave that returns to the monitoring point is

$$E_{r2} = (1 + \rho_1') E_{rL} = (1 + \rho_1') \left[ \rho_2 (1 + \rho_1) E_i \right]$$

Since  $\rho_1' = -\rho_1$ ,  $E_{r2}$  may be re-written as:

$$E_{r2} = \left[ \rho_2 (1 - \rho_1^2) \right] E_i$$

The part of  $E_{rL}$  reflected from the junction of  $Z'_0$  and  $Z_0$  (i.e.,  $\rho_1' E_{rL}$ ) is again reflected off the load

and heads back to the monitoring point only to be partially reflected at the junction of  $Z'_0$  and  $Z_0$ .

This continues indefinitely, but after some time the magnitude of the reflections approaches zero. It is now seen that although TDR is useful when observing multiple discontinuities, one must be aware of the slight complication they introduce when analyzing the display. It is fortunate that most practical measuring situations involve only small mismatches (e.g.,  $Z_0 \approx Z'_0$ ) and the effect of multiple reflections is almost nil. Even in this situation, however, it is advisable to analyze and clean up a system from the generator end. The reflection from the first of any number of discontinuities is unaffected by the presence of others. Therefore if it is remedied first and one then moves on to the second discontinuity, the complications introduced by re-reflections will not exist.

**STEP GENERATOR SOURCE IMPEDANCE.**

Until now nothing has been said concerning reflections which may have occurred at the generator end of the transmission line. In general, the source impedance of the step generator may not be equal to the characteristic impedance of the transmission line it drives. When this is the case, voltage waves returning from a mismatch or discontinuity in the system under test will be re-reflected at the generator end and complicate the analysis of the display (see Figure 11). It is almost essential, therefore, that the source impedance of the step generator matches the cable it drives. When this is the case, all reflections returning from the system under test pass the oscilloscope's monitoring point only once and are then absorbed in the source impedance of the step generator.

Figure 11. The photos on the right show the oscilloscope displays of two TDR systems investigating a transmission line terminated in a capacitor. In the upper photo, the source impedance of the step generator matches the characteristic impedance of the line under test ( $Z_s = Z_o = 50$  ohms). In the lower photo, however, this was not the case. Here the source impedance of the step generator was altered by inserting a short length of 75-ohm cable between the step generator (with  $Z_s = 50$  ohms) and the point where the sampling scope bridged the input to the line under test. The resulting mismatch caused the reflected wave returning from the capacitor to be re-reflected at the source, thus launching a second incident wave down the line. This second wave sends a second reflected wave from the capacitor back to the monitoring point. The second reflected wave, in turn, launches a third incident wave down the line. This process continues indefinitely, but unless the reflection coefficient at each end is equal to  $\pm 1$ , the reflections decrease in magnitude and only the first few are noticeable.

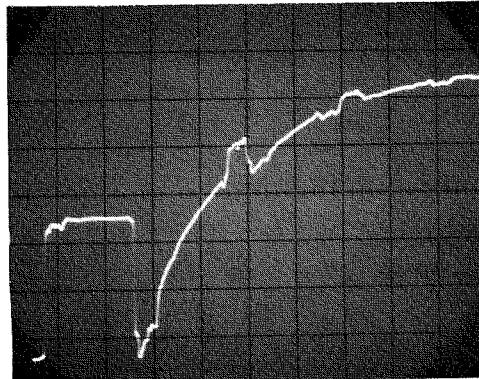
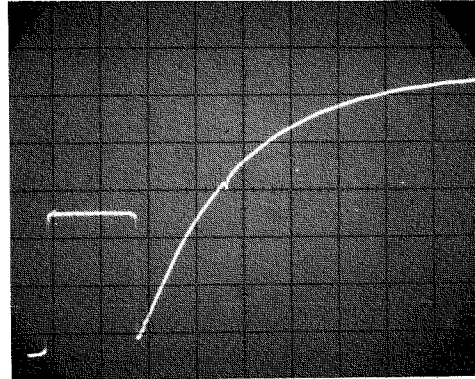



## SECTION IV

### PRACTICAL MEASURING CONSIDERATIONS

The discussion under Section III of this Application Note treated Time Domain Reflectometry academically. When one attempts to apply this theory to actual measuring situations, several compromises necessarily arise. The first of these involves the "step" generator. The best "step" generators now available have a rise time of about 30 picoseconds. Their output has very little overshoot, rounding or sag. The repetition rate of these devices can be as great as 100 Kc or so, sufficient for a steady display on a sampling oscilloscope. The ideal oscilloscope of Section III is best approached by a sampling oscilloscope with a rise time of approximately 90 picoseconds. The sampling scope has a high input impedance and also a wide dynamic range to allow small reflections to be observed at high gain despite their super-position on the relatively large incident step. Hewlett-Packard has designed a completely integrated fast rise "step" generator-sampling oscilloscope system especially for TDR. The Hewlett-Packard Model 1415A Time Domain Reflectometer, used in conjunction with the  $\text{hp}$  Model 140A Oscilloscope, is an ideal tool for these measurements (see Figures 12 and 13). In addition, since this system best approaches the idealized treatment in Section III, it will be beneficial to speak of practical measuring considerations in terms of its performance.

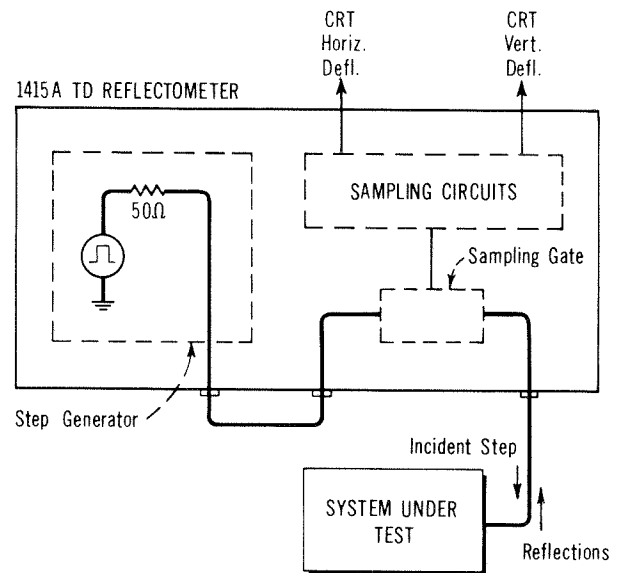

Figure 13. The  $\text{hp}$  1415A has both a 50-ohm source impedance and a high impedance sampling gate which bridges a feed-through section of 50-ohm transmission line.

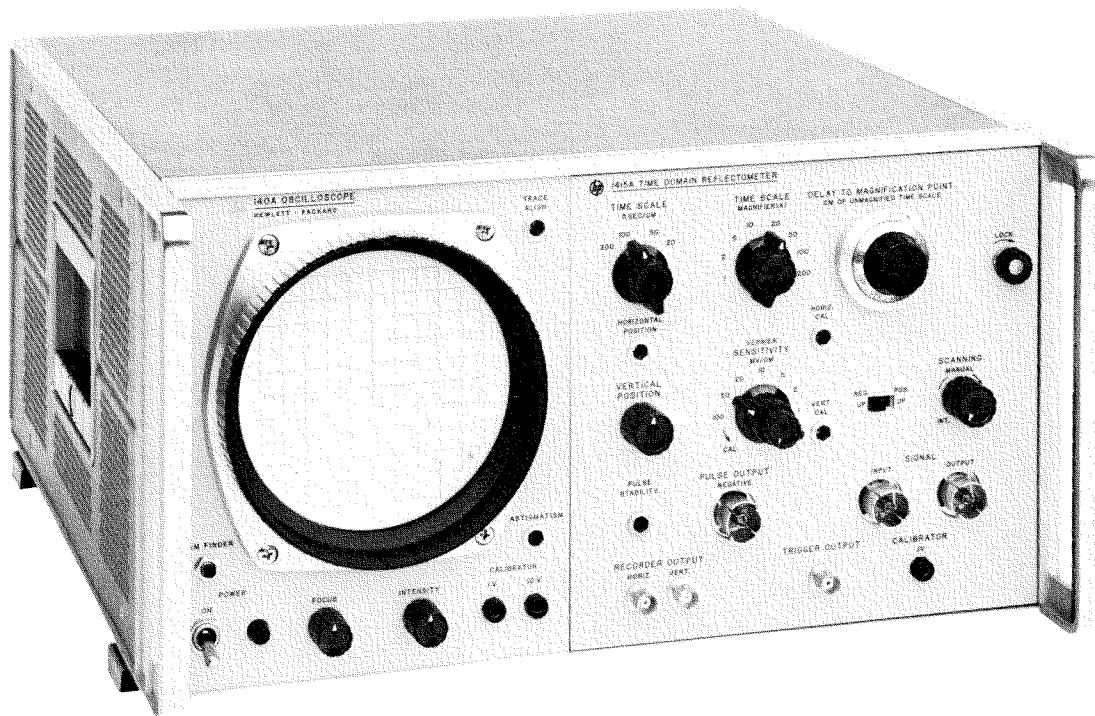

Figure 12. The  $\text{hp}$  1415A Time Domain Reflectometer is shown above plugged into the  $\text{hp}$  140A Oscilloscope. These two instruments comprise a compact TDR system

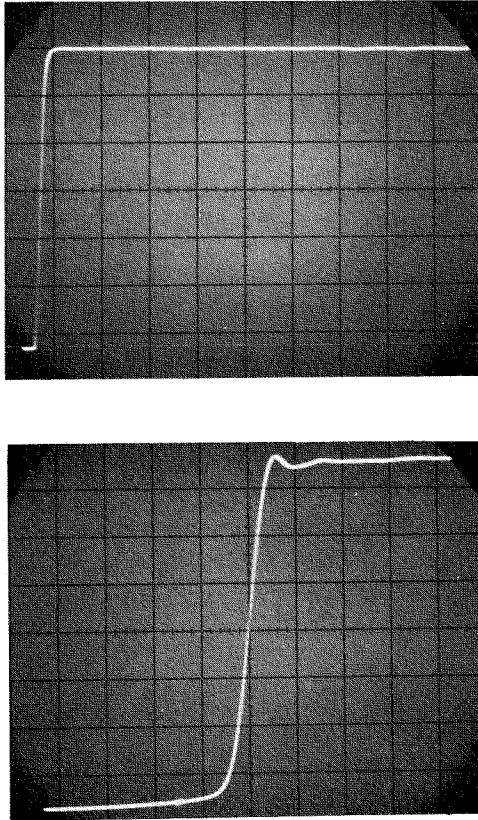

Figure 14. Above photos demonstrate the quality of the test step provided by the  $\text{tdp}$  1415A Time Domain Reflectometer. Upper photo was taken at a sweep speed of 200 ns/cm and shows no noticeable sag over a 1.8  $\mu\text{sec}$  period. The lower photo was taken at a sweep speed of 200 ps/cm and shows a rise time of 150 ps with minimal overshoot.

**RISE TIME.**

The system rise time of the  $\text{tdp}$  140A/1415A is approximately 150 picoseconds (see Figure 14). This becomes significant in the resolution between closely spaced discontinuities and in the shapes of the reflections from very small inductors and capacitors.

RESOLUTION.

When two discontinuities are spaced closer than approximately 1 cm, the 1415A is unaware that they exist as separate entities. The reflection observed is the sum of the reflections that would be observed if each discontinuity were isolated. It is impossible to acquire quantitative information for each discontinuity, but the composite reflection determines the effective discontinuity seen by the 1415A. Since this is essentially the discontinuity that any signal with frequency components below 2.3 gc will see, the test is valid for this frequency range (i.e., dc to 2.3 gc).

SMALL INDUCTORS AND CAPACITORS.

Treated ideally, the reflections from small inductors and small capacitors have very short time constants of the exponential transition from  $e_r(0)$  to

$e_r(\infty)$  and are only special cases of the examples of Figure 7. Under actual measuring conditions, however, the finite bandwidth of the "step" generator-oscilloscope system becomes a limiting factor in the display. Consider, for example, a series combination of R & L, where  $R = 50 \Omega = Z_0$  (of the cable feeding the R-L termination), and L is of the order of  $10^{-10}$  henry. Ideally the display would resemble Figure 15 (A); it actually resembles 15 (B).

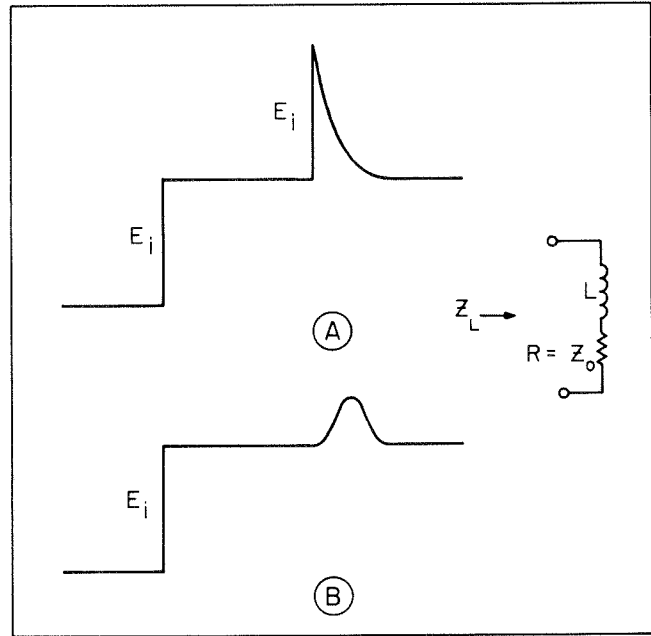

Figure 15. Ideal vs actual displays of reflection from a small inductor in series with  $R = Z_0$

Qualitatively one can understand what is happening in Figure 15 (B) by realizing that the time constant of the reflected wave is so short that it decays to its final value almost before the TDR system has begun its rise. Despite this limitation, quantitative information is still available concerning the magnitude of the small inductor causing the reflection. Recalling Equation (6):

$$\rho = \frac{E_r}{E_i} = \frac{Z_L - Z_0}{Z_L + Z_0}$$

and substituting  $Z_L = R + j\omega L = Z_0 + j\omega L$

$$\rho = \frac{(Z_0 + j\omega L) - Z_0}{(Z_0 + j\omega L) + Z_0} = \frac{j\omega L}{2Z_0 + j\omega L}$$

But since L is small, the product  $\omega L$  will be very much less than  $2Z_0$  unless  $\omega$  becomes very large. The finite rise time (i.e., limited bandwidth) of the TDR

system, however, dictates that the frequency spectrum of the displayed step will not contain frequency components beyond a certain "cutoff" frequency. Therefore  $\omega L$  can be neglected with respect to  $2Z_0$ , and:

$$\rho = \frac{E_r}{E_i} = \frac{j\omega L}{2Z_0} \quad \text{or} \quad E_r = \frac{L}{2Z_0} (j\omega E_i)$$

Continuing to talk in terms of the sinusoidal components of the displayed waveform:

$$E_i = E e^{j\omega t}$$

Then  $j\omega E_i = j\omega E e^{j\omega t} = \frac{dE_i}{dt}$ , and

$$E_r = \frac{L}{2Z_0} \frac{dE_i}{dt}$$

Therefore, the reflected wave will be a differentiated version of the incident step with its magnitude

proportional to  $\frac{L}{2Z_0} \cdot \frac{de_i}{dt}$ . Since both  $e_r(t)$  and  $\frac{de_i}{dt}$

can be read from the oscilloscope's display, L can be evaluated (see Figures 16 and 17).

A similar analysis is possible for the case of a small capacitor in shunt with a resistor of value  $Z_0$ . The results of this analysis are summarized in Figure 18.

In the cases where a small inductor is shunting a load resistor or a small capacitor is in series with a load resistor, a similar approximation does not exist to determine the value of L or C. When the exponential transition of the reflected voltage becomes faster than the rise time of the displayed step, the small shunt inductor becomes indistinguishable from a short circuit termination and the small series

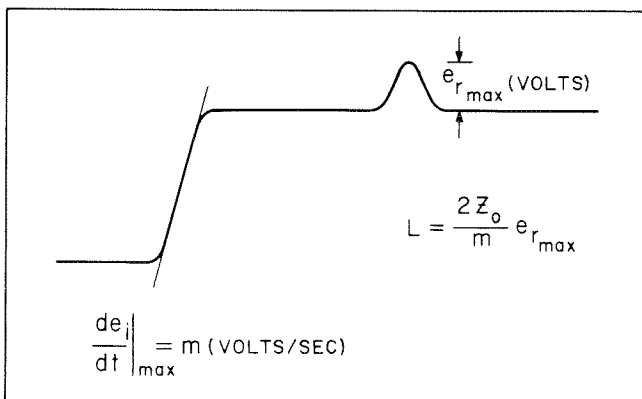

Figure 16. Determining the magnitude of small inductors in series with  $R = Z_0$

capacitor indistinguishable from an open circuit. As a practical matter, however, these cases are seldom encountered unless one is actually attempting to create a short or open termination.

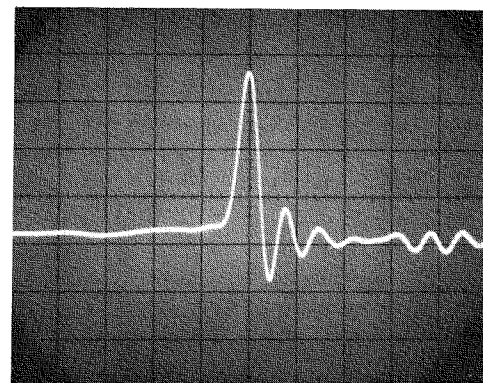
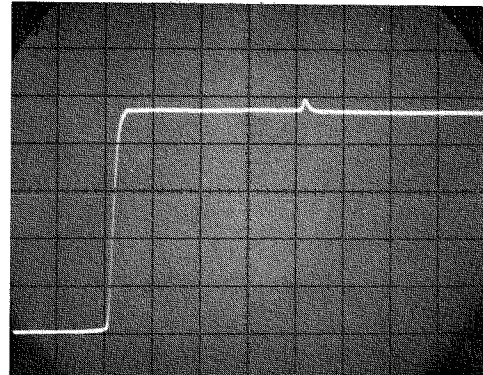

Figure 17. These photos show an actual reflection from a small inductor in series with  $R_L = Z_0$ . Upper photo was taken at 50 mv/cm sensitivity and 4 ns/cm sweep speed. Lower photo is an expanded view of the reflected wave; sensitivity = 10 mv/cm and sweep speed = 400 ps/cm. From this photo  $e_{r_{max}}$

is seen to be 34 mv. Since  $m \approx 3 \text{ mv/ps}$  and  $Z_0 = 50 \Omega$ ,  $L \approx \frac{2(50)}{3 \text{ mv/ps}} (34 \text{ mv}) = 1.1 \times 10^{-9} \text{ h}$ .

**AN ADDITIONAL PRECAUTION REGARDING RISE TIME.**

Recalling the section on cable loss, the signal attenuation through a transmission line was seen to depend on the values of R and G for that line. It was also stated that both R and G depend somewhat on frequency. In particular both increase with increasing frequency and therefore cause greater attenuation of the high frequency components of the "step" traveling down the line. This causes the rise time of the test "step" to decrease as it travels down the line and hence reduces the TDR system's ability to resolve closely spaced discontinuities on long or lossy lines. Furthermore, since the slope of the test waveform decreases as it moves down the line, more accuracy will be obtained when evaluating the reflections from small series inductors or small shunt capacitors if

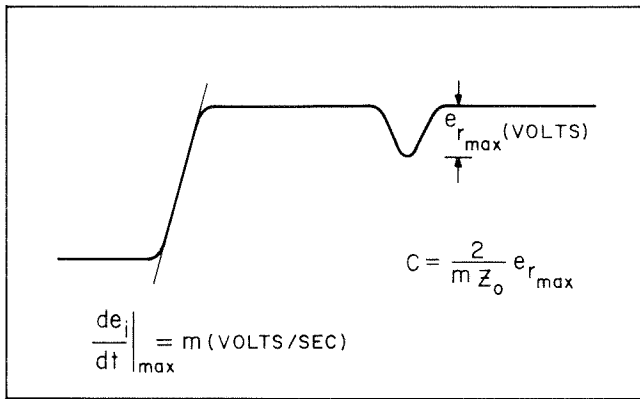

Figure 18. Determining the magnitude of small capacitors in shunt with  $R = Z_0$

one measures the maximum slope of the reflection returning from a good short placed just before the discontinuity in question and then uses this value for  $m$  in the equations of Figures 16 and 18. If the point just before the discontinuity is not accessible, placing the short as close as possible (preferably on the generator side) will at least give an estimate of the rise time (or, more importantly, the maximum slope) of the wave actually incident on the discontinuity in question. In well matched systems employing good cable, the degradation of rise time down the cable may not be appreciable, but in transmission systems using lossy cables or containing several small reactive discontinuities preceding the one in question, the rise time of the wave will be significantly degraded as it travels down the line. The only way to be certain of the rise time of the test "step" at a particular point on the line is to measure the rise time of the reflection returning from a short at that point.

#### TDR SYSTEMS.

In evaluating a proposed system for Time Domain Reflectometry, several things must be considered. Certainly the rise time of the system must be good to provide maximum resolution between discontinuities and to measure small reactive discontinuities. The "step" generator must also have a flat top and a minimum of overshoot and ringing on the leading edge. Additionally, its source impedance should match the line to be tested to eliminate reflections from the generator. (Although it is possible to insert a cable between the generator and the monitoring point to delay any re-reflections from a mismatched source until after those from the system under test, this method necessarily degrades the rise time of the stepped into the system. It is therefore more desirable to use a generator whose source impedance matches the characteristic impedance of the transmission line being tested.) Another important characteristic of the TDR system we have investigated is the high input impedance of the oscilloscope monitoring the voltage on the transmission line. Intricate combinations of padding and delay will permit low input impedance oscilloscopes to be used in an alternate TDR system, but the use of pads reduces the sensitivity of the system and

the delay cable required again degrades resolution. The straight forward TDR system that is possible with a high input impedance oscilloscope and a well matched step generator is very desirable.

One compromise that is feasible involves trading system rise time for step amplitude. "Step" generators with a rise time in the picosecond region presently have a maximum output of approximately 0.25 volt into 50 ohms. Resorting to a slower rise time unit (e.g., Hewlett-Packard Model 215A Pulse Generator with a rise time less than 1 nanosecond), an output of 10 volts into 50 ohms is available (see Figure 19). Using the maximum dynamic range of the sampling oscilloscope, this higher input step will allow reflection coefficients as small as  $10^{-4}$  to be measured from resistive discontinuities. This represents a factor of 10 improvement over that available with a 0.25 volt step, but it is achieved at the sacrifice of rise time and, hence, resolution.

#### APPLICATIONS.

The prime virtue of Time Domain Reflectometry is its ability to (A) simultaneously display the transmission quality of a system for frequencies from dc to a few gigacycles and to (B) isolate discontinuities so that they may be compensated individually on a broadband basis. For this reason, TDR is directly applicable to measuring cable parameters:  $Z_0$  (either its absolute value or uniformity with distance), loss (either series or shunt), and length. TDR is also useful for broadband reflection coefficient measurements of terminations; for broadband evaluations of individual components such as connectors and tees; and for determination of the broadband transmission quality of entire systems. It has also been used at Hewlett-Packard for specialized tasks such as the measurement of the resistive impedance of a crystal mixer which is being driven with a local oscillator voltage. As this technique becomes more well known, additional applications will arise.

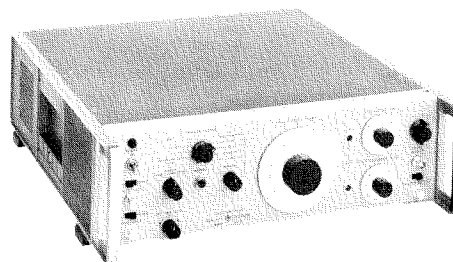
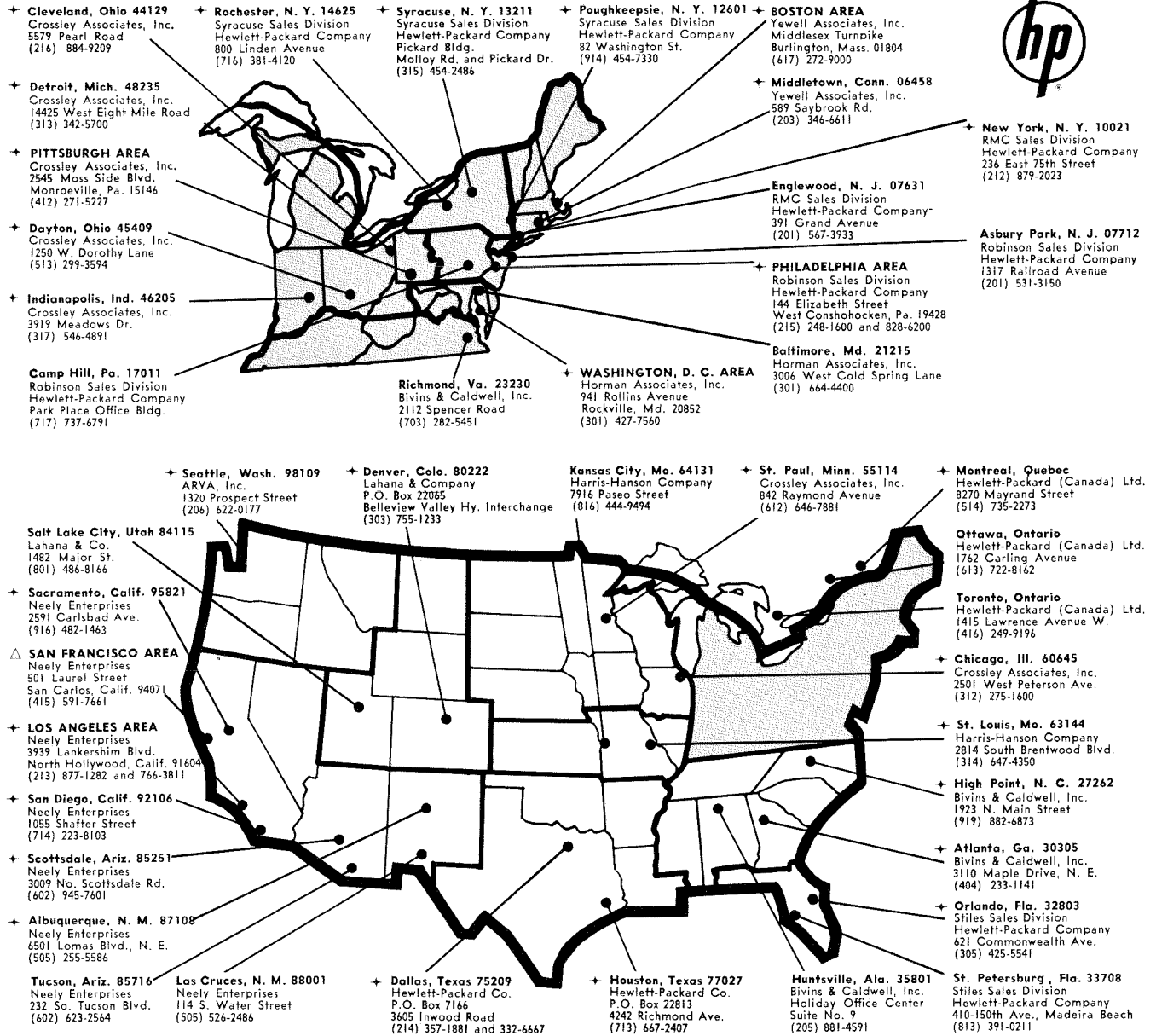

Figure 19. The  $\text{hp}$  Model 215A has a 50-ohm source impedance and delivers a 20 volt pulse into an open circuit. This instrument can be incorporated in a TDR system when extremely small resistive mismatches are to be measured.



# HEWLETT-PACKARD SALES AND SERVICE OFFICES IN NORTH AMERICA



△ For replacement parts and repair services in the San Francisco area, please contact Hewlett-Packard Company at: 395 Page Mill Road, Palo Alto, California 94306 (415) 326-3950.  
+ Indicates Instrument Repair Stations

## HEWLETT-PACKARD COMPANY

1501 Page Mill Road • Palo Alto, California 94304  
Tel: (415) 326-7000 • TWX: 415-492-9200 • Cable: HEWPACK

## DYMEC DIVISION

395 Page Mill Road • Palo Alto, California 94306  
Tel: (415) 326-1755 • TWX: 415-492-9363

## BOONTON RADIO COMPANY

Green Pond Road • Rockaway, New Jersey 07866  
Tel: Oakwood 7-6400 • Cable: BOONRACO

## HARRISON LABORATORIES

41 Industrial Road • Berkeley Heights, N. J. 07922  
Tel: 464-1234 • TWX: Summit, N. J.

## SANBORN COMPANY

Industrial Division • 175 Wyman St., Waltham, Mass. 02154  
Tel: (617) TW 4-6300 • TWX: 617-894-0789

## F. L. MOSELEY CO.

409 N. Fair Oaks Ave. • Pasadena, Calif. 91102 • Tel: (213) MUrray 1-0208 • TWX: PASA CAL 7687 • Cable MOCOPAS

