



A New Microwave Spectrum Analyzer

A new spectrum analyzer displays up to 2,000 Mega-cycles of the spectrum at a time for RFI checking, spectrum surveillance, and other wide-band investigations.



Fig. 1. Hewlett-Packard Model 8551A/851A Microwave Spectrum Analyzer enables evaluation of signals widely separated both in amplitude and frequency. Analyzer here displays harmonic and spurious outputs of frequency doubler throughout range from 10 Mc to above 10 Gc. Doubler generates 3800 Mc output in response to 1900 Mc input and Analyzer clearly shows how mistuning can cause certain diodes to produce non-harmonically related parametric oscillations.

Fig. 2. Wide measurement range of new -hp- Spectrum Analyzer is indicated by this pair of photos. First photo shows spectrum of RF pulse train as displayed with linear vertical deflection and 30 Mc spectrum width centered at 1500 Mc. Amplitudes of components beyond 12 Mc from center are not easily evaluated. Second photo shows same spectrum with logarithmic vertical deflection characteristics and 300 Mc spectrum width. Components out to 75 Mc from center are easily evaluated though they are more than 50 db down from center frequency (vertical calibration is 10 db/cm).

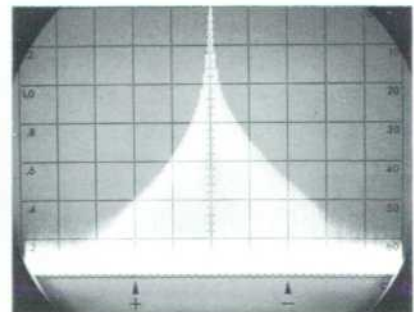
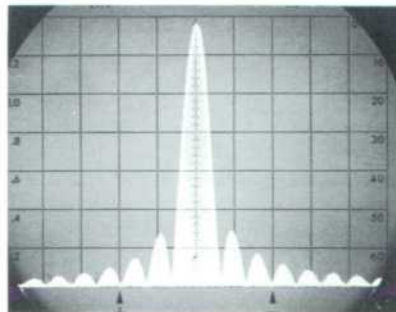

MICROWAVE spectrum analyzers are swept-frequency receivers with visual display. The basic function of a spectrum analyzer is to plot input signal amplitude as a function of frequency while the analyzer automatically tunes through a selected range of frequencies.

Spectrum analyzers are potentially useful in the laboratory as well as in the field because they provide quantitative information about several signals simultaneously. For instance, they facilitate adjustment of devices that operate with several different frequencies at the same time, such as parametric amplifiers. A spectrum analyzer connected to an antenna can display a plot of all detectable electromagnetic radiations over a selected frequency band, indicate the relative strength of each signal, and show individual frequency components of any one of the signals to provide useful information on sideband structure.

It has not always been possible, however, to make measurements with spectrum analyzers in a simple, straightforward manner. Broad-band analyzers often include image responses and a

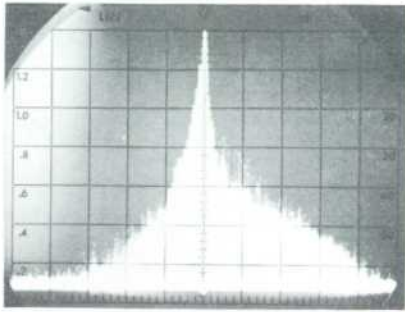

SPECTRUM SIGNATURES

Oscillograms of output frequency components of L-band radar illustrate usefulness of large dynamic display range of -hp- Spectrum Analyzer for spectrum signature measurements. Left photo, with 10 Mc/cm spectrum width, shows that radar generates measurable power in sidebands over more than 70

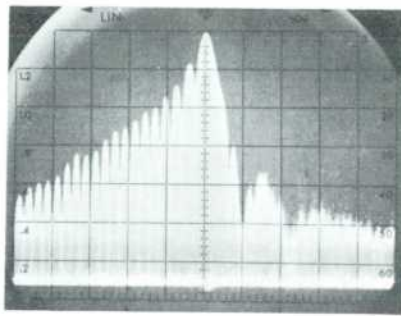

Mc range. Photo also shows transients that would escape notice on slower acting graphic recorders. Right photo, made with spectrum width of 3 Mc/cm, indicates how calibrated spectrum widths enable measurement of spacing between groups of frequency components; spacing of just under 1 Mc between envelope maxima indicates pulse width of slightly more than 1 μ sec.

variety of spurious responses resulting from harmonic and intermodulation products. Marker generators have been necessary to provide quantitative information in an indirect way.

It was for the purpose of eliminating operational difficulties and of making spectrum analysis a useful, flexible laboratory tool that Hewlett-Packard embarked upon the development of a spectrum analyzer and as a result, a spectrum analyzer is now available that not only reduces spurious responses significantly, but which is easier to use, in which all basic functions are completely calibrated, and which has a wider range of capabilities.

THE -HP- SPECTRUM ANALYZER

The new Hewlett-Packard 8551A/851A Spectrum Analyzer, in brief, is a multi-band instrument that responds to signals throughout a 10 Mc to 40 Gc frequency range and that is capable of sweeping over frequency ranges as wide as 2000 Mc. The instrument can sweep over narrow ranges as well, the necessary stability being provided by an unusual phase-lock system that locks the local oscillator to a stable reference oscillator even while tuning. Exceptionally flat frequency response is achieved, variations being less than ± 5 db over the full 2000 Mc sweeping range and ± 1 db over any 200 Mc range using fundamental mixing (± 2 db when working on local oscillator second harmonic).

The display circuits enable simultaneous display of signals having a wide 60 db amplitude range. The input mixer has a dynamic range greater than 95 db and a new RF attenuator increases the input range up to +30 dbm (1 watt).

The instrument establishes a new high with respect to freedom from spurious and residual responses. Operating features include a "Signal Identifier," that quickly identifies the frequency range of all displayed responses. The new -hp- Spectrum Analyzer requires far fewer controls than other wide-band analyzers, and the controls are calibrated so that frequency and relative amplitude of signals may be read directly without use of markers. The display dynamic range and wide frequency response of

this instrument enable direct measurements on signals widely separated both in frequency and in amplitude.

WIDE FREQUENCY RANGE

The Hewlett-Packard approach to the design of a microwave spectrum analyzer is to use a backward-wave oscillator as the first local oscillator in a swept-tuned, broad coverage, triple-conversion receiver. The backward-wave oscillator, which has been found to have better spectral purity than other voltage-tuned microwave tubes, can be tuned manually from 2 to 4 Gc and sweep-tuned electrically around the selected center frequency.

As shown in the simplified block diagram of Fig. 3, the BWO signal heterodynes with the input signals in the front-end mixer. Wide coverage from 10 to 40,000 Mc is obtained since there are no frequency sensitive circuits ahead of the first mixer. Any signals that generate a 2 Gc mixing product with the BWO signal then pass through the first IF amplifier (2 Gc) and subsequently appear as a vertical deflection on the cathode-ray tube.

The cathode-ray beam sweeps horizontally in synchronism with the BWO frequency sweep. A particular signal frequency component therefore appears as a vertical deflection at some point along the horizontal scale of the CRT graticule, as shown on page 8. The frequency of the signal component can be read from its position on the CRT, with reference to the settings of the calibrated *Tune* and *Spectrum Width* controls.

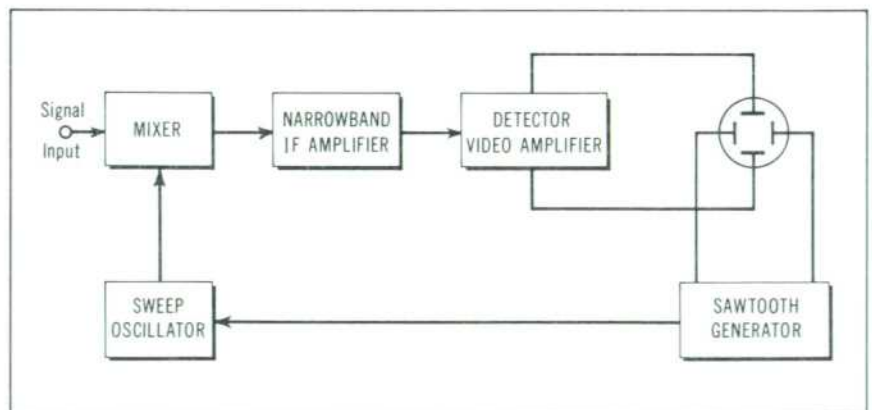

Fig. 3. Simplified block diagram of wide-band spectrum analyzer.

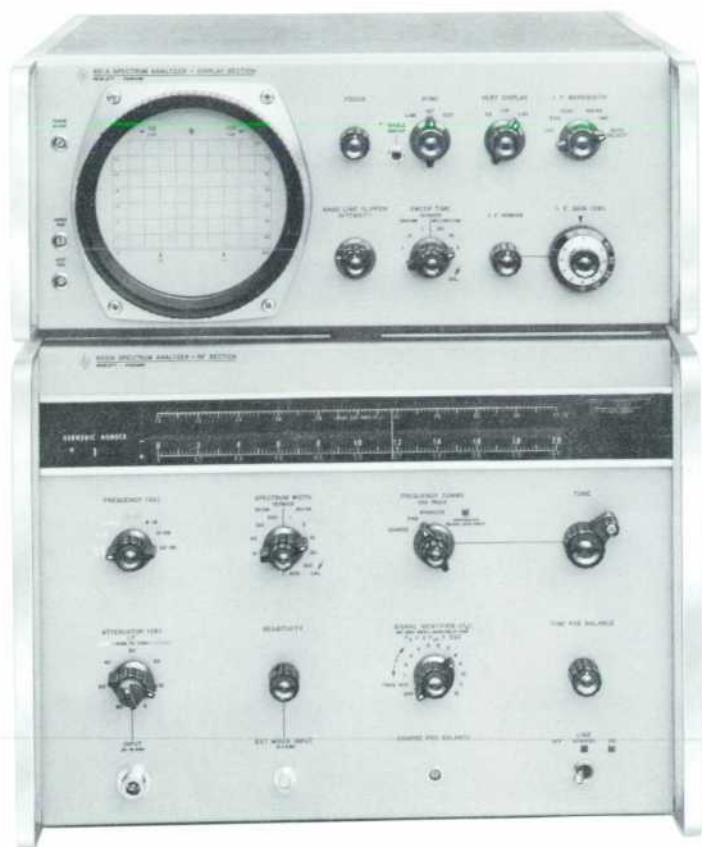

Fig. 4. Hewlett-Packard Model 8551A/851A Microwave Spectrum Analyzer is packaged in two modules that may be used on bench or mounted in standard relay racks with brackets supplied. Standard -hp- 5-inch CRT bezel mounts oscilloscope cameras directly. Pointer on frequency dial shows frequency of BWO first local oscillator on topmost scale. On lower scales, pointer shows frequency of

response appearing at center of CRT display. Frequency switch selects appropriate scales to correspond to input frequency range; number in window at left shows which harmonic of BWO generates responses in that frequency range. If frequency range of any response is not known, Signal Identifier (see text) quickly indicates proper scale to be used for measuring frequency of response.

The first IF amplifier, a cavity-tuned triode for large dynamic range, has a center frequency of 2000 Mc. The high 1st IF frequency provides wide image separation (4000 Mc), an important feature in a class of instruments where image frequencies have been troublesome. Wide image separation also makes it easier to use RF preselection filters for selecting or eliminating certain bands of frequencies.*

Spurious responses resulting from mixer operation have been a major cause of operating difficulties in previous spectrum analyzers. Considerable effort was expended at Hewlett-Packard in the design of a wideband

mixer that would generate a minimum amount of intermodulation. The new mixer responds to signals up to 0 dbm without signal compression, achieving a wide dynamic range. Particular attention also was paid to achieving flat frequency response in the mixer over the broad sweep widths.

A newly-designed 0-to-60 db attenuator precedes the mixer to reduce strong signals below the point where they would overdrive the mixer and create spurious responses. Although waveguide-beyond-cut-off attenuators have been used previously, this attenuator is significant because of its low insertion loss, which is 0 db at the low frequency end, and no more than 2 db

at 10 Gc. No cable patching is required to reduce the attenuation to zero when examining weak signals.

CALIBRATED CONTROLS

A major design effort was applied toward achieving calibrated controls for the new analyzer. Calibrated controls make it possible to read signal frequency and relative amplitude from the cathode ray tube graticule, and also assure measurement repeatability.

The tuning dial pointer indicates the frequency of a signal appearing at the center of the CRT. The *Spectrum Width* control, calibrated in kc or Mc per centimeter of CRT horizontal deflection, selects the range of the frequency sweep which is centered at the frequency selected by the *Tune* control.

The CRT graticule is calibrated vertically with three scales that correspond to the IF amplifier characteristics selected by the *Vertical Display* switch. The amplifier response can be linear, or proportional to the square of input signal voltage and thus indicative of power, or logarithmic. The 7 cm CRT graticule Log Scale is calibrated in db at 10 db per cm so that with the switch in the *Log* position, it is possible to view simultaneously signals that have more than a 60 db (1,000,000 to 1) range.

The input RF attenuator, the IF attenuator, the IF Bandwidth, and the Sweep Time switches also are calibrated.

RESOLUTION

The resolution of an analyzer, i.e., its ability to separate closely spaced signals on the frequency scale, is an important characteristic that is determined by the IF amplifier passband. Two adjacent signals merge into one response if the passband is broad enough to pass both signals at the same time, but will be plotted as two separate signals if the passband is narrow compared to the signal separation.

Although a narrow passband is desirable for high resolution, it also slows the rise time of the IF amplifier. If the passband is too narrow, the analyzer may sweep across a signal too fast for the IF voltage to build up to a steady-state level.

* Interdigital bandpass filters, -hp- Series 8430A, are available for use with the Spectrum Analyzer.

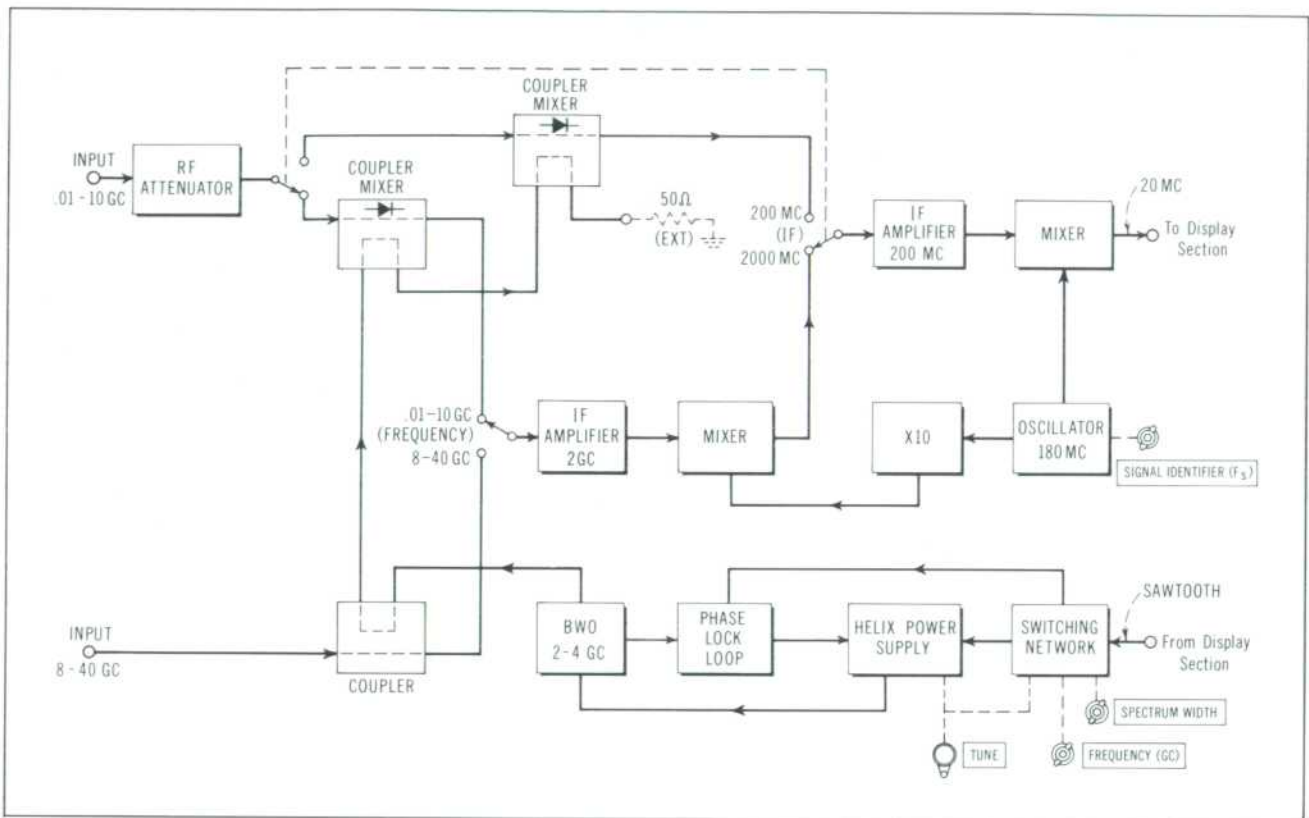

Fig. 5. Block diagram of Spectrum Analyzer RF Section. Only two inputs are needed to cover entire 0.01 to 40 Gc frequency range. Newly-developed RF attenuator does not require sepa-

rate input connector (see text). Input for 8-40 Gc signals sends BWO signal to external waveguide mixer and receives 2-Gc IF signal over same connecting cable.

The narrowest practical bandwidth therefore depends on the rate at which the instrument changes frequency, which is a function of both sweep speed and sweep width. For this reason, the bandwidth of the *-hp-* analyzer is not fixed but can be switched to be 1, 3, 10, 100, or 1000 kc. Ordinarily, a trial and error procedure is used to find the optimum bandwidth but this can be done automatically by a new operating feature on the *-hp-* analyzer. An *Auto Select* position on the *I.F. Bandwidth* switch programs the instrument to select the optimum bandwidth for each combination of spectrum width and sweep rate.

Examination of the spectra of short pulses, on the other hand, requires a broad passband. If the pulse width is shorter than the risetime of the IF amplifiers, the pulse will be attenuated because of the slow risetime. The *-hp-* analyzer provides a 1 Mc bandwidth with fast risetime to reduce the attenuation of short pulses. Although the broad bandwidth may allow indi-

vidual frequency components to overlap on the display, the spectrum envelope is preserved and this is of prime interest here.

SWEEP-TUNED PHASE LOCK

Short-term stability of the electrically-tuned BWO is 1 part in 10^5 , which means short term instabilities of typically 10 to 30 kc, undetectable on wide frequency sweeps. This instability becomes significant on very narrow sweeps, however.

To provide the stability necessary for narrow sweeps (<1 Mc/cm), a tunable phase-lock system locks the backward wave oscillator to a harmonic of a stable 10 Mc reference oscillator. The reference oscillator sweeps in synchronism with the BWO and the phase lock system impresses the stability of the 10 Mc oscillator on the BWO. Short term stability of the BWO is better than 1 kc p-p when locked.

A further refinement allows the analyzer to be tuned while the BWO is

phase-locked. The 10 Mc oscillator itself cannot be tuned over a wide range, but as the instrument is tuned, the reference oscillator tunes through its range over and over again while the phase detector automatically passes from harmonic to harmonic of the oscillator to retain phase lock. The BWO thus can be tuned through its entire range while phase-locked.

SIGNAL IDENTIFIER

Wide-band spectrum analyzers that use a swept first local oscillator without front-end pre-selection respond to signals that are anywhere within the bandwidth of the front end (e.g., 10 Mc to above 40 Gc). All signal frequencies within this range that develop suitable mixing products with any local oscillator harmonic will appear on the display. Identification of these responses has been one of the major problems with previous wide-band analyzers.

To quickly identify the frequency of any displayed response, the *-hp-* Spec-

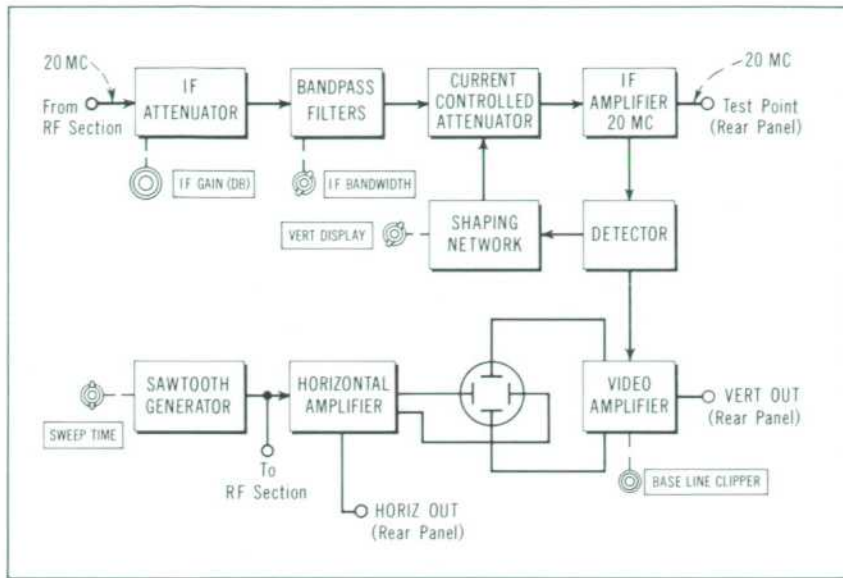

Fig. 6. Block diagram of Spectrum Analyzer Display Section.

trum Analyzer has a signal identifier. The identifier works by shifting the frequency of the second and third local oscillators. When the shift is made, a particular input signal must beat with a slightly different first local oscillator frequency in order to pass through the narrow-band 20 Mc third IF. This means, then, that a signal develops the proper IF frequency at a different point in the frequency sweep and as a result, the signal appears at a different point along the CRT horizontal scale. The amount of horizontal displacement depends not only on the frequency shift in the second and third LO but also on the harmonic number of the BWO harmonic that is beating with the signal.

The *Signal Identifier* is a multi-position switch that steps the frequency shift in the 2nd and 3rd LO signals to progressively greater degrees until the response under examination moves exactly 2 cm along the horizontal scale of the CRT. The switch is labeled to show which harmonic number then is producing the response and thus which frequency scale should be used (or apply the formula $F_s = nF_{L.O} \pm 2 \text{ Gc}$). Furthermore, whether the response shifts to the right or to the left on the horizontal scale depends on whether the signal lies above or below the particular har-

monic. The direction of shift indicates which one of each pair of frequency scales is to be used.

OTHER FEATURES

A block diagram of the -hp- 8551A Spectrum Analyzer RF Section is shown in Fig. 5. Only two input connectors are required to cover the wide range of input frequencies from 10 to 40,000 Mc. One input is coaxial and responds to all frequencies from 10 Mc to 10 Gc. Since higher frequencies are

most often encountered in waveguides, external waveguide mixers are available for frequencies from 8 to 40 Gc. The external mixers, connected to the other analyzer input through a single coaxial cable that carries both the local oscillator (LO) and IF signals, can be attached to the RF system at any convenient point. External mixers make it unnecessary to plumb waveguide directly into the analyzer.

The sawtooth voltage that sweeps the CRT is applied to the BWO helix power supply to frequency sweep the BWO. The amplitude of the sawtooth is controlled by the *Spectrum Width* control, which selects the width of the frequency sweep, and also by the *Frequency* (range) switch so that the frequency sweep of the indicated BWO harmonic is that shown by the *Spectrum Width* control. Because of the frequency vs. voltage characteristics of the backward wave oscillator, the sawtooth is reshaped to have a logarithmic rather than a linear rise. The center frequency of the backward wave oscillator is selected by changing the dc level of the helix voltage. A vernier *Spectrum Width* control enables continuous reduction in spectrum width all the way down to zero. At zero spectrum width, of course, the instrument functions as a fixed-tuned receiver.

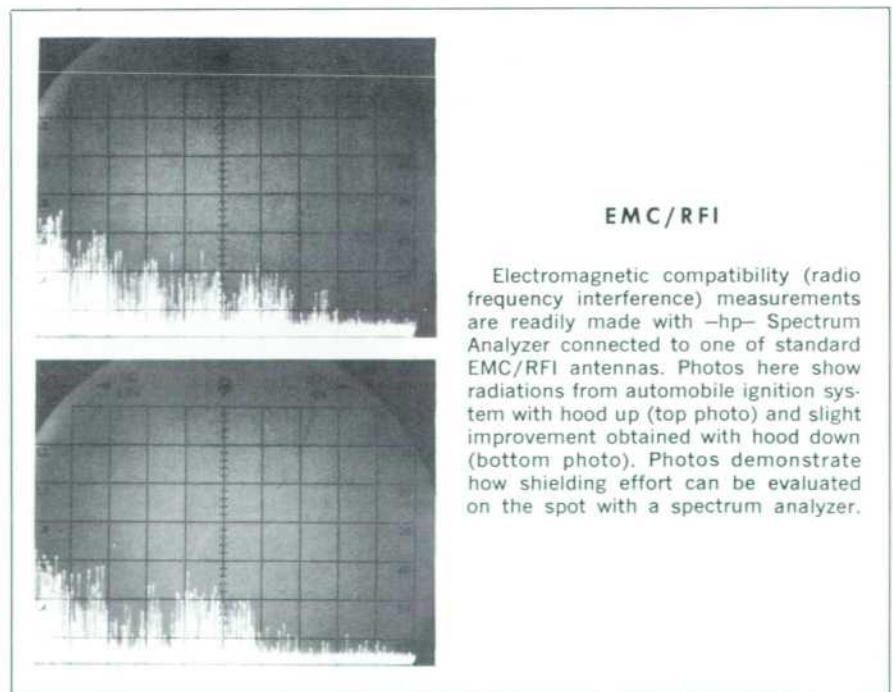

EMC/RFI

Electromagnetic compatibility (radio frequency interference) measurements are readily made with -hp- Spectrum Analyzer connected to one of standard EMC/RFI antennas. Photos here show radiations from automobile ignition system with hood up (top photo) and slight improvement obtained with hood down (bottom photo). Photos demonstrate how shielding effort can be evaluated on the spot with a spectrum analyzer.

The front-end mixer shown at the top of the block diagram of Fig. 5 is for use with input signals that are close to 2 Gc in frequency. This mixer feeds the 200 Mc second IF directly, bypassing the 2 Gc IF, so that there can be no feedthrough of 2 Gc signals. This arrangement is selected when the instrument controls are set for the 1.8-4.2 Mc range. Image separation here,

however, is 400 Mc but sensitivity is about 10 db higher than with the wideband mixer.

After conversion to a 20 Mc intermediate frequency the signal travels to the *-hp-* Model 851A Spectrum Analyzer Display Section, shown in the block diagram of Fig. 6. In the all solid-state Display Section, the 20 Mc signal passes through the precision IF

attenuator, through the filter sections, and through the current-controlled attenuator that shapes the amplifier gain vs. amplitude characteristics.

The detected IF signal is supplied through a video amplifier to the vertical deflection plates and to a rear panel connector for recording of CW signals, or for use as an AM-detected or slope-demodulated FM output

SPECIFICATIONS

-hp-

MODEL 851A/851A SPECTRUM ANALYZER

MODEL 851A RF SECTION

FREQUENCY CHARACTERISTICS

FREQUENCY RANGE:

COAXIAL INPUT: 10 Mc to 10 Gc
WAVEGUIDE INPUT: 8.2 to 40 Gc (accessory mixers and taper sections required).

SPECTRUM WIDTH: 10 calibrated spectrum widths from 100 kc to 2 Gc in a 1, 3, 10 sequence to 1 Gc. Vernier allows continuous adjustment between calibrated ranges and can be used to reduce width to zero.

SWEEP-FREQUENCY LINEARITY*:

±5% when LO is stabilized and swept 10 Mc or less;
±10% (typically ±5%) when LO is swept more than 10 Mc.

IMAGE SEPARATION:

4 Gc

PHASE LOCKING: Internal phase lock provided for stabilizing LO. LO sweep tracks sweep of voltage-tuned 10-Mc reference oscillator.

PHASE LOCK RANGE: Unit can be phase locked for spectrum widths up to $N \times 10$ Mc, where N is harmonic of LO.

PHASE LOCK TUNING: Reference oscillator automatically tracks with TUNE control over 2-Gc LO range.

TUNING: Selectable continuous coarse, fine, and stabilized (phase locked) tuning determines center frequency about which LO is swept. Tuning is by single front-panel TUNE control.

FINE TUNING: Frequency change of LO fundamental is 10 Mc ± 2 Mc per revolution of TUNE control up to ±20 Mc maximum accumulative error across band. Setability of signal on CRT with TUNE control: ±50 kc (fundamental mixing).

STABILIZED TUNING: Frequency change of LO fundamental is 10 Mc ± 1 Mc per revolution of TUNE control; maximum accumulative error across the band: ±2 Mc. Setability of signal on CRT with TUNE control: ±5 kc (fundamental mixing).

TUNING ACCURACY: ±1% of LO fundamental or harmonic.

SENSITIVITY (10 kc IF bandwidth):

10 Mc to 2 Gc, -95 dbm
1.8 to 4.2 Gc, -100 dbm
2 to 4 Gc, -85 dbm
4 to 6 Gc, -95 dbm
6 to 10 Gc, -80 dbm
8.2 to 18 Gc, -80 dbm
18 to 26 Gc, -75 dbm
26 to 40 Gc, -65 dbm

With source stability better than 1 kc, greater sensitivity can be achieved by use of narrower IF bandwidth.

SIGNAL IDENTIFIER: 14-position switch shifts display in proportion to harmonic of LO used in mixing; direction of shift depends on whether signal frequency is higher or lower than LO harmonic.

*Correlation between BW0 frequency and sweep position on Model 851A CRT as a percentage of selected spectrum width.

COAXIAL-INPUT ATTENUATOR:

RANGE: 0 to 60 db in 10-db steps.
INSERTION LOSS: 0 at 10 Mc; less than 2 db at 10 Gc.

MAXIMUM INPUT POWER (for 1-db compression):

COAXIAL INPUT: INPUT ATTENUATOR SETTING	MAX INPUT 2 Gc IF	TYPICAL 200 Mc IF	MAX INPUT
0 db	0 dbm	-5 dbm	
10 db	+10 dbm	+5 dbm	
20 db	+20 dbm	+15 dbm	
30 db	+30 dbm	+25 dbm	
40 thru 60 db	+30 dbm	+30 dbm	

WAVEGUIDE INPUT:

11521A EXTERNAL MIXER (8.2-12.4 Gc): typically -10 dbm
11517A EXTERNAL MIXER (12.4-40 Gc): typically -15 dbm

FREQUENCY RESPONSE:

COAXIAL INPUT: ±1 db over any 200-Mc range using fundamental mixing, ±2 db over any 200-Mc range using 2nd-harmonic mixing, ±5 db over any 2-Gc range (typically ±3 db) except when signal or LO is within 60 Mc of 2 Gc; includes mixer and RF attenuator response with attenuator setting ≥ 10 db.

IF OUTPUT FREQUENCY: ≥ 10 Mc

RESIDUAL LO FM: 1 kc peak-to-peak or less when phase locked; otherwise, approximately 30 kc peak-to-peak.

RESIDUAL RESPONSES (no input signal): Less than -90 dbm (-85 dbm when LO is within 60 Mc of 2 or 4 Gc) referred to signal input on fundamental mixing.

LO NOISE SIDEBANDS: Greater than 60 db below CW signal level 50 kc or more away from signal.

LO OUTPUT: Approximately 1 mw available. Output connector, female type N on rear panel.

ACCESSORIES AVAILABLE:

11517A P-K-R Band Waveguide Mixer, \$160.00.
11518A P-Band Taper Section, \$65.00.
11519A K-Band Taper Section, \$65.00.
11520A R-Band Taper Section, \$65.00.
11521A X-Band Waveguide Mixer, \$75.00.
PRICE: *-hp-* MODEL 851A, \$7,100.00.

-hp-

MODEL 851A DISPLAY SECTION

DISPLAY CHARACTERISTICS

VERTICAL DISPLAY:

AMPLITUDE CHARACTERISTICS: Linear, square (power), or logarithmic.
DYNAMIC RANGE: Linear, 70:1, square, 70:1; log, 60 db.
ACCURACY: Linear, ±3% of full scale; square, ±5% of full scale*; log, ±2 db*.

SWEEP RATE: Six calibrated rates from 3 msec/cm to 1 sec/cm in 1, 3, 10 sequence. Vernier provides continuous adjustment between calibrated rates and extends slowest rate to at least 3 sec/cm.

*Except pulse spectrums on 1-Mc IF bandwidth.

SWEEP RATE ACCURACY: ±3%.

SWEEP SYNCHRONIZATION:

INTERNAL: Sweep runs free.
LINE: Sweep synchronized with power-line frequency.

EXTERNAL: Sweep synchronized with externally applied signal +3 to +15 volts peak.

SINGLE SWEEP: Sweep actuated by front panel pushbutton.

IF BANDWIDTH:

MANUAL: Bandwidths of 1, 3, 10, 100 kc, and 1 Mc can be selected.

AUTO SELECT: One of above bandwidths automatically selected for best resolution of a CW signal with each combination of spectrum width and sweep rate.

BANDWIDTH ACCURACY: Individual bandwidths are calibrated within ±20%; bandwidth repeatability and stability typically better than ±3%.

IF INPUT:

CENTER FREQUENCY: 20 Mc.
INPUT IMPEDANCE: 50 ohms, nominal.
INPUT REQUIRED FOR 6-cm VERTICAL DISPLAY:

1-Mc bandwidth, -56 ± 3 dbm.
100-kc bandwidth, -66 ± 6 dbm.
10-kc bandwidth, -86 ± 6 dbm.
3-kc bandwidth, -86 ± 6 dbm.
1-kc bandwidth, -77 ± 6 dbm.

MAXIMUM CW INPUT SIGNAL: -14 dbm.

IF GAIN SET: Two-section attenuator provides 0 to 80 db attenuation in 1-db steps. One section provides 0 to 70 db attenuation in 10-db steps; the other, 0 to 10 db in 1-db steps. Vernier provides continuous adjustment between 1-db steps.

IF GAIN SET ACCURACY: 70-db section, ±0.5 db; 10-db section, ±0.1 db.

GENERAL

OUTPUT SIGNALS: Vertical and horizontal signals applied to CRT available for external monitoring.

VERTICAL: 0 to -4 volts; output impedance, 4700Ω.

HORIZONTAL: 10 v p-p ±0.3 v; sweep approximately symmetrical about zero. Output impedance 4700Ω.

CATHODE-RAY TUBE: 7.5-kv post-accelerator tube with P2 medium-persistence phosphor (others optional) and internal graticule. Light blue filter supplied.

INTERNAL GRATICULE: Parallax-free 7 x 10 cm, marked in cm squares with 2-mm subdivisions on major vertical and horizontal axes.

RFI: Conducted and radiated leakage limits are below those specified in MIL-I-16910.

PRICE: *-hp-* MODEL 851A, \$2,400.00.

OPTIONS:

07. P7 phosphor in lieu of P2 (amber filter supplied), no additional charge.
31. P31 phosphor in lieu of P2 (green filter supplied), no additional charge.

Prices f.o.b. factory.
Data subject to change without notice.

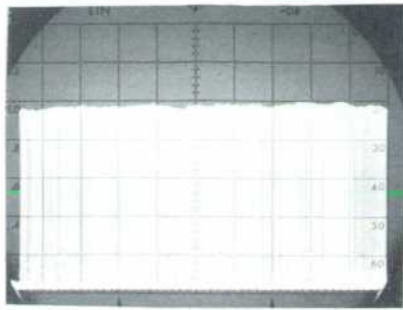

Fig. 7. Frequency response of *-hp-* Spectrum Analyzer throughout 1000 Mc range is shown in this time exposure photograph. Exposure was made while leveled signal generator was tuned from 850 Mc to 1850 Mc. Analyzer display was in "Log" mode, showing that frequency response variations are well within ± 2 db.

when the analyzer is in the fixed frequency (zero sweep width) mode. The 20 Mc IF signal, sampled ahead of the detector, also is available at a rear panel connector.

Horizontal deflection is controlled by a linear sawtooth voltage from the sweep generator. The sweep rate can be fast enough for flickerless viewing on the CRT or slow enough for X-Y

recording (the sweep voltage is available at a rear panel connector for external use). A single sweep capability is provided for CRT photography.

Other design features include a baseline clipper which blanks the cathode ray tube at the zero voltage level to prevent an overly bright baseline. The cathode ray tube has an internal graticule, similar to the well known internal graticule of the *-hp-* oscilloscopes, which eliminates parallax as a reading error.

The instrument is particularly well-shielded against radio frequency interference, both from the effect that external RFI sources may have on instrument performance and on the amount of leakage from the instrument itself.

SUMMARY

The *-hp-* Spectrum Analyzer is finding new applications in situations requiring the display of several different frequencies simultaneously, and is thus becoming a useful laboratory tool for tuning up and studying the per-



Fig. 8. External mixer connects Spectrum Analyzer to waveguide systems. Two mixers are available, one for X band and one for P, Q and R bands. Taper sections match various waveguide sizes to ridged waveguide of mixer.

formance of solid-state, microwave devices. The clean performance of the new analyzer also makes it useful for frequency surveillance and radio frequency spectrum control by enabling a wide range of RF signals at a particular location to be displayed simultaneously.

The broad frequency range and calibrated performance of the *-hp-* 8551A/851A Microwave Spectrum Analyzer promise to make frequency domain analysis become a general-purpose laboratory tool, much as time domain analysis has been enabled by modern calibrated oscilloscopes. As recent competitive activity shows, the new analyzer already is setting a new performance standard for the industry.

ACKNOWLEDGMENTS

The *-hp-* Model 8551A/851A Microwave Spectrum Analyzer was developed under the direction of Arthur Fong in the R and D Laboratories of the Hewlett-Packard Microwave Division. George C. Jung was project supervisor for the Display unit and the undersigned for the RF unit. Others in the electrical design team included R. W. Anderson, R. H. Bauhaus, J. D. Cardon, G. J. Eiler, and R. F. Rauskolb. The mechanical design team included E. H. Phillips, J. L. Boortz, and D. R. Veteran. We give particular credit to our product designers R. C. Given, W. R. Hanisch, J. M. Hedquest, and E. C. Hurd and to A. E. Inhelder for the industrial design. Our appreciation is also extended to Dr. H. C. Poulter, Manager of the Hewlett-Packard Microwave Division R and D Labs, for his advice and encouragement.

—Harley L. Halverson

BROAD SPECTRUM DISPLAYS

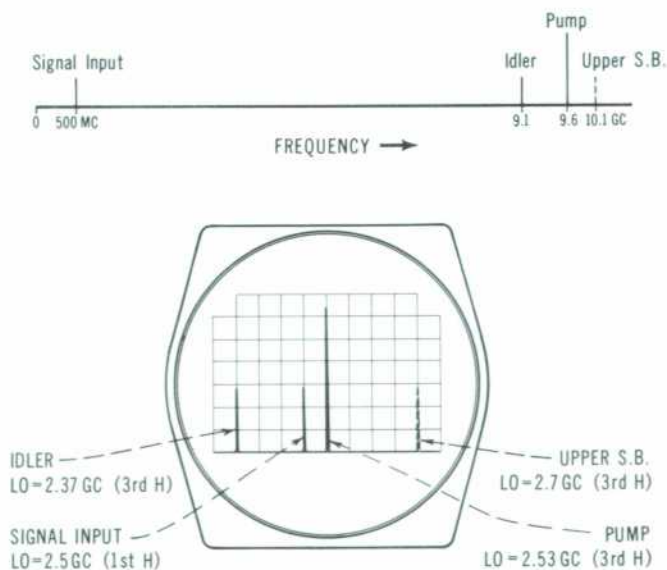

Drawing indicates how Spectrum Analyzer can serve in laboratory to display several signals widely separated in frequency at same time. Upper scale shows relative positions of parametric amplifier signals in frequency spectrum.

Spectrum Analyzer displays all signals at once by responding to input signal on fundamental range, and showing higher frequency signals as responses to local oscillator harmonics.

SPECTRUM SURVEILLANCE

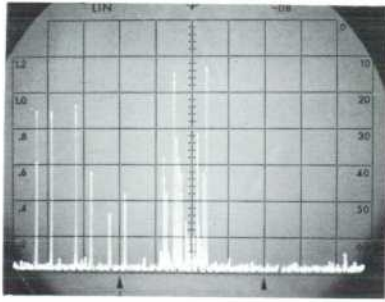

A

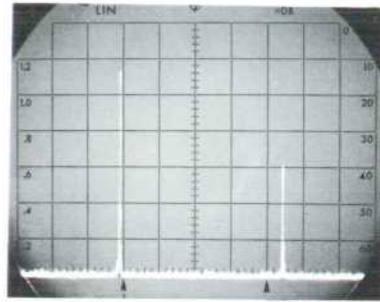

B

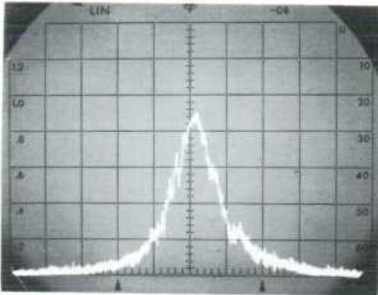

C

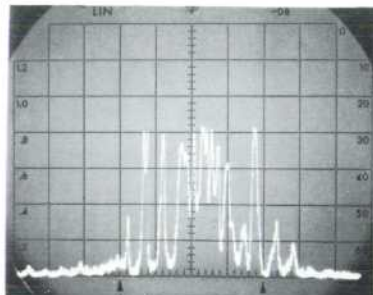

D

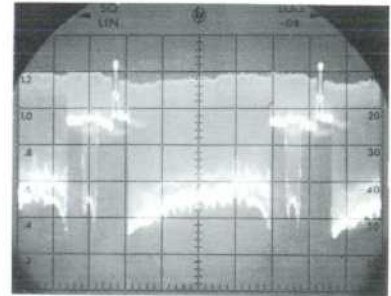

E

This series of photos is indicative of Spectrum Analyzer usefulness in spectrum surveillance. Photo A displays RF spectrum from 50 Mc to 150 Mc at Palo Alto, California, as detected by -hp- Spectrum Analyzer connected to simple dipole antenna. FM stations are in center of display and pairs of responses at left represent TV stations. Photo B shows expanded view of one TV station

with Analyzer set to sweep through 10 Mc range centered at 78 Mc. Calibrated sweep of 1 Mc/cm shows 4.5 Mc separation between video and sound carriers. Spectrum analyzers also provide information on sideband structure besides showing frequencies and relative power levels of all radiations within selected frequency ranges. Photos C and D show

illustrating characteristic behavior of FM signal when viewed in frequency domain; spectrum width here is 100 kc. Photo E shows amplitude modulation of video carrier when SPECTRUM WIDTH VERNIER is turned to zero while Analyzer is tuned to video carrier; Spectrum Analyzer functions here as fixed-tuned receiver.

DESIGN LEADERS



Arthur Fong

Art Fong first worked on the development of spectrum analyzers along with other microwave test equipment at the MIT Radiation Laboratory during World War II. A graduate of the University of California, he came to -hp- in 1946 where he was initially engaged in the development of the -hp- Model 803A VHF Impedance Bridge and other high-frequency measuring devices, including the widely-used -hp- Model 650A Test Oscillator. He later headed up the Signal Generator Group and was responsible for the well-known -hp- Models 606A, 614A, 620A Signal Generators among others. He is presently section manager in charge of Spectrum Analyzer development.



Harley L. Halverson

Harley Halverson joined Hewlett-Packard in 1957 while finishing up his M.S. degree at Stanford University. Between Stanford and graduation from South Dakota State College in 1954, Harley spent two years in the Air Force where he was in charge of an electronic instrument laboratory. At Hewlett-Packard, he worked on the -hp- 355-Series VHF attenuators and the -hp- Model 606A HF Signal Generator before becoming project supervisor of the -hp- Model 8551A Spectrum Analyzer RF Unit. One of the early proponents of nanosecond time delay reflectometry at Hewlett-Packard, Harley adopted the technique for wide-band production testing of RF attenuators.



George C. Jung

George Jung joined the -hp- engineering laboratories of Hewlett-Packard in 1959 after doing research work in Canada. His initial contribution to Hewlett-Packard test equipment was the double-bridge technique used in the -hp- 431 series Microwave Power Meters. He also worked on the -hp- 344A Transistorized Noise Figure Meter before assuming project leadership of the -hp- Model 851A Spectrum Analyzer Display unit. He is a graduate of the Middlebaar Technische of Holland and served two years in the Dutch Air Force, both as a pilot and as a supervisor of a landing-control radar installation. George also spent some years in the radar department of the Netherlands' equivalent of the FAA.