

# HEWLETT-PACKARD JOURNAL

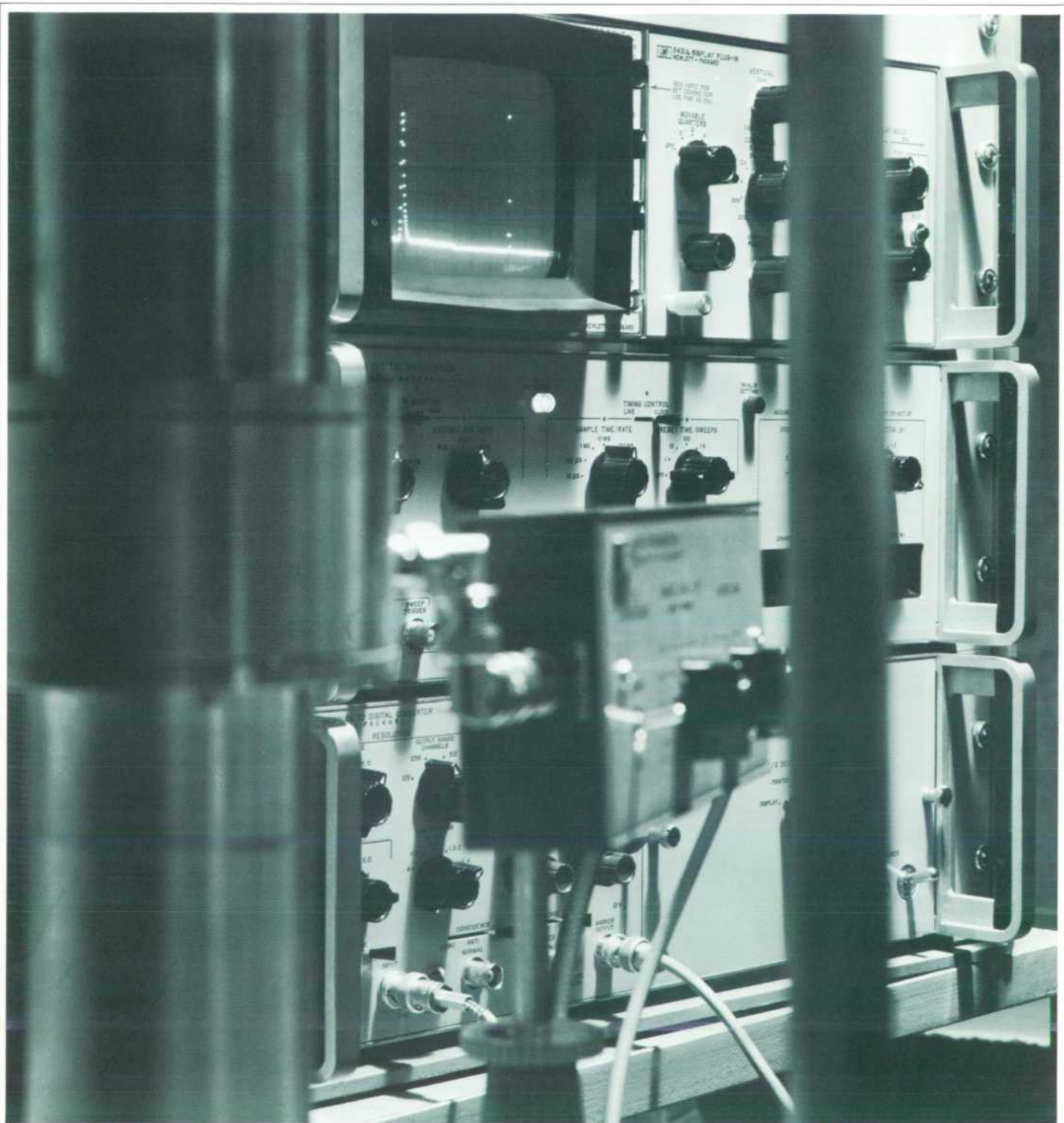

MARCH 1968

# Electronic Techniques in Gamma Ray Spectroscopy and Timing

By Tracy S. Storer

ELECTRONIC CIRCUITS AND ELECTRONIC TECHNIQUES have always been of great importance to the nuclear field—so much so, in fact, that workers in this field have themselves been major innovators of electronic art and practice. The importance of electronics here derives from the ease with which electronic instrumentation gives quantitative information about nuclear processes. In typical practice what is wanted is often gamma ray information, and this article concentrates on the techniques associated with measurement of gamma ray energy and time relationships. However, information concerning alpha, beta and other radiations is of broad interest.

The gamma rays discussed here originate in the nucleus of radioactive isotopes, i.e., chemical elements whose nuclei are unstable and emit radiation as they decay to stable states. Such radioactive isotope disintegration follows rules that are always the same for the same nucleus. These

rules can be set down in a so-called decay scheme. An example is shown in Fig. 1 for the case of the radioisotope cesium 137.

The basic decay scheme shown in Fig. 1 indicates that cesium 137 decays into barium 137 by emitting beta particles (electrons). Eight percent of the cesium nuclei decay directly into barium 137 nuclei, while 92% of the cesium nuclei first decay into excited barium 137m nuclei; then some 2½ minutes later, the excited nuclei decay to lowest energy or ground state by emitting gamma rays (high-energy electromagnetic radiation) having an energy level of 662 kilo electron volts (keV). Some heavy nuclei emit alpha particles. An alpha particle is a  ${}^2\text{He}^4$  nucleus (two protons and two neutrons).

The cesium 137 isotope, with a nucleus containing a total of 137 neutrons and protons, disintegrates with a half-life of 30 years. In other words, 30 years after any given instant the number of unstable cesium 137 nuclei will be half of that at the beginning of the period. Since the number of nuclei is halved, the amount of radiation (intensity) is also halved. With existing electronic systems half-lives between  $10^{-10}$  second and  $10^{10}$  years can be measured.

Like most natural events, radioactive decay is not a uniform function. Consequently, the term 'half-life' is meant to describe the value that would result if an infinite number of half-life measurements were made and the average value calculated. Individual decays, however, follow a Poisson distribution, i.e. the standard deviation is equal to the square root of the number of observed decay events. This fact enables the experimenter to calculate the probable accuracy of his result, assuming no instrumentation inaccuracy.

## Gamma Ray Detection

Gamma rays are high-energy electromagnetic radiations with very short wavelengths ( $10^{-15}$  to  $10^{-11}$  cm). They penetrate matter deeply—on the average much more deeply than do alpha and beta rays, which are charged particles. It is their deep penetration capability

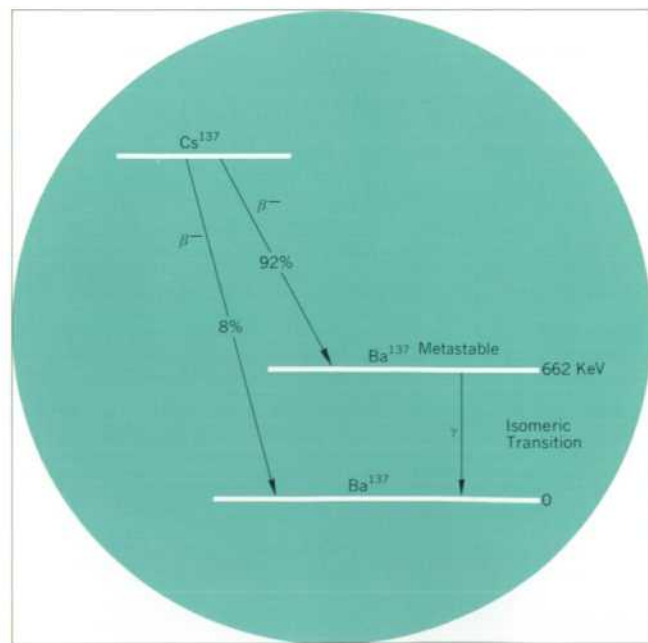

Fig. 1. Decay scheme for cesium-137.

that makes gamma rays useful in the laboratory and industry, in much the same way as are X-rays. X-rays, like gamma rays, are electromagnetic radiations. The distinction is only a matter of origin: X-rays originate from shell transitions by orbital electrons, whereas gamma rays originate in the nucleus.

Gamma rays are usually detected by observing effects they produce in matter when they encounter an atom. Important among these are the photoelectric effect and the Compton effect. The photoelectric effect (Fig. 2a) occurs when the gamma ray strikes one of the orbital electrons of the atom, transferring its energy to the electron. This process produces a free electron and an ionized atom.

The Compton effect (Fig. 2b) arises in the case where the gamma ray strikes an orbital electron in billiard-ball fashion, i.e., without imparting all of its energy to the electron. The electron is detached from the atom but receives only part of the gamma energy. The remaining energy persists as a scattered gamma ray with lower energy than the initial ray. It may collide with one or more other atoms, freeing other electrons.

These types of interactions occur variously in nuclear radiation detectors. In each detector type, some observable reaction results. Each type of detector, in one way or another, produces an electrical output charge suitable as an input for an electronic measuring system.

### Gamma Ray Spectra

Measurements characterizing gamma radiation are

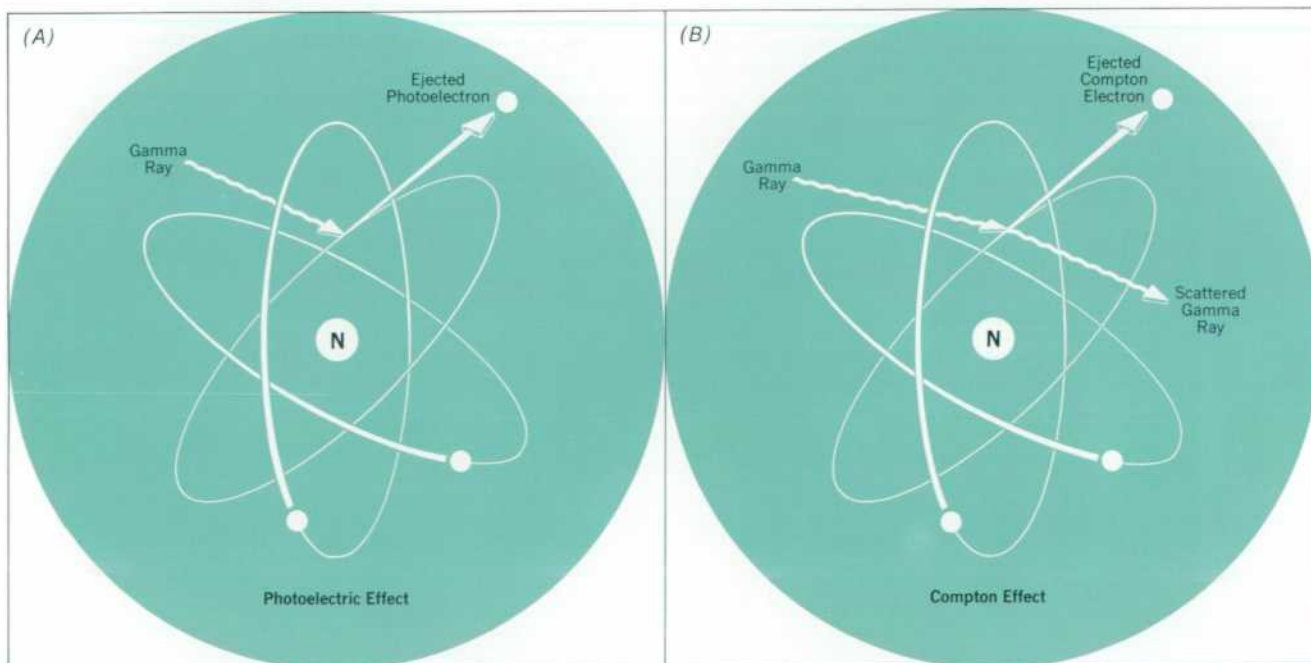

Fig. 2.

**Cover:** Gamma ray spectroscopy system displays counts vs. energy spectrum of isotope. Radiation is detected, and converted into an electrical charge by a solid-state germanium (lithium-drifted) detector at the bottom of the vertical column, at left of the photo. Detector inside column is cooled with liquid nitrogen to stabilize the detector and to lower its thermal noise. In center foreground is the preamplifier, which converts detector output charge to a voltage pulse, with amplitude proportional to energy. Amplification and pulse shaping prepare the signal for analysis in multichannel analyzer, upper right.

**In this Issue:** Electronic Techniques in Gamma Ray Spectroscopy and Timing; **page 2.** Multichannel Pulse-Height Analyzer with a Very Fast Analog-Digital Converter; **page 11.** A Charge-Sensitive Preamplifier for Nuclear Work; **page 16.** A Nuclear-Type Linear Amplifier with Plug-In Pulse-Shaping Delay Lines; **page 19.** NIM Bin; **page 21.** A Single-Channel Analyzer with Fast Multiple-Pulse Resolution; **page 22.**

chiefly made in either of two ways. One is to record the number of counts as a function of energy, in which case a gamma ray spectrum is obtained; the second method is to observe time relations, in which case several types of

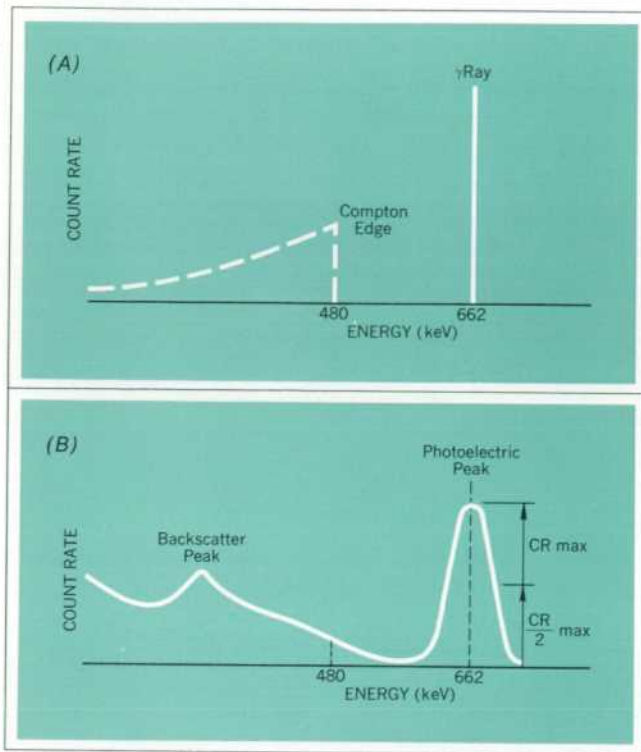

Fig. 3. Gamma spectra of  $\text{Cs}^{137}$  gamma radiation (A) Ideal, (B) Typical in practice.

information may be desired, as described later.

A gamma spectrum as measured by an ideal system might appear as in Fig. 3a, which is the ideal spectrum of the cesium 137 gamma radiation phenomena discussed earlier. In this spectrum a large peak appears at 662 keV. This is caused by the gamma energy radiated when the metastable barium 137 nucleus returns to its ground state (see decay scheme). There is also a continuum representing the energies imparted to Compton-scattered electrons as discussed above.

In practice, the spectra measured with actual systems (Fig. 3b) are not so well defined. Most noticeable is that the peaks of the spectrum are broadened to a greater or lesser extent by the characteristics of the devices used to detect gamma rays. Relating to this broadening, as a measure of the quality of a system, is its 'resolution.' This is a function both of the detector and of the associated circuitry. Resolution is commonly defined (Fig. 4) as the ratio of the full width at half the maximum height of the peak (FWHM) to the energy of the center of the peak. Thus, resolution indicates how well the detector can separate or resolve two different energy peaks. Typical resolutions for common gamma ray detectors range from about 10% to few tenths of a percent.

Also evident in Fig. 3b is a backscatter peak, which

results because a large number of gamma rays squarely strike matter between the source and the detector, losing much of their energy before detection.

### Energy Measurements

The measurements usually made in gamma ray work fall into the two broad groups mentioned previously: those made of the energy of the radiation and those made of its timing relative to another event. In addition, counting without regard to energy (often called gross counting) is also done (Fig. 5) to measure the intensity of the radiation. Intensity is measured in terms of counts per minute (or second).

A simple basic system for measuring the number of counts (intensity) in a given energy range is shown in block form in Fig. 6.

The system consists of a gamma ray detector (described later) which produces a burst of charge when a gamma ray is absorbed by the detector. This charge is amplified and shaped into either a unipolar or bipolar pulse (Fig. 7) whose amplitude (peak voltage) is proportional to the energy the gamma ray releases to the detector.

The pulse may next be applied to a single-channel pulse-height analyzer which performs the voltage-level-selecting function that enables the pulse amplitude to be measured. The analyzer includes two voltage-discriminators (Fig. 8) whose threshold levels are adjustable. By

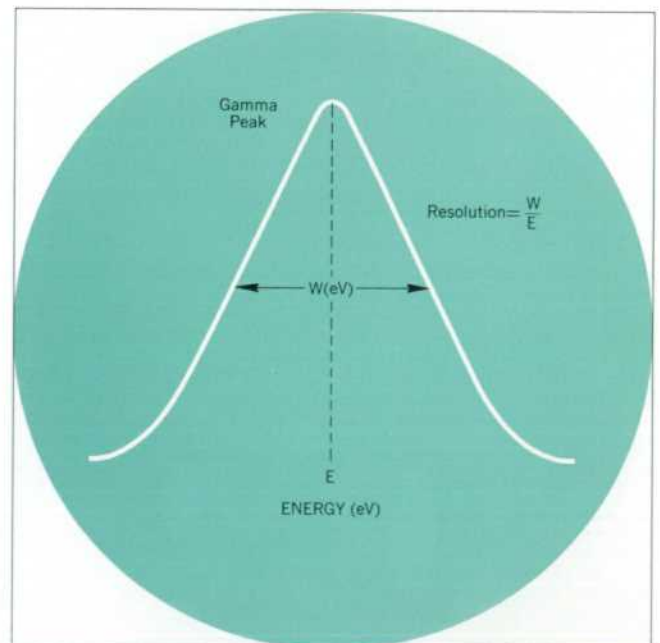

Fig. 4. Gamma spectrum resolution is the ratio of full width at half the peak's maximum height to energy of peak's center.

suitable setting of the two thresholds, it becomes possible to pass only pulses whose peak value falls within the range between these thresholds (Fig. 9). By this means it is possible to select the signals produced by those gamma rays with an energy level in the range to be investigated and to exclude all others. This is often called 'differential counting' to emphasize the fact that only those energies in the 'window' between upper and lower discriminators are counted.

The voltage discriminators can also be set merely to exclude pulses whose value falls below a selected level. By this means all gamma rays above a given energy level are passed by the discriminator. This arrangement is commonly called 'integral counting.'

The single channel analyzer produces an output pulse for each pulse passed by its discriminating arrangement. In a simple counting system this pulse could be applied to a scaler-timer which totalizes the number of pulses passed by the discriminator during a given time interval.

The system just described provides information as to the number of gamma rays detected within one energy 'window' during the course of the measurement. While this is useful information, one often wishes also a measurement of the *spectrum* of the energy of the gamma rays incident on the detector. This can be accomplished by repeating one at a time the measurements made with the above system for all desired energy 'windows'. While

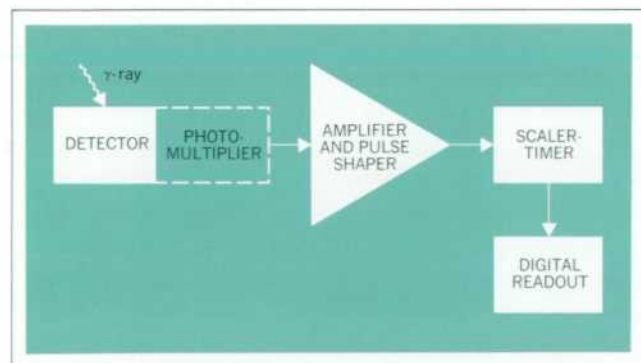

Fig. 5. Gross counting measures radiation intensity regardless of energy.

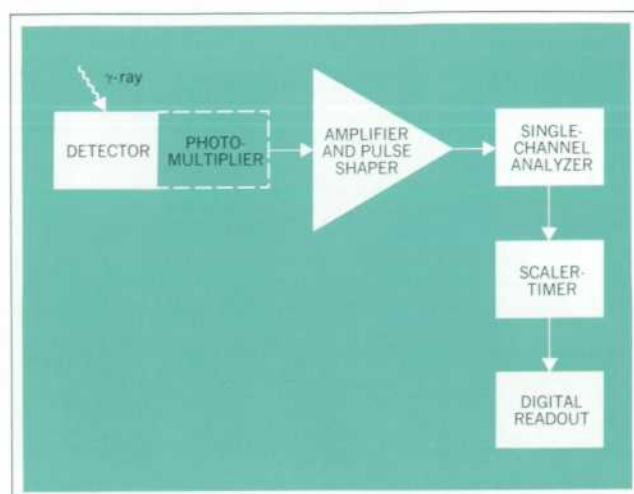

Fig. 6. With single-channel analyzer, radiation intensity may be measured in a given energy range.

such a method is somewhat slow and not appropriate where short half-lives are involved, it is nonetheless a useful and inexpensive method.

A more sophisticated measuring system can be obtained by replacing the single-channel pulse-height analyzer with a multichannel pulse-height analyzer. Discussed at more length in a separate article in this issue of the HP Journal, multichannel analyzers are quite sophisticated electronic instruments that will automatically measure the intensity (number of counts) of radiation in each of a large number of energy increments. A given energy range may be divided into as many as several thousand such increments, and the analyzer sorts incoming pulses into proper individual increments or channels according to their individual amplitudes. The speed of this measurement is obviously an important factor and much design effort is justified in attaining high analyzer speed. This reduces 'dead time', the time the analyzer requires to measure and sort each individual pulse. Dead times ranging from microseconds to tens of microseconds are achieved by the most modern analyzers.

The measurements made by the multichannel analyzer are stored in an internal memory and often later read out to produce records like those in Fig. 10.

### Time Measurements

The second general class of measurements made in this field is one in which the time of occurrence of the gamma ray relative to a reference event is of interest to the experimenter. Such situations occur when one gamma radiation is known to occur a specific interval of time

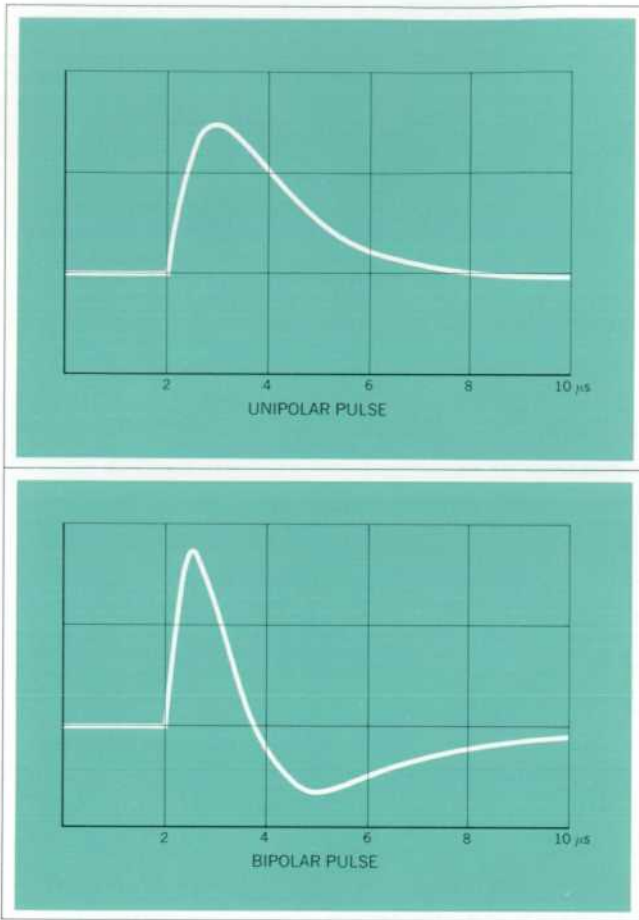

Fig. 7. Charge pulse may be shaped into unipolar or bipolar form for further processing.

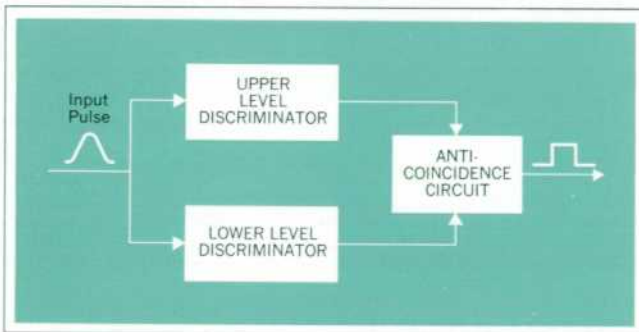

Fig. 8. With two discriminators, the system can be made to respond only to pulses whose peak value falls within a selected range.

after a trigger event. Or, again, it may be desired to count (or to avoid counting) a gamma ray that occurs at about the same time as another event. These types of measurements are commonly called delayed coincidence, coincidence and anti-coincidence, respectively.

Fig. 11 indicates a measurement arrangement often used to count gamma radiation intensity relative to a time reference. Two measurement channels are used, one of which contains an adjustable delay circuit which can be set to accommodate several measuring situations. One of these is to count the events that occur within a given time interval which begins a desired time after a reference event. In this case the timing circuit is adjusted so that the two channels have the desired difference in time delay. Typical delays are in the range from a few nanoseconds to several microseconds. The outputs of the two channels are logic pulses which are then applied to a coincidence circuit. If the two channels produce outputs within the time interval of interest, a pulse is then applied to the ensuing counting or logic circuits. Frequently, the output from a coincidence circuit is used to enable pulse height analysis of a selected event; the spectrum obtained from this type of system is referred to as a coincidence spectrum.

Another time measurement situation occurs when it is desired to obtain a spectrum of the time intervals between two related events. This can be obtained with the system indicated in Fig. 12. Here, the time interval between a reference event and a later event is applied to a time-to-pulse-height converter. The output of this circuit is a pulse whose peak amplitude is proportional to the time interval between the two events of interest. This waveform can then be applied to a multichannel analyzer which will enter a count into the channel corresponding to the length of each time interval. By this means a histogram is obtained which is a 'spectrum' of the time of occurrence of various events following the initial reference event.

Times of the order of nanoseconds or even less may be the intervals to be measured. Here it would obviously be desirable to use a fast rate-of-change point on the pulse as a reference timing point. In practice, however, the amplitude of the pulse may influence the timing of a selected fast-changing level on the pulse. Therefore, the reference point is commonly taken either at a low point on the leading edge of the pulse or at the zero crossing of a double-differentiated pulse.

A figure of merit for timing pick-off circuits is termed 'walk'. Assuming a constant pulse shape, 'walk' is change in time of pick-off with change in amplitude.

## Detectors

The foregoing has indicated how gamma ray energy and timing measurements are usually approached. It may be interesting to consider how gamma rays are detected and how the detector signals are processed.

The transducers used with nuclear radiation communicate to the electronic system the number, the timing, and, if desired, the energy of rays. Detectors commonly used include scintillation, semiconductor and gas proportional detectors. The scintillation detector is often preferred where high efficiency is more important than resolution\*; semiconductor types are increasingly used, particularly where high resolution is required. (See Fig. 10a and 10b.)

The scintillation detector has the highest efficiency of the three types because it normally has the greatest density and thus the highest probability of capturing an incident gamma ray. The scintillation material most commonly used is sodium iodide, thallium activated (commonly written as NaI(Tl)). When a gamma ray collides with an atom of such a scintillator the resulting scintillation or light flash has an intensity (number of photons) proportional to the energy of the gamma ray. Even in the case of an energetic (e.g., 1 MeV) gamma ray, however, the light flash is very small because the absolute energy in the gamma ray is only in the order of  $10^{-6}$  ergs ( $10^{-13}$  watts-seconds). Consequently, photomultipliers rather than simple photodetectors are used to obtain a usable electrical signal. The output from the photomultiplier is a pulse of electrons having a charge in the order of a picocoulomb and with a decay time-constant of 0.25 microsecond with NaI(Tl) detectors. The information about gamma energy lies in the *area* of the current pulse from the photomultiplier rather than in the peak or other value. Consequently, at some point in the electrical system, an integration must be performed to measure the area, i.e., total charge of the current pulse.

Another type of detector is formed from germanium or silicon semiconductor material, often doped with lithium atoms to obtain a wide depletion region when large-volume types are required. The material is usually in the form of a cylinder or a slab. Radiation absorbed by these semiconductors produces electron-hole pairs which are collected at two electrodes. These detectors might be regarded by electronic engineers essentially as back-biased diodes with junctions up to 1 cm wide, and of tens of  $\text{cm}^2$  area! Recently, detectors with active volumes in excess of  $100 \text{ cm}^3$  have been fabricated.

\* Efficiency is a measure of the probability that an incident gamma ray will interact with the material in the detector.

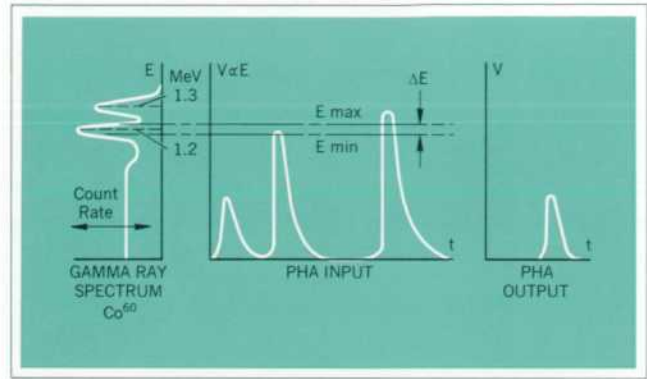

Fig. 9. When the two discriminators of the analyzer are adjusted to form a 'window,' only pulses whose level falls within the window range will produce a pulse output from the pulse height analyzer.

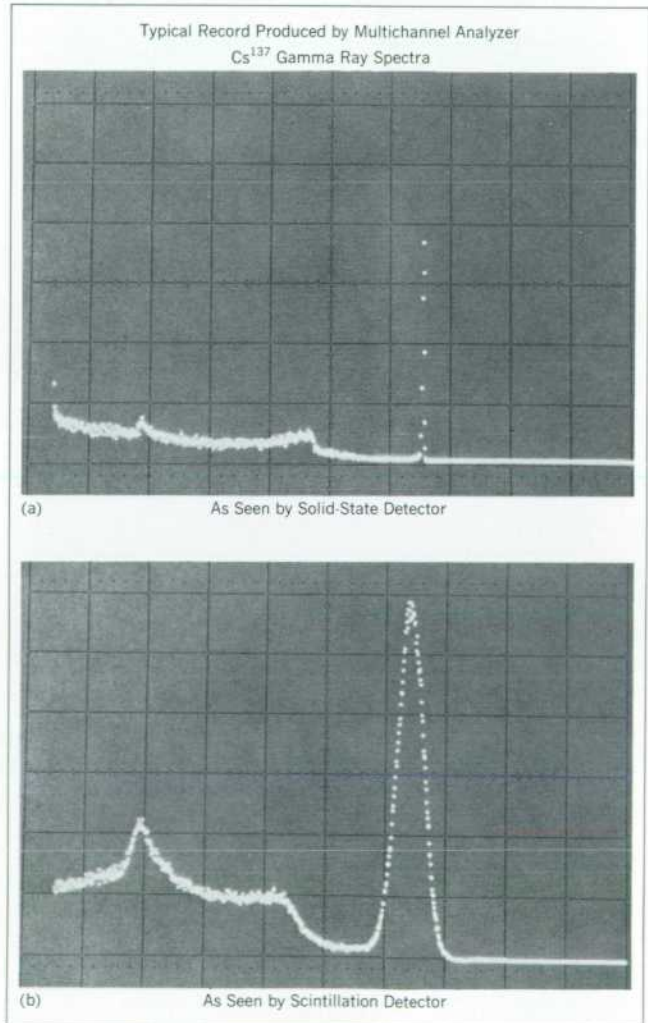

Fig. 10

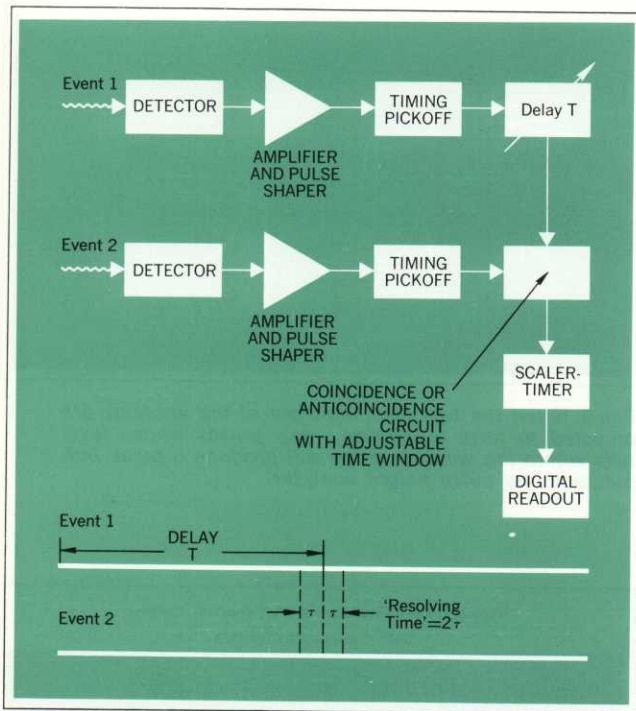

Fig. 11. Measuring arrangement to relate gamma radiation intensity (count rate) to time reference.

For gamma work the efficiency of such semiconductor detectors is not high at the higher energies because their density and volume are small compared with those of scintillators. However, the number of hole-electron pairs formed when radiation is captured is considerably higher than for other detector materials. The larger number of charge pairs leads in turn to higher resolution, better than 1% for the semiconductor detector. In addition, semiconductors can be fast—a few nanoseconds; charge collection time depends on detector thickness, carrier mobility and bias voltage. On the other hand, because there is no multiplication process, the charge produced by the semiconductor detector is many times smaller than that produced by the scintillation detector. A 1 MeV gamma ray will typically produce a pulse of  $5 \times 10^{-14}$  coulomb from a solid-state detector. Consequently, the semiconductor detector requires electronics of minimum noise to amplify and process the signal. The noise can sometimes be reduced by operating the detector or preamplifier, or both, at cryogenic temperatures, but this is something of an inconvenience. (The germanium lithium-drifted detector must remain cooled at all times to prevent the redistribution of lithium ions which would occur at room temperature and could quickly make the detector useless.)

The gas proportional detector somewhat resembles the familiar Geiger-Mueller tube except that it is designed to operate in such a range that its output is proportional to the amount of ionization produced by the absorbed ray. Proportional detectors internally multiply the amount of charge by a factor from one to  $10^4$  times or more. The magnitude of their output charge lies between that of the semiconductor and that of the scintillator.

### Signal Processing

The signal from the detectors mentioned above is a relatively short current pulse; the time integral of this current impulse is a charge proportional to the energy of the absorbed radiation. The preamplifiers and amplifiers which follow these detectors convert this impulse of charge into a voltage pulse whose height (peak amplitude) is proportional to energy. Thus, signal processing prepares the charge from the detector for the final step, pulse height analysis. In the case of a timing measurement, signal processing prepares the charge signal for use with a timing pick-off (time discriminator).

Fig. 13 shows a block diagram of a typical signal processing system, and Fig. 14 illustrates the operation of the system with waveforms. In the preamplifier, the current impulse (Fig. 14a) from the detector is converted to a voltage step whose amplitude is proportional to energy; to put it in electronic terminology, the preamplifier functions as an operational integrator and the integral of the current impulse is a step. The amplitude of the preamplifier voltage output step is proportional to energy and, if only one incident radiation event were to be analyzed, the amplitude of this step could be measured with a dc voltmeter.

However, to obtain the statistical information that is wanted, a long train of radiation events is to be analyzed. So it is important to reset the reference level of the system to zero as rapidly as possible and to be ready for the next event when it arrives. For this reason an exponential decay to zero is arranged in the preamplifier circuitry. A discharge path (R in Fig. 13) is provided across the integrating capacitor of the operational integrator; the preamplifier output, therefore, takes as its final form a rapid rise to a peak value followed by an exponential decay to zero (Fig. 14b); in nuclear electronics terminology this waveform is referred to as a 'tail pulse'. For reasons which relate to maximizing the signal-to-noise ratio at the detector-preamplifier interface, the time constant associated with the preamplifier tail pulse is often relatively long; values from 100  $\mu$ s to



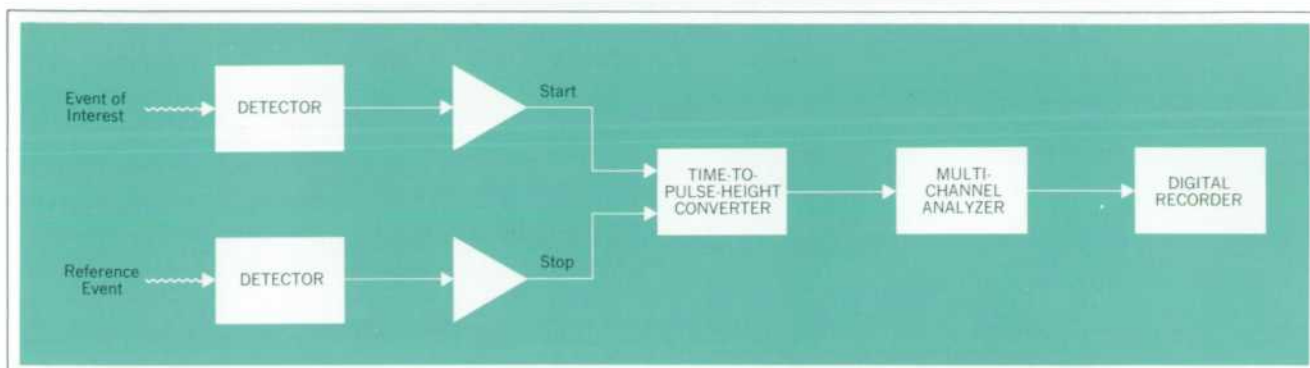

Fig. 12. Measuring arrangement to obtain a spectrum of the time-intervals between two related events.

1 ms are typical in systems where good energy resolution is desired.

The peak amplitude of the tail pulse just described is proportional to energy absorbed in the radiation detector, and this pulse, with sufficient additional voltage amplification, could be used to drive subsequent pulse-height analysis instrumentation. However, in most practical work two more steps are desirable before pulse height analysis. These are termed differentiation and integration, after the approximately analogous operations which can be performed with simple RC high-pass and low-pass networks. Differentiation and integration together are referred to as pulse-shaping techniques.

The differentiation operation helps to reset the reference level of the system to zero rapidly. If reset is slow, the randomly-arriving charge impulses from the detector will cause 'pulse pileup distortion,' i.e., successive voltage pulses will overlap, leading to errors in amplitude (energy) representation. It is desirable in most nuclear experiments to gather the required number of samples for statistical validity at the highest count rate possible

(consistent with an allowable degree of distortion) since the length of a single experiment can range to many minutes, hours or even days.

To narrow the pulses, one or two differentiation operations are commonly employed. Fig. 14c shows the result of one differentiation on the tail pulse of Fig. 14b; the waveform of Fig. 14d shows the effect after two differentiations. The shape shown after one differentiation is commonly termed unipolar, since the pulse is predominantly of one polarity. The shape after the second differentiation is termed bipolar, in contrast.

It is to be expected that a train of unipolar pulses will, when passed through an ac coupled system, exhibit more 'baseline shift' than a train of bipolar pulses.\*

In addition to differentiation by RC networks, it is, of course, possible to employ RL or more complex RLC networks. Another method of differentiation, commonly

\* Baseline shift is the change in the apparent height of a pulse as it passes through an ac-coupled system because at a pulse rate other than zero a voltage other than zero must exist across the ac-coupling capacitor. Unless baseline restoration or an ideal bipolar pulse shape is employed, the result is a count-rate-dependent distortion of pulse height.

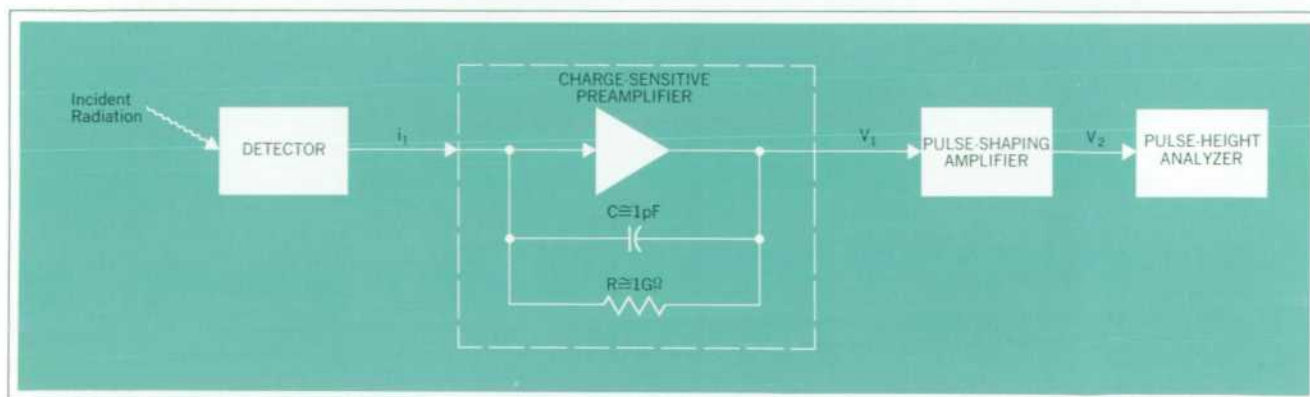

Fig. 13. Typical signal processing system.

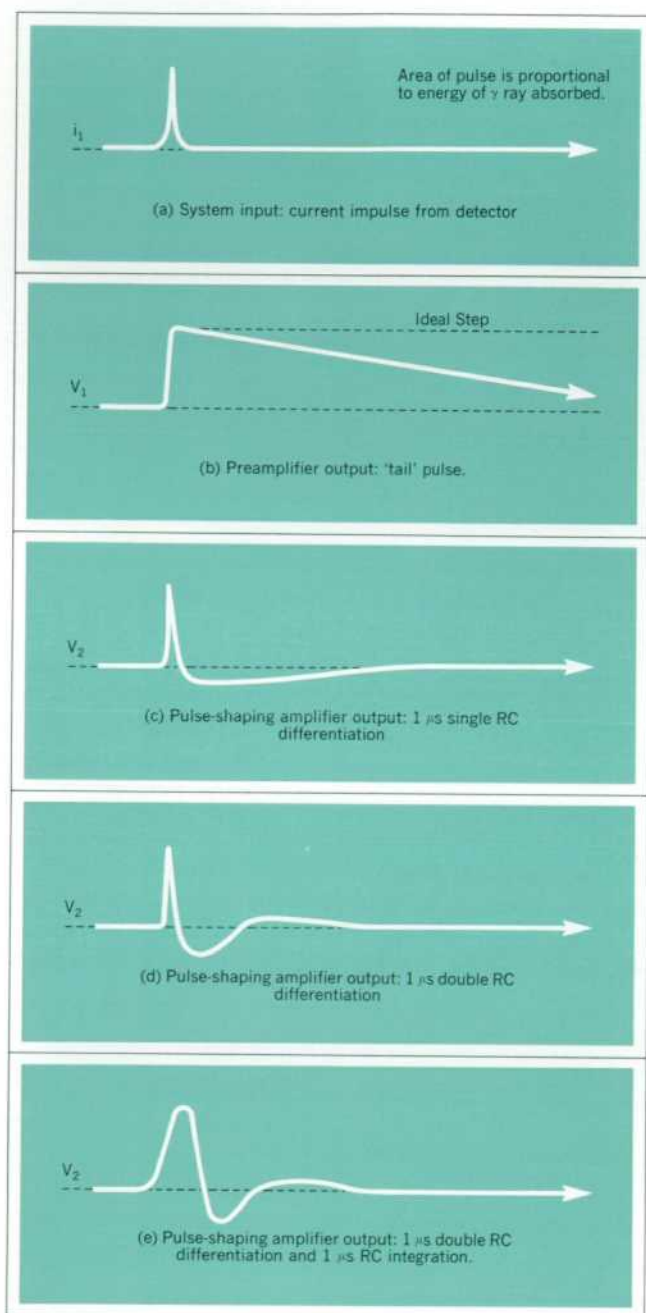

Fig. 14. Typical waveforms in signal-processing system.

used in high count-rate systems, employs delay line elements.

Integration, or low-pass filtering, is also normally employed in combination with differentiation to limit the bandwidth of the system, thereby reducing effects of high-frequency noise and improving signal-to-noise ratio. Differentiation, being high-pass filtering, also aids in rejecting low-frequency noise including that originating in power supplies.

Linearity of amplification is an important factor in signal processing for both energy and time measurements, to preserve pulse shape and minimize walk. The term 'linear amplifier' is commonly used in the nuclear field to denote a *precision* amplifying system.

The object of signal processing, and particularly of pulse shaping, is to provide for each particular experiment the best working compromise among the several performance parameters involved. Among the most important of these are: count rate, resolution (signal-to-noise ratio), pile-up distortion, baseline shift, timing errors and (while not discussed above) distortion due to overload effects.

The subject of signal processing is extensive and only a brief outline can be given here; there is an excellent summary: Nuclear Pulse Amplifiers—Fundamentals and Design Practice, E. Fairstein and J. Hahn, *Nuclear Electronics*, July 1965 to January 1966 (serialized).

#### Acknowledgment

With special gratitude, Dr. Jan Krugers' contribution to this article is acknowledged. Dr. Krugers gave us those sections which relate to radioactive decay and detectors. 📷



#### Tracy S. Storer

Tracy Storer has been working in the nuclear field on and off for some ten years. Before joining HP, he worked in nuclear R&D assignments for the U. S. Army. After joining HP in 1960, he served as group leader for the development of the 5243 and 5245 high-speed counters before entering his present assignment as section leader for the HP nuclear instrumentation design group. Tracy did his undergraduate work at Cornell University and graduate work in both electrical engineering and business at Stanford University.

# A Multichannel Pulse-Height Analyzer with a Very Fast Analog-Digital Converter

By W. A. Ross

AN UNUSUALLY INTERESTING ELECTRONIC INSTRUMENT, and one that has received more attention in the nuclear than in the electronics field, is the 'multichannel analyzer'. It is also termed a 'pulse-height analyzer', but that term is not always appropriate since such analyzers often work with signals other than pulses.

Basically, the multichannel analyzer discussed here classifies input signals into amplitude or time groups and continuously totalizes the number in each group. If, for example, the input is a series of pulses of random but bounded amplitudes, the multichannel analyzer will measure the distribution of the amplitudes as a function of voltage (Fig. 2). The pulses can be spaced as closely as a few microseconds and can be resolved into as many as 1024 ( $2^{10}$ ) incremental amplitude ranges ('channels') between selectable amplitude limits. The instrument will measure the amplitude distribution either of pulses ('pulse height analysis') or of increments of continuous signals ('sampled voltage analysis') (Fig. 3). It will also count and store in its memory the number of pulses occurring in individual intervals of time. The result would be, for example, a measurement of pulse rate as a function of time. This function is called 'multichannel scaling' or, often, 'multiscaling'.

The new analyzer is distinguished by the fact that it employs an advanced analog-to-digital converter having what is thought to be the fastest clock rate used in such a converter. The clock rate is 100 MHz. This high frequency yields the practical result that the analyzer digitizes amplitudes at a rate of 10 nanoseconds per channel. The analyzer sorts signal amplitudes into as many as 1024 channels, so that the 10-nanosecond unit rate results in a conversion time of approximately 10.24 microseconds for a largest-amplitude

signal. About 3 microseconds are required for auxiliary functions, giving the instrument the capability of sorting an input signal into one of 1024 amplitude channels in only 13 microseconds. Fewer channels can be used, if desired, with reduced conversion time. For example, 128 channels can be selected with 3.4-microsecond conversion time.

Other considerations of operational significance that have been accomplished in the design of the analyzer include:

- In contrast to usual practice, the ADC has been decoupled to assist in analyzing high count rates, and has a wideband input to accommodate fast risetime signals.
- The gain and baseline stability of the dc-coupled ADC are self-correcting and thus essentially drift-free.
- It is important in multiscaling that the memory cycle of the processor is but 2.2 microseconds and the accumulator can count at rates up to 10 MHz, allowing faster multichannel scaling than previously.
- The stability and linearity of the analog output circuits permits the X-output ramp to be used as a precision ramp in the MCS mode for controlling transducers such as a Mössbauer drive or those of other spectrometers.

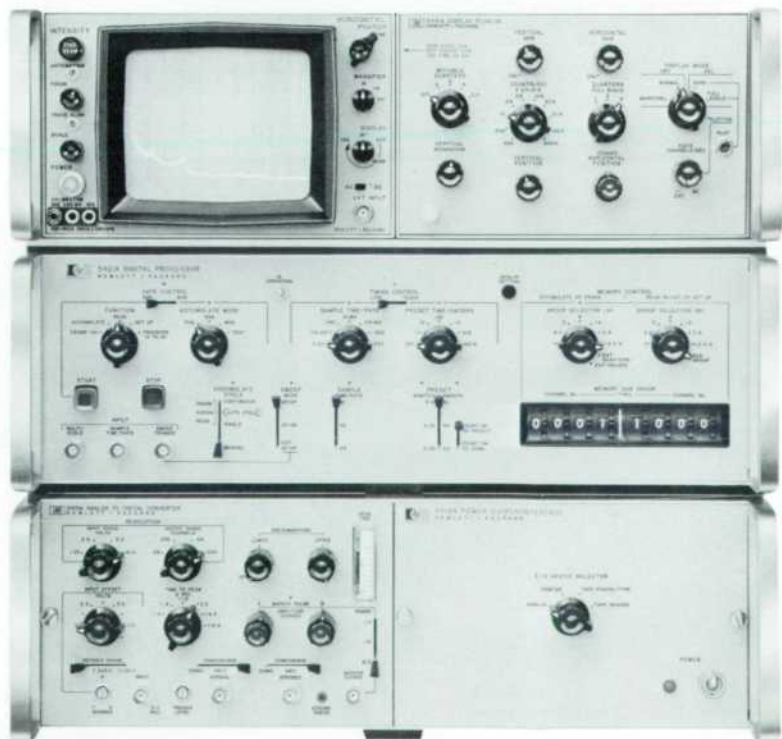

Fig. 1. Multichannel pulse-height analyzer with analog-to-digital converter operating at 100 MHz clock rate (HP Model 5400A).

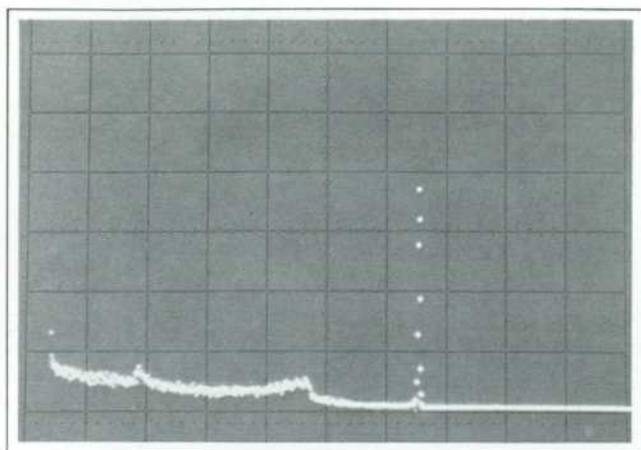

Fig. 2. Multichannel analyzer displays energy spectrum of  $Cs^{137}$ . Solid-state detector was used. Number of pulses (vertical) is displayed as a function of energy (horizontal).

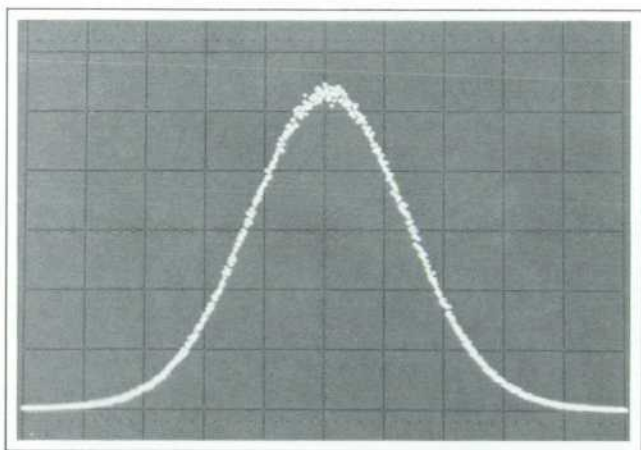

Fig. 3. Multichannel analyzer displays probability (vertical) as function of amplitudes (horizontal). Zero voltage is at center. This is a probability density display of Gaussian noise.

### Circuit Arrangement

An elemental block diagram (Fig. 4) of the new analyzer differs somewhat from past approaches because of the additional functions the analyzer is designed to perform. As is customary for pulse-height analysis, the amplitudes of individual input pulses are digitized in an analog-to-digital converter. The capability of performing amplitude analysis on continuous signals or noise, which is not usual, is achieved through the use of an input sampler which applies discrete samples of such signals to the A-D converter.

For simple counting (i.e., scaling) of signals as a function of time (multichannel scaling), an input signal

pulse train is applied to accumulator circuitry for counting.

The capacity of the memory is 1024 6-decimal-digit (24-bit) words, thus giving the analyzer its capability of storing the information for 1024 channels with up to 999,999 counts per channel.

Data stored in the memory are available externally in either digital or analog form and can be displayed on a cathode-ray tube display system.

Timing and control logic regulates the transmission of data to the various subsystems by means of a flag scheme similar to that used by a computer communicating with independent peripheral devices. This arrangement provides the most efficient use of operating time since it permits more than one subsystem, such as the memory, ADC and display subsystems, to operate simultaneously.

Often multichannel analyzers feed information to peripherals such as printers, punches, tape recorders, or computers. Easy interface to the whole range of such devices therefore is a most important criterion of a multichannel analyzer's performance (Fig. 5).

### Measurement Commentary

Traditionally, multichannel analyzers have been used primarily by those studying nuclear phenomena. The first analyzer was, in fact, developed by nuclear people to measure the distribution of pulse heights from a nuclear radiation detector. Today, such pulse height analysis is still the most common use for multichannel analyzers. However, as analyzers became available, experimenters adapted them to other measurement problems. Such problems include signal averaging, measurement of time interval distribution, recording of pulse-rate variation with time, and determining the amplitude probability distributions of various signals. As a result of their height-analysis capabilities, analyzers can be considered to be general-purpose histogram analyzers and are used in many disciplines including physics, chemistry, biology and electronics. The comments which follow expand upon how the new analyzer accomplishes some of these measurements.

### PHA Mode

In the analyzer's pulse-height analysis (PHA) mode, the measurement objective is to obtain a distribution of frequency of occurrence of the heights of a train of applied pulses. To obtain this distribution, the incoming pulses are sorted for pulse height by the analog-to-digital converter (ADC) into 1 of 1024 possible heights. The

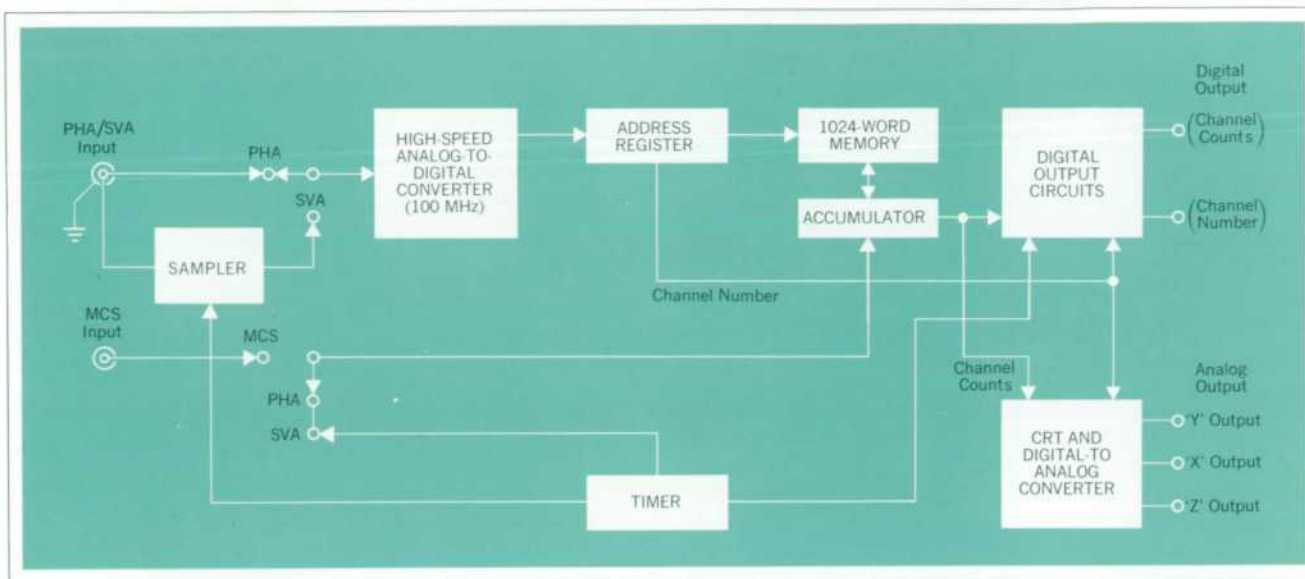

Fig. 4. Block diagram, HP Model 5400A Multichannel Analyzer.

## Differential Linearity

In a multichannel analyzer the uniformity of width of the individual voltage channels is important since it directly affects the accuracy of the analyzer's measurements. Channel width uniformity is denoted by the term 'differential linearity' where, say 1% differential linearity means that the deviation of channel widths from the average channel width is limited to 1% or less.

In the analog-to-digital converter portion of the new multichannel analyzer, the differential linearity is measured for each one of the 1024 channels on all instruments. This is done by applying to the ADC circuits a signal that is statistically equally likely to occur at all voltage levels of the ADC's input range. Therefore, all channels should have the same number of counts at the end of the measurement. The number of counts per channel is made

large so that statistical fluctuations are small. To determine the differential linearity, then, the count in each channel is applied to a programmed computer that gives a printout. An actual example is shown here. For this particular ADC, the printout shows the worst-case channel width deviation to be 0.6%; the measured standard deviation is 0.20%; the random count standard deviation is calculated as 0.15%; and the resulting standard deviation in channel width caused by differential non-linearity is but 0.13%. This performance is typical of experience to date with these units.

A computer-plotted histogram of the measured standard deviation of differential linearity is part of the computer printout, although it is not shown here.

5415A SN- 101 PAGE 2

### 6. DIFFERENTIAL LINEARITY

NOTE: THIS MEASUREMENT WAS MADE USING  
THE COMPTON SCATTER METHOD.

A. AVERAGE NUMBER OF COUNTS PER CHANNEL.....	=	470781 COUNTS
B. MEASURED PEAK DEVIATION OF CHANNEL WIDTH..	=	.60 PCT
C. MEASURED STD. DEVIATION OF CHANNEL WIDTH..	=	.20 PCT
D. CALCULATED STD. DEVIATION OF CHANNEL WIDTH DUE TO COUNTING STATISTICS.....	=	.15 PCT
E. CALCULATED STD. DEVIATION OF CHANNEL WIDTH DUE TO DIFFERENTIAL NON-LINEARITY...	=	.13 PCT

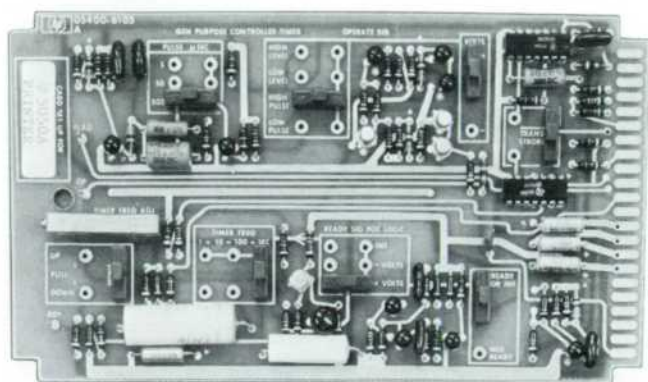

Fig. 5. Plug-in interchangeable circuit cards allow HP Model 4500A Multichannel Analyzer to operate directly with many peripherals, such as printers, punches, tape recorders, and computers. A general purpose output timing and control card is shown here; it is set up to match the analyzer to an HP Model 5050A printer but can be used also with other devices mentioned above by moving jumper connection plugs.

ADC is a ramp type in which an arriving pulse first charges a capacitor to the peak pulse amplitude. The capacitor is then discharged linearly to zero by a constant-current source. During the discharge, a binary counter counts a 100-MHz clock, resulting at full discharge in a counter reading representative of the initial capacitor charge, or pulse amplitude. This number represents a single channel in the analyzer's core memory, into which a count must now be added. To accomplish this, the counter reading is transferred into the memory address register. A read-memory operation then causes the contents of the addressed channel to be loaded into the accumulator. Next, a single count is added to the accumulator count, which was the cumulative number of counts in memory of that amplitude. Following this step, the new accumulator content is written back into the same memory channel. The net effect of these operations has been to increase by one the count in a particular channel of memory. Each time a pulse is received by the ADC, this sequence is followed, thereby compiling a distribution in which the channels correspond to particular pulse heights and the total count in each channel equals the number of pulses whose height corresponds to that channel. In a nuclear radiation experiment, in which the output of a radiation detector is applied to the analyzer, the pulse height distribution will be an energy distribution, i.e., radiation intensity (counts) vs. energy.

#### SVA Mode

In the sampled voltage analysis (SVA) mode, the analyzer operates nearly the same as in the PHA mode. The main difference is that the input signal is sampled

by a sampler and the samples are then analyzed. After many samples have been analyzed, the memory will contain a distribution of the number of occurrences of various sample amplitudes as a function of amplitude. This is, then, the probability density of the original input signal. The signal could be the output of a noisy system, allowing a quantitative measurement of the signal and noise characteristics in a way not possible using other techniques. Or it could be the output of an FM demodulator or frequency meter, allowing measurement of such quantities as oscillator instability and drift.

The highest frequency that can be analyzed is determined only by the bandwidth of the analyzer's sampler and can be extended by inserting a wide-band sampler ahead of the ADC. The limitation imposed by the Sampling Theorem—sampling at twice the maximum sampled frequency—does not apply because the sampling is incoherent rather than coherent.

#### MCS Mode

When using the analyzer for multi-channel scaling (MCS), successive channels in memory represent successive intervals of time after a start signal. The length of the time intervals can be selected over a range from 10 microseconds to 5 seconds, or controlled by an external signal. In each channel will be stored a number equal to the number of pulses received at the MCS input during the time interval selected for the channel. The memory thus stores pulse rate as a function of time. Input signals up to a 10-MHz rate can be processed.

A typical nuclear application of the MCS mode is recording the count rate of a decaying isotope as a function of time. In such an application one measurement sweep is made, after which the 'half-life curve' is stored in memory for external use as desired.



#### W. A. Ross

After completing his undergraduate work, 'Skip' Ross worked for two years designing automatic ground support equipment. Following that, he returned to school, joining HP in 1963 while finishing work towards an MSEE degree. He then did further work towards a Ph.D. E.E. degree in the HP Honors Cooperative Program. Since 1964 he has been group leader for the development of the multichannel analyzer.

Another application for which the MCS mode has been often used is 'signal averaging' for noise-reduction. Here, a periodic-signal-with-noise is applied to a voltage-to-frequency converter which in turn is applied to the MCS input of the analyzer. The resulting memory data are voltage (i.e., value proportional to v-to-f converter output frequency) as a function of time. If many analyzer sweeps are made, all being started in sync with the periodic signal, non-coherent noise will tend to be averaged out and the signal-to-noise ratio will be improved. An improvement in s/n ratio equal to the square root of the number of sweeps can be obtained.

## Design Group

A fast multichannel analyzer is by any measure a major design effort. In this project the following members of the HP nuclear instrumentation design group contributed significantly in the areas indicated: *5410A Power Supply*: Richard Ollins, *5415A Analog-Digital Converter*: James A. Doub and Jon R. Cross, *5421A Processor (Digital logic)*: Charles Heizman and Norman D. Marschke, *(Core memory)*: Charles Hershkowitz, *5431A Display Unit*: David W. Ricci, *Product design*: Charles Lowe, Larry A. Jackson, and William Anson, *Group leader and system design*: W. A. Ross.

## SPECIFICATIONS

### HP Model 5400A

#### Multichannel Analyzer

#### ACCUMULATION MODES

**PULSE HEIGHT ANALYSIS (PHA)**: In this mode, the analyzer accumulates a pulse height distribution. Amplitude sorting is performed by the ADC (Analog-to-Digital Converter). Storage is in the core memory. Automatic termination of the data accumulation may be employed by presetting the accumulation time. Coarse pulse amplitude discrimination is provided. Coincidence with an externally applied signal may also be a criterion for acceptance of a pulse.

#### INPUT PULSE REQUIREMENTS:

AMPLITUDE RANGE: 1.25 V; 2.5 V; 5 V; 10 V.  
POLARITY: Positive.  
PULSE SHAPE: >100 ns to peak above the baseline.  
INPUT IMPEDANCE: 1 k $\Omega$ , <60 pF shunt; dc coupled.  
TRIGGER LEVEL: 10 mV to 1 V adjustable (establishes timing).  
TIME TO PEAK: 0.4  $\mu$ s to 12.8  $\mu$ s in binary steps. (Sets time from trigger to start of rundown.)

#### ADC CLOCK RATE: 100 MHz.

OUTPUT RANGE: 128; 256; 512; 1024 channels.

#### CONVERSION GAIN (Channels Out/Volt In):

RANGE: 1024 channels/1.25 volts to 128 channels/10 volts.  
GAIN CHANGE ACCURACY: 2:1,  $\pm 0.1\%$ /step.  
TEMPERATURE STABILITY:  $\pm 0.005\%$ /°C.  
TIME DRIFT:  $< \pm 0.01\%$ /24 hours.

#### BASELINE (Input Offset):

VOLTAGE: Adjustable 0 to +10 V in 7 steps of 1.25 V/step + vernier.  
VERNIER: 0 to  $\pm 1.25$  V; 0 to  $\pm 25$  mV; OFF.  
STEP ACCURACY:  $\pm 10$  mV.  
COUNT RATE SHIFT: <1 channel to 90% dead time.  
TEMPERATURE STABILITY:  $< \pm 0.1$  mV/°C.  
TIME DRIFT:  $< \pm 1$  mV/24 hours at fixed temperature.

#### LINEARITY:

INTEGRAL LINEARITY:  $< \pm 0.1\%$  over 100% of range.  
DIFFERENTIAL LINEARITY:  $< \pm 1\%$  over 100% of range.

#### SIGNAL PROCESSING TIME:

**PULSE ANALYSIS TIME:**  
Up to 128 channels and up to 3.2  $\mu$ s coincidence strobe time—3.4  $\mu$ s.  
Up to 512 channels and up to 6.4  $\mu$ s coincidence strobe time—6.6  $\mu$ s.  
For 1024 channels or for greater than 6.4  $\mu$ s coincidence strobe time—13  $\mu$ s.

**SYSTEM NOISE (Channel Profile)**: Greater than 90% of the pulses from a calibrated, noise-free pulser will fall within the middle 67% of the channel. This represents less than 1 mV rms noise referred to the ADC input.

#### COINCIDENCE INPUTS (Normal and Strobed):

AMPLITUDE: 4–12 V.  
POLARITY: Positive.  
PULSE SHAPE: DC level or with specified timing.

#### DISCRIMINATORS (UPPER and LOWER LEVEL):

RANGE: 0 to +10 V.

#### CHANNEL CAPACITY: To 10<sup>6</sup> counts.

#### MEMORY SIZE:

1024 channels (standard).  
512 channels (optional).

**MULTICHANNEL SCALING (MCS)**: In this mode, the analyzer sequentially addresses each channel of the selected portion of memory and the contents of each address may be incremented by an input pulse string. Thus, each channel is used as a scaler. The DWELL TIME in each channel is pre-settable. There is no provision for coincidence or pulse

amplitude discrimination. While in the Multiscale Mode there is provision for vertical display. The address information is converted to an analog voltage and available for such applications as driving a Mössbauer apparatus.

#### INPUT PULSE REQUIREMENTS (AEC Standard Compatible)

AMPLITUDE: 4–12 V.  
POLARITY: Positive.  
INPUT IMPEDANCE: 1 k $\Omega$ , 50 pF shunt (dc coupled).  
MINIMUM PULSE WIDTH: 25 ns.  
MINIMUM PULSE SEPARATION: 65 ns.

#### PULSE PAIR RESOLUTION: 100 ns.

**PRESET SWEEPING**: 1 sweep to 500,000 sweeps (decade steps X multiplier in 1, 2, 5 steps), or EXTERNAL.

**PRESET SWEEPING**: 1 sweep to 500,000 sweeps (decade steps X multiplier in 1, 2, 5 steps).

**MEMORY GROUPING**: Store in any quarter, half or entire memory.

**SAMPLED VOLTAGE ANALYSIS (SVA)**: (Probability density functions, Mössbauer) Operation in this mode is identical to pulse height analysis except that the ADC continuously monitors a slowly changing voltage, samples it upon receipt of a pulse, and processes the sampled voltage as though it were a pulse.

#### INPUT SIGNAL REQUIREMENTS:

AMPLITUDE RANGE: 1.25 V; 2.5 V; 5 V; 10 V.  
POLARITY: Positive.  
BANDWIDTH:

1024 Channel Range: dc to 30 kHz.  
512 Channel Range: dc to 60 kHz.  
256 Channel Range: dc to 120 kHz.  
128 Channel Range: dc to 240 kHz.  
INPUT IMPEDANCE: 1 k $\Omega$ , <60 pF shunt, dc coupled.

#### ADC CLOCK RATE: 100 MHz.

OUTPUT RANGE: 128; 256; 512; 1024 channels.

#### CONVERSION GAIN (Channels Out/Volt In):

RANGE: 1024 channels/1.25 V to 128 channels/10 V.  
GAIN CHANGE ACCURACY: 2:1,  $\pm 0.1\%$ /step.  
TEMPERATURE STABILITY:  $< \pm 0.005\%$ /°C.

#### BASELINE (Input Offset): Same as PHA Mode.

#### LINEARITY: Same as PHA Mode.

#### SIGNAL PROCESSING TIME: Same as PHA Mode.

#### SYSTEM NOISE (Channel Profile): Same as PHA Mode.

**COINCIDENCE INPUTS (Normal and Strobed)**: Same as PHA Mode.

**ANALOG SET-UP MARKER GENERATION**: In this mode, 2 variable amplitude pulse generators in the ADC provide pulse pairs—first one amplitude, then the other—at a jack on the ADC panel. These pulses are routed through the linear signal processing electronics to be set up; i.e., linear amplifier, single channel analyzer, etc. The resulting pulses are routed into the ADC in the normal manner and converted to digital information. This information is reconverted to analog and provides a horizontal deflection for the display unit. Vertical stripes are generated on the CRT, and their horizontal position is an indication of the pulse amplitude at the ADC input. The stripes are displayed superimposed on a normal display of a spectrum stored in memory, and so may be used as references for adjusting system gain and baseline, as well as single channel analyzer settings.

#### READ-IN/READ-OUT MODES

##### CRT DISPLAY (Linear)

##### DISPLAY MODES:

**LIVE**: While data is being accumulated, the channels are addressed and their contents displayed as they are being incremented.

**STATIC**: The channels in a selected group are sequentially addressed and their contents are displayed.

##### ANALOG PLOTTER OUTPUT:

AMPLITUDE: +5 V full scale into open circuit.

IMPEDANCE: 100  $\Omega$ .

RESOLUTION: Vertical and Horizontal:  $\pm 0.1\%$  of full scale.  
INTEGRAL LINEARITY: Vertical and Horizontal:  $\pm 0.1\%$  of full scale.

ZERO DRIFT: Vertical and Horizontal:  $\pm 0.01\%$ /°C,  $\pm 0.1\%$ /day at fixed temperature, full scale.  
GAIN DRIFT: Vertical and Horizontal:  $\pm 0.05\%$ /°C,  $\pm 0.1\%$ /day at fixed temperature, full scale.

#### ANALOG OUTPUT (For Driving a Remote Oscilloscope):

VERTICAL: Same as Analog Plotter Output.  
HORIZONTAL: Same as Analog Plotter Output.  
UNBLANKING: Signals provided.  
MARKERS: Intensity only.

#### PARALLEL DIGITAL OUTPUT:

LOGIC LEVELS:  
A STATE: 0 V to +1 V, sink 20 mA.  
B STATE: 2400  $\Omega$  to +12 V.  
NEGATIVE VOLTAGES: Optional.  
OUTPUT CODE: 1-2-4-8 BCD (Binary Coded Decimal).  
MAXIMUM OUTPUT RATE: >60,000 channels/s.  
OUTPUT FORMAT:  
4 digits of address.  
6 digits of data.  
All 10 digits simultaneously.

#### ELAPSED TIME READOUT:

ANALOG: Point in first channel of memory group used is vertically displaced in proportion to time elapsed. Increments are in hundredths of a minute.  
DIGITAL: Number read-out of first channel of the memory group used gives the elapsed time in hundredths of a minute.

#### SERIAL DIGITAL OUTPUT:

LOGIC LEVELS:  
A STATE: 0 V to +1 V, sink 20 mA.  
B STATE: 2400  $\Omega$  to +12 V.  
NEGATIVE VOLTAGES: Optional.  
OUTPUT CODE: ASCII Standard (other codes optional).  
MAXIMUM OUTPUT RATE: >60,000 characters/s.

#### OUTPUT FORMAT:

Carriage return  
Line feed  
4-digit address  
Space  
6-digit channel data  
Leading 0's suppressed  
10 channels of data per line of type, separated by spaces.  
Each line begins as described above.

#### SERIAL DIGITAL READ-IN:

LOGIC LEVELS:  
A STATE: -2 V to +1.5 V.  
B STATE: +4 V to +12 V.  
'1' STATE: A or B by reversing plug-in board.  
NEGATIVE VOLTAGE: Optional.  
INPUT IMPEDANCE: 1k $\Omega$ .  
INPUT CODE: ASCII Standard, other codes available on special request.  
MAXIMUM INPUT RATE: >60,000 characters/s.  
INPUT FORMAT: Same as output format.

#### DIGITAL PROCESSOR OPERATIONS:

TRANSFER MEMORY QUARTERS: The contents of any quarter or either half of the memory may be transferred to any other quarter or the other half respectively. The data is retained in the sending memory group. Data previously stored in the receiving group is erased.

PRICE: HP 5400A with 1024 Channel Memory, \$9,500.00

#### MANUFACTURING DIVISION:

HP FREQUENCY & TIME DIVISION  
1501 Page Mill Road  
Palo Alto, California 94304

# A Charge-Sensitive Preamplifier for Nuclear Work

By James K. Koch

A PREAMPLIFIER WHICH IS USABLE, WITHOUT MODIFICATION, with *any* of the usual nuclear detectors is part of the HP nuclear instrumentation program. This ability to work with various detectors is a substantial convenience because usual practice has required either different preamplifiers for different detectors or considerable preamp modification when detectors are changed. To accommodate the differing electrical characteristics of various nuclear detectors, the preamplifier has switchable controls that provide a variety of pulse-shaping methods.

The preamplifier is arranged to include the load resistor for the detector as is the usual practice in the nu-

clear field. As a further convenience and again in contrast to existing practice, the resistor can be merely clipped into place in the preamplifier without special soldering or other circuit modifications.

The preamp has charge conversions of up to 1000 mV/picocoulomb which can then be increased up to 8 times into 50 ohms by the internal voltage-amplifying section.

The preamp is of the type known as 'charge-sensitive,' i.e., its output voltage is proportional to the amount of charge appearing in a burst at its input. This is necessary because the output of nuclear detectors is a burst of



Fig. 1. Charge-sensitive preamplifier (HP Model 5554A) is usable without modification with any of the usual nuclear detectors.



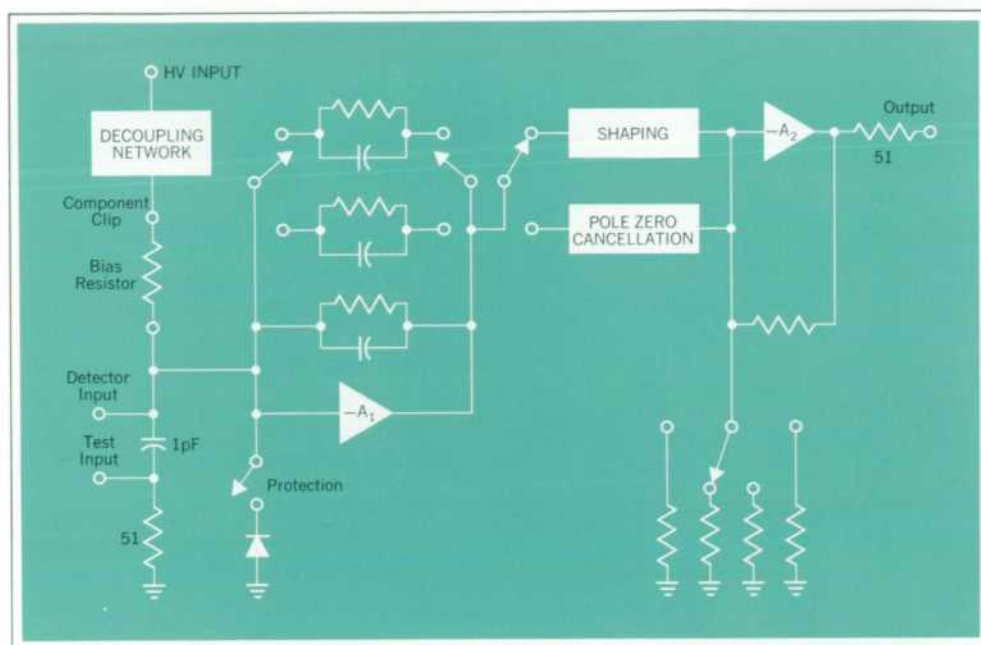

Fig. 3. Block diagram of preamplifier.

charge (a current pulse) when they absorb an increment of incident radiation. The standard configuration for such a charge-sensitive amplifier appears in Fig. 2. The triangle represents a conventional operational voltage amplifier. Input-output relations are as shown. The conversion gain of such a system is:

$$\frac{E}{Q} = \frac{-A}{C_{in} + C_F(1 + A)} \approx \frac{-1}{C_F} \text{ if } \begin{cases} A \gg 1 \\ (A + 1)C_F \gg C_{in} \end{cases}$$

where  $C_{in}$  is the input capacitance of the operational am-

plifier and  $C_F$  is the feedback capacitor. In practice a resistor is placed in parallel with  $C_F$  so that the output pulse voltage will have an exponential decay and will not build up with successive input pulses.

Fig. 3 shows a block diagram of the preamplifier circuit. Since high-voltage bias is generally applied to the detector at the preamp input, it is convenient to include the bias resistor in the preamp as shown. The preamp itself consists of a variable-gain charge-sensitive stage followed by a variable-gain voltage amplifier. The two stages can be coupled together in two ways to accomplish different pulse shaping. The first way is to differentiate the output of the charge-sensitive stage (Fig. 4). A pole-zero cancellation network cancels the charge-sensitive decay time-constant and introduces a new, shorter time-constant. Since there is still only one time-constant (one pole) in the transfer function, the resulting pulse will have no undershoot. Undershoot would be undesirable since it often increases the interaction between consecutive pulses. Use of the shorter time-constant is usually combined with additional pulse shaping later in the system.

The second selectable method of interstage coupling is through a shaping network (Fig. 4) consisting of a cascaded RC differentiator and integrator. Pole-zero cancellation is not needed in this case because the time-constant introduced by the shaping network is shorter by a factor of 1000 than the previous one. The resulting pulse shape is suitable for direct connection to subsequent pulse height analyzing equipment.

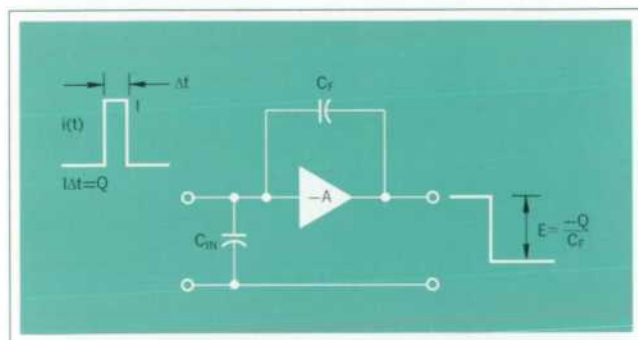



Fig. 2. Standard configuration for charge-sensitive preamplifier. Triangle represents a conventional operational voltage amplifier.

The voltage amplifier stage is a non-inverting operational circuit with gain settings of 2, 4, 8, and 16 and a constant output impedance of 50 ohms. When terminated in 50 ohms, the output will be divided by two to produce actual gains of 1, 2, 4, and 8.

The charge-sensitive stage is conventional except that the feedback elements may be switch-selected. The available gain values are compatible with all usual detectors. The values are 10, 100, and 1000 mV/pC. Since the smallest feedback capacitor is only 1 pF, stray capacitances are critical; it has thus been necessary to switch both ends of the capacitors.

A diode may be switched in between the input and ground to protect the input FET from large negative spikes arising from changing or disconnecting the high voltage on the bias resistor. Positive spikes and the resulting positive charges on the input capacitors can discharge through the N-channel FET in the positive direction with only small power dissipation. When lowest possible noise is required, the protection diode may be switched out of the circuit to reduce input capacitance.

The noise introduced by the preamp is determined by the input FET, the input resistance, and the input capacitance. Preamp noise becomes significant, however, only when using some solid-state and some proportional detectors. For low-noise work the input cables should be kept short to minimize input capacitance and the highest possible bias resistor should be used to keep input resistance at a maximum. 

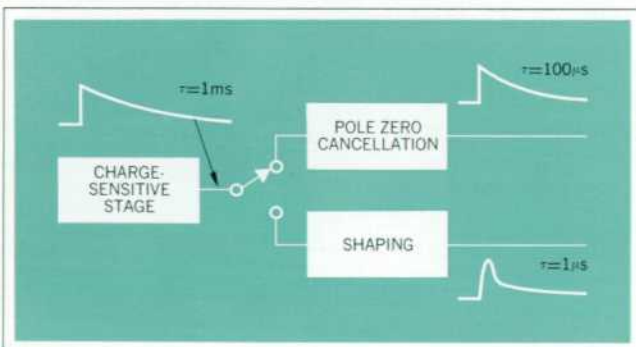

Fig. 4. Selectable interstage coupling networks give choice of pulse shaping functions.



### James K. Koch

After graduating from Iowa State University in 1965 with a B.S. degree in electrical engineering, Jim Koch (he pronounces it 'Cook') joined the HP nuclear instrument group. He has been designing nuclear instruments ever since.

At present he is also attending Stanford University in the HP Honors Co-op Program and expects to receive his MSEE degree shortly.

Jim is a member of IEEE, Tau Beta Pi, and Eta Kappa Nu. He spends much of his spare time in artistic pursuits, chiefly painting.

## SPECIFICATIONS

### HP Model 5554A Preamplifier

**SIGNAL INPUT POLARITY:** Either.

**HIGH VOLTAGE:** 2.5 kV max, either + or - as required for detector.

**HV DECOUPLING:** 3 stages,  $R = 1 \text{ M}$ ,  $C = 0.0047 \mu\text{F}$ ,  $\tau = 4.7 \text{ ms}$ .

**DETECTOR BIAS RESISTOR:** Inserts between spring-loaded clips. Three resistors are provided (1000 M, 100 M, 4.7 M); others may be used.

**FIRST STAGE CHARGE SENSITIVITY** (conversion gain):

WITH NON-SHAPED OUTPUT PULSE: 10, 100, or 1000 mVpC (millivolts per picocoulomb) nominal.

WITH SHAPED OUTPUT PULSE: 3, 30, 300 mV/pC nominal.

**SECOND STAGE VOLTAGE GAIN**

WITH  $R_L = 50 \Omega$ : 1, 2, 4, or 8.

WITH  $R_L \geq 500 \Omega$ : 2, 4, 8, or 16.

LOSS AS A FUNCTION OF INPUT CAPACITANCE: <3% at 100 pF for conversion gain 300 or 1000; otherwise much less.

**OUTPUT**

**POLARITY:** Inverted from input.

**POSITIVE OUTPUT:** Into a 50  $\Omega$  load, dynamic range is 5 V; into  $\geq 500 \Omega$ , 10 V (with voltage gain X2, X4, or X8).

**NEGATIVE OUTPUT:** Into a 50  $\Omega$  load, dynamic range is 3.5 V; into  $\geq 500 \Omega$ , 7 V (with voltage gain X2, X4, or X8).

**IMPEDANCE:** 50  $\Omega$ .

**TAIL PULSE:**

RISE TIME: 50 ns at zero external capacitance.

TAIL TIME CONSTANT: 100  $\mu\text{s}$ .

POLE-ZERO CANCELLATION.

**SHAPED PULSE:**

RC DIFFERENTIATION TIME CONSTANT: 1  $\mu\text{s}$ .

RC INTEGRATION TIME CONSTANT: 1  $\mu\text{s}$ .

**PRICE: 5554A, \$300.00.**

**MANUFACTURING DIVISION:** HP FREQUENCY & TIME DIVISION  
1501 Page Mill Road  
Palo Alto, California 94304

# A Nuclear-Type Linear Amplifier with Plug-In Pulse-Shaping Delay Lines

By Eric M. Ingman

IN THE NUCLEAR FIELD THE TERM 'LINEAR AMPLIFIER' has a somewhat different connotation than in the electronics field. In nuclear work a linear amplifier is a pulse amplifier with high linearity and often with circuits that shape the pulse (and thus degrade input-output linearity). Nuclear linear amplifiers generally have calibrated gain adjustable with high accuracy.

Such a nuclear amplifier is part of the HP nuclear instrumentation program. The new amplifier has all the usual characteristics. It also has new features of its own. Its risetime is several times faster than previous amplifiers of its type. As a result the amplifier's pulse-shaping circuits make it possible to reduce the pulse width to about one fourth of that previously practical. This, in turn, leads to the amplifier's ability to handle pulses at rates about 4 times faster than previous usual practice. The fast risetime is also important in giving the amplifier a low value of crossover 'walk,' i.e., shift of a reference point on the pulse with pulse amplitude.

Another convenience factor is pulse-shaping (delay) lines that merely plug in. These come in a variety of different time constants.

## Circuitry

Engineers in the electronics field may find the amplifier circuit arrangement is rather unusual and interesting (Fig. 2). The amplifier consists of an input attenuator, an inverter/non-inverter, an adjustable first differentiator, a post-amplification attenuator, an adjustable integrator, an amplitude limiter for overload signals, an adjustable second differentiator, and an output stage. To minimize noise from the first stages, the input and post-amplification attenuators operate from the same control so gain will be

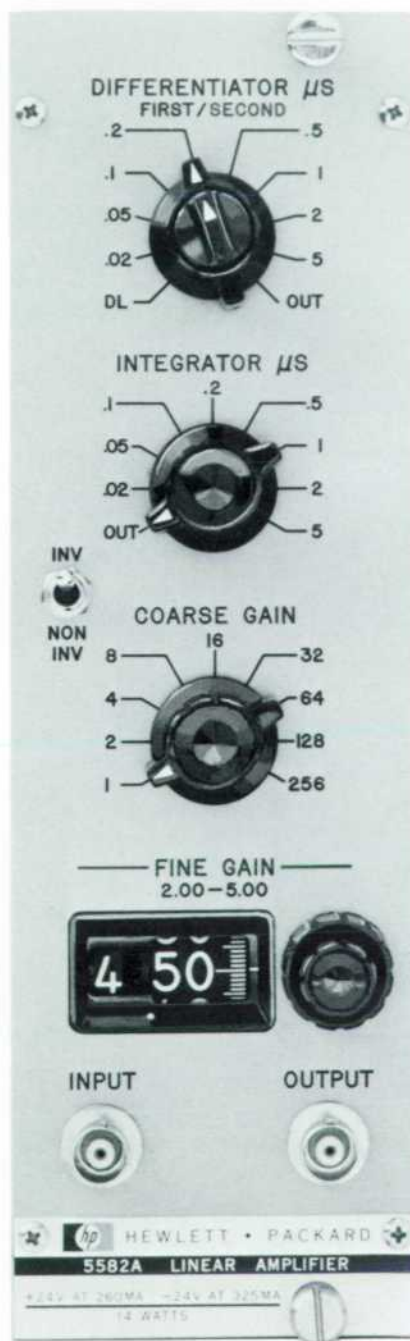

Fig. 1. Nuclear pulse amplifier in NIM module (HP Model 5582A).

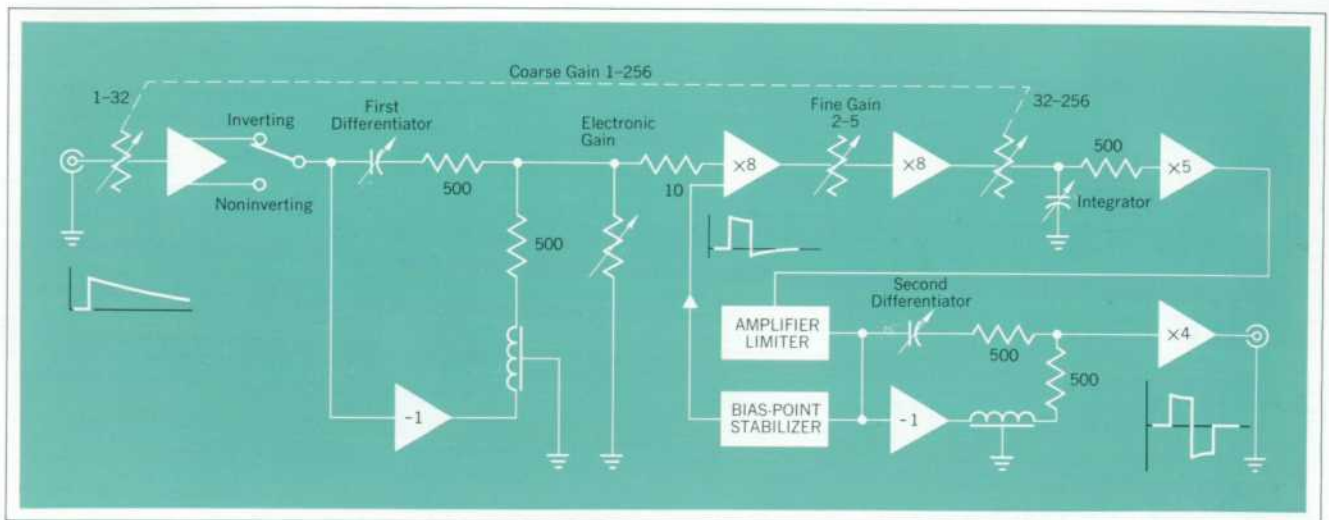

Fig. 2. Linear amplifier block diagram.

first reduced by the post-amplification attenuator before it is reduced by the input attenuator. Up to the first differentiator there is no voltage gain. The stages have been designed with wide dynamic range so that input pulses with long tails can pile up on one another without saturating the amplifier. Another point considered in providing high dynamic range was avoiding the possibility that some input signals might be large enough to overload later stages in the amplifier, then because of their long tails, hold the input stages in saturation for long times.

Two alternatives are provided for the first signal differentiation. One is plug-in type pulse-shaping delay lines. These shape the pulse by delaying the signal in one inverting path while a parallel straight-through path is also

provided. The two signals are then summed. Since the signal to be shaped has a fast rise and slow decay, the resultant signal after summing is one with fast rise and fast decay, as indicated in Fig. 2. The duration of this signal is equal to the delay of the delay line. The delay line branch uses active circuitry to compensate for delay-line loss and to accomplish the necessary inversion.

The second alternative for first signal differentiation is in the form of RC circuits with adjustable time-constants.

An electronic gain control is located at the output of the first differentiator. The circuit consists of two forward-biased diodes which control gain by shunting some signal current to ground. This gain control is then followed by a stage of voltage gain and a calibrated 'fine-gain' potentiometer.

The stages from the first differentiator to the output of the second differentiator are dc-coupled. The operating point is stabilized by dc non-linear feedback from the output of the amplitude-limited stage to the input of the first  $\times 8$  amplifier. The amplitude limiter is designed so that, in delay-line-mode operation, amplitude limiting cannot occur in the stages following second differentiation.

If limiting does occur after the second differentiator, then the bipolar pulse from the second differentiator will no longer have area balance above and below baseline, and so when it passes through a coupling the baseline will shift.

The output stage is ac-coupled and has an output impedance of less than 5 ohms, low enough to drive impedances of 90 or more ohms without affecting output level.



#### Eric M. Ingman

Born in England and later becoming a resident of Australia, Eric graduated in engineering from Sydney University. He then worked in England in a graduate training plan, again returning to Australia to work on the design of communications equipment.

He joined the HP nuclear instrumentation design group in 1964, working initially on the multichannel analyzer and later becoming group leader for the NIM instruments described in this issue.

## SPECIFICATIONS

### HP Model 5582A Linear Amplifier

#### INPUT:

POLARITY: Positive or Negative.  
IMPEDANCE: 1.5 k $\Omega$ , dc coupled.  
MAXIMUM VOLTAGE: 15 V peak, 15 V dc, without damage to input.

#### GAIN:

RANGE: 2 to 1280 by coarse and fine control.  
CONTROLS:  
COARSE: Switch from 1 to 256 in binary steps.  
FINE: Continuously variable from 2.00 to 5.00 (times coarse gain setting) by 3-turn pot with calibrated in-line digital display.  
RESETTABILITY: Fine gain, one minor division (0.2% of full range at constant temperature).

#### PULSE SHAPING:

RC MODE: Separate controls for integration, first and second differentiation.  
TIME CONSTANTS: 0.02–5  $\mu$ s in 1, 2, 5 sequence for integration, first and second differentiation.  
DELAY LINE MODE: Single or double; 1.0  $\mu$ s delay lines are standard. Plug-in delay lines from 100 ns to 1  $\mu$ s in 100 ns steps available on special order.

AMPLIFIER RISE TIME: < 40 ns, typically 25 ns.

AMPLIFIER BAND PASS: Typically 2 kHz to 6 MHz.

TEMPERATURE STABILITY: Gain shift < 0.05%/°C, typically 0.02%/°C.

#### OUTPUT:

AMPLITUDE:  $\pm 10$  V, except  $\pm 5$  V with 0.02  $\mu$ s and 0.05  $\mu$ s first and/or second differentiation time constants.  
IMPEDANCE: < 5  $\Omega$ .

MINIMUM LOAD IMPEDANCE: 90  $\Omega$ .

POLARITY: Positive and Negative.

DELAY: Typically 65 ns (relative to input).

INTEGRAL LINEARITY: < 0.3% with 1  $\mu$ s DDL and 0.1  $\mu$ s integration time constant.

DIFFERENTIAL LINEARITY: < 1%, 0.3% below 8 volts (typical).

NOISE: < 15  $\mu$ V rms, referred to input at maximum gain with 1  $\mu$ s integration time constant and 1  $\mu$ s single differentiation time constant. Typically 9  $\mu$ V with input terminated in 50  $\Omega$ .

CROSSOVER WALK: <  $\pm 0.5$  ns shift at constant gain from 10% of rated output to rated output with 1  $\mu$ s DDL shaping and 0.1  $\mu$ s integration time constant. For a 16:1 change in gain setting, walk is <  $\pm 5$  ns (with constant fine gain setting).

COUNT RATE SHIFT: < 0.05% with inputs to 10<sup>5</sup> counts/s, for Cs 137 (typical).

OVERLOAD: Amplifier recovers from a 200 X overload to 2% of the baseline in less than 3 non-overload pulse widths with 100  $\mu$ s preamp fall time constant (for 1  $\mu$ s DDL and 100 ns integration shaping). In 1  $\mu$ s double RC differentiation and 1  $\mu$ s integration shaping, the recovery from a corresponding overload to 2% of baseline is 2 non-overload pulse widths from end of non-overload pulse.

GAIN CONTROL INPUT: For external fine gain control, contact factory for applications information.

OPERATING TEMPERATURE: 0 to 55°C.

POWER REQUIRED: +24 V, 250 mA; -24 V, 325 mA. Power may be supplied by HP 5580A NIM POWER SUPPLY.

PREAMP POWER OUT: +24 V.

PRICE: \$550.00.

MANUFACTURING DIVISION: HP FREQUENCY & TIME DIVISION  
1501 Page Mill Road  
Palo Alto, California 94304

## NIM Bin

Nuclear instrumentation nowadays is commonly housed in packages which conform to concepts originated by the AEC Committee on Nuclear Instrument Modules. Standard modules fit up to 12 abreast in a 'bin,' which in turn fits the standard 19" EIA rack. The packages (NIMs, for Nuclear Instrument Modules) can be  $\frac{1}{12}$ th bin wide, or any integral number of twelfths. The bin may or may not contain a power supply for the NIMs,

but always has standard connectors for power. Power voltages are standardized. This is the HP 5580A NIM bin, containing power supply. 120 watts are divided among supply voltages of  $\pm 24$ ,  $\pm 12$ , and  $\pm 6$  vdc. Protective circuits guard against excessive current or voltage. The bin is blower cooled. (Also available is a bin 12 modules wide, the HP Model 5580B.)

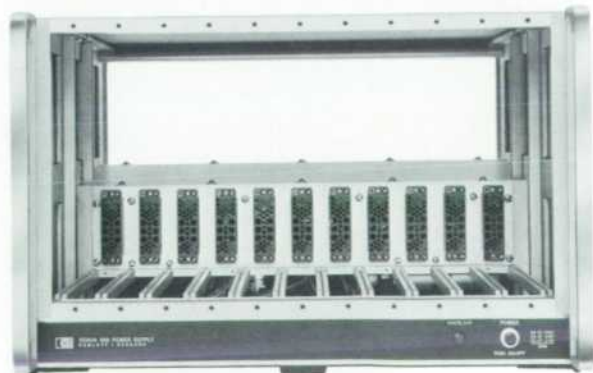



Fig. 1. New single-channel nuclear pulse-height analyzer (HP Model 5583A) with 200 nanosecond multiple pulse resolution.

## A Single-Channel Analyzer with Fast Multiple-Pulse Resolution

By Robert G. Wagstrom

SINGLE CHANNEL ANALYZERS ARE COMMONLY USED in nuclear work to sort voltage pulses according to their amplitude. Such analyzers generally consist of two amplitude discriminators which are biased at different levels and arranged to feed an anti-coincidence circuit. If the amplitude of an input pulse then falls *between* the levels at which the two discriminators are set, there is an input to the anti-coincidence circuit only from the lower discriminator. This one-only input meets the anti-coincidence requirement and an output pulse is produced by the anti-coincidence circuit. If the amplitude of the input pulse is *below* the lower threshold or *above* the upper threshold, there will be either no inputs or two inputs to the anti-coincidence circuit. Both of these conditions result in no output pulse. As a result, the single-channel analyzer accepts pulses of the chosen amplitude range and rejects all others. The differential between the two discriminator settings is often called the 'window' or ' $\Delta E$  window.' Commonly, the position of the 'window' can be varied over a range from zero to full scale so a continuum of pulse amplitudes can be examined or otherwise processed by subsequent equipment.

A new single-channel analyzer (SCA), Fig. 1, is unusual in several respects; most noticeable is fast multiple-pulse resolution of only 200 nanoseconds. In addition,

there is a leading edge output from each discriminator independent of the anti-coincidence circuit, and a 'dual-integral mode of operation' (Fig. 2).

### Single Channel Operation

In one single-channel mode of operation ( $\Delta E$ ), one discriminator control establishes the window width (.050-1.00 volts) and the second establishes the window's position relative to 0 volts. For spectrometry and other work the window can be swept either manually or electrically by an external stepped voltage. The sweep range possible is from 0 to 10 volts.

In the second single-channel mode of operation ( $E_{max}$ ), one discriminator control sets the upper window level and the second control the lower window level. Each control has a .050 to 10-volt range, so the analyzer will operate with a window of adjustable opening at a selected voltage above zero.

### Dual-integral Operation

Although the purpose of single-channel analysis is to select pulses that meet a particular amplitude criterion, it is nonetheless desirable in many instances to operate the unit as two independent discriminators and to know how many pulses are exceeding each discriminator threshold setting. Each discriminator has separate inputs

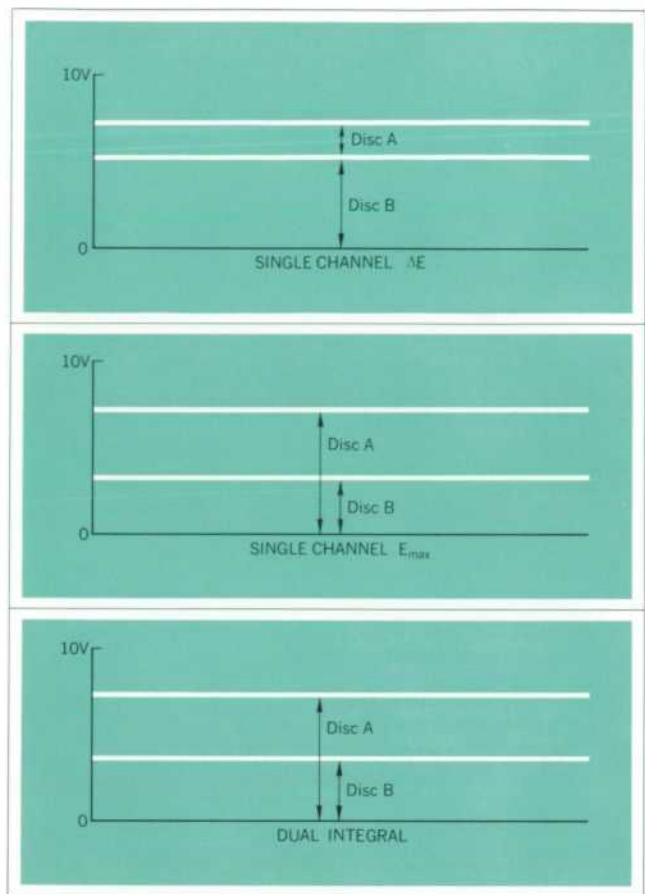

Fig. 2(a). Analyzer operating modes.

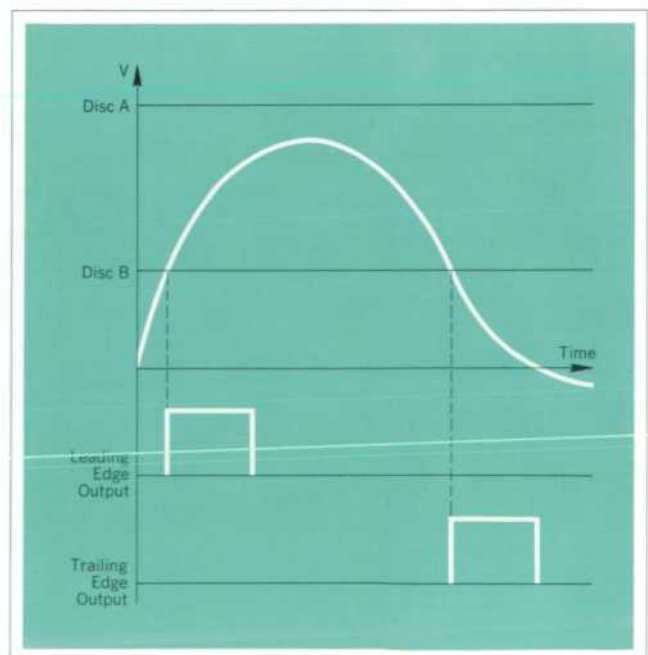

Fig. 2(b). Discriminator B generates an output pulse once as input wave rises through the predetermined level, and once again as input wave descends through that level.



### Robert G. Wagstrom

Bob Wagstrom joined the HP nuclear instrumentation group in 1965 after completing his graduate (MSEE) and undergraduate work at the University of Minnesota. At Minnesota he worked on nuclear instrumentation associated with the 68 MeV proton accelerator of the Minnesota physics department.

At HP he has worked on instruments comprising the NIM system.

and outputs, so in essence there are two channels, each with a lower-level discriminator. This permits subsequent equipment to totalize the number of input signals that exceed a threshold value. This gives rise to the term 'integral' operation. Each output is derived from the leading edge of the input pulse. Separate output pulses occur when leading edges of input pulses cross the discriminator threshold.

### Strobing

To analyze only pulses that occur in time coincidence with some second event, a 'strobing' technique is often used in nuclear work. For this purpose, the SCA is designed to accept strobing pulses. These are applied (Fig. 3) to the anti-coincidence circuit together with the outputs of the discriminators. When an external strobe pulse is not used, a substitute pulse is supplied internally (internal strobing). When an external strobing pulse is used, it must arrive after the peak of the input pulse being analyzed in order that the upper-level discriminator will, if appropriate, signal the anti-coincidence circuit before the strobe pulse occurs. In strobe operation, the output pulses from the anti-coincidence circuit will have the same timing information as the strobing pulses.

## SPECIFICATIONS

### HP Model 5583A Single Channel Analyzer

#### MODES OF OPERATION:

**Single Channel** —  $\Delta E$ , pulses between  $E_{min}$  and  $E_{min} + \Delta E$  are counted.

**Single Channel** —  $E_{max}$ , pulses between  $E_{min}$  and  $E_{min} + \Delta E$  are counted.

**Dual Integral**, pulses greater than  $E_{min}$  are counted.

**MULTIPLE PULSE RESOLUTION:** 200 ns.

#### INPUT CIRCUIT:

**IMPEDANCE:** Single Channel: 500  $\Omega$ . Dual Integral: 1 k $\Omega$ . Inputs are ac coupled. Maximum input rise time is determined by 1 ms input time constant.

**SINGLE CHANNEL AND DUAL INTEGRAL INPUT:** <15 V. Unipolar positive or bipolar, positive leading (negative on special order).

**DISCRIMINATOR RANGES:**  $E_{min}$  and  $E_{max}$  are adjustable from 0.05 V to 10.05 V.  $\Delta E$  is adjustable from 0.005 to 1.005 V.

**$\Delta E$  ACCURACY:** The  $\Delta E$  window width is within  $\pm 25$  mV of the dial reading for NaI shaped pulses.

**SENSITIVITY TO NARROW PULSES:** The discriminator sensitivity to a 30 ns wide pulse drops to 90% of the nominal sensitivity.

**INTEGRAL LINEARITY:**  $\pm 0.25\%$  of full scale for a NaI shape pulse.

**TEMPERATURE STABILITY:**  $< 0.01\%/^{\circ}\text{C}$  of full scale (1 mV/ $^{\circ}\text{C}$ ) change in  $E_{max}$  and  $E_{min}$  and  $< 0.1\%/^{\circ}\text{C}$  of full scale (1 mV/ $^{\circ}\text{C}$ ) change in  $\Delta E$ , both over 0 to 55 $^{\circ}\text{C}$  with allowable dc voltage tolerances as specified per TID-20893.

**OUTPUT:** All outputs are available in all three modes of operation. The outputs are dc coupled and are not damaged when shorted. Inputs and outputs conform to AEC preferred practice logic.

**PRICE:** \$550.00

**MANUFACTURING DIVISION:** HP FREQUENCY & TIME DIVISION  
1501 Page Mill Road  
Palo Alto, California 94304

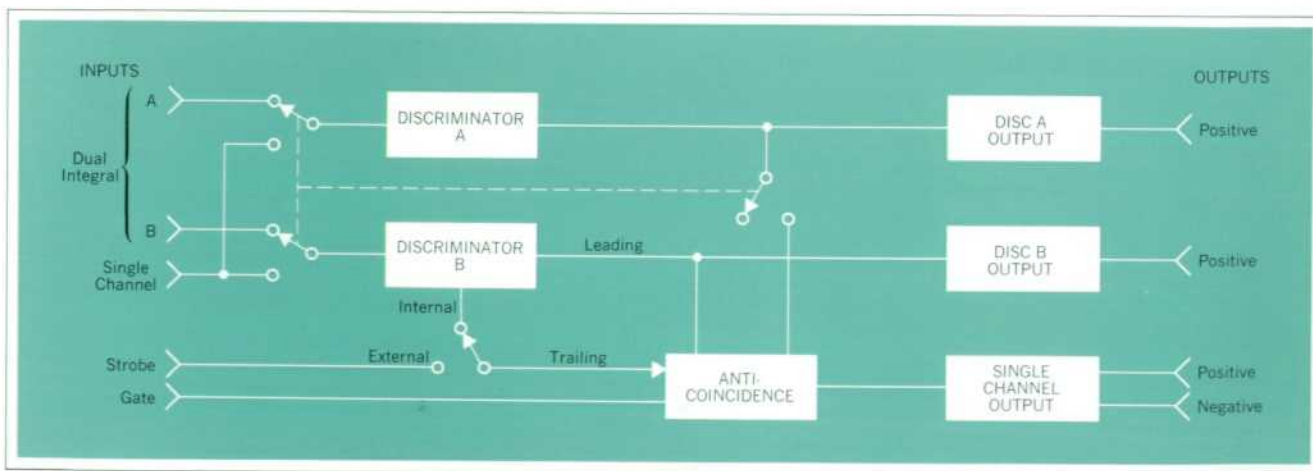

Fig. 3. Single channel analyzer block diagram.