

## Using Copper Tape to Fabricate RF Breadboard Circuits

*John Kristiansen  
Hewlett-Packard*

### Introduction

Do you use insulated wire when breadboarding your circuit boards? Do you also use insulated wire for high frequency circuits—for example, above 50 MHz? At these higher frequencies your wire begins to look like an inductor, and the whole circuit may start to oscillate at the slightest disturbance.

In this article I will describe another method of breadboarding RF circuits using adhesive-backed copper tape. Some of the advantages of using copper tape are:

- The copper tape does not look like an inductor at high frequencies
- The circuit is more stable at high frequencies—the tendency toward oscillation is minimized.
- The breadboard circuit is similar in appearance to the final printed circuit board
- The circuit is easier to trace and troubleshoot
- It is easier to make circuit changes on the board
- Copper tape is useful in building microwave stripline filters, bidirectional couplers, etc.

### Circuit Layout

If it's not already done, the first step is to mark your schematic with component reference designators, connector pin numbers, test point designations, etc., to identify all items and components that will appear on the layout (see Figure 1 for a simple schematic). You can start the initial layout by arranging a rough sketch of the circuitry to determine the most practical placement of components and traces. The next step is to adapt the sketch to a formal layout using a grid and a component template that will establish very accurate conductor paths, component body outlines, board outline and all other features. The layout should be drawn as viewed from the component side of the printed circuit board. The actual size board layout is based on a 0.100 grid

pattern; however, the preferred scale for paper layout is 2:1.

The 2:1 scale is easy to accomplish using 0.200 grid graph paper (sometimes called "engineering notebook paper"), which is what I used for this article. Mark your sheet of graph paper with sequential numbers across the top and down the side. As you lay your circuit out on the graph paper, each component lead (solder point) assumes a cross-reference number. These cross-reference numbers will be used for transferring the layout from the paper to the breadboard so you know where to place each component and the copper tape. An example is shown in Figures 2 and 3.

A standard component template is one of the most useful pieces of

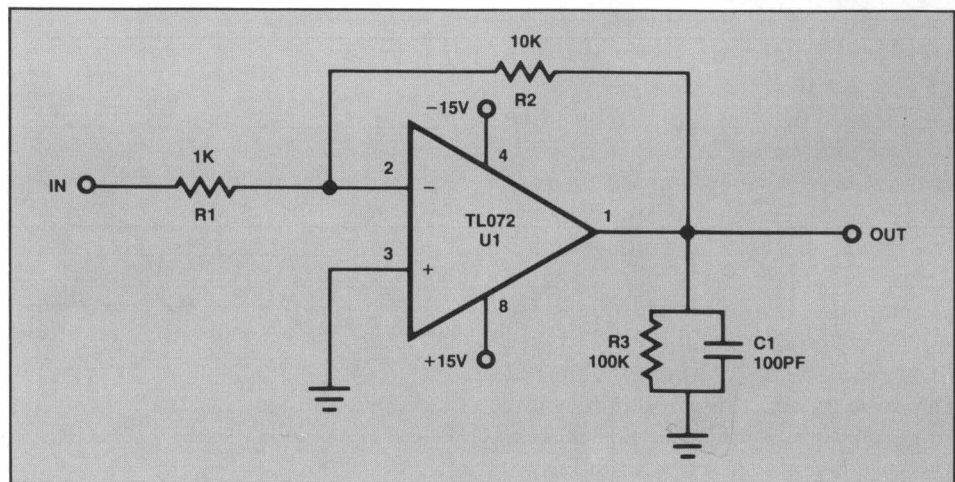

Figure 1. Sample circuit of inverting gain amplifier.

equipment you will use in designing breadboards. It not only saves valuable time but also assures that standard component lead spacing and body sizes are used. There are several models and styles available, one of which is shown in Figure 4.

If you don't use the template, the amount of space the component takes up is a matter of educated guesswork. For example, if you are using a predrilled breadboard (with the standard 0.100 inch spacing), you can lay a selection of components (with the leads already bent) on the breadboard and note how many holes are spanned. For example, a small precision resistor will span four or five holes. Larger components naturally span more holes. If you are using a solid breadboard without predrilled holes, you are almost forced into using the template or using the graph paper to determine the size of your components.

The next step is to take all the component designators you have noted on the circuit and record them on a plain sheet of paper. Place double-sided adhesive tape on the back side of the paper under the numbers and set the sheet aside. It will be used later as the components are placed on the breadboard.

In the next steps, you need a way to transfer the cross-reference points from the paper to the breadboard you are using. The boards we use at Hewlett-Packard are predrilled in a grid pattern on 0.100 inch centers (see Figure 5). You can also buy this type of breadboard at any good electronics store. Other common types of breadboard available are solid epoxy-fiberglass or phenolic material with a sheet of copper ground plane bonded to one side. The following procedure will work equally well on both types of board. The only difference is that the solid board requires more work in matching the reference points from the graph paper layout to the board, and in drilling the holes and undercutting the copper ground plane away from the holes.

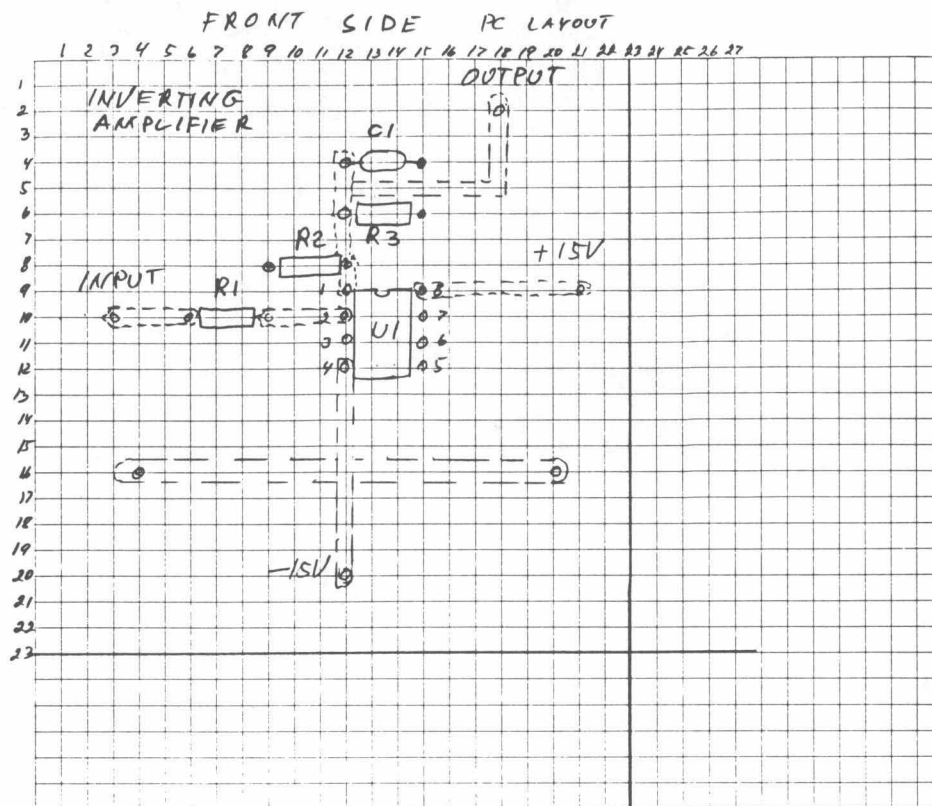

Figure 2. Initial graph paper layout of the PC board—component side

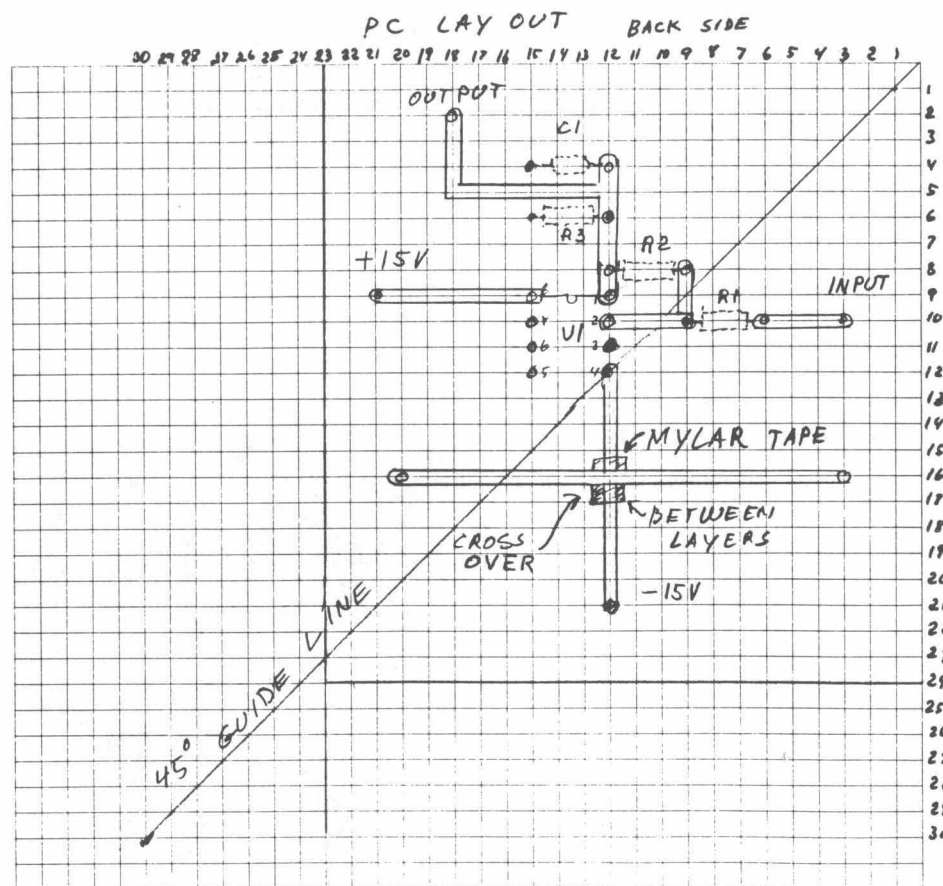
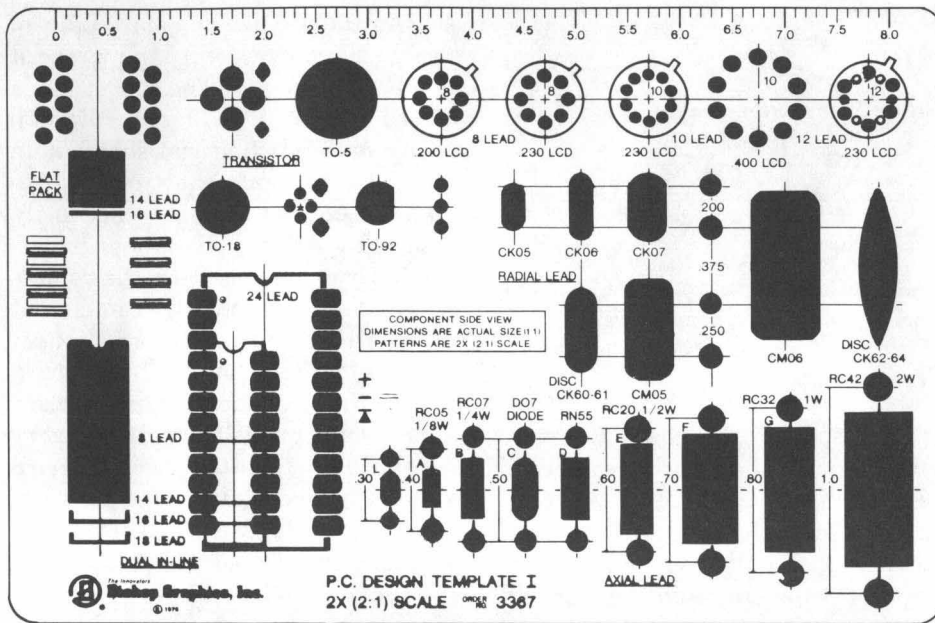

Figure 3. Initial graph paper layout of the PC board—copper tape side. The 45° guide line aids in finding cross reference numbers



### Marking Predrilled Breadboards

Put a strip of tape across the top and down the side of the board. Use any type of tape that is easy to write on. I use self-sticking typewriter correction tape that is commonly found in the office supplies cabinet. Mark the same sequential numbers on the breadboard so it matches the graph paper. See the example in Figure 6.

### Marking Undrilled Breadboards

Use the 0.100 or 0.200 inch graph paper and cut off small strips wide enough on which to write your numbers and as long as each edge of the board. Tape them to all four edges of the board. If you are using 0.200 inch paper, divide each square in half. The graph paper will provide you references in which to draw lines across the board, allowing you to transfer your graph paper layout to the board.

When drilling the holes to mount the components, you will find that the epoxy-fiberglass board (commonly called G-10) will dull ordinary drill

bits very quickly, so carbide bits are usually used for production work. Phenolic boards are much easier to drill. If you are limited to a standard drill bit index, with the smallest drill being a #60 (0.040 inch), you want to choose a size that will fit most of the components you are using. If you

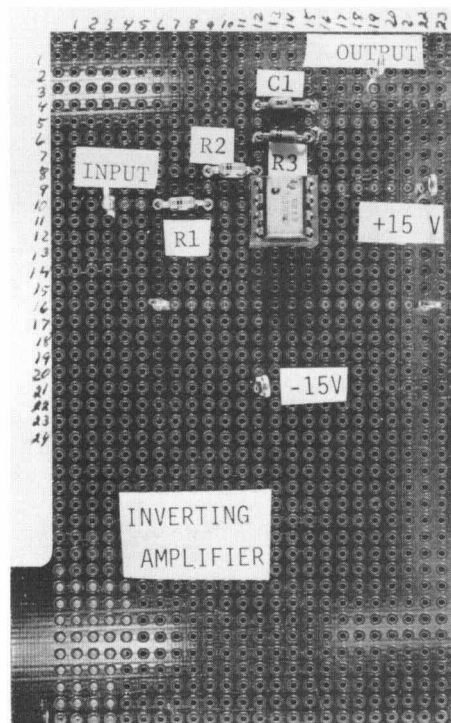

Figure 5. Typical PC board with holes predrilled on 0.100 grid

have access to smaller drills, I find that #67 bits are the right size for IC sockets, #65 for 1/8-1/4 watt resistors and diodes, and #60 to #55 for larger leads. If possible, use a Dremel drill press to be sure the holes are vertically aligned. This method is also less likely to break the brittle carbide bits. The #60 drill will be a little big, but it will do for most of the components, including the printed circuit board sockets. Drill the holes with the drill and then ream each hole with an 1/8-inch drill to undercut the copper away from the edge of the hole to keep the component lead from shorting to the ground plane (see Figure 7). Any holes that are meant to be grounded can be left as is. You can solder the lead directly to the ground plane.

### Circuit Board Layout

At this point, if you were using the wire method, you would begin loading the components on the board and wiring the connections. However, with copper tape, you lay the tape first then place the components.

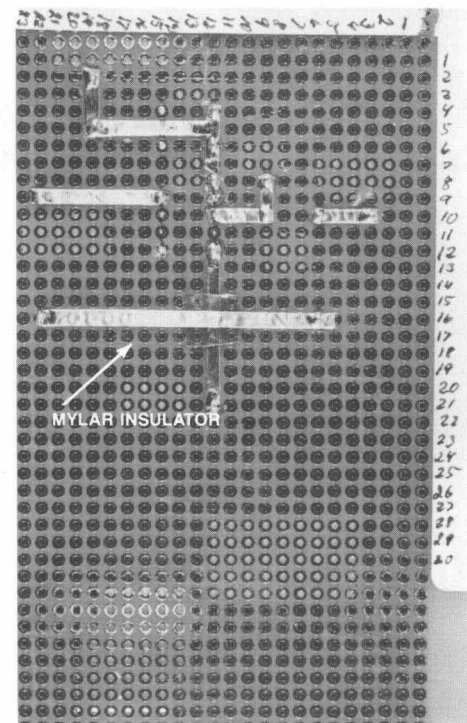

Figure 6. Board layout showing copper tape in place. Note mylar insulator where copper tape crosses

Cut off a piece of copper tape the same length as the board with a pair of scissors or X-ACTO knife. Next, use the X-ACTO knife and a good straight edge (I use a small metal ruler) and score the tape lengthwise in approximately 0.800 inch strips (slightly smaller than the 0.100 grid pattern), being careful not to cut through the adhesive backing tape. The narrow copper strips will easily lift off the backing tape and lie perfectly across the holes in the breadboard.

Start at a convenient location on your circuit and lay one end of the tape over the cross-reference number that matches your graph paper layout. Align the tape over the holes following the same path as the signal or Vcc line on the graph paper and press into place on the circuit board. Where one piece of copper tape crosses another, use a small piece of mylar tape as an insulator. See Figure 6. Where the junction of two pieces of copper tape (corners, power taps, continuations) need to make good electrical contact, always solder the connection. Do not rely on the adhesive.

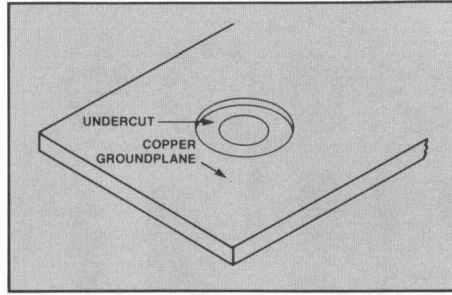

Figure 7. Undercutting copper away from hole

At each spot on the board where a component lead is to be soldered, poke a hole through the tape from the tape side of the board using a plastic-capped bulletin board pin. Insert the permanent components (such as IC and transistor sockets) and solder them in place where they poke through the tape. For those components that you are going to hand-select to fine-tune the circuit, use the printed circuit board sockets listed in Table 1. Enlarge the breadboard holes slightly from both sides of the board with the plastic-capped pin. If you drilled the holes with a #60 drill, the socket will probably fit without enlarging the hole. Insert a socket in the hole (it is easier to insert the

socket if you use a small pair of needle nose tweezers), and press it home with the pin. The socket has a closed end so it will not fill with solder or flux when you solder it in place. Components that require frequent replacing can now be easily inserted and removed without soldering. As you are inserting the components, cut the matching component designators from the recorded sheet and paste them on the breadboard next to the component. When you are done, your breadboard looks very similar to a printed circuit board instead of the usual "rats nest" of wires. The next issue of *Bench Briefs* will contain detailed calculations and instructions on how to use the copper tape to build a common stripline filter. □

Table 1. List of References

Description		HP P/N
Roll of Adhesive-Backed Copperfoil Tape 1" Wide	3M Scotch #1181	0460-0762
Roll of Adhesive-Backed Copperfoil Tape 3/4" Wide	Permacel #P-391	—
Roll of Clear Mylar Tape With Yellow Adhesive	3M Scotch #8428	—
Roll of Clear Mylar Tape With Clear Adhesive	3M Scotch #850	—
Terminal Test Point	0.038" Square	0360-0535
Printed Circuit Board Socket	0.038" OD Socket Size 0.03"	1251-1556
P.C Design Template I	Bishop Graphics #3367	—
2X (2:1) Scale	by Darryl Lindsey	
The Design & Drafting of Printed Circuits	Pub. by Bishop Graphics	

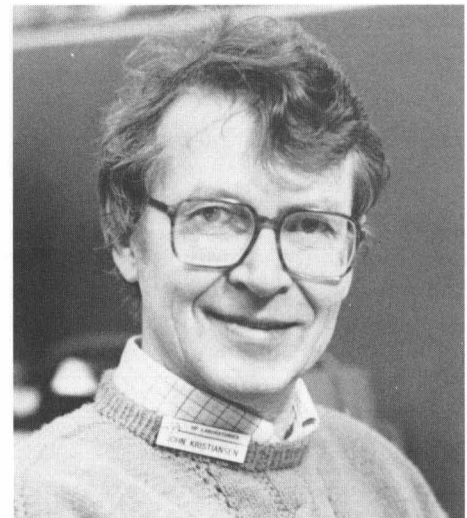

### John Kristiansen

John Kristiansen, a native of Denmark, joined Hewlett-Packard in 1984 and is working as a bench technician at HP Labs in the thin film department for disc storage technology. John enjoys 8mm sound film as a hobby, is married, has two boys and lives in Sunnyvale, California.

## Attention HP 8671/72 and 8673 Synthesized Signal Generator Owners

This issue of *Bench Briefs* contains new service notes that describe procedures for improving performance and protection, and tips on troubleshooting the microwave signal path of your generators.

For example, the rectifier assembly is a common unit in the HP 8671/72 and 8673 series of generators. Several service notes in this issue describe troubleshooting procedures to test if the diodes are shorted to the heat sink through a damaged anodized surface. If the surface is damaged, instructions are provided for placing a mica insulating washer between the heat sink and each of the rectifiers.

Detailed microwave signal path troubleshooting tips are provided for

the HP 8673B/C/D/E series of generators that help determine whether a fault is in the ALC circuitry or in the microwave signal path. To aid in MW path troubleshooting, the service note provides signal levels at various test points that reference back to the main troubleshooting section in the operating and service manual.

These service notes are free, just use the order form at the rear of *Bench Briefs*. □

## Safety-Related Service Notes

Service notes from HP relating to personal safety and possible equipment damage are of vital importance to our customers. To make you more aware of these important notes, they are printed on paper with a red border, and the service note number has a "-S" suffix. In order to make you immediately aware of any potential safety problems, we are highlighting safety-related service notes here with a brief description of each problem. Also, in order to draw your attention to safety-related service notes on the service note order form at the back of *Bench Briefs*, each appropriate number is highlighted by being printed in color.

### HP 3562A Dynamic Signal Analyzer

Product Safety Service Note 3562A-09-S describes a possible safety hazard that may exist if the instrument is operated at a nominal line frequency of 400 Hz and the protective earth ground is defeated. In these instances, the HP 3562A exceeds the 3.5 mA leakage current limit (by .7 mA) safety standard.

The HP 3562A operates within the safety standard for leakage current when operated within the stated line frequencies of 48 to 66 Hz. Therefore, make certain the instrument is operated only within these specified ac line frequencies of 48 to 66 Hertz.

For more information, order safety service note 3562A-09-S using the *Bench Briefs*' order form. The note describes a kit (HP P/N 03562-84405) containing a label to attach to the rear panel of the instrument.

### HP 9571A Digital Test Station

A potential shock hazard may exist if the power line ground connection to a protective earth terminal is defeated. Product Safety Service Note 9571A-25A-S reemphasizes this warning and describes a label (HP P/N 7121-4972) to be attached to the input power module near the access plate. Order this safety service note from this issue of *Bench Briefs*.

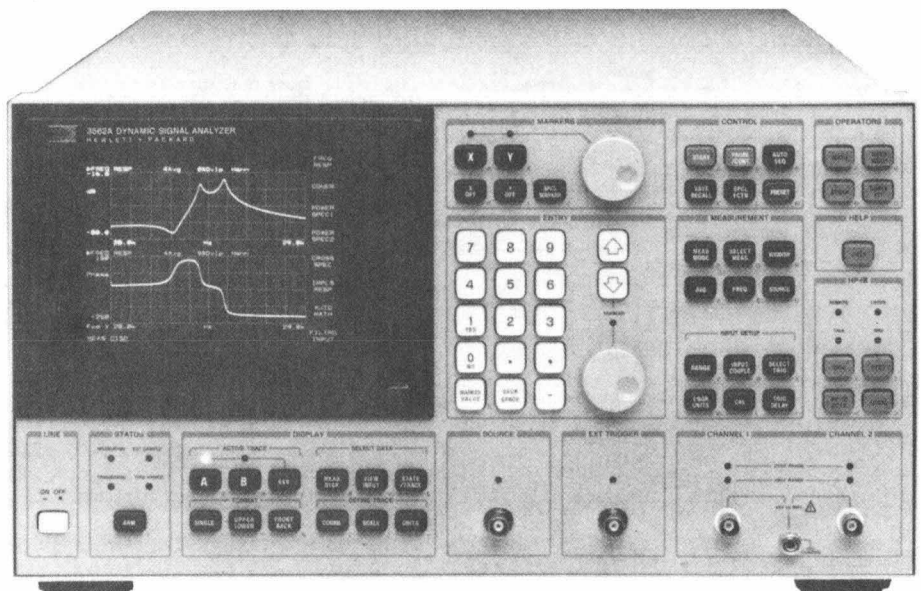

Model 3562A

## HP 85043A/B System Cabinets

Some of the cabinets may have improperly stripped wires that are connected to the circuit breakers and

terminal block. In these cases, the fastening screw pushes through the insulation making a poor contact with the wire. There have been two instances where these improperly stripped wires have caused the circuit

breakers and wire insulation to fail due to overheating.

For more information, please order safety service note 85043B-01-S from this issue of *Bench Briefs*. □

# supplement to **BENCH BRIEFS** SERVICE NOTE INDEX

## Need Any Service Notes?

They're free!

Here's the latest listing of service notes. They recommend modifications to Hewlett-Packard instruments to increase reliability, improve performance, or extend their usefulness.

Use the form at the rear of *Bench Briefs* to order, free of charge, service notes for several instruments.

If you would like to purchase large quantities of service notes covering a wide range of instruments, or if you desire a complete history of all service notes documenting all changes to your instruments, Hewlett-Packard offers a microfiche library for a one time charge. There is also a microfiche subscription service available that automatically updates the library on a quarterly schedule.

The part numbers for the service note microfiche library and subscription service are:

Library— 5951-6511  
Subscription service— 5951-6517

Contact your local HP Sales Office for ordering information. □

### HP 435B POWER METER

435B-3. All serials. Preferred replacement for capacitors A4C6 and A4C30.

### HP 436A POWER METER

436A-12. All serials. Preferred replacement for capacitors A2C4 and A2C6.

### HP 438A POWER METER

438A-6. All serials. Preferred replacement for capacitors A4C13 and A4C15.

### HP 1340A DISPLAY

1340A-8. All serials. Modification to prevent high voltage oscillator malfunction.

### HP 1345A DIGITAL DISPLAY

1345A-8. All serials. Modification to prevent high voltage oscillator malfunction.

### HP 1349A/D DIGITAL DISPLAY

1349A/D-5. All serials. Modification to prevent high voltage oscillator malfunction.

### HP 1650A/1651A LOGIC ANALYZER

1650A/1651A-1. 1650A serials: 2722A00535 and below; 1651A serials: 2723A00180 and below. 220V fuse change to Slo-Blo type.  
1650A/1651A-3. 1650A serials 2722A00833 and below; 1651A serials 2723A00313 and below. Intensity adjustment cable modification.

### HP 3235A/E SWITCH/TEST UNIT

3235A/E-5. All serials. HP 3235A Firmware Revisions.  
3235A/E-6. 3235A serials 2725A00626 and below; 3235x serials 2725A00562 and below. Additional RAM for HP 3235A processor.

### HP 3488A SWITCH/CONTROL UNIT

3488A-11B. All serials. Clarification on correct line fuses.

### HP 3552A TRANSMISSION TEST SET

3552A-17. Serials 2615U06653 and below. Preferred replacement for 12V battery packs.

### HP 3562A DYNAMIC SIGNAL ANALYZER

HP3562A-09-S. Serial prefix 2738A and below. Leakage current exceeds safety standard at line frequency of 400 Hz.

### HP 3746A SELECTIVE LEVEL MEASURING SET

3746A-4A. All serials. Retrofit procedure for adding option 012 tracking generator.  
3746A-26. All serials. Preferred replacement for A32Q22 dual FET.  
3746A-27. All serials. Preferred replacement for diodes A5CR1-4, A10CR1-4 and special option H40 A410CR1-4.

### HP 3764A DIGITAL TRANSMISSION ANALYZER

3764A-22A. Serials 2712U01594 and below. Preferred replacement of A3 or A3 (option 001/005) assembly.

### HP 3779C/D PRIMARY MULTIPLEX ANALYZERS

3779C-36. All serials. Recommended power transistor replacement on A29 power supply assembly.  
3779D-41. All serials. Conversion of HP 3779D option 002 to HP 3779D option 001.  
3779D-42. All serials. Recommended power transistor replacement on A29 power supply assembly.

### HP 3780A PATTERN GENERATOR/ERROR DETECTOR

3780A-33. Serials 2524U03804-2524U03933 inclusive. Possible faulty capacitors A30C1 and A30C2 with date code 8643L on A30 power supply assembly.

### HP 3781A/B PATTERN GENERATOR

3781A-5. Serials 2524U00837-2704U00886 inclusive. Possible faulty capacitors A30C1 and A30C2 with date code 8643L on A30 power supply assembly.  
3781B-11. Serials 2523U01091-2703U01170 inclusive. Possible faulty capacitors A30C1 and A30C2 with date code 8643L on A30 power supply assembly.

### HP 3782A/B ERROR DETECTOR

3782A-7. Serials 2524U00832-2524U00876 inclusive. Possible faulty capacitors A30C1 and A30C2 with date code 8643L on A30 power supply assembly.  
3782B-12. Serials 2636U01126-2703U1215 inclusive. Possible faulty capacitors A30C1 and A30C2 with date code 8643L on A30 power supply assembly.

### HP 3785A/B JITTER GENERATOR AND RECEIVER

3785A-21. Serials 2519U00646-2519U00718 inclusive. Possible faulty capacitors A30C1 and A30C2 with date code 8643L on A30 power supply assembly.  
3785B-19. Serials 2518U00651-2518U00710 inclusive. Possible faulty capacitors A30C1 and A30C2 with date code 8643L on A30 power supply assembly.

### HP 3787B DIGITAL DATA TEST SET

3787B-2. Serials 2703U00206 and below. Elimination of spurious pulses from DS1/1C Rx input (A5; U520).  
3787B-3. All serials. Conversion of HP 3787B standard to option 001 jitter measurement capability.

### HP 4938A NETWORK CIRCUIT ACCESS TEST SET

4938A-2A. Serials 2450A00702 and below. Modification to correct a potential failure.

### HP 4948A IN-SERVICE TRANSMISSION MEASURING SET

4948A-2. A8/A11 schematic diagram correction.  
4948A-3. All serials. Preferred replacement part number for A7 tray retaining screw MP61.  
4948A-5. All serials. Preferred replacement for display module MP7.

### HP 4952A PROTOCOL ANALYZER

4952A-2A. Serials 2725A and below, and 2739F and below. Improved yoke assembly.  
4952A-3A. Serials 2726A01194 and below, and serials 2635F20001 thru 2635F20454. Modification to fix potential disc access problem (non LIF format, disc out, disc error).

#### HP 4954A PROTOCOL ANALYZER

4954A-1. Serial number range listed in text of note. Firmware revision 1.1 upgrade to correct critical bugs and intermittent failures.  
4954A-2. Serial number range listed in text of note. Replacement of A5 U701 board enable driver.

#### HP 8160A PROGRAMMABLE PULSE GENERATOR

8160A-14. Serials 2650G00746 to 2650G00785 inclusive. Possible short of HP-IB REN line to ground causes unit to stay remote operation when addressed to listen.

#### HP 8180B DATA GENERATOR

8180B-1A. Serials 2640G00100 to 2640G00148. Improved firmware revision.

#### HP 8481A POWER SENSOR

8481A-5. All serials. Curing intermittent operation.

#### HP 8559A SPECTRUM ANALYZER

8559A-31. Serial prefix 2819A and below. Redesigned sweep generator board with improved +10 volt reference power supply to provide improved performance.

#### HP 8566A SPECTRUM ANALYZER

8566A-20B. All serials. HP 8566AB retrofit kit instructions (formerly 8566A+01K).

#### HP 8566B SPECTRUM ANALYZER

8566B-11A. All serials. HP 8566AB retrofit kit (formerly 8566A+01K).

#### HP 8568A SPECTRUM ANALYZER

8568A-44B. All serials. HP 8568AB retrofit kit instructions (formerly 8568A+01K).

#### HP 8568B SPECTRUM ANALYZER

8568B-12A. All serials. HP 8568AB retrofit kit (formerly 8568A+01K).

#### HP 8590A SPECTRUM ANALYZER

8590A-2A. All serials. Option H50 CATV retrofit installation instructions.  
8590A-5. All 75 Ohm input options (001). Instructions to correct the HP 8590A 75 Ohm option 001 readout from dBm to dBmV after replacing firmware ROMs.  
8590A-6. All 75 Ohm input options (001). 50 Ohm input. List of programs to correct or change the CRT readout from dBm to dBmV or from dBmV to dBm.  
8590A-7. All serials. Display modifications to improve performance.

#### HP 8642A/B SYNTHESIZED SIGNAL GENERATOR

8642A-6/8642B-6. A14 module serial prefixes 2531A and below. Modification to resolve low output power in the Heterodyne band.  
HP8642B-7. A19 module serial prefixes 2517A to 2640A inclusive. A19 doubler/attenuator module replacement for maximum output level degradation.

#### HP 8662A SYNTHESIZED SIGNAL GENERATOR

8662A-12C. Serial prefix 2429A and below. Modification to improve low frequency loop performance and eliminate intermittent status errors 03/04.  
8662A-15. All serials. Instructions for replacing the cooling fan.

#### HP 8663A SYNTHESIZED SIGNAL GENERATOR

8663A-6C. Serial prefix 2424A and below. Modification to improve low frequency loop performance and eliminate intermittent status errors 03/04.  
8663A-9. All serials. Instructions for replacing the cooling fan.

#### HP 8671B SYNTHESIZED SIGNAL GENERATOR

8671B-2. Serial prefix 2703A and below. Add mica insulators under diodes A3A12CR13 and A3A12CR14.  
8671B-03. All serials. Preferred replacement for precision resistors.

#### HP 8672A SYNTHESIZED SIGNAL GENERATOR

8672A-19. Serial prefix 2703A and below. Add mica insulators under diodes A3A12CR13 and A3A12CR14.  
8672A-20. All serials. Preferred replacement for precision resistors.

#### HP 8673B SYNTHESIZED SIGNAL GENERATOR

8673B-11. Serial prefix 2704A and below. Add mica insulators under diodes A3A12CR13 and A3A12CR14.  
8673B-12. All serials. Instructions for microwave signal path troubleshooting.  
8673B-13. Serial prefix 2640A through 2735A inclusive. Modifications to improve power supply reliability.  
8673B-14. All serials. Preferred replacement for precision resistors.

#### HP 8673C SYNTHESIZED SIGNAL GENERATOR

8673C-12. Serial prefix 2703A and below. Add mica insulators under diodes A3A12CR13 and A3A12CR14.  
8673C-13. All serials. Instructions for microwave signal path troubleshooting.  
8673C-14. Serial prefix 2640A through 2735A inclusive. Modifications to improve power supply reliability.  
8673C-15. All serials. Preferred replacement for precision resistors.

#### HP 8673D SYNTHESIZED SIGNAL GENERATOR

8673D-13. Serial prefix 2703A and below. Add mica insulators under diodes A3A12CR13 and A3A12CR14.  
8673D-14. All serials. Instructions for microwave signal path troubleshooting.  
8673D-15. Serial prefix 2640A through 2735 inclusive. Modifications to improve power supply reliability.  
8673D-16. All serials. Preferred replacement for precision resistors.

#### HP 8673E SYNTHESIZED SIGNAL GENERATOR

8673E-5. Serial prefix 2704A and below. Add mica insulators under diodes A3A12CR13 and A3A12CR14.  
8673E-6. All serials. Instructions for microwave signal path troubleshooting.  
8673E-07. Serial prefix 2640A through 2738A inclusive. Modifications to improve power supply reliability.  
8673E-08. All serials. Preferred replacement for precision resistors.

#### HP 8753A NETWORK ANALYZER

8753A-1. All serials. Instructions for creating A9 EPROM backup data.  
8753A-6/8757A-5. 8753A serials 2625A and below, 2625J and below, 2713U and below, and 8757A serials 2646A and below. Modification to prevent dust accumulation on the CRT and glass filter.  
8753A-7A. All serials. A3 source/A9 CPU/A11 phaselock assembly compatibility matrix.  
8753A-8. All serials. Firmware update/replacement kit (HP P/N 08753-60XXX).  
8753A-9. All serials. Revision A.01 performance test software.

#### HP 8757A SCALAR NETWORK ANALYZER

8757A-6. All serials. Modification to prevent intermittent memory loss.

#### HP 8902A MEASURING RECEIVER

8902A-5. Serial prefixes 2741A and below. Modification to resolve set reference error.

#### HP 8970A/B NOISE FIGURE METER

8970A-12. All serials. Preferred replacement for oscillator transistor A11A1Q1.  
8970B-2. All serials. Preferred replacement for oscillator transistor A11A1Q1.

#### HP MODEL 9571A DIGITAL TEST STATION

9571A-25A-S. All serials. Potential shock hazard if the power line ground connection to a protective earth terminal is defeated.

#### HP 37204A/B HP-IB EXTENDER

37204A-02. Serials 2547U03590 and below. Modification to correct power supply failure when both port fault lamps stay on.  
37204B-01. Serials 2626U00450 and below. Modification to correct power supply failure when both port fault lamps stay on.

#### HP 54110D DIGITIZING OSCILLOSCOPES

54110D-9. Serial prefixes 2710A and below. New analog power supply offers family compatibility.  
54110D-10. Serial prefixes 2710A and below. New primary power supply offers family compatibility and improves reliability.

#### HP 54111D DIGITIZING OSCILLOSCOPES

54111D-3. Serial prefixes 2719A and below. New primary power supply offers family compatibility and improves reliability.

#### HP 54112D DIGITIZING OSCILLOSCOPE

54112D-1A. Serials 2735A00173 and below. Modification to prevent loss of resolution or excessive noise on trace.

#### HP 54120T DIGITIZING OSCILLOSCOPES

54120T-6. All serials. How to obtain semi rigid "S" and semi rigid "U" cables used for test and adjustment.

#### HP 54201A/D DIGITIZING OSCILLOSCOPES

54201A/D-10. All serials. Locked high trace or no trace may be result of input FET failure.  
54201A/D-11. Serial prefixes 2716A and below. Improved input FET protection available.  
54201A/D-12. All serials. Software calibration procedure summary.

#### HP 70900A LOCAL OSCILLATOR

70900A-14B. All serials. Hardware/firmware compatibility.

#### HP 85029A VERIFICATION KIT

85029A-1. All serials. Transferring data files from replacement disc to the master disc.

#### HP 85043A/B SYSTEM CABINETS

85043B-1-S. 85043A serials 2622A01352 and below, and 85043B serials 2623A00172 and below. Elimination of a potential safety hazard in the circuit breakers.

#### HP 85046A/B S-PARAMETER TEST SET

85046A/B-1. 85046 serials 2542A01553 and below, and 85046B serials 2542A00220 and below. Modification to make sure attenuator and/or RF switch actuates.

#### HP 85051B 7 MM VERIFICATION KIT

85051B-1. Serials 2705A00001 through 2705A00162 certified/recertified before Oct. 1987. Exceptions: 2705A00137, 2705A00139, 2705A00146, 2705A00147, 2705A00150, 2705A00152, 12705A00154, 2705A00159, 2705A00160, 2705A00161. Modification to prevent possible damage to the 50 Ohm airline (part number 85051-60007) and 25 Ohm mismatch airline (part number 85051-60008) when used with the HP 85050C 7 MM precision calibration kit).

#### HP 85629A TEST AND ADJUSTMENT MODULE

85629A-1A. All serials. New ROM upgrade kit (HP P/N 85629-60002)

#### HP 85685A RF PRESELECTOR

85685A-13. Serial prefixes 2620A and below. Instructions for installing susceptibility improvement kit.  
85685A-15. Serial prefixes 2620A and below. Instructions for installing residual improvement kit.

# Service Note Order Form

If you want service notes, please check the appropriate boxes below and return this form separately to one of the following addresses.

Hewlett-Packard  
1820 Embarcadero Road  
Palo Alto, California 94303

For European customers (ONLY)

Hewlett-Packard  
Nederland BV  
Central Mailing Dept.  
P.O.Box 529  
1180 AM Amstelveen  
The Netherlands

Name \_\_\_\_\_

Firm \_\_\_\_\_

Address \_\_\_\_\_

City \_\_\_\_\_

State \_\_\_\_\_ Zip \_\_\_\_\_

- |  |                                   |  |  |  |  |
|--|-----------------------------------|--|--|--|--|
| <input type="checkbox"/> 435B-3        | <input type="checkbox"/> 3780A-33 | <input type="checkbox"/> 4954A-1         | <input type="checkbox"/> 8642B-7             | <input type="checkbox"/> 8673C-14        | <input type="checkbox"/> 8757A-6             |
| <input type="checkbox"/> 436A-12       | <input type="checkbox"/> 3781A-5  | <input type="checkbox"/> 4954A-2         | <input type="checkbox"/> 8662A-12C           | <input type="checkbox"/> 8673C-15        | <input type="checkbox"/> 8902A-5             |
| <input type="checkbox"/> 438A-6        | <input type="checkbox"/> 3781B-11 | <input type="checkbox"/> 8160A-14        | <input type="checkbox"/> 8662A-15            | <input type="checkbox"/> 8673D-13        | <input type="checkbox"/> 8970A-12            |
| <input type="checkbox"/> 1340A-8       | <input type="checkbox"/> 3782A-7  | <input type="checkbox"/> 8180B-1A        | <input type="checkbox"/> 8663A-6C            | <input type="checkbox"/> 8673D-14        | <input type="checkbox"/> 8970B-2             |
| <input type="checkbox"/> 1345A-8       | <input type="checkbox"/> 3782B-12 | <input type="checkbox"/> 8481A-5         | <input type="checkbox"/> 8663A-9             | <input type="checkbox"/> 8673D-15        | <input type="checkbox"/> 9571A-25A-S         |
| <input type="checkbox"/> 1349A/D-5     | <input type="checkbox"/> 3785A-21 | <input type="checkbox"/> 8559A-31        | <input type="checkbox"/> 8671B-2             | <input type="checkbox"/> 8673D-16        | <input type="checkbox"/> 37204A-02           |
| <input type="checkbox"/> 1650A/1651A-1 | <input type="checkbox"/> 3785B-19 | <input type="checkbox"/> 8566A-20B       | <input type="checkbox"/> 8671B-03            | <input type="checkbox"/> 8673E-5         | <input type="checkbox"/> 37204B-01           |
| <input type="checkbox"/> 1650A/1651A-3 | <input type="checkbox"/> 3787B-2  | <input type="checkbox"/> 8566B-11A       | <input type="checkbox"/> 8672A-19            | <input type="checkbox"/> 8673E-6         | <input type="checkbox"/> 54110D-9            |
| <input type="checkbox"/> 3235A/E-5     | <input type="checkbox"/> 3787B-3  | <input type="checkbox"/> 8568A-44B       | <input type="checkbox"/> 8672A-20            | <input type="checkbox"/> 8673E-07        | <input type="checkbox"/> 54110D-10           |
| <input type="checkbox"/> 3235A/E-6     | <input type="checkbox"/> 4938A-2A | <input type="checkbox"/> 8568B-12A       | <input type="checkbox"/> 8673B-11            | <input type="checkbox"/> 8673E-08        | <input type="checkbox"/> 54111D-3            |
| <input type="checkbox"/> 3488A-11B     | <input type="checkbox"/> 4948A-2  | <input type="checkbox"/> 8590A-2A        | <input type="checkbox"/> 8673B-12            | <input type="checkbox"/> 8753A-1         | <input type="checkbox"/> 54112D-1A           |
| <input type="checkbox"/> 3552A-17      | <input type="checkbox"/> 4948A-3  | <input type="checkbox"/> 8590A-5         | <input checked="" type="checkbox"/> 8673B-13 | <input type="checkbox"/> 8753A-6/8757A-5 | <input checked="" type="checkbox"/> 54120T-6 |
| <input type="checkbox"/> 3562A-09-S    | <input type="checkbox"/> 4948A-5  | <input type="checkbox"/> 8590A-6         | <input type="checkbox"/> 8673B-14            | <input type="checkbox"/> 8753A-7A        | <input type="checkbox"/> 54201A/D-10         |
| <input type="checkbox"/> 3746A-4A      | <input type="checkbox"/> 4952A-2A | <input type="checkbox"/> 8590A-7         | <input type="checkbox"/> 8673C-12            | <input type="checkbox"/> 8753A-8         | <input type="checkbox"/> 54201A/D-11         |
| <input type="checkbox"/> 3746A-26      | <input type="checkbox"/> 4952A-3A | <input type="checkbox"/> 8642A-6/8642B-6 | <input type="checkbox"/> 8673C-13            | <input type="checkbox"/> 8753A-9         | <input type="checkbox"/> 54201A/D-12         |
| <input type="checkbox"/> 3746A-27      |                                   |  |  |  | <input type="checkbox"/> 70900A-14B          |
| <input type="checkbox"/> 3764A-22A     |                                   |  |  |  | <input type="checkbox"/> 85029A-1            |
| <input type="checkbox"/> 3779C-36      |                                   |  |  |  | <input type="checkbox"/> 85043B-1-S          |
| <input type="checkbox"/> 3779D-41      |                                   |  |  |  | <input type="checkbox"/> 85046A/B-1          |
| <input type="checkbox"/> 3779D-42      |                                   |  |  |  | <input type="checkbox"/> 85051B-1            |

*Duplicated  
see 2987*

Please photocopy this order form if you do not want to cut off the page.

- 85629A-1A
- 85685A-13
- 85685A-15

HEWLETT-PACKARD COMPANY  
1820 Embarcadero Road  
Palo Alto, California 94303

**BENCH BRIEFS**  
**1ST QUARTER 1988**  
Volume 28 Number 1

Service information from  
Hewlett-Packard Company

To obtain a qualification form for a free  
subscription, send your request to the  
above address.

Reader comments or technical article  
contributions are welcomed.  
Please send them to the  
Bench Briefs Editor.  
Editor: Jim Bechtold  
Hewlett-Packard

Bulk Rate  
U.S. Postage  
PAID  
Sunnyvale, CA.  
Permit No.  
804

BECHTOLD, JAMES  
WORLDWIDE CUSTOMER SUPPORT  
DDIV 5000 BLDG 36UV

All rights reserved. Permission to reprint Bench Briefs granted upon written request to the Editor.

Printed in U.S.A.